



# Nenskra Hydropower Project

## Supplementary Environmental & Social Studies

### Annexes to Volume 2 Project Definition



DISCLOSURE AUTHORIZED

November 2017



**Annex 1 - References**

**Annex 2 - 2015 Ecological Expertise  
Conclusion**

**Annex 3 – 2015 ESIA Report**

## Annex 1. References

Castalia Limited. Economic Cost-Benefit Analysis of Nenskra Hydropower Project: Summary Report. Report to IFC. July 2017.
Ecofys Netherlands, 2011 International Comparison of Fossil Power Efficiency and CO2 intensity
GSE, Ten-Year Network Development Plan of Georgia for 2015-2025,
Hertwich and others, PNAS, 2015, Integrated life-cycle assessment of electricity-supply scenarios confirms global environmental benefit of low-carbon technologies. See <a href="http://www.pnas.org/cgi/doi/10.1073/pnas.1312753111">www.pnas.org/cgi/doi/10.1073/pnas.1312753111</a>
IFC, 2012, Guidance Note 1 - Assessment and Management of Environmental and Social Risks and Impacts.
Inter-American Development Bank, 2012, Liquid and Gaseous Fossil Fuel Power Plant Guidelines. An Approach to Reconciling the Financing of Fossil Fuel Power Plants with Climate Change Objectives.
Power Technology, 2014 Webpage: <a href="http://www.power-technology.com/features/featurepower-plant-om-how-does-the-industry-stack-up-on-cost-4417756/">http://www.power-technology.com/features/featurepower-plant-om-how-does-the-industry-stack-up-on-cost-4417756/</a>
Stucky, 2012, Nenskra Hydropower Project, Phase II Initial Design, Selection of Dam Site, Dam Type and Dam Height
Stucky, 2015, Nenskra HPP, Technical note on Small hydro installation in bottom outlet gate chamber.
UK Government- Department of Energy & Climate Change website: <a href="https://www.gov.uk/guidance/2050-pathways-analysis">https://www.gov.uk/guidance/2050-pathways-analysis</a>
UNDP, 2015, Georgia's Third National Communication to the UNFCCC
World Bank, 1996, Environment Department. Environmental Assessment Sourcebook Update, Chapter 17, Analysis of Alternatives in Environmental Assessment.
World Bank. 1998 Greenhouse Gas Assessment Guidebook

## Annex 2. Environmental Permit

**ORDER No I-768**

**By the Minister of Environment and Natural Resources Protection of Georgia**

---

**Tbilisi**

**02 / October / 2015**

On Approval of Ecological Expertise Conclusion on Construction and Exploitation of JSC Nenskra HEPP

On the basis of Georgian Law on Permission for Environmental Impact, article 4, paragraph 1, subparagraph "I" and paragraph 4 of the same article,

I ORDER:

1. Ecological Expertise Conclusion No60, 02.10.2015 on construction and exploitation of JSC Nenskra HEPP presented by the Ministry of Economy and Sustainable Development of Georgia LEPL Agency of Technical and Construction Supervision to be approved;
2. The Ecological Expertise Conclusion set forth in paragraph one of the Order is issued without any time limits;
3. JSC Nenskra is required to implement the terms and conditions provided by the Ecological Expertise Conclusion (No60, 02.10.2015);
4. The Order to be send to JSC Nenskra immediately;
5. The Order to become effective immediately upon the familiarization with it by JSC Nenskra;
6. The present Order can be appealed in the higher administrative body – the Government of Georgia (7, Ingorokva street, Tbilisi) or at the Administrative Board of Tbilisi City Court (12<sup>th</sup> km, D. Agmashenebeli Lane, Tbilisi) within a one month period upon the date of getting acquainted with it by the relevant party in the official way.

Grounds: Memorandum by the Head of the Department of Permissions for Environmental Impact Tamar Sharashidze; Letter by the Ministry of Economy and Sustainable Development of Georgia LEPL Agency of Technical and Construction Supervision (No04/856, 04.08.2015) and the Ecological Expertise Conclusion (No60, 02.10.2015).

Minister: *(signature and stamp provided)* Gigla Agulashvili

**Ministry of Environment and Natural Resources Protection of Georgia**

---

**#7093**

**05 / October / 2015**

To: JSC Nenskra

On the basis of article 54 of the General Administrative Code of Georgia we are hereby sending you:

1. A certified copy of Order No I-768 of October 1, 2015 On Approval of Ecological Expertise Conclusion on Construction and Exploitation of JSC Nenskra HEPP issued by the Minister of Environment and Natural Resources Protection of Georgia;
2. Ecological Expertise Conclusion (No60, 02.10.2015)

Head of the  
Department of  
Permissions for  
Environmental Impact

*(signature provided)* Tamar Sharashidze

**Ministry of Environment and Natural Resources Protection of Georgia**

---

**Ecological Expertise Conclusion on a Project**

**No60**

**October 02, 2015**

**1. General Data:**

1. Activity Description - Construction and Exploitation of JSC Nenskra HEPP.
2. Title and Address of the Person Performing the Activity - JSC Nenskra, 6, V. Beridze street, Tbilisi.
3. Location of Performing the Activity – Mestia Municipality, Chuberi Community.
4. Date of Receiving the Application – 04.08.2015.
5. Information on the Person Developing the Project – Gama Consulting Ltd.

For the purpose of receiving Ecological Expertise Conclusion Report on Evaluation of Environmental Impact of the Construction and Exploitation of Nenskra HEPP planned by JSC Nenskra has been presented by the Ministry of Economy and Sustainable Development of Georgia LEPL Agency of Technical and Construction Supervision for ecological expertise.

According to the Report on Evaluation of Environmental Impact:

The HEPP construction is planned in the Samegrelo-Zemo Svaneti region, namely, on the territory of Mestia municipality, in the river Nenskra gorge, where the river Nenskra and the river Nakra flow will be used. The project implies construction and exploitation of a low pressure HEPP with seasonal regulation and 230 MW installed capacity.

According to the project, the following infrastructure will be arranged during the construction process:

- 135 m tall and 820 m long rockfill dam on the Nenskra river;
- 940 m long inactive spillway;
- 182 mln m<sup>3</sup> capacity water reservoir;
- 13 m tall and 57 m long low threshold dam on the Nakra river;
- 12.4 km long derivational tunnel for water discharge from the Nakra river gorge to the Nenskra river gorge;
- 15.1 km long transmission tunnel from the river Nenskra reservoir to the pressure system;
- Alignment shaft;
- Pressure shaft;
- Powerhouse;
- Substation;
- Power transmission line.

An iron-concrete dam is planned to be arranged on the 1493 m level of the Nakra river whose height will be 13 m, and the length – 57 m; giving consideration to the local landscape, there will demonstrate itself a small pooling of water at the head race (with the 1500-2000 m<sup>2</sup> area of the water table), from which the water will be delivered to the derivational tunnel through the water intake device located on the right of the dam. According to the dam structure envisaged by the project, during the high water period the excess water and solid alluvion will be fully passed to the tail race. The water transmission in the high water period will be performed from the dam crest. It is planned to arrange a stilling well In the tail race, whereas for the purpose of prevention of erosion of the river banks protection walls will be arranged on both sides of the river.

To transfer water from the Nakra river to the Nenskra river gorge, a 12.4 km long and 4.5 m diameter derivational tunnel is planned to be arranged to be laid in the depth of the watershed ridge. The maximum permeability is going to be 46 m<sup>3</sup>/sec. The tunnel is planned to be laid with TBMs. Tunnel lining works are planned to start from the egress portal. The internal surface of the derivational tunnel will be lined with an iron-concrete layer. Ecological discharge transmission from the headworks is envisaged to take place through the fish pass to be arranged on the left of the dam. The length of the fish pass is going to be approximately 50-60 m.

Assessment and analysis of alternative versions to the project have been discussed and reviewed, among them: alternative version for inactivity, alternative versions to the project, alternatives for the HEPP type, comparative characterization of alternative

versions for the dam and power end location areas, alternative versions for the derivational system arrangement, comparative characterization of the alternative versions.

Alternative version for inactivity – in the event if the project of construction and exploitation of a HEPP on the Nenskra river proves to be not feasible, there will be no environmental impact, which will be related to the performance of construction works and operation. In the event of the project infeasibility, the development of the infrastructure and social and economic condition of the region will be suspended to a certain degree at the expense of the avoidance of the potential environmental impact. With consideration of rational design decisions and mitigating measures, the HEPP construction and operation will ensue significantly more important social and economic benefit than the alternative of the project inertness and therefore, it was discarded.

Alternative versions for the dam and power end location areas – 5 alternative versions of the dam location were discussed, out of which the fourth alternative was selected in which case the dam location is planned on the 1300 m level of the Nenskra river. The area of the dam placement is approximately 6-7 km from the village Tita.

The fact that in comparison with the first three variants the fourth one was characterized with low energetic efficiency was considered its significant positive factor, although the preference is given from the environmental point of view, since within the project impact zone there are mainly areas with high anthropogenic function what significantly reduces the risks of any impact on the biological environment. In the dam situational location there are generous amounts of solid alluvion accumulated in the river Nenskra gorge and can be used for production of inert material. This will accordingly minimize the risks related to the impact inflicted during the searching for inert material in other places and their transportation. As different from another variant (5<sup>th</sup>), natural resources (mineral resources (except for sand-gravel), mineral waters) existing in the dam and water reservoir area are not presented in it and relatively, there is no impact to be expected.

Comparative characterization of alternative versions power end location areas – the best alternative for location of an aboveground powerhouse is the area selected between village Lakhmi and village Lekalmakhi, to be more precise, its arrangement on the 705 m level of the river. The project area is situated at the outskirts of the village (only part of one personal land plot is covered by the zone of the direct impact), on the first terrace of the left bank of the river Nenskra. Taking into consideration the present condition of the land plot, preparation of the construction site will destroy a significant part of the vegetation cover in it. There is a graveled road leading to the designed powerhouse location area and before starting the construction works there will be necessity for conduction of its rehabilitation and extension (widening) works only. The power generated by the HEPP will be included into the state power system in the project 500/220 KW substation Jvari for which approximately 50 km long power transmission line will need to be installed. As different from the 5<sup>th</sup> variant, the natural resources (mineral resources (except for sand-gravel), mineral waters) existing in the dam and water reservoir area are not presented in it and relatively, there is no impact to be expected.

Alternative versions for the derivational system arrangement – the following alternatives have been studied in reference to the derivational system:

- Alternatives for arrangement of a derivational channel and derivational tunnel;
- Alternatives for the derivational tunnel shapes (annular or horse-shoe shaped);



- Alternatives for the methods of the derivational tunnel lining;
- Alternatives for management of the rocks worked out during the derivational tunnel lining;

The study of the background condition of the route of the derivational system placement revealed that using the derivational channel for transportation of water from the water reservoir is unacceptable, since the channel corridor will be situated on the slopes with extremely complex relief and accordingly, performance of the construction works will be connected to irrevocable significant impact on the environment.

Referring to the above said, the decision was adopted concerning the derivational tunnel arrangement which is going to be placed in the depth of the mountain on the right bank of the river Nenskra and in the conditions of correct management the risks of any potential negative impact on the environment will be minimized both on the construction and exploitation stages.

Out of the types of the possible negative impact on the environment related to the derivational tunnel arrangement the issue of disposing the rocks worked out during the process are given importance; the issue can be resolved in a positive way through finding an area suitable for permanent disposal of such wastes.

The background condition of the research area: the climate and meteorological conditions, topography, geological conditions, stratigraphy have been discussed.

The climate and meteorological conditions – the lowland areas of West Georgia (Kolkheti Lowland) are characterized with humid subtropical climate. The Caucasus Ridge is a natural barrier on the way of the cold air masses migrating from the North, whereas the humid air masses coming from the Black Sea are made to migrate upward, what caused intensive precipitations. East Georgia with its much drier climate shows the contrary picture.

The climate varies significantly following the increase of the height above the sea level, what creates a whole specter of climatic zones in as short a distance as only a few hundreds of kilometers in the entire area from the sea to the mountain peaks.

The upper, middle and lower streams of the river Enguri is characterized with cool and humid summers and snowy, long winters. There are permanently snow-clad glaciers in the higher mountains.

According to the Lakhmi meteorological station, the level of precipitations is approximately 1,267 mm per year and has a tendency of equal distribution throughout the year, with special intensity of rainfalls during summer and autumn months. The intensity of rainfalls increases with the increase of the height and on the peaks of the mountains it reaches 2800 mm, while in the highest points of the Caucasus Ridge it exceeds 3,200 mm even.

The duration of stable snow cover in the lowlands increases from 10-20 days to 100-150 days in mountainous regions. The stable snow cover is formed at a 500-600 m height from the sea level. The Alpine conditions are met from approximately 2.100 m of height. Above the 3000 m level the mountains are covered with snow and ice throughout a year (USAID, 2006). The snow cover in certain areas of the mountains reaches 4-6 m of thickness.

Geological conditions – there are different rocks of various ages in the project area and its peripheries, starting from Precambrian down to the Quaternary period. In the northern part of the project area and its periphery there are mainly gneiss, metagranites, migmatites, granitoids, amphibolites and clay schist, belonging to Precambrian-Paleozoic period. These sediments have undergone a metamorphosis in the amphibolite facies during the Hercynic formation of mountains and were incised with granite in the Paleozoic era. Gneiss, migmatites and similar metamorphic rocks, creating the foundation of the Caucasus, are covered with the sediments that existed in the low water sea conditions in the Ordovician, Silurian, Devonian, Carboniferous, Permian and Triassic periods. The sandstone, clay stone and diabase volcanic rocks laying among them belong to the earlier and middle Jurassic periods.

In order to identify the geotechnical parameters of the project area, 7 boring wells were arranged on the dam axis, 3 boring wells – on the spillway, 2 – on the derivational tunnel, 4 – on the power end placement area, 1 – along the pressure system route, 2 – on the axis of the dam placed on the river Nakra and 2 – by the tunnel ingress. The entire number of the boring wells is 21, and their cumulative length in the depth – 1632,5 m. The boring wells were subjected to such studies performed on the relevant levels, as testing the water pressure, water transmission capacity and manometric tests. Besides these, there were laboratory research of the cores taken out of the boring wells performed in order to identify the geotechnical parameters of the rocks laying under the structures.

According to the results of the engineering and geologic research, there are a few small scale geologically unstable (landslide) areas present in the Nenskra water reservoir cavern, all out of which are located below the project water reservoir pooling level. In the process of the water reservoir cavern preparation works, it is planned to remove the strata from the slopes that are in active dynamics, what will significantly decrease the risks of activation of landslide processes. In the event if the activation takes place at the stage of the reservoir exploitation, the landslide will be formed within the inactive storage capacity of the water reservoir and will not have a significant negative impact on the conditions of its exploitation.

The only potentially landslide zone in the headworks area is situated at the dam axis.

In view of development of dangerous geologic processes, there are risks connected to laying of new roads, since the works will be conducted on the slopes with complex relief, what is connected to cutting large areas of these slopes. Relevantly, strict control will need to be exercised over the implementation of the mitigating measures governed in the present report.

According to the results of the engineering and geologic research, there will take place crossing of two main faults in the process of tunneling. In the event of crossing a fault, there may appear water intrusion, for which the relevant appropriate reinforcement works will need to be performed.

The risks of activation of dangerous geodynamic processes in the process of HEPP operation will be connected to the water reservoir exploitation, as the increase of the humidity of the layers which the bank slopes are composed of, as well as the increase of humidity in the atmospheric air may cause activation of the landslide and erosive processes. Activation of dangerous geological processes is presumable in case of development of any accident emergency situations as well.

The risks of impacting the landslide and erosive zones lying in the tail race outside of the zone of direct impact of the reservoir will not be high, since the impact area scope spreads no longer than 5 km along the river flow direction. And there are no active landslide areas registered in this section.

According to the performed researches, a few zones of faulting were identified along the tunnel location. The two main zones situated in the project area are known under the titles Alibeck reverse fault and the main Caucasus pressure. Such faults and folds are found in multitude in the researched area, namely in the north-west, south-east and east-west directions. Two of them were established along the pressure tunnel, on the surface. In the pressure tunnel location there are two reverse faults identified, namely: km: 1+550, 1+750, km: 2+300 – 2+500, while emergence of two folds is possible on the km: 4+600 -4+800 and km 9+350 – 9+550. On the axis of the Nakra transmission tunnel, at 2+200 km, on the surface, the right lateral fault is visible.

Working with two faults in the process of pressure tunnel arrangement is inevitable, while we will not have to deal with other ones. Besides, contact with one fault will happen in the course of Nakra transmission tunnel arrangement.

At the stage of the HEPP exploitation, village Naki population may encounter a serious danger ensued by the river Lekvedari running to the north of the village bearing torrential character. The river Lekvedari gorge is situated in the central northern part of the village Naki and joins the river Nakra from the right. The river gorge is severely eroded and during generous precipitations allows for creation of torrential streams carrying large amounts of solid alluvion. The solid alluvion transported to the river Nakra gorge are systematically washed by the river Nakra waters, hence the risk of opening the direction toward the village for torrential streams is reduced.

After the commissioning of the Nakra dam the tail race of the dam will transmit only ecologic discharge and the main body of the water will be carried through the tunnel to the river Nenskra gorge. Relevantly, the river will lose the ability to transport the solid alluvion brought by the river Lekvedari what may ensue blocking of the river bed and moving the torrential streams toward the village. It is true that the risk of development of the hereby described scenario is not high, but still it is necessary to take the relevant mitigating measures out of which it is important to transmit the full discharge of the river Nakra in the tail race of the dam in order to ensure transportation of the solid alluvion carried by the river Lekvedari following the lower stream direction.

Seismology – in order to study seismicity of the research area different international seismic catalogues were used: the updated catalogue of earthquakes in the Caucasus, the Institute of Earth Sciences (database, unpublished material), the special catalogue developed within the scope of the program for assessment of the global seismic danger (Balasarian, et al. 1999), catalogues of North Eurasian earthquakes (1995-1999), catalogue of forceful earthquakes (Shebalin, Kondorskaya 1982), the special catalogue of the 1991 Racha earthquake epicenter zone (the Institute of Earth Sciences, unpublished material).

The research area demonstrated even higher seismic activity during the instrumental researches.

The project area of the Nenskra HEPP is situated in a seismically active region. There are a few active faults running in the research area vicinity. They have high seismic potential

-  $M=7$ . Severe earthquakes ( $M>6.0$ ) are related to these faults. Research of the project area seismic danger was performed using probability approach. Various levels of the seismic danger were calculated according to the recommendation by the international commission for high dams.

Hydrology – the calculation values of average annual discharges of the Nenskra river in the project dam section were established using the method of analogues. Data provided by the hydrological watch point Lakhmi 36 year (1931, 1934-43, 1956-80) observation were referred to as an analogue. In the mentioned period, the river Nenskra average annual discharge rates in the hydrological watch point Lakhmi section varied from 18,9  $m^3/sec$  (1943) to 57,7  $m^3/sec$  (1941).

The calculation values of average annual discharges of the Nakra river in the project headworks section were established using the method of analogues. Data provided by the hydrological watch point Naki 42 year (1931, 1938-40, 1942, 1948-49, 1951, 1953-86) observation were referred to as an analogue.

The calculation values of the maximum annual discharges of the Nenskra river in the project dam section were established using the method of analogues. Data provided by the hydrological watch point Lakhmi 33 year (1931, 1934, 1936, 1938-42, 1956-80) observation were referred to as an analogue.

In the mentioned period, the river Nenskra maximum annual discharge rates in the hydrological watch point Lakhmi section varied from 66,8  $m^3/sec$  (1934) to 196  $m^3/sec$  (1941).

The calculation values of the minimum annual discharges of the Nenskra river in the project dam section were established using the method of analogues. Data provided by the hydrological watch point Lakhmi 36 year (1931, 1934-43, 1956-80) observation were referred to as an analogue.

In the mentioned period, the river Nenskra minimum annual discharge rates in the hydrological watch point Lakhmi section varied from 3,50  $m^3/sec$  (1961) to 8,00  $m^3/sec$  (1980).

For the Nenskra HEPP 0,9  $m^3/sec$  and for the river Nakra water intake device 0,6  $m^3/sec$  are accepted as the minimal ecologic discharge rate.

The village Naki population uses the river Nakra water for household purposes, namely: for functioning water mills and crop irrigation. Fish is caught for personal consumption only and that too, in minor amounts, as the river is not rich in fish. For potable purposes the local community uses underground spring waters in which the region is quite rich, hence the river water is not used as potable. There are a few rises of mineral springs in the lower stream of the project dam and the village Naki area.

Referring to all the aforesaid, the volume of the discharge to be transferred through the tail race of the Nakra HEPP was established to be 1,2  $m^3/sec$  (instead of the calculated 0,6  $m^3/sec$ ). If we take it into our account that in the project location the river Nakra 95% provision minimal discharge makes up 0,77  $m^3/sec$ , in case of transmitting the established ecologic discharge, the portion between the dam and the first tributary will provide for the appropriate conditions for fish migration. The anticipated average annual volume in the lower stream of the river, with consideration of the tributary discharges

will make up 3,18 m<sup>3</sup>/sec, what will significantly reduce the risks of impact on both the natural and social environment.

There has been presented a plan of environmental protection and social monitoring, whose aim is to confirm the assessment of the potential impact, ensure compliance with the environmental and safety requirements of the legislation, control the risks of environmental/social impact, establish effectiveness of the measures taken toward mitigation and minimization, correct upon necessity, control of environmental impact and risks in the process of construction and exploitation.

The methods of monitoring include visual observation and gaging (upon necessity). The monitoring program describes the monitoring parameters, the time and frequency of monitoring, collection and analysis of the monitoring data. Planning of monitoring depends on the volume and importance of the impact/risks.

A plan of mitigating measures has been presented both for the construction and exploitation stages.

In the plan of mitigating measures presented for the construction stage the following issues are highlighted: atmospheric air, noise and vibration, the risks of occurrence of dangerous geologic processes, stability and quality of soil, surface waters, hydrologic regime, ground waters, landscape, flora, fauna, waste management, social and economic environment, soil utilization and housing, historical and archaeological monuments, personnel safety.

In the plan of mitigating measures presented for the construction stage the following issues are highlighted: atmospheric air, noise and vibration, the risks of occurrence of dangerous geologic processes, quality of soil, quality of surface waters, disturbance of the hydrologic regime – reduction of the level of water in the rivers, influence over the shifting of alluvion due to the presence of the dams and the reduction of the water stream in the river bed, flora, fauna, waste management, social and economic environment, soil utilization and housing, historical and archaeological monuments, personnel safety.

In order to minimize the risks of development of dangerous geodynamic processes in the process of the HEPP project units and roads construction the following recommendations are provided in the report:

- Before commencement of the construction works to ensure conduction of additional engineering and geologic researches in the Nakra headwork location;
- The formations being in active dynamics on the upper slopes of the project area (among them on the slopes of the water reservoir cavern) to be removed and the slopes to be provided with the gradient angle corresponding to their stability;
- The surface and ground waters to be carried in a way to avoid emergence of additional water content of the slopes beneath;
- The water transmission pipes, pipe bridges and other engineering structures in the road corridors should be subject to systematic monitoring of their technical condition and upon necessity the appropriate corrective works should be performed;
- In the construction works progress the landslide and erosion processes should be subject to monitoring and upon necessity the appropriate measures should be taken.

It is also mentioned that the risk of development of dangerous geologic processes at the stage of operation will be related to water reservoirs exploitation and therefore, the report contains the relevant recommendations according to which the mitigating measures should be considered both at the stage of preparation of the area for water reservoirs and at the stage of their exploitation, among these recommendations there are the ones as follows:

- The formations being in active dynamics on the slopes of the reservoir to be removed and the slopes to be provided with the gradient angle corresponding to their stability;
- The appropriate technical measures to be taken in the geologically active areas for strengthening the slopes (for instance, concrete screens to be arranged if required);
- In order to protect the vegetation cover on the slopes along the reservoir perimeter uncontrolled and unauthorized cutting of trees to be prohibited within the water protection zone and in the areas with sparse vegetation cover the groves of the sorts adapted to the local conditions to be planted;
- Throughout the HEPP life cycle dangerous geologic events and occurrences along the water reservoir perimeter should be subject to systematic monitoring and upon necessity the appropriate preventive measures should be taken (geologic study, development and implementation of a relevant project);
- In the high risk areas in view of avalanche and rockslide the appropriate technical protective facilities should be arranged;
- In the process of the water reservoir exploitation the assessment of the ground water circulation regime changes, formation of new water-bearing horizons and possibility of infiltration and the related impact on the mountain massives stability should be performed at the stage of pre-construction designing.

Each aspect which according to the report is subject to any impact, comes with the plans of the relevant mitigating measures set forth for both the construction and exploitation stages.

The conditions revealed in the result of the ecologic expertise are provided in Chapter III of the present Conclusion.

### **III. Conditions**

#### **The person performing the activities is obliged to:**

1. Ensure implementation of the mitigation measures set forth in the report, waste management plan, emergency response plan, environmental management and environmental monitoring plans in the period of construction and exploitation.
2. At the stage of detailed designing ensure performance of micro-seismic zoning of the construction site and establishing the activity of the tectonic fault closest to the structure (probability of differential motion) as well as study of the dam seismic stressed and deformed condition and development of the relevant document containing the analysis of the dam stability and the possibility of faulting and sudden emptying of the water reservoir in the event of light, normal intensity and severe earthquakes;
3. Within a one month time upon the issuance of the relevant permission, ensure development of a topographic map and its submittal to the Ministry of Environment and Natural Resources Protection of Georgia. The map should show the dangerous geological processes identified before the construction commencement (rockslide, landslide, erosion, torrents, avalanches);
4. In the process of construction ensure development of the appropriate mitigating measures for the areas identified with dangerous geological processes, monitoring and presenting the obtained results to the Ministry of Environment and Natural Resources Protection of Georgia;
5. In the event if in the course of the construction (both the roads and units of the HEPP infrastructure) there appear any additional dangerous geological processes the Ministry of Environment and Natural Resources Protection of Georgia should be informed on this, the appropriate mitigating measures should be developed, the processes should be monitored and reflected on the map of dangerous geological processes;
6. At the stage of exploitation ensure identification of the geodynamic processes activated in the result of the regional cumulative impact (from the Jvari water reservoir to the area of the Nenskra HEPP location, including the latter), their monitoring and development of the appropriate mitigating measures with consideration of the expected changes in the weather conditions and presentation to the Ministry of Environment and Natural Resources Protection of Georgia on the annual basis;
7. Before the commissioning ensure preparation of a hydrological report and its presentation to the Ministry of Environment and Natural Resources Protection of Georgia identifying the springs under the influence at the stages of construction and exploitation (indicating the GPS coordinates, providing the data on the hydrological regime - on the minimal and maximal debit and information on the sanitary condition). The monitoring plan should contain the frequency of the springs observation;
8. Before the commissioning, for the purpose of decreasing the negative impact on the environment, ensure development of the plans for management of the high temperature waters created in the result of turbine cooling and setting the appropriate mitigating measures;
9. In the process of construction and exploitation ensure monitoring of the masses transported by the river Lekvevari and Leknashura torrents to the river Nakra bed and in the event if the situation becomes more serious in the area, removal of the alluvion (the issues related to the alluvion removal and later storage/disposal should be agreed upon with the Ministry of Environment and Natural Resources Protection of Georgia);
10. Ensure identification of the damage inflicted to the ichthyo-fauna in the river Nenskra and the river Nakra in the process of construction and exploitation (blocking the river with barriers at the construction stage) and measures for

compensation and their presentation to the Ministry of Environment and Natural Resources Protection of Georgia. 1 million units of 4-5 gr current year production (a fish farm arrangement) to be considered as a compensation measure;

11. Within 3 months upon the obtaining of the relevant permit ensure installation of automatic (self-writing) level gages on the river Nenskra and the river Nakra and identifying the river Nenskra and the river Nakra discharge. The established discharge (daily and monthly) should be presented to the Ministry of Environment and Natural Resources Protection of Georgia on a quarterly basis. Besides, at the exploitation stage ensure placement of automatic level gages in the river Nenskra dam tail race to the river Tskhvamdiri tributary and below the tributary and presentation of the generated data (daily and monthly) to the Ministry of Environment and Natural Resources Protection of Georgia on a quarterly basis;
12. Not dispose the worked out rocks taken out of the tunnel on the bottom of the river Nenskra reservoir;
13. For approval by the Ministry of Environment and Natural Resources Protection of Georgia present to them the project for the areas selected for disposal of the worked out rocks (showing GIS coordinates);
14. Ensure execution of permanent monitoring on the changes in the air humidity and the dynamics of glacier thawing from June through September. The monitoring results should be presented to the Ministry of Environment and Natural Resources Protection of Georgia once per year;
15. Within 3 months upon the obtaining of the relevant permit ensure presentation of the preventive measures developed for natural disasters and accident response plans to the Ministry of Environment and Natural Resources Protection of Georgia;
16. At the stage of exploitation perform observation over the silting (filling with alluvion) of the reservoir in dynamics. Once per year the above information should be presented to the Ministry of Environment and Natural Resources Protection of Georgia for their discussion, according to which the exact period of sanding the water reservoir will be calculated;
17. In the process of construction periodically ensure development of the documents providing information on the volume of the fertile layer of soil, the spaces of the disposal areas and the GIS coordinates of these areas and presentation of these documents to the Ministry of Environment and Natural Resources Protection of Georgia;
18. Ensure meeting the requirement governed by the technical regulation approved by Governmental Decree No424, December 31, 2013 issued by the Government of Georgia On Removal, Retaining, Utilization and Recultivation of Fertile Layer of Soil;
19. Since the trees and plants growing in the area covered by the state forest fund fall under the impact zone in the project area, ensure agreeing upon and approval of the mentioned issue with LEPL National Forestry Agency before the commencement of the construction;
20. Ensure that the issue of observation over the filtration along the derivational tunnel is considered in the plans for mitigating measures;
21. Ensure that the water reservoir zone is added to the point for observation over filtration in the plan of exploitation monitoring included in the report;
22. Ensure that the dam is added to the point for observation over filtration in the plan of exploitation monitoring included in the report;
23. Ensure development of a plan for management of the produced inert waste material on the basis of the Waste Management Code and its presenting to the Ministry of Environment and Natural Resources Protection of Georgia;
24. In the event if the licensed areas are covered, ensure agreement with the organization holding the license for mining operations;



25. Ensure implementation of the measures for reducing the impact on the biodiversity that are dependent on the river water according to the activities performed during the construction process and in case of necessity exercise the relevant compensation actions;
26. Within 3 months upon the obtaining of the relevant permit ensure development of a plan for monitoring the botanical component of the biodiversity and presenting it to the Ministry of Environment and Natural Resources Protection of Georgia;
27. Within a one-year period upon the obtaining of the relevant permit ensure development of plans for conservation/restoration, specifications of the appropriate biological rehabilitation and compensation and their presenting to the Ministry of Environment and Natural Resources Protection of Georgia;
28. Ensure that the monitoring plan contains detailed and separately provided issues as follows: performance of observation over all the components of biodiversity; the condition to which they arrived in the result of the impact caused by the activities; mitigation and avoidance of impact, implementation and efficiency of the measures and actions set forth in the environmental impact report and determined in the result of the additional researches. Upon necessity additional mitigating and compensation measures need to be determined;
29. In the process of construction periodically ensure performance of researches on the plants, animals and habitats as governed by the environmental impact report and more specifically define the types of impact on them. Prepare a detailed, specific and effective package of impact reduction, its avoidance and compensation measures. The researches, as well as the information prepared on the basis thereof should contain the following details:
  - The areas of the habitats subjected to the impact/destruction; information on the purpose with which the specific areas are intended to be used (the information referring to the habitats with high conservation value should be especially detailed down); for the plots with high conservation value to be used as dumping areas, alternative areas with high conservation value should be discussed;
  - Information on the impact (cutting/destruction) of the plants appearing in the "Red List" of Georgia and should there be found any such species the number of the plants subjected to cutting/destruction (the number of stems and their volume);
  - Specific measures in order to avoid, reduce and in case of necessity compensate the potential high impact on the otter;
  - Detailed and specified measures for to avoid, reduce and in case of necessity compensate the impact on other animals, especially on the species contained in the "Red List" of Georgia, broken down according to the types of the impact and provided with the relevant reasoning;
  - Impact on animals should be discussed in the context of damaging/destroying their habitats, namely: there should be presented information on the habitats of this or that species of animals; in the event of destruction of these habitats the possibility of moving the animals to other areas (sufficiency of such areas, etc.).

#### **IV. Conclusion**

According to the Report on Evaluation of Environmental Impact of the Construction and Exploitation of Nenskra HEPP planned by JSC Nenskra, presented by the Ministry of Economy and Sustainable Development of Georgia LEPL Agency of Technical and Construction Supervision for the purpose of receiving Ecological Expertise Conclusion, the activity can be performed only through observance of the terms and conditions governed in Chapter III of the present Conclusion.

Head of the Department of  
Permissions for  
Environmental Impact

Tamar Sharashidze  
(Name, surname)

*(Signature and stamp provided)*  
*Locus sigilli*

## **Annex 3. 2015 ESIA report**



„Nenskra” JSC

Project on the Construction and Operation of Nenskra HPP

# Environmental and Social Impact Assessment Report

Executor

Gamma Consulting Ltd

Director  V. Gvakharia

Tbilisi 2015

## Table of Contents

<b>1</b>	<b>Introduction.....</b>	<b>10</b>
1.1	General Review .....	10
1.2	Goals and Basis of Preparation of the ESIA Report .....	10
<b>2</b>	<b>Legislative Framework.....</b>	<b>11</b>
2.1	Georgian Legislation and Institutional Framework.....	11
2.1.1	Objectives of National Policy .....	11
2.1.2	Regional and International Cooperation .....	12
2.1.2.1	Regional Cooperation .....	12
2.1.2.2	International Agreements.....	12
2.1.3	Institutional Framework for Environment Protection .....	13
2.1.4	Environmental Legislation .....	13
2.1.4.1	Synopsis of Georgian Environmental Laws .....	15
2.1.4.2	Environmental Standards .....	20
2.1.5	Environmental Impact Assessment Procedure in Georgia .....	22
2.2	Environmental and Social Standards of International Financial Institutions .....	23
2.2.1	Lender Policies and Standards.....	23
2.2.2	Environmental and Social Policy of EBRD, 2014.....	23
2.2.3	Environmental Standards of EU.....	33
<b>3</b>	<b>Assessment and Analysis of Alternative Versions of the Planned Activity .....</b>	<b>34</b>
3.1	Alternative Energy Sources .....	34
3.1.1	Hydro-Resources .....	34
3.1.2	Solar Energy .....	35
3.1.3	Wind Energy .....	35
3.1.4	Geothermal Energy.....	36
3.2	No-Action (Zero) Alternative.....	37
3.3	Alternatives of the Project.....	37
3.3.1	Alternatives of HPP Type.....	37
3.3.2	Alternatives of Dam and Power Unit Locations.....	38
3.3.2.1	Comparative Characteristics of the HPP Communication Locations .....	44
3.3.3	Alternative Versions of the Diversion System .....	44
3.4	Comparison of Alternatives .....	49
<b>4</b>	<b>Description of the Project.....</b>	<b>52</b>
4.1	General Overview .....	52
4.2	Headworks.....	55
4.3	Report on Stability of Nenskra Dam .....	63
4.3.1	Design Loads and Load Combinations .....	63
4.3.2	Stability Analyses of Upstream and Downstream Slopes Under Static and Dynamic Loading .....	63
4.3.2.1	Performance Criteria .....	63
4.3.2.2	Seepage Analysis .....	64
4.3.2.3	Slope Stability Analysis.....	65
4.3.2.4	Result Analysis .....	65
4.3.3	Stress and Displacement Analysis .....	65
4.3.4	Result Analysis.....	66
4.3.5	Prediction of Vertical Settlement Induced by the Seismic Loading.....	67
4.4	Diversion System.....	67
4.5	Power House .....	72
4.6	Transmission Line .....	76
4.7	Construction Works.....	78
4.7.1	General Overview.....	78
4.7.2	Nenskra Dam Construction Zone .....	80
4.7.3	Power Unit Construction Zone.....	81

4.7.4	Nenskra Tailrace Tunnel Construction Site (Tunnel Boring Machine Platform) .....	82
4.7.5	Surge Shaft .....	83
4.7.6	Pressure Shaft.....	83
4.7.7	Residential Premises for Workers.....	83
4.7.8	Nakra Intake.....	84
4.7.9	TBM Platform of Nakra Tailrace Tunnel.....	84
4.7.10	Roads.....	84
4.7.10.1	Nenskra Dam Site.....	84
4.7.10.2	Nakra Weir Site.....	88
4.7.11	Local Construction Materials.....	92
4.7.12	Terms of Performance and Personnel .....	93
4.7.13	Water Supply and Sewage System.....	94
4.7.13.1	Water Supply.....	94
4.7.13.2	Wastewater.....	95
4.7.13.3	Wastewater Treatment .....	96
<b>5</b>	<b>Environmental and Social Background Conditions of the Region.....</b>	<b>96</b>
5.1	General Overview .....	96
5.1.1	Determination of the Study Area.....	98
5.1.1.1	Study Region .....	98
5.1.1.2	The main study area.....	100
5.2	Physical Environment.....	101
5.2.1	Climate and Meteorological Conditions .....	101
5.2.2	Topography .....	106
5.2.3	Geological Conditions.....	107
5.2.3.1	General Overview .....	107
5.2.3.2	Geological Structure.....	108
5.2.3.3	Stratigraphy .....	109
5.2.3.3.1	Nakra Formation (€ n).....	111
5.2.3.3.2	Dolrini Formation (OSd) .....	111
5.2.3.3.3	Lukhrini Formation (S Dl).....	112
5.2.3.3.4	Kirari Formation (Dk).....	112
5.2.3.3.5	Quartz diorite (DCqd).....	112
5.2.3.3.6	Plagiogranite (D Cpg) .....	112
5.2.3.3.7	Kazakhtvibi Formation (Ck).....	113
5.2.3.3.8	Porphyritic Microclinegranite (Cpg) .....	113
5.2.3.3.9	Tskhenistskali Formation (PTRt) .....	113
5.2.3.3.10	Morghouli Formation (J mr).....	114
5.2.3.3.11	Muashi Formation (J ms ) .....	114
5.2.3.3.12	Diabase porphyry (Jd p ) .....	114
5.2.3.3.13	Sori Formation (Js) .....	115
5.2.3.3.14	Alluvium (Qal).....	115
5.2.3.3.15	Slope Debris (Qym).....	115
5.2.3.3.16	Alluvial Fan (Qay ).....	116
5.2.3.3.17	Fluvial Channel Deposits (Qaky) .....	116
5.2.3.3.18	Glacier Deposits (Q b).....	116
5.2.3.4	Structural Geology .....	117
5.2.3.4.1	Kinematical Analyses.....	118
5.2.3.4.1.1	The contour diagrams.....	118
5.2.3.5	Engineering Geology .....	122
5.2.3.5.1	Description of Boreholes .....	123
5.2.3.5.2	In Situ Tests.....	137
5.2.3.5.2.1	Laboratory Tests .....	138
5.2.3.6	Engineering-Geological Conditions of the HPP Communications .....	141
5.2.3.6.1	Dam Site .....	141
5.2.3.6.1.1	Covering Units and Weathered Rocks .....	141

5.2.3.6.1.2	Type of Rock Units .....	141
5.2.3.6.1.3	Permeability of Dam Axis (Filtration) .....	142
5.2.3.6.1.4	Stability of Dam Axis .....	143
5.2.3.6.1.5	Excavation and Rate of Excavation .....	144
5.2.3.6.2	Tunnels .....	149
5.2.3.6.2.1	Diversion Tunnel .....	149
5.2.3.6.2.2	Stability of Portals of Diversion Tunnel .....	149
5.2.3.6.2.3	Diversion Tunnel Portals and Alignment Excavation and Rate of Excavation .....	150
5.2.3.6.2.4	Pressure Tunnel .....	160
5.2.3.6.2.5	Stability of Pressure Tunnel .....	160
5.2.3.6.2.6	Pressure Tunnel Excavation and Rate of Excavation .....	162
5.2.3.6.2.7	Outlet Portal of Power Tunnel .....	164
5.2.3.6.2.8	Cerchar Abrasivity and Brazilian Test Result .....	165
5.2.3.6.2.9	TBM Approach Tunnel .....	165
5.2.3.6.2.10	Stability of Inlet Portal of TBM Approach Tunnel .....	166
5.2.3.6.2.11	TBM Approach Tunnel Excavation and Rate of Excavation .....	166
5.2.3.6.2.12	Cerchar Abrasivity and Brazilian Test Result .....	167
5.2.3.6.2.13	Surge Tank .....	169
5.2.3.6.2.14	Gate Shaft .....	171
5.2.3.6.3	Powerhouse Site .....	173
5.2.3.6.3.1	Bearing Capacity and Settlement .....	173
5.2.3.6.3.2	Stability of Powerhouse Nearby Slopes .....	174
5.2.3.6.3.3	Slope Excavation of Powerhouse and Rate of Excavation .....	175
5.2.3.6.4	Nakra Weir .....	178
5.2.3.6.4.1	Bearing Capacity and Settlement .....	178
5.2.3.6.4.2	Stability of Weir Axis .....	179
5.2.3.6.4.3	Nakra Tailrace Tunnel .....	181
5.2.3.6.4.4	Stability of Portal s of Nakra Tailrace Tunnel .....	181
5.2.3.6.4.5	Excavations of Nakra Tailrace Tunnel and Rate of Excavations .....	183
5.2.3.7	Cerchar Abrasivity and Brazilian Test Result .....	184
5.2.3.8	Groundwater Conditions during Tunneling .....	189
5.2.3.9	Fault Zones Along the Tunnels .....	189
5.2.3.10	Rock Mass Classification of Tunnels .....	189
5.2.3.11	Results and Recommendations .....	192
5.2.3.12	Geophysical Research Report .....	201
5.2.3.12.1	General Overview .....	201
5.2.3.12.1.1	Seismic Prospecting .....	201
5.2.3.12.1.2	Electric Resistivity Test .....	201
5.2.3.12.1.3	Equipment and methodology used .....	202
5.2.3.12.1.4	Data processing and Interpretation .....	203
5.2.3.12.1.5	Quality Control Procedures .....	204
5.2.3.12.1.6	Study Design and Obtained Results .....	204
5.2.3.12.1.7	Nenskra tunnel entrance and Nakra hydro-electric power Station territory .....	205
5.2.3.12.1.8	Nakra dam site .....	208
5.2.3.12.1.9	Nenskra tunnel entrance and Nakra hydro-electric power Station territory .....	209
5.2.3.12.1.10	Nenskra tunnel route area .....	211
5.2.3.12.1.11	Seismic Profiles .....	214
5.2.3.12.1.12	Physical and mechanical properties of the soil based study of seismic profiles .....	222
5.2.3.13	Seismic Hazard Analysis within the Project Area of Nenskra HPP .....	229
5.2.3.13.1	Seismotectonic Environment of the Project Area .....	229
5.2.3.13.2	Seismicity of the Region .....	232
5.2.3.13.3	Seismic Hazard Analysis .....	237
5.2.3.13.3.1	Review of published material .....	237
5.2.3.13.3.2	Probabilistic Seismic Hazard analysis of Nenskra HPP Site .....	237
5.2.3.13.3.3	Deterministic Hazard Analysis .....	242

5.2.3.13.4	Deaggregation of Seismic Hazard at Nenskra Dam Location.....	242
5.2.3.13.5	Conclusions .....	248
5.2.4	Soils.....	248
5.2.5	Hydrology .....	251
5.2.5.1	A Brief Hydrographic Description of the Rivers Nenskra and Nakra .....	251
5.2.5.2	Average Annual Flows.....	252
5.2.5.3	Maximum Flows.....	254
5.2.5.4	Minimum Flows .....	257
5.2.5.5	Solid Flow.....	259
5.2.5.6	Maximum Turbidity of River Nenskra .....	260
5.2.5.7	Evaporation from Water Surface.....	261
5.2.5.8	Glaciers .....	261
5.2.6	Biological Environment.....	265
5.2.6.1	Flora .....	265
5.2.6.1.1	Methodological and Conceptual Approaches for Description of Flora and Vegetation and Determination of Impacts on Ecosystem and Habitats .....	265
5.2.6.1.2	Description of Flora and Fauna within the Project Corridor .....	267
5.2.6.1.3	Detailed Characteristics of Flora and Vegetation Within the Project Area.....	271
5.2.6.1.4	Sensitive Areas .....	312
5.2.6.1.5	Georgia Red List Species Occurred in the Proposed Project Corridor .....	317
5.2.6.1.6	The amount of timber within the impact zone of Nenskra HPP project.....	318
5.2.6.2	Fauna .....	320
5.2.6.2.1	Terrestrial Fauna .....	320
5.2.6.2.2	Geography and Landscaped of the Middle Waists of the Rivers Nenskra and Nakra .....	321
5.2.6.2.3	Field Survey Methodology .....	322
5.2.6.2.4	Red List Species Within the Project Territory .....	322
5.2.6.2.5	Field Survey Results.....	324
5.2.6.2.6	Sensitive Areas and Danger .....	326
5.2.6.3	Invertebrates Fauna .....	327
5.2.6.3.1	Geography and Landscapes of Middle Reaches of Nenskra and Nakra Rivers .....	327
5.2.6.3.2	Survey Methodology for Invertebrates.....	327
5.2.6.3.3	Invertebrate Animal Species of the Red List Found Within the Project Region.....	328
5.2.6.4	Fish Fauna.....	331
5.2.6.4.1	Theoretical Basis of the Background Condition Monitoring.....	331
5.2.6.4.2	Field Survey Results.....	333
5.2.6.5	Protected Areas .....	334
5.2.6.5.1	General Background .....	334
5.2.6.5.2	Protected areas in the study area .....	334
5.2.7	Quality of Ambient Air .....	338
5.2.8	Noise Propagation.....	338
5.3	Socio-Economical Environment Within the Project Region.....	339
5.3.1	Socio-Economical Environment Research Area and Information Sources.....	339
5.3.2	General Overview.....	342
5.3.2.1	Economy of Georgia.....	342
5.3.2.2	Economy of Mestia Municipality .....	343
5.3.2.3	Industry and Transport .....	343
5.3.2.4	Agricultural Development in the Project Region.....	345
5.3.2.5	Tourism.....	346
5.3.2.6	Employment .....	349
5.3.3	Population and Demography .....	350
5.3.3.1	Population .....	350
5.3.3.2	Demographic Trends.....	351
5.3.4	Migration.....	352
5.3.5	Socially Unprotected – Vulnerable population .....	353
5.3.6	Healthcare .....	353



5.3.7	Sanitary and Epidemiological Situation .....	355
5.3.8	Education System and Cultural-Educational Institutions.....	355
5.3.9	Communication and Information Accessibility .....	357
5.3.10	Public Sector .....	357
5.3.11	International Economic Cooperation and Partner Organizations of the Region .....	360
5.3.12	Gender Issues of Svaneti Region.....	360
5.3.13	Cultural Heritage of Zemo Svaneti.....	360
5.3.13.1	Immovable Monuments.....	360
5.3.13.2	Cultural Heritage Monuments in the Influence Area of the Project .....	361
5.3.13.3	Care and Maintenance of Cultural Heritage Monuments.....	364
5.3.13.4	Traditions of Svaneti and Oral Cultural Heritage.....	364
<b>6</b>	<b>Environmental and Social Impact Assessment.....</b>	<b>366</b>
6.1	General Principles of ESIA Methodology .....	366
6.2	Impact Receptors and Sensitivity .....	367
6.3	Impact Description.....	368
6.4	Emissions in the Ambient Air .....	368
6.4.1	Impact Assessment Methodology.....	368
6.4.2	Impact Description .....	369
6.4.2.1	Construction Phase .....	369
6.4.2.2	Operation Phase .....	370
6.4.3	Mitigation Measures .....	371
6.4.4	Impact Assessment.....	372
6.5	Noise Distribution .....	373
6.5.1	Impact Assessment Methodology.....	373
6.5.2	Impact Description .....	373
6.5.2.1	Construction Phase .....	373
6.5.2.2	Operation.....	375
6.5.3	Mitigation Measures .....	375
6.5.4	Impact Assessment.....	377
6.6	Impact on Soil.....	378
6.6.1	Impact Assessment Methodology.....	378
6.6.2	Impact Description .....	378
6.6.2.1	Construction Phase .....	378
6.6.2.2	Operation.....	380
6.6.3	Mitigation Measures .....	380
6.6.4	Impact Assessment.....	382
6.7	Risk of Dangerous Geodynamic Process Development.....	383
6.7.1	Impact Assessment Methodology.....	383
6.7.2	Impact Description .....	383
6.7.2.1	Construction Phase .....	383
6.7.2.2	Operation Phase .....	386
6.7.3	Mitigation Measures .....	387
6.7.4	Impact Assessment.....	389
6.8	Impact on the Aquatic Environment .....	391
6.8.1	Impact Assessment Methodology.....	391
6.8.2	Impact Description .....	392
6.8.2.1	Construction/Mobilization Phase.....	392
6.8.2.2	Operation Phase .....	393
6.8.2.3	Determination of Ecological Flow.....	394
6.8.2.4	Impact on Glaciers .....	398
6.8.3	Mitigation Measures .....	399
6.8.3.1	Construction Phase .....	399
6.8.3.2	Operation Phase .....	400
6.8.4	Impact Assessment.....	401
6.9	Impact on Groundwater.....	403

6.9.1	Impact Assessment Methodology.....	403
6.9.2	Impact Assessment.....	403
6.9.2.1	Construction Phase .....	403
6.9.2.2	Operation Phase .....	404
6.9.3	Mitigation Measures .....	404
6.9.4	Impact Assessment.....	406
6.10	Impact on Biological Environment .....	407
6.10.1	Impact Assessment Methodology .....	407
6.10.2	Impact on Flora .....	408
6.10.2.1	Construction Phase .....	408
6.10.2.2	Operation Phase .....	412
6.10.3	Impact on Fauna .....	413
6.10.3.1	Construction Phase .....	413
6.10.3.2	Operation Phase .....	414
6.10.4	Impact on Fish Fauna .....	414
6.10.4.1	Construction Phase .....	414
6.10.4.2	Operation Phase .....	414
6.10.5	Impact on Protected Areas.....	416
6.10.6	Mitigation Measures.....	416
6.10.6.1	Flora.....	416
6.10.6.2	Fauna .....	417
6.10.6.3	Fish Fauna.....	418
6.10.7	Impact Assessment .....	419
6.11	Waste .....	422
6.11.1	Construction Phase.....	422
6.11.2	Operation Phase .....	424
6.11.3	Impact Assessment .....	426
6.12	Visual-Landscape Impact .....	428
6.12.1	Construction Phase.....	428
6.12.2	Operation Phase .....	428
6.12.3	Mitigation Measures.....	428
6.12.4	Impact Assessment .....	429
6.13	Impact on Socio-Economic Environment.....	430
6.13.1	Impact Assessment Methodology .....	430
6.13.2	Impact Description .....	431
6.13.2.1	Health and Safety .....	431
6.13.2.2	Availability of Resources .....	432
6.13.2.3	Land Ownership and Use .....	432
6.13.2.4	Employment .....	433
6.13.2.5	Demographic Changes .....	433
6.13.2.6	Input in Economy .....	434
6.13.2.7	Road Damage and Intensification of Traffic Flows .....	434
6.13.3	Impact Assessment .....	436
6.14	Impact on Cultural Heritage.....	439
6.14.1	Impact Assessment methodology .....	439
6.14.2	Impact Description .....	439
6.14.2.1	Construction Phase .....	439
6.14.2.2	Operation Phase .....	439
6.14.3	Mitigation Measures.....	439
6.14.4	Impact Summery .....	440
6.15	Expected Environmental Impact of Nenskra Reservoir and Cumulative Impact of Enguri Reservoirs (Nenskra, Khudoni, Jvari) on Local, Regional and Global Climate .....	440
6.15.1	Physical-Geographical Characteristics of Enguri Reservoir Cascade and Its Catchment Area and Hydro-Meteorological Learnability .....	440
6.15.1.1	Physical-Geographical Characteristics of the Basin and Cascade Morphometry .....	440

6.15.1.2	Meteorological Learnability and Research Methods of Enguri Reservoir Cascade .....	441
6.15.1.3	Realization of Analysis Method .....	444
6.15.2	Background Factors of Current Climate Changes and Regime of the Meteorological Elements ....	445
6.15.2.1	Background factors of current climate changes.....	445
6.15.2.2	Basic Meteorological Elements Regime .....	445
6.15.3	Expected Cumulative impact of Enguri Cascade Reservoirs on Local, regional and Global Climate 450	
6.15.3.1	Sensitive indicators of Global Climate Change and Background.....	450
6.15.3.2	Possible Cumulative Impact of the Reservoirs on the Various Scale Climate.....	450
6.15.3.3	Water Volumes Evaporated from the Reservoirs and Their Internal Annual Distribution.....	451
6.15.4	Greenhouse Gases (CO <sub>2</sub> ) regime in the Reservoirs and their Quantitative Assessment .....	453
6.15.5	Conclusions.....	454
6.16	Assessment of Dam Sustainability Risks and Possible Floods on Transit Sections of the River.....	455
6.17	Cumulative Impact.....	461
6.17.1	Construction Phase.....	461
6.17.2	Operation Phase .....	462
6.17.3	Impact summary .....	463
<b>7</b>	<b>Mitigation Measures and Monitoring .....</b>	<b>465</b>
7.1	Construction Phase .....	467
7.2	Operation Phase .....	476
<b>8</b>	<b>Environmental and Social Monitoring Plan .....</b>	<b>484</b>
8.1	Monitoring Plan – Preparation and Construction Works.....	485
8.2	Monitoring Plan – Operation Phase.....	489
<b>9</b>	<b>Possible Emergency Situations.....</b>	<b>492</b>
<b>10</b>	<b>Public Awareness and Participation in the ESIA Process.....</b>	<b>494</b>
10.1	Information on Comments and Suggestions Received during the Public Review.....	496
<b>11</b>	<b>Conclusions and Recommendations .....</b>	<b>529</b>
<b>12</b>	<b>Bibliographic Sources.....</b>	<b>532</b>
12.1	General Part.....	532
12.2	Impact on the Climate .....	535
12.3	Impact on Ambient Air.....	535
12.4	For the Assessment of the Dam Stability and Maximum Flows of Possible Floods in Transit Sections of the River .....	536
12.5	Flora and Vegetation.....	536
<b>13</b>	<b>Annexes .....</b>	<b>538</b>
13.1	Annex №1: Assessment of Cumulative Impact of Jvari, Khudoni and Nenskra Reservoirs on Local Climate.....	538
13.2	Annex N2 Emergency Response Plan .....	548
13.2.1	Types of Emergency Situation and their Description.....	548
13.2.2	Accidental Damage of Hydraulic Structures .....	549
13.2.3	Accidental Spills of Pollutants .....	549
13.2.4	Fire / explosion .....	549
13.2.5	Traffic Accidents .....	550
13.2.6	Personnel Traumatism and Incidents Related to their Health Safety.....	550
13.2.7	General Preventive Measures for Different Emergency Situations .....	550
13.2.8	Approximate Scale of Accidents .....	551
13.2.9	Emergency Response.....	553
13.2.9.1	Emergency Response in Case of Damage to Hydraulic Structures .....	553
13.2.9.2	Response to Hazardous Material Spill.....	553
13.2.9.3	Response During Fire.....	555
13.2.9.4	Response During Traffic Accidents.....	556

13.2.9.5	Response during Accidents Related to Human Injuries and Incidents Related to Their Health and Safety	556
13.2.9.5.1	First Aid during the bone fracture .....	557
13.2.9.5.2	First Aid During Wounds and Bleeding .....	557
13.2.9.5.3	First Aid in Case of Burn .....	558
13.2.9.5.4	First Aid in Case of Electrical Trauma .....	559
13.2.10	Equipment Necessary for Emergency Response .....	560
13.2.11	Necessary Qualification and Personnel Training.....	560
13.3	Annex 3: Measures considered for waste prevention and recovery .....	561
13.3.1	Legal Basis .....	561
13.3.2	Goals and Objectives of Waste Management Plan.....	561
13.3.3	Waste Management Hierarchy and Principles .....	562
13.3.4	Types and Approximate Quantities of Waste Generated during the Implementation of Planned Activities	562
13.3.5	Waste Management Process Description .....	563
13.3.5.1	Waste prevention and recovery measures .....	563
13.3.5.2	Waste separation .....	563
13.3.6	Methods and conditions for temporary storage of waste .....	564
13.3.7	Waste transportation rules.....	565
13.3.8	Waste treatment / final disposal .....	565
13.3.9	General requirements for the safe treatment of waste .....	565
13.3.10	Waste control methods .....	566

## 1 Introduction

### 1.1 General Review

The Strategic Development Plan of Georgia of 2011-2015 considers energy development as a top priority. This is due to the fact that Georgia cannot provide itself with fuel-energy resources and has to import 1 billion USD value energy every year. In addition, Georgia has a big potential of hydro-energy resources – 88,5 billion kWh annually, use of which does not exceed 10%. Therefore, one of the most important goals of the Georgia state policy is maximum consumption of energy resources – the Government plans to consume the renewable energy (according to “Energy policy of Georgia and state program, renewable energy - 2008”). Projects of small, medium and big HPPs is under review process, power generation and transmission projects are being implemented or are being developed, including trans boundary projects. Development of such projects will help to reduce energy source import and will increase the opportunity to export energy into neighboring countries.

For the development of energy policy construction and operation of the seasonally regulated HPP on the riv. Nenskra is one of the most important projects. According to the agreement with the Government of Georgia the project will be implemented by “Nenskra” JSC.

The project considers construction and operation of seasonally regulated HPP with capacity of 280 MW. Construction works will be conducted in two phases. On the first phase 210 MW capacity HPP will be constructed on the riv. Nenskra, on the second phase water from the riv. Nenskra will be released into the Nenskra ravine to generate additional 70 MW.

This document is an Environmental and Social Impact Assessment (ESIA) report for the HPP construction and Operation project. The document was prepared by Gamma Consulting Ltd for “Nenskra” JSC.

The project envisages the construction and operation of seasonal regulation HPP with a total installed capacity of 280 MW. This document is the Environmental Impact Assessment (EIA) report for the project on the construction and operation of the HPP on Nenskra River. The report is prepared by Gamma Consulting Ltd and the Client is JSC "Nenskra".

### 1.2 Goals and Basis of Preparation of the ESIA Report

The basis of the ESIA report is a Georgia law on “Environmental Permit”. According to the Article 4, Paragraph 1, subparagraph “m” “arrangement of HPP (with capacity of 2 MW and more) and TPP (with capacity of 10 MW and more)” is a subject for ecological expertise. Therefore, construction and operation of the HPP on the riv. Nenskra, in Mestia municipality is a subject for ecological expertise and it should be implemented on the basis of the expertise conclusion. The ecological expertise conclusion is issued by the Ministry of Environment Protection.

The implementation of Nenskra HPP project will be related to some negative environmental and social impacts, which will be associated with the destruction of a significant amount of vegetation, changes in hydrological, hydrogeological and geological conditions, negative impact on terrestrial and aquatic biological environment, as well as on social environment, in particular: Loss of forest and pastures, disturbance of population, etc. Therefore, the main goal of the ESIA is to identify such negative impacts and to determine their volume and spatial boundaries, which means:

- Study and analysis of technical documentation of the planned activity;
- Collection of information on natural and social environment;
- Determination of possible impacts (including residual and cumulative impacts) from the project as well as its alternatives after study and analysis of the given technical documents.

The very important parts of the ESIA are development of mitigation measures for possible impacts; development of environmental management and monitoring plans, informing population on the planned activity and ensuring their participation.

According to the Environmental and Social Policy of European Bank for Reconstruction and Development (EBRD), project on the construction and operation of Nenskra HPP belongs to the A category. Therefore, Environmental and Social Impact Assessment of the project should be carried out in accordance with the approaches established for the projects of this category.

The ESIA report for the Nenskra HPP Construction and Operation Project was prepared in accordance with requirements of local environmental legislation (Georgia law on “Environmental Permit” – 01.01.2008 and regulation on “Environmental Impact Assessment” – 15. 05. 2013) and Environmental and Social Policy (2014) of the European Bank for Reconstruction and Development (EBRD).

## **2 Legislative Framework**

Main goals of the energy sector policy are: full satisfaction of industrial and domestic-public needs by using energy resources of Georgia, diversification of energy import, insurance of economic independence and energy security.

This chapter discusses legal-institutional framework and study of impact, which will be included in report on Environmental and Social Impact Assessment.

### **2.1 Georgian Legislation and Institutional Framework**

#### **2.1.1 Objectives of National Policy**

Following the declaration of independence, Georgia has completely replaced its legislation, including its national environmental law. The national environmental laws are largely based on European legislation and the principles of the Rio Declaration. Whilst developing the new environmental law focus was given to the environmental challenges that the country faces and the principles of sustainable development.

Various programs and plans have been developed and implemented to promote a healthy environment and socio-economic development in the country. These include:

- The Program for Social and Economic Recovery and Economic Growth, approved in 2001 (Presidential Decree No.89);
- Poverty Reduction and Economic Growth Program of Georgian Government (Resolution No.3267 by the Parliament of Georgia, 2 June, 2010);
- The National Environmental Action Plan (NEAP) adopted in 2000 (Presidential Decree No.191), which expired in 2005. At present a replacement document project is developed which sets out environmental priorities to address;
- The National Biodiversity Strategy and Action Plan (NBSAP), adopted in 2005 (Resolution No.27 by the State Government).

Under the framework of the European Neighborhood Policy, the EU/Georgia Action Plan was adopted in 2006. The plan has a five-year validity date. Special mechanisms have been applied to implement and monitor the plan.

## 2.1.2 Regional and International Cooperation

### 2.1.2.1 Regional Cooperation

Regional cooperation in the field of Environment spreads over different sectors and levels:

- Georgia is one of the six countries (Armenia, Azerbaijan, the Caucasus part of Russian Federation, North-Eastern Turkey and part of North-Western Iran) composing the Caucasus Region and Eco region, historically and geographically interpreted as the isthmus between the Black and Caspian Seas;
- Georgia is also part of the Black Sea Countries and involved in the Black Sea conservation;
- The Regional Environmental Centre (REC) for the Caucasus works in Georgia.

**Figure 2.1.2.1.1.** Georgia in the Caucasus Region



### 2.1.2.2 International Agreements

Georgia has ratified many international conventions and agreements. Among them the following are relevant to the project:

- **Nature and biodiversity protection**
  - Convention on Biological Diversity (CBD), Rio de Janeiro, 1992;
  - Convention on *Wetlands of International Importance*, especially as Waterfowl Habitat, Ramsar, 1971;
  - Convention on International Trade in Endangered Species of Wild Fauna and Flora (CITES), Washington, 1973;
  - Convention on the Conservation of Migratory Species of Wild Animals (CMS), Bonn, 1979;
- **Climate Change**
  - United Nations Framework Convention on Climate Change, New-York, 1994;

- Montreal Protocol on Substances that Deplete the Ozone Layer, Montreal, 1987;
- Convention for the Protection of the Ozone Layer, Vienna, 1985;
- Kyoto Protocol, 1997;
- United Nations Convention to Combat Desertification (UNCCD), Paris, 1994;
- **Pollution and Hazards**
  - EUR-OPA Major Hazards Agreement;
- **Cultural Heritage**
  - European Convention for the Protection of the Architectural Heritage of Europe;
  - European Convention for the Protection of the Archaeological Heritage of Europe;
- **Public Information**
  - Convention on Access to Information, Public Participation in Decision Making Process and Access to Justice in Environmental Matters, Aarhus, 1998.

### 2.1.3 Institutional Framework for Environment Protection

The Constitution of Georgia has the main legislative and executive powers in the country.

The Parliament of Georgia is the major lawmaking organization. Regarding environmental issues, the Parliament is primarily responsible for the Commission on Environmental Protection and Natural Resources. Laws and guidance documents are adopted via the decrees of the President of Georgia, resolutions of the state government and normative orders of the respective Ministries.

The Ministry of Environment Protection (MOE) is the main authority responsible for governing and implementing decisions on state environmental policy, and making and implementing decisions on environmental issues and natural resources management; after legislative changes in 2011 management of natural resources transferred to the ministry of Energy of Georgia, which formed into the Ministry of Energy and Natural Resources.

The MOE is led by a Minister, and includes Deputy Ministers, several departments and associated institutions.

The Department of Licenses and Permits is in charge of the ecological examination of the Project presented by the investor, preparation of overall ecological examination, and the design and issuance of decisions made by ecological examination.

A sub-agency, the Inspectorate of Environmental Protection, is in charge of enforcement of the requirements of environmental permits and controls the implementation of environmental law using physical monitoring and legal enforcement measures.

Other sectorial ministries and/or institutions that will be involved in the project are as follows:

- Ministry of Energy and Natural Resources;
- Ministry of Culture and Monument Protection;
- Ministry of Agriculture;
- Ministry of Labor, Health and Social Affairs;
- Ministry of Economy and Sustainable Development;
- Ministry of Justice (in charge of Land Management).

### 2.1.4 Environmental Legislation

Georgian legislation comprises the Constitution, environmental laws, international agreements, subordinate legislation, normative acts, presidential orders and governmental decrees, ministerial orders, instructions and regulations. Georgia is signatory of a number of international conventions.



**The Constitution of Georgia** (adopted in 1995) lays down the legal framework that guarantees public access to information and forms a vital component of the overall public consultation process with regards to environmental conditions; though, the document does not directly address environmental issues.

Article 37 of the Constitution states that “any person has the right to live in a healthy environment, use natural and cultural resources”. At the same time, all people are obliged to care for natural and cultural environment”. According to Part 5 of the same article, “an individual has the right to obtain full, unbiased and timely information regarding his working and living environment”. According to the Constitution, the Georgian Government must secure the rational use of natural resources and protection of the environment.

Article 41, part 1 of the Constitution states that Georgian citizens have access to information available in state institutions concerning their personal matters, as well they have access to official documents provided they do not contain confidential information of state, professional or commercial importance.

The ESIA for the construction and operation of the HPP must be based on the following Georgian environmental laws<sup>1</sup> (see Table 2.1.4.1.).

**Table 2.1.4.1.** List of environmental laws of Georgia

Year	Law / Regulation
1994	on Soil Protection
1994	on protection of plants from harmful organisms
1995	Constitution of Georgia
1996	on System of Protected Areas
1996	on Protection of Environment
1996	on ownership of agricultural lands
1996	on wildlife
1997	on animal wildlife
1997	on Tourism and Recreation
1997	on water
1997	on compensations for consumption of Agricultural Lands for Non-agricultural Purposes
1998	on Hazardous Chemicals
1998	on Pesticides and Agrochemicals
1999	on State Complex Expertise and Approval of Construction Projects
1999	on Protection of Ambient Air
1999	Forestry Code of Georgia
1999	on Seizure of Property Rights for Necessary Public Needs
1999	on protection of plants from dangerous organisms
2005	on Red List and Red Book of Georgia
2005	on Licenses and Permits
2005	on Fire Safety
2005	on Privatization of State-owned Agricultural Land
2005	on Registration of Rights to Real Estate
2006	on Regulation and Engineering Protection of Sea and River Coasts of Georgia
2007	on Cultural Heritage
2007	on Status of Protected Areas
2007	on Ecological Examination
2007	on Environmental Impact Permit
2007	on Public Health

<sup>1</sup> As of 1 November, 2011

2007	on Entitlement of Ownership Rights to Lands Possessed (Employed) by Physical and Legal Persons of Private Law
2009	on Notary

#### 2.1.4.1 Synopsis of Georgian Environmental Laws

**Law of Georgia on Protection of Environment (enacted 1996)** regulates legal relationship between the bodies of the state authority and physical persons/legal entities in the scope of environmental protection and consumption of natural resources on all Georgian territory including its territorial waters, airspace, continental shelf and special economic zones.

The law concerns environmental education, environmental management, economic sanctions, licensing, standards, environmental impact assessment and related issues. The law considers various aspects of ecosystem protection, protected areas, global and regional environmental management, protection of ozone layer, biodiversity and the Black Sea, as well as discusses international cooperation aspects.

Besides, the law covers certain aspects of waste management. Management, import, export, re-exports and transit of waste is regulated according to rules stated in Georgian legislation. The law sets requirements for disposal of toxic, radioactive and other hazardous waste and restricts their discharge into surface water bodies.

**Law of Georgia on Environmental Impact Permit (2007)** gives a complete list of activities subject to obligatory ecological examination. According to Georgian law on “Environmental Impact Permit”, article 4, paragraph 1, sub-paragraph “m” “arrangement of 2 MW and above capacity HPP and 10 MW and above capacity TPP” needs ecological expertise. The law sets legal basis for issuance of environmental permit, implementation of ecological examination, public consultations and involvement in the processes. In this law, Environmental Impact Permit is defined as authorization for implementation of the planned development. According to the law, Environmental Impact Permit is issued by Georgian Ministry of Environment Protection after examination of applicant’s documents.

**Law on Public Health (2007)** aims at: facilitating health and healthy life style; ensuring an environment safe for human health; promoting reproduction health protection; preventing spreading of contagious or non-contagious diseases. The law defines rights and responsibilities of population and legal persons regarding public health care. To guarantee the safe environment the Ministry sets the qualitative standards for air, water, soil, noise, vibration, electromagnetic fields, which include permissible concentrations and exposure standards. Adherence to the standards is obligatory.

According to the law, all people present on Georgian territory are liable to: refrain from any activity containing risks to spread contagious/non-contagious diseases or causing health risks; maintain sanitary and epidemiological norms; comply sanitary and epidemiological norms.

**Law of Georgia on Licenses and Permits (2005)** - regulates organized activities or actions concerning unlimited circle of persons, is characterized with increased hazard to human life or health, involves especially important state or public interests, or is connected to consumption of the state resources. The law deals with spheres regulated by licenses and permits, defines full list of licenses and permits, and sets rules for granting, amending and abolishing licenses and permits. According to the law, the state regulates activity/action with license or permit only when licensing/permit issuing can really reduce the mentioned hazards or they incorporate the state and public interests.

In compliance with this law, the license or permit issued by a foreign country under an international agreement or law is recognized by Georgia and has the status similar to that granted to the documents issued by Georgia.

The law defines new principles for the license issuance. These are:

- “One-window” principle – a new concept adopted by the law, which obliges a licensing authority to ensure approval of additional licensing conditions by other authorities.
- “Silence gives consent” – a licensing administrative body is obliged to make a decision in due period of time after an application is submitted. Otherwise, if the decision is not announced by the end of this period, a license is deemed issued.
- “Umbrella principle” – a holder of the general license is not obliged to apply for specialized licenses.

**Law of Georgia on Ecological Expertise (adopted in 2007).** The law makes an ecological expertise obligatory for issuance of environmental impact or construction permits. An objective of the ecological expertise is to preserve ecological balance through incorporation of environmental requirements, sound use of natural resources and sustainable development principles. A positive conclusion of the ecological expertise is mandatory to obtain an environmental and/or construction permit. Ecological assessments are regulated by the Ministry of Environment Protection.

**Law of Georgia on Regulation and Engineering Protection of Sea and River Coasts of Georgia (2006):** the law establishes terms for complex and rational use of sea and river coastal zone of Georgia and ensures sustainability of coastal zone, as well as establishes state control over and liabilities for actions entailing erosive and abrasive processes.

**Law of Georgia on Soil (1996)** defines status of soil, describes their use, and sets out the types of licenses and rights and obligations of the users. The law sets responsibilities to preserve lands from contamination and ensures conformity of agricultural activities with relevant legal requirements.

**Law of Georgia on Water (adopted in 1997)** regulates major general legal relations:

- between the state governmental bodies and physical/legal persons in the field of water protection, study and consumption;
- in the field of water protection, study and consumption on land, underground, continental shelf, territorial water and especially active economic zones;
- in the sphere of commercial water production and international trade in water;
- defines competences of autonomous republics, local government and self-government in water related relations;
- in the sphere of groundwater protection, study and consumption consistent with requirements of the law of Georgia on “Natural Resources”;
- in the field of aquatic life protection, study, reproduction and consumption, in compliance with the law of Georgia on Fauna;
- Regarding consumption of fauna, flora, forest, land and other natural resources whilst water utilization.

Consistent with the legislation, water within the territory of Georgia is in the state ownership and can be provided only for consumption. Any actions directly or indirectly violating the state ownership rights for water are prohibited.

**Law of Georgia on Soil Protection (1994)** aims at ensuring preservation of integrity and improves fertility of soil. It defines obligation and responsibility of land users and the state regarding provision of soil protection conditions and ecologically safe production. The law sets the maximum permissible concentrations of hazardous matter in soil.

The law restricts: the use of fertile soil for non-agricultural purposes; execution of any activity without striping and preservation of top soil; open quarry processing without subsequent recultivation of the site; terracing without preliminary survey of the area and approved design; overgrazing; wood cutting; damage of soil protection facilities; any activity deteriorating soil quality (e.g. unauthorized chemicals/fertilizers, etc.).

**Law of Georgia on Protection of Atmospheric Air (1999, amend. 2000, 2007)** regulates protection of the atmospheric air from adverse anthropogenic impact within whole Georgian territory. Adverse anthropogenic impact is any man-caused effect on atmospheric air causing or capable to cause negative impact on human health and environment.

**Law of Georgia on System of Protected Areas (1997, amend. 2003, 2004, 2005, 2006)** sets categories of the protected area (including national park, state reserves, managed reserves, etc.) and defines activities allowed in their boundaries. Activities are permitted considering purpose of the area, requirements set out in legislation and individual regulations, management plans of protected areas, as well as international agreements and conventions signed by Georgia. The law provides restrictions over use of natural resources in national parks and other protected areas. In general, in the protected territories are prohibited:

- To damage or modify natural ecosystems;
- To destroy natural resources due to use or other purposes;
- To seize, damage or disturb natural ecosystems and species;
- To pollute environment;
- To introduce and multiply alien and exotic species of living organisms;
- To import into the territory explosive or poisonous materials;
- To carry out any other activities, restricted by the management plan of the protected area.

**Forest Code of Georgia (1999)** regulates spheres related to functions and use of forest, including protection, management of water catchment basin, wood production, etc. It allows for private ownership of forest and commercial woodcutting. According to the law, Forest Department of Georgia does not executed commercial woodcutting itself, but controls and manages these operations as grants this function to private enterprises. However, the Forest Department is carries responsibility over sanitary woodcutting and forest management. According to the Code, the Ministry of Environment Protection and Natural Resources delegated to the Department a right for issuance a woodcutting license. The Forest Code sets categories of protected forests, including those regulating soil and catchment basins, riparian and sub-alpine forest zones, floral species of the Red List, etc. The Forest Code is a framework law and requires execution of detailed regulations.

**Civil Code of Georgia (1997, June 26)** regulates private civil relations, determines rights of ownership, family and neighboring tenements and establishes inheritance rules. Ownership right enables the proprietor to freely manage or alienate owned assets. Paragraph 183 of the Code states, that purchasing of real estate shall be confirmed by a written agreement and ownership right of the buyer is registered in the public register. The Civil Code gives the proprietor right to alienate assets with right to build, usufruct or servitude.

The Code defines rules for neighboring tenements. According to paragraph 180, if a land parcel has not access to public roads and power, gas and water supply networks, the proprietor has right to request a neighbor to use his/her parcel to provide such communications and for this pays one-time compensation. The Code also defines other rights of neighboring tenements regarding bordering facilities, plants, fences and disturbances.

**Law of Georgia on Protection of Cultural Heritage (2007, May 8)** sets legal principles for protection of cultural heritage in Georgia. It obliges the state to protect cultural heritage and makes all citizens responsible to care for and protect it. According to the law, cultural heritage is preserved and managed by the Ministry of Culture, Monuments Protection and Sports and local governmental bodies. Protection of cultural heritage is managed under the constitutional agreement made between the state and Georgian Orthodox Church.

For alienation of state owned monuments, objects having cultural value, or land parcels contained in the archeological protection zone an agreement shall be made with the Ministry of Culture,

Monuments Protection and Sports. The agreement shall stipulate protection of cultural heritage in compliance with Georgian legislation. Monuments recognized as World's Cultural Heritage cannot be alienated. Only usage rights can be transferred for them.

**Law of Georgia on Notary System (2009, 12.04.)** defines arrangement of notary system and legal principles of its activity. According to the article 41 – in populated areas with no notary service, notary activities are implemented by local authorities, namely head (governor) of the board (city hall). The governor has a right to perform following notarial activities: will confirmation, take measures to protect inheritance property, test accuracy of the copy with an original document, verify alive citizen, receive a document for storage, verify signature on the document and etc. The representative of the board can perform these activities only in case of access to the electronic notary registry.

**Law of Georgia on Privatization of State-owned Agricultural Land (2005, June 8)** regulates the privatization of state-owned agricultural land. On the basis of this law, either leased or unleased state-owned agricultural land is subject to privatization. However, the categories of agricultural lands listed below are not subject to privatization:

- I. Grazing lands except grazing lands leased before enacting the law;
- II. Cattle-driving routes;
- III. First sub-zone (strict regime zone) of sanitary protection zone of water bodies utilized for water supply;
- IV. Forest fund land used for agricultural purposes
- V. Recreation lands;
- VI. Lands allocated to historical, nature and religious monuments;
- VIII. Agricultural lands being used by budgetary institutions and legal entities of public law in the form of usufruct.

Privatization of agricultural lands of categories II, II, IV and V is still allowed only for important projects and special decision upon privatization is to be made by Georgian Government if appealed by Georgian Ministry of Economic Development. Sanitary terms shall be adhered when privatizing lands of category III.

**Law of Georgia on Ownership to Agricultural Land (1996)** aims at rational land use, improvement of agrarian structure and prevention of land fragmentation. The law gives definition of an agricultural land, sets rules for its purchasing and alienation and role of the state to regulate relevant relationships.

The Law gives the ownership right to agricultural land to the state, citizen of Georgia, household (Komli) and legal person registered in accordance with the legislation of Georgia. According to articles 6 and 8, acquisition of agricultural land is allowed on the basis of ordinary rules and general restrictions. Ordinary rule considers land alienation without any permits and other limitations, and general restrictions consider land alienation only on the basis of the consent of co-owner of shared property. If not covered by the given law, Civil Code of Georgia regulates land-related (ownership) relations and rights.

**Law of Georgia on Entitlement of Ownership Rights to Lands Possessed (Employed) by Physical and Legal Persons of Private Law (2007, July 7)** regulates utilization of the state-owned lands and facilitates to development of land market via entitlement of legal ownership or utilization rights of physical and legal persons of private law, as well as other legal organized entities and squatters.

The law defines general terms and procedures for entitlement of the land ownership rights. Compliance of the appeal with territorial planning and strategic plan of the land management shall be studied when considering the entitlement case. Ownership right cannot be entitled to the following lands:

Cattle-driving routes;	Lands accommodating community infrastructure units (transport and underground utilities, water-supply,
------------------------	--

	sewage, communication and power-supply systems);
Water field (stock);	Lands of special purpose (allocated for defense and mobilization);
Protected area;	Lands accommodating state-owned objects;
Recreation parks, forest-parks, squares and others;	Cemetery and pantheon;
Historical, natural and religious monuments;	Sanitary and protection zones;
Land parcel of public use (playground, street, passage, road, pavement, shore) and recreation sites (park, forest-parks, squares, alley, protected area);	Land for oil and gas routes and their auxiliary facilities.
Land containing water reservoir, hydraulic works and sanitary-protection zones of these objects;	

**Law of Georgia on Registration of Rights to Real Estate (2005, December 28)** gives organizational and legal basis for registration of ownerships rights, encumbrance and mortgage on real estate, as well as liabilities of registration organs. Pursuant to the Law, ownership right to real property, mortgage, usufruct, servitude, lease, sub-lease, rent, sub-rent, lending are subject of registration in the Public Register (Article 13.2).

**The Law of Georgia on Rules for Expropriation of Ownership for Necessary Public Needs (1999)** defines terms, rules and procedures for expropriation of assets for necessary public needs. Expropriation for essential public needs requires the Presidential decree and the court decision. Decision of the court shall give detailed description of confessable property and due compensation to the owner.

The law lists the necessary public needs which may entail expropriation (article 2.2); these are construction/installation of:

- Roads and highways;
- Railways;
- oil, gas and oil product pipelines;
- Power transmission and distribution lines;
- Water supply, sewage and storm water drainage systems;
- Telephone lines;
- Premises and objects of public needs;
- Works required for national defense;
- Mining and reserve development.

After issuance of the Presidential decree a person seeking for expropriator's right announces in the central and local printed media about the project, its scope, area coverage and brief description of potentially confessable property. All the owners also shall be informed about the dates of application to the court and action proceeding.

An expropriator is liable to obtain property in agreement with the owner. Prior to negotiation expropriator evaluates the property and determines estimated compensation sum or other property according to fair market price (articles 6.1). Agricultural lands shall be evaluated together with price of crops could be yielded by the owner throughout the current agricultural year.

**Law of Georgia on Compensation of Land Substitute Costs and Damages due to Allocating Agricultural Land for Non-Agricultural Purposes (1997)** specifies requirements for compensating (a land replacement fee) the government and affected private landowners for degradation of land quality. Annex 1 of the law gives compensation sums of such damages. The law does not implicate remuneration due to damage of buildings, perennial plant or one-year crops.

### 2.1.4.2 Environmental Standards

Environmental standards establish quality standards for the environment and set maximum permitted concentrations in water, air and soil of substances hazardous to human health and the environment.

In Georgia soil quality is assessed by Methodological Guides on Assessment of Level of Chemical Pollution of Soil (MG 2.1.7.004-02). Georgian soil quality standards are given in Table 2.1.4.2.1.

**Table 2.1.4.2.1.** Soil quality characteristics

Compound	Units	Value
<b>Metals and Miscellaneous</b>		
Arsenic	mg/kg	2
Cadmium	mg/kg	2*
Copper	mg/kg	3-132*
Mercury	mg/kg	2.1
Nickel	mg/kg	4-80*
Lead	mg/kg	32-130*
Selenium	mg/kg	-
Zinc	mg/kg	23-220*
Total Petroleum Hydrocarbons	mg/kg	1,0
Cyanide	mg/kg	0.2
<b>Volatile Organic Compounds</b>		
Benzene	Benzene	Benzene
Toluene	Toluene	Toluene
Total xylenes	Total xylenes	Total xylenes
<b>Semi Volatile Compounds</b>		
Benzo(a)pyrene	Benzo(a)pyrene	Benzo(a)pyrene
Isopropylbenzene	Isopropylbenzene	Isopropylbenzene
<b>Pesticides</b>		
Atrazine	Atrazine	Atrazine
Lindane	Lindane	Lindane
DDT (and its metabolite)	DDT (and its metabolite)	DDT (and its metabolite)

\* Sodium and neutral (clay and clayey) pH >5.5 - No screening value available

Standards for groundwater quality are not set under Georgian law. Drinking water quality standards are commonly used instead as assessment criteria for groundwater.

Quality of drinking water is determined by the Technical Regulations for Drinking Water (approved by order #349/n of the Minister of Labor, Health and Social Affairs, 17.12.2007. Table 2.1.4.2.2. gives quality criteria for drinking water.

**Table 2.1.4.2.2.** Drinking water quality standards

Compound	Unit	Value
<b>Metals and Miscellaneous</b>		
Boron	mg/kg	0.5
Arsenic	mg/kg	0.01
Cadmium	mg/kg	0.003
Copper	mg/kg	2
Mercury	mg/kg	0.006
Nickel	mg/kg	0.07
Lead	mg/kg	0.01
Selenium	mg/kg	0.01

Zinc	mg/kg	3
Total Petroleum Hydrocarbons	mg/kg	0.1
Cyanide	mg/kg	0.07
Sulphate	mg/kg	250
Chloride	mg/kg	250
pH	pH value	6-9
Sodium	mg/kg	200

Quality of surface water is defined by order #130 on Protection of Georgian Surface Water by the Minister of Environmental Protection and Natural Resources of Georgia, 17 September 1996 and Sanitary Rules and Standards on Prevention of Surface Water Pollution approved by order #297/n on Approval of Environmental Qualitative Norms by Minister of Labor, health and Social Affairs, 16 August 2001. Some quantitative indicators of surface water quality are given in Table 2.1.4.2.3.

**Table 2.1.4.2.3.** Surface water quality standards

Determinants	Units	Maximum Permissible Concentration
pH		6.5-8.5
Na	mg/kg	200
Chloride	mg/kg	350
Cyanide (total)	mg/kg	0,17
Boron	mg/kg	0.53
COD	mg/kg	30
BOD	mg/kg	6
Total petroleum hydrocarbons	mg/kg	0,3
As	mg/kg	0.053
Cr6+	mg/kg	0.05
Cu	mg/kg	1,03
Hg	mg/kg	0.00053
Ni	mg/kg	0.13
Pb	mg/kg	0.03
Se	mg/kg	0.013
Zn	mg/kg	1,03
Phenols (total)	mg/kg	0.001
Benzene	mg/kg	0.5
Toluene	mg/kg	0.5
Ethylbenzene	mg/kg	0.01
Benzo(a)pyrene	mg/kg	0.000005

Maximum permissible concentrations (MPC) for air born pollutants are set by the hygienic standards on Maximum Permissible Concentrations of Air Born Pollutants for Settlements (HN 2.1.6. 002-01). MPCs for some air pollutants are given in Table 2.1.4.2.4.

**Table 2.1.4.2.4.** MPCs for some hazardous substances

Pollutant	MPC, mg/m <sup>3</sup>	
	Maximum One-Off	Average daily
Asbestos containing dust	0	Asbestos containing dust
Silicon dioxide >70%	0.15	Silicon dioxide >70%
Silicon dioxide 70%-20%	0.3	Silicon dioxide 70%-20%
Silicon dioxide <20%	0.5	Silicon dioxide <20%
Carbon Monoxide	5	Carbon Monoxide
Nitrogen Oxides	0.4	Nitrogen Oxides



Nitrogen Dioxide	0.2	Nitrogen Dioxide
Sulphur Dioxide	0.5	Sulphur Dioxide

**NB:** *maximum one-off limit means an instant concentration which shall not be surpassed.*

The quotas for MPC of hazardous substances discharged into the water bodies are defined under the law of Georgia on Water. MPCs are set on a site specific basis. Water quality standards in Georgia comply with the World Health Organization (WHO) recommendations.

### **Noise Standards**

To avoid noise nuisance during day-time and night an acoustic background sanitary standards on Noise at Work Places, Residential and Public Buildings and Residential Territories (SRS 2.2.4/2.1.8 003/004-01, Georgian Information Bulletin №90, 24.08.2001, paragraph 647) is accepted in Georgia. According to this standard document, noise level of 55 dBA and 45 dBA are taken as limit at the border of residential area respectively for day-time (7:00 am – 7:00 pm) and night hours (7:00 pm – 7:00 am); permissible noise level within industrial area is 70 dBA.

Georgian noise standard coincide with guideline values of World Health Organization (WHO<sup>2</sup>) and International Financial Corporation (IFC<sup>3</sup>).

### **2.1.5 Environmental Impact Assessment Procedure in Georgia**

Georgian Law on Licenses and Permits in Volume II, Chapter VI, Clause 24, paragraph 4, among other permits, introduces an Environmental Impact Permit. Georgian law on Environmental Impact Permit in Clause 4 stipulates that if activity subject to the ecological expertise does not require a construction permit, the Ministry of Environment (“Ministry” herein) issues an Environmental Impact Permit based on the opinion of ecological expertise. Activities subjected to the ecological examination are defined by paragraphs 1 and 2 of clause 4 of Georgian law on Environmental Impact Permit.

According to Georgian law on “Environmental Impact Permit”, article 4, paragraph 1, sub-paragraph “m” “arrangement of 2 MW and above capacity hydropower plant and 10 MW and above capacity TPP” needs ecological expertise. Considering this, construction and operation of the HPP must be implemented on the basis of ecological expertise issued by the Ministry of Environmental Protection of Georgia.

Paragraph 6 of the law engages an agent to organize a public discussion of EIA prior delivering it to the permit granting administrative organ. For arrangement of a public discussion an agent advertises about planned works in the central and regional newspapers. In a week after advertising the permit granting administrative organ shall be provided with hard and soft copies of EIA. A public discussion shall be held between 50-60 days after advertised. An advertisement shall include:

- goals, name and location of planned activities;
- address where public representatives may have access to documents (including EIA report);
- deadline to present opinion;
- time and place of public discussion.

According to paragraph 8 of the law, after public debate, documenting its outcomes and finalizing EIA, an agent is authorized to apply to the permit issuing administrative body with:

- EIA report worked out in compliance with legislative norms (5 hard copies and a soft copy);
- Layout of an area of planned activities (indicating distances);

<sup>2</sup> WHO: Guidelines for Community Noise, 1999

<sup>3</sup> IFS EHS Guidelines: Noise Management, April 2007

- Volumes and types of expected emission - a technical inventory report on stationary pollution sources and emitted hazardous substances, as well as a standard document on maximum permissible emission/discharge of hazardous substances – 4 copies;
- Executive summary of a proposed activity (technical summary);
- Statement on confidential part of filed documents.

Paragraph 9 of the law states that the Ministry decides upon issuance of the Permit in 20 days from application, as prescribed by simple administration rules of Georgian General Administrative Code, volume VI and Georgian law on Licenses and Permits.

## 2.2 Environmental and Social Standards of International Financial Institutions

Environmental and Social Impact Assessment must be carried out in accordance with:

- The EBRD's Environmental and Social Policy (2014) and its associated Performance Requirements, including compliance with relevant European Union directives (most prominently but not only the EU EIA directive);
- Requirements of other potential lenders, including the International Finance Corporation (IFC), the European Investment Bank (EIB), and commercial banks adhering to the Equator Principles;
- Applicable international conventions and protocols.

Lender Policies and Standards are given below.

### 2.2.1 Lender Policies and Standards

EBRD's 2014 Policy and standards applied by other International Financing Institutions (IFI) apply to the construction and operation project of Nenskra HPP, namely:

- EBRD Environmental and Social Policy (2014), including the 10 Performance Requirements which in turn includes relevant European Union directives (including directive on environment assessment and etc.);
- "The Equator Principles".

### 2.2.2 Environmental and Social Policy of EBRD, 2014

The Project has been given an 'A' categorization by EBRD. EBRD's environmental assessment requirements for Category A Projects are outlined in its 2014 Environmental and Social Policy. Of particular note, for category A projects EBRD requires:

- Preparation of an Environmental and Social Impact Assessment (ESIA).
- Compliance with its Performance Requirements (as applicable to category A projects) including:
  - PR1 - Environmental and social appraisal;
  - PR2 - Labor and working condition;
  - PR3 - Pollution prevention and abatement;
  - PR4 - Community health, safety and security;
  - PR5 - Land acquisition, involuntary resettlement and economic displacement;
  - PR6 - Biodiversity conservation and sustainable management of Living resources;
  - PR7 - Indigenous peoples (not applicable to this project);
  - PR8 - Cultural heritage;
  - PR9 - Financial intermediaries (not applicable to this project);
  - PR10 - Information disclosure and stakeholder engagement;
- Adherence to the UNECE Convention on Access to Information, Public Participation in Decision-Making and Access to Justice (Aarhus Convention).

- Compliance with good international environmental practice, such as:
  - EU standards; and
  - World Bank Group EHS Guidelines (where EU standards do not suffice).

The Project should also meet ILO core labor standards on:

- Forced labor (C105) [ratified by Georgia in 23.09.1996];
- Child Labor (C182) [ratified by Georgia in 24.07.2002];
- Discrimination (C111) [ratified by Georgia in 22.06.1993];
- Freedom of Association and the Right to Organize (C 87) [ratified by Georgia in 03.08.1999];
- Equal Remuneration (C100) [ratified by Georgia in 22.06.1993];
- Minimum Age (C138) [ratified by Georgia in 23.09.1996].

EBRD's requirements as prescribed in its Environmental and Social Policy and the underlying Performance Requirements which in turn reference compliance with numerous EU Directives, International Conventions and other sources of good practice represents a comprehensive suite of standards and principles for project finance. EBRD's requirements also capture the requirements of other financial institutions considering support to the project and are therefore adopted as the primary set of standards for this ESIA.

Brief gap analysis of EBRD environmental and social policy and Georgia legislation is given in the table 2.2.2.1.

**Table 2.2.2.1.** Gap analysis of EBRD environmental and social policy and Georgia legislation

PR	Description of requirement	Equivalent national requirements	Gaps
1	<p><b>Environmental and social appraisal</b></p> <p>Category A projects require a comprehensive environmental and/or social impact assessment, to identify and assess the potential future environmental and social impacts associated with the proposed project, identify potential improvement opportunities, and recommend any measures needed to avoid, or where avoidance is not possible, minimize and mitigate adverse impacts. This assessment will include an examination of alternatives. The ESIA shall meet PR 10 and any applicable requirements of national EIA law and other relevant laws.</p> <p>The environmental and social appraisal also requires:</p> <ul style="list-style-type: none"> <li>• Formalized participatory assessment process (i.e. meaningful stakeholder consultation). See PR10.</li> <li>• Consideration of trans boundary or global issues e.g. climate change adaptation;</li> <li>• Consideration of involuntary resettlement (and application of PR 5 below);</li> <li>• Cultural heritage and impact on indigenous peoples (if applicable);</li> <li>• Development of an Environmental and Social Action Plan (ESAP) which is often a standalone document;</li> <li>• Procedures for performance monitoring and review.</li> </ul> <p>The ESIA should also comply with the EU EIA Directive.</p>	<p>The list of activities subject to EIA procedure under the Georgian legislation differs from the list of activities defined in EU Directive on EIA (Annex I and II), the list of EBRD's Category 'A' projects and the list provided in Aarhus convention (Annex 1).</p> <p>The Law of Georgia on Permit for Impact on the Environment provides a list of activities subject to EIA procedure. This Project is subject to Georgian EIA procedure.</p> <p>There is no official scoping stage in Georgia and consequently there are no requirements/practices for identifying possible stakeholders and ensuring their participation at the scoping stage; public participation occurs only on the ESIA review stage. The public participation component is implemented by developer itself. The developer publishes information on planned activity in central and local newspapers, ensures availability of EIA report for public consideration, holds public hearing meeting(s) and receives written comments from members of the public which are incorporated in the final version of the ESIA report.</p> <p>The Ministry of Environment Protection and Natural Resources of Georgia (decision-maker) does not communicate with public.</p> <p>There is no requirement for stakeholder engagement or a formal grievance mechanism in Georgia that would ensure that consultation, disclosure and community engagement continues throughout construction and operation of the project.</p> <p>Georgian ESIA process does not require</p>	<p>No provisions regarding scoping at the early stage of EIA preparation available.</p> <p>No requirements/practices for identifying possible stakeholders. The involvement of the public in the EIA processes is limited to the provision of information to them and consultation.</p> <p>No community participation at early stage of the ESIA process.</p> <p>No obligation for development of a grievance mechanism.</p> <p>No communication between the Ministry of Environment Protection (decision-maker) and stakeholders.</p> <p>No obligation to ensure engagement of stakeholders throughout construction and operation of the project.</p>

		<p>consideration of climate change impacts and adaptation.</p>	
<p>2</p>	<p><b>Labor and working condition</b>                  EBRD policy requires that projects are compliant with applicable ILO conventions and certain EU requirements such that workers have fair terms of employment and rights and are provided with a safe working environment. In terms of the ESIA the key requirements of PR2 include:</p> <ul style="list-style-type: none"> <li>• Occupational Health and Safety</li> <li>• Training</li> <li>• Accommodation and other facilities</li> <li>• Retrenchment of workers (if collective dismissals are anticipated)</li> <li>• Supply chain management</li> </ul> <p>Workers must also have access to a grievance mechanism.</p>	<p>The Labor Code of Georgia refers to almost all issues addressed by IFC performance standard 2, including: Labor and Working Conditions - working conditions and terms of employment; non-discrimination and equal opportunity; child labor; safe and healthy working conditions etc. Employees belonging to certain professions related to: transportation and driving safety; weapon possession; radioactive substances, reactive liquids; ionizing radiation and sources of electromagnetic fields; personnel working with high risk pathogenic biological agents and; all kinds of independent medical or nursing activities, are subject to periodic medical screening. The Employer is responsible for compensating any harm caused to the health of the employee where the employer is responsible for such harm. The law on compensation of harm caused by hazardous substances obliges the employer, regardless of fault, to compensate the damage to the human lives and the health, environment, cultural heritage, property and economic interests, caused by hazardous substances. Georgia is a member to ILO conventions including: Forced labor (C105); Child Labor (C182); Discrimination (C111); Freedom of Association and the Right to Organize (C 87); Equal Remuneration (C100); Minimum Age (C138).</p>	<p>There is no clear legislative definition or prohibition of forced labor. The minimum age for hazardous work is unclear. The Labor Code does not set out any restrictions on types of work or working hours for children aged 14-16 years. There is no requirement for under-18s to undergo an appropriate risk assessment. Lack of legal protection for trade union members in the Labor Code discourages workers from organizing and joining trade unions. Employers are given power to make unilateral changes in relation to certain working terms and conditions and may revoke collective agreements at will. Employers are not required to give notice of termination of employment (including retrenchment) to employees, although they are required to give 2 months' notice to trade unions. There is no obligation to consult or develop a plan to mitigate the adverse impacts. There are no specific provisions on worker accommodation. Non-employee workers: there are no specific provisions on non-employee workers.</p>

			<p>There is no requirement in Georgia for the purchaser to enquire into compliance of suppliers with legal requirements re labor and working conditions.</p>
<p>3</p>	<p><b>Pollution prevention and abatement</b>                  The EBRD is a signatory to the European Principles of the Environment and requires compliance with EU environmental standards relating to industrial production, water and waste management, air and soil pollution, occupational health and protection of nature. The PR, amongst other objectives, promotes the reduction of greenhouse gas emissions. Key requirements of the PR are to:                  Apply pollution prevention techniques and technology to minimize human and environmental harm whilst remaining technically and financially feasible);                  Implement energy and resource efficiency measures;                  Manage wastes following the principles of the waste management hierarchy, and use legitimate waste contractors where necessary;                  Manage hazardous materials in a responsible manner where their use is unavoidable;                  Develop suitable emergency response plans;                  Monitor effluents and emissions on an ongoing basis;                  Consider impact to ambient conditions, taking account of background pollutant concentrations and proximity to sensitive receptors, and promote strategies that will improve ambient conditions;                  Report baseline and post construction GHG emissions (100,000 tones CO2 equivalent per year for the aggregate emissions of direct sources and indirect sources);                  Pesticide use (if applicable).</p>	<p>Pollution prevention and abatement is regulated by Georgia legislation and regulatory documents. Such aspects as protection of atmospheric air, water, soil, use of natural resources, wildlife are covered (see list of laws and regulations in Section 2.1, National Legislation).                  Georgia is a member state of international conventions promoting protection of physical and biological environment, including those related to ozone layer protection: Vienna Convention on the Protection of the Ozone Layer, ratified by Georgia in 1996; Montreal Protocol on Substances That Deplete the Ozone Layer, 1987, joined by Georgia in 1996 with amendments; UN Framework Convention on Climate Change, New York 1994, ratified by Georgia in 1994; Kyoto Protocol on Greenhouse Gas Emission Reductions, 1997, ratified by Georgia in 2005; Geneva Convention on Long-Range Trans boundary Air Pollution, 1979, ratified by Georgia in 1999, etc.                  Georgian environmental regulations support implementation of energy and resource efficiency measures; introduction of cleaner production approach and technologies; development of emergency response plans, etc.                  The draft environmental code is intended to bring together in a general framework law all environmental conventions ratified by Georgia along with new environmental legislation, with a view to introducing an innovative approach to harmonizing, systematizing, unifying and integrating existing and future environmental</p>	<p>Environmental regulations/legislation is being harmonized with EU, Article 43 of the Partnership and Cooperation Agreement between the European Union and Georgia provides that Georgia commits itself to harmonization of its legislation with that of the European Union. In accordance with 14 June 2001 Decree No.613 of President of Georgia “The Strategy of Harmonization of Georgian Legislation with that of the European Union” was developed and on 8 May 2004 Georgian government endorsed “National Program of Harmonization of Georgian Legislation with that of the European Union”.                  However, there are some differences between EU and Georgian regulations. Air quality and emission standards, for some of the components are more stringent in Georgia than in Europe. Standards for groundwater quality are not set under Georgian law. Drinking water quality standards are commonly used instead as</p>

		obligations.	<p>assessment criteria for groundwater.</p> <p>Georgian water legislation, unlike respective EU legislation does not provide for classification of water bodies in accordance with ecological status.</p> <p>The quotas for maximum permitted concentration (MPC) of hazardous substances discharged into the water bodies are defined under the law of Georgia on Water. MPCs are set on a Site specific basis. Water quality standards in Georgia are in accordance with the ISO recommendations.</p> <p>There is no direct provision to prohibit the direct discharge of dangerous substances into groundwater, although it is provided by Georgian Law on Minerals and Law on Water.</p> <p>There are no published EU soil quality guidelines, while in Georgia the method for assessment of the level of chemical pollution of soil (MI 2.1.7.004-02), approved by the Ministry of Labor, Health and Social Affairs, 2003 defines screening values for soil.</p> <p>There is no Georgian legislation on waste, except for household waste. There are no hazardous waste management plans in place.</p>
--	--	--------------	---

4	<p><b>Community health, safety and security</b></p> <p>Addresses a project's potential to increased community exposure to risks and impacts arising from temporary or permanent changes in population; transport of raw and finished materials; construction, operations and decommissioning; accidents, structural failures, and releases of hazardous materials. The PR requires that information concerning potential risks are disclosed and those risks are managed. Key requirements are that:</p> <p>Equipment and infrastructure is designed to withstand natural phenomena (e.g. seismic events) and safety controls are place to protect communities where moving equipment and/or vehicles are involved;</p> <p>Hazardous materials will be managed to prevent community exposure;</p> <p>Impacts from natural hazards, such as flooding, should not be exacerbated;</p> <p>Where necessary action plan shall be developed to prevent the spread of workforce induced communicable diseases;</p> <p>Emergency preparedness plans, taking account major accident hazards and the protection of local communities, should be developed;</p> <p>Security personnel will be hired, trained and monitoring in line with good international practice. This includes the principal of proportionality and conduct towards workers and members of the community. The port must investigate any allegations of abusive or unlawful acts by its security personnel.</p>	<p>Population health and safety is regulated by Georgian Law on Health Protection and the Law on Public Health. The objectives of these law are:</p> <ul style="list-style-type: none"> <li>To promote healthy life style and health;</li> <li>To ensure environment safe for human health;</li> <li>To promote reproductive health;</li> <li>To avoid spreading of contagious and non-contagious diseases.</li> </ul> <p>General measures for prevention of natural calamities, emergency situations and consequences thereof are addressed via the law of Georgia on Protection of Environment, whereas specific measures are set out in the law on Hazardous Industrial Objects.</p>	No gaps identified.
5	<p><b>Land acquisition, involuntary resettlement and economic displacement</b></p> <p>In case of involuntary resettlement special requirements in PR 5 will also apply, where involuntary resettlement includes both physical and economic displacement. In cases where there has been displacement as a result of conflict, prior to the EBRD's involvement, this PR supports the application of the Guiding Principles on Internal Displacement: Office of the High Commissioner for Human Rights. A fundamental objective of PR5 is to avoid or at least minimize involuntary resettlement by exploring alternative project designs wherever possible. Where not possible, mitigation measures might include compensation for loss of assets at full replacement cost (emphasis added). Affected individuals' standard of living should be better or at least no worse off as a result of the project.</p> <p>Key requirements of PR5 include:</p> <p>Consultation, including the opportunity to negotiate compensation packages and eligibility requirements</p>	<p>Compensation and ownership issues are regulated by:</p> <ul style="list-style-type: none"> <li>Law of Georgia on Privatization of State-owned Agricultural Land (2005);</li> <li>Law of Georgia on Ownership to Agricultural Land (1996);</li> <li>Law of Georgia on Entitlement of Ownership Rights to Lands Possessed (Employed) by Physical and Legal Persons of Private Law (2007);</li> <li>The Law of Georgia on Rules for Expropriation of Ownership for Necessary Public Needs (1999);</li> <li>Law of Georgia on Compensation of Land Substitute Costs and Damages due to Allocating Agricultural Land for Non-Agricultural Purposes (1997)</li> </ul>	<p>The law does not allow for compensation to informal (illegal) tenants/land users.</p> <p>There is no obligation for development of grievance mechanism.</p> <p>The law provides for compensation at market value (rather than replacement costs).</p>



	<p>Grievance mechanism, including an impartial recourse mechanism, consistent with PR10 (below)</p> <p>A census, where involuntary resettlement is unavoidable, to identify baseline conditions against a defined ‘cut-off’ date.</p> <p>Development of either a Resettlement Action plan (RAP) where physical displacement occurs or a Livelihood Restoration Framework (LRF) where there is only economic displacement.</p> <p>The RAP or LRF is generally a standalone plan developed to complement the ESIA.</p> <p>A RAP should include: the development of: a census and inventory of assets; description of the legal framework and measures available for legal assistance; engagement with affected parties; entitlement matrix; timetable for resettlement; and procedures for monitoring and evaluation of the RAP implementation.</p> <p>A LRF is similar to a RAP except deals with economic displacement and therefore land take timeframes, valuation and appeal processes.</p> <p>Note. EBRD policy requires compensation for lost assets at ‘full replacement cost’ which can be defined as the market value of the asset plus transaction costs. It also recognizes the need to compensate those without legal title and the provision of special assistance to the poor and the vulnerable.</p>	<p>In case temporary or permanent right of use of private land is required the issue of compensation and terms of use are to be negotiated with the owners. If negotiations fail and obtaining the right of use is imminent public necessity lawful expropriation can occur (Law of Georgia on the Rules for Expropriation of Ownership for Imminent Public Necessity). The decision on expropriation can be made only through a Presidential Decree, while the final decision is made only by a Regional Court. Potential expropriator is obliged to inform land owners and to negotiate conditions of compensation. Compensation can be made in cash, reflecting the actual market value of the property, or by means of other property with the same market value. The law does not mention the possibility of suggesting choices among feasible resettlement options in case of physical displacement (the law does not specify/distinguish physical and economic displacement).</p> <p>All disputes are settled through court.</p> <p>During evaluation of the cost of the agricultural land, compensation is calculated with consideration of potential income expected through realization of the harvest, except for the cases when the land is cultivated after evaluation of the cost.</p>	
<p>6</p>	<p><b>Biodiversity conservation and sustainable management of living resources</b></p> <p>The EBRD supports a precautionary approach to the management and conservation of biodiversity and is guided by applicable international law and conventions including:</p> <ul style="list-style-type: none"> <li>Convention on Biological Diversity;</li> <li>Convention on Wetlands of International Importance Especially as Waterfowl Habitat;</li> <li>Convention on the Conservation of Migratory Species of Wild Animals;</li> <li>Convention on the Protection of the Black Sea Against Pollution;</li> </ul>	<p>Biodiversity conservation and sustainable management of living resources is regulated by environmental legislation of Georgia such as:</p> <ul style="list-style-type: none"> <li>Law on Wildlife (1997, amend. 2001, 2003, 2004);</li> <li>Law on System of Protected Areas (1996);</li> <li>Law on Red; List and Red Book of Georgia (amend. 2006);</li> <li>Law on Establishment and Management of Kolkheti Protected Areas (1998, amend. 1999,</li> </ul>	<p>Mechanisms of compensation/offset in case of unavoidable impact on critical habitats/protected areas are available in Georgia, but needs elaboration.</p>

	<p>Council Directive 92/43/EEC May 1992 on the Conservation of Natural Habitats and of Wild Fauna and Flora, as amended;  Council Directive 79/409/EEC April 1979 on the Conservation of Birds.  The client will need to identify measures to avoid, minimize or mitigate potentially adverse impacts and, where appropriate and as a last resort, propose compensatory measures, such as biodiversity offsets, to achieve no net loss or a net gain of the affected biodiversity.</p>	<p>2003, 2005, 2007);  Law on Status of Protected Areas, 2007;  Biodiversity Protection Strategy and Action Plan, 2005;  Red List, 2005.  Georgia has ratified conventions including:  Convention on Biological Diversity;  Convention on Wetlands of International Importance Especially as Waterfowl Habitat;  Convention on the Conservation of Migratory Species of Wild Animals;  Convention on the Protection of the Black Sea Against Pollution.</p>	
7	<b>Indigenous people</b>	Not applicable	
8	<p><b>Cultural heritage</b>  EBRD requires that impact to irreplaceable cultural heritage is minimized consistent with the Convention Concerning the protection of the World Cultural and Natural Heritage and the Convention for the Safeguarding of Intangible Heritage. The EBRD therefore requires:  early identification (screening) of any cultural heritage objects or intangibles and where finds are identified, consultation notification of the relevant authorities;  Development of mitigation measures using international good practice, where avoidance is the preference;  Consultation with affected communities;  Development of a chance finds procedure, including the requirement to not disturb potential finds until an assessment has been made by a qualified specialist.</p>	<p>Georgia ratified UNESCO conventions of cultural heritage protection including the World Cultural and Natural Heritage and the Convention for the Safeguarding of Intangible Heritage.</p> <p>Furthermore cultural heritage issues are regulated by the law of Georgia on Protection of Cultural Heritage. According to the law protection and management of cultural heritage is responsibility of the Ministry of Culture and Monument Protection of Georgia.</p>	No significant gaps identified
9	<b>Financial Intermediaries</b>	Not applicable	
10	<p><b>Information disclosure and stakeholder engagement</b>  EBRD supports the approach of the UNECE Aarhus Convention and the right to 'meaningful consultation'. Key requirements in PR10 include:  Stakeholder identification and analysis, with special attention afforded to those that are disproportionately affected;  Engagement at the scoping stage (for Category A projects);  Preparation of a Stakeholder Engagement Plan (SEP) with a grievance</p>	<p>The Project is categorized "A" per EBRD Environmental and Social Policy, entailing a full Environmental and Social Impact Assessment (ESIA), and a public disclosure period of 60 days as a minimum. Per Georgian requirements it is understood that the Project warrants an Environmental Impact Assessment (EIA) with</p>	<p>Under Georgian law there is no requirement/practice for identifying possible stakeholders. The involvement of the public in the EIA processes is limited to the provision of information to them and consultation.</p>

<p>procedure, outlining consultation process and times/venues of meetings and other means of contacting the Project;</p> <p>Ongoing engagement and disclosure of information (duration of activities, potential impacts etc.);</p> <p>Disclosure of the ESIA, SEP, ESAP and Non-Technical Summary;</p> <p>A public disclosure period for the ESIA and other associated documents forming the disclosure package to be stay available in the public domain for a minimum of 60 days;</p> <p>In case of involuntary resettlement special requirements in PR 5 will also apply;</p> <p>Provision of periodic (no less than annually) reports to affected communities highlighting progress against the ESAP;</p> <p>For projects to which involuntary resettlement (PR5) applies, the client will ensure that there is an independent, objective appeal mechanism.</p>	<p>associated public consultation and public disclosure (not more than 60 days).</p> <p>However, Georgian procedure does not specify the need for consultation at the scoping stage (as discussed earlier), a formal Stakeholder Engagement Plan with a grievance procedure, ongoing disclosure and engagement beyond the formal disclosure period, and disclosure of certain stand-alone documents required under EBRD Policy.</p>	<p>No community participation at early stage of the ESIA process.</p> <p>No obligation for development of grievance mechanism.</p> <p>No communication between the Ministry of Environment Protection (decision-maker) and stakeholders.</p> <p>No obligation to ensure engagement of stakeholders throughout construction and operation of the project.</p>
---	---	--

### 2.2.3 Environmental Standards of EU

The key EU standards/reference documents are shown in the table below alongside the transposed Georgian legislation:

<b>EU legislation</b>	<b>Transposed or equivalent Georgian legislation</b>
EU Environmental Impact Assessment Directive (85/337/EEC) as amended (97/11/EC)	Regulation on Environmental Impact Assessment was approved by the Order No. 8 of the Minister of Environment, 2009, September 3; Law on Ecological Examination, 2007; Law on Environmental Impact Permit; Other laws, by-laws, statutory acts and regulations.
Council directive 92/43/EEC (1992) on the Conservation of Natural Habitats and of Wild Flora and Fauna (Natural 2000) – The Habitats Directive	Law on Protection of Environment (1996, amend 2000, 2003, 2007); Law on Wildlife (1997, amend. 2001, 2003, 2004); Law on System of Protected Areas (1996, amend.2003, 2004, 2005, 2006, 2007); Law on Red List and Red Book of Georgia (amend.2006); Law on Establishment and Management of Kolkheti Protected Areas (1998, amend. 1999, 2003, 2005, 2007);
<ul style="list-style-type: none"> <li>• Council Directive 78/659/EEC of 18 July on the quality of fresh waters needing protection or improvement in order to support fish life</li> </ul>	Law on Status of Protected Areas, 2007; Biodiversity Protection Strategy and Action Plan, 2005; Red List, 2005; Other laws, by-laws, statutory acts and regulations. Georgia is a party to CITES, Ramsar, CBD conventions.
<ul style="list-style-type: none"> <li>• Council Directive 79/409/EEC of 2 April 1979 on conservation of wild birds</li> </ul>	Law on Status of Protected Areas, 2007; Biodiversity Protection Strategy and Action Plan, 2005; Red List, 2005; Other laws, by-laws, statutory acts and regulations. Georgia is a party to CITES, Ramsar, CBD conventions.
Directive 2000/76/EC on the Incineration of Waste and (94/67/EC)	No special regulations regarding incineration of waste available, waste management/disposal issues are regulated under:
Directive 2008/98/EC on waste (Waste Framework Directive)	Law on Protection of Environment (1996, amend 2000, 2003, 2007); Law on Licenses and Permits, 2006; Law on Transit and Importation of Waste in Georgia; State Control of Protection of Environment; Law on Hazardous Substances; Sanitary Code;
<ul style="list-style-type: none"> <li>• Directive 1999/31/EC (as updated by 2003/33/EC) on the Landfill of Waste 91/689/EEC (amended by 94/31/EEC) controlled management of hazardous wastes</li> </ul>	Solid Municipal Waste Landfills arrangement and operation rules and norms; By-laws. Georgia is a party to Basel Convention
<ul style="list-style-type: none"> <li>• Directive 75/439/EEC (amended by 91/692/EEC) waste oil disposal</li> </ul>	Solid Municipal Waste Landfills arrangement and operation rules and norms; By-laws. Georgia is a party to Basel Convention
96/62/EC Framework Directive on Ambient Air Quality Assessment and Management (and Daughter Directives 99/30/EC (NO <sub>x</sub> , SO <sub>2</sub> , Pb and PM <sub>10</sub> ), 00/69/EC (benzene, CO), 02/3/EC:Ozone, 2008/50/EC on ambient air quality and cleaner air for Europe	Law on Protection of Environment (1996, amend 2000, 2003, 2007); Law on Licences and Permits, 2006; Law on Protection of Ambient Air (1999, amend. 2000, 2007).
Council Directive 67/548/EEC (1967) on the Classification, Packaging and Labeling of Dangerous Substances, as amended	N/a.

94/55/EC ADR Framework Directive regarding the transport of dangerous goods by road, as amended	Law on Protection of Environment (1996, amend 2000, 2003, 2007); Law on Licences and Permits, 2006; Law on Transit and Importation of Waste in Georgia; Sanitary Code; By-laws. Georgia is a party to Basel Convention.
Regulation (EEC) No 259/93 on the supervision and control of shipments of waste within, into and out of the European Community (the 'Trans boundary Waste Shipments Regulation')	Law on Transit and Importation of Waste in Georgia; Law on Hazardous Substances. Georgia is a party to Basel Convention.
Directive 2000/60/EC of the European Parliament and of the Council establishing a framework for the Community action in the field of water policy" or, in short, the EU Water Framework Directive	Law on Water (1997, amend.2003, 2004, 2005, 2006); Law on Environment Protection; Law on Public Health; Standard acts of the Ministry of Environment Protection.

### 3 Assessment and Analysis of Alternative Versions of the Planned Activity

Following versions are considered to be realistic alternatives of the planned activity:

1. Alternative energy sources;
2. No-action alternative;
3. Layout alternative of HPP types and infrastructure.

#### 3.1 Alternative Energy Sources

Main advantage of the renewable energy is absence of carbon dioxide emission. For example, production of 495 million kilowatt/hour (average annual production of the project HPP) using thermo-recourses require 306 000 tons of coal or 652 000 tons of oil. Considering:

- Combustion of 1 ton coal produces 1.8 tons of CO<sub>2</sub>;
- Combustion of 1 ton oil produces 3.2 tons of CO<sub>2</sub>.

Generation of 495 million kilowatt/hour using coal or oil will produce 550 800 tons and 208 6400 tons of CO<sub>2</sub>.

This comparison once again confirms advantages of the renewable energy. Positive and problematic sides of the renewable sources are discussed below.

##### 3.1.1 Hydro-Resources

Samegrelo-Zemo Svaneti region, as well as almost every region of Georgia, has a big hydro potential. Only small part of it is being used. In Georgia and money countries of the World use water as the main energy-source. The table below provides its advantages and limiting factors.

Advantage	Disadvantage
<ul style="list-style-type: none"> <li>• Lowest cost for watt-hour</li> <li>• No emissions</li> <li>• Predictable annual output</li> </ul>	<ul style="list-style-type: none"> <li>• Depends on availability of source and therefore cannot be applied everywhere</li> <li>• Has impact on water (except running HPPs)</li> </ul>

<ul style="list-style-type: none"> <li>• Periodical need for technical service and repair</li> </ul>	<ul style="list-style-type: none"> <li>• Containment of sediments may cause negative impact on sea coast formation</li> <li>• Initial construction costs may be high due to dam and infrastructure construction</li> <li>• Pipes may freeze in cold regions</li> <li>• Large dams can affect local climate</li> </ul>
--	---

### 3.1.2 Solar Energy

Despite the significant potential, solar energy is not developed in Georgia. According to theoretical calculations using solar energy can produce as much energy as combustion of 32.5 billion standard fuel.

Number of sunny days per year in most parts of Georgia is 200-250, while solar energy per 1m<sup>2</sup> is 1300-1800 kW.

For an ecological point of view the alternative is very effective. However, in recent years some ecologists expressed the opinion on harmful impact of the solar batteries manufacture process. The issue is under study.

Table below provides information on positive and negative aspects of solar energy:

Advantage	Disadvantage
<ul style="list-style-type: none"> <li>• Can be used anywhere</li> <li>• Has no emissions</li> <li>• Periodically requires small maintenance and technical service</li> <li>• Has a long life time</li> <li>• Does not require constant monitoring, can be left without surveillance for a long time</li> <li>• Can achieve project capacity on any place</li> <li>• Ease of installation</li> <li>• Noiseless functioning</li> <li>• Does not damage the ground, although the land cannot be used for any other purposes</li> </ul>	<ul style="list-style-type: none"> <li>• Expensive panels</li> <li>• Requires big number of batteries or another alternative source due to volatility if production</li> <li>• Requires good exposition towards rays (can only be installed on open, sunny areas)</li> <li>• Can affect biological environment due to required large space</li> </ul>

### 3.1.3 Wind Energy

Wind potential is assessed to be 2,300 MW. Currently there are several small capacity wind generators. According to official data, average wind speed in Georgia is 0.5-0.9 m/sec<sup>2</sup>. High wind speed is common for open areas of the Greater Caucasus, in the Mtkvari river ravine (section between Rustavi and Mtskheta) and South mountains of Georgia (near the Paravani lake). In some regions wind speed can exceed 15 m/sec, for example in the Mtkvari and Rioni rivers' ravines. In terms of wind energy consumption, Batumi adjacent area can also be interesting.

According to the wind atlas of Georgia (2004) 4 main zones are allocated, where average annual wind speed on the 30 m height is more than 6 m/sec and 2 zones, where wind speed is 5-6 m/sec. Wind zones with accordance of average annual speeds are given on the scheme 3.1.3.1. (Source: Georgian Wind Atlas, 2004).

**Figure 3.1.3.1. Wind zones of Georgia**

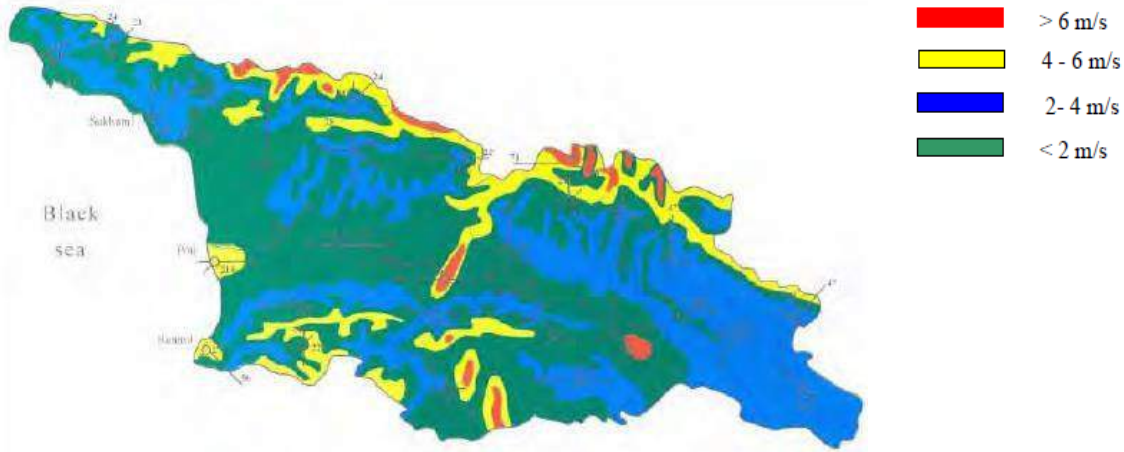

Table 3.1.3.1 provides information on advantages and disadvantages of the wind energy;

**Table 3.1.3.1.**

Advantage	Disadvantage
<ul style="list-style-type: none"> <li>• Low watt-hour price in case of good location</li> <li>• No emissions</li> <li>• Possibility to achieve project capacity</li> </ul>	<ul style="list-style-type: none"> <li>• Dependence on the source (right territory should be selected)</li> <li>• Expensive installation, need for heavy equipment</li> <li>• Visual effect</li> <li>• Impact on birds and bats</li> <li>• Requirement for large number of batteries or alternative source</li> <li>• Noise</li> <li>• Complexity of technical service/repair (due to necessity of working on height)</li> <li>• Wear of moving parts</li> <li>• In terms of dry regions requires water turbines to be cleaned from dust and insects</li> <li>• Incorrect installation may cause erosion</li> </ul>

**3.1.4 Geothermal Energy**

Problems of geothermal energy are mostly related to construction process and cover such issues as waste water, emissions, solid waste, damage of water wells and pipelines.

However, experience reveals, that wells and pipelines are rarely damaged during drilling work or operation. Accident may cause emissions of drilling additives, fluids and sulfur-hydrogen from underground formations. Pipeline damage may cause eruption of heavy metals, acids and other pollutants. In order to avoid such outcome, permanent technical service should be conducted (corrosion control, pressure monitoring, control of emission preventing equipment, valves). Emergency response plans should be developed, which makes consumption of geothermal resource more expensive on the initial stage.

Advantage	Disadvantage
<ul style="list-style-type: none"> <li>• Cheap, after arrangement/construction</li> <li>• Small emissions on the operation phase</li> <li>• Requires less area for production of one megawatt, rather than any other renewable resource</li> <li>• Is not dependent on weather changes</li> </ul>	<ul style="list-style-type: none"> <li>• Dependent on availability of resources</li> <li>• Requires high investment during search, drilling and installation works</li> <li>• Water and steam is often corrosive and is rich with dissolved elements, can clog or damage pipelines</li> <li>• Same amount of water must be pumped into</li> </ul>

	the horizon after use <ul style="list-style-type: none"> <li>• Risk of methane emission into the ambient air</li> </ul>
--	---

### 3.2 No-Action (Zero) Alternative

If the construction and operation project of the HPPs on the river Nenskra will not be implemented negative impacts on social and natural environment related to the construction works and operation will not take place.

The EIA report on the project has revealed, that together with negative impacts, positive impacts are also expected, however they will not take place, if the project will not be implemented.

One of the most important positive impacts of the project is expected social-economic benefits related to the project implementation. As the environmental baseline study showed, industrial infrastructure is less developed in the region (especially in Mestia Municipality). Main income of the population is agriculture, namely livestock. Importance of tourism in Svaneti is also increasing; however this does not ensure proper growth of revenue. Migration rate is also high (especially among youth); main reason for it is insufficient number of jobs.

Construction and operation of the HPP will contribute to the social-economic condition of the municipality. Significant amounts of taxes will fill the local budget (property tax, which is 1% of HPP balance value). Highly paid temporal and permanent jobs will be created, which will create employment opportunity for local population – as practice shows, unqualified workers are usually hired from local communities. Also, “Nenskra” JSC is planning to conduct trainings for workers, which will increase probability of employment of local population. It also should be noted, that due to necessity for housing conditions for workers, construction contractor will be interested in employing the local labor force.

In addition, supporting infrastructure and business activities will develop (meaning: small factories for building material production, transport service, food provision, household services, etc.), which in return will create additional income sources and jobs.

Construction of the given HPP is also important regarding improvement of the country’s economic situation. Given, that economy of Georgia is rapidly growing, domestic demand for electricity consumption is also increasing. In addition, due to energy-deficit growth, leading countries are trying to fill the gap by importing energy from neighboring countries. Georgia has a great potential in hydro-energy production, and currently, use of this potential is the main direction of the state policy. HPP operation will supply the country with additional energy, and satisfy internal needs; this will help to import the energy into the neighboring countries.

It can be concluded, that no-action plan will delay socio-economic condition of the region. With the consideration of rational decisions and appropriate mitigation measures construction and operation of the HPP will have more social-economic benefits, than no-action plan.

### 3.3 Alternatives of the Project

#### 3.3.1 Alternatives of HPP Type

In order to utilize hydro potential of the riv. Nenskra three possible schemes were discussed:

1. HPP operating on the natural runoff;
2. Riverbed type HPP;
3. One-step seasonal regulation high pressure HPP.

Regimes and therefore, seasonal output of the diversion and regulation type HPPs that operate on the natural runoff are significantly different due to seasonal changes in the river’s runoff. Namely:



- Output of the HPPs that operate on the natural runoff depend on the base load/regime if the river runoff. Considering hydrological regime of the river Nenskra annual production in spring-summer season (April-September) will be 80 % and in winter period (October-March) 20%;
- It should be noted, that the project capacity does not allow consumption of the river potential fully in spring-summer period;
- Seasonal regulation type HPP allows to reserve water and therefore, river potential will be used throughout the year. This scheme allows maximal generation of electricity even during dry periods. Operation regime of such HPP is highly flexible and is less dependent of seasonal distribution of runoff. These characteristics are very important for the winter period;
- Considering topographical, Geological and Hydrological characteristics of the riv. Nenskra and advantages of the project, it was decided to arrange the seasonal regulating HPP.

However, this alternative has its disadvantages. Namely:

- Approximately 3.7 km<sup>2</sup> area will be flooded due to reservoir arrangement;
- Vegetation cover, therefore, will be destroyed;
- High risk of impact on animals, including Ichthyofauna;
- Risk of activation of dangerous geological processes;
- Risks related to dam safety.

In case of implementing riverbed type HPP alternative, the risk of negative impact on environment will be significantly reduced (as there is no need of constructing a diversion tunnel, surge tank, pressure system and other communications). However, such HPP requires arrangement of dam and reservoir, which is characterized by impacts similar to seasonally regulated HPP. Installed capacity of riverbed type HPP depends on the height of the dam and supplied water flow. Therefore, in order to utilize flow of Nenskra River, it will be necessary to arrange a high dam.

In addition to the above mentioned, in case of arranging riverbed type HPP, pressuring will not be high, which will significantly reduce its energy efficiency. In case of adopted alternative, Nenskra HPP is a high pressure seasonally regulated power plant with high energy efficiency.

Due to low energy efficiency and necessity of high dam arrangement, riverbed type HPP alternative was considered unacceptable.

### 3.3.2 Alternatives of Dam and Power Unit Locations

5 different alternative locations for the dam and different heights of the dam for each location have been considered. Considering the demand of the client about the arrangement of high-pressure HPP, different heights (130, 150, 200 and 250 m) of the dam have been assessed. It should be noted that the reduced height of the dam will significantly minimize the risk of environmental impacts on environment. In each alternative, power house is planned to be arranged in sections selected between the altitudes of 1200-1600 m Nenskra River. Schematic plan of the proposed HPP is given in Figure 3.3.2.1., while the scheme of dam location alternatives is given in Figure 3.3.2.2. description of each alternative is given below.

For every alternative the power house will be located on the significant distance from the populated areas, agricultural lands, pastures and meadows. Selected territories are practically underdeveloped and are located in the narrow ravine of the river Nenskra or steep slopes covered with dense forest.

Significant amount of road arrangement works are required within the project. Currently, most part of the roads need to be reconstructed, additionally, in total 25.0-30.0 km long new road must be arranged.

**Alternative 1:** The dam will be arranged on the 1600 m level of the river, 1 km from the confluence of the rivers Nenskra and Dalari, downstream.

Distance between the dam and the nearest populated area (village Tita) is 14-15 km, and distance till the community center is 25-26 km. There is a ground road leading to the dam, which is located 4-5 km away from Tita. Selected area is located in the narrow ravine. Visual audit revealed no dangerous geological processes. The territory to be flooded is covered with forest. There are no pastures or agricultural plots on the territory.

In order to increase energy generation water from the riv. Nakra will be evacuated into the riv. Nenskra ravine, for this purpose low pressure facility will be arranged on the river Nakra. Water will be supplied by the 8 km long tunnel.

Three different dam heights are being considered – 150, 200 and 250 m. 250 m high dam will create 261.0 million m<sup>3</sup> and 4,5 km<sup>2</sup> area reservoir. Normal flooding will cover 5 km long section of the Nenskra valley and 2.5 km section of the Dalari valley. Arrangement of 150 and 200 m dam will reduce reservoir capacity and area to be flooded. In case of arranging dam of such height and considering the expected pressure, installed capacity of the HPP will not be less than 300 MW.

HPP will be supplied with water by 21 km long diversion tunnel with a diameter of 4.5 m. Another alternative version of the diversion type is also considered, the length of which will be 23 km. The tunnel will be arranged in the mountain, on the left bank of the river.

The over ground power plant will be arranged on the left bank of the river at the 705 m level, territory between the villages Lakhmi and Lekalmakhi.

An important disadvantage of this alternative is the fact that natural environment is represented within the areas of HPP communications and design road sections. Therefore, implementation of the project will be related to high risks of the impact on environment. It should be noted that an active landslide area is represented within the corridor of access road to the dam site and construction of the road within this section will cause activation of landslide processes.

**Alternative 2:** considers arrangement of the dam on the 1500 m level of the river Nenskra, 2.5-3.0 km from the Nenskra and Dalari confluence, downstream. This alternative also considers evacuation of the riv. Nakra water into the Nenskra valley and three heights for the dam (150, 200 and 250 m).

250 m high dam will cover 6.5-7.0 km section of the Nenskra valley and 1.0-1.5 km section of the Dalari valley. Reservoir area will be 297 million m<sup>3</sup>. Installed capacity of the HPP is identical to the first alternative. However, more volume of water can be regulated during the floods, which will ensure more electricity generation in winter.

The dam location is 12-13 km away from Tita. Arrangement of the new road is a must for this alternative as well. Section between I and II alternative dam locations has a risk of activation of dangerous geological processes. It should be noted that the project area is underdeveloped and virtually no traces of anthropogenic impacts are observed. In case of implementation of the project, high impact is expected on physical and biological environment.

Territory to be flooded is covered with dense forest on the both sides of the river. No agricultural lands or pastures are present.

The diversion tunnel will be arranged along the left bank of the river according to the route selected for the first alternative. Length of the tunnel will be approximately 19-20 km with a diameter of 4.5 m.

Power house and other communication will be arranged in accordance with the scheme selected for the first alternative.

**Figure 3.3.2.1.** Schematic plan of existing and project reservoir locations (m 1:200 000)

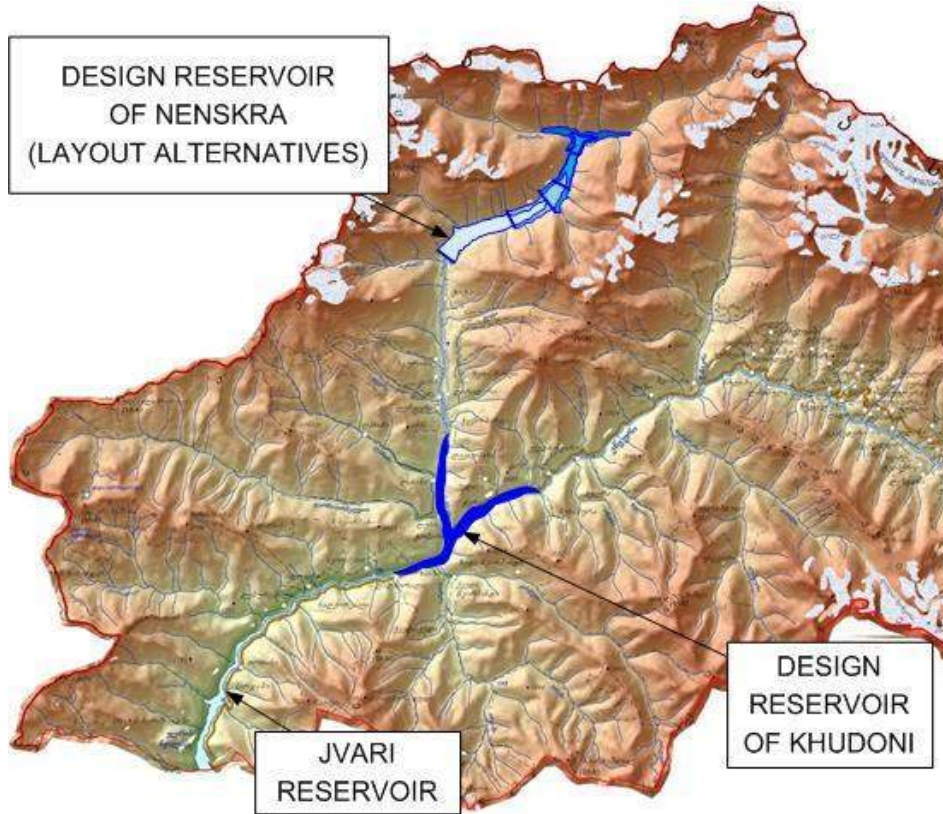
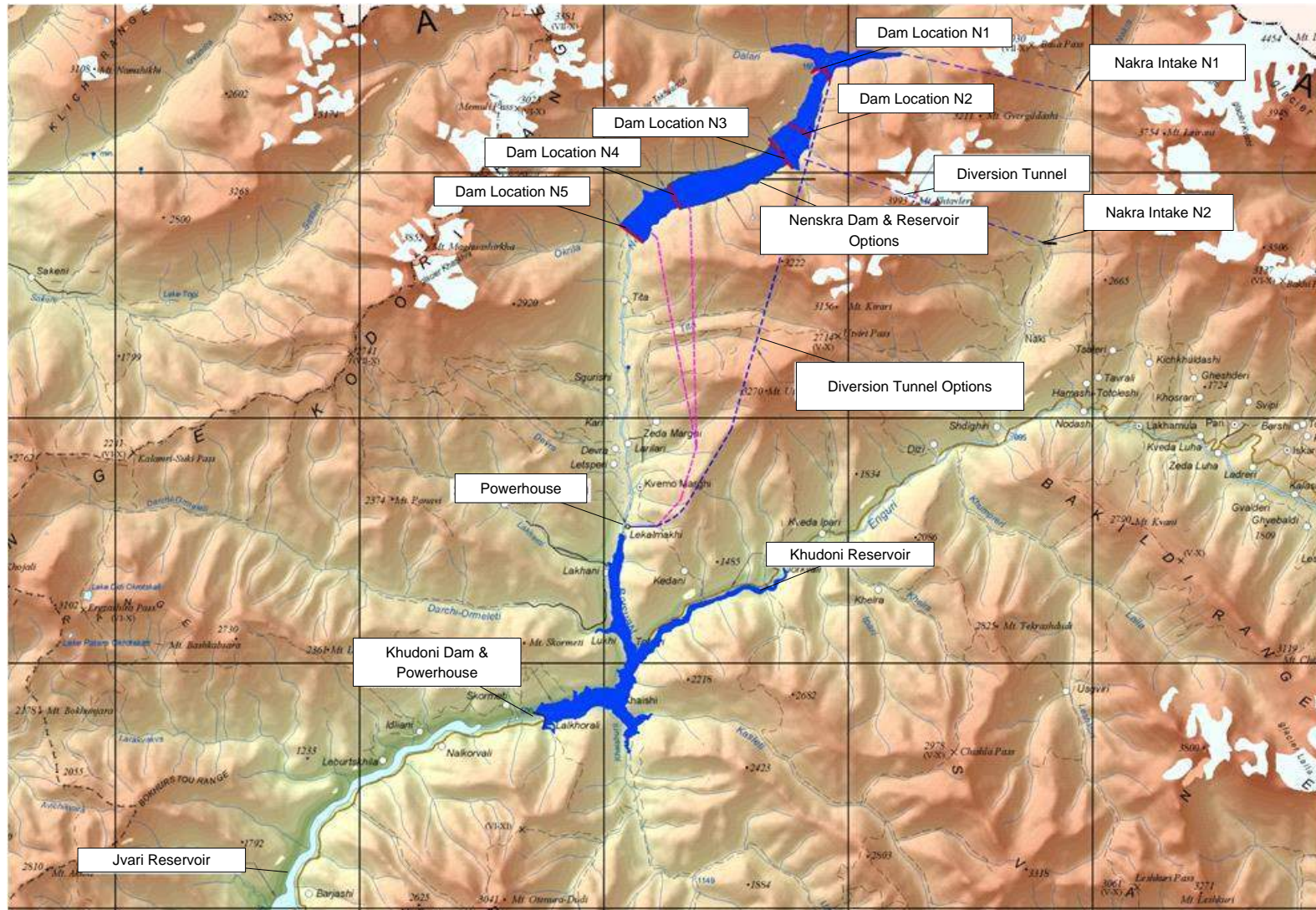
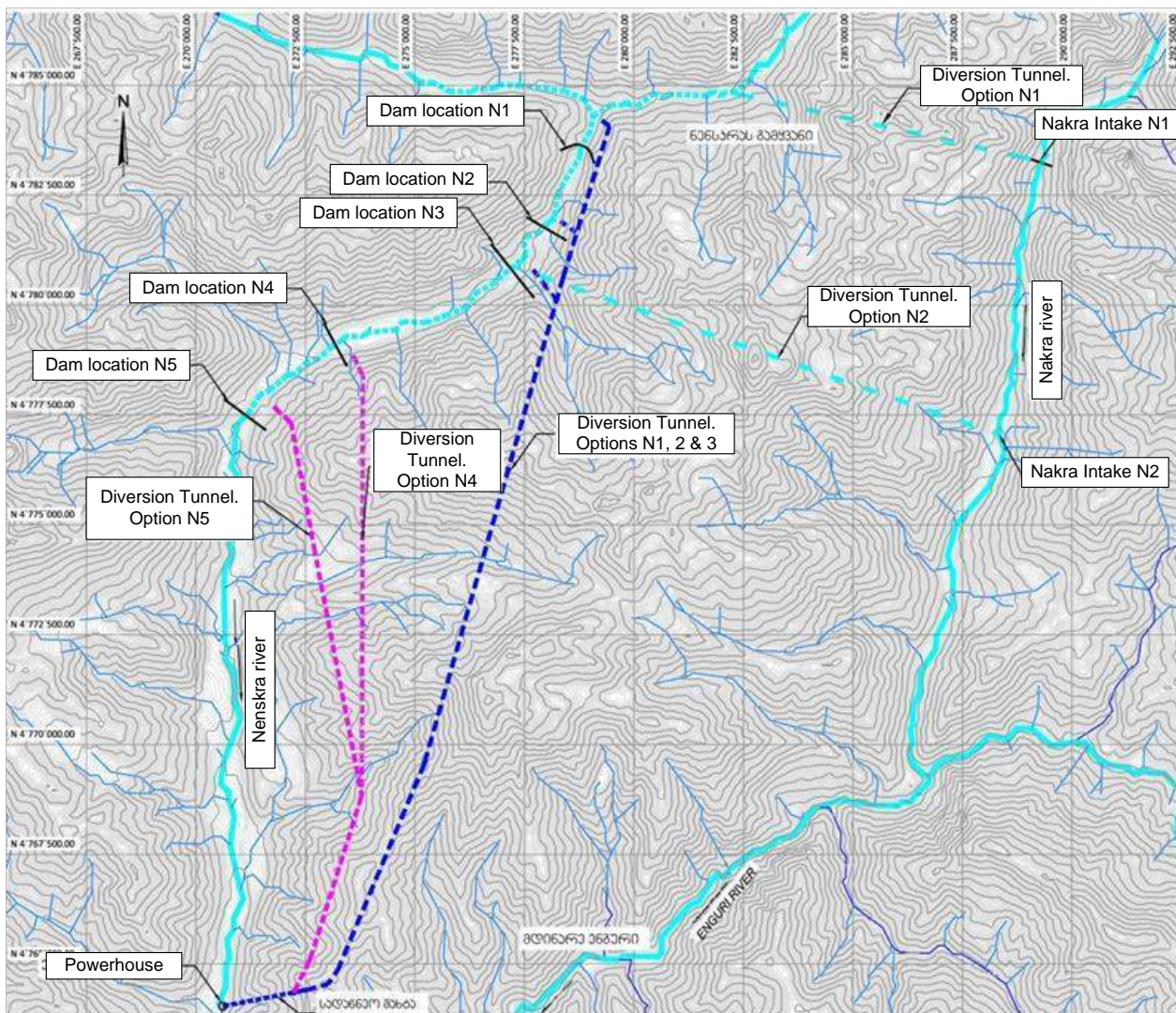

Figure 3.3.2.2. Schematic plan of dam locations (m 1:150 000)



**Figure 3.3.2.3.** Scheme of alternative locations of diversion tunnel

**Alternative 3:** considers dam arrangement on the 1475 m level of the river. Evacuation of Nakra water and three dam heights (150, 200 and 250 m) are also considered.

The highest dam will cover 7-8 km section of the Nenskra valley, section to be flooded in the Dalari valley is insignificant. It is important that unstable geological sections will be affected by this alternative, this will contribute to the development of the erosion and landslide processes. Agricultural plots and pastures are not present. Both banks of the river are covered with deciduous forests. In case of the third alternative, flooded area will not be less than 7.0-7.5 km<sup>2</sup> and the capacity of the reservoir will be about 200 million m<sup>3</sup>.

Distance between the dam and the nearest populated area (Tita) is 9-10 km. The alternative requires arrangement of the 3-4 km long new road, while existing ground road needs to be reconstructed.

Diversion tunnel allocation scheme is identical to I and II alternatives. Namely, diameter of the 17-18 km long diversion tunnel will be 4.5 m. The above ground power house will be arranged on the 705 m level, on the left bank of the river, on the territory between the villages Lakhmi and Lekalmakhi.

**Alternative 4:** version considers arrangement of the dam on the 1300 m level. Till the project point the riv. Nenskra has several small tributaries, together with the riv. Nakra this will increase energy efficiency of the HPP.

In case of implementation of this alternative reservoir water will cover number of state-owned lands, including pastures and meadows. it is also important, that local population uses this forests for firewood obtainment and entrepreneurs with the relevant license – for wood production.

For the IV alternative the diversion tunnel will be arranged on the left bank of the river. The length of the tunnel will be 15-16 km, diameter – 4.5 m. Power plant and other auxiliary communication location is identical to the first three alternatives.

The area selected for the arrangement of the dam is 6-7 km away from Tita village, out of which 2-3 km of the road needs to be rehabilitated.

Compared to the first three alternatives, this alternative is characterized by energy efficiency, however it is more favorable from environmental point of view, as the impact zone is mainly in the areas of high anthropogenic load, which significantly reduces impact on biological environment.

Alternative project solutions are discussed in detail in this EIA report.

**Alternative 5:** Arrangement of dam is planned on the 1190 m level, near the riv. Mtskhvadiri tributary, downstream. This version does not foresee consumption of the river Nakra.

This alternative considers 4 variants of dam height (130, 150, 200 and 250 m). Two options for diversion tunnel, aligning reservoir, pressure pipeline and power house location, including:

- 14 km long diversion tunnel will be located on the left bank of the river, in the mountain. power house and other auxiliary facilities will be located in accordance with previous four options;
- Diversion tunnel and other communications will be arranged on the right bank of the river. 14 km long tunnel will have 4.5 m diameter. Power house and transmission lines will be arranged near the village Lakhani.

The territory proposed for this alternative is 5-5.5 km away from Tita. Therefore, importance of this territory is rather high, as population uses it for pastures and hay. These territories are also being used for firewood collection and entrepreneurs with the relevant license – for wood production.

River slopes on the dam territory are covered with deciduous forest. There are many erosion and landslide sections on the slopes, this is related to high risk of dangerous geological processes activation.

In addition, the fifth alternative will create problems in terms of gold deposit utilization in the riv. Tskhvamdiri valley.

Two alternative versions for dam location are being considered: on the 1820 m level and 1480 m level of the river Nakra.

According to the above mentioned, construction of high dams (from 130 m to 250 m) was considered in case of all alternatives, which is a high risk of negative impact on physical and biological environment. As it is known, reduced height of the dam, reduces the flooded area and surface area of the reservoir and therefore, the environmental and social risks also reduce. Despite this, considering the importance of the project, priority has been given to the alternative according to which high dam will be constructed, because the proposed Nenskra HPP is planned to be a seasonal regulation power plant, which will operate at maximum capacity throughout the year (in spring-summer powerhouse will be supplied with full design flow, while in winter reservoir water will be used). In order to utilize the whole volume of the project river, alternative of high dam was selected.

In addition, in case of arranging high dam in Nenskra River valley, utilization of Nakra River water may be no longer needed. In this case, Nakra valley will not be affected, which should be considered as the best option. Such alternative was not considered because of own energy efficiency, as without utilization of Nakra River flow, the HPP could not be operated at full capacity and maximum installed capacity could not be achieved (in case of adopted alternative - 280 MW).

### 3.3.2.1 Comparative Characteristics of the HPP Communication Locations

According to the comparative analysis of the alternative versions for dam location the fourth alternative (therefore dam arrangement on the 1480 m level) was considered to be priority. This was determined by the following advantages:

- Territory to be covered with water has a high anthropogenic impact (mainly cut forests) and unlike the first three variants will have less negative impact on the biological environment;
- It will be necessary to rehabilitate 2-3 km long access road to the proposed dam area will be necessary, which, unlike the first three alternatives, which will have less effect on biological environment;
- In this area Nenskra valley is wider and has less inclined slopes, which decreases risk of activation of dangerous geological processes;
- Territory to be covered with water are mainly state-owned and therefore, physical and economical resettlement risks practically do not exist;
- The project dam is on a significant distance from the populated area (the village Tita) and therefore, impact on health and safety of population during construction works is minimal;
- Unlike the fifth alternative, no natural resources (minerals [except sand], mineral waters) are present and no impact is expected;
- Big amount of solid sediments are found on this territory, which can be used to produce inert materials for the construction. As the result, inert material obtainment in other areas and transportation-related impacts are reduced to minimum.

Best alternative location for over ground power house is the territory between the villages Lakhmi and Lekalmakhi, namely on the 705 m level of the river. The project territory is located near the village (direct impact is expected only on one land plot), on the first terrace of the left bank of the riv. Nenskra. Considering existing condition of the area, construction site arrangement will not be related to destruction of big amount of vegetation. There is a gravel road from the power house to the project territory, which will require rehabilitation and widening. The generated electricity can be engaged with the Power Grid using transmission line ("Caucasus") located on the right bank of the riv. Nenskra. For this purpose arrangement of 1 k long transmission line will be necessary.

### 3.3.3 Alternative Versions of the Diversion System

Following alternative versions have been researched:

- Diversion tunnel or diversion channel arrangement alternatives;
- Diversion tunnel form alternatives (circular or horseshoe shaped);
- Diversion tunnel arrangement method alternatives;
- Generated waste rock management alternatives.

Channel corridor will be located in extremely difficult terrain slopes and therefore, construction will be related to irreversible environmental impacts, such as:

- Channel location corridor and access roads must be arranged on the steep slopes, this complicates works and creates risks for dangerous geological process activation;
- Mountain slopes of the Nenskra valley are covered with dense forest, arrangement of diversion channel negative impact on biological environment will significantly increase;
- With consideration of project permeability of the channel (36.5 m<sup>3</sup>/sec) channel with rather large dimensions will be required, which is practically impossible due to the relief;
- Significant land loss (including pastures and meadows);

Proceeding for the said above, arrangement of diversion tunnel is much more convenient. It will be located on the mountain on the right bank of the riv. Nenskra and in terms of good management impact on the social and natural environment during construction and operation phases will be reduced to minimum.

Most significant negative impact related to the diversion tunnel arrangement, will be waste rock disposal. This issue can be solved by finding the proper area for disposal.

Following this, arrangement of the diversion tunnel was decided.

Construction of the Nakra river water evacuation tunnel has no alternatives, since according to the project the water must be evacuated from one valley to another divided by the high range.

**Table 3.3.3.1.** Comparative analysis of the diversion system alternatives

Alternative	Advantage	Disadvantage
<b>Diversion channel and diversion tunnel alternatives</b>		
Diversion channel	<ul style="list-style-type: none"> <li>• Relatively small financial costs</li> </ul>	<ul style="list-style-type: none"> <li>• High probability of system damage;</li> <li>• difficult terrain of the corridor complicates works and increases risks of dangerous geological process activation;</li> <li>• Negative impact risk on the biological environment is high;</li> <li>• Loss of pasture and hay lands;</li> <li>• Habitat fragmentation is anticipated;</li> <li>• Security-related risks among the population is high and etc.</li> </ul>
Diversion tunnel <b>(Proposed alternative)</b>	<ul style="list-style-type: none"> <li>• Reduction of negative impacts on the biological environment;</li> <li>• No loss of public lands (forests, pastures, hays);</li> <li>• Risks of dangerous geological process activation is relatively small;</li> <li>• No risk of habitat fragmentation;</li> <li>• Security-related risks are low.</li> </ul>	<ul style="list-style-type: none"> <li>• Significant financial costs for the construction works;</li> <li>• Need for disposal area for a big amount of waste rock;</li> <li>• Possible impact on the underground water debit.</li> </ul>
<b>Diversion tunnel form alternatives</b>		
Circular or horseshoe shaped	<ul style="list-style-type: none"> <li>• In terms of environmental impact there is no significant difference between these two variants</li> </ul>	
<b>Diversion tunnel arrangement method alternatives</b>		
Drilling-	<ul style="list-style-type: none"> <li>• Tunnel profile form does not</li> </ul>	<ul style="list-style-type: none"> <li>• Dangerous due to explosive consumption;</li> </ul>



blasting	<ul style="list-style-type: none"> <li>• create difficulties during works;</li> <li>• Flat bottom easy to achieve, railway tracks can be arranged;</li> <li>• Low risk of equipment breakouts.</li> </ul>	<ul style="list-style-type: none"> <li>• Tunnel walls are not smooth;</li> <li>• Tunnel arrangement takes a long time;</li> <li>• Collapse risk;</li> <li>• Material removal, water abstraction and blockage issues must be solved.</li> </ul>
Mechanical-tunnel boring machine <b>(Proposed alternative)</b>	<ul style="list-style-type: none"> <li>• Capability to do tunnel boring and finish works in the parallel regime;</li> <li>• Minimal volume of idle waste;</li> <li>• Ensuring integrity of surrounding rocks;</li> <li>• Tunneling speed and quality;</li> <li>• Complex nature of work (tunneling, concreting);</li> <li>• In case of one tunneling mechanism utilization no need for construction adit arrangement;</li> <li>• Only two portals needed (input and output). Portals will work in short period of time;</li> <li>• Safe – no use of explosive material.</li> </ul>	<ul style="list-style-type: none"> <li>• Relatively expensive;</li> <li>• Utilization of tunnel boring machine floor must be annihilate with cement, which requires more time and costs;</li> <li>• Firm, abrasive rocks may complicate work of the cutters;</li> <li>• Difficult to operate in exhausted, fragmented rocks;</li> <li>• Useful work time is reduced due to breakdowns and repairs (during operation in solid rocks). Usually works in 50% of time (depending on rock characteristics). Time loss due to cutter replacement;</li> <li>• Time required for material removal, water abstraction and blockage;</li> <li>• Requires electricity;</li> <li>• Requires water and use of drilling saline;</li> <li>• Requires removal of used water (drilling saline) and management.</li> </ul>
<b>Underground water control alternatives</b>		
Water abstraction with free-run <b>(Proposed alternative)</b>	<ul style="list-style-type: none"> <li>• Cheapest and easiest method</li> </ul>	<ul style="list-style-type: none"> <li>• A pump will be required in exceptional cases;</li> <li>• Water discharge and treatment (purification, filtration) issues need to be solved before discharge into the surface water;</li> <li>• If the underground water horizon is a water supply source free-run may reduce volume necessary for water supply;</li> <li>• Drainage affects distribution of hydraulic pressure.</li> </ul>
Cementation	<ul style="list-style-type: none"> <li>• In addition to water containment function reduces risk of surface lowering</li> </ul>	<ul style="list-style-type: none"> <li>• Expensive, time capacious, is not completely reliable even when arranged in accordance with all safety measures;</li> <li>• Requires cement and water.</li> </ul>
Freezing	<ul style="list-style-type: none"> <li>• Usually used for shafts, but can be used in tunneling as well</li> </ul>	<ul style="list-style-type: none"> <li>• Requires freezing agent</li> </ul>
Hydro isolation with PVC	<ul style="list-style-type: none"> <li>• No impact on underground water</li> </ul>	<ul style="list-style-type: none"> <li>• Requires isolation material, additional costs (material and arrangement costs)</li> </ul>
<b>Waste rock removal method alternatives</b>		
Railway transport	<ul style="list-style-type: none"> <li>• Energy efficient, can be used in different tunneling methods;</li> <li>• Can be used for any tunnel size;</li> <li>• Have no emissions.</li> </ul>	<ul style="list-style-type: none"> <li>• Requires arrangement of railway tracks and switches</li> </ul>
Belt conveyor <b>(Proposed alternative)</b>	<ul style="list-style-type: none"> <li>• Continuous removal of waste rock;</li> <li>• Has no emissions</li> </ul>	<ul style="list-style-type: none"> <li>• Requires frequent maintenance/repair;</li> <li>• Requires additional technical equipment.</li> </ul>

Truck	<ul style="list-style-type: none"> <li>Requires no infrastructure (e.g.: railway or conveyor)</li> </ul>	<ul style="list-style-type: none"> <li>Has emissions;</li> <li>Can only be used in large diameter tunnels.</li> </ul>
<b>Waste rock removal/disposal alternatives</b>		
Removal to permanent storage area <b>(Proposed alternative)</b>		<ul style="list-style-type: none"> <li>Requires relevant area for temporal storage;</li> <li>Transportation to the final storage area (additional costs).</li> </ul>
Utilization for the project <b>(Proposed alternative)</b>	<ul style="list-style-type: none"> <li>Waste rock reduction and useful utilization</li> </ul>	<ul style="list-style-type: none"> <li>Requires relevant area for temporal storage;</li> <li>Transportation to the utilization area.</li> </ul>
Transfer for utilization in other production	<ul style="list-style-type: none"> <li>No transportation costs;</li> <li>May be source for a small income.</li> </ul>	<ul style="list-style-type: none"> <li>Requires relevant area for temporal storage</li> </ul>

Two alternatives were considered: 1. Underground or over ground pressure pipeline; 2. Various schemes of pressure pipelines.

**Table 3.3.3.2.** Alternatives of the pressure system

Alternative	Advantage	Disadvantage
<b>Underground-over ground systems</b>		
Underground <b>(Proposed project)</b>	<ul style="list-style-type: none"> <li>Is protected from mechanical damage, vandalism and environmental factors (corrosion, freezing);</li> <li>Minimal impact on flora and fauna;</li> <li>Minimal impact on people and cattle free movement on operation phase;</li> <li>Less impact of temperature, less probability of compensators use;</li> <li>Less visual impact.</li> </ul>	<ul style="list-style-type: none"> <li>Requires land works (with relevant impact on the environment);</li> <li>Possible impact on underground water;</li> <li>Small possibility of visual inspection;</li> <li>Difficulties in repair/maintenance works.</li> </ul>
Underground inclined pressure pipeline	<ul style="list-style-type: none"> <li>Protected from mechanical damage and environmental factors;</li> <li>Minimum visual-landscape change during the operation phase;</li> <li>Less impact of temperature.</li> </ul>	<ul style="list-style-type: none"> <li>Large volume of excavations will be required during the arrangement of pipeline, which will be related to significant impact on physical and biological environment;</li> <li>Fragmentation of habitat during construction works;</li> <li>Risks of deterioration of soil quality;</li> <li>Risks of development of dangerous geological processes;</li> <li>Less possibility of visual control;</li> <li>Difficulties in terms of maintenance.</li> </ul>
Over ground	<ul style="list-style-type: none"> <li>Ease of monitoring on the operation phase;</li> <li>Does not require land works during</li> </ul>	<ul style="list-style-type: none"> <li>Less protected from environmental impacts;</li> <li>Requires use of anticorrosive coating;</li> </ul>

	<ul style="list-style-type: none"> <li>• maintenance and repair;</li> <li>• No underground water pollution risks.</li> </ul>	<ul style="list-style-type: none"> <li>• May interfere with free movement of people/cattle;</li> <li>• Habitat fragmentation is likely;</li> <li>• Visual impact.</li> </ul>
<b>Various schemes of pressure system</b>		
Vertical and then horizontal system <b>(Proposed project)</b>	<ul style="list-style-type: none"> <li>• No additional road construction required on the difficult geological and topographical sections;</li> <li>• Less impact on soil surface;</li> <li>• No risk of habitat fragmentation;</li> <li>• Less visual impact</li> </ul>	<ul style="list-style-type: none"> <li>• Adverse from economic point of view;</li> <li>• Requires hard work and time;</li> <li>• Risk of impact on underground water.</li> </ul>
Inclined pipeline	<ul style="list-style-type: none"> <li>• Less duration of works;</li> <li>• Lower service costs.</li> </ul>	<ul style="list-style-type: none"> <li>• Requires land works;</li> <li>• Impact on vegetation – due to land works;</li> <li>• Temporal fragmentation of habitats;</li> <li>• Risk of violation of soil/slope stability.</li> </ul>

### 3.4 Comparison of Alternatives

The table below provides information on possible positive and negative impacts and their comparison for different alternatives in the HPP construction and operation period.

**Indications:**

Construction Stage - CS

Operation Stage - OS

Positive Impact - 

Negative impact - 

Impact Not Expected -

Impact scale and probability is less than in case of other alternatives - L

Impact scale and probability is higher than in case of other alternatives - H

**Table 3.3.4.1.** Comparison of possible impacts on HPP construction and operation phases

Impact receptor  Alternative	Microclimate		Air				Soil				Water						Flora		Fauna (including Ichthyofauna)				Visual-landscape				Wastes				Social-economic environment								Cultural heritage	
			Dust		Emission		Quality		Stability (including geological structure)		Underground		Surface																											
	CS	OS	CS	OS	CS	OS	CS	OS	CS	OS			CS	OS	CS	OS	CS	OS	CS	OS	CS	OS	CS	OS	CS	OS	CS	OS	CS	OS	CS	OS	CS	OS	CS	OS				
1	2	3	4	5	6	7	8	9	10	11	12	13	14	15	16	17	18	19	20	21	22	23	24	25	26	27	28	29	30	31	32	33	34	35						
With no alternative project	No impact on the environment																																							
Regulation type HPP alternative		H	H		H		H		H	H	H		H				H					H	H			H									H					
Riverbed type HPP alternative		H	H		H		H		H	H	L		H			L	L					H	H			L									L					
Diversion type HPP alternative			L		L		L		L	L	L		L				L					L	L			L			L	L						L	L			

1	2	3	4	5	6	7	8	9	10	11	12	13	14	15	16	17	18	19	20	21	22	23	24	25	26	27	28	29	30	31	32	33	34	35	
• Head building alternatives:																																			
– Location alternatives:																																			
1. 1600 m a.s.l.																																			
2. 1500 m a.s.l.																																			
3. 1475 m a.s.l.																																			
4. 1300 m a.s.l.																																			
5. 1190 m a.s.l.																																			
• Diversion system alternatives:																																			
– Diversion channel and diversion tunnel:																																			
1. Diversion channel																																			
2. Diversion tunnel																																			
– Diversion tunnel form alternatives:	In terms of environment impact the form does not matter																																		
– Tunneling method alternatives:																																			
1. Drilling-blasting																																			
2. Tunneling machine																																			
– Underground water control alternatives:																																			
1. Water abstraction																																			
2. Cementation																																			



## Conclusion

Basing on comparative characteristic of the alternatives the priority should be given to:

- High pressure seasonal regulation type HPP;
- Alternative 4 of the project;
- Arrangement of diversion tunnel for water supply from the riv. Nakra valley to power unit;
- The best option for tunneling is tunnel boring machine;
- Utilization of free-run system for underground water during tunneling works;
- Arrangement of belt conveyor for waste rock withdrawal;
- Arrangement of underground, vertical pressure system.

## 4 Description of the Project

### 4.1 General Overview

HPP construction and operation project considers construction and operation of the high pressure seasonal regulation type HPP with installed capacity of 280 MW in Samegrelo-Zemo Svaneti region, namely on the territory of Mestia Municipality. The HPP will be arranged in the riv. Nenskra valley and will consume the rivers Nenskra and Nakra runoff.

Following infrastructure will be arranged on the HPP construction phase:

- 135 m high and 820 m long rock fill dam on the river Nenskra;
- 940 m long idle spillway;
- Reservoir with capacity of 182 million m<sup>3</sup>;
- 13 m high and 57 m long dam on the river Nakra;
- 12.4 km long diversion tunnel, for water evacuation from the riv. Nakra valley into the riv. Nenskra valley;
- 15.1 km long tailrace tunnel from Nenskra reservoir to pressure system;
- Pressure shaft;
- Powerhouse;
- Substation;
- Transmission line;

Communication allocation scheme is given in the scheme 4.1.1. Main parameters of the HPP are given in the table 4.1.1.

Scheme 4.1.1. HPP communication layout plan

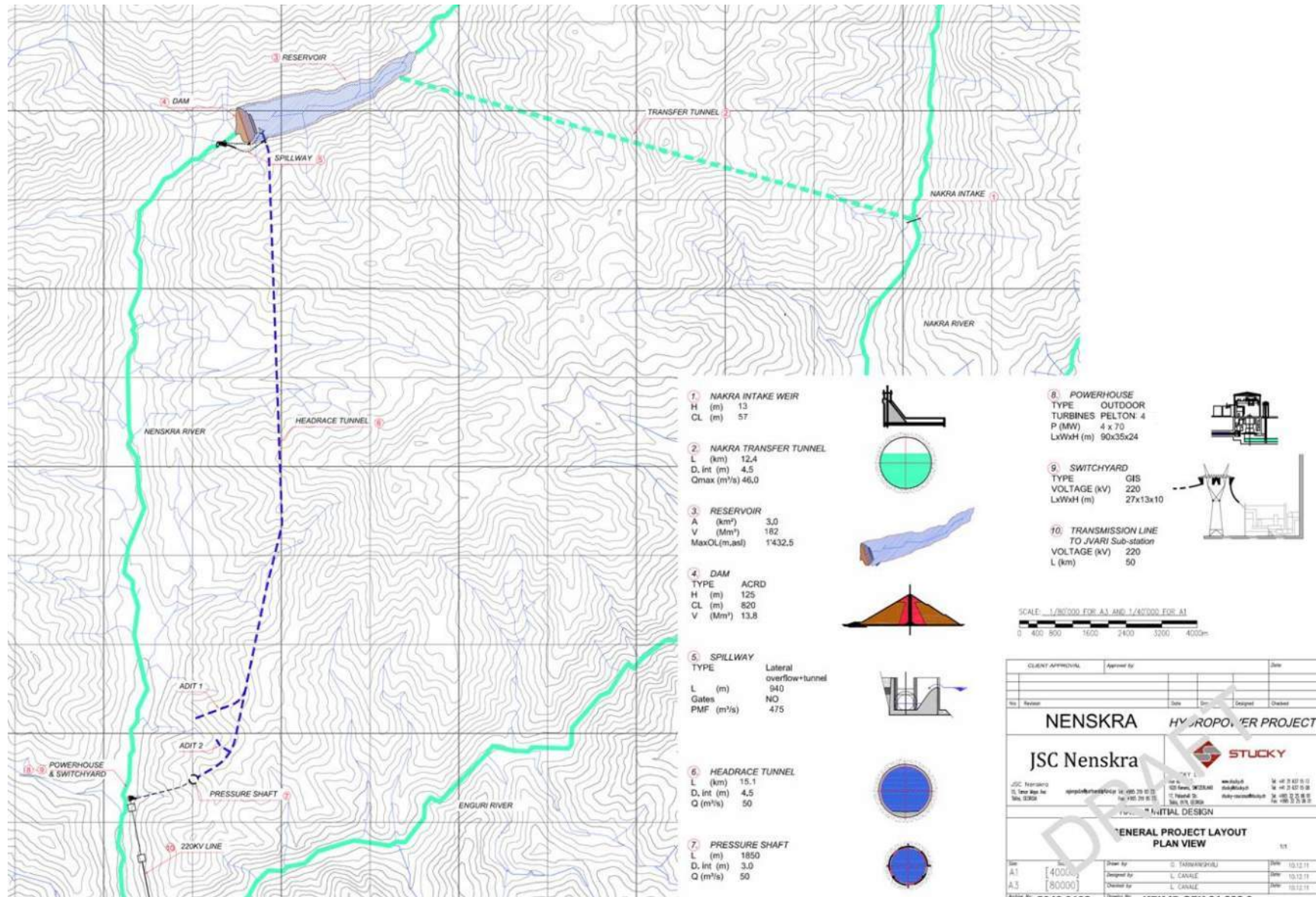



**Table 4.1.1.** Main technical features of the project HPP

<b>Nakra water intake dam</b>	
• Height (m)	13
• Length (m)	57
<b>Nakra diversion tunnel</b>	
• Length (km)	12,4
• Diameter (m)	4,5
• Maximal flow (m <sup>3</sup> /sec)	46,0
<b>Reservoir on the riv. Nenskra</b>	
• Water mirror area (km <sup>2</sup> )	3,0
• Capacity (million. m <sup>3</sup> )	182
• Maximal level (m a.s.l.)	1 432.5
<b>Fill dam on the riv. Nenskra</b>	
• Type	Rock fill
• Height (m)	135
• Length (m)	820
• Capacity (million. m <sup>3</sup> )	13.8
<b>Spillway</b>	
• Type	Lateral spillway + tunnel
• Length of the channel (m)	60
• Length of the tunnel (m)	880
• Maximal catastrophic flow (m <sup>3</sup> /sec)	457
<b>Tailrace tunnel</b>	
• Tunneling method	The tunnel boring machine (TBM)
• Length (km)	15,1
• Diameter (m)	4,5
• Maximum flow (m <sup>3</sup> /s)	50
• Finishing	Concrete
<b>Surge shaft</b>	
• Type	Vertical
• Depth (m)	186
• Diameter (m)	6.5
• Finishing	Concrete
<b>Pressure shaft</b>	
• Type	Vertical
• Depth (m)	1580
• Diameter (m)	3,0
• Maximum flow (m <sup>3</sup> /s)	50
• Finishing	Steel
<b>Power House – Power unit</b>	
• Type	Over ground
• Turbine type and quantity	Pelton 4
• Capacity (MW)	4 x 70
• Building dimensions (m)	96 x 35 x 24 (H)
<b>Substation</b>	
• Type	G.I.S
• Voltage (kV)	220
• Dimensions (m)	26 x 12 x 10 (H)
<b>Energy output</b>	
• Total annual output, GW/h	1194
• Sustainable annual output, GW/h	1139

• Output in winter period, GW/h	535/369
• Installed capacity of the HPP, MW	280
<b>Transmission line till Jvari substation</b>	
• Voltage (kV)	220
• length (km)	≈50

## 4.2 Headworks

The rock fill dam will be arranged on the 1315 m level of the riv. Nenskra. According to the project, the dimensions of the dam will be as follows: Height - 135 m, length - 820 m, width of the bottom – 407.9 m, width on the ridge – 10.0 m. From the headrace side the dam will be covered with concrete screen.

Water intake will be arranged on the right side of the dam, on the 1325 m level. Diversion tunnel will be arranged on the left bank; with its help water will be avoided from the construction site during construction works. In the dam operation process the tunnel will be used as the lower protective tunnel.

On the left side of the dam, arrangement of 940 m long reinforced concrete idle spillway is planned. Its capacity will be 457 m<sup>3</sup>/sec. On the bottom level of the spillway suppression well will be arranged (Scheme of suppression well is given in Figure 4.2.3). Catastrophic flow will be handled with the help of the idle spillway and bottom discharging tunnel. Ecological flow will be handled with lower discharging tunnel. Water will be discharged from the lower discharging tunnel into the spillway suppression well.

For regular supervision over safe operation of the proposed dam, project includes arrangement of a control-measuring systems, namely, following devices will be installed on the dam: seismometer, piezometers, soil compaction meters, temperature sensors, etc. Layout plan of control-measuring systems to be installed on the dam is given in Figure 4.2.4.

**Picture 4.2.1.** Project dam alignment view



The area selected for the dam arrangement is rather wide and flat. Significant amount of solid sediments is accumulated on the section, which can be used for production of inert materials for construction works.

Project dam scheme and cross section is given in figures 4.2.1 and 4.2.2.

Dam will create reservoir in the headrace with mirror surface area 3 km<sup>2</sup> and capacity of 182 million m<sup>3</sup>. Water level for normal operation conditions is 1430 m, maximum level is 1432 m.

According to the feasibility study, proposed HPP will supply state power grid with electricity throughout the whole year, due to which design flow will be supplied to powerhouse in spring-summer period. While, during the low waters, reservoir water will be used. Scheme of reservoir water flow is given on diagram below.

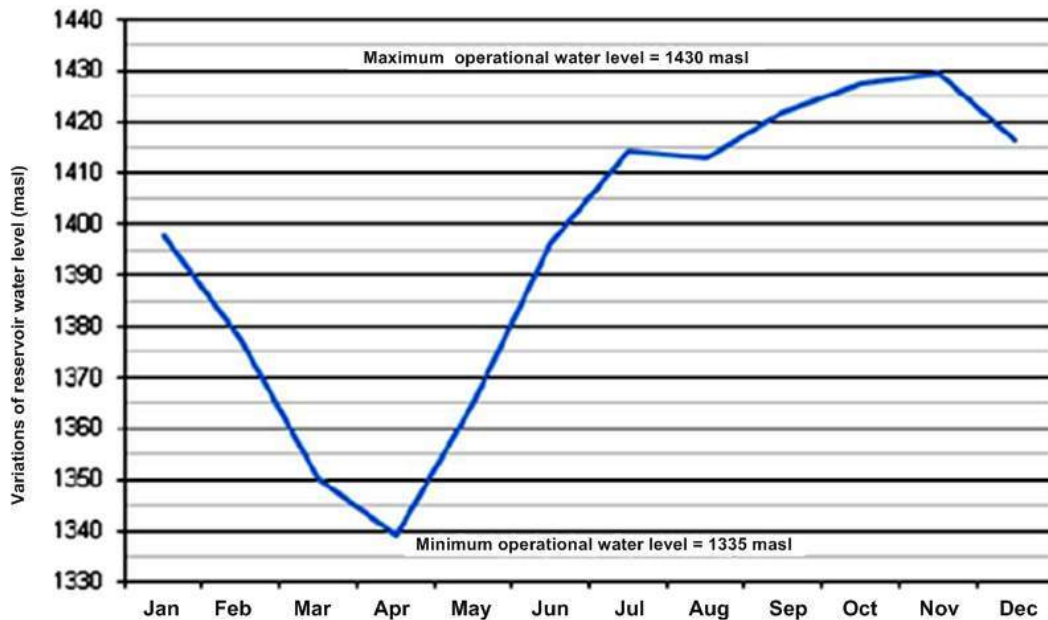

As shown from the diagram, maximum water level is expected in the second half of October, while the minimum level - in April.

According to the results of calculation of the life cycle of the reservoir is 72 years.

On the 1493 m level of the riv. Nakra a reinforced concrete dam arrangement is planned; its height will be 13 m, length 57 m. Considering the local terrain a small dike will be created on the headrace (1500-2000 m<sup>2</sup> mirror surface area). Water from here will be supplied to the diversion tunnel with water intake arranged on the right side of the dam. According to the dam construction, excess water and solid sediments will be leaded into the tailrace. During flood periods the water will be evacuated from the dam ridge. Suppression well will be arranged in the tailrace. In order to avoid erosion of the river banks protective walls will be arranged on both sides of the river.

Ecological flow will be released with the fish passage, which will be arranged on the left side of the dam. Length of the fish passage will be approximately 50-60 m.

General plan of headworks is given in Figure 4.2.5., while the plan of Nakra dam is given in Figure 4.2.6.

Figure 4.2.1. Scheme of the proposed dam

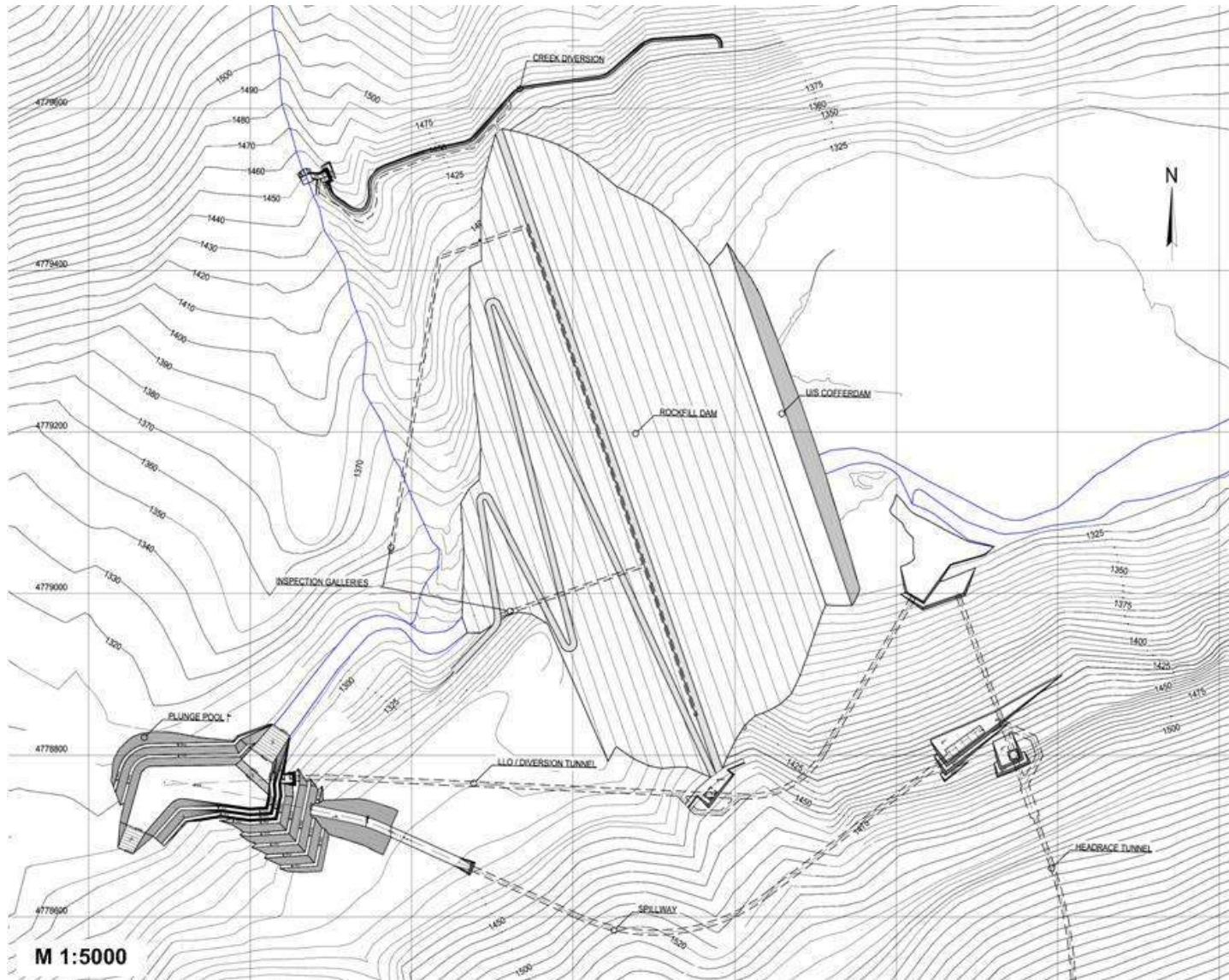
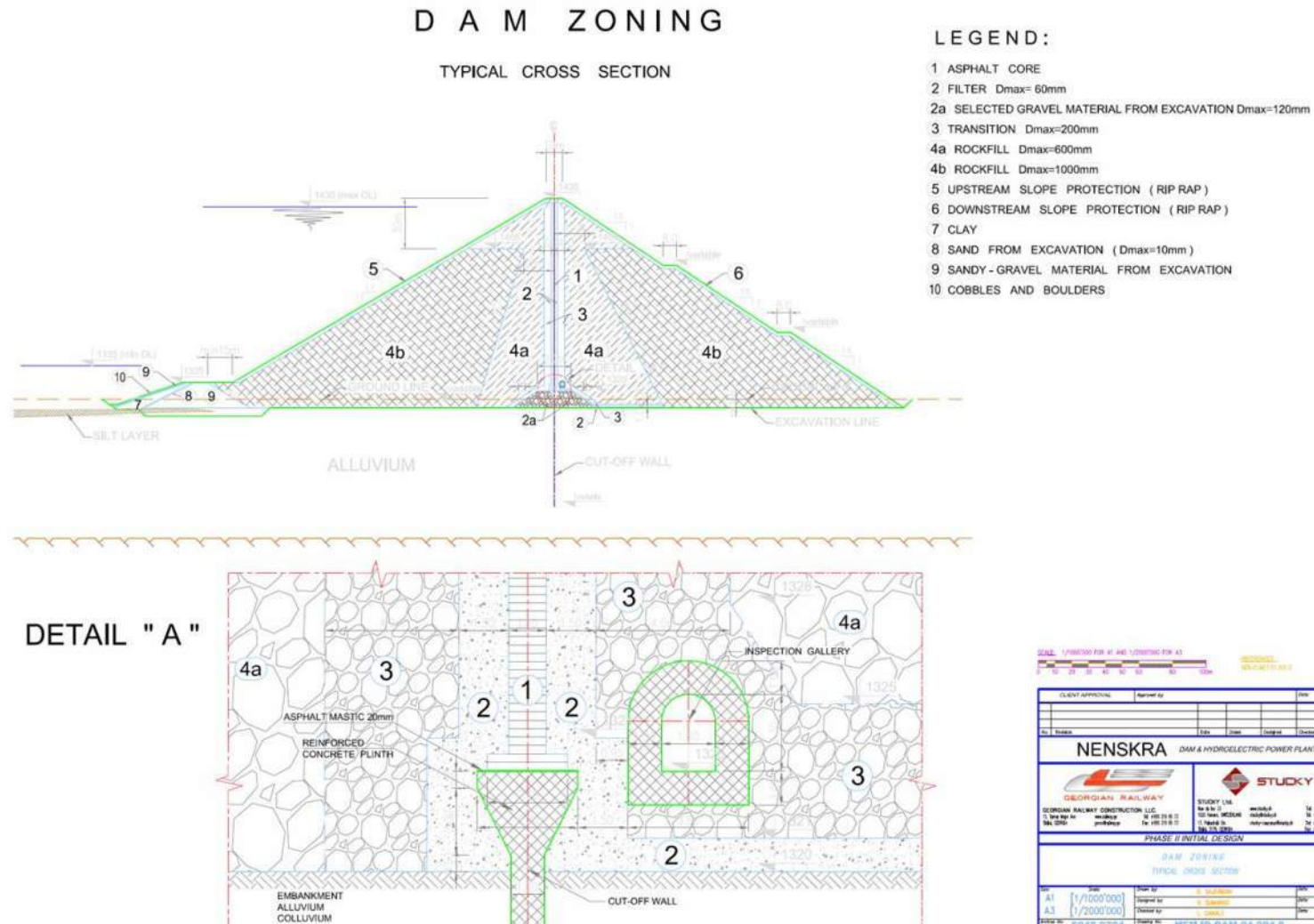

Figure 4.2.2. Cross section of the dam. M 1:2000



**Figure 4.2.3.** Scheme of the Suppression well M 1:5000



**Figure 4.2.4.** Layout plan of control-measuring systems of Nenskra dam

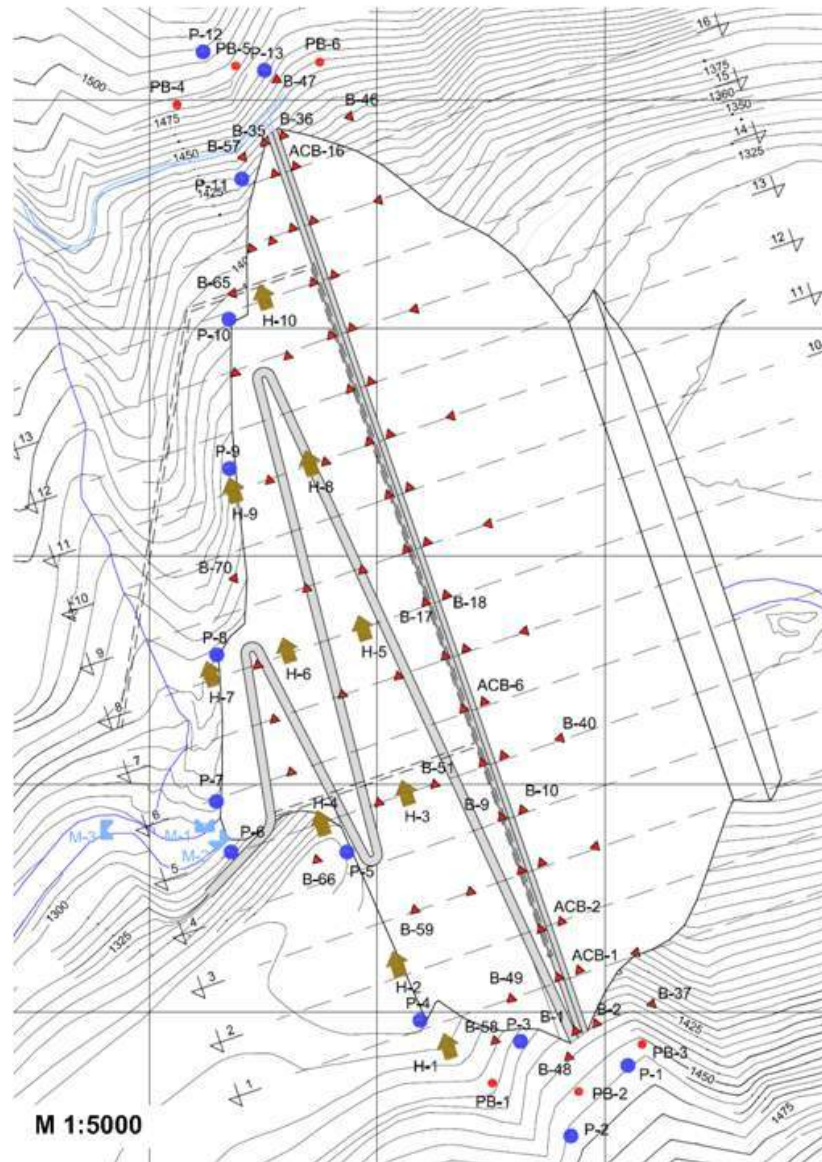

**LEGEND :**

- STRONG MOTION ACCELEROGRAPHS SMA - 1 ... SMA - 4
- MEASURING WEIRS M - 1 , M - 2 , M - 3
- PERMANENT BEACONS ( 6 POINTS ) PB-1 ... PB-6
- SURFACE BENCHMARKS B-1 ... B-70
- SURFACE BENCHMARKS B-1 ... B-70
- STANDPIPE PIEZOMETERS P-1 ... P-13
- SETTLEMENT CELLS SC1 - SC22
- EXTENSOMETERS E1 - E21 ( IN ASPHALT CORE )  
( EVERY EXTENSOMETER CONSISTS OF 4 SENSORS AT THE DISTANCE OF 6M )
- PORE PRESSURE CELLS PP1 - PP45
- SHEAR DISPLACEMENT GAUGES SD1 - SD5
- STRAIN GAUGES SG1 - SG20  
( SG 1,2,5,6,9,10,13,14,17,18 in the plinth concrete )  
( SG 3,4,7,8,11,12,15,16,19,20 in the cut-off wall )
- JOINTMETERS JM1 - JM10  
( TO MEASURE DISPLACEMENTS BETWEEN THE ASPHALT CORE AND THE FILTER ZONE )
- STRAIN GAUGES SM1 - SM20 ( in asphalt core )
- PRESURE CELLS TP1 - TP5
- TEMPERATURE SENSORS T1 - T5
- OBSERVATION HUTS H-1 ... H-10

Figure 4.2.5. General plan of Nakra headworks

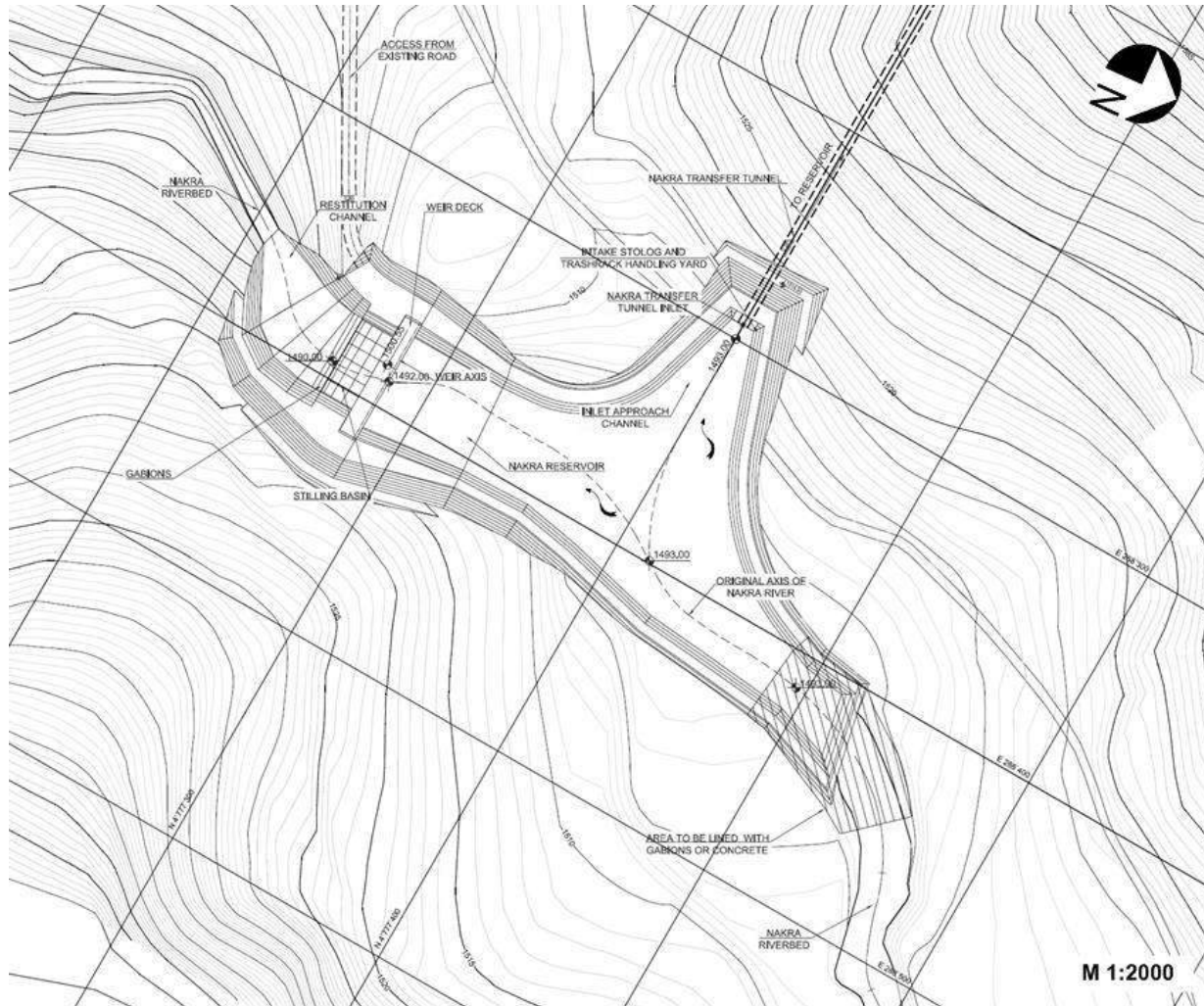



**Figure 4.2.6.** Plan of Nakra dam

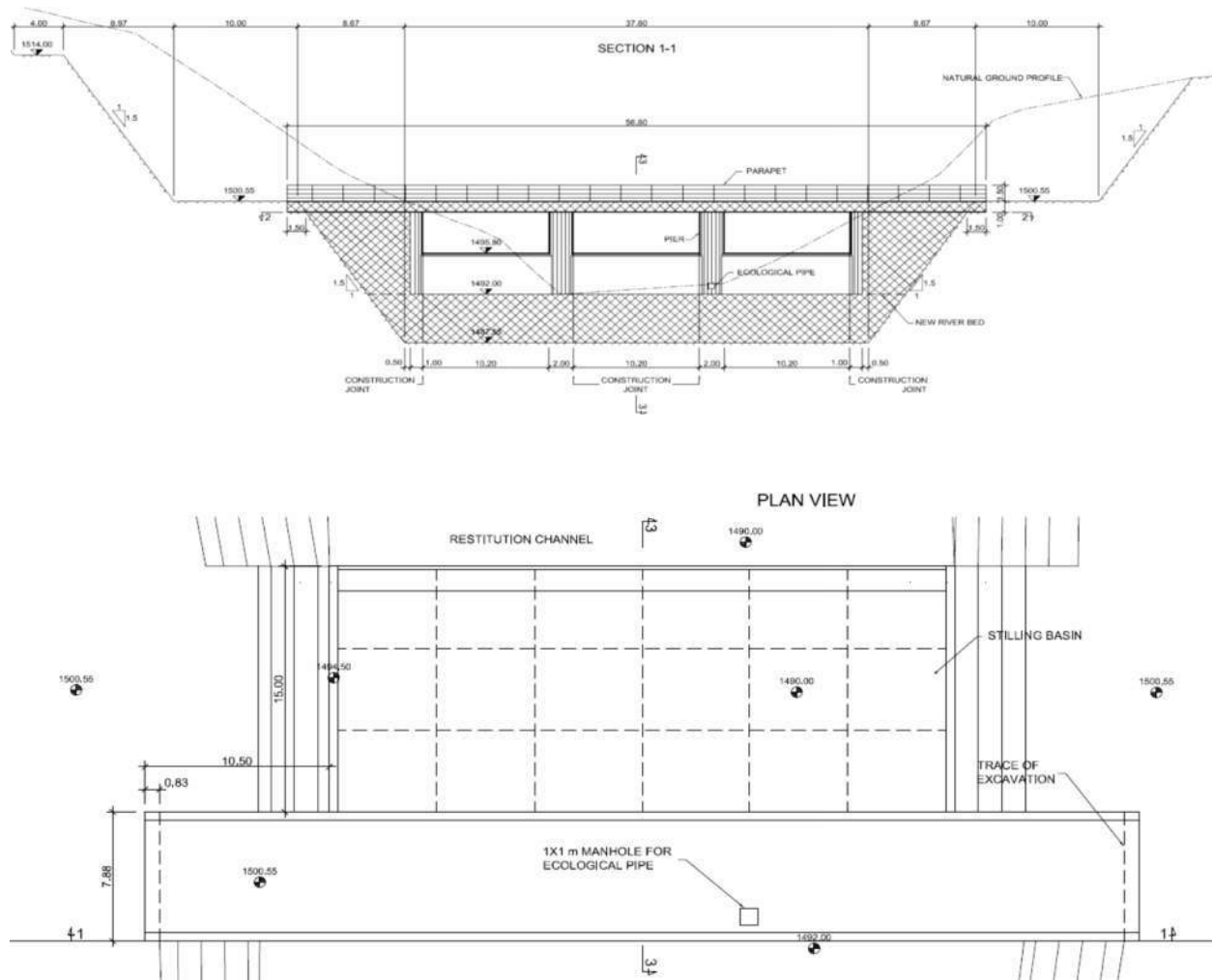

### 4.3 Report on Stability of Nenskra Dam

The aim of the report was to assess the structural safety of Nenskra rock fill dam under static and dynamic loading.

The work has been performed by STUCKY Ltd within the scope of the second phase of initial design (Phase II Initial Design, Structural Model Studies, June, 2012). At this stage of the design activities (Initial Design), stability and deformation analyses are performed for the more representative loading combinations and taking into account a simplified geometry (2D analyses) and material properties preliminarily estimated basing on available literature data. Detailed reports should be carried out at the design stage of construction in order to avoid additional questions about the safety of the dam.

Following calculations have been performed:

- Filtration analysis (determination of filtration flow characteristics and geometric parameters of the dam body);
- Slope stability analysis;
- Stress and displacement analysis.

#### 4.3.1 Design Loads and Load Combinations

Three approaches have been used during the analysis:

- Stability analyses of upstream and downstream slopes in case of activation of gravity load of cylindrical surfaces under static and dynamic loading;
- Stress-deformation analysis of the dam under static loading through elastic-plastic model;
- Prediction of Vertical Settlement Induced by the Seismic Loading

#### 4.3.2 Stability Analyses of Upstream and Downstream Slopes Under Static and Dynamic Loading

Following loading combinations are considered in the performed analysis:

- **EOC** (End of Construction) - Gravity load of dam self-weight;
- **FSL** (Fully Supply Level) - Gravity load of dam self-weight; pore-water pressure; Due to max. operating water elevation (1430.0 m asl);
- **PMF** (Probable Maximum Flood) - Gravity load of dam self-weight; pore-water pressure; Due to max. reservoir water elevation (1432.5 m asl);
- **FSLS** (FSL+Seismic load): - Gravity load of dam self-weight; pore-water pressure; Due to max. operating water elevation (1430.0 m asl); seismic horizontal inertial force.

##### 4.3.2.1 Performance Criteria

According to the normative documents of US Army Corps of Engineers (USACE) [1] and the Federal Energy Regulatory Commission (FERC) [2]. Minimum (normative) values of calculated safety factor for the considered static loading combinations are given in Table 4.3.2.1.1.

**Table 4.3.2.1.1.** Required minimum factors of safety for static loading combinations

Load combination	EOC	FSL	PMF
Required factor of safety	1.3	1.5	1.4

Two dynamic loading sub-combinations are considered in the present study, together with pseudostatic coefficients and minimum required safety factors resumed in Table 4.3.2.1.2.

**Table 4.3.2.1.2.** Required minimum factors of safety for dynamic loading combinations

Load combination	FSLS1	FSLS2
Pseudostatic horizontal coefficient $k_h$	0.13 (according to Seed [3])	0.19
Required factor of safety $F_s$	1.15 (according to Pike [2])	1.00

**4.3.2.2 Seepage Analysis**

Two different kinds of seepage analyses were performed in the present study by means of the Finite Element method.

Steady-state analyses, aimed to determine the free surface position in the embankment when Global Stability analyses are to be performed (see Figure 4.3.2.2.1.);

Transient analyses, when dam operational stages are considered (First stage – reservoir starts to fill after the dam reaches 1382.0 m elevation (see Figure 4.3.2.2.2.); Second stage – dam construction is completed (1435 m) and reservoir is partially filled (1361 m) (see Figure 4.3.2.2.3.); third stage – dam construction is completed (1435 m) and reservoir is filled (1435 m) (see Figure 4.3.2.2.2.)

**Figure 4.3.2.2.1.** Steady state seepage analysis: boundary conditions for FSL and PMF

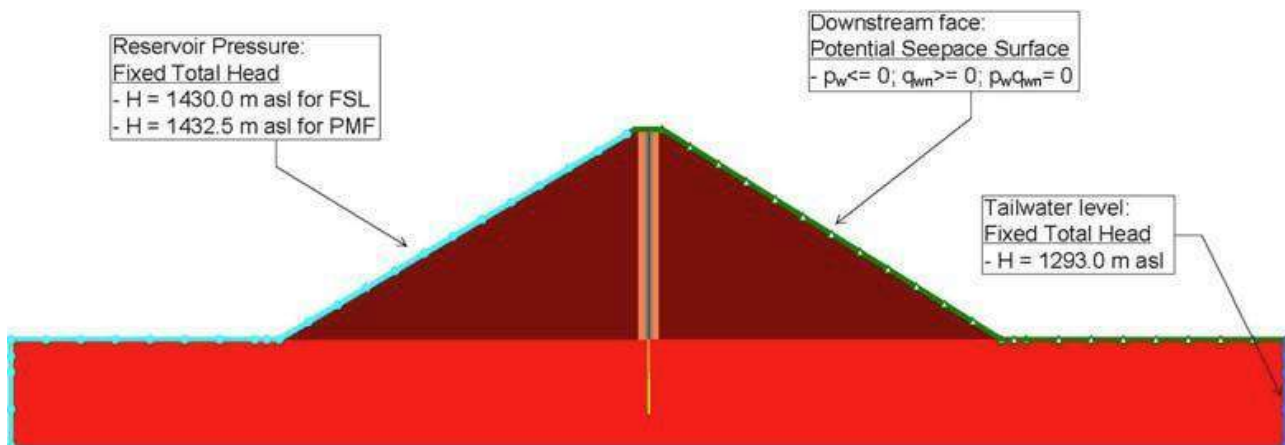

**Figure 4.3.2.2.2.** Transient seepage analysis: first stage of impounding

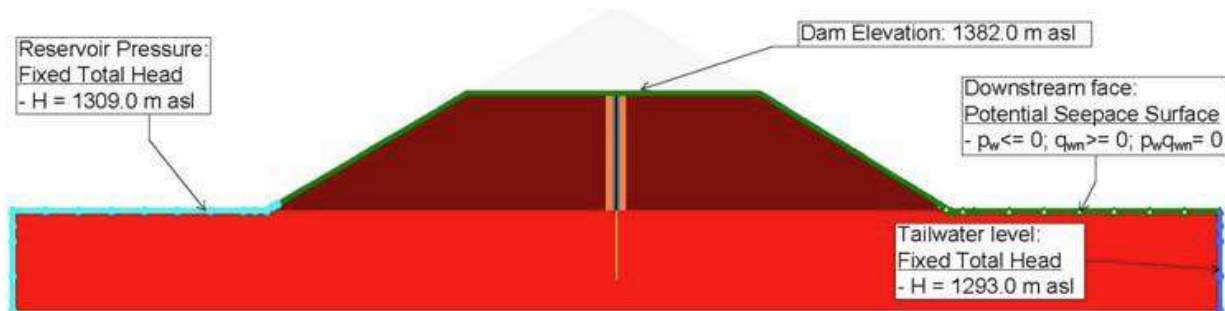

**Figure 4.3.2.2.3.** Transient seepage analysis: end of construction

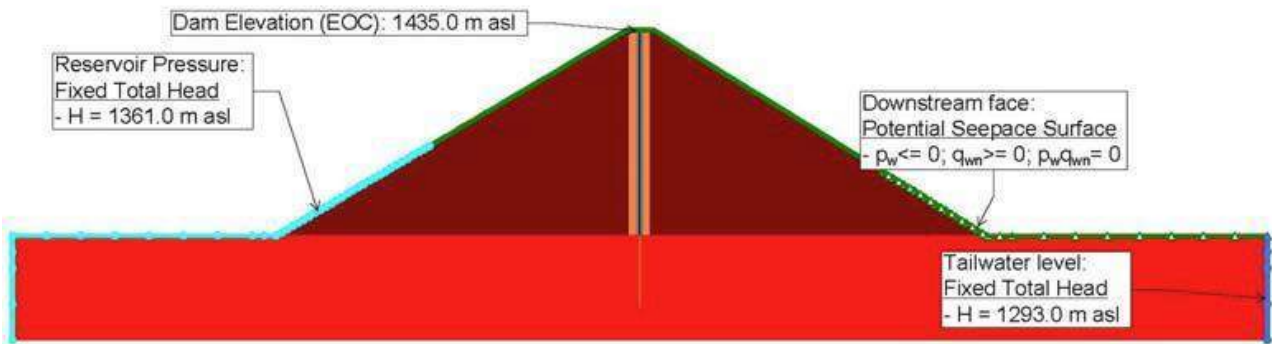

**Figure 4.3.2.2.4.** Transient seepage analysis: fully supply level

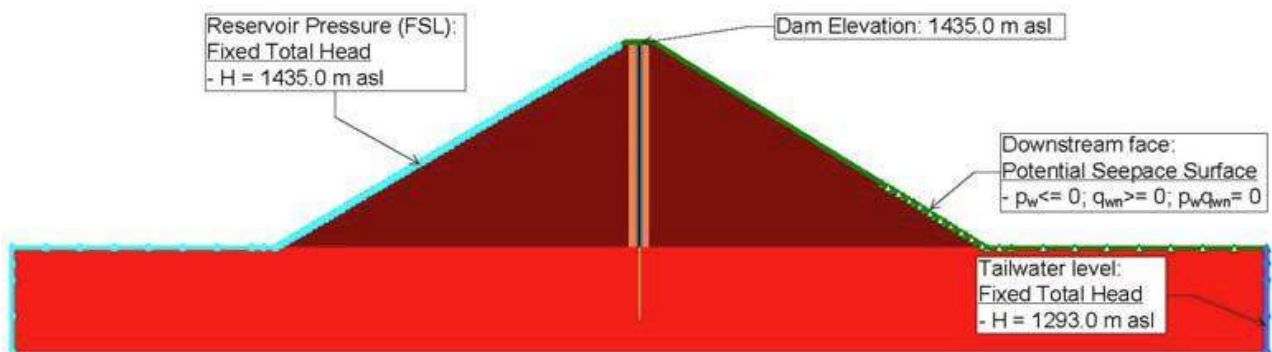

### 4.3.2.3 Slope Stability Analysis

After the seepage analysis, stability analyses of upstream and downstream slopes in case of activation of gravity load of cylindrical surfaces under static and dynamic loading has been performed.

### 4.3.2.4 Result Analysis

Table 4.3.2.4.1. Resumes the minimum safety factors obtained for all the considered static and dynamic loading combinations:

**Table 4.3.2.4.1.** Calculated minimum factors of safety for static and dynamic loading combinations

<i>Load combination</i>	EOC	FSL	PMF	FSLS1	FSLS2
Required factor of safety $F_s$	1.30	1.50	1.40	1.15	1.00
<i>Upstream</i>	1.73	1.82	1.82	1.18	1.01
<i>Downstream</i>	1.64			1.27	1.14

As it can be seen, the minimum stability requirements are always met.

### 4.3.3 Stress and Displacement Analysis

The stress and displacement analysis for the EOC and FSL loading combinations were performed by the Finite Element Method implemented in SIGMA/W, part of the geotechnical software package

GEOSTUDIO. In the present study, the construction operation was modeled by assuming 32 horizontal layers and an incremental non-linear (elastic-plastic) analysis was performed.

The following figures show some typical configurations of the embankment during construction.

**Figure 4.3.3.1.** Stress-deformation analysis: construction up before the impounding

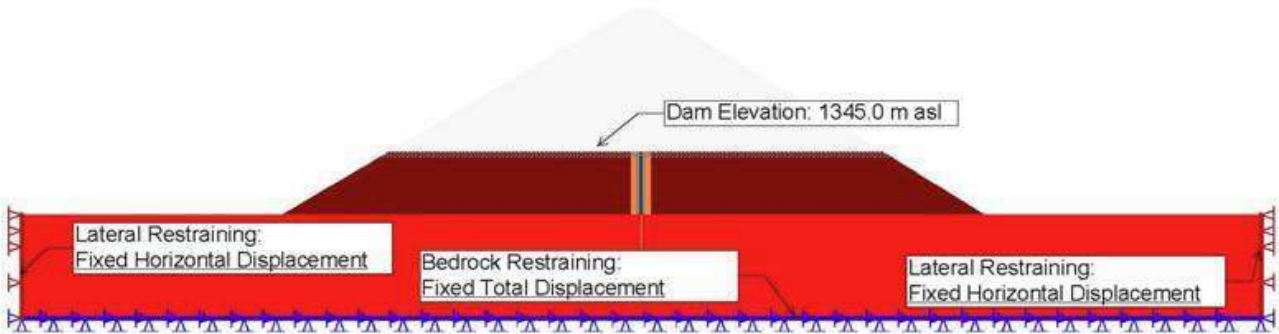

**Figure 4.3.3.2.** Stress-deformation analysis: first stage of impounding

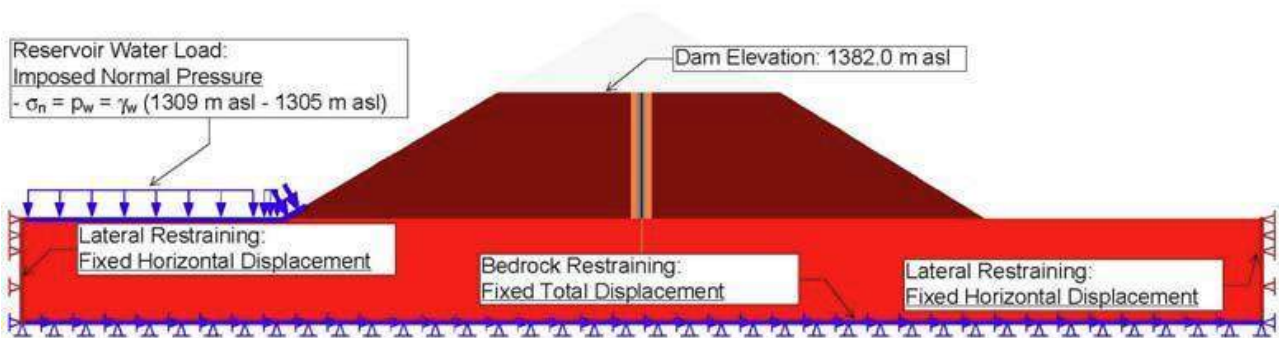

**Figure 4.3.3.3.** Stress-deformation analysis: end of construction

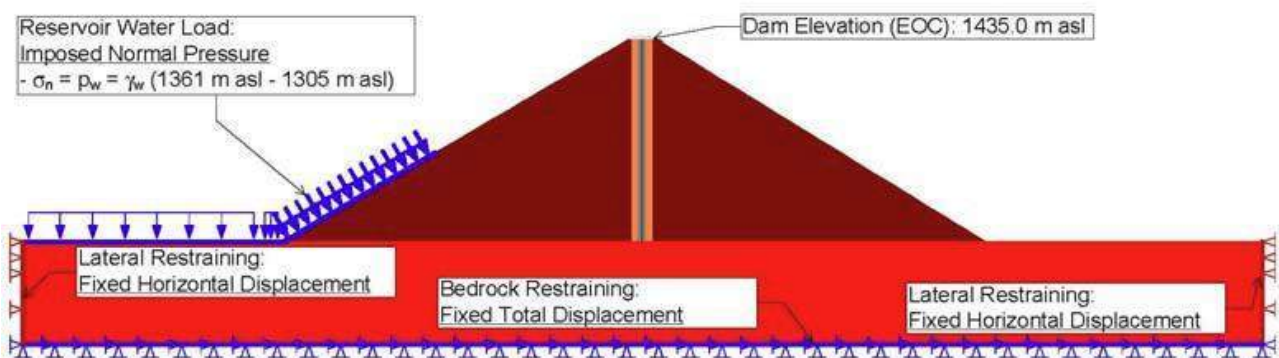

#### 4.3.4 Result Analysis

FSL loading combinations are most notable in terms of structural safety of the dam. The gradual process of filling the reservoir after reaching the dam height of 1382 meters, have little influence on the final stress-strained state of the structure. However, some differences still exist.

Crest horizontal displacement obtained in the former case is less than that one calculated with the latter methodology;

Crest heave is higher when the impounding is simulated after the dam completion.

#### 4.3.5 Prediction of Vertical Settlement Induced by the Seismic Loading

It is possible to estimate the vertical settlement induced by the seismic loading. The methodology proposed by Bureau (1997) is based on the Earthquake Severity Index (ESI) concept that can be estimated as follow:

$$ESI = PGA \times (M - 4.5)^3$$

By conservatively assuming an  $M = 7.5$  (= 7.0 in the seismic hazard report [3]) and considering that  $PGA = 0.66$  g for an MCE [3], the Earthquake Severity Index can be estimated equal to  $ESI = 18$ . By assuming an average friction angle for the rock fill of  $40^\circ - 45^\circ$ , the relative crest settlement can be estimated by means of the following chart:

**Figure 4.3.5.1.** Anticipated Seismic Settlement of a Rock fill Dam

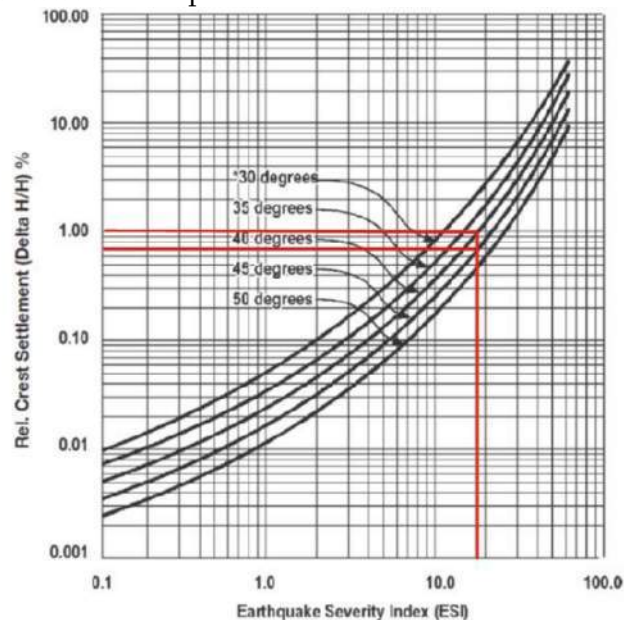

Therefore, a relative crest settlement varying from 0.7 % to 1.0 % could be expected. By assuming a total height  $H = 195$  m, the estimated vertical crest settlement due to seismic loading varies from 1.4m to 2.0m.

#### 4.4 Diversion System

For the water diversion from the **Nakra valley into the Nenskra valley**, arrangement of a 12.4 km long diversion tunnel is planned. Its diameter will be 4.5 m. It will be arranged in the depth of the watershed range. Maximum capacity of the tunnel will be  $46 \text{ m}^3/\text{sec}$ . The tunnel will be arranged with the tunnel boring machine. Tunneling works will begin with the outlet portal. The inner surface of the tunnel will be covered with reinforced concrete layer. Cross section of the tunnel is given in the Figure 4.4.1.

Construction site will be arranged at the outlet portal. For this purpose arrangement of the road is planned on the left bank of the reservoir. Relevant infrastructure will be arranged on the construction site, including residential premises for workers, crushing-sorting workshops, concrete unit and etc.

Waste rock (approximately 187 575 m<sup>3</sup>) will be transported via belt conveyor. Trucks will be loaded at the inlet portal. After this waste rocks will be removed to the selected permanent location area. Water withdrawal on the tunneling process will be possible via free-run system.

Additional flow from the riv. Nakra will accelerate the process of filling the reservoir. In addition, installation of 70 MW hydro aggregate will be possible.

In order to supply power unit with water from the reservoir arrangement of 15.1 km long tunnel is planned with the diameter of 4.5 m. It will be arranged in the depth of the ridge along the left bank of the river Nenskra. According to the project tunnel capacity will be 50 m<sup>3</sup>/sec.

The tunnel will be arranged by the tunnel boring machine. For this purpose construction adit will be arranged north to the upper level of the pressure shaft. With the adit the tunnel boring machine will reach to the tunnel level and then will proceed to work to the inlet portal. Inner surface of the tunnel will be covered with reinforced concrete layer.

The construction camp for the water lead tunnel and the pressure shaft construction will be arranged on the territory of the so-called “Zemo Naki” (territory adjacent to the inlet portal of the construction adit).



**Picture 4.4.1.** Territory for the construction camp



**Picture 4.4.2.** Territory of the adit inlet portal

Waste rock (approximately 330000 m<sup>3</sup>) will be removed from the tunnel by the belt conveyor and will be disposed in nearby natural ravine (see Picture 4.4.3.). According to the project, waste rock will be placed on the bottom of reservoir basin. Besides, tow alternative areas have been selected in the vicinity of Kvemo Marghi and Sgurishi villages.

**Picture 4.4.3.** Natural ravine selected for permanent disposal of waste rock



Underground water will be withdrawn from the tunnel with free-run system. Sedimentation pond will be arranged in order to clean underground water from suspended particles. After this, water will be withdrawn to the adjacent natural ravine via pipeline. After the connecting point with the construction adit, the tunnel will continue with a pressure tunnel, its diameter will be 3.5 m. This section of the tunnel will be arranged by blasting-drilling method. Inner surface of the tunnel will be covered with reinforced concrete layer and then with the steel coating (see Figure 4.4.2.). The pressure tunnel will be connected to the equalizing shaft (diameter 6 m, height 245 m), which will continue with pressure shaft. Height of the pressure shaft will be 1200 m, diameter 3.0 m, capacity 50 m<sup>3</sup>/sec. Shaft construction is identical to the pressure tunnel and represents a reinforced concrete pipe with a steel coating on the inner surface.

For construction of the pressure tunnel, equalizing shaft and pressure shaft arrangement of the second construction adit is planned, which will significantly reduce construction work period.

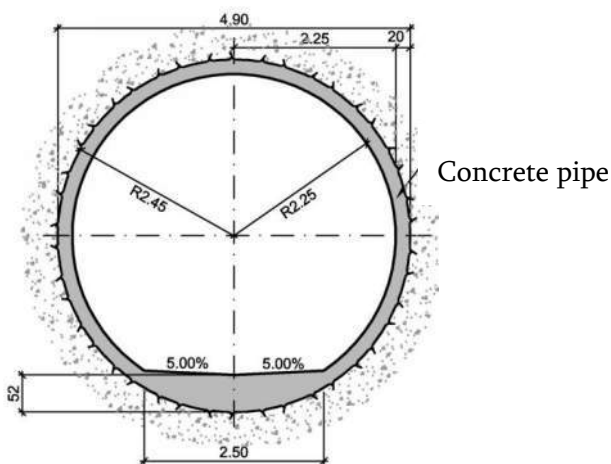

**Figure 4.4.1.** Cross section of tailrace tunnel

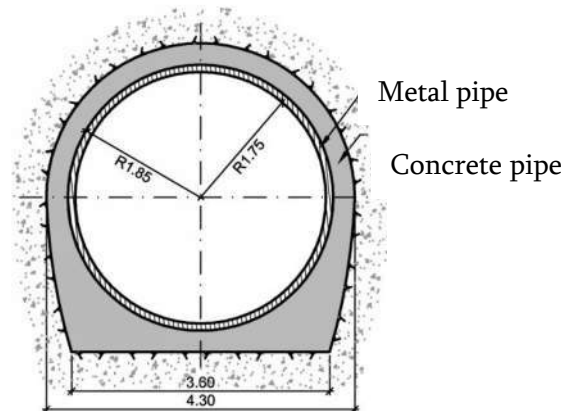

**Figure 4.4.2.** Cross section of pressure tunnel



**Figure 4.4.3.** Layout scheme for construction adits of tailrace tunnel and pressure shaft

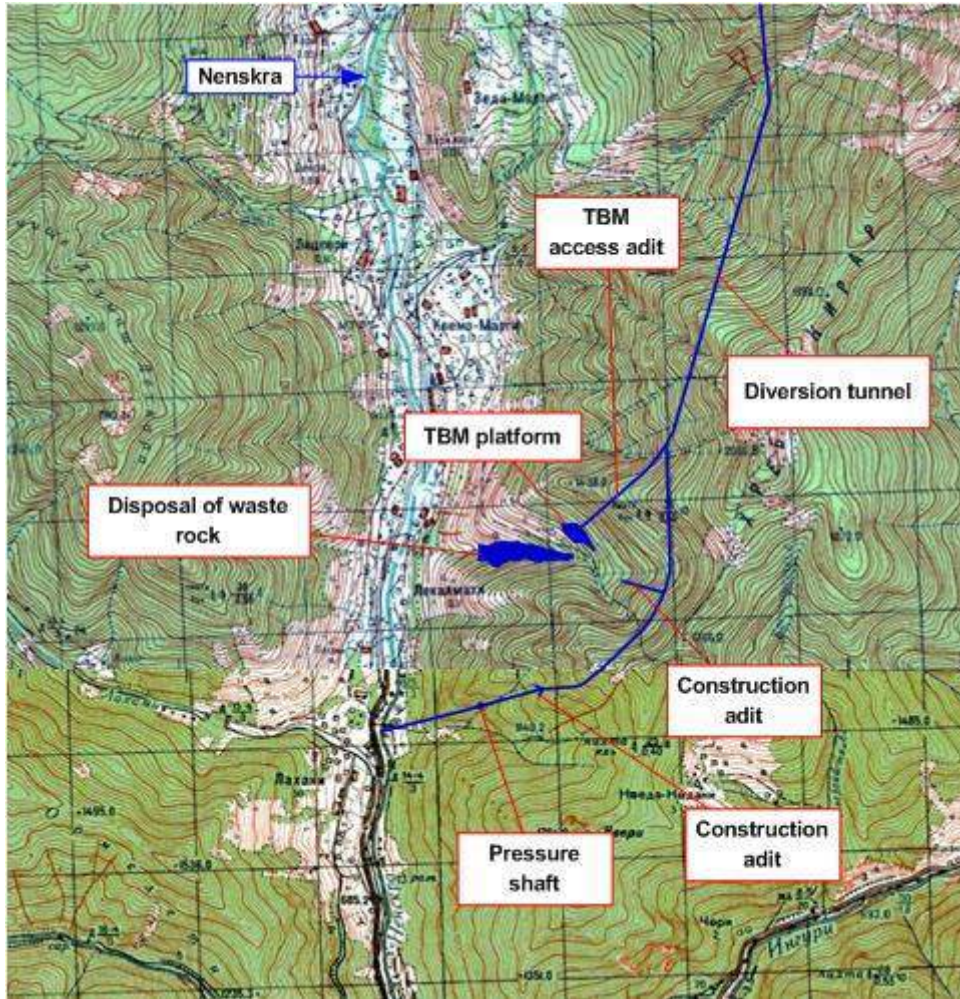
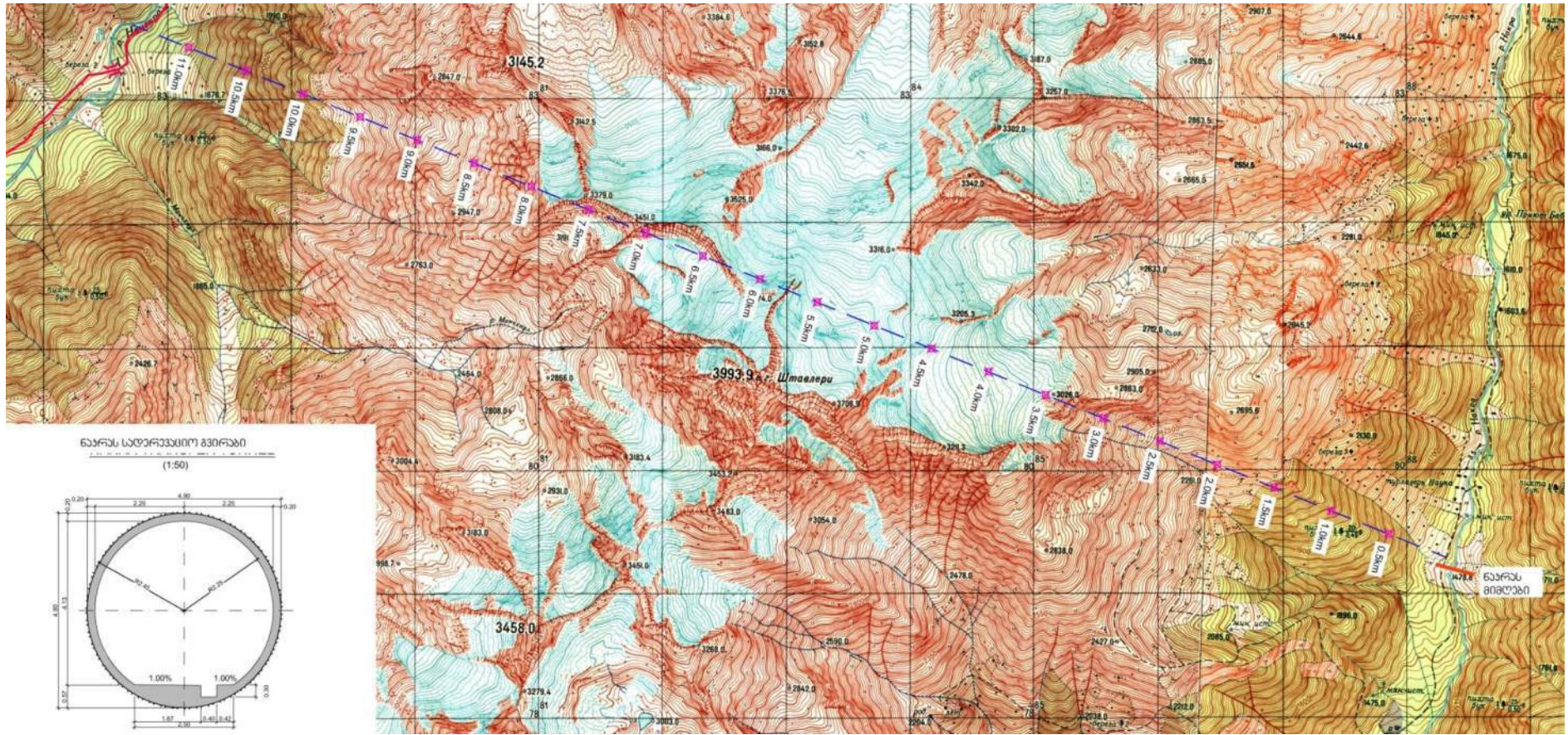

Figure 4.4.4. Plan of Nakra diversion tunnel



## 4.5 Power House

Power house of the HPP will be located on the first terrace of the left bank of the river Nenskra, 705 m a.s.l. Power unit includes – above ground powerhouse and substation. General plan of the powerhouse is given in the Figure 4.5.1. View of area selected for its arrangement is given in Picture 4.5.1.

**Picture 4.5.1.** View of the area selected for power house arrangement



Dimension of the project powerhouse are: length 90 m, width 35 m and height 24 m. The plan is given in Figure 4.5.2., while the general plant of the HPP is given in 4.5.3. The project considers arrangement of 4 Pelton type turbines. An independent pipes will be responsible for water supply to the four aggregates. The pipes will be equipped with independent spherical shutters.

The turbines will be cooled by the flowing water system. Local spring water will be used for this purpose. Water filtration system will be arranged in the powerhouse. Hot water from the cooling system will be discharged into the leading channel.

For the installation and technical services of hydro-aggregates and other equipment arrangement of bridge crane is planned.

Water from the tailrace will be discharged into the riv. Nenskra with the leading channel. On the left bank of the river, on the power unit perimeter, arrangement of the reinforced concrete protective wall is planned.

A 220 kV/a capacity substation will be arranged near the powerhouse, its dimensions are 26x12x10 m. According to the project, GIS type 220 kV/a capacity transformers will be installed.

In order to minimize distribution of oil in case of accidental oil spill, reinforced concrete reservoir will be arranged under the transformers.

For transformers and turbine oil storage purposes a special warehouse will be arranged in the powerhouse.

After the completion of the project, the parameters of the HPP will be:

- The total annual electricity output - 1194 GW / h;
- Sustainable electricity annual output - 1139 GW / h;
- Power generation during the winter season (October-March) - 535/369 GW / h;
- Installed capacity of the HPP - 280 MW.

Figure 4.5.1. General plan of power unit

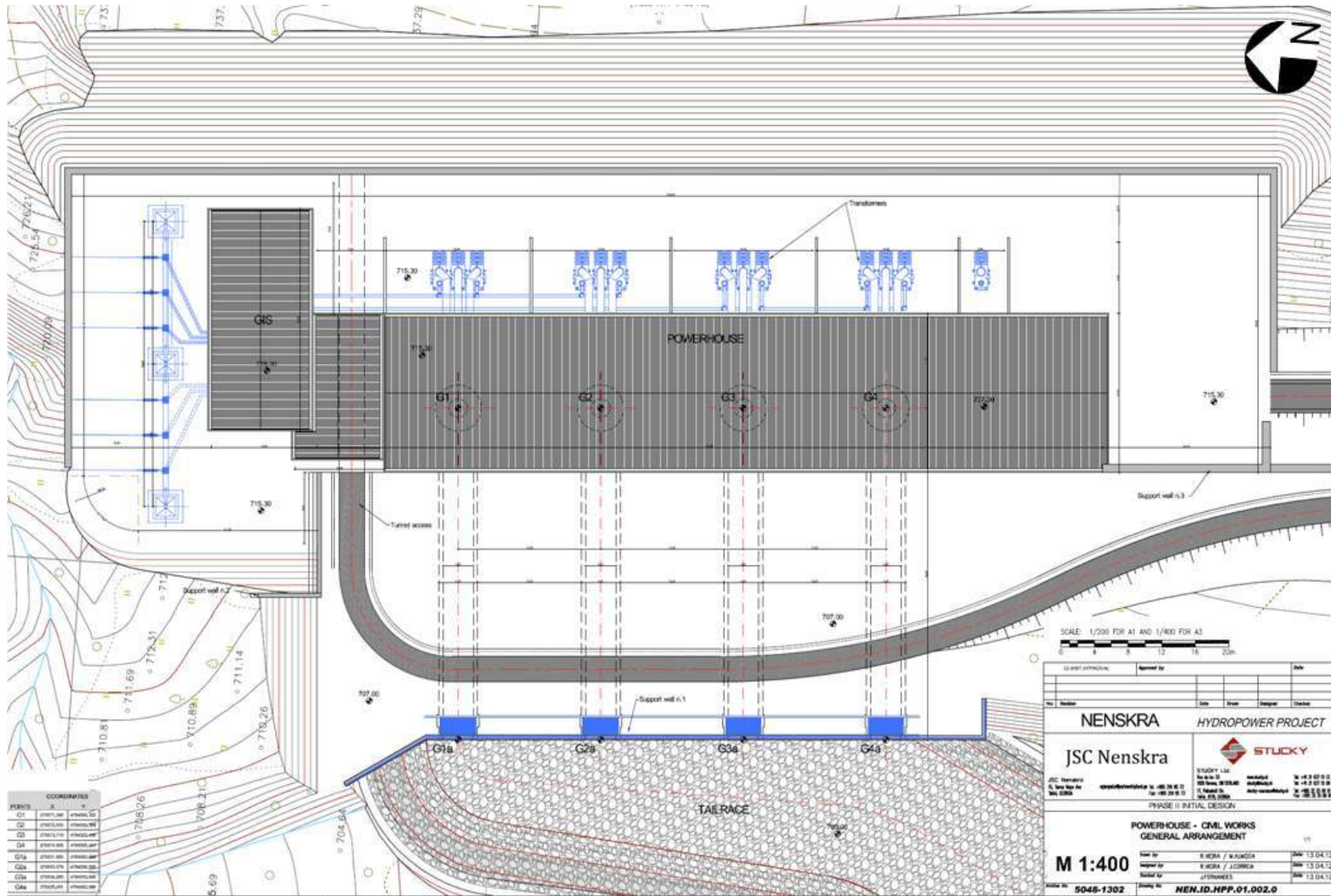



## 4.6 Transmission Line

After completion of the first phase of construction works, according to the technical conditions issued by the national energy system of Georgia, connection with the powerhouse network will be possible with 220 kV transmission line outgoing from the open distribution device of the HPP, which will be connected to the 220 kV open distribution device of the project 500/220 kV substation “Jvari”.

According to the economic density the project line cut “Nenskra HPP-Jvari” will be 2xAC-300/67, length will be approximately 50 km. Such line will provide conduction of total capacity of the HPP (280 MW). Substation Jvari, which is passed by the 500 kV transmission line “Kavkasioni”, will be connected to the 500 kV substation “Akhaltsikhe” with new 500 kV transmission line and with 220 kV transmission lines to the substations “Khorga” and “Khobi”.

After completion of the second phase of Nenskra HPP, when the installed capacity will rise till 280 MW, no additional works will be needed to connect with the grid and electricity will be transmitted with the existing transmission line.

The starting point of two-circuit 220 kV transmission line “Nenskra HPP- substation New Jvari” is portal of substation of the project Nenskra HPP, the last point is 220 kV portal of 500/220 kV substation “New Jvari”.

The route of the transmission line was chosen at desk in 3 different variants (A, B and C alternatives).

Difficult natural conditions are present on the proposed territories of the transmission line route, followings are important:

- Narrow valleys of the rivers Nenskra and Enguri;
- Poorly developed road network;
- Existence of the Enguri reservoir;
- Project Khudoni reservoir;
- Dense forests in valleys of both rivers;
- Dense hydrographic network;
- Complex terrain of the valley and big difference in altitudes;
- Crossings of different capacity (500, 110 and 35 kV) transmission lines on the alternative routes of project transmission lines and etc.

Possible technical characteristics of the alternatives of the transmission lines are given in Table 4.6.1.

**Table 4.6.1.** Possible technical characteristics of alternative transmission lines

Nº	Technical characteristic	A	B	C
1	Length, km	50	52	52.4
2	Crossing the riv. Nenskra	1	-	-
3	Crossing the riv. Enguri	1	2	2
4	Crossing Enguri reservoir or its part	6	4	4
5	Number of angle abutment	100	113	112
6	Number of interstage abutment	60	54	55
7	Crossing the riv. Lakhmi	1	-	-
8	Crossing the project Khudon reservoir	3	3	3

Scheme of alternatives of transmission line is given in Figure 4.6.1.

According to the presented scheme most part of the route B and C will be arranged along the Mestia-Zugdidi highway, on the left bank of Enguri reservoir, which will reduce need for new road arrangements and therefore, risk of negative impact on physical and biological environment will be reduced. However, proximity of highways and populated areas might have certain risk during construction works (especially during blasting works).

In case of variant A the transmission line will be arranged on the right bank of Enguri reservoir, along the corridor of transmission line “Kavkasioni”. Existing roads (road arranged for construction of “Kavkasioni”) can be used for transportation of building materials for the transmission line. In addition, the area is not populated and works will not be related to the risks of safety or resettlement.

As mentioned above, the alternatives were chosen at desk, therefore coordinates of pile locations are not yet determined. Considering this factor, selection of the best alternative version and conduction of environmental and social impact assessment is impossible at this stage. Environmental impact assessment will be developed after preparation of working project of transmission lines.

**Figure 4.6.1.** Scheme of alternatives of transmission lines

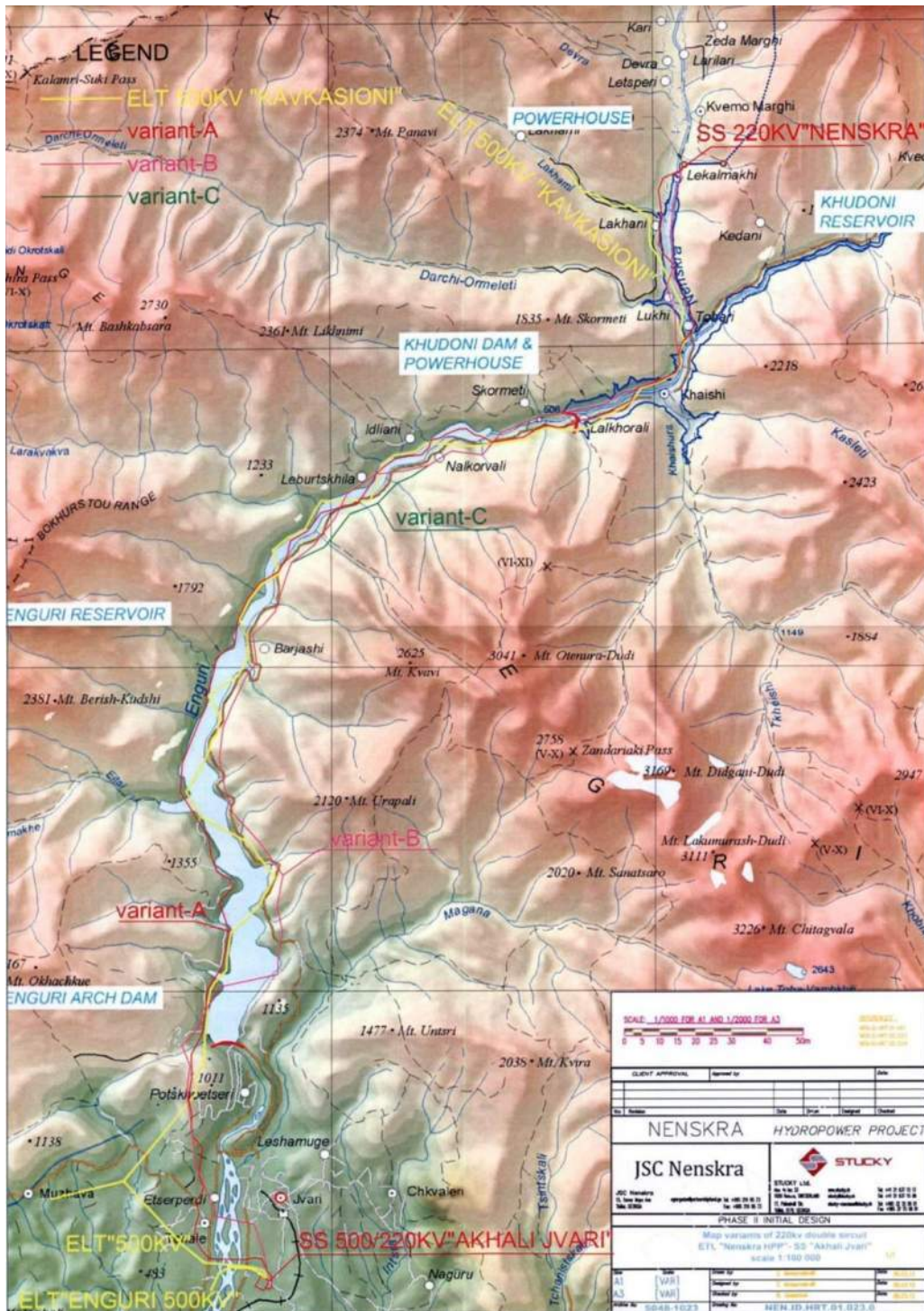



## 4.7 Construction Works

### 4.7.1 General Overview

Proposed conception of the construction camps was developed with consideration of the economic and ecological interests:

- Reduction of areas for construction camps – restriction of expropriation;
- Reduction of distances between the camps and also camps and construction sites – traffic restriction, reduction of need for new road arrangement, minimization of atmospheric emission.

The project territory needs to be divided into three zones. Each zone will operate independently, will have its own warehouses, workshops, offices for clients and consultants, offices and apartments for engineers and workers. Three zones will be presented as follows:

- Nenskra dam, where Nakra tailrace tunnel TBM platform is also considered;
- Power unit of the HPP, including pressure system construction site and Nenskra tailrace tunnel TBM platform is also considered;
- Nakra water intake.

Power unit zone will be the most important center for client management team, consultant's management and project team and contractor's management. Infrastructure developed for the project can be arranged on the powerhouse territory and can be used for plant operation-technical maintenance. As for the additional offices, workshops and warehouses – they can be used by local entrepreneurs after the project finalization.

Location of construction camps is given in Figure 4.7.1.1.

Figure 4.7.1.1. Location of construction sites

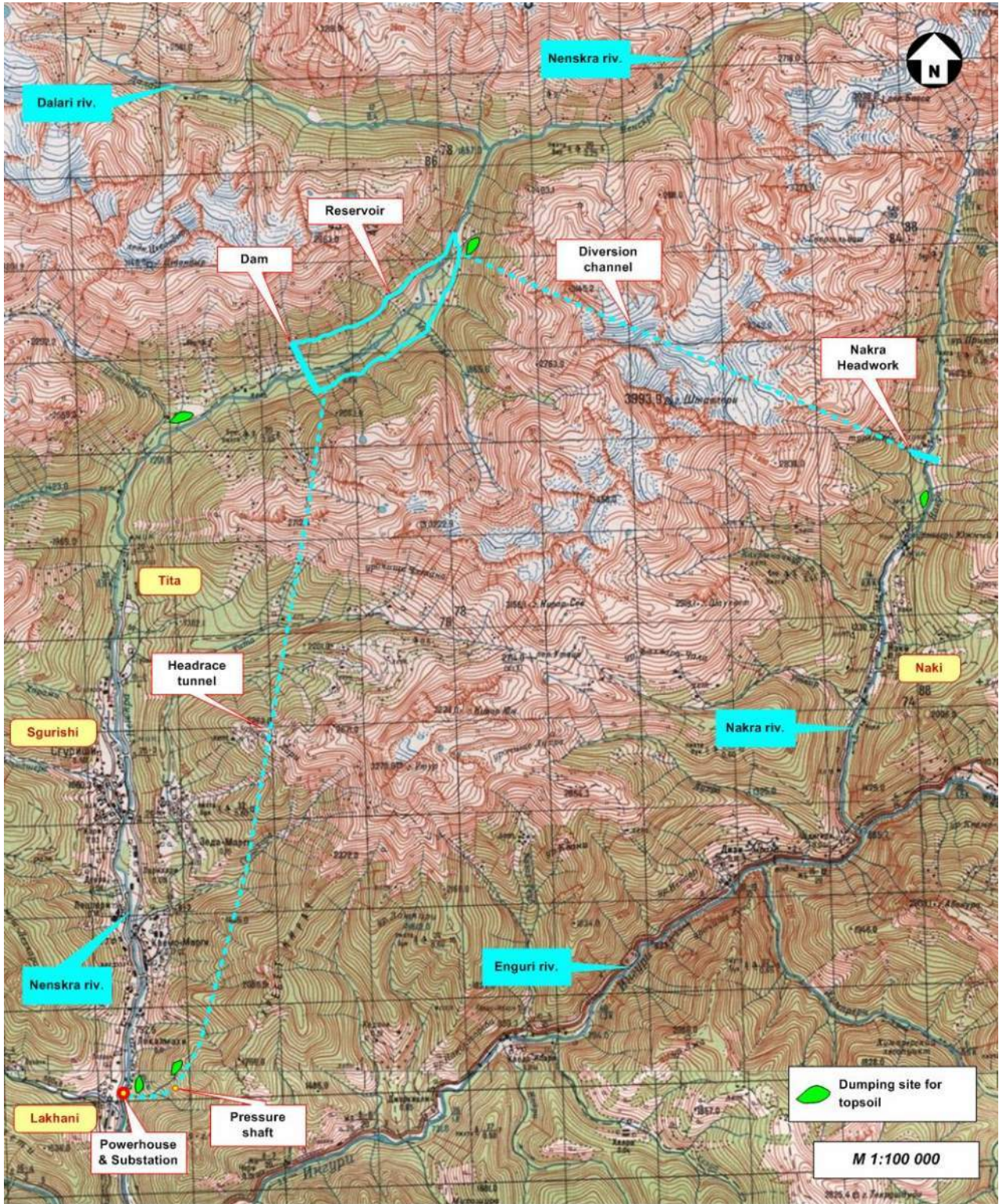

#### 4.7.2 Nenskra Dam Construction Zone

All infrastructure on this territory will be temporary structures, except the small technical maintenance building, which will be used during the operation of the dam. All construction infrastructure will be located downstream of the dam, namely: on a relatively flat terrain between the confluence of Memuli and Nenskra Rivers. It should be noted that the area selected for the construction site is not rich with vegetation cover and flat terrain creates favorable conditions for the arrangement of construction infrastructure.

Construction site will be partially used for Nakra tailrace tunnel TBM platform, namely: residential premises, warehouses and part of the workshops will be used. Construction materials will be supplied to Nakra platform through the road, which is planned to be arranged on the left bank of Nenskra River.

The construction infrastructure site and residential buildings for workers will be separately located on the construction camp territory. Following objects will be arranged on the construction infrastructure site:

- Crushing-sorting workshop for inert materials;
- Concrete unit;
- Asphalt-concrete plant (for asphalt required for dam);
- Parking for construction equipment and transport facilities;
- Auxiliary workshops and etc.

This construction camp will also serve construction of diversion tunnel of Nakra, for this purpose the road will be arranged on the left bank of the reservoir.

CFRD (concrete-faced rock fill dam) type infrastructure is related to the quarry arrangement with blasting and material transportation to the dam. The quarry will be arranged near the river Tskhandiri. This infrastructure requires mobile devices, such as quarry boring machine, excavator for big bulks, trucks with big capacities and strengthening rollers. Distance for transportation is 2.4-3.0 km.

Considering big amount of alluvial material on the bottom of the dam and its suitability for the concrete works, it will be used for construction of dam and other infrastructure.

Transportation and storage of alluvial material can begin before the construction works (on the preparation phase). This ensures collection of relevant amount of inert material in tailrace before the arrangement of the dam. Other related works are arrangement of the diversion tunnel, arrangement of a tunnel for the TBM and spillway. These works are related to the mobile equipment and experienced workers.

Offices and apartments for personnel, consultants, engineers and workers will be arranged to the north-west at an altitude of 1190-1200 m. there are several springs in the vicinity of the construction site, which can be used for drinking-agricultural purposes. It should be noted that chemical composition of groundwater in the region is in line with the requirements of technical regulation on drinking water.

Electricity will be provided from the local power grid. For this purpose a transmission line must be arranged between work area and the village Tita. It should also be considered, that the transmission line of Tita will need the rehabilitation works.

Given that energy supply is also related to the operation of the TBM, which needs 3-5 MW, arrangement of the transmission line is the best option. Plan of the rock-fill dam construction camp is given in Figure 4.7.2.1.

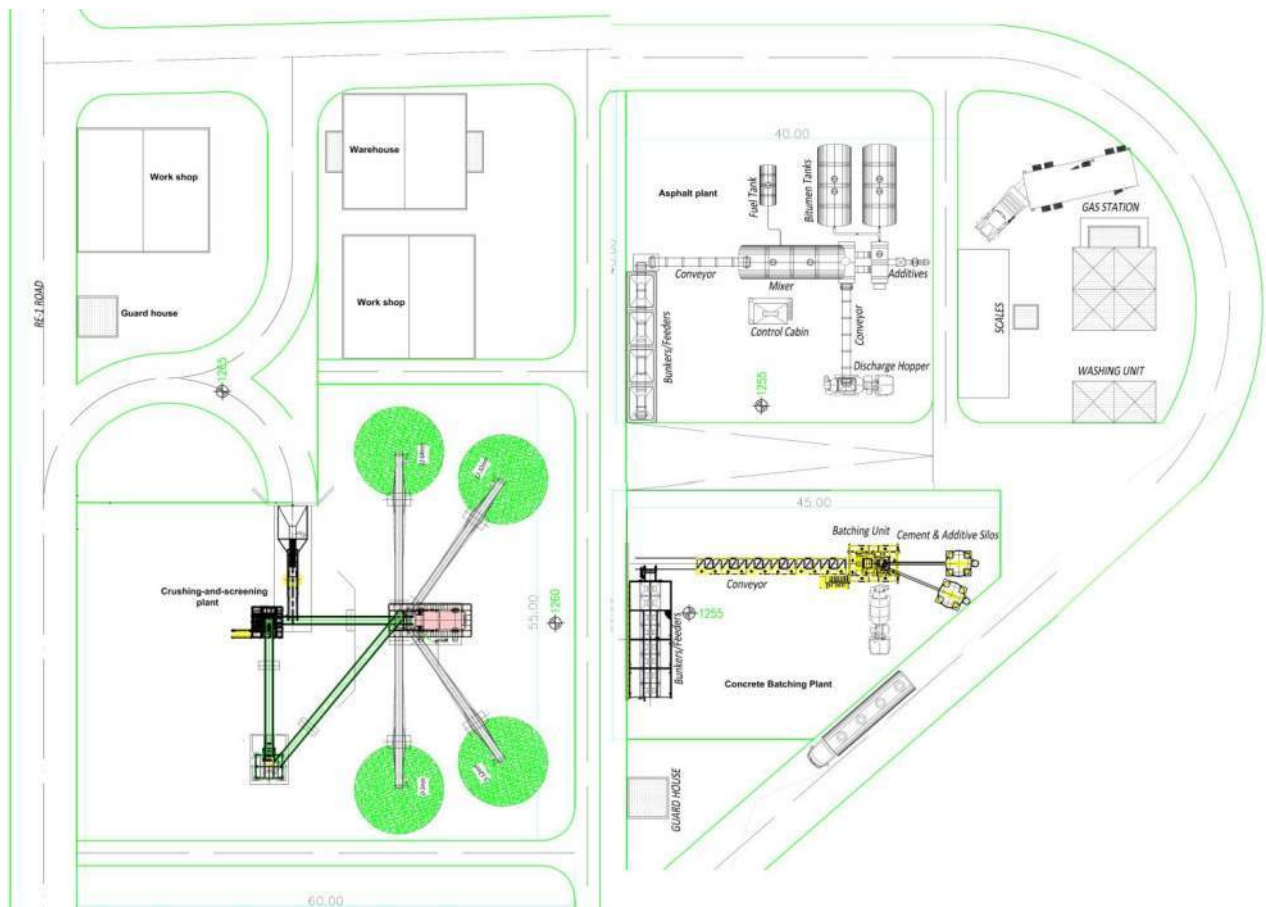
**Figure 4.7.2.1.** Scheme of Nenskra dam construction site

### 4.7.3 Power Unit Construction Zone

The power unit zone infrastructure will be of permanent nature. Main issues for the contractors are following:

- Providing TBM to the platform (600 m from the village Chuberi level);
- Provision of workers and materials to the platform;
- Arrangement of the equalizing shaft (diameter 6 m, length 245 m);
- Arrangement of vertical shaft, connecting pressure shafts and installation of the steel lining;
- Construction of the power unit.

Arrangement of concrete unit, building materials warehouses, workshops and other supporting infrastructures is planned within the construction site. Administrative residential premises for customer's management team and building contractor staff will be arranged on the territories adjacent to the construction site. Arrangement of the road is planned from Kvemo Marghi village for the purpose of construction materials and personnel transportation from power unit construction site. Part of the existing road corridor will be used for the arrangement of this access road. Construction site will be supplied with power from the existing network. As for the water supply, springs and wells existing in Kvemo Marghi and Lekalmakhi villages will be used. Prior to the construction works, the building contractor will select water resources and prepare the project of engineering infrastructure.

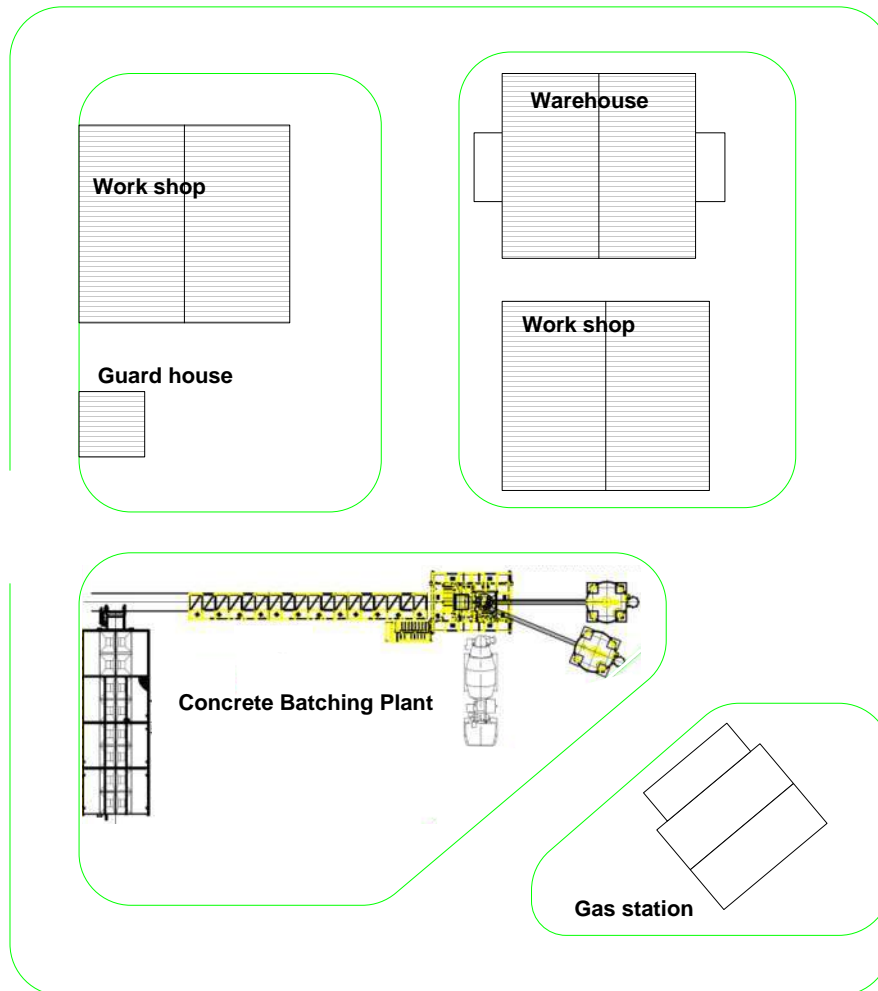
**Figure 4.7.3.1.** Plan of the construction site of Nenskra power unit

#### 4.7.4 Nenskra Tailrace Tunnel Construction Site (Tunnel Boring Machine Platform)

During the work planning the arrangement of the TBM infrastructure needs a careful evaluation. Most important issues are – location on the high level of the valley, material supply and waste disposal.

TBM will be deployed after arrangement of the platform and the access road. Certain parts of the TBM will be delivered by the trucks. Its largest part will probably weight 25-30 tons. In terms of correct road arrangement and utilization of the relevant equipment TBM delivery to the platform will not be hard.

The TBM will work non-stop during 12 months, hence, transportation of workers and material supply is an important issue.

Given the assumption, that the tunnel will be arranged in one direction only, number of prefabricated segments will be 50 000. A large area is required for storage of the segments, while this territory is only available in the grove, near the cement, reinforcement and equipment storage territory.

In terms of 15 m daily excavation, 60 segment of the lining must be delivered to the platform daily. Each segment weights 2,5 tons. This means 30 lads of trucks, 2-3 trucks per hour. In case of the maximum regime of the excavation, the TBM can reach the double depth, which would mean 60 loads of trucks daily. Delivery distance is estimated for the 16 km route both ways for two segments or 25 000 routes, which creates total distance of 40 000 km. Due to winter conditions, the road may be hard to access. In addition, there is a risk of environment impact, namely: emission of harmful substances, noise, dust and odor. Therefore, the appropriate mitigation measures will be required.

One of the effective solutions is rope-way. Each wagon of the modern 20-cart system installed on the ski resorts can shift approximately 3,5 tons. This system uses single or double rope-way and is stretched for 3,5 km. The speed is 7 m/sec. This means, that transportation of TBM parts and other material, as well as workers will be very effective and easy. This system has many positive sides. It is recommended to use it. Selection of the method of transportation of construction materials is the prerogative of construction contractor and the issue will be finally settled after its selection.

In order to prepare the concrete mixture for facing the tunnel, concrete unit with 30 m<sup>3</sup>/h will be arranged on TBM platform. Waste rock withdrawn from the tunnel will be used as an inert material. Water will be supplied from nearby ravine.

Another important issue is disposal of waste generated on the TBM operation stage. Amount of generated waste will be 330 000 m<sup>3</sup>. An important issue of the following phase will be possibility of waste utilization near the TBM portal. Materials from this area to a temporary disposal area will be transported by trucks or belt conveyors. From this point waste can be removed by trucks or belt conveyor. Utilization of belt conveyors in the sensitive areas is a wide spread practice. The conveyor does not produce noise, is clean and covered in order to prevent emissions. They can be used on long and short distances. Vertical conveyor length reaches 500 m.

A large part of the rocks stockpiled on TBM platform will be used for concrete production, while the rest part will be permanently stored in the upstream of Nenskra reservoir. Important is that waste rock generated from TBM will be of fine fraction and thus, arrangement of crushing-sorting aggregate is not required.

Required energy supply for the TBM is approximately 3-5 MW, therefore arrangement of the transmission line is foreseen. Diesel generators will be used for other works.

#### **4.7.5 Surge Shaft**

The most effective way to arrange the surge shaft is utilization of the cylinder perforator. All parts will be delivered to the platform by the trucks or rope-way. Waste rock will be disposed with the TBM wastes. The concrete plant arranged on the TBM platform will provide concrete for shaft paving.

#### **4.7.6 Pressure Shaft**

The pressure shaft will be excavated from two pressure tunnels. These tunnels (the diameter is approximately 4.5 m) will be excavated till the pressure shaft bottom and then the shafts will be arranged with the Alimak method (vertical drilling and blasting) or drilling from the upper platform. It implies, that waste will be managed from both tunnels and considering small amounts – approximately 3000 m<sup>3</sup> – will be utilized at the portals. Steel lining will be produced on the production field and transferred to both tunnels. Usually, each part weights 5 tons, and the length is 2 m. Therefore, the upper shaft will require 130 pieces, and the middle pressure tunnel and the shaft will require 170 pieces. They can be delivered either by trucks or by rope-way, if the rope-way will withstand the weight (each part weighs 5 tons).

#### **4.7.7 Residential Premises for Workers**

The residential premises for the management/engineering teams and workers will be of temporal nature and will be located on the territory of the construction camps.

The permanent offices will be arranged either by the pre-construction contractor or the main contractor. In future the office will be used by the client for the HPP operation purpose. The contractor will arrange temporary offices depending on the area. The residential areas for the client and the consultants will be also of permanent nature and later will be used for the HPP operation/service.

#### **4.7.8 Nakra Intake**

Considering a relatively small scale of construction works required for the arrangement of Nakra intake, a small area for the construction site will be enough, where concrete unit (30m<sup>3</sup>/h capacity), crushing-sorting plant, warehouses, workshops, shelters for equipment and vehicles, as well as administrative and residential premises will be arranged.

The construction camp will be of temporary nature and will operate only 1-1/2 year. A small permanent auxiliary building will be arranged here. Monitoring of all activities will be conducted from the central control point arranged on the power unit territory.

Local sand and gravel will be used for inert material production, as the transportation of the tunnel waste rock to the Nakra intake construction site will be unacceptable from both environmental and economic point of view.

#### **4.7.9 TBM Platform of Nakra Tailrace Tunnel**

Arrangement of TBM platform for Nakra tailrace tunnel is planned in Nenskra River valley, on the left bank of the proposed reservoir. Arrangement of access road to the platform is planned from Nenskra dam along the left bank, on the upper point of the maximum pool elevation of the reservoir.

Infrastructure required for TBM operation will be arranged on the platform, including containers used as rest stations for employees, storage containers for auxiliary materials, etc. Concrete facing of the internal surface of the tunnel will be possible through concrete unit of the Nenskra dam construction site, from where concrete mixture transportation distance will be about 4.7 km. Waste rock, withdrawn from the tunnel will be used as inert material for concrete production. Withdrawal of waste rock from tunnel is planned by belt conveyor and they will be temporarily stored on the platform. Most portion of the waste rock will be used for concrete production, while the rest part will be stored at the bottom of the proposed reservoir. Drainage water from the tunnel will be withdrawn with gravity flow. Arrangement of sediment ponds is planned on platforms for purification of drainage waters from suspended particles. Purified water will be discharged into Nenskra River. Residential premises existing near the Nenskra dam construction site will be used for workers employed for the construction of tunnels. Resting stations (containers) for employees will be arranged on the platform of Nakra tunnel.

About 4.5 km long power transmission line (10/04) will be withdrawn from the dam construction site through the proposed road corridor in order to supply TBM with electricity.

#### **4.7.10 Roads**

##### **4.7.10.1 Nenskra Dam Site**

The project includes the arrangement of roads in order to facilitate construction works of Nenskra HPP, some of which will be used during the construction phase and some (access road to the dam and Nakra tailrace tunnel, access road to the pressure system and access road to Nakra intake) will be further used during the operation phase. It should be noted that part of the proposed roads (e.g. access roads to

Nenskra dam and Nakra weir) will be arranged within the corridors of the existing roads, which will significantly reduce possible risks of environmental impacts.

Most of the design roads will be arranged in difficult terrain conditions, due to which slopes will be cut and drainage structures will be arranged at natural valleys crossing areas existing within the corridor. Waste rock generated during the construction of roads will be stored upstream of the dam, which will further be the bottom of the reservoir.

Description of the design roads is given below. Schemes of the proposed roads are given in Figures 4.7.10.1. and 4.7.10.2.

#### **A. Existing ERD road**

The length of the existing road to Nenskra dam is 15.13 km. The major part of the road (10-11km) has been rehabilitated in 2013-2014. Prior to the construction works, the rest part of the road should be rehabilitated. The project includes the extension of the road by 4.7 km, which will be used for the operation of quarries of inert materials upstream of the proposed dam.

The total length of the road will be 19 km. At present, this road is intensively used by local population.

Based on topographic survey of the road corridor, no significant earth works will be required. Arrangement of culverts is planned for the drainage of lateral tributaries existing in the corridor.

#### **B. NE-US-SPL Spillway Access Road to be Constructed**

In order to reach the spillway on right bank the construction of the NE-US-SPL road having a length of 1.66 km is planned. The road of concern shall branch from the existing ERD road at elevation 1'289 masl and shall reach to the spillway at elevation 1'445 masl thus having an overall inclination of 10%.

Along its alignment, for creek crossings, culverts with 2 x 1.80 x 1.80 at kilometers 0+505 and 0+810 and 2x2.20x2.20 at Km: 1+500 need to be constructed.

#### **C. NE-US-BRG ÷ GS Road To be Constructed**

NE-US-BRG÷GS Road is to be constructed from the existing bridge to reach the gate shaft platform on the left bank of the dam body originating from elevation 1'236 masl with an overall length of 3.16 km. After having reached the gate shaft platform, the road shall be extended down to the headrace tunnel inlet platform at elevation 1'329.60 masl.

Along its route, the road will cross various creeks, for such crossings, the below listed culverts at the defined changes and dimensions need to be constructed.

<b>section</b>	<b>Culvert Dimensions</b>
0+790.00	2 X 1.80 m X 1.80 m
1+240.00	1 X 1.80 m X 1.80 m
1+870.00	2 X 1.80 m X 1.80 m
2+290.00	1 X 1.50 m X 1.50 m
2+310.00	1 X 1.50 m X 1.50 m
2+540.00	1 X 2.00 m X 2.00 m
3+100.00	1 X 1.50 m X 1.50 m

#### **D. NE-US-BRG ÷ LLO Road to be constructed**

492 m long NE-US-BRG÷LLO Road is planned to be constructed to reach the low level outlet excavations. It branches from the NE-US-BRG÷GS road at elevation 1'317 masl and finally reaches to the



low level outlet platform at elevation 1'282 masl. Along its entire length, neither engineering structures like culverts, etc. nor masonry walls are required.

#### **E. NE-US-BRG ÷ HRT-I Road to be constructed**

NE-US-BRG÷HRT-I Road is planned to originate from the NE-US-BRG÷GS Road at elevation 1'362 masl and to reach to the headrace tunnel inlet platform at elevation 1'329.60 masl with a length of 1364 meters.

Before its end point, at change approximately 1+130, this road will also provide access to the low level outlet inlet platform situated at elevation 1325 masl.

Once the construction works related to diversion is completed, the portion between the low level entrance and headrace tunnel inlet will be under water. Consequently, this road will no longer be used to reach to headrace tunnel inlet.

In this respect, an alternative route to reach to the headrace tunnel inlet need to be considered.

Along its route, the road will cross various creeks, for such crossings, the below listed culverts at the defined changes and dimensions need to be constructed.

section	Culvert Dimensions
1+265.00	1 X 1.50 m X 1.50 m
0+540.00	1 X 1.80 m X 1.80 m
0+700.00	2 X 1.80 m X 1.80 m

#### **F. NE-US-GS ÷ HRT-I Road to be constructed**

As it is noted above, to enable headrace tunnel construction NE-US-GS÷HRT-I Road, which starts from the excavation berm of gate shaft platform at elevation 1'440 masl and descends down to elevation 1'329.60 masl within a length of around 1.63 km, is planned to be constructed.

Along its route, the road will cross various creeks, for such crossings, the below listed culverts at the defined changes and dimensions need to be constructed.

section	Culvert Dimensions
0+945.00	1 X 1.50 m X 1.50 m
1+050.00	1 X 1.80 m X 1.80 m
0+500.00	2 X 1.80 m X 1.80 m
1+225.00	2 X 1.80 m X 1.80 m

#### **G. NA-DS-GS ÷ PWH Road to be constructed**

The construction of the NA-DS-GS÷PWH road is planned to access the TBM platform of Nakra tailrace tunnel. The length of the road is 2.37 km and starts from surge shaft section, at 1'440 m elevation and extends till the Nakra tunnel platform, at 1'439 m elevation.

Along its route, the road will cross various streams and for such crossings, the below listed culverts at the defined sections and dimensions need to be constructed.

section	Culvert Dimensions
0+400.00	2 X 1.80 m X 1.80 m
0+830.00	1 X 1.50 m X 1.50 m

0+915.00	1 X 1.80 m X 1.80 m
1+390.00	1 X 1.50 m X 1.50 m
1+490.00	1 X 2.00 m X 2.00 m
2+210.00	2 X 1.80 m X 1.80 m
3+100.00	1 X 1.50 m X 1.50 m

#### H. NA-DS-GS ÷ ST Road to be constructed

A branch 1300 meters after the start point of the NA-DS-GS÷PWH road is targeted to reach the Nakra Surge Shaft Platform at elevation 1'665 masl with a length of approximately 1320 meters thus having an inclination of 11%.

Along its route, the road will cross various creeks, for such crossings, the below listed culverts at the defined changes and dimensions need to be constructed.

section	Culvert Dimensions
0+090.00	1 X 1.50 m X 1.50 m
0+205.00	1 X 2.00 m X 2.00 m
1+020.00	1 X 2.00 m X 2.00 m

#### I. NE-DS-ERD ÷ ADIT-1 Road to be constructed

The road of concern is targeted to reach the TBM Platform at elevation 1'185 masl with a length of approximately 3'941 meters.

The road branches from the existing road on the left bank of the Nenskra River at the upstream of Zemo Marghi Village. At this junction, the road elevation is 893 masl.

Along its route, the road will cross various creeks, for such crossings, the below listed culverts at the defined changes and dimensions need to be constructed.

section	Culvert Dimensions
2+310.00	1 X 1.50 m X 1.50 m
2+700.00	1 X 1.50 m X 1.50 m
3+010.00	1 X 1.80 m X 1.80 m
1+890.00	1 X 2.00 m X 2.00 m
0+980.00	4 X 2.00 m X 2.00 m
1+165.00	4 X 2.00 m X 2.00 m

#### J. NE-DS-ERD ÷ ADIT-2 Road to be constructed

3033 m long NE-DS-ERD÷ADIT-2 Road is planned to be constructed to reach the adit 2 tunnel inlet platform. It branches from the NE-DS-ERD÷ADIT-1 road at elevation 1'021 masl and finally reaches to adit 2 tunnel inlet platforms at elevation 1'300 masl.

Along its route, the road will cross various creeks, for such crossings, the below listed culverts at the defined changes and dimensions need to be constructed.

section	Culvert Dimensions
0+320.00	1 X 1.50 m X 1.50 m

0+730.00	1 X 1.50 m X 1.50 m
2+600.00	1 X 1.50 m X 1.50 m
2+770.00	1 X 1.50 m X 1.50 m
3+010.00	1 X 1.50 m X 1.50 m
1+080.00	1 X 1.80 m X 1.80 m

#### K. NE-DS-ADIT-2 ÷ HRT-O Road to be constructed

NE-DS- ADIT-2÷HRT-O Road starts from the excavation berm of adit 2 tunnel inlet platforms at elevation 1'300 masl and drives down to elevation 1'277 masl within a length of around 1.6 km thus having an inclination of 10%.

Along its route, the road will cross various creeks, for such crossings, the below listed culverts at the defined changes and dimensions need to be constructed.

section	Culvert Dimensions
0+205.00	1 X 1.80 m X 1.80 m
0+070.00	1 X 1.80 m X 1.80 m

#### L. NE-DS-ADIT-2 ÷ ST Road to be constructed

A branch 910 meters after the start point of the NE-DS- ADIT-2÷HRT-O road is aimed to reach the Nenskra Surge Shaft Platform at elevation 1'492 masl with a length of approximately 2040 meters.

Along its route, the road will cross various creeks, for such crossings, the below listed culverts at the defined changes and dimensions need to be constructed.

section	Culvert Dimensions
0+040.00	1 X 1.50 m X 1.50 m
0+775.00	1 X 1.50 m X 1.50 m

#### M. NE-DS-ERD ÷ PRS Road to be constructed

To access to the pressure shaft platform, 787 m long road, which branches from the existing road at elevation 753 masl and reaches to the platform at elevation 827 masl need to be constructed. Along its entire length, neither engineering structures like culverts, etc. nor masonry walls are required.

The Powerhouse site is accessible with the main access road along the river and no significant access requirements in terms of construction and/or rehabilitation are required.

### 4.7.10.2 Nakra Weir Site

#### A. Existing Road

The length of the road from Chuberi (where offices of the building contractor and the customer will be located) to the Nakra weir is 32 km. The first 20 km of the road is the section between Chuberi and the confluence of Nakra and Enguri rivers, while the remaining 12 km is the section between the confluence and the proposed dam area.

20 km section of the road is in good condition, while the 12 km section requires significant rehabilitation works in order to ensure safe movement of construction equipment and vehicles.

#### B. NA-US-ERD ÷ HRT-I Road to be constructed

A sidetrack from the existing road approximately at elevation 1551 masl follows a path almost parallel to Nakra river reaches to Nakra headrace tunnel inlet platform at elevation 1603.50 masl within 1685 meters. Along its entire length, neither engineering structures like culverts, etc. nor masonry walls are required.

### **C. NA-US-ERD ÷ WEIR Road to be constructed**

The access to the Nakra weir (1580 m long) will be ensured by an access road which branches from NA-US-ERD÷HRT-I Road at elevation and change of 1535 masl and 0+440, respectively. After its start point, between changes Km: 0+050 and 0+150, a 150 m long river crossing bridge need to constructed.

Similar to headrace inlet platform access road, neither culverts nor masonry walls are required.

The roads are to be constructed mostly in cut and shall be supported with masonry walls due to steepness of the natural topography. The table below presents the location of the masonry walls that have to be constructed for the above described access roads.

Figure 4.7.10.1. Scheme of the proposed roads within the area selected for the arrangement of the dam

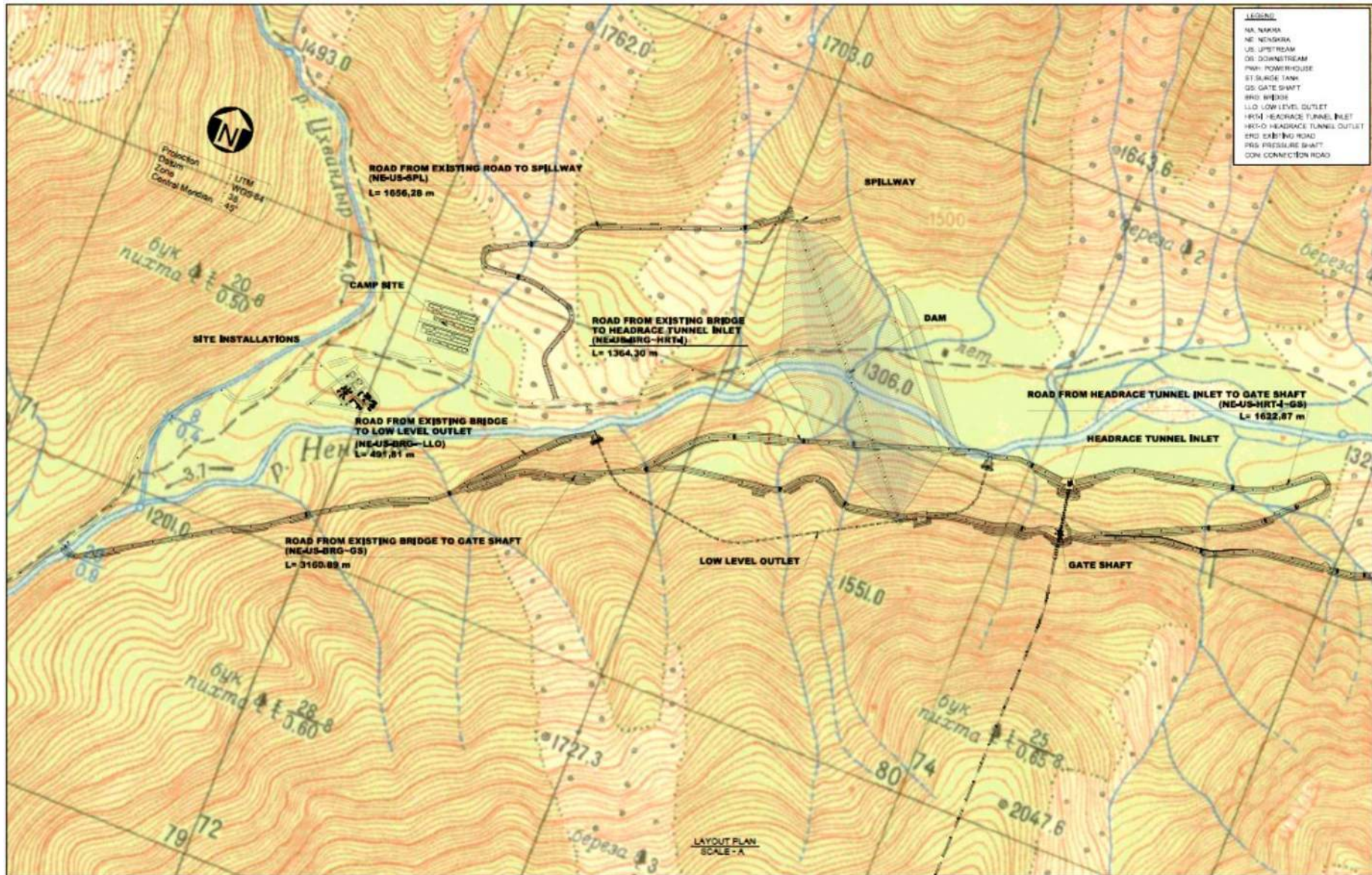
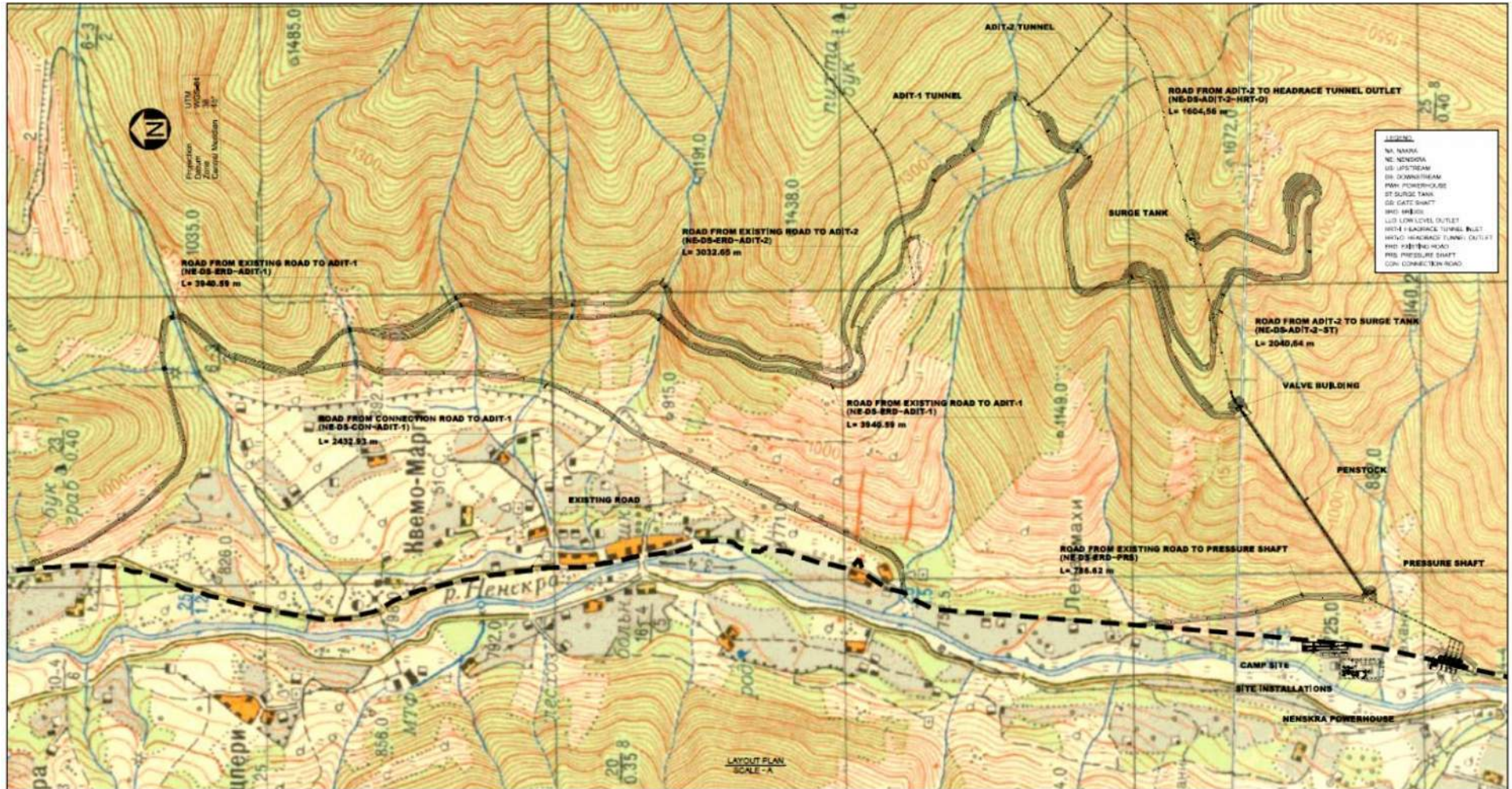

Figure 4.7.10.2. Scheme of the access roads to the TBM platform and pressure system



#### 4.7.11 Local Construction Materials

Construction of Nenskra HPP will be provided with both local and imported building material from other regions of the country. Mainly cement, metal structures and other materials will be brought from other regions, while inert materials (sand, gravel and stones) and timber will be extracted on site. Timber will be purchased from licensed factories operating in the municipality of Mestia, while inert materials will be extracted from quarries identified within the project area. Prior to the construction works of the HPP, construction contractor will provide geological conclusions of quarries and will obtain a license on utilization of Natural Resources through established procedure.

**Stone quarry:** due to the large size of rock-fill dam, significant amount of stone will be required. As a result of the exploration works, stone quarry suitable for the construction of the dam was found on the right slope of the confluence of Nenskra and Okrili rivers (see Figure 4.7.11.1.). The area selected for the quarry is approximately 4.5-5.0 ha (boundaries will be specified during the licensing process). The area is sharply inclined towards the south-east. Major part of the surface is covered with stones. Vegetation cover of the slope is mainly represented by spruce and pine trees. Alder is found along the river banks.

**Figure 4.7.11.1.** General view of the area selected for the stone quarry



Quarry drilling and blasting method will be used. Building material will be transported to the dam construction site by dump trucks. Based on the Environmental Legislation of Georgia after completion of works on the quarry, conditions for recultivation of the surface should be determined according to the license conditions. In general it can be said that preventive measures for reducing risks of geological hazards activation on slopes should be considered during operation and recultivation processes.

**Sand and gravel quarries:** Sand and gravel quarries suitable for the construction works were found in the upstream of the dam. 4 mining areas have been selected within approximately 4 km section of the river. 4.7 km long road will be arranged for transportation of inert materials from the quarries. The major part of the inert material will be extracted prior to the construction and will be stored within the construction site of the dam for further utilization.

License required for the extraction of inert material will be obtained by building contractor prior to the construction works. It should be noted that waste rock generated during the construction works will be disposed within the area selected for sand and gravel quarries and after this area will be covered by reservoir water. Therefore, recultivation of the surface of the quarries will not be required.

Inert material required for the construction of Nakra weir and intake will be extracted from quarry found in the vicinity of Nakra River. due to a small volume of planned construction works, area selected for the quarry is 1.5 ha (see Figure 4.7.11.2.). Terms and conditions of operation of the quarry and surface recultivation will be determined according the license on utilization of natural resources. The license will be obtained by building contractor after receiving construction permit.

**Figure 4.7.11.2.** Layout scheme of inert material quarries

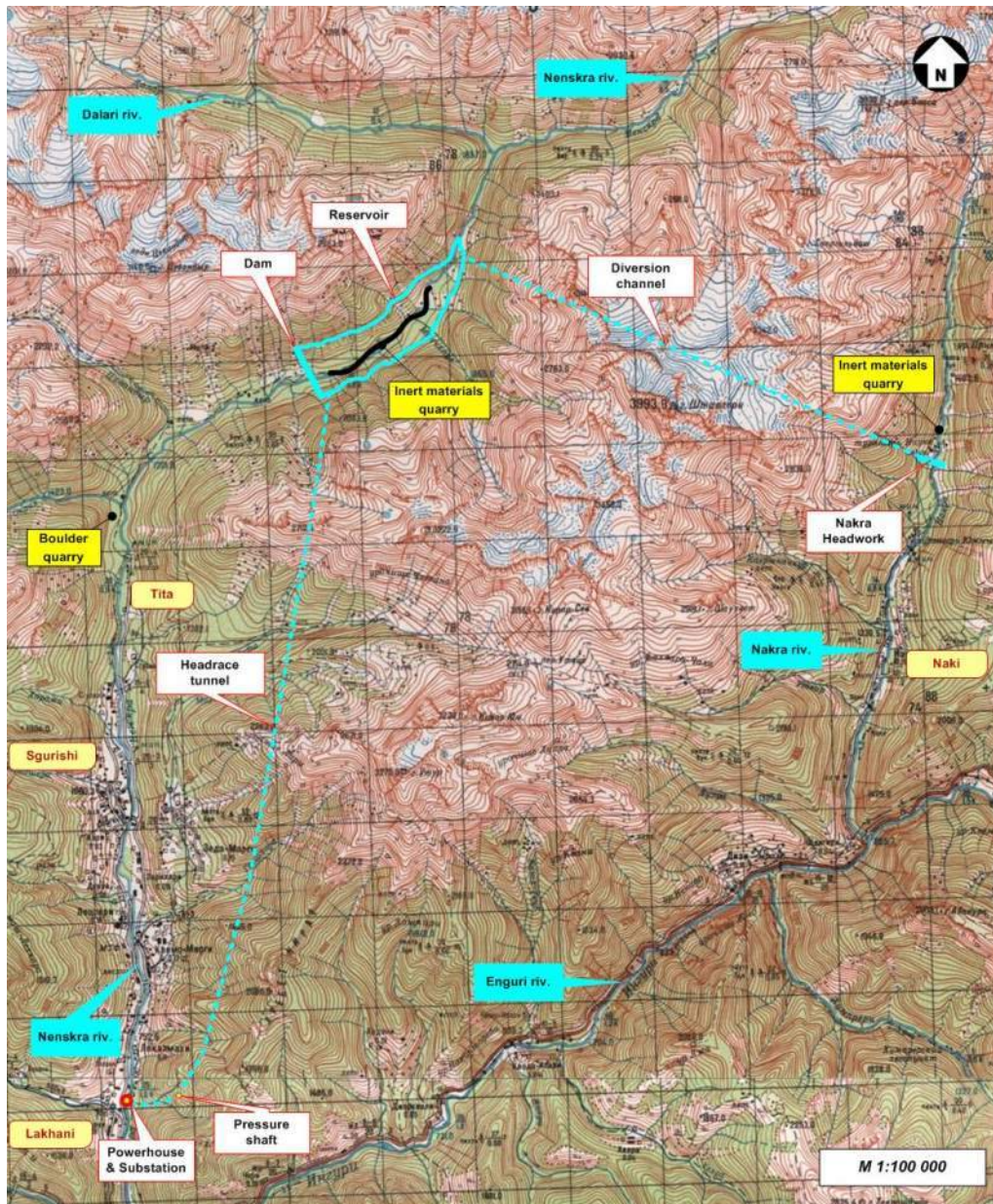

#### 4.7.12 Terms of Performance and Personnel

Tunnel arrangement will require the longest period of time. Relatively long period will be required for the construction of Nenskra dam, derivation system and power unit, which will last for about 6.0-6.5



years. In parallel with these works, construction of Nakra intake and tailrace tunnel will be launched, which will last about 4.0 – 4.5 years.

Required number of workers on the construction phase will be 500-600. According to the social policy of the “Nenskra” JSC a necessary condition of the contract will be employment of local population for unqualified works. According to the survey done within the local residents a certain group has been selected, which will be trained in order to raise their qualifications and later will be employed at the construction site.

In case of such approach, 300-350 local workers will be permanently employed during the construction phase, which is very important for the improvement of the socio-economic conditions of local population.

Number of permanent work places on the operation phase will be not less than 50-60. In order to increase employment opportunities for the local population the “Nenskra” JSC is planning to recruit the personnel through the competition and to give opportunity of training in existing HPPs of other countries.

#### **4.7.13 Water Supply and Sewage System**

##### **4.7.13.1 Water Supply**

In the period of construction works water will be required for drinking and technical purposes. There are springs in every territory selected for the construction camps (the area is rich with quality underground waters). These springs will be used for drinking purposes. Special reservoirs will be used for drinking water supply; water for technical purposes will be accumulated in the black steel reservoirs.

Drinking water volume depends on the number of workers and amount of water required for one worker. According to the technical-economic justification project, maximal number of workers on the construction phase will be 600, water rate for one worker per day is 25 l. Considering 250 work days per year, and volume of water for drinking purposes will be:

$$600 * 25 * 250 = 3\,750 \text{ m}^3/\text{annually}, 15 \text{ m}^3/\text{daily}$$

Besides this, the drinking water will be used for showers. According to the construction norms and regulations daily amount of water per one shower unit is 500 l. Given, that the project considers arrangement of 3 construction camps and each will have 5-6 shower units, required water volume will be:

$$18 * 500 * 250 = 2\,250 \text{ m}^3/\text{annually}, 9 \text{ m}^3/\text{daily}$$

**Total volume of drinking water required for the construction phase is 6000 m<sup>3</sup>/annual, 24 m<sup>3</sup>/daily.**

60 workers will be employed on the HPP operation phase. Water rate per one worker is 25 l. The HPP will be operating in a continuous mode, 365 days a year. Two shower units will be arranged in the power house. Therefore, volume of water required on the operation phase will be:

$$60 * 25 * 365 = 547,5 \text{ m}^3/\text{annually}, 1,5 \text{ m}^3/\text{daily}.$$

$$2 * 500 * 365 = 365 \text{ m}^3/\text{annually}, 1,0 \text{ m}^3/\text{daily}.$$

**In total 912,5 m<sup>3</sup>/annually, 2,5 m<sup>3</sup>/daily.**

All three construction camps consider arrangement of relevant infrastructure, including: car and technique parking lot, concrete units, mechanical workshops, wood processing factories, warehouses and etc. On the construction phase the technical water will be used for concrete mixing and washing of

construction equipment and vehicles. Water from the rivers Nenskra and Nakra will serve as a technical water.

Construction equipment and vehicles will be serviced on the parking lot arranged on the construction camp territory. It will also have a car-wash. 5-10 vehicles will be washed daily. Volume of water necessary for washing one vehicle is 350 l. Considering 250 work days per year amount of water required for these purpose is:

$$10 * 350 * 250 = 875 \text{ m}^3/\text{annually}, 3.5 \text{ m}^3/\text{daily}, 0,44 \text{ m}^3/\text{h}$$

Therefore, amount of water required for three construction camp car-washes is:

$$2625 \text{ m}^3/\text{annually}, 10.5 \text{ m}^3/\text{daily}, 1.32 \text{ m}^3/\text{h}$$

Amount of water required for concrete plant operation depends on amount of production. Average amount of water for 1 m<sup>3</sup> of concrete is 0,3 m<sup>3</sup>, concrete plant production will be approximately 50 m<sup>3</sup>/h. Considering, that the concrete plant will operate in one shift for 160 days per year, amount of produced concrete mixture will be  $160 * 8 * 50 = 64\ 000 \text{ m}^3/\text{annually}$ . Therefore, required water volume is  $64\ 000 * 0,3 = 19\ 200 \text{ m}^3/\text{annually}$ .

Water volume required for functioning of three concrete units is **57 600 m<sup>3</sup>/annually**.

Therefore, approximate amount of required technical water is 60 225 m<sup>3</sup>/annually.

#### 4.7.13.2 Wastewater

Household-fecal wastewater amount is dependent on the amount of drinking water, which decreases by 5% loss. Given this, possible amount of household-fecal wastewater on the construction phase will be **5700 m<sup>3</sup>/annually, 22,8 m<sup>3</sup>/daily**.

For the wastewater purification purpose arrangement of the compact wastewater treatment plant is planned. After the purification process the water will be discharged into the rivers Nenskra and Nakra.

Agricultural-fecal wastewater generated on TBM platform will be collected in the 15-20m<sup>3</sup> hermetic pits, from where it will be transported by cesspoolage truck and will be discharged into sewage collectors of construction sites for biological treatment. Biological toilets will be arranged on the territory of construction sites.

The staff will be employed during operation of the power plant and industrial-fecal wastewater will be generated within the areas of powerhouse and dam. Total volume of industrial-fecal water generated during the operation phase will be **867 m<sup>3</sup>/a, 2,4 m<sup>3</sup>/d**. Arrangement of compact treatment plant is planned for the treatment of wastewater, from where purified water will be discharged into Nenskra River. Sanitation pits will be arranged for the collection of wastewater generated at headworks, which will be treated by the treatment plant of the power house.

As it was mentioned above, technical water will be used only on the construction camp territories, and therefore industrial wastewater will be generated her. As the water required for the cement production is fully utilized industrial wastewater will be generated only during the car-washing process. Expected amount of industrial wastewater will be 95% of the required amount (5% will be lost due to evaporation or other reasons). Therefore, wastewater volume will be 2494 m<sup>3</sup>/annually, 9.975 m<sup>3</sup>/daily, 1.3 m<sup>3</sup>/h.

For car-wash wastewater purification compact oil-trap installation is planned.

No industrial wastewater will be generated on the construction camp territories. However, the drainage waters generated on the tunneling process must be considered, as they may be polluted with suspended particles. It should also be noted, that the entire perimeter of the diversion tunnel is presented by the cliff rocks and contamination of the drainage water with the suspended particles is not expected. In

order to prevent turbidity during the drainage water discharge sedimentation pond arrangements are planned.

#### 4.7.13.3 Wastewater Treatment

For the purification process of the household-fecal wastewater generated on the construction camps and the HPP installation of the “Biotal” type compact biological treatment facility is planned.

Expected composition of the purified wastewater will meet the 91/271/EEC requirements (May 21, 1991) on wastewater treatment, namely:

- Suspended particles – 35 mg/l;
- Biological oxygen demand – 15 mg/l;
- Total Phosphorous – 2 mg/l.

After the purification process the wastewater will be discharged into the river Nenskra.

Industrial wastewater will be purified by the YCB-M-20 type treatment facility (oil trap). According to the technical documentation concentration of the hydrocarbon in the purified water will be 0,3 mg/l, suspended particle concentration will be 60 mg/l. Purified water will be discharged into the river Nenskra.

## 5 Environmental and Social Background Conditions of the Region

### 5.1 General Overview

Georgia is situated in the south-eastern part of Europe, in the Caucasus. The Caucasus includes the territory between Black, Azov and Caspian seas, which is divided into North and South Caucasus by the Caucasus Mountains. Georgia is in South Caucasus, in its North-West part. It includes the ancient transportation crossroad, which is known as Silk Road.

Russian Federation is bordering Georgia from the North, Azerbaijan from the South-East, Armenia and Turkey from the South and Black Sea from the West. Country’s territory is approximately 69,700 km<sup>2</sup>; its terrestrial boundary length is 1,461 km and 9%-315 km of entire Black Sea coast line.

**Figure 5.1.1.** Georgia in Caucasus region



Georgia includes nine regions and two autonomous republics. Samegrelo-Zemo Svaneti region is situated in the central North-West part of Georgia. Total area of the region is 7,441 km<sup>2</sup>, which is 10.6% of the country's territory and according to the area; it is the second among the Georgian regions.

Abkhazia and Black Sea is bordering Samegrelo-Zemo Svaneti from the West, Russian federation from the North, Racha-Lechkhumi-Kvemo Svaneti region (border passes on the Svaneti and Egrisi ranges and on the Askhi array) from the North-East and East, Imereti region from the South-East and Guria region from the south.

**Figure 5.1.2.** Samegrelo-Zemo Svaneti in Georgia

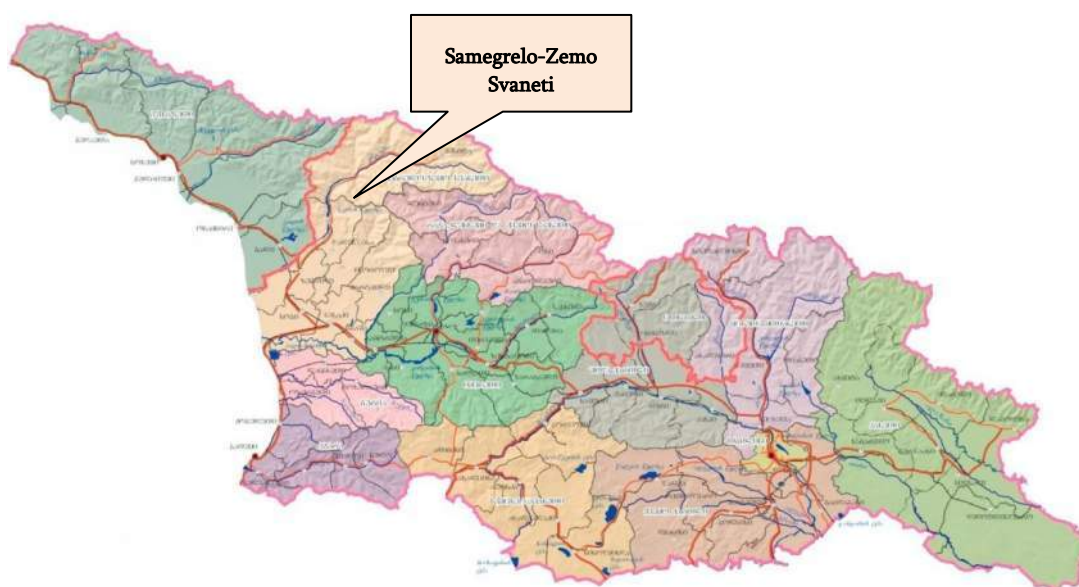

Samegrelo-Zemo Svaneti region includes 8 municipalities and self-governing city of Poti. Zugdidi is the regional center of Samegrelo-Zemo Svaneti.

**Table 5.1.1.** Territorial units of Samegrelo-Zemo Svaneti and their area

The name of administrative unit	Territory km <sup>2</sup>	City	Town	Village Board (community)	Village/Settlement
<b>Georgia</b>		<b>54</b>	<b>44</b>	<b>896</b>	<b>3688</b>
Samegrelo-Zemo Svaneti	74 000	8	2	138	488
Zugdidi Municipality	692	1	0	30	58
Senaki Municipality	520,7	1	0	14	63
Khobi Municipality	676	1	0	20	56
Abasha Municipality	320,8	1	0	15	40
Martvili Municipality	880,6	1	0	20	74
Chkhorotskhu Municipality	619,4	0	1	12	29
Tsalenjikha Municipality	64715	2	0	12	34
<b>Mestia Municipality</b>	<b>3 045</b>	<b>0</b>	<b>1</b>	<b>15</b>	<b>134</b>
Poti	65,8	1	0	0	0

Mestia municipality is situated in the upper part of the river Enguri basin and includes historical province of Zemo Svaneti. Its hypsometrical height is from 800 to 3600 meters. The territory includes 3044,5 km<sup>2</sup>, which is 4,4% of Georgian territory. Landscape represents mountainous narrow ravine, with length of 120 km and width 20-25 km.

**Figure 5.1.3** Mestia municipality in Samegrelo-Zemo Svaneti

Main range of Caucasus Mountains is bordering Mestia municipality from the North-East side, Svaneti-Abkhazia range from the west and ridge of the Svaneti range from the South.

### 5.1.1 Determination of the Study Area

Assessment of natural and social environment within the study area will be carried out for two areas:

- For the region under study, which may be within the indirect influence area of the HPP;
- For the main study area, which probably will be directly affected by the HPP project. This area covers Nenskra valley, from the village Lekalmakhi upstream, where power house, diversion tunnel, temporary and permanent access roads and the reservoir will be arranged. This area also covers Nakra valley, from the confluence of Enguri River, including the area of Nakra intake. Jvari reservoir area, as well as Khudoni reservoir area should be considered as the main areas.

#### 5.1.1.1 Study Region

Within the framework of environmental impact assessment of Nenskra HPP project, Samegrelo- Zemo Svaneti Region, including Mestia Municipality and Enguri River catchment area above Jvari dam reservoir is considered as the study area.

In case of implementing the project on the construction and operation of the HPP, risks of physical, biological and socio-economic impacts are existing not only within the project area, but in Mestia Municipality and Samegrelo- Zemo Svaneti region as well. Types of such impacts may be associated with the operation of the reservoir, which may affect the climate of the region. Besides socio-economic conditions may be changed, etc. The scheme of the study region is given in Figure 5.1.1.1.1.

**Figure 5.1.1.1.1.** Scheme of the study region (M. 1:200 000)

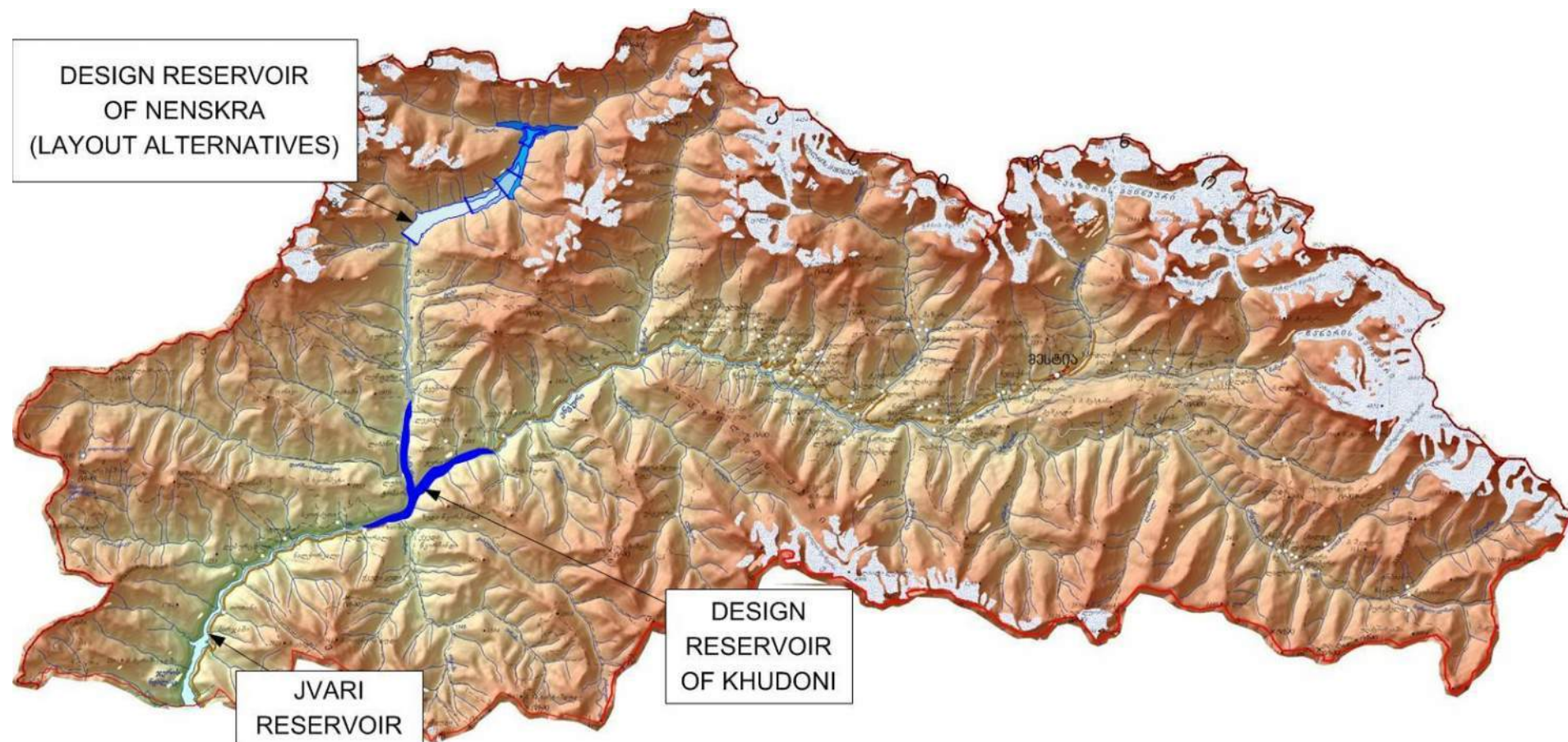

### 5.1.1.2 The main study area

The main study area of Nenskra HPP project covers the specific region, which could be directly impacted by the project and the study of which is essential for the assessment of environmental and social impact and determination of mitigation and compensation measures.

The main study areas include:

- Nenskra River catchment area from dam alignment to the Caucasian watershed line, as well as Nakra River catchment area from intake to the Caucasian watershed line. These areas were selected to evaluate water supply regime, water quality and solid sediment for the proposed reservoir;
- Area selected for the proposed reservoir and adjacent slopes;
- Nenskra River valley from Lekalmakhi village to the dam cross section. This area covers areas selected for the dam, diversion tunnel, powerhouse and other infrastructure, construction camps, access roads, borrow pits for building materials, etc. Diversion of the river water into the tailrace tunnel will cause hydrological changes within this section of the river. Impacts will be related to the extraction of inert materials, arrangement and operation of construction sites and access roads;
- Nakra River valley from the dam area to the confluence of Enguri River. Diversion of water into Nenskra River Valley will cause hydrological changes within this section of the river. Impact will be caused due to the arrangement and operation of the construction site and access roads, as well as due to the construction works in the riverbed.
- Khudonhesi reservoir, Engurhesi reservoir and Enguri River valley to the marine confluence. This should be considered as Nenskra HPP project may affect the operation of Khudoni and Enguri reservoirs.

Figure 5.1.1.2.1. Scheme of the study area (m. 1:200 000)



## 5.2 Physical Environment

### 5.2.1 Climate and Meteorological Conditions

**General overview:** lowland areas (Colchis Lowland) of West Georgia are characterized by a humid subtropical climate. Caucasian ridge is a natural barrier to cold air masses moving from the north and forces humid air masses moving from the direction of Black Sea to move above, which causes intense precipitations. The opposite situation is in East Georgia, climate of which is much drier.

The climate is significantly changing in accordance with the raising of the elevation from the sea level, which in the entire area from sea to peaks, forms the climatic zones spectrum only on a hundred kilometers distance.

Middle and upper waist of Enguri is characterized by cool and wet summer and snowy, long winter. Permanent glaciers are found in the high mountains.

**Temperature:** the average annual temperature in Western Georgia decreases along with the increase in altitude and ranges within 6-10°C in the mountain part of the lowland and within -2-4°C in the highland regions. The absolute minimum in the temperature, respectively, equals -30-35°C. South slope of the Zemo Svaneti ravine is the coldest place within the study area, average annual temperature in here is less than 2°C.

**Precipitation:** according to the Lakhmi meteo-station data, the precipitation level is approximately 1,267 mm in a year and is characterized by the tendency of equal distribution, with particular intensity of rain during summer and autumn months.

The rain intensity increases together with the increase in altitude and reaches 2800 mm on the peaks and more than 3,200 mm in the highest places of Caucasus Mountains.

**Snow Cover:** stable snow cover existence duration on the lowlands is 10-20 days and increases up to 100-150 days in the mountainous regions. Stable snow cover is forming on the 500-600 m altitude above the sea level. Alpine conditions can be found from 2.100 m. Above 3.000 meters, mountains are covered with snow and glacier during the whole year (USAID 2006). Snow cover height in some areas of the mountains reaches 4-6 m.

According to the observations conducted in village Lakhmi, snow cover on the project implementation territory can be found from November 27 until March 20. The average number of days with snow covers amounts 88. The number of snowy days in Mestia amounts 134 and snow cover lasts from November 7 until April 7.

Average annual snow cover height in village Lakhmi is 590 mm and in Mestia 670 mm.

In average, frost period during the year lasts from November to March. Period without frosts on Khaishi territory amounts 232 days and in Mestia 151 days. (Information about the snow cover of the design territory is given in Appendix).

**Wind:** the orography is affecting on the wind regime in West Georgia. Wind circulation from Black Sea towards the lowlands is noticeable. Average wind speed in forest-covered ravines does not exceed 2-3 m/s. The most frequent and strong winds are common for mountains and highland area passes, where average annual speed reaches 5.5-9.0 m/s:

**Solar Radiation:** average annual duration of solar radiation in most parts of Georgian territory is 1900-2200 hours. In mountainous areas, where in some places cloudiness can be detected, this rate decreases down to 1500-1300 hours.



The climate of the river Nenskra ravine is quite strict due to the high mountains and is characterized by high amplitude of temperature and abundance of atmospheric precipitation. Snow cover height in winter reaches 4,5-5 m. Stable snow cover is formed in the middle of November and lasts until the middle of April, which means in average 150 days. Average annual precipitation amount is 2000-2400 mm. Precipitation days number per year is approximately 160-180. Average annual temperature in the river Nenskra ravine is +8°C.

According to the seasons, average air temperatures ranges as follows: average January temperature -10°C, April +10°C, July +18°C and October +12°C. Average of the annual absolute minimums in January amounts -30°C. Average of the annual absolute maximums in August exceeds +38°C.

**The average annual air temperature by months**

Meteorological Station Title	I	II	III	IV	V	VI	VII	VIII	IX	X	XI	XII	Ave
Khaishi	-0.1	1	5	10.3	15.4	18.3	20.8	21	16.9	11.4	5.8	1.3	10.6

**Minimum average annual air temperature by months**

Meteorological Station Title	I	II	III	IV	V	VI	VII	VIII	IX	X	XI	XII	Ave
Khaishi	-2.5	-1.9	0.8	5.3	9.6	12.9	15.3	15.3	11.6	7.3	3.1	-0.7	6.3

**Maximum annual average air temperature by months**

Meteorological Station Title	I	II	III	IV	V	VI	VII	VIII	IX	X	XI	XII	Ave
Khaishi	2.7	5.1	10.6	17.3	22.8	25.2	27.2	27.7	23.6	16.9	9.1	4.1	16

**Minimum, Average and Maximum annual temperature of long-term observation on the atmospheric air**

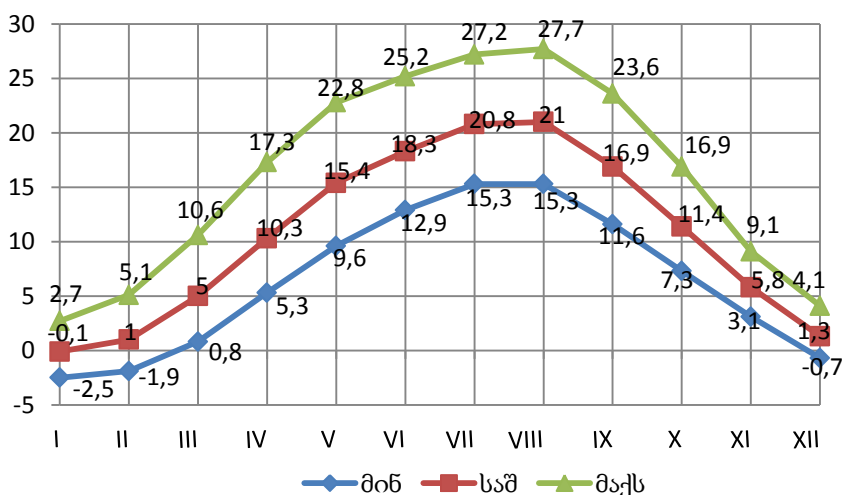

**Average annual temperature (OC) of the soil surface layer by months**

Meteorological Station Title	I	II	III	IV	V	VI	VII	VIII	IX	X	XI	XII	Ave
Average Min.	-5	-5	-1	4	9	13	16	15	12	7	1	-3	5
Average	-2	-1	5	13	19	23	26	26	18	11	4	-1	12
Average Max.	0	4	17	29	40	43	44	45	32	21	11	6	24

**Minimum, Average and Maximum annual temperature of multi-annual observations on the soil**

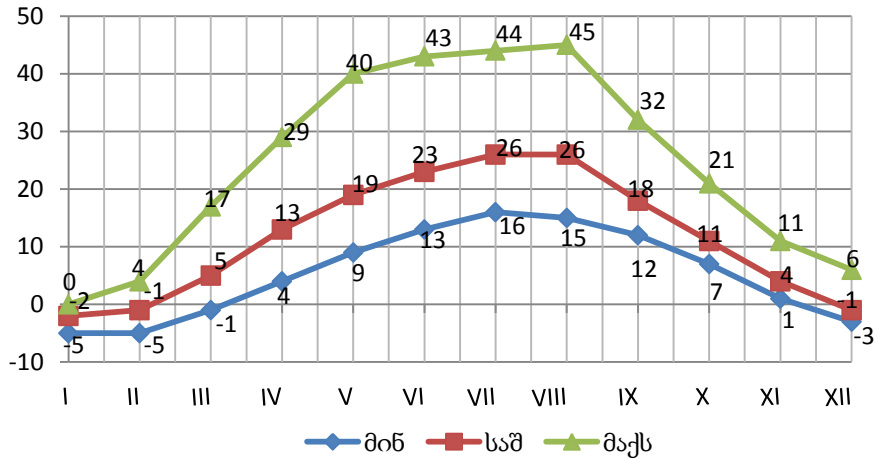

**Average annual wind directions repetition (%)**

Meteorological Station Title	N	NE	E	SE	S	SW	W	NW	Calm
Khaishi	3	11	54	1	0	2	23	6	52

**Average annual repetition of the wind direction (%)**

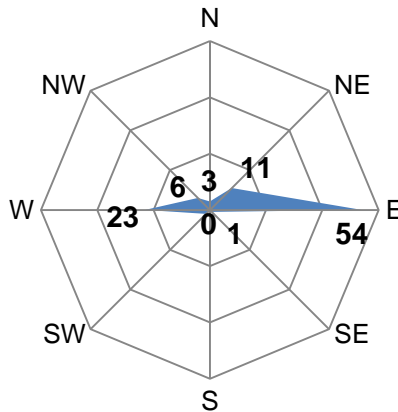

**Monthly and annual average wind speed (m/s)**

Meteorological Station Title	I	II	III	IV	V	VI	VII	VIII	IX	X	XI	XII	Ave
Khaishi	2	2	2,3	2,8	2,6	2,6	2,6	2,5	2	1,8	2	2,2	2,3

Average annual wind speed (m/s)

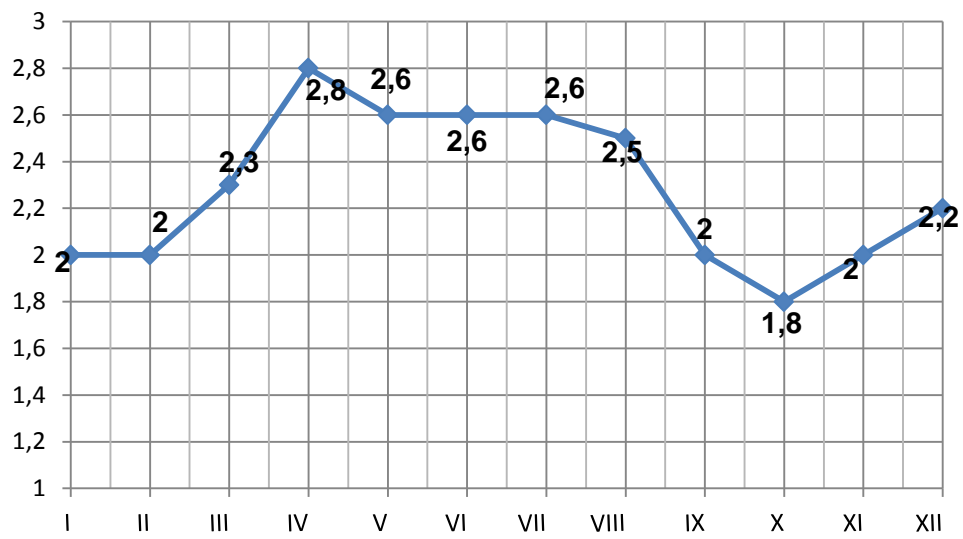

Relative humidity (%)

Meteorological Station Title	I	II	III	IV	V	VI	VII	VIII	IX	X	XI	XII	Ave
Khaishi	81	79	74	70	71	73	74	74	78	81	80	82	76

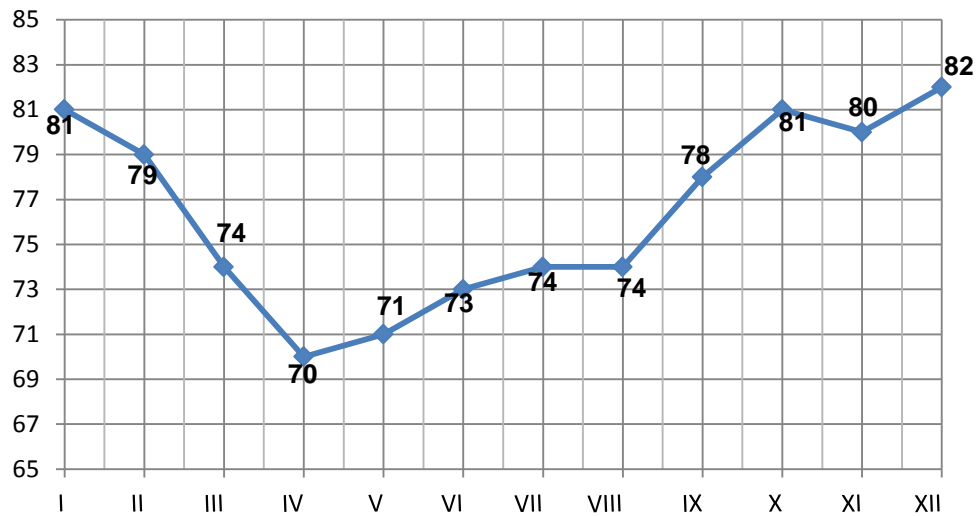

Precipitation (mm)

Meteorological Station Title	I	II	III	IV	V	VI	VII	VIII	IX	X	XI	XII	Σ
Lakhmi	120	111	94	86	93	100	95	90	104	132	114	128	1267

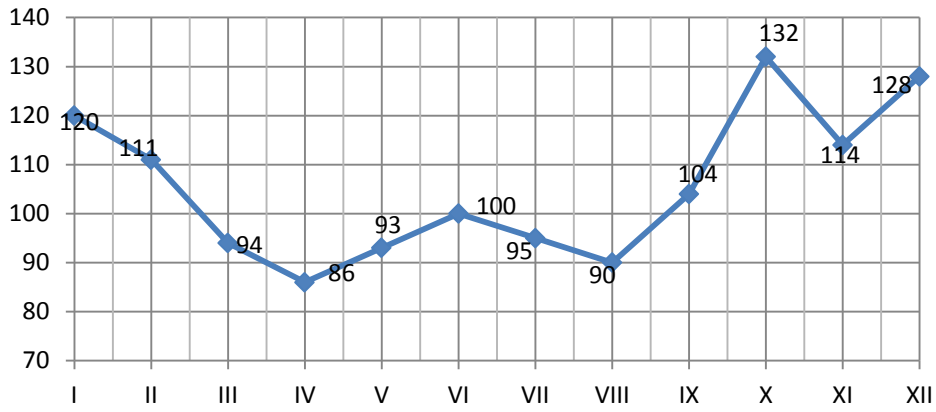

Number of snowy days by decades (Khaishi)

Month	Decade	Number of days
XII	3	5
I	1	5
I	2	6
I	3	7
II	2	8
II	3	6
III	1	5
III	2	4
	Σ	46

Total cloudiness in scales

Khaishi	I	II	III	IV	V	VI	VII	VIII	IX	X	XI	XII	Year
0-2	28	24	24	30	28	36	38	44	46	38	36	35	34
3-7	15	16	17	18	24	26	26	26	20	19	16	14	20
8-10	57	60	59	52	48	38	36	30	34	43	48	51	46

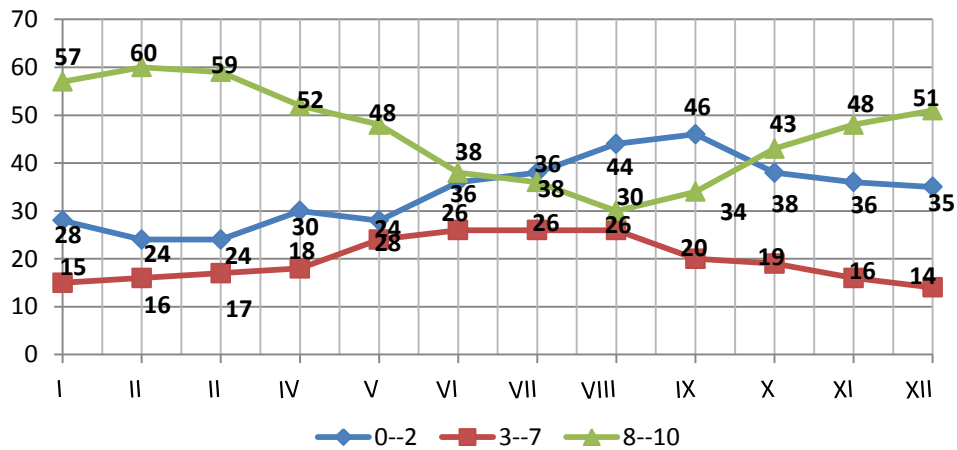

Lower cloudiness in scales

Khaishi	I	II	III	IV	V	VI	VII	VIII	IX	X	XI	XII	Year
0-2	44	42	43	47	50	54	55	61	59	56	54	52	52
3-7	20	21	25	24	26	25	26	23	22	21	18	17	22

8-10	36	37	32	29	24	21	19	16	19	23	28	31	26
------	----	----	----	----	----	----	----	----	----	----	----	----	----

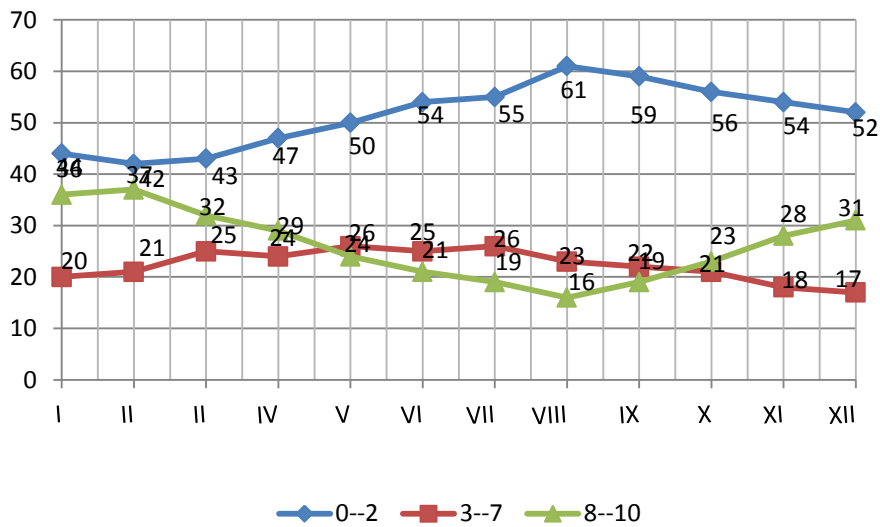

Average number of cloudy days per year (Khaishi)

I	II	III	IV	V	VI	VII	VIII	IX	X	XI	XII	Year
13.6	12.9	13.9	11.9	9.4	7.4	6.2	5.1	7	9.2	10.8	12.1	120

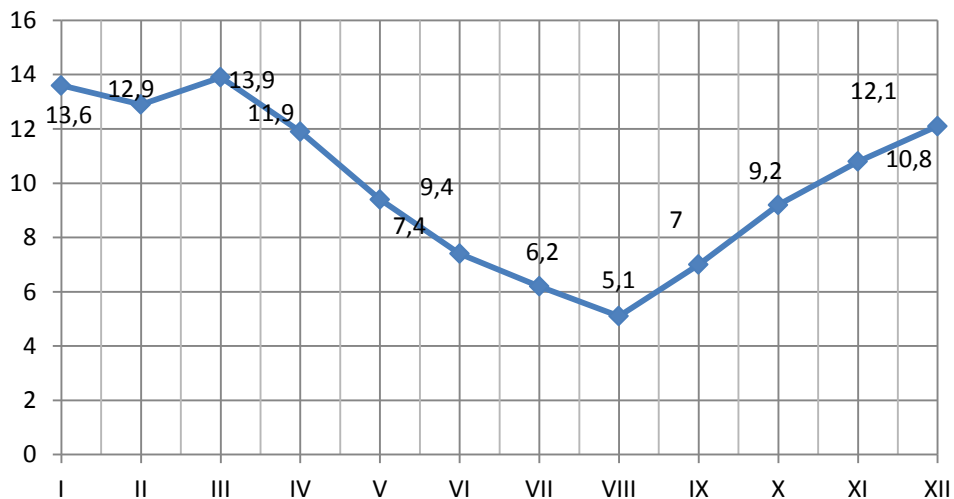

### 5.2.2 Topography

Enguri watershed, which is directed from North-East to South-West, is stretch over 200 km distance and includes 4,062 km<sup>2</sup> areas, from Great Caucasus range to Black Sea coast.

Watershed belongs to the Samegrelo-Zemo Svaneti region, apart for the lower side of ravine within Abkhazia. It is located at an altitude of approximately the same height, as Northern Greece and Northern Spain. According to the morphological characteristics, Enguri watershed can be divided into three parts, each approximately 70 km long: upper, central and lower valleys. The upper valley: the valley above the village Lakhani is directed towards the west. Two mountain ridges with more than 3,500 m height are contiguous to it: Great Caucasus Range to the North, with the highest point on the Shkhara (5,068 m) and Svaneti Mountains to the South, the highest point on the Lajla-Lekheli (4,008 m).

Most of the territory is situated at an altitude of 1000-3500 m above the sea level. The slopes are steep, with significant erosion indicators. The main valley bottom is quite wide and is densely covered by Svanetian settlements and rural-agricultural lands.

Enguri tributaries valleys, mostly directed from north to south, are much smaller and narrow. The exception is Mestia valley.

Central valley: the valley direction below Lakhani is changing and moving from south to west. Central valley, which is approximately 70 km and is situated from Lakhani until Jvari, is much narrower than upper and slopes are very steep. Valley is surrounded by mountains – Abkhazia range to the west and Svaneti Mountains to the east, which are lower than Great Caucasus Mountains and reaches 2000-3000 m heights.

Valleys of river tributaries go down on both sides. The most important is Nenskra ravine on the right side, above Khaishi. Village Kvemo Margi is connected with the village Sakeni in Abkhazia with the secondary ravine and pass, the road is currently under construction.

The ravine above Khaishi (between Lakhani and Tobari) approximately on 15 km distance goes into the narrow ravine.

A few widened and straightened places around the river provide the possibility to live. Here are settlements, agricultural lands and sawmills. The village Khaishi is situated on the biggest platform from them. The ravine below Khaishi is filled with 20 km of Enguri HPP reservoir.

### **5.2.3 Geological Conditions**

#### **5.2.3.1 General Overview**

The study area belongs to the Eurasian-Arabian plate collision zone in the Caucasus. Active tectonic features are: Northwest--trending joints, the biggest of which is directed from Abkhazian coast (Sukhumi, Ochamchire) towards the Greater Caucasus Mountain Range, and the Great Caucasus axis (from northeast to southwest) parallel faults. The Earth's crust throughout this area is divided into several tectonic blocks.

The first investigations have been carried out in June-November, 2011 by STUCKY. Geological Report was prepared in the form of feasibility study, while detailed study of axis of the dam and other structures has been postponed.

Detailed field works within the project area was launched on August 1, 2012 and was completed on February 13, 2013. Laboratory studies began on December 26, 2012 and were carried out in parallel with the local research. All studies have been completed on March 8, 2013.

In order to determine the geotechnical parameters of the foundation of structures at project site, there were drilled 7 boreholes at dam axis, 3 boreholes at axis of spillways, 2 boreholes at diversion tunnel, 4 boreholes at powerhouse site, 1 borehole at alignment of penstock, 2 boreholes at the axis of weir and 2 boreholes at the inlet of weir. The total number of boreholes is 21 and totally 1632, 5 meters in depth.

Some kinds of tests were performed like water pressure tests, permeability tests and pressure meter tests in the drilled boreholes at appropriate levels. Beside these, laboratory tests have been performed on the core samples taken from the boreholes during the drilling to determine the geotechnical parameters of the main rock under the structures.

### 5.2.3.2 Geological Structure

Nenskra Dam and HEPP Project are located south slopes of the Main Range of Great Caucasia that is the zone with northwest-southeast direction.

Caucasia is created by mountain ranges in 1100 km long from Caspian Sea at east up to Black sea. Caucasia is located between the African-Arabia plate and Eurasian plate that approaches each other. The Caucasia that situated at trusted zone and folded inland as a result of intercontinental collision at Oligocene-Early Miocene age is the district of outcrop of rocks of intensively mountain creation in pre-Hersinien, Hersinien and Alpine orogenesis. The Caucasia is divided three main sections. These are Great Caucasia, Transcaucasia and Little Caucasia. The Great Caucasia is mainly divided three sections from north towards south as zone of Laba-Malca, Main Ranges zone and zone of South Slopes. Mean Range zone creates the main axis of the Great Caucasia zone. The tectonic zone of Caucasia generally is distinguished from each other by thrust plane that dip  $70^{\circ}$ - $80^{\circ}$  towards the north.

At the period of Late-Proterozoic-Tertiary, The Caucasia comprises Tethys Ocean and African-Arabian continental margin of this ocean with island arcs in this system, rifts within island arcs and basins out of island arcs. The Caucasia and rifts out of island arcs that developed on the seduction zone toward the bottom of west Gondwana were separated from the other Upper-Precambrian-Cambrian crystalline main parts contained at the Alpine organic belt. Tethys Ocean was opened at the south of Periphery-Gondwana districts moving north. The Caucasia and other Periphery-Gondwana districts adding to the south continental margin of Eurasian had been taken approximately 350 million years. The prevalent granitoids plutons with microclenic on the subduction zone toward to under the Eurasian continental margin had been created at the rate of 320-280 m/year (Adamia and et al, 2011b). The development of the Great Caucasia basin had been started before Devonian age (Adamia and et al, 2011a). The Paleozoic ocean located south of the Caucasia had been not completely closed at this period and Mesozoic Tethys survived. The Caucasia at Mesozoic and Early Tertiary age had been represented south active margin of Eurasia plate and North Tethys district. The creation of mountain range and the collusion of African-Arabian plate with Europe plate had been occurred at the Quaternary age (Adamia and et al, 2011b).

There are different kinds of rock from Precambrian to Quaternary ages at the project site and their periphery. The main rock at the north of the project and their near periphery are gneiss, metagranite, migmatite, granitoids of S and I type, amphibolite and schist at Precambrian-Paleozoic age. These deposits had been metamorphosed at amphibolite facies at the Hercinien orogeny and cut by the granite in Paleozoic age (Adamia and at al, 1983). Gneiss, migmatite and similar metamorphic rocks that create seed of Caucasia are covered by the deposits that existed shallow sea conditions beginning from Ordovician to Silurian, Devonian, Carboniferous, Permian and Triassic. The interbedded sandstone, clay stone and diabasic volcanic rocks are seen Early-Middle Jurassic ages.

At the project area no young existence undeveloped after Jurassic age without Quaternary age. The main formation is the glacier deposits at the Quaternary age. Alluvium, alluvial fan, slope debris and fluvial channel deposits are other deposits of the Quaternary age.

At the middle part of the investigated area the units nearly E-W direction creates turndown anticline towards to north. At the both limb of this anticline that the rock type in Silurian-Devonian age of the seed, most of the rock type are seen as outcrop from Devonian to Silurian.

A lot of reverse fault and over thrust that extends to WNW-ESE or W-E direction are found at this district. The metamorphic base in Precambrian and Early Paleozoic age at this district is overlapped to the units in Jurassic age by over thrust and reverse fault. Beside this, Alibeck reverse fault that is the most tectonic line extends WNW-ESE or W-E direction and Main Caucasus Thrust are cut the units

along the both limbs of the anticline and forced the units towards to south. Tectonic map of the Caucasus is given in Figure 5.2.3.2.1.

Figure 5.2.3.2.1. Tectonic map of the Caucasus (Adamia et al. 2010).

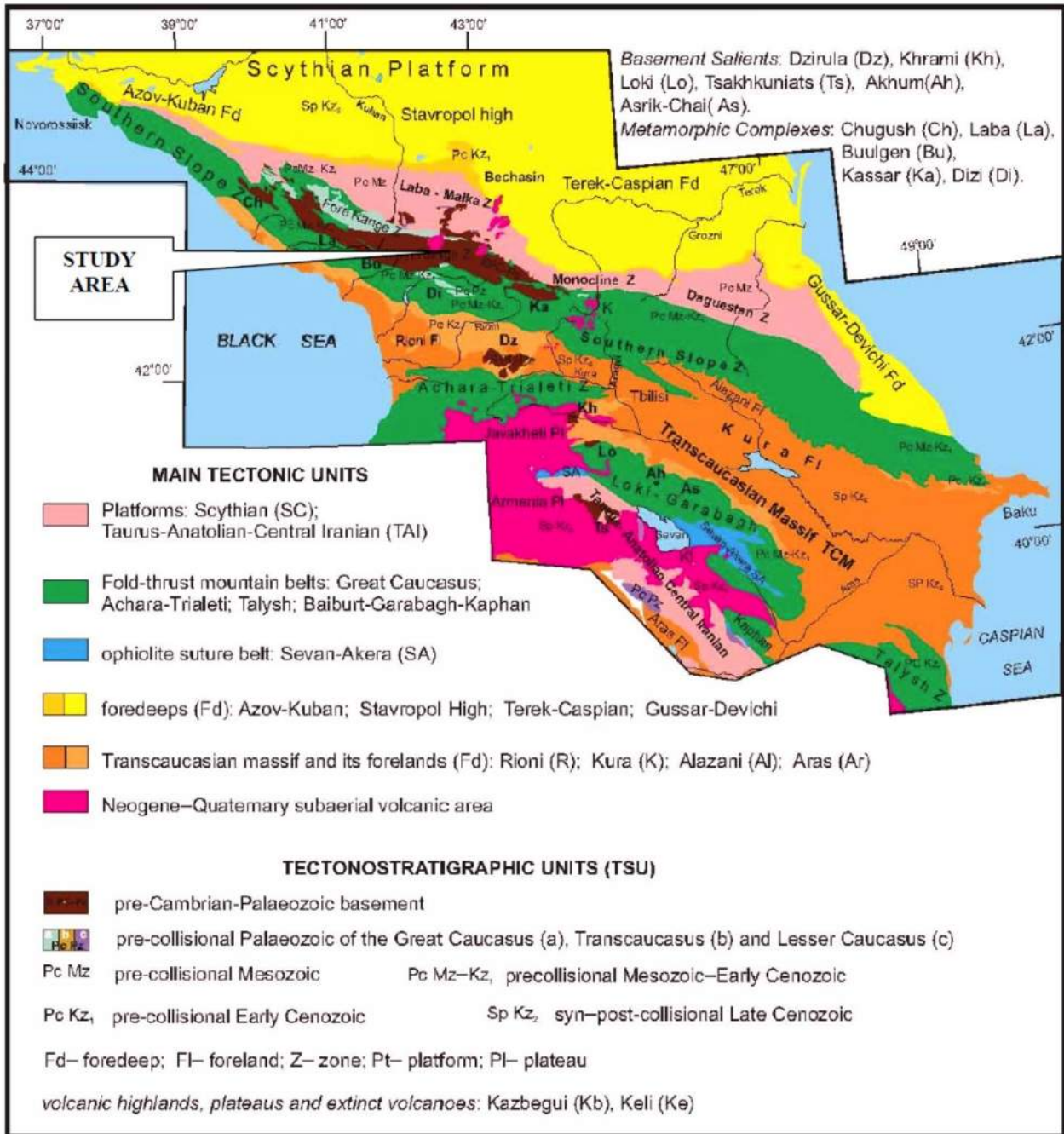

### 5.2.3.3 Stratigraphy

At the project located south slopes of the Main Range of Great Caucasia that is the zone with northwest-southeast direction, different kinds of rock types are located from the Precambrian to Quaternary. The stratigraphic column of the investigation area is given below in Figure 5.2.3.3.1.



Figure 5.2.3.3.1. The stratigraphic column of the investigation area

AGE	LITHOLOGY	EXPLANATIONS
QUATERNARY		Fluvial channel deposit (Qaky) Alluvium (Qal) Slope Debris (Qym) Alluvial Fan Deposits (Qay) Glacial Deposit (Qg)
MIDDLE UPPER JURASSIC		Sori Formation (Js): Shale, sandstone Diabase Porphyrite (Jdp)
LOWER JURASSIC		Muashi Formation (Jms): Sandstone, claystone, clay schist, quartz sandstone
LOWER JURASSIC		Morghouli Formation (Jmr): Clay schist, sandstone, conglomerate, diabase
PERMIAN TRIASSIC		Tskhenistskali Formation (PTrt): Shale, slate, phyllite, sandstone, conglomerate and marble lenses
CARBONIFEROUS		Pophiritic Microcline Granite (Cpg): Kazakhtvibi Formation (Ck): Phyllitized shale, slate, sandstone and lenses of marmorized limestone
UPPER DEVONIAN LOWER CARBONIFEROUS		Plagiogranite (DCpg) Quartz Diorite (DCqd)
DEVONIAN		Kirari Formation (Dk): Phyllite, phyllitized shale, sandstone, lenses of conglomerate and marmorized limestone
UPPER SILURIAN LOWER DEVONIAN		Lukhrini Formation (SDl): Phyllite, phyllitized shale, sandstone, lenses of conglomerate and marmorized limestone
ORDOVICIAN LOWER SILURIAN		Dolrini Formation (OSd): Migmatites, metagranite, schist, quartzite, amphibolite
CAMBRIAN PRECAMBRIAN		Nakra Formation (En): Migmatites, metagranite, schist, amphibolite

The Nakra Formation that is assumed the oldest formation of seed rocks of Great Caucasia main ranges are represented by gneiss, metagranite, schist, amphibolite and migmatite.

The Dolrini Formation that is composed of gneiss, migmatite and schist and Lukhrini Formation in Late-Silurian-Early Devonian age composing of metamorphic particles, fillite and quartz-porphry are located over this formation. Quartz diorite and plagiogranites that are in Late Devonian-Early Carboniferous age are cut these units.

Meta sedimentary rocks in Devonian age at the basin create Kirari formation, sedimentary rocks in Carboniferous age is named Kazakhtvibi formation. Porphyritic microcline granites in Carboniferous age are located by cutting all these units. The units in Permian-Triassic is represented by Tskhenistskali formation, the clay stone, sandstone, conglomerate and diabase in Early Jurassic age is Morghouli Formation, the classic rocks in Early Jurassic age is Muashi formation, shale, clay stone and sandstones in Early-Middle Jurassic age is Sori formation, are deposited. The diabase porphyritic rocks in Middle Jurassic are cut other units in Jurassic. Quaternary deposits are represented by alluvium, alluvial fan, fluvial channel deposits, slope debris and glacier deposits.

#### **5.2.3.3.1 Nakra Formation (Є n)**

The oldest formation in the investigated area is Nakra Formation represented and consisting of gneiss, metagranite, schist, amphibolite and migmatite. The formation is assumed the seed rocks of the Great Caucasia Ranges.

The Nakra Formation at the north of the project area which outcrops along the alignment of Nakra transfer tunnel is composed of gray, greenish gray and beige color metagranite, gneiss, granitic gneiss, migmatite and green, dark green, brown color amphibolite and schist. The Nakra Formation display very fractured structure on the upper part near the surface but towards to depth display wide fractures and good rock quality.

The bottom of the Nakra Formation is unknown because the oldest formation at the site. But, the upper parts of this formation are covered by Dolrini Formation in Ordovician-Silurian age and sometimes glacier deposits in Quaternary age. The formation is assumed as Precambrian-Cambrian age.

#### **5.2.3.3.2 Dolrini Formation (OSd)**

The Formation consisting of rock types such as older gneiss, migmatite and schist in Ordovician – Silurian age at the site is named as Dolrini Formation. The formation is generally composed of gray, greenish gray, green, dark green, gray and brown color gneiss, granitic gneiss, metagranite, migmatite and green, dark green and brown color quartzite, amphibolite and schist. Beside this, this formation is cut by the young granite, diabase and diorite. Dolrini Formation is located as a bed rock at the dam axis, diversion tunnel, spillway, and west of the reservoir of dam, at the inlet of Nenskra Power Tunnel and at the alignment of Nakra tunnel at the project.

The formation is composed of grey, greenish grey, white and beige color gneiss, granitic gneiss, metagranite, migmatite and sometimes amphibolite and schist at the project area. The metamorphic rocks that existing Dolrini Formation is cut by younger granite, micro granite and diabase. The granites are white, dirty white and beige color and include rich feldspat and quartz minerals. The schist enclave's in the granite. Diabase unit is green and dark green color and is seen as vein rock with plagioclase fenocrystalline.

The formation displays very fractured structure at the upper part near the surface of ground and developed joint sets in the unit. The fractures are generally unfilled but somewhere fractures are filled with silica. The surface of the fractures is generally corrugated, rough and iron oxide painted. The quartz bands are mostly seen in gneiss and schist as a thin-layer. The thickness of quartz bands change from one millimeter to 30 cm because of these rocks seems white color and display strong strength.

This formation is cut by plagioclase and quartzite in Late Devonian-Early Carboniferous age and porphyrite microcline granites and diorite in Carboniferous age.

Dolrini Formation is located over the Nakra formation in Precambrian-Cambrian age. The formation, which is along the south contact, overlapped on the units that is in Jurassic aged by the Alibeck thrust that's reverse fault. Dolrini Formation can be assumed in Ordovician Early Silurian age according to regional investigations.

#### **5.2.3.3.3 Lukhrini Formation (S Dl)**

The metamorphic particles, phyllite, quartzporphyri and albitporphyri at the investigated area that are Late Silurian-Early Devonian in age are named as Lukhrini Formation.

Lukhrini Formation is composed of the bands of phyllite, phyllitized shale, metasandstone, quartz-plagioclase porphyrites, albitoporphyre, lenses of marbled limestone. The unit is dark gray, blackish, light brown color and existed detritic fine-grained particles. Lukhrini Formation is cut by gabbro, pyroxene, granite, granodiorite and diorite in Dogger-Middle Jurassic in age.

The formation outcrops at the seed of an anticline where extends east-west direction, near the center of the project area, outcrops in between south of Tita and Zemo Marghi. Lukhrini Formation outcrops at the middle part of the Nenskra Transmission Tunnel.

The seed of anticline that existed bottom contact of the formation is not seen because of great tectonic lines at the investigated area. The formation is transitive with Kirari Formation in Devonian at upper part. Lukhrini Formation is assumed Late Silurian –Early Devonian in age.

#### **5.2.3.3.4 Kirari Formation (Dk)**

The meta sedimentary rocks are named by Kirari Formation that is Devonian age at investigated area. Kirari Formation is generally created by lenses phyllite, phyllitized shale, and metasandstone and rarely met conglomerate and marbled limestone. The formation is gray, dark gray, blackish and rarely beige color. The rock types created this formation is generally fine-grained meta sedimentary rocks observed the dip as regularly towards to north and south direction.

The formation outcrops at the seed of an anticline where extends east-west direction, near the center of the project area, outcrops in between south of Tita and Zemo Marghi.

Kirari Formation is located over Lukhrini Formation and under the Kazakhtvibi Formation in Carboniferous age. Kirari Formation is assumed Devonian age.

#### **5.2.3.3.5 Quartz diorite (DCqd)**

The Late Devonian – Early Carboniferous age quartz diorite is named as lithological nomenclature.

The formation outcrops at the twist part of the Nenskra river from northwest to south direction, at both side of the Nenskra river.

Quartz diorites cut the Dolrini Formation that is Ordovician-Silurian age. The south contact of the formation is developed as forced reverse fault zone from north to south. The age of the Quartz diorites is assumed Late Devonian-Early Carboniferous.

#### **5.2.3.3.6 Plagiogranite (D Cpg)**

The plagiogranite in Late Devonian-Early Carboniferous age is named as lithological nomenclature.

The formation outcrops at the seed of an anticline where extends east-west direction, near the center of the project area, outcrops in between south of Tita and Zemo Marghi.

Plagiogranite cut the Dolrini Formation that is Ordovician-Silurian age. The south contact of the formation that is tectonic is developed as forced reverse fault zone from north to south. The age of the Plagiogranite is assumed Late Devonian-Early Carboniferous.

#### **5.2.3.3.7 Kazakhtvibi Formation (Ck)**

The meta sedimentary rocks are named by Kazakhtvibi Formation that is Carboniferous age at investigated area.

Kazakhtvibi Formation is composed of mainly lenses that phyllitized shale, the formation is followed grey, dark gray and blackish color and observed laminated at the surface. The formation is observed grey, dark grey and blackish formation as plate at surface.

The formation outcrops at the seed of an anticline where dips toward to east near the center of the project outcrops in between south of Tita and Zemo Marghi.

Kazakhtvibi Formation creates folds with strike in ENE-SSW, dip in NW at the north of anticline direction and strike in WNW-ESE at the south of anticline direction. The layers in this unit are regular.

Formation is located over the Devonian age Kirari Formation. And the formation is covered by the Tskhenistskali formation. Tskhenistskali Formation is found as tectonics.

Kazakhtvibi Formation is assumed Turnasian-Early Carboniferous.

#### **5.2.3.3.8 Porphyritic Microclinegranite (Cpg)**

The Microcline granite in Carboniferous age is named as lithological nomenclature.

The formation outcrops at the twist part of the Nenskra River from northeast to south direction, at right side of the Nenskra River, at Nakra Transfer tunnel alignment and outlet of the tunnel.

Porphyritic Microcline granite is white color, coarse-grained and developing orientation on minerals. The joint sets are developed in the unit. The fractures are spaces, sometimes with silicium and iron oxide painted. The surface of the fractures is rough and corrugated. They are in the class of strong and hard rock. They create the high topography at the site.

They cut the Dolrini Formation that is Ordovician-Silurian age and Main Range zones that is Precambrian-Cambrian age. The boundary with these formations is developed contact metamorphism. The age of Porphyritic Microcline granite is Carboniferous.

#### **5.2.3.3.9 Tskhenistskali Formation (PTRt)**

The units which are Permian-Triassic age at the investigated area are named Tskhenistskali Formation. Tskhenistskali Formation outcrops at the both side of limbs of an anticline where east-west direction at the middle parts of the investigated area, in between south of Tita and Zemo Marghi, west of the Nenskra River and Nenskra Tunnel alignment.

The formation is generally created by lenses phyllite, phyllitized shale, metasandstone, metaconglomerate and marbled limestone. The unit is dark gray, grayish black, rarely light brown color. The rock types created formation are fine-middle layers and generally laminated. The unit having fragile

property at the surface and near to surface becomes massive towards to depth. Beside frequent joints, folds observing at the unit generally have regular deposit.

Tskhenistskali Formation lays Kazakhtvibi Formation in Carboniferous age. This formation is covered by Morghouli Formation in Early Jurassic age. Beside this, this unit is forced over the units from Devonian to Jurassic in age by the over thrust at the north of anticline. This unit is also overt rusted on the Tskhenistskali Formation in Early Jurassic age at the south of anticline. Tskhenistskali Formation is assumed that Permian-Triassic age according to regional investigation.

#### **5.2.3.3.10 Morghouli Formation (J mr)**

The old deposits in the Early Jurassic age as clay stone, sandstone, conglomerate and diabase units at the investigated area are named as Morghouli Formation.

The formation is located at the middle part of the investigated area that is east of the Nenskra river at Tita district and outcrops on the north limb of an anticline in east-west direction.

Morghouli Formation is composed of basically shale, clay stone, sandstone, coarse-grained sandstone and diabase. The formation is generally gray, dark gray, sometimes light brown color. The grains orientation is developed; sometimes foliation is developed and seems as schist. Morghouli Formation covers Tskhenistskali Formation and is covered by Muashi Formation in Early Jurassic age. The Formation is assumed as Early Jurassic age.

#### **5.2.3.3.11 Muashi Formation (J ms )**

Some of the clastic rocks at the region are named Muashi Formation in Early Jurassic age.

Muashi Formation outcrops at the middle part of the investigated area that is both side of the Nenskra river at north of Tita and Zemo Marghi district, at the alignment of Nenskra Power Tunnel.

Muashi Formation is composed of clay stone, sandstone, clayey schist and quartz. The formation is gray, dark gray, greenish gray and sometimes light brown color, sometimes foliations are seen and seems like schist. Painting by iron oxide between the layers are common, rarely includes organic materials as thin layers. In the formation sometimes faulting, crashing and brecciate structure and also silicification are seen as a result of faulting.

Muashi Formation is transitive with Morghouli Formation located beneath this formation. At the upper part, it is transive with Sori Formation in Middle-Late Jurassic age. The north contacts of the Muashi Formation are tectonics. Dolrini Formation in Ordovician-Early Silurian age is forced to the Muashi Formation by reverse fault that dip to north direction at north of Tita. Tskhenistskali Formation in Permian-Triassic aged at east of Zemo Marghi over thrust to Muashi Formation. The age of the formation is assumed Early-Jurassic.

#### **5.2.3.3.12 Diabase porphyry (Jd p )**

The Diabase porphyry in Middle Jurassic age at the investigated area is named as lithological nomenclature.

Diabase porphyry at the project area is observed as cutting out Muashi Formation at north of Tita, left bank of the Nenskra River. The unit is green, light green color, massive, sometimes seen as located inside the deposits in Jurassic age. The age of Diabase porphyry is assumed Middle Jurassic.

### 5.2.3.3.13 Sori Formation (Js)

Claystone, shale and sandstone in Early –Middle Jurassic age is named as Sori Formation.

Sori Formation outcrops at left bank of Nenskra River, south of Zemo Marghi, alignment of Nenskra Power Tunnel and alignment of the penstock at the project area.

The formation is composed of clay stone, sandstone, shale, slate and volcano sedimentary deposits. The unit is gray, dark gray and black color, middle-thick-very thick layered, rarely thin-middle layered. The unit displays flysh property. Sometimes volcano genetic sandstone, tuff and agglomerates are observed in the formation. The unit is represented as interbedded sandstone-clay stone at the project area.

The unit is rich in terms of content of coarse grained mica and quartz. The formation is generally following-up overturn folds. In the rock types created the Sori Formation joint systems are widespread developed. Sori Formation is transitive over Muashi Formation in Early Jurassic and under volcano sedimentary units in Dogger age.

### 5.2.3.3.14 Alluvium (Qal)

Alluvium formation is created by the deposits that accumulated as gravels, blocks, sand and clay materials over the flat areas along the Nenskra River and Nakra River. The alluvium material is widely deposited along the Nenskra River and Nakra river in somewhere the width of flat area reaching 700-800 m. The materials in alluvium are originated by gneiss, metagranite, granite, amphibolite, chert, quartzite, diorite, diabase, schist and sandstone. The particles are rounded, semi-rounded and rarely angular. The ratio of the fine-grained materials is lower due to the slope of the river channel. The ratio of fine-grained material is increased at the area where the slopes of the river channel reduced. According to the report of investigation prepared by STUCKY (2011), salty clayey level are found from 5 meter depth to 11 meter depth in the drilled borehole at right bank of the dam axis.

At the glacier period, the materials consisting of glacier deposits accumulated by glaciers are drifted particularly at Nenskra river valley, after that these deposits are covered by alluvium deposits by river action and flood. At the region, the thickness of alluvium deposits above 120 meters because of protection of the glacier deposits with covering the alluvium deposits.

### 5.2.3.3.15 Slope Debris (Qym)

Slope debris is created by rolling of the materials like block, gravel, sand, silt etc. from hillside to down as a result of gravity. The types of slope debris material are varying depending on type of the unit staying on slopes. Some materials transported by flooding created slope debris are originated gneiss, metagranite, granite, amphibolite, chert, quartzite, diorite, diabase, schist and sandstone. The grains are coarse at the bottom, fine at the top and the grains are angular, bed-middle graded. The grains are laterally graded.

This formation outcrops widespread the slopes of the valleys created by Nakra river, Nenskra river and their side-streams, dry-cracks at investigated area. The slope debris formation is covering the main rock at the project site up to 1380-1400 meter elevation. The glacier materials at high slopes created during glacier period are transported from the hillside to the bottom to provide materials for slope debris.

The slope debris formation depending on the formations including of gneissic, migmatitic rocks at north of the dam axis, reservoir and downstream are composed of gravels and blocks that are light brown, beige, gray color, angular, semi-angular shape, and generally originated gneissic, migmatitic, granitic and amphibolites. The slope debris formation at the south of project area are composed of gravel and blocks that is gray, dark grayish black color, fine-grained originated from the formations created at between

Devonian and Jurassic time. The thickness of the debris slope is between 10,0 meter and 45,0 meters.

#### **5.2.3.3.16 Alluvial Fan (Qay )**

Alluvial fan is the recent deposits in Quaternary time accumulated blocks, gravels, sands and silts etc. at the site where wide nutrition basin, the rivers having high degree abrasion and high degree transportation capacity like Nakra river, Nenskra river and their side-streams. At the top braided river, at the bottom meandering river, as move away from the source, the dimensions of grain size decrease.

They are observed at both side of the Nenskra river and Nakra river. Large-scale alluvial fans are found both bank of the dam axis.

Large – scale alluvial fan deposits are created because of high degree physical weathering of the rocks and glacier deposits at the top of mountain and by transportation of much more materials from the hillside to bottom.

Alluvial fan deposits are found at valley of Nakra river, dam axis (north of Nenskra river), reservoir and downstream and composed of light brown, beige, gray color, gneissic, granitic, migmatitic rocks and angular, semi-angular shape depending on the units that are gneissic, granitic, migmatitics. Alluvial fan formation is composed of gray, dark gray and black color gravels, blocks etc. originated by the deposits created from Devonian to Jurassic time and also sometimes glacier deposits of granitic, gneissic rocks and fine-grained particles. The thickness of the alluvial fan changes 70 meters to 80 meters.

#### **5.2.3.3.17 Fluvial Channel Deposits (Qaky)**

Fluvial channel deposits are represented by recent deposits developed widespread along the Nakra river, Nenskra river and their side-streams in Quaternary age.

The width of the channels reaches to 250-300 meter and cover very large area along the Nenskra river and Nakra river. The unit is composed of river deposits such as block, gravel, sand, clay. The unit include blocks, gravels, sands originated abundantly gneiss, gneissic granite, metagranite, migmatite, amphibolite, diorite, diabase, schist and sandstone, the shapes are rounded, semi-rounded, flat rarely angular. The most of the materials in these deposits are coarse-grained and block and gravel size. Fine-grained materials are very low ratio in the deposits. Fluvial channel deposits are composed of recent river sediments. The old period river deposits are covered by recent deposits. Fluvial channel deposits are changing from 20-40 meter thick at the investigated area.

#### **5.2.3.3.18 Glacier Deposits (Q b)**

The glacier deposits developed at Late Pleistocene-Holocene time are widespread precipitated along the highest pick from the hillside of Elbrus district that is 5642 m height, valley of Nenskra river and Nakra river.

At the project site the glacier deposit outcrops only at alignment of Nakra transfer tunnel and at the highest pick at north.

The glacier deposits are not seen along the valley because of covering by recent alluvial deposits.

The glacier deposits are composed of gravel, sand and silt that are well-graded grain size distribution, well rounded and polished.

The glacier deposits are filled U-shape valleys and after that mixed with materials of alluvium, alluvial fan and slope debris.

according to drilled boreholes by STUCKY (2011), the thickness of the glacier deposits nearly 60 meter beneath the alluvium. The thickness of the glacier deposits are estimated approximately 50-60 meter at the valley base.

#### 5.2.3.4 Structural Geology

Caucasia is created by mountain range having over thrust structure and developed inland fold as a result of intercontinental collusion between African-Arabian plate and Europe plate at Oligocene-Early Miocene time. The investigated area is located at south slope of main range of great Caucasia belt that the strike is northwest-southeast direction.

The tectonic zone of Caucasia, nearly NW-SE direction, generally are distinguished from each other by thrust plane that dip 700-800 towards to north. At Caucasia in Early Miocene time, main folding and forced to south begin after collusion of intercontinental.

At the region, the units and tectonic structures are located in the direction of WNW-SSE. Isoclinal folds which are dipping to north and forced faults are widespread developed at the region.

There are a lot of reverse fault and over thrust that is in direction of WNW-ESE or W-E and dip towards to north at the investigated area. The metamorphic base in Precambrian-Early Paleozoic age at the north of the investigated area is forced toward to the units that are Jurassic age as a result of these over thrusts and reverse faults. Beside this, Alibeck reverse fault that is the most tectonic line dips WNW- ESE or W-E and Main Caucasus Thrust are cut the units along the both limbs of the anticline and forced the units towards to south. The foliation is concentrated towards to NW-NE direction developed in metamorphic base created by gneiss, granitic gneiss, metagranite, amphibolite and schist.

The meta sedimentary deposits created from Devonian to Jurassic time have similar bedding and foliation that is generally in NW direction. The units are thin-bedded and laminated. The thickness of the layers of the units in Jurassic age are increased and become middle-thick and very thick.

The largest geological structure of the investigated area located folding and over thrust belt of Caucasia is the anticline which is S-W direction. The units in Silurian-Devonian age located south and north of the anticline that create the seed of the units constitute turndown isoclinal folds towards to north.

The joint sets are developed at all geological units depend on tectonics at the investigated area. Depending on over thrusting from north to south of all belts and tectonic zones of Caucasia, a lot of over thrust and reverse faults that are in the direction of WNW-ESS and dip towards the north are developed at the project area

Beside the reverse fault and over thrust, a lot of strike and oblique faults are observed at the project site. Because of the covering deposits like top soil, slope debris, alluvium, alluvial fan etc., to follow these faults is impossible so that these faults are not mapped.

African-Arabian plate moves towards to north direction and approach to Eurasian plate 20-30 mm every year. Some of this movement of plate that north-south direction is absorbed by south Caucasia suture zone. The left amount of energy is accumulated at Caucasia.



**5.2.3.4.1 Kinematical Analyses**

The kinematical analyses of bedding, joints and faults in the project area were performed and the compression-extension directions of the region and the tectonic development model of the study area were revealed. Therefore, the kinematical analyses were conducted with respect to the contour diagrams of bedding and rose diagrams of joints and the strike, dip and the deviation angle of slickenside of fault planes.

**5.2.3.4.1.1 The contour diagrams**

The contour diagrams depending on bedding orientation are given below according to the strike and dip angles measured from the metamorphic located at dam axis, from Sori Formation located at east of Zemo Magri and powerhouse site area (Figures 5.2.3.4.1.1- 5.2.3.4.1.3.)

**Figure 5.2.3.4.1.1.** The contour diagrams of metamorphoses located in dam axis.

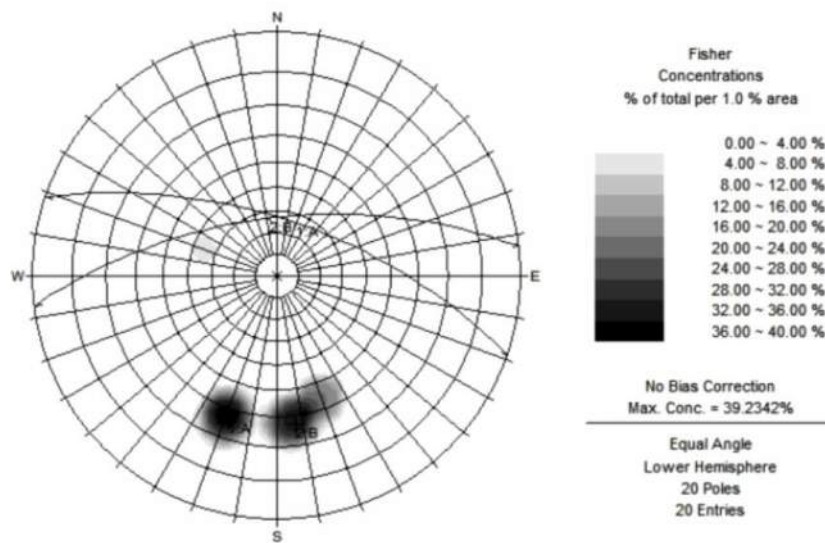

**Figure 5.2.3.4.1.2.** The contour diagrams of Sori Formation

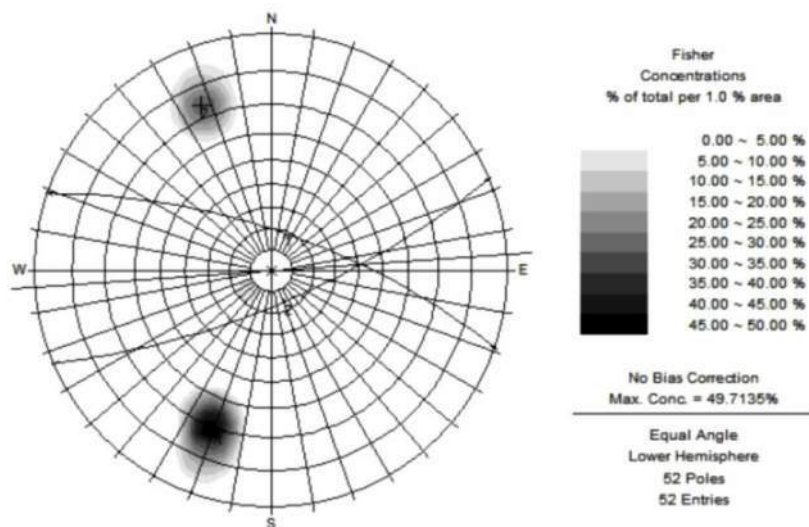

**Figure 5.2.3.4.1.3.** The contour diagrams of beddings located in east of Zemo Marghi

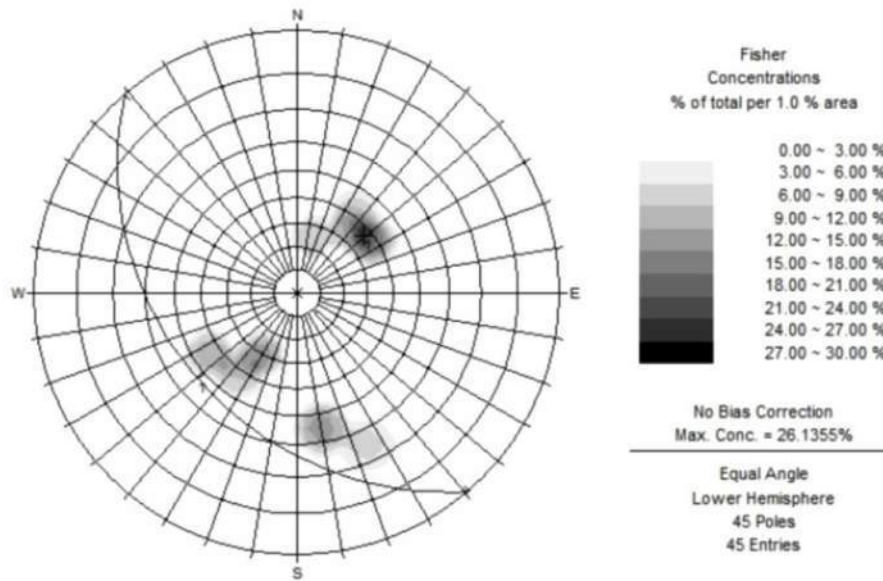

**Rose Diagrams of Joint Planes**

A number of discontinuity sets occurred in the study area according to the regional tectonic activity. Systematic joint plane measurements were carried out on the left and right embankment of the study area to find out the tectonic processes leading to the deformation of the region. These measurements were firstly evaluated on rose diagrams (Figures 5.2.3.4.1.4 - 5.2.3.4.1.7).

**Figure 5.2.3.4.1.4.** Rose diagram of joint systems on the right embankment

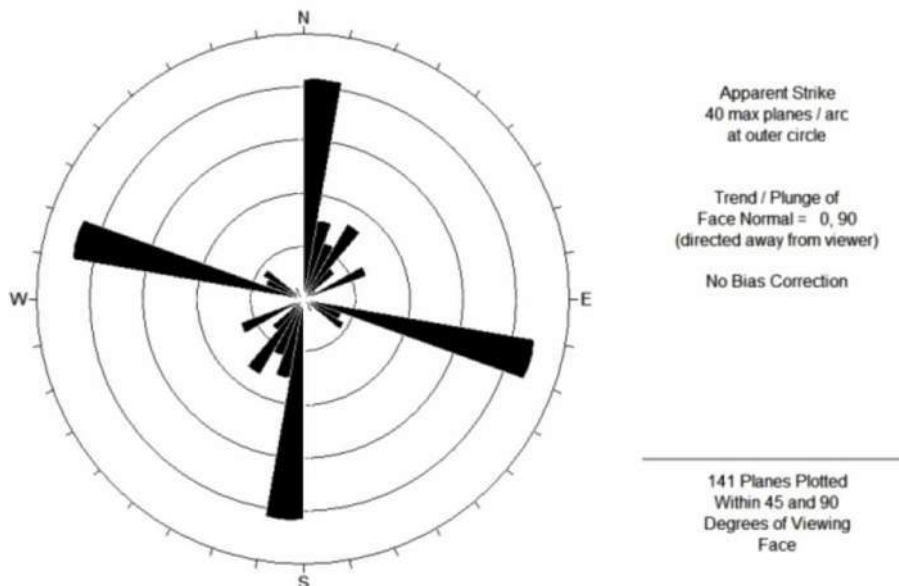

According to the stereographic net measurements, it is seen that there two main cracks systems developed on the right embankment. The acute angle between these cracks is nearly 70o and evaluated as shear cracks. The effective compressive pressure between these cracks is in the direction of N30-40W while the tensile stress is in the direction of N50-60W. The compression in the direction NW-SE that

effective on the developing of shear cracks and expansion in the direction of NE-SW differs in general regional creation.

**Figure 5.2.3.4.1.5.** Rose diagram of joint systems on the left embankment

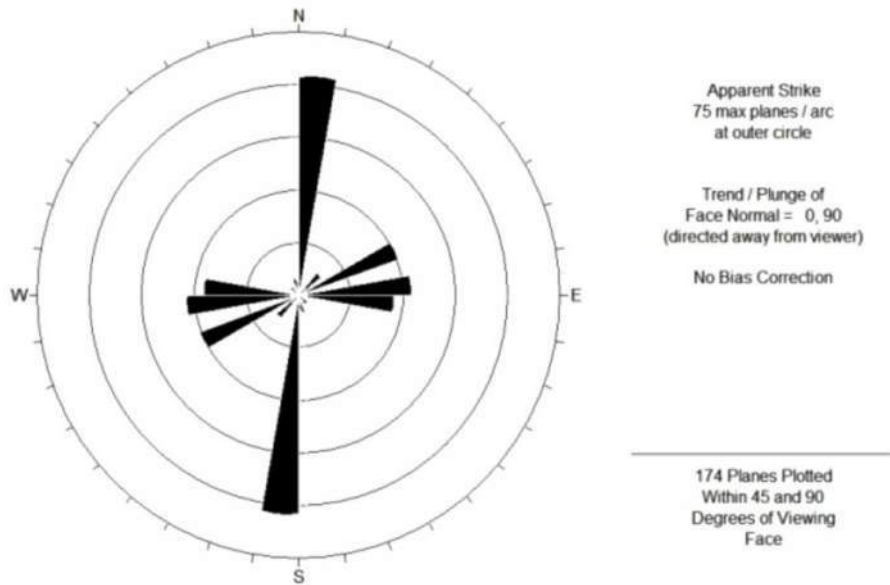

According to the stereographic net measurements, it is seen that the tension cracks systems developed on the left embankment. These tension cracks are generally developed on the direction of N-S and N 10 E. The direction of the pressure that created the tension cracks are the direction of N-S and N 10 E while the direction of the tensile stresses are developed on the direction of E-W and N 80 W. An effective compression direction in the region is compatible with the fault planes found by kinematic analysis.

**Figure 5.2.3.4.1.6.** Rose diagram of joint systems on the powerhouse and Jurassic formation

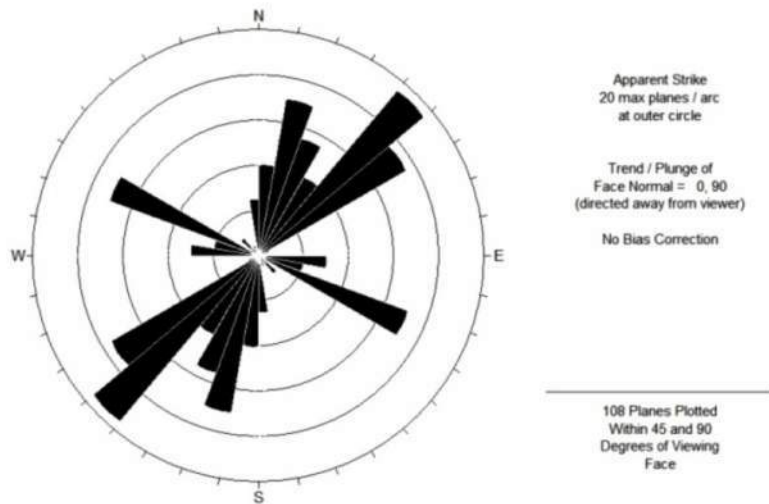

According to the stereographic net measurements of Jurassic formations, there are a lot of crack planes developed on the direction of NE-SW. But, it is the dominant tension cracks developing in the direction of N40-50E. The dominant compressive pressure is developed in the direction of N40-50E while tensile stress develops in the direction of N40-50W. Beside this, the shear cracks are also seen between these at 70 o angle. According to the stereographic net measurements of Jurassic formations at the plant site and north part, it is seen that the tensile cracks developed at the direction of N10-20E. The compressive pressure that creates the tensile cracks is again in the direction of N10-20E while tensile stress is in the direction of N70-80W. The compression at the direction of NNE-SSW is compatible with the fault planes

found by kinematic analysis.

**Figure 5.2.3.4.1.7.** Rose diagram of joint systems at the east of Zemo Marghi

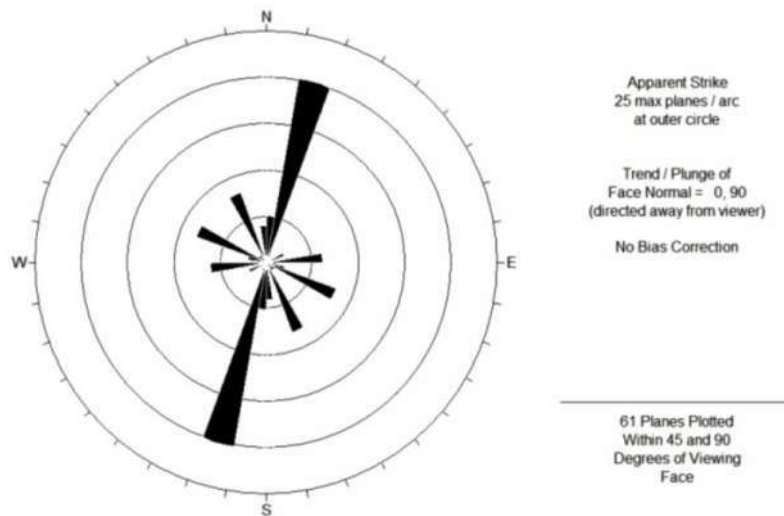

### Stereographic projection of fault plane solutions using Schmidt net and lower hemisphere

Many faults occurred in the study area with respect to the tectonic processes of the region. Kinematical analyses of fault planes were performed to reveal the tectonic evolution that formed the deformation in the region.

Beside thrusts and over thrust, strike-slip, reverse faults were developed in the study area. A total of 12 fault plane measurements were executed to signify the tectonic stresses within the region. Data obtained from sliding planes were evaluated by means of direct inversion method in Angelier software. Firstly, field data were processed in Angelier software to find out the regional stress.

At the investigated area, all the over thrust and reverse faults are evaluated all together on station -1. According to these measurements and displaying on stereographic nets for station-1;

N72° W/ 72° NE, deflection angle; 80° W Reverse Fault,

N72° W/ 78° NE, deflection angle; 77° W Reverse Fault,

N80° W/ 45° NE, deflection angle; 85° W Over thrust, N62° W/ 44° NE, deflection angle; 88° W Over thrust, The axis of the Principal stresses are;  $\sigma_1 = 359/16$ ,  $\sigma_1 = 90/2$ ,  $\sigma_1 = 188/74$ ;  $\varphi = 0,597$

At the investigated area, the strike-slip faults developed in the Jurassic Formation displaying left and right lateral developed between two over thrust faults are seen at station-2. The fault developing in this region is compressed in the direction of NNE-SSW and expanded in the direction of ESE-WNW. This result is compatible with N-S direction of compression.

According to these measurements and displaying on stereographic nets for station-2; N60° W/ 45° SW, deflection angle; 10° W Right Lateral Strike-Slip Fault, N75° E/ 70° SE, deflection angle; 30° E Left Lateral Strike-Slip Fault,

N30° W/ 42° SW, deflection angle; 10° N Right Lateral Strike-Slip Fault, N30° W/ 72° SW, deflection angle; 50° N Right Lateral Strike-Slip Fault, The axis of the Principal stresses are;  $\sigma_1 = 03/16$ ,  $\sigma_1 = 219/53$ ,  $\sigma_1 = 104/17$ ;  $\varphi = 0,499$

At the investigated area, the strike-slip faults and reverse faults developed at the northeast part of project area are seen at station-3. The fault developing in this region is compressed in the direction of N- S. This result is compatible with N-S direction of compression.

According to these measurements and displaying on stereographic nets for station-3; N65° E/ 45° NW, deflection angle; 87° S Reverse Fault, N50° W/ 80° SW, deflection angle; 20° W Right Lateral Strike-Slip Fault, N60° E/ 34° NW, deflection angle; 85° E Reverse Fault, N85° E/ 65° NW, deflection angle; 88° E Reverse Fault,

The axis of the Principal stresses are;  $\sigma_1 = 354/11$ ,  $\sigma_1 = 90/25$ ,  $\sigma_1 = 244/62$ ;  $\varphi = 0,374$

### 5.2.3.5 Engineering Geology

On the dam site, the eight boreholes named DBH-1, DBH-2, DBH-3, DBH-4, DBH-5, DBH-6, DBH-7 and SBH-1 were drilled as totally 1044 meters depth. In these boreholes, the 163 numbers water pressure tests were performed to determine permeability of main rock under dam foundation.

In addition to these, the three boreholes named SBH-3, SBH-4 and SBH-5 were drilled on the alignment of spillway and diversion as totally 200 meters depth.

At the powerhouse site, the four boreholes named PBH-1, PBH-2, PBH-3 and PBH-4 were drilled as totally depth of 160 meter to determine geotechnical parameters of powerhouse foundation. The 80 numbers pressure meter tests were performed to determine allowable bearing capacity of powerhouse foundation.

One borehole named TBH-3 at the alignment of diversion tunnel and one borehole named TBH-4 at inlet of Approach Tunnel were drilled as totally 118,5 meter depth to determine geotechnical parameters of the units at tunnel level and their overburden. The 9 numbers water pressure tests were performed in the boreholes at the level of tunnel section to determine permeability of the unit at tunnel section and overburden units.

On the Nakra weir site, the two boreholes named NWBH-1 and NWBH-3 were drilled at weir axis and two boreholes named NTBH-1 and NTBH-2 were drilled at alignment of Nakra transfer tunnel inlet as totally depth of 100 meter. In the boreholes named NWBH-1 and NWBH-3, The 22 permeability and 25 pressure meter tests were performed to determine permeability and allowable bearing capacity of weir foundation.

The specifications of drilling boreholes are given in the Table 5.2.3.5.1. Each borehole is described separately in detail. The zone of coordinates is 38 and datum is ED50.

**Table 5.2.3.5.1.** The coordinates and depths of the boreholes

Location	Borehole No.	Depth (m)	Coordinates		Core Box (Number)
			X	Y	
NENSKRA DAM SITE	DBH-1	40,00	4779306	273266	5,00
NENSKRA DAM SITE	DBH-2	80,00	4779182	273309	5,00
NENSKRA DAM SITE	DBH-3	72,00	4779056	273352	7,00
NENSKRA DAM SITE	DBH-4	27,00	4778927	273397	2,00
NENSKRA DAM SITE	DBH-5	200,00	4779295	273405	22,00
NENSKRA DAM SITE	DBH-6	200,00	4779207	273481	38,00
NENSKRA DAM SITE	DBH-7	225,00	4779076	273560	45,00
NENSKRA DAM SITE	SBH-1	200,00	4779004	273670	39,00
SPILWAY	SBH-3	50,00	4778840	273073	8,00
SPILWAY	SBH-4	80,00	4778898	272931	5,00
SPILWAY	SBH-5	70,00	4778943	272942	5,00
POWERHOUSE	PBH-1	40,00	4764201	270682	7,00
POWERHOUSE	PBH-2	40,00	4764176	270683	8,00
POWERHOUSE	PBH-3	40,00	4764145	270685	5,00
POWERHOUSE	PBH-4	40,00	4764160	270724	6,00
PENSTOCK ALIGNMENT	TBH-3	68,50	4764210	270819	12,00
APPROACH TUNNEL INLET	TBH-4	50,00	4765946	272226	9,00
NAKRA INTAKE	NTBH-1	20,00	4777577	288353	2,00
NAKRA INTAKE	NTBH-2	40,00	4777575	288301	5,00
NAKRA WEIR AXIS	NWBH-1	20,00	4777456	288421	2,00
NAKRA WEIR AXIS	NWBH-3	30,00	4777453	288362	3,00

### 5.2.3.5.1 Description of Boreholes

#### Borehole DBH-1

Location	: Left Bank
Depth	: 40,00 m
Coordinates X	: 4779306
Y	: 273266
Elevation	: 1319 m
Diameter of Borehole	: HQ, →NQ
Type of Drilling Bit	: HQ-NQ Emprenie Diamond
Casing	: PQ, →HQ

The borehole DBH-1 was drilled at the left bank of the dam axis vertically and 40 meter depth.

The units encountered in the borehole DBH-1 are:

0,00 m – 40,00 m Channel Deposits (Recent Alluvium) (Qaky); Brown, gray color, generally blocky, the diameter of blocks sometimes in between 10-40 cm, semi rounded semi-angular shape, sandy, medium-coarse gravel. The gravels are originated granite, gneiss and rarely schist.

There is no ground water table.

<b>Borehole DBH-2</b>	
Location	: Left Bank
Depth	: 80,00 m
Coordinate X	: 4779182
Y	: 273309
Elevation	: 1327 m
Diameter of Borehole	: HQ → NQ → BQ
Type of Drilling Bit	: HQ-NQ-BQ Emprenie Diamond
Casing	: PQ → HQ → NQ

The borehole DBH-2 was drilled at the left bank of the dam axis vertically and 80 meter in depth.

The units encountered in the borehole DBH-2 are:

0,00 m – 80,00 m Alluvium (Qal) ; Brown, gray color, generally blocky, the diameter of blocks sometimes in between 10-40 cm, semi rounded- semi angular shape, sandy, medium-coarse gravel. The gravels are originated granite, gneiss and rarely schist.

<b>Borehole DBH-3</b>	
Location	: Left Bank
Depth	: 72,00 m
Coordinates X	: 4779056
Y	: 273352
Elevation	: 1365 m
Diameter of Borehole	: PQ → HQ → NQ
Type of Drilling Bit	: HQ-NQ Emprenie Diamond
Casing	: PQ → HQ

The borehole DBH-3 was drilled at the left bank of the dam axis vertically and 72 meter in depth.

The units encountered in the borehole DBH-3 are:

0,00 m – 46,00 m Alluvial Fun (Qay); Brown, gray color, generally blocky, the diameter of blocks sometimes in between 10-40 cm, semi rounded-semi angular shape, sandy, medium-coarse gravel. The gravels are originated granite, gneiss and rarely schist.

46,00 m – 72,00 m | Dolrini Formation (Osd); Meta Granite, Granitic Gneiss; dark gray, blackish color, generally very fractured, locally fractured. Fractures are generally bias and locally developed nearly vertically. The fractures are generally filled with silicium and locally iron oxides. The surface of the fractures is rough, medium – less weathered and locally fresh. Rock quality is very weak-weak and having high strength.

The percentage of core is 41%, mean RQD is 33% and rock quality is weak. There is no ground water table.

Highly permeable levels are from 46,00 to 72,00 m and the value of Lugeon between 12,65 - <25.

Borehole DBH-4	
Location	: Left bank
Depth	: 27,00 m
Coordinates X	: 4778927
Y	: 273397
Elevation	: 1450 m
Diameter of Borehole	: PQ
Type of Drilling Bit	: HQ Emprenie Diamond
Casing	: PQ

The borehole DBH-4 was drilled at the left bank of the dam axis vertically and 27 meter in depth.

The units encountered in the borehole DBH-4.

0,00 m – 27,00 m | Alluvial Fan (Qay); Brown, gray color, generally blocky, the diameter of blocks sometimes in between 20-35 cm, semi rounded-semi angular shape, sandy, medium-coarse gravel. The gravels are originated granite, gneiss and rarely schist.

The percentage of core 27,00 %. There is no ground water table.

Borehole DBH-5	
Location	: Thalweg
Depth	: 200,00 m
Coordinates X	: 4779295
Y	: 273405
Elevation	: 1315 m
Diameter of Borehole	: PQ → HQ → NQ
Type of Drilling Bit	: HQ-NQ Emprenie Diamond
Casing	: PQ → HQ

The borehole DBH-5 was drilled at the Thalweg of the left bank of the dam axis vertically and 200 meter in depth.

The units encountered in the borehole DBH-5 are:



0,00 m – 40,00 m	Channel Deposits (Recent Alluvium) (Qaky); Brown, gray color, generally blocky, the diameter of blocks sometimes in between 25-60 cm, semi rounded semi angular shape, sandy, medium-coarse gravel. The gravels are originated granite, gneiss and rarely schist.
40,00 m – 127,00 m	Alluvium (Qal); Brown, gray color, generally blocky, the diameter of blocks sometimes in between 25-95 cm, semi rounded-semi angular shape, sandy, medium-coarse gravel. The gravels are originated granite, gneiss and rarely schist.
127,00 m – 200,00 m.	Dolrini Formation (Osd); Meta Granite, Granitic Gneiss; dark gray, blackish color, generally very fractured, locally fractured. Fractures are generally bias and locally developed nearly vertically. The fractures are generally filled with silicium and locally iron oxides. The surface of the fractures is rough, medium – less weathered and locally fresh. Rock quality is fair-good and high strength.

The percentage of core is 53%, mean RQD is 30% and rock quality is poor. There is no GWT  
 The permeable levels are from 128,00 to 142,00 m, the values of Lugeon are between 14,46-17,04.  
 The highly permeable levels are from 145,00 to 176,00 m and the values of Lugeon >25.

<b>Borehole DBH-6</b>	
Location	: Left bank
Depth	: 200,00 m
Coordinates X	: 4779207
Y	: 273481
Elevation	: 1318 m
Diameter of Borehole	: PQ → HQ → NQ
Type of Drilling Bit	: HQ-NQ Emprenie Diamond
Casing	: PQ → HQ

The borehole DBH-6 was drilled at the Thalweg of the left bank of the dam axis vertically and 200 meter in depth.

The units encountered in the borehole DBH-6 are;

0,00 m – 48,00 m	Alluvium (Qal); Brown, gray color, generally blocky, the diameter of blocks sometimes in between 25-60 cm, semi rounded-semi angular shape, sandy, medium-coarse gravel. The gravels are originated granite, gneiss and rarely schist.
48,00 m – 200,00 m	Dolrini Formation (Osd); Meta Granite, Granitic Gneiss; dark gray, blackish color, generally very fractured, locally fractured. Fractures are generally bias and locally developed nearly vertically. The fractures are generally filled with silicium and locally iron oxides. The surface of the fractures is rough, medium –less weathered and locally fresh. Rock quality is fair and high strength.

The percentage of core is 86%, mean RQD is 60% and rock quality is fair. The ground water table is at top of the borehole, the other word GWT is 0,00 m depth.

The permeable levels are from 53,00 to 55,70 m and from 64,60 to 66,80 m and the value of Lugeon >25. In between 19,90-21,52; 82,00-109,50 m and 122,00-196,00 m also the value of Lugeon are between 12,54-24,96.

The highly permeable levels are from 51,00 to 55,50 m, from 69,80 to 82,00 m and from 118,00 to 120,00 m. The value of Lugeon is >25.

Borehole DBH-7	
Location	: Left bank
Depth	: 225,00 m
Coordinates X	: 4779076
Y	: 273560
Elevation	: 1365 m
Diameter of Borehole	: PQ → HQ → NQ
Type of Drilling Bit	: HQ-NQ Empreie Diamond
Casing	: PQ → HQ

The borehole DBH-7 was drilled at the left bank of the dam axis vertically and 225 meter in depth. The units encountered in the borehole DBH-7 are:

0,00 m – 26,00 m	Slope Debris (Qym); Gray, white and black colored, generally moderate-coarse blocky, 25-30 cm in diameter, semi rounded-semi angular. Generally, the gravels are originated by granite, rarely schist.
26,00 m – 110,60 m	Dolrini Formation (Osd); In general, they are created beige, gray and light yellowish brown colored granitic gneiss, mica, quartzite, generally very fractured. The fractures are generally bias, rarely horizontal or nearly horizontal. The surface of the fractures is generally unfilled, locally silicified and iron oxide painted, moderately weathered rarely less weathered -fresh. Rock quality is Fair-good and having excellent strength.
110,60 m-125,80 m	Dolrini Formation (Osd); In general, they are created beige, gray and light yellowish brown colored Leuco granite, granitic gneiss, mica, quartzite, generally very fractured. The fractures are generally bias, rarely horizontal or nearly horizontal. The surface of the fractures are generally unfilled, locally silicified and iron oxide painted, moderately weathered rarely little weathered- fresh. Rock quality is good rarely fair and having excellent strength.
125,80 m-136,70 m	Dolrini Formation (Osd); In general, they are created beige, gray and light yellowish brown colored granitic gneiss, mica, quartzite, generally fractured. The fractures are generally bias, rarely horizontal or nearly horizontal. The surface of the fractures are generally unfilled, locally silicified and iron oxide painted, moderately weathered rarely little altered-fresh. Rock quality is good- excellent rarely fair and having

	excellent strength.
136,70 m-151,60 m	Diabase; Gray, beige, greenish and light brown colored, in general highly jointed and in some places fractured, joints are diagonal and close to the vertical, joint surfaces filled with quartzite and plaster of iron oxide, high- medium weathered, fresh, rock quality is weak-medium and rarely fine.
151,60 m-225,00 m	Dolrini Formation (Osd); In general, they are created beige, gray and light yellowish brown colored granitic gneiss, mica, quartzite, generally fractured. The fractures are generally bias, rarely horizontal or nearly horizontal. The surface of the fractures are generally unfilled, locally silicified and iron oxide painted, moderately weathered rarely little altered-fresh. Rock quality is good- excellent and having excellent strength.

The percentage of core in this borehole is generally 80%, mean RQD 60% and rock quality is fair There is no ground water table.

Permeable levels are from 32,00 to 36,00 m, from 62,00 to 68,00 m, from 78,00 to 82,00 m, from 96,00 to 102,00 m, from 114,00 to 178,00 m, from 184,00 to 194,00 m and from 202,00 to 225,00 m.

The values of the Lugeon are between 7,66 and 23,79.

Highly permeable levels are from 28,00 to 32,00 m, from 38,00 to 60,00 m, from 68,00 to 78,00 m, from 82,00 to 96,00 m, from 102,00 to 114,00 m, from 180,00 to 182,00 m and from 194,00 to 198,00 m. The values of Lugeon is >25.

Borehole SBH-1	
Location	: Left Bank
Depth	: 200,00 m
Coordinate X	: 4779004
Y	: 273670
Elevation	: 1427 m
Diameter of Borehole	: PQ → HQ → NQ
Type of Drilling Bit	: HQ-NQ Emprenie Diamond
Casing	: PQ → HQ

The borehole SBH-1 was drilled at the left bank of the dam axis nearly crest vertically and 200 meter in depth.

The units encountered in the borehole SBH-1 are:

0,00 m – 20,00 m	Slope Debris (Qym); Grayish, white and bay colored, generally the blocks are 15-25 cm in diameter sometimes reach 65 cm in diameter. The gravels are coarse, semi rounded-semi angular and originated from granite and gneiss.
20,00 m – 48,00 m	Dolrini Formation (Osd); are composed of dark gray, grayish white and black colored Metagranite, quartz schist, mica schist. The units are very fractured-fractured, the fractures are generally bias and nearly vertically. The surfaces of the fractures are filled with quartz and iron oxide painted, moderately-highly weathered rarely less weathered and fresh. The rock quality is poor-very poor

	and having moderately strong-strong strength.
48,00 m – 200,00 m	Dolrini Formation (Osd); are composed of gray, beige, greenish and light brown colored Meta Granite, Granite, Gneiss, Amphibolite. The units are fractured in general. The fractures are generally bias rarely developed horizontally, the surface of the fractures are unfilled in general but rarely filled with silicium and iron oxide painted, generally moderately weathered locally less weathered-fresh. The rock quality is moderate and having moderately strong-strong strength.

The percentage of core in this borehole is generally 80%, mean RQD nearly 55% and rock quality is fair. There is no ground water table.

Permeable levels are from 20,00 to 24,00 m, from 30,00 to 33,50 m, from 38,00 to 45,00 m, from 51,00 to 58,00 m, from 62,00 to 106,00 m, from 121,00 to 142,00 m and from 155,00 to 200,00 m. The Lugeon value are between 7,44-24,55.

Highly permeable levels are from 24,00 to 28,00 m, from 35,00 to 38,00 m, from 45,00 to 48,00 m, from 58,00 to 62,00 m, from 106,00 to 118,80 m and from 142,00 to 150,00 m. The Lugeon value is >25.

Borehole SBH-3	
Location	: Alignment of Spillway
Depth	: 50,00 m
Coordinate X	: 4778840
Y	: 273073
Elevation	: 1394 m
Diameter of Borehole	: PQ → HQ → NQ
Type of Drilling Bit	: HQ-NQ Emprenie Diamond
Casing	: PQ → HQ

The borehole SBH-3 was drilled at the left bank and spillway axis vertically and 50 meter in depth.

The units encountered in the borehole SBH-3 are:

0,00 m – 20,50 m	Alluvial Fan (Qay); Brown colored, beige and grey colored, blocky in general sometimes block diameter reaches 70 cm. Generally blocks are semi rounded- semi angular. The blocks and gravels are originated by granite and gneiss rarely schist.
20,50 m – 50,00 m	Dolrini Formation (Osd); are composed of gray, beige and greenish and light brown colored Meta Granite, Biotite, Micro Granite. The units are very fractured in general. The fractures are generally bias rarely developed horizontally, the surface of the fractures are unfilled in general but rarely filled with silicium and iron oxide painted, generally moderately weathered locally less weathered-fresh. The rock quality is poor-very poor and having moderately strong strength.

The percentage of core in this borehole is meanly 65%, mean RQD is nearly 15% and rock quality is poor-very poor. There is no ground water table.

---

**Borehole SBH-4**

---

Location	:	Alignment of Spillway
Depth	:	80,00 m
Coordinate	X	: 4778898
	Y	: 272931
Elevation	:	1370 m
Diameter of Borehole	:	PQ → HQ → NQ → BQ
Type of Drilling Bit	:	HQ-NQ-BQ Emprenie Diamond
Casing	:	PQ → HQ → NQ

The borehole SBH-4 was drilled at the left bank and spillway axis vertically and 80 meter in depth. The unit encountered in the borehole SBH-4 is:

0,00 m – 80,00 m	Alluvial Fan (Qay) ; is composed of brown, beige and gray colored, blocky, sometimes the diameter of the blocks reach to 30 cm. The blocks are semi rounded-semi angular shape and originated granite and gneiss.
------------------	---

The percentage of core in this borehole is meanly 30%. There is no ground water table.

---

**Borehole SBH-5**

---

Location	:	Alignment of Spillway
Depth	:	70,00 m
Coordinate	X	: 4778943
	Y	: 272942
Elevation	:	1360 m
Diameter of Borehole	:	PQ → HQ → NQ → BQ
Type of Drilling Bit	:	HQ-NQ-BQ Emprenie Diamond
Casing	:	PQ → HQ → NQ

The borehole SBH-5 was drilled at the left bank and spillway alignment axis vertically and 70 meter in depth.

The unit encountered in the borehole SBH-5 is:

0,00 m – 70,00 m Alluvial Fan (Qay) ; is composed of brown, beige and gray colored, blocky sandy gravels, sometimes the diameter of the blocks reach to 56 cm. The blocks are semi rounded-semi angular shape and originated granite and gneiss.

The percentage of core in this borehole is meanly 30%. There is no ground water table.

---

**Borehole PBH-1**

---

Location	:	Site of HEPP
Depth	:	40,00 m
Coordinate	X	: 4764201
	Y	: 270682
Elevation	:	715 m
Diameter of Borehole	:	PQ → HQ → NQ
Type of Drilling Bit	:	HQ-NQ Emprenie Diamond
Casing	:	PQ → HQ

The borehole PBH-1 was drilled at the Site of HEPP, drilled vertically and 40 meter in depth.

Inside the borehole every 2 meter intervals pressure meter tests were performed to determine the strength parameters of the HEPP foundation unit.

The units encountered in the borehole PBH-1 are:

00,00 m – 7,40 m	Slope Debris (Qym); is composed of gray-brown colored, blocky unit in general rarely diameter of the blocks reach to 15 cm. It is generally originated clayey sandy gravel. Fine-moderate particles of gravels are originated granite.
7,40 m - 40,00 m	Sori Formation (Js); is composed of dark and light gray, black colored sandstone, shale They are generally wide-moderate fractured sometimes very fractured. The fractures are generally bias, rarely nearly vertically and filled with silicium, sometimes iron oxides painted. The surface of the fractures is planer and rough, highly-moderately weathered sometimes less weathered and fresh. The rock quality is fair-good, having strong strength and displays lamination.

The percentage of core in this borehole is meanly 80%, mean RQD nearly 60% and rock quality is fair-good. There is no ground water table.

---

**Borehole PBH-2**

---

Location	:	Site of HEPP
Depth	:	40,00 m
Coordinate	X	: 4764176
	Y	: 270683
Elevation	:	713.m
Diameter of Borehole	:	PQ → HQ → NQ
Type of Drilling Bit	:	HQ-NQ Emprenie Diamond
Casing	:	PQ → HQ

The borehole PBH-2 was drilled at the Site of HEPP, drilled vertically and 40 meter in depth.

The pressure meter tests were performed to determine the strength parameters of the HEPP foundation

inside the borehole every 2 meter intervals.

The units encountered in the borehole PBH-2 are;

0,00 m – 10,10 m	Slope Debris (Qym); is composed of gray-brown colored blocky unit in general, rarely diameter of the blocks reach to 25 cm. It is generally clayey sandy gravel. Fine-moderate particles of gravels are originated granite and clay stone
10,10 m – 40,00 m	Sori Formation (Js); is composed of dark and light gray, black colored sandstone, shale They are generally wide-moderate fractured sometimes very fractured. The fractures are generally bias, rarely nearly vertically and filled with silicium, sometimes iron oxides painted. The surface of the fractures is planer and rough, highly-moderately weathered sometimes less weathered and fresh. The rock quality is fair-good, having strong strength and displays lamination.

The percentage of core in this borehole is meanly 80%, mean RQD nearly 50% and rock quality is poor-fair. There is no ground water table.

**Borehole PBH-3**

Location	: Site of HEPP
Depth	: 40,00 m
Coordinate X	: 4764145
Y	: 270685
Elevation	: 713 m
Diameter of Borehole	: PQ → HQ → NQ
Type of Drilling Bit	: HQ-NQ Emprenie Diamond
Casing	: PQ → HQ

The borehole PBH-3 was drilled at the Site of HEPP, drilled vertically and 40 meter in depth.

The pressure meter tests were performed to determine the strength parameters of the HEPP foundation inside the borehole every 2 meter intervals.

The units encountered in the borehole PBH-3 are:

0,00 m – 7,00 m	Slope Debris (Qym); is composed of gray-brown colored, blocky in general rarely diameter of the blocks reach to 30 cm. It is generally clayey sandy gravel. Fine-moderate particles of gravels are originated granite, clay stone and schist
7,00 m – 40,00 m	Sori Formation (Js); is composed of dark and light gray, black colored sandstone, shale. They are generally wide-moderate fractured sometimes very fractured. The fractures are generally bias, rarely nearly vertically and filled with silicium, sometimes iron oxides painted. The surface of the fractures are corrugated and rough, highly-moderately weathered sometimes less weathered and fresh. The rock quality is poor-very poor, having strong strength and displays lamination.

The percentage of core in this borehole is meanly 55%, mean RQD nearly 12% and rock quality is poor-very poor. There is no ground water table.

---

**Borehole PBH-4**

---

Location	:	Site of HEPP
Depth	:	40,00 m
Coordinates	X	: 4764160
	Y	: 270724
Elevation	:	738 m
Diameter of Borehole	:	PQ → HQ → NQ
Type of Drilling Bit	:	HQ-NQ Emprenie Diamond
Casing	:	PQ → HQ

The borehole PBH-4 was drilled at the Site of HEPP, drilled vertically and 40 meter in depth.

The pressure meter tests were performed to determine the strength parameters of the HEPP foundation inside the borehole every 2 meter intervals.

The units encountered in the borehole PBH-4 are:

0,00 m – 17,00 m	Slope Debris (Qym); is composed of gray-brown colored, blocky in general rarely diameter of the blocks reach to 25 cm. It is generally clayey sandy gravel. Fine-moderate particles of gravels are originated granite, clay stone and schist
17,00 m – 40,00 m	Sori Formation (Js); is composed of dark and light gray, black colored sandstone, shale. They are generally wide-moderate fractured sometimes very fractured. The fractures are generally bias, rarely nearly vertically and filled with silicium, sometimes iron oxides painted. The surface of the fractures are corrugated and rough, highly-moderately weathered sometimes weathered and fresh. The rock quality is fair-good, having moderately strong- less strong strength and displays lamination.

The percentage of core in this borehole is meanly 60%, mean RQD nearly 55% and rock quality is fair-good. There is no ground water table.

---

**Borehole TBH-3**

---

Location	:	Inlet of powerhouse
Depth	:	68,50 m
Coordinate	X	: 4764210
	Y	: 270819
Elevation	:	776 m
Diameter of Borehole	:	PQ → HQ → NQ
Type of Drilling Bit	:	HQ-NQ Emprenie Diamond
Casing	:	PQ → HQ

The borehole TBH-3 was drilled at the alignment of Penstock Tunnel, drilled vertically and 68,50 meter in depth.

The units encountered in the borehole TBH-3 are:



0,00 m – 24,00 m	Alluvial Fan (Qay); is composed of gray, beige, black and light brown colored sandy gravelly blocks. The diameter of the block is up to 90 cm in some levels. The shape of the blocks is semi angular-semi rounded and originated from clay stone, gneiss and granite, rarely schist.
24,00 m – 68,50 m	Sori Formation (Js); are composed of dark and light gray, black colored sandstone, shale. They are generally wide-moderate fractured sometimes very fractured. The fractures are generally bias, rarely nearly vertically and horizontal. The fractures are enclosed and filled with silicium reaching 12 mm wide, sometimes iron oxides painted. The surface of the fractures are corrugated and rough, highly-moderately weathered sometimes less weathered and fresh. The rock quality is fair-poor, having moderately strong and displays lamination.

The percentage of core in this borehole is meanly 80%, mean RQD nearly 45% and rock quality is fair-poor. There is no ground water table.

Permeable levels are from 27,50 to 29,50 m, from 52,50 to 54,50 m and from 58,00 to 60,00 m. The values of Lugeon are between 0,71 and 0,81.

Semi-permeable levels are from 33,00 to 35,00 m, from 35,00 to 37,00 m, from 42,30 to 44,30 m, from 47,00 to 49,00 m, from 61,00 to 63,00 m and from 66,00 to 68,00 m. The values of Lugeon is between 1,15 and 4,31.

#### Borehole TBH-4

Location	:	Inlet of Approach Tunnel
Depth	:	50,00 m
Coordinate	X	: 4765946
	Y	: 272226
Elevation	:	1230 m
Diameter of Borehole	:	PQ → HQ → NQ
Type of Drilling Bit	:	HQ-NQ Emprenie Diamond
Casing	:	PQ → HQ

The borehole TBH-4 was drilled at the inlet of Approach Tunnel, drilled vertically and 50,00 meter in depth.

The units encountered in the borehole TBH-4 are:

0,00 m – 3,40 m	Slope Debris (Qym) is composed of gray-brown color, medium-coarse gravels and the diameter of blocks reach 20 cm in somewhere. The blocks and gravels are originated from clay stone and sandstone.
3,40 m – 50,00 m	Sori Formation (Js); Light gray, beige and brown colored sandstone, shale that is the member of Sori Formation is generally wide-moderate fractured sometimes very (intense) fractured and crushed. The fractures developed bias in general. The fractures are filled with silicium, sometimes iron oxides painted. The surface of the fractures is corrugated and rough, less weathered- fresh. The rock quality is fair, having moderately strong.

The percentage of core in this borehole is meanly 80%, mean RQD nearly 50% and rock quality is fair. There is no ground water table.

---

**Borehole NTBH-1**

---

Location	:	Inlet of Nakra transfer tunnel
Depth	:	20,00 m
Coordinate	X	: 4777577
	Y	: 288353
Elevation	:	1490 m
Diameter of Borehole	:	HQ→NQ
Type of Drilling Bit	:	NQ Emprenie Diamond
Casing	:	HQ

The borehole NTBH-1 was drilled at the inlet of Nakra transfer tunnel, drilled vertically and 20,00 meter in depth.

The unit encountered in the borehole NTBH-1 is:

0,00 m – 20,00 m	Alluvial Fan (Qay); is composed of brown, beige and gray color sandy gravelly blocks. The gravels are medium to coarse size and the diameter of blocks reach 70 cm in somewhere. The blocks and gravels are semi rounded-semi angular and originated from granite and gneiss.
------------------	---

The percentage of core in this borehole is meanly 45%. There is no ground water table.

---

**Borehole NTBH-2**

---

Location	:	Inlet of Nakra transfer tunnel
Depth	:	40,00 m
Coordinate	X	: 4777575
	Y	: 288301
Elevation	:	1510 m
Diameter of Borehole	:	PQ→HQ→NQ
Type of Drilling Bit	:	HQ-NQ Emprenie Diamond
Casing	:	PQ→HQ

The borehole NTBH-2 was drilled at the inlet of Nakra transfer tunnel, drilled vertically and 40,00 meter in depth.

The units encountered in the borehole NTBH-2 are;

0,00 m – 19,00 m	Alluvial Fan (Qay); is composed of brown, beige and gray color sandy gravelly blocks. The gravels are medium to coarse size and the diameter of blocks reach 80 cm in somewhere. The blocks and gravels are semi rounded-semi angular and originated from granite and gneiss.
19,00 m – 40,00 m	Dolrini Formation (Osd); are composed of dark gray-grayish white, beige and black colored Meta Granite, Granite, Schist, Amphibolite. The units are very fractured-crushed in general, rarely wide fractures. The fractures are developed generally bias and nearly vertically, the surface of the fractures are

filled within quartz in general and iron oxide painted, generally moderately weathered locally highly-moderately weathered. The rock quality is poor-very poor and having moderately strong strength.

The percentage of core in this borehole is meanly 50%, mean RQD nearly 34% and rock quality is poor. There is no ground water table.

<b>Borehole NWBH-1</b>	
Location	: Axis of weir
Depth	: 20,00 m
Coordinate X	: 4777456
Y	: 288421
Elevation	: 1490 m
Diameter of Borehole	: PQ → HQ → NQ
Type of Drilling Bit	: HQ-NQ Emprenie Diamond
Casing	: PQ → HQ

The borehole NWBH-1 was drilled at the axis of Nakra weir, drilled vertically and 20,00 meter in depth  
The unit encountered in the borehole NWBH-1 is:

0,00 m – 20,00 m | Alluvial Fan (Qay); Brown and beige color, generally found as sandy gravelly blocky unit. Blocks size reach 30 cm. The shape of blocks is semi rounded-semi angular and originated granite and gneiss in general.

The percentage of core in this borehole is meanly 30%. There is no ground water table. According to permeability tests.

Permeable levels are from 0,00 m to 8,00 m. K constants of the unit is between  $8,08 \times 10^{-4}$  and  $9,33 \times 10^{-4}$ .

Highly permeable levels are from 8,00 m to 20,00 m. K constants of the unit is between  $1,14 \times 10^{-4}$  and  $1,67 \times 10^{-4}$ . There is no ground water table.

<b>Borehole NWBH-3</b>	
Location	: Axis of weir
Depth	: 30,00 m
Coordinates X	: 4777453
Y	: 288362
Elevation	: 1510 m
Diameter of Borehole	: PQ → HQ → NQ
Type of Drilling Bit	: HQ-NQ Emprenie Diamond
Casing	: PQ → HQ

The borehole NWBH-3 was drilled at the axis of Nakra weir, drilled vertically and 30,00 meter in depth  
The unit encountered in the borehole NWBH-3 is:

0,00 m – 30,00 m | Alluvial Fan (Qay); Brown and beige color, generally found as sandy gravelly blocky unit. Blocks size reach 30 cm. The shape of blocks is semi rounded-semi angular and originated granite and gneiss in general.

The percentage of core in this borehole is meanly 30%. There is no ground water table. According to permeability tests

Permeable levels are from 0,00 m to 6,00 m. K constants of the unit is between  $5,67 \times 10^{-4}$  and  $8,05 \times 10^{-4}$ .

Highly permeable levels are from 6,00 m to 24,00 m. K constants of the unit is between  $1,06 \times 10^{-4}$  and  $1,35 \times 10^{-4}$ . There is no ground water table.

### 5.2.3.5.2 In Situ Tests

The 105 pressure meter tests are performed in the boreholes PBH-1, PBH-2, PBH-3, PBH-4 at powerhouse, NWBH-1 and NWBH-3 at Nakra Weir at each 2,00 meter intervals. The logs and graphics of the pressure meter tests are given at Appendix-4. The results of the analysis that is performed for bearing capacity and settlement of each foundation of construction is given under the subject of “Bearing Capacity and Settlement” for powerhouse and weir.

The 172 water pressure tests are performed in the boreholes DBH-3, DBH-5, DBH-6, DBH-7 and SBH-1 at dam axis at each 2,0 or 5,0 meter intervals. The results of the WPT are given in drilling logs.

The 22 permeability tests are performed in the boreholes NWBH-1 and NWBH-3 at Nakra Weir at each 2.0 meter intervals. The results of the WPT are given in drilling logs. The number of in-situ tests is given at the Table 5.2.3.5.2.1.

**Table 5.2.3.5.2.1.** The number of in-situ tests

BOREHOLE №	BOREHOLE DEPTH (m)	PRESSUREMETER	WPT	PERMEABILITY
DBH-1	40			
DBH-2	80			
DBH-3	72		12	
DBH-4	27			
DBH-5	200		6	
DBH-6	200		25	
DBH-7	225		78	
SBH-1	200		42	
SBH-3	50			
SBH-4	80			
SBH-5	70			
PBH-1	40	20		
PBH-2	40	20		
PBH-3	40	20		
PBH-4	40	20		
TBH-3	68,5		9	
TBH-4	50			
NTBH-1	20			
NTBH-2	40			

NWBH-1	20	10		10
NWBH-3	30	15		12
<b>TOTAL</b>		<b>105</b>	<b>172</b>	<b>22</b>

#### 5.2.3.5.2.1 Laboratory Tests

The 409 core samples have been taken from boreholes for laboratory testing. The list of samples is given at the Table.

The following laboratory studies have been conducted on core samples taken during the drilling works: Abrasivity index (CAI), Modulus of Elasticity and Poisson Ratio, Uniaxial Compressive Strength, Brazilian method, Specific Gravity, Water Absorption, Natural Unit Weight. In addition, petrographic description of samples has been conducted.

Detailed description of laboratory studies is given in Annex.

**Table 5.2.3.5.2.1.1.** List of samples

BOREHOLE №	BOREHOLE DEPTH (m)	CERCHAR INDEX TEST	ELASTISITY/ POISSON RATIO	UNIAXIAL COMPRESSIVE STRENGTH	BRAZILIAN TEST	SPECIFIC GRAVITY	WATER ABSORPTION	UNIT WEIGHT	PETROGRAPHY
DBH-1	40								
DBH-2	80								
DBH-3	72	2	3	9	1	2	2	9	2
DBH-4	27								
DBH-5	200	-	11	12	3	6	6	12	
DBH-6	200	2	4	16	2	4	4	16	2
DBH-7	225	2	3	15	2	5	5	15	6
SBH-1	200	3	9	24	3	7	7	24	4
SBH-3	50	2	2	8	1	2	2	8	2
SBH-4	80								
SBH-5	70								
PBH-1	40	1	2	3	2	1	1	3	
PBH-2	40	2	2	5	1	3	3	5	
PBH-3	40	1	1	2	1	1	1	2	
PBH-4	40	-	2	2	1	3	3	2	
TBH-3	68,5	3	3	6	-	3	3	6	2
TBH-4	50	2	3	6	1	3	3	6	
NTBH-1	20								
NTBH-2	40	1	2	3	1	1	1	3	
NWBH-1	20								
NWBH-3	30								
<b>TOTAL</b>		<b>21</b>	<b>47</b>	<b>111</b>	<b>19</b>	<b>41</b>	<b>41</b>	<b>111</b>	<b>18</b>

Figure 5.2.3.5.2.1.1. Engineering-geological map of the project region

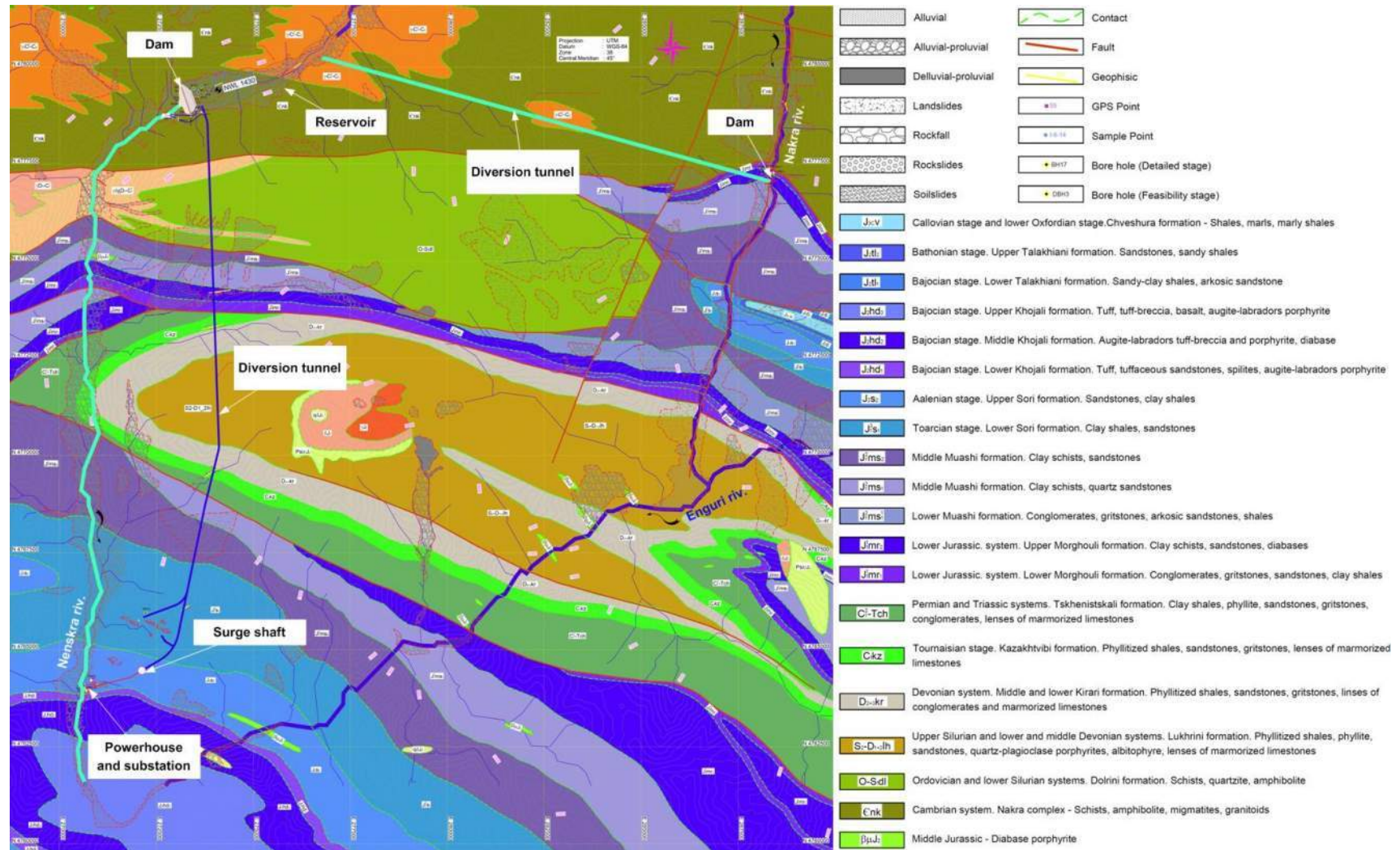

### **5.2.3.6 Engineering-Geological Conditions of the HPP Communications**

#### **5.2.3.6.1 Dam Site**

On the dam site, the eight boreholes named DBH-1, DBH-2, DBH-3, DBH-4, DBH-5, DBH-6, DBH-7 and SBH-1 were drilled as totally depth of 1044 meter. In these boreholes, The 163 water pressure tests were performed to determine permeability of dam foundation units. Beside these, the core samples taken from the boreholes during the drilling to have been subjected laboratory tests to determine the geotechnical parameters of the main rock under the structures.

The boreholes DBH-1, DBH-2, DBH-3 and DBH-4 were drilled on the axis planned firstly. But, because of very thick alluvium and alluvial fan deposits encountered in all of the four boreholes at the left bank of the dam, dam axis was shifted up towards to upstream direction. So, the boreholes DBH-5, DBH-6 and DBH-7 were drilled in addition to these boreholes. And also, decided to represent the borehole SBH-1 as crest borehole extending to 200,00 m depth.

##### **5.2.3.6.1.1 Covering Units and Weathered Rocks**

The units encountered in the borehole DBH-5 are Channel Deposits (Recent alluvium) (Q<sub>aky</sub>) in between 0,00 m – 40,00 m and Alluvium (Q<sub>al</sub>) in between 40,00 m – 127,00.

The units encountered in the borehole DBH-6 is Alluvium (Q<sub>al</sub>) in between 0,00 m – 48,00 m.

The units encountered in the borehole DBH-7 is Slope Debris (Q<sub>ym</sub>) in between 0,00 m – 26,00 m. The units encountered in the borehole SBH-1 is Slope Debris (Q<sub>ym</sub>) in between 0,00 m – 20,00 m. According to description of boreholes, from crest point to the Thalweg of the left bank, the cover units, having 20,00 m – 127,00 m thickness was determined.

The less-medium weathered zone of the foundation rock is approximately 2,0 m.

Briefly, the thickness of the derivate and separated materials such as alluvium, alluvial fans, slope debris etc. reach to 130 meter at thalweg and 20 meter at the crest of the dam axis at left bank.

##### **5.2.3.6.1.2 Type of Rock Units**

The rock units encountered in the borehole DBH-5 is Dolrini Formation (O<sub>sd</sub>) in between 127,00 m – 200,00 m. The foundation rock is Meta Granite, Granitic Gneiss; dark gray, blackish color, generally very fractured, locally fractured. Its fractures are generally bias and locally developed nearly vertically and generally filled with silicium and locally iron oxides. The surface of the fractures is rough, medium – less weathered and locally fresh. Rock quality is fair-good and high strength.

The percentage of core is 53%, mean RQD is 30% and rock quality is poor. There is no GWT

The permeable levels are from 128,00 to 142,00 m, the values of Lugeon are between 14,46-17,04. The highly permeable levels are from 145,00 to 176,00 m and the values of Lugeon >25.

The rock units encountered in the borehole DBH-6 is Dolrini Formation (O<sub>sd</sub>) in between 48,00 m – 200,00 m. The foundation rock is Meta Granite, Granitic Gneiss; dark gray, blackish color, generally very fractured, locally fractured. Its fractures are generally bias and locally developed nearly vertically and generally filled with silicium and locally iron oxides. The surface of the fractures is rough, medium – less weathered and locally fresh. Rock quality is fair and high strength.

The percentage of core is 86%, mean RQD is 60% and rock quality is fair. The ground water table is at top of the borehole, the other word GWT is 0,00 m depth.

The permeable levels are from 53,00 to 55,70 m and from 64,60 to 66,80 m and the value of Lugeon >25.



In between 19,90-21,52; 82,00-109,50 m and 122,00-196,00 m also the value of Lugeon are between 12,54-24,96.

The highly permeable levels are from 51,00 to 55,50 m, from 69,80 to 82,00 m and from 118,00 to 120,00 m. The value of Lugeon is >25.

The rock units encountered in the borehole DBH-7 is Dolrini Formation (Osd) in between 26,00 m – 200,00 m. The rock quality is fair-good and having excellent strength in between 26,00 m – 94,00 m, good rarely fair in between 94,00 m-132,00 m, good-excellent rarely fair in between 132,00 m-184,00 m and good-excellent in between 184,00 m-225,00 m.

The foundation rock is generally beige, gray and light yellowish brown colored granitic gneiss, mica, quartzite and generally very fractured. The fractures are generally bias, rarely horizontal or nearly horizontal. The surface of the fractures are generally unfilled, locally silicified and iron oxide painted, moderately weathered rarely little weathered-fresh.

The percentage of core in this borehole is generally 80%, mean RQD 60% and rock quality is fair. There is no ground water table.

Permeable levels are from 32,00 to 36,00 m, from 62,00 to 68,00 m, from 78,00 to 82,00 m, from 96,00 to 102,00 m, from 114,00 to 178,00 m, from 184,00 to 194,00 m and from 202,00 to 225,00 m.

The values of the Lugeon are between 7,66 and 23,79.

Highly permeable levels are from 28,00 to 32,00 m, from 38,00 to 60,00 m, from 68,00 to 78,00 m, from 82,00 to 96,00 m, from 102,00 to 114,00 m, from 180,00 to 182,00 m and from 194,00 to 198,00 m. The values of Lugeon is >25.

The rock units encountered in the borehole SBH-1 are Slope Debris (Qym) in between 0,00 m – 20,00 m and Dolrini Formation (Osd); 20,00 m – 200,00 m. The rock quality poor-very poor and having moderately strong-strong strength in between 20,00 m – 48,00 m and moderate in between 48,00 m – 200,00 m.

The foundation rock is composed of gray, beige, greenish and light brown colored Meta Granite, Granite, Gneiss, Amphibolite. The units are fractured in general. The fractures are generally bias rarely developed horizontally, the surface of the fractures are unfilled in general but rarely filled with silicium and iron oxide painted, generally moderately weathered locally less weathered-fresh.

The percentage of core in this borehole is generally 80%, mean RQD nearly 55% and rock quality is fair. There is no ground water table.

Permeable levels are from 20,00 to 24,00 m, from 30,00 to 33,50 m, from 38,00 to 45,00 m, from 51,00 to 58,00 m, from 62,00 to 106,00 m, from 121,00 to 142,00 m and from 155,00 to 200,00 m. The Lugeon value are between 7,44-24,55.

Highly permeable levels are from 24,00 to 28,00 m, from 35,00 to 38,00 m, from 45,00 to 48,00 m, from 58,00 to 62,00 m, from 106,00 to 118,80 m and from 142,00 to 150,00 m. The Lugeon value is >25.

#### **5.2.3.6.1.3 Permeability of Dam Axis (Filtration)**

In Stucky's investigation, the seismic refraction surveys were carried out throughout the investigation campaign and were adapted to the geological model through the various drilling and mapping data. The most of the depth of boreholes were 30,0 m and one of them was 86,0 m. The boreholes drilled by STUCKY were not encountered the rock units at dam axis. The depth of alluvium was determined by seismic refraction surveys as 80 m. According to this result, the impermeable curtain were suggested to

60,0 in depth by STUCKY.

But, in our investigation, the thickness of alluvium at thalweg is greater than 127,0 m according to result of the boreholes.

The alluvium formation is composed of gravels, blocks, sand and rarely clay materials over the flat areas along the Nenskra River. The alluvium material is widely deposited along the Nenskra river in somewhere the width of flat area reaching 700-800 m. The materials in alluvium are originated by gneiss, metagranite, granite, amphibolite, chert, quartzite, diorite, diabase, schist and sandstone. The particles are rounded, semi-rounded and rarely angular. The size of blocks varies between 20,0 – 95,0 cm. The ratio of the fine-grained materials is lower due to the slope of the river channel. The ratio of fine-grained material is increased at the area where the slopes of the river channel reduced. Because of the alluvium formation is composed of gravels, blocks and beside this, due to the circulation water had not been come back to the outside of the borehole during the drilling operation, the alluvium is assumed as permeable-highly permeable. Also, permeable and highly permeable levels in base rock units are observed in the boreholes drilled at left bank.

In this case, either the alluvium unit will be excavated nor the slurry trench will be designed inside the alluvium up to the depth of 130,0 m on thalweg and in addition to this, the length of impermeable curtain should be extended to the left and right bank along to the crest of dam in a depth of 55,0 m at least if the project doesn't permit to water leakage beneath the dam axis.

#### 5.2.3.6.1.4 Stability of Dam Axis

In Stucky's work, according to the report of investigation prepared by STUCKY (2011), salty sand and sand units were encountered up to the 12,0 in depth, in the borehole BH-7 located in the right bank. In this borehole, the more clean sand and salty sand were observed than the other boreholes. In this case, the depth of excavation under the dam at this location should be involved up to bottom of this sandy salty zone.

On banks, there is a semi loose-hard covering materials were observed. The details were given in previous chapter. The all of the slope debris units on the banks and weathering parts of the foundation rock (bedrock) also should be removed at cut-off excavation to settle the dam axis on strong part of the bedrock.

After the weathering zone, the foundation rock has moderately strong and strong strength. It is poor and moderately strong in jointed and fractured parts.

#### Engineering Characteristics of the Foundation Rock (Bedrock) Unit at Dam Axis at Left Bank

Natural Unit Weight ( $\gamma_{Nat}$ )	: 2.70-2.72 gr/cm <sup>3</sup>
Uniaxial Comprehensive Strength	: 850-1000 kg/cm <sup>2</sup> = 85.0-100.0 MPa
Modulus of Elasticity	: 450.000-540.000 kg/cm <sup>2</sup> = 45.000-54.000 MPa
Poisson Ratio	: 0,23
RQD	: % 50-75
Permeability	: 5-25 Lugeon, permeable between >25 Lugeon, highly permeable.

**5.2.3.6.1.5 Excavation and Rate of Excavation**

The covering materials like alluvium/recent alluvium and slope debris covering the bedrock and weathering parts of the foundation rock are taken into account to excavate at the dam axis.

**Slope Analysis at Left Bank**

The slope ratio for excavation of the alluvial fan or slope debris can be assumed as 1:1 (H:V). The kinematic analysis of left bank of dam axis is carried out for the slope ratio 1/3 (1: Horizontal, 3: Vertical) given Figure 5.2.3.9.6.1.

**Figure 5.2.3.6.1.5.1.** The kinematic analysis of left bank of dam axis

**Analysis against to Planer Slip;**

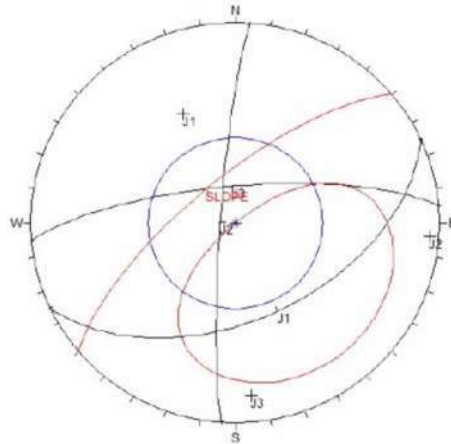

Orientations	
ID	Dip / Direction
1	50 / 155
2	84 / 274
3	75 / 355
4	72 / 320

Equal Area  
Lower Hemisphere  
0 Poles  
0 Entries

**Analysis against to Wedge Failure;**

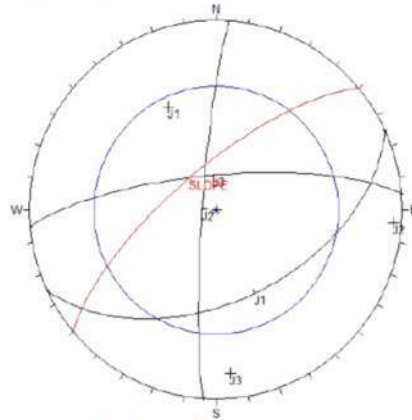

Orientations	
ID	Dip / Direction
1	50 / 155
2	84 / 274
3	75 / 355
4	72 / 320

Equal Area  
Lower Hemisphere  
0 Poles  
0 Entries

**Analysis against to Toppling;**

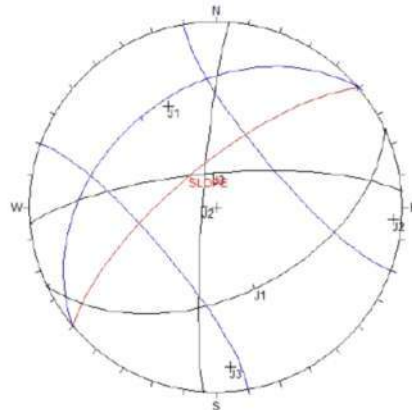

Orientations	
ID	Dip / Direction
1	50 / 155
2	84 / 274
3	75 / 355
4	72 / 320
5	37 / 320

Equal Area  
Lower Hemisphere  
0 Poles  
0 Entries

**Results of the Kinematic Analysis**

Planer Slip	No potential risk
Wedge Failure	No potential risk
Toppling	No potential risk

As a results of these analysis for left bank of the dam axis after removing of alluvial fan or slope debris materials, the slope ratio that is 1/3 (1: Horizontal, 3: Vertical) can be taken. But, the measurements of the discontinuities of the bedrock at the left bank must be carried out after removing of the loose material from the surface at the construction stage to exactly decided the slope angle of excavation and space and length of the bolts, if needed, because of analysis carrying out by using the data taken from the rocks located outside.

**Slope Analysis at Right Bank**

The slope ratio for excavation of the alluvial fan or slope debris can be assumed as 1:1 (H:V). The kinematic analysis of right bank of dam axis is carried out for the slope ratio 1/3 (1: Horizontal, 3: Vertical) given Figure 5.2.3.6.9.2.

**Figure 5.2.3.6.1.5.2.** The kinematic analysis of right bank of dam axis

**Analysis against to Planer Slip;**

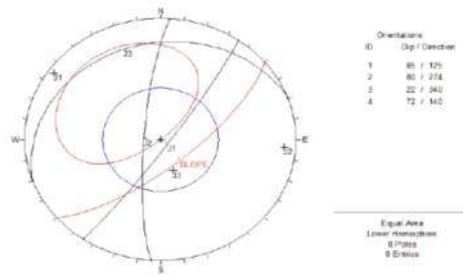

**Analysis against to Wedge Failure;**

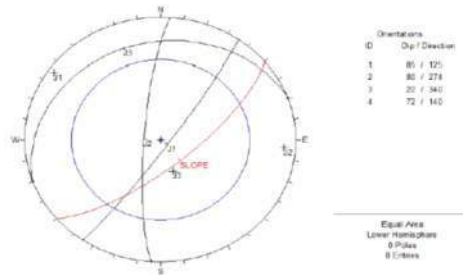

**Analysis against to Toppling;**

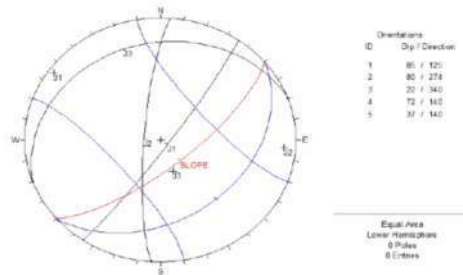

**Results of the Kinematic Analysis**

Planer Slip	No potential risk
Wedge Failure	No potential risk
Toppling	No potential risk

As a results of these analysis for right bank of the dam axis after removing of alluvial fan or slope debris materials, the slope ratio that is 1/3 (1:H, 3:V) can be taken. But, the measurements of the discontinuities of the bedrock at the left bank must be carried out after removing of the loose material from the surface at the construction stage to exactly decided the slope angle of excavation and space and length of the bolts, if needed, because of analysis carrying out by using the data taken from the rocks located outside.

According to the depth of excavation at left and right bank is suggested minimum 20,00 – 30,00 m and the maximum 80,0 m (additional, nearly 3.0 m weathered parts from foundation rock) and 130,00 meter on thalweg at alluvium excavation.

Rate of Excavation can be assumed as follows:

- % 85 Hard Pan
- % 15 Hard Rock

Excavations will be performed by ripper, digger, hydraulic breaker and blasting in some places.

**Figure 5.2.3.6.1.5.3. Dam on Nenskra River (Geological plan)**

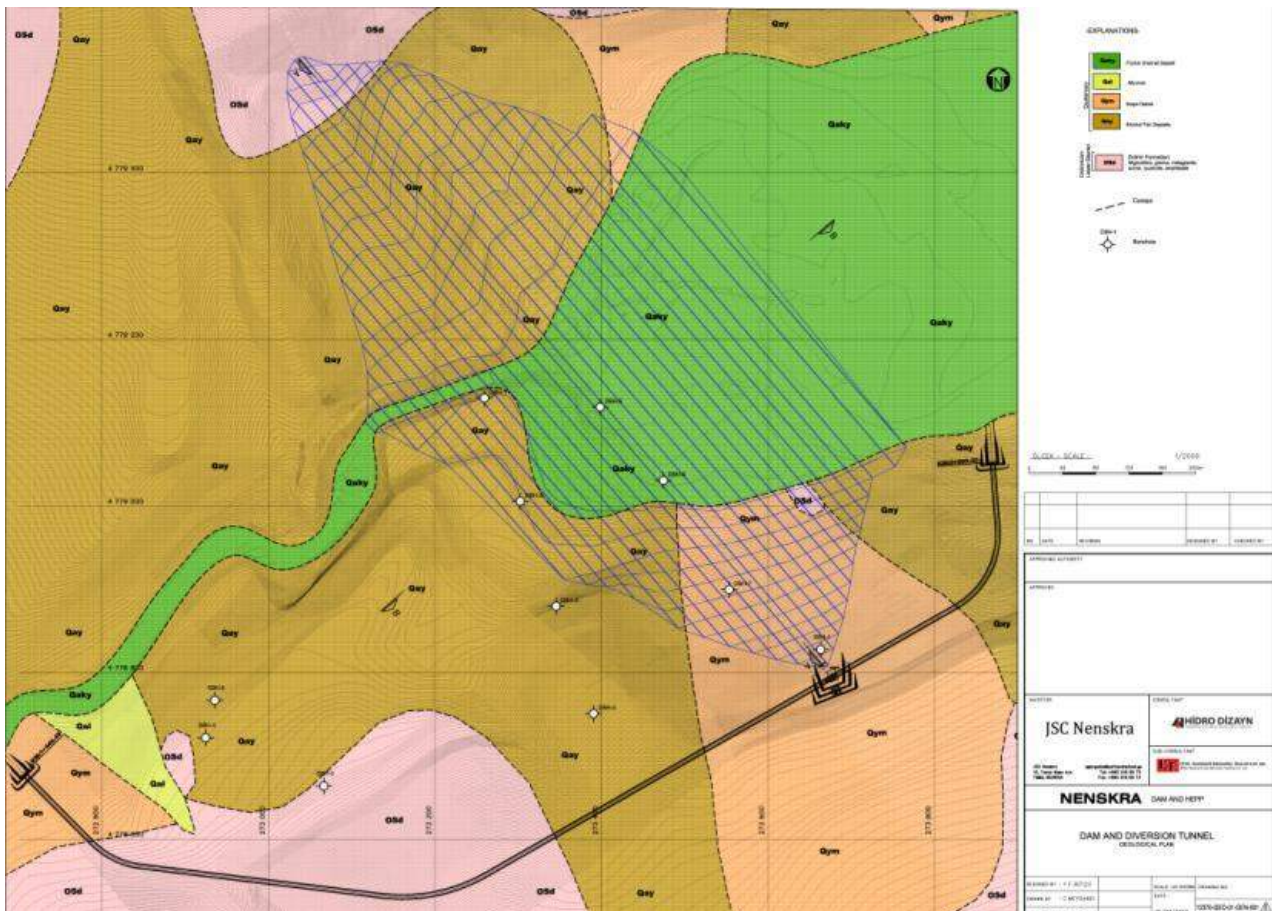
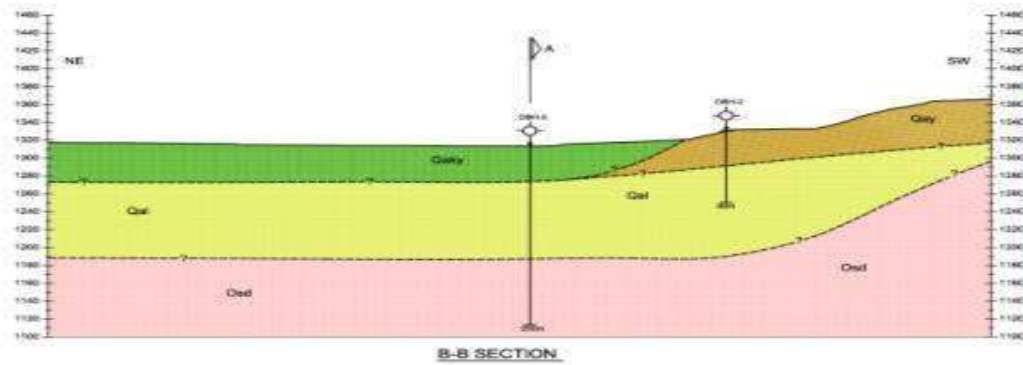
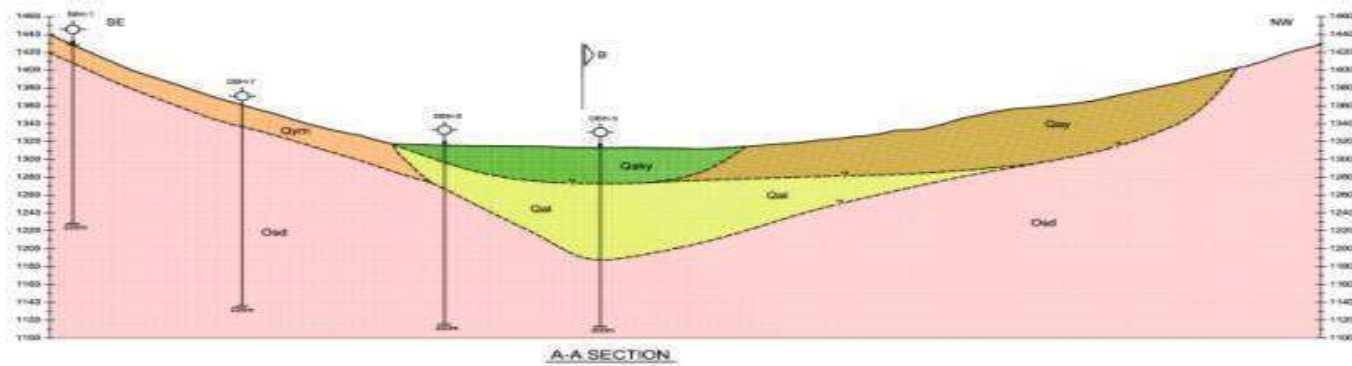

Figure 5.2.3.6.1.5.4. Dam on Nenskra River (geological profiles)



**EXPLANATIONS:**

QYP	Quaternary Deposits
Qsk	Siltstone
Qsl	Sandstone
Qcl	Claystone
Qsd	Dolomite Formation

Legend symbols: Control, Benchmark

**SCALE:** 1/5000

NO.	DATE	REVISION	APPROVED BY	DESIGNED BY

**JSC Nenskra**

**HYDRO DIZAYN**

**NENSKRA DAM AND RESERVOIR**

Figure 5.2.3.6.1.5.5. Tailrace tunnel (geological profile)

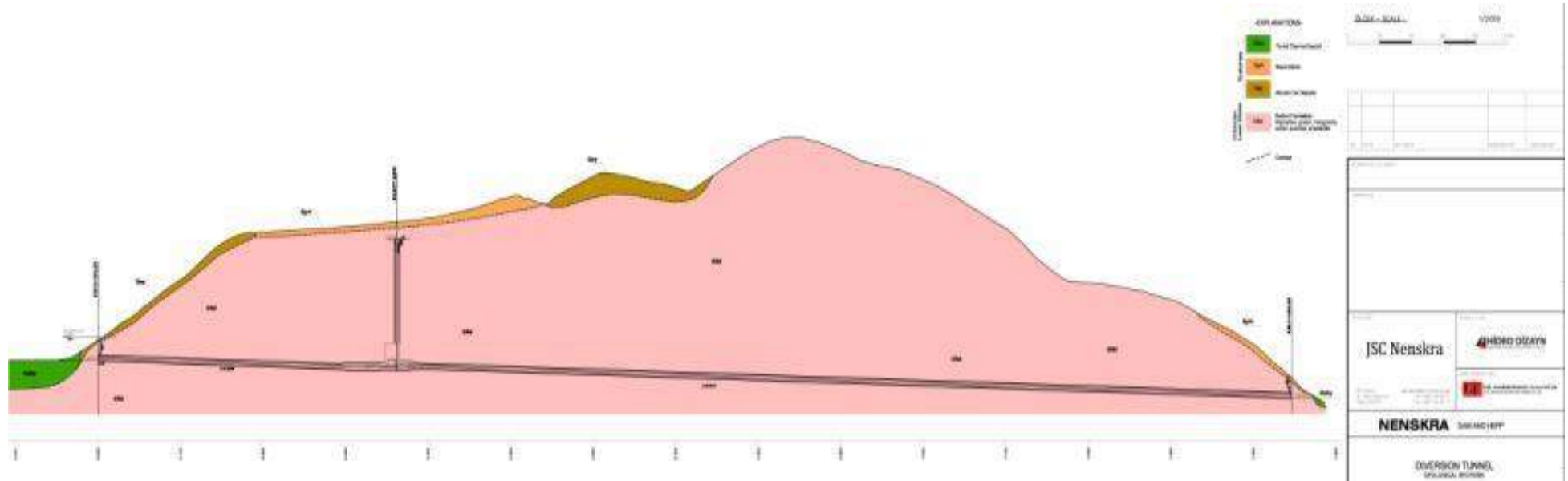

## **5.2.3.6.2 Tunnels**

### **5.2.3.6.2.1 Diversion Tunnel**

On the near of alignment of diversion tunnel, the boreholes named SBH-1, SBH-3, SBH-4 and SBH-5 and drilled as totally depth of 200 meter were taken into account.

The units encountered in the borehole SBH-1 are slope debris (Qym) in between 0,00 m – 20,00 m and Dolrini Formation (Osd) in between 20,00 m – 200,00 m. Dolrini Formation are composed of gray, beige and greenish and light brown colored Meta Granite, Biotite, Micro Granite. The units are very fractured in general. The fractures are generally bias rarely developed horizontally, the surface of the fractures are unfilled in general but rarely filled with silicium and iron oxide painted, generally moderately weathered locally less weathered-fresh. The rock quality is poor-very poor and having moderately strong strength. The percentage of core in this borehole is generally 80%, mean RQD nearly 55% and rock quality is fair. There is no ground water table.

The units encountered in the borehole SBH-3 are Alluvial Fan (Qay) in between 0,00 m – 20,50 m and Dolrini Formation (Osd) in between 20,50 m – 50,00 m. The percentage of core in this borehole is meanly 65%, mean RQD is nearly 15% and rock quality is poor-very poor. There is no ground water table.

The unit encountered in the borehole SBH-4 is Alluvial Fan (Qay) in between 0,00 m – 80,00 m. It is composed of brown, beige and gray colored, blocky, sometimes the diameter of the blocks reach to 30 cm. The blocks are semi rounded-semi angular shape and originated granite and gneiss. The percentage of core in this borehole is meanly 30%.

The unit encountered in the borehole SBH-5 is Alluvial Fan (Qay) in between 0,00 m – 70,00 m. It is composed of brown, beige and gray colored, blocky sandy gravels, sometimes the diameter of the blocks reach to 56 cm. The blocks are semi rounded-semi angular shape and originated granite and gneiss. The percentage of core in this borehole is meanly 30%. There is no ground water table.

Consequently, a part of diversion tunnel was observed within loose blocky alluvial fan (Qay) that is determined in SBH – 3, SBH – 4 and SBH – 5. At the same time, it was determined that high portal excavations in parallel with the steep morphology at the inlet and outlet site were performed in the same material. Therefore, the new route considered to be more appropriate geologically was determined as a result of field survey.

### **5.2.3.6.2.2 Stability of Portals of Diversion Tunnel**

In this suggested location, the unit encountered in the inlet portal of diversion tunnel is Alluvial Fan (Qay) and in the outlet portal is Slope Debris (Qym). The units encountered in the inlet portal of spillway tunnel are Slope Debris (Qym) and in the outlet portal is Alluvial Fan (Qay). The thickness of alluvial fan is expected shallow and short longitudinally. Because of this reason, the inlet of diversion tunnel should be planned as cut-and-cover tunnel or the alluvial fan which is located in between crown of inlet and max. water level should be excavated. After the excavation of this unit, the tunnel alignment will be located at rocks of Dolrini Formation (Osd). The Dolrini Formation is very fractured in general. The fractures are generally bias rarely developed horizontally, the surface of the fractures are unfilled in general but rarely filled with silicium and iron oxide painted, generally moderately weathered locally less weathered-fresh. The rock quality is poor-very poor and having moderately strong strength.

On portal, there will be semi loose-hard covering materials such as the certain part of alluvial fan and slope debris on the bedrock and weathering parts of the foundation rock.



**Engineering Characteristics of the Unit of Diversion Tunnel**

Natural Unit Weight ( $\gamma_{Nat}$ )	: 2.63-2.88 gr/cm <sup>3</sup>
Uniaxial Comprehensive Strength	: 450-1 200 kg/cm <sup>2</sup> = 45.0-120.0 MPa
Modulus of Elasticity	: 450 000-550 000 kg/cm <sup>2</sup> = 45 000-55 000 MPa
Poisson Ratio	: 0,23-0,25
RQD	: % 15-50

**5.2.3.6.2.3 Diversion Tunnel Portals and Alignment Excavation and Rate of Excavation**

On portal, there will be semi loose-hard covering materials such as the certain part of alluvial fan and slope debris on the bedrock and weathering parts of the foundation rock.

Because of covering of the main rock unit by alluvial fan material at the inlet part of the diversion tunnel, some measurements of dip and strike of joints of the main rock at upper parts (high elevation) where main rock displays outcrops. These measurements were taken into account for kinematic analysis of slope stability.

**Inlet Portal of Diversion Tunnel**

The slope ratio for excavation of the alluvial fan can be assumed as 1:1 (H:V). The kinematic analysis of inlet portal of the diversion tunnel is carried out for the slope ratio 1/5 (1: Horizontal, 5: Vertical) given Figure 5.2.3.6.2.3.1.

**Figure 5.2.3.6.2.3.1.** The kinematic analysis of inlet portal of the diversion tunnel

**Analysis against to Planer Slip;**

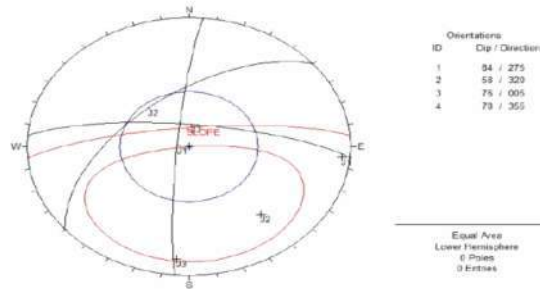

**Analysis against to Wedge Failure;**

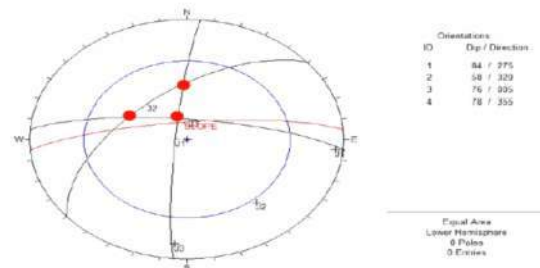

**Analysis against to Toppling**

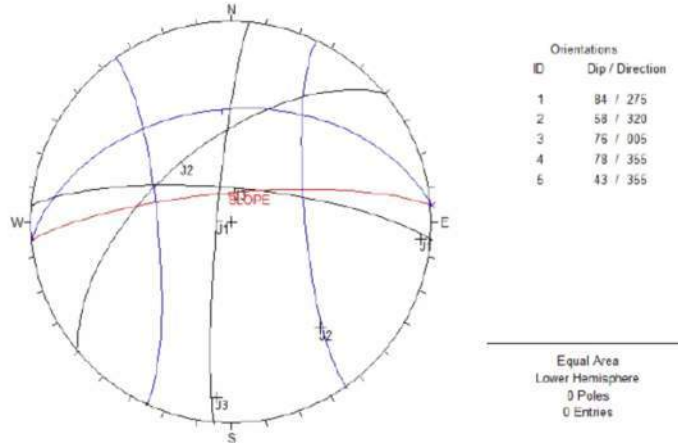

**Results of the Kinematic Analysis**

Planer Slip	Because of J2 and J3 numbered discontinuities staying inside of envelope, <b>there is a potential risk for planer slip.</b>
Wedge Failure	Because of the intersection points of J1-J2, J2-J3 and J1-J3 numbered discontinuities sets staying inside of critical zone, <b>there is a potential risk for wedge failure.</b>
Toppling	<b>No potential risk</b>

The slope ratio of inlet portal at main rock should not be assumed 1/5 (1: Horizontal, 5: Vertical) because of potential risks at this slope ratio by wedge failure and planer slip. The safety slope degree was determined 50o from the vertical axis by slope analysis as seen Figure-10.4. It means that slope ratio is nearly 1/1,5.

**Figure 5.2.3.6.2.3.2.** The kinematic analysis of inlet portal of the diversion tunnel

**Analysis against to Planer Slip;**

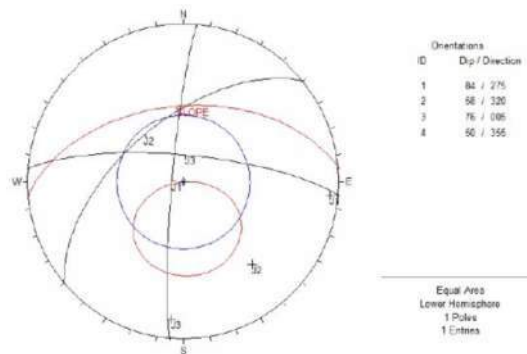

**Analysis against to Wedge Failure;**

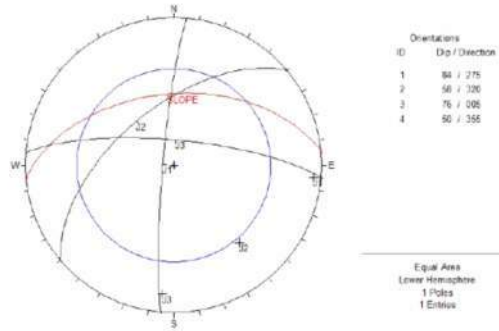

**Analysis against to Toppling;**

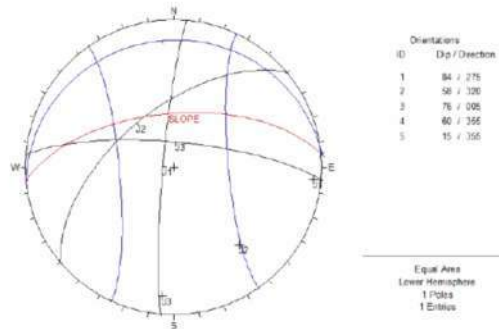

**Results of the Kinematic Analysis**

Planer Slip	No potential risk
Wedge Failure	No potential risk
Toppling	No potential risk

As a results of these analysis for inlet portal of diversion tunnel after removing of alluvial fan materials, the slope ratio that is 1/3 (1: Horizontal, 3: Vertical) can be taken with the requirement to use bolt and wire meshes for binding of the blocks to the bedrock and holding of fine particles on the slope. Shotcrete can be applied over wire meshes with drainage system if it is needed according to the condition of slope surfaces. If the shotcrete application certainly is needed, the drainage system necessarily be used to throw out the water accumulated behind of the shotcrete. But, the measurements of the discontinuities of the bedrock at the inlet portal must be carried out after removing of the loose material from the portal surface at construction stage to exactly decided the slope angle of excavation and space and length of the bolts because of analysis carrying out by using the data taken from the rocks located outside of the tunnel inlet portal.

**Outlet Portal of Diversion Tunnel**

The slope ratio for excavation of the slope debris can be assumed as 1:1 (H:V)

The kinematic analysis of outlet portal of the diversion tunnel is carried out for the slope ratio 1/5 (1: Horizontal, 5: Vertical) given Figure 5.2.3.6.2.3.3.

**Figure 5.2.3.6.2.3.3.**The kinematic analysis of outlet portal of the diversion tunnel

**Analysis against to Planer Slip;**

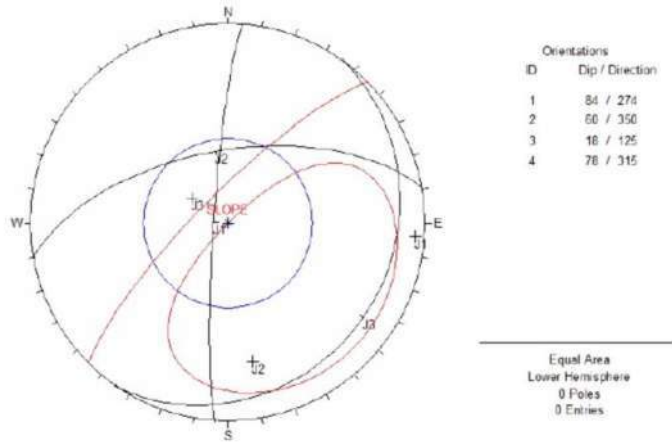

**Analysis against to Wedge Failure;**

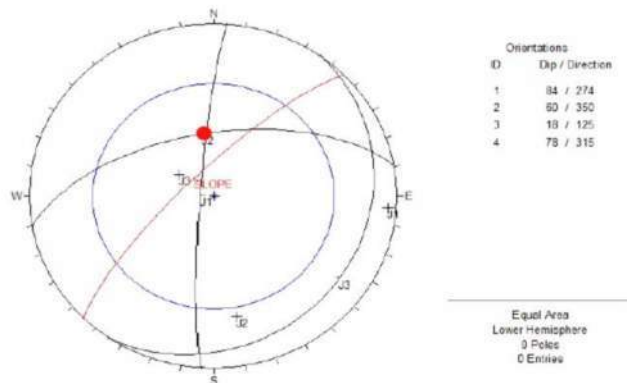

**Analysis against to Topping;**

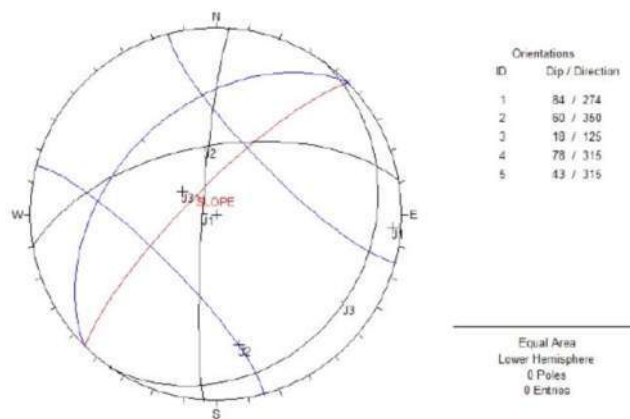

**Results of the Kinematic Analysis**

<b>Planer Slip</b>	Because of J2 numbered discontinuity staying inside of envelope, there is a potential risk for planer slip.
--------------------	---

<b>Wedge Failure</b>	Because of the intersection points of J1-J2 numbered discontinuities sets staying inside of critical zone, <b>there is a potential risk for wedge failure.</b>
<b>Toppling</b>	<b>No potential risk</b>

The slope ratio of inlet portal at main rock should not be assumed 1/5 (1: Horizontal, 5: Vertical) because of potential risks at this slope ratio by wedge failure and planer slip. The safety slope degree was determined 64o from the vertical axis by slope analysis as seen Figure-10.6. It means that slope ratio is nearly 1/2.

**Figure 5.2.3.6.2.3.4.** The kinematic analysis of outlet portal of the diversion tunnel

**Analysis against to Planer Slip;**

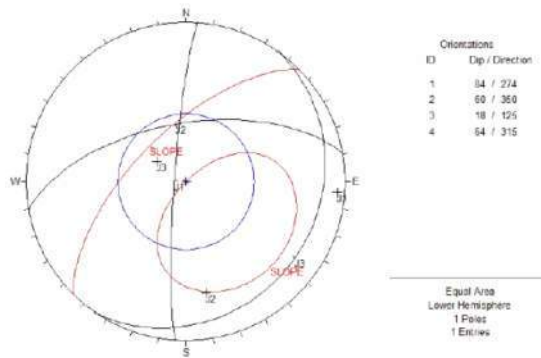

**Analysis against to Wedge Failure;**

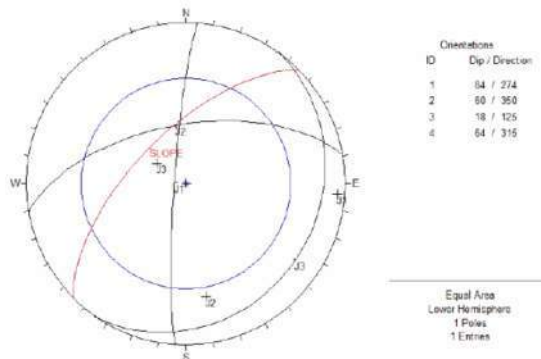

**Analysis against to Toppling;**

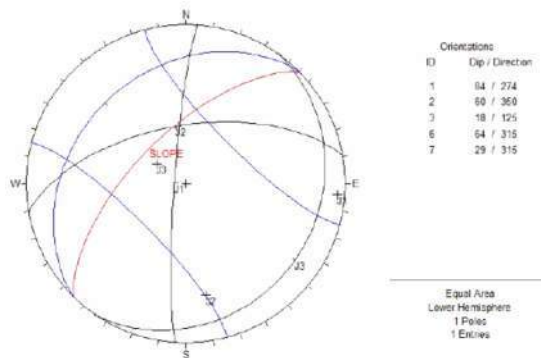

### Results of the Kinematic Analysis

Planer Slip	No potential risk
Wedge Failure	No potential risk
Toppling	No potential risk

As a results of these analysis for outlet portal of diversion tunnel after removing of slope debris materials, the slope ratio that is 1/3 (1:Horizontal, 3:Vertical) can be taken with the requirement to use bolt and wire meshes for binding of the blocks to the bedrock and holding of fine particles on the slope. Shotcrete can be applied over wire meshes with drainage system if it is needed according to the condition of slope surfaces. If the shotcrete application certainly is needed, the drainage system necessarily is used to throw out the water accumulated behind of the shotcrete. But, the measurements of the discontinuities of the bedrock at the inlet portal must be carried out after removing of the loose material from the portal surface at construction stage to exactly decided the slope angle of excavation and space and length of the bolts because of analysis carrying out by using the data taken from the rocks located outside of the tunnel outlet portal.

At the alignment of tunnels, the excavation will be going on in the rocks of Dolrini Formation. The covering materials like alluvial fan and slope debris on the bedrock and weathering parts of the foundation rock are taken into account to excavate at the portals. According to this, the rate of excavation can be assumed as follows:

- 10% Hard Pan
- 10 % Soft Rock
- 80 % Hard Rock

Excavations will be performed by ripper, digger, hydraulic breaker and blasting in some places.

### Cerchar Abrasivity and Brazilian Test Result

The tests of cerchar abrasivity index (CAI) were performed on samples taken from boreholes of DBH-3, SBH-1, SBH-3, SBH-6 and SBH-7. According to test result, The CAI value varies between 2,39 – 4,29 and class is “very abrasive” and "extremely abrasive". The results of Cerchar Index Test are given at Appendix-5.

Cerchar Abrasivity Index test is widely accepted throughout the world to represent rock abrasion as it pertains to tool wear and life in tunneling and construction activities. So, the results of CAI shows that **the cutters which are located on TBM face should be design for very abrasive and extremely abrasive rock conditions.**

In addition to this, the tests of Brazilian tensile strength test were performed on samples taken from boreholes of SBH-1, SBH-3, DBH-3, DBH-6 and DBH-7. According to test result, the mean strengths varies between 6,60 – 13,84 MPa.

Figure 5.2.3.6.2.3.5. General geological plan of Nenskra tunnel

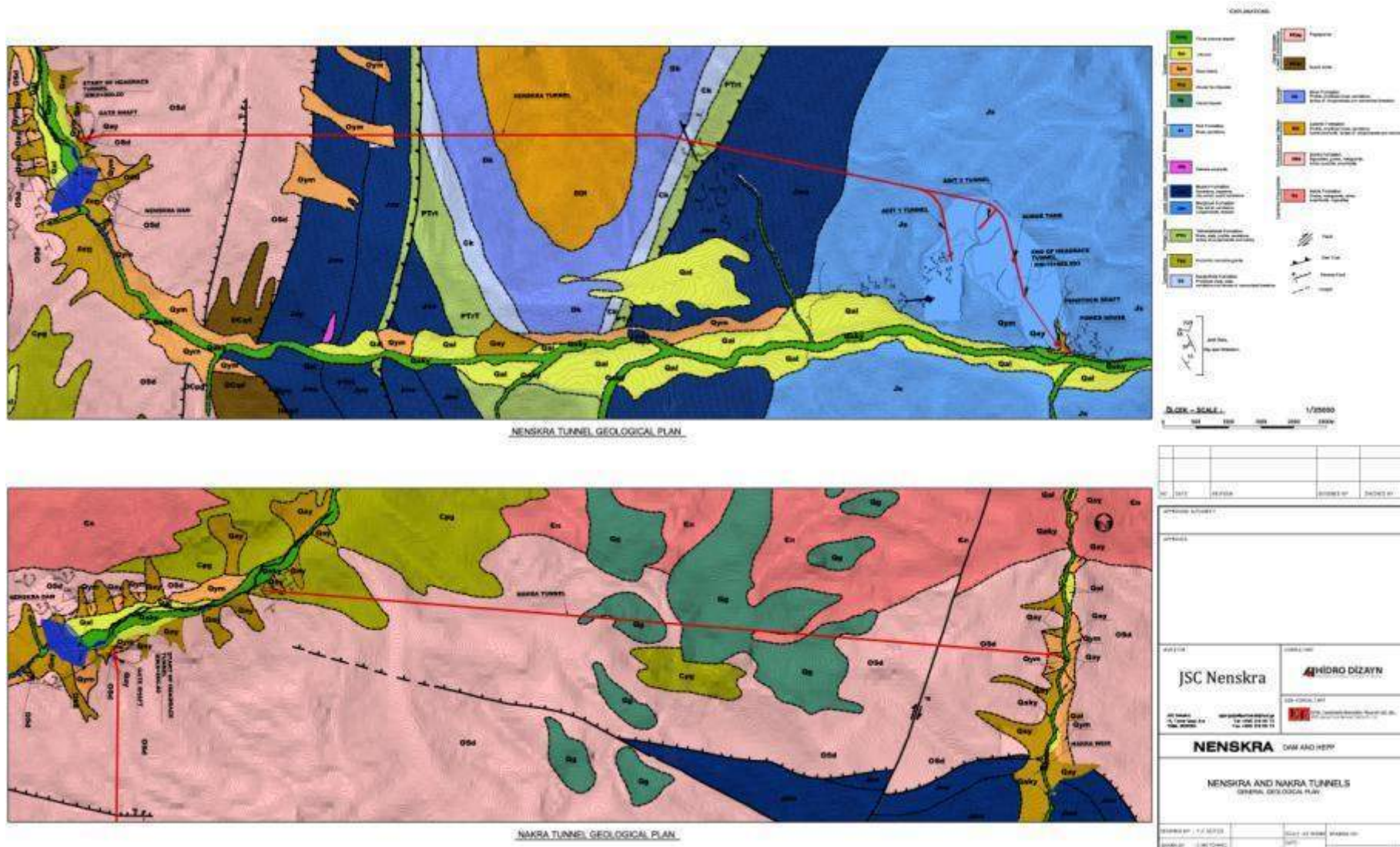

Figure 5.2.3.6.2.3.6. Entrance of headrace tunnel (geological plan)





Figure 5.2.3.6.2.3.7. Entrance of headrace tunnel (geological profiles)

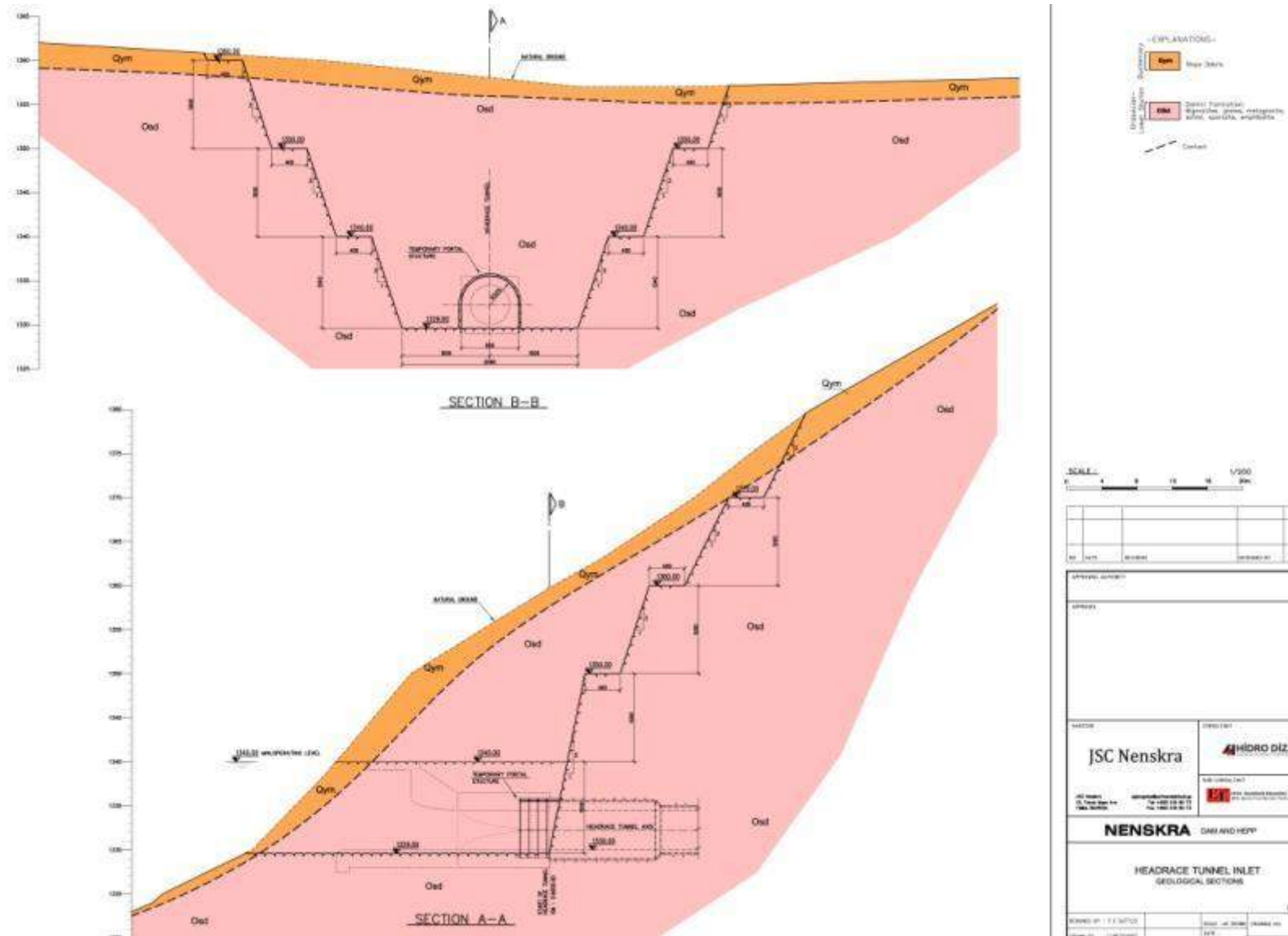
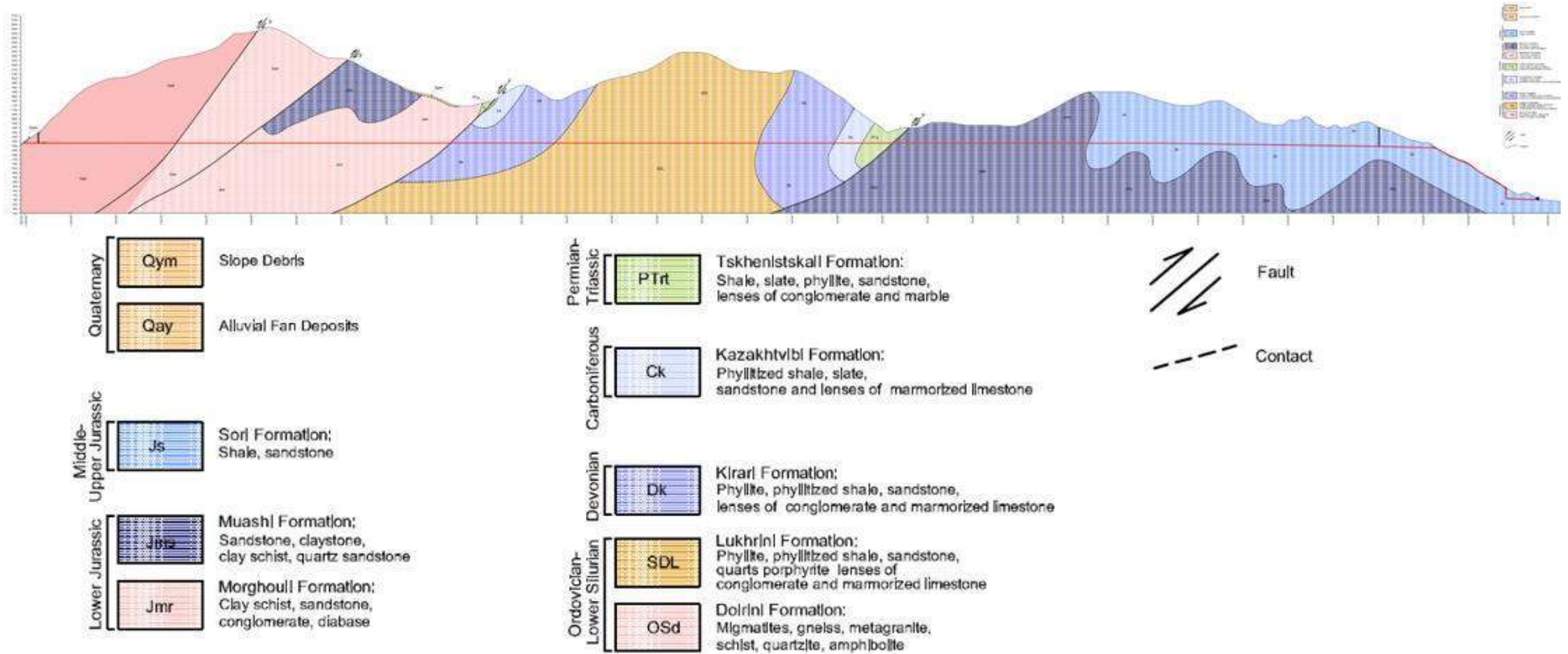

Figure 5.2.3.6.2.3.8. Nenskra headrace tunnel (geological profile)



#### 5.2.3.6.2.4 Pressure Tunnel

There are two boreholes named SBH-1 and TBH-3 were drilled near the alignment of power tunnel. The borehole SBH-1 represents the rocks of inlet part of power tunnel. The units encountered in the borehole SBH-1 are Slope Debris (Qym) in between 0,00 m – 20,00 m and Dolrini Formation (OSd) in between 20,00 m – 200,00 m.

Up to the 48,0 m in depth, rock quality of Dolrini Formation is poor-very poor and having moderately strong-strong strength. After the 48,0 m, the rock quality is moderate and having moderately strong-strong strength.

The percentage of core in this borehole is generally 80%, mean RQD nearly 55% and rock quality is fair. There is no ground water table.

Permeable levels are from 20,00 to 24,00 m, from 30,00 to 33,50 m, from 38,00 to 45,00 m, from 51,00 to 58,00 m, from 62,00 to 106,00 m, from 121,00 to 142,00 m and from 155,00 to 200,00 m. The Lugeon value are between 7,44-24,55.

Highly permeable levels are from 24,00 to 28,00 m, from 35,00 to 38,00 m, from 45,00 to 48,00 m, from 58,00 to 62,00 m, from 106,00 to 118,80 m and from 142,00 to 150,00 m. The Lugeon value is >25. The borehole TBH-3 represents the rocks of end of power tunnel and penstock alignment.

The units encountered in the borehole TBH-3 are Alluvial Fan (Qay) in between 0,00 m – 24,00 m and Sori Formation (Js) in between 24,00 m – 68,50 m.

The rock quality of Sori Formation is fair-poor and having moderately strong and displays lamination.

The percentage of core in this borehole is meanly 80%, mean RQD nearly 45% and rock quality is fair-poor. There is no ground water table.

Permeable levels are from 27,50 to 29,50 m, from 52,50 to 54,50 m and from 58,00 to 60,00 m. The values of Lugeon are between 0,71 and 0,81.

Semi-permeable levels are from 33,00 to 35,00 m, from 35,00 to 37,00 m, from 42,30 to 44,30 m, from 47,00 to 49,00 m, from 61,00 to 63,00 m and from 66,00 to 68,00 m. The values of Lugeon is between 1,15 and 4,31.

#### 5.2.3.6.2.5 Stability of Pressure Tunnel

On portals, there will be semi loose-hard covering materials such as the certain part of alluvial fan and slope debris on the bedrock and weathering parts of the foundation rock. The unit encountered in the inlet portal of power tunnel is alluvial fan (Qay). According to results of drilling in vicinity of portal and site observation, the thickness of alluvial fan is determined as greater than 20,00 m. So, the excavation of power tunnel portal is impossible in this unit. Because of this, it is suggested that shifting of the inlet of power tunnel to the upstream part. The thickness of slope debris (Qay) is expected shallow and short longitudinally. After the excavation of alluvial fan covering the new inlet portal, it is expected to scrape alluvial deposits located in between crown of inlet and max. water level because of the fluctuation of water level in operation.

After the portal excavation, the tunnel alignment will be passed from firstly Dolrini Formation (OSd) and then respectively Morghouli Formation, Kirari Formation, Lukhrini Formation, Kirari Formation, Kazakhtvibi Formation, Tskhenistskali Formation, Muashi Formation and at finally Sori Formation. The outlet portal will not be generated. The lining of tunnel will be connected with penstock lining in Sori Formation (Js). The rocks of all formations are generally very fractured at surface conditions. The fractures are generally bias rarely developed horizontally, the surface of the fractures are unfilled in general but rarely filled with silicium and iron oxide painted, generally moderately weathered locally

less weathered-fresh. The rock quality is poor-very poor at the surface and having moderately strong strength at tunnel depth.

Generally permeable conditions are expected at inlet and alignment of power tunnel up to the Sori Formation, but low permeable conditions are expected when advancing in Sori Formation, locally high permeable conditions may be expected in the contact zones and where intrusive dykes and other intrusive are crossed.

The tunnel portals can be established by conventional methods and supported with conventional rock bolts and fiber shotcrete. Rock qualities will vary in general the tunnels will be only lightly supported with mainly spot temporary bolts and fiber shotcrete. Because of the tunneling in between Km: 12+543 – 15+605 by conventional methods, the sheared zones may require systematic temporary bolts / fiber shotcrete or light steel ribs. The type and properties of machine should be designed suitable for the injection purpose. The evaluation of rock mass classification is given further at chapter 10.7.

The full and systematic support of bolts and fiber shotcrete after each blast will be required at surge shaft. Occasional steel ribs may be required. The permeability around the shafts is expected to be very low due to the dominance of sandstone/clay stone.

A continuous updating of the geological and geomechanical conditions and model during tunneling.

#### **Engineering Characteristics of the Unit of Power Tunnel (Sori Formation)**

Natural Unit Weight ( $\rho_{\text{Nat}}$ )	: 2.65-2.74 gr/cm <sup>3</sup>
Uniaxial Compressive Strength	: 643-11 820 kg/cm <sup>2</sup> = 64.3-118.2 MPa
Modulus of Elasticity	:231 364 -476 977 kg/cm <sup>2</sup> = 23 136-47 697 MPa
Poisson Ratio	: 0,20-0,25
RQD	: 12-60%

#### **Engineering Characteristics of the Unit of Power Tunnel (Dolrini Formation)**

Natural Unit Weight ( $\rho_{\text{Nat}}$ )	: 2.61-2.94 gr/cm <sup>3</sup>
Uniaxial Compressive Strength	: 488.60-2 401.30 kg/cm <sup>2</sup> = 48.80-240.1 MPa
Modulus of Elasticity	:287 215-771 947 kg/cm <sup>2</sup> = 22 721-77 194 MPa
Poisson Ratio	: 0,18-0,27
RQD	: 33-60%

#### **Sori Formation for the engineering properties of rock material.**

Type	V	IV	III	II	I
Unconfined compressive strength of intact rock $\sigma_{ci}$ (MPa)	42	60	85	140	140
Intact rock parameter (mi) Disturbance factor (Df)	16	18	19	21	21
Intact rock deformation modulus (MPa)	0,10	0,10	0,20	0,30	0,30

**Sori Formation for the rock mass properties.**

Type	V	IV	III	II	I
Geological Strength Index (GSI)	35	41	49	52	60
Global rock mass compressive strength $\sigma'_{cm}$ (MPa)	6,2	10,8	17,8	31,1	37,5
Rock mass deformation modulus (MPa)	1 573	3 098	5 531	9 514	15 088

**Dolrini Formation for the engineering properties of rock material.**

Type	V	IV	III	II	I
Unconfined compressive strength of intact rock $\sigma_{ci}$ (MPa)	60	85	116	148	148
Intact rock parameter (mi) Disturbance factor (Df)	21	24	26	28	28
Intact rock deformation modulus (MPa)	0,10	0,30	0,30	0,40	0,40

**Dolrini Formation for the rock mass properties.**

Type	V	IV	III	II	I
Geological Strength Index (GSI)	42	49	54	63	66
Global rock mass compressive strength $\sigma'_{cm}$ (MPa)	11.98	18.79	29.98	46.46	50.07
Rock mass deformation modulus (MPa)	4 738	8 317	14 377	24 100	27 678

**5.2.3.6.2.6 Pressure Tunnel Excavation and Rate of Excavation**

On inlet portal of power tunnel, there will be semi loose-hard covering material such as the certain part of slope debris on the bedrock and weathering parts of the foundation rock.

In this case, the slope ratio can be recommended as follows; Inlet Portal of Power Tunnel. The slope ratio for excavation of the slope debris can be assumed as 1:1 (H:V)

The kinematic analysis of inlet portal of the power tunnel after removed the slope debris materials is carried out for the slope ratio 1/5 (1: Horizontal, 5: Vertical) given in Figure 5.2.3.6.2.6.1.

**Figure 5.2.3.6.2.6.1.** The kinematic analysis of inlet portal of power tunnel

**Analysis against to Planer Slip;**

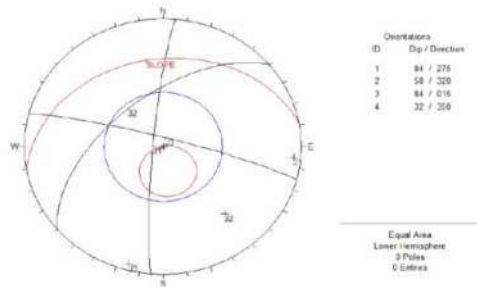

**Analysis against to Wedge Failure;**

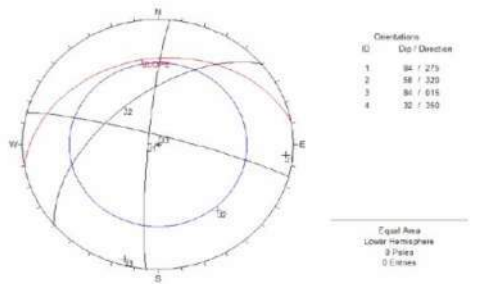

**Analysis against to Toppling**

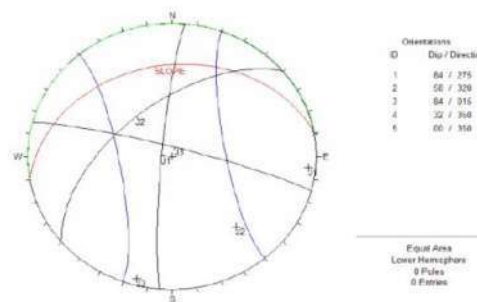

**Results of the Kinematic Analysis**

Planer Slip	No potential risk
Wedge Failure	No potential risk
Toppling	No potential risk

As a results of these analysis for inlet portal of power tunnel after removing of slope debris materials, the slope ratio that is 1/5 (1: Horizontal, 5: Vertical) can be taken with the requirement to use bolt and wire meshes for binding of the blocks to the bedrock and holding of fine particles on the slope. Shotcrete can be applied over wire meshes with drainage system if it is needed according to the condition of slope surfaces. If the shotcrete application certainly is needed, the drainage system necessarily is used to throw out the water accumulated behind of the shotcrete. But, the measurements of the discontinuities of the bedrock at the inlet portal must be carried out after removing of the loose material from the portal surface at construction stage to exactly decided the slope angle of excavation and space and length of the bolts because of analysis carrying out by using the data taken from the rocks located outside of the tunnel inlet portal.

**5.2.3.6.2.7 Outlet Portal of Power Tunnel**

The slope ratio for excavation of the slope debris can be assumed as 1/1 (H/V). The kinematic analysis of outlet portal of the power tunnel after removed the slope debris materials is carried out for the slope ratio 1/5 (1: Horizontal, 5: Vertical) given Figure 5.2.3.6.2.7.1.

**Figure 5.2.3.6.2.7.1.** The kinematic analysis of outlet portal of the power tunnel

**Analysis against to Planer Slip;**

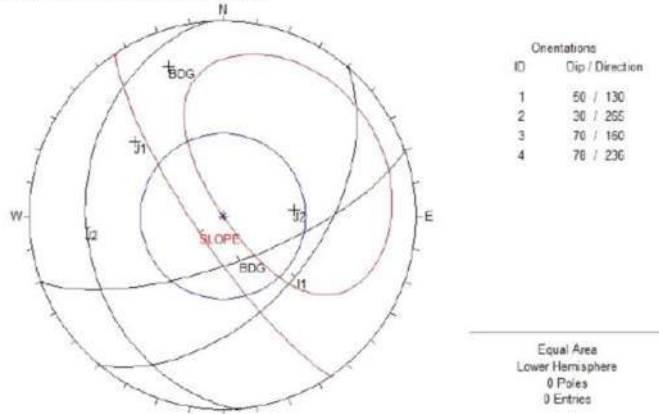

**Analysis against to Wedge Failure;**

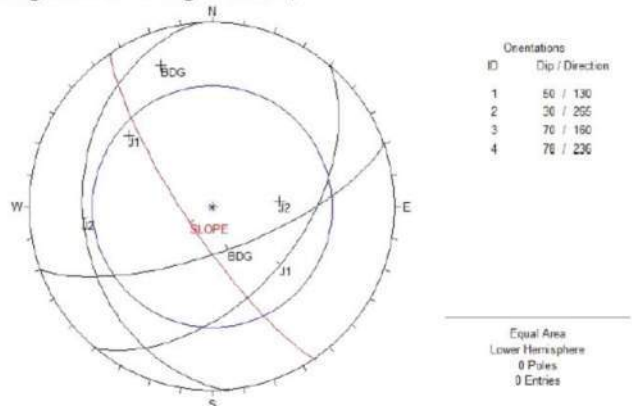

**Analysis against to Toppling;**

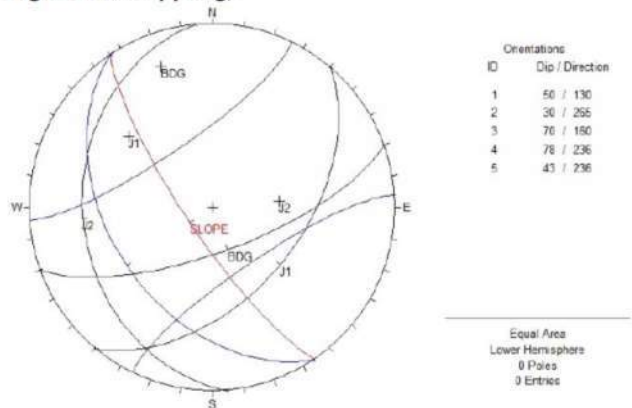

**Results of the Kinematic Analysis**

Planer Slip	No potential risk
Wedge Failure	No potential risk

Toppling	No potential risk
----------	-------------------

As a results of these analysis for outlet portal of power tunnel after removing of slope debris materials, the slope ratio that is 1/5 (1: Horizontal, 5: Vertical) can be taken with the requirement to use bolt and wire meshes for binding of the blocks to the bedrock and holding of fine particles on the slope. Shotcrete can be applied over wire meshes with drainage system if it is needed according to the condition of slope surfaces. If the shotcrete application certainly is needed, the drainage system necessarily is used to throw out the water accumulated behind of the shotcrete. But, the measurements of the discontinuities of the bedrock at the outlet portal must be carried out after removing of the loose material from the portal surface at construction stage to exactly decided the slope angle of excavation and space and length of the bolts because of analysis carrying out by using the data taken from the rocks located outside of the tunnel outlet portal.

At the alignment of tunnels, the excavation will be going on in different rocks of different formations. The units encountered at alignment of tunnel were cut frequently by the intrusive and dyke of young granites, quartz diorite and diabase porphyry. In this condition, the contact metamorphism could be seen at contact of these rocks and intrusive and dykes. So, very hard rock zones will be encountered at the excavation of power tunnel.

The covering material like slope debris on the bedrock and weathering parts of the foundation rock are taken into account to excavate at the portals. According to this, the rate of excavation can be assumed as follows:

- 10% Hard Pan
- 10 % Soft Rock
- 75 % Hard Rock
- 5 % Very hard rock

#### **5.2.3.6.2.8 Cerchar Abrasivity and Brazilian Test Result**

The tests of cerchar abrasivity index (CAI) were performed on samples taken from boreholes of PBH-1, PBH-2, PBH-3, DBH-3, SBH-1, SBH-3, SBH-6, SBH-7, TBH-3. According to test result, The CAI value varies between 0,87– 4,29 and class is “slightly abrasive” in one sample from PBH-2, “very abrasive” and “extremely abrasive” in others. The results of Cerchar Index Test are given at Appendix-5.

The results of CAI shows that the cutters which is located on TBM face should be design for very abrasive and extremely abrasive rock conditions.

In addition to this, the tests of Brazilian tensile strength were performed on samples taken from boreholes of PBH-1, PBH-2, PBH-3, SBH-1, SBH-3, DBH-3, DBH-6 and DBH-7. According to test result, the mean strengths varies between 6,26 – 14,66 MPa.

#### **5.2.3.6.2.9 TBM Approach Tunnel**

The one borehole named TBH-4 were drilled as totally depth of 50,0 meter to determine geotechnical parameters of tunnel level and their overburden units. The 9 water pressure tests were performed to determine permeability of overburden units.

The units encountered in the borehole TBH-4 are Slope Debris (Qym) in between 0,00 m – 3,40 m and Sori Formation (Js) in between 3,40 m – 50,00 m.

Light gray, beige and brown colored sandstone, shale that is the member of Sori Formation is generally



wide-moderate fractured sometimes very (intense) fractured and crushed. The fractures developed bias in general. The fractures are filled with silicium, sometimes iron oxides painted. The surfaces of the fractures are corrugated and rough, less weathered- fresh. The rock quality is fair, having moderately strong.

The percentage of core in this borehole is meanly 80%, mean RQD nearly 50% and rock quality is fair. There is no ground water table.

#### 5.2.3.6.2.10 Stability of Inlet Portal of TBM Approach Tunnel

The unit encountered in the inlet portal of Approach Tunnel is Slope Debris (Qym). The lining and junction of power tunnel will be in Sori Formation (Js). Because of the units will be excavated by the inlet portal excavation, the tunnel alignment will be located at Sori Formation. The formation is composed of clay stone, sandstone, shale, slate and volcano sedimentary deposits. The unit is middle-thick-very thick layered, rarely thin-middle layered. The unit displays flysh property. Sometimes volcano genetic sandstone, tuff and agglomerates are observed in the formation. The unit is represented as interbedded sandstone-clay stone at the project area. The unit is rich in terms of content of coarse grained mica and quartz. The formation is generally following-up overturn folds. In the rock types created the Sori Formation joint systems are widespread developed. The rocks of Sori Formations are generally very fractured at surface conditions. The rock quality is poor-very poor at the surface and having moderately strong strength at depth.

#### 5.2.3.6.2.11 TBM Approach Tunnel Excavation and Rate of Excavation

On inlet portal of Approach Tunnel, there will be semi loose-hard covering material such as the certain part of slope debris on the bedrock and weathering parts of the foundation rock.

In this case, the slope ratio can be recommended as follows:

- 1/1 (H/V) for the excavation in slope debris,

Under the slope debris, Sori Formation is seen as bedrock at the inlet portal of TBM tunnel. The features of this bedrock are similar to the bedrock at outlet portal of power tunnel. So that, after the removing of slope debris materials, the same slope ratio can be taken as 1/5 (1: Horizontal, 5: Vertical) with the requirement to use bolt and wire meshes for binding of the blocks to the bedrock and holding of fine particles on the slope. Shotcrete can be applied over wire meshes with drainage system if it is needed according to the condition of slope surfaces. If the shotcrete application certainly is needed, the drainage system necessarily is used to throw out the water accumulated behind of the shotcrete. But, the measurements of the discontinuities of the bedrock at the inlet portal must be carried out after removing of the loose material from the portal surface at construction stage to exactly decided the slope angle of excavation and space and length of the bolts because of analysis carrying out by using the data taken from the rocks located outside of the tunnel.

At the alignment of Approach Tunnels, the excavation will be going on in the rocks of Sori formation. The unit encountered at alignment of tunnel were cut frequently by the intrusive and dyke of young granites, quartz diorite and diabase porphyry. In this condition, the contact metamorphism can be occurred at contact of these rocks and intrusive and dykes. So, the very hard rock zones will be observed at the excavation of power tunnel.

The covering material like slope debris on the bedrock and weathering parts of the foundation rock are taken into account to excavate at the portals. According to this:

- 3 % Hard Pan
- 15 % Soft Rock
- 80 % Hard Rock
- 2 % Very hard rock.

#### 5.2.3.6.2.12 Cerchar Abrasivity and Brazilian Test Result

The tests of cerchar abrasivity index (CAI) were performed on samples taken from boreholes of TBH-4. According to test result, the CAI value varies between 1,33 – 2,74 and class is "abrasive" and "very abrasive". The results of Cerchar Index Test are given at Appendix-5.

The results of CAI shows that **the cutters which is located on TBM face should be design for very abrasive and extremely abrasive rock conditions.**

In addition to this, the tests of Brazilian tensile strength were performed on samples taken from boreholes of TBH-4. According to test result, the mean strengths is 12,77 MPa.

Figure 5.2.3.6.2.12.1. TBM entrance tunnel on Nenskra (geological profile)

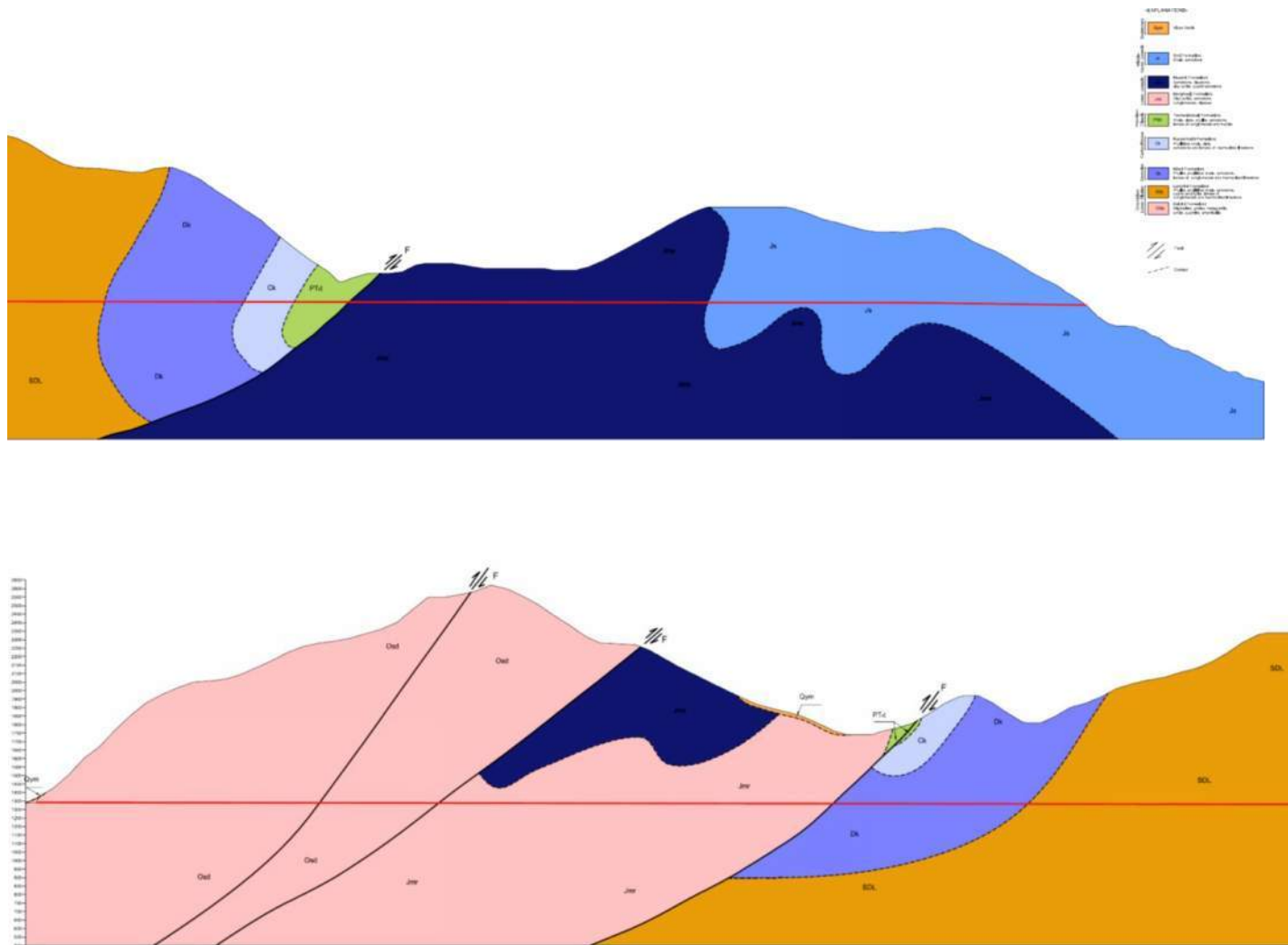

### 5.2.3.6.2.13 Surge Tank

Surge Tank is located between Km: 14+992-15+027 distance from the power tunnel start. The elevation of surge tank axis is 1508 m at the surface, 1292 m at tunnel invert. The Sori Formation will be cut along the surge tank during the excavation.

Sori Formation is composed of dark and light gray, black colored sandstone, shale. They are generally wide-moderate fractured sometimes very fractured. The fractures are generally oblique, rarely nearly vertically and filled with silicium, sometimes iron oxides painted. The surface of the fractures is planer and rough, highly-moderately weathered sometimes less weathered and fresh. The rock quality is fair-good, having strong strength and displays lamination.

According to borehole drilled vicinity of surge tank, the percentage of core in this borehole is meanly 80%, mean RQD nearly 60% and rock quality is fair-good. Section 10.2.2.1 presents the engineering properties of the rock types belong to Sori Formation which comprises the surge tank.

According to some analysis carried out for Sori Formation and because of the surge tank being significant structure, after removing of very thin slope debris materials, the slope ratio can be taken as 1/3 (1:H, 3:V) with the requirement to use bolt and wire meshes for binding of the blocks to the bedrock and holding of fine particles on the slope. Shotcrete can be applied over wire meshes with drainage system if it is needed according to the condition of slope surfaces. If the shotcrete application certainly is needed, the drainage system necessarily is used to throw out the water accumulated behind of the shotcrete. But, the measurements of the discontinuities of the bedrock at the inlet portal must be carried out after removing of the loose material from the portal surface at construction stage to exactly decide the slope angle of excavation and space and length of the bolts because of analysis carrying out by using the data taken from the rocks located outside.

Figure 5.2.3.6.2.13.1. Geological plan and profile of surge shaft

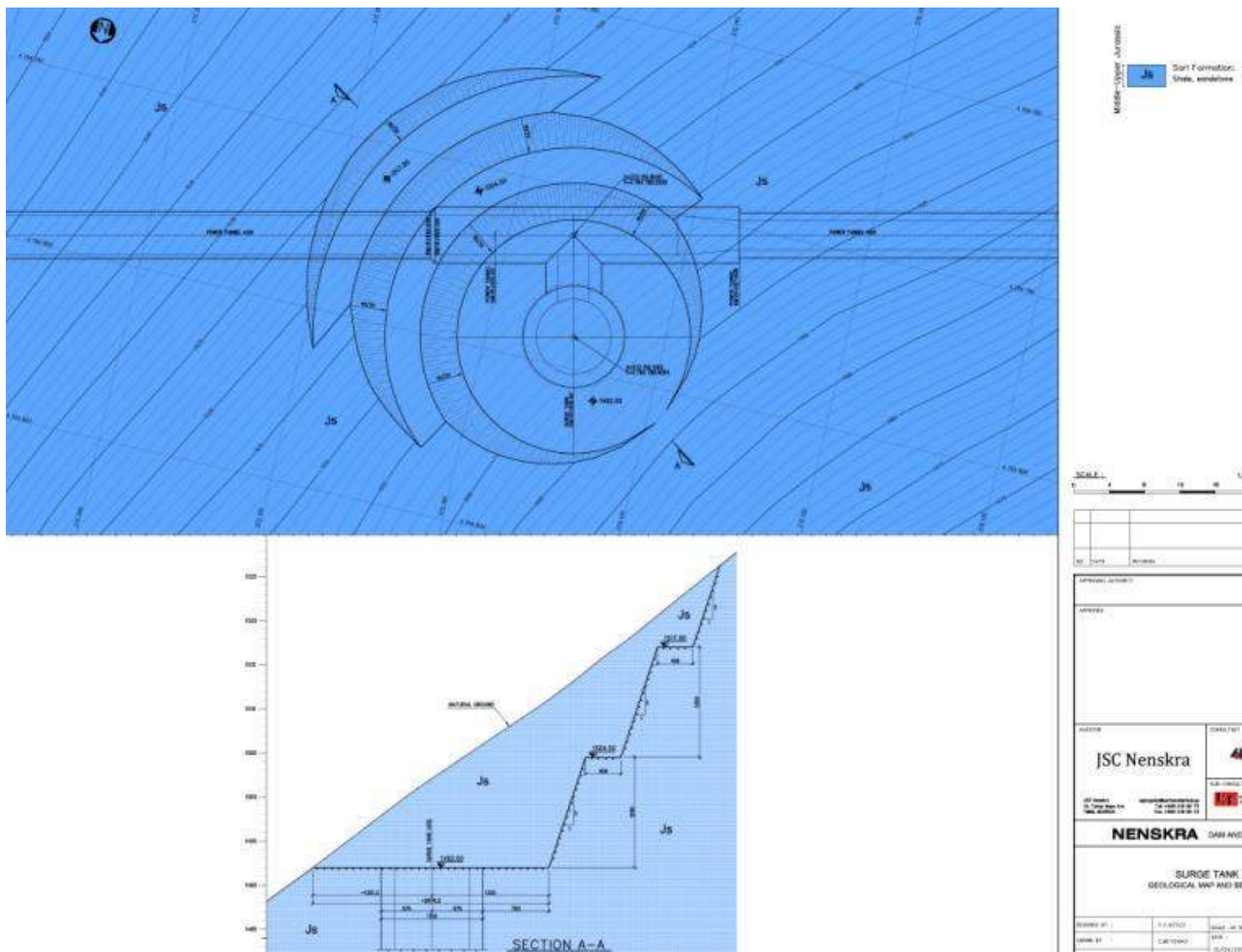

#### 5.2.3.6.2.14 Gate Shaft

Gate shaft is located between Km: 0+129-0+148,80 distance from the power tunnel start. The elevation of gate shaft axis is 1450 m at the ground of surface, 1327 m at tunnel excavation invert. The Dolrini Formation (Osd) will be cut along the surge tank during the excavation.

The Dolrini Formation is very fractured in general. The fractures are generally bias rarely developed horizontally, the surface of the fractures are unfilled in general but rarely filled with silicium and iron oxide painted, generally moderately weathered locally less weathered-fresh. The rock quality is poor-very poor and having moderately strong strength.

Section 10.2.2.1 presents the engineering properties of the rock types belong to Dolrini Formation which comprises the surge tank.

According to some analysis carried out for Dolrini Formation after removing of very thin slope debris materials, the slope ratio can be taken as 1/5 (1:H, 5:V) with the requirement to use bolt and wire meshes for binding of the blocks to the bedrock and holding of fine particles on the slope. Shotcrete can be applied over wire meshes with drainage system if it is needed according to the condition of slope surfaces. If the shotcrete application certainly is needed, the drainage system necessarily be used to throw out the water accumulated behind of the shotcrete. But, the measurements of the discontinuities of the bedrock at the inlet portal must be carried out after removing of the loose material from the portal surface at construction stage to exactly decide the slope angle of excavation and space and length of the bolts because of analysis carrying out by using the data taken from the rocks located outside.

Figure 5.2.3.6.2.14.1. Geological plan and profile of gate shaft

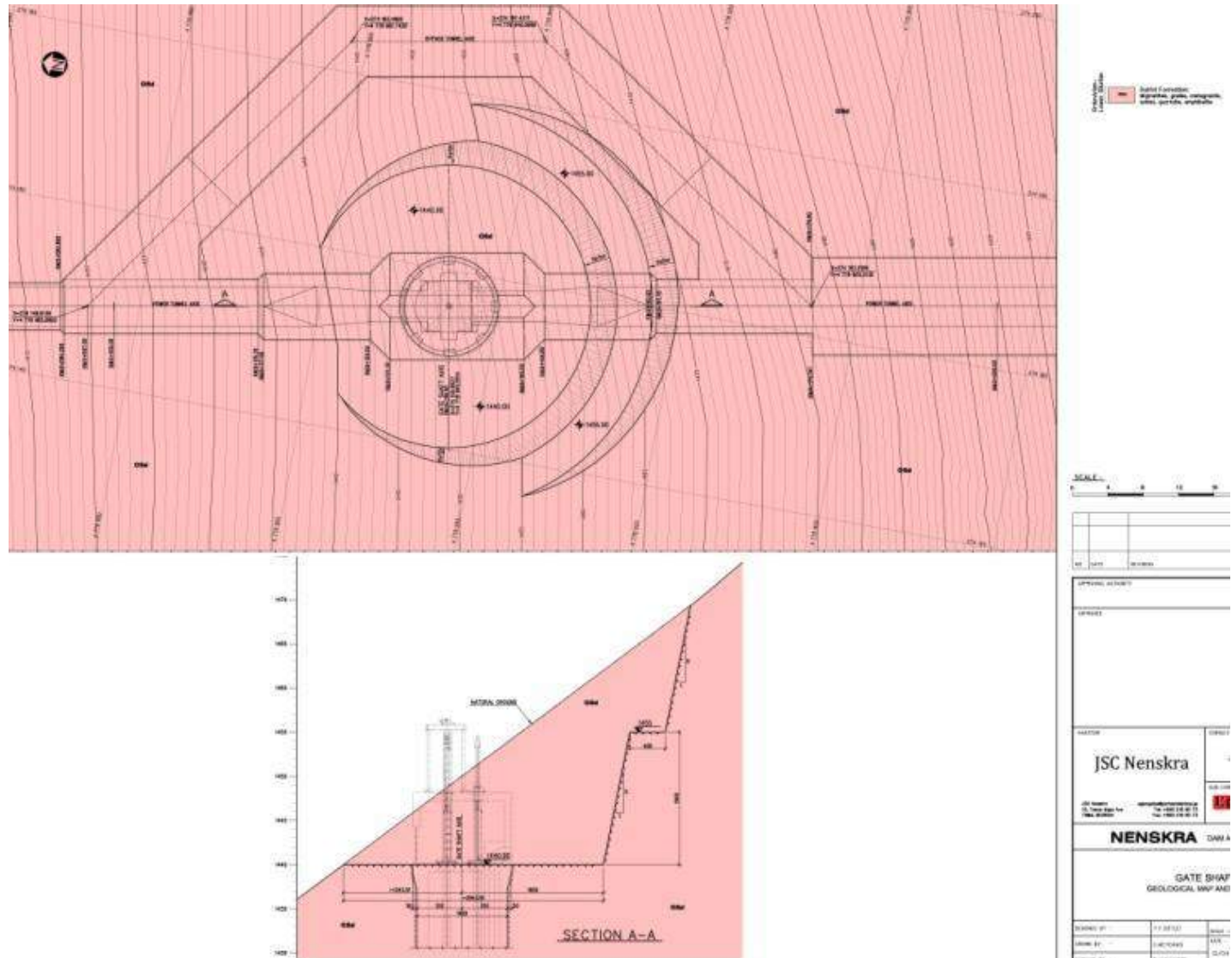

### 5.2.3.6.3 Powerhouse Site

Because of alluvial fan deposits on the penstock place and powerhouse site, the site of powerhouse was relocated to downstream direction. It was thought that the alluvial fan deposit would cause the damage on penstock at construction instantly.

The foundation elevation of powerhouse begins 690 meter ended nearly 695 meter according to the project. The boreholes of PBH-1, PBH-2 and PBH-3 were drilled at powerhouse foundation area and PBH-4 was drilled at slope area of powerhouse located at backside. The pressure meter tests were carried out at each 2.0 meter interval in the boreholes. Beside this, the core samples were taken from the borehole.

The units encountered in the boreholes PBH-1, 2 and 3 are Slope Debris (Qym) varies between 7,00–10,10 and Sori Formation (Js) up to the end of the boreholes. Sori Formation is composed of dark and light gray, black colored sandstone, shale they are generally wide-moderate fractured sometimes very fractured. The fractures are generally oblique, rarely nearly vertically and filled with silicium, sometimes iron oxides painted. The surface of the fractures is planer and rough, highly-moderately weathered sometimes less weathered and fresh. The rock quality is fair-good, having strong strength and displays lamination.

The percentage of core in this borehole is meanly 80%, mean RQD nearly 60% and rock quality is fair-good. There is no ground water table. The limit values obtained from the laboratory test which are performed on samples taken from boreholes in this area are presented below.

#### Engineering Characteristics of the Foundation Unit (Bedrock) of Powerhouse

Natural Unit Weight ( $\gamma_{\text{Nat}}$ )	: 2.65-2.70 gr/cm <sup>3</sup>
Uniaxial Comprehensive Strength	: 643-1 820 kg/cm <sup>2</sup> = 64.3-182.0 MPa
Modulus of Elasticity	: 231 364-476 977 kg/cm <sup>2</sup> = 23 136-47 697 MPa
Poisson Ratio	: 0,20-0,25
RQD	: 12-55%

#### 5.2.3.6.3.1 Bearing Capacity and Settlement

Because of boreholes drilled at the approximately 713-715 meter elevation, excavation depth of foundation is assumed 23-25 meter and bearing capacity and settlements are calculated by using pressure meter and laboratory tests results one by one.

##### According to Pressure meter Tests Results

The results of pressure meter tests in boreholes are taken into account and it is assumed that foundation having 24 meter width and 35 meter length will be constructed after nearly 25 meter excavation. By using these data, the allowable bearing capacity were calculated in between,  $q_a = 22,40 - 36,30$  kg/cm<sup>2</sup> without overburden pressure (The calculations are given in detail Appendix-4). The collective results of bearing capacity are given at the Table 5.2.3.6.3.1.1.



**Table 5.2.3.6.3.1.1.** The bearing capacity results of pressure meter test for powerhouse site

Borehole No	Depth of Foundation Df	Size of Foundation B x L	BEARING CAPACITY			
			Bearing Capacity (qa) kg/cm <sup>2</sup>	Factor of Safety (FS)	Overburden Pressure (q <sub>0</sub> ) kg/cm <sup>2</sup>	Allowable Bearing Capacity (q <sub>a</sub> ) kg/cm <sup>2</sup>
PBH-1	25,0	24,0 x 35,0	87,77	3,0	-	29,26
PBH-2	23,0	24,0 x 35,0	109,00	3,0	-	36,33
PBH-3	23,0	24,0 x 35,0	67,21	3,0	-	22,40

According to the data, the reasonable permissible capacity of the power house is  $q_a = 20,00 \text{ kg/cm}^2$ .

Under the  $10,0 \text{ kg/cm}^2$  project load, the amount of settlement will be nearly,  $S = 1,45 - 2,12 \text{ cm}$ , below the same foundation. The collective results of amount of settlement are given at the Table 5.2.3.6.3.1.2.

**Table 5.2.3.6.3.1.2.** Table of amount of settlement for powerhouse site

Borehole No	Depth of Foundation Df	Size of Foundation B x L	SETTLEMENT		
			Amount of Settlement depending on P	Project Load kg/cm <sup>2</sup>	Settlement depending on Project Load cm
PBH-1	25,0	24,0 x 35,0	$0,155 \times P$	10,0	1,55
PBH-2	23,0	24,0 x 35,0	$0,145 \times P$	10,0	1,45
PBH-3	23,0	24,0 x 35,0	$0,212 \times P$	10,0	2,12

### 5.2.3.6.3.2 Stability of Powerhouse Nearby Slopes

The units encountered at the excavation of powerhouse site are Alluvial Fan (Qay) and Sori Formation (Js). The alluvial fan is the recent deposits in Quaternary age accumulated blocks, gravels, sands and silts etc. at the site where wide nutrition basin, the rivers having high degree abrasion and high degree transportation capacity. The Sori formation is composed of clay stone, sandstone, shale, slate and volcano sedimentary deposits. The unit is middle thick-very thick layered, rarely thin-middle layered. The unit displays flysh property. Sometimes volcano genetic sandstone, tuff and agglomerates are observed in the formation. The unit is represented as interbedded sandstone-clay stone at the project area. The unit is rich in terms of content of coarse grained mica and quartz. The formation is generally following-up overturn folds. In the rock types created the Sori Formation joint systems are widespread developed. The rocks of Sori Formations are generally very fractured at surface conditions. The rock quality is poor-very poor at the surface and having moderately strong strength towards to depth.

There will be semi loose-hard covering material such as the thick part of alluvial fan deposit on the bedrock and weathering parts of the foundation rock. It was thought that the alluvial fan deposit would cause the damage on penstock at construction instantly. Because of the thick alluvial fan deposits on the penstock site and slope of powerhouse, the site of powerhouse was relocated to downstream direction.

Because of the foundation settling on the same bedrock, the allowable bearing capacity of the foundation of powerhouse can be assumed as the same with old site.

#### **5.2.3.6.3.3 Slope Excavation of Powerhouse and Rate of Excavation**

**Because of the thick alluvial fan deposits on the penstock place and slope of powerhouse, the site of powerhouse was relocated to downstream direction.**

At the new site, all units can be excavated by mechanically and blasting will not be required. The power tunnels and the manifold are all located in the same formation. The slope wall of the powerhouse will be a piled and anchored wall with anchors embedded into the rock.

In this case, the slope ratio can be recommended as follows:

- 1/1 (H/V) for the excavation in slope debris,
- 1/5 (H/V) for the rock unit

The excavation will be going on the slope debris deposits and rocks of Sori formation.

The covering material on the bedrock and weathering parts of the foundation rock are taken into account to excavate;

- 35 % Hard Pan
- 20 % Soft Rock
- 40 % Hard Rock
- 5 % Very hard rock

Excavations will be performed by ripper, digger, hydraulic breaker.

Figure 5.2.3.6.3.3.1. Nenskra powerhouse (geological plan)

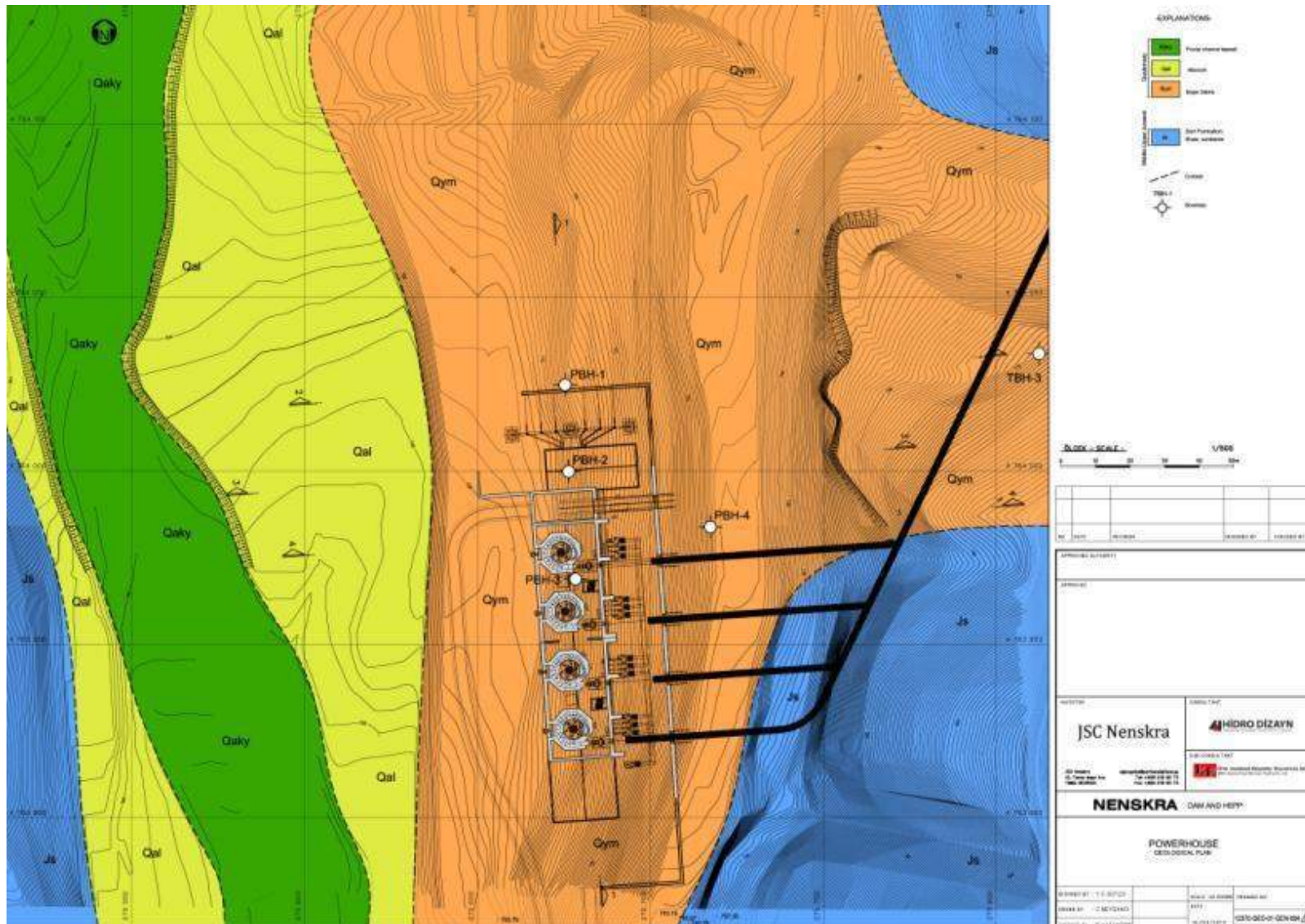
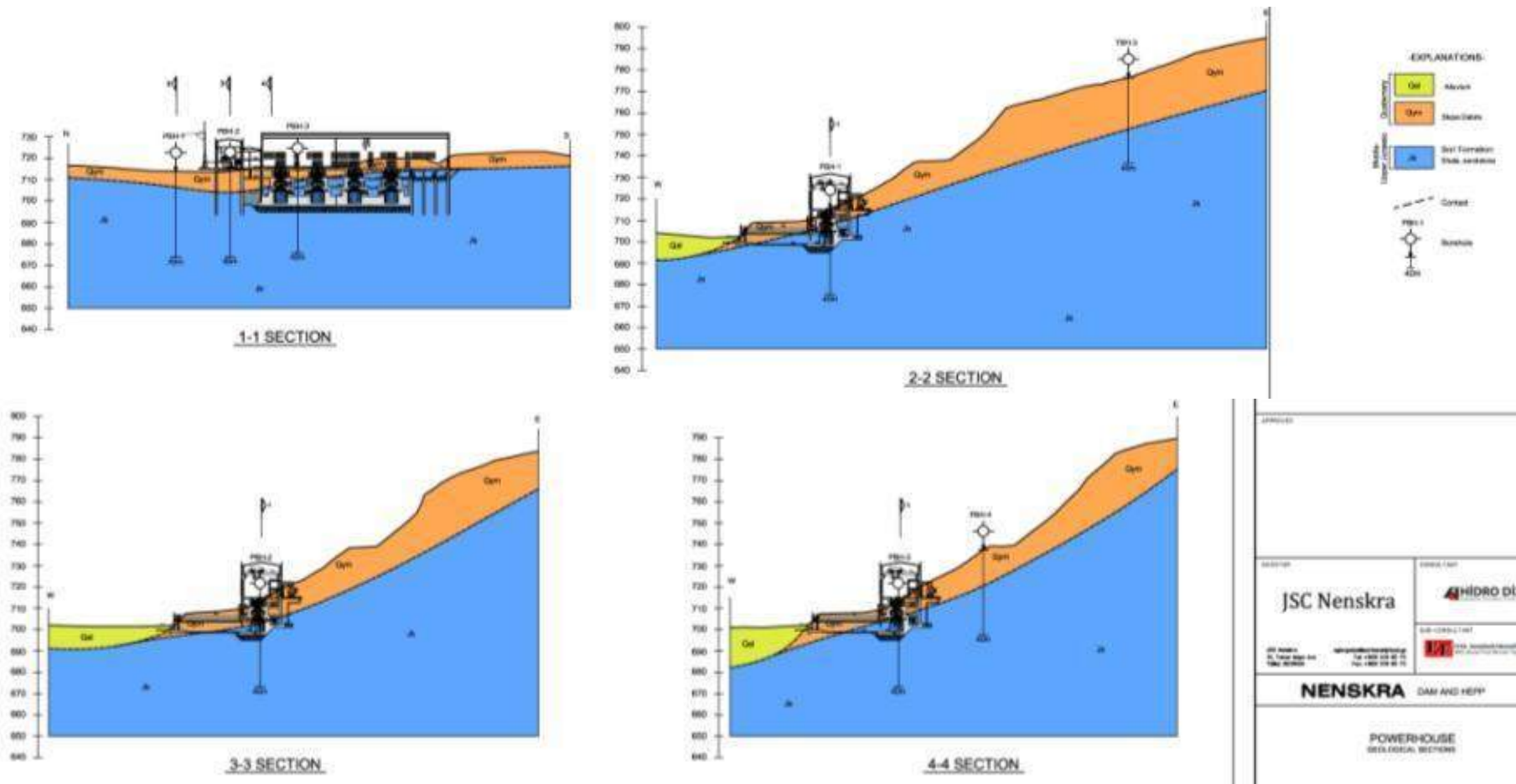

Figure 5.2.3.6.3.3.2. Nenskra powerhouse (geological profiles)



#### 5.2.3.6.4 Nakra Weir

The borehole NWBH-1 and NWBH-3 were drilled at the side of the river. The borehole NWBH-2 was not drilled due to hard transportation conditions at the location. The pressure meter tests were performed at each 2.0 meter interval in the boreholes. And also two boreholes, NTBH-1 and NTBH-2, were drilled at alignment of tunnel inlet. The core samples were taken from the borehole NTBH-2. The bearing capacity and settlements of slope debris are calculated by using pressure meter test results.

The foundation site of Nakra weir is located on alluvial fan. According to the site observation and core description, the thickness of alluvial fan is higher than 25,0 m at weir axis.

The unit encountered in the borehole NWBH-1 is Alluvial Fan (Qay) in between 0,00 m – 20,00 m. It is brown and beige in color, generally found as sandy gravelly blocky unit. Block size reaches up to 30 cm. The shape of blocks is semi rounded-semi angular and originated granite and gneiss in general.

The percentage of core in this borehole is meanly 30%. There is no ground water table. According to permeability tests;

Permeable levels are from 0,00 m to 8,00 m. K constants of the unit is between  $8,08 \times 10^{-4}$  and  $9,33 \times 10^{-4}$ .

Highly permeable levels are from 8,00 m to 20,00 m. K constants of the unit is between  $1,14 \times 10^{-4}$  and  $1,67 \times 10^{-4}$ . There is no ground water table.

The unit encountered in the borehole NWBH-3 is Alluvial Fan (Qay) in between 0,00 m – 30,00 m. It is brown and beige in color, generally found as sandy gravelly blocky unit. Block size reaches up to 30 cm. The shape of blocks is semi rounded-semi angular and originated granite and gneiss in general.

The percentage of core in this borehole is meanly 30%. There is no ground water table.

According to permeability tests:

Permeable levels are from 0,00 m to 6,00 m. K constants of the unit is between  $5,67 \times 10^{-4}$  and  $8,05 \times 10^{-4}$ .

Highly permeable levels are from 6,00 m to 24,00 m. K constants of the unit is between  $1,06 \times 10^{-4}$  and  $1,35 \times 10^{-4}$ . There is no ground water table.

##### 5.2.3.6.4.1 Bearing Capacity and Settlement

The boreholes NWBH-1, NWBH-2 and NWBH-3 were planned to drill on the axis of weir firstly. The borehole NWBH-1 and NWBH-3 were drilled at the side of the river. The borehole NWBH-2 was not drilled due to hard transportation conditions at the location of the borehole. The bearing capacity and settlements of units are calculated by using pressure meter and laboratory tests results for the planned weir site.

##### According to Pressure meter Tests Results

The results of pressure meter tests in boreholes are taken into account and it is assumed that foundation having 25 meter width and 40 meter length will be constructed after nearly 5,0 meter excavation. The depth and size of foundation were proposed by assumptions. By using these data, the weir will be seated on debris slope, so the allowable bearing capacity of debris slope were calculated in between,  $q_a = 1,24 - 1,63 \text{ kg/cm}^2$  without overburden pressure (The calculations are given in detail Appendix-4). The collective results of bearing capacity are given at the Table 5.2.3.6.4.1.1.

**Table 5.2.3.6.4.1.1.** The allowable bearing capacity depending on pressure meter test for Nakra weir site

Borehole No	Depth of Foundation Df	Size of Foundation B x L	BEARING CAPACITY			
			Bearing Capacity (qu) kg/cm <sup>2</sup>	Safety Factor (F)	Overburden Pressure (qo) kg/cm <sup>2</sup>	Allowable Bearing Capacity (qa) kg/cm <sup>2</sup>
NWBH-1	5,0	25,0 x 40,0	4,90	3,0	-	1,63
NWBH-3	5,0	25,0 x 40,0	3,73	3,0	-	1,24

Under the 1,24 kg/cm<sup>2</sup> project load, the amount of settlement will be nearly, S= 10,06 – 10,54 cm, below the same foundation. The collective results of amount of settlement are given at the Table 5.2.3.6.4.1.2.

**Table 5.2.3.6.4.1.2.** The table of amount of settlement for Nakra weir site

Borehole No	Depth of Foundation Df	Size of Foundation B x L	SETTLEMENT		
			Amount of Settlement depending on P	Project Load kg/cm <sup>2</sup>	Settlement depending on Project Load cm
NWBH-1	5,0	25,0 x 40,0	8,50 x P	1,24	10,54
NWBH-3	5,0	25,0 x 40,0	8,11 x P	1,24	10,06

These results show that the foundation unit is very weak for a weir. And also, the thickness of debris slope shows that the excavation under the weir foundation is impossible.

#### According to Uniaxial Compressive Strength

At alignment of tunnel inlet, two boreholes were drilled. The core samples were taken from the borehole NTBH-2. After the depth of 19,0 m, The rock unit is Meta Granit. The same rock unit is observed in the new weir axis site. The limit values obtained from the laboratory test which are performed on samples taken from boreholes in this area are presented below.

#### Engineering Characteristics of the Foundation Unit (Bedrock) of Nakra Weir

Natural Unit Weight ( $\rho_{Nat}$ ) : 2.64-2.65 gr/cm<sup>3</sup>

Uniaxial Comprehensive Strength : 730.9-1 504.5 kg/cm<sup>2</sup> = 73.1-150.5 MPa  
 Modulus of Elasticity : 378 662- 472 091 kg/cm<sup>2</sup> = 37 866-47 209 MPa  
 Poisson Ratio : 0,24

#### 5.2.3.6.4.2 Stability of Weir Axis

The foundation site of Nakra weir is located on alluvial fan (Qay). According to the site observation and core description, the thickness of alluvial fan is higher than 25,0 m. The depth of foundation rock unit was not determined in the boreholes. And also, at the left and right bank of weir axis, the wide and long alluvium fan deposits were observed. Between Nakra village and weir site area, the actual four alluvial fans were developed on other river beds. The views of alluvial fan on the left and right banks and location of boreholes of NWBH-1 and NTBH-2 are given below.

As it is shown in Photo 5.2.3.6.4.2.1. and Photo 5.2.3.6.4.2.2., the weir site is located on alluvial fan. It seems that it is impossible to be settled on the shallow foundation in this unit. The foundation excavation should be deepening up to 25,0 m or more. In this case, the sliding and creeping will be developed on the slopes of excavation composed of alluvial fan deposited actually.

Due to the thickness of alluvial fan, the low bearing capacity and annual glacier movements towards the valley accumulated as alluvial fan, the axis of weir is suggested to be shifted towards upstream part approximately 2,5 km far away. In this new site, the foundation unit is composed of mostly rock and it is expected that the thickness of slope debris is shallow. The foundation rock unit is Dolrini Formation (OSd) containing older gneiss, migmatite and schist.

Because of the difficulties of transportation of drilling machine and the heavy winter conditions, the boreholes at the suggested site were not been drilled. The boreholes should be drilled and the geotechnical properties of rock should be determined at the construction stage after cutting of tries.

**Photo 5.2.3.6.4.2.1.** Borehole NWBH-1 and alluvial fan



**Photo 5.2.3.6.4.2.2.** Borehole NTBH-2 and alluvial fan



#### 5.2.3.6.4.3 Nakra Tailrace Tunnel

Two boreholes, NTBH-1 and NTBH-2, were drilled at alignment of tunnel inlet. The core samples were taken from the borehole NTBH-2. The inlet portal of Nakra tailrace tunnel was located on alluvial fan. According to the site observation and core description, the thickness of alluvial fan is higher than 25, 0 m. The alluvial fan materials are loose and thick to create inlet portal and tunneling. **So that, the site of Nakra weir and inlet portal of Nakra tailrace tunnel is shifted towards to upstream part, approximately 2, 5 km far away.**

The unit encountered in the borehole NTBH-1 is alluvial Fan (Qay) in between 0, 00 m – 20, 00 m. It is composed of brown, beige and gray color sandy gravelly blocks. The gravels are medium to coarse size and the diameter of blocks reach 70 cm in somewhere. The blocks and gravels are semi rounded-semi angular and originated from granite and gneiss.

The percentage of core in this borehole is meanly 45%. There is no ground water table.

The units encountered in the borehole NTBH-2 are Alluvial Fan (Qay) in between 0,00 m – 19,00 m and Dolrini Formation (Osd) in between 19,00 m – 40,00 m.

Dolrini Formation are composed of dark gray-grayish white, beige and black colored Meta Granite, Granite, Schist, Amphibolite. The units are very fractured-crushed in general, rarely wide fractures. The fractures are developed generally bias and nearly vertically, the surface of the fractures are filled within quartz in general and iron oxide painted, generally moderately weathered locally highly-moderately weathered. The rock quality is poor-very poor and having moderately strong strength.

The percentage of core in this borehole is meanly 50%, mean RQD nearly 34% and rock quality is poor. There is no ground water table.

The rock of outlet portal of Nakra tailrace tunnel is composed of Porphyritic Microcline granite, white colored, coarse-grained and developing orientation on minerals. The joint sets are developed in the unit. The fractures are spaces, sometimes with silicium and iron oxide painted. The surface of the fractures is rough and corrugated. They are in the class of strong and hard rock. They create the high topography at the site. The two samples were taken from the outcrops of rock.

The inlet portal of Nakra tailrace tunnel was located on alluvial fan. According to the site observation and core description, the thickness of alluvial fan is higher than 25, 0 m. The alluvial fan materials are so loose and so thick to create inlet portal and tunneling. That's why, the site of Nakra weir and inlet of Nakra tailrace tunnel is shifted towards to upstream part, approximately 2, 5 km far away.

#### 5.2.3.6.4.4 Stability of Portal s of Nakra Tailrace Tunnel

The unit encountered in the inlet portal of Nakra Tailrace tunnel is thin layer slope debris (Qym) over the Dolrini Formation (Osd) as a bedrock and also seen on part of the alignment at the shifted site. At the outlet portal of the tunnel, Porphyritic Microcline granite (cpg) as bedrock is seen.

##### Inlet Portal of Nakra Tailrace Tunnel

At the inlet portal of the Nakra Tailrace tunnel, the bedrock as Dolrini Formation is covered by thin layer slope debris deposits. After the excavation of slope debris, excavation will be performed on the Dolrini Formation at inlet portal. The slope analysis for Dolrini Formation can be used to determine the excavation slope ratio for this inlet. That's why, after removing of slope debris materials, the slope ratio that is 1/5 (1: Horizontal, 5: Vertical) can be taken with the requirement to use bolt and wire meshes for binding of the blocks to the bedrock and holding of fine particles on the slope. But, the measurements of the discontinuities of the bedrock at the inlet portal must be carried out after removing of the loose



material from the portal surface at construction stage to exactly decided the slope angle of excavation and space and length of the bolts because of analysis carrying out by using the data taken from the rocks located outside of the tunnel inlet portal.

For slope debris, slope ratio can be assumed as 1/1.

**Outlet Portal of Nakra Tailrace Tunnel**

The slope ratio for excavation of the slope debris can be assumed as 1/1 (H/V). The kinematic analysis of outlet portal of the power tunnel after removed the slope debris materials is carried out for the slope ratio 1/5 (1: Horizontal, 5: Vertical) given in Figure 5.2.3.6.4.4.1.

**Figure 5.2.3.6.4.4.1.** The kinematic analysis of outlet portal of the Nakra tailrace tunnel

**Analysis against to Planer Slip;**

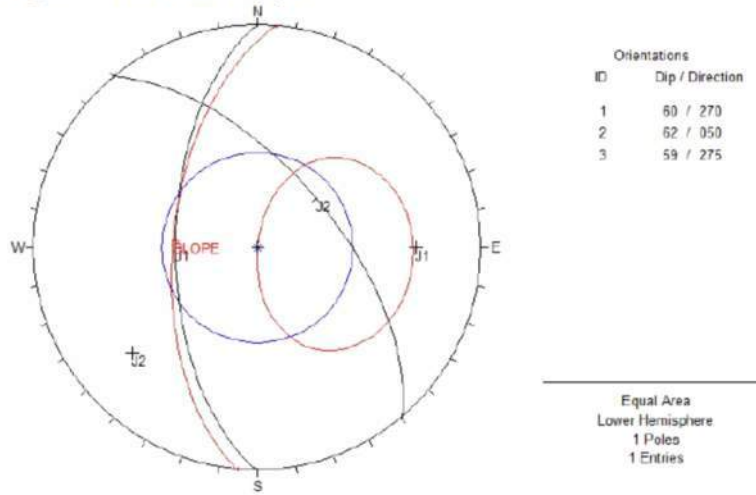

**Analysis against to Wedge Failure;**

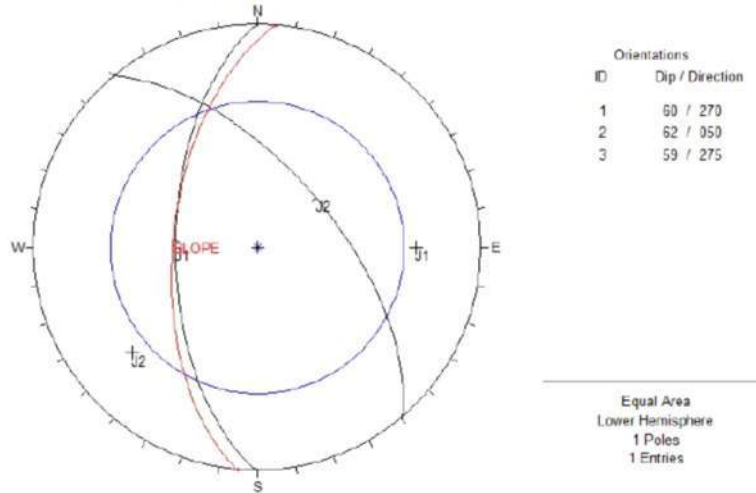

**Analysis against to Toppling**

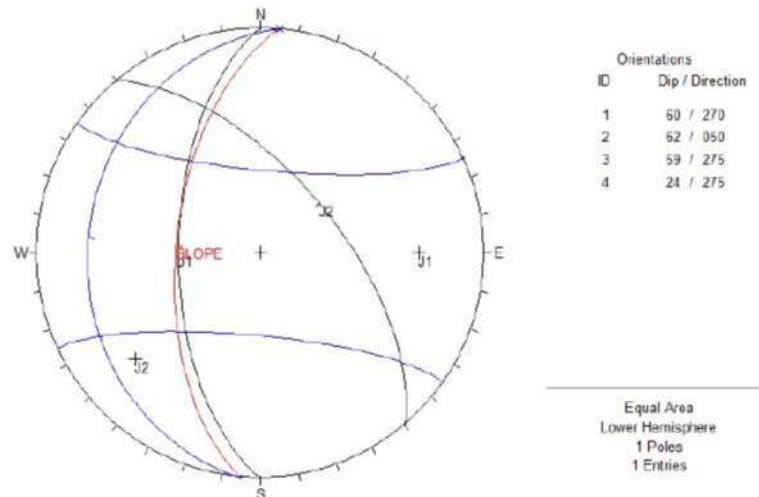

**Results of the Kinematic Analysis**

Planer Slip	No potential risk
Wedge Failure	No potential risk
Toppling	No potential risk

As a results of these analysis for outlet portal of Nakra tailrace tunnel after removing of slope debris materials, the slope ratio that is 1/5 (1: Horizontal, 5: Vertical) can be taken with the requirement to use bolt and wire meshes for binding of the blocks to the bedrock and holding of fine particles on the slope. But, the measurements of the discontinuities of the bedrock at the outlet portal must be carried out after removing of the loose material from the portal surface at construction stage to exactly decided the slope angle of excavation and space and length of the bolts because of analysis carrying out by using the data taken from the rocks located outside of the tunnel outlet portal.

**5.2.3.6.4.5 Excavations of Nakra Tailrace Tunnel and Rate of Excavations**

On the new inlet portal of Nakra tailrace tunnel, there will be semi loose-hard covering materials such as the certain part of alluvial fan and slope debris as a thin layer on the bedrock and weathering parts of the foundation rock that is Dolrini Formation (Osd). The outlet portal of Nakra tailrace tunnel will be excavated rock units of Porphyritic Microcline granite (cpg) and slope debris that is cover the bedrock.

In this case, the slope ratio can be recommended as follows;

1/1 (H/V) for the excavation in alluvial fan and slope debris,

1/5 (H/V) for the rock unit. At the alignment of tunnels, the excavation will going on in the rocks of Dolrini Formation (Osd). The covering materials like alluvial fan and slope debris on the bedrock and weathering parts of the foundation rock are taken into account to excavate at the inlet and outlet portals. According to this, the rate of excavation can be assumed as follows;

- 10 % Hard Pan
- 10 % Soft Rock
- 80 % Hard Rock

Excavations will be performed by ripper, digger, hydraulic breaker and blasting in some places.

#### **5.2.3.7 Cerchar Abrasivity and Brazilian Test Result**

The tests of cerchar abrasivity index (CAI) were performed on samples taken from boreholes of NTBH-2. According to test result, The CAI value is 3,71 and class is "very abrasive". The results of Cerchar Index Test are given at Appendix-5.

The results of CAI shows that the cutters which is located on TBM face should be design for very abrasive and extremely abrasive rock conditions.

In addition to this, the tests of Brazilian tensile strength were performed on samples taken from boreholes of NTBH-2. According to test result, The mean strengths is 9,17 MPa.

Figure 5.2.3.7.1. General geological plan of Nakra tunnel

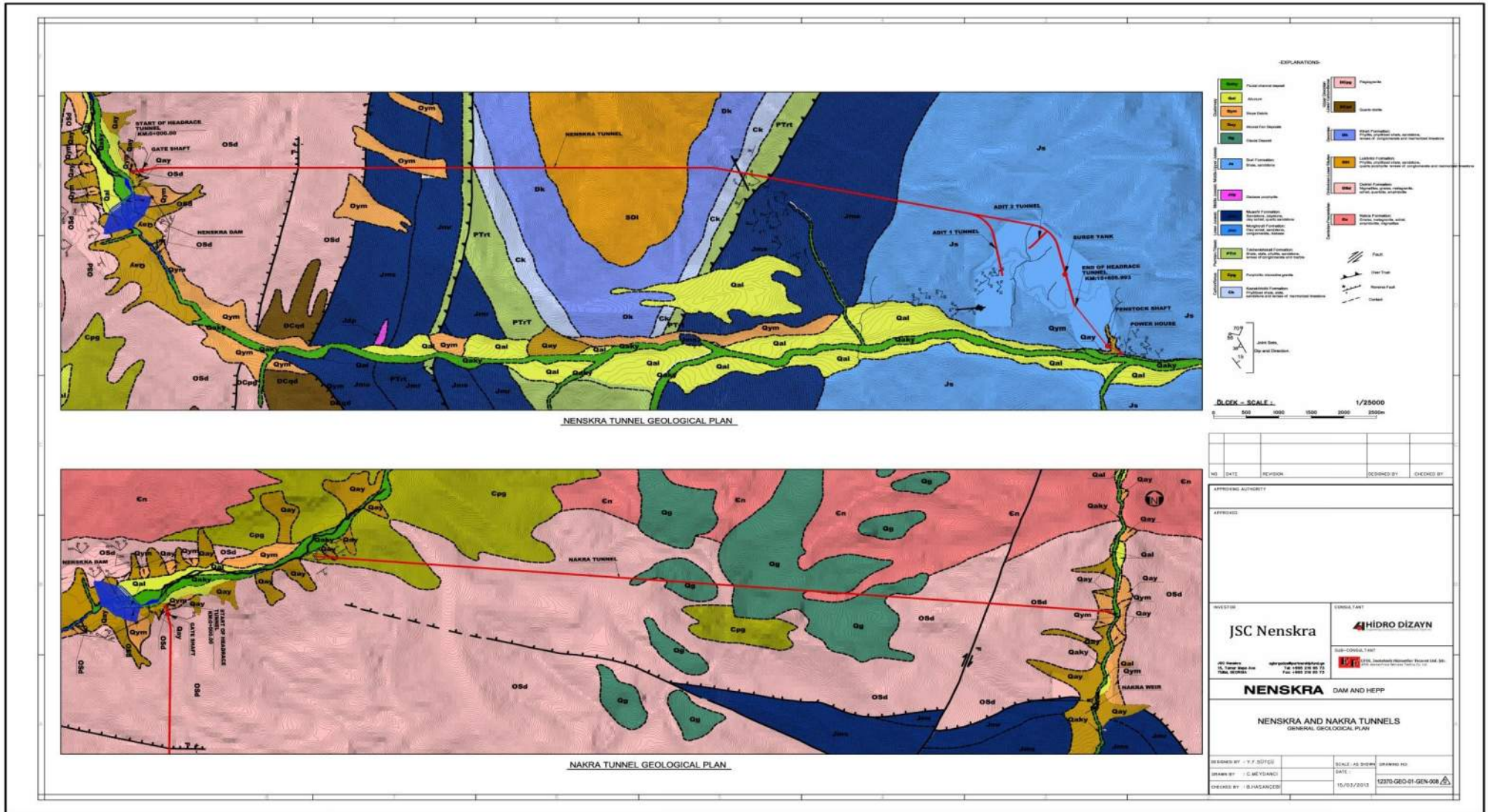

Figure 5.2.3.7.2. Nakra tunnel entrance (geological plan)

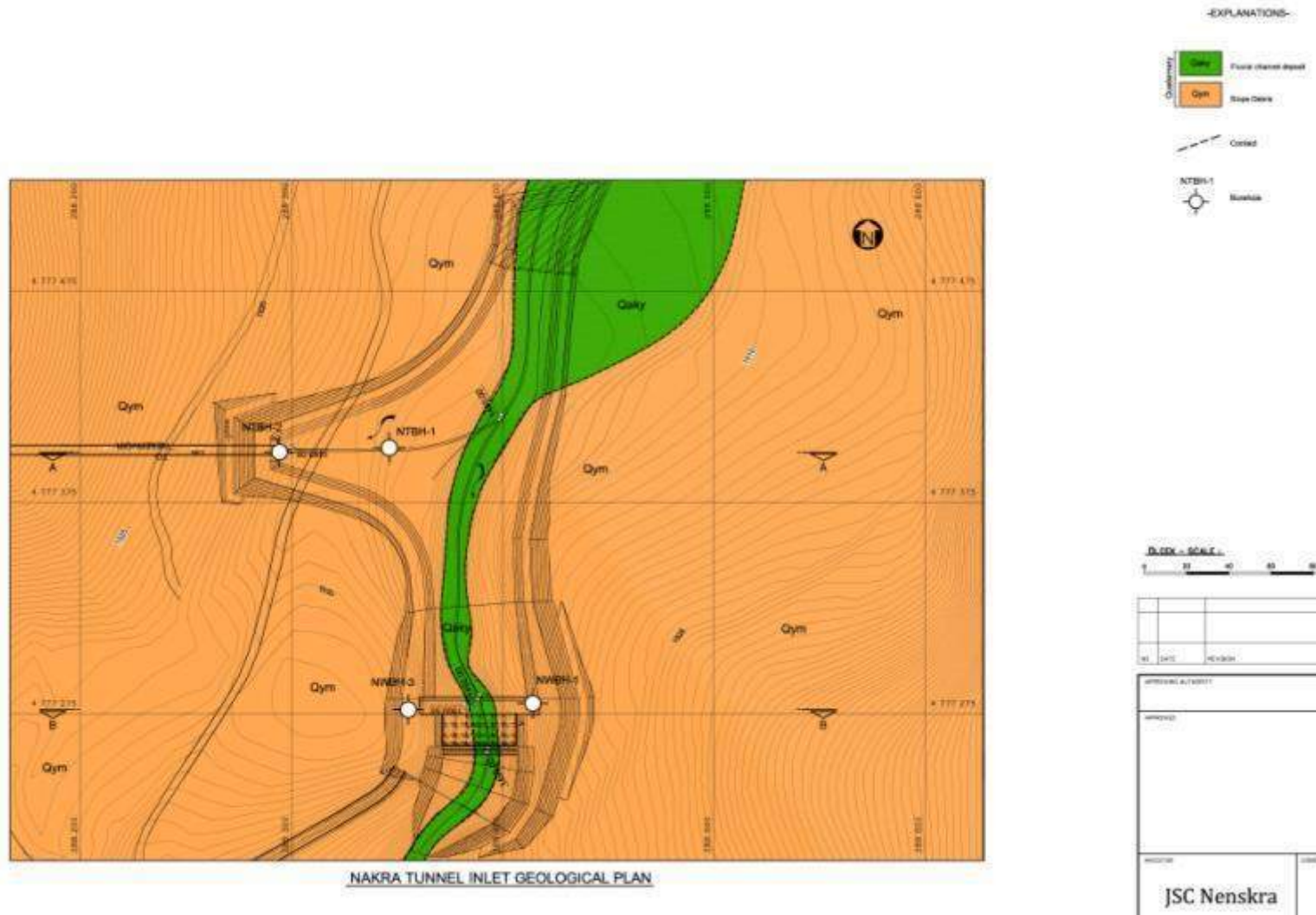
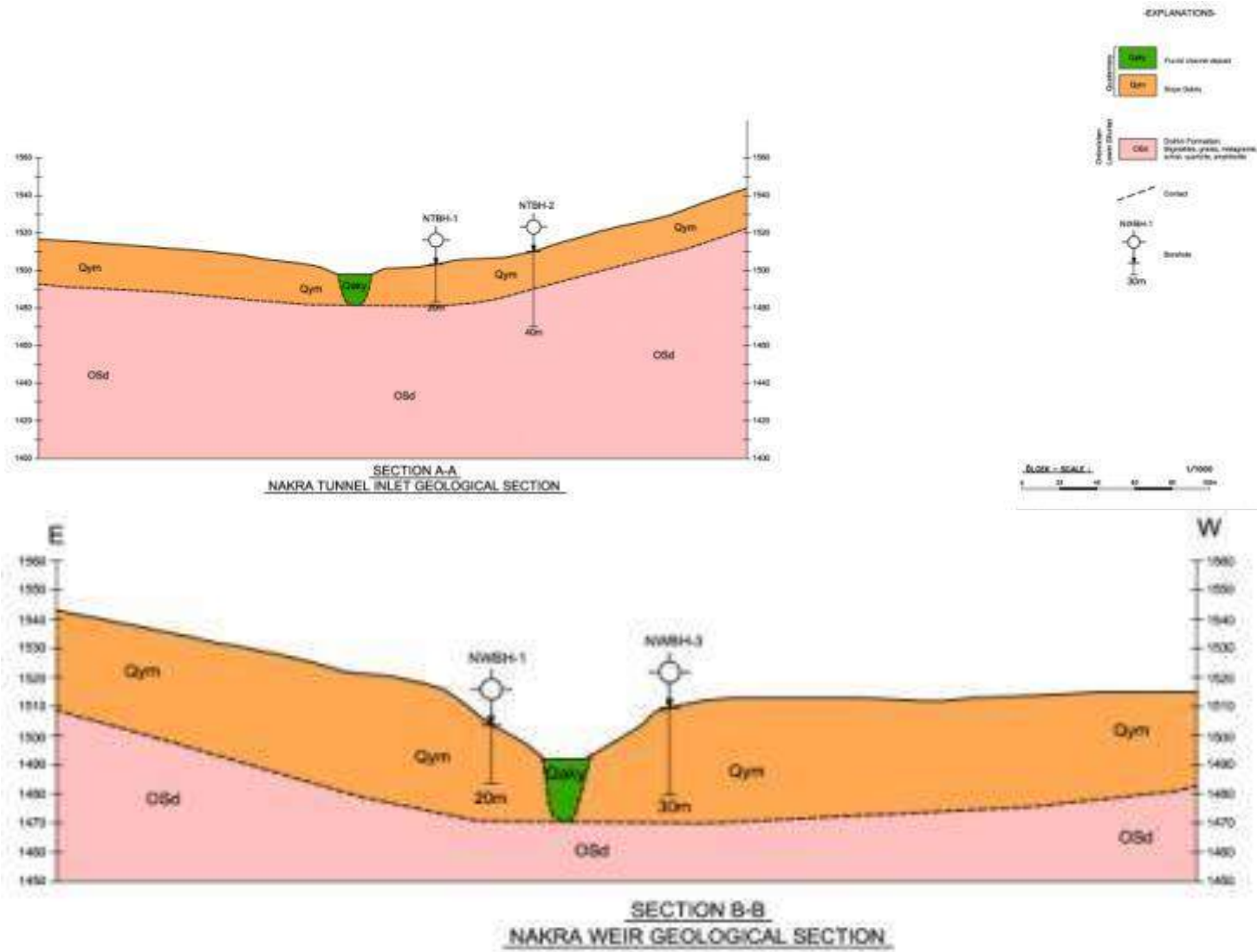
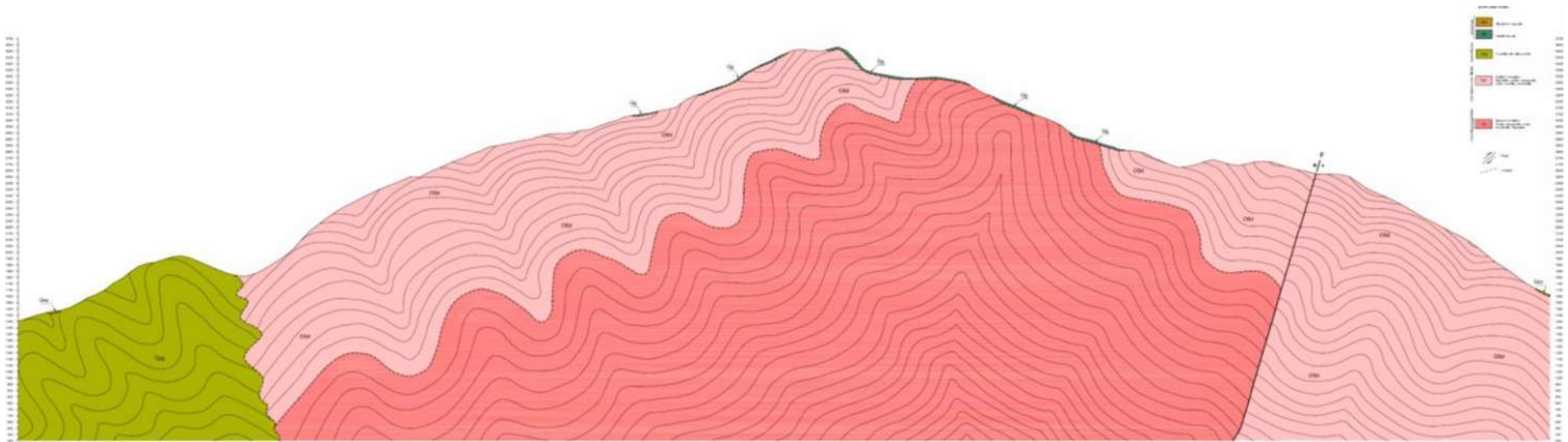

Figure 5.2.3.7.3. Nakra tunnel entrance and dam (geological plan)



**Figure 5.2.3.7.4.** Geological profile of Nakra tunnel



### 5.2.3.8 Groundwater Conditions during Tunneling

The base rock is generally granitic gneiss, mica, quartzite and generally very fractured. The fractures are generally bias, rarely horizontal or nearly horizontal. The surface of the fractures are generally unfilled, locally silicified and iron oxide painted, moderately weathered rarely little weathered-fresh.

Because of no layer bearing ground water, there is no exact groundwater table along the tunnel alignment. The possible few groundwater moves at fractures, cracks and joints in the formation that located along the tunnel alignment. Because of these structures of formation, the advent of instantaneous water is not predicted during the tunneling along the formation. But only the advent of instantaneous shearing zones and including clay units at fault zones due to the existing of fault.

In generally, the advent of water will be seen during the tunneling because of the water percolation particularly at rainy and snowy seasons.

### 5.2.3.9 Fault Zones Along the Tunnels

During the site investigation, some fault zones were determined along the tunnel alignments written as below, from the surface. The main two faults at the project area are known as Alibeck reverse fault and Main Caucasus Thrust. There are a lot of reverse fault and over thrust that is in direction of WNW-ESE or W-E and dip towards to north at the investigated area. The two of them were observed along the power tunnel from the surface. At the power tunnel alignment, the two reverse faults on Km: 1+550 - 1+750, Km: 2+300 - 2+500 and the two overt Hurst on Km: 4+600 - 4+800, Km: 9+350 - 9+550 are predicted. At the Nakra transfer tunnel alignment, on the 2+200 kilometers, the right lateral strike faults was observed at the surface.

The two main faults will be encountered but the others will not be probably encountered while the tunneling at power tunnel. And also, the one fault will be encountered while the tunneling at Nakra transfer tunnel.

A continuous updating of the geological and geomechanical conditions should be performed during tunneling and if required tunnel modeling should be revised.

At these fault zones, the advent of instantaneous water may be predicted during the tunneling along shearing zones and including clay units due to the existing of fault. The consolidation injection may be required at these zones for treatment of tunnel section. Because of the tunneling by TBM, the type and properties of machine should be designed suitable for the injection purpose.

### 5.2.3.10 Rock Mass Classification of Tunnels

RMR classification of Bieniawski and Q-Rock classification (Barton, 1974) are used Rock mass classification along the alignment of tunnels.

The Rock Mass Rating (RMR) system, is that only a few basic parameters relating to the geometry and mechanical condition of the rock mass are used. In the case of the RMR system, these are:

- (a) the uniaxial compressive strength of the intact rock; (b) discontinuity spacing;
- (c) condition of discontinuity surfaces; (d) groundwater conditions; and
- (e) orientation of discontinuities relative to the engineered structure.

The way in which these parameters are used to provide an overall rating is shown in Tables for each tunnel conditions.

The Q-rating is developed by assigning values to six parameters. These are:



- (a) RQD;
- (b) number of discontinuity sets;
- (c) roughness of the 'most unfavorable' discontinuity;
- (d) degree of alteration or filling along the weakest discontinuity;
- (e) water inflow; and
- (f) stress condition. The Q-value is expressed as where (RQD) rock quality designation, (Jn) joint set number (related to the number of discontinuity sets), (Jr) joint roughness number (related to the roughness of the discontinuity surfaces), (Ja) joint alteration number (related to the degree of alteration or weathering of the discontinuity surfaces), (Jw) joint water reduction number (relates to pressures and inflow rates of water within the discontinuities), and (SRF) stress reduction factor (related to the presence of shear zones, stress concentrations and squeezing and swelling rocks).

$$Q = (RQD/Jn) \times (Jr/Ja) \times (Jw/SRF)$$

Evaluated parameters according to Q-System are given in Tables for each tunnels. And then, Support requirements were given for the Q-system.

Where:

- 1) Rock Quality Designation (RQD)
- 2) Joint Set Number (Jn)
- 3) Joint Roughness Number (Jr)
- 4) Joint Alteration Number (Ja)
- 5) Joint Water Reduction Factor (Jw)
- 6) Stress Reduction Factor (SRF)

$RMR \approx 9 \ln Q + 44$ ( Bieniawski, 1989)	$Q \approx e^{\frac{(RMR - 44)}{9}}$	(1)
$RMR \approx 15 \log Q + 50$ ( Barton, 1995 - 2002)	$Q \approx 10^{\frac{(RMR - 50)}{15}}$	(2)

(1) RMR ≈ -18.2	2.6	23.3	44	58.5	64.7	77.2	85.4	97.9	106.2		
(2) RMR ≈ 5	V	VI	III	59	65	II	74	80	89	I	95

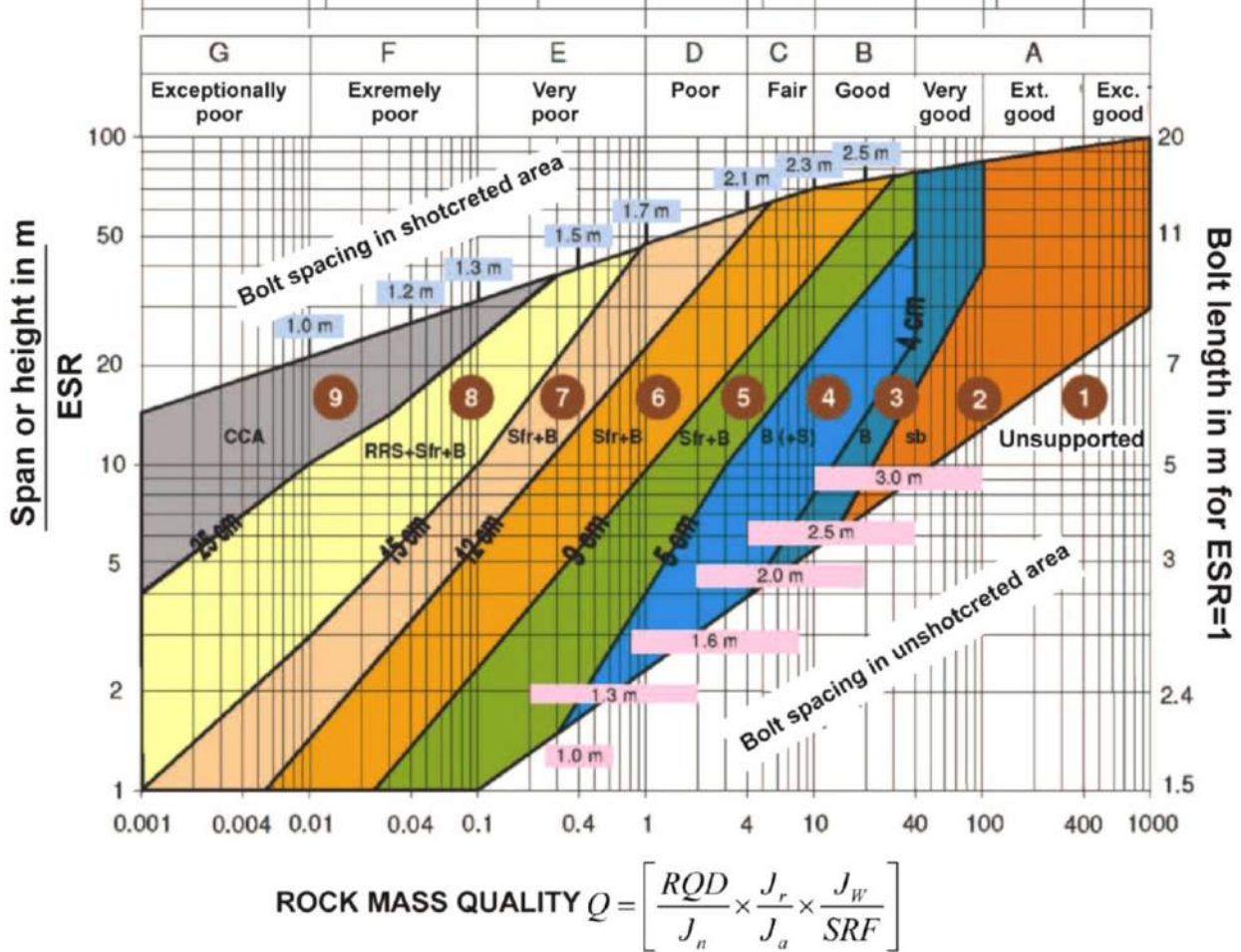

**REINFORCEMENT CATEGORIES**

1) Unsupported	6) Fiber reinforced shotcrete, 90-120 mm, and bolting
2) Spot bolting	7) Fiber reinforced shotcrete, 120-150 mm, and bolting
3) Systematic bolting	8) Fiber reinforced shotcrete, >150 mm, with reinforced ribs of shotcrete and bolting
4) Systematic bolting with 40-100 mm unreinforced shotcrete	9) Cast concrete lining
5) Fiber reinforced shotcrete, 50-90 mm, and bolting	Rock mass classification system (Grimstad and Barton 1993, Barton 1995 and 2002)

### 5.2.3.11 Results and Recommendations

1. The first investigations were carried out on during the period June to November 2011 by STUCKY JV. A Geological Report was compiled as part of the Feasibility Report. And the detailed investigations of the left bank of dam axis and other structures were retained to a later date.
2. This report includes the geological and geotechnical investigation of Nenskra Dam (especially left bank) and HEPP project located on the Nenskra River in Chuberi Village at the north part of Georgia.
3. In order to determine the geotechnical parameters There were drilled 8 boreholes at Dam axis, 3 boreholes at axis of spillways, 2 boreholes at diversion tunnel, 4 boreholes at Site of HEPP, 2 boreholes at the axis of weir and 2 boreholes at the inlet of weir. The drillings that having depth of totally 1632,5 meters and number of boreholes is 21.
4. At the project located south slopes of the Main Range of Great Caucasia that is the zone with northwest-southeast direction, different kinds of rock types are located from the Precambrian to Quaternary. The Nakra Formation that is assumed the oldest formation of seed rocks of Great Caucasia main ranges are represented by gneiss, metagranite, schist, amphibolite and Migmatite. The Dolrini Formation that is composed of gneiss, Migmatite and schist and Lukhrini Formation in Late-Silurian-Early Devonian age composing of metamorphic particles, fillite and quartz-porphyry are located over this formation. Quartzdiorite and plagioglasgranites that are in Late Devonian-Early Carboniferous age are cut these units.
5. On the dam site, the eight boreholes named DBH-1, DBH-2, DBH-3, DBH-4, DBH-5, DBH-6, DBH-7 and SBH-1 were drilled as totally depth of 1044 meter. The boreholes DBH-1, DBH-2, DBH-3 and DBH-4 were drilled on the axis planned firstly. But at all of the four boreholes, due to encounter the alluvium and alluvial fan at the left bank of dam axis was shifted up to upstream direction. So, the boreholes DBH-5, DBH-6 and DBH-7 were drilled in addition to these boreholes. And also, decided to represent the borehole SBH-1 as crest borehole extending to 200,00 m.
6. **According to description of boreholes, from crest point to the thalweg of the left bank, the cover units, having 20,00 m – 127,00 m thickness was determined.** The less-medium weathered zone of the foundation rock is approximately 2,0 m. Briefly, the thickness of the derivate and separated materials such as alluvium, alluvial fans, slope debris etc. reach to 130 meter at thalweg and 20 meter at the crest of the dam axis at left bank. The thickness of the loose materials that cover the bedrock changes from 20 m to 130 m.
7. **The rock units encountered in the all of the boreholes are Dolrini Formation (Osd) and Sori Formation.** The foundation rock of all structures in the project is composed of Meta Granite, Granitic Gneiss; dark gray, blackish color, generally highly fractured, locally fractured. Its fractures are generally oblique and locally developed nearly vertically and generally filled with silicium and locally iron oxides. The surface of the fractures is rough, medium – less weathered and locally fresh. Rock quality is fair- good and high strength.
8. The alluvium formation is composed of gravels, blocks, sand and rarely clay materials over the flat areas along the Nenskra River. The alluvium material is widely deposited along the Nenskra River in somewhere the width of flat area reaching 700-800 m. The materials in alluvium are originated by gneiss, metagranite, granite, amphibolite, chert, quartzite, diorite, diabase, schist and sandstone. The particles are rounded, semi-rounded and rarely angular. The size of blocks varies between 20,00 – 95,00 cm. According to results of water pressure tests, the class of permeability of foundation rock is determined as “permeable-highly permeable”. **So that, the calculation of impermeable curtain suggested by STUCK should be revised and the depth of curtain should be lengthen.**
9. **Either the alluvium unit will be excavated nor the slurry trench will be designed inside the alluvium up to the depth of 130,00 m on thalweg and in addition to this, the length of**

**impermeable curtain should be extended to the left and right bank along to the crest of dam in a depth of 55,0 m at least if the project doesn't permit to water leakage beneath the dam axis.**

10. In Stucky's work, according to the report of investigation prepared by STUCKY (2011), The highly salty sand and sand units were encountered up to the 12,0 in depth, in the borehole BH-7 located in the right bank. In this borehole, the more clean sand and salty sand were observed than the other boreholes. In this case, **the depth of excavation under the dam at this location, should be included the sandy salty zone, other word up to 12 m depth. On banks, there is a semi loose-hard covering materials were observed. The all of the slope debris and alluvial fan deposits on the banks and weathering parts of the foundation rock (bedrock) also should be removed at cut-off excavation to settle the dam axis on strong part of the bedrock.**
11. The covering materials like alluvium/recent alluvium and slope debris on the bedrock and weathering parts of the foundation rock (bedrock) are taken into account to excavate at the dam axis. According to this; The depth of excavation is suggested at least 20,00 – 30,00 meter (nearly 3.0 m on foundation rock) at left and right bank and 130,0 m on Thalweg for alluvium. Rate of Excavation can be assumed as % 75 Hard Pan, % 25 Hard Rock. Excavations will be performed by ripper, digger, hydraulic breaker and blasting in some places.
12. On the alignment of spillway, three boreholes named SBH-3, SBH-4 and SBH-5 were drilled as totally depth of 200 meter. According to results of boreholes, due to highly thick of slope debris, to be settled the spillway on the loose material is impossible. **Because of this reason, it is suggested that shifting of the spillway structure to the right bank.**
13. **Engineering Characteristics of the Bedrock at Dam Axis at Left Bank could be taken as** Natural Unit Weight ( $\gamma_{\text{Nat}}$ ); 2.70-2.72 gr/cm<sup>3</sup> , Uniaxial Comprehensive Strength; 85.0-100.0 MPa, Modulus of Elasticity; 45.000-54.000 MPa, Poisson Ratio; 0,23, RQD; : % 50-75, Permeability; between less permeable and highly permeable. According to the kinematic analysis, the slope ratio of the bedrock for excavation maximum 10 m height at left and right bank of the dam site could be suggested as 1/3 (1:Horizontal, 1: Vertical), for slope debris and alluvial fan the slope ratio could be suggested as 1/1. If it is assumed the depth of excavation at left and right bank is suggested minimum 20,00 – 30,00 m and the maximum 80,0 m (additional, nearly 3.0 m weathered parts from foundation rock) and 130,00 meter on thalweg at alluvium excavation, the rate of excavation can be assumed as 85% Hard pan, 15% Hard rock.
14. A part of diversion tunnel was observed within loose blocky alluvial fan (Qay) that is determined in SBH – 3, SBH – 4 and SBH – 5. At the same time, it was determined that high portal excavations in parallel with the steep morphology at the inlet and outlet site were performed in the same material. Therefore, the new route considered to be more appropriate geologically was determined as a result of field survey. Inlet portal, outlet portal and alignment of Diversion tunnel will be cut Dolrini Formation that are composed of gray, beige and greenish and light brown colored Meta Granite, Biotite, Micro Granite. The units are very fractured in general. The fractures are generally bias rarely developed horizontally, the surface of the fractures are unfilled in general but rarely filled with silicium and iron oxide painted, generally moderately weathered locally less weathered-fresh. The rock quality is poor- very poor and having moderately strong strength. The percentage of core in this borehole is generally 80%, mean RQD nearly 55% and rock quality is fair. There is no ground water table. Because of this reason, the inlet of diversion tunnel should be planned as cut-and-cover tunnel or the alluvial fan which is located in between crown of inlet and maximum water level should be excavated.
15. **Engineering Characteristics of the Unit of Diversion Tunnel could be suggested as** Natural Unit Weight ( $\gamma_{\text{Nat}}$ ); 2.63-2.88gr/cm<sup>3</sup>, Uniaxial Comprehensive Strength; 45.0-120.0 MPa, Modulus of Elasticity; 45.000-55.000 MPa, Poisson Ratio; 0,23-0,25, RQD; 15-50%. **The parameters of Hoek Brown Classification of inlet part is suggested for bad conditions;** sigci; 60 MPa, GSI; 42, mi; 21, D; 0.1, Ei; 30000 MPa. The slope ratio for excavation of the slope debris and alluvial fan at outlet and

inlet portal can be assumed as 1:1 (H:V). As a results of these analysis for inlet portal of diversion tunnel after removing of alluvial fan materials, the slope ratio that is 1/3 (1: Horizontal, 3: Vertical) can be taken with the requirement to use bolt and wire meshes for binding of the blocks to the bedrock and holding of fine particles on the slope. Shotcrete can be applied over wire meshes with drainage system if it is needed according to the condition of slope surfaces. If the shotcrete application certainly is needed, the drainage system necessarily is used to throw out the water accumulated behind of the shotcrete.

16. Because of observing of the Dolrini formation from inlet portal along to outlet portal of diversion tunnel, it is assumed that all the tunnel alignment has only two RMR value for bad condition and good condition. RMR values of diversion tunnel can be suggested as 74 and classification is II, 'Good Rock' for good condition and RMR value is 47 and classification is III, 'Fair Rock' for bad condition. The Q mass classification were also carried out for power tunnel and given in the report in detail. The advancement of the tunnel during construction should be followed and observed in detail by coming out materials and behavior of the rocks to rearrange of the tunnel project.
17. According to test result of bedrock of diversion tunnel, The CAI value varies between 2,39 – 4,29 and class is "very abrasive" and "extremely abrasive". So, the results of CAI shows that the cutters which is located on TBM face should be design for very abrasive and extremely abrasive rock conditions.
18. The inlet portal of Power Tunnel enters from Alluvial Fan (Qay) that covers Dolrini Formation (OSd). The thickness of alluvial fan is determined as greater than 20,00 m. So, the excavation of power tunnel portal is impossible in this unit. It is suggested that shifting of the inlet of power tunnel to the upstream part. The thickness of slope debris (Qay) is expected shallow and short longitudinally. After the excavation of slope debris covering the inlet portal, it is expected to scrape slope debris located in between crown of inlet and max. water level because of the fluctuation of water level in operation. The inlet portal will be existed at Dolrini Formation (OSd) which is poor-very poor in rock quality and having moderately strong-strong strength. Then respectively Morghouli Formation, Kirari Formation, Lukhrini Formation, Kirari Formation, Kazakhtvibi Formation, Tskhenistskali Formation, Muashi Formation and at finally Sori Formation will be cut. The Sori Formation is covered by the alluvial fan at planned site and also thick layer alluvial fan covers the sori formation at alignment of penstock. **Because of the thick alluvial fan deposits on the penstock site and slope of powerhouse, the site of powerhouse, penstock and outlet portal of the power tunnel was relocated to downstream direction.** The rock quality of Sori Formation is fair-poor and having moderately strong and displays lamination.
19. Generally permeable conditions are expected at inlet and alignment of power tunnel up to the Sori Formation, but low permeable conditions are expected when advancing in Sori Formation, locally high permeable conditions may be expected in the contact zones and where intrusive dykes and other intrusive are crossed. The tunnel portals can be established by conventional methods and supported with conventional rock bolts and fiber shotcrete. Rock qualities will vary in general the tunnels will be only lightly supported with mainly spot temporary bolts and fiber shotcrete. Because of the tunneling in between outlet portal and TBM junction part by conventional methods, the sheared zones may require systematic temporary bolts / fiber shotcrete or light steel ribs. The type and properties of machine should be designed suitable for the injection purpose.
20. **Engineering Characteristics of the unit (Sori Formation) of Power Tunnel alignment could be suggested as** Natural Unit Weight (Nat); 2.65-2.74 gr/cm<sup>3</sup>, Uniaxial Comprehensive Strength; 64.3-118.2 MPa, Modulus of Elasticity; 23.136-47.697 MPa, Poisson Ratio; 0,20-0,25, RQD; 12-60%. **Engineering Characteristics of the unit (Dolrini Formation) of Power Tunnel alignment could be suggested as** Natural Unit Weight (□Nat); 2.61-2.94 gr/cm<sup>3</sup>, Uniaxial Comprehensive Strength; 48.80-240.1 MPa, Modulus of Elasticity; 22.721-77.194 MPa, Poisson Ratio; 0,18-0,27, RQD; 33-60%. The parameters of Hoek Brown Classification of power tunnel alignment and

penstock are suggested in section 10.2.2.1.

21. **The slope ratio for slope debris and alluvial fan deposits at excavation could be suggested as 1/1 (1: H, 1: V). As a results of kinematic analysis for inlet and outlet portal of power tunnel after removing of slope debris materials, the slope ratio that is 1/5 (1: H, 5: V) can be taken with the requirement to use bolt and wire meshes for binding of the blocks to the bedrock and holding of fine particles on the slope. Shotcrete can be applied over wire meshes with drainage system if it is needed according to the condition of slope surfaces. If the shotcrete application certainly is needed, the drainage system necessarily be used to throw out the water accumulated behind of the shotcrete.**
22. The unit encountered in the inlet portal of Approach Tunnel is Slope Debris (Qym). The lining and junction of power tunnel will be in Sori Formation (Js). Because of the units will be excavated by the inlet portal excavation, the tunnel alignment will be located at Sori Formation. The formation is composed of clay stone, sandstone, shale, slate and volcano sedimentary deposits. after the removing of slope debris materials, at the inlet portal of TBM tunnel, slope ratio of excavation can be taken as 1/5 (1: H, 5: V) with the requirement to use bolt and wire meshes for binding of the blocks to the bedrock and holding of fine particles on the slope. Shotcrete can be applied over wire meshes with drainage system if it is needed according to the condition of slope surfaces. If the shotcrete application certainly is needed, the drainage system necessarily is used to throw out the water accumulated behind of the shotcrete. But, the measurements of the discontinuities of the bedrock at the inlet portal must be carried out after removing of the loose material from the portal surface at construction stage to exactly decided the slope angle of excavation and space and length of the bolts because of analysis carrying out by using the data taken from the rocks located outside of the tunnel inlet portal.
23. The rock classification of power tunnel due to RMR rating varies between II and III, for fault zone is IV. RMR values for inlet of power tunnel can be suggested as 74 and II. Group Good Rock for good condition and 47 and III group Fair Rock for bad condition. For outlet portal of power tunnel (Km:13+250-15+450), RMR value can be suggested as 69 and II. Group Good Rock for good condition and 47 and III group Fair Rock for bad condition. For tunnel alignment between Km: 2+400-4+600, RMR value can be suggested as 58 III group Fair Rock, between Km: 4+600-8+900 and Km9+200-13+250 can be assumed 65 II. Group Good Rock. The Q mass classification were also carried out for power tunnel and given in the report in detail. The advancement of the tunnel during construction should be followed and observed in detail by coming out materials and behavior of the rocks to rearrange of the tunnel project.
24. The Cerchar index (CAI) varies between 0,87 – 4,29. The value of 0,87 is result of only one sample. According to test result of Cerchar Index Tests, **the class of rock unit which is mostly Dolrini Formation (OSd) encountered at inlet of power tunnel and in the power tunnel alignment is mostly “Abrasive and More Abrasive” and rarely “High Abrasive”.** In addition to these, The indirect tensile strength due to Brazilian test results varies between 6,26 – 14,66 MPa in Sori Formation (Js) and varies between 9,03 – 13,84 MPa in Dolrini Formation (OSd). At the alignment of approach Tunnels, the excavation will be going on in the rocks of Sori formation. The unit encountered at alignment of tunnel were cut frequently by the intrusive and dyke of young granites, quartz diorite and diabase porphyry. In this condition, the contact metamorphism can be occurred at contact of these rocks and intrusive and dykes. So, the very hard rock zones will be observed at the excavation of power tunnel.
25. Surge Tank is located between Km: 14+992-15+027 distance from the power tunnel start. The elevation of surge tank axis is 1508 m at the surface, 1292 m at tunnel invert. The Sori Formation will be cut along the surge tank during the excavation. Engineering Characteristics of the bedrock at Surge Tank are suggested in section 10.2.2.1. The Engineering classification of the formation at surge tank according to the Hoek Brown is suggested in section 10.2.2.1. **According to some**

analysis carried out for Sori Formation and because of the surge tank being significant structure, after removing of very thin slope debris materials, the slope ratio can be taken as 1/3 (1:H, 3:V) with the requirement to use bolt and wire meshes for binding of the blocks to the bedrock and holding of fine particles on the slope. Shotcrete can be applied over wire meshes with drainage system if it is needed according to the condition of slope surfaces. If the shotcrete application certainly is needed, the drainage system necessarily be used to throw out the water accumulated behind of the shotcrete.

26. Gate shaft is located between Km: 0+129-0+148,80 distance from the power tunnel start. The elevation of gate shaft axis is 1450 m at the ground of surface, 1327 m at tunnel excavation invert. The Dolrini Formation (Osd) will be cut along the gate shaft during the excavation. Engineering Characteristics of the Unit of Gate Shaft are suggested in section 10.2.2.1. The parameters of Hoek Brown Classification are suggested in section 10.2.2.1. **According to some analysis carried out for Dolrini Formation, after removing of very thin slope debris materials, the slope ratio can be taken as 1/5 (1:H, 5:V) with the requirement to use bolt and wire meshes for binding of the blocks to the bedrock and holding of fine particles on the slope. Shotcrete can be applied over wire meshes with drainage system if it is needed according to the condition of slope surfaces. If the shotcrete application certainly is needed, the drainage system necessarily is used to throw out the water accumulated behind of the shotcrete.**
27. The boreholes of PBH-1, PBH-2 and PBH-3 were drilled at powerhouse foundation area and PBH-4 was drilled at slope area of powerhouse located at backside. The pressure meter tests were performed at each 2.0 meter interval in the boreholes. Beside this, the core samples were taken from the borehole. The units encountered in the boreholes PBH-1, 2 and 3 are Slope Debris (Qym) varies between 7,00 – 10,10 and Sori Formation (Js) up to the end of the boreholes. The bearing capacity and settlement problem is not expected according to results of in-situ and laboratory test.
28. **Engineering Characteristics of the Foundation Unit (Bedrock) of Powerhouse could be suggested as** Natural Unit Weight ( $\gamma_{Nat}$ ); 2.65-2.70 gr/cm<sup>3</sup>, Uniaxial Comprehensive Strength; 64.3-182.0 MPa, Modulus of Elasticity; 23.136-47.697 MPa, Poisson Ratio; 0,20-0,25, RQD; 12-55%. It is assumed that foundation having 24 meter width and 35 meter length will be constructed after nearly 25 meter excavation, allowable bearing capacity can be suggested in between,  $q_a = 22,40 - 36,30$  kg/cm<sup>2</sup> without overburden pressure. **There will be semi loose-hard covering material such as the thick part of alluvial fan deposit on the bedrock and weathering parts of the foundation rock. It was thought that the alluvial fan deposit would cause the damage on penstock at construction instantly. Because of the thick alluvial fan deposits on the penstock site and slope of powerhouse, the site of powerhouse was relocated to downstream direction. Because of the foundation settling on the same bedrock, the allowable bearing capacity of the foundation of powerhouse can be assumed as the same with planned site.** In this case, the slope ratio can be recommended as follows; 1/1 (H/V) for the excavation in slope debris 1/5 (H/V) for the rock unit.
29. The borehole NWBH-1 and NWBH-3 were drilled at the side of the Nakra river. The borehole NWBH-2 was not drilled due to difficult conditions at the location. The pressure meter tests were performed at each 2.0 meter interval in the boreholes. The foundation site of Nakra weir is located on alluvial fan. According to the site observation and core description, the thickness of alluvial fan is higher than 25,0 m at weir axis. **Due to the thickness of alluvial fan, the low bearing capacity and annual glacier movements towards the valley accumulated as alluvial fan, the axis of weir is suggested to be shifted towards upstream part approximately 2,5 km far away.** In this new site, the foundation unit is composed of mostly rock and the thickness of slope debris is suggested that will be shallow. **Because of the difficulties of transportation of drilling machine and the heavy winter conditions, the boreholes at the suggested site were not been drilled.** The boreholes should be drilled and the geotechnical properties of rock should be determined at the construction stage

after cutting of tries.

30. The inlet portal of Nakra Transfer Tunnel is composed of Dolrini Formation that contains dark gray-grayish white, beige and black colored Meta Granite, Granite, Schist, Amphibolite. At the outlet portal of the tunnel, Porphyritic Microcline granite (cpg) as bedrock is seen. The bedrock as Dolrini Formation is covered by thin layer slope debris deposits. Porphyritic Microcline granite (cpg) that is found at outlet portal of the tunnel is also covered by slope debris. **After removing of slope debris materials, the slope ratio that is 1/5 (1: Horizontal, 5: Vertical) can be taken with the requirement to use bolt and wire meshes for binding of the blocks to the bedrock and holding of fine particles on the slope. But, the measurements of the discontinuities of the bedrock at the inlet portal must be carried out after removing of the loose material from the portals surfaces at construction stage to exactly decided the slope angle of excavation and space and length of the bolts because of analysis carrying out by using the data taken from the rocks located outside of the tunnel portals.**
31. The rock classification of Nakra Transfer Tunnel due to RMR rating varies between II and III, for fault zone is IV. RMR values for inlet (Km:0+00-2+200) of Nakra tunnel can be suggested as 65 and Classification is II, 'Good Rock' for good condition and 50 and Classification is III, Fair Rock for bad condition. For outlet portal (Km:10+200-12+000) of Nakra tunnel, RMR value can be suggested as 65 and Classification is II, 'Good Rock' for good condition and 48 and Classification is III, 'Fair Rock' for bad condition. At Km: 2+200 there is a right lateral strike fault and this zone could be assumed as approximately 50 m. RMR value for this zone could be suggested 28 and classification is IV, 'Poor Rock'. For tunnel alignment between Km: 2+200- 8+600, RMR value can be suggested as 74 and Classification is II 'Good Rock' for good condition and RMR value is 42, Classification is III, 'Fair Rock' for bad condition. For tunnel alignment between Km: 8+600-10+200, RMR value can be suggested as 74 and Classification is II 'Good Rock' for good condition and RMR value is 47, Classification is III, 'Fair Rock' for bad condition. The Q mass classification were also carried out for Nakra tunnel and given in the report in detail. The advancement of the tunnel during construction should be followed and observed in detail by coming out materials and behavior of the rocks to rearrange of the tunnel project.
32. The main two faults at the project area are known as Alibeck reverse fault and Main Caucasus Thrust. There are a lot of reverse fault and over thrust that is in direction of WNW-ESE or W-E and dip towards to north at the investigated area. The two of them were observed along the power tunnel from the surface. At the power tunnel alignment, the two reverse faults on Km: 1+550 - 1+750, Km: 2+300 -2+500 and the two over thrust on Km: 4+600 - 4+800, Km: 9+350 - 9+550 are predicted. At the Nakra transfer tunnel alignment, on the 2+200 kilometers, the right lateral strike faults was observed at the surface. The two main faults will be encountered but the others will not be probably encountered while the tunneling at power tunnel. And also, the one fault will be encountered while the tunneling at Nakra transfer tunnel. A continuous updating of the geological and geomechanical conditions should be performed during tunneling and if required tunnel modeling should be revised. At these fault zones, the advent of instantaneous water may be predicted during the tunneling along shearing zones and including clay units due to the existing of fault. The consolidation injection may be required at these zones for treatment of tunnel section. For fault zones that are displayed at the map and profiles along the tunnel route, RMR values could be suggested as 28 and classification is IV, 'Poor Rock'.
33. According to RMR classification, for three different class, Primary Support Requirements are as follows:



Rock Mass Classification	Rock Bolts (20mm Diameter fully alignment)	Shotcrete	Steel Support
II	Locally bolts in crown 3.0 m long, spaced 2.5 m with occasional wire mesh.	50 mm in crown where required	None
III	Systematic bolts 3.0 - 4.0 m long, spaced 1.5-2.0 m in crown and walls with wire mesh in crown.	50-100 mm in crown and 30 mm in sides	None
IV	Systematic bolts 4-5 m long, spaced 1-1.5 m in crown and walls with wire mesh.	100-150 mm in crown and 100 mm in sides	Light to medium ribs spaced 1.5 m where required

34. According to Q-rock mass classification, for four different class the support requirements is as follows;

Q Support Class	Suggestions
1	Unsupported.
3	Systematic Bolting.
4	Systematic bolting with 40-100 mm unreinforced shotcrete.
5	Fiber reinforced shotcrete 50-90 mm and bolting

35. Cerchar Abrasivity Index test is widely accepted throughout the world to represent rock abrasion as it pertains to tool wear and life in tunneling and construction activities. So, the results of CAI shows that the cutters which are located on TBM face should be design for very abrasive and extremely abrasive rock conditions.
36. The measurements of the discontinuities of the bedrocks at inlet and outlet portals of all tunnels and at dam axis must be carried out after removing of the loose material from the portals surface and dam axis at construction stage to exactly decided the slope angle of excavation and space and length of the bolts and also the thickness of shotcrete because of analysis carrying out by using the data taken from the rocks located in vicinity of all tunnel portals and above crest of dam. Shotcrete can be applied over wire meshes with drainage system if it is needed according to the condition of slope surfaces. If the shotcrete application certainly is needed, the drainage system necessarily is used to throw out the water accumulated behind of the shotcrete. And also the faults and weak zones should be certainly followed at construction stage because of the faults marked on tunnels profiles determining from the surface that is 500 to 1000 meter far away from the tunnel alignment. Besides these, because of winter condition and no access road for drilling machine, the new shifted site of Nakra weir and Nakra tunnel inlet portal should be investigated by drilling operation, if possible, just before the construction stage to check the data taken from surface investigation and surface observation.

Figure 5.2.3.11.1. Valve Chamber Yard (Geological Plan)

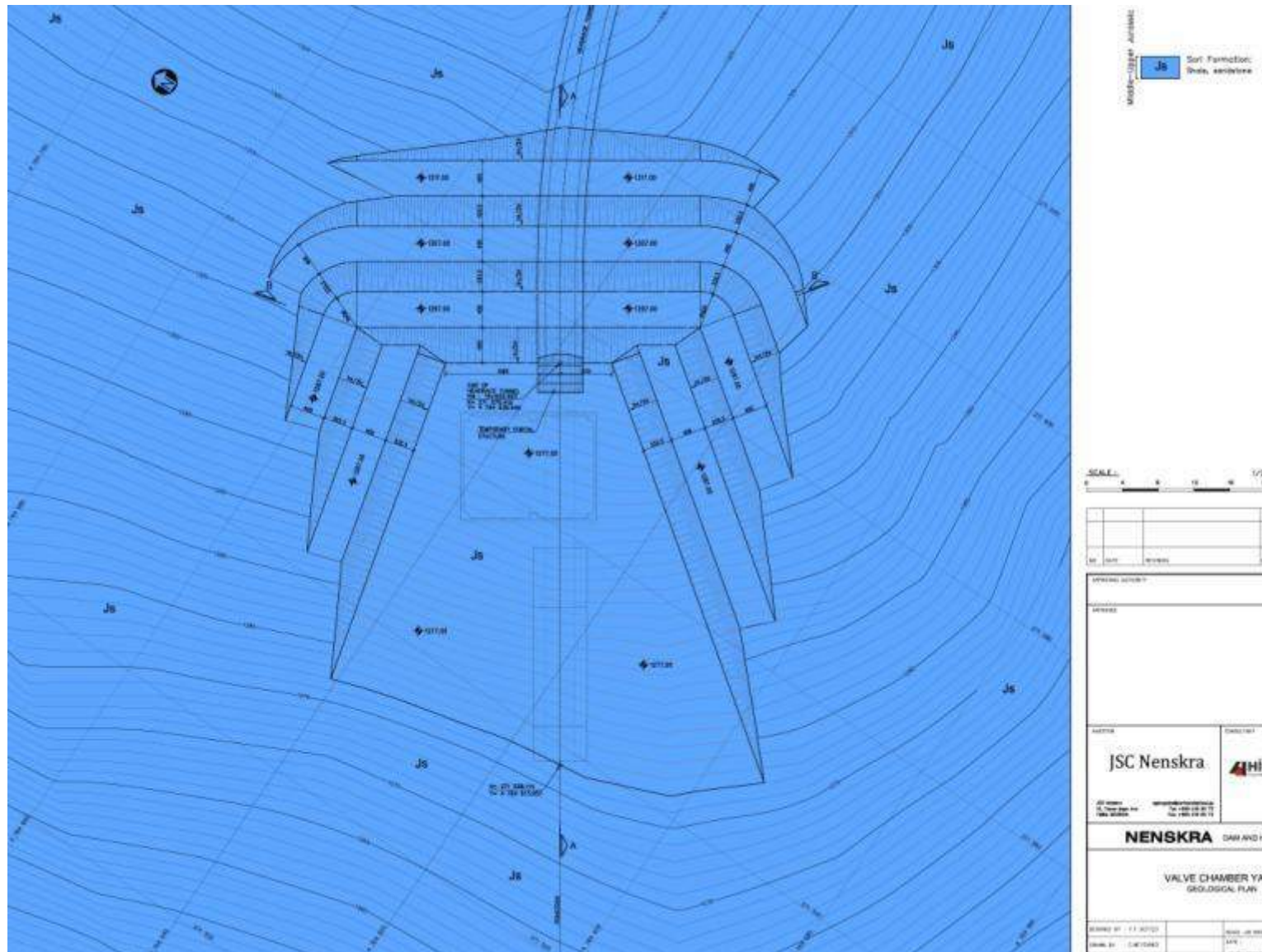
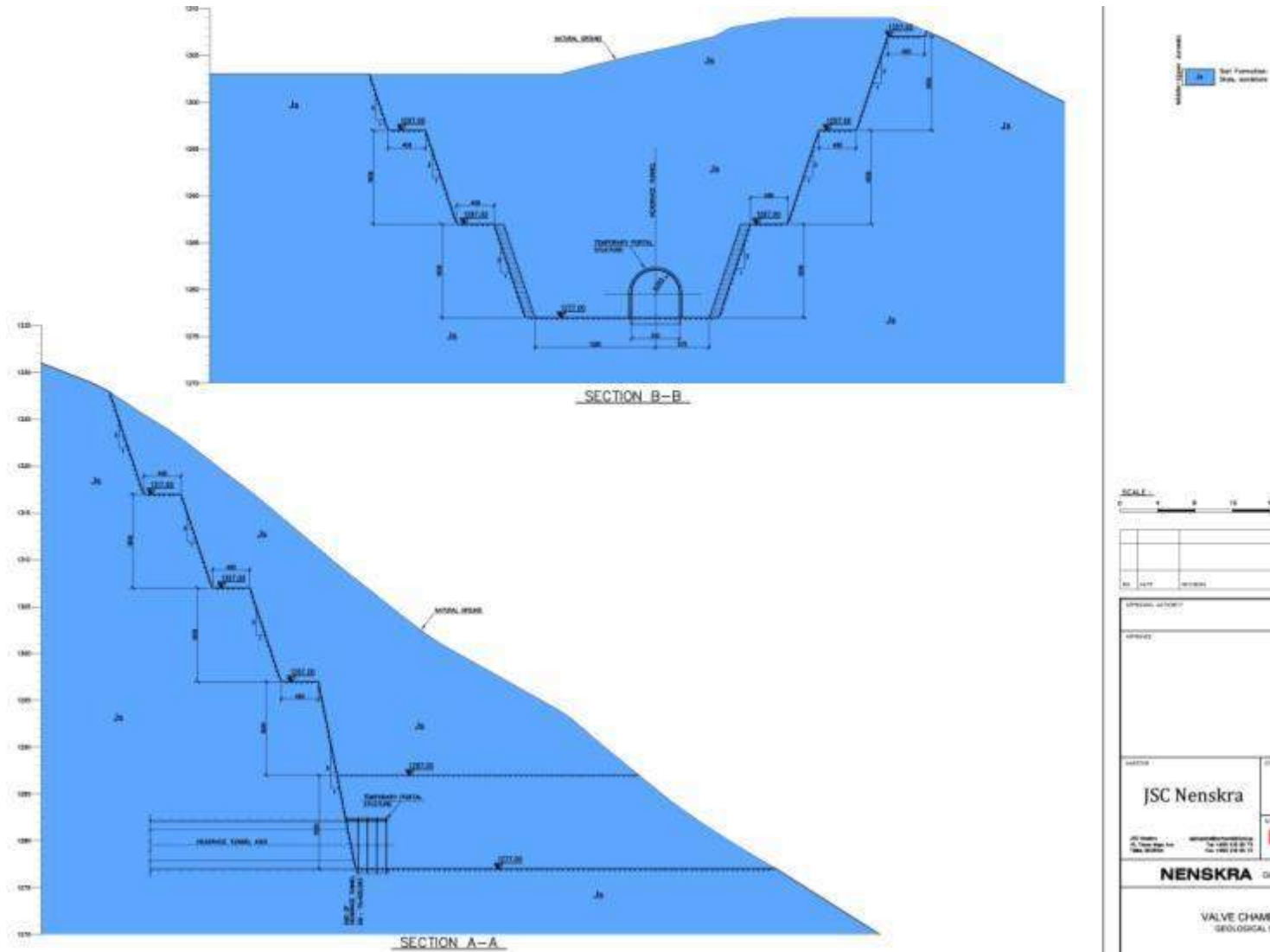

Figure 5.2.3.11.2. Valve Chamber Yard (Geological Profile)



### 5.2.3.12 Geophysical Research Report

#### 5.2.3.12.1 General Overview

##### 5.2.3.12.1.1 Seismic Prospecting

Study of local physical properties of soils is one of the important tasks of engineering-geological investigations. Wide variety of field and laboratory techniques is available, each with different advantages and limitations with respect to different problems. The selection of testing techniques for measurement of dynamic soil properties requires careful consideration and understanding of the specific problem at hand. Efforts should always be made to use tests or test procedures that replicate the initial stress conditions and the anticipated cycling loading conditions as closely as possible (Kramer 1996).

Our main task was study of soil structure for study area end assessment of physical-mechanical properties for the identified layers. We have used seismic prospecting methods to assess elastic wave's velocity distribution pattern in the constructed profiles. Shear and Body wave velocities are strongly related to physical-mechanical conditions of soils. Sharp changes in elastic wave's velocities, forms so cold refraction surfaces and well distinguishes major soil layers.

The seismic refraction test allows the wave propagation velocity and thickness of surface layers to be determined from the ground surface. The test involves measurement of the travel times of P and S waves from an impulse source to a linear array points along the ground surface at different distances from the source. In favorable conditions, following physical-mechanical parameters can be measured and calculated:

$V_p$  – P wave velocity (m/s)

$V_s$  – S wave velocity (m/s)

$\rho$  – Density (gr/sm<sup>3</sup>)

$\mu$  - Poisson's coefficient

$E_d$  - Elasticity Dynamic Module (MPa)

$G_d$  - Shift Dynamic Module (MPa)

K – Bulk module (Mpa)

##### 5.2.3.12.1.2 Electric Resistivity Test

Electric Resistivity Test measures the resistance of the soil to electricity by passing a current through the soil. The purpose of electrical surveys is to determine the subsurface resistivity distribution by making measurements on the ground surface. From these measurements, the true resistivity of the subsurface can be estimated, though more frequently so called apparent resistivity values are used. The ground resistivity is related to various geological parameters such as the mineral and fluid content, porosity and degree of water saturation in the rock.

DC-resistivity methods measure the electrical-resistivity distribution of the subsurface. DC or low-frequency alternating electric current is transmitted into the ground by two electrodes, and the potential difference is measured between a second pair of electrodes. The apparent resistivity of the subsurface is calculated by using Ohm's Law and applying a geometric correction (Telford and others, 1990). The geometrically corrected measurements are apparent resistivity rather than true resistivity, because a resistively homogeneous subsurface is assumed. Subsurface resistivity values are

controlled by material resistivity, lithology, and the presence, quality, and quantity of ground water (Haeni and others, 1993). The maximum penetration depth of the resistivity measurement is directly proportional to the electrode spacing and inversely proportional to the subsurface conductivity (Edwards, 1977).

Profiling with 2D dc-resistivity methods is conducted by making measurements along a surface profile using different offsets. The 2D dc-resistivity profiling data are inverted to create a model of resistivity along a section of the subsurface.

#### **5.2.3.12.1.3 Equipment and methodology used**

Study was done using refracted waves method, at different linear profiles. 46m, 115m, 230m and 575m long profiles were used, with 2m, 5m, 10m and 25m step between the geophones. Constructed profiles were used to separate different Engineering Geological Layers (EGL) based on different velocities of elastic wave propagation and calculated the physical-mechanical parameters of soils. For this purposes 46m long profiles were used, with vertical and horizontal components of Geophones, to be able detecting body-P and shear-S waves.

For the registration and processing of primary and shear waves, so called Z-Z and Y-Y blow – registration system was used. Seismic waves were generated using 10 kg hammer hit on the 15 mm thick titanium plate. Relatively large dimensions of the plate enable better transformation of blow energy to elastic vibration energy of rock or soil. S waves were generated using the same hammer hit in horizontal direction – on the wall of 50 cm deep pit.

Typical 5 hit system was used for 46m, 115m long profiles, 2 hits at the beginning and end of the profile, 1 hit at the center point and 2 remote hits. For the recording of seismic waves 24 channel digital engineering seismograph OYO McSeis SX was used, with 10 and 100 Hz geophones (Horizontal as well as vertical components were used).

5-7 explosion system was used for 230m, 575m long profiles,, with 2 explosions at the beginning and end of the profile, 1 explosion at the center point and 2-4 remote explosions (1-2 at each site) to achieve better depth resolution. Special holes were drilled in rock for explosives to achieve high elastic energy transmission to rock and secure safety. For the recording of seismic waves 24 channel digital engineering seismograph OYO McSeis SX was used, with 10Hz geophones. For the registration and processing of body waves, vertical component the geophones with 10Hz natural frequency were used. Seismic waves were generated using explosive sources from 0.25 to 5 kg values (Powergel Magnum 365 was used) and special seismic detonators with zero delay in explosion.

Allied Tigre 64ch resistivity meter was used, capable to make accurate electrical measurements in the most extreme environments, with following parameters:

- Penetration depths of 700 meters.
- Choice of current settings from 0.5mA to 200mA, with automatic gain steps
- Measurements to be made between 400 Kohm and 0.001 ohm.
- Three square wave frequencies
- Choice of up to 16 cycles per measurement.
- Self-potential monitoring.

Wenner-Schlumberger array was used. The sensitivity plot for the Wenner Alpha array has almost horizontal contours beneath the center of the array. Because of this property, it is relatively sensitive to vertical

Changes in the subsurface resistivity below the center of the array. However, it is less sensitive to horizontal changes in the subsurface resistivity. In general, the Wenner-Schlumberger array is good in resolving vertical changes (i.e. horizontal structures), but relatively poor in detecting horizontal changes (i.e. narrow vertical structures). Among the common arrays, it has the strongest signal strength. This can be an important factor if the survey is carried in areas with high background noise. ImagerPro 2006 - Windows based acquisition software package was used. Later for processing and analysis it was also used in conjunction with other processing software such as RES2DINV.

2-D electrical imaging/tomography surveys are usually carried out using a large number of electrodes, 25 or more (32 in our study), along a straight line connected to a multi-core cable. Normally a constant spacing between adjacent electrodes is used. A laptop microcomputer together with an electronic switching unit is used to automatically select the relevant four electrodes for each measurement.

Wenner -Schlumberger array was used for profiling in current work. As a result we have inverted resistivity sections of two-dimensional direct-current resistivity data for 5 profiles.

#### 5.2.3.12.1.4 Data processing and Interpretation

Seismic data was processed using **WinSystem** (<http://www.wgeosoft.ch/software/default2.html>). Mainly the ABC method was applied for the interpretation of seismic records. This method, incorporated in WinSism software, allows controlling every stage of data processing and introducing necessary corrections, thus avoiding accidental artifacts and misinterpretation. In other words, ABC method is somehow smoothing the real situation along the profile but well preserves the overall parameters and soil structure. In rare cases GRM and SHP methods were used, due to the limitations in ABC method (in case of high dipping angle of refraction surface), though the resulted profiles were carefully cross-checked and revised.

Compression P waves were picked up mainly according to the first arrivals on the vertical Z-Z component of seismograms for profiles. These waves usually have low amplitudes on horizontal component Y-Y they and attenuate rapidly. So far their presence on the horizontal components does not affect registration of S wave onsets.

For S shear wave picking vertical and horizontal components were used. Shear waves were well distinguished after P wave arrivals. They have larger amplitudes, lower apparent velocities and lower frequencies. On some seismograms acoustic waves were clearly identified. They have higher frequencies and apparent velocity 340 m/sec. These waves were caused by hammer blow on the metallic plate.

The surface waves were clearly observed after S wave arrivals. They have higher amplitudes, lower velocities and lower frequencies. Though, the surface wave method was not used for S wave velocity estimation. Wave picking was carried out manually and on the bases of these data the travel time curves were compiled using WinSism 10.6 program code and cross-sections for each profile were compiled as well. P and S wave velocities were calculated from seismic data.

Poisson's ratio was estimated for the geo-engineering layers on constructed seismic profiles for which both P and S wave velocities were estimated. An elastic constant that is a measure of the compressibility of material perpendicular to applied stress, or the ratio of latitudinal to primary strain. Poisson's ratio can be

expressed in terms of properties that can be measured in the field, including velocities of P-waves and S-waves as shown below, commonly used formula was applied:  $\mu = \frac{1}{2} (V_p^2 - 2V_s^2) / (V_p^2 - V_s^2)$ .

### 5.2.3.12.1.5 Quality Control Procedures

Initial phase of quality control involved assuring the tight fixation of geophones in soil and good electric contacts with strings. Before starting recording reflected waves, usually several test shoots were compiled to ensure reasonable transmission of seismic wave's energy to geophones and their proper functioning.

The main criteria for the quality control of field data (seismograms) are resolution of informative signal. While acquiring the data it was checked that the first onsets should be readable at the beginning, end and middle traces of the record. This criterion was satisfied by increasing the staking number and selecting the adequate source of seismic waves (Hammer or Dropping weight). In any case it was secured, that still the overall wave-front could be readable on the profile and missing onsets could be extended from other channels, taking in to account phase correction. In such cases changes in frequency content due to changes in source to receiver distances were also considered. In case of the remote hits the visibility of first onsets of seismic waves was not the main criteria, as tracing a single phase of the wave through the channels was enough, the same time it was controlled that the informative phase should not be overlaid by other waves.

### 5.2.3.12.1.6 Study Design and Obtained Results

On the territory of dam's and tunnel's project sites of Nenskra-Nakra hydroelectric power plant 22 seismic and 5 electrical profiles were investigated. The location of those profiles is given in the following table:

**Table 5.2.3.12.1.6.1. Profile Coordinates. Projection - UTM Zone 38(WGS 84 Datum)**

The coordinates of starting and ending point of each profile, the length of the profile and the wave parameter are listed below:

Profile	X-start	Y-start	X-end	Y-end	Length	Notes
1	270728.1	4764048.2	270717.9	4763933.7	115	P
2	270717.9	4763933.7	270707.6	4763888.9	46	P,S
3	270656.4	4764037.1	270652.0	4763922.2	115	P
4	270614.9	4763997.0	270610.5	4763951.2	46	P,S
5	272059.2	4765739.1	272031.2	4765775.7	46	P
2-1	288736.1	4779043.0	288773.0	4778934.1	115	P
2-2	288714.2	4779030.9	288751.3	4779003.8	46	P,S
2-3	270905.1	4764165.7	270901.5	4764211.6	46	P,S
2-4	270708.3	4763909.2	270658.0	4764002.2	115	P
3-1	270996.4	4764128.9	270909.5	4764053.5	115	P
3-2	270902.1	4764046.7	270787.8	4764033.8	115	P
3-3	270870.1	4764037.1	270824.4	4764032.0	46	P,S
3-4	273971.2	4773327.7	273926.6	4773316.3	46	P,S
3-5	273934.8	4769574.1	273897.3	4769547.4	46	P,S
3-6	274417.9	4774260.8	273848.0	4774184.6	575	P
3-7	274084.8	4774206.3	274130.3	4774213.0	46	P,S
3-8	273350.0	4766138.0	273154.9	4766016.2	230	P
3-9	288727.5	4779089.7	288766.5	4778863.0	230	P
3-10	288655.3	4779132.8	288646.8	4779087.6	46	P,S
3-11	274231.0	4773374.6	273670.7	4773245.4	575	P
3-12	274118.5	4769698.7	273751.1	4769449.5	575	P

3-13	276036.2	4779976.3	276229.3	4780101.3	230	P
3-14	276193.5	4780072.4	276229.3	4780101.3	46	P,S
3-15	274206.9	4779597.0	273993.6	4779511.0	230	P
E-1	270708.8	4763894.4	270728.1	4764048.2	155	E
E-2	273980.7	4773326.1	273828.2	4773298.8	155	E
E-3	273934.8	4769574.1	273802.9	4769492.7	155	E
E-4	273997.2	4774196.8	274151.0	4774216.4	155	E
E-5	288712.0	4779072.7	288765.4	4778927.1	155	E

The seismic profiles conditionally are grouped in four different sections:

1. Hydropower plant and Penstock- Nenskra territory;
2. Nakra dam site;
3. Nenskra tunnel entrance and Nakra hydro-electric power Station territory;
4. Nenskra tunnel route area.

In the presented report we shall discuss each section and describe detail analyses of each seismic profile.

#### 5.2.3.12.1.7 Nenskra tunnel entrance and Nakra hydro-electric power Station territory

In the vicinity of Nenskra hydroelectric power station foundation five 115-meter and four 46-meter seismic profiles were made, one of the seismic profiles was made in the end of penstock area (profile №2-3). One electric profile was made along the first and the second seismic profiles in order to obtain additional information about the structure of the soil and the ground water level to establish.

Based on distribution of primary wave velocities in the 115-meter-long seismic profiles, 40 meters depth seismic cross sections have been constructed.

Since the cross-correlation of share waves is associated with certain difficulties, we selected optimal distribution scheme of geophones, where the distance between is 2 meters and the wave penetration depth is 30 meters using a remote source approach. In order to determine physical-mechanical parameters and share wave velocities of soil, 46 meter length profiles have been carried out.

**Figure 5.2.3.12.1.7.1.** Scheme of Seismic and electric profiles. The red line without an arrow-ending denotes the tunnel route.





For each study areas out of four, the three engineering geological elements (hereinafter referred to: EGE) were introduced to analyze seismic profiles. According to the propagation of seismic waves, they can be interpreted as the core elements of different lithology and geotechnical properties. Each geological layer geometry (depth and thickness) were determined according to the P- primary wave propagation, S-wave propagation velocity- $V_s$ . was assessed as well.

EGE 1 –Loose soil: formed particularly from slope of the upper part of the mountain of study area.

EGE 2 – Composed of bedrock fragments, clay shales and large fragmented sandstones with deposited boulder fillers;

EGE 3 - the bedrock - the sequence of clay shales and sandstones;

Let's discuss the structure of each specific profile according EGE:

Nº1-profile: Along the entire, profile at 3-5 m depth EGE 1 is observed with primary wave velocity is  $V_p = 610-950$  m / sec. This layer is bounded from below by EGE 2, with the thickness ranging from 9-28 meters, the smallest thickness is observed at the end of the profile. Estimated velocity of the layer is  $V_p = 1370-2370$  m/s. The big change is likely due to the different, denser distribution of boulders in there. The EGE 3 layer below has the velocity  $V_p = 3390$  m/s.

Electric profile E1 confirms the results obtained from the Seismic profile Nº1. Below we list the correspondence of resistivity values to the EGE-s

$\Omega/m$	EGE	$V_p$ m /s
3396-9261	I	610-950
2430-4745	II	1370-2370
891-1700	II	3390

For the rest of the Electric profiles we have not observed good correlation between Electric and Seismic profiles. We think that the reason is the complexity of the structure.

Nº2 profile: At 3-7 meter depth is observed a layer of EGE 1 with the primary wave velocity  $V_p = 650-1010$  m / s and the share wave velocity  $V_s = 330-550$  m / sec.

EGE 1 is bounded from below by EGE having thickness in 1 - 7 meter range and velocity  $V_p = 1050-1490$  m. Share wave velocity of the layer is  $V_s = 640-750$  m / sec. relatively small thickness of the layer is observed from the beginning profile in the interval of 30-46m.

Based on our observations of these layers down to a depth of 30 meters have been marked layer EGE 3 with velocity  $V_p = 3130$  m / sec and  $V_s = 1600$  m / sec.

Nº3 profile:- Along the all profile, at depth of the 7-9m EGE 1 is observed with primary wave velocity  $V_p = 580-950$  m / sec.

This layer is bounded from below by EGE 2, with the thickness ranging from 5-17 meters, the smallest thickness marked in the beginning and end of the profile and corresponding are velocities  $V_p = 2350-3200$  m / s. Since we have not had an actual geological data, based only on geophysical data we think, that higher velocities' are likely due to the large concentration of boulders or the layer represents bedrock surface layer of the weakened part below.

The EGE 3 layer below has the velocity  $V_p = 3980$  m / s.

Nº4 profile:-At 2-3 meters of layer EGE 1 is observed with primary wave velocity  $V_p = 330-570$  m / s and the share wave velocity  $V_s = 200-270$  m / sec.

EGE 1 is bounded below by EGE 2 layer, having thickness in 5 - 10 meter range and velocity  $V_p = 1850-1900$  m / s. Share wave velocity is  $V_s = 850-1000$  m / sec.

Based on our observation the layer EGE 3 down to a depth of 30 meters is observed with velocities of  $V_p = 2750$  m / sec and  $V_s = 1550$  m / sec.

№2-4 profile:-At the depth of the 4-6m layer of EGE 1 is observed with primary wave velocity  $V_p = 550-900$  m / sec.

This layer is bounded from below by layer EGE 2, with the thickness ranging from 5-17 meters, the smallest thickness is denoted from the beginning and in the end of the profile, having velocities  $V_p = 1320-2460$  m / s. Velocity variation is likely due to the large boulders of no uniform distribution.

The layer of EGE 3 has a velocity  $V_p = 3518$  m / s.

№2-3 Profile: Profile is located 200m away from Hydropower plan territory in the end of a penstock. For these profiles above represented EGE –s are relevant as well.

At 1-2 meters depth layer of EGE 1 is identified with primary wave velocity  $V_p = 600-830$  m / s and the share wave velocity  $V_s = 300-430$  m / sec.

EGE 11 is bounded from below by EGE 2 and it is more likely to be weathered layer having thickness of 5 - to 8-meter range and velocity  $V_p = 1100-1170$  m / s. Share wave velocity  $V_s = 550-620$  m / sec.

The layers below the EGE-2 are more likely to be less weathered layer. Those layers may have a relatively high velocities  $V_p = 1860$  m / sec and  $V_s = 1000$  m / sec due to water saturation of the soil.

In the north of Nenskra hydroelectric power station, in the valley has been made two 115 m and a 46 m-long seismic profile:

№3-1 Profile: - At the 4-6m layer of EGE 1 is observed with the primary wave velocity  $V_p = 680-830$  m /sec.

This layer is bounded from below by EGE 2, with the thickness ranging from 20-30 meters, and the velocities  $V_p = 1750-1970$  m / s.

The EGE 3 layers below has the velocity  $V_p = 3330$  m / s.

№3-3 Profile: Along the all profile at depth of 5-6m EGE 1 is observed and its primary wave velocity is  $V_p = 655-775$  m / sec.

This layer is bounded from below by EGE 2, with the thickness ranging from 8-20 meters and velocities  $V_p = 1600-2010$  m / s.

The EGE 3 layer below has velocity  $V_p = 3320$  m / s.

It should be noted that, at remote shot of - 60 meters, on the №3-2 profile, at the 21th geophone, was observed minima of diffracted wave with -0.104 seconds delay. Based on our calculations for the third layer, the wave propagation velocity is 3320 m / s. Using simplified modeling, we can assume that in the vertical plane of the profile, from 21st geophone, in 135 m radius area reflective surface is observed.

Profile №3-3: At 1-2 meters depth range layer of EGE 1 is introduced with primary wave velocity  $V_p = 430-730$  m / s and the share wave velocity  $V_s = 220-260$  m / sec.

This layer is bounded from below likely by more weathered part of EGE 1 and probably EGE 2, having total thickness in a range of 6 - 10 meters. Primary wave velocity of the layer is  $V_p = 950-1060$  m / sec and share wave velocity is  $V_s = 400-510$  m/sec.

Below above described layers more likely less weathered EGE-2 is presented. Primary wave velocity of the layer is  $V_p = 1600 \text{ m / s}$  and share wave velocity is  $V_s = 920 \text{ m / sec}$ .

In the Annex 2 corresponding table is attached, where other physical-mechanical parameters of the soil are listed. Those parameters are determined in the using seismic profiles №2, 4, 2-3 and 3-3 identified EGE-s.

#### 5.2.3.12.1.8 Nakra dam site

In the vicinity of the Nakra dam were carried out a 230-meter, the 115-meter and two 46 meter seismic (Dynamic elastic parameters were determined for those profiles) profile. Also has been made one electrical profile.

In this case, we have identified four EGE for seismic profiles, different from those identified for Nenskra case.

Based on seismic wave propagation velocities and engineering –geological parameters the layers can be interpreted as main EGE-s of different lithology and properties. Geometry (depth and thickness) of each geological layer were determined according to the P-wave velocity and S wave velocity was calculated as well.

EGE 1 – loose soil formed form the upper part of the slope - Quaternary;

EGE 2 - bedrock: composed of migmatites and granite large fragmented material with loos boulder filler;

EGE 3 - bedrock: composed of migmatites and granite large rock fragments drawn from a large Concentration of boulders;

EGE 4 – bedrock represented by migmatites and granite.

Above described EGE-s are geophysical data interpretation taking into consideration existed geological information of the area.

**Figure 5.2.3.12.1.8.1.** Distribution of the Seismic and Electric Profiles



№2-1 Profile: -Along the all profile at depth of the 1-3m layer of EGE 1 is observed with primary wave velocity  $V_p = 440-690$  m / sec.

This layer is bounded from below by EGE 2, with the thickness ranging from 9-18 meters, the smallest thickness is marked in the beginning of the profile, with the velocities  $V_p = 970-1380$  m / s.

The EGE 3 layer is presented below with velocity  $V_p = 3080$  m / s.

№2-2 Profile: - At 3-5 meters depth layer of EGE 1 is identified with primary wave velocity  $V_p = 590-980$  m / s and the share wave speed  $V_s = 250-350$  m / sec.

EGE 1 is bounded from below by EGE 2, thickness is from 11 - to 16-meter range and velocity  $V_p = 1010-1440$  m / s and  $V_s = 450-760$  m / sec.

Below those 2 layers the layer of EGE 3 is likely to be presented with the velocity  $V_p = 2950$  m / sec and  $V_s = 1300$  m / sec.

№3-9 Profile: -At 7-20 meters depth of the layer of the combination of EGE 1 and EGE 2 are presented with primary wave velocity  $V_p = 470-1090$  m / s.

This layer is likely to be bounded from below by EGE 3 having thickness of 25 - to 50-meter range and velocity  $V_p = 2200-2600$  m / s.

The EGE 4 layer is observed below with the velocity  $V_p = 4530$  m / s.

№3-10 Profile: At 6 meters depth of the profile the layer of EGE 1 is observed with the primary wave velocity  $V_p = 510-600$  m / s and the share wave velocity  $V_s = 270-350$  m / sec.

EGE1 is bounded from below by EGE2, having thickness from 10 - to 12-meter range and velocity  $V_p = 1000-1170$  m / s and  $V_s = 600-700$  m / sec.

Below those 2 layers the layer of EGE 3 is likely to be presented with velocity  $V_p = 2950$  m / sec and  $V_s = 1700$  m / sec.

#### **5.2.3.12.1.9 Nenskra tunnel entrance and Nakra hydro-electric power Station territory**

Near the tunnel entrance of Nenskra and in the vicinity of Nakra hydroelectric power station one 230-meter, the 115-meter and two 46 meter seismic (To determine dynamic elastic parameters) profiles have been made. One electrical profile was carried out as well. (Fig. 5.2.3.12.1.9.1.).

EGE 1 – loose soil formed from the upper part of the slope - Quaternary;

EGE 2 - bedrock: composed of migmatites and granite large fragmented material with loose boulder filler;

EGE 3 - bedrock: composed of migmatites and granite large rock fragments drawn from a large concentration of boulders;

EGE 4 – bedrock represented by migmatites and granite.

Above described EGE-s are geophysical data interpretation taking into consideration existed geological information of the area.

№3-13 Profile: -Along all the profile, at 4-5m depth layer of EGE1 is presented with primary wave velocity  $V_p = 500-660$  m / sec.

This layer is bounded from below by combined layer of EGE2 and EGE 3 having thickness ranging from 45-60 meters, and the velocities  $V_p = 1950-2530$  m / s.

The layer of EGE 4 seen below has a velocity  $V_p = 4980$  m / s.

№3-11 Profile: - At 1 meter depth of the profile EGE 1 observed with primary wave velocity EGE 1  $V_p = 450-830$  m / s and the shear wave velocity  $V_s = 220-350$  m / sec. The difference in thickness of this layer with the similar layer from 3-13 profile is due to the distance between geophones.

This layer is bounded from below by EGE 2, having thickness 5 - 12 meter range and velocity  $V_p = 900-2150$  m / sec and  $V_s = 470-1100$  m / sec.

Below of those layers the EGE 3 is likely to be recorded with velocity  $V_p = 3620$  m / sec and  $V_s = 2150$  m / Sec.

№3-15 Profile: - At the depth of 3-7m of the profile EGE1 is presented with primary wave  $V_p = 470-670$  m / sec.

This layer is bounded from below by combination of layers of EGE 2 EGE 3, having thickness ranging from 50-60 meters, and the velocities  $V_p = 1740-2070$  m / s.

The layer of EGE 4 recorded has velocity  $V_p = 3500$  m / s.

**Figure 5.2.3.12.1.9.1.** Distribution of the Seismic and electric Profiles



### 5.2.3.12.1.10 Nenskra tunnel route area

The tunnel route crosses a variety of geological formations in the study area; therefore to develop unified EGE system is associated with certain difficulties. Thus for the seismic profile made along this route, we will use different EGE system for each of them.

Along the tunnel route three 575-meter, one 230-meter, four 46-meter and three electrical seismic profile have been made.

**Figure 5.2.3.12.1.10.1.** Distribution of the Seismic Profiles

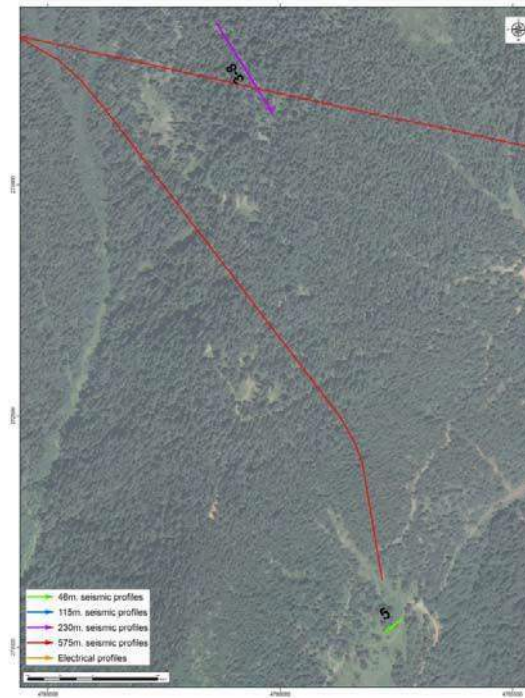

№3-8 Profile: -Along the all profile at depth 10-12 meters is observed loose Quaternary soil having primary wave velocity  $V_p = 580-610$  m / sec.

This layer is bounded from below with layer of weathered clay and sandstone having thickness ranging from 27-47 meters, and the velocities  $V_p = 1430-2480$  m / s.

The layer below is most likely to be sequence of clay and sandstone. This hypothesis is confirmed here by velocity of elastic waves  $V_p = 3350$  m / s.

№5 Profile: -located at the entrance of the tunnel profile and in the zone of project temporary road area.

№5 Profile: --At 3,5-4 meters depth of the profile observed Quaternary and loose soil with primary wave velocity  $V_p = 320-580$  m / sec.

This layer is likely to be bounded from below by the layer of sparse boulders drawn of sequence of large fragments of clay shale and sandstone , having strength of 12 - to 16-meter range and speed  $V_p = 780-1280$  m / s.

Below those layers, the layer with primary wave velocity  $V_p = 2470$  m / s. is expected to be consistent with the velocity of the clay shale and sandstone large fragments with dense boulder filler. Sequence of weathered clay shale sandstone layer.

**Figure 5.2.3.12.1.10.2.** Distribution of the Seismic Profiles

№3-12-Profile: - Along the entire depth of 16-20 meters is observed an intensely weathered layer of loose soil and Dizzy series hardened shales, with primary wave velocity  $V_p = 1060-1190$  m / s.

This layer is bounded from below by hardened Dizzy series of weathered shale zone with the thickness ranging from 30-80 meters, and the velocities  $V_p = 2590-3950$  m / s.

The layers below presents well preserved dizzy series hardened shale zone, primary wave velocity  $V_p = 5000$  m / s.

№3-5-Profile: - Att 0.5-1.5 meters depth of the profile observed primary wave velocity  $V_p = 290-500$  m /s and the share wave velocity  $V_s = 150-250$  m / sec. Corresponding to loose soil.

This layer is bounded from below by Dizzy series intensely hardened weathered shales zone, with depth of 0.7 - 12 meter range and velocity  $V_p = 980-1100$  m / sec and  $V_s = 450-520$  m / sec. The combination of the first and the second layers of this profile represent the first layer of the profile 3-12.

Below those layers most likely the layer of Dizzy series, intensely weathered hardened shale zone is presented with velocity  $V_p = 2500$  m / sec and  $V_s = 1400$  m / sec.

**Figure 5.2.3.12.1.10.3.** Distribution of the Seismic Profiles

№3-11-Profile: -Along the entire profile, at the depth of 10-30 observed composite zone of loose soil and intensively weathered, hardened shale of Dizzy series with primary wave velocity  $V_p = 1055-1340$  m / s.

This layer is bounded from below by weathered, hardened shale of Dizzy series zone with the thickness ranging from 50-100 meters, and the velocities  $V_p = 2410-3850$  m / s.

Below of above described layers, there is a preserved layer of hardened shale zone of Dizzy series, which is demonstrated here as well with the velocity of primary waves  $V_p = 5380$  m / s.

№3-4-profile: -At 0.5 meters depth layer of loose soil is observed with primary wave velocity  $V_p = 700-1100$  m / s and the share wave velocity  $V_s = 300-460$  m / sec.

This layer is bounded from below by intensively weathered, hardened shale zone of Dizzy series. Thickness of the zone is in 3 - 11 meter range and velocity is  $V_p = 1270-1500$  m / s and the share wave velocity is  $V_s = 710-750$  m / sec. The united first and the second layer of this profile, is the first layer of the profile 3-11.

Below of those layers zone of the intensively weathered hardened shale of dizzy series with velocity  $V_p = 2200$  m / sec and  $V_s = 1290$  m / sec.

№3-6-profile: -Along the all profile at the depth of 10-14m is observed the combined layer of loose soil and clay shales intensively weathered zone and the combination of the primary wave velocity  $V_p = 880-960$  m / sec.

This layer is bounded from below by weathered clay shale zone with the thickness ranging from 20-70 meters, and the velocity  $V_p = 3000-3500$  m / s.



The layer, bounding above described layers from below is most likely well preserved clay shale zone, which is confirmed here by elastic wave velocity of  $V_p = 4620 \text{ m / s}$ .

№3-7-profile: - At 1-1.5 meters deep a layer of loose soil is observed with primary wave velocity  $V_p = 350-620 \text{ m / s}$  and the share wave velocity  $V_s = 200-320 \text{ m / sec}$ .

This layer is bounded from below by intensively weathered clay shales zone, having thickness of 2 to 6-meter range and velocity  $V_p = 1050-1300 \text{ m / s}$  and  $V_s = 430-530 \text{ m / sec}$ . The combination of the first and the second layers of these profile is the first layer of the 3-6 profile.

Probably intensively weathered clay shale layer bounds the above layers from below with velocities:  $V_p = 1950 \text{ m / sec}$  and  $V_s = 1000 \text{ m / sec}$ .

**5.2.3.12.1.11 Seismic Profiles**

Colors refer to P wave velocity

Profile №1

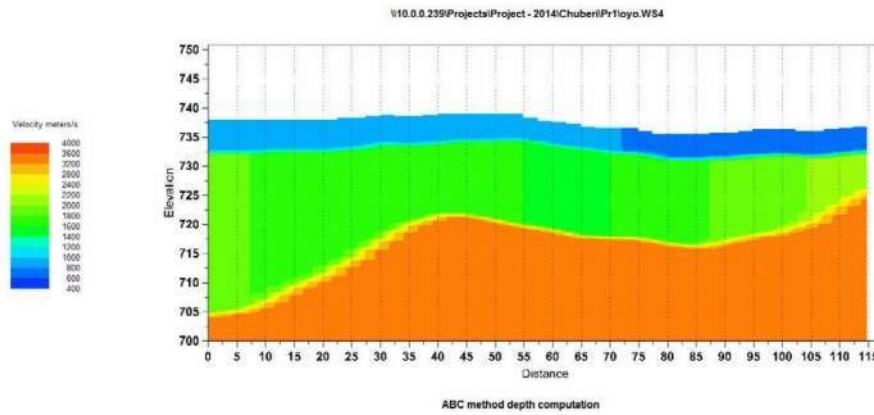

Profile №2

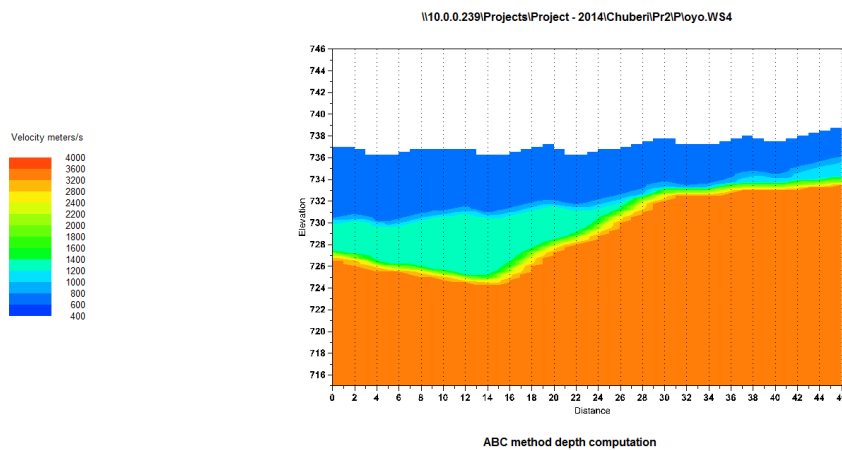

### Profile №3

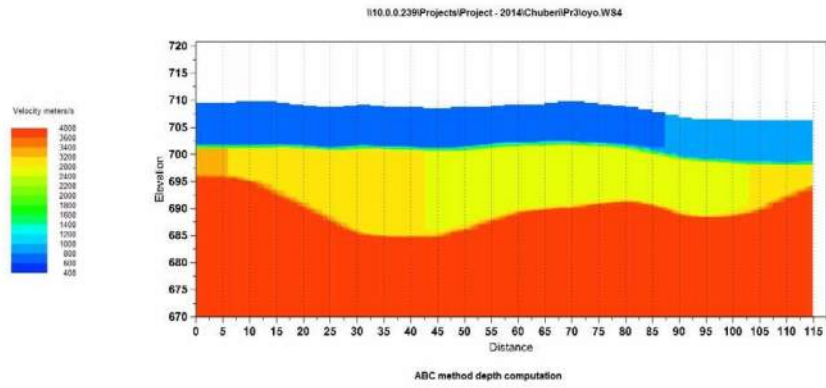

### Profile №4

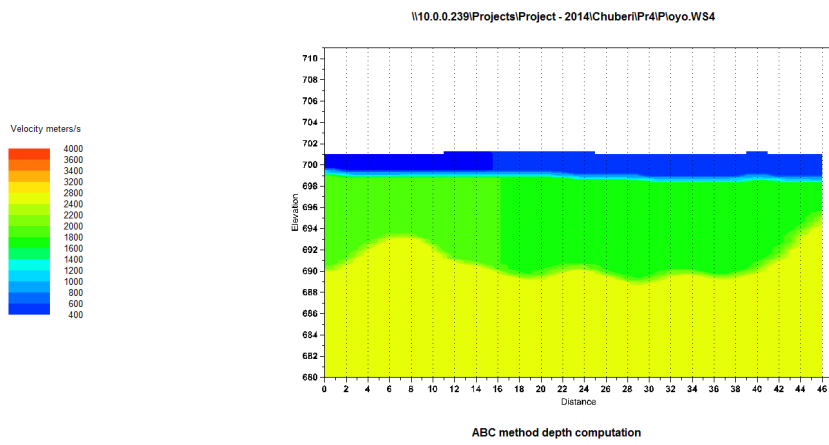

### Profile №5

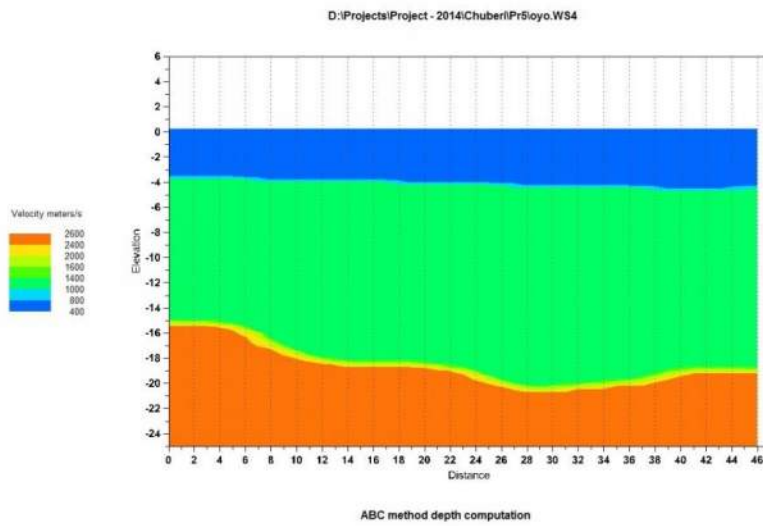

### Profile №2-1

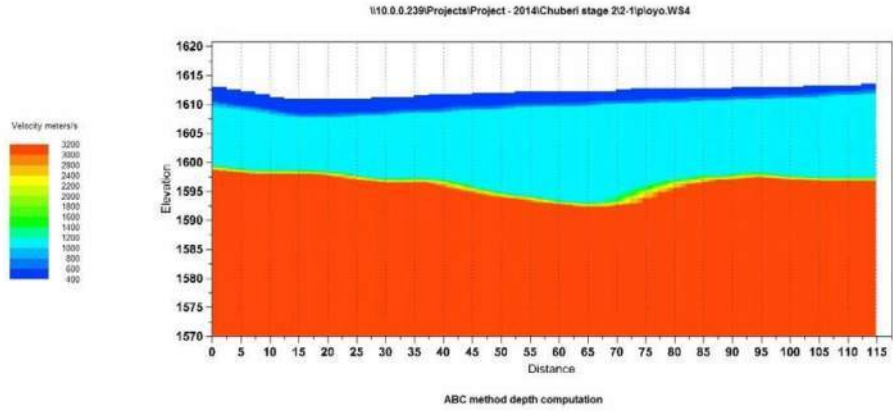

### Profile №2-2

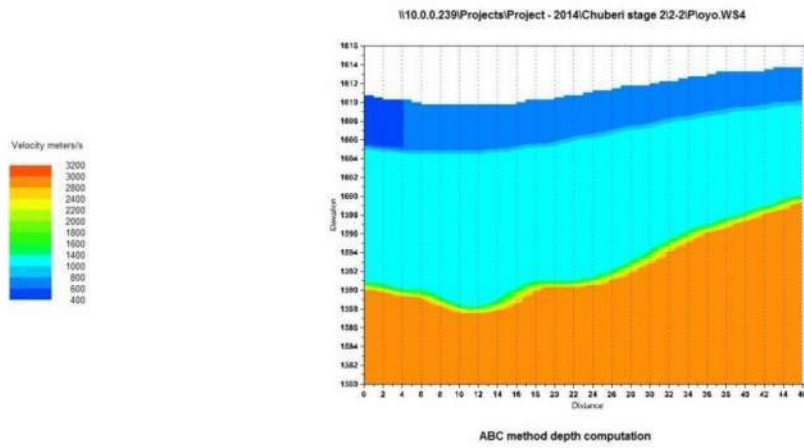

### Profile №2-3

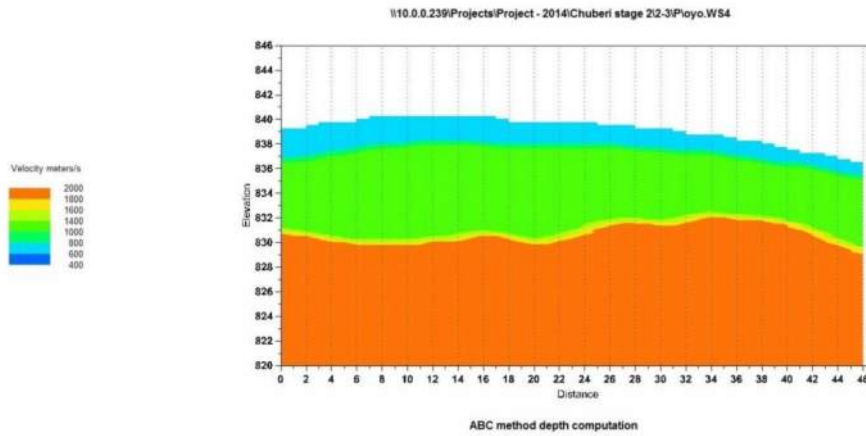

### Profile №2-4

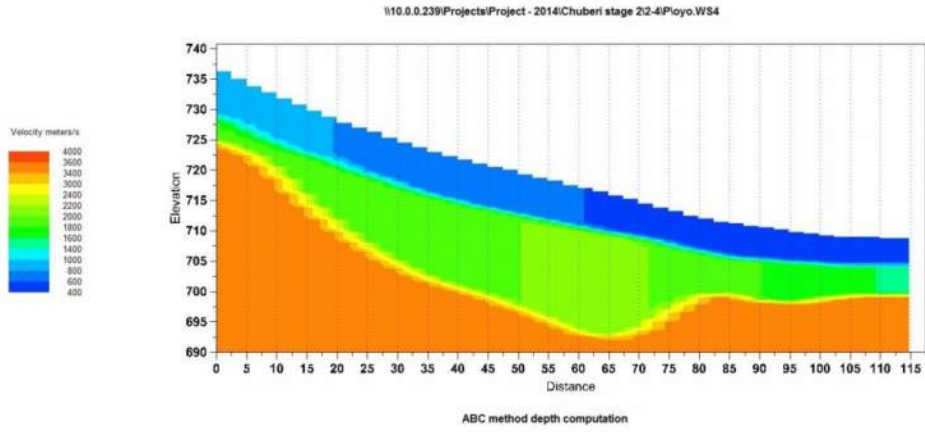

### Profile №3-1

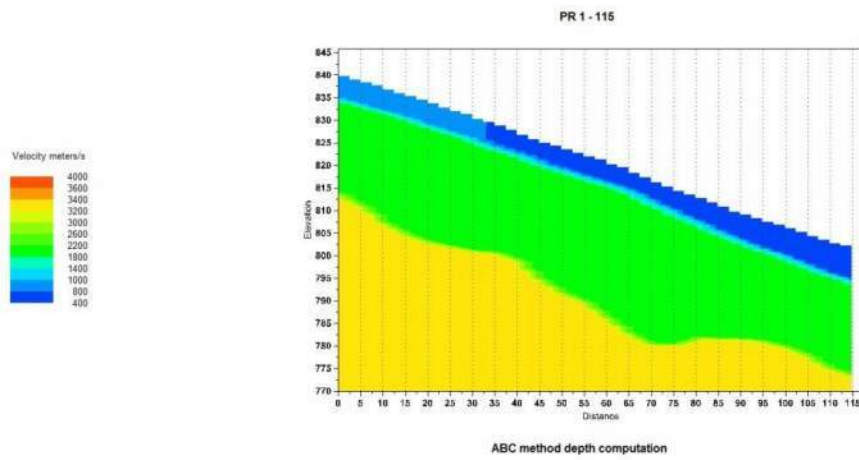

### Profile №3-2

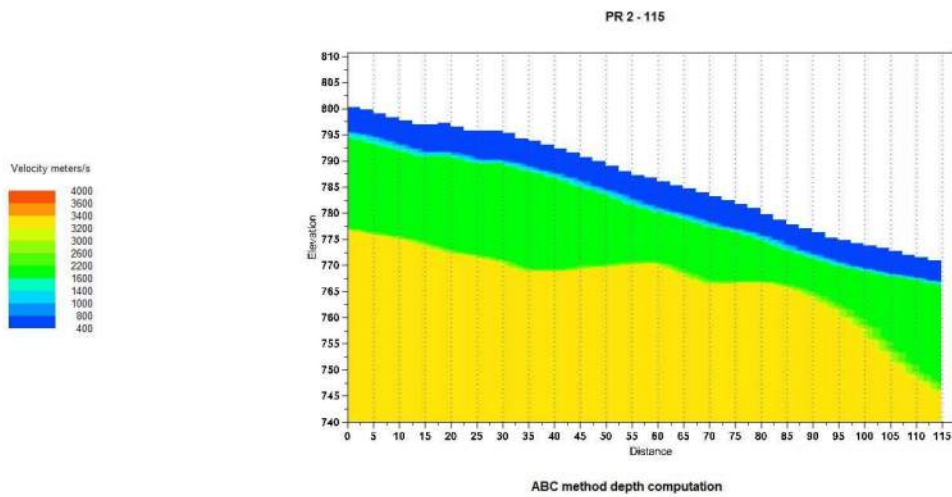

### Profile №3-3

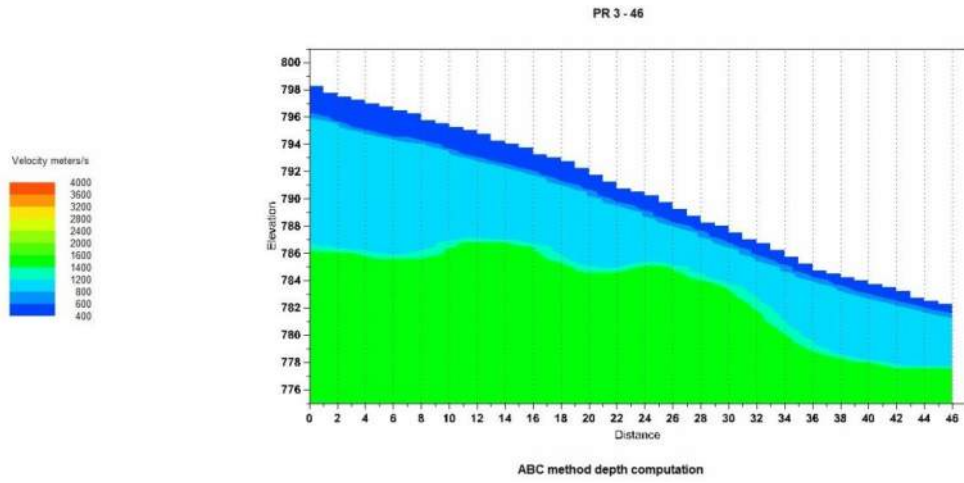

### Profile №3-4

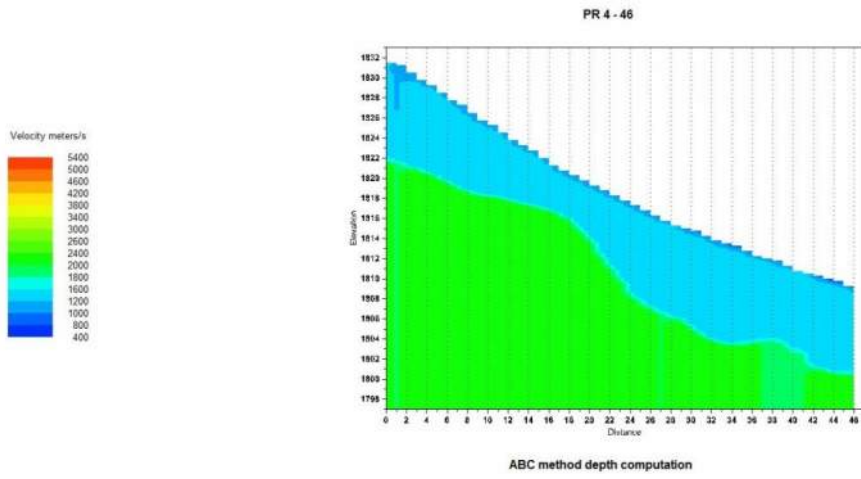

### Profile №3-5

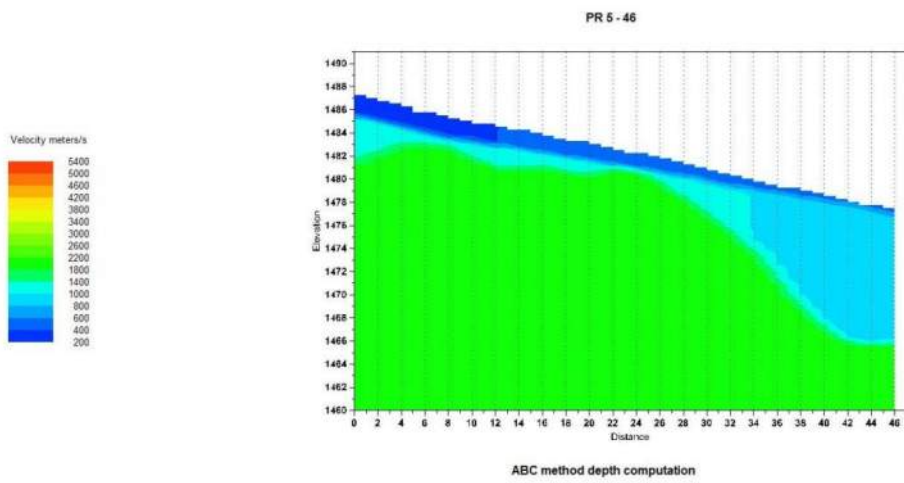

### Profile №3-6

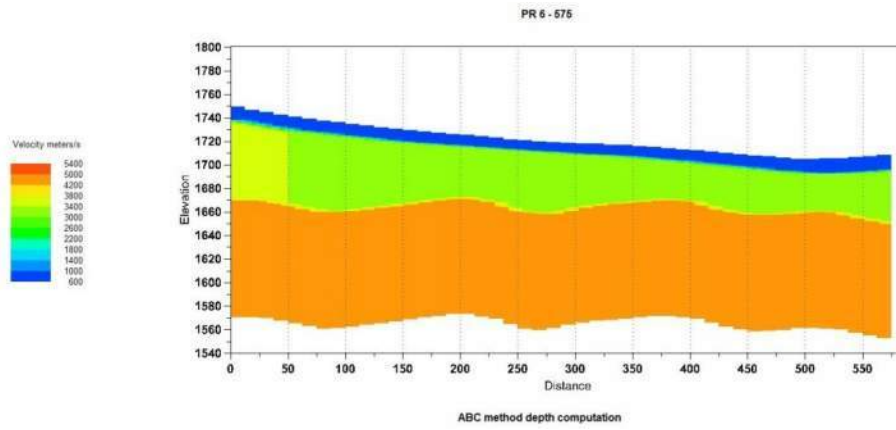

### Profile №3-7

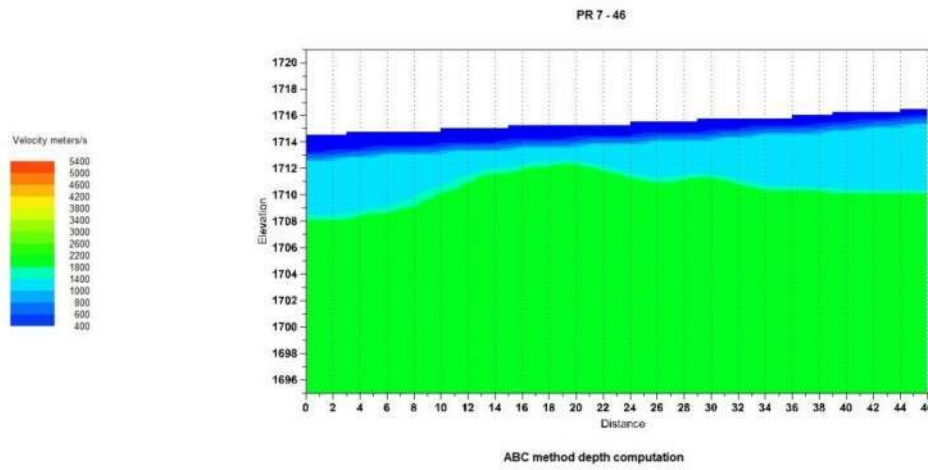

### Profile №3-8

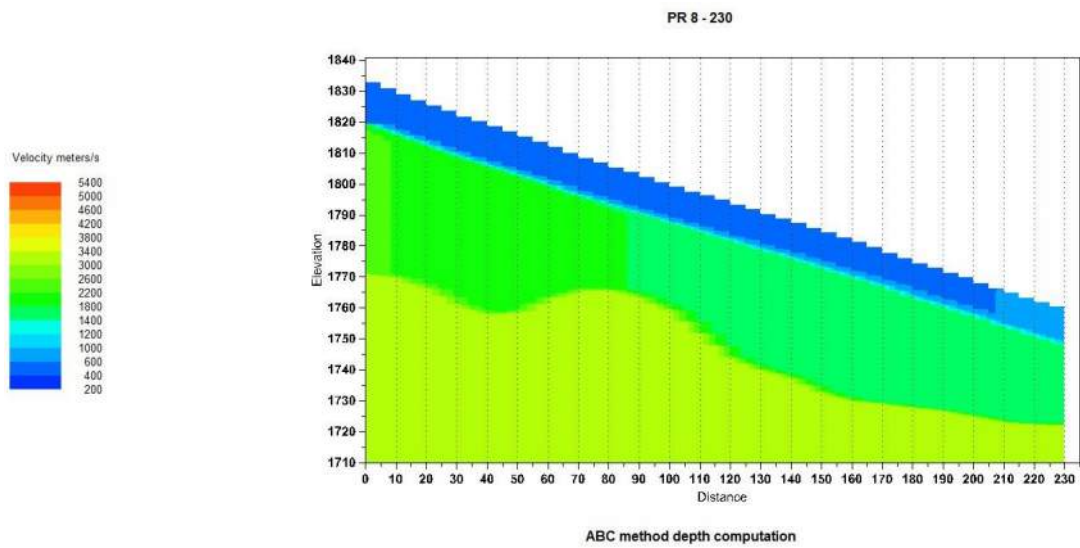

### Profile №3-9

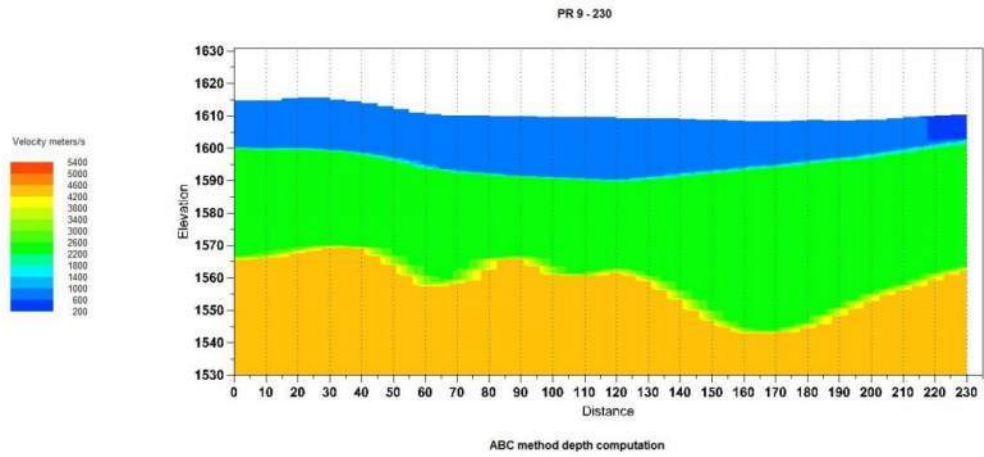

### Profile №3-10

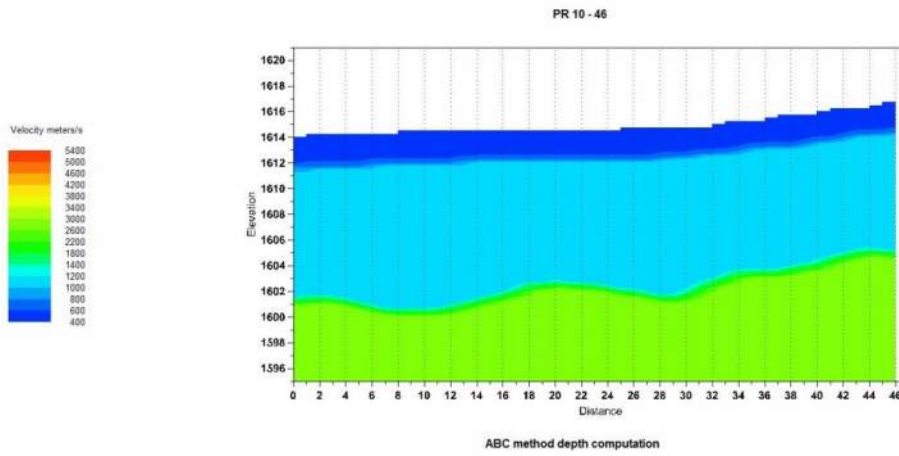

### Profile №3-11

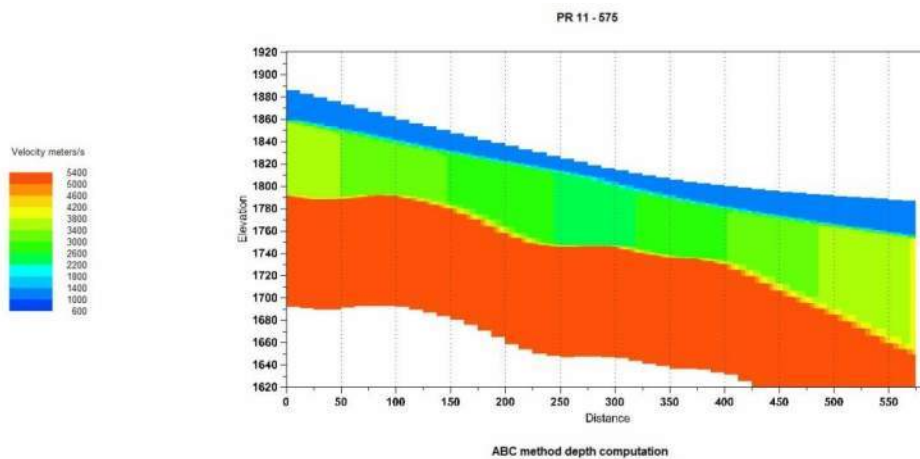

### Profile №3-12

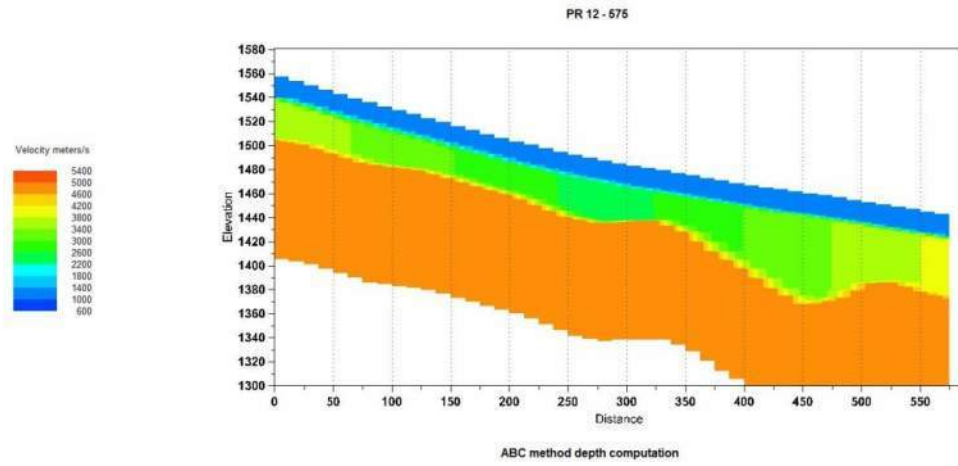

### Profile №3-13

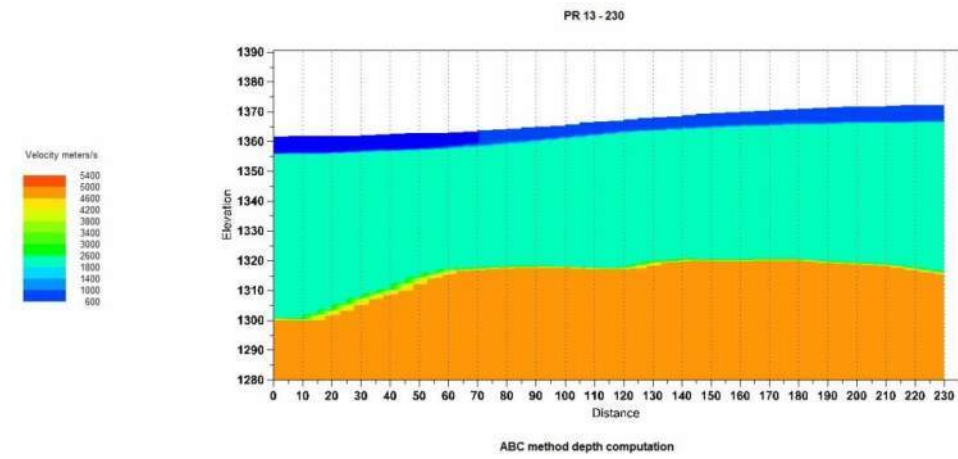

### Profile №3-14

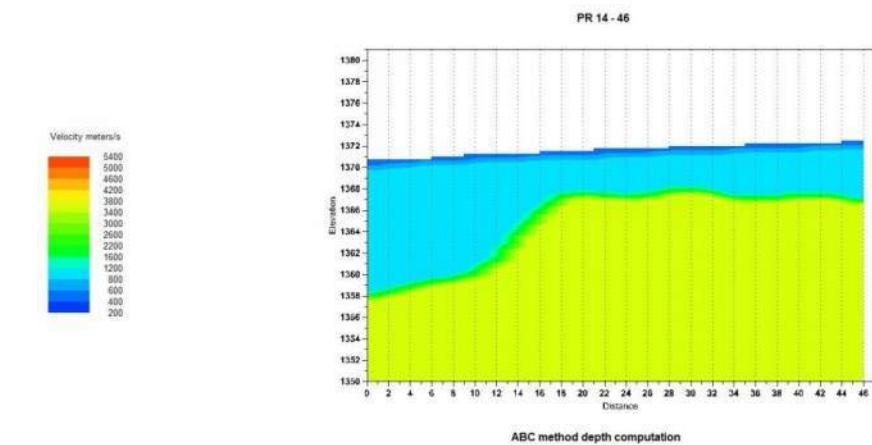



Profile №3-15

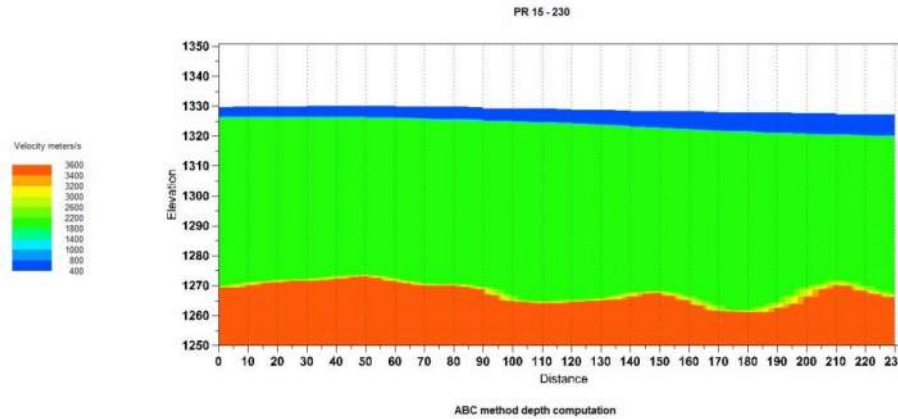

5.2.3.12.1.12 Physical and mechanical properties of the soil based study of seismic profiles

Table 5.2.3.12.1.12.1. Physical and mechanical properties of the soil based study of seismic profiles. Each profile is divided into equal longitudinal sections geophones 1-8, 9-16 and 17-24. The geotechnical parameters were calculated for each layer and each section.

V<sub>p</sub> - P wave velocity (m/sec)

E<sub>d</sub> - Elasticity Dynamic Module Pa

V<sub>s</sub> - S wave velocity (m/sec)

G - Shift Module Pa

ρ - Density (gr/cm<sup>3</sup>) by Gardner's equation

K - Bulk module (Mpa)

μ - Poisson's Coefficient

Profile№2

V <sub>p</sub> m/s	V <sub>s</sub> m/s	V <sub>s</sub> /V <sub>p</sub>	ρ gr/cm <sup>3</sup>	μ	G Mpa	E <sub>d</sub> Mpa	K Mpa
layer 1							
670	330	0.49	1.58	0.34	172	460	479
730	390	0.53	1.61	0.30	245	637	532
1010	550	0.54	1.75	0.29	529	1363	1078
Layer 2							
1330	750	0.56	1.87	0.27	1053	2668	1907
1270	640	0.50	1.85	0.33	758	2016	1974
1330	720	0.54	1.87	0.29	970	2509	2018
Layer 3							
3130	1600	0.51	2.32	0.32	5936	15708	14802

Profile№4

V <sub>p</sub> m/sec	V <sub>s</sub> m/sec	V <sub>s</sub> /V <sub>p</sub>	ρ gr/cm <sup>3</sup>	μ	G MPa	E <sub>d</sub> MPA	K MPA
Layer1							
330	200	0.61	1.32	0.21	53	128	73
530	270	0.51	1.49	0.32	108	287	273
570	250	0.44	1.51	0.38	95	261	366
Layer2							
1850	1000	0.54	2.03	0.29	2033	5260	4247

1900	950	0.50	2.05	0.33	1847	4926	4926
1900	850	0.45	2.05	0.37	1479	4066	5417
Layer3							
2750	1550	0.56	2.24	0.27	5393	13669	9786

**Profile№2-2**

Vp m/sec	Vs m/sec	Vs/Vp	$\rho$ gr/cm <sup>3</sup>	$\mu$	G MPa	Ed MPA	K MPA
Layer1							
590	250	0.42	1.53	0.39	95	266	405
680	260	0.38	1.58	0.41	107	303	589
980	350	0.36	1.73	0.43	212	606	1382
Layer2							
1440	760	0.53	1.91	0.31	1103	2883	2489
1070	560	0.52	1.77	0.31	556	1458	1289
1010	450	0.45	1.75	0.38	354	974	1311
Layer3							
2950	1300	0.44	2.28	0.38	3861	10653	14734

**Profile№2-3**

Vp m/sec	Vs m/sec	Vs/Vp	$\rho$ gr/cm <sup>3</sup>	$\mu$	G MPa	Ed MPA	K MPA
Layer1							
600	300	0.50	1.53	0.33	138	368	368
630	340	0.54	1.55	0.29	180	465	377
830	430	0.52	1.66	0.32	308	810	736
Layer2							
1160	550	0.47	1.81	0.35	547	1483	1705
1100	620	0.56	1.79	0.27	686	1739	1245
1170	550	0.47	1.81	0.36	548	1490	1751
Layer3							
1860	1000	0.54	2.04	0.30	2036	5280	4329

**Profile№3-3**

Vp m/sec	Vs m/sec	Vs/Vp	$\rho$ gr/cm <sup>3</sup>	$\mu$	G MPa	Ed MPA	K MPA
Layer1							
430	220	0.51	1.41	0.32	68	181	170
450	220	0.49	1.43	0.34	69	186	197
730	260	0.36	1.61	0.43	109	311	713
Layer2							
1060	480	0.45	1.77	0.37	408	1117	1444
950	400	0.42	1.72	0.39	275	767	1186
990	510	0.52	1.74	0.32	452	1193	1101
Layer3							
1600	920	0.58	1.96	0.25	1659	4159	2807

**Profile№3-4**

Vp m/sec	Vs m/sec	Vs/Vp	P gr/cm <sup>3</sup>	$\mu$	G MPa	Ed MPA	K MPA
Layer1							
970	420	0.43	1.73	0.38	305	845	1221
700	300	0.43	1.59	0.39	144	398	590
1100	460	0.42	1.79	0.39	378	1053	1657
Layer2							
1270	750	0.59	1.85	0.23	1041	2565	1597
1300	710	0.55	1.86	0.29	938	2416	1895
1500	730	0.49	1.93	0.34	1028	2765	2970
Layer3							
2200	1290	0.59	2.12	0.24	3533	8748	5565

**Profile№3-5**

Vp m/sec	Vs m/sec	Vs/Vp	$\rho$ gr/cm <sup>3</sup>	$\mu$	G MPa	Ed MPA	K MPA
Layer1							
36	200	0.56	1.35	0.28	54	138	103
50	250	0.50	1.47	0.33	92	244	244
29	150	0.52	1.28	0.32	29	76	69
Layer2							
110	520	0.47	1.79	0.36	483	1309	1517
110	520	0.47	1.79	0.36	483	1309	1517
98	450	0.46	1.73	0.37	351	960	1197
Layer3							
250	1400	0.56	2.19	0.27	4296	10926	7972

**Profile№3-7**

Vp m/sec	Vs m/sec	Vs/Vp	$\rho$ gr/cm <sup>3</sup>	$\mu$	G MPa	Ed MPA	K MPA
Layer1							
35	200	0.57	1.34	0.26	54	135	93
40	230	0.58	1.39	0.25	73	184	124
62	320	0.52	1.55	0.32	158	418	383
Layer2							
105	440	0.42	1.76	0.39	342	952	1490
110	430	0.39	1.79	0.41	330	931	1720
130	530	0.41	1.86	0.40	523	1464	2449
Layer3							
195	1000	0.51	2.06	0.32	2060	5445	5087

**Profile№3-10**

Vp m/sec	Vs m/sec	Vs/Vp	$\rho$ gr/cm <sup>3</sup>	$\mu$	G MPa	Ed MPA	K MPA
Layer1							
51	270	0.53	1.47	0.31	107	280	240
60	350	0.58	1.53	0.24	188	467	302
54	300	0.56	1.49	0.28	134	343	256

Layer2							
110	700	0.64	1.79	0.16	875	2029	994
100	600	0.60	1.74	0.22	628	1530	906
117	700	0.60	1.81	0.22	888	2170	1297
Layer3							
295	1700	0.58	2.28	0.25	6603	16525	11079

**Profile№3-14**

Vp	Vs m/sec	Vs/Vp	$\rho$ gr/cm <sup>3</sup>	$\mu$	G MPa	Ed MPA	K MPA
Layer1							
51	220	0.43	1.47	0.39	71	198	288
45	250	0.56	1.43	0.28	89	228	170
83	350	0.42	1.66	0.39	204	567	874
Layer2							
107	600	0.56	1.77	0.27	638	1622	1179
90	470	0.52	1.70	0.31	375	985	875
215	1100	0.51	2.11	0.32	2554	6757	6352
Layer3							
362	2150	0.59	2.40	0.23	11115	27288	16690

Electric profiles

Chuberi electric profile E-1

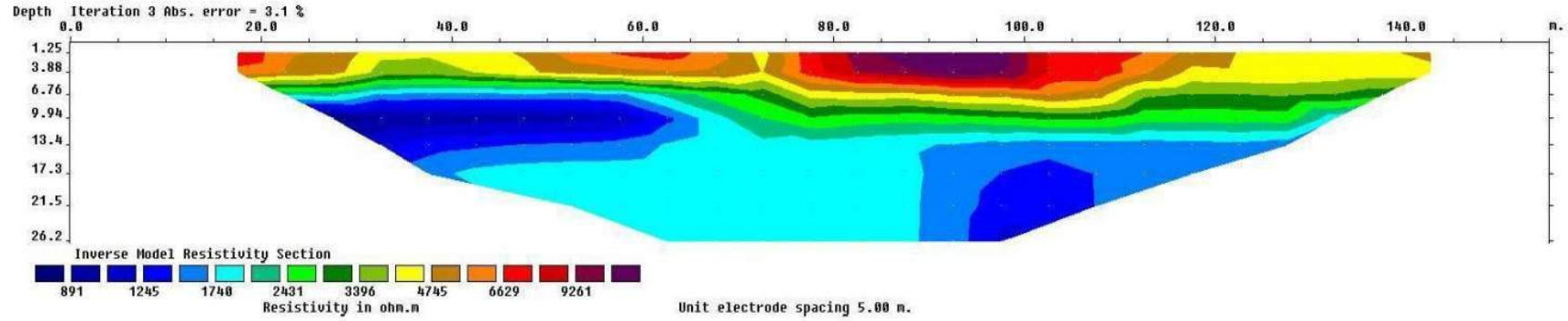

Marghi electric profile E-2

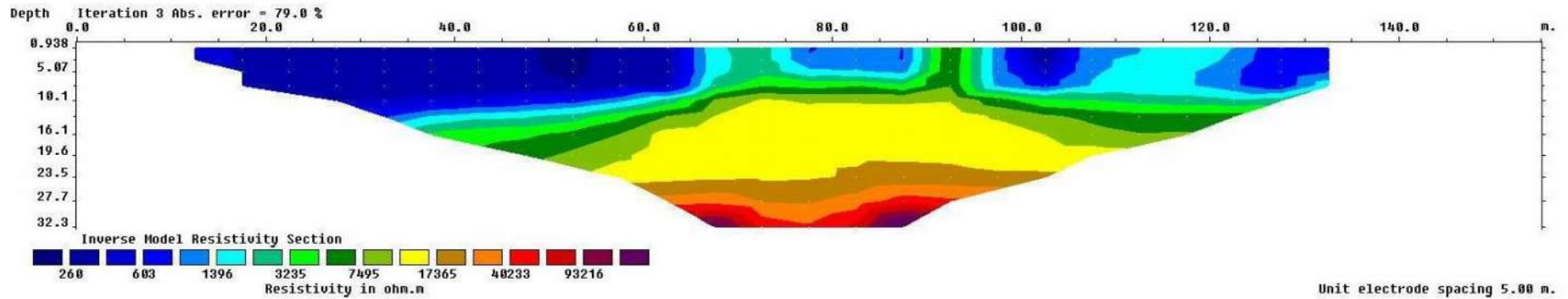

### Gvashkhara electric profile E-3

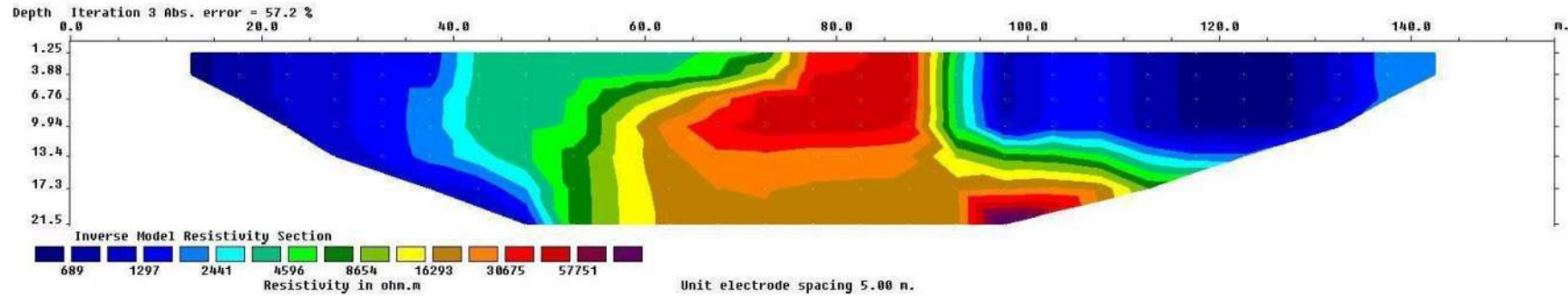

### Tita electric profile E-4

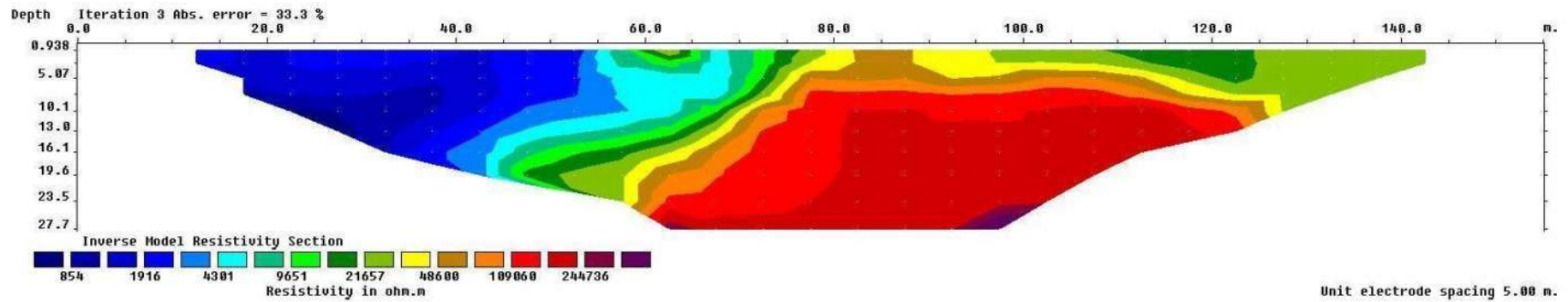

### Nakra electric profile E-5

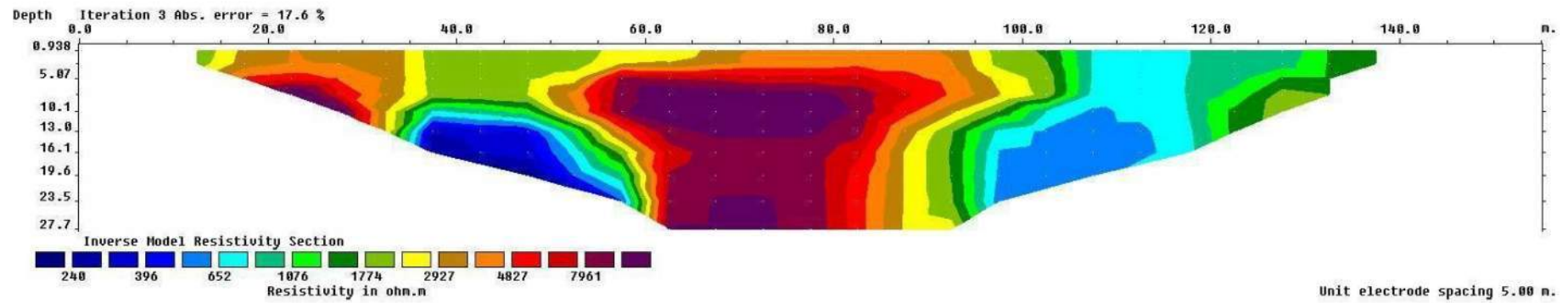

### 5.2.3.13 Seismic Hazard Analysis within the Project Area of Nenskra HPP

#### 5.2.3.13.1 Seismotectonic Environment of the Project Area

The territory under investigation is situated in the western part of Greater Caucasus near the outflow of rivers Nenska and Nakra. These rivers are tributaries of Enguri River. According to the tectonic scheme of Georgia (Gamkrelidze 2003) this area is quite complex. Here is the intersection of different zones of the folded system of the Greater Caucasus: Central raising subzone (crystal heart) of Main ridge zone, Kazbeg-Lagodekhi zone (folded-scaly), Chkhaltva subzone (monocline-scaly) of Chkhaltva- Laila zone (folded-scaly) and Jurassic folded porphyrite subzone of the Gagra-Java (folded) zone. Figure 5.2.3.13.1.1 shows a Tectonical Zoning Schematic Map of Georgia (E. Gamkrelidze, 2003).

**Table 5.2.3.13.1.1.** Scheme of Tectonic Zoning of the Territory of Georgia: (a) Main tectonic zones of Georgia; (b) Tectonic scheme of the area. The studied site is highlighted.

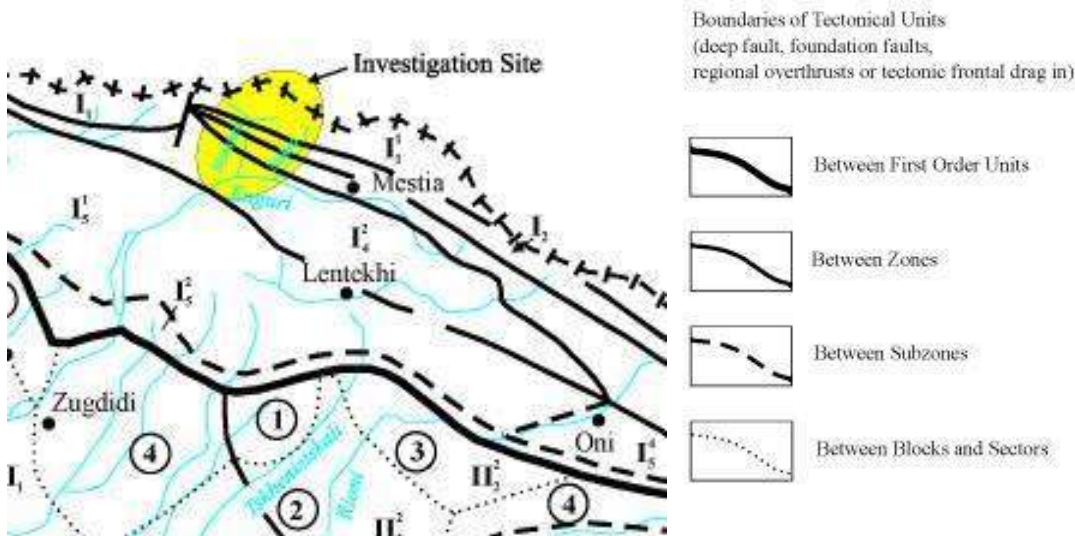
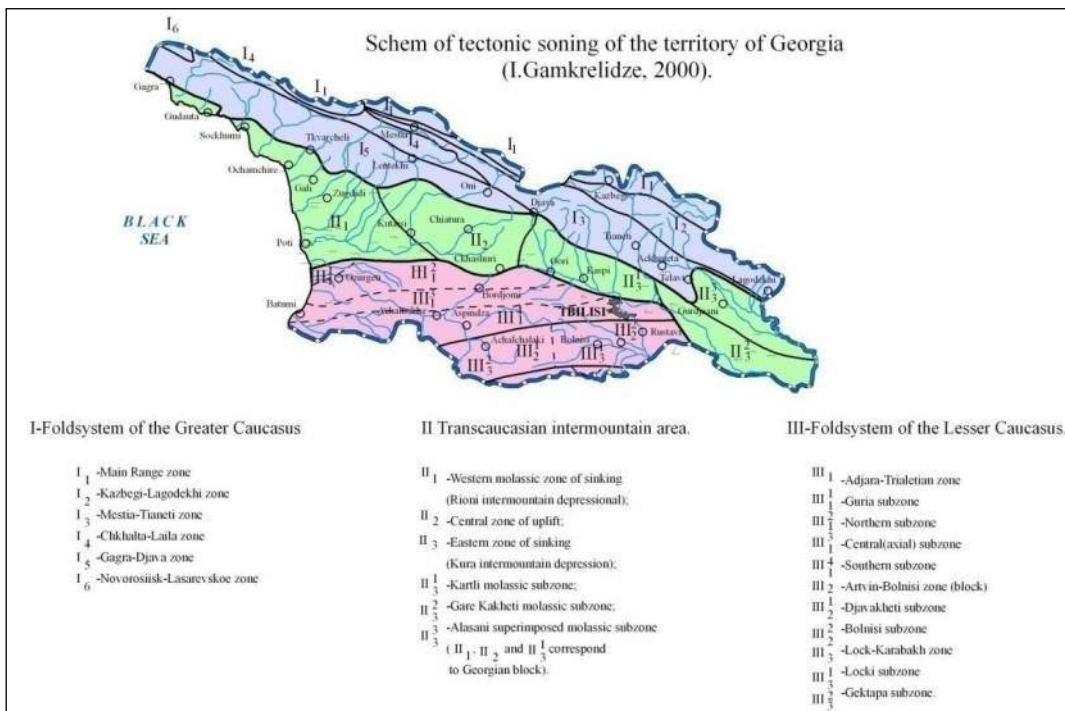



The active faults in the investigated region according to the different papers are shown in Figures 3-5 and the corresponding parameters are given in Table 1. The location and parameters of the faults are based on several published and unpublished materials (Gamkrelidze et al. 1998, Gamkrelidze 2003, Geguchadze et al. 1985, Adamia et al. 1992, Balassanyan et al. 1999, Rogojin 2000, Kharashvili et al. 1977, Varazanashvili 1998, Javakhishvili, Varazanashvili 1997 and Adamia et al. unpublished material, 2006).

These studies give slightly different schemes, but there is the main similar feature - the active faults with seismic potential  $M=7.0$  situated close to the site. Figures 5.2.3.13.1.2. and 5.2.3.13.1.3. are more detail and they show fault system in the vicinity of the site. This is the Main thrust of the Great Caucasus. According to Gamkrelidze et al. 1988, there is another fault system – Frontal overthrust of the greater Caucasus – in close vicinity to the dam site, but in the studied area these faults are so close, that we considered it as one fault system. Our decision is supported by other investigators (Adamia et al 2006) who haven't considered this fault at all.

Below the description of the Main thrust fault system according to the Adamia et al. unpublished material, 2006 is given:

“The Main thrust represents a complex system of faults located along the watershed range of the Great Caucasus. On the map of Seism active structures it is depicted as a single generalized line, whereas actually there exist a great number of sub parallel, en echelon or bifurcated, faults trending from WNW to ESE (see the alternative map), in the so-called “Caucasian” strike.

**Figure 5.2.3.13.1.2.** Map of seismic source zones compiled according to map of active faults Gamkrelidze et al. 1998

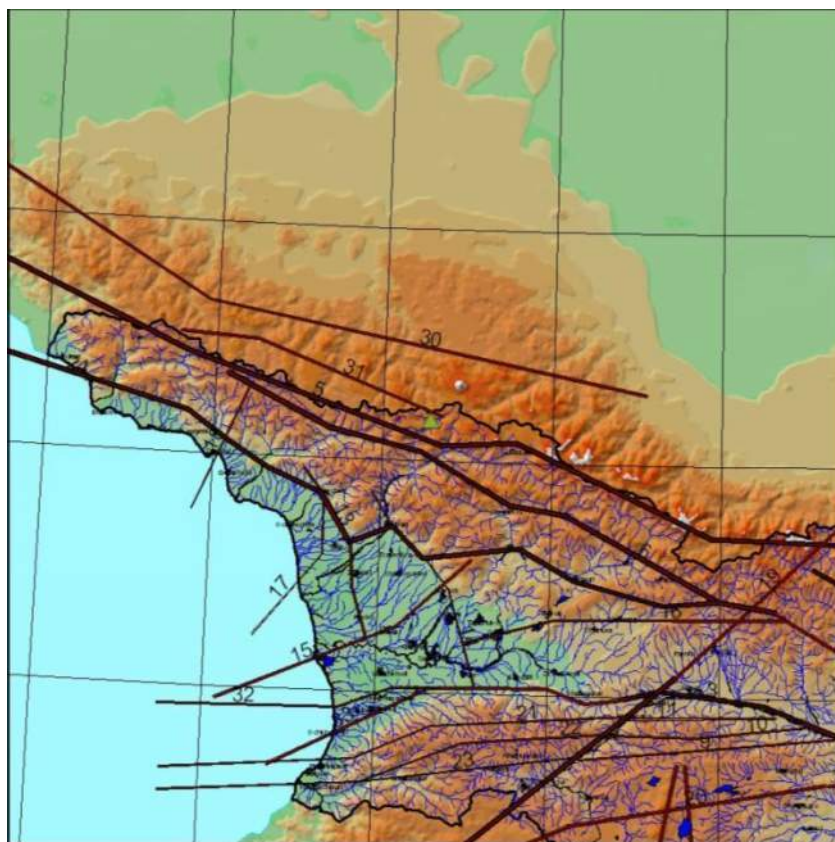

The Main thrust has been identified on the basis of geological data. Along this fault the basement rocks (metamorphites, migmatites, gneisses and various intrusive rocks of Late Proterozoic-Middle Paleozoic age) exposing in the Main Range zone of the central segment of the Great Caucasus overthrust Lower Jurassic black slate formation and locally shallow-marine molasse sequences of Late Paleozoic.

The Main thrust is well expressed topographically and is readily interpreted on the aerial and space imageries. In some places the fault created well-expressed tectonic scarps and benches due to the different lithology and resistance to denudation of rocks composing its northern upthrown limb (crystallinum) and downthrown southern one (shales).

To the west and east from the central segment of the Main Range zone, the crystalline core plunges beneath the sedimentary rocks and the system of faults forming the Main thrust runs within the monotonous sedimentary Mesozoic and Cenozoic rocks. Here the faults are reflected in the relief very vaguely and their attribution to the Main thrust often becomes, to a considerable degree, uncertain. Both crystalline basement rocks and rocks of the sedimentary cover are strongly deformed into a system of linear folds of the Caucasian strike.

**Figure 5.2.3.13.1.3.** Map of source zones compiled according to the map of active faults Adamia et al. 2006

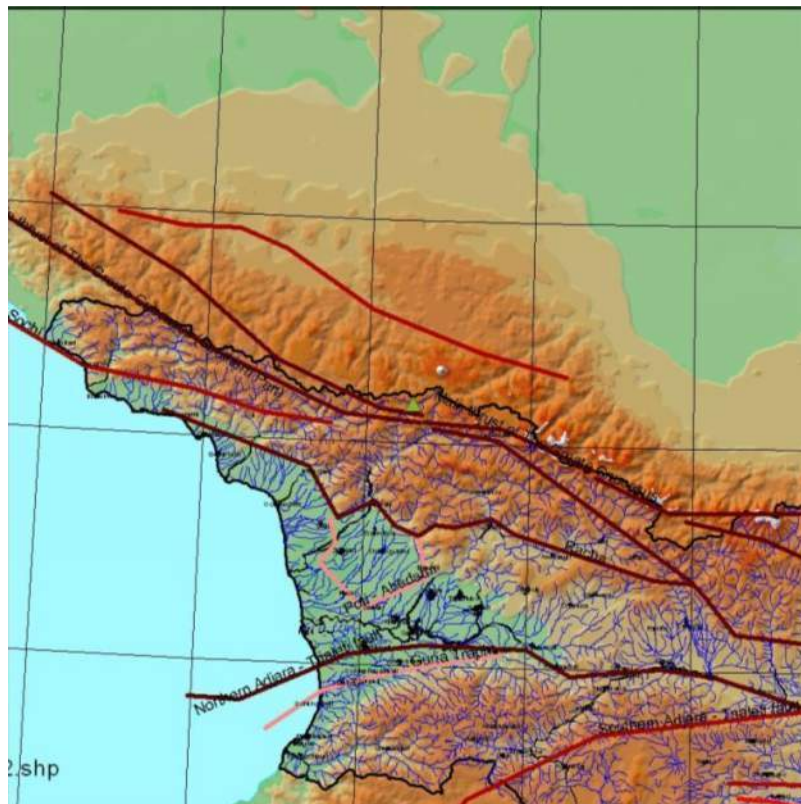

All the faults of the Main thrust system are steeply inclined to the north conditioning the imbricate structure of the Main Range zone. The fault planes usually dip to NNE.

By their kinematics the faults belong to reverse faults that are unambiguously confirmed by geological and, locally, geophysical data. In particular, fault plane solutions are usually in good compliance with geological observation, indicating the reverse faulting with some right-lateral strike-slip component.

The amplitude of horizontal displacement on the Main thrust has not yet been defined. The vertical component of the displacement within its central segment is estimated, according to geological evidence,

at several km for a few million years. Fission track data indicate slip rates on the Main thrust equal to 4-12 mm/yr. To the west and east from the central segment uplift rates are gradually decreasing.” The parameters of this and other active faults are given below (in the chapter Probabilistic Seismic Hazard Analysis).

**Figure 5.2.3.13.1.4.** Map of source zones according to Balassanian et al 1999

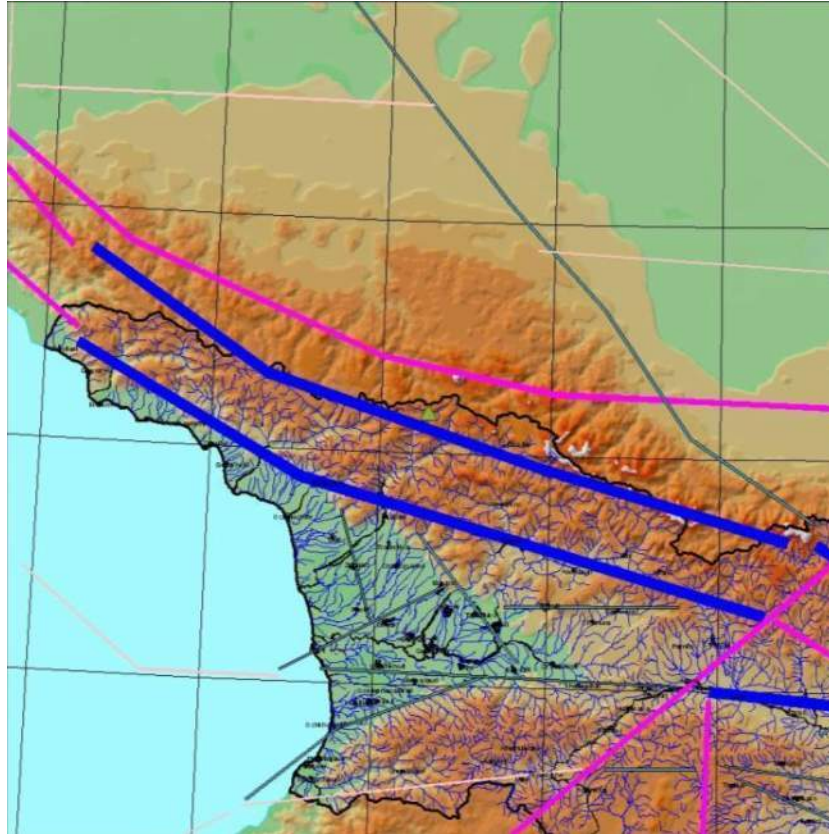

### 5.2.3.13.2 Seismicity of the Region

Various catalogues of historical and instrumental seismicity of the region have been analyzed. Here is the list of catalogues: Corrected Catalogue of Caucasus, Institute of Earth Sciences (in data base of IES, unpublished material), The Special Catalogue of Earthquakes for GSHAP test area Caucasus (SCETAC), compiled in the frame of the Global Seismic Hazard Assessment Program (GSHAP), for the period 2000 BC-1993, N.V. Kondorskaya (editor) (Balassanyan et al. 1999), earthquake catalogues of Northern Eurasia (for 1995-1999), catalogue of strong earthquakes (Shebalin, Kondorskaya 1982). Special catalogue for the Racha earthquake 1991 epicentral area (Institute of Earth Sciences, unpublished material). Additionally data from Bius, Ye. I.; 1948, Tskhakaia, A.D, Papalashvili, V.G; 1973 was used.

Catalogues of earthquakes consists of two different parts: historical and instrumental. Documentary historical catalogue stretches back to the beginning of the Christian era. The parameters of historical earthquakes are determined on the basis of the intensity data analysis, from contemporary documentary description of damage caused by earthquakes. For the older events the errors, in both location and date, may be substantial. The accuracy of parameters of instrumental period is much higher. The instrumental period in Caucasus has begun in 1899. At the beginning of the 20th century some seismic stations were installed in Georgia. They were equipped by the low sensitive apparatus generally of mechanical type.

The data of early instrumental (till 1930) period has nearly the same quality as in the 19th century. Parameters of earthquakes mainly estimated on the basis of intensity data and therefore we consider catalogue of this period as historical.

**Figure 5.2.3.13.2.1.** Epicenters of historical earthquakes (until 1930)

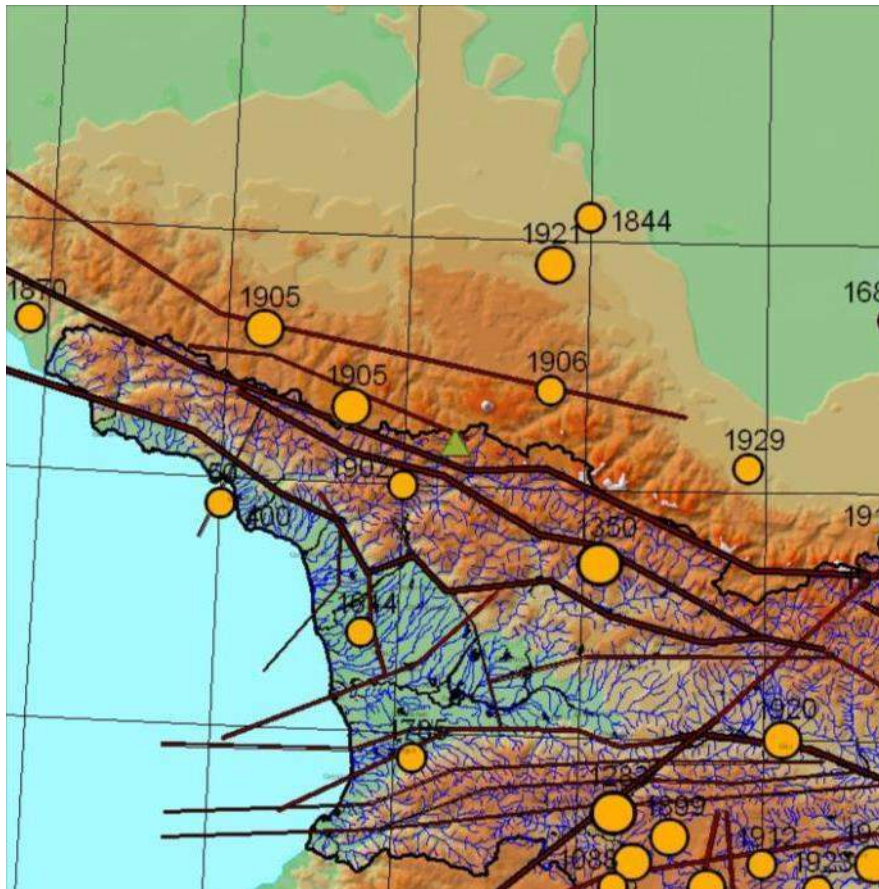

The studied site has affected from strong earthquakes several times. Parameters of historical earthquakes are given in table 1. The oldest events (50 and 500) were estimated on the bases of very poor data, therefore the accuracy is very low (errors for epicentre estimation are about 100 km, for magnitude and intensity more than 1 unit). The strongest event occurred in 1350 at the distance of about 80 km from the site. The magnitude of this earthquake estimated as 7.0 and intensity in epicenter 9-10 on MSK scale (Varazanashvili, Papalashvili 1998). According to the attenuation model estimated intensity on the HPS site could be 5-6 on MSK scale. But as we have noted above the accuracy of these estimations are too low (errors for epicentre estimation may be larger than 50 km, for magnitude 0.5 and for intensity 1 unit).

The earthquakes of 1088, 1261, 1283 are defined better and they are quite far from the Nenskra site as well as more late historical and early instrumental earthquakes of 1899, 1906, 1912, 1913, 1920, 1925. The event of 1614 has very sparse data and it wasn't so strong to affect dam site (distance about 90 km). The closest strong event occurred in 1902 at the distance of about 25km, but the data about this event is even more discrepant then medieval data. There is no intensity data and maybe this is the 1905 earthquake (New Catalogue).The earthquake of 1905 is contradictory as well. Earlier it was considered as Black sea earthquake (New catalogue), This event was followed by the strong aftershock. We think the distance between these events is the result of sparse data. Hence from the historical and early instrumental data we have general pattern of seismicity, but can't use these data for hazard analysis.

Parameters of historical earthquakes with magnitude  $M \geq 5$  are given in Table below.

**Table 5.2.3.13.2.1.** Parameters of historical earthquakes with magnitude  $M \geq 5$ 

Year	Month	Day	Hour	Minute	Second	Lat	Long	Depth	Intensity (MSK scale)	Magnitude
50	0	0	0	0	00.0	42.900	41.000	10	8.0	5.5
400	0	0	0	0	00.0	42.900	41.000	10	8.0	5.5
1088	4	22	0	0	00.0	41.500	43.300	15	9.0	6.5
1261	0	0	0	0	00.0	41.400	43.200	10	8.0	5.3
1283	0	0	0	0	00.0	41.700	43.200	15	9.5	7.0
1350	0	0	0	0	00.0	42.700	43.100	15	9.5	7.0
1614	0	0	0	0	00.0	42.400	41.800	10	8.0	5.5
1688	0	0	0	0	00.0	43.700	44.700	15	7.0	5.3
1785	0	0	0	0	00.0	41.900	42.100	10	8.0	5.5
1844	12	26	50	0	00.0	44.100	43.000	10	7.0	5.0
1870	7	8	7	20	00.0	43.600	39.900	13	7.5	5.3
1899	12	31	10	50	00.0	41.600	43.500	9	8.5	6.3
1902	6	18	23	53	10.0	43.000	42.000	30		5.2
1905	10	21	11	1	26.0	43.300	41.700	35	7.0	6.4
1905	10	21	13	20	44.0	43.600	41.200	32	6.0	5.6
1906	9	25	0	48	36.0	43.400	42.800	26	5.5	5.0
1912	10	12	19	48	57.0	41.400	43.700	28	6.5	5.6
1912	10	13	2	22	56.0	41.500	44.000	30	6.0	5.0
1913	4	20	3	13	34.0	41.500	44.600	36	6.0	5.6
1915	1	14	5	9	43.0	42.800	44.700	19	7.0	5.4
1915	1	21	22	20	00.0	42.800	44.700	30	6.0	5.2
1920	2	20	11	44	25.0	42.000	44.100	11	8.5	6.2
1921	6	29	11	37	55.0	43.900	42.800	22	7.0	5.6
1923	5	12	22	57	23.0	41.400	44.300	20	6.0	5.2
1929	2	10	17	20	07.0	43.100	43.900	17	7.0	5.3

Epicenters of earthquakes during the instrumental period are given in the Figure below:

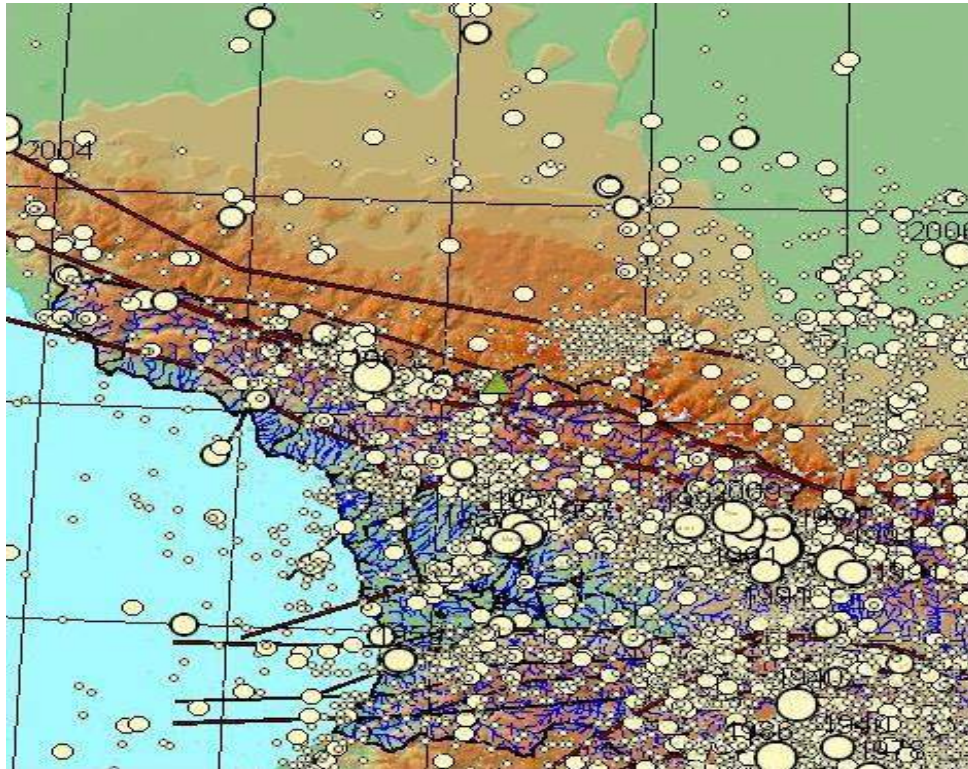
**Figure 5.2.3.13.2.2.** Epicenters of earthquakes during the instrumental period

The swarm of earthquakes occurred southern to the dam territory in 1957. The epicenters of these events are at the distance of about 75 km from the site. The swarm was connected with Poti-Abedati active fault.

The strong earthquake occurred in 1963 North West to the dam at the distance of 50 km. The magnitude of earthquake was  $M_s=6.4$  and intensity in epicentre  $I_0=9$  on MSK scale. The earthquake has damaged building in the villages and triggered huge landslides and rock falls. This event has affected the site with intensity 7 on MSK scale.

**Table 5.2.3.13.2.2.** Parameters of instrumental earthquakes with magnitude  $M \geq 5$ 

Year	Month	Day	Hour	Minute	Second	Lat	Long	Depth	Intensity (MSK scale)	Magnitude
1940	5	7	22	23	38.0	41.700	43.800	16	8.0	6.0
1940	7	10	13	10	48.0	41.500	44.000	18	6.5	5.1
1957	1	26	16	30	46.7	42.520	42.400	12	7.0	5.3
1957	1	29	15	17	28.4	42.470	42.450	16	7.0	5.1
1957	1	29	15	21	25.0	42.430	42.350	12	8.0	5.3
1959	5	20	19	49	13.0	41.870	41.850	9	7.5	5.1
1963	7	16	18	27	14.0	43.180	41.650	10	9.0	6.4
1978	1	2	6	31	26.9	41.375	44.162	19	8.0	5.3
1986	5	13	8	44	01.3	41.450	43.700	10	8.0	5.6
1991	4	29	9	12	45.3	42.429	43.698	12		6.9
1991	4	29	9	16	02.9	42.521	43.679	5		5.5
1991	4	29	18	30	39.0	42.469	43.520	6		6.0
1991	4	29	20	32	55.8	42.320	43.633	6		5.3
1991	5	3	20	19	37.4	42.526	43.253	10		5.3

1991	6	15	0	5	91.8	42.356	43.979	15	8.0	6.1
1991	7	4	6	26	29.6	42.319	44.060	10		5.3
2004	11	15	10	23	04.9	44.278	39.718	11		5.0
2006	2	6	4	8	01.3	42.525	43.545	6		5.2
2006	9	26	12	8	22.7	43.800	44.577	15		5.0
2009	9	7	22	41	36.1	42.563	43.468	11	7.5	6.0

The main event in the region was the Racha earthquake of 1991. The Racha earthquake that occurred on April 29, 1991, at 09:12:48.1 GMT in the southern border of Greater Caucasus is the biggest event ever recorded in the region. The earthquake killed more than 200 people, left approximately 60 000 homeless and caused damage over thousands of square kilometers. A maximum intensity of 9 on the MSK scale was observed. The epicenter was situated in a distance of about 150 km from the dam site.

The main shock was followed by aftershocks that extended over several months. Among them there were three strong aftershocks with magnitude greater than  $M_s \geq 5.5$ : April 29, at 18:30,  $M_s=6.1$ , May 3 at 20:19  $M_s=5.5$  and June 15 at 00:59,  $M_s=6.2$ . These events caused farther damage and casualties. The loss was 10 billion Soviet Rubles. This area was seismically very active during last 2 decades. On September 7, 2009 strong earthquake  $M=6.0$  occurred in the same region. The earthquake was followed by hundreds of aftershocks.

This earthquake was connected with Gagra-Java active fault. The fault is still very active. GPS measurements show that earth crust movement is quite intensive here. The intermountain region is moving towards the Greater Caucasus with average velocity 4-5 mm per year (McClutsky et al 2000). GPS measurements are in good accordance with geological and seismological investigations (Triep et al 1995, Jibson et al. 1994).

**Figure 5.2.3.13.2.3.** Epicenters of earthquakes during the instrumental period (1930-2010)

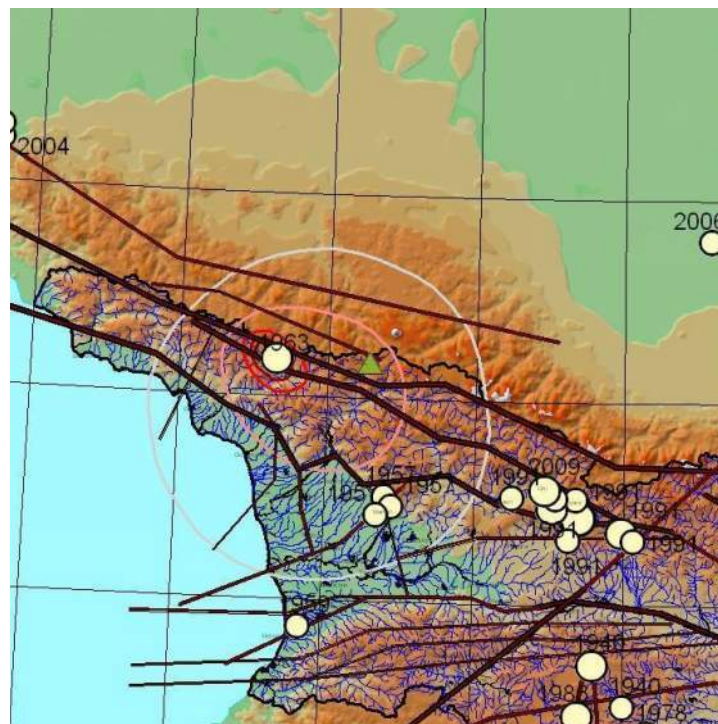

### 5.2.3.13.3 Seismic Hazard Analysis

#### 5.2.3.13.3.1 Review of published material

Seismic hazard analysis of the region has been studied in numerous scientific articles and reports. These studies were mainly connected with seismic hazard assessment of Georgia and compilation of seismic zoning maps. In our report we will analyze studies since 90-ies, as earlier works have serious drawbacks.

**Figure 5.2.3.13.3.1.1.** Seismic zoning map of Georgia

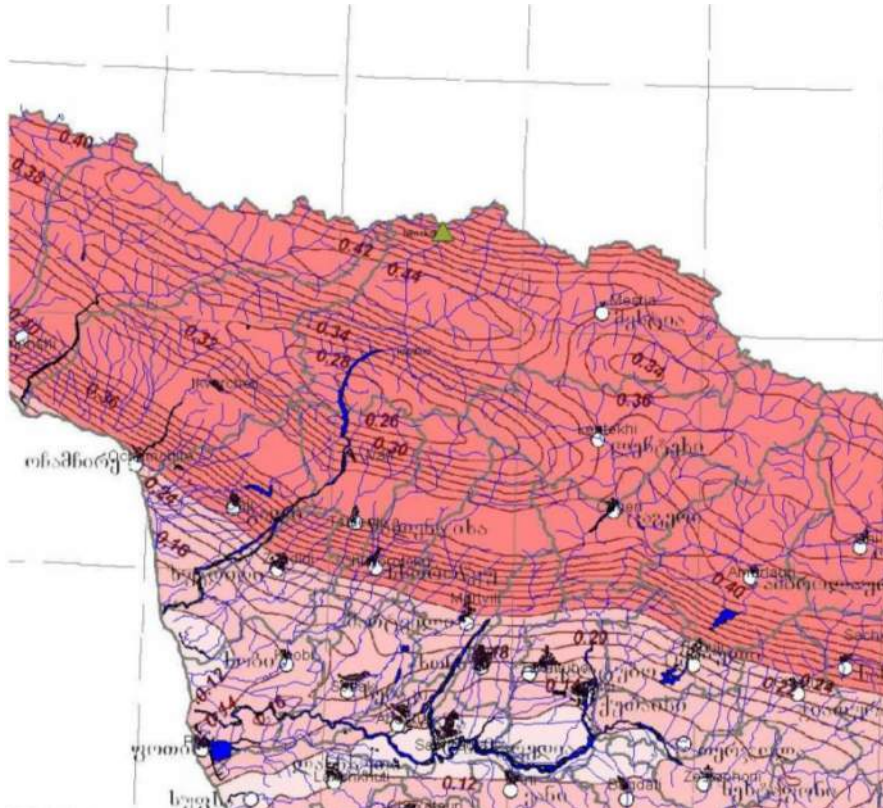

According to the acting seismic zoning map of Georgia the site is situated in the area of intensity 9 on MSK scale and pga 0.34g. The hazard map for seismic zoning was compiled in 1999, but adopted in 2010. Using Cornell approach, namely computer program SEISRISK III after Bender and Perkins 1987. Earthquake effect was estimated using different parameters: intensity (MSK scale) and peak ground acceleration (PGA). Intensity (MSK scale) was traditionally used for seismic zoning in former USSR. The attenuation model given in (Javakhishvili et al., 1998) was used. For PGA motion instrumental data in Caucasus and adjacent regions was used (Smit et al. 2000).

#### 5.2.3.13.3.2 Probabilistic Seismic Hazard analysis of Nenskra HPP Site

The probabilistic seismic hazard analyses have been carried out for the territory of Nenskra HPP. Probabilistic seismic hazard analysis (PSHA) is a standard procedure for seismic hazard assessment (Cornell, 1968; Kramer 1996, McGuire, 2004). This commonly adopted methodology incorporates the influence of all potential sources of earthquakes and their corresponding activity rates. The concept of a potential source of earthquakes plays a very important role in this methodology. A potential source of earthquakes, which can be in the form of a point, a fault, or area, is allocation where future earthquakes may occur. To describe a potential source of earthquakes, one must decide its form, size, boundary, and



the activity rates of earthquakes having various magnitudes. Hence, the Cornell-McGuire methodology is fundamentally a source-based approach and consists of four steps:

**Figure 5.2.3.13.3.2.1.** Map of seismic source zones

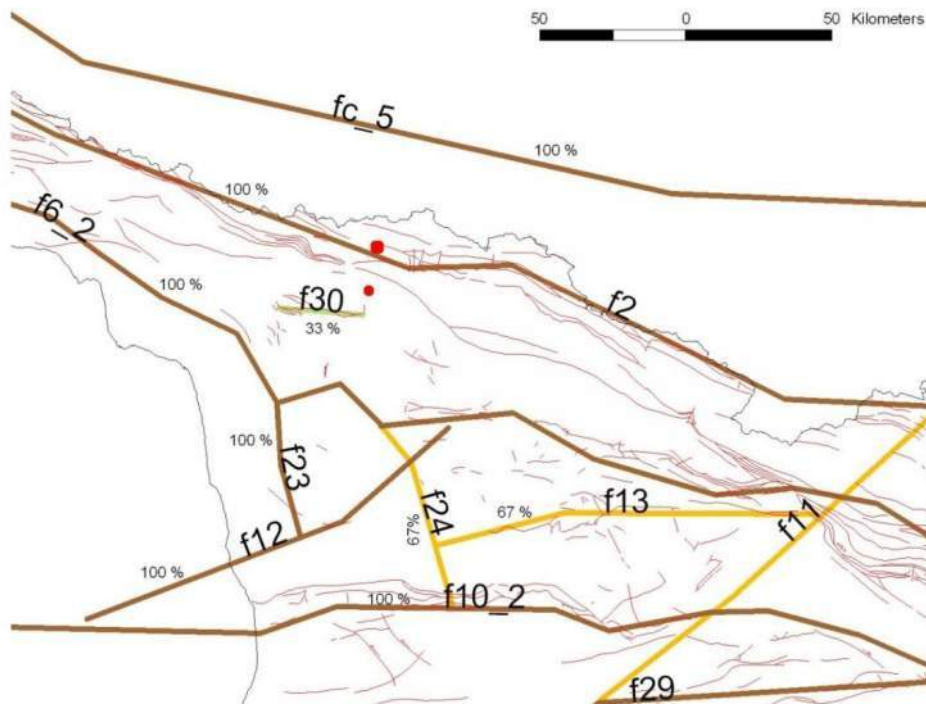

- a. **definition of earthquake source zones.** As it was described above, the area is one of the most tectonically active regions of Caucasus as evidenced by the number of moderate and strong earthquakes. Different ideas exist about the seismogenesis in the Caucasus. To take into proper account for those different hypotheses, it was decided to consider alternative seismotectonic schemes and compiled seismic source model. Two main alternative tectonic schemes were used for compilation of seismic source model. These tectonic models were described in Gamkrelidze et al. 1998, Adamia et al 2006. Additionally the detailed geological reports were considered for improvement of the tectonic scheme.

**Table 5.2.3.13.3.2.1.**

SSZ Name	length of the fault km	slip rate of fault (Average quaternary rates of displacement)	distance to fault (from dam site)	Last Event (with M>4.5)	kinematics (slip style of fault)
Main thrust of The Greater Caucasus (MGC)	1000	0.4	3 km	2004	Thrust, right lateral slip
Gagra – Java (GJ)	1200	0.5-0.8	45 km	2006	Thrust, right lateral slip
Photi-Abedati (PA)	90	0.4	65 km	1957	Thrust, left-lateral slip

Northern marginal of Adjara-Trialeti (NAT)	500	0.1	15 km	1988	Thrust
Tskhakaia - Tsaishi	50	0.4		1614?	right-lateral,reverse
Adjaris - Tskali - Tedzami	137 85 115	0.4	4 km	-	Thrust
North_caucasus (Pshekish-Tirniauz)	240	-	42 km		Reverse fault with right-lateral component
Khudoni local fault	35	-	15	-	
Borjomi-Kazbegi (BK)	1350	1.3	74 km	1999	Thrust, left-lateral slip
Vartsikhe - Gegechkori	75	0.4		-	right-lateral,reverse
Kutaisi-Sachkhere (KS)	130	0.5	97 km	1908?	Thrust

In the standard PSHA, seismic sources are modeled as lines representing the surficial projection of faults or as wide areas, where the earthquakes can occur randomly. As it was noted two basic seismogenic zonation have been considered for the present study: they represent different levels of seismotectonic knowledge. The first seismogenic zonation (Gamkrelidze et al. 1998) was compiled in 1998 and this scheme was used for probabilistic hazard assessment of Georgia (seismic zonation map of Georgia in the seismic code of 2010). The second seismogenic zonation (Adamia et al. 2006) represents more recent model on seismogenic sources available for the Caucasus and derives from seismotectonic studies performed in Georgia in the framework of an international project called CauSIN (<http://CauSIN.org>). In this schema faults are segmented but single seismicity rates were estimated, including all the segments.

The final scheme of active faults in the investigated region is shown in Figures4-2 and the corresponding parameters are given in Table 4- and 4-2. The location and parameters of the faults are based on several published and unpublished materials (Gamkrelidze et al. 1998, Gamkrelidze 2003, Geguchadze et al. 1985, Adamia et al. 1992, Balassanyan et al. 1999, Rogojin 2000, Kharashvili et al. 1977, Varazanashvili 1998, Javakhishvili, Varazanashvili 1997 and Adamia et al. unpublished material, 2006).

- b. definition of seismicity recurrence characteristics of source zones.** Seismicity of the region, as well as the catalogues and data bases used in the study are described in the previous report. The seismicity within each source zone was analyzed using the catalogue of earthquakes of Caucasus. The catalogue was checked and revised. Some hypocentral parameters of earthquakes have been recalculated. Any complete earthquake catalogue is clearly non-Poisoning. The probabilistic analysis relies mainly on the assumption that seismicity follows a Poisson process; therefore it is essential to remove any non-Poisoning behavior from catalogues. The process of declustering is not an entirely straightforward procedure. There are different methods for declustering of catalogues. Special algorithm was used for definition of foreshocks, aftershocks and swarms (Javakhishvili et al 2004). Obtained frequency-magnitude distribution for each source zones was normalized in time and *a* and *b* values for Guttenberg-Richter relationship were estimated using least square approach.

**Table 5.2.3.13.3.2.2.** Parameters of seismic source zones

	NAME	FAULT_Number	a	b	M <sub>MAX</sub>
1	Main thrust of The Greater Caucasus	f2	1.73	0.56	7.0
2a	Gagra - Java	f6_1	1.59	0.53	7.0
2b	Gagra - Java	f6_2	1.46	0.65	6.1

3	Poti - Abedathi	f12	1.10	0.58	6.1
4	Northern marginal of Adjara - Trialeti zone	f10	2.61	0.92	7.0
5	Tskhakaia - Tsaishi	f23	0.57	0.64	5.5
6	Adjaris - Tskali - Tedzami	f29	2.16	0.78	6.4
7	North_caucasus	fc_5	3.14	1.18	6.1
8	Khudoni local fault	f30	0.26	0.38	5.2
9	Tskhinvali - Kazbegi	f11	2.36	0.89	7.0
10	Vartsikhe - Gegechkori	f24	0.38	0.50	5.2
11	Kutaisi - Sachkhere	f13	0.66	0.53	5.2

c. **Ground Motion Attenuation.** Attenuation laws are functions valid for particular regional conditions, describing the expected ground motion at a site due to an event of a specified magnitude at a specified distance. Attenuation laws are derived using real measured data, typically from a large database of events. By relating the measured ground motion at a site with the distance and magnitude of the event, a best fit (the corresponding attenuation law) for the selected database can be found. The attenuation relationships were used in logic tree with equal probability 0.5.

d. **Seismic hazard calculation.**

Cornell methodology, namely computer program SEISRISK III after Bender and Perkins 1987, was used for calculations. Hazard values were calculated for 2 sites: dam site (Dam Location 42.21E 43.12N) and HPP site (HPP Location 42.18E 43.00N). Dam site is shown by red square and HPP site by red circle.

Calculations were carried out for the wider region in order to take into account border zones, whose seismicity can affect seismic hazard in the territory under study. According to the computer program three different models can be used for seismic source zones: point, linear and areal source models. We have used only linear models, as we assume, this model is more reasonable from the point of view of earthquake source mechanics. For each zone seismic rate of earthquakes above the threshold magnitude was estimated, the above noted b values and Mmax was used for calculating of seismic rate of each magnitude range (from Mthreshold to Mmax by step 0.5 unit).

According to the ICOLD recommendations 200 years exposure period was chosen for the dam and the following different levels of hazard were calculated for the sites:

- 1) OBE1 (Operating Basic Earthquake): return period of 475 years.
- 2) OBE2: return period of 145 years.
- 3) SEE (Safety Evaluation Earthquake): return period of 3000 years.
- 4) MCE (Maximum Credible Earthquake): with a return period of 10000 years.

The final results of the calculation are given below:

Seismic hazard for dam site:

- 1) OBE1 (Operating Basic Earthquake):– 0.3 g
- 2) OBE2:– **0.18 g**
- 3) SEE (Safety Evaluation Earthquake):– **0.54 g**
- 4) MCE (Maximum Credible Earthquake):– **0.66 g**

Figure 5.2.3.13.3.2.2. Hazard curve for dam site

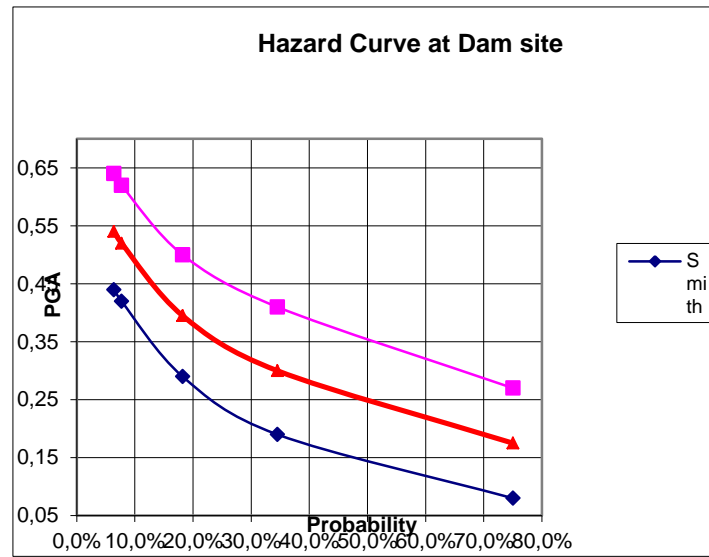

Seismic hazard for HPP site:

- 1) OBE1 (Operating Basic Earthquake): – **0.18 g**
- 2) OBE2:- **0.11 g**
- 3) SEE (Safety Evaluation Earthquake)– **0.35 g**
- 4) MCE (Maximum Credible Earthquake):- **0.54 g**

Figure 5.2.3.13.3.2.3. Hazard curve for HPP site

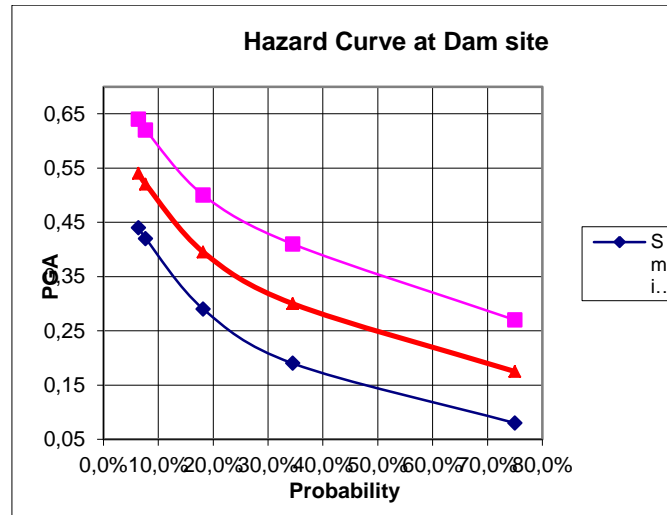

As it was noted in the previous report, seismic hazard levels of the sites are quite high, especially for the dam site. This is mainly connected with the fault f2 in our scheme – the Main thrust of The Greater Caucasus. The fault has high seismic potential and situated very close, or maybe under the site for dam construction.

**5.2.3.13.3 Deterministic Hazard Analysis**

On the bases of the above noted seismic source zones we have calculated deterministic hazard on the site. The deterministic seismic hazard analysis involves the development of a particular seismic scenario upon which a ground motion hazard evaluation is based (Kramer 1997, Reiter 1990). The scenario consists of the postulated occurrence of an earthquake of a specified location. In deterministic analysis of the seismic hazard, regardless of other complicated, side parameters in seismology, it is only the main reason of the earthquake, i.e. the main seismic sources (faults) and their most intensive seismic state, which taken into consideration. In other words, in this method, the considered view is that if seismic design is carried out for the worst state, considered safety for the investigated site against earthquake will be obtained conservatively. The most important disadvantages of this method against the probabilistic method may be the lack of possibility of entering the structure life time and the conservative responses that might be taken from this parameter.

The logic tree approach was used and attenuation model Smith et al. 2000 and Ambraseys et al. 2005 were used for calculations. The 84 percentile of PGA was used. These data models gets result value for pga = 0.68 g for the studied site.

**5.2.3.13.4 Deaggregation of Seismic Hazard at Nenskra Dam Location**

From the figures and tables it is seen, that the seismic hazard is mainly connected with Main thrust of The Greater Caucasus fault – distance 10km from the site. The magnitude of mostly hazardous events change smoothly from 7.0 (for 10000 years return period,) to 4.5 (for 145years return period,). Contribution of other faults in total hazard level for the same range of return periods is less, but should be considered as well. The closest beans from these Main thrust of The Greater Caucasus system produce about 90% of hazard for long (MCE, SEE) return periods and corresponding PGA level. Different situation is observed for the OBE1, OBE2 probability hazard level. This PGA level can be produced by moderate earthquake in the vicinity of site, moderate and strong earthquakes on the distances 10-20kms or strong earthquakes on the distance of 20-50kms (Gagra-Java fault).

Results of deaggregation are given in Figures and Tables below.

**Deaggregation of Seismic Hazard within the Proposed Dam Area**

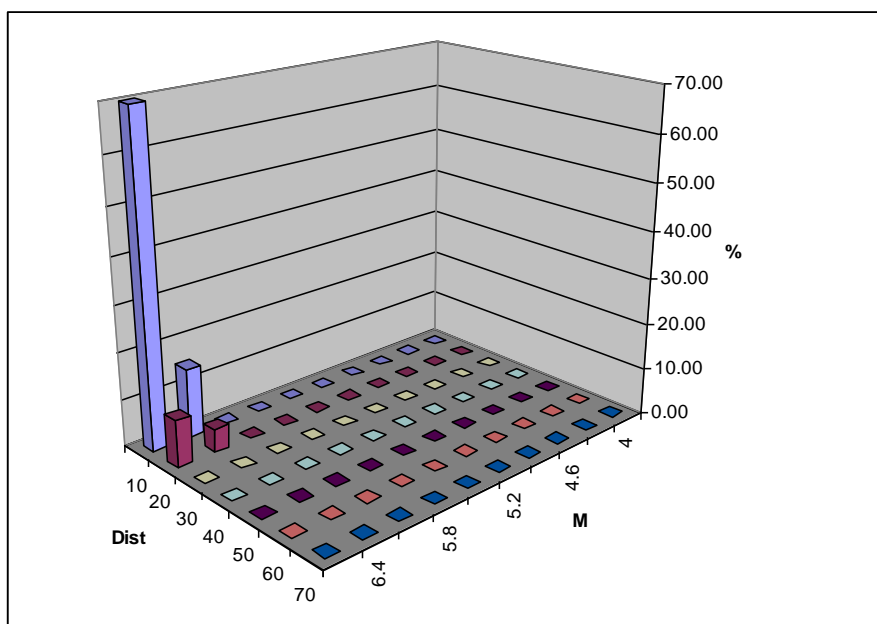

M/D	0-10	10-20	20-30	30-40	40-50	50-60	60-70
3.7	0.00	0.00	0.00	0.00	0.00	0.00	0.00
4.0	0.00	0.00	0.00	0.00	0.00	0.00	0.00
4.3	0.00	0.00	0.00	0.00	0.00	0.00	0.00
4.6	0.00	0.00	0.00	0.00	0.00	0.00	0.00
4.9	0.00	0.00	0.00	0.00	0.00	0.00	0.00
5.2	0.00	0.00	0.00	0.00	0.00	0.00	0.00
5.5	0.00	0.00	0.00	0.00	0.00	0.00	0.00
5.8	0.00	0.00	0.00	0.00	0.00	0.00	0.00
6.1	0.00	0.00	0.00	0.00	0.00	0.00	0.00
6.4	0.00	0.00	0.00	0.00	0.00	0.00	0.00
6.7	<b>14.93</b>	<b>5.01</b>	0.00	0.00	0.00	0.00	0.00
7.0	<b>71.01</b>	<b>9.13</b>	0.00	0.00	0.00	0.00	0.00

Figure 5.2.3.13.4.1. Deaggregation of seismic hazard for MCE (Maximum Credible Earthquake): with a return period of 10000 years

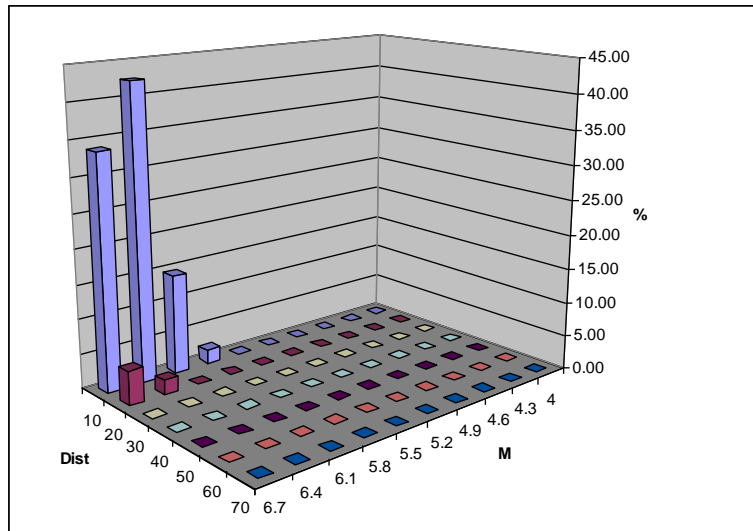

M/D	0-10	10-20	20-30	30-40	40-50	50-60	60-70
3.7	0.00	0.00	0.00	0.00	0.00	0.00	0.00
4.0	0.00	0.00	0.00	0.00	0.00	0.00	0.00
4.3	0.00	0.00	0.00	0.00	0.00	0.00	0.00
4.6	0.00	0.00	0.00	0.00	0.00	0.00	0.00
4.9	0.00	0.00	0.00	0.00	0.00	0.00	0.00
5.2	0.00	0.00	0.00	0.00	0.00	0.00	0.00
5.5	0.00	0.00	0.00	0.00	0.00	0.00	0.00
5.8	0.00	0.00	0.00	0.00	0.00	0.00	0.00
6.1	<b>2.10</b>	0.00	0.00	0.00	0.00	0.00	0.00
6.4	<b>14.54</b>	0.00	0.00	0.00	0.00	0.00	0.00
6.7	<b>42.52</b>	<b>2.08</b>	0.00	0.00	0.00	0.00	0.00
7.0	<b>33.83</b>	<b>4.93</b>	0.00	0.00	0.00	0.00	0.00

Figure 5.2.3.13.4.2. Deaggregation of seismic hazard for SEE (Safety Evaluation Earthquake): return period of 3000 years

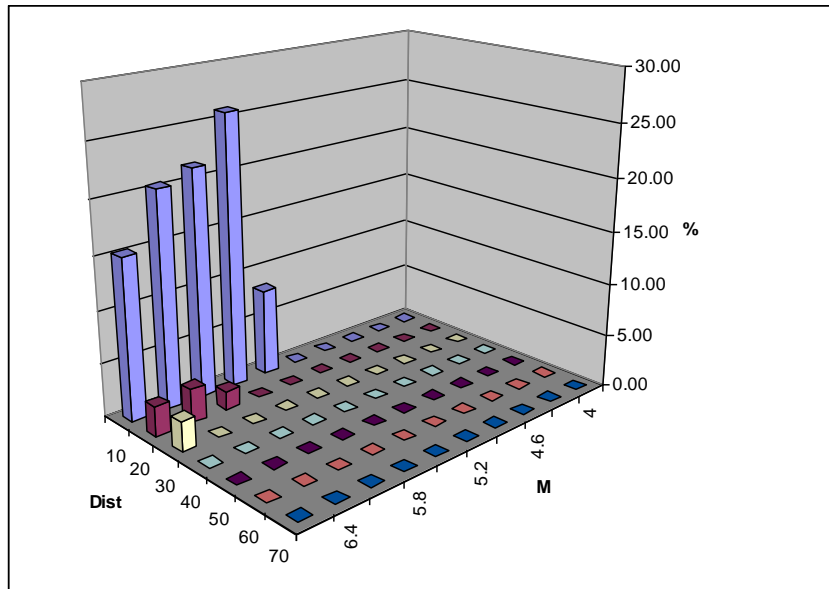

M/D	0_10	10_20	20_30	30_40	40-50	50_60	60_70
3.7	0.00	0.00	0.00	0.00	0.00	0.00	0.00
4.0	0.00	0.00	0.00	0.00	0.00	0.00	0.00
4.3	0.00	0.00	0.00	0.00	0.00	0.00	0.00
4.6	0.00	0.00	0.00	0.00	0.00	0.00	0.00
4.9	0.00	0.00	0.00	0.00	0.00	0.00	0.00
5.2	0.00	0.00	0.00	0.00	0.00	0.00	0.00
5.5	0.00	0.00	0.00	0.00	0.00	0.00	0.00
5.8	8.32	0.00	0.00	0.00	0.00	0.00	0.00
6.1	25.94	0.00	0.00	0.00	0.00	0.00	0.00
6.4	21.62	1.76	0.00	0.00	0.00	0.00	0.00
6.7	20.56	3.22	0.00	0.00	0.00	0.00	0.00
7.0	15.34	2.80	2.80	0.00	0.00	0.00	0.00

Figure 5.2.3.13.4.3. Deaggregation of seismic hazard OBE1 (Operating Basic Earthquake): return period of 475 years

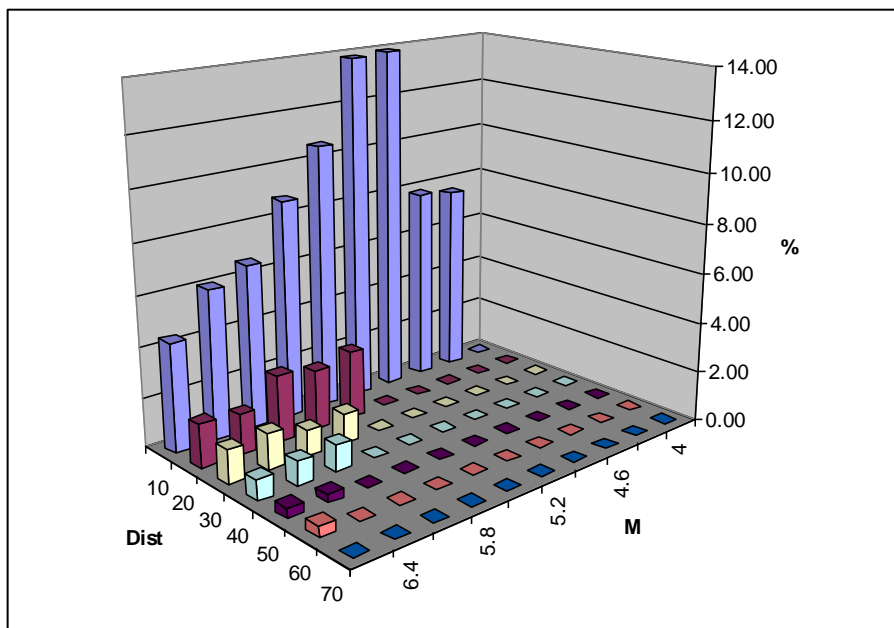

M/D	0_10	10_20	20_30	30_40	40-50	50_60	60_70
3.7	0.00	0.00	0.00	0.00	0.00	0.00	0.00
4.0	0.00	0.00	0.00	0.00	0.00	0.00	0.00
4.3	0.00	0.00	0.00	0.00	0.00	0.00	0.00
4.6	<b>7.64</b>	0.00	0.00	0.00	0.00	0.00	0.00
4.9	<b>7.83</b>	0.00	0.00	0.00	0.00	0.00	0.00
5.2	<b>13.93</b>	0.00	0.00	0.00	0.00	0.00	0.00
5.5	<b>13.86</b>	0.00	0.00	0.00	0.00	0.00	0.00
5.8	<b>10.67</b>	<b>2.72</b>	0.00	0.00	0.00	0.00	0.00
6.1	<b>8.80</b>	<b>2.39</b>	<b>1.20</b>	0.00	0.00	0.00	0.00
6.4	<b>6.61</b>	<b>2.68</b>	<b>1.05</b>	<b>1.05</b>	0.00	0.00	0.00
6.7	<b>6.03</b>	<b>1.60</b>	<b>1.44</b>	<b>0.96</b>	<b>0.32</b>	0.00	0.00
7.0	<b>4.37</b>	<b>1.75</b>	<b>1.34</b>	<b>0.83</b>	<b>0.42</b>	<b>0.42</b>	0.00

Figure 5.2.3.13.4.4. Deaggregation of seismic hazard OBE2: return period of 145 years

Deaggregation of Seismic Hazard at Nenskra HPP Power House Location

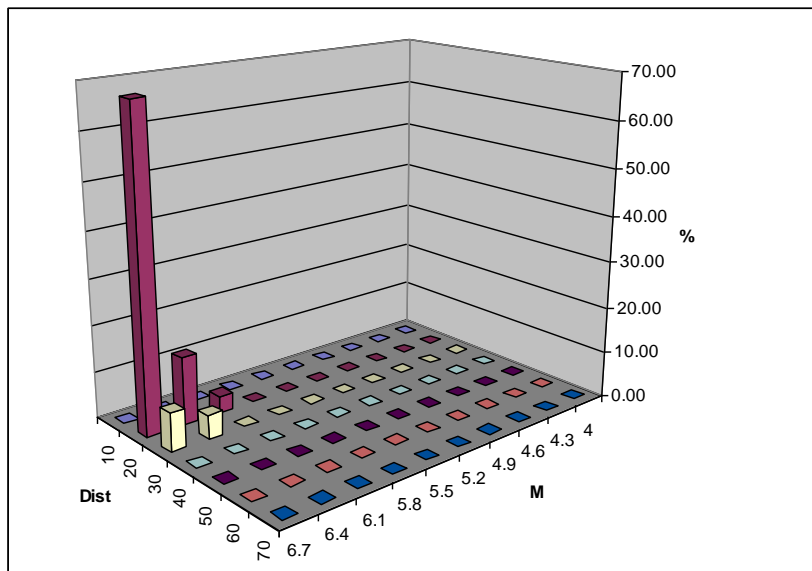

M/D	0_10	10_20	20_30	30_40	40-50	50_60	60_70
3.7	0.00	0.00	0.00	0.00	0.00	0.00	0.00
4.0	0.00	0.00	0.00	0.00	0.00	0.00	0.00
4.3	0.00	0.00	0.00	0.00	0.00	0.00	0.00
4.6	0.00	0.00	0.00	0.00	0.00	0.00	0.00
4.9	0.00	0.00	0.00	0.00	0.00	0.00	0.00
5.2	0.00	0.00	0.00	0.00	0.00	0.00	0.00
5.5	0.00	0.00	0.00	0.00	0.00	0.00	0.00
5.8	0.00	0.00	0.00	0.00	0.00	0.00	0.00
6.1	0.00	0.00	0.00	0.00	0.00	0.00	0.00
6.4	0.00	<b>3.68</b>	0.00	0.00	0.00	0.00	0.00
6.7	0.00	<b>14.73</b>	<b>5.13</b>	0.00	0.00	0.00	0.00
7.0	0.00	<b>68.21</b>	<b>8.25</b>	0.00	0.00	0.00	0.00

Figure 5.2.3.13.4.5. Deaggregation of seismic hazard for MCE (Maximum Credible Earthquake): with a return period of 10000 years



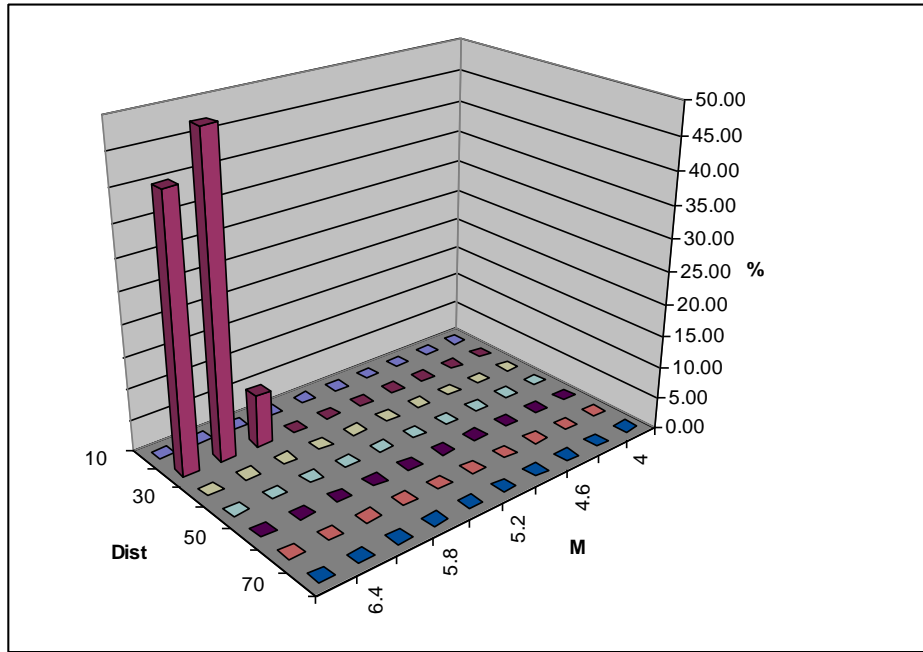

M/D	0-10	10-20	20-30	30-40	40-50	50-0	60-70
3.7	0.00	0.00	0.00	0.00	0.00	0.00	0.00
4.0	0.00	0.00	0.00	0.00	0.00	0.00	0.00
4.3	0.00	0.00	0.00	0.00	0.00	0.00	0.00
4.6	0.00	0.00	0.00	0.00	0.00	0.00	0.00
4.9	0.00	0.00	0.00	0.00	0.00	0.00	0.00
5.2	0.00	0.00	0.00	0.00	0.00	0.00	0.00
5.5	0.00	0.00	0.00	0.00	0.00	0.00	0.00
5.8	0.00	0.00	0.00	0.00	0.00	0.00	0.00
6.1	0.00	0.00	0.00	0.00	0.00	0.00	0.00
6.4	0.00	8.28	0.00	0.00	0.00	0.00	0.00
6.7	0.00	49.34	0.00	0.00	0.00	0.00	0.00
7.0	0.00	42.37	0.00	0.00	0.00	0.00	0.00

Figure 5.2.3.13.4.6. Deaggregation of seismic hazard for SEE (Safety Evaluation Earthquake): return period of 3000 years

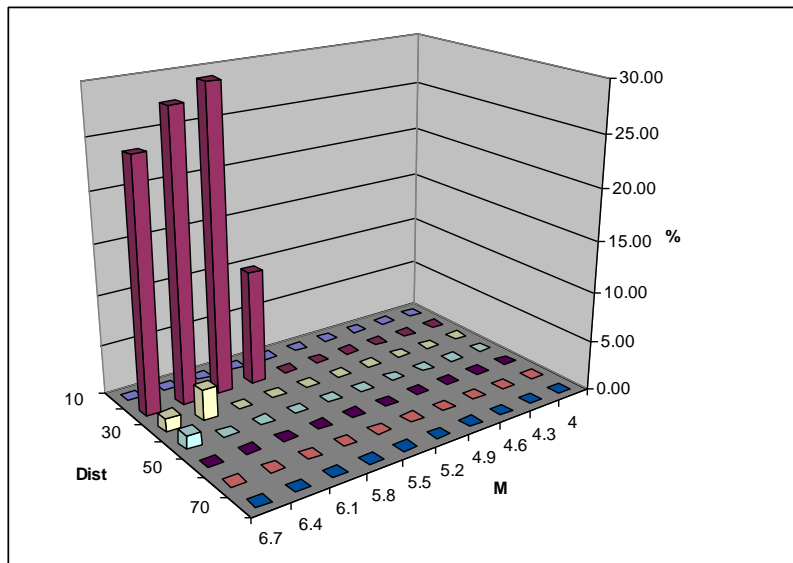

M/D	0-10	10-20	20-30	30-40	40-50	50-60	60-70
3.7	0.00	0.00	0.00	0.00	0.00	0.00	0.00
4.0	0.00	0.00	0.00	0.00	0.00	0.00	0.00
4.3	0.00	0.00	0.00	0.00	0.00	0.00	0.00
4.6	0.00	0.00	0.00	0.00	0.00	0.00	0.00
4.9	0.00	0.00	0.00	0.00	0.00	0.00	0.00
5.2	0.00	0.00	0.00	0.00	0.00	0.00	0.00
5.5	0.00	0.00	0.00	0.00	0.00	0.00	0.00
5.8	0.00	0.00	0.00	0.00	0.00	0.00	0.00
6.1	0.00	11.33	0.00	0.00	0.00	0.00	0.00
6.4	0.00	29.97	0.00	0.00	0.00	0.00	0.00
6.7	0.00	28.38	3.02	0.00	0.00	0.00	0.00
7.0	0.00	24.67	1.31	1.31	0.00	0.00	0.00

Figure 5.2.3.13.4.7. Deaggregation of seismic hazard OBE1 (Operating Basic Earthquake): return period of 475 years

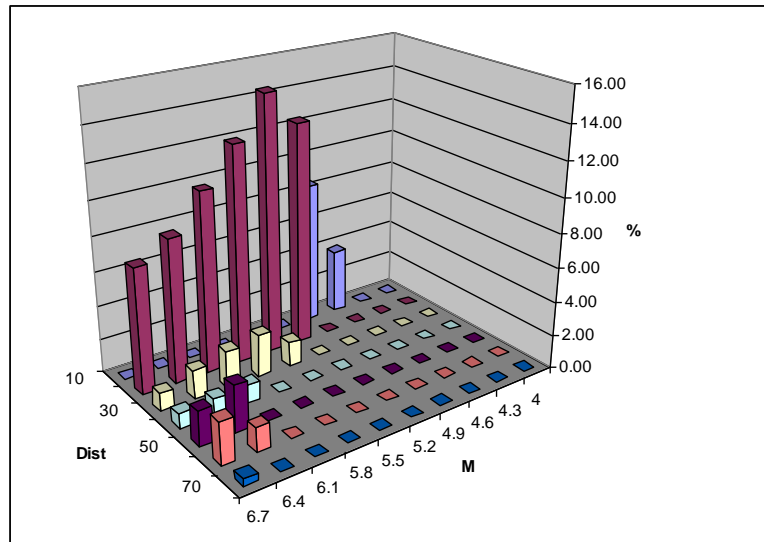

M/D	0-10	10-20	20-30	30-40	40-50	50-60	60-70
3.7	0.00	0.00	0.00	0.00	0.00	0.00	0.00
4.0	0.00	0.00	0.00	0.00	0.00	0.00	0.00
4.3	0.00	0.00	0.00	0.00	0.00	0.00	0.00
4.6	0.00	0.00	0.00	0.00	0.00	0.00	0.00
4.9	<b>3.80</b>	0.00	0.00	0.00	0.00	0.00	0.00
5.2	<b>8.37</b>	0.00	0.00	0.00	0.00	0.00	0.00
5.5	0.00	<b>13.03</b>	0.00	0.00	0.00	0.00	0.00
5.8	0.00	<b>15.02</b>	<b>1.39</b>	0.00	0.00	0.00	0.00
6.1	0.00	<b>12.62</b>	<b>2.46</b>	0.00	0.00	0.00	0.00
6.4	0.00	<b>10.53</b>	<b>2.15</b>	<b>1.08</b>	0.00	0.00	0.00
6.7	0.00	<b>8.41</b>	<b>1.69</b>	<b>0.98</b>	<b>2.72</b>	<b>1.36</b>	0.00
7.0	0.00	<b>7.31</b>	<b>1.04</b>	<b>0.85</b>	<b>2.01</b>	<b>2.44</b>	<b>0.43</b>

Figure 5.2.3.13.4.8. Deaggregation of seismic hazard OBE2 (Operating Basic Earthquake): return period of 145 years

### 5.2.3.13.5 Conclusions

The Nenskra HPP site is situated in seismically active region. Several active faults with seismic potential  $M=7$  are situated in close vicinity of site. Strong earthquakes  $M>6.0$  were connected with these faults.

We recommend carrying out the detailed investigations of the active fault (segment of the Main thrust of The Greater Caucasus) near the dam site.

Seismic hazard of the studied area was assessed using probabilistic approaches. Different hazard levels according to ICOLD recommendations were calculated.

The results are given for dam site and HPP site:

The final results of the calculation are given below:

Seismic hazard for dam site:

- 1) OBE1 (Operating Basic Earthquake):– **0.3 g**
- 2) OBE2– **0.18 g**
- 3) SEE (Safety Evaluation Earthquake):– **0.54 g**
- 4) MCE (Maximum Credible Earthquake):– **0.66 g**

Seismic hazard for HPP site:

- 1) OBE1 (Operating Basic Earthquake): – **0.18 g**
- 2) OBE2:– **0.11 g**
- 3) SEE (Safety Evaluation Earthquake– **0.35 g**
- 4) MCE (Maximum Credible Earthquake):– **0.54 g**

### 5.2.4 Soils

Following types of soils are represented within Mestia Municipality area (see Figure 5.2.4.1.):

- Raw soil fragments of the Great Caucasus mountain range (glaciers);
- Mountain brown forest soils in the most parts of the upper and central valley;
- Calcareous black soils in some places, which is associated with calcareous geological background;
- Alluvial soils along the river bed, large deposits in the coastal plain;
- Red soils and nettle soils in the Colchis lowlands.

As for the Nenskra HPP infrastructure location area, following soil types are present:

- Along the river beds - alluvial soils;
- On slopes adjacent to the river banks - brown forest acid soils
- On mountain slopes of the valley - brown forest podsol soils;
- In the alpine zones - mountain meadow soils;
- In high mountains – glaciers.

During the audit, it has been revealed that the areas within the influence zone are most represented by the mountain and forest black soils. Soils are heavily eroded almost throughout the entire study area. They are developed on sedimentary and weathered rocks. Alluvial deposits are found along the rivers.

It should be noted that the slopes within the most parts of the project area are very steep and mostly, they are vertical rocky slopes where topsoil is scarce and of low value. Fertile soil layer is more or less well represented at Nenskra dam area, in the floodplain of the right bank of the river (approximately 4.5-5.0 ha), within the area selected for the arrangement of the construction camp for Nenskra dam

(approximately 2.0-2.5 ha), powerhouse area (approximately 3.0 ha), on TBM platforms arranged for Nenskra and Nakra tunnels (approximately 2.7 and 2.3. ha). As it has been revealed during the audit, an average of 8-10 cm fertile soil layer is represented within these areas.

Figure 3.2.4.1. Soil scheme of West Georgia

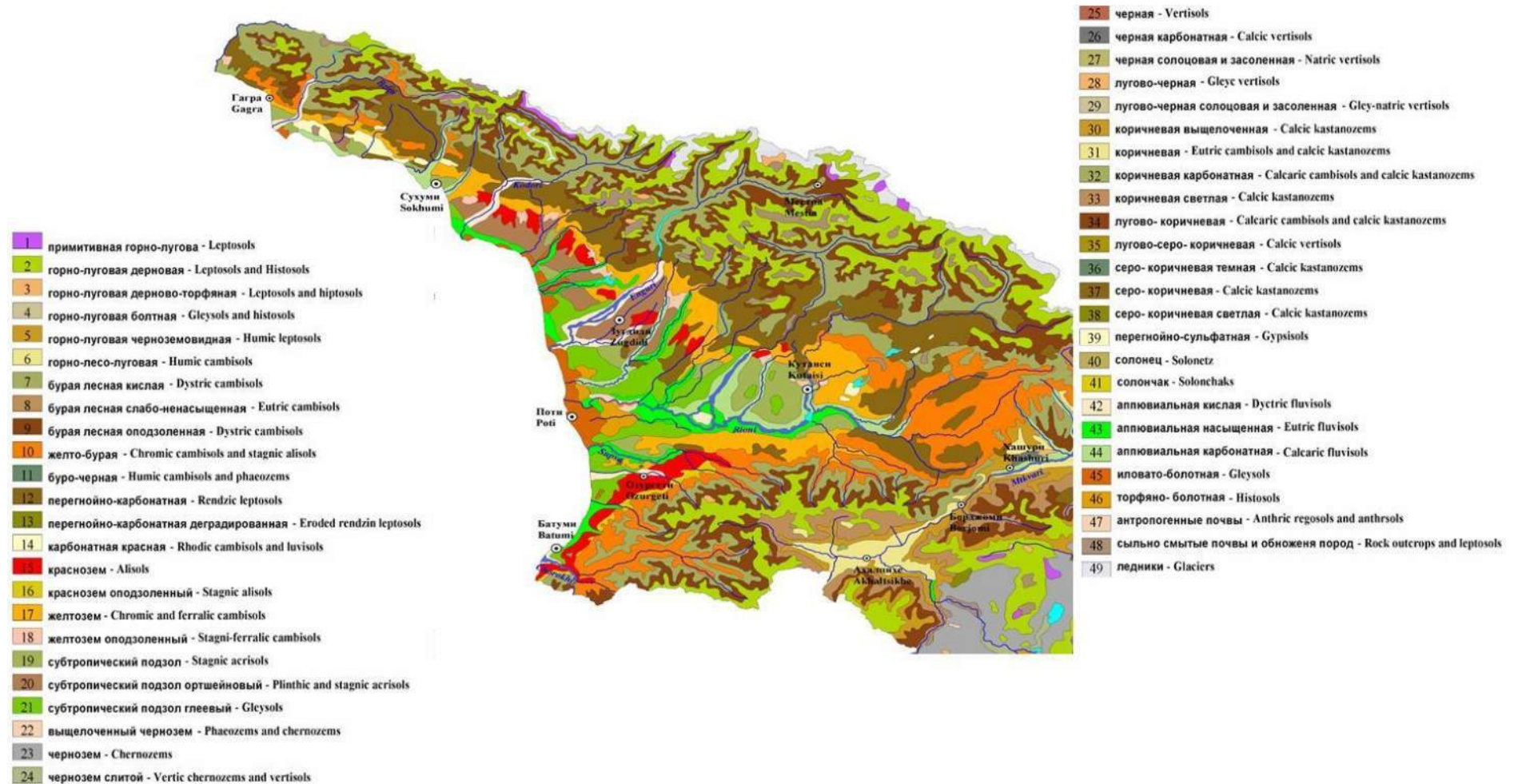

## 5.2.5 Hydrology

### 5.2.5.1 A Brief Hydrographic Description of the Rivers Nenskra and Nakra

River Nenskra starts from the south slope of the Caucasus, to the 1,5 km from north-west of Donghuz-Orunbashi pass, on 3200 m elevation and joins river Enguri from the right side at the village Shdigiri. The river length from the river-head until the confluence is 22 km, gross fall 2314 m, an average inclination of 105‰, catchment area 169 km<sup>2</sup>.

The river basin is located on south slopes of Caucasus ridge from 1300 to 3900 m and has an asymmetrical form. There are 32 glaciers on the territory of river basin.

Granite, gneiss and crystalline shale participate in the geological structure of the upper and middle part of the basin, in the lower part we meet black shale and sandstone. Main rocks are covered with clay soil the thickness of which is reducing on the steep slopes of ridges. The vegetation of upper part of basin is presented with alpine meadows, which are changed with mixed forests in the beginning, then with deciduous forests. 50% of basin before the designed dam section is covered with forest.

The river ravine is mainly pan type and it takes V shape on certain areas. Ravine bottom width along the whole length varies from 50 to 200 m. ravine slopes are steep (30-500) and are combined with adjacent ridges along the whole length. Bilateral terraces pass along the entire length of the ravine. Their width is 20m, length not more than 300-400 m. The river does not have the grove.

The river flows in deep, moderately tortuous and in mainly not branched canal, which is blocked up with rock fragments and large boulders. Rock fragments and large boulders create rapids sections the height of which reaches 2 m.

River soil width changes from 4 to 17 m, depth from 0,4 to 2,5 m and speed from 3 to 5 m/s.

The river is nourished by glaciers, snow, rain and ground waters. Its water regime is characterized with flood in the warm period of the year and with shallowness in cold period. Flood usually begins in late March or early April and reaches a maximum in June or July. Flooding continues to decrease until the end of September. In some years the floods cause by rain coincides the floods, which cause water level rise to the maximum. In the spring-summer period (IV-VIII) 73% of annual runoff runs down the river, including 50% comes in June-August. 7% of annual runoff comes in the winter.

Ice events last for 15-30 days. During the shallowness the river water is clean, transparent and suitable for drinking.

Until the designed dam section the river length is 26,2 km, gross fall 1700 m, average inclination 65‰, catchment area 219 km<sup>2</sup>. Several tributaries with a total length of 23,4 km join the river before this section. 25 big and small glaciers with a total area of 30,1 km<sup>2</sup> exists in the river basin before this section.

Until the designed headworks section, the arrangement of which is considered on 1300 m elevation above sea level, the river length is 14,4 km, gross fall 1717 m, average inclination 119‰, catchment area 86,3 km<sup>2</sup>. Several main tributaries are connecting the river before the designed section with a total length of 15,4 km. tributaries canals are characterized by very high inclinations, there are several waterfalls on them, the height of which is 20-25 m. 11 glaciers with a total area of 17,4 km<sup>2</sup> exists in the basin before the designed section.

The river basin is located on the south slope of Caucasus ridge. Its watershed elevations vary from 3030 m to 3994 m. Granite, gneiss and crystalline shale participate in the geological structure of the basin, which are covered with clay soil. The vegetation of upper part of basin is presented with alpine meadows, which are changed with deciduous forests below. 25% of basin before the designed section is covered with forest.

River ravine from the headwater to the designed section is a trapezium form. Ravine bottom width is within 300-400 m. Ravine slopes are very steep and vertical in some places. Ravine slopes are fragmented by tributaries and deeply undercut gorges. Bilateral terraces pass along the river from 2600 m elevation until the designed section. The river groove is weakly expressed. River bed is moderately tortuous and mainly not branched. Soil width changes from 2-5 m to 10-15 m, depth from 0,2-0,4 to 0,7-0,8 m and speed from 4,0 m/s to 3,5 m/s.

The river is nourished by glaciers, snow, rain and ground waters. Its water regime is characterized with flood in the warm period of the year and with shallowness in cold period. In some years the floods cause by rain coincides the floods, which cause water level rise to the maximum. During the shallowness the river water is clean, transparent and suitable for drinking.

There are no water users on the river before designed section.

### 5.2.5.2 Average Annual Flows

The reporting values of average annual flows of the river Nenskra in the designed dam section are defined by analog method. 36 year (1931,1934-43,1956-80 years) observation data of hydro post Lakhmi is taken as analog.

In this period, the values of average annual flows of river Nenskra in the hydro post Lakhmi section varied from 18,9 m<sup>3</sup>/s (1943) to 57,7 m<sup>3</sup>/s (1941).

As a result of statistical processing of 36 year variation line of observation data with a great convincing method, when the parameters  $C_v$  and  $C_s$  are defined by special monogram, as statistical  $\lambda_2$  and  $\lambda_3$  function, the following parameters of distribution curve are obtained:

- Average multiannual flow  $Q_0=30,4$  m<sup>3</sup>/s;
- Variation coefficient  $C_v=0,19$ ;
- Asymmetry coefficient  $C_s=3C_v=0,57$ .

The parameters for assessment of variation line represent ability are determined:

- Ratio of average square error of average multiannual flow is  $\varepsilon_{Q_0}=3,2\%$  and ratio average square error of variation coefficient is  $\varepsilon_{C_v}=11,7\%$ .

Obtained parameters are satisfactory, because  $\varepsilon_{Q_0} < 5\%$  and  $\varepsilon_{C_v} < 15\%$ .

Average square deviation is also determined, which is equal to  $\delta=5,78$ .

By the obtained parameters of distribution curve and three-parameter distributor ordinates, the different provision values of average annual flows of the river Nenskra in hydro post Lakhmi section are defined.

Reporting values of average annual flows of the river Nakra in designed headworks section is determined by analog method. 42 year (1931,1938-40,1942,1948-49,1951,1953-86 years) observation data of hydro post Naki is taken as analog.

In this period, the values of average annual flows of river Nakra in the hydro post Naki section varied from 7,29 m<sup>3</sup>/s (1967) to 18,5 m<sup>3</sup>/s (1948).

As a result of statistical processing of 42 year variation line of the observation data, the following parameters of the distribution curve is obtained by the moments method:

- Average multiannual flow  $Q_0=11,7$  m<sup>3</sup>/s;
- Variation coefficient  $C_v=0,26$ ;
- Asymmetry coefficient taken for average annual flows, obtained  $C_s=2C_v=0,52$ .

Variation line representability assessment parameters are determined:

- Ratio of average square error of average multiannual flow is  $\varepsilon_{Q_0} = 4,0\%$  and ratio average square error of variation coefficient is  $\varepsilon_{C_v} = 11,2\%$ .

The obtained parameters are satisfactory, because  $\varepsilon_{Q_0} < 5\%$  and  $\varepsilon_{C_v} < 15\%$ .

Average square deviation is also determined, which is equal to  $\delta = 3,04$ .

By distribution curve obtained parameters and three-parameter distributor ordinates the average annual flows values of different provision in hydro post Naki section is determined.

Reduction from analogs (river Nenskra – hydro station Lakhmi, river Nakra – hydro station Naki) to designed sections is carried out by reduction factors, the values of which are obtained by catchment areas ratio.

In the designed dam section the catchment area of river Nenskra will be equal to 219 km<sup>2</sup> and 468 km<sup>2</sup> in hydro station Lakhmi section. From here, reduction factor from analogue section to designed dam section will be equal to 0,468.

In the designed headworks section river Nakra catchment area is equal to 86,3 km<sup>2</sup> and 126 km<sup>2</sup> in hydro station Naki section. From here, reduction factor from analog section to designed headworks section will be equal to 0,685.

By multiplying average annual values of different provision, determined in analog sections, on reduction factors, average annual flows values in designed sections are obtained.

The table provides the values of different provision average annual flows of rivers Nenskra and Nakra in hydro stations Lakhmi, Naki and designed sections.

**Table 5.2.5.2.1.** Average annual flows of the rivers Nenskra and Nakra different provision in Q m<sup>3</sup>/s.

River	Section	F km <sup>2</sup>	Q <sub>0</sub> m <sup>3</sup> /s	C <sub>v</sub>	C <sub>s</sub>	K	Provision P%						
							10	25	50	75	80	90	95
Nenskra	Hydro station Lakhmi	468	30.4	0.19	0.57	–	37.9	33.9	29.9	26.3	25.5	23.5	21.9
	Designed	219	14.2	–	–	0.468	17.7	15.9	14.0	12.3	11.9	11.0	10.2
Nakra	Hydro station Nakra	126	11.7	0.26	0.52	–	15.7	13.6	11.4	9.52	9.11	8.03	7.22
	Designed	86.3	8.01	–	–	0.685	10.8	9.32	7.81	6.52	6.24	5.50	4.95

Internal annual distribution of calculating provision (10%, 50%, 90%) average annual flows by months is carried out by two methods – actual years method and in analog section (hydro stations Lakhmi, Naki) simultaneously to the internal annual distribution of average multiannual flow.

Since, in the individual months of the actual years, average monthly flows of 90% provision exceed 50% provision average monthly flows and 50% provision average monthly flows exceed 10% provision average monthly flows, internal annual distribution of calculating provision average annual flows by actual years have not been taken as calculating values. In addition, internal annual distribution of one particular year may not reflect real picture of internal annual distribution of calculating provision average annual flow. Therefore, in designed sections as calculating values, internal annual distribution carried out simultaneously to internal annual distribution of average multiannual flows in analog sections have been obtained.



Internal annual distribution of accounting provision of average annual flows by months in hydro post Lakhmi and designed dam section, the value of river sanitary flow is given too (which in accordance with the standards of recent years amounts 10% of average multiannual flow of river in water intake section) and amount of water in the river to be saved in reservoir by considering the sanitary flow keeping.

**Table 5.2.5.2.2.** Rivers Nenskra and Nakra accounting provision average annual flows in designed sections

Catchment Area (Alternatives)	Average elevation, m.a.s.l	q l/s/km <sup>2</sup>	Area, km <sup>2</sup>	Q m <sup>3</sup> /s
Nakra 1	2911	118	45	5.29
Nakra 2	2750	113	87	9.83
Option 1	2739	77	163	12.55
Option 4	2650	74	222	16.43
Option 5	2601	73	256	18.69

### 5.2.5.3 Maximum Flows

Maximum flow accounting values of river Nenskra in designed dam section determined by the analog method. 33 year (1931, 1934, 1936, 1938-42, 1956-80 years) observation data of hydro post Lakhmi is taken as analog.

In this period, maximum flow values of river Nenskra in hydro post Lakhmi section varied from 66,8 m<sup>3</sup>/s (1934) to 196 m<sup>3</sup>/s (1941). As a result of statistical processing of variation line of the 33 year observation data by method of moments, the following parameters of distribution curve is obtained:

- The average multiannual value of maximum flows  $Q_0=127$  m<sup>3</sup>/s;
- Variation coefficient  $C_v=0,26$ ;
- Asymmetry coefficient, determined on probability cellular of empirical and theoretical nearest points coincidence,  $C_s=2C_v=1.40$ ;
- The parameters of variation line representability assessment is defined: relative average square error of average multiannual flow, which equals  $\varepsilon_{Q_0}=4,53\%$ ;
- Relative average square error of variation coefficient, which equals to  $\varepsilon_{C_v}=12,7\%$ .

Obtained parameters are satisfactory, because in accordance with the same СНиП 2.01.14-83 requirements  $\varepsilon_{Q_0} < 5\%$  and  $\varepsilon_{C_v} < 15\%$ . Average square deviation is also determined, which equals to  $\delta = 33,0$ .

By obtained distribution curve parameters and three-parameter distributor ordinates the different provision values of minimum flows of river Nenskra is determined in hydro post Lakhmi section.

Maximum flow accounting values of river Nakra in headworks section determined by the analog method. 47 year (1931-32, 1938-43, 1946, 1948-86 years) observation data of hydro post Naki is taken as analog.

In this period, maximum flow values of river Nakra in hydro post Naki section varied from 26,2 m<sup>3</sup>/s (1977) to 99,5 m<sup>3</sup>/s (1948). As a result of statistical processing of variation line of the 47 year observation data by method of moments, the following parameters of distribution curve is obtained:

- The average multiannual value of maximum flows  $Q_0=45,2$  m<sup>3</sup>/s;
- Variation coefficient  $C_v=0,33$ ;

- Asymmetry coefficient, determined on probability cellular of empirical and theoretical nearest points coincidence,  $C_s=4C_v=1,32$ ;

The parameters for variation line representability assessment are determined:

- Relative average square error of average multiannual flow, which is equal  $=4,8\%$  and relative average square error of variation coefficient, which is equal to  $\varepsilon_{C_v} = 10,8\%$ .
- The obtained parameters are satisfactory, because  $\varepsilon_{Q_0} < 5\%$  and  $\varepsilon_{C_v} < 15\%$ .
- Average square deviation is also determined, which is equal to  $\delta = 14,9$ .

By obtained distribution curve parameters and three-parameter distributor ordinates the different provision values of minimum flows of river Nakra is determined in hydro post Naki section.

Reduction from analog sections to designed sections is carried out by reduction factor, the value of which is obtained by following formula,

$$K = \left( \frac{F_{sapr.}}{F_{an.}} \right)^n$$

Where:

$F_{sapr.}$  - is the river catchment area in designed section (on the river Nenskra  $F_{sapr.} = 219 \text{ km}^2$ , on river Nakra  $F_{sapr.} = 86,3 \text{ km}^2$ );

$F_{an.}$  - is the catchment area of the river in the analog/ hydro post section (on Nenskra- hydro post Lakhmi  $F_{an.} = 468 \text{ km}^2$ , on Nakra hydro post Naki  $F_{an.} = 126 \text{ km}^2$ );

$n$  - is the reduction quality indicator, the value of which in case of maximum flows is obtained equal to 0,5.

By submitting the given numerical values in above given formula, the reduction factor value from hydro post Lakhmi to designed dam section is obtained and equals to 0,545 and from hydro post Naki to designed headworks section equals to 0,828. By multiplying the maximum flows determined in analog sections on reduction factors, the maximum flows in designed sections are obtained.

Below, in the Table 5.2.6.3.1. The maximum flow values of different provision of the rivers Nenskra and Nakra in hydro stations Lakhmi, Naki and in designed sections are given.

**Table 5.2.5.3.1.** Maximum flows of different provision of the rivers Nenskra and Nakra  $Q \text{ m}^3/\text{s}$ .

River	Section	F km <sup>2</sup>	Q <sub>0</sub> m <sup>3</sup> /s	C <sub>v</sub>	C <sub>s</sub>	K	Provision P%						
							0.1	0.3	1	3	5	10	20
Nenskra	Hydro post Lakhmi	468	127	0.26	1.04	-	290	260	230	200	190	170	150
	Designed	219	59.4	-	-	0.545	160	145	125	110	105	93.0	82.0
Nakra	Hydro post Naki	126	45.2	0.33	1.32	-	125	109	93.1	79.3	73.1	64.4	55.8
	Deigned	86.3	37.4	-	-	0.828	104	90.2	77.1	65.7	60.5	53.3	46.2

As the table shows, maximum water flows in the designed section are reduced, which can be explained by not registering some actual maximum flows by the hydro posts.

Therefore, the reporting values of maximum water flows of the river Nenskra in the designed dam section are determined by the reduction factor recommended by СНиП 2.01.14-83, which is used on the rivers having more than 100 km<sup>2</sup> catchment area. Maximum flows of river Nakra water in designed headworks section are determined in the same СНиП by the marginal density formula, the use of which is permitted on the rivers having less than 100 km<sup>2</sup> catchment areas.

It should be noted, that glaciers are not participating in maximum flows formation of water due to the pouring rain, because only solid sediment in a form of snow or thin fractional hail is coming on the glaciers surface, immediate melting of which and its melted water occurrence in the river-bed is excluded. Therefore, during calculation of maximum water flows due to the heavy rains, glaciers area must be reduced from the river catchment area, which on river Nenskra amounts 30,1 km<sup>2</sup> and on the river Nakra 17,4 km<sup>2</sup>.

The reduction factor, which has determined maximum water flows of river Nenskra in the designed dam section, has the following form:

$$Q_{1\%} = q_{200} \cdot \left( \frac{200}{F} \right)^{n_3} \cdot F \cdot \lambda \quad \text{m}^3/\text{s}$$

Where;

$Q_{1\%}$  -is maximum water flow of 1% provision in m<sup>3</sup>/s;

$q_{200}$  -is the module (m<sup>3</sup>/km<sup>2</sup>) of maximum water flow of 1% provision reduced to 200 km<sup>2</sup>. Its value is taken from the specially processed isoline map and in our case equals to 1,5;

$F$  - is the catchment area in designed section. In our case the catchment area of river Nenskra in designed section without the glacier area is equal to 189 km<sup>2</sup>;

$n_3$  - is the maximum flow module reduction quality indicator. Its value is taken from special table and in our case is equal to 0,55;

$\lambda$  - is the reduction factor from maximum water flow of 1% provision to other provisions. Its value is taken from specially processed table.

By submitting the given numerical values in above given reduction formula, maximum flow values of river Nenskra water in designed dam section are obtained.

Marginal density formula, by which is determined the values of maximum water flows of river Nakra in the designed headrowks section, has the following form:

$$Q_{1\%} = A_{1\%} \cdot \varphi \cdot H_{1\%} \cdot F \quad \text{m}^3/\text{s}$$

Where;

$Q_{1\%}$  - maximum flow of 1% provision (100 year repeatability) of water in design section m<sup>3</sup>/s.

$A_{1\%}$  - is maximum runoff module of 1% provision, expressed in  $\varphi \cdot H_{1\%}$  dependence shares. Its value, depends on canal hydro-morphometric characteristic  $\Phi_{\text{canal}}$  and on slopes runoff  $\tau_{\text{slope}}$  time, obtained from specially processed table.

Canal hydro-morphometric characteristic  $\Phi_{\text{canal}}$  value is obtained with:

$$\Phi_{\text{canal}} = \frac{1000 \cdot L}{m \cdot i_{\text{kal}}^{0,33} \cdot F^{0,25} \cdot (\varphi \cdot H_{1\%})^{0,25}}$$

Where:

$L$  - river length in km, from the headwater to designed section, which equals to 14,4 km;

$m$  - is the ravine canal roughness factor, taken from specially processes table (in our case its value is equal to 10);

$i_{kal}$  - canal inclination in ‰, which in our case is equal to 119‰ ;

$F$  - catchment area in km, which in our case without glaciers area is equal to 68,9 km<sup>2</sup>;

$\varphi$  - is the maximum runoff coefficient. Its value, depended on soil layer existing in the catchment area, is taken from the specially processed table (in our case its value, for clay soil conditions, is equal to 0,40);

$H_{1\%}$  - is the sediments daily maximums 1% provision value in mm. Its value will be taken from the nearest meteorological station in accordance with the multiannual observation data. Since, it is impossible to obtain mentioned data from the meteorological station existing near the catchment area of river Nakra, sediments daily maximums 1% provision value is taken from СНиП 2.01.14-83 attached map, according to which, daily sediments 1% provision value in this region is equal to 200 mm.

During slope runoff,  $\tau_{slope}$  value is obtained for mountain rivers recommended by the same СНиП  $\tau_{slope}=10$  min;

By submitting the given numerical values in above presented formulas it is obtained  $\Phi_{canal}=84,4$  and  $\tau_{slope}=10$  min; from this  $A_{1\%}=0,0352$  and maximum flow of water of 1% provision of the river Nakra in designed headworks section  $Q_{1\%}=195$  m<sup>3</sup>/s.

Reduction from 1% provision on other provisions is carried out by specially processed reduction factors given in the same СНиП.

The values of maximum flows different provision of the rivers Nenskra and Nakra in designed sections are given in the table.

**Table 5.2.5.3.2.** Maximum flows of the water of rivers Nenskra and Nakra in design section

River	Provision P%						
	0.1	0.3	1	3	5	10	20
Nenskra	410	365	295	230	205	160	120
Nakra	275	245	195	155	135	110	80,0

The maximum flow of 10000 year repeatability for river Nakra is obtained 231 m<sup>3</sup>/s and 288 m<sup>3</sup>/s for river Nenskra. The accounting catastrophic flood accordingly 375 m<sup>3</sup>/s and 467 m<sup>3</sup>/s.

#### 5.2.5.4 Minimum Flows

Minimum flow accounting values of river Nenskra in designed dam section determined by the analogue method. 36 year (1931,1934-43,1956-80 years) observation data of hydro post Lakhmi is taken as analogue.

In this period, minimum flow values of river Nenskra in hydro post Lakhmi section varied from 3,50 m<sup>3</sup>/s (1961) to 8,00 m<sup>3</sup>/s (1980). As a result of statistical processing of variation line of the 36 year observation data by method of moments, the following parameters of distribution curve is obtained:

- Average multiannual value of minimum flows  $Q_0=5,19$  m<sup>3</sup>/s;
- Variation coefficient  $C_v=0,20$ ;
- Asymmetry coefficient, determined on probability cellular of empirical and theoretical nearest points coincidence,  $C_s=2C_v=0.40$ .

The parameters of variation line representability are defined:

The ratio square error of average multiannual flow  $\varepsilon_{Q_0} = 3,30\%$  and the ratio square error of variation coefficient, which is equal to  $\varepsilon_{C_v} = 12,0\%$ . Obtained parameters are satisfactory, because  $\varepsilon_{Q_0} < 5\%$  and  $\varepsilon_{C_v} < 15\%$ . Average square deviation is also determined, which is equal to  $\delta = 1,038$ .

By obtained distribution curve parameters and three-parameter distributor ordinates the different provision values of minimum flows of river Nenskra is determined in hydro post Lakhmi section.

Reduction from hydro post Lakhmi section to the designed dam section is carried out by reduction factor, the value of which, as in case of average annual flows, is equal to 0,468. By multiplying the minimum flows determined in hydro post Lakhmi section on the reduction factor, the values of minimum flows in designed dam section is obtained.

Minimum flow accounting values of river Nakra in headworks section determined by the analog method. 44 year (1931-32,1938-40,1942-43,1948-49,1951,1953-86 years) observation data of hydro post Naki is taken as analog.

In this period, minimum flow values of river Nakra in hydro post Naki section varied from 1,15 m<sup>3</sup>/s (1961) to 5,60 m<sup>3</sup>/s (1953). As a result of statistical processing of variation line of the 44 year observation data by method of moments, the following parameters of distribution curve is obtained: the average multiannual value of minimum flows  $Q_0 = 2,43$  m<sup>3</sup>/s; variation coefficient  $C_v = 0,39$ ; asymmetry coefficient is taken for minimum flows obtained,  $C_s = 2C_v = 0,78$ . The parameters for variation line representability assessment are defined:

The ratio square error of average multiannual flow  $\varepsilon_{Q_0} = 5,8\%$  and the ratio square error of variation coefficient, which is equal to  $\varepsilon_{C_v} = 11,4\%$ . Obtained parameters are satisfactory, because  $\varepsilon_{Q_0} < 10\%$  and  $\varepsilon_{C_v} < 15\%$ . Average square deviation is also determined, which is equal to  $\delta = 0,95$ .

By obtained distribution curve parameters and three-parameter distributor ordinates the different provision values of minimum flows of river Nakra is determined in hydro post Naki section.

Reduction from hydro post Naki section to the designed headworks section is carried out by reduction factor, the value of which, as in case of average annual flows, is equal to 0,685. By multiplying the minimum flows determined in hydro post Naki section on the reduction factor, the values of minimum flows in designed headworks section is obtained.

The values of lowest minimum flows of different provision of rivers Nenskra and Nakra in hydro posts Lakhmi, Naki and designed sections are given in the Table 5.2.6.4.1.

**Table 5.2.5.4.1.** The lowest minimum flows of different provision of rivers Nenskra and Nakra, in Q m<sup>3</sup>/s.

River	Section	F km <sup>2</sup>	Q <sub>0</sub> m <sup>3</sup> /s	C <sub>v</sub>	C <sub>s</sub>	K	Provision P%						
							75	80	85	90	95	97	99
Nenskra	Hydro post Lakhmi	468	5.19	0.20	0.40	–	4.45	4.31	4.11	3.91	3.61	3.42	3.08
	Designed	219	2.43	–	–	0.468	2.08	2.02	1.92	1.83	1.69	1.60	1.44
Nakra	Hydro post Naki	126	2.43	0.39	0.78	–	1.74	1.62	1.47	1.32	1.12	0.98	0.77
	Designed	86.3	1.66	–	–	0.685	1.19	1.11	1.01	0.90	0.77	0.67	0.53

### 5.2.5.5 Solid Flow

The values of different provision of river Nenskra solid flow is determined in hydro post Lakhmi section, so their values for design section are only for orientation character purpose.

On river Nenskra, in hydro post Lakhmi section, observations on solid runoff was carried out during 24 years (1956-78, 1980). In this period, the solid flow values of river Nenskra in hydro post Lakhmi section varied within 0.78 kg/s (1960) – 7,0 kg/s (1961). As a result of statistical processing of the variation line of 24 year observation data based on requirements of СНиП 2.01.14-83 of great convincing method, the following parameter of distribution curve is obtained:

- Average multiannual value of solid runoff  $R_0=2,45$  kg/s;
- Variation coefficient  $C_v=0,67$ ;
- Asymmetry coefficient  $C_s=3,5C_v=2,34$ .

By obtained distribution curve parameters and three-parameter distributor ordinates the different provision values of solid flow (suspended sediments) of river Nenskra is determined in hydro post Lakhmi section.

Bottom sediments determination methods are very weakly developed. The main reason for this is the existence of not improved measuring tools and bottom sediments movement study complexity. Thus, bottom sediment amount on mountainous rivers by theoretical calculations are taken within 30-90% of suspended sediments. In our case, bottom sediments movement of river Nenskra is equal to 45% of the taken suspended sediments.

Suspended solid sediments, bottom sediments and the relative volume values of their sum of river Nenskra in hydro station Lakhmi section is given in the Table 5.2.6.5.1.

**Table 5.2.5.5.1.** Solid flow of river Nenskra in hydro post Lakhmi section

Provision P%	0.5	1	3	5	10	20
Suspended sediments R kg/s	9.8	8.4	6.4	5.5	4.4	3.4
Bottom sediments G kg/s	4.4	3.8	2.9	2.5	2.0	1.5
The sum of solid flow R kg/s+ G kg/s	14.2	12.2	9.3	8.0	6.4	4.9
Solid flow volume W thousand tons	448	385	294	252	200	155

The solid runoff of the river Nakra is not studied. Therefore, its solid runoff values in designed section are determined by method which is given in hydrological guide “Surface water resources of USSR, Volume IX, edition I”.

According to this method, the water turbidity in the designed section is determined originally by following formula:

$$\rho = 1000 \cdot \alpha \cdot \sqrt{i_{auz}} \text{ g/m}^3$$

Where  $\alpha$  is basin erosion coefficient. Its value is taken from special map and for an average of river Nakra basin location region amounts 0,30.

$i_{auz}$  is the catchment area inclination in units, which is equal to 0.563.

By submitting the given numerical values in above given formula the average multiannual turbidity on river Nakra in designed section is obtained, which is equal to 225 g/m<sup>3</sup>.

Average multiannual flow if suspended solid sediments are obtained by the formula:

$$R = Q_0 \cdot \rho \text{ kg/s}$$

Here  $Q_0$  is the average multiannual flow of water in designed section.

From here, average multiannual flow of suspended solid sediments in the designed headworks section of river Nakra will be equal to 1,80 kg/s.

The values of different provision of average annual flow of the suspended solid sediments are obtained by multiplying the average multiannual flow of solid sediments on specially processed coefficients. Bottom sediments amount in this case is equal to 45% of suspended sediments.

Table 5.2.6.5.2 provides the flows of suspended solid sediments and bottom sediments of river Nakra and the values of different provision of their annual runoff in the designed headworks section.

**Table 5.2.6.5.2.** Solid sediment flow of river Nakra and different provision values of their annual runoff in design section

Provision P%	1	10	25
Suspended particle R kg/s	6.05	3.55	2.35
bottom sediment G kg/s	2.70	1.60	1.05
The sum of solid flow R kg/s+ G kg/s	8.75	5.15	3.4
The volume of solid flow W thousand tons	276	162	107

#### 5.2.5.6 Maximum Turbidity of River Nenskra

Values of different provision of maximum turbidity of the river Nenskra are determined in hydro post Lakhmi section, so their values for design section represent the orientation nature.

On the river Nenskra, in the section of hydro post Lakhmi, observations on solid runoff and on water turbidity were carried out for 24 years (1956-78, 1980). In this period, the maximum turbidity values of river Nenskra in the section of hydro post Lakhmi varied between 380 g/m<sup>3</sup> (1957, 1959) to 4000 g/m<sup>3</sup> (1956).

As a result of statistical processing of the variation line of 24 year observation data based on requirements of СНиП 2.01.14-83 by graph-analytical method, when the asymmetry coefficient Cs defined as a S function of sloping coefficient, the following parameters of distribution curve is applied:

- Average multiannual value of maximum turbidity  $\bar{Q}=1610$  g/m<sup>3</sup>;
- Coefficient of variation  $C_v=0,81$ ;
- Coefficient of asymmetry  $C_s=2,0$ ;
- Average square deviation  $\delta =1305$ .

By accepted parameters of distribution curve and ordinates of binomial curve the values of different provision of maximum turbidity of the river Nenskra is determined in hydro post Lakhmi section.

Table 5.2.5.6.1 provides the values of different provision of maximum turbidity of the river Nenskra in hydro post Lakhmi section.

**Table 5.2.5.6.1.** Maximum turbidity of river Nenskra in hydro post Lakhmi section.

Provision P%	0.5	1	3	5	10	20
Maximum Turbidity $\rho_0$ g/m <sup>3</sup> .	7800	6300	4900	4200	3300	2400

Maximum turbidity data for river Nakra is not available and the characteristics of river Nenskra can be used.

### 5.2.5.7 Evaporation from Water Surface

There are no observations available on evaporation from water surface in the river Nenskra basin. Therefore, the rate of evaporation from the water surface is taken from the monograph of V. Gvakharia “Geographical modeling of evaporation from the reservoirs of mountainous countries, Tbilisi, 1986”.

This monograph includes evaporation rate from water surface for Mestia, which is located on 1441 m above sea level, which approximately corresponds the normal flooding level (1433 m). Proceeding from this, the values published in monograph about the evaporation from the water surface use as calculation values for designed reservoir.

Evaporation rate calculated for Mestia from water surface by months is given in Table 5.2.5.7.1.

**Table 5.2.5.7.1.** Monthly evaporation rate from the water surface and annual sum in mm

Point	H 0	I	II	III	IV	V	VI	VII	VIII	IX	X	XI	XII	Year
Mestia	1441	-	-	-	59	109	123	145	145	91	62	31	-	765

It should be noted, that during the cold period (XII-III) of the year there will be no evaporation from the water surface, because the average monthly in mentioned months in accordance with the Mestia data amounts -4,10; -6,00; and -0.50, which definitely will cause the creation of sustainable ice layer on the water surface of designed reservoir and which will reduce the useful volume of reservoir by a certain amount.

### 5.2.5.8 Glaciers

As it was mentioned above, project rivers are glacier rivers and they are mainly fed by glaciers existing at their sources.<sup>4</sup> Glaciers of Nenskra River basin amounts 24.9% of the glaciers of Enguri basin.

Morphometric and morphographic conditions of Nenskra valley relief causes uneven layout of glaciers. Valley glaciers are mainly observed in basins of right tributaries of Nenskra River and on north-western slopes of Shdavleri Range.

Small cirque glaciers are represented on the southern slopes of the Caucasus.

According to K. Podozersky, there were 54 glaciers in Nenskra River basin, covering 50.54 km<sup>2</sup> area. Based on 1960 topographic mapping data (R. Gobejishvili), there were 75 glaciers, covering 48.62 km<sup>2</sup> area. Such changes were caused, first of all, due to the facts that small glaciers have been disappeared, while on the other hand, due to fragmentation of valley glaciers. According to the data of 2014, there are 67 glaciers, covering 25.58 km<sup>2</sup> area.

Morphology of Nenskra River valley relief causes the existence of numerous small cirque glaciers. Such glaciers hold 44.77% of the glaciers of the entire basin, followed by cirque-valley glaciers (22.38%) and valley glaciers (19.40%). However, situation according to the areas covered by these glaciers is controversial. Valley glaciers hold 55.98% of the glaciers of the entire Nenskra River basin, cirque-valley glaciers hold 25.99%, while cirque glaciers hold 14.69%. share of other morphological types of glaciers is insignificant (see Figure 5.2.5.8.).

<sup>4</sup> Information prepared of monograph „Glaciers of Georgia”, Tbilisi 2014. According to the given information.



**Figure 5.2.5.8.1.** Distribution of glaciers in Nenskra Rive valley according to their morphological types

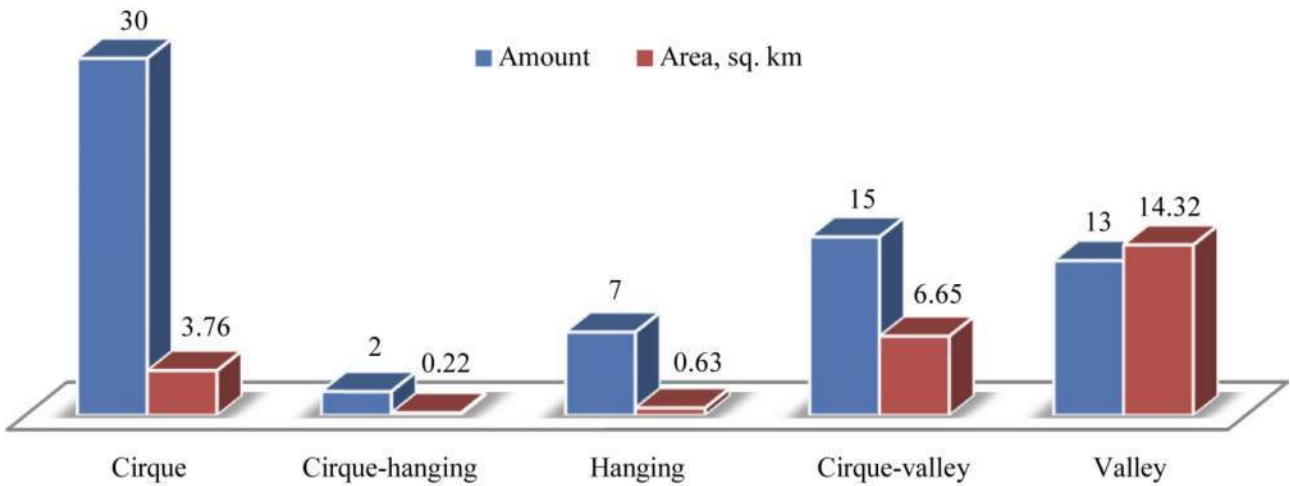

In Nenskra River valley, glaciers are mainly located on Kharikhra and Shdavleri ranges, which have submeridional direction. Therefore, glaciers with northern exposition dominate there. They hold 53.73% share of glaciers of the entire basin, covering 59.81% of the area (see Figure 2.5.8.2.).

Kharikhra and Shdavleri glaciers are distinguished in the Nenskra River basin according to their morphological and morphometric features and dimensions.

**Shdavleri glacier** is a valley-type glacier of western exposition, its length is of 4.58 km and the area—2.31 km<sup>2</sup>. In 1960 its area was 2.48 km<sup>2</sup> (see Picture 5.2.5.8.1.). The ice tongue ends at a height of 2730 m. The glacier starts from the two independent firns, which are located on the northern slope of the Mount Shdavleri (3994 m). The eastern firn is connected to the firn of the glaciers of the Nakra River. Two icefalls are developed at a whole length of the Shdavleri glacier, one - when flowing out from the firn and another - in the middle part of the tongue. The ice tongue is covered with the thin weathered material and is well expressed in the relief. The tongue ends by a pointed form. The lateral stade moraines well expressed on the both sides of the tongue protect it from contamination; inside the stade moraines there can be found the well expressed microstade moraine by which it is possible to identify the parameters of the glacier retreating. By the data of 2014, the area of the Shdavleri glacier is 2.31km<sup>2</sup> and its ice tongue ends at a height of 2730 m above sea level.

**Figure 5.2.5.8.2.** Distribution of the glaciers in the Nenskra River basin according to the exposition.

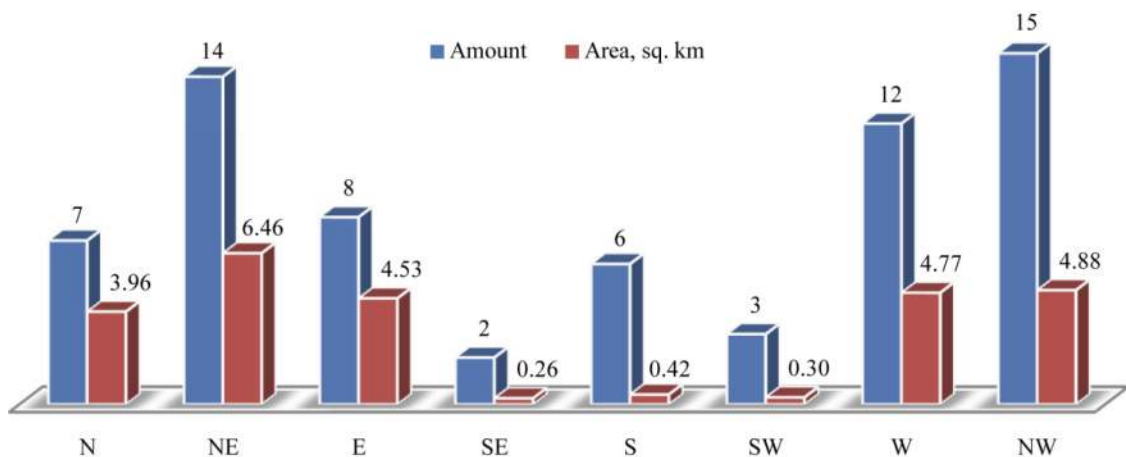

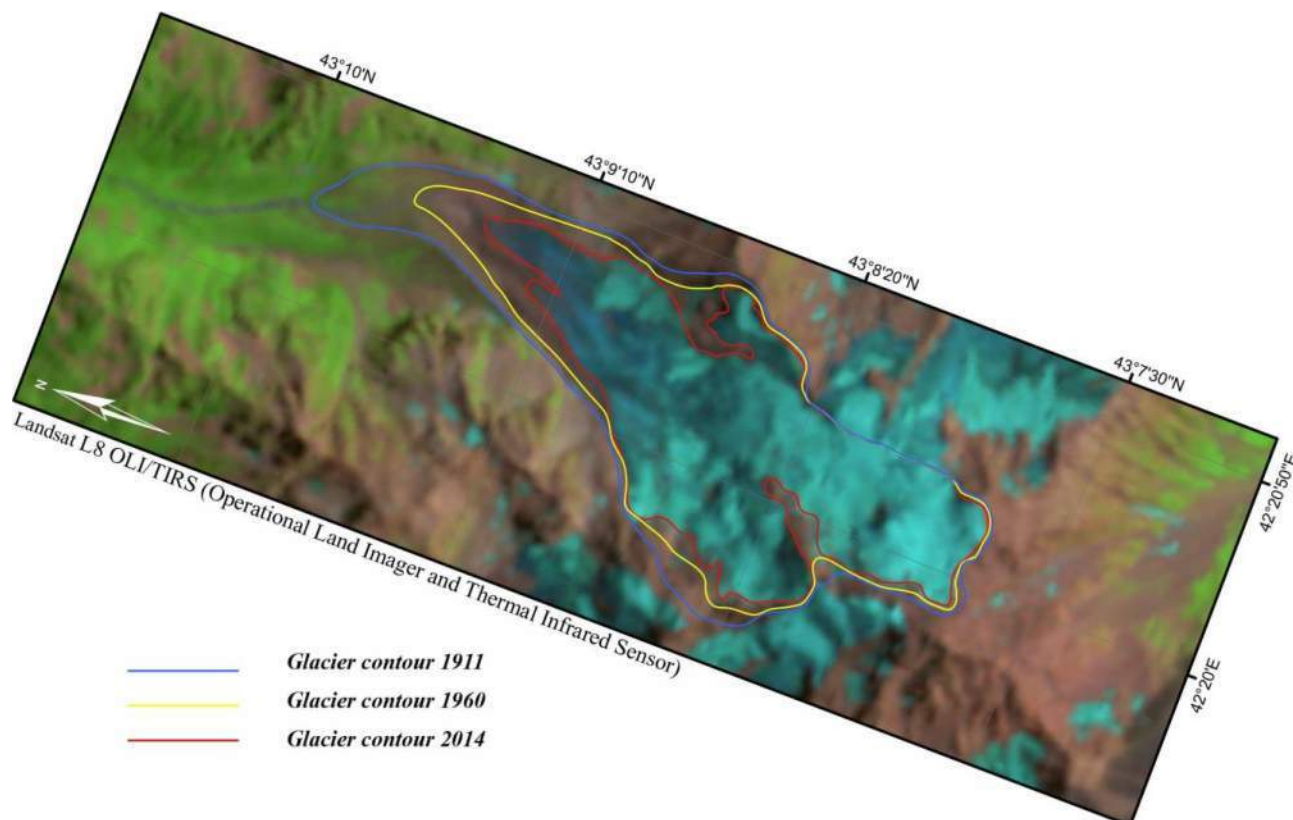
**Picture 5.2.5.8.1.** Shdavleri glacier retreat in 1911-1960-2014.

By K. Podozerskiy there were 26 glaciers Nakra River basin with a total area of 20.24 km<sup>2</sup>. By the data of 1960 there were 31 glaciers with the area of 18.49 km<sup>2</sup>. Increasing in the number of glaciers and reduction in their area within the mentioned two periods were well subjected to the increase in number of the glaciers in the first part of the 20th century in parallel with the reduction in the total area of the glaciers, but the picture is different in the last 54-year period. By the data of 2014 there are 28 glaciers in the basin with a total area of 10.21 km<sup>2</sup>. We can see that in this period the number of glaciers was decreased by 3 and the area was reduced by 44.79%.

In the Enguri River basin the Nakra River basin is behind the rivers of Nenskra, Mulkhura and Dolra and the northern slope of the Svaneti range by the number of glaciers.

The ratio of the number and area of the glaciers indicates that there are basically the small cirque glaciers in this gorge. The glaciers are distributed by morphological types and exposition as follows (see Figures 5.2.5.8.3. and 5.2.5.8.4.).

The largest glaciers of the basin—the Nakra and Leadashti are located in the western slope of the Kvishi range.

**Leadashti Glacier** is the largest glacier in the Nakra River basin with an area of 3.47 km<sup>2</sup>. It is a valley type glacier and has an extensive firm field, the glacier tongue is clean and after flowing from the firm ends at the ledge. Its length is 5.63 km. The ice tongue ends at a height of 3170 m above sea level. The firm exposition is southern, while the lower section of the firm and the tongue are of western direction. Due to grandiose ledge the glacier does not have the moraines. In early times the ice tongue had a form of an icefall and the loose material was collected at the bottom and ledge. The ice tongue overflows from the top of the ledge still today at a short distance. In 1960 the area of the Leadashti glacier was 4.29 km<sup>2</sup>. On this basis, we can specify that the glacier area was reduced by 19.11% in the years of 1960-2014.



## 5.2.6 Biological Environment

### 5.2.6.1 Flora

The report includes results of literature review and scientific researches, the aim of which was to review flora and fauna within the influence zone of the project on the construction and operation of the HPP on Nenskra River, namely to identify sensitive habitats and communities.

Botanical descriptions were carried out in the area of interest basing on literature sources, field surveys and also experience and knowledge. In addition, it should be noted, that botanical studies, carried out in order to obtain more detailed information, made it possible to fill the existing gaps and provide the basic materials for proper ESIA of project planning and construction activities from the botanical point of view. Hence, the expected negative and residual impacts due to construction activities of the planned project corridor on the flora and vegetation of the adjacent areas have been revealed.

The project impact area is represented by various conservative value plant communities and species (endemic, rare, listed in the Red list or the Red Book), also economical plants (medicinal, aromatic, wild fruit, fiber, decorative, drinking, timber and fuel wood, forage, hay-pasture, wild ancestors of agriculture crops and etc.).

Together with endangered species and sensitive habitats (sites) having different conservation value special attention is given to forested areas and the urgent necessity to mitigate the residual impact on forest ecosystems is emphasized. In case where a residual impact is identified in these areas, the eco-compensation measures should be undertaken which imply the rehabilitation/restoration of the equivalent forest habitats. As for humid territories, impact causes increase of water surface area and such land will be subtracted from useful land fund. Although water-marsh vegetation re-develops and peat collection process begins, but it takes thousands of years to fill such caves.

#### 5.2.6.1.1 Methodological and Conceptual Approaches for Description of Flora and Vegetation and Determination of Impacts on Ecosystem and Habitats

Ecosystems along the Project impact zone are usually characterized in terms of habitat/vegetation types such as identified in Ketskhoveri (1960), Nakhutsrishvili (1999), Kvachakidze (1996), etc. Species composition of different ecosystems and habitats are given on the base of bibliographic data and field surveys.

According to our estimation many species of vascular plants are represented within the corridor of interest of the Project. However, as stated by Morris (1995) "In principle, assessment of the flora should include all vascular plants, bryophytes, lichens, algae and fungi, although the importance of the groups varies in different communities". Nonetheless, vascular plants are considered to be the main indicator of terrestrial ecosystems, e.g. all forms of life in a given landscape.

As mentioned above together with endangered plant species and sensitive habitats having different conservation value special attention is paid to forested areas including artificial forest plantations. This is on the ground that forests are considered as special environmental protection areas, unique and most important ecosystems with high ecological, aesthetic, cultural, historical and geological properties (Harcharik, 1997; Isik et al., 1997). In other words, "forests are more valuable as forests than under some other forms of land use" (Harcharik, 1997), "people are making greater demands on forests for recreation, pleasure, scenery and conservation of biological diversity" (Lanly, 1997).

It is of decided significance that on project impact areas, among them in the cases of Project construction through forested territories it is practically impossible to reinstate and maintain former natural stands in

the state before construction. Consequently, the recommendation is given to implement Forest eco-compensation programs (Forest offset) or offset other ecosystems/plant communities to mitigate residual impacts due to Project construction activities.

As for humid territories, residual impact causes increase of water surface area and such land will be subtracted from useful land fund. Although water-marsh vegetation re-develops and peat collection process begins, but it takes thousands of years to fill such caves.

Detrimental impacts to the protection of biodiversity, protected areas and forestry have to be reduced to the absolute minimum and unavoidable residual environmental damages have to be offset by an eco-compensation scheme. In particular the impacts on forest ecosystems have to be evaluated and offset by adequate mitigation and eco-compensation measures with the goal to restore the equivalent forest habitat.

In this context the calculation of damages to forest ecosystems by the Project construction activities according to the “none-net loss”, “net gain principle” and “habitat hectare” approach is recommended to define the exact ratio for forest eco-compensation based upon modern methodologies and international best practice.

The habitat hectare scoring method is a common approach to determine the value of vegetation in non-monetary units. The environmental proxy used i.e. the “currency” in which the value of vegetation is expressed is the “habitat hectare”.

#### **Habitat area [ha] x habitat score = habitat-hectares**

This method serves to assess a number of site-based habitat and landscape components against a pre-determined ‘benchmark’ relevant to the vegetation type being assessed. Benchmarks have to be defined for different ecological vegetation classes (EVC). The benchmark for each EVC has to describe the average characteristics of mature and apparently long undisturbed biodiversity and native vegetation occurring in the bioregions in which habitats shall be assessed. The notion of mature and apparently long undisturbed benchmark is relative to the EVC; e.g. a forest benchmark can be based on the average for stands of 20 year old trees with no signs of significant anthropogenic disturbance. Each EVC must contain a range of information required for carrying out a habitat hectare scoring exercise. When carrying out a habitat hectare scoring exercise a habitat score indicating the quality of the vegetation relative to the EVC benchmark is assigned to each of the areas assessed. Multiplying the habitat score by the habitat area (in hectares) allows determining the quality of vegetation. Whereby units of “habitat hectares” are used as a common measuring rod to compare the relative value of different ecosystems within one EVC. The habitat hectare exercise foresees an in-situ assessment of natural vegetation to collect a range of visually assessed information of several vegetation components across the habitat zone. The vegetation components that have to be included and assessed depend on the eco-region specific ecosystem composition.

In a second step the visually assessed information on the vegetation components is analyzed and used to calculate the habitat score for the area.

The components of the habitat score can be calculated. The Australian State Government of Victoria, Department of Sustainability and Environment, which is a worldwide leading institution in applying the habitat hectare approach, use the following components and estimations:

**Table 5.2.6.1.1.1.** Components and weightings of the habitat score in Victoria, Australia

Component		Max. value(%)
Site condition	Large trees	10
	Tree (canopy) cover	5
	Understory (non-tree) strata	25

	lack of weeds	15
	Recruitment	10
	Organic litter	5
	Logs	5
Landscape context	Patch size	10
	Neighborhood	10
	Distance to core area	5
<b>Total</b>		<b>100</b>

### 5.2.6.1.2 Description of Flora and Fauna within the Project Corridor

The project territory covers botanical-geographical region of Nenskra-Nakra catchment area, which is located on the West part of Svaneti. From the North the region's boundary is the main watershed; the West boundary matches administrative boundary of Svaneti; the East boundary runs along the Nakra-Dolara watershed – Tsalgmili ridge; the South boundary runs along the right bank of Enguri River.

The Enguri river is the main artery of Zemo Svaneti. It originates in Namkvami (Engur-Ukhvani) glacier and flows near the village Khaishiti on 550 m a.s.l. Enguri valley within this region is a rocky cleft located between rock buttresses of Svaneti and Abkhazia-Svaneti and Samegrelo ridges. Enguri valley runs through this botanical-geographical region, in paleozoic metamorphic suite (the Dizi series), middle-Jurassic porphyrite suite (near Khaishi) and cretaceous limestone (near Larakvakva and above Jvari).

Svaneti-Abkhazia ridge separates from the Caucasus range near the mountain Gvandra. Eastern branches of the Svaneti-Abkhazia gorge are: Dalari and Tskhandiri rivers watershed; Paravani ridge, which is a watershed for the rivers Lagami and Darchi; Likhnila gorge, which is a watershed for the rivers Darchi and Larakvakva. It begins with the Bishkapsara mountain and reaches Bokunsta-Larakvakva and Gandishi. Another orographic unit of the region is Shtaueli ridge, which separates from the Caucasus and represents a watershed for Nenskra and Nakra rivers (Maruashvili, 1970).

Nenskra and Nakra rivers are among the large tributaries of Enguri River. Nenskra River originates from southern slopes of the Caucasus. Upper reaches are presented by karts shale stones, while the lower part is presented by clay-shales and carbonate suite. In this part, it crosses “Deisi” and “Liasi” clay-shales, sand-stones and volcanic rocks.

The Nenskra river is relatively narrow until the Tetnashera confluence. Right tributaries are: Dalari, Tskhandiri, Okrila, Kharali, Tetnashera, Devra, Lagamo, Darchie; left tributaries are – Manchkhapuri, Tita, Margi, Gvashkhara.

Nakra River runs from the glacier and joins Enguri River at 918-1000 m elevation above sea level. Nakra valley is located in crystalline rocks, clay-shales and carbonate and paleolit metamorphosed suite. Until the village Nakra river flows through a narrow valley. It is bordered by Shtauler, Tsalgmili and main gorges. U-shaped valley is clearly expressed near the source of the river (Ukleba, 1952; Maruashvili, 1970).

Annual amount of precipitation in the region, as well as in the western part of Zemo Svaneti is 1200-1350 mm. Average annual temperature is 10-14°; annual temperature of the coldest month is 0,6°; average temperature of the warmest month is 20,9°.

Amount of precipitation increases above the forest belt. The upper border of the forest belt is at 2000-2300m elevation. Dark coniferous forests dominate in the phytolandscape of the region, as well as of Zemo Svaneti. This part of the region is similar to the Kodori valley forests. Evergreen undergrowth is

represented by Cherry Laurel, Rhododendron and Holly. Cherry Laurel is widespread in Larakvakva and Ormeleti valleys. Different mixed deciduous forests dominate in the lower zones. Especially notable are Georgian oak forests along Enguri River, near the confluence of Nenskra River, on the bottom of Nakra River adjacent to Naki village. The peculiarity of the region in the lower part of the forest belt is reflected by well-developed evergreen undergrowth. It has been observed in Larakvakva and Ormeleti valleys.

Exposed limestone of Chekaderi mountain is observed near the confluence of Larakvakva and Enguri rivers, on the right bank of Enguri River, which is a northern branch of Samegrelo ridge. Remains of flora cenotic complex of Colchis limestone are represented there, which is unique for Svaneti. Pine-oak cenoses mixed with *Sesleria* are also represented there, which is characteristic for Western Transcaucasia. Understory is dominated by representatives of Colchian dendroflora: Colchis ivy, Smilax, Broom and Red Dogwood; a lot of Blackberry is found on secondary ecotopes. Smilax is widespread there. Above mentioned Moor grass (*Sesleria anatolica*) is observed on calcific rocky gravel ecotopes. Endemic to Abkhazia and Samegrelo – Colchic *Kemulariella* (*Kemulariella colchica*), which grows on humid rocks; limestone endemic to Abkhazia and Racha-Lechkhumi - *Asperula kemulariae*; limestone endemic to the Western Transcaucasia - *Epimedium colchicum*, which is the component of the oak forest. The same complex of oak is observed on the right bank of Enguri River between Khaishi and Dizi. *Arachne colchica* (*Leptopus colchicus*) grows on gravel ecotopes. This specie is also observed in Chuberi. Sumac and Smoketree should also be noted. A rare, eastern Mediterranean species of Greek Bladderpod (*Alyssoides graeca*) are spread near Dizi village, at approximately 950m a.s.l., on clay shale stones and gravel ecotopes of the right bank of the bottom of valley. Yellow alyssum (*Alyssoides*) is a new specie for Georgian flora. This specie is rare in the Caucasus and it is common in Teberda-Zhelenchuki valleys. *Valeriana alliariifolia* and *Saturea spicigera* are characteristic for botanical-geographic region of Nenskra-Nakra, as well as for other regions and for the bottom of Enguri and its tributaries valleys.

Deciduous forest with beech-hornbeam and chestnut inclusions are found at 1500-1600m elevation in some places of the region. For example, on the slopes of the right bank near Naki village, which is developed within the dark coniferous forest zone. Such forests are especially well developed at 1700-1800 m elevation. This elevation should be considered as optimal for fir-spruce forests (Dolukhanov, Sakhokia, Kharadze, 1946). Above 2000 m elevation, dark coniferous forest zone changes into subalpine zone. Caucasian whortleberry (*Vaccinium arctostaphylos*) is widespread within the dark coniferous forest zone; Beech forests are developed between Tskhvandiri and Dalari. *Senecio pojarkovae*, which is an important specie for agricultural activities is widespread within the areas where dark coniferous forests have been deforested.

Phytocoenologically, vegetation of geobotanical district of Svaneti is rich and diverse. In the western and eastern parts of the depression, due to significant differences in climate conditions (climate in the western part is milder, marine; in the eastern part - more continental, strict), as well as due to uneven impact and other natural or artificial reasons, vegetation structure significantly varies from each other.

The forest zone reaches 1800-1850 m elevations. The difference between the forests of the Western and Eastern parts of Svaneti depression is significant.

Relict forests (formations, associations) are widespread in the western part of Zemo Svaneti. Vegetation cover of the western part of the region reveals certain similarities to the vegetation cover of geobotanical region of Abkhazia- Samegrelo. In the sub zone of the forest, at about 1000-1200m elevation, forest vegetation is dominated by mixed broadleaf forests (mixed broadleaf forests sub zone). The major species of these forests (edificatory) are Beech (*Fagus orientalis*), Chestnut (*Castanea sativa*), Hornbeam (*Carpinus caucasica*). These species are mixed with Lime (*Tilia caucasica*), Norway Maple (*Acer platanoides*), Painted Maple (*Acer laetum*), etc. A significant part of the forests are represented by relict

Colchis understory (*Rhododendron* - *Rhododendron ponticum*, Cherry Laurel - *Laurocerasus officinalis*, Caucasian bilberry - *Vaccinium arctostaphylos*, etc.) Among monodominant and bidominant broadleaf forests most widespread are species such as Sweet chestnut (*Castanea sativa*), Caucasian Hornbeam (*Carpinus caucasica*), Oriental Beech (*Fagus orientalis*), Beech-Hornbeam, Hornbeam-Chestnut. Relatively dry slopes of south, south-east and south-west part are dominated by Georgian oak (*Quercus iberica*) and hornbeam-oak forests. An interesting relict oak forests are found on limestone slopes, where relict species are developed, such as (Barrenwort - *Epimedium colchicum*, *Arachne colchica*, Abraham-Isaac-Jacob - *Trachystemon orientale*, etc.) Alder forest (*Alnus barbata*) is developed in river flood plains (proalluvial terrace). Mixed coniferous-deciduous and coniferous forest groves are developed in subzone, namely, spruce forest (*Picea orientalis*), fir forest (*Abies nordmanniana*), Pine forest (*Pinus sosnowskyi*), spruce-beech, pine-spruce, spruce-fir forests, etc.

The composition of the forest vegetation formation is sharply changing from 1000-1100 m elevation to 1800-1850 m elevation a.s.l. Forest vegetation cover is dominated by Beech forest (*Fagus orientalis*) and dark coniferous (spruce - *Picea orientalis*, Fir - *Abies nordmanniana*) forests. Pine forests (*Pinus kochiana*) are less developed there. It should be noted that the western part of Svaneti is less populated and due to this fact quite a large number of intact and slightly disturbed forest communities are observed there (excellent Beech forest arrays are preserved on northern slopes of Samegrelo and Letchkhumi mountain range). A significant part of the forests (Beech, Fir, Spruce, Beech-Fir) are represented by relict Colchis undergrowth (cherry laurel - *Laurocerasus officinalis*, rhododendron - *Rhododendron ponticum*, Caucasian bilberry - *Vaccinium arctostaphylos*, Yellow Azalea - *Rhododendron luteum*, etc.).

Some other phytolandscape and floristic features of Nenskra-Nakra region should also be noted. Hypnum sedge and sphagnum glacier bogs are developed in subalpine zone, on Svaneti-Abkhazia and Tsalgmili ridges. Especially noteworthy are Bashkapskara ridge bog (source of Ormeleti River, right side of Nenskra), Shavlura bog (sources of Devra) with Sphagnum developments, where a rare Palaearctic species - *Scheuchzeria palustris* – is developed.

Peat-wetlands are quite widespread in mountainous region of Svaneti, especially in Zemo Svaneti; However, they are rarely developed on large areas. Almost all types of boges are found in this region of Georgia, though, meso-oligotrophic boges are still dominant. Most of them are developed at the upper boundary of Spruce-Fir forests, within 1800-2000 m elevation above sea level. A peat accumulation process is intensive in these boges.

From geobotanical point of view, the most interesting peat-boges are those that are developed within the basin of Nenskra River (Chubrula). One of them is described in detail by A. Dolukhanov (1941). These boges are located at about 1750m a.s.l. the name of its surroundings is Chamkharkhi. The plain existing around this bog is covered by broad leaf grass meadow. Spruce-Fir forests are developed on slopes, which are mixed by Beech and Maple trees. Sphagnetumsc heuchzerieto-caricosum, Sphagnetum scheuchzeriosum and Sphagnetum caricosum are developed in most parts of this bog. Sphagnum magellanicum and Sph. Angustifolium dominate in moss cover of these associations. They are mixed with some other species of sphagnum and *Drepanocladus fluitans*. Caricetum inflatae drepanocladiosum, Caricetum irriguae drepanocladiosum, Scheuchzerietum palustrae purum and Sedge are developed on the surface of peat lands. Here, development of bog is at oligotrophic stage. Peat-bog surface is wavy.

In the basin of the same valley, at 2200 m above sea level, bog is developed on slightly steep slopes of Ormaleti-Sakeni watershed ridge, which is surrounded by broad leaf herb meadows and Rhododendrons. This bog is characterized by one meter thick layer of peat, which covers the surface and neighboring meadow is gradually swamped by water drained from it. The vegetation of the bog is



dominated by *Caricetum kotschyanae hypnosum* and *Caricetum kotschyanae sphagnosum*. *Caricetum canescenti drepanocladiosum* is also represented.

Bog similar to Chamkharkhi is developed on the right side of Nenskra River, on watershed of Lakhmi and Devlura. It is located at 1800 m above sea level and it is surrounded by Fir forest. A few Birch, Mountain Maple and Beech trees are found along the bog. The name of the surroundings of this bog is Shamprili. This marshy is in the meso-trophic stage of its development. Its shoreline is convexed, while its inner part is concaved and is close to the groundwater level. A narrow dingle is developed between the land and convexed line of the bog, in which the water drained from peat is accumulated. This dingle is bogging. Bogging moves ashore.

Vegetation of Shamprili peat-bog is dominated by *Cariceta inflatae* and *Cariceta irriguae*. *Scheuchzerieta palustrae* and *Caricetum canescenti sphagnosum* are also represented on a relatively small areas. *Sphagnum subsecundum* and *Sph. Teres* are dominant in moss synusia; relatively low abundance of *Drepanocladus fluitans* is observed in Sphagnum cover, while rarely it is dominant in moss synusia of some association (*Caricetum inflatae drepanocladiosum*, *Scheuchzerietum palustrae drepanocladiosum*). Associations of *Scheuchzerieta palustrae* are mostly developed in the middle of marshes.

To the West of the described bog, at about 1900 m elevation, there is a quite large peat-bog, which is known as Dombailara. It is developed at the sources of Lakhamistskali River, which is the right tributary of Chubrula River. The area is surrounded by fir forest. Birch, Mountain Maple, Alder and two species of willow grow on the shores and in the bogs. Dombailara peat-bog is developed on the terrain generated from old glacier, apparently as a result of waterlogging moraine lakes. Its surface is separated by small streams, which form large plots. Different complexes of sedge – sphagnum are developed on them. For instance, *Sphagnetum caricosum lasiocarpae* and *Sphagnetum caricosum limosae* are developed on one isolated plot of the bog. Fragments of *Caricetum canescenti calliergonosum* are also found. *Sphagnum angustifolium* and *Sph. Magellanicum* dominate in moss synusia of sphagnums. First type of sphagnum dominates on relatively aqueous peat, while the second type – on surfaces that are less saturated with water. Other mosses are also represented, but they have subordinate significance. *Sphagneta caricosa* dominate on the second part of peat-bog. In vegetation synusia of this association dominate *Carex inflata*, *C. canescens*, *C. irrigua*, *C. limosa*, *C. Dacica*, while in moss synusia – *Sphagnum angustifolium* and *Sph. subsecundum* or rarely *Sphagnum magellanicum* and *Sph. amblyphyllum*. Other types of moss are also found. *Sphagnetum molinoso-caricosum* is developed on the third isolated plot, which covers the smallest area and in which the moss cover is developed by above mentioned species, while grass synusia is dominated by *Carex irrigua*, *Eriophorum vaginatum*, *Potentilla erecta*, *Nardus glabriculumis*, etc. *Caricetum dacicae purum*, *Caricetum dacicae calliergonosum* and *Caricetum dacicae sphagnosum*, as well as fragments of *Sphagnetum caricosum* are developed on the fourth plot of the wetland, which is about a fifth of the entire area of the array. This section of Dombailara is mainly covered by complex of eutrophic associations, while the rest part of the wetland – by meso-oligotrophic types of plants.

Dombailara wetland vegetation is developed on a deep peat layer, the organogenic part of which is formed by remains of moss and sedge. Development of wetland is at meso-trophic stage. *Sphagnetum caricoso-nardosum* is developed on a relatively small area of land, in above mentioned complex of Sedge – Sphagnum. It covers peat bog with most elevated surface. At the final stage of the development of the peat-bogs, most frequently are developed different types of Moor Matgrasses and relatively rarely – Rhododendrons. Fragments of Rhododendrons are represented in some places and occupies an elevated micro relief.

Peat-bogs are far less common in Nakra River basin. Eutrophic wetlands fed by soil are mostly found there. Wetlands in this basin are mainly found watershed ridge of Nenskra and Nakra Rivers (Utviri Mountain pass). The sedge bogs fed by soil are found in the lower part of the watershed ridge, on the

right side of Nakra Valley, at about 1600-2000 m a.s.l. this bogs are mainly dominated by *Caricetum dacicae purum*, *Caricetum dacicae hypnosum*. There also are some fragments of *Caricetum muricatae philonotiosum* and *Caricetum muricatae sphagnosum*. Their moss cover is developed by *Sphagnum squarrosum*, while synusia of herbaceous species is developed by plant species rare to the Caucasus, such as *Primula grandis* and *Cardamine seidlitziana*. Solid peat layers are developed in these bogs, the thickness of which reaches 50-60cm. These bogs are found in the complex of tall Herbaceous and broad-leaf grass meadows.

Different types of wetlands are developed on the left slopes of Nakra River – on Nakra-Maulashi watershed ridge, below the Muhashtobi wetland at 1500 m a.s.l., near Tsaleri village. The name of the surroundings of this wetland is Tsigrani. *Potamogetonetum natantis purum* is developed in the deepest watery part of this wetland, which is surrounded by Bulrush. Along the shoreline, *Blysmetum compressi hypnosum* are found together with sedge of previous wetland (*Caricetum canescenti hypnosum* and *Caricetum dacicae ulacomnium*). The wetland is fed by mineral springs. That's why there is no *Sphagnum* on peat surface. There are several eutrophic wetlands in the vicinity, which are fed by mineral springs. Associations of *Blysmeta compressi hypnosa* and *Junceta lampocarpi hypnosa* are developed in these wetlands. These types of wetlands are also widespread in Dolara valley, mainly in the vicinity of Mazeri and Guli villages. They are developed on the bottom of the valley or on slightly steep slopes and cover small areas.

Based on phytocoenological content of the vegetation and distribution of major types of vegetation, 11 subzones have been determined within high mountainous region of Svaneti (Kimeridze, 1985). Except the mentioned feature, they more or less differ from each other by composition of flora, as well as by degradation of meadows and soil erosion. The project area is located within the first subzone. Below are some of the features of the first subzone according to the locations and the main indicators of vegetation.

The first subzone is located in the western part of the Caucasus Mountain Range, from Svaneti-Abkhazia ridge to the source of Dolra River. The landscape is dominated by alpine Cranesbills, broad leaf grasses and polydominant forb meadows. Mat-grass is developed on a relatively soft terrain and *Rhododendrons* - on sloping terrain. Eutrophic and meso-oligotrophic boges are developed in some areas with inclusions of *Scheuchzeria palustris*. One of this type of bog was first described by Dolukhanov (1941), and then by Kimeridze (1964). *Sphagnum* mosses and the specific wetland mosses are most abundant in this micro-zone.

Floristically rich Colchis subalpine tall herbaceous species are developed within the Nenskra and Nakra valleys. Many new species of plants existing in these basins have been described by Sommier and Levier (1900). A rare Colchis and Caucasian species, such as *Cirsium albovianum*, *Angelica tatiana*, *Lilium keselringianum*, etc., are observed in these valleys.

Subnival zone is represented on high ridges and peaks above 3200 m elevation. Vegetation cover is represented by open cenoses, fragments of alpine meadows can be also found. Vegetation of the Svaneti Caucasus, from Dolra valley to Tetnuldi, is dominated by rare subnival species to Svaneti - *Delphinium caucasicum*, *Pseudovesicaria digitata* and others (Kimeridze, 1985). Botanical-geographical region of Nenskra-Nakra is characterized by western Caucasus specie - *Jurinea pumila* and Caucasus – Asia specie - *Coluteocarpus vesicaria*.

### 5.2.6.1.3 Detailed Characteristics of Flora and Vegetation Within the Project Area

Conducted botanical studies cover botanical-geographical region of the rivers Nenskra and Nakra catchment area. Therefore, expected negative and residual impact from the construction and operation of the HPP on the flora and vegetation in the project corridor and adjacent area was determined. Various

plant communities and species of different conservation value (rare, endemic species, species from the Red List and the Red Book of Georgia), as well as plants with economic value were detected.

During the botanical survey, cover and abundance of vegetation were estimated according to the Drude Scale. Drude scale symbols indicate the cover and abundance of species. These symbols are: Soc (socialis)- dominant species, cover-abundance is more than 90%; Cop3 (coptosal) - aq high number of species, cover-abundance is 70-90%; Cop2 - represented by a variety of species, cover-abundance is 50-70%; Cop1- cover-abundance is 50-70%; Sp3 (sporsal)- cover-abundance is approximately 30%; Sp2 (sporsal)- cover-abundance is approximately 20%; Sp1 (sporsal)- cover-abundance is approximately 10%; Sol (solitarie) – small amount of species, cover-abundance is up to 10%; Un (unicum) – one individ.

**Plot №1.1.** GPS coordinates are N43°07'58.9"/E 042°12'51.2", 1320 1320 m a.s.l. Inclination – 25°. Habitat with high conservation value. Following plants are developed on this area: Beech (*Fagus orientalis*) forest with Cherry laurel (*Laurocerasus officinalis*) undergrowth, which is mixed by Spruce (*Picea orientalis*), Fir (*Abies nordmanniana*), Elm (*Tilia caucasica*), Maple (*Acer platanoides*), Elder (*Sambucus nigra*), Hazelnuts (*Corylus avellana*), Blackberry (*Rubus* sp.), Elderflower (*Sambucus ebulus*), Fern (*Matteuccia struthiopteris*). *Acer platanoides*-pbh-130cm, height - 30m, *Fagus orientalis*- pbh -170cm, height -20m. *Salvia glutinosa* is massively weeding above mentioned areas. Alder forest (*Alnus incana*) is represented in the lower part. Such type of forests are also found in the upper floodplain, which is mixed with Beech (*Fagus orientalis*). Alder forest with fern and blackberry (*Matteuccia struthiopteris*) are also represented there. Rowan (*Sorbus caucasigena*), Hornbeam (*Carpinus caucasica*), Birch (*Betula litwinowii*), common hazel (*Corylus avellana*). Alder forest is developed at 1364 m a.s.l. *Senecio pojarkovae*, *S. platyphylloides*, *Delpinium flexuosum* are found on alluvial fans.



**Plot №1.1.** Beech forest with cherry laurel understory



**Plot №1.1.** Beech forest with cherry laurel understory



**Plot №1.1.** Common hazel (*Corylus avellana*)



**Plot №1.1.** Ostrich fern (*Matteuccia struthiopteris*)

**Plot №2.** GPS coordinates are N43°08'14.1"/E 042°13'57.3", 1370 m a.s.l. Inclination 20°-25°. Habitat with average conservation value. The following species of mixed deciduous forest are represented on this area: Georgian Oak (*Quercus iberca*), Hornbeam (*Carpinus caucasica*), Lime (*Tilia caucasica*), Rowan (*Sorbus caucasigena*). Spruce-Fir forest is observed in the upper part (*Picea orientalis*, *Abies nordmanniana*). *Senecio pojarkovae*, *Delphinium flexuosum* are developed on alluvial fans. *Atropa caucasica*, *Hydrocotyle ramiflora*, *Salvia glutinosa*, *Sinene compacta* are found at the edge of the forests. From here, water will flow up on slopes at 80m and this area will be flooded.



Plot №1.2. Mixed deciduous forest



Plot №1.2. marsh penny (*Hydrocotyle ramiflora*)



Plot №1.2. Glutinous sage (*Salvia glutinosa*)



Plot №1.2. Rowan (*Sorbus caucasigena*)



Plot №1.2. *Senecio pojarkovae*



Plot №1.2. *Sinene compacta*



**Plot №1.2.** Mixed deciduous forest



**Plot №1.2.** Caucasus Belladonna (*Atropa caucasica*)



**Plot №1.2.** Mixed deciduous forest

**Plot №1.3.** GPS coordinates are N43°08'19.3"/E 042°14'19.6", 1380 m a.s.l. Inclination 15°-20°. Exposition – East. High conservation value habitat: Beech forest (*Fagus orientalis*) with Black Sea holly (*Ilex colchica*) understory. Beech forest is degraded (deforestation). Large Beech trees are also found –pbh – 1.5m, height - 30m. Mixed with Fir (*Abies nordmanniana*), Spruce (*Picea orientalis*), Lime (*Tilia caucasica*), Maple (*Acer platanoides*). Elder (*Sambucus ebulus*) is found at the edges of the forest. Fragment of subalpine tall herbaceous is represented within this area - *Senecio pojarkovae*, *Gadelia lactiflora*, after which Alder forest is developed (*Alnus incana*) with Cherry laurel (*Laurocerasus officinalis*) undergrowth; Beech forest with Black Sea holly understory is represented there.



**Plot №1.3.** Beech forest with Black Sea holly understory



**Plot №1.3.** Elder (*Sambucus ebulus*)



**Plot №1.3.** Beech Forest



**Plot №1.3.** Riverside terrace - Alder



**Plot №1.3.** Fragment of subalpine tall herbaceous -  
*Senecio pojarkovae*



**Plot №1.3.** Black Sea holly (*Ilex colchica*)



**Plot №1.3.** Beech forest (*Fagus orientalis*) with Black Sea holly (*Ilex colchica*) understory.



**Plot №1.3.** Beech forest (*Fagus orientalis*) with Black Sea holly (*Ilex colchica*) understory.



**Plot №1.3.** Milky bellflower (*Gadelia lactiflora*)

**Plot №1.4.** GPS coordinates are N43°08'26.1"/E 042°14'51.5", 1405 m a.s.l. Inclination 25°-30°. High conservation value habitat. Beech Forest (*Fagus orientalis*) with Colchis relic undergrowth (tall, Caucasian cranberries - *Vaccinium arctostaphylos*). Beech (*Fagus orientalis*)-pbh-150cm, height-25m (maximum), pbh-60cm, height -15m (minimum); Gentian (*Gentiana schistocalyx*) is represented from herbaceous plants.



**Plot №1.4.** Beech Forest (*Fagus orientalis*) with Colchis relic undergrowth



**Plot №1.4.** Gentian (*Gentiana schistocalyx*)



**Plot №1.4.** Tall, Caucasian cranberries -*Vaccinium arctostaphylos*



**Plot №1.4.** Beech Forest (*Fagus orientalis*) with tall, Caucasian cranberries undergrowth

**Plot №1.5.** GPS coordinates are N43°08'36.7"/E 042°15'00.7", 1377 m a.s.l. Inclination 35°. High conservation value habitat. Beech forest (*Fagus orientalis*) is developed within this area with Spruce (*Picea orientalis*). King Solomon's-seal (*Polygonatum polyanthemum*) is developed from herbaceous plants.



**Plot №1.5.** Beech forest (*Fagus orientalis*) with dead layer



**Plot №1.5.** Beech forest (*Fagus orientalis*) with dead layer mixed with Spruce (*Picea orientalis*)



**Plot №1.5.** Beech forest with dead layer



**Plot №1.5.** King Solomon's-seal (*Polygonatum polyanthemum*)



**Plot №1.5.** Beech forest with dead layer mixed with Spruce

**Plot №1.6.** GPS coordinates are N43°08'40.9"/E 042°15'11.4", 1400 m a.s.l. Inclination - 25°. High conservation value habitat. Fir forest (*Abies nordmanniana*) is developed within this area, which is



mixed with Spruce (*Picea orientalis*) and Beech (*Fagus orientalis*), Blackberry (*Rubus* sp.) and Elder (*Sambucus ebulus*) are found in the undergrowth.



**Plot №1.6.** Fir forest mixed with Spruce and Beech



**Plot №1.6.** Fir forest mixed with Spruce and Beech

**Plot №1.7.** GPS coordinates are N43°08'49.6"/E 042°15'25.8", 1430 m a.s.l. Inclination 10°-15°. Medium conservation value habitat. Alder forest (*Alnus incana*) is developed within this area, which is mixed with Spruce (*Picea orientalis*) in some places.



**Plot №1.7.** Alder forest (*Alnus incana*)



**Plot №1.7.** Alder forest (*Alnus incana*) mixed with Spruce (*Picea orientalis*) in some places.



**Plot №1.7.** Mixed deciduous forest

On the other side, on the left bank of the river, mixed deciduous forest is represented with the following species: Hornbeam (*Carpinus caucasica*), Beech (*Fagus orientalis*), Lime (*Tilia caucasica*), Georgian Oak (*Quercus iberca*), Maple (*Acer platanoides*); Spruce (*Picea orientalis*)- Fir (*Abies nordmanniana*) forest is

developed on a slope with 25° inclination, Inula - *Telekia speciosa* is also found there. High conservation value habitat.

**Plot №1.8.** GPS coordinates are N43°00'37.7"/E 042°12'08.8", 1176 m a.s.l. above Chuberi, which is an approximate location of tunnel outlet. This will be an area for TBM platform or construction site. Area is 300mX200m (1 ha and 200 m). Exposition – South-West, inclination 20°-25°. High conservation value habitat. Caucasian Wild Pear (*Pyrus caucasica*) grow in the forest. Spruce (*Picea orientalis*) - Fir (*Abies nordmanniana*) forest is developed there. The forest where Caucasian Wild Pear is found is a low conservation value habitat. While Spruce-Fir forest is a high conservation value habitat. Fir -pbh-3m, height-20m; Spruce-pbh-2m, height-16m. Young Fir trees are also found. Pasture-forb meadow is represented there. Jupiter's sage (*Salvia glutinosa*), Elder (*Sambucus ebulus*), *Phytolacca americana*, *Digitalis ciliata* are found at the edges of the forest.



**Plot №1.8.** Caucasian wild pear (*Pyrus caucasica*)



**Plot №1.8.** Spruce-Fir forest



**Plot №1.8.** Spruce-Fir forest



**Plot №1.8.** Foxgloves - *Digitalis ciliata*



**Plot №1.8.** Spruce-Fir forest

**Plot №1.9.** GPS coordinates are N43°00'24.7"/E 042°12'25.8", 1215 m a.s.l. High conservation value habitat. This is an area for tunnel outlet. A narrow road will be arranged between plot №8 and this section and Fir (*Abies nordmanniana*)-Beech (*Fagus orientalis*) forest with dead layer will be deforested. Beech-pbh-120cm, height-25m; Fir-pbh-30cm, height-7m. Maple (*Acer platanoides*) and Black Sea holly (*Ilex colchica*) are represented in undergrowth. Exposition – West, inclination – 35°. Young trees of Elder (*Sambucus ebulus*), Jupiter's sage (*Salvia glutinosa*), Hairy foxglove (*Digitalis ciliata*), Common hazel (*Corylus avellana*) and Spruce (*Picea orientalis*) are found in open areas.



**Plot №1.9.** Fir-Beech forest with dead layer



**Plot №1.9.** Fir-Beech forest with dead layer



**Plot №1.9.** Fir-Beech forest with dead layer



**Plot №1.9.** Foxgloves- *Digitalis ciliata*

**Plot №1.10.** GPS coordinates are N43°00'33.7"/E 042°12'14.8", 1196 m a.s.l. Exposition – South, inclination - 35°. High conservation value habitat. This area is a forested slope. This is an area for waste rock disposal. Forest will be destroyed throughout the entire slope, in which Spruce (*Picea orientalis*)–Beech (*Fagus orientalis*) forest with dead layer is developed. Beech-80cm-pbh, height-25m; Spruce-1m-pbh, Height-12m; mixed with Hornbeam (*Carpinus caucasica*)-pbh-25cm, height-12m, Chestnut (*Castanea sativa*)-pbh-25cm, height-15m (rarely in this section); in the lower part, Georgian Oak (*Quercus iberica*) is also mixed. Hairy foxglove (*Digitalis ciliata*) is also found there.



**Plot №1.10.** Spruce-Beech forest with dead layer



**Plot №1.10.** Spruce-Beech forest with dead layer



**Plot №1.10.** Hairy foxglove (*Digitalis ciliata*)



**Plot №1.10.** Beech (*Fagus orientalis*)



**Plot №1.10.** Spruce-Beech forest with dead layer

**Plot №1.11.** GPS coordinates are N43°00'47.6"/E 042°11'31.9", 711 m a.s.l. Inclination - 5°. Low conservation value habitat. Within this section, on riverside terrace Alder forest (*Alnus barbata*) and Caucasian wild pear (*Pyrus caucasica*) are represented. This is an area for construction site.



**Plot №1.11. Riverside terrace with Alder forest**  
(*Alnus barbata*) and Caucasian wild pear (*Pyrus caucasica*)

**Plot №1.12.** GPS coordinates are N42°59'41.2"/E 042°11'14.1", 774 m a.s.l. Inclination - 5°-15°. Low conservation value habitat. Area of pastures, agricultural plots, etc. Area for powerhouse, offices and etc.



**Plot №1.12.** Agro-landscape, agricultural plots, pastures, etc.

**Plot №1.13.** GPS coordinates are N43°07'22.8"/E 042°23'59.1", 1400 m a.s.l. High conservation value habitat. Nakra valley – area where the riv. Nakra water will be discharged into the riv. Nenskra. On the right bank of the river, on riverside terrace Alder forest (*Alnus incana*) is represented (inclination of the slope - 5°-10°), on the upper terrace – Beech (*Fagus orientalis*) -Fir (*Abies nordmanniana*) forest (inclination of the slope - 25°). The right bank of the river will not be affected.



Plot №1.13. Nakra River – Alder forest (*Alnus incana*)

Plot №1.13. Beech-Fir forest



Plot №1.13. Beech-Fir forest

## Plot 2.1. Sparse Beech forest mixed with Maple, Fir and Spruce

Type of plant community	Sparse Beech forest mixed with Maple, Fir and Spruce
Conservation value	Medium
Location	Nenskra River valley, Mashrichala, construction site
Sample plot №	2.1
Area of sample plot (m <sup>2</sup> )	100
GPS coordinates	N43°12'66.6"/E42°19'75.0"
Height a.s.l. (m)	1264
Aspect	–
Inclination	0°
Structural Features of plant communities	
Max. DBH (cm)	92
Average DBH (cm)	70
Max. height of the tree (m)	27
Average height of the tree (m)	25
Number of trees within a sample plot	25
Coverage of tree layers (%)	15-20
Coverage of shrub layers (%)	–
Heights of shrubs (cm)	–
Grass cover layer (%)	90
Height of grass cover (cm)	150
Moss layer (%)	–
Number of the highest plant species	14
Types	Cover-abundance according to Drude scale
Tree layer	
Beech - <i>Fagus orientalis</i>	Sp <sup>2</sup>
Maple - <i>Acer platanoides</i>	Sp <sup>1</sup>
Nordmann fir - <i>Abies nordmanniana</i>	Sol
<i>Picea orientalis</i>	Sol

Shrubs	
Shrub species have not been recorded	–
Grass cover	
Common nettle - <i>Urtica dioica</i>	Sp <sup>3</sup>
Curly dock - <i>Rumex crispus</i>	Sp <sup>3</sup>
Horse Mint - <i>Mentha longifolia</i>	Sp <sup>2</sup>
Danewort - <i>Sambucus ebulus</i>	Sp <sup>1</sup>
Knotgrass - <i>Polygonum aviculare</i>	Sp <sup>1</sup>
Houndstongue - <i>Cynoglossum officinale</i>	Sp <sup>1</sup>
Hedge mustard - <i>Sisimbrium officinale</i>	Sol
Trifolium anbiguum	Sol
High Mallow - <i>Malva sylvestris</i>	Sol
Kentucky bluegrass - <i>Poa pratensis</i>	Sol
Moss cover	
Moss species have not been recorded	–



**Plot 2.1.** Sparse Beech forest mixed with Maple, Fir and Spruce



**Plot 2.1.** Sparse Beech forest mixed with Maple, Fir and Spruce

**Plot 2.2. Alder forest with Yellow Azalea undergrowth mixed with Spruce**

Type of plant community	Alder forest with Yellow Azalea undergrowth mixed with Spruce
Conservation value	Medium
Location	Confluence of Nenskra and Khokrili Rivers, area of stone quarry
Sample plot N <sup>o</sup>	2.2
Area of sample plot (m <sup>2</sup> )	100
GPS coordinates	N43°11'12.2"/E42°18'28.1"
Height a.s.l. (m)	1199
Aspect	East
Inclination	20-25°
Structural Features of plant communities	
Max. DBH (cm)	15
Average DBH (cm)	12
Max. height of the tree (m)	10



Average height of the tree (m)	7
Number of trees within a sample plot	30-40
Coverage of tree layers (%)	50-60
Coverage of shrub layers (%)	60-70
Heights of shrubs (cm)	400
Grass cover layer (%)	50-60
Height of grass cover (cm)	100
Moss layer (%)	–
Number of the highest plant species	9
<b>Species</b>	<b>Cover-abundance according to Drude scale</b>
<b>Tree layer</b>	
Common Alder - <i>Alnus barbata</i>	Cop <sup>2</sup>
<i>Picea orientalis</i>	Sp <sup>1</sup>
<b>Shrubs</b>	
Common Rhododendron - <i>Rhododendron ponticum</i> - Oldest relic of the Tertiary period	Cop <sup>1</sup>
<b>Grass cover</b>	
Male Fern - <i>Dryopteris filix-mas</i>	Cop <sup>2</sup>
Wood sorrel - <i>Oxalis acetosella</i>	Sp <sup>2</sup>
Wild strawberry - <i>Fragaria vesca</i>	Sp <sup>2</sup>
Jupiter's sage - <i>Salvia glutinosa</i>	Sp <sup>1</sup>
<i>Cardamine pectinata</i>	Sol
Great willowherb - <i>Epilobium hirsutum</i>	Sol
<b>Moss cover</b>	
Moss species have not been recorded	–



**Plot 2.2.** Alder forest with Yellow Azalea undergrowth mixed with Spruce



**Plot 2.2.** Common rhododendron (*Rhododendron ponticum*)



**Plot 2.2.** Alder forest with Yellow Azalea undergrowth mixed with Spruce

### Plot 2.3. Alder Forest

<b>Type of plant communities</b>	<b>Alder Forest</b>
<b>Conservation value</b>	<b>Low</b>
Location	Confluence of Nenskra and Khokrili Rivers, area of stone quarry
Sample plot №	2.3
Area of sample plot (m <sup>2</sup> )	100
GPS coordinates	N43°11'12.2"/E42°18'28.1"
Height a.s.l. (m)	1190
Aspect	South
Inclination	10-15°
<b>Structural Features of plant communities</b>	
Max. DBH (cm)	8
Average DBH (cm)	4
Max. height of the tree (m)	8
Average height of the tree (m)	5
Number of trees within a sample plot	30-40
Coverage of tree layers (%)	50-60
Coverage of shrub layers (%)	–
Heights of shrubs (cm)	–
Grass cover layer (%)	30
Height of grass cover (cm)	100
Moss layer (%)	–
Number of the highest plant species	7
<b>Species</b>	<b>Cover-abundance according to Drude scale</b>
<b>Tree layer</b>	
Common Alder - <i>Alnus barbata</i>	Cop <sup>2</sup>
<b>Shrubs</b>	
Shrub species have not been recorded	–
<b>Grass cover</b>	

Wood sorrel - <i>Oxalis acetosella</i>	Sp <sup>3</sup>
Wild strawberry - <i>Fragaria vesca</i>	Sp <sup>2</sup>
Jupiter's sage - <i>Salvia glutinosa</i>	Sp <sup>1</sup>
Male Fern - <i>Dryopteris filix-mas</i>	Sp <sup>1</sup>
<i>Cardamine pectinata</i>	Sol
Great willowherb - <i>Epilobium hirsutum</i>	Sol
<b>Moss cover</b>	
Moss species have not been recorded	–



**Plot 2.3. Jupiter's sage (*Salvia glutinosa*)**



**Plot 2.3. Alder forest**

#### Plot 2.4. Alder forest mixed with young trees of Spruce and Fir

Type of plant communities	Alder forest mixed with young trees of Spruce and Fir
Conservation value	Medium
Location	Confluence of Nenskra and Khokrili Rivers, area of stone quarry
Sample plot N <sup>o</sup>	2.4
Area of sample plot (m <sup>2</sup> )	100
GPS coordinates	N43°11'12.2"/E42°18'28.1"
Height a.s.l. (m)	1190
Aspect	East
Inclination	3-5°
<b>Structural Features of plant communities</b>	
Max. DBH (cm)	25
Average DBH (cm)	22
Max. height of the tree (m)	12
Average height of the tree (m)	8
Number of trees within a sample plot	40-50
Coverage of tree layers (%)	30-40
Coverage of shrub layers (%)	–
Heights of shrubs (cm)	–
Grass cover layer (%)	20

Height of grass cover (cm)	60
Moss layer (%)	–
Number of the highest plant species	8
<b>Species</b>	<b>Cover-abundance according to Drude scale</b>
<b>Tree layer</b>	
Common Alder - <i>Alnus barbata</i>	Cop <sup>1</sup>
<i>Picea orientalis</i>	Sol
<i>Abies nordmanniana</i>	Sol
<b>Shrubs</b>	
Shrub species have not been recorded	–
<b>Grass cover</b>	
White stonecrop - <i>Sedum album</i>	Sp <sup>2</sup>
Male fern - <i>Dryopteris filix-mas</i>	Sp <sup>2</sup>
Wild strawberry - <i>Fragaria vesca</i>	Sp <sup>1</sup>
<i>Trachistemon orientale</i>	Sp <sup>1</sup>
Jupiter's sage - <i>Salvia glutinosa</i>	Sp <sup>1</sup>
Herb-Robert - <i>Geranium robertianum</i>	Sol
Showy Calamint - <i>Calamintha grandiflora</i>	Unicum
<b>Moss cover</b>	
Moss species have not been recorded	–



**Plot 2.4.** Alder forest mixed with young trees of Spruce and Fir



**Plot 2.4.** Alder forest mixed with young trees of Spruce and Fir

#### Plot 2.5. Alder forest on the riverside terrace

Type of plant communities	Alder forest on the riverside terrace
Conservation value	Low
Location	Nenskra River valley, upper point of waterlogging
Sample plot N <sup>o</sup>	2.5
Area of sample plot (m <sup>2</sup> )	100
GPS coordinates	N43°14'05.7"/E42°24'86.6"
Height a.s.l. (m)	1373
Aspect	–
Inclination	0°
<b>Structural Features of plant communities</b>	

Max. DBH (cm)	15
Average DBH (cm)	12
Max. height of the tree (m)	8
Average height of the tree (m)	6
Number of trees within a sample plot	30
Coverage of tree layers (%)	40-50
Coverage of shrub layers (%)	50-60
Heights of shrubs (cm)	250
Grass cover layer (%)	70-80
Height of grass cover (cm)	30
Moss layer (%)	50
Number of the highest plant species	8
<b>Species</b>	<b>Cover-abundance according to Drude scale</b>
<b>Tree layer</b>	
Common Alder - <i>Alnus barbata</i>	Cop <sup>3</sup>
<b>Shrubs</b>	
Rubus sp.	Sp <sup>3</sup>
Juniperus depressa	Sp <sup>1</sup>
Common hazel - <i>Corylus avellana</i>	Sp <sup>1</sup>
Myricaria alopecuroides	Sol
<b>Grass cover</b>	
Wild strawberry - <i>Fragaria vesca</i>	Cop <sup>2</sup>
White stonecrop - <i>Sedum album</i>	Cop <sup>1</sup>
Jupiter's sage - <i>Salvia glutinosa</i>	Sp <sup>2</sup>
<b>Moss cover</b>	
Moss layer (%)	Cop <sup>1</sup>



**Plot 2.5.** Alder forest on the riverside terrace



**Plot 2.5.** Alder forest on the riverside terrace

**Plot 2.6. Alder forest (young) on the riverside terrace**

Type of plant communities	Alder forest (young) on the riverside terrace
Conservation value	Low
Location	Nenskra River valley, upper point of waterlogging
Sample plot N°	2.6
Area of sample plot (m <sup>2</sup> )	100
GPS coordinates	N43°13'94.7"/E42°24'77.8"
Height a.s.l. (m)	1308
Aspect	–
Inclination	0°
Structural Features of plant communities	
Max. DBH (cm)	7
Average DBH (cm)	5
Max. height of the tree (m)	7
Average height of the tree (m)	4
Number of trees within a sample plot	60
Coverage of tree layers (%)	50
Coverage of shrub layers (%)	5-10
Heights of shrubs (cm)	100
Grass cover layer (%)	20-30
Height of grass cover (cm)	80
Moss layer (%)	5-10
Number of the highest plant species	11
Species	Cover-abundance according to Drude scale
Tree layer	
Grey alder - <i>Alnus incana</i>	Cop <sup>2</sup>
Common Alder - <i>Alnus barbata</i>	Cop <sup>1</sup>
Shrubs	
<i>Rubus</i> sp.	Sp <sup>1</sup>
Grass cover	
<i>Sedum oppositifolium</i>	Cop <sup>2</sup>
Wild strawberry - <i>Fragaria vesca</i>	Sp <sup>1</sup>
Male fern - <i>Dryopteris filix-mas</i>	Sp <sup>1</sup>
Lady's mantle - <i>Alchemilla</i> sp.	Sol
<i>Lapsana communis</i>	Sol
Jupiter's sage - <i>Salvia glutinosa</i>	Sol
Wood bluegrass - <i>Poa nemoralis</i>	Sol
Mouse-ear hawkweed - <i>Hieracium pilosella</i>	Sp <sup>2</sup>
Moss cover	
Moss layer (%)	Sp <sup>1</sup>



**Plot 2.6.** Alder forest (young) on the riverside terrace

**Plot 2.7. Alder forest with blackberry undergrowth**

Type of plant communities	Alder forest with blackberry undergrowth
Conservation value	Low
Location	Nenskra River valley, right bank, area of waterlogging
Sample plot N°	2.7
Area of sample plot (m <sup>2</sup> )	100
GPS coordinates	N43°13'94.7"/E42°24'77.8"
Height a.s.l. (m)	1306
Aspect	South-East
Inclination	5-10°
Structural Features of plant communities	
Max. DBH (cm)	60
Average DBH (cm)	45
Max. height of the tree (m)	25
Average height of the tree (m)	20
Number of trees within a sample plot	30
Coverage of tree layers (%)	80
Coverage of shrub layers (%)	70-80
Heights of shrubs (cm)	150
Grass cover layer (%)	30-35
Height of grass cover (cm)	80
Moss layer (%)	–
Number of the highest plant species	5
Species	Cover-abundance according to Drude scale
Tree layer	
Common Alder - <i>Alnus barbata</i>	Cop <sup>3</sup>
Shrubs	
Rubus sp.	Cop <sup>2</sup>
Grass cover	
Male fern - <i>Dryopteris filix-mas</i>	Sp <sup>2</sup>
Sweet Woodruff - <i>Asperula odorata</i>	Sp <sup>3</sup>

Der Raue Beinwell - <i>Symphytum asperum</i>	Sol
<b>Moss cover</b>	
Moss species have not been recorded	–



Plot 2.7. Alder forest with blackberry undergrowth

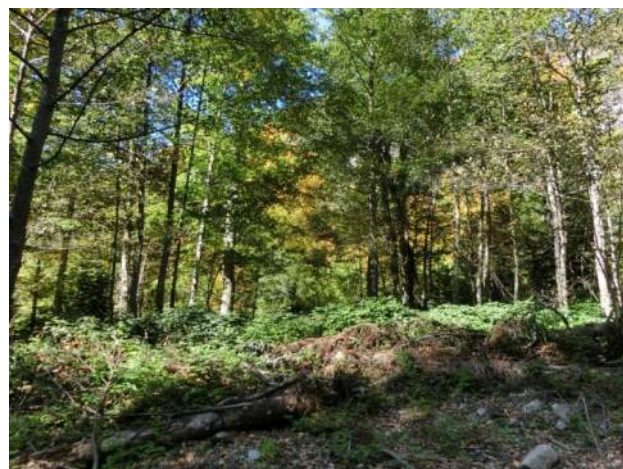

Plot 2.7. Alder forest with blackberry undergrowth

#### Plot 2.8. Young Fir forest mixed with Birch, Blackberry undergrowth

Type of plant communities	Young Fir forest mixed with Birch, Blackberry undergrowth
Conservation value	Medium
Location	Nenskra River valley, right bank, area of waterlogging
Sample plot №	2.8
Area of sample plot (m <sup>2</sup> )	100
GPS coordinates	N43°13'85.6"/E42°24'29.0"
Height a.s.l. (m)	1379
Aspect	South-East
Inclination	5-10°
<b>Structural Features of plant communities</b>	
Max. DBH (cm)	54
Average DBH (cm)	17
Max. height of the tree (m)	20
Average height of the tree (m)	14
Number of trees within a sample plot	30-40
Coverage of tree layers (%)	40-50
Coverage of shrub layers (%)	70-80
Heights of shrubs (cm)	300
Grass cover layer (%)	–
Height of grass cover (cm)	–
Moss layer (%)	–
Number of the highest plant species	4
<b>Species</b>	<b>Cover-abundance according to Drude scale</b>
<b>Tree layer</b>	
Caucasian Fir - <i>Abies nordmanniana</i>	Cop <sup>1</sup>



Betula litwinowii	Sol
<b>Shrubs</b>	
Rubus sp.	Cop <sup>2</sup>
Corylus avellana	Sp <sup>1</sup>
<b>Grass cover</b>	
Grass species have not been recorded	–
<b>Moss cover</b>	
Moss species have not been recorded	–



**Plot 2.8.** Young Fir forest mixed with Birch,  
Blackberry undergrowth



**Plot 2.8.** Young Fir forest mixed with Birch,  
Blackberry undergrowth

#### Plot 2.9. Dead layered beech forest mixed with Fir and Spruce

<b>Type of plant communities</b>	<b>Dead layered beech forest mixed with Fir and Spruce</b>
<b>Conservation value</b>	<b>Medium</b>
Location	Nenskra River valley, right bank, area of waterlogging
Sample plot №	2.9
Area of sample plot (m <sup>2</sup> )	100
GPS coordinates	N43°14'34.9"/E42°23'91.8"
Height a.s.l. (m)	1370
Aspect	East
Inclination	5-10°
<b>Structural Features of plant communities</b>	
Max. DBH (cm)	45
Average DBH (cm)	15
Max. height of the tree (m)	25
Average height of the tree (m)	18
Number of trees within a sample plot	50
Coverage of tree layers (%)	80
Coverage of shrub layers (%)	60-70
Heights of shrubs (cm)	150
Grass cover layer (%)	–
Height of grass cover (cm)	–

Moss layer (%)	–
Number of the highest plant species	4
<b>Species</b>	<b>Cover-abundance according to Drude scale</b>
<b>Tree layer</b>	
Oriental Beech - <i>Fagus orientalis</i>	Cop <sup>2</sup>
Caucasian Fir - <i>Abies nordmanniana</i>	Cop <sup>1</sup>
Caucasian Spruce - <i>Picea orientalis</i>	Sp <sup>3</sup>
<b>Shrubs</b>	
Rubus sp.	Cop <sup>2</sup>
<b>Grass cover</b>	
Grass species have not been recorded	–
<b>Moss cover</b>	
Moss species have not been recorded	–



Plot 2.9. Dead layered beech forest mixed with Fir and Spruce

#### Plot 2.10. Beech Forest mixed with Black Fern

<b>Type of plant communities</b>	<b>Beech Forest mixed with Black Fern</b>
<b>Conservation value</b>	<b>Medium</b>
Location	Nenskra River valley, right bank, area of waterlogging
Sample plot N <sup>o</sup>	2.10
Area of sample plot (m <sup>2</sup> )	100
GPS coordinates	N43°14'34.9"/E42°23'91.8"
Height a.s.l. (m)	1370
Aspect	West
Inclination	10-15°
<b>Structural Features of plant communities</b>	
Max. DBH (cm)	45
Average DBH (cm)	35
Max. height of the tree (m)	25
Average height of the tree (m)	20
Number of trees within a sample plot	50
Coverage of tree layers (%)	60

Coverage of shrub layers (%)	30
Heights of shrubs (cm)	150
Grass cover layer (%)	50-60
Height of grass cover (cm)	200
Moss layer (%)	–
Number of the highest plant species	4
<b>Species</b>	<b>Cover-abundance according to Drude scale</b>
<b>Tree layer</b>	
Oriental Beech - <i>Fagus orientalis</i>	Cop <sup>2</sup>
<b>Shrubs</b>	
Rubus sp.	Sp <sup>3</sup>
<b>Grass cover</b>	
Ostrich fern - <i>Matteuccia struthiopteris</i>	Cop <sup>3</sup>
Danewort - <i>Sambucus ebulus</i>	Sp <sup>1</sup>
<b>Moss cover</b>	
Moss species have not been recorded	–



Plot 2.10. Beech Forest mixed with Black Fern



Plot 2.10. Black Fern (*Matteuccia struthiopteris*)

### Plot 2.11. Beech forest mixed with Holly

<b>Type of plant communities</b>	<b>Beech forest mixed with Holly</b>
<b>Conservation value</b>	<b>High</b>
Location	Nenskra River valley, right bank, area of waterlogging
Sample plot N°	2.11
Area of sample plot (m <sup>2</sup> )	100
GPS coordinates	N43°08'19.3"/E 042°14'19.6", 1380
Height a.s.l. (m)	1380
Aspect	West
Inclination	10-15°
<b>Structural Features of plant communities</b>	
Max. DBH (cm)	60

Average DBH (cm)	45
Max. height of the tree (m)	25
Average height of the tree (m)	18
Number of trees within a sample plot	30
Coverage of tree layers (%)	50
Coverage of shrub layers (%)	60-70
Heights of shrubs (cm)	100
Grass cover layer (%)	–
Height of grass cover (cm)	–
Moss layer (%)	–
Number of the highest plant species	5
<b>Species</b>	<b>Cover-abundance according to Drude scale</b>
<b>Tree layer</b>	
Oriental Beech - <i>Fagus orientalis</i>	Cop <sup>2</sup>
Caucasian Spruce - <i>Picea orientalis</i>	Sp <sup>2</sup>
Caucasian Fir - <i>Abies nordmanniana</i>	Sol
<b>Shrubs</b>	
Black Sea holly - <i>Ilex colchica</i> – besides the Caucasus, it is found in Stranja (Balkans) and Chaneti (Asia Minor)	Cop <sup>2</sup>
Rubus sp.	Sp <sup>2</sup>
<b>Grass cover</b>	
Grass species have not been recorded	–
<b>Moss cover</b>	
Moss species have not been recorded	–



Plot 2.11. Beech forest mixed with Holly



Plot 2.11. Black Sea holly (*Ilex colchica*)



Plot 2.11. Beech forest mixed with Holly

**Plot 2.12. Beech forest with Cherry laurel undergrowth**

Type of plant communities	Beech forest with Cherry laurel undergrowth
Conservation value	High
Location	Nenskra River valley, right bank, area of waterlogging
Sample plot N°	2.12
Area of sample plot (m <sup>2</sup> )	100
GPS coordinates	N43°08'19.3"/E 042°14'19.6", 1380
Height a.s.l. (m)	1370
Aspect	East
Inclination	15-20°
Structural Features of plant communities	
Max. DBH (cm)	26
Average DBH (cm)	20
Max. height of the tree (m)	18
Average height of the tree (m)	14
Number of trees within a sample plot	30
Coverage of tree layers (%)	80
Coverage of shrub layers (%)	70-80
Heights of shrubs (cm)	400
Grass cover layer (%)	–
Height of grass cover (cm)	–
Moss layer (%)	–
Number of the highest plant species	7
Species	Cover-abundance according to Drude scale
Tree layer	
Oriental Beech - <i>Fagus orientalis</i>	Cop <sup>2</sup>
Caucasian Spruce - <i>Picea orientalis</i>	Sp <sup>3</sup>
<i>Tilia caucasica</i>	Sp <sup>1</sup>
Shrubs	

Cherry laurel - <i>Laurocerasus officinalis</i> - the oldest tertiary relict of Eastern Mediterranean area	Cop <sup>2</sup>
Rubus sp.	Sp <sup>2</sup>
Common hazel - <i>Corylus avellana</i>	Sp <sup>1</sup>
Guelder-rose - <i>Viburnum opulus</i>	Sol
<b>Grass cover</b>	
Grass species have not been recorded	–
<b>Moss cover</b>	
Moss species have not been recorded	–

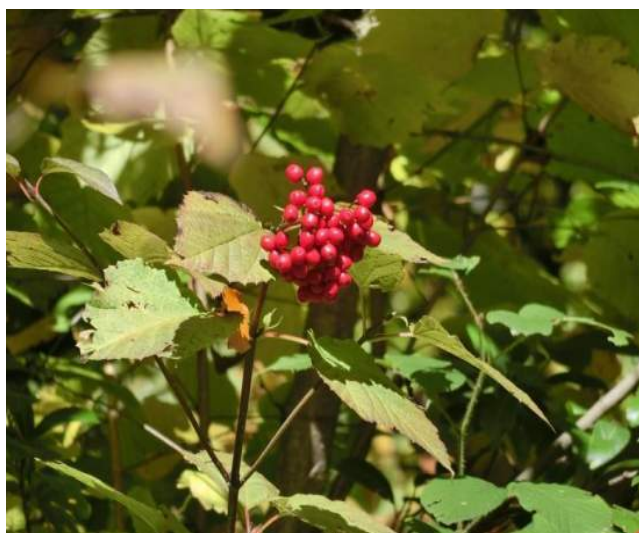

Plot 2.12. Guelder-rose - *Viburnum opulus*

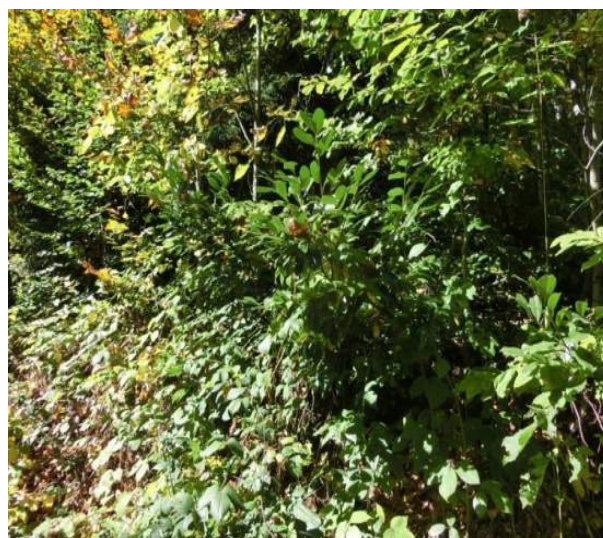

Plot 2.12. Beech forest with Cherry laurel undergrowth



Plot 2.12. Cherry laurel (*Laurocerasus officinalis*)

### Plot 2.13. Aspect of Calendula on Alluvial fan

Type of plant communities	Aspect of Calendula on Alluvial fan
Conservation value	Medium
Location	Nenskra River valley, right bank, area of waterlogging
Sample plot N°	2.13
Area of sample plot (m <sup>2</sup> )	10
GPS coordinates	N43°13'69.7"/E42°23'09.6"
Height a.s.l. (m)	1348

Aspect	East
Inclination	5°
<b>Structural Features of plant communities</b>	
Height of grass cover (cm)	200
Grass cover layer (%)	90
Moss layer (%)	70-80
Number of the highest plant species	9
Number of moss species	2
<b>Species</b>	<b>Cover-abundance according to Drude scale</b>
<b>Grass cover</b>	
Senecio pojarkovae - Endemic to the Caucasus	Cop <sup>1</sup>
Kentucky bluegrass - Poa pratensis	Cop <sup>2</sup>
Caucasian clover - Trifolium ambiguum	Cop <sup>1</sup>
Wild strawberry - Fragaria vesca	Sp <sup>3</sup>
Stonecrops - Sedum sp.	Sp <sup>2</sup>
Wood violet - Viola odorata	Sol
Nipplewort - Lapsana communis	Sol
Cinquefoils - Potentilla sp.	Sol
Dame's rocket - Hesperis matronalis	Unicum
<b>Moss cover</b>	
Moss layer (%)	Cop <sup>3</sup>



Plot 2.13. Aspect of Calendula



Plot 2.13. Aspect of Calendula



Plot 2.13. Aspect of Calendula

Plot 2.13. Dame's rocket - *Hesperis matronalis*

**Plot 2.14. Hazelnut on riverside terrace**

Type of plant communities	Hazelnut on riverside terrace
Conservation value	Low
Location	Nenskra River valley, right bank, area of waterlogging
Sample plot №	2.14
Area of sample plot (m <sup>2</sup> )	50
GPS coordinates	N43°13'66.6"/E42°22'91.4"
Height a.s.l. (m)	1345
Aspect	South-East
Inclination	5°
Structural Features of plant communities	
Height of shrubs (cm)	600
Height of grass cover (cm)	40
Shrubs layer (%)	60-70
Grass cover layer (%)	20
Moss cover layer (%)	–
Number of the highest plant species	7
Number of moss species	–
Species	Cover-abundance according to Drude scale
Shrubs	
Common hazel - <i>Corylus avellana</i>	Cop <sup>2</sup>
Rubus sp.	Sol
Grass cover	
Wood violet - <i>Viola odorata</i>	Sp <sup>2</sup>
Sweet Woodruff - <i>Asperula odorata</i>	Sp <sup>1</sup>
Herb-Robert - <i>Geranium robertianum</i>	Sp <sup>1</sup>
<i>Sedum oppositifolium</i>	Sp <sup>2</sup>
Male fern - <i>Dryopteris filix mas</i>	Sol
Moss cover	
Moss species have not been recorded	–



Plot 2.14. Hazelnut on riverside terrace



Plot 2.14. Hazelnut on riverside terrace



**Plot 2.15. Beech forest mixed with Norway maple**

Type of plant communities	Beech forest mixed with Norway maple
Conservation value	Medium
Location	Nenskra River valley, right bank, area of waterlogging
Sample plot N <sup>o</sup>	2.15
Area of sample plot (m <sup>2</sup> )	100
GPS coordinates	N43°13'69.3"/E42°22'73.5"
Height a.s.l. (m)	1340
Aspect	–
Inclination	0°
Structural Features of plant communities	
Max. DBH (cm)	60
Average DBH (cm)	40
Max. height of the tree (m)	25
Average height of the tree (m)	20
Number of trees within a sample plot	30
Coverage of tree layers (%)	40-50
Coverage of shrub layers (%)	30-40
Heights of shrubs (cm)	100
Grass cover layer (%)	50-60
Height of grass cover (cm)	150
Moss layer (%)	–
Number of the highest plant species	11
Species	Cover-abundance according to Drude scale
Tree layer	
Oriental Beech - <i>Fagus orientalis</i>	Cop <sup>1</sup>
Norway maple - <i>Acer platanoides</i>	Sp <sup>1</sup>
Shrubs	
<i>Rubus</i> sp.	Cop <sup>1</sup>
Grass cover	
<i>Pteridium tauricum</i>	Cop <sup>1</sup>
Danewort - <i>Sambucus ebulus</i>	Sp <sup>3</sup>
Wood sorrel - <i>Oxalis acetosella</i>	Sp <sup>2</sup>
<i>Sedum oppositifolium</i>	Sp <sup>2</sup>
Calamint - <i>Calamintha grandiflora</i>	Sol
Sweet Woodruff - <i>Asperula odorata</i>	Sp <sup>1</sup>
Jupiter's sage - <i>Salvia glutinosa</i>	Sp <sup>1</sup>
Male Fern - <i>Dryopteris filix mas</i>	Sol
Moss cover	
Moss species have not been recorded	–



Plot 2.15. Beech forest mixed with Norway maple



Plot 2.15. Norway maple - *Acer platanoides*



Plot 2.15. Norway maple - *Acer platanoides*

#### Plot 2.16. Alder forest with Blackberry undergrowth

Type of plant communities	Alder forest with Blackberry undergrowth
Conservation value	Medium
Location	Nenskra River valley, right bank, area of waterlogging
Sample plot №	2.16
Area of sample plot (m <sup>2</sup> )	100
GPS coordinates	N43°13'33.0"/E42°22'04.2"
Height a.s.l. (m)	1348
Aspect	—
Inclination	0°
<b>Structural Features of plant communities</b>	
Max. DBH (cm)	100
Average DBH (cm)	60
Max. height of the tree (m)	25
Average height of the tree (m)	20
Number of trees within a sample plot	25
Coverage of tree layers (%)	80
Coverage of shrub layers (%)	60-70

Heights of shrubs (cm)	50
Grass cover layer (%)	5-10
Height of grass cover (cm)	60
Moss layer (%)	–
Number of the highest plant species	9
<b>Species</b>	<b>Cover-abundance according to Drude scale</b>
<b>Tree layer</b>	
Alder - <i>Alnus barbata</i>	Cop <sup>2</sup>
<b>Shrubs</b>	
Rubus sp.	Cop <sup>2</sup>
<b>Grass cover</b>	
Male fern - <i>Dryopteris filix mas</i>	Sp <sup>2</sup>
Wood sorrel - <i>Oxalis acetosella</i>	Sp <sup>1</sup>
Wild strawberry - <i>Fragaria vesca</i>	Sp <sup>1</sup>
Laser trifolium	Sp <sup>1</sup>
Wood violet - <i>Viola odorata</i>	Sol
<i>Sedum oppositifolium</i>	Sp <sup>1</sup>
Sweet Woodruff - <i>Asperula odorata</i>	Sp <sup>1</sup>
<b>Moss cover</b>	
Moss species have not been recorded	–



**Plot 2.16.** Alder forest with Blackberry undergrowth



**Plot 2.16.** Alder forest with Blackberry undergrowth



**Plot 2.16.** Male fern - *Dryopteris filix mas*

**Plot №2.16<sup>o</sup>.** GPS coordinates are N43°13'36.0"/E 42°21'00.4", 1331 m a.s.l. In the valley, slightly downwards there is an area for dam arrangement, which is narrowed in this section. On the right bank of the river Alder forest is developed on riverside terrace, while Hazelnut and Goat willow are developed on the slope. On the left bank of the river - mixed deciduous forest with Fir and Spruce. Medium conservation value habitat.



**Plot №2.16<sup>o</sup>.** Alder forest – on riverside terrace; on the left bank of the river - mixed deciduous forest with Fir and Spruce

**Plot №2.17.** GPS coordinates are N43°01'06.5"/E 42°20'26.3", 1211 m a.s.l. Exposition – South-West, inclination - 10-15°. Young Spruce-Fir trees. Medium conservation value habitat.

Surrounding area is represented by grass forb meadow - pasture with weeded elder. There is a plantation of wild apple in the forest. Holly grows in Fir saplings, *Cyclamen vernum* (CITES) at the foot of Fir, as well as Wild Pear tree.



**Plot №2.17.** Young Spruce-Fir forest



**Plot №2.17.** Plantation of wild apple in the forest



**Plot №2.17.** Holly in Fir saplings



**Plot №2.17.** *Cyclamen vernalis*

**Plot №2.18.** GPS coordinates are N43°01'06.5"/E 42°20'26.3", 1210 m a.s.l. there is a slope, where waste rock excavated from the tunnel will be disposed. Exposition –South, inclination 35°. Dead layered Spruce-Beech, in some places mixed with Blackberry. *Fagus orientalis*-D-35cm, H-20m; *Picea orientalis*-D-30cm, H-20m. Tree layer -80%. High conservation value habitat.



**Plot №2.18.** Dead layered Spruce-Beech

**Plot 2.19. Fir forest**

Type of plant communities	Fir forest
Conservation value	Medium
Location	Nakra River water intake
Sample plot N°	2.19
Area of sample plot (m <sup>2</sup> )	100
GPS coordinates	N43°12'28.8"/E42°39'89.7"
Height a.s.l. (m)	1599
Aspect	East
Inclination	10-15°
Structural Features of plant communities	
Max. DBH (cm)	48
Average DBH (cm)	30
Max. height of the tree (m)	20
Average height of the tree (m)	18
Number of trees within a sample plot	35
Coverage of tree layers (%)	80
Coverage of shrub layers (%)	–
Heights of shrubs (cm)	–
Grass cover layer (%)	3
Height of grass cover (cm)	100
Moss layer (%)	80
Number of the highest plant species	10
Species	Cover-abundance according to Drude scale
Tree layer	
Caucasian Fir - <i>Abies nordmanniana</i>	Cop <sup>3</sup>
Oriental Beech - <i>Fagus orientalis</i>	Sol
Shrubs	
Shrub species have not been recorded	–
Grass cover	
Male Fern - <i>Dryopteris filix mas</i>	Sp <sup>1</sup>
Ordinary violet - <i>Viola odorata</i>	Sp <sup>1</sup>
Sanicle - <i>Sanicula europaea</i>	Sol
Sweet Woodruff - <i>Asperula odorata</i>	Sol
Wood sorrel - <i>Oxalis acetosella</i>	Sp <sup>1</sup>
Wall lettuce - <i>Mycelis muralis</i>	Sol
Herb-Robert - <i>Geranium robertianum</i>	Sol
Rough comfrey - <i>Symphytum asperum</i>	Sol
Moss cover	
Moss layer (%)	Cop <sup>3</sup>



Plot 2.19. Fir forest

## Plot 2.20. Fir-Beech forest

Type of plant communities	Fir-Beech forest
Conservation value	Medium
Location	Nakra River water intake
Sample plot №	2.20
Area of sample plot (m <sup>2</sup> )	100
GPS coordinates	N43°12'28.8"/E42°39'89.7"
Height a.s.l. (m)	1540
Aspect	South
Inclination	10-15°
<b>Structural Features of plant communities</b>	
Max. DBH (cm)	105
Average DBH (cm)	50
Max. height of the tree (m)	25
Average height of the tree (m)	20
Number of trees within a sample plot	35
Coverage of tree layers (%)	50-60
Coverage of shrub layers (%)	–
Heights of shrubs (cm)	–
Grass cover layer (%)	3-5
Height of grass cover (cm)	100
Moss layer (%)	10
Number of the highest plant species	11
<b>Species</b>	<b>Cover-abundance according to Drude scale</b>
<b>Tree layer</b>	
Oriental Beech - <i>Fagus orientalis</i>	Cop <sup>2</sup>
Caucasian Fir - <i>Abies nordmanniana</i>	Sp <sup>2</sup>
<b>Shrubs</b>	
Shrub species have not been recorded	–
<b>Grass cover</b>	

Kentucky bluegrass - <i>Poa pratensis</i>	Sp <sup>2</sup>
wild strawberry - <i>Fragaria vesca</i>	Sp <sup>1</sup>
Sweet Woodruff - <i>Asperula odorata</i>	Sp <sup>1</sup>
Male fern - <i>Dryopteris filix mas</i>	Sp <sup>1</sup>
Wood sorrel - <i>Oxalis acetosella</i>	Sp <sup>1</sup>
Sanicle - <i>Sanicula europaea</i>	Sol
Caucasian stonecrop - <i>Sedum oppositifolium</i>	Sol
Jupiter's sage - <i>Salvia glutinosa</i>	Sol
Euphorbia macroceras	Unicum
<b>Moss cover</b>	
Moss layer (%)	Sp <sup>1</sup>



**Plot 2.20.** Fir-Beech forest



**Plot 2.20.** Fir-Beech forest



**Plot 2.20.** *Sweet Woodruff - Asperula odorata*



**Plot 2.20.** Fir-Beech forest





Plot2.20. cut Fir tree

## Plot 2.21. Beech-Fir forest

Type of plant communities	Beech-Fir forest
Conservation value	Medium
Location	Nakra River water intake
Sample plot №	2.21
Area of sample plot (m <sup>2</sup> )	100
GPS coordinates	N43°12'28.8"/E42°39'89.7"
Height a.s.l. (m)	1540
Aspect	East
Inclination	40-45°
<b>Structural Features of plant communities</b>	
Max. DBH (cm)	105
Average DBH (cm)	50
Max. height of the tree (m)	25
Average height of the tree (m)	20
Number of trees within a sample plot	35
Coverage of tree layers (%)	50-60
Coverage of shrub layers (%)	10
Heights of shrubs (cm)	80
Grass cover layer (%)	3-5
Height of grass cover (cm)	80
Moss layer (%)	5-10
Number of the highest plant species	10
<b>Species</b>	<b>Cover-abundance according to Drude scale</b>
<b>Tree layer</b>	
Caucasian Fir - <i>Abies nordmanniana</i>	Cop <sup>2</sup>
Oriental Beech - <i>Fagus orientalis</i>	Sp <sup>2</sup>
<b>Shrubs</b>	
Rubus sp.	Sp <sup>1</sup>
<b>Grass cover</b>	

Sweet Woodruff - <i>Asperula odorata</i>	Sp <sup>1</sup>
Kentucky bluegrass - <i>Poa pratensis</i>	Sp <sup>1</sup>
Wood sorrel - <i>Oxalis acetosella</i>	Sol
Rough comfrey - <i>Symphytum asperum</i>	Sol
Jupiter's sage - <i>Salvia glutinosa</i>	Sol
Male fern - <i>Dryopteris filix mas</i>	Sol
Clamint - <i>Calamintha grandiflora</i>	Sol
<b>Moss cover</b>	
Moss layer (%)	Sp <sup>1</sup>



Plot 2.21. Beech-Fir forest



Plot 2.21. Beech-Fir forest

### Plot 2.22. Alder forest

<b>Type of plant communities</b>	<b>Alder forest</b>
<b>Conservation value</b>	<b>Medium</b>
Location	Nakra River water intake
Sample plot N <sup>o</sup>	2.22
Area of sample plot (m <sup>2</sup> )	100
GPS coordinates	N43°12'28.8"/E42°39'89.7"
Height a.s.l. (m)	1530
Aspect	South-East
Inclination	3-5°
<b>Structural Features of plant communities</b>	
Max. DBH (cm)	44
Average DBH (cm)	30
Max. height of the tree (m)	12
Average height of the tree (m)	6
Number of trees within a sample plot	50-60
Coverage of tree layers (%)	30-40
Coverage of shrub layers (%)	5
Heights of shrubs (cm)	80
Grass cover layer (%)	5

Height of grass cover (cm)	80
Moss layer (%)	5-10
Number of the highest plant species	10
<b>Species</b>	<b>Cover-abundance according to Drude scale</b>
<b>Tree layer</b>	
Alder - <i>Alnus barbata</i>	Cop <sup>1</sup>
<b>Shrubs</b>	
Rubus sp.	Sol
<b>Grass cover</b>	
Curly dock - <i>Rumex crispus</i>	Sp <sup>2</sup>
<i>Ranunculus caucasicus</i> – Endemic to the Caucasus	Sp <sup>2</sup>
Self-heal - <i>Prunella vulgaris</i>	Sp <sup>1</sup>
<i>Sedum oppositifolium</i>	Sp <sup>1</sup>
Sedges - <i>Carex</i> sp.	Sp <sup>1</sup>
Male fern - <i>Dryopteris filix mas</i>	Sol
Jupiter's sage - <i>Salvia glutinosa</i>	Sol
Great willowherb - <i>Epilobium hirsutum</i>	Sol
<b>Moss cover</b>	
Moss layer (%)	Sp <sup>1</sup>



Plot 2.22. Alder forest



Plot 2.22. on the left side, Alder forest on riverside terrace

#### 5.2.6.1.4 Sensitive Areas

Detail botanical survey of the project corridor revealed sensitive areas. Therefore, basing on literature review and field surveys following average and high sensitive areas were identified:

##### High Sensitive Areas:

- **Plot №1.1.** GPS coordinates are N43°07'58.9"/E 042°12'51.2", 1320 m a.s.l. Inclination 25°. Following plants are developed on this area: Beech (*Fagus orientalis*) forest with Cherry laurel (*Laurocerasus officinalis*) undergrowth, which is mixed by Spruce (*Picea orientalis*), Fir (*Abies nordmanniana*), Elm (*Tilia caucasica*), Maple (*Acer platanoides*), Elder (*Sambucus nigra*), Hazelnuts (*Corylus avellana*), Blackberry (Rubus sp.), Elderflower (*Sambucus ebulus*), Fern (*Matteuccia struthiopteris*). *Acer platanoides*-pbh-130cm, height - 30m, *Fagus orientlis*- pbh - 170cm, height -20m. *Salvia glutinosa* is massively weeding above mentioned areas. Alder forest

(*Alnus incana*) is represented in the lower part. Such type of forests are also found in the upper floodplain, which is mixed with Beech (*Fagus orientalis*). Alder forest with fern and blackberry (*Matteuccia struthiopteris*) are also represented there. Rowan (*Sorbus caucasigena*), Hornbeam (*Carpinus caucasica*), Birch (*Betula litwinowii*), common hazel (*Corylus avellana*). Alder forest is developed at 1364 m a.s.l. *Senecio pojarkovae*, *S. platyphylloides*, *Delpinium flexuosum* are found on alluvial fans.

- **Plot №1.3.** GPS coordinates are N43°08'19.3"/E 042°14'19.6", 1380 m a.s.l. Inclination 15°-20°. Exposition – East. High conservation value habitat: Beech forest (*Fagus orientalis*) with Black Sea holly (*Ilex colchica*) understory. Beech forest is degraded (deforestation). Large Beech trees are also found –pbh – 1.5m, height - 30m. Mixed with Fir (*Abies nordmanniana*), Spruce (*Picea orientalis*), Lime (*Tilia caucasica*), Maple (*Acer platanoides*). Elder (*Sambucus ebulus*) is found at the edges of the forest. Fragment of subalpine tall herbaceous is represented within this area - *Senecio pojarkovae*, *Gadalia lactiflora*, after which Alder forest is developed (*Alnus incana*) with Cherry laurel (*Laurocerasus officinalis*) undergrowth; Beech forest with Black Sea holly understory is represented there.
- **Plot №1.4.** GPS coordinates are N43°08'26.1"/E 042°14'51.5", 1405 m a.s.l. Inclination 25°-30°. High conservation value habitat. Beech Forest (*Fagus orientalis*) with Colchis relic undergrowth (tall, Caucasian cranberries - *Vaccinium arctostaphylos*). Beech (*Fagus orientalis*)-pbh-150cm, height-25m (maximum), pbh-60cm, height -15m (minimum); Gentian (*Gentiana schistocalyx*) is represented from herbaceous plants.
- **Plot №1.5.** GPS coordinates are N43°08'36.7"/E 042°15'00.7", 1377 m a.s.l. Inclination 35°. High conservation value habitat. Beech forest (*Fagus orientalis*) is developed within this area with Spruce (*Picea orientalis*). King Solomon's-seal (*Polygonatum polyanthemum*) is developed from herbaceous plants.
- **Plot №1.6.** GPS coordinates are N43°08'40.9"/E 042°15'11.4", 1400 m a.s.l. Inclination - 25°. Fir forest (*Abies nordmanniana*) is developed within this area, which is mixed with Spruce (*Picea orientalis*) and Beech (*Fagus orientalis*), Blackberry (*Rubus* sp.) and Elder (*Sambucus ebulus*) are found in the undergrowth. On the other side, on the left bank of the river, mixed deciduous forest is represented with the following species: Hornbeam (*Carpinus caucasica*), Beech (*Fagus orientalis*), Lime (*Tilia caucasica*), Georgian Oak (*Quercus iberca*), Maple (*Acer platanoides*); Spruce (*Picea orientalis*)- Fir (*Abies nordmanniana*) forest is developed on a slope with 25° inclination, Inula - *Telekia speciosa* is also found there.
- **Plot №1.8.** GPS coordinates are N43°00'37.7"/E 042°12'08.8", 1176 m a.s.l. above Chuberi, which is an approximate location of tunnel outlet. This will be an area for TBM platform or construction site. Area is 300mX200m (1 ha and 200 m). Exposition – South-West, inclination 20°-25°. High conservation value habitat. Caucasian Wild Pear (*Pyrus caucasica*) grow in the forest. Spruce (*Picea orientalis*) - Fir (*Abies nordmanniana*) forest is developed there. The forest where Caucasian Wild Pear is found is a low conservation value habitat. While Spruce-Fir forest is a high conservation value habitat. Fir -pbh-3m, height-20m; Spruce-pbh-2m, height-16m. Young Fir trees are also found. Pasture-forb meadow is represented there. Jupiter's sage (*Salvia glutinosa*), Elder (*Sambucus ebulus*), *Phytolacca americana*, *Digitalis ciliata* are found at the edges of the forest.
- **Plot №1.9.** GPS coordinates are N43°00'24.7"/E 042°12'25.8", 1215 m a.s.l. High conservation value habitat. This is an area for tunnel outlet. A narrow road will be arranged between plot №8 and this section and Fir (*Abies nordmanniana*)-Beech (*Fagus orientalis*) forest with dead layer will be deforested. Beech-pbh-120cm, height-25m; Fir-pbh-30cm, height-7m. Maple (*Acer platanoides*) and Black Sea holly (*Ilex colchica*) are represented in undergrowth. Exposition – West, inclination - 35°. Young trees of Elder (*Sambucus ebulus*), Jupiter's sage (*Salvia*

- glutinosa*), Hairy foxglove (*Digitalis ciliata*), Common hazel (*Corylus avellana*) and Spruce (*Picea orientalis*) are found in open areas.
- **Plot №1.10.** GPS coordinates are N43°00'33.7"/E 042°12'14.8", 1196 m a.s.l. Exposition – South, inclination - 35°. High conservation value habitat. This area is a forested slope. This is an area for waste rock disposal. Forest will be destroyed throughout the entire slope, in which Spruce (*Picea orientalis*)–Beech (*Fagus orientalis*) forest with dead layer is developed. Beech-80cm-pbh, height-25m; Spruce-1m-pbh, Height-12m; mixed with Hornbeam (*Carpinus caucasica*)-pbh-25cm, height-12m, Chestnut (*Castanea sativa*)-pbh-25cm, height-15m (rarely in this section); in the lower part, Georgian Oak (*Quercus iberica*) is also mixed. Hairy foxglove (*Digitalis ciliata*) is also found there.
  - **Plot №1.13.** GPS coordinates are N43°07'22.8"/E 042°23'59.1", 1400 m a.s.l. High conservation value habitat. Nakra valley – area where the riv. Nakra water will be discharged into the riv. Nenskra. On the right bank of the river, on riverside terrace Alder forest (*Alnus incana*) is represented (inclination of the slope - 5°-10°), on the upper terrace – Beech (*Fagus orientalis*) - Fir (*Abies nordmanniana*) forest (inclination of the slope - 25°). The right bank of the river will not be affected.
  - **Plot №2.11. Beech forest mixed with Holly.** Right bank of Nenskra River, area of waterlogging. GPS coordinates are N43°08'19.3"/E 042°14'19.6". Height – 1380 m a.s.l. Aspect – West. Inclination 10-15°. Following tree species are represented there: Beech (*Fagus orientalis*), Spruce (*Picea orientalis*), Caucasian fir (*Abies nordmanniana*). Following shrub species are represented: Black Sea holly (*Ilex colchica*), which is found not only in Caucasus, but in Stranja (Balkans) and Chaneti (Asia Minor), *Rubus* sp.: Grass species have not been recorded.
  - **Plot №2.12. Beech forest with Cherry laurel undergrowth.** Right bank of Nenskra River, area of waterlogging. GPS coordinates are N43°08'19.3"/E 042°14'19.6", 1380. Height – 1370 m a.s.l. Aspect – East. Inclination - 15-20°. Following tree species are represented there: Beech (*Fagus orientalis*), Spruce (*Picea orientalis*), Caucasian Lime (*Tilia caucasica*); Following shrub species are represented: Cherry laurel (*Laurocerasus officinalis*) - Tertiary relicts of the oldest area of the eastern Mediterranean Sea, *Rubus* sp., *Corylus avellana*, *Viburnum opulus*; Grass species have not been recorded.
  - **Plot №2.18.** GPS coordinates are N43°01'06.5"/E 42°20'26.3", 1210 m a.s.l. There is a slope, where waste rock excavated from the tunnel will be disposed. Exposition –South, inclination 35°. Dead layered Spruce-Beech, in some places mixed with Blackberry. *Fagus orientalis*-D-35cm, H-20m; *Picea orientalis*-D-30cm, H-20m. Tree layer -80%. High conservation value habitat.

#### Medium sensitive areas:

- **Plot №1.2.** GPS coordinates are N43°08'14.1"/E 042°13'57.3", 1370 m a.s.l. Inclination 20°-25°. Habitat with average conservation value. The following species of mixed deciduous forest are represented on this area: Georgian Oak (*Quercus iberica*), Hornbeam (*Carpinus caucasica*), Lime (*Tilia caucasica*), Rowan (*Sorbus caucasigena*). Spruce-Fir forest is observed in the upper part (*Picea orientalis*, *Abies nordmanniana*). *Senecio pojarkovae*, *Delphinium flexuosum* are developed on alluvial fans. *Atropa caucasica*, *Hydrocotyle ramiflora*, *Salvia glutinosa*, *Sinene compacta* are found at the edge of the forests. From here, water will flow up on slopes at 80m and this area will be flooded.
- **Plot №1.7.** GPS coordinates are N43°08'49.6"/E 042°15'25.8", 1430 m a.s.l. Inclination 10°-15°. Alder forest (*Alnus incana*) is developed within this area, which is mixed with Spruce (*Picea orientalis*) in some places.

- **Plot №2.1. Sparse Beech forest mixed with Maple, Fir and Spruce.** Nenskra River valley, Mashrichala, construction camp area. GPS coordinates are N43°12'66.6"/E42°19'75.0". height - 1264 m a.s.l. Inclination - 0°. Following tree species are represented there: Beech (*Fagus orientalis*), Maple (*Acer platanoides*), *Caucasian Fir (Abies nordmanniana)* - Sub endemic to the Caucasus, Asia Minor, Spruce (*Picea orientalis*) - Sub endemic to the Caucasus, Asia Minor; Shrub species have not been recorded. Following grass species are found there: *Urtica dioica*, *Rumex crispus*, *Mentha longifolia*, *Sambucus ebulus*, *Polygonum aviculare*, *Cynoglossum officinale*, *Sisimbrium officinale*, *Trifolium anbiguum*, *Malva sylvestris*, *Poa pratensis*;
- **Plot №2.2. Alder forest with Yellow Azalea undergrowth mixed with Spruce.** Confluence of Nenskra and Khokrili rivers, stone quarry area. GPS coordinates are N43°11'12.2"/E42°18'28.1". Height - 1199 m a.s.l. Aspect - West. Inclination - 20-25°. Following tree species are represented there: Common Alder (*Alnus barbata*), Spruce (*Picea orientalis*). Following shrub species are represented there: Common rhododendron (*Rhododendron ponticum*) - oldest relic of the Tertiary period. Following grass species are found there: *Dryopteris filix-mas*, *Oxalis acetosella*, *Fragaria vesca*, *Salvia glutinosa*, *Cardamine pectinata*, *Epilobium hirsutum*;
- **Plot №2.4. Alder forest mixed with young Spruce and Fir trees.** Confluence of Nenskra and Khokrili rivers, stone quarry area. GPS coordinates are N43°11'12.2"/E42°18'28.1". Height - 1199 m a.s.l. Aspect - East. Inclination - 3-5°. Following tree species are represented there: Common Alder (*Alnus barbata*), Spruce (*Picea orientalis*), *Caucasian Fir (Abies nordmanniana)*, Asia Minor. Shrub species have not been recorded. Following grass species are found there: *Sedum album*, *Dryopteris filix-mas*, *Fragaria vesca*, *Trachistemon orientale*, *Salvia glutinosa*, *Geranium robertianum*, *Calamintha grandiflora*;
- **Plot №2.8. Young Fir forest mixed with Birch and with blackberry undergrowth.** Right bank of Nenskra River, area of waterlogging. GPS coordinates are N43°13'85.6"/E42°24'29.0". Height - 1379 m a.s.l. Aspect - South-East. Inclination - 5-10°. Following tree species are represented there: *Caucasian Fir (Abies nordmanniana)*, Birch (*Betula litwinowii*). Following shrub species are represented: *Rubus sp.*, *Corylus avellana*. Grass species have not been recorded there.
- **Plot №2.9. Dead layered Beech forest mixed with Fir and Spruce trees.** Right bank of Nenskra River, area of waterlogging. GPS coordinates are N43°14'34.9"/E42°23'91.8". Height - 1370 m a.s.l. Aspect - East. Inclination - 5-10°. Following tree species are represented there: Beech (*Fagus orientalis*), *Caucasian Fir (Abies nordmanniana)*, Spruce (*Picea orientalis*). Following shrub species are represented: *Rubus sp.* Grass species have not been recorded there.
- **Plot №2.10. Beech forest mixed with Black Fern.** Right bank of Nenskra River, area of waterlogging. GPS coordinates are N43°14'34.9"/E42°23'91.8". Height - 1370 m a.s.l. Aspect - West. Inclination - 10-15°. Following tree species are represented there: Beech (*Fagus orientalis*). Following shrub species are represented: *Rubus sp.*, Following grass species are found there: *Matteuccia struthiopteris*, *Sambucus ebulus*.
- **Plot №2.13. Aspect of Calendula on Alluvial fan.** Right bank of Nenskra River, area of waterlogging. GPS coordinates are N43°13'69.7"/E42°23'09.6". Height - 1348 m a.s.l. Aspect - East. Inclination - 5°. Following grass species are found there: *Senecio pojarkovae* - Endemic to the Caucasus, *Poa pratensis*, *Trifolium ambiguum*, *Fragaria vesca*, *Sedum sp.*, *Viola odorata*, *Lapsana communis*, *Potentilla sp.*, *Hesperis matronalis*. Moss species are also represented.
- **Plot №2.15. Beech forest mixed with Norway maple.** Right bank of Nenskra River, area of waterlogging. GPS coordinates are N43°13'69.3"/E42°22'73.5". Height - 1340 m a.s.l. Inclination - 0°. Following tree species are represented there: *Fagus orientalis*, *Acer platanoides*. Following shrub species are represented: *Rubus sp.* Following grass species are found there: *Pteridium tauricum*, *Sambucus ebulus*, *Oxalis acetosella*, *Sedum oppositifolium*, *Calamintha grandiflora*, *Asperula odorata*, *Salvia glutinosa*, *Dryopteris filix mas*;

- **Plot №2.16. Alder forest with blackberry undergrowth.** Right bank of Nenskra River, area of waterlogging. GPS coordinates are N43°13'33.0"/E42°22'04.2". Height – 1348 m a.s.l. Inclination -0°. Following tree species are represented there: *Alnus barbata*. Following shrub species are represented: *Rubus* sp., Following grass species are found there: *Dryopteris filix mas*, *Oxalis acetosella*, *Fragaria vesca*, *Laser trifolium*, *Viola odorata*, *Sedum oppositifolium*, *Asperula odorata*.
- **Plot №2.16<sup>a</sup>.** GPS coordinates are N43°13'36.0"/E 42°21'00.4", 1331 m a.s.l. In the valley, slightly downwards there is an area for dam arrangement, which is narrowed in this section. On the right bank of the river Alder forest is developed on riverside terrace, while Hazelnut and Goat willow are developed on the slope. On the left bank of the river - mixed deciduous forest with Fir and Spruce. Medium conservation value habitat.
- **Plot №2.17.** GPS coordinates are N43°01'06.5"/E 42°20'26.3", 1211 m a.s.l. Exposition – South-West, inclination - 10-15°. Young Spruce-Fir trees. Medium conservation value habitat. Surrounding area is represented by grass forb meadow - pasture with weeded elder. There is a plantation of wild apple in the forest. Holly grows in Fir saplings, *Cyclamen vernalis* (CITES) at the foot of Fir, as well as Wild Pear tree.
- **Plot №2.19. Fir forest.** Nenskra River water intake. GPS coordinates are: N43°12'28.8"/E42°39'89.7". Height – 1599 m a.s.l. Aspect – East. Inclination - 10-15°. Following tree species are represented there: Caucasian Fir (*Abies nordmanniana*), Beech (*Fagus orientalis*). Shrub species have not been found. Following grass species are observed there: *Dryopteris filix mas*, *Viola odorata*, *Sanicula europaea*, *Asperula odorata*, *Oxalis acetosella*, *Mycelis muralis*, *Geranium robertianum*, *Symphytum asperum*. Moss species are also represented.
- **Plot №2.20. Fir- Beech forest.** Nenskra River water intake. GPS coordinates are N43°12'28.8"/E42°39'89.7". Height - 1540. Aspect – South. Inclination - 10-15°. Following tree species are represented there: *Fagus orientalis*, *Abies nordmanniana* - Sub endemic to the Caucasus, Asia Minor. Shrub species have not been found. Following grass species are observed there: *Poa pratensis*, *Fragaria vesca*, *Asperula odorata*, *Dryopteris filix mas*, *Oxalis acetosella*, *Sanicula europaea*, *Sedum oppositifolium*, *Salvia glutinosa*, *Euphorbia macroceras*. Moss species are also represented.
- **Plot №2.21. Beech-Fir forest.** Nenskra River water intake. GPS coordinates are N43°12'28.8"/E42°39'89.7". Height – 1540 m a.s.l. Aspect – East. Inclination - 40-45°. Following tree species are represented there: *Abies nordmanniana*, *Fagus orientalis*. Following shrub species are represented: *Rubus* sp., Following grass species are observed there: *Asperula odorata*, *Poa pratensis*, *Oxalis acetosella*, *Symphytum asperum*, *Salvia glutinosa*, *Dryopteris filix mas*, *Calamintha grandiflora*. Moss species are also represented.
- **Plot №2.22. Alder forest.** Nenskra River water intake. GPS coordinates are N43°12'28.8"/E42°39'89.7". Height – 1530 m a.s.l. Aspect – South-East. Inclination - 3-5°. Following tree species are represented there: *Alnus barbata*. Following shrub species are represented: *Rubus* sp. Following grass species are observed there: *Rumex crispus*, *Prunella vulgaris*, *Sedum oppositifolium*, *Carex* sp., *Dryopteris filix mas*, *Salvia glutinosa*, *Epilobium hirsutum*. Moss species are also represented.

Figure 5.2.6.1.4.1. Habitats Location Scheme

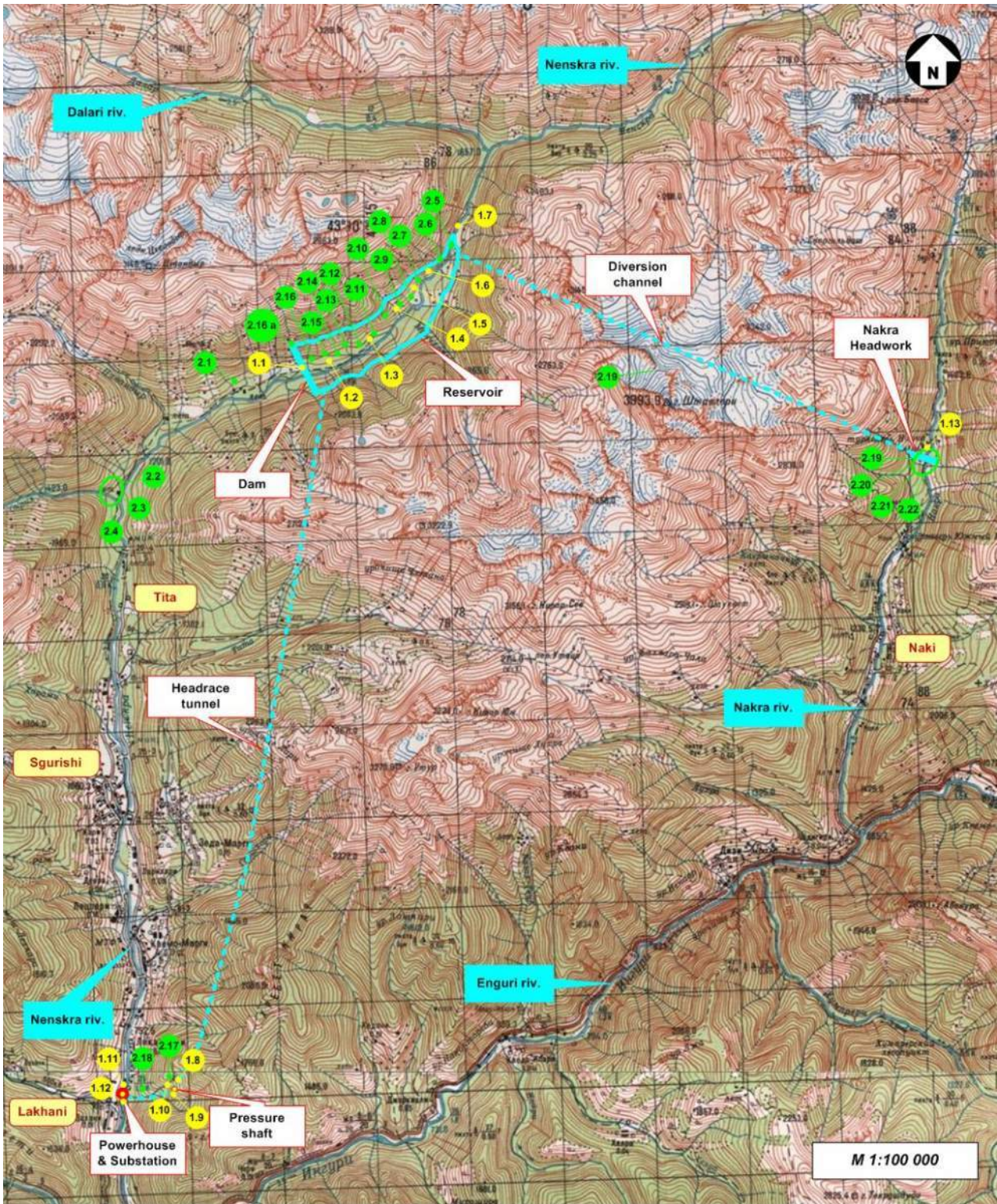

5.2.6.1.5 Georgia Red List Species Occurred in the Proposed Project Corridor

It should be mentioned that Georgia Red List including 56 species of vegetation is not complete. Presently the existing list of Red List species is being modified. In particular, the herbaceous plants are being identified according to IUCN categories (identification of categories of their state and conservation



status). After extrapolation of the aforementioned data an actual number of Georgia Red List species may significantly increase.

**After the completion of the detailed field botanical survey, 1 specie included in Georgia Red List was identified in the designed project corridor:** Common chestnut (*Castanea sativa* Mill). Status of the Georgia Red List specie identified in the designed project corridor is following:

<i>Nº</i>	Latin Name	English Name	Category of State and Protection Status
<b>Angiosperms</b>			
1	<i>Castanea sativa</i> Mill.	Common chestnut	VU

Besides the above-mentioned, populations of some rare, endangered and vulnerable species are occurring in the project corridor: Cherry laurel (*Laurocerasus officinalis*) - Tertiary relicts of ancient Eastern Mediterranean area, Ciliate foxglove (*Digitalis ciliata*) (Species whose numbers are declining), Georgian oak (*Quercus iberica*), Caucasian Lime (*Tilia caucasica*), Common pear (*Pyrus caucasica*), *Sorbus caucasigena*, Caucasus Belladonna (*Atropa caucasica*) (rare species); Common rhododendron (*Rhododendron ponticum*) - oldest relic of the tertiary period; Black Sea holly (*Ilex colchica*) – besides the Caucasus, this specie is found in Stranja (Balkans) and Chaneti (Asia Minor); Endemic to the Caucasus: *Senecio pojarkovae*. Also, *Cyclamen vernum*, which is a specie protected by the Convention on International Trade in Endangered Species of Wild Fauna and Flora (CITES 1975; universal). Species protected by the Berne Convention have not been observed within the project corridor.

#### 5.2.6.1.6 The amount of timber within the impact zone of Nenskra HPP project

The Nenskra-Nakra hydro technical complex, which is planned at the bordering valleys of two fast rivers with quite high-waters – Nenskra and Nakra (the right tributaries of Enguri river), from the one side, is presented as temporary, and from the other side, as active projected structure (with territories). Namely:

- I. By main impoundment, or reservoir; the construction of 135 m height dam is considered on the bottom of Nenskra valley in order to impound this reservoir, at an altitude of 1315 m asl. (GPS coordinates: 0273056; 4779030). The projected area, covered by reservoir mirror surface, will be approximately 300-500 ha.
- II. By prospective workers camp, which will be arranged near projected dam of Nenskra, at an altitude of 1265 m asl (GPS coordinates: 0272033; 4778662). This projected section, the area of which does not exceed 2 ha, is planned on the right bank of Nenskra river and is one particular plain of costal terraces.
- III. By the projected area of stone quarry mine, which covers both banks of Okrili River (the right tributary of Nenskra) and is limited with about 2.5 ha (1195 meters asl, GPS- coordinates: 0270783; 4777015). From the geomorphological point of view, the object is alluvial fan, formed by the action of Okrili river, which is characterized by a slight inclination (10 degrees) and it is built by large proluvial rubbles.
- IV. By the exit portal of water outlet tunnel, which is projected at the left side of Nenskra river, at the head of the village Chuberi (the altitude is 1200 m asl, GPS coordinates: 0272024; 4765795). This projected area is presented here by structural terraces with insignificant inclination (5 degrees), which is elevated from the bottom of Nenskra river in vertical section with about 170-200 m. The area of this terrace, which is very well revealed on the inclined slope of the mountain, is no more than 1,5 ha.
- V. By dumping area of broods, which is in 150-200 m away from projected area of above-mentioned exit portal and is presented as steep slope with 35-degree-inclination, directed to the

south. To be more precisely, only the section of existing slope is meant, which covers just 2 ha area and is considered for arrangement of future landfill ( 1150 m asl, GPS coordinates: 0272042; 4765640).

- VI. By the entrance portal of water outlet tunnel, which, as projected area, will be arranged on the second river territory-in Nakra river valley, at 1550 m asl (GPS coordinates: 0288308; 4777807). The mentioned projected object, which is in some 80-100 m away from Nakra river-bed , is presented by slope with insignificant inclination (15 degrees), directed to the east and covers about 1,5 ha area.

All above-listed projected areas, with different degrees, are covered by forest groves as well. Our main goal is to define the cubical volume of them as wholly, so according to separate species.

The calculation of timber amount was carried out by so-called “evaluation method”, which was based on the following data:

- The area of the projected territory;
- The share part (%) of the area covered by forest of the whole area of the given projected territory;
- The share part (%) of some taxation units of the forest within the project areas covered by forest;
- The content formula of the grove (layer) according to species;
- The average height of tree species, dominant in the grove (layer);
- The average age of tree species, dominant in the grove (layer);
- The relative frequency multiplier of the grove (layer);
- The standard calculation table of grove (layer) volume;

The registration and calculation results are given below in the tables, which show that the total amount of timber on the projected area of Nenskra-Nakra is 24572.5 cubic meters wood. Most of them are beech wood, the alder, fir, etc., while the least are birch and elm. (see table 5.2.7.1.6.2.)

The largest part of recorded timber (23470 cubic meters) is on the projected area, and the rest – the smaller part (1100 cubic meters) is distributed on other projected areas of hydro technical complex (see the table 5.2.7.1.6.2.).

According to the unit of the area (1 ha), the largest amount of the wood was found in the groves of the forest, which is distinguished, from one side, with high relative frequency, and from the other side, with huge sizes of the trees, forming this frequency. The existence of such groves on the projected area of the future reservoir is found within the second and the third taxation units, as well as within the projected area of the landfill (see the table 5.2.7.1.6.1.).

Among the species of the trees recorded by us, the assortment structure of the timber is not the same and is presented as by small, so by medium and large sizes of the timber. But if the recorded size of the wood among the beech, fir, spruce and other species, is presented mainly by medium and large-sized timber, in case of alder, on the contrary, the amount of small timber is prevailed on the amount of medium and large size timber. For example, according to our assessment, the timber of small assortments of alder trees (2970 cubic meters) is 54% of recorded amount of the specie, while the amounts of the medium and huge timber is only 46% (2485 cubic meters).

**Table 5.2.6.1.6.1.** Distribution of the timber cubical volume, located on the unit area (1 ha), according to tree species and taxation units

Project areas and taxation units	Tree species									
	Alder	Spruce	Beech	Fir	Maple	Birch	Elm	Basswood	Hornbeam	Total
Reservoir										
•	45									45
•	35	6	9	4	2	0.5	0.5			57
•	10	18	196	15	35		1	5	2	280
•	20	80	100	135	3					340
Camp		15	40	25	15					95
Quarry	70	8	6							85
Exit portal		40	10	30	5					90
Soil ground		60	60	80						200
Entrance portal			90	20						110

**Table 5.2.6.1.6.2.** The distribution of timber amount (cubical volume) according to tree species, projected areas and taxation units

Project areas and taxation units	Tree species									
	Alder	Spruce	Beech	Fir	Maple	Birch	Elm	Basswood	Hornbeam	Total
Reservoir	5280	3330	8560	4990	1054	20	45	125	66	23470
•	2970									2970
•	1400	240	360	160	80	20	20			2280
•	250	450	4900	375	875		25	125		7000
•	660	2640	3300	4455	99				66	11220
Camp		30	80	50	30		2.5			190
Quarry	175	20	15						7.5	212.5
Exit portal		60	15	45	7.5					135
Soil ground		120	120	160						400
Entrance portal			135	30						165
Total	5455	3560	8925	5275	1091.5	20	47.5	125	73.5	24572.5

## 5.2.6.2 Fauna

### 5.2.6.2.1 Terrestrial Fauna

The report is based on the literature review, conducted in the past but yet unpublished field works and field studies ( 2011- 2014 yy). The goal of the study is to identify important habitats and species of animals within the influence zone of the project.

First of all, attention is paid to the species protected by the laws and international treaties (species from the red list, species protected by the Bonn Convention, etc.), as well as to animals of high conservation importance for the local population and interesting for tourists.

It should be also considered, that the National Park of Zemo Svaneti covers a part of the design reservoir, therefore, incorrect planning and management of the HPP may cause certain problems in future (air, water and soil pollution, fire and etc.).

#### 5.2.6.2.2 Geography and Landscaped of the Middle Waists of the Rivers Nenskra and Nakra

Construction area includes the section of Nenskra River valley from Lakhami village surroundings, where the powerhouse and substation will be located (660 – 700 m a.s.l.) to Mashrichala where the reservoir will be filled up (1560 m a.s.l.) Construction area also includes water intake on Nakra River upstream of Naki village (1510 -1550 m a.s.l.). According to zoogeography the South Caucasus is in the East sub-district of the Mediterranean sea of the Palearctic zone. The rivers Nenskra and Nakra are located in the Caucasus part of this sub-district (Верещагин 1959; Гаджиев 1986) and the fauna of these valleys contains the relevant zoogeographical units. Valleys of the rivers within the project area are characterized by following plant species: deciduous forest, mainly different types of Beech forests, Georgian Oak and Chestnut are found in the lower part, dark coniferous forest of Fir-Spruce, only Spruce (rarely) and mixed forests (Figure 5.2.7.2.2.1.). Traces of deforestation are easily notable except remote areas.

Nenskra River valley from Lakhami village to Tita village is quite densely populated. However, stands of natural vegetation are still preserved in many areas between the settlements and agricultural lands: riverside Alder forests, fragments of Beech and Spruce-Fir (Figure 5.2.7.2.2.2.)

Corn is cultivated on the deforested areas. There are many fruit trees in private plots (Apple, Wild Pear and Walnut). Chestnuts is also found in the lower part of the valley. All this leads to the concentration of wild animals near villages in Autumn.

**Figure 5.2.6.2.2.1.** Fragment of mixed forest in Nenskra River valley



**Figure 5.2.6.2.2. Fragment of natural vegetation near Tita village**



### **5.2.6.2.3 Field Survey Methodology**

#### **Mammals survey methodology**

Large and medium mammals are registered by the footprints on the 1-5 km routes, also visually, both in daytime and night. Specie composition and quantity of small mammals are determined using standard methods – traps (live-catching traps). Based on the obtained results, capture rate per 100 trap-day is determined and relative number of animals in the complex of small mammals is estimated. To determine mole existence land verdures are being registered.

Bats are registered with long visual observation of routes, also forests, trees, underground shelters, buildings and areas adjacent to the reservoir. Bats registration is also being conducted using ultrasound detectors Pettersson D 200 and Pettersson D 240. Large amount of specie on a small area indicates on a colony. In such cases a colony is being registered, its volume is roughly defined.

#### **Birds survey methodology**

Birds are observed on the routes and polling sections. Nests and other concentration points of birds protected by law and rare birds are also being registered. Quantity of birds is established using different standard methods (for plain landscapes and for mountainous landscapes), specie belongings are also determined vie sound.

#### **Reptiles and amphibians survey methods**

Reptiles and amphibians are registered in shelters and reservoirs.

### **5.2.6.2.4 Red List Species Within the Project Territory**

The list of terrestrial vertebrate species included in the Red List of Georgia and inhabiting within the Mestia municipality territory or project area is given in Table 5.2.6.2.4.1.

Table 5.2.6.2.4.1.

№	Latin name	Georgian name	English name	Status
<b>Mammals</b>				
1	<i>Barbastella barbastellus</i>	ევროპული მარქათელა	Western Barbastelle	VU
2	<i>Lutra lutra</i>	წავი	Common Otter	VU
3	<i>Ursus arctos</i>	მურა დათვი	Brown Bear	VU
4	<i>Lynx lynx</i>	ფოცხვერი	European Lynx	VU
5	<i>Sciurus anomalus</i>	კავკასიური ციცივი	Caucasian Squirrel	VU
<b>Birds</b>				
6	<i>Neophron percnopterus</i>	ფასკუნჯი	Egyptian Vulture	VU
7	<i>Gypaetus barbatus</i>	ბატკანძერა	Lammergeier	VU
8	<i>Aegypius monachus</i>	სვავი	Black Vulture	EN
9	<i>Gyps fulvus</i>	ორბი	Eurasian Griffon Vulture	VU
10	<i>Aquila chrysaetus</i>	მთის არწივი	Imperial Eagle	2 VU
11	<i>Aquila heliaca</i>	ბეგობის არწივი	Golden Eagle	3 VU
12	<i>Aquila clanga</i>	მყივანი არწივი	Spotted Eagle	4 VU
13	<i>Accipiter brevipes</i>	ქორცქვიტა	Levant Sparrowhawk	5 VU
14	<i>Falco biarmicus</i>	წითურთავა ბარი	Lanner Falcon	6 VU
15	<i>Falco cherrug</i>	გავაზი	Saker Falcon	CR
16	<i>Falco vespertinus</i>	თვალშავი	Red-footed Falcon	EN
17	<i>Buteo rufinus</i>	ველის კაკაჩა	Long-legged Buzzard	VU
18	<i>Buteo lagopus</i>	ფეხბანჯგვლიანი კაკაჩა	Rough-legged Buzzard	VU
19	<i>Athene noctua</i>	ჭოტი	Little Owl	VU
<b>Reptiles</b>				
20	<i>Vipera dinniki</i>	დინნიკის გველგესლა	Dinnik's viper	VU
21	<i>Vipera kaznakovi</i>	კავკასიური გველგესლა	Caucasus viper	EN

Georgia is a signatory of the Bonn Convention on “protection of migratory species” and also agreement on “protection of European bats EUROBATS”. According to this agreement, Georgia is obliged to protect 12 species of bats inhabiting on this territory (see Table 5.2.6.2.4.2.).

Table 5.2.6.2.4.2.

№	Latin name	Georgian name	English name
1	<i>Rhinolophus ferrumequinum</i>	დიდი ცხვირნალა	Greater Horseshoe Bat
2	<i>Rhinolophus hipposideros</i>	მცირე ცხვირნალა	Lesser Horseshoe Bear
3	<i>Myotis blythii</i>	წვეტყურა მლამიობი	Lesser Mouse-eared Bat
4	<i>Myotis mystacinus</i>	ულვაშა მლამიობი	Whiskered Bat
5	<i>Myotis brandtii</i>	ბრანტის მლამიობი	Brandt's Bat
6	<i>Myotis nattereri</i>	ნატერერის მლამიობი	Natterer's Bat
7	<i>Nyctalus lasiopterus</i>	გიგანტური მელამურა	Giant Noctule Bat
8	<i>Nyctalus noctula</i>	წითური მელამურა	Common Noctule
9	<i>Eptesicus serotinus</i>	მეგვიანე ღამურა	Serotine Bat
10	<i>Pipistrellus pipistrellus</i>	ჯუჯა ღამორი	Common Pipistrelle
11	<i>Barbastella barbastellus</i>	ევროპული მარქათელა	Western Barbastelle
12	<i>Plecotus auritus</i>	რუხი ყურა	Brown Big-eared Bat

Bats inhabiting in the middle reaches of Nenskra and Nakra rivers, protected by the Bonn Convention.

Georgia is also obliged to protect birds listed in the agreement on “protection of Africa-Eurasian Migratory Water birds”. There are no many species from the list in Nenskra basin, but nevertheless, several species are found (see Table 5.2.6.2.4.3.)

**Table 5.2.6.2.4.3.**

№	Latin name	Georgian name	English name
1	<i>Milvus migrans</i>	ძერა	Black Kite
2	<i>Charadrius dubius</i>	მცირე წინტალა	Little Ringed Plover
3	<i>Tringa ochropus</i>	შავი ჭოვილო	Green Sandpiper
4	<i>Actitis hypoleucos</i>	მებორნე	Common Sandpiper
5	<i>Riparia riparia</i>	მენაპირე მერცხალი	Sand Martin

Other species of the agreement can be found on the territory only during migration and therefore, cannot be affected by the HPP construction.

### 5.2.6.2.5 Field Survey Results

Following information on inhabiting species was gathered during the field surveys:

**Mammals:** Least weasel (*Mustela nivalis*), European pine marten (*Martes martes*), Red fox (*Vulpes vulpes*), Wildcat (*Felis sylvestris*), Roe deer (*Capreolus capreolus*), Wood mouse (*Sylvaemus sp.*), Red squirrel (*Sciurus vulgaris*), Edible dormouse (*Glis glis*), Forest dormouse (*Dryomys nitedula*), Robert’s snow vole (*Chionimys roberti*). Bats: Whiskered/Brandt’s bat (*Myotis mystacinus/brandtii*), Natterer’s bat (*Myotis nattereri*), Common noctule (*Nyctalus noctula*), Greater noctule bat (*Nyctalus lasiopterus*), Common pipistrelle (*Pipistrellus pipistrellus*), Serotine bat (*Eptesicus serotinus*), Brown long-eared bat (*Plecotus auritus*), Greater horseshoe bat and Lesser horseshoe bat (*Rhinolophus ferrumequinum, Rhinolophus hipposideros*), Lesser mouse-eared bat (*Myotis blythii*).

**Birds:** Booted eagle (*Aquila pennatus*), Common buzzard (*Buteo buteo*), Eurasian sparrowhawk (*Accipiter nisus*), Northern goshawk (*Accipiter gentilis*), Common kestrel (*Falco tinnunculus*), Eurasian hobby (*Falco subbuteo*), Peregrine falcon (*Falco peregrinus*), Common sandpiper (*Actitis hypoleucos*), Little ringed plover (*Charadrius dubius*), Stock dove (*Columba oenas*), Common wood pigeon (*Columba palumbus*), Common cuckoo (*Cuculus canorus*), Towny owl (*Strix aluco*), Eurasian scops owl (*Otus scops*), Boreal owl (*Aegolius funereus*), European nightjar (*Caprimulgus europaeus*), Common swift (*Apus apus*), Hoopoe (*Upupa epops*), Black woodpecker (*Dryocopus martius*), European green woodpecker (*Picus viridis*), Great spotted woodpecker (*Dendrocopos major*), Middle spotted woodpecker (*Dendrocopos medius*), Lesser spotted woodpecker (*Dendrocopos minor*), Eurasian wrunneck (*Jynx torquilla*), Shore lark (*Eremophila alpestris*), Skylark (*Alauda arvensis*), Woodlark (*Lullula arborea*), Shore lark (*Eremophila alpestris*), Barn swallow (*Hirundo rustica*), Common house martin (*Delichon urbica*), Eurasian crag martin (*Ptyonoprogne rupestris*), Water pipit (*Anthus spinoletta*), Tree pipit (*Anthus trivialis*), White wagtail (*Motacilla alba*), Grey wagtail (*Motacilla cinerea*), White-throated dipper (*Cinclus cinclus*), Dunnock (*Prunella modularis*), European robin (*Erithacus rubecula*), Common redstart (*Phoenicurus phoenicurus*), Black redstart (*Phoenicurus ochruros*), northern wheatear (*Oenanthe oenanthe*), Whinchat (*Saxicola rubetra*), African stonechat (*Saxicola torquatus*), Song thrush (*Turdus philomelos*), Mistle thrush (*Turdus viscivorus*), Common blackbird (*Turdus merula*), Ring ouzel (*Turdus torquatus*), Common rock thrush (*Monticola saxatilis*), Blackcap (*Sylvia atricapilla*), Common whitethroat (*Sylvia communis*), Marsh warbler (*Acrocephalus palustris*), Chiffchaff (*Phylloscopus collybita*), Greenish warbler (*Phylloscopus nitidus*), Eurasian wren (*Troglodytes troglodytes*), Spotted flycatcher (*Muscicapa striata*), Red-breasted flycatcher (*Ficedula parva*), Great tit (*Parus major*), Black tit (*Parus ater*), Blue tit (*Parus caeruleus*), Long-tailed tit (*Aegithalos caudatus*), Goldcrest (*Regulus regulus*),

Eurasian nuthatch (*Sitta europaea*), Kruper's nuthatch (*Sitta krueperi*), Wallcreeper (*Tichodroma muraria*), Short-toed treecreeper (*Certhia brachydactyla*), Eurasian treecreeper (*Certhia familiaris*), Red-backed shrike (*Lanius collurio*), Eurasian jay (*Garrulus glandarius*), Hooded crow (*Corvus cornix*), Common raven (*Corvus corax*), House sparrow (*Passer domesticus*), Chaffinch (*Fringilla coelebs*), Linnet (*Carduelis cannabina*), Twite (*Carduelis flavirostris*), European goldfinch (*Carduelis carduelis*), European greenfinch (*Chloris chloris*), Red-fronted serin (*Serinus pusillus*), Finch (*Spinus spinus*), Eurasian bullfinch (*Pyrrhula pyrrhula*), Common crossbill (*Loxia curvirostra*), Hawfinch (*Coccothraustes coccothraustes*), Common rose finch (*Carpodacus erythrinus*), Rock bunting (*Emberiza cia*), Corn bunting (*Miliaria calandra*).

**Reptiles:** Darevskia brauneri, Darevskia caucasica, Darevskia rudis, Darevskia derjugini, Dice snake (*Natrix tessellata*), Coronella austriaca.

**Amphibians:** European green toad (*Bufo viridis*), Marsh frog (*Rana ridibunda*), Long-legged wood frog (*Rana macrocnemis*).

It should be noted that habitats of Red List species have not been recorded within the project area during the field surveys conducted in 2011, as well as in 2014. As it is given in Figure 5.2.6.2.5.1., protected species have been identified outside the influence zone of the project, namely: habitats of Otter (*Lutra lutra*) have been observed in the vicinity of the confluence of Tskhvamdiri River and its downstream flow. Especially large number of this specie has been recorded within the area adjacent to Tita village, that is in the distance of not less than 5.5 km from direct influence zone of the project. Traces and droppings of Brown Bear (*Ursus arctos*) have been recorded downstream of the confluence of Nenskra and Nakra rivers, on the slopes of the left bank, approximately in the distance of 4 km from reservoir pool elevation zone. Based on the information provided by the local population, injuries of domestic animals by wolves (*Canis lupus*) or lynx (*Lynx lynx*) have not been recorded over the past years, which indicates that these species are not represented in the project area of influence and neither their traces were identified during the field studies .

During the field studies conducted on the project area, the protected species of raptiles, such as Dinnick's Viper (*Vipera dinniki*) and Caucasian Viper (*Vipera kaznakovi*) were not found. It is noteworthy, that above-mentioned species could not be identified during studies relating to other projects (Lasleti HPP 2, Mestiachala HPP 2, Mestia town WWTP).

Bird species included in the Red List of Georgia (Bearded Vulture (*Gypaetus barbatus*), griffon vulture (*Gyps fulvus*), the golden eagle (*Aquila chrysaetos*)) are not inhabiting within the project area. This species inhabit at high elevations.



Figure 5.2.6.2.5.1. Scheme of locations of protected species identified during the field surveys

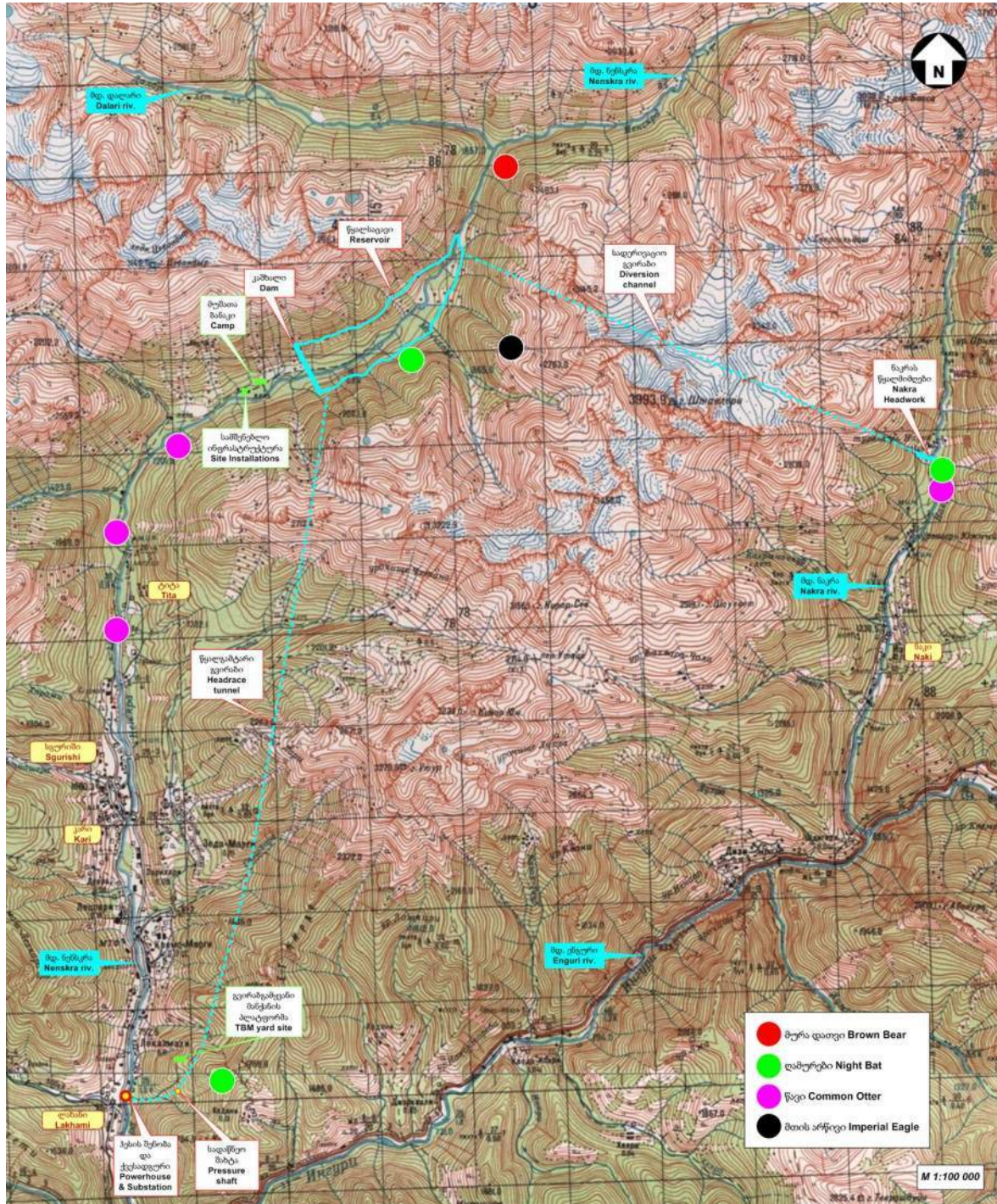

### 5.2.6.2.6 Sensitive Areas and Danger

Sensitive areas in the influence area are forested sections that border with flood districts or are directly flooded. Dam construction and tunnel inlet and outlet portal areas are also sensitive, as the construction requires cutting the trees. Construction can have following impact on the biodiversity:

1. Rehabilitation works will increase noise and vibration, plants will be covered with dust, which will affect food base for animals (Яблоков, Остроумов 1985);
2. Disturbance of birds and bats will increase in the vicinity of highway;

3. Flooding and cutting the trees will cause destruction of habitats, especially from bats that mostly inhabit trees in the forest. Destruction of such trees will result the decrease of bats and will increase number of mosquitoes and threat of malaria in future;
4. Contamination of water and soil with harmful substances will affect amphibians, birds, otter population. Poisoning of soil and water can last for years; this will decrease number of animal species (Яблоков, Остроумов 1985) and disappearance of rare species.

The riv. Nenskra valley is rich with animals, this makes it more sensitive area, all classes of vertebrates is more fully presented here than in Nakra valley. This is caused by various landscapes of the area, while the Nakra valley is very narrow and is therefore inhabited by animals that are adapted to living on steep slopes.

Flooding will destroy every tree that grows near the water and forest, this will cause destruction of bats and birds nesting places, since these animal groups mostly live on forest-side areas. Flooding will result shifting of the forest boundary and its faunistic complex will start to develop from the beginning. This process might take many years, as different species have different reactions on catastrophes of this kind. Considering anthropogenic influence this process might take even more years.

### **5.2.6.3 Invertebrates Fauna**

The report is based on literature review and the results of scientific research (September 9–12, 2014). The goal of field works was to determine habitats of invertebrates within the impact zone and to identify invertebrates spread within this area, to find species included in the Red List.

#### **5.2.6.3.1 Geography and Landscapes of Middle Reaches of Nenskra and Nakra Rivers**

According to zoogeography the South Caucasus is in the East sub-district of the Mediterranean sea of the Palearctic zone. The rivers Nenskra and Nakra are located in the Caucasus part of this sub-district (Верещагин 1959; Гаджиев 1986). Physical-geographically it is located in sub-district of the small Caucasus (Ukleba, 1981). Middle reaches of Nenskra and Nakra Rivers include three landscapes – deciduous forest, coniferous forest, including mixed forests between these two areas and secondary meadows around the settled areas, which are used as pastures and cornfield. Most landscape is represented by deciduous and mixed forests, western slopes are represented by coniferous forests or mixed forest with a superiority of coniferous trees. These 4 landscapes are well preserved in inaccessible areas, while it is much degraded in easily accessible areas due to human impact (wood cutting).

#### **5.2.6.3.2 Survey Methodology for Invertebrates**

1. Adult phase of large invertebrates are recorded visually on transects. This includes butterflies, beetles, dragonflies, bees, locusts, spiders, mollusks;
2. Mosquito trapping and identification;
3. Overturn of stones and soil layers;
4. Inspection of plants and plant waste;
5. Photo capture;
6. Whisk off insect by stick on tents;
7. Inspection of the bottom of the reservoir through sifting of sand;
8. Inspection of excrements of insectivores animals.

### 5.2.6.3.3 Invertebrate Animal Species of the Red List Found Within the Project Region

Below is the list of Invertebrate animal species included in the Red List of Georgia that inhabit or may be found in the middle reaches of Nenskra and Nakra rivers, within the influence zone of the proposed HPP construction.

N	English Name	Latin Name
1	Alpine bumble bee	Bombus alpigenus
2	Violet carpenter bee	Xylocopa violacea
3	Caucasian Apollo	Parnassius nordmanni
4	Apollo	Parnassius apollo
5	Alpine Longhorn	Rosalia alpina
6	Caucasian Goldenring	Cordulegaster mzymtae

1. *Alpine bumble bee* – is found in alpine zone;
2. *Violet carpenter bee* – this specie has not be recorded by us. They inhabit in relatively low areas, though outside the project area;
3. *Caucasian Apollo* - is mostly found in alpine zone;
4. *Appolo* - inhabits above the border of the upper forest and it will not affected by the project;
5. *Alpine Longhorn* – may be found within the construction area, though their death may be easily avoided. As this specie is mainly inhabiting on dead trees (mainly Beech), damaged and dead trees should be removed and disposed on slope, which will not be flooded;
6. *Caucasian Goldenring* – is found in streams of alpine zone. Therefore, impact of the project on this specie is not expected.

#### Field Survey Results

As a result of the surveys we obtained information on the existence of the following invertebrates:

<ol style="list-style-type: none"> <li>1. <b><i>Dragonflies (Odonata):</i></b> <ol style="list-style-type: none"> <li>1. Sympetrum pedemontanum</li> <li>2. Aeshna cyanea Muller.</li> <li>3. Coenagrion lunulatum Charp.</li> </ol> </li> <li>2. <b><i>Locusts (Orthoptera):</i></b> <ol style="list-style-type: none"> <li>1. Green Locust - Tettigonia viridissima L. (photo)</li> <li>2. Oecantus pellucens Scop.</li> <li>3. Psophus stridulus L.</li> </ol> </li> <li>3. <b><i>Earwigs (Dermaptera):</i></b> <ol style="list-style-type: none"> <li>1. Forficula auricularia L.</li> </ol> </li> <li>4. <b><i>Bugs (Hemiptera)</i></b> <ol style="list-style-type: none"> <li>1. Stephanitis pyri F.</li> <li>2. Pyrrhocoris apterus L.</li> </ol> </li> <li>5. <b><i>Beetles (Coleoptera)</i></b> <ol style="list-style-type: none"> <li>1. Cicindela hybrida L.</li> <li>2. Calosoma sycophanta L.</li> <li>3. Aphodius fimetarius L.</li> <li>4. Oryctes nasicornis L.</li> <li>5. Melolonta hippocastani F.</li> <li>6. Epicometis hirta Poda.</li> <li>7. Cetonia aurata L.</li> <li>8. Evodinus interrogationis L.</li> <li>9. Allosterna tabacicolor Deg.</li> <li>10. Aromia moschata L.</li> </ol> </li> </ol>	<ol style="list-style-type: none"> <li>8. <b><i>Night butterflies</i></b> <ol style="list-style-type: none"> <li>1. Geometra papilionaria ( L 1758)</li> <li>2. Sterrha rufaria (Hubner, 1799)</li> <li>3. Sterrha cericeata (Hubner, 1813)</li> <li>4. Sterrha inornata (Howorth, 1809)</li> <li>5. Oporinia autumnata Bork, 1794</li> <li>6. Enthephria ignorata Stgr, 1892</li> <li>7. Orthonama obsipata Fabricius, 1799</li> <li>8. Operophtera brumata (Photo)</li> </ol> </li> <li>9. <b><i>Khvatrebi</i></b> <ol style="list-style-type: none"> <li>1. Plusia gamma, L</li> <li>2. Scotia segetum, L</li> <li>3. Apamea monoglypha, Hufn.</li> <li>4. Noctua pronula, L</li> <li>5. Mamestra persicariae, L.</li> <li>6. Eupsilia transversa Hufn.</li> <li>7. Apatele psi, L.</li> <li>8. Phlogopflora meticulosa, L.</li> <li>9. Bena prasinana, L.</li> <li>10. Chrysaspidia festucae, L.</li> <li>11. Autographa gamma, L.</li> </ol> </li> </ol>
---	---

11. *Rosalia alpina* L.
12. *Monochamus sutor* L.
- 6. *caddis flies (Mecoptera)***
  1. *Panorpa communis*
  2. *Phryganea grandis*
- 7. *Day butterflies (Rophalocera)***
  1. *Erynnis tages* L 1758
  2. *Muschampia cribrellum* (Eversmann, 1841)
  3. *Pyrgus carthami* (Hubner, [1813])
  4. *Carterocephalus palaemon* (Pallas, 1771)
  5. *Anthocharis cardamines* (L, 1758)
  6. *Pieris rapae* ((L, 1758)
  7. *Pieris napi* (L, 1758)
  8. *Pontia daplidice* (L, 1758)
  9. *Colias croceus* (Fourcroy, 1758)
  10. *Gonepteryx rhamni* (L, 1758)
  11. *Lycaena phlaeas* (L, 1761)
  12. *Lycaena virgaureae* (L, 1758)
  13. *Celastrina argiolus* (L, 1758)
  14. *Glaucopsyche alexis* (Poda, 1761)
  15. *Plebejus argus* (L, 1758)
  16. *Melanargia russiae* (Esp, 1783)
  17. *Erebia aethiops* (Esper, 1777)
  18. *Erebia melancholica* Herr.-Shaff, 1846
  19. *Lasiommata maera* (L, 1758)
  20. *Maniola jurtina* (L, 1758)
  21. *Hipparchia syriaca* (Staudinger, 1871)
  22. *Polignonia c-album* (L, 1758)
  23. *Nymphalis antiopa* (L, 1758)
  24. *Vanessa atalanta* (L, 1758)
  25. *Vanessa cardui* (L, 1758)
  26. *Vanessa aglais urticae* (L, 1758)
  27. *Inachis io* (L, 1758)
  28. *Euphydryas aurinia* (Rottenburg, 1775)
  29. *Melitaea caucasogenita* (Verity, 1930)
  30. *Melitaea phoebe* ([Denis&Schiffer], 1775)
  31. *Argynnis paphia* (L, 1758)
  32. *Argynnis niobe* (L, 1758)
  33. *Clossiana dia* (L, 1767)

**10. *Datunelebi***

1. *Epicalia villica*, L.
2. *Arctia caja*, L.
3. *Panaxia dominula*, L.

**11. *Sphinx***

1. *Macroglossum stellatarum*, L.

**12. *Bees***

1. *Xylocopa valga*
2. *Bombus lapidarius*
3. *Bombus hortorum*
4. *Bombus hypnorum*

**13. *Flies***

1. *Volucella bombylans*
2. *Syrphus ribesii*
3. *Stomoxys calcitrans*
4. *Lucilia sericata*

**14. *Mecoptera***

1. *Panorpa communis*

**15. *Molluscs***

1. *Oxychilus glaber*
2. *Cepaea nemoralis*

**Picture 5.2.6.3.1.** Some species that are spread within the study area*Gonepteryx rhamni**Pieris napi**Licaena phlaeas**Vanessa cardui*

Construction area of Nenskra HPP is located in mountainous, mixed forest zone. part of the flooded area is a mountainous forest of floodplain. In spring this area is flooded.

Widespread invertebrates are represented within this area. Alpine Longhorn should to be noted, which is included in the Red List of Georgia, as well as in the list of USN. Their destruction can be avoided by removing and disposing dead Beech trees on slopes outside the project area.

**Picture 5.2.6.3.2.** Wood log damaged by bugs

Due to the construction of the dam, stable conditions will be created for the development and breeding of water insects and their productivity will be increased. Construction may create some temporary problems, in particular the number of insects may be reduced.

#### 5.2.6.4 Fish Fauna

The Nenskra HPP project may have a potential impact on the hydrobiology of the rivers Nenskra, Nakra and their tributaries, namely the rivers Dalari, Tita, Tetnashera, Devra, Markhi, Lakhami, Darchi. Due to this reason preliminary surveys were conducted and mitigation measures were developed.

Detailed study of the Ichthyofauna of the rivers Nenskra and Nakra were conducted in order to determine possible impact on fish population and identify mitigation measures for these impacts caused by the project.

The literary sources helped to gather information on fish species of the region and their migration. In addition, fishery was carried out on the rivers Nenskra and Nakra in order to determine:

- What fish species inhabit the project influence area;
- What protected or rare fish species inhabit the project influence area;
- If there are any sensitive habitats (e.g.. reproduction areas) in the Nenskra and Nakra project region;
- If there are any ecologically significant habitats for the fish in the vicinity of dam and water intake construction/operation areas;
- Potential impact of the HPP construction and operation scheme on the main rivers and their tributaries.

In order, to achieve the goal, studies were divided into two stages. Namely:

1. Preliminary works:
  - Study of literature and development of the area plan, identification of the most important areas, planning of future works with consideration of the received information;
2. Main works:
  - Collection of field information on fish and fish living environment in accordance of the developed plan and further analysis of the information.

##### 5.2.6.4.1 Theoretical Basis of the Background Condition Monitoring

Rivers in the construction and operation zone of the HPP have a rapid flow, high oxygen content, low temperatures, low organic matter content and water level changes (seasonal and daily). Maximum water flow reaches 20-30 m<sup>3</sup>/sec, minimum is 15-20 m<sup>3</sup>/sec. Water mineralization is low (40-150 mg/l), leading components are bicarbonates (50% and more).

Biogenic element concentration is low – concentration of nitrate and nitrite is one hundredth mg/l. Low-rustiness indicates on low content of organic 3-8 O<sub>2</sub> mg/l. Substrates of the river bottom are represented by rocks, stones and sand mixture, also boulders.

Hydrobiont specie composition is typical for mountain rivers. This is a peculiar world for amphibiont insects. Most part of life cycle these insects spends in worm stage (sometimes for several years). Such long-term development can be explained by lack of food resources.

Practically whole benthos consists of five groups: Plecoptera, Ephemeroptera, Trichoptera, Chironomidae and other Diptera. Mollusca and Crustacea are not presented. Strong effect of water flow prevents development of plankton and periphyton. For this reason, study of the spatial distribution of ecological modification of hydrobiont is only possible through benthos research.

It is known, that physical-geographical indicators of mountain regions are determined by high zoning. Zoning is difficult to define, main difficulty is objective characteristics of physical-geography of the mountainous region. Zones in mountains are narrow and closely tied to the vertical profile line. In such conditions certain amount of hydrobionts can cross all tiers and get into the foothill regions. This is contributed also by high dynamics of water and high conservatism of water environment.

Rivers of Caucasus have many tributaries, which simultaneously are characterized by relative shallowness. Capacity of most tributaries does not exceed several m<sup>3</sup>.

In term of small flow of tributaries floods can be disastrous for hydrobionta, especially when they cause specific event – landslide.

Survival of hydrobionta in such extreme conditions is unstudied biological problem. This is even more interesting, because insect with relatively slow development cycle live in rivers as worm for 2-3 years (e.g.: Perla, Perlodes ). These insect must survive several catastrophic events, when a flow brings large cobble stones and fling them.

Following factors affect quantitative characteristics of hydrobionta:

- Seasonal factor;
- Trophic conditions;
- Imago emergence;
- Anthropogenic impact.

Ecological factors of biocenosis formation:

- Stream type – river, spring, etc.;
- Flow speed;
- Substrate nature.

Therefore, during ecological analysis of the flow three biological types are considered together with ecological factors that affect hydro-objects, in order to define anthropogenic impact from others, primarily from climatic factors.

Thus, number of factors will affect species composition of hydrobionta, among which the most important factors are:

- Substrate nature;
- Flow speed;
- Nature of the riverbed;
- Transparency;
- Water chemistry;
- Water temperature;
- Water flow capacity;
- Landscape attachment.

#### 5.2.6.4.2 Field Survey Results

Ichthyofauna of the rivers Nenskra and Nakra is not sufficiently studied, especially fish population of their tributaries. In the upper part of the rivers, in the zone of the HPP construction and operation, Ichthyofauna is represented by the spring trout. It is known that the trout creates the “mountain form” trout populations on the heights of 2000-2500 m, it is characterized by slow growth rate and late occurrence of the sexual maturity.

**Fauna of the Spring Trout in the reservoirs of the study region** – a spring trout is extremely sensitive towards oxygen fluctuation in the water. Marginal content of oxygen in the water for trout is 3,5 mg/l. Fry on the initial development stage is particularly demanding to the oxygen. Less the oxygen in the water – more hindered a growth of fry is.

Water flow has a very important part in growth and sustainability of fry. According to Schaperkhaus (1956) data, trout gains 41% more when the water flow is 12 l/min, than in terms of 6 l/min.

Study revealed, that trout can normally stand fluctuation of pH when the rate is within 6-9.

In addition, water transparency also plays a major role in fry development. But transparency level varies depending on the seasonal changes of the water level, which affects flow velocity and increases flow capacity and therefore, increases amount of particles in the water.

In general, it is known, that average flow speed of glacial rivers is significantly high in July-August. Number of species in mountainous sections is three times less, than in lower sections.

There are averagely 5-6 organisms on the 0,1 m<sup>2</sup> area of the riv. Nenskra bottom, which can be used as food for trout.

Unlike other mountainous Ichthyofauna representatives, trout feeding continues throughout late autumn and winter.

Daily and seasonal feeding of trout can be represented as follows: most intensive period is beginning of April-late June. It was possible to catch a trout with a rod three times a day, which indicates on increased migration activities at 7-8, 12-14 and 19-20 hours. Remaining period of the day trout remains motionless.

There are so-called “feeding places” on the spring trout distribution areas; these areas are migration destinations of trout.

Feeding decreases by the end of July and August. Trout almost does not appear in daytime and reveals feeding activity only in the morning and evening.

October is a second phase for feeding increase, which reaches the highest level in November. In this period trout nourishes 3 times a day and is expressed in feeding migration towards the “feeding area”.

“Feeding areas” are characterized by seasonal changes, which are related to seasonal peaks in reproduction of various edible species.

Feeding activity drops in the beginning of December and lasts till the beginning of April. As for the hunting method of trout – hydro-fauna in the study region is represented by Ephemeroptera, Plecoptera and Trichoptera worms, which live a moving and active life, therefore, hunting method is mainly searching for food with sight.



As for the main components of trout food, their ration mostly consist of Gammaridae. Total share of this organisms in trout ration is 87% in summer and 95,4% in winter.

Percentage composition of trout food ration can be characterized as follows (in percentage):

#### Hydrobionts - Trout diet components

№	Hydrobionts – trout diet components	Percentage ration in nutrition ration
1	<i>Gammaridae</i>	79,5-95
2	<i>Thendipedidae</i>	1,9-9,7
3	<i>Trihoptera</i>	1,5-3,1
4	<i>Mollusca*</i>	0,1-1,5
5	<i>Ephemeroptera, Plecoptera</i>	0,1-0,8
6	Flying insects	0,2-2,1
7	Other	0,4 – 3,1

\* Group Mollusca is not represented in the highest precincts and their representatives are mainly spread in the lowest sections.

The field research and local amateur fishermen survey revealed that project section of Nenskra River does not represent trout reproduction area. However, this section is important in terms of feeding base for fish. Fish reproduction areas are mainly represented upstream of Nenskra River and in its tributaries, including Okrili, Tskhvamdiri, Devra, Tita, etc. therefore, in case of implementation of the project, there is a high risk of losing feeding base for fish.

As for the project section of Nakra River, reproduction areas are not represented there at all, as such areas are observed only upstream of the river. As field surveys revealed, project section of the river is used as a feeding base by trout. However, feeding base is very poor and therefore, number of fish is very small compared to Nenskra River.

### 5.2.6.5 Protected Areas

#### 5.2.6.5.1 General Background

The total are of the protected areas of Georgia is 495 892 ha, which is approximately 7% of country's territory. Approximately 75% of the protected areas are covered by forests. There are 14 state reserves, 8 national parks, 12 reserves, 14 natural monuments and 2 protected landscapes in Georgia.

#### 5.2.6.5.2 Protected areas in the study area

Planned protected areas are registered currently on the territory of Mestia municipality, which is located within the 600-5200 m altitude and is represented by the following categories: national park of Zemo Svaneti and protected landscape of Zemo Svaneti. Its planned area is 75 901 ha. Therefore we can say, that the study area (upper part of the rivers Nenskra and Nakra ravines) represents the component part of planned protected areas of Zemo Svaneti (see the Figures 5.2.6.5.2.1. and 5.2.6.5.2.2.).

The planned protected area of Zemo Svaneti represents a high ecological value and eco-tourism development territory. Due to the complex relief and diverse climatic conditions, the vegetation is diverse as well. Existence of many endemic, relict and rare species indicates on the specificity of Svanetian flora. 212 species of Caucasian endemic flora is in Svaneti, 52 species – of Georgian flora and 9 species – belong to Svaneti endemic itself.

The territory of Svaneti is the part of Colchis botanical-geographic province, where are many relict species, such as Common Rhododendron (*Rhododendron ponticum*), Cherry-laurel (*Laurocerasus officinalis*), Ilex (*Ilex colchica*), Colchis Plush (*Hedera colchica*), Colchis box-tree (*Buxus colchica*), Azalea (*Rhododendron luteum*), high Bilberry (*Vaccinium arctostaphylos*) and others.

The wildlife on the territory of national park in Zemo Svaneti is very diverse. From mammals are widespread: badger (*Meles meles*), wolf (*Canis lupus*), fox (*Vulpes vulpes*), wild cat (*Felis silvestris*), forest marten (*Martes foina*), roe deer (*Capreolus capreolus*), Caucasian isler bigan (*Sorex caucasicus*), Caucasian mole (*Talpa caucasica*).

From the Georgian “Red List” species, widespread are chamois (*Rupicapra rupicapra*), the east Caucasian aurochs (*Capra cylindricornis*), the west Caucasian aurochs (*Capra caucasica*), brown bear (*Ursus arctos*) and others.

Birds, within the national park of Zemo Svaneti, that should be noted first of all are the ones enlisted in Georgian “Red List”: Bearded vulture (*Gypaetus barbatus*), griffon (*Aegypius monachus*), griffon vulture (*Gyps fulvus*), the mountain eagle (*Aquila chrysaetos*) and others.

Reptiles and amphibians also can be found on the territory of national park of Zemo Svaneti. Amphibians are green toad (*Bufo viridis*), European tree frog (*Hyla arborea*) and Caucasian parsley frog (*Pelodytes caucasicus*). In the rivers is found trout (*Salmo trutta*).

Many interesting architectural monument is on the adjacent territories of national park, mainly churches, in which the medieval paintings are preserved. Archeological excavations have revealed the important monuments.

The protected landscape territory of Zemo Svaneti is located in the basin of river Enguri (Mestia district). By the orographic point of view, protected landscape territory of Zemo Svaneti is located between south range of main watershed of Caucasus and northern slope of Svaneti range. It is characterized by a fragmented landscape. Protected landscape territory of Zemo Svaneti is characterized by relatively soft, windless, moderately humid climate, snowy winter and cool summer.

On the protected landscape area can be found the species enlisted in Georgian “Red List”, such as elm (*Ulmus glabra*), yew (*Taxus baccata*), mountain oak (*Quercus macranthera*), (*Daphne Alboviana*), chestnut (*Castanea sativa*), as well as, rare endemic species – Enguri campanula (*Campanula svanetica*), Svanetian buttercup (*Ranunculus svaneticus*) and others.

Widespread mammals are: hedgehog (*Erinaceus europaeus*), Greater White-toothed Shrew (*Crocidura russula*), hare (*Lepus europaeus*), Caucasian water Isler Bigan (*Sorex caucasicus*), forest marten (*Martes foina*), fox (*Vulpes vulpes*), badger (*Meles meles*), also, brown bear (*Ursus arctos*) enlisted in Georgian “Red List” and others.

The birds to be found are enlisted in Georgian “Red List” are: mountain eagle (*Aquila chrysaetos*), vulture (*Gypaetus barbatus*), long-legged buzzard (*Buteo rufinus*), common cuckoo (*Cuculus canorus*), pigeon (*Columba palumbus*), mistle thrush (*Turdus viscivorus*), jays (*Garrulus glandarius*), owl (*Athene noctua*), common wood owl (*Strix aluco*), green woodpecker (*Picus viridis*), great spotted woodpecker (*Dendrocopos major*), lesser spotted woodpecker (*Dendrocopos minor*) and others.

The designed HPP communications deployment territories are not included within the territories of protected areas of Zemo Svaneti.

Figure 5.2.6.5.2.1. Protected areas of Georgia

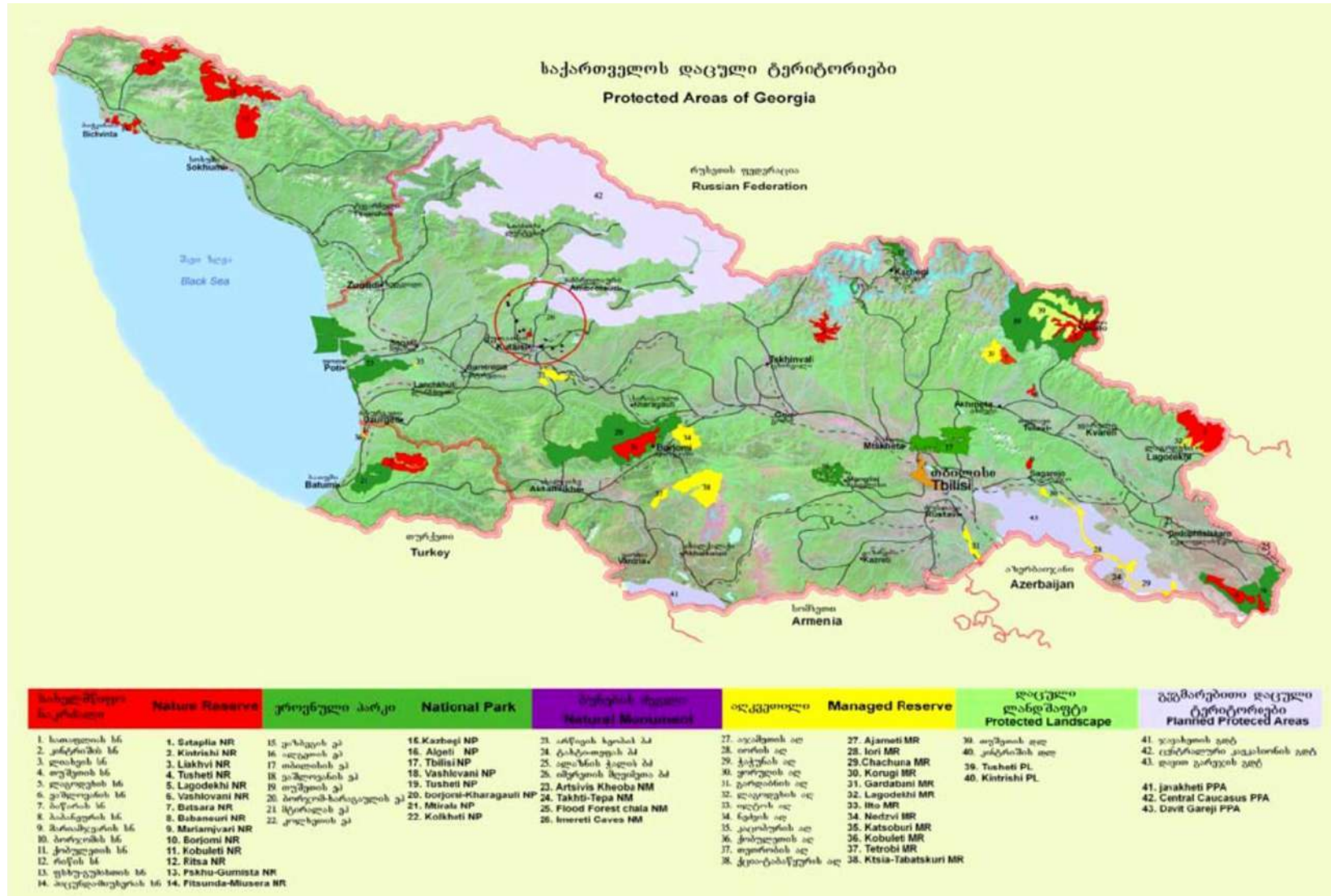

**Figure 5.2.6.5.2.2.** Part of project national park of Svaneti (Nenskra and Nakra ravines)

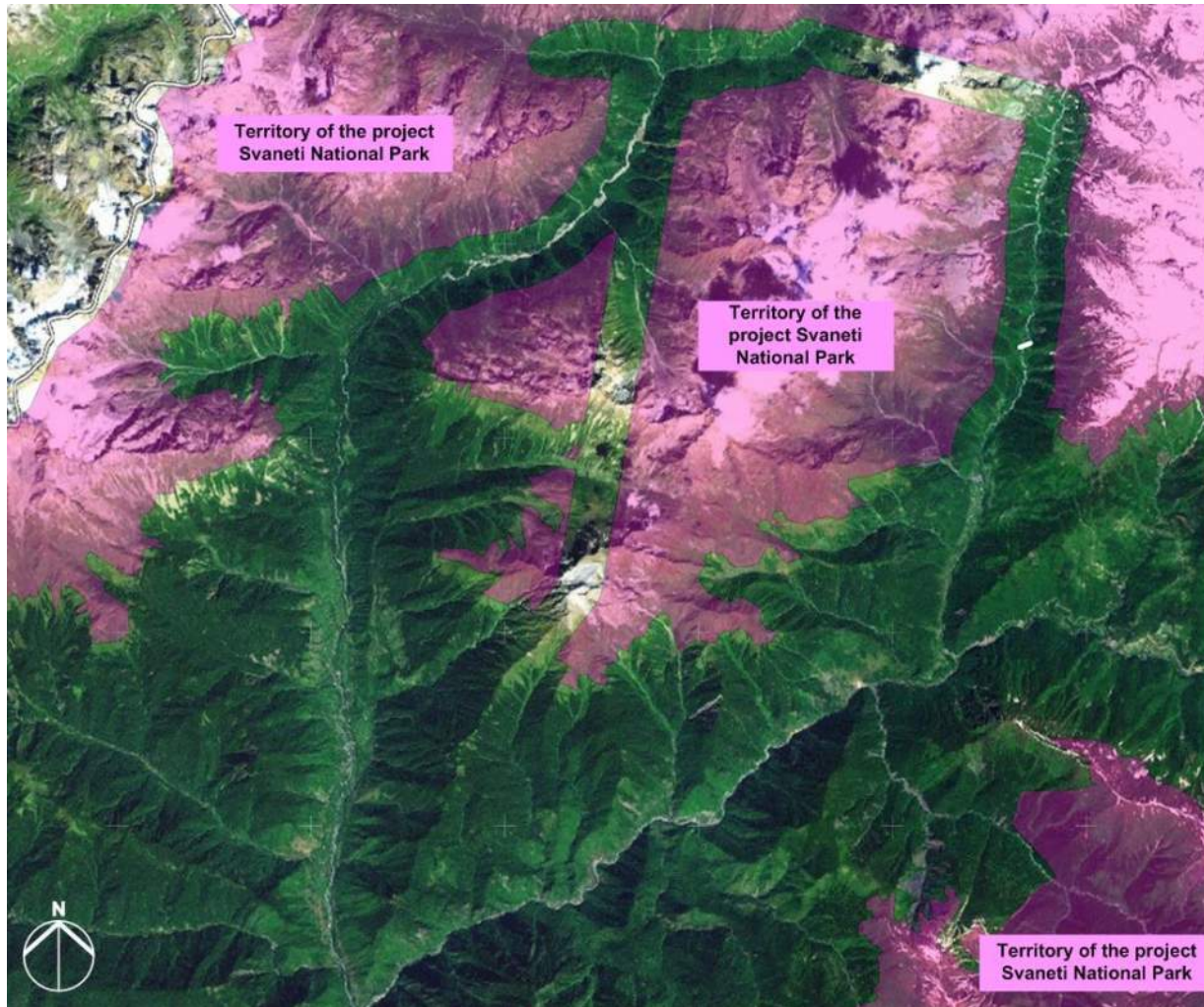

**Note:** The project national park is given in pink color

### 5.2.7 Quality of Ambient Air

No observations are conducted on the ambient air quality on the territory of Mestia municipality and therefore, for the ambient air background pollution evaluation on the project site, it was considered as reasonable to use the N 3 Annex of “about the maximum permissible levels of harmful substances or/and temporarily agreed emissions limits of calculation method” approved regulation by the Minister of Environment Protection and Natural resources of Georgia 20.10.2008, order N 705. Appendix is envisaged for ambient air background conditions assessment of those territories, for which there is no observation data. According to the Appendix, ambient air quality assessment is based on amount of population of the residential area (see Table 5.2.7.1.).

**Table 5.2.7.1.** Background concentration (mg/m<sup>3</sup>) estimated values

Population amount (thousand people)	Dust	Sulfur dioxide	Nitrogen dioxide	Carbon monoxide
250-125	0.4	0.05	0.03	1.5
125-50	0.3	0.05	0.015	0.8
50-10	0.2	0.02	0.008	0.4
<10	0	0	0	0

If we take into account, that total amount of population on the adjacent territories of the project site does not exceed 10000 people, it can be said that atmospheric air is practically clear.

### 5.2.8 Noise Propagation

The noise propagation levels in Georgia are regulated by the normative document – sanitary norms 2.2.4/2.1.8. 003/004-01 “noise at the workplace, residential, public buildings and on the residential development area”. According to this normative document, the noise propagation level norm on the border of residential development territory for night hours (from 23:00 until 07:00) is 45 dba acceptable and for the daytime hours (from 07:00 until 23:00) 55 dba.

Noise propagation sources are not located on the project sites. In the nearest populated areas of the designed dam and power unit, the noise propagation levels mainly are due to the road traffic.

In order to identify the baseline levels of noise propagation on the project site, the instrumental measurements has been conducted. Noise and vibration measurements were carried out by means of measurement tool - ИВІІІ-1 (the tool has passed the meteorological testing). Measurements were carried out during day hours (within the interval of 12:00 – 16:00). Measurement results are given in Table 5.2.8.1.

According to the results given in the table, exceeding the normative levels of noise propagation has not been identified on the project site.

**Table 5.2.8.1.** The results of measurement of noise levels

№	Name of measuring point	Point coordinates	Results of measurement, dba
1	Boundary of residential zone of the village Tita		34
2	Dam project area		27
3	The area selected for the power unit construction		36

### 5.3 Socio-Economical Environment Within the Project Region

Administrative center of the Mestia Municipality is Mestia borough. Administrative-territorial division of Mestia Municipality coincides with the historically established communities. These are Mestia and 15 rural communities: Ushguli, Kala, Ipari, Tsvirmi, Mulakhi, Lenjeri, Latali, Tskhumari, Becho, Eceri, Lakhamula, Nakra, Chuberi, Khaishi.

There are 10 villages in the Chuberi community council: Lower Margi, Devra, Upper Margi, Larilari, Lakhami, Lekulmakhi, Lecferi, Sgurishi, Tita, Kari.

There are six villages in Nakra community council: Nakra, Tavrali, Kichkhuldashi, Chubari, Caleri, Kherkhvashi.

#### 5.3.1 Socio-Economical Environment Research Area and Information Sources

According to the feasibility study, Nenskra HPP project will be implemented on the territories of Chuberi council and partly, Nakra council in Mestia Municipality.

Following settlements are located in the project influence zone:

- Chuberi council: Tita, Chuberi, Sgurishi, Lower Marghi and Upper Marghi villages;
- Nakra council: Nakra village.

**Figure 5.3.1.1.** The scheme of settlements in Nenskra and Nakra river valleys

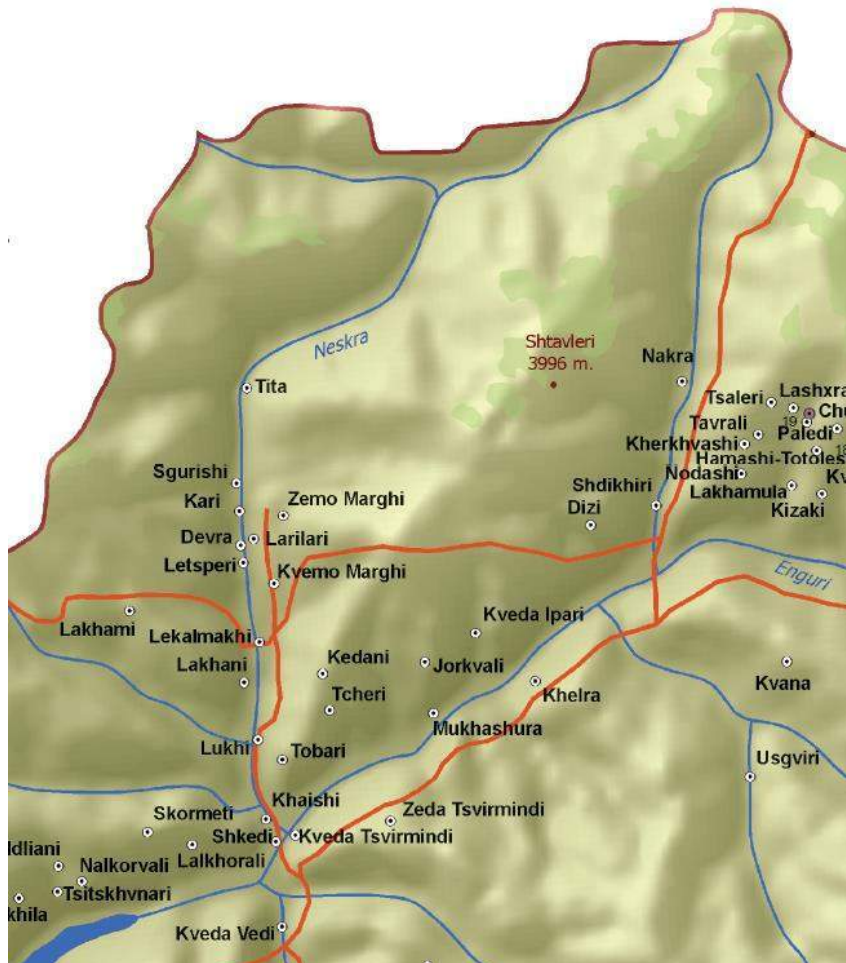

Socio-economic background of the Mestia municipality and these two neighboring councils will be discussed further, namely:

- Economy and employment;
- Population and demography;
- Health care and education;
- Technical infrastructure;
- Public sector and media;
- Cultural resources.

Information on the socio-economic condition has been obtained from literature sources, local authorities and other official sources, including:

- Official web-site of the National Statistics Office of the Ministry of Economy and Sustainable Development of Georgia, [www.geostat.ge](http://www.geostat.ge);
- Official web-sites of Mestia Municipality;
- Institute of Analysis and Social Research, [www.issa-georgia.com](http://www.issa-georgia.com);
- Department of Economic Policy of the Ministry of Economy and Sustainable Development, [www.economy.ge](http://www.economy.ge);
- International Organization for Migration, [www.iom.ge](http://www.iom.ge);
- Georgian National Tourism Agency, [www.gnta.ge](http://www.gnta.ge);
- National Center for Disease Control and Public Health, [www.ncdc.ge](http://www.ncdc.ge);
- Ministry of Refugees and Accommodations, [www.mra.gov.ge](http://www.mra.gov.ge);
- Social Service Agency, [www.ssa.gov.ge](http://www.ssa.gov.ge);
- Municipal Service Providers' Association, [www.mspa.ge](http://www.mspa.ge);
- NGO Liaison Office, [www.parliamentngo.ge](http://www.parliamentngo.ge);
- The Ministry of Regional Development and Infrastructure, [www.mrdi.gov.ge](http://www.mrdi.gov.ge);
- Official web-site of Samegrelo-Zemo Svaneti regional administration, [www.szs.gov.ge](http://www.szs.gov.ge);
- Official web-site of Mestia Municipality, [www.mestia.ge](http://www.mestia.ge).

Figure 5.3.1.2. Scheme of Mestia Municipality

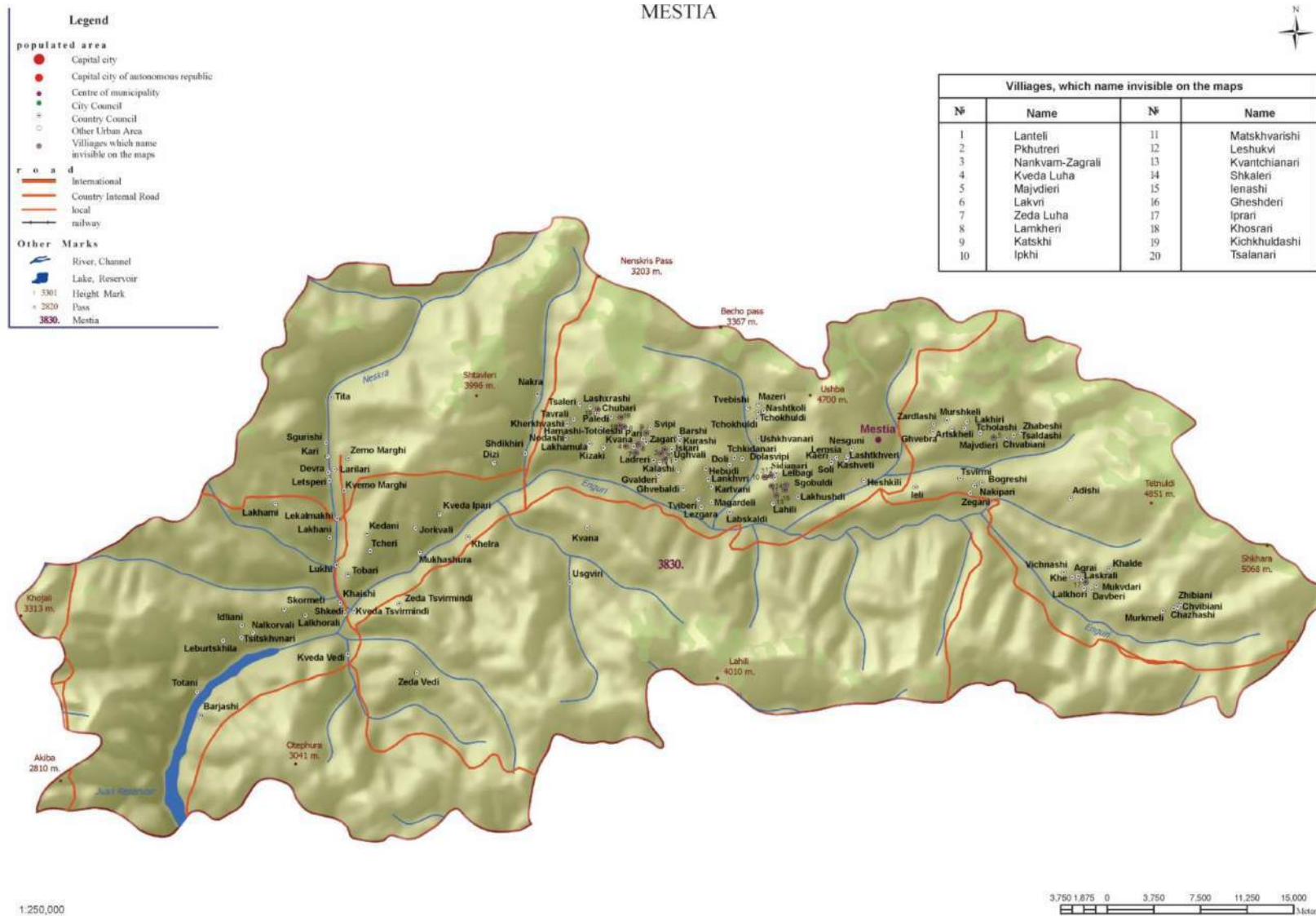



## 5.3.2 General Overview

### 5.3.2.1 Economy of Georgia

Since the 80's of the past century country's economic condition has worsened in process of independent state establishment. Armed conflict and civil war even more complicated situation of Georgia.

Since 2000, the economy of Georgia started rapid but unsustainable growth and in 2001-2007 years the GDP growth reached 6-12%, which exceeded world's GDP growth rate (3-5% annually) twice and more.

In 2008, the conflict with Russia made an impact on the GDP of Georgia, due to which the economical annual growth rate has fallen to 2.1%. In 2009 the country's GDP reduced by 4% more, due to the global crisis because the foreign direct investments has reduced (Drewry, 2010).

Important revival of the country's economy was noted since 2010, namely: in 2010 the nominal GDP of Georgia amounted 20 791 million GELs and the real growth of GDP in comparison with the 2009 was 6,4%.

In 2010, GDP per capita amounted 4686 GEL (2629.0 USD), which was 14.3% more than the same index of 2009. Country's GDP has the largest share in industry and trade. Transport and communications also have a significant share. Agriculture is still leading the field, but in this field, decrease is identified as well as in household goods processing.

In 2011, GDP amounted 2434 million GEL, which is 17.4% more than the same index of previous year.

In 2012, GDP of Georgia amounted 26 167.3 million GEL, which is 7.5% more than the same index of previous year. Real GDP growth rate was 6.2% more and deflator index was 1.2% more compared with the previous year.

According to preliminary data, GDP in 2013 amounted 26 824.9 million GEL in current prices, which is 2.5% more than the same index of previous year. Real GDP growth rate was 3.2% more and deflator index was 0.7% more compared with the previous year.

**Table 5.3.2.1.1.** Sectorial distribution of GDP OF Georgia

Field	2009	2010	2011	2012	2013
Agriculture, forestry and hunting, fishing	9.4	8.4	8.8	8.6	9.3
Industry	15.4	16.1	17.1	16.7	17.2
Construction	6.5	6.1	6.7	7.8	6.7
Trade	15.1	16.8	16.9	16.7	17.3
Transport and communication	11.2	11.5	10.5	10.6	10.7
Other	42.4	41.1	39.9	39.5	38.8

**Source:** National Statistics Office of Georgia (2014)

Samegrelo-Zemo Svaneti region is in the 5<sup>th</sup> position in the total share of production and is characterized by the growing trend of production – Table 5.3.2.1.2.

**Table 5.3.2.1.2.** Output in the regions in 2008-2014. Million GEL.

Region	2008	2009	2010	2011	2012	2013	2014
Georgia	10 248.4	11 003.1	13 303.7	19 239.9	19 239.9	19 239.9	19 239.9
Tbilisi	6 615.7	7 467.6	8 691.5	12718.8	15 643.8	15 643.8	3 707.4
Kvemo Kartli	991.9	1 119.4	1 424.5	1 844.4	1 844.4	1 844.4	1 844.4
Imereti	701.0	479.5	762.0	1 089.8	1 089.8	1 089.8	1 089.8
A/R of Adjara	584.4	613.9	714.6	1 125.2	1 125.2	1 125.2	1 125.2
Samagrello-Zemo Svaneti	379.0	473.7	580.5	836.2	836.2	836.2	836.2
Shida Kartli	402.8	273.8	333.3	619.9	619.9	619.9	619.9
Kakheti	152.1	181.7	226.3	319.8	319.8	319.8	319.8
Mtskheta-Mtianeti	125.3	138.3	203.2	239.1	239.1	239.1	239.1
Samtskhe-Javakheti	134.7	118.2	192.4	259.0	259.0	259.0	259.0
Guria	96.2	74.6	88.7	115.0	115.0	115.0	115.0
Racha-Lechkhumi – Kvemo Svaneti	19.9	19.4	27.1	27.1	27.1	27.1	27.1

**Source:** National Statistics Office of Georgia (2014)

Level of economic development in Samegrelo-Zemo Svaneti is significantly different in its various municipalities. Poti is the port city of Georgia, therefore important trading turnover share of the country belongs to it. Coastal Khobi municipality is relatively developed. The situation is different in the central and mountainous regions, which are mainly agricultural regions.

### 5.3.2.2 Economy of Mestia Municipality

Mestia Municipality is mountainous. In addition to severe climate and complex landscape development of the municipality was hampered by deteriorated infrastructure. The municipality has a low budget and small income.

The budget offices of the Mestia Municipality do not pay the VAT, as for other institutions and organizations – taxes are not fixed in the municipality. Share of total production of the municipality in the GDP is 0,1%. An average annual income per capita has always been much lower than the country's indicator.

Most part of the revenue is supplemented with tax incomes, such as land and property taxes. The rest budget is being filled with regular transfer. This is reflected in the budget of 2014 - Table 5.3.2.2.1.

**Table 5.3.2.2.1.** Local budget approved by the Mestia council.

Year	Transfers allocated from the state budget funds	Municipality revenue	Total
2013	2 255.1 thousand GEL	3 736.4 thousand GEL	5 991.5 thousand GEL

### 5.3.2.3 Industry and Transport

According to the data of 2013, turnover rates by industry in Samegrelo-Zemo Svaneti reaches 442.2 million GEL. There are 60 LTDs and 20 General Partnerships in Mestia Municipality. According to the data of 2013, the number of employees in industry sector is more than 4530 people. The average monthly salaries of employees in this sector are 432.9 GEL.

The industry is mainly determined by wood production. Forest is the main vegetation cover of the municipality area (45.8% of the territory). Territory of forest management is 100.0 ha. 30 million m<sup>3</sup> of forest resource is registered on the municipality territory. 1 medium and 11 small enterprises operate in this field. Most of them are located in Khaishi, Chuberi and Nakra.

In 2001-2005 forest management works have been carried out within Georgia forestry support project of the World Bank; subjects of the program were industrial forest fund areas.

Local inert material extraction-processing has taken place to provide materials for central road construction. Currently 3 mini concrete plants, 2 inert material crushing-sorting workshop is operating.

Low rate of economic activity is caused by undeveloped industries of the region, which consist mainly from household and family type small businesses.

There are several already implemented or current state-funded investment projects.

Projects of 2008-2013 significantly improved local infrastructure. These projects are:

- Potable water system rehabilitation and water supply in boroughs and villages;
- Construction of new airport;
- Rehabilitation of sewage system in Mestia;
- Rehabilitation of cultural and educational institutions;
- Construction/rehabilitation of roads;
- Rural support program;
- Upgrade of Mestia center and main streets;
- Reconstruction of the old part of town and restoration of immovable monuments of cultural heritage;
- Arrangement of protective gabions and bridges;
- Creation, arrangement of tourism infrastructure.

#### **Transport Infrastructure:**

Distance between administrative center and important strategic points are following:

- Mestia-Tbilisi – 475 km;
- Mestia-Zugdidi – 136 km;
- Mestia-the nearest port city (Poti) – 226 km;
- Mestia-the nearest airport (Mestia airport) – 2 km;
- Mestia-the nearest railway station (Zugdidi) – 136 km.

Transport artery of the municipality is automobile roads. Distance between the internal state importance road Zugdidi-Mestia-Lasdili and railway is 136 km and is of II-III category. Total length of regional internal roads is over 170 km and is of V category. 16 communities are located along the road on different distances from the main points (Mestia, Zugdidi).

Transport industry is represented by three organizations:

- “Mestia Tour” Ltd provides passenger and baggage transportation services;
- “Auto Industry” Ltd;
- “Traffic Department” Ltd.

The length of local roads has been measured in 2013, the total length of which is 687 km. Construction of Chuberi road and Nakra central road is considered by the budget of 2014.

### 5.3.2.4 Agricultural Development in the Project Region

According to statistical data, 33.6%, i.e. 90 213 ha of agricultural lands in Samegrelo- Zemo Svaneti region is in private ownership. 4.3% of arable land is leased to farmers. Almost 100% of hay and pasture lands are state-owned.

Currently unused state-owned agricultural land is being involved in the agricultural production process through privatization. This increases production volume, although the situation in the Mestia Municipality is different.

Since 1992 government was giving land property rights to the residents. However, villagers received 1.25 ha of land, city (Mestia) residents received even less.

In March 1996 Law on Agricultural Land Ownership was adopted. Due to lack of land in Zemo Svaneti all agricultural and arable-sowing land was privately owned. Currently the National Agency of Public Registry is conducting the land registration. Mestia Municipality has no privatized agricultural lands, therefore, land privatization was not conducted in this region.

**Table 5.3.2.4.1.** Distribution of hay and pasture lands in the region and Mestia Municipality according to ownership forms

№	Territorial Entities	Total agricultural and pasture lands	Including	
			Private sector	State sector
1	Mestia	92883.0	0	92883.0
2	Region	153129.0	341.8	152787.2

**Source:** Regional Administration of Samegrelo-Zemo Svaneti, [www.szs.gov.ge](http://www.szs.gov.ge)

Region is characterized mainly with natural economy and lack of agricultural-sowing and pasture lands. Population is self-employed in agriculture.

Agriculture priorities are:

- Horticulture;
- Livestock;
- Beekeeping.

Due to harsh climate and mountainous terrain livestock is advantageously developed. Food base for animals is sub-alpine and alpine hay-pastures.

Forest soils are mostly represented with friable soil, which are used for organic farming; small amount of grain crops are sown, also greens and potatoes are being cultivated.

Agricultural production capacity have not changed in recent years, the population suffers from annual natural disasters.

Average meat production is 1,774.5 tons, which is 18.8% of total production of the region. Milk production is 5.94 tons, which is 6.3% of total production of the region. Average production of potatoes is 4,265.1 tones.

Agricultural lands of Mestia Municipality are 94 092.0 ha, which is 32.1% of the whole territory. Land areas by type: arable lands – 1 209 ha (1% of the territory), hay lands – 2 064 ha (2.6% of the territory), pasture – 90 819.0 ha (28.9% of the territory), perennial plants – 51 ha, forest and bushes – 144.5 ha (47% of the territory).

Personal plots are 1 186 ha, number of farmers with small plots (1.25 ha) is 2770. Agricultural production is not mechanized and is being implemented on small plots.

Cattle and livestock products play an important part in economy of the region population. Except milk and meat production it is also a family capital, bulls are being used as a work force, as equipment for land processing in terms of such complicated relief is useless.

**Table 5.3.2.4.2.** Number of cattle and poultry

Territorial entities	Cattle	Cows	Pigs	Goats and sheep	Bulls	Horses	Poultry
Mestia	16678	11375	-	3470	4453	840	20420
Region	214913	139766	17217	21009	7413	14178	1136049

There are no large farms, farmer's associations, cooperatives and others in the municipality. There are no points of delivery and warehousing either.

Main activity in natural agriculture (household) is cattle breeding, however, they also have pigs, goats and poultry, cultivate potatoes, fruit and vegetables, corn, produce milk products, species.

Pastures divide in two parts: near pastures and far pastures. They belong to the communities and are being used by households. Near pastures are being used for milking cows, for daily use.

Remote, alpine pastures, are used for bulls and calves. In Svaneti conditions the cattle needs 5-6 months of care. Hay demands exceed fodder production 3.6 times. Standard size of the fields is 0.7 ha. Mowing is dependent on annual climate conditions and altitude of mowing lands. Earliest period for hay is June and the last month is October.

In recent year swine farming has reduced due to Montgomery disease.

In 2010 the farmers' service center was opened in Mestia. Local agro-industrial production is not developed, as well as canning industry.

Hunting is widespread. Population does not fish on commercial basis, however there is a high-quality fish in the river.

Together with animal breeding, potato production is also a priority. It is developed as a private sector. In last 3 years production has reduced due to non-profitability.

Beekeeping is very popular in Svaneti. Horticulture is only a subject for private consumption. Only small part is being sold or bartered. Population sells beef, potato, cheese, honey, species (so-called "Svanetian salt") in local and city (Zugdidi, Tbilisi, Kutaisi) markets.

### 5.3.2.5 Tourism

The Department of Tourism and Resorts of Georgia recognized Zemo Svaneti as a preferable region in terms of tourism development in 2007. Approximately 20 projects have been implemented in the Mestia municipality tourism sector in 2008-2010, including several hotels and cafes, internet service, rural-agricultural market of Mestia, route marking, traffic signs arrangement and other.

Touristic infrastructure rehabilitation programs implementation began in municipality.

The program, "family touristic sustainable industry development in Zemo Svaneti", ensured creation of touristic production in Svaneti and establishment of guest house network.

Currently, 120 guest house owners have undertaken the trainings, 84 among them are working, including 45 successfully. Guest houses have passed the certification, which was held by Biological Farming Association ELKANA.

One person from Nakra community council has passed the training. No one has passed the training from the Chuberi council.

Mestia Tourist Information Centre was opened in 2010. 63 hotels, guides and vehicle hiring are available via Mestia Tourist Information Agency. Agency does not include Nakra and Chuberi communities.

Svaneti Mountain Tourism Centre, which is located in the town of Mestia, always generously host tourists. Provide them with the information about the guest houses and restaurants in the settlement. Also, inform them about Svan folk exhibitions and provide required consultation.

In order to promote the development of tourism in the region, peephole stations have been arranged in Mestia. Foreign and local tourists are given the opportunity to see the beauty of the Caucasus range and Upper Svaneti gorge in close view from Zuruldi and Tskhakvzagari mountains.

During the implementation of the project, 10 local workers have been employed, while during the operation of the peephole stations, 4 local residents are constantly employed. The project is designed for 10-12 years.

8 kilometers from Mestia, through pine forest, there is a Hatsvali, which has a high potential for tourism development. 2 400-meter-long ski run operates there for already 3 years, which is not far behind the Europe's leading ski resorts.

Above the ski run, there is a beautiful birch forest, from which tourists can enjoy the view of a huge Ushba mountains, white slopes of Tetnuldi and fill lungs with fresh air, which are also attractive in terms of tourism.

29 mountain guides have been trained, including 18 certified and 8 for touristic rescue routes. 18 mountain-touristic and horse riding routes are marked.

Tourists are also served by local transport. 16 local drivers are officially working by contract with the National Tourism Agency of Georgia. The main types of transport are: 4 seat jeep, 6 seat delica and minibus. Since 2010, flights are also available. During winter, the airport can receive small planes with a seating capacity of 18 passengers. During summer, the airport can receive the planes with a seating capacity of 50 passengers

Since 2010, tourists and visitors in Zemo Svaneti, in fact, visit throughout the year. The majority of the tourists are foreigners. Most of them have used the travel agency located in Tbilisi. The internal tourism has also activated in the last 2 years.

High seasonality in tourism comes in July-September. The winter months are loaded by touristic point of view, favored by skiing track arrangement.

Skiing tracks data is:

- I – length 1900 ∅. type – red, harder than the average, sport;
- II – length 2565 ∅. type – blue, the average difficulty;

- Ski lift length 1407 m, the number of seats 40. Initial height 1800 m above the sea level. Start – 2350 m. The third track is being constructed.

**Table 5.3.2.5.1. Tourism Infrastructure Facilities**

Facilities	Number
Local tour-firms	2
Hotel	4
Family Room (Guesthouse)	94
Hostel	1
Cafe and Bar	4
Restaurant	1
Dining Room	1
Svanetian kitchen (in family)	6
Marked trail	18
Ski lift	2
Ski run	2
Information Center	2
Travel Agency	2

In the average of 200 families are involved in the tourism services. These are guesthouses, guides and other services. The local touristic production is offered as by local, as well as by the regional and other travel companies. These are:

- Bike and quadrocycle rentals – 2 local services;
- Horse Riding tours;
- Svanetian Kitchen;
- Svanetian folklore and hymnography introduction;
- Adventure tours, ski Ski-tour and Sky-tour with paragliding. Event, “gold mining”, Christmas in Latali, Lamproba in Mestia (14 February).

The tourism sector in the so-called lower mountains is less developed, however, the tourism potential of the lower villages is also high. For example, Nakra valley is one of the most popular valley for the hike crusade amateurs.

**Table 5.3.2.5.2. Touristic locations in Mestia municipality**

Unit Type	Location	Title
Lakes	Mulakhi-Tsvirmi road section	Ughviri Lake
	Mestia:	Koruldi 3 lakes
	Becho:	Meziri (Tvebishi)
Grotto	Mestia:	Zaargashi – artificial cave remaining after mining-ore. Shgedi – natural cave.
	Nakra	S. Naki
Picnic	Mestia:	Kakhiri, Hatsvali,
	Ipari, Kala:	Ughviri pass, valleys
Rafting	Mestia:	river Mestia Chala
	Becho:	river Shikhris Chala
	Nakra:	river Nakra (in the upper part)
	Adishi:	river Adishchala
	Ushguli:	upper part of river Enguri

Fishing tourism	Chuberi,	Nenskra
	Lakhamula,	Doli
	Pari,	Adishchala
	Khaishi	Khaishura, Enguri
	Becho,	Dolra, Tvebishi
	Ipari	Mulkhra
Horse Riding tourism	Mestia- Zhabeshi-Adishi-Ifrali-Ushguli.	
Monuments of nature	Ipari – Adishi	Adishi glacier in the sources of river Adishura
	Ipari –Halde	river Halde – in upper part of Chaladi basin “Perkhulis Kva” stone.
Hiking valleys	Tviberi-Zhabeshi, Chalaadi-Mestia, Ushguli-Shkhara glacier, Zuruldi-Mestia, Lekhziri-Mazeri-Tvibeshi, glacier of Ushba. Mazeri-Guli-Mestia, Nakra valley.	
Skiing	Mestia	Koruldi, Shgedi
	Tsvirmi	Adishi
Waterfalls	Khaishi	Dizi
	Becho	Mazershi - Shdugvra
View locations	Mestia	Zuruldi, Hatsvali, Gvaldi, Tskhakv-Zagar, Kheshkildi.
	Becho	Zargashi, Meziri, Detsil, Guli
	Latali	Kvana, Bal-Zagar

Source: Samegrelo-Zemo Svaneti Regional Administration [www.szs.gov.ge](http://www.szs.gov.ge).

### 5.3.2.6 Employment

The unemployment rate in Georgia amounted 14.6% in 2013. This rate is quite high in Samegrelo-Zemo Svaneti and amounts 15.8%. (see Figure 5.3.2.6.1.)

Figure 5.3.2.6.1. Unemployment rate in different regions of Georgia, %

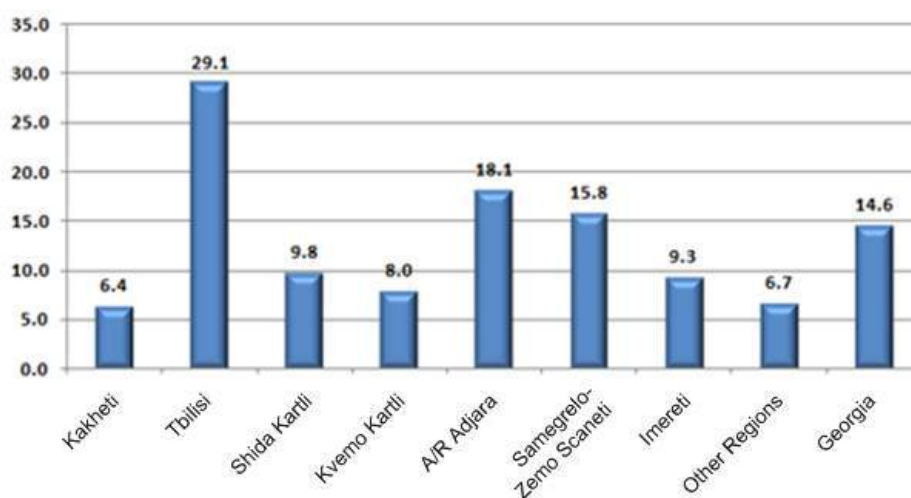

\* Racha-Lechkhumi and including Kvemo Svaneti

\*\* Samtskhe-Javakheti, Guria, Mtskheta-Mtianeti



In Table 5.3.2.6.1., the number of population able to work and their employment in Georgia and Samegrelo-Zemo Svaneti is provided. As the table shows, the half of the population belongs to the self-employment.

**Table 5.3.2.6.1.** The employment index for Samegrelo-Zemo Svaneti region for 2013

	Samegrelo-Zemo Svaneti	Georgia
Total active population (labor force)	216.0	2003.9
Employed	181.9	1712.1
Hired	50.4	658.2
Self-employed	128.3	1043.8
Not classified	3.3	10.0
Unemployed	34.1	291.8
The population outside the labor force	91.5	1022.3
Unemployment rate %	15.8	14.6
Activity rate %	70.2	66.2
Employment rate %	59.1	56.6

The majority of Mestia municipality population is employed in agriculture and is considered as self-employed households, where the activity is low-productive and low cost-effective.

### 5.3.3 Population and Demography

#### 5.3.3.1 Population

The population density in Samegrelo-Zemo Svaneti region is 63 person/km<sup>2</sup>. The average population density in Mestia municipality is 4.7 person/ km<sup>2</sup>, which is because of migration and partly due to the complicated relief.

**Table 5.3.3.1.1.** Samegrelo-Zemo Svaneti, Mestia municipality population density in 2007-2014

	2007	2008	2009	2010	2011	2012	2013	2014
Georgia	4,394.7	4,382.1	4,385.4	4,436.4	4 469.2	4 497.6	4483.8	4490.5
Samegrelo-Zemo Svaneti	469.8	467.7	468.0	74.1	477.1	479.5	476.9	476.3
Mestia municipality	14.2	14.3	14.4	14.5	14.6	14.6	14.5	14.5

**Source:** National Statistics Office of Georgia, 2014 [www.statistics.ge](http://www.statistics.ge).

Here are ethnic composition indexes of the region's and Mestia municipality population. The municipality is ethnically homogenous.

**Table 5.3.3.1.2.** Ethnic composition of individual municipalities population in Georgia and Samegrelo-Zemo Svaneti region.

	Georgia	Samegrelo-Zemo Svaneti	Mestia municipality
Georgian	83.8%	98.6%	99.39%
Abkhazian	0.1%	0.1%	0.1%
Armenian	5.7%	0.1%	0.1%
Russian	1.5%	0.9%	0.4%
Ukrainian	0.2%	0.1%	0.01%

Municipality includes 418 families (household). Table 5.3.3.1.3 shows the number of population and families in the communities.

**Table 5.3.3.1.3.** Permanent number of population of Mestia municipality councils

Community title	Total family	Permanent population	Temporary absent among them	Refugee	Total
Mestia	815	2780	227	136	2916
Ushguli	70	299	-	-	299
Kala	29	109	9	-	108
Ipari	97	403	16	22	425
Tsvirmi	101	539	12	27	566
Mulakhi	257	1006	50	39	1045
Lenjeri	298	1051	29	85	1136
Latali	387	1276	52	110	1386
Tskhumari	218	604	-	35	639
Becho	368	1065	72	75	1150
Etseri	249	761	86	45	806
Pari	97	338	23	46	384
Lakhamula	123	370	41	91	461
Nakra	127	385	20	27	412
Chuberi	312	1177	37	120	1297
Khaishi	462	1416	24	54	1470
Total	4 138	14591	698	912	14 500

**Source:** Data of Mestia municipality council

### 5.3.3.2 Demographic Trends

In Georgia in 2013, the live birth number amounted 58.878, which is 0.2% less than the index of the previous year, 2012. Increase of death and insignificant reduction of birth rate impacted on the natural increase. The highest increase between the regions was observed in Tbilisi, 4.652 units. Negative natural growth was identified in Samegrelo- Zemo Svaneti region: -277 units. (Table 5.3.3.2.1.)

**Table 5.3.3.2.1.** Demographic values for the Georgian regions

Region	Birth Rate	Death Rate	Natural Growth
Georgia	57878	48553	9325
Tbilisi	17010	12358	4652
Kvemo Kartli	6730	4280	2450
Adjara	5909	3289	2620
Imereti	8496	8691	-195
Shida Kartli	4063	3512	551
Samegrelo and Zemo Svaneti	5066	5343	-277
Samtskhe-Javakheti	2394	2068	326
Kakheti	5014	4921	93
Guria	1575	1910	-335
Mtskheta-Mtianeti	1279	1418	-139
Racha – Lechkhumi and Qvemo Svaneti	342	763	-421

**Source:** National Statistics Office of Georgia, 2013

Regional demographic data, as well as the data of Georgia and Mestia municipality is shown in Table 5.3.3.2.2.

**Table 5.3.3.2.2.** Demographic data of Samegrelo-Zemo Svaneti

	Birth Rate	Death Rate	Natural Growth
Samegrelo-Zemo Svaneti	5 066	5 343	-277
Mestia municipality	177	124	-35
Georgia	57 878	48 553	9 325

Source: National Statistics office of Georgia, 2014

**5.3.4 Migration**

In 2013, the number of emigrants in Georgia was 95 064, while the total number of immigrants amounted to 92458 people.

Except the forced relocation, the main causes of migration from Georgia are adverse socio-economic conditions, long-term unemployment and abroad education.

The ecological migration should be noted separately. 35204 injured families are registered in Georgia due to the natural disasters, including 11 thousand families in urgent need of resettlement.

The process of ecological migrants resettlement is ongoing from Svaneti and mountainous region of Adjara. In 1981-2006, they were settled in Samtskhe-Javakheti and Kvemo Kartli regions.

**Figure 5.3.4.1.** Ecological migration processes in Georgia, 1981-2006 in Samtskhe-Javakheti and Kvemo Kartli from Svaneti and mountainous region of Adjara

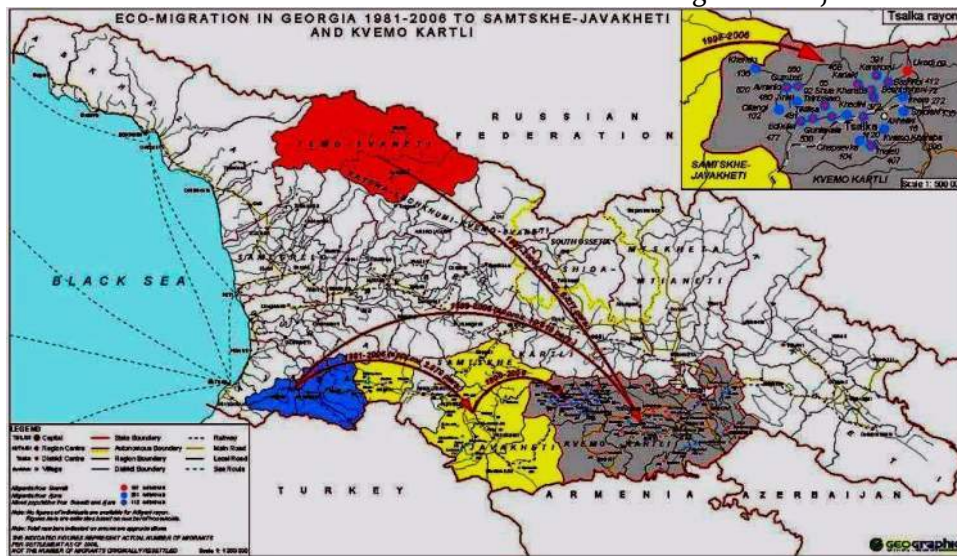

Ecological migration processes are caused by the fact, that a change of residence is considered to be the only solution against natural catastrophes. In Svaneti the migration started in 1987, when hundreds of families left Svaneti because of the large snowfall. 22 villages are devastated. Population of Zemo Svaneti until 1987 was 19500 people.

In 1987 the region of Zemo Svaneti has been studied by geologists. The results of natural disasters impacts were assessed on separate communities. Their study was based on field works in different communities (Mestia, Tsvimri, Tskhumari). They assessed the main risk factors and issued the recommendations on residence changing for the population from the especially avalanche-dangerous locations. Table 5.3.4.1. reflects the total migration result during 2009-2011 years.

**Table 5.3.4.1.** Population migration in Mestia municipality

Settlement	2009 – 2011 years	
	emigration, family	immigration, family
Mestia region	330	87
village Chuberi	22	10
village Nakra	7	6

**Source:** Labor, Public Health and Social Protection, Veterans, Refugees and Internally Displaced Persons Department of Mestia municipality.

### 5.3.5 Socially Unprotected – Vulnerable population

In 2013, compared with 2012, the number of pensioners in Samegrelo-Zemo Svaneti, which is shown in Table 5.3.5.1.

**Table 5.3.5.1.**

	2012	2013
Georgia, total	856990	857011
Samegrelo-Zemo Svaneti	94581	94425

The following categories of vulnerable population were defined in the Mestia municipality:

- Pensioners – total number of state pension recipients in the region is 1 755. 215 are from Chuberi and 75 are from Nakra;
- Veterans of the World War II and armed conflicts – 26 persons: 4 members and 22 equalized to them;
- Disabled – 406 people, of which I group – 49 and II group – 255. Accordingly, 15 in Chuberi, of which: I group – 3; II group – 12 and in Nakra 8, of which I group - 2; II group – 6;
- Poor families (families whose income is less than the minimum prescribed for living) – 963 families are registered in the database of helpless families, of which 10 families are in Chuberi and 6 in Nakra;
- The amount of families receiving subsistence assistance is 630;
- Internally Displaced Persons – 912 people, which amounts 172 families. 120 persons (22 families) in Chuberi and 27 persons (7 families) in Nakra.

**Source:** Labor, Public Health and Social Protection, Veterans, Refugees and Internally Displaced Persons Department of Mestia municipality. Social Services Agency, office of Mestia.

### 5.3.6 Healthcare

Medical-prophylactic institutions network of Health Care system in Mestia municipality is represented in Table 5.3.6.1.

**Table 5.3.6.1.** Types of medical institutions and number of personnel of Health Care network.

Types of Medical Institutions	Number	Number of doctors	Number of nurses
“Polyclinic and Maternity House Unification of Mestia” Ltd.	1	15	16
“Mestia Ambulance Service - 03” Ltd.	1	8	12
“Mestia Stationary Hospital” Ltd.	1	8	18

Dental Clinic	1	3	2
“Mestia Public Healthcare Service” NPLE	1	6	5
Ambulatory	12	12	12
<b>Total</b>	<b>17</b>	<b>42</b>	<b>65</b>
Including			
Chuberi Ambulatory	1	1	1
Nakra Ambulatory	1	1	1

The medical staff is shown in the Table 5.3.6.2.

**Table 5.3.6.2.** Medical staff of Medical-prophylactic institutions

Administrative unit	Number of doctors	Provision on 100000 inhabitants	Paramedical staff	Provision on 100000 inhabitants	Paramedical personnel number on 1 doctor
Georgia	18486	419.1	14060	318.8	0.8
Samegrelo-Zemo Svaneti	1194	253.5	1208	256.5	1.0
Mestia Municipality	35	241.4	35	241.4	1.0

**Source:** Healthcare, Statistical Handbook, Georgia, 2013

In Samegrelo-Zemo Svaneti region, child mortality rate is not high in comparison with the country's and other regions corresponding indices, namely: Infant mortality rate per 1000 born amounts 6.4. 0-1 years death rate on every 1000 born alive is 3.6 and 2.0 on every 1000 born alive 0-6 days and prenatal mortality rate on every 100 born is 8.5. Table 5.3.6.3. provides child mortality rates across the country and by regions.

**Table 5.3.6.3.** Child mortality rate by country and regions

Region	Children 0-15 years of age			Including					
	Total	At the hospital	At home	0 - 1 years of age			1 - 5 years of age		
				Total	At the hospital	At home	Total	At the hospital	At home
Adjara	55	42	13	46	39	7	7	2	5
Tbilisi	462	461	1	374	374		47	47	
Kakheti	25	15	10	19	14	5	3	1	2
Imereti	149	140	9	131	129	2	8	6	2
Samegrelo and Zemo Svaneti	14	7	7	6	6		6	1	5
Shida Kartli	16	12	4	11	11		2	1	1
Kvemo Kartli	21	11	10	11	9	2	7	2	5
Guria	8	3	5	3	3		2		2
Samtskhe-Javakheti	8	6	2	6	5	1	1		1
Mtskheta-Mtianeti	2	1	1	1	1		1		1
Georgia	760	698	62	608	591	17	84	60	24

**Source:** The National Center for Disease Control and Public Health of Georgia, 2013.

The lethality rate of children is low in Mestia municipality which is shown in Table 5.3.6.4.

**Table 5.3.6.4.** Lethality rate of children per 1000 born

Administrative unit	Children up to 1 year	
	Number	Rate
Georgia	608	1.6
Samegrelo-Zemo Svaneti	6	10.5

**Source:** Healthcare, Statistical Handbook, Georgia, 2013

2 pharmacy is functioning in municipality: Pharmacy I/E “Ido Japaridze” and pharmacy of “Pharma Depo” network. Both are located in Mestia.

Diseases typical for Mestia municipality, Nakra and Chuberi communities. Widespread diseases are not exclusively characteristic for Zemo Svaneti and morbidity rate do not differ significantly in comparison with other regions, including nutritional diseases, high blood pressure, cardio-vascular diseases, upper respiratory tract infections, asthma, arthritis and others.

Endemic goiter is an exception, the indicator of which in lower villages and in particular in Nakra and Chuberi, is lower.

The Malaria disease was identified in 1961 in Chuberi community and the research has held by the Institute of Tropical Diseases. The fact was confirmed, the mosquito Anopheles hotbed has been identified. Since, disinfection is held every 2 years in the areas of wetlands and malaria disease facts has not been repeated.

Malignant cancer disease cases are also high: 30 cases annually.

### 5.3.7 Sanitary and Epidemiological Situation

Following issues have been and remain problematic in terms of Sanitary-epidemiological and labor relations:

There is no a sanitary landfill, due to which the waste is not properly managed within the territory of the municipality. For this purpose, a written appeal has been sent to the Ministry of Regional Development and Infrastructure and Ministry of Finance, as well as to the Solid Waste Company with the request to resolve this problem at least through transporter station in case the sanitary landfill with an environmental permit is not constructed.

Butchery and lack of veterinary laboratories, due to which an untested meat and dairy products are sold. Supervision Service is seeking an investor to solve this problem.

Disinfection and revaccination service does not exist.

### 5.3.8 Education System and Cultural-Educational Institutions

According to the July 2011 data, 24 public secondary schools are functioning in Mestia municipality, 1 orphans and homeless children boarding-school. 17 preschool institutions in the region are on the state funding.

College of professional education “Tetnuldi” is functioning since 2008 in Mestia. 2 art and 4 sport schools are on a local budget subsidy. Currently, the orphanage boarding school reorganization is being implemented and family-type children’s houses are established. General educational school

and pre-school institutions does not exist in the region. Currently, gymnasium subordinated to the Patriarchate and named after Ilia Martali is undergoing the accreditation.

Youth House is functioning in Mestia, where 2 teachers are working with 15 students. Folklore handicrafts teaching is being held in 4 institutions. 20 craft masters are working in Mestia municipality in various types of handmade crafts.

Data of educational institutions are given in Table 5.3.8.1.

**Table 5.3.8.1.** Educational Institutions in Mestia municipality

Institution Types	Number of Institutions	Number of Students	Number of Teachers
Pre-school	17	349	34
Chuberi	2	38	2
Nakra	1	13	1
Basic 9-year	5	163	56
Overall general	21	1770	430
Chuberi	2	262	47
Nakra	1	73	21
Gymnasium	1	29	2
Vocational College	1	172	15
Sport School	4	765	53
Art School	2	24	4
Boarding-School	1	27	10

In public schools of Mestia municipality 1933 students are studying and 497 teachers are employed.

There is 2 public-secondary schools in Chuberi community: Chuberi center and Karsgurshi (Karsi) public-secondary school. Number of teachers – 47 and number of students – 229. There is 1 public-secondary school in Nakra community, number of teachers – 21 and number of students – 73.

There are two kindergartens, 2 teachers and 38 children in Chuberi community. In Nakra community there is 1 kindergarten, where 1 teacher is working with 13 children.

There are 4 open sports grounds in Mestia municipality: Mestia, Latali, Becho, Chuberi.

Mestia is the administrative, cultural and social center of the municipality. But each community has the local hotbed of the culture. In some places it is the Culture House or non-governmental organization, whose activities include the mentioned directions. Often, such hotbeds are represented by the people who are engaged in cultural activities.

There are 4 museums in Mestia municipality: Historical-Ethnographic museum of Mestia, museum of mountaineer and climber Michael Khergiani, museum of poet and publicist Revaz Margiani. Village Chajashi reserve museum (open-air museum).

In addition, the Ethnography Museum in the name of Mevlud Charqseliami is functioning in Ushguli, 7 private exposition and art saloon is available.

The majority of cultural and social institutions in Mestia municipality are located in Mestia. Rural clubs are in 6 communities, these are: Becho, Latali, Etseri, Tskhumari, Chuberi, Nakra.

Main Library and its 7 branches are functioning in the Mestia municipality. There are no branches in Chuberi and Nakra.

In addition to religious and common types of festivals, also annually are held:

- Mishaoba – July 7, is dedicated to Michael Khergiani;
- Guramoba – is held every 5 years – September 12, is dedicated to Guram Tikanadze;
- Lataloba, Ushguloba – the village name-day;
- Borisoba – is dedicated to Boris Kakhiani.

Mestia municipality hosts a variety of festivals and shows. Sport competitions are held regularly, several annual athletic and winter sports.

### 5.3.9 Communication and Information Accessibility

Postal code of Mestia municipality is 3200. 1 post office is functioning in Mestia, “Mestia Mail” Ltd.

2 Magti antenna is installed the opposite ridges of Mestia and Becho, which covers the main villages of Zemo Svaneti and provides the mobile connection of Magti and Geocell. Beeline is starting to function. Most of the institutions and families communicate through the Magti-Fix.

Wireless internet by Magti-Fix and Geo-Fix, as well as by the telephone and also through wireless antenna. There is a satellite internet. The internet is in all organizations, is in hotels and guest houses, mainly in all of the NGO’s.

#### Television

Throughout Svaneti, almost every family has a satellite antenna. The main TV-channels of Georgia is available through them: “Rustavi-2”, “Imedi”, “Pirveli Arkhi”, channels which can be fixed through satellite antenna. The situation is similar in Nakra and Chuberi communities.

The local radio-broadcasting do not exist. Available only via satellite antenna. Such is the situation throughout the whole territory, including Chuberi and Nakra communities.

#### The Local Press

2 local newspapers are published in Mestia municipality:

- “Udzleveli Mkhedari” – the newspaper of Mestia and Zemo Svaneti eparchy. Monthly newspaper. Published since 2007. Edition – 500 copies. Editor: Mziuri Asumbani. Contact Tel: 5 57 50 89 11;
- “Lile” – news release of Mestia municipality council. Editor: Irma Jachvliani. Contact Mob: 5 55 70 88 72. Published since 2010, once a month. The newspaper is free. Extends through the deputy’s office and the attorneys. Edition: - 200 copies. If the issue contains very important information, 500 copies may be printed.

The central press is spread by the special representative of Georgian Press, which primarily serves organizations of Mestia. Organizations and rarely population subscribes such popular publications, such as: “Reitingi”, “Kviris Palitra”, “Sarke”, “Gza”, “24 Saati”, “Prime Time”, “Sportis Siakhleebi”, “Sakartvelos Respublika”, “Kronika”. The press is subscribed by 6-7 organizations. The press is not distributed in villages and communities.

In other communities, including Chuberi and Nakra, the press is deficit and its purchase is spontaneous during the trip.

### 5.3.10 Public Sector

Information and a brief description about the NGOs existing on the territories of Mestia municipality, is given in Table 5.3.10.1.



**Table 5.3.10.1.** Information about the NGO's existing within the project area

<b>№</b>	<b>Title</b>	<b>Occupational Field</b>	<b>Supervisor</b>	<b>Contact Information</b>
<b>1</b>	<b>2</b>	<b>3</b>	<b>4</b>	<b>5</b>
1	Svaneti Tourism Centre	Founded in July 2006. Tourism development promotion in Zemo Svaneti. Sustainable development of family tourism industry in Zemo Svaneti.	Zaur Chartolani Chairman	790 10 17 27 5 99 41 93 53 www.svanetitrekking.ge svaneti_trekking_ge@yahoo.com
2	Elesiastic and Secular Culture Center “Lagusheda”	Founded in 2004. Introduction of the creative activities among the young generation of Zemo Svaneti, promotion of religious and secular culture of Zemo Svaneti.	Father George Chartolani Chairman	5 99 92 23 02
3	Union, “The Youth Centre of Svaneti in the Name of Guram Tikanadze”	Cultural heritage, art, science, social-cultural and youth issues in Svaneti.	Koba Parjiani Chairman	5 98 74 97 99
4	Community Association “Latali”	Civil, cultural and economic development promotion of Zemo Svaneti and in particular Latali community society, engagement in local governance.	Gigla Parjiani Chairman	5 99 44 79 78 grigoli_74@yahoo.com
5	Union of disabled persons and refugees of Mestia.	Founded in 2001. Association for disabled and refugees, other vulnerable psycho-social rehabilitation-adaptation, integration of Zemo Svaneti. Area: Etseri, becho, Latali, Lenjeri.	Gulnazi Belkania	5 996 26 05, 599 4249 23 belqania-gulnazi@rambler.ru
6	Lenjeri Crafts Development Centre	Founded in 2008. Maintain the traditions of folk crafts, vocational training, community activities.	Shalva Guledani	5 99 98 36 35
7	Communities development and assistance union	Promotion to establishing the community unions among the communities in Zemo Svaneti, support for agriculture.	Paata Kaldani Chairman	5 99 93 49 92
8	Pro-Mestia Georgia	Opening the ambulatory in the village Mulakhi, setting up a pilot organic farming.	Rusiko Gujejiani Contact person	5 99 38 08 95 mulahi@posta.ge
9	M. Khergiani Museum Foundation	The promotion of Michael Khergiani deeds. Care-maintenance of his museum.	Eka Niguriani Chairman	5 55 45 86 07

10	Union “Mazeri”	NGO of Becho community		
11	Association of Svanetian towers historical successors	Public engagement in protection-maintenance of historical-cultural monuments within the Mestia municipality.	Gocha Khorguani Chairman	5 77 400 396 gocha-mazeri@mail.ru
12	Nenskra	Chuberi community organization	Chairman	
13	Meokhi 2010	Legal Assistance	Irina Gurchiani Chairman	790 300 876;
14	The local Red Cross organization	Red Cross programs in Zemo Svaneti	Mano Ratiani Chairman	599-56-84-17 manonisvaneti@yahoo.com
15	Educators and Scientists Free Trade Union – Mestia branch	Protection the rights of teachers in Zemo Svaneti	Nestan Maghediani Acting Chairman	595 92 93 49
16	CTC- (Center for consultancy and training) community resource-center of Mestia	Works since 2006. Community development	Pavle Tvaliashvili-Project Director. Irina Gurchiani-Resource Centre Manager	599556234; 790 300 876;
17	Youth bank	Founded in August 2009. EPF’s Youth Regional Project.	George Tserediani – Head. Maia Tavadze – Project Manager.	598 159157
18	Network: “Women of the Mountain Region”	Women’s rights protection in Zemo Svaneti, development of their civil, cultural and economic society.	Rusiko Nakani Chairman	599 59 91 42 <a href="mailto:Ruso-Nakani@rambler.ru">Ruso-Nakani@rambler.ru</a>
19	Fair Elections	Ensuring fair and transparent elections in the region.	Zviad Nikloziani – representative. Teona Topchishvili – Manager of the Head Office.	598 420 95022 18 97
20	CENN – “Caucasus Environmental NGO Network” representation in Svaneti.	Community engagement in the environmental issues. Study: evaluation of the Svanetian towers conditions. Village Becho	Rezo Getiashvili – Project manager. Londa Khorguani – Organization representative in Svaneti.	<a href="mailto:rezo.getiashvili@cenn.org">rezo.getiashvili@cenn.org</a> T: 32 75 19 03/04 F: 32 75 19 05 M: 593 78 87 55

Source: CTC Web-site of the Mestia municipality resource-centre [www.ctc.org.ge](http://www.ctc.org.ge); [www.ews.blogspot.com](http://www.ews.blogspot.com)

### 5.3.11 International Economic Cooperation and Partner Organizations of the Region

Dozens of international organizations and foundations are working in the region, which are helping the local government to implement infrastructure, health, gender, urban, business, media and other projects.

These organizations are: UNDP, CARE International, CHF, IOCC, UNICEF, „Urban Institute“.

The international funds: USAID, SIDA, MCG, EED. FAO, GTZ. ACH against hunger, FFW UN world food program, CHF international - Georgia.

Financial Institutions:

- World Bank
- European Bank for Reconstruction and Development
- Asian development bank

Partner Organizations:

- The Union of Georgian Mountain Activists;
- Organic Farm “Elkana”;
- Youth Science-Information Association of Imereti region “ASA”.

### 5.3.12 Gender Issues of Svaneti Region

Traditionally, the women were given more freedom in the mountainous families and society, because she was carrying the life severity equally to the men (see the traditions of Svaneti). In modern society, the leading specialists of the self-governing structures are mostly women. Several NGO's are headed by women (see the public sector). Recently, a few small grants were devoted to the promotion of women's vocational studies and needlework. Regional organization of the mountain women exists in the region. Women are active in business as well.

However, family violence and discrimination against women still exists among the families, especially during the land and property related issues resolution.

### 5.3.13 Cultural Heritage of Zemo Svaneti

#### 5.3.13.1 Immovable Monuments

Number of registered monuments in Mestia Municipality is 947 (608 local and 339 national monuments). 45 of 152 are mural churches. 342 living complex or their remaining are registered. In fact, this material covers most of the historic communities and villages and together with archeological monuments covers the whole residential area.

The oldest monument found in Svaneti belongs to the stone age, Neolithic age.

42 villages of Zemo Svaneti are city-planning monuments. In order to maintain monuments of Svaneti, in 1970 Laghami, the district of Mestia, was declared as national reserve and in 1971 the National Preserve of Ushgul-Chajashi was created. In 1983-85 certification of the monuments was carried out. On the basis of the nomination of the Georgian Government, since 1996 Chajashi, the village of the Ushguli community, was listed in the list of the best monuments of cultural heritage of the World (UNESCO;WHC-96/CONF.202/8.Rev.N709, on the basis of IV and V criteria).

Generally churches of Zemo Svaneti are small (5-20 m<sup>2</sup>), little Basilica shaped and is dated from the beginning of the 9<sup>th</sup> century to the 17<sup>th</sup> century. Creativeness of this architecture reaches peak in 10<sup>th</sup>-12<sup>th</sup> centuries. Churches were built with local Shirimi stones or cobblestones and were covered with limestone from outside.

Svaneti is important regarding secular architecture. Svanetian house was made for a big family of 30-50 people. Such families existed until the 20<sup>th</sup> century.

Watchtowers, roads, bridges and churches were built, they had water supply and irrigation systems. The last tower was built in 17<sup>th</sup> century and the last Machubi was built in the beginning of 20<sup>th</sup> century in Mulakhi.

Houses and towers are approximately dated by churches situated around them and by legends. 52 towers are named and dated.

### 5.3.13.2 Cultural Heritage Monuments in the Influence Area of the Project

#### Nakra community:

Caves of were used as residential areas in medieval are. Residential complex of Tavrali.

#### Chuberi Community:

There are two monuments in Chuberi community: Church complex of Saint George in the village Lakhami and the cemetery. Both of them belong to the medieval period.

By the information of the O. Lortkiphanidze Archeological Centre there are 335 archeological monuments in Svaneti. Including: the Neolithic Age - 3; the Bronze Age - 52; ancient Period - 35; the Medieval era - 235. The archeological material chronologically belongs to different stages of The Bronze Age, Ancient Period and the Medieval.

Regardless of matters which were sparse in the population or sacrificed to churches, important archeological monuments have been extracted, settlements of Ushguli, Etseri, Skareshi. Also stadiums of metallurgical manufacture.

“There is no any pattern in the layout of archaeological monuments, which would enable us to consider their distribution. In addition, due to the complex, often gently sloping terrain, cultural layers are exposed. Thus, during any (even a minor) excavations, an unexpected discovery or damage of archaeological monuments is possible.”

**Source:** Letter of the professor B. Maisuradze to the Deputy Minister of Environment and Natural Resources Protection of Georgia - S. Akhobadze, №06-08.02 / 682,2.895, 29.12.2005.

The archeological material proves that settlements of The Bronze Age and Ancient Period existed on the territory.

General geography of copper and copper product discovery in Zemo Svaneti: Kala, Skareshi hill, Iphrari, Chuberi, Nakra, Ipari, Lasili Settlement, Mestia.

Table\_5.3.13.2.1. shows types of archeological monuments in Chuberi and Nakra.

**Table 5.3.13.2.1.** Archeological monuments in Chuberi and Nakra

Village	Types of archeological monuments from Bronze - Early Iron Age
Chuberi	Object of metallurgical production. Random achievement.
Nakra	Object of metallurgical production. Random achievement.
Village	Archeological monuments from the Ancient Period.
Chuberi	Settlement, object of metallurgical production, random achievement, grave type, cremation material.
Nakra	Fortress, random achievement, cremation material.

Archeological cereals are found in Chuberi, Nakra and Etseri, which belong to the Late Bronze Age and those are: wheat, rye, millet and oats.

377 pieces of gold of Alexander Macedonian were found in Georgia, 367 of them have been found in Chuberi and Nakra, with the coins of Pantikapea.

Archeological works in Chuberi have started since the 20<sup>th</sup> century. Archeological monuments are found in several villages:

- Grave type monument of the village Larilari, which is situated on the left terrace of Nenskra, 900 a.s.l. - 1964 archeological works;
- Reminders of metallurgical production in the village Upper Marghi;
- Ruins of fortress in Upper Marghi;
- Reminders of metallurgical production in the village Lower Marghi;
- The deposit of Larilari;
- Cemetery from The Ancient Period (partially extracted);
- The reminders of settlement on the bank of river Nenskra, in Lower Marghi;
- Mtavarangelozi church of the 9<sup>th</sup> century, village Lakhami;
- Reminders of metallurgical production in Lakhami.

National craft is taught in four institutions. 20 masters of national craft are working on different types of national craft, in the municipality of Mestia.

Figure 5.3.13.2.1. Layout of the cultural heritage within the project area

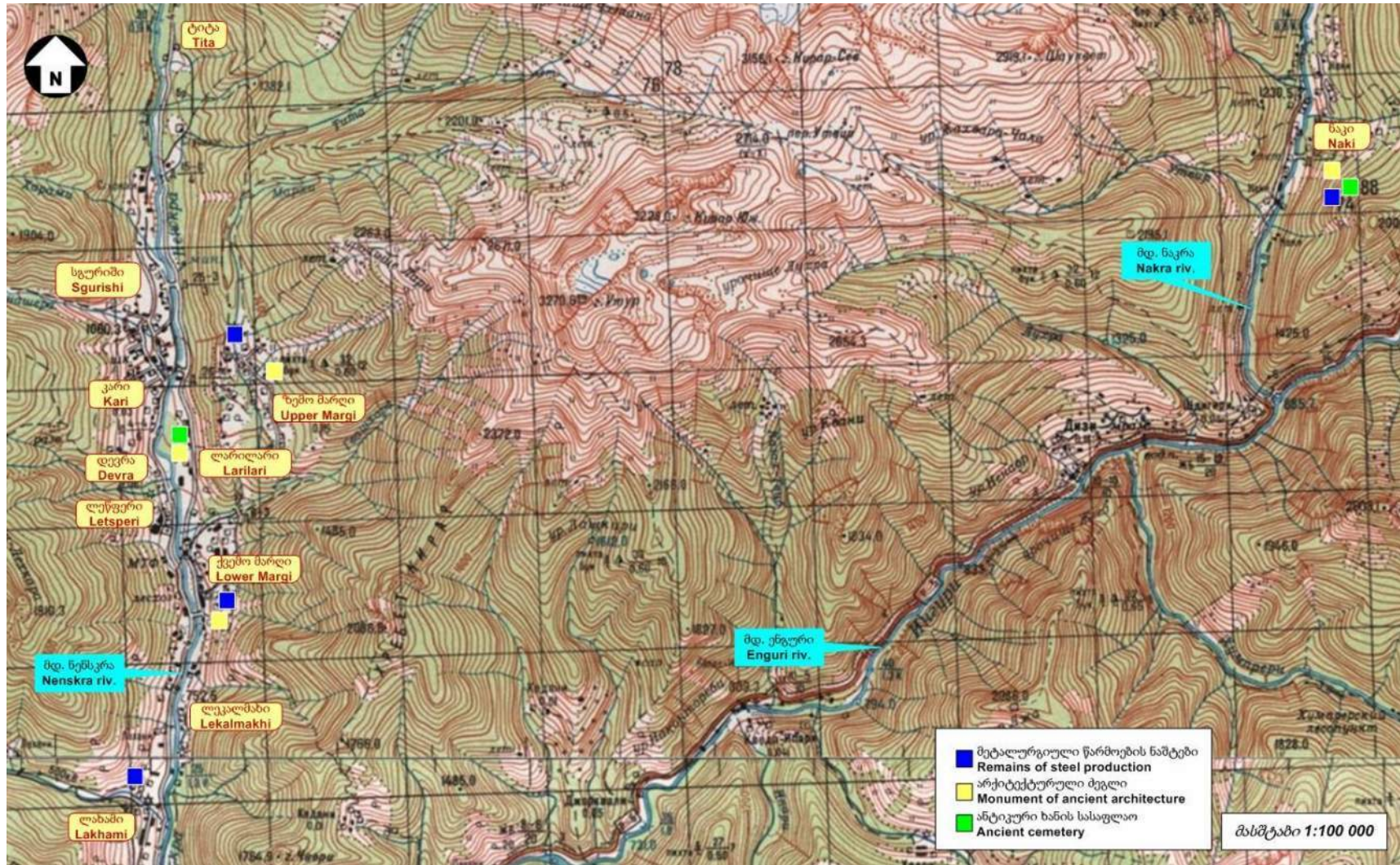

### 5.3.13.3 Care and Maintenance of Cultural Heritage Monuments

The agency for Protection of Georgian National Monuments was founded in 2006. There is no local institution which takes care of monuments in Mestia municipality. Monuments under Mestia jurisdiction are controlled by the Historical-Ethnographical museum of Mestia, eparchy and Cultural Department of Mestia municipality.

Most of immovable monuments are in difficult conditions. It is shown in Table 5.3.13.3.1.

**Table 5.3.13.3.1.** Conditions of the remaining towers

Condition of tower	%
Destroyed	7.7
Partially destroyed	9.4
Deteriorated	18.2
Cracked	18.5
Damaged roof	20.3
Without roof	25.9
Foundation needs to be strengthened	5.9
Merlons are destroyed	7.8
Floors are damaged	54.9

8 towers were renovated by the National Agency of Monument Protection in 2009. 9 towers were renovated in 2010. The agency developed renovation project for 50 towers in 2011, 26 of these towers are in the process of renovation, or they are already finished. In 2009-2013, 91 towers, 7 churches, 2 Machubi have been renovated in Mestia, Mulakhi, Lenjeri, Etseri, Ipari, Ushguli, Latali, Becho, Lakhamula, Ieli, Adishi and Tsvimri.

Based on the statement of the National Agency for Cultural Heritage Preservation of Georgia, research and diagnostic work will be carried out for the 10th century Ipkh church in Latali in 2014.

This year, up to 20 project documentation will be prepared for Mestia towers with the financial support of the National Agency for Cultural Heritage Preservation of Georgia. Restoration of the most damaged towers is planned in this year as well.

### 5.3.13.4 Traditions of Svaneti and Oral Cultural Heritage

Upper Svaneti is presented by archaic ethnography and by people with traditional lifestyle and old customs. Local culture of Svaneti continues since Early Bronze Age till today. Svanetian traditions were mixed with modern tendency on each stage of Svanetian society development.

General reason of this is geopolitical and historical location of Svaneti. Nowadays, local community has different, non-materialistic values. Since the society has kept its authenticity, it is interesting with its ethnographical, linguistic and mythological facts.

Svanetian language is one of the Georgian branches from the family of Iberian-Caucasian languages. Svanetian is unwritten language. Historically Georgian was always literary, official and national language of Svaneti.

There are surname, community, village and general celebrations in Svaneti. Lemziri (temple bread) was baked on each celebration and general feasts were also very common. Old traditions are reflected in modern Svanetian lifestyle and includes different aspects, such as:

- Involvement in state structure and administration of community;
- Justice and property issues;
- Respecting dead people and ancestors, arrangement of family and gender relationship;
- Organizing labor (construction) and agriculture.

Believes and cults coming from Archaic era are still kept in Svaneti. They are often mixed with Christianity, those are: believes related to productivity and continuation of surname, cults of dead people and ancestors. Pagan deities and Christian saints are often mixed.

The most common and sustainable local cultural institution is: fraternal societies have been created within one genus as a result of the collapse of a large family, union of which within the gorge creates a territorial community.

Community was ruled in a democratic way in Svaneti. Ruler was Makhvsh, community leader, who was chosen on the community meeting.

Each type of civil or criminal issues were discussed at local court. The court consisted of judge-mediators, who were known as Morvali in Svaneti.

Arable land and sowing land were private property, but mowing land, pasture and forest belonged to the community. Ground and forest icon existed, which was used for needs of church and religion celebrations. Issues like using mowing land, pasture and forest, changing of pastures, distribution of lands, establishment land borders were controlled by Makhvsh. Each issue was discussed by Makhvsh and 4-5 persons.

Agriculture was very well developed in Svaneti. Wheat, oats, millets and other cereals were produced. Unique types of wheat were produced here. Svanetians used traditional agricultural methods, such as: choosing agriculture places and grounds, resting of grounds and fertility. They were guided by national agrarian calendar, used optimal working tools, had developed irrigation system. They also built clay tubes and little aqueducts if it was necessary for the irrigation system. National astronomy was developed. Svanetians took care of high productivity at the beginning of new year. Lamproba was celebrated at the beginning of February. Also building snow tower, so-called Murkvamoba or Jgrboba, were winter celebrations.

Cult of ancestors is strong till today in Svaneti. Liphanaali is one of the main appearance in pagan celebrations which takes part in winter and lasts some days. This is general celebration for whole Upper Svaneti.

In conditions of Svaneti, animals need to be cared 5-6, sometimes 7-8 months. Caring of animal is cold Likhvaari. Neighbor region's alpine pastures were rarely used and it was more common for Khaishi, Chuberi and Nakra community. Because of high mountains, rocks and meteorological conditions, it was almost impossible to take animals to the far winter pastures. Therefore, alpine type of farming was used. Some animals are cared of in villages even nowadays and the rest in summer period are moved to alpine pasture Labavi. Many rituals took part in animal's dwelling, which were done in order to increase productivity. Domestic things and furniture were decorated with zoomorphic details, such as images of sheep, horse, bull and aurochs. Images of bear and wolf are rarely used. Cult of bull is kept till today, for example Kvirikoba celebration (27<sup>th</sup> of July), when freely grown bulls battle each other. It is called Liushkvar.

Hunting and gathering had important role in Svaneti lifestyle and were related to the cult of nature forces. The indicators are temples on the top of mountain and hunting paths, legends related to the lakes. Soiling of some lakes or even walking near them with a stick can cause thunder. Such holy lakes



exist near Chuberi, Nakra and Mestia, also in Ushguli, Pharsi and Latali. There are some holy places in Pharsi and Kartvani and it is forbidden to mow there.

Labor distribution was depended on blood relations and age. Nadi was labor cooperation, when family was helped by neighbors and relatives to take harvest, without benefits. Labor cooperation, which was based on neighbor's help, was used for construction of stone houses and towers, which were called Lindi.

Oral cultural heritage of Zemo Svaneti is kept in song-legends. Those are: song about Betqili, Kviriai, Lile, which is a chant of sun.

Many legends are related to geographical objects: lakes, ridges, passes. Legends about origins or locations of specific surnames are passed to generations in oral way.

Each community and village has its local traditional celebrations, as orthodox so pagan rituals (Svimmishoba, Chagboba, Lichanishoba, etc.) They are related to the cult of productivity. Oral legends are also often related to celebrations. These celebrations are often visited by whole Svaneti. The most popular celebrations are:

- Kvirikoba - Kala (27<sup>th</sup> of July);
- Lamproba – 14<sup>th</sup> of February;
- Liphaanali - lasts since 19<sup>th</sup> of January till the following Monday;
- Liuskhvari, Lamarioba, Akhanakheoba - Ushguli. Spring, Summer;
- Gulatakhsh-becho – Spring;
- Lichanishoba - Adishshi. Summer;
- Mkher-taringzel - Latali, 21<sup>st</sup> of July;
- Ieloba - Ieli. Summer;
- Kaishoba - kaishi. Autumn;
- Kashuetoba – Lenjeri;
- Lighunvari, Hilishi, Murkvamoba or Jgvib - Mestia, Lenjeri;
- Lalxoraal Mishladagh – Etseri;
- Hilishi, Mhli – Nakra;

## **6 Environmental and Social Impact Assessment**

### **6.1 General Principles of ESIA Methodology**

This chapter includes expected environmental and social impact assessment during construction and operation process of HPP on the river Nenskra. Methods used for impact assessment, as well as quantitative and qualitative criteria were developed for unitary and standardization of the assessment system, which ensures the objectivity of the assessment. Impact assessment methodology preparation was based on the recommendations of World Bank and other International Financial Institutions (EBRD, IFC, ADB).

The determined values for quality indicators of environmental objects (air, water, soil and others) in normative documents of Georgian, EU and International Financial Corporation/World Bank are used for quantitative criteria for those factors of the impact, the qualitative indicators can't be defined (for example, impact on ecosystems and population). The quantitative criteria have been defined on basis of baseline data analysis, considering impact object value and sensitivity. In cases, when it was impossible

to introduce quantitative criteria for impact assessment, qualitative criteria have been prepared by considering accepted international approaches.

Impact on natural and social environment has been assessed in accordance with the preliminary determined criteria. During the assessment, special attention was paid to the impact which has been considered as significant in the given conditions.

*EU directive 97/11: "during environmental impact assessment receptors which will be affected with the project should be considered".*

In order to assess expected changes in natural and social environment, it is necessary to collect and analyze the information about the current situation in the project impact area. The volume of the expected changes is determined on the basis of obtained information, impact recipient objects – receptors would be identified and their sensitivity will be assessed, which is necessary for determining the importance of the impact. After determining the significance of the impact its acceptability is determined, alternative options with less negative impact, necessity of mitigation measures and mitigating measures itself.

The following scheme was used for environmental and social impact assessment of the planned activities:

**Step I: Determination of basic impact types and research format**

Determination of the impact based on general analysis of activities, which may be important for these types of projects.

**Step II: Study of the environmental baseline – search and analysis of the existing information**

Identification of the receptors, which are expected to be affected by the planned activities, determination of sensitivity of the receptors.

**Step III: Characterization and assessment of the impact**

Impact character, probability, significance other characteristic determination by considering the sensitive receptors, description of the expected changes in the environment and assessment of their significance.

**Step IV: Determination of the mitigation measures**

Significant impact mitigation, prevention or compensating measure determination.

**Step V: Residual impact assessment**

Determination of the expected value of change in the environment after implementation of the mitigation measures.

**Step VI: Monitoring and management strategy development**

Monitoring the effectiveness of the mitigation measures is needed to ensure, that the impact must not exceed the predetermined values, effectiveness of the mitigation measures must be confirmed, or the necessity of the corrective measures must be identified.

## **6.2 Impact Receptors and Sensitivity**

Implementation of the works may cause such qualitative and quantitative characteristic changes of physical and biological resources in the impact area, such as:

- Air quality and acoustic background of the environment;
- Soil stability and quality;
- Capacity and quality of surface and groundwater;
- Visual changes of the landscapes;
- Habitats, flora and fauna amount;
- Historical-archeological values of the study area;
- and more.

The population, which may be impacted by the planned activity, includes people living, working or involved in other activities (e.g.. vocation, travel) nearby the designed facility. Facility staff is considered as a potential sensitive receptor.

Receptor sensitivity is related to the impact volume and ability of the receptor to counteract the change or restore after the change, as well as with its relative ecological, social or economic value.

### **6.3 Impact Description**

The main impact factors were determined to assess environmental impacts on the construction and operation phases. Assessment of the expected impact is conducted in accordance with the following classifications:

- The character – positive or negative, direct or indirect;
- Volume – very low, low, medium, high or very high;
- Event probability – low, medium or high risk;
- Impact area – working section, area or region;
- Duration – short, medium or long term;
- Reversibility – reversible or irreversible.

Thus, expected change and character, impact area and duration, reversibility and risk realization probability of every potential impact have been identified for both phases of the project, basis of which proved its importance.

The impact has been mainly determined quantitatively. For certain environmental objects, for which the quality standards are set, the assessment was made on the basis of these norms. When quantitative assessment was impossible, the impact was assessed qualitatively, considering its characteristics and pre-developed criteria.

## **6.4 Emissions in the Ambient Air**

### **6.4.1 Impact Assessment Methodology**

Georgian normative documents have been used to assess the impact on atmospheric air quality, which determines air quality standard. Standards are defined for health protection, because the impact on health depends as on the concentration of harmful substances, as well as on duration of the impact. These two parameters are included in the assessment criteria.

**Table 6.4.1.1.** Air quality impact assessment criteria

Ranging	Category	Short-term Concentration (< 24 hr)	Long-term concentration (> 24 hr)	Annual Emission	Dust Propagation (long-term, or frequently)
1	Very Low	C < 0.5 mpc	C < 0.1 mpc	Annual emission is less than 0.5% of country's annual emissions	Invisible increase
2	Low	0.5 mpc < C < 0.75 mpc	0.1 mpc < C < 0.2 mpc	Annual emission is 0.5-2% of country's annual emissions	Visible increase
3	Medium	0.75 mpc < C < 1 mpc	0.2 mpc < C < 0.5 mpc	Annual emission is 2-5% of country's annual emissions	Slightly disturbs population, but does not impact negatively on the health
4	High	1 mpc < C < 1.5 mpc	0.5 mpc < C < 1 mpc	Annual emission is 5-10% of country's annual emissions	Sufficiently disturbs population and especially the sensitive persons
5	Very High	C > 1.5 mpc	C > 1 mpc	Annual emission is more than 10% of the country's annual emissions	Greatly disturbs population, impacts on health

**Note:** C – Estimated concentration by considering the background in the environment

## 6.4.2 Impact Description

### 6.4.2.1 Construction Phase

Two main stages are distinguished during the construction works of Nenskra HPP: earth works and construction of the power plant infrastructure facilities. Arrangement of the construction site is planned, infrastructure of which will mainly include: operation of vehicles and road construction machinery, concrete units and fuel refilling station with relevant tanks.

In addition, crushing-sorting facility of inert materials and asphalt-concrete machine will be arranged within the construction site of Nenskra dam. As for Nakra weir construction site, only crushing-sorting facility of inert materials will be arranged there.

Sources of air pollution within all construction sites will be presented with organized and unorganized emission sources. Namely: organized sources – emission pipe for asphalt-concrete equipment (in cyclones after cleaning form dust), concrete and mineral powder silos, fuel reservoirs. Unorganized sources – operation of transportation, inert material crushing machine and belt conveyors.

Works implemented on every construction site are practically identical (the only difference is timeline due to volume of works) and therefore, calculations were made on the example of construction site (as for most loaded infrastructure, including asphalt-concrete plant) and calculation results are used for modeling of ambient air of other constructions, which was implemented using special computer program for emission calculation [1]. It must be noted, that these objects are located on big distances from the nearest residential areas ( $\approx$  5-9 km) and thus, risk of spreading harmful substances is minimal.

Thus, calculations were made for emission of construction camps of rock-fill dam. The scheme of emission sources and control points on the construction camp territory is given in the figure 6.4.2.1.1., graphic material of calculation is given in Annex №2.

**Figure 6.4.2.1.1. . Location of control points**

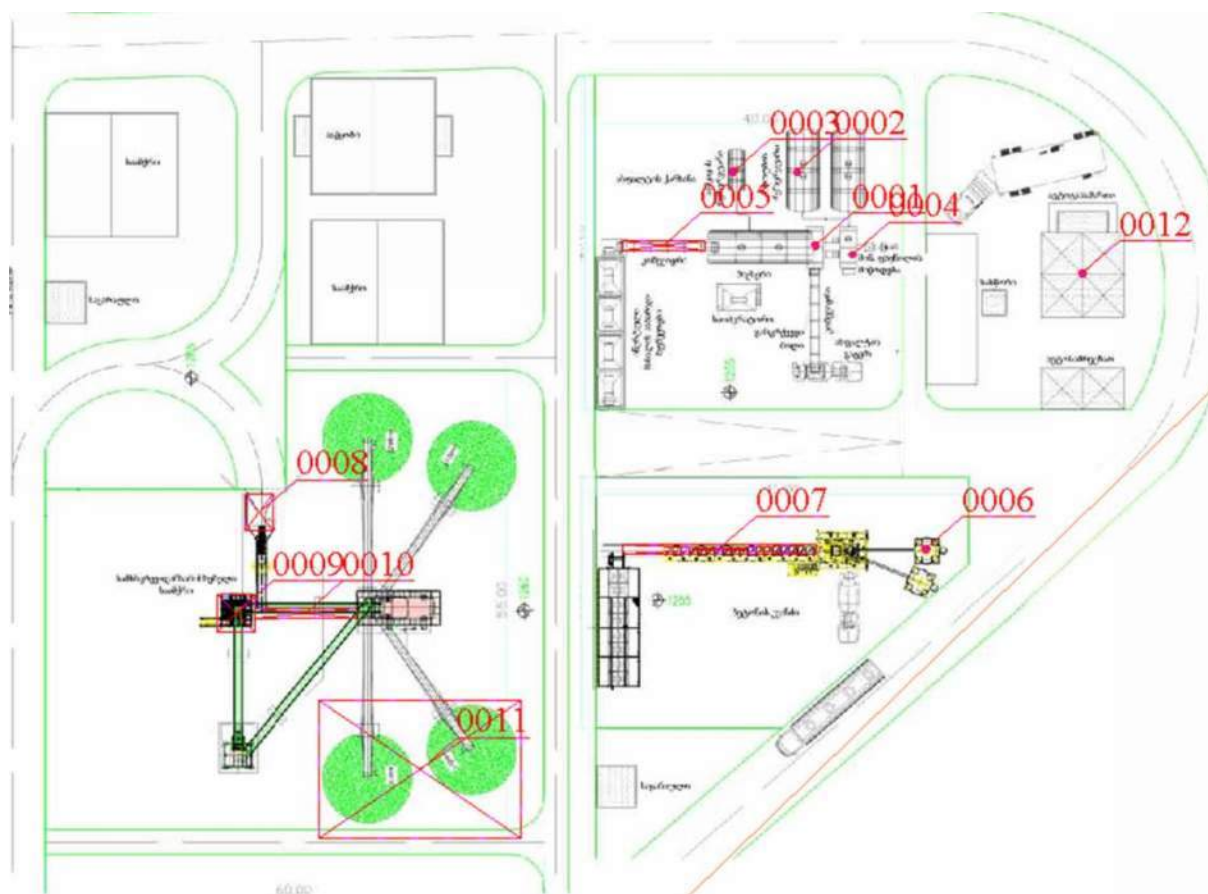

### 6.4.2.2 Operation Phase

As it is known, emission of the harmful substances in the air during the HPP operation is not expected. In this regard, we can only discuss diesel-generator, which will only be used in emergency situations. According to the results of the calculations performed for the construction phase (calculation is conducted with the participation of other sources), emissions of harmful substances associated with the diesel-generator operation, is not significant. On the operation phase, when only diesel-generator will operate, negative impact associated with emissions of harmful substances, is not expected. Emissions are expected during the HPP repair works. Emissions volume and significance will depend on the volume of works to be done and production locations, but much reversible and time-limited.

### 6.4.3 Mitigation Measures

On HPP construction phases, in order to minimize the emissions of harmful substances in the atmospheric air, implementation of the following mitigation measures is recommended:

- Ensuring the technical functionality of construction equipment and vehicles;
- Systematic implementation of dust reduction measures in dry weather (e.g., construction sites and roads watering, protection of rules of bulk construction material storage and others);
- Implementation of precautionary measures in order to avoid excessive dust emission during land works and materials loading-unloading (e.g., restriction loading-unloading material dropping from a big height);
- Optimum speed protection of the vehicle movement;
- Ensure personnel with an appropriate protection equipment (Respirators);
- Training personnel before starting works and after once in a 6 months;
- In case of complaints entry, their record/registering and appropriate action.

In order to reduce emissions expected on the HPP operation process of repair activities implementation, it is necessary to conduct similar measures intended for the construction phase.

#### 6.4.4 Impact Assessment

Table 6.4.4.1. Air quality deterioration due to emissions

Phase	Description of Impact and Impact Sources	Impact receptors	Description and assessment of the residual impact
Construction Phase	<p><b><i>Dust, combustion products, welding aerosols and other harmful substances emission in the air</i></b></p> <ul style="list-style-type: none"> <li>- Dust source – Land works, earth and bulk construction material transportation, storage-use of bulk construction material, others;</li> <li>- Combustion products source – works, which require construction and special equipment usage, including land works, construction material transportation, infrastructure arrangement, approach road, wastewater abstraction and treatment system construction, others;</li> <li>- Welding aerosols source – metal construction installation works;</li> <li>- Other harmful substances – Gaseous emissions of chemical substances (oil-lubricant material, fuel reservoirs and etc.) existing on the site.</li> </ul>	Residents of nearby settlements, the project workers, biological environment of the project implementation area	<p>Direct negative, temporary (≈6 years) impact</p> <p><b><u>Significance:</u></b> Low</p>
Operation Phase	<p><b><i>Dust, combustion products, welding aerosols and other harmful substances emission in the air during maintenance/repair works</i></b></p> <ul style="list-style-type: none"> <li>- Dust source – earth transportation, storage-usage of bulk construction material, others;</li> <li>- Combustion product source – construction and special equipment operation;</li> <li>- Welding aerosols source – metal construction install/dismantle works;</li> <li>- Other harmful substances - Gaseous emissions of chemical substances (oil-lubricant material, paints and etc.) existing on the site.</li> </ul>	HPP personnel and biological environment	<p>Direct negative, temporary, short-term impact.</p> <p><b><u>Significance:</u></b> Very Low</p>

## 6.5 Noise Distribution

### 6.5.1 Impact Assessment Methodology

Georgia regulates noise levels with document Sanitary Norms 2.2.4/2.1.8 003/004-01 Noise at Work Places, Residential and Public Buildings and Residential Territories. Noise shall not exceed standards set by the document.

**Table 6.5.1.1.** The noise related impact assessment criteria

Ranging	Category	Residential Area	Work in industrial or commercial zones
1	Very Low	Acoustic background increased by less than 3dBA <sup>5</sup> , in residential zone <50dBA in daytime and <45dBA in nighttime	Acoustic background increased by less than 3dBA and <70 dBA
2	Low	Acoustic background increased by 3–5dBA, in residential zone <55dBA in daytime and <45dBA in nighttime	Acoustic background increased by 3–5dBA and <70 dBA
3	Medium	Acoustic background increased by 6–10dBA at sensitive receptors, in residential zone >55dBA in daytime and >45dBA in nighttime	<70 dBA, acoustic background increased by 6–10dBA at sensitive receptors
4	High	Acoustic background increased more than 10dBA at sensitive receptors, in residential zone >70dBA in daytime and >45dBA in nighttime	>70 dBA, acoustic background increased more than 10dBA at sensitive receptors
5	Very high	Acoustic background increased more than 10dBA at sensitive receptors, in residential zone >70dBA in daytime and either impulsive or tonal noise present, >45dBA in nighttime	>70 dBA, either tonal or impulsive noise present

### 6.5.2 Impact Description

#### 6.5.2.1 Construction Phase

Octave levels of the sound pressure in the reference point (the nearest settlement – dwelling house of the village Tita), are calculated by the following formula:

$$L = L_p - 15 \lg r + 10 \lg \Phi - \frac{\beta_a r}{1000} - 10 \lg \Omega,$$

where,

$L_p$  – octave level of the noise source capacity;

$\Phi$  – noise source direction factor, non-dimensional, is determined throughout trial and changes from 1 to 8 (depends on spatial angle of sound radiation);

$r$  – the distance from the source of the noise to the reference point;

<sup>5</sup> Most people cannot perceive such change.



$\Omega$  – spatial angle of sound radiation, which will be:  $\Omega = 4\pi$ -when located in the space;  $\Omega = 2\pi$ - when located on the surface of the territory;  $\Omega = \pi$  - double ribbed angle;  $\Omega = \pi/2$  – triple ribbed angle;

$\beta_a$  – sound damping in the air (dBa/km) tabular description.

Average geometric frequencies of the octave lines, H Hz.	63	125	250	500	1000	2000	4000	8000
$\beta_a$ dBa/km	0	0.3	1.1	2.8	5.2	9.6	25	83

Noise source levels on the noise-generating section are summarized in the formula:

$$10 \lg \sum_{i=1}^n 10^{0,1L_{pi}}$$

Where:  $L_{pi}$  – is i-type noise source capacity.

Following assumptions are made to perform the calculation:

- 1) If distance between some noise sources, located on the same site, is less than distance until the reference point, sources are combined into one group. The total noise level is calculated by the following formula:  $10 \lg \sum_{i=1}^n 10^{0,1L_{pi}}$  ;
- 2) To assess total level of noise source distribution, as a distance to accounting point was used their distance from geometric center;
- 3) For simplicity, the calculations are performed for the sound equivalent levels (dBA) and average value of its octave indicator is taken as sound damping coefficient in the air  $\beta_{ave}=10.5$  dBA/km.

The calculation was conducted in two conventional points, during the simultaneous operation of all the machinery-equipment on the selected site, considering the minimum screening of the noise (worst case scenario). The noise generated during the construction of the HPP infrastructure and road rehabilitation/arrangement works is considered (see Table 6.5.2.1.1.). Calculation have not been conducted for Nenskra and Nakra dam areas, since the distance between these areas and the nearest residential areas is more than 6-7 km, therefore there is no chance that the noise caused by the construction works within these construction sites will reach the receptor.

According to the results of calculations given in the table, noise emissions from construction sites are within the allowed standard values. It should be noted that simultaneous operation of the machinery is excluded, besides construction works will be conducted only during day-hours. If necessary, personnel will be equipped with safety devices (headphones).

Abnormal emission of noise within residential zone will be expected due to the movement of vehicles, as part of the building material will be transported through the villages (Lekalmakhi, Kvemo Marghi, Zemo Marghi, Naki) within the project impact zone. Movement of vehicles within the populated areas will be significantly reduced due to the fact that inert material and stone quarries will be located in the vicinity of construction sites, which is an only mitigation measure to be considered.

Impact caused by noise propagation will be significant for the local wildlife, which will be connected to the migration of animal species in the other areas. But the impact is temporary type and after completion of the construction works, the majority of species will be returned to its old habitats.

Table 6.5.2.1.1.

Area	The main working machines-equipment	Noise equiv. level at gener. on site, dBA	Distance to nearest receptor	Noise equiv. level to the nearest receptor, dBA	Norm <sup>6</sup>
Tunnel exit, surge tank, penstock, construction site	<ul style="list-style-type: none"> <li>○ Truck;</li> <li>○ Excavator;</li> <li>○ Crane;</li> <li>○ Concrete mixer;</li> <li>○ Boring machine;</li> <li>○ Ventilation equipment;</li> <li>○ Water pumps;</li> <li>○ Compressor;</li> <li>○ Generator;</li> <li>○ Bulldozer.</li> </ul>	95	7500	15	During day hours – 55 dBA and at night – 45 dBA
Powerhouse, substation, construction site	<ul style="list-style-type: none"> <li>○ Truck;</li> <li>○ Excavator;</li> <li>○ Bulldozer;</li> <li>○ Crane;</li> <li>○ Water and concrete pump;</li> <li>○ Concrete mixer.</li> </ul>	109	250	9	

### 6.5.2.2 Operation

The main source of noise propagation during the operation of HPP is 3 hydro turbines. If we consider that the noise characteristics of these types of turbines amounts 90 dBA, noise equivalent level during the simultaneous functioning of all three turbines on generation site will reach 94.8 dBA. By entering these figures into formula we will get that noise equivalent level at the nearest receptor will be 51.2 dBA. Considering that the turbines will have a closed casing (reduces noise within 5-10 dBA) and will be located in the power house (concrete wall reduces noise up to 20-25 dBA), noise level at the nearest residential zone will not exceed the normal rates.

Three transformers will be installed in the substation, including two power and one own consumption. According to the project, they will be located in the closed building of the substation, which will significantly (20-25 dBA) reduce noise emission from the transformers and thus, noise will not be exceeded near the boundaries of the residential zone.

On the operational phase, noise may be caused during the maintenance/repair by its repair works and/or vehicle movement. This “additional” impact will be short-term and depends on volume and duration of the works.

### 6.5.3 Mitigation Measures

Implementation of the following mitigation measures are to be considered in order to minimize the noise and vibration propagation levels during the construction and operation phases of the HPP:

- Ensure proper maintenance of equipment;
- Wherever possible, implementation of “Noisy” works only during daytime;

<sup>6</sup> Sanitary regulations on "noise in workplaces, residential and public buildings and residential areas"

- Prior to implementing “Noisy” works, nearby population should be warned and relevant explanations should be provided;
- Social issues (holidays and weekends) should be considered while determining the time for the implementation of “Noisy” construction works;
- Generators and other noisy equipment should be arranged far from the sensitive receptors (area covered with vegetation and residential houses);
- Movement of vehicles within the residential zone should be reduced as far as possible;
- Optimal speed for transportation should be established;
- Wherever possible, protecting screens between residential zones and noise propagation sources should be arranged. The screens can be made with different materials (e.g. screens made with timber boards). Screen protective features depend on the material and thickness of boards. For example:
  - Fencing with pine boards (thickness 30 mm) - 12 dBa;
  - Fencing with oak boards (thickness 45 mm) - 27 dBa.
- To ensure a personnel with protection means (earmuffs);
- Frequent changes of staff employed on a noisy works;
- Staff instruction before starting the work and after once in a 6 months;
- In case of grievance entry, their recording/registration and appropriate action;

## 6.5.4 Impact Assessment

Table 6.5.4.1. Noise impact summary

Description of Impact and Impact Sources	Impact receptors	Residual Impact Description and Assessment					
		Significance	Probability	Impact area	Duration	Reversibility	Residual impact
<b>Construction phase:</b>							
<p><b>Noise propagation</b></p> <ul style="list-style-type: none"> <li>– Construction equipment, equipment-machinery, construction operations;</li> <li>– Noise caused by vehicles.</li> </ul>	Population, workers, animals inhabiting within the surrounding areas	Direct, Negative	Medium risk	In approximately 1.0 km radius from construction site and in the vicinity of the construction site	During the construction phase	Reversible	<b>Low</b> , considering the mitigation measures – <b>very low</b>
<p><b>Noise propagation</b></p> <ul style="list-style-type: none"> <li>– Noise caused by transport operations</li> </ul>	Population of Lekalmakhi, Kvemo marghi, Zemo Marghi and Naki villages	Direct, Negative	High risk	Residential zone near the roads used during transport operations	During the construction phase	Reversible	<b>Medium</b> , considering the mitigation measures – <b>low</b>
<b>Operation phase:</b>							
<p><b>Noise emission in air</b></p> <ul style="list-style-type: none"> <li>– Noise generated during the operation of hydro aggregates and transformers;</li> <li>– Noise caused by transport operations;</li> <li>– Noise generated during maintenance. Repair works.</li> </ul>	Population, workers, animals inhabiting within the surrounding areas	Direct, Negative	Low risk	In approximately 0.2 km radius from the power house	Long term	Medium	<b>Low</b> , considering the mitigation measures – <b>very low</b>

## 6.6 Impact on Soil

### 6.6.1 Impact Assessment Methodology

Impact value on the soil, ground and bottom sediments quality is assessed by the following parameters:

- Impact intensity, area and duration;
- Towards changes of their sensitivity;
- Their ability to restore.

**Table 6.6.1.1.** Impact assessment criteria on soil, ground and bottom sediments

Ranging	Category	Destruction of the fertile soil layer	Soil/Ground Pollution
1	<b>Very Low</b>	Less than 3% of the project area has been destroyed for ever	Soil/ground background conditions have changed unnoticeably
2	<b>Low</b>	3%-10% of the project area has been destroyed for ever	The concentration of pollutants have increased by less than 25%, but less than the permitted value, 6 months will be needed for the soil/ground quality restoration
3	<b>Medium</b>	10%-30% of the project area has been destroyed for ever	The concentration of pollutants have increased by 25-100%, but less than the permitted value, 6-12 months will be needed for the soil/ground quality restoration
4	<b>High</b>	30-50% of the project area has been destroyed forever; small areas are damaged outside of the project area, recultivation of which is possible after completion of the construction works	The concentration of pollutants have increased by more than 100%, or exceeds the permitted value, 1-2 years will be needed for the soil/ground quality restoration
5	<b>Very High</b>	More than 50% of the project area has been destroyed forever; small areas are damaged outside of the project area, recultivation of which is possible after completion of the construction works	The concentration of pollutants have increased by more than 100%, or exceeds the permitted value, more than 2 years will be needed for the soil/ground quality restoration

### 6.6.2 Impact Description

#### 6.6.2.1 Construction Phase

During preparation works (camp arrangement, construction site preparation and roads rehabilitation/construction) and construction (ground works, vehicle-equipment working) process the impact on soil integrity and stability (especially during the work on the slopes), soil quality (oil/fuel spill, invalid management of explosive materials and waste, damage/destruction of fertile soil layer) may take place.

Fuel/lubricant materials supplies would not be on the construction site which excludes probability of soil contamination due to spills. Soil contamination with the oil products is possible in case of fuel leakage from the construction equipment.

Fuel storage tanks will be located within the construction camps on the area with insulating layer. This area will be fenced by soil bank with clay screen. Inner surface area of the embankment around the tanks will not be less than 110% of their capacity, which will prevent fuel emission in the surrounding areas.

In case of hazardous waste formation on the workplaces, their allocation will take place in special containers and will be disposed in temporary storage facility specially arranged within the construction site. Hazardous waste will be removed from the construction site by the licensed contractor.

Household waste will be collected in lidded containers. A new sanitary landfill is planned to be arranged on approximately 1.2 ha area in the vicinity of Nenskra dam construction site in order to neutralize household waste generated within the construction site. It should be noted that there is no landfill with environmental permit in Mestia Municipality.

A temporary disposal area for waste rock withdrawn from the tunnels is planned to be arranged on Nenskra and Nakra tailrace tunnels' TBM platforms. Some part of the waste rock will be used for concrete production, while the rest part will be permanently disposed in the proposed reservoir basin. Waste rock will be also used for facing temporary and permanent road surfaces. Taking this into account, the risks of contaminating area with waste rock will be minimized.

There is a high risk of loss and damage of topsoil during the implementation of earth works required for the arrangement of construction infrastructure, as well as during the preparation of the proposed reservoir basin and arrangement of new roads. The total influence area of Nenskra HPP project is 450 ha. As it is stated in Paragraph 5.2.4., the major part of the project area is a sharply inclined rocky slopes where the topsoil is represented only on relatively flat terrain in the floodplains of the rivers. Prior to the construction, topsoil will be removed and stored throughout approximately 15.5 ha area. According to the results of onsite audit, the average height of topsoil is 10cm. Based on preliminary calculations, prior to the construction approximately 15500 m<sup>3</sup> topsoil should be removed and stored according to the established norms (see Paragraph 6.6.3.). After completing the construction works stockpiled topsoil will be used for recultivation of construction site areas, as well as the areas adjacent to HPP infrastructure.

The scheme of estimated temporary disposal areas (storage areas will be specified by building contractor) is given in Figure 6.6.2.1.1.

As it is given in the Figure, topsoil will be stored on the territories of construction sites and construction camps. All areas selected for topsoil storage are non-agricultural areas. All areas, except the powerhouse and its construction site falls within the forest fund area. Areas selected for the construction of powerhouse is owned by Municipality.

It should be noted that the selected building contractor's obligation includes detailed construction project development, for which additional surveys will be conducted. Therefore, areas for topsoil disposal may be changed.

In case of proper management and mitigation measures, significant deterioration of soil quality is not expected.

It should be noted that after completion of the construction works, equipment and materials / waste will be removed from the territory, temporary structures will be dismantled and the area will be revegetated. These measures will significantly reduce the risk of the emergence of erosion.

Drawing 6.6.2.1.1. The topsoil storage areas layout plan

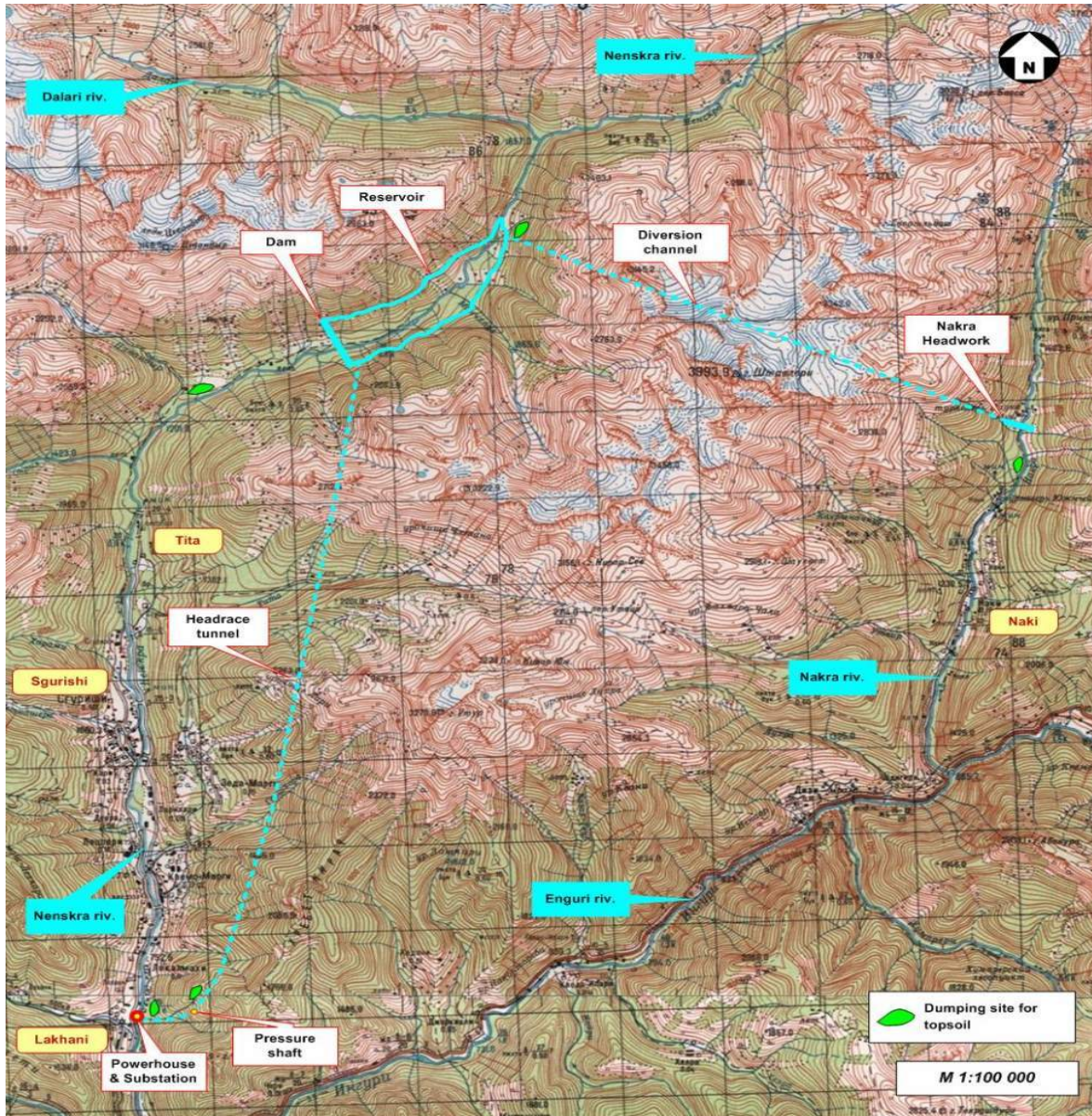

### 6.6.2.2 Operation

In HPP operation process, deterioration of the bottom sediments quality of soil and river Nenskra may be caused by incorrect waste (solid, liquid) management and by violating the rules of storage/use of the lubricants.

The impact is also expected during implementation of the repairing works. Although the impact on the construction phase is similar to the expected impact, but will be with significantly less intensive and durable.

### 6.6.3 Mitigation Measures

The following mitigation measures should be taken by the building contractor in order to prevent the destruction of topsoil:

- Prior to the construction works, the topsoil should be removed and temporarily disposed on pre-selected areas. Earth works should be carried out in accordance with the requirements of the

technical regulation N424 approved on December 31, 2013 by the Government of Georgia on “the removal of topsoil, storage and recultivation”;

- Removed soil should be disposed in a separate dump area. Dump area should be protected from wind dispersal and from washing out by atmospheric precipitation. The area selected for the soil disposal should be away from the water body at least by 50 m.
- Height of the dumps should not exceed 2 m. Slopes of the dump area should be given an appropriate tilt angle (45°); Water discharge canals should be arranged throughout the perimeter;
- After completion of construction works, stockpiled soil should be used for recultivation works;
- Strict protection of the working site borders to avoid possible damage of topsoil and soil compaction of the “neighboring” areas;
- Protection of the roads intended for the vehicle movement (prohibition of passing off the road) in order to prevent possible soil compaction;

Following measures should be implemented during the construction phase in order to reduce risks of soil contamination:

- Machinery and equipment should be checked regularly. In case of damage or fuel / oil spill, the damage should be promptly eliminated. Damaged vehicles should not be allowed on the construction site;
- Materials and waste should be disposed so that to avoid erosion. implemented so that it does not avoid erosion;
- Proper management of the industrial-fecal wastewater;
- Potentially polluting areas of storm water should be protected from precipitation;
- If fuel storage tank is arranged, it should be fenced with concrete or clay, the inner capacity of which will not be less than 110% of the reservoir capacity. Prevention of accidental oil spills is possible through fencing the fuel storage tank;
- Restriction of refueling/maintenance of the machinery/equipment on the construction sites;
- In case of fuel/oil spill, localization of the spilled material and immediate cleaning of the contaminated area. Personnel should be provided with appropriate means (adsorbents, shovels, etc.) and personal security equipment;
- Contaminated soil and ground for further remediation should be taken out from the territory by the contractor equipped with an appropriate permit on these activities;
- Training of the personnel prior to the construction works;
- Territory cleaning and recultivation works after completion of the construction works.
- Training of the personnel on environmental and safety issues, before starting the work;
- Training of the personnel on environmental and safety issues prior to the construction works.

The following measures must be ensured by the operator company, in order to prevent pollution of soil during the HPP operation phase:

- Systematic supervision of fulfilling the measures considered in the waste management plan;
- Control of the fuel/oil storage and usage rules;
- In case of fuel/oil spill, cleaning of the territory and removal of the contaminated soil and ground for further remediation;
- Disposal of the spill result liquidation means on the territories of substations and oil storages;
- Training of the personnel on environmental and safety issues during recruitment and then once a year;
- Mitigation measures considered for the construction phase should be taken during the repair works.



## 6.6.4 Impact Assessment

**Table 6.4.4.1.** Assessment of risk of topsoil loss and quality deterioration

Description of impact and impact sources	Impact receptors	Assessment of residual impact					
		Significance	Probability	Impact area	Duration	Reversibility	Residual impact
<b>Construction phase:</b>							
<b><i>Loss of topsoil</i></b> – Earth works; – Preparation of reservoir basin; – Movement of vehicles and construction equipment, etc.	Population, vegetation cover, animals, surface and groundwater	Direct, Negative	High risk	Working areas, dump area and road corridors	Short term	Mostly irreversible.	<b>High</b> , considering mitigation measures – <b>medium</b>
<b><i>Soil contamination</i></b> – Oil products or other chemical substances spill, contamination with waste.	Population, vegetation cover, animals, surface and groundwater	Direct, Negative	Medium risk	Mainly local spills are expected	Short term	Reversible	<b>Medium</b> , considering mitigation measures – <b>low</b>
<b>Operation phase:</b>							
<b><i>Damage of topsoil:</i></b> – Movement of vehicles and equipment, etc.	Population, vegetation cover, animals, surface and groundwater	Direct, Negative	Low risk	Road corridors	Long term	Reversible	<b>Low or very low</b>
<b><i>Soil contamination</i></b> – Oil products or other chemical substances spill, contamination with waste.	Population, vegetation cover, animals, water	Direct, Negative	Low risk	Mainly local spills are expected	Short term	Reversible	<b>Medium</b> , considering mitigation measures – <b>very low</b>

## 6.7 Risk of Dangerous Geodynamic Process Development

### 6.7.1 Impact Assessment Methodology

In dangerous geological processes is discussed such gravitational processes on the Earth's surface, such as ravine formation, landslide, debris flow, rockslide, mudflow and others and which may be caused or activated as a result of project implementation. Increase of the geodynamic processes development risk is associated with existing geologically dangerous areas, which are sensitive to the certain impact. Accordingly, risks are assessed by considering receptor and project activity.

**Table 6.7.1.1.** Assessment criteria of geodynamic processes activation risks

Ranging	Category	Geo hazardous (ravine formation, landslide, debris flow, rockslide, mudflow) risks
1	Very Low	The project does not include any type of activities at geo-hazardous areas/zones; the project activities practically are not related to the geo hazard causing risks.
2	Low	Preventative measures are considered during works in the geo-hazardous areas/zones that would effectively eliminate geological risks. Activities on the geologically safe areas do not cause erosion, or other changes, which may cause the geo-hazards. Geo-hazard management/effective plan of mitigation measures is developed and is being implemented.
3	Medium	Preventative measures are considered during works in the geo-hazardous areas/zones that would effectively eliminate geological risks. During implementation of the activities on geologically safe areas may cause development of such processes (e.g., erosion) which may cause geo-hazards without effective management. Geo-hazard management/effective plan of mitigation measures is developed and is being implemented.
4	High	Despite the preventative measures on the geo-hazardous areas/zones there is a risk of geo-hazardous processes development, or implementation of the activities caused geo-hazardous processes on the geologically safe areas. Geo-hazard management/mitigation measures plan do not exist or is less effective.
5	Very High	Despite the preventative measures on the geo-hazardous areas/zones there is a risk of geo-hazardous processes development, or implementation of the activities caused geo-hazardous processes on the geologically safe areas. Geo-hazard management/mitigation measures plan does not exist or is less effective.

### 6.7.2 Impact Description

#### 6.7.2.1 Construction Phase

The risks of hazardous geodynamic processes development may be related to the construction of hydraulic structures, arrangement of temporary and operational roads, construction of powerhouse, etc.

At the initial design stage, while discussing 5 alternatives for the location of headworks, the best alternative area has been selected according to the relatively low risk of dangerous geological processes development. In terms of this criteria, as well as with other criteria, the most reliable alternative has been selected – area at 1300 m elevation of Nenskra River. Areas for other communications of the HPP have been selected according to the same approach.

However, during the second stage of study, a variety of other dangerous geological processes development centers have been identified within the study region (see Figure 6.7.2.1.1.), namely:

Based on engineering-geological survey results, small geologically unstable (landslide) areas are observed in Nenskra reservoir basin, out of which all of them are located below the pool elevation of the proposed reservoir. During the preparation of reservoir basin, it is planned to remove active layers from slopes, which will significantly reduce the risk of landslides. In case of landslide activation at the operation phase of the reservoir, the landslide will be developed within the dead volume of the reservoir and will not significantly affect its operational conditions.

At headworks area, the only potential landslide area is located at dam axis, due to which decision has been made about reversing the left bank of the dam towards upstream. In addition, prior to the construction at the detailed design phase, building contractor should carry out further studies and determine the measures necessary for safe operation of the dam according to the obtained results.

As it is given in engineering-geological survey report of Nakra headworks area (Paragraph 5.2.3.6.4.1.2.), long and wide alluvial layers are observed on the left and right banks of dam axis. Therefore, at the construction and operation phases there are some risks of the development of dangerous geological processes. Detailed studies of dam alignments will be carried out at the initial stage of construction design and if engineering solutions of the project will not be enough to minimize the risks, dam will be arranged on the area selected about 2.5 km upstream. In case of changing the location, Environmental Impact Assessment for the construction and operation of Nakra dam will be separately prepared and will be submitted to ecological examination.

As it is given in Figure 6.7.2.1.1., several landslide areas are observed downstream of Nenskra dam, while in the upstream part of the dam, in about 3.5-4.0 km from dam tail there is an active landslide area. However, all of them are located outside the influence zone of the project.

In terms of development of dangerous geological processes, risks will be related to the arrangement of new roads, as construction works will be carried out on slopes with difficult terrain, due to which a large area of slopes should be cut off. Therefore, a strict control over the implementation of the mitigation measures proposed in this report will be required.

At the preliminary construction design stage, engineering geological studies of road corridors will be carried out, during which additional mitigation measures will be determined.

Based on the results of engineering-geological study, two main faults will be crossed during the arrangement of tunnels. Usually, engineering geological information is updated regularly during tunnel construction and additional engineering and technical measures are planned and implemented. In case of crossing the faults, water inflow may occur, for which implementation of appropriate reinforcement measures will be required. According to engineering-geological research materials, for the profiles along faults and tunnel rout the following RMR has been proposed: 28, Class IV "bad rocks".

Figure 6.7.2.1.1. Layout scheme of high-risk areas in terms of dangerous geological processes development identified within the project region

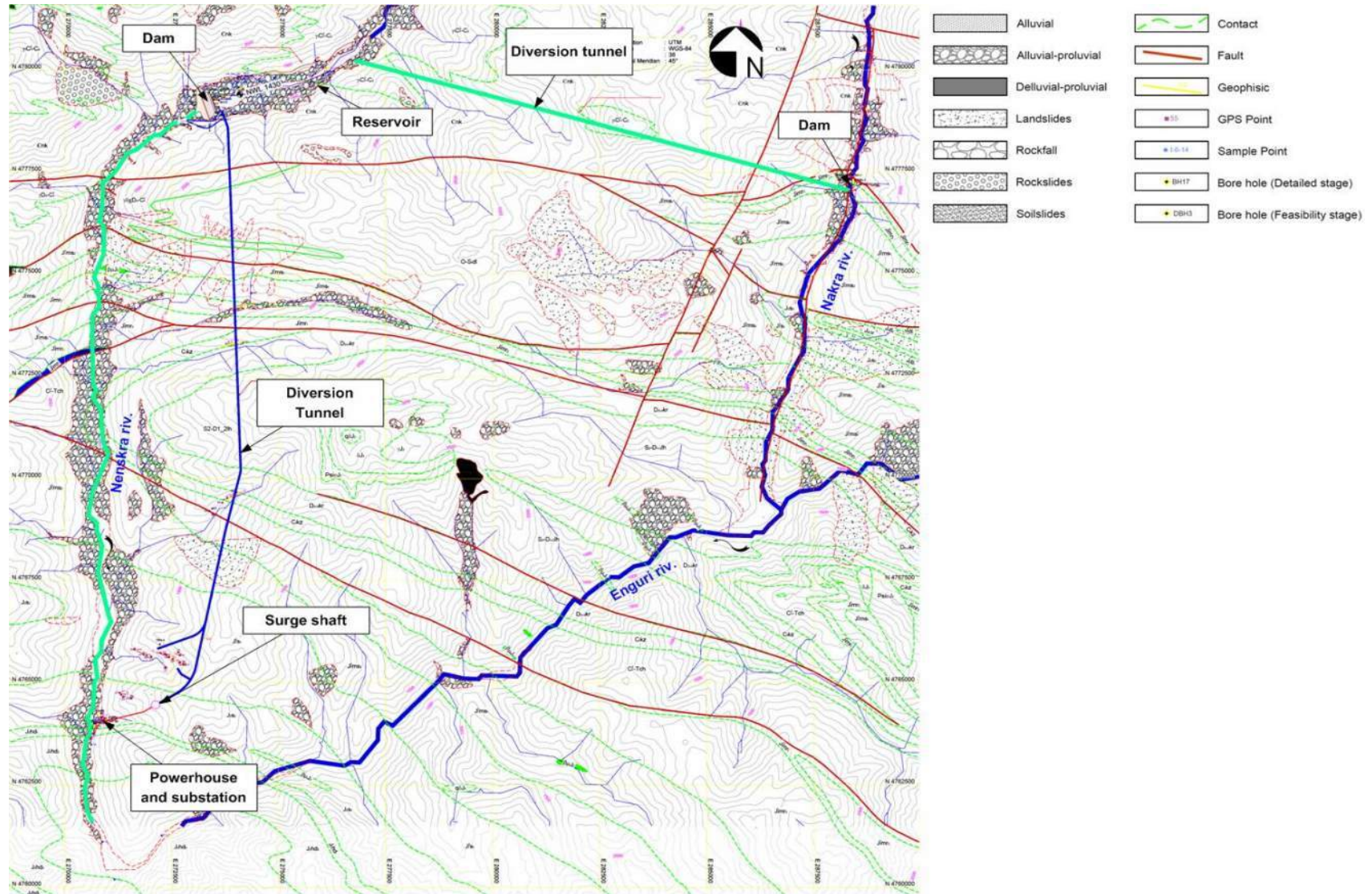

### 6.7.2.2 Operation Phase

In process of HPP operation, hazardous geodynamic processes activation risks will be related to the reservoir operation, because the dampness of coast slopes builder rocks will increase and atmospheric air dampness growth may cause landslide and erosion processes activation. Hazardous geological processes activation is also expected in case of emergency situations.

As it is given in Paragraph 6.7.2.1., small landslide areas are observed within reservoir basin, at lower pool elevation. Prior to the reservoir filing, active layers will be removed and stabilized. After the reservoir is filled, in case of landslide activation, it will be developed within the dead volume of the reservoir. It should be noted that due to a small size of landslide bodies, landslide and erosion processes will not cause significant reduction of reservoir volume. Considering that near the dam area both rivers are characterized by small volume of solid sediments, life cycle of Nenskra reservoir will be quite long (according to the calculation – 72 years).

As for the landslide area on the left side of the dam axis, its additional study and implementation of stabilization measures are planned prior to construction, which minimizes the risks of negative impact on the operational phase.

The risk of the impact on landslide and erosion areas existing downstream outside the direct impact zone of the reservoir, as area of influence will extend not more than 5 kilometers. Active landslide areas are not recorded within this section.

Separate assessment is required for avalanches and rock falls, as Nenskra River slopes are steep and rocky. In terms of avalanche development, there are two high risk areas within the reservoir basin. They are located on the right bank, in about 2-2.2 km from the dam. In this section, reservoir basin is relatively narrow and in case of avalanche development or rock fall, the risk of strong wave formation or dam damage is minimal. Probability of such an event is minimized by the fact that Nenskra HPP is of seasonal regulation and its will operate at full capacity only during winter (from November to April). Therefore, in the avalanche risk period only 70% of the reservoir will be filled with water. Therefore, the risk of overflow of the generated wave on the threshold of the dam is not high.

In addition to the above mentioned, the difference between level of reservoir crest and maximum water level of the reservoir will be in compliance with the international standards, which excludes the possibility of wave overflow.

Though the risk of the negative impact of avalanche and rock fall is minimal, building contractor will determine the risks of avalanches and rock falls within reservoir basin at detailed design stage.

In addition, at the preliminary stage of the construction building contractor will consider the arrangement of avalanche protection structures.

During the operation phase, Lekvedari River, which is characterized by mudflows and which runs North to Naki village, may pose some significant threat to the population of this village. Lekvedari River valley is located in the North of Naki village and joins Nakra River from right side. The river valley is strongly eroded and during abundant rainfall mudflows are generated with large amount of solid sediments. At present, solid sediment is regularly washed by Nakra River water and therefore, the risk of spreading mudflow to the village is reduced.

After Nakra dam is being operated, only ecological flow will be released downstream of the dam and major part of water will be discharged in Nenskra River valley through the tunnel. Therefore, the river will lose the capacity of transporting solid sediment brought by Lekvedari River, due to which the riverbed may be blocked and mudflow may spread towards the village. Although there is no a high risk of developing this scenario, appropriate mitigation measures should be considered. The most important mitigation measure is that during the flood a full flow of Nakra River should be released downstream of the dam in order to ensure downstream transportation of solid sediment from Lekvedari River.

It should be noted that protection of Naki village area is still relevant matter, as mudflow hazard is also expected from upper part of Lekvedari River and activation of such processes will not be related to the operation of Nakra dam. Based on seismic hazard studies and geophysical research materials, Nenskra dam area and reservoir basin is located within high seismic hazard zone, which has been considered in the design of the dam. According to various scenarios discussed in Nenskra dam report (see Paragraph 4.3.), proposed structure is reliable and designed for high seismic risks.

Based on the results of seismic and geological survey, reservoir filling will not cause the activation of seismic processes. It should be noted that this issue is not emphasized even in recommendations of the International Commission on Large Dams. Additional report on Nenskra dam and modeling is planned at the detailed design stage.

### 6.7.3 Mitigation Measures

The following mitigation measures are necessary in order to minimize the risks of development of the geo-hazardous processes during construction of designed units and roads of HPP:

- Prior to the construction works, additional engineering-geological surveys should be conducted within Nakra headworks areas;
- The formations in the active dynamic of the upper slopes should be removed within the project area (including from the slopes of the reservoir basin) and slopes must get stable corresponding deviation angle;
- At the preliminary stage of design, additional survey of landslide area on the left slope of Nenskra dam should be carried out and engineering and technical activities required for safe operation of the dam should be determined;
- Withdrawal of the surface and groundwater should be organized, under the condition, that it would not lead to the additional flooding of below existing slopes;
- In order to avoid deformation of the road embankment, gabions should be arranged if necessary;
- Arrangement of the concrete channels (cuvettes) along the project corridor is necessary, in order to prevent development of the erosion and landslide processes during road construction period;
- Atmospheric and groundwater flow from the slopes of the channels arranged along the roads and diversion channels should be discharged in the adjacent natural ravines or in river Nenskra;
- Systematic monitoring of technical condition of culverts and other engineering structures within the road corridor is required. Appropriate corrective works should be carried out in case of need;
- Monitoring of the landslide and erosion processes is necessary in process of construction works and implementation of the corresponding measures in case of need;
- In case of crossing the faults existing on the design routes of tunnels, specific engineering and technical activities should be planned and implemented on the basis of engineering and geological assessment of the intersection. (Class IV, "bad rocks");
- In case of emergency situations caused by dam damage in different scenarios, modeling of flooding process and its scale downstream of the dam will be carried out during construction designing stage and the report will be submitted to the Ministry of Environment and Natural Resources Protection of Georgia.

Risks of development of the geo-hazardous processes on the operation phase will be related to the reservoirs operation, therefore mitigation measures should be considered as on the reservoirs territories arrangement phase, as well as on the operation phase, including:

- The formations in the active dynamic should be removed from every slope of the reservoir and slopes must get stable corresponding deviation angle;
- Appropriate technical measures should be conducted for strengthening of the slopes (e.g., arrangement of the concrete screens) on the geologically active areas;

- Uncontrolled cutting of the trees must be prohibited in order to protect the vegetation existing on the slopes of the reservoir, and on those territories, where there is a lack of the vegetation, cultivation with the coppices consisting of adapted plants to the local conditions must be done;
- Monitoring over geo-hazardous processes on the reservoirs perimeter should be ensured during the whole life cycle of the HPP and if necessary, appropriate preventative measures should be carried out (geological studies, project development and implementation);
- Appropriate protective technical structures should be arranged in high-risk areas in terms of development of avalanche and rock falls;
- Assessment of possible groundwater circulation regime change, a new aquifer formation and infiltration during operation of the reservoir, as well as related impact on its stability will be carried out at the preliminary design of the construction;
- Regulate the water level of the reservoir during an avalanche-hazardous period in order to ensure that water level of the reservoir does not exceed 70-75% of the total volume.
- During the flood periods, the total volume of the river flow should be released downstream of Nakra dam in order to minimize the risk of solid sediment (brought from Lekvedari River) accumulation in Nakra riverbed and to minimize negative impact on Nakra village;
- In order to prevent mudflow solid sediment accumulation in Nakra riverbed, which may be brought from Lekvedari River, riverbed will be cleaned by technical means, if necessary;
- During the detailed designing of Nenskra dam, additional report on seismic stability of the dam will be prepared.

## 6.7.4 Impact Assessment

Table 6.7.4.1. Activation and development of Geo hazards

Description of impact and impact sources	Impact receptors	Assessment of residual impact					
		Significance	Probability	Impact area	Duration	Reversibility	Residual impact
<b>Construction phase:</b>							
<p><i>Geohazards, including Landslides, erosion, collapse, gulling activation / development and so forth.</i></p> <ul style="list-style-type: none"> <li>– Soil/slope removal and storage;</li> <li>– Preparation of reservoir basin and cutting of trees and plants;</li> <li>– Construction of HPP infrastructure;</li> <li>– Construction and transport operation, especially using heavy equipment.</li> </ul>	Land resources (plants, animals, water); Population. Also safety of facilities under construction	Direct, Negative	High risk	Temporary and permanent road corridors	Medium term. In some cases, long-term	Generally reversible	Based on local conditions and effectiveness of prevention/ mitigation measures may vary from <b>medium</b> to <b>high</b> impact. In case of mitigation measures, impact will be mainly reduced to a <b>low</b> impact.
<b>Operation phase:</b>							
<p><i>Geohazards, including Landslides, erosion, collapse, gulling activation / development and so forth.</i></p> <ul style="list-style-type: none"> <li>– Power plant facilities and maintenance roads;</li> <li>– Operation of Nenskra reservoir;</li> <li>– Maintenance/repair works and transport operations, especially use of heavy equipment.</li> </ul>	Land resources (plants, animals, water); Population. Also safety of facilities under construction	Direct, Negative	Medium risk	Access roads to power plant communications	Long term	Generally reversible	In case of mitigation measures, <b>low</b> impact is expected.



<p><b>Development of avalanche slopes in the vicinity of the reservoir.</b></p> <ul style="list-style-type: none"> <li>– Risks related to landslide from surrounding slopes</li> </ul>	<p>Population downstream of the dams and biological environment</p>	<p>Indirect, Negative</p>	<p>Low risk</p>	<p>Nenskra River valley downstream of the dam</p>	<p>Short term</p>	<p>Reversible</p>	<p><b>Low,</b> In case of mitigation measures, <b>very low</b></p>
<p><b>Activation of mudflow events on Lekvedari River.</b></p> <ul style="list-style-type: none"> <li>– The risk of activation of mudflow events on Naki village territory from Lekvedari River</li> </ul>	<p>Population of Naki village</p>	<p>Indirect, Negative</p>	<p>Medium risk</p>	<p>Naki village territory</p>	<p>Short term</p>	<p>Reversible</p>	<p><b>Medium,</b> In case of mitigation measures, <b>low</b></p>

## 6.8 Impact on the Aquatic Environment

### 6.8.1 Impact Assessment Methodology

Negative impact is expected on water environment during construction and operation of the designed HPP, including:

- Impact on solid sediment movement of the river, river-bed dynamic and on stability of the banks;
- Change of rivers water capacity;
- Deterioration of rivers water quality.

Impact is assessed by considering the intensity, impact area and the sensitivity of river-bed/banks of the river.

**Table 6.8.1.1.** Assessment criteria for the impact on surface water

Range	Category	Impact on sediment movement	Change of rivers water capacity	Deterioration of water quality of the river Nenskra
1	Very Low	The change of the solid run-off is practically invisible, there is no impact on the river-bed or on the banks of the river	Change of the capacity is invisible, does not impact on the water habitat/ichthyofauna. Water use has not changed	Background concentration of the substances and water turbidity has invisibly changed
2	Low	Solid run-off has changed by 1-5% in the tailrace/lower water intake flow along the whole length of the river or on its certain sections, which may cause some impact on sensitive areas, but the erosion processes has not been activated significantly.	The river capacity on certain sections has changed by 10%, impact is temporary (e.g., will be restored after completion of construction works) or is seasonal (e.g., there will be only shallowness), does not impact on water habitats/ichthyofauna. Water use has changed temporarily or slightly.	Concentration or turbidity of the water has changed by less than 50%, but does not exceed maximum permissible concentration
3	Medium	Solid run-off has changed by 5-10% in the tailrace/lower water intake flow along the whole length of the river or on its certain sections, which cause some impact on sensitive areas, significant activation of the erosion processes is expected, or development of the erosion processes on the erosion hazardous areas.	The river capacity on certain sections has changed by 10-30%, impact is temporary (e.g., will be restored after completion of construction works) or is seasonal (e.g., there will be only shallowness), certain impact on water habitats/ichthyofauna is expected. Water use has changed temporarily and slightly.	Concentration or turbidity of the water has changed by 50-100%, but does not exceed maximum permissible concentration
4	High	Solid run-off has changed by 10-15% in the tailrace/lower water intake flow along the whole length of the river	The river capacity on certain sections has changed by 30-50%, which is irreversible by character, significantly impacts on water habitats, impact on	Concentration or turbidity of the water has changed by more than 100%, or exceeded maximum

		or on its certain sections, which cause significant impact on sensitive areas, existing erosion processes has significantly activated or erosion is being developed on erosion hazardous areas.	ichthyofauna is expected, visibly impacts on water use.	permissible concentration
<b>5</b>	<b>Very High</b>	Solid run-off has changed by >15% in the tailrace/lower water intake flow along the whole length of the river or on its certain sections, which significantly impacts the lower flow of the river, including sensitive areas, existing erosion processes has significantly activated, erosion developed on erosion hazardous or on previously stable areas.	The river capacity on certain sections has changed by more than 50%, impact is irreversible, lack of flow significantly impacts on water habitats, there is an impact on ichthyofauna, water use has significantly changed.	Concentration or turbidity of the water has changed by more than 200% and exceeded maximum permissible concentration

**6.8.2 Impact Description**

**6.8.2.1 Construction/Mobilization Phase**

Impact on surface water is expected due to the works nearby the surface water facility:

Potential risks include:

- Pollution from vehicles/equipment as a result of fuel/oil spill;
- Increase of turbidity of water in the river-bed or during works to its vicinity;
- Pollution with construction and other wastes, including untreated wastewater.

As for the risk of groundwater contamination, it is expected on the sections where not deep water horizons are identified. The impact on groundwater may be:

- Direct – during ground works (drilling, basement digging and other);
- Indirect – due to the hydraulic connection between contaminated surface water and groundwater.

In terms of the impact on surface water quality special attention should be paid to the dam construction process, as construction works are implemented directly in riverbed, which may be related to the risk of pollution of water with suspended particles and oil products.

According to the project, construction tunnel will be arranged prior to the construction of Nenskra dam. Cofferdams will be arranged in the upstream and downstream of the proposed dam. Therefore, construction works will be implemented in dry riverbed, which minimizes the risks of pollution of the river water. The risk of water pollution is expected only during the arrangement of cofferdams and it will be a short-term impact.

According to the project, construction of Nakra dam will be launched on the left bank of the river. The river will be diverted towards the right bank and construction works will be implemented in dry

riverbed. After the left side of the dam is constructed, construction works will be implemented on the right side. Construction of the dam with such a scheme will minimize the risk of water pollution.

Conditions of the river sediment transportation will not be changed during the construction phase as construction works will not result in disruption of the river flow and the total volume of both solid and liquid flow will be released downstream.

There is a risk of pollution of river water with suspended particles (increased turbidity) as the water from diversion tunnel will be discharged into the river. If we consider that sedimentation pits are planned to be arranged on TBM platforms of both Nenskra and Nakra diversion tunnels and purified drainage waters will be discharged into surface waters, the risk of pollution will not be high.

As it is given in Paragraph 4.6.12.3., agricultural-fecal and industrial wastewater generated within the construction sites will be treated through proper treatment facilities, while so-called "biological toilets" will be arranged at the construction sites, which will be discharging into sewage system of the construction site.

Project-related impact can be reduced due to the correct organization of works/management practice and mitigation measures given in this report.

### **6.8.2.2 Operation Phase**

The risk of the impact on river water quality during the operation of Nenskra HPP is relatively low, but the risk of impact on solid sediment movement and hydrological regime is significant.

If we consider, that the design HPP is a seasonal regulation-type HPP, significant change of hydrological regime is downstream of Nenskra River dam. Only ecological flow will remain in this section of the river, which should be considered as high quality impact on biological environment. 2 km away from the dam, Tskhvamdiri River joins Nenskra River, the average annual flow of which is 1.8m<sup>3</sup>/s, while in about 1 km – Okrili River from the confluence of Tskhvamdiri River, due to which impact on biological environment will be reduced to some extent.

Similar impact is expected during the operation of Nakra dam, but the difference is the significant distance between important tributaries of the river in the tailrace.

According to the project, compact biological treatment facility (BIOTAL type) installation is planned for agricultural-fecal wastewater treatment formed in the power unit. Treated water will be discharged in river Nenskra. Agricultural-fecal wastewater formed on the headworks will be collected in the sanitation pits, from where it will be removed by special machinery and discharged in the sewage system of the power unit.

During the operation phase, except for maintenance works near water bodies, impact on water environment is not expected. The impact will depend on the type and scale of the planned works. Mitigation measures will be similar to the ones determined for the construction phase.

During the operation phase of the HPP, change of hydrological regime of the project rivers will lead to the change of solid sediment transportation conditions, namely: During the whole life cycle of the reservoir, solid sediment transportation in the tailrace of the dam will be practically stopped, which must be considered as significant negative impact. But the impact will be positive on Enguri reservoir and designed Khudoni reservoir, which is reflected by prolongation of life cycle of these reservoirs.

A sharp decline of water level downstream of the dam and accumulation of the major part of solid sediments in the reservoir will negatively affect the river bed processes of Nenskra, may result in

activation of erosion processes. In this regard, a relatively high risk is within 2 km long section downstream of Nenskra dam (up to Tskhvamdiri River confluence), where mainly only ecological flow will be released. It should be noted that tributary of Nenskra River, which is about 350-400 m away is characterized with mudflows and periodically brings large amount of solid sediments. A sharp decline of water level may lead to accumulation of sediments within this section of Nenskra River and the riverbed may be blocked. In order to prevent such process, necessary volume of accumulated sediments should be washed out from the dam and water should be released.

Considering that downstream of the dam, about 2 km away, Nenskra River joins Tskhvadiri River and other tributaries, impact on riverbed processes will not be significant. However, it should be systematically controlled and appropriate corrective measures should be taken, if necessary.

Considering the parameters of the Nakra dam, the risk of hindering sediment transportation is minimal as during the floods the full volume of sediments will be released downstream.

Downstream of the dam, Nakra River has several mudflow type tributaries, which creates the risk of solid sediment accumulation at the confluences of Nakra River and the risk of blocking the riverbed. In order to prevent the development of negative riverbed processes, systematic monitoring and downstream release of flow will be required.

According to the project, Nenskra reservoir will be of seasonal regulation. Therefore, HPP will operate at its full capacity in spring and summer. Water will be stored in the reservoir and will be utilized during the low water periods. Accordingly, during the whole period of reservoir operation, only ecological flow will be released downstream of the dam.

Reservoir operation will minimize downstream flood hazards, which have been significantly effecting local population (especially the population of Kvemo Marghi, Chuberi community and Lakhmi villages). Based on this, dam operation will cause positive impact in terms of preventing floods in settlements of Chuberi community.

Water will be released downstream of Nenskra dam only in case of flood flow during the maximum pool elevation of the reservoir. In this case, water will be released through spillway of the dam, which is designed for releasing flood flows. In addition to the above mentioned, water may be released in case of emergency situation, namely, in case of dam damage. Possible risks of damage of the dam and maximum flows of floods in settlements are discussed in Paragraph 6.16. of the EIA report.

In order to minimize the risks associated with a sudden release of water downstream of the dam, arrangement and operation of warning systems are considered according to the HPP project.

### **6.8.2.3 Determination of Ecological Flow**

According to the project, Nenskra HPP is a seasonal regulation HPP. Water from the proposed reservoir to the power unit will be supplied through a diversion tunnel. Consequently, natural flow of Nenskra River will be significantly reduced downstream of the dam till the section where the water will be discharged from the HPP. River water will be diverted to Nenskra reservoir through Nakra dam and diversion tunnel, due to which the volume of water within approximately 16 km long section of Nakra River will be sharply reduced. Proposed rivers are glacial rivers, which are characterized by seasonal and daily variations in water flow. The rivers are characterized by high flows during the warm period of the year and during the daytime, which is associated with the melting of glaciers.

A sharp decline in water level of rivers will negatively impact biological environment, as well as livelihoods of water-related animals and plants. Negative impact is also expected on water consumers downstream of the dam. Changed hydrological regime of the rivers may lead to a change of geomorphological conditions of riverbeds and may negatively affect groundwater (including sources of the mineral water).

According to environmental and social baseline survey results (see section 5.2.6.4.), only one species of fish inhabits in the proposed rivers and their tributaries - brook trout, which is included in the Red List of Georgia. Based on field survey results and information provided by local population, Nenskra River and its tributaries are characterized by an abundance of fish, while relatively small amount of fish is observed in Nakra River. It should also be noted that only amateur fishing is common in local population. The best sites for fishing are river sources and small tributaries, where spawning areas and relatively more food are represented. However, local population is fishing in other places as well, including sections in the downstream of the proposed dam.

Arrangement of fish way at 135m high Nenskra dam is not planned, as based on international experience, its operation at average or high dams is ineffective (in such cases, the fish Lifters are used, but in practice neither this gave the desired result). According to the project, Nenskra HPP will be of seasonal regulation and therefore, water level will be changed according to seasons, which is one of the main factors hindering the operation of fish way.

Based on the above mentioned, arrangement of the dam will cause suspension of fish migration towards spawning areas in the upstream of the dam, which will somehow negatively affect fish breeding. It should be noted that Nenskra River has several tributaries with sufficient water downstream of the dam, which are also used by trout as spawning and feeding areas.

Significant water users are not represented downstream of Nenskra dam. River water is not used for agricultural purposes (mills, irrigation systems, etc.). Small tributaries of the river are used for this purpose, which are abundantly represented within the project section of the valley. River water is not used as a water supply source for populated areas. Population rarely (mostly in winter) uses small tributaries for drinking purposes. The river water is rarely used for recreation purposes. Because of its glacial origin, water temperature is very low in summer and swimming is impossible.

Geomorphologically, Nenskra River basin mostly has trapezoidal shape. Tributary canyons and V-shaped valleys are deeply cut in. The width of the bottom of Nenskra valley is 50-200m, slopes are concaved and their inclination changes between 30-50°.

There are many terraces along the riverbed. Their width is up to 20 m, length – 0.2-0.3 km, in some places 0.3-0.4 km, inclined towards the river by 2-3°.

Riverbed in upper reaches is narrow (5-7 m) and deep (0.8-1.2 m), formed in solid rocks. In the middle reaches of the river, riverbed becomes wider and it is less deep. In the downstream of the proposed dam till Tita village, the width of the riverbed still reduces, though exception is the sections near Tskhvamdiri and Okrili rivers confluences, where the riverbed is significantly widened. Below Tetrashera River confluence, the river is deeply sawing crystalline shale, due to which the riverbed is a narrow canyon with length of 0.2-0.3 km.

The width of the river in the lower reaches is 15-17m, the depth is 0.4-2.5 m, and the narrowest section is 5-6 m. The riverbed along the entire length is blocked by large boulders, which create rapids, the height of which is within 1-2 meters.

Negative impact associated with the operation of Nenskra dam will be partially reduced by tributaries existing downstream of the dam, out of which particularly noteworthy are Tskhvamdiri River (2km from the dam) and Okrili River (3 km from the dam). It should be noted that these tributaries are water-

abundant rivers (average annual flow of Tskhvamdiri River is 1.8m<sup>3</sup>/s and average annual flow of Okrili River is 1.45m<sup>3</sup>/s).

Nenskra River has several more important tributaries in the downstream of the above mentioned tributaries, from which the most significant tributaries are: Kharami River – 6 km from the dam, Tetrashera River – 7 km from the dam, Devra River – 9 km from the dam, Tita River – 4.5 km from the dam, Marghi River – 9 km from the dam, etc.

Based on the above mentioned, a sharp decline in water level is only expected within 2 km long section of Nenskra River remained between Tskhvamdiri confluence and proposed dam. The remaining part of the riverbed in the downstream of the dam will be supplied with water from tributaries, which will significantly, but not completely reduce the expected negative impact. A high degree of negative impact on brook trout is expected only within the above mentioned 2 km long section. Consequently, there is a high risk of negative impact on water-related animal species within this section of the river, for instance the Otter, which is included in the Red List of Georgia. It should be mentioned that this specie is found in all sections of Nenskra River and its distribution area will not be decreased significantly. The fact that brook trout has the ability to create its micro-population should also be considered. Namely: In case of creating artificial barrier in the riverbed, the species is not threatened by destruction. Clear examples of this are many rivers of Georgia, where in spite of high dams brook trout has never been destructed.

All the above mentioned characteristic features of Nenskra valley have been considered during the determination of ecological flow to be released downstream of Nenskra dam.

It should be noted that Georgia does not still have its national standard for the determination of ecological flow. Though, the method of Switzerland has been used as a guide for determining the ecological flow (design documentation of Nenskra HPP has been developed by the Swiss company).

According to Swiss law N 814.20 concerning the protection of water resources, minimum ecological flow is  $Q_{347}$ , water flow expected during 347 days or more of the year.

According to  $Q_{347}$ , minimum ecological flow to be released is calculated as follows:

- If  $Q_{347}=500$  l/s, minimum ecological flow should be 280 l/s, while 31 l/s to be added to each subsequent 100 l/s;
- If  $Q_{347}=2500$  l/s, minimum ecological flow should be 900 l/s, while 21.3 l/s to be added to each subsequent 100 l/s;
- If  $Q_{347}=10000$  l/s, minimum ecological flow should be 2500 l/s, while 150 l/s to be added to each subsequent 1000 l/s.

Water flow curves have been elaborated for project dams alignments (see Figure):

**Figure 6.8.2.3.1.1.** Water flow curves for determination of  $Q_{347}$

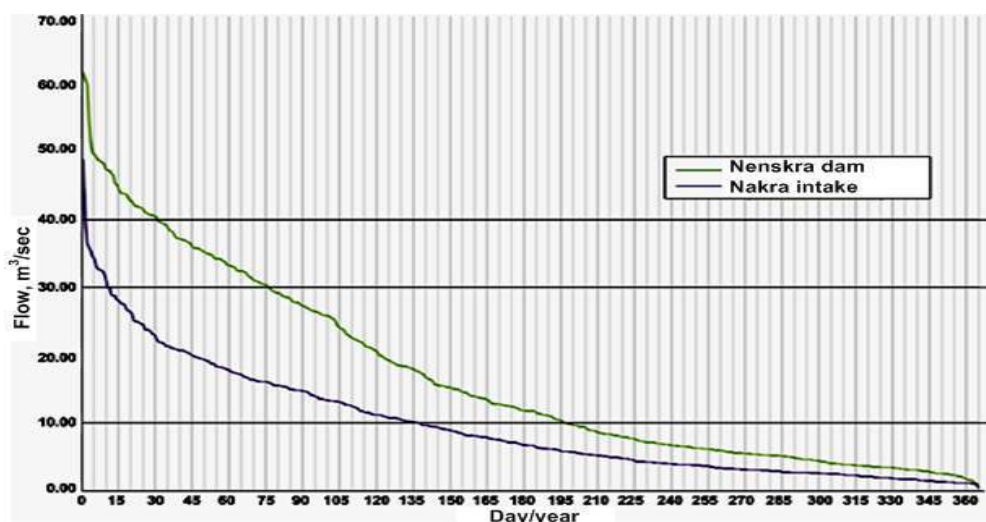

By the given curve,  $Q_{347}$  has been determined for headworks alignment and based on this, minimum ecological flow has been assessed, namely:

**Nenskra dam area:**  $Q_{347}=2.67 \text{ m}^3/\text{s}$ , which is equal to 2670 l/s, accordingly  $900+1.7 \times 21.3=936 \text{ l/s}$ , **0.9  $\text{m}^3/\text{s}$ .**

**Nakra Intake:**  $Q_{347}=1.40 \text{ m}^3/\text{s}$ , which is equal to 1400 l/s, accordingly  $280+9 \times 31=559 \text{ l/s}$ , **0.6  $\text{m}^3/\text{s}$ .**

Based on the calculations performed in accordance with the above mentioned methodology, minimum ecological flow for Nenskra dam is **0.9  $\text{m}^3/\text{s}$**  and for Nakra intake - **0.6  $\text{m}^3/\text{s}$** .

If we consider that within the 2 km long section of high risk, the river mainly flows through a narrow bed, water level will not be less than 0.35-0.4 meters, while the wet perimeter of the riverbed will be within 4.5-5.0 meters. Therefore, it should be noted that there will be minimum conditions for vitality of brook trout within this section of the river (it should be noted that about 350-400 m away downstream of the dam, Nenskra River joins small right tributary).

After the construction of Nenskra dam, upstream migration of fish will be impossible and therefore, 2 km long section to the confluence of Tskhvamdiri River will lose the function of migration route for fish and will be used by trout as other small tributaries of the river.

As it is already mentioned, there are no significant water consumers in the downstream of Nenskra dam and therefore, the risk of negative impact on water consumers is minimal.

Population of the settlements existing downstream of the dam (except the residents of Kvemo Marghi, which also use shaft wells) use spring waters, which are not filtrates of Nenskra River. Negative impact is not expected on mineral waters (there are two such springs within the influence zone – one on the left bank of the river near Sugrishi village and another on the right bank of the river in the downstream of Okrili River confluence). Mineral water springs are formed in deep layers and they are less impacted by the hydrological regime of Nenskra River.

In terms of the impact on geomorphological conditions of the river section within the influence zone, a particular attention should be paid to the natural ravine, which is 0.35-0.4 km away from the downstream of the dam and which is a right tributary of Nenskra River. Natural ravine is characterized by mudflows and during the floods it brings a large volume of solid sediments. These sediments could not be washed by an established ecological flow and they may be accumulated, which will require artificial interference. In particular, if necessary, release of water required and enough for washing mudflow sediments downstream of the dam.

As it was mentioned above, minimum ecological flow for Nakra intake is 0.6  $\text{m}^3/\text{s}$ . However, specific characteristics of Nakra River and dam operation conditions should be considered, namely:

13 meter high dam with fish passage is planned to be arranged on Nakra River so that trout inhabiting there can migrate and therefore, determined ecological flow should be sufficient for smooth operation of fish passage.

Nakra River valley is characterized by complex geomorphological conditions, as riverbed is strongly inclined and is blocked by large boulders almost throughout the entire length, which creates up to 2-meter high groves. Particularly difficult terrain is observed in the lower part of the riverbed, 5-6 km long section from the confluence.

It should be noted that unlike Nenskra River, there are no significant tributaries in the downstream of Nakra dam. The nearest two right tributaries – Kakrinachuri (average annual flow is 1.08 $\text{m}^3/\text{s}$ ) and Ughviri (average annual flow is 0.9 $\text{m}^3/\text{s}$ ) is 5 - 6 km away from the dam alignment. Therefore, during the operation of the dam, a sharp decline in water level is expected within 5 km long section of the river.

Population of Naki village uses Nakra River water for agricultural purposes, namely: for mills functioning and irrigation of agricultural crops. Fishing is not popular in this area as this river is not rich



with fish. Local population uses groundwater sources for drinking purposes, which are abundant in the region and the river water is not used for drinking purposes. Several mineral springs are found within the territory of Naki village and downstream of the proposed dam.

Based on the above mentioned, ecological flow to be released downstream of Nakra dam is **1.2 m<sup>3</sup>/s** (instead of 0.56m<sup>3</sup>/s, which has been determined by design organization according to Swiss methodology). P95 minimum flow of Nakra River within the project area is 0.77m<sup>3</sup>/s and in case of releasing determined ecological flow, the necessary conditions for fish migration between Nakra weir and the first tributary section will be ensured. Taking into account the flows of tributaries, expected average annual flow in the downstream of the river will be 3.18m<sup>3</sup>/s, which will significantly reduce both environmental and social impacts.

#### 6.8.2.4 Impact on Glaciers

In the World Glacier Monitoring Service report, prepared under the auspices of the United Nations World Environment Programme (UNEP), it is noted that "Global climate change has brought us to unprecedented melting of mountain glaciers." Nowadays, mountain glaciers are intensively melting all over the world. According to the data presented in World Glacier Monitoring Service report, in 2000-2005, ice thickness on 30 controlled glaciers has been reduced by 0.6 m (1 m water is equivalent to 1.1.m thickness of ice).

In 2000-2005, average speed of glacier melting was 1.6 times higher than in '90s of 20<sup>th</sup> century and 3 times higher than in '80s<sup>[7]</sup>. It should be noted that mountain glacier melt is increasing every year by 12 gig tons<sup>[8]</sup>.

On the 20<sup>th</sup> session of the United Nations Climate Change Conference, which has been held in Lima (Peru) in December of 2014, data of the National Oceanic and Atmospheric Administration has been represented, which proved that average temperature in January-October of 2014 was the highest since 1880, i.e. from the moment from which the measurement of these parameters has been launched.

Global climate change has also impacted the glaciers of the Caucasus, which are experiencing a noticeable degradation in the last half century.

The table below shows the data, reflecting the dynamics of glaciers in Georgia and namely, in Enguri, Nenskra and Nakra River basins. ,

**Table 6.8.2.4.1.** Glacier dynamics in the years 1960-2014

	Number of glaciers			Areas covered by glaciers (km <sup>2</sup> )		
	1960	2014	Change	1960	2014	Change
Georgia	786	637	-149	555.88	355.80	-200.08
Enguri River basin	299	269	-30	332.47	223.39	-109.08
Nenskra River basin	75	67	-8	48.62	25.58	-23.04
Nakra River basin	31	28	-3	18.49	10.21	-8.28

**Source:** Glaciers of Georgia, Tbilisi 2014

Based on the data given in Table, average annual reduction in the areas covered by glaciers in 1960-2014 amounted to: throughout Georgia -3,70 km<sup>2</sup> (200,08 km<sup>2</sup> : 54), in Enguri River basin - 2,02 km<sup>2</sup>, in Nenskra River basin - 0,43km<sup>2</sup> and in Nakra River basin - 0.25 km<sup>2</sup>.

<sup>7</sup> [www.org./news/story/ID=6949](http://www.org./news/story/ID=6949)

<sup>8</sup> [Ria.ru/arctic-news/20110309](http://Ria.ru/arctic-news/20110309)

Different rates of average annual reduction of glaciers areas are due to the fact that in 1960, mainly small cirque glaciers were observed in Georgia, which have disappeared in the last half century (Glaciers of Georgia, Tbilisi 2014). In the period, a total of 149 glaciers have disappeared in Georgia, including 30 glaciers in Enguri River basin. As for the Nenskra and Nakra river basins, only 11 glaciers have melted there.

Based on the above mentioned, it can be said that during the last 50 years, areas of glaciers have been intensively reducing in the basins of the project rivers.

It is possible to consider both direct and indirect exposures to glaciers during the implementation of planned activities, including:

**At the construction phase** indirect impact on glacier may be related to the deterioration of air quality (increase of dust concentrations), but if we consider that there is a significant distance between the project areas and glaciers, there is no the risk of negative impact at all.

**For the operation phase** we should consider the risk of direct impact related to local and regional climate change. Indirect impact is not expected during the operation phase.

As it is given in Paragraph 6.15., the influence zone of Nenskra reservoir includes ~14,0 km area upstream of the dam, ~3,0 km area downstream of the dam, while in elevation - 0,6-0,8 km area. Therefore, some of the glaciers of Nenskra valley may fall within the influence area, while impact on Nakra glaciers is not expected at all.

Operation of the reservoir will be related to increased moisture, increased wind speed and decreased temperature within local circulation area. Amount of precipitation is expected to increase as well. Based on this, operation of the reservoir will not have negative impact on glacier melting process in Nenskra valley.

However, during the operation phase of the reservoir it is recommended to carry out monitoring of glacier stability within Nenskra River valley.

### 6.8.3 Mitigation Measures

#### 6.8.3.1 Construction Phase

In order to reduce the negative impact on the surface waters, construction contractor shall ensure the following conditions:

- Equipment to be placed at least 50 m away from the surface water facility (if it is not possible, constant control and security measures to prevent water pollution);
- Avoid the blocking of the river-bed during operating in or near the river-bed;
- Ensure the maintenance of the machinery/equipment, in order to reduce the risk of fuel/oil spill to the minimum;
- Segregated collection of the waste formed during the works and temporary warehousing on the special allocated areas, away from the water facility;
- Restriction of refueling/maintenance of the machinery/equipment on the construction sites. If there is an urgent need, it should be done at least 50 m away from the water, by implementation the certain security measures of prevention of spill (and consequently soil and water pollution);
- In case of fuel/oil spill on the soil, localization of the spilled material and immediate cleaning of the contaminated area in order to prevent the getting of pollutant in the water;
- Restriction of the car-wash near the river-beds;
- Restriction of the wastewater discharge without treatment. This is most notable in process of construction camp functioning;

- Arrangement of the drainage system and temporary treatment depositing tanks for the surface run-off;
- Training of the personnel on environmental and safety issues.

Considering the above mentioned, it can be said, that the risk of contamination of the surface waters in process of construction works, significantly depends on implementation of the measures by the construction contractor under the terms of environmental management, as well as on the quality of monitoring on the waste management and functionality of the equipment. Accordingly, considering the mitigation measures, it can be said, that residual impact can be assessed as medium or low-quality impact.

### 6.8.3.2 Operation Phase

Implementation of the following mitigation measures is necessary, in order to minimize the impact on surface waters on HPP operation phase:

- **Measures against deterioration of the water quality:**
  - Systematic control over implementation of measures considered by the waste management plan;
  - Arrangement of the compact biological treatment facilities of the agricultural-fecal wastewaters for every power unit and control over effectiveness of its operation;
  - Systematic supervision on fuel/oil storage and usage rules;
  - In case of fuel/oil emergency spill, localization of the pollution and implementation of measures to prevent deterioration of the surface waters;
  - Training personnel on environmental and safety issues;
  - Water quality monitoring in the tailraces of the HPP. Sampling for laboratorial studies must be conducted downstream, at least 200 m away from the discharge point.
- **Measures to minimize the impact on hydrological regime of the river:**
  - Systematic control over passing the sanitary flow in the tailraces of the dams;
- **Measures to minimize the impact on transportation of the solid sediments:**
  - Systematic washing of the headrace of Nakra and passing the accumulated sediments in the tailrace of the dam during the flood;
  - Systematic monitoring of ongoing river-bed processes downstream of the dam. In order to prevent sediment accumulation, water should be released periodically;
- **Measures to minimize the risk of flooding downstream of the dams:**
  - Warning alarm systems (sound and light alarms, warning the population using loud speakers) will be arranged downstream of Nenskra and Nakra dams throughout the whole perimeter of the rivers;
  - Nenskra reservoir will be filled so that during the floods the reservoir will not be completely filled.
- **During the operation phase of Nenskra reservoir, glacier stability monitoring will be carried out.**

6.8.4 Impact Assessment

Table 6.8.4.1. Impact on surface waters

Description of impact and impact sources	Impact receptors	Assessment of residual impact					
		Significance	Probability	Impact area	Duration	Reversibility	Residual impact
<b>Construction Phase:</b>							
<p><b><i>Pollution of surface water with suspended particles, hydrocarbon and other substances</i></b></p> <ul style="list-style-type: none"> <li>- Sources of pollution with suspended particles - contaminated surface runoff, construction works near or in the riverbed;</li> <li>- Sources of pollution with hydrocarbon / chemical substances – discharge of surface runoff contaminated due to spills, or their direct discharge into water body;</li> <li>- Other sources of pollution - industrial or household solid / liquid waste generated within the construction camps.</li> </ul>	Population, river inhabitants	Direct, in some cases indirect (e.g. as a result of pollutants spill, discharge of contaminated surface runoff into the rivers). Negative	Medium risk, considering mitigation measures –low risk	21km long section of Nenskra river in the downstream of the proposed dams and 16km long section of Nakra river till the confluence of Enguri River	Medium-term (impact within the construction phase)	Reversible	<b>Low,</b> In some cases (works in the riverbed) – <b>medium</b>
<b>Operation Phase:</b>							
<b><i>Changes in river water flow</i></b>	Population, river inhabitants and terrestrial animals	Direct, Negative	High risk	15 km long section of Nenskra River from the dam to the power house and 16km long section of Nakra River from the dam to the confluence of Enguri River	Long-term	Irreversible	<b>High,</b> Considering mitigation measures - <b>medium</b>

<p><b><i>Impact on sediment transportation</i></b></p> <ul style="list-style-type: none"> <li>- Changes in geomorphological conditions of the river and stability disturbance</li> </ul>	<p>Population, river inhabitants</p>	<p>Direct, Negative</p>	<p>High risk for Nakra River, medium risk for Nenskra River</p>	<p>21km long section of Nenskra river and 16km long section of Nakra river from the dams to the confluence of Enguri River</p>	<p>Long-term</p>	<p>Irreversible</p>	<p><b>Medium</b> for Nenskra River, <b>High</b> for Nakra River, considering mitigation measures – <b>low</b></p>
<p><b><i>Pollution of surface waters with suspended particles, hydrocarbon and other substances</i></b></p> <ul style="list-style-type: none"> <li>- Sources of pollution with suspended particles : <ul style="list-style-type: none"> <li>o Surface runoff contaminated with solid particles generated from non-cultivated areas of the power plant infrastructure facilities;</li> </ul> </li> <li>- Sources of pollution with hydrocarbon / chemical substances: <ul style="list-style-type: none"> <li>o HPP water pollution with turbine oil;</li> <li>o Discharge of contaminated surface runoff into the water bodies.</li> </ul> </li> <li>- Solid / liquid household waste, construction solid / liquid waste generated during the repair works.</li> </ul>	<p>Population, river inhabitants</p>	<p>Direct, in some cases indirect (e.g. as a result of pollutants spill, discharge of contaminated surface runoff into the rivers). Negative</p>	<p>Low risk</p>	<p>Nenskra River, downstream of the power unit</p>	<p>Short-term</p>	<p>Reversible</p>	<p><b>Low</b></p>

## 6.9 Impact on Groundwater

### 6.9.1 Impact Assessment Methodology

**Table 6.9.1.1.** Assessment criteria for the impact on groundwater

Range	Category	The change of groundwater capacity	Deterioration of Groundwater <sup>9</sup> Quality
1	Very Low	Capacity invisibly changed	Background concentration of the substances has changed invisibly
2	Low	Groundwater level has significantly decreased, but has not influenced on the bore-hole water level or on spring water flow	II group <sup>10</sup> substances concentration is less than the permissible for the drinking water
3	Medium	Groundwater level has significantly decreased, at the same time obtaining of water from the bore-holes has reduced, impacts on the springs flow	II group substances concentration is exceeding the permissible for the drinking water
4	High	Bore-holes are temporarily not working, uncharged has reduced in the surface water facilities, which leads to the seasonal drought and environmental impact	Concentration of harmful substances of I group are being identified
5	Very High	Bore-holes are dehumidified, there are no uncharged in the surface water facilities, there are major risks of drought and environmental impact	Concentration of harmful substances of I group exceed the permissible in the drinking water

### 6.9.2 Impact Assessment

#### 6.9.2.1 Construction Phase

The risk of debit change in groundwater (including mineral water sources) at the construction phase is expected during the arrangement of diversion tunnels of Nenskra and Nakra, as well as during the construction of pressure system of the HPP, as in this case deep geological structures will be directly affected.

Arrangement of the proposed tunnels is planned far away from the populated areas, at high elevations of the valleys. Hence it can be said that the tunneling process would not affect the formation area of the groundwater existing within the residential zone. In addition, it should be noted that TBM will be used for the arrangement of diversion tunnels (drill and blast method will only be used for the construction of pressure system), which significantly reduces the risks of impact.

There are certain risks of groundwater pollution due to the earth works required for the arrangement of foundations of the HPP infrastructure. Such risks are relatively high at dam sites and within the construction site of the power unit. In general, all construction sites should be considered sensitive and measures should be taken in order to prevent groundwater contamination.

In order to prevent contamination of groundwater, implementation of mitigation measures related to the protection of soil quality is significant, as these two objects of the environment are closely related to each other. In order to reduce risks of atmospheric pollutants movement into deep layers of a particular focus should be made on timely removal and remediation of contaminated soil layer.

<sup>9</sup> Georgian law does not regulate underground water quality, that is why standard for drinking water was used

<sup>10</sup> EU directive 80/68/EEC, 1979, December 17, on „protection of groundwater from different hazardous substances“

### 6.9.2.2 Operation Phase

The risk of negative impact on groundwater quality during the operation of the HPP is expected only within the power unit area, which may be related to oil spills or incorrect waste management. If we consider that the substation of the HPP and oil storage will be located in closed facilities, in case of accidental spill the risk of groundwater contamination with oil is minimal.

Based on the mitigation measures given in this report, temporary storage of hazardous waste will be arranged in the building of the power unit and hermetic containers will be arranged throughout the entire area. There is a risk of the impact on groundwater quality during the repair works, though the impact will be short-term and less intensive in comparison with the construction works.

The risk of debit change in groundwater (including mineral water sources) during the operation phase may be related to the existence of diversion tunnels and to the reduction of the water level in the tailrace of the dams. As it is given in Paragraph 6.9.2.1., diversion tunnels will be arranged at high elevations of the valleys, far away from populated areas and therefore, the risk of the impact on sources used for drinking water is not high.

As for the impact related to the reduction of water levels in rivers, it will not be significant, as the vast majority of spring sources are located on the slopes of Nenskra and Nakra rivers and they are not fed by river filtrates. There is a risk of the impact on shaft wells used in Kvemo Marghi village. Monitoring of groundwater quality and capacity should be conducted during the construction and operation phases and if necessary, mitigation measures should be carried out.

Population intensively uses the mineral water sources existing near Sgurishi village and in Naki village. As for the mineral water spring on the right bank of Nenskra River, it is less consumed by the population, as during the summer floods the source of the spring is covered by water. Although the risk of the impact on mineral waters is not high, it is necessary to conduct monitoring.

Water level and quality of mineral water springs should be monitored during the construction and operation phases. According to the results of the monitoring, appropriate mitigation measures should be planned and implemented, if necessary.

Based on the above mentioned, impact on groundwater during the operation of the HPP can be assessed as medium risk.

### 6.9.3 Mitigation Measures

The following mitigation measures are required to be conducted in order to reduce the probability of groundwater contamination during the construction phase:

- Machinery and equipment should be checked regularly. In case of damage and fuel/oil spills, damage should be immediately eliminated. Damaged vehicles are not allowed on the construction sites;
- Proper management of generated economic and fecal wastewater;
- Wastewater potentially polluting areas should be protected from precipitation;
- Fuel storage tanks should have an insulating layer with concrete or clay fencing, the inner capacity of which will not be less than 110% of the total capacity of the reservoir. In case of accidental oil spills, prevention of pollutants distribution is possible through fencing;
- Prohibition of machinery / equipment fueling and / or maintenance works within the construction sites;

- In case of fuel/oil emergency spill, localization of the pollution material and immediate cleaning of the contaminated area. Personnel should be provided with appropriate means (adsorbents, shovels, etc.) and with personal protective equipment;
- Contaminated soil must be removed from the territory for further remediation activities by licensed contractor;
- Instruction of the personnel prior to the works;
- After completion of the construction works, the area should be cleaned and prepared for revegetation;
- Training of personnel on environmental and safety issues prior to the works.

During the operation of the HPP, the operator company should provide the following mitigation measures in order to prevent soil pollution:

- Systematic control over implementation of measures considered by the waste management plan;
- Systematic supervision on fuel / oil storage and usage rules;
- In case of fuel/oil emergency spill, the area should be cleaned and contaminated soil should be removed from the territory for further remediation;
- Spill liquidation means should be provided for substations and oil storage facilities;
- Training of personnel on environmental and safety issues after completion of works and then, once in a year;
- During the maintenance works, mitigation measures considered for the construction phase should be implemented.
- In order to determine negative impact on mineral water springs within the project region expected during the implementation of planned activities, systematic monitoring should be carried out during the construction and operation phases. Monitoring should include the survey of water level and quality of the springs, while research intensity should not be less than once a quarter.

The major mitigation measure for the reduction of the impact on groundwater capacity is to release ecological flow downstream of the head power unit, which will be systematically controlled.



## 6.9.4 Impact Assessment

Table 6.9.4.1. Summary of the impact on groundwater

Description of impact and impact sources	Impact receptors	Assessment of residual impact					
		Significance	Probability	Impact area	Duration	Reversibility	Residual impact
<b>Construction Phase:</b>							
<p><b>Change of groundwater capacity</b></p> <ul style="list-style-type: none"> <li>– Arrangement of foundations of the HPP infrastructure, preparation of the reservoir basin and other earth works;</li> <li>– During tunneling process</li> </ul>	Residents of nearby settlements, animals, surface waters with hydraulic connection with them	Direct, Negative	Low risk, during tunneling – medium	Areas selected for design facilities	Limited to the construction phase	Reversible	<b>Low</b>
<p><b>Ground water quality deterioration</b></p> <ul style="list-style-type: none"> <li>– Due to the earth works;</li> <li>– As a result of the movement of pollutants in the deep layers and surface water pollution</li> </ul>	Residents of nearby settlements, animals, surface waters with hydraulic connection with them	Mainly indirect, in some cases direct, negative	Low risk	Construction sites and construction camps	Medium-term	Reversible	<b>Medium.</b> Considering mitigation measures - <b>low</b>
<b>Operation Phase:</b>							
<p><b>Change of groundwater capacity</b></p> <ul style="list-style-type: none"> <li>– Due to the existence of Nenskra and Nakra diversion tunnels</li> <li>– Due to the reduction of water flows downstream of the proposed dams</li> </ul>	Population, animals	Indirect, Negative	Medium risk	Project section of Nenskra and Nakra rivers	Long-term	irreversible	<b>Medium.</b> Considering mitigation measures - <b>low</b>
<p><b>Ground water quality deterioration</b></p> <ul style="list-style-type: none"> <li>– As a result of the movement of pollutants in the deep layers and surface water pollution</li> </ul>	Residents of nearby settlements, animals, surface waters with hydraulic connection with them	Mainly indirect, in some cases direct, negative	Low risk	Mainly the area selected for the power unit	Medium-term	Reversible	<b>Very low</b>

## 6.10 Impact on Biological Environment

### 6.10.1 Impact Assessment Methodology

Introduced qualitative criteria for terrestrial and aquatic environment impact assessment for following categories:

- Habitats integrity, where the habitats expected loss and fragmentation is assessed, potential capacity reduction of ecosystems and impact on natural corridors;
- Species behavior, where their behavior change is assessed, physical changes due to visual changes, noise and atmospheric emissions, also impact on reproduction is assessed, coupling, spawning, daily and seasonal migration, activity, mortality;
- Restoration ability of habitat/specie;
- Protected habitats, protected territories, protected landscapes and natural monuments.

The following criteria are used for assessment of significance of the ecological impact:

- Impact probability, intensity, area and duration, which determined the impact value;
- Habitat or species sensitivity towards the direct impact, or towards the changes caused by the impact;
- Species or habitats restoration ability;
- Protective and ecological value of impact receptors, including species, populations, communities, habitats, landscapes and ecosystems;
- Impact on protected receptors is considered as high impact.

Criteria for impact assessment on ecological systems are given in the table 6.10.1.1.

**Table 6.10.1.1.** Terrestrial and aquatic ecology impact assessment criteria

Range	Category	Impact on integrity of habitats	Impact on species behavior	Habitats/species restoration ability	Impact on protected habitats
1	Very Low	Insignificant impact on integrity of the habitat	Behavior change is invisible, the death of small mammals/fish species with no value is expected, and there is no danger of invasive species spread.	Will be restored in a short time (<1 year) after completion of recultivation works	There is no impact on the areas protected by State Law and International Conventions
2	Low	Visible impact on the integrity of low value habitat, including less valuable 10-20 ha terrestrial habitat loss	Behavior change may be identified by using the standard methods, the death of small mammals/fish species with no value is expected, there is no danger of invasive species spread	Will be restored in 2 years after completion of the recultivation works	Temporary, short-term, minor impact is expected on the territories protected by State Law or International Conventions, which will not cause long-term disturbance of ecological integrity

3	medium	Visible impact on the locally valuable habitat integrity, its reduction, valuable habitat reduction, or less valuable 20-50 ha terrestrial habitat loss	Endemic and other valued species behavior change may be identified through standard methods, death of single copies of less valuable animal species, appearing of invasive species is expected	Will be restored in 2-5 years after completion of the recultivation works	Minor impact is expected on the territories protected by State Law/International Conventions, however ecosystem will recover in 3 years
4	High	Protected in country of locally valuable habitat reduction, or 50-100 ha less valuable terrestrial habitat loss	Behavior changes of species protected in country may be identified through standard methods, death of single copies of protected or valuable animal species is expected, invasive species have spread	Will be restored in 5-10 years after completion of the recultivation works	Minor impact is expected on the territories protected by State Law/International Conventions, mitigation measures are necessary for ecosystem restoration and up to 5 years
5	Very high	reduction of habitats with international importance, State protected or locally valuable, or >100 ha less valuable habitat loss	Behavior changes of internationally protected species may be identified through standard methods, single copies of protected or valuable animal species are dying, invasive species have spread	More than 10 years will be needed for restoration after completion of the recultivation works	There is an impact on the territories protected by State Law or International Conventions.

## 6.10.2 Impact on Flora

### 6.10.2.1 Construction Phase

Detailed botanical survey has revealed high conservation value species within the project corridor and the negative impact on botanical receptors of the project area has been determined (flora and vegetation), after which any conservation / restoration and compensation measures will be identified and appropriate bio-restoration specifications and compensation plans, as well as monitoring plan for botanical components of biodiversity will be developed. In addition, a program for rare species conservation should be developed, which includes the following species: *Laurocerasus officinalis* - the oldest Tertiary relict of the eastern Mediterranean, *Digitalis ciliate* - (Species whose numbers are declining), *Quercus iberica*, *Tilia caucasica*, *Pyrus caucasica*, *Sorbus caucasigena*, *Atropa caucasica* (rare plants); *Rhododendron ponticum* - oldest relic of the tertiary period; *Ilex colchica* - from Colchis, it is also found in Stranja (Balkans) and Chanet (Asia Minor); Caucasian endemic: *Senecio pojarkovae*, also population of *Cyclamen vernum*, which is protected under the Convention on International Trade in Endangered Species of Wild Fauna and Flora (CITES 1975; universal). Besides, identification of baseline conditions will help to conduct monitoring of restoration of the project's compensation areas and biodiversity botanical components after the completion of the construction works.

During the botanical survey, qualitative and quantitative identification of endemic and rare species will be carried out and species relevant mitigation measures will be developed, specifications of which will be given in complex restoration, bio-restoration and compensation measures plan. In case of implementing these measures, protection and conservation of high conservation value plant species directly or indirectly impacted by the project during the construction period will be ensured and vegetation cover will be restored within the project corridor.

Following measures are recommended in order to ensure plant conservation: transfer live plants to conservation centers and breeding with seeds, which must be collected in the natural environment. Due to big risk related to replanting, breeding of the target plants must be conducted with seeds, which leads to increased probability of conservation measure success and provides required number of plants for further reintroduction in relevant habitats.

These plants will form a live collection in the relevant conservation centers. After completion of the construction works, they must be reintroduced in the project corridor or in their natural habitats.

It is essential, that on other project areas, including forests, restoration is practically impossible. For this reason a mandatory and recommended measure would be conduction of offset (eco-compensatory), which means restoration of equivalent forest habitat. As for wetlands, surface water area significantly increases during the residual impact and such area is lost forever. Although wetland plants start to develop on such areas, it takes thousands of years to fill them with organic content.

Damage of the ecosystem of the forest can be calculated with exact proportional ration, which is based on modern methodology and the best practice, namely: “net gain principle” and “habitat-hectare” approaches.

Habitat-hectare method is a conventional approach for determination of vegetation value. The environmental proxy is a “habitat-hectare”. Habitat is assessed to estimate component volumes of habitat areas and landscapes in respect of predefined “initial conditions” (the benchmark). The benchmarks are determined for different ecological classes of vegetation (mek).

#### **Habitat area (ha) X Habitat point = Habitat-hectare**

Since Georgia does not use habitat-hectare approach on regular basis, mek and benchmarks must be determined on the basis of information on representative sample areas, which will be presented in the ESIA of the project.

Environmental damage must be calculated in accordance with the following document: Decree #2 of 2011, February 2 on ‘method for environmental damage determination’ signed by the minister of Environment Protection and natural Resources.

If the arrangement of the project corridor will be related to wood-cutting, this action will not be part of the EIA document. It is a subject of agreement between client, Ministry of Energy and Natural Resources and Ministry of Environment Protection. After approval of the EIA documentation, list of activities must be established, including volume of trees to be cut, and detailed inventory of the forest included in the State Forest Fund.

**Removal of “Red List” plants (endangered) from natural environment:** Georgian law on “the Red List” and “the Red Book” determines particular cases for replacement of the Red List plants from environment, namely:

According to the article #24 on “obtaining endangered wild plants or plant parts”:

Endangered wild plants or their parts can be obtained only in following cases:

- a) Restoration and breeding in natural environment (cultivation);
- b) Cultivation in dendrological and botanical gardens;
- c) Agricultural purposes, cultivation in artificial environment (only in those cases, when the wild plant is artificially cultivated);

- d) Scientific purposes;
- e) During sanitary cutting conducted in order to improve the sanitary condition of the forest;
- f) During implementation of the projects of state and public importance;
- g) In case naturally broken, withered and withering woody plants included in the Red List of Georgia are found within the state forest fund area;
- h) In case naturally broken, withered and withering woody plants included in the Red List of Georgia are found within the national park zone and protected landscape area;
- i) For security reasons during the operation of the existing enterprises and infrastructure.

In case of extraction of endangered wild plants or their parts (from the natural environment) for the purposes considered in above listed “a”, “d” and “i” clauses, written consent issued by the Ministry of Environmental Protection; in case of circumstances considered by “e”, “g” and “h” clauses, decision is made by the authority considered by 15 and 16 Articles of the Forest Code of Georgia. In case of circumstances considered by “f” clause, decision is made by the Government of Georgia.

Authorities considered by Article 15 and Article 16 of the Forest Code of Georgia are:

- a) Agency of Protected Areas of Georgia, which manages the state forest fund protected areas and their resources;
- b) Department of Natural Resources, which manages the state forest fund, protected areas of the local and state forest fund, except the forest fund existing in autonomous republics of Abkhazia and Adjara;
- c) Self-government unit, which through relevant services manages the local forests, within the authorities granted by the legislation and by following requirements set by of the Forest Code;
- d) The relevant authorities of autonomous republics of Abkhazia and Adjara, which manage forest funds existing within the territory of autonomous republics of Abkhazia and Adjara.

**Change of land category of the forest fund and use of state forest fund for specific purposes:** Change of forest land category: rules and procedures in changes of forest land category are held in accordance with Decree #5 of 2010, February 15 on “granting the special purpose category to the state forest fund lands” issued by the Minister of environment Protection and Natural Resources. Currently, the order is annulled and its provisions are reflected in “Rules of Forest Management” approved by the Government on August 20, 2010, under the Order №242. In particular, Chapter V - “Use of State Forest Fund for Special Purpose” has been added.

Based on this rule, special purpose forest can be used for following reasons:

- a) Construction, reconstruction (rehabilitation) and dismantling of hydro-electric scheme, pipeline, roads, communication and transmission communications, channels;
- b) Implementation of fire-preventive measures and liquidation of flood and other extreme situation consequences;
- c) Protection of infrastructure operation limitation or damage due to possible fall of trees;
- d) Study or extraction of minerals;
- e) Reconstruction of the cultural heritage (rehabilitation), archaeological excavations, archaeological prospecting;
- f) Oil and gas operations.

Permit for using forest for a special purpose and for implementing special cutting within the territory of state Forest Fund is issued by the Ministry of Environment and Natural Resources Protection, except cases considered under Article 68 (paragraph 5) and Article 69 (paragraph 3) of the Forest Code (in this

case decision is made by the Government of Georgia and this part of the Forest Code considers the following cases: Any changes, aimed at reduction of the State Forest Fund should be substantiated. In case of special cuttings, timber production on 35° and more slopes is allowed only in case of state significance construction. In case of state significance construction on slopes, which are inclined by 30°-35°, timber extraction is allowed only after a special survey and in case of implementing forest restoration activities).

A person interested in using a special purpose forest is submitting an application to the relevant ministry, which later sends the documents to the relevant authorities. In case of positive answer, the ministry sends all the documents (in cases of activities provided in sections a, d and e above) to the Ministry of Economy and Sustainable Development and Ministry of Culture and Monument Protection, in case of positive reply from them, begins the procedure of application and document discussion. For b and c cases, the decision is made on basis of proposal from the forest fund managing body.

In order to grant a right to use a special purpose forest following documents must be submitted: in case of a, d, e and f, following documents must be attached as well:

1. Motivation, reason and timeframes for use of a special purpose forest;
2. For legal private person and individual entrepreneur – extraction from registry of the entrepreneur or non-profit (non-commercial) legal persons; for a physical person – copy of the ID or passport; for legal public person – certified copy of foundation documents;
3. Survey drawing of the selected area in the UTM coordination system certified by the implementer of the drawing;
4. Wood-cut necessity justification;
5. Information on existence of Red List species on the selected territory.

In case of “d” clause, application shall be accompanied by a copy of document confirming permit on survey and extraction of minerals. In case of “e”, application shall be accompanied by issued by the Ministry Culture and Monument Protection.

For the b and c cases, following documents must be attached to the Forest Fund Management authority proposal:

1. For private legal entities and individual entrepreneurs - extraction from registry of the entrepreneur or non-profit (non-commercial) legal persons; for a physical person – copy of the ID or passport; for legal public person – certified copy of foundation documents;
2. Wood-cut necessity justification;
3. Information on existence of Red List species on the selected territory, while The additional document for the c case is information on volume of trees to be cut and exact species

After obtaining the right to use the special purpose forest, the minister issues administrative-legal act on the basis of which the Forest Fund Management authority signs the agreement with the interested person (except for the b and c cases) on forest use. The contract should be registered in the National Agency of Public Registry.

For wood manufacturing while using the special purpose forest, the area is marked by the interested party and the costs are covered by the interested parties.

**Land expulsion from the forest fund:** land can be expelled in accordance with decree #240 of 2010, August 13 on “rules for bordering the state forest fund”, issued by the Government of Georgia.

The rule determines legal relations related to bordering the forest fund, and does not spread on the legal relations related to the determination of the borders of the protected areas in the forest fund.

The boundaries of the state forest fund were determined by the Government of Georgia on the basis of normative act submitted by the Ministry of Environment Protection and Natural Resources. The Ministry of Economy and Sustainable Development will apply to the National Agency of Public Registry in order to correct the borders of the State Forest Fund.

The Government will start to discuss the issue on the correction of the borders of the State Forest Fund on the basis of the initiation from physical, legal persons or their unions, state and local government agencies or institutions, relevant authorities of the Autonomous Republic of Abkhazia and Adjara.

The need of correcting the borders of the State Forest Fund (necessity), purpose (goal) should be specified in the appeal of the initiators to the Ministry and it should include the cadastral survey drawing of the relevant area (attached electronically).

The Ministry has the right to review the issue on the correction of the borders of the State Forest Fund on its initiative as well.

After decision of the government, the ministry submits the relevant documents to the National Agency of Public Registry.

The state forest fund boundary must be determined with appropriate technologies (geoinformational system) on the basis of the photo plan and other evidences (state coordinate system - WGS-84/UTM).

#### **6.10.2.2 Operation Phase**

Direct impact on vegetation during the operation phase is not expected, but there will be an indirect impact, which may be related to the impact of reservoir on local climate and reduction of water level in the tailrace of the dam.

Based on the assessment results, impact on local climate is expected during the operation of Nenskra reservoir, namely: There will be early frosts in the coastal zone of the reservoir and it will cause fading of freshly fallen out buds and sprouts. Considering that plants within the reservoir area are adapted to the harsh climatic conditions, impact would not be significant.

The reduction of water levels in rivers can have a negative effect on the water-loving plant species. Only Alder trees are represented within the influence zone of the project near Nenskra and Nakra riverbeds. In case of systematic release of the determined ecological flow downstream of the dams, impact will not be significant.

Planting and growing the cultural and decorative plants and trees is envisaged on the adjacent territories of HPP, which should be considered as significant mitigation measure.

### 6.10.3 Impact on Fauna

#### 6.10.3.1 Construction Phase

HPP construction is related to temporal concern of fauna and possible migration from areas of influence. Construction works might affect animal biodiversity as follows:

- Vibration and noise levels will increase during construction works, plants will be covered with dust, which will affect feeding base for vertebrate and invertebrate species;
- Concern factors will increase for birds and bats living near the road;
- Arranged trenches poses a risk to small animals. They might fall into the trench and get injured;
- Limitation of movements due to construction of temporary structures, temporary fragmentation of habitat;
- Cutting plants on reservoir locations will destroy whereabouts of animals, this will especially affect bats, which live mainly in trees near the forest (184 such trees have been identified on the study area during the audit). Destruction of such trees will cause decrease of number of bats;
- In case of pollution of water and soil with harmful substances fish, amphibians, water birds and otters will suffer.

Having said that, direct (collision/damage, fragmentation of habitats and destruction) and indirect (migration due to noise/vibration, emissions and etc.) impacts are expected. Sources of impacts are:

- Transport;
- Machinery and people;
- Cleaning of reservoir area and therefore disturbance of animal habitats.

On the construction phase animals/birds will not migrate on far distances. After completion of construction and “stop” of source of concern animals/birds will return to their original habitat, except reservoir areas, which will be permanently lost.

It should be noted that the project region is inhabited by Georgian Red List species, such as brown bear, otter, lynx, Caucasian squirrel, wild goat and chamois. Though the project area represents suitable habitat for wild goat and chamois, but the trace of their existence have not been observed during the expeditions (2010, 2011 and 2014). According to local population, wild goat and chamois inhabit at high elevations of the valley, which can be explained by high anthropogenic load.

Based on the above mentioned, the risk of direct impact on wild goat and chamois is minimal during the implementation of planned activities. However, significant part of the habitat will be lost, which could be used by these animal species. It should be noted that areas selected for dam and reservoir are under high anthropogenic load. Habitat of the upstream of Nenskra River valley will remain intact.

Unlike the wild goat and chamois, other animal species that are included in the Red List of Georgia may be found within the project area. Due to this fact, mitigation measures should be systematically implemented. Prior to the construction works, Biodiversity Management Plan will be prepared. The monitoring plan includes implementation of systematic researches during the construction and operation phases.

As it is given in Paragraph 5.2.6.2.4., 14 bird species that are included in the Red List of Georgia are observed within the project region. Therefore, their habitats may be destroyed during the removal of vegetation cover. Relatively high risk of negative impact is expected during the removal of vegetation cover from reservoir basin, as in this case about 400 ha area will be influenced. In order to minimize the impact, removal of vegetation cover from project areas are planned to be implemented during relatively less sensitive period in terms of breeding.



### **6.10.3.2 Operation Phase**

Direct negative impact on animals, except for ichthyofauna (impact on ichthyofauna is discussed in a separate chapter), is less possible. Significant negative impact will be already made during the preparation of areas for reservoir basin and other infrastructure facilities.

There is a risk of habitat fragmentation during the operation phase, which will be related to the existence of the reservoir and roads. Considering the low intensity of traffic on access roads, impact on animal species will not be significant.

It should be noted, that cenosis of hydro-fauna typical for the lakes will be formed in the designed reservoir, which will improve the habitat of water-related species (especially invertebrates) and increase of their number is expected.

Living environment for water-loving bird species will be improved during the operation of the reservoir, which will be related to the increase in their number.

## **6.10.4 Impact on Fish Fauna**

### **6.10.4.1 Construction Phase**

During the construction phase, there is a risk of negative impact on fish fauna in case of water quality deterioration in Nenskra and Nakra rivers, which may be associated with implementation of works in riverbeds, improper management of waste and wastewater, etc.

Arrangement of diversion tunnel and cofferdam is planned prior to the construction of Nenskra dam, after which works will be implemented in the riverbeds. In case of Nakra dam, initially works will be implemented on the left side of the riverbed and then on the right side. Considering this, risks related to water quality deterioration during the construction of the dams will be reduced to a minimum and accordingly, impact on fish fauna will not be significant.

Considering the measures proposed for the management of waste and wastewater generated during the construction phase, the risk of pollution of surface waters will not be high. Therefore it is possible to minimize the risk of exposure to water biological environment. Activation of illegal fishing is expected during the construction phase, which will require appropriate mitigation measures, in particular: Construction personnel should be informed on the administrative liability in case of illegal fishing.

### **6.10.4.2 Operation Phase**

Operation of reservoirs and dams on the proposed rivers will violate conditions of fish reproduction and existence. Hydrological, thermal, hydro-chemical and hydro-biological conditions change, this affects fish movements, breeding and feeding. Diversion system of HPP will change the annual seasonality of river run-off.

Unnatural variation of water level will cause the reduction of “feeding places”, untimely formation of suitable water level for reproduction will cause the death of spawn, time restriction of fry latency in reproduction areas, due to which, they still weak will slide from the reproduction areas. The above-mentioned negative impact of flow regulation will be especially identified in shallow waters.

The results of impact on ecosystem, which is related to the anthropogenic regulation of rivers run-off, can be grouped as follows:

- First level impacts: physical, chemical and geomorphological changes caused by river blocking and changes in natural flow regime;
- Second level impacts: changes in primary biological productivity of ecosystem;
- Third level impacts: changes in fish community, which is caused by results of the first (e.g. changes in reproduction conditions) or the second (reduce of available plankton) level impacts.

As it is given in Paragraph 5.2.6.4.2. of the EIA report, fish breeding areas are less represented in the project section of Nenskra River and this section is more important in term of losing the food base for the fish species. With this regard, 3 km long section of the river within the reservoir basin and 2 km long section downstream of the dam to Tskhvamdiri confluence should be distinguished, where only ecological flow (0.9 m<sup>3</sup>/s) will be released and therefore, food base of fish will be reduced to minimum.

Impact is not expected on breeding areas existing upstream of Nenskra River and in tributaries. However, existence of high dam will exclude fish movement towards the upstream. Due to this fact, breeding areas from downstream of the dam at confluences of Nenskra and Dalari rivers will be lost for the brook trout.

Water level will be significantly reduced within the section from Tskhvamdiri River confluence to tailrace tunnel of the HPP. However, the flow of Tskhvamdiri, Okrili and other tributaries together with ecological flow will ensure habitat for fish. Therefore, considering the planned mitigation and compensation measures, risk of negative impact will not be high.

Fish way will be arranged on Nakra dam and determined ecological flow (1.2. m<sup>3</sup>/s) will ensure minimal habitat for brook trout and possibility of moving towards breeding areas.

Following measures are planned to be implemented in order to minimize the risk of negative impact on brook trout:

- Fish protector equipment installation on water intake facilities of Nenskra and Nakra;
- Maximal protection of fishing regulation requirements on the rivers Nenskra and Nakra and at the same time, determined number of brook trout fry will be released upstream and downstream of the dam every year;

The fish protection facility must be installed in accordance with decree #7 on “List of equipment, rules and terms for extraction in accordance with animal planet objects and the species” signed by the minister of Energy and Natural Resources in 2011, April 6, article 17, namely: water intake facility with reception of 5000 m<sup>3</sup> daily must be equipped with fish protection facility/device.

As the researches of western European specialists has shown, fish-protection facilities are the most rational system of fish-protection equipment, which use hydraulic methods, due to which the fish is not getting into the water intake system. Unlike the mechanical methods of fish-protection (enclosed nets, gratings), hydraulic methods represent more effective and safe means. In comparison with the acoustic, electro and optical methods, proposed method is much reliable and cheaper.

Arrangement of fish-passage must be considered on the Nakra dam.

### 6.10.5 Impact on Protected Areas

As shown in Figure 6.9.5.1. infrastructure objects and roads are located outside the borders of the protected areas. Diversion tunnels will be arranged deep under the protected areas, however, considering that the tunneling works will be conducted via TBM, impact on biological environment or geological structure of residents of the protected areas will be minimum.

**Figure 6.10.5.1.** Project HPP infrastructure in respect of the protected areas



### 6.10.6 Mitigation Measures

#### 6.10.6.1 Flora

During the construction phase, following mitigation measures are proposed in order to reduce the impact on vegetation cover and habitat integrity:

- Boundaries of the construction sites and traffic routes should be strictly determined in order to protect vegetation cover from damage;
- Trees should be cut under the supervision of authorized specialists;
- In order to compensate for the damage to the vegetation, forest groves should be cultivated in accordance to the scheme agreed with the Ministry of Environment and Natural Resources Protection of Georgia and local authorities. Local species of trees should be used;
- Prior to the works, construction personnel should be instructed on issues related to the protection of vegetation cover and liability for illegal cutting of trees;

- In order to minimize the risk of habitat fragmentation, artificial passages will be arranged within the construction corridor.

During the operation phase, following mitigation measures are proposed in order to reduce the impact on vegetation cover and habitat integrity:

- During the implementation of large scale repair and maintenance works, mitigation measures of the impact on vegetation cover considered for the construction phase should be carried out;
- In order to raise awareness of local population, signs prohibiting illegal logging should be installed within the project area;
- Strict control of the HPP personnel to eradicate illegal logging

#### 6.10.6.2 Fauna

During the construction phase, following mitigation measures should be considered in order to minimize impact on terrestrial animals:

- Period for the construction works to be implemented in the vicinity of the river will be selected so that it does not coincide with the Otter breeding period. It should be noted that Otter mainly breeds in February-April. The little ones are born in April-May, June-August and often in December-February;
- Prior to the works, access roads, river crossings places (especially near sensitive areas) will be checked in order to record the traces of nests of predatory birds and predatory mammals;
- Identified nests and holes will be recorded and working near these areas should be prohibited from April to July;
- Vegetation cover within the access road corridors and areas of construction infrastructure should be preserved as much as possible in order to minimize the risk of destruction of trees with hollows;
- If Otter holes are observed within the boundaries of the construction areas, work will be performed in a less sensitive period for breeding this specie;
- In case of identifying Otter holes within the boundaries of the construction sites, further actions should be carried out in accordance with the Law of Georgia on the “Red List” and “Red Book” of Georgia;
- Personnel employed on the construction should be instructed and warned. Code of Conduct prohibiting hunting / fishing will be developed;
- Construction corridor will be protected as earth works should not transmit across the selected zone and in order to avoid additional damage to otter holes, bird nests and shelters of bats. Earthworks will be controlled by personnel with appropriate knowledge;
- Strict observance of the boundaries of traffic routes;
- Selection of the optimum speed for traffic in order to reduce the probability of direct impact on animals (collision);
- Pits and trenches will be surrounded with barriers to prevent the fall of animals. For large species – sharp-colored ribbon, for small animals – any flat material – tin, polyethylene and etc. Long boards or logs must be launched into trenches and pits, so that small animals could get out. Trenches must be inspected before filling them with soil.
- To use the minimum amount of light in order to reduce the spread of light;
- Activities causing too much disturbance of animals should be implemented in a short period of time, in no breeding period of time;

- After the completion of construction works, up to 1500 artificial shelters of various types will be arranged (in accordance with the determined methodology) in order to compensate the damage to bats;
- In order to minimize negative impact on fauna, removal of vegetation cover should be performed during relatively less sensitive period in terms of animal breeding (autumn-winter);
- After the completion of construction works, areas adjacent to access roads and the HPP communications will be revegetated, which will reduce the impact related to habitat fragmentation?

In addition:

- Proper management of waste;
- Mitigation measures for water, soil and air pollution, noise propagation will be carried out (see relevant Chapters).

During the operation phase, mandatory ecological flow will be released downstream of the dams. Forest groves will be cultivated in order to compensate for the damage to the vegetation cover. As mentioned above, 1500 artificial shelters will be arranged for bats. It is considered to raise awareness of the personnel and local population on illegal hunting/fishing and monitoring will be conducted.

### 6.10.6.3 Fish Fauna

Following mitigation measures are proposed in order to minimize impact on fish fauna:

- Ecological flow should be released downstream of the dam and the volume of the released water should be systematically controlled;
- Arrangement of fish ways is planned on Nakra River, which will create natural conditions for fish migration;
- Technical functionality and efficiency of the fish way should be monitored, which is especially important during the fish reproduction and migration periods;
- In order to minimize the risk of fish damage (death) in intake and turbines of the HPP, fish-passing device will be arranged on water intakes;
- In the first 3-5 years of operation, monitoring of ichthyofauna species should be ensured in order to develop additional mitigation measures, if necessary. Namely: release of 70 thousand and 50 thousand stream trout fingerlings in Nenskra and Nakra Rivers annually. This activity should be agreed with the Ministry of Environment and Natural Resources Protection of Georgia.
- Appropriate fish species should be selected for reproduction in Nenskra reservoir, which should be agreed with the Ministry of Environment and Natural Resources Protection of Georgia.

In addition:

- All mitigation measures for preventing surface water quality deterioration (see relevant section);
- A code of conduct prohibiting illegal fishing will be developed and staff will receive appropriate training.

### 6.10.7 Impact Assessment

Table 6.10.7.1. Impact on wildlife

Description of impact and impact sources	Impact receptors	Assessment of residual impact					
		Significance	Probability	Impact area	Duration	Reversibility	Residual impact
<b>Construction Phase:</b>							
<p><b><i>Vegetation destruction/damage:</i></b></p> <p>– <i>Direct impact:</i></p> <ul style="list-style-type: none"> <li>○ Vegetation cutting on the reservoir territory;</li> <li>○ Vegetation cutting on areas of access roads and infrastructure;</li> <li>○ Herbaceous surface damage on construction sites, camps and access roads.</li> </ul> <p>– <i>Indirect impact:</i></p> <ul style="list-style-type: none"> <li>○ Air pollution;</li> <li>○ Water pollution;</li> <li>○ Soil contamination and erosion.</li> </ul>	Local population, animals	Direct and indirect, Negative	Very high risk	<ul style="list-style-type: none"> <li>– Direct impact area – project area and corridors of access roads;</li> <li>– Indirect impact area – areas adjacent to the project area</li> </ul>	Medium term. In some cases - long-term	Reversible. In some cases - irreversible	<b>High or medium</b>
<p><b><i>Impact on terrestrial fauna:</i></b></p> <p>– <u>Direct impact:</u></p> <ul style="list-style-type: none"> <li>○ Direct impact of human or equipment;</li> <li>○ Changed illumination background at night;</li> <li>○ Transport collision, falling into trenches, etc;</li> <li>○ illegal hunting.</li> </ul> <p>– <u>Indirect impact:</u></p> <ul style="list-style-type: none"> <li>○ Cutting down the vegetation within the areas of the HPP and</li> </ul>	Animal species inhabiting within the project area, local population	Direct and indirect, Negative	High risk	Areas of the HPP infrastructure facilities, reservoir basins, areas adjacent to construction sites, corridors of the construction roads.	Medium term. In some cases - long-term	Mainly reversible. In some cases - irreversible	<b>Medium</b>

<ul style="list-style-type: none"> <li>construction infrastructures;</li> <li>○ Removal of vegetation from reservoir basin;</li> <li>○ Air pollution;</li> <li>○ Change of acoustic background;</li> <li>○ Possible pollution of surface and ground waters;</li> <li>○ Soil contamination and erosion;</li> <li>○ Visual impact.</li> </ul>							
<p><b>Impact on ichthyofauna:</b></p> <ul style="list-style-type: none"> <li>- Direct impact sources: <ul style="list-style-type: none"> <li>○ River abstraction for hydraulic structures arrangement;</li> <li>○ Illegal fishing;</li> <li>○ Arrangement of hydraulic structures;</li> <li>○ Arrangement of vehicle passes.</li> </ul> </li> <li>- Indirect impact sources: <ul style="list-style-type: none"> <li>○ Water pollution;</li> <li>○ Pollution of bottom sediments.</li> </ul> </li> </ul>	<p>Biological environment of Nenskra and Nakra rivers</p>	<p>Mainly indirect, Negative</p>	<p>Low or medium risk</p>	<p>River sections downstream of the dams, flows in the vicinity of the construction sites and construction camps</p>	<p>Within the construction phase</p>	<p>Reversible</p>	<p><b>Low</b></p>
<p><b>Operation Phase:</b></p>							
<p><b>Vegetation destruction/damage, habitat fragmentation:</b></p> <ul style="list-style-type: none"> <li>- Direct impact: <ul style="list-style-type: none"> <li>○ Mowing grass cover on substation area;</li> <li>○ Damage of plants during maintenance and transport operations;</li> </ul> </li> <li>- Indirect impact sources: <ul style="list-style-type: none"> <li>○ Air pollution;</li> <li>○ Surface and groundwater</li> </ul> </li> </ul>	<p>Areas of the HPP infrastructure facilities, access roads, animals, local population</p>	<p>Direct Negative</p>	<p>Medium risk</p>	<p>Area of influence is the area of the HPP infrastructure facilities and corridors of the access roads</p>	<p>Long-term</p>	<p>Reversible</p>	<p><b>Low</b></p>

<p>pollution;</p> <ul style="list-style-type: none"> <li>○ Soil pollution and erosion;</li> <li>○ Impact related to the change of local climate.</li> </ul>							
<p><b><i>Impact on terrestrial fauna:</i></b></p> <ul style="list-style-type: none"> <li>– Direct impact sources: <ul style="list-style-type: none"> <li>○ Significant reduction of water level downstream of the dams;</li> <li>○ Maintenance works and transport operations;</li> </ul> </li> <li>– Indirect impact sources: <ul style="list-style-type: none"> <li>○ Air pollution;</li> <li>○ Change of acoustic background;</li> <li>○ Change of illumination background at night;</li> <li>○ Possible pollution of surface and ground waters;</li> <li>○ Soil contamination and erosion;</li> <li>○ Visual impact.</li> </ul> </li> </ul>	<p>Animals inhabiting within the areas of the HPP infrastructure facilities</p>	<p>Direct and indirect, Negative</p>	<p>High or medium risk</p>	<p>Areas adjacent to the HPP infrastructure facilities</p>	<p>Long-term</p>	<p>Mainly irreversible</p>	<p><b>Medium</b></p>
<p><b><i>Impact on ichthyofauna:</i></b></p> <ul style="list-style-type: none"> <li>– <u>Direct impact sources:</u> <ul style="list-style-type: none"> <li>○ Changes in hydrological regime of the rivers;</li> <li>○ Existence of reservoirs on Nenskra and Nakra rivers;</li> <li>○ Illegal fishing;</li> <li>○ Maintenance works.</li> </ul> </li> <li>– Indirect impact sources: <ul style="list-style-type: none"> <li>○ Surface waters pollution;</li> <li>○ pollution of bottom sediments.</li> </ul> </li> </ul>	<p>Biological environment of Nenskra and Nakra rivers</p>	<p>Direct and indirect, Negative</p>	<ul style="list-style-type: none"> <li>– direct impact – very high;</li> <li>– indirect impact – low</li> </ul>	<p>Downstream and upstream of Nenkra and Nakra dams</p>	<p>Long-term</p>	<p>Mainly irreversible</p>	<p><b>High or medium</b></p>



## 6.11 Waste

### 6.11.1 Construction Phase

Formation of as not hazardous inert materials, as well as hazardous materials is expected during the HPP construction works. Not hazardous waste is:

- Waste rock excavated during the tunnel construction;
- Waste due to vegetation clearance;
- Polyethylene waste (packaging/sealing materials);
- Ferrous and non-ferrous scrap metal;
- Domestic waste, etc.

Waste collection on the territories of construction camp and construction sites must be conducted by segregate method, for which the construction contractor must provide disposal of the required number of marked containers. Containers must be placed on specific locations.

The main part of wood formed during the arrangement process of construction sites and road corridors will be used for implementation of construction works and the remains will be handled to local population for fuel usage.

Considering the specificity of construction works, ferrous and nonferrous scrap metal amount will not be significant. Such waste will be handled to scrap receiving points.

Household waste will be collected in the closed containers with special labels. Household waste accumulated on the construction sites will be removed to the construction camp territory and from here, together with waste from construction camps, will be removed to the landfill prepared prior to the construction. During the audit, area for sanitary landfill has been selected on the left bank of Nenskra River, between Sgurishi and Tita villages. After the building contractor will be identified through the competition, the area for the arrangement of sanitary landfill will be determined and agreed with Ministry of Environment and Natural Resources Protection of Georgia. Investor is responsible for the arrangement of sanitary landfill, while construction of landfill will be performed by the contractor company.

Total amount of household waste expected in process of construction works will be approximately  $600 \cdot 0,73 = 438 \text{ m}^3/\text{y}$ .

Accumulation of significant amount (approximately 520-525 thousand  $\text{m}^3$ ) of waste rock is expected in process of diversion tunnels arrangement, as well as during the arrangement of construction roads. Due to the complex terrain, it will be difficult to select area for waste rock disposal. It should be considered that the waste rock will be used as an inert material during the concrete production. Approximately 40-45% of waste rock can be used for this purpose. In addition, waste rock (approximately 5-8% of total) generated during the drilling and blasting works for pressure system can be used for bank reinforcement activities (river Nenskra banks on the adjacent territories of HPP engine house deployment and at other areas in accordance with the requirement of local municipality), also for road works.

Due to the local complex terrain, "Nenskra" JSC made decision that about 45-50% of waste rock will be disposed on the bottom of the reservoir. Although, due to this method the so-called dead volume of the reservoir will be somehow reduced, environmental and social risks related to the disposal of such waste will be completely excluded.

About 260-270 thousand waste rock will be disposed in reservoir basin. Considering that the reservoir volume will be 282 million m<sup>3</sup> and its life cycle will be 72 years, reduction of reservoir useful volume and related negative impact on electricity generation will not be significant. Life cycle of the reservoir may be reduced by 2.0-2.5 years.

However, alternative areas for the disposal of waste rock have been determined during the negative impact assessment process, namely: areas adjacent to Kvemo Marghi and Sgurishi villages. Total area of the territory selected for the disposal of waste rock will not be less than 4.5 -5.0 ha, which will be enough for the disposal of above mentioned volume of waste rock.

Project documentation of arrangement, filling and closure (recultivation) of the disposal area will be prepared prior to the construction works and will be agreed with the Ministry of Environment and Natural Resources Protection of Georgia. Layout scheme of waste rock disposal areas is given in Figure 6.11.1.1.

Generation of following types and quantities of hazardous waste is expected during implementation of the works on construction phase:

- Paint residues and paint packages - 800-1000 kg/y;
- Residues of fuels and lubricants - 1200-1500 kg/y;
- Out-of-date and damaged accumulators - 65-70 unit/y;
- Oil filters from building machinery and vehicle – 120-125 unit/y;
- Used rubber tires - 200-250 unit/y;
- Welding electrodes -500-600 kg/y;
- Soil/ground pollution with petroleum hydrocarbons due to accidental oil spills – volume depends on spill scale.

Drilling-blasting works, during the arrangement of pressure system, will be implemented by the subcontractor company having an adequate permit on these activities. Allocation of special storehouse on the territory of construction camp is intended for the explosive materials deployment. Explosive materials will be daily delivered on the workplaces and remaining materials will be returned in the stock at the end of the day.

Other hazardous wastes will be temporarily kept at the construction camp, in a special facility (20-25 m<sup>2</sup> area wagon-container is recommended). The facility shall be provided with wash stand, as well as with shelves to place waste. Waste shall be labeled.

Hazardous waste generated at construction grounds shall be transported to the temporary storage facility by waste management personnel of a building contractor with use of special vehicles (waste should be removed from construction grounds as accumulated, but at least once per three days interval). After removing from temporary storage facilities final waste management measures (neutralization, utilization, and disposal) should be carried out by adequately licensed contractor.

Soil/ground polluted due to small oil spills (3-5 m<sup>3</sup>) can be remediated in situ (e.g. in situ bioremediation). After large spills remove contaminated soil/ground shall be taken out of the territory for remediation. Spill site shall be recultivated using clean ground. It is rational to transfer polluted soil/ground for remediation to an adequately licensed contractor.

Figure 6.11.1.1. Layout scheme of waste rock disposal area

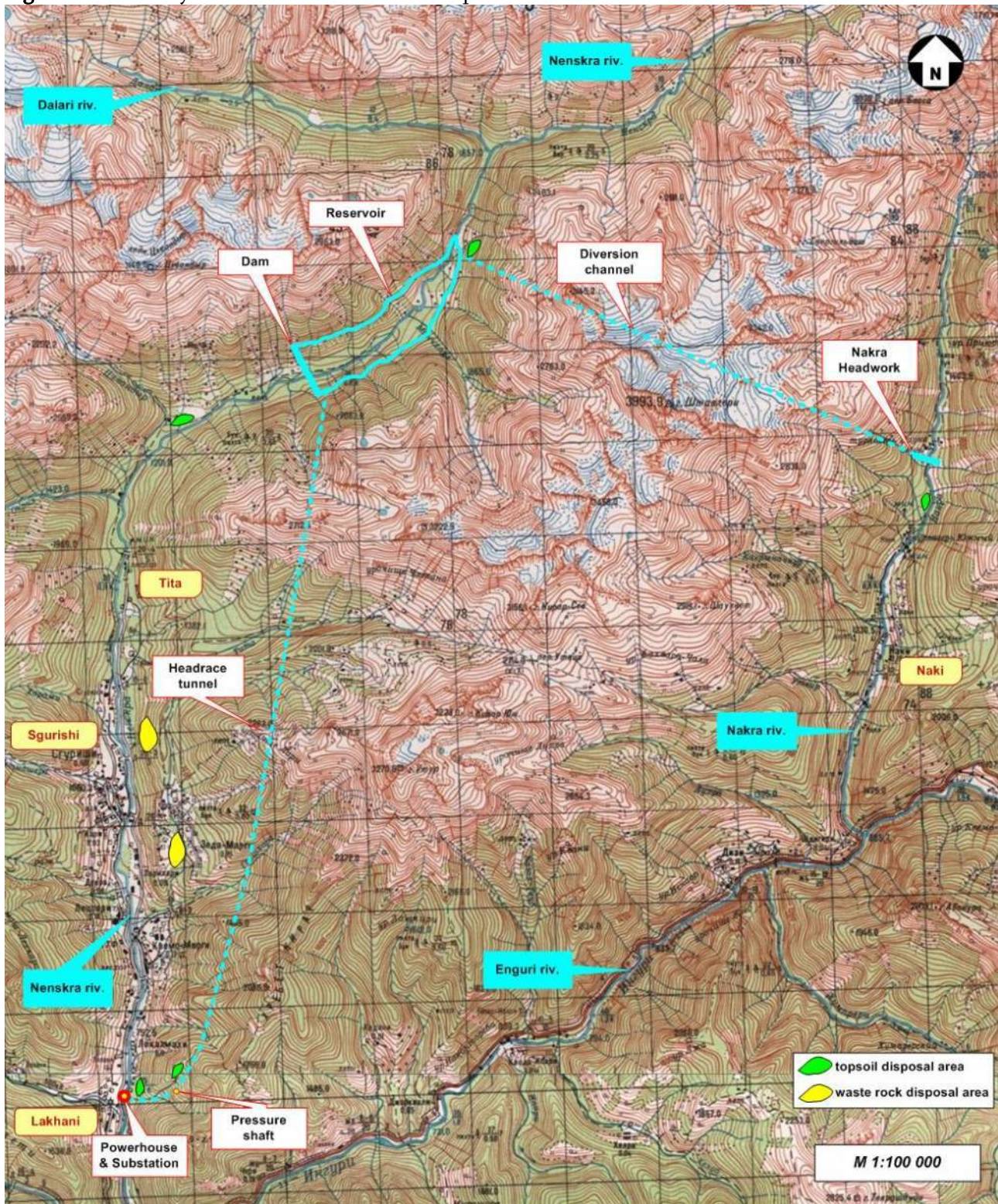

### 6.11.2 Operation Phase

Creation of significant amount of waste is not expected on HPP operation phase. Besides the household waste, there will also be created such hazardous waste, such as:

- Turbine oil waste - 200-250 kg/y;
- Out-of-date and damaged accumulators - 2-3 unit/y;

- Oil filters from building machinery and vehicle - 2-3 unit/y;
- Used rubber tires - 10-15 unit/y;
- Welding electrodes -10-12 kg/y;
- Soil/ground polluted with petroleum hydrocarbons due to accidental oil spills – volume depends on spill scale;
- Ferrous and non-ferrous scrap metal - 30-40 kg/y;
- Fluorescence lamps - 20-25 unit/y;
- Cartridges of laser printers – 2-3 unit/y;
- Solid waste produced from refining of transformer oil -3-5 kg/y;
- etc.

Special warehouse storeroom needs to be allocated for temporary disposal of the hazardous waste, which must be arranged in accordance with the environmental requirements, namely:

- Warehouse floor and walls must be revetment with ceramic tiles;
- Warehouse ceiling must be painted with wet strength paint;
- Warehouse should be equipped with following facilities:
  - Exhaust ventilation system;
  - Wash-stand and tap to wash the territory;
  - Water-intake trap.
- Arrangement of shelves and racks are necessary for the waste disposal;
- Iron grates should be arranged on the doors and windows;
- Waste disposal is allowed only in hermetic packages, which must have proper labeling.

Hazardous waste removal from the HPP territory and further management must be implemented by the contractor company equipped with an appropriate permit on these activities. Hazardous waste management conditions are given in Appendix N 1.

The amount of household waste accumulated in process of HPPs operation, depends on the amount of the personnel. On HPP approximately 50-60 people will be employed. If we consider, that at one worker during the year approximately 0.7 m<sup>3</sup> household wastes will be formed, the total number of household waste will be 42m<sup>3</sup>/y.

Household waste from power unit territory will be removed on sanitary landfill, which will be arranged during the construction phase and which will be operated by the HPP administration and will be also used by local population. Waste generated within the area of headworks will be collected in tight containers and according to the accumulation (but not less than once in 3 days) will be removed to the landfill.

Detailed information on waste management plan for the construction and operation phases is given in Annex 3.

### 6.11.3 Impact Assessment

Table 6.11.3.1. Impact associated with the waste management

Description of impact and impact sources	Impact receptors	Assessment of residual impact					
		Significance	Probability	Impact area	Duration	Reversibility	Residual impact
<b>Construction phase:</b>							
<p><b><i>Impact on solid household waste landfill</i></b> – Increase of the load on landfill</p> <p><b><i>Impact on areas for temporary disposal of solid waste</i></b> – Impact on soil and surface/groundwaters – Visual impact, including pollution of the area with waste.</p> <p><b><i>Impact on areas for temporary disposal of mining waste</i></b> – Impact of water generated on dumping areas on water and soil; – visual and landscape impacts</p> <p><b><i>Impact on drainage water discharge facilities</i></b> – Change of turbidity and pH balance</p> <p><b><i>Impact on the areas where the liquid household waste is formed</i></b> – Pollution of soil in case of leakage</p>	Animals inhabiting within the project influence area, including fish fauna. Population	Direct negative	Medium risk	Areas adjacent to the construction sites and camps	Medium term	Reversible	<b>Low</b>
<b>Operation phase:</b>							
<p><b><i>Impact on areas for temporary disposal of solid waste</i></b> – Impact on soil and surface/groundwater – Visual impact, including pollution of the area with waste.</p> <p><b><i>Impact on the areas where the liquid household</i></b></p>	Animals inhabiting within the project influence area, including fish fauna. Population	Direct negative	Low risk	Mainly power unit area	Long-term	Over time reversible	<b>Very low</b>

<p><i>waste is formed</i></p> <ul style="list-style-type: none"> <li>- Pollution of the area in case of leakage</li> </ul> <p><i>Impact on the liquid household waste discharge facilities</i></p> <ul style="list-style-type: none"> <li>- Deterioration of the water quality</li> </ul> <p>-</p>							
--	--	--	--	--	--	--	--

## **6.12 Visual-Landscape Impact**

### **6.12.1 Construction Phase**

During preparatory and construction works certain landscape and visual impact will occur due to increased traffic, construction sites, presence of personnel and machinery, and building structures. Construction works will cause partial alteration of usual views and landscape.

Since the HPP infrastructure facilities construction sites are away from settlements, the possible visual-landscape changes during the works for the local population will be less noticeable, except for the HPP building. Potential receptors of these changes could be hunters, herdsman and lumbermen. Some construction sites may be seen from the road, though considering distances it should not cause significant discomfort for passengers passing on the road. High rock-fill dam designed on river Nenskra and sharp reduction of water level in the tailraces of dams will be related to the significant negative visual impact.

After finishing the construction all the personnel, machinery, building materials and waste will be moved out of construction sites. Temporary structures will be also dismantled and removed, and the territory will be recultivated. However, the dams, HPPs, power house facilities and substations will be left. All these will cause significant alteration of the landscape and similar changes are unavoidable during implementation of such project.

Impact mitigation is possible by reasonable selection of buildings colors and designs.

### **6.12.2 Operation Phase**

Through the operation phase main landscape/visual impact will be associated with the permanent buildings, out of which particularly noteworthy are 135 m high concrete dam of Nenskra and power unit. It should be noted that part of the power infrastructure will be less visible - project envisages the arrangement of underground diversion pipeline and pressure systems, which will cause less visual impact during the operational phase and will not cause significant fragmentation of habitats. Special negative visual impact is expected due to a sharp decline of water level downstream of the dams. As in case of other similar projects, adaption to them may take place after a while and permanent structures of the HPP will have less impact on visual receptors.

Some impact is also expected due to repair and rehabilitation works. This impact is similar to the one on the construction phase though much smaller. Impact volume will depend on type and scale of works.

### **6.12.3 Mitigation Measures**

Mitigation of visual landscape impact will be possible through implementing the following measures:

- Reasonable selection of color and design of the building, so as to be combined with the environment;
- Temporary structures, materials and waste should be arranged and disposed in relatively invisible places;
- Sanitary and environmental conditions should be protected during the construction and operation phases;
- Recultivation works should be carried out (especially within the construction camps and spoil areas);
- Decorative trees should be planted around the power unit after the completion of construction works.

## 6.12.4 Impact Assessment

Table 6.12.4.1. Visual-landscape impact

Description of impact and impact sources	Impact receptors	Assessment of residual impact					
		Significance	Probability	Impact area	Duration	Reversibility	Residual impact
<b>Construction Phase:</b>							
<p><b>Visual-Landscape Impact::</b></p> <ul style="list-style-type: none"> <li>– Cutting down trees in working areas and in the corridors of access roads;</li> <li>– Removal of vegetation from reservoir basin;</li> <li>– Construction camps and temporary structures;</li> <li>– Disposal of waste rock and other waste;</li> <li>– Construction works and transportation</li> </ul>	Animals inhabiting in the vicinity of the HPP infrastructure and access roads, hunters and persons employed on the production of wood, local population, tourists	Direct, negative	Medium risk	Areas adjacent to construction sites and camps, (Distribution area depends on the terrain, the visibility conditions)	Medium term	Reversible	<b>Mainly low</b>
<b>Operation phase:</b>							
<p><b>Visual-Landscape Impact::</b></p> <ul style="list-style-type: none"> <li>– Change of the river debit;</li> <li>– HPP infrastructure facilities;</li> <li>– Maintenance works.</li> <li>–</li> </ul>	Animals inhabiting in the vicinity, hunters, woodcutters, tourists and others.	Direct, negative. In some cases-positive	Medium, in some cases (Nenskra dam) very high risk	Areas adjacent to the HPP infrastructure Distribution area depends on the terrain, the visibility conditions)	Long-term	Over times reversible	<b>Low</b>



## 6.13 Impact on Socio-Economic Environment

### 6.13.1 Impact Assessment Methodology

During socio-economic impact assessment both, negative and positive impacts are considered. Three-category system is used for assessment of impact – low impact, medium impact and high impact. See assessment criteria in table 6.13.1.1.

**Table 6.13.1.1.** Assessment criteria of socio-economic impact

Range	Category	Socio-Economic impact
<b>Positive</b>		
1	<b>Low</b>	<ul style="list-style-type: none"> <li>– Employment in local population increased by less than 0.1%</li> <li>– Average income of local population increased by 10%</li> <li>– Budget income of the region increased by 1%</li> <li>– Local infrastructure/power supply is slightly improved, resulting improved living/subsistence and economic environment for local population</li> </ul>
2	<b>Medium</b>	<ul style="list-style-type: none"> <li>– Employment in local population increased by 0.1-1%</li> <li>– Average income of local population increased by 10-50%</li> <li>– Budget income of the region increased by 1-5%</li> <li>– Noticeable improvement of infrastructure/power supply, resulting improved living/subsistence and economic environment for local population and development of regional economy</li> </ul>
3	<b>High</b>	<ul style="list-style-type: none"> <li>– Employment of local population increased by more than 1%</li> <li>– Average income of local population increased by more than 50%</li> <li>– Budget income of the region increased by more than 5%</li> <li>– Significant improvement of infrastructure/power supply, resulting significant improvement of living/subsistence environment and encouragement of regional/national economic development</li> </ul>
<b>Negative</b>		
1	<b>Low</b>	<ul style="list-style-type: none"> <li>– Small time delay in availability of resources and infrastructure, which will not affect income of local population, neither long-term negative impact is expected on economic activity of local population</li> <li>– Short time drop of living quality of local population, which will not result in long-term negative impact</li> <li>– No impact on health</li> <li>– Insignificant impact on safety</li> <li>– Long-term, although easy adoptable impact on environment</li> <li>– Increase of local population by 10% due to migration</li> </ul>
2	<b>medium</b>	<ul style="list-style-type: none"> <li>– Small time delay in availability of resources and infrastructure, which will affect lifestyle of population for a short period of time, although long-term negative impact is not expected on economic activity of local population</li> <li>– Short time drop of living quality of local population, which will not result in long-term negative impact</li> <li>– Certain impact on health is expected, but no increase of mortality risk</li> <li>– Certain safety-related risks are expected</li> <li>– Complaints regarding some impacts are expected</li> <li>– Increase of population by 10-30% due to migration</li> </ul>
3	<b>High</b>	<ul style="list-style-type: none"> <li>– Some resources and infrastructures are unavailable for local population, due to which they have to change their lifestyle and resulting long term negative impact on their economic activity</li> <li>– Significant fall of local population life quality</li> <li>– Significant impact on health, resulting probability of increasing mortality risk</li> <li>– Certain safety-related risks are expected</li> <li>– Corrupt deals regarding employment and nepotism are expected</li> </ul>

	<ul style="list-style-type: none"> <li>– Population constantly complains about impacts, resulting conflict situations between population and staff</li> <li>– Local population increased by more than 30% due to migration, resulting unacceptable cultural environment for local population, creation of new settlements is expected</li> </ul>
--	--

## 6.13.2 Impact Description

### 6.13.2.1 Health and Safety

During the construction phase, health and safety risks of population and personnel may be associated with the various harmful impacts of the project, such as atmospheric emissions, increased acoustic background, traffic flow growth and others.

According to the various harmful factors impact assessment on the environment, main risks of health and safety are associated with the noise propagation and traffic flow increase. If we consider, that project area is away from nearest settlement by significant distance, the impact would not be significant.

Social risks are also associated with the health and safety, such as infectious disease (including AIDS and venereal diseases) spreading threat. Impact is associated with the staff and workers migration in process of construction and operation. Appropriate preventive measures will be necessary on both, construction and operation phases. Furthermore, if we consider, that local population will be mainly employed on construction works, the risk of spreading the mentioned diseases is minimal.

Direct impact on health of population and personnel may be: Accidents, power strokes, falling from heights, injuries during working with construction techniques and so forth. To prevent direct impacts protection of safety measures and constant supervision are a must. Safety protection measures include:

- Personnel training on safety issues;
- Provide employees with personal protective equipment;
- Arrangement of restricting, warning and indicative signs for safety of population and personnel;
- Fencing of areas dangerous for health;
- Arrangement of standard medical boxes within areas dangerous for health and construction sites and camps;
- Proper maintenance of vehicles and equipment;
- Maximum protection of the safety rules, speed limits during transportation related activities;
- Limitation of usage of roads in settled areas;
- Control and prohibition of unauthorized and unprotected access to the construction site;
- Regular assessment of risks to determine specific risk factors for population and for management of such risks.
- Insurance of staff working on heights ropes and special mountings;
- Recording of incidents and accidents.

In addition:

- Implementation of all measures to avoid ambient air, water and soil quality deterioration. Carry out noise mitigation measures.

Additional preventive measures for health and safety are considered in "Emergency Response Plan".

### 6.13.2.2 Availability of Resources

As mentioned, the large part of the project area is a state property (state forest lands). After completion of construction works, the areas used for construction sites will be recultivated and only HPP communications deployment locations will be permanently lost, including area to be covered with reservoir water ( $\approx 3.8 \text{ km}^2$ ).

Part of the project area is intensively used by local population for grazing, collecting firewood, gathering of wild fruits and other purposes. In case of project implementation, population will permanently lose the possibility of using these territories, which will cause a low but negative impact on their economic situation.

Significant amount of inert materials (sand, gravel, and stone) will be required for the construction of the dams, extraction of which is planned in surrounding areas. The exact number of inert materials necessary for the construction works implementation will be determined after the detailed engineering project is developed. It should be noted, that for production of inert materials, based on appropriate results of laboratory research, the waste rock of diversion tunnel may be used, which would significantly reduce the expected impact risk.

Timber material required for the construction works will be purchased from local wood processing enterprises, which is a positive influence on the improvement of the local economic activity.

An important natural resource used in process of construction works is water, which is taken from river Nenskra. Considering the river flow, the impact due to industrial water intake will be insignificant.

### 6.13.2.3 Land Ownership and Use

As given in previous chapter, the main part of land plots necessary for the project implementation are located on the state forest fund territories and represents public usage land for the population (cattle pasture, wood, gathering wood products and others). If we consider the significant distance between the project area and settlement, they are not intensively used for public purposes. In general it can be said, that project implementation will be associated with 3.7-3.8 km<sup>2</sup> state owned land loss, 95% of which is covered with forest. Therefore, expected impact should be assessed as high negative impact. It should be noted that the procedures related to the exclusion of the areas occupied by the forestry fund will be conducted during the public discussion of the EIA.

Only 4 privately owned lands are within the project influence area, which are located on the territory selected for the arrangement of construction infrastructure for the power unit. Lands will be purchased based on the mutual agreement, in accordance with the procedures considered by the environmental and social policy of EBRD.

Areas for the arrangement of the HPP communications and construction infrastructure are selected so that the project would not be related to physical resettlement, while only 4 privately owned lands will be subjected to economic displacement, which should be considered as a positive impact of the project. However, as mentioned above, significant part of the project area is actively used by population and project implementation will limit their activities to some extent.

During the meetings conducted in the environmental impact assessment process, discontent related to property rights have not been expressed. Complaints or disputes related to property rights are not recorded by March 2014.

#### 6.13.2.4 Employment

Construction works will be performed in two stages. In the first stage, arrangement of Nenskra dam, diversion tunnel and power unit is planned, which will take about 6.0-6.5 years. After the operation of the HPP, the second stage of construction works will be launched, which will last for 5.0-5.5 years. 500-600 people will be employed at different stages of the construction and 50-60 people during the operation phase. In addition, on the construction phase activation of construction materials and services business activities is expected, which is the guarantee of additional job creation. This will be significant positive impact on local population employment and social condition and may be considered as minor positive impact for the region.

According to the survey conducted during the EIA process, the local population has some work experience in construction activities. Also, JSC "Nenskra" is planning to train local young people for the purpose of employing them on the construction works. Targeted training of local youth is also planned in the respective universities.

However, there are certain types of negative impact related to the employment, in particular:

- Employment expectations and dissatisfaction of local population;
- Violation of workers' rights;
- Reduction of employment and dissatisfaction after the completion of the construction works;
- The risk of conflict between the local and non-local employees should be taken into consideration.

In order to avoid such kind of conflicts between the local population and employees, the following measures should be taken:

- Development of the staff recruitment policy and publishing in local (office) and municipal (administrative building);
- Employment on the basis of appropriate testing;
- Signing individual work contract with each employee;
- Agreement signed with personnel should include Articles on all plans, procedures and mitigation measures, as well as Articles related to monitoring of security plans and reports on accidents;
- Providing information about their work - code of conduct;
- All non-local employees should be informed about local habits and culture;
- While purchasing different material, preference should be given to local products in order to support local enterprises;
- Develop and practice a grievance mechanism.
- Complaints of the personnel will be recorded.

#### 6.13.2.5 Demographic Changes

Project does not provide a permanent settlement construction for workers, because the local population (on average 80% of all personnel) will be mainly employed in process of construction and operation. Significant demographic changes are not expected on any of the phases of project implementation.

During the construction phase, populations that left region for seeking jobs may return to their homes, which will have a positive impact on the demographic conditions.

According to the criteria given in impact methodology, corresponds to low impact.

### 6.13.2.6 Input in Economy

The implementation of the project of the hydroelectric power station construction and operation will significantly contribute to social and economic development of Mestia municipality and socio-economical development of Samegrelo-Zemo Svaneti region. In the construction of the HPP building materials from local resources will be used, which will encourage the activity of building material producers. The favorable impact of local population employment is also noteworthy.

Implementation of the HPP project will be related to a significant investment and tax revenue growth, which is important for the country's economic development.

After the HPP has been launched the power system will get extra energy, which is extremely important for the country's independence with respect to power resources. Moreover, the HPP is of seasonal regulation and state power system will receive extra energy during the winter.

During the operation phase, both the central budget and the local budget will receive additional income. With this regard, noteworthy is the local budget revenues, in particular: property tax will be transferred into the local budget (1% of balance value of HPP communication) and land tax (approximately 380 ha), which will not be less than 10-12 million GEL per year. Considering this, the project will have a significant positive impact on the socio-economic development of Mestia Municipality.

### 6.13.2.7 Road Damage and Intensification of Traffic Flows

The road crossing the villages of Chuberi community and passing Nakra village will be used for construction materials transportation during the construction works. Currently, rehabilitation activities were carried for the access road to Nenskra dam. The rest of the roads require rehabilitation works. Further deterioration of road surface is expected due to intensive transportation, especially during the heavy equipment movement.

Implementation of rehabilitation of local roads is envisaged prior to starting the construction works, which also includes several bridge arrangement or rehabilitation of existing ones.

Significant mitigation measure for minimizing the negative impact on traffic flows in settlements is that the inert materials (stones, sand and gravel) quarries are found within their intensive use areas. In addition, waste rock withdrawn from the tunnels will be used for concrete production. All this will reduce traffic intensity by about 50-60% within the populated areas.

In order to reduce the risk of dissatisfaction of the local population, construction works will be planned so that to minimize the potential negative impacts, namely:

- Systematic control of construction equipment and vehicles;
- Optimum access - bypass routes will be selected;
- Limited movement of vehicles (especially caterpillar technique) on public roads;
- Notify population about work time and period;
- All damaged sections of road will be restored as soon as possible in order to be available to the public;
- Specially allocated personnel will control the movement of vehicle within the settlements;
- Speed limiting road signs will be arranged within the settlements;
- Warning, pointing and prohibiting signs will be arranged in the vicinity of the construction sites;
- Complaints will be recorded and appropriate response will be ensured.

Intensive traffic is not expected during the operation phase of the HPP. There will be some increase during the maintenance works, but will not be significant compared with the construction phase.

The HPP administration will permanently repair damaged access roads to the HPP communications, which will improve the conditions for the movement of the local population, which is important for the social point of view.

### 6.13.3 Impact Assessment

Table 6.13.3.1. Socio-Economic Impact

Description of impact and impact sources	Impact receptors	Assessment of residual impact					
		Significance	Probability	Impact area	Duration	Reversibility	Residual impact
<b>Construction Phase:</b>							
<p><b><i>Impact on Land Ownership and Use</i></b></p> <ul style="list-style-type: none"> <li>– Impact on neighboring land owners - any kind of activities on their lands, or any property damage;</li> <li>– Limited use of forest, water and land resources.</li> </ul>	Local population	Direct Negative	Medium risk	Chuberi community villages, Naki village	During the construction phase only	Reversible	Considering mitigation measures – <b>low</b>
<p><b><i>Positive impact related to employment</i></b></p>	Local population	Direct Positive	High probability	Mestia Municipality (especially Chuberi and Naki communities)	During the construction phase only	Reversible	<b>High</b>
<p><b><i>Negative impact related to employment:</i></b></p> <ul style="list-style-type: none"> <li>• Employment expectations and dissatisfaction of local population;</li> <li>• Violation of workers' rights;</li> <li>• Reduction of employment and dissatisfaction after the completion of the construction works;</li> <li>• The risk of conflict between the local and non local employees should be taken into consideration.</li> </ul>	Personnel and local residents	Direct Negative	Medium risk	Mestia Municipality (especially Chuberi and Naki communities)	During the construction phase only	Reversible	<b>Low</b>
<p><b><i>Input in economics and employment</i></b></p> <ul style="list-style-type: none"> <li>– Stimulation/development of construction business and its satellites business activities</li> <li>– Establishment of work places</li> </ul>	Municipal economy, construction and other business activities, the local population	Direct Positive	High probability	Impact area may be regional and national scale	During the construction phase only. Some of the impact may be long-term (e.g.	Reversible	<b>High positive</b>

– Increased budget receipts					improvement of infrastructure)		
<b>Road damage</b> – Movement of heavy equipment <b>Loaded traffic</b> – Movement of any machinery <b>Limited movement</b> – Blocking roads in order to implement works safely	Local infrastructure, population	Direct Negative	High risk	Roads used for the project purposes, which are also used by population	During the construction phase only	Reversible	<b>High</b> - Considering mitigation measures – <b>medium</b>
<b>Health and safety:</b> – Direct (e.g.: accidents, power stroke, falling from heights, injuries from construction techniques, etc.); and – Indirect (emissions, increased acoustic background, climate change, contamination of water and soil).	Personnel and local residents	Direct or indirect Negative	Medium risk - Considering mitigation measures – low risk	Construction sites and nearby residential zones	During the construction phase only	Reversible	<b>Medium</b> - Considering mitigation measures – <b>low</b>
<b>Operation phase:</b>							
<b>Availability of resources:</b> – Reduced runoff of Nenskra and Nakra rivers; – Reduction of land resources for public use (pastures, wood production, etc).	Local residents, for whom resources will be limited	Direct Negative	High risk	Population of Chuberi community	Long-term	Irreversible	<b>Medium</b>
<b>Local roads:</b> – Periodic rehabilitation of roads (Positive social impact)	Local population	Indirect, Positive	Medium probability	Nearby residential zones (Chuberi and Naki communities)	Long-term	-	<b>High</b>
<b>Improvement of transport infrastructure</b>	Local infrastructure, population	Direct Positive	Medium probability	Nearby residential zones (Chuberi and Naki communities)	Long-term	Reversible	<b>High</b>



<p><b><i>Input in economics and employment</i></b></p> <ul style="list-style-type: none"> <li>- Additional jobs;</li> <li>- Increased budget revenues.</li> <li>- Generation of additional power</li> </ul>	<p>The country's economic conditions, local production and population</p>	<p>Direct Positive</p>	<p>High probability</p>	<p>Impact area may be regional and national scale</p>	<p>Long-term</p>	<p>Irreversible</p>	<p>Local and regional levels - <b>high</b>; At state level - <b>High</b></p>
<p><b><i>Health and safety:</i></b></p> <ul style="list-style-type: none"> <li>- Changes in local climate due to the reservoir operation</li> </ul>	<p>Population of Chuberi community</p>	<p>Direct Negative</p>	<p>Low probability</p>	<p>3-5 km section downstream of Nenskra dam</p>	<p>Long-term</p>	<p>Irreversible</p>	<p>Low</p>

## 6.14 Impact on Cultural Heritage

### 6.14.1 Impact Assessment methodology

**Table 6.14.1.1.** Assessment criteria for impact on the cultural heritage

Range	Category	Damage/Destruction of Cultural Heritage
1	Very Low	The risk of impact is insignificant because of the large distance from the object or because of the used method of construction/operation
2	Low	1-10% of the insignificant object may be damaged/destroyed
3	Medium	10-25% of locally significant object may be damaged/destroyed
4	High	25-50% of locally significant object may be damaged/destroyed, or the object of regional significance may be damaged
5	Very high	50-100% of locally significant object may be damaged/destroyed, object of regional significance may be damaged, national or international significance protected object may be damaged

### 6.14.2 Impact Description

#### 6.14.2.1 Construction Phase

The risks of impact on the cultural heritage during the construction phase would not be high, as it has been identified during the field works, no historical, architectural or archeological sites were found in the areas of project influence has not been found.

Archeological sites can be discovered later during ground works. In this case a building contractor is obliged to immediately suspend works and invite specialists from authorized organs for the expertise by Georgian legislation in order to assess site importance and make decision about continuation of works.

#### 6.14.2.2 Operation Phase

Indirect impact on cultural heritage is possible during the operation phase, which will be related to the local climate changes caused by intensive evaporation of water from the surface of the reservoirs, particularly increase of air humidity.

According to the results of local climate impact assessment, the risk of the impact on cultural heritage is not high.

### 6.14.3 Mitigation Measures

In process of construction works, the signs of archeological monument or some artifact identification the requirements of Georgian law on “Cultural Heritage Protection” must be considered, including: the works should stop immediately and the study of the archeological monument should be conducted by the authorized specialist on these activities. Continuation of works is possible after determination of value of the historical monument and on basis of obtaining appropriate permission.

#### 6.14.4 Impact Summery

Phase	Description of Impact and Impact Sources	Impact Receptors	Impact Description and Assessment
Construction and operation Phase	<p><b><i>Impact on Cultural heritage</i></b></p> <ul style="list-style-type: none"> <li>- Direct impact is not expected;</li> <li>- Indirect impact is possible on the monuments 3-5 km away from the reservoirs.</li> </ul>	Object of cultural heritage, population, touristic environment	<p>Damage or destruction of monuments of cultural heritage is not expected</p> <p><b><u>Significance:</u> Low</b></p>

### 6.15 Expected Environmental Impact of Nenskra Reservoir and Cumulative Impact of Enguri Reservoirs (Nenskra, Khudoni, Jvari) on Local, Regional and Global Climate

#### 6.15.1 Physical-Geographical Characteristics of Enguri Reservoir Cascade and Its Catchment Area and Hydro-Meteorological Learnability

##### 6.15.1.1 Physical-Geographical Characteristics of the Basin and Cascade Morphometry

The catchment basin of river Enguri is meridian distribution territory: area 4060 km<sup>2</sup>. Average height 1840 m, highest 5201 m (peak Shkhara), length 215 km and average width 19 km.

The river starts at 2520 m height by 2 glacier flow connection.

Its fall is 2520 m, upper and middle body is located in the “Svaneti cave”. This fact has an essential impact on its water regime, because the atmospheric precipitation vertical distribution is reverse-proportional of the location height.

More than 240 tributaries connect to the river, the most abundant among them is Mukhura (27km), Dolra (20 km), Nakra (22 km), Nenskra (46 km), Tkheishi (18 km), Magana (24 km) Dajumi (61 km).

The river is feeding from glaciers, due to which it is so water abundant in summer months [11, 12], that causes a big interest in terms of energy and municipal water supply. Its energy potential is studied in 1970-1980 years [10, 13] and on basis of this studies HPP construction sections are selected on it [10]. Engurhesi is operating since 1978, the regulation basin of which is Jvari (Enguri) reservoir. It is created up from village Jvari, on 4<sup>th</sup> km. This reservoir by its volume is the largest in Georgia and second among the Caucasian mountainous reservoirs, after Chirkei reservoir (Table 6.15.1.1.1.).

Currently, preparation works for Khudoni HPP construction re-conservation are being held. Its construction begun in 1980’s, but stopped in 1990’s due to social-political events. This reservoir in terms of environmental impact creates the united system together with the Jvari reservoir, because this actually will be the continuance of the last mentioned. In this case, reservoirs flooded water surface length will be 20.0 km and mirror surface area will reach ~19,0 km<sup>2</sup>. The third step of the cascade will be Nenskra reservoir. This reservoir will be built for energy purposes as well on one of the largest tributary of river Enguri, river Nenskra.

**Table 6.15.1.1.1.** Morphometry of Enguri reservoirs cascade

Reservoir	Action time, year	Morphometry of the basin				Morphometry of the reservoirs				
		Area, km <sup>2</sup>	Length, km	Height, m		Volume, million.m <sup>3</sup>	Elevation level, m	Mirror surface km <sup>2</sup>	Depth, m	Length, km
				Average	Greater					
Jvari	1978-2010	3170	131	2210	5021	1093	510	13,5	226	13,0
Khaishi	~2014	3130	118	2230	5021	364	720	5,3	200	7,0
Nenskra	~2015	470	42	2300	3994	200	1430	5,5	110	10,7

According to its characteristics it will be a typical mountain reservoir, which will be created by river closing with 120 m high dam on 35 km distance from Khudoni reservoir dam. Its mirror surface will reach 5,5 km<sup>2</sup>, length 10,7 km, volume 200 million m<sup>3</sup> and the largest depth will be 110.

Nenskra reservoir will be 52,0 km away from Jvari reservoir dam. According to the reservoirs deployment and morphometry, if they do not bounder, cascade impact on the environment and climate must be discussed as two basin impact on the environment. The lower reservoir mirror surface will be created by Jvari and Khaishi reservoirs mirror surfaces ( $\Sigma F=19,0$  km<sup>2</sup>), which are tight on each other and upper, Nenskra reservoir mirror, the mirror surface of which will reach 3.0 km<sup>2</sup>.

Similar reservoirs operation and observation long term data analysis confirm, that before the study problem realization the following should be strictly defined:

- Reservoir regulation type;
- Internal annual change of its morphometry, especially volume and mirror surface;
- Ice layer staying dates, if the reservoir is freezing;
- Strong winds direction, seasonal distribution and duration;
- Simultaneousness of main meteorological elements with mentioned events and with their internal annual changes

In case of ignorance or insufficient considering of these conditions, the study results will be sharply diverted from the actual and error value will be more.

### 6.15.1.2 Meteorological Learnability and Research Methods of Enguri Reservoir Cascade

In the river Enguri basin before 1990's more than 20 meteorological station and post was functioning, but their number reduced to 4 at 2010.

Therefore, in order to assess the meteorological events in Nenskra reservoir basin, boundary river Sakeni basin (Upper Abkhazia) meteorological stations data (until 2008) functioning in Zemo and Kvemo Azhara and climatic information of analog-reservoirs basins must be used.

11 sediment-measurer posts were functioning in cascade basin only on 4 of them are implementing the observations in now days. Lakhami sediment-measurer post was conducting the direct observations on Nenskra reservoir basin.

In the bordered basins, Khaishi and Azhara meteorological stations and posts were selected by representability principles (Table 6.15.1.2.1.). The statistical lines created by their observation data are of sufficient duration (exceed 30 years) and to characterize the climate of study basin with satisfactory precise.

**Figure 6.15.1.2.1.** Mutual disposition of Enguri cascade reservoirs and local circulation zones within their action regions

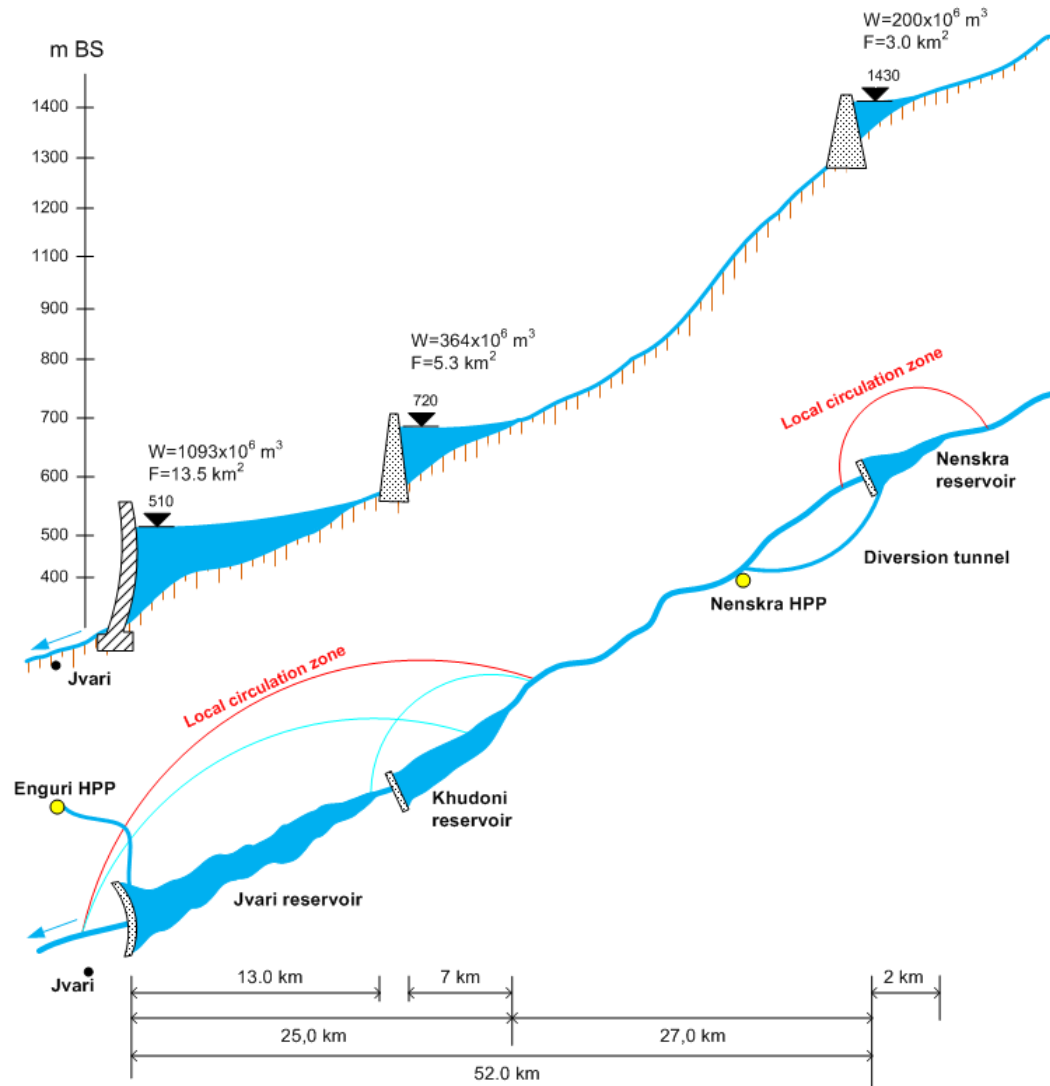

**Table 6.15.1.2.1.** Meteorological study of Nenskra reservoir construction region

Meteorological Station	Height asl	Meteorological elements and observation period, year							Comments
		Air temperature	Wind	Atmospheric precipitation		Relative humidity	Saturation deficit	Water vapor resilience	
				Rain	Snow				
Mestia	1441	1936-2010	1940-1990	1938-1990		1960-1990	1936-1990	1936-1990	Operating
Becho	1270	1912-16, 1931-44 1945-58	1947-1990	1912-1917; 1927-1990	1912-1917 1927-1990				Closed
Khaishi(Nenskra confluence)	730	1933-1990	1936-1990 1940-1990	1936-1990	1936-1990	1936-1990	1936-1990	1936-1990	Closed
Jvari	268	1936-1990	1941-1990	1931-34; 1936-1990	1931-1934 1936-1990	1941-1990	1941-1990	1941-1990	Operating
Engurhesi dam	280	1963-1980		1963-1980					Closed
Zemo Azhara	952	1934-1954	1936-1954	1936-1954	1908-1954	1937-1954	1937-1954	1937-1954	Occupied
Kvemo Azhara	595	1953-1990	1953-1990	1953-1990	1953-1990	1953-1990	1953-1990	1953-1990	Occupied
Lakhamula	1200			1932-1942, 1944-1990	1936-1990				Closed
Lakhami	800			1935-1948, 1950-1990	1948-1990				Closed

### 6.15.1.3 Realization of Analysis Method

The possible area of Nenskra reservoir construction is mountainous, sparsely populated region. In its basin only one, Lakhamula sediment-measurer was operating and it stopped functioning in 1990's (Table 2). Due to this, the analog method use will be necessary for studies sufficient reliability and effectiveness, which includes the use of local climate defining conditions and meteorological information, as well as the use of meteorological network observation data from the adjacent basins. This kind of information is orientation climatic indicators.

Study region climatic regime assessment by 75-95% provision is available by analog method and this assessment will be as much precise, as more similarity will be between study and analog basins.

Tsalka and Shaori reservoirs are used as analog for the Nenskra reservoir, which by morphometry and climatic indicators acting in basin is getting most similar to the study object.

Analog reservoirs are located in the low and moderate mountain zones (1000-2000). Among them, Shaori reservoir which was created by closing the river Didichala, during filling in (normal flood horizon - *NFH*) fill up to 1133,5 m above the sea level. its volume on this elevation is 91 million m<sup>3</sup>, mirror surface 13,0 km<sup>2</sup>, largest depth 15,2 m, regulation type – seasonal (fills up with flood runoffs, empties in the rest of the time of year) and is covered with sustainable ice cover from December to April.

Tsalka reservoir, which is created by river Ktsia closing, is located on 1512 m above sea level during filling (*NFH*) Its capacity on this elevation is 313 million m<sup>3</sup>, mirror surface 33,7 km<sup>2</sup>, largest depth 25,0 m, regulation type \_ seasonal, frozen from November until April.

The severity (G) of impact on the reservoir climate with other characteristics is the mirror area (F) function:

$$GG=f(.,F,..) \quad (1)$$

The impact on reservoir climate is analyzed in accordance with statistical lines of observations of sediment-measurer and meteorological stations operating close towards its mirror perimeter, (1) taking into account the dependence.

According to this data, Shaori reservoir influence on climate in direction of Nikortsmina ~7,0 km and in direction of Tlughu ~6 km is distributed. Tsalka reservoir, the mirror surface of which 2,5 times exceeds Shaori mirror surface and 6 times exceeds mirror surface of Nenskra, the impact is essential to the west in direction of village Beshkenasheni (Beshtasheni) on 10-15 km and on 8-10 km to the east and south, in direction of villages Santa, Kizilkilisa and rekha. Korsu volcanic hill significantly reduces the impact of the reservoir on microclimate of Tsalka, the hill height to reservoir mirror is ~120 m.

Therefore, analog reservoirs impact on climate is actual in the local circulation area, in horizontally local wind (breeze, mountain-ravine) and vertically condensation level limits. The height if this is direct proportionally depended on reservoir confining ravine slopes inclination and height and passes on an average of 0.5-0.8 km from the reservoir mirror.

According to the analog method, the area of impact of the Nenskra reservoir will be bordered by local circulation processes, including mountain-ravine wind distribution and evaporated water condensation level location. The area of this impact will be actual from reservoir along the ravine on 2-4 km, vertically on 0,4-0,6 km.

### 6.15.2 Background Factors of Current Climate Changes and Regime of the Meteorological Elements

#### 6.15.2.1 Background factors of current climate changes

Current climate warming has an impact on meteorological elements in cascade basin. Here, it is clearly shown the long term change of these elements with 90 year periodicity (Figure 6.15.2.1.1.). Such changes of the air temperature coincides to the 90 year cycle of the sun. Previous fluctuation of temperature begun in 1890's, reached the peak in 1940's and ended up in 1986-1990's. The characteristic of such temperature fluctuation is that at the end of the cycle the temperature of air exceeded average temperature of 1900's by 0.3-0.5°C. The current fluctuation started in 1990's and according to its decade growth amount it is expected, that if this process will develop like the previous one, the temperature will grow similarly fast and at 2020-2025 will exceed the maximum of 1940's. Its rate during 1990-2010 confirms this, when it raised by almost 1,00C. The other background factors of climate change in the study area are humidity, atmospheric precipitation and strong winds frequencies increase.

Such conclusions are obtained as a result of such complex studies, which was conducted in accordance with the first (1998-1999) and second (2009) Georgian National Post of Framework Convention on Climate Change.

**Figure 6.15.2.1.1.** Air (above) and sea water average temperatures changes in Georgian seacoast

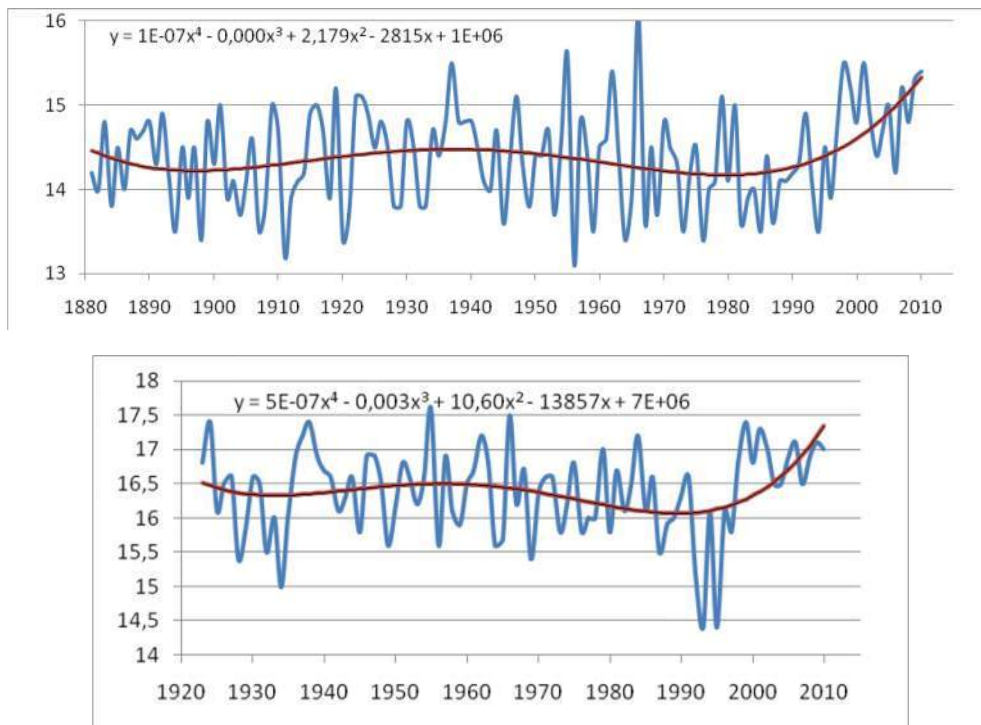

#### 6.15.2.2 Basic Meteorological Elements Regime

The coldest month in the vicinity of Nenskra reservoir is January (Table 6.15.2.2.1.). Its average temperature is -4-6°C, absolute minimum goes down to -35°C. The winter in here is almost 5 months; the air temperature is negative from the second half of November until the second half of April. Short, cool summer, which is warmer in July-August period, is characterized by sharp change of the temperature. Even in the warmer month, July (16,4°C), sometimes the temperature goes down to 10-12 12°C, which is the result of diversion caused by the air masses slide from the high ridges of the Caucasus (Tables 6.15.2.2.2-6.15.2.2.4.). The fact should be noted, that temperature decrease to 0°C is even



expected in August. The absolute maximum of the air temperature is also observed in this month 35°C, absolute minimum -35°C is measured in January. Accordingly, the highest amplitude of the air temperature in here reaches 70 °C.

**Table 6.15.2.2.1.** Average air temperature

Station	Height	I	II	III	IV	V	VI	VII	VIII	IX	X	XI	XII	Year
Mestia	1441	-6.0	-4.6	-0.5	5.2	11.0	14.0	16.4	16.3	12.0	7.1	1.6	-4.1	5.7
Becho	1270	-4.7	-3.3	0.3	5.9	11.5	14.4	17.2	17.0	12.6	7.7	2.4	-2.9	6.5
Khaishi	730	-0.1	1.0	5.0	10.3	15.4	18.3	20.8	21.0	16.9	11.4	5.8	1.3	10.6
Jvari	268	4.3	5.0	8.1	12.5	16.9	19.7	21.9	22.2	19.4	15.8	11.2	7.0	13.7
Zemo Azhara	952	-0.6	0.4	3.7	8.8	13.3	15.0	18.8	18.7	15.2	10.7	6.3	2.1	9.4
Kvemo Azhara	595	-0.7	0.5	4.9	10.1	14.7	17.6	20.1	19.8	15.7	10.8	5.8	0.8	10.0

**Table 6.1452.2.2.** Absolute minimum air temperature

Station	Height asl	I	II	III	IV	V	VI	VII	VIII	IX	X	XI	XII	Year
Mestia	1441	-35	-30	-26	-16	-6	-2	-1	0	-5	-14	-24	-30	-35
Becho	1270	-33	-29	-22	-12	-5	-1	0	1	-4	-12	-22	-28	-33
Zemo Azhara	952	-21	-20	-17	-7	-1	3	5	5	-2	-10	-12	-14	-21
Kvemo Azhara	595	-21	-20	-16	-7	-2	4	5	4	-3	-10	-14	-16	-21
Khaishi	730	-22	-18	-14	-5	0	6	8	7	1	-5	-14	-19	-22
Jvari	268	-21	-18	-13	-4	0	8	9	9	3	-5	-13	-17	-21

**Table 6.15.2.2.3.** Average maximum air temperature

Station	Height asl	I	II	III	IV	V	VI	VII	VIII	IX	X	XI	XII	Year
Mestia	1441	0.0	2.0	6.2	12.0	18.1	21.6	21.6	24.8	20.4	14.8	8.5	1.9	12.9
Becho	1270	1.7	4.0	7.3	13.4	19.4	22.4	26.0	26.0	21.4	15.7	8.8	3.6	14.1
Zemo Azhara	952	3.4	4.8	8.9	15.3	20.0	22.3	24.8	25.0	21.5	16.3	11.3	6.4	15.0
Kvemo Azhara	595	3.4	5.7	10.5	16.9	22.2	24.4	26.5	26.8	22.7	18.5	11.7	4.9	16.2
Khaishi	730	2.7	5.1	10.6	17.3	22.8	25.2	27.2	27.7	23.6	16.9	9.1	4.1	16.0
Jvari	268	7.9	9.2	13.0	18.4	23.1	25.4	27.0	27.7	25.0	21.0	15.8	10.6	18.7

**Table 6.15.2.2.4.** Absolute maximum air temperature

Station	Height asl	I	II	III	IV	V	VI	VII	VIII	IX	X	XI	XII	Year
Mestia	1441	11	15	23	27	27	30	34	35	33	27	22	14	35
Becho	1270	12	18	24	28	31	34	37	38	34	29	26	16	38
Zemo Azhara	952	16	22	27	33	33	36	39	39	35	32	25	21	39
Kvemo Azhara	595	16	22	28	33	35	36	40	41	37	33	26	21	41
Khaishi	730	14	20	29	32	34	37	39	41	37	31	26	20	41
Jvari	268	21	25	33	35	36	39	40	40	40	35	29	22	40

On the study reservoir water area impact seasonal, day-night and Fion, mainly south and north Rumb winds, which is limited by ravine orientation (Table 6.15.2.2.5). Mountain-ravine winds will actively

participate in the local circulation processes development, which will move in direction of reservoir and its tributaries, from reservoir to mountain ridges and back. They will carry up the humid from the reservoirs on 0,7-0,8 km and horizontally on 3-4 km, will carry up the evaporated humid and increase the humidity in the local processes action area.

The wind speed, due to the surrounding of upper part of Enguri ravine (Svaneti cave), is relatively low. Its average values is 1,3-1,5 m/s (Table 6.15.2.2.6.).

The strongest winds in here are seasonal winds. Every year it is expected, that their speed, the speed on 8,0 m height will reach 16 m/s, 21 m/s speed wind is expected in every 5 years and 26 m/s wind speed in every 20 years..

Windy days are more recent in April-May, seasonal wind action time

**Table 6.15.2.2.5.** Wind direction and no wind days repeated (%)

Station	N	NE	E	SE	S	SW	W	NW	No wind days
Mestia	30	16	5	3	6	18	3	4	67
Becho	24	7	1	2	3	25	19	19	59
Zemo Azhara	15	4	1	7	17	15	7	34	48
Kvemo Azhara	4	22	10	2	2	35	21	4	74
Khaishi	3	11	54	1	0	2	23	6	52
Jvari	55	4	3	4	20	6	5	2	13

**Table 6.15.2.2.6.** Average wind speed (m/s)

Station	Vane	I	II	III	IV	V	VI	VII	VIII	IX	X	XI	XII	Year
Mestia	11	0.6	0.8	1.2	1.6	1.7	1.4	1.4	1.2	1.0	0.7	0.6	0.5	1.1
Becho	11	0.6	0.7	1.1	1.3	1.5	1.3	1.6	1.1	1.0	0.7	0.5	0.4	1.0
Zemo Azhara	11	1.0	1.0	1.1	1.3	1.3	1.3	1.4	1.3	1.1	1.1	1.1	1.0	1.2
Kvemo Azhara	11	0.3	0.5	1.1	1.2	1.2	1.4	1.4	1.1	0.8	0.7	0.4	0.3	0.9
Khaishi	10	2.0	2.0	2.3	2.8	2.6	2.6	2.6	2.5	2.0	1.8	2.0	2.2	2.3
Jvari	10	5.9	6.3	4.6	4.4	3.8	2.8	2.2	2.7	3.5	5.4	6.4	7.8	4.7

**Table 6.15.2.2.7.** Number of days with strong wind ( $\geq 15$  m/s)

Station	Height	I	II	III	IV	V	VI	VII	VIII	IX	X	XI	XII	Year
Mestia	1441	0.04	0.09	0.2	0.4	0.8	0.6	0.4	0.7	0.3	0.2	0.04	0.04	4
Becho	1270													
Zemo Azhara	952													
Kvemo Azhara	595													
Khaishi	730	0.04	0.2	0.4	0.8	0.7	0.7	0.2	0.4	0.1	0.0	0.0	0.0	1
Jvari	268	8.5	8.4	5.2	5.3	4.8	1.6	1.4	2.3	3.0	7.0	7.0	11.0	66

**Table 6.15.2.2.8.** Wind vane speed (m/s) with different probability

Stations	Possible wind speed (m/s) once				
	Annually	In 5 years	In 10 years	In 15 years	In 20 years
Mestia	16	21	24	25	26
Kvemo Azhara	10	13	14	15	16
Khaishi	14	16	17	18	19
Jvari	36	44	47	49	51

In the basin of river Enguri and specifically in Nenskra ravine, atmospheric precipitation distribution is reverse-proportional of location height, (table 6.12.2.2.9). By Lakhmi sediment-measuring observation in the lower flow of river Nenskra, on 800-1000 m height sediments annual sum is ~1270 mm. By location height and atmospheric precipitation vertical distribution curve conducted extrapolation sediments annual amount in the Nenskra reservoir vicinity is 1200-1500 mm. After reservoir will start the functioning the evaporated moisture major part (70-80 %) will stay within the local circulation area, the rest will be removed away from this area by the strong winds. By considering this information and due to the current climate change characterized by moisture growth it is expected, that sediments number on the reservoirs water area to increase up to 1300-1350 mm.

Sediments internal annual distribution in the study area is unequal. Its major amount (~60 %) comes in warm period (IV-X months). Most sediment-abundant is October (132 mm) and the dry one is August (90 mm).

Similar to the analog-reservoirs, here the ice events will start in December and from January to April its whole mirror will be covered with the ice.

**Table 6.15.2.2.9.** Number of sediments (mm) in Jvari reservoir basin

Point	Height asl	Sediments mm.
<b>Jvari</b>	<b>268</b>	<b>2158</b>
Jvari dam (in tailrace)	280	2097
Chuberi	600	1825
Khaishi	730	1429
Lakhmi	800	1267
Dizi	1120	1110
Lakhamula	1200	1019
Becho	1270	988
Mestia	1441	918

According to the conducted studies, Nenskra reservoir impact will be negative: evaporation and wind speed will increase, this will have an essential impact on climate and environment as a whole. In accordance with its mirror morphometric, ravine slopes inclination and height the impact area includes the territory 16-18 km upstream the river, 4,5 downstream and 0,8-1,0 in height.

In addition, this impact will be significant from the start of ice events until stable ice creation and in period of ice breakage. This process will be shown by creation of early freezes, which can damage buildings and cause the death of tree buds and sprouts.

**Table 6.15.2.2.10. Atmospheric precipitation (mm)**

Station	Height asl	Observation time, year	Basin	I	II	III	IV	V	VI	VII	VIII	IX	X	XI	XII	Cold XI-III	Warm IV-X	Year
Naki	1160	1950-1990	Enguri	128	118	99	91	98	106	101	95	110	140	121	136	602	741	1343
Becho	1270	1912-1990	“	94	77	63	73	96	84	76	75	81	107	83	79	396	592	988
Dizi	1120	1933-1990	“	105	98	82	75	81	88	83	79	91	116	100	112	497	613	1110
Mestia	1441	1938-2010	“	68	61	70	75	85	80	78	76	81	95	76	73	348	570	918
Lakhami	802	1935, 1948- 1990	Nenskra	120	111	94	86	93	100	95	90	104	132	114	128	567	700	1267
Khaishi	730	1932-1990	Enguri	124	114	96	89	95	103	98	92	107	135	117	131	582	719	1301
Chuberi	600	1934-1958	“	159	147	124	114	122	132	125	119	137	173	150	169	749	922	1671
Engurhesi	280	1960-1990	“	174	157	151	128	139	185	202	168	176	153	137	139	758	1151	1909
Jvari	268	1936-2010	“	196	178	170	144	157	209	229	193	198	172	155	157	856	1302	2158
Zemo Azhara	952	1934-1954	“	164	140	133	110	125	138	128	128	154	152	140	155	732	935	1667
Kvemo Azhara	595	1951-1990	“	152	131	124	103	117	129	120	120	143	141	131	144	682	873	1555

### 6.15.3 Expected Cumulative impact of Enguri Cascade Reservoirs on Local, regional and Global Climate

#### 6.15.3.1 Sensitive indicators of Global Climate Change and Background

Current climate changes in the study area are reflected by the growth of air temperature, atmospheric precipitation, humidity and strong winds [1,7,5,6]. Climate warming process in the basin of the Black Sea began in 1900's, in the plains of Western Georgia it is ongoing since 1905-1907 (Figure 3), in medium and high mountains is likely to have started after 5-7 years. The basis of this supposition is the essential activation of glacier melting in 1920-1940. This process developed in variable-speed until 1990's and in next decades it activated so much, that air temperature growth in 1990-2010 reached 1,3-1,5°C.

Compared with an average value of 1931-1951, atmospheric precipitation number in Jvari increased by 40 mm and in Mestia by 67 mm. Besides, the air temperature of January in Mestia increased by 1,60°C, in April by 0,4 and in October by 0,8°C. It should be noted, that winter temperature growth is partly compensated by summer temperature decrease, due to which the average annual temperature fluctuation is practically insignificant.

Accordingly, this climatic elements transformation began much earlier than in 1978, when the Jvari reservoir started operating. This time, we should find out what will be the impact of reservoirs cascade on these processed and contrary, will the reservoirs cascade impact on local, regional (West Georgia) and global climate.

#### 6.15.3.2 Possible Cumulative Impact of the Reservoirs on the Various Scale Climate

According to the information, river Enguri reservoirs cascade is within three climatic zones [2].

Jvari reservoir experiences humid subtropical climate impact, which is characterized by moderately cold winter, long humid summer, deep seasonal invasions of air masses and fions, which here is metamorphic, heated air variety of cold airs coming from the north to the ravine is open from the west, so the south-west wind is more frequent in here, which is bringing warm humid air in the river ravine formed on the sea. In addition to these winds, local processes also have a significant impact on the atmospheric circulation, among which the main are ravine-mountain winds, fions and other air convective circulation units. Air convective circulation is formed directly on the reservoir and includes ravine slopes and ridge. It is getting stronger or weakening due to the influence of the sea in accordance with the seasons of the year. Therefore, its action radius depends on west and south-west winds action periods and power.

Khudoni reservoir will be within the humid climate action area, where winter is cold, summer – long and moderately humid. Dry winds and fions are frequent here as well, but their frequency and speed is significantly low, than on Jvari.

Unlike to these reservoirs, Nenskra reservoir will be within moderately humid climate influence area, where the climate is relatively dry, winter is cold and with precipitation, summer is short and cool. Reservoir will be covered with the ice in the winter. Ice events will start in late November, the stable ice will exist from December to March and will be completely released of ice in the second half of April. Its impact on climate will be essential in spring, when the whole ice cover will start melting-breaking and in the late autumn, before the ice events will start.

The significant difference between water and air temperature in these periods and strong wind will activate evaporation. Evaporated moisture in form of snow-ice will lie on buildings, fruit trees and will damage them. The damage caused by early freezes is heavier, because the freezes cause the death of buds and sprouts, due to which the useful plants start premature aging, infertility and death. The population

living in the vicinity of the reservoir will get a heavy living conditions, who are sick with rheumatism or/and respiratory and require vascular system treatment.

According to the Nenskra reservoir mirror area, local and seasonal circulation action radius, the territory will occur within its action area, which includes upstream the dam 13,0-14,0 km, downstream 3,0-4,0 and in height 0,6-0,8 km. In addition, its impact will be stronger before the ice events start until the stable ice creation period and during the ice breakage period.

After the Khudoni reservoir will start operating, one total water tank will be created by two reservoirs, the impact of which on the climate will be more essential than in case of their separated existence. Its mirror morphometric ( $F \approx 19,0 \text{ km}^2$ ,  $L = 20,0 \text{ km}$ ) will be more supportive for the local circulation processes strengthening, because the water surface is less rough than forest covered bottom and slopes of ravine and poses less resistance to the wind. Probably, the wind strengthened by 5-8% will also significantly activate evaporation and will raise the condensation level, presumably up to 1,0-1,1 km.

The combined water tank impact on the climate is limited by the area, which includes village Jvari and the bottom margin of which passes down from the Jvari reservoir on 3-4 km. Its upper margin upstream the river on 25-27 km and vertically distributes up to  $\sim 1,0-1,1 \text{ km}$ .

Considering the existing knowledge and analog-water tanks (Tsalka and Shaori-Tkibuli) microclimate regimes study results it is note expected, that Nenskra and Jvari-Khudoni reservoirs influence areas will interflow each other. The section within the river ravine, the length of which is  $\geq 23 \text{ km}$ , consists of two unequal parts, of which the upper is located in Svaneti cave and the second one below this cave. The air masses movement between them is complicated by natural barrier, which are created by transverse mountain ridges.

From the water winks located on the opposite side of this natural barrier the Nenskra impact is enough only for local climate transformation and Jvari-Khudoni united reservoir will have an essential impact as on local, as well as on the part of foothill ravine Enguri climate (Jvari-Chkaduashi).

### 6.15.3.3 Water Volumes Evaporated from the Reservoirs and Their Internal Annual Distribution

For the river Enguri ravine population the growth of reservoirs amount means the growth of evaporated water volume, which is also strengthened by first sensitive indicator [6].

According to the studies conducted in the Caucasus region [8], in 1980's the evaporate water layer defining expression from the reservoirs have been created:

$$E = 0,29(e_0 - e_{200})(1 + 0,227W_{200}) \text{ mm/day.} \quad (2)$$

Here  $(e_0 - e_{200})$  displays water vapor partial pressure difference between reservoir surface and 2,0 m height and  $W_{200}$  – wind speed on the same 2,0 m height.

It is obvious, from the reservoir, the mirror surface of which is  $F \text{ km}^2$ , in the given time ( $N \text{ day}$ ) section evaporated water volume ( $U \text{ m}^3$ ) represents the following type of product:

$$U = F \cdot E \cdot N. \quad (3)$$

For reservoirs cascade:

$$U_s = N \sum_{i=1}^n F_i E_i \quad (4)$$

Here  $F_i$  – is the mirror area of separate reservoir ( $\text{km}^2$ ),  $E_i$  – water layer thickness evaporated from this reservoir (mm),  $N$  – reporting period (day).

The main members in these expressions are wind speed ( $W_{200}$ ), the size of water mirror ( $\Sigma F_i$ ) and  $(e_0 - e_{200})$  the difference of water vapor partial pressure, which is water (accordingly air too) temperatures function.

All three members in terms of the time are acceleratable: reservoir surface temperature will rise in proportion with the air temperature, water surface area will increase in accordance with the cascade growth and wind speed increase supportive conditions has been already mentioned above.

Considering the obtained expressions and time transformation of climate sensitive indicators, it is available to calculate by ~90-95% provision air temperature increase ( $\Delta t$ ), wind speed increase ( $\Delta W$ ) and evaporated water volumes ( $\Delta U$ ).

According to the analysis of climate change previous 90 day cycle, at the end of current warming phase air temperature in the Enguri cascade area will reach 14-15°C. This temperature along the reservoirs cascade can be distributed as follows: in the Jvari-Khudoni reservoirs are 14,8°C and at Nenskra 13,5°C, an average of 14,0°C for the cascade.

It is expected, that in the next decades that Jvari-Khudoni reservoirs average surface temperature in the warm periods of the year reach ~11,0-11,5°C.

By considering the approximate values of water and air temperatures  $E_0 - e_{200}$  parameter will be ~0,4-0,6.

Reservoirs mirror surface changes in accordance with the regulation type and seasons of the year. In the seasonal regulation reservoirs on the spring, before the flood starts, water level and its relevant mirror area, i.e., evaporation surface is very small. Water temperature is also low at this time and will be on an average of 2,0-3,5°C limits. Evaporation on Nenskra reservoir in this season will be minimal (Table 6.15.3.3.1.). Unlike it, evaporation from unfreezing Khudoni and Jvari reservoirs the lowest will be in the winter, highest in summer-autumn (VIII-IX months).

Usually, the water is warmer in autumn, but in this season the mirror area is less and so the evaporated moisture volume is less, than in summer.

**Table 6.15.3.3.1.** Evaporated humid volume and its internal annual distribution

Reservoir	Evaporated water amount, million m <sup>3</sup>				
	Spring	Summer	Autumn	Winter	year
Jvari	0,8	1,2	0,9	0,6	3,5
Khudoni	0,4	0,7	0,5	0,3	1,9
Nenskra	0,3	0,6	0,4	~0	1,3

Accordingly, after this cascade will fully operate, the water volume evaporated from the reservoirs will almost double and reach – 6,0-7,0 million m<sup>3</sup>. This amount of humid will move within local circulation area. During the seasonal strong winds it is expected that small part of them (20-25 %) may be carried out by winds out from the mentioned areas, which will expand their area of influence, but not so much that all three reservoirs will create a united microclimate.

Therefore, Nenskra and Jvari-Khudoni reservoirs impact is discussed as two, separate objects impact on the climate. Besides, Nenskra will have an essential impact only on local climate and Jvari-Khudoni reservoirs will impact as local, as well as on the Colchis north part – Jvari-Sachkaduo areas.

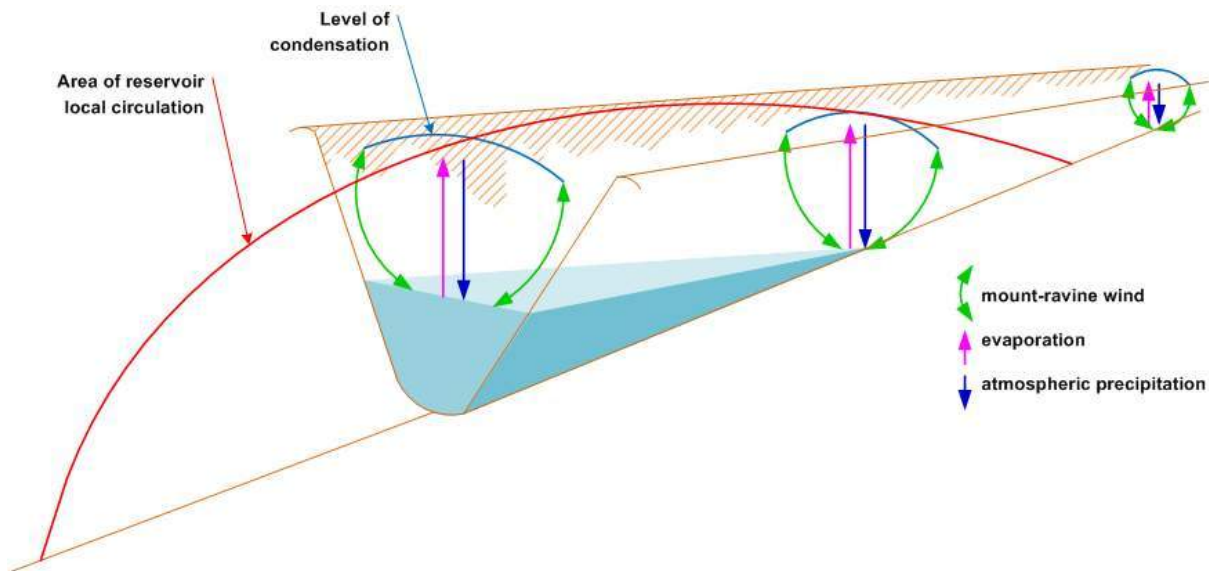

**Figure 6.15.3.3.1.** Factors and their impact area on the local circulation of mountain reservoirs (schematic section)

#### 6.15.4 Greenhouse Gases (CO<sub>2</sub>) regime in the Reservoirs and their Quantitative Assessment

Main ways of greenhouse gases creation in the mountainous reservoirs are river runoff, live organisms vivifying and human activities. Their amount is the largest in the first decades of reservoir existence, because in this time especially intensively going on the utilization of stuck construction and vegetation cover waste, as well as soil and other natural elements. In subsequent periods, in proportion to mentioned sources exhaustion the number of these gases are reducing and in the last period of reservoir existence, when its siltation knife edge will reach limited volume, the annual number of these gases in the runoff is changing in proportion to their number.

Their seasonal and multiannual regulation reservoirs feature is, that they are filling and emptying by flood and shallowness relevant periodicity. In the section of several months within filling phases, a variety of mineral and organic material gathers in the dish, which is intensively decaying or is being used and finally goes directly or somehow in the atmosphere by greenhouse gases CO<sub>2</sub> form.

River Enguri and its tributaries carry the CO<sub>2</sub> in Enguri cascade, partly it is the result of vivifying of living organisms. Its regime is determined by reservoirs regulation type, ice events and activity of living organisms. This gas in atmosphere goes through water mirror and riding the devastation process through HPP turbines [16].

In the river Enguri runoff the largest concentration of carbon dioxide is 12,5 mg/l measured in hydro post Jvari section during the flood in 1954. The maximum concentration of this gas during autumn flood is 4,2 mg/l, much less than the above mentioned, which is explained by above mentioned factors.

For CO<sub>2</sub> assessment in the Nenskra reservoir, it will be preferable to use Tsalka and Sioni reservoirs as analogs, because these reservoirs freezes and besides their hydro chemical regime is relatively well studied [9, 13].

CO<sub>2</sub> transition from reservoirs into the atmosphere is carried out through their mirror surface. In addition, if this object is seasonal or multiannual regulation, its mirror area during the year changes from minimal area (emptying process phase) to maximum (at the end of filling phase).



Therefore, during any kind of assessments it is necessary to use the value of mirror area, which corresponds the average value of its annual variation in ice-free condition. This mirror value for Nenskra reservoir is 3,5 km<sup>2</sup>.

By international forums and commissions [8] recommended methods, from every square meter of mountainous reservoirs 1,5 kg CO<sub>2</sub> goes into the atmosphere. From Nenskra reservoir, by using this recommendation and the actual average value of its mirror, the number of CO<sub>2</sub> transitioned into the atmosphere per year will be 4000 tons.

Gali reservoir data use for Jvari-Khaishi reservoirs CO<sub>2</sub> study is the most representative. This reservoir fills up with the water released from them, is nonfreezing and is satisfactorily studied.

By using the actual total mirror area ( $\Sigma F=12,0$  km<sup>2</sup>) of the above mentioned recommendation, the annual amount of CO<sub>2</sub> released by them will be 18000 tons, from which the Khaishi reservoir share will 6000 tons.

Accordingly, after the Enguri cascade will start operating the additional 22000 tons of carbon dioxide will get into the atmosphere. It is expected, that main part of this gas (30-40%) is used in the local circulation area by vegetation cover, especially by forests and the rest is distributed on the adjacent territories by the strong winds.

In Georgia, annually 10 million tons of carbon dioxide goes into the atmosphere. The share of Enguri cascade with this amount is so small, that it will not have an essential influence on the climate change and residents comfort.

### 6.15.5 Conclusions

1. In mountain, in excessive humidity zone created reservoir negatively impact on the climate, because it increases evaporation, wind speed, reduces air temperature and deteriorates comfortable conditions; in the humid lack areas its impact is reversed – softens the climate by increasing the moisture from the mirror and watered slopes by evaporated moisture;
2. In the Nenskra seasonal regulation reservoir the highest water level will be in the summer. The evaporation at that time will be maximum in volume and intensity, but it will have negative consequences in November-December and April-May – ice layer creation-removal time. Within its influence zone will be the territory, which includes upstream the river from the dam ~14,0 km, downstream ~3,0 and in height 0,6-0,8 km.
3. Sharp temperature difference between water and air and strong wind will cause intensive evaporation – “reservoir evaporation”. Humid, lays down on buildings, fruit trees and will damage them in a form of ice-snow. The damage caused by early freezes will be heavier, because the freezes cause the fade of plants buds and sprouts, which in the end gives the result of premature aging, infertility and death of the useful plants. The living conditions of population living in the vicinity will be deteriorated in this periods, the people who are concerned by rheumatic, respiratory and vascular diseases;
4. The impact of water tank created by the Jvari-Khudoni reservoir on the climate will be more essential, than in the case of their separate existence. Its mirror morphometric ( $F \approx 19,0$  კმ<sup>2</sup>,  $L = 20,0$  km) is more supportive for local circulation processes strengthening, because the elongated mirror of these reservoirs will strengthen the wind by 5-8% and this will significantly activate evaporation and rise the condensation level even higher;

5. The impact of this reservoir will distribute on the part of the ravine, the lower border of which passes on 3-4 km from Jvari reservoir and upstream of the upper river on 25-27 km and in height on  $\sim 0,8-1,0$  from the mirror;
6. Nenskra and Jvari-Khudoni reservoirs impact must be considered as two independent units impact on local climate change. Jvari-khudoni influence on the regional, Colchis climate and will only reach until Jvari-Sachkaduo areas;
7. After the cascade will become fully operational, the annual volume of the evaporated humid will increase up to  $\sim 7,0$  million  $m^3$ . This amount of moisture will mainly move within the local circulation area. During the seasonal winds it is expected, that certain part (20-25%) of the humid will be taken away from the mentioned areas, which will not be enough for three reservoirs to create a united climatic area;
8. Cascade, after the Khudoni and the Nenskra will start to operate, annually in average will release 22 000 t carbon dioxide in the air, most of it (12 000 t) will be released from Jvari reservoir and least of it from Nenskra (4000 t);
9. Cascade impact on the rest of the Georgian territory and especially on the global climate is practically excluded, due to its totally small mirror surface and relatively low vertical location.

#### 6.16 Assessment of Dam Sustainability Risks and Possible Floods on Transit Sections of the River

First of all we must discuss possible seismic risks of the dam break. The works [1,2] present schematic maps of tectonic partition of the territory of Georgia and seismic zoning of South Caucasus. According to these maps, Upper-Abkhazia-Svaneti region are observed to have at least 4-5 fault lines. According to [2], these lines are marked (from north to south) as f24a, f24, f38G, f39, f40. Hearths marked on the map are characterized by earthquakes of following maximum magnitude  $\max = 7; 6.7; 6.7; 6.7; 6.7$  and 6.1. It should be noted, that one of the fault lines (f24) crossed Enguri valley in the area, where construction of Khudoni and Nenskra HPPs are planned. Apart from that, according to map of probable micro seismic intensity also provided in [2] the given region is in the zone with possible earthquake with magnitude  $M=5$ , with a probability of 2%, 5% and over 10% of risk for the 50 years period. This means, that such earthquakes are expected approximately at least once every 50 years. Naturally, more powerful earthquakes ( $M=6$  or 7) are less likely, for example  $p=0.005-0.01$ , i.e. once every 200 or 100 years. Thus, seismic activity in the areas of planned Khudoni and Nenskra HPP dams is quite high, which could lead to earthquakes with magnitude no less than  $M=6-7$ , with a risk  $p=0.005-0.01$ . This may cause damage of a dam or if not a total, at least its partial failure. Regarding seismic and meteorological (heavy and intense rains) risks let us consider sustainability of the dam. Figure 6.16.1 presents vertical cut of the dam and forces acting on it.

**Figure 6.16.1.** General view of the dam and cross section (dimensions given in meters)

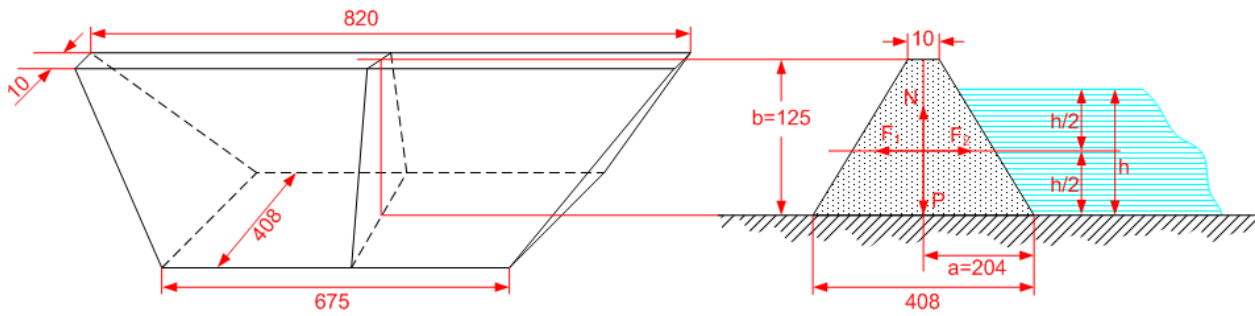

Resultant of vertical forces equals  $F=P-N$ , where  $P=mg$  is force and  $N=\rho g \frac{h}{2} S$  – water pressure force. Here  $m$  – mass of the dam,  $g$ -gravity acceleration,  $\rho$  - water density,  $h$  – average height of impoundment,  $S$ area of lateral surface area. Along the horizontal axis following impact the dam -  $F_1=N=\rho g \frac{h}{2} S$  pressure strength and  $F_2 = \mu F = \mu(P - N) = \mu(mg - \rho g \frac{h}{2} S)$  friction force near dam foundation. Here  $\mu$  is friction coefficient. Ratio is as follows:

$$K = \frac{F_2}{F_1} = \frac{\mu(mg - \rho g \frac{h}{2} S)}{\rho g \frac{h}{2} S} = \mu \left( \frac{2m}{\rho h S} - 1 \right), \quad (1)$$

which represents a ratio of dam stability. If condition  $K>1$  takes place then the dam will be sustainable. As for instability of the dam, it will happen if the ratio is  $K<1$ .

$$\mu \left( \frac{2m}{\rho h S} - 1 \right) < 1; \frac{2m}{\rho h S} < \frac{1}{\mu} + 1, \text{ from where}$$

$$h > \frac{2m}{\rho S} \frac{1}{\frac{1}{\mu} + 1}. \quad (2)$$

Basing on the project data we can calculate dam parameters within (2). Namely, according to the drawing,  $a=204$  m and  $b=125$  m, therefore  $c = \{(204-5)^{0.5} + 125^{0.5}\}^{0.5} = 235$  m. Length of dam crest is  $d=820$  m, and length of the base  $d_2 = 675$  m. Therefore, area of lateral surface (trapezoid) is  $S = \frac{d_1 + d_2}{2} c = \frac{820 + 675}{2} * 235 = 1.76 \times 10^5 \text{ m}^2$ . Dam volume is  $W = \frac{b}{3} (S_1 + (S_1 S_2)^{0.5} + S_2)$ , where  $S_1$  is area of its upper base and  $S_2$ - of lower base. Namely:  $S_1 = 820 \times 10 = 8200 \text{ m}^2$ ,  $S_2 = 675 \times 408 = 275400 \text{ m}^2$ . Therefore,  $W = 13.8 \times 10^6 \text{ m}^3$ . Volume of the dam will be  $m = \rho_1 W = 2.5 \times 10^3 \frac{\text{kg}}{\text{m}^3} \times 13.8 \times 10^6 \text{ m}^3 = 3.5 \times 10^{10} \text{ kg}$ . Apart from that we can evaluate an average height of impoundment  $h_1$ , since the area of reservoir mirror is  $\approx S_3 = 3 \text{ km}^2$ , length  $L \approx 1.5$  km, width  $l \approx 2$  km and volume  $V = 186 \times 10^6 \text{ m}^3$ , then

$$h_1 = \frac{V}{S_3} = \frac{V}{lL} = \frac{186 \times 10^6 \text{ m}^3}{3 \times 10^6 \text{ m}^2} \approx 67 \text{ m}.$$

According to (2) we will get:

$$h > \frac{2 \times 3.45 \times 10^{10} \text{ kg}}{10^3 \frac{\text{kg}}{\text{m}^3} \times 1.76 \times 10^5 \text{ m}^2} \cdot \frac{1}{\frac{1}{0.5} + 1}; \quad h > 130 \text{ m}$$

Thus, for dam instability average depth of water in the reservoir has to be approximately 1135 m, i.e. exceed existing average depth by  $h/h_1 = 2$ . How can we interpret the outcome? Because volume of the reservoir is  $V = h_1 l L$ , therefore increase of depth  $h_1$  by 2.0 means increase of volume also by 2.0. However, due to project parameters it is impossible. Therefore, width of the reservoir (I) or better yet – length  $L$

shall be increased by 2.0. Hence, if the length of the reservoir was increased by 2.0 and its value is  $L \approx 3.0$  km, then the ratio of the dam will be  $K < 1$ . Increase of volume by 2.0 means that its value will become  $V_1 = 400 \times 10^6 \text{ m}^3$ . In such case additional volume of water is  $\Delta V = V_1 - V = 200 \times 10^6 \text{ m}^3$ . In this regard we can determine meteorological risks, i.e. strength, duration and intensity of rains that can form the additional volume of mentioned water  $\Delta V$ .

The total catchment area of the rivers Enguri, Nenskra, Nakra and their tributaries exceed  $Q = 2000 \text{ km}^2$ . Therefore, value of heavy rains must be  $I = \frac{\Delta V}{Q} = \frac{200 \times 10^6 \text{ m}^3}{2000 \text{ km}^2} = 0.1 \text{ m} = 100 \text{ mm}$  on the mentioned area. How likely is a rainfall of such volume? Meteorological part of this report presented a list of stations out of which 4 were selected that better described basins of the mentioned rivers. The stations are: Jvari, Khaishi, Chuberi, Lakhmi. In warm periods of the year total precipitation of 100-200 mm is observed during 2 to 8 months. Therefore, possibilities for such precipitation will be as follows:

$$\text{Jvari} - p = \frac{8}{12} = \frac{2}{3} = 0.67;$$

$$\text{Khaishi} - p = \frac{4}{12} = \frac{1}{3} = 0.33;$$

$$\text{Chuberi} - p = \frac{8}{12} = \frac{2}{3} = 0.67;$$

$$\text{Lakhmi} - p = \frac{2}{12} = \frac{1}{6} = 0.17.$$

These are high values. But there is one important point here: sums of such precipitation were observed during month. Therefore, they cannot jeopardize the dam. For instability of a dam it is necessary for such precipitations to occur in a short period of time – for example in one day or within a few days. To evaluate possibilities of such rainfall we do not have relevant observation data – values of multiannual daily precipitation. We may find a solution if considering law on distribution of daily precipitation. Distribution function of such precipitation (density probability) is characterized by visible asymmetry in large precipitation. Therefore, it is acceptable to describe distribution of daily precipitation using a gamma-function:

$$f(x) = A x^\alpha e^{-x/\beta} \quad (3) \quad \text{where, } \alpha > -1, \beta > 0, A = \frac{1}{\beta^{(\alpha+1)} \Gamma(\alpha+1)}, \Gamma - \text{ is a gamma-function}$$

for the first two moments of the distribution function we get:

$$\bar{x} = M[x] = \int x f(x) dx = (\alpha+1)\beta, \quad (3)$$

$$D[x] = \int (x - \bar{x})^2 f(x) dx = \beta^2(\alpha+1). \quad (4)$$

Basing on (3) and (4) as well as on annual and monthly distribution of precipitation, we stop at following values of the parameters:

$x = 5 \text{ mm}$  (average value of daily precipitation);

$$\alpha = 1; \beta = 2.5; A = 0.16; D = 12.5 \text{ mm}^2 \text{ (dispersion);}$$

$\sigma = \sqrt{D} = 3.5 \text{ mm}$  (mean square deviation) and finally

$$f(x) = 0.16x e^{-0.4x} \quad (5)$$

Value of meteorological risk can be determined basing on (5), for example for  $x \geq 20 \text{ mm}$  precipitation:

$$F(x \geq 20) = \int_{20}^{\infty} f(x) dx = 0.019$$

Risk of dam failure can take place if no less than 20 mm precipitation will be observed on the catchment areas of the rivers mentioned above during 5 days in a row. Risk of such an event is:

$$\Phi = [F(x \geq 20)]^5 = (1.9 \times 10^{-2})^5 = 2.5 \times 10^{-9}$$

For comparison see F and  $\Phi$  values for 25 and 50 mm cases:

$$F(x \geq 25) = 3.1 \times 10^{-3}; \quad \Phi = [F(x \geq 25)]^4 = 9 \times 10^{-11} \approx 10^{-10};$$

$$F(x \geq 50) = 2.7 \times 10^{-7}; \quad \Phi = [F(x \geq 50)]^2 = 7.3 \times 10^{-14} \approx 10^{-13}$$

As we can see risk of 25 and 50 mm precipitation during 4 and 2 days straight is very low -  $10^{-10}$  and  $10^{-13}$ .

Given the results we may assume, that seismic risk issues are more significant for the instability of the dam than an impact of meteorological processes.

In accordance with requirements of environmental impact assessment we can review case of total dam failure and determine maximum flow on transit sections of the river if such event occurs. For this purpose we can use depictions and formulas of hydraulic nature provided in [3]. Namely, maximum water level and maximum flow at dam failure place will be:

$$H_m = 0.5 h_1 = 33.5 \text{ m};$$

$$R_m = 1.9 d h_1^{1.5} = 1.9 \times 820 \times 67^{1.5} = 8.5 \times 10^5 \text{ m}^3/\text{s}$$

For the section 5 km away from the dam

$$H_1 = \frac{H_m}{1 + 0.15 L_1} = \frac{33.5}{1 + 0.14 \times 5} = 19.1 \text{ m}$$

$$R_1 = R_m \frac{L}{L + L_1} = 8.5 \times 10^5 \frac{1.5}{1.5 + 5} = 2 \times 10^5 \text{ m}^3/\text{s}$$

For the section 10 km away from the dam

$$H_2 = \frac{H_m}{1 + 0.15 L_2} = \frac{33.5}{1 + 0.15 \times 10} = 13.4 \text{ m}$$

$$R_2 = R_m \frac{L}{L + L_2} = 8.5 \times 10^5 \frac{1.5}{1.5 + 10} = 1.1 \times 10^5 \text{ m}^3/\text{s}$$

For the section 15 km away from the dam

$$H_3 = \frac{H_m}{1 + 0.15 L_3} = \frac{33.5}{1 + 0.15 \times 15} = 10.3 \text{ m}$$

$$R_3 = R_m \frac{L}{L + L_3} = 8.5 \times 10^5 \frac{1.5}{1.5 + 15} = 7.7 \times 10^4 \text{ m}^3/\text{s}$$

At Khudoni HPP area

$$H_4 = \frac{H_m}{1+0.15L_4} = \frac{33.5}{1+0.15*17.5} = 9.2 \text{ m}$$

$$R_4 = R_m \frac{L}{L+L_4} = 8.5 \times 10^5 \frac{1.5}{1.5+17.5} = 6.7 \times 10^4 \text{ m}^3/\text{s}$$

As we can see, after every 5 km-s maximum flow of the wave decreases by one range. At Khudoni dam site it reaches about 200 m<sup>3</sup>/s and negative impact of the flood will be significantly mitigated. However, it should also be noted, that the main threat is height of the wave and a high speed of distribution. Time required for emptying the entire reservoir is very little. It would be:

$$T = \frac{V}{R_m} = \frac{200 \times 10^6}{8.5 \times 10^5} = 235 \text{ s} \approx 4 \text{ min} .$$

Initial speed of wave distribution can be approximately evaluated as:

$$U = \frac{L}{T} = \frac{1.5 \text{ km}}{4 \text{ min}} \approx 0.4 \frac{\text{km}}{\text{min}} = 6.7 \frac{\text{m}}{\text{s}} .$$

Then, the minimal time required for a wave to reach Khudoni dam after failure of Nenskra dam is:

$$T_1 = \frac{L_5}{U} = \frac{17.5 \text{ km}}{0.4 \text{ km/min}} \approx 44 \text{ min},$$

**Where L<sub>5</sub> is a distance between the dams. In reality, due to spread of the flow water levels and flows will be less, and due to reduction of wave speed value of T<sub>1</sub> will be more than 44 minutes.**

With consideration of dam type selected (rock fill dam) there is almost no risk of full dam failure in a small period of time. Even in worst case scenario the dam can be collapsing for days and even weeks. Therefore, we must consider a partial failure of the dam. We should suppose that due to seismic activity a crack appeared on the upper central part of the dam, which turned into a gap due to water pressure and water flow quickly expanded it. In such case bed cut by the flow in the dam mostly has a trapezoid shape – the middle part resembles ‘spillway’.

That is why water level and flow during flood can be calculated with a famous formula in hydraulics [3]. Figure 6.16.2 provides scheme of partially damaged dam.

**Figure 6.16.2.** Cross-section of partially damaged dam

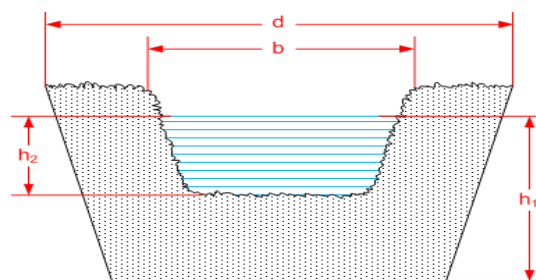

Maximum water level and maximum flow during flood on the transit sections of the river along the flow can be calculated with a following formula:

$$H_i = \frac{h_2}{10 \frac{0.3b}{d} (1+0.15L_i)} \quad (6)$$

$$R_i = \frac{1.9bh_2^{3/2}L}{L+L_i} \quad (7)$$

Indications provided in the previous part of the paper were used for the parameters included in the formula.  $h_2$  represents impoundment level for the lower base of the bed cut in the dam (see figure 6.13.2.). In case of full failure of the dam  $b=d$  and  $h_2=h_1$ , then from (6) and (7) we get formulas used before.

Below you will find calculation results for partial failure of Nenskra dam – water level and maximum flows during flooding on transit sections of the river.

At collapsed area of the dam  $h_2=h_{1/2}=33,5$  m,  $b=400$  m,  $L_i=0$ . The following comes out of (6) and (7):

$$H_m = \frac{h_2}{10^{0.3b/d}} = \frac{33.5}{10^{0.3 \cdot 400/820}} = 23.7 \text{ m},$$

$$R_m = 1.9bh_2^{3/2} = 1.9 \times 400 \times (33.5)^{3/2} = 1.5 \times 10^5 \text{ m}^3/\text{s}$$

For the section 5 km away from the dam

$$H_1 = \frac{H_m}{1 + 0.15L_1} = \frac{23.7}{1 + 0.15 \times 5} = 13.5 \text{ m},$$

$$R_1 = \frac{R_m L}{L + L_1} = \frac{1.5 \times 10^5 \times 1.5}{1.5 + 5} = 3.5 \times 10^4 \text{ m}^3/\text{s}$$

For the section 10 km away from the dam

$$H_2 = \frac{H_m}{1 + 0.15L_2} = \frac{23.7}{1 + 0.15 \times 10} = 9.5 \text{ m},$$

$$R_2 = \frac{R_m L}{L + L_2} = \frac{1.5 \times 10^5 \times 1.5}{1.5 + 10} = 2 \times 10^4 \text{ m}^3/\text{s}$$

For the section 15 km away from the dam

$$H_3 = \frac{H_m}{1 + 0.15L_3} = \frac{23.7}{1 + 0.15 \times 15} = 7,3 \text{ m},$$

$$R_3 = \frac{R_m L}{L + L_3} = \frac{1.5 \times 10^5 \times 1.5}{1.5 + 15} = 1.4 \times 10^4 \text{ m}^3/\text{s}$$

At Khudoni HPP area

$$H_4 = \frac{H_m}{1 + 0.15L_4} = \frac{23.7}{1 + 0.15 \times 17.5} = 6.5 \text{ m},$$

$$R_3 = \frac{R_m L}{L + L_4} = \frac{1.5 \times 10^5 \times 1.5}{1.5 + 17.5} = 1.2 \times 10^4 \text{ m}^3/\text{s}$$

Emptying time for a half volume of the reservoir is

$$T = \frac{V/2}{R_m} = \frac{100 \times 10^6 \text{ m}^3}{1.5 \times 10^5 \text{ m}^3/\text{s}} = 666,7 \text{ s} \approx 11 \text{ min}$$

Initial speed of wave will reach value of

$$V = \frac{L}{T} = \frac{1.5 \text{ km}}{666.7 \text{ s}} \approx 2.3 \text{ m/s}$$

Minimal time for a wave to reach Khudoni dam from Nenskra dam will be

$$T_1 = \frac{L_5}{V} = \frac{17.5 \text{ km}}{2.3 \text{ m/s}} \approx 2 \text{ h}$$

**Thus, wave due to flooding is characterized with high parameter values at Khudoni dam as for full failure of the dam so for its partial damage. This may create a challenging situation during operation of Nenskra and Khudoni HPPs. However, spread of the flood flow in Nenskra and Enguri valleys will significantly reduce water levels and values of maximum parameters of the flow. Time for a wave to cover the distance between the dams – 2 hours – is also enough to take the measures.**

## 6.17 Cumulative Impact

Construction and operation project of Nenskra HPP is the only project planned in terms of long-term program by Georgian Government in the valley of river Enguri.

Cumulative impact expected on the HPP operation phase of designed HPP may be discussed by two main scenarios, namely:

1. Designed HPP – plus Jvari reservoir;
2. Designed HPP – plus Jvari reservoir – plus designed Khudoni reservoir and plus HPPs planned in the upper part of river Enguri.

### 6.17.1 Construction Phase

According to the results of field works, there are no ongoing important construction activities in the ravine of river Enguri or in the ravines of its tributaries (rivers Nenskra and Nakra). Cumulative impact expected on the construction phase, can be discussed by considering Nenskra HPP, as well as Khudoni HPP simultaneous construction.

It is expected, that Nenskra HPP and Khudoni HPP construction works will be held at the same time and the cumulative impact is expected.

On the Construction phase, the types of cumulative impact to be discussed are: atmospheric emission (harmful substances, including dust), waste, noise and vibration, flora, fauna, aquatic environment, landscapes, cultural heritage, land alienation, socio-economic issues and other.

**Noise and emission of the harmful substances:** According to the results of the calculation, on designed HPP construction phase the impact caused by the noise and emissions of the harmful substances will not be significant. If we take into account, that the construction sites of the planned Nenskra HPP and Khudoni HPP would be significantly away from each other, the risk of cumulative impact is insignificant.

**Impact on biological environment:** The areas selected for the designed HPPs construction distinguish with biodiversity and accordingly, construction works will be associated with significant impact on biological environment (it is noteworthy, that project includes reservoirs arrangement and operation). In case of both project implementation, significant are of vegetation will be destroyed, disruption of animal shelters, habitat destruction and others. Although the HPPs infrastructure facilities are away from each other on a significant distance, but negative impact on biological environment has to be considered as significant.

In case of hydraulic structure construction in a parallel regime, deterioration of rivers water quality is possible and negative impact on aquatic biological environment related to it.

**Impact on water quality and hydrological regime of the rivers:** In process of construction works deterioration of river water quality is expected in case of incorrect waste (including wastewater) management and violation of environmental requirements during construction works in the river-bed.



Minimization of possible cumulative impact would be available by considering the determined environmental management and monitoring.

It is notable, that significant impact on rivers hydrological regime and solid sediment transportation during the construction phase is not expected.

**Socio-Economic Environment:** On the construction phase of designed HPPs possible important positive impact types on socio-economic environment are:

- Significant amount of temporary jobs will be created for implementation of the construction works, where the local labor will be employed mainly (an absolute majority of low-skill workers, which is the important interest of executor companies);
- HPPs construction process will be associated with activation of supporting business activities (construction material production, trade and service fields, food production and others). Accordingly, creation of additional jobs and improvement of population socio-economic condition is expected;
- Project implementation will be related with revenue growth of local municipal budget and if we consider, that Mestia municipality is still on governmental grant, there will be a significant positive impact.

From the possible negative impact types, land-use conditions change is important, because both projects include the seasonal regulated type HPPs construction and the arrangement of potential territories to be covered with reservoirs water, will be related with significant amount of lands loss. In case if Nenskra HPP project implementation the impact will spread on the state lands, Khudoni HPP case will be associated with significant amount of private and public land loss. Khudoni HPP project is also related to the large volume of physical resettlement.

For minimizing the expected impact, in case of land acquisition and necessity of physical resettlement process must be implemented in accordance with the requirement of Georgian legislation and international financial organizations (EB, EBRD, IFC) standards.

It should be noted, that public health and safety risks will not be significant, because the construction sites are away from the residential zones on a significant distance. Safety risks will be associated with the traffic flow growth, which will be significant in case of simultaneous implementation of both projects.

### 6.17.2 Operation Phase

From the possible cumulative impact types on the designed HPPs operation phase significant ones will be: Impact on hydrological environment of the river (water and solid sediment flow change); impact on ichthyofauna and on local and global climate.

**Change of Hydrological Regime of the River:** Only ecological flow will be released in the tailraces of the designed dams on rivers Nenskra and Nakra, which will cause the sharp decrease of existing water level in the rivers, which is high quality impact, but such impact would not effect on Khudoni HPP operation regime or on its tailrace. Therefore, cumulative impact is not expected.

**Impact on Solid Sediment Transportation:** The Project Rivers (Nenskra and Nakra) are not characterized with a big amount of sediments. According to calculation, life cycle of the reservoir will be 72 years. It should be noted, that the dam will not have a cumulative impact on the transportation regime of the solid sediments as in the flood period most part of sediments will be removed to the tailrace.

On the Nenskra HPP operation phase, solid sediment transportation in the tailrace will be stopped during the whole life-cycle of the reservoir, which will have certain impact on the Javri reservoir, however, considering small amount of solid sediments cumulative impact will not be significant.

**Impact on Water Quality:** as designed, as well as current and planned HPPs operation phase, cumulative impact may be related with deterioration of water quality of the rivers. Contamination of water environment on the HPPs operation phase usually is associated with incorrect waste management or with violation of rules of fuel/oil storage/usage. Accordingly, minimization of this impact is possible in terms of appropriate environmental management and monitoring.

**Impact on Ichthyofauna:** Cumulative impact on ichthyofauna is especially notable from the impact types expected during the HPP operation phase, because the multitude of the current and planned dams will practically make the ability of fish to achieve at the reproduction sites impossible.

Fish-passage arrangement is planned on the dam of river Nenskra, which will reduce the negative impact quality, but fish-passage arrangement on the dams of Khudoni and Nenskra is practically impossible.

Because of the possible cumulative impact, in order to compensate the damage on ichthyofauna it is recommended to arrange 2-3 fish reproduction facility, where the fry of protected species (river trout) will breed and released in the headraces. These industries must also have commercial (marketable fish production and sale) means, to ensure the cover of expanses of fish breed from its own revenues. This measure is necessary, because in this case, the investor will only pay the construction and operation costs of the industry and the further operation will be implemented by its own revenues.

**Possible Climate Change:** According to the results of calculations given in the report, only local climate changes are expected during the Nenskra HPP operation. But if we take into account the Jvari reservoir, designed Khudoni reservoir and prospective HPPs possible impact, climate change of the region is expected. Impact on global climate is not expected.

**6.17.3 Impact summary**

Description of impact and impact source	Residual impact characteristics and assessment
<b>Construction phase</b>	

<p><b>Deterioration of air quality and change in acoustic background:</b></p> <ul style="list-style-type: none"> <li>• Preparatory works;</li> <li>• Construction works;</li> <li>• Movement of construction equipment and vehicles.</li> </ul> <p><b>Impact on biological environment:</b></p> <ul style="list-style-type: none"> <li>• Noise and vibration distribution;</li> <li>• Cleaning of reservoir and infrastructure territories from vegetation cover;</li> <li>• Deterioration of water quality;</li> <li>• Dissolution of animal habitats.</li> </ul> <p><b>Impact on water quality and hydrological regime of the rivers:</b></p> <ul style="list-style-type: none"> <li>• Construction of hydraulic structures;</li> <li>• Violation of waste management rules;</li> <li>• Mismanagement of sewage and drainage water.</li> </ul> <p><b>Socio-economic environment:</b></p> <ul style="list-style-type: none"> <li>• Impact on land ownership and use;</li> <li>• Damage of road surface;</li> <li>• Overload of vehicle flow;</li> <li>• Impact on extraction-consumption of natural resources;</li> <li>• Impact on population life quality and demographic conditions;</li> <li>• Contribution to economy.</li> </ul>	<p>Direct, negative, temporary impact Duration – construction phase</p> <p><b>Significance:</b> Low</p> <p>Direct negative impact Duration – construction phase</p> <p><b>Significance:</b> Very high</p> <p>Direct, negative, temporary impact Duration – construction phase</p> <p><b>Significance:</b> Medium</p> <p>Direct, negative, temporary impact Duration – construction phase</p> <p><b>Significance:</b></p> <ul style="list-style-type: none"> <li>• Land ownership and use - <b>High</b></li> <li>• Damage of road surface – <b>Medium</b> <ul style="list-style-type: none"> <li>• Traffic - <b>Medium</b></li> <li>• Natural resources - <b>Medium</b>;                             <ul style="list-style-type: none"> <li>• Health and safety - <b>Low</b>;</li> </ul> </li> <li>• Contribution to economy – <b>Positive High.</b></li> </ul> </li> </ul>
---	--

**Operation phase**

<p><b>Deterioration of air quality and change in acoustic background:</b></p> <ul style="list-style-type: none"> <li>• Evaporation from surface of the reservoir mirror;</li> <li>• Greenhouse gas emissions.</li> </ul> <p><b>Changes of hydrological regime:</b></p> <ul style="list-style-type: none"> <li>• Significant reduction of water level in rivers;</li> <li>• Limitation of solid sediment transportation of the riv. Nenskra;</li> <li>• Visual landscape changes.</li> </ul> <p><b>Impact on biological environment:</b></p> <ul style="list-style-type: none"> <li>• Water-related improvement of living conditions of birds and animals;</li> <li>• Limitation of fish migration;</li> <li>• Indirect impact on flora and fauna related to operation of reservoir.</li> </ul> <p><b>Impact on local, regional and global climate:</b></p> <ul style="list-style-type: none"> <li>• Local climate change – Nenskra reservoir;</li> <li>• Regional climate change – existing and project reservoirs;</li> <li>• Risk of activation of dangerous geological processes;</li> <li>• Impact on health and safety of population;</li> <li>• Impact on biological environment.</li> </ul>	<p>Direct, negative, permanent impact <b>Significance:</b> Medium</p> <p>Direct, negative, permanent impact <b>Significance:</b> High</p> <p>Direct, negative, permanent impact <b>Significance:</b> High</p> <p>Direct, negative, permanent impact <b>Significance:</b> Low</p>
--	--

## 7 Mitigation Measures and Monitoring

Environmental mitigation measures are ordered as follows:

- Impact avoidance /prevention
- Impact reduction
- Impact mitigation
- Damage compensation

Impact can be avoided and risks reduced using best construction and operation practices. Designed project considers some measures of mitigation. However, as not every impact can be avoided, a plan of mitigation measures for every phase is worked out to ensure maximum environmental safety of the project.

The plan is “live” document and is to be amended and corrected on the basis of monitoring/observation. In case of any changes in working procedures corresponding amendments are to be made in the mitigation measures plan. A person responsible for environmental issues of the company will be responsible to ensure environmental monitoring and management. Throughout the construction phase responsibility on environmental management is shared between the company and building contractor.

Information on the mitigation measures and monitoring activates required for the possible impact of the project is represented in the Table below. In particular:

I column – Description of the expected impact according to specific receptors, Types of activities related to the impact and estimated significance of the impact (5-grade classification is used for the estimation of the impact significance: "very low", "low", "medium", "high" or "very high");

II column - Primary objectives of environmental impact mitigation measures;

III column - List of mitigation measures for reducing or eliminating the significance of the impacts (quality), estimated significance of residual (after mitigation measure are carried out) impact (estimated significance of the residual impacts is also assessed by the above mentioned 5-grade classification);

IV column

- Responsible for implementation of mitigation measures;
- Which stages of the project will be more effective for implementing mitigation measures;
- The costs of mitigation measures (Approximate costs will be estimated, according to the 3-point classification: "low" - <\$ 25,000; "medium" - 25000-100000 \$; "high" -> \$ 100,000).

## 7.1 Construction Phase

Receptor/Impact	Impact Description	Mitigation Measures	Description
<b>Construction Stage</b>			
Atmospheric air	<ul style="list-style-type: none"> <li>Flue gases from vehicles, building machinery and domestic generators;</li> <li>Dust due to ground works;</li> <li>Dust due to transportation operations;</li> <li>Dust due to handling of building materials;</li> <li>Welding aerosols</li> </ul>	<ul style="list-style-type: none"> <li>Ensure proper working conditions of machinery;</li> <li>Carry out measures for suppression of dust emission as needed (e.g. watering the work area and roads);</li> <li>Provide preventive measures to avoid excessive dust emission during ground-works and handling of building materials (e.g. prohibition of material dropping from height during loading/unloading);</li> <li>Ensure that vehicle's speed is optimal;</li> <li>Equip personnel with proper protecting equipment (masks) as needed;</li> <li>Instruct personnel before works are launched;</li> <li>Register and response on complaints whenever occur.</li> </ul>	<b>Impact significance and likelihood:</b> low, expected
			<b>Responsible for implementation of mitigation measures:</b> JSC "Nenskra" and Building contractor
			<b>Monitoring:</b> control over implementation conditions of the mitigation measures
			<b>Responsible for monitoring:</b> JSC "Nenskra" and Building contractor
			<b>Monitoring expenses:</b> No additional expenses
Noise and vibration	<ul style="list-style-type: none"> <li>Noise and vibration due to transportation operations</li> <li>Noise and vibration due to building machinery operations</li> <li>Noise and vibration related to the blasting works in stone quarry</li> </ul>	<ul style="list-style-type: none"> <li>Ensure proper working conditions of machinery;</li> <li>Execute "noisy" works in daytime;</li> <li>Equip personnel with proper protecting equipment (ear-protectors) as needed;</li> <li>Instruct personnel before works are launched;</li> <li>Register and response on complaints whenever occur;</li> <li>Ensure personnel with ear-protectors on the operation phase; in the machinery hall, operational must be arranged with special noise-insulation material.</li> </ul>	<b>Impact significance and likelihood:</b> low, expected
			<b>Responsibility for implementation of mitigating measures:</b> JSC "Nenskra" and Building contractor
			<b>Monitoring:</b> technical checkup of machinery
			<b>Responsibility for monitoring:</b> JSC "Nenskra" and Building contractor
			<b>Monitoring costs:</b> No extra costs
The risk of hazardous geological processes activation	<ul style="list-style-type: none"> <li>Formation of erosions and landslides throughout preparation of construction grounds and access roads</li> <li>Development of erosion</li> </ul>	<ul style="list-style-type: none"> <li>Prior to the construction works, additional engineering-geological surveys should be conducted at Nakra headworks;</li> <li>Remove active landslide formations from upper parts of slopes within the project area (including from the slopes of the reservoir basin) and contour slopes at gradient ensuring stability;</li> </ul>	<b>Impact significance and likelihood:</b> medium, possible
			<b>Responsibility for implementation of mitigating measures:</b> JSC "Nenskra" and Building contractor
			<b>Monitoring:</b> current survey

	<p>and landslide processes due to impact of filtration water from the diversion tunnel</p>	<ul style="list-style-type: none"> <li>• At the preliminary stage of design, additional survey of landslide area on the left slope of Nenskra dam should be carried out and engineering and technical activities required for safe operation of the dam should be determined;</li> <li>• Drain surface and ground water so that prevent extra-watering lower of slopes;</li> <li>• Arrange timber gabions below road subgrade to prevent road deformation;</li> <li>• Provide concrete canals (ditches) along roads to prevent erosion and landslides when constructing motor-roads;</li> <li>• Ground water of direct storm water and slope runoffs from roadside ditches must be discharged into the river Nenskra;</li> <li>• After completing the construction works, it is necessary to conduct recultivation and greening works on the territories of the construction sites and construction camps;</li> <li>• Assessment of possible groundwater circulation regime change, a new aquifer formation and infiltration and related impacts on mountain stability during the operation phase of the reservoir;</li> <li>• In case of emergency situations caused by dam damage in different scenarios, modeling of flooding process and its scale downstream of the dam will be carried out during construction designing stage and the report will be submitted to the Ministry of Environment and Natural Resources Protection of Georgia.</li> </ul>	<p><b>Responsibility for monitoring:</b> JSC "Nenskra" and Building contractor</p> <hr/> <p><b>Monitoring costs:</b> no extra costs</p> <hr/> <p><b>Mitigating measure costs:</b> should be stipulated by project documents</p>
<p>Soil stability</p>	<ul style="list-style-type: none"> <li>• Soil stability destruction, fertile soil layer damage risk during the construction works.</li> </ul>	<ul style="list-style-type: none"> <li>• Follow safety norms introduced for the projected works;</li> <li>• Provide protective works as needed;</li> <li>• Removal and temporary storage of topsoil till it is reused for recultivation;</li> <li>• Removal and temporary storage of topsoil at preliminary selected areas; earth works should be carried out according to the requirements established in technical regulation N424 on</li> </ul>	<p><b>Impact significance and likelihood:</b> medium, possible</p> <hr/> <p><b>Responsibility for implementation of mitigating measures:</b> JSC "Nenskra" and Building contractor</p> <hr/> <p><b>Monitoring:</b> current survey</p> <hr/> <p><b>Responsibility for monitoring:</b> Constructor</p> <hr/> <p><b>Monitoring costs:</b> no extra costs</p>

		<p>the "Topsoil removal, storage, use and reclamation" approved by the Government of Georgia on December 31, 2013;</p> <ul style="list-style-type: none"> <li>• Preliminary removed topsoil and excavated soil should be stored on separate disposal areas. These areas should be protected from wind and precipitation. Disposal area should be at least 50 m away from surface water bodies;</li> <li>• Height of the dumps should not exceed 2 m. Slopes of the dump area should be given an appropriate tilt angle (45°);</li> <li>• Water discharge canals should be arranged throughout the perimeter;</li> <li>• After completion of construction works, stockpiled soil should be used for recultivation works;</li> <li>• Strict protection of the working site borders to avoid possible damage of topsoil and soil compaction of the "neighboring" areas;</li> <li>• Protection of the roads intended for the vehicle movement (prohibition of passing off the road) in order to prevent possible soil compaction;</li> <li>• Instruct personnel before works;</li> <li>• Register all potential risks on time and ensure prompt response.</li> </ul>	<p><b>Mitigating measure costs:</b> Costs of activities should be included in the project estimates.</p>
<p>Soil quality</p>	<ul style="list-style-type: none"> <li>• soil pollution by wastes;</li> <li>• Soil pollution due to fuel/oil spilling.</li> </ul>	<ul style="list-style-type: none"> <li>• Ensure proper working conditions of machinery to avoid fuel/oil spilling. Proper management of the fuel/oil materials;</li> <li>• Personnel instruction before starting the work;</li> <li>• Ensure proper waste management, including separation and reuse as possible, store waste not appropriate for reuse in special containers and move out of the territory ;</li> <li>• Localize and clean spilt fuel/oil;</li> <li>• Provide corresponding equipment (containers, spill collection implements, etc.);</li> <li>• Remove all potential pollutants when works are finished.</li> </ul>	<p><b>Impact significance and likelihood:</b> low, possible</p> <p><b>Responsibility for implementation of mitigating measures:</b> JSC "Nenskra" and Building contractor</p> <p><b>Monitoring:</b> engineering supervision; waste management schedule control; visual soil control</p> <p><b>Responsibility for monitoring:</b> JSC "Nenskra" and Building contractor</p> <p><b>Monitoring costs:</b> no extra costs</p> <p><b>Costs of mitigating measures:</b> in case of fuel/lubricant spills, low costs of equipment and technology acquisition for pollution elimination</p>
<p>Surface water</p>	<ul style="list-style-type: none"> <li>• Pollution due to ground</li> </ul>	<ul style="list-style-type: none"> <li>• Ensure proper working conditions of machinery to avoid</li> </ul>	<p><b>Impact significance and likelihood:</b> high, possible</p>



	<ul style="list-style-type: none"> <li>works;</li> <li>Pollution during the process of construction of the dam and bank protecting bund;</li> <li>Pollution due to improper waste management;</li> <li>Pollution by fuel/oil spilling;</li> </ul>	<p>fuel/oil spilling;;</p> <ul style="list-style-type: none"> <li>Whenever in-situ machinery maintenance is unavoidable, do it apart from water bodies;</li> <li>Ensure proper material management;</li> <li>Ensure wastewater management – construct settling ponds if needed</li> <li>Ensure proper waste management, including separation and reusing as possible, temporarily store waste not appropriate for reuse in special containers, follow safety norms and dispose of on the nearest landfill on the contractual basis;</li> <li>Localize and clean spilt fuel/oil;</li> <li>Instruct personnel before starting works;</li> <li>Provide necessary equipment (containers, spill collection implements, etc.);</li> <li>Remove all potential pollutants after finishing work;</li> </ul>	<p><b>Responsibility for implementation of mitigating measures:</b> JSC "Nenskra" and Building contractor</p> <p><b>Monitoring:</b> engineering supervision/control; control of waste management schedule; visual control of water and soil state</p> <p><b>Monitoring responsibility:</b> JSC "Nenskra" and Building contractor</p> <p><b>Monitoring costs:</b> no extra costs</p> <p><b>Costs of mitigating measures:</b> in case of fuel/lubricant spill, low costs of pollution elimination, technical equipment and means/ if necessary, costs of construction of settlement tanks, which does not involve large expenses</p>
<p>Hydrological regime</p>	<ul style="list-style-type: none"> <li>Disastrous alteration of water level and flow</li> </ul>	<ul style="list-style-type: none"> <li>The impact is not anticipated;</li> <li>Mitigation measures are not required;</li> <li>During construction of the dams the river will be temporarily diverted; however it will not alter the river's hydrological regime;</li> </ul>	<p><b>Impact significance and likelihood:</b> low, not very probable</p> <p><b>Responsibility for implementation of mitigating measures:</b> not stipulated</p> <p><b>Monitoring:</b> not envisaged</p> <p><b>Responsibility for monitoring:</b> is not stipulated</p>
<p>Ground water</p>	<ul style="list-style-type: none"> <li>Quality deterioration due to polluted surface waters;</li> <li>Water quality deterioration due to fuel/oil spilling during construction works</li> </ul>	<ul style="list-style-type: none"> <li>Ensure proper maintenance of machinery / equipment in order to avoid fuel / oil spills;</li> <li>If onsite maintenance is required, area should be selected far away from water bodies;</li> <li>Proper management of materials;</li> <li>Management of storm water – arrangement of settler if necessary;</li> <li>Proper management of waste – separation, reuse if possible, useless waste collection in special containers, temporary placement within the area according to the</li> </ul>	<p><b>Impact significance and likelihood:</b> low, less probable</p> <p><b>Responsibility for implementation of mitigating measures:</b> construction contractor</p> <p><b>Monitoring:</b> engineering supervision/control; control of waste management schedule; visual control of water and soil state</p> <p><b>Responsibility for monitoring:</b> JSC "Nenskra" and Building contractor</p> <p><b>Monitoring costs:</b> no extra costs</p>

		<p>safety requirements and transportation to the preliminary agreed landfill by the relevant contractor;</p> <ul style="list-style-type: none"> <li>• Localization / cleaning of spilled fuel/oil material;</li> <li>• Instruct personnel prior to the works;</li> <li>• Ensure appropriate technical equipment and inventory (containers, spill collection equipment, etc.);</li> <li>• Removal of all potential pollutants after the completion of the works.</li> </ul>	<p><b>Costs of mitigating measures:</b> in case of fuel/lubricant spill, equipment and technology low costs for pollution elimination; other measures do not involve extra costs</p>
Landscape	<ul style="list-style-type: none"> <li>• Landscape and visual alteration due to constructions of headworks, power unit and power transmission lines;</li> <li>• Landscape and visual alteration due to increased traffic flow</li> </ul>	<ul style="list-style-type: none"> <li>• Visual impact due to transportation operations is unavoidable, though it is quite low and short-term;</li> <li>• After completing construction, landscape changes (due to presence of dams, power house and other permanent buildings) can be partially mitigated using natural materials and reasonable coloring for better merging with environment.</li> <li>• Clear and recultivation the territory post construction.</li> </ul>	<p><b>Impact significance and likelihood:</b> medium, expectable</p>
			<p><b>Responsibility for implementation of mitigating measures:</b> JSC "Nenskra" and Building contractor</p>
			<p><b>Monitoring:</b> visual, aiming at sanitary and environmental control of the area</p>
			<p><b>Responsibility for monitoring:</b> JSC "Nenskra"</p>
Flora	<ul style="list-style-type: none"> <li>• Direct impact on vegetation cover (removing-destroying of the vegetation from the territories which will be covered with reservoirs water, as well as from</li> </ul>	<ul style="list-style-type: none"> <li>• In order to minimize the risk of damage of the existing vegetation adjacent to the territories of construction sites and camps, as well as in the vicinity of road corridors, strict protection of the vehicle movement and construction camp borders;</li> <li>• Instruct personnel about the vegetation protection issues, before starting works;</li> <li>• Before starting the work, numbering and taxation of the trees and plants existing on the territories which must be covered by</li> </ul>	<p><b>Impact significance and likelihood:</b> very high, possible</p>
			<p><b>Responsibility for implementation of mitigating measures:</b> JSC "Nenskra" and Building contractor</p>
			<p><b>Monitoring:</b> strictly observe traffic routs and construction area borders; engineering supervision of machinery and equipment</p>
			<p><b>Responsibility for monitoring:</b> JSC "Nenskra"</p>
			<p><b>Monitoring costs:</b> no extra costs</p>

	<p>corridors of new roads and areas selected for the arrangement of other infrastructure);</p> <ul style="list-style-type: none"> <li>• Indirect impact – dust, flue gasses</li> </ul>	<p>reservoir water as well as on the construction sites and designed roads, must be conducted;</p> <ul style="list-style-type: none"> <li>• Trees and plants cutting down works should be conducted under the supervision of authorized department of the Ministry of Energy and Natural Resources;</li> <li>• Wherever protected species are found, their extraction from the environment shall be done in compliance with Georgian Law on Georgian Red List and Red Book, paragraph 24, clause 1, sub clause ‘v’, what shall be done in agreement to the Ministry of Environment Protection of Georgia;</li> <li>• In order to compensate the damage on vegetation, the forest stands must be cultivated to stabilize the ravine slopes. Local varieties of trees must be used for forest stands;</li> <li>• The compensation value due to the destroyed forest on the territory of reservoir is determined on the basis of taxation research;</li> <li>• Prior to construction works, construction equipment and vehicles management plan should be worked out.</li> </ul>	<p><b>Costs of mitigating measures:</b></p> <ul style="list-style-type: none"> <li>• Compensation for the destroyed vegetation cover will be related to high costs;</li> <li>• Other activities do not involve extra costs.</li> </ul>
<p>Fauna</p>	<ul style="list-style-type: none"> <li>• Impact on ichthyofauna due to deterioration of surface water quality throughout ground works and construction operations in whole;</li> <li>• Permanent derangement of the habitats as a result</li> </ul>	<ul style="list-style-type: none"> <li>• Control traffic routes and building site borders;</li> <li>• Define optimal vehicle speed to minimize dust emission;</li> <li>• Define optimal vehicle speed to reduce direct impact (collision) risk;</li> <li>• Prohibit machinery honing to minimize fauna disturbance;</li> <li>• Ensure proper working conditions of machinery to reduce noise/vibration;</li> <li>• It is recommended to fence working sites during ground works</li> </ul>	<p><b>Impact significance and likelihood:</b> high, possible</p> <p><b>Responsibility for implementation of mitigating measures:</b> JSC "Nenskra" and Building contractor</p> <p><b>Monitoring:</b> control of waste management; engineering supervision of the equipment;</p> <p><b>Responsibility for monitoring:</b> JSC "Nenskra"</p> <p><b>Monitoring costs:</b> no extra costs</p>

	<p>of vegetation cleaning on the territories which must be covered with reservoir's water (bats shelter destruction);</p> <ul style="list-style-type: none"> <li>• Temporary disturbance of local fauna due to vehicle/machinery and personnel motion (direct impact – collision, indirect impact – dust, flue gases).</li> </ul>	<p>to avoid falling of small mammals in ditches;</p> <ul style="list-style-type: none"> <li>• Ensure proper waste management to avoid water pollution;</li> <li>• Follow all preventive measures against water turbidity increase while working next to water objects;</li> <li>• Execute construction works during the less sensitive period for the water's biological environment;</li> <li>• In order to compensate the damage caused by destruction of the bats shelters, the artificial bat shelters should be arranged after completion of the construction in accordance with the accepted methodology, in particular 1300 - 1500 units of different types of shelters must be arranged;</li> <li>• Prepare biodiversity monitoring plant prior to construction works and submit to the Ministry of Environmental and Natural Resources Protection of Georgia;</li> <li>• In order to minimize negative impact on fauna, removal of vegetation cover should be performed in relatively less sensitive periods in terms of breeding (autumn – winter);</li> <li>• Instruct personnel before starting work on illegal hunting and animal protection issues.</li> </ul>	<p><b>Costs of mitigating measures:</b></p> <ul style="list-style-type: none"> <li>• Bats shelter arrangement will be related to low costs;</li> <li>• Costs in case of fencing the ditches during the land works, which are not related to the significant financial expenses;</li> <li>• Other activities are not related to additional costs.</li> </ul>
<p>Waste</p>	<ul style="list-style-type: none"> <li>• Building waste</li> <li>• Domestic waste</li> </ul>	<ul style="list-style-type: none"> <li>• Ferrous and nonferrous metal should be delivered to the relevant services;</li> <li>• Wood-material partially should be used at the site, the useless waste for this purpose delivered to the local population to use it as fuel;</li> <li>• Domestic waste formed on the territories of construction sites and camps should be placed on the dump of Mestia;</li> <li>• Arrangement of the so-called sanitary landfill on the</li> </ul>	<p><b>Impact significance and likelihood:</b> minor, possible</p> <p><b>Responsibility for implementation of mitigating measures:</b> JSC "Nenskra" and Building contractor</p> <p><b>Monitoring:</b> Control of waste management/removal</p> <p><b>Responsibility for monitoring:</b> JSC "Nenskra"</p> <p><b>Monitoring costs:</b> no extra costs</p>

		<p>territory of Chuberi community, which will also be used by the local population,</p> <ul style="list-style-type: none"> <li>• Special warehouse storerooms should be arranged on the territories of construction camps for temporary disposal of hazardous waste and hermetic containers with special marking to be placed on the construction sites;</li> <li>• Appropriately trained staff to be provided for the waste management, which will be periodically trained and tested;</li> <li>• Removal of the hazardous waste from the construction camps for the further management to be done by the contractor having an appropriate permission on these activities.</li> </ul>	<p><b>Costs of mitigating measures</b></p> <ul style="list-style-type: none"> <li>• Low cost of arrangement of the special storehouse for temporary disposal of the hazardous waste and hermetic container purchasing costs;</li> <li>• Low costs for sanitary landfill arrangement;</li> <li>• Other activities are not related to extra costs.</li> </ul>
<p>Socio-economic environment</p>	<ul style="list-style-type: none"> <li>• Impact on traffic flow and infrastructure;</li> <li>• Discomfort due to landscape alteration;</li> <li>• Electromagnetic radiation;</li> <li>• Restriction of free passage;</li> <li>• Employment</li> </ul>	<ul style="list-style-type: none"> <li>• Impact of transportation operations on traffic intensity and corresponding visual discomfort will be insignificant on construction phase. No mitigation measures needed;</li> <li>• During preliminary works roads will be reconditioned-positive effect;</li> <li>• Ensure that population's/passenger's passage is minimally obstructed during road rehabilitation/construction;</li> <li>• Notify population about work time-frame;</li> <li>• Landscape changes due to construction can be mitigated using materials merged with environment by its color and texture;</li> <li>• Local population will be employed for preparatory and construction works;</li> <li>• Considering distances from substations to the nearest receptors electromagnetic field impact on population is not expected and transmission line will be installed outside the boundaries of residential zone. No mitigation measures needed;</li> </ul>	<p><b>Impact significance and likelihood:</b> Small, anticipated</p> <p><b>Responsibility for implementation of mitigating measures:</b> JSC "Nenskra" and Building contractor</p> <p><b>Monitoring:</b> control over the measures to be implemented during the construction process</p> <p><b>Responsibility for monitoring:</b> JSC "Nenskra"</p> <p><b>Costs of mitigation measures:</b> costs of combining colors and structure of building materials with the environment will be included in the project estimate.</p>
<p>Land use and resettlement</p>	<ul style="list-style-type: none"> <li>• Loss of the public lands under the state ownership due to reservoir</li> </ul>	<ul style="list-style-type: none"> <li>• Preparation of cadastral documentation of the lands existing within the territories of project influence zone;</li> <li>• Inventory/identification and assessment of the house and real estate owned privately and assessment in accordance</li> </ul>	<p><b>Impact significance and likelihood:</b> medium, expectable</p> <p><b>Responsibility for implementation of mitigating measures:</b> JSC "Nenskra"</p>

	<p>arrangement;</p> <ul style="list-style-type: none"> <li>• Temporary loss of land within the area selected for the placement of construction infrastructure;</li> <li>• Acquisition of land plots existing within the power unit area and building infrastructure disposal area.</li> </ul>	<p>with the mutual agreement;</p> <ul style="list-style-type: none"> <li>• Defining the usage conditions for the temporary and permanent land use in accordance with the requirements of the Georgian legislation and social policy of the International Financial Organizations;</li> <li>• Inform one family living within the project influence zone about the physical and economical resettlement issues;</li> <li>• Preparation of the resettlement action plan and presenting to stakeholders;</li> <li>• Paying the damages to the population and business sector for every single incident on basis of an agreement with property owner.</li> </ul>	<p><b>Monitoring:</b> Systematic control over the implementation of the measures provided in the resettlement plan</p> <p><b>Responsibility for monitoring:</b> JSC "Nenskra"</p> <p><b>Costs of monitoring:</b> not related to the extra costs</p> <p><b>Costs of mitigation measures:</b> medium costs related to land acquisition</p>
<p>Historical/ archeological sites</p>	<ul style="list-style-type: none"> <li>• Damage or loss</li> </ul>	<ul style="list-style-type: none"> <li>• Stop works whenever any artifact is discovered. Ensure that artifact is examined by qualified archeologists. Ensure its conservation or delivery to a vault if necessary. Continue works only after permission is obtained.</li> </ul>	<p><b>Impact significance and likelihood:</b> medium, expectable</p> <p><b>Responsibility for implementation of mitigating measures:</b> JSC "Nenskra" and Building contractor</p> <p><b>Monitoring:</b> observation</p> <p><b>Responsibility for monitoring:</b> JSC "Nenskra"</p> <p><b>Monitoring costs:</b> not related to the extra costs</p> <p><b>Costs of mitigation measures:</b> currently costs are not needed. The necessity can be found in case of discovering the late archaeological monuments.</p>
<p>Occupational safety</p>	<ul style="list-style-type: none"> <li>• Traumatism and accidents</li> </ul>	<ul style="list-style-type: none"> <li>• Provide instructions;</li> <li>• Equip personnel by personal protection equipment;</li> <li>• Systematic control over maintenance of the ventilation systems during the construction of tunnels and head shaft;</li> <li>• Installing the methane detectors on workplaces in the tunnels and arrangement of the appropriate sound signaling system;</li> <li>• Personnel health insurance.</li> </ul>	<p><b>Impact significance and likelihood:</b> medium, anticipated</p> <p><b>Responsibility on mitigation measures:</b> JSC "Nenskra" and Building contractor</p> <p><b>Monitoring:</b> Periodic control</p> <p><b>Responsibility on monitoring:</b> JSC "Nenskra"</p> <p><b>Mitigation measures cost:</b> Staff health insurance costs; <b>Low</b> costs for individual protection of personnel</p>
<p><b>The estimated cost of mitigation measures, based on the general assessment given in this table, will be about 2.5-3.0 million US dollars.</b></p>			

7.2 Operation Phase

Receptor/Impact	Impact Description	Mitigation measures	Description
<b>Operation Phase</b>			
Ambient air	<ul style="list-style-type: none"> <li>In process of HPPs operation, emissions of harmful substances in the air is expected only during the repair works, which would not be intensive</li> </ul>	<ul style="list-style-type: none"> <li>The emissions related to the repairing works implementation are identical to the emissions of the construction phase, but much less intensive. Accordingly, implementation of the same mitigation measures is required.</li> </ul>	<p><b>Impact significance and likelihood:</b> low, expected</p> <p><b>Responsible for implementation of mitigation measures:</b> contractor company</p> <p><b>Monitoring:</b> Maintenance checkup of machinery</p> <p><b>Responsible for monitoring:</b> operator company</p> <p><b>Monitoring expenses:</b> No additional expenses</p> <p><b>Expenses for implementation of mitigation measures:</b> low costs of personal security means of the staff; Other measures require no extra costs</p>
Noise and vibration	<ul style="list-style-type: none"> <li>Noise vibration formed during the operation of hydro aggregates and power transformers;</li> <li>In process of repair works:                             <ul style="list-style-type: none"> <li>Noise and vibration caused by the vehicle movement;</li> <li>Noise and vibration caused by the construction equipment.</li> </ul> </li> </ul>	<ul style="list-style-type: none"> <li>Aggregates will be placed in closed building of the HPP and accordingly noise propagation levels would not exceed the norm values;</li> <li>Because of the significant distance from the residential areas, noise propagation from the open distribution devices would not exceed the norm levels;</li> <li>The noise propagation levels related to the repair works implementation are identical to the construction works, but short-term and less intensive;</li> <li>Providing special ear-protectors for the personnel;</li> <li>In the machinery hall, operational office must be arranged with special noise-insulation material.</li> </ul>	<p><b>Impact significance and likelihood:</b> low, expected</p> <p><b>Responsibility for implementation of mitigating measures:</b> operator company</p> <p><b>Monitoring:</b> technical checkup of machinery during the repair works</p> <p><b>Responsibility for monitoring:</b> Operator Company</p> <p><b>Monitoring costs:</b> No extra costs</p> <p><b>Expenses for implementation of mitigation measures:</b> costs of personal security means for the staff; Other measures require no extra costs</p>
Activation of geo hazardous processes	<ul style="list-style-type: none"> <li>Erosion and landslide processes development on the perimeter of the reservoirs coasts</li> </ul>	<ul style="list-style-type: none"> <li>Protection of vegetation existing on the reservoirs slopes and cultivation of new forest stands if necessary;</li> <li>By the geo-hazardous processes development point of view, implementation of preventative measures on the high risk areas, including drainage system and slope strengthening works;</li> <li>Monitoring over geo-hazardous processes on the reservoirs</li> </ul>	<p><b>Impact significance and likelihood:</b> low, possible</p> <p><b>Responsibility for implementation of mitigating measures:</b> operator company</p> <p><b>Monitoring:</b> systematic observation</p> <p><b>Responsibility for monitoring:</b> operator company</p> <p><b>Monitoring costs:</b> no extra costs</p>

		<p>perimeter should be ensured during the whole life cycle of the HPP and if necessary, appropriate preventative measures should be carried out (geological studies, project development and implementation);</p> <ul style="list-style-type: none"> <li>• In order to minimize the risk of negative impact due to accumulation of mudflow solid sediment in Nakra riverbed brought by Lekvedari River and related impact on Naki village, after occurring such an event full flow of the river should be released downstream of Nakra dam till the sediments are fully washed out;</li> <li>• During the flood periods, the total volume of the river flow should be released downstream of Nakra dam in order to minimize the risk of solid sediment (brought from Lekvedari River) accumulation in Nakra riverbed and to minimize negative impact on Nakra village;</li> <li>• In case of dam damage and unplanned release of water, population should be informed by emergency alarm systems arranged within the settlements downstream of the dam;</li> <li>• Systematic control of reservoir perimeter conditions;</li> <li>• Appropriate protective technical structures should be arranged in high-risk areas in terms of development of avalanche and rock falls;</li> <li>• During the detailed designing of Nenskra dam, additional report on seismic stability of the dam will be prepared.</li> </ul>	<p><b>Mitigating measure costs:</b> costs will be determined according to the results of monitoring.</p>
<p>Soil Quality</p>	<ul style="list-style-type: none"> <li>• Soil pollution with household waste;</li> <li>• Pollution in case of fuel/oil spill.</li> </ul>	<ul style="list-style-type: none"> <li>• Supervision over implementation of the measures considered by the waste management plan;</li> <li>• Fuel and transformer and turbine oil storage and usage rule protection control;</li> <li>• In case of pollution with fuel and oil spill, localization of the contamination distribution and clean of the contaminated soil and ground;</li> <li>• Training the personnel on fuel and oil storage/usage issues</li> </ul>	<p><b>Impact significance and likelihood:</b> low, possible</p> <p><b>Responsibility for implementation of mitigating measures:</b> operator company</p> <p><b>Monitoring:</b> waste management schedule control; visual soil control</p> <p><b>Responsibility for monitoring:</b> operator company</p> <p><b>Monitoring costs:</b> no extra costs</p>



		<p>before starting the works;</p> <ul style="list-style-type: none"> <li>• Substation and oil storage ensuring with appropriate technical equipment and inventory (containers, spill collector chambers, etc.).</li> </ul>	<p><b>Costs of mitigating measures:</b> in case of fuel/lubricant spills, equipment and technology costs for pollution elimination</p>
Surface Water	<ul style="list-style-type: none"> <li>• Pollution because of the improper waste management;</li> <li>• Pollution because of the fuel/oil spill.</li> </ul>	<ul style="list-style-type: none"> <li>• Ensure systematic release of ecological flow in the tailrace of Nenskra and Nakra dams;</li> <li>• Arrangement of the compact biological facility for sewage water treatment of the HPPs buildings;</li> <li>• Arrangement of sanitation holes for household-fecal wastewater collecting;</li> <li>• Proper waste management – separation re-use as possible, placement of the useless waste in the special containers, temporary disposal on the territory by protecting the safety requirements and withdrawal from the territory on the agreed landfill by an appropriate contractor;</li> <li>• Arrangement of the storages on HPP territory for temporary disposal of the hazardous waste. Removal of the hazardous waste from the territory must be conducted by the contractor equipped with an appropriate permission on these activities;</li> <li>• Systematic control over the fuel and oil storage/usage rule protection;</li> <li>• In case of fuel/oil spill, localization of the spilled product and clean of the territory;</li> <li>• Substation and oil storage ensuring with appropriate technical equipment and inventory (containers, spill collector chambers, etc.);</li> <li>• Training personnel before starting the works and after once in a year.</li> </ul>	<p><b>Impact significance and likelihood:</b> low, possible</p>
			<p><b>Responsibility for implementation of mitigating measures:</b> operator company</p>
			<p><b>Monitoring:</b> Control of systematic release of ecological flow in the tailrace of Nenskra and Nakra dams; control of waste management schedule; fuel/oil storage and usage control; visual control of water and soil state</p>
			<p><b>Monitoring responsibility:</b> operator company</p>
			<p><b>Monitoring costs:</b> no extra costs</p>
			<p><b>Costs of mitigating measures:</b></p> <ul style="list-style-type: none"> <li>• In case of fuel/lubricant spill, low costs of pollution elimination, technical equipment and means;</li> <li>• The costs of arrangement of the storages for temporary disposal of the harmful substances and treatment facilities should be considered in the accounting of the project documentation;</li> <li>• Low costs of purchasing the necessary containers for collection of the waste.</li> </ul>
Violation of hydrological regime	<ul style="list-style-type: none"> <li>• Maintain sufficient water flow for the socio-economic</li> </ul>	<ul style="list-style-type: none"> <li>• In case of normal pool elevation, ecological flow will be automatically released downstream of the dam (through fish way). In case of minimum pool elevation, additional gate (lock) should be arranged;</li> </ul>	<p><b>Impact significance and likelihood:</b> high, possible</p>
			<p><b>Responsibility for implementation of mitigating measures:</b> operator company</p>

	<ul style="list-style-type: none"> <li>use;</li> <li>Maintain sufficient water flow from the ecological point of view - Less impact on water and water-related biological environment.</li> </ul>	<ul style="list-style-type: none"> <li>Hydrological parameters near the headwork structure will be systematically recorded. Release of ecological flow downstream of the headwork structure will be controlled.</li> <li>Administration of the HPP will record all the complaints and responded to all of them.</li> </ul>	<p><b>Monitoring:</b> Control of systematic release of ecological flow in the tailrace dams;</p> <p><b>Monitoring responsibility:</b> operator company</p> <p><b>Monitoring costs:</b> no extra costs</p> <p><b>Costs of mitigating measures:</b> no extra costs</p>
<p>Impact on sediment transportation due to the existence of the dams and reduction of water flow in the riverbed.</p>	<p>Violation of the dynamics of Nenskra and Nakra riverbeds and stability of coastal zone</p>	<ul style="list-style-type: none"> <li>During the floods, rinsing screens should be fully opened in order to release sediment downstream of Nakra dam;</li> <li>Twice a year, during spring and autumn, after the floods, the Nakra dam will be monitored on the release of sediments;</li> <li>Based on the monitoring results, if it is determined that the release of sediments downstream is hindered, appropriate preventive measures should be taken (e.g. cleaning the upstream by excavator);</li> <li>Monitoring of riverbed processes (four times a year) downstream of the project dams and if necessary, planned water release downstream of the dams.</li> </ul>	<p><b>Impact significance and likelihood:</b> high, possible</p> <p><b>Responsibility for implementation of mitigating measures:</b> operator company</p> <p><b>Monitoring:</b> Control of solid sediment accumulation in the upstream of Nakra dam.</p> <p><b>Monitoring responsibility:</b> operator company</p> <p><b>Monitoring costs:</b> no extra costs</p> <p><b>Costs of mitigating measures:</b> Extra costs will be required in case of using technical means for cleaning the upstream of the dam.</p>
<p>Ground Water</p>	<ul style="list-style-type: none"> <li>Pollution with solid and liquid waste;</li> <li>Deterioration of ground water as a result of fuel/oil spill.</li> </ul>	<ul style="list-style-type: none"> <li>Ensure all preventive measures against deterioration of surface water quality (see corresponding paragraphs);</li> <li>Monitoring of streams existing in the tailrace of Nenskra and Nakra dams will be required. If debit decreases, alternative sources of water supply for population should be arranged;</li> <li>Systematic monitoring of mineral water springs. Monitoring should include surveys of water level and</li> </ul>	<p><b>Impact significance and likelihood:</b> low, less probable</p> <p><b>Responsibility for implementation of mitigating measures:</b> operator company</p> <p><b>Monitoring:</b> control of measures defined by the waste management plan; supervision over protection of rules of fuel/oil storage/usage.</p> <p><b>Responsibility for monitoring:</b> operator company</p>

		<p>quality of the springs. Research intensity should be at least once a quarter.</p>	<p><b>Monitoring costs:</b> no extra costs</p> <p><b>Costs of mitigating measures:</b></p> <ul style="list-style-type: none"> <li>• In case of fuel/lubricant spill, costs of pollution elimination, technical equipment and means;</li> <li>• The costs of arrangement of the storages for temporary disposal of the harmful substances and treatment facilities should be considered in the accounting of the project documentation;</li> <li>• The costs of purchasing the necessary containers for segregate collection of the waste would not be significant;</li> <li>• Arrangement of alternative sources of water supply for population, if necessary, will be related to medium costs.</li> </ul>
<p>Flora</p>	<ul style="list-style-type: none"> <li>• Indirect impact – possible negative impact related to the local climate change</li> </ul>	<ul style="list-style-type: none"> <li>• Implementation of mitigation measures considered by the biodiversity management plan;</li> <li>• mitigation measures for local climate change does not exist;</li> </ul>	<p><b>Impact significance and likelihood:</b> medium, possible</p> <p><b>Responsibility for implementation of mitigating measures:</b> mitigation measures are not available</p> <p><b>Monitoring:</b> Monitoring over the possible impact on wild cultural plants on the adjacent territories of the reservoir</p> <p><b>Responsibility for monitoring:</b> operator company</p> <p><b>Monitoring costs:</b> low costs will be needed for the botanical researches, inviting specialists, which will not be high.</p> <p><b>Costs of mitigating measures:</b> compensation measures for the vegetation cover damaged during the construction phase will be associated with high costs during the first 5 years of the operation of the HPP.</p>

Fauna	<ul style="list-style-type: none"> <li>• Damage or death of the birds due to impact of lighting systems of dam and HPP facilities;</li> <li>• Bird injury or death due to the impact from transmission line;</li> <li>• Impact in process of repair works implementation, which would not be significant</li> <li>• Permanent restriction of movement of the ichthyofauna in the headrace of the dam;</li> <li>• The risk of getting of fish in the water-intake and their death;</li> <li>• Surface water contamination.</li> </ul>	<ul style="list-style-type: none"> <li>• Optimization of night lighting systems, in order to minimize the impact on birds and installing the special device on the transmission line to frighten the birds;</li> <li>• In order to compensate the damage caused by destruction of the bats shelters, the artificial bat shelters should be arranged in accordance with the accepted methodology, in particular 1300 – 1500 units of shelters must be arranged;</li> <li>• Arrangement of the fish-passage maximally close to the natural hydrological conditions must be considered for the Nakra water intake dam</li> <li>• Automatic monitoring system should be installed on the fish-passage and control should be set over its technical functioning conditions;                             <ul style="list-style-type: none"> <li>• In case if the fish-passage effectiveness during the 3-5 years of monitoring would not be more than 60-65%, 45-50 thousand trout fry should be annually released in Makara River;</li> </ul> </li> <li>• The ecological flow from Nakra dam should be released through the fish-passage, which will ensure creation of the natural conditions for black trout migration;</li> <li>• in order to compensate the damage to the ichthyofauna due to the rock-fill dam arrangement, 60 thousand trout fry should be annually released in Nenskra River;</li> <li>• Prevention of water pollution by ensuring appropriate waste management and protection of fuel/oil usage rules;</li> <li>• Permanent restriction of fish obtaining on 1500-2000 m distance in the tailrace of the dam;</li> <li>• Training personnel before starting the works and then once a year.</li> <li>• Prior to the construction works, biodiversity management plant should be prepared and submitted to the Ministry of Environmental and Natural Protection of Georgia.</li> </ul>	<p><b>Impact significance and likelihood:</b> high, possible</p>
			<p><b>Responsibility for implementation of mitigating measures:</b> operator company</p>
			<p><b>Monitoring:</b></p> <ul style="list-style-type: none"> <li>• Control of night lighting systems conditions;</li> <li>• Control over effectiveness of the fish passage and fish protector facility usage;</li> <li>• River trout monitoring;</li> <li>• Waste management control.</li> </ul>
			<p><b>Responsibility for monitoring:</b> client and construction contractor</p>
			<p><b>Monitoring costs:</b> costs will be needed for inviting the specialist for river trout monitoring</p>
			<p><b>Costs of mitigating measures:</b> Medium costs will be required for the implementation of mitigation measures.</p>
Waste	<ul style="list-style-type: none"> <li>• Industrial waste;</li> </ul>	<ul style="list-style-type: none"> <li>• Waste collection by using the segregative method;</li> </ul>	<p><b>Impact significance and likelihood:</b> minor, possible</p>

	<ul style="list-style-type: none"> <li>• Domestic waste.</li> </ul>	<ul style="list-style-type: none"> <li>• Ferrous and nonferrous metal should be delivered to the relevant services;</li> <li>• Household waste should be disposed on the landfill of Mestia;</li> <li>• Special warehouse storerooms should be arranged on the territory of HPP for temporary disposal of the hazardous waste;</li> <li>• Appropriately trained staff to be provided for the waste management, which will be periodically trained and tested;</li> <li>• Removal of the hazardous waste for the further management to be done by the contractor having an appropriate permission on these activities.</li> </ul>	<p><b>Responsibility for implementation of mitigating measures:</b> operator company</p> <p><b>Monitoring:</b> Control of waste management</p> <p><b>Responsibility for monitoring:</b> operator company</p> <p><b>Monitoring costs:</b> no extra costs</p> <p><b>Costs of mitigating measures</b></p> <ul style="list-style-type: none"> <li>• Cost of arrangement of the special storehouse for temporary disposal of the hazardous waste should be considered in the accounting of HPP project documentation;</li> <li>• Waste collecting container purchasing costs would not be high;</li> <li>• Other activities are not related to extra costs.</li> </ul>
<p>Socio-economic environment</p>	<ul style="list-style-type: none"> <li>• Creation of permanent jobs and employment of local population</li> </ul>	<ul style="list-style-type: none"> <li>• Maximum employment of the local population during the HPPs operation phase;</li> <li>• Organization of theoretical and practical trainings for the selected persons from local population in order to prepare qualified personnel.</li> </ul>	<p><b>Impact significance and likelihood:</b> minor, expected</p> <p><b>Responsibility for implementation of mitigating measures:</b> operator company</p> <p><b>Monitoring:</b> periodic control over HPP personnel qualification</p> <p><b>Responsibility for monitoring:</b> operator company</p> <p><b>Costs of mitigation measures:</b> personnel training costs would not be high</p>
<p>Personnel Safety</p>	<ul style="list-style-type: none"> <li>• Negative impact of electromagnetic radiation on HPP personnel;</li> <li>• Injuries and accidents.</li> </ul>	<ul style="list-style-type: none"> <li>• Arrangement of the protective screens and reducing the period of personnel presence in the radiation zone, in order to minimize the electromagnetic radiation on the HPP staff;</li> <li>• Instruction;</li> <li>• Providing personnel with protection equipment;</li> <li>• Health insurance of the personnel.</li> </ul>	<p><b>Impact significance and likelihood:</b> medium, expected</p> <p><b>Responsibility on mitigation measures:</b> operator company</p> <p><b>Monitoring:</b> Control of protection of the working conditions and occupational safety rules</p> <p><b>Responsibility on monitoring:</b> operator company</p>

			<p><b>Mitigation measures cost:</b>                  Staff health insurance costs; Costs for individual protection of personnel</p>
--	--	--	---

## **8 Environmental and Social Monitoring Plan**

The aim of environment monitoring is:

- Confirmation of potential impact assessment;
- Control/assurance compliance of environmental and safety with the legislative/regulation requirements;
- Risks and environmental/social impact control;
- Assurance of public/stakeholders with relevant information;
- Determining the effectiveness of mitigation and minimization measures, correction-if necessary;
- Control of environmental impact and risks in process of construction and operation.

Monitoring methods include visual observation and measurements (if necessary). Monitoring program describes the monitoring parameters, monitoring time and frequency, monitoring data collection and analysis. Monitoring capacity depends on significance of expected impact/risk.

### 8.1 Monitoring Plan – Preparation and Construction Works

Control object/action	Control/sampling point	Method	Frequency/Time	The Purpose	Responsible Person
1	2	3	4	5	6
Air (dust and emissions)	<ul style="list-style-type: none"> <li>• Construction sites;</li> <li>• Construction camps;</li> <li>• Access roads to the construction sites;</li> <li>• Nearest receptor (residential zone)</li> </ul>	<ul style="list-style-type: none"> <li>• Visual control;</li> <li>• Control over technical functionality of the machinery/equipment;</li> <li>• Instrumental measurements.</li> </ul>	<ul style="list-style-type: none"> <li>• Daily, during earth works, periodically in dry weather;</li> <li>• Daily, during the construction works, including road construction and rehabilitation;</li> <li>• During intensive transport operations in dry weather on a daily basis;</li> <li>• Measurements if necessary and in case of complaints;</li> <li>• Checking the functionality of the equipment before starting the work;</li> <li>• Instrumental measurements if necessary and in case of complaints.</li> </ul>	<ul style="list-style-type: none"> <li>• Ensuring the compliance of the quality with the established norms;</li> <li>• Minimal disturbance of the population;</li> <li>• Ensuring safety of the personnel;</li> <li>• Minimal disturbance of the vegetation/flora and fauna.</li> </ul>	<ul style="list-style-type: none"> <li>• Client;</li> <li>• Building Contractor;</li> </ul>



Noise (if necessary)	<ul style="list-style-type: none"> <li>• Construction sites;</li> <li>• The nearest receptor (settlement).</li> </ul>	<ul style="list-style-type: none"> <li>• Control of stabilities of structures;</li> <li>• Control of functionality of the machinery/equipment;</li> <li>• Instrumental measurements.</li> </ul>	<ul style="list-style-type: none"> <li>• Check of functionality of the equipment before starting the work;</li> <li>• Instrumental measurements periodically, or after receiving complaints.</li> </ul>	<ul style="list-style-type: none"> <li>• Ensuring the compliance with the health and safety norms;</li> <li>• Comfortable working conditions for staff;</li> <li>• Maintenance of stability of structures;</li> <li>• Minimal disturbance of fauna/population.</li> </ul>	<ul style="list-style-type: none"> <li>• Building Contractor;</li> <li>• Client.</li> </ul>
Soils (if necessary)	<ul style="list-style-type: none"> <li>• Construction sites;</li> <li>• Construction camps;</li> <li>• Material and waste disposal areas.</li> </ul>	<ul style="list-style-type: none"> <li>• Control, supervision;</li> <li>• Control of functionality of the machinery/equipment;</li> <li>• Control through laboratory tests.</li> </ul>	<ul style="list-style-type: none"> <li>• Periodic inspection;</li> <li>• Inspection after completion of the work;</li> <li>• Laboratory tests in case of pollutants spill.</li> </ul>	<ul style="list-style-type: none"> <li>• Maintenance of stability and quality of the soil.</li> </ul>	<ul style="list-style-type: none"> <li>• Building Contractor;</li> <li>• Client.</li> </ul>
Geological risks	<ul style="list-style-type: none"> <li>• Project areas;</li> <li>• Construction sites;</li> <li>• Corridors of construction roads.</li> </ul>	<ul style="list-style-type: none"> <li>• Visual audit;</li> <li>• Engineering-geological survey in case of need.</li> </ul>	<ul style="list-style-type: none"> <li>• At least once in a quarter at the preliminary stage and during construction works.</li> </ul>	<ul style="list-style-type: none"> <li>• Minimization of risks of geological hazards.</li> </ul>	<ul style="list-style-type: none"> <li>• Building Contractor;</li> <li>• Client.</li> </ul>

Water quality	<ul style="list-style-type: none"> <li>• Construction camps;</li> <li>• Construction sites during the works near the surface water bodies (intake, near road construction sites).</li> </ul>	<ul style="list-style-type: none"> <li>• Visual audit;</li> <li>• Control of functionality of the machinery/equipment;</li> <li>• Solid waste management control;</li> <li>• Wastewater management control;</li> <li>• Controlling the technical functionality of treatment facility;</li> <li>• Laboratory tests.</li> </ul>	<ul style="list-style-type: none"> <li>• During arrangement of the construction sites (near the water bodies) especially after rain/snow;</li> <li>• In process of work (near the water bodies or in the riverbed);</li> <li>• During solid waste transportation/storage;</li> <li>• Checking the functionality of the equipment before starting the work;</li> <li>• Maintenance of treatment plant – periodically;</li> <li>• Laboratory tests – after the spillage of pollutants or damage of treatment plant.</li> </ul>	<ul style="list-style-type: none"> <li>• Ensuring the water quality protection;</li> <li>• Minimizing the potential impact on fish fauna.</li> </ul>	<ul style="list-style-type: none"> <li>• Building Contractor;</li> <li>• Client.</li> </ul>
Vegetation cover	<ul style="list-style-type: none"> <li>• Construction camps;</li> <li>• Areas adjacent to construction site and dam site;</li> <li>• Reservoir area;</li> <li>• Corridors of roads to be rehabilitated or arranged.</li> </ul>	<ul style="list-style-type: none"> <li>• Visual control;</li> </ul>	<ul style="list-style-type: none"> <li>• Recording of vegetation cover in terms of quantity and species prior to works;</li> <li>• Control during the working hours; unplanned control;</li> <li>• Possible restoration of the vegetation after completion of the works.</li> </ul>	<ul style="list-style-type: none"> <li>• Maximum possible maintain of the vegetation;</li> <li>• Minimal disturbance of Fauna/population.</li> </ul>	<ul style="list-style-type: none"> <li>• Building Contractor;</li> <li>• Client.</li> </ul>

Fauna	<ul style="list-style-type: none"> <li>• Areas adjacent to construction camps;</li> <li>• Construction sites of dams or adjacent areas;</li> <li>• Reservoir areas;</li> <li>• Areas adjacent to corridors of roads to be rehabilitated or constructed;</li> <li>• Biological environment of Nenskra and Nakra Rivers;</li> </ul>	<ul style="list-style-type: none"> <li>• Visual control in order to identify species included in the Red List of Georgia;</li> <li>• Observance over animal species in order to determine the impact.</li> </ul>	<ul style="list-style-type: none"> <li>• Systematic control during construction works.</li> </ul>	<ul style="list-style-type: none"> <li>• Minimize impact on fauna;</li> <li>• Minimize possible impact on fish fauna.</li> </ul>	<ul style="list-style-type: none"> <li>• Building Contractor;</li> <li>• Client.</li> </ul>
Waste	<ul style="list-style-type: none"> <li>• Construction sites or adjacent areas;</li> <li>• Waste disposal area.</li> </ul>	<ul style="list-style-type: none"> <li>• Visual inspection of the territory;</li> <li>• Waste management control.</li> </ul>	<ul style="list-style-type: none"> <li>• Periodically, especially during the windy weather.</li> </ul>	<ul style="list-style-type: none"> <li>• Soil, water quality protection;</li> </ul>	<ul style="list-style-type: none"> <li>• Building Contractor;</li> <li>• Client.</li> </ul>
labor Safety	<ul style="list-style-type: none"> <li>• The area of works.</li> </ul>	<ul style="list-style-type: none"> <li>• Inspection;</li> <li>• Existence of the individual protection means and periodic control of functionality.</li> </ul>	<ul style="list-style-type: none"> <li>• Periodic monitoring during the working period.</li> </ul>	<ul style="list-style-type: none"> <li>• Ensuring compliance of health and safety with regulations;</li> <li>• Prevent injuries or reduce to a minimum.</li> </ul>	<ul style="list-style-type: none"> <li>• Building Contractor;</li> <li>• Client.</li> </ul>

## 8.2 Monitoring Plan – Operation Phase

Control object/action	Control/sampling point	Method	Frequency/Time	The Purpose	Responsible Person
Noise	<ul style="list-style-type: none"> <li>Power house and substation territory</li> </ul>	<ul style="list-style-type: none"> <li>periodic control;</li> <li>Ensuring the technical functionality of the equipment.</li> </ul>	<ul style="list-style-type: none"> <li>Periodic control;</li> <li>In case of entry of personnel complaints;</li> <li>After conducting the repair works.</li> </ul>	<ul style="list-style-type: none"> <li>Ensuring the compliance of health and safety with the regulations;</li> <li>Minimal impact on personnel;</li> <li>Minimal impact on Fauna.</li> </ul>	<ul style="list-style-type: none"> <li>Operator company</li> </ul>
Soil stability	<ul style="list-style-type: none"> <li>Control of the slope-strengthening means on the reservoirs perimeter;</li> <li>Control of the water amount and quality of the filtration waters at the shoulders of the dams and from the bottom.</li> </ul>	<ul style="list-style-type: none"> <li>Inspection;</li> <li>Inspection, laboratorial control of the water quality if necessary.</li> </ul>	<ul style="list-style-type: none"> <li>Periodic; after heavy rains/snow.</li> <li>regular, quarterly</li> </ul>	<ul style="list-style-type: none"> <li>Ensuring safety;</li> <li>Prevention of suffusion events.</li> </ul>	<ul style="list-style-type: none"> <li>Operator company</li> <li>Operator company</li> </ul>
Soil quality	<ul style="list-style-type: none"> <li>Substation territory;</li> <li>Waste disposal areas.</li> </ul>	<ul style="list-style-type: none"> <li>Visual control;</li> <li>Laboratory analysis as required.</li> </ul>	<ul style="list-style-type: none"> <li>After changing/adding transformer oil.</li> </ul>	<ul style="list-style-type: none"> <li>Soil quality assurance;</li> <li>Prevention of surface water pollution risk by surface run-off.</li> </ul>	<ul style="list-style-type: none"> <li>Operator company</li> </ul>
Accumulation of solid sediments in reservoirs	<ul style="list-style-type: none"> <li>River confluence area in reservoir.</li> </ul>	<ul style="list-style-type: none"> <li>Visual control.</li> </ul>	<ul style="list-style-type: none"> <li>Annually during the spring and autumn floods.</li> </ul>	<ul style="list-style-type: none"> <li>Minimization of solid sediment accumulation in Nakra reservoir;</li> <li>Minimization of negative impact risk on the banks of the river Nakra.</li> </ul>	<ul style="list-style-type: none"> <li>Operator company</li> </ul>
Geological risks	<ul style="list-style-type: none"> <li>HPP communications deployment areas;</li> <li>Slopes of Nenskra reservoir basin;</li> </ul>	<ul style="list-style-type: none"> <li>Visual audit;</li> <li>Engineering-geological study if necessary;</li> <li>Study of water level and</li> </ul>	<ul style="list-style-type: none"> <li>Systematically during 5 years of operation of the HPP on a quarterly basis and then once a year;</li> </ul>	<ul style="list-style-type: none"> <li>Minimize geological hazards activation risks;</li> <li>Prevent landslide and erosion processes as a</li> </ul>	<ul style="list-style-type: none"> <li>Operator company</li> </ul>

	<ul style="list-style-type: none"> <li>• Valleys of Nakra River tributaries;</li> <li>• Control of new sources along diversion tunnels.</li> </ul>	quality of existing and new springs along diversion tunnels.	<ul style="list-style-type: none"> <li>• Control of springs during 5 years, once in a six months.</li> </ul>	result of impact of tunnel filtration waters.	
Change of groundwater level and quality	<ul style="list-style-type: none"> <li>• Spring and wells existing within the project influence zone;</li> <li>• Mineral water springs downstream of Nenskra and Nakra dams.</li> </ul>	<ul style="list-style-type: none"> <li>• Measurement of water level in springs and wells;</li> <li>• Laboratory tests of water quality.</li> </ul>	<ul style="list-style-type: none"> <li>• During the first 5 years of HPP operation on a quarterly basis.</li> </ul>	<ul style="list-style-type: none"> <li>• Control of changes in groundwater level and quality.</li> </ul>	<ul style="list-style-type: none"> <li>• Operator company</li> </ul>
Biological Environment	<ul style="list-style-type: none"> <li>• Recording the fish migration on the fish-passage of river Nakra dam by using the special equipment during 3-5 years after the start of the operation;</li> <li>• Studying the river trout populations in the headrace and tailrace of the river;</li> <li>• Accounting the habitats of protected animal species on the perimeter of the reservoir;</li> <li>• Control over the ecological flow release in the tailrace of the dam;</li> <li>• Vegetation cover and cultural plants conditions control on the adjacent territories of the reservoir.</li> </ul>	<ul style="list-style-type: none"> <li>• Visual audit;</li> <li>• The fish migration monitoring with the special equipment;</li> <li>• Quantitative assessment of river trout in the headrace of the dam;</li> <li>• Quantitative assessment of protected animal species on the adjacent territories of the reservoir;</li> <li>• Wild and cultural plants evaluation on the adjacent territories of the dam.</li> </ul>	<ul style="list-style-type: none"> <li>• Fish-passage effectiveness control during 3-5 years after the start of operation;</li> <li>• River trout population assessment twice a year during 3 years after the start of operation;</li> <li>• Identification of habitats of the protected animal species and vegetation cover conditions study once a for 3 years year after the start of the operation;</li> <li>• Regular accounting of the ecological flow release in the tailraces of the dams.</li> </ul>	<ul style="list-style-type: none"> <li>• Minimization of possible negative impact on the biological environment</li> </ul>	<ul style="list-style-type: none"> <li>• Operator company</li> </ul>

Climate	<ul style="list-style-type: none"> <li>• Reservoir surfaces and adjacent territories.</li> </ul>	<ul style="list-style-type: none"> <li>• Temperature, relative humidity and wind regime control by the nearest weather station data.</li> </ul>	<ul style="list-style-type: none"> <li>• During the year.</li> </ul>	<ul style="list-style-type: none"> <li>• Assessment of impact on local climate.</li> </ul>	<ul style="list-style-type: none"> <li>• Operator company</li> </ul>
Waste	<ul style="list-style-type: none"> <li>• Headworks;</li> <li>• Power unit/substation territory;</li> <li>• Waste disposal territory.</li> </ul>	<ul style="list-style-type: none"> <li>• Visual inspection of the territory;</li> <li>• Waste management control.</li> </ul>	<ul style="list-style-type: none"> <li>• Periodically, especially during the windy weather.</li> </ul>	<ul style="list-style-type: none"> <li>• Soil, water quality protection.</li> </ul>	<ul style="list-style-type: none"> <li>• Operator company</li> </ul>
Labor Safety	<ul style="list-style-type: none"> <li>• Production area.</li> </ul>	<ul style="list-style-type: none"> <li>• Inspection;</li> <li>• Existence of the individual protection means and periodic control of functionality.</li> </ul>	<ul style="list-style-type: none"> <li>• Periodic control during the production.</li> </ul>	<ul style="list-style-type: none"> <li>• Ensure the compliance of health and safety with the regulations;</li> <li>• Injuries prevention/minimizing.</li> </ul>	<ul style="list-style-type: none"> <li>• Operator company</li> </ul>

Monitoring (except for laboratory procedures in case of need) does not require any additional costs. Monitoring to be done during repair-rehabilitation works is similar to the one specified for the construction process. Monitoring duration and frequency depends on scale, type and duration of rehabilitation/repair

## 9 Possible Emergency Situations

Followings may be considered as the expected emergency situations:

Emergency situation	Impact Description and Response
<b>Construction Phase</b>	
Disturbance of soil stability	<ul style="list-style-type: none"> <li>• Possible risks on the water intake, power unit and tunnel arrangement phase are identical to the risks of the similar type construction works;</li> <li>• Diversion tunnel arrangement works may damage the rocks along the route and develop erosion processes;</li> <li>• Prior the construction works the contractor must consider possible emergency situations and develop a relevant action plan;</li> <li>• Monitoring, appropriate response when necessary;</li> <li>• Staff training.</li> </ul>
Fuel/oil spill	<ul style="list-style-type: none"> <li>• Machine and equipment failure may cause pollution of soil and/or water with oil. In order to prevent this outcome technical functionality of the machines and equipment must be controlled. Relevant measures must be carried out in case of oil spill (cleaning of the spill area and remediation);</li> <li>• Area monitoring, appropriate response when necessary;</li> <li>• Staff training.</li> </ul>
Fire	<ul style="list-style-type: none"> <li>• In order to prevent fire requirements on fire safety must be fulfilled;</li> <li>• Staff training.</li> </ul>
Injuries	<ul style="list-style-type: none"> <li>• Safety rules violation may increase injury risks;</li> <li>• Staff training is required (on first aid and safety issues);</li> <li>• Providing personnel with individual protection equipment;</li> <li>• Protection/control of the relevant security measures;</li> <li>• Medical insurance of the staff.</li> </ul>
<b>Operation phase</b>	
Fire	<ul style="list-style-type: none"> <li>• Fire on the power unit of the HPP may cause air pollution with combustion products;</li> <li>• In order to prevent fire requirements on fire safety must be fulfilled, namely: automatic fire alarm system installation, functionality of indoor and outdoor fire extinguishing systems, development of evacuation plan;</li> <li>• Strict observance of safety rules;</li> <li>• Staff training.</li> </ul>
Fuel/oil spill	<ul style="list-style-type: none"> <li>• Machine and equipment failure may cause soil and/or water pollution with oil products. In order to prevent this outcome technical functionality of the machines and equipment must be controlled. Relevant measures must be carried out in case of oil spill (cleaning of the spill area and remediation);</li> </ul>

	<ul style="list-style-type: none"> <li>• In order to minimize distribution of oil in case of transformer or turbine oil spill into the tailrace water, special catching technical equipment must be used;</li> <li>• Daily registration of turbine oil consumption;</li> <li>• Strict observance of safety rules;</li> <li>• Monitoring;</li> <li>• Staff training.</li> </ul>
Turbine and transformer oil spill	<ul style="list-style-type: none"> <li>• In order to prevent oil spill technical functionality of oil-containing equipment (e.g. transformers) must be controlled and repaired when necessary;</li> <li>• Removal and neutralization of contaminated soil in case of oil spill;</li> <li>• Arrangement of oil collecting tank for emergency discharge on the territory of the substation;</li> <li>• In case of spill of big amount of oil, localization and collection of spill;</li> <li>• Strict observance of safety rules;</li> <li>• Monitoring;</li> <li>• Staff training.</li> </ul>
Accidental damage of the hydraulic structures	<ul style="list-style-type: none"> <li>• Damage of hydraulic structures may cause wash-off of the upper layers of the soil and ground;</li> <li>• Area flooding;</li> <li>• Damage of pressure pipe may cause risk of soil stability violation;</li> <li>• Reduction of possible emergencies through regular monitoring and relevant measure implementation;</li> <li>• Strict observance of safety rules;</li> <li>• Staff training.</li> </ul>
Injuries	<ul style="list-style-type: none"> <li>• Safety rules violation may increase injury risks;</li> <li>• In order to avoid accidents safety rules must be strictly fulfilled;</li> <li>• Staff training;</li> <li>• Medical insurance of the staff.</li> </ul>



Emergency response plan will be determined in relevant instructions. The HPP must have an evacuation plan, small technical facilities/equipment to respond on small-scale emergencies, personal protection and communication means (telephone, fax) in order to notify and call support/rescue services (ambulance, fire station) in case of emergency.

Every emergency situation will be registered, its causes will be identified. Appropriate remediation works will be conducted, if necessary.

All units will be equipped with first aid kits, fire inventory. Trainings on operation and safety issues will be held periodically.

Plan of possible emergency situations during the construction and operation phases of the HPP is given in Annex 2.

## 10 Public Awareness and Participation in the ESIA Process

Stakeholders (potentially affected by the project) were identified in the beginning of the Environmental and Social Impact Assessment Process, a brief description of the planned activities and form for public questions was prepared. Information was prepared on Georgian language.

A program for public engagement was developed in order to ensure engagement of all potential stakeholders. Participation procedure was developed for all groups, as well as information volume and format, schedule, feedback mechanisms, required resources and personnel. Information on different measures to be undertaken on various stages of the project are given in Table 10.1.

**Table 10.1.**

Stage/phase	Engagement Procedure/Method	Provided Information/Format
<b>Planning Stage</b>	<ul style="list-style-type: none"> <li>• Interviews with state officials;</li> <li>• Interviews with environmental services and experts;</li> <li>• Meetings with personnel, environmental experts.</li> </ul>	<ul style="list-style-type: none"> <li>• Press releases and public information through media;</li> <li>• Technical documentation;</li> <li>• Presentation;</li> <li>• Participatory process.</li> </ul>
<b>ESIA Stage</b>	<ul style="list-style-type: none"> <li>• Interviews with stakeholders;</li> <li>• Questionnaires;</li> <li>• Public meeting (population, NGOs, etc.)</li> </ul>	<ul style="list-style-type: none"> <li>• Non-technical documentation;</li> <li>• Project summary;</li> <li>• Participatory process.</li> </ul>
<b>Construction and Operation Stage</b>	<ul style="list-style-type: none"> <li>• “Open doors” principle;</li> <li>• Complaints response mechanism.</li> </ul>	<ul style="list-style-type: none"> <li>• Feedback</li> </ul>

The information about appointment of public hearing was published in the issue of April 4<sup>th</sup> 2015, of the newspaper “Sakartvelos Respublika”(The Republic of Georgia). The public hearing will be held in administrative building of Mestia municipality (address: Mestia town, Seti square # 1) at 12: 00 a.m. on June 2, 2015.

The public hearing of EIA report in Chuberi and Nakra communities, that got in the project impact zone, will be held on June the 1<sup>st</sup>, 2015, namely:

- In the community center of Nakra community- June 1, 2015, at 12:00 a.m.
- In the community center of Chuberi community- June 1, 2015, at 16:00 p.m.

In order to inform local population, on April 24 and 25, 2015 preliminary meetings will be held in the villages of Nakra community (villages: Naki, Lekalmakhi, Zeda Marghi, Larilari, Sgurishi, Tita, Lakhami).

Information on comments and suggestions received during the public review is given in Paragraph 10.

### 10.1 Information on Comments and Suggestions Received during the Public Review

№	Comments and Suggestions	Content of Comments and Suggestions	Reply
1	Ministry of Environment and Natural Resources Protection of Georgia.	<p>According to the Environment Impact Assessment (EIA) Vol.1, Pg - 15 (chapter – 3.3), alternatives of riverbed type HPP, seasonal regulation HPP and run-of-the river HPP were discussed on the design phase of the project. From the mentioned alternatives, construction of seasonal regulation HPP was preferred due to the higher generation, but there is nothing said about the amount of generated electricity in case of construction of run-of the river HPP cascade. Except this heights of dam (250m, 200m, 150m) and alternatives of areas for arrangement of dams are presented in the report. With the purpose of assessment of impact on the environment, different options of dam height are discussed in the report, but from the suggested versions, case of arrangement of tall dam (250m) on five different areas is most significant, namely, 1km lower at the confluences of riv. Nakresi and riv. Dalari, on the benchmarks of 1600 m (1), 1500 m (2), 1475 m (3), 1300 m (4) and 1190 m (5). In case of construction of 250m dam, reservoir storage capacity is presented only in the case of first alternative (261 mln m3), but nothing is said about the amount of generated electricity in case of construction of 261 mln m3 reservoir. Except this, information on amount of area, which will be inundated, if the dam is arranged on the lower altitudes, is not given in the report. There is also nothing said about how much electricity will be generated in such case. How reduction of height of dam will reflect on the areas and energy characteristics is still uncertain.</p>	Comment is considered:

		<p>Hence, it is obscure what kind of criteria were used for comparing of alternatives and why the selected alternative was preferred. In order to become obvious the preference of the selected alternative, information about the territories, storage capacity of reservoir and the amount of generated electricity of other alternatives should be presented in the report as well.</p>	
<p>2</p>	<p>„—————”</p>	<p>Assessment and analysis of alternatives of planned activities are presented in the Environment Impact Assessment (EIA), but alternatives are insufficient and additional issues must be discussed, including:</p> <p>Alternative 1 – selection of dams according to their height and not design is quite unjustified and vague. There is no information about the fact that why didn't they study the case of construction of dam with height less than 135m. As a whole, construction of low and middle height dams reduces risks on the environment.</p> <p>Alternative 2 – Presented alternative must discuss the issue of increasing storage capacity of Nenskra reservoir with rising of dam's height, in order to exclude any impact on riv.Nakra gorge, the option of diversion of riv. Nakra shouldn't be discussed.</p> <p>Alternative 3 – Riverbed type HPP is mentioned just once in the report and the information about it is not sufficient. Such HPPs are operating in many countries of the world and accordingly, in the report construction of riverbed Type HPP must be discussed, instead of reservoir HPP.</p> <p>Alternative 4 – The report must assess and compare the case of replacement of diversion in riv. Nakra and riv. Nenskra gorges by construction of small riverbed HPP in Nakra gorge. How positively it</p>	<p>Comments are taken into account :</p> <p>Taking into account the risks of impact on the environment, height of the dam is essential, because this feature determines the space of areas that will be flooded, space of water surface and the scales of negative impacts on natural and social environment. The issue about the reason of selection 135m dam is given in the paragraph 3.3.2.</p> <p>It must be noted that riverbed type HPP essentially needs arrangement of dam and reservoir.</p>

		<p>will impact on the environment must be also describe in the 4th alternative.</p> <p>Above mentioned issues must be discussed in the Environment Impact Assessment based on ecological examination.</p>	
3	„_____”	<p>In the presented report, geological issues connected to some dangerous geological receptors are not described. Potential impact is presumable on these receptors during the construction and operation periods.</p> <p>Accordingly, basic information of geological and geomorphological structure must be given in the EIA based on the ecological examination. The report should consist of the information about possible avalanches, landslides and torrents in the area of reservoir, as well as some possible erosive and sedimentation processes in the lower area of the dam.</p>	Comment is considered:
4	„_____”	<p>Engineering-geological map is not presented in the EIA report. Rocks developed in the study area should have been included in the map, according to the appropriate classification. Potential sites of existing/possible hazardous geodynamic processes should have been also presented in the map. Accordingly, mentioned issues must be taken into account and reflected in the EIA based on the ecological examination.</p>	<p>Comment is considered :</p> <p>See EIA drawings 5.2.3.5.1. and 6.7.2.1.1.</p>
5	„_____”	<p>Impact of the reservoir on the stability of slopes (so called, absorption effect, treatment of slope, possibility of provoke landslide and gravitation processes and the danger of landslide and rockslide into the reservoir) is not assessed in the Environment Impact Assessment (EIA). (There is only unreasonable consideration about jeopardy snow avalanches); to resolve the above mentioned issues, additional surveys should be carried out and results should be reflected in the EIA based on the ecological</p>	<p>Comment is considered :</p> <p>See EIA report, paragraph: 6.7.2.1.</p>

		examination.	
6	„—————,„	Change of regime of subterranean water circulation, possibility of formation and infiltration of new aquifers and impact on the stability of massifs are not considered in the EIA. The above mentioned issue needs additional surveys. Results should be reflected in the EIA based on the ecological examination.	In the process of reservoir operation, assessment obligations regarding changes of regime of subterranean water circulation, possibility of formation and infiltration of new aquifers and impact on the stability of massifs are determined for the contractor on pre-construction design phase.
7	„—————,„	In case of diversion of riv. Nakra to Nenskra gorge, surplus amount of hard deposits of torrential tributaries (Lekvedari, Lankashe, Utviri) will be formed in Nakra gorge. According to the presented report, when the river stage rises in riv. Nakra,, discharge of total river flow should be carried out, but the EIA report must also consider the alternative options. In case of development such scenario, the mentioned measures may be insufficient, so the report must present alternative mechanisms to prevent blocking the gorge by torrential streams and to avoid flooding the village.	Comment is considered:  According to paragraph 6.7.2.1., in case of necessity, clearing of mouths of torrential tributaries from hard deposits will be carried out by using some vehicles.
8	„—————,„	Hydro geological conditions of the region, information about aquifers, including about groundwater zones, groundwater tables and water content are not considered in the presented report. Accordingly, the mentioned issues must be completely presented in the EIA based on ecological examination.	Measurements of groundwater table are implemented in all boreholes of all objects of HPP project infrastructure and hydro geological conditions are presented in corresponding paragraphs of engineering and geological part of the report.
9	„—————,„	Stability of adjacent upper slope of power station and the possibility of its destabilization by landside processes are not assessed in the EIA report. The above mentioned issue needs additional surveys that must be considered in the Environment Impact Assessment based on the	Comment is considered:  Results of surveys of stability of adjacent slopes of power unit are

		ecological examination.	presented in the paragraph 5.2.3.6.3.1.2. of the EIA.
10	„—————“	Geomorphological conditions of the study area are not considered in the report. Identification of some hazardous geological processes, as well as relieving “secret” processes would have been possible, if the mentioned geomorphological conditions were presented in the report. Accordingly, these issues must be detailed considered in the EIA report based on the ecological examination.	<p>According to the engineering-geological surveys of the EIA, geomorphological conditions of all project sites are already studied.</p> <p>Facts of appearing rocks and drilled boreholes are already geotechnically assessed in the project are. As to the results, corresponding measures are determined.</p> <p>Contractor, responsible for the detailed project, will inspect and/or in case of necessity will implement additional surveys on the construction design phase.</p>
11	„—————“	According to the EIA, Vol 1, pg. 170, “several zones of faults along the alignment of tunnels were determined. In the alignment of pressure tunnel two reversed faults are presented, in particular on: 1+550 - 1+750 km, , 2+300 - 2+500 km, and forming of two folds is possible on 4+600 - 4+800 km and 9+350 - 9+550 km. On the axis of Nakra culvert, on 2+200 km, right lateral fault exists. Working with two main faults during arrangement of pressure tunnel is inevitable, except this, we won’t prevent from touching with one fault during arrangement of Nakra culvert”. At the same time, nothing is said about faults in part of “mitigation measures” (vol.2, pg.23) of the report. Faults along the project tunnels must be properly estimated and in case of necessity, mitigation measures must be worked out. All the issues must be presented in the	Comment is considered:

		EIA report based on the ecological examination.	
12	„—————”	Information about disposal areas of waste rocks, which will be taken out from diversion tunnel or will be produced as a result of road construction, is not presented in the EIA report. Possibilities of changes of geological environment and especially geo-dynamic conditions by the impact of waste rock disposal area will be discussed in materials containing the mentioned issues. Accordingly, additional surveys are essential and their results must be reflected in the EIA based on ecological examination.	<p>Comment is considered:</p> <p>According to the feasibility study of HPP construction, disposal of 50% of waste and excavated rocks is planned at the bottom of reservoir, within the dead zone. Apart this, within the process of environment impact assessment, two alternatives for disposals were selected, where storage of waste rocks will be possible.</p> <p>Arrangement of disposals and recultivation projects will be prepared by contractor, on the pre-construction phase. Projects of disposals will be agreed with the Ministry of Environment and natural resources protection of Georgia.</p>
13	„—————”	Construction area of Nenskra HPP is situated in the underground water feeding zone that is presented by creviced volcanic rocks. Due to the fact that surface waters drain in the utmost depths, which fills the underground water level, at the same time, exclusion of provoke of landslide processes is significant. The mentioned issue is not considered in the report, so some additional surveys are necessary and based on this fact, rate of vertical filtration should be presented in the EIA report based on the ecological examination.	<p>The river is feeding with subterranean waters, though there is no landslide hazard zone in upper area of reservoir impoundment, which may have been activated due to rising of underground water table.</p> <p>At the area of dam crest, its watertight function will be ensured by encapsulation methods (wall of diaphragm and watertight wall). Hence, risks won't refer to downstream of reservoir. During the mobilization (before launching construction works), contractor will implement additional surveys, which will be focused on above mentioned encapsulation measures.</p> <p>During the detailed design, contractor will carry out analysis and determine leakage processes under the diaphragm wall. Leakage</p>



			will be limited in any case and won't cause landslide.
14	„—————,“	According to the EIA report, mitigation measures of hazardous geological processes are general and it doesn't consider geological and geodynamical features of the arrangement site of Nenskra hydro technical constructions. The above mentioned issue must be presented in the EIA report based on the ecological examination.	Comment is considered:
15	„—————,“	Cumulative impact of Nenskra hydro technical constructions on the geological environment is not considered in the EIA report. Mentioned issues must be presented in the EIA report based on the ecological examination.	Comment is considered:
16	„—————,“	As to the EIA report, development of landslide, erosion and suffusion processes as a result of filtration waters derived from the diversion tunnel, is not considered in the paragraph of "Description of activation of hazardous geological processes". And the paragraph – "Mitigation measures" doesn't consider monitoring and implementation of corresponding measures for newly discovered springs along the diversion tunnel 72-2... Accordingly, above mentioned issues must be considered in the EIA report based on the ecological examination.	Comment is considered:  As to the plan of monitoring, special measures for newly discovered springs and those situated along the tunnels are considered
17	„—————,“	Plan of head unit is also presented in the EIA report pg. 37, draw. 4.2.1). According to the drawing, emergency spillway is not installed till the area of riverbed and it doesn't provide joining the downstream. The drawing also shows "impact section of water stream ", information regarding the issue is not given in the report. Accordingly, what impact will have the water stream on slopes from the impact section to the	See EIA report, paragraph 4.2, drawing 4.2.1

		riverbed and if it causes some erosive processes must be considered in the EIA report based on the ecological examination.	
18	„—————,„	As to the EIA report, “construction of project roads is planned in the condition of complex relief, due to the fact, cutting off slopes and arrangement of culvert installations on the crossing areas of natural gorges will be necessary.” It is noteworthy that in the process of road construction, before cutting of the slopes and arrangement of culvert installations, detail engineering and geological study of the area and in case of necessity, consideration of some safety engineering constructions is essential. Accordingly, information about surveys must be presented in the EIA report based on the ecological examination.	Comment is considered:  See EIA report, paragraph 6.7.2.1.
19	„—————,„	In the EIA report, preliminary prognosis are not considered about hazardous geological processes (exhaustion of slope rocks, rock fall, landslide, erosion, torrent avalanche) caused by construction impact. Due to the fact that engineering conditions are rather complex in riv. Nenskra and riv. Nakra gorges, rivers are characterized by V and U form gorges, their slopes are mostly vertical and instable, during the construction and operation, activation of geological processes, such as exhaustion of slope rocks, rock fall, avalanches, landslide processes, erosive and torrential processes are presumable. (At the same time cutting off the slopes are planned during the road constructions that will promote hazardous geodynamic processes). Accordingly, monitoring plan of dangerous geological processes must be focused on above mentioned issues in the report and liquidation measures based on ecological examinations for negative results must be worked out and considered in the EIA report.	Comment is considered: see EIA report, paragraph 6.7.2.1.

20	„—————,“	Cumulative impact of Nenskra hydro technical constructions on the geological environment is not assessed in the EIA report. The mentioned issue must be considered in the EIA report based on the ecological examination.	Comment is considered:
21	„—————,“	Necessity of arrangement of special defense constructions (installations for keeping torrents and avalanches), from avalanches and torrential flows on the adjacent sensitive sites of the reservoir should be discussed in the EIA report based on the ecological examination, in order to avoid their negative impact on creating of presumable waves in the reservoir.	Comment is considered:  See EIA report, paragraph 6.7.2.2.
22	„—————,“	Information on the filtration stability and calculation of this stability of the dam must be presented in the report. There must be considered also what kind of measures should be carried out in the foundation and slopes of the dam.	Comment is considered:  See EIA report, paragraph 4.3.
23	„—————,“	According to the EIA report, “faults and folds are recorded in the study area; two of them are fixed along the pressure tunnel”. Accordingly assertion the fact that inflow of ground waters during construction of tunnels is not presumable is quite inadmissible. The mentioned issue requires additional surveys and the results must be considered in the EIA report based on the ecological examination.	“Nenskra” – Geology
24	„—————,“	Study area presents the feeding zone of underground waters, where soil structures are maximally opened, rocks are intensively creviced, especially its upper side. In such conditions, groundwater pollution is inevitable during the construction and operation phases. Accordingly, monitoring of subterranean waters, at least on the drainage channel area, is essential. The issue must be discussed in the EIA report based on the	Comment is considered:

		ecological examination.	
25	„—————„	According to the EIA report, “for treatment of surface and subterranean waters, arrangement of drainage on the edge of the ravine is considered, water will be diverted by the pipeline to the ravine. There is no information about parameters of drainage system in the report. Accordingly, the issue must be presented in the EIA report based on the ecological examination.	Comment is considered:
26	„—————„	According to the EIA report, “there is a spring, which may be used for domestic-potable water supply”, “springs of villages Kvemo Margha and Lekalmakhi will be used for water supply”, “region is rich with springs, which will be used for water supply”. Reserves of springs selected for water supply, chemical composition, mineralization, bacteriological validity, as well as how regime of these components are changing as to the seasons and the distance from spring to the construction site must be presented in the report. Hydro geological conclusion about quantity and quality rate of condition of spring, as well as arrangement of sanitary zones and water transportation conditions should be presented in the report.	Comment is considered:
27	„—————„	Vol. 2, pg. 41 – population intensively use mineral springs in village Sgurishi and village Nakra areas, as for the mineral water springs on the right bank of riv, Nenskra, in the downstream of mouth of riv. Okrila, population don’t use it so actively, because in summer, when the water level rises, the spring’s outlet is covered with water. Despite the fact that, impact risk on mineral springs is not high, implementation of monitoring is necessary. Information about the monitoring must be presented in the	Comment is considered:

		EIA report based on the ecological examination.	
28	„—————,„	According to the presented report, water intake is situated on the altitude of 1325m a.s.l, where Absolut minimal temperature is 30-35%, in such conditions formation of lump ice is quite possible. Accordingly, in the mountainous region, during the severe winter conditions possibility of lump ice formation is increased, so in order to prevent ice penetration into the intake, construction of protective installations and warming of iron grills must be considered in the report. There is nothing said about preventing of lump ice penetration into the water intake. Mentioned issue must be presented in the EIA report based on the ecological examination.	Intake of Nenskra HPP is an abyssal one, which will be located on the elevation of 1325 m a.s.l, normal operation level of the reservoir amounts to 1430 m a.s.l. Accordingly, in case of freezing reservoir surface there is no risk of deterioration of intake operation conditions.  Except the mentioned fact, decreasing of water level in the reservoir till the water mark of the intake is quite inadmissible.
29	„—————,„	According to the report, “thin layers of quartz are in gneiss and shales”. This record is incorrect, as quartz generally is not presented with forms of layers, they may exist just as vein quartz and faults, due to its hydro thermal genesis. Accordingly, the issue needs assertion and it must be presented in the EIA based on the ecological examination.	Comment is considered:
30	„—————,„	There is incorrect information in the report: “formation is crossed by gabbro, granites, and granitites and diorites middle Jurassic layers. All of them are rocks, except pyroxene, it is a mineral, so it can't form the crossing layer independently. The above mentioned information needs correction and it must be presented in the EIA report based on the ecological examination.	Comment is considered:
31	„—————,„	There are many incorrect geological terms, including: “clay stones” – similar term doesn't exist in geological literature, if clay is hardened and doesn't mix in the water, it is called “argillite”, if it is more	Comment is considered:

		metamorphosed, and it is “shale”. The term – “diabase porphin” is also incorrect, the correct version is – “diabase porphyrit”, “ironstone”, iron ore, iron mineralization. These issues need correction and they must be reflected in the EIA based on the ecological examination.	
32	„—————“	Main hydrological data in tables about riv. Nenskra and riv. Nakra must be presented in the report. They must be daily and average monthly data (about maximal, average and minimal flows). Amount of environmental flow, amount of necessary and excess water flow of the HPP must be presented in tables, according to months (% must be indicated).	<p>Comment is considered:</p> <p>According to the feasibility study, Nenskra HPP is seasonal regulation and full generation of electricity will be implemented in spring and summer and during the winter shallow period as well. For this purpose water accumulation will be carried out in reservoir in spring and summer and hydro aggregates will be provided by full project flow. Hence, just environmental flows will be discharged in downstream of dams.</p> <p>It must be noted that in case of run off regulation HPPs operation, when the water level raises, surplus water streams to the direction of downstream.</p>
33	„—————“	According to the report, minimal environmental flow rate is 0.85m <sup>3</sup> /s. As to the same document, method of calculation of environmental flow worked out by the USAID is not adopted in our country, but for calculation of the mentioned flow approaches of this method are used. Methods of calculation of environmental flow using in Switzerland were used as a guideline. Swiss method of calculation of environmental flow must be determined in the EIA report. Parameters using for calculation model must be presented in the report, otherwise, mentioned rate - 0.85m <sup>3</sup> /s will be just “number”, which was adopted by using unspecified	<p>Comment is considered:</p> <p>See EIA report, paragraph 6.3.2.3. According to the report, calculated environment flow for Nenskra dam is 0.9m<sup>3</sup>/s and for Nakra dam – 0.6m<sup>3</sup>/s. By taking into account the hydrological and geomorphological conditions of riv. Nakra, decision of increasing flow to 1.2m<sup>3</sup>/s was made, that importantly exceeds 95% minimal flow (0.77m<sup>3</sup>/s) and 50% average long-term flow of 10% (0.78m<sup>3</sup>/s). Due to it, in case of discharge of environmental flow (1.2m<sup>3</sup>/s) into</p>

		<p>and disapproved method in the country. There is no specification and reasoning's about how adequately were determined the suggested environmental flows, notwithstanding, environmental flow is less than 10% of the average annual flow. The issue becomes more complicated when the matter refers to conditions of hydrological survey of rivers Nenskra and Nakra and this specific rate of minimal environmental flow needs additional explanation and specification. It must be specified how does the mentioned rate presents the environmental flow according to which, minimal impact will be presumable during the operation of hydro technical installations. Sufficient amount of environmental flow that will stay in watercourses should be considered, as it is essential for aquifer biodiversity and the issue must be presented in the EIA report based on the ecological examination.</p>	<p>the downstream of dam planned on riv. Nakra, negative impact on biological and social environment won't be so high.</p> <p>In the downstream of riv. Nenskra dam there is high impact risk on the 2-km section from the dam to the mouth of riv. Tskhvamdiri. The fact is also taken into account that in case of construction of high dam, this section of the river will lose the function of fish migration route. It is also noteworthy that places for fish breeding and spawning are not presented in this section of the river.</p>
34	„—————,„	<p>The issue of emergency discharge of water in winter months must be considered in the EIA report based on ecological examination. Corresponding figures and diagrams must be presented (November-February) in the report. Mitigation measures should be also worked out and protection of village Lekalmakhi from flooding must be also considered in the report.</p>	<p>Comment is considered:</p> <p>Risks of damage of the dam, maximal flows of possible flooding in settlements and periods of flood waves are considered in the paragraph 6.16.</p> <p>Accordingly, risks of flooding are assessed for summer and winter periods.</p>
35	„—————,„	<p>Study of bottom and hard deposits is not sufficiently considered in the report. Possible impacts on riverbed processes in the river gorge during construction and operation period are also insufficiently presented.</p>	<p>Comment is considered:</p> <p>According to the data of HPPs Lakhami and Naki, information</p>

		<p>Water flows of river and distribution of run off the river is directly connected to the amount of bottom and hard deposits and distribution in time, which influences on the riverbed formation processes. Dam construction will cause some changes in erosive and accumulative processes in the riverbed. If before dam construction, the energy of the river was used for transportation of bottom and hard deposits, after the construction of the dam, these deposits will precipitate in the reservoir and the free river energy will be used for flushing the riverbed. Accordingly, the issue needs additional surveys and it must be presented in the EIA report based on the ecological environment.</p>	<p>about the solid deposits of rivers Nenskra and Nakra is given in the paragraph 5.2.5.5. According to the report, construction executor has the obligation to study hydrological regime of the rivers during the preparation of project and construction works.</p> <p>Assessment of conditions of solid deposits transportation is also presented in the report, paragraph 6.8.2.2.. According to the paragraph, there is high risk of impact in the 2km section downstream of Nenskra dam (till the mouth of river Tskhvamdiri), recurrent discharges are planned on the section.</p> <p>Impact won't be important on the other sections of the river, because the water flow of riv. Nenskra provides transportation of hard deposits, which are reduced by the construction of reservoir.</p> <p>Due to the design of dam, recurrent flushing of planned upstream and the main amount of hard deposits will be discharged in the downstream of the river during the rising of water level in the riverbed.</p>
<p>36</p>	<p>„—————,“</p>	<p>Operation of HPP in winter is considered in the report without any hydrological study that creates lots of potential hazards in the downstream of the dam. Accordingly, the mentioned issue must be presented in the EIA report based on the ecological examination.</p>	<p>According to the paragraph 5.2.5. of the report, hydrological features of the rivers are determined as a result of 36-year observation on Lakhmi hydro station of river Nenskra and 42-year observation on Naki hydro station of river Nakra.</p> <p>Construction executor is imposed the obligation to implement permanent hydrological measurements on project alignments of dams of riv. Nenskra and riv. Nakra during preparation of design</p>



			projects and construction phases. This fact will give us the opportunity to specify the calculated costs for these alignments.
37	„—————,“	<p>According to the ordinance of Georgian government N423, “Technical regulation on fishery and protection of fish fauna”, December 31 (Article 14), intakes with water withdrawal daily rate of 5000m<sup>3</sup> must be equipped with fish excluders”. As to the report, due to hydro dynamic changes quantity of brown trout will be reduced in river Nenskra and river Nakra. Arrangement of fish excluders on both rivers are considered as mitigation measures. But as to the same report (pg 32), arrangement of fish pass is not planned on 135m dam on river Nenskra, due to its inefficiency. Accordingly, the reason of this fact must be detailed considered (with proper specification). Why not arrangements of fish pass are planned on the dam – is it inefficient or is it impossible? The report must reply all these questions.</p>	<p>As it is noted in the comment, according to the report, obligation of arrangement of fish excluders on the intakes of both HPP is considered.</p> <p>According to the project, arrangement of shish pass is planned on the dam of river Nakra, but it is not planned on Nenskra dam due to its height and different operation conditions.</p> <p>According to the international experience, arrangement of fish pass is not advisable on tall dams (best indicator of efficiency rate of fish excluders doesn’t exceed 50-55% on low dams).</p> <p>At the same time, Nenskra reservoir is seasonal regulation and seasonal change of water level in the upstream of the dam is within 80m. The mentioned situation complicates the conditions of operation of fish pass even in case of low dams.</p> <p>Corresponding mitigation measures with purpose of compensation of negative impact regarding the absence of fish pass are also considered. These measures also imply annual letting certain amount of fish fries of brown trout in the upstream and downstream of dams.</p>
38	„—————,“	<p>Information about glaciers is just generally presented in the report. There is nothing said about the melting dynamics of glaciers, it is noteworthy</p>	<p>Comment is considered:</p>

		<p>that most of glaciers of River Enguri basin are situated in riv. Nenskra gorge. Main provocative source of hazardous geological process are glaciers. Fast melting of glaciers mustn't be considered as beneficial process for energy, it must be assessed as negative impact on the environment and appropriate preventive and mitigation measures should be considered in case of development any hazardous processes.</p> <p>Accordingly, additional surveys about reservoirs' impact on glaciers are required. Mentioned issues must be considered and presented in the EIA report based on the ecological examination.</p>	<p>See paragraphs 5.2.5.8. and 6.8.2.4.</p> <p>Of the report.</p>
39	„—————,„	<p>Information about seismic condition of the area for arrangement of Nenskra dam and possible earthquake load that must be calculated for construction of 135m dam in order to provide seismic stability of the dam in seismic activity region is not presented in the EIA report.</p>	<p>Comment is considered:</p> <p>See paragraph 5.2.3.8. Of the report. Total materials about seismic survey are presented in the report.</p>
40	„—————,„	<p>Accordingly, modern seismic survey using of the latest methodology should be carried out according to the recommendations of “International Commission of Large Dams” (ICOLD, 2010) Study results must be reflected in the EIA report based on the ecological examination.</p>	<p>Comment is considered:</p> <p>Survey on seismic conditions is carried out in accordance with recommendation of “International Commission of Large Dams” (ICOLD, 2010) and the results are presented in the report, paragraph 5.2.3.8.</p>
41	„—————,„	<p>Possibility of provoke seismic processed with filling reservoir is not considered in the report. The issue must be presented in the EIA report based on the ecological examination.</p>	<p>Comment is considered:</p> <p>See paragraph 6.7.2.2. of the report.</p> <p>According to the study results of seismic conditions of the project area and engineering geological surveys, filling of the reservoir is</p>

			not connected to activation of seismic processes.
42	„—————,“	<p>According to information transferred by the Technical and Construction Supervision Agency of the Ministry of Economy and Sustainable Development of Georgia, (for the first phase of construction permit, you transferred information with Shap files), it was determined that the total area of the construction is 2536539,77m<sup>2</sup>, from where 31618,68m<sup>2</sup> belongs to fund of National Forestry Agency. But according to your files – “Shap”, transferred to the Ministry of Environment and Natural Resources Protection of Georgia (for public hearing of the EIA), total construction area is 3932137,89 m<sup>2</sup>, from where 882998,49m<sup>2</sup> occurs within the area of National Forestry Agency fund. As it turned out information transferred to the both Ministries differs from each other. Accordingly, the issue requires additional specification and presenting of specified “shape” files.</p>	<p>Comment is considered:</p>
43	„—————,“	<p>Five options of HPP construction are considered in the report, (pg.15-16-17), in all cases areas covered with forests will be inundated, as full cartographical materials are not available. At this stage, it’s still unclear which areas will be flooded and which wood resources will be destroyed. The issue needs additional specification and results must be presented in the report.</p>	<p>Comment is considered:</p> <p>5 alternative options Nenskra dam were considered on the preliminary stage of the feasibility study. All of them are far from the settlements and locate in the forestry areas.</p> <p>According to the analysis of alternatives, 4th option was selected (river Nenskra benchmark of 1300m). As to the selected option, dam and reservoir will be arranged on the active anthropogenic impact areas that together some other criteria was the only basic solution for the selection the alternatives.</p> <p>Determination of wood resources on project areas will be carried out on the pre-construction phase, during the study of vegetation</p>

			cover within the frames of gaining forest usage permit.
44	„—————,„	Pg 59 – cutting off the slopes covered with forest (spruce, pine tree and alder) is considered by the project. Cutting down trees is determined for arrangement of roads and quarries (pg 67) – exact area and amount of wood resources are not specified yet. The above mentioned information needs requires specification and results must be presented in the EIA report based on the ecological examination.	All studied project areas within the project area of “Nenskra HPP” were cartographically marked and specified in advance and it corresponds to the technical part of the project. So, it is unclear for us which inaccuracy is implied in the comment of our opponent.
45	„—————,„	(Pg.240-241) – term “young Trees” is indicated in the “detailed” botanic description of project area. The diameter and age of trees is unknown. The mentioned issue needs additional specification and results must be presented in the EIA report based on the ecological examination.	Diameter of trees is indicated in the paragraph 5.2.6.1.6. Of the report. As for the age of trees, it is not subject of botanic survey. Accordingly, we don’t agree with the comment.
46	„—————,„	Nothing is said about possible negative impacts on adjoining unique wood clusters (change of xerophytes species due to surplus humidity, etc.). The issue must be considered in the EIA report based on the ecological examination.	The fact must be stressed that climate of the region is soft and humid. According to the botanic survey of the report, xerophytes species are not developed in the project area. Due to the above mentioned fact and taking into account the temperate climate of the region, “change of xerophytes species by surplus humidity” is not presumable in the project area.
47	„—————,„	(Pg.233-274) – description of modeling areas (Drude model was used) as a result of botanic fieldworks, doesn’t give the possibility to general characterization of wood clusters by the forestry standpoint. For example: Composition of clusters – which are basic and secondary species, is uncertain in the report. It is just mentioned that 30-40 trees are growing in the modeling area, all of them are same middle height and diameter – these specification won’t be sufficient for describing of clusters. Rates of modeling areas are not generalized on the total study	We don’t agree with the comment, as using of Drude model in phytocoenological description is widely adopted method for detailed botanic fieldworks. Structural features of vegetation communities, including forestry plants are completely presented in the botanic part of EIA report.  As for the survey, which was carried out to assert the areas of inundation and cutting down trees, it is presented in the paragraph 5.2.6.1.6 - “Accounting of timber amount within impact area of

		area and the territories, where cutting down of trees and inundation is presumable. The issue must be considered and presented in the EIA report based on the ecological examination.	Nenskra HPP” - of the EIA report
48	„—————,„	Pg .277- When the matter refers to flooding and sinking of forests on the territory of Forestry fund, accounting of timber amount by using so called “Estimating method” is quite insufficient; for example, average age, average height and average frequency multiplier of trees developed in cluster (storey) are uncertain in the report. Using of standard tables for calculation of cluster (storey) amount is also obscure.	Method selection for calculation of timber amount is determined by period of time. From measuring and estimating methods, we selected so called “estimating method”. This method successfully provides solution of the task in frames of ecological examination. As for the issue of using of standard tables for calculation of cluster amounts, our response is positive: generations of experienced foresters have been using this method for many years, at the same time these tables were drawn up and worked out by professor Tretyakov in 1930s of the last century.
49	„—————,„	Pg.277 – It is noted that “timber amount in the area of “Nenskra-Nenskra” is 2600 m3, beech trees occupies the most territory” – but there is nothing said about the exact amount of beech in the report. It is also noted that “the most part of timber 23 470 m3 is developed on the project area of reservoir, and then rest 1100 m3 – beyond the reservoir territory”. As to the report, the total timber amount is 2600 m3 on the project area, this inaccuracy needs correction.	We accept this comment, instead of indicated number – 2600 m3 , there must be written 24572,5 m3 wood, the total amount of standing trees, which we recorded in the project area of “Nenskra HPP”. From this total amount, beech trees were the majority on the area. Despite the fact that we didn’t indicate the exact cubic meter of beech trees, we pointed to the table 5.2.6.1.6.2. , where the total cubic meter of all timber, as well as cubic meter of each species of trees were presented.
50	„—————,„	Determination of damage amount on the project area, located in the forestry fund, is impossible on the basis of “detailed” botanic study and assessment. Accordingly, the issue must be considered in the EIA based on the ecological examination.	“Detailed” botanic study within the project area is the basis of identification of vegetation communities and species of different conservation value. On the study background, assessment of damage on habitats of high and average conservation value is carried out and after that corresponding mitigation measures will be worked

			out. At the same time, it is noteworthy that the more obvious is concentration of vegetation cover with endangered, critical endangered and species developed on the limited areas, the more damage will be presumable as a result of project implementation. In such case, it makes no sense the project area will locate within the forestry fund or beyond its borders.
51	„—————,„	Pg.225 – For determination of ecological compensation for negative impacts, using of so called method “Habitat/hectares” is recommended. Accordingly, expedience of the method is required additional specification.	So called method of Habitat-hex – “Benchmark”, which is widely used in State of Victoria, in Australia, was successfully used for projects of Baku-Tbilisi-Ceyhan pipeline and South Caucasus pipeline and as the survey implemented by high modern standards, this method gained international recognition (authors: M. Kimeridze, P. Herbst, K. Susan). Supposedly, the author is not aware of the mentioned survey. This report is kept in the national Forestry Agency, representations of the WB and UNDP in Georgia. Except this, results of these surveys are assessed as best ones and published in many international scientific magazines and publications. So, we don't agree the comment.
52	„—————,„	In the presented report, in descriptions of forest communities, amount of tree-trunks on 100m2 modeling areas, including high productivity of clusters, is unbelievably high (from 25 to 60 trees). If secondary, small trees are also included in the total amount of trees, the issue needs specification and differentiation. The above mentioned issue must be considered in the EIA report based on the ecological examination.	We agree the opponent's comment that the number of accounted trees within 100m2 area is exaggerated (but at the same time, we would like to note that these estimations are made during botanic studies and not forestry studies). Hence, not only trees with small, average and large diameter were accounted, but the tree-trunks with the smaller diameter ( $\alpha < 8\text{sm}$ ) as well. As a whole, natural restoration of forest is recorded.
53	„—————,„	Projective cover of understory of forest phytocoenosis (underbrush, grasses) are estimated by Drude Scale in the report. For more	We don't agree with the comment, because estimation and description of projective cover of understory of forest phytocoenosis

		specification, percentage indicators and Dominic Scale must be used. The issue must be presented in the EIA report based on the ecological examination.	by Dude Scale is commonly used method.
54	„—————,„	The phytocoenological descriptions of plants provided in the EIA report should include the information about the important components of the ecosystem features like microrelief, soil, dead cover and the indicators of the forest natural renewal. These issues should be discussed in the EIA report represented at the ecological expertise.	We disagree the comment as the descriptions, namely, the microrelief, soil, dead cover and the indicators of the forest natural renewal are not subjected to the botanical description of the environmental impact report.
55	„—————,„	The EIA report includes the botanical description of the impact zones, by the plots. The costs (high, average, low) for habitat conservation are also given. Although, the report doesn't involve the names and areas of the habitats subjected to the impact/destruction as well as the names and areas of the habitats by the plots. The description mostly includes the information about what purpose the certain area will be used. The abovementioned issues must be discussed in the EIA report represented at the ecological expertise.	The name of the plant community type represents the name of the habitat. As for the area of the habitats, the precise identification will be provided during the development of the conservation and compensation plans given in the corresponding paragraphs of the EIA report.
56	„—————,„	The alternative areas without a high compensation value are required to be discussed for the plots with the high price for conservation in the EIA report represented at the ecological expertise. Otherwise, the appropriate argumentation should be provided regarding this issue. Such an argumentation is needed for the other facilities without any alternative locations suggested in the EIA report.	Due to the complex relief, the areas of a high compensation value that have no alternatives are considered as unalterable. As for finding the alternative place for the landfills, the additional research will be conducted through the pre-construction phase to determine the adequate territories.
57	„—————,„	It is noted in the report that there is one variety of plant (Chestnut) in the project area which is included in the Red List of Georgia, although there are no data indicating its volume or quantity. The abovementioned issues must be discussed in the EIA report represented at the ecological expertise. The document should also include the information whether it's planned to cut/destroy the given varieties in which case the quantity of the trees subjected to cutting should be indicated.	There are total of 9 varieties of standing trees included in our report, namely: Fir-tree, Beech, Maple, Birch, Elm, Lime and Hornbeam. None of them are included in the Red List as a botanical species. As for the enlisted Chestnut ( <i>Castanea sativa</i> ), this tree has been spotted in 2011, at the project area of Nenskra HPP during the detailed botanical research – Plot №1.10. GPS coordinates - N43000'33.7"/E 042012'14.8", 1196 masl. South exposition, inclination-350. This species are rarely involved in Spruce-Beech forests on this slope. The evaluative method also allows accounting

			only the cubic volume of the individual species of trees and not the quantity. At this stage, it is unknown if this plot will be affected, as this area is considered for storing the waste rocks generated from the tunnel construction. If the plot is used for this very purpose (which less probably), the quantity of the trees included in Red List which are intended to be cut will be defined. The actions will be taken in accordance with the Law of Georgia on "Red Book" and "Red List".
58	„—————,„	There is a following note in the report (Impact on Flora, the subparagraph – 6.10.2.1): “the detailed botanical research has found the species of the high conservation value in the project corridor and the negative effects of the construction and operation on the botanical receptors (flora) of the project area have been identified, after which, any conservation/restoration and compensation measures will be identified and the bio-restoration specifications and compensation plans along with the monitoring plan for the botanical component of the biodiversity will be developed. Also, the program of conservation should be developed for the rare species of flora”. It’s important to prepare and submit the abovementioned plans and to include them in the EIA report represented at the ecological expertise.	In regard to this issue there is a note in the corresponding paragraph of the EIA – 6.10.2 Impact on Flora, 6.10.2.1 Construction Phase: “The abovementioned plans and mitigation measures will be implemented during construction and operation passes. The plans will include the forest habitats restoration, based on the results of the biodiversity monitoring. It’s noteworthy that the detailed specifications of the complex restoration plans, bio-restoration plan and the conservation program for the species of flora with a high compensation value will be developed at the early stage of the construction, although, the major conceptual aspects of this plan are described in the EIA report. The biodiversity (botanical aspect) monitoring plan involves monitoring of both the communities of sensitive plants and the species of a high compensation value. It should also be emphasized that the detailed phytosociological descriptions and the assessment of the species of a high compensation value are given in details in EIA report and the results of the research will be used for the comparative analysis during the following monitoring, to assess the quality of the restoration of the habitats”.
59	„—————,„	In the subparagraph 5.2.6.2.4 the species (the ones included in the Red List of Georgia) of terrestrial vertebrates are given, which inhabit Mestia Municipality and possibly in the region of project implementation.	<b>The comment is considered:</b> The changes have been made in the corresponding paragraphs of



		Caucasian turn and chamois are not mentioned in this list (table 5.2.6.2.4.1.). It is known that the specified areas are their habitats. According to the data available for the ministry, Caucasian tur does not inhabit this area, although this is not caused by the nonexistence of the inadequate habitats, but rather the effect/impact on them. Chamois is spotted at the territory. Therefore the abovementioned issues should be considered in the compensation actions and their packages are required to be represented. The additional area inspections are also required to identify other animals. The data of the provided and planned field researches should be reflected in the EIA report represented at the ecological expertise.	EIA (5.2.6.2.4., 6.10.3.2. and etc.).  It should also be noted that the research of dung has been provided several times (2010, 2011 and 2014) in the project region by the experts and none of the expeditions have found the clues of the existence of Caucasian tur or chamois. According to the local community, these species can be spotted at the upper elevations.
60	„—————,“	The report informs that the areas inhabited by the otter have not been identified during the field researches the drawing 5.2.6.2.5.1 is given to support this. The drawing shows that otter inhabits the areas where the river flow will be significantly reduced by the water abstraction from both Nenskra and Nakra rivers (the excerpts from the EIA about the impact on water biodiversity are also given in this regard). Therefore, the EIA report represented at the ecological expertise should reflect the expected effects on otter and other representatives of the biodiversity which are depended on water recourses and the appropriate mitigation and compensation measures should be determined.	<b>The comment is considered:</b>  The appropriate mitigation and compensation measures are given in the EIA report in order to minimize the effects on the animal species depended on water and its biological environment.
61	„—————,“	One of the mitigation measures noted in the EIA report is as follows: „In case the otter burrows are identified within the construction area, the further actions will be taken in accordance with the Law of Georgia on Red List and Red Book“. This note is unclear and therefore it's necessary to determine the certain actions and to reflect them in the EIA report represented at the ecological expertise.	<b>The comment is considered:</b>  The appropriate changes have been made in the corresponding paragraphs of EIA.
62	„—————,“	The document states: “All the trees that grow by the water or at the edge of the forest will be destroyed during the flood. This will destroy the nests of the bats and most of the birds, as many of the species mostly inhabit the forest edges. The forest edge will change due to the flood and its complex of fauna will be created again. This process will last for long,	<b>The comment is considered:</b>  Based on the mitigation measures given in the EIA report the vegetation will be removed at the project area and especially at the reservoir cavern during the least sensitive time in terms of bird breeding. This will minimize the damage of the nests and therefore

		because different species react differently at such disasters, so the restoration of the faunistic complexes may take some decades or more in the circumstances of the anthropogenic effects". Therefore, the effect on animals should be discussed in a context of damage/destruction of the habitats, in particular: The information should be provided about the appropriate habitats of the animal species, about the possible migration to new areas (the sufficiency of such areas and etc.) in case the habitats get destroyed. Also, it's important to develop the compensating measures. The abovementioned should be reflected in the EIA report represented at the ecological expertise.	the risks related to the negative effects on animals.  Furthermore, the preparation of biodiversity management plan is planned before the construction, involving more detailed information about the mitigation and compensation measures for the negative impacts on animals.
63	„—————,“	The EIA report represented at the ecological expertise should include the information about the identified reproduction and feeding areas (the river/area description, coordinates, the number of areas and etc.) of the trout existed in the tributaries downstream the Nenskra River and the sufficiency (in terms of its acceptable state under the impact; the comparison to the lost areas and etc.) of these reproduction areas should be approved. The adequate package for the compensation activities is required to be developed in terms of the impact on biodiversity of water (caused by the fish pass in the Nenskra dam, by the destruction of the trout reproduction areas by the significant impact expected during the construction, by the reduction of the water flow in the rivers and etc.) and other components of the biodiversity (all the issues indicated above), showing the details of the compensation of all the components of the biodiversity subjected to the damage by the work implementation (in terms of the types of impacts).	<b>The comment is considered:</b>  See the paragraphs 5.2.6.4.2. and 6.10.4.2. of the EIA report.
64	„—————,“	The mitigation measures of the EIA considers that 60 000 fingerlings of trout is planned to be released in Nenskra River annually for compensation. The EIA report represented at the ecological expertise should provide the argumentation about how the planned compensation measure (60 000 fingerlings) mitigates the impact on fish.	<b>The comment is considered:</b>  As stated in the EIA report, the operator company is obliged to release 70 k fingerlings in Nenskra River and 50 k in Nakra River annually, to compensate the damage on the ichthyofauna.  In accordance to the monitoring plan of the operation, the inspection of ichthyofauna is planned though the first 5 years of the

			HPP operation. The required number of fingerlings can be regulated according to the monitoring results.  Also
65	„—————,“	There are following flaws in the EIA report represented at the ecological expertise: <ul style="list-style-type: none"> <li>• The legends and data of the drawings provided in the project are not in Georgian language;</li> <li>• The drawings and graphs lack of parameters;</li> <li>• There are same numbers indicated in the drawings of the dam and head race construction zones of Nenskra;</li> </ul>	<b>The comments are considered:</b>
66	„—————,“	The areas are not specified in the report for the disposal territories considered for storing the removed fertile soil layer, also there is no description for the areas, GIS coordinates, forms of ownership, category, soil cover and etc. These issues are required to be solved and reflected in the EIA report represented at the ecological expertise.	<b>The comment is considered:</b>  See the paragraph 6.6.2.1 of the EIA report.
67	„—————,“	The implementer should fulfill the requirements of the technical regulations approved by the government resolution - №424 (31.12.2013) on “Fertile soil layer removal, storage, usage and recultivation”.	The paragraph 6.6.3. of the EIA report („Mitigation Measures”) states that during the construction, the removed fertile soil layer will be managed in accordance with the requirements of the technical regulations approved by the government resolution - №424 (31.12.2013) on “Fertile soil layer removal, storage, usage and recultivation”.
68	„—————,“	The EIA report represented at the ecological expertise should include the information about the composition of the waste rocks and the alternative conditions for their final storage.	The information about the geological structure of the areas of the tunnels and the other infrastructural facilities of the HPP is given in the paragraph 5.2.3. of the EIA report. Considering that the boreholes have not been made on the tunnel routes, at this stage, it’s not possible to determine exactly the composition of the waste rocks taken from the tunnel.  As for determining the alternative locations for storing the waste rocks, the comments have been considered and the location is chosen for the landfill of dead rocks nearby the villages: Kvemo

			Marghi and Sgurishi. See the paragraph 6.11.1. of the EIA report.
69	„—————,“	According to the document, the accumulated hazardous waste will be stored in the specially allocated containers and will be moved to the temporary storage facility. The schematic drawings should include the abovementioned storage; According to the EIA, the arrangement of the new sanitary landfill is planned for the neutralization of the accumulated household waste at the 1.2 Ha areas near the construction camp of Nenskra dam. The document should specify who is supposed to carry out the abovementioned activities in accordance with legislation.	<b>The comment is considered:</b> See the paragraph 6.11.1 of the EIA report.
70	„—————,“	In case the work implementation is related to the accumulation of more than 200 T nonhazardous waste, or over 1000 T inert waste, or/and any volume of hazardous waste annually, it is required to develop the waste management plan considering the requirements of the Georgian Law on „Waste Management Code“.	<b>The comment is considered:</b> See the EIA report, annex N3
71	„—————,“	The EIA report states: “The waste rocks taken from the tunnel will be stored at the reservoir area which will be covered with water during the reservoir operation“. The report doesn’t discuss the possible damage the waste rocks can cause to the dam if located at the reservoir area, or how it can affect the duration of the reservoir operation and the way it would affect the operation. The abovementioned important issues require additional studies and argumentation as placing the dead rocks at the bottom of the reservoir will cause the adverse impact on the duration of the reservoir operation which would reflect negatively on the country’s energy efficiency.	<b>The comment is considered:</b> As noted in the EIA report, approximately 260 k-270 k waste rocks are planned to be disposed in the reservoir cavern. Considering that the reservoir volume will be 282 mln. m <sup>3</sup> and the life cycle amounts 72 years, the negative impact on the energy generation will not be significant. As a counterweight to this, the environmental-social risks related to the disposal of the dead rocks and the waste rocks will be minimized.  Also, two alternative versions have been chosen for storing the dead rocks in the process of the EIA. These areas enable storing the full volume of the generated waste. The design documentation of the landfills will be prepared and approved by the Ministry of Environment and Natural Resources Protection of Georgia at the construction phase.

<p>72</p>	<p>„—————„</p>	<p>The environmental impact assessment report states, that the waste rock placement area is located 120-200 meters away from the exit portal and is featured as a steep slope, also, it's pointed out, that it will occupy only 2 hectares of the bulk slope. According the report, considered waste rock placement area represents a forested slope, where the tunnel construction waste rocks will be dumped and the forest located on the slope (where the high conservation value habitat is widespread) will be destroyed. The report doesn't mention the amount of waste rocks needed to be cast on this area during the tunneling; therefore, it's hard to define if the selected 2 hectares is enough. Additional information about the landfill area is needed to be included in the rapport, namely, besides the fact that the waste rock dumping will harm the selected area, given the valley's morphological conditions, it should be analyzed, if the water rock dumping causes a development of the hazardous geological processes, the risk of which is quite high. Also, the report makes no mention about the project of the expected false rock landfill during the roads construction process. Accordingly, in the IEA rapport represented on the ecological expertise, the alternatives of the false rock placement areas should be discussed. As for the freed rocks available after the river. Nenskra overthrow, the placement of which is planned on the reservoir territory, the report should mention the amount of the rocks placement planned in the riverbed, which creates a problem for the hydrological regime that means the risk of existence of problems in terms of geological stability and reservoir safety.</p>	<p><b>The comment is considered</b></p> <p>In the initial draft of the project, the placement of the waste rocks withdrawn from the Nenskra's headrace tunnel was planned in the natural ravine adjacent to the boring machine (TBM) platform. Considering the high conservation value of the biological environment of the ravine and the high risk of development of highly hazardous geodynamical processes, a reservoir cavernous and selected territories at the village Lower Marghi and village Sgurishi at the left bank of the river. Nenskra, together with the investing company, was chosen for the final placement of the waste and waste rocks.</p>
<p>73</p>	<p>„—————„</p>	<p>Represented EIA rapport (page 161) states, that "due to the thickness of alluvial fan, low load and the annual movement of the glaciers to the direction of the valley, we consider expedient to move dam axis to the upstream, in particular about 2.5 km. Due to the difficulties related to drilling mashie transportation and winter's difficult conditions, arrangement of boreholes on the offered site was not made. Arranging</p>	<p><b>The comment is considered</b></p> <p>The area for the dam construction on the river. Nakra is planned by the project author company "Shtuki Caucasus" and defined appropriate engineering solutions for prevention the development of the hazardous geological processes. The record about the</p>

		<p>boreholes and rock characteristics engineering-geological study must be carried out during the construction phase, after the trees are removed.” In the EIA rapport represented on the ecological expertise, a specified territory for the dam location should be shown and not the estimate one. If the work implementer considers recommendations of the authors of the report, which is about the relocation of the dam to the upstream, the EIA rapport represented on the ecological expertise should contain detailed engineering-geological studies of the selected territory and the complete baseline studies, which is considered for dam safety assessment. Also, if the dam location territory stays the same, the EIA rapport represented on the ecological expertise should contain an answer for the question: How the arrangement of the dam will be implemented in the geologically difficult environment.</p>	<p>relocation of the dam alignment to the upstream, shown in the paragraph 5.2.3.6.4.1.2. Is of recommendatory nature and the final decision will be made during the construction design phase.</p> <p>If the decision about the dam relocation to the upstream is made according the detailed survey results planned on this phase, the Nakra intake updated project’s EIA will be conducted according the legislation of Georgia and submitted to the ecological expertise.</p>
74	„—————,“	<p>Represented EIA rapport does not include a comprehensive and detailed plan of action for emergency situations. According the different scenarios of the Nenskra dam arising accident (Breakthrough of the dam, landslide body, avalanche getting into the reservoir, water flow over the dam crest) the mathematical forecasting modeling (one-dimensional (1D) and, if necessary, two-dimensional (2D) modeling) of the flooding process and the scale at the downstream should be developed, with indicating the flooding territory boundaries and a breakthrough wave values.</p> <p>These issues require immediate treatment and needs to be included in the EIA rapport represented at the ecological expertise as soon as possible.</p>	<p><b>The comment is considered</b></p> <p>Some additions are included in emergency response plan. Also, the paragraph 6.16. From the EIA rapport represents the dam stability risks and maximum flow calculation of the flood in the river transit areas.</p> <p>As for the flooding process and scales software modeling at the downstream of the dam during the emergency situations according the different scenarios, this obligation is determined by the investor company and will be implemented during the construction design phase.</p> <p>The report will be submitted to the Ministry of Environment and Natural Resources.</p>
75	„—————,“	<p>The represented EIA report does not contain information about the early warning system in case of the accident, and does not contain accident</p>	<p><b>The comment is considered</b></p> <p>See the emergency response plan in the EIA rapport. The final</p>

		liquidation and mitigation plan.	version of the emergency response plan will be prepared before the exploitation of the HPP.
76	„—————,“	The represented EIA rapport does not contain flooding area forecasting, even when there is no breakthrough in the dam, the water run through the existing waste way during the intensive flood is performed. Therefore, the above-mentioned issue needs to be developed and included in the EIA report represented on the ecological expertise.	<b>The comment is considered</b> Before the HPP construction, on the construction design phase, the flood wave spreading software modeling during the emergency situations at the downstream of the dam, during which the determination of the possible flooding forecast zones in case of the catastrophic flow implementation will be provided. The results of the modeling will be submitted to the Ministry of Environment and Resources Protection before the start of the construction.
77	„—————,“	EIA report contains two options of setting a penstock. An inclined culvert option is also needed to be considered in the EIA report represented on the ecological expertise.	<b>The comment is considered</b> See the paragraph 3.3.3., greed 3.3.3.2. from the EIA report
78	„—————,“	According the given coordinates, HPP construction and project area, partly contains Jorkvali gabbo-diabase ore contours transferred in the national balance, also territories, on which the mineral extraction licenses (N0000195; N1000586) are obtained. According the above-mentioned, before representing the document on the ecological expertise, the issue needs to be agreed on with the license owner, in order to protect the rights of the licensee as well as to avoid the activities hampering circumstances. Please be informed, that the document represented on the ecological expertise must be accompanied by an agreement document. Also, because of the mine located on the project area, the issue needs to be agreed on with the National Environmental Agency.	<b>The comment is considered</b> According the latest scheme of the placement of Nenskra HPP's facilities, Jorkvali gabbro-diabase ore does not fall within the area of influence of the project. As for the utilization of Natural Resources and agreement will be made with the owners of N0000195 and N1000586 licenses before the start of the construction during the detailed construction project development process.

79	„—————,“	EIA report represented for the preliminary review is accompanied by the Shp-files, which are intended for each infrastructural facilities intended for the project. Among them the coordinates of “Nakra HPP” in the river. Nenskra’s valley is notable. In terms of this issue, nothing is said in the EIA report, so if building of the “Nakra HPP” is planned in the Nenskra valley, the report should contain complete information which requires consideration of relevant procedures.	<p><b>The comment is considered</b></p> <p>Inaccuracies are corrected</p>
80	„—————,“	Volume 1- EIA report, page 32 and 33 – according the given information the project HPP requires 220 kV substation and transmission line. Also, the value 2, page-8 of the report discusses the planning of asphalt installation and fuel refilling station’s appropriate reservoirs arrangement at the structural camps. According the subparagraphs “g” and “l” of the fourth paragraph of the law of Georgia “about the Environmental Impact Permit” , the asphalt production and arrangement of the 220 kV transmission line and substation is referred to the activities requiring ecological expertise, so before starting, the implementer should act according the procedures established by law. As for the fuel reservoirs, if their capacity is 1000 m <sup>3</sup> and more, arrangement of reservoirs should also be provided according the procedures established by law.	<p><b>The comment is considered</b></p> <p>As given in the 4.6 paragraph of the EIA report, 220 kV transmission line construction project will be implemented by “Georgian State Electric System”, therefore after the preparation of the project documentation, the EIA procedure will be performed by this company.</p> <p>The information about the possible risks of environmental impact in case of bitumen-concrete factory exploitation for producing bitumen needed for the Nenskra dam construction is given in the EIA report. So we think that performing factory’s environmental impact assessment procedure additionally is not necessary. If, during the ecological expertise the implementation of additional EIA for the bitumen-concrete factory will be required, it will be done before beginning the construction.</p> <p>As for the fuel reservoir capacity, the current idea is that the total capacity will be less than 1000m<sup>3</sup>.</p>



81	„—————,“	Volume 1, page 45 and 54- according the EIA report, the turbines will be cooled with the flow water system. For this purpose, the local spring water will be used, as for the dam construction, the stone extraction is needed, for which the career will be constructed. These issues require an agreement with the National Environmental Agency (license).	<p><b>The comment is considered</b></p> <p>During the pre-construction design phase, implementation of the procedures, required for obtaining mineral extraction license for materials and stone mining, is planned, at the same time an agreement will be made with the National Environmental Agency about the required water abstraction technical regulations for cooling systems.</p>
82	„—————,“	Volume 1, page 72 according the EIA report for agricultural-fecal wastewater ( generated on the construction bases territory) treatment the arrangement of a compact biological treatment facilities is planned, also arrangement of the oil trap for industrial wastewater treatment ( page 73). The filtered wastewater will be discharged in the rivers (Nenskra, Nakra). Due to this, EIA report should be accompanied with the maximum permissible discharge standards discharged in the Surface water facility, indicating the discharge points. Additionally the EIA report should contain collection, treatment and discharge of the water solution used for the drilling equipment.	<p><b>The comment is considered</b></p> <p>A maximum permissible discharge standard accompanies the EIA report.</p>
83	„—————,“	The EIA report (page 35) states, that at the right side (bank) of the dam will be arranged a water intake, while at the left – construction tunnel and the spillway. The layout of the facilities on the drawings in the report (page 35 and 37) are reversed, while on the page 39, according the text. Above issue needs specification and should be included in EIA report represented on the ecological expertise.	<p><b>The comment is considered</b></p>
84	„—————,“	The EIA report states, that handling catastrophically costs are carried out with idle spillway and “lower discharging tunnel”. Also, dissipator well is mentioned in the report but not marked on the drawing 4.2.1	<p><b>The comment is considered</b></p>

85	„—————,“	The EIA report states that the “lower discharge tunnel” is used for discharge of the sanitary flow. The EIA report represented on the ecological expertise should include the information about the type of lock that is used for locking the tunnel.	The lock type will be specified during the pre-construction design phase. Also it should be noted, that in terms of ecology, for implementation of environmental flow the issue of the lock type should not be considered as of a big importance.
86	„—————,“	The EIA report (p.23) states: “The connection of Nenskra HPP to the state energy system will be carried out with the 1km and 500 kV long “kavkasioni” transmission line, which is contradictory in relation with the information on page 33 – the voltage (220 kV) of the substation indicated in the table of the technical parameters as well as with the scheme of the power output on page 49. Therefore, the abovementioned issue should be clarified in the EIA report represented at the ecological expertise.	<b>The comment is considered</b>
87	„—————,“	The EIA report (volume 1; page-57) states: „It’s an important fact that the rocks generated with the TBM are small fractional and the arrangement of the crushing-sorting plant is not necessary”, while the page 41 informs that the arrangement of the crushing-sorting plant is considered. The above mentioned contradictory information requires clarification and consideration in the EIA report represented at the ecological expertise.	<b>The comment is considered</b>
88	„—————,“	Regarding “the approval of the regulation on environmental impact assessment” the decree of the minister of environment and natural resources protection of Georgia #31 (15.05.2013) states: “The process of the environment impact assessment covers the identification of all kinds of sources, types and rates of impacts expected on the environment as well as the assessment of their integrated ecological, social and economic results”. According to this very decree, “the planned EIA should include the assessment of the ecological, social and economic results of the work, informing the society and inquiring their opinions”. Therefore, these	<b>The comment is considered</b>

	issues should be considered and described in the EIA report represented at the ecological expertise.	
--	--	--

## 11 Conclusions and Recommendations

The following conclusions and recommendations are prepared in process of environmental and social impact assessment of HPPs construction and operation project on the river Nenskra:

### Conclusions:

1. According to the project, construction and operation of high-pressure seasonal regulation HPP on Nenskra River, with installed capacity of 280 MW. Electricity generated by the HPP will be supplied to the state energy system during the shallow-water period (mainly during the winter months), which is very important for the country's energy independence;
2. According to the project, construction of the following infrastructure facilities is planned: 135 m high rock-fill dam on river Nenskra, which will create reservoir with 3 km<sup>2</sup> water mirror surface area, 15.1 km long and 4.5 m diameter drainage tunnel, low-threshold (13 m) dam on river Nakra, 12.4 km long and 4.5 m diameter diversion tunnel in order to discharge the water of river Nakra into the ravine of river Nenskra and power unit in the village Chuberi;
3. If we consider, that construction sites and construction camps necessary for the HPP infrastructure facilities will be on a large distance from the residential zones, the impact caused by the atmospheric air quality deterioration will not be significant;
4. According to the results of calculation given in the report, on the operation phase of the designed reservoir greenhouse gas (carbon dioxide, methane) emissions will not be significant;
5. According to the results of calculation, on HPP construction and operation phases, the impact related to the noise distribution on population will not be significant. Exceeding the standardized noise levels may only be related to the traffic intensity increase in the populated areas. Significant impact is expected on the animals inhabiting adjacent to the construction sites, but there will be a temporary disturbance and after completion of the construction works they will return to their habitats;
6. Considering the distance between the nearest residential areas and power unit and transmission line corridor, measures to mitigate the impact of electric fields on the population are not necessary;
7. If we take into account the present low levels of traffic intensity on the populated areas within the project influence zone, significant overload of the traffic flows of populated areas during implementation of construction works is not expected;
8. According to the results of the analysis given in the report, impact on a global or regional climate during the designed reservoir operation phase is not expected. Local climate change will take place on the reservoirs adjacent territories, namely along the river Nenskra ravine maximum 3.0-3.5 km away from the reservoir;
9. Operation of Nenskra, Jvari and Khudini reservoirs will not be related to the cumulative effect (see Appendix #1);
10. Construction territories of the designed HPP communication are not within the protected areas of Zemo Svaneti and therefore, the risk of direct negative impact on protected areas is reduced to a minimum;

11. Although the project implementation will be related to the significant negative impact on the biological environment, but it should be noted, that the creation of reservoirs will improve the water related habitat of animals and birds;
12. According to the research results conducted in process of ESIA, project implementation will not be related to the physical resettlement. Also, economic resettlement of the registered real estate is not expected;
13. HPP construction and operation project implementation will be related to a positive impact on socio-economic environment, namely:
  - Significant amount of temporary and permanent jobs will be created for the HPP infrastructure facilities construction and operation, which is important for the employment of local labor resources;
  - In case of project implementation, activation of local business sector (construction materials manufacturing, food production, trade, services, etc.) is expected, which is an important source of additional job creation and socio-economic status improvement of population;
  - HPP construction and operation project includes implementation of rehabilitation works of the local infrastructure (roads, transmission lines, water supply systems, communication devices and etc.), which should be considered as the positive impact for the local population;
  - Local (property tax) budget revenues will sharply increase on the HPP operation phase, which is a significant positive impact on the socio-economic conditions of local population;
  - Proceeding from this, implementation of planned activity will cause a positive impact as for socio-economic development of the Mestia municipality and Samegrelo-Zemo Svaneti region, as well as for the Country.

**In addition, it should be noted, that possible negative impacts will be related to the construction and operation of dams, namely:**

1. Approximately 3.7-3.8 km<sup>2</sup> of state-owned lands will be covered with dam water. This territory will be permanently lost for the population, as the land of public use;
2. A significant impact on biological environment is expected in the dam arrangement process, namely:
  - Slopes on the territory of project dam and access road corridors require cleaning from vegetation (approximately 1.3 million trees and bushes will be cut), which is a major negative impact;
  - Destruction of plants will cause disruption of animal (including bats) habitats and therefore, will have a negative impact on fauna;
3. Significant negative impact on the biological environment is expected in process of arrangement of waste rock disposals, emerged during arrangement of construction camps, temporary roads, tunnels and other facilities;
4. Significant anthropogenic load will be related to the impact on local wildlife, but it should be considered, that the impact will be of temporary nature and animals will return to their habitats (except dam areas, which will be permanently lost) after finalizing the works;
5. Significant impact is expected from habitat fragmentation related to the construction of roads, which is of temporary nature and will be completed after finalizing of construction and recultivation works;
6. On the rock-fill dam operation phase the fish (river trout) migration possibility into the headrace will be fully limited, which should be considered as the high degree negative impact;

7. Hydrological changes of river Nenskra and Nakra will take place on the dams operation phase, namely, only environmental flow will be released in the tailraces of the dams, which will significantly deteriorate the living conditions of water's biological environment and will be related to the negative visual-landscape changes; Solid sediment transportation will be practically stopped in the tailrace of rock-fill dam, which will negatively impact on the river Nenskra banks development dynamic;
8. According to the cumulative impact assessment materials of designed Nenskra HPP reservoir and existing Jvari reservoir, as well as designed (Khudoni reservoir) and prospective HPPs reservoirs, significant climate changes of the region is not expected. Mainly there will be local changes, namely: number of atmospheric precipitation will increase in the local circulation area of the air, the wind speed will increase (especially maximum), the air layer temperature near the water will rise.
9. The electric transmission line alternatives scheme of "Nenskrahesi-Jvari" in process of ESIA was prepared at desk and the specific locations of piles deployment are not determined. Accordingly, environmental impact assessment procedure of electric transmission line must be carried out after developing the working project.

**Recommendations:**

1. Before HPP construction works damage of environment must be calculated and relevant financial-economical assessment must be submitted to the Ministry of Environment Protection;
2. For the temporary disposal of hazardous waste on the construction phase relevant warehouses must be arranged on the territory of construction camps, for the operation phase the warehouses must be arranged on the HPP territory;
3. Hazardous waste formed on the HPP construction and operation phases must be removed from the territory and managed by the contractor holding a relevant permit;
4. Substations must be provided with vacuum switches;
5. Hydrological parameters of the rivers must be systematically registered on the HPP dam. Control must be established over sanitary flow in the tailrace of the dam;
6. To optimize rules on storage and usage of oils in the HPP operation process storage building must be arranged on the territories, which will be equipped with means of oil spill prevention and distribution;
7. On the accessible places of substation and oil storages kits for liquidation of oil spill consequences must be placed;
8. For every oil spill case the power plant operator company must implement pollution prevention activities immediately and notify the Ministry of Environment Protection;
9. For purification/neutralization of industrial-fecal waste water emerging on the HPP power unit territory a compact biological treatment facility must be arranged;
10. In order to clarify number of plants and specie composition to be cut during HPP construction phase additional research must be carried out after preparation of detailed engineering project, when areas of construction sites, routes of temporary roads and most importantly, territories to be covered with dam water will be precise;
11. In order to compensate the vegetation cover damaged on the HPP infrastructure construction process the project documentation must consider recultivation and planting works, for these purposes preferably local plant species must be used;

12. In case of detection of protected species in process of dam area cleaning from vegetation, they must be removed in accordance with requirements of law on “Red List and Red Book of Georgia”, Article 24, paragraph 1, sub-paragraph f);
13. In order to compensate vegetation damage forest stands must be cultivated on the territory of the Chuberi village, located on the slope of the left bank of the river Nenskra. For these purposes local tree species must be used;
14. Automatic monitoring system must be arranged on the fish passage and control over the technical condition must be established;
15. In order to compensate damage caused by destruction of bats’ shelters, 1300-1500 different types of artificial shelters must be arranged after the finalizing of construction works;
16. To minimize risks of hazardous geodynamical process development on the HPP infrastructure and road construction phase, following mitigation measures must be considered:
  - On the perimeter of the project dams and upper slopes of the roads landslide formations under active dynamics must be removed and slopes must be given a relevant inclination angle of stability;
  - Surface and ground waters must be withdrawn not to cause additional moisturizing of lower slopes;
  - To avoid deformation of road subgrades, concrete gabion must be arranged under it;
  - To prevent risks of erosion and landslide process development on the road construction phase, concrete canals (ditches) must be arranged along the road;
  - Atmospheric and ground waters from channels arranged along the roads must be discharged into the riv. Nenskra and its tributaries;
  - After completing the construction works the construction sites must be recultivated and planting works must be conducted.
17. Extraction of inert materials from the riv. Nenskra valley should be allowed on the basis of license on minerals extraction;
18. Periodical trainings (once every 6 months) and tests must be conducted for the HPP service staff on the environmental and occupational safety issues;
19. Environmental impact assessment of “Nenskrahesi-Jvari” 50 km long and 220 voltage electric transmission line planned for the Nenskrahesi generated electricity to be joined into the network, must be conducted after preparing the working process.
20. Organization of health insurance for staff is desirable.

## 12 Bibliographic Sources

### 12.1 General Part

1. საქართველოს კანონი „გარემოს დაცვის შესახებ“;
2. საქართველოს კანონი „გარემოზე ზემოქმედების ნებართვის შესახებ“;
3. საქართველოს კანონი „ეკოლოგიური ექსპერტიზის შესახებ“;
4. საქართველოს კანონი „ატმოსფერული ჰაერის დაცვის შესახებ“;
5. საქართველოს კანონი „წყლის შესახებ“;
6. საქართველოს კანონი „ლიცენზიებისა და ნებართვების შესახებ“;
7. საქართველოს კანონი „ელექტროენერგეტიკისა და ბუნებრივი გაზის შესახებ“ (1999 წ)
8. საქართველოს კანონი „ნიადაგის დაცვის შესახებ“;

9. საქართველოს კანონი „დაცული ტერიტორიების შესახებ“;
10. საქართველოს კანონი „საქართველოს წითელი ნუსხისა და წითელი წიგნის შესახებ“;
11. სანიტარიული წესები და ნორმები «ჰიგიენური მოთხოვნები სამუშაოების შესრულებისადმი სამრეწველო სიხშირის (50 ჰც) ელექტრული ველის ზემოქმედების პირობებში (სანწიდან 2.2.4. 008 - 02);
12. სანიტარიული წესები და ნორმები „ხმაური სამუშაო ადგილებზე, საცხოვრებელი, საზოგადოებრივი შენობების სათავსოებში და საცხოვრებელი განაშენიანების ტერიტორიაზე“;
13. სანიტარიული ნორმები და წესები “ზედაპირული წყლების დაბინძურებისაგან დაცვის შესახებ”;
14. კლიმატის ცნობარი – ჰაერი, ნიადაგი, ტემპერატურა. მე-14 გამოშვება, ჰიდრომეტგამი.
15. კლიმატის ცნობარი – ქარი. მე-14 გამოშვება, ჰიდრომეტგამი.
16. სნწ II-91-77. სამრეწველო საწარმოთა ნაგებობები.
17. სნწ „სეისმომდეგი მშენებლობა“ (პნ 01. 01-09);
18. სნწ „სამშენებლო კლიმატოლოგია“ (პნ 01. 05-08);
19. სნწ 2.01.02-85\*. ხანძარსაწინააღმდეგო ნორმები.
20. „ჰიგიენური მოთხოვნები მყარი საყოფაცხოვრებო გადანაყრების პოლიგონების მოწყობისა და ექსპლუატაციისადმი“ (სანწიდან 2.1.7. 005. \_ 02);
21. „საწარმოო ვიბრაცია. ვიბრაცია საცხოვრებელი და საზოგადოებრივი შენობების სათავსოებში“ (ს. ნ. 2.2 4/2 1.8. 000-01);
22. საქართველოს კანონი ცხოველთა სამყაროს დაცვის შესახებ, საქართველოს პრეზიდენტის ბრძანება №540, 1996 წ. 26 დეკემბერი.
23. საქართველოს წითელი ნუსხა, საქართველოს პრეზიდენტის ბრძანება №303, 2006 წ. 2 მაისი.
24. ბუხნიკაშვილი ა. 2004. მასალები საქართველოს წვრილ ძუძუმწოვართა (Insectivora, Chiroptera, Lagomorpha, Rodentia) კადასტრისათვის. გამ “უნივერსალი”, თბილისი: 144 გვ.
25. გურიელიძე ზ. 1996. საშუალო და მსხვილი ძუძუმწოვრები. წიგნში: “საქართველოს ბიომრავალფეროვნების პროგრამის მასალები”. თბილისი: 74-82.
26. კუტუბიძე მ 1985. საქართველოს ფრინველების სარკვევი. თსუ გამომცემლობა, თბილისი: 645 გვ.
27. ჯანაშვილი ა. 1963. საქართველოს ცხოველთა სამყარო. ტ. III. ხერხემლიანები. თსუ გამომცემლობა, თბილისი: 460 გვ.
28. უკლება დ. 1981. ფიზიკურ-გეოგრაფიული დარაიონება // ქართული საბჭოთა ენციკლოპედია. ტ. საქართველოს სსრ. //თბილისი: 28-30.
29. Верещагин Н.К. 1959. Млекопитающие Кавказа. История формирования фауны // Изд. АН СССР, М.-Л. : 703 с.
30. Гаджиев Ф.А. 1986. Животный мир. В кн.: Г. Габриелян (ред.), Физическая География Закавказья. Ереван, изд-во Ереванского гос. Ун-та.
31. Девдариани Г.С. 1986. Закавказская депрессия. В кн.: Г. Габриелян (ред.), Физическая География Закавказья. Ереван, изд-во Ереванского гос. Ун-та.
32. Кузнецов А.А. 1983. Список птиц Верхней Сванетии // Распространение и систематика птиц. Сборник трудов Зоологического музея МГУ, том 21: 186-190
33. Мусеибов М.А., Назарян Х.Е., Габриелян Г.К., Джакели Х.Г. 1986. Физико-географическое зонирование. В кн.: Г. Габриелян (ред.), Физическая География Закавказья. Ереван, изд-во Ереванского гос. Ун-та.
34. Яблоков А. В., Остроумов С. А. 1985. Уровни охраны живой природы. М.: Наука: 176 с.



35. საქართველოს ცხოველთა სამყარო; 4 ტომი, რბილტანიანები(მტკნარი წყლისა და ხმელეთის მოლუსკები), დამდგარი წყალსატევების დატოტვილუვამიანი და ნიჩაბფეხიანი კიბოსნაირები, თევზები; გამომცემლობა მეცნიერება, 1973
36. დემეტრაშვილი მ საქართველოს მტკნარი წყლების სარეწაო თევზები. საქ. სსრ.მეცნ. აკადემიის გამომცემლობა. თბილისი. 1963
37. შარვაშიძე ვ. საქართველოს თევზები (სარკვევი). გამომცემლობა “განათლება”. თბილისი. 1982
38. Эланидзе Р.Ф. 1983. Ихтиофауна рек и озер Грузии семейство Salmonidae лососевие. Институт зоологии АН ГССР. Тбилиси: Мецниереба.320 с.(с.38-55).
39. Эланидзе Р.Ф., Деметрашвили М.Г., Бурчуладзе О.Г., Курашвили Б.Е. 1970. Рыбы пресных вод Грузии (атлас). «Мецниереба». Тбилиси. 114 с.
40. Определитель пресноводных беспозвоночных России и сопредельных территорий. Т. 3. Паукообразные. Низшие насекомые. СПб., 1997
41. Определитель пресноводных беспозвоночных России и сопредельных территорий. Т. 2. Ракообразные. СПб., 1995
42. Определитель пресноводных беспозвоночных России и сопредельных территорий. Т. 1. Низшие беспозвоночные. СПб., 1994
43. Определитель пресноводных беспозвоночных России и сопредельных территорий. Т. 2. Низшие беспозвоночные. СПб., 1994
44. Полевой определитель планктона. Т. 1- 3. Зоологический институт АН СССР, Л., 1972
45. Структура локальной популяции у пресноводных рыб; Т. 1 – 2; Академия наук СССР, Рыбинск; 1990
46. Догель В.А. Зоология беспозвоночных – М., Высшая Школа – 198
47. Межгосударственная координационная водохозяйственная комиссия Центральной Азии (МКВК)
48. Канадское агентство международного развития (CIDA), Университет МакГилл, Центр Брейса по управлению водными ресурсами, Программа «Наука для мира» НАТО - Экологические попуски - Публикации Тренингового центра МКВК. Выпуск 1, Ташкент 2003
49. Шевченко С.С. Обеспечение на стадии проектирования электромагнитной совместимости воздушных линий электропередачи с ихтиофауной пересекаемых водоёмов.
50. Жукинский В.Н. - Влияние абиотических факторов на разнокачественность и жизнеспособность рыб в раннем онтогенезе – М; Агропромиздат, 1986
51. Масликов В.И. – Экологическая безопасность ГЭС (Основы и их практическое применение) – Санкт-Петербург, 2002
52. Порядин А. Ф. Устройство и эксплуатация водозаборов. — М.: Стройиздат, 1984 Saulius Stakėnas, Kęstutis Skrupskelis - Impact of Small Hydro Power Plants on Salmonid Fishes Spawning Migrations, Institute of Ecology of Vilnius University
53. Чугунова Н.И. Руководство по изучению возраста и роста рыб (Методическое пособие по ихтиологии) – АН СССР, М.-1959
54. Fish Passage Technologies: Protection at Hydropower Facilities, OTA-ENV-641 (Washington, DC: U.S. Government Printing Office, September 1995).
55. Walter K. Dodds – Freshwater Ecology: Concepts and Environmental Applications – Academic Press, 2002
56. Никольский Г.В. Теория динамики стада рыб как биологическая основа рациональной эксплуатации и воспроизводства рыбных ресурсов; М., Наука-1965
57. Elliot J.M. Quantitative Ecology and the Brown Trout, Oxford University Press, 1994

## 12.2 Impact on the Climate

1. გ. გიგინეიშვილი, გ. მეტრეველი, თ. გზირიშვილი, ბ. ბერიტაშვილი. კლიმატის თანამედროვე გლობალური დათბობის გავლენა საქართველოს ზღვის სანაპირო ზონაზე. გაერო, კლიმატის ცვლილების ჩარჩო კონვენციის ეროვნული სააგენტო, თსუ, საქართველოს გეოგრაფიული საზოგადოება. თბილისი, 1999. 74 გვ.
2. მიტროვანე კორძახია. საქართველოს ჰავა. თბილისი, 1961
3. გიორგი მეტრეველი, ავთანდილ წიქარიშვილი. მთის წყალსაცავების გავლენა კლიმატზე. თსუ, მეტეოროლოგია-კლიმატოლოგიის კათედრა. 1980
4. მანანა სალუქვაძე. ზემო სვანეთის ზვავსაშიშროება. თბილისი, 2011
5. საქართველოს პირველი ეროვნული შეტყობინება კლიმატის ცვლილების ჩარჩო კონვენციისათვის. თბილისი, 1999
6. საქართველოს მეორე ეროვნული შეტყობინება კლიმატის ცვლილების ჩარჩო კონვენციისათვის. თბილისი, 2009
7. Climate Change 2007. Synthesis Report. A Report of the Intergovernmental Panel on Climate Change. Fourth Assessment Report. WMO. UNEP. Cambridge, 2007
8. [www.russiandams.ru/otchet-vkp/](http://www.russiandams.ru/otchet-vkp/). კაშხლები და განვითარება. მსოფლიო კომისიის 2000 წლის მოხსენება “ახალი მეთოდური გადაწყვეტილების მიღებისათვის.”
9. Гвахария В.К. Испарение с водной поверхности водоемов Кавказа. Мецниереба 1973.
10. Метревели Г.С. Водохранилища Закавказья. Ленинград, Гидрометеоиздат, 1985
11. Метревели Г.С. Рехвишвили Ш.Д, Заиление горных водохранилищ., Москва, 2002
12. Сванидзе Г.Г., Гагуа В.П., Сухишвили Э.В. Возобновляемые энергоресурсы Грузии. Ленинград, Гидрометеоиздат, 1987
13. Супаташвили Г.Д., Пцкиаладзе Т.А. и др. Гидрохимическое исследование водоемов Грузинской ССР... Труды ТГУ. т А2. 1971
14. Водные ресурсы Закавказья. Ленинград, Гидрометеоиздат, 1988
15. Многолетные данные о режиме и ресурсах поверхностных вод суши. Том 9. Грузинская ССР. Ленинград, Гидрометеоиздат, 1987
16. Ресурсы поверхностных вод СССР. Том 9, Закавказье, Дагестан, вып. 1. Западное Закавказье. Ленинград, Гидрометеоиздат, 1974
17. Справочник по климату СССР, вып. 14. Атмосферные осадки, влажность, снежный покров. Ленинград, Гидрометеоиздат, 1970
18. Справочник по климату СССР, вып. 14. Температура воздуха. Ленинград, Гидрометеоиздат, 1970
19. Справочник по климату СССР, вып. 14. Ветер. Ленинград, Гидрометеоиздат, 1970

## 12.3 Impact on Ambient Air

1. УПРЗА ЭКОЛОГ, версия 3.00 ФИРМА "ИНТЕГРАЛ" Санкт-Петербург 2001-2005г.
2. «Методическим пособием по расчету, нормированию и контролю выбросов загрязняющих веществ в атмосферный воздух», СПб., 2005.
3. «Методическим пособием по расчету выбросов от неорганизованных источников в промышленности строительных материалов», Новороссийск, 2001;
4. Временными методическими указаниями по расчету выбросов загрязняющих веществ (пыли) в атмосферу при складировании и перегрузке сыпучих материалов на предприятиях речного флота», Белгород, 1992
5. საქართველოს გარემოსა და ბუნებრივი რესურსების დაცვის მინისტრის 28.07.03 წლის ბრძანება № 67 “დაბინძურების სტაციონარული წყაროებიდან ატმოსფერულ ჰაერში

- გაფრქვევების ფაქტობრივი რაოდენობის განსაზღვრის ინსტრუმენტული მეთოდის, დაბინძურების სტაციონარული წყაროებიდან ატმოსფერულ ჰაერში გაფრქვევების ფაქტობრივი რაოდენობის დამდგენი სპეციალური გამზომ-საკონტროლო აპარატურის სტანდარტული ჩამონათვალისა და დაბინძურების სტაციონარული წყაროებიდან ტექნოლოგიური პროცესების მიხედვით ატმოსფერულ ჰაერში გაფრქვევების ფაქტობრივი რაოდენობის საანგარიშო მეთოდის შესახებ”;
6. Методика проведения инвентаризации выбросов загрязняющих веществ в атмосферу автотранспортных предприятий (расчетным методом). М, 1998. Дополнения и изменения к Методике про ведения инвентаризации выбросов загрязняющих веществ в атмосферу автотранспортных предприятий (расчетным методом). М, 1999.
  7. МЕТОДИКА проведения инвентаризации выбросов загрязняющих веществ в атмосферу для баз дорожной техники (расчетным методом) Москва 1998.
  8. Расчет выбросов загрязняющих веществ при проведении горных работ в соответствии с «Методикой расчета вредных выбросов (сбросов) для комплекса оборудования открытых горных работ (на основе удельных показателей)»: Люберцы, 1999.
  9. Методические указания по определению выбросов загрязняющих веществ в атмосферу из резервуаров", утвержденные приказом Госкомэкологии России N 199 от 08.04.1998. Учтены дополнения от 1999 г., введенные НИИ Атмосфера, а также письмо НИИ Атмосфера от 29.09.2000 г. по дополнению расчета выбросов на АЗС.
  10. Методика проведения инвентаризации выбросов загрязняющих веществ в атмосферу для асфальтобетонных заводов (расчетным методом) Москва, 1998.

#### 12.4 For the Assessment of the Dam Stability and Maximum Flows of Possible Floods in Transit Sections of the River

1. Гамкрелидзе И.П. Вновь о тектоническом расчленение территории Грузии. Материалы научной сессии, посвященной 110-летию со дня рождения акад. А.И.Джанелидзе. Труды, Инст. Геологии. новая серия, вып. 115, Тбилиси, 2000, с. 204-208.
2. Atlas of GIS – based maps of natural disaster hazards for the Southern Caucasus (earthquakes, landslides, debris flows, avalanches and flash – floods). Editor: T. Chelidze, Tbilisi, 2006-2007, 48p.
3. ვ. ცომაია, გ. გაჩეჩილაძე, თ. ცინცაძე, ს. გორგიჯანიძე, მ. ფხაკაძე. ნაზღვევი წყალდიდობები და წყალმოვარდნები საქართველოში. ჰიდრომეტეოროლოგიის ინსტიტუტი, 2009, 134გვ.

#### 12.5 Flora and Vegetation

1. დოღუხანოვი ა., სახოკია მ., ხარაძე ა. 1946. ზემო სვანეთის მცენარეული საფარის ძირითადი ნიშნები. თბილისის ბოტ. ინსტ. შრომები, 9.
2. ზურებიანი ბ. 1976. მესტია-ჭალის ხეობის ფლორა და მცენარეულობა. დისერტაცია. თბილისი.
3. ივანიაშვილი მ. 2000. ბიოლოგიური მრავალფეროვნების საერთაშორისო გარემოსდაცვითი კანონი. მერიდიანი, თბილისი.
4. კეცხოველი ნ. ნ. 1935. საქართველოს მცენარეულობის ტიპები. თბილისი.
5. კეცხოველი ნ.ნ. 1957. საქართველოს კულტურულ მცენარეთა ზონები. მეცნიერება. თბილისი.

6. კეცხოველი ნ.ნ. 1959. საქართველოს მცენარეული საფარის რუკა. დანართი წიგნისა: საქართველოს მცენარეული საფარი”. თბილისი.
7. კეცხოველი ნ.ნ., 1960. საქართველოს მცენარეული საფარი. თბილისი. მარუაშვილის ლ. 1970. საქართველოს ფიზიკური გეოგრაფია. თბილისი.
8. მაყაშვილი ა. 1995. საქართველოს ხეები და ბუჩქები (რედ. გ. ნახუცრიშვილი და ნ. ზაზანაშვილი). WWF, თბილისი.
9. ოჩიაური დ. 1966. ახალი მონაცემები საქართველოს ფლორისათვის. საქ. მეც. აკად. მოამბე, ტ.41, № 3.
10. საქართველოს კანონი დაცული ტერიტორიების სისტემის შესახებ მიღებული საქართველოს პარლამენტის მიერ (7 მარტი, 1996). საქართველოს პარლამენტის ნორმატიული აქტები, თბილისი, 2000, 10-17.
11. საქართველოს მცენარეების სარკვევი. 1969. 2. საქ. მეცნ. აკად. გამოც., თბილისი.
12. საქართველოს ფლორა. 1941-1952. 1-8. საქ. მეცნ. აკად. გამოც., თბილისი.
13. საქართველოს ფლორა. 1970-2000. 1-13. მეცნიერება, თბილისი.
14. საქართველოს სსრ წითელი წიგნი. 1982. საბჭოთა საქართველო, თბილისი.
15. ქვაჩაკიძე რ. 1996. საქართველოს გეობოტანიკური დარაიონება. მეცნიერება, თბილისი.
16. ქიმერიძე კ, 1985. მაღალმთის მდელოების გავრცელების კანონზომიერება ენგურისა და ცხენისწყლის აუზებში. კრებულში სვანეთის ფლორა და მცენარეულობა. თბილისის ბოტ. ინსტ. შრომები, ტ. XXX.
17. ქიმერიძე კ. 1979. ქვემო სვანეთის მაღალმთის მდელოები. ქვემო სვანეთის მცენარეული საფარის დაცვისა და გამოყენების საკითხებისადმი მიძღვნილი ბოტანიკის ინსტიტუტის სამეცნიერო სესია. თბილისი.
18. Гагнидзе Р. И. 1974. Ботанико-географический анализ флороценотического комплекса субальпийского высокогорья Кавказа. Тбилиси.
19. Долуханов А.Г. 1989. Растительность Грузии. 1. Лесная растительность Грузии. Мецниереба, Тбилиси.
20. Зайконникова Т. И. 1975. Новый вид рябины на Кавказе. Бот. журн., 59, 2.
21. Зыков И. В. 1956. Факторы высокогорья в горных ландшафтах. Бот. журн., 41, 8.
22. Панютин П. С. 1939. Высокогорье Западного Кавказа. Изв. геогр. общ., 71, 9.
23. Федоров Ан. А. 1952. История высокогорной флоры Кавказа в четвертичное время, как пример автохтонного развития третичной основы. Мат. четверт. пер. СССР, 3, М.-Л.
24. Харадзе А. Л. 1944. Очерк флоры субнивального пояса Верхней Сванети. Зам. сист. геогр. раст. (Тбилиси) 12.
25. Харадзе А. Л. 1965. О субнивальном поясе Большого Кавказа. Зам. сист. геогр. раст. (Тбилиси) 25.
26. Черепанов С.К. 1981. Сосудистые растения СССР. Наука, Ленинград.
29. Akhalkatsi, M., Kimeridze, M., Lorenz, R., Kuenkele, S., Mosulishvili, M. 2003. Diversity and Conservation of Georgian Orchids. Tbilisi.
30. Bitsadze, M., Rukhadze, A. (2001). The species of wild fauna and flora of Georgia in the appendix lists of the Convention on International Trade in Endangered Species of the Wild Fauna and Flora (CITES). Tbilisi.
31. Braun-Blanquet, J. 1964. Pflanzensoziologie, Grundzüge der Vegetationskunde, 3rd ed. Springer, Wien-New York.
32. Wiener, L. 1979. Environmental impact assessment. 2<sup>nd</sup> ed. McGraw-Hill. New York, London, Tokyo, Toronto.
33. Canter L.W. 1996. Environmental impact assessment. 2<sup>nd</sup> ed. McGraw-Hill. New York, London, Tokyo, Toronto.
34. Convention on Biological Diversity. 1995. UNEP. Switzerland (Russian version).

35. Council of Europe. Convention on the conservation of European wildlife and natural habitats. Bern, 19.09.1979.
36. Forest Code of Georgia. 1999. Tbilisi.
37. Groombridge B. (ed.). 1992. Global biodiversity: Status of the Earth's Living Resources. Chapman & Hall, London, 47-52.
38. Harcharik D.A. 1997. The future of world forestry. *Unasylyva* 190/191, 48, 4-8.
39. Hilton-Taylor, C. (compiler). 2000. 2000 IUCN Red List of Threatened Species. IUCN, Gland, Switzerland and Cambridge, UK.
40. Isik K., Yaltirik F., Akesen A. 1997. The interrelationship of forests, biological diversity and the maintenance of natural resources. *Unasylyva* 190/191, 48, 19-29.
41. IUCN. 2001. IUCN Red List Categories and Criteria: Version 3.1. IUCN Species Survival Commission. IUCN, Gland, Switzerland and Cambridge, UK.
42. IUCN. 2003. 2003 IUCN Red List of Threatened Species. [web application]. Available at [www.iucnredlist.org](http://www.iucnredlist.org). (Accessed: 27 September 2004).
43. IUCN 2004. 2004 IUCN Red List of Threatened Species. [web application]. Available at: <http://www.iucnredlist.org>.
44. IUCN Red List Guidelines 2004 [web application]. Available at: <http://www.iucnredlist.org>.
45. Lanly J.-P. 1997. World forest resources: situation and prospects. *Unasylyva* 190/191, 48, 9-18.
46. Morris P. 1995. Ecology overview. EIA. 197-225.
47. Morris P., Thurling D., Shreeve T. 1995. Terrestrial ecology. EIA, 227-241.
48. Nakhutsrishvili G. 1999. The Vegetation of Georgia. *Braun-Blanquetia*, 15, 1-74.
49. Northen H.T. 1968. Introductory plant science. Third ed. The Ronald Press Company, New York.
50. Red List of Endangered Species of Georgia. 2003. Legisl. Proc. 3, Order N76, GSS Codex, GSS code- [www.gss-ltd.com](http://www.gss-ltd.com).
51. Red List of Georgia. 2006. Internet version, order.
52. Sakhokia M.F. 1961 (ed.). Botanical excursions over Georgia. Tbilisi.
53. The 2000 IUCN red list of threatened species. 2000 UNEP, WCMC.
54. WDPA Consortium. 2004. 2004 World Database on Protected Areas. IUCN-WCPA and UNEP-WCMC, Gland, Switzerland, Washington, DC, USA and Cambridge, UK.

## 13 Annexes

### 13.1 Annex №1: Assessment of Cumulative Impact of Jvari, Khudoni and Nenskra Reservoirs on Local Climate

The goal is determination of space-time scales and intensity (magnitude and direction of effect). For this purpose mathematical method of turbulent heat exchange or moist exchange in terrestrial side layer of the atmosphere on the background of the horizontal wind was used. The problem is solved in two stages. On the first stage the effect of impact from Jvari and Khudoni reservoir system is determined. Khudoni reservoir, length of which is about  $L_2=5.5$  km, is practically bind with Jvari reservoir ( $L_1=20$ km). They are separated by Khudoni dam, but in terms of impact on climate it is important, that maximum mileage of wind along Enguri ravine on the surfaces of both reservoirs is  $L_1L_2=25.5$  km. To solve this problem we are locating origin of coordinate in the beginning of the Jvari reservoir, but the fields of air temperature and humidity (partial pressure of water vapor) are received from the data from Jvari and Khaishi

meteorological stations. Same applies to the temperature of the water surface and data on partial pressure in vicinity, for wind magnitude values measured on the vane height.

Due to 12 km long distance between the end of Khudoni reservoir and Nenskra dam and reservoir ( $L_3=1.5$  km) the analogical task is solved for Nenskra reservoir on the second stage. For this purpose Khaishi and Lakhami meteorological data will be used, transformed for the Nenskra dam height level. Assessment of cumulative impact effect of all three reservoirs is carried out by interference of results of both tasks and determination of total volume of impact. If the scale of impact of first two reservoirs does not exceed 12 km, then the cumulative effect is attachment (continuation) of the second solution to the first. If the solutions will be covered, then total values of impact coefficient, temperature and humidity resulted from the solution of both tasks will be taken for the cover points.

**Task I – Impact of Jvari and Khudoni reservoir system on environment**

Impact of Jvari and Khudoni reservoir system on microclimate can be calculated on the basis of equation of turbulent heat exchange or moist exchange in terrestrial side layer of the atmosphere. According to the scheme given in the figure 1, coordinate origin is placed in the starting point of the relatively narrow line  $L=L_1L_2$  long reservoir system. Ox axis is directed along the reservoirs, Oz axis is directed vertically up. In terms of two-dimensional stationary task, the equation has the following form:

$$u_1 \left(\frac{z}{z_1}\right)^p \frac{\partial q}{\partial x} = \frac{\partial}{\partial z} \left[ k_1 \left(\frac{z}{z_1}\right)^{1-p} \frac{\partial q}{\partial z} \right], \quad (1)$$

Where q is a temperature of humidity, x and z therefore, horizontal and vertical coordinates,  $u_1$  – wind speed along the Ox axis on the  $z_1=10$ m height of vane, p – empirical constant,  $k_1$  – turbulence coefficient.

**Figure 13.1.1.** Mathematical model equation solution area of Jvari, Khudoni and Nenskra reservoir system cumulative impact in xOz plane

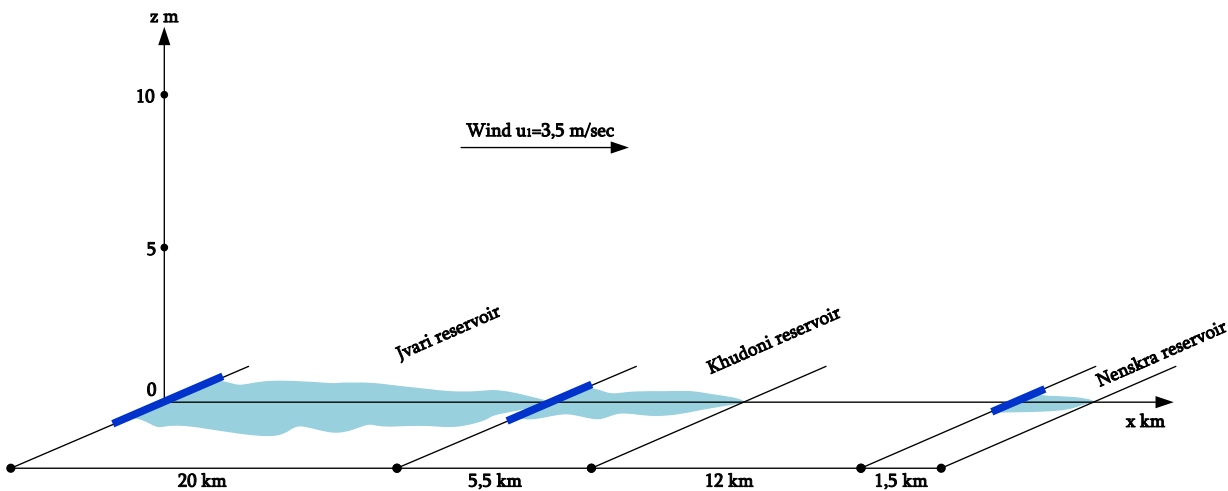

The solution was found in the area  $(x=0, z=0)$ , where  $q(x,z)$  meets the following boundary conditions:

$$[q(x, z)]_{x=0} = f(z), \quad [q(x, z)]_{z=0} = \varphi(x) . \quad (2)$$

Analytic solution recorded in integral from using these boundary conditions (1) is given in [1,2].

Let us consider a relatively easy case [3,4]. Let us assume, that

$$f(z) = \text{const}, \quad \varphi(x) - \varphi(0) = \begin{cases} \Delta = \text{const}, & \text{when } 0 < x \leq L, \\ 0, & \text{when } x > L. \end{cases} \quad (3)$$

Thus,  $\Delta$  is a background deviation (contrast) of temperature or humidity, given with boundary conditions. Then, analytical solution of equation (1) is given as follows

$$q(x,z) = \varphi(0) + \Delta \cdot n(x,z), \quad (4)$$

$$\text{when } n = 1 - \frac{\Gamma(m, \frac{s^2}{4t})}{\Gamma(m)}, \text{ when } 0 < x \leq L, \quad n = \frac{\Gamma(m, \frac{s^2}{4(t-t_L)}) - \Gamma(m, \frac{s^2}{4t})}{\Gamma(m)}. \quad \text{when } x > L.$$

Here  $\Gamma(m)$  – is a gamma function,  $\Gamma\left(m, \frac{s^2}{4t}\right) = \int_0^{\frac{s^2}{4t}} \sigma^{m-1} e^{-\sigma} d\sigma$  – incomplete gamma function

$$m = \frac{p}{2p+1}, \quad s = \left(\frac{z}{z_1}\right)^{(2p+1)/2}, \quad t = \frac{p^2}{4m^2} \cdot \frac{k_1 x}{u_1 z_1^2}, \quad t_L = \frac{p^2}{4m^2} \cdot \frac{k_1 L}{u_1 z_1^2}.$$

Coefficient  $(x,y)$  on the solution (4) varies in the interval (0,1). Its physical meaning is in showing what part of background deviation is increase of meteo-element in the given space point. In the areas, where the impact form the reservoir in maximal  $n \rightarrow 1$ , and on the big heights from the surface and long distances form the bank  $n \rightarrow 0$ . In accordance with the physical nature the  $n$  coefficient can be called an influence coefficient.

Let us calculate the  $n$  numeral value for  $z=2m$  height using following data:  $z_1=10m$ ;  $u_1=3.5$  m/sec;  $k_1=5m^2/sec$ ;  $p=1/8=0.125$ ;  $m=0.1$ ;  $L=L_1+L_2=25.5km$ . The results are given in the table 1.

## **Task II – determination of cumulative effect with separation of Nenskra reservoir and of all three reservoirs (Jvari, Khudoni and Nenskra) system.**

Similarly to the task I impact coefficient values  $z=2m$  was only calculated for Nenskra reservoir for following data:  $z_1=10m$ ;  $u_1=3.5m/sec$ ;  $k_1=5m^2/sec$ ;  $p=0.125$ ;  $m=0.1$ ;  $L=L_3=1.5$  km. The results for  $n_2$  are given in the table 2. The same table provides information on values of  $n_1$  total impact coefficient of Jvari and Khudoni systems. As we can see, Jvari and Khudoni reservoir systems impact effect in the beginning of Nenskra reservoir and dam is only 5% ( $n_1=0.05$ ) of contrast. Maximum impact of the Nenskra reservoir is observed 1.5 km away from the dam (at the end of the reservoir) and is  $n_2=0.4$ . But an impact from Jvari and Khudoni system is also to be foreseen. For this reason, total effect on this distance is  $n=n_1+n_2=0.45$ . Thus, table 2 provides information on values  $n=n_1+n_2$  of cumulative effect of all three reservoirs with dependence on the distance. From the end of the Nenskra reservoir on the 0,5 km distance is  $n=0.15$  and then slowly decreases to  $n=0.04-0.05$  form the coordinate beginning on  $L=45-50$  km distances (5-10 km from Nenskra reservoir edge). Cumulative effect becomes insignificant from the beginning of the coordinate system on the distances  $L=80-100$  km – here it is only 1% ( $n=0,01$ ). Figure 2 shows curve representing cumulative effect of impact from reservoir system on microclimate of the environment.

According to the value of cumulative effect of all three reservoirs is rapidly reducing and its maximal value above the reservoirs for the upper level  $H=100$  m of boundary layer of the atmosphere does not exceed 5-10% of contrast.

Table demonstrates differences in temperatures of air and water and humidity (partial pressure of water vapor) on the reservoir surfaces, background contrasts. For this purpose data from Jvari and Khaishi meteorological stations was used. In addition, values of temperatures of reservoir water surface, rivers Nenskra and Enguri presented in the hydro-meteorological guides and several scientific publications [5-8].



**Table 13.1.1.** Calculated annual values of Jvari and Khudoni reservoir system impact coefficient  $n_1(x,z)$  for  $z=2m$  height

Xkm	Jvari dam	0.5	1	2	3	4	5	10	15	20	Khudoni dam	25	25.5	26	27	28	30	35	37.5
$n_1(x,2)$		0.33	0.37	0.41	0.44	0.45	0.46	0.50	0.52	0.53		0.54	0.54	0.22	0.15	0.12	0.09	0.06	0.05
Jvari reservoir										Khudoni reservoir		Distance free of water 12 km.							

**Table 13.1.2.**  $n_2$  meaning of Nenskra reservoir impact coefficient and changes in  $n=n_1+n_2$  coefficient of cumulative impact of all three reservoirs

xkm.	Nenskra dam	38.0	38.5	39	39.5	40	41	42	43	44	45	50	60	70	80	90	100
$n_1(x,2)$		0.05	0.05	0.05	0.05	0.05	0.04	0.04	0.04	0.04	0.04	0.03	0.02	0.02	0.01	0.01	0.01
$n_2(x,2)$		0.33	0.37	0.40	0.10	0.09	0.04	0.03	0.02	0.01	0.01	0.01	0.005	0.005	0	0	0
$n=n_1+n_2$		0.38	0.42	0.45	0.15	0.14	0.08	0.07	0.06	0.05	0.05	0.04	0.025≈ 0.03	0.025 ≈0.03	0.01	0.01	0.01
		Nenskra reservoir			Cumulative interference of impact of all three reservoirs												

**Table 13.1.3.** Changes of coefficient reflecting cumulative effect of the impact from Jvari, Khudoni and Nenskra reservoir system with dependence on the distance ( $z=2m$  for height)

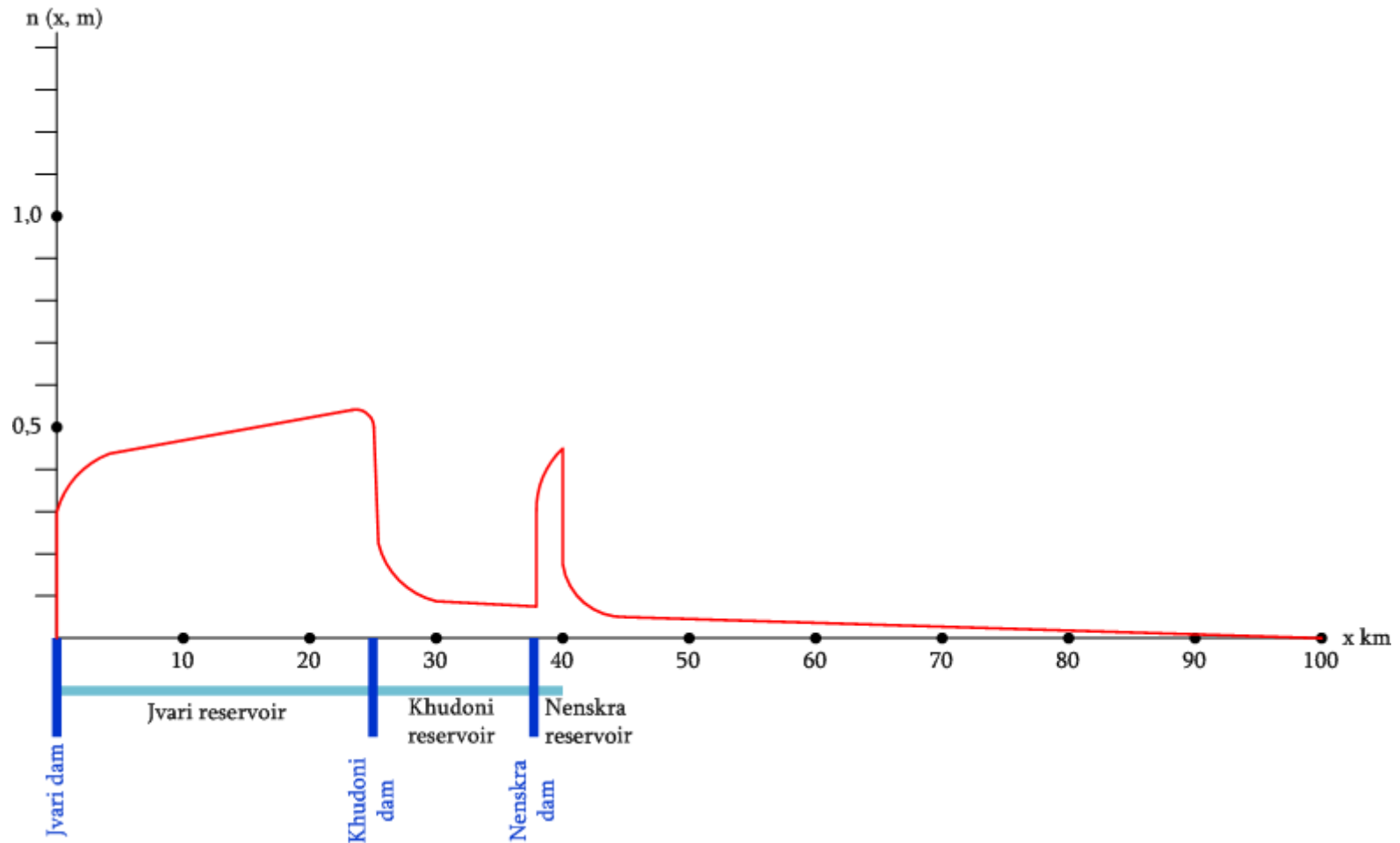

**Table 13.1.4.** Distribution of air temperature and humidity expressed by cumulative effect in accordance with distance for z=2m height

Distance from Jvari dam, km	Jvari reservoir										Khudoni reservoir		Distance free of water – 12 km						Nenskra reservoir					Comment		
	0.5	1	2	3	4	5	10	15	20	25	25.5	26	27	28	30	35	37.5	38	38.5	39	39.5	40				
Temperature	Jvari dam (H=0.3km)										Khudoni dam (H=0.5 km)		End of Khudoni reservoir (H=0.7 km)						Nenskra dam (H=1.3 km)			End of Nenskra reservoir (H=1.4 km)				
	13.87	13.84	13.77	13.71	13.64	13.58	13.25	12.93	12.6	11.42	11.3	10.29	9.96	9.64	8.99	7.36	6.55	6.33	6.19	5.9	5.68	5.47	Natural distribution			
	-0.83	-0.93	-1.03	-1.1	-1.13	-1.15	-1.25	-1.3	-1.33	-1.19	-1.19	-0.48	-0.33	-0.2	-0.2	-0.13	-	0.11	0.11	0.11	-0.11	-	0.11	Impact of Nenskra reservoir		
	13.04	12.91	12.74	12.61	12.51	12.43	12	11.63	11.27	10.23	10.11	9.91	9.63	9.38	8.79	7.23	6.44	6.25	6.05	5.83	5.58	5.37	0.01	0.01	Impact of Jvari and Khudoni reservoirs	
Partial pressure of water vapor	Jvari dam (H=0.3km)										Khudoni dam (H=0.5 km)		End of Khudoni reservoir (H=0.7 km)						Nenskra dam (H=1.3 km)			End of Nenskra reservoir (H=1.4 km)				
	11.08	11.05	11.01	10.96	10.91	10.87	10.63	10.4	10.16	9.75	9.66	9.54	9.31	9.07	8.6	8.38	7.79	7.63	7.48	7.32	7.16	7.01	7.01	7.01	Natural distribution	
	0.5	0.56	0.62	0.66	0.68	0.69	0.75	0.78	0.8	0.81	0.81	0.38	0.23	0.18	0.14	0.09	0.08	0.08	0.08	0.08	0.08	0.08	0.08	0.08	Impact of Jvari and Khudoni reservoirs	
	11.58	11.61	11.63	11.62	11.59	11.56	11.38	11.18	10.96	10.56	10.47	9.87	9.54	9.25	8.74	8.47	7.87	8.37	8.3	8.2	7.44	7.27	7.27	7.27	7.27	Impact of Nenskra reservoir
																										Effect of cumulative impacts form all three reservoirs

Relative humidity %	15,85	15,82	15,75	15,69	15,62	15,56	15,22	14,9	14,59	13,5	13,39	12,52	12,24	11,98	11,46	10,27	9,71	9,57	9,43	9,29	9,15	9,02	Saturated vapor pressure in air temperature conditions
	69,9	69,9	69,9	69,9	69,9	69,9	69,8	69,8	69,6	72,2	72,1	76,2	76,1	75,7	75,0	81,6	80,2	79,7	79,3	78,8	78,3	77,7	Natural distribution
	13,48									11,32								9,81					Saturated vapor pressure in water temperature conditions
	85,9	86,1	86,3	86,2	86	85,8	84,4	82,9	81	93,3	92,5	78,8	77,9	77,2	76,3	82,5	81,1	85,3	84,6	83,6	81,3	80,6	Effect of cumulative impacts form all three reservoirs

**Table 13.1.5.** Background contrasts of water and air temperatures and humidity (partial pressure)

Thermal contrast		Humidity contrasts	
Hydro-meteorological element	Element value	Hydro-meteorological element	Element value
Air temperature from Jvari reservoir dam °C	13.9	Air temperature from Jvari reservoir dam °C	13.9
Air temperature from Khudoni reservoir dam °C	10.6	Air temperature from Khudoni reservoir dam °C	10.6
Average air temperature for Jvari-Khudoni system °C	12.3	Average air temperature for Jvari-Khudoni system °C	12.3
Water surface temperature for Jvari reservoir °C	11.4	Water surface temperature for Jvari reservoir °C	11.4
Water surface temperature for Khudoni reservoir °C	8.8	Water surface temperature for Khudoni reservoir °C	8.8
Average temperature of water surface for Jvari-Khudoni system °C	10.1	Average temperature of water surface for Jvari-Khudoni system °C	10.1
Water and air temperature differences (contrast) for Jvari-Khudoni system °C	-2.2	Water and air temperature differences (contrast) for Jvari-Khudoni system °C	-2.2
Air temperature for Nenskra reservoir °C	6.6	Air temperature for Nenskra reservoir °C	6.6
Water surface temperature for Nenskra reservoir °C	6.7	Water surface temperature for Nenskra reservoir °C	6.7
Water and air temperature contrast for Nenskra reservoir °C	0.1	Water and air temperature contrast for Nenskra reservoir °C	0.1

Values of air temperature and partial pressure for Nenskra reservoir dam were restored using following formulas [9]:

$$t=15-6.5xH \quad \text{and} \quad e=13.9-4.7xH,$$

where  $t$  is air temperature ( $^{\circ}\text{C}$ ),  $e$  partial pressure (hpa), and  $H$  altitude a.s.l. in km. These formulas describe distribution of temperature and humidity according to the height for mountainous regions, such as Enguri ravine.

According to the table 3 thermal contrast for Jvari-Khudoni reservoir system is  $(\Delta t)_1=-2.2^{\circ}\text{C}$  and for Nenskra reservoir -  $(\Delta t)_2=0.1^{\circ}\text{C}$ . This means that for the most part of the year (e.g., 7-8 warm months of the year) Jvari-Khudoni system has a cooling system on the environment [4]. In case of Nenskra reservoir, dam of which is located 1.3 km a.s.l, the thermal contrast is low, but positive. This means, that the reservoir water temperature is either more or same as the air temperature, which is typical for freezing reservoirs.

Finally, the table 4 and the figure 3 present distribution of temperatures and humidity (partial pressure, relative humidity) of cumulative impact effect of Jvari, Khudoni and Nenskra reservoir system according to the distance for  $Z=2\text{m}$  height. For this purpose data from tables 2 and 3 and figure 1.2.1.2. were used.

First lines of the tables for each element provide information on its natural distribution, i.e. those, which would take place without reservoirs. The second line provides changes in element value and rating, caused by the impact from reservoirs. This is achieved with multiplying the contrast by impact coefficient. The third line provides element distribution, which is formed by the joint impact of reservoir system. This distribution is achieved with consideration of value and rate of element changes.

As we can see, Jvari and Khudoni reservoirs affect the distribution of temperature and humidity the most. Maximal changes are noticed above the reservoirs. In the 12 km free of water zone natural and transformed distributions approach each other. Impact of Nenskra reservoir comparing to Jvari and Khudoni reservoirs is weak, but still noticeable. Joint impact from all three reservoirs is expressed by temperature lowering and raise of humidity. These effects are important in 40 km zone starting from Jvari reservoir dam. After 40 km zone (on a 1 km distance from Nenskra reservoir end) the difference between natural and transformed distribution of temperature goes down to  $0.1^{\circ}\text{C}$  (1-2%), partial pressure is increased by approximately 0.3 hpa (3-4%), while relative humidity is increased only by 3% (3-4%).

Impact on wind regime is mainly caused by surface transformation, when after transfer from the land to the reservoir the air flow slides on the smooth surface. In [4] the quantity of wind changes is assessed on the basis of logarithmic law on vertical distribution of air flow speed. On the  $Z=2\text{m}$  height above the reservoir water the wind speed may increase 2-3 times. This change is taking place in relatively narrow zone in 0.1-0.5 km away from the beginning of the reservoir. Also, the wind returns to its natural regime after transferring from reservoir back to land. Unlike changes in temperature and humidity, wind transformation scale is less and does not exceed 1 km from the bank line [1,4].

Due to the fact, that air flow mileage on the surface in case of Nenskra reservoir is less ( $L_3=1.5\text{ km}$ ) than on the Jvari-Khudoni reservoir ( $L=L_1+L_2=25.5\text{ km}$ ) and also considering, that after this the flow continues movement over the 12 km water free section till Nenskra reservoir, change in wind regime will be noticeable in 25-30 km zone, from the beginning of Jvari reservoir.

Joint impact on the atmospheric precipitation regime can take place due to vapor regime, which is created during the evaporation process from each reservoir. This amount of vapor is not collected above the reservoir and is distributed to the catchment areas of Enguri, Nenskra, Nakra and other neighboring rivers. Annual amount of evaporation can be calculated using the following formula [4]:

$$E = Pd(0.013 + 0.00085t) + 600 \quad ,$$

Where E is an evaporated water layer (in mm) during the year, P – sum of annual precipitation (mm), d – saturated humidity deficit (hpa or mbar), t°C – air temperature. Using the characteristics from table 3, amount of evaporated water from Jvari reservoir is:

$$V_1 = E_1 \times S_1 = 729 \text{ mm} \times 19 \text{ km}^2 = 13.9 \times 10^6 \text{ m}^3,$$

From Khudoni reservoir :

$$V_2 = E_2 \times S_2 = 620 \text{ mm} \times 5.5 \text{ km}^2 = 3.3 \times 10^6 \text{ m}^3,$$

From Nenskra reservoir:

$$V_3 = E_3 \times S_3 = 647 \text{ mm} \times 3 \text{ km}^2 = 1.9 \times 10^6 \text{ m}^3.$$

Amount of annual evaporation from all three reservoirs will be  $V = V_1 + V_2 + V_3 = 19.1 \times 10^6 \text{ m}^3$  water. Only half of this amount transfers into atmospheric precipitations [4], which are annually distributed mainly over total catchment areas of Enguri, Nenskra, Nakra and their tributaries not less than  $S = 1000 \text{ km}^2$ . Amount of additional precipitation with cumulative impact will be:

$$\Delta P = \frac{0.5V}{S} \approx 10 \text{ mm}.$$

This is a very small increasing. It is 0.5% of precipitation annual norm of Jvari meteorological station, and for Khaishi, Lakhmi, Becho and Mestia stations – approximately 1% of annual norm. Therefore, we can state, that amount of atmospheric precipitation under the influence of joint impact from the reservoirs is not changing.

**Considering results of all surveys we can state, that significant change in the climate of the region due to cumulative impacts from Jvari, Khudoni and Nenskra reservoirs is not expected.**

**Figure 13.1.2.** Transformation of temperature (a), partial pressure (b) and relative humidity (c) caused by Jvari, Khudoni and Nenskra impact for Z=2m height.

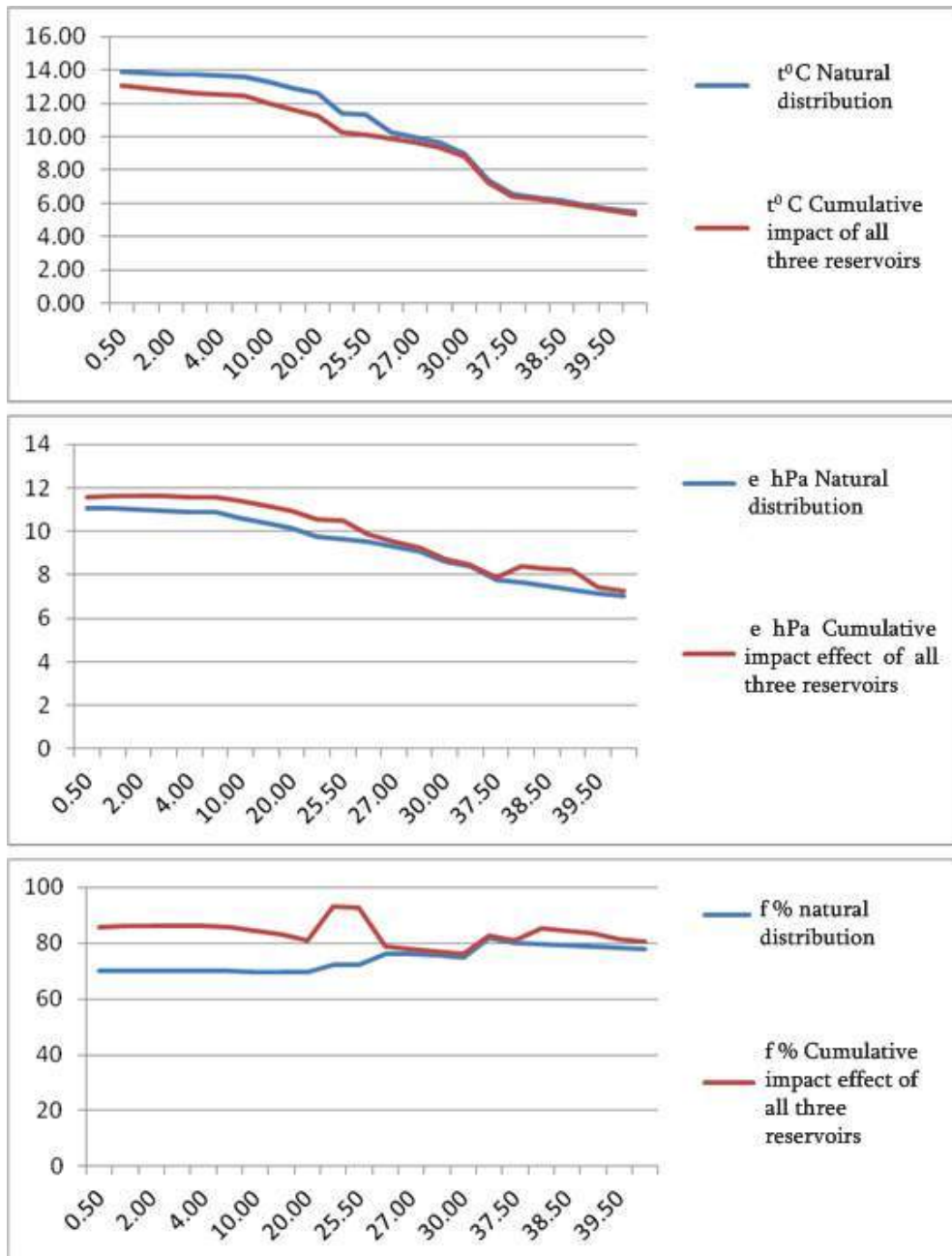

## 13.2 Annex N2 Emergency Response Plan

### 13.2.1 Types of Emergency Situation and their Description

Considering specificities of planned activities, following types of emergency situations are expected:

- Emergency situations related to the damage of headworks;
- Emergency situations related to the damage of other hydraulic structures;
- Fire / explosion;
- Spill of hazardous substances, including oil spill;

- Traffic accidents;
- Personnel traumatism and incidents related to their health safety.
- Emergency situations of natural character.

It is noteworthy, that emergency situations, listed above, may be subsequent and development of one emergency situation may initialize another one.

### 13.2.2 Accidental Damage of Hydraulic Structures

Hydraulic structures damage factors can be:

- Anthropogenic: mistakes made during the design stage, violation of construction and operation norms, the lack of professionalism of the staff, incompetence and negligence, hostilities, terrorist acts;
- Natural: extreme water runoff, hazardous meteorological phenomena, earthquakes, landslides, avalanches and others.

Breakdown of hydraulic structures can be expressed as follows:

- Damage of headworks (dam, water intake);
- Damage of diversion channel and penstock, violation of its filtration resistance;
- Damage and malfunction of technological equipment (intake regulatory shields).

Number of circumstances reduce risks of damage of hydraulic structures and further unwanted situations, namely:

- Arrangement of large dam and reservoir is not planned, which reduces the risks of damage of water intake;
- The project area is characterized by sustainable geological conditions and in case of implementing relevant reinforcement works, risks of development of geological hazards are not high.

### 13.2.3 Accidental Spills of Pollutants

Oil spill risk may be related to a violation of the conditions of their storage, fuel or oil leakage from vehicles and equipment and so forth. Sensitive districts, where hazardous substances spill may occur are construction camps (mainly warehouses) and all construction sites, where machinery and other equipment are intensively used.

High-risk areas during the operation phase are the following:

- Substations (transformer oil spills and dissemination);
- Power House (Turbine oil spill and dissemination);
- Oil products and other hazardous materials storage areas.

Subsequent processes of such emergencies may be:

- Fire/explosion;
- Poisoning of personnel or population.

### 13.2.4 Fire / explosion

Risk of fire eruption-propagation and explosion occurs both during construction and operation phases. Sensitive districts for fire eruption and explosion, during construction phase are construction camp,



namely warehouses of easily flammable and explosive materials. During the operation phase, fire eruption and explosion is mainly expected within the powerhouse and substation areas.

The main factor of accident may be anthropogenic, namely: indifference of personnel and violation of safety norms, violation of storage rules for fuels, oils and other explosive substances and etc. However, fire and explosion may also be caused by the natural disaster (e.g. earthquake).

Subsequent process of fire/explosion may be:

- Salvo emission/spill of hazardous substances;
- Traumas of personnel or population and accidents related to their health.
- In case of strong landscape fire, there is a risk of development of geodynamic processes.

### **13.2.5 Traffic Accidents**

Trucks and heavy machinery will be used during construction works. During their movement on public and access roads, following are expected:

- Collision with transport means, real estate or livestock of local population;
- Collision with local population;
- Collision with project personnel;
- Collision with other project machinery;
- Collision with local infrastructure facilities;

High risk of traffic accidents will be related to relatively intensified traffic. A number of preventive measures should be taken in order to minimize the risks of traffic accidents, including: limitation of traffic speed, arrangement of warning signs, selection of optimal routes for vehicles, regulation of traffic by standard-bearer, etc.

### **13.2.6 Personnel Traumatism and Incidents Related to their Health Safety**

Except incidents related to other emergency situations, personnel traumatism may also be related to:

- Incidents related to heavy machinery/equipment used for project implementation;
- Fall from large heights;
- Poisoning with used chemical substances;
- Electric shock, during working near aggregates under high voltage (especially during operation phase).

### **13.2.7 General Preventive Measures for Different Emergency Situations**

Preventive measures for hydraulic structures damage:

- In parallel with the construction of hydraulic structures, fundamental scientific research should be carried out;
- During emergency situations (damage to the dam, unplanned release of water), arrangement of emergency notification system (sound and light alarms, warning population using loud speakers) in order to inform population downstream of Nenskra and Nakra dams;
- Staff professional development and training courses in the field of emergency situations;
- Systematic maintenance of control measurement systems of the dam;
- Monitoring of dangerous geodynamic processes, technical condition of the dam and other hydro technical structures;

- Protection of safety standards, adjustment of engineering solutions as appropriate during all stages of construction and operation of the dam;
- Protection of hydro-system.

Preventive measures for hazardous substance spill:

- Strict supervision over implementation of fuel and chemicals' storage and use terms. Fitness of storage vessel must be checked before storing;
- The technical functionality of oil containing equipment should be periodically monitored;
- Termination of works / suspension of equipment and machinery operation and implementation of maintenance works after detection of minor spill, so that incident would not become large-scale.

Preventive measures for fire/explosion:

- Periodical training and testing of personnel on fire prevention issues;
- Storage of easily flammable and explosive substances at safe places. Installation of corresponding warning signs at their warehouses;
- Implementation of fire safety rules and arrangement of functional firefighting equipment at the territory;
- Implementation of electricity safety rules;
- Arrangement of lightning conductors in open substations and monitoring their functionality.

Preventive measures for traffic accidents:

- Selection of optimal transport movement routes and speed restrictions;
- Improvement of temporary and permanent access roads and their maintenance throughout the whole cycle of the project;
- Installation of warning, prohibiting and pointing road signs at access roads and construction camps;
- During movement of special and oversized machinery they should be escorted by specially equipped machinery and trained experienced personnel.

Preventive measures for personnel traumatism/injury:

- Periodical training and testing of personnel on labor safety issues;
- Provision of personnel with individual protection means;
- Personnel must be insured by special ropes and cartridges during implementation of high elevation works;
- Warning signs should be arranged within the dangerous zones;
- In closed spaces (e.g. Power house) evacuation posters should be arranged on the walls;
- Preparation of special staff, which will control implementation of safety norms at construction sites and will register facts of violation

### 13.2.8 Approximate Scale of Accidents

According to expected emergencies, liquidation resources and legislative requirements, accidents and emergency situations are sorted in 3 groups. Table 13.8.2.1 gives description of emergency situations according to their level, indicating corresponding reaction.

**Table 13.2.8.1.** Description of Emergencies according to their levels

Accidents	Level		
	I level	II level	III level
<b>General</b>	The internal resources are sufficient for emergency liquidation	External resources and workforce are needed for emergency liquidation	Involvement of regional and country resources for emergency liquidation
<b>Damage of other hydraulic structures</b>	Minor damage of hydraulic structures that is temporary, but will not interrupt significantly HPP operation. The provocation of other emergencies is less expected. HPP personnel will manage to liquidate emergency.	Hydraulic structures damage, which significantly impede the functioning of the power plant and the other risks provoking an emergency situation.	Significant damage to hydraulic structures (bank protection structures injury, significant damage to the pipeline, etc.). There is a high risk of flooding and damage to infrastructure facilities. It is needed to mobilize external resources for rapid elimination of the accident.
<b>Hazardous substance spillage</b>	Local spillage, which does not need external interference and can be eliminated with internal resources. The risks of spreading of the substance on large areas and river contamination do not exist.	Large spills (spills of hazardous substances 0.3 tons to 200 tons). There are risk of substance spreading in the area and the risk of the river pollution.	Large spills (more than 200 tons)
<b>Fire /Explosion</b>	Local fire, which does not need any external interference and is easily controlled. The meteorological conditions are not conducive to the rapid spread of the fire. There are no inflammable and explosive sections/ warehouses and materials.	Large fires, which spread quickly due to the weather conditions. There are inflammable/explosive areas/ warehouses and materials. It is necessary to call the local fire squad.	A large fire, which spread rapidly. The ignition risk of surrounding neighborhoods and provocation of other emergencies is high. The approach to the territory is complicated. The inclusion of the regional fire service for the liquidation of the incident is necessary.
<b>Road accidents</b>	The damage of equipment, vehicles, infrastructure and non-valuable items takes place. Human health is not in danger.	The damage of the equipment, vehicles, infrastructure and valuable objects takes place. There is the threat to human health or II level traumatism is registered.	The damage of the equipment, vehicles, infrastructure and valuable objects takes place. There is the high risk of development of other emergencies. There is the threat to human health or III level traumatism is registered.
<b>Personnel injury / Traumatism</b>	<ul style="list-style-type: none"> <li>• One incident of traumatism;</li> <li>• Light fracture, bruises;</li> <li>• I degree burns (skin surface layer damage);</li> <li>• Assistance to injured personnel and the liquidation of the incident is possible by local medical service.</li> </ul>	<ul style="list-style-type: none"> <li>• Individual cases of accidents;</li> <li>• Severe fracture - a fracture of the joints of the middle;</li> <li>• II degree burns (deep layer of the skin lesions);</li> <li>• There is the need to move injured personnel to the local medical facility.</li> </ul>	<ul style="list-style-type: none"> <li>• Several traumatic accidents;</li> <li>• Severe fracture - Articular fracture etc.;</li> <li>• III and IV degree burns (skin, hypodermic tissues and muscle lesions);</li> <li>• There is the need to move injured personnel to the regional or Tbilisi medical service centers with relevant profile.</li> </ul>

**Note:** Considering the scale of the project, its duration and specificity of location, the anticipated emergency situations will be mainly of I levels and less likely of II level, except hydraulic structures damage. The risk of damage of Nenskra dam can be assessed as III level emergency situation.

### 13.2.9 Emergency Response

#### 13.2.9.1 Emergency Response in Case of Damage to Hydraulic Structures

A person who will detect the damage to the dam or the development of geological hazards shall be obliged to immediately notify the incident to a superior person - a senior operator and provide him/her with detailed information about the damaged sections. Further activities should be carried out in accordance to the instructions of the superior person.

During the accidents, strategic actions of senior operator are as follows:

- After receiving detailed information on damage/accident, analyze the situation, determine the related processes and approximate scale of accident (level);
- To ask the person being in the place of the incident, the information provider or competent staff for immediate implementation of primary preventive measures (closing or opening of culvert gates, etc.), so that there is no threat to their health and safety;
- Competent personnel, emergency services and, if necessary, other resources should be notified about the incident;
- To ask competent personnel for locking the hydro-turbine vents;
- Arrangement of emergency notification systems (voice alarm, loud speakers) downstream of Nenskra and Nakra dams in order to inform the population about the dam damage or unplanned release of water.

#### 13.2.9.2 Response to Hazardous Material Spill

This section discusses only I and II scale emergency response strategy. The types of hazardous substances spill response are significantly determined by ground surface, also, the initial condition. Consequently, emergency response is presented for the following scenarios:

- Hazardous substances spill on impervious surface (asphalt, concrete cover);
- Hazardous substances spill on pervious surface (ground, gravel, vegetation)
- Spill of the hazardous substances in the river.

In case of hazardous substances (mainly oil products) spill on the impervious surface, it is necessary to implement the following strategic actions:

- Information transfer according to the emergency notification scheme;
- Stopping every device-equipment working on the site;
- Blocking the pollution source (if any);
- Ask personnel to mobilize equipment and personal protection means for emergency response;
- Block the entrances of household-fecal sewage systems (lids of wells);
- In case of necessity, it is necessary to arrange barriers with suitable impervious material (sand bags, plastic sheets, plastic coat and others) in such way, that it will stop spilled material or limit its movement;
- Barriers must be arranged perpendicular to the sidewalks or in shape of horseshoe, so that the open side will be directed to meet the substances flow;
- Gather the spilled oil products by using brooms and linens;
- For drying in the spilled substances, absorbent pads usage is necessary;
- Gather the oil products in such way, that it will be possible to collect them in container and then removal;
- After absorption of the oil, these pads should be placed in polyethylene bags (if needed, these pads might be reused);

- The site should be completely cleaned from residual oil products, in order to exclude the wash-off of the pollutants by the rain water;
- After completion of cleaning operations, every cleaning material must be collected, wrapped and warehoused in relevantly safe areas.

In case of hazardous substances spill on the pervious surface, it is necessary to implement the following strategic actions:

- Information transfer according to the other personnel and emergency service;
- Stopping every device-equipment working on the site;
- Ask personnel to mobilize equipment and personal protection means for emergency response;
- Block the entrances of household-fecal sewage systems (lids of wells);
- Absorbents should be placed together in such way to create continuous barrier (fence) in front of the edge of moving oil products. Ends of the barrier must be folded in front, so that it will have a shape of a horseshoe;
- Spilled oil products containment place must be covered with polyethylene membrane sheets, in order to prevent the oil occurrence in the lower layers of soil;
- It should be noted, that if it is not available to lay down the polyethylene sheets, then the barrier arrangement will cause the oil accumulation on one place, which in turn will cause soil saturation with oil and oil products occurrence in the lower layers;
- For drying in the spilled substances, absorbent pads usage is necessary;
- Gather the oil products in such way, that it will be possible to collect them in container and then remove;
- After absorption of the oil, these pads should be placed in polyethylene bags (if needed, these pads might be reused);
- The site should be completely cleaned from residual oil products, in order to exclude the wash-off of the pollutants by the rain water;
- After completion of cleaning operations, every cleaning material must be collected, wrapped and warehoused in relevantly safe areas.
- Processing of vegetation and upper layer of the soil on existing on the ground surface must begin right after removal of the pollution source or after stopping the leakage;
- When the whole spilled oil products will be cleaned, removal and remediation works implementation must start under supervision of construction works manager/head of the facility and invited specialists with a relevant competence.

In case of oil products spill in the river or drainage channels, it is necessary to implement the following strategic actions:

- Information transfer according to the emergency notification scheme;
- Information of population living downstream the river about the spill;
- Stop every device-equipment working on site (if there is a case of turbine oils spill in the water, it is an obligatory condition to stop the work of hydro-turbines in sequence);
- Blocking the pollution source (if any);
- Ask personnel to mobilize the necessary equipment for emergency response and personal protection means;
- Clear the vegetation existing on the river bank with the scythe;
- Immediately fence the polluted section of the river with wood boards. In case of additional necessity, usage of ground filled bags is available;

- Removal of oil products gathered on the river surface must be carried out with sanitation vehicles;
- Absorbent pads must be used for drying the oil products spilled on the soil;
- After absorption of the oil, pads must be placed in polyethylene bags for waste.

### 13.2.9.3 Response During Fire

The strategic actions of the person and the personnel working in the vicinity, who detected fire or smoke, are as follows:

- Termination of works on every site, except for safety measures;
- Assessment of the situation, reconnaissance of fire hearth and adjacent territories;
- Withdrawal of the equipment-devices from the areas, where the fire spreading is possible;
- Electrical equipment should be turned out from the circuit;
- In case if fire is strong and it is hard to approach the fire hearth, some kind of fire or explosive hazardous sites/substances are located adjacently, then:
  - Get away from the danger zone;
  - Inform senior manager/operator about the accident;
  - Wait for rescue team and when they appear, inform them about the fire reasons and the situation in the vicinity of fire hearth;
- In case if the fire is not strong, the fire hearth is easily approachable and getting near to it is not dangerous for your health. At the same time, there are certain risks of fire distribution on adjacent territories, then, act as follows:
  - Inform senior manager/operator about the accident;
  - Search for the nearest fire stand and supply yourself with necessary fire inventory (fire extinguisher, axe, crowbar, bucket and etc.);
  - Try to liquidate fire hearth with fire extinguisher, in accordance with the instruction shown on the fire extinguisher;
  - In case if there is no fire stand on the site, use sand or water for fire hearth liquidation or cover it with less flammable thick cloth;
  - In case if the electrical equipment turned into the circuit are near the fire hearth, it is prohibited to use water;
  - In case of fire in the closed space, do not window the room (except for special needs), because the fresh air supports fire and fire scale growth.

Strategic actions of site manager/chief operator in case of fire:

- Gathering detailed information on fire hearth location, existing/stored devices-equipment in the vicinity and substances;
- Information transfer in accordance with the notification scheme;
- Visiting the accident place and reconnaissance of the situation, risks analysis and assessment of expected fire scales (I, II or III scale);
- Ask whole personnel to use vehicles and fire extinguishing equipment;
- Controlling and managing the personnel actions.

In case of landscape fire, emergency service is participating in fire liquidation measures. As well as HPP personnel (in accordance with the instruction of head of the power house and H & SE officer), also local population in case of necessity. During forest fire extinguishing, except for the above listed instruction, also are used the following basic approaches:

- Forest fire lower boundaries sweeping with green branches, brooms and bag cloths;
- On the low fire boundaries of the forest, throwing ground with shovels and spades;
- Blocking line or channel arrangement to stop the fire distribution;
- Inhibiting channel arrangement must take place in direction of construction camps, construction sites and in direction to the territories where easily flammable and explosive substances are disposed, in case of fire distribution risks.

#### **13.2.9.4 Response During Traffic Accidents**

During the accident of road transport, it is necessary to implement the following strategic actions:

- To stop vehicles/equipment;
- Transmission of information in accordance with the emergency report scheme;
- In case if there is no danger for human health and there are no risks of provoking other emergency situations (for example: collision of other vehicles, explosion, fire, oil spill, hydrodynamic accident or others), then:
  - Get out of the vehicle/equipment or get away from the accident place and stand on a safe distance;
  - Wait for the police/rescue team to come.
- In case of further threats, act as follows:
  - Get out of the vehicle/equipment or get away from the accident place and stand on a safe distance;
  - If the vehicle accident has occurred on the dangerous section of the road of public use (for example: in the turning, there visual field on the road is limited), then ask to the accident witness to stop the cars moving in direction of an accident location;
  - If you are alone on the accident place, place the warning signs or sharp color safe signs on the road away from the place of an accident, so that those signs will be visible for the drivers moving in direction of an accident place and will ensure the car stop;
  - In case of explosion, fire, oil spill, hydraulic accident and others, act in accordance with the strategy given in the relevant paragraphs;
  - In case if there is a threat on the health of a person, do not try to move the body;
  - If the injured person is lying in the middle of the street, cover him with something and confine the accident location, so that it will be seen from a distance;
  - Remove everything from him, which might be making asphyxia (belt, scarf);
  - First aid to the injured in accordance with the first aid strategy given in the relevant paragraphs (but remember, by extra movement of the injured person, you might create additional risks to his health).

#### **13.2.9.5 Response during Accidents Related to Human Injuries and Incidents Related to Their Health and Safety**

The person, who is taking care of injured person, must notify ambulance about an accident as a first action. Before the rescue will appear, injured person must receive first aid service in accordance with the tactics given below in following chapters. Before carrying out medical service, it is necessary to assess the situation and determine if approaching and helping an injured person might create some threat.

### 13.2.9.5.1 First Aid during the bone fracture

Open and closed bone fractures are being distinguished:

- For the open fracture is characterized the violence of skin cover integrity. In this case, there is wound and bleeding in the damaged area. There is a high risk of infection in case of open fracture. In case of open fracture:
  - Promptly call helper, so that helper will immobilize the damaged area of the injured person, while you will process the wound;
  - Cover the wound with clean cloth and directly press on it to stop the bleeding. Do not press directly on broken bone fragments;
  - Without touching the wound with fingers, surround the damaged area with a clean cloth and fix it;
  - If the broken bone fragment is seen in the wound, place the soft cloth around the bone fragment in such way, that the cloth will not be removed and the bandage would not impact on bone fragments. Fix the bandage in such way, that it will not disrupt the blood circulation below the wrapped place;
  - Carry out a broken bone immobilization, in the same way as during covered fracture;
  - Check pulse, capillary filling and sensitivity below the wrapped place once in every 10 minutes.
- We are dealing with a closed fracture, if the skin integrity is not damaged in the injured area. In this case, hemorrhage and edema are observed in the injured area. In case of closed fracture:
  - Ask injured person to stay still and fix the damaged part of the fracture above and below it by hand, before it will be immobilized (fixed);
  - For a good fixation, fix the injured part of the body on uninjured part. If the fracture is on the hand, fix it on the body with triangle bandage. If the fracture is on the leg, fix the damaged leg on another leg;

Check pulse, sensitivity and capillary filling below the wrapped place once in every 10 minutes. If the blood circulation or sensitivity is reduced, make a less tight bandage.

### 13.2.9.5.2 First Aid During Wounds and Bleeding

There are three types of bleeding:

- There is a little blood. In this case is risk of infection:
  - Clean the wound of injured person with any colorless liquid suitable for drinking;
  - Wrap the wound with clean cloth.
- There is a lot of blood. In this case there is a risk of blood loss:
  - Cover the wound with several layers of cloth and make pressure bandage;
  - If the blood is still leaking, tighten the cloth to the wound again (do not take off the blood-drenched cloth) and strongly press on blood source area.
- The blood is pouring like a fountain from the wound. In this case the blood loss is very fast. In this case you must push finger (or fingers) on the artery projection area to avoid this and then put a bandage.

The areas of load on the artery are: the lower third of an arm and upper third of the thigh. The bandage should be fixed like this:

- The bandage is fixed only in extreme case, because often it leads to irreversible damage;
- The bandage is fixed above wound;



- The location where the bandage will be fixed must be covered with cloths. If the wound area is bare, we should place clean cloth under the bandage;
- First bandage must be tight (fixed as possible), then the bandage is getting tight and in addition placed 3-4 times (rope, belt and etc. can be used instead of bandage);
- The bandage should be fixed for 1 hour in the winter and for 2 hours in summer. Then we should release and after 5-10 minutes fix it slightly above from the original location;
- Check if the bandage is properly fixed – if it is properly fixed, there should be no pulse on limb;
- What we should not do;
- Do not put a hand in the wound;
- Do not take anything from the wound. If some foreign body is seen in the wound, we should try to maximally fix it (put a bandage around this body).
- Internal bleeding is hardly determinable damage. Suspect internal bleeding, when the shock signs are observed after getting injured, but there is no significant blood loss. In case of internal bleeding:
  - Lay injured person on his back and rise his legs up;
  - Remind tight clothes on neck, chest, waist;
  - Do not give food, medicine or drinks to injured person. If injured person is conscious and is very thirsty, just wet his lips;
  - Warm injured person – cover with blanket or cloth;
  - Check the pulse in every 10 minutes, as well as breathing and consciousness. If the person is losing mind, place him in safe location.

### 13.2.9.5.3 First Aid in Case of Burn

The burn might be developed by hot objects and steam impact (thermal burn), by chemical substances impact on the skin (chemical burn), electricity impact (electrical burn). In order to properly carry out first aid, you must determine the degree of burn, which depends on damage depth and damage area (on what part is the burn distributed).

- The first aid measures during the burn are:
  - It is dangerous to breath in the smoke, so if there is a smoke in the room and it is not available to window fast, remove the injured person on a safe place, on a fresh air;
  - If the clothes are burning on the person, do not start to roll his body, pour the water on the body (in case of electrical burning, usage of water next to the equipment in the circuit, is prohibited);
  - If there is no possibility to use water, cover the body with non-synthetic cloth;
  - It is necessary to start cooling the burnt area in time with cold water (in case of I and II scale burn, water it for 10-15 minutes, in case of III and IV scale burn wrap it with clean wet cloth and then cool it in the water in such wrapped conditions);
  - Remove the cloth and other objects, from the damaged area, which may interrupt blood flow. Do not remove cloth pieces, which are stick to the damaged area;
  - Cover the damaged area with sterile wrapping. This would reduce the likelihood of infection;
  - Breathing in a hot air is possible when burnt, which leads to the burning of respiratory tracts. If the victim has hard noisy breathing, facial or neck burn, singed hair cover of face

and nose, swelled mouth and lips, swallowing difficulty, cough, hoarseness voice – suspect the respiratory tracts burn and wait for the medical service;

- Constantly check breathing and pulse before the medical service will come, be ready to carry out reanimation measures;
- It is not allowed to take off the clothes particles from the burnt skin, cause this may lead to the deepening of the damage;
- It is not allowed to destroy the integrity of blebs, because the skin cover is damaged and it makes a favorable conditions for the invasion of infection in the body;
- Do not use ointments, lotions or oils for processing the damaged parts;
- It is prohibited to process the chemical burn areas with neutralizing solutions/ For example, alkaline caused burn treatment with acid.

#### 13.2.9.5.4 First Aid in Case of Electrical Trauma

There are three types of electrical trauma:

- The trauma caused by high-voltage electricity. The damage developed as a result of high voltage traumas, are fatal in most cases. Severe burns are being developed at this time. Due to the strong muscle compression the injured person is often threw away on a significant distance, which leads to serious injuries. In case of high-voltage power trauma:
  - It is prohibited to get close to the injured person, before the electricity will be turned off and if necessary, the isolation will be made. Remain 18 m radius safe distance. Do not let other witnesses to approach the injured person;
  - After receiving electric trauma, as soon as approaching the injured person, open the breathing ways without moving head back, by moving the lower jaw in front;
  - Check breathing and circulation signs. Be prepared to make reanimation measures;
  - If the injured person is unconscious but is breathing, place him in a safe location;
  - Carry out first aid in case of burns and other injuries.
- The electrical trauma caused by low-voltage electricity. Low-voltage electricity trauma may turn into serious damages and even death reason. Often, this kind of electrical trauma is caused by damaged plugs, wiring and equipment. When standing on a wet floor or touching undamaged electrical wiring with wet hands, the risks of getting the electrical trauma are sharply increasing. In case of low-voltage power caused trauma:
  - Do not touch the injured person, if he is touching the power source;
  - Do not use metal object for removing the power source;
  - If you are able, stop power supply (turn off the power switch). If it is not available, turn off the electrical equipment from the power source;
  - If you are not able to switch off the electricity, then stand on dry insulation thing (for example: a plank of wood, on rubber or plastic pad, on book or pile of newspapers);
  - Remove the victim's body from the power source by broom, stick, and chair. You can move the victim's body away from the power source, or vice versa, the power source away from the body, if it is more convenient;
  - Without touching the body of injured person, tie a rope around his foot and shoulders and move away from the power source;
  - At least, grab the injured person in dry not-tight cloth and move him away from the power source;
  - If the victim is unconscious, open the airways, check the breathing and pulse;

- If the victim is unconscious, is breathing and has a pulse, place in a safe location. Cool the burned areas and wrap it;
- If the visible injuries are not seen on the victim and feels good, advice to take a rest.
- The electrical trauma caused by lightning/thunder:
  - Various traumas, burns, face and eyes damage is often by the electrical trauma. Sometimes the lightning may cause a sudden death.
  - Quickly move damaged person from the place of the accident and serve with first aid as in case of different type of the electrical trauma.

### 13.2.10 Equipment Necessary for Emergency Response

In process of construction and operation, in terms of accident development, the standard equipment must exist on high risk sites, namely:

Personal protection means for emergency response: on construction stage – on construction camps; on operation stage – in special room in power house. Personal protection means are:

- Helmets;
- Safety glasses;
- Uniforms with reflective stripes;
- Waterproof boots;
- Gloves.

Fire extinguishing equipment:

- Standard fire extinguisher: on every site, as well as on every special machines and equipment;
- Buckets, sand, shovels and etc.;
- Properly equipped fire stands;
- Fire truck – the nearest fire fighters team truck will be used (from Zugdidi).

Emergency medical service equipment:

- Standard medical boxes: Standard medical boxes for vehicles: on every project vehicle and equipment;
- Ambulance car – the ambulance car of Zugdidi medical center will be used.

Spill response equipment:

- Heavy duty plastic bags;
- Absorbent pads;
- Gloves;
- Drip trays;
- Buckets;
- Polyethylene film.

### 13.2.11 Necessary Qualification and Personnel Training

Testing of each system of emergency response must be periodically implemented, obtained experience must be documented and weak spots should be improved (the same should take place in case of accident realization).

The whole staff, employed on treatment facility construction and operation, must undergo introductory training, which includes emergency response course. Personnel additional training registration system should exist and be kept at offices of customer or contractors.

### 13.3 Annex 3: Measures considered for waste prevention and recovery

#### 13.3.1 Legal Basis

The waste management plan has been prepared on the basis of requirements of the "Waste Management Code". Under the Article 14, first clause of the Law "those individuals and legal entities, who produce more than 200 tons of non-dangerous waste during a year or more than 1000 tons of inert materials or any amount of dangerous waste, are obliged to develop waste management plan of the company". Waste Management Plan should be updated every 3 years or in case changes have been made to the types and quantities of generated waste.

Since significant amount of non-hazardous and inert waste and hazardous waste are expected to be generated during the planned activities, waste management plan has been developed for the construction and operation of Nenskra HPP, which includes:

- Information on generated waste;
- Information on preventive and recovery measures;
- Information on separation of generated waste;
- Information on temporary storage and conditions of waste;
- Information on waste transportation;
- Information on waste treatment;
- Information on requirements for safe treatment of waste;
- Information on waste control.

#### 13.3.2 Goals and Objectives of Waste Management Plan

The waste management plan establishes the rules for collection, transportation, disposal and recycling of industrial and household waste generated during the construction and operation of Nenskra HPP, in compliance with environmental, sanitary and epidemiological norms and rules.

Main objectives of waste management process:

- Identification waste types;
- Waste separation collection, protection of norms established for their temporary disposal, in order to exclude negative impact of waste on environment and human health;
- Protection of rules of waste transportation, to avoid scattering of waste, loss, emergency situation, the environment and human health damage;
- Using methods safe for environment and human health during neutralization, processing or utilization of waste;
- Reduction of waste quantity;
- Recycling of waste;
- Determination of the responsibilities of personnel on waste management;
- Recording of industrial and household waste.

This plan includes all types of activities causing waste generation, including:

- Activities under normal operating conditions;
- Activities under not normal operating conditions (e.g. maintenance and construction works);
- Activities during emergency situations.

Plan guidelines are mandatory for all employees and contractors of the company carrying out the work.

### 13.3.3 Waste Management Hierarchy and Principles

Georgia's waste management policy and Georgian legislation on waste management are based on the following hierarchy:

- Prevention;
- Preparation for waste recycling;
- Recycling;
- Other types of recovery, including energy recovery;
- Disposal.

Following should be considered while determining specific duties:

- Environmental benefits;
- Technical feasibility through using the best available techniques;
- Economic viability.

Waste management should be carried out without endangering the environment and human health, in particular, so that the waste management:

- Should not endanger water, air, soil, flora and fauna;
- Should not cause harm due to noise and odor;
- Should not cause negative impact on the whole area, especially - on protected areas and cultural heritage.

Waste management is carried out by the following principles:

- Principles "precautionary measures" - measures should be taken to prevent the impact of waste to the environment, even if there is no scientifically proven data;
- Principle "polluter pays" - waste generating or waste holder shall bear the costs related to waste management;
- "Proximity principle" - waste should be handled at the nearest waste treatment facility, taking into account the environmental and economic efficiency;
- "Self-reliance principle" - to develop and operate an integrated and adequate network of municipal disposal or recovery facilities.

### 13.3.4 Types and Approximate Quantities of Waste Generated during the Implementation of Planned Activities

Types and approximate quantities of waste generated during the implementation of planned activities are given in Table 13.3.4.1.

Table 14.3.4.1.

Category	Type	Approximate quantity	
		Construction phase	Operation phase
<b>Hazardous:</b>	Paint residues and paint packaging	800-1000 kg	15-20 kg/a
	Outdated and malfunctioning batteries	60-70 unit	2-3 unit/a
	Oil filters of construction equipment, vehicles, etc.	120-125 unit	5-8 unit/a
	Oil waste, lubricants (liquid)	650-850 kg	-
	Polluted rags and other cleaning products	60-80 kg	15-200 kg/a
	Used rubber tires	200-250 unit	10-15 unit/a

		Welding electrodes	500-600 kg	10-12 kg/a
		Fluorescent lamps, and so forth. Mercury-containing items	50-60 unit	20-35 unit/a
		Laser cartridges	30-40 unit	2-3 unit/a
		Petroleum hydrocarbons contaminated soil	Depends on scale of spills	
<b>Non-hazardous, including:</b>	<b>Inert</b>	Soil excavated and brought from tunnel, which is not useful for the construction works	520-525 thousand m <sup>3</sup> is expected	-
	<b>Household</b>	Household waste generated by personnel	438 m <sup>3</sup>	42 m <sup>3</sup> /a
	<b>Other</b>	Polyethylene waste (packaging and sealing materials, pipes and so on.).	180-200 kg	30-35 kg/a
		Wood waste	Will be specified at construction design phase	10-15 m <sup>3</sup> /a
		Ferrous and non-ferrous scrap	25-30 t	1-2 t/a

### 13.3.5 Waste Management Process Description

#### 13.3.5.1 Waste prevention and recovery measures

Following waste prevention and recovery measures are considered for the planned activities (construction and operation of Nenskra HPP):

- Any type of building materials, products or substances will be brought into the area by the quantity required for proper implementation of construction / technology processes. Materials will not be stored on the territory for a long time;
- Major part of construction material, structures, materials required for technology processes will be imported on the territory in finished form (e.g. inert materials, timber, etc.);
- During purchasing of building materials, structures, subjects necessary for technological processes, priority will be given to environmental and quality products. Product will be checked for compliance with international standards;
- Preference will be given to re-use or recycling, biologically degradable and safe for the environment substances, materials and chemical compounds;
- Borders of the construction corridors will be strictly controlled in order not to exceed the designated areas and to avoid additional inert and vegetation waste generation;
- Generated waste will be reused as much as possible (e.g. steel structures, plastic materials, etc.).

#### 13.3.5.2 Waste separation

During the implementation of the planned activities, waste separate collection methods according to their types and hazards will be organized and implemented:

- Two different colors of plastic containers with relevant markings will be arranged in construction camps and sites, as well as on the powerhouse area during the operation phase;
- Outdated and malfunctioning batteries (drained of accumulator acid) will be removed directly to a temporary storage area (storage facility) and disposed in wooden boxes, which will have a metal pallets;

- Liquid hazardous wastes (oils, lubricants, paint residues, etc.) will be separately collected in closed plastic or metal barrels and will be removed to a temporary storage area;
- Luminescent lamps and so forth. Mercury-containing items will be placed in well-closed plastic bags and then in a cardboard packaging and will be removed to a temporary storage area;
- Laser printer cartridges will be placed in well-closed plastic bags and will be removed to a temporary storage area;
- Used tires will be collected on waste generation areas, on open areas with solid pavement;
- Contaminated soil will be stored in the vicinity of the place of occurrence, on an area with solid cover;
- Excavated, unused soil will be disposed on a landfill;
- Wood waste will be collected on-site of generation, on a specially designated site; Sawdust – in shed or on area covered with polyethylene;
- Ferrous and non-ferrous scrap will be accumulated in a specially designated place;
- Polyethylene waste (packaging and sealing materials, pipes, etc.) will be accumulated in a specially designated place;

Following will be prohibited:

- Accumulation of waste at the site of generation for a long time (more than 1 week);
- Storing of hazardous waste in containers designated for solid household waste;
- Collection and storage of liquid hazardous waste in open areas, not protected from precipitation;
- Burning of rubber or other waste;
- Discharging oil, lubricants, electrolyte into river or sewer systems;
- Mechanical impact on accumulators and cartridges.

### 13.3.6 Methods and conditions for temporary storage of waste

Landfill will be arranged for the disposal of waste rock generated during the implementation of the planned activities. After the disposal of waste rock, stockpile areas will be recultivated.

Following conditions should be considered for temporary storage sites of waste generated during the planned activities:

- During the construction and operation phases, storage facility (container type) will be arranged for hazardous waste, in accordance to the following requirements. Facilities will have appropriate designation and will be protected from exposure to atmospheric precipitation and strangers encroachment;

Temporary storage of waste will meet the following requirements:

- The whole perimeter of the site will be fenced in order to exclude spills of harmful substances into the river or soil;
- Convenient access road to the site should be ensured;

- Precipitation and wind exposure to the waste is subject to the effective protection (shed, waste container, etc.);
- Appropriate signs will be arranged throughout the perimeter and site will be protected from strangers;

### **13.3.7 Waste transportation rules**

Waste will be transported in full compliance with the sanitary and environmental regulations:

- All operations related to waste loading / unloading and transportation will be mechanized and impermeable;
- Loss and scattering of waste during transportation is prohibited;
- During transportation, the accompanying person will have the document - "demand on the removal of hazardous waste", which must be confirmed by the management.
- After the completion of transportation operations, vehicles should be cleaned and washed (washing vehicles in riverbeds is prohibited);
- A vehicle used for waste transportation should have a warning sign.

### **13.3.8 Waste treatment / final disposal**

Household waste accumulated in containers will be removed to the nearest landfill (2-3 times in month).

According to the current environmental legislation, logged trees will be stored on an area specified by the "National Forestry Agency" and will be granted to the same organization for further management.

Other types of wood waste will be used again where possible or after appropriate procedures will be handed over to the local authorities / communities. Useless plant waste will be removed to the existing landfill.

In accordance with the accumulation, all kinds of hazardous waste will be transferred to an appropriate licensed contractor for further management (contractor will be revealed before the start of the activity).

Landfill will be arranged for final disposal of waste rock.

### **13.3.9 General requirements for the safe treatment of waste**

- Personnel who are engaged in the field of waste management (collection, storage, transportation, receipt / delivery) would have undergone appropriate training on health and safety issues;
- Staff will be provided with special uniforms, footwear and personal protective equipment. If necessary, staff clothing are subject to special treatment, especially after performing works related to hazardous waste;
- Personnel should be able to carry out first aid in case of poisoning or trauma during working with waste;
- A person who has not taken the proper training, has no special clothing or is sick, will not be allowed on working area;
- In case of disposing several types of waste together, their compatibility will be considered;



- Storing of personal clothing, uniforms, individual protection means, as well as eating on waste accumulation areas is prohibited;
- During working with waste, personal hygiene norms should be protected, before eating and after finishing the work it is necessary to wash hands with soap and warm water;
- In case there are some signs of poisoning, a person should stop working and must apply to the nearest medical centre and notify the authorities of the structural unit;
- Fire fighting equipment will be provided on fire hazardous waste collection sites. In such areas, smoking is strictly forbidden;
- Personnel should be aware of the waste properties and fire fighting rules. Extinguishing of burning easily inflammable or combustible liquids is possible through fire-extinguishers, sand or asbestos tissues;
- To extinguish the burning solvents with water is prohibited.

### **13.3.10 Waste control methods**

During the construction and operation phases, properly trained personal will be allocated, who will be periodically trained and tested. These personnel will produce a special journal in which the volume of generated, accumulated and removed waste will be recorded.

People responsible for waste management will systematic control the following:

- Suitability of waste collection containers;
- Labeling on the containers;
- Condition of temporary disposal sites / storage for waste;
- Volume of accumulated waste and compliance with the established standards (visual control);
- Protection of periodicity of waste removal from structural unit area;
- Protection of environmental security and safety protection requirements.

# SLR



global environmental solutions



Industry



Infrastructure



Mining & Minerals



Oil & Gas



Planning & Development



Renewable & Low Carbon



Waste Management