

# DEWALT®



**POWERTOOLS AND ACCESSORIES CATALOGUE  
GUARANTEED TOUGH.®**

**2011**



# DEWALT<sup>®</sup>

## ENGINEERING EXCELLENCE

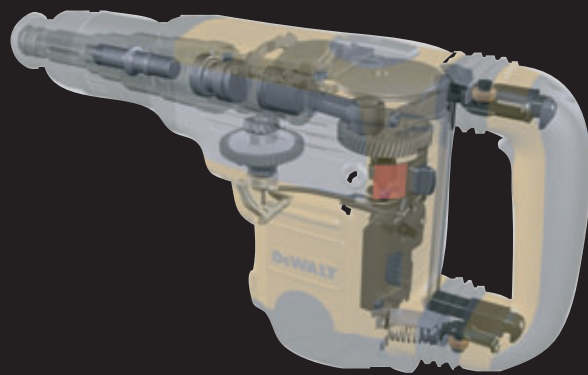

**30** Years of experience in engineering professional construction power tools at our in-house facility in Idstein, Germany



**50** Years of experience in designing and manufacturing world class drilling solutions for the construction industry at our in-house facility in Buchberg, Germany

- Simulation software developed in partnership with the automotive industry
- Industry leading application-based testing facilities
- Cutting edge drilling accessories manufacture
- Award winning design

**In-house design and manufacture ensures that the quality of DEWALT drilling solutions exceeds the requirements of the most demanding professional applications**



### END USER RESEARCH

- On average, we speak to 20,000 users every year as part of the product development process
- A comprehensive understanding of the real applications that our users perform enables us to generate product features that are a genuine benefit to our users



### INNOVATIVE PRODUCTS

- To support our users and drive our industry forward, DEWALT consistently develop truly innovative products, across multiple categories
- This technical strength is regularly recognised by international design awards



### COMPLETE PROFESSIONAL QUALITY PRODUCT RANGE

- DEWALT is a full range power tool and accessories supplier for the building contractor and professional tradesman

### USER LOYALTY

- The cast-iron DEWALT guarantee and premium service network ensure that our users have faith in the quality of our products. First-time buyers will become loyal DEWALT users
- DEWALT is heavily involved in end-user events across Europe - building our brand reputation, and generating huge excitement around our diverse product portfolio





|                                 |           |
|---------------------------------|-----------|
| <b>FEATURES QUICK REFERENCE</b> | <b>4</b>  |
| <b>PRODUCT QUICK REFERENCE</b>  | <b>5</b>  |
| <b>PRODUCT INNOVATIONS</b>      |           |
| Heavy Duty Cordless             | 6         |
| Compact Cordless                | 8         |
| The 10.8 Volt System            | 10        |
| Construction Instruments        | 12        |
| Heavy Duty Construction         | 14        |
| Dust And Vibration Management   | 16        |
| Mitre Saws                      | 18        |
| Portable Woodworking            | 20        |
| Jobsite Saws                    | 22        |
| <b>WARRANTY AND SERVICE</b>     | <b>24</b> |

## POWER TOOLS & ATTACHMENTS

### CORDLESS

|                              |    |
|------------------------------|----|
| The 36 Volt System           | 26 |
| 24 Volt SDS-Hammers          | 28 |
| The 18 Volt System           | 28 |
| The 14.4 Volt System         | 37 |
| The 12 Volt System           | 41 |
| The 7.2 Volt System          | 44 |
| The 3.6 Volt System          | 45 |
| Area Light, Radio and Vacuum | 45 |
| The 10.8 Volt System         | 46 |
| Battery and Charger Systems  | 47 |

### CONSTRUCTION INSTRUMENTS

|   |    |
|---|----|
| Laser Level Kit, Self Levelling Lasers                            | 48 |
| Laser Pointer & Plumb Bob, Distance Measurer & Auto Level Package | 49 |
| Tile Laser, Laser Level Attachments                               | 50 |

### SCREWDRIVERS

|                                       |    |
|---------------------------------------|----|
| Drywall Screwdrivers                  | 51 |
| Versaclutch Screwdrivers              | 51 |
| Screwdrivers for Self Drilling Screws | 52 |
| Impact Wrenches                       | 52 |

### DRILLS

|                      |    |
|----------------------|----|
| Drill/ Mixers        | 53 |
| Percussion Drills    | 53 |
| Rotary Drills        | 55 |
| Magnetic Drill Press | 57 |

### DIAMOND DRILLS

|                                    |    |
|------------------------------------|----|
| Diamond Drilling System            | 58 |
| Diamond Drills                     | 60 |
| Drilling Stands for Diamond Drills | 60 |
| Wet Tile Saw                       | 61 |
| Diamond Drill Attachments          | 61 |

### HAMMERS

|                               |    |
|-------------------------------|----|
| Rotary & Combination Hammers  | 62 |
| Dust Extraction               | 63 |
| Chipping & Demolition Hammers | 65 |

### METAL WORKING

|                       |    |
|-----------------------|----|
| Small Angle Grinders  | 67 |
| Medium Angle Grinders | 70 |
| Large Angle Grinders  | 71 |
| Die Grinders          | 74 |
| Chop Saws             | 75 |
| Sander                | 75 |
| Polisher              | 75 |

### NAILERS

|                  |    |
|------------------|----|
| Staplers         | 76 |
| Roofing Nailers  | 76 |
| Framing Nailers  | 76 |
| Palm Nailer      | 77 |
| Finish Nailers   | 77 |
| Cordless Nailers | 78 |

### WOODWORKING

|                              |    |
|------------------------------|----|
| Routers                      | 79 |
| Dovetail Jigs                | 80 |
| Router Attachments           | 81 |
| Trimmers                     | 83 |
| Jointers                     | 83 |
| Planers                      | 84 |
| Orbital Sanders              | 85 |
| Detail Sanders               | 85 |
| Random Orbital Sanders       | 86 |
| Belt Sanders                 | 86 |
| Linishing/ Grinding Machines | 87 |
| Heatgun                      | 87 |

### SAWING

|                    |    |
|--------------------|----|
| Plunge Saw         | 88 |
| Jigsaws            | 89 |
| Circular Saws      | 90 |
| Reciprocating Saws | 91 |
| Alligator® Saws    | 92 |

### MITRE SAWS

|                           |    |
|---------------------------|----|
| Crosscut Mitre Saws       | 93 |
| Compound Mitre Saws       | 93 |
| Slide Compound Mitre Saws | 94 |
| Mitre Saw Attachments     | 95 |
| Table Top Mitre Saws      | 96 |

### MACHINERY

|                 |     |
|-----------------|-----|
| Table Saws      | 97  |
| Rolling Stand   | 97  |
| Jobsite Saws    | 98  |
| Radial Arm Saws | 100 |
| Bandsaws        | 100 |
| Thicknessers    | 101 |
| Dust Extraction | 102 |

### BRUSH PAIRS

**103**

### ACCESSORIES

#### MASONRY DRILLING

|  |     |
|--|-----|
| EXTREME DeWALT® Masonry Drill Bits               | 105 |
| Masonry Drill Bits                               | 105 |
| Multi-Material Drill Bits                        | 106 |
| SDS-Plus EXTREME DeWALT® 2 Drill Bits            | 106 |
| EXTREME DeWALT® XLR Full Head Carbide Drill Bits | 109 |
| SDS-Plus 4-Cutter Drill Bits                     | 110 |
| SDS-Max Hammer Drill Bits                        | 110 |
| SDS-Plus Chisels                                 | 111 |
| EXTREME DeWALT® Chisels                          | 111 |
| SDS-Max Chisels                                  | 112 |
| 19mm Hexagon Chisels                             | 112 |
| Pavement Breaker Chisels                         | 112 |
| Light Duty SDS-Plus Core Drills                  | 113 |
| Heavy Duty SDS-Max Core Drills                   | 113 |
| Single Piece Cores                               | 113 |
| Through Drilling Bits                            | 114 |
| Drive Adaptors & Adaptor - SDS-Plus              | 114 |

### METAL DRILLING

|  |     |
|--|-----|
| HSS-CO EXTREME DeWALT® Cobalt Metal Drill Bits | 115 |
| EXTREME DeWALT® 2 Metal Drill Bits             | 116 |
| HSS-G DIN 338 Jobber Metal Drill Bits          | 117 |
| HSS-G DIN 340 Long Series Metal Drill Bits     | 118 |
| EXTREME DeWALT® Impact Step Bits               | 119 |
| Step Drills                                    | 119 |
| EXTREME DeWALT® Impact Drill Bits              | 120 |

### WOOD DRILLING

|   |     |
|---|-----|
| Brad Point Wood Drill Bits                | 120 |
| Frame Drill Bits                          | 121 |
| TCT Hinge Boring Bits                     | 121 |
| Wood Auger Drill Bits                     | 121 |
| Self Feed Drill Bits                      | 122 |
| EXTREME DeWALT® Flat Wood Drill Bits      | 122 |
| EXTREME DeWALT® Long Flat Wood Drill Bits | 122 |
| Flatwood Drill Bits                       | 123 |

### HOLESAWS

|                                       |     |
|---------------------------------------|-----|
| EXTREME DeWALT® Impact Holesaws       | 124 |
| Bi-Metal Deep Cut Holesaws            | 124 |
| Bi-Metal Holesaw Sets                 | 125 |
| Carbide Grit Holesaws                 | 125 |
| Carbide Grit Holesaw Sets             | 125 |
| EXTREME DeWALT® Quick Change Mandrels | 126 |
| Holesaw Mandrels and Accessories      | 126 |

### DRILLING ACCESSORIES

|               |     |
|---------------|-----|
| Mixer Tools   | 126 |
| Chucks & Keys | 127 |

### SCREWDRIVING

|  |     |
|--|-----|
| Screwdriving Accessories                 | 128 |
| EXTREME DeWALT® Impact Sets              | 130 |
| DeWALT 'Flip & Drive' Units              | 131 |
| EXTREME DeWALT® Impact Rated Socket Sets | 131 |

### DRILLING & SCREWDRIVING SETS

|                         |     |
|-------------------------|-----|
| Drilling Accessory Sets | 132 |
| Mag Box Magnetic Sets   | 133 |
| Tough Case Storage      | 133 |
| Modular Accessory Cases | 134 |
| Mini Mac Case Sets      | 134 |

### CIRCULAR SAW BLADES

|  |     |
|--|-----|
| EXTREME DeWALT® Stationary Circular Saw Blades | 135 |
| Stationary Circular Saw Blade Guide            | 137 |
| EXTREME DeWALT® Portable Circular Saw Blades   | 138 |
| Cordless Circular Saw Blades                   | 139 |
| Portable Circular Saw Blades                   | 139 |
| Portable Circular Saw Blade Guide              | 140 |
| Insert Rings                                   | 142 |

### JIGSAW BLADES

|   |     |
|---|-----|
| XPC Wood Cutting Blades                         | 143 |
| Wood Cutting Blades                             | 144 |
| EXTREME DeWALT® Bi-Metal Cutting Blades T-Shank | 145 |
| Metal Cutting Blades                            | 145 |
| Wood & Metal Cutting Blades                     | 146 |
| EXTREME DeWALT® Special Material Blades         | 146 |
| Wood & Metal Cutting Blade Kits                 | 146 |

### RECIPROCATING SAW BLADES

|                          |     |
|--------------------------|-----|
| Wood Cutting Blades      | 147 |
| Metal Cutting Blades     | 147 |
| General Purpose Blades   | 148 |
| Demolition Blades        | 148 |
| Reciprocating Blade Sets | 148 |
| Specialist Blades        | 149 |

### ALLIGATOR® SAW BLADES

**149**

### SPECIALIST WOODWORKING ACCESSORIES

|                                     |     |
|-------------------------------------|-----|
| Bandsaw Blades                      | 150 |
| Planer Blades & Jointer Accessories | 150 |

### ROUTER BITS

**151**

### COATED ABRASIVES

|                             |     |
|-----------------------------|-----|
| Full Sheet                  | 153 |
| Hand Sanding Block          | 153 |
| Half Sheet                  | 154 |
| Third Sheet                 | 154 |
| Quarter Sheet               | 155 |
| Detail                      | 156 |
| Rolls                       | 156 |
| Belts                       | 157 |
| Grinding Belts              | 158 |
| Honing Belts                | 158 |
| Nylon Loop Discs            | 159 |
| Extreme DeWALT® Fibre Discs | 160 |
| Flap Discs                  | 160 |

### PADS & BONNETS

|                                 |     |
|---------------------------------|-----|
| 'Quick Fit' Platens             | 161 |
| Backing Pads & Bonnets          | 161 |
| Angle Grinder Polishing Bonnets | 161 |

### BONDED ABRASIVES

|   |     |
|---|-----|
| Metal Cutting & Grinding Discs                        | 162 |
| Chop Saw Wheel  | 162 |
| Stainless Steel & Thin Metal Cutting & Grinding Discs | 163 |
| Aluminium Cutting Discs                               | 163 |
| High Speed Stone Cutting Discs                        | 163 |
| Stone Cutting & Grinding Discs                        | 164 |
| Grinding Wheels & Honing Wheels                       | 164 |
| Grinding Cups   | 164 |
| Wire Brushes  | 165 |

### DIAMOND DISCS

|                                  |     |
|----------------------------------|-----|
| Diamond Disc Guide               | 166 |
| High Performance Diamond Discs   | 167 |
| Dry Diamond Discs                | 168 |
| Wet & Dry Diamond Tile Saw Blade | 168 |

### DIAMOND DRILLS

|                                       |     |
|---------------------------------------|-----|
| Dry Diamond Core Drills & Dosensenker | 169 |
| Wet Diamond Core Bits                 | 170 |
| Adaptors, Extension Rods & Pilot Bits | 171 |
| Diamond Tile Drill Bits               | 171 |



















### NAILER ACCESSORIES



















|         |     |
|---------|-----|
| Nails   | 172 |
| Staples | 173 |

### DeWALT SERVICE

|                       |     |
|-----------------------|-----|
| 5 Star Service        | 174 |
| Service Agent Network | 175 |

The icons under each tool indicate the product features. Check details for information.

-  **DRILLING/CHISELLING MODES**  
Single mode for chiselling only
-  **TWO MODE**  
For rotary and hammer drilling
-  **THREE MODE**  
For rotary, hammer drilling and chiselling
-  **IMPACT MECHANISM**  
Uses rotary impacts to generate extremely high torque
-  **TWO AND THREE SPEED SELECTOR**  
Many DeWALT tools are available with multiple speeds to offer greater control in a variety of applications
-  **XRP®**  
The range of XRP® cordless powertools have extreme run-time and power
-  **CONSTANT SPEED**  
A constant speed is maintained under operational load
-  **ELECTRONIC VARIABLE SPEED CONTROL**  
The speed can be adjusted from low to high giving greater control in each application
-  **SOFT START**  
Electronic soft start to limit start-up current and reduce kick reaction which could misalign the accessory
-  **LOW VIBRATION SIDE HANDLE**  
Low-Vibration side handle with a damped mechanism
-  **ANTI-MASS**  
Anti-Mass Counter-balance system helps reduce vibration
-  **SUSPENDED HANDLES**  
Suspended handles dramatically reduce vibration, increasing productivity and end user comfort
-  **ANTI-VIBRATION FLOATING HANDLE**  
No matter where it is pressed, the whole handle is completely damped from top to bottom reducing the vibration to the user
-  **WET & DRY**  
Tool is designed to work with water feed
-  **3-POSITION KEYLESS SHOE**  
To maximise blade life
-  **4-POSITION KEYLESS BLADE CLAMP**  
Allows quick blade change, flush cutting and versatility
-  **PLUNGE ACTION**  
Parallel plunge action for accuracy and cut finish
-  **GUIDE RAIL COMPATIBLE**  
Tool can be used with DeWALT guide rail system

-  **COMPLETE TORQUE CONTROL**  
The Complete Torque Control offers a patented two step clutch system. On the pre-set lowest torque the user can complete 80% of his applications in a safer way. The highest torque setting is perfect for core drilling and big diameter applications with solid bits
-  **CLUTCH**  
Clutch protects the operator against kick back and the tool against overload should the accessory jam
-  **TOOL FREE ADJUSTMENT**  
The accessory in use, guard or shoe of the tool can be changed or adjusted without the need of a screwdriver, key or spanner
-  **KEYLESS CHUCK**
-  **QUICK CHANGE CHUCK**  
Ideal solution to change easily between SDS and 3 jaw chuck systems
-  **SPINDLE LOCK**  
Spindle is locked by pushing a button allowing quick and easy change of accessories
-  **FORWARD AND REVERSE**  
Forward and reverse action for screwdriving applications
-  **PENDULUM BLADE ACTION**  
Adjustable pendulum blade action provides improved cutting performance in comparison to a conventional blade action
-  **DUST EXTRACTION**  
Dust Extraction into either a dust bag on the tool or through an attachment to a dust extraction unit
-  **EASILY ACCESSIBLE BRUSHES**  
Brushes accessible for easy servicing reducing down time
-  **ELECTRONIC BRUSH WEAR INDICATOR**  
Service light in the tool handle indicates when the brushes require changing.
-  **DUST EJECTION SYSTEM**  
Rejects the majority of dust sucked into a grinder leaving clean air only to pass over the motor, resulting in increased durability
-  **HOOK & LOOP**  
Hook & Loop bases allow easy attachment of sand paper
-  **PALM GRIP**  
Tool designed for single-handed operation
-  **BATTERIES**  
Cordless tools (with the exception of bare units) come with either one or two batteries as standard equipment. The battery chemistry can be Nickel Cadmium (NiCd), Nickel Metal Hydride (NiMH) or Lithium-Ion (Li-Ion). Please refer to individual tool specifications for clarification of which battery or batteries come with your selected tool
-  **COMPACT BATTERY**  
Compact batteries are smaller and lighter than standard batteries, and require less charging time
-  **CORDED/CORDLESS**  
Tool can be powered by mains electricity source, or by DeWALT batteries
-  **CARRYING CASE**  
Supplied with heavy duty carrying case

| Cat. No.          | Page | Cat. No.         | Page | Cat. No.          | Page   | Cat. No.          | Page | Cat. No.          | Page |
|-------------------|------|------------------|------|-------------------|--------|-------------------|------|-------------------|------|
| D21160            | 57   | D26500/ D26500K  | 84   | DC235KL           | 26     | DC840KB           | 43   | DW630             | 75   |
| D21441            | 56   | D26501K          | 84   | DC300KL/ DC300KN  | 27     | DC845KB           | 43   | DW650/ DW650E     | 86   |
| D21510            | 53   | D27107/ D27107V  | 98   | DC305KL/ DC305KN  | 27     | DC901KL/ DC901KN  | 26   | DW670             | 83   |
| D21520            | 53   | D27111/ D27112   | 96   | DC308KL/ DC308KN  | 27     | DCD710S2          | 46   | DW677             | 84   |
| D21570K           | 55   | D27300/ D27300T  | 101  | DC330KB/ DC330KA/ |        | DCD920B2          | 30   | DW680/ DW680K     | 84   |
| D21580K           | 60   | D27900           | 102  | DC330N            | 35     | DCD920L2          | 30   | DW682K            | 83   |
| D215821           | 60   | D27901           | 102  | DC330KL           | 34     | DCD925B2          | 29   | DW685K            | 83   |
| D21582K           | 60   | D27902           | 129  | DC352KBR/ DC352KN | 35     | DCD925L2          | 29   | DW711             | 96   |
| D215831           | 61   | D28065           | 70   | DC385KB/ DC385N   | 34     | DCD930B2          | 38   | DW712/ DW712N     | 93   |
| D21583K           | 60   | D28111           | 67   | DC385KL           | 34     | DCD930L2          | 38   | DW713XPS/ DW713   | 93   |
| D21585            | 60   | D28113/ D28113K  | 67   | DC390KB/ DC390KA/ |        | DCD935B2          | 37   | DW716EXPS/ DW716  | 94   |
| D215851           | 61   | D28116           | 67   | DC390N            | 35     | DCD935L2          | 37   | DW717XPS          | 94   |
| D21620K           | 57   | D28117           | 67   | DC390KL           | 35     | DCD940B2          | 42   | DW718XPS/ DW718   | 94   |
| D21717K/ D21716/  |      | D28130           | 68   | DC411KB/ DC411KA/ |        | DCD945B2          | 41   | DW721KN/ DW722KN  | 100  |
| D21716K           | 53   | D28132C          | 68   | DC411N            | 34     | DCF610S2          | 46   | DW728KN/ DW729KN  | 100  |
| D21721K/ D21720K/ | 54   | D28133           | 69   | DC411KL           | 34     | DCF815S2          | 46   | DW733             | 102  |
| D21720            |      | D28134           | 68   | DC415KL/ DC415KN  | 27     | DKC210S2          | 47   | DW738             | 100  |
| D21805/ D21805K/  |      | D28135/ D28135K  | 69   | DC500             | 45     | DKC211S2          | 47   | DW739             | 101  |
| D21805KS          | 54   | D28136           | 69   | DC509             | 27     | DCL510N           | 46   | DW743N            | 99   |
| D23550            | 90   | D28137           | 69   | DC515N            | 36     | DE7400            | 97   | DW744XP           | 97   |
| D23551            | 90   | D28139           | 68   | DC520KA/ DC520N   | 32     | DW030P            | 49   | DW745             | 97   |
| D23620/ D23620K   | 90   | D28141           | 70   | DC527N            | 36     | DW059K2H/ DW059K2 | 32   | DW753             | 87   |
| D23650K           | 90   | D28142           | 68   | DC528N            | 44     | DW060K            | 50   | DW754             | 87   |
| D23651K           | 90   | D28400           | 72   | DC540K/ DC540     | 44     | DW074K            | 48   | DW755             | 87   |
| D23700            | 91   | D28401           | 72   | DC542K/ DC542     | 43     | DW075PK           | 48   | DW777/ DW771      | 93   |
| D24000S           | 61   | D28413           | 71   | DC547K/ DC547     | 36     | DW079KH           | 48   | DW831             | 70   |
| D25012K/ D25012N  | 62   | D28414           | 73   | DC600KA           | 45     | DW079PKH          | 48   | DW840             | 70   |
| D25013K/ D25013C/ |      | D28415           | 74   | DC602KB           | 43, 78 | DW082K            | 49   | DW849             | 75   |
| D25013N           | 62   | D28421           | 73   | DC608KB           | 33, 78 | DW084K            | 49   | DW872             | 75   |
| D25123K           | 62   | D28422           | 71   | DC616KB           | 33, 78 | DW087K            | 49   | DW876             | 101  |
| D25124K           | 62   | D28423           | 73   | DC618KB/ DC618KN  | 33, 78 | DW096PK           | 49   | DW882             | 74   |
| D25223K           | 62   | D28432C          | 73   | DC721KB/ DC721KA/ |        | DW152             | 53   | DW904             | 44   |
| D25301D           | 63   | D28490           | 72   | DC720KA           | 31     | DW217             | 56   | DW906             | 41   |
| D25302DH          | 26   | D28491           | 71   | DC722C2           | 30     | DW221             | 56   | DW908             | 36   |
| D25323K           | 63   | D28492/ D28492K  | 72   | DC722KL/ DC722N   | 30     | DW236I            | 56   | DW915             | 44   |
| D25324K           | 63   | D28493           | 71   | DC725KB/ DC725KA  | 30     | DW246             | 57   | DW918             | 41   |
| D25325K           | 63   | D28495           | 71   | DC727C2           | 29     | DW263K            | 52   | DW919             | 36   |
| D25330K           | 65   | D28498           | 74   | DC727KL/ DC727N   | 29     | DW264K            | 52   | DW920K            | 44   |
| D25404K           | 64   | D28700           | 75   | DC731KB/ DC731KA/ |        | DW268K            | 51   | DW934K2H/         |      |
| D25405K           | 64   | D28715           | 75   | DC730KA           | 38     | DW269K            | 51   | DW934K2/ DW934    | 35   |
| D25501K           | 64   | D28750           | 73   | DC732C2           | 38     | DW274K/ DW274KN   | 51   | DW941K            | 41   |
| D25601K           | 64   | D28885           | 74   | DC732KL/ DC732N   | 38     | DW275K/ DW275KN   | 51   | DW960             | 31   |
| D25602K           | 64   | D51180           | 77   | DC733C2           | 39     | DW292             | 52   | DW965K            | 42   |
| D25711K           | 65   | D51238K          | 77   | DC733K2/ DC733KB/ |        | DW294             | 52   | DW966K            | 40   |
| D25712K           | 65   | D51257K          | 77   | DC733KA/ DC733KN  | 39     | DW304PK           | 91   | DW979K2           | 43   |
| D25762K           | 65   | D51276K          | 78   | DC733KL           | 39     | DW310K            | 91   | DWC410            | 61   |
| D25831K           | 65   | D51321           | 76   | DC735KB/ DC735KA  | 37     | DW311K            | 91   | DWD014/ DWD014S   | 55   |
| D25870K           | 66   | D51430           | 76   | DC737C2           | 37     | DW331K            | 89   | DWD024/ DWD024K/  |      |
| D25899K           | 66   | D51431           | 76   | DC737KL/ DC737KN  | 37     | DW333K            | 89   | DWD024S/ DWD024KS | 53   |
| D25901K           | 66   | D51825           | 76   | DC740KA/ DC740K2  | 42     | DW341K            | 89   | DWD112/ DWD112S   | 55   |
| D25941K           | 66   | D51850           | 76   | DC743KB/ DC742KA  | 42     | DW343K            | 89   | DWD115KS          | 56   |
| D25980/ D25980K   | 66   | D51855           | 77   | DC745KB/ DC745KA  | 42     | DW390/ DW391      | 92   | DWD221            | 57   |
| D26200            | 79   | D51856           | 77   | DC800KL/ DC800KN  | 26     | DW392             | 92   | DWD522KS          | 54   |
| D26203            | 79   | DC013            | 45   | DC820KB           | 32     | DW393             | 92   | DWD524KS          | 54   |
| D26204K           | 79   | DC019            | 45   | DC822KL/ DC822N   | 32     | DW394             | 92   | DWD525KS          | 55   |
| D26410            | 86   | DC020            | 45   | DC825KB           | 32     | DW432/ DW433      | 86   | DWD530KS          | 55   |
| D26411            | 87   | DC212KA/ DC212N  | 29   | DC827C2           | 31     | DW443             | 86   | DW5520K           | 88   |
| D26420/ D26421    | 85   | DC213KB          | 28   | DC827KL/ DC827N   | 31     | DW609             | 83   | DW5520KR          | 88   |
| D26422/ D26423    | 85   | DC213KL          | 28   | DC830KB           | 41     | DW615             | 79   |                   |      |
| D26430            | 85   | DC222KA          | 28   | DC832KL/ DC832N   | 40     | DW621K/ DW621     | 79   |                   |      |
| D26441            | 85   | DC223KA          | 28   | DC835KB           | 40     | DW624             | 80   |                   |      |
| D26453            | 86   | DC224KA/ DC224KB | 28   | DC837C2           | 40     | DW625EK/ DW625E   | 80   |                   |      |
| D26480            | 85   | DC234KL          | 26   | DC837KL/ DC837N   | 40     | DW626             | 80   |                   |      |



**DEWALT heavy duty cordless products offer SPEED, POWER & PRODUCTIVITY - what else do you need?**

**4 reasons to buy DEWALT XRP**



**ALL NEW**



DCD925L2

- **DURABILITY** - Robust all metal transmission provides reliability and longer tool life
- **APPLICATION SPEED** - DEWALT innovative 3 speed gear box provides optimal torque to speed ratio for the most common jobsite applications
- **EFFICIENCY** - Exclusive self-tightening chuck prevents bit slippage and is easy to apply
- **POWERFUL** - Frameless Motor and efficient power delivery system ensure tasks are completed easily and quickly

**18V PLATFORM**

DEWALT long life lithium ion batteries provide up to 2X the number of recharges of NiCd and NiMH

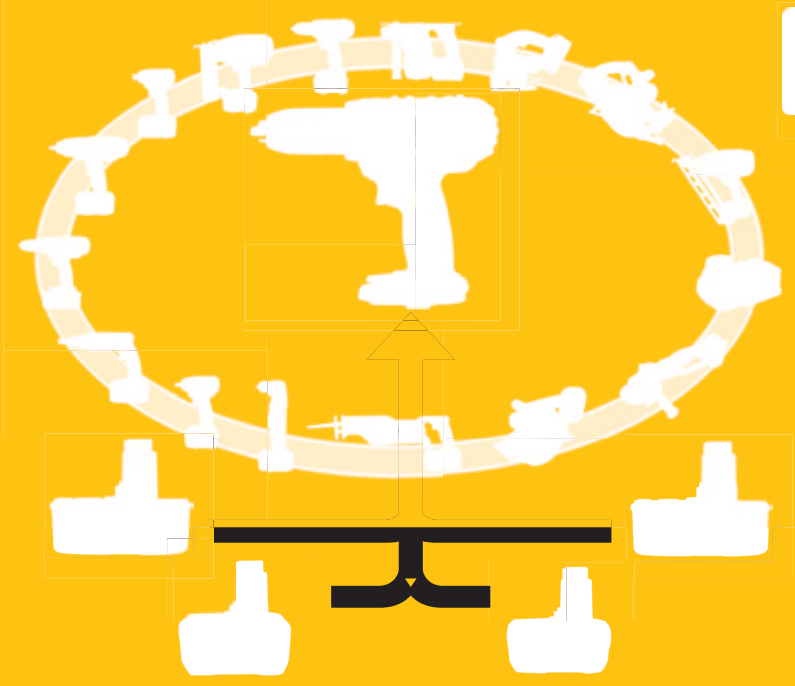

All DEWALT Lithium Ion powertools have been designed to maximise your productivity - perfectly combining POWER and USER COMFORT

**➤ Other heavy duty cordless products from DEWALT**



DC213KL - 18V 3 MODE SDS-PLUS



DC390KL - 18V 165MM CIRC SAW



DC305KL - 36V RECIP SAW

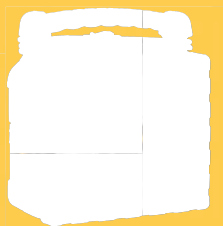

DC020 - 12V-18V AREA LIGHT



**DEWALT compact cordless products offer superior task efficiency for repetitive applications and better access to confined work spaces**

**4 reasons to buy DEWALT Compact Impact Tools**



DC837KL

- **POWER VS SIZE** - DEWALT Impact Drivers deliver incredible power, whilst retaining an extremely compact profile
- **CONTROL** - Ergonomic design, full variable speed switch and electronic motor brake for complete control
- **DURABILITY** - Rugged Aluminium front housing provides greater heat dispersion for longer tool life
- **DO MORE WITH 1 TOOL** - DEWALT has the most comprehensive range of Impact Accessories on the market, including:

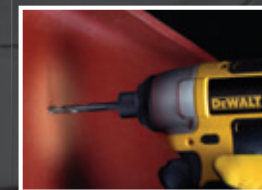

Extreme Impact Drill Bits



Extreme Impact Screwdriver bits



Extreme Impact Holesaws



Extreme Impact Sockets

**MAXIMISE YOUR EFFICIENCY!**

Now Available - DEWALT COMPACT Lithium Ion Batteries

**COMPACT**  
**LITHIUM ION**



- **SMALLER** - more versatile
- **LIGHTER** - less user fatigue
- **FASTER** - less charge time

**BACKWARDS COMPATIBLE IN OVER 40 TOOLS**



➤ **Other compact cordless products from DEWALT**



DC822KL - 18V IMPACT WRENCH



DC727KL - 18V 2SP COMBI



DW965K - 12V RIGHT ANGLE DRILL



DC500 - 18V CORDLESS VAC



**10.8V range delivers total control optimising user efficiency**

**4 reasons to buy DEWALT 10.8V Screwdriver**



DCF610S2

- **ERGONOMICS** - Designed for comfort, the soft grip fits perfectly into the palm of your hand - pick up the tool and try for yourself!
- **DELIVERY OF POWER** - Optimized control and power over full range of jobsite applications
- **BIT RETENTION** - Innovative chuck holds 25mm hex bits securely, without the need for a holder and allows for single-handed operation
- **BALANCE** - The tool foot design and slide pack battery system mean that the tool will stand upright, so the user can always keep it close to hand

**Coming in 2011...**

**10.8V INFRA RED THERMOMETER**

Measures the temperature of an object from a distance!



DCT414S1

- Find leaks / hot spots
- Evaluate sealing / insulation
- Confirm water / pipe temperatures
- Inspect equipment

- User adjustable colour change indicator for hot/cold spots
- Adjustable emissivity - precise temperature measurement for different materials
- -30°C - 500°C temperature range



**➤ Other 10.8V Cordless products from DEWALT**



DCD710S2 - 10.8V DRILL DRIVER



DCF815 - 10.8V IMPACT DRIVER



DCL510 - 10.8V TORCH



DT7965 - MAG BOX



The result of thousands of hours of user research  
- DeWALT Lasers are exactly what you asked us to build

**4**

**reasons to buy the DeWALT Cross-Line Laser**



DW087

- **INDUSTRY BENCHMARK** - The DeWALT Cross-Line Laser is trusted on over 100,000 jobsites across Europe\*
- **EASE OF USE** - Each button performs 1 function, DeWALT removes all unnecessary complexity
- **VERSATILITY** - Built in pivot mechanism, can be easily mounted on any common work surface
- **DURABILITY** - Designed specifically to maintain accuracy and withstand tough jobsite conditions (internal shock-absorbing mechanism/ full rubber over-mould)

**HAVE YOU ALSO TRIED ...**



**DeWALT Laser Distance Measure**

Designed specifically to withstand tough construction site conditions

- **Accurate**
- **Easy to Use**
- **Jobsite tough**



**➤ Other laser products from DeWALT**



DW079KH - SELF LEVELLING LASER



DW084 - 4 BEAM LASER POINTER



DW096 - X26 AUTO LEVEL



DW060 - TILE LASER

\*estimate based on DeWALT annual sales figures and product lifespan



**DEWALT SDS-MAX commercial construction hammers offer both performance and protection. No Compromise**

**4 reasons to buy DEWALT 40-45mm Combination Hammer**



D25602K



➤ **COMFORT** - Shock absorbing rear and side handles for increased user comfort

➤ **DURABLE** - Heat resistant mechanism due to oil filled gearbox. Chain driven gearbox for longer tool life

➤ **Performance** - Oversized mechanism mechanism for more impact energy. Variable speed for optimal control



➤ **TECHNOLOGY** - Complete Torque Control system offers the user a low setting for standard applications, but a higher 'overdrive' setting for heavier tasks such as core drilling and large diameter bits

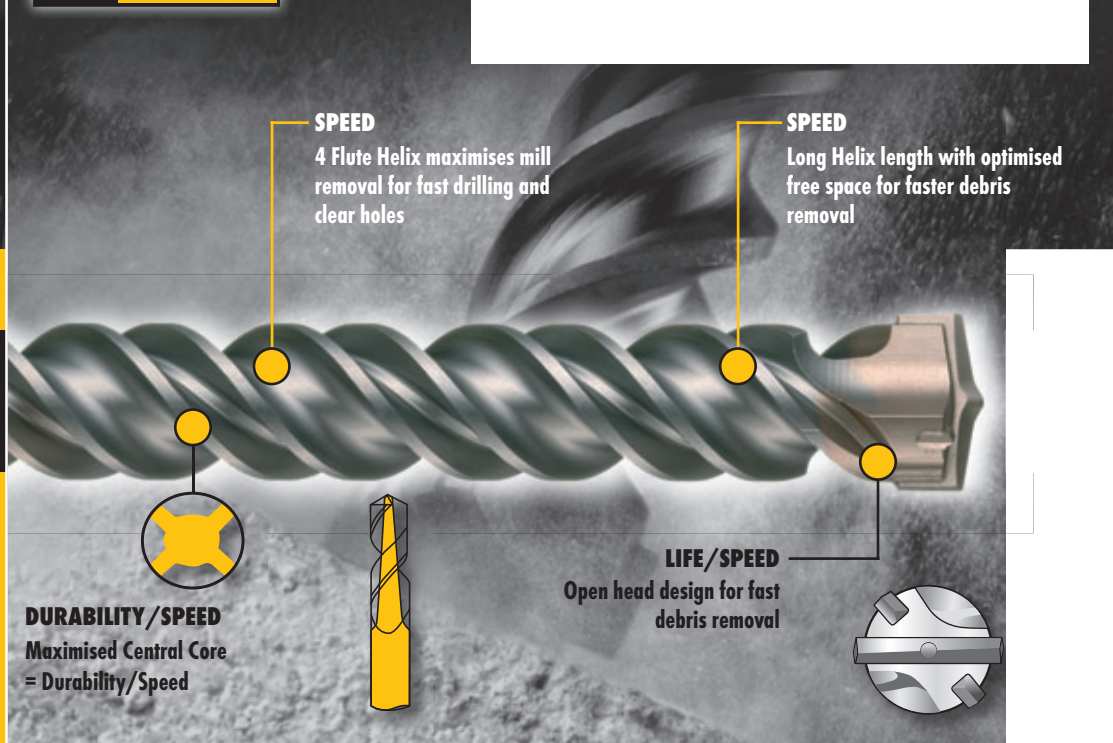

➤ **Other Heavy Duty Construction products from DEWALT**



D25980 - 30KG BREAKER



D25762K - 9KG SDS-MAX HAMMER



D28498 - 9 INCH GRINDER

[www.DeWALT.ae/en/safety/vibration/calculator](http://www.DeWALT.ae/en/safety/vibration/calculator)

**GUARANTEED TOUGH.**



**DEWALT has developed efficient dust and vibration management products for improved user safety and comfort**

**4 reasons to buy DEWALT 26mm Low Vibration L-Shape Hammer**



D25324



- **ACTIVE VIBRATION CONTROL SYSTEM** - AVC system and **FULLY FLOATING** rear handle dramatically reduce vibration, while the working end of the tool delivers the full force of the hammer to ensure maximum productivity
- **IMPROVED ERGONOMIC DESIGN** - Combined with AVC means the user can work for longer without tiring, and with reduced exposure to vibration
- **TOOL LIFE** - Optimised seals and robust design prevent dust ingress and prolong the life of the tool in a tough jobsite conditions
- **USER HEALTH** - Optional dust extraction system protects the user from harmful dust and supports a safe working environment

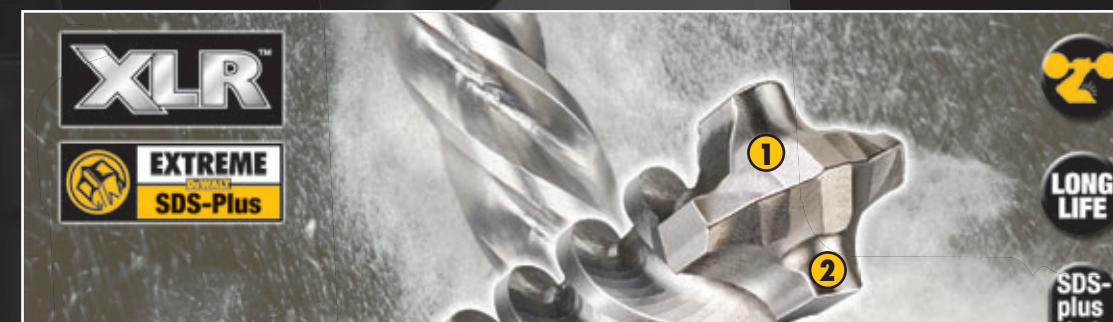

- 1** 2x more carbide than SDS-Plus 2-cutters for long life & extreme durability
- 2** Unique tip geometry for cleaner, concentric holes
- 3** Four flute spiral design for optimum debris removal and fast drilling

**➤ Other construction products from DEWALT**



D25124K - HEAVY DUTY 3 MODE SDS-PLUS



D25223 - LOW VIBRATION 3 MODE SDS-PLUS



D25013 - TRADESMAN 3 MODE SDS-PLUS



D28113 - 115MM GRINDER

[www.DeWALT.ae/en/safety/vibration/calculator](http://www.DeWALT.ae/en/safety/vibration/calculator)

**GUARANTEED TOUGH.**



**DEWALT manufactures precision engineered mitre saws which offer accuracy, performance and durability**

**4**

**reasons to buy DW717XPS**



DW717XPS

**XPS**  
CROSS CUT POSITIONING SYSTEM



**THE NEW SHADOW CUT-LINE SYSTEM**



- **REPEATABLE ACCURACY** - Impressive specification, outstanding build quality and exclusive precision mitre and bevel adjustment system
- **BUILT FOR DURABILITY AND LONG-LIFE** - Powerful 1675 Watt motor delivers extended power and durability. Superior design ensures DeWALT mitre saws are tough enough to withstand the jobsite environment
- **XPS CUT-LINE** - Unlike lasers, the XPS system requires no adjustment, the shadow of the blade shows exactly where the cut will be
- **GREATER PRODUCTIVITY** - Illuminated work surface and fast accurate alignment

**DEWALT's best selling compact mitre saw**

- Ultra-compact
- Easy to carry
- Reliable
- Repeatable accuracy
- Easy to slide



DW777

**➤ Other mitre saws from DEWALT**



DW712 - 216MM SLIDE MITRE SAW



DW713XPS - 250MM MITRE SAW



DW716XPS - 305MM MITRE SAW



DW718XPS - 305MM SLIDE MITRE SAW



**DEWALT manufacture class leading wood working tools to provide professional tradesmen and craftsmen with a full range of high quality products**

**4 reasons to buy the DEWALT Plunge Saw**



DWS520KR



- **ACCURACY** - Superior tooth design and excellent rail system with fixed rail adjusters to eliminate deflection during a cut
- **QUALITY OF FINISH**
  - 48 tooth blade gives fine finish and very little breakout in laminates
  - DEWALT guide rail system offers anti-splinter strips on both sides of the rail
- **SPEED AND PRODUCTIVITY** - Rapid adjustment and fast, accurate cuts
- **SAFETY** - Anti kickback function stops the saw from moving backwards along the rail

**The DEWALT Guide Rail System**



SPEED

PRODUCTIVITY

ACCURACY

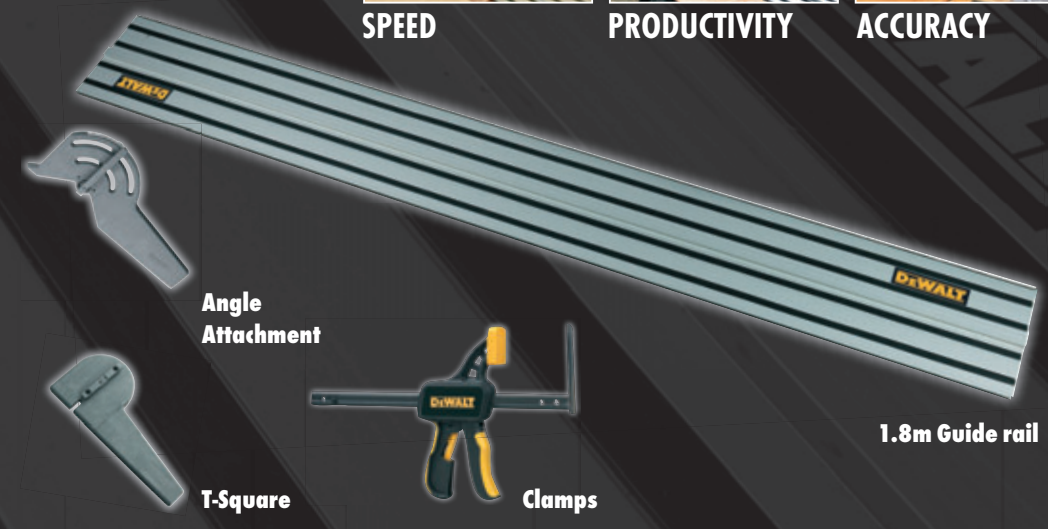

1.8m Guide rail

**➤ Other portable wood working products from DEWALT**



DW625EK - 2000 WATT 1/2" ROUTER



DW331K - 701 WATT JIGSAW



D26453 - 125MM RANDOM ORBIT SANDER



D26501K - 4MM PLANER



**DEWALT Jobsite Saws are designed for durability and provide class-leading functionality - without compromising on accuracy**

**4 reasons to buy DEWALT Combination Saws**



D27107



- **ACCURACY** - Workshop accuracy - this machine has been designed for the needs of kitchen fitters to roofers. Ideal for cutting anything from cornice to roof joists - Giving you quality cuts every time
- **VERSATILITY** - Large accurate mitre saw combined with an accurate table saw in a mobile compact design - improving productivity
- **POWER** - Outstanding power to meet the most demanding site & workshop applications - Designed for tough environments
- **CAPACITY** - 305mm Blade delivers a capacity to suit the vast majority of applications with 81mm depth of cut and a cross cut of 205mm. You only need one machine which saves space, time and money

**Outstanding Portability**

**Purpose built rolling stand dedicated to DW745 and DW744 table saws**

- **Lightweight**
- **Robust**
- **Easy set-up**



**➤ Other jobsite saws from DEWALT**



D23620K - 62MM CIRC SAW



DW311K - 1200 WATT RECIP SAW



D27111 - TABLE TOP MITRE SAW



DW745 - 250MM TABLE SAW



**DEWALT**

**30** DAY NO RISK SATISFACTION GUARANTEE

**1** YEAR FREE SERVICE CONTRACT

**1** YEAR WARRANTY

**GUARANTEED TOUGH**

# DeWALT offers an outstanding guarantee for professional users of our products



**DEWALT**

**TOTAL SERVICE**

**PROVIDING EXTRA PEACE OF MIND**

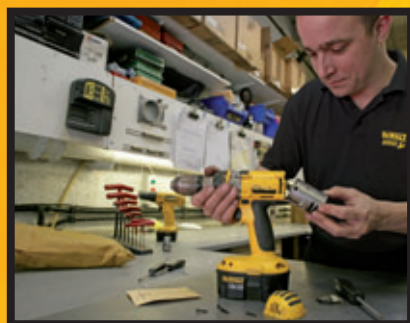

**30 DAY NO RISK SATISFACTION GUARANTEE**

If you are not completely satisfied with the performance of your DeWALT product, simply return it to the point of purchase within 30 days for a full refund or exchange. Product must be complete as purchased and proof of purchase must be produced. Spare parts and Accessories are excluded unless failed under warranty.



**1 YEAR FREE SERVICE CONTRACT**

If you require maintenance or service for your DeWALT product within 12 months of purchase, you are entitled to one service free of charge, undertaken at an authorised DeWALT repair agent. Proof of purchase must be produced. Includes labour. Spare parts and Accessories are excluded, unless failed under warranty.

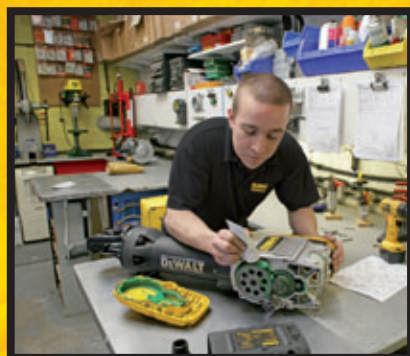

**1 YEAR FULL WARRANTY**

In the unlikely event that your DeWALT product becomes defective due to faulty materials or workmanship within 12 months of purchase, DeWALT guarantees to replace all defective parts free of charge or - at our discretion - replace the unit free of charge.

This is provided that:

- The product has not been misused
- The product has been subject to fair wear and tear
- Repairs have not been attempted by unauthorised persons
- Proof of purchase is produced

In order to make a claim, you will need to submit proof of purchase to the vendor or an authorised repair agent.



This guarantee statement is in addition to and in no way prejudices your contractual rights as a professional user or your statutory rights as a private non-professional user. The guarantee is valid within the territories of the Member States of the European Union and the European Free Trade Area. A list of authorised DeWALT repair agents and full details of our after-sales service and contacts are available on pages 174-176, or online at:

[www.DEWALT.ae](http://www.DEWALT.ae)

**TOTAL SERVICE IS THE HAMMER PROTECTION PLAN THAT OFFERS COMPLETE PEACE OF MIND WITH NO UNEXPECTED SERVICE COSTS**

If your hammer drill breaks down simply deliver it to any authorised DeWALT repair agent, and it will be repaired and returned to you quickly and efficiently.



**WHAT DOES TOTAL SERVICE COVER?**

- Wear & Tear
- Manufacturing defects
- Brush Change
- DeWALT Parts & retest

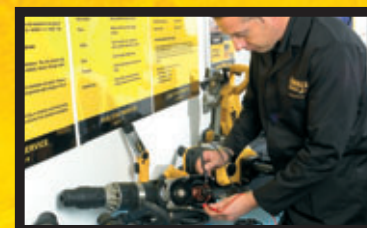

**WHERE CAN I BUY A TOTAL SERVICE PLAN?**

DeWALT Total Service is available at select DeWALT distributors. Please ask your DeWALT representative.

AVAILABLE

**2**

YEAR PLAN

You can also find a full list of the Terms & Conditions on the website.

[www.DEWALT.ae](http://www.DEWALT.ae)

**YOUR BENEFITS**

- LOWER ANNUAL RUNNING COSTS FOR YOUR TOOL
- BETTER FINANCIAL PLANNING - GUARANTEED FIXED COSTS
- LESS DOWN TIME - FAST SERVICE TURNAROUND
- CONVENIENCE
- COMPLETE PEACE OF MIND





**36 Volt Dedicated Cordless Hammer with Integrated Dust Extraction System DC235KL**



Ideal for drilling anchors and fixing holes into concrete, brick and masonry from 4 mm to 26 mm, with Dust Extraction System up to 16 mm in diameter. Rotation stop for light chiseling applications in plaster, tiles and render. Internal mechanism connected to external housings via spring dampeners meaning significantly lower vibration, reduced user fatigue allowing longer operating periods. Includes D25302DH Dust Extraction System with quick-fit system for easy tool free assembly and release.

**Standard Equipment:** Integrated D25302DH dust extraction system with Hepa filter, 1 hour charger, 2 batteries Li-Ion, Side handle with dust extraction adaptation, Quick release SDS-Plus toolholder, Quick release 13mm 3 jaw chuck, Grease, Heavy duty carrying case

|                                   |               |
|-----------------------------------|---------------|
| Battery Capacity                  | Li-Ion 2.2 Ah |
| Power Output                      | 450 Watts     |
| No Load Speed                     | 0-1150 rpm    |
| Impact Energy                     | 2.5 J         |
| Blows per Minute                  | 0-4300 bpm    |
| Tool Holder                       | SDS-Plus      |
| Max. Drilling Capacity [Wood]     | 30 mm         |
| Max. Drilling Capacity [Metal]    | 13 mm         |
| Max. Drilling Capacity [Concrete] | 26 mm         |
| Weight                            | 5.6 kg        |
| Length                            | 502 mm        |



**36 Volt Heavy Duty 3 Mode Quick Change Chuck Dedicated Cordless Hammer DC234KL**



Ideal for drilling anchors and fixing holes into concrete, brick and masonry from 4 mm to 26 mm. Rotation stop for light chiselling applications in tiles and plaster and impact stop mode for rotary drilling only in wood and steel. Internal mechanism connected to external housings via spring dampeners meaning significantly lower vibration, reduced user fatigue allowing longer operating periods. Quick Release SDS-Plus Toolholder and 3 jaw chuck supplied for easy switching between hammer/rotary hammer and rotary only applications.

**Standard Equipment:** 1 hour charger, 2 batteries, Multi-position side handle, 13 mm diameter 3 jaw keyless quick change chuck, Grease, Heavy duty carrying case

|                                   |               |
|-----------------------------------|---------------|
| Battery Capacity                  | Li-Ion 2.2 Ah |
| Power Output                      | 450 Watts     |
| No Load Speed                     | 0-1150 rpm    |
| Impact Energy                     | 2.5 J         |
| Blows per Minute                  | 0-4300 bpm    |
| Tool Holder                       | SDS-Plus      |
| Max. Drilling Capacity [Wood]     | 30 mm         |
| Max. Drilling Capacity [Metal]    | 13 mm         |
| Max. Drilling Capacity [Concrete] | 26 mm         |
| Weight                            | 3.8 kg        |
| Length x Height                   | 320 x 230 mm  |



**Cordless Dust Extraction System D25302DH**



Ideal for dust free drilling up to 16 mm in diameter with any DeWALT 28V or 36V SDS-Plus hammer. Powered by an independent motor maintaining maximum hammer performance with no decrease in durability. High quality washable HEPA filter capable of achieving 99.5% efficiency with dust particles as small as 0.3 microns. Quick-fit system for easy tool free assembly and release.

**Standard Equipment:** Cordless dust extraction system, Side handle with dust extraction adaptation, Telescope, extraction head and depth rod, Connector pipe, Large kit box

|                         |                                       |
|-------------------------|---------------------------------------|
| Fits                    | Any DeWALT 28V or 36V SDS-Plus Hammer |
| Collar Diameter         | 54 mm                                 |
| Max. Drill Bit Diameter | 16 mm                                 |
| Max. Drill Bit Length   | 210 mm                                |
| Max. Drilling Depth     | 150 mm                                |
| Hose Length             | 215 mm                                |
| Hose Diameter           | 32 mm                                 |
| Weight                  | 1.8 kg                                |
| Length x Height         | 502 x 360 mm                          |



**36 Volt 13 mm Heavy Duty Hammer Drill DC901KL / DC901KN\***



Powerful 36 Volt combination tool for heavy duty hammer drilling and screwdriving applications. Three speed settings for optimum performance in high torque, normal use and high speed applications. 22 position adjustable torque control for uniform results and optimised precision when screwdriving.

**Standard Equipment:** 1 hour charger, 2 batteries, Multi position side handle, Heavy duty carrying case

|                                  |                                |
|----------------------------------|--------------------------------|
| Battery Capacity                 | Li-Ion 2.2 Ah                  |
| Chuck Capacity                   | 1.5-13 mm                      |
| Power Output                     | 750 Watts                      |
| No Load Speed                    | 0-400 / 0-1200 / 0-1600 rpm    |
| Beats per Minute                 | 0-6800 / 0-20400 / 0-27200 bpm |
| Max Torque                       | 42 Nm                          |
| Max. Drilling Capacity [Wood]    | 65 mm                          |
| Max. Drilling Capacity [Metal]   | 13 mm                          |
| Max. Drilling Capacity [Masonry] | 16 mm                          |
| Weight                           | 3 kg                           |
| Length x Height                  | 267 x 260 mm                   |

\*N version sold as bare unit



**36 Volt Heavy Duty High Torque Impact Wrench DC800KL / DC800KN**



Powerful fan cooled motor delivers up to 440 Nm of max torque and up to 2500 impacts per minute for heavy duty fastening applications. All metal gearing for efficient power transmission and long tool life. Aluminium front housing for better weight and balance. Modular component design for easy access and fast service.

**Standard Equipment:** 1 hour charger, 2 batteries, Heavy duty carrying case

|                    |               |
|--------------------|---------------|
| Battery Capacity   | Li-Ion 2.2 Ah |
| Bit Holder         | 1/2"          |
| Power Output       | 800 Watts     |
| No Load Speed      | 1400 rpm      |
| Impacts per Minute | 2500 ipm      |
| Max. Torque        | 440 Nm        |
| Max. Bolt Diameter | M20           |
| Weight             | 3.4 kg        |
| Length x Height    | 273 x 275 mm  |



**36 Volt Heavy Duty Cordless Finishing Grinder DC415KL / DC415KN**



Powerful DeWALT fan cooled motor delivers maximum power and durability. 6,500 rpm provides high power for cutting and grinding applications. Battery pack produces 36 Volt power at equivalent weight to 18 Volt NiCd/NiMH pack weight.

**Standard Equipment:** 1 hour charger, 2 batteries, Keyless protective guard, 2 position anti vibration side handle, Wrench, Heavy duty carrying case

|                    |               |
|--------------------|---------------|
| Battery Capacity   | Li-Ion 2.2 Ah |
| Max. Disc Diameter | 125 mm        |
| Power Output       | 815 Watts     |
| No Load Speed      | 6500 rpm      |
| Spindle Thread     | M14           |
| Weight             | 3.5 kg        |
| Length x Height    | 340 x 150 mm  |

\*N version sold as bare unit



**36 Volt Heavy Duty Cordless Reciprocating Saw DC305KL / DC305KN**



Powerful DeWALT fan cooled motor with replaceable brushes and variable speed delivers fast cutting action up to 3000 strokes per minute and 29 mm stroke length. 4-position keyless blade clamp allows quick blade change, flush cutting, and versatility. Battery pack produces 36 Volt power at equivalent weight to 18 Volt NiCd/NiMH pack weight.

**Standard Equipment:** 1 hour charger, 2 batteries, Wood cutting blade, Heavy duty carrying case

|                     |               |
|---------------------|---------------|
| Battery Capacity    | Li-Ion 2.2 Ah |
| Power Output        | 710 Watts     |
| No Load Stroke Rate | 0-3000 spm    |
| Stroke Length       | 29 mm         |
| Weight              | 3.81 kg       |
| Length x Height     | 440 x 200 mm  |

\*N version sold as bare unit



**36 Volt Heavy Duty Cordless Circular Saw DC300KL / DC300KN**



184 mm, 24 tooth carbide tipped blade allows for efficient run-time and fast, smooth cut finish at maximum 62 mm depth of cut. 0-50° bevel capacity with lever-action detents at 22.5° and 45° allows for aggressive bevel cuts while allowing users to locate common angles quickly. Battery pack produces 36 Volt power at equivalent weight to 18 Volt NiCd/NiMH pack weight.

**Standard Equipment:** 1 hour charger, 2 batteries, 184 mm 24 tooth carbide blade, Rip fence, Heavy duty carrying case

|                  |               |
|------------------|---------------|
| Battery Capacity | Li-Ion 2.2 Ah |
| Blade Diameter   | 184 mm        |
| Power Output     | 940 Watts     |
| No Load Speed    | 4000 rpm      |
| Bevel Capacity   | 50°           |
| Weight           | 4.49 kg       |
| Length x Height  | 406 x 255 mm  |

\*N version sold as bare unit



**36 Volt Heavy Duty Cordless Jigsaw DC308KL / DC308KN**



Powerful DeWALT fan cooled motor with replaceable brushes and variable speed delivers fast cutting action up to 2,700 strokes per minute. Dust blower keeps line of cut clear of chips. Battery pack produces 36 Volt power at equivalent weight to 18 Volt NiCd/NiMH pack weight.

**Standard Equipment:** 1 hour charger, 2 batteries, Anti-splinter shoe insert, Anti-scratch shoe cover, Dust extraction adaptor, 4 blades, Heavy duty carrying case

|                           |               |
|---------------------------|---------------|
| Battery Capacity          | Li-Ion 2.2 Ah |
| Power Output              | 550 Watts     |
| No Load Stroke Rate       | 0-2700 spm    |
| Stroke Length             | 26 mm         |
| Bevel Capacity            | 45°           |
| Max. Depth of Cut [Wood]  | 130 mm        |
| Max. Depth of Cut [Metal] | 10 mm         |
| Weight                    | 3.4 kg        |
| Length x Height           | 300 x 215 mm  |

\*N version sold as bare unit



**36V Heavy Duty Flashlight DC509**



Lockable head clip offers versatility and convenience of a lantern. Flashlight with flexible neck for multi-directional hands-free lighting. Compact, lightweight design with impact resistant housing. 8 hours continuous run time with the 36V Li-Ion battery pack.

|                 |              |
|-----------------|--------------|
| Bulb Type       | Xenon        |
| Battery Type    | Li-Ion 36 V  |
| Weight          | 0.52 kg      |
| Length x Height | 200 x 130 mm |

\*Batteries and charger sold separately





**24 Volt Heavy Duty SDS-Plus 3 Mode Quick Change Chuck Dedicated Cordless Hammer** DC224KA/ DC224KB\*



Ideal for drilling anchors and fixing holes into concrete, brick and masonry from 4 mm to 22 mm  
 Rotation stop for light chiselling applications in plaster, tiles and render and Impact stop mode for rotary drilling only in wood and steel  
 Internal mechanism connected to external housings via spring dampeners meaning significantly lower vibration, reduced user fatigue allowing longer operating periods  
 Quick Release SDS-Plus Toolholder and 3 Jaw Chuck supplied for easy switching between hammer/rotary hammer and rotary only applications

**Standard Equipment:** 1 hour charger, 2 batteries, Multi-position side handle, 13 mm diameter 3 jaw keyless quick change chuck, Grease, Heavy duty carrying case

|                                   |              |
|-----------------------------------|--------------|
| Battery Capacity                  | NiCd 2.0 Ah  |
| Power Output                      | 300 Watts    |
| No Load Speed                     | 0-1100 rpm   |
| Impact Energy                     | 2.1 J        |
| Blows per Minute                  | 0-4200 bpm   |
| Tool Holder                       | SDS-Plus     |
| Max. Drilling Capacity [Wood]     | 30 mm        |
| Max. Drilling Capacity [Metal]    | 13 mm        |
| Max. Drilling Capacity [Concrete] | 22 mm        |
| Weight                            | 4.0 kg       |
| Length x Height                   | 310 x 240 mm |

\*Available with 3.0 NiMH batteries as B-version



**24 Volt Heavy Duty SDS-Plus 3 Mode Dedicated Cordless Hammer** DC223KA



Ideal for drilling anchors and fixing holes into concrete, brick and masonry from 4 mm to 22 mm  
 Rotation stop for light chiselling applications in plaster, tiles and render and Impact stop mode for rotary drilling only in wood and steel  
 Internal mechanism connected to external housings via spring dampeners meaning significantly lower vibration, reduced user fatigue allowing longer operating periods  
 Large 19 mm optimised hammer mechanism delivers corded drilling performance

**Standard Equipment:** 1 hour charger, 2 batteries, Multi-position side handle, Grease, Heavy duty carrying case

|                                   |              |
|-----------------------------------|--------------|
| Battery Capacity                  | NiCd 2.0 Ah  |
| Power Output                      | 300 Watts    |
| No Load Speed                     | 0-1100 rpm   |
| Impact Energy                     | 2.1 J        |
| Blows per Minute                  | 0-4200 bpm   |
| Tool Holder                       | SDS-Plus     |
| Max. Drilling Capacity [Wood]     | 30 mm        |
| Max. Drilling Capacity [Metal]    | 13 mm        |
| Max. Drilling Capacity [Concrete] | 22 mm        |
| Weight                            | 3.9 kg       |
| Length x Height                   | 290 x 240 mm |



**24 Volt Heavy Duty SDS-Plus 2 Mode Dedicated Cordless Hammer** DC222KA



Ideal for drilling anchors and fixing holes into concrete, brick and masonry from 4 mm to 22 mm  
 Impact stop mode for rotary drilling only in wood, ceramic, steel  
 Internal mechanism connected to external housings via spring dampeners meaning significantly lower vibration, reduced user fatigue allowing longer operating periods  
 Large 19 mm optimised mechanism delivers corded drilling performance

**Standard Equipment:** 1 hour charger, 2 batteries, Multi-position side handle, Grease, Heavy duty carrying case

|                                   |              |
|-----------------------------------|--------------|
| Battery Capacity                  | NiCd 2.0 Ah  |
| Power Output                      | 300 Watts    |
| No Load Speed                     | 0-1100 rpm   |
| Impact Energy                     | 2.1 J        |
| Blows per Minute                  | 4200 bpm     |
| Tool Holder                       | SDS-Plus     |
| Max. Drilling Capacity [Wood]     | 30 mm        |
| Max. Drilling Capacity [Metal]    | 13 mm        |
| Max. Drilling Capacity [Concrete] | 22 mm        |
| Weight                            | 3.8 kg       |
| Length x Height                   | 290 x 240 mm |



**18 Volt Heavy Duty SDS-Plus 3 Mode Dedicated Cordless Hammer** DC213KL



Ideal for drilling anchors and fixing holes into concrete, brick and masonry from 4 mm to 20 mm  
 Rotation stop for light chiselling applications in plaster, tiles and render and Impact stop mode for rotary drilling only in wood and steel  
 Internal mechanism connected to external housings via spring dampeners meaning significantly lower vibration, reduced user fatigue allowing longer operating periods

New 2.0Ah 18 Volt Lithium Ion battery, delivers higher performance and durability with 25 percent smaller battery and 200grams lighter. Overall unit weight less than 3kg

**Standard Equipment:** 40 minute charger, 2 batteries, Multi-position side handle, Grease, Heavy duty carrying case

|                                   |               |
|-----------------------------------|---------------|
| Battery Capacity                  | 2.0 Li-Ion Ah |
| Power Output                      | 300 Watts     |
| No Load Speed                     | 0-1100 rpm    |
| Impact Energy                     | 2.1 J         |
| Blows per Minute                  | 0-4200 bpm    |
| Tool Holder                       | SDS-Plus      |
| Max. Drilling Capacity [Wood]     | 26 mm         |
| Max. Drilling Capacity [Metal]    | 13 mm         |
| Max. Drilling Capacity [Concrete] | 20 mm         |
| Weight                            | 2.9 kg        |
| Length x Height                   | 270 x 192 mm  |



**18 Volt Heavy Duty SDS-Plus 3 Mode Dedicated Cordless Hammer** DC213KB



Ideal for drilling anchors and fixing holes into concrete, brick and masonry from 4 mm to 20 mm  
 Rotation stop for light chiselling applications in plaster, tiles and render and Impact stop mode for rotary drilling only in wood and steel  
 Internal mechanism connected to external housings via spring dampeners meaning significantly lower vibration, reduced user fatigue allowing longer operating periods  
 Large 19 mm optimised hammer mechanism delivers corded drilling performance

**Standard Equipment:** 40 minute charger, 2 batteries, Multi-position side handle, Grease, Heavy duty carrying case

|                                   |              |
|-----------------------------------|--------------|
| Battery Capacity                  | NiMH 2.6 Ah  |
| Power Output                      | 300 Watts    |
| No Load Speed                     | 0-1100 rpm   |
| Impact Energy                     | 2.1 J        |
| Blows per Minute                  | 0-4200 bpm   |
| Tool Holder                       | SDS-Plus     |
| Max. Drilling Capacity [Wood]     | 26 mm        |
| Max. Drilling Capacity [Metal]    | 13 mm        |
| Max. Drilling Capacity [Concrete] | 20 mm        |
| Weight                            | 3.1 kg       |
| Length x Height                   | 295 x 192 mm |



**18 Volt SDS-Plus 2 Mode Dedicated Hammer** DC212KA/ DC212N\*



Ideal for drilling anchors and fixing holes into concrete, brick and masonry from 4 mm to 20 mm  
 Large 19 mm optimised hammer mechanism delivers corded drilling performance  
 Efficient and compact gearbox for longer runtime and lighter weight  
 Extremely compact design and rear mounted battery for excellent balance and optimum comfort

**Standard Equipment:** 1 hour charger, 2 batteries, Multi-position side handle, Grease tube, Heavy duty carrying case

|                                   |              |
|-----------------------------------|--------------|
| Battery Capacity                  | NiCd 2.0 Ah  |
| Power Output                      | 300 Watts    |
| No Load Speed                     | 0-1100 rpm   |
| Impact Energy                     | 2.1 J        |
| Blows per Minute                  | 0-4200 bpm   |
| Tool Holder                       | SDS-Plus     |
| Max. Drilling Capacity [Wood]     | 26 mm        |
| Max. Drilling Capacity [Metal]    | 13 mm        |
| Max. Drilling Capacity [Concrete] | 20 mm        |
| Weight                            | 3.1 kg       |
| Length x Height                   | 295 x 195 mm |

\*Available as bare unit, without batteries and charger as N-version



**18 Volt 13 mm XRP Li-Ion Heavy Duty Hammer Drill** DCD925L2



Powerful 18 Volt XRP combination tool for heavy duty drilling and screwdriving applications  
 DeWALT built frameless motor reduces size and increases efficiency producing excellent runtime  
 22 position adjustable torque control for uniform results and optimised precision when screwdriving

**Standard Equipment:** 40 minute charger, 2 batteries, Multi position side handle, Heavy duty carrying case

|                                  |                            |
|----------------------------------|----------------------------|
| Battery Capacity                 | Li-Ion 2.0 Ah              |
| Chuck Capacity                   | 1.5-13 mm                  |
| Power Output                     | 450 Watts                  |
| No Load Speed                    | 0-500/0-1250/0-2000 rpm    |
| Beats per Minute                 | 0-8500/0-21250/0-34000 bpm |
| Max Torque                       | 55 Nm                      |
| Max. Drilling Capacity [Wood]    | 50 mm                      |
| Max. Drilling Capacity [Metal]   | 13 mm                      |
| Max. Drilling Capacity [Masonry] | 16 mm                      |
| Weight                           | 2.5 kg                     |
| Length x Height                  | 247 x 252 mm               |



**18 Volt 13 mm XRP Heavy Duty Hammer Drill** DCD925B2



Powerful 18 Volt XRP Combi tool for heavy duty drilling and screwdriving applications  
 DeWALT built frameless motor reduces size and increases efficiency producing excellent runtime  
 Ultra smooth 3 speed selector for optimum performance in high torque, normal use and high speed applications.  
 22 position adjustable torque control for uniform results and optimised precision when screwdriving

**Standard Equipment:** 40 min multi chemistry charger, 2 batteries, Multi position side handle, Heavy duty carrying case

|                                  |                            |
|----------------------------------|----------------------------|
| Battery Capacity                 | 2.6 NiMH Ah                |
| Chuck Capacity                   | 1.5-13 mm                  |
| Power Output                     | 450 Watts                  |
| No Load Speed                    | 0-500/0-1250/0-2000 rpm    |
| Beats per Minute                 | 0-8500/0-21250/0-34000 bpm |
| Max Torque                       | 55 Nm                      |
| Max. Drilling Capacity [Wood]    | 50 mm                      |
| Max. Drilling Capacity [Metal]   | 13 mm                      |
| Max. Drilling Capacity [Masonry] | 16 mm                      |
| Weight                           | 2.9 kg                     |
| Length x Height                  | 247 x 248 mm               |



**18 Volt 13 mm Compact Hammer Drill** DC727KL/ DC727N\*



Powerful 18 Volt combination tool for hammer drilling and screwdriving applications  
 17 position adjustable torque control for consistent screwdriving into a variety of materials with different screw sizes  
 13 mm single sleeve keyless chuck with automatic spindle lock for quick and easy bit change with one hand

**Standard Equipment:** 40 minute charger, 2 batteries, Heavy duty carrying case

|                                  |                    |
|----------------------------------|--------------------|
| Battery Capacity                 | Li-Ion 2.0 Ah      |
| Chuck Capacity                   | 1.5-13 mm          |
| Power Output                     | 375 Watts          |
| No Load Speed                    | 0-500 / 0-1700 rpm |
| Beats per Minute                 | 0-8500/0-29000 bpm |
| Max Torque                       | 41 Nm              |
| Max. Drilling Capacity [Wood]    | 38 mm              |
| Max. Drilling Capacity [Metal]   | 13 mm              |
| Max. Drilling Capacity [Masonry] | 13 mm              |
| Weight                           | 2.2 kg             |
| Length x Height                  | 225 x 239 mm       |

\*Available as bare unit, without batteries and charger as N-version



**18 Volt 13mm Compact Hammer Drill** DC727C2



Powerful 18 Volt combination tool for hammer drilling and screwdriving applications  
 13 mm single sleeve keyless chuck with automatic spindle lock for quick and easy bit change with one hand  
 17 position adjustable torque control for consistent screwdriving into a variety of materials with different screw sizes  
 Provided with Compact Li-Ion battery

**Standard Equipment:** 40 minute charger, 2 x 1.1Ah Compact Lithium batteries, Heavy duty carrying case

|                                  |                    |
|----------------------------------|--------------------|
| Battery Capacity                 | Li-Ion 1.1 Ah      |
| Chuck Capacity                   | 1.5-13 mm          |
| Power Output                     | 350 Watts          |
| No Load Speed                    | 0-500 / 0-1700 rpm |
| Beats per Minute                 | 0-8500/0-29000 bpm |
| Max Torque                       | 41 Nm              |
| Max. Drilling Capacity [Wood]    | 38 mm              |
| Max. Drilling Capacity [Metal]   | 13 mm              |
| Max. Drilling Capacity [Masonry] | 13 mm              |
| Weight                           | 1.84 kg            |
| Length x Height                  | 225 x 225 mm       |





18 Volt 13mm Compact Hammer Drill

DC725KB/ DC725KA\*



Powerful 18 Volt combination tool for hammer drilling and screwdriving applications  
13 mm single sleeve keyless chuck with automatic spindle lock for quick and easy bit change with one hand  
17 position adjustable torque control for consistent screwdriving into a variety of materials with different screw sizes  
All metal gearing for efficient power transmission and longer tool life

**Standard Equipment:** 1 hour charger, 2 batteries, Heavy duty carrying case

|                                  |                     |
|----------------------------------|---------------------|
| Battery Capacity                 | NiMH 2.6 Ah         |
| Chuck Capacity                   | 1.5-13 mm           |
| Power Output                     | 400 Watts           |
| No Load Speed                    | 0-500/ 0-1700 rpm   |
| Beats per Minute                 | 0-8500/ 0-29000 bpm |
| Max Torque                       | 44 Nm               |
| Max. Drilling Capacity [Wood]    | 38 mm               |
| Max. Drilling Capacity [Metal]   | 13 mm               |
| Max. Drilling Capacity [Masonry] | 13 mm               |
| Weight                           | 2.4 kg              |
| Length x Height                  | 225 x 239 mm        |

\*Available as bare unit, without batteries and charger as N-version



18 Volt 13 mm XRP Li-Ion Heavy Duty Cordless Drill Driver

DCD920L2



Powerful 18 Volt drill driver for heavy duty drilling and screwing applications  
DEWALT built frameless motor reduces size and increases efficiency producing excellent runtime.  
22 position adjustable torque control for uniform results and optimised precision when screwdriving

**Standard Equipment:** 40 Minute Charger, 2 batteries, Multi position side handle, Heavy duty carry case

|                                |                         |
|--------------------------------|-------------------------|
| Battery                        | 2.0 Li-Ion              |
| Chuck Capacity                 | 1.5-13 mm               |
| Power Output                   | 450 Watts               |
| No Load Speed                  | 0-500/0-1250/0-2000 rpm |
| Max. Torque                    | 55 Nm                   |
| Max. Drilling Capacity [Wood]  | 50 mm                   |
| Max. Drilling Capacity [Metal] | 13 mm                   |
| Weight                         | 2.4 kg                  |
| Length x Height                | 240 x 252 mm            |



18 Volt 13 mm XRP Heavy Duty Drill Driver

DCD920B2



Powerful 18 Volt XRP Drill Driver for heavy duty drilling and screwdriving applications  
DEWALT built frameless motor reduces size and increases efficiency producing excellent runtime  
Ultra smooth 3 speed selector for optimum performance in high torque, normal use and high speed applications.  
22 position adjustable torque control for uniform results and optimised precision when screwdriving

**Standard Equipment:** 40 min multi chemistry charger, 2 batteries, Multi position side handle, Heavy duty carrying case

|                                |                         |
|--------------------------------|-------------------------|
| Battery                        | NiMH 2.6 Ah             |
| Chuck Capacity                 | 1.5-13 mm               |
| Power Output                   | 450 Watts               |
| No Load Speed                  | 0-500/0-1250/0-2000 rpm |
| Max. Torque                    | 55 Nm                   |
| Max. Drilling Capacity [Wood]  | 50 mm                   |
| Max. Drilling Capacity [Metal] | 13 mm                   |
| Weight                         | 2.8 kg                  |
| Length x Height                | 240 x 248 mm            |



18 Volt 13 mm Compact Drill Driver

DC722KL/ DC722N\*



Powerful 18 Volt drill driver for drilling and screwdriving applications  
13mm single sleeve keyless chuck with automatic spindle lock for quick and easy bit change with one hand  
Battery pack produces 18 Volt power at less than 12 Volt NiCd/NiMH pack weight providing the ultimate ergonomic solution

**Standard Equipment:** 40 minute charger, 2 batteries, Heavy duty carrying case

|                                |                    |
|--------------------------------|--------------------|
| Battery Capacity               | 2.0 Li-Ion Ah      |
| Chuck Capacity                 | 1.5-13 mm          |
| Power Output                   | 375 Watts          |
| No Load Speed                  | 0-500 / 0-1700 rpm |
| Max Torque                     | 41 Nm              |
| Max. Drilling Capacity [Wood]  | 38 mm              |
| Max. Drilling Capacity [Metal] | 13 mm              |
| Weight                         | 2.1 kg             |
| Length x Height                | 210 x 239 mm       |

\*Available as bare unit, without batteries and charger as N-version



18 Volt 13mm Compact Drill Driver

DC722C2



Powerful 18 Volt drill driver for drilling and screwdriving applications  
13mm single sleeve keyless chuck with automatic spindle lock for quick and easy bit change with one hand  
17 position adjustable torque control for consistent screwdriving into a variety of materials with different screw sizes  
Compatible with all DeWALT 18V battery packs

**Standard Equipment:** 40 minute charger, 2 x 1.1Ah Compact Lithium batteries, Heavy duty carrying case

|                                |                    |
|--------------------------------|--------------------|
| Battery Capacity               | 1.1 Li-Ion Ah      |
| Chuck Capacity                 | 1.5-13 mm          |
| Power Output                   | 350 Watts          |
| No Load Speed                  | 0-500 / 0-1700 rpm |
| Max Torque                     | 41 Nm              |
| Max. Drilling Capacity [Wood]  | 38 mm              |
| Max. Drilling Capacity [Metal] | 13 mm              |
| Weight                         | 1.74 kg            |
| Length x Height                | 210 x 225 mm       |



18 Volt 13 mm Compact Drill Driver

DC721KB/ DC721KA/ DC720KA



Powerful 18 Volt drill driver for drilling and screwdriving applications  
13mm single sleeve keyless chuck with automatic spindle lock for quick and easy bit change with one hand  
17 position adjustable torque control for consistent screwdriving into a variety of materials with different screw sizes  
All metal gearing for efficient power transmission and longer tool life

**Standard Equipment:** 1 hour charger, 2 batteries, Heavy duty carrying case

|                                |                    |
|--------------------------------|--------------------|
| Battery Capacity               | NiMH 2.6 Ah        |
| Chuck Capacity                 | 1.5-13 mm          |
| Power Output                   | 400 Watts          |
| No Load Speed                  | 0-500 / 0-1700 rpm |
| Max Torque                     | 44 Nm              |
| Max. Drilling Capacity [Wood]  | 38 mm              |
| Max. Drilling Capacity [Metal] | 13 mm              |
| Weight                         | 2.3 kg             |
| Length x Height                | 210 x 239 mm       |



18 Volt 10mm Right Angle Drill - Bare Unit

DW960



Powerful fan cooled motor delivers up to 33 Nm of sustained torque for turning large drill bits and fasteners  
2 speed ranges 0-475/0-1500 rpm for increased user flexibility to achieve a wide range of applications  
Forward, reverse, variable speed and electronic motor brake for total control  
Durable, right angle transmission with sealed ball bearings and cut-steel gears for a longer tool life

|                                |                            |
|--------------------------------|----------------------------|
| Battery Capacity               | fits 2.0, 2.4, 2.6, 3.0 Ah |
| Chuck Capacity                 | 1.0-10 mm                  |
| Power Output                   | 300 Watts                  |
| No Load Speed                  | 0-475 / 0-1500 rpm         |
| Max Torque                     | 33 Nm                      |
| Max. Drilling Capacity [Wood]  | 28 mm                      |
| Max. Drilling Capacity [Metal] | 10 mm                      |
| Weight                         | 1.2 (2.2) kg               |
| Length x Height                | 323 x 125 mm               |



18 Volt Compact Impact Driver

DC827KL/ DC827N



Durable frameless high speed motor delivers up to 150 Nm of torque  
All metal gearing for efficient power transmission and long tool life  
Aluminium front housing provides greater heat dispersion increasing motor life  
Improved variable speed switch and electronic motor brake for complete control for both setting and removing fasteners

**Standard Equipment:** 40 minute charger, 2 batteries, Heavy duty carrying case

|                    |               |
|--------------------|---------------|
| Battery Capacity   | 2.0 Li-Ion Ah |
| Bit Holder         | 1/4"          |
| Power Output       | 250 Watts     |
| No Load Speed      | 0-2400 rpm    |
| Impacts per Minute | 0-2700 ipm    |
| Max Torque         | 150 Nm        |
| Max. Bolt Diameter | M12           |
| Weight             | 1.7 kg        |
| Length x Height    | 146 x 231 mm  |



18 Volt Compact Impact Driver

DC827C2



Durable frameless high speed motor delivers up to 150 Nm of torque  
All metal gearing for efficient power transmission and long tool life  
Aluminium front housing provides greater heat dispersion increasing motor life  
Improved variable speed switch and electronic motor brake for complete control for both setting and removing fasteners

**Standard Equipment:** 40 minute charger, 2 x 1.1Ah Compact Lithium batteries, Heavy duty carrying case

|                    |               |
|--------------------|---------------|
| Battery Capacity   | 1.1 Li-Ion Ah |
| Bit Holder         | 1/4"          |
| Power Output       | 250 Watts     |
| No Load Speed      | 0-2400 rpm    |
| Impacts per Minute | 0-2700 ipm    |
| Max Torque         | 150 Nm        |
| Max. Bolt Diameter | M12           |
| Weight             | 1.4 kg        |
| Length x Height    | 146 x 230 mm  |



DeWALT IMPACT DRILLING AND SCREWDRIVING

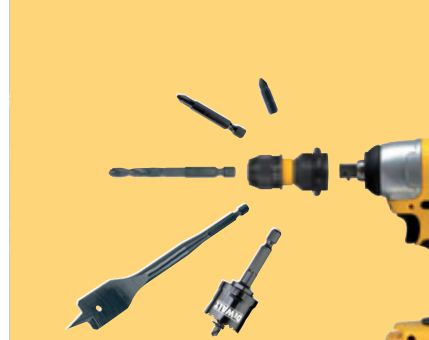

The DeWALT EXTREME Impact range allows the user to perform more applications using the same tool.

DeWALT supplies Impact Rated:

- Screw-driving bits
- Drill bits
- Hole-saws
- Flat-wood Bits

All these fastening and drilling bits have been designed to withstand the high torque generated by DeWALT Impact drivers.

For the complete range of IMPACT drilling and screwdriving accessories see pages 119, 120, 122, 123, 128



18 Volt Compact Impact Driver

DC825KB



Durable frameless high speed motor delivers up to 150 Nm of torque  
All metal gearing for efficient power transmission and long tool life  
Aluminium front housing provides greater heat dispersion increasing motor life  
Improved variable speed switch and electronic motor brake for complete control for both setting and removing fasteners

**Standard Equipment:** 40 minute charger, 2 batteries, Heavy duty carrying case

|                    |              |
|--------------------|--------------|
| Battery Capacity   | NiMH 2.6 Ah  |
| Bit Holder         | 1/4"         |
| Power Output       | 250 Watts    |
| No Load Speed      | 0-2400 rpm   |
| Impacts per Minute | 0-2700 ipm   |
| Max Torque         | 150 Nm       |
| Max. Bolt Diameter | M12          |
| Weight             | 2.0 kg       |
| Length x Height    | 146 x 231 mm |



18 Volt High Torque Impact Wrench

DW059K2H/ DW059K2



Powerful fan cooled motor delivers up to 418 Nm of sustained torque and up to 2600 impacts per minute for heavy duty fastening applications  
All metal gearing for efficient power transmission and long tool life  
Magnesium front housing for better weight and balance  
Modular component design for easy access and fast service

**Standard Equipment:** 1 hour charger, 2 batteries, Heavy duty carrying case

|                    |              |
|--------------------|--------------|
| Battery Capacity   | NiMH, 2.6 Ah |
| Bit Holder         | 1/2"         |
| Power Output       | 365 Watts    |
| No Load Speed      | 1650 rpm     |
| Impacts per Minute | 2600 ipm     |
| Max. Torque        | 418 Nm       |
| Max. Bolt Diameter | M20          |
| Weight             | 3.4 kg       |
| Length x Height    | 264 x 260 mm |



18 Volt Compact Impact Wrench

DC822KL/ DC822N



Durable Frameless high speed motor delivers up to 195 Nm of torque  
All metal gearing for efficient power transmission and long tool life  
Aluminium front housing provides greater heat dispersion increasing motor life  
Improved variable speed switch and electronic motor brake for complete control for both setting and removing fasteners

**Standard Equipment:** 40 minute charger, 2 batteries, Heavy duty carrying case

|                    |               |
|--------------------|---------------|
| Battery Capacity   | 2.0 Li-Ion Ah |
| Bit Holder         | 1/2"          |
| Power Output       | 250 Watts     |
| No Load Speed      | 0-2400 rpm    |
| Impacts per Minute | 0-2700 ipm    |
| Max. Torque        | 195 Nm        |
| Max. Bolt Diameter | M16           |
| Weight             | 1.7 kg        |
| Length x Height    | 146 x 231 mm  |

LITHIUM ION

18 Volt Compact Impact Wrench

DC820KB



Durable frameless high speed motor delivers up to 195 Nm of torque  
All metal gearing for efficient power transmission and long tool life  
Aluminium front housing provides greater heat dispersion increasing motor life  
Improved variable speed switch and electronic motor brake for complete control for both setting and removing fasteners

**Standard Equipment:** 40 minute charger, 2 batteries, Heavy duty carrying case

|                    |              |
|--------------------|--------------|
| Battery Capacity   | NiMH, 2.6 Ah |
| Bit Holder         | 1/2"         |
| Power Output       | 250 Watts    |
| No Load Speed      | 0-2400 rpm   |
| Impacts per Minute | 0-2700 ipm   |
| Max. Torque        | 195 Nm       |
| Max. Bolt Diameter | M16          |
| Weight             | 2.0 kg       |
| Length x Height    | 146 x 231 mm |



18 Volt Drywall Screwdriver

DC520KA/ DC520N



Removable depth sensitive "set and forget" nosepiece for consistent fastener depth  
Two speed settings, variable speed and reverse switch for maximum user control  
Up to 20 Nm of sustainable torque for maximum performance  
High performance fan cooled motor with replaceable brushes for maximum power and durability

**Standard Equipment:** 1 hour charger, 2 batteries, Magnetic bit holder, Screwdriver bit, Drywall nosepiece, Heavy duty carrying case

|                  |                  |
|------------------|------------------|
| Battery Capacity | NiCd 2.0 Ah      |
| Tool Holder      | (Hex) 6.35 mm    |
| Power Output     | 360 Watts        |
| No Load Speed    | 0-900/0-2900 rpm |
| Max Torque       | 20 Nm            |
| Weight           | 2.2 kg           |
| Length x Height  | 307 x 231 mm     |



18 Volt Heavy Duty 16 Gauge Cordless Nail Gun

DC618KB/ DC618KN



Versatility in the loading and unloading of fasteners - 20 degree angled magazine 120 nail capacity  
The tool works as fast as you do with consistent nail penetration  
The sequential operating mode allows for precision placement and the bump operating mode provides the user with production speed  
Depths can be easily referenced utilising numbered dial and user does not sacrifice performance when changing depths

**Standard Equipment:** 1 hour charger, 2 batteries, DeWALT safety glasses, Reversible belt hook, No-mark tip, Heavy duty carrying case

|                       |                   |
|-----------------------|-------------------|
| Nail Diameter         | 1.6 mm            |
| Battery Capacity      | NiMH 2.6 Ah       |
| Magazine angle        | 20 °              |
| Nail Length           | 32-63 mm          |
| Magazine capacity     | Up to 120 Nails   |
| Magazine loading      | Rear - load       |
| Firing mode           | Bump & Sequential |
| Height x Length       | 320 x 330 mm      |
| Weight                | 3.9 kg            |
| Nailer Operating Mode | Selective         |
| Integrated Belt Hook  | Yes               |
| Jam Clearing          | Yes               |
| Features              | LED Headlights    |



18 Volt 18 Gauge Cordless Nailer

DC608KB



The tool works as fast as you do with consistent nail penetration  
The sequential operating mode allows for precision placement and the bump operating mode provides the user with production speed  
Depths can be easily referenced utilising numbered dial and user does not sacrifice performance when changing depths  
Provides easy access to the nosepiece for the simple removal of a jammed fastener without the use of screwdrivers or tool wrenches

**Standard Equipment:** 1 hour charger, 2 batteries, Heavy duty carrying case

|                       |                   |
|-----------------------|-------------------|
| Nail Diameter         | 1.2 mm            |
| Battery Capacity      | NiMH 2.6 Ah       |
| Magazine angle        | 0 °               |
| Nail Length           | 16-50 mm          |
| Magazine capacity     | 110 Nails         |
| Magazine loading      | Side Load         |
| Firing mode           | Bump & Sequential |
| Length x Height       | 295 x 290 mm      |
| Weight                | 3.4 kg            |
| Nailer Operating Mode | Selective         |
| Integrated Belt Hook  | Yes               |
| Jam Clearing          | Yes               |



18 Volt Heavy Duty 16 Gauge Straight Cordless Nailer

DC616KB



Versatility in the loading and unloading of fasteners - straight magazine 110 nail capacity  
The tool works as fast as you do with consistent nail penetration  
The sequential operating mode allows for precision placement and the bump operating mode provides the user with production speed  
Depths can be easily referenced utilising numbered dial and user does not sacrifice performance when changing depths

**Standard Equipment:** 1 hour charger, 2 batteries, DeWALT safety glasses, Reversible belt hook, No-mark tip, Heavy duty carrying case

|                       |                   |
|-----------------------|-------------------|
| Nail Diameter         | 1.6 mm            |
| Battery Capacity      | NiMH 2.6 Ah       |
| Magazine angle        | 0 °               |
| Nail Length           | 32-63 mm          |
| Magazine capacity     | 110 Nails         |
| Magazine loading      | Rear - load       |
| Firing mode           | Bump & Sequential |
| Length x Height       | 330 x 320 mm      |
| Weight                | 3.9 kg            |
| Nailer Operating Mode | Selective         |
| Integrated Belt Hook  | Yes               |
| Jam Clearing          | Yes               |
| Features              | LED indicators    |





**18 Volt Finishing Grinder DC411KL**



Powerful DEWALT fan cooled motor delivers maximum power and durability 6,500 rpm provides high power for cutting and grinding applications Battery pack produces 18 Volt power at less than 12 Volt NiCd / NiMH pack weight providing the ultimate ergonomic solution

**Standard Equipment:** 40 Min Charger, 2 batteries, Keyless protective guard, 2 position side handle, Heavy duty carrying case

|                    |               |
|--------------------|---------------|
| Battery Capacity   | Li-Ion 2.0 Ah |
| Max. Disc Diameter | 125 mm        |
| Power Output       | 405 Watts     |
| No Load Speed      | 6500 rpm      |
| Spindle Thread     | M14           |
| Weight             | 2.9 kg        |
| Length x Height    | 375 x 147 mm  |



**18 Volt Finishing Grinder DC411KB / DC411KA / DC411N**



Powerful DEWALT fan-cooled motor delivers maximum power and durability 6,500 rpm provides high power for cutting and grinding applications Steel cut spiral bevel gears provide highest level of durability and low vibration increasing user productivity Convenient trigger switch with lock-off button for easier gripping

**Standard Equipment:** 1 hour charger, 2 batteries, Keyless protective guard, 2 position side handle, Heavy duty carrying case

|                    |              |
|--------------------|--------------|
| Battery Capacity   | NiMH 2.6 Ah  |
| Max. Disc Diameter | 125 mm       |
| Power Output       | 405 Watts    |
| No Load Speed      | 6500 rpm     |
| Spindle Thread     | M14          |
| Weight             | 3.2 kg       |
| Length x Height    | 375 x 147 mm |



**18 Volt Heavy Duty Reciprocating Saw DC385KL**



Powerful DEWALT fan cooled motor with replaceable brushes and variable speed delivers fast cutting action up to 3,000 strokes per minute and 28.6 mm stroke length Four-position blade clamp allows for flush cutting and increased versatility Battery pack produces 18 Volt power at less than 12 Volt NiCd / NiMH battery pack weight providing the ultimate ergonomic solution

**Standard Equipment:** 40 Min Charger, 2 batteries, Wood and metal blade, Heavy duty carrying case

|                     |               |
|---------------------|---------------|
| Battery Capacity    | Li-Ion 2.0 Ah |
| Power Output        | 390 Watts     |
| No Load Stroke Rate | 0-3000 spm    |
| Stroke Length       | 28.6 mm       |
| Weight              | 3.4 kg        |
| Length x Height     | 435 x 188 mm  |



**18 Volt Heavy Duty Reciprocating Saw DC385KB / DC385N**



Powerful DEWALT fan cooled motor with replaceable brushes and variable speed delivers fast cutting action up to 3,000 strokes per minute and 28.6 mm stroke length 4-position blade clamp allows for flush cutting and increased versatility Lever-action keyless blade clamp for quick and easy blade changes Variable speed trigger, lock-off switch and electronic motor brake for quick controlled cuts and enhanced work safety

**Standard Equipment:** 40 Min Charger, 2 batteries, Wood and metal blade, Heavy duty carrying case

|                     |              |
|---------------------|--------------|
| Battery Capacity    | 2.6 NiMH Ah  |
| Power Output        | 390 Watts    |
| No Load Stroke Rate | 0-3000 spm   |
| Stroke Length       | 28.6 mm      |
| Weight              | 3.70 kg      |
| Length x Height     | 435 x 188 mm |



**18 Volt Heavy Duty Jigsaw DC330KL**



Powerful DEWALT fan-cooled motor with replaceable brushes and variable speed. Fast cutting action up to 3000 strokes per minute Dust blower keeps line of cut clear of dust and debris Battery pack produces 18 Volt power at less than 12 Volt NiCd / NiMH battery pack weight providing the ultimate ergonomic solution

**Standard Equipment:** 40 minute charger, 2 batteries, Anti-scratch shoe cover, 1 XPC Wood blade, Heavy duty carrying case

|                           |               |
|---------------------------|---------------|
| Battery Capacity          | Li-Ion 2.0 Ah |
| Power Output              | 400 Watts     |
| No Load Stroke Rate       | 0-3000 spm    |
| Stroke Length             | 26 mm         |
| Bevel Capacity            | 45 °          |
| Max. Depth of Cut [Wood]  | 135 mm        |
| Max. Depth of Cut [Metal] | 10 mm         |
| Weight                    | 3.1 kg        |
| Length x Height           | 285 x 213 mm  |



**18 Volt Heavy Duty Jigsaw DC330KB / DC330KA / DC330N**



Powerful DEWALT fan cooled motor with replaceable brushes and variable speed delivers fast cutting action up to 3000 strokes per minute Dust blower keeps line of cut clear of chips Tool free adjustable shoe with anti-scratch cover bevels 45 degrees in both directions Quick and easy patented keyless blade change system accepts t-shank blades

**Standard Equipment:** 1 hour charger, 2 batteries, Anti-scratch shoe cover, 1 XPC Wood blade, Heavy duty carrying case

|                           |              |
|---------------------------|--------------|
| Battery Capacity          | NiMH 2.6 Ah  |
| Power Output              | 400 Watts    |
| No Load Stroke Rate       | 0-3000 spm   |
| Stroke Length             | 26 mm        |
| Bevel Capacity            | 45 °         |
| Max. Depth of Cut [Wood]  | 135 mm       |
| Max. Depth of Cut [Metal] | 10 mm        |
| Weight                    | 3.4 kg       |
| Length x Height           | 285 x 213 mm |



**18 Volt Heavy Duty Circular Saw DC390KL**



Ultra thin kerf 165 mm, 24 tooth carbide-tipped blade allows for efficient run time and fast, smooth cut finish at maximum 55 mm depth of cut Powerful DEWALT fan cooled motor with replaceable brushes delivers up to 3700 rotation per minute for fast cutting action Battery pack produces 18 Volt power at less than 12 Volt NiCd / NiMH pack weight providing the ultimate ergonomic solution

**Standard Equipment:** 40 Min Charger, 2 batteries, 165 mm carbide blade, Rip fence, Hex key, Heavy duty carrying case

|                  |               |
|------------------|---------------|
| Battery Capacity | Li-Ion 2.0 Ah |
| Blade Diameter   | 165 mm        |
| Power Output     | 390 Watts     |
| No Load Speed    | 3700 rpm      |
| Bevel Capacity   | 50 °          |
| Weight           | 3.9 kg        |
| Length x Height  | 406 x 259 mm  |



**18 Volt Heavy Duty Circular Saw DC390KB / DC390KA / DC390N**



Ultra thin kerf 165 mm, 24 tooth carbide tipped blade allows for efficient run-time and fast, smooth cut finish at maximum 55 mm depth of cut Powerful DEWALT fan cooled motor with replaceable brushes delivers up to 3700 rotation per minute for fast cutting action Keyless bevel angle and depth of cut adjustment with easy to read scale for maximum cordless versatility Extremely durable design offering a cast magnesium shoe and full metal guarding to withstand rough job site conditions

**Standard Equipment:** 1 hour charger, 2 batteries, 165 mm carbide blade, Rip fence, Hex key, Heavy duty carrying case

|                  |              |
|------------------|--------------|
| Battery Capacity | NiMH 2.6 Ah  |
| Blade Diameter   | 165 mm       |
| Power Output     | 390 Watts    |
| No Load Speed    | 3700 rpm     |
| Bevel Capacity   | 50 °         |
| Weight           | 4.2 kg       |
| Length x Height  | 406 x 259 mm |



**18 Volt Heavy Duty Plunge Saw with 1.5m Rail DC352KBR / DC352KN\***



Parallel plunge allows the user to maintain a smooth and constant hand position while cutting A 24 tooth blade gives a fine and accurate cut and maximises runtime and power Rail adjustment allows the saw to be adjusted to accurately move along the rail The anti kickback function stops the saw from moving backwards along the rail and helps stop the saw climbing out of the work piece when making plunge cuts

**Standard Equipment:** 1 hour charger, 2 batteries, 24 tooth precision circular saw blade, Heavy duty carrying case, 1.5m rail

|   |              |
|---|--------------|
| Battery Capacity                            | NiMH 2.6 Ah  |
| Power Output                                | 390 Watts    |
| No Load Speed                               | 3200 rpm     |
| Blade Diameter                              | 165 mm       |
| Blade Bore                                  | 20 mm        |
| Bevel Capacity                              | 47 °         |
| Max. Depth of Cut at 90° [with guide rails] | 55 mm        |
| Max. Depth of Cut at 45° [with guide rails] | 40 mm        |
| Weight                                      | 5.6 kg       |
| Length x Height                             | 349 x 264 mm |

\*N version sold as bare unit and does not include guide rail



**18 Volt Heavy Duty Metal Cutting Circular Saw DW934K2H / DW934K2 / DW934\***



Robust cool-running 173mm, 40 tooth tungsten carbide tipped blade for burr-free cuts at constant 61 mm cutting depth throughout the life of the blade Powerful DEWALT fan cooled motor with replaceable brushes and new transmission design Left side blade design, the new gun-sight line of cut indicator and the unique chemically treated glass window for enhanced line of cut visibility Extremely durable design offering an anti-magnetic stainless shoe and full metal guarding to withstand rough job site conditions

**Standard Equipment:** 1 hour charger, 2 batteries, 173mm tungsten carbide blade, Hex key, Heavy duty carrying case

|                  |              |
|------------------|--------------|
| Battery Capacity | NiMH 2.6 Ah  |
| Blade Diameter   | 173 mm       |
| Power Output     | 315 Watts    |
| No Load Speed    | 3100 rpm     |
| Bevel Capacity   | -            |
| Weight           | 3.8 kg       |
| Length x Height  | 365 x 195 mm |

\*DW934 version sold as bare unit





18 Volt 600 ml Satchet and 310 ml Cartridge Sealant Gun

DCS47K/DC547\*



2900 N push force suitable for high viscosity urethanes and adhesives  
Variable speed control dial for pre-selection of dispensing speed  
Electronic trigger with variable speed and automatic overload protection  
Ergonomic T-handle design with rubber grip for extra comfort

**Standard Equipment:** 1 hour charger, 1 battery, Cartridge holder, Satchet barrel, Conversion kit

|                  |                     |
|------------------|---------------------|
| Battery Capacity | NiMH 2.6 Ah         |
| Carrier Size     | 310-600 ml          |
| Applicator       | Cartridge & Satchet |
| Push Force       | 2900 N (295Kg)      |
| Push Speed       | 635 mm/min          |
| Weight           | 3.3/2.3* kg         |
| Length x Height  | 734 x 322 mm        |

\*DC547 sold as bare unit



18 Volt Handheld Wet/Dry Vacuum - Bare Unit

DC515N



Runs off current 18 Volt battery platform allowing quick and easy change between different tools with a single battery  
High efficiency filter traps 99.7% of dust as small as drywall and cement dust  
1.9 Litre tank capacity allows for the cleaning up of larger amounts of material  
The rubber hose is extendable to 1 metre for added flexibility for a wide range of applications

**Standard Equipment:** No batteries included, 1 metre heavy duty rubber hose, Crevice tool, Wide nozzle

|                              |              |
|------------------------------|--------------|
| Voltage                      | 18 V         |
| Battery                      | Not included |
| Power Input                  | 180 Watts    |
| Max. Airflow                 | 15.9 l/sec   |
| Tank volume                  | 1.9 l        |
| Power Source                 | DC           |
| Hose Nozzle Outside Diameter | 32 mm        |
| Blower                       | No           |
| Weight                       | 1.2 (2.2) kg |
| Length x Height              | 460 x 200 mm |

18 Volt Fluorescent Light - Bare Unit

DC527N\*



Compact, lightweight design with impact resistant housing  
Battery and charger sold separately  
Rubber overmold for increased durability  
4 prong bulb for added bulb stability

|                 |             |
|-----------------|-------------|
| Bulb Type       | Fluorescent |
| Battery Type    | 18 V        |
| Weight          | 0.5 kg      |
| Length x Height | 155 x 0 mm  |

\*Spare bulb available - DE5273

18 Volt Heavy Duty Flexible Flashlight - Bare Unit

DW919\*



Wide angle beam with metal reflector and Xenon bulbs for greater brightness  
Lockable head clip offers versatility and convenience of a lantern.  
Flashlight with flexible neck for multi-directional hands-free lighting  
Compact, lightweight design with impact resistant housing

|                 |              |
|-----------------|--------------|
| Bulb Type       | Xenon        |
| Battery Type    | 18 V V       |
| Weight          | 0.45 kg      |
| Length x Height | 130 x 180 mm |

\*Spare bulb available - DE9083

18 Volt Flashlight - Bare Unit

DW908\*



Wide angle beam with metal reflector and Xenon bulbs for greater brightness  
Flashlight with 90 degree pivoting head and 5 set positions for multi directional lighting (including horizontal and vertical lighting)  
Compact, lightweight design with impact resistant housing  
On board spare bulb storage

|                 |             |
|-----------------|-------------|
| Bulb Type       | Xenon       |
| Battery Type    | 18 V V      |
| Weight          | 0.34 kg     |
| Length x Height | 85 x 240 mm |

\*Spare bulb available - DE9083

14.4 Volt 13 mm XRP Li-Ion Heavy Duty Hammer Drill

DCD935L2



Powerful 14.4 Volt XRP combination tool for heavy duty drilling and screwdriving applications  
DeWALT built frameless motor reduces size and increases efficiency producing excellent runtime  
22 position adjustable torque control for uniform results and optimised precision when screwdriving

**Standard Equipment:** 40 min multi chemistry charger, 2 batteries, Multi position side handle, Heavy duty carrying case

|                                  |                            |
|----------------------------------|----------------------------|
| Battery Capacity                 | Li-Ion 2.0 Ah              |
| Chuck Capacity                   | 1.5-13 mm                  |
| Power Output                     | 325 Watts                  |
| No Load Speed                    | 0-425/0-1200/0-1800 rpm    |
| Beats per Minute                 | 0-7225/0-20400/0-30600 bpm |
| Max Torque                       | 50 Nm                      |
| Max. Drilling Capacity [Wood]    | 45 mm                      |
| Max. Drilling Capacity [Metal]   | 13 mm                      |
| Max. Drilling Capacity [Masonry] | 14 mm                      |
| Weight                           | 2.4 kg                     |
| Length x Height                  | 247 x 252 mm               |



14.4 Volt 13mm XRP Heavy Duty Hammer Drill

DCD935B2



Powerful 14.4 Volt XRP Combi tool for heavy duty drilling and screwdriving applications  
DeWALT built frameless motor reduces size and increases efficiency producing excellent runtime  
22 position adjustable torque control for uniform results and optimised precision when screwdriving  
Dual Collar design for quick and easy changing between hammer, drill and screw modes

**Standard Equipment:** 40 minute multi chemistry charger, 2 batteries, Multi position side handle, Heavy duty carrying case

|                                  |                            |
|----------------------------------|----------------------------|
| Battery Capacity                 | NiMH 2.6 Ah                |
| Chuck Capacity                   | 1.5-13 mm                  |
| Power Output                     | 325 Watts                  |
| No Load Speed                    | 0-425/0-1200/0-1800 rpm    |
| Beats per Minute                 | 0-7225/0-20400/0-30600 bpm |
| Max Torque                       | 50 Nm                      |
| Max. Drilling Capacity [Wood]    | 45 mm                      |
| Max. Drilling Capacity [Metal]   | 13 mm                      |
| Max. Drilling Capacity [Masonry] | 14 mm                      |
| Weight                           | 2.7 kg                     |
| Length x Height                  | 247 x 248 mm               |



14.4 Volt 13mm Compact Hammer Drill

DC737KL/DC737KN



Powerful 14.4 Volt combination tool for hammer-drilling and screw-driving applications  
Compact, lightweight design  
17 position adjustable torque control for consistent screwdriving into a variety of materials with different screw sizes  
Two speed settings, variable speed and reverse switch for controllable use

**Standard Equipment:** 40 minute charger, 2 batteries, Heavy duty carrying case

|                                  |                       |
|----------------------------------|-----------------------|
| Battery Capacity                 | Li-Ion 2.0 Ah         |
| Chuck Capacity                   | 1.5-13 mm             |
| Power Output                     | 270 Watts             |
| No Load Speed                    | 0-400 / 0-1450 rpm    |
| Beats per Minute                 | 0-6,800/ 0-25,000 bpm |
| Max Torque                       | 37 Nm                 |
| Max. Drilling Capacity [Wood]    | 35 mm                 |
| Max. Drilling Capacity [Metal]   | 13 mm                 |
| Max. Drilling Capacity [Masonry] | 13 mm                 |
| Weight                           | 2.1 kg                |
| Length x Height                  | 225 x 239 mm          |



14.4 Volt 13mm Compact Hammer Drill

DC737C2



Powerful 14.4 Volt combination tool for hammer-drilling and screw-driving applications  
Compact, lightweight design  
17 position adjustable torque control for consistent screwdriving into a variety of materials with different screw sizes  
Two speed settings, variable speed and reverse switch for controllable use

**Standard Equipment:** 40 minute charger, 2 x 1.1Ah Compact Lithium batteries, Heavy duty carrying case

|                                  |                       |
|----------------------------------|-----------------------|
| Battery Capacity                 | Li-Ion 1.1 Ah         |
| Chuck Capacity                   | 1.5-13 mm             |
| Power Output                     | 250 Watts             |
| No Load Speed                    | 0-400 / 0-1450 rpm    |
| Beats per Minute                 | 0-6,800/ 0-25,000 bpm |
| Max Torque                       | 37 Nm                 |
| Max. Drilling Capacity [Wood]    | 35 mm                 |
| Max. Drilling Capacity [Metal]   | 13 mm                 |
| Max. Drilling Capacity [Masonry] | 13 mm                 |
| Weight                           | 1.7 kg                |
| Length x Height                  | 225 x 240 mm          |



14.4 Volt 13mm Compact Hammer Drill

DC735KB/DC735KA



Powerful 14.4 Volt combination tool for hammer drilling and screwdriving applications  
13 mm single sleeve keyless chuck with automatic spindle lock for quick and easy bit change with one hand  
17 position adjustable torque control for consistent screwdriving into a variety of materials with different screw sizes  
All metal gearing for efficient power transmission and longer tool life

**Standard Equipment:** 1 hour charger, 2 batteries, Heavy duty carrying case

|                                  |                     |
|----------------------------------|---------------------|
| Battery Capacity                 | NiMH 2.6 Ah         |
| Chuck Capacity                   | 1.5-13 mm           |
| Power Output                     | 295 Watts           |
| No Load Speed                    | 0-400/ 0-1450 rpm   |
| Beats per Minute                 | 0-6800/ 0-25000 bpm |
| Max Torque                       | 40 Nm               |
| Max. Drilling Capacity [Wood]    | 35 mm               |
| Max. Drilling Capacity [Metal]   | 13 mm               |
| Max. Drilling Capacity [Masonry] | 13 mm               |
| Weight                           | 2.2 kg              |
| Length x Height                  | 225 x 239 mm        |





14.4 Volt 13mm XRP Li-Ion Heavy Duty Drill Driver DCD930L2



Powerful 14.4 Volt XRP drill driver for heavy duty drilling and screwdriving applications  
 DEWALT built frameless motor reduces size and increases efficiency producing excellent runtime  
 Ultra smooth 3 speed selector for optimum performance in high torque, normal use and high speed applications

**Standard Equipment:** 40 min multi chemistry charger, 2 batteries, Heavy duty carry case, Multi position side handle

|                                |                         |
|--------------------------------|-------------------------|
| Battery                        | 2.0 Li-Ion              |
| Chuck Capacity                 | 1.5-13 mm               |
| Power Output                   | 325 Watts               |
| No Load Speed                  | 0-425/0-1200/0-1800 rpm |
| Max. Torque                    | 50 Nm                   |
| Max. Drilling Capacity [Wood]  | 45 mm                   |
| Max. Drilling Capacity [Metal] | 13 mm                   |
| Weight                         | 2.3 kg                  |
| Length x Height                | 240 x 252 mm            |

XRP LITHIUM ION

14.4 Volt 13mm XRP Heavy Duty Drill Driver DCD930B2



Powerful 14.4 Volt XRP drill driver for heavy duty drilling and screwdriving applications  
 DEWALT built frameless motor reduces size and increases efficiency producing excellent runtime  
 Ultra smooth 3 speed selector for optimum performance in high torque, normal use and high speed applications.  
 22 position adjustable torque control for uniform results and optimised precision when screwdriving

**Standard Equipment:** 40 minute multi chemistry charger, 2 batteries, Multi position side handle, Heavy duty carrying case

|                                |                         |
|--------------------------------|-------------------------|
| Battery                        | NiMH 2.6 Ah             |
| Chuck Capacity                 | 1.5-13 mm               |
| Power Output                   | 325 Watts               |
| No Load Speed                  | 0-425/0-1200/0-1800 rpm |
| Max. Torque                    | 50 Nm                   |
| Max. Drilling Capacity [Wood]  | 45 mm                   |
| Max. Drilling Capacity [Metal] | 13 mm                   |
| Weight                         | 2.6 kg                  |
| Length x Height                | 240 x 248 mm            |

XRP

14.4 Volt 13mm Compact Drill Driver DC732KL/ DC732N



Powerful 14.4 Volt drill driver for drilling and screwdriving applications  
 13mm single sleeve keyless chuck with automatic spindle lock for quick and easy bit change with one hand  
 Battery pack produces 14.4 Volt power at less than 9.6 Volt NiCd/NiMH pack weight providing the ultimate ergonomic solution

**Standard Equipment:** 40 minute charger, 2 batteries, Heavy duty carrying case

|                                |                    |
|--------------------------------|--------------------|
| Battery Capacity               | 2.0 Li-Ion Ah      |
| Chuck Capacity                 | 1.5-13 mm          |
| Power Output                   | 270 Watts          |
| No Load Speed                  | 0-400 / 0-1450 rpm |
| Max. Torque                    | 37 Nm              |
| Max. Drilling Capacity [Wood]  | 35 mm              |
| Max. Drilling Capacity [Metal] | 13 mm              |
| Weight                         | 2 kg               |
| Length x Height                | 210 x 239 mm       |

LITHIUM ION

14.4V 13mm Compact Drill Driver DC732C2



Powerful 14.4 Volt drill driver for drilling and screwdriving applications  
 Compact, lightweight design  
 17 position adjustable torque control for consistent screwdriving into a variety of materials with different screw sizes  
 Two speed settings, variable speed and reverse switch for controllable use

**Standard Equipment:** 40 minute charger, 2 x 1.1Ah Compact Lithium batteries, Heavy duty carrying case

|                                |                    |
|--------------------------------|--------------------|
| Battery Capacity               | 1.1 Li-Ion Ah      |
| Chuck Capacity                 | 1.5-13 mm          |
| Power Output                   | 250 Watts          |
| No Load Speed                  | 0-400 / 0-1450 rpm |
| Max. Torque                    | 37 Nm              |
| Max. Drilling Capacity [Wood]  | 35 mm              |
| Max. Drilling Capacity [Metal] | 13 mm              |
| Weight                         | 1.7 kg             |
| Length x Height                | 210 x 240 mm       |

COMPACT LITHIUM ION

14.4 Volt 13mm Compact Drill Driver DC731KB/ DC731KA/ DC730KA\*



Powerful 14.4 Volt drill driver for drilling and screwdriving applications  
 13mm single sleeve keyless chuck with automatic spindle lock for quick and easy bit change with one hand  
 17 position adjustable torque control for consistent screwdriving into a variety of materials with different screw sizes  
 All metal gearing for efficient power transmission and longer tool life

**Standard Equipment:** 1 hour charger, 2 x 2.6Ah NiMH batteries, Heavy duty carrying case

|                                |                    |
|--------------------------------|--------------------|
| Battery Capacity               | NiMH 2.6 Ah        |
| Chuck Capacity                 | 1.5-13 mm          |
| Power Output                   | 295 Watts          |
| No Load Speed                  | 0-400 / 0-1450 rpm |
| Max. Torque                    | 40 Nm              |
| Max. Drilling Capacity [Wood]  | 35 mm              |
| Max. Drilling Capacity [Metal] | 13 mm              |
| Weight                         | 2.1 kg             |
| Length x Height                | 210 x 239 mm       |

\*DC730KA has 10mm chuck, DC731KA

COMPACT

14.4V 10mm Cordless Li-Ion Drill Driver DC733KL



Powerful 14.4 Volt drill driver for drilling and screwdriving applications  
 10 mm single sleeve chuck and spindle lock for quick and easy bit change with one hand  
 Two speed settings, variable speed and reverse switch for maximum control  
 14 position adjustable torque control for consistent screwdriving into a variety of materials with different screw sizes

**Standard Equipment:** 40min Multi Chemistry Charger, 2 x 2.0Ah Li-Ion batteries, Heavy duty carrying case

|                                |                    |
|--------------------------------|--------------------|
| Battery Capacity               | Li-Ion 2.0 Ah      |
| Chuck Capacity                 | 1-10mm mm          |
| Power Output                   | 195 Watts          |
| No Load Speed                  | 0-400 / 0-1300 rpm |
| Max. Torque                    | 30 Nm              |
| Max. Drilling Capacity [Wood]  | 30 mm              |
| Max. Drilling Capacity [Metal] | 10 mm              |
| Weight                         | 1.8 kg             |
| Length x Height                | 220 x 240 mm       |

LITHIUM ION

14.4 Volt 10mm Drill Driver DC733K2/ DC733KB/ DC733KA/ DC733KN



Powerful 14.4 Volt drill driver for drilling and screwdriving applications  
 10 mm single sleeve chuck and spindle lock for quick and easy bit change with one hand  
 Two speed settings, variable speed and reverse switch for maximum control  
 14 Position adjustable torque control for consistent screwdriving into a variety of materials with different screw sizes

**Standard Equipment:** 1 hour charger, 2 batteries, heavy duty carrying case

|                                |                  |
|--------------------------------|------------------|
| Battery Capacity               | NiCd 2.0 Ah      |
| Chuck Capacity                 | 1-10 mm          |
| Power Output                   | 195 Watts        |
| No Load Speed                  | 0-400/0-1300 rpm |
| Max. Torque                    | 30 Nm            |
| Max. Drilling Capacity [Wood]  | 30 mm            |
| Max. Drilling Capacity [Metal] | 10 mm            |
| Weight                         | 2.0 kg           |
| Length x Height                | 220 x 235 mm     |

COMPACT

14.4 Volt 10mm Compact Drill Driver DC733C2



Powerful 14.4 Volt drill driver for drilling and screwdriving applications  
 10 mm single sleeve chuck and spindle lock for quick and easy bit change with one hand  
 Two speed settings, variable speed and reverse switch for maximum control  
 14 position adjustable torque control for consistent screwdriving into a variety of materials with different screw sizes

**Standard Equipment:** 40min Multi Chemistry Charger, 2 x 1.1Ah Compact Li-Ion batteries, Heavy duty carrying case

|                                |                    |
|--------------------------------|--------------------|
| Battery Capacity               | Li-Ion 1.1 Ah      |
| Chuck Capacity                 | 1-10mm mm          |
| Power Output                   | 195 Watts          |
| No Load Speed                  | 0-400 / 0-1300 rpm |
| Max. Torque                    | 30 Nm              |
| Max. Drilling Capacity [Wood]  | 30 mm              |
| Max. Drilling Capacity [Metal] | 10 mm              |
| Weight                         | 1.5 kg             |
| Length x Height                | 220 x 220 mm       |

COMPACT LITHIUM ION

**DEWALT EXTREME 2 METAL™**

**DEWALT Extreme 2 Metal drill bits are ideal for fast, accurate, burr-free drilling.**

- Up to 4x faster than standard HHS-R bits, and up to 50% stronger
- The DEWALT twin tip design eliminates 'walking' allowing for accurate hole positioning and more efficient drilling
- Gold Ferrous Oxide coating prevents over-heating for longer bit life

For the complete range of EXTREME 2 METAL drill bits see page 116



14.4 Volt 10mm Compact Right Angle Drill DW966K



Powerful fan cooled motor delivers up to 24 Nm of sustained torque for turning large drill bits and fasteners  
2 speed ranges 0-400/0-1,250 rpm for increased user flexibility to achieve a wide range of applications  
Forward, reverse, variable speed and electronic motor brake for total control  
Multi-grip trigger provides comfort and convenience by allowing the user to get into tighter spaces while still having access to the trigger

**Standard Equipment:** 1 hour charger, 1 battery, Heavy duty carrying case

|                                |                   |
|--------------------------------|-------------------|
| Battery Capacity               | NiCd 2.0 Ah       |
| Chuck Capacity                 | 1.0-10 mm         |
| Power Output                   | 220 Watts         |
| No Load Speed                  | 0-400/0-1,250 rpm |
| Max Torque                     | 24 Nm             |
| Max. Drilling Capacity [Wood]  | 28 mm             |
| Max. Drilling Capacity [Metal] | 10 mm             |
| Weight                         | 2.1 kg            |
| Length x Height                | 323 x 125 mm      |



14.4 Volt Compact Impact Driver DC837KL/ DC837N



Durable frameless high speed motor delivers up to 140 Nm of torque  
All metal gearing for efficient power transmission and long tool life  
Aluminium front housing provides greater heat dispersion increasing motor life  
Improved variable speed switch and electronic motor brake for complete control for both setting and removing fasteners

**Standard Equipment:** 40 minute fast charger, 2 batteries, Heavy duty carrying case.

|                    |                |
|--------------------|----------------|
| Battery Capacity   | Li-Ion, 2.0 Ah |
| Bit Holder         | 1/4"           |
| Power Output       | 240 Watts      |
| No Load Speed      | 0-2400 rpm     |
| Impacts per Minute | 0-2700 ipm     |
| Max Torque         | 140 Nm         |
| Max. Bolt Diameter | M12            |
| Weight             | 1.6 kg         |
| Length x Height    | 146 x 231 mm   |



14.4 Volt Compact Impact Driver DC837C2



Durable frameless high speed motor delivers up to 140 Nm of torque  
All metal gearing for efficient power transmission and long tool life  
Aluminium front housing provides greater heat dispersion increasing motor life  
Improved variable speed switch and electronic motor brake for complete control for both setting and removing fasteners

**Standard Equipment:** 40 minute fast charger, 2 x 1.1Ah Compact Lithium batteries, Heavy duty carrying case.

|                    |                |
|--------------------|----------------|
| Battery Capacity   | Li-Ion, 1.1 Ah |
| Bit Holder         | 1/4"           |
| Power Output       | 240 Watts      |
| No Load Speed      | 0-2400 rpm     |
| Impacts per Minute | 0-2700 ipm     |
| Max Torque         | 140 Nm         |
| Max. Bolt Diameter | M12            |
| Weight             | 1.4 kg         |
| Length x Height    | 146 x 230 mm   |



14.4 Volt Compact Impact Driver DC835KB



Durable frameless high speed motor delivers up to 140 Nm of torque  
All metal gearing for efficient power transmission and long tool life  
Aluminium front housing provides greater heat dispersion increasing motor life  
Improved variable speed switch and electronic motor brake for complete control for both setting and removing fasteners

**Standard Equipment:** 40 minute fast charger, 2 batteries, Heavy duty carrying case

|                    |              |
|--------------------|--------------|
| Battery Capacity   | NiMH 2.6 Ah  |
| Bit Holder         | 1/4"         |
| Power Output       | 240 Watts    |
| No Load Speed      | 0-2400 rpm   |
| Impacts per Minute | 0-2700 ipm   |
| Max Torque         | 140 Nm       |
| Max. Bolt Diameter | M12          |
| Weight             | 1.8 kg       |
| Length x Height    | 146 x 231 mm |



14.4 Volt Compact Impact Wrench DC832KL/ DC832N



Durable frameless high speed motor delivers up to 180 Nm of torque  
All metal gearing for efficient power transmission and increased tool life  
Aluminium front housing provides greater heat dispersion increasing motor life  
Improved variable speed switch and electronic motor brake for complete control for both setting and removing fasteners

**Standard Equipment:** 40 minute fast charger, 2 batteries, Heavy duty carrying case.

|                    |                |
|--------------------|----------------|
| Battery Capacity   | Li-Ion, 2.0 Ah |
| Bit Holder         | 1/2"           |
| Power Output       | 240 Watts      |
| No Load Speed      | 0-2400 rpm     |
| Impacts per Minute | 0-2700 ipm     |
| Max. Torque        | 180 Nm         |
| Max. Bolt Diameter | M16            |
| Weight             | 1.6 kg         |
| Length x Height    | 146 x 231 mm   |



14.4 Volt Compact Impact Wrench DC830KB



Durable frameless high speed motor delivers up to 180 Nm of torque  
All metal gearing for efficient power transmission and long tool life  
Aluminium front housing provides greater heat dispersion increasing motor life  
Improved variable speed switch and electronic motor brake for complete control for both setting and removing fasteners

**Standard Equipment:** 40 minute fast charger, 2 batteries, Heavy duty carrying case

|                    |              |
|--------------------|--------------|
| Battery Capacity   | NiMH 2.6 Ah  |
| Bit Holder         | 1/2"         |
| Power Output       | 240 Watts    |
| No Load Speed      | 0-2400 rpm   |
| Impacts per Minute | 0-2700 ipm   |
| Max. Torque        | 180 Nm       |
| Max. Bolt Diameter | M16          |
| Weight             | 1.8 kg       |
| Length x Height    | 146 x 231 mm |



14.4 Volt Shear DW941K



Powerful DeWALT fan cooled motor with replaceable brushes delivers high speed cutting in 1.2 mm sheet metal at 4.4 m/min  
Head swivels 360° which allows user to access tight quarters while maintaining comfort  
Variable speed and electronic brake for greater control and user safety  
42.7 m maximum length of cut per charge in 1.2 mm sheet metal

**Standard Equipment:** 1 hour charger, 1 battery, Allen key, Heavy duty carrying case

|                           |              |
|---------------------------|--------------|
| Battery Capacity          | NiCd 2.0 Ah  |
| Power Output              | 295 Watts    |
| No Load Stroke Rate       | 0-2300 spm   |
| Max. Depth of Cut [Metal] | 1.2 mm       |
| Weight                    | 2.4 kg       |
| Length x Height           | 336 x 230 mm |



14.4 Volt Heavy Duty Flexible Flashlight - Bare Unit DW918



Wide angle beam with metal reflector and Xenon bulbs for greater brightness  
Flashlight with flexible neck for multi-directional, hands free lighting  
Lockable head clip offers versatility and convenience of a lantern.  
Compact, lightweight design with impact resistant housing

|                 |              |
|-----------------|--------------|
| Bulb Type       | Xenon        |
| Battery Type    | 14.4 V V     |
| Weight          | 0.45 kg      |
| Length x Height | 130 x 180 mm |

\*Spare bulb available - DE9043

14.4 Volt Flashlight - Bare Unit DW906



Wide angle beam with metal reflector and Xenon bulbs for greater brightness  
Flashlight with 90 degree pivoting head and 5 set positions for multi directional lighting (including horizontal and vertical lighting)  
Compact, lightweight design with impact resistant housing  
On board spare bulb storage

|                 |             |
|-----------------|-------------|
| Bulb Type       | Xenon       |
| Battery Type    | 14.4 V V    |
| Weight          | 0.34 kg     |
| Length x Height | 85 x 240 mm |

\*Spare bulb available - DE9043

12 Volt 13mm XRP Heavy Duty Hammer Drill DCD945B2



Powerful 12 Volt XRP Combi tool for heavy duty drilling and screwdriving applications  
DeWALT built frameless motor reduces size and increases efficiency producing excellent runtime  
Ultra smooth 3 speed selector for optimum performance in high torque, normal use and high speed applications.  
22 position adjustable torque control for uniform results and optimised precision when screwdriving

**Standard Equipment:** 40 min multi chemistry charger, 2 batteries, Multi position side handle, Heavy duty carrying case

|                                  |                            |
|----------------------------------|----------------------------|
| Battery Capacity                 | NiMH 2.6 Ah                |
| Chuck Capacity                   | 1.5-13 mm                  |
| Power Output                     | 285 Watts                  |
| No Load Speed                    | 0-425/0-1200/0-1800 rpm    |
| Beats per Minute                 | 0-7225/0-20400/0-30600 bpm |
| Max Torque                       | 44 Nm                      |
| Max. Drilling Capacity [Wood]    | 38 mm                      |
| Max. Drilling Capacity [Metal]   | 13 mm                      |
| Max. Drilling Capacity [Masonry] | 13 mm                      |
| Weight                           | 2.5 kg                     |
| Length x Height                  | 247 x 248 mm               |





12 Volt 13mm Compact Hammer Drill

DC745KB/ DC745KA



Powerful 12 Volt combination tool for hammer drilling and screwdriving applications  
13 mm single sleeve keyless chuck with automatic spindle lock for quick and easy bit change with one hand  
17 position adjustable torque control for consistent screwdriving into a variety of materials with different screw sizes  
All metal gearing for efficient power transmission and longer tool life

**Standard Equipment:** 1 hour charger, 2 batteries, Heavy duty carrying case

|                                  |                     |
|----------------------------------|---------------------|
| Battery Capacity                 | NiMH 2.6 Ah         |
| Chuck Capacity                   | 1.5mm-13 mm         |
| Power Output                     | 240 Watts           |
| No Load Speed                    | 0-400/ 0-1450 rpm   |
| Beats per Minute                 | 0-6800/ 0-25000 bpm |
| Max Torque                       | 35 Nm               |
| Max. Drilling Capacity [Wood]    | 28 mm               |
| Max. Drilling Capacity [Metal]   | 13 mm               |
| Max. Drilling Capacity [Masonry] | 13 mm               |
| Weight                           | 2.1 kg              |
| Length x Height                  | 225 x 239 mm        |



12 Volt 13mm XRP Heavy Duty Drill Driver

DCD940B2



Powerful 12 Volt XRP Drill Driver for heavy duty drilling and screwdriving applications  
DEWALT built frameless motor reduces size and increases efficiency producing excellent runtime  
Ultra smooth 3 speed selector for optimum performance in high torque, normal use and high speed applications.  
22 position adjustable torque control for uniform results and optimised precision when screwdriving

**Standard Equipment:** 40 minute multi chemistry charger, 2 batteries, Multi position side handle, Heavy duty carrying case

|                                |                         |
|--------------------------------|-------------------------|
| Battery                        | NiMH 2.6 Ah             |
| Chuck Capacity                 | 1.5-13 mm               |
| Power Output                   | 285 Watts               |
| No Load Speed                  | 0-425/0-1200/0-1800 rpm |
| Max. Torque                    | 44 Nm                   |
| Max. Drilling Capacity [Wood]  | 38 mm                   |
| Max. Drilling Capacity [Metal] | 13 mm                   |
| Weight                         | 2.4 kg                  |
| Length x Height                | 240 x 248 mm            |



12 Volt 13mm Compact Drill Driver

DC743KB/ DC742KA\*



Powerful 12.0 Volt drill driver for drilling and screwdriving applications  
13mm single sleeve keyless chuck with automatic spindle lock for quick and easy bit change with one hand  
17 position adjustable torque control for consistent screwdriving into a variety of materials with different screw sizes  
All metal gearing for efficient power transmission and longer tool life

**Standard Equipment:** 1 hour charger, 2 x 2.6Ah NiMH batteries, Heavy duty carrying case

|                                |                    |
|--------------------------------|--------------------|
| Battery Capacity               | NiMH 2.6 Ah        |
| Chuck Capacity                 | 1.5-13 mm          |
| Power Output                   | 240 Watts          |
| No Load Speed                  | 0-400 / 0-1450 rpm |
| Max Torque                     | 35 Nm              |
| Max. Drilling Capacity [Wood]  | 28 mm              |
| Max. Drilling Capacity [Metal] | 13 mm              |
| Weight                         | 2.0 kg             |
| Length x Height                | 210 x 239 mm       |

\*DC742KA has 10mm chuck



12 Volt 10mm Drill Driver

DC740KA/ DC740K2



Powerful 12 Volt drill driver for drilling and screwdriving applications  
10 mm single sleeve chuck and spindle lock for quick and easy bit change with one hand  
14 position adjustable torque control for consistent screwdriving into a variety of materials with different screw sizes  
Removable Belt Clip

**Standard Equipment:** 1 hour charger, 2 batteries, Heavy duty carrying case

|                                |                  |
|--------------------------------|------------------|
| Battery Capacity               | NiCd 1.3 Ah      |
| Chuck Capacity                 | 1-10 mm          |
| Power Output                   | 190 Watts        |
| No Load Speed                  | 0-350/0-1200 rpm |
| Max Torque                     | 26 Nm            |
| Max. Drilling Capacity [Wood]  | 25 mm            |
| Max. Drilling Capacity [Metal] | 10 mm            |
| Weight                         | 1.7 kg           |
| Length x Height                | 220 x 225 mm     |



12 Volt 10mm Compact Right Angle Drill

DW965K



Powerful fan cooled motor delivers up to 20 Nm of sustained torque for turning large bits and fasteners  
2 speed ranges 0-400/0-1200 rpm for increased user flexibility providing a wide range of applications  
Multi-grip trigger provides comfort and convenience by allowing the user to get into tighter spaces while still having access to the trigger  
Forward, reverse, variable speed and electronic motor brake for total control

**Standard Equipment:** 1 hour charger, 1 battery, Heavy duty carrying case

|                                |                    |
|--------------------------------|--------------------|
| Battery Capacity               | NiCd 2.0 Ah        |
| Chuck Capacity                 | 1.0-10 mm          |
| Power Output                   | 190 Watts          |
| No Load Speed                  | 0-400 / 0-1200 rpm |
| Max Torque                     | 20 Nm              |
| Max. Drilling Capacity [Wood]  | 25 mm              |
| Max. Drilling Capacity [Metal] | 10 mm              |
| Weight                         | 2.0 kg             |
| Length x Height                | 323 x 125 mm       |



12 Volt Compact Impact Driver

DC845KB



Durable frameless high speed motor delivers up to 130 Nm of torque  
All metal gearing for efficient power transmission and long tool life  
Aluminium front housing provides greater heat dispersion increasing motor life  
Improved variable speed switch and electronic motor brake for complete control for both setting and removing fasteners

**Standard Equipment:** 40 minute charger, 2 batteries, Heavy duty carrying case

|                    |              |
|--------------------|--------------|
| Battery Capacity   | NiMH 2.6 Ah  |
| Bit Holder         | 1/4"         |
| Power Output       | 220 Watts    |
| No Load Speed      | 0-2400 rpm   |
| Impacts per Minute | 0-2700 ipm   |
| Max Torque         | 130 Nm       |
| Max. Bolt Diameter | M12          |
| Weight             | 1.7 kg       |
| Length x Height    | 146 x 231 mm |



12 Volt Compact Impact Wrench

DC840KB



Durable frameless high speed motor delivers up to 160 Nm of torque  
All metal gearing for efficient power transmission and long tool life  
Aluminium front housing provides greater heat dispersion increasing motor life  
Improved variable speed switch and electronic motor brake for complete control for both setting and removing fasteners

**Standard Equipment:** 40 minute charger, 2 batteries, Heavy duty carrying case

|                    |              |
|--------------------|--------------|
| Battery Capacity   | NiMH 2.6 Ah  |
| Bit Holder         | 1/2"         |
| Power Output       | 220 Watts    |
| No Load Speed      | 0-2400 rpm   |
| Impacts per Minute | 0-2700 ipm   |
| Max. Torque        | 160 Nm       |
| Max. Bolt Diameter | M16          |
| Weight             | 1.7 kg       |
| Length x Height    | 146 x 231 mm |



12 Volt Drywall Screwdriver

DW979K2



Removable depth sensitive "set and forget" nosepiece for consistent fastener depth  
6.35 mm hex shank magnetic tool holder  
Up to 8.5 Nm of sustainable torque for maximum performance  
Two speed settings, variable speed and reverse switch for maximum control

**Standard Equipment:** 1 hour charger, 2 batteries, Magnetic bit holder, Screwdriver bit, Heavy duty carrying case

|                  |                    |
|------------------|--------------------|
| Battery Capacity | NiCd 2.0 Ah        |
| Tool Holder      | (Hex) 6.35 mm      |
| Power Output     | 220 Watts          |
| No Load Speed    | 0-800 / 0-2300 rpm |
| Max Torque       | 8.5 Nm             |
| Weight           | 1.9 kg             |
| Length x Height  | 307 x 231 mm       |



12 Volt 18 Gauge Cordless Nailer

DC602KB



The tool works as fast as you do with consistent nail penetration  
The sequential operating mode allows for precision placement and the bump operating mode provides the user with production speed  
Depths can be easily referenced utilising numbered dial and user does not sacrifice performance when changing depths  
Provides easy access to the nosepiece for the simple removal of a jammed fastener without the use of screwdrivers or tool wrenches

**Standard Equipment:** 30 minute charger, 2 batteries, Heavy duty carrying case

|                         |                   |
|-------------------------|-------------------|
| Nail Diameter           | 1.2 mm            |
| Battery Capacity        | NiMH 2.6 Ah       |
| Magazine angle          | 0 °               |
| Nail Length             | 16-50 mm          |
| Magazine capacity       | 110 Nails         |
| Magazine loading        | Side Load         |
| Firing mode             | Bump & Sequential |
| Length x Width x Height | 295 x 95 x 290 mm |
| Weight                  | 3.0 kg            |
| Nailer Operating Mode   | Selective         |
| Integrated Belt Hook    | Yes               |
| Jam Clearing            | Yes               |



12 Volt 600 ml Satchet and 310 ml Cartridge Cordless Sealant Gun

DC542K/ DC542\*



2900 N push force suitable for high viscosity urethanes and adhesives  
Variable speed control dial for pre-selection of dispensing speed  
Electronic trigger with variable speed & automatic overload protection  
Ergonomic T-handle design with rubber grip for extra comfort

**Standard Equipment:** 1 hour charger, 1 battery, Satchet barrel, Cartridge holder, Conversion kit

|                  |                     |
|------------------|---------------------|
| Battery Capacity | 2.6 Ah              |
| Carrier Size     | 310-600 ml          |
| Applicator       | Cartridge & Satchet |
| Push Force       | 2900 N (295Kg)      |
| Push Speed       | 584 mm/min          |
| Weight           | 3.1/2.4* kg         |
| Length x Height  | 734 x 322 mm        |

\*DC542 sold as bare unit





12 Volt 310 ml Cartridge Sealant Gun

DC540K/ DC540



2900 N push force suitable for high viscosity urethanes and adhesives  
Variable speed control dial for pre-selection of dispensing speed  
Electronic trigger with variable speed & automatic overload protection  
Ergonomic T-handle design with rubber grip for extra comfort

**Standard Equipment:** 1 hour charger, 1 battery, Cartridge holder

|                  |                |
|------------------|----------------|
| Battery Capacity | 2.6 Ah         |
| Carrier Size     | 310 ml         |
| Applicator       | Cartridge      |
| Push Force       | 2900 N (295Kg) |
| Push Speed       | 584 mm/min     |
| Weight           | 2.8/2.1 kg     |
| Length x Height  | 472 x 322 mm   |



12 Volt Heavy Duty Flexible Flashlight - Bare Unit

DW915



Wide angle beam with metal reflector and Xenon bulbs for greater brightness  
Spare extra-bright xenon bulb inside lens cover so a replacement is always on-hand.  
Flashlight with flexible neck for multi-directional hands-free lighting  
Lockable head clip offers versatility and convenience of a lantern

|                 |              |
|-----------------|--------------|
| Bulb Type       | Xenon        |
| Battery Type    | 12 V V       |
| Weight          | 0.45 kg      |
| Length x Height | 130 x 180 mm |

\*Spare bulb available - DE9043

12 Volt Flashlight - Bare Unit

DW904



Wide angle beam with metal reflector and Xenon bulbs for greater brightness  
Flashlight with 90 degree pivoting head and 5 set positions for multi directional lighting (including horizontal and vertical lighting)  
Compact, lightweight design with impact resistant housing  
On board spare bulb storage

|                 |             |
|-----------------|-------------|
| Bulb Type       | Xenon       |
| Battery Type    | 12 V V      |
| Weight          | 0.34 kg     |
| Length x Height | 85 x 240 mm |

\*Spare bulb available - DE9043

12 / 14.4 Volt Fluorescent Light - Bare Unit

DC528N



Compact, lightweight design with impact resistant housing  
Battery and charger sold separately  
Rubber overmold for increased durability  
4 prong bulb for added bulb stability

|                 |              |
|-----------------|--------------|
| Bulb Type       | Fluorescent  |
| Battery Type    | 12 / 14.4 V  |
| Weight          | 0.5 kg       |
| Length x Height | 155 x 370 mm |

\*Spare bulb available - DE5273

7.2 Volt Two Position Screwdriver

DW920K



Hinged handle with position lock for two grip positions (in-line and pistol grip)  
15 position adjustable torque control for consistent screwdriving into a variety of materials with different screw sizes  
Variable speed and reverse switch for added versatility  
Electronic motor brake for better control

**Standard Equipment:** 1 hour charger, 1 battery, Heavy duty carrying case

|                  |               |
|------------------|---------------|
| Battery Capacity | NiCd 1.3 Ah   |
| Tool Holder      | (Hex) 6.35 mm |
| Power Output     | 125 Watts     |
| No Load Speed    | 0-500 rpm     |
| Max Torque       | 10 Nm         |
| Weight           | 1 kg          |
| Length x Height  | 355 x NA mm   |



3.6 Volt Compact 3 Position Screwdriver

DC600KA



A 3 position locking pivot operated from left or right and a gearbox diameter of only 40 mm for easy access to the tightest of working spaces with maximum user control  
Two speed control and 8 torque settings ideal for screwdriving applications and pilot drilling  
Pistol grip, soft grip handle and a rapid actuation switch for superior ergonomics and maximum user control in any working position  
Quick release 6.35 mm magnetic collet for ease of use and convenience

**Standard Equipment:** 1 hour charger, 2 batteries, Screwdriver bit, Heavy duty carrying case

|                  |               |
|------------------|---------------|
| Battery Capacity | NiCd 1.2 Ah   |
| Tool Holder      | (Hex) 6.35 mm |
| Power Output     | n/a Watts     |
| No Load Speed    | 200/600 rpm   |
| Max Torque       | 6 Nm          |
| Weight           | 0.7 kg        |
| Length x Height  | 300 x 65 mm   |



Multi Chemistry Corded/Cordless Radio Charger

DC013



Runs off mains and 7.2 Volt to 18 Volt Li-ION/NiCd/NiMH batteries  
Blow molded protective roll cage with 6 impact resistance points for maximum job site durability  
Charges DEWALT 7.2 Volt to 18 Volt Li-ION/NiCd/NiMH batteries  
High efficiency weather resistant speakers with bass ports and bass boost for maximum job site listening experience

**Standard Equipment:** No batteries included

|                    |                  |
|--------------------|------------------|
| Battery            | Li-ION/NiMH/NiCd |
| Radio Power Source | AC - DC          |
| Radio Frequencies  | AM- FM Stereo    |
| Charging Time      | 30-70 min        |
| Length x Height    | 490 x 290 mm     |
| Weight             | 6.7 kg           |

LITHIUM ION NiMH NiCd

Cordless or Corded Wet/Dry Vacuum

DC500



Runs off of 12-18 Volt DeWALT battery packs or mains supply  
High efficiency filter traps 99.7% of dust as fine as 0.3 Microns  
Vacuums Wet or Dry without the need to change the filter  
Heavy Duty Washable Filter

**Standard Equipment:** No batteries included, 2 metre heavy duty rubber hose, Crevice tool, Wide nozzle, Dust extraction adaptor

|                              |              |
|------------------------------|--------------|
| Voltage                      | 12-18 V      |
| Battery                      | Not included |
| Power Input                  | 300 Watts    |
| Max. Airflow                 | 15.9 l/sec   |
| Tank volume                  | 7.5 l        |
| Power Source                 | AC/DC        |
| Hose Nozzle Outside Diameter | 32 mm        |
| Blower                       | Yes          |
| Length x Height              | 390 x 360 mm |
| Weight                       | 4.6 kg       |

LITHIUM ION NiMH NiCd

Cordless / Corded Area Flashlight

DC019



Runs off mains and 12 Volt to 18 Volt DeWALT Li-ion / NiCd / NiMH batteries  
Compact and lightweight design provides quick and easy transport and storage  
Spring-loaded battery holder keeps battery in place when transporting from place to place

**Standard Equipment:** No batteries included

|                 |                   |
|-----------------|-------------------|
| Power Source    | 12 - 18 V DC - AC |
| Voltage         | 12- 18 V          |
| Battery         | Not included      |
| Bulb Type       | Fluorescent       |
| Brightness      | 2700 Lumens       |
| Charge time     | NA hr             |
| Weight          | 2.2 kg            |
| Length x Height | 165 x 159 mm      |

LITHIUM ION NiMH NiCd

Cordless / Corded Area Light

DC020\*



Runs off of mains and 12 Volt to 18 Volt DeWALT Li-Ion / NiCd / NiMH battery packs  
2 power outlets offer more versatility for jobsite power  
Compact, lightweight design provides quick and easy fold up, transport and storage  
Spring loaded battery hold down keeps batteries in place when transporting around the jobsite

**Standard Equipment:** No batteries included

|                 |                  |
|-----------------|------------------|
| Power Source    | 12 - 18V DC - AC |
| Voltage         | 12- 18 V         |
| Battery         | Not included     |
| Bulb Type       | Fluorescent      |
| Brightness      | 2700 Lumens      |
| Charge time     | NA hr            |
| Weight          | 2.4 kg           |
| Length x Height | 165 x 159 mm     |

LITHIUM ION NiMH NiCd

\* Battery and charger sold separately



10.8 Volt 10mm Compact Drill Driver

DCD710S2



Powerful 10.8V drill driver for drilling and screwdriving applications  
 15 Position adjustable torque control for consistent screwdriving into a variety of materials with different screw sizes  
 Ergonomic handle and rubber overmold to provide ultimate end user comfort  
 Parabolic switch profile allowing for greater control over speed of application

Standard Equipment: 40 min charger, 2 Batteries, Kit box

|                                |                  |
|--------------------------------|------------------|
| Battery Capacity               | 1.3 Ah           |
| Chuck Capacity                 | 1.5 - 10 mm      |
| Power Output                   | 180 (MWO) Watts  |
| No Load Speed                  | 0-400/0-1500 rpm |
| Max Torque                     | 25 Nm            |
| Max. Drilling Capacity [Wood]  | 19 mm            |
| Max. Drilling Capacity [Metal] | 10 mm            |
| Weight                         | 1.1 kg           |
| Length x Height                | 185 x 195 mm     |



10.8 Volt Screwdriver

DCF610S2



Powerful 10.8V Screwdriver for screwdriving & drilling applications  
 15 Position adjustable torque control for consistent screwdriving into a variety of materials with different screw sizes  
 6.35mm 'drop in' keyless hex driver allows for quick, one handed fitment  
 3 LED 'Halo' ring provides maximum illumination to work piece

Standard Equipment: 40 min charger, 2 x 10.8V 1.3Ah Li-Ion batteries, Kit box

|                  |              |
|------------------|--------------|
| Battery Capacity | 1.3 Ah       |
| Bit Holder       | 6.35mm       |
| Power Output     | 154 Watts    |
| No Load Speed    | 0-1050 rpm   |
| Max Torque       | 8 Nm         |
| Weight           | 0.96 kg      |
| Length x Height  | 158 x 190 mm |



10.8 Volt Compact Impact Driver

DCF815S2



Compact, durable design delivers 107Nm of torque  
 Parabolic switch profile allowing for greater control over speed  
 6.35mm 'drop in' keyless hex driver allows for quick, one handed fitment  
 3 LED 'Halo' ring provides maximum illumination to work piece

Standard Equipment: 40 min charger, 2 Batteries, Kit Box

|                    |               |
|--------------------|---------------|
| Battery Capacity   | 1.3 Ah        |
| Bit Holder         | 1/4" (6.35mm) |
| Power Output       | 147 Watts     |
| No Load Speed      | 0-2450 rpm    |
| Impacts per Minute | 3400 ipm      |
| Max Torque         | 107 Nm        |
| Max. Bolt Diameter | 6mm           |
| Weight             | 1.04 kg       |
| Length x Height    | 158 x 195 mm  |



10.8 Volt Compact LED Flashlight - Bare Unit

DCL510N



Compact, lightweight design with impact resistant housing  
 Flashlight head can rotate 180 degrees horizontally  
 Flashlight head also rotates 180 degrees vertically with ratchet lock  
 Flashlight has belt clip, magnetic mount or can be free standing,

|                   |             |
|-------------------|-------------|
| Bulb Type         | LED         |
| Battery chemistry | Li-Ion      |
| Height x Length   | 123 x 52 mm |
| Weight            | 0.15 kg     |
| Battery Type      | 10.8 V      |



\*Battery and charger sold separately

10.8 Volt Compact Impact Driver/Screwdriver Twin Pack

DCK210S2



DCF815 10.8V Impact driver delivering 107Nm torque, 2450 RPM with 3400 BPM.  
 DCF610 10.8V Screwdriver delivering 0 - 1050 rpm.  
 Both tools feature 6.35mm 'drop in' hex retention, allowing 25mm bits to be inserted directly.  
 3 LED 'Halo' ring provides maximum illumination to work piece

Standard Equipment: 1 x DCF815 10.8V Compact Cordless Impact Driver, 1 x DCF610 10.8V Compact Cordless Screwdriver, 2 x 10.8V 1.3Ah Li-Ion batteries, 1 x 10.8V 40min charger, 1 x Heavy Duty Kit Bag

|                  |        |
|------------------|--------|
| Voltage          | 10.8 V |
| Battery Capacity | 1.3 Ah |



10.8 Volt Compact Drill Driver/Impact Driver Twin Pack

DCK211S2



DCF815 10.8V Impact driver delivering 107Nm torque, 0-2450 RPM with 3400 BPM.  
 DCD710 10.8V Drill driver with 10mm chuck and 0-450/1500 RPM  
 DCD710 features 15+1 position adjustable torque control  
 DCF815 features 3 LED 'Halo' ring, providing maximum illumination to work piece.

Standard Equipment: 1 x DCD710 10.8V 10mm Compact cordless drill driver, 1 x DCF815 10.8V Compact Cordless Impact Driver, 2 x 10.8V 1.3Ah Li-Ion batteries, 1 x 10.8V 40min charger, 1 x Heavy Duty Kit Bag

|                  |        |
|------------------|--------|
| Voltage          | 10.8 V |
| Battery Capacity | 1.3 Ah |



DEWALT Cordless Battery System

|                                 |                         | Amp Hours           |  | 1 hour | 1 hour | 40 minutes | 1 hour | 1 hour | 1 hour | 1 hour | 1 hour | 40 minutes |
|---------------------------------|-------------------------|---------------------|--|--------|--------|------------|--------|--------|--------|--------|--------|------------|
|                                 |                         |                     |  | DE9000 | DE0246 | DE9135     | DE9136 | DC013  | DE9116 | DE9216 | DCB100 |            |
| <br>NiCd<br>DE9096              | <br>NiCd                | 7.2V DE9057 1.3 Ah  |  |        |        | ✓          | ✓      | ✓      | ✓      | ✓      |        |            |
|                                 |                         | 9.6V DE9062 1.3 Ah  |  |        |        | ✓          | ✓      | ✓      | ✓      | ✓      |        |            |
|                                 |                         | 12V DE9074 1.3 Ah   |  |        |        | ✓          | ✓      | ✓      | ✓      | ✓      |        |            |
|                                 |                         | 14.4V DE9094 1.3 Ah |  |        |        | ✓          | ✓      | ✓      | ✓      | ✓      |        |            |
|                                 |                         | 18V DE9098 1.3 Ah   |  |        |        | ✓          | ✓      | ✓      | ✓      | ✓      |        |            |
|                                 |                         | 24V DE0243 2.0 Ah   |  | ✓      |        |            |        |        |        |        |        |            |
|                                 |                         |                     |  |        |        |            |        |        |        |        |        |            |
| <br>NiMH<br>DE9503              | <br>NiMH                | 12V DE9501 2.6 Ah   |  |        |        | ✓          | ✓      | ✓      | ✓      | ✓      |        |            |
|                                 |                         | 14.4V DE9502 2.6 Ah |  |        |        | ✓          | ✓      | ✓      | ✓      | ✓      |        |            |
|                                 |                         | 18V DE9503 2.6 Ah   |  |        |        | ✓          | ✓      | ✓      | ✓      | ✓      |        |            |
|                                 |                         | 24V DE0241 3.0Ah    |  | ✓      |        |            |        |        |        |        |        |            |
| <br>Compact Li-Ion<br>DE9181    | <br>COMPACT LITHIUM ION | 14.4V DE9141 1.1Ah  |  |        |        | ✓          | ✓      | ✓      |        |        |        |            |
|                                 |                         | 18V DE9181 1.1Ah    |  |        |        | ✓          | ✓      | ✓      |        |        |        |            |
|                                 |                         |                     |  |        |        |            |        |        |        |        |        |            |
| <br>Heavy Duty Li-Ion<br>DE9180 | <br>DE9360 LITHIUM ION  | 18V DE9180 2.0 Ah   |  |        |        | ✓          | ✓      | ✓      |        |        |        |            |
|                                 |                         | 14V DE9140 2.0Ah    |  |        |        | ✓          | ✓      | ✓      |        |        |        |            |
|                                 |                         | 28V DE9280 2.2Ah    |  | ✓      |        |            |        |        |        |        |        |            |
|                                 |                         | 36V DE9360 2.2Ah    |  | ✓      |        |            |        |        |        |        |        |            |
| <br>10.8V Li-Ion<br>DCB121      | <br>10.8V LITHIUM ION   | 10.8V DCB121 1.3 Ah |  |        |        |            |        |        |        |        | ✓      |            |
|                                 |                         |                     |  |        |        |            |        |        |        |        |        |            |



Horizontal and Vertical Rotary Laser Kit

DW079PKH



Fully self-levelling horizontal and vertical rotary laser for internal and external applications  
 Levelling accuracy of 0.1 mm/m combined with DeWALT durability  
 Built in beam-splitting prism allows easy 90° lay out and plumb up applications  
 The remote control features a manual button to allow the user to tilt the laser plane in the X and Y axis

**Standard Equipment:** DW079KH, Digital Detector (DE0772-XJ), Combi grade rod (DE0737-XJ), Heavy duty telescopic tripod (DE0735-XJ), Gradient bracket (DE0738-XJ), Wireless (IR) remote control, 18 Volt 2.6Ah NiMH battery, 1 hour charger, Laser target card, Wall mount, Laser enhancement glasses, Heavy duty carrying case

|                                  |   |
|----------------------------------|---|
| Laser class                      | 3R, <5mW                                      |
| Levelling accuracy               | +/- 0.1 mm/m                                  |
| Self-levelling range             | +/- 5°  |
| Indoor visibility range          | 30 m  |
| Max. Working Range with Receiver | 300 m   |
| Rotation speed                   | 0, 10, 50, 200, 600 rpm                       |
| Sloping range in X and Y axis    | +/- 5°  |
| Power Source                     | 9.6V - 18V, NiCd/NiMH/Li-ion DeWALT batteries |
| Tripod connection                | 5/8"  |
| Weight                           | 2.0 kg  |
| Length x Height                  | 305 x 190 mm                                  |



Horizontal and Vertical Self-Levelling Rotary Laser

DW079KH



Fully self-levelling horizontal and vertical rotary laser for internal and external applications  
 Levelling accuracy of 0.1 mm/m combined with DeWALT durability  
 Built in beam-splitting prism allows easy squaring and plumb bob applications  
 The remote control features a manual button to allow the user to tilt the laser plane in both X and Y axis

**Standard Equipment:** Wireless (IR) remote control, 18 Volt 2.6Ah NiMH battery, 1 hour charger, Wall mount, Laser target card, Laser enhancement glasses, Digital detector (DE0772-XJ), Heavy duty carrying case

|                                  |   |
|----------------------------------|---|
| Laser class                      | 3R, <5mW                                      |
| Levelling accuracy               | +/- 0.1 mm/m                                  |
| Self-levelling range             | +/- 5°  |
| Indoor visibility range          | 30 m  |
| Max. Working Range with Receiver | 300 m   |
| Rotation speed                   | 0, 10, 50, 200, 600 rpm                       |
| Sloping range in X and Y axis    | +/- 5°  |
| Power Source                     | 9.6V - 18V, NiCd/NiMH/Li-ion DeWALT batteries |
| Tripod connection                | 5/8"  |
| Weight                           | 2.0 kg  |
| Length x Height                  | 305 x 190 mm                                  |



Self-Levelling Horizontal and Vertical Rotary Laser Kit

DW075PK



Fully automatic horizontal and vertical rotary laser  
 Levelling accuracy of 0.2mm/m  
 Wireless (IR) remote control operated scan mode generates a line between two points for an extremely bright beam over long distances which can then be moved by the user leaving hands free  
 Built in beam splitting prism allows easy squaring applications

**Standard Equipment:** DW075 transmitter, Laser Detector, Wall mount, Laser target card, Laser enhancement glasses, Heavy duty carrying case, Construction grade rod, Construction tripod

|                                  |                |
|----------------------------------|----------------|
| Laser class                      | 3R, <5mW       |
| Levelling accuracy               | +/- 0.2 mm/m   |
| Self-levelling range             | +/- 5°         |
| Indoor visibility range          | 15 m           |
| Max. Working Range with Receiver | 100 m          |
| Rotation speed                   | 0, 60, 600 rpm |
| Power Source                     | 2 x D          |
| Tripod connection                | 5/8"           |



Self-Levelling Horizontal Rotary Laser

DW074K



Fully automatic horizontal laser  
 Vertical manual levelling via easy to operate adjustment buttons, no dials for faster set up  
 Levelling accuracy of 0.2mm/m  
 Protected rotary head and weather proof design deliver class-leading exterior jobsite durability

**Standard Equipment:** DW074 transmitter, Laser Detector, Wall mount, Laser target card, Laser enhancement glasses, Heavy duty carrying case

|                                  |                |
|----------------------------------|----------------|
| Laser class                      | 3R, <5mW       |
| Levelling accuracy               | +/- 0.2 mm/m   |
| Self-levelling range             | +/- 5°         |
| Indoor visibility range          | 15 m           |
| Max. Working Range with Receiver | 100 m          |
| Rotation speed                   | 0, 60, 600 rpm |
| Power Source                     | 2 x D          |
| Tripod connection                | 5/8"           |



Laser Plumb Bob

DW082K



Self-Levelling plumb bob is accurate to ± 0.2 mm/m  
 Self-Levelling up to 4 degrees surface angle, finds plumb in seconds - no vials or knobs to adjust  
 One button operation is fast and easy to use  
 Focused laser beam keeps dot small even over long distances for improved accuracy and visibility

**Standard Equipment:** 4 x AA size alkaline batteries, Heavy duty carrying case

|                         |              |
|-------------------------|--------------|
| Laser class             | 2, <1mW      |
| Levelling Accuracy      | +/- 0.2 mm/m |
| Self-levelling range    | +/- 4°       |
| Number of beams         | 2            |
| Direction of beams      | up/down      |
| Indoor visibility range | 15 m         |
| Power Source            | 6V - 4x AA   |
| Tripod connection       | 1/4"         |
| Weight                  | 0.46 kg      |
| Length x Height         | 108 x 125 mm |



Self Levelling Plumb, Level and Square 4 Beam Laser Pointer

DW084K



Self levelling 4 beam laser is accurate to ±0.2 mm/m  
 Self levelling up to 4 degrees surface angle, finds plumb in seconds - no vials or knobs to adjust  
 One button operation is fast and easy to use  
 Focused laser beam keeps dots small even over long distances for improved accuracy and visibility

**Standard Equipment:** 4 x AA size alkaline batteries, Heavy duty carrying case

|                         |                      |
|-------------------------|----------------------|
| Laser class             | 2, <1mW              |
| Levelling Accuracy      | +/- 0.2 mm/m         |
| Self-levelling range    | +/- 4°               |
| Number of beams         | 4                    |
| Direction of beams      | up/down/level/square |
| Indoor visibility range | 25 m                 |
| Power Source            | 6V - 4x AA           |
| Tripod connection       | 1/4"                 |
| Weight                  | 0.55 kg              |
| Length x Height         | 128 x 100 mm         |



Laser Distance Measurer

DW030P



Laser distance measurer (LDM) manufactured to withstand the inevitable drops, falls and knocks on the Job site  
 It has a range of up to 30m and at this distance the unit will have an accuracy variance no greater than 3mm  
 The unit has raised, oversized buttons to avoid miss measures  
 'One button, one function' when selecting the unit to give linear meter readings, square meter calculations and cubic metre calculations. It will add or subtract readings and calculate distance in Metric and Imperial.

**Standard Equipment:** 2 x 1.5v dc LR03 (AAA-size) batteries, Horizontal Belt Pouch, Wrist Lanyard

|                         |                                       |
|-------------------------|---------------------------------------|
| Laser class             | Class 2                               |
| Levelling Accuracy      | 3mm @ 30m                             |
| Number of beams         | 1                                     |
| Indoor visibility range | 30m m                                 |
| Power Source            | 2 x 1.5v dc LR03 (AAA-size) batteries |
| Weight                  | 0.15 with batteries kg                |
| Length x Height         | 115mm x 26mm mm                       |

26 x Auto Level Package

DW096PK



26 x magnification for 100 m+ range  
 360° horizontal circle for precise measuring of horizontal angles  
 Vial set-up with final 1° self levelling capability for extra ease of use  
 Magnetically dampened compensator that maintains compensation over product life and for easy setup with optimum range and accuracy

**Standard Equipment:** Heavy duty 2.44 m aluminum grade rod, Aluminium construction tripod, String plumb bob, Heavy duty carrying case

|                        |                  |
|------------------------|------------------|
| Levelling Type         | Auto             |
| Magnification          | 26x              |
| Accuracy               | 2 mm             |
| Range                  | 100 m            |
| Stadia Ratio           | 1:100            |
| Horizontal Circle Type | Continuous Drive |
| Weight                 | 1.72 kg          |
| Length x Height        | 207 x 145 mm     |



Self-Levelling Line Laser (Horizontal and Vertical)

DW087K



Self-levelling cross line laser is accurate to ±0.3 mm/m in levelling applications  
 Self-Levelling up to 4 degrees surface angle with automatic out of level indication, marks a levelled line in seconds  
 2 button operation and low battery indication for ease of use  
 Built in magnetic pivot bracket mounts easily on metal surfaces

**Standard Equipment:** 3 x AA size alkaline batteries, Wall mount bracket, Heavy duty carrying case

|                         |                |
|-------------------------|----------------|
| Laser class             | 2, <1mW        |
| Accuracy                | +/- 0.3 mm/m   |
| Number of beams         | 2              |
| Direction of beams      | vertical/level |
| Indoor visibility range | 15 m           |
| Self-Levelling Range    | +/- 4°         |
| Power Supply            | 4.5V - 3x AA   |
| Tripod connection       | 1/4"           |
| Weight                  | 0.46 kg        |
| Length x Height         | 112 x 113 mm   |





**Tile Laser DW060K**

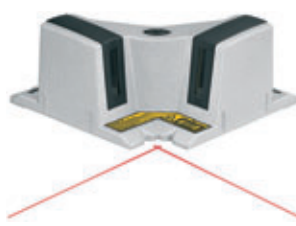

Beams cross at 90 degrees for precision set out.  
Thin narrow beams aid alignment and increase accuracy.  
One button operation for easy of use.  
Cast Aluminium Body for increased accuracy and job site durability.

**Standard Equipment:** 2 x C-size alkaline batteries, Target card, Heavy duty carrying case

|                         |              |
|-------------------------|--------------|
| Laser class             | 2, <1mW      |
| Accuracy                | +/- 0.2 mm/m |
| Number of beams         | 2            |
| Direction of beams      | Forward      |
| Indoor visibility range | 15 m         |
| Power Supply            | 3v - 2 x C   |
| Tripod connection       | No           |
| Weight                  | 1.26 kg      |
| Length x Height         | 285 x 95 mm  |

**Laser Level Attachments**



| Cat. No. | Description                                  |
|----------|--|
| DE0730   | Laser Target Card                            |
| DE0734   | Aluminium Construction Grade Rod             |
| DE0735   | Elevated Laser Construction Tripod           |
| DE0736   | Aluminium Construction Tripod                |
| DE0737   | 2.4m Construction Grade Rod                  |
| DE0738   | Gradient Setting Bracket                     |
| DE0772   | Waterproof Digital Laser Detector with Clamp |
| DE0841   | Lightweight 1/4 inch Mini Tripod             |
| DE0842   | Floor to Ceiling 1/4 inch Laser Pole         |
| DE0731   | 5/8" to 1/4" tripod adaptor                  |

**Drywall Screwdriver DW274K/ DW274KN\***



Ideal for fastening drywall and panels to wooden or metal studs  
Removable depth sensitive "set and forget" nosepiece for consistent fastener depth  
Lightweight and compact design to reduce user fatigue and increase productivity  
Soft grip surface on handle and switch to reduce vibration and enhance user comfort

**Standard Equipment:** Depth sensitive nose, Screwdriver bit holder & Ph2 screwdriver bit, Belt clip, Heavy duty carrying case

|                     |               |
|---------------------|---------------|
| Max Torque          | 10 Nm         |
| Power Input         | 540 Watts     |
| Power Output        | 295 Watts     |
| No Load Speed       | 0-4000 rpm    |
| Max. Screw Diameter | 4.8 mm        |
| Tool Holder         | (Hex) 6.35 mm |
| Weight              | 1.3 kg        |
| Length x Height     | 306 x 186 mm  |

**High Speed Drywall Screwdriver DW275K/ DW275KN\***



Ideal for fastening drywall and panels to wooden or metal studs  
Removable depth sensitive "set and forget" nosepiece for consistent fastener depth  
High speed for increased productivity  
Lightweight and compact design to reduce user fatigue and increase productivity

**Standard Equipment:** Depth sensitive nose, Screwdriver bit holder & Ph2 screwdriver bit, Belt clip, Heavy duty carrying case

|                     |               |
|---------------------|---------------|
| Max Torque          | 10 Nm         |
| Power Input         | 540 Watts     |
| Power Output        | 295 Watts     |
| No Load Speed       | 0-5300 rpm    |
| Max. Screw Diameter | 4.8 mm        |
| Tool Holder         | (Hex) 6.35 mm |
| Weight              | 1.3 kg        |
| Length x Height     | 306 x 186 mm  |

**Versadutch Screwdriver DW268K**



Ideal for screwdriving applications in wood, plastic and metal  
Versatile tool with torque control up to 26 Nm  
Unique Versa Clutch Torque Control System allows a torque level to be set whilst maintaining an override capability for driving screws into material of inconsistent density such as wood  
Lightweight and compact design to reduce user fatigue and increase productivity

**Standard Equipment:** Heavy duty carrying case

|                     |               |
|---------------------|---------------|
| Max Torque          | 4.26 Nm       |
| Power Input         | 540 Watts     |
| Power Output        | 295 Watts     |
| No Load Speed       | 0-2500 rpm    |
| Max. Screw Diameter | 6.3 mm        |
| Tool Holder         | (Hex) 6.35 mm |
| Weight              | 1.3 kg        |
| Length x Height     | 301 x 187 mm  |

**High Torque Versadutch Screwdriver DW269K**



Ideal for screwdriving applications in wood, plastic and metal  
Versatile tool with torque control up to 42 Nm  
Unique Versa Clutch Torque Control System allows a torque level to be set whilst maintaining an override capability for driving screws into material of inconsistent density such as wood  
Lightweight and compact design to reduce user fatigue and increase productivity

**Standard Equipment:** Heavy duty carrying case

|                     |               |
|---------------------|---------------|
| Max Torque          | 4.42 Nm       |
| Power Input         | 540 Watts     |
| Power Output        | 295 Watts     |
| No Load Speed       | 0-1000 rpm    |
| Max. Screw Diameter | 6.3 mm        |
| Tool Holder         | (Hex) 6.35 mm |
| Weight              | 1.3 kg        |
| Length x Height     | 301 x 187 mm  |



**Screwdriver for Self Drilling Screws DW263K**



Ideal for fascia, cladding and roofing applications  
Specially designed for working with self-drilling screws  
Removable depth sensitive "set and forget" nosepiece for consistent fastener depth  
Lightweight and compact design to reduce user fatigue and increase productivity

**Standard Equipment:** 8 mm magnetic bit holder for self drilling screws, nose adaptors (13 mm, 15 mm), Depth sensitive nose, Heavy duty carrying case

|                     |               |
|---------------------|---------------|
| Max Torque          | 14.5 Nm       |
| Power Input         | 540 Watts     |
| Power Output        | 295 Watts     |
| No Load Speed       | 0-2500 rpm    |
| Max. Screw Diameter | 6.3 mm        |
| Tool Holder         | (Hex) 6.35 mm |
| Weight              | 1.3 kg        |
| Length x Height     | 301 x 186 mm  |



**High Torque Screwdriver for Self Drilling Screws DW264K**



Ideal for fascia, cladding and roofing applications  
Specially designed for working with self-drilling screws  
Removable depth sensitive "set and forget" nosepiece for consistent fastener depth  
Lightweight and compact design to reduce user fatigue and increase productivity

**Standard Equipment:** 8 mm magnetic bit holder for self drilling screws, nose adaptors (13 mm, 15 mm), Depth sensitive nose, Heavy duty carrying case

|                     |               |
|---------------------|---------------|
| Max Torque          | 18 Nm         |
| Power Input         | 540 Watts     |
| Power Output        | 295 Watts     |
| No Load Speed       | 0-2000 rpm    |
| Max. Screw Diameter | 6.3 mm        |
| Tool Holder         | (Hex) 6.35 mm |
| Weight              | 1.3 kg        |
| Length x Height     | 301 x 186 mm  |



**Heavy Duty Impact Wrench 1/2" DW292**



440 Nm of deliverable torque in forward and reverse  
Higher torque and faster speed increased productivity  
Soft grip handle to reduce vibrations and to enhance user comfort  
Robust design for increased durability

**Standard Equipment:** 1/2 inch ring retainer

|                    |              |
|--------------------|--------------|
| Max Torque         | 440 Nm       |
| Power Input        | 710 Watts    |
| Power Output       | 370 Watts    |
| No Load Speed      | 2200 rpm     |
| Impacts per Minute | 2700 ipm     |
| Max. Bolt Diameter | M20          |
| Bit Holder         | 1/2"         |
| Weight             | 3.2 kg       |
| Length x Height    | 292 x 216 mm |



**Heavy Duty Impact Wrench 3/4" DW294**



440 Nm of deliverable torque in forward and reverse  
Robust 3/4" anvil  
Compact and light weight to reduce user fatigue  
Soft grip handle to reduce vibrations and to enhance user comfort

**Standard Equipment:** 3/4 inch ring retainer

|                    |              |
|--------------------|--------------|
| Max Torque         | 440 Nm       |
| Power Input        | 710 Watts    |
| Power Output       | 370 Watts    |
| No Load Speed      | 2200 rpm     |
| Impacts per Minute | 2700 ipm     |
| Max. Bolt Diameter | M20          |
| Bit Holder         | 3/4"         |
| Weight             | 3.2 kg       |
| Length x Height    | 292 x 216 mm |



**IMPACT SOCKETS**



**DEWALT Extreme Impact Rated sockets provide maximum durability.**

- Manufactured to the highest standards to ensure long life and durability
- Clear, laser etched diameter markings on each socket
- Designed for use with 1/2" drive wrenches, but also comes with 1/4" to 1/2" adaptor

For the complete range of Impact Sockets see page 131

**13 mm Mixer and Rotary Drill D21520**



Variable speed reversing switch offers greater control for a wider range of applications  
550 RPM provides increased torque for heavy duty drilling and mixing  
Robust design and metal gear case for greater durability  
2-position rear spade handle and 3-position side handle gives greater control

**Standard Equipment:** 3-position side handle, 2-position rear handle, Chuck key with holder

|                 |                 |
|-----------------|-----------------|
| Chuck Capacity  | 2.0-13 mm       |
| Spindle Thread  | 5/8" x 16 U.N.F |
| Tool Holder     | Keyed Chuck     |
| Power Input     | 710 Watts       |
| Power Output    | 560 Watts       |
| Max Torque      | 50 Nm           |
| No Load Speed   | 0-550 rpm       |
| Max. Capacity   | 160 mm          |
| Weight          | 3.4 kg          |
| Length x Height | 400 x 215 mm    |



**Mixer with M14 Fitment D21510**



Ideal for mixing viscous materials like paints, mortar, drywall compound, etc.  
Forward operation only  
550 RPM provides increased torque for heavy duty mixing  
Uses mixer baskets up to 160mm (M14 thread)

**Standard Equipment:** 3-position side handle, 2-position rear handle, M14 connector

|                 |                  |
|-----------------|------------------|
| Spindle Thread  | 5/8" x 16 U.N.F. |
| Tool Holder     | M14              |
| Power Input     | 710 Watts        |
| Power Output    | 560 Watts        |
| Max Torque      | 50 Nm            |
| No Load Speed   | 0-550 rpm        |
| Max. Capacity   | 160 mm           |
| Weight          | 3.0 kg           |
| Length x Height | 420 x 215 mm     |



**Heavy Duty Morse Taper (No 2) Mixer and Rotary Drill DW152**



Drilling large holes up to 23 mm diameter in metal  
Two speed and high torque for continuous drilling even through hard materials  
Ergonomic breast plate and two side handles for adjustment of the working position  
No.2 Morse Taper tool holder for heavy duty applications

**Standard Equipment:** 2 side handles, Breast plate, Morse taper-M14 adaptor, Drift key

|                 |                   |
|-----------------|-------------------|
| Tool Holder     | No. 2 morse taper |
| Power Input     | 1050 Watts        |
| Power Output    | 680 Watts         |
| Max Torque      | 118/58 Nm         |
| No Load Speed   | 400/800 rpm       |
| Max. Capacity   | 53 mm             |
| Weight          | 7.5 kg            |
| Length x Height | 435 x 605 mm      |



**650W 13mm Percussion Drill DWD024/ DWD024K/ DWD024S/ DWD024KS\***



Low weight ensures the drill is easy to use and it reduces user fatigue  
Compact design enables comfortable use and allows access to tight spaces  
An excellent power to size ratio results in a powerful, durable drill in a compact size  
Trigger sensitive variable speed switch allows a user to drill slowly for precision accuracy when starting to drill a hole

**Standard Equipment:** Chuck key, Multi-position side handle, Depth stop

|                                   |                 |
|-----------------------------------|-----------------|
| Chuck Capacity                    | 1.5-13 mm       |
| Power Input                       | 650 Watts       |
| Power Output                      | 302 Watts       |
| Max Torque                        | 8.6 Nm          |
| No Load Speed                     | 0-2800 rpm      |
| Blows per Minute                  | 47600 bpm       |
| Max. Drilling Capacity [Wood]     | 25 mm           |
| Max. Drilling Capacity [Steel]    | 13 mm           |
| Max. Drilling Capacity [Concrete] | 16 mm           |
| Spindle Thread                    | 1/2" x 20 U.N.F |
| Weight                            | 1.82 kg         |
| Length x Height                   | 255 x 180 mm    |

\*Available with heavy duty carrying case as K version and with keyless chuck as S version

**701 Watt single speed Percussion Drill D21717K/ D21710KM\***



More powerful for heavy duty applications  
Soft grip to enhance user comfort  
Jampot construction design for added durability and ease of service  
Variable speed control with forward and reverse mode to suit different materials

**Standard Equipment:** keyless chuck, multi-position side handle, depth stop, kitbox

|                                   |                 |
|-----------------------------------|-----------------|
| Chuck Capacity                    | 1.5-13 mm       |
| Power Input                       | 701 Watts       |
| Power Output                      | 360 Watts       |
| Max Torque                        | 12 Nm           |
| No Load Speed                     | 0-2600 rpm      |
| Blows per Minute                  | 0-44200 bpm     |
| Max. Drilling Capacity [Wood]     | 30 mm           |
| Max. Drilling Capacity [Steel]    | 13 mm           |
| Max. Drilling Capacity [Concrete] | 16 mm           |
| Spindle Thread                    | 1/2" x 20 U.N.F |
| Weight                            | 1.8 kg          |
| Length x Height                   | 280 x 185 mm    |

\*D21710KM available with keyed chuck



650 W - 2 Speed Percussion Drill

D21721K / D21720K / D21720\*



Very compact and lightweight to enhance user comfort  
Two speed gearbox for increased torque and more versatility  
Variable speed control with forward and reverse mode to suit different materials  
Dust sealed switch for added durability

**Standard Equipment:** Keyless Chuck, kitbox, multi position side-handle, depth stop

|                                   |                       |
|-----------------------------------|-----------------------|
| Chuck Capacity                    | 1.5-13 mm             |
| Power Input                       | 650 Watts             |
| Power Output                      | 325W Watts            |
| Max Torque                        | 30/12 Nm              |
| No Load Speed                     | 0-1100 / 0-2600 rpm   |
| Blows per Minute                  | 0-19000 / 0-44200 bpm |
| Max. Drilling Capacity [Wood]     | 40/25 mm              |
| Max. Drilling Capacity [Steel]    | 13 mm                 |
| Max. Drilling Capacity [Concrete] | 16 mm                 |
| Spindle Thread                    | 1/2" x20 U.N.F.       |
| Weight                            | 2.1 kg                |
| Length x Height                   | 330 x 199 mm          |

\*Available with heavy duty carrying case as K version and with keyed chuck as D21720



770 W - 2 Speed Percussion Drill

D21805 / D21805K / D21805KS\*



Two speed gearbox for increased torque  
Improved drilling performance due to new motor wind  
Improved ergonomics with new polymer gear case  
New gear design to give improved life

**Standard Equipment:** Keyed chuck, Chuck key, Multi-position side handle, Depth stop

|                                   |                       |
|-----------------------------------|-----------------------|
| Chuck Capacity                    | 1.5-13 mm             |
| Power Input                       | 770 Watts             |
| Power Output                      | 425 Watts             |
| Max Torque                        | 40/20 Nm              |
| No Load Speed                     | 0-1100 / 0-2700 rpm   |
| Blows per Minute                  | 0-18700 / 0-45900 bpm |
| Max. Drilling Capacity [Wood]     | 35 mm                 |
| Max. Drilling Capacity [Steel]    | 13 mm                 |
| Max. Drilling Capacity [Concrete] | 20 mm                 |
| Spindle Thread                    | 1/2" X 20 U.N.F.      |
| Weight                            | 2.3 kg                |
| Length x Height                   | 352 x 199 mm          |

\*Available with heavy duty carrying case as K version and with keyless chuck as S version



950 W - 2 Speed Percussion Drill

DWD522KS



Improved drilling performance from powerful new motor gives improved performance in heavy duty applications  
Innovative mode selection collar allows intuitive control for optimal performance  
Two speed gearbox for increased versatility  
Mechanical clutch increases user control and protection

**Standard Equipment:** multi-position side handle, depth stop, Heavy Duty Carrying Case.

|                                   |                   |
|-----------------------------------|-------------------|
| Chuck Capacity                    | 1.5-13 mm         |
| Power Input                       | 950 Watts         |
| Power Output                      | 415 Watts         |
| Max Torque                        | 40/20 Nm          |
| No Load Speed                     | 0-1250 0-3500 rpm |
| Blows per Minute                  | 0-56000 bpm       |
| Max. Drilling Capacity [Wood]     | 40 mm             |
| Max. Drilling Capacity [Steel]    | 13 mm             |
| Max. Drilling Capacity [Concrete] | 20 mm             |
| Spindle Thread                    | 1/2" X 20 U.N.F.  |
| Weight                            | 2.8 kg            |
| Length x Height                   | 370 x 210 mm      |



1100 W - 2 Speed Pistol Percussion Drill

DWD524KS



Improved drilling performance from powerful new motor gives improved performance in heavy duty applications  
Innovative mode selection collar allows intuitive control for optimal performance  
Two speed gearbox for increased versatility  
Mechanical clutch increases user control and protection

**Standard Equipment:** multi-position side handle, depth stop, Heavy Duty Carrying Case.

|                                   |                   |
|-----------------------------------|-------------------|
| Chuck Capacity                    | 1.5-13 mm         |
| Power Input                       | 1100 Watts        |
| Power Output                      | 540 Watts         |
| Max Torque                        | 40/20 Nm          |
| No Load Speed                     | 0-1200 0-3500 rpm |
| Blows per Minute                  | 0-5600 bpm        |
| Max. Drilling Capacity [Wood]     | 40 mm             |
| Max. Drilling Capacity [Steel]    | 13 mm             |
| Max. Drilling Capacity [Concrete] | 20 mm             |
| Spindle Thread                    | 1/2" X 20 U.N.F.  |
| Weight                            | 2.8 kg            |
| Length x Height                   | 370 x 210 mm      |



EXTREME MASONRY DRILL BITS



**Extreme DEWALT Masonry Drill Bits offer class-leading percussion drilling performance:**

- Last up to 2x longer than a standard masonry bit
- Optimum carbide grade maximizes durability
- Ideal for drilling for anchors, plastic fixings, and pipe-work clearance holes

For the complete range of EXTREME Masonry drill bits see page 105

1100 W - 2 Speed Mid-Handle Percussion Drill

DWD525KS



Improved drilling performance from powerful new motor gives improved performance in heavy duty applications  
Two speed gearbox for increased versatility  
Mechanical clutch increases user control and protection  
Innovative mode selection collar allows intuitive control for optimal performance

**Standard Equipment:** multi-position side handle, depth stop, Heavy Duty Carrying Case.

|                                   |                   |
|-----------------------------------|-------------------|
| Chuck Capacity                    | 1.5-13 mm         |
| Power Input                       | 1100 Watts        |
| Power Output                      | 540 Watts         |
| Max Torque                        | 40/20 Nm          |
| No Load Speed                     | 0-1250 0-3500 rpm |
| Blows per Minute                  | 0-56000 bpm       |
| Max. Drilling Capacity [Wood]     | 40 mm             |
| Max. Drilling Capacity [Steel]    | 13 mm             |
| Max. Drilling Capacity [Concrete] | 20 mm             |
| Spindle Thread                    | 1/2" X 20 U.N.F.  |
| Weight                            | 2.8 kg            |
| Length x Height                   | 345 x 225 mm      |



1300 W - 2 Speed Percussion Drill

DWD530KS



Improved drilling performance from powerful new motor gives improved performance in heavy duty applications  
Two speed gearbox for increased versatility  
Electro-Mechanical clutch increases user control and protection  
Innovative mode selection collar allows intuitive control for optimal performance

**Standard Equipment:** multi-position side handle, depth stop, Heavy Duty Carrying Case.

|                                   |                   |
|-----------------------------------|-------------------|
| Chuck Capacity                    | 1.5-13 mm         |
| Power Input                       | 1300 Watts        |
| Power Output                      | 680 Watts         |
| Max Torque                        | 40/20 Nm          |
| No Load Speed                     | 0-1100 0-2700 rpm |
| Blows per Minute                  | 0-56000 bpm       |
| Max. Drilling Capacity [Wood]     | 40 mm             |
| Max. Drilling Capacity [Steel]    | 13 mm             |
| Max. Drilling Capacity [Concrete] | 20 mm             |
| Spindle Thread                    | 1/2" X 20 U.N.F.  |
| Weight                            | 2.8 kg            |
| Length x Height                   | 370 x 215 mm      |



2 Speed Dry Diamond Drill with 16mm Keyed Chuck

D21570K



New motor gives improved performance in applications with dry core bits up to 127 mm in bricks or soft masonry  
Two speed gearbox for increased versatility when drilling in wood, metal and concrete with standard drill bits  
Heavy duty 16mm keyless steel chuck allows quick bit change whilst offering excellent bit retention  
Innovative mode selection collar allows intuitive control for optimal performance

**Standard Equipment:** Multi-Position side handle, Depth Stop, Heavy Duty Carrying Case

|                                  |                   |
|----------------------------------|-------------------|
| Spindle Thread                   | 1/2" X 20 U.N.F.  |
| Power Input                      | 1300 Watts        |
| Power Output                     | 680 Watts         |
| No Load Speed                    | 0-1100 0-2700 rpm |
| Max. Drilling Capacity [Masonry] | 100 mm            |
| Weight                           | 2.4 kg            |
| Length x Height                  | 352 x 215 mm      |



10mm 0-2800rpm Rotary Drill

DWD014 / DWD014S\*



Compact design enables comfortable one handed use and allows access to tight spaces  
Low weight ensures the drill is easy to use and it reduces user fatigue  
Variable speed dial switch ensures control to suit different hole sizes in different materials  
Trigger sensitive variable speed switch allows a user to drill slowly for precision accuracy when starting to drill a hole

**Standard Equipment:** Chuck key

|                                |                  |
|--------------------------------|------------------|
| Chuck Capacity                 | 1.0-10 mm        |
| Power Input                    | 550 Watts        |
| Power Output                   | 269 Watts        |
| Max Torque                     | 7.9 Nm           |
| No Load Speed                  | 0-2800 rpm       |
| Max. Drilling Capacity [Wood]  | 25 mm            |
| Max. Drilling Capacity [Steel] | 10 mm            |
| Spindle Thread                 | 1/2" X 20 U.N.F. |
| Weight                         | 1.34 kg          |
| Length x Height                | 225 x 170 mm     |

\*Available with keyless chuck as S version



10 mm Rotary Drill with Keyed Chuck

DWD 112 / DWD 112S\*



Rubber grip gives maximum comfort to the user while drilling  
Ideal for use in a woodworking or light metal fabrication workshop to drill small holes into wood or sheet metal  
Size, balance and weight designed for one handed operation  
Variable speed switch control to suit different materials

|                                |                  |
|--------------------------------|------------------|
| Chuck Capacity                 | 1.0-10 mm        |
| Power Input                    | 701 Watts        |
| Power Output                   | 358 Watts        |
| Max Torque                     | 10.9 Nm          |
| No Load Speed                  | 0-2500 rpm       |
| Max. Drilling Capacity [Wood]  | 25 mm            |
| Max. Drilling Capacity [Steel] | 10 mm            |
| Spindle Thread                 | 1/2" X 20 U.N.F. |
| Weight                         | 1.8 kg           |
| Length x Height                | 230 x 190 mm     |

\*Available with keyless chuck as S version



**10 mm Mid-Handle Rotary Drill DWD115KS**



Rubber grip gives maximum comfort to the user while drilling  
Ideal for use in a woodworking or light metal-fabrication workshop to drill small holes into wood or sheet metal  
All metal 10 mm keyless chuck for quick and easy bit change  
Well balanced mid-handle design similar to a cordless drill

**Standard Equipment:** Kitbox

|                                |                 |
|--------------------------------|-----------------|
| Chuck Capacity                 | 1.0-10 mm       |
| Power Input                    | 701 Watts       |
| Power Output                   | 358 Watts       |
| Max Torque                     | 10.9 Nm         |
| No Load Speed                  | 0-2500 rpm      |
| Max. Drilling Capacity [Wood]  | 25 mm           |
| Max. Drilling Capacity [Steel] | 10 mm           |
| Spindle Thread                 | 1/2" x 20 U.N.F |
| Weight                         | 1.9 kg          |
| Length x Height                | 230 x 190 mm    |



**High Speed Rotary Drill DW217**



Ideal for high speed drilling of small, precise holes in metal or wood  
High overload capacity motor prevents failure in heavy duty applications  
10 mm keyless chuck for quick and easy bit change with one hand to aid productivity  
Heavy duty metal gear box for added durability

**Standard Equipment:** None

|                                |                 |
|--------------------------------|-----------------|
| Chuck Capacity                 | 0.5-10 mm       |
| Power Input                    | 675 Watts       |
| Power Output                   | 340 Watts       |
| Max Torque                     | 8.2 Nm          |
| No Load Speed                  | 0-4000 rpm      |
| Max. Drilling Capacity [Wood]  | 20 mm           |
| Max. Drilling Capacity [Steel] | 8 mm            |
| Spindle Thread                 | 3/8" x 24 U.N.F |
| Weight                         | 1.2 kg          |
| Length x Height                | 247 x 177 mm    |



**Rotary Drill DW221**



Ideal for drilling applications in wood, aluminium, soft steel and alloys  
High overload capacity motor prevents failure in heavy duty applications  
10 mm keyless chuck with innovative spindle lock system for quick and easy bit change with one hand to aid productivity  
Heavy duty metal gear box for added durability

**Standard Equipment:** None

|                                |                 |
|--------------------------------|-----------------|
| Chuck Capacity                 | 1.5-10 mm       |
| Power Input                    | 701 Watts       |
| Power Output                   | 385 Watts       |
| Max Torque                     | 13.8 Nm         |
| No Load Speed                  | 0-2500 rpm      |
| Max. Drilling Capacity [Wood]  | 25 mm           |
| Max. Drilling Capacity [Steel] | 10 mm           |
| Spindle Thread                 | 1/2" x 20 U.N.F |
| Weight                         | 1.3 kg          |
| Length x Height                | 275 x 190 mm    |



**Rotary Drill for Stainless Steel DW236i**



Ideal for drilling large holes in stainless steel  
High overload capacity motor prevents failure in heavy duty applications  
13 mm keyless chuck with innovative spindle lock system for quick and easy bit change with one hand to aid productivity  
Heavy duty metal gear box for added durability

**Standard Equipment:** Multi-position side handle, 6 piece cobalt drill bit set

|                                |                 |
|--------------------------------|-----------------|
| Chuck Capacity                 | 1.5-13 mm       |
| Power Input                    | 701 Watts       |
| Power Output                   | 385 Watts       |
| Max Torque                     | 35.8 Nm         |
| No Load Speed                  | 0-850 rpm       |
| Max. Drilling Capacity [Wood]  | 30 mm           |
| Max. Drilling Capacity [Steel] | 13 mm           |
| Spindle Thread                 | 1/2" x 20 U.N.F |
| Weight                         | 1.6 kg          |
| Length x Height                | 295 x 198 mm    |



**770 W - 2 Speed Rotary Drill with Clutch D21441**



Ideal for use in heavy steel fabrication  
Two speed gearbox for increased torque  
Improved drilling performance due to new motor wind  
New patented ball clutch to give greater user control

**Standard Equipment:** Multi-position side handle, Depth stop

|                                |                     |
|--------------------------------|---------------------|
| Chuck Capacity                 | 1.5-13 mm           |
| Power Input                    | 770 Watts           |
| Power Output                   | 425 Watts           |
| Max Torque                     | 40/20 Nm            |
| No Load Speed                  | 0-1100 / 0-2700 rpm |
| Max. Drilling Capacity [Wood]  | 35 mm               |
| Max. Drilling Capacity [Steel] | 13 mm               |
| Spindle Thread                 | 1/2" x 20 U.N.F     |
| Weight                         | 2.2 kg              |
| Length x Height                | 352 x 199 mm        |



**High Torque Rotary Drill DW246**



Ideal for use in steel fabrication and construction industry  
High overload capacity motor prevents failure in heavy duty applications  
13 mm keyless chuck with innovative spindle lock system for quick and easy bit change with one hand to aid productivity  
High torque for easy conversion to light duty mixer supported by a triple gear reduction

**Standard Equipment:** Multi-position side handle

|                                |                 |
|--------------------------------|-----------------|
| Chuck Capacity                 | 1.5-13 mm       |
| Power Input                    | 701 Watts       |
| Power Output                   | 385 Watts       |
| Max Torque                     | 57.3 Nm         |
| No Load Speed                  | 0-600 rpm       |
| Max. Drilling Capacity [Wood]  | 35 mm           |
| Max. Drilling Capacity [Steel] | 13 mm           |
| Spindle Thread                 | 1/2" x 20 U.N.F |
| Weight                         | 1.6 kg          |
| Length x Height                | 310 x 195 mm    |



**Low Speed Electronic Rotary Drill DWD221**



Ideal for use in steel fabrication and construction industry  
High overload capacity motor prevents failure in heavy duty applications  
13 mm keyless chuck with innovative spindle lock system for quick and easy bit change with one hand to aid productivity  
e-clutch feature automatically switches off the unit in case of jammed drill bits to prevent motor overload and increase user protection

**Standard Equipment:** Multi-position side handle

|                                |                 |
|--------------------------------|-----------------|
| Chuck Capacity                 | 1.5-13 mm       |
| Power Input                    | 800 Watts       |
| Power Output                   | 385 Watts       |
| Max Torque                     | 57.3 Nm         |
| No Load Speed                  | 0-650 rpm       |
| Max. Drilling Capacity [Wood]  | 38 mm           |
| Max. Drilling Capacity [Steel] | 13 mm           |
| Spindle Thread                 | 1/2" x 20 U.N.F |
| Weight                         | 2.3 kg          |
| Length x Height                | 310 x 215 mm    |



**10 mm Right Angle Rotary Drill D21160\***



Ideal for working in tight or narrow spaces  
Compact and lightweight design for easy handling  
The full body paddle switch supports the natural shape of your hand and ensures less user fatigue for prolonged use  
High torque to enable larger diameter hole drilling

**Standard Equipment:** Chuck keys

|                                |                 |
|--------------------------------|-----------------|
| Chuck Capacity                 | 1.0-10 mm       |
| Power Input                    | 350 Watts       |
| Power Output                   | 180 Watts       |
| Max Torque                     | 9.2 Nm          |
| No Load Speed                  | 0-1200 rpm      |
| Max. Drilling Capacity [Wood]  | 20 mm           |
| Max. Drilling Capacity [Steel] | 10 mm           |
| Spindle Thread                 | 3/8" x 24 U.N.F |
| Weight                         | 1.7 kg          |
| Length x Height                | 262 x 50 mm     |

\*230V only

**2 Speed Magnetic Drill Press - 50 mm D21620K**



Delivers high level of performance for fast, clean and accurate drilling into steel  
Compact and light weight unit which is both easy to transport and easy to position for drilling.  
The universal quick release cutter holder is quick and easy to operate : no Allen key needed. It accepts any annular cutter with 19 mm round shank (Weldon) with one or more flats.  
No volt switch prevents inadvertent restart after power failure

**Standard Equipment:** Quick release cutter holder, Gravity fed cutting fluid tank, Reversible press handle, Drilling guard, Safety strap, Heavy duty carrying case

|                                   |                          |
|-----------------------------------|--------------------------|
| Power Input                       | 1150 Watts               |
| Spindle Thread                    | 1/2" x 20 UNF            |
| No Load Speed                     | 350/650 rpm              |
| Cutter holder                     | 19mm Weldon shank (3/4") |
| Max cutting depth with cutters    | 50 mm                    |
| Max cutting diameter with cutters | 50 mm                    |
| Drill point pressure              | 317 Kg                   |
| Clamping force                    | 10000 N                  |
| Length of drill stroke            | 147 mm                   |
| Weight                            | 13 kg                    |
| Magnetic base dimensions          | 180 x 84 mm              |



**HSS-G JOBBER METAL DRILL BITS**



**DEWALT HSS-G Jobber Metal Drill Bits offer rapid drilling, long life and excellent hole concentricity.**

- Precision ground from solid stock to 118 degree point angle
- Diameter tolerance to h8
- Suitable for portable or stationary drilling in steel cast steel, alloyed and non-alloyed, grey cast iron etc... up to 900N/mm<sup>2</sup>

For the complete range of HSS-G JOBBER metal drill bits see pages 117/118

**DRY**

Do you drill only into soft materials such as bricks, Poroton blocks, light breezeblock or limestone?

You need a Dry Drilling System

NO  
See below

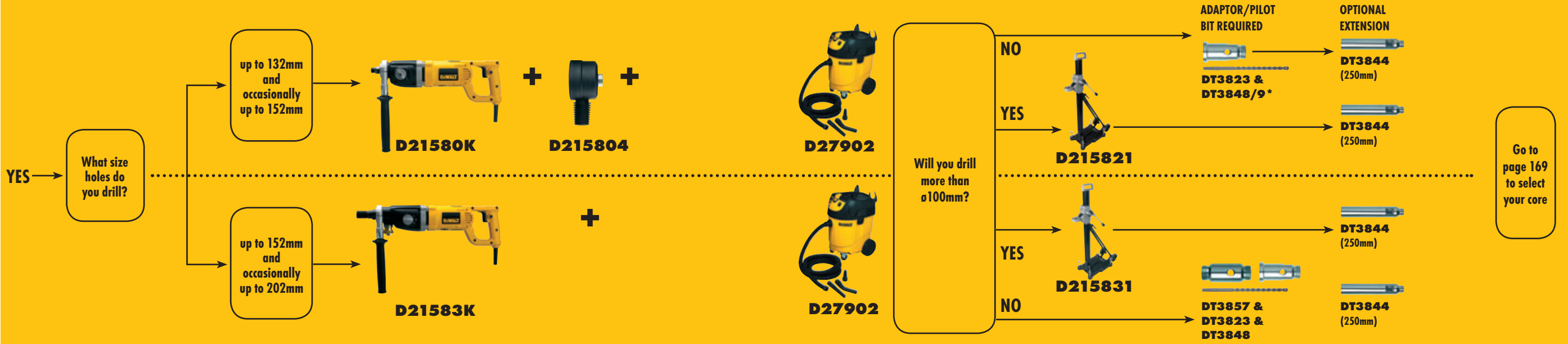

\*Longer pilot drill bit (DT3849) required when using D215804 dust extraction adaptor

Go to page 169 to select your core

**WET**

Do you drill into hard materials such as reinforced concrete, natural stones or engineering bricks?

You need a Wet Drilling System

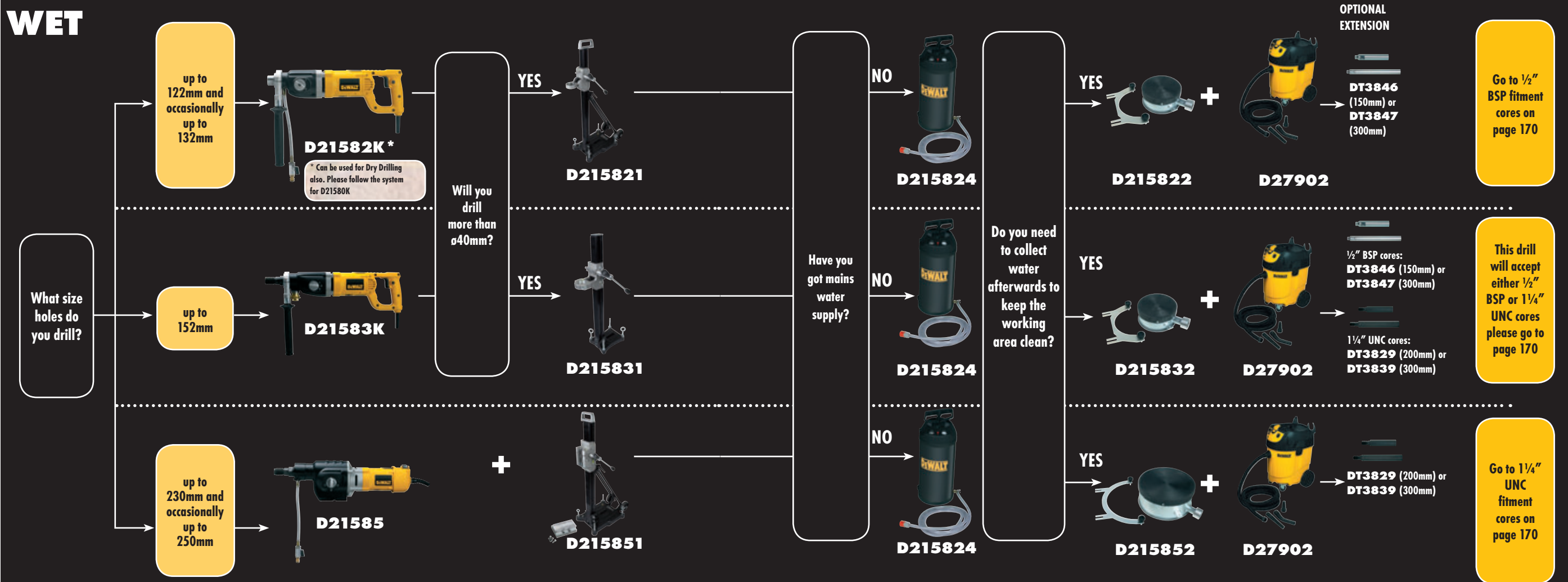

Go to 1/2" BSP fitment cores on page 170

This drill will accept either 1/2" BSP or 1 1/4" UNC cores please go to page 170

Go to 1 1/4" UNC fitment cores on page 170



**1705 W - 2 Speed Dry Diamond Drill D21580K**



Ideal tool for electrical, plumbing or HVAC applications when drilling only into masonry and bricks  
Quick and accurate core drilling into brick and masonry up to 152 mm  
Increased power makes the job easier and faster  
Overload and thermal protection increase the life of the tool

**Standard Equipment:** Multi-position side handle, Heavy duty carrying case

|                                  |                   |
|----------------------------------|-------------------|
| Spindle Thread                   | 1/2" Male BSP     |
| Power Input                      | 1705 Watts        |
| Power Output                     | 1150 Watts        |
| No Load Speed                    | 0-1100/0-2350 rpm |
| Max. Drilling Capacity [Masonry] | 152 mm            |
| Collar Diameter                  | 53 mm             |
| Weight                           | 5.4 kg            |
| Length x Height                  | 480 x 165 mm      |



**1705 W - 2 Speed Wet & Dry Diamond Drill D21582K\***



Ideal tool for electrical, plumbing or HVAC applications when drilling into masonry and concrete  
Quick and accurate dry drilling into bricks and masonry up to 152 mm  
Integrated water swivel for core drilling into harder material up to 132 mm such as natural stone, concrete, engineering bricks and reinforced concrete  
Increased power makes the job easier and faster

**Standard Equipment:** Multi-Position side handle, PRCD (in-line circuit breaker), Water supply hose with integrated tap, Heavy duty carrying case

|                                   |                     |
|-----------------------------------|---------------------|
| Spindle Thread                    | 1/2" Female BSP     |
| Power Input                       | 1705 Watts          |
| Power Output                      | 1150 Watts          |
| No Load Speed                     | 0-1100 / 0-2350 rpm |
| Max. Drilling Capacity [Concrete] | 132 mm              |
| Max. Drilling Capacity [Masonry]  | 152 mm              |
| Collar Diameter                   | 53 mm               |
| Weight                            | 5.9 kg              |
| Length x Height                   | 480 x 165 mm        |

\*110V only



**1910 W - Heavy Duty 3 Speed Wet & Dry Diamond Drill D21583K\***



Ideal tool for heavy duty electrical, plumbing or HVAC applications when drilling predominantly into concrete  
Integrated water swivel for core drilling into the hardest material up to 152 mm such as natural stone, concrete, engineering brick and reinforced concrete  
Quick and accurate core drilling into brick and masonry up to 202 mm  
When dry drilling, a dust extractor can be plugged directly onto the drill to increase drilling performance

**Standard Equipment:** Multi-position side handle, PRCD (in-line circuit breaker), Connector for water supply, Connector for dust extraction, Heavy duty carrying case

|                                   |                                   |
|-----------------------------------|-----------------------------------|
| Spindle Thread                    | 1 1/4" Male UNC & 1/2" Female BSP |
| Power Input                       | 1910 Watts                        |
| Power Output                      | 1300 Watts                        |
| No Load Speed                     | 0-1000 / 0-2400 / 0-4600 rpm      |
| Max. Drilling Capacity [Concrete] | 152 mm                            |
| Max. Drilling Capacity [Masonry]  | 202 mm                            |
| Collar Diameter                   | 60 mm                             |
| Weight                            | 6.4 kg                            |
| Length x Height                   | 550 x 165 mm                      |

\*110V only



**2500 W - Heavy Duty 3 Speed Wet Diamond Drilling Motor D21585**



Ideal tool for heavy duty electrical, plumbing, HVAC or general construction applications when drilling into concrete  
Integrated water swivel for core drilling into any material up to 250 mm  
High powered motor delivers best in class performance for frequent Heavy duty drilling  
3 Mechanical speeds deliver optimum drilling speed

**Standard Equipment:** PRCD (in-line circuit breaker), Water supply hose with integrated tap

|                                   |                       |
|-----------------------------------|-----------------------|
| Spindle Thread                    | 1 1/4" Male UNC       |
| Power Input                       | 2500 Watts            |
| Power Output                      | 1500 Watts            |
| No Load Speed                     | 500 / 1200 / 2000 rpm |
| Max. Drilling Capacity [Concrete] | 250 mm                |
| Max. Drilling Capacity [Masonry]  | 300 mm                |
| Collar Diameter                   | N/A mm                |
| Weight                            | 11.2 kg               |
| Length x Height                   | 570 x 160 mm          |



**Small Drilling Stand - 53 mm Collar D215821**



Ideal for occasional drilling of large holes into concrete or masonry  
Small and compact for easy transport to the job site  
Smooth sliding carriage delivers best in class drilling accuracy  
Reversible press handle offers tool-free handle set-up

|   |        |
|---|--------|
| Column Length                                 | 680 mm |
| Collar Diameter                               | 53 mm  |
| Max Drilling Diameter with Water Collector    | 102 mm |
| Max Drilling Diameter without Water Collector | 152 mm |
| Weight  | 7 kg   |

**Medium Drilling Stand with integrated vacuum base - 60 mm Collar D215831**



For heavy duty drilling into masonry and concrete  
Quick release tool holder allows a quick set up on the jobsite  
Support brackets increase the rigidity of the column  
Integrated vacuum base for an even quicker set up (vacuum pump required)

|   |        |
|---|--------|
| Column Length                                 | 995 mm |
| Collar Diameter                               | 60 mm  |
| Max Drilling Diameter with Water Collector    | 152 mm |
| Max Drilling Diameter without Water Collector | 172 mm |
| Inclinable                                    | 45 °   |
| Weight  | 16 kg  |

**Stand for Drilling Motor (D21585) D215851**



For heavy duty drilling into masonry and concrete with D21585 drilling motor  
Large base delivers higher stability and improved drilling accuracy  
Integrated vacuum base for an even quicker set up (vacuum pump required)  
Support brackets increase the rigidity of the column

|   |        |
|---|--------|
| Column Length                                 | 995 mm |
| Collar Diameter                               | N/A mm |
| Max Drilling Diameter with Water Collector    | 250 mm |
| Max Drilling Diameter without Water Collector | 300 mm |
| Inclinable                                    | 45 °   |
| Weight  | 22 kg  |

**250mm Slide Table Wet Tile Saw & Leg Stand D240005**



Stainless steel rail system is intergrated into the tile saw frame, ensuring accurate cuts  
Cantilevering rail / cart system allows for 610 mm ripping capacity  
Low weight allows one person to transport and set up saw  
Plunge feature allows the user to make quick plunge cuts for electrical outlets together with an intergrated 45 / 22.5 degree feature for quick angle cuts

**Standard Equipment:** D240001 leg stand, DT3734 cutting disc, Extension table, Side and rear water collector, Hex key

|                |              |
|----------------|--------------|
| Power Input    | 1600 Watts   |
| Wheel Diameter | 250 mm       |
| No Load Speed  | 4200 rpm     |
| Depth of cut   | 95 mm        |
| Width x Length | 690 x 860 mm |
| Weight         | 32 kg        |



**110 mm Hand Held Wet Tile Saw DWC410\***



1300 W motor delivers the cutting power to cut through granite, porcelain, concrete and other stone materials  
Premium 110 mm diameter continuous rim blade allows the user to cut a variety of different materials from ceramics to concrete up to 34 mm deep - wet or dry  
Water line and adjustable nozzle feeds water to the blade decreasing dust and increasing blade performance and life  
Bevels to 45 degrees for quick angled cuts

**Standard Equipment:** 110 mm wet / dry continuous rim diamond blade, Water feed line, Tools for blade change

|                 |              |
|-----------------|--------------|
| Power Input     | 1300 Watts   |
| Power Output    | 800 Watts    |
| Wheel Diameter  | 110 mm       |
| No Load Speed   | 13000 rpm    |
| Depth of cut    | 34 mm        |
| Length x Height | 252 x 166 mm |
| Weight          | 3.0 kg       |



\*For information on Diamond Blades - see page 168

**Mechanical Anchoring for Diamond Drill Stands Vacuum Pump and Attachments for Diamond Drills Diamond Drill Attachments**



| Cat. No. | Description                    | Fits                        |
|----------|--------------------------------|-----------------------------|
| D215825  | Fastening set for concrete     | D215821 / D215831 / D215851 |
| D215826  | Fastening set for masonry      | D215821 / D215831 / D215851 |
| D215827  | 10 x spare dowels for concrete | D215825                     |
| D215828  | Spare dowel for masonry        | D215826                     |



| Cat. No. | Description                 | Fits              |
|----------|-----------------------------|-------------------|
| D215837  | Vacuum pump                 | D215831 / D215851 |
| D215838  | Spare 3 m vacuum hose       | D215837           |
| D215839  | Vacuum set (seal and valve) | D215831           |
| D215859  | Vacuum set (seal and valve) | D215851           |



| Cat. No. | Description                        | Fits                        |
|----------|------------------------------------|-----------------------------|
| D215834  | Reduction ring 60 to 53 mm collar  | D215831                     |
| D215835  | Quick action bracing bracket       | D215821 / D215831 / D215851 |
| D215854  | 5 Copper ring for 1 1/4" core bits | D21583K / D21585            |

22 mm SDS-Plus Rotary Hammer

D25012K/ D25012N



Drilling 4-22mm diameter anchor holes into concrete and masonry  
Impact stop for drilling in wood, steel, plastic and screwdriving applications  
Variable speed switch and full power in forward and reverse for total control  
Very compact design and low weight

**Standard Equipment:** Multi-position side handle, Depth stop, Heavy duty carrying case

|                                   |              |
|-----------------------------------|--------------|
| Power Input                       | 650 Watts    |
| Power Output                      | 300 Watts    |
| No Load Speed                     | 0-1550 rpm   |
| Blows per Minute                  | 0-4150 bpm   |
| Impact Energy                     | 0-2.4 J      |
| Tool Holder                       | SDS-Plus     |
| Max. Drilling Capacity [Wood]     | 30 mm        |
| Max. Drilling Capacity [Metal]    | 13 mm        |
| Max. Drilling Capacity [Concrete] | 22 mm        |
| Max. Drilling Capacity [Core bit] | 50 mm        |
| Weight                            | 2.3 kg       |
| Length x Height                   | 325 x 210 mm |



22 mm SDS-Plus Combination Hammer

D25013K/ D25013C/ D25013N\*



Drilling 4-22mm diameter anchor holes into concrete and masonry...  
Impact stop for drilling in wood, steel, plastic and screwdriving applications  
Rotation stop for light chiselling in concrete and masonry  
Variable speed switch and full power in forward and reverse for total control

**Standard Equipment:** Multi-position side handle, Depth stop, Heavy duty carrying case

|                                   |              |
|-----------------------------------|--------------|
| Power Input                       | 650 Watts    |
| Power Output                      | 300 Watts    |
| No Load Speed                     | 0-1550 rpm   |
| Blows per Minute                  | 0-4550 bpm   |
| Impact Energy                     | 0-2.4 J      |
| Tool Holder                       | SDS-Plus     |
| Max. Drilling Capacity [Wood]     | 30 mm        |
| Max. Drilling Capacity [Metal]    | 13 mm        |
| Max. Drilling Capacity [Concrete] | 22 mm        |
| Max. Drilling Capacity [Core bit] | 50 mm        |
| Weight                            | 2.3 kg       |
| Length x Height                   | 325 x 210 mm |

\*Available with 3 jaws keyed chuck and SDS-Plus adaptor as C version



26mm Heavy Duty SDS-Plus Combination Hammer

D25123K



Ideal for drilling anchor and fixing holes into concrete and masonry from 4 to 26 mm in diameter  
Impact-stop for drilling in wood, steel, ceramic and screwdriving applications  
Rotation-stop for light chiselling applications in brick, soft masonry and occasionally concrete  
Large 22 mm hammer mechanism delivers high performance with low stress to the critical components resulting in better durability

**Standard Equipment:** Multi position side handle, Depth stop, Heavy duty carrying case

|                                   |              |
|-----------------------------------|--------------|
| Power Input                       | 800 Watts    |
| Power Output                      | 395 Watts    |
| No Load Speed                     | 0-1150 rpm   |
| Blows per Minute                  | 0-4300 bpm   |
| Impact Energy                     | 0-3.4 J      |
| Tool Holder                       | SDS-Plus     |
| Max. Drilling Capacity [Wood]     | 30 mm        |
| Max. Drilling Capacity [Metal]    | 13 mm        |
| Max. Drilling Capacity [Concrete] | 26 mm        |
| Max. Drilling Capacity [Core bit] | 65 mm        |
| Weight                            | 2.9 kg       |
| Length x Height                   | 352 x 200 mm |



26mm Heavy Duty SDS-Plus Combination Hammer with Quick Change Chuck

D25124K



Ideal for drilling anchor and fixing holes into concrete and masonry from 4 to 26 mm in diameter  
Rotation-stop for light chiselling applications in brick, soft masonry and occasionally concrete  
Impact-stop and Quick Change Removable Chuck for drilling in wood, steel, ceramic and screwdriving applications  
Large 22 mm hammer mechanism delivers high performance with low stress to the critical components resulting in better durability

**Standard Equipment:** "Quick Change" 13 mm 3-jaw keyless chuck, Multi-Position side handle, Depth stop, Heavy duty carrying case

|                                   |              |
|-----------------------------------|--------------|
| Power Input                       | 800 Watts    |
| Power Output                      | 395 Watts    |
| No Load Speed                     | 0-1150 rpm   |
| Blows per Minute                  | 0-4300 bpm   |
| Impact Energy                     | 0-3.4 J      |
| Tool Holder                       | SDS-Plus     |
| Max. Drilling Capacity [Wood]     | 30 mm        |
| Max. Drilling Capacity [Metal]    | 13 mm        |
| Max. Drilling Capacity [Concrete] | 26 mm        |
| Max. Drilling Capacity [Core bit] | 65 mm        |
| Weight                            | 2.9 kg       |
| Length x Height                   | 352 x 200 mm |



26mm SDS-Plus Combination Hammer D-Handle Low Vibration

D25223K



Ideal for drilling holes and fixing anchors into concrete and masonry from 4 to 26 mm in diameter  
The "D-handle" design makes it particularly suitable for vertical down drilling  
Active Vibration Control system with floating handle delivers extremely low vibration and more comfort  
Rotation-stop for light chiselling applications in soft masonry and occasionally concrete and impact-stop for drilling in wood, steel and screwdriving applications

**Standard Equipment:** Multi-position side handle, Depth stop, Heavy duty carrying case

|                                   |              |
|-----------------------------------|--------------|
| Power Input                       | 800 Watts    |
| Power Output                      | 395 Watts    |
| No Load Speed                     | 0-1150 rpm   |
| Blows per Minute                  | 0-4300 bpm   |
| Tool Holder                       | SDS-Plus     |
| Max. Drilling Capacity [Wood]     | 30 mm        |
| Max. Drilling Capacity [Metal]    | 13 mm        |
| Max. Drilling Capacity [Concrete] | 26 mm        |
| Max. Drilling Capacity [Core bit] | 65 mm        |
| Weight                            | 3.2 kg       |
| Length x Height                   | 450 x 200 mm |



For more information on vibration and to calculate the vibration exposure from your power tool visit: [www.Dewalt.ae/en/safety/vibration/calculator](http://www.Dewalt.ae/en/safety/vibration/calculator)

26mm L-Shape SDS-Plus Combination Hammer Low Vibration

D25323K/ D25313K\*



Ideal for drilling holes and fixing anchors into concrete and masonry from 4 to 26 mm in diameter  
Active Vibration Control system with floating handle delivers extremely low vibration and more comfort  
Rotation-stop for light chiselling applications in soft masonry and occasionally concrete and impact-stop for drilling in wood, steel and screwdriving applications  
Large 22 mm hammer mechanism delivers high performance with low stress to the critical components

**Standard Equipment:** Multi-position side handle, Depth stop, Heavy duty carrying case

|                                   |              |
|-----------------------------------|--------------|
| Power Input                       | 800 Watts    |
| Power Output                      | 395 Watts    |
| No Load Speed                     | 0-1150 rpm   |
| Blows per Minute                  | 0-4300 bpm   |
| Impact Energy                     | 0-3.4 J      |
| Tool Holder                       | SDS-Plus     |
| Max. Drilling Capacity [Wood]     | 30 mm        |
| Max. Drilling Capacity [Metal]    | 13 mm        |
| Max. Drilling Capacity [Concrete] | 26 mm        |
| Max. Drilling Capacity [Core bit] | 65 mm        |
| Weight                            | 3.4 kg       |
| Length x Height                   | 314 x 225 mm |

\*D25313K available without anti-vibration features



26mm L-Shape SDS-Plus Combination Hammer with 3 jaw Quick Change Chuck Low Vibration

D25324K



Ideal for drilling holes and fixing anchors into concrete and masonry from 4 to 26 mm in diameter  
Active Vibration Control system with floating handle delivers extremely low vibration and more comfort  
Rotation-stop for light chiselling applications in soft masonry and occasionally concrete  
Impact stop and Quick Change Removable Chuck for precise drilling in wood and steel and screwdriving applications

**Standard Equipment:** Multi position side handle, Quick Adjustment depth stop, Quick Change 13 mm 3 Jaw Keyless Chuck for rotary drilling, Heavy duty carrying case

|                                   |              |
|-----------------------------------|--------------|
| Power Input                       | 800 Watts    |
| Power Output                      | 395 Watts    |
| No Load Speed                     | 0-1150 rpm   |
| Blows per Minute                  | 0-4300 bpm   |
| Impact Energy                     | 0-3.4 J      |
| Tool Holder                       | SDS-Plus     |
| Max. Drilling Capacity [Wood]     | 30 mm        |
| Max. Drilling Capacity [Metal]    | 13 mm        |
| Max. Drilling Capacity [Concrete] | 26 mm        |
| Max. Drilling Capacity [Core bit] | 65 mm        |
| Weight                            | 3.5 kg       |
| Length x Height                   | 329 x 225 mm |



26mm L-Shape SDS-Plus Combination Hammer Integrated Dust Extraction Low Vibration

D25325K



Ideal for drilling holes and fixing anchors into concrete and masonry from 4 to 26 mm in diameter, and up to 16 mm with Dust Extraction System  
Rotation-stop for light chiselling in soft masonry and occasionally concrete and Impact-stop with Quick Change Removal Chuck for precise drilling in wood, steel and screwdriving applications  
Active Vibration Control system with floating handle delivers extremely low vibration  
Hepa filter improves dust filtering ensuring minimum dust levels emitted into atmosphere

**Standard Equipment:** Integrated dust extraction system with Hepa filter, Multi position side handle, Quick adjustment depth stop, Quick change 13 mm 3 jaw keyless chuck for rotary drilling, Heavy duty carrying case

|                                   |              |
|-----------------------------------|--------------|
| Power Input                       | 800 Watts    |
| Power Output                      | 395 Watts    |
| No Load Speed                     | 0-1150 rpm   |
| Blows per Minute                  | 0-4300 bpm   |
| Impact Energy                     | 0-3.4 J      |
| Tool Holder                       | SDS-Plus     |
| Max. Drilling Capacity [Wood]     | 30 mm        |
| Max. Drilling Capacity [Metal]    | 13 mm        |
| Max. Drilling Capacity [Concrete] | 26 mm        |
| Max. Drilling Capacity [Core bit] | 65 mm        |
| Weight                            | 5.1 kg       |
| Length x Height                   | 462 x 291 mm |



SDS-Plus Dust Extraction Telescope

D25301D\*



For use with DEWALT corded and cordless SDS-Plus hammers  
Ideal for dust free drilling up to 16 mm in diameter  
Quick-fit system for easy tool free assembly and release  
Tough and versatile to meet the needs of the most demanding applications with a compact design to maintain visibility and extremely light weight to minimise user fatigue

**Standard Equipment:** Side handle with dust extraction adaptation, Telescope and extraction head, Rubber hose, 43mm adaptor, Carton box

|                         |                              |
|-------------------------|------------------------------|
| Fits                    | Corded and Cordless SDS-Plus |
| Collar Diameter         | 43 / 54 mm                   |
| Max. Drill Bit Diameter | 16 mm                        |
| Max. Drill Bit Length   | 224 mm                       |
| Max. Drilling Depth     | 150 mm                       |
| Hose Length             | 1500 mm                      |
| Hose Diameter           | 35 mm                        |
| Weight                  | 1.2 kg                       |

\*For dust extraction vacuums see page 102

XLR ACCESSORIES



Our ultimate SDS-Plus Concrete drilling solution

- SOLID CARBIDE head provides long life and extreme durability
- 4 cutter tip geometry provides cleaner, more concentric holes for supreme fixing retention
- 4 flute spiral gives optimum debris removal - for the hardest hitting hammers

For the complete range of XLR drill bits see page 109

For more information on vibration and to calculate the vibration exposure from your power tool visit: [www.Dewalt.ae/en/safety/vibration/calculator](http://www.Dewalt.ae/en/safety/vibration/calculator)



**32 mm Heavy Duty SDS-Plus Combination Hammer**

**D25404K**



Ideal for drilling large anchor, fixing and through holes in concrete and masonry from 6 to 32 mm in diameter  
Rotation-stop for light chiselling applications, render and tile removal  
Impact-stop for drilling in wood, ceramic, steel and screwdriving applications  
Large hammer mechanism construction guarantees longer tool life and superior performance

**Standard Equipment:** Quick release removable tool holder, Multi-position side handle, Heavy duty carrying case

|                                   |              |
|-----------------------------------|--------------|
| Power Input                       | 900 Watts    |
| Power Output                      | 550 Watts    |
| No Load Speed                     | 0-730 rpm    |
| Blows per Minute                  | 0-4100 bpm   |
| Impact Energy                     | 0-4.8 J      |
| Tool Holder                       | SDS-Plus     |
| Max. Drilling Capacity [Wood]     | 40 mm        |
| Max. Drilling Capacity [Metal]    | 16 mm        |
| Max. Drilling Capacity [Concrete] | 6-32 mm      |
| Max. Drilling Capacity [Core bit] | 90 mm        |
| Weight                            | 4.9 kg       |
| Length x Height                   | 385 x 230 mm |



**32mm Heavy Duty SDS-Plus Combination Hammer QCC and Accessory Pack**

**D25405K**



Ideal for drilling large anchor, fixing and through holes in concrete and masonry from 6 to 32mm in diameter  
Rotation-stop for light chiselling applications, render and tile removal  
Impact-stop for drilling in wood, ceramic, steel and screwdriving application  
Large hammer mechanism construction guarantees longer tool life and superior performance

**Standard Equipment:** heavy duty carrying case, multi-position side handle, quick release removable tool holder, quick change 3 jaw chuck, 2 x SDS-Plus drill bits, 20mm flat SDS-Plus chisel, 4 x HSS drill bits, 4 x brad point wood drill bits, 20mm flatwood drill bit, 25mm flatwood drill bit, toughcase accessory organiser, safety glasses, workgloves

|                                   |            |
|-----------------------------------|------------|
| Power Input                       | 900 Watts  |
| Power Output                      | 550 Watts  |
| No Load Speed                     | 0-730 rpm  |
| Blows per Minute                  | 0-4100 bpm |
| Impact Energy                     | 0-4.8 J    |
| Tool Holder                       | SDS-Plus   |
| Max. Drilling Capacity [Wood]     | 40 mm      |
| Max. Drilling Capacity [Metal]    | 16 mm      |
| Max. Drilling Capacity [Concrete] | 6-32 mm    |
| Max. Drilling Capacity [Core bit] | 90 mm      |
| Weight                            | 4.9 kg     |
| Length x Height                   | 385 x . mm |



**40 mm SDS-Max Combination Hammer**

**D25501K**



Ideal for drilling anchor fixing and through holes in concrete and masonry from 12 to 40 mm in diameter. Core drilling up to 90 mm  
Chain drive improves durability and increases efficiency together with an oil filled gearbox to ensure total component lubrication and superior heat dissipation  
Ergonomic, compact and slim line design maximises control and offers easy access to confined spaces  
Excellent power to weight ratio: 11 Joules of impact energy delivered by a 6 kg hammer

**Standard Equipment:** Multi-position side handle with depth stop, Heavy duty carrying case

|   |              |
|---|--------------|
| Power Input                               | 1100 Watts   |
| Power Output                              | 500 Watts    |
| Load Speed                                | 400 rpm      |
| Blows per Minute                          | 2740 bpm     |
| Impact Energy                             | 11 J         |
| Tool Holder                               | SDS-Max      |
| Max. Drilling Capacity [Concrete]         | 40 mm        |
| Max. Drilling Capacity [Breakthrough bit] | 55 mm        |
| Max. Drilling Capacity [Core bit]         | 90 mm        |
| Weight                                    | 6.15 kg      |
| Length x Height                           | 457 x 245 mm |



**45mm SDS-Max Combination Hammer**

**D25601K**



Ideal for drilling anchor fixing and through holes in concrete and masonry from 12 to 45 mm in diameter. Core drilling up to 100 mm  
Chain drive improves durability and increases efficiency together with an oil filled gearbox to ensure total component lubrication and superior heat dissipation  
Ergonomic, compact and slim line design maximises control and offers easy access to confined spaces  
Active Vibration Control system incorporating a floating rear handle and damped side handle to reduce vibration

**Standard Equipment:** Multi-position anti-vibration side handle with depth stop, Heavy duty carrying case

|   |               |
|---|---------------|
| Power Input                               | 1250 Watts    |
| Power Output                              | 615 Watts     |
| Load Speed                                | 210-415 rpm   |
| Blows per Minute                          | 1430-2840 bpm |
| Impact Energy                             | 2-12 J        |
| Tool Holder                               | SDS-Max       |
| Max. Drilling Capacity [Concrete]         | 45 mm         |
| Max. Drilling Capacity [Breakthrough bit] | 65 mm         |
| Max. Drilling Capacity [Core bit]         | 100 mm        |
| Weight                                    | 6.8 kg        |
| Length x Height                           | 477 x 245 mm  |



**45 mm SDS-Max Combination Hammer**

**D25602K**



Ideal for drilling anchor fixing and through holes in concrete and masonry from 12 to 45 mm in diameter. Core drilling up to 100 mm  
Chain drive improves durability and increases efficiency together with an oil filled gearbox to ensure total component lubrication and superior heat dissipation  
Active Vibration Control system incorporating a floating rear handle and damped side handle to reduce vibration  
Complete Torque Control. A patented 2 step clutch allows the user to select one of two settings for different diameter drill and core bits providing the maximum level of protection in all drilling applications

**Standard Equipment:** Multi-position anti-vibration side handle with depth stop, Heavy duty carrying case

|   |               |
|---|---------------|
| Power Input                               | 1250 Watts    |
| Power Output                              | 615 Watts     |
| Load Speed                                | 210-415 rpm   |
| Blows per Minute                          | 1430-2840 bpm |
| Impact Energy                             | 2-12 J        |
| Tool Holder                               | SDS-Max       |
| Max. Drilling Capacity [Concrete]         | 45 mm         |
| Max. Drilling Capacity [Breakthrough bit] | 65 mm         |
| Max. Drilling Capacity [Core bit]         | 100 mm        |
| Weight                                    | 6.9 kg        |
| Length x Height                           | 477 x 245 mm  |



For more information on vibration and to calculate the vibration exposure from your power tool visit: [www.DEWALT.ae/en/safety/vibration/calculator](http://www.DEWALT.ae/en/safety/vibration/calculator)

**48 mm SDS-Max Combination Hammer**

**D25711K**



Ideal for drilling anchor fixing and through holes in concrete and masonry from 12 to 48 mm in diameter. Core drilling up to 115 mm  
Active Vibration Control system incorporating a floating handle delivers extremely low vibration  
Electronic variable speed and impact energy control  
Lock-on switch for chipping

**Standard Equipment:** Multi-position side handle, Heavy duty carrying case

|   |               |
|---|---------------|
| Power Input                               | 1250 Watts    |
| Power Output                              | 840 Watts     |
| Load Speed                                | 132-265 rpm   |
| Blows per Minute                          | 1225-2450 bpm |
| Impact Energy                             | 1.5-13 J      |
| Tool Holder                               | SDS-Max       |
| Max. Drilling Capacity [Concrete]         | 48 mm         |
| Max. Drilling Capacity [Breakthrough bit] | 80 mm         |
| Max. Drilling Capacity [Core bit]         | 115 mm        |
| Weight                                    | 8.7 kg        |
| Length x Height                           | 528 x 268 mm  |



**48 mm SDS-Max Combination Hammer**

**D25712K**



Ideal for drilling anchor fixing and through holes in concrete and masonry from 12 to 48 mm in diameter. Core drilling up to 125 mm  
Active Vibration Control system incorporating a counterbalance mass and floating handle delivers extremely low vibration  
Complete Torque Control. A patented 2 step clutch allows the user to select one of two settings for different diameter drill and core bits providing the maximum level of protection in all drilling applications  
Electronic variable speed and impact energy control

**Standard Equipment:** Multi-position side handle, Heavy duty carrying case

|   |               |
|---|---------------|
| Power Input                               | 1300 Watts    |
| Power Output                              | 840 Watts     |
| Load Speed                                | 137-275 rpm   |
| Blows per Minute                          | 1260-2520 bpm |
| Impact Energy                             | 2-14 J        |
| Tool Holder                               | SDS-Max       |
| Max. Drilling Capacity [Concrete]         | 48 mm         |
| Max. Drilling Capacity [Breakthrough bit] | 80 mm         |
| Max. Drilling Capacity [Core bit]         | 125 mm        |
| Weight                                    | 9.1 kg        |
| Length x Height                           | 528 x 268 mm  |



**52 mm SDS-Max Combination Hammer**

**D25762K**



Ideal for drilling anchor fixing and through holes in concrete and masonry from 12 to 52 mm in diameter. Core drilling up to 150 mm  
Active Vibration Control system incorporating a counterbalance mass and floating handle delivers extremely low vibration  
Electronic variable speed and impact energy control  
Complete Torque Control. A patented 2 step clutch allows the user to select one of two settings for different diameter drill and core bits providing the maximum level of protection in all drilling applications

**Standard Equipment:** Multi-position side handle, Heavy duty carrying case

|   |               |
|---|---------------|
| Power Input                               | 1500 Watts    |
| Power Output                              | 980 Watts     |
| Load Speed                                | 125-250 rpm   |
| Blows per Minute                          | 1150-2300 bpm |
| Impact Energy                             | 3-18 J        |
| Tool Holder                               | SDS-Max       |
| Max. Drilling Capacity [Concrete]         | 52 mm         |
| Max. Drilling Capacity [Breakthrough bit] | 80 mm         |
| Max. Drilling Capacity [Core bit]         | 150 mm        |
| Weight                                    | 9.9 kg        |
| Length x Height                           | 561 x 272 mm  |



**3 kg Heavy Duty SDS-Plus L-Shaped Dedicated Chipping Hammer**

**D25330K**



Ideal for light chiselling applications in brick, light masonry and occasionally concrete  
Quick change chisel adjustment allows fast orientation of the chisel through 12 preset positions  
Large 22 mm hammer mechanism delivers high performance with low stress to the critical components  
Improved sealing for maximum protection from dust ingress ensuring long tool life

**Standard Equipment:** Multi position side handle, Heavy duty carrying case

|                  |              |
|------------------|--------------|
| Power Input      | 650 Watts    |
| Power Output     | 400 Watts    |
| Blows per Minute | 0-4100 bpm   |
| Impact Energy    | 0-3.1 J      |
| Tool Holder      | SDS-Plus     |
| Weight           | 3.0 kg       |
| Length x Height  | 296 x 225 mm |



**SDS-Max Dedicated Chipping Hammer**

**D25831K**



Ideal for light demolition, surface preparation or chiseling grooves and channel openings in brick, masonry and light concrete  
Chain drive improves durability and increases efficiency together with an oil filled gearbox to ensure total component lubrication and superior heat dissipation  
Ergonomic, compact and slim line design maximises control and offers easy access to confined spaces  
Electronic variable speed and impact energy control

**Standard Equipment:** Multi-position side handle, Heavy duty carrying case

|                  |               |
|------------------|---------------|
| Power Input      | 1250 Watts    |
| Power Output     | 615 Watts     |
| Blows per Minute | 1430-2840 bpm |
| Impact Energy    | 2-12 J        |
| Tool Holder      | SDS-Max       |
| Weight           | 6.1 kg        |
| Length x Height  | 477 x 245 mm  |



For more information on vibration and to calculate the vibration exposure from your power tool visit: [www.DEWALT.ae/en/safety/vibration/calculator](http://www.DEWALT.ae/en/safety/vibration/calculator)

SDS-Max Dedicated Demolition Hammer

D25870K



Ideal for demolition and surface preparation in brick, masonry and concrete  
Active Vibration Control system incorporating a counterbalance mass and floating handle delivers extremely low vibration  
Variable chisel locking at 24 positions to provide the perfect approach for all applications  
Electronic variable impact energy/speed for total control

**Standard Equipment:** Multi-position side handle, 1 point chisel, Heavy duty carrying case

|                  |               |
|------------------|---------------|
| Power Input      | 1300 Watts    |
| Power Output     | 840 Watts     |
| Blows per Minute | 1260-2520 bpm |
| Impact Energy    | 2-14 J        |
| Tool Holder      | SDS-Max       |
| Weight           | 8.0 kg        |
| Length x Height  | 528 x 268 mm  |



10 kg Demolition Hammer

D25899K



Powerful and durable 1500 Watt motor delivers outstanding concrete breaking performance  
In line design for better handling and quick change chisel adjustment allows fast orientation of the chisel through 12 preset positions  
Magnesium housings ensure maximum durability and minimum weight  
Compact, streamlined design allows access in confined areas

**Standard Equipment:** Multi position side handle, Heavy duty carrying case

|                  |              |
|------------------|--------------|
| Power Input      | 1500 Watts   |
| Power Output     | 750 Watts    |
| Blows per Minute | 2040 bpm     |
| Impact Energy    | 25 J         |
| Tool Holder      | SDS-Max      |
| Weight           | 9.6 kg       |
| Length x Height  | 650 x 250 mm |



10 kg Demolition Hammer

D25901K



Powerful and durable 1500 Watt motor delivers outstanding concrete breaking performance  
Active Vibration Control system incorporating a counterbalance mass and floating handle delivers extremely low vibration  
In line design for better handling and quick change chisel adjustment allows fast orientation of the chisel through 12 preset positions  
Magnesium housings ensure maximum durability and minimum weight

**Standard Equipment:** Multi position side handle, Chisel, Grease, Cloth, Heavy duty carrying case

|                  |               |
|------------------|---------------|
| Power Input      | 1500 Watts    |
| Power Output     | 750 Watts     |
| Blows per Minute | 1020-2040 bpm |
| Impact Energy    | 5-25 J        |
| Tool Holder      | SDS-Max       |
| Weight           | 10.6 kg       |
| Length x Height  | 690 x 250 mm  |



12 kg Demolition Hammer

D25941K



Powerful and durable 1600 Watt motor delivers outstanding concrete breaking performance  
Active Vibration Control system incorporating a counterbalance mass and floating handle delivers extremely low vibration  
In line design for better handling and quick change chisel adjustment allows fast orientation of the chisel through 12 preset positions  
Magnesium housings ensure maximum durability and minimum weight

**Standard Equipment:** Multi position side handle, Pointed chisel, Grease, Cloth, Heavy duty carrying case

|                  |              |
|------------------|--------------|
| Power Input      | 1600 Watts   |
| Power Output     | 790 Watts    |
| Blows per Minute | 1620 bpm     |
| Impact Energy    | 30.6 J       |
| Tool Holder      | 19mm Hex     |
| Weight           | 13.1 kg      |
| Length x Height  | 750 x 250 mm |



30 kg Pavement Breaker

D25980/ D25980K\*



Large oversize mechanism delivers extreme durability and excellent breaking performance  
2000 Watt motor delivers outstanding efficiency and durability  
Active Vibration Control offers safer, more comfortable use and more productivity  
Suspended Handle System absorbs the rebound and, working with the AVC, delivers the lowest vibration on the market

|                  |              |
|------------------|--------------|
| Power Input      | 2000 Watts   |
| Power Output     | 986 Watts    |
| Blows per Minute | 870 bpm      |
| Impact Energy    | 68 J         |
| Tool Holder      | 28 mm Hex    |
| Weight           | 31 kg        |
| Length x Height  | 780 x 620 mm |



\*K version comes with trolley (D259801)

For more information on vibration and to calculate the vibration exposure from your power tool visit: [www.Dewalt.ae/en/safety/vibration/calculator](http://www.Dewalt.ae/en/safety/vibration/calculator)

900 W - 115 mm Small Angle Grinder

D28113/ D28113K



Dust ejection system removes majority of debris from the air which passes over the motor, preventing abrasion and tracking  
Small girth allow comfortable gripping resulting in superior ergonomics  
The low profile gear case allows access in confined areas  
Anti vibration side handle to improve user comfort

**Standard Equipment:** Protective keyless guard, Multi-position anti vibration side handle, Inner and outer disc flange, Spanner

|                    |             |
|--------------------|-------------|
| Power Input        | 900 Watts   |
| No Load Speed      | 10000 rpm   |
| Max. Disc Diameter | 115 mm      |
| Spindle Thread     | M14         |
| Weight             | 2.1 kg      |
| Length x Height    | 285 x 80 mm |



850 W - 115 mm Small Angle Grinder

D28111



Small girth allows comfortable gripping resulting in superior ergonomics  
The low profile gear case allows access in confined areas  
Abrasion protected motor for increased durability  
Anti lock flange prevents flanges from permanently locking up and locking the disc on

**Standard Equipment:** Protective guard, Multi-position side handle, Inner and outer disc flange, Spanner

|                    |             |
|--------------------|-------------|
| Power Input        | 850 Watts   |
| No Load Speed      | 10000 rpm   |
| Max. Disc Diameter | 115 mm      |
| Spindle Thread     | M14         |
| Weight             | 2.1 kg      |
| Length x Height    | 270 x 80 mm |



1100 W - 115 mm Variable Speed Small Angle Grinder

D28116



The electronic variable speed control offers added tool control and enables the tool to be used at optimum conditions to suit the accessory and material  
Electro-mechanical clutch reduces the "kickback" transmitted to the operator if the cutting disc jams

No volt release switch will prevent the unit starting when plugged in, even if the switch is in the on position. Switch must be consciously reset before power is delivered

Overload protection will prevent the unit over heating by shutting the unit off until the unit has cooled down

**Standard Equipment:** Protective keyless guard, Multi-position anti vibration side handle, Inner and outer disc flanges, Spanner

|                    |                  |
|--------------------|------------------|
| Power Input        | 1100 Watts       |
| No Load Speed      | 2800 - 10000 rpm |
| Max. Disc Diameter | 115 mm           |
| Spindle Thread     | M14              |
| Weight             | 2.3 kg           |
| Length x Height    | 315 x 80 mm      |



1100 W - 115 mm Variable Speed Autobalancer Small Angle Grinder

D28117



Autobalancer reduces vibration resulting in greater comfort

The electronic variable speed control offers added tool control and enables the tool to be used at optimum conditions to suit the accessory and material  
Electro-mechanical clutch reduces the "kickback" transmitted to the operator if the cutting disc jams

No volt release switch will prevent the unit starting when plugged in, even if the switch is in the on position. Switch must be consciously reset before power is delivered

**Standard Equipment:** Protective keyless guard, Multi position anti vibration side handle, Inner and outer disc flanges, Spanner

|                    |                  |
|--------------------|------------------|
| Power Input        | 1100 Watts       |
| No Load Speed      | 2800 - 10000 rpm |
| Max. Disc Diameter | 115 mm           |
| Spindle Thread     | M14              |
| Weight             | 2.5 kg           |
| Length x Height    | 315 x 90 mm      |





850 W - 125 mm Small Angle Grinder D28139



Small girth allows comfortable gripping resulting in superior ergonomics  
The low profile gear case allows access in confined areas  
Abrasion protected motor for increased durability  
Anti lock flange prevents flanges from permanently locking up and locking the disc on

**Standard Equipment:** Protective guard, Multi-position side handle, Inner and outer disc flange, Spanner

|                    |             |
|--------------------|-------------|
| Power Input        | 850 Watts   |
| No Load Speed      | 10000 rpm   |
| Max. Disc Diameter | 125 mm      |
| Spindle Thread     | M14         |
| Weight             | 2.1 kg      |
| Length x Height    | 270 x 80 mm |



900 W - 125 mm Small Angle Grinder D28130



Dust ejection system removes majority of debris from the air which passes over the motor, preventing abrasion and tracking  
Small girth allow comfortable gripping resulting in superior ergonomics  
The low profile gear case allows access in confined areas  
Anti vibration side handle to improve user comfort

**Standard Equipment:** Protective guard, Multi-position anti vibration side handle, Inner and outer disc flange, Spanner

|                    |             |
|--------------------|-------------|
| Power Input        | 900 Watts   |
| No Load Speed      | 10000 rpm   |
| Max. Disc Diameter | 125 mm      |
| Spindle Thread     | M14         |
| Weight             | 2.2 kg      |
| Length x Height    | 285 x 80 mm |



1100 W - 125 mm Small Angle Grinder D28134



Dust ejection system removes majority of debris from the air which passes over the motor, preventing abrasion and tracking  
Small girth allow comfortable gripping resulting in superior ergonomics  
The low profile gear case allows access in confined areas  
New guard design allows guard fitment, adjustment or removal without the use of tools, for increased flexibility

**Standard Equipment:** Protective keyless guard, Multi-position side handle, Inner and outer disc flange, Spanner

|                    |             |
|--------------------|-------------|
| Power Input        | 1100 Watts  |
| No Load Speed      | 10000 rpm   |
| Max. Disc Diameter | 125 mm      |
| Spindle Thread     | M14         |
| Weight             | 2.2 kg      |
| Length x Height    | 285 x 80 mm |



115mm Paddle Switch Grinder D28143



A non locking paddle switch ensures the grinder switches off automatically when the unit is released  
Dust ejection system removes majority of debris from the air which passes over the motor, preventing abrasion and tracking  
Small girth allows user to maintain a comfortable grip, resulting in superior ergonomics  
Anti-vibration side handle to improve user comfort

**Standard Equipment:** 115mm Protective guard, Inner and outer disc flange, Spanner, Multi positioned anti vibration side handle

|                    |             |
|--------------------|-------------|
| Power Input        | 1100 Watts  |
| No Load Speed      | 10000 rpm   |
| Max. Disc Diameter | 115 mm      |
| Spindle Thread     | M14         |
| Weight             | 2.2 kg      |
| Length x Height    | 285 x 80 mm |



1200 W - 125 mm Small Angle Grinder D28132C



Dust ejection system removes majority of debris from the air which passes over the motor, preventing abrasion and tracking  
Anti lock flange prevents flanges from permanently locking up  
Abrasion protected motor for increased durability  
New guard design allows guard fitment, adjustment or removal without the use of tools, for increased flexibility

**Standard Equipment:** Protective keyless guard, Multi-position anti vibration side handle, Inner and outer disc flange, Spanner

|                    |             |
|--------------------|-------------|
| Power Input        | 1200 Watts  |
| No Load Speed      | 10000 rpm   |
| Max. Disc Diameter | 125 mm      |
| Spindle Thread     | M14         |
| Weight             | 2.5 kg      |
| Length x Height    | 300 x 80 mm |



1500 W - 125 mm Variable Speed Small Angle Grinder D28136



The electronic variable speed control offers added tool control and enables the tool to be used at optimum conditions to suit the accessory and material  
Electro-mechanical clutch reduces the "kickback" transmitted to the operator if the cutting disc jams  
No volt release switch will prevent the unit starting when plugged in, even if the switch is in the on position. Switch must be consciously reset before power is delivered  
Overload protection will prevent the unit over heating by shutting the unit off until the unit has cooled down

**Standard Equipment:** Protective keyless guard, Multi position anti vibration side handle, Inner and outer disc flanges, Spanner

|                    |                  |
|--------------------|------------------|
| Power Input        | 1500 Watts       |
| No Load Speed      | 2800 - 10000 rpm |
| Max. Disc Diameter | 125 mm           |
| Spindle Thread     | M14              |
| Weight             | 2.6 kg           |
| Length x Height    | 315 x 90 mm      |



1100 W - 125 mm Electronic Small Angle Grinder D28133



Electro-mechanical clutch reduces the "kickback" transmitted to the operator if the cutting disc jams  
No volt release switch will prevent the unit starting when plugged in, even if the switch is in the on position. Switch must be consciously reset before power is delivered  
Overload protection will prevent the unit over heating by shutting the unit off until the unit has cooled down  
Dust ejection system removes majority of debris from the air which passes over the motor, preventing abrasion and tracking

**Standard Equipment:** Protective keyless guard, Multi position anti vibration side handle, Inner and outer disc flanges, Spanner

|                    |             |
|--------------------|-------------|
| Power Input        | 1100 Watts  |
| No Load Speed      | 10000 rpm   |
| Max. Disc Diameter | 125 mm      |
| Spindle Thread     | M14         |
| Weight             | 2.3 kg      |
| Length x Height    | 315 x 80 mm |



1400 W - 125 mm Small Angle Grinder D28135/ D28135K\*



Dust ejection system removes majority of debris from the air which passes over the motor, preventing abrasion and tracking  
Anti lock flange prevents flanges from permanently locking up and locking the disc on  
Abrasion protected motor for increased durability  
New guard design allows guard fitment, adjustment or removal without the use of tools, for increased flexibility

**Standard Equipment:** Protective keyless guard, Multi-position anti vibration side handle, Inner and outer disc flanges, Spanner

|                    |             |
|--------------------|-------------|
| Power Input        | 1400 Watts  |
| No Load Speed      | 10000 rpm   |
| Max. Disc Diameter | 125 mm      |
| Spindle Thread     | M14         |
| Weight             | 2.5 kg      |
| Length x Height    | 300 x 80 mm |

\*K version comes with kitbox



1500 W - 125 mm Variable Speed Autobalancer Small Angle Grinder D28137



Autobalancer reduces vibration resulting in greater comfort  
The electronic variable speed control offers added tool control and enables the tool to be used at optimum conditions to suit the accessory and material  
Electro-mechanical clutch reduces the "kickback" transmitted to the operator if the cutting disc jams  
No volt release switch will prevent the unit starting when plugged in, even if the switch is in the on position. Switch must be consciously reset before power is delivered

**Standard Equipment:** Protective keyless guard, Multi positioned anti vibration side handle, Inner and outer disc flanges, Spanner

|                    |                  |
|--------------------|------------------|
| Power Input        | 1500 Watts       |
| No Load Speed      | 2800 - 10000 rpm |
| Max. Disc Diameter | 125 mm           |
| Spindle Thread     | M14              |
| Weight             | 2.7 kg           |
| Length x Height    | 315 x 90 mm      |



1400 W - 125 mm Medium Angle Grinder DW831



Large diameter high power motor for superior performance  
High temperature resin coated field for increased durability  
Special air channels designed into field case to optimise motor cooling  
Spindle lock for quick wheel changes

**Standard Equipment:** Protective guard, Side handle, Inner and outer disc flanges, Spanner

|                    |              |
|--------------------|--------------|
| Power Input        | 1400 Watts   |
| Power Output       | 900 Watts    |
| No Load Speed      | 10000 rpm    |
| Max. Disc Diameter | 125 mm       |
| Spindle Thread     | M14          |
| Weight             | 3.1 kg       |
| Length x Height    | 385 x 115 mm |

1250 W - 125 mm Small Angle Grinder D28065



Dust ejection system removes majority of debris from the air which passes over the motor, preventing abrasion and tracking  
Ergonomic main handle with rubber grip allows for maximum comfort when grinding for long periods of time  
Abrasion protected motor for increased durability  
New guard design allows guard fitment, adjustment or removal without the use of tools, for increased flexibility

**Standard Equipment:** Protective keyless guard, Multi-position anti vibration side handle, Inner and outer disc flanges, Spanner

|                    |              |
|--------------------|--------------|
| Power Input        | 1250 Watts   |
| Power Output       | 680 Watts    |
| No Load Speed      | 9000 rpm     |
| Max. Disc Diameter | 125 mm       |
| Spindle Thread     | M14          |
| Weight             | 2.6 kg       |
| Length x Height    | 385 x 110 mm |

1400 W - 150 mm Small Angle Grinder D28141



Dust ejection system removes majority of debris from the air which passes over the motor, preventing abrasion and tracking  
Anti lock flange prevents flanges from permanently locking up and locking the disc on  
Abrasion protected motor for increased durability  
New guard design allows guard fitment, adjustment or removal without the use of tools, for increased flexibility

**Standard Equipment:** Protective keyless guard, Multi-position anti vibration side handle, Inner and outer disc flanges, Spanner

|                    |             |
|--------------------|-------------|
| Power Input        | 1400W Watts |
| No Load Speed      | 9000 rpm    |
| Max. Disc Diameter | 150 mm      |
| Spindle Thread     | M14         |
| Weight             | 2.6 kg      |
| Length x Height    | 300 x 80 mm |

1800 W - 180 mm Angle Grinder DW840



High temperature resin coated field for increased durability  
Large diameter high power motor for excellent performance  
Maximum power to weight ratio and superior tool balance  
Special air channels designed into field case to optimise motor cooling

**Standard Equipment:** Protective guard, Side handle, Inner and outer disc flanges, Spanner

|                    |              |
|--------------------|--------------|
| Power Input        | 1800 Watts   |
| Power Output       | 1180 Watts   |
| No Load Speed      | 8000 rpm     |
| Max. Disc Diameter | 180 mm       |
| Spindle Thread     | M14          |
| Weight             | 4.0 kg       |
| Length x Height    | 405 x 120 mm |

DEWALT DIAMOND BLADES



**The DEWALT Laser range of Diamond Blades is designed to offer the right blade for the right task.**

- Diamond blades containing a high concentration of top quality diamonds for excellent cutting performance in extremely hard materials
- Segments Laser Welded to the core for use in tougher applications
- High quality, low carbon steel core reduces core distortion at high temperatures

For the complete range of diamond blades see page 166-168

2000 W - 180 mm Angle Grinder D28491



Abrasion protected motor for increased durability  
Two position side handle allows the user to optimise handle position to give maximum comfort.  
Spindle lock for quick wheel changes  
Brush window allows quick brush replacement

**Standard Equipment:** Protective guard, Side handle, Inner and outer disc flanges, Spanner

|                    |              |
|--------------------|--------------|
| Power Input        | 2000 Watts   |
| Power Output       | 1054 Watts   |
| No Load Speed      | 8500 rpm     |
| Max. Disc Diameter | 180 mm       |
| Spindle Thread     | M14          |
| Weight             | 5.5 kg       |
| Length x Height    | 490 x 151 mm |

2200 W - 180 mm Angle Grinder D28493



Abrasion protected motor for increased durability  
Two position side handle allows the user to optimise handle position to give maximum comfort  
Spindle lock for quick wheel changes  
Brush window allows quick brush replacement

**Standard Equipment:** Protective guard, Side handle, Inner and outer disc flanges, Spanner

|                    |              |
|--------------------|--------------|
| Power Input        | 2200 Watts   |
| Power Output       | 1246 Watts   |
| No Load Speed      | 8500 rpm     |
| Max. Disc Diameter | 180 mm       |
| Spindle Thread     | M14          |
| Weight             | 5.5 kg       |
| Length x Height    | 490 x 151 mm |

2200 W - 180 mm Heavy Duty Angle Grinder D28413\*



Quick adjustment tool free guard  
Abrasion protected high power motor for increased motor durability  
Fully leaded stator windings for increased motor durability  
Five position side handle for improved balance in cutting and grinding applications  
Cut-off brushes to prolong motor life

**Standard Equipment:** Protective tool free guard, Inner and outer flange set, Spanner

|                    |              |
|--------------------|--------------|
| Power Input        | 2200 Watts   |
| Power Output       | 1540 Watts   |
| No Load Speed      | 8500 rpm     |
| Max. Disc Diameter | 180 mm       |
| Spindle Thread     | M14          |
| Weight             | 5.9 kg       |
| Length x Height    | 450 x 145 mm |

\*Actual product differs from image

2400 W - 180 mm Heavy Duty Angle Grinder D28422



Soft start to limit start up current and reduce kick back  
Anti vibration side handle  
Quick adjustment tool free guard  
Abrasion protected high power motor for increased motor durability

**Standard Equipment:** Protective tool free guard, Anti vibration side handle, Inner and outer flange set, Spanner

|                    |              |
|--------------------|--------------|
| Power Input        | 2400 Watts   |
| Power Output       | 1680 Watts   |
| No Load Speed      | 8500 rpm     |
| Max. Disc Diameter | 180 mm       |
| Spindle Thread     | M14          |
| Weight             | 6.5 kg       |
| Length x Height    | 470 x 145 mm |

2400 W - 180 mm Heavy Duty Angle Grinder with No Volt Release Switch D28495



No volt release switch prevents the unit starting when plugged in, even if the switch is lock on. Switch must consciously reset before power is delivered  
Torque limiting clutch reduces the maximum torque reaction transmitted to the operator if the disc jams  
Overload protection will prevent the motor overheating by shutting off the unit until the unit cools down  
Soft start to limit start-up current and reduce kick back

**Standard Equipment:** Protective keyless guard, Anti vibration side handle, Inner and outer disc flanges, Spanner

|                    |              |
|--------------------|--------------|
| Power Input        | 2400 Watts   |
| Power Output       | 1246 Watts   |
| No Load Speed      | 8500 rpm     |
| Max. Disc Diameter | 180 mm       |
| Spindle Thread     | M14          |
| Weight             | 5.5 kg       |
| Length x Height    | 490 x 151 mm |



2200 W - 230 mm Angle Grinder

D28492/ D28492K

Abrasion protected motor for increased durability  
Two position side handle allows the user to optimise handle position to give maximum comfort  
Spindle lock for quick wheel changes  
Brush window allows quick brush replacement

**Standard Equipment:** Protective guard, Side handle, Inner and outer disc flanges, Spanner

|                    |              |
|--------------------|--------------|
| Power Input        | 2200 Watts   |
| Power Output       | 1246 Watts   |
| No Load Speed      | 6500 rpm     |
| Max. Disc Diameter | 230 mm       |
| Spindle Thread     | M14          |
| Weight             | 5.5 kg       |
| Length x Height    | 490 x 151 mm |



2000 W - 230 mm Angle Grinder

D28490

Abrasion protected motor for increased durability  
Two position side handle allows the user to optimise handle position to give maximum comfort  
Spindle lock for quick wheel changes  
Brush window allows quick brush replacement

**Standard Equipment:** Protective guard, Side handle, Inner and outer disc flanges, Spanner

|                    |              |
|--------------------|--------------|
| Power Input        | 2000 Watts   |
| Power Output       | 1054 Watts   |
| No Load Speed      | 6500 rpm     |
| Max. Disc Diameter | 230 mm       |
| Spindle Thread     | M14          |
| Weight             | 5.5 kg       |
| Length x Height    | 490 x 151 mm |



2000 W - 230 mm Heavy Duty Angle Grinder

D28401

Quick adjustment tool free guard  
Abrasion protected high power motor for increased motor durability  
Five position side handle for improved balance in cutting and grinding applications  
Cut off brushes to prolong motor life

**Standard Equipment:** Protective tool free guard, Side handle, Inner and outer flange set, Spanner

|                    |              |
|--------------------|--------------|
| Power Input        | 2000 Watts   |
| Power Output       | 1400 Watts   |
| No Load Speed      | 6500 rpm     |
| Max. Disc Diameter | 230 mm       |
| Spindle Thread     | M14          |
| Weight             | 5.8 kg       |
| Length x Height    | 450 x 145 mm |



2000 W - 230 mm Heavy Duty Angle Grinder

D28400

Soft start to limit start-up current and reduce kick back  
Quick Adjustment tool free guard  
Abrasion protected high power motor for increased motor durability  
Five position side handle for improved balance in cutting and grinding applications

**Standard Equipment:** Protective tool free guard, Side handle, Inner and outer flange set, Spanner

|                    |              |
|--------------------|--------------|
| Power Input        | 2000 Watts   |
| Power Output       | 1400 Watts   |
| No Load Speed      | 6500 rpm     |
| Max. Disc Diameter | 230 mm       |
| Spindle Thread     | M14          |
| Weight             | 5.9 kg       |
| Length x Height    | 450 x 145 mm |



2200 W - 230 mm Heavy Duty Angle Grinder

D28414\*

Quick adjustment tool free guard  
Abrasion protected high power motor for increased motor durability  
Fully loaded stator windings for increased motor durability  
Five position side handle for improved balance in cutting and grinding applications  
Cut-off brushes to prolong motor life

**Standard Equipment:** Protective tool free guard, Inner and outer flange set, Spanner

|                    |              |
|--------------------|--------------|
| Power Input        | 2200 Watts   |
| Power Output       | 1540 Watts   |
| No Load Speed      | 6500 rpm     |
| Max. Disc Diameter | 230 mm       |
| Spindle Thread     | M14          |
| Weight             | 6.0 kg       |
| Length x Height    | 450 x 145 mm |



2300 W - 230 mm Heavy Duty Angle Grinder

D28421

Anti vibration side handle  
Quick adjustment tool free guard  
Abrasion protected high power motor for increased motor durability  
Five position side handle for improved balance in cutting and grinding applications

**Standard Equipment:** Protective tool free guard, Anti vibration side handle, Inner and outer flange set, Spanner

|                    |              |
|--------------------|--------------|
| Power Input        | 2300 Watts   |
| Power Output       | 1610 Watts   |
| No Load Speed      | 6500 rpm     |
| Max. Disc Diameter | 230 mm       |
| Spindle Thread     | M14          |
| Weight             | 6.6 kg       |
| Length x Height    | 470 x 145 mm |



2400 W - 230 mm Heavy Duty Angle Grinder

D28423

Soft start to limit start-up current and reduce kick back  
Anti vibration side handle  
Seven position rotating back handle  
Quick adjustment tool free guard

**Standard Equipment:** Protective tool free guard, Anti vibration side handle, Inner and outer flange set, Spanner

|                    |              |
|--------------------|--------------|
| Power Input        | 2400 Watts   |
| Power Output       | 1680 Watts   |
| No Load Speed      | 6500 rpm     |
| Max. Disc Diameter | 230 mm       |
| Spindle Thread     | M14          |
| Weight             | 6.6 kg       |
| Length x Height    | 490 x 145 mm |



2600 W - 230 mm Heavy Duty Angle Grinder

D28432C

Soft start to limit start-up current and reduce kick back  
Anti vibration side handle  
Seven position rotating back handle  
Quick adjustment tool free guard

**Standard Equipment:** Protective tool free guard, Anti vibration side handle, Inner and outer flange set, Spanner

|                    |              |
|--------------------|--------------|
| Power Input        | 2600 Watts   |
| Power Output       | 1820 Watts   |
| No Load Speed      | 6500 rpm     |
| Max. Disc Diameter | 230 mm       |
| Spindle Thread     | M14          |
| Weight             | 6.6 kg       |
| Length x Height    | 490 x 145 mm |



2400 W - 230 mm Heavy Duty Angle Grinder

D28750

Soft start to limit start-up current and reduce kick back  
Anti vibration side handle  
Seven position rotating back handle  
Quick adjustment tool free guard

**Standard Equipment:** Protective tool free guard, Anti vibration side handle, Inner and outer flange set, Spanner

|                    |              |
|--------------------|--------------|
| Power Input        | 2400 Watts   |
| Power Output       | 1680 Watts   |
| No Load Speed      | 5000 rpm     |
| Max. Disc Diameter | 230 mm       |
| Spindle Thread     | M14          |
| Weight             | 6.6 kg       |
| Length x Height    | 490 x 145 mm |



2200 W - 230 mm Low Vibration Heavy Duty Angle Grinder D28415



Autobalancer gives low vibration (4.1m/s<sup>2</sup> triaxially) resulting in greater end user comfort  
Soft start to limit start-up current and reduce kick back  
Anti vibration side handle  
Quick adjustment tool free guard

**Standard Equipment:** Protective tool free guard, Anti vibration side handle, Inner and outer flange set, Spanner

|                    |              |
|--------------------|--------------|
| Power Input        | 2200 Watts   |
| Power Output       | 1540 Watts   |
| No Load Speed      | 6500 rpm     |
| Max. Disc Diameter | 230 mm       |
| Spindle Thread     | M14          |
| Weight             | 6.1 kg       |
| Length x Height    | 450 x 145 mm |



230mm No volt release switch LAG D28498



No volt release switch prevents the unit starting when plugged in, even if the switch is lock on. Switch must consciously reset before power is delivered  
Torque limiting clutch reduces the maximum torque reaction transmitted to the operator if the disc jams  
Overload protection will prevent the motor overheating by shutting off the unit until the unit cools down  
Soft start to limit start-up current and reduce kick back

**Standard Equipment:** Protective keyless guard, Anti vibration side handle, Inner and outer disc flanges, Spanner

|                    |              |
|--------------------|--------------|
| Power Input        | 2400 Watts   |
| Power Output       | 1246 Watts   |
| No Load Speed      | 6500 rpm     |
| Max. Disc Diameter | 230 mm       |
| Spindle Thread     | M14          |
| Weight             | 5.5 kg       |
| Length x Height    | 490 x 151 mm |



1800 W - 150 mm Straight Angle Grinder DW882



Abrasion protected high power motor for increased durability  
Rubberized front grip for better control  
Brush access window for better serviceability  
Cut-off brushes to prolong motor life

**Standard Equipment:** Protective guard, Inner and outer disc flanges, Abrasive 150 mm disc, Spanner

|                    |              |
|--------------------|--------------|
| Power Input        | 1800 Watts   |
| Power Output       | 1200 Watts   |
| No Load Speed      | 5600 rpm     |
| Max. Disc Diameter | 150 mm       |
| Spindle Thread     | M16          |
| Weight             | 6.7 kg       |
| Length x Height    | 650 x 155 mm |



500 W - Single Speed Die Grinder D28885



Short body allows access when grinding in confined spaces  
Hardened, precision-ground collet ensures that all attachments run perfectly true and concentrically  
Cut-off brushes to prolong motor life  
Ergonomic design results in user comfort allowing strain free grinding

**Standard Equipment:** 6 mm collet, Spanner

|                 |             |
|-----------------|-------------|
| Power Input     | 500 Watts   |
| Power Output    | 300 Watts   |
| No Load Speed   | 27000 rpm   |
| Collet Size     | 6 mm        |
| Weight          | 1.4 kg      |
| Length x Height | 250 x 70 mm |
| Spindle lock    | No          |



Collets



| Cat. No. | Description |
|----------|-------------|
| D288861  | 3 mm Collet |
| D288862  | 1/8" Collet |
| D288863  | 6 mm Collet |
| D288864  | 1/4" Collet |
| D288865  | 8 mm Collet |

2200 Watt 355 mm Abrasive Chop Saw D28700



Horizontal handle for superior ergonomics and less user fatigue  
Quick release clamp results in less time in changing the work piece  
High power abrasion protected motor delivers high overload capabilities for greater durability  
Spindle lock for quick and easy wheel change

**Standard Equipment:** Metal cutting disc, Hex key

|  |              |
|--|--------------|
| Power Input  | 2200 Watts   |
| Power Output                                       | 1350 Watts   |
| No Load Speed                                      | 3800 rpm     |
| Wheel Diameter                                     | 355 mm       |
| Max. Cutting Capacity at 90° [Square Profile]      | 119 x 119 mm |
| Max. Cutting Capacity at 90° [Rectangular Profile] | 115 x 130 mm |
| Max. Cutting Capacity at 90° [L-Shape Profile]     | 137 x 137 mm |
| Max. Cutting Capacity at 90° [Rounded Profile]     | 115 mm       |
| Max. Cutting Capacity at 45° [Square Profile]      | 98 x 98 mm   |
| Max. Cutting Capacity at 45° [Rectangular Profile] | 115 x 98 mm  |
| Max. Cutting Capacity at 45° [L-Shape Profile]     | 98 x 98 mm   |
| Max. Cutting Capacity at 45° [Rounded Profile]     | 98 mm        |
| Weight   | 16 kg        |
| Length x Height                                    | 486 x 378 mm |



2200 Watt 355 mm High Performance Chop Saw D28715



Keyless blade clamp allows quick, hassle free blade change  
Electronic soft start to limit start-up current and kick back reaction  
High power abrasion protected motor delivers high overload capabilities for greater durability  
Keyless mitre adjustments for quick and simple operations

**Standard Equipment:** Metal cutting disc, Hex key, Keyless blade clamp

|  |              |
|--|--------------|
| Power Input  | 2200 Watts   |
| Power Output                                       | 1350 Watts   |
| No Load Speed                                      | 4000 rpm     |
| Wheel Diameter                                     | 355 x 2.5 mm |
| Max. Cutting Capacity at 90° [Square Profile]      | 120 x 120 mm |
| Max. Cutting Capacity at 90° [Rectangular Profile] | 100 x 200 mm |
| Max. Cutting Capacity at 90° [L-Shape Profile]     | 140 x 140 mm |
| Max. Cutting Capacity at 90° [Rounded Profile]     | 130 mm       |
| Max. Cutting Capacity at 45° [Square Profile]      | 113 x 113 mm |
| Max. Cutting Capacity at 45° [Rectangular Profile] | 100 x 140 mm |
| Max. Cutting Capacity at 45° [L-Shape Profile]     | 120 x 120 mm |
| Max. Cutting Capacity at 45° [Rounded Profile]     | 130 mm       |
| Weight   | 18 kg        |
| Length x Height                                    | 520 x 435 mm |



2200 Watt 355 mm Tungsten Carbide Tipped Metal Cutting Chop Saw DW872



Burr-free cuts at constant cutting depth throughout the life of the blade  
High power 2200 Watt motor with electronic soft start for metal cutting  
Robust cool-running 355 mm, 70 tooth tungsten carbide tipped blade  
Extra wide steel base for larger working area and increased stability

**Standard Equipment:** 355 mm metal carbide blade, Hex key, Auxiliary clamp

|  |              |
|--|--------------|
| Power Input  | 2200 Watts   |
| Power Output                                       | 1350 Watts   |
| No Load Speed                                      | 1300 rpm     |
| Wheel Diameter                                     | 355 mm       |
| Max. Cutting Capacity at 90° [Square Profile]      | 100 x 100 mm |
| Max. Cutting Capacity at 90° [Rectangular Profile] | 75 x 130 mm  |
| Max. Cutting Capacity at 90° [L-Shape Profile]     | 92 x 92 mm   |
| Max. Cutting Capacity at 90° [Rounded Profile]     | 130 mm       |
| Max. Cutting Capacity at 45° [Square Profile]      | 79 x 79 mm   |
| Max. Cutting Capacity at 45° [Rectangular Profile] | 79 x 123 mm  |
| Max. Cutting Capacity at 45° [L-Shape Profile]     | 56 x 56 mm   |
| Max. Cutting Capacity at 45° [Rounded Profile]     | 79 mm        |
| Weight   | 22.5 kg      |
| Length x Height                                    | 525 x 430 mm |



1200 W - 178 mm Sander DW630



Abrasion protected motor for increased durability  
Dust sealed bearings for long product life  
Precision heat treated gears for smooth power transmission  
Spindle lock for ease of disc changing

**Standard Equipment:** Rubber backing pad, Threaded flange, Two pin spanner, Side handle & guard

|                    |              |
|--------------------|--------------|
| Power Input        | 1200 Watts   |
| Power Output       | 700 Watts    |
| No Load Speed      | 5000 rpm     |
| Max. Disc Diameter | 178 mm       |
| Spindle Thread     | M14          |
| Weight             | 3.2 kg       |
| Length x Height    | 410 x 140 mm |



1150 W - 178 mm Variable Speed Right Angle Polisher DW849



Full power variable speed electronics with constant speed control  
Abrasion protected high power motor for increased durability  
Heat treated precision gears for smooth power transmission  
Top rubber bumper to protect from scratching the work piece

**Standard Equipment:** Rubber backing pad, Polishing bonnet, Outer flange, Side handle

|                    |              |
|--------------------|--------------|
| Power Input        | 1150 Watts   |
| Power Output       | 670 Watts    |
| No Load Speed      | 0-3000 rpm   |
| Max. Disc Diameter | 178 mm       |
| Spindle Thread     | M14          |
| Weight             | 3.8 kg       |
| Length x Height    | 455 x 135 mm |





Medium Crown Stapler 11.1 mm D51430



5-position indexed depth setting is lockable and repeatable, which enables the user to find the perfect depth, saving time and materials  
The rear load magazine is fast and easy to load and unload with a 160 staples capacity  
Open contact tip allows for better visibility and durability  
Tool-free jam clearing feature eliminates down-time from bent nails caught in the nose piece

**Standard Equipment:** Safety glasses, 28 ml bottle of pneumatic tool oil, Replacement sequential trigger

|                                   |                        |
|-----------------------------------|------------------------|
| Staple diameter                   | 1.6 mm (16 gauge)      |
| Magazine angle                    | 0 °                    |
| Staple length capacity            | 25-51 mm               |
| Staple width                      | 11.1 mm                |
| Magazine Capacity                 | 160 Staples            |
| Magazine loading                  | Rear load              |
| Operating pressure range          | 4.8 - 8.3 Bar          |
| Air consumption per shot @6.9 Bar | 1.1 l                  |
| Firing mode                       | Bump trigger installed |
| Length x Height                   | 290 x 370 mm           |
| Weight                            | 2.1 kg                 |



Medium Crown Stapler 12.7 mm D51431



5-position indexed depth setting is lockable and repeatable, which enables the user to find the perfect depth, saving time and materials  
The rear load magazine is fast and easy to load and unload with a 160 staples capacity  
Open contact tip allows for better visibility and durability  
Tool-free jam clearing feature eliminates down-time from bent nails caught in the nose piece

**Standard Equipment:** Safety glasses, 28 ml bottle of pneumatic tool oil, Replacement sequential trigger

|                                   |                        |
|-----------------------------------|------------------------|
| Staple diameter                   | 1.6 mm (16 gauge)      |
| Magazine angle                    | 0 °                    |
| Staple length capacity            | 25-51 mm               |
| Staple width                      | 12.7 mm                |
| Magazine Capacity                 | 160 Staples            |
| Magazine loading                  | Rear load              |
| Operating pressure range          | 4.8 - 8.3 Bar          |
| Air consumption per shot @6.9 Bar | 1.1 l                  |
| Firing mode                       | Bump trigger installed |
| Length x Height                   | 290 x 370 mm           |
| Weight                            | 2.1 kg                 |



Coil Roofing Nailer D51321



2.2 kg magnesium housing and magazine aid to provide lightweight nailer  
Tool-free adjustable depth setting allows for quick and easy depth of drive setting  
Titanium exhaust cap protects tool from impacts to the cap  
Quick release jam clearing feature eliminates down-time removing bent nails caught in nosepiece

**Standard Equipment:** Safety glasses, 34 ml bottle of pneumatic tool oil, Replacement sequential trigger

|                                   |                 |
|-----------------------------------|-----------------|
| Nail Style                        | Full round head |
| Magazine angle                    | 15 °            |
| Nail Length                       | 19-45 mm        |
| Nail diameter range               | 2.9 - 3.8 mm    |
| Magazine capacity                 | 120 Nails       |
| Energy @ 6.9 Bar                  | 70 Nm           |
| Operating pressure range          | 4.8 - 8.3 Bar   |
| Air consumption per shot @6.9 Bar | 1.18 l          |
| Length x Height                   | 290 x 265 mm    |
| Weight                            | 2.2 kg          |



Full Head Framing Nailer D51850



Optimised design, generates power for the toughest applications using less air consumption  
Unique motor design generates power to bury nails in both standard framing timber and engineered timber with minimal recoil  
Tool-free adjustable depth allows for quick and easy depth of drive setting  
Dry fire lockout extends bumper life by preventing tool from firing when magazine is empty

**Standard Equipment:** Replacement sequential trigger

|                                   |                 |
|-----------------------------------|-----------------|
| Nail Style                        | Full round head |
| Magazine angle                    | 20 °            |
| Nail Length                       | 50 - 90 mm      |
| Nail diameter range               | 2.9 - 3.8 mm    |
| Magazine capacity                 | 65 Nails        |
| Energy @ 6.9 Bar                  | 101.7 Nm        |
| Operating pressure range          | 4.8 - 8.3 Bar   |
| Air consumption per shot @6.9 Bar | 2.04 l          |
| Length x Height                   | 482 x 362 mm    |
| Weight                            | 3.7 kg          |



Clipped Head Framing Nailer D51825



Optimised design generates power for the toughest applications and using less air consumption  
Tool-free adjustable depth allows for quick and easy depth of drive setting  
Driver piston catch allows for a consistent drive each time  
Unique motor design generates power to bury nails in both standard framing timber and engineered timber with minimal recoil

**Standard Equipment:** Replacement sequential trigger

|                                   |               |
|-----------------------------------|---------------|
| Nail Style                        | Clipped head  |
| Magazine angle                    | 31-34 °       |
| Nail Length                       | 50 - 90 mm    |
| Nail diameter range               | 2.9 - 3.3 mm  |
| Magazine capacity                 | 80 Nails      |
| Energy @ 6.9 Bar                  | 101.7 Nm      |
| Operating pressure range          | 4.8 - 8.3 Bar |
| Air consumption per shot @6.9 Bar | 2.04 l        |
| Length x Height                   | 482 x 362 mm  |
| Weight                            | 3.70 kg       |



Palm Nailer D51180



Lightweight - Compact Design  
Jobsite versatility - Will drive most 19-83 mm jobsite nails  
Durability - Full metal housing to withstand jobsite abuse  
Magnetic Tip - For easy nail placement

**Standard Equipment:** Bottle of oil, Leather comfort grip, Safety Glasses

|                                   |               |
|-----------------------------------|---------------|
| Nail Style                        | Bulk          |
| Nail Length                       | 19-89 mm      |
| Nail diameter range               | 10 mm         |
| Operating pressure range          | 5.0 - 8.5 Bar |
| Air consumption per shot @6.9 Bar | 0.4 l         |
| Length x Height                   | 105 x 125 mm  |
| Weight                            | 1.2 kg        |

100 mm Framing Nailer D51856



Fires nails up to 100 mm  
Tool-free adjustable depth allows for quick and easy depth of drive setting  
Dry fire lockout extends bumper life and prevents tool from firing when magazine is empty  
Bump and sequential trigger allows rapid change for varying applications

|                                   |              |
|-----------------------------------|--------------|
| Nail Style                        | Clipped head |
| Magazine angle                    | 34 °         |
| Nail Length                       | 57-100 mm    |
| Nail diameter range               | 2.8-3.3 mm   |
| Magazine capacity                 | 90 Nails     |
| Energy @ 6.9 Bar                  | 100 Nm       |
| Operating pressure range          | 4.8-8.3 Bar  |
| Air consumption per shot @6.9 Bar | 2.5 l        |
| Length x Height                   | 507 x 373 mm |
| Weight                            | 3.8 kg       |



Coil framing Nailer D51855



Optimized power design, generates power for the toughest applications and delivers less air consumption  
Unique engine design generates power to bury nails in both standard framing lumber and engineered lumber with minimal recoil  
Tool-free adjustable depth allows for quick and easy depth of drive setting  
Dry fire lockout extends bumper life by preventing tool from actuating when magazine is empty

**Standard Equipment:** Bump fire trigger (optional)

|                                   |                |
|-----------------------------------|----------------|
| Nail Style                        | Full Head Coil |
| Magazine angle                    | 15 °           |
| Nail Length                       | 38-90 mm       |
| Nail diameter range               | 2.5-3.3 mm     |
| Magazine capacity                 | 300 Nails      |
| Energy @ 6.9 Bar                  | 102 Nm         |
| Operating pressure range          | 4.8-8.3 Bar    |
| Air consumption per shot @6.9 Bar | 2.04 l         |
| Length x Height                   | 370 x 320 mm   |
| Weight                            | 3.7 kg         |



18 Gauge Brad Nailer Kit D51238K



16-50 mm nail capacity provides a complete range for trim carpenters and woodworkers  
4-position indexed depth setting is lockable and repeatable, which enables the user to find the perfect depth, saving time and materials  
Top and side low nail indicator windows to allow the user to quickly and easily see when it is time to reload - before they punch empty holes into their wood  
Tool-free jam clearing feature eliminates down-time from bent nails caught in the nose piece

**Standard Equipment:** Safety glasses, 28 ml bottle of pneumatic tool oil, Allen wrench, Replacement sequential trigger, Heavy duty carrying case

|                                   |                        |
|-----------------------------------|------------------------|
| Magazine angle                    | 0 °                    |
| Nail Diameter                     | 1.2 mm (18 gauge)      |
| Nail Length                       | 16 - 50 mm             |
| Magazine capacity                 | 110 Nails              |
| Magazine loading                  | Side load              |
| Operating pressure range          | 4.8 - 8.3 Bar          |
| Air consumption per shot @6.9 Bar | 1.0 l                  |
| Firing mode                       | Bump trigger installed |
| Length x Height                   | 216 x 222 mm           |
| Weight                            | 1.27 kg                |



16 Gauge Finish Nailer D51257K



5-position indexed depth setting is lockable and repeatable, enabling the user to set the depth and save time and materials  
Sealed lube dual-tech motor works as an oil free and oil lube unit  
Tool-free features: adjustable belt hook, nail depth adjustment, jam clearing, 360 degree exhaust meaning less down-time for adjustment  
For maximum convenience, this tool uses a patented dual-load magazine that can be loaded by either load & lock or lock & load

**Standard Equipment:** Replacement sequential trigger, Heavy-duty carrying case

|                                   |                        |
|-----------------------------------|------------------------|
| Magazine angle                    | 0 °                    |
| Nail Diameter                     | 1.6 mm (16 gauge)      |
| Nail Length                       | 32 - 63 mm             |
| Magazine capacity                 | 100 Nails              |
| Magazine loading                  | Rear load, dual load   |
| Operating pressure range          | 4.8 - 8.3 Bar          |
| Air consumption per shot @6.9 Bar | 1.27 l                 |
| Firing mode                       | Bump trigger installed |
| Length x Height                   | 299 x 269 mm           |
| Weight                            | 1.75 kg                |



15 Gauge Angled Finish Nailer

D51276K



5-position indexed depth setting is lockable and repeatable, enabling the user to set the depth and save time and materials  
 Sealed Lube Dual Tech: motor works as an oil free and oil lube unit.  
 Tool-free features: adjustable belt hook, nail depth adjustment, jam clearing, 360 degree exhaust meaning less down-time for adjustment  
 Low profile no-mark pad gives the user greater visibility whilst protecting surfaces from being damaged

**Standard Equipment:** Replacement sequential trigger, Heavy duty carrying case

|                                   |  |
|-----------------------------------|--|
| Magazine angle                    | 34 °                                   |
| Nail Diameter                     | 1.8 (15Ga) mm                          |
| Nail Length                       | 25-63 mm                               |
| Magazine capacity                 | 100 Nails                              |
| Magazine loading                  | Rear Load, Load & Lock / Lock & Load   |
| Operating pressure range          | 4.8-8.3 Bar                            |
| Air consumption per shot @6.9 Bar | 1.9 l                                  |
| Firing mode                       | Sequential, with optional bump trigger |
| Length x Height                   | 330 x 292 mm                           |
| Weight                            | 1.75 kg                                |



18 Volt Heavy Duty 16 Gauge Cordless Nail Gun

DC618KB



Versatility in the loading and unloading of fasteners - 20 degree angled magazine 120 nail capacity  
 The tool works as fast as you do with consistent nail penetration  
 The sequential operating mode allows for precision placement and the bump operating mode provides the user with production speed  
 Depths can be easily referenced utilising numbered dial and user does not sacrifice performance when changing depths

**Standard Equipment:** 1 Hour Charger, 2 batteries, DeWALT safety glasses, Reversible belt hook, No-mark tip, Heavy duty carrying case

|                       |                   |
|-----------------------|-------------------|
| Nail Diameter         | 1.6 mm            |
| Battery Capacity      | NiMH 2.6 Ah       |
| Magazine angle        | 20 °              |
| Nail Length           | 32-63 mm          |
| Magazine capacity     | Up to 120 Nails   |
| Magazine loading      | Rear - load       |
| Firing mode           | Bump & Sequential |
| Length x Height       | 330 x 320 mm      |
| Weight                | 3.9 kg            |
| Nailer Operating Mode | Selective         |
| Integrated Belt Hook  | Yes               |
| Jam Clearing          | Yes               |
| Features              | LED Headlights    |



18 Volt 18 Gauge Cordless Nailer

DC608KB



The tool works as fast as you do with consistent nail penetration  
 The sequential operating mode allows for precision placement and the bump operating mode provides the user with production speed  
 Depths can be easily referenced utilising numbered dial and user does not sacrifice performance when changing depths  
 Provides easy access to the nosepiece for the simple removal of a jammed fastener without the use of screwdrivers or tool wrenches

**Standard Equipment:** 1 Hour Charger, 2 batteries, Heavy duty carrying case

|                       |                   |
|-----------------------|-------------------|
| Nail Diameter         | 1.2 mm            |
| Battery Capacity      | NiMH 2.6 Ah       |
| Magazine angle        | 0 °               |
| Nail Length           | 16-50 mm          |
| Magazine capacity     | 110 Nails         |
| Magazine loading      | Side Load         |
| Firing mode           | Bump & Sequential |
| Length x Height       | 295 x 290 mm      |
| Weight                | 3.4 kg            |
| Nailer Operating Mode | Selective         |
| Integrated Belt Hook  | Yes               |
| Jam Clearing          | Yes               |



18 Volt Heavy Duty 16 Gauge Straight Cordless Nailer

DC616KB



Versatility in the loading and unloading of fasteners - straight magazine 110 nail capacity  
 The tool works as fast as you do with consistent nail penetration  
 The sequential operating mode allows for precision placement and the bump operating mode provides the user with production speed  
 Depths can be easily referenced utilising numbered dial and user does not sacrifice performance when changing depths

**Standard Equipment:** 1 Hour Charger, 2 batteries, DeWALT safety glasses, Reversible belt hook, No-mark tip, Heavy duty carrying case

|                       |                   |
|-----------------------|-------------------|
| Nail Diameter         | 1.6 mm            |
| Battery Capacity      | NiMH 2.6 Ah       |
| Magazine angle        | 0 °               |
| Nail Length           | 32-63 mm          |
| Magazine capacity     | 110 Nails         |
| Magazine loading      | Rear - load       |
| Firing mode           | Bump & Sequential |
| Length x Height       | 330 x 320 mm      |
| Weight                | 3.9 kg            |
| Nailer Operating Mode | Selective         |
| Integrated Belt Hook  | Yes               |
| Jam Clearing          | Yes               |
| Features              | LED indicators    |



12 Volt 18 Gauge Cordless Nailer

DC602KB



The tool works as fast as you do with consistent nail penetration  
 The sequential operating mode allows for precision placement and the bump operating mode provides the user with production speed  
 Depths can be easily referenced utilising numbered dial and user does not sacrifice performance when changing depths  
 Provides easy access to the nosepiece for the simple removal of a jammed fastener without the use of screwdrivers or tool wrenches

**Standard Equipment:** 1 Hour Charger, 2 batteries, Heavy duty carrying case

|                       |                   |
|-----------------------|-------------------|
| Nail Diameter         | 1.2 mm            |
| Battery Capacity      | NiMH 2.6 Ah       |
| Magazine angle        | 0 °               |
| Nail Length           | 16-50 mm          |
| Magazine capacity     | 110 Nails         |
| Magazine loading      | Side Load         |
| Firing mode           | Bump & Sequential |
| Length x Height       | 295 x 290 mm      |
| Weight                | 3.0 kg            |
| Nailer Operating Mode | Selective         |
| Integrated Belt Hook  | Yes               |
| Jam Clearing          | Yes               |



900W 8mm ( 1/4" ) Premium Plunge & Fixed Base Router Combination

D26204K



Full wave electronic speed control with feedback ensures the selected speed is maintained under any load for a consistent finish in all grades of timber, aluminium and plastics  
 Variable speed control 16,000 to 27,000 which enables the router bit to be optimised for application  
 Compact, light weight design that increase ease of use and user comfort  
 Aluminium motor housing can be transitioned quickly to a fixed base attachment increasing the versatility of the machine

**Standard Equipment:** 2 x Parallel fences, 2 x Dust extraction adaptor, 8 mm collet (1/4" GB), 17 mm spanner, 17 mm guide bush, Plunge and Fixed base, Centering cone, Tough Kit Box

|                        |                 |
|------------------------|-----------------|
| Power Input            | 900 Watts       |
| Power Output           | 620 Watts       |
| No Load Speed          | 16000-27000 rpm |
| Plunge Stroke/Movement | 55 mm           |
| Collet Size            | 6-8 mm          |
| Max. Cutter Diameter   | 36 mm           |
| Weight                 | 2.9 kg          |
| Length x Height        | 110 x 270 mm    |



900W 8mm ( 1/4" ) Fixed Base Router

D26200



Full wave electronic speed control with feedback ensures the selected speed is maintained under any load for a consistent finish in all grades of timber, aluminium and plastics  
 Variable speed control 16,000 to 27,000 enables router bit to be optimised for application  
 Depth ring and clamping mechanism combine to ensure motor remains accurate  
 Aluminium motor housing and base construction provides long term durability

**Standard Equipment:** Parallel fence, Dust extraction adaptor, 8 mm collet (1/4" GB), 17 mm spanner, Also available as accessories - Plunge base, Round base with guide bush application - Guide rail attachment

|                        |                 |
|------------------------|-----------------|
| Power Input            | 900 Watts       |
| Power Output           | 620 Watts       |
| No Load Speed          | 16000-27000 rpm |
| Plunge Stroke/Movement | 55 mm           |
| Collet Size            | 6-8 mm          |
| Max. Cutter Diameter   | 36 mm           |
| Weight                 | 1.9 kg          |
| Length x Height        | 120 x 200 mm    |



900W 8mm (1/4") Variable Speed Plunge Router

D26203



Full wave electronic speed control with feedback ensures the selected speed is maintained under any load for a consistent finish in all grades of timber, aluminium and plastics  
 Variable speed control 16,000 to 27,000 which enables the router bit to be optimised for application  
 Compact, light weight design that increase ease of use and user comfort  
 Aluminium motor housing can be transitioned quickly to a fixed base attachment ( not included ) increasing the versatility of the machine

**Standard Equipment:** Parallel fence, Dust extraction adaptor, 8 mm collet (1/4" GB), 17 mm spanner, 17 mm guide bush, Centering Cone

|                        |                 |
|------------------------|-----------------|
| Power Input            | 900 Watts       |
| Power Output           | 620 Watts       |
| No Load Speed          | 16000-27000 rpm |
| Plunge Stroke/Movement | 55 mm           |
| Collet Size            | 6-8 mm          |
| Max. Cutter Diameter   | 36 mm           |
| Weight                 | 2.9 kg          |
| Length x Height        | 110 x 270 mm    |



900 W - 1/4" (6-8 mm) Variable Speed Plunge Router

DW615



Soft start to eliminate any small initial movement that might misalign the cutter  
 Lightweight and compact design increases ease of use as the cutter remains visible at all times for error free routing  
 Two column precision guide for plunging accuracy in a high quality aluminium housing with phosphor bronze bushing so that carefully controlled plunge cuts can be made

Electronic speed control ensures that a consistent finish is achieved in all grades of timber, aluminium and plastics since the full wave electronic control ensures the selected speed is maintained under any load

**Standard Equipment:** Parallel fence & 2 guide rods, 17 mm guide bush, Dust extraction adaptor, 17/13 mm & 8 mm spanners, 8 mm collet (1/4" GB)

|                        |                |
|------------------------|----------------|
| Power Input            | 900 Watts      |
| Power Output           | 590 Watts      |
| No Load Speed          | 8000-24000 rpm |
| Plunge Stroke/Movement | 55 mm          |
| Collet Size            | 6-8 mm         |
| Max. Cutter Diameter   | 36 mm          |
| Weight                 | 2.9 kg         |
| Length x Height        | 110 x 260 mm   |



1100 Watt 1/4" (6-8mm) Variable Speed Plunge Router

DW621K/ DW621\*



Unique through the column dust extraction for excellent cutter visibility - no adaptor or hose which restrict visibility is required  
 Full wave electronic speed control with feedback ensures the selected speed is maintained under any load for a consistent finish in all grades of timber, aluminium and plastics

Two column precision guide with phosphor bronze bushing - the extra broad column provides superior rigidity for the greatest accuracy in this size of router  
 Power switch located in the handle for ease of use features lock off and lock on actions

**Standard Equipment:** Parallel fence with fine adjustment, Dust extraction adaptor and cap, 8mm collet (1/4" GB), 17/10mm spanner, 24 mm guide bush, Heavy duty carrying case, Also available in a 1400W 12mm ( 1/2" ) version

|                        |                |
|------------------------|----------------|
| Power Input            | 1100 Watts     |
| Power Output           | 620 Watts      |
| No Load Speed          | 8000-24000 rpm |
| Plunge Stroke/Movement | 55 mm          |
| Collet Size            | 6-8 mm         |
| Max. Cutter Diameter   | 36 mm          |
| Weight                 | 4.1 kg         |
| Length x Height        | 165 x 325 mm   |



\*Jan 2011 - DW622 - 1400 Watt (8-12mm) variable speed plunge router



2000 Watt 1/2" (12mm) Variable Speed Plunge Router

DW625EK / DW625E



Soft start to eliminate small initial movements that might misalign the cutter, especially important with such a powerful router  
Two column precision guide with large phosphor bronze bushes for plunging accuracy in a high quality die cast aluminium housing so that carefully controlled plunge cuts can be made  
Electronic speed control ensures that the same fine finish is achieved in all grades of timber, aluminium and plastics since the full wave electronic control ensures the selected speed is maintained under any load  
Large comfortable handles with the on/off switch and plunge lock at your finger tips for excellent control

|                        |                |
|------------------------|----------------|
| Power Input            | 2000 Watts     |
| Power Output           | 1400 Watts     |
| No Load Speed          | 8000-20000 rpm |
| Plunge Stroke/Movement | 80 mm          |
| Collet Size            | 6-12.7 mm      |
| Max. Cutter Diameter   | 50 mm          |
| Weight                 | 5.1 kg         |
| Length x Height        | 290 x 295 mm   |

**Standard Equipment:** Parallel fence with fine adjustment, Dust extraction adaptor, 30mm guide bush, 12mm collet (1/2" UK), 22mm spanner, Heavy duty carrying case



2300 W - 1/2" (12 mm) Variable Speed Plunge Router

DW626



Powerful 2300 Watt motor with massive overload reserves to deal with the most demanding of applications in freehand, template or inverted table operations  
Soft start to eliminate any small initial movement that might misalign the cutter, especially important with such a powerful router  
Two column precision guide with large phosphor bronze bushes for plunging accuracy in a high quality die cast aluminium housing so that carefully controlled plunge cuts can be made  
Electronic speed control ensures that the same fine finish is achieved in all grades of timber, aluminium and plastics since the full wave electronic control ensures the selected speed is maintained under any load

|                        |                |
|------------------------|----------------|
| Power Input            | 2300 Watts     |
| Power Output           | 1560 Watts     |
| No Load Speed          | 8000-21000 rpm |
| Plunge Stroke/Movement | 70 mm          |
| Collet Size            | 8-12 mm        |
| Max. Cutter Diameter   | 50 mm          |
| Weight                 | 7 kg           |
| Length x Height        | 290 x 320 mm   |

**Standard Equipment:** Parallel fence with fine adjustment, Dust extraction adaptor (factory fitted), 30 mm guide bush, 8 mm & 12 mm collet (1/2" GB), 22 mm spanner, Heavy duty carrying case



1600 W - 1/2" (12 mm) Plunge Router

DW624



1600 Watt of power make this unit ideal for heavy duty use where a single speed is sufficient  
Routing depth setting with fine adjustment and magnified scale for simple setting  
Two column precision guide with large phosphor bronze bushes for plunging accuracy in a high quality die cast aluminium housing so that carefully controlled plunge cuts can be made  
Large comfortable handles with the on/off switch and plunge lock at your finger tips for excellent control

|                        |              |
|------------------------|--------------|
| Power Input            | 1600 Watts   |
| Power Output           | 960 Watts    |
| No Load Speed          | 20000 rpm    |
| Plunge Stroke/Movement | 62 mm        |
| Collet Size            | 6-12.7 mm    |
| Max. Cutter Diameter   | 40 mm        |
| Weight                 | 5.1 kg       |
| Length x Height        | 290 x 295 mm |

**Standard Equipment:** Parallel fence with fine adjustment, Dust extraction adaptor, 30 mm guide bush, 22 mm spanner, 12 mm collet (1/2" GB)



Dovetail Jigs



- Cuts through, half-blind, rebated half-blind and sliding dovetail joints as well as finger joints
- Fully adjustable combs and offset stops ensure perfect joints
- Patented adjustable cutter depth stops give extremely accurate, repeatable joint size and tightness
- Patented alignment lines for quick, accurate jig set-up
- Twin dual-cam clamps with pre-mounted abrasive pads firmly grip the whole width of the wood
- Heavy-duty steel base with chamfered front panel for maximum rigidity and durability
- Setup instructions mounted on jig for ease of use
- Detachable combs give infinite joint lengths
- DE6215 miniature dovetail template available separately for miniature half-blind, through and finger joints

| Cat. No. | Description                        | Standard Equipment   | Capacity    | Pitch   |
|----------|------------------------------------|--|-------------|---------|
| DE6212   | Multi-Functional Dovetail Jig      | 8mm shank dovetail & straight cutters (1/4" GB); Guide bushes; 3 base adaptors; 2 templates; Offset guides | 305 x 30 mm | 25.4 mm |
| DE6215   | Miniature Dovetail Comb for DE6212 | 8mm dovetail & straight cutters (1/4" GB); Guide bushes; Offset guides                                     | 305 x 35 mm | 12.7 mm |

Collets

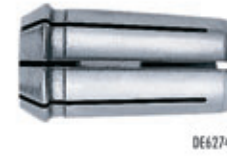

DE6274



DE6259

| Cat. No. | Description           | D26200 | D26203 | DW609 | DW614 | DW615 | DW621/K | DW622/K | DW624 | DW625E/EK | DW626 | DW629 | DW670 |
|----------|-----------------------|--------|--------|-------|-------|-------|---------|---------|-------|-----------|-------|-------|-------|
| DE6257   | 12.7 mm Collet        |        |        |       |       |       |         |         |       |           |       |       |       |
| DE6258   | 12 mm Collet          |        |        |       |       |       |         |         |       |           |       |       |       |
| DE6259   | 10 mm Collet          |        |        |       |       |       |         |         |       |           |       |       |       |
| DE6260   | 8 mm Collet           |        |        |       |       |       |         |         |       |           |       |       |       |
| DE6261   | 6.35 mm (1/4") Collet |        |        |       |       |       |         |         |       |           |       |       |       |
| DE6262   | 6 mm Collet           |        |        |       |       |       |         |         |       |           |       |       |       |
| DE6272   | 6 mm Collet           |        |        |       |       |       |         |         |       |           |       |       |       |
| DE6273   | 6.35 mm (1/4") Collet |        |        |       |       |       |         |         |       |           |       |       |       |
| DE6274   | 8 mm Collet           |        |        |       |       |       |         |         |       |           |       |       |       |
| DE6275   | 9.52 mm (3/8") Collet |        |        |       |       |       |         |         |       |           |       |       |       |
| DE6276   | 10 mm Collet          |        |        |       |       |       |         |         |       |           |       |       |       |
| DE6277   | 12 mm Collet          |        |        |       |       |       |         |         |       |           |       |       |       |
| DE6278   | 12.7 mm (1/2") Collet |        |        |       |       |       |         |         |       |           |       |       |       |
| DE6950   | 6 mm Collet           |        |        |       |       |       |         |         |       |           |       |       |       |
| DE6951   | 6.35 mm (1/4") Collet |        |        |       |       |       |         |         |       |           |       |       |       |
| DE6952   | 8 mm Collet           |        |        |       |       |       |         |         |       |           |       |       |       |

Guide Bushes

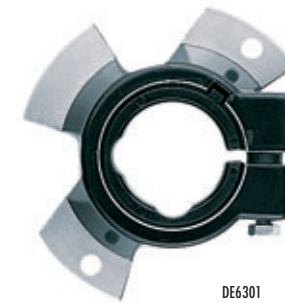

DE6301



DE6960



DE6991

| Cat. No. | Description  | D26200 | D26203 | DW609 | DW614 | DW615 | DW621/K | DW622/K | DW624 | DW625E/EK | DW626 | DW629 | DW670 |
|----------|--|--------|--------|-------|-------|-------|---------|---------|-------|-----------|-------|-------|-------|
| DE6301   | Guide bush system                                      |        |        |       |       |       |         |         |       |           |       |       |       |
| DE6310   | 10 mm guide bush - use with DE6301                     |        |        |       |       |       |         |         |       |           |       |       |       |
| DE6324   | 24 mm guide bush - use with DE6301                     |        |        |       |       |       |         |         |       |           |       |       |       |
| DE6327   | 27 mm guide bush - use with DE6301                     |        |        |       |       |       |         |         |       |           |       |       |       |
| DE6330   | 30 mm guide bush - use with DE6301                     |        |        |       |       |       |         |         |       |           |       |       |       |
| DE6340   | 40 mm guide bush - use with DE6301                     |        |        |       |       |       |         |         |       |           |       |       |       |
| DE6427   | 27 mm guide bush - fixes to base                       |        |        |       |       |       |         |         |       |           |       |       |       |
| DE6430   | 30 mm guide bush - fixes to base                       |        |        |       |       |       |         |         |       |           |       |       |       |
| DE6440   | 40 mm guide bush - fixes to base                       |        |        |       |       |       |         |         |       |           |       |       |       |
| DE6910   | 10.8 mm guide bush - fixes to base                     |        |        |       |       |       |         |         |       |           |       |       |       |
| DE6914   | 14 mm guide bush - fixes to base                       |        |        |       |       |       |         |         |       |           |       |       |       |
| DE6916   | 16 mm guide bush - fixes to base                       |        |        |       |       |       |         |         |       |           |       |       |       |
| DE6917   | 17 mm guide bush - fixes to base                       |        |        |       |       |       |         |         |       |           |       |       |       |
| DE6918   | 18 mm guide bush - fixes to base                       |        |        |       |       |       |         |         |       |           |       |       |       |
| DE6920   | 20 mm guide bush - fixes to base                       |        |        |       |       |       |         |         |       |           |       |       |       |
| DE6924   | 24 mm guide bush - fixes to base                       |        |        |       |       |       |         |         |       |           |       |       |       |
| DE6926   | 26 mm guide bush - fixes to base                       |        |        |       |       |       |         |         |       |           |       |       |       |
| DE6927   | 27 mm guide bush - fixes to base                       |        |        |       |       |       |         |         |       |           |       |       |       |
| DE6930   | 30 mm guide bush - fixes to base                       |        |        |       |       |       |         |         |       |           |       |       |       |
| DE6940   | 40 mm guide bush - fixes to base                       |        |        |       |       |       |         |         |       |           |       |       |       |
| DE6960   | Complete set of 12 base-fixing guide bushes (10-40 mm) |        |        |       |       |       |         |         |       |           |       |       |       |
| DE6961   | 10 mm guide bush - fixes to base                       |        |        |       |       |       |         |         |       |           |       |       |       |
| DE6989   | 17 mm guide bush - fixes to base                       |        |        |       |       |       |         |         |       |           |       |       |       |
| DE6990   | 24 mm guide bush - fixes to base                       |        |        |       |       |       |         |         |       |           |       |       |       |
| DE6991   | 27 mm guide bush - fixes to base                       |        |        |       |       |       |         |         |       |           |       |       |       |
| DE6992   | 30 mm guide bush - fixes to base                       |        |        |       |       |       |         |         |       |           |       |       |       |

Dust Extraction



| Cat. No. | Description                          | D26200 | D26203 | DW609 | DW614 | DW615 | DW621/K | DW622/K | DW624 | DW625E/EK | DW626 | DW629 | DW670 |
|----------|--------------------------------------|--------|--------|-------|-------|-------|---------|---------|-------|-----------|-------|-------|-------|
| DE6211   | Fits post-1999 models of DW624/5/6/9 |        |        |       |       |       |         |         | •     | •         | •     | •     |       |
| DE6269   | Fits pre-1999 models of DW624/5/6/9  |        |        |       |       |       |         |         | •     | •         | •     |       |       |

Thread Adaptors



| Cat. No. | Description   | D26200 | D26203 | DW609 | DW614 | DW615 | DW621/K | DW622/K | DW624 | DW625E/EK | DW626 | DW629 | DW670 |
|----------|---|--------|--------|-------|-------|-------|---------|---------|-------|-----------|-------|-------|-------|
| DE6281   | M12 thread collet conversion / spindle extension kit. For use with DE6282 or DE6283 |        |        |       |       |       |         |         | •     | •         | •     | •     |       |
| DE6282   | 12.7 mm (1/2") shank - M12 adaptor  |        |        |       |       |       |         |         | •     | •         | •     |       |       |
| DE6283   | 12 mm shank - M12 adaptor   |        |        |       |       |       |         |         | •     | •         | •     |       |       |

Fine Height Adjusters



| Cat. No. | Description            | D26200 | D26203 | DW609 | DW614 | DW615 | DW621/K | DW622/K | DW624 | DW625E/EK | DW626 | DW629 | DW670 |
|----------|------------------------|--------|--------|-------|-------|-------|---------|---------|-------|-----------|-------|-------|-------|
| DE6956   | Fits DW621/20/15/14/13 |        |        |       | •     | •     | •       |         |       |           |       |       |       |
| DE6966   | Fits DW624/5/6/9       |        |        |       |       |       |         |         | •     | •         | •     | •     |       |

Fences, Bars, Bases & Copy Follower



| Cat. No. | Description   | D26200 | D26203 | DW609 | DW614 | DW615 | DW621/K | DW622/K | DW624 | DW625E/EK | DW626 | DW629 | DW670 |
|----------|---|--------|--------|-------|-------|-------|---------|---------|-------|-----------|-------|-------|-------|
| DE6263   | Fence holder with fine adjustment. Compatible with DE6265 copy follower |        |        |       | •     | •     | •       |         | •     | •         | •     | •     |       |
| DE6913   | Universal micro adjustable fence with dust extraction port              |        |        |       | •     | •     | •       |         | •     | •         | •     | •     |       |
| DE6265   | Micro adjustment roller follower. Compatible with DE6263                |        |        |       | •     | •     | •       |         | •     | •         | •     | •     |       |
| DE6905   | Trammel bar for cutting circles   |        |        |       | •     | •     | •       |         |       |           | •     |       |       |
| DE6284   | Circular Sub Base   |        |        |       |       |       |         |         | •     | •         |       | •     |       |

600 W - (6-8 mm) Laminate Trimmer

DW670



Especially for small radius, chamfers and shaping edges  
Light weight makes it ideal for one hand use and accurate work  
Copy follower system with 19 mm ball bearing for long life, comfort and precision  
Spindle lock mechanism for quick and easy cutter changes with a single spanner

**Standard Equipment:** Square base, 8 mm, 6 mm and 1/4" collets, Copy follower and fence, 17/19 mm spanner, Dust extraction adaptor

|                        |             |
|------------------------|-------------|
| Power Input            | 600 Watts   |
| Power Output           | 340 Watts   |
| No Load Speed          | 30000 rpm   |
| Plunge Stroke/Movement | 22 mm       |
| Collet Size            | 6 - 8 mm    |
| Max. Cutter Diameter   | 28 mm       |
| Weight                 | 1.9 kg      |
| Length x Height        | 90 x 230 mm |



600 W - Laminate Trimmer

DW609\*



Ideal for laminate trimming and general edge work, especially intensive production work  
Large base plate for good balance and control on the edge of the work piece  
Pistol grip design with built in on/off switch for greater control and safety  
Accurate edge trimming through the copy follower and built in fine height and edge adjusters

**Standard Equipment:** 8 mm collet (1/4" GB), Self aligning guide with slider, Following roller, 13/17 mm & 11/13 mm spanners

|                      |              |
|----------------------|--------------|
| Power Input          | 600 Watts    |
| Power Output         | 400 Watts    |
| No Load Speed        | 24000 rpm    |
| Collet Size          | 8 mm         |
| Max. Cutter Diameter | 32 mm        |
| Weight               | 3.3 kg       |
| Length x Height      | 230 x 240 mm |

\*240V only

600 W - Biscuit Jointer

DW682K



Rack and pinion control provides precise vertical adjustment and fence alignment  
Pre-set cutting depths for 0, 10 and 20 biscuit sizes with additional fine adjustment for ultimate accuracy  
Grooving setting with up to 20 mm depth of cut gives increased versatility  
Anti slide grippers, eight guiding notches and fence window to aid accurate cuts

**Standard Equipment:** Tungsten carbide tipped grooving cutter, Shavings bag, Spanner, 35 mm Dust extraction spout, Heavy duty carrying case

|                       |              |
|-----------------------|--------------|
| Power Input           | 600 Watts    |
| Power Output          | 335 Watts    |
| No Load Speed         | 10000 rpm    |
| Max. Cutter Diameter  | 100 mm       |
| Max. Cutting Depth    | 20 mm        |
| Fence adjustment      | 0-90 °       |
| Joint Groover Setting | 4 mm         |
| Weight                | 3.0 kg       |
| Length x Height       | 320 x 150 mm |



600 W - Flat Dowel Jointer and Groover

DW685K\*



This tool combines a flat dowel jointer with a groover making this one of our most versatile tools  
Guiding notches on base and fine adjustment screws for extremely accurate operation  
45° corner joints are extremely easy to make with the special bevel fence  
Smooth pivot action for precise control, especially important for the start and end of a groove

**Standard Equipment:** Tungsten carbide tipped grooving cutter (105 mm), Parallel fence, Single-position side handle, Heavy duty carrying case

|                       |              |
|-----------------------|--------------|
| Power Input           | 600 Watts    |
| Power Output          | 360 Watts    |
| No Load Speed         | 7500 rpm     |
| Max. Cutter Diameter  | 100/105 mm   |
| Max. Cutting Depth    | 24 mm        |
| Fence adjustment      | 45 °         |
| Joint Groover Setting | 9.5-18 mm    |
| Weight                | 2.8 kg       |
| Length x Height       | 360 x 145 mm |

\*240V only

Replacement Inserts



| Cat. No. | Fits   |
|----------|--------|
| DE6853   | DW685K |

Dust Extraction Adaptors



| Cat. No. | Fits   |
|----------|--------|
| DE6852   | DW685K |



**4 mm Electronic Planer D26501K**



A powerful planer that copes effortlessly with hard woods, even at maximum depth of cut, giving a smooth, consistent finish  
Electronic brake stops the blades in 2 seconds for safety  
Front handle depth control in clearly marked 0.1 mm steps for accurate setting with positive indexing  
3 chamfering grooves in the front shoe simplify precision fitting jobs

**Standard Equipment:** Tungsten carbide tipped reversible blades, Parallel fence, Rebate depth guide, Dust extraction spout, Chip ejector, Chip deflector and high capacity collapsible collection container, Heavy duty carrying case

|                      |              |
|----------------------|--------------|
| Power Input          | 1150 Watts   |
| Power Output         | 680 Watts    |
| No Load Speed        | 11500 rpm    |
| Maximum Depth of Cut | 4 mm         |
| Rebating Depth       | 25 mm        |
| Planer Width         | 82 mm        |
| Shoe Length          | 320 mm       |
| Drum Diameter        | 64 mm        |
| Weight               | 4.0 kg       |
| Length x Height      | 320 x 180 mm |



**4 mm Planer D26500 / D26500K\***



A powerful planer that copes effortlessly with hard woods, even at maximum depth of cut, giving a smooth, consistent finish  
Left and right chip ejection for convenience  
Front handle depth control in clearly marked 0.1 mm steps for accurate setting with positive indexing  
3 chamfering grooves in the front shoe simplify precision fitting jobs

**Standard Equipment:** Tungsten carbide tipped reversible blades, Parallel fence, Rebate depth guide, Dust extraction spout, Chip ejector

|                      |              |
|----------------------|--------------|
| Power Input          | 1050 Watts   |
| Power Output         | 620 Watts    |
| No Load Speed        | 13500 rpm    |
| Maximum Depth of Cut | 4 mm         |
| Rebating Depth       | 25 mm        |
| Planer Width         | 82 mm        |
| Shoe Length          | 320 mm       |
| Drum Diameter        | 64 mm        |
| Weight               | 4.0 kg       |
| Length x Height      | 320 x 180 mm |



\*K version available with kitbox

**2.5 mm Planer DW680 / DW680K\***



Low weight and perfect balance make this planer ideal for single handed use in awkward applications  
Front handle depth control in clearly marked 0.1 mm steps for accurate setting with a positive stop position  
High power motor for smooth results, even in hard woods  
3 different size chamfering grooves in the front shoe simplify precision fitting jobs

**Standard Equipment:** Tungsten carbide tipped reversible blades, Parallel fence, Dust extraction adaptor

|                      |              |
|----------------------|--------------|
| Power Input          | 600 Watts    |
| Power Output         | 350 Watts    |
| No Load Speed        | 15000 rpm    |
| Maximum Depth of Cut | 2.5 mm       |
| Rebating Depth       | 12 mm        |
| Planer Width         | 82 mm        |
| Shoe Length          | 290 mm       |
| Drum Diameter        | 54 mm        |
| Weight               | 3.2 kg       |
| Length x Height      | 290 x 170 mm |



\*K version available with kitbox

**1.5 mm Planer DW677**



Low weight and perfect balance make this planer ideal for single handed use in awkward applications  
Front handle depth control in clearly marked 0.1 mm steps for accurate setting with a positive stop position.  
A large planer blade drum rotating at high speed provides an excellent finish  
3 different size chamfering grooves in the front shoe simplify precision fitting jobs

**Standard Equipment:** Tungsten carbide tipped reversible blades, Parallel fence, Dust extraction spout

|                      |              |
|----------------------|--------------|
| Power Input          | 600 Watts    |
| Power Output         | 350 Watts    |
| No Load Speed        | 15000 rpm    |
| Maximum Depth of Cut | 1.5 mm       |
| Rebating Depth       | 12 mm        |
| Planer Width         | 82 mm        |
| Shoe Length          | 290 mm       |
| Drum Diameter        | 54 mm        |
| Weight               | 2.8 kg       |
| Length x Height      | 290 x 170 mm |



**Dust Extraction Adaptor**



| Cat. No. | Fits           |
|----------|----------------|
| DE2651   | D26500, D26501 |
| DE6775   | DW677, DW680   |

**Chip Containers**



| Cat. No. | Fits                       |
|----------|----------------------------|
| DE2650   | D26500(K) D26501K          |
| DE6784   | DW677 DW680 DW678K DW678EK |

**1/4 Sheet Orbital Palm Grip Sander D26441**



230 Watt motor sands at 14,000 orbits per minute, providing a superior finish  
Sealed 100% ball-bearing construction provides longer life  
Dual plane counter-balance low-vibration design reduces user fatigue  
Textured anti-slip top and body grip provides ultimate comfort and control during prolonged use

**Standard Equipment:** Sanding sheets, Paper punch, Dust bag with built-in extractor connection

|                   |              |
|-------------------|--------------|
| Power Input       | 230 Watts    |
| Power Output      | 120 Watts    |
| Rotation speed    | 14000 rpm    |
| Orbits Per Minute | 28000 opm    |
| Orbit Size        | 1.4 mm       |
| Paper Size        | 140x115 mm   |
| Pad Size          | 108x115 mm   |
| Weight            | 1.4 kg       |
| Length x Height   | 130 x 160 mm |



**1/3 Sheet Electronic Orbital Sander D26422 / D26423**



High performance motor with aluminium bearing seats for continuous use and a long life  
Small orbit size for a smooth finish  
Efficient dust collection using integrated dustbag or external dust extractor for a better sanding performance and sheet life  
Optional hook and loop base pad included to enable fast sanding sheet changes

**Standard Equipment:** Fabric and paper dust bags with built-in extractor connection and support tray, Nylon hook & loop sanding pad, Hook & loop sanding sheet

|                   |                 |
|-------------------|-----------------|
| Power Input       | 350 Watts       |
| Power Output      | 190 Watts       |
| Rotation speed    | 12000-22000 rpm |
| Orbits Per Minute | 24000-44000 opm |
| Orbit Size        | 2.5 mm          |
| Paper Size        | 93 x 230 mm     |
| Pad Size          | 92 x 190 mm     |
| Weight            | 2.6 kg          |
| Length x Height   | 270 x 190 mm    |



**1/2 Sheet Electronic Orbital Sander D26420 / D26421\***



High performance motor with aluminium bearing seats for continuous use and a long life  
Small orbit size for a smooth finish  
Efficient dust collection using integrated dustbag or external dust extractor for a better sanding performance and sheet life  
Optional hook and loop base pad included to enable fast sanding sheet changes

**Standard Equipment:** Fabric and paper dust bags with built-in extractor connection and support tray, Nylon hook & loop sanding pad, Hook & loop sanding sheet

|                   |                 |
|-------------------|-----------------|
| Power Input       | 350 Watts       |
| Power Output      | 190 Watts       |
| Rotation speed    | 12000-22000 rpm |
| Orbits Per Minute | 24000-44000 opm |
| Orbit Size        | 2.5 mm          |
| Paper Size        | 113 x 280 mm    |
| Pad Size          | 112 x 236 mm    |
| Weight            | 2.8 kg          |
| Length x Height   | 270 x 190 mm    |



\*D26421 - non-electronic version (22.000 opm)

**Detail Sander D26430\***



High performance motor for extended life  
Large orbit size for high stock removal  
Dust collection using integrated extraction or external dust extractor for a better sanding performance and sheet life  
Interchangeable quick fit sanding pad, with optional scraper blade or louver attachments

**Standard Equipment:** Dust Cartridge, Hook & Loop sanding sheet

|                   |                 |
|-------------------|-----------------|
| Power Input       | 300 Watts       |
| Power Output      | 130 Watts       |
| Rotation speed    | 14000-22000 rpm |
| Orbits Per Minute | 28000-44000 opm |
| Orbit Size        | 1.8 mm          |
| Paper Size        | 93 x 93 x 93 mm |
| Pad Size          | 93 x 93 x 93 mm |
| Weight            | 1.3 kg          |
| Length x Height   | 305 x 100 mm    |



\*240V only

**500 W - Compact Belt Sander D26480**



Ergonomic palm grip design with soft grip maximises user comfort and control in all applications  
Lightweight configuration increases ease of use  
Flush sided design allows sanding right up to an edge or vertical surface  
Dust sealed construction maximises unit life

**Standard Equipment:** Belt Pack, Dust Extraction Port, Secondary Handle

|                 |              |
|-----------------|--------------|
| Power Input     | 500 Watts    |
| Power Output    | 350 Watts    |
| Belt Speed      | 365 m/min    |
| Belt Size       | 64 x 356 mm  |
| Sanding Size    | 64 x 80 mm   |
| Weight          | 2.4 kg       |
| Length x Height | 200 x 120 mm |



**125 mm Random Orbit Palm Grip Sander D26453\***



Controlled finishing system controls pad speed and minimises gouging during start up  
 Compact palm grip design  
 Sealed 100% ball-bearing construction provides longer life  
 Dust-sealed switch prevents contamination

**Standard Equipment:** Sanding sheet, Fabric dust bag with built-in extractor ports

|                   |                 |
|-------------------|-----------------|
| Power Input       | 280 Watts       |
| Power Output      | 120 Watts       |
| Rotation speed    | 7000-12000 rpm  |
| Orbits Per Minute | 14000-24000 opm |
| Orbit Size        | 2.4 mm          |
| Paper Size        | 125 mm          |
| Weight            | 1.6 kg          |
| Length x Height   | 130 x 160 mm    |



\*240V only

**150 mm Pistol Grip Dual-Orbit Random Orbit Sander D26410**



Two orbit size settings: a 3 mm orbit for fine finishing and a 6 mm orbit for fast material removal  
 Controlled finishing system eliminates start-up scratching by keeping the sanding pad at a controlled speed  
 Variable speed for heat sensitive sanding, polishing and superior finishing  
 Dust sealed switch and bearings for a long life

**Standard Equipment:** Sanding sheet, Fabric and paper dust bags with built-in extractor connection and support tray

|                   |                  |
|-------------------|------------------|
| Power Input       | 400 Watts        |
| Power Output      | 250 Watts        |
| Rotation speed    | 4000 - 10000 rpm |
| Orbits Per Minute | 8000-20000 opm   |
| Orbit Size        | 3.0 & 6.0 mm     |
| Paper Size        | 150 mm           |
| Weight            | 2.7 kg           |
| Length x Height   | 129 x 200 mm     |



**150 mm Body Grip Random Orbit Sander DW443\***



Controlled finishing system eliminates start-up scratching by keeping the sanding pad at a controlled speed  
 Variable speed for heat sensitive sanding, polishing and superior finishing  
 Right angle design and side handle make this sander ideal for extended use especially when sanding large surfaces, such as boat hulls, walls, doors and tables  
 Dust sealed switch and bearings for a long life

**Standard Equipment:** Sanding sheets, Multi-position side handle, Dust bag

|                   |                   |
|-------------------|-------------------|
| Power Input       | 530 Watts         |
| Power Output      | 295 Watts         |
| Rotation speed    | 4,200 - 7,600 rpm |
| Orbits Per Minute | 8,400-15,200 opm  |
| Orbit Size        | 5.0 mm            |
| Paper Size        | 150 mm            |
| Weight            | 2.7 kg            |
| Length x Height   | 320 x 125 mm      |



\*240V only

**800 W - 75 mm Belt Sander DW432/ DW433**



Automatic tracking, with manual override provides precise belt running to the users requirements  
 Efficient dust collection using integrated dust container or external dust extractor for a better sanding performance and belt life  
 Three wheel design increases contact area of sanding belt giving improved sanding performance  
 Two handle arrangement for good balance and control, can be used single handed.

**Standard Equipment:** Sanding belt, Dust container

|                 |              |
|-----------------|--------------|
| Power Input     | 800 Watts    |
| Power Output    | 360 Watts    |
| Belt Speed      | 427 m/min    |
| Belt Size       | 75 x 533 mm  |
| Sanding Size    | 75 x 140 mm  |
| Weight          | 5.6 kg       |
| Length x Height | 280 x 150 mm |



**1010 W - Heavy Duty Belt Sander DW650/ DW650E\***



Robust construction using aluminium and dust sealed bearings for extended life  
 High performance motor to minimise slow down in use  
 2 central handles arranged for good balance and control, especially when flush sanding  
 Efficient dust collection using integrated dustbag or external dust extractor for a better sanding performance and sheet life

**Standard Equipment:** Sanding belt, Dust bag

|                 |              |
|-----------------|--------------|
| Power Input     | 1010 Watts   |
| Power Output    | 560 Watts    |
| Belt Speed      | 350 m/min    |
| Belt Size       | 100 x 560 mm |
| Sanding Size    | 100 x 110 mm |
| Weight          | 6.3 kg       |
| Length x Height | 340 x 210 mm |

\*E version is variable speed

**415 W - 150/40 mm Linishing/Grinding Machine DW753**



Quiet and vibration free high torque induction motor  
 Grinding wheel with workpiece clamp for exact grinding and sharpening  
 Leather honing belt with adjustable support for concave/convex shapes  
 Robust lightweight aluminium base

**Standard Equipment:** Grinding wheel, 2 x Honing belts, Clamping and tool sharpening attachments, Spark guard, Spanner

|                 |              |
|-----------------|--------------|
| Power Input     | 415 Watts    |
| Power Output    | 300 Watts    |
| No Load Speed   | 2750 rpm     |
| Wheel Diameter  | 150 mm       |
| Wheel Width     | 25 mm        |
| Bore Size       | 20 mm        |
| Belt Size       | 577x40 mm    |
| Weight          | 9.3 kg       |
| Length x Height | 310 x 215 mm |

**415 W - 125 mm Dual Honing/Grinding Machine DW754**



Quiet and vibration free high torque induction motor  
 Grinding wheel with workpiece clamp for exact grinding and sharpening  
 Honing wheel with machining support  
 Robust lightweight aluminium base

**Standard Equipment:** Grinding wheel, Honing wheel, Clamping and tool sharpening attachments, Spark guards, Spanner

|                 |              |
|-----------------|--------------|
| Power Input     | 415 Watts    |
| Power Output    | 300 Watts    |
| No Load Speed   | 2750 rpm     |
| Wheel Diameter  | 125 mm       |
| Wheel Width     | 25 mm        |
| Bore Size       | 20 mm        |
| Belt Size       | None mm      |
| Weight          | 9.3 kg       |
| Length x Height | 310 x 215 mm |

**415 W - 125/45 mm Wet Linishing/Grinding Machine DW755**



Water supply for an optimal finish on the cutting edge  
 Quiet and vibration free high torque induction motor  
 Grinding wheel with workpiece clamp for exact grinding and sharpening  
 Leather honing belt with adjustable support for concave/convex shapes

**Standard Equipment:** Grinding wheel, Clamping and tool sharpening attachments, Top and reservoir, Spark guard, Spanner

|                 |              |
|-----------------|--------------|
| Power Input     | 415 Watts    |
| Power Output    | 300 Watts    |
| No Load Speed   | 2750 rpm     |
| Wheel Diameter  | 125 mm       |
| Wheel Width     | 20 mm        |
| Bore Size       | 20 mm        |
| Belt Size       | 715x45 mm    |
| Weight          | 9.5 kg       |
| Length x Height | 310 x 320 mm |

**1800W Standard Heatgun D26411**



Durable design with added protection for the heating element  
 Light weight ergonomics and compact design for increased comfort and application use  
 Two air flows to maximise control in most applications  
 Large stable support stand to ensure safety in stationary applications

**Standard Equipment:** Cone nozzle, Fish tail surface nozzle

|                       |                    |
|-----------------------|--------------------|
| Power Input           | 1800 Watts         |
| Operating Temperature | 50-400 / 50-600 °C |
| Air Flow              | 250 / 450 l/min    |
| Weight                | 0.80 kg            |
| Length x Height       | 253 x 210 mm       |

**Specialist Platens & Backing Pads, Dust Extraction Adaptors, Dust Filters & Bags**



| Cat. No. | Description   | Fits          |
|----------|---|---------------|
| D264301  | Louvre attachment                                     | D26430        |
| D264302  | Replacement hook & loop pad liner                     | D26430        |
| D264303  | Replacement foam sanding pad                          | D26430        |
| D264306  | 50 mm Scraper Blade                                   | D26430        |
| D264411  | 1/4 Sheet Hook & Loop Platen                          | D26441, DW411 |
| D264412  | 1/4 Sheet Foam Backed Platen                          | D26441, DW411 |
| DE2639   | 150 mm 6 & 8-hole pattern                             | D26410, DW443 |
| DE2643   | 150 mm medium-hard hook and loop platen               | D26410        |
| DE2644   | 150 mm soft hook and loop platen                      | D26410        |
| DE2645   | 160 mm sponge backed disc for sanding curved surfaces | D26410, DW443 |
| DE2646   | 160 mm Polishing Sponge                               | D26410, DW433 |
| DE2647   | 160 mm Lambswool Buffing Disc                         | D26410, DW443 |
| DE2648   | 160 mm felt disc for fine finishing                   | D26410, DW443 |
| DE2649   | 150 mm nylon coarse polishing / oxide removal disc    | D26410, DW443 |



| Cat. No. | Fits          |
|----------|---------------|
| D264304  | D26430        |
| DE4050   | DW432, DW433  |
| DE6502   | DW650, DW650E |



| Cat. No. | Fits                                   | Description                    | Pack Qty |
|----------|--|--------------------------------|----------|
| D264305  | D26430                                 | Dust filters                   | 10       |
| DE2642   | D26410, D26420, D26421, D26422, D26423 | Pack of 5 disposable dust bags | 5        |



55mm Depth of Cut Heavy Duty Plunge Saw + 1.5m Guide Rail DWSS20KR



55mm depth of cut allows the trimming and sizing of most common door sizes  
 Parallel plunge allows the user to maintain a smooth and constant hand position while cutting  
 The anti kickback function stops the saw from moving backwards along the rail and helps stop the saw from climbing out of the work piece when making plunge cuts  
 A 48 tooth blade gives a fine and accurate finish with very little breakout in laminates

**Standard Equipment:** 48 tooth precision circular saw blade, Heavy duty carrying case

|  |                 |
|--|-----------------|
| Power Input                                | 1300 Watts      |
| Power Output                               | 690 Watts       |
| No Load Speed                              | 1750 - 4000 rpm |
| Blade Diameter                             | 165 mm          |
| Blade Bore                                 | 20 mm           |
| Bevel Capacity                             | 47 °            |
| Max. Depth of Cut at 90°[with guide rails] | 55 mm           |
| Max. Depth of Cut at 45°[with guide rails] | 40 mm           |
| Weight                                     | 5.1 kg          |
| Length x Height                            | 303 x 265 mm    |



55 mm Depth of Cut Heavy Duty Plunge Saw DWSS20K



55mm depth of cut allows the trimming and sizing of most common door sizes  
 Parallel plunge allows the user to maintain a smooth and constant hand position while cutting  
 The anti kickback function stops the saw from moving backwards along the rail and helps stop the saw from climbing out of the work piece when making plunge cuts  
 A 48 tooth blade gives a fine and accurate finish with very little breakout in laminates

**Standard Equipment:** 48 tooth precision circular saw blade, Heavy duty carrying case

|  |                 |
|--|-----------------|
| Power Input                                | 1300 Watts      |
| Power Output                               | 690 Watts       |
| No Load Speed                              | 1750 - 4000 rpm |
| Blade Diameter                             | 165 mm          |
| Blade Bore                                 | 20 mm           |
| Bevel Capacity                             | 47 °            |
| Max. Depth of Cut at 90°[with guide rails] | 55 mm           |
| Max. Depth of Cut at 45°[with guide rails] | 40 mm           |
| Weight                                     | 5.1 kg          |
| Length x Height                            | 303 x 265 mm    |



Guide Rails



| Cat. No. | Description   |
|----------|---|
| DWS5021  | 1 m guide rail                                      |
| DWS5022  | 1.5 m guide rail                                    |
| DWS5023  | 2.6 m guide rail                                    |
| DWS5025  | Bag - for use with 1 m and 1.5 m DEWALT guide rails |
| DWS5026  | Clamps for use with DEWALT guide rails              |
| DWS5027  | 'T' square attachment for guide rails               |
| DWS5028  | Angle attachment for guide rails                    |
| DWS5029  | Replacement edge strip                              |
| DWS5030  | Replacement 'Teflon' strip                          |
| DWS5031  | Router attachment for guide rail                    |

701 W - Heavy Duty Top Handle Jigsaw DW331K



Quick and easy patented keyless blade change system accepts T - shank blades  
 Powerful 701 Watt motor with variable speed delivers fast cutting action up to 3100 strokes per minute  
 Patented anti-vibration counterbalance mechanism and rubber grip provide smooth operation  
 4-position pendulum action controls the aggressiveness or smoothness of cuts

**Standard Equipment:** Blade, Anti-scratch cover, Anti-splinter insert, Dust extraction adaptor, Heavy duty carrying case

|   |              |
|---|--------------|
| Power Input                               | 701 Watts    |
| Power Output                              | 445 Watts    |
| No Load Stroke Rate                       | 0-3100 spm   |
| Stroke Length                             | 26 mm        |
| Bevel Capacity                            | 45 °         |
| Max. Cutting Capacity [Wood]              | 135 mm       |
| Max. Cutting Capacity [Steel]             | 12 mm        |
| Max. Cutting Capacity [Non Ferrous Metal] | 30 mm        |
| Weight                                    | 2.8 kg       |
| Length x Height                           | 250 x 210 mm |



701 W - Heavy Duty Body Grip Jigsaw DW333K



Quick and easy patented keyless blade system accepts T - shank blades  
 Powerful 701 Watt motor with variable speed delivers fast cutting action up to 3100 strokes per minute  
 Patented anti-vibration counter-balance mechanism and rubber grip provide smooth operation  
 4-position pendulum action controls the aggressiveness or smoothness of cuts

**Standard Equipment:** Blade, Anti-scratch cover, Anti-splinter insert, Dust extraction adaptor, Heavy duty carrying case

|   |              |
|---|--------------|
| Power Input                               | 701 Watts    |
| Power Output                              | 445 Watts    |
| No Load Stroke Rate                       | 800-3100 spm |
| Stroke Length                             | 26 mm        |
| Bevel Capacity                            | 45 °         |
| Max. Cutting Capacity [Wood]              | 135 mm       |
| Max. Cutting Capacity [Steel]             | 12 mm        |
| Max. Cutting Capacity [Non Ferrous Metal] | 30 mm        |
| Weight                                    | 2.8 kg       |
| Length x Height                           | 265 x 210 mm |



550 W - Top Handle Compact Jigsaw DW341K



Keyless blade change with patented anti-deflection clamp design for ease of use and accuracy  
 Compact, ergonomic, design gives user comfort and versatility in use  
 Variable speed dial and trigger allows controlled cutting in all materials  
 Adjustable pendulum action gives increased cutting performance and longer saw blade life

**Standard Equipment:** Blade, Allen key, Anti-scratch shoe cover, Dust extraction shield, Vacuum adaptor, Heavy duty carrying case

|   |              |
|---|--------------|
| Power Input                               | 550 Watts    |
| Power Output                              | 350 Watts    |
| No Load Stroke Rate                       | 0-3100 spm   |
| Stroke Length                             | 20 mm        |
| Bevel Capacity                            | 45 °         |
| Max. Cutting Capacity [Wood]              | 85 mm        |
| Max. Cutting Capacity [Steel]             | 10 mm        |
| Max. Cutting Capacity [Non Ferrous Metal] | 20 mm        |
| Weight                                    | 2.0 kg       |
| Length x Height                           | 230 x 200 mm |



550 W - Body Grip Compact Jigsaw DW343K



Keyless blade change with patented anti-deflection clamp design for ease of use and accuracy  
 Compact, ergonomic, design gives user comfort and versatility in use  
 Variable speed dial allows controlled cutting in all materials  
 Adjustable pendulum action gives increased cutting performance and longer saw blade life

**Standard Equipment:** Blade, Allen key, Anti-scratch shoe cover, Vacuum adaptor, Dust extraction shield, Heavy duty carrying case

|   |              |
|---|--------------|
| Power Input                               | 550 Watts    |
| Power Output                              | 350 Watts    |
| No Load Stroke Rate                       | 650-3100 spm |
| Stroke Length                             | 20 mm        |
| Bevel Capacity                            | 45 °         |
| Max. Cutting Capacity [Wood]              | 85 mm        |
| Max. Cutting Capacity [Steel]             | 10 mm        |
| Max. Cutting Capacity [Non Ferrous Metal] | 20 mm        |
| Weight                                    | 2.0 kg       |
| Length x Height                           | 250 x 185 mm |



**JIGSAW BLADES**

**XPC**

**XPC - DEWALT's ultimate jigsaw blade solution for control and accuracy of cut**

- Premium steel for maximum durability and thicker body for easy control and ultimate accuracy
- Optimised tooth geometry for longer life and reduced breakout
- Increased speed - large deep gullets for easy chip removal
- Plunge point tip design for easy plunge cut

For the complete range of jigsaw blades see page 143

55 mm Depth of Cut Heavy Duty Circular Saw D23550



Compact, well balanced and easy to use circular saw with 55 mm cutting depth  
Quick and easy depth and angle adjustment  
High torque motor for durability and power for cutting job site and joinery materials  
Aluminium shoe for accuracy and durability

**Standard Equipment:** Precision 12 tooth saw blade, Rip fence, Blade spanner

|  |              |
|--|--------------|
| Power Input                                | 1050 Watts   |
| Power Output                               | 570 Watts    |
| No Load Speed                              | 5000 rpm     |
| Blade Diameter                             | 165 mm       |
| Blade Bore                                 | 20 mm        |
| Bevel Capacity                             | 45 °         |
| Max. Depth of Cut at 90°[with guide rails] | 51 mm        |
| Max. Depth of Cut at 45°[with guide rails] | 37 mm        |
| Weight                                     | 4.1 kg       |
| Length x Height                            | 270 x 215 mm |

52mm Depth of Cut Circular Saw D23551



Compact, well balanced and easy to use circular saw with 52 mm cutting depth  
Quick and easy depth and angle adjustment  
High torque motor for durability and power for cutting job site and joinery materials  
Guide rail compatible for quick and easy use with the DeWALT guide rail system

**Standard Equipment:** Precision 12 tooth saw blade, Rip fence, Blade spanner

|  |              |
|--|--------------|
| Power Input                                | 1050 Watts   |
| Power Output                               | 570 Watts    |
| No Load Speed                              | 5000 rpm     |
| Blade Diameter                             | 165 mm       |
| Blade Bore                                 | 20 mm        |
| Bevel Capacity                             | 45 °         |
| Max. Depth of Cut at 90°[with guide rails] | 47 mm        |
| Max. Depth of Cut at 45°[with guide rails] | 32 mm        |
| Weight                                     | 4.4 kg       |
| Length x Height                            | 270 x 215 mm |

65 mm Depth of Cut Precision Circular Saw D23650K



Scale for precise cutting depth setting to 65 mm  
General purpose ripping, cross-cutting and bevelling circular saw for wood and other construction materials  
High torque motor for durability and power for cutting job site and joinery materials  
Stable block construction for low vibration running and long service life

**Standard Equipment:** Precision 18 tooth saw blade, Rip Fence, Blade Spanner, Heavy duty carrying case

|  |              |
|--|--------------|
| Power Input                                | 1350 Watts   |
| Power Output                               | 800 Watts    |
| No Load Speed                              | 5000 rpm     |
| Blade Diameter                             | 190 mm       |
| Blade Bore                                 | 30 mm        |
| Bevel Capacity                             | 55 °         |
| Max. Depth of Cut at 90°[with guide rails] | 61 mm        |
| Max. Depth of Cut at 45°[with guide rails] | 41 mm        |
| Weight                                     | 5.4 kg       |
| Length x Height                            | 355 x 245 mm |

62mm Depth of Cut Heavy Duty Circular Saw D23651K



Scale for precise cutting depth setting to 62 mm  
General purpose ripping, cross-cutting and bevelling circular saw for wood and other construction materials  
High torque motor for durability and power for cutting job site and joinery materials  
Guide rail compatible for quick and easy use with the DeWALT guide rail system

**Standard Equipment:** Precision 18 tooth saw blade, Rip Fence, Blade Spanner, Heavy duty carrying case

|  |              |
|--|--------------|
| Power Input                                | 1350 Watts   |
| Power Output                               | 800 Watts    |
| No Load Speed                              | 5000 rpm     |
| Blade Diameter                             | 190 mm       |
| Blade Bore                                 | 30 mm        |
| Bevel Capacity                             | 55 °         |
| Max. Depth of Cut at 90°[with guide rails] | 57 mm        |
| Max. Depth of Cut at 45°[with guide rails] | 44 mm        |
| Weight                                     | 6.0 kg       |
| Length x Height                            | 355 x 245 mm |

65 mm Depth of Cut Tradesman Circular Saw D23620/ D23620K\*



Compact, well balanced and easy to use circular saw with 65 mm depth of cut  
High torque motor gives durability and power for cutting job site and joinery materials  
Efficient dust extraction port to minimize airborne dust particles when connected to an extractor unit  
Gears and drive spindle mounted in a durable cast aluminium housing

**Standard Equipment:** 18 tooth saw blade, Rip fence, Blade spanner

|  |              |
|--|--------------|
| Power Input                                | 1150 Watts   |
| Power Output                               | 570 Watts    |
| No Load Speed                              | 5000 rpm     |
| Blade Diameter                             | 184 mm       |
| Blade Bore                                 | 16 mm        |
| Bevel Capacity                             | 50 °         |
| Max. Depth of Cut at 90°[with guide rails] | N/A mm       |
| Max. Depth of Cut at 45°[with guide rails] | N/A mm       |
| Weight                                     | 5.1 kg       |
| Length x Height                            | 315 x 250 mm |

\*K version comes with kitbox

86mm Depth of Cut Circular Saw D23700



High power, durable motor delivers excellent power even at maximum depth of cut  
Stable block construction for low vibration running and long service life  
Spindle lock for ease of blade change  
Optimum balance for fatigue-free operation

**Standard Equipment:** 24 tooth Precision saw blade, Rip fence, Blade spanner

|  |              |
|--|--------------|
| Power Input                                | 1750 Watts   |
| Power Output                               | 960 Watts    |
| No Load Speed                              | 4700 rpm     |
| Blade Diameter                             | 235 mm       |
| Blade Bore                                 | 30 mm        |
| Bevel Capacity                             | 45 °         |
| Max. Depth of Cut at 90°[with guide rails] | N/A mm       |
| Max. Depth of Cut at 45°[with guide rails] | N/A mm       |
| Weight                                     | 8.2 kg       |
| Length x Height                            | 430 x 290 mm |

1200 Watt Heavy Duty Reciprocating Saw DW311K



1200 Watt motor delivers increased power for heavy duty applications  
Orbital action delivers fast cutting in wood applications  
0-2,600 SPM and 28 mm stroke length for fast and efficient cutting  
Keyless adjustable shoe easily adjusts depth of cut and extends the blade life

**Standard Equipment:** 1 professional bi-metal blade, Heavy duty carrying case

|  |             |
|--|-------------|
| Power Input                                    | 1200 Watts  |
| Power Output                                   | 630 Watts   |
| No Load Stroke Rate                            | 0-2600 spm  |
| Stroke Length                                  | 28 mm       |
| Max. Cutting Capacity [Wood]                   | 300 mm      |
| Max. Cutting Capacity [Steel Sections & Pipes] | 130 mm      |
| Max. Cutting Capacity [PVC]                    | 160 mm      |
| Weight   | 4.0 kg      |
| Length x Height                                | 460 x 60 mm |

1200 Watt Heavy Duty Reciprocating Saw DW310K\*



1200 Watt motor delivers increased power for heavy duty applications  
0 - 2,600 SPM and 28 mm stroke length for fast and efficient cutting  
Keyless adjustable shoe easily adjusts the depth of cut and extends the blade life  
Variable speed trigger provides control and versatility

**Standard Equipment:** 1 professional bi-metal blade, Heavy duty carrying case

|  |             |
|--|-------------|
| Power Input                                    | 1200 Watts  |
| Power Output                                   | 630 Watts   |
| No Load Stroke Rate                            | 0-2600 spm  |
| Stroke Length                                  | 28 mm       |
| Max. Cutting Capacity [Wood]                   | 300 mm      |
| Max. Cutting Capacity [Steel Sections & Pipes] | 130 mm      |
| Max. Cutting Capacity [PVC]                    | 160 mm      |
| Weight   | 4.0 kg      |
| Length x Height                                | 460 x 60 mm |

\*240V only

1050 Watt - Reciprocating Saw DW304PK\*



1050 Watt motor designed for heavy duty applications  
4 position blade clamp allows for flush cutting and increased versatility  
With a 29 mm stroke length, the DW304PK delivers excellent cutting performance  
Lever-action keyless blade clamp for quick and easy blade changing

**Standard Equipment:** 1 professional bi-metal blade, Heavy duty carrying case

|  |              |
|--|--------------|
| Power Input                                    | 1050 Watts   |
| Power Output                                   | 525 Watts    |
| No Load Stroke Rate                            | 0-2800 spm   |
| Stroke Length                                  | 29 mm        |
| Max. Cutting Capacity [Wood]                   | 280 mm       |
| Max. Cutting Capacity [Steel Sections & Pipes] | 100 mm       |
| Max. Cutting Capacity [PVC]                    | 130 mm       |
| Weight   | 3.5 kg       |
| Length x Height                                | 435 x 178 mm |

\*240V only

**PROFESSIONAL SAW BLADES**

**DEWALT High Performance Professional Saw Blades**

- Deliver outstanding performance across a wide variety of wood, composite materials and non-ferrous metals
- Excellent surface finish ensured by laser-cut expansion slots that also reduce noise and vibration
- Longer intervals between re-sharpening through use of large micro-grain carbide teeth
- Consistently precise cutting from a balanced and tensioned laser-cut plate

For the complete range of saw blades see page 135-142



275 mm ALLIGATOR® Power Saw

DW390/ DW391



Blades available for cutting wood, drywall, plastic and porcelain blocks  
 Long life, low vibration double blade system with blade break of less than 3 secs  
 Ergonomic design and rubberised handles for superior handling and less fatigue  
 Two saw blades running in opposite directions so the material will not move while cutting

**Standard Equipment:** Hard metal blade, Saw blade protection guard, Hex key

|                     |              |
|---------------------|--------------|
| Power Input         | 1350 Watts   |
| Power Output        | 700 Watts    |
| No Load Stroke Rate | 3300 spm     |
| Stroke Length       | 38 mm        |
| Blade Length        | 275 mm       |
| Blade Stop          | 3 s          |
| Weight              | 4.0 kg       |
| Length x Height     | 345 x 210 mm |



425 mm ALLIGATOR® Power Saw For Cutting Bricks

DW392



Ideal for cutting aerated concrete (gasbeton) and drywall  
 Constant speed for optimal cutting capabilities  
 Powerful motor to meet all application needs  
 Two long life and durable saw blades running in opposite directions so the material will not move while cutting

**Standard Equipment:** Hard metal set of blades (yellow) for breeze block, drywall, Saw blade protection guard, Hex key

|                     |              |
|---------------------|--------------|
| Power Input         | 1350 Watts   |
| Power Output        | 700 Watts    |
| No Load Stroke Rate | 3300 spm     |
| Stroke Length       | 38 mm        |
| Blade Length        | 425 mm       |
| Blade Stop          | 3 s          |
| Weight              | 4.3 kg       |
| Length x Height     | 490 x 210 mm |



425 mm ALLIGATOR® Power Saw for cutting Poroton Bricks

DW393



Ideal for cutting Class 20 thermal bricks (Poroton brick/ Porotherm brick)  
 Constant speed for optimal cutting capabilities  
 Powerful motor to meet all application needs  
 Two long life and durable saw blades running in opposite directions so the material will not move while cutting

**Standard Equipment:** Hard metal set of blades (black) for porosite brick, Saw blade protection guard, Hex key

|                     |              |
|---------------------|--------------|
| Power Input         | 1350 Watts   |
| Power Output        | 700 Watts    |
| No Load Stroke Rate | 3300 spm     |
| Stroke Length       | 38 mm        |
| Blade Length        | 425 mm       |
| Blade Stop          | 3 s          |
| Weight              | 4.3 kg       |
| Length x Height     | 490 x 210 mm |



425mm ALLIGATOR® Power Saw

DW394



Two 39 tooth Tungsten carbide tipped blades enable the user to cut class 20 Poroton bricks  
 Constant speed for optimal cutting capabilities  
 Powerful motor to meet all application needs  
 Two long life and durable saw blades running in opposite directions so the material will not move while cutting

**Standard Equipment:** Hard metal set of blades (black) for porosite brick, Saw blade protection guard, Hex key

|                     |              |
|---------------------|--------------|
| Power Input         | 1350 Watts   |
| Power Output        | 700 Watts    |
| No Load Stroke Rate | 3300 spm     |
| Stroke Length       | 38 mm        |
| Blade Length        | 425 mm       |
| Blade Stop          | 3 s          |
| Weight              | 4.3 kg       |
| Length x Height     | 490 x 210 mm |

ALLIGATOR BLADES



**DEWALT ALLIGATOR® Saw Blades are essential to optimise the performance of your Alligator saw**

Ideal for fast and easy cutting in:

- Building blocks
- Wood
- Plywood
- Chipboard
- Drywall

For the complete range of Alligator Saw Blades see page 149

216 mm Crosscut Mitre Saw

DW777/ DW771\*



**Cut Capacities**

|         |             |             |
|---------|-------------|-------------|
| 90°/90° | 270x60 mm   | 265 x 62 mm |
| 45°/90° | 190 x 60 mm | 189 x 62 mm |
| 90°/45° | 270 x 48 mm | 173 x 62 mm |
| 45°/45° | 190 x 48 mm | 190 x 48 mm |

The classic pull saw design improved and updated for the modern user  
 New 1800 Watt motor for powerful cutting in all materials  
 The base and fence have been machined to meet the accuracy requirements of the most demanding applications  
 Compact internal rail design for huge cutting capacity in a highly transportable format

**Standard Equipment:** 24 tooth saw blade, 2 bench mounting bolts, Blade spanner

|                             |              |                 |
|-----------------------------|--------------|-----------------|
|                             | DW777        | DW771           |
| Power Input                 | 1800 Watts   | 1600 Watts      |
| Power Output                | 1100 Watts   | 1100 Watts      |
| Blade Speed                 | 6300 rpm     | 2600 - 5200 rpm |
| Blade Diameter              | 216 mm       | 216 mm          |
| Blade Bore                  | 30 mm        | 30 mm           |
| Bevel Capacity              | 48 °         | 48 °            |
| Mitre Capacity [right/left] | 50/50 °      | 50/50 °         |
| Weight                      | 14.0 kg      | 14.0 kg         |
| Depth                       | 550 mm       | 550 mm          |
| Length x Height             | 490 x 590 mm | 490 x 590 mm    |



216 mm Slide Compound Mitre Saw

DW712/ DW712N



**Cut Capacities**

|         |             |
|---------|-------------|
| 90°/90° | 300 x 70 mm |
| 45°/90° | 215 x 70 mm |
| 90°/45° | 300 x 50 mm |
| 45°/45° | 212 x 50 mm |

New mitre angle adjustment system provides accurate and consistent setting of mitre angles between 0 and 60° right and 0 and 50° left  
 The innovative grooving stop allows adjustment of the cutting depth for grooving and rebating applications  
 The large dual sliding fence mechanism gives maximum support in large material cuts at any angle or combination of angles  
 The aluminium base construction provides stability to the saw while still retaining its portability

**Standard Equipment:** 24 tooth saw blade, On-board blade spanner

|                             |               |
|-----------------------------|---------------|
| Power Input                 | 1600 Watts    |
| Power Output                | 930 Watts     |
| Blade Speed                 | 3700-4600 rpm |
| Blade Diameter              | 216 mm        |
| Blade Bore                  | 30 mm         |
| Bevel Capacity              | 48/2 °        |
| Mitre Capacity [right/left] | 60/50 °       |
| Weight                      | 19.5 kg       |
| Depth                       | 457 mm        |
| Length x Height             | 580 x 480 mm  |



250mm Compound Mitre Saw

DW713XPS/ DW713\*



**Cut Capacities**

|         |             |             |
|---------|-------------|-------------|
| 90°/90° | 162 x 41 mm | 95 x 89 mm  |
| 45°/90° | 114 x 41 mm | 67 x 89 mm  |
| 90°/45° | 162 x 25 mm | 95 x 61 mm  |
| 45°/45° | 114 x 25 mm | 114 x 25 mm |

Powerful universal motor delivers plenty of cutting power in high torque cutting applications  
 Ultra smooth head actuation for safe precise cuts at any angle or compound angle  
 Extremely light unit weight with rugged construction for maximum jobsite versatility  
 XPS Shadow line cut indicator provides fast accurate alignment of the blade while illuminating the work piece for increased productivity

**Standard Equipment:** 24 tooth precision saw blade, Blade spanner, Dust bag

|                             |              |
|-----------------------------|--------------|
| Power Input                 | 1600 Watts   |
| Power Output                | 1000 Watts   |
| Blade Speed                 | 5000 rpm     |
| Blade Diameter              | 250 mm       |
| Blade Bore                  | 30 mm        |
| Bevel Capacity              | 48/3 °       |
| Mitre Capacity [right/left] | 50/50 °      |
| Weight                      | 13.6 kg      |
| Depth                       | 485 mm       |
| Length x Height             | 600 x 425 mm |

\*DW713 version does not have XPS

250 mm Slide Compound Mitre Saw

DW717XPS



**Cut Capacities**

|         |             |             |
|---------|-------------|-------------|
| 90°/90° | 320 x 76 mm | 302 x 88 mm |
| 45°/90° | 226 x 76 mm | 213 x 88 mm |
| 90°/45° | 320 x 50 mm | 302 x 58 mm |
| 45°/45° | 226 x 50 mm | 226 x 50 mm |

Maximum rear fence vertical cut capacity 152mm

XPS Shadow line cut indicator provides fast accurate alignment of the blade while illuminating the work piece for increased productivity  
Compact and lightweight design characteristics deliver a saw with enormous capacity which is easy to transport around the jobsite  
Linear horizontal rails utilise bronze guides to provide maximum precision when cutting materials up to 320 mm wide  
The large dual sliding fence gives maximum support in large material cuts at any angle or combination of angles. This provides maximum stability and accuracy.

**Standard Equipment:** 60 tooth blade, Blade spanner, Dust bag

|                             |              |
|-----------------------------|--------------|
| Power Input                 | 1675 Watts   |
| Power Output                | 750 Watts    |
| Blade Speed                 | 4000 rpm     |
| Blade Diameter              | 250 mm       |
| Blade Bore                  | 30 mm        |
| Bevel Capacity              | 48/48 °      |
| Mitre Capacity (right/left) | 50/60 °      |
| Weight                      | 23 kg        |
| Depth                       | 541 mm       |
| Length x Height             | 718 x 442 mm |

305mm Double Bevel Mitre Saw

DW716EXPS / DW716\*



**Cut Capacities**

|         |             |             |
|---------|-------------|-------------|
| 90°/90° | 190 x 85 mm | 203 x 72 mm |
| 45°/90° | 134 x 85 mm | 142 x 72 mm |
| 90°/45° | 190 x 56 mm | 203 x 47 mm |
| 45°/45° | 134 x 56 mm | 142 x 47 mm |

XPS Shadow line cut indicator provides fast accurate alignment of the blade while illuminating the work piece for increased productivity  
Powerful 95mm universal motor provides superior power in high torque cutting applications  
Solid aluminium base and fence machined to exacting tolerances delivers precision cuts in the largest materials.  
Stainless steel detent system has been designed to maintain accuracy for the life of the machine.

**Standard Equipment:** 80 tooth TCG blade, Blade and guard spanner

|                             |               |
|-----------------------------|---------------|
| Power Input                 | 1600 Watts    |
| Blade Speed                 | 1900-3600 rpm |
| Blade Diameter              | 305 mm        |
| Blade Bore                  | 30 mm         |
| Bevel Capacity              | 50/50 °       |
| Mitre Capacity (right/left) | 50/50 °       |
| Weight                      | 18 kg         |
| Depth                       | 680 mm        |
| Length x Height             | 620 x 690 mm  |

\*DW716 version does not have XPS

305mm Compound Slide Mitre Saw + XPS

DW718XPS / DW718\*



**Cut Capacities**

|         |             |             |             |
|---------|-------------|-------------|-------------|
| 90°/90° | 345 x 71 mm | 50 x 163 mm | 327 x 90 mm |
| 45°/90° | 241 x 71 mm | 35 x 163 mm | 231 x 90 mm |
| 90°/45° | 345 x 48 mm | 50 x 114 mm | 327 x 58 mm |
| 45°/45° | 242 x 52 mm | 35 x 114 mm | 242 x 52 mm |

XPS Shadow line cut indicator provides fast accurate alignment of the blade while illuminating the work piece for increased productivity  
Compact and lightweight design characteristics deliver a saw with enormous capacity which is easy to transport around the jobsite  
Electronic speed control for adjusting cutting speed when cutting materials other than wood  
Linear horizontal rails utilise bronze guides to provide maximum precision when cutting materials up to 345 mm wide

**Standard Equipment:** 60 tooth blade, Blade spanner, Dust bag

|                             |                 |
|-----------------------------|-----------------|
| Power Input                 | 1600 Watts      |
| Power Output                | 960 Watts       |
| Blade Speed                 | 1900 - 3400 rpm |
| Blade Diameter              | 305 mm          |
| Blade Bore                  | 30 mm           |
| Bevel Capacity              | 48/48 °         |
| Mitre Capacity (right/left) | 50/60 °         |
| Weight                      | 24.8 kg         |
| Depth                       | 470 mm          |
| Length x Height             | 770 x 396 mm    |

\*DW718 version does not have XPS

For DW702 / 713 / 706 / 706E / 708 / 017 / 712 / 716 / 716E / 717 / 718 / D27111 / D27112



| Cat. No. | Item            | Description                             |
|----------|-----------------|---|
| DE7080   | 1               | Extension kit                           |
| DE7051   | 2               | Length stop                             |
| DE7082   | 3               | Vertical clamp                          |
| DE7088   | Illustrated     | Dust extraction adaptor. For DW708 only |
| DE7053   | Not illustrated | Dust bag                                |
| DE7084   | Not illustrated | Crown stops                             |

For DW700 / 701 / 707 / 711 / 771 / 777



| Cat. No. | Item        | Description                                |
|----------|-------------|--|
| DE3490   | 1           | Table end plate                            |
| DE3491   | 2           | Pair of guide rods, 500 mm length          |
| DE3492   | 3           | Length stop for short work pieces          |
| DE3462   | 4           | Swivel stop                                |
| DE3493   | 5           | Leg stand                                  |
| DE3494   | 6           | Pair of guide rods, 1000 mm length         |
| DE3495   | 7           | Material support plate                     |
| DE3477   | 8           | Adjustable support stand 740 mm            |
| DE3499   | Illustrated | Workpiece clamp                            |
| DE7777   | Illustrated | Dust extraction kit 100 mm connection port |
| DE7778   | Illustrated | Dust extraction kit 35 mm connection port  |

Mitre Saw Workstation



- Accommodates all DEWALT mitre saws
- Lightweight aluminium construction provides portability in and around the jobsite
- 1.7 metre beam extends to support up to 3.9 metres for use with large workpieces
- The beam can support up to 182 kg providing maximum flexibility and capacity
- Work stops can be converted into end stops for repetitive cutting to length
- Integral folding legs avoids unnecessary assembly
- Integrated carry handle provides ease of transportation
- Cutting to length
- Roofing timbers
- All material support requirements
- Large workpiece support

| Cat. No. | Fits                  | Description                      |
|----------|-----------------------|----------------------------------|
| DE7023   | All DEWALT mitre saws | Heavy Duty Mitre Saw Workstation |

For DE7023

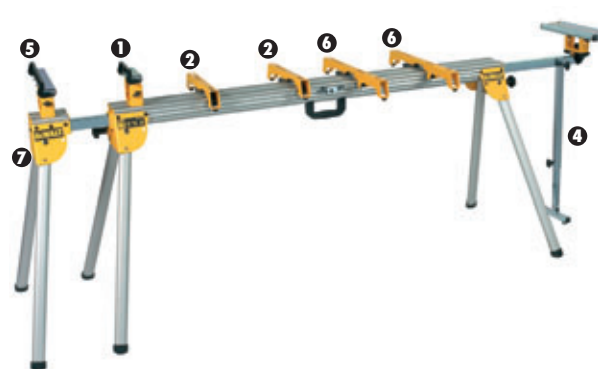

| Cat. No. | Item            | Description                      |
|----------|-----------------|----------------------------------|
| DE7024   | 1               | Work support                     |
| DE7025   | 2               | Mounting bracket                 |
| DE7027   | 3               | Roller work support              |
| DE7028   | 4               | Extension arm support            |
| DE7029   | 5               | Increased width work support     |
| DE7030   | 6               | Increased length mitre brackets  |
| DE7031   | 7               | Heavy duty extension arm support |
| DE7026   | Not illustrated | Carry strap                      |



260 mm Table Top Mitre Saw

DW711



**Cut Capacities**

|         |             |             |
|---------|-------------|-------------|
| 90°/90° | 125 x 55 mm | 140 x 40 mm |
| 45°/90° | 90 x 55 mm  | 100 x 40 mm |
| 90°/45° | 125 x 50 mm | 140 x 20 mm |
| 45°/45° | 90 x 50 mm  | 100 x 20 mm |

50mm 175mm

Powerful dust protected 1300 Watt induction motor, provides years of maintenance free service  
 Integrated blade brake, for active user protection and additional machine safety  
 Precision cast aluminium machined base and table top, guarantees high quality precision cuts in both cutting modes  
 High and stable back fence increases accuracy in all mitering applications

**Standard Equipment:** 260 mm 24 tooth tungsten carbide tipped saw blade, Top guard with extraction, Blade spanner, Hex key, Push stick

|   |              |
|---|--------------|
| Power Input                                       | 1300 Watts   |
| Power Output                                      | 900 Watts    |
| Blade Speed                                       | 2750 rpm     |
| Blade Diameter                                    | 260 mm       |
| Blade Bore  | 30 mm        |
| Bevel Capacity                                    | 48 °         |
| Mitre Capacity [right/left]                       | 50 °         |
| Max. Cutting Capacity [Sawbench position 90°/90°] | 50 mm        |
| Weight  | 20.0 kg      |
| Depth   | 590 mm       |
| Length x Height                                   | 490 x 620 mm |
| Max. Cutting Capacity at 90°/90°                  | 96 mm        |
| Max. Ripping Capacity [right]                     | 175 mm       |
| Max. Ripping Capacity [left]                      | 60 mm        |

305 mm Slide Table Top Mitre Saw

D27112



**Cut Capacities**

|         |             |
|---------|-------------|
| 90°/90° | 285 x 90 mm |
| 45°/90° | 200 x 90 mm |
| 90°/45° | 285 x 62 mm |
| 45°/45° | 200 x 62 mm |

51mm 200mm

Lightweight, powerful 1600 Watt universal motor for demanding applications  
 Combination saw with crosscut and ripping capabilities  
 Slide mechanism incorporated to increase cross cut capacity  
 Precision cast aluminium base and table top guarantees high precision cuts in both cutting modes

**Standard Equipment:** Saw blade, Push Stick, Blade Wrench, Rip Fence, Table Saw Blade Guard, Allen Key

|   |              |
|---|--------------|
| Power Input                                       | 1600 Watts   |
| Power Output                                      | 1370 Watts   |
| Blade Speed                                       | 3650 rpm     |
| Blade Diameter                                    | 305 mm       |
| Blade Bore  | 30 mm        |
| Bevel Capacity                                    | 45 °         |
| Mitre Capacity [right/left]                       | 60/50 °      |
| Max. Cutting Capacity [Sawbench position 90°/90°] | 51 mm        |
| Weight  | 23.0 kg      |
| Depth   | 980 mm       |
| Length x Height                                   | 580 x 710 mm |
| Max. Cutting Capacity at 90°/90°                  | 285 x 90 mm  |
| Max. Ripping Capacity [right]                     | 200 mm       |
| Max. Ripping Capacity [left]                      | 220 mm       |

305 mm Slide Table Top Mitre Saw

D27111



**Cut Capacities**

|         |             |
|---------|-------------|
| 90°/90° | 220 x 90 mm |
| 45°/90° | 155 x 90 mm |
| 90°/45° | 220 x 62 mm |
| 45°/45° | 155 x 62 mm |

51mm 200mm

Combination saw with crosscut and ripping capabilities  
 Powerful 1500 Watt induction motor to meet the needs of the most demanding applications  
 Precision cast aluminium base and table top guarantees high precision cuts in both cutting modes  
 Slide mechanism incorporated to increase cross cut capacity

**Standard Equipment:** Saw blade, Push Stick, Blade Wrench, Rip Fence, Table Saw Blade Guard, Allen Key

|   |              |
|---|--------------|
| Power Input                                       | 1500 Watts   |
| Power Output                                      | 1100 Watts   |
| Blade Speed                                       | 3000 rpm     |
| Blade Diameter                                    | 305 mm       |
| Blade Bore  | 30 mm        |
| Bevel Capacity                                    | 45 °         |
| Mitre Capacity [right/left]                       | 60/50 °      |
| Max. Cutting Capacity [Sawbench position 90°/90°] | 51 mm        |
| Weight  | 26.5 kg      |
| Depth   | 800 mm       |
| Length x Height                                   | 580 x 710 mm |
| Max. Cutting Capacity at 90°/90°                  | 220x90 mm    |
| Max. Ripping Capacity [right]                     | 200 mm       |
| Max. Ripping Capacity [left]                      | 220 mm       |

Heavy Duty Electronic Portable Table Saw

DW744XP

77mm 57mm 625mm



Powerful 2000 Watt motor for high performance in all applications  
 Telescoping fence rails provide over 610 mm of rip capacity in a portable design for cutting large sheet materials to size  
 Cast aluminium table top design ensures accuracy and precision  
 Soft start electronics increases accuracy and motor durability

**Standard Equipment:** 24 tooth SERIES 40° saw blade, Mitre fence, 2 blade spanners, Parallel fence, Dust port reducer, Push stick

|                               |              |
|-------------------------------|--------------|
| Power Input                   | 2000 Watts   |
| Power Output                  | 1600 Watts   |
| Blade Speed                   | 3000 rpm     |
| Blade Diameter                | 250 mm       |
| Blade Bore                    | 30 mm        |
| Bevel Capacity                | -3 to 48 °   |
| Max. Ripping Capacity [right] | 625 mm       |
| Max. Ripping Capacity [left]  | 342 mm       |
| Table Size                    | 627 x 678 mm |
| Weight                        | 35 kg        |
| Depth                         | 740 mm       |
| Length x Height               | 680 x 465 mm |

Heavy Duty Lightweight Table Saw

DW745

77mm 57mm 410mm



22 kg unit weight and optimised footprint make this the most portable saw in its class  
 Fence system provides 410 mm of rip capacity in a portable design for cutting large sheet materials to size  
 Steel roll cage protects saw against jobsite drops and impacts  
 Powerful 1700 Watt motor for high performance in all applications

**Standard Equipment:** 24 tooth SERIES 30° saw blade, Mitre fence, 2 blade spanners, Parallel fence, Dust port reducer, Push stick

|                               |              |
|-------------------------------|--------------|
| Power Input                   | 1700 Watts   |
| Power Output                  | 1100 Watts   |
| Blade Speed                   | 3800 rpm     |
| Blade Diameter                | 250 mm       |
| Blade Bore                    | 30 mm        |
| Bevel Capacity                | -3 to 48 °   |
| Max. Ripping Capacity [right] | 410 mm       |
| Max. Ripping Capacity [left]  | 315 mm       |
| Table Size                    | 630 x 570 mm |
| Weight                        | 22 kg        |
| Depth                         | 742 mm       |
| Length x Height               | 577 x 425 mm |

Heavy Duty Rolling Saw Workstation

DE7400



Large Heavy-Duty wheels designed to easily roll over steps, kerbs, and jobsite debris  
 Folding legs with quick release levers which retract under the stand in a few seconds for easy and quick transport  
 Lightweight aluminium construction which improves the portability  
 Heavy-Duty kick stand allows the stand to balance upright for mobility and storage

**Standard Equipment:** Universal Brackets to attach most Table saws

305 mm Combination Saw

D27107 / D27107V



**Cut Capacities**

|         |             |             |
|---------|-------------|-------------|
| 90°/90° | 50 x 155 mm | 205 x 63 mm |
| 45°/90° | 45 x 155 mm | 160 x 63 mm |
| 90°/45° | 60 x 110 mm | 205 x 50 mm |
| 45°/45° | 60 x 100 mm | —           |

|          |       |
|----------|-------|
| Max. Cut | 81 mm |
| Max. Cut | 56 mm |

The next generation of TGS combination saw combines the accuracy of modern mitre saws with the power and capacity of dedicated table saws  
 Electronic pack provides massive overload protection and constant cutting speed for optimal cutting performance  
 305 mm head provides an massive 155 mm depth of cut  
 New mitre and bevel adjustment systems ensure high accuracy and simple adjustment  
**Standard Equipment:** 48 tooth saw blade, Parallel fence, Riving knife, Push stick, Mitre dust collector, Table saw guard, Assembly wrench

|   |              |
|---|--------------|
| Power Input                                       | 2000 Watts   |
| Power Output                                      | 1400 Watts   |
| Blade Speed                                       | 4000 rpm     |
| Blade Diameter                                    | 305 mm       |
| Blade Bore  | 30 mm        |
| Bevel Capacity                                    | 48 °         |
| Mitre Capacity [right/left]                       | 48/48 °      |
| Max. Cutting Capacity [Sawbench position 90°/90°] | 0 - 81 mm    |
| Max. Cutting Capacity [Sawbench position 90°/45°] | 0 - 56 mm    |
| Weight  | 40 kg        |
| Depth   | 800 mm       |
| Length x Height                                   | 720 x 770 mm |



For D27107 / D27105



| Cat. No. | Item        | Description                                  |
|----------|-------------|--|
| D271055  | 1           | Sliding table for D27105/7 TGS               |
| D271057  | 2           | Replacement table saw guard for D27105/7 TGS |
| D271058  | 3           | Right extension table for D27105/7 TGS       |
| DE3460   | 4           | Length stop for short workpieces             |
| DE3462   | 5           | Swivel stop                                  |
| DE3474   | 6           | Adjustable support stand                     |
| DE3491   | 7           | Pair of guide rods, 500 mm length            |
| DE3494   | 8           | Pair of guide rods, 1000 mm length           |
| DE3495   | 9           | Material support plate                       |
| D271051  | Illustrated | Clamp assembly                               |
| D271052  | Illustrated | Mitre gauge for D27105/7 TGS                 |
| D271053  | Illustrated | Crown stop for D27105/7 TGS                  |
| D271054  | Illustrated | Dust extraction kit for D27105/7 TGS         |
| D271059  | Illustrated | Laser site line attachment                   |



250 mm Combination Saw

DW743N



**Cut Capacities**

|         |             |             |
|---------|-------------|-------------|
| 90°/90° | 140 x 68 mm | 180 x 20 mm |
| 45°/90° | 95 x 70 mm  | 120 x 46 mm |
| 90°/45° | 70 x 95 mm  | 150 x 20 mm |

|          |       |
|----------|-------|
| Max. Cut | 70 mm |
| Max. Cut | 32 mm |

The classic TGS flip-over bevelling saw  
 Rapid tool free transformation from a saw bench to a mitre saw provides flexibility in a range of site and workshop applications  
 New high output heavy duty high torque induction motor provides years of maintenance free use, suitable for workshop applications where low noise characteristics are desirable  
 Updated design for maximum cutting capacity across the range of mitre and bevel angles

**Standard Equipment:** 30 tooth saw blade, Parallel fence, Push stick, 4 detachable legs, Saw blade guard, Assembly tool

|   |              |
|---|--------------|
| Power Input                                       | 2000 Watts   |
| Power Output                                      | 1550 Watts   |
| Blade Speed                                       | 2850 rpm     |
| Blade Diameter                                    | 250 mm       |
| Blade Bore  | 30 mm        |
| Bevel Capacity                                    | 45 °         |
| Mitre Capacity [right/left]                       | 45 / 45 °    |
| Max. Cutting Capacity [Sawbench position 90°/90°] | 0 - 70 mm    |
| Max. Cutting Capacity [Sawbench position 90°/45°] | 0 - 32 mm    |
| Weight  | 37 kg        |
| Depth   | 670 mm       |
| Length x Height                                   | 700 x 750 mm |



For DW743N



| Cat. No. | Item            | Description                                       |
|----------|-----------------|---|
| DE3491   | 1               | Pair of guide rods, 500 mm length                 |
| DE3460   | 2               | Length stop for short workpieces                  |
| DE3474   | 3               | Adjustable support stand                          |
| DE3494   | 4               | Pair of guide rods, 1000 mm length                |
| DE3462   | 5               | Swivel stop                                       |
| DE3495   | 6               | Material support plate                            |
| DE3454   | Illustrated     | 2 x push sticks                                   |
| DE3472   | Illustrated     | Right side extension table                        |
| DE3489   | Illustrated     | Roller support                                    |
| DE3496   | Illustrated     | Replacement mitre fence for use in bench saw mode |
| DE3497   | Illustrated     | Roller support table                              |
| DE3500   | Illustrated     | Shaving extraction kit                            |
| DE3461   | Not Illustrated | Clamp assembly                                    |
| DE3471   | Not Illustrated | Single sliding table                              |
| DE3473   | Not Illustrated | Ripping/parallel fence                            |
| DE3488   | Not Illustrated | Replacement table saw guard                       |

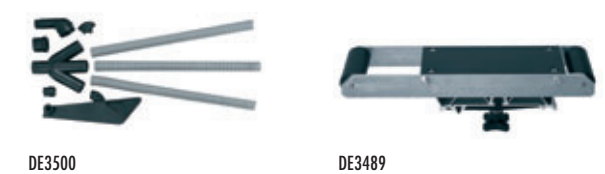

DE3497

DE3496

DE3472

DE3454



300mm RADIAL ARM SAW

DW721KN / DW722KN

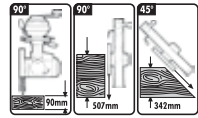

Free standing radial arm saw with 507mm of crosscut capacity and 90 mm depth of cut  
Solid cast iron arm and four roller bearings in the motor head assembly ensure high accuracy and durability  
Quiet maintenance free induction motor delivers high power even at the maximum cutting capacities of the machine. Also available in three phase voltage as a DW722KN  
Simple yet positive controls and adjustment scales enable the width, depth and angle of cut to be set with accuracy in seconds

**Standard Equipment:** 32 tooth saw blade, Assembly tools, Automatic safety return, Blade brake, Legstand

|                    | DW721KN        | DW722KN        |
|--------------------|----------------|----------------|
| Power Input        | 2000 Watts     | 3000 Watts     |
| Power Output       | 1580 Watts     | 2280 Watts     |
| Blade Speed        | 3000 rpm       | 3000 rpm       |
| Blade Diameter     | 300 mm         | 300 mm         |
| Blade Bore         | 30 mm          | 30 mm          |
| Max. Cutting Speed | 36 m/sec       | 36 m/sec       |
| Weight             | 115 kg         | 115 kg         |
| Depth              | 1200 mm        | 1200 mm        |
| Length x Height    | 1490 x 1470 mm | 1490 x 1470 mm |

350mm Radial Arm Saw

DW728KN / DW729KN\*

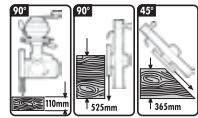

The industrial radial arm saw performs accurate crosscuts time after time. Unrivalled reputation in the professional woodworking industry  
Solid cast iron arm machined to provide arm tracks with no inserts, increasing accuracy and life  
Simple yet positive controls and adjustment scales enable the width, depth and angle of cut to be set with accuracy in seconds  
Quiet maintenance free induction motor delivers high power even at the maximum cutting capacities of the machine. Also available in three phase voltage as DW729K

**Standard Equipment:** 32 tooth saw blade, Assembly tools, Automatic safety return, Blade brake, Legstand

|                    | DW728KN        | DW729KN        |
|--------------------|----------------|----------------|
| Power Input        | 2200 Watts     | 4000 Watts     |
| Power Output       | 1820 Watts     | 3300 Watts     |
| Blade Speed        | 2800 rpm       | 2780 rpm       |
| Blade Diameter     | 350 mm         | 350 mm         |
| Blade Bore         | 30 mm          | 30 mm          |
| Max. Cutting Speed | 53 m/sec       | 53 m/sec       |
| Weight             | 149 kg         | 149 kg         |
| Depth              | 1380 mm        | 11380 mm       |
| Length x Height    | 1800 x 1450 mm | 1800 x 1450 mm |

\*DW729K is a 3-phase unit

155 mm 2 Speed Bandsaw

DW738\*



High quality, rigid, cast aluminium construction suitable for wood, non-ferrous metal, foam, composites and plastics applications  
Two speed control for multiple applications  
Large balanced aluminium band wheels with rubber linings ensure smooth quiet operation  
Large aluminium saw table with high quality, wear resistant coating and replaceable insert

**Standard Equipment:** Saw blade, Rip fence

|                     |               |
|---------------------|---------------|
| Power Input         | 749 Watts     |
| Power Output        | 550 Watts     |
| Max. Cutting Height | 155 mm        |
| Max. Cutting Width  | 310 mm        |
| Cutting Speed       | 330/800 m/min |
| Table Size          | 380 x 380 mm  |
| Weight              | 23.0 kg       |
| Depth               | 520 mm        |
| Length x Height     | 660 x 1550 mm |

\*240V only

155 mm Variable Speed Bandsaw

DW739\*



High quality, rigid, cast aluminium construction suitable for wood, non-ferrous metal, foam, composites and plastics applications  
Adjustable blade speed from 300 to 800 m/min increases control in delicate operations  
Large aluminium saw table with high quality, wear resistant coating and replaceable insert  
Bevel adjustment from 0° to 45°

**Standard Equipment:** Saw blade, Rip fence

|                     |               |
|---------------------|---------------|
| Power Input         | 749 Watts     |
| Power Output        | 550 Watts     |
| Max. Cutting Height | 155 mm        |
| Max. Cutting Width  | 310 mm        |
| Cutting Speed       | 330-800 m/min |
| Table Size          | 380 x 380 mm  |
| Weight              | 23.0 kg       |
| Depth               | 520 mm        |
| Length x Height     | 660 x 1550 mm |

\*240V only



200 mm 2 Speed Bandsaw

DW876\*



All steel welded construction provides extreme rigidity and accuracy even at maximum depths of cut  
500 x 500 mm aluminium extruded table provides a large support area built for flatness and accuracy  
Easy to adjust blade tensioning with integrated tension indicator for different blade types and applications  
Micro switch incorporated in door to prevent accidental starting while open

**Standard Equipment:** Diamond ground steel blade, No volt release switch, Legstand, Mitre and rip fence

|                     |               |
|---------------------|---------------|
| Power Input         | 1000 Watts    |
| Power Output        | 750 Watts     |
| Max. Cutting Height | 200 mm        |
| Max. Cutting Width  | 310 mm        |
| Cutting Speed       | 380/880 m/min |
| Table Size          | 500x500 mm    |
| Weight              | 54.0 kg       |
| Depth               | 650 mm        |
| Length x Height     | 770 x 1590 mm |

\*240V only



Machinery Planer Thicknesser

D27300\*



Large aluminium fence for accurate bevel angles in the surface planing mode  
Large, extruded aluminium top planing table for high accuracy and ease of use  
Integrated motor design to save space and improve transportation  
New control design to improve ease of use and accuracy of adjustment

**Standard Equipment:** HSS knives, Adjustable fence, Allen keys, Spanner, Blade setting gauge, Dust extraction mouthpiece, Push stick, Legset

|                           |               |
|---------------------------|---------------|
| Power Input               | 2100 Watts    |
| Power Output              | 1600 Watts    |
| No Load Speed             | 6200 rpm      |
| Max. Capacity             | 260 mm        |
| Max. Depth of Cut         | 4 mm          |
| Max. Planing Depth        | 3 mm          |
| Planer Table Size         | 1000 x 260 mm |
| Thicknesser Table Size    | 500 x 250 mm  |
| Max. Thicknesser Capacity | 160 mm        |
| Feed Rate                 | 5 m/min       |
| Weight                    | 53 kg         |
| Depth                     | 700 mm        |
| Length x Height           | 1050 x 950 mm |

\*240V only



317 mm Portable Thicknesser

DW733



4 post column design allows the cutter head to move up and down smoothly and accurately  
 Large infeed and outfeed tables provide added material support when cutting large materials to improve the surface finish  
 Powerful 1800 Watt motor makes large surface planing easy  
 Designed for portability on the job site and in small workshops

**Standard Equipment:** Dust shroud and adaptor, Allen key, Blade spanner, Blade changing guides

|                           |              |
|---------------------------|--------------|
| Power Input               | 1800 Watts   |
| Power Output              | 1000 Watts   |
| No Load Speed             | 10000 rpm    |
| Max. Capacity             | 317 mm       |
| Max. Planing Depth        | 2 mm         |
| Max. Thicknesser Capacity | 152 mm       |
| Feed Rate                 | 8 m/min      |
| Weight                    | 33.6 kg      |
| Depth                     | 310 mm       |
| Length x Height           | 520 x 445 mm |



27 Litre Dust Extractor

D27900\*



Wet and dry pick up with separate motor cooling system for extended operating times in workshop or site environment  
 Powerful motor generating 208 mbar of vacuum pressure  
 Built-in power take off socket allows power tool connection for automatic switching of the vacuum system  
 Light and powerful, this machine is easily transportable with the carrying handle or transport wheels

**Standard Equipment:** 4 m x 35 mm extraction hose, 35 mm stepped adaptor, Crevice tool, Dust bag

|                                     |              |
|-------------------------------------|--------------|
| Power Input                         | 1200 Watts   |
| Power Take Off Rating: UK & Ireland | N/A Watts    |
| Power Take Off Rating: Switzerland  | N/A Watts    |
| Power Take Off Rating: Europe       | N/A Watts    |
| Max. Airflow                        | 4020 l/min   |
| Capacity                            | 27 ltr       |
| Wet/Dry Capacity                    | 14 ltr       |
| Weight                              | 7.5 kg       |
| Length x Height                     | 420 x 525 mm |

\*240V only



45 Litre Dust Extractor

D27901\*



Wet and dry pick up with a large 45 litre capacity  
 Automatic start and stop control when the power tool is operated, machine continues to run for 15 seconds to allow all dust to be cleared from system  
 Built-in power take off socket allows power tool connection for automatic switching of the vacuum system  
 Light and powerful, this machine is easily transportable with the carrying handle or transport wheels

**Standard Equipment:** 4 m x 35 mm extraction hose, Crevice tool, Universal hose adaptor, Dust bag

|                                     |              |
|-------------------------------------|--------------|
| Power Input                         | 1200 Watts   |
| Power Take Off Rating: UK & Ireland | 1800 Watts   |
| Power Take Off Rating: Switzerland  | 1100 Watts   |
| Power Take Off Rating: Europe       | 2200 Watts   |
| Max. Airflow                        | 3420 l/min   |
| Capacity                            | 45 ltr       |
| Wet/Dry Capacity                    | 45 ltr       |
| Weight                              | 11.0 kg      |
| Length x Height                     | 505 x 640 mm |

\*240V only



45 Litre Dust Extractor with Constant Automatic Filter Cleaning

D27902\*



Wet and dry pick up with variable suction control allows for the reduction of suction power if required  
 Constant suction power even with the finest concrete and wood dust  
 The filter is automatically cleaned every 15 seconds reducing filter clogging and delivering constant air flow

**Standard Equipment:** 4 m x 35 mm extraction hose, Crevice tool, Universal hose adaptor, Dust bag

|                       |              |
|-----------------------|--------------|
| Power Input           | 1380 Watts   |
| Power Take Off Rating | 2200 Watts   |
| Max. Airflow          | 3660 l/min   |
| Capacity              | 45 ltr       |
| Wet/Dry Capacity      | 45 ltr       |
| Weight                | 13.5 kg      |
| Length x Height       | 520 x 695 mm |

\*110V only



BRUSH PAIRS



| Fits                        | Pair Number | Voltage   | Fits                   | Pair Number | Voltage   |
|-----------------------------|-------------|-----------|------------------------|-------------|-----------|
| D21101 (T1 + 2)             | 578393-02   | 230V      | D28132                 | 1003860-00  | 230V      |
| D21441 (T1 + 2)             | 578393-02   | 230V      | D28132C                | 1003857-00  | 230V      |
| D21620K (T1)                | 596825-00   | 115V-230V | D28133                 | 1003860-00  | 230V      |
| D21710 (T1 + 2 + 3 + 5)     | 578393-02   | 230V      | D28134                 | 1003860-00  | 230V      |
| D21711 (T1 + 2 + 3 + 5)     | 578393-02   | 230V      | D28135                 | 1003857-00  | 230V      |
| D21716 (T1 + 2)             | 578393-02   | 230V      | D28136                 | 1003857-00  | 230V      |
| D21717 (T1 + 2)             | 578393-02   | 230V      | D28137                 | 1003857-00  | 230V      |
| D21720 (T1 + 2 + 3 + 4 + 5) | 578393-02   | 230V      | D28139                 | 1003860-00  | 230V      |
| D21721 (T1 + 2 + 4)         | 578393-02   | 230V      | D28141                 | 1003857-00  | 230V      |
| D21805 (T1)                 | 578393-02   | 230V      | D28151                 | 1003859-00  | 230V      |
| D21810 (T1)                 | 578393-02   | 230V      | D28152                 | 1003859-00  | 230V      |
| D21815 (T1)                 | 578393-02   | 230V      | D28153                 | 1003861-00  | 230V      |
| D25011K (T1)                | N032831     | 230V      | D28154                 | 1003861-00  | 230V      |
| D25012K (T1)                | N032831     | 230V      | D28155                 | 1003861-00  | 230V      |
| D25013K (T1)                | N032831     | 230V      | D28156                 | 1003859-00  | 230V      |
| D25101K (T1 + 2 + 3)        | 585475-00   | 230V      | D28157                 | 1003861-00  | 230V      |
| D25102K (T1 + 2 + 3)        | 585475-00   | 230V      | D28187                 | 1003861-00  | 230V      |
| D25103K (T1 + 2 + 3 + 4)    | 585475-00   | 230V      | D28400 (T1 + 2)        | 585041-00   | 230V      |
| D25104K (T1 + 2 + 3)        | 585475-00   | 230V      | D28401 (T1 + 2)        | 585041-00   | 230V      |
| D25112K (T1)                | 585475-00   | 230V      | D28410 (T1 + 2)        | 585041-00   | 230V      |
| D25113K (T1)                | 585475-00   | 230V      | D28411 (T1 + 2)        | 585041-00   | 230V      |
| D25114K (T1)                | 585475-00   | 230V      | D28413 (T1 + 2)        | 585041-00   | 230V      |
| D25201K (T1 + 2 + 3)        | 585475-00   | 230V      | D28414 (T1 + 2)        | 585041-00   | 230V      |
| D25203K (T1 + 2 + 3)        | 585475-00   | 230V      | D28415 (T1 + 2)        | 585041-00   | 230V      |
| D25213K (T1)                | 585475-00   | 230V      | D28420 (T1)            | 585041-00   | 230V      |
| D25223K (T1)                | 585475-00   | 230V      | D28421 (T1 + 2)        | 585041-00   | 230V      |
| D25303K (T1 + 2 + 3)        | 584429-00   | 230V      | D28422 (T1 + 2)        | 585041-00   | 230V      |
| D25304K (T1 + 2 + 3)        | 584429-00   | 230V      | D28423 (T1 + 2)        | 585041-00   | 230V      |
| D25313K (T1)                | 584429-00   | 230V      | D28430 (T1)            | 585041-00   | 230V      |
| D25314K (T1)                | 584429-00   | 230V      | D28432C (T1 + 2)       | 585041-00   | 230V      |
| D25323K (T1)                | 584429-00   | 230V      | D28490 (T1)            | 585041-00   | 230V      |
| D25324K (T1)                | 584429-00   | 230V      | D28491 (T1)            | 585041-00   | 230V      |
| D25330K (T1 + 2)            | 584429-00   | 230V      | DC210K (T1)            | 493511-00   | N/A       |
| D25404K (T2)                | 487131-00   | 230V      | DC212K (T1)            | 493511-00   | N/A       |
| D25405K (T2)                | 487131-00   | 230V      | DC213 (T1)             | 493511-00   | N/A       |
| D25500K (T1 + 2)            | 582621-00   | 230V      | DC213KL (T1)           | 493511-00   | N/A       |
| D25600K (T1 + 2)            | 327148-01   | 230V      | DC222K (T1)            | 493511-00   | N/A       |
| D25700K (T1)                | 489256-00   | 230V      | DC223K (T1)            | 493511-00   | N/A       |
| D25701K (T1 + 2)            | 489256-00   | 230V      | DC224K (T1)            | 493511-00   | N/A       |
| D25730K (T1 + 2)            | 489256-00   | 230V      | DC330 (T1)             | 493511-00   | N/A       |
| D25830K (T1 + 2)            | 327148-01   | 230V      | DC520K (T1)            | 493511-00   | N/A       |
| D25840K (T1)                | 489256-00   | 230V      | DC920K (T10)           | 493511-00   | N/A       |
| D25890K (T1)                | 489256-00   | 230V      | DC925K (T10)           | 493511-00   | N/A       |
| D25899 (T1)                 | 1005550-02  | 230V      | DC930K (T10)           | 493511-00   | N/A       |
| D25900K (T1 + 2)            | 588698-00   | 230V      | DC935K (T10)           | 493511-00   | N/A       |
| D25901K (T1)                | 1005550-02  | 230V      | DC940K (T10)           | 493511-00   | N/A       |
| D25940K (T1 + 2)            | 588698-00   | 230V      | DC945K (T10)           | 493511-00   | N/A       |
| D25941K (T1)                | 1005550-02  | 230V      | DC980K (T10)           | 493511-00   | N/A       |
| D25980 (T1 + 2)             | 1005550-02  | 230V      | DC981K (T10)           | 493511-00   | N/A       |
| D26410 (T1)                 | 589016-00   | 230V      | DC984K (T1)            | 493511-00   | N/A       |
| D26410 (T1)                 | 596106-00   | 230V      | DC984K (T1)            | 493511-00   | N/A       |
| D26420 (T1)                 | 589016-00   | 230V      | DW205 (T1 + 2)         | 578393-02   | 230V      |
| D26420 (T1)                 | 596106-00   | 230V      | DW223K (T3)            | 578393-02   | 230V      |
| D26421 (T1)                 | 589016-00   | 230V      | DW241                  | 578393-02   | 230V      |
| D26421 (T1)                 | 596106-00   | 230V      | DW268 (T5)             | N023113     | 230V      |
| D26422 (T1)                 | 589016-00   | 230V      | DW331 (T1)             | 589016-00   | 230V      |
| D26422 (T1)                 | 596106-00   | 230V      | DW333 (T1)             | 589016-00   | 230V      |
| D26423 (T1)                 | 589016-00   | 230V      | DW341 (T1 + 2)         | 494040-00   | 230V      |
| D26423 (T1)                 | 596106-00   | 230V      | DW341K (T1 + 2)        | 494043-00   | 230V      |
| D26441 (T1 + 2)             | 1006269-00  | 230V      | DW343 (T2)             | 494040-00   | 230V      |
| D26451 (T1)                 | 1006269-00  | 230V      | DW343K (T1 + 2)        | 494043-00   | 230V      |
| D26453 (T1)                 | 1006269-00  | 230V      | DW448                  | 1003859-00  | 230V      |
| D26500                      | 575963-00   | 230V      | DW451 (T1 + 2)         | 1003859-00  | 230V      |
| D26501 (T1)                 | 575963-03   | 230V      | DW456 (T1 + 2)         | 1003861-00  | 230V      |
| D27900 (T1)                 | 597226-00   | 230V      | DW625E (T6)            | 869368-00   | 230V      |
| D27901 (T1)                 | 597093-00   | 230V      | DW626 (T1)             | 585443-00   | 230V      |
| D28108                      | 1003859-00  | 230V      | DW678 (T1 + 2 + 3 + 4) | 575963-00   | 230V      |
| D28111                      | 1003860-00  | 230V      | DW678E (T1 + 2 + 4)    | 575963-03   | 230V      |
| D28113                      | 1003860-00  | 230V      | DW770 (T1)             | 659512-00   | 115V-230V |
| D28116                      | 1003860-00  | 230V      | DW770 (T1)             | 659513-00   | 115V-230V |
| D28117                      | 1003860-00  | 230V      | DW771 (T1 + 2)         | 659512-00   | 115V-230V |
| D28127                      | 1003859-00  | 230V      | DW771 (T1 + 2)         | 659513-00   | 115V-230V |
| D28128                      | 1003859-00  | 230V      | DW777 (T1 + 2)         | 659512-00   | 115V-230V |
| D28129                      | 1003859-00  | 230V      | DW777 (T1 + 2)         | 659513-00   | 115V-230V |
| D28130                      | 1003860-00  | 230V      | DW5520 (T1)            | 1007368-00  | 230V      |

- Spare parts such as brush pairs can only be purchased by a DeWALT Service Agent. To find your nearest Service Agent, visit our service web site: [www.2helpU.com](http://www.2helpU.com)
- Repairs on power tools should be carried out by an authorised technician
- Any attempt by anyone other than an authorised service repair agent to service a tool during the warranty period will invalidate the warranty for said tool.
- To have the most recent data on spare parts: technical features and the tools they fit, visit our service web site: [www.2helpU.com](http://www.2helpU.com)





# ACCESSORIES SECTION

**YOUR PREMIUM DEWALT TOOLS DESERVE THE RIGHT ACCESSORY**

**USING PROFESSIONAL QUALITY ACCESSORIES WILL IMPROVE THE PERFORMANCE OF YOUR TOOL**



## ICON REFERENCE

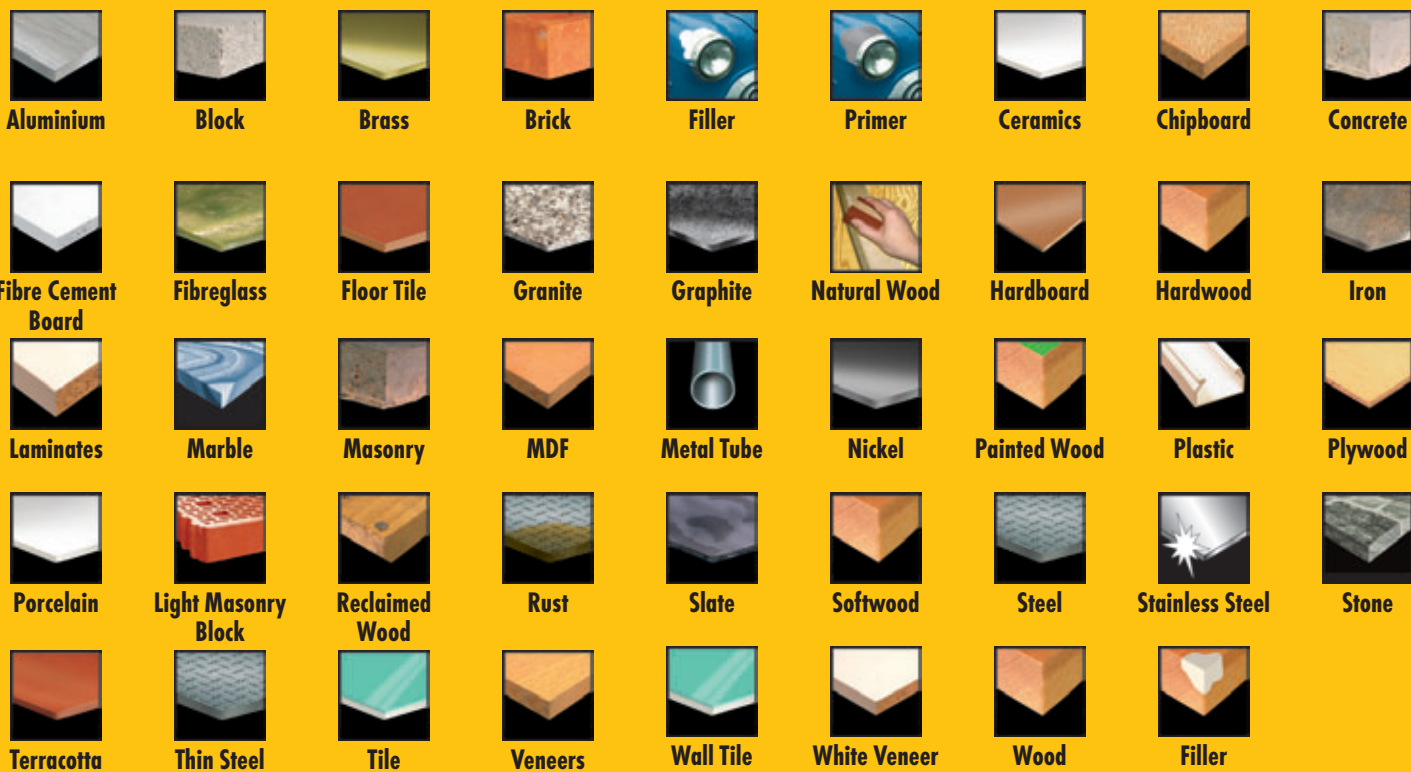

## EXTREME DEWALT® MASONRY DRILL BITS



### APPLICATIONS

- Typically used for drilling anchor, plastic plug, fixing or pipework clearance holes.
- Suitable for masonry, brick, stone, tiles and light concrete.

### FEATURES

- Lasts up to 2x longer and delivers up to 50% more holes per charge than a standard masonry bit.
- Unique Carbide Grade - optimum grade maximises durability.

### SINGLE PACKS

| Cat. No.  | Diameter mm | Length mm | Working Length mm | Pack Qty. | M.O.Q. | Barcode       |
|-----------|-------------|-----------|-------------------|-----------|--------|---------------|
| DT6695-QZ | 3           | 110       | 70                | 1         | 1      | 5035048061879 |
| DT6699-QZ | 3.5         | 110       | 70                | 1         | 1      | 5035048014028 |
| DT6696-QZ | 4           | 110       | 70                | 1         | 1      | 5035048061886 |
| DT6671-QZ | 4           | 75        | 50                | 1         | 1      | 5035048060568 |
| DT6672-QZ | 5           | 85        | 50                | 1         | 1      | 5035048060575 |
| DT6673-QZ | 5           | 150       | 100               | 1         | 1      | 5035048060582 |
| DT6674-QZ | 5.5         | 85        | 50                | 1         | 1      | 5035048060599 |
| DT6675-QZ | 6           | 100       | 60                | 1         | 1      | 5035048060605 |
| DT6676-QZ | 6           | 150       | 100               | 1         | 1      | 5035048060612 |
| DT6677-QZ | 6           | 200       | 150               | 1         | 1      | 5035048060629 |
| DT6678-QZ | 6.5         | 100       | 60                | 1         | 1      | 5035048060636 |
| DT6679-QZ | 6.5         | 150       | 100               | 1         | 1      | 5035048060643 |
| DT6680-QZ | 7           | 100       | 60                | 1         | 1      | 5035048060650 |
| DT6681-QZ | 7           | 150       | 100               | 1         | 1      | 5035048060667 |
| DT6682-QZ | 8           | 120       | 80                | 1         | 1      | 5035048060674 |
| DT6683-QZ | 8           | 200       | 150               | 1         | 1      | 5035048060681 |
| DT6684-QZ | 9           | 120       | 80                | 1         | 1      | 5035048060698 |
| DT6685-QZ | 10          | 120       | 80                | 1         | 1      | 5035048060704 |
| DT6686-QZ | 10          | 200       | 150               | 1         | 1      | 5035048060711 |
| DT6687-QZ | 12          | 150       | 100               | 1         | 1      | 5035048060728 |
| DT6688-QZ | 12          | 200       | 150               | 1         | 1      | 5035048060735 |
| DT6689-QZ | 13          | 150       | 100               | 1         | 1      | 5035048060742 |
| DT6690-QZ | 14          | 150       | 100               | 1         | 1      | 5035048060759 |
| DT6691-QZ | 14          | 200       | 150               | 1         | 1      | 5035048060766 |
| DT6692-QZ | 16          | 150       | 100               | 1         | 1      | 5035048060773 |
| DT6693-QZ | 16          | 200       | 150               | 1         | 1      | 5035048060780 |



### EXTREME DEWALT® MASONRY DRILL BIT SETS

| Cat. No.   | Description   | Diameter mm        | Pack Qty. | M.O.Q. | Barcode       |
|------------|---|--------------------|-----------|--------|---------------|
| DT6956-QZ  | 5 piece set in plastic cassette.  | 4, 5, 6, 8, 10     | 5         | 1      | 5035048060797 |
| DT79288-QZ | Small tough case in blister with EXTREME DEWALT® Masonry drill bits. Ph2x4, Pz2x4, Ph2x50mm, Pz2x50mm, Slotted 5.5x50mm, Magnetic holder, Magnetic drive guide. | 4, 5, 5.5, 6, 7, 8 | 19        | 1      | 5035048072219 |

## MASONRY DRILL BITS



### APPLICATIONS

- Typically used for drilling anchor, plastic plug, fixing or pipework clearance holes.
- Suitable for masonry, brick/blockwork, stone.

### FEATURES

- Rotary/percussion masonry drill bit 130° Douglas form carbide tip.
- Shank diameter of drill bits 10-13 mm is reduced to 9.5 mm.
- Shank diameter of drill bits larger than 13 mm is reduced to 12.7 mm.

### SINGLE PACKS

| Cat. No.  | Diameter mm | Length mm | Working Length mm | Pack Qty. | M.O.Q. | Barcode       |
|-----------|-------------|-----------|-------------------|-----------|--------|---------------|
| DT6500-QZ | 3           | 60        | 28                | 1         | 1      | 5011402382309 |
| DT6504-QZ | 4           | 75        | 38                | 1         | 1      | 5011402372379 |
| DT6505-QZ | 5           | 85        | 44                | 1         | 1      | 5011402372416 |
| DT6502-QZ | 5.5         | 85        | 44                | 1         | 1      | 5011402372454 |
| DT6552-QZ | 5.5         | 150       | 82                | 1         | 1      | 5011402372478 |
| DT6506-QZ | 6           | 100       | 54                | 1         | 1      | 5011402372492 |
| DT6556-QZ | 6           | 150       | 82                | 1         | 1      | 5011402372515 |
| DT6606-QZ | 6           | 200       | 135               | 1         | 1      | 5011402372539 |
| DT6503-QZ | 6.5         | 100       | 54                | 1         | 1      | 5011402372553 |
| DT6507-QZ | 7           | 100       | 54                | 1         | 1      | 5011402372614 |
| DT6557-QZ | 7           | 150       | 82                | 1         | 1      | 5011402372638 |
| DT6508-QZ | 8           | 120       | 67                | 1         | 1      | 5011402372676 |
| DT6558-QZ | 8           | 150       | 82                | 1         | 1      | 5011402372690 |
| DT6608-QZ | 8           | 200       | 135               | 1         | 1      | 5011402372713 |
| DT6708-QZ | 8           | 400       | 230               | 1         | 1      | 5011402372737 |
| DT6509-QZ | 9           | 120       | 67                | 1         | 1      | 5011402372751 |
| DT6510-QZ | 10          | 120       | 67                | 1         | 1      | 5011402372836 |
| DT6560-QZ | 10          | 150       | 82                | 1         | 1      | 5011402372850 |
| DT6610-QZ | 10          | 200       | 135               | 1         | 1      | 5011402372874 |
| DT6710-QZ | 10          | 400       | 230               | 1         | 1      | 5011402372898 |
| DT6732-QZ | 10          | 600       | 400               | 1         | 1      | 5011402382361 |
| DT6562-QZ | 12          | 150       | 82                | 1         | 1      | 5011402372935 |
| DT6612-QZ | 12          | 200       | 135               | 1         | 1      | 5011402372959 |
| DT6712-QZ | 12          | 400       | 230               | 1         | 1      | 5011402372973 |
| DT6733-QZ | 12          | 600       | 400               | 1         | 1      | 5011402382378 |
| DT6563-QZ | 13          | 150       | 82                | 1         | 1      | 5011402372997 |
| DT6564-QZ | 14          | 150       | 82                | 1         | 1      | 5011402373055 |
| DT6714-QZ | 14          | 400       | 230               | 1         | 1      | 5011402373093 |
| DT6734-QZ | 14          | 600       | 400               | 1         | 1      | 5011402382385 |
| DT6566-QZ | 16          | 150       | 82                | 1         | 1      | 5011402373130 |
| DT6716-QZ | 16          | 400       | 230               | 1         | 1      | 5011402373154 |
| DT6735-QZ | 16          | 600       | 400               | 1         | 1      | 5011402382392 |
| DT6718-QZ | 18          | 400       | 230               | 1         | 1      | 5011402373192 |
| DT6720-QZ | 20          | 400       | 230               | 1         | 1      | 5011402373239 |



MASONRY DRILL BITS



MASONRY DRILL BIT SETS

| Cat. No.  | Description                     | Diameter mm    | Pack Qty. | M.O.Q. | Barcode       |
|-----------|---------------------------------|----------------|-----------|--------|---------------|
| DT6952-QZ | 5 piece set in plastic cassette | 4, 5, 6, 8, 10 | 5         | 1      | 5011402373413 |

MULTI MATERIAL DRILL BITS



MULTI MATERIAL DRILL BITS

| Cat. No.  | Diameter mm | Length mm | Working Length mm | Pack Qty. | M.O.Q. | Barcode       |
|-----------|-------------|-----------|-------------------|-----------|--------|---------------|
| DT6515-QZ | 3           | 113       | 83                | 1         | 1      | 5035048066010 |
| DT6516-QZ | 3.5         | 113       | 83                | 1         | 1      | 5035048066027 |
| DT6517-QZ | 4           | 103       | 73                | 1         | 1      | 5035048066034 |
| DT6518-QZ | 5           | 113       | 83                | 1         | 1      | 5035048066041 |
| DT6527-QZ | 5.5         | 113       | 83                | 1         | 1      | 5035048077504 |
| DT6528-QZ | 5.5         | 200       | 170               | 1         | 1      | 5035048077511 |
| DT6519-QZ | 6           | 123       | 93                | 1         | 1      | 5035048066058 |
| DT6529-QZ | 6           | 200       | 170               | 1         | 1      | 5035048077528 |
| DT6520-QZ | 6.5         | 123       | 93                | 1         | 1      | 5035048066065 |
| DT6530-QZ | 6.5         | 200       | 170               | 1         | 1      | 5035048077535 |
| DT6521-QZ | 7           | 123       | 93                | 1         | 1      | 5035048066072 |
| DT6522-QZ | 8           | 134       | 104               | 1         | 1      | 5035048066089 |
| DT6531-QZ | 8           | 200       | 170               | 1         | 1      | 5035048077542 |
| DT6523-QZ | 9           | 134       | 104               | 1         | 1      | 5035048066096 |
| DT6524-QZ | 10          | 134       | 104               | 1         | 1      | 5035048066102 |
| DT6533-QZ | 10          | 200       | 170               | 1         | 1      | 5035048077559 |
| DT6525-QZ | 12          | 153       | 123               | 1         | 1      | 5035048066119 |
| DT6526-QZ | 13          | 160       | 130               | 1         | 1      | 5035048066126 |

APPLICATIONS

- Suitable for wood, plastics, mild steel and non ferrous metals and masonry.
- For use in rotary or percussion drilling modes.

FEATURES

- Unique 120° tip grind for maximum sharpness.
- Fully supported carbide head gives faster drilling and extended life.
- Non slip shank ensures better retention in chuck.

SDS-Plus EXTREME DeWALT® 2 DRILL BITS



SINGLE PACKS

| Cat. No.  | Diameter mm | Length mm | Working Length mm | Pack Qty. | M.O.Q. | Barcode       |
|-----------|-------------|-----------|-------------------|-----------|--------|---------------|
| DT9625-QZ | 3           | 135       | 75                | 1         | 1      | 5035048014011 |
| DT9500-QZ | 3.5         | 110       | 50                | 1         | 1      | 5035048054758 |
| DT9502-QZ | 4           | 110       | 50                | 1         | 1      | 5035048054772 |
| DT9503-QZ | 4           | 160       | 100               | 1         | 1      | 5035048054789 |
| DT9504-QZ | 5           | 110       | 50                | 1         | 1      | 5035048054796 |
| DT9505-QZ | 5           | 160       | 100               | 1         | 1      | 5035048054802 |
| DT9506-QZ | 5           | 210       | 150               | 1         | 1      | 5035048054819 |
| DT9507-QZ | 5           | 310       | 250               | 1         | 1      | 5035048054826 |
| DT9620-QZ | 5           | 460       | 400               | 1         | 1      | 5035048061855 |
| DT9508-QZ | 5.5         | 110       | 50                | 1         | 1      | 5035048054833 |
| DT9509-QZ | 5.5         | 160       | 100               | 1         | 1      | 5035048054840 |
| DT9510-QZ | 5.5         | 210       | 150               | 1         | 1      | 5035048054857 |
| DT9511-QZ | 5.5         | 260       | 200               | 1         | 1      | 5035048054864 |
| DT9512-QZ | 5.5         | 310       | 250               | 1         | 1      | 5035048054871 |
| DT9513-QZ | 5.5         | 460       | 400               | 1         | 1      | 5035048054888 |
| DT9514-QZ | 6           | 110       | 50                | 1         | 1      | 5035048054895 |
| DT9515-QZ | 6           | 160       | 100               | 1         | 1      | 5035048054901 |
| DT9516-QZ | 6           | 210       | 150               | 1         | 1      | 5035048054918 |
| DT9517-QZ | 6           | 260       | 200               | 1         | 1      | 5035048054925 |
| DT9621-QZ | 6           | 310       | 250               | 1         | 1      | 5035048061862 |
| DT9518-QZ | 6           | 460       | 400               | 1         | 1      | 5035048054932 |
| DT9519-QZ | 6.5         | 110       | 50                | 1         | 1      | 5035048054949 |
| DT9520-QZ | 6.5         | 160       | 100               | 1         | 1      | 5035048054956 |
| DT9521-QZ | 6.5         | 210       | 150               | 1         | 1      | 5035048054963 |
| DT9522-QZ | 6.5         | 260       | 200               | 1         | 1      | 5035048054970 |
| DT9523-QZ | 6.5         | 310       | 250               | 1         | 1      | 5035048054987 |
| DT9524-QZ | 7           | 110       | 50                | 1         | 1      | 5035048054994 |
| DT9525-QZ | 7           | 160       | 100               | 1         | 1      | 5035048055007 |
| DT9526-QZ | 7           | 210       | 150               | 1         | 1      | 5035048055014 |
| DT9527-QZ | 7           | 260       | 200               | 1         | 1      | 5035048055021 |
| DT9528-QZ | 8           | 110       | 50                | 1         | 1      | 5035048055038 |
| DT9529-QZ | 8           | 160       | 100               | 1         | 1      | 5035048055045 |

APPLICATIONS

- Suitable for fast drilling of plug, anchor or clearance holes in masonry, stone, concrete and brick/block work.

FEATURES

- The innovative EXTREME DeWALT® 2 SDS-Plus drill bit is amongst the very best in terms of its durability drilling life and speed.
- The Superior carbide grade ensures a tip with outstanding durability which gives consistent drilling life.
- The NEW 4 FLUTE SPIRAL incorporates a maximized central core for increased durability and energy transmission.
- The 140° tip design ensures better bit penetration and longer life.
- Hardened Steel body for extra strength and reduced breakage.

SDS-Plus EXTREME DeWALT® 2 DRILL BITS



SINGLE PACKS

| Cat. No.  | Diameter mm | Length mm | Working Length mm | Pack Qty. | M.O.Q. | Barcode       |
|-----------|-------------|-----------|-------------------|-----------|--------|---------------|
| DT9530-QZ | 8           | 210       | 150               | 1         | 1      | 5035048055052 |
| DT9531-QZ | 8           | 260       | 200               | 1         | 1      | 5035048055069 |
| DT9532-QZ | 8           | 310       | 250               | 1         | 1      | 5035048055076 |
| DT9533-QZ | 8           | 410       | 350               | 1         | 1      | 5035048055083 |
| DT9534-QZ | 8           | 460       | 400               | 1         | 1      | 5035048055090 |
| DT9535-QZ | 8           | 600       | 540               | 1         | 1      | 5035048055106 |
| DT9536-QZ | 9           | 160       | 100               | 1         | 1      | 5035048055113 |
| DT9537-QZ | 9           | 210       | 150               | 1         | 1      | 5035048055120 |
| DT9539-QZ | 10          | 110       | 50                | 1         | 1      | 5035048055144 |
| DT9540-QZ | 10          | 160       | 100               | 1         | 1      | 5035048055151 |
| DT9541-QZ | 10          | 210       | 150               | 1         | 1      | 5035048055168 |
| DT9542-QZ | 10          | 260       | 200               | 1         | 1      | 5035048055175 |
| DT9543-QZ | 10          | 310       | 250               | 1         | 1      | 5035048055182 |
| DT9544-QZ | 10          | 350       | 300               | 1         | 1      | 5035048055199 |
| DT9545-QZ | 10          | 460       | 400               | 1         | 1      | 5035048055205 |
| DT9546-QZ | 10          | 600       | 550               | 1         | 1      | 5035048055212 |
| DT9547-QZ | 10          | 1000      | 950               | 1         | 1      | 5035048055229 |
| DT9548-QZ | 11          | 160       | 100               | 1         | 1      | 5035048055236 |
| DT9549-QZ | 11          | 210       | 150               | 1         | 1      | 5035048055243 |
| DT9550-QZ | 11          | 260       | 200               | 1         | 1      | 5035048055250 |
| DT9551-QZ | 11          | 310       | 250               | 1         | 1      | 5035048055267 |
| DT9552-QZ | 12          | 160       | 100               | 1         | 1      | 5035048055274 |
| DT9553-QZ | 12          | 200       | 150               | 1         | 1      | 5035048055281 |
| DT9554-QZ | 12          | 260       | 200               | 1         | 1      | 5035048055298 |
| DT9555-QZ | 12          | 300       | 250               | 1         | 1      | 5035048055304 |
| DT9556-QZ | 12          | 350       | 300               | 1         | 1      | 5035048055311 |
| DT9557-QZ | 12          | 450       | 400               | 1         | 1      | 5035048055328 |
| DT9558-QZ | 12          | 600       | 550               | 1         | 1      | 5035048055335 |
| DT9559-QZ | 12          | 1000      | 950               | 1         | 1      | 5035048055342 |
| DT9560-QZ | 13          | 160       | 100               | 1         | 1      | 5035048055359 |
| DT9561-QZ | 13          | 200       | 150               | 1         | 1      | 5035048055366 |
| DT9562-QZ | 13          | 260       | 200               | 1         | 1      | 5035048055373 |
| DT9563-QZ | 13          | 300       | 250               | 1         | 1      | 5035048055380 |
| DT9565-QZ | 13          | 450       | 400               | 1         | 1      | 5035048055403 |
| DT9566-QZ | 14          | 160       | 100               | 1         | 1      | 5035048055410 |
| DT9567-QZ | 14          | 200       | 150               | 1         | 1      | 5035048055427 |
| DT9568-QZ | 14          | 260       | 200               | 1         | 1      | 5035048055434 |
| DT9569-QZ | 14          | 300       | 250               | 1         | 1      | 5035048055441 |
| DT9570-QZ | 14          | 450       | 400               | 1         | 1      | 5035048055458 |
| DT9571-QZ | 14          | 600       | 550               | 1         | 1      | 5035048055465 |
| DT9572-QZ | 14          | 1000      | 950               | 1         | 1      | 5035048055472 |
| DT9573-QZ | 15          | 160       | 100               | 1         | 1      | 5035048055489 |
| DT9574-QZ | 15          | 200       | 150               | 1         | 1      | 5035048055496 |
| DT9575-QZ | 15          | 260       | 200               | 1         | 1      | 5035048055502 |
| DT9576-QZ | 15          | 300       | 250               | 1         | 1      | 5035048055519 |
| DT9577-QZ | 15          | 450       | 400               | 1         | 1      | 5035048055526 |
| DT9578-QZ | 16          | 160       | 100               | 1         | 1      | 5035048055533 |
| DT9579-QZ | 16          | 200       | 150               | 1         | 1      | 5035048055540 |
| DT9580-QZ | 16          | 260       | 200               | 1         | 1      | 5035048055557 |
| DT9581-QZ | 16          | 300       | 250               | 1         | 1      | 5035048055564 |
| DT9582-QZ | 16          | 450       | 400               | 1         | 1      | 5035048055571 |
| DT9583-QZ | 16          | 600       | 550               | 1         | 1      | 5035048055588 |
| DT9584-QZ | 16          | 800       | 750               | 1         | 1      | 5035048055595 |
| DT9585-QZ | 16          | 1000      | 950               | 1         | 1      | 5035048055601 |
| DT9586-QZ | 17          | 200       | 150               | 1         | 1      | 5035048055618 |
| DT9587-QZ | 18          | 200       | 150               | 1         | 1      | 5035048055625 |
| DT9588-QZ | 18          | 250       | 200               | 1         | 1      | 5035048055632 |
| DT9589-QZ | 18          | 300       | 250               | 1         | 1      | 5035048055649 |
| DT9590-QZ | 18          | 450       | 400               | 1         | 1      | 5035048055656 |
| DT9591-QZ | 18          | 600       | 550               | 1         | 1      | 5035048055663 |
| DT9592-QZ | 18          | 800       | 750               | 1         | 1      | 5035048055670 |
| DT9593-QZ | 18          | 1000      | 950               | 1         | 1      | 5035048055687 |
| DT9596-QZ | 19          | 450       | 400               | 1         | 1      | 5035048055717 |
| DT9597-QZ | 20          | 200       | 150               | 1         | 1      | 5035048055724 |
| DT9598-QZ | 20          | 300       | 250               | 1         | 1      | 5035048055731 |
| DT9599-QZ | 20          | 450       | 400               | 1         | 1      | 5035048055748 |
| DT9600-QZ | 20          | 600       | 550               | 1         | 1      | 5035048055755 |
| DT9601-QZ | 20          | 1000      | 950               | 1         | 1      | 5035048055762 |
| DT9602-QZ | 22          | 250       | 200               | 1         | 1      | 5035048055779 |
| DT9603-QZ | 22          | 300       | 250               | 1         | 1      | 5035048055786 |
| DT9604-QZ | 22          | 450       | 400               | 1         | 1      | 5035048055793 |
| DT9605-QZ | 22          | 600       | 550               | 1         | 1      | 5035048055809 |
| DT9606-QZ | 22          | 800       | 750               | 1         | 1      | 5035048055816 |
| DT9607-QZ | 22          | 1000      | 950               | 1         | 1      | 5035048055823 |
| DT9609-QZ | 24          | 250       | 200               | 1         | 1      | 5035048055847 |
| DT9610-QZ | 24          | 450       | 400               | 1         | 1      | 5035048055854 |
| DT9611-QZ | 25          | 250       | 200               | 1         | 1      | 5035048055861 |
| DT9612-QZ | 25          | 300       | 250               | 1         | 1      | 5035048055878 |
| DT9613-QZ | 25          | 450       | 400               | 1         | 1      | 5035048055885 |
| DT9614-QZ | 25          | 1000      | 950               | 1         | 1      | 5035048055892 |
| DT9615-QZ | 26          | 250       | 200               | 1         | 1      | 5035048055908 |
| DT9616-QZ | 26          | 450       | 400               | 1         | 1      | 5035048055915 |
| DT9617-QZ | 26          | 800       | 750               | 1         | 1      | 5035048055922 |
| DT9618-QZ | 30          | 250       | 200               | 1         | 1      | 5035048055939 |
| DT9619-QZ | 30          | 450       | 400               | 1         | 1      | 5035048055946 |

APPLICATIONS

- Suitable for fast drilling of plug, anchor or clearance holes in masonry, stone, concrete and brick/block work.

FEATURES

- The innovative EXTREME DeWALT® 2 SDS-Plus drill bit is amongst the very best in terms of its durability drilling life and speed.
- The Superior carbide grade ensures a tip with outstanding durability which gives consistent drilling life.
- The NEW 4 FLUTE SPIRAL incorporates a maximized central core for increased durability and energy transmission.
- The 140° tip design ensures better bit penetration and longer life.
- Hardened Steel body for extra strength and reduced breakage.





SDS-Plus EXTREME DeWALT® 2 DRILL BITS



APPLICATIONS

- Suitable for fast drilling of plug, anchor or clearance holes in masonry, stone, concrete and brick/block work.

FEATURES

- The innovative EXTREME DeWALT® 2 SDS-Plus drill bit is amongst the very best in terms of its durability drilling life and speed.
- The Superior carbide grade ensures a tip with outstanding durability which gives consistent drilling life.
- The NEW 4 FLUTE SPIRAL incorporates a maximized central core for increased durability and energy transmission.
- The 140° tip design ensures better bit penetration and longer life.
- Hardened Steel body for extra strength and reduced breakage.

BULK PACKS

| Cat. No.  | Diameter mm | Length mm | Working Length mm | Pack Qty. | M.O.Q. | Barcode       |
|-----------|-------------|-----------|-------------------|-----------|--------|---------------|
| DT9800-QZ | 5           | 110       | 50                | 10        | 1      | 5035048055953 |
| DT9803-QZ | 5           | 160       | 100               | 10        | 1      | 5035048055984 |
| DT9806-QZ | 5.5         | 110       | 50                | 10        | 1      | 5035048056011 |
| DT9809-QZ | 5.5         | 160       | 100               | 10        | 1      | 5035048056042 |
| DT9812-QZ | 6           | 110       | 50                | 10        | 1      | 5035048056073 |
| DT9814-QZ | 6           | 110       | 50                | 100       | 1      | 5035048056097 |
| DT9815-QZ | 6           | 160       | 100               | 10        | 1      | 5035048056103 |
| DT9816-QZ | 6           | 160       | 100               | 50        | 1      | 5035048056110 |
| DT9817-QZ | 6           | 160       | 100               | 100       | 1      | 5035048056127 |
| DT9818-QZ | 6           | 210       | 150               | 10        | 1      | 5035048056134 |
| DT9848-QZ | 6           | 210       | 150               | 50        | 1      | 5035048013977 |
| DT9820-QZ | 6.5         | 160       | 100               | 10        | 1      | 5035048056158 |
| DT9846-QZ | 6.5         | 210       | 150               | 10        | 1      | 5035048013953 |
| DT9847-QZ | 6.5         | 210       | 150               | 50        | 1      | 5035048013960 |
| DT9823-QZ | 7           | 160       | 100               | 10        | 1      | 5035048056189 |
| DT9826-QZ | 8           | 110       | 50                | 10        | 1      | 5035048056219 |
| DT9827-QZ | 8           | 160       | 100               | 10        | 1      | 5035048056226 |
| DT9828-QZ | 8           | 160       | 100               | 50        | 1      | 5035048056233 |
| DT9829-QZ | 8           | 160       | 100               | 100       | 1      | 5035048056240 |
| DT9830-QZ | 8           | 210       | 150               | 10        | 1      | 5035048056257 |
| DT9831-QZ | 8           | 260       | 200               | 10        | 1      | 5035048056264 |
| DT9833-QZ | 10          | 110       | 50                | 10        | 1      | 5035048056288 |
| DT9834-QZ | 10          | 160       | 100               | 10        | 1      | 5035048056295 |
| DT9835-QZ | 10          | 160       | 100               | 50        | 1      | 5035048056301 |
| DT9837-QZ | 10          | 210       | 150               | 10        | 1      | 5035048056325 |
| DT9838-QZ | 10          | 260       | 200               | 10        | 1      | 5035048056332 |
| DT9839-QZ | 12          | 160       | 100               | 10        | 1      | 5035048056349 |
| DT9840-QZ | 12          | 160       | 100               | 50        | 1      | 5035048056356 |
| DT9841-QZ | 12          | 200       | 150               | 10        | 1      | 5035048056363 |
| DT9842-QZ | 12          | 260       | 200               | 10        | 1      | 5035048056370 |
| DT9843-QZ | 14          | 160       | 100               | 10        | 1      | 5035048056387 |
| DT9844-QZ | 14          | 200       | 150               | 10        | 1      | 5035048056394 |

SDS-Plus EXTREME DeWALT® 2 DRILL BIT SETS

| Cat. No.  | Description                      | Diameter mm     | Pack Qty. | M.O.Q. | Barcode       |
|-----------|----------------------------------|-----------------|-----------|--------|---------------|
| DT9700-QZ | 4 piece set in plastic cassette. | 5,6,8,10        | 4         | 1      | 5035048056400 |
| DT9701-QZ | 7 piece set in metal cassette.   | 5,6x2,8x2,10,12 | 7         | 1      | 5035048056417 |
| DT9702-QZ | 4 piece set in plastic cassette. | 5,5,7,8,10      | 4         | 1      | 5035048056424 |

EXTREME DeWALT® XLR FULL HEAD CARBIDE DRILL BITS



APPLICATIONS

- Suitable for drilling plug & anchor holes in masonry, all types of stone and concrete.

FEATURES

- New solid carbide drill tip with optimised 4 cutter geometry offers the highest levels of drill bit life and durability from DeWALT to date.
- 4 cutter geometry drills a more concentric hole to offer the best fixing retention.
- 4 flute spiral aids consistent drilling speed and efficient debris removal.
- Unique bonding system joins the solid carbide head to the 4 flute spiral as one to ensure the highest standards available in DeWALT® SDS-Plus drilling to date.



SINGLE PACKS

| Cat. No.  | Diameter mm | Length mm | Working Length mm | Pack Qty. | M.O.Q. | Barcode       |
|-----------|-------------|-----------|-------------------|-----------|--------|---------------|
| DT8907-QZ | 5           | 110       | 50                | 1         | 1      | 5035048077689 |
| DT8908-QZ | 5           | 160       | 100               | 1         | 1      | 5035048077696 |
| DT8909-QZ | 5           | 210       | 150               | 1         | 1      | 5035048077702 |
| DT8910-QZ | 5.5         | 110       | 50                | 1         | 1      | 5035048077719 |
| DT8911-QZ | 5.5         | 160       | 100               | 1         | 1      | 5035048077726 |
| DT8912-QZ | 6           | 110       | 50                | 1         | 1      | 5035048077733 |
| DT8913-QZ | 6           | 160       | 100               | 1         | 1      | 5035048077740 |
| DT8914-QZ | 6           | 210       | 150               | 1         | 1      | 5035048077757 |
| DT8915-QZ | 6           | 260       | 200               | 1         | 1      | 5035048077764 |
| DT8916-QZ | 6.5         | 160       | 100               | 1         | 1      | 5035048077771 |
| DT8917-QZ | 6.5         | 210       | 150               | 1         | 1      | 5035048077788 |
| DT8918-QZ | 6.5         | 260       | 200               | 1         | 1      | 5035048077795 |
| DT8919-QZ | 6.5         | 310       | 250               | 1         | 1      | 5035048077801 |
| DT8920-QZ | 7           | 160       | 100               | 1         | 1      | 5035048077818 |
| DT8921-QZ | 7           | 210       | 150               | 1         | 1      | 5035048077825 |
| DT8922-QZ | 8           | 110       | 50                | 1         | 1      | 5035048077832 |
| DT8923-QZ | 8           | 160       | 100               | 1         | 1      | 5035048077849 |
| DT8924-QZ | 8           | 210       | 150               | 1         | 1      | 5035048077856 |
| DT8925-QZ | 8           | 260       | 200               | 1         | 1      | 5035048077863 |
| DT8926-QZ | 8           | 310       | 250               | 1         | 1      | 5035048077870 |
| DT8927-QZ | 8           | 460       | 400               | 1         | 1      | 5035048077887 |
| DT8928-QZ | 10          | 160       | 100               | 1         | 1      | 5035048077894 |
| DT8929-QZ | 10          | 210       | 150               | 1         | 1      | 5035048077901 |
| DT8930-QZ | 10          | 260       | 200               | 1         | 1      | 5035048077917 |
| DT8931-QZ | 10          | 310       | 250               | 1         | 1      | 5035048077924 |
| DT8932-QZ | 10          | 460       | 400               | 1         | 1      | 5035048077931 |
| DT8933-QZ | 12          | 160       | 100               | 1         | 1      | 5035048077948 |
| DT8934-QZ | 12          | 200       | 150               | 1         | 1      | 5035048077955 |
| DT8935-QZ | 12          | 260       | 200               | 1         | 1      | 5035048077962 |
| DT8936-QZ | 12          | 310       | 260               | 1         | 1      | 5035048077979 |
| DT8937-QZ | 12          | 460       | 410               | 1         | 1      | 5035048077986 |
| DT8938-QZ | 14          | 160       | 100               | 1         | 1      | 5035048077993 |
| DT8939-QZ | 14          | 200       | 150               | 1         | 1      | 5035048078000 |
| DT8940-QZ | 14          | 260       | 200               | 1         | 1      | 5035048078013 |
| DT8941-QZ | 14          | 310       | 250               | 1         | 1      | 5035048078020 |
| DT8942-QZ | 14          | 460       | 400               | 1         | 1      | 5035048078037 |

BULK PACKS

| Cat. No.  | Diameter mm | Length mm | Working Length mm | Pack Qty. | M.O.Q. | Barcode       |
|-----------|-------------|-----------|-------------------|-----------|--------|---------------|
| DT8950-QZ | 5           | 110       | 50                | 10        | 1      | 5035048078105 |
| DT8951-QZ | 5           | 160       | 100               | 10        | 1      | 5035048078112 |
| DT8952-QZ | 5           | 210       | 150               | 10        | 1      | 5035048078129 |
| DT8953-QZ | 5.5         | 110       | 50                | 10        | 1      | 5035048078136 |
| DT8954-QZ | 5.5         | 160       | 100               | 10        | 1      | 5035048078143 |
| DT8955-QZ | 6           | 110       | 50                | 10        | 1      | 5035048078150 |
| DT8956-QZ | 6           | 160       | 100               | 10        | 1      | 5035048078167 |
| DT8957-QZ | 6           | 210       | 150               | 10        | 1      | 5035048078174 |
| DT8958-QZ | 6           | 260       | 200               | 10        | 1      | 5035048078181 |
| DT8959-QZ | 6.5         | 160       | 100               | 10        | 1      | 5035048078198 |
| DT8960-QZ | 6.5         | 210       | 150               | 10        | 1      | 5035048078204 |
| DT8961-QZ | 6.5         | 260       | 200               | 10        | 1      | 5035048078211 |
| DT8962-QZ | 7           | 160       | 100               | 10        | 1      | 5035048078228 |
| DT8963-QZ | 7           | 260       | 150               | 10        | 1      | 5035048078235 |
| DT8964-QZ | 8           | 110       | 50                | 10        | 1      | 5035048078242 |
| DT8965-QZ | 8           | 160       | 100               | 10        | 1      | 5035048078259 |
| DT8966-QZ | 8           | 210       | 150               | 10        | 1      | 5035048078266 |
| DT8967-QZ | 10          | 160       | 100               | 10        | 1      | 5035048078273 |
| DT8968-QZ | 10          | 210       | 150               | 10        | 1      | 5035048078280 |
| DT8969-QZ | 10          | 260       | 200               | 10        | 1      | 5035048078297 |
| DT8970-QZ | 10          | 310       | 260               | 10        | 1      | 5035048078303 |
| DT8971-QZ | 12          | 160       | 100               | 10        | 1      | 5035048078310 |
| DT8972-QZ | 12          | 200       | 150               | 10        | 1      | 5035048078327 |
| DT8973-QZ | 14          | 200       | 150               | 10        | 1      | 5035048078334 |

EXTREME DeWALT® FULL HEAD CARBIDE DRILL BIT SETS

| Cat. No.  | Description  | Diameter mm        | Pack Qty. | M.O.Q. | Barcode       |
|-----------|--|--------------------|-----------|--------|---------------|
| DT8976-QZ | 7 piece set in metal cassette                                    | 5, 6x2, 8x2, 10,12 | 7         | 1      | 5035048078341 |
| DT8977-QZ | Medium Tough Case with SDS-Plus XLR Full Head Carbide drill bits | 5, 6x2, 8x2, 10,12 | 10        | 1      | 5035048078358 |



SDS-Plus 4-CUTTER DRILL BITS

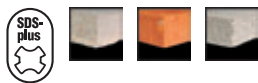

SINGLE PACKS

| Cat. No.  | Diameter mm | Length mm | Working Length mm | Pack Qty. | M.O.Q. | Barcode       |
|-----------|-------------|-----------|-------------------|-----------|--------|---------------|
| DT9680-QZ | 16          | 250       | 200               | 1         | 1      | 5035048066133 |
| DT9681-QZ | 16          | 450       | 400               | 1         | 1      | 5035048066140 |
| DT9682-QZ | 18          | 250       | 200               | 1         | 1      | 5035048066157 |
| DT9683-QZ | 18          | 450       | 400               | 1         | 1      | 5035048066164 |
| DT9684-QZ | 20          | 250       | 200               | 1         | 1      | 5035048066171 |
| DT9685-QZ | 20          | 450       | 400               | 1         | 1      | 5035048066188 |
| DT9686-QZ | 22          | 250       | 200               | 1         | 1      | 5035048066195 |
| DT9687-QZ | 22          | 450       | 400               | 1         | 1      | 5035048066201 |
| DT9688-QZ | 24          | 250       | 200               | 1         | 1      | 5035048066218 |
| DT9689-QZ | 24          | 450       | 400               | 1         | 1      | 5035048066225 |
| DT9690-QZ | 25          | 250       | 200               | 1         | 1      | 5035048066232 |
| DT9691-QZ | 25          | 450       | 400               | 1         | 1      | 5035048066249 |
| DT9692-QZ | 26          | 450       | 400               | 1         | 1      | 5035048066256 |
| DT9693-QZ | 28          | 250       | 200               | 1         | 1      | 5035048066263 |
| DT9694-QZ | 28          | 450       | 400               | 1         | 1      | 5035048066270 |
| DT9695-QZ | 30          | 250       | 200               | 1         | 1      | 5035048066287 |
| DT9696-QZ | 30          | 450       | 400               | 1         | 1      | 5035048066294 |

APPLICATIONS

- For fixing holes and through holes 16mm - 30mm.

FEATURES

- 4 flute spiral with maximum flute entry enables faster debris removal.
- Maximised central core enables more efficient energy transmission to the drill bit head.
- Fully supported carbide head gives longer life and cleaner, more concentric holes for better fixing retention.
- Open head design ensures faster drilling.

SDS-MAX HAMMER DRILL BITS



SINGLE PACKS

| Cat. No.  | Diameter mm | Length mm | Working Length mm | Cutters | Pack Qty. | M.O.Q. | Barcode       |
|-----------|-------------|-----------|-------------------|---------|-----------|--------|---------------|
| DT9400-QZ | 12          | 340       | 200               | 2       | 1         | 1      | 5035048059678 |
| DT9401-QZ | 12          | 540       | 400               | 2       | 1         | 1      | 5035048059685 |
| DT9402-QZ | 12          | 670       | 550               | 2       | 1         | 1      | 5035048059692 |
| DT9403-QZ | 13          | 340       | 200               | 2       | 1         | 1      | 5035048059708 |
| DT9404-QZ | 13          | 540       | 400               | 2       | 1         | 1      | 5035048059715 |
| DT9405-QZ | 14          | 340       | 200               | 2       | 1         | 1      | 5035048059722 |
| DT9406-QZ | 14          | 540       | 400               | 2       | 1         | 1      | 5035048059739 |
| DT9407-QZ | 15          | 340       | 200               | 2       | 1         | 1      | 5035048059746 |
| DT9408-QZ | 15          | 540       | 400               | 2       | 1         | 1      | 5035048059753 |
| DT9409-QZ | 16          | 340       | 200               | 4       | 1         | 1      | 5035048059760 |
| DT9410-QZ | 16          | 540       | 400               | 4       | 1         | 1      | 5035048059777 |
| DT9411-QZ | 18          | 340       | 200               | 4       | 1         | 1      | 5035048059784 |
| DT9412-QZ | 18          | 540       | 400               | 4       | 1         | 1      | 5035048059791 |
| DT9413-QZ | 19          | 340       | 200               | 4       | 1         | 1      | 5035048059807 |
| DT9414-QZ | 19          | 540       | 400               | 4       | 1         | 1      | 5035048059814 |
| DT9415-QZ | 19          | 670       | 550               | 4       | 1         | 1      | 5035048059821 |
| DT9416-QZ | 20          | 340       | 200               | 4       | 1         | 1      | 5035048059838 |
| DT9417-QZ | 20          | 540       | 400               | 4       | 1         | 1      | 5035048059845 |
| DT9418-QZ | 20          | 920       | 800               | 4       | 1         | 1      | 5035048059852 |
| DT9419-QZ | 22          | 340       | 200               | 4       | 1         | 1      | 5035048059869 |
| DT9420-QZ | 22          | 540       | 400               | 4       | 1         | 1      | 5035048059876 |
| DT9421-QZ | 22          | 920       | 800               | 4       | 1         | 1      | 5035048059883 |
| DT9422-QZ | 24          | 340       | 200               | 4       | 1         | 1      | 5035048059890 |
| DT9423-QZ | 24          | 540       | 400               | 4       | 1         | 1      | 5035048059906 |
| DT9424-QZ | 25          | 340       | 200               | 4       | 1         | 1      | 5035048059913 |
| DT9425-QZ | 25          | 540       | 400               | 4       | 1         | 1      | 5035048059920 |
| DT9426-QZ | 25          | 920       | 800               | 4       | 1         | 1      | 5035048059937 |
| DT9427-QZ | 26          | 340       | 200               | 4       | 1         | 1      | 5035048059944 |
| DT9428-QZ | 26          | 540       | 400               | 4       | 1         | 1      | 5035048059951 |
| DT9429-QZ | 28          | 380       | 250               | 4       | 1         | 1      | 5035048059968 |
| DT9430-QZ | 28          | 570       | 450               | 4       | 1         | 1      | 5035048059975 |
| DT9431-QZ | 28          | 670       | 550               | 4       | 1         | 1      | 5035048059982 |
| DT9432-QZ | 30          | 380       | 250               | 4       | 1         | 1      | 5035048059999 |
| DT9433-QZ | 30          | 570       | 450               | 4       | 1         | 1      | 5035048060001 |
| DT9434-QZ | 32          | 380       | 250               | 4       | 1         | 1      | 5035048060018 |
| DT9435-QZ | 32          | 570       | 450               | 4       | 1         | 1      | 5035048060025 |
| DT9436-QZ | 32          | 920       | 800               | 4       | 1         | 1      | 5035048060032 |
| DT9437-QZ | 35          | 380       | 250               | 4       | 1         | 1      | 5035048060049 |
| DT9438-QZ | 35          | 570       | 450               | 4       | 1         | 1      | 5035048060056 |
| DT9439-QZ | 35          | 670       | 550               | 4       | 1         | 1      | 5035048060063 |
| DT9440-QZ | 36          | 570       | 450               | 4       | 1         | 1      | 5035048060070 |
| DT9441-QZ | 38          | 380       | 250               | 4       | 1         | 1      | 5035048060087 |
| DT9442-QZ | 38          | 570       | 450               | 4       | 1         | 1      | 5035048060094 |
| DT9443-QZ | 38          | 670       | 550               | 4       | 1         | 1      | 5035048060100 |
| DT9444-QZ | 40          | 380       | 250               | 4       | 1         | 1      | 5035048060117 |
| DT9445-QZ | 40          | 570       | 450               | 4       | 1         | 1      | 5035048060124 |
| DT9446-QZ | 40          | 920       | 800               | 4       | 1         | 1      | 5035048060131 |
| DT9447-QZ | 42          | 570       | 450               | 4       | 1         | 1      | 5035048060148 |
| DT9448-QZ | 45          | 570       | 450               | 4       | 1         | 1      | 5035048060155 |
| DT9449-QZ | 50          | 570       | 450               | 4       | 1         | 1      | 5035048060162 |
| DT9450-QZ | 52          | 570       | 450               | 4       | 1         | 1      | 5035048060179 |

APPLICATIONS

- For use with SDS-Max drive hammer drills (Hilti type F,G or Y) for anchor, fixing or clearance holes in masonry concrete, brick or block work.

FEATURES

- 4 flute spiral with maximum flute entry enables faster debris removal.
- Maximised central core enables more efficient energy transmission to the drill bit head.
- Fully supported carbide head gives longer life and cleaner, more concentric holes for better fixing retention.
- Open head design ensures faster drilling.



SDS-Plus CHISELS



SINGLE PACKS

| Cat. No.  | Description     | Width mm | Length mm | Pack Qty. | M.O.Q. | Barcode       |
|-----------|-----------------|----------|-----------|-----------|--------|---------------|
| DT6801-QZ | Pointed         | -        | 250       | 1         | 1      | 5011402371426 |
| DT6802-QZ | Flat            | 20       | 250       | 1         | 1      | 5011402371433 |
| DT6803-QZ | Flat            | 40       | 200       | 1         | 1      | 5011402371440 |
| DT6804-QZ | Sliding Chasing | 22       | 250       | 1         | 1      | 5011402371457 |
| DT6805-QZ | Hollow/Gouge    | 22       | 240       | 1         | 1      | 5011402371464 |
| DT6806-QZ | Tile Chisel     | 40       | 200       | 1         | 1      | 5011402371471 |
| DT6807-QZ | TCT Comb        | 32       | 130       | 1         | 1      | 5011402371488 |
| DT6810-QZ | TCT Comb        | 32       | 200       | 1         | 1      | 5035048014301 |

APPLICATIONS

- For light chipping and chiselling of tile, mortar, glazing compounds and other masonry products with hammers with a rotation stop feature.

EXTREME DeWALT CHISELS

Coming soon in 2011



APPLICATIONS

- For heavy duty chiselling, channelling and demolition tasks in concrete/rebar and hard stone.
- The new EXTREME chisels combined with DeWalt demolition hammers are ideal for even the toughest requirements.

FEATURES

- High grade toughened steel shank designed for optimum durability in heavy duty tasks.
- Fully hardened steel for high wear resistance and increased service life.
- Innovative cutting geometry and aggressive angles for improved material removal over complete life of chisel



EXTREME DeWALT SDS-MAX CHISELS

| Cat. No.  | Description                      | Width mm | Length mm | Pack Qty. | M.O.Q. | Barcode       |
|-----------|----------------------------------|----------|-----------|-----------|--------|---------------|
| DT6888-QZ | 300mm pointed chisel SDS-Max     | -        | 300       | 1         | 1      | 5035048082393 |
| DT6889-QZ | 400mm pointed chisel SDS-Max     | -        | 400       | 1         | 1      | 5035048082409 |
| DT6890-QZ | 600mm pointed chisel SDS-Max     | -        | 600       | 1         | 1      | 5035048082416 |
| DT6811-QZ | 300mm x 25mm flat chisel SDS-Max | 25       | 300       | 1         | 1      | 5035048082423 |
| DT6812-QZ | 400mm x 25mm flat chisel SDS-Max | 25       | 400       | 1         | 1      | 5035048082430 |
| DT6810-QZ | 360mm x 50mm flat chisel SDS-Max | 50       | 360       | 1         | 1      | 5035048082447 |

EXTREME DeWALT 19MM CHISELS

| Cat. No.  | Description                       | Width mm | Length mm | Pack Qty. | M.O.Q. | Barcode       |
|-----------|-----------------------------------|----------|-----------|-----------|--------|---------------|
| DT6953-QZ | 400mm pointed chisel 19mm hex     | -        | 400       | 1         | 1      | 5035048082461 |
| DT6954-QZ | 600mm pointed chisel 19mm hex     | -        | 600       | 1         | 1      | 5035048082478 |
| DT6958-QZ | 400mm x 25mm flat chisel 19mm hex | 25       | 400       | 1         | 1      | 5035048082485 |
| DT6959-QZ | 600mm x 25mm flat chisel 19mm hex | 25       | 600       | 1         | 1      | 5035048082492 |

EXTREME DeWALT 28MM CHISELS

| Cat. No.  | Description                       | Width mm | Length mm | Pack Qty. | M.O.Q. | Barcode       |
|-----------|-----------------------------------|----------|-----------|-----------|--------|---------------|
| DT6971-QZ | 520mm pointed chisel 28mm hex     | -        | 520       | 1         | 1      | 5035048082508 |
| DT6972-QZ | 520mm x 36mm flat chisel 28mm hex | 28       | 520       | 1         | 1      | 5035048082515 |

EXTREME DeWALT 30MM CHISELS

| Cat. No.  | Description                       | Width mm | Length mm | Pack Qty. | M.O.Q. | Barcode       |
|-----------|-----------------------------------|----------|-----------|-----------|--------|---------------|
| DT6808-QZ | 520mm pointed chisel 30mm hex     | -        | 520       | 1         | 1      | 5035048083246 |
| DT6809-QZ | 520mm x 36mm flat chisel 30mm hex | 36       | 520       | 1         | 1      | 5035048083253 |



SDS-MAX CHISELS



SINGLE PACKS

| Cat. No.  | Description      | Width mm | Length mm | Pack Qty. | M.O.Q. | Barcode       |
|-----------|------------------|----------|-----------|-----------|--------|---------------|
| DT6820-QZ | Pointed          | -        | 300       | 1         | 1      | 5011402378067 |
| DT6821-QZ | Pointed          | -        | 400       | 1         | 1      | 5011402378104 |
| DT8087-QZ | Pointed          | -        | 600       | 1         | 1      | 5035048061411 |
| DT6822-QZ | Flat             | 25       | 300       | 1         | 1      | 5011402378074 |
| DT6823-QZ | Flat             | 25       | 400       | 1         | 1      | 5011402378111 |
| DT6824-QZ | Flat             | 50       | 360       | 1         | 1      | 5011402378128 |
| DT6825-QZ | Flat             | 80       | 300       | 1         | 1      | 5011402378081 |
| DT8088-QZ | Flat             | 25       | 600       | 1         | 1      | 5035048061428 |
| DT6826-QZ | Hollow/Gouge     | 26       | 300       | 1         | 1      | 5011402378098 |
| DT6832-QZ | Sliding Chasing  | 32       | 300       | 1         | 1      | 5035048034217 |
| DT6833-QZ | Sliding Chasing  | 35       | 380       | 1         | 1      | 5035048034224 |
| DT6834-QZ | Tile Chisel      | 80       | 300       | 1         | 1      | 5035048034231 |
| DT6837-QZ | TCT Comb Chisel  | 38       | 280       | 1         | 1      | 5035048034248 |
| DT8090-QZ | Clay Spade       | 110      | 400       | 1         | 1      | 5035048034514 |
| DT8091-QZ | Asphalt Cutter   | 90       | 400       | 1         | 1      | 5035048034521 |
| DT8092-QZ | Earth Rod Driver | 13       | 260       | 1         | 1      | 5035048034538 |
| DT8093-QZ | Earth Rod Driver | 16.5     | 260       | 1         | 1      | 5035048034545 |

APPLICATIONS

- For heavy duty chiselling, channelling, and demolition tasks in concrete, stone (medium hardness), floor and wall tiles, general masonry and mortar.

FEATURES

- DeWALT has a wide range of chisels covering most common applications. Specially toughened steel and micro-processor controlled heat treatment ensures consistent tough bits with long life.

19MM HEXAGON CHISELS



SINGLE PACKS

| Cat. No.  | Description    | Width mm | Length mm | Pack Qty. | M.O.Q. | Barcode       |
|-----------|----------------|----------|-----------|-----------|--------|---------------|
| DT6940-QZ | Pointed        | -        | 400       | 1         | 1      | 5035048025031 |
| DT6941-QZ | Pointed        | -        | 600       | 1         | 1      | 5035048025048 |
| DT6942-QZ | Flat           | 25       | 400       | 1         | 1      | 5035048025055 |
| DT6943-QZ | Flat           | 25       | 600       | 1         | 1      | 5035048025062 |
| DT6944-QZ | Flat           | 60       | 300       | 1         | 1      | 5035048025079 |
| DT6945-QZ | Flat           | 60       | 450       | 1         | 1      | 5035048025086 |
| DT6946-QZ | Flat wide      | 140      | 350       | 1         | 1      | 5035048025093 |
| DT6947-QZ | Clay Spade     | 115      | 400       | 1         | 1      | 5035048058893 |
| DT6948-QZ | Asphalt Cutter | 90       | 400       | 1         | 1      | 5035048058909 |

APPLICATIONS

- For heavy duty chiselling, channelling, and demolition tasks in concrete, stone (medium hardness), floor and wall tiles, general masonry and mortar.

PAVEMENT BREAKER CHISELS



28MM PAVEMENT BREAKER CHISELS

| Cat. No.  | Description       | Width mm | Length mm | Pack Qty. | M.O.Q. | Barcode       |
|-----------|-------------------|----------|-----------|-----------|--------|---------------|
| DT6927-QZ | Bull point        | -        | 500       | 1         | 1      | 5035048070505 |
| DT6928-QZ | Clay Spade        | 140      | 540       | 1         | 1      | 5035048070512 |
| DT6929-QZ | Cold Chisel       | 32       | 500       | 1         | 1      | 5035048070529 |
| DT6932-QZ | Scaling Tool      | 75       | 500       | 1         | 1      | 5035048070536 |
| DT6933-QZ | Ground Rod Driver | -        | 400       | 1         | 1      | 5035048070543 |
| DT6934-QZ | Asphalt Cutter    | 115      | 430       | 1         | 1      | 5035048070550 |
| DT6935-QZ | Tamper Shank      | -        | 400       | 1         | 1      | 5035048070567 |
| DT6936-QZ | Tamping Plate     | 150      | 150       | 1         | 1      | 5035048070574 |

APPLICATIONS

- Heavy duty breaking of concrete, asphalt & stone. Heavy duty tamping tasks and earth rod driving.

30MM PAVEMENT BREAKER CHISELS

| Cat. No.  | Description    | Width mm | Length mm | Pack Qty. | M.O.Q. | Barcode       |
|-----------|----------------|----------|-----------|-----------|--------|---------------|
| DT6827-QZ | Scaling Tool   | 75       | 500       | 1         | 1      | 5035048083260 |
| DT6828-QZ | Clay Spade     | 140      | 540       | 1         | 1      | 5035048083277 |
| DT6839-QZ | Asphalt Cutter | 115      | 430       | 1         | 1      | 5035048083284 |

LIGHT DUTY SDS-Plus CORE DRILLS

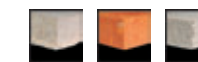

LIGHT DUTY SDS-Plus CORE DRILLS

| Cat. No.  | Diameter mm | Length mm | Pack Qty. | M.O.Q. | Barcode       |
|-----------|-------------|-----------|-----------|--------|---------------|
| DT6740-QZ | 30          | 72        | 1         | 1      | 5035048013595 |
| DT6741-QZ | 35          | 72        | 1         | 1      | 5035048013601 |
| DT6742-QZ | 40          | 72        | 1         | 1      | 5035048013618 |
| DT6743-QZ | 45          | 72        | 1         | 1      | 5035048013625 |
| DT6744-QZ | 50          | 72        | 1         | 1      | 5035048013632 |
| DT6745-QZ | 68          | 72        | 1         | 1      | 5035048013649 |
| DT6746-QZ | 72          | 72        | 1         | 1      | 5035048013656 |
| DT6747-QZ | 80          | 72        | 1         | 1      | 5035048013663 |
| DT6748-QZ | 90          | 72        | 1         | 1      | 5035048013670 |

APPLICATIONS

- For fitting drainage and water pipes, heating pipes, switches, junction & distribution boxes.
- To be used with light duty SDS-Plus core drills - must be used with a pilot bit.

LIGHT DUTY CORE ADAPTORS

| Cat. No.  | Description      | Length mm | Pack Qty. | M.O.Q. | Barcode       |
|-----------|------------------|-----------|-----------|--------|---------------|
| DT6750-QZ | SDS-Plus adaptor | 110       | 1         | 1      | 5035048013687 |
| DT6751-QZ | SDS-Plus adaptor | 300       | 1         | 1      | 5035048013694 |
| DT6752-QZ | Hex adaptor      | 110       | 1         | 1      | 5035048013700 |
| DT6753-QZ | Pilot drill      | 120       | 1         | 1      | 5035048013717 |

HEAVY DUTY SDS-MAX CORE DRILLS

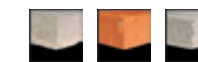

HEAVY DUTY SDS-MAX CORE DRILLS

| Cat. No.  | Diameter mm | Length mm | Pack Qty. | M.O.Q. | Barcode       |
|-----------|-------------|-----------|-----------|--------|---------------|
| DT6760-QZ | 40          | 107       | 1         | 1      | 5035048013724 |
| DT6761-QZ | 50          | 107       | 1         | 1      | 5035048013731 |
| DT6762-QZ | 68          | 107       | 1         | 1      | 5035048013748 |
| DT6763-QZ | 80          | 107       | 1         | 1      | 5035048013755 |
| DT6764-QZ | 90          | 107       | 1         | 1      | 5035048013762 |
| DT6765-QZ | 100         | 107       | 1         | 1      | 5035048013779 |
| DT6766-QZ | 125         | 107       | 1         | 1      | 5035048013786 |

APPLICATIONS

- For clean round holes in blocks, bricks and light concrete.
- To be used with Heavy duty SDS-Max Core drills in conjunction with a pilot bit.

HEAVY DUTY CORE ADAPTORS

| Cat. No.  | Description     | Length mm | Pack Qty. | M.O.Q. | Barcode       |
|-----------|-----------------|-----------|-----------|--------|---------------|
| DT6770-QZ | SDS-Max Adaptor | 180       | 1         | 1      | 5035048013793 |
| DT6771-QZ | SDS-Max Adaptor | 400       | 1         | 1      | 5035048013809 |
| DT6772-QZ | Pilot bit       | 155       | 1         | 1      | 5035048013816 |
| DT6773-QZ | Extension Piece | 280       | 1         | 1      | 5035048013823 |

SINGLE PIECE CORES



SINGLE PIECE CORES

| Cat. No.  | Description  | Diameter mm | Length mm | Pack Qty. | M.O.Q. | Barcode       |
|-----------|--------------|-------------|-----------|-----------|--------|---------------|
| DT6780-QZ | SDS-Max core | 50          | 300       | 1         | 1      | 5035048013830 |
| DT6783-QZ | SDS-Max core | 68          | 300       | 1         | 1      | 5035048013847 |
| DT6784-QZ | SDS-Max core | 80          | 300       | 1         | 1      | 5035048013854 |
| DT6785-QZ | Pilot bit    | -           | 185       | 1         | 1      | 5035048013908 |

- For SDS-Max hammer drills - for drilling holes in concrete or masonry from 50 to 80mm diameter.

THROUGH DRILLING BITS



- For drilling through holes (55 to 80mm diameter) up to 550mm depth in concrete and masonry.

THROUGH DRILLING BITS

| Cat. No.  | Description                  | Diameter mm | Length mm | Pack Qty. | M.O.Q. | Barcode       |
|-----------|------------------------------|-------------|-----------|-----------|--------|---------------|
| DT6790-QZ | SDS-Max through drilling bit | 55          | 550       | 1         | 1      | 5035048013861 |
| DT6791-QZ | SDS-Max through drilling bit | 65          | 550       | 1         | 1      | 5035048013878 |
| DT6792-QZ | SDS-Max through drilling bit | 80          | 550       | 1         | 1      | 5035048013885 |
| DT6793-QZ | Pilot bit                    | -           | 88        | 1         | 1      | 5035048013892 |

ADAPTOR - SDS-Plus



- Allows use of round shank drill bits in SDS-Plus fitment hammers. USE IN ROTARY MODE ONLY.

ADAPTOR - SDS-Plus

| Cat. No.  | Description   | Pack Qty. | M.O.Q. | Barcode       |
|-----------|---|-----------|--------|---------------|
| DT7030-QZ | SDS-Plus - 1/2" x 20 UNF (Chuck adaptor)                        | 1         | 1      | 5011402371419 |
| DT6829-QZ | SDS-Plus - 1/2" x 20 UNF chuck adaptor / screwdriver bit holder | 1         | 1      | 5035048034170 |

DRIVE ADAPTORS



- Allows interchangeability between tool & hammer bit fitments.

DRIVE ADAPTORS

| Cat. No.  | Description         | Pack Qty. | M.O.Q. | Barcode       |
|-----------|---------------------|-----------|--------|---------------|
| DT6830-QZ | SDS-Max to SDS-Plus | 1         | 1      | 5011402378135 |



HSS-CO EXTREME DeWALT® COBALT DRILL BITS

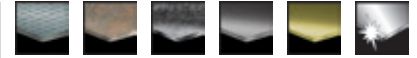

APPLICATIONS

- Suitable for portable or stationary drilling of high alloy content steels and metals with a tensile strength up to 1100N/mm<sup>2</sup> e.g. heat and acid proof steel, cast iron, bronze, welded seams, stainless and chrome nickel steels.

FEATURES

- Faster drilling - up to 4x faster than standard HSS-R drill bits.
- Increased durability - up to 50% stronger than standard HSS-R drill bits.
- Cleaner, more accurate, burr-free holes due to recessed cutting wings.
- Innovative tapered web greatly reduces breakage.
- No-Slip shank with 3 flats eliminates slipping in the chuck (diameters 5.0mm and above only).
- Gold Ferrous Oxide coating prevents overheating for longer bit life.
- 5% cobalt alloyed High Speed Steel for stability at high temperatures when drilling tough materials.



SINGLE PACKS

| Cat. No.  | Diameter mm | Length mm | Working Length mm | Pack Qty. | M.O.Q. | Barcode       |
|-----------|-------------|-----------|-------------------|-----------|--------|---------------|
| DT5630-QZ | 1.0         | 34        | 12                | 2         | 1      | 5035048076958 |
| DT5631-QZ | 1.5         | 40        | 18                | 2         | 1      | 5035048076965 |
| DT5632-QZ | 1.6         | 43        | 20                | 2         | 1      | 5035048076972 |
| DT5403-QZ | 2           | 49        | 24                | 2         | 1      | 5011402375912 |
| DT5404-QZ | 2.5         | 57        | 30                | 2         | 1      | 5011402375936 |
| DT5405-QZ | 3           | 61        | 33                | 2         | 1      | 5011402375950 |
| DT5633-QZ | 3.1         | 65        | 36                | 2         | 1      | 5035048076989 |
| DT5634-QZ | 3.3         | 65        | 36                | 2         | 1      | 5035048076996 |
| DT5408-QZ | 3.5         | 70        | 39                | 2         | 1      | 5011402375974 |
| DT5409-QZ | 4           | 75        | 43                | 2         | 1      | 5011402375998 |
| DT5635-QZ | 4.1         | 75        | 43                | 1         | 1      | 5035048077009 |
| DT5636-QZ | 4.2         | 75        | 43                | 1         | 1      | 5035048077016 |
| DT5412-QZ | 4.5         | 80        | 47                | 1         | 1      | 5011402376018 |
| DT5637-QZ | 4.9         | 86        | 46                | 1         | 1      | 5035048077023 |
| DT5414-QZ | 5           | 86        | 52                | 1         | 1      | 5011402376032 |
| DT5638-QZ | 5.1         | 86        | 46                | 1         | 1      | 5035048077030 |
| DT5415-QZ | 5.5         | 93        | 57                | 1         | 1      | 5011402376056 |
| DT5416-QZ | 6           | 93        | 57                | 1         | 1      | 5011402376070 |
| DT5639-QZ | 6.1         | 101       | 58                | 1         | 1      | 5035048077047 |
| DT5417-QZ | 6.5         | 101       | 63                | 1         | 1      | 5011402376094 |
| DT5640-QZ | 6.8         | 109       | 66                | 1         | 1      | 5035048077054 |
| DT5418-QZ | 7           | 109       | 69                | 1         | 1      | 5011402376117 |
| DT5641-QZ | 7.5         | 109       | 66                | 1         | 1      | 5035048077061 |
| DT5642-QZ | 7.8         | 117       | 75                | 1         | 1      | 5035048077078 |
| DT5643-QZ | 7.9         | 117       | 75                | 1         | 1      | 5035048077085 |
| DT5419-QZ | 8           | 117       | 75                | 1         | 1      | 5011402376131 |
| DT5644-QZ | 8.5         | 117       | 72                | 1         | 1      | 5035048077092 |
| DT5421-QZ | 9           | 125       | 81                | 1         | 1      | 5011402376155 |
| DT5645-QZ | 9.5         | 125       | 78                | 1         | 1      | 5035048077108 |
| DT5422-QZ | 10          | 133       | 87                | 1         | 1      | 5011402376179 |
| DT5646-QZ | 10.2        | 133       | 84                | 1         | 1      | 5035048077115 |
| DT5647-QZ | 10.5        | 133       | 84                | 1         | 1      | 5035048077122 |
| DT5424-QZ | 11          | 142       | 94                | 1         | 1      | 5011402376193 |
| DT5648-QZ | 11.5        | 142       | 91                | 1         | 1      | 5035048077139 |
| DT5426-QZ | 12          | 151       | 101               | 1         | 1      | 5011402376216 |
| DT5649-QZ | 12.2        | 151       | 98                | 1         | 1      | 5035048077146 |
| DT5650-QZ | 12.5        | 151       | 98                | 1         | 1      | 5035048077153 |
| DT5427-QZ | 13          | 151       | 101               | 1         | 1      | 5011402376230 |

BULK PACKS

| Cat. No.  | Diameter mm | Length mm | Working Length mm | Pack Qty. | M.O.Q. | Barcode       |
|-----------|-------------|-----------|-------------------|-----------|--------|---------------|
| DT5660-QZ | 1.5         | 40        | 18                | 10        | 1      | 5035048077160 |
| DT5661-QZ | 1.6         | 43        | 20                | 10        | 1      | 5035048077177 |
| DT5442-QZ | 2           | 49        | 24                | 10        | 1      | 5011402384518 |
| DT5443-QZ | 2.5         | 57        | 30                | 10        | 1      | 5011402384525 |
| DT5444-QZ | 3           | 61        | 33                | 10        | 1      | 5011402384532 |
| DT5662-QZ | 3.1         | 65        | 36                | 10        | 1      | 5035048077184 |
| DT5446-QZ | 3.2         | 65        | 36                | 10        | 1      | 5011402384549 |
| DT5447-QZ | 3.3         | 65        | 36                | 10        | 1      | 5011402384608 |
| DT5448-QZ | 3.5         | 70        | 39                | 10        | 1      | 5011402384563 |
| DT5449-QZ | 4           | 75        | 43                | 10        | 1      | 5011402384570 |
| DT5450-QZ | 4.1         | 75        | 43                | 10        | 1      | 5011402384587 |
| DT5451-QZ | 4.2         | 75        | 43                | 10        | 1      | 5011402384594 |
| DT5452-QZ | 4.5         | 80        | 47                | 10        | 1      | 5011402384600 |
| DT5453-QZ | 4.8         | 86        | 52                | 10        | 1      | 5011402384617 |
| DT5663-QZ | 4.9         | 86        | 46                | 10        | 1      | 5035048077191 |
| DT5454-QZ | 5           | 86        | 52                | 10        | 1      | 5011402384624 |
| DT5455-QZ | 5.1         | 86        | 52                | 10        | 1      | 5011402384631 |
| DT5456-QZ | 5.2         | 86        | 52                | 10        | 1      | 5011402384648 |
| DT5457-QZ | 5.5         | 93        | 57                | 10        | 1      | 5011402384655 |
| DT5458-QZ | 6           | 93        | 57                | 10        | 1      | 5011402384662 |
| DT5664-QZ | 6.1         | 101       | 58                | 10        | 1      | 5035048077207 |
| DT5459-QZ | 6.5         | 101       | 63                | 10        | 1      | 5011402384679 |
| DT5460-QZ | 6.8         | 109       | 69                | 10        | 1      | 5011402384686 |
| DT5461-QZ | 7           | 109       | 69                | 10        | 1      | 5011402384693 |
| DT5462-QZ | 7.5         | 109       | 69                | 10        | 1      | 5011402384709 |
| DT5665-QZ | 7.8         | 117       | 75                | 10        | 1      | 5035048077214 |
| DT5666-QZ | 7.9         | 117       | 75                | 10        | 1      | 5035048077221 |
| DT5463-QZ | 8           | 117       | 75                | 10        | 1      | 5011402384716 |
| DT5464-QZ | 8.5         | 117       | 75                | 10        | 1      | 5011402384723 |
| DT5465-QZ | 9           | 125       | 81                | 10        | 1      | 5011402384730 |
| DT5466-QZ | 9.5         | 125       | 81                | 10        | 1      | 5011402384747 |
| DT5467-QZ | 10          | 133       | 87                | 10        | 1      | 5011402384754 |
| DT5468-QZ | 10.2        | 133       | 87                | 10        | 1      | 5011402384761 |
| DT5667-QZ | 10.5        | 133       | 84                | 5         | 1      | 5035048077238 |
| DT5469-QZ | 11          | 142       | 94                | 5         | 1      | 5011402384778 |
| DT5668-QZ | 11.5        | 142       | 91                | 5         | 1      | 5035048077245 |
| DT5470-QZ | 12          | 151       | 101               | 5         | 1      | 5011402384785 |
| DT5669-QZ | 12.2        | 151       | 98                | 5         | 1      | 5035048077252 |
| DT5670-QZ | 12.5        | 151       | 98                | 5         | 1      | 5035048077269 |
| DT5471-QZ | 13          | 151       | 101               | 5         | 1      | 5011402384792 |



EXTREME DeWALT® 2 METAL DRILL BITS

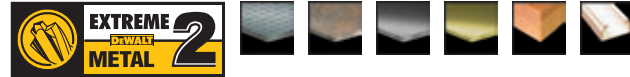

APPLICATIONS

- Suitable for portable drilling of steel, alloyed and non-alloyed up to 900 N/mm<sup>2</sup>.
- For drilling sheet or thin materials (suitable for use in wood and plastics).

FEATURES

- Faster drilling - up to 4x faster than standard HSS-R drill bits.
- Increased durability - up to 50% stronger than standard HSS-R drill bits.
- Cleaner, more accurate, burr-free holes due to recessed cutting wings.
- Innovative tapered web greatly reduces breakage.
- No-Slip shank with 3 flats eliminates slipping in the chuck (diameters 5.0mm and above only).
- Gold Ferrus Oxide coating prevents overheating for longer bit life.



For drilling sets see page 134

SINGLE PACKS

| Cat. No.  | Diameter mm | Length mm | Working Length mm | Pack Qty. | M.O.Q. | Barcode       |
|-----------|-------------|-----------|-------------------|-----------|--------|---------------|
| DT5034-QZ | 1           | 34        | 12                | 2         | 1      | 5035048034767 |
| DT5035-QZ | 1.5         | 40        | 18                | 2         | 1      | 5035048034774 |
| DT5600-QZ | 1.6         | 43        | 20                | 2         | 1      | 5035048076811 |
| DT5036-QZ | 2           | 49        | 24                | 2         | 1      | 5035048034781 |
| DT5037-QZ | 2.5         | 57        | 30                | 2         | 1      | 5035048034798 |
| DT5038-QZ | 3           | 61        | 33                | 2         | 1      | 5035048034804 |
| DT5601-QZ | 3.1         | 65        | 36                | 2         | 1      | 5035048076828 |
| DT5039-QZ | 3.2         | 65        | 36                | 2         | 1      | 5035048034811 |
| DT5040-QZ | 3.3         | 65        | 36                | 2         | 1      | 5035048034828 |
| DT5041-QZ | 3.5         | 70        | 39                | 2         | 1      | 5035048034835 |
| DT5042-QZ | 4           | 75        | 43                | 2         | 1      | 5035048034842 |
| DT5063-QZ | 4.1         | 75        | 43                | 1         | 1      | 5035048052648 |
| DT5043-QZ | 4.2         | 75        | 43                | 1         | 1      | 5035048034859 |
| DT5044-QZ | 4.5         | 80        | 46                | 1         | 1      | 5035048034866 |
| DT5045-QZ | 4.8         | 86        | 46                | 1         | 1      | 5035048034873 |
| DT5046-QZ | 5           | 86        | 46                | 1         | 1      | 5035048034880 |
| DT5064-QZ | 5.1         | 86        | 46                | 1         | 1      | 5035048052655 |
| DT5065-QZ | 5.2         | 86        | 46                | 1         | 1      | 5035048052662 |
| DT5066-QZ | 5.4         | 93        | 52                | 1         | 1      | 5035048052679 |
| DT5047-QZ | 5.5         | 93        | 57                | 1         | 1      | 5035048034897 |
| DT5048-QZ | 6           | 93        | 57                | 1         | 1      | 5035048034903 |
| DT5603-QZ | 6.1         | 101       | 58                | 1         | 1      | 5035048076842 |
| DT5049-QZ | 6.5         | 101       | 58                | 1         | 1      | 5035048034910 |
| DT5067-QZ | 6.8         | 109       | 66                | 1         | 1      | 5035048052686 |
| DT5050-QZ | 7           | 109       | 66                | 1         | 1      | 5035048034927 |
| DT5051-QZ | 7.5         | 109       | 66                | 1         | 1      | 5035048034934 |
| DT5604-QZ | 7.8         | 117       | 75                | 1         | 1      | 5035048076859 |
| DT5605-QZ | 7.9         | 117       | 75                | 1         | 1      | 5035048076866 |
| DT5052-QZ | 8           | 117       | 72                | 1         | 1      | 5035048034941 |
| DT5053-QZ | 8.5         | 117       | 72                | 1         | 1      | 5035048034958 |
| DT5054-QZ | 9           | 125       | 78                | 1         | 1      | 5035048034965 |
| DT5055-QZ | 9.5         | 125       | 78                | 1         | 1      | 5035048034972 |
| DT5056-QZ | 10          | 133       | 84                | 1         | 1      | 5035048034989 |
| DT5606-QZ | 10.2        | 133       | 84                | 1         | 1      | 5035048076873 |
| DT5057-QZ | 10.5        | 133       | 84                | 1         | 1      | 5035048034996 |
| DT5058-QZ | 11          | 142       | 91                | 1         | 1      | 5035048052006 |
| DT5059-QZ | 11.5        | 142       | 91                | 1         | 1      | 5035048052013 |
| DT5060-QZ | 12          | 151       | 98                | 1         | 1      | 5035048052020 |
| DT5061-QZ | 12.5        | 151       | 98                | 1         | 1      | 5035048052037 |
| DT5062-QZ | 13          | 151       | 98                | 1         | 1      | 5035048052044 |

BULK PACKS

| Cat. No.  | Diameter mm | Length mm | Working Length mm | Pack Qty. | M.O.Q. | Barcode       |
|-----------|-------------|-----------|-------------------|-----------|--------|---------------|
| DT5535-QZ | 1           | 34        | 12                | 10        | 1      | 5035048052051 |
| DT5536-QZ | 1.5         | 40        | 18                | 10        | 1      | 5035048052068 |
| DT5615-QZ | 1.6         | 43        | 20                | 10        | 1      | 5035048076880 |
| DT5537-QZ | 2           | 49        | 24                | 10        | 1      | 5035048052075 |
| DT5538-QZ | 2.5         | 57        | 30                | 10        | 1      | 5035048052082 |
| DT5539-QZ | 3           | 61        | 33                | 10        | 1      | 5035048052099 |
| DT5616-QZ | 3.1         | 65        | 36                | 10        | 1      | 5035048076897 |
| DT5540-QZ | 3.2         | 65        | 36                | 10        | 1      | 5035048052105 |
| DT5541-QZ | 3.3         | 65        | 36                | 10        | 1      | 5035048052112 |
| DT5542-QZ | 3.5         | 70        | 39                | 10        | 1      | 5035048052129 |
| DT5543-QZ | 4           | 75        | 43                | 10        | 1      | 5035048052136 |
| DT5544-QZ | 4.2         | 75        | 43                | 10        | 1      | 5035048052143 |
| DT5545-QZ | 4.5         | 80        | 46                | 10        | 1      | 5035048052150 |
| DT5546-QZ | 4.8         | 86        | 46                | 10        | 1      | 5035048052167 |
| DT5617-QZ | 4.9         | 86        | 46                | 10        | 1      | 5035048076903 |
| DT5547-QZ | 5           | 86        | 46                | 10        | 1      | 5035048052174 |
| DT5567-QZ | 5.1         | 86        | 46                | 10        | 1      | 5035048052181 |
| DT5568-QZ | 5.2         | 86        | 46                | 10        | 1      | 5035048052188 |
| DT5548-QZ | 5.5         | 93        | 57                | 10        | 1      | 5035048052195 |
| DT5549-QZ | 6           | 93        | 57                | 10        | 1      | 5035048052198 |
| DT5618-QZ | 6.1         | 101       | 58                | 10        | 1      | 5035048076910 |
| DT5550-QZ | 6.5         | 101       | 58                | 10        | 1      | 5035048052204 |
| DT5551-QZ | 7           | 109       | 66                | 10        | 1      | 5035048052211 |
| DT5552-QZ | 7.5         | 109       | 66                | 10        | 1      | 5035048052228 |
| DT5619-QZ | 7.8         | 117       | 75                | 10        | 1      | 5035048076927 |
| DT5620-QZ | 7.9         | 117       | 75                | 10        | 1      | 5035048076934 |
| DT5553-QZ | 8           | 117       | 72                | 10        | 1      | 5035048052235 |
| DT5554-QZ | 8.5         | 117       | 72                | 10        | 1      | 5035048052242 |
| DT5555-QZ | 9           | 125       | 78                | 10        | 1      | 5035048052259 |
| DT5556-QZ | 9.5         | 125       | 78                | 10        | 1      | 5035048052266 |
| DT5557-QZ | 10          | 133       | 84                | 10        | 1      | 5035048052273 |
| DT5621-QZ | 10.2        | 133       | 84                | 10        | 1      | 5035048076941 |
| DT5558-QZ | 10.5        | 133       | 84                | 10        | 1      | 5035048052280 |
| DT5559-QZ | 11          | 142       | 91                | 10        | 1      | 5035048052297 |
| DT5560-QZ | 11.5        | 142       | 91                | 10        | 1      | 5035048052303 |
| DT5561-QZ | 12          | 151       | 98                | 10        | 1      | 5035048052310 |
| DT5562-QZ | 12.5        | 151       | 98                | 10        | 1      | 5035048052327 |
| DT5563-QZ | 13          | 151       | 98                | 10        | 1      | 5035048052334 |

HSS-G DIN 338 JOBBER METAL DRILL BITS

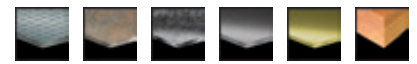

APPLICATIONS

- Suitable for portable or stationary drilling in steel cast steel, alloyed and non-alloyed material, grey cast-iron, spherical-graphite cast iron, sintered iron, nickel, brass, etc up to 900N/mm<sup>2</sup>.

FEATURES

- Precision ground twist drill bit for rapid drilling, long life and excellent concentricity.
- Ground from solid stock right hand cutting, type N flute, precision ground at 118° point angle.
- Diameter tolerance to h8.
- Drills above 13mm (1/2") have a shank reduced to 12.7mm.



SINGLE PACKS

| Cat. No.  | Diameter mm | Length mm | Working Length mm | Pack Qty. | M.O.Q. | Barcode       |
|-----------|-------------|-----------|-------------------|-----------|--------|---------------|
| DT5201-QZ | 1           | 34        | 12                | 2         | 1      | 5011402373437 |
| DT5200-QZ | 1.1         | 36        | 14                | 2         | 1      | 5035048080481 |
| DT5207-QZ | 1.2         | 38        | 16                | 2         | 1      | 5035048080498 |
| DT5210-QZ | 1.3         | 38        | 16                | 2         | 1      | 5035048080504 |
| DT5223-QZ | 1.4         | 40        | 18                | 2         | 1      | 5035048080511 |
| DT5202-QZ | 1.5         | 40        | 18                | 2         | 1      | 5011402373451 |
| DT5225-QZ | 1.6         | 43        | 20                | 2         | 1      | 5035048080528 |
| DT5231-QZ | 1.7         | 43        | 20                | 2         | 1      | 5035048080535 |
| DT5236-QZ | 1.8         | 46        | 22                | 2         | 1      | 5035048080542 |
| DT5237-QZ | 1.9         | 46        | 22                | 2         | 1      | 5035048080559 |
| DT5203-QZ | 2           | 49        | 24                | 2         | 1      | 5011402373475 |
| DT5238-QZ | 2.1         | 49        | 24                | 2         | 1      | 5035048080566 |
| DT5239-QZ | 2.2         | 53        | 27                | 2         | 1      | 5035048080573 |
| DT5240-QZ | 2.3         | 53        | 27                | 2         | 1      | 5035048080580 |
| DT5241-QZ | 2.4         | 57        | 30                | 2         | 1      | 5035048080597 |
| DT5204-QZ | 2.5         | 57        | 30                | 2         | 1      | 5011402373499 |
| DT5242-QZ | 2.6         | 57        | 30                | 2         | 1      | 5035048080603 |
| DT5243-QZ | 2.7         | 61        | 33                | 2         | 1      | 5035048080610 |
| DT5244-QZ | 2.8         | 61        | 33                | 2         | 1      | 5035048080627 |
| DT5245-QZ | 2.9         | 61        | 33                | 2         | 1      | 5035048080634 |
| DT5205-QZ | 3           | 61        | 33                | 2         | 1      | 5011402373512 |
| DT5246-QZ | 3.1         | 65        | 36                | 2         | 1      | 5035048080641 |
| DT5206-QZ | 3.2         | 65        | 36                | 2         | 1      | 5011402373536 |
| DT5247-QZ | 3.3         | 65        | 36                | 2         | 1      | 5035048080658 |
| DT5248-QZ | 3.4         | 70        | 39                | 2         | 1      | 5035048080665 |
| DT5208-QZ | 3.5         | 70        | 39                | 2         | 1      | 5011402373574 |
| DT5249-QZ | 3.6         | 70        | 39                | 2         | 1      | 5035048080672 |
| DT5250-QZ | 3.7         | 70        | 39                | 2         | 1      | 5035048080689 |
| DT5251-QZ | 3.8         | 75        | 43                | 2         | 1      | 5035048080696 |
| DT5252-QZ | 3.9         | 75        | 43                | 2         | 1      | 5035048080702 |
| DT5209-QZ | 4           | 75        | 43                | 2         | 1      | 5011402373598 |
| DT5253-QZ | 4.1         | 75        | 43                | 1         | 1      | 5035048080719 |
| DT5211-QZ | 4.2         | 75        | 43                | 1         | 1      | 5011402373635 |
| DT5254-QZ | 4.3         | 80        | 47                | 1         | 1      | 5035048080726 |
| DT5269-QZ | 4.4         | 80        | 47                | 1         | 1      | 5035048076477 |
| DT5212-QZ | 4.5         | 80        | 47                | 1         | 1      | 5011402373659 |
| DT5270-QZ | 4.6         | 80        | 47                | 1         | 1      | 5035048076484 |
| DT5271-QZ | 4.7         | 80        | 47                | 1         | 1      | 5035048076491 |
| DT5213-QZ | 4.8         | 86        | 52                | 1         | 1      | 5011402373673 |
| DT5272-QZ | 4.9         | 86        | 52                | 1         | 1      | 5035048076507 |
| DT5214-QZ | 5           | 86        | 52                | 1         | 1      | 5011402373697 |
| DT5273-QZ | 5.1         | 86        | 52                | 1         | 1      | 5035048076514 |
| DT5274-QZ | 5.2         | 86        | 52                | 1         | 1      | 5035048076521 |
| DT5275-QZ | 5.3         | 86        | 52                | 1         | 1      | 5035048076538 |
| DT5276-QZ | 5.4         | 93        | 57                | 1         | 1      | 5035048076545 |
| DT5215-QZ | 5.5         | 93        | 57                | 1         | 1      | 5011402373710 |
| DT5277-QZ | 5.6         | 93        | 57                | 1         | 1      | 5035048076552 |
| DT5278-QZ | 5.7         | 93        | 57                | 1         | 1      | 5035048076569 |
| DT5279-QZ | 5.8         | 93        | 57                | 1         | 1      | 5035048076576 |
| DT5280-QZ | 5.9         | 93        | 57                | 1         | 1      | 5035048076583 |
| DT5216-QZ | 6           | 101       | 63                | 1         | 1      | 5011402373734 |
| DT5281-QZ | 6.1         | 101       | 63                | 1         | 1      | 5035048076590 |
| DT5282-QZ | 6.2         | 101       | 63                | 1         | 1      | 5035048076606 |
| DT5283-QZ | 6.3         | 101       | 63                | 1         | 1      | 5035048076613 |
| DT5284-QZ | 6.4         | 101       | 63                | 1         | 1      | 5035048076620 |
| DT5217-QZ | 6.5         | 101       | 63                | 1         | 1      | 5011402373758 |
| DT5285-QZ | 6.6         | 101       | 63                | 1         | 1      | 5035048076637 |
| DT5255-QZ | 6.7         | 101       | 63                | 1         | 1      | 5035048080733 |
| DT5256-QZ | 6.8         | 109       | 69                | 1         | 1      | 5035048080740 |
| DT5257-QZ | 6.9         | 109       | 69                | 1         | 1      | 5035048080757 |
| DT5218-QZ | 7           | 109       | 69                | 1         | 1      | 5011402373772 |
| DT5258-QZ | 7.1         | 109       | 69                | 1         | 1      | 5035048080764 |
| DT5259-QZ | 7.2         | 109       | 69                | 1         | 1      | 5035048080771 |
| DT5286-QZ | 7.3         | 109       | 69                | 1         | 1      | 5035048080788 |
| DT5287-QZ | 7.4         | 109       | 69                | 1         | 1      | 5035048080795 |
| DT5288-QZ | 7.6         | 117       | 75                | 1         | 1      | 5035048080801 |
| DT5289-QZ | 7.7         | 117       | 75                | 1         | 1      | 5035048080818 |
| DT5290-QZ | 7.8         | 117       | 75                | 1         | 1      | 5035048080825 |
| DT5291-QZ | 7.9         | 117       | 75                | 1         | 1      | 5035048080832 |
| DT5219-QZ | 8           | 117       | 75                | 1         | 1      | 5011402373796 |
| DT5292-QZ | 8.1         | 117       | 75                | 1         | 1      | 5035048080849 |
| DT5293-QZ | 8.2         | 117       | 75                | 1         | 1      | 5035048080856 |
| DT5294-QZ | 8.3         | 117       | 75                | 1         | 1      | 5035048080863 |
| DT5295-QZ | 8.4         | 117       | 75                | 1         | 1      | 5035048080870 |
| DT5220-QZ | 8.5         | 117       | 75                | 1         | 1      | 5011402373819 |
| DT5296-QZ | 8.6         | 125       | 81                | 1         |        |               |

HSS-G DIN 338 JOBBER METAL DRILL BITS

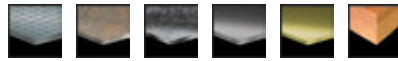

APPLICATIONS

- Suitable for portable or stationary drilling in steel cast steel, alloyed and non-alloyed material, grey cast-iron, spherical-graphite cast iron, sintered iron, nickel, brass, etc up to 900N/mm<sup>2</sup>.

FEATURES

- Precision ground twist drill bit for rapid drilling, long life and excellent concentricity.
- Ground from solid stock right hand cutting, type N flute, precision ground at 118° point angle.
- Diameter tolerance to h8.
- Drills above 13mm (1/2") have a shank reduced to 12.7mm.

SINGLE PACKS

| Cat. No.  | Diameter mm | Length mm | Working Length mm | Pack Qty. | M.O.Q. | Barcode       |
|-----------|-------------|-----------|-------------------|-----------|--------|---------------|
| DTS420-QZ | 9.9         | 133       | 87                | 1         | 1      | 5035048081006 |
| DTS422-QZ | 10          | 133       | 87                | 1         | 1      | 5011402373857 |
| DTS423-QZ | 10.2        | 133       | 87                | 1         | 1      | 5035048081013 |
| DTS425-QZ | 10.5        | 133       | 87                | 1         | 1      | 5035048081020 |
| DTS424-QZ | 11          | 142       | 94                | 1         | 1      | 5011402373895 |
| DTS428-QZ | 11.5        | 142       | 94                | 1         | 1      | 5035048081037 |
| DTS426-QZ | 12          | 151       | 101               | 1         | 1      | 5011402373932 |
| DTS429-QZ | 12.5        | 151       | 101               | 1         | 1      | 5035048081044 |
| DTS427-QZ | 13          | 151       | 101               | 1         | 1      | 5011402373956 |
| DTS430-QZ | 13.5        | 151       | 101               | 1         | 1      | 5035048081051 |
| DTS428-QZ | 14          | 160       | 108               | 1         | 1      | 5011402373970 |
| DTS431-QZ | 14.5        | 160       | 108               | 1         | 1      | 5035048081068 |
| DTS429-QZ | 15          | 169       | 114               | 1         | 1      | 5011402373994 |
| DTS432-QZ | 15.5        | 169       | 114               | 1         | 1      | 5035048081075 |
| DTS430-QZ | 16          | 178       | 120               | 1         | 1      | 5011402374014 |
| DTS433-QZ | 16.5        | 178       | 120               | 1         | 1      | 5035048081082 |
| DTS434-QZ | 17          | 178       | 120               | 1         | 1      | 5035048081099 |
| DTS435-QZ | 17.5        | 178       | 120               | 1         | 1      | 5035048081105 |
| DTS436-QZ | 18          | 191       | 130               | 1         | 1      | 5035048081112 |
| DTS437-QZ | 18.5        | 191       | 130               | 1         | 1      | 5035048081129 |
| DTS438-QZ | 19          | 198       | 135               | 1         | 1      | 5035048081136 |
| DTS439-QZ | 19.5        | 198       | 135               | 1         | 1      | 5035048081143 |
| DTS472-QZ | 20          | 205       | 140               | 1         | 1      | 5035048081150 |

BULK PACKS

| Cat. No.  | Diameter mm | Length mm | Working Length mm | Pack Qty. | M.O.Q. | Barcode       |
|-----------|-------------|-----------|-------------------|-----------|--------|---------------|
| DTS301-QZ | 1           | 34        | 12                | 10        | 1      | 5011402383504 |
| DTS311-QZ | 2           | 49        | 24                | 10        | 1      | 5011402383603 |
| DTS321-QZ | 3           | 61        | 33                | 10        | 1      | 5011402383702 |
| DTS332-QZ | 4           | 75        | 43                | 10        | 1      | 5011402383818 |
| DTS342-QZ | 5           | 86        | 52                | 10        | 1      | 5011402383917 |
| DTS352-QZ | 6           | 93        | 57                | 10        | 1      | 5011402384013 |
| DTS362-QZ | 7           | 109       | 69                | 10        | 1      | 5011402384112 |
| DTS372-QZ | 8           | 117       | 75                | 10        | 1      | 5011402384211 |
| DTS382-QZ | 9           | 125       | 81                | 10        | 1      | 5011402384310 |
| DTS392-QZ | 10          | 133       | 87                | 10        | 1      | 5011402384419 |
| DTS473-QZ | 10.2        | 133       | 87                | 5         | 1      | 5035048081167 |
| DTS393-QZ | 10.5        | 133       | 87                | 5         | 1      | 5011402384426 |
| DTS394-QZ | 11          | 142       | 94                | 5         | 1      | 5011402384433 |
| DTS395-QZ | 11.5        | 142       | 94                | 5         | 1      | 5011402384440 |
| DTS396-QZ | 12          | 151       | 101               | 5         | 1      | 5011402384457 |
| DTS398-QZ | 13          | 151       | 101               | 5         | 1      | 5011402384471 |

HSS-G DIN 338 JOBBER METAL DRILL BIT SETS

| Cat. No.  | Description                       | Diameter mm  | Pack Qty. | M.O.Q. | Barcode       |
|-----------|-----------------------------------|--|-----------|--------|---------------|
| DTS921-QZ | 10 piece set in plastic cassette. | 1, 2, 3, 4, 5, 6, 7, 8, 9, 10  | 10        | 1      | 5011402374137 |
| DTS922-QZ | 13 piece set in plastic cassette. | 1.5, 2, 2.5, 3, 3.5, 4, 4.5, 5 (x2), 5.5, 6, 6.5   | 13        | 1      | 5011402374151 |
| DTS923-QZ | 19 piece set in metal cassette.   | 1, 1.5, 2, 2.5, 3, 3.5, 4, 4.5, 5, 5.5, 6, 6.5, 7, 7.5, 8, 8.5, 9, 9.5, 10   | 19        | 1      | 5011402374175 |
| DTS929-QZ | 29 piece set in metal case        | 1, 1.5, 2, 2.5, 3, 3.2, 3.3, 3.5, 4, 4.5, 5, 5.5, 6, 6.5, 7, 7.5, 8, 8.5, 9, 9.5, 10, 10.5, 11, 11.5, 12, 12.5, 13 | 29        | 1      | 5035048077429 |



HSS-G DIN 340 LONG SERIES METAL DRILL BITS

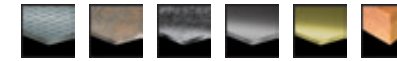

APPLICATIONS

- Used either portable or stationary for drilling of deep holes in steel cast steel, alloyed and non-alloyed material, grey cast-iron, spherical-graphite cast iron, sintered iron, nickel, brass, etc up to 900N/mm<sup>2</sup>.

BULK PACKS

| Cat. No.  | Diameter mm | Length mm | Working Length mm | Pack Qty. | M.O.Q. | Barcode       |
|-----------|-------------|-----------|-------------------|-----------|--------|---------------|
| DTS776-QZ | 1.56        | 85        | 55                | 10        | 1      | 5035048081174 |
| DTS707-QZ | 3           | 100       | 66                | 10        | 1      | 5011402385331 |
| DTS777-QZ | 3.1         | 100       | 66                | 10        | 1      | 5035048081181 |
| DTS709-QZ | 3.2         | 106       | 69                | 10        | 1      | 5011402385348 |
| DTS778-QZ | 3.3         | 106       | 69                | 10        | 1      | 5035048081198 |
| DTS712-QZ | 3.5         | 112       | 73                | 10        | 1      | 5011402385355 |
| DTS717-QZ | 4           | 119       | 78                | 10        | 1      | 5011402385379 |
| DTS719-QZ | 4.2         | 119       | 78                | 10        | 1      | 5011402385393 |
| DTS722-QZ | 4.5         | 126       | 82                | 10        | 1      | 5011402385409 |
| DTS725-QZ | 4.8         | 132       | 87                | 10        | 1      | 5011402385416 |
| DTS779-QZ | 4.9         | 132       | 87                | 10        | 1      | 5035048081204 |
| DTS726-QZ | 5           | 132       | 87                | 10        | 1      | 5011402385423 |
| DTS731-QZ | 5.5         | 139       | 91                | 10        | 1      | 5011402385447 |
| DTS736-QZ | 6           | 139       | 91                | 10        | 1      | 5011402385454 |
| DTS780-QZ | 6.1         | 139       | 91                | 10        | 1      | 5035048081211 |
| DTS741-QZ | 6.5         | 148       | 97                | 10        | 1      | 5011402385461 |
| DTS781-QZ | 6.8         | 148       | 97                | 10        | 1      | 5035048081228 |
| DTS746-QZ | 7           | 156       | 102               | 10        | 1      | 5011402385478 |
| DTS748-QZ | 7.5         | 156       | 102               | 10        | 1      | 5011402385485 |
| DTS782-QZ | 7.8         | 156       | 102               | 10        | 1      | 5035048081235 |
| DTS783-QZ | 7.9         | 156       | 102               | 10        | 1      | 5035048081242 |
| DTS749-QZ | 8           | 165       | 109               | 10        | 1      | 5011402385492 |
| DTS784-QZ | 8.5         | 165       | 109               | 10        | 1      | 5035048081259 |
| DTS785-QZ | 9.5         | 175       | 115               | 10        | 1      | 5035048081266 |
| DTS753-QZ | 10          | 184       | 121               | 10        | 1      | 5011402385515 |
| DTS786-QZ | 10.2        | 184       | 121               | 5         | 1      | 5035048081273 |
| DTS787-QZ | 10.5        | 184       | 121               | 5         | 1      | 5035048081280 |
| DTS755-QZ | 11          | 195       | 128               | 5         | 1      | 5011402385522 |
| DTS788-QZ | 11.5        | 195       | 128               | 5         | 1      | 5035048081297 |
| DTS757-QZ | 12          | 200       | 134               | 5         | 1      | 5011402385539 |
| DTS789-QZ | 12.5        | 200       | 134               | 5         | 1      | 5035048081303 |
| DTS759-QZ | 13          | 205       | 134               | 5         | 1      | 5011402385546 |

EXTREME DEWALT IMPACT STEP BITS



Coming soon in 2011

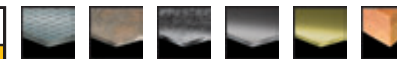

APPLICATIONS

- For drilling and enlarging existing holes from 4mm to 34mm

FEATURES

- Durable hex shank designed to fit all impact drivers

STEP DRILLS

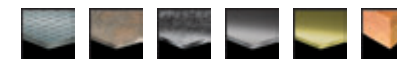

FEATURES

- For drilling and enlarging existing holes from 14mm up to 34mm

SINGLE PACKS

| Cat. No.  | Description        | Pack Qty. | M.O.Q. | Barcode       |
|-----------|--------------------|-----------|--------|---------------|
| DTS026-QZ | 4-12mm Step Drill  | 1         | 1      | 5035048077276 |
| DTS027-QZ | 6-18mm Step Drill  | 1         | 1      | 5035048077283 |
| DTS030-QZ | 14-25mm Step Drill | 1         | 1      | 5035048077290 |
| DTS031-QZ | 20-34mm Step Drill | 1         | 1      | 5035048077306 |



EXTREME DeWALT IMPACT DRILL BITS

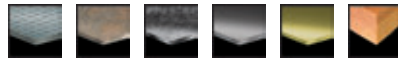

FEATURES

- Full range of metal drill bits designed and optimised for use in an impact driver.
- Unique tip design eliminates walking and increases drilling speed.
- Single piece design, optimised flute angle and hardening process deliver extreme life in impact driver applications.



SINGLE PACKS

| Cat. No.   | Diameter mm | Length mm | Working Length mm | Pack Qty. | M.O.Q. | Barcode       |
|------------|-------------|-----------|-------------------|-----------|--------|---------------|
| DT50600-QZ | 3           | 64        | 26                | 1         | 1      | 5035048081723 |
| DT50601-QZ | 3.2         | 67        | 29                | 1         | 1      | 5035048081730 |
| DT50602-QZ | 3.5         | 70        | 29                | 1         | 1      | 5035048081747 |
| DT50603-QZ | 4           | 71        | 30                | 1         | 1      | 5035048081754 |
| DT50604-QZ | 4.2         | 71        | 31                | 1         | 1      | 5035048081761 |
| DT50605-QZ | 4.5         | 75        | 31                | 1         | 1      | 5035048081778 |
| DT50606-QZ | 4.8         | 76        | 32                | 1         | 1      | 5035048081785 |
| DT50607-QZ | 5           | 78        | 33                | 1         | 1      | 5035048081792 |
| DT50608-QZ | 5.5         | 78        | 35                | 1         | 1      | 5035048081808 |
| DT50609-QZ | 6           | 80        | 37                | 1         | 1      | 5035048081815 |
| DT50610-QZ | 6.5         | 81        | 38                | 1         | 1      | 5035048081822 |
| DT50611-QZ | 7           | 89        | 45                | 1         | 1      | 5035048081839 |
| DT50612-QZ | 7.5         | 95        | 50                | 1         | 1      | 5035048081846 |
| DT50613-QZ | 8           | 102       | 50                | 1         | 1      | 5035048081853 |
| DT50614-QZ | 8.5         | 102       | 50                | 1         | 1      | 5035048081860 |
| DT50615-QZ | 9           | 102       | 50                | 1         | 1      | 5035048081877 |
| DT50616-QZ | 10          | 102       | 50                | 1         | 1      | 5035048081884 |
| DT50617-QZ | 11          | 102       | 50                | 1         | 1      | 5035048081891 |
| DT50618-QZ | 12          | 102       | 50                | 1         | 1      | 5035048081907 |
| DT50619-QZ | 13          | 102       | 50                | 1         | 1      | 5035048081914 |

SETS

| Cat. No.    | Description  | Diameter mm                          | Pack Qty. | M.O.Q. | Barcode       |
|-------------|--------------|--------------------------------------|-----------|--------|---------------|
| DT705008-QZ | 10 piece set | 3, 3.2, 3.5, 4, 4.5, 5, 6, 8, 10, 12 | 10        | 1      | 5035048081921 |

BRAD POINT WOOD DRILL BITS



APPLICATIONS

- Suitable for drilling hardboard, plywood, chipboard and all natural hard and softwood.
- Typically used for doweling applications or wood screw clearance holes.

FEATURES

- Manufactured from chrome vanadium alloyed steel.
- Centre location point and outer cutting spurs for clean accurate holes.

SINGLE PACKS

| Cat. No.  | Diameter mm | Length mm | Working Length mm | Pack Qty. | M.O.Q. | Barcode       |
|-----------|-------------|-----------|-------------------|-----------|--------|---------------|
| DT4503-QZ | 3           | 70        | 46                | 1         | 1      | 5011402385553 |
| DT4504-QZ | 4           | 80        | 52                | 1         | 1      | 5011402385560 |
| DT4505-QZ | 5           | 90        | 60                | 1         | 1      | 5011402385577 |
| DT4506-QZ | 6           | 100       | 66                | 1         | 1      | 5011402385584 |
| DT4507-QZ | 7           | 110       | 72                | 1         | 1      | 5011402385591 |
| DT4508-QZ | 8           | 120       | 80                | 1         | 1      | 5011402385607 |
| DT4509-QZ | 9           | 130       | 84                | 1         | 1      | 5011402385614 |
| DT4510-QZ | 10          | 133       | 90                | 1         | 1      | 5011402385621 |
| DT4511-QZ | 11          | 150       | 100               | 1         | 1      | 5011402385638 |
| DT4512-QZ | 12          | 155       | 102               | 1         | 1      | 5011402385645 |
| DT4513-QZ | 13          | 155       | 102               | 1         | 1      | 5011402385652 |
| DT4514-QZ | 14          | 160       | 107               | 1         | 1      | 5011402385669 |
| DT4516-QZ | 16          | 165       | 112               | 1         | 1      | 5011402385683 |
| DT4518-QZ | 18          | 200       | 130               | 1         | 1      | 5011402385690 |
| DT4520-QZ | 20          | 200       | 130               | 1         | 1      | 5011402385706 |

SETS

| Cat. No.  | Description                     | Diameter mm    | Pack Qty. | M.O.Q. | Barcode       |
|-----------|---------------------------------|----------------|-----------|--------|---------------|
| DT4535-QZ | 5 piece set in plastic cassette | 4, 5, 6, 8, 10 | 5         | 1      | 5011402385713 |



FRAME DRILL BITS



APPLICATIONS

- For very rapid and accurate drilling of clean holes in hard/softwoods and laminates.

SINGLE PACKS

| Cat. No.  | Diameter mm | Length mm | Pack Qty. | M.O.Q. | Barcode       |
|-----------|-------------|-----------|-----------|--------|---------------|
| DT4870-QZ | 7           | 600       | 1         | 1      | 5035048014035 |
| DT4871-QZ | 8           | 600       | 1         | 1      | 5035048014042 |
| DT4872-QZ | 10          | 600       | 1         | 1      | 5035048014059 |
| DT4873-QZ | 12          | 600       | 1         | 1      | 5035048014066 |
| DT4874-QZ | 16          | 600       | 1         | 1      | 5035048014073 |
| DT4875-QZ | 18          | 600       | 1         | 1      | 5035048014080 |
| DT4876-QZ | 20          | 600       | 1         | 1      | 5035048014097 |
| DT4877-QZ | 22          | 600       | 1         | 1      | 5035048014103 |

TCT HINGE BORING BITS



APPLICATIONS

- Typically used to fit cantilever hinges.

FEATURES

- Tungsten carbide tipped wood boring tool for clean accurate flat bottom recess holes.
- Hexagonal shank facilitates a firm chuck grip.

SINGLE PACKS

| Cat. No.  | Diameter mm | Length mm | Pack Qty. | M.O.Q. | Barcode       |
|-----------|-------------|-----------|-----------|--------|---------------|
| DT4541-QZ | 26          | 65        | 1         | 1      | 5011402386161 |
| DT4542-QZ | 30          | 65        | 1         | 1      | 5011402386178 |
| DT4543-QZ | 35          | 65        | 1         | 1      | 5011402386185 |

WOOD AUGER DRILL BITS



APPLICATIONS

- Typically used for boring clean precise holes through beams, joists, doors etc.

FEATURES

- Threaded centre point to aid accurate drilling.
- Outer cutting spur provides clean holes with less splintering.
- Special "Lewis" spiral flute allows for fast removal of debris and rapid drilling.

SINGLE PACKS

| Cat. No.  | Diameter mm | Length mm | Working Length mm | Pack Qty. | M.O.Q. | Barcode       |
|-----------|-------------|-----------|-------------------|-----------|--------|---------------|
| DT4600-QZ | 6           | 200       | 100               | 1         | 1      | 5011402385720 |
| DT4602-QZ | 8           | 200       | 100               | 1         | 1      | 5011402385737 |
| DT4604-QZ | 10          | 200       | 100               | 1         | 1      | 5011402385744 |
| DT4606-QZ | 12          | 200       | 100               | 1         | 1      | 5011402385751 |
| DT4608-QZ | 14          | 200       | 100               | 1         | 1      | 5011402385768 |
| DT4610-QZ | 16          | 200       | 100               | 1         | 1      | 5011402385775 |
| DT4612-QZ | 18          | 200       | 100               | 1         | 1      | 5011402385782 |
| DT4614-QZ | 20          | 200       | 100               | 1         | 1      | 5011402385799 |
| DT4615-QZ | 22          | 200       | 100               | 1         | 1      | 5011402385805 |
| DT4616-QZ | 24          | 200       | 100               | 1         | 1      | 5011402385812 |
| DT4618-QZ | 26          | 200       | 100               | 1         | 1      | 5011402385829 |
| DT4619-QZ | 28          | 200       | 100               | 1         | 1      | 5011402385836 |
| DT4620-QZ | 30          | 200       | 100               | 1         | 1      | 5011402385843 |
| DT4621-QZ | 32          | 200       | 100               | 1         | 1      | 5011402385850 |
| DT4632-QZ | 8           | 380       | 280               | 1         | 1      | 5011402385867 |
| DT4634-QZ | 10          | 380       | 280               | 1         | 1      | 5011402385874 |
| DT4636-QZ | 12          | 380       | 280               | 1         | 1      | 5011402385881 |
| DT4638-QZ | 14          | 380       | 280               | 1         | 1      | 5011402385898 |
| DT4640-QZ | 16          | 380       | 280               | 1         | 1      | 5011402385904 |
| DT4642-QZ | 18          | 380       | 280               | 1         | 1      | 5011402385911 |
| DT4644-QZ | 20          | 380       | 280               | 1         | 1      | 5011402385928 |
| DT4645-QZ | 22          | 380       | 280               | 1         | 1      | 5011402385935 |
| DT4646-QZ | 24          | 380       | 280               | 1         | 1      | 5011402385942 |
| DT4648-QZ | 26          | 380       | 280               | 1         | 1      | 5011402385959 |
| DT4649-QZ | 28          | 380       | 280               | 1         | 1      | 5011402385966 |
| DT4650-QZ | 30          | 380       | 280               | 1         | 1      | 5011402385973 |
| DT4651-QZ | 32          | 380       | 280               | 1         | 1      | 5011402385980 |



SELF FEED DRILL BITS

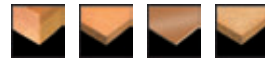

APPLICATIONS

- For rapid drilling of clean large diameter holes in wood.

FEATURES

- 2 x sharp cutting edges for extremely fast drilling in woods with reduced risk of binding.
- Aggressive 'Self feed' spur for rapid penetration into material.
- Non slip shank gives better bit retention in chuck.

SINGLE PACKS

| Cat. No.  | Diameter mm   | Pack Qty. | M.O.Q. | Barcode       |
|-----------|---|-----------|--------|---------------|
| DT4575-QZ | 25  | 1         | 1      | 5035048072004 |
| DT4576-QZ | 28  | 1         | 1      | 5035048072011 |
| DT4577-QZ | 32  | 1         | 1      | 5035048072028 |
| DT4578-QZ | 35  | 1         | 1      | 5035048072035 |
| DT4579-QZ | 38  | 1         | 1      | 5035048072042 |
| DT4580-QZ | 41  | 1         | 1      | 5035048072059 |
| DT4581-QZ | 45  | 1         | 1      | 5035048072066 |
| DT4582-QZ | 51  | 1         | 1      | 5035048072073 |
| DT4583-QZ | 54  | 1         | 1      | 5035048072080 |
| DT4584-QZ | 57  | 1         | 1      | 5035048072097 |
| DT4585-QZ | 65  | 1         | 1      | 5035048072103 |
| DT4586-QZ | 68  | 1         | 1      | 5035048072110 |
| DT4587-QZ | 74  | 1         | 1      | 5035048072127 |
| DT4588-QZ | 76  | 1         | 1      | 5035048072134 |
| DT4589-QZ | 92  | 1         | 1      | 5035048072141 |
| DT4590-QZ | 117   | 1         | 1      | 5035048072158 |
| DT4591-QZ | Self Feed Set - 5 pce (35mm, 38mm, 54mm, 65mm plus extension bar 140mm) | 1         | 1      | 5035048072165 |
| DT4592-QZ | Self Feed Extension piece 140mm   | 1         | 1      | 5035048072172 |

EXTREME DeWALT® FLATWOOD DRILL BITS

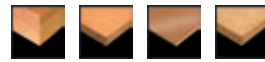

APPLICATIONS

- For the rapid drilling of holes in wood.
- Suitable for natural hard and soft wood, chipboard and other man made materials.
- Ideal for door locks, mortising, electrical and plumbing work.

FEATURES

- Extra thick robust steel shank for outstanding durability and bit life.
- Chamfered outer cutting spurs for clean, very fast drilling and extended drilling life.
- Precision ground central point with optimised design for faster material penetration and increased drilling speed.

SINGLE PACKS

| Cat. No.   | Diameter mm                                  | Length mm | Pack Qty. | M.O.Q. | Barcode       |
|------------|--|-----------|-----------|--------|---------------|
| DT4762-QZ  | 10   | 152       | 1         | 1      | 5035048072950 |
| DT4763-QZ  | 12   | 152       | 1         | 1      | 5035048072967 |
| DT4764-QZ  | 13   | 152       | 1         | 1      | 5035048072974 |
| DT4765-QZ  | 14   | 152       | 1         | 1      | 5035048072981 |
| DT4766-QZ  | 16   | 152       | 1         | 1      | 5035048072998 |
| DT4767-QZ  | 18   | 152       | 1         | 1      | 5035048073001 |
| DT4768-QZ  | 20   | 152       | 1         | 1      | 5035048073018 |
| DT4769-QZ  | 22   | 152       | 1         | 1      | 5035048073025 |
| DT4770-QZ  | 24   | 152       | 1         | 1      | 5035048073032 |
| DT4771-QZ  | 25   | 152       | 1         | 1      | 5035048073049 |
| DT4772-QZ  | 26   | 152       | 1         | 1      | 5035048073056 |
| DT4773-QZ  | 28   | 152       | 1         | 1      | 5035048073063 |
| DT4774-QZ  | 30   | 152       | 1         | 1      | 5035048073070 |
| DT4775-QZ  | 32   | 152       | 1         | 1      | 5035048073087 |
| DT4776-QZ  | 35   | 152       | 1         | 1      | 5035048073094 |
| DT4777-QZ  | 38   | 152       | 1         | 1      | 5035048073100 |
| DT4778-QZ  | 40   | 152       | 1         | 1      | 5035048073117 |
| DT79438-QZ | 8 piece set (12, 16, 18, 20, 22, 25, 28, 32) | 152       | 1         | 1      | 5035048073292 |

EXTREME DeWALT® LONG FLATWOOD DRILL BITS

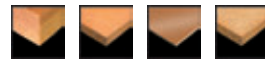

APPLICATIONS

- For the rapid drilling of holes in wood.
- Suitable for natural hard and soft wood, chipboard and other man made materials.
- Ideal for door locks, mortising, electrical and plumbing work.

FEATURES

- Extra thick robust steel shank for outstanding durability and bit life.
- Chamfered outer cutting spurs for clean, very fast drilling and extended drilling life.
- Precision ground central point with optimised design for faster material penetration and increased drilling speed.

SINGLE PACKS

| Cat. No.  | Diameter mm | Length mm | Pack Qty. | M.O.Q. | Barcode       |
|-----------|-------------|-----------|-----------|--------|---------------|
| DT4780-QZ | 10          | 406       | 1         | 1      | 5035048073124 |
| DT4781-QZ | 12          | 406       | 1         | 1      | 5035048073131 |
| DT4783-QZ | 14          | 406       | 1         | 1      | 5035048073155 |
| DT4784-QZ | 16          | 406       | 1         | 1      | 5035048073162 |
| DT4785-QZ | 20          | 406       | 1         | 1      | 5035048073179 |
| DT4786-QZ | 22          | 406       | 1         | 1      | 5035048073186 |
| DT4787-QZ | 24          | 406       | 1         | 1      | 5035048073193 |
| DT4788-QZ | 25          | 406       | 1         | 1      | 5035048073209 |
| DT4789-QZ | 26          | 406       | 1         | 1      | 5035048073216 |
| DT4791-QZ | 30          | 406       | 1         | 1      | 5035048073230 |
| DT4792-QZ | 32          | 406       | 1         | 1      | 5035048073247 |
| DT4793-QZ | 35          | 406       | 1         | 1      | 5035048073254 |

FLATWOOD DRILL BITS



APPLICATIONS

- For the rapid drilling of holes in wood.
- Suitable for natural hard and soft wood, chipboard and other man made materials.
- Ideal for door locks, mortising, electrical and plumbing work.

FEATURES

- High quality chrome vanadium flat drill bit.
- Ground central point and cutting edges for accurate location and clean cutting.
- Ground chip breaker to reduce splintering providing relatively clean holes and improved drilling efficiency.

SINGLE PACKS

| Cat. No.  | Diameter mm | Length mm | Pack Qty. | M.O.Q. | Barcode       |
|-----------|-------------|-----------|-----------|--------|---------------|
| DT4810-QZ | 10          | 150       | 1         | 1      | 5011402385997 |
| DT4812-QZ | 12          | 150       | 1         | 1      | 5011402386000 |
| DT4813-QZ | 13          | 150       | 1         | 1      | 5011402386017 |
| DT4814-QZ | 14          | 150       | 1         | 1      | 5011402386024 |
| DT4816-QZ | 16          | 150       | 1         | 1      | 5011402386031 |
| DT4818-QZ | 18          | 150       | 1         | 1      | 5011402386048 |
| DT4820-QZ | 20          | 150       | 1         | 1      | 5011402386055 |
| DT4822-QZ | 22          | 150       | 1         | 1      | 5011402386062 |
| DT4824-QZ | 24          | 150       | 1         | 1      | 5011402386079 |
| DT4825-QZ | 25          | 150       | 1         | 1      | 5011402386086 |
| DT4826-QZ | 26          | 150       | 1         | 1      | 5011402386093 |
| DT4828-QZ | 28          | 150       | 1         | 1      | 5011402386109 |
| DT4830-QZ | 30          | 150       | 1         | 1      | 5011402386116 |
| DT4832-QZ | 32          | 150       | 1         | 1      | 5011402386123 |
| DT4835-QZ | 35          | 150       | 1         | 1      | 5011402386130 |
| DT4838-QZ | 38          | 150       | 1         | 1      | 5011402386147 |

FLATWOOD DRILL BIT EXTENSION

| Cat. No.  | Length mm  | Pack Qty. | M.O.Q. | Barcode       |
|-----------|------------|-----------|--------|---------------|
| DT4849-QZ | 300 x 1/4" | 1         | 1      | 5035048058923 |





EXTREME IMPACT HOLESAWS



APPLICATIONS

- Ideal for cutting holes in thin metals, plastics and fibreglass board
- For use with all Impact drivers and wrenches

FEATURES

- Optimised tooth design for faster drilling and more holes per charge
- Thin walled design for optimum efficiency in cutting thin materials
- Durable hex shank designed to fit all impact drivers
- Ejection spring for easy plug removal
- Single piece design to avoid lock up on mandrel

SINGLE PACKS

| Cat. No.  | Diameter mm | Depth of Cut mm | Pack Qty. | M.O.Q. | Barcode       |
|-----------|-------------|-----------------|-----------|--------|---------------|
| DT8253-QZ | 19          | 5               | 1         | 1      | 5035048079959 |
| DT8254-QZ | 22          | 5               | 1         | 1      | 5035048079966 |
| DT8255-QZ | 25          | 5               | 1         | 1      | 5035048079973 |
| DT8256-QZ | 29          | 5               | 1         | 1      | 5035048079980 |
| DT8257-QZ | 32          | 5               | 1         | 1      | 5035048079997 |
| DT8258-QZ | 35          | 5               | 1         | 1      | 5035048080009 |
| DT8259-QZ | 38          | 5               | 1         | 1      | 5035048080016 |

BI-METAL DEEP CUT HOLESAWS

APPLICATIONS

- Ideal for cutting holes in steel, stainless steel, brass, copper, aluminium, wood, plastic and other composites.

FEATURES

- Industrial, rugged hole saws designed for heavy duty cutting in standard or deep cut applications.
- Extra hard variable pitch high speed steel teeth.
- M3 Steel cutting edge providing extended holesaw life.
- 12.5 mm deeper cut than standard bi-metal hole saw.
- Increased depth of cutting edge providing extended holesaw cutting life.

SINGLE PACKS

| Cat. No.  | Diameter mm | Depth of Cut mm | Pack Qty. | M.O.Q. | Barcode       |
|-----------|-------------|-----------------|-----------|--------|---------------|
| DT8116-QZ | 16          | 38              | 1         | 1      | 5011402370290 |
| DT8119-QZ | 19          | 38              | 1         | 1      | 5011402370306 |
| DT8120-QZ | 20          | 38              | 1         | 1      | 5011402370313 |
| DT8121-QZ | 21          | 38              | 1         | 1      | 5035048061145 |
| DT8122-QZ | 22          | 38              | 1         | 1      | 5011402370320 |
| DT8124-QZ | 24          | 38              | 1         | 1      | 5035048061152 |
| DT8125-QZ | 25          | 38              | 1         | 1      | 5011402370337 |
| DT8127-QZ | 27          | 38              | 1         | 1      | 5035048061169 |
| DT8129-QZ | 29          | 38              | 1         | 1      | 5011402370344 |
| DT8130-QZ | 30          | 38              | 1         | 1      | 5035048061176 |
| DT8132-QZ | 32          | 38              | 1         | 1      | 5011402370351 |
| DT8133-QZ | 33          | 38              | 1         | 1      | 5035048061183 |
| DT8135-QZ | 35          | 38              | 1         | 1      | 5011402370368 |
| DT8138-QZ | 38          | 40              | 1         | 1      | 5011402370375 |
| DT8141-QZ | 40          | 40              | 1         | 1      | 5035048061206 |
| DT8140-QZ | 41          | 40              | 1         | 1      | 5011402370382 |
| DT8143-QZ | 43          | 40              | 1         | 1      | 5035048061213 |
| DT8145-QZ | 44          | 40              | 1         | 1      | 5011402370399 |
| DT8146-QZ | 46          | 40              | 1         | 1      | 5035048061220 |
| DT8148-QZ | 48          | 40              | 1         | 1      | 5035048053683 |
| DT8151-QZ | 51          | 40              | 1         | 1      | 5011402370405 |
| DT8152-QZ | 52          | 40              | 1         | 1      | 5035048061237 |
| DT8154-QZ | 54          | 40              | 1         | 1      | 5035048053690 |
| DT8157-QZ | 57          | 40              | 1         | 1      | 5011402370412 |
| DT8160-QZ | 60          | 40              | 1         | 1      | 5035048053706 |
| DT8164-QZ | 64          | 40              | 1         | 1      | 5011402370429 |
| DT8165-QZ | 65          | 40              | 1         | 1      | 5035048061244 |
| DT8167-QZ | 67          | 40              | 1         | 1      | 5011402370436 |
| DT8168-QZ | 68          | 40              | 1         | 1      | 5035048061251 |
| DT8170-QZ | 70          | 40              | 1         | 1      | 5035048053713 |
| DT8173-QZ | 73          | 40              | 1         | 1      | 5011402370443 |
| DT8176-QZ | 76          | 40              | 1         | 1      | 5035048053720 |
| DT8179-QZ | 79          | 40              | 1         | 1      | 5035048053737 |
| DT8183-QZ | 83          | 40              | 1         | 1      | 5011402370450 |
| DT8186-QZ | 86          | 40              | 1         | 1      | 5035048053744 |
| DT8189-QZ | 89          | 40              | 1         | 1      | 5035048061268 |
| DT8192-QZ | 92          | 40              | 1         | 1      | 5035048053751 |
| DT8195-QZ | 95          | 40              | 1         | 1      | 5011402370467 |
| DT8202-QZ | 102         | 40              | 1         | 1      | 5035048053799 |
| DT8205-QZ | 105         | 40              | 1         | 1      | 5035048053805 |
| DT8208-QZ | 108         | 40              | 1         | 1      | 5035048053812 |
| DT8265-QZ | 111         | 40              | 1         | 1      | 5035048014271 |
| DT8214-QZ | 114         | 40              | 1         | 1      | 5035048053829 |
| DT8221-QZ | 121         | 40              | 1         | 1      | 5035048053836 |
| DT8227-QZ | 127         | 40              | 1         | 1      | 5035048053843 |
| DT8240-QZ | 140         | 40              | 1         | 1      | 5035048053850 |
| DT8252-QZ | 152         | 40              | 1         | 1      | 5035048053867 |
| DT8260-QZ | 160         | 40              | 1         | 1      | 5035048061282 |
| DT8266-QZ | 177         | 40              | 1         | 1      | 5035048014288 |
| DT8267-QZ | 210         | 40              | 1         | 1      | 5035048014295 |



BI-METAL HOLESAW SETS

FEATURES

- Sets designed specifically for plumbers, electricians and general purpose users.
- All sets supplied in durable plastic boxes for easy transportation and storage



BI-METAL HOLESAW SETS

| Cat. No.  | Description  | Pack Qty. | Barcode       |
|-----------|--|-----------|---------------|
| DT8104-XJ | General purpose set in plastic kitbox, 2x hex shank mandrels, 2x pilot drill bits, 9 hole saws ø 16, 19, 25, 32, 38, 44, 48, 51, 64mm. | 13 pieces | 5035048053768 |
| DT8105-XJ | Electrician's set in plastic kitbox, 2x hex shank mandrels, 2x pilot drill bits, 7 hole saws ø 22, 29, 35, 38, 44, 51, 64mm.           | 11 pieces | 5035048053775 |
| DT8106-XJ | Plumber's set in plastic kitbox, 2x hex shank mandrels, 2x pilot drill bits, 9 hole saws ø 19, 22, 29, 35, 38, 44, 57, 64, 76mm.       | 13 pieces | 5035048053782 |
| DT8110-XJ | Electrician's set in plastic kitbox, 2x hex shank mandrels, 2x pilot drill bits, 7 hole saws ø 16, 20, 25, 32, 40, 51, 64mm.           | 11 pieces | 5035048061336 |
| DT8111-XJ | Electrician's set in plastic kitbox, 2x hex shank mandrels, 2x pilot drill bits, 7 hole saws ø 20, 25, 35, 32, 40, 51, 64mm.           | 11 pieces | 5035048061343 |

EXTREME DeWALT HOLESAW SETS

| Cat. No.  | Description  | Pack Qty. | M.O.Q. | Barcode       |
|-----------|--|-----------|--------|---------------|
| DT8270-QZ | EXTREME DeWALT® EXTREME 11 piece set in plastic kit box - 1x small quick change mandrel, 1x large quick change mandrel, 2x EXTREME pilot drill bits, 7 hole saws ø 22, 29, 35, 44, 51, 64, 68 mm | 11        | 1      | 5035048073414 |
| DT8269-QZ | EXTREME DeWALT® 11 piece Plumbers Kit - 1x small quick change mandrel, 1x large quick change mandrel, 2x EXTREME pilot drill bits, 7 hole saws ø 19, 22, 29, 38, 44, 51, 57mm                    | 11        | 1      | 5035048073995 |
| DT8273-QZ | EXTREME DeWALT® 11 piece Electricians Kit - 1x small quick change mandrel, 1x large quick change mandrel, 2x EXTREME pilot drill bits, 7 hole saws ø 16, 20, 25, 32, 35, 51,64mm                 | 11        | 1      | 5035048074008 |

CARBIDE GRIT HOLESAWS

APPLICATIONS

- Ideal for cutting holes in masonry, light concrete, fibre glass and other abrasive composites.

FEATURES

- Nickel alloy brazed carbide grit edge (Hrc 85) ensures long life, 'go anywhere' performance.
- Dual directional cut ensures smooth cutting action with no 'kickback'.
- Wear resistant grit ensures longer life when working with abrasive materials such as masonry/concrete.



CARBIDE GRIT HOLESAWS

| Cat. No.  | Diameter mm | Depth of Cut mm | Pack Qty. | M.O.Q. | Barcode       |
|-----------|-------------|-----------------|-----------|--------|---------------|
| DT8118-QZ | 16          | 40              | 1         | 1      | 5035048012345 |
| DT8123-QZ | 19          | 40              | 1         | 1      | 5035048012116 |
| DT8126-QZ | 20          | 40              | 1         | 1      | 5035048012123 |
| DT8128-QZ | 22          | 40              | 1         | 1      | 5035048012130 |
| DT8131-QZ | 25          | 40              | 1         | 1      | 5035048012147 |
| DT8134-QZ | 29          | 40              | 1         | 1      | 5035048012154 |
| DT8136-QZ | 32          | 40              | 1         | 1      | 5035048012161 |
| DT8139-QZ | 35          | 40              | 1         | 1      | 5035048012178 |
| DT8142-QZ | 38          | 40              | 1         | 1      | 5035048012185 |
| DT8144-QZ | 40          | 40              | 1         | 1      | 5035048012192 |
| DT8147-QZ | 44          | 40              | 1         | 1      | 5035048012208 |
| DT8149-QZ | 48          | 40              | 1         | 1      | 5035048012215 |
| DT8150-QZ | 51          | 40              | 1         | 1      | 5035048012352 |
| DT8155-QZ | 54          | 40              | 1         | 1      | 5035048012369 |
| DT8156-QZ | 57          | 40              | 1         | 1      | 5035048012222 |
| DT8163-QZ | 64          | 40              | 1         | 1      | 5035048012239 |
| DT8172-QZ | 76          | 40              | 1         | 1      | 5035048012246 |
| DT8174-QZ | 68          | 40              | 1         | 1      | 5035048072875 |
| DT8175-QZ | 83          | 40              | 1         | 1      | 5035048072882 |
| DT8177-QZ | 102         | 40              | 1         | 1      | 5035048072899 |

CARBIDE GRIT HOLESAW SETS

FEATURES

- Sets designed specifically for plumbers, electricians and general purpose users.
- All sets supplied in durable plastic boxes for easy transportation and storage.



CARBIDE GRIT HOLESAW SETS

| Cat. No.  | Description  | Pack Qty. | M.O.Q. | Barcode       |
|-----------|--|-----------|--------|---------------|
| DT8275-QZ | Electrician's set in plastic kitbox, 2 x hex shank mandrels, 2 x pilot drill bits, 7 holesaws ø 16, 20, 25, 32, 40, 51, 64           | 11        | 1      | 5035048012307 |
| DT8276-QZ | Electrician's set in plastic kitbox, 2 x hex shank mandrels, 2 x pilot drill bits, 7 holesaws ø 20, 25, 32, 38, 44, 51, 64           | 11        | 1      | 5035048012314 |
| DT8277-QZ | General purpose set in plastic kitbox, 2 x hex shank mandrels, 2 x pilot drill bits, 9 holesaws ø 16, 19, 25, 32, 38, 44, 48, 51, 64 | 13        | 1      | 5035048012321 |
| DT8278-QZ | Plumber's set in plastic kitbox, 2 x hex shank mandrels, 2 x pilot drill bits, 9 holesaws ø 19, 22, 29, 35, 38, 44, 57, 64, 76       | 13        | 1      | 5035048012338 |

EXTREME DeWALT QUICK CHANGE MANDRELS



FEATURES

- Fast, tool free changeovers.
- Quick release collar to prevent hole saw lock up
- Available as single units and in sets

FOR USE WITH BI-METAL HOLESAWS

| Cat. No.  | Description  | Pack Qty. | M.O.Q. | Barcode       |
|-----------|--|-----------|--------|---------------|
| DT8286-QZ | EXTREME Small Quick Change Mandrel (No drive pins) ø 14mm - 30mm       | 1         | 1      | 5035048073377 |
| DT8288-QZ | EXTREME DeWALT™ Large Quick Change Mandrel (Drive pins) ø 32mm - 210mm | 1         | 1      | 5035048073391 |
| DT8289-QZ | EXTREME DeWALT™ EXTREME Replacement pilot drill (6.3mm diameter)       | 1         | 1      | 5035048073407 |

HOLESAW MANDRELS AND ACCESSORIES



FEATURES

- Quick release mandrel prevents lock up of the holesaw on the mandrel enabling easy removal.

FOR USE WITH BI-METAL HOLESAWS

| Cat. No.  | Description  | Pack Qty. | M.O.Q. | Barcode       |
|-----------|--|-----------|--------|---------------|
| DT8101-QZ | Mandrel for 14 - 29 mm diameter hole saws. For 10 mm capacity chuck or larger.               | 1         | 1      | 5011402370474 |
| DT8102-QZ | Quick release mandrel for 32 - 210mm diameter hole saws. For 13 mm capacity chuck or larger. | 1         | 1      | 5011402370481 |
| DT8103-QZ | Replacement pilot drill bit (6.3 mm diameter).   | 1         | 1      | 5011402370498 |
| DT8290-QZ | Extension Rod 300mm. For use with holesaw mandrel DT8102                                     | 1         | 1      | 5035048061299 |
| DT8295-QZ | Plug Ejection Spring   | 1         | 1      | 5035048061312 |
| DT8107-QZ | Quick release mandrel - SDS+ fitment - for 14-30mm diameter holesaws                         | 1         | 1      | 5035048053935 |
| DT8108-QZ | Quick release mandrel - SDS+ fitment - for 32-210mm diameter holesaws                        | 1         | 1      | 5035048061329 |

HOLESAW MANDRELS AND ACCESSORIES



FOR USE WITH CARBIDE GRIT HOLESAWS

| Cat. No.  | Description                     | Pack Qty. | M.O.Q. | Barcode       |
|-----------|---------------------------------|-----------|--------|---------------|
| DT8280-QZ | Pilot bit masonry - long        | 1         | 1      | 5035048012253 |
| DT8285-QZ | Pilot bit masonry - small       | 1         | 1      | 5035048013939 |
| DT8281-QZ | Small mandrel & masonry bit     | 1         | 1      | 5035048012260 |
| DT8282-QZ | Large mandrel & masonry bit     | 1         | 1      | 5035048012277 |
| DT8283-QZ | SDS & small mandrel & pilot bit | 1         | 1      | 5035048012284 |
| DT8284-QZ | SDS & large mandrel & pilot bit | 1         | 1      | 5035048012291 |

MIXER TOOLS



MIXER TOOLS

APPLICATIONS

- For wallpaper paste, gloss paint, emulsion, mortar and plaster.

FEATURES

- Universal stirring/mixing tool for hand-held drills with a 13mm chuck. Mixing effect from bottom to top.
- Suitable for DW130.
- M14 version also available.

| Cat. No.  | Diameter mm | Length mm | Pack Qty. | Shank | M.O.Q. | Barcode       |
|-----------|-------------|-----------|-----------|-------|--------|---------------|
| DT4950-QZ | 100         | 600       | 1         | Hex   | 1      | 5035048027202 |
| DT4951-QZ | 120         | 600       | 1         | Hex   | 1      | 5035048027219 |
| DT4952-QZ | 120         | 600       | 1         | M14   | 1      | 5035048011300 |

CHUCKS AND KEYS

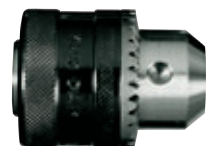

APPLICATIONS

- Professional heavy duty chucks & keys.
- For use with DeWALT and other makes of drills.

FEATURES

- Choose from metal or plastic body.
- Single or twin sleeved.
- Carbide jaws for extra grip.

KEYLESS CHUCKS 10MM/13MM

| Cat. No.  | Chuck Capacity mm | Fitment       | Sleeves | Metal/ Plastic | Pack Qty. | M.O.Q. | Barcode       |
|-----------|-------------------|---------------|---------|----------------|-----------|--------|---------------|
| DT7001-QZ | 10                | 1/2" x 20 UNF | 2       | Plastic        | 1         | 1      | 5011402371358 |
| DT7040-QZ | 10                | 3/8" x 24 UNF | 2       | Plastic        | 1         | 1      | 5035048060209 |
| DT7041-QZ | 10                | 1/2" x 20 UNF | 2       | Metal          | 1         | 1      | 5035048060216 |
| DT7042-QZ | 10                | 1/2" x 20 UNF | 1       | Metal          | 1         | 1      | 5035048060223 |
| DT7002-QZ | 13                | 1/2" x 20 UNF | 2       | Plastic        | 1         | 1      | 5011402371365 |
| DT7043-QZ | 13                | 1/2" x 20 UNF | 2       | Metal          | 1         | 1      | 5035048060230 |
| DT7044-QZ | 13                | 1/2" x 20 UNF | 2       | Metal/carbide  | 1         | 1      | 5035048060247 |
| DT7045-QZ | 13                | 1/2" x 20 UNF | 1       | Metal          | 1         | 1      | 5035048060254 |
| DT7046-QZ | 13                | 1/2" x 20 UNF | 1       | Metal/carbide  | 1         | 1      | 5035048060261 |
| DT7025-QZ | 13                | 1/2" x 20 UNF | 2       | Plastic/Metal  | 1         | 5      | 5035048061718 |

KEYED CHUCKS 10MM/13MM

| Cat. No.  | Chuck Capacity mm | Fitment       | Pack Qty. | M.O.Q. | Barcode       |
|-----------|-------------------|---------------|-----------|--------|---------------|
| DT7013-QZ | 10                | 3/8" x 24 UNF | 1         | 1      | 5035048060186 |
| DT7011-QZ | 10                | 1/2" x 20 UNF | 1         | 1      | 5011402371372 |
| DT7012-QZ | 13                | 1/2" x 20 UNF | 1         | 1      | 5011402371389 |
| DT7014-QZ | 13                | 5/8" x 16 UNF | 1         | 1      | 5035048060193 |

CHUCK KEYS

| Cat. No.  | Chuck Capacity mm                     | Pack Qty. | M.O.Q. | Barcode       |
|-----------|---------------------------------------|-----------|--------|---------------|
| DT7021-QZ | Fits 10 mm and 13 mm chucks (S2).     | 1         | 1      | 5011402371396 |
| DT7022-QZ | Fits 5/8" x 16 UNF keyed chucks (S9). | 1         | 1      | 5035048060506 |

SPECIAL CHUCKS/ADAPTORS

| Cat. No.  | Chuck Capacity mm | Fitment   | Pack Qty. | M.O.Q. | Barcode       |
|-----------|-------------------|---|-----------|--------|---------------|
| DT7005-QZ | 13                | 1/2" x 20 UNF keyed chuck with SDS adaptor.                         | 1         | 1      | 5035048060278 |
| DT7030-QZ | -                 | SDS-Plus - 1/2" x 20 UNF (Chuck adaptor).                           | 1         | 1      | 5011402371419 |
| DT6829-QZ | -                 | SDS-Plus - 1/2" x 20 UNF Chuck adaptor / screwdriver bit holder.    | 1         | 1      | 5035048034170 |
| DT7017-QZ | 13                | 2 Sleeve plastic chuck for 2&4kg quick change hammers (eg. D25104K) | 1         | 1      | 5035048061695 |
| DT7018-QZ | 13                | 2 Sleeve metal chuck for 2&4kg quick change hammers (eg. D25104K)   | 1         | 1      | 5035048061701 |





SCREWDRIVING ACCESSORIES



APPLICATIONS

- For all heavy duty screwdriving applications

FEATURES

- Durable hex shank designed to fit all impact drivers
- Full hex body design for increased strength and life
- Optimised tip design for reduced cam out
- Heat treated body for increased durability

EXTREME DEWALT IMPACT BITS FOR POZIDRIV SCREWS

| Cat. No.  | Size | Description     | Pack Qty. | M.O.Q. | Barcode       |
|-----------|------|-----------------|-----------|--------|---------------|
| DT7386-QZ | Pz1  | 25mm Impact bit | 5         | 1      | 5035048082201 |
| DT7387-QZ | Pz2  | 25mm Impact bit | 5         | 1      | 5035048082218 |
| DT7388-QZ | Pz3  | 25mm Impact bit | 5         | 1      | 5035048082225 |
| DT7390-QZ | Pz1  | 50mm Impact bit | 5         | 1      | 5035048082249 |
| DT7391-QZ | Pz2  | 50mm Impact bit | 5         | 1      | 5035048082256 |
| DT7392-QZ | Pz3  | 50mm Impact bit | 5         | 1      | 5035048082263 |

EXTREME DEWALT IMPACT BITS FOR PHILLIPS SCREWS

| Cat. No.  | Size | Description     | Pack Qty. | M.O.Q. | Barcode       |
|-----------|------|-----------------|-----------|--------|---------------|
| DT7993-QZ | Ph1  | 25mm Impact bit | 5         | 1      | 5035048082270 |
| DT7994-QZ | Ph2  | 25mm Impact bit | 5         | 1      | 5035048082287 |
| DT7995-QZ | Ph3  | 25mm Impact bit | 5         | 1      | 5035048082294 |
| DT7997-QZ | Ph1  | 50mm Impact bit | 5         | 1      | 5035048082317 |
| DT7998-QZ | Ph2  | 50mm Impact bit | 5         | 1      | 5035048082324 |
| DT7999-QZ | Ph3  | 50mm Impact bit | 5         | 1      | 5035048082331 |

EXTREME IMPACT BITS FOR TORX® SCREWS

| Cat. No.  | Size | Description     | Pack Qty. | M.O.Q. | Barcode       |
|-----------|------|-----------------|-----------|--------|---------------|
| DT7379-QZ | T10  | 25mm Impact bit | 5         | 1      | 5035048082133 |
| DT7380-QZ | T15  | 25mm Impact bit | 5         | 1      | 5035048082140 |
| DT7381-QZ | T20  | 25mm Impact bit | 5         | 1      | 5035048082157 |
| DT7382-QZ | T25  | 25mm Impact bit | 5         | 1      | 5035048082164 |
| DT7383-QZ | T27  | 25mm Impact bit | 5         | 1      | 5035048082171 |
| DT7384-QZ | T30  | 25mm Impact bit | 5         | 1      | 5035048082188 |
| DT7385-QZ | T40  | 25mm Impact bit | 5         | 1      | 5035048082195 |
| DT7393-QZ | T10  | 50mm Impact bit | 5         | 1      | 5035048082843 |
| DT7394-QZ | T15  | 50mm Impact bit | 5         | 1      | 5035048082850 |
| DT7395-QZ | T20  | 50mm Impact bit | 5         | 1      | 5035048082867 |
| DT7396-QZ | T25  | 50mm Impact bit | 5         | 1      | 5035048082874 |
| DT7397-QZ | T27  | 50mm Impact bit | 5         | 1      | 5035048082881 |
| DT7398-QZ | T30  | 50mm Impact bit | 5         | 1      | 5035048082898 |
| DT7399-QZ | T40  | 50mm Impact bit | 5         | 1      | 5035048082904 |

SCREWDRIVING ACCESSORIES

APPLICATIONS

- For all screwdriving applications.

FEATURES

- High quality professional screwdriver bits.
- Flexible Torsion Zone absorbs torque peaks and reduces breakage.
- All bits are provided in sturdy plastic re-useable storage containers.

SLOTTED BITS

| Cat. No.  | Size  | Description              | Pack Qty. | M.O.Q. | Barcode       |
|-----------|-------|--------------------------|-----------|--------|---------------|
| DT7105-QZ | 4.5mm | 25mm Torsion bit Slotted | 5         | 1      | 5035048012437 |
| DT7106-QZ | 5.5mm | 25mm Torsion bit Slotted | 5         | 1      | 5035048012444 |
| DT7116-QZ | 5.5mm | 25mm Torsion bit Slotted | 20        | 1      | 5035048012475 |
| DT7107-QZ | 6.5mm | 25mm Torsion bit Slotted | 5         | 1      | 5035048012451 |
| DT7117-QZ | 6.5mm | 25mm Torsion bit Slotted | 20        | 1      | 5035048012482 |

TORSION BITS FOR POZIDRIV SCREWS

| Cat. No.  | Size | Description                     | Pack Qty. | M.O.Q. | Barcode       |
|-----------|------|---------------------------------|-----------|--------|---------------|
| DT7210-QZ | Pz0  | 25mm Torsion bit                | 5         | 1      | 5035048012499 |
| DT7211-QZ | Pz1  | 25mm Torsion bit                | 5         | 1      | 5035048012505 |
| DT7217-QZ | Pz1  | 25mm Torsion bit                | 20        | 1      | 5035048012512 |
| DT7212-QZ | Pz2  | 25mm Torsion bit                | 5         | 1      | 5035048012529 |
| DT7218-QZ | Pz2  | 25mm Torsion bit                | 20        | 1      | 5035048012536 |
| DT7213-QZ | Pz3  | 25mm Torsion bit                | 5         | 1      | 5035048012543 |
| DT7219-QZ | Pz3  | 25mm Torsion bit                | 20        | 1      | 5035048012550 |
| DT7214-QZ | Pz4  | 32mm Torsion bit                | 5         | 1      | 5035048012567 |
| DT7225-QZ | Pz1  | 50mm bit with "extra grip" ribs | 5         | 1      | 5035048013083 |
| DT7226-QZ | Pz2  | 50mm bit with "extra grip" ribs | 5         | 1      | 5035048013090 |
| DT7227-QZ | Pz3  | 50mm bit with "extra grip" ribs | 5         | 1      | 5035048013106 |

SCREWDRIVING ACCESSORIES

APPLICATIONS

- For all screwdriving applications.

FEATURES

- High quality professional screwdriver bits.
- Flexible Torsion Zone absorbs torque peaks and reduces breakage.
- All bits are provided in sturdy plastic re-useable storage containers.

TORSION BITS FOR PHILLIPS SCREWS

| Cat. No.  | Size | Description                     | Pack Qty. | M.O.Q. | Barcode       |
|-----------|------|---------------------------------|-----------|--------|---------------|
| DT7230-QZ | Ph0  | 25mm Torsion bit                | 5         | 1      | 5035048012574 |
| DT7231-QZ | Ph1  | 25mm Torsion bit                | 5         | 1      | 5035048012581 |
| DT7237-QZ | Ph1  | 25mm Torsion bit                | 20        | 1      | 5035048012598 |
| DT7232-QZ | Ph2  | 25mm Torsion bit                | 5         | 1      | 5035048012604 |
| DT7238-QZ | Ph2  | 25mm Torsion bit                | 20        | 1      | 5035048012611 |
| DT7233-QZ | Ph3  | 25mm Torsion bit                | 5         | 1      | 5035048012628 |
| DT7234-QZ | Ph4  | 32mm Torsion bit                | 5         | 1      | 5035048012642 |
| DT7235-QZ | Ph2  | 25mm Reduced tip                | 5         | 1      | 5035048066430 |
| DT7236-QZ | Ph2  | 25mm Reduced tip                | 20        | 1      | 5035048066423 |
| DT7245-QZ | Ph1  | 50mm bit with "extra grip" ribs | 5         | 1      | 5035048013113 |
| DT7246-QZ | Ph2  | 50mm bit with "extra grip" ribs | 5         | 1      | 5035048013120 |
| DT7247-QZ | Ph3  | 50mm bit with "extra grip" ribs | 5         | 1      | 5035048013137 |

HEX BITS

| Cat. No.  | Size | Description  | Pack Qty. | M.O.Q. | Barcode       |
|-----------|------|--------------|-----------|--------|---------------|
| DT7165-QZ | 4    | 25mm Hex bit | 5         | 1      | 5035048012659 |
| DT7166-QZ | 5    | 25mm Hex bit | 5         | 1      | 5035048012666 |
| DT7167-QZ | 6    | 25mm Hex bit | 5         | 1      | 5035048012673 |
| DT7168-QZ | 8    | 25mm Hex bit | 5         | 1      | 5035048012680 |

SQUARE BITS

| Cat. No.  | Size | Description     | Pack Qty. | M.O.Q. | Barcode       |
|-----------|------|-----------------|-----------|--------|---------------|
| DT7170-QZ | 1    | 25mm Square bit | 5         | 1      | 5035048013564 |
| DT7171-QZ | 2    | 25mm Square bit | 5         | 1      | 5035048013571 |
| DT7172-QZ | 3    | 25mm Square bit | 5         | 1      | 5035048013588 |

SCREWDRIVER BITS FOR TORX® SCREWS

| Cat. No.  | Size | Description       | Pack Qty. | M.O.Q. | Barcode       |
|-----------|------|-------------------|-----------|--------|---------------|
| DT7251-QZ | T8   | 25mm bit for Torx | 5         | 1      | 5035048012703 |
| DT7252-QZ | T9   | 25mm bit for Torx | 5         | 1      | 5035048012710 |
| DT7253-QZ | T10  | 25mm bit for Torx | 5         | 1      | 5035048012727 |
| DT7254-QZ | T15  | 25mm bit for Torx | 5         | 1      | 5035048012734 |
| DT7265-QZ | T15  | 25mm bit for Torx | 20        | 1      | 5035048012741 |
| DT7255-QZ | T20  | 25mm bit for Torx | 5         | 1      | 5035048012758 |
| DT7266-QZ | T20  | 25mm bit for Torx | 20        | 1      | 5035048012765 |
| DT7270-QZ | T20  | 25mm bit for Torx | 50        | 1      | 5035048012772 |
| DT7256-QZ | T25  | 25mm bit for Torx | 5         | 1      | 5035048012789 |
| DT7267-QZ | T25  | 25mm bit for Torx | 20        | 1      | 5035048012796 |
| DT7271-QZ | T25  | 25mm bit for Torx | 50        | 1      | 5035048012802 |
| DT7257-QZ | T27  | 25mm bit for Torx | 5         | 1      | 5035048012819 |
| DT7258-QZ | T30  | 25mm bit for Torx | 5         | 1      | 5035048012826 |
| DT7268-QZ | T30  | 25mm bit for Torx | 20        | 1      | 5035048012833 |
| DT7272-QZ | T30  | 25mm bit for Torx | 50        | 1      | 5035048012840 |
| DT7259-QZ | T40  | 25mm bit for Torx | 5         | 1      | 5035048012857 |
| DT7290-QZ | T10  | 70mm bit for Torx | 5         | 1      | 5035048013182 |
| DT7291-QZ | T15  | 70mm bit for Torx | 5         | 1      | 5035048013199 |
| DT7292-QZ | T20  | 70mm bit for Torx | 5         | 1      | 5035048013205 |
| DT7293-QZ | T25  | 70mm bit for Torx | 5         | 1      | 5035048013212 |
| DT7294-QZ | T27  | 70mm bit for Torx | 5         | 1      | 5035048013229 |
| DT7295-QZ | T30  | 70mm bit for Torx | 5         | 1      | 5035048013236 |
| DT7296-QZ | T40  | 70mm bit for Torx | 5         | 1      | 5035048013243 |

60 MM DOUBLE ENDED BITS

| Cat. No.  | Size | Description            | Pack Qty. | M.O.Q. | Barcode       |
|-----------|------|------------------------|-----------|--------|---------------|
| DT7304-QZ | Pz1  | 60mm double ended bits | 5         | 1      | 5035048013144 |
| DT7305-QZ | Pz2  | 60mm double ended bits | 5         | 1      | 5035048013151 |
| DT7315-QZ | Ph2  | 60mm double ended bits | 5         | 1      | 5035048013175 |

110 MM POWER BITS

| Cat. No.  | Size | Description | Pack Qty. | M.O.Q. | Barcode       |
|-----------|------|-------------|-----------|--------|---------------|
| DT7203-QZ | Pz2  | 110mm bit   | 5         | 1      | 5035048013250 |
| DT7204-QZ | Ph2  | 110mm bit   | 5         | 1      | 5035048013267 |



SCREWDRIVING ACCESSORIES

APPLICATIONS

- For all screwdriving applications.

PILOT BITS, DRIVE GUIDES & HOLDERS



| Cat. No.  | Length mm | Description                               | Pack Qty. | M.O.Q. | Barcode       |
|-----------|-----------|---|-----------|--------|---------------|
| DT7501-QZ | 57        | Non-magnetic                              | 1         | 1      | 5011402371327 |
| DT7500-QZ | 60        | Magnetic                                  | 1         | 1      | 5011402371310 |
| DT7511-QZ | 60        | Quick change bit holder                   | 1         | 1      | 5035048078365 |
| DT7515-QZ | 60        | Quick connector                           | 1         | 1      | 5035048013274 |
| DT7516-QZ | 60        | Rapidfix holder                           | 1         | 1      | 5035048013281 |
| DT7615-QZ | 38        | Hex Shank Pilot bit 3mm                   | 3         | 1      | 5035048013298 |
| DT7616-QZ | 43        | Hex Shank Pilot bit 4mm                   | 2         | 1      | 5035048013304 |
| DT7617-QZ | 48        | Hex Shank Pilot bit 6mm                   | 2         | 1      | 5035048013311 |
| DT7701-QZ | 80        | DeWALT Screw drive guide 9.5mm diameter   | 1         | 1      | 5035048031995 |
| DT7702-QZ | 120       | DeWALT Screw drive guide 12mm diameter    | 1         | 1      | 5035048032008 |
| DT7508-QZ |           | 1/2" SQ to 1/4" Hex Impact Wrench Adaptor | 1         | 1      | 5035048082034 |
| DT7512-QZ |           | 1/4" hex to 1/2" square adaptor           | 1         | 1      | 5035048083055 |

SCREWDRIVING SETS



APPLICATIONS

- For all screwdriving applications.

FEATURES

- High quality professional screwdriver bits.
- Flexible Torsion Zone absorbs torque peaks and reduces breakage.
- All bits are provided in sturdy plastic re-useable storage containers.

SCREWDRIVING SETS

| Cat. No.  | Pieces | Description   | Pack Qty. | M.O.Q. | Barcode       |
|-----------|--------|---|-----------|--------|---------------|
| DT7917-QZ | 11     | TORX® 7, 8, 9, 10, 15, 20, 25, 27, 30, 40, Magnetic bit holder.   | 1         | 1      | 5035048060445 |
| DT7944-QZ | 31     | 31 Piece Set with 1x2, Pz2x3, Pz3x1, Ph1x2, Ph2x2, Ph3x1, S14.5x1, S15.5x1, S16.5x1, T10x2, T15x2, T20x2, T25x2, T30x2, T40x2, H3x1, H4x2, H5x1 & Quick Connector | 1         | 1      | 5035048078372 |
| DT7945-QZ | 11     | TORX® Quick Connector set (T7,8,9,10,15,20,25,27,30,40)   | 1         | 1      | 5035048013328 |
| DT7946-QZ | 11     | Torx/Pazi Quick Connector set (T15,20,25,30,40Pz1,2x2,2x3)  | 1         | 1      | 5035048013335 |
| DT7915-QZ | 11     | Torsion with "Extra Grip" ribs, Incl Pz 1,2,3 Ph 1,2,3 Slotted 4.5, 5.5,6.5,8 Magnetic bit holder   | 1         | 1      | 5035048060421 |
| DT7916-QZ | 11     | Torsion with "Extra Grip" ribs, Incl Pz 1, 2, 3 Ph 1, 2, 3, T10, 15, 20, 25 Magnetic bit holder   | 1         | 1      | 5035048060438 |
| DT7947-QZ | 11     | Torsion Pz/Ph Quick Connector set (Pz1,2x2,2x3,Ph1,2x2,2x3)   | 1         | 1      | 5035048013342 |
| DT7948-QZ | 11     | Torsion Pz/Ph/Sl Quick Connector set (Pz1,2x2,3,Ph1,2x2,3 Sl 5.5,6.5)   | 1         | 1      | 5035048013359 |

EXTREME DeWALT IMPACT SETS



APPLICATIONS

- For all heavy duty screwdriving applications

FEATURES

- Durable hex shank designed to fit all impact drivers
- Full hex body design for increased strength and life
- Optimised tip design for reduced cam out
- Heat treated body for increased durability

EXTREME DeWALT IMPACT SETS

| Cat. No.    | Description                         | Pack Qty. | M.O.Q. | Barcode       |
|-------------|-------------------------------------|-----------|--------|---------------|
| DT705018-QZ | 29pc Impact Screwdriving set        | 29        | 1      | 5035048082591 |
| DT705028-QZ | 26pc Impact Drill Drive set - PH/PZ | 29        | 1      | 5035048082607 |
| DT705038-QZ | 26pc Impact Drill Drive set - T     | 29        | 1      | 5035048082614 |



DeWALT 'FLIP & DRIVE' SYSTEM

APPLICATIONS

- For use in hard and soft wood, composite board and MDF.
- Ideal for cabinet making, furniture assembly, remodelling and shop fitting.

FEATURES

- Complete drill drive accessory system for drilling countersink & pilot holes in one action and screwdriving.
- One-handed connector release with push forward collar for easily changing between drilling and screwdriving applications.
- 5/16" (8mm) shank for added durability.

'FLIP & DRIVE' UNITS



| Cat. No.  | Size  | Description   | Pack Qty. | Barcode       |
|-----------|-------|---|-----------|---------------|
| DT7600-XJ | No.6  | Connector, countersink, pilot drill bit & Pz2 screw driver bit. | 1         | 5035048052365 |
| DT7601-XJ | No.8  | Connector, countersink, pilot drill bit & Pz2 screw driver bit. | 1         | 5035048052372 |
| DT7602-XJ | No.10 | Connector, countersink, pilot drill bit & Pz2 screw driver bit. | 1         | 5035048052389 |
| DT7603-XJ | No.12 | Connector, countersink, pilot drill bit & Pz2 screw driver bit. | 1         | 5035048052396 |

PILOT BITS



| Cat. No.  | Size  | Description     | Pack Qty. | Barcode       |
|-----------|-------|-----------------|-----------|---------------|
| DT7608-XJ | No.6  | Pilot drill bit | 3         | 5035048031773 |
| DT7609-XJ | No.8  | Pilot drill bit | 3         | 5035048031780 |
| DT7610-XJ | No.10 | Pilot drill bit | 3         | 5035048031797 |

COUNTERSINK & PILOT



| Cat. No.  | Size  | Description                             | Pack Qty. | Barcode       |
|-----------|-------|---|-----------|---------------|
| DT7604-XJ | No.6  | Pilot drill bit & 4 cutter countersink. | 1         | 5035048052402 |
| DT7605-XJ | No.8  | Pilot drill bit & 4 cutter countersink. | 1         | 5035048052419 |
| DT7606-XJ | No.10 | Pilot drill bit & 4 cutter countersink. | 1         | 5035048031759 |
| DT7607-XJ | No.12 | Pilot drill bit & 4 cutter countersink. | 1         | 5035048031766 |

DeWALT 'FLIP & DRIVE' SETS

| Cat. No.  | Size           | Description   | Pack Qty. | Barcode       |
|-----------|----------------|---|-----------|---------------|
| DT7612-XJ | No.6, 8,10, 12 | Case containing No.6 connector, countersink, pilot bit & Pz 2, No.8, 10, 12 countersink & pilot bits, Pz2 x2, Ph2 x2. | 1         | 5035048031810 |



DeWALT IMPACT RATED SOCKET SETS



DeWALT IMPACT RATED SOCKET SETS

| Cat. No.  | Description   | M.O.Q. | Barcode       |
|-----------|---|--------|---------------|
| DT7506-QZ | 17 Pce Impact Socket Set (6,8,10,11,12,13,14,16,17,18,19,20,21,22,24,27mm & 1/4" to 1/2" Adaptor) | 1      | 5035048078624 |
| DT7507-QZ | 9 Pce Impact Socket Set (10,13,15,17,19,22,24,27mm) 1/4" to 1/2" Adaptor                          | 1      | 5035048078631 |
| DT7512-QZ | 1/4" to 1/2" Impact Driver Adaptor  | 1      | 5035048083055 |

HEXAGONAL SOCKET DRIVERS - 50 MM

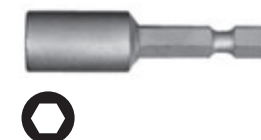

SINGLE PACKS

| Cat. No.  | Size | Description       | Pack Qty. | M.O.Q. | Barcode       |
|-----------|------|-------------------|-----------|--------|---------------|
| DT7415-QZ | 6    | Magnetic          | 1         | 1      | 5035048061473 |
| DT7416-QZ | 6.35 | Magnetic          | 1         | 1      | 5035048061480 |
| DT7401-QZ | 7    | Magnetic          | 1         | 1      | 5011402371181 |
| DT7402-QZ | 8    | Magnetic          | 1         | 1      | 5011402371198 |
| DT7403-QZ | 10   | Magnetic          | 1         | 1      | 5011402371204 |
| DT7422-QZ | 11   | Magnetic          | 1         | 1      | 5035048077580 |
| DT7423-QZ | 11   | 12 Point Magnetic | 1         | 1      | 5035048077597 |
| DT7404-QZ | 13   | Magnetic          | 1         | 1      | 5011402371211 |
| DT7424-QZ | 17   | Magnetic          | 1         | 1      | 5035048077603 |



DRILLING ACCESSORY SETS - MASONRY



MASONRY DRILL BIT SETS

| Cat. No.  | Description                     | Diameter mm    | Pack Qty. | M.O.Q. | Barcode       |
|-----------|---------------------------------|----------------|-----------|--------|---------------|
| DT6952-QZ | 5 piece set in plastic cassette | 4, 5, 6, 8, 10 | 5         | 1      | 5011402373413 |



EXTREME DeWALT® MASONRY DRILL BIT SETS

| Cat. No.  | Description   | Diameter mm        | Pack Qty. | M.O.Q. | Barcode       |
|-----------|---|--------------------|-----------|--------|---------------|
| DT6956-QZ | 5 piece set in plastic cassette.  | 4,5,6,8,10         | 5         | 1      | 5035048060797 |
| DT7928-QZ | Small tough case in blister with EXTREME DeWALT® Masonry drill bits. Ph2x4, Pz2x4, Ph2x50mm, Pz2x50mm, Slotted 5.5x50mm, Magnetic holder, Magnetic drive guide. | 4, 5, 5.5, 6, 7, 8 | 19        | 1      | 5035048072219 |



SDS-PLUS EXTREME DeWALT® 2 DRILL BIT SETS

| Cat. No.  | Description                      | Diameter mm     | Pack Qty. | M.O.Q. | Barcode       |
|-----------|----------------------------------|-----------------|-----------|--------|---------------|
| DT9700-QZ | 4 piece set in plastic cassette. | 5,6,8,10        | 4         | 1      | 5035048056400 |
| DT9701-QZ | 7 piece set in metal cassette.   | 5,6x2,8x2,10,12 | 7         | 1      | 5035048056417 |
| DT9702-QZ | 4 piece set in plastic cassette. | 5,5,7,8,10      | 4         | 1      | 5035048056424 |

DRILLING ACCESSORY SETS - METAL



EXTREME DeWALT® 2 METAL DRILL BIT SETS

| Cat. No.   | Description  | Pack Qty. | M.O.Q. | Barcode       |
|------------|--|-----------|--------|---------------|
| DT7920B-QZ | Small tough case in blister with EXTREME DeWALT® 2 Metal drill bits 1.5, 2, 2.5, 3, 3.2, 3.5, 4, 4.5, 5, 5.5, 6, 6.5, 7.   | 13        | 1      | 5035048072189 |
| DT7921B-QZ | Small tough case in blister with EXTREME DeWALT® 2 Metal drill bits 1.5, 2, 2.5, 3, 3.2, 3.5, 4, 4.5, 5, 5.5, 6, 6.5, 7.   | 13        | 1      | 5035048072196 |
| DT7926-XJ  | Large tough case with EXTREME DeWALT® 2 Metal drill bits 1.5, 2, 2.5, 3, 3.2, 3.3, 3.5, 4, 4.2, 4.5, 4.8, 5, 5.5, 6, 6.5, 7, 7.5, 8, 8.5, 9, 9.5, 10, 10.5, 11, 11.5, 12, 12.5, 13 mm. | 29        | 1      | 5035048052341 |

HSS-R DIN 338 JOBBER METAL DRILL BIT SETS

| Cat. No.  | Description                       | Diameter mm  | Pack Qty. | M.O.Q. | Barcode       |
|-----------|-----------------------------------|--|-----------|--------|---------------|
| DT5911-QZ | 10 piece set in plastic cassette. | 1, 2, 3, 4, 5, 6, 7, 8, 9, 10  | 10        | 1      | 5011402383191 |
| DT5912-QZ | 13 piece set in plastic cassette. | 1.5, 2, 2.5, 3, 3.2, 3.5, 4, 4.5, 5(x2), 5.5, 6, 6.5   | 13        | 1      | 5011402383207 |
| DT5913-QZ | 19 piece set in metal cassette.   | 1, 1.5, 2, 2.5, 3, 3.5, 4, 4.5, 5, 5.5, 6, 6.5, 7, 7.5, 8, 8.5, 9, 9.5, 10   | 19        | 1      | 5011402383214 |
| DT5930-QZ | 29 piece set in metal case.       | 1, 1.5, 2, 2.5, 3, 3.2, 3.3, 3.5, 4, 4.2, 4.5, 4.8, 5, 5.5, 6, 6.5, 7, 7.5, 8, 8.5, 9, 9.5, 10, 10.5, 11, 11.5, 12, 12.5, 13 | 29        | 1      | 5035048077436 |

HSS-G DIN 338 JOBBER METAL DRILL BIT SETS

| Cat. No.  | Description                       | Diameter mm  | Pack Qty. | M.O.Q. | Barcode       |
|-----------|-----------------------------------|--|-----------|--------|---------------|
| DT5921-QZ | 10 piece set in plastic cassette. | 1, 2, 3, 4, 5, 6, 7, 8, 9, 10  | 10        | 1      | 5011402374137 |
| DT5922-QZ | 13 piece set in plastic cassette. | 1.5, 2, 2.5, 3, 3.2, 3.3, 3.5, 4, 4.5, 5 (x2), 5.5, 6, 6.5   | 13        | 1      | 5011402374151 |
| DT5923-QZ | 19 piece set in metal cassette.   | 1, 1.5, 2, 2.5, 3, 3.5, 4, 4.5, 5, 5.5, 6, 6.5, 7, 7.5, 8, 8.5, 9, 9.5, 10   | 19        | 1      | 5011402374175 |
| DT5929-QZ | 29 piece set in metal case        | 1, 1.5, 2, 2.5, 3, 3.2, 3.3, 3.5, 4, 4.2, 4.5, 4.8, 5, 5.5, 6, 6.5, 7, 7.5, 8, 8.5, 9, 9.5, 10, 10.5, 11, 11.5, 12, 12.5, 13 | 29        | 1      | 5035048077429 |



HSS-CO EXTREME DeWALT® COBALT DRILL BIT SETS

| Cat. No.  | Description                         | Diameter mm  | Pack Qty. | M.O.Q. | Barcode       |
|-----------|-------------------------------------|--|-----------|--------|---------------|
| DT5940-QZ | 6 piece set in plastic cassette     | 2, 3, 4, 5, 6, 8   | 6         | 1      | 5011402376254 |
| DT5928-QZ | 29 piece Cobalt set in plastic case | 1, 1.5, 2, 2.5, 3, 3.2, 3.3, 3.5, 4, 4.2, 4.5, 4.8, 5, 5.5, 6, 6.5, 7, 7.5, 8, 8.5, 9, 9.5, 10, 10.5, 11, 11.5, 12, 12.5, 13 mm. | 29        | 1      | 5035048077412 |

DRILLING ACCESSORY SETS - WOOD



WOOD DRILL BIT SETS

| Cat. No.  | Description                     | Diameter mm                             | Pack Qty. | M.O.Q. | Barcode       |
|-----------|---------------------------------|---|-----------|--------|---------------|
| DT4535-QZ | 5 piece set in plastic cassette | 4, 5, 6, 8, 10                          | 5         | 1      | 5011402385713 |
| DT4591-QZ | 5 piece self feed bit set.      | 35, 38, 54, 65 plus Extension bar 140mm | 5         | 1      | 5035048072165 |

MAG BOX MAGNETIC SETS



APPLICATIONS

- Flexible storage solution fits most common accessories

FEATURES

- Compact design for easy storage and portability
- High impact materials for optimum durability
- High strength magnets and built in hooks for increased functionality

MAG BOX MAGNETIC SETS

| Cat. No.  | Description  | Pack Qty. | M.O.Q. | Barcode       |
|-----------|--|-----------|--------|---------------|
| DT7918-QZ | Magnetic Set - Ph1, Ph2, Ph3, PZ1, PZ2 x 2, PZ3, T20, T25, 50mm Ph2, 50mm Ph3, Magnetic holder, 7mm, 8mm, 10mm socket drivers                                | 15        | 1      | 5035048082553 |
| DT7919-QZ | Magnetic Impact Set - Ph1, Ph2, Ph3, PZ1, PZ2 x 2, PZ3, T20, T25, 50mm Ph2, 50mm Ph3, Magnetic holder, 7mm, 8mm, 10mm socket drivers                         | 15        | 1      | 5035048082560 |
| DT7965-QZ | Magnetic Impact Set - 3mm, 4mm Impact drills, Ph1, Ph2, Ph3, PZ1, PZ2 x 2, PZ3, T20, T25, 50mm Ph2, 50mm Ph3, Magnetic holder, 7mm, 8mm, 10mm socket drivers | 20        | 1      | 5035048083208 |

TOUGH CASE STORAGE



SMALL TOUGH CASE SETS

| Cat. No.    | Description  | Pack Qty. | M.O.Q. | Barcode       |
|-------------|--|-----------|--------|---------------|
| DT7928B-QZ  | Small tough case in blister with 6 piece EXTREME DeWALT® Masonry drill bits 4, 5, 5.5, 6, 7, 8. Ph2x4, Pz2x4, Ph2x50mm, Pz2x50mm, Slotted 5.5x50mm, Magnetic holder, Magnetic drive guide. | 19        | 1      | 5035048072219 |
| DT7920B-QZ  | Small tough case in blister with EXTREME DeWALT® 2 Metal drill bits 1.5, 2, 2.5, 3, 3.2, 3.5, 4, 4.5, 5, 5.5, 6, 6.5, 7.   | 13        | 1      | 5035048072189 |
| DT7921B-QZ  | Small tough case in blister with EXTREME DeWALT® 2 Metal drill bits 1.5, 2, 2.5, 3, 3.2, 3.5, 4, 4.5, 5, 5.5, 6, 6.5, 7.   | 13        | 1      | 5035048072196 |
| DT7922B-QZ  | Small tough in blister case with Ph1, 2x6, 3, Pz1, 2x6, 3, T10, 15, 20, 25, 30, 40, Slotted 5.5, 8, Ph2x50mm, Pz2x50mm, Slotted 5.5x50mm, Magnetic holder, Magnetic drive guide.           | 29        | 1      | 5035048072202 |
| DT7942-QZ   | Small tough case with EXTREME DeWALT® Cobalt bits 4, 1.5, 2, 2.5, 3, 3.2, 4, 4.5, 5, 5.5, 6, 6.5, 7  | 13        | 1      | 5035048066003 |
| DT70500B-QZ | 10 piece Impact metal drilling set 3, 3.2, 3.5, 4, 4.5, 5, 6, 8, 10, 12  | 10        | 1      | 5035048081921 |
| DT70501B-QZ | 29pc Impact Screwdriving set   | 29        | 1      | 5035048082591 |
| DT70502B-QZ | 26pc Impact Drill Drive set - PH/PZ  | 29        | 1      | 5035048082607 |
| DT70503B-QZ | 26pc Impact Drill Drive set - T  | 29        | 1      | 5035048082614 |

MEDIUM TOUGH CASE SETS

| Cat. No.   | Description  | Pack Qty. | M.O.Q. | Barcode       |
|------------|--|-----------|--------|---------------|
| DT7933B-QZ | Medium tough case set in blister with 45 screwdriving bits. (Pz2x10, Ph2x10, Sl6x5, Sl4x5, T10x5, T15x3, T25x3) screwguide, bit holder and nutdrivers (x2).  | 45        | 1      | 5035048072233 |
| DT7934B-QZ | Medium tough case 42 piece Hex Shank set in blister with Screwdriver bits - Pz2x10, Ph2x10, Sl6x5, Pz2x2(50mm), Ph2x2(50mm), Hex Shank pilot drill bits - 1.5mmx2, 2mmx2, 3mmx2, 4mmx1, 5mmx1, 6mmx1, Screwguide, bit holder and nutdrivers(x2).   | 42        | 1      | 5035048072240 |
| DT7935B-QZ | Medium tough case in blister with SDS Plus EXTREME DeWALT® 2 drill bits 5, 6x2(110mm), 6x2, 7, 8, 9, 10, 12, 160mm   | 10        | 1      | 5035048072257 |
| DT7937B-QZ | Medium tough case in blister with SDS Plus EXTREME DeWALT® 2 drill bits 5, 6, 6.5, 7, 8, Extreme® Masonry drill bits 4, 5, 2x6, 7, 2x8, Pz1x2, Pz2x2, Pz3, Ph1, Ph2x2, Ph3 25mm bits   | 21        | 1      | 5035048072271 |
| DT7939-QZ  | Medium tough case with SDS Plus EXTREME DeWALT® 2 drill bits 5, 5.5, 6, 7, 8, Pz1x2, Pz2x2, Pz3, Ph1, Ph2x2, Ph3 25mm bits, T10, T15, T20, T25, T30, T40 25mm bits, Sl4.5mm, Sl5.5mm, Sl6.5mm 25mm bits, Pz1x2, Pz2x2, Pz3, Ph1x2, Ph2x2, Ph3 50mm bits, T20, T25, T30 70mm bits, Magnetic bit holder, 7mm, 8mm socket drivers                         | 39        | 1      | 5035048011386 |
| DT7936B-QZ | Medium tough case in blister with SDS EXTREME DeWALT® Plus 2 drill bits 5, 6, 6.5, 8, 10, Pz1x2, Pz2x2, Pz3, Ph1, Ph2x2, Ph3 25mm bits, T10, T15, T20, T25, T30, T40 25mm bits, Sl4.5mm, Sl5.5mm, Sl6.5mm 25mm bits, Pz1x2, Pz2x2, Pz3, Ph1x2, Ph2x2, Ph3 50mm bits, T20, T25, T30 70mm bits, Magnetic bit holder, 7mm socket driver, 8mm socket drive | 39        | 1      | 5035048072264 |
| DT7938B-QZ | Medium tough case set in blister with EXTREME DeWALT® 2 Metal drill bits 1, 1.5, 2, 2.5, 3, 3.2, 3.3, 3.5, 4, 4.2, 4.5, 4.8, 5, 5.5, 6, 6.5, 7, 7.5, 8, 10, 12, Pz1, Pz2x2, Pz3, Ph1, Ph2, Ph3, T20, T25 25mm bits, Magnetic drive guide, Magnetic bit holder, T20, T25 70mm, Pz2 bits, Ph2 50mm bits  | 36        | 1      | 5035048072288 |

LARGE TOUGH CASE SETS

| Cat. No.  | Description   | Pack Qty. | M.O.Q. | Barcode       |
|-----------|---|-----------|--------|---------------|
| DT7926-XJ | Large tough case with EXTREME DeWALT® 2 Metal drill bits 1, 1.5, 2, 2.5, 3, 3.2, 3.3, 3.5, 4, 4.2, 4.5, 4.8, 5, 5.5, 6, 6.5, 7, 7.5, 8, 8.5, 9, 9.5, 10, 10.5, 11, 11.5, 12, 12.5, 13 mm. | 29        | 1      | 5035048052341 |
| DT5928-QZ | Cobalt 29 piece set with Plastic Tough Case 1, 1.5, 2, 2.5, 3, 3.2, 3.3, 3.5, 4, 4.2, 4.5, 4.8, 5, 5.5, 6, 6.5, 7, 7.5, 8, 8.5, 9, 9.5, 10, 10.5, 11, 11.5, 12, 12.5, 13 mm.              | 29        | 1      | 5035048077412 |
| DT5929-QZ | HSS-G 29 piece set with Metal Case 1, 1.5, 2, 2.5, 3, 3.2, 3.3, 3.5, 4, 4.2, 4.5, 4.8, 5, 5.5, 6, 6.5, 7, 7.5, 8, 8.5, 9, 9.5, 10, 10.5, 11, 11.5, 12, 12.5, 13 mm.                       | 29        | 1      | 5035048077429 |
| DT5930-QZ | HSS-R 29 piece set with Metal Case 1, 1.5, 2, 2.5, 3, 3.2, 3.3, 3.5, 4, 4.2, 4.5, 4.8, 5, 5.5, 6, 6.5, 7, 7.5, 8, 8.5, 9, 9.5, 10, 10.5, 11, 11.5, 12, 12.5, 13 mm.                       | 29        | 1      | 5035048077436 |



MODULAR ACCESSORY CASES



Made from tough, heavy-duty plastic, the full size modular accessory case can carry a very large selection of accessory items as well as providing plenty of storage space for other consumables such as plugs and fixings.

MODULAR ACCESSORY CASES

| Cat. No.  | Description  | M.O.Q. | Barcode       |
|-----------|--|--------|---------------|
| DT9289-QZ | 90 piece set   | 1      | 5035048082041 |
| DT9290-QZ | 106 piece set  | 1      | 5035048082058 |
| DT9291-QZ | 95 piece set including EXTREME DeWALT® Masonry, Extreme DeWALT® 2 Metal, Flatwood, SDS Plus, Torx, Pz, Ph & pilot bits                       | 1      | 5035048012376 |
| DT9292-QZ | 100 piece set including EXTREME DeWALT® Masonry, Extreme DeWALT® 2 Metal, Flatwood, SDS Plus, Torx, Slotted, Pz, Ph, 50mm bits & pilot bits  | 1      | 5035048012383 |
| DT9293-QZ | 100 piece set including EXTREME DeWALT® Masonry, Extreme DeWALT® 2 Metal, Flatwood, Bradpoint, Torx, Slotted, Pz, Ph, 50mm bits & pilot bits | 1      | 5035048012390 |
| DT9294-QZ | 100 piece set including EXTREME DeWALT® Masonry, Extreme DeWALT® 2 Metal, Flatwood, Bradpoint, Torx, Slotted, Pz, Ph, 50mm bits & pilot bits | 1      | 5035048012406 |
| DT9296-QZ | 90 piece set   | 1      | 5035048061626 |
| DT9298-QZ | 106 piece set  | 1      | 5035048245385 |
| DT9299-QZ | 100 piece set  | 1      | 5035048245392 |

MINI MAC CASE SETS



Offering excellent value, the more compact 'Mini' modular accessory case provides the same robustness and job-site durability as well as being easy to store away in situations where space is at a premium.

MINI MAC CASE SETS

| Cat. No.  | Description   | M.O.Q. | Barcode       |
|-----------|---|--------|---------------|
| DT9281-QZ | 63 piece set with EXTREME DeWALT® Masonry (4,5,6x2,8x2 mm), EXTREME DeWALT® 2 Metal (1,5,2,2,5,3,3,5,4,4,5,5,5,5,6,6,5,7mm). Screwdriver bits: 50mm Pz2, Ph2, SlS.5, Sl6.5, 25mm Ph1, Ph2x3, Ph3, Pz1, Pz2x23, Pz3, T15, T20x2, T25x3, T30, T40, Magnetic bit holder and drive guide  | 1      | 5035048073308 |
| DT9282-QZ | 57 piece set with Brad Point (3,4,5,6,8,10,12mm), EXTREME DeWALT® Flatwood (12,14,16,20,22,25mm). Screwdriver bits: 50mm Pz2, Ph2, SlS.5, Sl6.5, 25mm Ph1, Ph2x2, Ph3, Pz1, Pz2x3, Pz3, T15, T20x22, T25x3, T30, T40, Magnetic bit holder and drive guide   | 1      | 5035048073315 |
| DT9283-QZ | 69 piece set with EXTREME DeWALT® SDS-Plus (6x110,6x160x2,8x160x2,10x160), EXTREME DeWALT® 2 Metal (1,5,2,2,5,3,3,5,4,4,5,5,5,5,6,6,5,7mm), EXTREME DeWALT® Masonry (4,5,6x2,8x2 mm). Screwdriver bits: 50mm Pz2, Ph2, SlS.5, Sl6.5, 25mm Ph1, Ph2x2, Ph3, Pz1, Pz2x3, Pz3, T15, T20x22, T25x3, T30, T40, Magnetic bit holder and drive guide | 1      | 5035048073322 |
| DT9284-QZ | 77 piece set with EXTREME DeWALT® Cobalt (1,5,2,2,5,3,3,5,4,4,5,5,5,5,6,6,5,7mm), EXTREME DeWALT® 2 Metal (1,1,5,2,2,5,3,3,2,3,3,3,5,4,4,2,4,5,4,8,5,5,5,6,6,5,7,7,5,8,10,12mm) Screwdriver bits: 50mm Pz2, Ph2, SlS.5, Sl6.5, 25mm Ph1, Ph2x3, Ph3, Pz1, Pz2x23, Pz3, T15, T20x2, T25x3, T30, T40, Magnetic bit holder and drive guide       | 1      | 5035048073339 |
| DT9285-QZ | 65 piece set with HSS-G (1,1,5,2,2,5,3,3,2,3,3,3,5,4,4,2,4,5,4,8,5,5,5,6,6,5,7,7,5,8,10,12mm). Screwdriver bits: 50mm Pz2, Ph2, SlS.5, Sl6.5, 25mm Ph1, Ph2x3, Ph3, Pz1, Pz2x23, Pz3, T15, T20x2, T25x3, T30, T40, Magnetic bit holder and drive guide  | 1      | 5035048073346 |
| DT9286-QZ | 72 piece set with Masonry Bits (4,5,6x2,8x2 mm), HSS-G (1,1,5,2,2,5,3,3,2,3,3,3,5,4,4,2,4,5,4,8,5,5,5,6,6,5,7,7,5,8,10,12mm). Screwdriver bits: 50mm Pz2, Ph2, SlS.5, Sl6.5, 25mm Ph1, Ph2x2, Ph3, Pz1, Pz2x3, Pz3, T15, T20x22, T25x3, T30, T40, Magnetic bit holder and drive guide   | 1      | 5035048073353 |
| DT9287-QZ | 85 piece set with HSS-G (1,1,5,2,2,5,3,3,2,3,3,3,5,4,4,2,4,5,4,8,5,5,5,6,6,5,7,7,5,8,10,12mm). Screwdriver bits: 50mm Pz2, Ph2, SlS.5, Sl6.5, 25mm Ph1, Ph2x23, Ph3, Pz1, Pz2x23, Pz3, T15, T20x2, T25x3, T30, T40, Magnetic bit holder and drive guide   | 1      | 5035048073445 |

EXTREME DeWALT® STATIONARY CIRCULAR SAW BLADES



• See individual blades for machine fitment, material suitability and finish.

- Teeth remain sharp for longer through use of extra-large sub micrograin carbide teeth.
- Exceptional surface finish due to unique anti-vibration slots that minimise blade vibration.
- Extended cutting life in difficult materials such as tropical hardwoods and MDF through use of corrosion resistant carbide teeth.
- Excellent blade to spindle fitting is provided by honed arbor holes.



EXTREME DeWALT® STATIONARY CIRCULAR SAW BLADES

| Cat. No.  | Diameter / Bore | Plate / Kerf | Teeth | Grind | Rake | Fast Rip | General Purpose | Fine Finish | Extra Fine Finish | Aluminium | Barcode       |
|-----------|-----------------|--------------|-------|-------|------|----------|-----------------|-------------|-------------------|-----------|---------------|
| DT4211-QZ | 210/30          | 1.8/2.6      | 18    | ATB   | 25°  | •        |                 |             |                   |           | 5035048057360 |
| DT4221-QZ | 210/30          | 1.8/2.6      | 24    | ATB   | -5°  |          | •               |             |                   |           | 5035048057421 |
| DT4250-QZ | 210/30          | 1.8/2.6      | 40    | ATB   | 10°  |          |                 | •           |                   |           | 5035048057520 |
| DT4252-QZ | 210/30          | 1.8/2.6      | 48    | ATB   | -5°  |          |                 | •           |                   |           | 5035048057544 |
| DT4253-QZ | 210/30          | 1.8/2.6      | 56    | TCG   | -5°  |          |                 | •           |                   |           | 5035048057551 |
| DT4285-QZ | 210/30          | 1.8/2.6      | 80    | TCG   | -5°  |          |                 |             | •                 | •         | 5035048057698 |
| DT4254-QZ | 215/30          | 1.8/2.6      | 60    | TCG   | -5°  |          |                 | •           |                   |           | 5035048057568 |
| DT4310-QZ | 216/30          | 1.8/2.6      | 24    | ATB   | -5°  | •        |                 |             |                   |           | 5035048057827 |
| DT4320-QZ | 216/30          | 1.8/2.6      | 48    | ATB   | -5°  |          | •               |             |                   |           | 5035048057902 |
| DT4350-QZ | 216/30          | 1.8/2.6      | 60    | ATB   | -5°  |          |                 | •           |                   |           | 5035048058107 |
| DT4370-QZ | 216/30          | 1.8/2.6      | 60    | TCG   | -5°  |          |                 |             | •                 |           | 5035048058220 |
| DT4286-QZ | 216/30          | 1.8/2.6      | 80    | TCG   | -5°  |          |                 |             |                   | •         | 5035048057704 |
| DT4213-QZ | 250/30          | 2.2/3.0      | 24    | ATB   | -5°  | •        |                 |             |                   |           | 5035048057384 |
| DT4311-QZ | 250/30          | 2.2/3.0      | 24    | FT    | 10°  | •        |                 |             |                   |           | 5035048057834 |
| DT4321-QZ | 250/30          | 2.2/3.0      | 30    | ATB   | 10°  |          | •               |             |                   |           | 5035048057919 |
| DT4226-QZ | 250/30          | 2.2/3.0      | 30    | ATB   | 20°  |          | •               |             |                   |           | 5035048057476 |
| DT4322-QZ | 250/30          | 2.2/3.0      | 40    | ATB   | 10°  |          | •               |             |                   |           | 5035048057926 |
| DT4323-QZ | 250/30          | 2.2/3.0      | 48    | ATB   | 20°  |          | •               |             |                   |           | 5035048057933 |
| DT4351-QZ | 250/30          | 2.2/3.0      | 60    | ATB   | 10°  |          |                 | •           |                   |           | 5035048058114 |
| DT4352-QZ | 250/30          | 2.2/3.0      | 60    | TCG   | -5°  |          |                 | •           |                   |           | 5035048058121 |
| DT4353-QZ | 250/30          | 2.2/3.0      | 80    | ATB   | 10°  |          |                 | •           |                   |           | 5035048058138 |
| DT4354-QZ | 250/30          | 2.2/3.0      | 80    | ATB   | -5°  |          |                 | •           |                   |           | 5035048058145 |
| DT4287-QZ | 250/30          | 2.2/3.0      | 80    | TCG   | -5°  |          |                 |             | •                 | •         | 5035048057711 |
| DT4373-QZ | 250/30          | 2.2/3.0      | 80    | TCG   | 10°  |          |                 |             | •                 |           | 5035048058251 |
| DT4282-QZ | 250/30          | 2.2/3.0      | 96    | TCG   | -5°  |          |                 |             | •                 | •         | 5035048057667 |
| DT4214-QZ | 260/30          | 1.8/2.6      | 24    | ATB   | 15°  | •        |                 |             |                   |           | 5035048057391 |
| DT4312-QZ | 260/30          | 1.8/2.6      | 24    | ATB   | 15°  | •        |                 |             |                   |           | 5035048057841 |
| DT4324-QZ | 260/30          | 1.8/2.6      | 48    | ATB   | 10°  |          | •               |             |                   |           | 5035048057940 |
| DT4280-QZ | 260/30          | 1.8/2.6      | 80    | TCG   | -5°  |          |                 |             | •                 | •         | 5035048057643 |
| DT4314-QZ | 300/30          | 2.2/3.0      | 30    | ATB   | 10°  | •        |                 |             |                   |           | 5035048057865 |
| DT4327-QZ | 300/30          | 2.2/3.0      | 48    | ATB   | 10°  |          | •               |             |                   |           | 5035048057971 |
| DT4328-QZ | 300/30          | 2.2/3.0      | 60    | ATB   | 10°  |          | •               |             |                   |           | 5035048057988 |
| DT4329-QZ | 300/30          | 2.2/3.0      | 60    | TCG   | 10°  |          |                 | •           |                   |           | 5035048057995 |
| DT4357-QZ | 300/30          | 2.2/3.0      | 72    | TCG   | 10°  |          |                 | •           |                   |           | 5035048058176 |
| DT4281-QZ | 300/30          | 2.2/3.0      | 80    | TCG   | -5°  |          |                 |             | •                 | •         | 5035048057650 |
| DT4376-QZ | 300/30          | 2.2/3.0      | 96    | TCG   | 10°  |          |                 |             | •                 |           | 5035048058299 |
| DT4378-QZ | 300/30          | 2.2/3.0      | 96    | TCG   | -5°  |          |                 |             |                   | •         | 5035048058305 |
| DT4210-QZ | 305/30          | 1.8/2.6      | 32    | ATB   | -5°  | •        |                 |             |                   |           | 5035048057353 |
| DT4330-QZ | 305/30          | 2.2/3.0      | 36    | ATB   | -5°  |          | •               |             |                   |           | 5035048058008 |
| DT4340-QZ | 305/30          | 2.2/3.0      | 48    | ATB   | 10°  |          | •               |             |                   |           | 5035048061909 |
| DT4260-QZ | 305/30          | 1.8/2.6      | 60    | ATB   | -5°  |          |                 | •           |                   |           | 5035048057629 |
| DT4331-QZ | 305/30          | 2.2/3.0      | 60    | ATB   | -5°  |          |                 | •           |                   |           | 5035048058015 |
| DT4283-QZ | 305/30          | 1.8/2.6      | 80    | TCG   | -5°  |          |                 |             | •                 |           | 5035048057674 |
| DT4288-QZ | 305/30          | 2.2/3.0      | 80    | TCG   | -5°  |          |                 |             | •                 | •         | 5035048057728 |
| DT4290-QZ | 305/30          | 2.2/3.0      | 96    | TCG   | -5°  |          |                 |             | •                 | •         | 5035048057742 |
| DT4215-QZ | 315/30          | 2.2/3.0      | 24    | ATB   | 10°  | •        |                 |             |                   |           | 5035048057407 |
| DT4332-QZ | 315/30          | 2.2/3.0      | 48    | ATB   | 10°  |          | •               |             |                   |           | 5035048058022 |
| DT4358-QZ | 315/30          | 2.2/3.0      | 72    | ATB   | 10°  |          |                 | •           |                   |           | 5035048058183 |
| DT4289-QZ | 315/30          | 2.2/3.0      | 80    | TCG   | -5°  |          |                 |             | •                 | •         | 5035048057735 |
| DT4333-QZ | 350/30          | 2.2/3.0      | 42    | ATB   | 10°  |          | •               |             |                   |           | 5035048058039 |
| DT4334-QZ | 350/30          | 2.2/3.0      | 54    | ATB   | 10°  |          | •               |             |                   |           | 5035048058046 |
| DT4359-QZ | 350/30          | 2.2/3.0      | 80    | TCG   | -5°  |          |                 | •           |                   |           | 5035048058190 |
| DT4360-QZ | 350/30          | 2.2/3.0      | 84    | ATB   | 10°  |          |                 | •           |                   |           | 5035048058206 |
| DT4291-QZ | 350/30          | 2.2/3.0      | 96    | TCG   | -5°  |          |                 |             | •                 | •         | 5035048057759 |
| DT4317-QZ | 400/30          | 2.5/3.0      | 36    | ATB   | 10°  |          | •               |             |                   |           | 5035048057896 |
| DT4338-QZ | 400/30          | 2.5/3.5      | 60    | ATB   | 10°  |          | •               |             |                   |           | 5035048058084 |



FLAT TOP GRIND (FT)

Teeth ground flat across top with 0 degree bevel. Best for ripping and general purpose, where quality of finish is less important than cut force.



ALTERNATE TOP BEVEL (ATB)

Teeth where the top bevel alternates from left to right, with bevel angle ranging 10 to 25 degrees. Ideal for cross cutting in hard and softwoods and general purpose woodcutting.



TRIPLE CHIP GRIND (TCG)

Flat top teeth alternate with slightly trapezoidal teeth that make a narrower cut, to prevent chipping brittle materials such as laminates.



HOLLOW GRIND (HG)

Very sharp edges designed to leave a chip-free finish - top and bottom. Ideal for cutting double sided composite board, eg. melamine.





EXTREME DeWALT® PORTABLE CIRCULAR SAW BLADES



- See individual blades for machine fitment, material suitability and finish.

- Excellent surface finish ensured by laser-cut expansion slots that reduce vibration and noise.
- Consistently precise cutting from a balanced and tensioned laser-cut plate.
- Longer intervals between re-sharpenings through use of large micrograin carbide teeth.

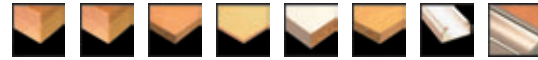

EXTREME DeWALT® PORTABLE CIRCULAR SAW BLADES

| Cat. No.  | Diameter / Bore | Plate / Kerf | Teeth | Grind | Rake | Fast Rip | General Purpose | Fine Finish | Extra Fine Finish | Aluminium | Barcode       |
|-----------|-----------------|--------------|-------|-------|------|----------|-----------------|-------------|-------------------|-----------|---------------|
| DT4053-QZ | 150/20          | 1.8/2.6      | 30    | ATB   | 10°  |          |                 |             |                   |           | 5035048056943 |
| DT4081-QZ | 150/20          | 1.8/2.6      | 40    | TCG   | -5°  |          |                 |             |                   |           | 5035048057124 |
| DT4004-QZ | 152/20          | 1.8/2.6      | 12    | ATB   | 25°  | •        |                 |             |                   |           | 5035048056592 |
| DT4022-QZ | 152/20          | 1.8/2.6      | 18    | ATB   | 25°  |          | •               |             |                   |           | 5035048056745 |
| DT4055-QZ | 152/20          | 1.8/2.6      | 30    | ATB   | 10°  |          |                 | •           |                   |           | 5035048056967 |
| DT4005-QZ | 160/16          | 1.8/2.6      | 24    | ATB   | 25°  |          | •               |             |                   |           | 5035048056608 |
| DT4056-QZ | 160/16          | 1.8/2.6      | 36    | ATB   | 10°  |          |                 | •           |                   |           | 5035048056974 |
| DT4083-QZ | 160/16          | 1.8/2.6      | 48    | TCG   | -5°  |          |                 |             |                   |           | 5035048057148 |
| DT4006-QZ | 160/20          | 1.8/2.6      | 12    | ATB   | 25°  | •        |                 |             |                   |           | 5035048056615 |
| DT4023-QZ | 160/20          | 1.8/2.6      | 24    | ATB   | 25°  |          | •               |             |                   |           | 5035048056752 |
| DT4057-QZ | 160/20          | 1.8/2.6      | 36    | ATB   | 10°  |          |                 | •           |                   |           | 5035048056981 |
| DT4084-QZ | 160/20          | 1.8/2.6      | 48    | TCG   | -5°  |          |                 |             |                   |           | 5035048057155 |
| DT4024-QZ | 160/30          | 1.8/2.6      | 24    | ATB   | 25°  |          | •               |             |                   |           | 5035048056769 |
| DT4085-QZ | 160/30          | 1.8/2.6      | 48    | TCG   | -5°  |          |                 |             |                   |           | 5035048057162 |
| DT4025-QZ | 165/16          | 1.8/2.6      | 24    | ATB   | 25°  |          | •               |             |                   |           | 5035048056776 |
| DT4026-QZ | 165/20          | 1.8/2.6      | 24    | ATB   | 25°  |          | •               |             |                   |           | 5035048056783 |
| DT4087-QZ | 165/20          | 1.8/2.6      | 48    | TCG   | -5°  |          |                 |             |                   |           | 5035048057186 |
| DT4007-QZ | 165/30          | 1.8/2.6      | 12    | ATB   | 25°  | •        |                 |             |                   |           | 5035048056622 |
| DT4027-QZ | 165/30          | 1.8/2.6      | 24    | ATB   | 25°  |          | •               |             |                   |           | 5035048056790 |
| DT4088-QZ | 165/30          | 1.8/2.6      | 48    | TCG   | -5°  |          |                 |             |                   |           | 5035048057193 |
| DT4058-QZ | 170/30          | 1.8/2.6      | 30    | ATB   | 10°  |          |                 | •           |                   |           | 5035048056998 |
| DT4059-QZ | 180/30          | 1.8/2.6      | 30    | ATB   | 10°  |          |                 | •           |                   |           | 5035048057001 |
| DT4091-QZ | 180/30          | 1.8/2.6      | 48    | TCG   | -5°  |          |                 |             |                   |           | 5035048057223 |
| DT4012-QZ | 184/16          | 1.8/2.6      | 12    | ATB   | 25°  | •        |                 |             |                   |           | 5035048056677 |
| DT4011-QZ | 184/16          | 1.8/2.6      | 16    | ATB   | 25°  | •        |                 |             |                   |           | 5035048056660 |
| DT4031-QZ | 184/16          | 1.8/2.6      | 28    | ATB   | 25°  |          | •               |             |                   |           | 5035048056837 |
| DT4063-QZ | 184/16          | 1.4/2.6      | 40    | ATB   | 10°  |          |                 | •           |                   |           | 5035048057049 |
| DT4092-QZ | 184/16          | 1.8/2.6      | 48    | TCG   | -5°  |          |                 |             |                   |           | 5035048057230 |
| DT4032-QZ | 184/20          | 1.8/2.6      | 28    | ATB   | 25°  |          | •               |             |                   |           | 5035048056844 |
| DT4062-QZ | 184/20          | 1.8/2.6      | 40    | ATB   | 10°  |          |                 | •           |                   |           | 5035048057032 |
| DT4034-QZ | 190/20          | 1.8/2.6      | 28    | ATB   | 10°  |          | •               |             |                   |           | 5035048056868 |
| DT4065-QZ | 190/20          | 1.8/2.6      | 40    | ATB   | 10°  |          |                 | •           |                   |           | 5035048057063 |
| DT4095-QZ | 190/20          | 1.8/2.6      | 48    | TCG   | -5°  |          |                 |             |                   |           | 5035048057261 |
| DT4013-QZ | 190/30          | 1.8/2.6      | 16    | ATB   | 25°  | •        |                 |             |                   |           | 5035048056684 |
| DT4033-QZ | 190/30          | 1.8/2.6      | 28    | ATB   | 10°  |          | •               |             |                   |           | 5035048056851 |
| DT4064-QZ | 190/30          | 1.8/2.6      | 40    | ATB   | 10°  |          |                 | •           |                   |           | 5035048057056 |
| DT4094-QZ | 190/30          | 1.8/2.6      | 48    | TCG   | -5°  |          |                 |             |                   |           | 5035048057254 |
| DT4096-QZ | 200/30          | 1.8/2.6      | 56    | TCG   | -5°  |          |                 |             |                   |           | 5035048057278 |
| DT4224-QZ | 230/30          | 2.2/3.0      | 28    | ATB   | 25°  |          | •               |             |                   |           | 5035048057452 |
| DT4225-QZ | 230/30          | 2.2/3.0      | 40    | ATB   | 10°  |          |                 | •           |                   |           | 5035048057469 |
| DT4256-QZ | 230/30          | 2.2/3.0      | 56    | TCG   | -5°  |          |                 |             |                   |           | 5035048057582 |
| DT4037-QZ | 235/25.4        | 2.2/3.0      | 28    | ATB   | 25°  |          | •               |             |                   |           | 5035048056889 |
| DT4068-QZ | 235/25.4        | 2.2/3.0      | 40    | ATB   | 10°  |          |                 | •           |                   |           | 5035048057094 |
| DT4098-QZ | 235/25.4        | 2.2/3.0      | 56    | TCG   | -5°  |          |                 |             |                   |           | 5035048057292 |
| DT4015-QZ | 235/30          | 2.2/3.0      | 18    | ATB   | 25°  | •        |                 |             |                   |           | 5035048056707 |
| DT4036-QZ | 235/30          | 2.2/3.0      | 28    | ATB   | 25°  |          | •               |             |                   |           | 5035048056882 |
| DT4067-QZ | 235/30          | 2.2/3.0      | 40    | ATB   | 10°  |          |                 | •           |                   |           | 5035048057087 |
| DT4097-QZ | 235/30          | 2.2/3.0      | 56    | TCG   | -5°  |          |                 |             |                   |           | 5035048057285 |
| DT4016-QZ | 240/30          | 2.2/3.0      | 18    | ATB   | 20°  | •        |                 |             |                   |           | 5035048056714 |
| DT4038-QZ | 240/30          | 2.2/3.0      | 28    | ATB   | 20°  |          | •               |             |                   |           | 5035048056905 |
| DT4069-QZ | 240/30          | 2.2/3.0      | 40    | ATB   | 20°  |          |                 | •           |                   |           | 5035048057100 |
| DT4099-QZ | 240/30          | 2.2/3.0      | 56    | TCG   | -5°  |          |                 |             |                   |           | 5035048057308 |

CORDLESS CIRCULAR SAW BLADES



- Heavy duty tungsten carbide tips maintain cutting edge for longer blade life.
- Thin kerf blade design - yields more cuts per charge by minimising battery drain.
- Triple action sharpening process which grinds the tip to a razor sharp edge for a smooth finish.
- Specifically designed for use with DEWALT Cordless Trimsaws. The range comprises of blades for cutting wood and for cutting plastic & non-ferrous metals.

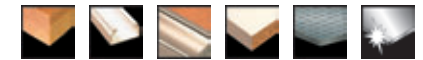

CORDLESS CIRCULAR SAW BLADES

| Cat. No.  | Diameter / Bore | Plate / Kerf | Teeth | Grind | Rake | Fast Rip | General Purpose | Fine Finish | Extra Fine Finish | Aluminium | Stainless Steel | Barcode       |
|-----------|-----------------|--------------|-------|-------|------|----------|-----------------|-------------|-------------------|-----------|-----------------|---------------|
| DT1200-QZ | 136/10          | 1.5          | 16    | ATB   | +20° | •        |                 |             |                   |           |                 | 5011402378159 |
| DT1201-QZ | 136/10          | 1.5          | 24    | ATB   | +20° |          | •               |             |                   |           |                 | 5011402370160 |
| DT1202-QZ | 136/10          | 1.5          | 30    | FT    | +3°  |          |                 | •           | •                 |           |                 | 5011402378173 |
| DT1203-QZ | 165/10          | 1.5          | 18    | ATB   | +20° | •        |                 |             |                   |           |                 | 5035048031056 |
| DT1204-QZ | 165/10          | 1.5          | 24    | ATB   | +20° |          | •               |             |                   |           |                 | 5035048031063 |
| DT1205-QZ | 165/10          | 1.5          | 36    | FT    | +3°  |          |                 | •           | •                 |           |                 | 5035048031186 |
| DT1208-QZ | 165/20          | 1.5          | 16    | ATB   | +20° | •        |                 |             |                   |           |                 | 5035048060490 |
| DT1207-QZ | 165/20          | 1.5          | 24    | ATB   | +20° |          | •               |             |                   |           |                 | 5035048060483 |
| DT1206-QZ | 165/20          | 1.5          | 36    | FT    | +3°  |          |                 | •           | •                 |           |                 | 5035048060476 |
| DT1210-XJ | 173/20          | 2.2          | 50    | TCG   | 0°   |          |                 |             |                   | •         |                 | 5035048056431 |
| DT1266-QZ | 173/20          | 1.8          | 40    | MTCG  | 0°   |          |                 |             |                   |           | •               | 5035048080429 |
| DT1211-QZ | 184/20          | 1.8          | 24    | ATB   | +18° |          | •               |             |                   |           |                 | 5035048061992 |

PORTABLE CIRCULAR SAW BLADES



- See individual blades for machine fitment, material suitability and finish.

- Precision ground cutting angles for excellent blade sharpness and faster cutting.
- "K20" extra robust carbide and unique wedge shoulder design for greater durability.
- Thick steel plate hard body for professional quality.



FOR CONSTRUCTION MATERIALS

| Cat. No.  | Diameter / Bore | Plate / Kerf | Teeth | Grind | Rake | Additional Insert Rings | Fast Rip | General Purpose | Barcode       |
|-----------|-----------------|--------------|-------|-------|------|-------------------------|----------|-----------------|---------------|
| DT1164-QZ | 150/20          | 1.5/2.4      | 12    | ATB   | +20° |                         | •        |                 | 5035048011263 |
| DT1140-QZ | 152/20          | 1.5/2.4      | 12    | ATB   | +20° |                         | •        |                 | 5035048011010 |
| DT1141-QZ | 152/20          | 1.5/2.4      | 24    | ATB   | +10° |                         |          | •               | 5035048011027 |
| DT1142-QZ | 160/20          | 1.5/2.4      | 18    | ATB   | +20° | 16                      |          | •               | 5035048011034 |
| DT1143-QZ | 160/20          | 1.5/2.4      | 30    | ATB   | +10° | 16                      |          | •               | 5035048011041 |
| DT1166-QZ | 165/20          | 1.5/2.4      | 18    | ATB   | +20° |                         | •        |                 | 5035048080290 |
| DT1167-QZ | 165/20          | 1.5/2.4      | 30    | ATB   | +10° |                         |          | •               | 5035048080306 |
| DT1144-QZ | 165/30          | 1.5/2.4      | 18    | ATB   | +20° | 16, 20                  |          | •               | 5035048011058 |
| DT1145-QZ | 165/30          | 1.5/2.4      | 30    | ATB   | +10° | 16, 20                  |          | •               | 5035048011065 |
| DT1146-QZ | 170/30          | 1.5/2.4      | 18    | ATB   | +20° |                         | •        |                 | 5035048011072 |
| DT1147-QZ | 170/30          | 1.5/2.4      | 30    | ATB   | +10° |                         |          | •               | 5035048011089 |
| DT1149-QZ | 184/16          | 1.7/2.6      | 18    | ATB   | +20° |                         | •        |                 | 5035048011102 |
| DT1151-QZ | 184/16          | 1.7/2.6      | 30    | ATB   | +10° |                         |          | •               | 5035048011126 |
| DT1148-QZ | 184/30          | 1.7/2.6      | 18    | ATB   | +20° | 20                      |          | •               | 5035048011096 |
| DT1150-QZ | 184/30          | 1.7/2.6      | 30    | ATB   | +10° | 20                      |          | •               | 5035048011119 |
| DT1165-QZ | 190/16          | 1.7/2.6      | 18    | ATB   | +20° |                         | •        |                 | 5035048014318 |
| DT1152-QZ | 190/30          | 1.7/2.6      | 18    | ATB   | +20° | 20                      |          | •               | 5035048011133 |
| DT1153-QZ | 190/30          | 1.7/2.6      | 40    | ATB   | +10° | 16, 20                  |          | •               | 5035048011140 |
| DT1175-QZ | 230/30          | 1.7/2.6      | 24    | ATB   | +20° |                         | •        |                 | 5035048080313 |
| DT1176-QZ | 230/30          | 1.7/2.6      | 40    | ATB   | +10° |                         |          | •               | 5035048080320 |
| DT1156-QZ | 235/30          | 1.7/2.6      | 24    | ATB   | +20° | 25.4                    | •        |                 | 5035048011171 |
| DT1157-QZ | 235/30          | 1.7/2.6      | 40    | ATB   | +10° | 25.4                    |          | •               | 5035048011188 |



- FAST RIP**
- Blades designed for fast rip of soft and hard natural wood
  - Ideal for pre-sizing applications
  - ATB grind geometry, low tooth count and aggressive rake angles



- GENERAL PURPOSE & CROSS CUT**
- For all purpose rip and cross cutting in natural wood, plywood, laminates and particle board
  - ATB grind geometry, medium tooth count and positive rake angles allow the blades to cut at higher feed speeds



- FINE FINISH & CROSS CUT**
- For smooth cross cuts in plywood, softwood, and all hardwoods
  - ATB grind geometry, high tooth count and tuned grinding angles give excellent surface finish



- EXTRA FINE FINISH**
- Blades designed for EXTRA fine cuts in plywood, veneers, laminates and plastics
  - Blades are tuned to avoid breakout on laminate materials
  - TCG grind geometry gives excellent surface finish on workpiece



- ALUMINIUM CUTTING**
- Blades optimised for cutting in Aluminium
  - TCG grind geometry gives clean and accurate finish on workpiece



PORTABLE CIRCULAR SAW BLADES 150mm TO 240mm



- STEP 1: SELECT TOOL FITMENT & BLADE SIZE
- STEP 2: SELECT MATERIAL TO BE CUT
- STEP 3: SELECT FINISH REQUIRED

| 1.  |   | Diameter Ø mm<br>Bore Ø mm |          |       | 150<br>20 | 152<br>20 | 160<br>16 | 160<br>20 | 160<br>30 | 165<br>16 | 165<br>20 |        | 165<br>30 | 170<br>30 | 180<br>30 | 184<br>16 | 184<br>20 | 184<br>30 | 190<br>16 | 190<br>20 | 190<br>30 | 200<br>30 | 230<br>30 | 235<br>25.4 | 235<br>30 | 240<br>30 |        |        |
|---|---|----------------------------|----------|-------|-----------|-----------|-----------|-----------|-----------|-----------|-----------|--------|-----------|-----------|-----------|-----------|-----------|-----------|-----------|-----------|-----------|-----------|-----------|-------------|-----------|-----------|--------|--------|
| 2. Material   | 3. Cut  | Teeth                      | Geometry | Angle |           |           |           |           |           |           |           |        |           |           |           |           |           |           |           |           |           |           |           |             |           |           |        |        |
| Plywood<br>Natural Wood<br>MDF  | Fast Rip                                      | 12                         | ATB      | 25    |           | DT4004    |           | DT4006    |           |           |           |        |           | DT4007    |           |           |           |           |           |           |           |           |           |             |           |           |        |        |
|   |   | 16                         | ATB      | 25    |           |           |           |           |           |           |           |        |           |           |           |           |           |           |           |           |           |           |           |             |           |           |        |        |
|   |   | 18                         | ATB      | 25    |           |           |           |           |           |           |           |        |           |           |           |           |           |           |           |           |           |           |           |             |           |           | DT4015 | DT4016 |
|   | General Purpose                               | 18                         | ATB      | 25    |           | DT4022    |           |           |           |           |           |        |           |           |           |           |           |           |           |           |           |           |           |             |           |           |        |        |
|   |   | 24                         | ATB      | 25    |           |           | DT4005    | DT4023    | DT4024    | DT4025    | DT4026    |        | DT4027    |           |           |           |           |           |           |           |           |           |           |             |           |           |        |        |
|   |   | 28                         | ATB      | 10    |           |           |           |           |           |           |           |        |           |           |           |           |           |           |           |           | DT4034    | DT4033    |           |             |           |           |        |        |
|   |   | 28                         | ATB      | 20    |           |           |           |           |           |           |           |        |           |           |           |           |           |           |           |           |           |           |           |             |           |           | DT4038 |        |
|   |   | 28                         | ATB      | 25    |           |           |           |           |           |           |           |        |           |           |           |           | DT4031    | DT4032    |           |           |           |           |           | DT4224      | DT4037    | DT4036    |        |        |
|   | Fine Finish                                   | 30                         | ATB      | 10    |           | DT4053    | DT4055    |           |           |           |           |        |           |           | DT4058    | DT4059    |           |           |           |           |           |           |           |             |           |           |        |        |
|   |   | 36                         | ATB      | 10    |           |           |           | DT4056    | DT4057    |           |           |        |           |           |           |           |           |           |           |           |           |           |           |             |           |           |        |        |
|   |   | 40                         | ATB      | 10    |           |           |           |           |           |           |           |        |           |           |           |           | DT4063    | DT4062    |           |           | DT4065    | DT4064    |           | DT4225      | DT4068    | DT4067    | DT4069 |        |
|   |   | 40                         | ATB      | 20    |           |           |           |           |           |           |           |        |           |           |           |           |           |           |           |           |           |           |           |             |           |           |        |        |
|   |   | 48                         | ATB      | 5     |           |           |           |           |           |           |           |        | DT1090    |           |           |           |           |           |           |           |           |           |           |             |           |           |        |        |
|   | Veneers<br>Laminates<br>Plastics<br>Aluminium | Extra Fine Finish          | 40       | TCG   | -5        | DT4081    |           |           |           |           |           |        |           |           |           |           |           |           |           |           |           |           |           |             |           |           |        |        |
|   |   |                            | 48       | TCG   | -5        |           |           |           | DT4084    | DT4085    |           | DT4087 |           | DT4088    |           | DT4091    | DT4092    |           |           |           | DT4095    | DT4094    |           |             |           |           |        |        |
| 56  |   |                            | TCG      | -5    |           |           |           |           |           |           |           |        |           |           |           |           |           |           |           |           |           |           | DT4096    | DT4256      | DT4098    | DT4097    | DT4099 |        |
| Construction Materials<br>Softwood<br>Reclaimed wood<br>Wood with nails | Fast Rip                                      | 12                         | ATB      | 20    | DT1164    | DT1140    |           |           |           |           |           |        |           |           |           |           |           |           |           |           |           |           |           |             |           |           |        |        |
|   |   | 18                         | ATB      | 20    |           |           |           | DT1142    |           |           | DT1166    |        | DT1144    | DT1146    |           | DT1149    |           | DT1148    | DT1165    |           | DT1152    |           |           |             |           |           |        |        |
|   |   | 24                         | ATB      | 20    |           |           |           |           |           |           |           |        |           |           |           |           |           |           |           |           |           |           |           |             |           | DT1156    |        |        |
|   | General Purpose                               | 24                         | ATB      | 20    |           | DT1141    |           |           |           |           |           |        |           |           |           |           |           |           |           |           |           |           |           |             |           |           |        |        |
|   |   | 30                         | ATB      | 20    |           |           |           | DT1143    |           |           | DT1167    |        | DT1145    | DT1147    |           | DT1151    |           | DT1150    |           |           |           |           |           |             |           |           |        |        |
|   | 40  | ATB                        | 20       |       |           |           |           |           |           |           |           |        |           |           |           |           |           |           |           |           | DT1153    |           |           |             | DT1157    |           |        |        |

For geometry details refer to page 135

EXTREME DeWALT® PORTABLE CIRCULAR SAW BLADES



• Blades designed specifically for use with plunge saws. See individual blades for details.



FOR PLUNGE SAWS

| Cat. No.  | Diameter / Bore | Plate / Kerf | Teeth | Grind | Rake | Fast Rip | General Purpose | Fine Finish | Extra Fine Finish | Aluminium | Barcode       |
|-----------|-----------------|--------------|-------|-------|------|----------|-----------------|-------------|-------------------|-----------|---------------|
| DT1089-QZ | 165/20          | 1.6/2        | 18    | ATB   |      | •        |                 |             |                   |           | 5035048083383 |
| DT1091-QZ | 165/20          | 1.6/2        | 40    | ATB   |      |          | •               |             |                   |           | 5035048072677 |
| DT1090-QZ | 165/20          | 1.6/2        | 48    | ATB   |      |          |                 | •           |                   |           | 5035048066416 |
| DT1086-QZ | 165/20          | 1.6/2        | 48    | TCG   |      |          |                 |             | •                 |           | 5035048083352 |
| DT1087-QZ | 165/20          | 1.6/2        | 54    | MTCG  |      |          |                 |             | •                 |           | 5035048083369 |
| DT1088-QZ | 165/20          | 1.6/2        | 54    | TCG   |      |          |                 |             | •                 | •         | 5035048083376 |

BLADE FOR CORDLESS MITRE SAW



Specially for use with DW017 24V Mitre Saw



BLADE FOR CORDLESS MITRE SAW

| Cat. No.  | Blade Diameter | Bore Size mm | Plate Thickness mm | Kerf Thickness mm | Tooth Count | Grind Geometry | Rake Angle | Barcode       |
|-----------|----------------|--------------|--------------------|-------------------|-------------|----------------|------------|---------------|
| DT1700-QZ | 216            | 30           | 1.6                | 2.4               | 24          | ATB            | 0°         | 5035048056448 |

INSERT RINGS



INSERT RINGS

| Cat. No.  | Outside diameter mm | Inside diameter mm | Thickness mm | Pack Qty. | M.O.Q. | Barcode       |
|-----------|---------------------|--------------------|--------------|-----------|--------|---------------|
| DT1094-QZ | 30                  | 16                 | 1.8          | 10        | 10     | 5011402382071 |
| DT1095-QZ | 30                  | 20                 | 1.8          | 10        | 10     | 5011402382088 |
| DT1096-QZ | 30                  | 25                 | 1.8          | 10        | 10     | 5011402382095 |
| DT1099-QZ | 30                  | 25                 | 2.2          | 10        | 10     | 5011402382101 |

XPC WOOD CUTTING BLADES



FEATURES

- Unique jigsaw blade solution for ultimate control and accuracy of cut, even on the tightest of corners
- New optimised tooth angle provides long life and clean tear-free cuts at high speed in all wood materials
- Plunge Point tip design for easy plunge cutting with no 'kick-back' in all wood materials
- Extra long life bi-metal blades provide up to twice the number of cuts of standard HCS blades

T SHANK & U-SHANK

| Cat. No.  | Applications   | Overall Length mm | Working Length mm | Tooth Pitch mm | Max DOC mm | Equivalent Bosch Reference | Pack Qty. | Barcode       |
|-----------|--|-------------------|-------------------|----------------|------------|----------------------------|-----------|---------------|
| DT2205-QZ | For clean and fast accurate cutting in wood, chipboard, plywood, laminates and plastic up to 30mm thick.                                     | 100               | 75                | 2.5            | 30         | T101B                      | 5         | 5035048074978 |
| DT2206-QZ | For clean and fast accurate cutting in wood, chipboard, plywood, laminates and plastic up to 30mm thick.                                     | 100               | 75                | 2.5            | 30         | T101B                      | 20        | 5035048074985 |
| DT2207-QZ | Downcutter blade for clean, splinter free cutting in laminates and wood up to 40mm thick.  | 100               | 75                | 2.5            | 40         | T101BR                     | 5         | 5035048074992 |
| DT2209-QZ | For clean and fast accurate cutting in wood, chipboard, plywood, laminates and plastic up to 60mm thick.                                     | 100               | 75                | 4.2            | 60         | T101D                      | 5         | 5035048074992 |
| DT2210-QZ | For clean and fast accurate cutting in wood, chipboard, plywood, laminates and plastic up to 60mm thick.                                     | 100               | 75                | 4.2            | 60         | T101D                      | 20        | 5035048074992 |
| DT2211-QZ | For coarse accurate cutting in wood, chipboard, plywood, laminates and plastic up to 60mm thick.   | 100               | 75                | 3.1            | 60         | T111C                      | 5         | 5035048074992 |
| DT2212-QZ | For coarse accurate cutting in wood, chipboard, plywood, laminates and plastic up to 60mm thick.   | 100               | 75                | 3.1            | 60         | T111C                      | 20        | 5035048074992 |
| DT2213-QZ | For fast accurate cutting in wood, chipboard, plywood, laminates and plastic up to 60mm thick.   | 100               | 75                | 4.2            | 60         | T144D                      | 5         | 5035048074992 |
| DT2214-QZ | For fast accurate cutting in wood, chipboard, plywood, laminates and plastic up to 60mm thick.   | 100               | 75                | 4.2            | 60         | T144D                      | 20        | 5035048074992 |
| DT2216-QZ | Scroller blade for fast accurate curve cutting in wood, chipboard and plywood up to 15mm thick. NOT suitable for plunge cutting              | 82                | 54                | 2.0            | 15         | T119B0                     | 5         | 5035048074992 |
| DT2217-QZ | Bi-metal blade for extra long life. For clean and fast accurate cutting in wood, chipboard, plywood, laminates and plastic up to 30mm thick. | 100               | 75                | 2.5            | 30         | T101BF                     | 3         | 5035048074992 |
| DT2218-QZ | Bi-metal blade for extra long life. For clean and fast accurate cutting in wood, chipboard, plywood, laminates and plastic up to 60mm thick. | 100               | 75                | 4.0            | 60         | T1101DF                    | 3         | 5035048074992 |
| DT2219-QZ | Bi-metal blade for extra long life. Downcutter blade for clean, splinter free cutting in laminates and wood up to 40mm thick.                | 100               | 75                | 2.5            | 40         | T101BRF                    | 3         | 5035048074992 |
| DT2220-QZ | Bi-metal blade for extra long life. For fast accurate cutting in wood, chipboard, plywood, laminates and plastic up to 60mm thick.           | 100               | 75                | 4.0            | 60         | T144DF                     | 3         | 5035048074992 |
| DT2221-QZ | Bi-metal blade for extra long life. For fast accurate cutting in aluminium up to 15mm and plastics up to 30mm                                | 100               | 75                | 3.0            | 30         | T127DF                     | 3         | 5035048074992 |
| DT2208-QZ | For clean and fast accurate cutting in wood, chipboard, plywood, laminates and plastic up to 30mm thick. U shank blade                       | 94                | 75                | 2.5            | 30         | U101B                      | 5         | 5035048074992 |
| DT2215-QZ | For fast accurate cutting in wood, chipboard, plywood, laminates and plastic up to 60mm thick. U shank blade                                 | 94                | 75                | 4.0            | 60         | U144D                      | 5         | 5035048074992 |

BLADE KITS

| Cat. No.  | Description         | Contents   | Barcode       |
|-----------|---------------------|--|---------------|
| DT2296-QZ | 10 piece jigsaw kit | DT2209 x2, DT2205 x2, DT2213 x2, DT2216, DT2218, DT2217, DT2220    | 5035048065142 |
| DT2298-QZ | 14 piece jigsaw kit | DT2209 x3, DT2205 x3, DT2213 x3, DT2216 x2, DT2218, DT2217, DT2220 | 5035048065159 |

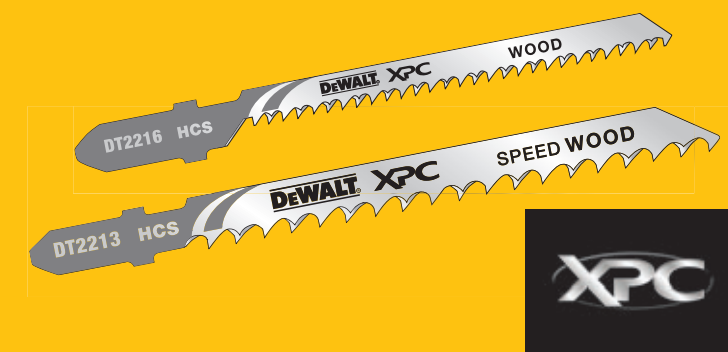



WOOD CUTTING BLADES



FEATURES

- DEWALT HCS jigsaw blades are engineered to deliver a quality cut in a variety of materials, including wood, laminates and plastics.
- Made from high carbon steel.
- For use in soft materials such as wood, laminates, plywood, chipboard and plastics.



T SHANK

| Cat. No.  | Applications   | Overall Length mm | Working Length mm | Tooth Pitch mm | Max DOC mm | Equivalent Bosch Reference | Pack Qty. | Barcode       |
|-----------|--|-------------------|-------------------|----------------|------------|----------------------------|-----------|---------------|
| DT2177-QZ | For coarse, straight cuts in wood & plastic up to 60mm thick.  | 100               | 72                | 3              | 60         | T111C                      | 20        | 5035048033210 |
| DT2187-QZ | For coarse, straight cuts in wood & plastic up to 60mm thick.  | 100               | 72                | 3              | 60         | T111C                      | 100       | 5035048033227 |
| DT2050-QZ | Scroller blade - for softwoods, plywood & chipboard - basic cutting up to 15mm thick.                                    | 76                | 48                | 2              | 15         | T119B0                     | 5         | 5035048060896 |
| DT2052-QZ | Wood, chip & fibreboard - fast/clean cutting up to 60mm thick.   | 116               | 87                | 3              | 65         | T301CD                     | 5         | 5035048060919 |
| DT2053-QZ | For wood & laminates - downcutter for 'splinter free' cuts.  | 100               | 73                | 2.5            | 40         | T101BR                     | 5         | 5035048060926 |
| DT2164-QZ | For fast, straight cuts in wood, chipboard, plywood, laminated chipboard & plastic up to 60mm thick.                     | 100               | 68                | 4              | 60         | T101D                      | 5         | 5035048033128 |
| DT2174-QZ | For fast, straight cuts in wood, chipboard, plywood, laminated chipboard & plastic up to 60mm thick.                     | 100               | 68                | 4              | 60         | T101D                      | 20        | 5035048033159 |
| DT2184-QZ | For fast, straight cuts in wood and chipboard up to 60mm thick.  | 100               | 68                | 4              | 60         | T101D                      | 100       | 5035048033203 |
| DT2165-QZ | For straight, fine cuts in wood, chipboard, plywood, laminated chipboard & plastic up to 30mm thick.                     | 100               | 73                | 2.5            | 30         | T101B                      | 5         | 5035048033135 |
| DT2175-QZ | For straight, fine cuts in wood, chipboard, plywood, laminated chipboard & plastic up to 30mm thick.                     | 100               | 73                | 2.5            | 30         | T101B                      | 20        | 5035048033166 |
| DT2185-QZ | For straight, fine cuts in wood, chipboard, plywood, laminated chipboard & plastic up to 30mm thick.                     | 100               | 73                | 2.5            | 30         | T101B                      | 100       | 5035048033197 |
| DT2168-QZ | For fine, curve cutting in wood, chipboard, plywood, laminated chipboard & plastic up to 30mm thick.                     | 76                | 47                | 1.4            | 30         | T101AO                     | 5         | 5035048033234 |
| DT2049-QZ | For clean extra straight cutting in wood and chipboard up to 60mm thick. (Extra thick blade).                            | 100               | 68                | 4              | 60         | T101DP                     | 5         | 5035048060889 |
| DT2051-QZ | Wood & plywood, chip & fibreboard - fast/rough cutting up to 85mm thick.   | 132               | 100               | 4              | 85         | T301DL                     | 5         | 5035048060902 |
| DT2077-QZ | Scroller blade - for wood & chipboard - fast curve cutting up to 60mm thick.   | 100               | 70                | 4              | 60         | T244D                      | 5         | 5035048060858 |
| DT2166-QZ | For fast, straight cuts in wood and chipboard up to 60mm thick.  | 100               | 68                | 4              | 60         | T144D                      | 5         | 5035048033142 |
| DT2176-QZ | For fast, straight cuts in wood and chipboard up to 60mm thick.  | 100               | 68                | 4              | 60         | T144D                      | 20        | 5035048033173 |
| DT2186-QZ | For fast straight cuts in wood, chipboard, plywood, laminated chipboard & plastic up to 60mm thick.                      | 100               | 68                | 4              | 60         | T144D                      | 100       | 5035048033180 |
| DT2169-QZ | For fast, straight cuts in wood & chipboard up to 100mm thick.   | 152               | 116               | 4              | 100        | T344D                      | 5         | 5035048033241 |
| DT2048-QZ | For clean cuts in wood, chipboard, plywood & laminates up to 65mm thick.   | 116               | 87                | 2.5            | 65         | T301BCP                    | 5         | 5035048060872 |
| DT2074-QZ | For straight fine cuts in wood - cuts flush to surface 180°.   | 112               | 74                | 2.3            | 65         | T142HB                     | 1         | 5035048060827 |
| DT2075-QZ | For fast extra straight cutting in wood and chipboard up to 60mm thick. (Extra thick blade).                             | 100               | 68                | 4              | 60         | T144DP                     | 5         | 5035048060834 |
| DT2076-QZ | For fast extra straight cutting in wood and chipboard up to 100mm thick. (Extra thick blade).                            | 152               | 116               | 4              | 100        | T344DP                     | 5         | 5035048060841 |
| DT2057-QZ | For wood, chipboard & fibreboards up to 65mm thick. Progressor blade for fast cutting in different material thicknesses. | 116               | 91                | 2-3            | 65         | T234X                      | 5         | 5035048060964 |
| DT2167-QZ | For fast, rough cuts in thick construction timber up to 120mm thick.   | 180               | 155               | 4              | 120        | T744D                      | 5         | 5035048014455 |

U SHANK

| Cat. No.  | Applications  | Overall Length mm | Working Length mm | Tooth Pitch mm | Max DOC mm | Equivalent Bosch Reference | Pack Qty. | Barcode       |
|-----------|---|-------------------|-------------------|----------------|------------|----------------------------|-----------|---------------|
| DT2062-QZ | For basic cuts in wood & chipboard up to 60mm thick.                                      | 91                | 70                | 2.5            | 60         | U111D                      | 5         | 5035048061015 |
| DT2060-QZ | For straight fine cuts in wood, chipboard, plywood, laminates & plastic up to 30mm thick. | 100               | 78                | 2.5            | 30         | U101B                      | 5         | 5035048060995 |
| DT2061-QZ | For fast straight cuts in wood & chipboard up to 60mm thick.                              | 100               | 76                | 4              | 60         | U144D                      | 5         | 5035048061008 |

EXTREME DEWALT® BI-METAL METAL CUTTING BLADES



FEATURES

- DEWALT HSS jigsaw blades are engineered to deliver a quality cut in a variety of ferrous and non-ferrous materials.
- EXTREME DEWALT® bi-metal blades are designed for long life and extra durability in ferrous and non-ferrous materials
- Fully hardened high speed steel for increased durability.
- For use in aluminium, ferrous and non-ferrous materials.

T SHANK

| Cat. No.  | Applications   | Overall Length mm | Working Length mm | Tooth Pitch mm | Max DOC mm | Equivalent Bosch Reference | Pack Qty. | Barcode       |
|-----------|--|-------------------|-------------------|----------------|------------|----------------------------|-----------|---------------|
| DT2150-QZ | For fast cuts in steel to 3mm thick. Also for aluminium, copper, brass and other soft metals to 3mm thick.     | 86                | 61                | 1              | 3          | T118AF                     | 3         | 5035048059425 |
| DT2154-QZ | For fast cuts in steel to 6mm thick. Also for aluminium, copper, brass and other soft metals from 3-5mm thick. | 76                | 51                | 1.8            | 6          | T118BF                     | 3         | 5035048059432 |
| DT2156-QZ | For fast cuts in sheet metal to 2.5mm thick.   | 76                | 51                | 0.8            | 2.5        | T118GF                     | 3         | 5035048059449 |
| DT2054-QZ | Bi-Metal - scroller blade for mainly metal - curve cutting & thin sheet metal from 1.5-4mm thick.              | 82                | 55                | 1.5            | 4          | T118EOF                    | 5         | 5035048060933 |

METAL CUTTING BLADES

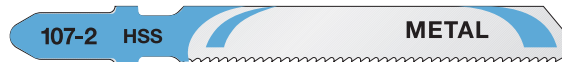

FEATURES

- DEWALT HSS jigsaw blades are engineered to deliver a quality cut in a variety of ferrous and non-ferrous materials.
- Fully hardened high speed steel for increased durability.
- For use in aluminium, ferrous and non-ferrous materials.

T SHANK

| Cat. No.  | Applications   | Overall Length mm | Working Length mm | Tooth Pitch mm | Max DOC mm | Equivalent Bosch Reference        | Pack Qty. | Barcode       |
|-----------|--|-------------------|-------------------|----------------|------------|-----------------------------------|-----------|---------------|
| DT2160-QZ | For straight cuts in thin metal, non-ferrous metal, aluminium & sheet metal from 1.5-4mm thick.  | 76                | 50                | 1.2            | 4          | T118A                             | 5         | 5035048033050 |
| DT2170-QZ | For straight cuts in thin metal, non-ferrous metal, aluminium & sheet metal from 1.5-4mm thick.  | 76                | 50                | 1.2            | 4          | T118A                             | 20        | 5035048033098 |
| DT2190-QZ | For straight cuts in thin metal, non-ferrous metal, aluminium & sheet metal from 1.5-4mm thick.  | 76                | 50                | 1.2            | 4          | T118A                             | 100       | 5035048034057 |
| DT2161-QZ | For straight cuts in thick metal, non-ferrous metal & aluminium from 2.5-6mm thick.  | 76                | 50                | 2              | 6          | T118B                             | 5         | 5035048033067 |
| DT2171-QZ | For straight cuts in thick metal, non-ferrous metal & aluminium from 2.5-6mm thick.  | 76                | 50                | 2              | 6          | T118B                             | 20        | 5035048033104 |
| DT2191-QZ | For straight cuts in thick metal, non-ferrous metal & aluminium from 2.5-6mm thick.  | 76                | 50                | 2              | 6          | T118B                             | 100       | 5035048034064 |
| DT2162-QZ | For straight cuts in very thin metal, non-ferrous metal & aluminium from 0.8-2mm thick.  | 76                | 50                | 0.7            | 2          | T118G                             | 5         | 5035048033074 |
| DT2172-QZ | For straight cuts in very thin metal, non-ferrous metal, sheet metal & aluminium from 0.8-2mm thick.   | 76                | 50                | 0.7            | 2          | T118G                             | 20        | 5035048033111 |
| DT2085-QZ | For straight cuts in thin metal, non-ferrous metal (1.5-3mm) and aluminium up to 65mm thick.   | 132               | 108               | 1.2            | 3          | T318A                             | 5         | 5035048070581 |
| DT2163-QZ | For fast, straight cuts in aluminium 4-15mm; metal & non-ferrous metal 4-6mm & plastic up to 30mm thick.   | 100               | 72                | 3              |            | Aluminium 15, Metal 6, Plastic 30 | 5         | 5035048033081 |
| DT2058-QZ | For metal plate - thick & thin pipes & profiles, aluminium for thicknesses of 1.5-10mm. Progressor blade for fast cutting in different material thicknesses. | 100               | 74                | 1.2-2.6        | 10         | T123X                             | 5         | 5035048060971 |

METAL CUTTING BLADES



FEATURES

- DEWALT HSS jigsaw blades are engineered to deliver a quality cut in a variety of ferrous and non-ferrous materials.
- Fully hardened high speed steel for increased durability.
- For use in aluminium, ferrous and non-ferrous materials.

U SHANK

| Cat. No.  | Applications  | Overall Length mm | Working Length mm | Tooth Pitch mm | Max DOC mm | Equivalent Bosch Reference | Pack Qty. | Barcode       |
|-----------|---|-------------------|-------------------|----------------|------------|----------------------------|-----------|---------------|
| DT2063-QZ | Metal cutting blade - medium sheet steel 2.5-6mm thick. | 70                | 50                | 2              | 6          | U118B                      | 5         | 5035048061022 |

**WOOD & METAL CUTTING BLADES**



**T SHANK**

| Cat. No.  | Overall Length mm | Working Length mm | Tooth Pitch mm | Max DOC mm        | Equivalent Bosch Reference | Pack Qty. | Barcode      |
|-----------|-------------------|-------------------|----------------|-------------------|----------------------------|-----------|--------------|
| DT2059-QZ | 132               | 101               | 2.4 - 5        | Wood 65, Metal 10 | T345XF                     | 5         | 503504806988 |

**APPLICATIONS:**

- BIM - for wood up to 65mm thick & metals, pipes and profiles 3 - 10mm thick.
- Progressor blade for fast cutting in different material thicknesses.

**EXTREME DeWALT® SPECIAL MATERIAL BLADES**



**T SHANK**

| Cat. No.  | Applications   | Overall Length mm | Working Length mm | Tooth Pitch mm | Max DOC mm | Equivalent Bosch Reference | Pack Qty. | Barcode       |
|-----------|--|-------------------|-------------------|----------------|------------|----------------------------|-----------|---------------|
| DT2080-QZ | For clean and straight cuts in all laminates up to 15mm thick.                                     | 82                | 59                | 1.7            | 15         | T101BIF                    | 5         | 5035048014400 |
| DT2081-QZ | For clean and curved cuts in all laminates up to 15mm thick.                                       | 82                | 59                | 1.4            | 15         | T101AOF                    | 3         | 5035048014417 |
| DT2055-QZ | Tungsten Carbide Tipped blade (ICT) for stainless steel sheet metal (inox) from 1.5 - 5mm thick.   | 82                | 55                | 1.4            | 5          | T118EHM                    | 1         | 5035048060940 |
| DT2101-QZ | Tungsten carbide for stainless steel, sheet & mild steel 1.2 - 3mm.                                | 76                | 47                | 1              | 3          | T118AHM                    | 1         | 5035048059340 |
| DT2082-QZ | For thin Metal and inox cutting - new technology up to 2mm thick.                                  | 82                | 59                | 0.8            | 1-2        | T118GFS                    | 1         | 5035048014424 |
| DT2083-QZ | For medium Metal and inox cutting - new technology up to 4mm thick.                                | 82                | 59                | 1.4            | 1.5 - 4    | T118EFS                    | 1         | 5035048014431 |
| DT2056-QZ | Tungsten Carbide Tipped blade (ICT) for fibreglass, plastics & corian up to 65mm thick.            | 132               | 100               | 4.3            | 65         | T341HM                     | 1         | 5035048060957 |
| DT2103-QZ | Tungsten carbide tipped blade for ceramic tiles, fibreglass & reinforced plastic to 20mm thick.    | 100               | 69                | 4.3            | 20         | T141HM                     | 1         | 5035048059364 |
| DT2102-QZ | Tungsten carbide grit blade for ceramic tiles, fibreglass & reinforced plastic to 10mm thick.      | 76                | 50                | -              | 10         | T130RF                     | 1         | 5035048059357 |
| DT2201-QZ | Knife blade for soft materials, rubber, foam & polystyrene up to 100mm thick.                      | 152               | 125               | -              | 100        | T313AW                     | 5         | 5011402370764 |
| DT2084-QZ | For straight and curved cuts in Sandwich materials and medium thick sheet metal up to 120mm thick. | 180               | 148               | 2              | 120        | T718BF                     | 5         | 5035048014448 |

**APPLICATIONS**

- Specialist blades for cutting a wide variety of materials
- See individual blades for details



**WOOD & METAL CUTTING BLADE KITS**



**WOOD & METAL CUTTING BLADE KITS**

| Cat. No.  | Description                              | Contents  | Barcode       |
|-----------|--|---|---------------|
| DT2290-QZ | 10 piece jigsaw kit - wood cutting       | DT2165 x 2, DT2050 x 1, DT2168 x 1, DT2177 x 2, DT2166 x 2, DT2075 x 2 (Bosch equivalent T101B, T11980, T101AQ, T111C, T144D, T144DP) | 5035048061077 |
| DT2292-QZ | 10 piece jigsaw kit - metal cutting      | DT2160 x 3, DT2172 x 2, DT2054 x 1, DT2161 x 2, DT2163 x 2 (Bosch equivalent T118A, T118G, T118E0F, T118B, T127D)                     | 5035048061084 |
| DT2294-QZ | 10 piece jigsaw kit - wood/metal cutting | DT2165 x 2, DT2050 x 2, DT2163 x 2, DT2177 x 2, DT2160 x 2 (Bosch equivalent T101B, T11980, T127D, T111C, T118A)                      | 5035048061091 |



**WOOD CUTTING BLADES**

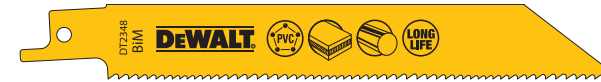

**APPLICATIONS**

- Blades available for almost all materials and applications

**FEATURES**

- Bi-metal construction combining HCS and HSS for increased flexibility and durability.
- Tough cutting edge made from M2 High Speed Steel.
- Raker tooth pitch to maximise blade durability.
- Universal 1/2" (13mm) shank suitable for DeWALT, Bosch, Hitachi, Flex, Makita, Metabo, Skil.
- New "Plunge Point" tip for fast and accurate plunge cutting into all wood materials

**APPLICATIONS**

- For fast cuts in wood and plastics.

**FEATURES**

- High Carbon Steel construction.
- For use in wood, plywood, laminates and plastics.
- Universal 1/2" (13mm) shank suitable for DeWALT, Bosch, Hitachi, Flex, Makita, Metabo, Skil.



**METAL CUTTING BLADES**



**APPLICATIONS**

- Blades available for almost all materials and applications

**FEATURES**

- Bi-metal construction combining HCS and HSS for increased flexibility and durability.
- Tough cutting edge made from M2 High Speed Steel.
- Raker tooth pitch to maximise blade durability.
- Universal 1/2" (13mm) shank suitable for DeWALT, Bosch, Hitachi, Flex, Makita, Metabo, Skil.

**BI-METAL**

| Cat. No.  | Applications  | Length mm | Pitch mm  | Equivalent Bosch Reference | Pack Qty. | Barcode       |
|-----------|---|-----------|-----------|----------------------------|-----------|---------------|
| DT2351-QZ | Fine, fast cuts, specially for curve cutting in wood and plastic.   | 152       | 4.2       | S611DF                     | 5         | 5035048033319 |
| DT2359-QZ | Fast cuts in wood with nails and tough plastics. New "Plunge Point" tip for fast and accurate plunge cutting into all wood materials. | 152       | 4.2       | S611VF                     | 5         | 5035048034583 |
| DT2349-QZ | Fast cuts in wood with nails and tough plastics. New "Plunge Point" tip for fast and accurate plunge cutting into all wood materials. | 228       | 4.2       | S1111VF                    | 5         | 5035048034590 |
| DT2320-QZ | Fast cuts in wood with nails and tough plastics. New "Plunge Point" tip for fast and accurate plunge cutting into all wood materials. | 228       | 4.2       | S111VF                     | 100       | 5035048034071 |
| DT2350-QZ | Fast cuts in wood with nails and tough plastics. New "Plunge Point" tip for fast and accurate plunge cutting into all wood materials. | 305       | 4.2       | S1411VF                    | 5         | 5035048033302 |
| DT2344-QZ | Fine, fast cuts, specially for curve cutting in wood and plastic. Ideal for use with cordless reciprocating saws.                     | 152       | 3.6 - 5.1 | S711VF                     | 5         | 5035048034668 |

**HCS**

| Cat. No.  | Applications  | Length mm | Pitch mm | Equivalent Bosch Reference | Pack Qty. | Barcode       |
|-----------|---|-----------|----------|----------------------------|-----------|---------------|
| DT2362-QZ | Fine fast and curved cuts in wood and plastic.  | 152       | 4.2      | S611D                      | 5         | 5035048033272 |
| DT2363-QZ | Fine fast cuts and curve cuts in wood and plastic.  | 228       | 4.2      | S1544D                     | 5         | 5035048033289 |
| DT2364-QZ | Fine fast cuts and curve cuts in wood and plastic.  | 305       | 4.2      | S1344D                     | 5         | 5035048033296 |
| DT2402-QZ | Progressor blade for different material thicknesses. Construction timber (6 - 150mm), chipboard and MDF (6-60mm), plywood, plastic (6 - 150mm), wooden panels (to 175mm).   | 203       | 2.4 - 4  | S2345X                     | 5         | 5035048072691 |
| DT2410-QZ | Progressor blade for different material thicknesses. Construction timber (6 - 150mm), chipboard and MDF (6-60mm), plywood, plastic (6 - 150mm), wooden panels (to 175mm). Ideal for use with cordless recip saws. | 203       | 2.5 - 4  | SA2345X                    | 5         | 5035048072721 |
| DT2430-QZ | Coarse wood with no nails (20-100mm), living wood and pruning (to 100mm). Ideal for plunge and curve cutting.   | 152       | 8.5      | S617K                      | 5         | 5035048072806 |
| DT2352-QZ | Coarse, fast cuts in wood (logs and pruning).   | 240       | 5 - 6.5  | S1531L                     | 5         | 5035048033326 |
| DT2432-QZ | Coarse wood with no nails (20-250mm), living wood and pruning (to 250mm).   | 305       | 8.5      | S1617K                     | 5         | 5035048072813 |

**BI-METAL**

| Cat. No.  | Applications  | Length mm | Pitch mm   | Equivalent Bosch Reference | Pack Qty. | Barcode       |
|-----------|---|-----------|------------|----------------------------|-----------|---------------|
| DT2385-QZ | Fine cuts in metal, sheet material, pipes and profiles up to 1.5mm thick.   | 152       | 1.1        | S922AF                     | 5         | 5035048034620 |
| DT2384-QZ | Cuts in metal, sheet metal, pipes and profiles up to 3mm thick.   | 152       | 1.4        | S922EF                     | 5         | 5035048034613 |
| DT2354-QZ | Cuts in metal, sheet metal, pipes and profiles up to 3mm thick.   | 203       | 1.4        | S1022EF                    | 5         | 5035048033340 |
| DT2361-QZ | Fast cuts in ferrous and non-ferrous metal, sheet metal, pipes and profiles from 3-8mm thick.                                       | 152       | 1.8        | S922BF                     | 5         | 5035048034606 |
| DT2353-QZ | Fast cuts in ferrous and non-ferrous metal, sheet metal, pipes and profiles from 3-8mm thick.                                       | 203       | 1.8        | S1022BF                    | 5         | 5035048033333 |
| DT2323-QZ | Fast cuts in ferrous and non-ferrous metal, sheet metal, pipes and profiles from 3-8mm thick.                                       | 203       | 1.8        | S1022BF                    | 100       | 5035048034101 |
| DT2346-QZ | Ferrous and non-ferrous metals up to 3mm thick. Ideal for use with cordless reciprocating saws.                                     | 152       | 1.4        | S922EF                     | 5         | 5035048034682 |
| DT2404-QZ | Progressor blade for different material thicknesses. Thin to thick sheet metal (1 - 8mm), thin to thick metal profiles (5 - 100mm). | 150       | 1.4 - 3.35 | S123XF                     | 5         | 5035048072707 |

**HARD METAL**

| Cat. No.  | Applications                   | Length mm | Pitch mm | Barcode       |
|-----------|--------------------------------|-----------|----------|---------------|
| DT2407-QZ | 152mm hard metal cutting blade | 152       | 4.2      | 5035048083321 |
| DT2408-QZ | 152mm hard metal cutting blade | 152       | 2.5      | 5035048083338 |
| DT2409-QZ | 152mm hard metal cutting blade | 152       | 2        | 5035048083345 |



GENERAL PURPOSE BLADES



APPLICATIONS

- Blades available for almost all materials and applications

FEATURES

- Bi-metal construction combining HCS and HSS for increased flexibility and durability.
- Tough cutting edge made from M2 High Speed Steel.
- Raker tooth pitch to maximise blade durability.
- Universal 1/2" (13mm) shank suitable for DeWALT, Bosch, Hitachi, Flex, Makita, Metabo, Skil.

BI-METAL

| Cat. No.  | Applications  | Length mm | Pitch mm  | Equivalent Bosch Reference | Pack Qty. | Barcode       |
|-----------|---|-----------|-----------|----------------------------|-----------|---------------|
| DT2348-QZ | For use in tough plastics, sandwich material and pipes from 3-12mm thick.   | 152       | 1.8-2.5   | S922VF                     | 5         | 5035048034637 |
| DT2387-QZ | For use in tough plastics, sandwich material and pipes from 3-12mm thick.   | 203       | 1.8-2.5   | S1122VF                    | 5         | 5035048034644 |
| DT2355-QZ | For use in heavy gauge metal, rubber, fibreglass and angle iron.  | 305       | 1.8-2.5   | S1222VF                    | 5         | 5035048033357 |
| DT2345-QZ | General purpose for wood, wood with nails, aluminium and fibreglass. Ideal for use with cordless reciprocating saws.  | 152       | 2.5       | S922VF                     | 5         | 5035048034675 |
| DT2406-QZ | Progressor blade for different material thicknesses. Wood with nails/metal, chipboard (5 - 150mm), sheet metal, aluminium profiles (3 - 18mm), plastic, fibre glass, reinforced plastic profiles (5 - 150mm). | 203       | 2.4 - 4.6 | S3456XF                    | 5         | 5035048072714 |

DEMOLITION BLADES



APPLICATIONS

- Ideal or extreme applications and demolition tasks.
- For cutting hard and soft wood including wood with nails.
- Range also includes metal and plastic cutting (sheet metals, profiles and tubes).

FEATURES

- Wider blade body gives greater stability during cutting.
- Thicker blade ensures greater strength.
- Bi-metal construction gives strong, flexible blade and hardened teeth.
- Deeper tooth strip ensures longer cutting life.
- New "Plunge Point" tip for fast and accurate plunge cutting into all wood materials

BI-METAL

| Cat. No.  | Applications  | Length mm | Pitch mm | Equivalent Bosch Reference | Pack Qty. | Barcode       |
|-----------|---|-----------|----------|----------------------------|-----------|---------------|
| DT2300-QZ | For fast/rough cutting of hard & soft woods. New "Plunge Point" tip for fast and accurate plunge cutting into all wood materials. | 152       | 4.2      | S610VF                     | 5         | 5035048059500 |
| DT2307-QZ | For fast/rough cutting of hard & soft woods. New "Plunge Point" tip for fast and accurate plunge cutting into all wood materials. | 228       | 4.2      | S1110DF                    | 5         | 5035048059555 |
| DT2314-QZ | For fast/rough cutting of hard & soft wood. New "Plunge Point" tip for fast and accurate plunge cutting into all wood materials.  | 305       | 4.2      | S1210DF                    | 5         | 5035048059609 |
| DT2303-QZ | For fast cutting of metals - sheet, profiles & tube   | 152       | 1.8      | S923BEF                    | 5         | 5035048059531 |
| DT2304-QZ | For fast cutting of metals - sheet, profiles & tubes  | 152       | 1.8      | S923BEF                    | 100       | 5035048059548 |
| DT2310-QZ | For fast cutting of metals - sheet, profiles & tubes  | 228       | 1.8      | S1125VF                    | 5         | 5035048059586 |
| DT2301-QZ | For fast cutting of metals, plastics & sandwich materials.  | 152       | 2.5      | S920CF                     | 5         | 5035048059517 |
| DT2302-QZ | For fast cutting of metals, plastics & sandwich materials.  | 152       | 2.5      | S920CF                     | 100       | 5035048059524 |
| DT2308-QZ | For fast cutting of metals, plastics & 'sandwich materials'   | 228       | 2.5      | S1120CF                    | 5         | 5035048059562 |
| DT2309-QZ | For fast cutting of metals, plastics & 'sandwich materials'   | 228       | 2.5      | S1120CF                    | 100       | 5035048059579 |

RECIPROCATING BLADE SETS



RECIPROCATING BLADE SETS

| Cat. No.  | Description                   | Contents   | Barcode       |
|-----------|-------------------------------|--|---------------|
| DT2440-QZ | 6 piece set and storage case  | DT2307 x 2, DT2349 x 2, DT2353 x 2                         | 5035048072912 |
| DT2441-QZ | 12 piece set and storage case | DT2307 x 1, DT2349 x 3, DT2359 x 2, DT2353 x 3, DT2361 x 3 | 5035048072929 |

SPECIALIST MATERIAL BLADES



APPLICATIONS

- Specialist blades for cutting a wide variety of materials
- See individual blades for details

SPECIALIST MATERIAL BLADES

| Cat. No.  | Applications  | Length mm | Pitch mm | Equivalent Bosch Reference | Pack Qty. | Barcode       |
|-----------|---|-----------|----------|----------------------------|-----------|---------------|
| DT2356-QZ | Bi metal construction blade for splinter free cuts in plaster.  | 152       | 1.8      | S628DF                     | 5         | 5035048033364 |
| DT2332-QZ | Wear resistant carbide grit edged blade for cutting light masonry blocks, bricks, abrasive materials, ceramics, fibreglass, mild steel and wood with nails.     | 152       | 2        | -                          | 1         | 5035048011287 |
| DT2333-QZ | Wear resistant carbide grit edged blade for cutting light masonry blocks, bricks, abrasive materials, ceramics, fibreglass, mild steel and wood with nails.     | 228       | 2        | S1130Riff                  | 1         | 5035048011294 |
| DT2335-QZ | Tungsten carbide toothed blade for cutting light masonry blocks, bricks, abrasive materials.  | 235       | 1        | -                          | 1         | 5035048014264 |
| DT2400-QZ | Bi-metal construction blade for pallet repair, wood with nails (5 - 175mm), sheet metal pipes, aluminium profiles (3 - 12mm). Ideal for flexible flush cutting. | 225       | 2.5      | S1122HF                    | 100       | 5035048072684 |
| DT2401-QZ | Bi-metal construction blade for pallet repair, wood with nails (5 - 175mm), sheet metal pipes, aluminium profiles (3 - 12mm). Ideal for flexible flush cutting. | 200       | 1.8-2.5  | S1122HF                    | 100       | 5035048082577 |
| DT2420-QZ | Tungsten carbide tipped blade for cutting aerated Concrete, red brick and fibre cement to 150mm.  | 240       | 12.7     | S1543HM                    | 1         | 5035048072752 |
| DT2421-QZ | Tungsten carbide tipped blade for cutting aerated Concrete, red brick and fibre cement to 250mm.  | 305       | 12.7     | S1243HM                    | 1         | 5035048072769 |
| DT2422-QZ | Tungsten carbide tipped blade for cutting aerated Concrete, red brick and fibre cement to 400mm.  | 457       | 12.7     | S2243HM                    | 1         | 5035048072776 |
| DT2423-QZ | Tungsten carbide tipped blade for aerated Concrete, red brick and fibre cement, reinforced plastics (6 - 100mm). Ideal for abrasive materials.                  | 152       | 4.3      | S641HM                     | 1         | 5035048072783 |
| DT2426-QZ | Tungsten carbide tipped blade for stainless steel plates (2 - 4mm), stainless steel profiles (2 - 80mm), fibre glass, reinforced plastics (2 - 15mm).           | 150       | 1.4      | S922EHM                    | 2         | 5035048072790 |

ALLIGATOR® SAW BLADES



APPLICATIONS

- Ideal for fast and easy cutting in building blocks, wood, plywood, chipboard and drywall. See individual blades for details.

FEATURES

- Blades designed with HSS or TCT teeth to optimise the performance of the DeWALT Alligator® Power Saw.

ALLIGATOR® SAW BLADES

| Cat. No.  | Applications                      | Overall Length mm | Working Length mm | Tip Material | Pack Qty. | M.O.Q. | Barcode       |
|-----------|-----------------------------------|-------------------|-------------------|--------------|-----------|--------|---------------|
| DT2960-QZ | Drywall, Board.                   | 360               | 275               | HSS          | 1         | 1      | 5035048025390 |
| DT2961-QZ | Hardwood, Softwood, Plywood.      | 360               | 275               | HSS          | 1         | 1      | 5035048025406 |
| DT2962-QZ | Plywood, Chipboard and MDF.       | 360               | 275               | TCT          | 1         | 1      | 5035048025413 |
| DT2963-QZ | Building Block, Class 12 Paroton. | 360               | 275               | TCT          | 1         | 1      | 5035048025420 |
| DT2964-QZ | Building Block, Class 12 Paroton. | 528               | 425               | TCT          | 1         | 1      | 5035048033258 |
| DT2965-QZ | Building Block, gas beton.        | 528               | 425               | TCT          | 1         | 1      | 5035048033265 |
| DT2966-QZ | Building Block, Class 20 Paroton. | 528               | 425               | TCT          | 1         | 1      | 5035048058855 |



BANDSAW BLADES



FEATURES

- High Grade Steel.
- Sharp ground teeth slice through the workpiece, producing a fine finish. (Wood cutting blades only).

FEATURES

- High Grade Steel.
- Sharp ground teeth slice through the workpiece, producing a fine finish. (Wood cutting blades only).

APPLICATIONS

- Range for most wood and some steel applications.

FEATURES

- Premium Grade Steel.
- Ultra sharp diamond ground teeth slice cleanly through the work piece producing a sandpaper fine finish (woodcutting blades only).
- Edge hardened teeth maintain ultra sharp edge.

FOR USE WITH DW738 AND DW739

| Cat. No.  | Primary Application             | Overall Length mm | Width mm | Thickness mm | Pitch mm | Pack Qty. | Barcode       |
|-----------|---------------------------------|-------------------|----------|--------------|----------|-----------|---------------|
| DT8480-QZ | Wood-Fretsaw Blade.             | 2095              | 3        | 0.6          | 4.2      | 1         | 5035048025543 |
| DT8481-QZ | General Purpose Blade.          | 2095              | 12       | 0.6          | 4.2      | 1         | 5035048025550 |
| DT8482-QZ | Wood - thick cuts.              | 2095              | 16       | 0.6          | 6.4      | 1         | 5035048025567 |
| DT8483-QZ | Wood - contour.                 | 2095              | 6        | 0.6          | 3.2      | 1         | 5035048025574 |
| DT8484-QZ | Non-ferrous Metal - Thin cuts.  | 2095              | 6        | 0.6          | 1.8      | 1         | 5035048025581 |
| DT8485-QZ | Non-ferrous Metal - Thick cuts. | 2095              | 12       | 0.6          | 3.2      | 1         | 5035048025598 |
| DT8486-QZ | Wood, Formica and Laminates.    | 2095              | 10       | 0.6          | 3.2      | 1         | 5035048025604 |

FOR USE WITH DW876

| Cat. No.  | Primary Application                     | Overall Length mm | Width mm | Thickness mm | Pitch mm | Pack Qty. | Barcode       |
|-----------|---|-------------------|----------|--------------|----------|-----------|---------------|
| DT8470-QZ | Wood - Fretsaw Blade.                   | 2215              | 4        | 0.6          | 1.8      | 1         | 5011402380978 |
| DT8471-QZ | Wood - contour / scroll.                | 2215              | 6        | 0.4          | 4.2      | 1         | 5011402380985 |
| DT8472-QZ | Wood - Rip & Cross cut.                 | 2215              | 10       | 0.4          | 4.2      | 1         | 5011402380992 |
| DT8473-QZ | Wood - Fast rip cut, medium composites. | 2215              | 16       | 0.6          | 6.4      | 1         | 5011402381005 |
| DT8474-QZ | Wood - Fast rip cut, thick wood.        | 2215              | 20       | 0.6          | 6.4      | 1         | 5011402381012 |
| DT8475-QZ | Metal - Non-ferrous - thin steel.       | 2215              | 6        | 0.6          | 1.4      | 1         | 5011402381029 |
| DT8476-QZ | Metal - Non-ferrous - thick steel.      | 2215              | 12       | 0.6          | 1.8      | 1         | 5011402381036 |

PLANER BLADES



FOR USE WITH DW676K

| Cat. No.  | Description                        | Pack Qty. | M.O.Q. | Barcode       |
|-----------|------------------------------------|-----------|--------|---------------|
| DT3901-QZ | 80mm TCT reversible planer blades. | 1 pair    | 1      | 5035048059456 |

FOR USE WITH DW677, DW678K, DW678EK AND DW680K

| Cat. No.  | Description                        | Pack Qty. | M.O.Q. | Barcode       |
|-----------|------------------------------------|-----------|--------|---------------|
| DT3905-QZ | 82mm HSS reversible planer blades. | 1 pair    | 1      | 5011402381852 |
| DT3906-QZ | 82mm TCT reversible planer blades. | 1 pair    | 1      | 5011402381869 |

JOINTER ACCESSORIES



BISCUIT JOINTER BLADES

| Cat. No.  | Blade Diameter | Blade Thickness mm | Bore Size mm | Tooth Count | M.O.Q. | Barcode       |
|-----------|----------------|--------------------|--------------|-------------|--------|---------------|
| DT1306-QZ | 102            | 3.9                | 22           | 12          | 1      | 5011432382118 |
| DT1307-QZ | 105            | 2.4                | 22           | 30          | 1      | 5011402382125 |

BISCUITS

| Cat. No.  | Size | Description     | Pack Qty. | M.O.Q. | Barcode       |
|-----------|------|-----------------|-----------|--------|---------------|
| DT3930-QZ | 0    | 6 - 12 mm board | 1000      | 1      | 5035048025369 |
| DT3931-QZ | 10   | 13-18 mm board  | 1000      | 1      | 5035048025376 |
| DT3932-QZ | 20   | >19 mm board    | 1000      | 1      | 5035048025383 |

Straight Cutters



APPLICATIONS

- For general cutting of straight edges, slots, grooves and straight rebates in hard woods, MDF, HDF, plywood and chipboard
- Can be used for straight trimming of laminates

FEATURES

- Single flute cutters available for fast cutting.
- Two flute cutters available for superior finish
- Long reach bits for deep grooving and mortising. Include carbide bottom plate for easier plunge cutting and long life in abrasive materials
- Straight cutter with bearing for following a template
- Available with 8mm and 12mm shanks (also available in 1/4" & 1/2" shanks for UK and Eire only)

Straight Cutters

| Cat. No.  | Description                  | Shank mm (A) | Cut Diameter mm (B) | Working Length mm (C) | Total Length mm | Barcode       |
|-----------|------------------------------|--------------|---------------------|-----------------------|-----------------|---------------|
| DR1002-XC | Straight Cutter - 1 Flute    | 8            | 4                   | 10                    | 48              | 7392585010011 |
| DR1003-XC | Straight Cutter - 2 Flutes   | 8            | 5                   | 12                    | 50              | 7392585010028 |
| DR1004-XC | Straight Cutter - 2 Flutes   | 8            | 6                   | 19                    | 55              | 7392585010035 |
| DR1005-XC | Straight Cutter - 2 Flutes   | 8            | 8                   | 20                    | 55              | 7392585010042 |
| DR1006-XC | Straight Cutter - 2 Flutes   | 8            | 10                  | 20                    | 52              | 7392585010059 |
| DR1007-XC | Straight Cutter - 2 Flutes   | 8            | 12                  | 20                    | 52              | 7392585010066 |
| DR1008-XC | Straight Cutter - 2 Flutes   | 8            | 14                  | 20                    | 52              | 7392585010073 |
| DR1009-XC | Straight Cutter - 2 Flutes   | 8            | 15                  | 20                    | 52              | 7392585010080 |
| DR1010-XC | Straight Cutter - 2 Flutes   | 8            | 16                  | 20                    | 52              | 7392585010097 |
| DR1011-XC | Straight Cutter - 2 Flutes   | 8            | 18                  | 20                    | 52              | 7392585010103 |
| DR1012-XC | Straight Cutter - 2 Flutes   | 8            | 20                  | 20                    | 52              | 7392585010110 |
| DR1013-XC | Straight Cutter - 2 Flutes   | 8            | 22                  | 20                    | 52              | 7392585010127 |
| DR1014-XC | Straight Cutter - 2 Flutes   | 8            | 24                  | 20                    | 52              | 7392585010134 |
| DR1015-XC | Straight Cutter - 2 Flutes   | 8            | 25                  | 20                    | 52              | 7392585010141 |
| DR6011-XC | Straight Cutter - 2 Flutes   | 12           | 25                  | 30                    | 70              | 7392585010257 |
| DR1020-QZ | Straight Cutter - 2 Flutes   | 8            | 12                  | 30                    | 90              | 5035048073490 |
| DR1022-QZ | Straight Cutter - 2 Flutes   | 8            | 16                  | 30                    | 90              | 5035048073513 |
| DR1023-QZ | Long Reach Straight Cutters  | 12           | 12                  | 50                    | 94              | 5035048073520 |
| DR1024-QZ | Long Reach Straight Cutters  | 12           | 16                  | 50                    | 90              | 5035048073537 |
| DR1101-XC | Straight Cutter with bearing | 8            | 12                  | 25                    | -               | 7392585010264 |

Profiles For Grooving / Moulding



APPLICATIONS

- For hard woods, MDF and plywood
- For grooving and moulding various profiles

FEATURES

- Two cutting flutes for superior finish

Profiles For Grooving / Moulding

| Cat. No.  | Description                | Shank mm (A) | Cut Diameter mm (B) | Working Length mm (C) | Radius mm (D) | Barcode       |
|-----------|----------------------------|--------------|---------------------|-----------------------|---------------|---------------|
| DR1402-XC | Straight Cutter - 2 Flutes | 8            | 8                   | 8                     | 4             | 7392585010325 |
| DR1403-XC | Straight Cutter - 2 Flutes | 8            | 12                  | 9.5                   | 6             | 7392585010332 |
| DR1302-XC | Straight Cutter - 2 Flutes | 8            | 12.7                | 12.7                  | 90            | 7392585010295 |
| DR1301-XC | Straight Cutter - 2 Flutes | 8            | 12.7                | 15.9                  | 60            | 7392585010288 |

Edge Trimmers / Cutters



APPLICATIONS

- For cutting, trimming and bevelling soft woods, hard woods, MDF and laminates

Edge Trimmers / Cutters

| Cat. No.  | Description                  | Shank mm (A) | Cut Diameter mm (B) | Working Length mm (C) | Radius mm (D) | Barcode       |
|-----------|------------------------------|--------------|---------------------|-----------------------|---------------|---------------|
| DR2201-XC | Trimming Cutter Triple Flute | 8            | 12.7                | 25.4                  | 68            | 7392585010523 |
| DR4401-XC | Straight Cutter - 2 Flutes   | 8            | 31.8                | 12.7                  | -             | 7392585011162 |
| DR2502-XC | 3 Wing Slotting Cutter       | -            | 8                   | 47.6                  | 3             | 7392585010608 |
| DR2503-XC | 3 Wing Slotting Cutter       | -            | 8                   | 47.6                  | 4             | 7392585010615 |
| DR2504-XC | 3 Wing Slotting Cutter       | -            | 8                   | 47.6                  | 5             | 7392585010622 |
| DR2701-XC | Arbor with Bearing           | 8            | 8                   | -                     | -             | 7392585010646 |
| DR2603-XC | 2 Wing Flat Bottom Slotter   | 8            | 40                  | 4                     | 10.5          | 7392585011476 |
| DR2604-XC | 2 Wing Flat Bottom Slotter   | 8            | 40                  | 5                     | 10.5          | 7392585011483 |



Edge Profiling and Moulding

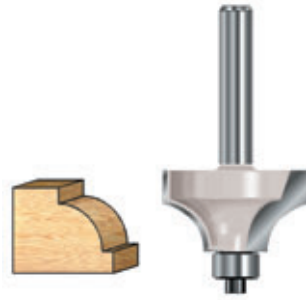

APPLICATIONS

- For creating decorative edges on worktops, furniture, cabinet doors, window sills and picture frames
- For soft wood, hardwood, MDF and plywood

FEATURES

- Two cutting flutes for superior finish
- Available with replacement ball bearing where applicable

Edge Profiling and Moulding

| Cat. No.  | Description                 | Shank mm (A) | Cut Diameter mm (B) | Working Length mm (C) | Radius mm (D) | Barcode       |
|-----------|-----------------------------|--------------|---------------------|-----------------------|---------------|---------------|
| DR3102-XC | Cove Cutter with Bearing    | 8            | 19.5                | 9.5                   | 5             | 7392585010851 |
| DR3103-XC | Cove Cutter with Bearing    | 8            | 22.2                | 12.7                  | 6.35          | 7392585010868 |
| DR3104-XC | Cove Cutter with Bearing    | 8            | 28.6                | 12.7                  | 9.5           | 7392585010875 |
| DR6701-XC | Chamfer with Bearing        | 12           | 44.5                | 15.9                  | 45            | 7392585010585 |
| DR2402-XC | Bevel Trimmer with Bearing  | 8            | 28                  | 11.2                  | 45            | 7392585010578 |
| DR3801-XC | Covetto Cutter with Bearing | 8            | 25.4                | 12.7                  | 4.8           | 7392585011025 |
| DR2802-XC | Rounding Over Cutter        | 8            | 18.7                | 9.5                   | 3             | 7392585010660 |
| DR2803-XC | Rounding Over Cutter        | 8            | 22.7                | 9.5                   | 5             | 7392585010667 |
| DR2804-XC | Rounding Over Cutter        | 8            | 25.4                | 12.7                  | 6.35          | 7392585010684 |
| DR2805-XC | Rounding Over Cutter        | 8            | 28.6                | 12.7                  | 8             | 7392585010691 |
| DR2806-XC | Rounding Over Cutter        | 8            | 31.8                | 15.9                  | 9.5           | 7392585010707 |
| DR2807-XC | Rounding Over Cutter        | 8            | 38.1                | 19                    | 12.7          | 7392585010714 |
| DR2903-XC | Beading Cutter              | 8            | 25.4                | 12.7                  | 6.35          | 7392585010769 |
| DR2905-XC | Beading Cutter              | 8            | 31.8                | 15.9                  | 9.5           | 7392585010783 |
| DR3301-XC | Ogee Cutter                 | 8            | 31.8                | 12.7                  | 4.8           | 7392585010905 |
| DR3401-XC | Roman Ogee Cutter           | 8            | 27                  | 11.9                  | 4             | 7392585010929 |
| DR3501-XC | Ogee Fillet Cutter          | 8            | 34.9                | 14.3                  | 4.8           | 7392585010943 |
| DR3602-XC | Classic Ogee Cutter         | 8            | 31.8                | 14.3                  | 4.8           | 7392585010967 |
| DR3702-XC | Classic Roman Ogee Cutter   | 8            | 31.8                | 15.9                  | 4.8           | 7392585010998 |

Dovetail & Glue Jointing

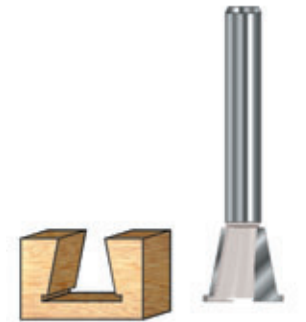

APPLICATIONS

- For soft woods, hard woods, MDF, Plywood and Chipboard

FEATURES

- Two cutting flutes for superior finish
- Replacement ball bearings available where applicable

Dovetail & Glue Jointing

| Cat. No.  | Description                    | Shank mm (A) | External Diameter mm (B1) | Internal Diameter mm (B2) | Angle ° | Barcode       |
|-----------|--------------------------------|--------------|---------------------------|---------------------------|---------|---------------|
| DR4201-XC | Dovetail Cutter                | 8            | 14.3                      | 12.7                      | 13.5    | 7392585011131 |
| DR1028-QZ | Dovetail Cutter                | 8            | 14.3                      | N/A                       | 13.5    | 5035048073575 |
| DR5301-XC | Router Hinge Bit               | 8            | 35                        | -                         | -       | 7392585011346 |
| DR4701-XC | Tongue & Groove Set            | 8            | 41                        | 6.35                      | 9.5     | 7392585011230 |
| DR4301-XC | Off Set Tongue & Groove Cutter | 8            | 30.2                      | 25.4                      | -       | 7392585011148 |
| DR4801-XC | Rail & Stile - Roman Ogee      | 8            | 41                        | 23.8                      | 4.76    | 7392585011254 |
| DR4901-XC | Rail & Stile - Classical       | 8            | 41                        | 23.8                      | 2.38    | 7392585011278 |

Replacement Ball Bearings

| Cat. No.  | Description         | External Diameter mm (B1) | Internal Diameter mm (B2) | Range | Barcode       |
|-----------|---------------------|---------------------------|---------------------------|-------|---------------|
| DR9907-XC | Replacement Bearing | 15.9                      | 6.35                      | 4.76  | 7392585011421 |

Router Bit Sets



Router Bit Sets

| Cat. No.  | Description  | Barcode       |
|-----------|--|---------------|
| DR9992-XC | 12 Piece Router bit set - Straight bit x3, Trimming cutter with BB, Rounding over bit with BB x2, Core box, Dovetail cutter, V-groove bit, Cove bit with BB, Roman ogee with BB, Chamfer bit with BB   | 5035048940211 |
| DR9994-QZ | 22 Piece Router bit set - Straight bit x6, Trimming cutter with BB, Rounding over bit with BB x2, Core box x2, Dovetail cutter, V-groove bit x2, Cove bit with BB x2, Roman ogee with BB, Chamfer bit with BB, Beading nit, New traditional beading bit of Freud, Bevel trim cutter with BB, Rebate cutter with BB | 5035048905630 |

FULL SHEET 230mm x 280mm



APPLICATIONS

- Wood and paint preparation and finish.

FEATURES

- High quality aluminium oxide grain gives superior finish.
- Strong & flexible D/C weight backing.
- Stearate coating helps reduce clogging (80g and above).



ALUMINIUM OXIDE PAPER

| Cat. No.  | Description                  | Grit Size | Pack Qty. | M.O.Q. | Barcode       |
|-----------|------------------------------|-----------|-----------|--------|---------------|
| DT3230-QZ | Multi Purpose Wood/paint-dry | 40        | 1         | 10     | 5035048073612 |
| DT3231-QZ | Multi Purpose Wood/paint-dry | 60        | 1         | 10     | 5035048073629 |
| DT3232-QZ | Multi Purpose Wood/paint-dry | 80        | 1         | 10     | 5035048073636 |
| DT3233-QZ | Multi Purpose Wood/paint-dry | 120       | 1         | 10     | 5035048073643 |
| DT3234-QZ | Multi Purpose Wood/paint-dry | 180       | 1         | 10     | 5035048073650 |
| DT3235-QZ | Multi Purpose Wood/paint-dry | 240       | 1         | 10     | 5035048073667 |
| DT3236-QZ | Multi Purpose Wood/paint-dry | 320       | 1         | 10     | 5035048073674 |
| DT3238-QZ | Multi Purpose Wood/paint-dry | 60        | 1         | 50     | 5035048073698 |
| DT3239-QZ | Multi Purpose Wood/paint-dry | 80        | 1         | 50     | 5035048073704 |
| DT3240-QZ | Multi Purpose Wood/paint-dry | 120       | 1         | 50     | 5035048073711 |
| DT3241-QZ | Multi Purpose Wood/paint-dry | 180       | 1         | 50     | 5035048073728 |
| DT3242-QZ | Multi Purpose Wood/paint-dry | 240       | 1         | 50     | 5035048073735 |

APPLICATIONS

- Fine sanding of primers and fillers.

FEATURES

- Flexible waterproof latex paper backing enables easier sanding on contoured surfaces and finishing applications.
- High quality sharp aluminium oxide grain provides excellent finish.
- High water resistance - no paper curl.



WATERPROOF PAPER

| Cat. No.  | Description             | Grit Size | Pack Qty. | M.O.Q. | Barcode       |
|-----------|-------------------------|-----------|-----------|--------|---------------|
| DT3244-QZ | Multi Purpose Wet & Dry | 180       | 1         | 10     | 5035048073759 |
| DT3245-QZ | Multi Purpose Wet & Dry | 240       | 1         | 10     | 5035048073766 |
| DT3246-QZ | Multi Purpose Wet & Dry | 320       | 1         | 10     | 5035048073773 |
| DT3247-QZ | Multi Purpose Wet & Dry | 400       | 1         | 10     | 5035048073780 |
| DT3248-QZ | Multi Purpose Wet & Dry | 1000      | 1         | 10     | 5035048073797 |
| DT3249-QZ | Multi Purpose Wet & Dry | 1200      | 1         | 10     | 5035048073803 |

APPLICATIONS

- Rust removal, surface grinding deburring and final finish.

FEATURES

- Heavyweight 'J' Cloth backing - tough durable sanding on metals.
- Industrial grade Aluminium oxide grain - fast aggressive stripping/sanding.

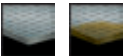

METALWORKING CLOTH

| Cat. No.  | Description                               | Grit Size | Pack Qty. | M.O.Q. | Barcode       |
|-----------|---|-----------|-----------|--------|---------------|
| DT3281-QZ | Steel, Stainless Steel, Non-Ferrous Metal | 80        | 1         | 10     | 5035048073872 |
| DT3282-QZ | Steel, Stainless Steel, Non-Ferrous Metal | 120       | 1         | 10     | 5035048073889 |
| DT3283-QZ | Steel, Stainless Steel, Non-Ferrous Metal | 180       | 1         | 10     | 5035048073896 |
| DT3284-QZ | Steel, Stainless Steel, Non-Ferrous Metal | 240       | 1         | 10     | 5035048073902 |
| DT3285-QZ | Steel, Stainless Steel, Non-Ferrous Metal | 320       | 1         | 10     | 5035048073919 |

HAND SANDING BLOCK

| Cat. No.  | Description        | Pack Qty. | M.O.Q. | Barcode       |
|-----------|--------------------|-----------|--------|---------------|
| DT3199-QZ | Hand Sanding Block | 1         | 1      | 5035048082829 |



**HALF SHEET 115mm x 280mm**



**APPLICATIONS**

- For all sanding and finishing tasks on wood, painted surfaces and fillers.

**FEATURES**

- Industrial grade abrasive paper for all stripping, sanding and finishing tasks on wood, paint and fillers.
- High quality aluminium oxide grain gives superior finish.
- Resin bonding provides excellent grain adhesion and heat resistance for powered sanding.
- Tough, durable "E" weight backing ensures longer life and performance.



PRE-PUNCHED Fits: DeWALT, Bosch, Festool, Makita, Metabo, Hitachi, Peugeot, Ryobi

| Cat. No.  | Description                  | Grit Size | Pack Qty. | M.O.Q. | Barcode       |
|-----------|------------------------------|-----------|-----------|--------|---------------|
| DT8570-QZ | Multi Purpose Wood/paint-dry | 40        | 10        | 1      | 5035048070598 |
| DT8510-QZ | Multi Purpose Wood/paint-dry | 60        | 10        | 1      | 5035048069202 |
| DT8511-QZ | Multi Purpose Wood/paint-dry | 80        | 10        | 1      | 5035048069219 |
| DT8512-QZ | Multi Purpose Wood/paint-dry | 120       | 10        | 1      | 5035048069226 |
| DT8513-QZ | Multi Purpose Wood/paint-dry | 180       | 10        | 1      | 5035048069233 |
| DT8514-QZ | Multi Purpose Wood/paint-dry | 220       | 10        | 1      | 5035048069240 |

**HALF SHEET 'QUICK FIT' 115mm x 228mm**



**APPLICATIONS**

- For all sanding and finishing tasks on wood, painted surfaces and fillers.

**FEATURES**

- Industrial grade abrasive paper for all stripping, sanding and finishing tasks on wood, paint and fillers.
- High quality aluminium oxide grain gives superior finish.
- Resin bonding provides excellent grain adhesion and heat resistance for powered sanding.
- Tough, durable "E" weight backing ensures longer life and performance.



PRE-PUNCHED Fits: DeWALT, Bosch, Festool, Makita, Metabo, Hitachi, Peugeot, Ryobi

| Cat. No.  | Description                  | Grit Size | Pack Qty. | M.O.Q. | Barcode       |
|-----------|------------------------------|-----------|-----------|--------|---------------|
| DT8574-QZ | Multi Purpose Wood/paint-dry | 40        | 10        | 1      | 5035048070635 |
| DT8550-QZ | Multi Purpose Wood/paint-dry | 60        | 10        | 1      | 5035048069608 |
| DT8551-QZ | Multi Purpose Wood/paint-dry | 80        | 10        | 1      | 5035048069615 |
| DT8552-QZ | Multi Purpose Wood/paint-dry | 120       | 10        | 1      | 5035048069622 |
| DT8553-QZ | Multi Purpose Wood/paint-dry | 180       | 10        | 1      | 5035048069639 |

**THIRD SHEET 93mm x 230mm**



**APPLICATIONS**

- For all sanding and finishing tasks on wood, painted surfaces and fillers.

**FEATURES**

- Industrial grade abrasive paper for all stripping, sanding and finishing tasks on wood, paint and fillers.
- High quality aluminium oxide grain gives superior finish.
- Resin bonding provides excellent grain adhesion and heat resistance for powered sanding.
- Tough, durable "E" weight backing ensures longer life and performance.



PRE-PUNCHED Fits: DeWALT, Bosch, Festool, Makita, Metabo, Ryobi, Skil, AEG

| Cat. No.  | Description                  | Grit Size | Pack Qty. | M.O.Q. | Barcode       |
|-----------|------------------------------|-----------|-----------|--------|---------------|
| DT8590-QZ | Multi Purpose Wood/paint-dry | 60        | 10        | 1      | 5035048069905 |
| DT8591-QZ | Multi Purpose Wood/paint-dry | 80        | 10        | 1      | 5035048069912 |
| DT8592-QZ | Multi Purpose Wood/paint-dry | 120       | 10        | 1      | 5035048069929 |
| DT8488-QZ | Multi Purpose Wood/paint-dry | 40        | 25        | 1      | 5035048070727 |
| DT8595-QZ | Multi Purpose Wood/paint-dry | 60        | 25        | 1      | 5035048069950 |
| DT8596-QZ | Multi Purpose Wood/paint-dry | 80        | 25        | 1      | 5035048069967 |
| DT8597-QZ | Multi Purpose Wood/paint-dry | 120       | 25        | 1      | 5035048069974 |
| DT8598-QZ | Multi Purpose Wood/paint-dry | 180       | 25        | 1      | 5035048069981 |

**THIRD SHEET 'QUICK FIT' 93mm x 190mm**



**APPLICATIONS**

- For all sanding and finishing tasks on wood, painted surfaces and fillers.

**FEATURES**

- Industrial grade abrasive paper for all stripping, sanding and finishing tasks on wood, paint and fillers.



PRE-PUNCHED Fits: DeWALT, AEG, Bosch, Casals, Einhell, Festool, Hitachi, Makita, Metabo, Peugeot, Skil

| Cat. No.  | Description                  | Grit Size | Pack Qty. | M.O.Q. | Barcode       |
|-----------|------------------------------|-----------|-----------|--------|---------------|
| DT8620-QZ | Multi Purpose Wood/paint-dry | 60        | 10        | 1      | 5035048070208 |
| DT8621-QZ | Multi Purpose Wood/paint-dry | 80        | 10        | 1      | 5035048070215 |
| DT8622-QZ | Multi Purpose Wood/paint-dry | 120       | 10        | 1      | 5035048070222 |
| DT8623-QZ | Multi Purpose Wood/paint-dry | 180       | 10        | 1      | 5035048070239 |
| DT8624-QZ | Multi Purpose Wood/paint-dry | 240       | 10        | 1      | 5035048070246 |

**QUARTER SHEET**

**APPLICATIONS**

- For all sanding and finishing tasks on wood, painted surfaces and fillers.

**FEATURES**

- Industrial grade abrasive paper for all stripping, sanding and finishing tasks on wood, paint and fillers.
- High quality aluminium oxide grain gives superior finish.
- Resin bonding provides excellent grain adhesion and heat resistance for powered sanding.
- Tough, durable "E" weight backing ensures longer life and performance.



QUARTER SHEET 115mm x 140mm Fits: DeWALT, Bosch, Makita, Ryobi, Skil

| Cat. No.  | Description                  | Grit Size | Pack Qty. | M.O.Q. | Barcode       |
|-----------|------------------------------|-----------|-----------|--------|---------------|
| DT3001-QZ | Multi Purpose Wood/paint-dry | 40        | 10        | 1      | 5035048066546 |
| DT3002-QZ | Multi Purpose Wood/paint-dry | 60        | 10        | 1      | 5035048066553 |
| DT3004-QZ | Multi Purpose Wood/paint-dry | 100       | 10        | 1      | 5035048066560 |
| DT3005-QZ | Multi Purpose Wood/paint-dry | 150       | 10        | 1      | 5035048066577 |
| DT3007-QZ | Multi Purpose Wood/paint-dry | 220       | 10        | 1      | 5035048066584 |
| DT3011-QZ | Multi Purpose Wood/paint-dry | 40        | 25        | 1      | 5035048058947 |
| DT3012-QZ | Multi Purpose Wood/paint-dry | 60        | 25        | 1      | 5035048058954 |
| DT3014-QZ | Multi Purpose Wood/paint-dry | 100       | 25        | 1      | 5035048058961 |
| DT3015-QZ | Multi Purpose Wood/paint-dry | 150       | 25        | 1      | 5035048058978 |
| DT3017-QZ | Multi Purpose Wood/paint-dry | 220       | 25        | 1      | 5035048058985 |

QUARTER SHEET 'QUICK FIT' 115mm x 115mm Fits: DeWALT, Bosch, Makita, Hitachi, Metabo

| Cat. No.  | Description                  | Grit Size | Pack Qty. | M.O.Q. | Barcode       |
|-----------|------------------------------|-----------|-----------|--------|---------------|
| DT3020-QZ | Multi Purpose Wood/paint-dry | 40        | 10        | 1      | 5035048014462 |
| DT3021-QZ | Multi Purpose Wood/paint-dry | 60        | 10        | 1      | 5035048014486 |
| DT3022-QZ | Multi Purpose Wood/paint-dry | 80        | 10        | 1      | 5035048014509 |
| DT3023-QZ | Multi Purpose Wood/paint-dry | 120       | 10        | 1      | 5035048014523 |
| DT3024-QZ | Multi Purpose Wood/paint-dry | 180       | 10        | 1      | 5035048014547 |
| DT3025-QZ | Multi Purpose Wood/paint-dry | 240       | 10        | 1      | 5035048014561 |
| DT3026-QZ | Multi Purpose Wood/paint-dry | 320       | 10        | 1      | 5035048071953 |
| DT3030-QZ | Multi Purpose Wood/paint-dry | 40        | 25        | 1      | 5035048014479 |
| DT3031-QZ | Multi Purpose Wood/paint-dry | 60        | 25        | 1      | 5035048014493 |
| DT3032-QZ | Multi Purpose Wood/paint-dry | 80        | 25        | 1      | 5035048014516 |
| DT3033-QZ | Multi Purpose Wood/paint-dry | 120       | 25        | 1      | 5035048014530 |
| DT3034-QZ | Multi Purpose Wood/paint-dry | 180       | 25        | 1      | 5035048014554 |
| DT3035-QZ | Multi Purpose Wood/paint-dry | 240       | 25        | 1      | 5035048014578 |
| DT3036-QZ | Multi Purpose Wood/paint-dry | 320       | 25        | 1      | 5035048070819 |

QUARTER SHEET 'QUICK FIT' 80mm x 133mm Fits: Festool

| Cat. No.  | Description                  | Grit Size | Pack Qty. | M.O.Q. | Barcode       |
|-----------|------------------------------|-----------|-----------|--------|---------------|
| DT3100-QZ | Multi Purpose Wood/paint-dry | 40        | 25        | 1      | 5035048082638 |
| DT3104-QZ | Multi Purpose Wood/paint-dry | 60        | 25        | 1      | 5035048082645 |
| DT3109-QZ | Multi Purpose Wood/paint-dry | 80        | 25        | 1      | 5035048082652 |
| DT3110-QZ | Multi Purpose Wood/paint-dry | 120       | 25        | 1      | 5035048082669 |
| DT3114-QZ | Multi Purpose Wood/paint-dry | 180       | 25        | 1      | 5035048082676 |



DETAIL SANDING SHEETS



APPLICATIONS

- For all sanding and finishing tasks on wood, painted surfaces and fillers.

FEATURES

- Industrial grade abrasive paper for all stripping, sanding and finishing tasks on wood, paint and fillers.
- High quality aluminium oxide grain gives superior finish.
- Resin bonding provides excellent grain adhesion and heat resistance for powered sanding.
- Tough, durable "E" weight backing ensures longer life and performance.



PRE-PUNCHED 93mm x 93mm Fits: DeWALT, Bosch, AEG, Makita, Metabo, Skil, Kress

| Cat. No.  | Description          | Grit Size | Pack Qty. | M.O.Q. | Barcode       |
|-----------|----------------------|-----------|-----------|--------|---------------|
| DT3090-QZ | Detail Sanding Sheet | 40        | 10        | 1      | 5035048061770 |
| DT3091-QZ | Detail Sanding Sheet | 60        | 10        | 1      | 5035048061787 |
| DT3092-QZ | Detail Sanding Sheet | 80        | 10        | 1      | 5035048061794 |
| DT3093-QZ | Detail Sanding Sheet | 120       | 10        | 1      | 5035048061800 |
| DT3094-QZ | Detail Sanding Sheet | 180       | 10        | 1      | 5035048061817 |
| DT3095-QZ | Detail Sanding Sheet | 240       | 10        | 1      | 5035048061824 |

PRE-PUNCHED 94mm x 94mm Fits: Festool

| Cat. No.  | Description          | Grit Size | Pack Qty. | M.O.Q. | Barcode       |
|-----------|----------------------|-----------|-----------|--------|---------------|
| DT3560-QZ | Detail Sanding Sheet | 40        | 10        | 1      | 5035048067338 |
| DT3561-QZ | Detail Sanding Sheet | 60        | 10        | 1      | 5035048067345 |
| DT3562-QZ | Detail Sanding Sheet | 80        | 10        | 1      | 5035048067352 |
| DT3563-QZ | Detail Sanding Sheet | 120       | 10        | 1      | 5035048067369 |
| DT3564-QZ | Detail Sanding Sheet | 180       | 10        | 1      | 5035048067376 |

ROLLS



APPLICATIONS

- For all sanding and finishing tasks on wood, painted surfaces and fillers.

FEATURES

- Industrial grade abrasive paper for all stripping, sanding and finishing tasks on wood, paint and fillers.
- High quality aluminium oxide grain gives superior finish.
- Resin bonding provides excellent grain adhesion and heat resistance for powered sanding.
- Tough, durable "E" weight backing ensures longer life and performance.



ROLLS - HALF SHEET & QUARTER SHEET

| Cat. No.  | Description                  | Grit Size | Size (Length x Width) | Pack Qty. | M.O.Q. | Barcode       |
|-----------|------------------------------|-----------|-----------------------|-----------|--------|---------------|
| DT3580-QZ | Multi Purpose Wood/paint-dry | 60        | 5m x 115mm            | 1         | 1      | 5035048067079 |
| DT3581-QZ | Multi Purpose Wood/paint-dry | 80        | 5m x 115mm            | 1         | 1      | 5035048067086 |
| DT3582-QZ | Multi Purpose Wood/paint-dry | 120       | 5m x 115mm            | 1         | 1      | 5035048067093 |
| DT3583-QZ | Multi Purpose Wood/paint-dry | 180       | 5m x 115mm            | 1         | 1      | 5035048067109 |
| DT3584-QZ | Multi Purpose Wood/paint-dry | 220       | 5m x 115mm            | 1         | 1      | 5035048067116 |

ROLLS - THIRD SHEET

| Cat. No.  | Description                  | Grit Size | Size (Length x Width) | Pack Qty. | M.O.Q. | Barcode       |
|-----------|------------------------------|-----------|-----------------------|-----------|--------|---------------|
| DT3154-QZ | Multi Purpose Wood/paint-dry | 40        | 5m x 93mm             | 1         | 1      | 5035048082942 |
| DT3590-QZ | Multi Purpose Wood/paint-dry | 60        | 5m x 93mm             | 1         | 1      | 5035048067178 |
| DT3591-QZ | Multi Purpose Wood/paint-dry | 80        | 5m x 93mm             | 1         | 1      | 5035048067185 |
| DT3592-QZ | Multi Purpose Wood/paint-dry | 120       | 5m x 93mm             | 1         | 1      | 5035048067192 |
| DT3593-QZ | Multi Purpose Wood/paint-dry | 180       | 5m x 93mm             | 1         | 1      | 5035048067208 |
| DT3594-QZ | Multi Purpose Wood/paint-dry | 220       | 5m x 93mm             | 1         | 1      | 5035048067215 |
| DT3579-QZ | Multi Purpose Wood/paint-dry | 40        | 25m x 93mm            | 1         | 1      | 5035048070871 |
| DT3595-QZ | Multi Purpose Wood/paint-dry | 60        | 25m x 93mm            | 1         | 1      | 5035048067222 |
| DT3596-QZ | Multi Purpose Wood/paint-dry | 80        | 25m x 93mm            | 1         | 1      | 5035048067239 |
| DT3597-QZ | Multi Purpose Wood/paint-dry | 120       | 25m x 93mm            | 1         | 1      | 5035048067246 |
| DT3598-QZ | Multi Purpose Wood/paint-dry | 180       | 25m x 93mm            | 1         | 1      | 5035048067253 |
| DT3599-QZ | Multi Purpose Wood/paint-dry | 220       | 25m x 93mm            | 1         | 1      | 5035048067260 |

BELTS



APPLICATIONS

- For all stripping sanding and finishing tasks on wood, metal and painted surfaces.

FEATURES

- Heavy duty "X" weight backing cloth.
- Heat resistant resin bonding.
- High quality Aluminium Oxide grain for fast, aggressive stock removal and fine finishing on wood, metal or painted surfaces.
- EXTREME belts (grits up to 120) have an 'Anti Static' resin bonding - reduces clogging and ensures more efficient dust extraction - Longer belt sanding life.



100mm x 610mm Fits: Hitachi, Makita, Ryobi

| Cat. No.  | Description                   | Grit Size | Pack Qty. | M.O.Q. | Barcode       |
|-----------|-------------------------------|-----------|-----------|--------|---------------|
| DT3320-QZ | Multi Purpose Wood/paint-belt | 40        | 3         | 1      | 5035048068151 |
| DT3321-QZ | Multi Purpose Wood/paint-belt | 60        | 3         | 1      | 5035048068168 |
| DT3322-QZ | Multi Purpose Wood/paint-belt | 80        | 3         | 1      | 5035048068175 |
| DT3323-QZ | Multi Purpose Wood/paint-belt | 100       | 3         | 1      | 5035048068182 |
| DT3324-QZ | Multi Purpose Wood/paint-belt | 150       | 3         | 1      | 5035048068199 |
| DT3670-QZ | Multi Purpose Wood/paint-belt | 40        | 10        | 1      | 5035048068205 |
| DT3671-QZ | Multi Purpose Wood/paint-belt | 60        | 10        | 1      | 5035048068212 |
| DT3672-QZ | Multi Purpose Wood/paint-belt | 80        | 10        | 1      | 5035048068229 |
| DT3673-QZ | Multi Purpose Wood/paint-belt | 100       | 10        | 1      | 5035048068236 |
| DT3674-QZ | Multi Purpose Wood/paint-belt | 150       | 10        | 1      | 5035048068243 |

100mm x 560mm Fits: DeWALT, AEG, Ryobi

| Cat. No.  | Description                   | Grit Size | Pack Qty. | M.O.Q. | Barcode       |
|-----------|-------------------------------|-----------|-----------|--------|---------------|
| DT3312-QZ | Multi Purpose Wood/paint-belt | 40        | 3         | 1      | 5035048025642 |
| DT3314-QZ | Multi Purpose Wood/paint-belt | 60        | 3         | 1      | 5035048025659 |
| DT3315-QZ | Multi Purpose Wood/paint-belt | 80        | 3         | 1      | 5035048025666 |
| DT3316-QZ | Multi Purpose Wood/paint-belt | 100       | 3         | 1      | 5035048025673 |
| DT3362-QZ | Multi Purpose Wood/paint-belt | 120       | 3         | 1      | 5035048034484 |
| DT3318-QZ | Multi Purpose Wood/paint-belt | 150       | 3         | 1      | 5035048025680 |
| DT3685-QZ | Multi Purpose Wood/paint-belt | 40        | 10        | 1      | 5035048068458 |
| DT3686-QZ | Multi Purpose Wood/paint-belt | 60        | 10        | 1      | 5035048068465 |
| DT3687-QZ | Multi Purpose Wood/paint-belt | 80        | 10        | 1      | 5035048068472 |
| DT3626-QZ | Multi Purpose Wood/paint-belt | 100       | 10        | 1      | 5035048070826 |
| DT3688-QZ | Multi Purpose Wood/paint-belt | 120       | 10        | 1      | 5035048068489 |

75mm x 533mm Fits: DeWALT, Bosch, Hitachi, Atlas Copco, Holz-Her, Makita, Metabo, Peugeot, Ryobi, Skil

| Cat. No.  | Description                   | Grit Size | Pack Qty. | M.O.Q. | Barcode       |
|-----------|-------------------------------|-----------|-----------|--------|---------------|
| DT3376-QZ | Multi Purpose Wood/paint-belt | 60        | 3         | 1      | 5035048068717 |
| DT3377-QZ | Multi Purpose Wood/paint-belt | 80        | 3         | 1      | 5035048068724 |
| DT3628-QZ | Multi Purpose Wood/paint-belt | 100       | 3         | 1      | 5035048070840 |
| DT3301-QZ | Multi Purpose Wood/paint-belt | 40        | 10        | 1      | 5011402375172 |
| DT3302-QZ | Multi Purpose Wood/paint-belt | 60        | 10        | 1      | 5011402375189 |
| DT3303-QZ | Multi Purpose Wood/paint-belt | 80        | 10        | 1      | 5011402375196 |
| DT3304-QZ | Multi Purpose Wood/paint-belt | 100       | 10        | 1      | 5011402375202 |
| DT3629-QZ | Multi Purpose Wood/paint-belt | 120       | 10        | 1      | 5035048070857 |
| DT3305-QZ | Multi Purpose Wood/paint-belt | 150       | 10        | 1      | 5011402375219 |
| DT3307-QZ | Multi Purpose Wood/paint-belt | 220       | 10        | 1      | 5011402375226 |

75mm x 480mm Fits: Elu

| Cat. No.  | Description                   | Grit Size | Pack Qty. | M.O.Q. | Barcode       |
|-----------|-------------------------------|-----------|-----------|--------|---------------|
| DT3364-QZ | Multi Purpose Wood/paint-belt | 40        | 3         | 1      | 5035048053942 |
| DT3365-QZ | Multi Purpose Wood/paint-belt | 60        | 3         | 1      | 5035048053959 |
| DT3366-QZ | Multi Purpose Wood/paint-belt | 80        | 3         | 1      | 5035048053966 |
| DT3367-QZ | Multi Purpose Wood/paint-belt | 100       | 3         | 1      | 4024048053973 |
| DT3368-QZ | Multi Purpose Wood/paint-belt | 120       | 3         | 1      | 5035048053980 |
| DT3369-QZ | Multi Purpose Wood/paint-belt | 150       | 3         | 1      | 5035048053997 |

75mm x 457mm Fits: Makita, Metabo, Peugeot, Skil

| Cat. No.  | Description                   | Grit Size | Pack Qty. | M.O.Q. | Barcode       |
|-----------|-------------------------------|-----------|-----------|--------|---------------|
| DT3640-QZ | Multi Purpose Wood/paint-belt | 40        | 3         | 1      | 5035048068809 |
| DT3641-QZ | Multi Purpose Wood/paint-belt | 60        | 3         | 1      | 5035048068816 |
| DT3642-QZ | Multi Purpose Wood/paint-belt | 80        | 3         | 1      | 5035048068823 |
| DT3643-QZ | Multi Purpose Wood/paint-belt | 100       | 3         | 1      | 5035048068830 |
| DT3644-QZ | Multi Purpose Wood/paint-belt | 150       | 3         | 1      | 5035048068847 |



BELTS

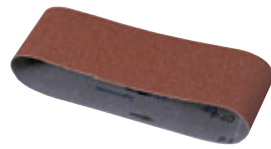

APPLICATIONS

- For all stripping, sanding and finishing tasks on wood, metal and painted surfaces.

FEATURES

- Flexible J weight backing cloth.
- Heat resistant resin bonding.
- High quality Aluminium Oxide grain for fast, accurate stock removal and fine finishing on wood, metal or painted surfaces.



64mm x 356mm (MINI BELT SANDER)

| Cat. No.  | Description                   | Grit Size | Pack Qty. | M.O.Q. | Barcode       |
|-----------|-------------------------------|-----------|-----------|--------|---------------|
| DT3661-QZ | Multi Purpose Wood/paint-belt | 60        | 3         | 1      | 5035048069011 |
| DT3662-QZ | Multi Purpose Wood/paint-belt | 80        | 3         | 1      | 5035048069028 |
| DT3663-QZ | Multi Purpose Wood/paint-belt | 100       | 3         | 1      | 5035048069035 |
| DT3664-QZ | Multi Purpose Wood/paint-belt | 150       | 3         | 1      | 5035048069042 |
| DT3299-QZ | Multi Purpose Wood/paint-belt | 220       | 3         | 1      | 5035048071960 |
| DT3666-QZ | Multi Purpose Wood/paint-belt | 60        | 10        | 1      | 5035048069066 |
| DT3667-QZ | Multi Purpose Wood/paint-belt | 80        | 10        | 1      | 5035048069073 |
| DT3668-QZ | Multi Purpose Wood/paint-belt | 100       | 10        | 1      | 5035048069080 |
| DT3669-QZ | Multi Purpose Wood/paint-belt | 150       | 10        | 1      | 5035048069097 |

GRINDING BELTS



APPLICATIONS

- For use with bench grinder.
- Coarse grits or shaping metal, wood and ceramics.

FEATURES

- High performance 'X' weight backing cloth.
- Heat resistant resin bonding.
- High quality aluminium oxide grain.



40mm x 577mm

| Cat. No.  | Description   | Grit Size | Pack Qty. | M.O.Q. | Barcode       |
|-----------|---------------|-----------|-----------|--------|---------------|
| DT3340-QZ | Grinding belt | 40        | 3         | 1      | 5035048034262 |
| DT3341-QZ | Grinding belt | 60        | 3         | 1      | 5035048034279 |
| DT3342-QZ | Grinding belt | 80        | 3         | 1      | 5035048034286 |
| DT3343-QZ | Grinding belt | 100       | 3         | 1      | 5035048034293 |
| DT3344-QZ | Grinding belt | 120       | 3         | 1      | 5035048034309 |
| DT3345-QZ | Grinding belt | 150       | 3         | 1      | 5035048034316 |
| DT3346-QZ | Grinding belt | 240       | 3         | 1      | 5035048034323 |
| DT3347-QZ | Grinding belt | 320       | 3         | 1      | 5035048034330 |

45mm x 715mm

| Cat. No.  | Description   | Grit Size | Pack Qty. | M.O.Q. | Barcode       |
|-----------|---------------|-----------|-----------|--------|---------------|
| DT3349-QZ | Grinding belt | 40        | 3         | 1      | 5035048034354 |
| DT3350-QZ | Grinding belt | 60        | 3         | 1      | 5035048034361 |
| DT3351-QZ | Grinding belt | 80        | 3         | 1      | 5035048034378 |
| DT3352-QZ | Grinding belt | 100       | 3         | 1      | 5035048034385 |
| DT3353-QZ | Grinding belt | 120       | 3         | 1      | 5035048034392 |
| DT3354-QZ | Grinding belt | 150       | 3         | 1      | 5035048034408 |
| DT3355-QZ | Grinding belt | 240       | 3         | 1      | 5035048034415 |
| DT3356-QZ | Grinding belt | 320       | 3         | 1      | 5035048034422 |

HONING BELTS



FEATURES

- Use after regrinding tools to bring them to a very sharp edge.
- Use in conjunction with DeWALT honing paste.

40mm X 577mm

| Cat. No.  | Description         | Pack Qty. | M.O.Q. | Barcode       |
|-----------|---------------------|-----------|--------|---------------|
| DT3395-QZ | Leather honing belt | 1         | 1      | 5035048054017 |

45mm X 715mm

| Cat. No.  | Description         | Pack Qty. | M.O.Q. | Barcode       |
|-----------|---------------------|-----------|--------|---------------|
| DT3396-QZ | Leather honing belt | 1         | 1      | 5035048054024 |

HONING PASTE

| Cat. No.  | Description  | Pack Qty. | M.O.Q. | Barcode       |
|-----------|--------------|-----------|--------|---------------|
| DT3398-QZ | Honing Paste | 1         | 1      | 5035048054031 |

'QUICK FIT NYLON' LOOP DISCS

APPLICATIONS

- For all stripping sanding and finishing tasks on wood, metal and painted surfaces.

FEATURES

- Heat resistant resin adhesive bond, ideal for power sanding.
- Tough, durable paper backing ensures longer disc life and performance.
- Stearate coating reduces clogging, excellent for softwoods & painted surfaces (grits 80 or greater).
- Quick Fit nylon loop backing allows fast and easy disc changeover.



8 HOLES PUNCHED Ø125mm Fits: DeWALT, AEG, Bosch, Atlas Copco, Festool, Elu, Fein, Hitachi, Kress, Makita, Metabo, Skil

| Cat. No.  | Description                  | Grit Size | Pack Qty. | M.O.Q. | Barcode       |
|-----------|------------------------------|-----------|-----------|--------|---------------|
| DT3101-QZ | Multi Purpose Wood/paint-dry | 40        | 10        | 1      | 5035048058992 |
| DT3102-QZ | Multi Purpose Wood/paint-dry | 60        | 10        | 1      | 5035048059005 |
| DT3103-QZ | Multi Purpose Wood/paint-dry | 80        | 10        | 1      | 5035048059012 |
| DT3105-QZ | Multi Purpose Wood/paint-dry | 120       | 10        | 1      | 5035048059029 |
| DT3106-QZ | Multi Purpose Wood/paint-dry | 180       | 10        | 1      | 5035048059036 |
| DT3107-QZ | Multi Purpose Wood/paint-dry | 240       | 10        | 1      | 5035048059043 |
| DT3108-QZ | Multi Purpose Wood/paint-dry | 320       | 10        | 1      | 5035048059050 |
| DT3111-QZ | Multi Purpose Wood/paint-dry | 40        | 25        | 1      | 5035048059067 |
| DT3112-QZ | Multi Purpose Wood/paint-dry | 60        | 25        | 1      | 5035048059074 |
| DT3113-QZ | Multi Purpose Wood/paint-dry | 80        | 25        | 1      | 5035048059081 |
| DT3115-QZ | Multi Purpose Wood/paint-dry | 120       | 25        | 1      | 5035048059098 |
| DT3116-QZ | Multi Purpose Wood/paint-dry | 180       | 25        | 1      | 5035048059104 |
| DT3117-QZ | Multi Purpose Wood/paint-dry | 240       | 25        | 1      | 5035048059111 |
| DT3118-QZ | Multi Purpose Wood/paint-dry | 320       | 25        | 1      | 5035048059128 |

8 HOLES PUNCHED Ø125mm Fits: Festool

| Cat. No.  | Description                  | Grit Size | Pack Qty. | M.O.Q. | Barcode       |
|-----------|------------------------------|-----------|-----------|--------|---------------|
| DT3119-QZ | Multi Purpose Wood/paint-dry | 40        | 25        | 1      | 5035048082683 |
| DT3120-QZ | Multi Purpose Wood/paint-dry | 60        | 25        | 1      | 5035048082690 |
| DT3124-QZ | Multi Purpose Wood/paint-dry | 80        | 25        | 1      | 5035048082706 |
| DT3129-QZ | Multi Purpose Wood/paint-dry | 120       | 25        | 1      | 5035048082713 |
| DT3130-QZ | Multi Purpose Wood/paint-dry | 180       | 25        | 1      | 5035048082720 |
| DT3139-QZ | Multi Purpose Wood/paint-dry | 240       | 25        | 1      | 5035048082911 |

6 HOLES PUNCHED Ø150mm Fits: DeWALT, Bosch, Hitachi, Metabo, Peugeot

| Cat. No.  | Description                  | Grit Size | Pack Qty. | M.O.Q. | Barcode       |
|-----------|------------------------------|-----------|-----------|--------|---------------|
| DT3121-QZ | Multi Purpose Wood/paint-dry | 40        | 10        | 1      | 5035048059135 |
| DT3122-QZ | Multi Purpose Wood/paint-dry | 60        | 10        | 1      | 5035048059142 |
| DT3123-QZ | Multi Purpose Wood/paint-dry | 80        | 10        | 1      | 5035048059159 |
| DT3125-QZ | Multi Purpose Wood/paint-dry | 120       | 10        | 1      | 5035048059166 |
| DT3126-QZ | Multi Purpose Wood/paint-dry | 180       | 10        | 1      | 5035048059173 |
| DT3127-QZ | Multi Purpose Wood/paint-dry | 240       | 10        | 1      | 5035048059180 |
| DT3128-QZ | Multi Purpose Wood/paint-dry | 320       | 10        | 1      | 5035048059197 |
| DT3131-QZ | Multi Purpose Wood/paint-dry | 40        | 25        | 1      | 5035048059203 |
| DT3132-QZ | Multi Purpose Wood/paint-dry | 60        | 25        | 1      | 5035048059210 |
| DT3133-QZ | Multi Purpose Wood/paint-dry | 80        | 25        | 1      | 5035048059227 |
| DT3135-QZ | Multi Purpose Wood/paint-dry | 120       | 25        | 1      | 5035048059234 |
| DT3136-QZ | Multi Purpose Wood/paint-dry | 180       | 25        | 1      | 5035048059241 |
| DT3137-QZ | Multi Purpose Wood/paint-dry | 240       | 25        | 1      | 5035048059463 |
| DT3138-QZ | Multi Purpose Wood/paint-dry | 320       | 25        | 1      | 5035048059258 |

9 HOLES PUNCHED Ø150mm Fits: Festool

| Cat. No.  | Description                  | Grit Size | Pack Qty. | M.O.Q. | Barcode       |
|-----------|------------------------------|-----------|-----------|--------|---------------|
| DT3151-QZ | Multi Purpose Wood/paint-dry | 40        | 25        | 1      | 5035048068083 |
| DT3152-QZ | Multi Purpose Wood/paint-dry | 60        | 25        | 1      | 5035048068090 |
| DT3153-QZ | Multi Purpose Wood/paint-dry | 80        | 25        | 1      | 5035048068106 |
| DT3155-QZ | Multi Purpose Wood/paint-dry | 120       | 25        | 1      | 5035048068113 |
| DT3156-QZ | Multi Purpose Wood/paint-dry | 180       | 25        | 1      | 5035048068120 |

9 HOLES PUNCHED Ø225mm Fits: Festool, Flex

| Cat. No.  | Description                  | Grit Size | Pack Qty. | M.O.Q. | Barcode       |
|-----------|------------------------------|-----------|-----------|--------|---------------|
| DT3164-QZ | Multi Purpose Wood/paint-dry | 60        | 10        | 1      | 5035048082782 |
| DT3169-QZ | Multi Purpose Wood/paint-dry | 80        | 10        | 1      | 5035048082799 |
| DT3179-QZ | Multi Purpose Wood/paint-dry | 100       | 10        | 1      | 5035048082928 |
| DT3170-QZ | Multi Purpose Wood/paint-dry | 120       | 10        | 1      | 5035048082805 |





EXTREME DeWALT FIBRE DISCS



APPLICATIONS

- Stock removal /stripping tasks on metal and derusting.

FEATURES

- Extra tough Vulcanised fibre backing for aggressive fast sanding.
- Extremely durable hard Zirconia grain for fast aggressive stock removal on metals.
- Heat resistant resin bond keeps the abrasive grain in place for longer ensuring longer disc life.
- Cool cut for low discolouration of metal.

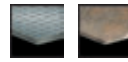

115mm Ø

| Cat. No.  | Description | Grit Size | Pack Qty. | M.O.Q. | Barcode       |
|-----------|-------------|-----------|-----------|--------|---------------|
| DT3201-QZ | Fibre Disc  | 40        | 25        | 1      | 5011402375257 |
| DT3202-QZ | Fibre Disc  | 60        | 25        | 1      | 5011402375271 |
| DT3203-QZ | Fibre Disc  | 80        | 25        | 1      | 5011402375295 |
| DT3205-QZ | Fibre Disc  | 100       | 25        | 1      | 5035048067277 |
| DT3206-QZ | Fibre Disc  | 120       | 25        | 1      | 5035048067284 |

125mm Ø

| Cat. No.  | Description | Grit Size | Pack Qty. | M.O.Q. | Barcode       |
|-----------|-------------|-----------|-----------|--------|---------------|
| DT3211-QZ | Fibre Disc  | 40        | 25        | 1      | 5011402375356 |
| DT3212-QZ | Fibre Disc  | 60        | 25        | 1      | 5011402375370 |
| DT3213-QZ | Fibre Disc  | 80        | 25        | 1      | 5011402375394 |
| DT3215-QZ | Fibre Disc  | 100       | 25        | 1      | 5035048067291 |
| DT3216-QZ | Fibre Disc  | 120       | 25        | 1      | 5035048067307 |

FLAP DISCS



APPLICATIONS

- For rust removal, grinding and cleaning metal.

FEATURES

- Tough durable zirconia grain.
- Very strong with very high removal rate.
- Low noise.
- Cool grinding.

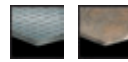

FLAP DISCS

| Cat. No.  | Description    | Diameter mm | Grit Size | Pack Qty. | M.O.Q. | Barcode       |
|-----------|----------------|-------------|-----------|-----------|--------|---------------|
| DT3269-QZ | Type 29 Angled | 100mm       | 60        | 10        | 1      | 5035048077344 |
| DT3274-QZ | Type 29 Angled | 100mm       | 80        | 10        | 1      | 5035048077351 |
| DT3255-QZ | Type 29 Angled | 115mm       | 36        | 10        | 1      | 5035048075166 |
| DT3256-QZ | Type 29 Angled | 115mm       | 60        | 10        | 1      | 5035048075173 |
| DT3257-QZ | Type 29 Angled | 115mm       | 80        | 10        | 1      | 5035048075180 |
| DT3258-QZ | Type 29 Angled | 115mm       | 120       | 10        | 1      | 5035048075197 |
| DT3265-QZ | Type 29 Angled | 125mm       | 36        | 10        | 1      | 5035048075203 |
| DT3266-QZ | Type 29 Angled | 125mm       | 60        | 10        | 1      | 5035048075210 |
| DT3267-QZ | Type 29 Angled | 125mm       | 80        | 10        | 1      | 5035048075227 |
| DT3268-QZ | Type 29 Angled | 125mm       | 120       | 10        | 1      | 5035048075234 |
| DT3208-QZ | Type 27 Flat   | 100mm       | 36        | 10        | 1      | 5035048077375 |
| DT3209-QZ | Type 27 Flat   | 100mm       | 60        | 10        | 1      | 5035048077382 |
| DT3218-QZ | Type 27 Flat   | 100mm       | 80        | 10        | 1      | 5035048077399 |
| DT3219-QZ | Type 27 Flat   | 100mm       | 120       | 10        | 1      | 5035048077405 |
| DT3292-QZ | Type 27 Flat   | 115mm       | 36        | 10        | 1      | 5035048075241 |
| DT3293-QZ | Type 27 Flat   | 115mm       | 60        | 10        | 1      | 5035048075258 |
| DT3294-QZ | Type 27 Flat   | 115mm       | 80        | 10        | 1      | 5035048075265 |
| DT3295-QZ | Type 27 Flat   | 115mm       | 120       | 10        | 1      | 5035048075272 |
| DT3308-QZ | Type 27 Flat   | 125mm       | 36        | 10        | 1      | 5035048075289 |
| DT3309-QZ | Type 27 Flat   | 125mm       | 60        | 10        | 1      | 5035048075296 |
| DT3310-QZ | Type 27 Flat   | 125mm       | 80        | 10        | 1      | 5035048075302 |

'QUICK FIT' PLATENS

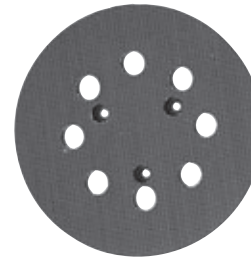

FEATURES

- Quick Fit replacement platens for DeWALT Random Orbit Sanders. Hardness grade - medium.

'QUICK FIT' PLATENS

| Cat. No.  | Description                  | Diameter mm | Pack Qty. | M.O.Q. | Barcode       |
|-----------|------------------------------|-------------|-----------|--------|---------------|
| DT3600-QZ | Quick Fit Platen             | 125         | 1         | 1      | 5035048059265 |
| DT3601-QZ | Quick Fit Platen             | 150         | 1         | 1      | 5035048059272 |
| DE2639-XJ | 150MM 6 & 8 HOLE BACKING PAD | 150         | 1         | 1      | 5035048136553 |

BACKING PADS & BONNETS



APPLICATIONS

- For use with angle grinder fibre discs and polishing bonnets.

FEATURES

- Thermoplastic backing pad supplied with flange locking nut.

BACKING PADS & BONNETS

| Cat. No.  | Diameter mm | Max Speed | Bore Size mm | Pack Qty. | M.O.Q. | Barcode       |
|-----------|-------------|-----------|--------------|-----------|--------|---------------|
| DT3610-QZ | 115         | 13000 rpm | M 14         | 1         | 1      | 5035048059289 |
| DT3611-QZ | 125         | 15000 rpm | M 14         | 1         | 1      | 5035048059296 |
| DT3612-QZ | 178         | 8500 rpm  | M 14         | 1         | 1      | 5035048059302 |

ANGLE GRINDER POLISHING BONNETS



APPLICATIONS

- High Speed polishing on a wide variety of surfaces (e.g.) unpainted metals and stone.

FEATURES

- Lambswool pile polishing bonnets.

ANGLE GRINDER POLISHING BONNETS

| Cat. No.  | Diameter mm | Pack Qty. | M.O.Q. | Barcode       |
|-----------|-------------|-----------|--------|---------------|
| DT3620-QZ | 115         | 1         | 1      | 5035048059319 |
| DT3621-QZ | 125         | 1         | 1      | 5035048059326 |
| DT3622-QZ | 178         | 1         | 1      | 5035048059333 |
| DT3557-QZ | 125         | 1         | 1      | 5035048083031 |
| DT3558-QZ | 150         | 1         | 1      | 5035048083048 |

POLISHING FOAMS

| Cat. No.  | Diameter mm | Pack Qty. | M.O.Q. | Barcode       |
|-----------|-------------|-----------|--------|---------------|
| DT3555-QZ | 115         | 1         | 1      | 5035048083017 |
| DT3558-QZ | 150         | 1         | 1      | 5035048083048 |

CLEANING FLEECES

| Cat. No.  | Diameter mm | Pack Qty. | M.O.Q. | Barcode       |
|-----------|-------------|-----------|--------|---------------|
| DT3550-QZ | 115         | 1         | 1      | 5035048082980 |

**METAL CUTTING DISCS**



**APPLICATIONS**

- Cutting ferrous metals such as steel, iron, rebar and welds.

**FEATURES**

- Professional grade aluminium oxide.
- Premium resin bond.
- Reinforced fibre glass.

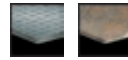

**FLAT**

| Cat. No.  | Diameter mm | Material | Thickness mm | Bore Size mm | Pack Qty. | M.O.Q. |
|-----------|-------------|----------|--------------|--------------|-----------|--------|
| DT3403-QZ | 100         | A30TBF   | 2.5          | 16           | 1         | 25     |
| DT3405-QZ | 115         | A46TBF   | 1.6          | 22.2         | 1         | 25     |
| DT3400-QZ | 115         | A30TBF   | 2.5          | 22.2         | 1         | 25     |
| DT3409-QZ | 125         | A46TBF   | 1.6          | 22.2         | 1         | 25     |
| DT3410-QZ | 125         | A30TBF   | 2.5          | 22.2         | 1         | 25     |
| DT3415-QZ | 150         | A30TBF   | 2.5          | 22.2         | 1         | 25     |
| DT3420-QZ | 180         | A30TBF   | 3            | 22.2         | 1         | 25     |
| DT3430-QZ | 230         | A30TBF   | 3            | 22.2         | 1         | 25     |

**DEPRESSED CENTRE**

| Cat. No.  | Diameter mm | Material | Thickness mm | Bore Size mm | Pack Qty. | M.O.Q. |
|-----------|-------------|----------|--------------|--------------|-----------|--------|
| DX7907-AE | 100         | A24R7BF  | 3.0          | 22.2         | 25        | 25     |
| DX7927-AE | 115         | A24R7BF  | 3.0          | 22.2         | 25        | 25     |
| DX7947-AE | 125         | A24R7BF  | 3.0          | 22.2         | 25        | 25     |
| DX7967-AE | 180         | A24R7BF  | 3.0          | 22.2         | 25        | 25     |
| DX7987-AE | 230         | A24R7BF  | 3.0          | 22.2         | 25        | 25     |

**METAL GRINDING DISCS**



**APPLICATIONS**

- For general metal grinding applications on ferrous and non-ferrous metals, including weld and surface preparation.

**FEATURES**

- Professional grade aluminium oxide.
- Reinforced fibre glass.
- Premium resin bond.

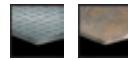

**DEPRESSED CENTRE**

| Cat. No.  | Diameter mm | Material | Thickness mm | Bore Size mm | Pack Qty. | M.O.Q. |
|-----------|-------------|----------|--------------|--------------|-----------|--------|
| DX7901-AE | 100         | A30R7BF  | 6.0          | 16.0         | 10        | 10     |
| DX7921-AE | 115         | A30R7BF  | 6.0          | 22.2         | 10        | 10     |
| DX7941-AE | 125         | A30R7BF  | 6.0          | 22.2         | 10        | 10     |
| DX7961-AE | 180         | A30R7BF  | 6.0          | 22.2         | 10        | 10     |
| DX7981-AE | 230         | A30R7BF  | 6.0          | 22.2         | 10        | 10     |

**CHOP SAW WHEEL**



**APPLICATIONS**

- Cutting ferrous metals such as steel, iron, rebar and welds.

**FEATURES**

- Professional grade aluminium oxide.
- Premium resin bond.
- Reinforced fibre glass.



**FOR METAL**

| Cat. No.  | Diameter mm | Material | Thickness mm | Bore Size mm | Pack Qty. | M.O.Q. |
|-----------|-------------|----------|--------------|--------------|-----------|--------|
| DX7701-AE | 300         | AS36RBF  | 2.8          | 25.4         | 10        | 10     |
| DX7711-AE | 350         | AS36RBF  | 3.0          | 25.4         | 10        | 10     |
| DX7721-AE | 350         | AS36RBF  | 3.2          | 25.4         | 10        | 10     |

**FOR STONE**

| Cat. No.  | Diameter mm | Material | Thickness mm | Bore Size mm | Pack Qty. | M.O.Q. |
|-----------|-------------|----------|--------------|--------------|-----------|--------|
| DX7702-AE | 300         | CS36RBF  | 3.5          | 25.4         | 10        | 10     |
| DX7712-AE | 350         | CS36RBF  | 3.5          | 25.4         | 10        | 10     |



**STAINLESS STEEL AND THIN METAL CUTTING DISCS**



**APPLICATIONS**

- For cutting all types of steel.

**FEATURES**

- Professional grade aluminium oxide formulation for high durability, aggressive cutting action and long life.

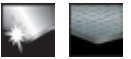

**FLAT**

| Cat. No.   | Diameter mm | Material    | Thickness mm | Bore Size mm | Pack Qty. | M.O.Q. |
|------------|-------------|-------------|--------------|--------------|-----------|--------|
| DT3440-QZ  | 100         | A60TBF      | 1.0          | 16.0         | 1         | 25     |
| DT3442-QZ  | 115         | A60TBF      | 1.0          | 22.2         | 1         | 25     |
| DT3445-QZ  | 125         | A60TBF      | 1.0          | 22.2         | 1         | 25     |
| DT3443-QZ* | 115         | A/ WA30T BF | 2.5          | 22.2         | 1         | 25     |
| DT3446-QZ* | 125         | A/ WA30T BF | 2.5          | 22.2         | 1         | 25     |
| DT3447-QZ* | 180         | A/ WA30T BF | 2.8          | 22.2         | 1         | 25     |
| DT3449-QZ* | 230         | A/ WA30T BF | 2.8          | 22.2         | 1         | 25     |

\*Special Stainless Steel cutting only

**DEPRESSED CENTRE**

| Cat. No.   | Diameter mm | Material       | Thickness mm | Bore Size mm | Pack Qty. | M.O.Q. |
|------------|-------------|----------------|--------------|--------------|-----------|--------|
| DX7907S-AE | 100         | AS24R7BF Inox. | 3.0          | 16.0         | 25        | 25     |
| DX7927S-AE | 115         | AS24R7BF Inox. | 3.0          | 16.0         | 25        | 25     |
| DX7967S-AE | 180         | AS24R7BF Inox. | 3.0          | 16.0         | 25        | 25     |
| DX7987S-AE | 230         | AS24R7BF Inox. | 3.0          | 16.0         | 25        | 25     |

**STAINLESS STEEL GRINDING DISCS**



**APPLICATIONS**

- For cutting all types of steel.

**FEATURES**

- Professional grade aluminium oxide formulation for high durability, aggressive cutting action and long life.

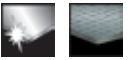

**DEPRESSED CENTRE**

| Cat. No.   | Diameter mm | Material       | Thickness mm | Bore Size mm | Pack Qty. | M.O.Q. |
|------------|-------------|----------------|--------------|--------------|-----------|--------|
| DX7901S-AE | 100         | AS24R7BF Inox. | 6.0          | 16.0         | 25        | 25     |
| DX7921S-AE | 115         | AS24R7BF Inox. | 6.0          | 22.2         | 25        | 25     |
| DX7961S-AE | 180         | AS24R7BF Inox. | 6.0          | 22.2         | 25        | 25     |
| DX7981S-AE | 230         | AS24R7BF Inox. | 6.0          | 22.2         | 25        | 25     |

**ALUMINIUM CUTTING DISCS**



**APPLICATIONS**

- Fast cutting and long life in aluminium.

**FEATURES**

- Professional grade aluminium oxide and silicone carbide.
- Premium resin bond.
- Reinforced fibre glass.



**FLAT**

| Cat. No.   | Diameter mm | Material | Thickness mm | Bore Size mm | Pack Qty. | M.O.Q. |
|------------|-------------|----------|--------------|--------------|-----------|--------|
| DT3453-QZ  | 115         | AC46TBF  | 1.6          | 22.2         | 1         | 25     |
| DT3454-QZ  | 125         | AC46TBF  | 1.6          | 22.2         | 1         | 25     |
| DX7907A-AE | 100         |          | 3            | 16.0         | 25        | 1      |
| DX7927A-AE | 115         |          | 3            | 22.2         | 25        | 1      |
| DX7967A-AE | 180         |          | 3.2          | 22.2         | 25        | 1      |
| DX7987A-AE | 230         |          | 3.2          | 22.2         | 25        | 1      |

**ALUMINIUM GRINDING DISCS**



**FEATURES**

- Professional grade aluminium oxide and silicone carbide.
- Premium resin bond.
- Reinforced fibre glass.



**FLAT**

| Cat. No.   | Diameter mm | Material | Thickness mm | Bore Size mm | Pack Qty. | M.O.Q. |
|------------|-------------|----------|--------------|--------------|-----------|--------|
| DX7901A-AE | 100         |          | 7            | 16.0         | 10        | 1      |
| DX7921A-AE | 115         |          | 7            | 22.2         | 10        | 1      |
| DX7961A-AE | 180         |          | 7            | 22.2         | 10        | 1      |
| DX7981A-AE | 230         |          | 7            | 22.2         | 10        | 1      |



STONE CUTTING DISCS



APPLICATIONS

- For cutting general masonry products including concrete, stone and aggregate.

FEATURES

- Professional grade silicon carbide.
- Premium resin bond.
- Fibre glass reinforcements.



FLAT

| Cat. No.  | Diameter mm | Material | Thickness mm | Bore Size mm | Pack Qty. | M.O.Q. |
|-----------|-------------|----------|--------------|--------------|-----------|--------|
| DT3404-QZ | 100         | C30TBF   | 2.5          | 16.0         | 1         | 25     |
| DT3401-QZ | 115         | C30TBF   | 2.5          | 22.2         | 1         | 25     |
| DT3411-QZ | 125         | C30TBF   | 2.5          | 22.2         | 1         | 25     |
| DT3417-QZ | 150         | C30TBF   | 2.5          | 22.2         | 1         | 25     |
| DT3421-QZ | 180         | C30TBF   | 3            | 22.2         | 1         | 25     |
| DT3431-QZ | 230         | C30TBF   | 3            | 22.2         | 1         | 25     |

DEPRESSED CENTRE

| Cat. No.  | Diameter mm | Material | Thickness mm | Bore Size mm | Pack Qty. | M.O.Q. |
|-----------|-------------|----------|--------------|--------------|-----------|--------|
| DX7908-AE | 100         | C24R7BF  | 3.0          | 16.0         | 25        | 25     |
| DX7928-AE | 115         | C24R7BF  | 3.0          | 22.2         | 25        | 25     |
| DX7948-AE | 125         | C24R7BF  | 3.0          | 22.2         | 25        | 25     |
| DX7968-AE | 180         | C24R7BF  | 3.0          | 22.2         | 25        | 25     |
| DX7988-AE | 230         | C24R7BF  | 3.0          | 22.2         | 25        | 25     |

STONE GRINDING DISCS



APPLICATIONS

- For cutting general masonry products including concrete, stone and aggregate.

FEATURES

- Professional grade silicon carbide.
- Premium resin bond.
- Fibre glass reinforcements.



DEPRESSED CENTRE

| Cat. No.  | Diameter mm | Material | Thickness mm | Bore Size mm | Pack Qty. | M.O.Q. |
|-----------|-------------|----------|--------------|--------------|-----------|--------|
| DT3461-QZ | 115         | C24TBF   | 7.0          | 22.2         | 1         | 25     |
| DT3462-QZ | 125         | C24TBF   | 7.0          | 22.2         | 1         | 25     |
| DT3463-QZ | 180         | C24TBF   | 7.0          | 22.2         | 1         | 25     |
| DT3464-QZ | 230         | C24TBF   | 7.0          | 22.2         | 1         | 25     |

WIRE BRUSHES

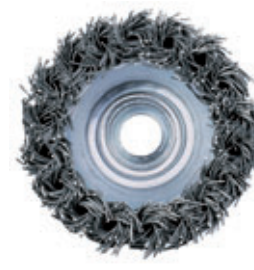

APPLICATIONS

- Aggressive twist knot wire wheel and cup brushes for heavy duty cleaning work, derusting and deburring
- Crimped wire wheel and cup brushes for medium duty cleaning
- Wire wheel and cup brushes for multi purpose cleaning applications in hard to reach areas

FEATURES

- Highly specified wire grades for optimum material removal
- High wire content for extra brush durability

WIRE WHEEL BRUSHES FOR DRILLS For: Cleaning Work eg Paint, Rust, Scale, Burr and Rust Removal

| Cat. No.  | Diameter mm | Wire Length mm | Bore Size mm | Pack Qty. | M.O.Q. | Barcode       |
|-----------|-------------|----------------|--------------|-----------|--------|---------------|
| DT3496-QZ | 40          | 8              | 6            | 1         | 1      | 5035048079423 |
| DT3494-QZ | 50          | 8              | 6            | 1         | 1      | 5035048079430 |
| DT3408-QZ | 60          | 10             | 6            | 1         | 1      | 5035048079447 |
| DT3418-QZ | 75          | 10             | 6            | 1         | 1      | 5035048078454 |
| DT3419-QZ | 100         | 10             | 6            | 1         | 1      | 5035048079461 |
| DT3425-QZ | 75          | 10             | 6            | 1         | 1      | 5035048079478 |
| DT3426-QZ | 75          | 10             | 6            | 1         | 1      | 5035048079485 |

WIRE CUP BRUSHES FOR DRILLS For: Medium duty work on surfaces eg paint removal, de-rusting, cleaning, deburring, descaling

| Cat. No.  | Diameter mm | Wire Length mm | Bore Size mm | Pack Qty. | M.O.Q. | Barcode       |
|-----------|-------------|----------------|--------------|-----------|--------|---------------|
| DT3427-QZ | 17          | 25             | 6            | 1         | 1      | 5035048079492 |
| DT3428-QZ | 25          | 25             | 6            | 1         | 1      | 5035048079508 |
| DT3429-QZ | 30          | 30             | 6            | 1         | 1      | 5035048079515 |
| DT3435-QZ | 40          | 17             | 6            | 1         | 1      | 5035048079522 |
| DT3436-QZ | 50          | 16             | 6            | 1         | 1      | 5035048079539 |
| DT3437-QZ | 60          | 18             | 6            | 1         | 1      | 5035048079546 |
| DT3439-QZ | 75          | 19             | 6            | 1         | 1      | 5035048079560 |
| DT3441-QZ | 50          | 16             | 6            | 1         | 1      | 5035048079577 |
| DT3495-QZ | 50          | 16             | 6            | 1         | 1      | 5035048079584 |

CRIMPED WIRE WHEEL BRUSHES FOR BENCH GRINDERS For: Light and medium cleaning jobs

| Cat. No.  | Diameter mm | Wire Length mm | Bore Size mm | Pack Qty. | M.O.Q. | Barcode       |
|-----------|-------------|----------------|--------------|-----------|--------|---------------|
| DT3451-QZ | 100         | 20             | 20           | 1         | 1      | 5035048079607 |
| DT3455-QZ | 115         | 20             | 20           | 1         | 1      | 5035048079621 |
| DT3448-QZ | 125         | 20             | 20           | 1         | 1      | 5035048079591 |
| DT3456-QZ | 150         | 25             | 32           | 1         | 1      | 5035048079638 |
| DT3459-QZ | 200         | 25             | 32           | 1         | 1      | 5035048079645 |

TWIST KNOT WIRE WHEEL BRUSHES FOR ANGLE GRINDERS For: Heavy duty cleaning work eg deburring, paint stripping, rust removal

| Cat. No.  | Diameter mm | Wire Length mm | Bore Size mm | Pack Qty. | M.O.Q. | Barcode       |
|-----------|-------------|----------------|--------------|-----------|--------|---------------|
| DT3460-QZ | 100         | 22             | 16           | 1         | 1      | 5035048079652 |
| DT3466-QZ | 115         | 22             | 22.2         | 1         | 1      | 5035048079676 |
| DT3502-QZ | 115         | 22             | 22.2         | 1         | 1      | 5011402375790 |
| DT3452-QZ | 150         | 22             | 22.2         | 1         | 1      | 5035048079614 |
| DT3470-QZ | 180         | 40             | 22.2         | 1         | 1      | 5035048079683 |

CRIMPED WIRE CUP BRUSHES FOR ANGLE GRINDERS For: Medium duty work on surfaces eg paint removal, de-rusting, cleaning, deburring

| Cat. No.  | Diameter mm | Wire Length mm | Bore Size mm | Pack Qty. | M.O.Q. | Barcode       |
|-----------|-------------|----------------|--------------|-----------|--------|---------------|
| DT3475-QZ | 65          | 19             | M10          | 1         | 1      | 5035048079690 |
| DT3480-QZ | 65          | 19             | M14          | 1         | 1      | 5035048079706 |
| DT3488-QZ | 75          | 23             | M14          | 1         | 1      | 5035048079713 |
| DT3489-QZ | 100         | 26             | M14          | 1         | 1      | 5035048079720 |
| DT3490-QZ | 100         | 26             | 5/8"         | 1         | 1      | 5035048079737 |
| DT3465-QZ | 125         | 26             | M14          | 1         | 1      | 5035048079669 |

TWIST KNOT WIRE CUP BRUSHES FOR ANGLE GRINDERS For: Heavy duty cleaning work

| Cat. No.  | Diameter mm | Wire Length mm | Bore Size mm | Pack Qty. | M.O.Q. | Barcode       |
|-----------|-------------|----------------|--------------|-----------|--------|---------------|
| DT3491-QZ | 60          | 18             | M10          | 1         | 1      | 5035048079744 |
| DT3500-QZ | 65          | 18             | M14          | 1         | 1      | 5011402375776 |
| DT3492-QZ | 75          | 22             | M14          | 1         | 1      | 5035048079751 |
| DT3501-QZ | 100         | 24             | M14          | 1         | 1      | 5011402375783 |
| DT3493-QZ | 100         | 24             | 5/8"         | 1         | 1      | 5035048079768 |

SELECT THE BLADE FOR THE MATERIAL



| Professional High Performance   |                                 |                           |      |         |                                 | Professional Sintered                |      |  |
|---------------------------------|---------------------------------|---------------------------|------|---------|---------------------------------|--------------------------------------|------|--|
| Building materials/<br>Concrete | Abrasive Materials/<br>Concrete | Hard Concrete/<br>Granite | Tile | Asphalt | Building materials/<br>Concrete | Turbo-Building<br>Materials/Concrete | Tile |  |
| 1                               | 2                               | 3                         | 4    | 6       |                                 |                                      |      |  |

|  |   |   |   |   |   |   |   |
|--|---|---|---|---|---|---|---|
| VERY ABRASIVE AND NOT COMPACT                              |   |   |   |   |   |   |   |
| ASPHALT  |   |   |   | ● |   |   |   |
| GREEN CONCRETE   |   |   |   | ● |   |   |   |
| LIGHT EXPANDED CLAY BLOCK (Argex, Syporex, Poroton)        | ○ | ● |   | ● |   |   |   |
| SILICA BASED ABRASIVE REFRACTORY (Brick)                   | ○ | ● |   | ● |   |   |   |
| BREEZE BLOCK   | ● | ● |   | ● |   |   |   |
| MEDIUM-ABRASIVE AND COMPACT                                |   |   |   |   |   |   |   |
| MARBLE CEMENT BLOCK (Granito, Terrazo)                     | ● | ● |   | ○ | ○ | ○ | ○ |
| FIBROUS CONCRETE (Eternit roof tile)                       | ● | ● |   | ○ | ○ | ○ | ○ |
| CELLULAR CONCRETE  | ● | ● |   | ○ | ○ | ○ | ○ |
| FIRED CLAY (Brick, roof tile)                              | ● | ● |   | ○ | ○ | ○ | ○ |
| GYPSUM PLASTER   | ● | ● |   | ○ | ○ | ○ | ○ |
| NATURAL SOFT STONES (Limestone, Sandstone)                 | ● | ● |   | ○ | ○ | ○ | ○ |
| SOFT REFRACTORY (Hand made bricks, abrasive concrete)      | ● | ● | ○ | ○ | ○ | ○ | ○ |
| CONCRETE ROOF TILE   | ● | ● | ○ | ○ | ○ | ○ | ○ |
| KALKSANDSTEIN (KSS)  | ● | ● | ○ |   | ● | ● |   |
| ABRASIVE AND VERY COMPACT                                  |   |   |   |   |   |   |   |
| SOFT AGGREGATES CONCRETE (Industrial floors)               | ● | ● | ○ |   | ● | ● |   |
| MEDIUM-HARD SANDSTONE                                      | ● | ● | ○ |   | ● | ● |   |
| ABRASIVE MARBLE (Crystalline)                              | ● | ● | ○ |   | ● | ● |   |
| MEDIUM-HARD REFRACTORY (Facing bricks, Limestone concrete) | ● | ● | ○ |   | ● | ● |   |
| FIRED CLAY, EARTHENWARE PIPE                               | ● | ● | ○ |   | ● | ● |   |
| MEDIUM-HARD AND COMPACT                                    |   |   |   |   |   |   |   |
| NATURAL SLATE, SCHIST                                      | ● | ○ | ○ |   | ○ | ○ |   |
| CONCRETE (Kerb, Paving block, Driveway blocks)             | ● | ● | ○ |   | ○ | ○ |   |
| LIGHT REINFORCED CONCRETE                                  | ● | ● |   |   | ○ | ○ |   |
| MEDIUM-HARD AGGREGATES CONCRETE (Industrial floors)        | ● | ● | ● |   | ○ | ○ |   |
| CURED CONCRETE, MEDIUM-HARD AGGREGATES                     | ● | ● | ● |   | ○ | ○ |   |
| HARD NATURAL SANDSTONE                                     | ● | ● | ● |   | ○ | ○ |   |
| HARD AND COMPACT   |   |   |   |   |   |   |   |
| HARD MARBLE  | ○ | ● | ● |   | ○ | ○ |   |
| REINFORCED CONCRETE (Lintels)                              | ○ | ● | ● |   | ○ | ○ |   |
| CURED CONCRETE, HARD AGGREGATES, FLINT                     | ○ | ● | ● |   |   |   |   |
| FACING BRICK   | ○ | ● | ● |   |   |   |   |
| QUARTZITE  |   | ● | ● |   |   |   |   |
| HARD REFRACTORY (Hard bricks, Medium concrete)             |   | ● | ● |   |   |   |   |
| SOFT GRANITE (Black)                                       |   | ● | ● |   |   |   |   |
| VERY HARD  |   |   |   |   |   |   |   |
| LIGHT REINFORCED CONCRETE, FLINT AGGREGATES                |   | ● | ● |   |   |   |   |
| COLOURED GRANITE   |   | ● | ● |   |   |   |   |
| SILICON CARBIDE REFRACTORIES (Bricks)                      |   | ● | ● |   |   |   |   |
| OTHERS   |   |   |   |   |   |   |   |
| SOFT TILE (Terracotta, Ceramic)                            |   |   |   | ○ |   | ○ | ● |
| HARD TILE (Gräs)   |   |   |   | ● |   |   |   |
| STONEWARE (Porcelain tiles)                                |   |   |   | ● |   |   |   |
| MORTAR (Joints)  |   |   |   |   |   |   |   |

● Recommended Material ○ Suitable Material

LASER BLADES



APPLICATIONS

- For use in standard construction materials including concrete, brick, tiles and paving slabs.

FEATURES

- The best choice of diamond blade for fast, aggressive cuts in most standard construction materials.
- Segments laser welded to the core for use in tougher applications.
- High quality, low carbon steel core reduces core distortion at high temperatures, giving better cutting performance and longer life.

LASER SEGMENTED BLADES/CONCRETE

| Cat. No. | Diameter mm | Bore Size mm | Pack Qty. | M.O.Q. |
|----------|-------------|--------------|-----------|--------|
| DX3701   | 100         | 20/16        | 1         | 1      |
| DX3721   | 115         | 22.2         | 1         | 1      |
| DX3761   | 180         | 22.2         | 1         | 1      |
| DX3781   | 230         | 22.2         | 1         | 1      |

APPLICATIONS

- Especially designed for abrasive block cutting applications.

FEATURES

- High performance also in solid concrete.
- Removal of dust is faster which improves safety in operation.



EXTREME BLADE FOR ABRASIVE BLOCK CUTTING

| Cat. No. | Diameter mm | Bore Size mm | RPM   | Pack Qty. | M.O.Q. |
|----------|-------------|--------------|-------|-----------|--------|
| DX4701   | 100         | 20/16        | 15000 | 1         | 1      |
| DX4721   | 115         | 22.2/20      | 13300 | 1         | 1      |
| DX4761   | 180         | 22.2         | 8500  | 1         | 1      |
| DX4781   | 230         | 22.2         | 6500  | 1         | 1      |

APPLICATIONS

- For marble/granite cutting.

FEATURES

- Laser welded segments.
- Designed for Industrial applications.
- Suitable for dry applications.



LASER SEGMENTED BLADES/MARBLE & GRANITE

| Cat. No. | Diameter mm | Bore Size mm | Pack Qty. | M.O.Q. |
|----------|-------------|--------------|-----------|--------|
| DX3801   | 100         | 20/16        | 1         | 1      |
| DX3821   | 115         | 22.2         | 1         | 1      |
| DX3861   | 180         | 22.2         | 1         | 1      |
| DX3881   | 230         | 22.2         | 1         | 1      |

APPLICATIONS

- Cool clean cutting of masonry construction materials particularly suitable for marble, granite and natural stone.

FEATURES

- Sintered diamond wheel for dry cutting general masonry materials.
- Turbo rim design provides cooler, cleaner cutting of harder materials.



EVOLUTION HYBRID RIM BLADES/MARBLE & GRANITE

| Cat. No. | Diameter mm | Bore Size mm | Pack Qty. | M.O.Q. |
|----------|-------------|--------------|-----------|--------|
| DX3901   | 100         | 20/16        | 1         | 1      |
| DX3921   | 115         | 22.2         | 1         | 1      |
| DX3961   | 180         | 22.2         | 1         | 1      |
| DX3981   | 230         | 22.2         | 1         | 1      |

DIAMOND BLADES



APPLICATIONS

- For porcelain tiles, floor and wall tiles, slate, concrete tiles, bricks, terracotta etc.
- Not recommended for use on wet tile slabs.

FEATURES

- Diamond blade containing a high concentration of top quality diamonds with excellent cutting performance in extremely hard materials.
- High quality, low carbon steel core reduces core distortion at high temperatures, giving better cutting performance and longer life.

DIAMOND BLADES FOR TILE CUTTING

| Cat. No. | Diameter mm | Bore Size mm | Pack Qty. | M.O.Q. |
|----------|-------------|--------------|-----------|--------|
| DX3101   | 100         | 20.0/16.0    | 1         | 1      |
| DX3121   | 115         | 22.2         | 1         | 1      |



DIAMOND DISCS

FEATURES

- Laser welded segmented.
- Designed for industrial use.
- Longer life and sharp cutting.
- For wet application.



MARBLE CUTTING BLADES

| Cat. No. | Diameter mm | Segment Length mm | Segment Thickness mm | Segment Height mm | Pack Qty. | M.O.Q. |
|----------|-------------|-------------------|----------------------|-------------------|-----------|--------|
| DX3012   | 306         | 48                | 3.0                  | 10                | 1         | 1      |
| DX3014   | 356         | 48                | 3.0                  | 10                | 1         | 1      |
| DX3016   | 406         | 48                | 3.2                  | 10                | 1         | 1      |
| DX3018   | 456         | 40                | 3.6                  | 10                | 1         | 1      |

GRANITE CUTTING BLADES

| Cat. No. | Diameter mm | Segment Length mm | Segment Thickness mm | Segment Height mm | Pack Qty. | M.O.Q. |
|----------|-------------|-------------------|----------------------|-------------------|-----------|--------|
| DX3212   | 306         | 40                | 3.0                  | 10                | 1         | 1      |
| DX3214   | 356         | 40                | 3.0                  | 10                | 1         | 1      |
| DX3216   | 406         | 40                | 3.2                  | 10                | 1         | 1      |
| DX3218   | 456         | 40                | 3.6                  | 10                | 1         | 1      |

CONCRETE CUTTING BLADES

| Cat. No. | Diameter mm | Segment Length mm | Segment Thickness mm | Segment Height mm | Pack Qty. | M.O.Q. |
|----------|-------------|-------------------|----------------------|-------------------|-----------|--------|
| DX3414   | 350         | 40                | 2.8                  | 7.0               | 1         | 1      |
| DX3416   | 400         | 40                | 3.2                  | 7.0               | 1         | 1      |
| DX3418   | 450         | 40                | 3.6                  | 7.0               | 1         | 1      |
| DX3424   | 600         | 40                | 4.0                  | 7.0               | 1         | 1      |

ASPHALT CUTTING BLADES

| Cat. No. | Diameter mm | Segment Length mm | Segment Thickness mm | Segment Height mm | Pack Qty. | M.O.Q. |
|----------|-------------|-------------------|----------------------|-------------------|-----------|--------|
| DX3512   | 306         | 40                | 3.0                  | 5.5+1.5           | 1         | 1      |
| DX3514   | 354         | 40                | 3.0                  | 5.5+1.5           | 1         | 1      |
| DX3516   | 406         | 40                | 3.0                  | 5.5+1.5           | 1         | 1      |
| DX3518   | 457         | 40                | 3.6                  | 5.5+1.5           | 1         | 1      |
| DX3520   | 508         | 40                | 3.6                  | 5.5+1.5           | 1         | 1      |

UNIVERSAL MATERIAL

| Cat. No. | Diameter mm | Bore Size mm | Segment Width mm | Segment Height mm | Pack Qty. | M.O.Q. |
|----------|-------------|--------------|------------------|-------------------|-----------|--------|
| DX3501*  | 100         | 20           | 1.6              | 10                | 5         | 1      |
| DX3521*  | 115         | 22.2         | 1.6              | 10                | 5         | 1      |
| DX3561*  | 180         | 22.2         | 2.3              | 10                | 5         | 1      |
| DX3581*  | 230         | 22.2         | 2.3              | 10                | 5         | 1      |
| DX2501   | 100         | 20           | 1.6              | 7                 | 5         | 1      |
| DX2521   | 115         | 22.2         | 1.6              | 7                 | 5         | 1      |
| DX2561   | 180         | 22.2         | 2.3              | 7                 | 5         | 1      |
| DX2581   | 230         | 22.2         | 2.3              | 7                 | 5         | 1      |

\*Premium Turbo



WET DIAMOND TILE SAW

APPLICATIONS

- Fine finish cutting tiles, ceramics etc.

FEATURES

- Continuous rim design for fine finish in hard materials.
- Sintered dry cutting wheel with 25.4mm bore.
- Music slots for hard materials eg. stone and granite (DT3734XJ).

WET DIAMOND TILE SAW

| Cat. No.  | Diameter mm | Bore Size mm | Segment Height mm | Segment Width mm | Pack Qty. | M.O.Q. | Barcode       |
|-----------|-------------|--------------|-------------------|------------------|-----------|--------|---------------|
| DT3733-XJ | 250         | 25.4         | 5                 | 1.6              | 1         | 1      | 5035048012413 |
| DT3734-XJ | 250         | 25.4         | 8                 | 1.6              | 1         | 1      | 5035048012420 |



WET & DRY TILE SAW



APPLICATIONS

- For manual wet and dry cutting of tiles.

FEATURES

- Continuous rim design for fine finish in all tile materials
- DT3715-QZ designed for extra fine finish in porcelain, marble and granite tiles.

WET & DRY TILE SAW

| Cat. No.  | Diameter mm | Bore Size mm | Segment Height mm | Segment Width mm | Pack Qty. | M.O.Q. | Barcode       |
|-----------|-------------|--------------|-------------------|------------------|-----------|--------|---------------|
| DT3714-QZ | 110         | 20           | 5                 | 1.6              | 1         | 1      | 5035048083109 |
| DT3715-QZ | 110         | 20           | 8                 | 1.6              | 1         | 1      | 5035048083116 |



DRY DIAMOND CORE DRILLS

APPLICATIONS

- Standard 1/2" BSP female fitment to allow usage with DeWalt and other diamond drill brands (use in conjunction with adaptor for machines with different threads).
- For dry drilling clean large diameter holes in masonry and stone.

FEATURES

- Optimised diamond segment design for high speed drilling and long life in a wide range of building materials.
- Laser welding to prevent segment loss when dry drilling
- Solid core body for optimum dust extraction performance.



FITMENT 1/2" BSP (FEMALE) UNIVERSAL

| Cat. No.  | Diameter mm | Length mm | Number of Segments | Pack Qty. | M.O.Q. | Barcode       |
|-----------|-------------|-----------|--------------------|-----------|--------|---------------|
| DT3876-QZ | 28          | 300       | 1                  | 1         | 1      | 5035048070918 |
| DT3877-QZ | 32          | 300       | 1                  | 1         | 1      | 5035048070925 |
| DT3885-QZ | 38          | 150       | 3                  | 1         | 1      | 5035048070932 |
| DT3886-QZ | 48          | 150       | 4                  | 1         | 1      | 5035048070949 |
| DT3887-QZ | 52          | 150       | 3                  | 1         | 1      | 5035048070956 |
| DT3888-QZ | 60          | 150       | 3                  | 1         | 1      | 5035048070963 |
| DT3889-QZ | 65          | 150       | 3                  | 1         | 1      | 5035048070970 |
| DT3890-QZ | 72          | 150       | 4                  | 1         | 1      | 5035048070987 |
| DT3891-QZ | 78          | 150       | 4                  | 1         | 1      | 5035048070994 |
| DT3892-QZ | 82          | 150       | 4                  | 1         | 1      | 5035048071007 |
| DT3893-QZ | 91          | 150       | 4                  | 1         | 1      | 5035048071014 |
| DT3894-QZ | 107         | 150       | 4                  | 1         | 1      | 5035048071021 |
| DT3895-QZ | 117         | 150       | 5                  | 1         | 1      | 5035048071038 |
| DT3896-QZ | 127         | 150       | 5                  | 1         | 1      | 5035048071045 |
| DT3897-QZ | 132         | 150       | 5                  | 1         | 1      | 5035048071052 |
| DT3898-QZ | 152         | 150       | 6                  | 1         | 1      | 5035048071069 |

FITMENT 1 1/4" UNC (FEMALE) - LONG LIFE

| Cat. No. | Diameter mm | Length mm | Thread         | Pack Qty. | M.O.Q. |
|----------|-------------|-----------|----------------|-----------|--------|
| DT9708QZ | 52          | 500       | 1 1/4" UNC (F) | 1         | 10     |
| DT9709QZ | 57          | 500       | 1 1/4" UNC (F) | 1         | 10     |
| DT9731QZ | 60          | 500       | 1 1/4" UNC (F) | 1         | 10     |
| DT9732QZ | 65          | 500       | 1 1/4" UNC (F) | 1         | 10     |
| DT9733QZ | 72          | 500       | 1 1/4" UNC (F) | 1         | 10     |
| DT9734QZ | 78          | 500       | 1 1/4" UNC (F) | 1         | 10     |
| DT9756QZ | 82          | 500       | 1 1/4" UNC (F) | 1         | 10     |
| DT9757QZ | 87          | 500       | 1 1/4" UNC (F) | 1         | 10     |
| DT9758QZ | 91          | 500       | 1 1/4" UNC (F) | 1         | 10     |
| DT9759QZ | 102         | 500       | 1 1/4" UNC (F) | 1         | 10     |
| DT9782QZ | 107         | 500       | 1 1/4" UNC (F) | 1         | 10     |
| DT9783QZ | 112         | 500       | 1 1/4" UNC (F) | 1         | 10     |
| DT9784QZ | 122         | 500       | 1 1/4" UNC (F) | 1         | 10     |
| DT9785QZ | 127         | 500       | 1 1/4" UNC (F) | 1         | 10     |
| DT9786QZ | 132         | 500       | 1 1/4" UNC (F) | 1         | 10     |
| DT9787QZ | 142         | 500       | 1 1/4" UNC (F) | 1         | 10     |
| DT9788QZ | 152         | 500       | 1 1/4" UNC (F) | 1         | 10     |
| DT9789QZ | 162         | 500       | 1 1/4" UNC (F) | 1         | 10     |
| DT9790QZ | 172         | 500       | 1 1/4" UNC (F) | 1         | 10     |
| DT9791QZ | 178         | 500       | 1 1/4" UNC (F) | 1         | 10     |
| DT9792QZ | 187         | 500       | 1 1/4" UNC (F) | 1         | 10     |
| DT9793QZ | 200         | 500       | 1 1/4" UNC (F) | 1         | 10     |
| DT9794QZ | 212         | 500       | 1 1/4" UNC (F) | 1         | 10     |
| DT9795QZ | 225         | 500       | 1 1/4" UNC (F) | 1         | 10     |
| DT9796QZ | 250         | 500       | 1 1/4" UNC (F) | 1         | 10     |
| DT9797QZ | 300         | 500       | 1 1/4" UNC (F) | 1         | 10     |



FITMENT 1/2" BSP (MALE)

| Cat. No. | Diameter mm | Length mm | Thread       | Pack Qty. | M.O.Q. |
|----------|-------------|-----------|--------------|-----------|--------|
| DT9861QZ | 10          | 400       | 1/2" BSP (M) | 1         | 10     |
| DT9862QZ | 12          | 400       | 1/2" BSP (M) | 1         | 10     |
| DT9863QZ | 14          | 400       | 1/2" BSP (M) | 1         | 10     |
| DT9864QZ | 16          | 400       | 1/2" BSP (M) | 1         | 10     |
| DT9865QZ | 18          | 400       | 1/2" BSP (M) | 1         | 10     |
| DT9866QZ | 20          | 400       | 1/2" BSP (M) | 1         | 10     |
| DT9867QZ | 22          | 400       | 1/2" BSP (M) | 1         | 10     |
| DT9868QZ | 25          | 400       | 1/2" BSP (M) | 1         | 10     |
| DT9869QZ | 28          | 400       | 1/2" BSP (M) | 1         | 10     |
| DT9870QZ | 30          | 400       | 1/2" BSP (M) | 1         | 10     |
| DT9871QZ | 32          | 400       | 1/2" BSP (M) | 1         | 10     |
| DT9872QZ | 35          | 400       | 1/2" BSP (M) | 1         | 10     |
| DT9873QZ | 37          | 400       | 1/2" BSP (M) | 1         | 10     |
| DT9874QZ | 42          | 400       | 1/2" BSP (M) | 1         | 10     |
| DT9875QZ | 47          | 400       | 1/2" BSP (M) | 1         | 10     |
| DT9876QZ | 52          | 400       | 1/2" BSP (M) | 1         | 10     |



DOSENSENKER

APPLICATIONS

- User length of 62mm, M16 fitment.
- Used for electrical installations e.g wall sockets or boxes etc.

DOSENSENKER

| Cat. No.  | Diameter mm | Length mm | Thread | Number of Segments | Pack Qty. | M.O.Q. | Barcode       |
|-----------|-------------|-----------|--------|--------------------|-----------|--------|---------------|
| DT3865-QZ | 68          | 62        | M16F   | 3                  | 1         | 1      | 5035048071076 |
| DT3866-QZ | 82          | 62        | M16F   | 4                  | 1         | 1      | 5035048071083 |

ACCESSORIES FOR DOSENSENKER

| Cat. No.  | Thread Conversion from    | Thread Conversion to | Range | Pack Qty. | M.O.Q. | Barcode       |
|-----------|---------------------------|----------------------|-------|-----------|--------|---------------|
| DT3864-QZ | 1/2" BSP F                | M16M                 | Dry   | 1         | 1      | 5035048072349 |
| DT3868-QZ | 3 Jaw Chuck               | M16M                 | Dry   | 1         | 1      | 5035048072356 |
| DT3869-QZ | SDS Plus                  | M16M                 | Dry   | 1         | 1      | 5035048072363 |
| DT3873-QZ | 120mm A Taper pilot drill |                      | Dry   | 1         | 1      | 5035048066607 |

WET DIAMOND CORE BITS



APPLICATIONS

- Standard 1/2" BSP male fitment to allow usage with DeWALT and other diamond drill brands (use in conjunction with adaptor for machines with different threads).

FEATURES

- Optimised diamond segment design for high speed drilling and long life in a wide range of building materials.
- Laser welding to prevent segment loss when wet drilling.
- Available in 2 performance grades for fast cutting and long life in both standard and hard materials.



FITMENT 1/2" BSP (MALE) UNIVERSAL

| Cat. No.  | Diameter mm | Length mm | Number of Segments | Pack Qty. | M.O.Q. | Barcode       |
|-----------|-------------|-----------|--------------------|-----------|--------|---------------|
| DT9710-QZ | 25          | 350       | 1                  | 1         | 1      | 5035048071274 |
| DT9712-QZ | 30          | 350       | 1                  | 1         | 1      | 5035048071298 |
| DT9714-QZ | 37          | 350       | 4                  | 1         | 1      | 5035048071311 |
| DT9715-QZ | 40          | 350       | 4                  | 1         | 1      | 5035048071328 |
| DT9716-QZ | 45          | 350       | 5                  | 1         | 1      | 5035048071335 |
| DT9717-QZ | 52          | 350       | 5                  | 1         | 1      | 5035048071342 |
| DT9718-QZ | 60          | 350       | 6                  | 1         | 1      | 5035048071359 |
| DT9719-QZ | 65          | 350       | 7                  | 1         | 1      | 5035048071366 |
| DT9720-QZ | 72          | 350       | 7                  | 1         | 1      | 5035048071373 |
| DT9721-QZ | 78          | 350       | 8                  | 1         | 1      | 5035048071380 |
| DT9722-QZ | 82          | 350       | 8                  | 1         | 1      | 5035048071397 |
| DT9724-QZ | 102         | 350       | 9                  | 1         | 1      | 5035048071410 |
| DT9726-QZ | 112         | 350       | 10                 | 1         | 1      | 5035048071434 |
| DT9727-QZ | 122         | 350       | 11                 | 1         | 1      | 5035048071441 |
| DT9728-QZ | 127         | 350       | 11                 | 1         | 1      | 5035048071458 |
| DT9729-QZ | 132         | 350       | 12                 | 1         | 1      | 5035048071465 |
| DT9730-QZ | 152         | 350       | 13                 | 1         | 1      | 5035048071472 |

APPLICATIONS

- Standard 1/2" BSP male fitment to allow usage with DeWALT and other diamond drill brands (use in conjunction with adaptor for machines with different threads).

FEATURES

- Optimised diamond segment design for use with hard materials.
- Laser welding to prevent segment loss when wet drilling.



FITMENT 1/2" BSP (MALE) HARD MATERIALS

| Cat. No.  | Diameter mm | Length mm | Number of Segments | Pack Qty. | M.O.Q. | Barcode       |
|-----------|-------------|-----------|--------------------|-----------|--------|---------------|
| DT9735-QZ | 25          | 350       | 1                  | 1         | 1      | 5035048071489 |
| DT9736-QZ | 28          | 350       | 1                  | 1         | 1      | 5035048071496 |
| DT9737-QZ | 30          | 350       | 1                  | 1         | 1      | 5035048071502 |
| DT9738-QZ | 32          | 350       | 1                  | 1         | 1      | 5035048071519 |
| DT9740-QZ | 40          | 350       | 4                  | 1         | 1      | 5035048071533 |
| DT9742-QZ | 52          | 350       | 5                  | 1         | 1      | 5035048074557 |
| DT9743-QZ | 60          | 350       | 6                  | 1         | 1      | 5035048071564 |
| DT9744-QZ | 65          | 350       | 7                  | 1         | 1      | 5035048071571 |
| DT9746-QZ | 78          | 350       | 8                  | 1         | 1      | 5035048071595 |
| DT9747-QZ | 82          | 350       | 8                  | 1         | 1      | 5035048071601 |
| DT9748-QZ | 91          | 350       | 9                  | 1         | 1      | 5035048071618 |
| DT9749-QZ | 102         | 350       | 9                  | 1         | 1      | 5035048071625 |
| DT9751-QZ | 112         | 350       | 10                 | 1         | 1      | 5035048071649 |
| DT9752-QZ | 122         | 350       | 11                 | 1         | 1      | 5035048071656 |
| DT9753-QZ | 127         | 350       | 11                 | 1         | 1      | 5035048071663 |
| DT9754-QZ | 132         | 350       | 12                 | 1         | 1      | 5035048071670 |
| DT9755-QZ | 152         | 350       | 13                 | 1         | 1      | 5035048071687 |



WET DIAMOND CORE BITS



APPLICATIONS

- Standard 1 1/4" UNC female fitment to allow usage with DeWALT and other diamond drill brands (use in conjunction with adaptor for machines with different threads).

FEATURES

- Optimised diamond segment design for high speed drilling and long life in a wide range of building materials.
- Available in 2 performance grades for fast cutting and long life in both standard and hard materials.

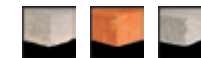

FITMENT 1 1/4" UNC (FEMALE) UNIVERSAL

| Cat. No.  | Diameter mm | Length mm | Number of Segments | Pack Qty. | M.O.Q. | Barcode       |
|-----------|-------------|-----------|--------------------|-----------|--------|---------------|
| DT9760-QZ | 52          | 400       | 5                  | 1         | 1      | 5035048071694 |
| DT9761-QZ | 60          | 400       | 6                  | 1         | 1      | 5035048071700 |
| DT9762-QZ | 65          | 400       | 7                  | 1         | 1      | 5035048071717 |
| DT9763-QZ | 72          | 400       | 7                  | 1         | 1      | 5035048071724 |
| DT9764-QZ | 78          | 400       | 8                  | 1         | 1      | 5035048071731 |
| DT9765-QZ | 82          | 400       | 8                  | 1         | 1      | 5035048071748 |
| DT9766-QZ | 91          | 400       | 9                  | 1         | 1      | 5035048071755 |
| DT9767-QZ | 102         | 400       | 9                  | 1         | 1      | 5035048071762 |
| DT9768-QZ | 107         | 400       | 10                 | 1         | 1      | 5035048071779 |
| DT9769-QZ | 112         | 400       | 10                 | 1         | 1      | 5035048071786 |
| DT9770-QZ | 122         | 400       | 11                 | 1         | 1      | 5035048071793 |
| DT9771-QZ | 127         | 400       | 11                 | 1         | 1      | 5035048071809 |
| DT9772-QZ | 132         | 400       | 12                 | 1         | 1      | 5035048071816 |
| DT9773-QZ | 152         | 400       | 13                 | 1         | 1      | 5035048071823 |
| DT9774-QZ | 162         | 400       | 13                 | 1         | 1      | 5035048071830 |
| DT9775-QZ | 178         | 400       | 14                 | 1         | 1      | 5035048071847 |
| DT9776-QZ | 187         | 400       | 15                 | 1         | 1      | 5035048071854 |
| DT9777-QZ | 200         | 400       | 16                 | 1         | 1      | 5035048071861 |
| DT9778-QZ | 212         | 400       | 16                 | 1         | 1      | 5035048071878 |
| DT9779-QZ | 225         | 400       | 17                 | 1         | 1      | 5035048071885 |
| DT9780-QZ | 250         | 400       | 17                 | 1         | 1      | 5035048071892 |
| DT9781-QZ | 300         | 400       | 22                 | 1         | 1      | 5035048071908 |

ACCESSORIES

ADAPTERS

| Cat. No.  | Thread Conversion from            | Thread Conversion to | Applications | Pack Qty. | M.O.Q. | Barcode       |
|-----------|-----------------------------------|----------------------|--------------|-----------|--------|---------------|
| DT3800-QZ | 1/2" BSP M                        | 1 1/4" UNC M         | Wet          | 1         | 1      | 5035048071106 |
| DT3801-QZ | Hilti DCM1/DO80                   | 1/2" BSP F           | Wet          | 1         | 1      | 5035048071113 |
| DT3803-QZ | Hilti DCM1.5, DD1160, DCM2, DD250 | 1 1/4" UNC M         | Wet          | 1         | 1      | 5035048071120 |
| DT3809-QZ | 5/8" x 16UNF                      | 1/2" BSP M           | Dry          | 1         | 1      | 5035048071137 |
| DT3812-QZ | M18                               | 1/2" BSP M           | Dry          | 1         | 1      | 5035048071144 |
| DT3813-QZ | 3 jaw chuck                       | 1/2" BSP M           | Dry          | 1         | 1      | 5035048071151 |
| DT3815-QZ | SDS Plus                          | 1/2" BSP M           | Dry          | 1         | 1      | 5035048071168 |
| DT3823-QZ | 1/2" BSP F                        | 1/2" BSP M           | Dry          | 1         | 1      | 5035048071182 |
| DT3857-QZ | 1/2" BSP M                        | 1/2" BSP M           | Wet to Dry   | 1         | 1      | 5035048071946 |
| DT3858-QZ | 1 1/4" UNC F                      | 1/2" BSP F           | Wet          | 1         | 1      | 5035048072325 |



EXTENSION RODS

| Cat. No.  | Thread Conversion from | Thread Conversion to | Length mm | Applications | Pack Qty. | M.O.Q. | Barcode       |
|-----------|------------------------|----------------------|-----------|--------------|-----------|--------|---------------|
| DT3829-QZ | 1 1/4" UNC F           | 1 1/4" UNC M         | 150       | Wet          | 1         | 1      | 5035048071199 |
| DT3839-QZ | 1 1/4" UNC F           | 1 1/4" UNC M         | 300       | Wet          | 1         | 1      | 5035048071205 |
| DT3846-QZ | 1/2" BSP M             | 1/2" BSP F           | 150       | Wet          | 1         | 1      | 5035048071236 |
| DT3844-QZ | 1/2" BSP F             | 1/2" BSP M           | 150       | Dry          | 1         | 1      | 5035048071212 |
| DT3847-QZ | 1/2" BSP M             | 1/2" BSP F           | 300       | Wet          | 1         | 1      | 5035048071243 |



PILOT BITS

| Cat. No.  | Length mm | Applications | Pack Qty. | M.O.Q. | Barcode       |
|-----------|-----------|--------------|-----------|--------|---------------|
| DT3848-QZ | 225       | Dry          | 1         | 1      | 5035048071250 |
| DT3849-QZ | 300       | Dry          | 1         | 1      | 5035048071267 |



DIAMOND TILE DRILL BITS



APPLICATIONS

- Diamond grit edged head - tough & hard wearing - enables 'easy start' drilling at 45° into material and copes with almost any hardness of tile.
- Open head design helps more effective cooling with water.
- Ejection slot enables easy removal of material 'core' after drilling in deeper tiles.

FEATURES

- Clean concentric holes in all wall and floor tiles (up to and including Class 5 hardness), porcelain, marble, granite and slate. Ideal for installing fixtures and fittings in bathrooms and kitchens.



| Cat. No.  | Diameter mm | Description                   | Pack Qty. | M.O.Q. | Barcode       |
|-----------|-------------|-------------------------------|-----------|--------|---------------|
| DT6037-QZ | 5           | Diamond Tile Drill            | 1         | 1      | 5035048066300 |
| DT6038-QZ | 6           | Diamond Tile Drill            | 1         | 1      | 5035048066317 |
| DT6039-QZ | 7           | Diamond Tile Drill            | 1         | 1      | 5035048066324 |
| DT6040-QZ | 8           | Diamond Tile Drill            | 1         | 1      | 5035048066331 |
| DT6041-QZ | 10          | Diamond Tile Drill            | 1         | 1      | 5035048066348 |
| DT6042-QZ | 12          | Diamond Tile Drill            | 1         | 1      | 5035048066355 |
| DT6043-QZ | 15          | Diamond Tile Drill            | 1         | 1      | 5035048066362 |
| DT6044-QZ | 20          | Diamond Tile Drill            | 1         | 1      | 5035048066379 |
| DT6045-QZ | 25          | Diamond Tile Drill            | 1         | 1      | 5035048066386 |
| DT6046-QZ | -           | Mixed Pack Diamond Tile Drill | 1         | 1      | 5035048066393 |



NAILS

NAILS FOR CORDLESS FINISHING NAILERS (16 GAUGE 20°)



DC618

| Cat. No.  | Description     | Type       | Diameter mm | Length mm | Pack Qty. | M.O.Q. | Barcode       |
|-----------|-----------------|------------|-------------|-----------|-----------|--------|---------------|
| DT9900-QZ | Galvanised      | Angled 20° | 1.39 x 1.61 | 32        | 2500      | 1      | 5035048061640 |
| DT9901-QZ | Galvanised      | Angled 20° | 1.39 x 1.61 | 38        | 2500      | 1      | 5035048061657 |
| DT9902-QZ | Galvanised      | Angled 20° | 1.39 x 1.61 | 44        | 2500      | 1      | 5035048061664 |
| DT9903-QZ | Galvanised      | Angled 20° | 1.39 x 1.61 | 50        | 2500      | 1      | 5035048061671 |
| DT9904-QZ | Galvanised      | Angled 20° | 1.39 x 1.61 | 63        | 2500      | 1      | 5035048061688 |
| DT9910-QZ | Stainless Steel | Angled 20° | 1.39 x 1.61 | 32        | 2500      | 1      | 5035048011461 |
| DT9911-QZ | Stainless Steel | Angled 20° | 1.39 x 1.61 | 38        | 2500      | 1      | 5035048011478 |
| DT9912-QZ | Stainless Steel | Angled 20° | 1.39 x 1.61 | 44        | 2500      | 1      | 5035048011485 |
| DT9913-QZ | Stainless Steel | Angled 20° | 1.39 x 1.61 | 50        | 2500      | 1      | 5035048011492 |
| DT9914-QZ | Stainless Steel | Angled 20° | 1.39 x 1.61 | 63        | 2500      | 1      | 5035048011508 |

NAILS FOR ANGLED FINISHING NAILERS (15 GAUGE 34°)



DS1276

| Cat. No.  | Description | Type       | Diameter mm | Length mm | Pack Qty. | M.O.Q. | Barcode       |
|-----------|-------------|------------|-------------|-----------|-----------|--------|---------------|
| DT9920-QZ | Galvanised  | Angled 34° | 1.75 x 1.75 | 32        | 4000      | 1      | 5035048011515 |
| DT9921-QZ | Galvanised  | Angled 34° | 1.75 x 1.75 | 38        | 4000      | 1      | 5035048011522 |
| DT9922-QZ | Galvanised  | Angled 34° | 1.75 x 1.75 | 44        | 4000      | 1      | 5035048011539 |
| DT9923-QZ | Galvanised  | Angled 34° | 1.75 x 1.75 | 50        | 4000      | 1      | 5035048011546 |
| DT9924-QZ | Galvanised  | Angled 34° | 1.75 x 1.75 | 63        | 4000      | 1      | 5035048011553 |
| DT9986-QZ | Inox        | Angled 34° | 1.75 x 1.75 | 32        | 4000      | 1      | 5035048079287 |
| DT9987-QZ | Inox        | Angled 34° | 1.75 x 1.75 | 38        | 4000      | 1      | 5035048079294 |
| DT9988-QZ | Inox        | Angled 34° | 1.75 x 1.75 | 44        | 4000      | 1      | 5035048079300 |
| DT9989-QZ | Inox        | Angled 34° | 1.75 x 1.75 | 50        | 4000      | 1      | 5035048079317 |
| DT9995-QZ | Inox        | Angled 34° | 1.75 x 1.75 | 63        | 4000      | 1      | 5035048079324 |

NAILS FOR STRAIGHT FINISHING NAILERS (16 GAUGE)



DS1257

| Cat. No.  | Description | Type     | Diameter mm | Length mm | Pack Qty. | M.O.Q. | Barcode       |
|-----------|-------------|----------|-------------|-----------|-----------|--------|---------------|
| DT9930-QZ | Galvanised  | Straight | 1.38 x 1.64 | 35        | 5000      | 1      | 5035048011560 |
| DT9931-QZ | Galvanised  | Straight | 1.38 x 1.64 | 38        | 5000      | 1      | 5035048011577 |
| DT9932-QZ | Galvanised  | Straight | 1.38 x 1.64 | 44        | 5000      | 1      | 5035048011584 |
| DT9934-QZ | Galvanised  | Straight | 1.38 x 1.64 | 50        | 5000      | 1      | 5035048011591 |
| DT9935-QZ | Galvanised  | Straight | 1.38 x 1.64 | 63        | 5000      | 1      | 5035048011607 |

NAILS FOR STRAIGHT FINISHING NAILERS (18 GAUGE)



DS1238

| Cat. No.  | Description | Type     | Diameter mm | Length mm | Pack Qty. | M.O.Q. | Barcode       |
|-----------|-------------|----------|-------------|-----------|-----------|--------|---------------|
| DT9940-QZ | Galvanised  | Straight | 1.00 x 1.25 | 16        | 5000      | 1      | 5035048011614 |
| DT9941-QZ | Galvanised  | Straight | 1.00 x 1.25 | 20        | 5000      | 1      | 5035048011621 |
| DT9942-QZ | Galvanised  | Straight | 1.00 x 1.25 | 25        | 5000      | 1      | 5035048011638 |
| DT9943-QZ | Galvanised  | Straight | 1.00 x 1.25 | 30        | 5000      | 1      | 5035048011645 |
| DT9944-QZ | Galvanised  | Straight | 1.00 x 1.25 | 35        | 5000      | 1      | 5035048011652 |
| DT9945-QZ | Galvanised  | Straight | 1.00 x 1.25 | 40        | 5000      | 1      | 5035048011669 |
| DT9946-QZ | Galvanised  | Straight | 1.00 x 1.25 | 44        | 5000      | 1      | 5035048011676 |
| DT9947-QZ | Galvanised  | Straight | 1.00 x 1.25 | 50        | 5000      | 1      | 5035048011683 |
| DT9927-QZ | Inox        | Straight | 1.00 x 1.25 | 20        | 5000      | 1      | 5035048079355 |
| DT9928-QZ | Inox        | Straight | 1.00 x 1.25 | 25        | 5000      | 1      | 5035048079362 |
| DT9929-QZ | Inox        | Straight | 1.00 x 1.25 | 30        | 5000      | 1      | 5035048079379 |
| DT9936-QZ | Inox        | Straight | 1.00 x 1.25 | 35        | 5000      | 1      | 5035048079386 |
| DT9937-QZ | Inox        | Straight | 1.00 x 1.25 | 40        | 5000      | 1      | 5035048079393 |
| DT9938-QZ | Inox        | Straight | 1.00 x 1.25 | 44        | 5000      | 1      | 5035048079409 |
| DT9939-QZ | Inox        | Straight | 1.00 x 1.25 | 50        | 5000      | 1      | 5035048079416 |

NAILS

NAILS FOR CLIPPED-HEAD FRAMERS (34°)



DS1825

| Cat. No.  | Description           | Type       | Diameter mm | Length mm | Pack Qty. | M.O.Q. | Barcode       |
|-----------|-----------------------|------------|-------------|-----------|-----------|--------|---------------|
| DT9955-QZ | Hot Dipped Galvanised | Angled 34° | 2.85        | 50        | 2500      | 1      | 5035048013410 |
| DT9956-QZ | Hot Dipped Galvanised | Angled 34° | 3.05        | 63        | 2500      | 1      | 5035048013427 |
| DT9959-QZ | Hot Dipped Galvanised | Angled 34° | 2.90        | 75        | 2500      | 1      | 5035048072370 |
| DT9996-QZ | Hot Dipped Galvanised | Angled 34° | 3.10        | 90        | 2500      | 1      | 5035048072387 |

NAILS FOR FULL ROUND-HEAD FRAMERS (20°)



DS1850

| Cat. No.  | Description           | Type       | Diameter mm | Length mm | Pack Qty. | M.O.Q. | Barcode       |
|-----------|-----------------------|------------|-------------|-----------|-----------|--------|---------------|
| DT9965-QZ | Hot Dipped Galvanised | Angled 20° | 2.87        | 50        | 4000      | 1      | 5035048013458 |
| DT9966-QZ | Hot Dipped Galvanised | Angled 20° | 3.05        | 63        | 4000      | 1      | 5035048013465 |
| DT9969-QZ | Hot Dipped Galvanised | Angled 20° | 2.90        | 75        | 2500      | 1      | 5035048072394 |
| DT9998-QZ | Hot Dipped Galvanised | Angled 20° | 3.10        | 90        | 2500      | 1      | 5035048072400 |

NAILS FOR COIL ROOFING NAILERS (15°)



DS1321

| Cat. No.  | Description           | Type       | Diameter mm | Length mm | Pack Qty. | M.O.Q. | Barcode       |
|-----------|-----------------------|------------|-------------|-----------|-----------|--------|---------------|
| DT9976-QZ | Hot Dipped Galvanised | Angled 15° | 3.10        | 25        | 7000      | 1      | 5035048013502 |
| DT9977-QZ | Hot Dipped Galvanised | Angled 15° | 3.10        | 32        | 7000      | 1      | 5035048013519 |
| DT9978-QZ | Hot Dipped Galvanised | Angled 15° | 3.10        | 38        | 7000      | 1      | 5035048013526 |

NAILS FOR COIL FRAMING NAILERS (15°)

| Cat. No.  | Description           | Type       | Diameter mm | Length mm | Pack Qty. | M.O.Q. | Barcode       |
|-----------|-----------------------|------------|-------------|-----------|-----------|--------|---------------|
| DT9916-QZ | Hot Dipped Galvanised | Angled 15° | 2.90        | 63        | 4500      | 1      | 5035048079249 |
| DT9917-QZ | Hot Dipped Galvanised | Angled 15° | 3.10        | 75        | 4500      | 1      | 5035048079256 |
| DT9918-QZ | Hot Dipped Galvanised | Angled 15° | 3.10        | 90        | 4500      | 1      | 5035048079263 |

STAPLES

STAPLES FOR 11.1MM MEDIUM CROWN STAPLERS (16 GAUGE)



DS1430

| Cat. No.  | Description | Type         | Diameter mm | Length mm | Pack Qty. | M.O.Q. | Barcode       |
|-----------|-------------|--------------|-------------|-----------|-----------|--------|---------------|
| DT9980-QZ | Staples     | Crown 11.1mm | 1.33 x 1.60 | 25        | 5000      | 1      | 5035048011829 |
| DT9981-QZ | Staples     | Crown 11.1mm | 1.33 x 1.60 | 32        | 5000      | 1      | 5035048011836 |
| DT9982-QZ | Staples     | Crown 11.1mm | 1.33 x 1.60 | 38        | 5000      | 1      | 5035048011843 |
| DT9983-QZ | Staples     | Crown 11.1mm | 1.33 x 1.60 | 44        | 5000      | 1      | 5035048011850 |
| DT9984-QZ | Staples     | Crown 11.1mm | 1.33 x 1.60 | 50        | 5000      | 1      | 5035048011867 |

STAPLES FOR 12.7MM MEDIUM CROWN STAPLERS (16 GAUGE)



DS1431

| Cat. No.  | Description | Type         | Diameter mm | Length mm | Pack Qty. | M.O.Q. | Barcode       |
|-----------|-------------|--------------|-------------|-----------|-----------|--------|---------------|
| DT9990-QZ | Staples     | Crown 12.7mm | 1.33 x 1.60 | 25        | 5000      | 1      | 5035048011874 |
| DT9991-QZ | Staples     | Crown 12.7mm | 1.33 x 1.60 | 32        | 5000      | 1      | 5035048011881 |
| DT9992-QZ | Staples     | Crown 12.7mm | 1.33 x 1.60 | 38        | 5000      | 1      | 5035048011898 |
| DT9993-QZ | Staples     | Crown 12.7mm | 1.33 x 1.60 | 44        | 5000      | 1      | 5035048011904 |
| DT9994-QZ | Staples     | Crown 12.7mm | 1.33 x 1.60 | 50        | 5000      | 1      | 5035048011911 |







**DEWALT®**

**SERVICE**

★★★★★  
**OUR PROMISE OF 5-STAR SERVICE QUALITY, CONVENIENCE AND SPEED**

**DeWALT 5-STAR SERVICE STARTS WITH CONVENIENCE**

At the heart of DeWALT's 5 star service promise are its 5 star service agents which are conveniently located throughout the country, with specialists always available to answer any questions whether you are on or off the jobsite.

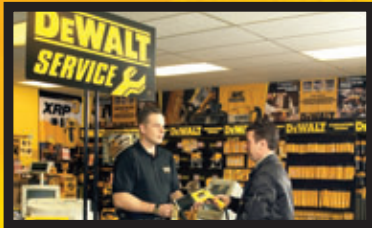

**SPEED OF REPAIR**

Having your tools back in action in the fastest time possible is our prime objective. Subject to parts availability, most repairs should not take more than 48 hours in the workshop and for those smaller urgent repairs we provide a "while-u-wait" service.



**HIGHEST QUALITY**

Highest Quality is assured with DeWALT factory trained technicians carrying out all repairs with all work being backed by our 30 day warranty. Each DeWALT repair comes with our personal "satisfaction tag" listing all the work done and a DeWALT contact telephone number should you be less than 100% happy with the repair.

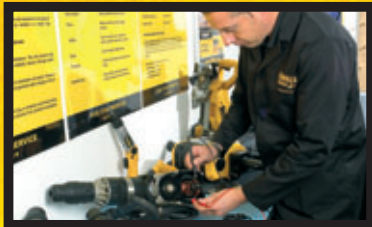

**WARRANTY REPAIRS**

All 5 star service agents carry out warranty repairs. If the tool is covered by its original DeWALT 1 year Warranty, all repairs are free, including parts and labour. Proof of purchase must be produced.

**TO LOCATE YOUR NEAREST 5 STAR AGENT PLEASE GO TO PAGE 175 OF THIS CATALOGUE OR VISIT:**

**www.DeWALT.ae**

Not all DeWALT service agents are 5 star rated. Those that are not may not be able to provide all services available above but will display in-store a detailed list of their selected services.

**DeWALT GENUINE FACTORY PARTS**

All parts used in repairs are original, ensuring both the highest quality and a perfect fit every time.

**ALL BACKED UP BY THE DeWALT ON-LINE SERVICE**

Instantly accessed via the internet providing information on our wide range of products and services, including dealer and service locations, spare parts and technical support.



**SERVICE AGENT NETWORK**

**UAE**

**BLACK & DECKER (OVERSEAS) GMBH**

DUBAI  
 P.O. BOX 5420, DUBAI  
 TEL.: +971-4-8127400/8127406  
 FAX: +971-4-2822765  
 service.mea@blackdecker.com

**IDEAL STAR WORKSHOP EQPT. TRADING LLC**

DUBAI  
 P.O. BOX 37116, AL QUOZ, DUBAI  
 TEL.: +971-4-3474160  
 FAX: +971-4-3474157  
 idealeq@emirates.net.ae

**ALEBRAH ENGINEERING SERVICE**

DUBAI  
 P.O. BOX 78954, AL QUSAIS, DUBAI  
 TEL.: +971-4-2540066  
 FAX: +971-4-2540077  
 alebrah@eim.ae

**BURJ AL MADEENA**

SHARJAH  
 INDUSTRIAL AREA NO 1, OPP PAKISTANI MASJID P.O. BOX 37635, SHARJAH  
 TEL.: +971-6-5337747  
 FAX: +971-6-5337719  
 dewaltuae@hotmail.com

**MC COY MIDDLE EAST LLC**

SHARJAH  
 P.O. BOX 25793, SHARJAH  
 TEL.: +971-6-5395931  
 FAX: +971-6-5395932  
 mccoyrak@gmail.com

**MC COY MIDDLE EAST LLC**

RAS AL KHAIMAH  
 P.O. BOX 10584, RAS AL KHAIMAH  
 TEL.: +971-7-2277095  
 FAX: +971-7-2277096  
 mccoy@emirates.net.ae

**AL SUKOON GEN. TRDG. CO. LLC**

AJMAN  
 P.O. BOX 2975, AJMAN  
 TEL.: +971-6-7435725 / 7438317  
 FAX: +971-6-7437350  
 sukoon@eim.ae

**ZILLION EQUIPMENT AND SPARE PARTS TRADING LLC**

AL AIN  
 P.O. BOX 19740, OPP. BIN SADAL / TRIMIX REDY MIX SANAIYA, AL AIN  
 TEL.: +971-3-7216690  
 FAX: +971-3-7216103  
 zilliontrdg@gmail.com

**LIGHT HOUSE ELECTRICAL**

ABU DHABI  
 P.O. BOX 120, ABU DHABI  
 TEL.: +971-2-6726131  
 FAX: +971-2-6720667  
 dewalt\_lhe@hotmail.com

**LIGHT HOUSE ELECTRICAL**

MUSAFFAH  
 P.O. BOX 120, ABU DHABI  
 TEL.: +971-2-5548315  
 FAX: +971-2-5540461  
 dewalt\_lhe@hotmail.com

**BAHRAIN**

**ALFOUZ SERVICES CO. WLL**

TUBLI  
 P.O. BOX 26562, TUBLI, MANAMA  
 TEL.: +973-17783562 / 17879987  
 FAX: +973-17783479  
 alfouz@batelco.com.bh

**KAVALANI & SONS W.L.L.**

SITRA  
 P.O. BOX 71, SITRA, MANAMA  
 TEL.: +973-17732888  
 FAX: +973-17737379  
 info@kavalani.com

**KUWAIT**

**AL OMAR TECHNICAL CO.**

SAFAT  
 P.O. BOX 4062, SAFAT 13041, KUWAIT  
 TEL.: +965-24848595 / 24840039  
 FAX: +965-24845652  
 alexotc@usa.net

**FAWAZ AL ZAYANI ESTABLISHMENT**

SHUWAIKH  
 P.O. BOX 42426, SHOP NO.18, AL HUMAZI COMMERCIAL COMPLEX, KHALIFA AL JASSIM, SHUWAIKH, KUWAIT  
 TEL.: +965-24828710  
 FAX: +965-24828716  
 dewaltkuwait@hotmail.com

**FAWAZ AL ZAYANI ESTABLISHMENT**

FAHAHEEL  
 FAHAHEEL INDUSTRIAL AREA, MAIN ST., SANAYA, KUWAIT  
 TEL.: +965-23925830  
 FAX: +965-24828716  
 dewaltkuwait@hotmail.com

**OMAN**

**AL JIZZI COMPANY LLC**

RUWI  
 P.O. BOX 1704, PC 112 RUWI, OMAN  
 TEL.: +968-24832618 / 24835153  
 FAX: +968-24831334  
 aljizied@omantel.net.om

**AL HASSAN TECHNICAL & CONSTRUCTION SUPPLIES LLC**

RUWI  
 P.O. BOX 1948, P.C. 112, RUWI  
 TEL.: +968-24810575  
 FAX: +968-24810287  
 umakant.b@al-hassan.com; hamriya.sr@al-hassan.com

**OMAN HARDWARE CO. LLC**

RUWI  
 P.O. BOX 635, RUWI POSTAL CODE 112  
 TEL.: +968-24815131  
 FAX: +968-24816491  
 omanhard@omantel.net.om



**OMAN**

**KHIMJI RAMDAS**

MUSCAT  
 P.O. BOX 19, POST CODE 100, GHALA, MUSCAT, OMAN  
 TEL.: +968-24595906 / 907  
 FAX: +968-24852752  
 bilal.m@khimjiramdas.com

**QATAR**

**TEYSEER INDUSTRIAL SUPPLIES & SERVICES CO. WLL**

DOHA  
 55, AL WAKALAT ST. (BETWEEN ST. 18 & 19) SALWA INDUSTRIAL AREA, P.O. BOX 40523 DOHA, QATAR  
 TEL.: +974-4581536  
 FAX: +974-4682024  
 manish@tisco-qatar.com; tool.service@tisco-qatar.com

**SHAHEEN ELECTRICAL WORKS & TRADING CO. WLL**

DOHA  
 GATE 34, ST. 44 INDUSTRIAL AREA P.O. BOX 9756, DOHA  
 TEL.: +974-460 02 30 / 460 05 25  
 FAX: +974-460 13 38  
 shaheenel@gmail.com

**KSA**

**IND. MAT. ORGANIZATION (IMO)**

RIYADH  
 P.O. BOX 623, RAIL STREET, RIYADH  
 TEL.: +966-1-402 63 20 / 402 63 50  
 FAX: +966-1-403 79 70  
 service@imo.com.sa

**FAWAZ EBRAHIM AL ZAYANI TRADING EST.**

DAMMAM  
 P.O. BOX 76026, AL KHOBAR # 31952  
 TEL.: +966-3-8140914  
 FAX: +966-3-8140824  
 dewaltdammam@hotmail.com

**MSS (AL-MOJIL SUPPLY & SERVICES)**

RIYADH  
 P.O. BOX 450, JUBAIL 31951.OPP-GULF BRIDGE LIBRARY & RIYADH HOUSE  
 TEL.: +966-3-3612850, 3624487, 3621729  
 FAX: +966-3-3623589, 3620783  
 mssjubail@almojilservices.com; alex.chang@almojilservices.com

**EAC (AL YOUSEF CONTG. & TRDG. EST.)**

JEDDAH  
 P.O. BOX 30377, JEDDAH -21477  
 TEL.: +966-2-6519912  
 FAX: +966-2-6511153  
 golamkibria77@yahoo.com





# DEWALT<sup>®</sup>

## SERVICE

**KSA**

**MOHAMED AHMED BIN AFIF EST.**

YANBU  
P.O. BOX 530, YANBU, AL BAHR  
TEL.: +966-4-3222626/ 3228867  
FAX: +966-4-3222210  
binafifyanbu@hotmail.com

**GARZIZ TRADING FOR BLDG MAT&DECORATION**

MADINA  
P.O. BOX 3364, MADINA  
TEL.: +966-4-826 14 90, 822 76 36  
FAX: +966-4-826 57 41,  
agarziz@yahoo.com

**SULTAN GARMENT FACTORY (RSC)**

RIYADH  
P.O. BOX 29912, RIYADH 11467, KSA  
TEL.: +966-1-4055148 / 4042889  
FAX: +966-1-4055148  
rscservice@diginet.sa

**AL BAWARDI TOOLS & HARDWARE**

DAMMAM  
P.O. BOX 112, DAMMAM 31411  
TEL.: +966-3-8335555  
FAX: +966-3-8350772  
marketingtools@albawardi.com

**AL BAWARDI TOOLS & HARDWARE**

RIYADH  
P.O. BOX 68, RIYADH 11411  
TEL.: +966-1-4484999  
FAX: +966-1-4487877  
marketingtools@albawardi.com

**AL BAWARDI TOOLS & HARDWARE**

JEDDAH  
P.O. BOX 16905, JEDDAH 21474  
TEL.: +966-2-6444547  
FAX: +966-2-64439024  
marketingtools@albawardi.com

**ALGERIA**

**SARL OUTILLAGE CORPORATION**

08, RUE MED BOUDIAF (EX TELLA ACHEN) CHERAGA, ALGER  
TEL.: 00213-0-21375130  
FAX: 00213-0-21369667  
hakim@outillage-dz.com; meram@t-2.net

**ANGOLA**

**ANGOFERRARIA, LDA.**

RUA ROBERT SHIELDS, Nº 61, LUANDA, ANGOLA  
TEL.: 00244-222-395837 / 222-395034  
FAX: 00244-222-394790  
angoferraria@gmail.com; sequeira.angoferraria@gmail.com

**AZERBAIJAN**

**ROYALTON HOLDINGS LTD.**

41 KHAGANI ST. APT. 47 AZ1001 BAKU- AZERBAIJAN  
TEL.: 00994-12-4935544  
FAX: 00994-12-5980378  
jai@royaltonholdings.com; office@royaltonholdings.com

**EGYPT**

**ELFARAB S.A.E.**

15-NABIL EL WAKKAD STREET,DOKKI,GIZA, EGYPT  
TEL.: 00202-37603946  
FAX: 00202-33352796  
elfarabi@elfarabi.com

**ETHIOPIA**

**SEIF TEWFIK SHERIF**

ARADA SUB CITY, KEBELE 01-02, GLOBAL INSURANCE BLDG.,  
2ND FLR. ROOM 43 P.O. BOX 2525 ADDIS ABABA, ETHIOPIA  
TEL.: 00-251-11-1563968/ 1563969  
FAX: 00-251-11-1558009  
seif@ethionet.et; nawanag@ethionet.et

**IRAQ**

**AL-SARD CO. FOR GENERAL TRADING LTD**

JBARA BLDG. 3FLR.AL RASHEED ST. BAGHDAD, IRAQ  
TEL.: 00964-18184102  
dewalt.service@yahoo.com

**JORDAN**

**AMMAN WEST STORES-BASHITI**

210 GARDEN ST. TLA' A LI, P.O. BOX 1564 TLA ALI AMMAN  
11953 JORDAN  
TEL.: 00962-6-5350009  
FAX: 00962-6-5350012  
ali@bashitistores.com

**KENYA**

**DEXTRON TOOLS LTD.**

P.O. BOX 20121-00200, SHARIFF HOUSE, KIMATHI STREET,NAIROBI  
TEL.: 00254-20-6905000/ 2358021  
FAX: 00254-20-6905111/ 6905112  
dextron@alibhaishariff.co.ke; noor@alibhaishariff.co.ke

**LEBANON**

**EST. SHAYA & AZAR S.A.R.L.**

BOULVARD JDEIDEH - MAR TAKLA - BOUCHRIEH .P.O. BOX 90545  
JDEIDEH.BEIRUT - LEBANON  
TEL.: 00961 1 872305 / 306  
FAX: 00961 1 872303  
shayazar@dm.net.lb

**LIBYA**

**NORTH AFRICA TRADING ( EL GHOUL BROTHERS)**

P.O. BOX 348, 7 OCTOBER STREET 11, BENGHAZI  
TEL.: 00218-3388706/ 00218-51-2629558  
FAX: 00218-61-909 41 23  
maryam\_farooq2003@yahoo.com; nagie@emirates.net.ae;  
salm.ae@ltnet.net

**MAURITIUS**

**ROBERT LE MARIE LIMITED**

OLD MOKA ROAD, BELL VILLAGE, P.O. BOX 161, PORT LOUIS  
TEL.: 00230-212 1865/ 212 2847  
FAX: 00230-2080843  
a.blackburn.rlm@rlmgroup.mu; n.georges.rlm@rlmgroup.mu

**MOROCCO**

**ETS LOUIS GUILLAUD & CIE**

31, RUE PIERRE PARENT, CASABLANCA -21000  
TEL.: 022-301446/ 305971/ 317815/315576  
FAX: 022-444518/ 317888  
boumadiane.azedine@elg.ma

**NIGERIA**

**MERIDIAN POWER TOOLS LTD.**

GR.FLOOR, #1 ALHAJI MASHA RD, NEXT TOTESLIM BALOGUN STADIUM,  
NEAR NATIONAL STADIUM SURULERE, LAGOS, NIGERIA  
TEL.: 00234-1-7740431 / 7740410  
FAX: 00234-1-7913798  
braj@meridian-nigeria.com

**PAKISTAN**

**NORTHERN TOOLINGS (PVT) LTD.-LAHORE**

86- RAILWAY ROAD, LAHORE - 7, PAKISTAN  
TEL.: 0092-423-7651220/ 7641675  
FAX: 0092-423-7641674  
zhayee@northern.pk; import@northern.pk

**SOUTH AFRICA**

**BENRAY TOOL WHOLESALERS C.C.**

91 TURFFONTEIN ROAD, STAFFORD, JOHANNESBURG, 2001 P.O. BOX  
260037 EXCOM 2023 SOUTH AFRICA  
TEL.: 0027-11-6838350  
FAX: 0027-11-6837456  
dewaltservice@benray.co.za

**TANZANIA**

**GENERAL MOTORS INVESTMENT LTD.**

14 VINGUNGUTI-NYERERE ROAD, P.O.BOX 16541,DAR ES SALAAM,  
TANZANIA  
TEL.: 00255-22-2865022/ 2862661/ 2862671/ 2862659  
FAX: 00255-22-2862667  
ezra@gmi-tz.com; info@gmi-tz.com; chiwelesa@yahoo.com

**TUNISIA**

**ETS. MOHAMED GHORBEL**

26, RUE AHMED TULLI, TUNIS.  
TEL.: 00216-71-346366 / 71793848  
FAX: 00216-71-343154  
slim.ghorbel@gnet.tn; mohghorbel@planet.tn

**UGANDA**

**THE BUILDING CENTER (U) LTD.**

52 STATION ROAD, KITGUM HOUSE, P.O. BOX 7436 KAMPALA, UGANDA  
TEL.: 00256-041-4234567/ 4259754  
FAX: 00256-041-4236413  
tbc@africaonline.co.ug; chris@tbcu.co.ug

**YEMEN**

**MIDDLE EAST TRADING CO. (METCO)**

5TH FLR.HAYEL SAEED ANAM BLDG. AL-MUGAMMA ST. TAIZ, YEMEN  
TEL.: 00967-4-213455  
FAX: 00967-4-219869  
tamer.metco@gmail.com; tamer@metcotrading.com;  
metco@metcotrading.com



## IN STORE MERCHANDISING AND DISPLAY SYSTEM

- FLEXIBLE, MODULAR SYSTEM
- CLEAR PRODUCT DIFFERENTIATION AND COMMUNICATION
- STRONG DEWALT BRANDING

Products sold as per dealer's valid price list. Please refer to price list for stock availability.

All products shown are in compliance with the appropriate European regulations.

DeWALT is a member of EPTA

Dual voltage - all DeWALT power tools are supplied in both 230 Volts and 115 Volts options unless otherwise stated. Please contact your local dealer for availability.

DeWALT reserves the right to revise product specifications at any time without notice.

All measurements are in millimetres (mm) unless otherwise stated.

WARNING: all warranties are country/region specific. Tools purchased e.g. in the USA or via the internet, and imported into Europe, which are not CE approved, not only violate EU legislation, but will not be supported/serviced in Europe by DeWALT as a result.

Only European tools are covered by a European warranty.

GUARANTEED TOUGH, ROBUSTESSE GARANTIE, DeWALT EXTREME, DeWALT, EXTREME DeWALT, DeWALT EXTREME IMPACT, DeWALT GUARANTEED TOUGH, SERIES 20, SERIES 30, SERIES 40, SERIES 60, AVC, XRP, XPC, XLR, and ALLIGATOR are registered trademarks of The Black and Decker Corporation. The yellow and black colour scheme is used on DeWALT power tools and accessories as a trademark.

GORE Wet/Dry Filter is a trademark of W.L Gore & Associates Inc.



Registered Trade Marks of Robert Bosch GmbH. Torx<sup>®</sup> is a Registered Trade Mark of Acument Intellectual Properties, LLC.

# DEWALT®

**POWERTOOLS &  
ACCESSORIES  
CATALOGUE 2011**

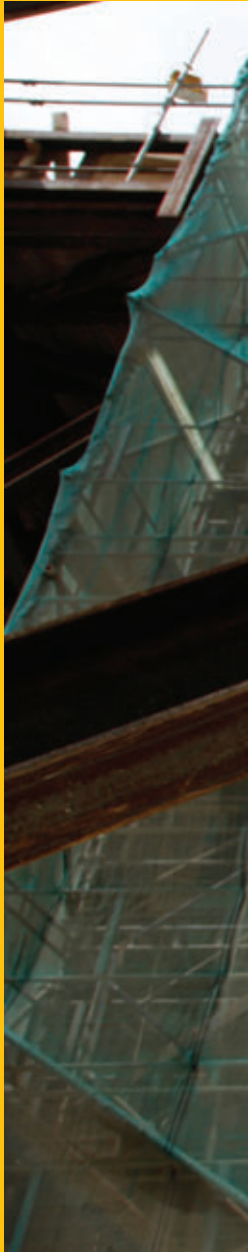

**[www.DEWALT.ae](http://www.DEWALT.ae)**

MP09603-AE