



MasterChef
IRELAND

OFFICIAL
APPLIANCE
PARTNER

June 2013

A TASTE OF THE NEFF COLLECTION



CircoTherm®

WE ARE A FAN!

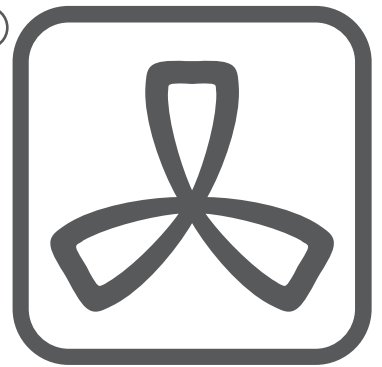

CLEAR BENEFITS WITH CIRCOTHERM® TECHNOLOGY BY NEFF

- Cook a three course meal at the same time with multi-level cooking and, better still, have no flavour transfer across dishes.
- Get cooking faster with little or no pre-heating of the oven.
- Better cooking results because of even heat transference through the oven cavity AND no loss of heat when opening the oven door.
- Moist, succulent roast dinners are achieved easily thanks to the speed at which the heat is delivered throughout the oven.
- No need to turn food on the grill, the air circulates to give perfect results EVERYTIME.



THE BENCHMARK FOR ALL FAN OVENS

THE PRINCIPLE:

CircoTherm® works by drawing air in from the oven via a powerful fan. It then heats up the air and forces it right back into the oven cavity through strategically placed ducts in the rear wall.

By continuously circulating hot air around the oven in this way the desired temperature is achieved more quickly and evenly than in a normal oven, saving time and energy as little or no preheating is required.

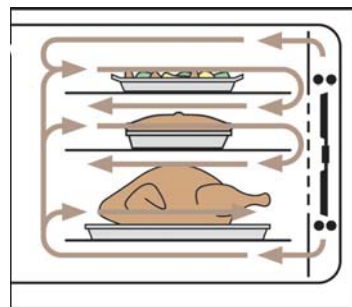

Because the hot air is focused directly onto the food being cooked, the heat is evenly distributed on shelf positions 1, 3 and 4. Shelf position 2 will have a lower temperature.

In fact, a complete three course meal can be cooked at the same time on the three shelf levels without the flavours intermingling. With CircoTherm® temperatures are lower so there is less splashing and spitting, making the oven much easier to clean.

All Neff ovens also come with additional CeramiClean® liners which effectively absorb and oxidise grease particles so that they don't build up over time, thus, requiring minimum maintenance. The great thing is these liners never need replacing.

CircoTherm® is great for roasting because of the way and the speed at which the heat is delivered - as a result, roasts are quickly sealed. This means the juices are retained, producing less shrinkage and moist, succulent joints.

CircoTherm® is the perfect way to cook foods which usually need to be grilled. There's no need to turn fish, burgers, steaks or sausages as the air circulates around them providing an even cooking result.

SOME OF THE UNIQUE NEFF FEATURES

SLIDE&HIDE® DOOR

The Slide&Hide® door, unique to Neff, slides smoothly away beneath the oven providing more space in the kitchen and easy access to the oven.



REVOLUTION HANDLE

When the oven door is opened, the Revolution Handle rotates towards you in a smooth, circular motion making opening and closing your oven easy and safe.



AQUAASSIST

AquaAssist provides a moist cooking environment to help achieve beautiful food that is perfectly succulent and tender, and retains its colour throughout the cooking process.



FLEXINDUCTION HOBS

FlexInduction hobs provide greater flexibility by using an enlarged single zone that heats pans of any size, positioned anywhere in the zone.



POINT & TWIST

Simply place the metallic dial in the centre of the control area, point it towards the zone you want to activate and twist to select the power level you want.



VITAFRESH 0°C

VitaFresh 0°C compartments store meat, fish, fruit or vegetables at their optimum humidity levels ensuring that the nutrients and vitamins are retained for up to three times longer.



SUPERCOOL & SUPERFREEZE

Adding fresh food to your fridge or freezer may increase the internal temperature. Use the SuperCool or SuperFreeze function to quickly chill the freshly added food and return the appliance to its ideal temperature.



NEFFSPARKLE® SYSTEM

A combination of delicate washing programmes, glass-friendly baskets, a lower spray pressure, gentle drying and a water softener that will keep your glasses in pristine condition.



CIRCOCARE DRUM

Raised droplets across the surface of the drum and specially designed paddles ensure deeper detergent penetration and a more thorough rinse. A powerful yet gentle wash.



TASTE OF NEFF QUICK REFERENCE GUIDE



Appliances which have this symbol are part of the Neff MasterChef promotion and can be bought at the reduced, highlighted price.



Appliances which have this symbol have Neff's unique Slide&Hide® door, explained above.



These appliances are part of the Series 3 range. Match with other appliances from the same series to create a truly in sync kitchen.



Appliances which have this symbol are only available through authorised Neff Trade Partners.



Appliances which have this symbol have Neff's Revolution Handle, explained above.



These appliances are part of the Series 5 range. Match with other appliances from the same series to create a truly in sync kitchen.



CIRCOTHERM® SINGLE OVEN

- ▶ CeramiClean® Liners (back & roof)
- ▶ Automatic On/Off Programmer
- ▶ 67 Litre Capacity
- ▶ A Rated ▶ 6 Functions
- ▶ QuickConnect Shelf Supports
- ▶ Silver Display EasyClock
- ▶ Triple Glazed Door
- ▶ Stainless Steel

RRP: €599
Code: B14M42N3GB



W RRP: €599
Code: B14M42W3GB
(4-5 day lead time)



B RRP: €599
Code: B14M42S3GB



Now €749

CIRCOTHERM® SINGLE OVEN

- ▶ CeramiClean® Liners (back, roof & sides)
- ▶ Automatic On/Off Programmer
- ▶ 67 Litre Capacity
- ▶ A Rated ▶ 10 Functions
- ▶ QuickConnect Shelf Supports
- ▶ Silver Display EasyClock
- ▶ Triple Glazed Door
- ▶ Stainless Steel

RRP: €799
Code: B15M52N3GB



CIRCOTHERM® SINGLE OVEN

- ▶ CeramiClean® Liners (back, roof & sides)
- ▶ Automatic On/Off Programmer
- ▶ 67 Litre Capacity
- ▶ A Rated ▶ 9 Functions
- ▶ QuickConnect Shelf Supports
- ▶ Silver Display EasyClock
- ▶ Triple Glazed Door
- ▶ Stainless Steel

RRP: €799
Code: B15M52S3GB



Now €849

CIRCOTHERM® SINGLE OVEN

- ▶ SoftClose Slide&Hide® Door
- ▶ Revolution Handle
- ▶ CeramiClean® Liners (back & roof)
- ▶ Automatic On/Off Programmer
- ▶ 67 Litre Capacity ▶ A Rated ▶ 6 Functions
- ▶ QuickConnect Shelf Supports
- ▶ Silver Display EasyClock
- ▶ Triple Glazed Door ▶ Stainless Steel

RRP: €949
Code: B44M42N3GB



Now €899

CIRCOTHERM® SINGLE OVEN

- ▶ SoftClose Slide&Hide® Door
- ▶ Revolution Handle
- ▶ CeramiClean® Liners (back, roof & sides)
- ▶ Automatic On/Off Programmer
- ▶ 67 Litre Capacity ▶ A Rated ▶ 10 Functions
- ▶ QuickConnect Shelf Supports
- ▶ Silver Display EasyClock
- ▶ Triple Glazed Door ▶ Stainless Steel

RRP: €999
Code: B45M52N3GB



S3

CIRCOTHERM® SINGLE OVEN

- ▶ CeramiClean® Liners (back, roof & sides)
- ▶ Automatic On/Off Programmer
- ▶ 67 Litre Capacity ▶ A Rated
- ▶ 11 Functions
- ▶ QuickConnect Shelf Supports
- ▶ Silver Display EasyClock & Temperature Display
- ▶ Triple Glazed Door ▶ Stainless Steel

RRP: €1,099
Code: B15E52N3GB



S3

CIRCOTHERM® SINGLE OVEN

- ▶ CeramiClean® Liners (back, roof & sides)
- ▶ Automatic On/Off Programmer
- ▶ 67 Litre Capacity ▶ A Rated
- ▶ 11 Functions
- ▶ QuickConnect Shelf Supports
- ▶ Silver Display EasyClock & Temperature Display
- ▶ Triple Glazed Door ▶ Black

RRP: €1,049
Code: B15E52S3GB



S3

CIRCOTHERM® SINGLE OVEN

- ▶ SoftClose Slide&Hide® Door
- ▶ Revolution Handle
- ▶ CeramiClean® Liners (back, roof & sides)
- ▶ Automatic On/Off Programmer
- ▶ 67 Litre Capacity ▶ A Rated ▶ 11 Functions
- ▶ QuickConnect Shelf Supports
- ▶ Silver Display EasyClock & Temperature Display ▶ Stainless Steel

RRP: €1,199
Code: B45E52N3GB



Now €1,249

S3

CIRCOTHERM® SINGLE OVEN

- ▶ SoftClose Slide&Hide® Door
- ▶ Revolution Handle
- ▶ CeramiClean® Liners (back, roof & sides)
- ▶ Automatic On/Off Programmer
- ▶ 67 Litre Capacity ▶ A Rated ▶ 11 Functions
- ▶ FlexiRail® System with Telescopic Rails
- ▶ Silver Display EasyClock & Temperature Display ▶ Stainless Steel

RRP: €1,399
Code: B45E74N3GB



Now €969

S3

CIRCOTHERM® SINGLE OVEN

- ▶ Pyrolytic Cleaning
- ▶ Automatic On/Off Programmer
- ▶ 65 Litre Capacity ▶ A Rated ▶ 11 Functions
- ▶ QuickConnect Shelf Supports
- ▶ Silver Display EasyClock & Temperature Display
- ▶ Quadruple Glazed Door
- ▶ Stainless Steel

RRP: €1,099
Code: B15P52N3GB



S3

CIRCOTHERM® SINGLE OVEN

- ▶ Pyrolytic Cleaning
- ▶ Automatic On/Off Programmer
- ▶ 65 Litre Capacity ▶ A Rated ▶ 11 Functions
- ▶ QuickConnect Shelf Supports
- ▶ Silver Display EasyClock & Temperature Display
- ▶ Quadruple Glazed Door
- ▶ Black

RRP: €1,099
Code: B15P52S3GB



AQUAASSIST® SINGLE OVEN

- ▶ SoftClose Slide&Hide® Door
- ▶ Revolution Handle
- ▶ CeramiClean® Liners (back, roof & sides)
- ▶ Automatic On/Off Programmer
- ▶ 67 Litre Capacity ▶ A Rated ▶ 13 Functions
- ▶ QuickConnect Shelf Supports
- ▶ Silver Display EasyClock & Temperature Display ▶ Stainless Steel

RRP: €1,699

Code: B45C52N3GB



Now €1,349

CIRCOTHERM® SINGLE OVEN

- ▶ SoftClose Slide&Hide® Door
- ▶ Revolution Handle
- ▶ CeramiClean® Liners (back, roof & sides)
- ▶ Automatic On/Off Programmer
- ▶ 67 Litre Capacity ▶ A Rated
- ▶ 14 Functions ▶ FlexiRail® System
- ▶ Silver Clear-Text Display
- ▶ Triple Glazed Door ▶ Stainless Steel

RRP: €1,449

Code: B46E54N3GB



Now €899

CIRCOTHERM® DOUBLE OVEN

- ▶ CeramiClean® Liners (back & roof)
- ▶ Automatic On/Off Programmer
- ▶ 35/67 Litre Capacity ▶ A Rated
- ▶ 2/6 Functions
- ▶ Conventional and Grill in Top Oven
- ▶ QuickConnect Shelf Supports
- ▶ Silver Display EasyClock
- ▶ Triple Glazed Doors ▶ Stainless Steel

RRP: €999

Code: UI4M42N3GB



W RRP: €999
Code: UI4M42W3GB
(4-5 day lead time)



Now €849

B RRP: €999
Code: UI4M42S3GB



Now €1,099

CIRCOTHERM® DOUBLE OVEN

- ▶ CeramiClean® Liners (back, roof & sides)
- ▶ Automatic On/Off Programmer
- ▶ 35/67 Litre Capacity ▶ A Rated
- ▶ 3/8 Functions
- ▶ Conventional and Grill in Top Oven
- ▶ QuickConnect Shelf Supports
- ▶ Silver Display EasyClock
- ▶ Triple Glazed Doors ▶ Stainless Steel

RRP: €1,199

Code: UI5M52N3GB



Now €1,099

CIRCOTHERM® DOUBLE OVEN

- ▶ CeramiClean® Liners (back, roof & sides)
- ▶ Automatic On/Off Programmer
- ▶ 35/67 Litre Capacity ▶ A Rated
- ▶ 3/8 Functions
- ▶ Conventional and Grill in Top Oven
- ▶ QuickConnect Shelf Supports
- ▶ Silver Display EasyClock
- ▶ Triple Glazed Doors ▶ Black

RRP: €1,199

Code: UI5M52S3GB



CIRCOTHERM® DOUBLE OVEN

- ▶ CeramiClean® Liners (back, roof & sides)
- ▶ Automatic On/Off Programmer
- ▶ 35/67 Litre Capacity ▶ A Rated
- ▶ 5/11 Functions
- ▶ Conventional and Grill in Top Oven
- ▶ QuickConnect Shelf Supports
- ▶ Silver Display EasyClock & Temperature Display ▶ Stainless Steel

RRP: €1,599

Code: UI5E52N3GB



CIRCOTHERM® DOUBLE OVEN

- ▶ CeramiClean® Liners (back, roof & sides)
- ▶ Automatic On/Off Programmer
- ▶ 35/67 Litre Capacity ▶ A Rated
- ▶ 5/11 Functions
- ▶ Conventional and Grill in Top Oven
- ▶ QuickConnect Shelf Supports
- ▶ Silver Display EasyClock & Temperature Display ▶ Black

RRP: €1,599

Code: UI5E52S3GB



Now €1,049

CIRCOTHERM® DOUBLE OVEN

- ▶ CeramiClean® Liners (back & roof)
- ▶ Automatic On/Off Programmer
- ▶ 35/50 Litre Capacity ▶ A Rated
- ▶ Built Under Installation ▶ 2/6 Functions
- ▶ Conventional and Grill in Top Oven
- ▶ QuickConnect Shelf Supports
- ▶ Silver Display EasyClock
- ▶ Triple Glazed Doors ▶ Stainless Steel

RRP: €1,149

Code: UI7M42N3GB



W RRP: €1,149
Code: UI7M42W3GB
(4-5 day lead time)



B RRP: €1,149
Code: UI7M42S3GB



“ Impress your guests with this unique Slide&Hide® oven door. Guaranteed to give the wow factor!! ”

Lynn, Neff Expert



Now €979

MICROWAVE / COMBI OVEN

- ▶ Electronic Control
- ▶ CeramiClean® Liners (back only)
- ▶ 15 Automatic Cooking Programmes
- ▶ 4 Functions ▶ 36 Litre Capacity
- ▶ 5 Microwave Power Levels
- ▶ Max Microwave Power 1000W
- ▶ Silver Display EasyClock & Temperature Display ▶ Stainless Steel

RRP: €1,079

Code: C57M70N3GB



MICROWAVE / COMBI OVEN

- ▶ Electronic Control
- ▶ CeramiClean® Liners (back only)
- ▶ 15 Automatic Cooking Programmes
- ▶ 4 Functions ▶ 36 Litre Capacity
- ▶ 5 Microwave Power Levels
- ▶ Max Microwave Power 1000W
- ▶ Silver Display EasyClock & Temperature Display ▶ Black

RRP: €1,079

Code: C57M70S3GB (4-5 day lead time)



MULTIFUNCTION OVEN & MICROWAVE

- ▶ Electronic Control
- ▶ CeramiClean® Liners (back & roof)
- ▶ 70 Automatic Cooking Programmes
- ▶ 8 Functions ▶ 42 Litre Capacity
- ▶ 5 Microwave Power Levels
- ▶ Max Microwave Power 900W
- ▶ Silver ClearText Display ▶ Automatic Safety Switch Off ▶ Stainless Steel

RRP: €1,299

Code: C67M70N3GB



Now €1,399

MULTIFUNCTION OVEN & MICROWAVE

- ▶ Electronic Control
- ▶ Pyrolytic Cleaning
- ▶ 70 Automatic Cooking Programmes
- ▶ 9 Functions ▶ 42 Litre Capacity
- ▶ 5 Microwave Power Levels
- ▶ Max Microwave Power 1000W
- ▶ Silver ClearText Display ▶ Automatic Safety Switch Off ▶ Stainless Steel

RRP: €1,499

Code: C67P70N3GB



COFFEE CENTRE

- ▶ Electronic Control
- ▶ Cleaning & Descaling Programmes
- ▶ 7 Functions ▶ 2.5 Litre Water Tank
- ▶ 1kg Bean & 0.7 Litre Milk Containers
- ▶ Size, Strength & Grinding Level Selectable
- ▶ Personalised "My Coffee" Setting
- ▶ Brita "Intenza" Water Filter
- ▶ LCD ClearText Display ▶ Stainless Steel

RRP: €1,649

Code: C77V60N2GB



STEAM OVEN

- ▶ Electronic Control
- ▶ Descaling Programme
- ▶ 20 Automatic Programmes
- ▶ 4 Functions ▶ 38 Litre Capacity
- ▶ Steaming 35 °C - 100 °C
- ▶ 1.3 Litre Water Tank
- ▶ Silver Display EasyClock & Temperature Display ▶ Stainless Steel

RRP: €1,169

Code: C47D22N3GB



CIRCOSTEAM COMBINATION OVEN

- ▶ Electronic Control
- ▶ Cleaning & Descaling Programmes
- ▶ 40 Automatic Programmes
- ▶ 5 Functions ▶ 35 Litre Capacity
- ▶ Steaming 35 °C - 100 °C
- ▶ 1.3 Litre Water Tank ▶ A Rated
- ▶ Silver Display EasyClock & Temperature Display ▶ Stainless Steel

RRP: €1,399

Code: C47C22N3GB



Now €1,449

CIRCOSTEAM COMBINATION OVEN

- ▶ Electronic Control
- ▶ Revolution Handle
- ▶ Cleaning & Descaling Programmes
- ▶ 70 Automatic Cooking Programmes
- ▶ 10 Functions ▶ 35 Litre Capacity
- ▶ Steaming 35 °C - 100 °C
- ▶ 1.3 Litre Water Tank ▶ A Rated
- ▶ Silver ClearText Display ▶ Stainless Steel

RRP: €1,549

Code: C47C62N3GB



STEAM OVEN

- ▶ Electronic Control
- ▶ Descaling Programme
- ▶ 20 Automatic Programmes
- ▶ 2 Functions ▶ 22 Litre Capacity
- ▶ Steaming 40 °C - 100 °C
- ▶ 0.9 Litre Water Tank
- ▶ Silver Display EasyClock ▶ Stainless Steel
- ▶ Left or Right Hinged Door Options

RRP: €1,099

Code: C44R20/C44L20N3GB



MICROWAVE OVEN & GRILL

- ▶ Electronic Control
- ▶ 16 Automatic Programmes
- ▶ 3 Functions ▶ 21 Litre Capacity
- ▶ 5 Microwave Power Levels
- ▶ Max Microwave Power 900W
- ▶ Silver Display EasyClock
- ▶ Stainless Steel
- ▶ Left or Right Hinged Door Options

RRP: €899

Code: C54L70/C54R70N3GB



50cm MICROWAVE OVEN

- ▶ Electronic Control
- ▶ 11 Automatic Programmes
- ▶ 17 Litre Capacity
- ▶ 5 Microwave Power Levels
- ▶ Max Microwave Power 800W
- ▶ 1 Recipe Memory Position
- ▶ Left Hinged Door
- ▶ Silver Display ▶ Stainless Steel

RRP: €449

Code: H53W50N3GB



50cm MICROWAVE OVEN

- ▶ Electronic Control
- ▶ 11 Automatic Programmes
- ▶ 17 Litre Capacity
- ▶ 5 Microwave Power Levels
- ▶ Max Microwave Power 800W
- ▶ 1 Recipe Memory Position
- ▶ Left Hinged Door
- ▶ Silver Display ▶ Black

RRP: €349

Code: H53W50S3GB



60cm MICROWAVE OVEN

- ▶ Electronic Control
- ▶ 11 Automatic Programmes
- ▶ 17 Litre Capacity
- ▶ 5 Microwave Power Levels
- ▶ Max Microwave Power 800W
- ▶ 1 Recipe Memory Position
- ▶ Left Hinged Door
- ▶ Silver Display ▶ Stainless Steel

RRP: €479

Code: H53W60N3GB



60cm MICROWAVE OVEN

- ▶ Electronic Control
- ▶ 11 Automatic Programmes
- ▶ 17 Litre Capacity
- ▶ 5 Microwave Power Levels
- ▶ Max Microwave Power 800W
- ▶ 1 Recipe Memory Position
- ▶ Left Hinged Door
- ▶ Silver Display ▶ Black

RRP: €399

Code: H53W60S3GB



MICROWAVE OVEN

- ▶ Electronic Control
- ▶ 11 Automatic Programmes
- ▶ 25 Litre Capacity
- ▶ 5 Microwave Power Levels
- ▶ Max Microwave Power 900W
- ▶ 1 Recipe Memory Position
- ▶ Left Hinged Door
- ▶ Silver Display ▶ Stainless Steel

RRP: €499

Code: H56W20N3GB



W RRP: €499
Code: H56W20W3GB
(4-5 day lead time)



B RRP: €479
Code: H56W20S3GB



WARMING DRAWER

- ▶ Electronic Control
- ▶ 4 Settings
- ▶ 6 Place Settings ▶ 20 Litre Capacity
- ▶ Max Weight Capacity: 25kg
- ▶ Max Temp: 80°C Min Temp: 30°C
- ▶ Toughened Glass Drawer Base
- ▶ Bevelled Design Bar Handle
- ▶ Stainless Steel

RRP: €499

Code: N21H40N3GB



WARMING DRAWER

- ▶ Electronic Control
- ▶ 4 Settings
- ▶ 6 Place Settings ▶ 20 Litre Capacity
- ▶ Max Weight Capacity: 25kg
- ▶ Max Temp: 80°C Min Temp: 30°C
- ▶ Toughened Glass Drawer Base
- ▶ Bevelled Design Bar Handle
- ▶ Black

RRP: €599

Code: N21H40S3GB (4-5 day lead time)



WARMING DRAWER

- ▶ Electronic Control
- ▶ 4 Settings
- ▶ 12 Place Settings ▶ 52 Litre Capacity
- ▶ Max Weight Capacity: 25kg
- ▶ Max Temp: 80°C Min Temp: 30°C
- ▶ Toughened Glass Drawer Base
- ▶ Bevelled Design Bar Handle
- ▶ Stainless Steel

RRP: €569

Code: N22H40N3GB



WARMING DRAWER

- ▶ Electronic Control
- ▶ 4 Settings
- ▶ 12 Place Settings ▶ 52 Litre Capacity
- ▶ Max Weight Capacity: 25kg
- ▶ Max Temp: 80°C Min Temp: 30°C
- ▶ Toughened Glass Drawer Base
- ▶ Bevelled Design Bar Handle
- ▶ Stainless Steel

RRP: €649

Code: N22H40S3GB (4-5 day lead time)



60cm 4 ZONE CERAMIC HOB

- ▶ 4 QuickLight Cooking Zones
- ▶ 9 Power Levels
- ▶ Residual Heat Indicators
- ▶ Fixed Bevelled Oval Controls at Side
- ▶ Frameless with Front Facetted Glass

RRP: €399

Code: T11K40X2

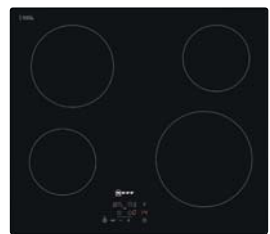

60cm 4 ZONE CERAMIC HOB

- ▶ 4 QuickLight Cooking Zones
- ▶ Residual Heat Indicators
- ▶ Electronic Touch Controls
- ▶ LED Display for Each Zone
- ▶ 17 Power Levels
- ▶ LED Timer for Each Zone
- ▶ Child Lock & Safety Cut Out Facility
- ▶ Frameless with Front Facetted Glass

RRP: €649

Code: T10B40X2



80cm 4 ZONE CERAMIC HOB

- ▶ 4 QuickLight Cooking Zones
- ▶ Residual Heat Indicators
- ▶ Electronic Touch Controls
- ▶ 17 Power Levels
- ▶ 3 Dual and/or Extendable Zones
- ▶ LED Display for Each Zone
- ▶ Child Lock & Safety Cut Out Facility
- ▶ Frameless With Facetted Edge

RRP: €899

Code: T11D83X2



Now €799



60cm 4 ZONE INDUCTION HOB

- ▶ 4 Power Boost Zones
- ▶ Residual Heat Indicators
- ▶ Electronic Touch Controls
- ▶ 17 Power Levels
- ▶ LED Displays with Switch-Off Timer
- ▶ Child Lock & Safety Cut Out Facility
- ▶ Frameless

RRP: €599

Code: T40B30X2



60cm 4 ZONE INDUCTION HOB

- ▶ 4 Power Boost Zones
- ▶ Residual Heat Indicators
- ▶ Electronic Touch Controls
- ▶ 17 Power Levels
- ▶ QuickStart Function
- ▶ LED Displays with Switch-Off Timer
- ▶ Child Lock & Safety Cut Out Facility
- ▶ Frameless

RRP: €699

Code: T40B31X2GB



60cm 4 ZONE INDUCTION HOB

- ▶ 4 Power Boost Zones
- ▶ Residual Heat Indicators
- ▶ Electronic Touch Controls
- ▶ 17 Power Levels
- ▶ QuickStart Function
- ▶ LED Display for Each Zone
- ▶ Child Lock & Safety Cut Out Facility
- ▶ Bevel Front

RRP: €749

Code: T41D40X2



60cm 4 ZONE INDUCTION HOB

- ▶ 4 Power Boost Zones
- ▶ Residual Heat Indicators
- ▶ Electronic Touch Controls
- ▶ 17 Power Levels
- ▶ QuickStart Function
- ▶ LED Display for Each Zone
- ▶ Child Lock & Safety Cut Out Facility
- ▶ Bevel Front

RRP: €799

Code: T41B30X2



60cm 4 ZONE INDUCTION HOB

- ▶ 4 Power Boost Zones
- ▶ Residual Heat Indicators
- ▶ Electronic Touch Controls
- ▶ 17 Power Levels
- ▶ QuickStart Function
- ▶ LED Display for Each Zone
- ▶ Child Lock & Safety Cut Out Facility
- ▶ Flushline Installation

RRP: €999

Code: T45D40X2 (4-5 day lead time)

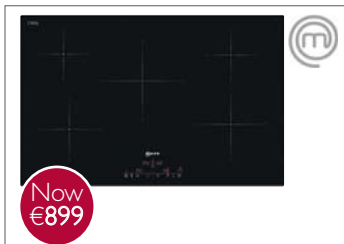

80cm 5 ZONE INDUCTION HOB

- ▶ 5 Power Boost Zones
- ▶ Residual Heat Indicators
- ▶ Touch Control ▶ 17 Power Levels
- ▶ QuickStart Function
- ▶ LED Displays with Switch-Off Timer
- ▶ Child Lock & Safety Cut Out Facility
- ▶ Bevel Front

RRP: €999

Code: T41D82X2

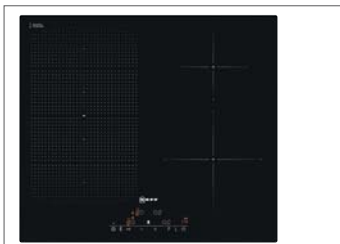

60cm FLEX ZONE INDUCTION HOB

- ▶ 1 Flex Zone, 2 Single Zones
- ▶ Power Boost for all Zones
- ▶ Residual Heat Indicators
- ▶ 17 Power Levels
- ▶ QuickStart Function
- ▶ LED Displays with Switch-Off Timer
- ▶ Child Lock & Safety Cut Out Facility
- ▶ Bevel Front

RRP: €1,099

Code: T51D53X2



80cm FLEX ZONE INDUCTION HOB

- ▶ 1 Flex Zone, 2 Single Zones
- ▶ Power Boost for all Zones
- ▶ Residual Heat Indicators
- ▶ 17 Power Levels
- ▶ QuickStart Function
- ▶ LED Displays with Switch-Off Timer
- ▶ Child Lock & Safety Cut Out Facility
- ▶ Bevel Front

RRP: €1,299

Code: T51D86X2

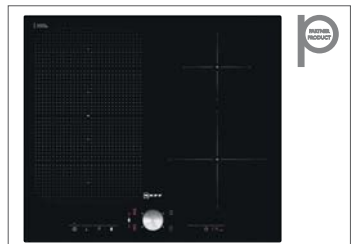

60cm 4 ZONE FLEXINDUCTION HOB

- ▶ Power Boost For All Zones
- ▶ Residual Heat Indicators
- ▶ "Point & Twist" Control ▶ 17 Power Levels
- ▶ 1 FlexInduction Zone, 2 Single
- ▶ QuickStart Function
- ▶ LED Displays with Switch-Off Timer
- ▶ Child Lock & Safety Cut Out Facility
- ▶ Bevel Front

RRP: €1,199

Code: T51T53X2 (4-5 day lead time)

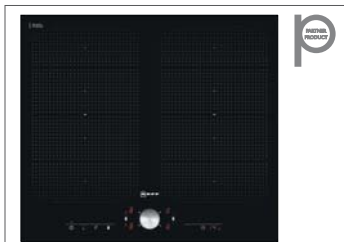

60cm 4 ZONE FLEXINDUCTION HOB

- ▶ 4 Power Boost Zones
- ▶ Residual Heat Indicators
- ▶ "Point & Twist" Control ▶ 17 Power Levels
- ▶ 2 FlexInduction Zones
- ▶ Automatic Pan Recognition
- ▶ LED Displays with Switch-Off Timer
- ▶ Child Lock & Safety Cut Out Facility
- ▶ Bevel Front

RRP: €1,299

Code: T51T55X2 (4-5 day lead time)



60cm 4 ZONE FLEXINDUCTION HOB

- ▶ 4 Power Boost Zones
- ▶ Residual Heat Indicators
- ▶ "Point & Twist" Control ▶ 17 Power Levels
- ▶ 2 FlexInduction Zones
- ▶ Automatic Pan Recognition
- ▶ LED Displays with Switch-Off Timer
- ▶ Child Lock & Safety Cut Out Facility
- ▶ Bevel Glass / Steel Trim

RRP: €1,399

Code: T54T55N2

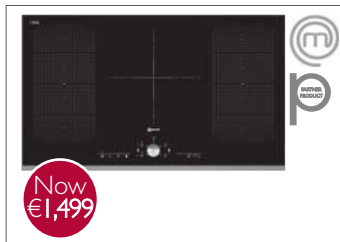

90cm 5 ZONE FLEXINDUCTION HOB

- ▶ 5 Power Boost Zones
- ▶ Residual Heat Indicators
- ▶ "Point & Twist" Control ▶ 17 Power Levels
- ▶ 2 FlexInduction Zones, 1 Standard Zone
- ▶ Automatic Pan Recognition
- ▶ LED Displays with Switch-Off Timer
- ▶ Child Lock & Safety Cut Out Facility
- ▶ Bevel Glass / Steel Trim

RRP: €1,799

Code: T54T95N2



90cm 5 ZONE FLEXINDUCTION HOB

- ▶ 5 Power Boost Zones
- ▶ Residual Heat Indicators
- ▶ "Point & Twist" Control ▶ 17 Power Levels
- ▶ 3 FlexInduction Zones
- ▶ Automatic Pan Recognition
- ▶ LED Displays with Switch-Off Timer
- ▶ Child Lock & Safety Cut Out Facility
- ▶ Bevel Glass / Steel Trim

RRP: €2,249

Code: T54T97N2 (4-5 day lead time)



60cm 4 BURNER GAS HOB

- ▶ 1 High Speed, 2 Standard & 1 Economy
- ▶ Enamel Pan Supports
- ▶ Flame Failure Safety Device
- ▶ Ignition via Control Dials
- ▶ Bevelled Oval Controls at Side
- ▶ Stainless Steel / Black / White

RRP: €299
Code: T2IS3INI/SI/WI



60cm 4 BURNER GAS HOB

- ▶ 1 High Speed, 2 Standard & 1 Economy
- ▶ Cast Iron Pan Supports
- ▶ Flame Failure Safety Device
- ▶ Ignition via Control Dials
- ▶ Bevelled Oval Controls at Side
- ▶ Stainless Steel / Black / White

RRP: €349
Code: T2IS36NI/SI/WI



60cm 4 BURNER GAS HOB

- ▶ 1 Wok Style, 2 Standard & 1 Economy
- ▶ Cast Iron Pan Supports
- ▶ Flame Failure Safety Device
- ▶ Ignition via Control Dials
- ▶ Bevelled Oval Controls at Side
- ▶ Stainless Steel

RRP: €399
Code: T2IS46NI



60cm 4 BURNER GAS HOB

- ▶ 1 High Speed, 2 Standard, 1 Economy & 1 3.3KW Wok Burner
- ▶ Cast Iron Pan Supports
- ▶ Flame Failure Safety Device
- ▶ Ignition via Control Dials
- ▶ Bevelled Oval Controls at Front
- ▶ Black Glass Control Panel
- ▶ Stainless Steel

RRP: €529
Code: T23R46N0



Now €399

60cm 4 BURNER GAS HOB

- ▶ 1 High Speed, 2 Standard & 1 Economy
- ▶ Cast Iron Pan Supports
- ▶ Flame Failure Safety Device
- ▶ Ignition via Control Dials
- ▶ Bevelled Oval Controls at Front
- ▶ Black Glass Control Panel
- ▶ Stainless Steel

RRP: €449
Code: T23S36N0GB



60CM 4 BURNER GAS HOB

- ▶ 1 High Speed, 2 Standard, 1 Economy
- ▶ Black Enamel Pan Supports
- ▶ Flame Failure Safety Device
- ▶ Ignition via Control Dials
- ▶ Bevelled Oval Controls at Side
- ▶ Black Tempered Glass
- ▶ Frameless

RRP: €429
Code: T6IS3IS1



60cm 4 BURNER GAS HOB

- ▶ 1 High Speed, 2 Standard, 1 Economy
- ▶ Cast Iron Pan Supports
- ▶ Flame Failure Safety Device
- ▶ Ignition via Control Dials
- ▶ Bevelled Oval Controls at Front
- ▶ Black Tempered Glass
- ▶ Frameless or Flushline

RRP: €529
Code: T62S26SI (4-5 day lead time)



Now €649

70cm 5 BURNER GAS HOB

- ▶ 1 High Speed, 2 Standard, 1 Economy & 1 Wok
- ▶ Cast Iron Pan Supports
- ▶ Flame Failure Safety Device
- ▶ Ignition via Control Dials
- ▶ Bevelled Oval Controls at Front
- ▶ Black Tempered Glass
- ▶ Frameless or Flushline

RRP: €749
Code: T63S46S1



Now €449

70cm 5 BURNER GAS HOB

- ▶ 1 High Speed, 2 Standard, 1 Economy & 1 Wok
- ▶ Cast Iron Pan Supports
- ▶ Flame Failure Safety Device
- ▶ Ignition via Control Dials
- ▶ Bevelled Oval Controls at Front
- ▶ Stainless Steel

RRP: €499
Code: T25S56N0GB



70cm 5 BURNER GAS HOB

- ▶ 1 High Speed, 2 Standard, 1 Economy & 1 Wok
- ▶ Cast Iron Pan Supports
- ▶ Flame Failure Safety Device
- ▶ Ignition via Control Dials
- ▶ Bevelled Oval Controls at Front
- ▶ Black

RRP: €499
Code: T25S56S0 (4-5 day lead time)



70cm 5 BURNER GAS HOB

- ▶ 1 High Speed, 2 Standard, 1 Economy & 1 Wok
- ▶ Dual Control Wok Burner
- ▶ Cast Iron Pan Supports
- ▶ Flame Failure Safety Device
- ▶ Ignition via Control Dials
- ▶ Bevelled Oval Controls at Front
- ▶ Stainless Steel

RRP: €699
Code: T26R66N0

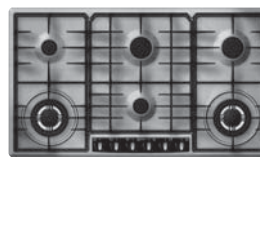

90cm 6 BURNER GAS HOB

- ▶ 2 Standard, 2 Economy & 2 Wok
- ▶ Cast Iron Pan Supports
- ▶ Flame Failure Safety Device
- ▶ Ignition via Control Dials
- ▶ Bevelled Oval Controls at Front
- ▶ Black Glass Control Panel
- ▶ Stainless Steel

RRP: €799
Code: T29S96NI



53cm CANOPY HOOD

- ▶ Single Motor
- ▶ Max Extraction: 280m³/h
- ▶ Noise Level 67dB Max
- ▶ 2 Speeds Plus Intensive
- ▶ 2 x 40W Bulbs
- ▶ Rocker Switch Control Operation
- ▶ For Ducted or Recirculation

RRP: €169

Code: D5625X0GB



53cm CANOPY HOOD

- ▶ Twin Motor
- ▶ Max Extraction: 500m³/h
- ▶ Noise Level 71 dB Max
- ▶ 3 Speeds Plus Intensive
- ▶ 2 x 20W Low Energy Halogen Lamps
- ▶ 2 x Metal Grease Filters
- ▶ Slide Control Operation
- ▶ For Ducted or Recirculation

RRP: €349

Code: D5645X0GB



73cm CANOPY HOOD

- ▶ Twin Motor
- ▶ Max Extraction: 650m³/h
- ▶ Noise Level 72dB Max
- ▶ 3 Speeds Plus Intensive
- ▶ 2 x 20W Low Energy Halogen Lamps
- ▶ 2 x Metal Grease Filters
- ▶ Slide Control Operation
- ▶ For Ducted or Recirculation

RRP: €379

Code: D5855X0GB



60cm INTEGRATED HOOD

- ▶ Single Motor
- ▶ Max Extraction: 280m³/h
- ▶ Noise Level 68dB Max
- ▶ 3 Speeds
- ▶ 1 x 40W Bulb
- ▶ Rocker Switch Control Operation
- ▶ For Ducted or Recirculation
- ▶ Furniture Door Required

RRP: €159

Code: D2615X0GB



60cm INTEGRATED HOOD

- ▶ Single Motor
- ▶ Max Extraction: 360m³/h
- ▶ Noise Level 64dB Max
- ▶ 3 Speeds ▶ 2 x 40W Bulbs
- ▶ 2 x Metal Grease Filters
- ▶ Rocker Switch Control Operation
- ▶ For Ducted or Recirculation
- ▶ Furniture Door Required

RRP: €229

Code: D2654X0GB



60cm INTEGRATED HOOD

- ▶ Single Motor
- ▶ Max Extraction: 540m³/h
- ▶ Noise Level 67dB Max
- ▶ 3 Speeds Plus Intensive ▶ 2 x 40W Bulbs
- ▶ 2 x Metal Grease Filters
- ▶ Slide Control Operation
- ▶ For Ducted or Recirculation
- ▶ Furniture Door Required

RRP: €299

Code: D2664X0GB



60cm CANOPY HOOD

- ▶ Max Extraction: 300m³/h
- ▶ Noise Level 63dB Max
- ▶ 3 Speeds
- ▶ 2 x 40W Bulbs
- ▶ Switch Control Operation
- ▶ For Ducted or Recirculation
- ▶ Handle/Décor Panel Included

RRP: €249

Code: D4618X0GB



90cm TELESCOPIC HOOD

- ▶ Max Extraction: 700m³/h
- ▶ Noise Level 69dB Max
- ▶ 3 Speeds Plus Intensive
- ▶ 3 x 20W Low Energy Halogen Lamps
- ▶ 2 x Metal Grease Filters
- ▶ Slide Control Operation

RRP: €599

Code: D4972X0GB



60cm CHIMNEY HOOD

- ▶ Max Extraction: 400m³/h
- ▶ Noise Level 67dB Max
- ▶ 3 Speeds
- ▶ 2 x 20W Low Energy Halogen Lamps
- ▶ 2 x Metal Grease Filters
- ▶ Rocker Switch Control Operation
- ▶ For Ducted or Recirculation
- ▶ Also In Black - €319

RRP: €349

Code: D66B21N0GB/S0GB



90cm CHIMNEY HOOD

- ▶ Max Extraction: 400m³/h
- ▶ Noise Level 67dB Max
- ▶ 3 Speeds
- ▶ 2 x 20W Low Energy Halogen Lamps
- ▶ 3 x Metal Grease Filters
- ▶ Rocker Switch Control Operation
- ▶ For Ducted or Recirculation
- ▶ Also In Black - €379

RRP: €449

Code: D69B21N0GB/S0GB



60cm CHIMNEY HOOD

- ▶ Max Extraction: 650m³/h
- ▶ Noise Level 73dB Max
- ▶ 3 Speeds Plus Intensive
- ▶ 2 x 20W Low Energy Halogen Lamps
- ▶ 1 x Metal Grease Filter
- ▶ Soft Touch Button Controls
- ▶ Curved Glass Canopy ▶ LED Display
- ▶ For Ducted or Recirculation

RRP: €699

Code: D86G45N0GB (4-5 day lead time)



90cm WALL MOUNTED HOOD

- ▶ Max Extraction: 430m³/h
- ▶ Noise Level 71 dB Max
- ▶ 3 Speeds Plus Intensive
- ▶ 2 x 20W Low Energy Halogen Lamps
- ▶ 1 x Metal Grease Filter
- ▶ Switch Control Operation
- ▶ Curved Glass Canopy ▶ LED Display
- ▶ For Ducted or Recirculation

RRP: €699

Code: D89G21N0GB (4-5 day lead time)



60cm CHIMNEY HOOD

- ▶ Max Extraction: 690m³/h
- ▶ Noise Level 73dB Max
- ▶ 3 Speeds Plus Intensive
- ▶ 2 x 20W Low Energy Halogen Lamps
- ▶ 2 x Metal Grease Filters
- ▶ Soft Touch Button Controls
- ▶ Bevelled Glass Fascia Panel ▶ LED Display
- ▶ For Ducted or Recirculation

RRP: €789

Code: D76M55N0GB (4-5 day lead time)



Now €599

90cm CHIMNEY HOOD

- ▶ Max Extraction: 740m³/h
- ▶ Noise Level 72dB Max
- ▶ 3 Speeds Plus Intensive
- ▶ 3 x 20W Low Energy Halogen Lamps
- ▶ 3 x Metal Grease Filters
- ▶ Soft Touch Button Controls
- ▶ Bevelled Glass Fascia Panel ▶ LED Display
- ▶ For Ducted or Recirculation

RRP: €799

Code: D79M55N0GB



Now €799

90cm CHIMNEY HOOD

- ▶ Max Extraction: 420m³/h
- ▶ Noise Level 71dB Max
- ▶ 3 Speeds Plus Intensive
- ▶ 2 x 20 Watt Bulbs
- ▶ 2 x Metal Grease Filter
- ▶ Electronic Control Via Soft Touch Btn
- ▶ Glass Canopy
- ▶ For Ducted or Recirculation

RRP: €899

Code: D89D55N1GB



90cm AIRDELUXE CHIMNEY HOOD

- ▶ Max Extraction: 750m³/h
- ▶ Noise Level 59dB Max
- ▶ 3 Speeds Plus Intensive
- ▶ 2 x 5 Watt LED Strips
- ▶ 1 x Metal Grease Filter
- ▶ Electronic Control With Soft Touch
- ▶ Stainless Steel Filter Covers
- ▶ For Ducted Only

RRP: €2,199

Code: D99LI0N0GB (4-5 day lead time)



90cm ISLAND CHIMNEY HOOD

- ▶ Max Extraction: 620m³/h
- ▶ Noise Level 72dB Max
- ▶ 3 Speeds
- ▶ 4 x 25W Low Energy Halogen Lamps
- ▶ 1 x Metal Grease Filter
- ▶ Push Button Operation
- ▶ Glass Canopy
- ▶ For Ducted or Recirculation

RRP: €999

Code: I89E2IN0GB (4-5 day lead time)



90cm ISLAND CHIMNEY HOOD

- ▶ Max Extraction: 680m³/h
- ▶ Noise Level 72dB Max
- ▶ 3 Speeds Plus Intensive
- ▶ 4 x 20W Low Energy Halogen Lamps
- ▶ 3 x Metal Grease Filters
- ▶ Soft Touch Button Controls ▶ LED Display
- ▶ Slimline Canopy Design
- ▶ For Ducted or Recirculation

RRP: €1,149

Code: I79S45N0GB (4-5 day lead time)



90cm ISLAND CHIMNEY HOOD

- ▶ Max Extraction: 720m³/h
- ▶ Noise Level 74dB Max
- ▶ 3 Speeds Plus Intensive
- ▶ 4 x 20W Low Energy Halogen Lamps
- ▶ 2 x Metal Grease Filters
- ▶ Soft Touch Button Controls ▶ LED Display
- ▶ St/Steel with Glass Canopy Sides
- ▶ For Ducted or Recirculation

RRP: €1,349

Code: I89D55N1GB (4-5 day lead time)



90cm ISLAND CHIMNEY HOOD

- ▶ Max Extraction: 720m³/h
- ▶ Noise Level 74dB Max
- ▶ 3 Speeds Plus Intensive
- ▶ 4 x 20W Low Energy Halogen Lamps
- ▶ 3 x Metal Grease Filters
- ▶ Soft Touch Button Controls ▶ LED Display
- ▶ Stainless Steel
- ▶ For Ducted or Recirculation

RRP: €1,599

Code: I79M56N1GB (4-5 day lead time)

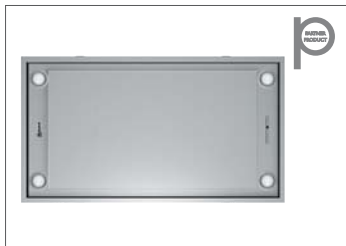

90cm CEILING MOUNTED HOOD

- ▶ Max Extraction: 820m³/h
- ▶ Noise Level 69dB Max
- ▶ 3 Speeds Plus Intensive
- ▶ 4 x 20W Low Energy Halogen Lamps
- ▶ 3 x Metal Grease Filters
- ▶ Remote Control Operation
- ▶ LED Display ▶ Rim Ventilation
- ▶ For Ducted Operation

RRP: €1,599

Code: I99C68N0GB (4-5 day lead time)



90cm DOWNDRAFT HOOD

- ▶ Max Extraction: 750m³/h
- ▶ Noise Level 77dB Max
- ▶ 3 Speeds Plus 2 Intensive
- ▶ 1 x 5 Watt LED Light Strip
- ▶ 2 x Metal Grease Filters
- ▶ Touch Control Operation
- ▶ LED Display ▶ Rim Ventilation
- ▶ For Ducted Operation

RRP: €2,499

Code: I99L59N0GB (4-5 day lead time)





BUILT IN FREEZER

- ▶ Total Capacity: 98 Litres
- ▶ A Rated
- ▶ Annual Energy Consumption - 193kWh
- ▶ Mechanical Control
- ▶ SuperFreeze Function
- ▶ 3 Freezer Drawers
- ▶ 4 Star Freezer Rating
- ▶ Fully Integrated

RRP: €679

Code: G4344X7GB



BUILT IN AUTODEFROST FRIDGE

- ▶ Total Capacity: 141 Litres
- ▶ A+ Rated
- ▶ Annual Energy Consumption - 124kWh
- ▶ Mechanical Control
- ▶ CircoCool Shelving
- ▶ Daylight Enhanced Interior Light
- ▶ 3 x Safety Glass Shelves
- ▶ Full Width Pull Out Drawer

RRP: €529

Code: K4316X7GB



BUILT IN AUTODEFROST FRIDGE

- ▶ Total Capacity: 125 Litres
- ▶ 15 Litre 4 Star Freezer ▶ A++ Rated
- ▶ Annual Energy Consumption - 140kWh
- ▶ Mechanical Control
- ▶ CircoCool Shelving
- ▶ Daylight Enhanced Interior Light
- ▶ 2 x Safety Glass Shelves
- ▶ 1 x Vegetable Container with Lid

RRP: €679

Code: K4336X8GB



BUILT IN AUTODEFROST FRIDGE

- ▶ Total Capacity: 206 Litres
- ▶ 17 Litre 4 Star Freezer ▶ A+ Rated
- ▶ Annual Energy Consumption - 235kWh
- ▶ Electronic Control
- ▶ CircoCool Shelving
- ▶ SuperCool Function
- ▶ 5 x Safety Glass Shelves
- ▶ 1 x Vegetable Drawer

RRP: €899

Code: K5654X7GB



BUILT IN AUTODEFROST FRIDGE

- ▶ Total Capacity: 153 Litres
- ▶ A+ Rated
- ▶ Annual Energy Consumption - 129kWh
- ▶ Electronic Control
- ▶ SuperCool Function
- ▶ 4 x Safety Glass Shelves
- ▶ 1 x Vegetable Drawer
- ▶ Pull Out Fridge Tray

RRP: €729

Code: K5604X7GB (4-5 day lead time)



BUILT IN 50:50 FRIDGE/FREEZER

- ▶ 167L Fridge & 95L Freezer
- ▶ A+ Rated
- ▶ Annual Energy Consumption - 300kWh
- ▶ Mechanical Control
- ▶ CircoCool Shelving
- ▶ 3 x Safety Glass Shelves
- ▶ 1 x Vegetable Drawer
- ▶ 4 x Freezer Drawers

RRP: €899

Code: K4204X7GB



BUILT IN 70:30 FRIDGE/FREEZER

- ▶ 219L Fridge & 60L Freezer
- ▶ A+ Rated
- ▶ Annual Energy Consumption - 290kWh
- ▶ Mechanical Control
- ▶ 5 x Safety Glass Shelves
- ▶ 1 x Vegetable Drawer
- ▶ 1 x Chrome Bottle Rack
- ▶ 3 x Freezer Drawers

RRP: €899

Code: K8524X7GB



BUILT IN FRIDGE

- ▶ Total Capacity: 192 Litres
- ▶ A+ Rated
- ▶ Annual Energy Consumption - 155kWh
- ▶ Electronic Control
- ▶ VitaFresh® 0°C Compartment
- ▶ Telescopic FlexiRail® Drawers
- ▶ 5 x Safety Glass Shelves
- ▶ Pull Out Fridge Tray

RRP: €1,159

Code: K5724X7GB (4-5 day lead time)



BUILT IN FREEZER

- ▶ Total Capacity: 97 Litres
- ▶ A+ Rated
- ▶ Annual Energy Consumption - 204kWh
- ▶ Mechanical Control
- ▶ SuperFreeze Function
- ▶ 4 Freezer Drawers

RRP: €759

Code: G5624X7GB (4-5 day lead time)



BUILT IN LARDER FRIDGE

- ▶ Total Capacity: 308 Litres
- ▶ A+ Rated
- ▶ Annual Energy Consumption - 149kWh
- ▶ Daylight Enhanced Interior Light
- ▶ Electronic Control ▶ SuperCool Function
- ▶ Dynamic Cooling ▶ Telescopic FlexiRail®
- ▶ 7 Safety Glass Shelves
- ▶ 2 x Vegetable Drawer

RRP: €1,199

Code: K4655X7GB



BUILT IN FREEZER

- ▶ Total Capacity: 213 Litres ▶ A+ Rated
- ▶ Annual Energy Consumption - 325kWh
- ▶ LED Interior Lighting
- ▶ Electronic Touch Control
- ▶ SuperFreeze Function
- ▶ 6 Safety Glass Shelves
- ▶ 5 Freezer Drawers & 2 Flaps
- ▶ NoFrost - Never Have To Defrost Again

RRP: €1,799

Code: G4655X7GB (4-5 day lead time)



BUILT IN FRIDGE

- ▶ Total Capacity: 280L
- ▶ 36L Litre 4* Freezer
- ▶ A+ Rated
- ▶ Annual Energy Consumption - 209kWh
- ▶ Bright Interior Lighting 1 x 25 Watt
- ▶ Dynamic Cooling
- ▶ SuperFreeze Function
- ▶ 5 Safety Glass Shelves

RRP: €1,149

Code: K4664X7GB



AMERICAN FRIDGE/FREEZER

- ▶ Total Capacity: 528 Litres ▶ 177L Freezer
- ▶ St/Steel Doors ▶ A+ Rated
- ▶ Annual Energy Consumption - 486kWh
- ▶ Daylight enhanced interior light
- ▶ Electronic Control ▶ MultiAirFlow Cooling
- ▶ Illuminated Water & Ice Door Dispenser
- ▶ SuperCool & SuperFreeze Functions
- ▶ NoFrost - Never Have To Defrost Again

RRP: €2,699

Code: K5930DIGB



AMERICAN FRIDGE/FREEZER

- ▶ Total Capacity: 518 Litres ▶ 175L Freezer
- ▶ Fully Clad St/Steel ▶ A+ Rated
- ▶ Annual Energy Consumption - 438kWh
- ▶ Interior Lighting ▶ VarioBox with 3 Settings
- ▶ Electronic Control ▶ MultiAirFlow Cooling
- ▶ Illuminated Water & Ice Door Dispenser
- ▶ SuperCool & SuperFreeze Functions
- ▶ NoFrost - Never Have To Defrost Again

RRP: €3,499

Code: K3990X7GB (4-5 day lead time)



COOLDELUXE FRIDGE/FREEZER

- ▶ 189L Fridge & 62L Freezer ▶ A++ Rated
- ▶ Annual Energy Consumption - 250kWh
- ▶ LED Interior Lighting ▶ Electronic Control
- ▶ Dynamic Cooling ▶ AirFresh Filter
- ▶ VitaFresh® °C Compartment
- ▶ Telescopic FlexiRail® Drawers
- ▶ SuperCool & SuperFreeze Functions
- ▶ NoFrost - Never Have To Defrost Again

RRP: €2,799

Code: K8345X0 (4-5 day lead time)



AMERICAN FRIDGE/FREEZER

- ▶ Total Capacity: 562Litres ▶ 177L Freezer
- ▶ St/Steel Look Doors ▶ A+ Rated
- ▶ Annual Energy Consumption - 455kWh
- ▶ 2 x 25 Watt Interior Fridge Light
- ▶ Electronic Control ▶ MultiAirFlow Cooling
- ▶ In Door Water & Ice Dispenser
- ▶ SuperCool & SuperFreeze Functions
- ▶ NoFrost - Never Have To Defrost Again

RRP: €2,499

Code: K5920L0GB



COOLDELUXE FRIDGE

- ▶ Total Capacity: 306 Litres ▶ A++ Rated
- ▶ Annual Energy Consumption - 133kWh
- ▶ LED Interior Lighting
- ▶ Electronic Control ▶ Dynamic Cooling
- ▶ VitaFresh® °C compartment
- ▶ Telescopic FlexiRail® Drawers
- ▶ 7 Safety Glass Shelves
- ▶ SuperCool Function

RRP: €2,999

Code: K8315X0 (4-5 day lead time)



COOLDELUXE FREEZER

- ▶ Total Capacity: 213 Litres
- ▶ A++ Rated
- ▶ Annual Energy Consumption - 244kWh
- ▶ LED Interior Lighting
- ▶ Electronic Control
- ▶ 5 Freezer Drawers & 2 Flaps
- ▶ SuperFreeze Function
- ▶ NoFrost - Never Have To Defrost Again

RRP: €2,449

Code: G8320X0 (4-5 day lead time)



THE NEFF COOLDELUXE RANGE

The built in CoolDeluxe Range is the perfect mix of quality design and state-of-the-art technology such as Telescopic FlexiRail® drawers, 0 °C VitaFresh® humidity controlled zones, energy efficient LED lighting and EasyLift glass shelving and door compartments.



W RRP: €649
Code: S41E50W0GB
(4-5 day lead time)



B RRP: €649
Code: S41E50S0GB



60cm SEMI-INTEGRATED DISH-WASHER

- ▶ 6 Programmes & VarioSpeed® Plus
- ▶ 13 Place Settings ▶ A++ Energy Rating
- ▶ Noise Level 42dB Max
- ▶ Water Consumption 9.5 Litres
- ▶ Time Delay ▶ AquaStop Technology
- ▶ DosageAssist Detergent Dispenser
- ▶ NeffSparkle® Program
- ▶ VarioFlex® Baskets ▶ Silver LED Display

RRP: €899

Code: S41M63N1GB



60cm SEMI-INTEGRATED DISH-WASHER

- ▶ 6 Programmes & VarioSpeed® Plus
- ▶ 14 Place Settings ▶ A++ Energy Rating
- ▶ Noise Level 41dB Max
- ▶ Water Consumption 9.5 Litres
- ▶ Time Delay ▶ AquaStop Technology
- ▶ DosageAssist ▶ NeffSparkle® Program
- ▶ VarioFlex® Plus Baskets
- ▶ VarioDrawer Plus ▶ Silver ClearText Display

RRP: €999

Code: S41T69N2GB



60cm FULLY INTEGRATED DISHWASHER

- ▶ 5 Programmes
- ▶ 12 Place Settings ▶ A+ Energy Rating
- ▶ Noise Level 52dB Max
- ▶ Water Consumption 14 Litres
- ▶ AquaStop Technology
- ▶ DosageAssist Detergent Dispenser
- ▶ Vario Baskets
- ▶ Red LED Indicators

RRP: €649
Code: S51E50X2GB



60cm FULLY INTEGRATED DISHWASHER

- ▶ 6 Programmes & VarioSpeed® Plus
- ▶ 13 Place Settings ▶ A++ Energy Rating
- ▶ Noise Level 42dB Max
- ▶ Water Consumption 9.5 Litres
- ▶ Time Delay ▶ AquaStop Technology
- ▶ DosageAssist ▶ NeffSparkle® Program
- ▶ VarioFlex® Baskets ▶ InfoLight
- ▶ LED Display

RRP: €849
Code: S51M63X2GB



60cm FULLY INTEGRATED DISHWASHER

- ▶ 6 Programmes & VarioSpeed® Plus
- ▶ 14 Place Settings ▶ A++ Energy Rating
- ▶ Noise Level 42dB Max
- ▶ Water Consumption 9.5 Litres
- ▶ Time Delay ▶ AquaStop Technology
- ▶ DosageAssist ▶ NeffSparkle® Program
- ▶ VarioFlex® Plus Baskets ▶ TimeLight
- ▶ VarioDrawer Plus ▶ LED Display

RRP: €949
Code: S51T69X3GB (4-5 day lead time)



60cm FULLY INTEGRATED DISHWASHER

- ▶ 6 Programmes & VarioSpeed® Plus
- ▶ 13 Place Settings ▶ A++ Energy Rating
- ▶ Noise Level 42dB Max ▶ 86.5cm High
- ▶ Water Consumption 9.5 Litres
- ▶ Time Delay ▶ AquaStop Technology
- ▶ DosageAssist ▶ NeffSparkle® Program
- ▶ VarioFlex® Baskets ▶ InfoLight
- ▶ LED Display

RRP: €999
Code: S72M63X2GB



45cm IN-LINE DISHWASHER

- ▶ 6 Programmes & VarioSpeed®
- ▶ 6 Place Settings ▶ A+ Energy Rating
- ▶ Noise Level 47dB Max
- ▶ Water Consumption 7.5 Litres
- ▶ Time Delay ▶ AquaStop Technology
- ▶ DosageAssist Detergent Dispenser
- ▶ Hygiene Option ▶ Silver Front Display
- ▶ Silver Baskets with Foldable Plate Racks

RRP: €799
Code: S65M63NIGB (4-5 day lead time)



60cm IN-LINE DISHWASHER

- ▶ 6 Programmes & VarioSpeed®
- ▶ 8 Place Settings ▶ A+ Energy Rating
- ▶ Noise Level 47dB Max
- ▶ Water Consumption 8.7 Litres
- ▶ Time Delay ▶ AquaStop Technology
- ▶ DosageAssist Detergent Dispenser
- ▶ Hygiene Option ▶ Silver Front Display
- ▶ Silver Baskets with Foldable Plate Racks

RRP: €999
Code: S66M63NIGB (4-5 day lead time)



INTEGRATED WASHING MACHINE

- ▶ 5 Programmes ▶ A+ Energy Rating
- ▶ 7kg Capacity
- ▶ Max Spin Speed 1200rpm
- ▶ 46dB Washing & 63dB Spinning
- ▶ AquaStop Technology
- ▶ CircoCare Drum System
- ▶ 3D AquaSpa Wash System
- ▶ Inverse Logic - Up To 40% Faster

RRP: €1,099
Code: W5420X0GB



INTEGRATED WASHING MACHINE

- ▶ 10 Programmes ▶ A+ Energy Rating
- ▶ 7kg Capacity ▶ Max Spin Speed 1400rpm
- ▶ 46dB Washing & 64dB Spinning
- ▶ AquaStop Technology
- ▶ CircoCare Drum System
- ▶ 3D AquaSpa Wash System
- ▶ Inverse Logic - Up To 40% Faster
- ▶ Time Delay (1-24 Hours) ▶ LED Display

RRP: €1,199
Code: W5440X0GB (4-5 day lead time)



INTEGRATED WASHER DRYER

- ▶ 8 Programmes ▶ B Energy Rating
- ▶ 6kg Washing & 3kg Drying
- ▶ Max Spin Speed 1400rpm
- ▶ 57dB Washing & 74dB Spinning
- ▶ AquaSecure Plus Technology
- ▶ 3D AquaSpa Wash System
- ▶ Time Delay (1-19 Hours)
- ▶ LED Display ▶ Child Safety Lock

RRP: €1,499
Code: V6320X0GB



FREESTANDING WASHING MACHINE

- ▶ 9 Programmes ▶ A+++ Energy Rating
- ▶ 7kg Capacity ▶ Max Spin Speed 1400rpm
- ▶ 54dB Washing & 75dB Spinning
- ▶ Antivibration Design
- ▶ Self Cleaning Detergent Drawer
- ▶ Active Water Management
- ▶ Time Delay (1 - 24 Hours)
- ▶ Large LED Display ▶ Child Safety Lock

RRP: €869
Code: W7460X0GB (4-5 day lead time)



FREESTANDING TUMBLE DRYER

- ▶ 9 Programmes ▶ B Energy Rating
- ▶ 8kg Capacity ▶ Condenser Dryer
- ▶ Noise Level 63dB Max
- ▶ Steam Function for Drying & Refreshing
- ▶ Drum Interior Light
- ▶ Sensor Drying
- ▶ Time Delay (1 - 24 Hours)
- ▶ Large LCD Display ▶ Child Safety Lock

RRP: €899
Code: R8580X1GB (4-5 day lead time)



FREESTANDING WASHER DRYER

- ▶ 12 Programmes ▶ B Energy Rating
- ▶ 7kg Washing & 4kg Drying
- ▶ Max Spin Speed 1400rpm
- ▶ 54dB Washing & 73dB Spinning
- ▶ AirCondensation Drying Technology
- ▶ CircoCare Drum System
- ▶ Time Delay (1 - 24 Hours)
- ▶ Large LED Display ▶ Child Safety Lock

RRP: €1,399
Code: V7446X0GB (4-5 day lead time)

Accessories

Accessories



Shelf Supports/Telescopic Rail
Use In Ovens With QuickConnect
Shelf Supports Only

Z1701X2 RRP: €69
(In Stock)



Telescopic Rail
Use In Ovens With The FlexiRail
System Only

Z1785X3 RRP: €59
(In Stock)



System Steamer
For Use With Single & Double
Ovens

N8642X3 RRP: €359
(In Stock)



Grill Pan
With Wire Insert & Handle

Z1240X2 RRP: €69
(4 - 5 Day Lead Time)



Two Piece Enamelled
Pan Insert

Z1512X0 RRP: €49
(4 - 5 Day Lead Time)



Full Width Glass Tray
Suitable For All Models

Z1262X0 RRP: €69
(4 - 5 Day Lead Time)



Non-Stick Baking Tray
Suitable For All Models

Z1343X0 RRP: €49
(4 - 5 Day Lead Time)



Enamel Pan - Extra Deep

Z1272X0 RRP: €99
(4 - 5 Day Lead Time)



Neff Bread &
Pizza Baking Stone

Z1913X0 RRP: €159
(In Stock)



Neff Porcelain Tray
Ceramic Oven to Table Dish

Z1665X0 RRP: €39
(In Stock)



Neff Steam Rack For Use
With Z9410XZ1 Oval Roaster

Z9415X1 RRP: €129
(In Stock)



Neff Oval Roaster For Use
With Flexinduction Zones
Hob

Z9410X1 RRP: €219
(In Stock)



Neff Griddle Plate For Use
With Flexinduction Zones
Hob

Z9416X2 RRP: €229
(In Stock)



Neff Teppan Yaki For Use
With Flexinduction Zones
Hob

Z9417X2 RRP: €389
(In Stock)



Neff Stacking Kit Accessory
for Drying

CZ11390 RRP: €29
(4 - 5 Day Lead Time)

Oven Specifications

B14M42/B15M52/B15E52/
B15P52

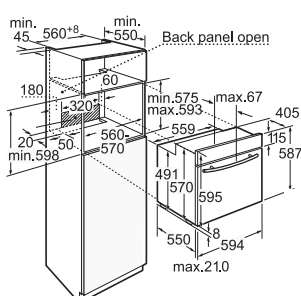

B45M52/B45E52/B44M42/
B45E74/B46E54/B45C52

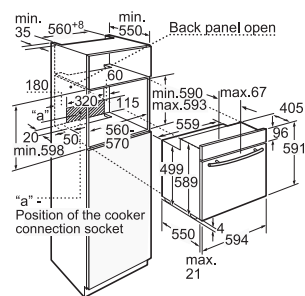

U14M42/U15M52/U15E52

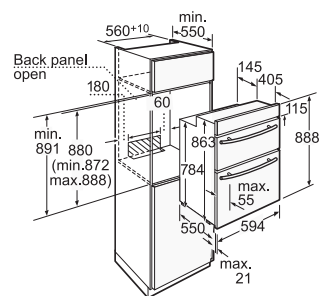

U17M42

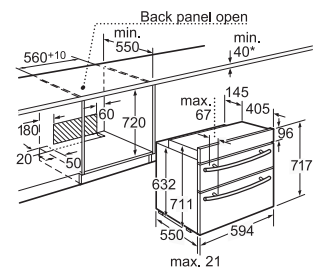

* For installation under an induction
hob min. 50 mm

Compact Appliance Specifications

C57M70

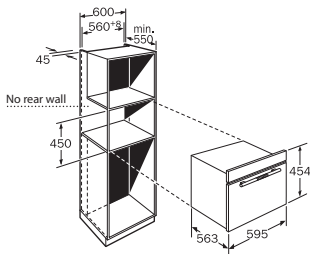

C67M70/C67P70

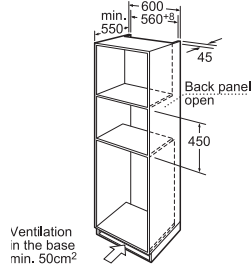

C77V60

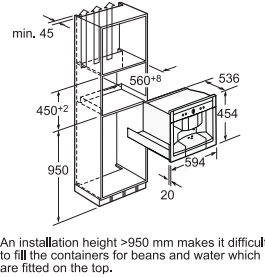

C47D22/C47C22/C47C62

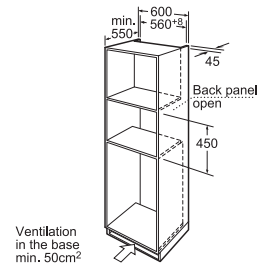

C44R20/C44L20/
C54L70/C54R70

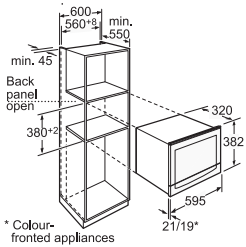

H53W50/H53W60

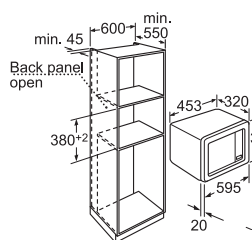

H56W20

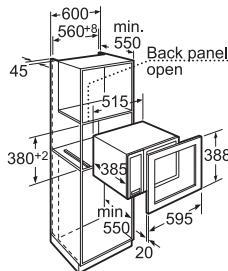

N21H40

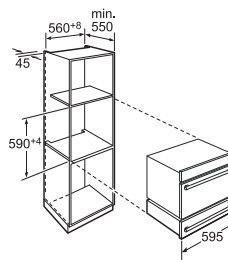

N22H40

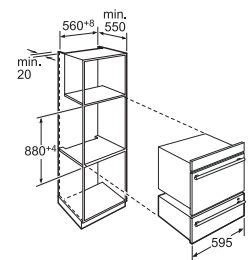

Hob Specifications

T1IK40/ T1OB40

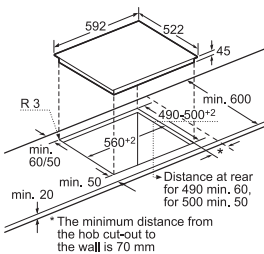

T1ID83

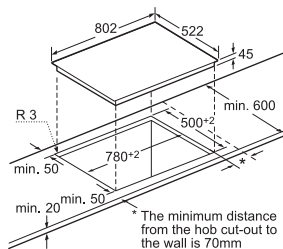

T40B30 /T40B31/T41D40/T41B30

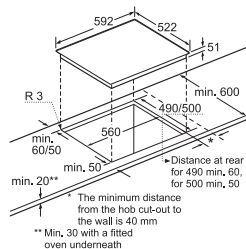

T45D40

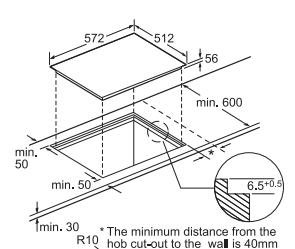

T41D82

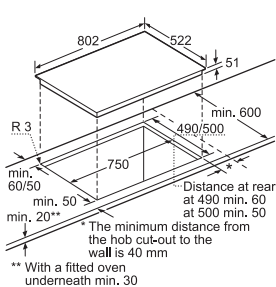

T51T55/T51D53/T51T53

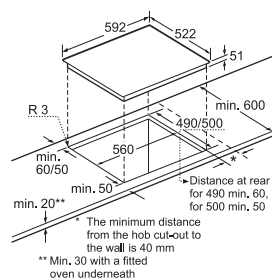

T51D86

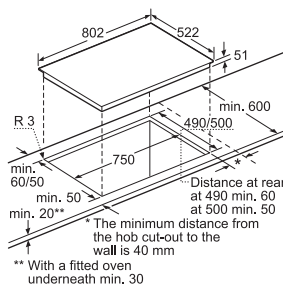

T54T55

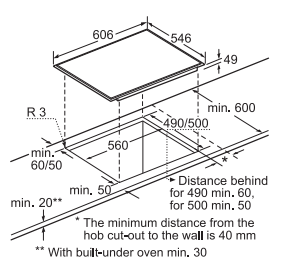

T54T95/ T54T97

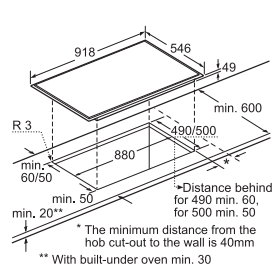

T21S31/T21S36/T21S46

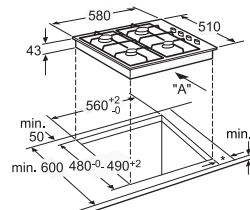

T23R46/T23S36

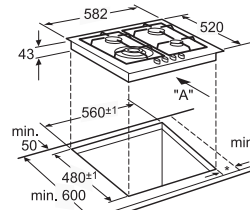

T61S31

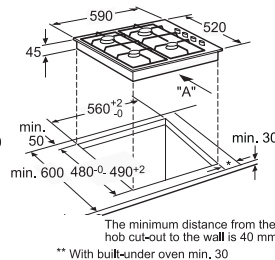

T62S26

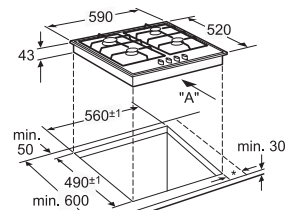

Hob Specifications

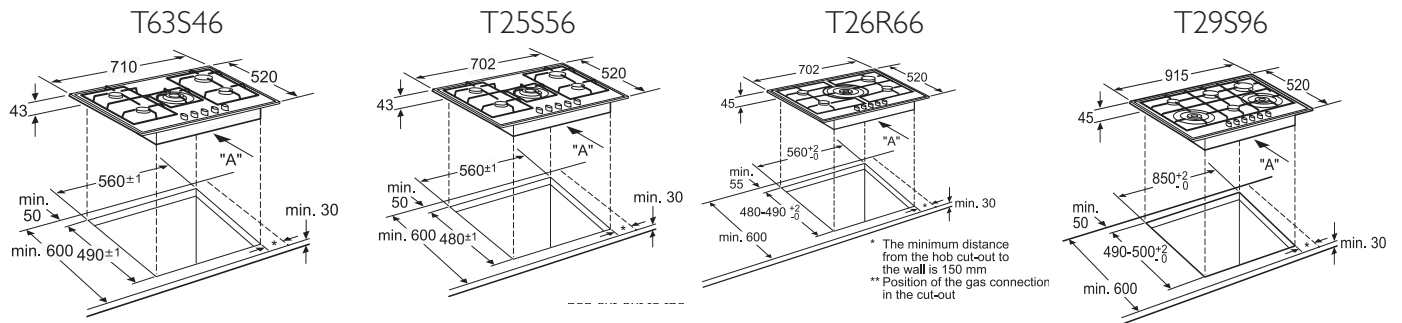

Hood Specifications

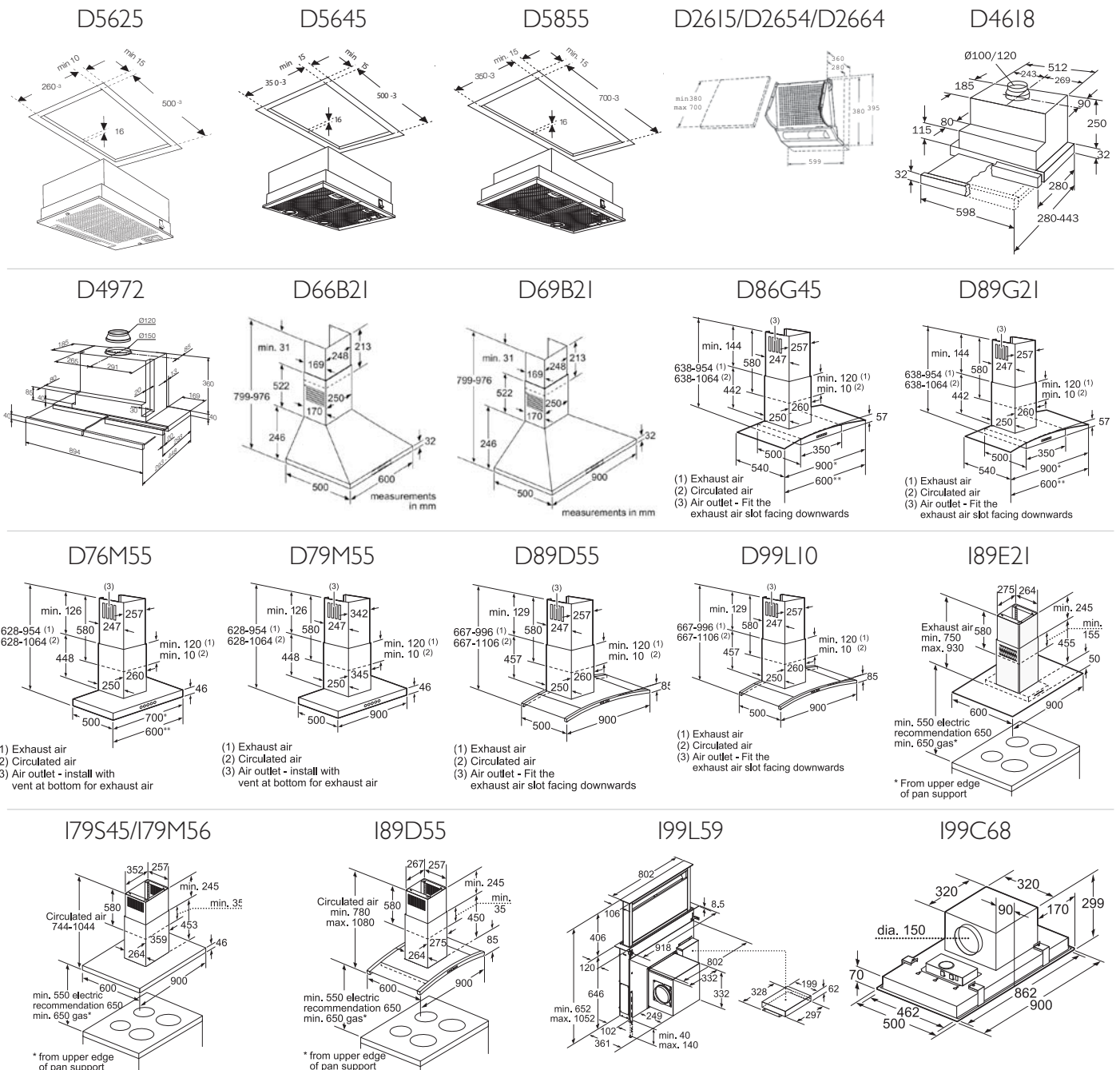

Refrigeration Specifications

K4316/G4344/K4336

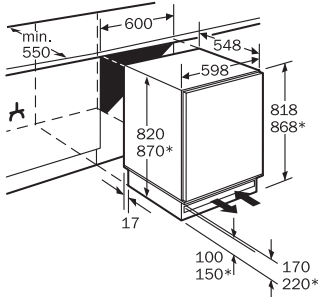

K5654

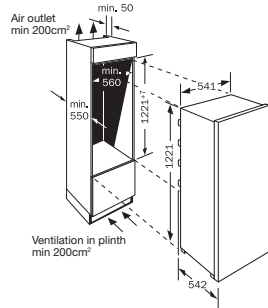

K4204

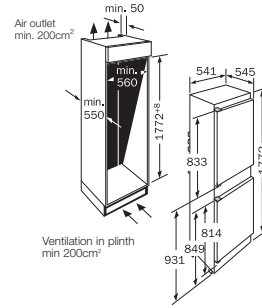

K8524

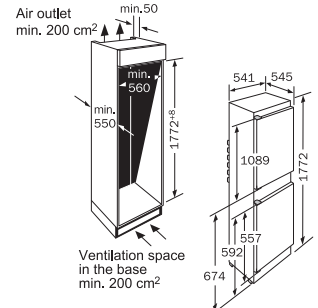

K5724

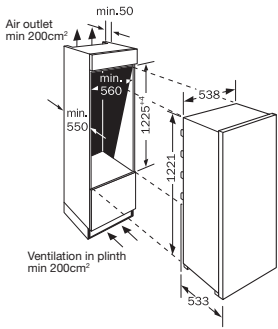

K5604/G5624

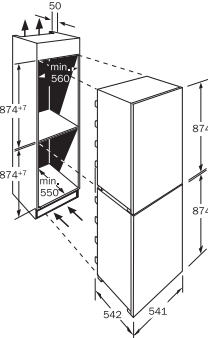

K4655

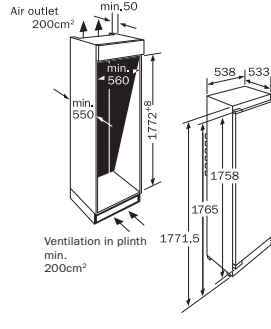

G4655

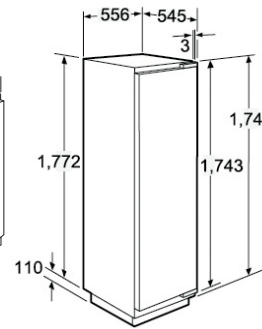

K5724

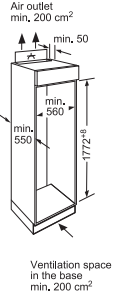

K5920/K5930

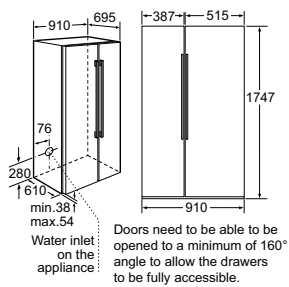

If the appliance is positioned near an oven, a distance of 30mm must be maintained.

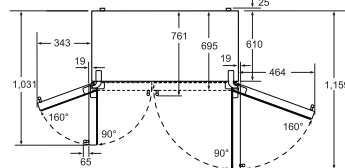

Doors need to be able to be opened to a minimum of 160° angle to allow the drawers to be fully accessible.

K3990

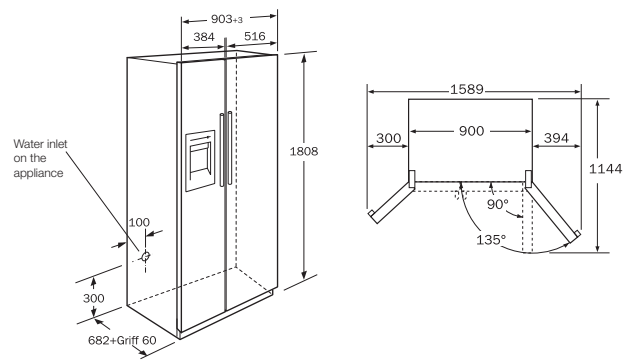

K8345

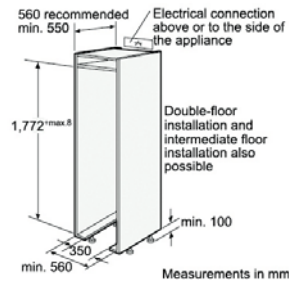
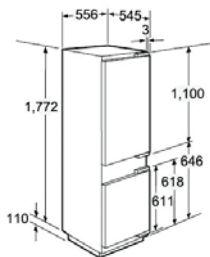

K8315/G8320

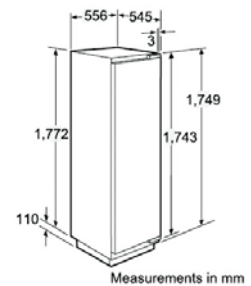
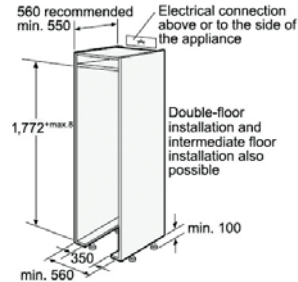

Dishwasher Specifications

S4IE50/S4IM63/S4IT69

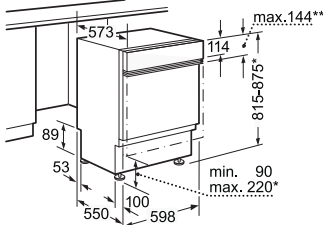

** Stainless steel fascia up to max. 143mm
 * Because of height-adjustable screw feet:
 when appliance height is 815, base height is 90-160mm
 when appliance height is 875, base height is 150-220mm

S65M63

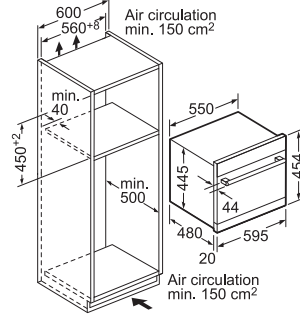

S66M63

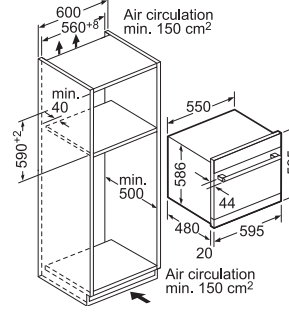

S5IE50/S5IM63/S5IT69

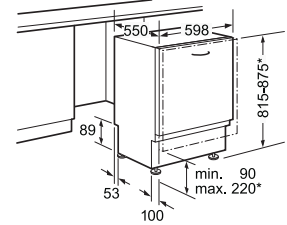

* Because of height-adjustable screw feet:
 when appliance height is 815, base height is 90-160mm
 when appliance height is 875, base height is 150-220mm

S72M63

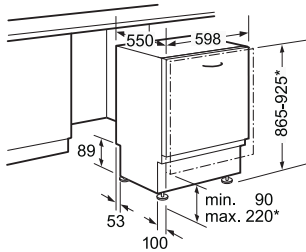

** Stainless steel fascia up to max. 143mm
 * Because of height-adjustable screw feet:
 when appliance height is 865, base height is 90-160mm
 when appliance height is 925, base height is 150-220mm

Laundry Specifications

W5420/W5440

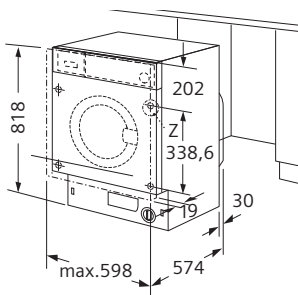

V6320

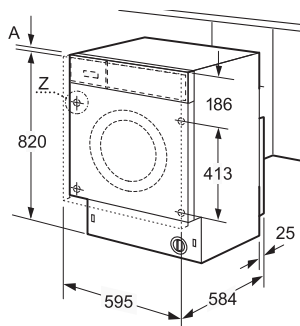

W7460

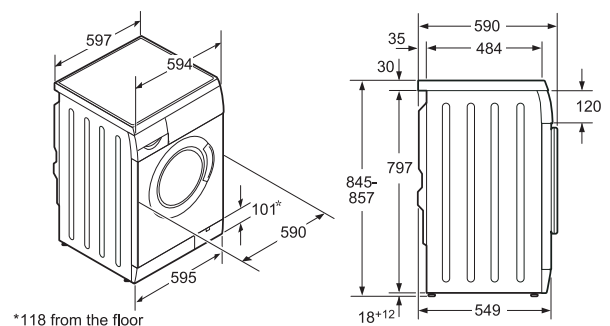

*118 from the floor

R8580

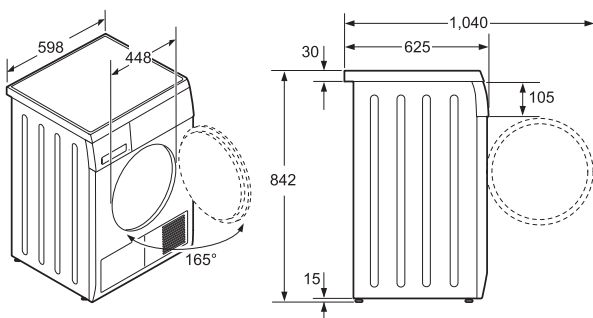

V7446

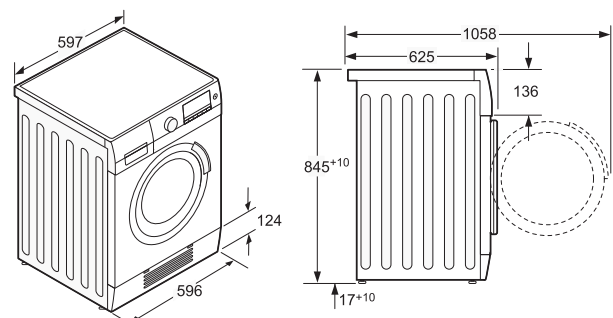

THE NEFF LEARNING CENTRE

Open Monday to Friday from 9am to 5pm in Citywest, Dublin, the Neff Learning Centre is the ideal setting to find a Neff appliance that will truly suit your needs.

With a vast range of Neff product on display and our expert advisors on hand you will have full opportunity to make a choice that will make your kitchen really special.



NEFF DEMONSTRATIONS

The Neff Learning Centre is also home to our purpose built demonstration theatre.

Here you can see Neff's unique features and benefits firsthand and fully experience just how the Neff CircoTherm® way of cooking generates perfect results every time.

Our product demonstrator also holds Neff demonstrations in retail outlets throughout the country. For a full listing and information on how to book your place visit the Nationwide Demonstrations page at www.neff.ie

For more information or to make an appointment please ring: (01) 413 6416



Roasting with CircoTherm® JENNY BRISTOW'S RACK OF LAMB WITH A GREMOLATA CRUSH AND LEMON GRAVY

Method:

Gently warm the olive oil in a pan and add the garlic, lemon zest, black pepper and parsley or rosemary. Mix lightly. Add the bread crumbs and continue to cook until the mixture binds.

Ask your butcher to prepare a rack of lamb, ensuring that all fat is scraped away from the bone, leaving at least 2 inches of the bones bare of fat. Pat dry the flesh section of the lamb with kitchen paper and cover with the gremolata crush, patting down carefully and firmly to ensure the crush will stay on after cooking.

Place in a roasting tin, sprinkle with the olive oil and cook in a preheated oven at CircoTherm 170°C or gas mark 6 for 35-40 minutes. The lamb will be pink when cooked. Increase the cooking time if you prefer your lamb well done.

Strain the meat juices from the roasting dish into a saucepan and add the lemon zest and honey. Heat through for 2 minutes. If you need to thicken the gravy, mix the flour with the water and stir in. Bring the gravy to the boil and continue boiling for 1 minute. Serve immediately and enjoy.

Ingredients:

Gremolata Crush

- 4 dessert spoons of olive oil
- 4 cloves of garlic - finely chopped
- Zest of 2 lemons - coarsely grated
- ½ a tea spoon of black pepper
- 2 dessert spoons of finely chopped parsley/rosemary
- 110 grams / 4 ounces white bread crumbs

Lemon Gravy

- 275ml / ½ a pint of meat juices
- Zest of ½ a lemon
- 2 dessert spoons of honey
- 10 grams / 2 ounces plain flour - optional
- 2-3 dessert spoons of water

Oven roasting is popular at any time of the year and is especially good using the CircoTherm® forced air cooking system which is at the heart of Neff ovens.

The great advantages of this lie in the fact that the oven heats up quickly with no need to pre-heat and secondly the combination of fast flowing hot air plus natural evaporation creates a uniquely moist heat which gives you extra succulent meat or lamb and caramelised vegetables.

In this recipe I have combined lamb with some lemon, herbs, parsley, garlic and a little olive oil.



Neff is the Preferred Appliance of Jenny Bristow. For more of Jenny's recipes visit www.jennybristow.com



While every effort is made to ensure the information contained within this promotional leaflet is correct, no responsibility can be accepted for any errors, omissions or alternatives to specifications or prices.

Retail prices quoted are non binding distributor recommended retail prices and include VAT. Due to our policy of continuous development, Neff reserves the right to alter specifications and prices without notice.

Prices will be applied as are current at the date of despatch. Colours must be specified where applicable. A copy of the company's full conditions of sale is available upon request.



KAL
4078 Kingswood Road
Citywest Business Campus
Dublin 24

T: 01 413 6444
F: 01 413 6464
info@kal.ie
www.kal.ie

