

General Disclaimer

One or more of the Following Statements may affect this Document

- This document has been reproduced from the best copy furnished by the organizational source. It is being released in the interest of making available as much information as possible.
- This document may contain data, which exceeds the sheet parameters. It was furnished in this condition by the organizational source and is the best copy available.
- This document may contain tone-on-tone or color graphs, charts and/or pictures, which have been reproduced in black and white.
- This document is paginated as submitted by the original source.
- Portions of this document are not fully legible due to the historical nature of some of the material. However, it is the best reproduction available from the original submission.

HS236-9060

NASA-CR-174231 SQT

E85-10059

THEMATIC

MAPPER

(E85-10059 NASA-CR-174231) THEMATIC MAPPER.

N85-16270

VOLUME 1: CALIBRATION REPORT FLIGHT MODEL,

LANDSAT 5 Final Report (Santa Barbara

Research Center) 248 p HC A11/MF A01

Unclas

CSC L 14B G3/43 00C59

CALIBRATION REPORT FLIGHT MODEL - LANDSAT 5

PREPARED FOR

NATIONAL AERONAUTICS AND SPACE ADMINISTRATION

GODDARD SPACE FLIGHT CENTER

GREENBELT, MD 20771

CONTRACT NAS5-24200



SEPTEMBER 1984

VOLUME I

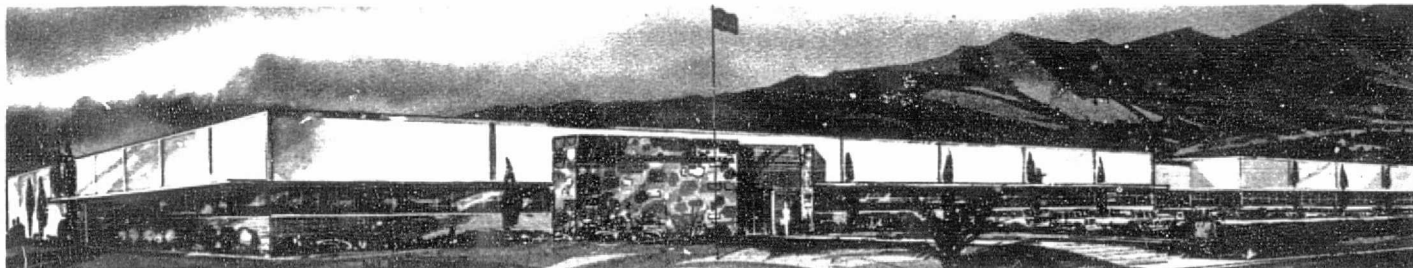

SANTA BARBARA RESEARCH CENTER

A Subsidiary of Hughes Aircraft Company



SEPTEMBER 1984

THEMATIC MAPPER

FINAL CALIBRATION REPORT

Contract No. NAS 5-24200



R. C. Cooley

R. C. Cooley

J. C. Lansing

J. C. Lansing

HUGHES

AIRCRAFT COMPANY

SANTA BARBARA RESEARCH CENTER

a subsidiary

1 INTRODUCTION

This is a report on the calibration of the Flight 1 Model Thematic Mapper. It is divided as follows:

	Page
1. Introduction.	
2. Spectral Response	1
3. Radiometric Calibration of Bands 1-5 and 7.	32
4. Radiometric Calibration of Thermal Band 6	52
5. Square Wave Response.	66
6. Line Spread Profiles and the White Light Leaks.	73
7. Coherent Noise.	155
8. The Scan Profile.	157
9. Commands and Telemetry.	224

The body of the report summarizes the calibration data, some of which is attached. The more voluminous data are bound separately and fewer copies were made. These will be available at GSFC or SBRC upon request.

Table 1.1 lists all the references.

TABLE 1.1 - References

<u>Reference</u>		<u>Title</u>	<u>Author</u>	<u>Date</u>
1.1		"GSFC Specification - Thematic Mapper System and Associated Test Equipment"		4-78
**1.2		"Flight Model Preshipment Review"		
*2.1	HS236-8162	"F-1 TM System Relative Response"	C. J. Kent	9-23-82
*2.2	HS236-7873	"TM Spectral Matching"	M. J. Grady	3-1-82
*2.3	HS236-8084-2	"Spectral Matching Test Results, 2nd Revision"	J. Lansing	7-21-82
*3.1	HS236-8151	"48" SIS Calibration Data for Flight Model TM"	J. Walker	10-25-82
*3.2	HS236-8101	"TM AC02R Test Result Summary Flight 1 Model"	J. Lansing & J. Walker	8-9-82
*4.1	HS236-7398-1	"BL-10 Clarifications (Revised)"	W. Shockency & J. Lansing	6-25-82
*4.2		"Thematic Mapper Thermal Band Radiometry"	L. Linstrom	5-8-83
*4.3	HS236-9042	"TM FI Band 6 Calibration for Ground System"	J. Lansing	12-8-83
*4.4	HS236-8167	"TM FI Band 6 Calibration"	J. Lansing	12-2-82
*6.1	HS236-8043	"TM AC07R Test Result Summary, Flight Model Number 1"	J. C. Campbell	6-29-82
**6.2		"TM PFPA Flight Band #1 S/N 401"		11-19-81
**6.3		"TM PFPA Flight Band #2 S/N 401"		10-5-81
**6.4		"TM PFPA Flight Band #3 S/N 401"		8-28-81
**6.5		"TM PFPA Flight Band #4 S/N 401"		10-5-81
**6.6		"Thematic Mapper Band 5 Cold Focal Plane Flight S/N 201"		3-15-82
**6.7		"Thematic Mapper Band 6 Cold Focal Plane Flight S/N 201"		4-15-82
**6.8		"Thematic Mapper Band 7 Cold Focal Plane Flight S/N 201"		3-15-82
*6.9	HS236-8163	"Light Leaks in the Prime Focal Plane Assembly-II"	D. Brandshaft	11-19-82
8.1	HS236-2080	"Thematic Mapper Scan Mirror Assembly Flight -1 Model Unit Acceptance Test Data Package"	N. J. Constantinides	3-24-81
*8.2	HS236-1891	"Thematic Mapper SMA Along-Scan Profile Review-Meeting of July 17, 1980"	P. R. Prince	4-9-80
**9.1	HS236-1887	"Thematic Mapper Telemetry Handbook"	Janice Takeda	7-80
**9.2	HS Ref. #D4596	"Thematic Mapper Command Handbook"	Janice Takeda	12-80

*indicates a reference that is included in this report.

**indicates a separately bound reference that was sent with this report.

2- SPECTRAL RESPONSE

The TM's spectral response was computed from the spectral response of its components. The results of this computation are presented in reference 2.1.

Spectral response data must be used in the radiometric calibration of the TM (see section 3). The spectral response curves given in tables 3.1 -3.6 were generated for this purpose before the more thorough calculations in reference 2.1 were complete. The small differences between the two sets of curves do not have a significant effect on the radiometric calibrations.

The uniformity of the spectral responses of the detectors within a band is specified in reference 1.1. as follows: "After system calibration, the peak-to-peak signal variations between channels within any of the first five bands and band seven, when all channels of a band are viewing the same scene radiance, shall be less than 0.5 percent of the minimum saturation levels (see 3.2.9.4) for the two test conditions whose parameters are given in Table III. For the first test condition the radiance varies linearly between the levels specified for the "lower band edge" and the "upper band edge". For the second condition the radiance of the scene is wavelength independent at the levels specified in the "flat" column.

TABLE III

Band No.	Spectral Radiance at Lower Band Edge (mw/cm ² -sr-μm)	Spectral Radiance at Upper Band Edge (mw/cm ² -sr-μm)	In Band Flat Radiance (mw/cm ² -sr)	Minimum Saturation levels From 3.2.9.4 (mw/cm ² -sr)
1	5.7	10.0	0.45	1.00
2	9.9	9.1	0.77	2.33
3	3.2	7.8	0.25	1.35
4	13.2	14.1	1.93	3.00
5	2.3	1.7	0.40	0.60
7	0.47	0.41	0.12	0.43

The spectral matching test is briefly described in reference 2.2. Test results are presented in reference 2.3. Bands 1 and 4 do not appear to meet their spectral matching specifications.

SANTA BARBARA RESEARCH CENTER

A Subsidiary of Hughes Aircraft Company

INTERNAL MEMORANDUM

TO J. L. Engel

CC: Data Bank
Optics File
Distribution

DATE: 9 November 1982

SUBJECT: F-1 TM System Relative
Spectral ResponseREF: 2221-729
HS236-8162
FROM: C. J. Kent

BLDG. B11 MAIL STA. 78

EXT. 6268

Ref: HS236-7213, T.M. System Spectral Response

Relative spectral response curves have been analytically obtained for the Flight 1 T.M., to satisfy the AC01 spectral coverage test, by using data taken from system component measurements. A description of the methods used in deriving this data and a consideration of the adequacy of the calculated spectral response in fulfilling the objectives of AC01 are detailed in the referenced memo, HS236-7213.

Filter and detector response values (with the exception of the Band 6 detectors) are the same as used for proto flight calculations. The values were obtained from witness sample(s) representative of all components in a single lot. All of the TM filters, for each spectral band, were cut out of a single large substrate. Similarly, the detectors used on the F-1 model were from the same manufacturing lot as those used on the P.F. model (with the exception of Band 6). The scan mirror data used in the calculations is data measured on SLC mirror samples (as was done in the P.F. model calculations). Relay sphere response data is also the same as used in P.F. calculations since all the spherical relay mirrors are from a single coating lot. All of the remaining system components have unique response data which were used in the calculations.

Table 1 is a summary of the optical throughput for each band. Table 2 is a summary of the lower and upper band edges (relative 50% points). The $a + b\lambda$ correction factor has not been used in the calculations.

Following Table 2 are plots of the relative spectral response in each band for A) the entire system, and B) the optics only, i.e., no filter or detector. Also attached are the points used in plotting each curve.

C. J. Kent

CJK:kpc

Attachment

T.M. FLIGHT 1 MODEL
AVG. THROUGHPUT OPTICAL TRANSMISSION

COMPONENT \ BAND	1	2	3	4	5	6	7	μm
	.45-.52	.52-.60	.63-.69	.76-.90	1.55-1.75	10.4-12.5	2.08-2.35	
Scan Mirror	.960	.950	.951	.950	.968	.947	.972	
Primary Mirror	.951	.959	.969	.974	.984	.955	.976	
Secondary Mirror	.951	.959	.969	.974	.984	.955	.976	
SLC Mirrors (2)	.960 .964	.950 .958	.951 .961	.950 .964	.968 .971	.947 .950	.976 .976	
Filters (Band Width-Δλ)	.920 .066	.945 .083	.900 .069	.950 .130	.850 .216	.800 1.190	.850 .250	
Spherical Relay Mirror	-	-	-	-	.959	.972	.967	
Folding Mirror	-	-	-	-	.972	.980	.973	
Ambient Window	-	-	-	-	.972	.962	.984	
Dewar Window	-	-	-	-	.982	.965	.998	
Throughput	.739	.751	.734	.784	.666	.550	.693	

TABLE 1

T.M. FLIGHT 1 MODEL
SPECTRAL BAND COVERAGE SUMMARY

Band	Lower Band Edge (Rel. 50%)	Upper Band Edge (Rel. 50%)	Bandwidth $\Delta\lambda$
	μm	μm	μm
1	.4522	.5178	.0656
2	.5280	.6095	.0815
3	.6263	.6933	.0670
4	.7760	.9045	.1285
5	1.5674	1.7840	.2166
6	10.4500	12.4300	1.9800
7	2.0971	2.3490	.2519

Table 2

TM FLIGHT MODEL
S/N 001 BAND 001

11-NOV-82
DETECTOR S/N X FILTER S/N X



ORIGINAL PAGE IS
OF POOR QUALITY

TM FLIGHT MODEL
S/N 001 BAND 001

11-NOV 82
DETECTOR S/N X FILTER S/N X

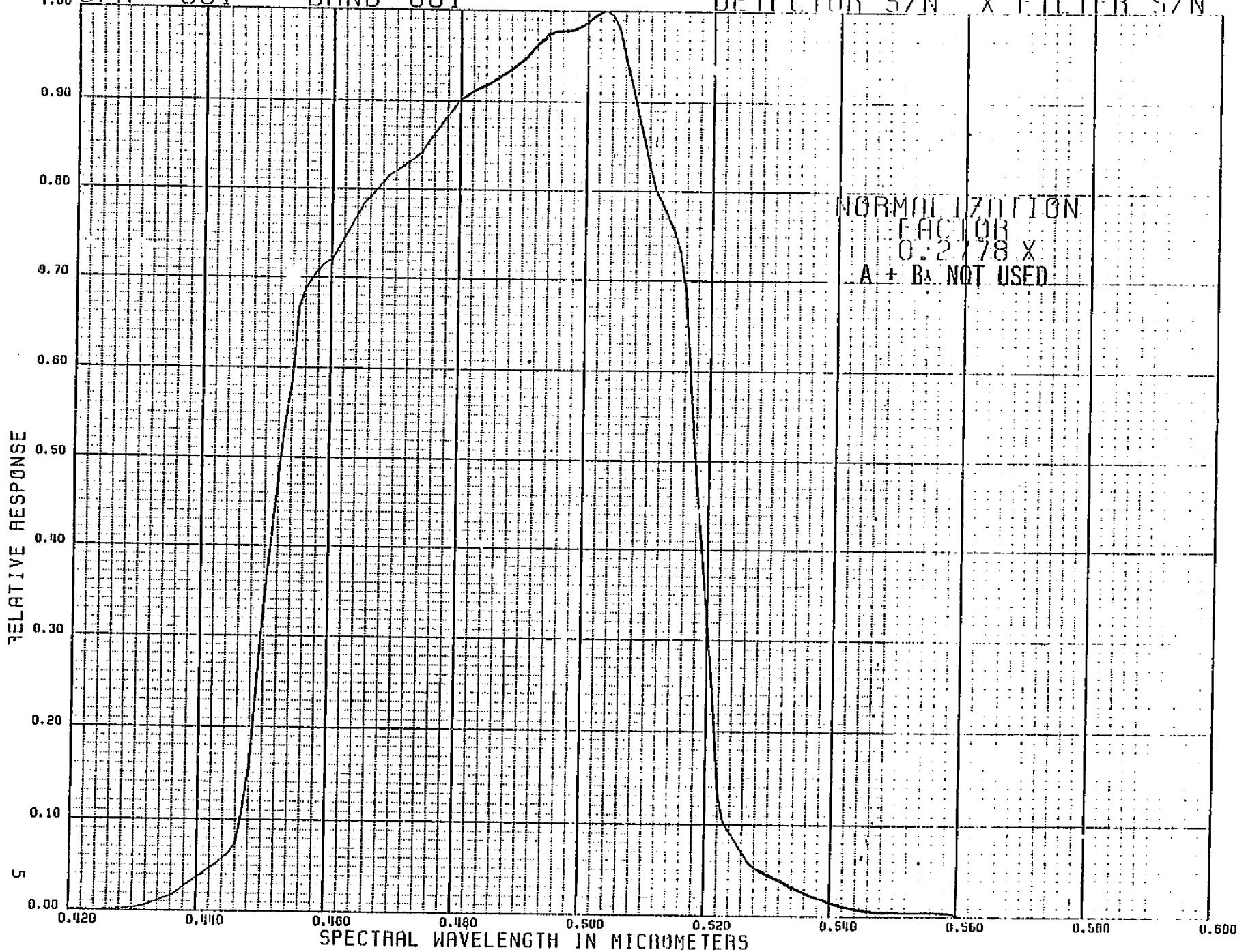

ORIGINAL PAGE IS
OF POOR QUALITY

11-NOV-82

TM FLIGHT MODEL
S/N 001 BAND 001

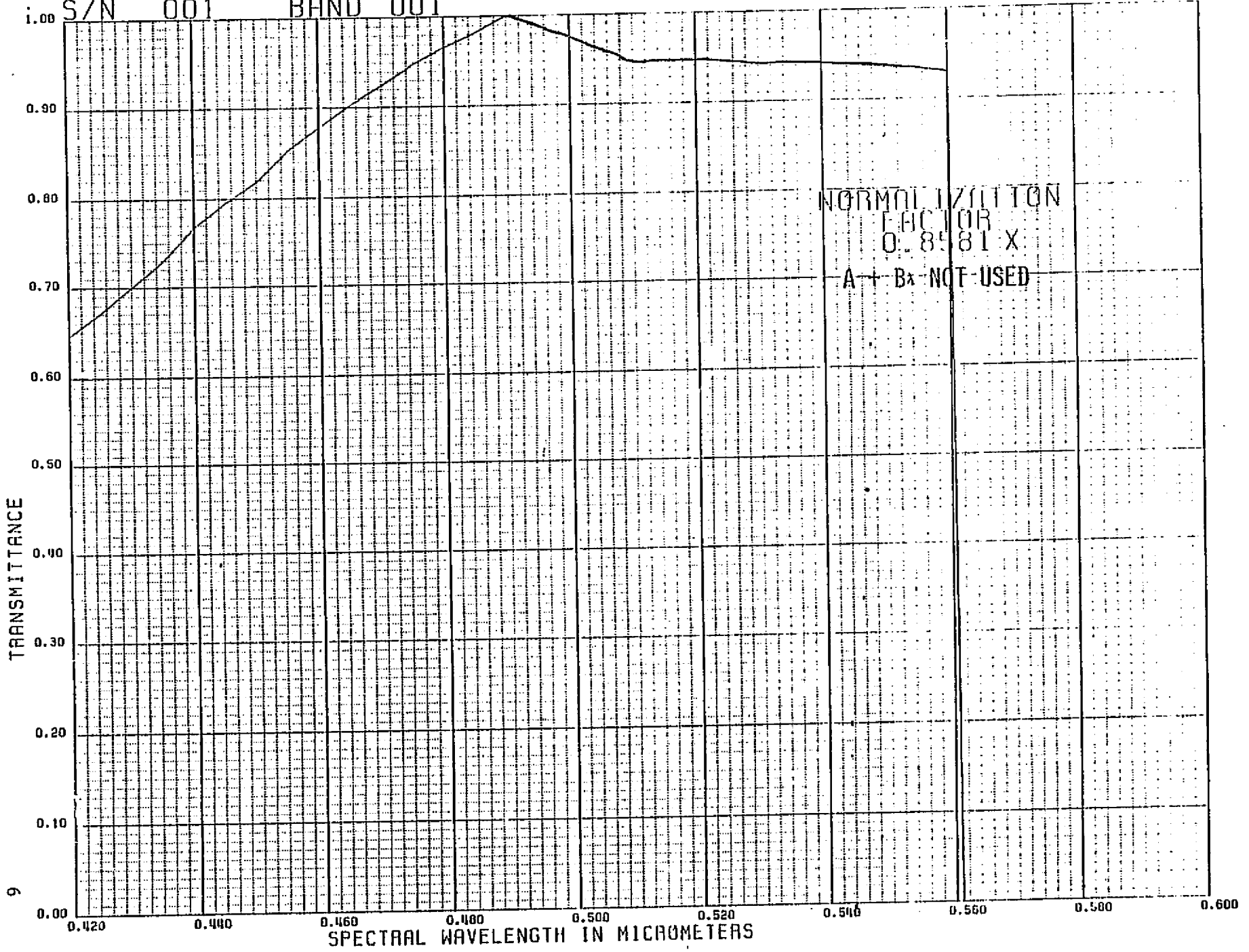

NORMALIZATION
FACTOR
0.8581 X
A + Bx NOT USED

ORIGINAL PAGE IS
OF POOR QUALITY

TM FLIGHT MODEL
S/N 001 BAND 002

11-NOV-82
DETECTOR S/N X FILTER S/N X

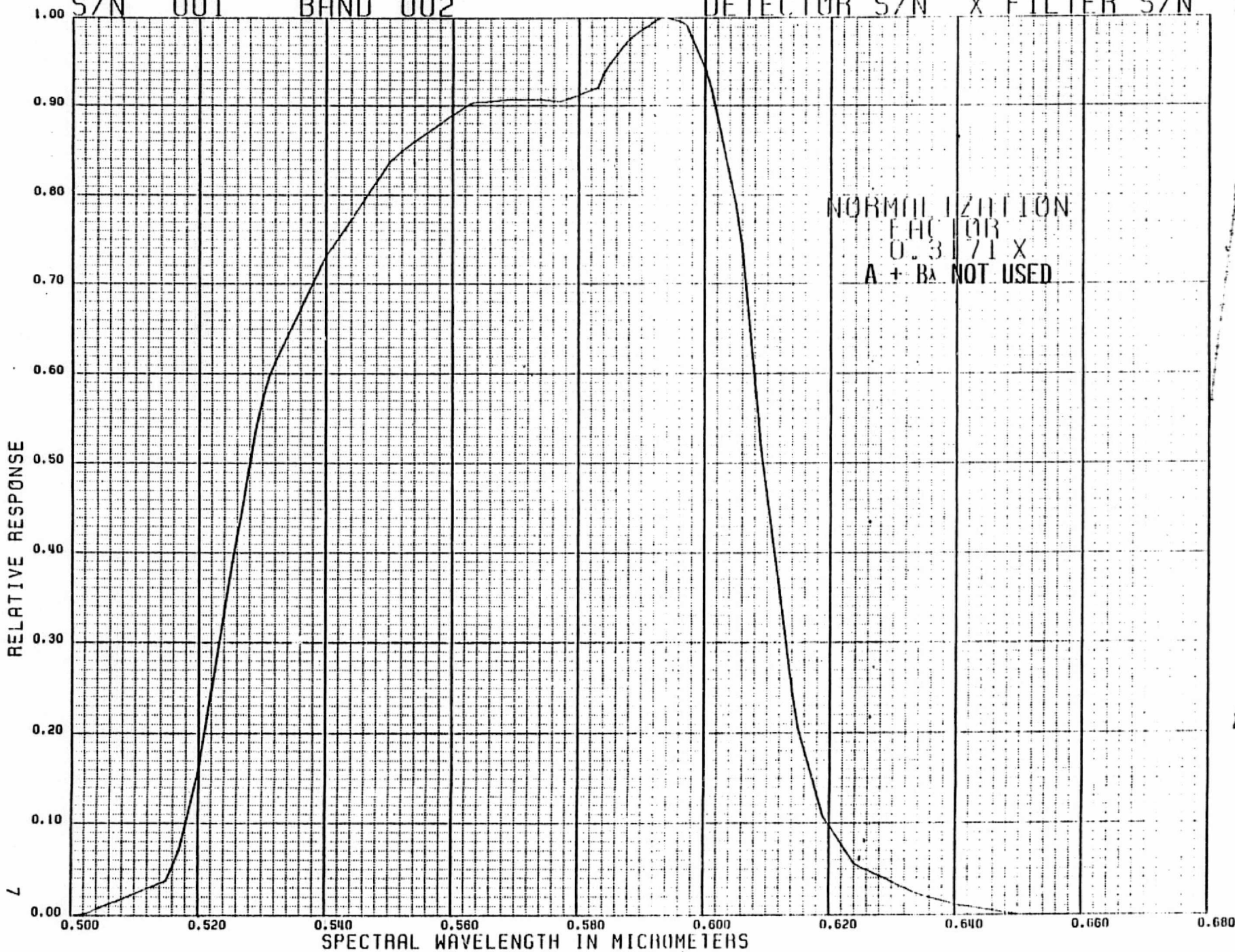

NORMALIZATION
FACTOR
0.371 X
A + B_λ NOT USED

ORIGINAL PAGE IS
OF POOR QUALITY

ORIGINAL PAGE IS
OF POOR QUALITY

TM FLIGHT MODEL
S/N 001 BAND 002

11-NOV 82

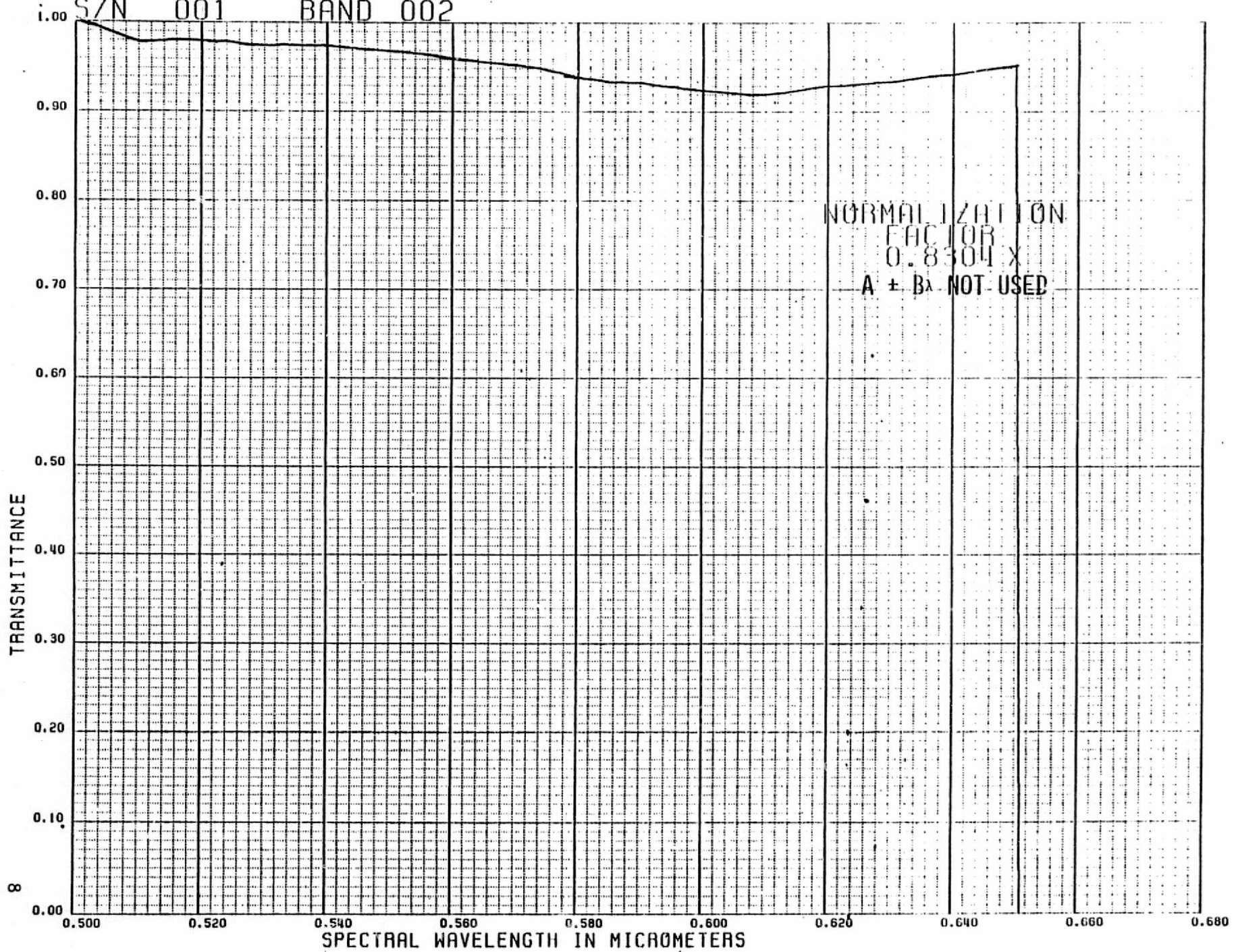

NORMALIZATION
FACTOR
0.8304 X
A ± Bλ NOT USED

ORIGINAL PAGE IS
OF POOR QUALITY

TM FLIGHT MODEL
S/N 001 BAND 003

11-NOV-82
DETECTOR S/N 0 FILTER S/N X

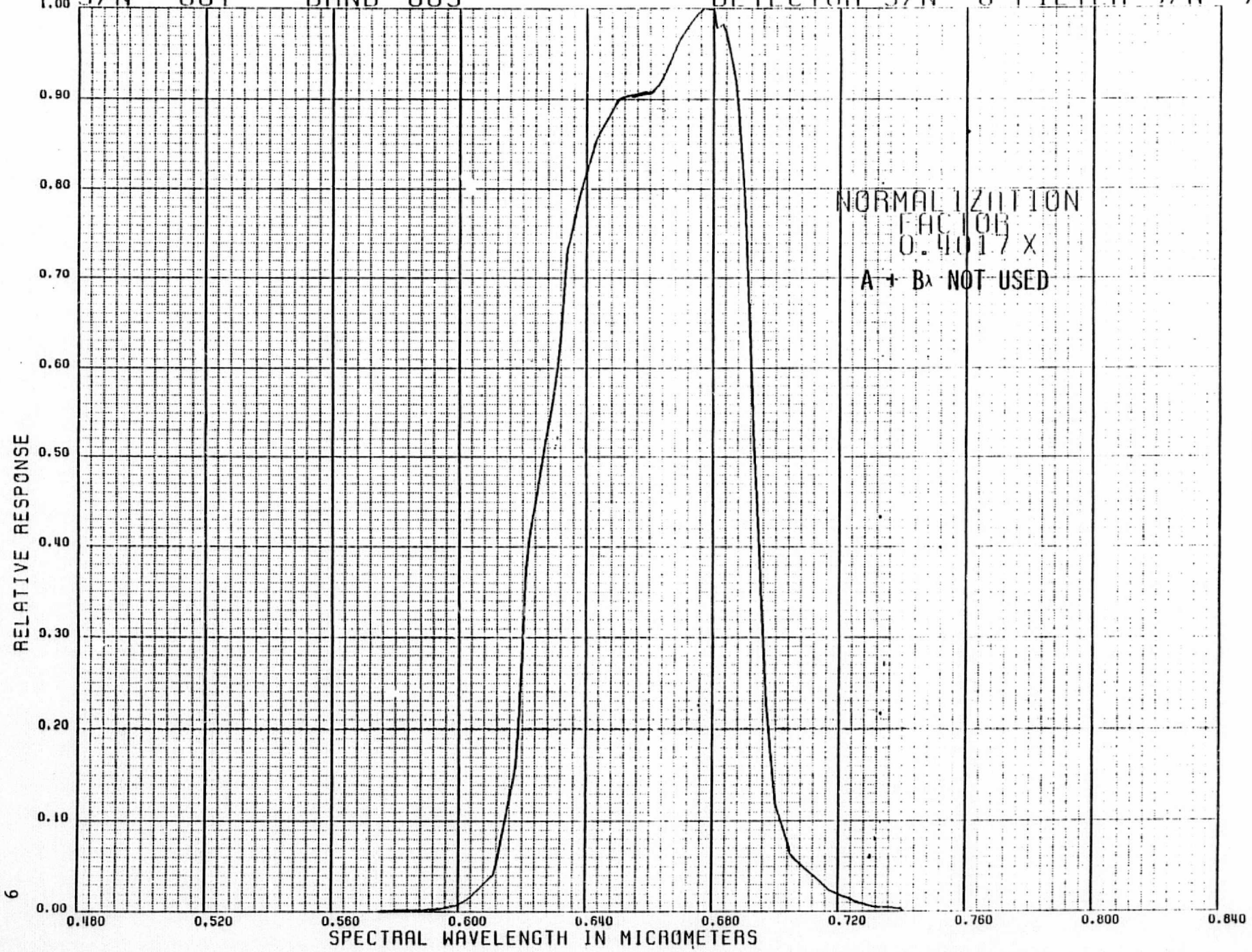

ORIGINAL PAGE IS
OF POOR QUALITY

TM FLIGHT MODEL
S/N 001 BAND 003

11-NOV-82

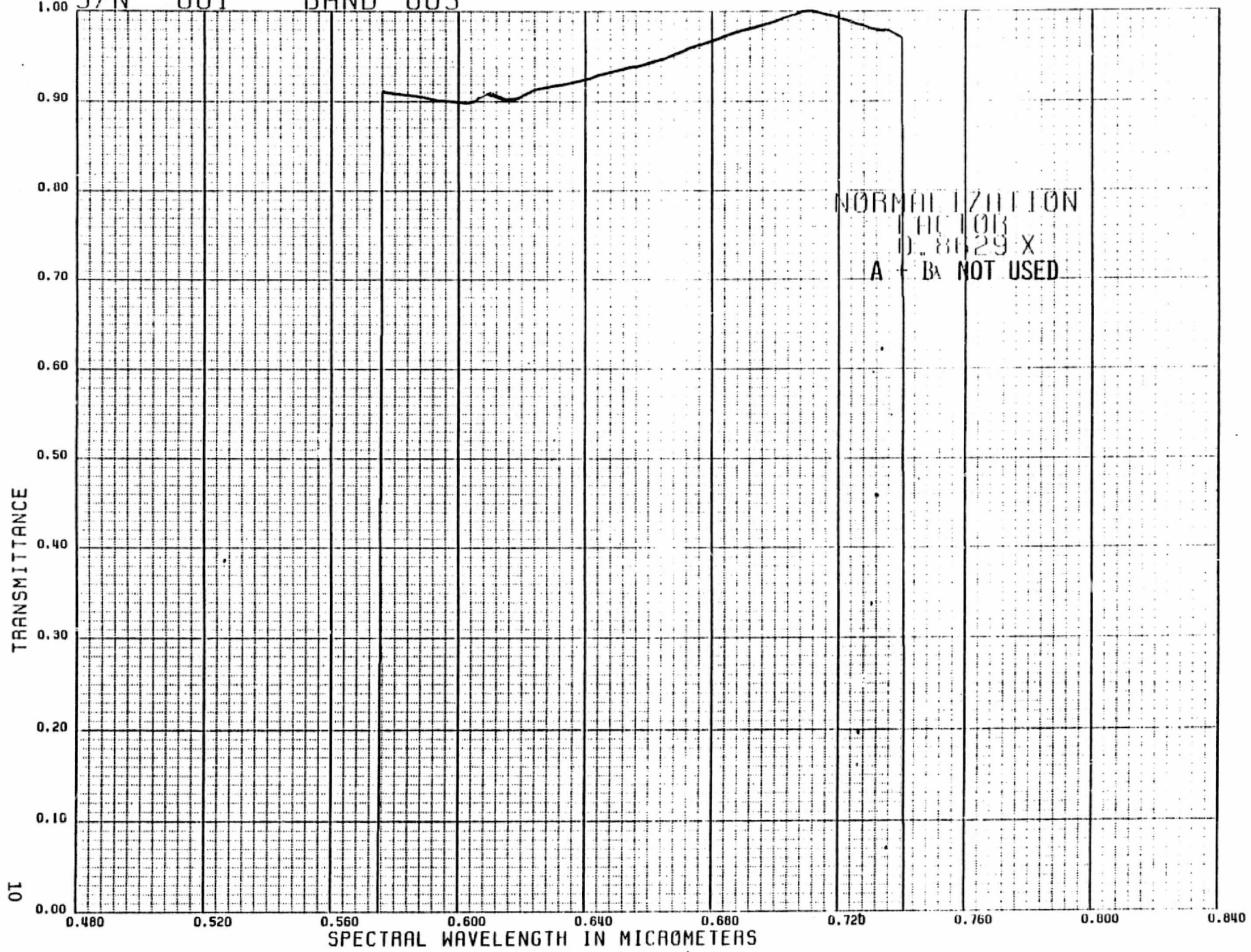

NORMALIZATION
FACTOR
0.8629 X
A - BA NOT USED

ORIGINAL PAGE IS
OF POOR QUALITY

TM FLIGHT MODEL
S/N 001 BAND 004

11-NOV-82
DETECTOR S/N X FILTER S/N X

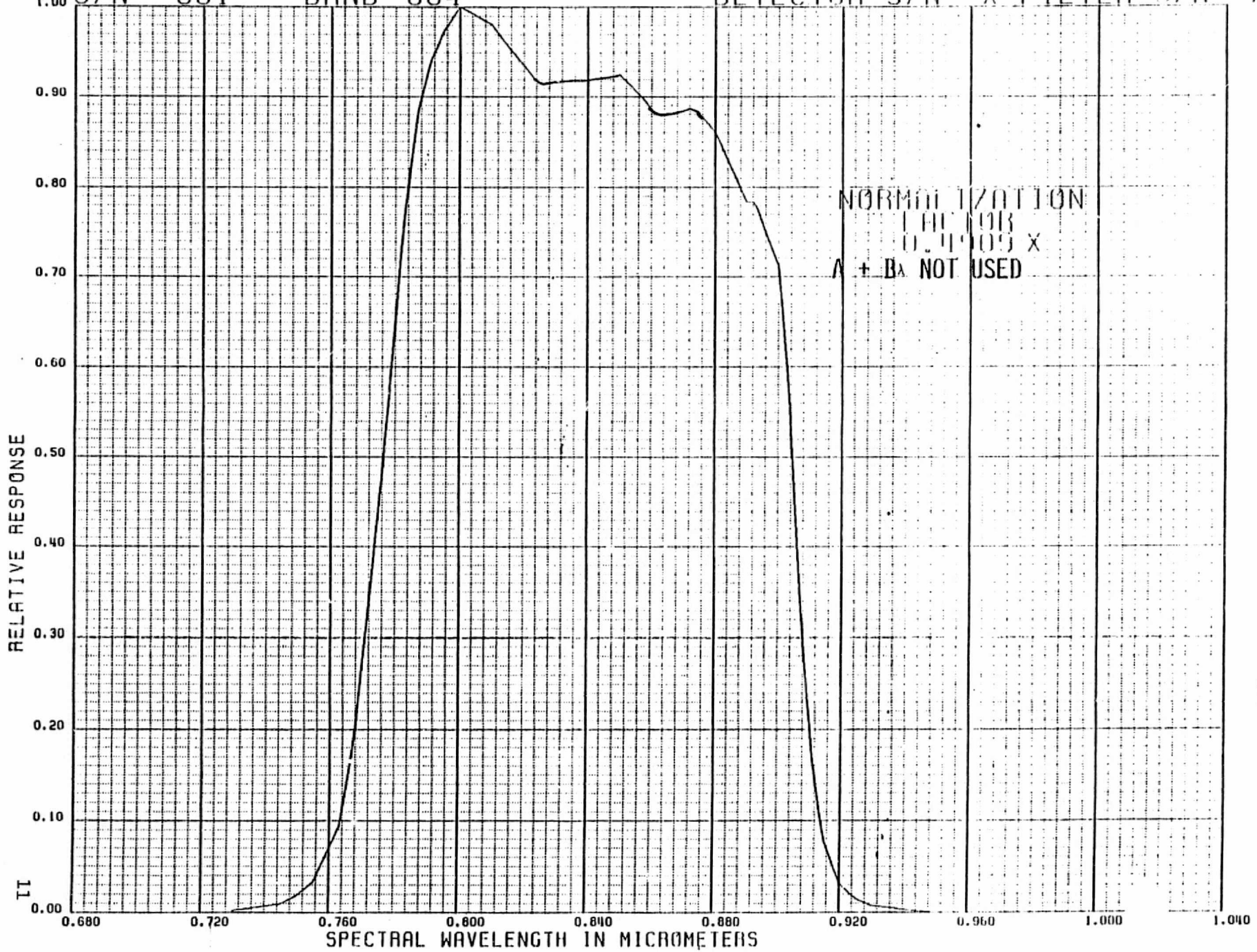

NORMALIZATION
FACTOR
0.4909 X
A + B NOT USED

ORIGINAL PAGE IS
OF POOR QUALITY

ORIGINAL PAGE IS
OF POOR QUALITY

TM FLIGHT MODEL
S/N 001 BAND 004

11-NOV 82

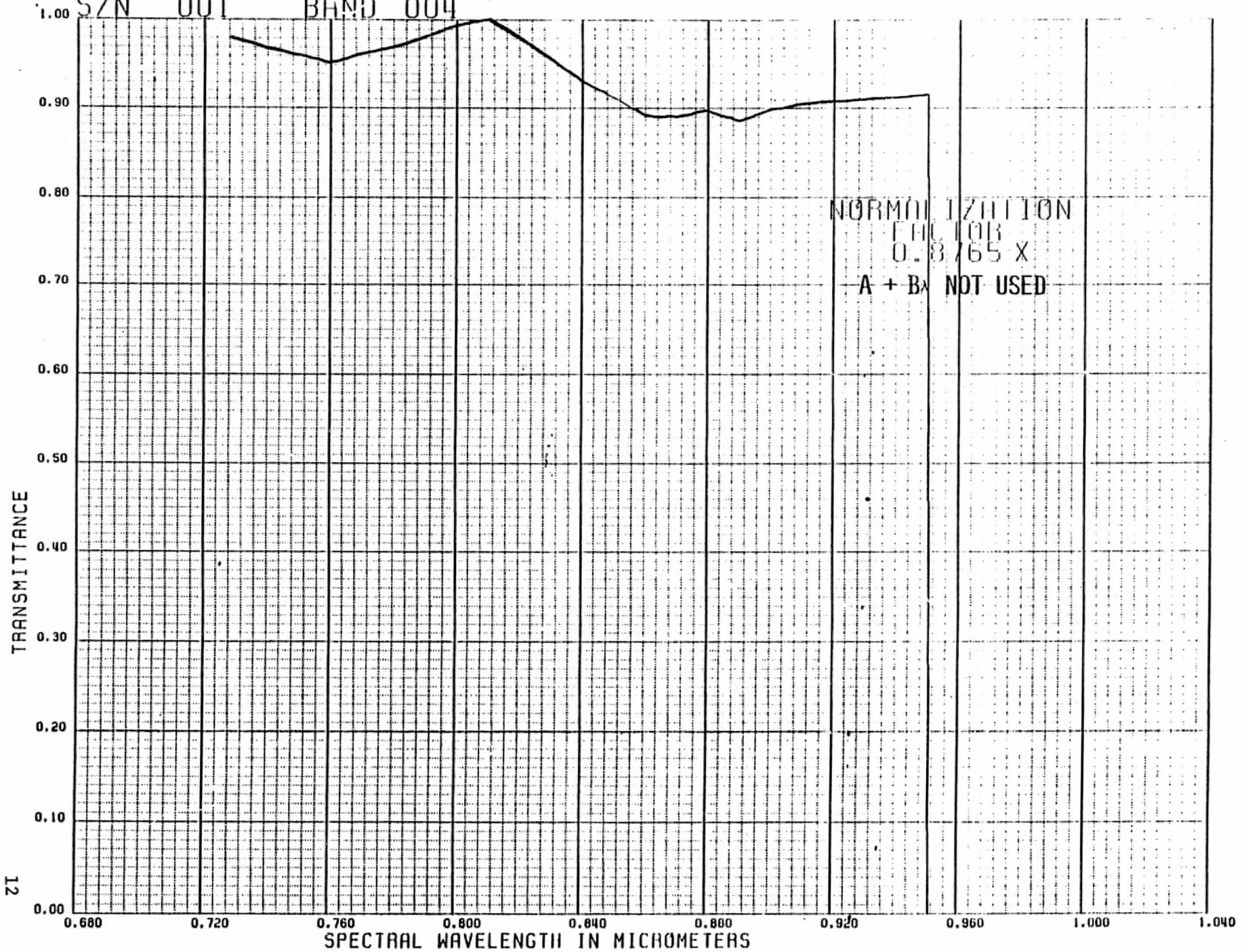

TM FLIGHT MODEL
S/N 001 BAND 005

3-NOV-82
DETECTOR S/N 1 3 FILTER S/N 1

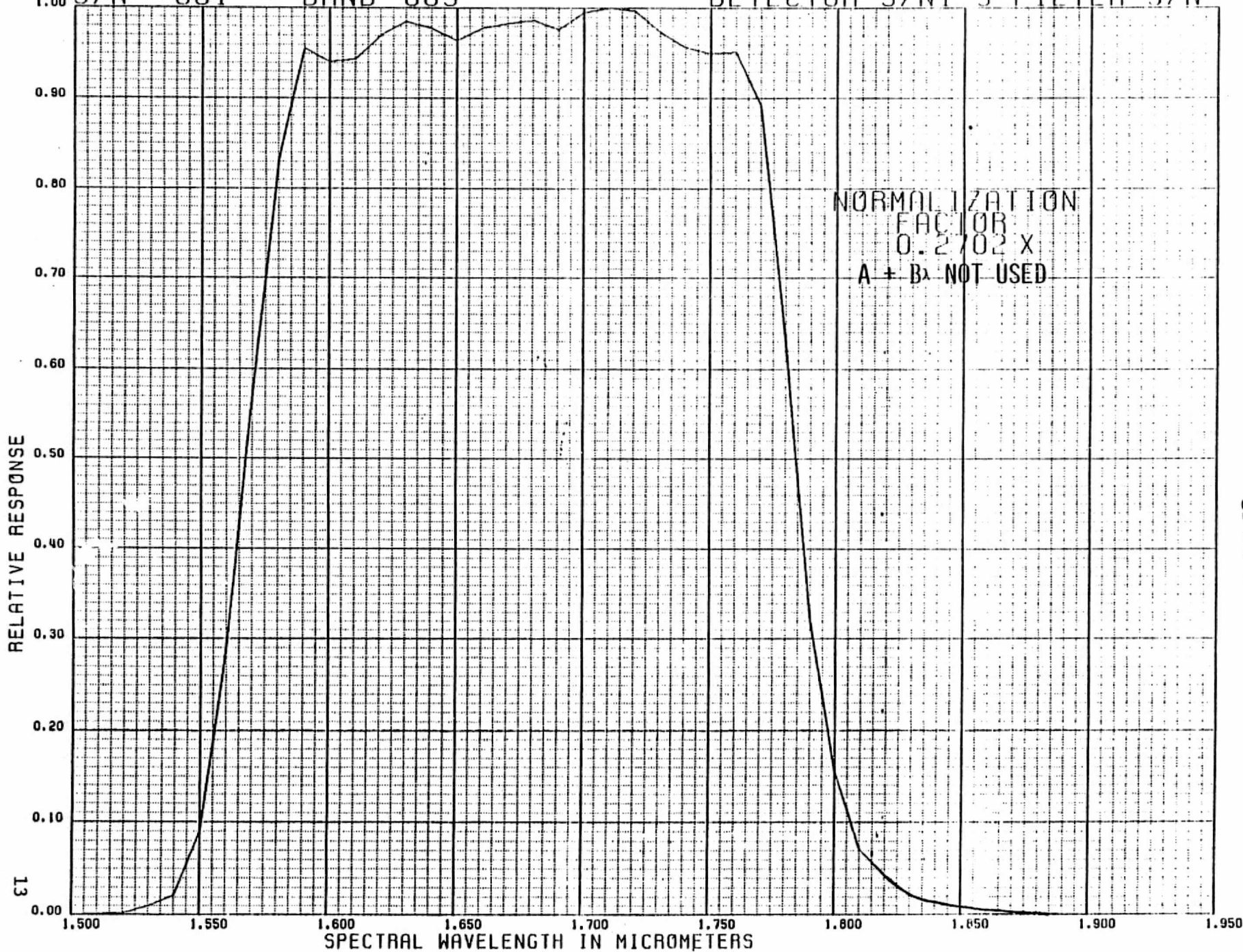

ORIGINAL PAGE IS
OF POOR QUALITY

TM FLIGHT MODEL
S/N 001 BAND 005

3-NOV-82

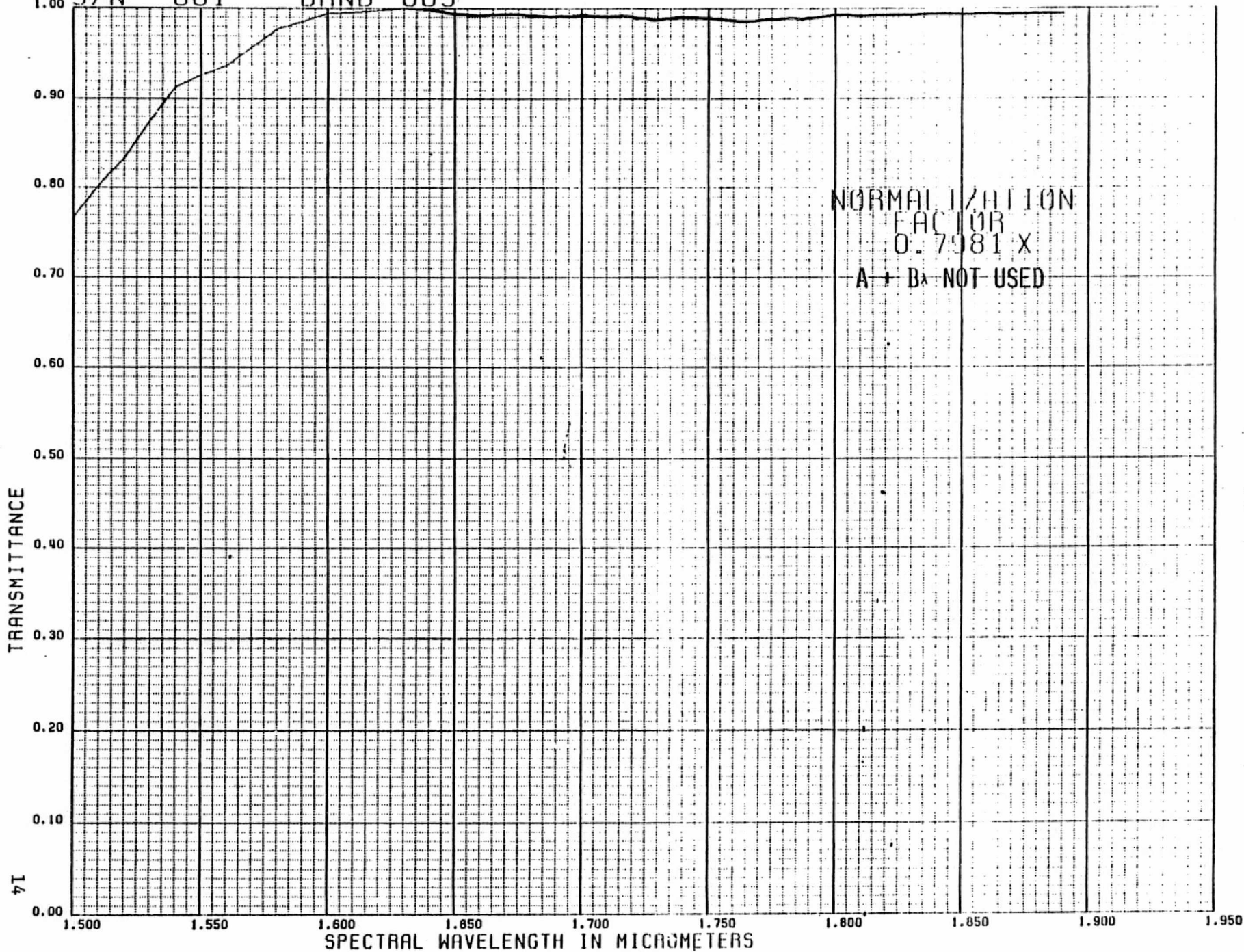

ORIGINAL PAGE IS
OF POOR QUALITY

TM FLIGHT MODEL
S/N 001 BAND 007

3-NOV-82
DETECTOR S/N149 FILTER S/N 1



ORIGINAL PAGE IS
OF POOR QUALITY

TM FLIGHT MODEL
S/N 001 BAND 007

3-NOV-82

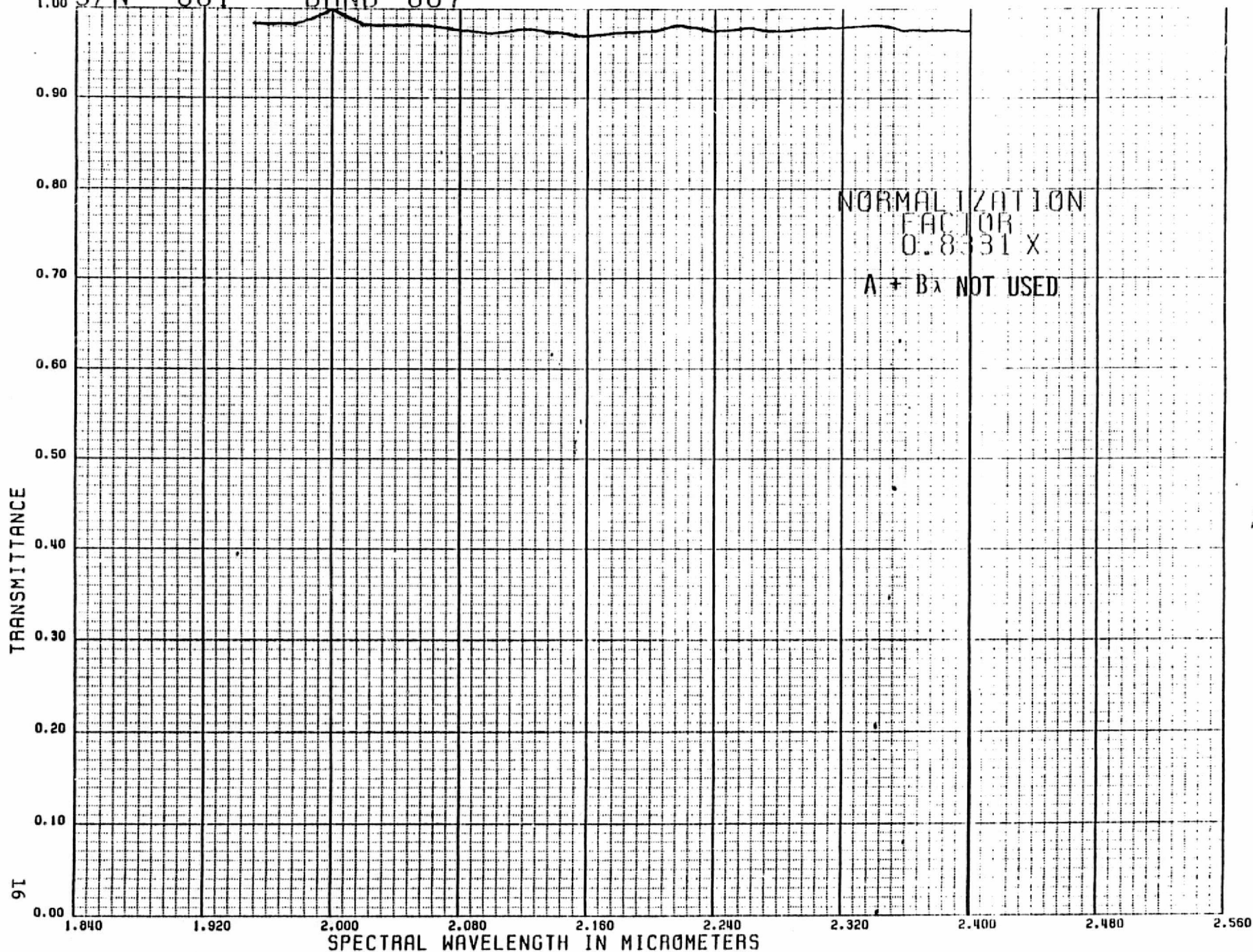

ORIGINAL PAGE IS
OF POOR QUALITY

TM FLIGHT MODEL
S/N 001 BAND 006

DET'S 143
95°K

12-NOV-82
DETECTOR S/N120 FILTER S/N 3



ORIGINAL PAGE IS
OF POOR QUALITY

TM FLIGHT MODEL
S/N 001 BAND 006

12-NOV-82

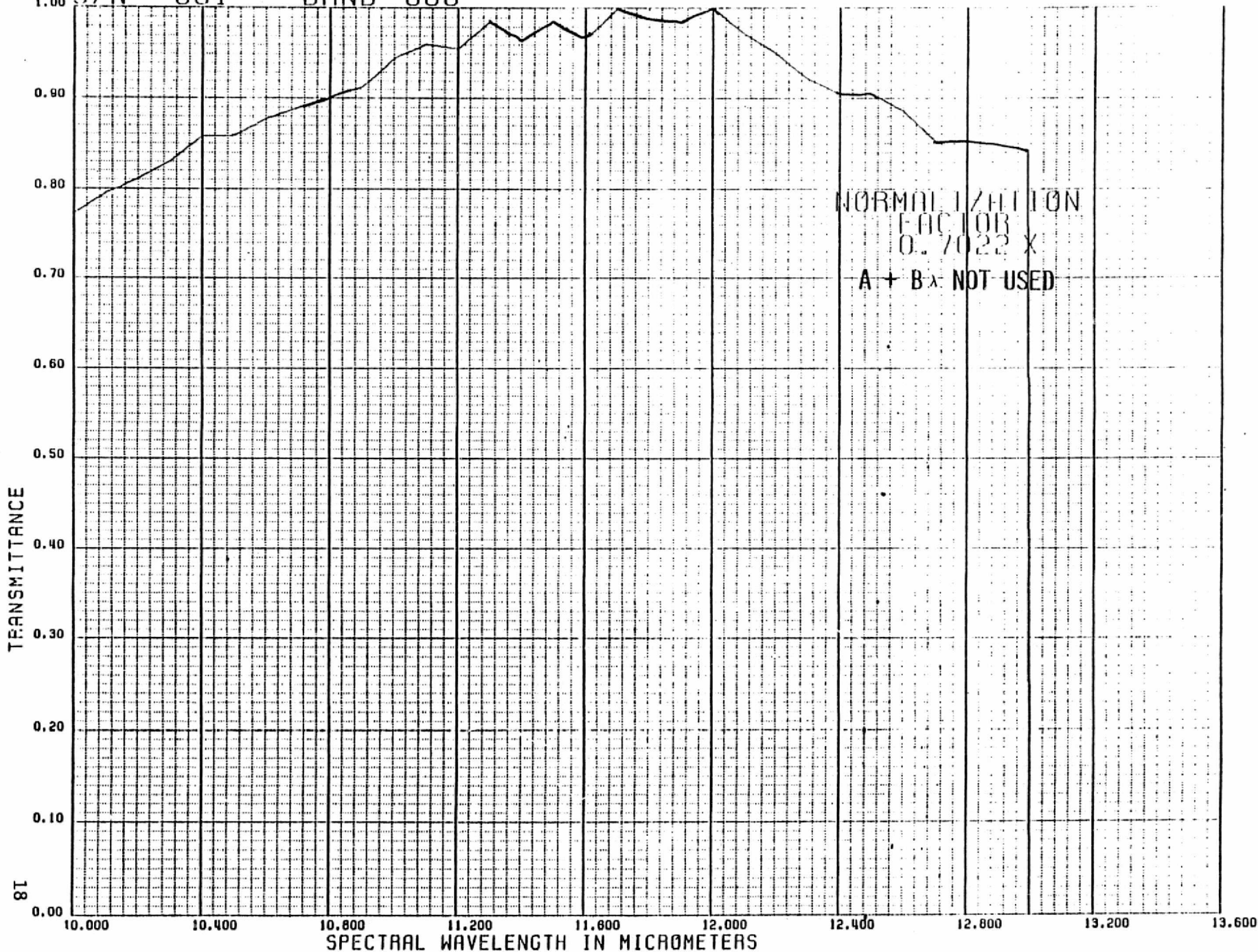

ORIGINAL PAGE IS
OF POOR QUALITY

TM FLIGHT MODEL
S/N 001 BAND 006

DET'S 294
95°K

12-NOV-82
DETECTOR S/N120 FILTER S/N 3

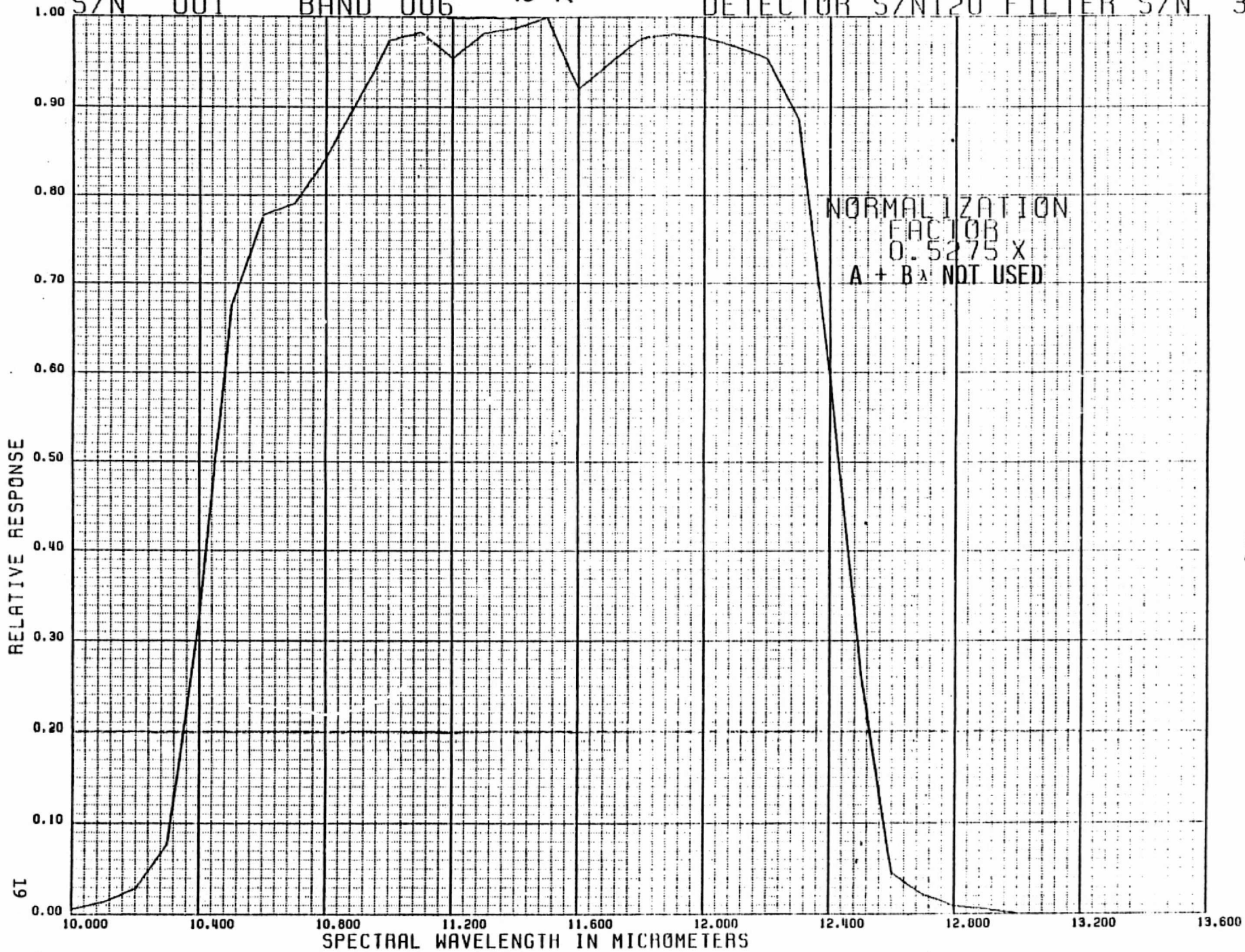

ORIGINAL PAGE IS
OF POOR QUALITY

ORIGINAL PAGE IS
OF POOR QUALITY

19

TM FLIGHT MODEL
S/N 001 BAND 006

12-NOV 82

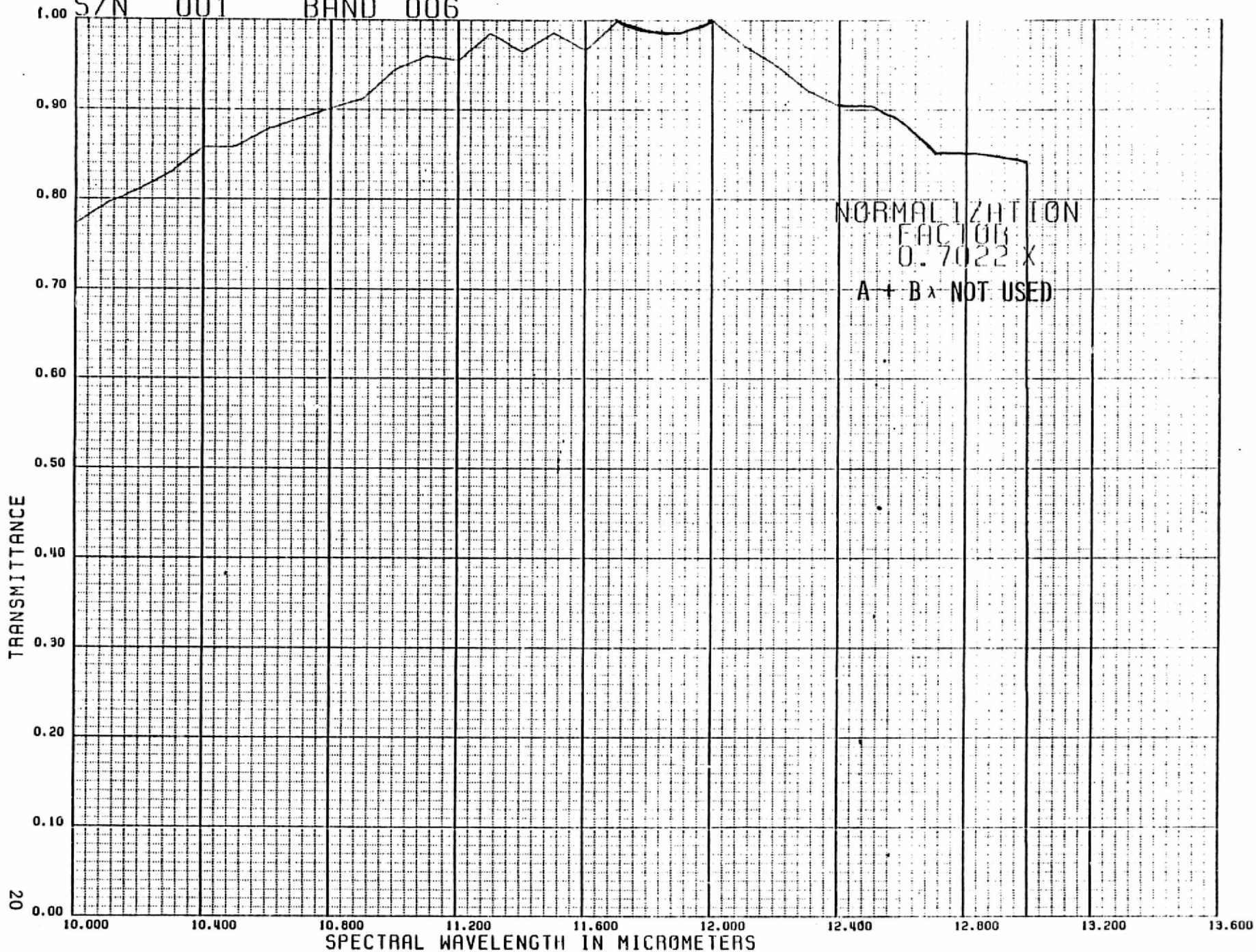

ORIGINAL PAGE IS
OF POOR QUALITY

ORIGINAL PAGE IS
OF POOR QUALITY

SANTA BARBARA RESEARCH CENTER

A Subsidiary of Hughes Aircraft Company

INTERNAL MEMORANDUM

TO: J. B. Young
R. V. Howitt

SUBJECT: TM Spectral Matching

CC: Optics File
Data Bank (6)

DATE: March 1, 1982

REF: 2221-520
HS236-7873

FROM: M. J. Grady

BLDG. B11 MAIL STA. 78
EXT. 6269

In the proposed spectral matching test the Thematic Mapper is first calibrated using the 48" integrating sphere, and is then presented with a scene radiance of different spectral shape using a filtered source at the focal point of Collimator #3. The desired spectral radiance of this scene was determined as follows. On the basis of the spectral radiance curve for the 48" integrating sphere, (figure 1), the derivative of the radiance in each spectral band was computed assuming closest linear fit. Shaping the scene radiance amounts to modeling $dL/d\lambda$ (where L = spectral radiance). Guidelines for doing this were taken from Table III of the GSFC Specification "Thematic Mapper System and Associated Test Equipment." The criterion taken from this table is the difference in $dL/d\lambda$ between two scenes for a given band. Figure 2 depicts $dL/d\lambda$ characteristics for the large sphere and the desired characteristics of the collimator, on the basis of the normalized GSFC spec criterion. Figure 3 shows the resulting spectral radiance.

Figure 4 gives the spectral radiance of Collimator #3, prior to insertion of filters, given the data in figure 5. The table below gives the desired filter characteristics as well as the filters chosen.

Band	λ (um)	Desired Transmission Ratio Between End Points	Filter Chosen	Actual Transmission Ratio Between End Points
1	.45- .52	1: .83	Corning 4-70	1: .81
2	.52- .60	1: .78	Corning 1-57	1: .80
3	.63- .69	1: .46	Corning 4-69	1: .44
4	.76- .90	1: .41	Schott KG2	1: .39
5	1.55-1.75	1:1.38	Corning 4-67	1:1.32
7	2.08-2.35	1:1.56	Corning 5-59	1:1.57

Figure 6 displays the transmission curves for the above filters.

J. B. Young
R. V. Howitt

-2-

March 1, 1982
2221-520
HS236-7873

TM Spectral Matching

It should be noted that the last column above represents nominal catalog values only. One of these filters is presently in-house (Corning 1-57); the rest will need to be ordered.

Figure 7 shows the test layout. The TM is oriented with its optical axis at 30° to the normal of an 18" flat which folds the collimator output. The flat is removed and the 48" integrating sphere placed in position. After calibration, the 18" flat is set back in place and measurements are made using the collimator output. After initial alignment, it will not be necessary to move the TM during the test.

Michael J. Grady

Michael J. Grady

SPECTRAL RADIANCE OF 48" INTEGRATING SPHERE

ORIGINAL PAGE IS
OF POOR QUALITY

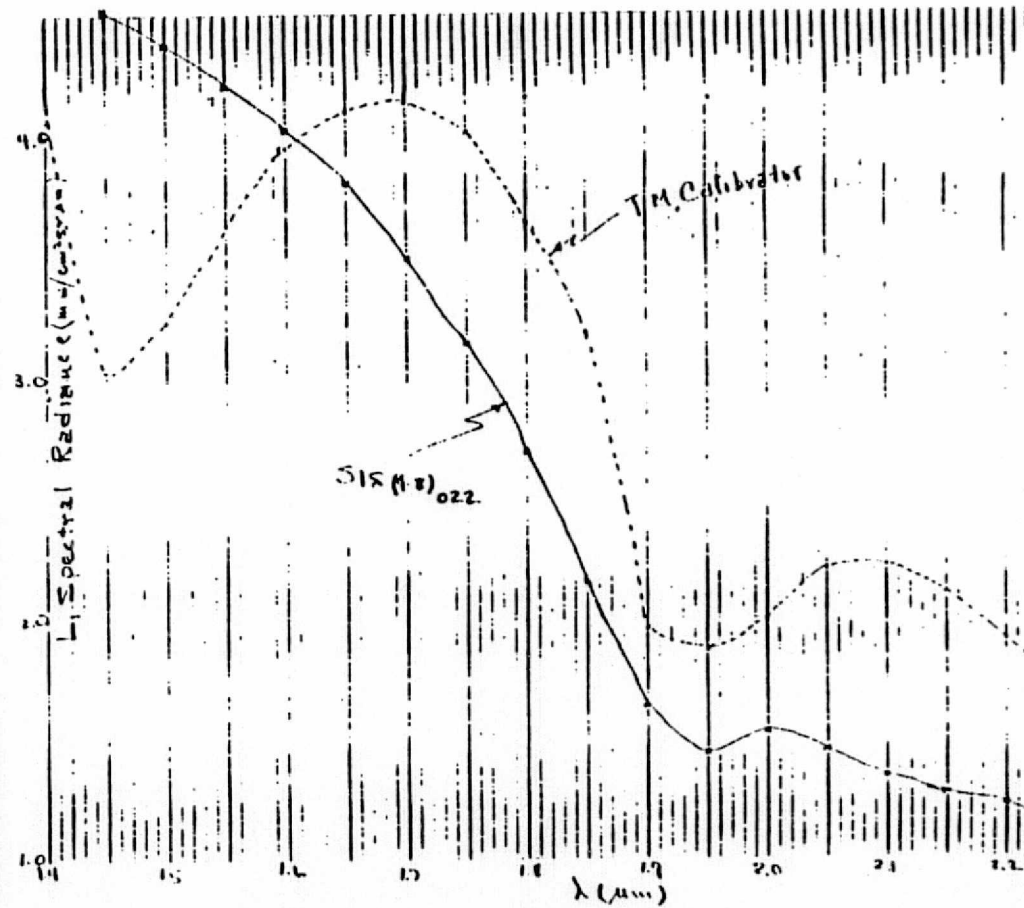
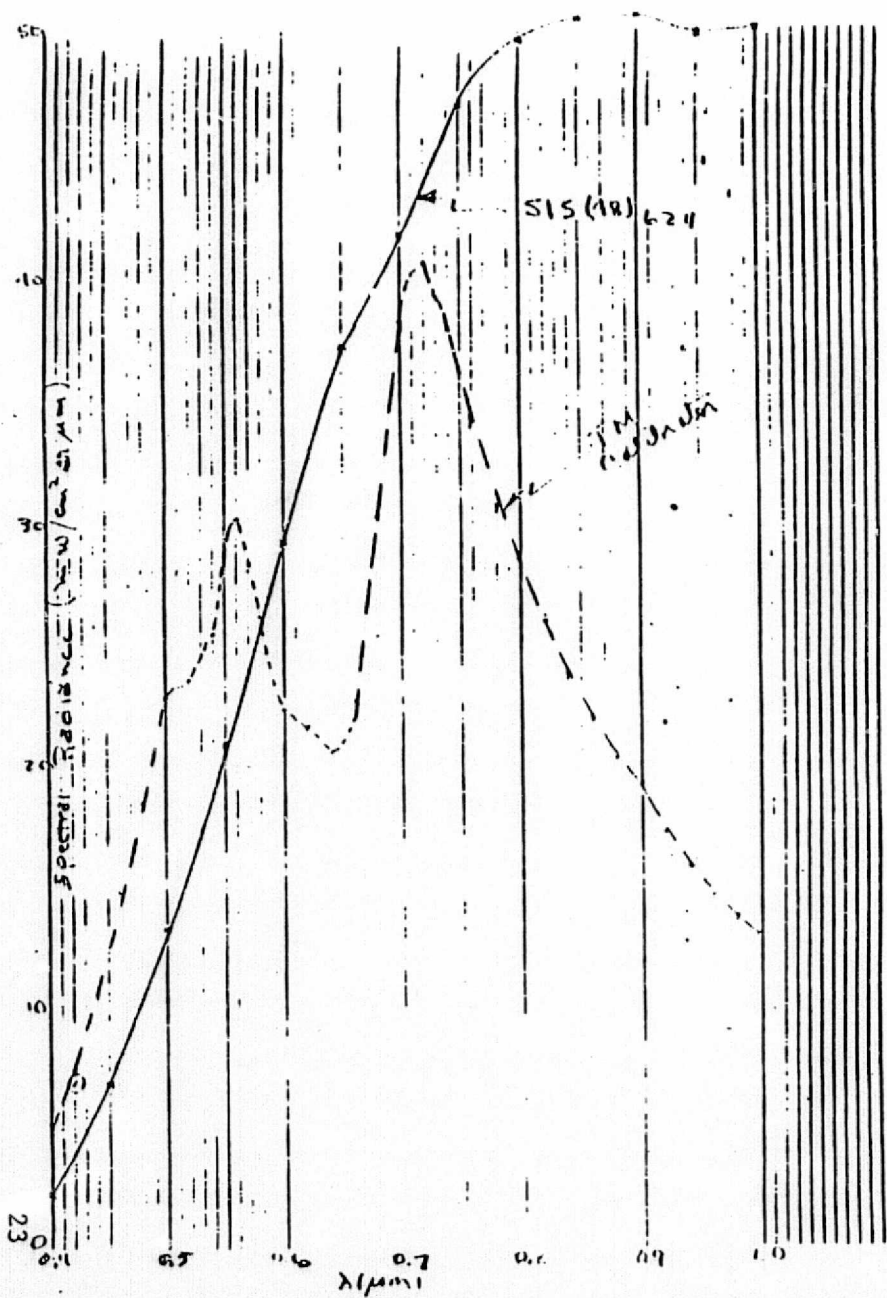

FIGURE 1

$dL/d\lambda$ VALUES FOR 48" INTEGRATING SPHERE AND IDEAL "SECOND SCENE"
 (ARROWS POINT FROM SPHERE $dL/d\lambda$ TO THAT OF "SECOND SCENE")

ORIGINAL PAGE IS
 OF POOR QUALITY

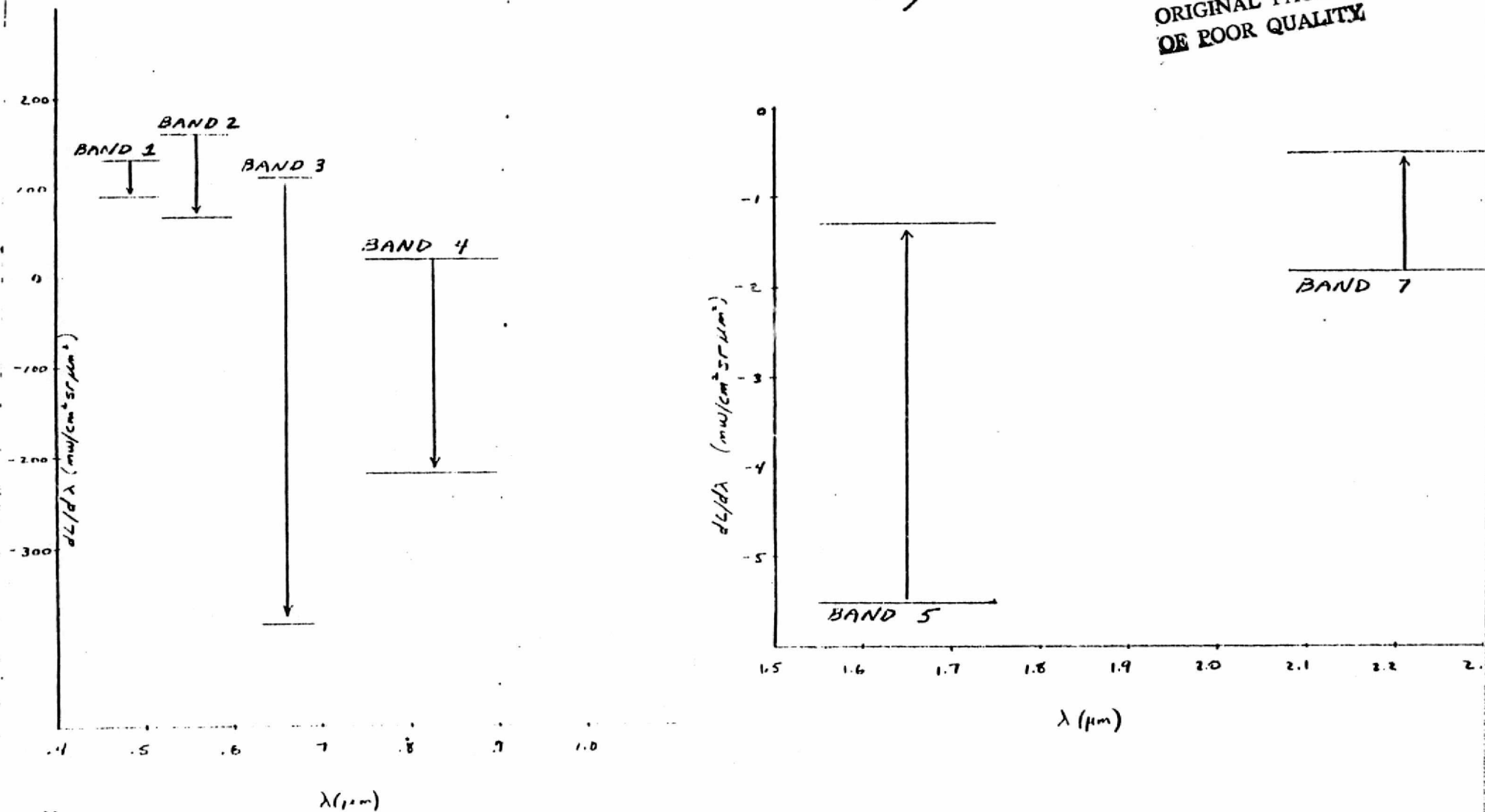

FIGURE 2

IDEAL SPECTRAL RADIANCE
OF "SECOND SOURCE"

ORIGINAL PAGE IS
OF POOR QUALITY

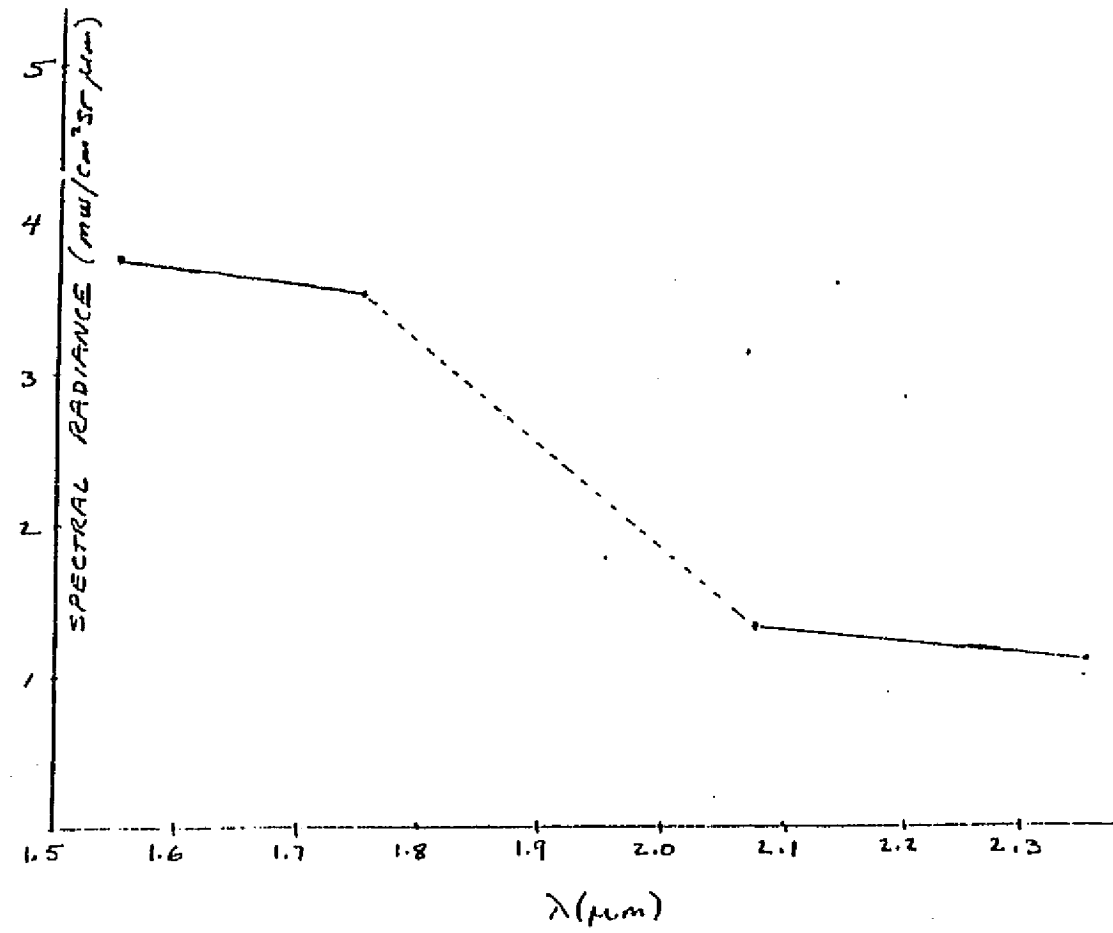
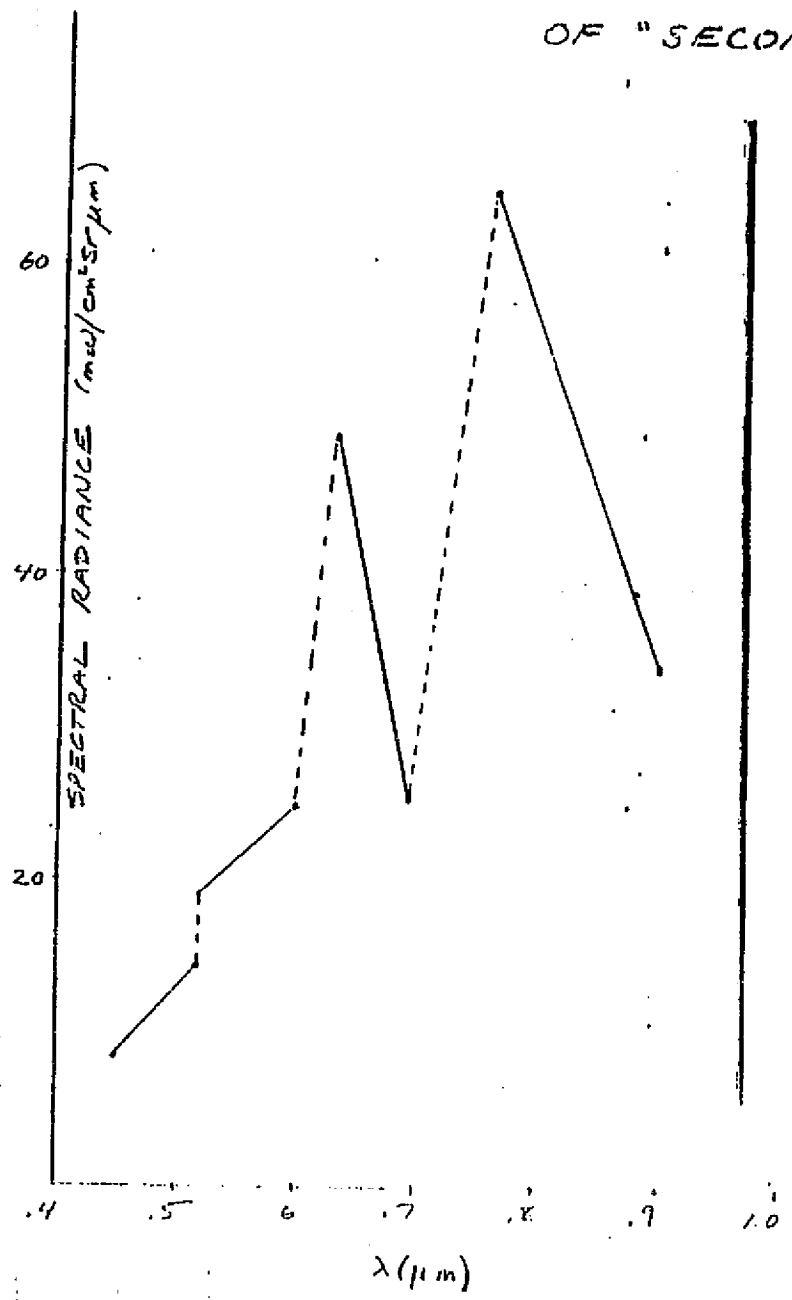
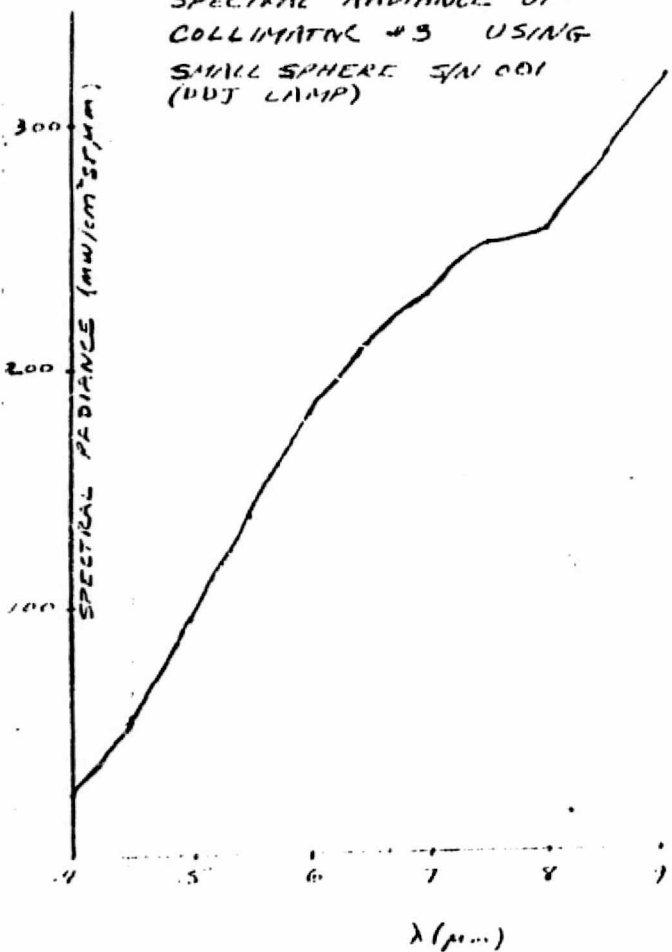

FIGURE 3

SPECTRAL RADIANCE OF COLLIMATOR #3

ORIGINAL PAGE IS
OF POOR QUALITY

SPECTRAL RADIANCE OF
COLLIMATOR #3 USING
SMALL SPHERE S/N 001
(DDJ LAMP)



SPECTRAL RADIANCE OF COLLIMATOR #3
USING SMALL SPHERE S/N 001 (DDJ LAMP)

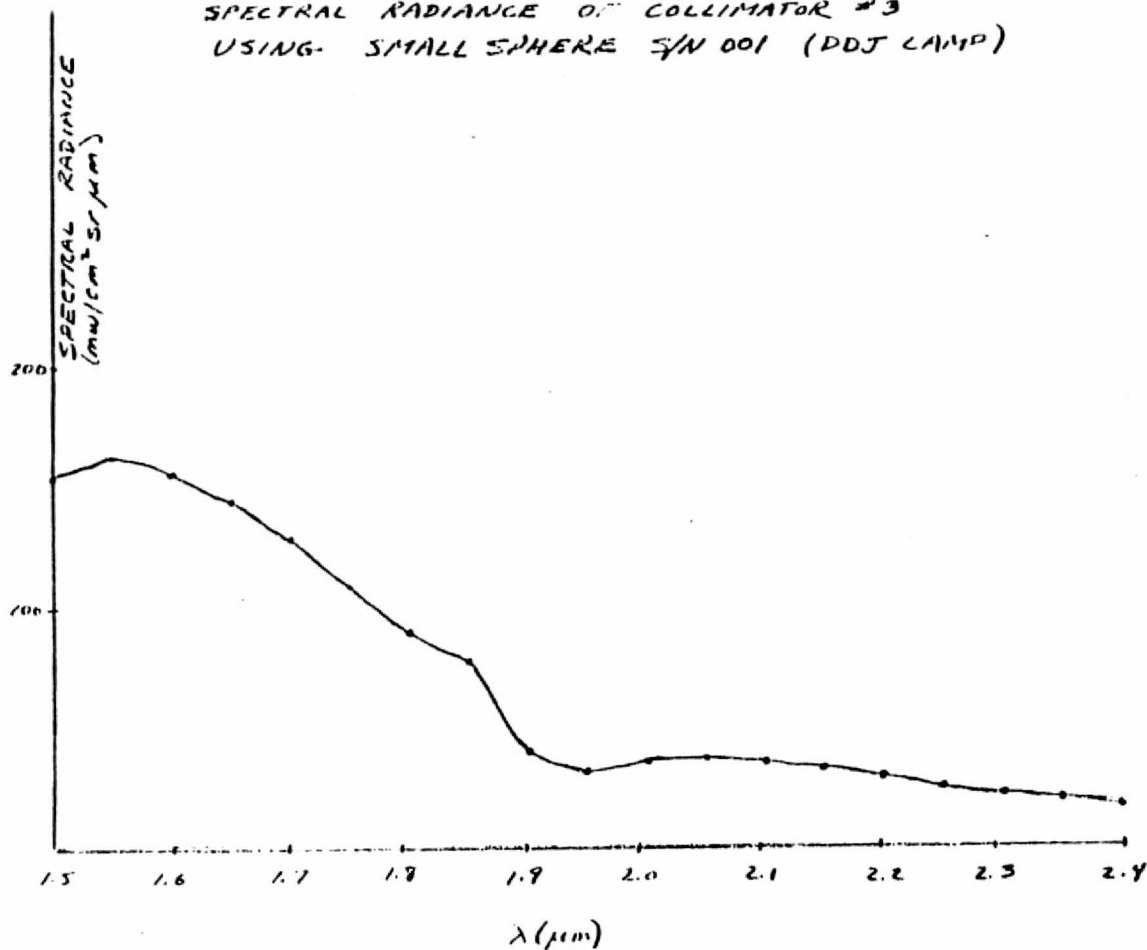

FIGURE 4

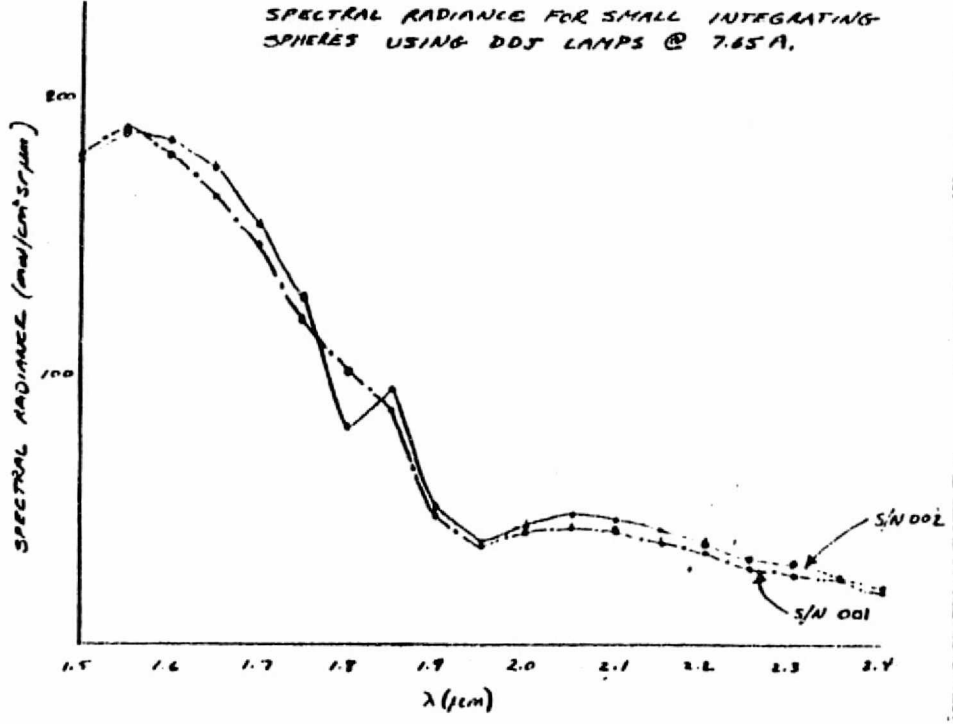
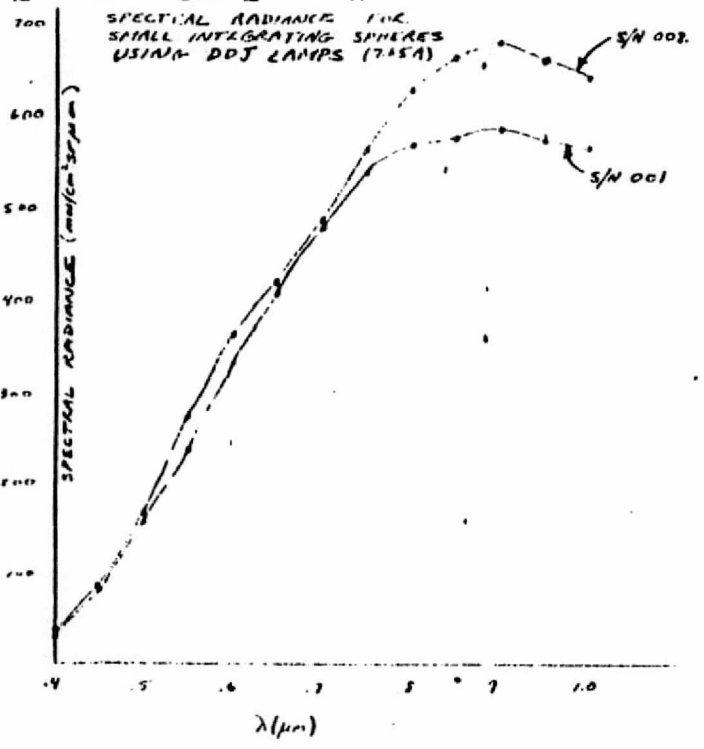
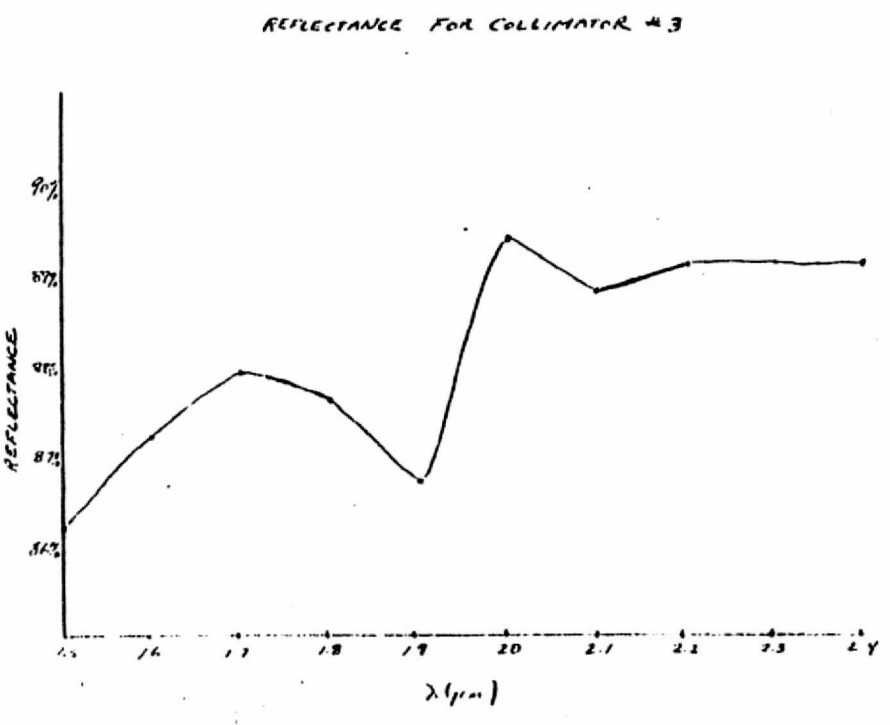
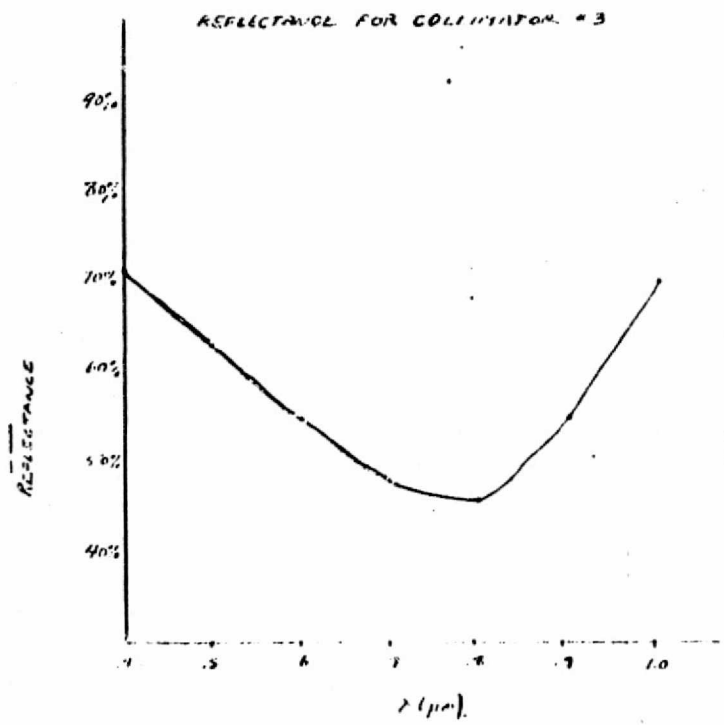

FIGURE 5



ORIGINAL PAGE IS
OF POOR QUALITY

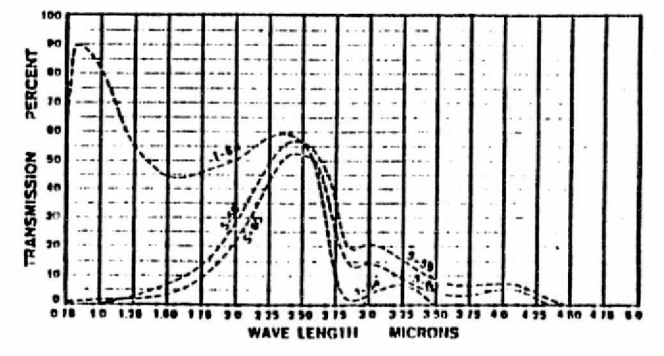
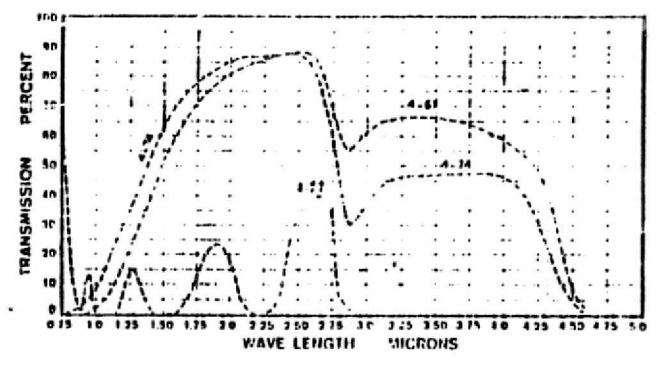
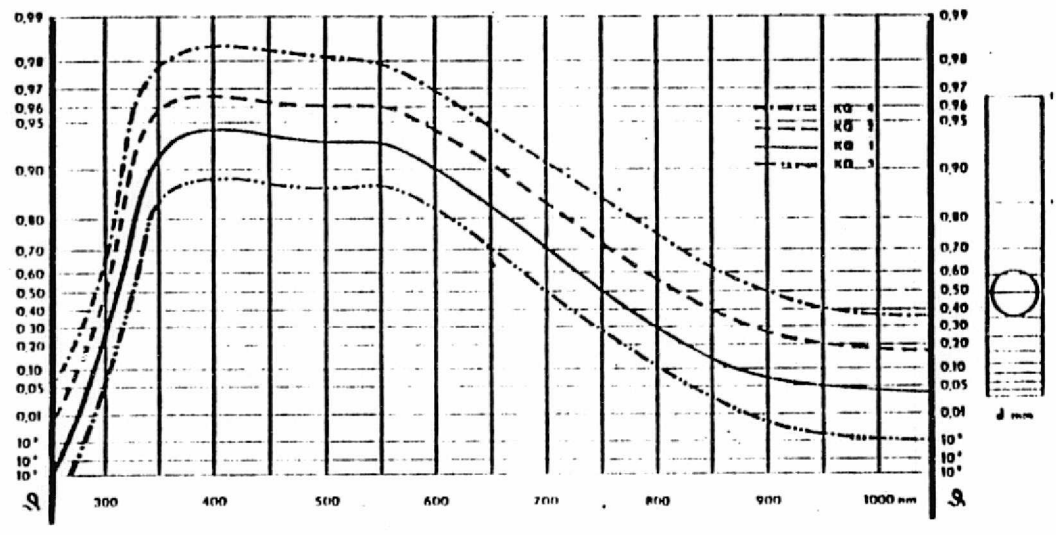
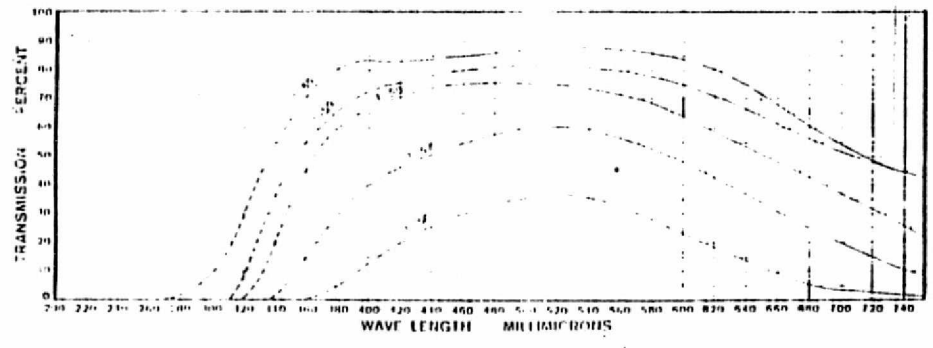
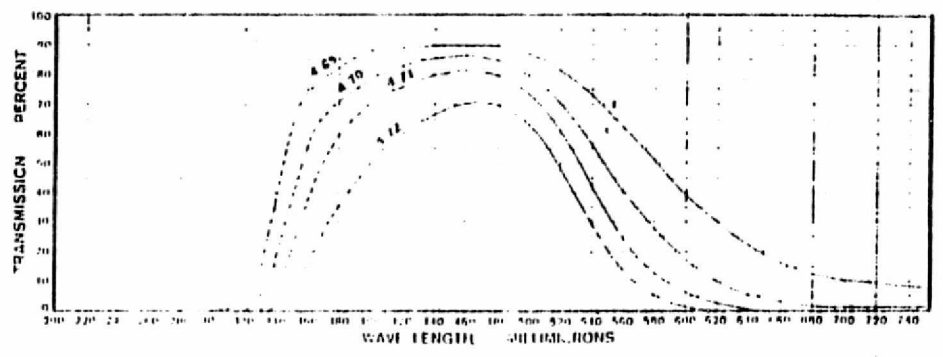
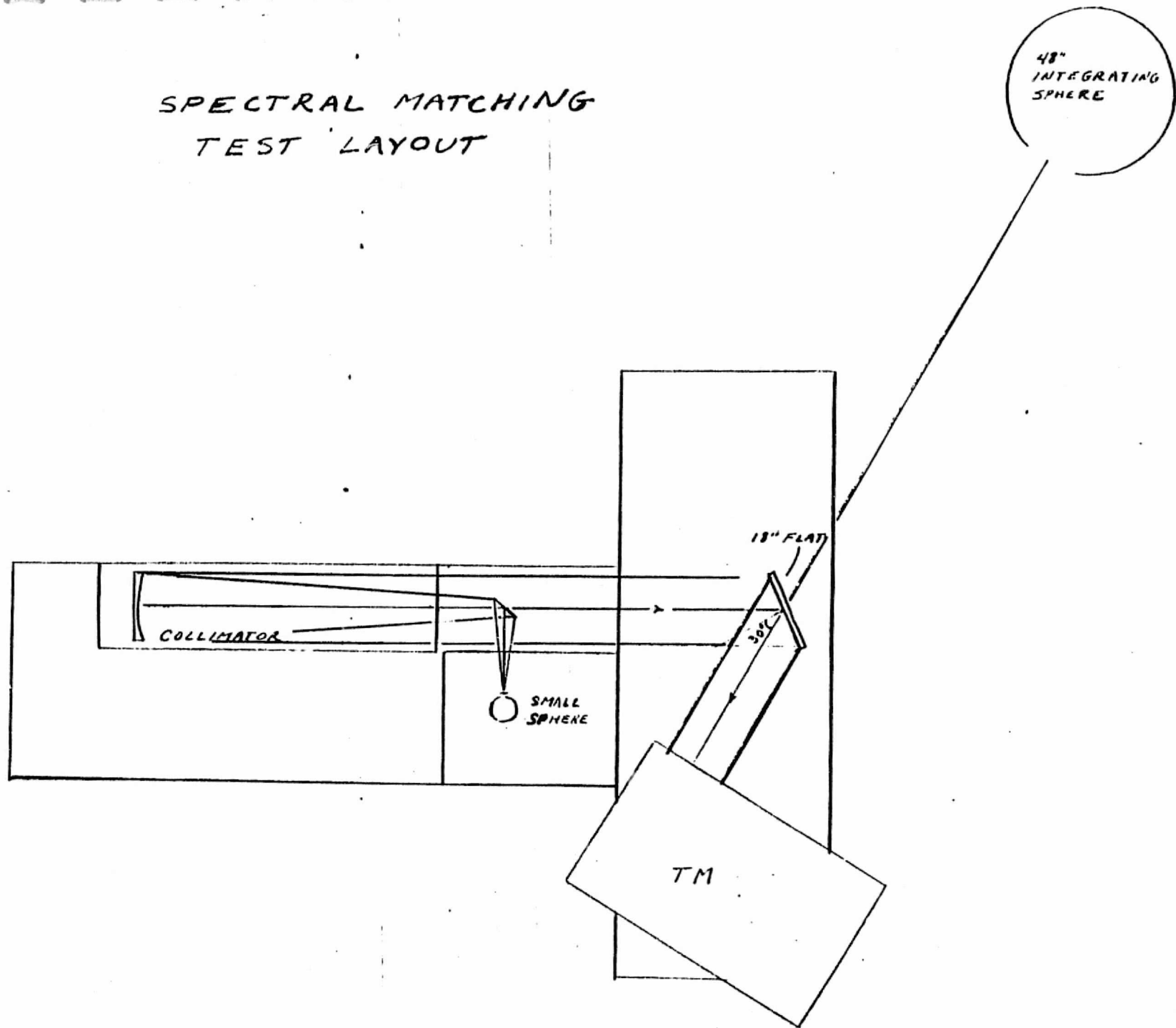

FIGURE 6

SPECTRAL MATCHING TEST LAYOUT



ORIGINAL PAGE IS
OF POOR QUALITY

FIGURE 7

ORIGINAL PAGE IS
OF POOR QUALITY

table.

Bands 1 and 4 are outside the specification requirements. Assuming that the tests and analysis described here are valid, the detector arrays and band filters are the items which are possible sources of the variations. These are discussed in some detail in Reference 2.

The detectors and filters were fabricated using the latest technology, so it is not known that any improvement could be made. Recommendation: use as is.

Table 1. Spectral matching summary:
Maximum channel-to-channel variation

Band	Test 1	Test 2	Test 3	Test 3 corrected	Final value
					PERCENT
1	*	0.89	0.80	0.46 ***	0.46 ***
2	0.54	0.45	**		0.45
3	0.30	0.35	**		0.35
4	1.76	1.50	0.62	1.74 ***	1.74 ***
5	*	0.73	0.11		0.11
7	*	0.42	**		0.42

*Bad data

**Data not reduced

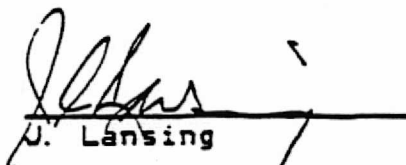
J. Lansing

*** Numbers revised

3 - RADIOMETRIC CALIBRATION OF BANDS 1-5 and 7

Absolute radiometric calibration of the TM reflected light bands proceeds through 4 steps:

- 1) Calibration of the 48" integrating sphere.
- 2) Calibration of the TM against the 48" integrating sphere in air.
- 3) Calibration of the external calibrator against the TM in air.
- 4) Calibration of the TM against the external calibrator in air and vacuum.

The last two steps are required because the TM's radiometric sensitivity changes when it goes from air to vacuum. This vacuum shift is caused by the outgassing of the multilayer coatings on the TM's mirrors and band-pass filters. The external calibrator has fewer coatings in its optical system and they are thinner than those in the TM. Thus, the external calibrator should not have a significant vacuum shift.

The results of step 1 were reported in reference 3.1. The measured values of the spectral radiance from the integrating sphere as a function of wavelength and radiance level are given in table 3.7. This data, together with the relative response data given in tables 3.1 -3.6 was used to calculate the band average spectral radiance from the integrating sphere as a function of radiance level and spectral band. The results are given in table 3.8. Finally, the values in table 3.8 were multiplied by the nominal bandwidths of spectral bands to yield a nominal in band radiance as a function of radiance level and spectral band. These numbers are given in table 3.9.

(The relative response information in tables 3.1 -3.6 was calculated from measurements of the spectral responses of the TM's components, e.g., mirror reflectivities, filter passbands, and detector responses. A more definitive calculation was performed after the data in tables 3.1 -3.6 was compiled. The results of this calculation are given in reference 2.1. The difference between the two calculations are negligible in this context.)

Step 2 has been repeated six times.

Test	Date	Location	TM Power Supply Used
A	July '82	SBRC	Primary
B	Oct. '82	GE	Primary
C	Jan. '83	GE	Redundant
D	Jan. '83	GE	Primary
E	Aug. '83	GE	Primary
F	Sep. '83	GE	Primary

The change observed over this test series was:

Band	Percent Change
1	-6.0
2	-4.6
3	-4.7
4	-1.8
5	0
7	+1.3

Reference 3.2 reports on the results of the first of these tests, signal to noise measurements, and data from the on board calibrator (OBC). Data is presented in both tabular and graphic form. The primary data from step 2 is a table of TM channel outputs vs integrating sphere radiance level. The data for all four tests is reported in tables 3.10A -3.10D. Tables 3.11A -3.11D give the results of straight line fits of channel output vs band average spectral radiance. Gains are given in units of (mux counts/(mW/cm²-sr- μ m)) and offsets in mux counts.

The OBD can be run in either of two modes, normal mode and backup mode. In normal mode the calibration lamp outputs are held at one of eight preset levels by a photodiode based feedback loop. In backup mode each calibration lamp is driven with a preset current. In either case the OBC shines a calibrated light into each detector every time the shutter passes over the focal plane. Thus, the detectors see a pulse of light once each scan and the height of the pulse serves to calibrate the TM. Ideally, the calibration pulse would rise to a maximum intensity, stay at this maximum intensity for some period of time, then fall off to zero. The actual calibration pulses do not show this "flat topped" behavior. As a result, the observed pulse height depends on the measurement algorithm. The measurement algorithm used at SBRC is this:

All data samples are collected from a window or portion of the scan which includes the entire calibration pulse. The largest data sample is found and multiplied by a fraction F. The data samples closest in value to that product are found and assumed to represent the pulse edges. The sample halfway between those samples and the N samples on either side of it are averaged to give the pulse amplitude. N is selected to avoid the pulse edge region. See figure 3.1.

3.12

Drifts in the OBC calibrations were observed during thermal vacuum testing of the flight model Thematic Mapper. These appeared to track with the temperature of the Mapper. Correlation analysis of the OBC calibration data and several temperature measurements inside the Mapper was done. The best correlation was obtained using shutter flag temperature. The visible bands (1-3) had the highest correlation with correlation coefficients of greater than 0.95 except for the odd detectors of band 3 which were around 0.9. Band 4 and Band 5 odd detectors had correlation coefficients ranging from 0.82 to 0.93. Band 7 and the even detectors of band 5 had poor correlations of less than 0.8. See Table 1.

Correction of calibration data as a function of shutter flag temperature resulted in a significant improvement in the standard deviation across 20 to 30 calibrations as shown in Table 2. Uncorrected calibration deviations ranged from 0.9% to 3.4%. Corrected calibration deviations ranged from 0.3% to 0.7%, the typical improvement being a factor of 3. Band 7 showed poor calibration using the OBC with standard deviations of approximately 30%. Corrections were not performed on channels having a correlation coefficient less than 0.8.

The results of 3.12 are presented in Table 12A & B.

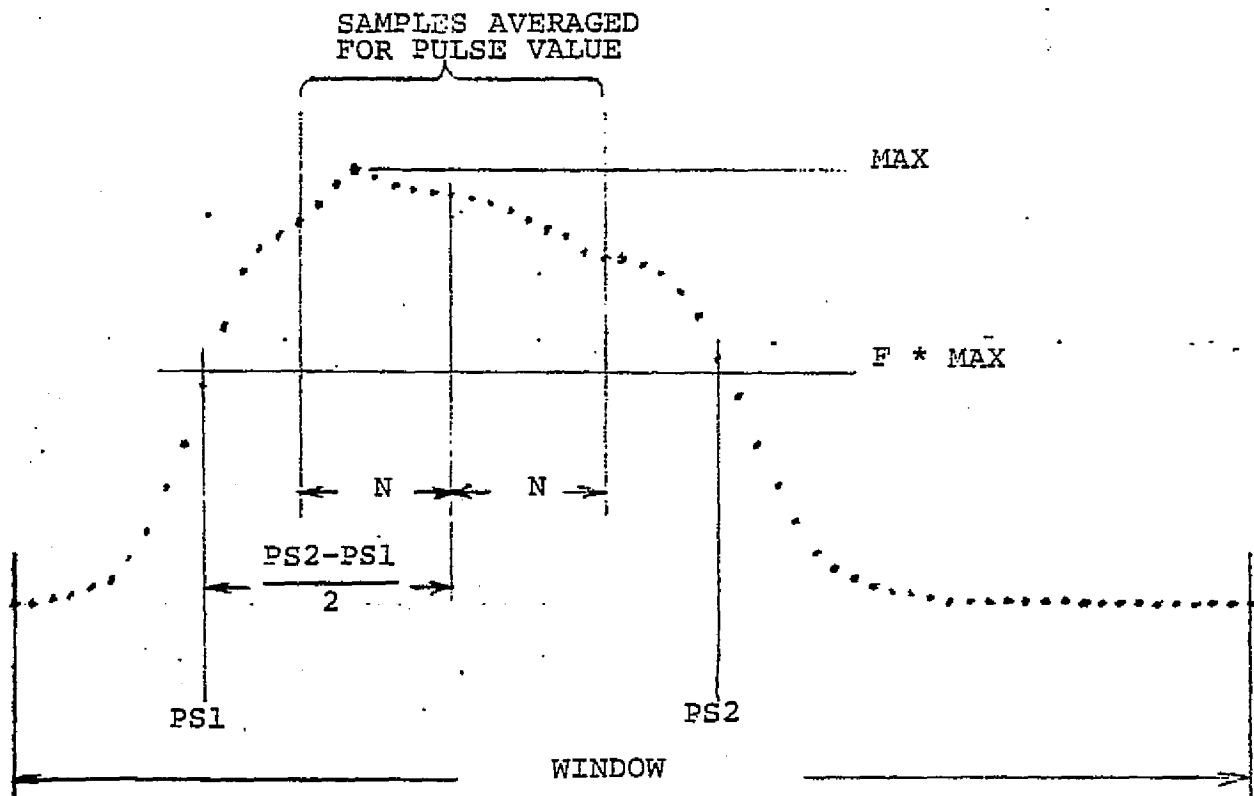

FIGURE 3.1 PULSE VALUE ALGORITHM

WAVELENGTH (μm)	RELATIVE RESPONSE (%)	WAVELENGTH (μm)	RELATIVE RESPONSE (%)
0.419	0.07	0.492	96.45
0.423	0.09	0.494	97.83
0.428	0.20	0.496	98.10
0.432	0.60	0.498	98.37
0.436	1.70	0.500	99.13
0.440	3.71	0.502	100.00
0.442	4.72	0.504	99.74
0.444	5.79	0.506	95.45
0.446	7.47	0.508	89.24
0.448	15.68	0.509	83.11
0.450	33.99	0.511	78.94
0.452	47.52	0.513	75.81
0.454	58.69	0.515	68.73
0.456	68.95	0.517	48.22
0.458	71.11	0.519	31.93
0.460	72.16	0.521	13.26
0.462	74.70	0.523	9.13
0.464	77.31	0.525	6.98
0.466	79.42	0.527	5.33
0.468	80.98	0.529	4.66
0.470	82.25	0.531	3.98
0.472	83.27	0.533	3.30
0.474	84.40	0.535	2.62
0.476	86.44	0.537	2.06
0.478	88.43	0.539	1.62
0.480	90.47	0.543	0.93
0.482	91.32	0.547	0.56
0.484	92.17	0.551	0.48
0.486	93.06	0.555	0.40
0.488	94.00	0.559	0.31
0.490	94.93		

TABLE 3.1 - RELATIVE RESPONSE vs WAVELENGTH FOR BAND 1

WAVELENGTH (μm)	RELATIVE RESPONSE (%)	WAVELENGTH (μm)	RELATIVE RESPONSE (%)
0.501	0.21	0.573	90.69
0.505	1.25	0.575	90.57
0.509	2.33	0.577	90.73
0.513	3.47	0.579	91.24
0.515	5.44	0.581	91.56
0.517	9.82	0.583	92.92
0.519	16.35	0.585	95.91
0.521	24.79	0.587	97.68
0.523	33.41	0.589	98.71
0.525	41.90	0.591	99.67
0.527	49.99	0.593	100.00
0.529	57.18	0.595	99.61
0.531	61.42	0.597	97.57
0.533	64.31	0.599	94.28
0.535	67.22	0.601	88.70
0.537	70.15	0.603	82.10
0.539	73.12	0.605	73.87
0.541	75.20	0.607	59.01
0.543	77.30	0.609	46.16
0.545	79.41	0.611	35.47
0.547	81.53	0.613	24.64
0.549	83.67	0.615	17.96
0.551	84.83	0.617	13.06
0.553	85.94	0.619	9.69
0.555	86.95	0.621	7.60
0.557	87.92	0.623	5.49
0.559	88.90	0.625	4.85
0.561	89.83	0.627	4.22
0.563	90.44	0.631	2.92
0.565	90.50	0.635	1.89
0.567	90.62	0.639	1.15
0.569	90.74	0.643	0.69
0.571	90.72	0.647	0.23

TABLE 3.2 - RELATIVE RESPONSE vs WAVELENGTH FOR BAND 2

WAVELENGTH (μm)	RELATIVE RESPONSE (%)	WAVELENGTH (μm)	RELATIVE RESPONSE (%)
0.575	0.17	0.650	90.69
0.583	0.20	0.661	91.48
0.587	0.22	0.663	92.71
0.591	0.29	0.665	94.17
0.595	0.47	0.667	95.68
0.599	0.79	0.669	97.05
0.603	1.73	0.671	98.05
0.607	3.06	0.673	99.00
0.609	3.75	0.675	99.71
0.611	5.55	0.677	100.00
0.613	9.06	0.679	99.88
0.615	12.63	0.681	99.11
0.617	16.27	0.683	97.37
0.619	29.59	0.685	93.89
0.621	40.88	0.687	88.54
0.623	45.06	0.689	78.79
0.625	49.25	0.691	60.55
0.627	53.45	0.693	44.15
0.629	57.77	0.695	29.44
0.631	63.78	0.697	19.17
0.633	73.29	0.699	11.87
0.635	76.46	0.701	9.72
0.637	79.51	0.703	7.56
0.639	81.88	0.705	5.85
0.641	84.29	0.707	5.25
0.643	86.19	0.709	4.64
0.645	87.48	0.711	4.02
0.647	88.79	0.713	3.40
0.649	90.12	0.715	2.77
0.651	90.31	0.719	2.00
0.653	90.49	0.723	1.39
0.655	90.60	0.731	0.56
0.657	90.65	0.739	0.31

TABLE 3.3 - RELATIVE RESPONSE vs WAVELENGTH FOR BAND 3

WAVELENGTH (μm)	RELATIVE RESPONSE (%)	WAVELENGTH (μm)	RELATIVE RESPONSE (%)
0.730	0.23	0.842	92.41
0.734	0.42	0.846	92.65
0.738	0.61	0.850	92.88
0.742	0.79	0.854	91.37
0.746	1.12	0.858	89.79
0.750	1.87	0.862	88.47
0.754	2.99	0.866	88.50
0.758	5.56	0.870	88.76
0.762	8.65	0.874	88.63
0.766	15.83	0.878	87.14
0.770	27.62	0.882	84.81
0.774	41.48	0.886	81.69
0.778	57.04	0.890	78.63
0.782	74.20	0.894	77.17
0.786	85.95	0.898	73.28
0.790	93.34	0.902	63.21
0.794	96.96	0.906	40.46
0.798	99.32	0.910	21.20
0.802	100.00	0.914	9.65
0.806	99.24	0.918	4.97
0.810	98.39	0.922	2.50
0.814	96.55	0.926	1.38
0.818	94.76	0.930	0.75
0.822	93.01	0.934	0.59
0.826	91.93	0.938	0.43
0.830	92.06	0.942	0.28
0.834	92.16	0.946	0.14
0.838	92.25		

TABLE 3.4 - RELATIVE RESPONSE vs WAVELENGTH FOR BAND 4

WAVELENGTH (μm)	RELATIVE RESPONSE (%)	WAVELENGTH (μm)	RELATIVE RESPONSE (%)
1.506	0.05	1.698	99.11
1.512	0.10	1.704	99.69
1.516	0.15	1.710	100.00
1.524	0.46	1.716	99.81
1.529	0.92	1.722	99.23
1.536	1.65	1.728	97.85
1.542	3.51	1.734	96.71
1.548	7.67	1.740	95.69
1.554	16.94	1.746	95.29
1.560	29.05	1.752	95.07
1.566	45.78	1.758	95.17
1.572	62.39	1.764	92.80
1.578	77.80	1.770	89.18
1.584	88.00	1.776	73.36
1.590	95.55	1.782	56.62
1.596	94.68	1.788	38.09
1.602	94.15	1.794	25.35
1.608	94.34	1.800	15.47
1.614	95.46	1.806	10.45
1.620	97.03	1.812	6.57
1.626	97.91	1.818	4.91
1.632	98.35	1.824	3.48
1.638	97.90	1.830	2.17
1.644	97.24	1.836	1.64
1.650	96.47	1.842	1.20
1.656	97.27	1.848	0.94
1.662	97.90	1.854	0.68
1.668	98.20	1.860	0.43
1.674	98.43	1.866	0.36
1.680	98.64	1.872	0.30
1.686	98.05	1.878	0.23
1.692	98.02	1.884	0.13

TABLE 3.5 - RELATIVE RESPONSE vs WAVELENGTH FOR BAND 5

WAVELENGTH (μm)	RELATIVE RESPONSE (%)	WAVELENGTH (μm)	RELATIVE RESPONSE (%)
1.763	0.04	2.137	59.77
1.970	0.10	2.194	99.95
1.977	0.17	2.201	100.00
1.984	0.37	2.208	99.69
1.991	0.65	2.215	99.39
1.998	0.93	2.222	98.37
2.005	1.26	2.229	96.43
2.012	1.61	2.236	94.50
2.019	1.95	2.243	93.60
2.026	2.81	2.250	93.48
2.033	3.69	2.257	93.36
2.040	4.73	2.264	92.21
2.047	6.67	2.271	70.66
2.054	8.63	2.278	69.13
2.061	11.37	2.285	84.68
2.068	16.00	2.292	79.79
2.075	20.67	2.299	74.93
2.082	27.97	2.306	77.55
2.089	36.82	2.313	80.17
2.096	49.76	2.320	82.05
2.103	60.54	2.327	79.50
2.110	71.28	2.334	76.94
2.117	82.21	2.341	69.56
2.124	87.82	2.348	50.09
2.131	91.28	2.355	30.57
2.138	94.77	2.362	16.91
2.145	95.24	2.369	11.11
2.152	95.18	2.376	5.25
2.159	95.13	2.383	2.18
2.166	96.67	2.390	1.23
2.173	98.22	2.397	0.27
2.180	99.58		

TABLE 3.6 - RELATIVE RESPONSE vs WAVELENGTH FOR BAND 7

λ (μm)	RADIANCE LEVEL									
	1	2	3	4	5	6	7	8	9	10
0.40	2.647	2.293	1.946	1.558	1.198	1.198	1.038	0.871	0.712	0.488
0.45	6.854	5.912	4.985	4.021	3.095	3.095	2.681	2.241	1.826	1.270
0.50	13.407	11.527	9.660	7.829	6.026	6.026	5.197	4.374	3.546	2.504
0.55	21.102	18.155	15.250	12.419	9.428	9.428	8.094	6.870	5.536	4.002
0.60	28.924	24.901	20.937	17.062	13.191	13.191	11.308	9.584	7.701	5.596
0.65	36.436	31.263	26.301	21.453	16.610	16.610	14.214	12.085	9.689	7.120
0.70	42.739	36.241	31.035	25.260	19.577	19.577	16.758	14.253	11.433	8.453
0.75	47.612	41.060	34.596	28.315	21.891	21.891	18.699	15.949	12.759	9.523
0.80	50.294	43.452	36.617	30.041	23.250	23.250	19.815	16.973	13.538	10.210
0.85	50.809	43.936	37.042	30.413	23.600	23.600	20.062	17.257	13.718	10.453
0.90	51.429	44.480	37.527	30.853	24.027	24.027	20.404	17.561	13.939	10.690
0.95	50.826	43.961	37.136	30.508	23.782	23.782	20.182	17.387	13.788	10.601
1.50	24.870	21.535	18.216	14.942	11.652	11.651	9.919	8.504	6.771	5.215
1.55	23.996	20.811	17.604	14.457	11.296	11.296	9.533	8.266	6.503	5.121
1.60	22.640	19.654	16.609	13.651	10.664	10.664	8.992	7.815	6.144	4.854
1.65	21.283	18.459	15.600	12.860	10.047	10.047	8.474	7.363	5.790	4.588
1.70	19.571	16.960	14.337	11.832	9.246	9.246	7.784	6.787	5.325	4.245
1.75	17.535	15.213	12.843	10.605	8.282	8.282	6.976	6.084	4.778	3.809
1.80	14.959	13.055	10.994	9.151	7.105	7.105	5.979	5.246	4.120	3.291
2.05	8.104	7.045	5.935	4.903	3.834	3.834	3.230	2.818	2.214	1.772
2.10	7.438	6.436	5.464	4.500	3.515	3.515	2.953	2.575	2.013	1.623
2.15	7.065	6.152	5.232	4.278	3.359	3.359	2.812	2.468	1.922	1.554
2.20	6.761	5.878	4.990	4.091	3.199	3.199	2.701	2.351	1.854	1.471
2.25	6.033	5.239	4.410	3.624	2.784	2.784	2.352	2.074	1.642	1.265
2.30	5.268	4.526	3.677	3.182	2.504	2.504	2.099	1.815	1.410	1.141
2.35	4.703	4.111	3.462	2.849	2.231	2.231	1.869	1.635	1.273	1.027

TABLE 3.7A - SPECTRAL RADIANCE ($\text{mW}/\text{cm}^2/\mu\text{m}/\text{ster}$) FROM THE 48" INTEGRATING SPHERE AS A FUNCTION OF RADIANCE LEVEL AND WAVELENGTH. (NOTE LEVELS 5 AND 6 ARE IDENTICAL.)

RADIANCE LEVEL

λ (μm)	11	12	13	14	15	16	17	18	19	20
0.40	0.448	0.407	0.329	0.247	0.210	0.169	0.160	0.120	0.078	0.041
0.45	1.158	1.056	0.856	0.642	0.540	0.437	0.419	0.307	0.205	0.103
0.50	2.287	2.090	1.675	1.261	1.065	0.865	0.810	0.593	0.396	0.200
0.55	3.665	3.350	2.668	2.016	1.702	1.382	1.286	0.949	0.634	0.320
0.60	5.127	4.685	3.713	2.802	2.365	1.915	1.799	1.330	0.888	0.451
0.65	6.524	5.960	4.723	3.563	3.007	2.433	2.290	1.694	1.130	0.574
0.70	7.738	7.069	5.634	4.249	3.590	2.911	2.723	2.008	1.338	0.680
0.75	8.736	7.976	6.331	4.784	4.046	3.285	3.046	2.259	1.499	0.761
0.80	9.375	8.567	6.774	5.131	4.346	3.537	3.237	2.401	1.594	0.808
0.85	9.617	8.799	6.915	5.261	4.458	3.637	3.277	2.441	1.624	0.821
0.90	9.834	9.008	7.068	5.385	4.568	3.734	3.334	2.478	1.651	0.834
0.95	9.761	8.944	7.002	5.344	4.539	3.712	3.290	2.449	1.633	0.827
1.50	4.807	4.394	3.482	2.662	2.264	1.865	1.618	1.209	0.797	0.399
1.55	4.725	4.336	3.358	2.573	2.187	1.799	1.558	1.163	0.774	0.387
1.60	4.482	4.113	3.182	2.441	2.074	1.708	1.475	1.103	0.733	0.366
1.65	4.232	3.883	3.016	2.311	1.965	1.620	1.396	1.040	0.691	0.345
1.70	3.915	3.592	2.784	2.131	1.816	1.496	1.288	0.958	0.635	0.320
1.75	3.514	3.221	2.503	1.916	1.635	1.350	1.153	0.858	0.566	0.285
1.80	3.027	2.788	2.165	1.661	1.423	1.174	0.991	0.726	0.487	0.249
2.05	1.631	1.500	1.167	0.895	0.763	0.633	0.534	0.393	0.262	0.130
2.10	1.499	1.381	1.061	0.819	0.694	0.580	0.481	0.357	0.239	0.115
2.15	1.433	1.317	1.007	0.771	0.662	0.544	0.463	0.343	0.227	0.118
2.20	1.347	1.228	0.974	0.730	0.620	0.524	0.450	0.326	0.206	0.096
2.25	1.176	1.088	0.833	0.656	0.555	0.466	0.367	0.278	0.190	0.089
2.30	1.053	0.965	0.736	0.560	0.479	0.399	0.337	0.249	0.161	0.080
2.35	0.945	0.861	0.665	0.499	0.436	0.359	0.306	0.223	0.139	0.076

TABLE 3.7B - SPECTRAL RADIANCE ($\text{mW}/\text{cm}^2/\mu\text{m}/\text{ster}$) FROM THE 48" INTEGRATING SPHERE AS A FUNCTION OF RADIANCE LEVEL AND WAVELENGTH.

RADIANCE LEVEL	BAND 1	BAND 2	BAND 3	BAND 4	BAND 5	BAND 7
1	11.478	24.187	37.600	50.606	20.106	6.337
2	9.877	20.821	32.170	43.745	17.444	5.495
3	8.291	17.497	27.190	36.879	14.738	4.665
4	6.716	14.252	22.165	30.275	12.148	3.827
5	5.156	10.934	17.169	23.483	9.489	2.990
6	5.156	10.934	17.169	23.483	9.489	2.990
7	4.450	9.381	14.695	19.979	7.996	2.515
8	3.742	7.953	12.492	17.159	6.961	2.196
9	3.036	6.400	10.018	13.655	5.469	1.721
10	2.142	4.634	7.369	10.374	4.342	1.373
11	1.956	4.245	6.751	9.537	4.006	1.266
12	1.786	3.879	6.167	8.724	3.675	1.162
13	1.435	3.082	4.894	6.870	2.850	0.897
14	1.080	2.327	3.692	5.219	2.184	0.686
15	0.911	1.964	3.117	4.422	1.859	0.585
16	0.739	1.592	2.523	3.606	1.532	0.489
17	0.696	1.490	2.371	3.263	1.318	0.409
18	0.510	1.100	1.753	2.426	0.982	0.302
19	0.341	0.735	1.169	1.613	0.651	0.198
20	0.172	0.372	0.594	0.816	0.327	0.097

TABLE 3. B - BAND AVERAGE SPECTRAL RADIANCE ($\text{mW}/\text{cm}^2/\mu\text{m}/\text{ster}$) FROM THE 48" INTEGRATING SPHERE AS A FUNCTION OF RADIANCE LEVEL.

RADIANCE LEVEL	BAND 1	BAND 2	BAND 3	BAND 4	BAND 5	BAND 7
1	0.803	1.935	2.256	7.085	4.021	1.711
2	0.691	1.666	1.930	6.124	3.489	1.484
3	0.580	1.400	1.631	5.163	2.948	1.259
4	0.470	1.140	1.330	4.238	2.430	1.034
5	0.361	0.875	1.030	3.288	1.898	0.807
6	0.361	0.875	1.030	3.288	1.898	0.807
7	0.311	0.751	0.882	2.797	1.599	0.679
8	0.262	0.636	0.750	2.402	1.392	0.593
9	0.213	0.512	0.601	1.912	1.094	0.465
10	0.150	0.371	0.442	1.452	0.868	0.371
11	0.137	0.340	0.405	1.335	0.801	0.342
12	0.125	0.310	0.370	1.221	0.735	0.314
13	0.100	0.247	0.294	0.962	0.570	0.242
14	0.076	0.186	0.222	0.731	0.437	0.185
15	0.064	0.157	0.187	0.619	0.372	0.158
16	0.052	0.127	0.151	0.505	0.306	0.132
17	0.049	0.119	0.142	0.457	0.264	0.110
18	0.036	0.088	0.105	0.340	0.196	0.082
19	0.024	0.059	0.070	0.226	0.130	0.053
20	0.012	0.030	0.036	0.114	0.065	0.026

TABLE 3.9 - NOMINAL IN BAND RADIANCE (mW/cm²/ster) FROM THE 48" INTEGRATING SPHERE AS A FUNCTION OF RADIANCE LEVEL. THE BANDWIDTHS USED IN PREPARING THIS TABLE WERE:

BAND 1	0.07 μ m
BAND 2	0.08 μ m
BAND 3	0.06 μ m
BAND 4	0.14 μ m
BAND 5	0.20 μ m
BAND 7	0.27 μ m

CHANNEL GAINS in Counts/(mw/ μ m/cm²/ster)

CHAN	BAND 1	BAND 2	BAND 3	BAND 4	BAND 5	BAND 7
1	16.90	8.31	10.65	11.14	79.08	145.61
2	16.84	8.27	10.78	11.09	78.20	144.46
3	17.05	8.26	10.67	11.01	78.65	145.66
4	16.81	8.25	10.74	10.95	78.28	145.09
5	17.11	8.27	10.64	11.06	78.72	146.69
6	16.77	8.23	10.60	11.28	78.70	144.52
7	17.02	8.25	10.51	11.04	78.11	146.09
8	16.84	8.34	10.69	11.14	79.55	145.67
9	16.89	8.23	10.55	10.94	78.72	145.61
10	16.95	8.28	10.67	11.17	79.35	145.36
11	16.99	8.31	10.56	11.06	79.33	146.72
12	16.95	8.34	10.72	11.05	79.22	146.08
13	16.91	8.29	10.61	11.04	78.76	144.74
14	16.77	8.25	10.72	11.06	78.34	145.97
15	16.89	8.33	10.67	11.02	78.74	145.86
16	16.92	8.20	10.76	11.11	79.03	145.44

CHANNEL OFFSETS in Counts

CHAN	BAND 1	BAND 2	BAND 3	BAND 4	BAND 5	BAND 7
1	2.36	2.36	2.53	2.73	3.27	3.72
2	1.97	1.73	2.06	1.94	3.03	3.10
3	1.89	1.95	2.07	2.37	2.99	3.15
4	1.87	1.70	1.83	1.98	3.07	3.13
5	1.79	1.63	2.00	2.03	2.94	3.08
6	1.99	1.94	1.89	2.26	3.09	3.13
7	1.78	1.66	2.01	2.65	2.93	3.03
8	2.03	1.81	1.96	2.14	3.27	3.15
9	1.67	1.80	2.15	2.23	3.00	2.97
10	1.79	1.79	1.96	1.97	3.20	3.06
11	1.60	1.93	2.05	2.32	2.96	3.06
12	1.73	1.71	1.92	1.96	3.04	2.96
13	1.75	1.71	1.94	2.02	2.94	2.86
14	1.91	1.74	1.95	2.12	3.17	3.19
15	1.66	1.74	1.97	2.10	2.92	2.96
16	1.86	1.64	1.98	2.02	3.11	3.15

TABLE 3.11A - TM CHANNEL GAINS AND OFFSETS FROM THE CALIBRATION AGAINST THE 48" INTEGRATING SPHERE TAKEN ON

CHANNEL GAINS in Counts/(mW/ μ m/cm²/ster)

CHAN	BAND 1	BAND 2	BAND 3	BAND 4	BAND 5	BAND 7
1	16.26	8.12	10.56	11.26		
2	16.18	8.08	10.66	11.20		
3	16.37	8.07	10.58	11.12		
4	16.18	8.08	10.65	11.08		
5	16.43	8.09	10.56	11.17		
6	16.13	8.05	10.52	11.16		
7	16.33	8.07	10.43	11.14		
8	16.18	8.15	10.60	11.25		
9	16.21	8.04	10.47	11.07		
10	16.28	8.10	10.60	11.30		
11	16.31	8.12	10.48	11.16		
12	16.29	8.15	10.62	11.18		
13	16.23	8.11	10.53	11.16		
14	16.13	8.07	10.64	11.19		
15	16.24	8.14	10.58	11.15		
16	16.27	8.01	10.68	11.23		

CHANNEL OFFSETS in Counts

CHAN	BAND 1	BAND 2	BAND 3	BAND 4	BAND 5	BAND 7
1	2.16	2.17	1.33	2.03		
2	1.83	1.44	0.84	1.39		
3	1.74	1.72	0.87	1.69		
4	1.73	1.41	0.61	1.28		
5	1.66	1.38	0.74	1.42		
6	1.86	1.72	0.67	1.56		
7	1.63	1.46	0.73	2.04		
8	1.98	1.64	0.78	1.53		
9	1.53	1.60	0.87	1.42		
10	1.67	1.50	0.71	1.25		
11	1.50	1.73	0.74	1.65		
12	1.60	1.51	0.67	1.24		
13	1.51	1.46	0.62	1.32		
14	1.74	1.49	0.67	1.43		
15	1.53	1.50	0.67	1.36		
16	1.71	1.49	0.71	1.32		

TABLE 3.11B - TM CHANNEL GAINS AND OFFSETS FROM THE CALIBRATION AGAINST THE 48" INTEGRATING SPHERE TAKEN ON

CHANNEL GAINS in Counts/(mW/μm/cm²/ster)

CHAN	BAND 1	BAND 2	BAND 3	BAND 4	BAND 5	BAND 7
1	16.23	8.10	10.55	11.23		
2	16.14	8.06	10.64	11.18		
3	16.34	8.04	10.57	11.10		
4	16.15	8.06	10.63	11.06		
5	16.40	8.07	10.55	11.15		
6	16.10	8.03	10.51	11.14		
7	16.32	8.05	10.41	11.12		
8	16.15	8.13	10.58	11.22		
9	16.19	8.02	10.46	11.05		
10	16.26	8.08	10.58	11.27		
11	16.30	8.10	10.47	11.14		
12	16.26	8.13	10.60	11.15		
13	16.24	8.09	10.51	11.14		
14	16.09	8.05	10.62	11.17		
15	16.21	8.12	10.57	11.13		
16	16.24	7.99	10.66	11.21		

CHANNEL OFFSETS in Counts

CHAN	BAND 1	BAND 2	BAND 3	BAND 4	BAND 5	BAND 7
1	2.16	2.11	1.17	1.91		
2	1.84	1.41	0.72	1.24		
3	1.73	1.73	0.70	1.55		
4	1.74	1.38	0.48	1.20		
5	1.65	1.33	0.59	1.28		
6	1.88	1.67	0.51	1.43		
7	1.59	1.40	0.57	1.90		
8	1.99	1.61	0.68	1.41		
9	1.50	1.55	0.72	1.36		
10	1.66	1.47	0.59	1.13		
11	1.43	1.73	0.60	1.53		
12	1.60	1.47	0.57	1.13		
13	1.55	1.43	0.48	1.21		
14	1.75	1.46	0.57	1.29		
15	1.51	1.48	0.52	1.25		
16	1.70	1.46	0.58	1.22		

TABLE 3.11C - TM CHANNEL GAINS AND OFFSETS FROM THE CALIBRATION AGAINST THE 48" INTEGRATING SPHERE TAKEN ON

CHANNEL GAINS in Counts/(mW/μm/cm²/ster)

CHAN	BAND	BAND	BAND	BAND	BAND	BAND
	1	2	3	4	5	7
1	15.60	7.88	10.21	10.90	78.98	147.59
2	15.48	7.85	10.28	10.84	78.05	146.21
3	15.66	7.84	10.19	10.78	78.50	147.37
4	15.47	7.84	10.27	10.73	78.24	146.55
5	15.71	7.85	10.19	10.82	78.65	148.87
6	15.44	7.82	10.16	10.81	78.69	146.33
7	15.61	7.84	10.04	10.80	78.17	148.43
8	15.48	7.92	10.25	10.89	79.48	147.98
9	15.51	7.81	10.10	10.73	78.72	147.65
10	15.57	7.82	10.23	10.94	78.83	147.31
11	15.61	7.89	10.10	10.80	79.34	148.67
12	15.59	7.92	10.28	10.81	79.21	148.46
13	15.58	7.88	10.16	10.80	78.78	146.48
14	15.42	7.84	10.27	10.86	78.33	148.37
15	15.54	7.91	10.22	10.78	78.93	147.43
16	15.56	7.78	10.30	10.86	79.11	147.81

CHANNEL OFFSETS in Counts

CHAN	BAND	BAND	BAND	BAND	BAND	BAND
	1	2	3	4	5	7
1	2.30	2.27	2.46	2.66	3.57	3.82
2	1.93	1.54	1.99	2.14	3.26	3.22
3	1.87	1.87	1.97	2.43	3.27	3.36
4	1.89	1.54	1.73	1.95	3.27	3.28
5	1.76	1.51	1.84	2.20	3.13	3.11
6	1.97	1.82	1.74	2.31	3.25	3.26
7	1.74	1.56	1.86	2.64	3.12	3.01
8	2.12	1.74	1.88	2.21	3.50	3.24
9	1.64	1.71	2.01	2.15	3.28	3.10
10	1.80	1.59	1.81	2.00	3.38	3.19
11	1.58	1.88	1.87	2.41	3.24	3.12
12	1.76	1.61	1.77	2.07	3.29	3.02
13	1.63	1.60	1.75	2.14	3.15	3.04
14	1.85	1.60	1.81	2.17	3.37	3.24
15	1.64	1.64	1.79	2.17	3.18	3.11
16	1.83	1.58	1.88	2.13	3.35	3.28

TABLE 3.11D - TM CHANNEL GAINS AND OFFSETS FROM THE CALIBRATION AGAINST THE 48" INTEGRATING SPHERE TAKEN ON

CORRELATION - SHUTTER FLAG TEMP VS. ON-BOARD CALIBRATOR CALIBRATION

TABLE 12A

BAND	1	2	3	4	5	7
DETECTOR						
1	0.9523	0.9583	0.8832	0.8301	0.7261	0.6607
3	0.9556	0.9621	0.9092	0.8475	0.8205	0.7129
5	0.9584	0.9658	0.9124	0.8498	0.8277	0.6958
7	0.9558	0.9645	0.8990	0.9217	0.8615	0.6414
9	0.9594	0.9666	0.9066	0.8202	0.8568	0.6840
11	0.9557	0.9697	0.9068	0.8415	0.8664	0.6997
13	0.9511	0.9645	0.9021	0.8709	0.8527	0.6953
15	0.9521	0.9636	0.9036	0.8265	0.8182	0.7253
AVE	0.9551	0.9644	0.9029	0.8510	0.8287	0.6894
2	0.9669	0.9686	0.9629	0.8955	0.3589	0.7513
4	0.9703	0.9657	0.9936	0.9279	0.4056	0.7858
6	0.9673	0.9673	0.9938	0.8850	0.3904	0.7840
8	0.9676	0.9699	0.9949	0.9330	0.4002	0.6887
10	0.9668	0.9691	0.9938	0.9249	0.0403	0.7552
12	0.9700	0.9724	0.9935	0.8919	0.3757	0.7605
14	0.9675	0.9706	0.9945	0.8992	0.3438	0.7549
16	0.9673	0.9614	0.9944	0.8497	0.2713	0.7648
AVE	0.9682	0.9681	0.9902	0.9009	0.3233	0.7557

TABLE 12B Uncorrected and temperature corrected calibration data

DET	UNCORRECTED DATA											
	BAND 1		2		3		4		5		7	
	AVE	STD	AVE	STD	AVE	STD	AVE	STD	AVE	STD	AVE	STD
1	0.967	0.016	0.978	0.014	1.025	0.015	1.023	0.009	1.037	0.032	0.912	0.282
3	0.967	0.015	0.980	0.013	1.023	0.014	1.025	0.010	1.049	0.031	0.939	0.290
5	0.965	0.015	0.981	0.014	1.024	0.014	1.023	0.009	1.058	0.031	0.943	0.292
7	0.968	0.016	0.980	0.014	1.023	0.014	1.024	0.009	1.051	0.033	0.941	0.292
9	0.969	0.015	0.979	0.013	1.023	0.014	1.019	0.009	1.055	0.032	0.947	0.293
11	0.964	0.015	0.977	0.014	1.025	0.015	1.021	0.007	1.049	0.032	0.945	0.292
13	0.968	0.015	0.974	0.014	1.024	0.014	1.024	0.009	1.054	0.033	0.948	0.293
15	0.962	0.015	0.972	0.014	1.023	0.014	1.024	0.009	1.050	0.032	0.939	0.290

2	0.971	0.018	0.986	0.016	1.036	0.034	1.027	0.010	1.001	0.026	0.897	0.278
4	0.965	0.016	0.996	0.015	1.063	0.035	1.024	0.009	0.990	0.018	0.905	0.280
6	0.962	0.017	0.996	0.015	1.059	0.035	1.026	0.010	1.004	0.025	0.900	0.278
8	0.963	0.018	0.989	0.014	1.060	0.036	1.025	0.010	1.015	0.023	0.904	0.280
10	0.965	0.016	0.980	0.013	1.063	0.035	1.024	0.009	0.683	0.040	0.905	0.280
12	0.966	0.018	0.975	0.015	1.060	0.037	1.025	0.010	1.005	0.018	0.904	0.280
14	0.963	0.018	0.974	0.014	1.060	0.035	1.028	0.011	1.008	0.021	0.903	0.279
16	0.963	0.017	0.970	0.013	1.060	0.033	1.027	0.010	1.000	0.026	0.903	0.279

DET	CORRECTED DATA											
	BAND 1		2		3		4		5		7	
	AVE	STD	AVE	STD	AVE	STD	AVE	STD	AVE	STD	AVE	STD
1	0.968	0.005	0.978	0.005	1.027	0.005	1.022	0.004	1.037	0.032	0.912	0.282
3	0.968	0.005	0.980	0.005	1.023	0.006	1.025	0.005	1.051	0.019	0.939	0.290
5	0.965	0.007	0.981	0.004	1.025	0.007	1.022	0.004	1.060	0.019	0.943	0.292
7	0.969	0.004	0.980	0.004	1.025	0.007	1.023	0.005	1.054	0.018	0.941	0.292
9	0.970	0.004	0.979	0.004	1.024	0.007	1.020	0.004	1.055	0.018	0.947	0.293
11	0.965	0.007	0.978	0.005	1.025	0.007	1.021	0.003	1.050	0.016	0.945	0.292
13	0.969	0.004	0.974	0.005	1.025	0.007	1.022	0.004	1.055	0.018	0.948	0.293
15	0.962	0.006	0.973	0.005	1.025	0.007	1.024	0.005	1.052	0.019	0.939	0.290

2	0.971	0.004	0.988	0.005	1.068	0.005	1.029	0.004	1.001	0.026	0.897	0.278
4	0.966	0.007	0.998	0.005	1.065	0.005	1.023	0.005	0.990	0.018	0.905	0.280
6	0.962	0.005	0.998	0.005	1.060	0.004	1.027	0.005	1.004	0.025	0.900	0.278
8	0.964	0.007	0.989	0.004	1.062	0.005	1.026	0.005	1.015	0.023	0.904	0.280
10	0.966	0.006	0.981	0.004	1.064	0.005	1.023	0.005	0.683	0.040	0.905	0.280
12	0.969	0.004	0.975	0.005	1.063	0.006	1.025	0.005	1.005	0.018	0.904	0.280
14	0.965	0.007	0.975	0.005	1.062	0.005	1.030	0.004	1.008	0.021	0.903	0.279
16	0.965	0.007	0.971	0.004	1.062	0.005	1.029	0.004	1.000	0.026	0.903	0.279

4 RADIOMETRIC CALIBRATION OF THERMAL BAND

The reference sources for calibrating the thermal band are two conical blackbodies available at the focus of a collimator in the assembly called the calibrator. The blackbodies' accuracy is estimated to be $\pm 1\%$ with the major inaccuracy added by calibrator mirror reflectance, estimated to be $\pm 6\%$. A full aperture infrared source had been planned for more accurate calibration, but since the specified absolute accuracy was "...better than 10% of full scale radiance....," that source was deleted to save costs.

The spectral radiance supplied by the calibrator is calculated by means described in Ref 4.1, and the gain is calculated as the ratio of signal counts difference to spectral radiance difference, when the two blackbodies are viewed in succession.

At the time of the calibration, the signal counts while viewing the calibrating shutter and the mirror on the shutter which relays the radiance of the onboard blackbody are also recorded, and the temperatures of the shutter and blackbody. The spectral radiance of each of these is calculated similarly to that for the calibrator blackbodies. The difference in counts divided by the difference in radiance for the shutter and onboard blackbody are referred to as internal gain. The internal gain can be calculated from telemetered quantities when the TM is in orbit and used with the ground calibration data to adjust the output such that a blackbody filling the TM aperture causes zero counts at 260K temperature and 255 counts at 320K. The process is described in references 4.2-4.4.

SANTA BARBARA RESEARCH CENTER
 A Subsidiary of Hughes Aircraft Company
 INTERNAL MEMORANDUM

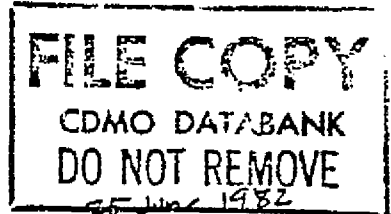

TO: Distribution

CC: G. Hyde

DATE: ~~10 April 1981~~REF: HS236-7398-1
J. Lansing

FROM: W. Shockency

SUBJECT: BL-10 Clarifications (Revised)

BLDG. 774 MAIL STA. 79
EXT. 4351

REF: HS236-6666, Test Requirements for BL-10, Radiometric
 Calibration of Bd. 6, 29 April 1980.

I. Introduction

The purpose of this IDC is to clarify the method of determining L_{EFF} (effective radiance shown in Appendix B* in referenced ICD, and to call out more explicit definition of the end points of the detectors transfer characteristics. Since the issuance of the initial IDC, more quantitative measurements have been made on both the throughput of the entire TM instrument and the External Calibrator.

II. Spectral Response

Table C-1 of Appendix BB depicts the normalized response of the TM (from radiance input to the aperture to output of the Bd. 6 detectors) for the 3 expected temperature states of the CFPA, 90°, 95° and 105°K.

The L_{EFF} in Eq. 3 of Appendix BB is first applied to determine the TM response to an IDEAL BB. Once this is determined for a given IDEAL BB within the specified range of the TM (L_{EFF} 260°K to L_{EFF} 320°K), the External Calibrator BB (either the REF_{BB} or MTF_{BB}) equivalent radiance is determined by applying equations A, 2, and 3.

To clarify this process, the expressions relating L_{EFF} for an IDEAL BB, MTF_{BB} , and REF_{BB} are given in Appendix BB, also. It is recommended that tables be constructed for L_{EFF} (IDEAL BB) and L_{EFF} (MTF_{BB} and REF_{BB}) which will be useful in determining CALIBRATOR BB temperature commands for desired L_{EFF} (IDEAL BB).

* This Appendix is superseded by the attached Appendix BB.

III. External Calibrator

The expressions in Appendix BB have been modified to show the appropriate transfer characteristic of the REF_{BB} and MTF_{BB} .

Note that the REF and MTF L_{EFF} transfer equations are different in that the optical paths are different.

IV. Graphical TM Detector Model

The attached graph, Figure I, of Appendix BB is a model of a typical detector expected transfer curve. The purpose of the figure is to show how points on the curve are to be determined--by calculation, measurements, or by derivation (a combination of measurements and calculations). The end points on this curve which will be determined by temperature commands of the External Calibrator BB's represent specified equivalent SCENE temperatures. These temperatures are used as the boundary extremes throughout all testing in BL-10; therefore, any place in the BL-10 (HS236-6666) document end point commands are called out, the temperatures of $MTF_{BB} = 251.3^{\circ}K^*$ and $REF_{BB} = 323.8^{\circ}K^*$ are to be used.

V. NETD Calculations

A. In reference document, pg. 16a, change to

Temp. °K	$\partial L / \partial T (MW/Cm^2-SR-^{\circ}K)$ @ CFPA = 90°K-105°K	
300	0.0137	.0131
320	0.0164	.0151
	PROTFLIGHT	FLIGHT 1

B. In Ref., pg. 16e, change to

$$1) \rho_m = 0.85, 2) \rho_R = 0.89, 3) \epsilon = 0.995$$

C. In Ref., pg. 17f, - eliminate (f)

D. In Ref., pg. 19, NETD

$$L_{EFF} = \text{effective radiance for IDEAL BB}$$

$$\partial L_{EFF} / \partial T = \text{data base values}$$

* Note the command temperatures to the External Calibrator BB's have been determined by applying the process described in I-III.

APPENDIX BB

A. Radiance/Temperature Relations

Several data reduction processes require conversions relating radiance and temperature from various thermal sources within the TM, Ideal BB, and External Calibrator. The following expression is to be used:

$$L = \frac{1.19096 \cdot 10^4}{\lambda^5 \left(\text{EXP} \frac{1.43879 \cdot 10^4}{\lambda T} - 1 \right)}$$

(Eq. A)

~~(Eq. A)~~
L = spectral radiance in Watts/cm² - sr - μm

λ = μm wavelength

T = temperature, °K

B. Radiance Calibration Determinations from External Calibrator

The spectral radiance, L_{EFF} , which is proportional to the TM multiplexer output is basically a function of two elements. One element is the radiance from the Calibrator or an Ideal BB, and the other is the effective transfer characteristics of the TM components.

The first element may be expressed by the following equation:

$$L_{CALIB/BB} = \rho_{CALIB} \epsilon_{BB} L_{T1_{BB}} + (1 - \rho_{CALIB} \epsilon_{BB}) L_{T2M} \quad (\text{Eq 1})$$

$$\rho_{CALIB} = 0.89 \text{ for Ref}_{BB}, 0.85 \text{ for MTF}_{BB}$$

$$\epsilon_{BB} = 0.995$$

$$L_{T1_{BB}} = \text{Radiance of BB at } T_1 \text{ from (EqA)}$$

$$L_{CALIB} = \text{radiance out of CALIB}$$

APPENDIX BB (Cont'd)

L_{T_2M} = radiance of the calibrator mirrors (composite) as function of their temp.,

$$T_2 = \frac{2T_{250} + 2T_{251} + T_{253}}{5} \text{ where subscripts are parameter numbers.}$$

The second element has been determined by measuring the thruput of the TM instrument and is depicted in the following table:

PROTFLIGHT

Table C-1 TM Thruput for Bd 6

λ (μm)	CFPA			(2) FLIGHT 1 (ALL CFPA TEMPS.)	
	(90°K)	(95°K)	(105°K)	DET. 1,3	DET. 2,4
10.2	.0306	.0306	.0306	.028	.029
10.4	.409	.409	.409	.323	.329
10.6	.836	.836	.836	.752	.778
10.8	.919	.919	.891	.784	.841
11.0	.998	.998	.838	.881	.975
11.2	.876	.876	.596	.899	.955
11.4	.907	.803	.367	.969	.988
11.6	.891	.685	.247	.939	.921
11.8	.721	.437	.166	.954	.977
12.0	.437	.260	.114	.914	.978
12.2	.262	.164	.09	.884	.955
12.4	.094	.067	.003	.545	.594
12.6	.006	.004	--	.042	.046
12.8	.0008	.0006	--	.008	.009

The effective spectral radiance, L_{EFF} , is calculated from the following:

$$L_{EFF} = \frac{\Sigma(1) \quad (2) \quad \Delta\lambda}{\Sigma(2) \quad \Delta\lambda} \quad \star \quad \text{(Eq. 3)}$$

$$\Delta\lambda = 0.2\mu\text{(from 10.2 to 12.8}\mu\text{m)}$$

\star see following page for alternate equation

APPENDIX BB (Cont'd)

The calculations for (1) in this equation use the actual measured temperatures, T_2 , of the mirrors in the calibrator.

Take ^{weighted} average of calibrator mirror temperatures using telemetry parameter numbers ~~24, 26, and 27~~. This is required in the data reduction, printouts, and plots wherever L_{EFF} is called out for either the MTF or REF blackbody.

The above effective radiance takes into account the actual spectral shape of the TM transmission and detector responsivity. This effective radiance can be translated to scene temperature by substituting an IDEAL BB for the (Eq. 1) and finding the temperature of the BB which gives the same effective radiance as the calibrator. Conversely, particular temperatures of interest can be substituted to find effective radiance.

ALTERNATE EQUATION

$$L_{EFF} = K_1 / (\exp(K_2/T) - 1) \quad (Eq. 4)$$

or conversely,

$$T = K_2 / \ln(K_1 / L_{EFF} + 1) \quad (Eq. 5)$$

where

CFPA Temperature	Protoflight	Flight 1 *	
		Det. 1,3	Det. 2,4
90K	$K_1 = 67.1632$ $K_2 = 1284.3$	60.844 1260.77	60.708 1260.35
95K	$K_1 = 69.527$ $K_2 = 1293.1$	same as 90K	
105K	$K_1 = 74.571$ $K_2 = 1311.1$	same as 90K	

* Using average values, $K_1 = 60.76$, $K_2 = 1260.56$, gives results within 0.05% for F1.

TM RESPONSE TO IDEAL BB

$$L_{\text{EFF BB}}^{(\text{TM})} = \frac{\sum \frac{\lambda_2}{\lambda_1} (1) (2) \Delta\lambda}{\sum \frac{\lambda_2}{\lambda_1} (2) \Delta\lambda}$$

where (1) $L_{\text{BB, TEMP}} = \frac{1.19096 \times 10^4}{\lambda^5 \left(\text{EXP} \frac{1.43879 \times 10^4}{\lambda T} - 1 \right)}$

in watts/cm²sr μm, λ = μm, T240 to 340°K

in 5°K(INC)

$$\Delta\lambda = 0.2\mu\text{m}$$

(2) (See Attached Table) and calculate for

TM @ 90°K, L_{EFF} μm 5°K(INC) for 240 to 340°K
 95°K
 105°K

TM RESPONSE TO REFBB/CALIB.

$$L_{\text{EFF, CALIB}}^{(\text{TM})} = \frac{\sum \frac{\lambda_2}{\lambda_1} (1) (2) \Delta\lambda}{\sum \frac{\lambda_2}{\lambda_1} (2) \Delta\lambda}$$

(2) See Attached Table @ TM (90°K)

$$(1) L_{\text{CALIB/REF}_{\text{BB}}} = (0.995) (.89) L_{\text{BB}_{T_c}}^{(10.2, 12.8)} + [1 - .995(.89)] L_{T_c M}$$

$$L_{T_c M}^{(10.2, 12.8)} \\ T_c = 297 \text{ (OR } T_2 \text{ IN APPENDIX BB)}$$

Calculate (1) for $T_c = 325, 320, 315, 300^\circ\text{K}, 322.7$

TM RESPONSE TO MTF_{BB}/CALIB

In Above Process, Replace (1) by Following:

$$(1) L_{\text{CALIB/MTF}_{\text{BB}}} = (0.995) (.85) L_{\text{MTF}}^{(10.2, 12.8)} + [1 - .995(.85)] L_{T_2 M}$$

$$L_{T_2 M}^{(10.2, 12.8)} \\ T_2 = 297 \text{ (OR } T_2 \text{ IN APPENDIX BB)}$$

Calculate (1) for $T_{\text{MTF}} = 240, 247, 260, 300, 315, 251, 325, 320, 255, 297, 305$

$$L_{\text{EFF}}^{(\text{TM}) \text{ CALIB}} = \frac{\sum \frac{\lambda_2}{\lambda_1} (1) (2) \Delta\lambda}{\sum \frac{\lambda_2}{\lambda_1} (2) \Delta\lambda}$$

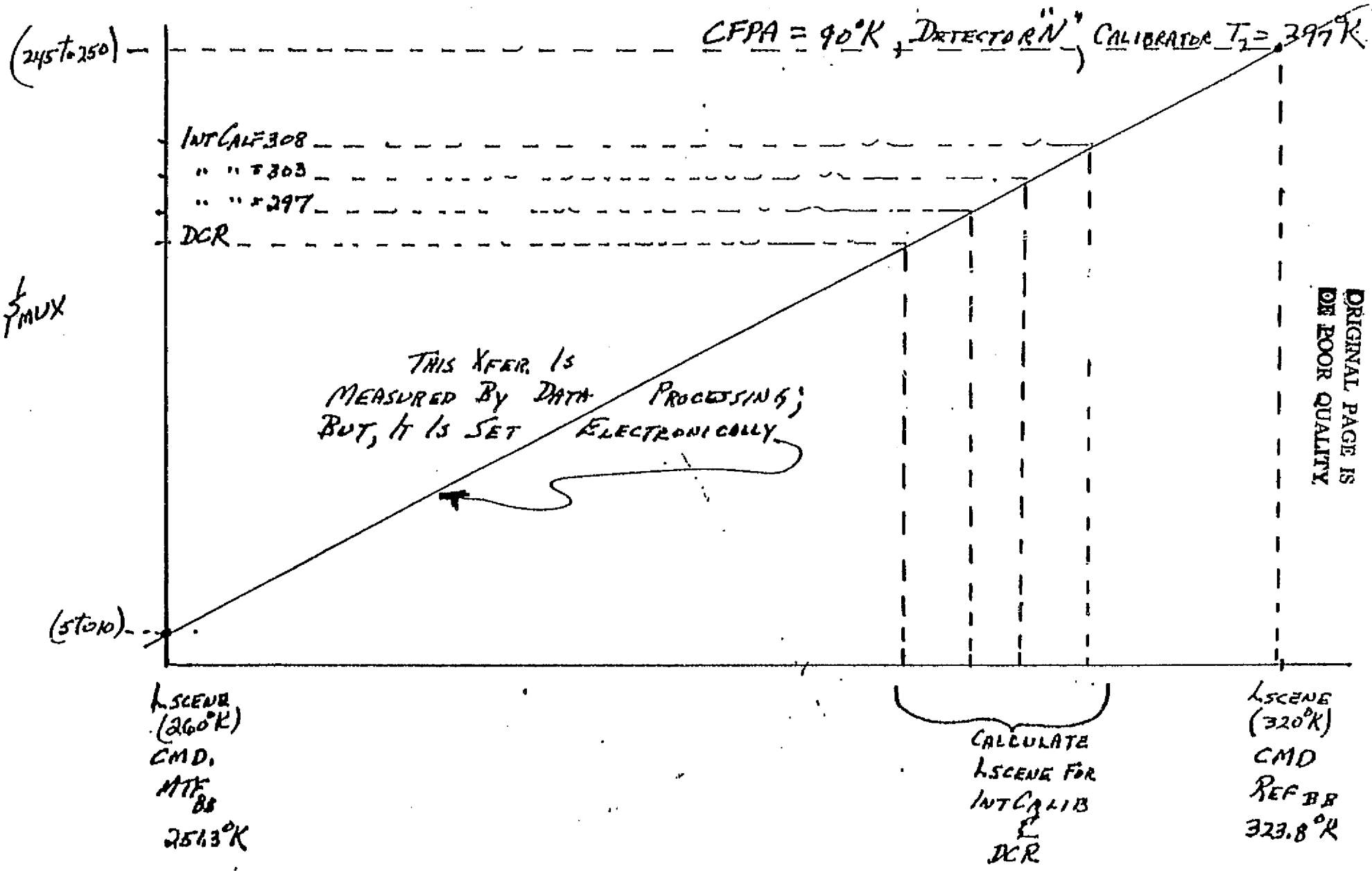

FIG I. — L_{EFF} [RESPONSE OF TM TO SCENE (IDEAL BB)] — CALCULATED
 " " " TO EXT. CALIB — DERIVED/MEASURE
 " " " INT CALIB./DCR — " "

Then substitution from item 4 of Table 1 can be used to derive new "constants" for equation (8) of reference 2. These should be checked for variation with temperature.

$$T_{sh} = (CS - \bar{t}) / 4.61$$

Equation (10) of Ref. 2 can be modified using item 2 of Table 1 to give:

$$GC = \left(\frac{1}{c + dT_{sh}} \right) * FBB$$

Equation (9) can be rewritten using item 1 of Table 1.

$$N = (CE - CS) / GC + a + bT_{sh}$$

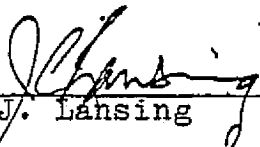

J. Lansing

TABLE 1. FLIGHT 1 BAND 6 CALIBRATION

1. Shutter scene-equivalent radiance ($\text{mW}/\text{cm}^2\text{-sr-}\mu\text{m}$):

	1	2	3	4
$L_{\text{esh}} = a + b T_{\text{sh}}$, $a = 0.49$	0.47	0.47	0.49	0.47
$b = 0.014$	0.015	0.015	0.014	0.015
$T_{\text{sh}} = \text{shutter temperature, } ^\circ\text{C}$				

2. Ratio of internal gain to external gain:

$G'/G = c + dT_{\text{sh}}$, $c = 1.41$	1.45	1.42	1.47
$d = 0.003$	0.010	0.002	0.010

3. Internal blackbody scene-equivalent radiance:

$L_{\text{ebb}} =$	1.07	1.09	1.06	1.09
--------------------	------	------	------	------

4. MUX counts at DC restore:

$Q_{\text{sh}} = \bar{f} + 4.61 T_{\text{sh}}$, $\bar{f} = 29.2$	29.3	29.3	29.2
---	------	------	------

The overall gain of the TM may be written

$$GC = (CT - CB) / (N - Nesh) \quad (13)$$

where Nesh is the shutter scene-equivalent radiance. Rearranging;

$$N = (CT - CB + Nesh * GC) / GC \quad (14)$$

comparing to Eq. (7);

$$KC = Nesh * GC \quad (15)$$

Eq.(8) for GC uses the constants shown in Reference 2; Table 1; Item 2 (repeated here) and a shutter temperature of 10°C. Some improvement in accuracy should result if the actual shutter temperature were used.

$$GC = FEB / (c + d Tsh) \quad (16)$$

where

	Channel 1	2	3	4
c=	1.41	1.45	1.42	1.47
d=	0.003	0.010	0.002	0.010

Eq. (9) for KC used Eq (15); Eq (12) and Reference 2; Table 1; Item 1. The last is shown here:

$$Nesh = a + b Tsh \quad (17)$$

where

	Channel 1	2	3	4
a=	0.490	0.466	0.489	0.465
b=	0.0139	0.0148	0.0137	0.0148

Note that if actual shutter temperature is used in Eq (16) in place of Eq (8); Eq (16) must also be used in calculating KC.

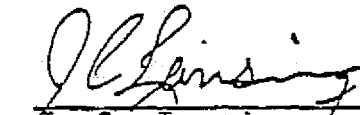
J. C. Lansing

5 - SQUARE WAVE RESPONSE

The TM's square wave response (SWR) was measured using the BL16/17 test procedures. Tables 5.7 - 5.9 are derived from the output of a BL16/17 test conducted during thermal vacuum testing at Hughes-EI Segundo. Figures 5.1 - 5.6 are graphs of the band average SWR as a function of spatial frequency. They were copied from reference 1.2.

The computed values of the SWR are somewhat pessimistic because they are not corrected for the MTF of the calibrator. A realistic correction for the calibrator MTF would increase the SWR at 30 meters by a factor of about 1.15. The correction factor for wider bars would be smaller.

One would expect to see small changes in the TM's SWR as a result of launch vibrations, thermal cycling, and drying of the TM's graphite-epoxy telescope tube.

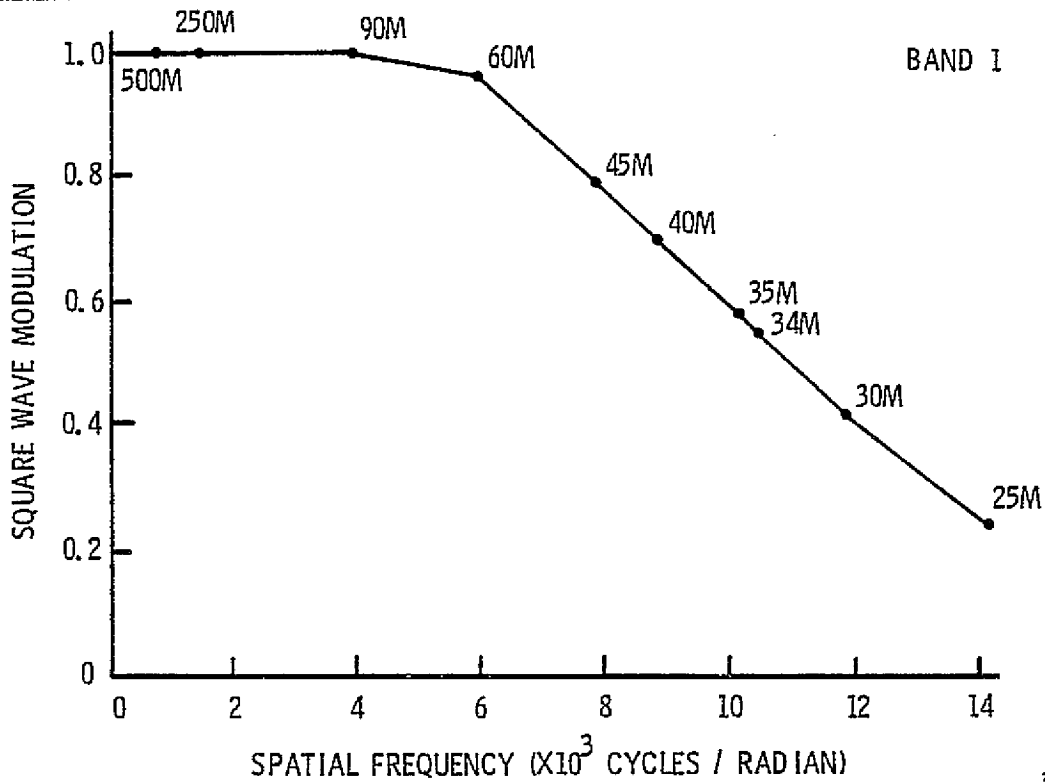

Figure 5.1

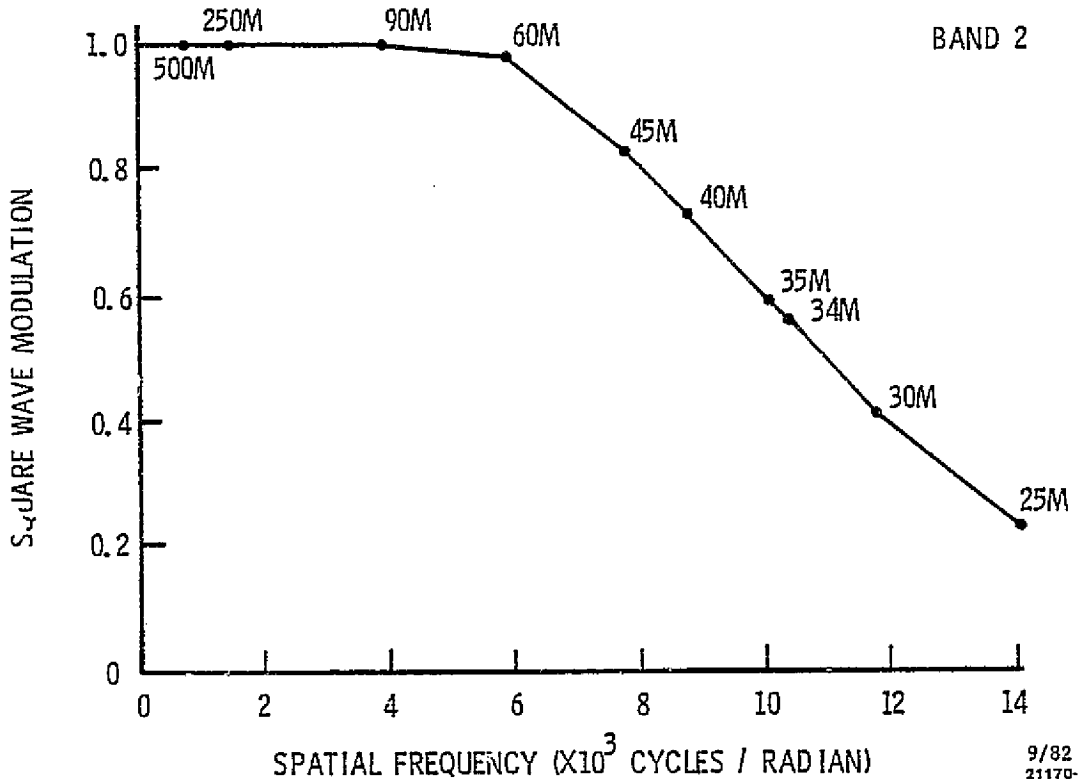

Figure 5.2

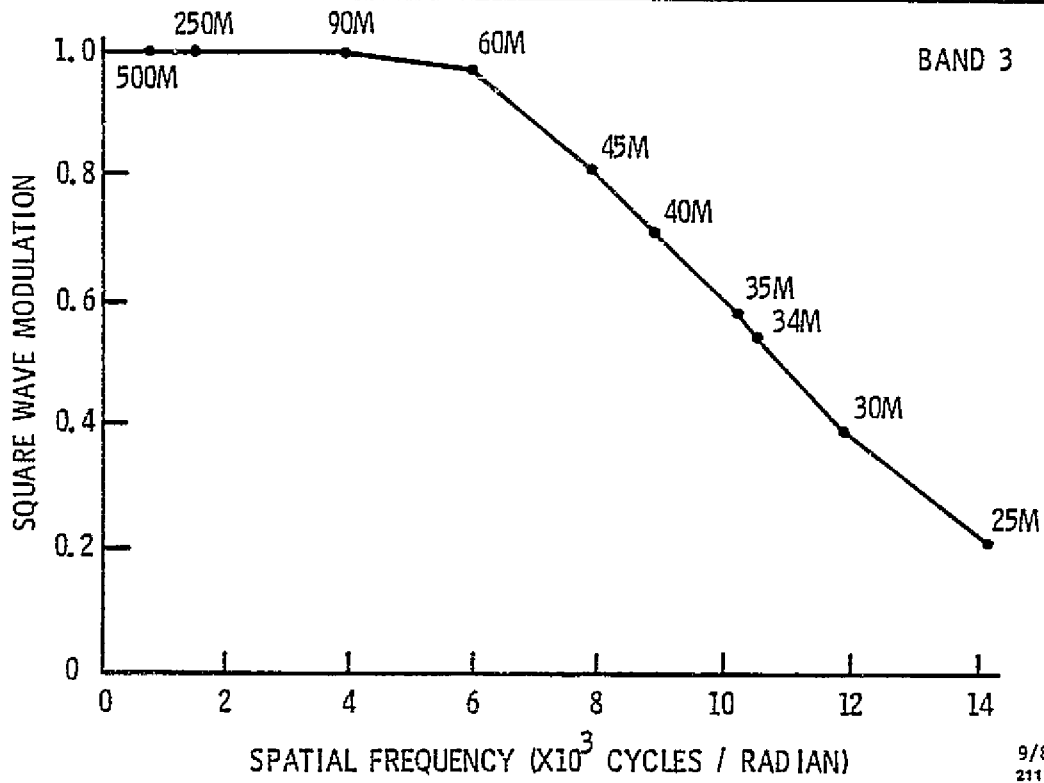

Figure 5.3

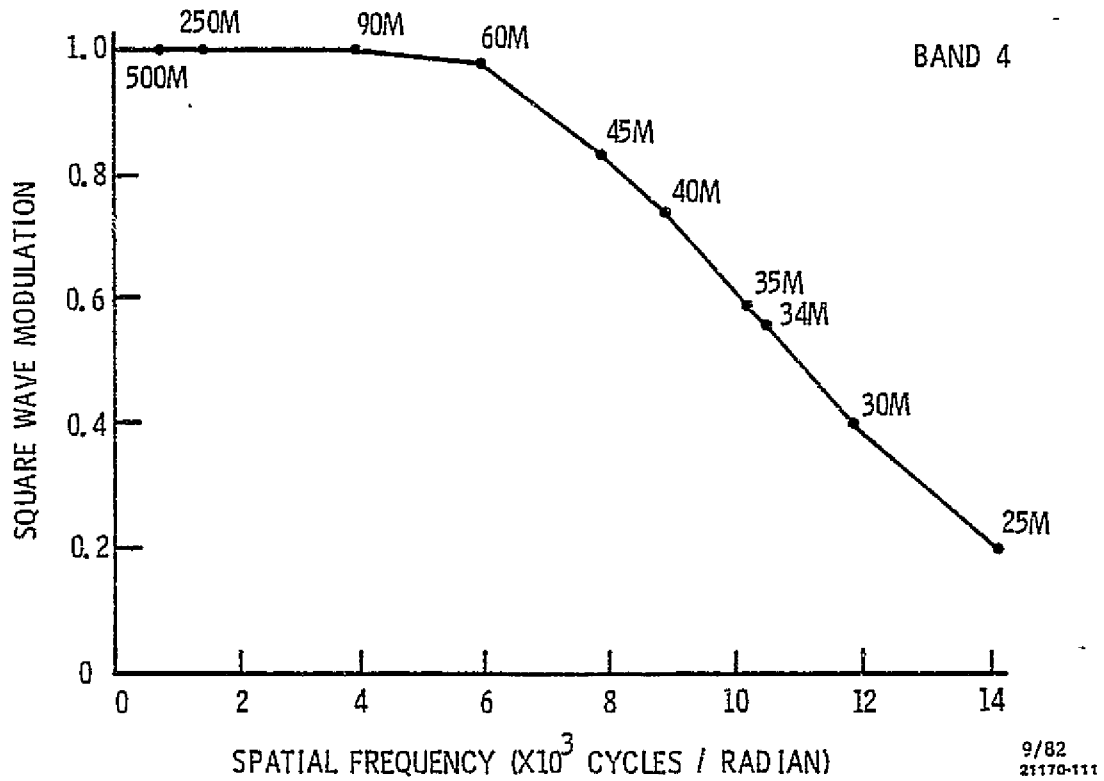

Figure 5.4

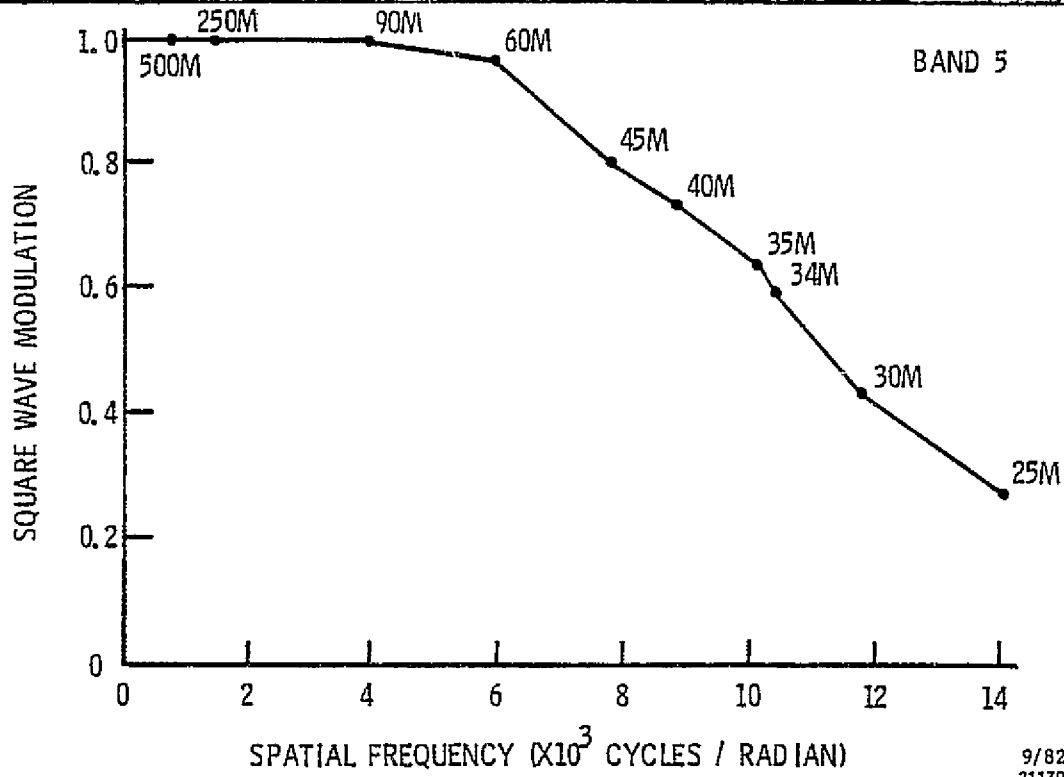

Figure 5.5

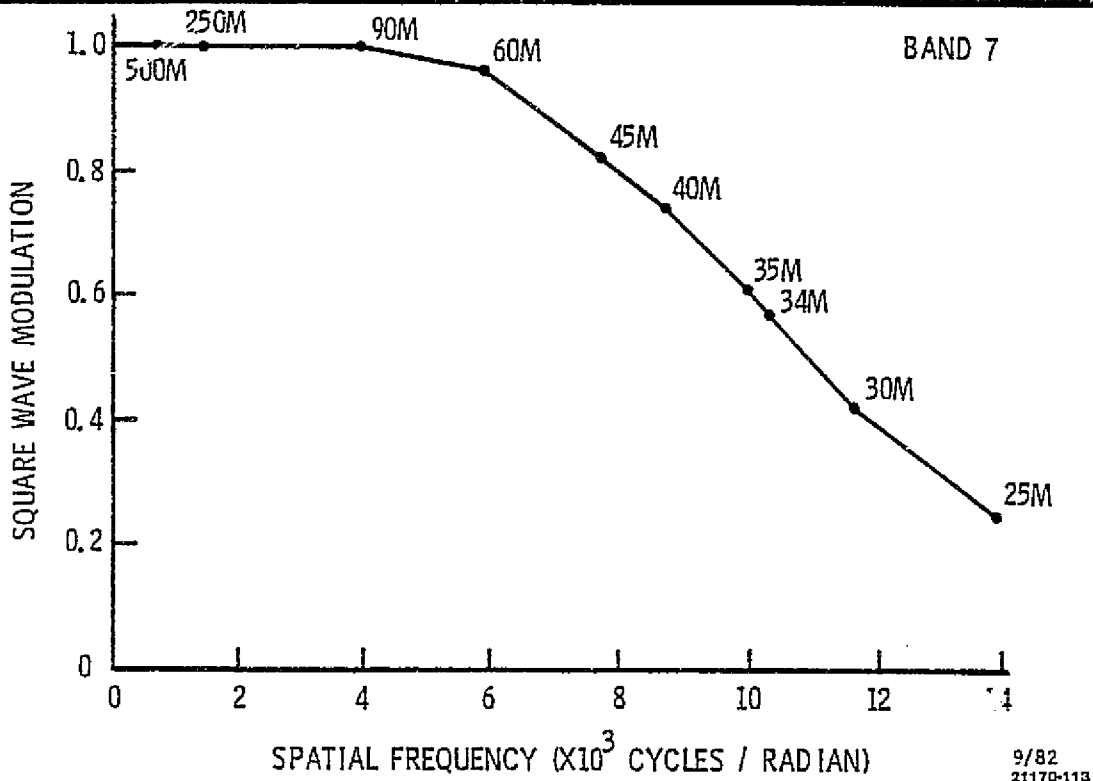

Figure 5.6

BAND 1

BAR SIZE (meters)	CHANNEL																BAND AVG	STAND DEV
	1	2	3	4	5	6	7	8	9	10	11	12	13	14	15	16		
90	1.00	1.00	1.00	1.00	1.00	1.00	1.00	1.00	1.00	1.00	1.00	1.00	1.00	1.00	.99	1.00	1.00	0.002
60	.99	.95	1.00	.98	.99	.96	.94	.96	.97	.98	.96	.99	.97	.95	.92	.97	.97	0.021
45	.83	.78	.85	.82	.84	.79	.77	.79	.79	.80	.79	.80	.79	.75	.73	.77	.79	0.031
40	.73	.69	.75	.71	.74	.69	.68	.70	.71	.71	.69	.70	.70	.66	.64	.67	.70	0.028
35	.60	.58	.61	.59	.60	.57	.57	.58	.60	.59	.58	.57	.59	.55	.56	.55	.58	0.018
34	.57	.54	.58	.55	.56	.53	.54	.55	.57	.56	.55	.54	.56	.53	.53	.52	.55	0.017
30	.41	.41	.42	.41	.41	.41	.40	.42	.43	.43	.42	.41	.42	.42	.41	.41	.41	0.008
25	.22	.22	.22	.23	.22	.23	.24	.24	.26	.27	.26	.26	.27	.26	.27	.24	.24	0.020

BAND 2

BAR SIZE (meters)	CHANNEL																BAND AVG	STAND DEV
	1	2	3	4	5	6	7	8	9	10	11	12	13	14	15	16		
90	1.00	1.00	1.00	1.00	1.00	1.00	1.00	1.00	1.00	1.00	1.00	1.00	1.00	1.00	1.00	1.00	1.00	0.000
60	.97	.98	.99	.99	.99	.99	.96	.99	.97	.99	.99	.98	.95	.98	.98	.99	.98	0.012
45	.82	.83	.85	.84	.84	.85	.82	.86	.83	.83	.84	.85	.80	.82	.81	.82	.83	0.016
40	.71	.73	.74	.74	.74	.75	.72	.75	.74	.73	.74	.74	.71	.73	.72	.73	.73	0.012
35	.56	.57	.59	.59	.58	.60	.58	.61	.59	.59	.60	.61	.59	.62	.59	.62	.59	0.017
34	.53	.54	.56	.55	.55	.57	.54	.58	.56	.55	.57	.58	.55	.59	.55	.58	.56	0.017
30	.39	.40	.42	.41	.39	.42	.41	.43	.42	.40	.40	.43	.41	.43	.40	.43	.41	0.014
25	.21	.22	.23	.22	.20	.24	.23	.23	.23	.22	.21	.25	.23	.25	.22	.24	.23	0.014

BAND 3

BAR SIZE (meters)	CHANNEL																BAND AVG	STAND DEV
	1	2	3	4	5	6	7	8	9	10	11	12	13	14	15	16		
90	1.00	1.00	1.00	1.00	1.00	1.00	1.00	1.00	1.00	1.00	1.00	1.00	1.00	1.00	1.00	1.00	1.00	0.000
60	.95	.98	1.00	.98	.97	.94	.99	.97	.97	.96	.97	.98	.96	.96	.99	.97	.97	0.015
45	.80	.83	.85	.82	.82	.78	.84	.82	.82	.79	.81	.82	.78	.80	.79	.79	.81	0.021
40	.70	.71	.74	.72	.72	.68	.74	.72	.72	.69	.70	.72	.69	.70	.73	.70	.71	0.018
35	.55	.57	.58	.58	.57	.54	.59	.59	.58	.56	.58	.60	.58	.58	.60	.58	.59	0.016
34	.52	.53	.54	.54	.54	.51	.56	.55	.55	.53	.54	.56	.55	.54	.57	.55	.54	0.015
30	.39	.38	.39	.40	.40	.39	.39	.39	.40	.38	.38	.39	.39	.39	.40	.40	.39	0.007
25	.22	.20	.20	.20	.23	.21	.19	.21	.20	.20	.19	.19	.21	.22	.23	.23	.21	0.014

TABLE 5.7 - SQUARE WAVE RESPONSE FOR BANDS 1, 2 AND 3

BAND 4

BAR SIZE (meters)	CHANNEL																BAND AVG	STAND DEV
	1	2	3	4	5	6	7	8	9	10	11	12	13	14	15	16		
90	1.00	1.00	1.00	1.00	1.00	1.00	1.00	1.00	1.00	1.00	1.00	1.00	1.00	1.00	1.00	1.00	1.00	0.000
60	.97	.99	.99	.99	.96	1.00	.97	.97	.95	.99	.98	.99	.94	.99	.97	1.00	.98	0.018
45	.83	.86	.85	.86	.82	.88	.83	.82	.81	.84	.83	.83	.78	.82	.77	.80	.83	0.029
40	.73	.76	.76	.76	.72	.78	.74	.73	.72	.74	.73	.74	.69	.74	.70	.72	.74	0.023
35	.57	.60	.60	.60	.57	.63	.59	.58	.59	.60	.59	.61	.56	.62	.58	.60	.59	0.019
34	.54	.56	.56	.56	.53	.59	.56	.54	.55	.56	.56	.57	.53	.58	.55	.57	.56	0.017
30	.38	.40	.38	.39	.39	.41	.40	.37	.39	.39	.39	.41	.38	.43	.40	.41	.40	0.015
25	.19	.20	.18	.19	.19	.19	.19	.17	.19	.19	.19	.20	.22	.23	.24	.24	.20	0.021

BAND 5

BAR SIZE (meters)	CHANNEL																BAND AVG	STAND DEV
	1	2	3	4	5	6	7	8	9	10	11	12	13	14	15	16		
90	1.00	1.00	1.00	1.00	1.00	1.00	1.00	1.00	.99	1.00	1.00	1.00	1.00	1.00	1.00	1.00	1.00	0.002
60	.95	.92	.97	.98	.97	.99	.99	.96	.99	.98	1.00	1.00	.99	.95	.96	.92	.97	0.025
45	.82	.81	.82	.86	.83	.83	.84	.78	.81	.80	.85	.89	.82	.75	.76	.73	.81	0.042
40	.74	.72	.75	.77	.75	.77	.77	.72	.74	.73	.77	.81	.73	.68	.71	.66	.74	0.037
35	.61	.58	.63	.63	.63	.66	.68	.63	.65	.63	.67	.72	.64	.61	.62	.60	.64	0.034
34	.58	.55	.60	.58	.59	.62	.62	.59	.61	.60	.64	.69	.61	.58	.59	.57	.60	0.032
30	.43	.42	.42	.42	.41	.43	.43	.42	.44	.46	.47	.52	.45	.44	.44	.43	.44	0.027
25	.26	.27	.25	.24	.24	.26	.27	.25	.28	.31	.30	.33	.29	.29	.30	.31	.28	0.027

BAND 7

BAR SIZE (meters)	CHANNEL																BAND AVG	STAND DEV
	1	2	3	4	5	6	7	8	9	10	11	12	13	14	15	16		
90	1.00	1.00	1.00	1.00	1.00	1.00	1.00	1.00	1.00	.99	1.00	1.00	1.00	1.00	1.00	1.00	1.00	0.002
60	.94	.92	.94	.96	.94	.98	.98	.98	.97	.97	.97	.98	.95	.98	.94	.92	.96	0.022
45	.80	.77	.81	.84	.82	.86	.83	.86	.80	.84	.80	.85	.80	.84	.78	.77	.82	0.030
40	.74	.70	.74	.76	.74	.77	.75	.78	.72	.77	.72	.77	.72	.76	.69	.68	.74	0.031
35	.58	.57	.59	.60	.58	.63	.62	.64	.62	.64	.63	.63	.61	.65	.58	.57	.61	0.027
34	.54	.53	.54	.57	.55	.59	.59	.59	.59	.59	.60	.59	.58	.61	.55	.54	.57	0.026
30	.41	.40	.42	.44	.41	.45	.43	.43	.42	.44	.43	.43	.43	.43	.41	.40	.42	0.015
25	.24	.27	.24	.25	.25	.25	.24	.25	.23	.26	.24	.24	.24	.25	.24	.26	.25	0.010

TABLE 5.8 - SQUARE WAVE RESPONSE FOR BANDS 4, 5 AND 7

BAND 6

BAR SIZE (meters)	CHANNEL				BAND AVG	STAND DEV
	1	2	3	4		
441.2	1.00	1.00	1.00	1.00	1.00	0.000
352.9	.98	.99	.98	.99	.99	0.006
240.0	.90	.92	.88	.92	.91	0.019
180.0	.75	.76	.71	.77	.75	0.026
176.5	.75	.75	.71	.76	.74	0.022
141.2	.58	.60	.56	.60	.59	0.019
120.0	.42	.44	.41	.44	.43	0.015
100.8	.25	.28	.25	.28	.27	0.017
88.2	.16	.17	.17	.18	.17	0.008
78.4	.13	.11	.12	.12	.12	0.008
70.6	.12	.12	.14	.12	.13	0.010

TABLE 5.9 - SQUARE WAVE RESPONSE FOR BAND 6

6 - MEASUREMENTS OF THE LINE SPREAD FUNCTION AND WHITE LIGHT LEAKS

The TM's track direction line spread function (TDLSF) for a given channel is defined as the response of that channel to a line source oriented in the scan direction as a function of the sources' track direction displacement from the TM's optical axis. For the TM, there are two different scan direction line spread functions (SDLSF's). The optical SDLSF is measured with the scan mirror locked in place. It is defined as a channel's response to a line source oriented in track direction as a function of the sources scan direction displacement from the TM's optical axis. Thus, the optical LSF depends on the telescope optics and detector geometry. The system level SDLSF is measured with a stationary source and a moving scan mirror. It is defined as a channel's response to a line source oriented in the track direction as a function of scan mirror displacement. The system level SDLSF depends on the optical line spread function and the AC electronic response of the amplifiers.

The TDLSF and the optical SDLSF were measured in AC07R (see ref. 6.1). The line spread functions were measured for 4 detectors in each of bands 1-5 and 7. The measured line spread functions became progressively wider as the TM warmed up. This result is thought to arise from the buildup of thermal gradients in the airpath within the telescope tube. The effect of airpath non-uniformity is the chief uncertainty in these measurements. A reasonable estimate of the system level SDLSF for a given channel can be made by convolving a band average optical SDLSF with the channel's amplifier response. (Amplifier responses are given in references 6.2 - 6.8).

Small anomalous peaks in the SDSLF were observed during AC07R. These peaks were attributed to white light leaks. A special test was run at GE in order to better characterize these leaks. The results of this test are summarized in reference 6.9. The test involved measuring the system level SDLSF for all channels of bands 1-5 and 7. plots of the data for bands 1-4 have been sent with this report. A sample plot is shown in figure 6.1. The peaks associated with the white light leaks are marked with arrows.

There are three sources of uncertainty in using the white light leak test data as a calibration of the TM's system level SDLSF. First as in AC07R, the TM was run in air. Thus temperature gradients in the air path are a problem. Furthermore, the TM was run for a longer time in these tests than in AC02R. Second, there is an undershoot in the TM's response following to the line source. If the TM's response were linear, this undershoot would result in a negative output signal. In fact the signal is clipped at zero. This non-linearity, which is not normally observed in scene data,

affects the ringing that follows passage of the line source. The magnitude of this effect is not clear. The third problem only affects bands 5 and 7. The line source used in this measurement was a narrow slit. One side of the slit was defined by a strip of metal foil. The other side was defined by both a photographic emulsion and another foil strip (see figure 6.2). Unfortunately, the emulsion was not totally opaque in bands 5 and 7 data is not shown on the plots. However, it is possible to use the transmission model shown in figure 6.2 and the redundant data for the forward and reverse scans to remove the slit shape from the profiles. (The relative sizes and transmissions of the clear slit and emulsion are fitted parameters.) Work on this project was interrupted by a computer failure and never resumed.

In spite of these problems, the measured system level SDLSF's may be useful in analyzing the TM's line spread function and white light leaks. Therefore, the data that went into making the plots for bands 1 - 4 and the band 5 and 7 data are supplied in tabular form on a computer compatible tape. The tape was written in ASCII at 1600 BPI by a VAX 11/780. Data is grouped into files. Figure 6.3 describes the interpretation of the file names. Table 6.4 provides a list of files on the tape. Figure 6.5 is a dump of a short section of one of those files. The first two columns give the scan mirror position in minor frames and clock pulses. There are 21 clock pulses in a minor frame. The TM scans at the rate of one IFOV per minor frame. Thus the entry on the bottom line of figure 6.5 means that the scan angle was $1 + 15/21$ IFOV's from an arbitrary origin. The third column is the number of scans that were averaged in order to get the results in columns 4-19. Columns 4-19 give the detector responses in mux counts. Notice that the responses of the odd channels are given first followed by the responses of the even channels.

29 June 1982
2221-620
HS236-8043

F. R. Phillips

-2-

TM AC07R Test Result Summary, Flight Model Number 1

GSFC measurement specifications are given in terms of angular requirements. The along track (X-direction) dimension and across track (Y-direction) dimension is defined for each detector as the angular difference between the points where the detector's response is 50 percent of maximum when sweeping in the respective direction. Maximum half-width dimensions are given as 43.2 microradians for Bands 1 through 4, 46.35 microradians for Bands 5 and 7, and 174.4 microradians for Band 6, the thermal band. The far field requirement is that the measured response be less than one percent of maximum for angular distances equal to or greater than twice the detector width.

2.0 Test Description

The test is performed at SBRC with the Thematic Mapper mounted on a precision rotary table. The T.M. is aligned to a collimator with the scan line corrector off and scan mirror locked at midscan. The angular orientation of the T.M. is determined and monitored by autocollimating a theodolite on a reference mirror attached to the T.M. However, as the collimator is subject to off axis image degradation, it is necessary to move the T.M. four times during the test. These movements and subsequent orientations are determined and also monitored using the theodolite. The source is projected towards the T.M. through the collimator which uses a computer driven X-Y stepping stage to position the illuminated slit. Interferometric monitoring is used to measure stage movement.

For Bands 1-5 and 7 measurements, a tungsten ribbon filament lamp is used as the source. The lamp and slit are initially mounted together on the stages in a vertical position (for sweeping in the Y-direction). The source and slit are subsequently rotated 90 degrees about a horizontal axis for sweeping the X-direction. The larger input signal needed to resolve far field response is achieved by increasing the lamp current.

For previous Protoflight Band 6 testing, a blackbody source was used. The change from vertical to horizontal scanning was achieved using separate perpendicular slits mounted in a reticle wheel. However, for the current Flight Model Number 1 testing, this part of the procedure was omitted from the test requirements per the conditions described in Deviation Request D-156.

TM AC07R Test Result Summary, Flight Model Number 1

The test configuration was modified from that given in the AC07R test procedure. This was done for convenience and to provide computer controlled T.M. turn-on and Thermal Shutdown enablement. The use of an optional test configuration was requested per Request for Deviation D-154 and is described in reference SBRC Memo HS236-8004. The set-up is a mixed configuration defined as much as possible per HAC configuration drawings 3533100-300-1 and 3533100-300-2 and with reference to released SBRC test procedures. A similar option was used previously for Flight Model IA04 testing.

3.0 Test Results

Test data has been obtained for Bands 1-5 and 7 in the form of reduced data tabulations and field-of-view plots for selected channels and each type of scan (X or Y). Measurements were made on detectors 1, 2, 15 and 16 for Bands 1, 2, 3, 5 and 7. But due to SIU difficulties (resulting in no signal from detector 16), detectors 1, 2, 14 and 15 were used for Band 4. Reduced data tabulations indicate that all detectors (with the possible exception of those for Band 6) exhibit some calculated half-widths in excess of those desired by the specifications. As requested by Deviation D-156 and documented by SBRC referenced Memo HS236-8011, Band 6 IGFOV's sizes were calculated from spot scan data measured at the component level of detector array fabrication. This alternate procedure was used to facilitate schedule by avoiding the repetition of Band 6 test difficulties encountered earlier during Protoflight Band 6 testing, e.g. very small signal levels, thermal insensitivity, and unsolved problems with D.C. restore operation.

Far field response for all Bands is typically greater than the desired 1 percent at least for regions immediately adjacent to the twice detector width field points. In addition, normalization problems were encountered in matching the far field to near field data. In spite of software changes made to correct the problem after it was first discovered during Protoflight testing, residual effects are evident in some of the plots (see Appendix A for plots). Of greater current concern has been the recent observations of spurious secondary peaks in sensitivity well away from the nominal channel centers. Such effects were not seen during previous Protoflight testing. They were first observed on Flight 1 Band 1 detectors during manual scanning of the slit stage and were later found to be present for the other detectors in the prime focal plane array. (Bands 5 and 7 detectors, on the other hand, exhibit no such anomalies.) These discrepancies were recorded on Failure Report FR#5776 and are discussed in SBRC Memo HS236-8027. They were seen initially on Band 1 with magnitudes of up to 10% of peak signal and to a lesser extent for the other Bands in the prime focal plane array. They appear to be

TM AC07R Test Result Summary, Flight Model Number 1

due to leakage of white light entering thru the +Y half of the telescope entrance aperture and being leaked to the detectors perhaps thru inadequately shielded substrate edges. Later analysis and additional data indicate that the problem is not as severe as originally feared. The maximum effect as seen on Band 1 is reduced to 1 or 2% when spectral shape factors are taken into consideration. This should amount to not more than a few MUX counts for a typical mid-range scene level of the T.M. Correction of the problem at the focal plane would be expected to require disassembly of the telescope and a resulting major program delay. Such drastic action is not being recommended at the present time.

4.0 Discussion and Conclusion

A number of difficulties were encountered during the running of these tests. These may be roughly divided into hardware and software type problems. The former consist of problems with vibration, alignment, temperature and electronics. The latter include problems with command files, databases, and plot normalizations. In addition some evidence exists which indicates that optical effects may be degrading the data by producing raised skirts and rounded off IFOVS. Many difficulties were at least partially resolved before and/or during the testing by modifications of the test setup and/or by corrections to the software. Others were investigated later by means of "special tests" intended to determine their causes.

A. Hardware Problems

Apparent vibration problems were present from the start of the test. A source of what at first appeared to be severe vibration problems turned out to be the "muffin fan" used to cool the TM power supply. Turning the fan off during collects cured this problem.

Later during the lamp calibration portions of the tests, "mechanical" drift problems were encountered in the Y-scan as the location of the peak signal appeared to change with time. During one 20 minute interval, 10 steps of drift (~ 1 IFOV) were observed all in the positive Y-direction.

In addition to vibration and drift, electrical hookup problems arose associated with D.C. restore operation. At two points during the test the equipment failed to work properly making it impossible to collect meaningful data. The initial problem occurred because the scope was inadvertently hooked up to monitor the reference output from the chopper controller rather than the gate output from the D.C. Restore Module thus resulting in

TM AC07R Test Result Summary, Flight Model Number 1

a phasing error. A second problem arose when (without our knowledge) the D.C. Restore cable, W5050, was disconnected during a first shift troubleshooting operation and was left unattached. This resulted in a severely distorted square wave signal output at the scope. The source of the problem was eventually revealed, but only after a thorough configuration check and only after considerable frustration and loss of valuable test time.

An additional electrical problem occurred in the form of a complete loss of test area power and telemetry at one point during far field collects. This was traced to the tripping of a control room (pallet) circuit breaker due to the increased lamp source current. Running the lamp at a slightly lower operating level avoided the problem for subsequent collects.

Room environmental effects were ever present in the form of air turbulence and temperature variations. To minimize these effects a plastic tunnel was installed prior to the test completely surrounding the collimator. To reduce turbulence room air handlers were turned off at least one hour prior to testing. The room temperature stabilized at between 69° and 70°F as recorded in the data master. Specific heat sources present in the test setup included the lamp source itself, the laser used with the stage monitor interferometers, and the motors which drive the Aerotech stages and chopper wheel.

Perhaps the most significant thermal problem was associated with internal heating of the T.M. itself. As the test progressed, one of the most closely watched telemetry parameters became the T.M. power supply temperature. We saw a direct correlation between high power supply temperature (approaching an indicated 32°C) and severely distorted data. Early in the test we intentionally let the power supply heat up in order to study the effect as a function of time. As we watched and let the temperature rise to approximately 32°C, the measured Band 7 FOV half-width increased from less than 50 microradians to about 60 microradians. The next evening when we repeated the measurements with the power supply cold (about 22°C), the values were reduced to a reasonable 46 microradians. Band 5 X-scan data was taken at a warm power supply temperature just prior to running Band 7. However, no attempt was made to improve on Band 5 measurements. Only Band 7 (the worst case) was rerun in order to demonstrate that we could improve the measurements by lowering the power supply temperature. Perhaps, given better environmental controls, all measurements could be improved to some extent. This would be particularly true for the Band 5 X-scan.

TM AC07R Test Result Summary, Flight Model Number 1

After this experience, we modified our procedure to include an approximate one hour cooling off time between data collects using a "Muffin Fan" to dissipate the heat. Good data collects were obtained in this manner.

Alignment problems (or at least uncertainties) arose as the source/slit and T.M. were positioned and repositioned at various points during the test. The source/slit had to be detached from its mount and the lamp removed in order to reposition it each time a change was made between X and Y scans. This resulted in some uncertainty in the alignment position of the filament image on the slit for the various sets of data.

The effect of this possible misalignment was minimized by the addition of metal masking over the opaque portions of the slit (these areas were previously found to be a source of leakage that contributed to severely raised FOV skirts on Protoflight data).

Other areas of only minor concern include source non-uniformity and optical system focus. The lamp filament image was centered on the slit each time the lamp was repositioned and should be quite uniform in intensity over the active slit area. All data was collected at the nominal focal plane of the collimator. Previous IA04R test data indicates that this position is .005 to .006 inch from best focus as determined by MTF. A small degradation (less than 1 microradian image blur) is expected to result from this condition. Another small uncertainty is the focal length of the collimator. The presently used value is 109.225 inch as compared with 109.285 inch as used for the Protoflight.

B. Software Problems

Software problems appeared early in the test. Initial attempts at collects resulted in failure due to an improper version of AC07R software having been installed on BTCE #1 and #2 disks. This caused reverse Aerotech stage control with a movement to relative rather than the desired absolute positions. Files were updated via an ECR to provide correct motion of the stages. In addition, the Data Select Unit appeared to have a marginal "handshake" with the System Test Computer causing an occasional failure to collect. Due to the structure of the command files, a single failure to collect video data during a multicollect formation of a single video file could stop the test and prevent data reduction. Some reattachment of cable connectors and adjustments by a Digital Equipment Corporation service man resulted in satisfactory operation during the remainder of the test. Some work was done to restructure the command

F. R. Phillips

-7-

TM AC07R Test Result Summary, Flight Model Number 1

files, but the change was never implemented. There was no signal from Band 4 Detector 16. This was due to a known SIU Channel A problem. This difficulty was avoided by making a database change to collect from Band 4 Detector 14 instead. An additional SIU problem was present on Band 5 Detector 1 which required that we cycle the AOTS Band 5 power occasionally in order to get Band 5 Detector 1 to work properly.

C. Conclusion

This report has described the results of running the AC07R Spatial Coverage Test on the T.M. Flight Model Number 1. The test appears to be extremely sensitive to environmental effects such as temperature and air path fluctuations. While an attempt was made to control these factors, it is unclear whether the disappointing test results should be interpreted as measurements of the T.M.'s performance or merely as worst case "lower limits" to its performance. The quality of the test data appears consistent with that obtained from ambient tests on similar instruments. The test procedure and command files were used successfully for Bands 1 thru 5 and 7 and will be ready for future testing. Several problems were successfully resolved during AC07R itself while others needed to be investigated further by supplemental testing. The problem of peaks of spurious sensitivity in the far field region has not been completely resolved, though it is better understood now than when first observed. Its effects are not as severe as originally feared. A close look to inspect for this condition should be included in any future AC07R testing and additional care should be taken in fabrication and masking of any new Prime Focal Plane Arrays. A test for light leaks should be performed at the component level of assembly.

Unless otherwise directed, we will consider the alternate test used for Band 6 to be acceptable for use on subsequent T.M. models. A test procedure change is planned to include this option.

The attached tables summarize the test results in general and help to point out some of the problem areas. Table 1 is a summary of LSF (Field-of-View) half-widths identified by band, channel, and type of scan. Out-of-spec. conditions are identified where they occurred. Table 2 is a listing of detector spacings within each array as obtained from the reduced data tabulations. Table 3 is a summary of

29 June 1982

2221-620

HS236-8043

F. R. Phillips

-8-

TM AC07R Test Result Summary, Flight Model Number 1

out-of-field response values obtained graphically from the field-of-view response plots. Out-of-field response has been calculated first as the percentage of total out-of-field signal to total in-field signal and then again as an average per IFOV spacing over the total length of the non-zero skirts. Table 4 lists calculated Band 6 IGFOV sizes based upon detector and telescope measurements.

Prepared by: J. C. Campbell
J. C. Campbell, Optics

Concurrence: C. J. Kent
C. J. Kent, Optics

Concurrence: D. G. Brandshaft
D. G. Brandshaft, Systems Analysis

Approval: G. S. Pews
G. S. Pews, Director, Systems Test

Approval: J. L. Engel
J. L. Engel, Manager, Systems Engineering

TABLE 1.
LSF Half-Widths

<u>Collection Date</u>	<u>Band</u>	<u>Channel</u>	<u>Scan</u>	<u>LSF Width</u> (μ r)	<u>In Spec.</u>	<u>Out of Spec.</u>
6/13	1	1	Y	46.29		x
6/11	1	1	X	44.79		x
6/13	1	2	Y	45.25		x
6/11	1	2	X	45.08		x
6/13	1	15	Y	45.98		x
6/11	1	15	X	43.40		x
6/13	1	16	Y	44.33		x
6/11	1	16	X	43.24		x
6/13	2	1	Y	44.49		x
6/11	2	1	X	45.92		x
6/13	2	2	Y	44.61		x
6/11	2	2	X	45.61		x
6/13	2	15	Y	44.69		x
6/11	2	15	X	44.09		x
6/13	2	16	Y	44.67		x
6/11	2	16	X	42.91	x	
6/9	3	1	Y	44.67		x
6/10	3	1	X	44.17		x
6/9	3	2	Y	43.58		x
6/10	3	2	X	43.31		x
6/9	3	15	Y	43.61		x
6/10	3	15	X	44.07		x
6/9	3	16	Y	43.74		x
6/10	3	16	X	42.70	x	

TABLE 1.

LSF Half-Widths

<u>Collection Date</u>	<u>Band</u>	<u>Channel</u>	<u>Scan</u>	<u>LSF Width</u> (μ r)	<u>In Spec.</u>	<u>Out of Spec.</u>
6/9	4	1	Y	44.39		x
6/10	4	1	X	45.65		x
6/9	4	2	Y	45.92		x
6/10	4	2	X	43.78		x
6/9	4	14	Y	45.32		x
6/10	4	14	X	44.27		x
6/9	4	15	Y	44.27		x
6/10	4	15	X	42.94	x	
6/12	5	1	Y	44.80	x	
6/12	5	1	X	51.35		x
6/12	5	2	Y	44.48	x	
6/12	5	2	X	50.46		x
6/12	5	15	Y	44.65	x	
6/12	5	15	X	51.00		x
6/12	5	16	Y	44.45	x	
6/12	5	16	X	49.79		x
6/12	7	1	Y	45.79	x	
6/12	7	1	X	46.74		x
6/12	7	2	Y	45.35	x	
6/12	7	2	X	46.44		x
6/12	7	15	Y	45.36	x	
6/12	7	15	X	53		x
6/12	7	16	Y	45.03	x	
6/12	7	16	X	46.92		x

TABLE 2.
Detector Spacings

<u>Collection Date</u>	<u>Band/ Channels</u>	<u>Distance Between Channels In X-Direction</u>	
		(μ -radians) (Measured)	(Nominal)
6/11	B1/D2, D16	592.37	595.00
6/11	B2/D2, D16	590.14	595.00
6/10	B3/D2, D16	595.78	595.00
6/10	B4,D1, D15	597.05	595.00
6/12	B5/D2, D16	589.50	595.00
6/12	B7/D2, D16	586.72	595.00

TABLE 3.
 Out-of-Field Response
 Bands 1-5, and 7

<u>Processing/ Date</u>	<u>Band</u>	<u>Channel</u>	<u>Scan</u>	<u>In-Field Response*</u> (±2 IFOVS)	<u>Out-of-Field Response*</u> (Skirts)	<u>Total Percent</u>	<u>Average (Per IFOV) Percent</u>
6/13	1	2	Y	1115	26	2.3	.22
6/11	1	2	X	1064	62	5.8	.35
6/13	2	2	Y	1058	11	1.0	.28
6/11	2	2	X	1067	29	2.7	.23
6/9	3	2	Y	1080	29	2.7	.42
6/10	3	2	X	1090	37	3.9	.33
6/9	4	2	Y	1057	9	0.9	.55
6/10	4	2	X	1017	8	0.8	.32
6/12	5	2	Y	1118	46	4.1	.58
6/12	5	2	X	1263	44	3.5	.54
6/12	7	2	Y	1137	55	4.8	.53
6/12	7	2	X	1123	37	3.3	.37

*Arbitrary Units (graph paper units)

Table 4. Band 6 Calculated IGFOV
Based upon detector and telescope measurements

Detector #	HW _Y (inch)	HW _X (inch)	Cross Scan IGFOV _Y	Along Scan IGFOV _X
1	.00780		162.5μr	
1		.00820		170.8 μr
2	.00760		158.3μr	
2		.00824		171.7 μr
3	.00786		163.8μr	
3		.00830		172.9 μr
4	.00800		166.7μr	
4		.00832		173.32μr

IGFOV = Detector Half-Width \div (EFL_{TM} x Relay Magnification, M_R)

EFL = 95.995

M_R = 0.5

Specification is: IFOV \leq 174.4μr

Accuracy of Measurement: \pm 16μr

APPENDIX A

FIELD OF VIEW PLOTS

NEAR AND FAR FIELD DATA FOR

Y - AXIS, BAND 3 CHANNEL 2

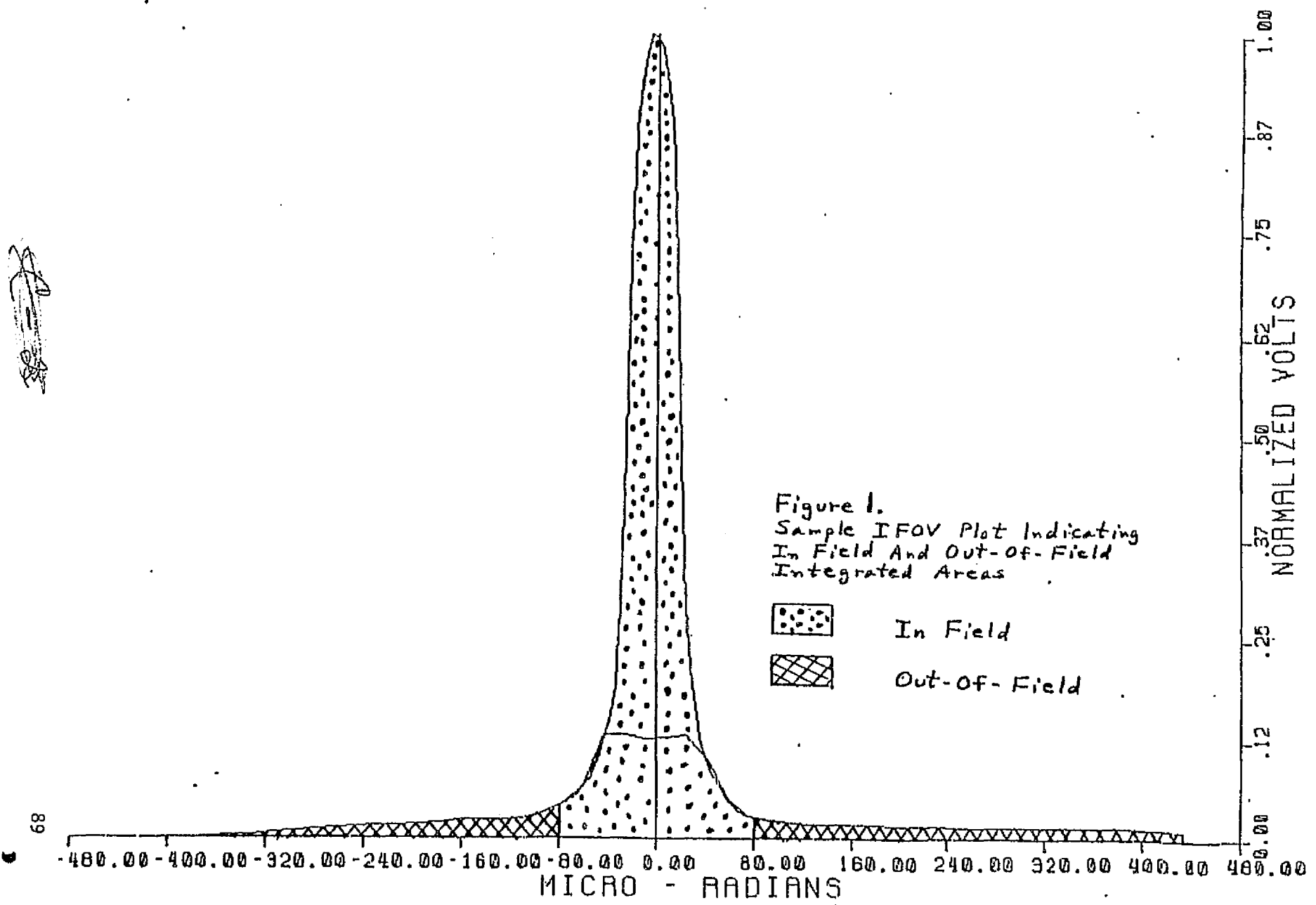



Figure 1.
Sample IFOV Plot Indicating
In Field And Out-Of-Field
Integrated Areas

-  In Field
-  Out-Of-Field

68

-480.00 -400.00 -320.00 -240.00 -160.00 -80.00 0.00 80.00 160.00 240.00 320.00 400.00 480.00
MICRO - RADIANS

1.00
.87
.75
.62
.50
.37
.25
.12
0.00
NORMALIZED VOLTS

NEAR AND FAR FIELD DATA FOR

Y - AXIS, BAND 1 CHANNEL 1

13-JUN-82

01:35:43

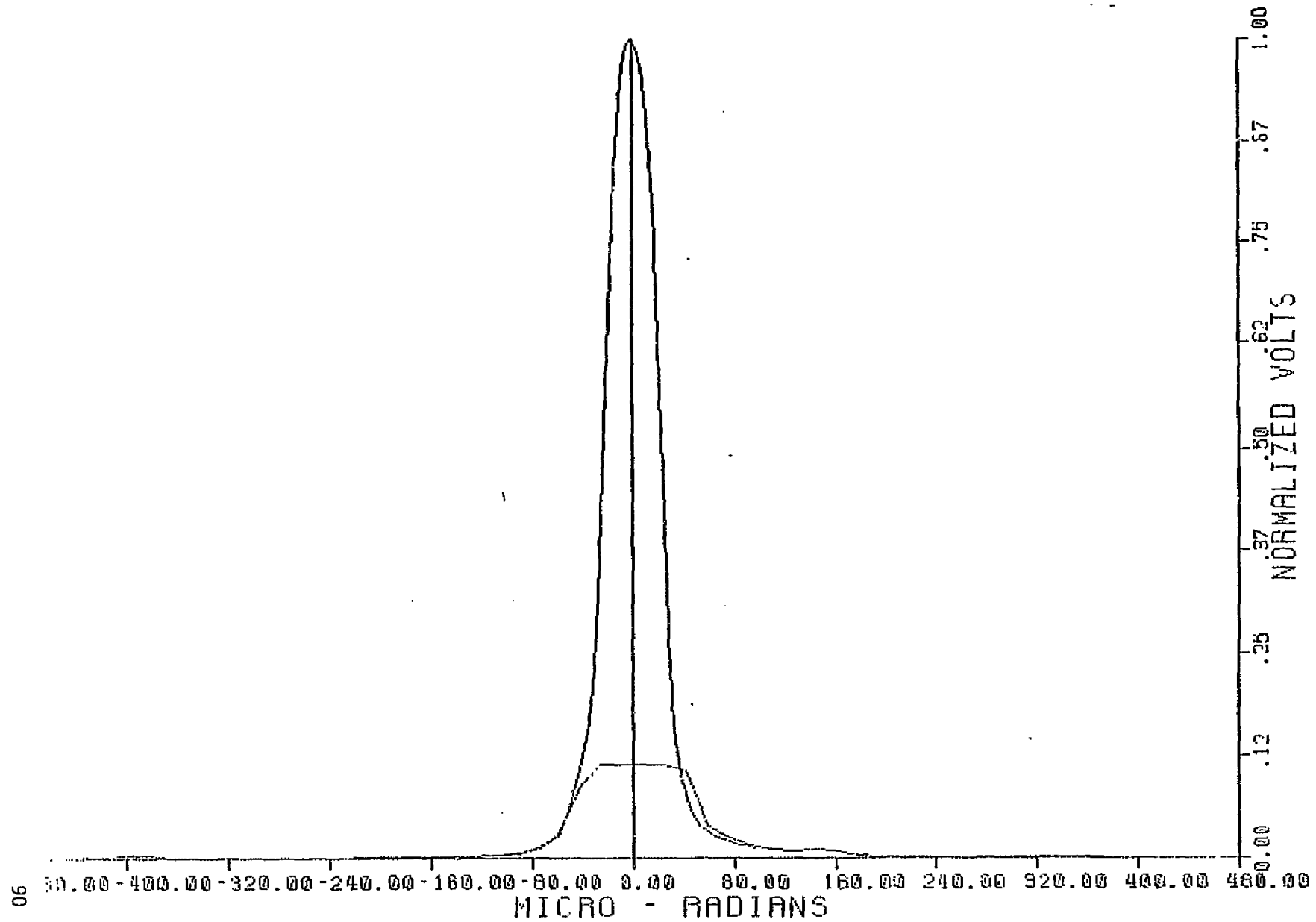

06

NEAR AND FAR FIELD DATA FOR

X - - AXIS, BAND 1 CHANNEL 1

11-JUN-82

05:13:40

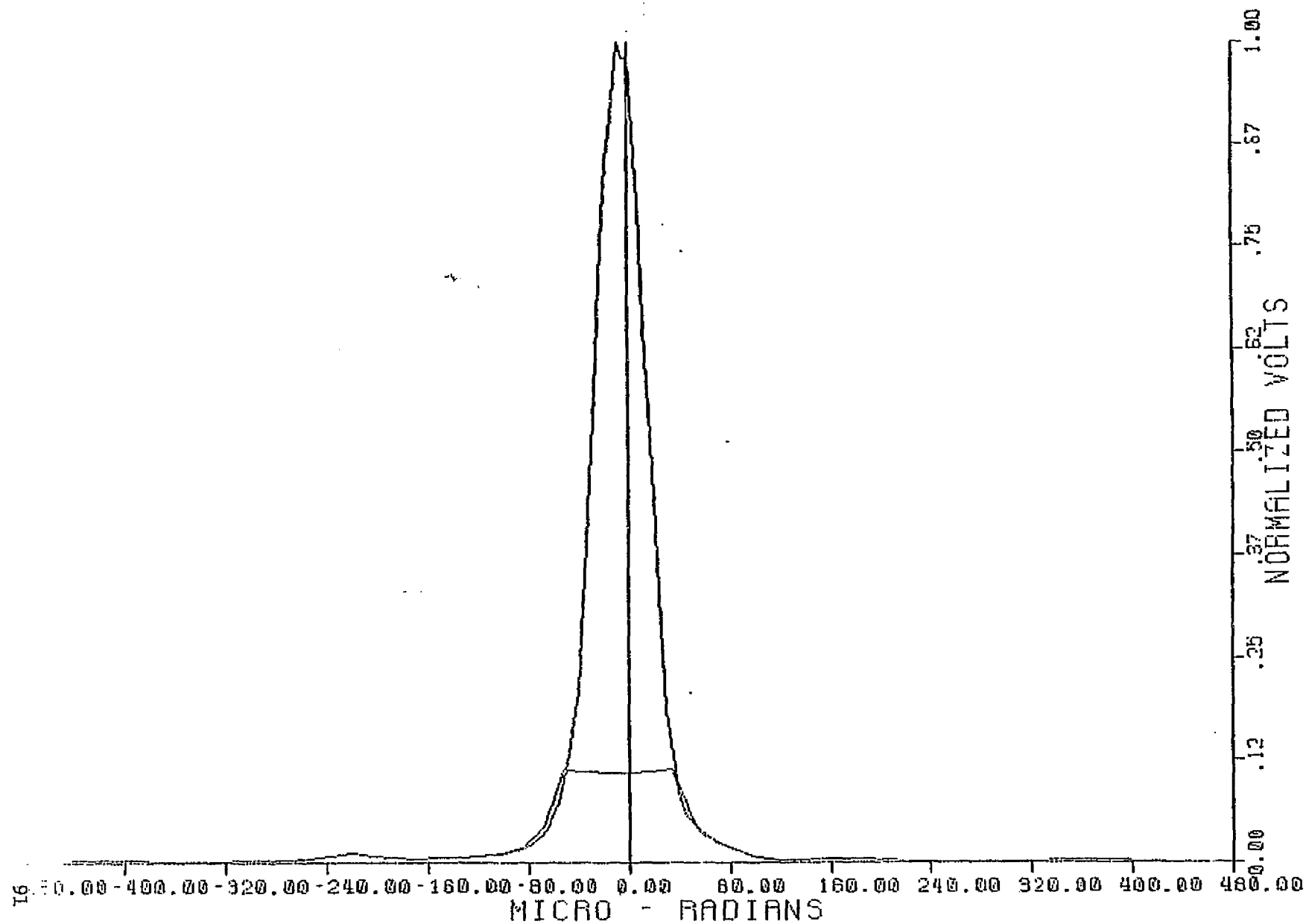

NEAR AND FAR FIELD DATA FOR
13-JUN-82

Y - AXIS, BAND 1 CHANNEL 2
01:37:25

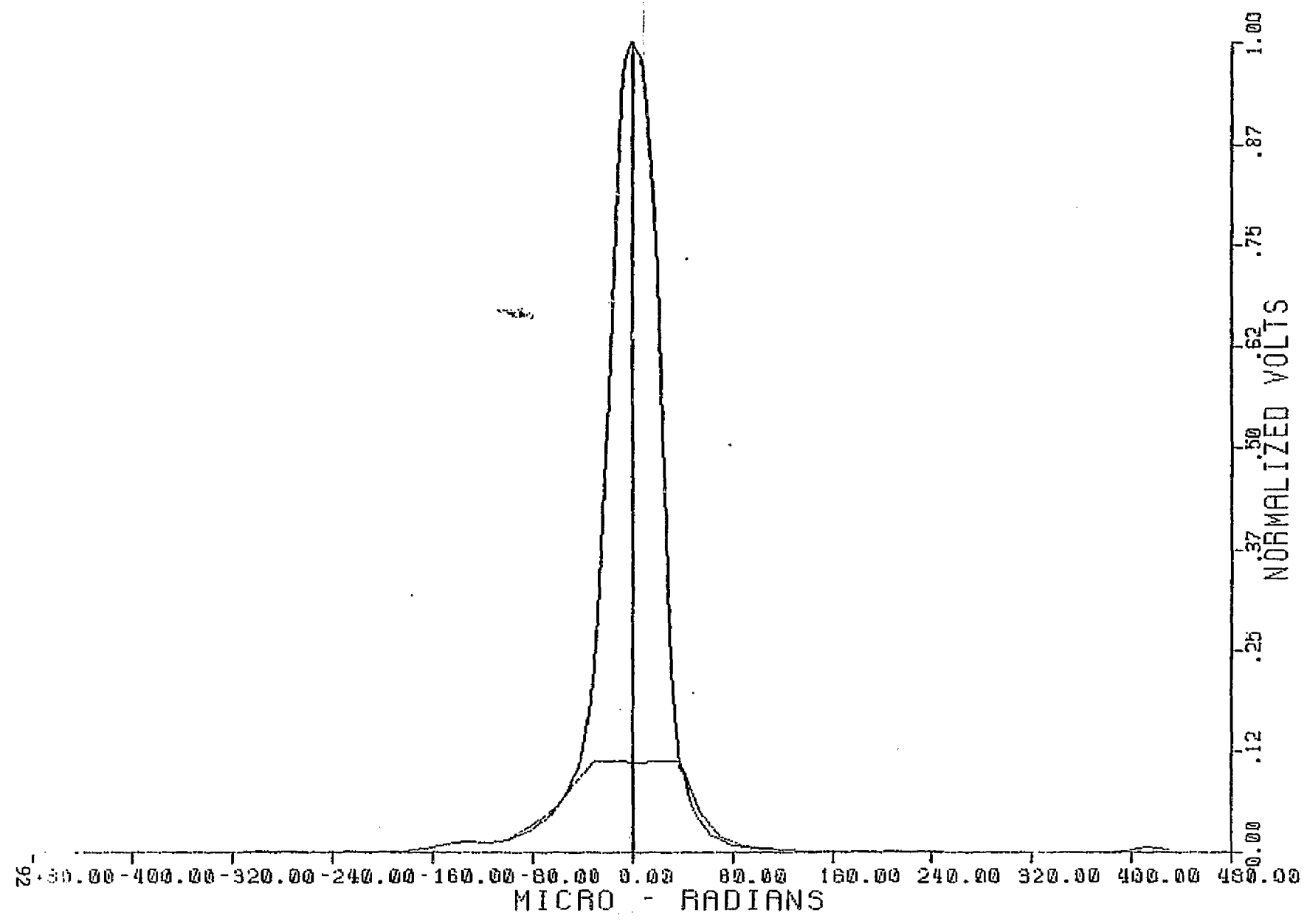

NEAR AND FAR FIELD DATA FOR

X - AXIS, BAND 1 CHANNEL 2

11-JUN-82

05:13:47

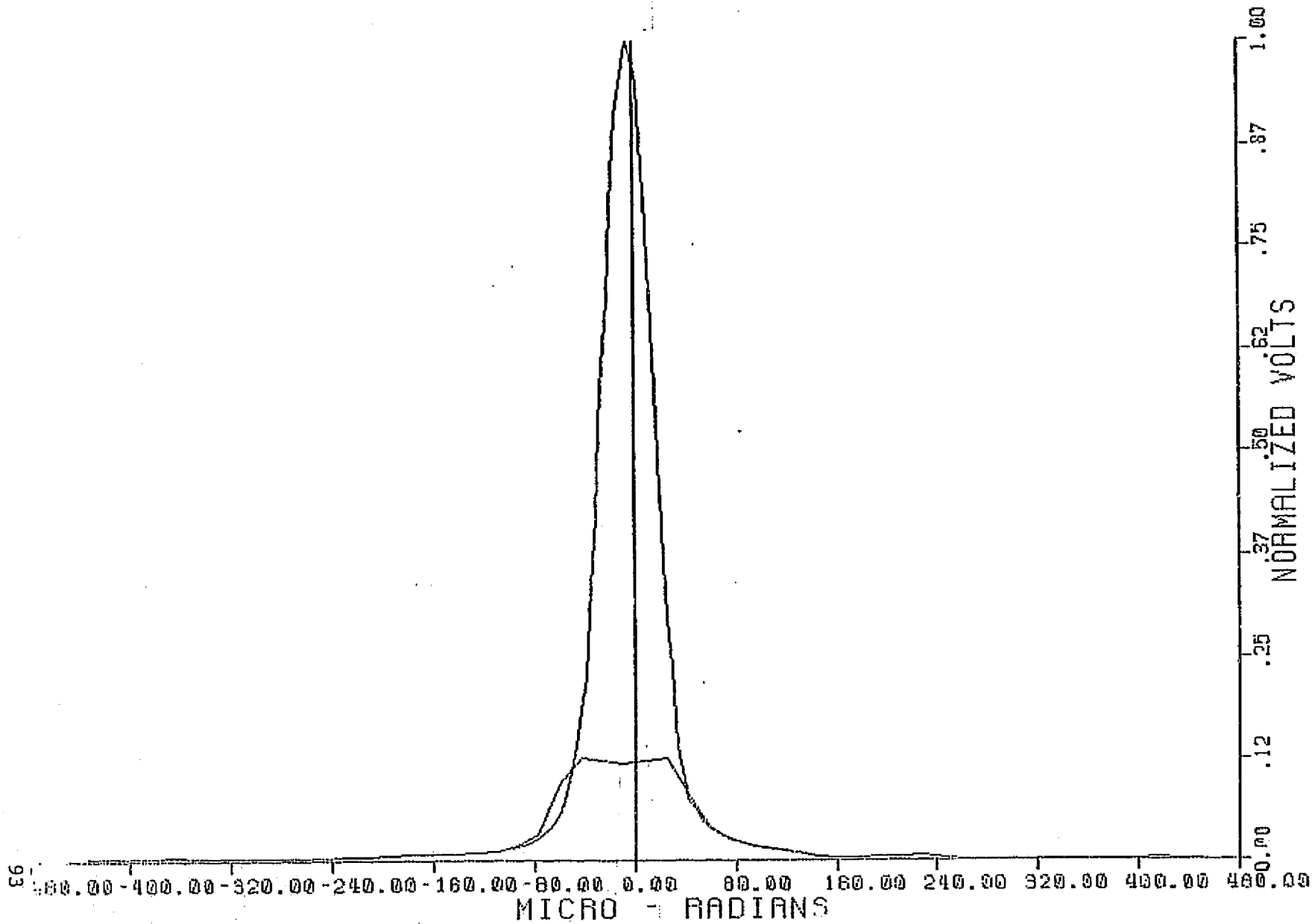

NEAR AND FAR FIELD DATA FOR

Y - AXIS, BAND 1 CHANNEL 15

13-JUN-82

01:35:49

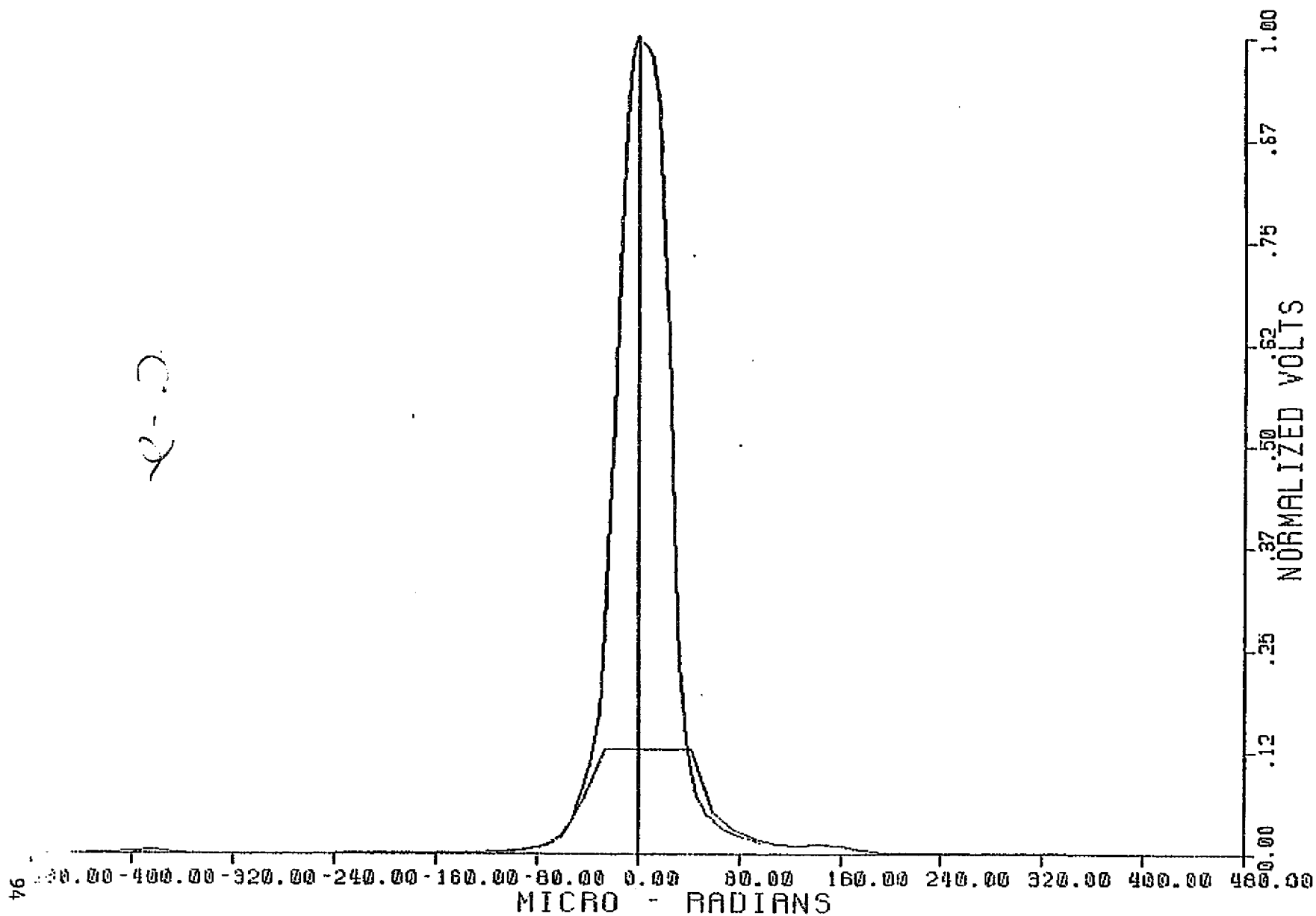

NEAR AND FAR FIELD DATA FOR

X - AXIS, BAND 1 CHANNEL 15

11-JUN-82

05:07:48

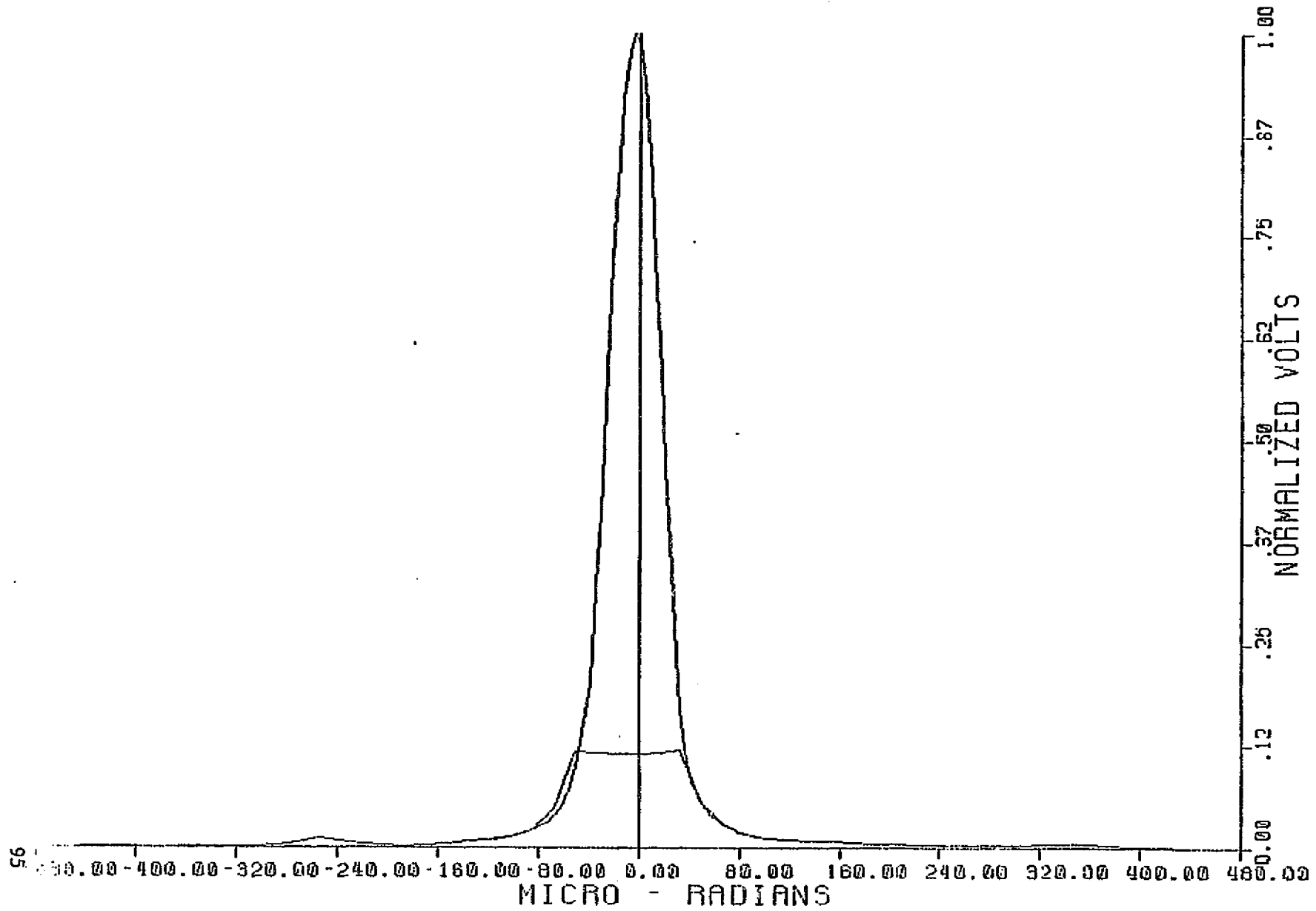

NEAR AND FAR FIELD DATA FOR

Y - AXIS, BAND 1 CHANNEL 16

13-JUN-82

01:37:32

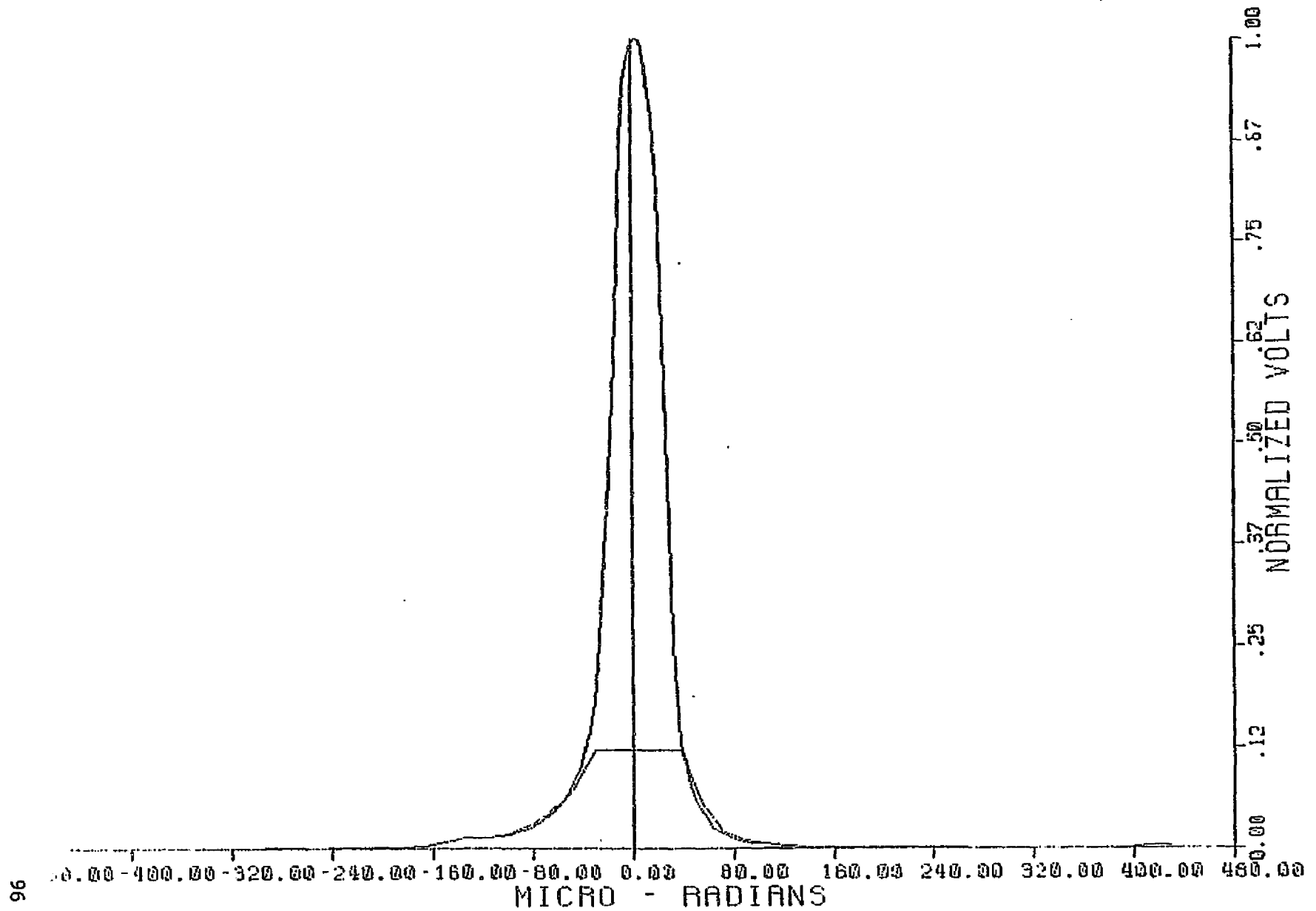

NEAR AND FAR FIELD DATA FOR

X - AXIS, BAND 1 CHANNEL 16

11-JUN-82

05:07:59

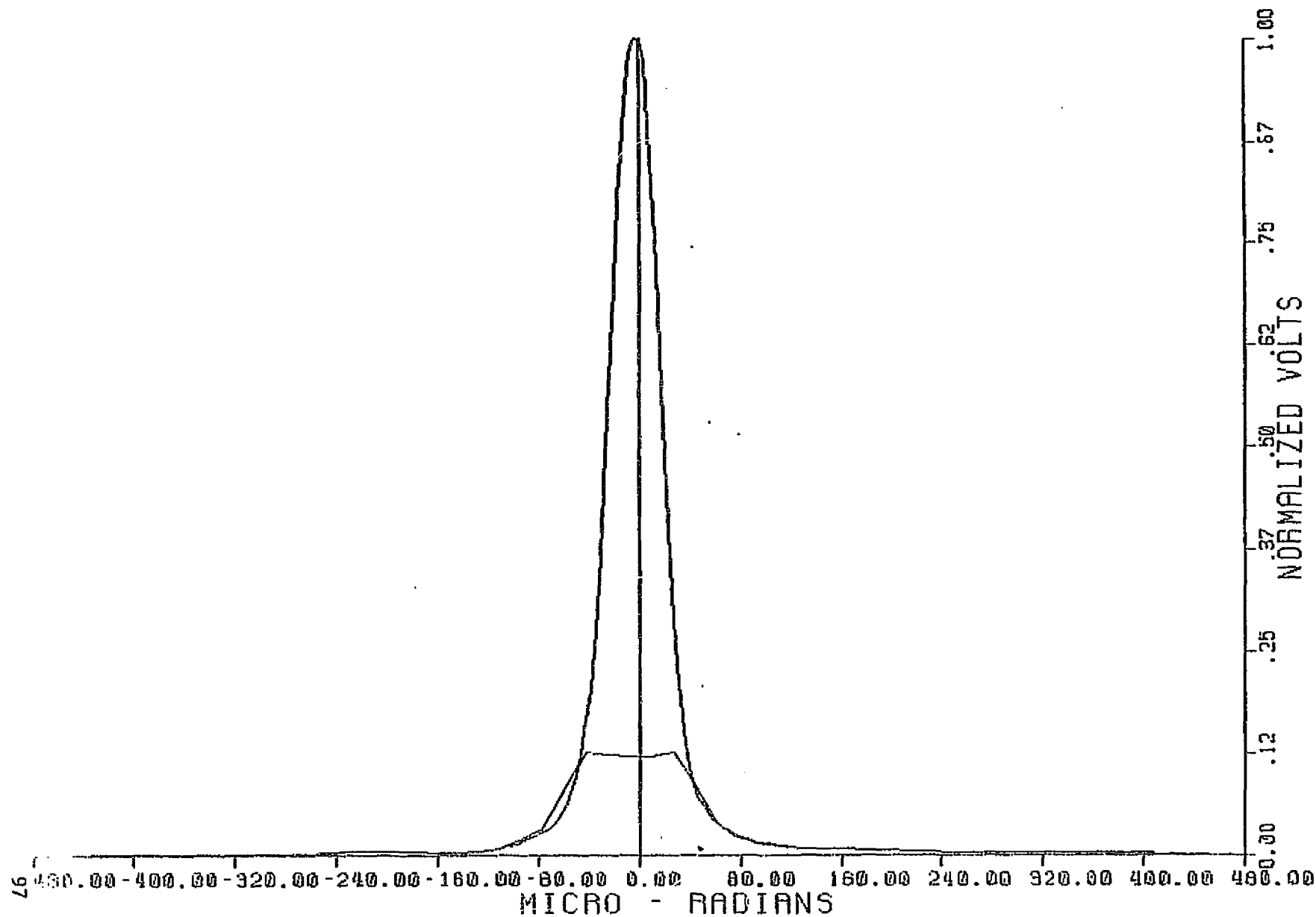

NEAR AND FAR FIELD DATA FOR

Y - AXIS, BAND 2 CHANNEL 1

13-JUN-82

02:19:18

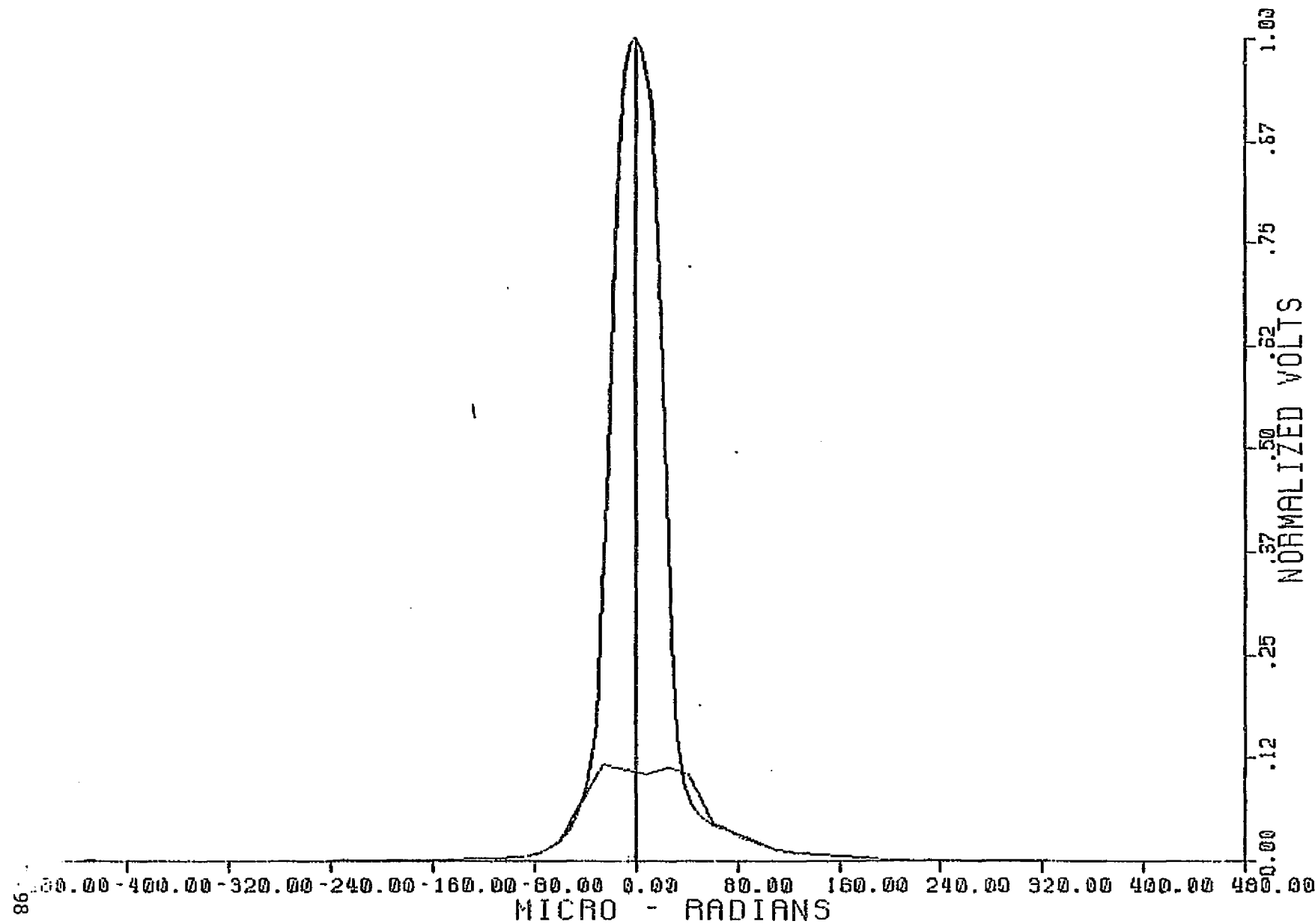

NEAR AND FAR FIELD DATA FOR

X - AXIS, BAND 2 CHANNEL 1

11-JUN-82

04:11:49

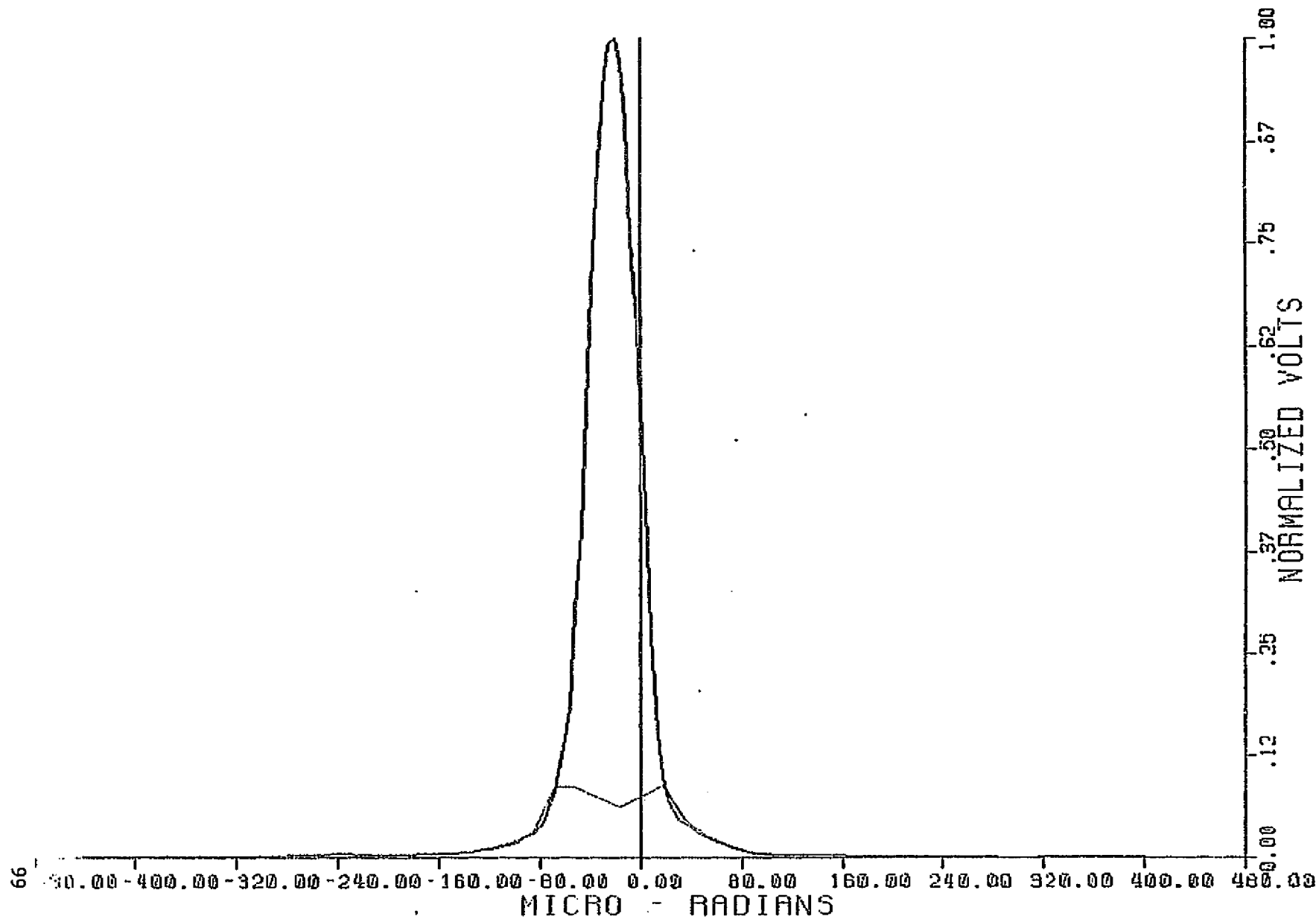

NEAR AND FAR FIELD DATA FOR

13-JUN-82

Y - AXIS, BAND 2 CHANNEL 2

02:21:07

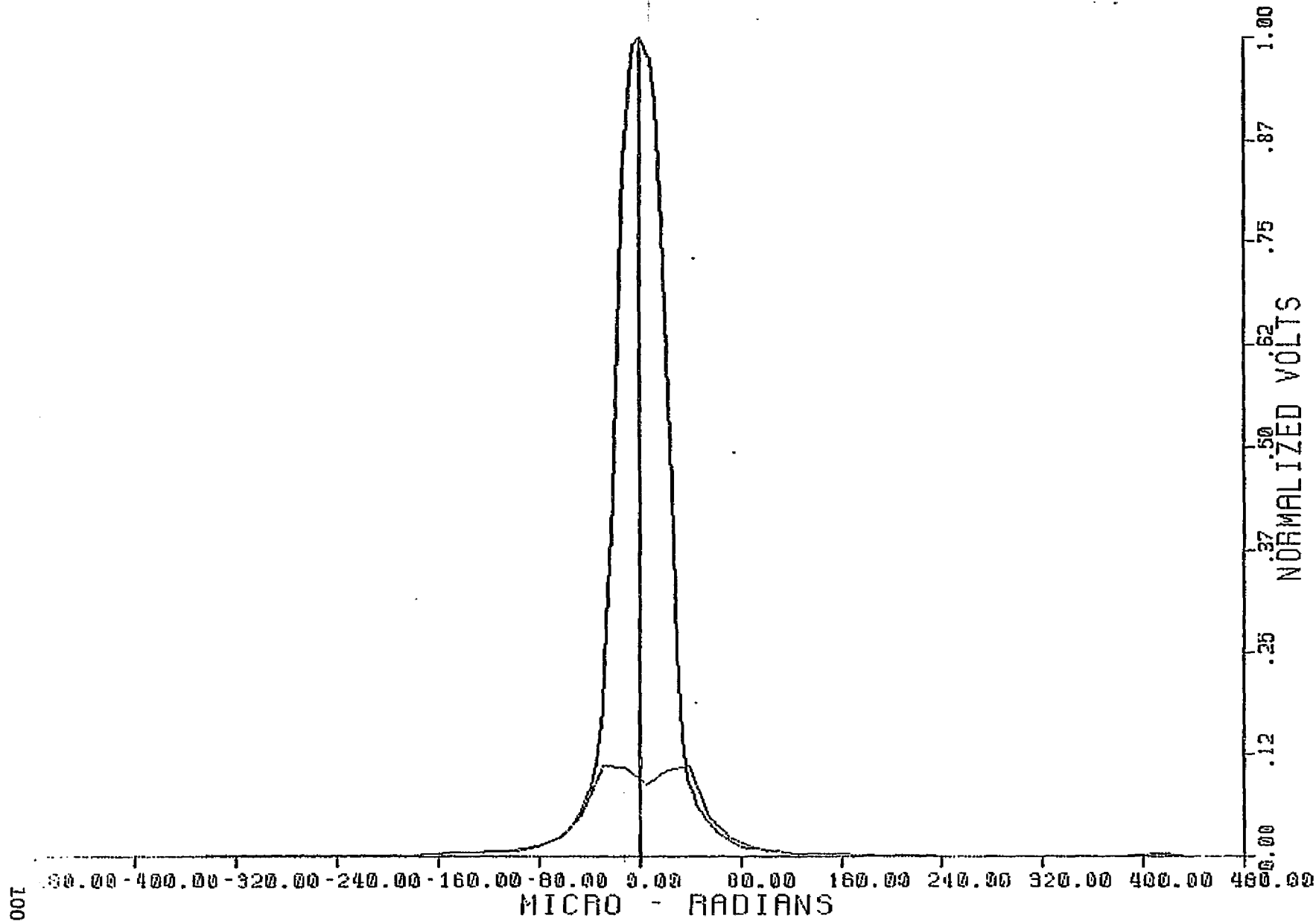

NEAR AND FAR FIELD DATA FOR

11-JUN-82

X - AXIS, BAND 2 CHANNEL 2

04:11:56

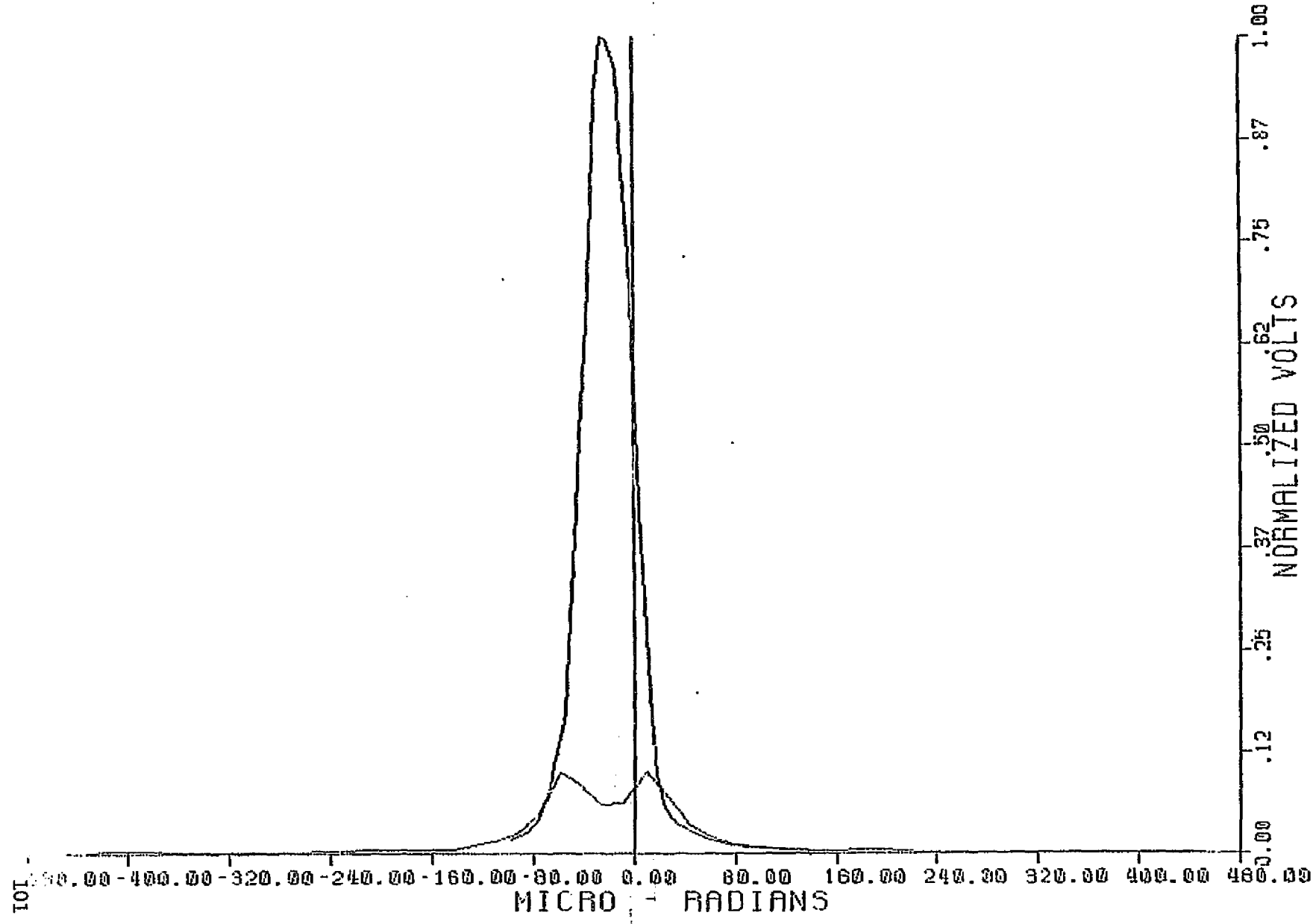

NEAR AND FAR FIELD DATA FOR

13-JUN-82

Y - AXIS. BAND 2 CHANNEL 15

02:19:25

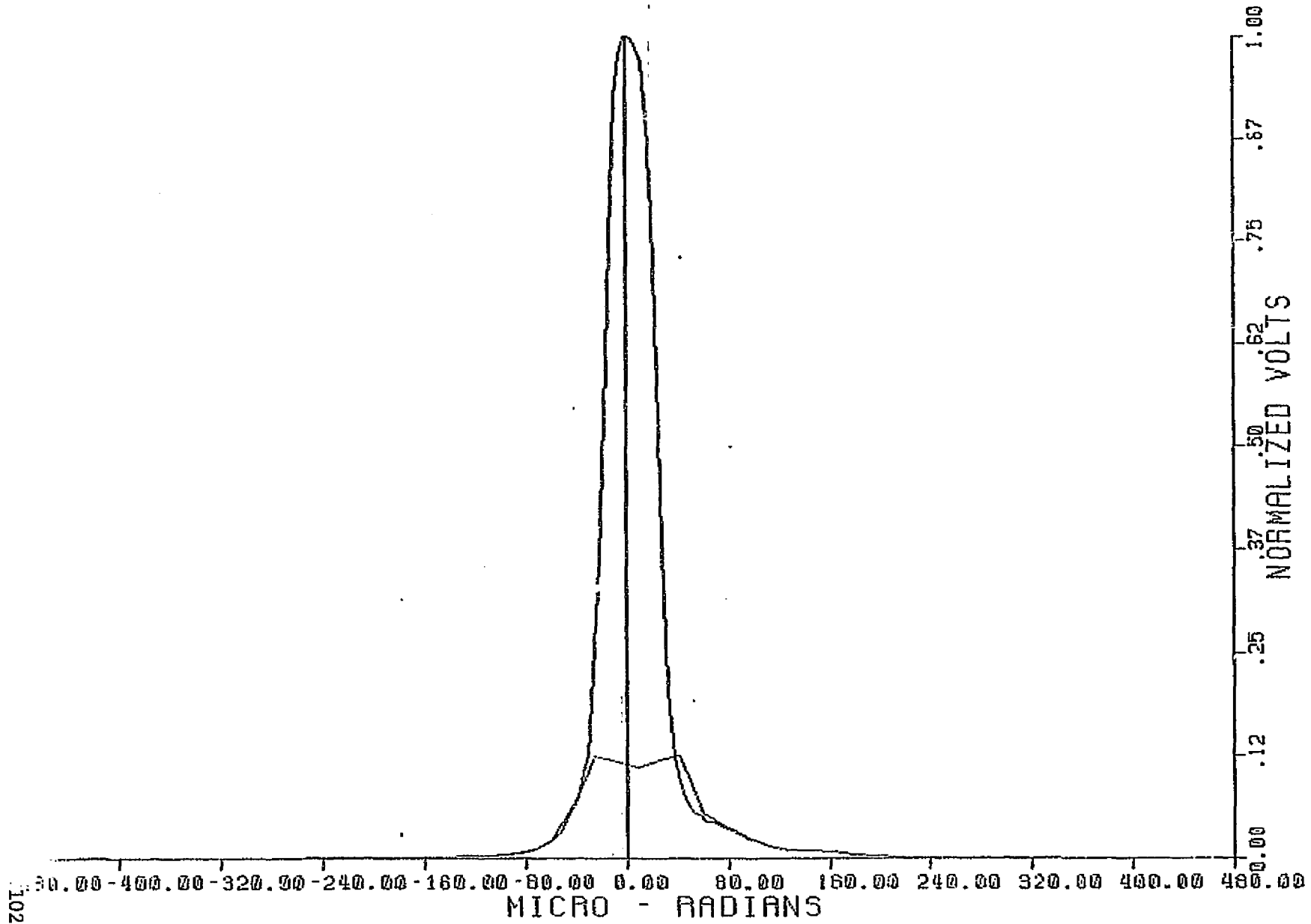

NEAR AND FAR FIELD DATA FOR

X - AXIS, BAND 2 CHANNEL 15

11-JUN-82

04:05:40

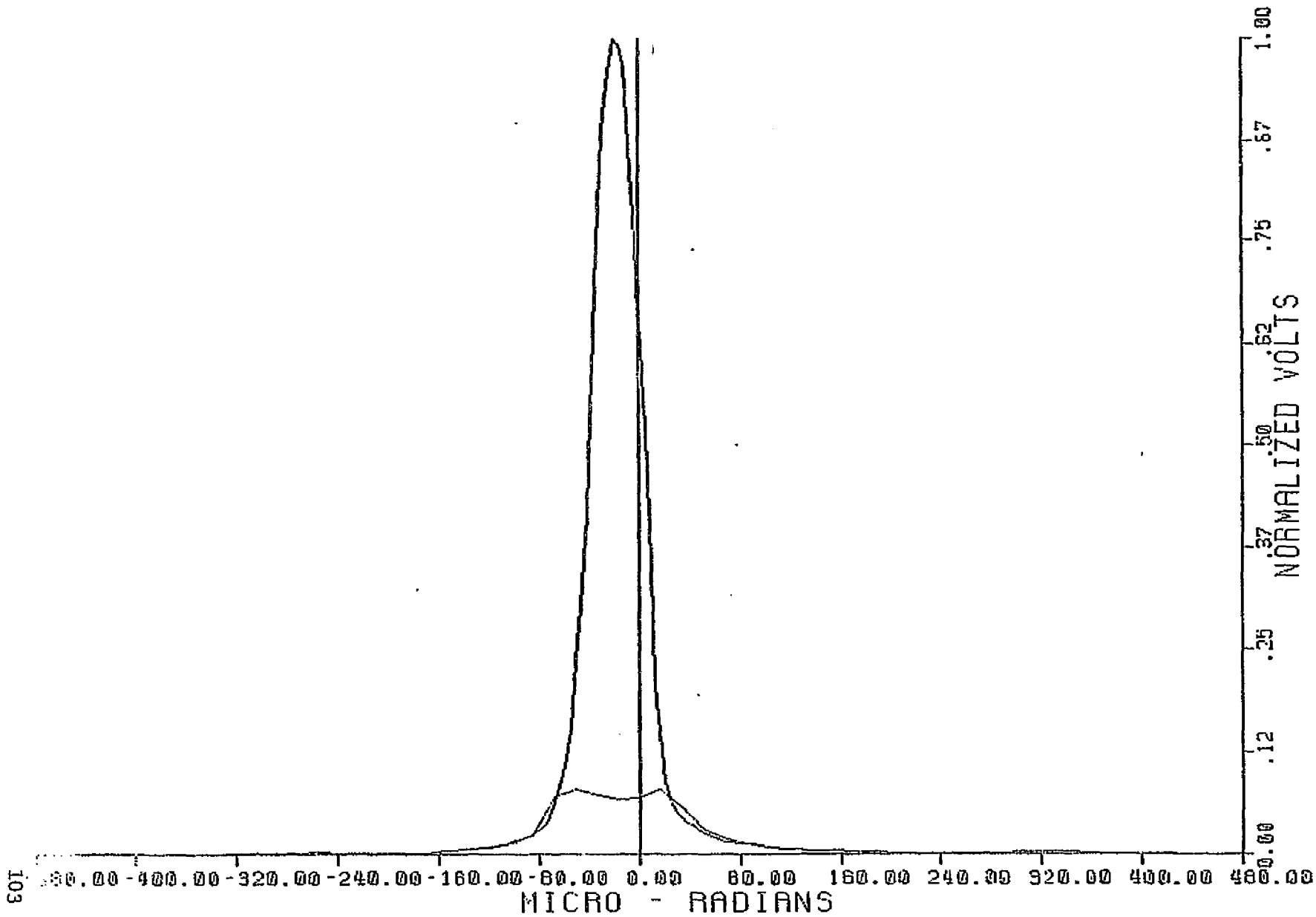

NEAR AND FAR FIELD DATA FOR

13-JUN-82

Y - AXIS, BAND 2 CHANNEL 16

02:21:13

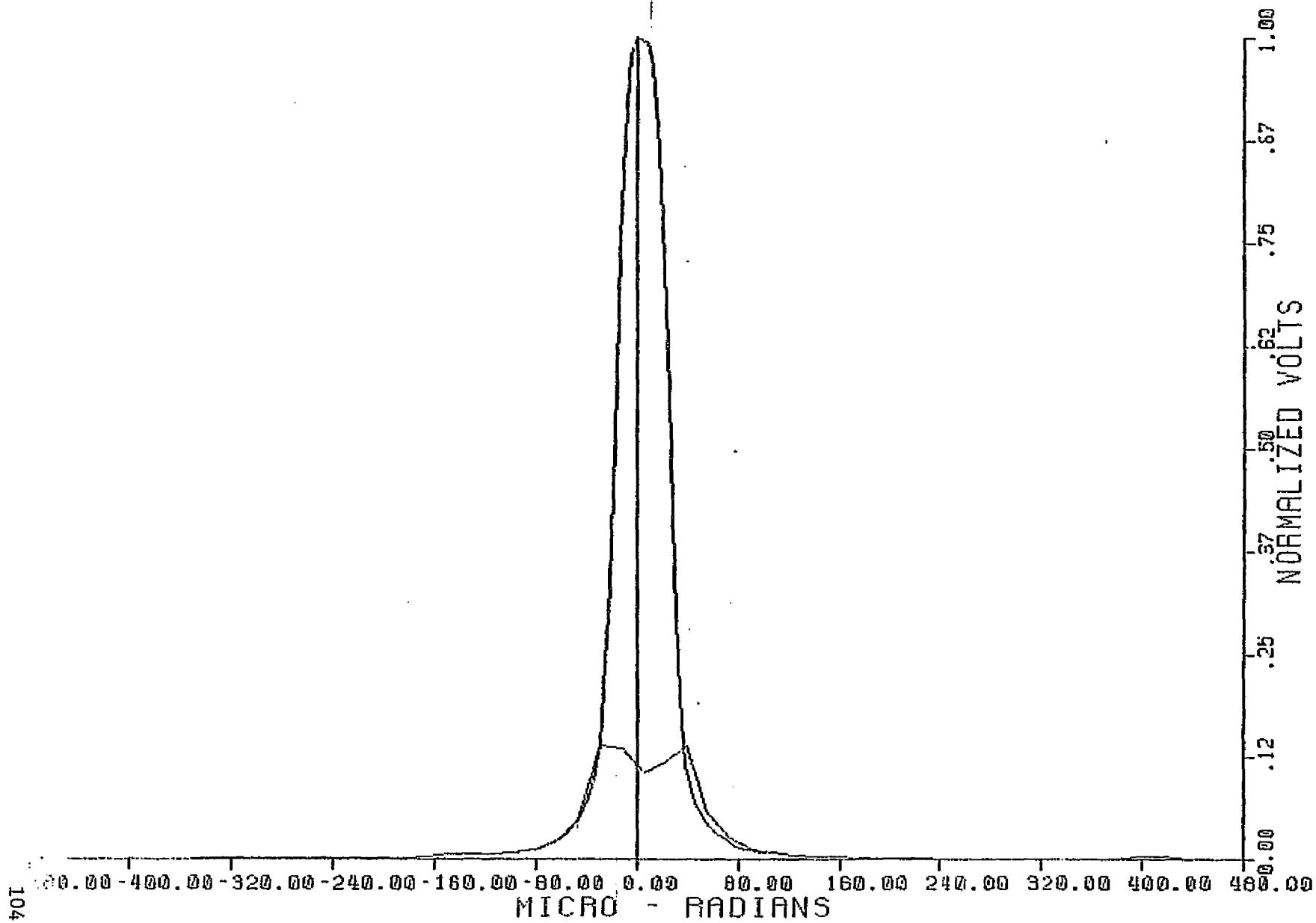

NEAR AND FAR FIELD DATA FOR

11-JUN-82

X - AXIS, BAND 2 CHANNEL 16

04:05:51

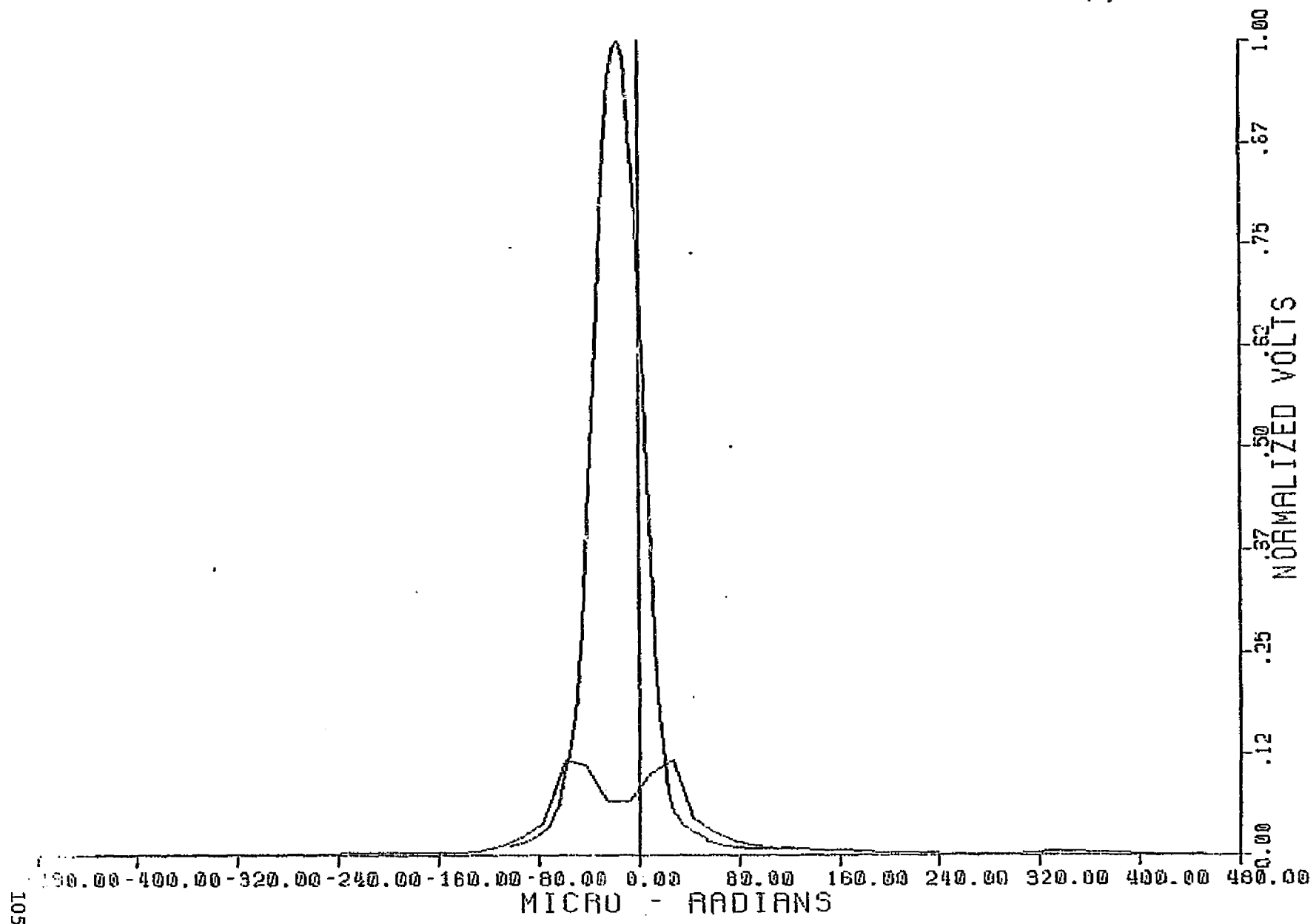

105

NEAR AND FAR FIELD DATA FOR

Y - AXIS, BAND 3 CHANNEL 1

09-JUN-82

23:10:23

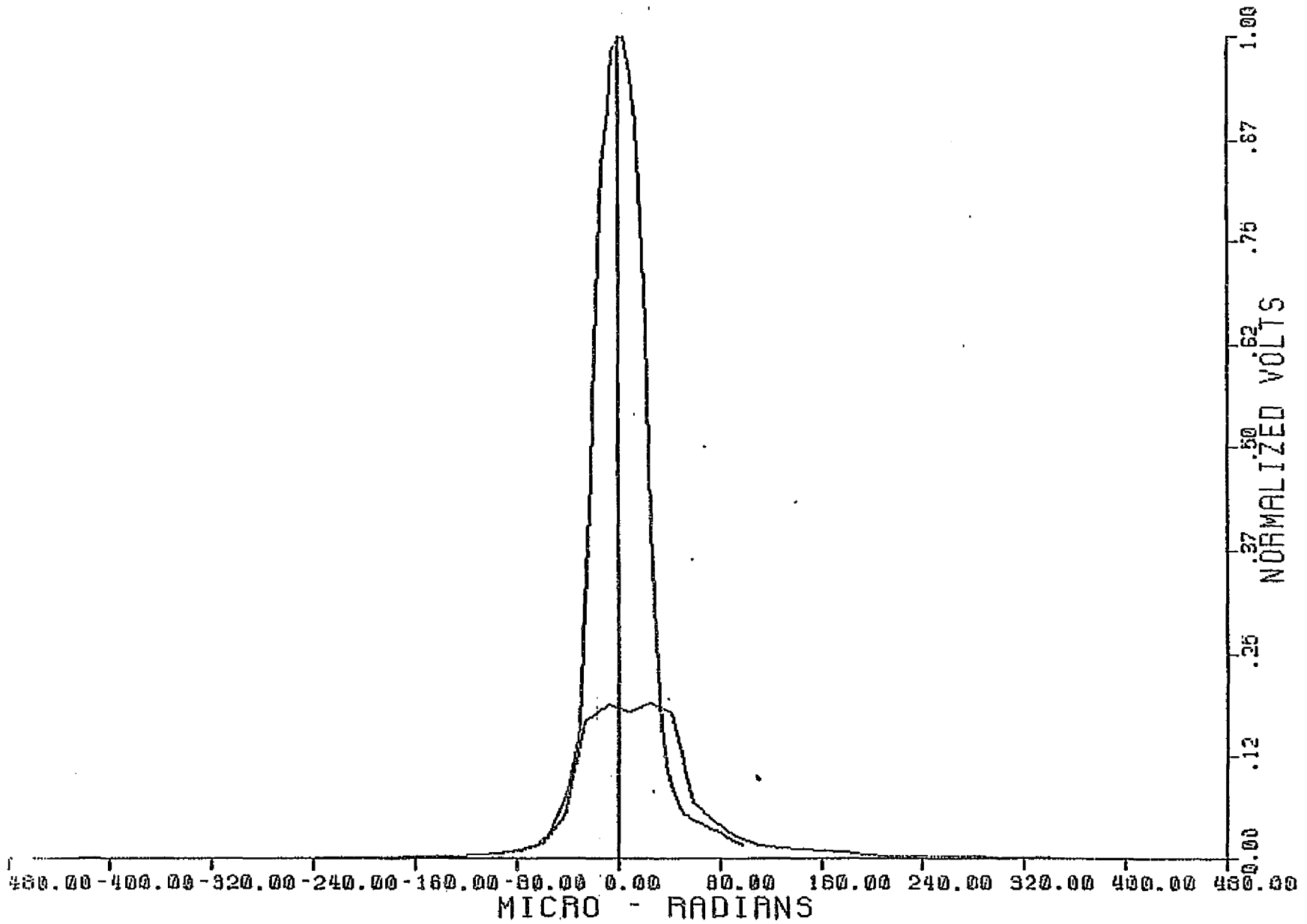

NEAR AND FAR FIELD DATA FOR

10-JUN-82

X - AXIS. BAND 3 CHANNEL 1

22:48:37

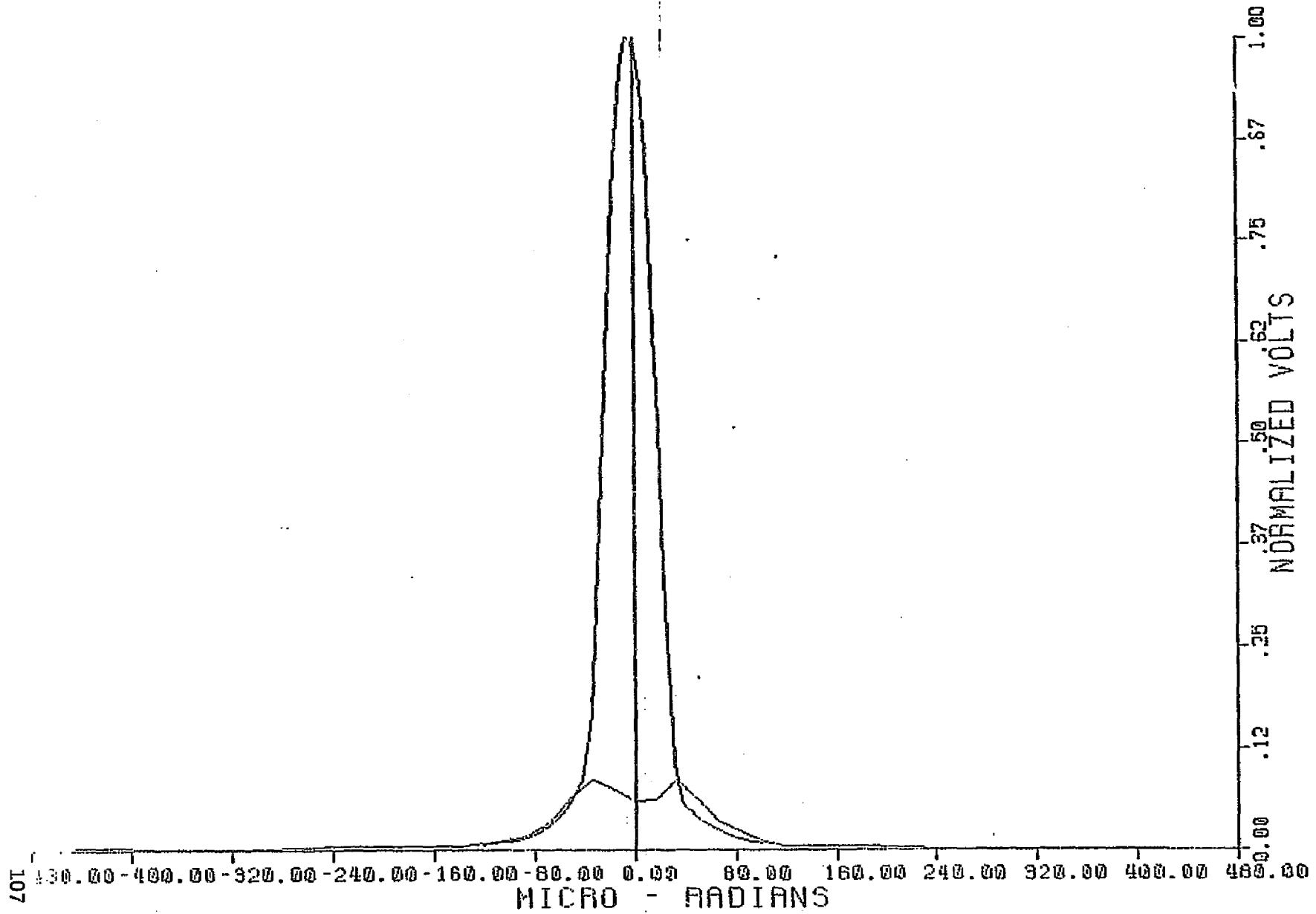

NEAR AND FAR FIELD DATA FOR

09-JUN-82

Y - AXIS, BAND 3 CHANNEL 2

23:12:10

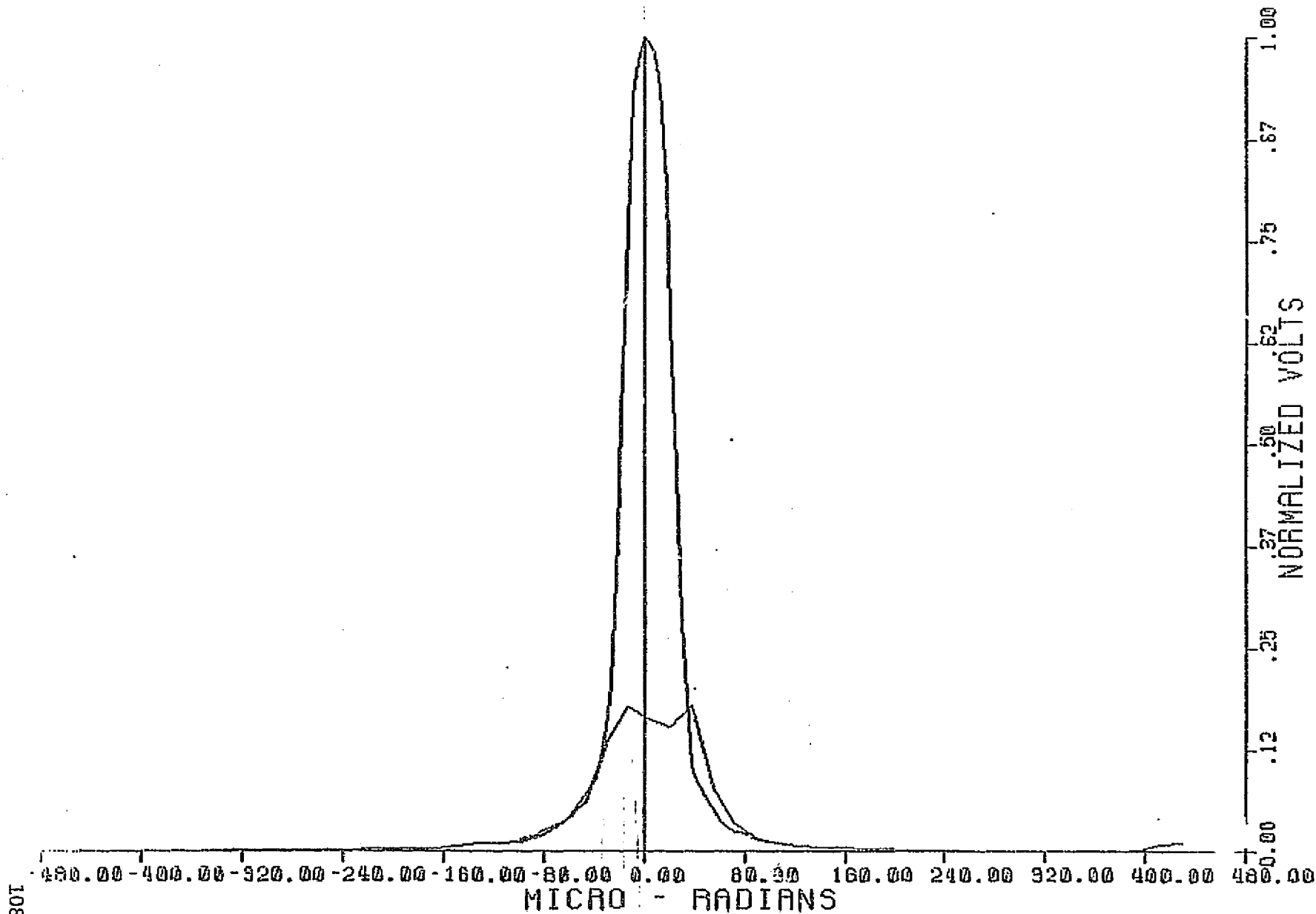

NEAR AND FAR FIELD DATA FOR

10-JUN-82

X - AXIS, BAND 3 CHANNEL 2

22:48:47

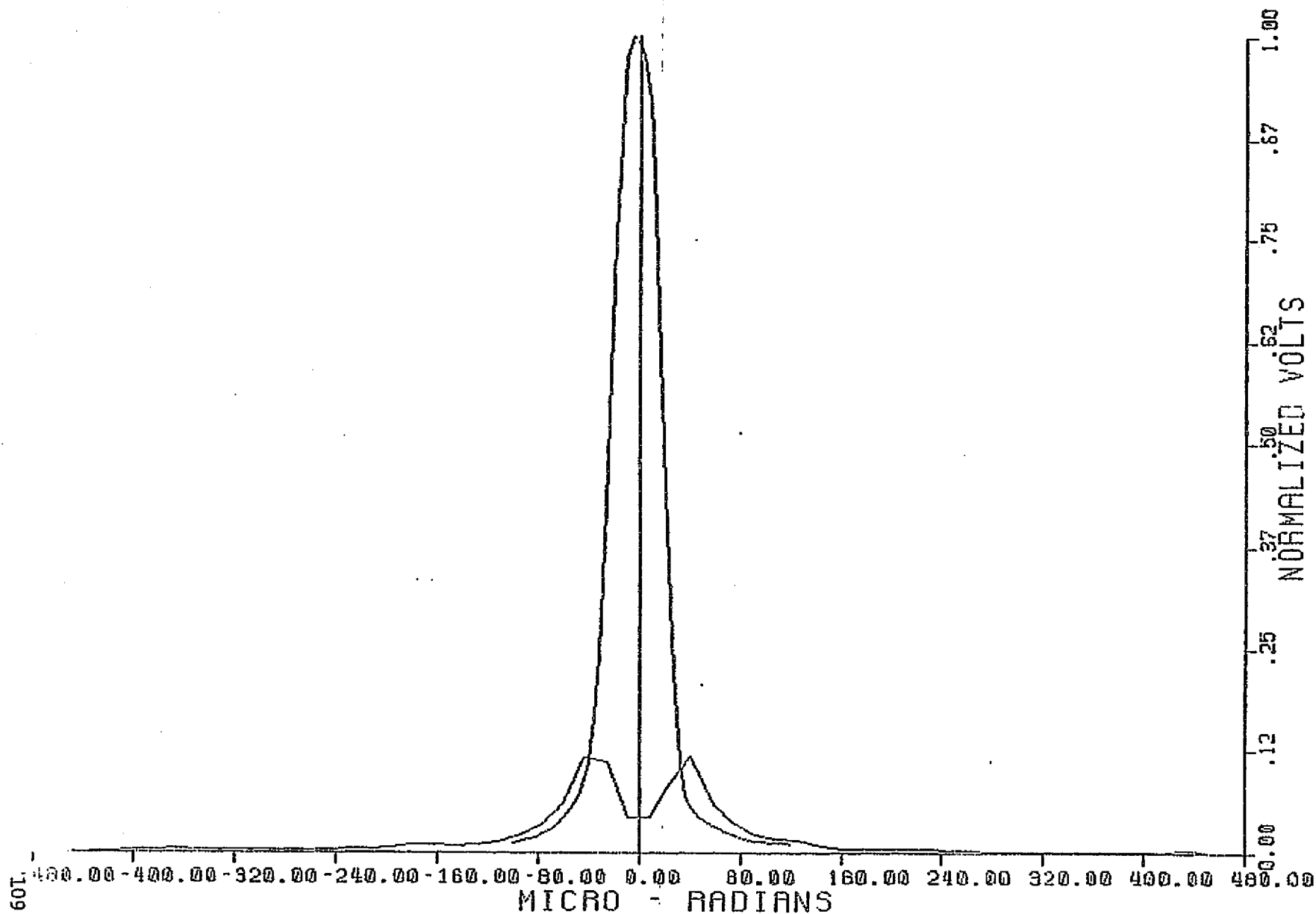

NEAR AND FAR FIELD DATA FOR

Y - AXIS, BAND 3 CHANNEL 15

09-JUN-82

23:10:32

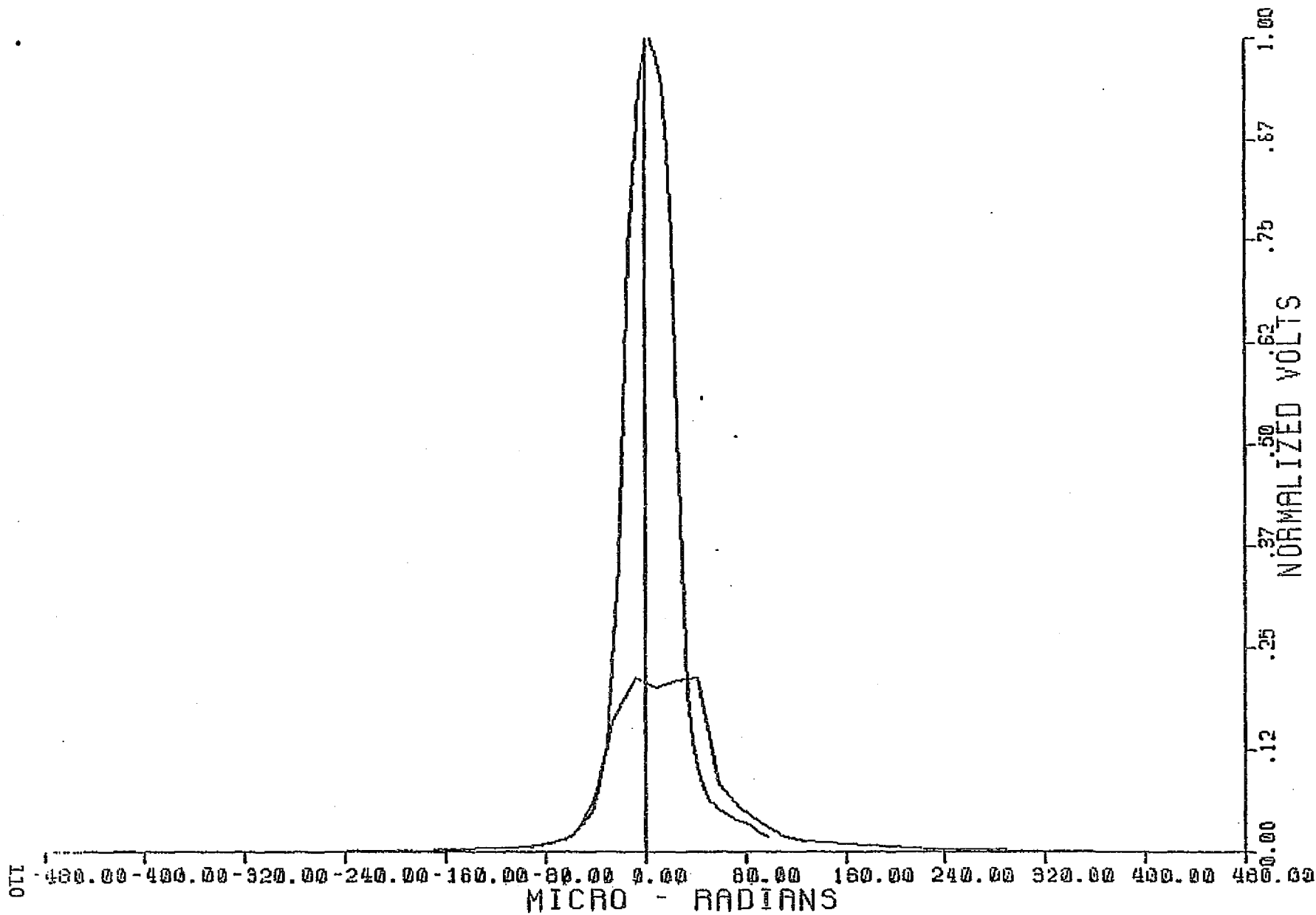

NEAR AND FAR FIELD DATA FOR

X - AXIS, BAND 3 CHANNEL 15

10-JUN-82

22:42:49

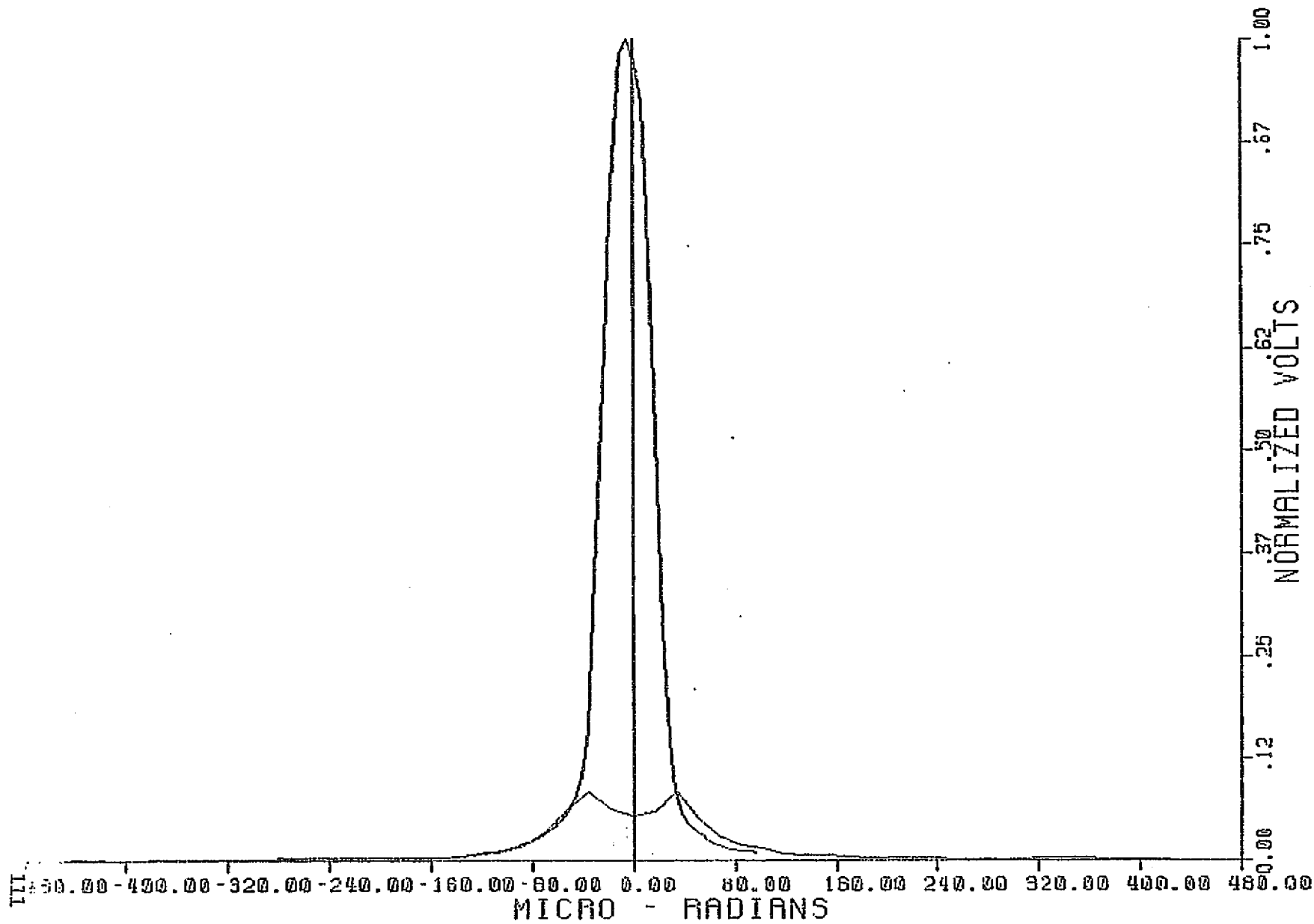

NEAR AND FAR FIELD DATA FOR

Y - AXIS, BAND 3 CHANNEL 16

09-JUN-82

23:12:16

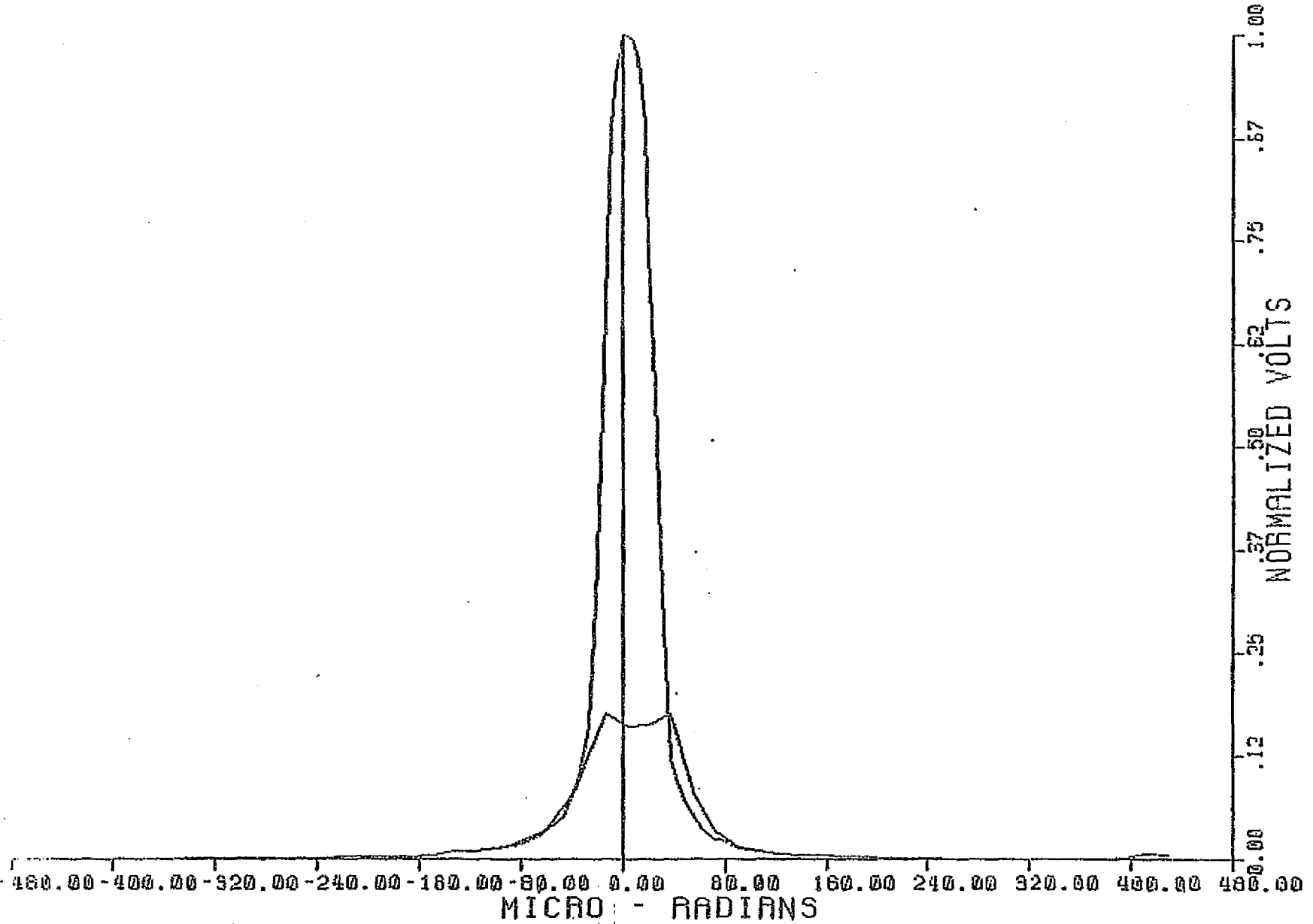

NEAR AND FAR FIELD DATA FOR

X - AXIS, BAND 3 CHANNEL 16

10-JUN-82

22:42:57

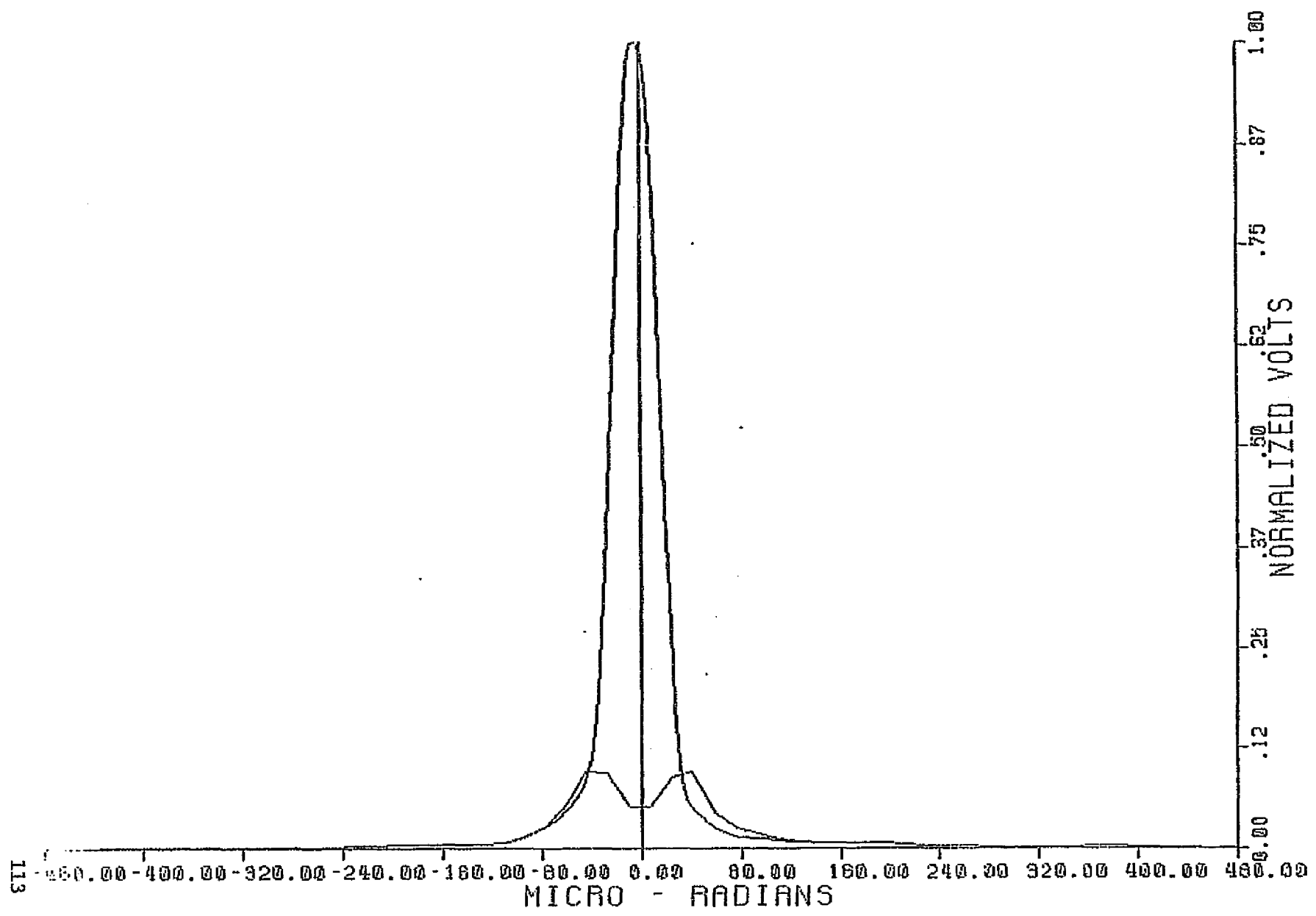

113

NEAR AND FAR FIELD DATA FOR

Y - AXIS, BAND 4 CHANNEL 1

09-JUN-82

21:55:34

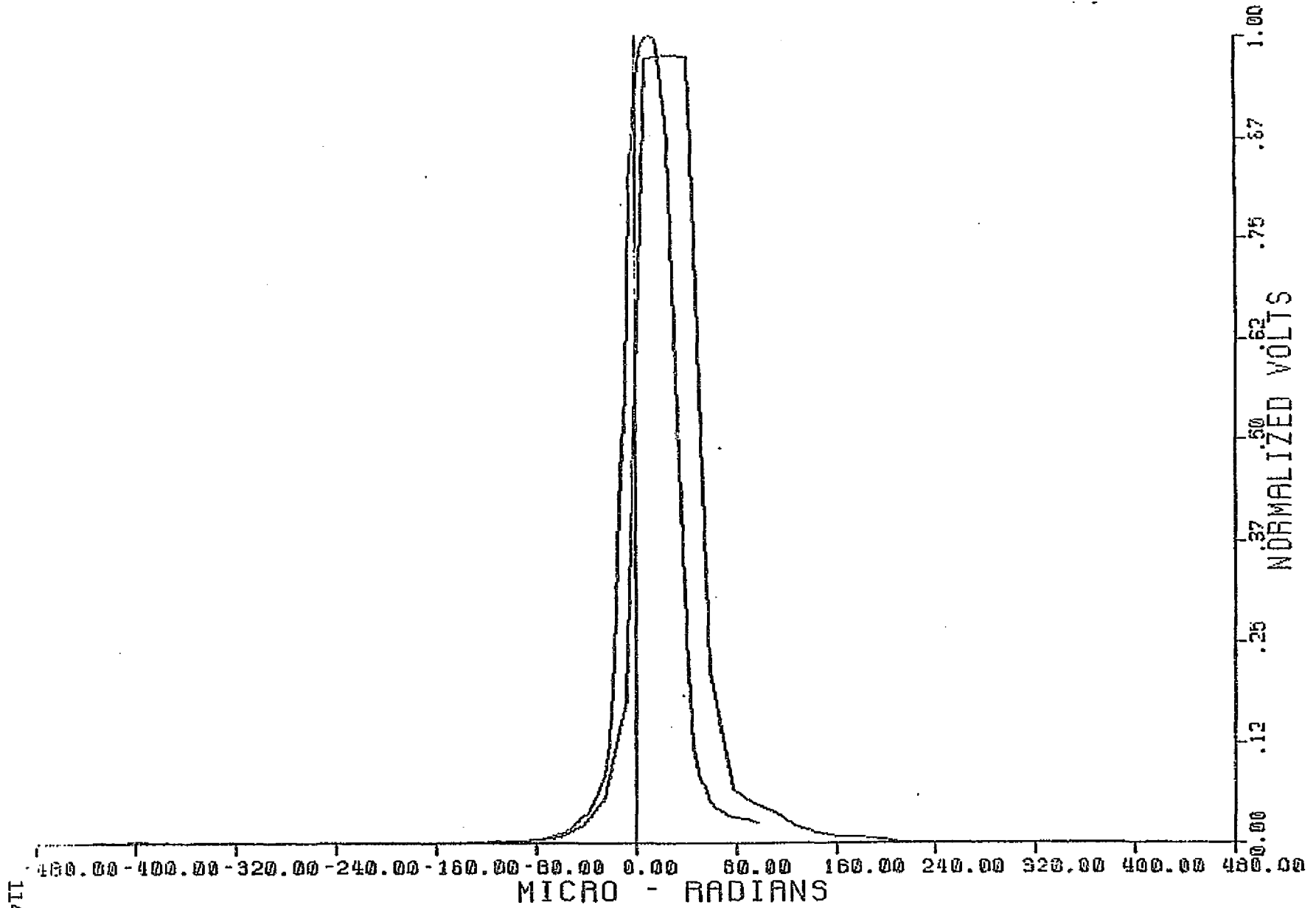

NEAR AND FAR FIELD DATA FOR

X - AXIS. BAND 4 CHANNEL 1

10-JUN-82

23:50:22

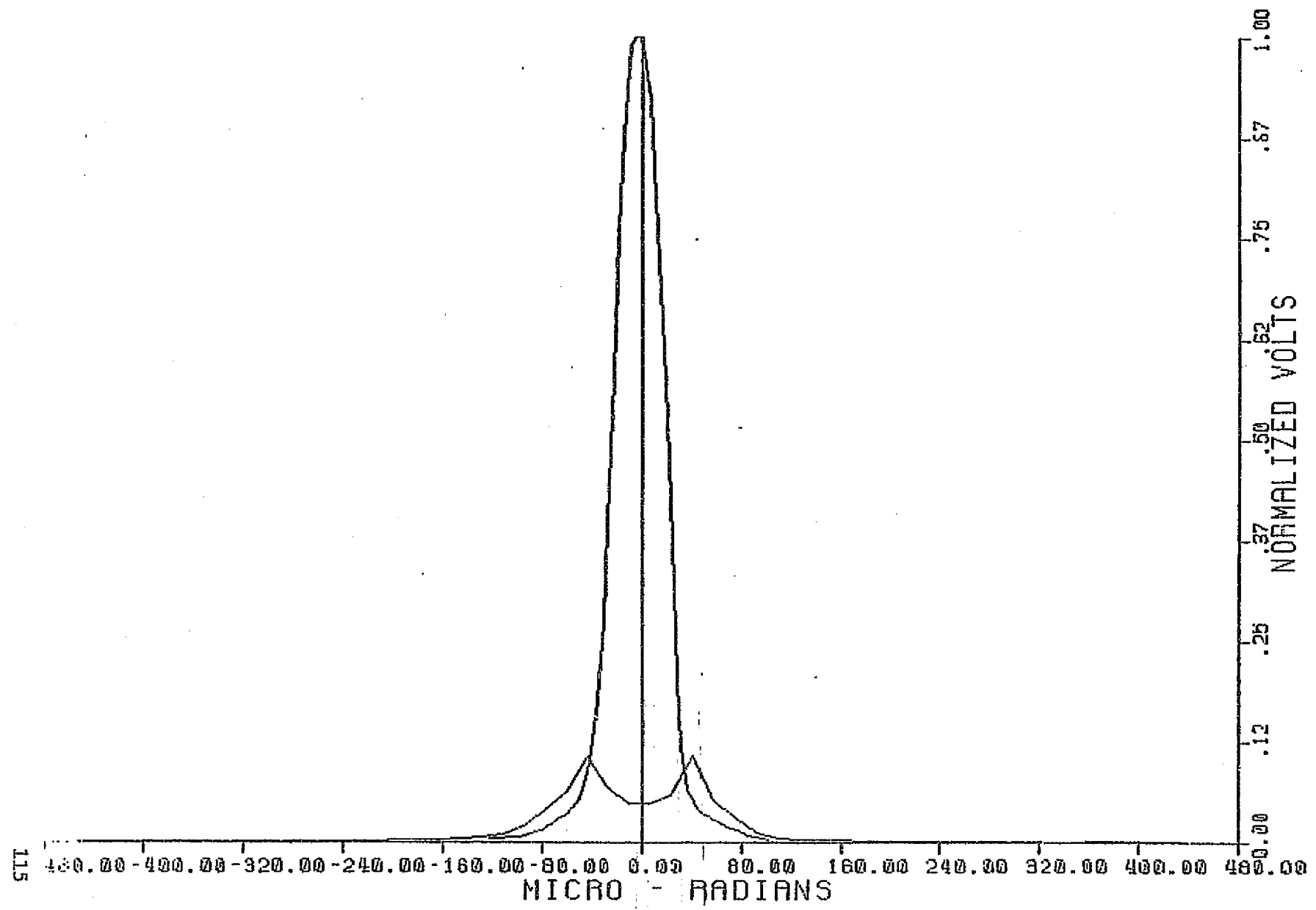

115

NEAR AND FAR FIELD DATA FOR

Y - AXIS, BAND 4 CHANNEL 2

09-JUN-82

21:57:11

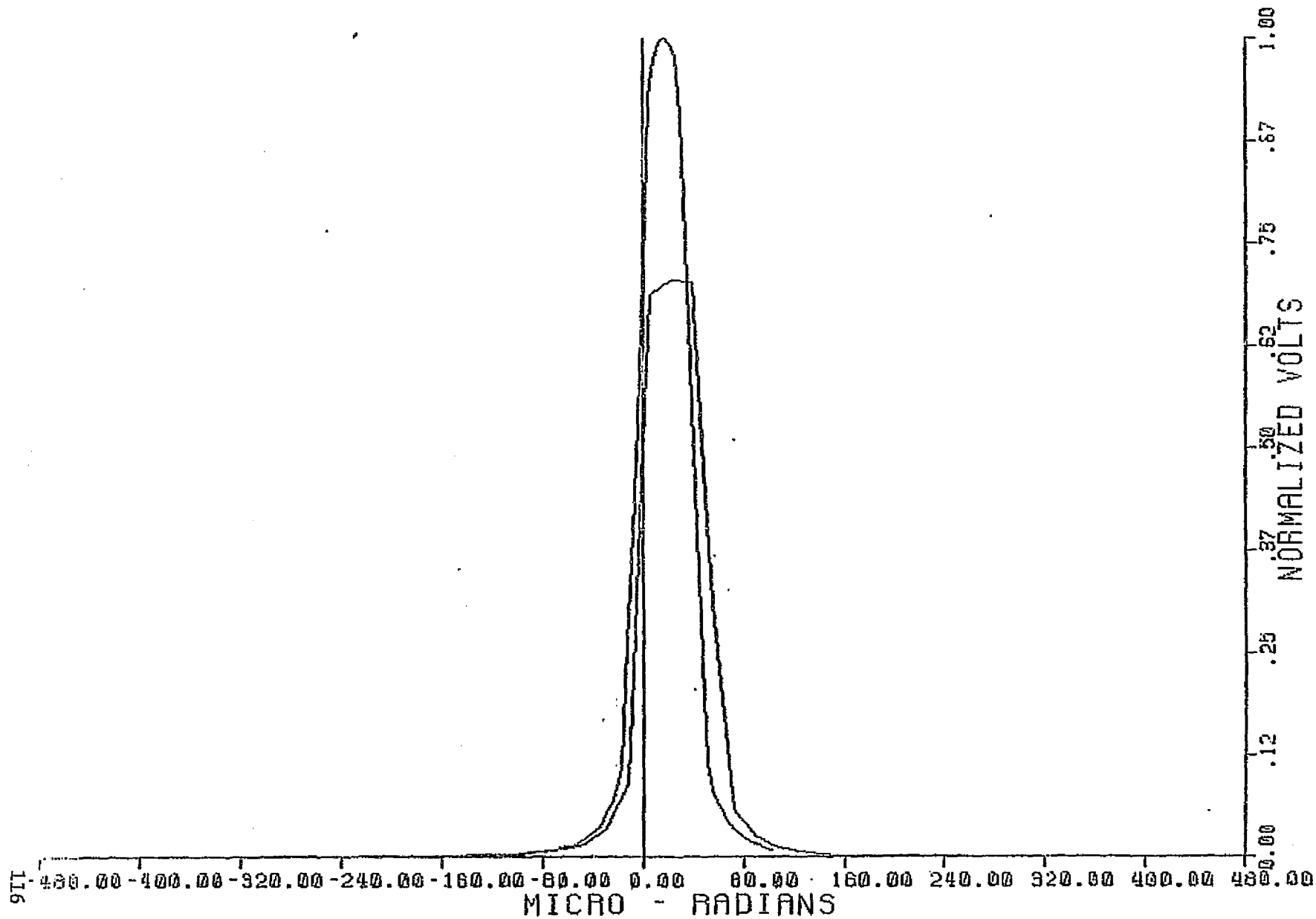

NEAR AND FAR FIELD DATA FOR

X - AXIS, BAND 4 CHANNEL 2

10-JUN-82

23:50:30

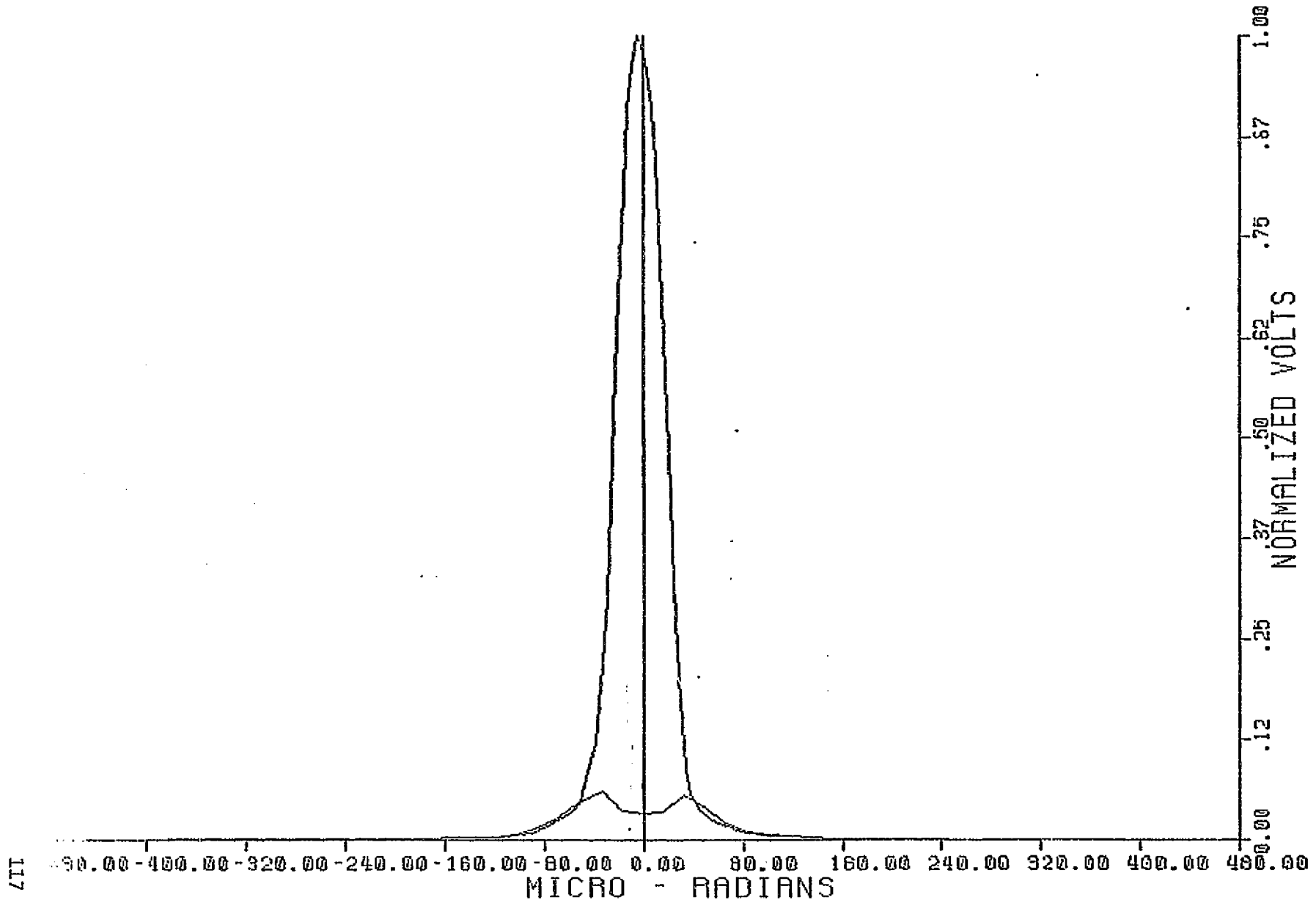

117

NEAR AND FAR FIELD DATA FOR

Y - AXIS, BAND 4 CHANNEL 14

09-JUN-82

21:57:17

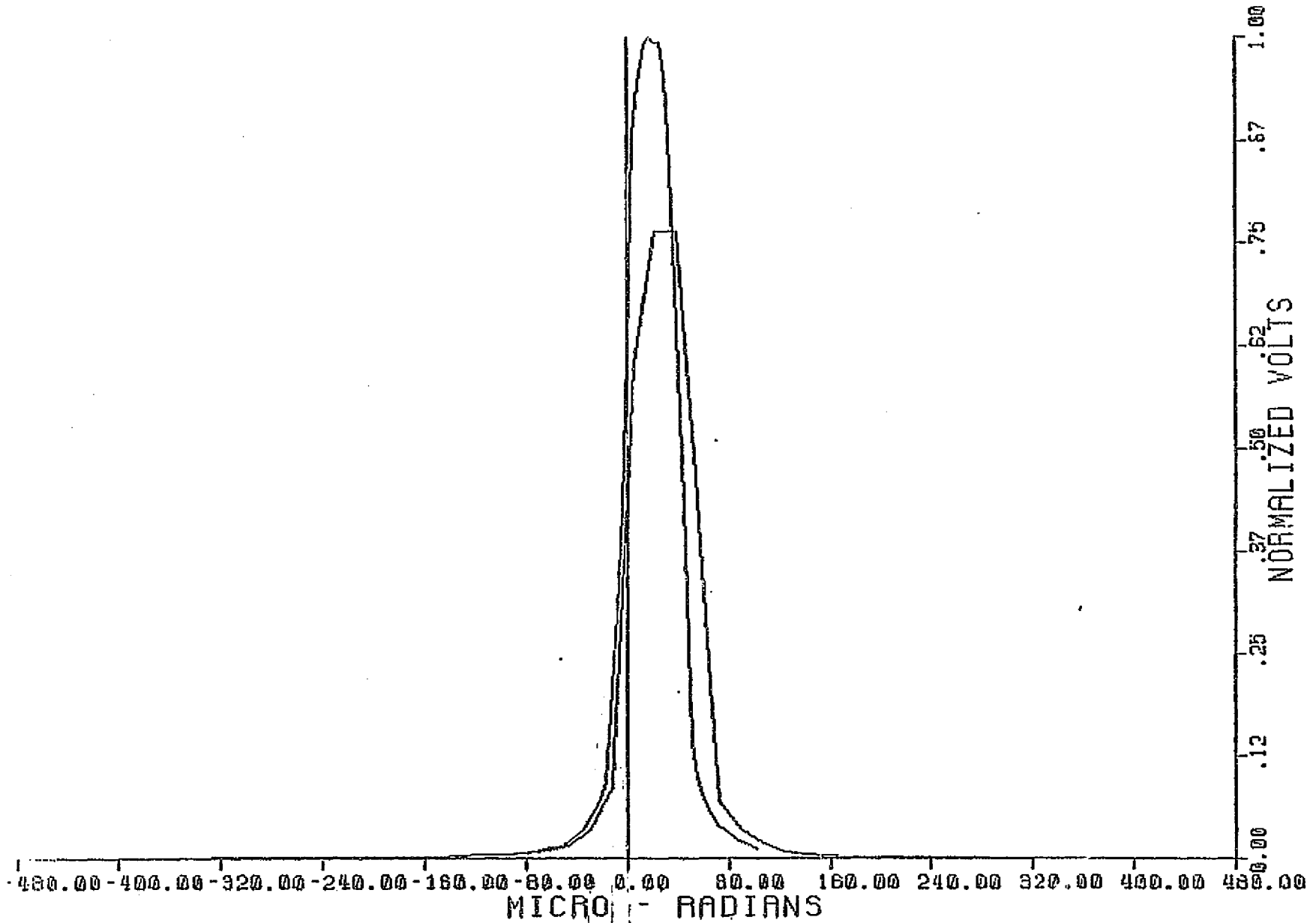

NEAR AND FAR FIELD DATA FOR

X - AXIS, BAND 4 CHANNEL 14

10-JUN-82

23:41:41

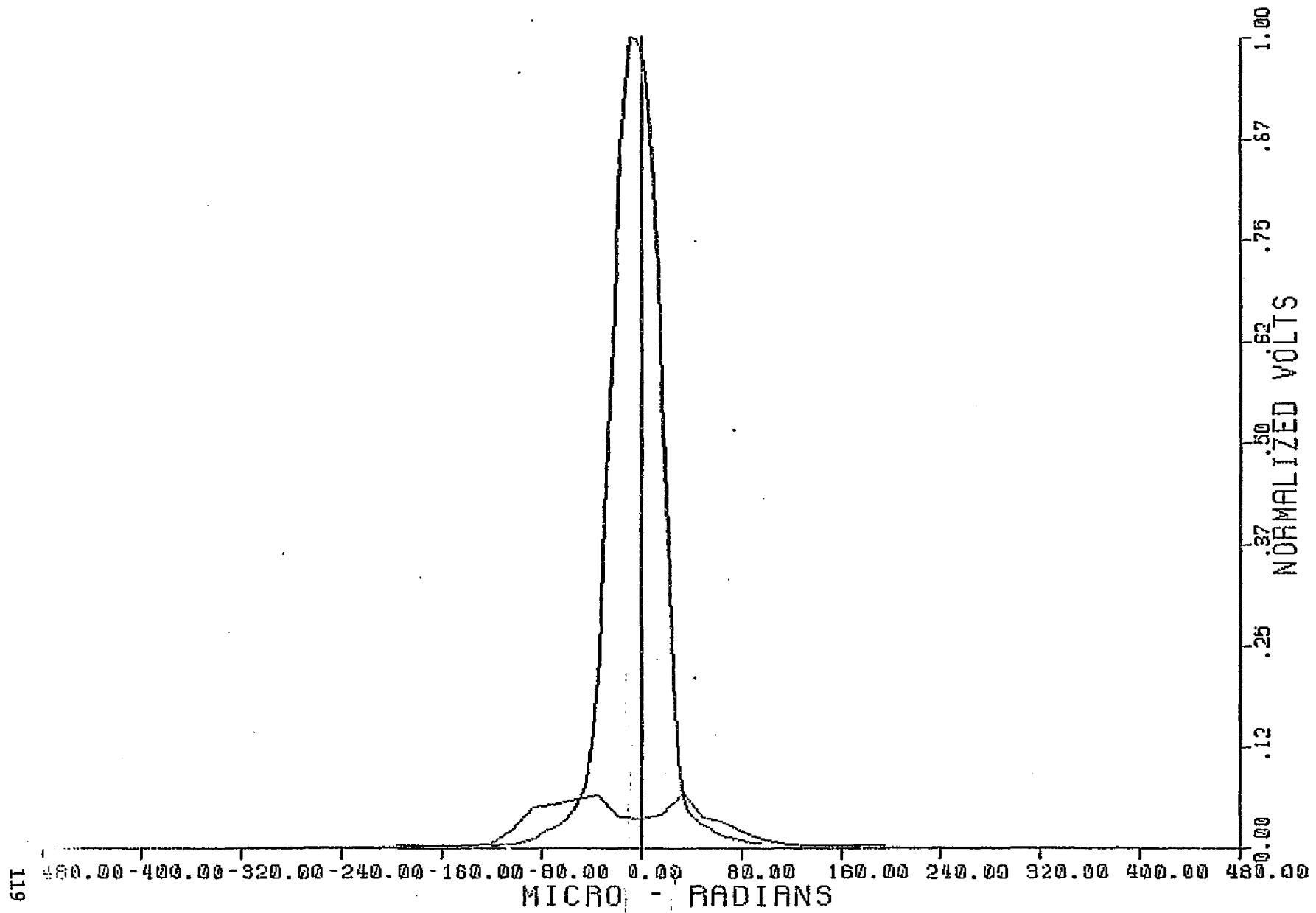

6TI

NEAR AND FAR FIELD DATA FOR

Y - AXIS, BAND 4 CHANNEL 15

09-JUN-82

21:55:39

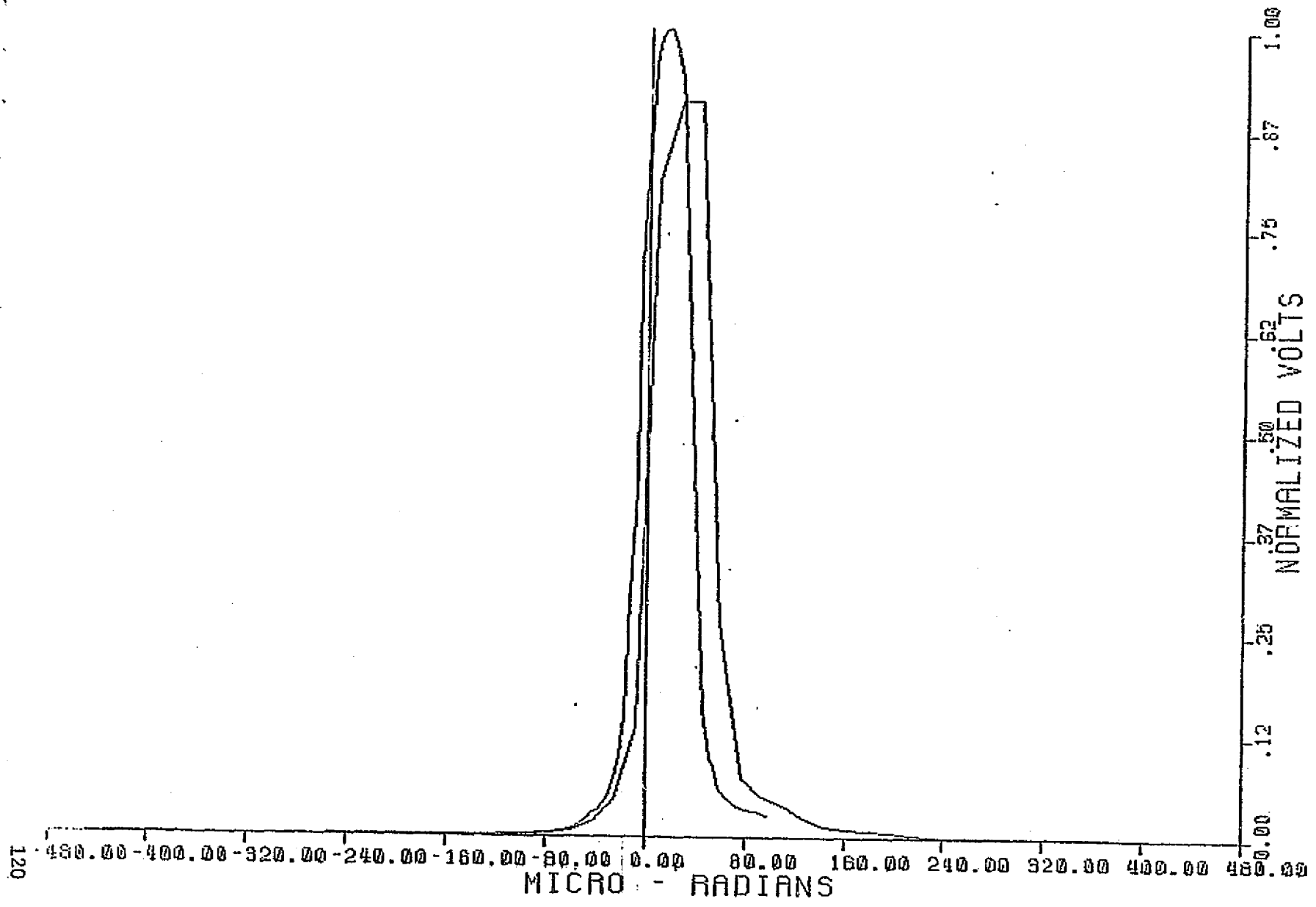

NEAR AND FAR FIELD DATA FOR

X - AXIS, BAND 4 CHANNEL 15

10-JUN-82

23:41:50

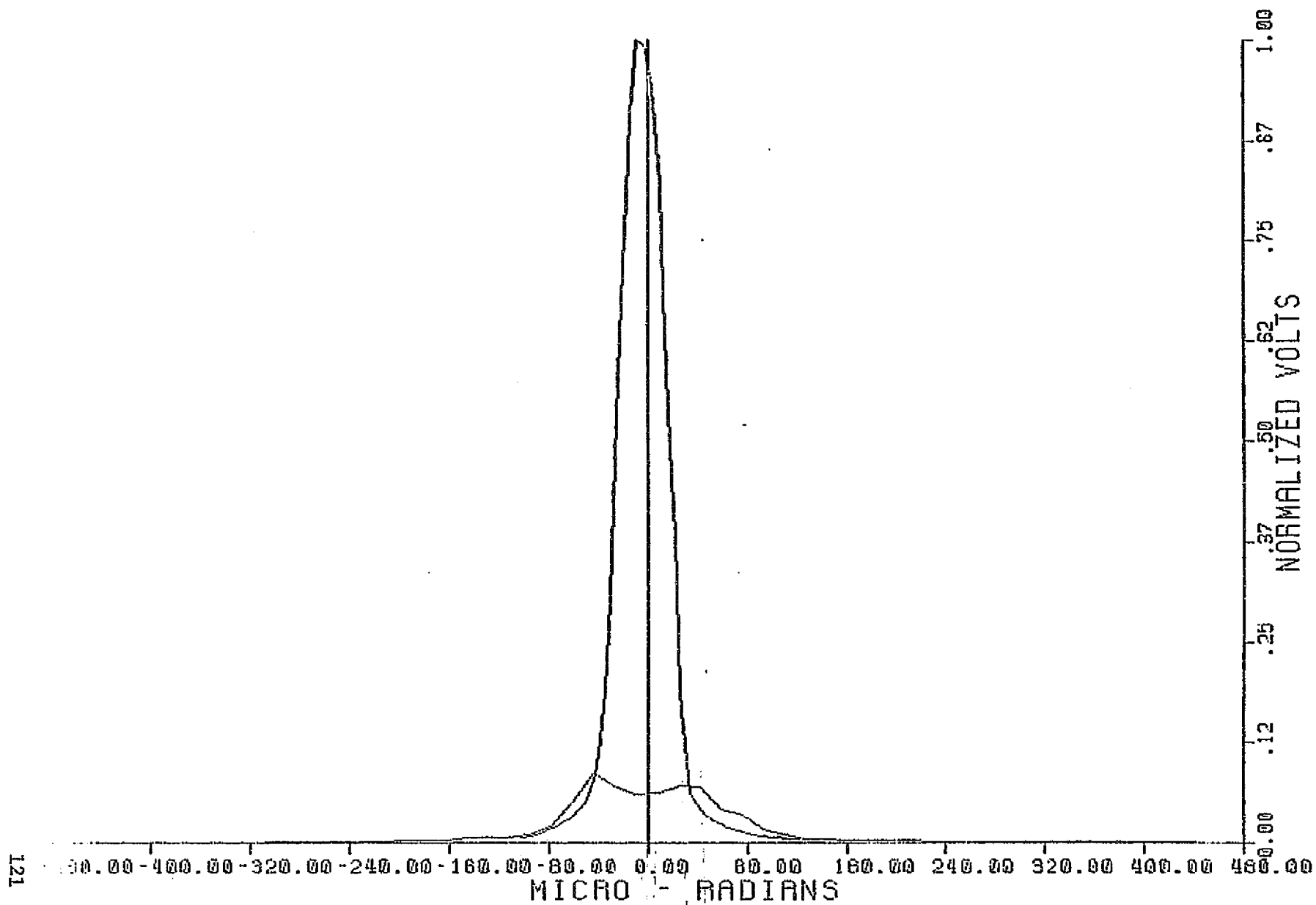

NEAR AND FAR FIELD DATA FOR

Y - AXIS, BAND 5 CHANNEL 1

12-JUN-82

23:17:51

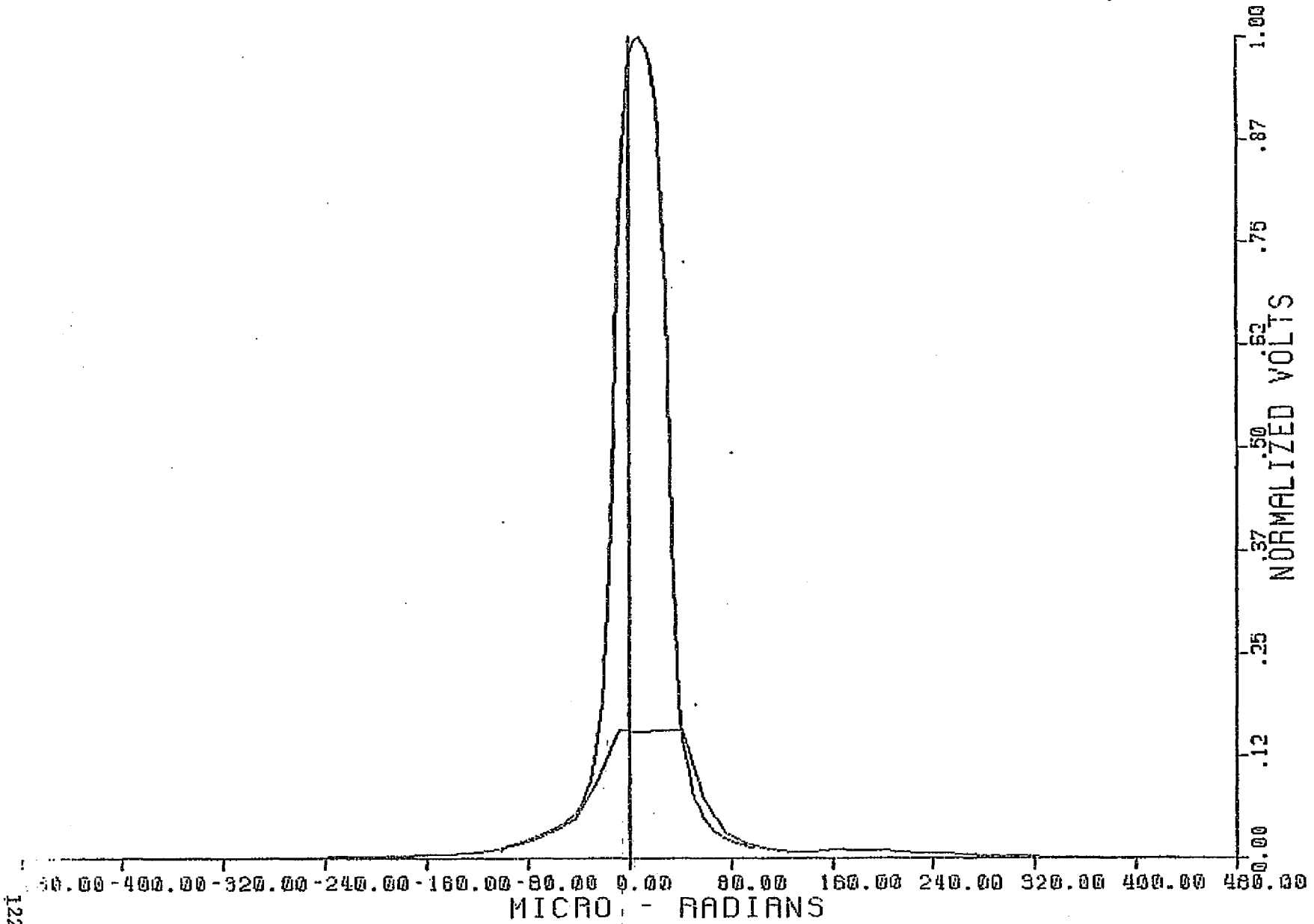

NEAR AND FAR FIELD DATA FOR

X - AXIS, BAND 5 CHANNEL 1

12-JUN-82

00:49:31

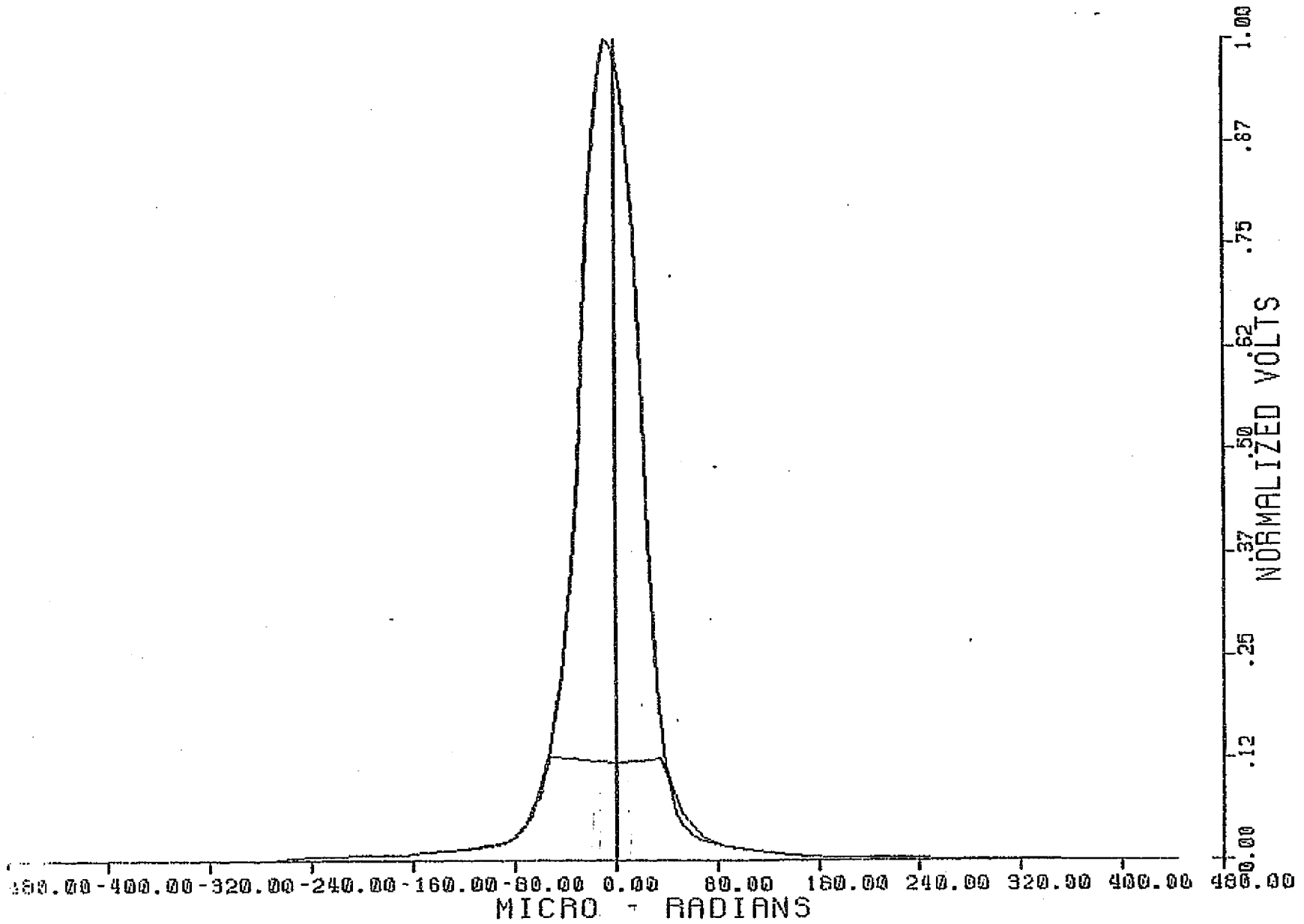

NEAR AND FAR FIELD DATA FOR

Y - AXIS, BAND 5 CHANNEL 2

12-JUN-82

23:19:28

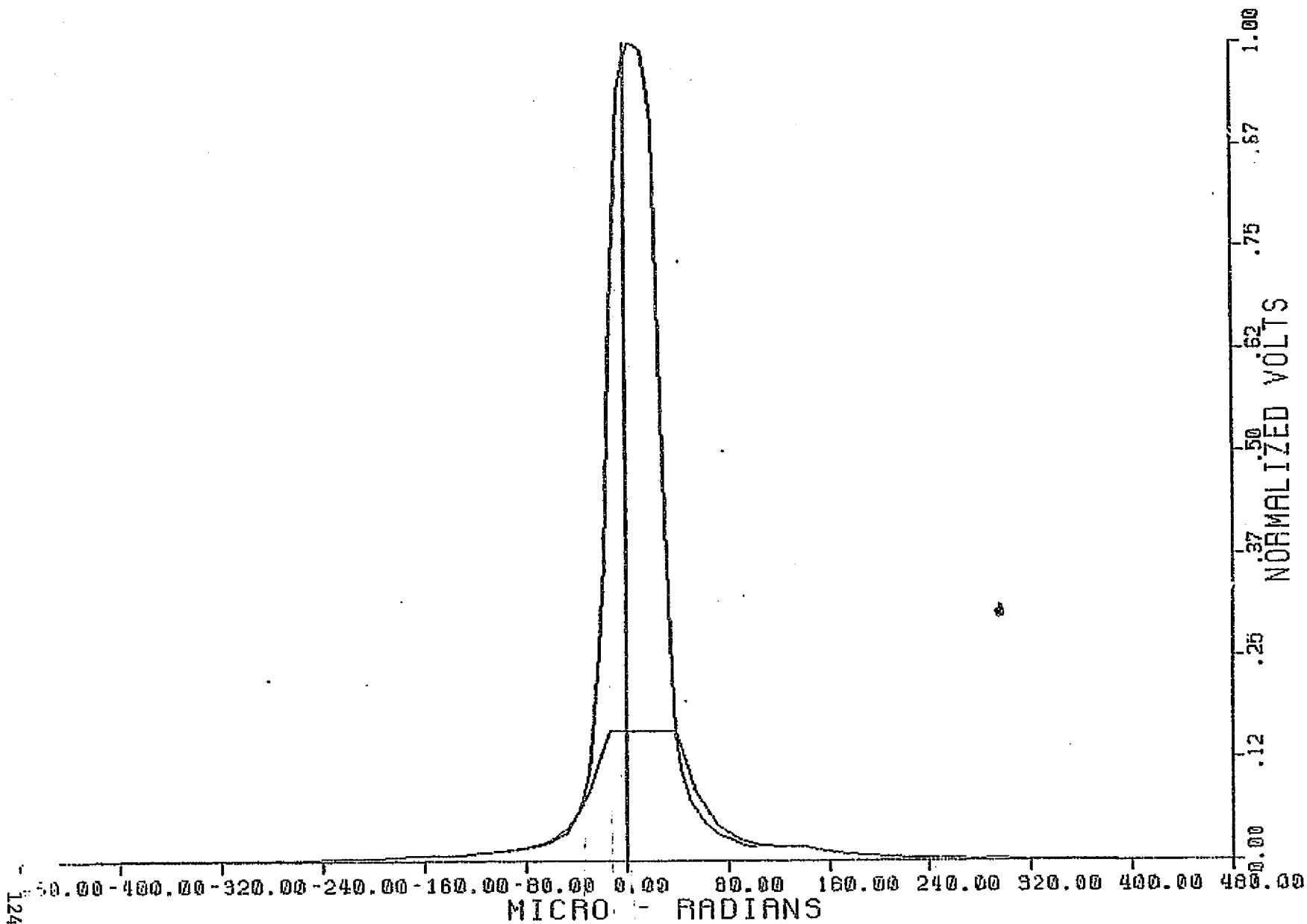

NEAR AND FAR FIELD DATA FOR

X - AXIS. BAND 5 CHANNEL 2

12-JUN-82

00:49:38

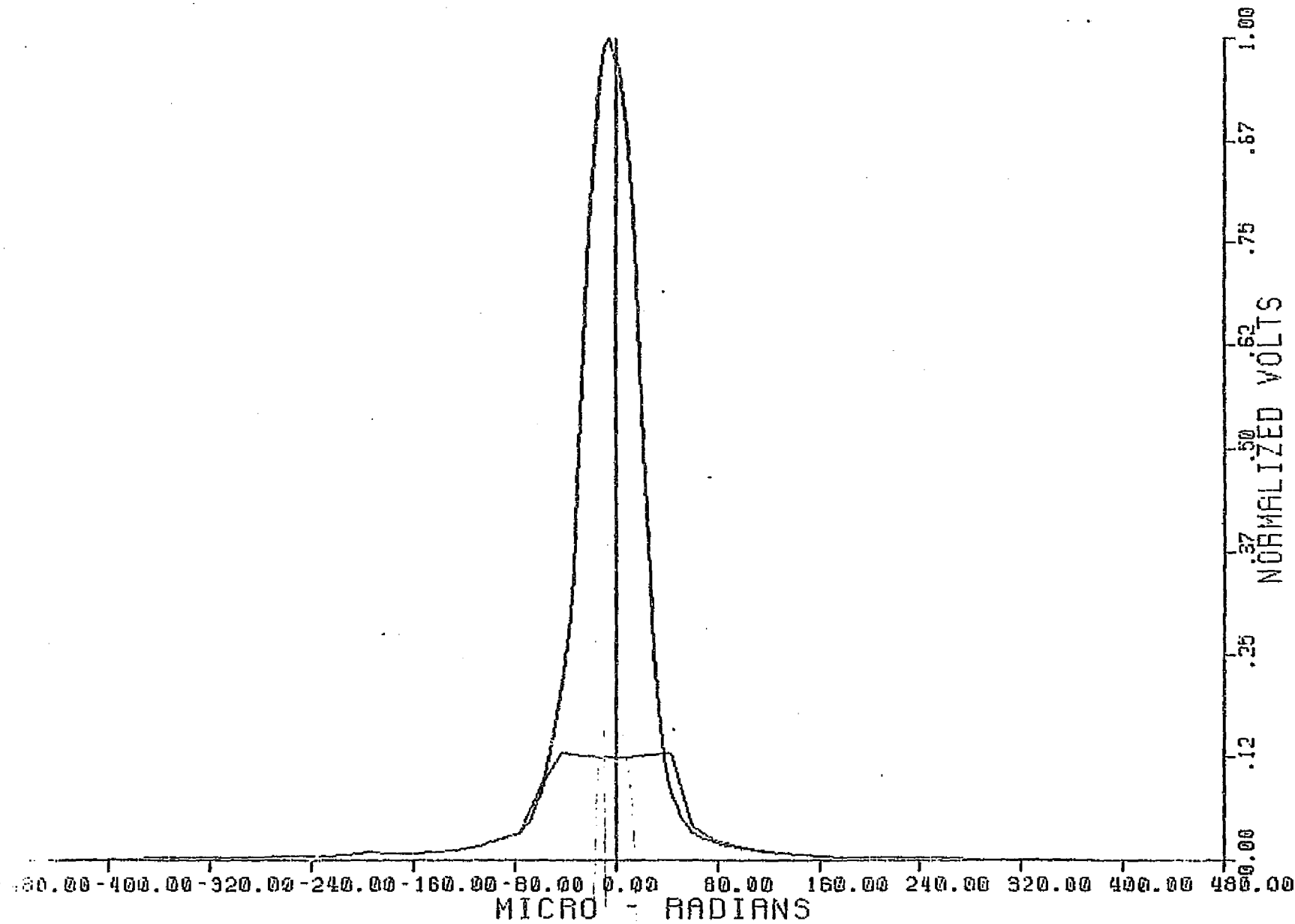

NEAR AND FAR FIELD DATA FOR

Y - AXIS, BAND 5 CHANNEL 15

12-JUN-82

23:17:57

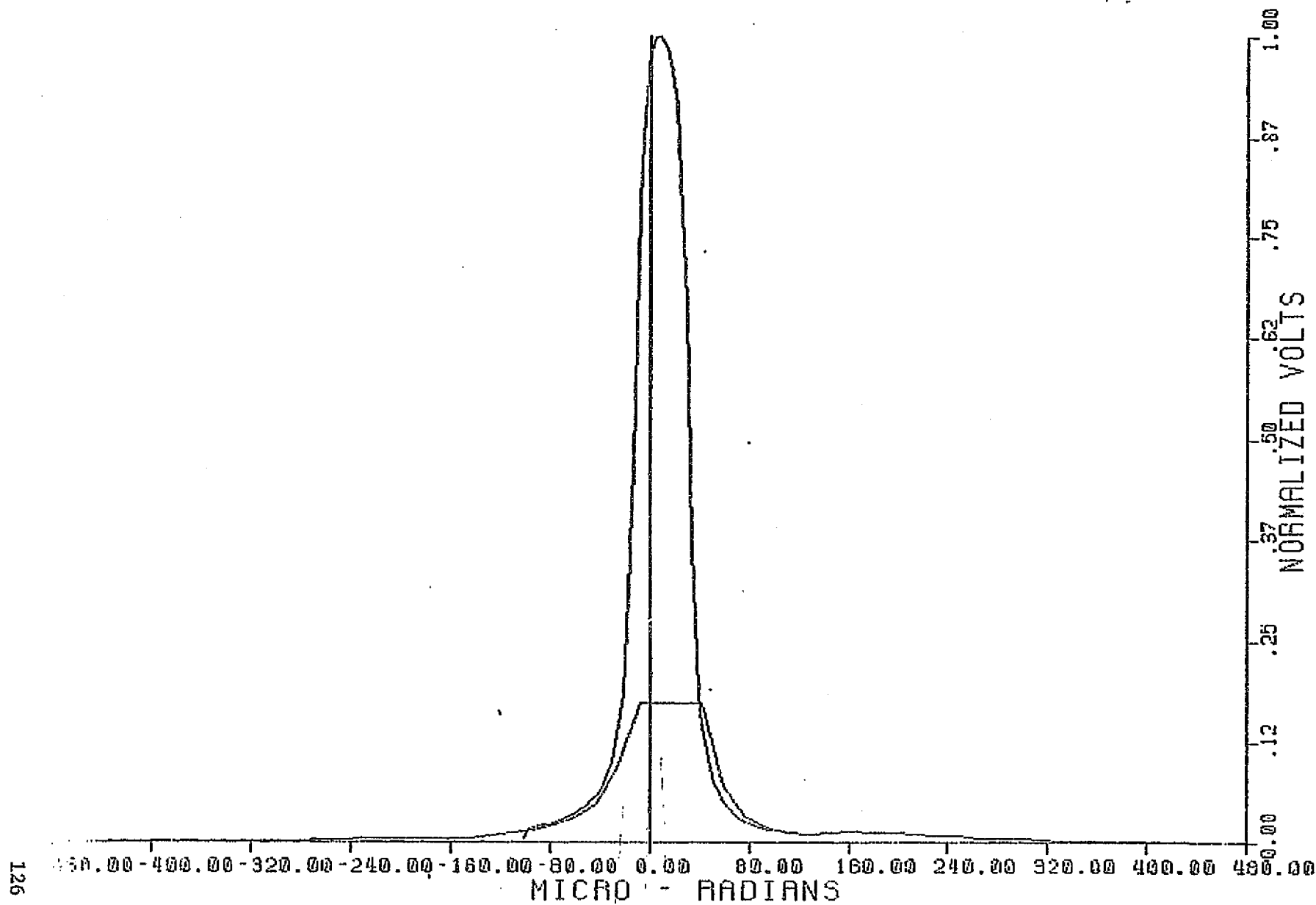

NEAR AND FAR FIELD DATA FOR

X - AXIS, BAND 5 CHANNEL 15

12-JUN-82

00:44:13

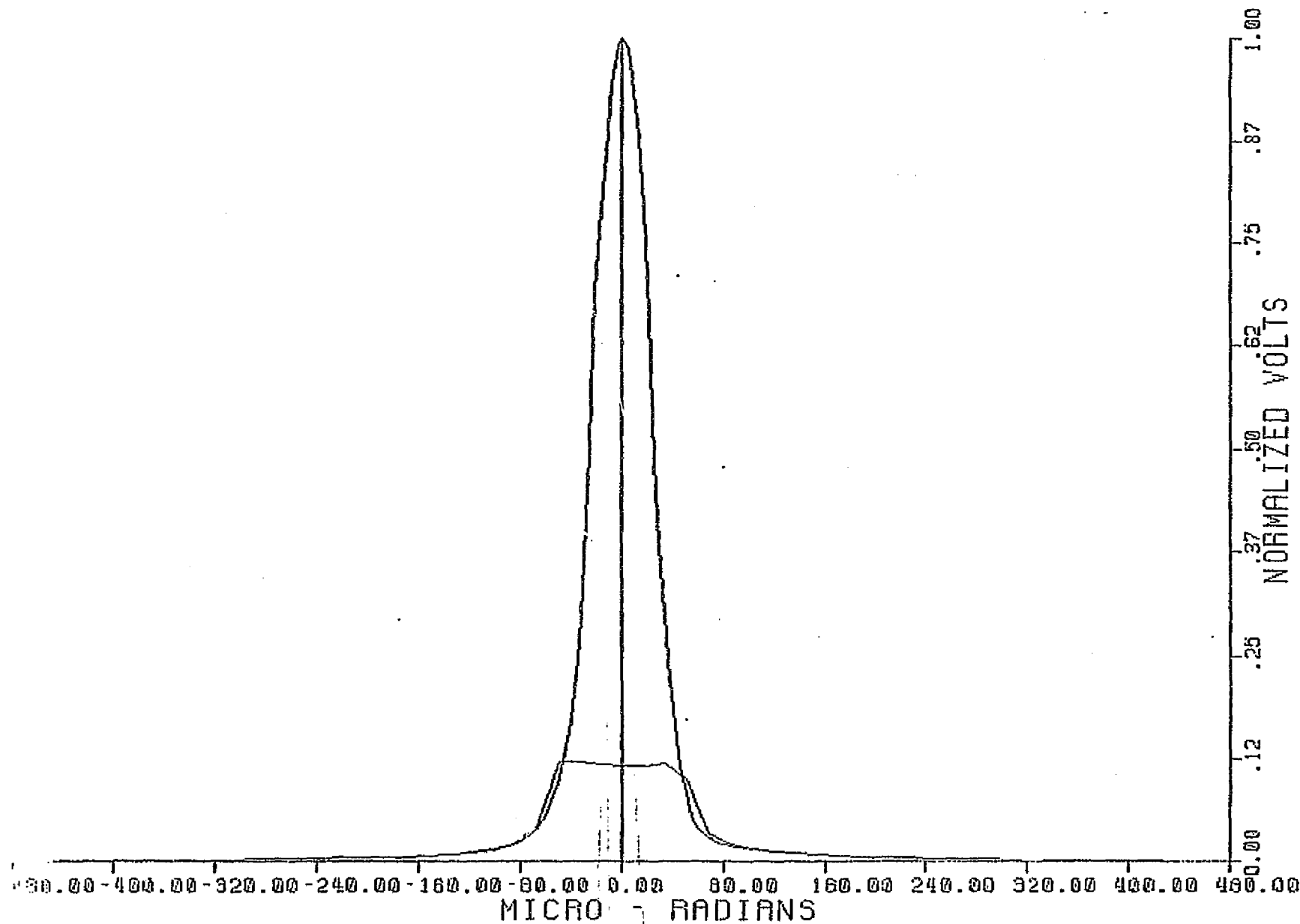

NEAR AND FAR FIELD DATA FOR

Y - AXIS, BAND 5 CHANNEL 16

12-JUN-82

23:19:34

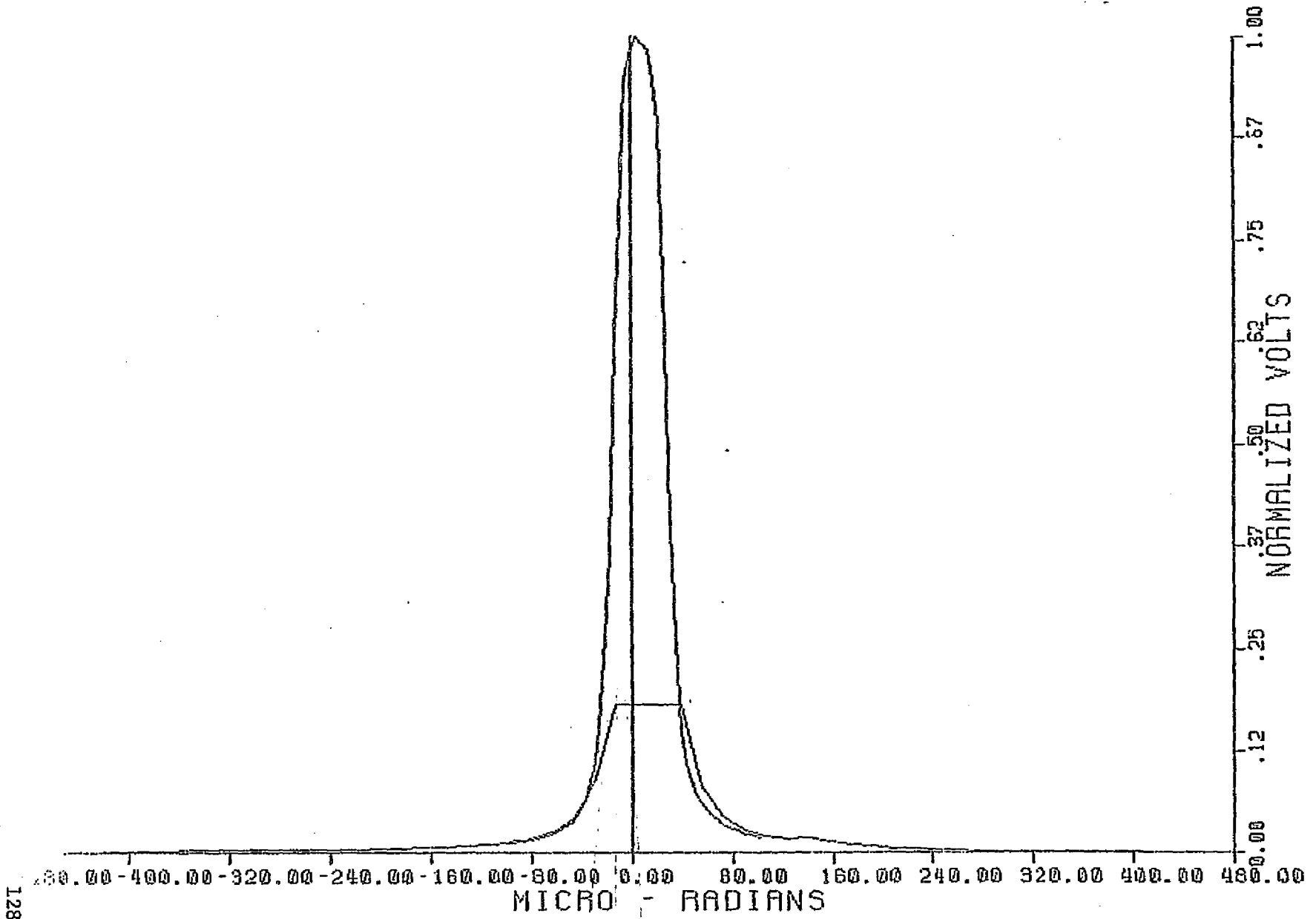

NEAR AND FAR FIELD DATA FOR

X - AXIS, BAND 5 CHANNEL 16

12-JUN-82

00:44:22

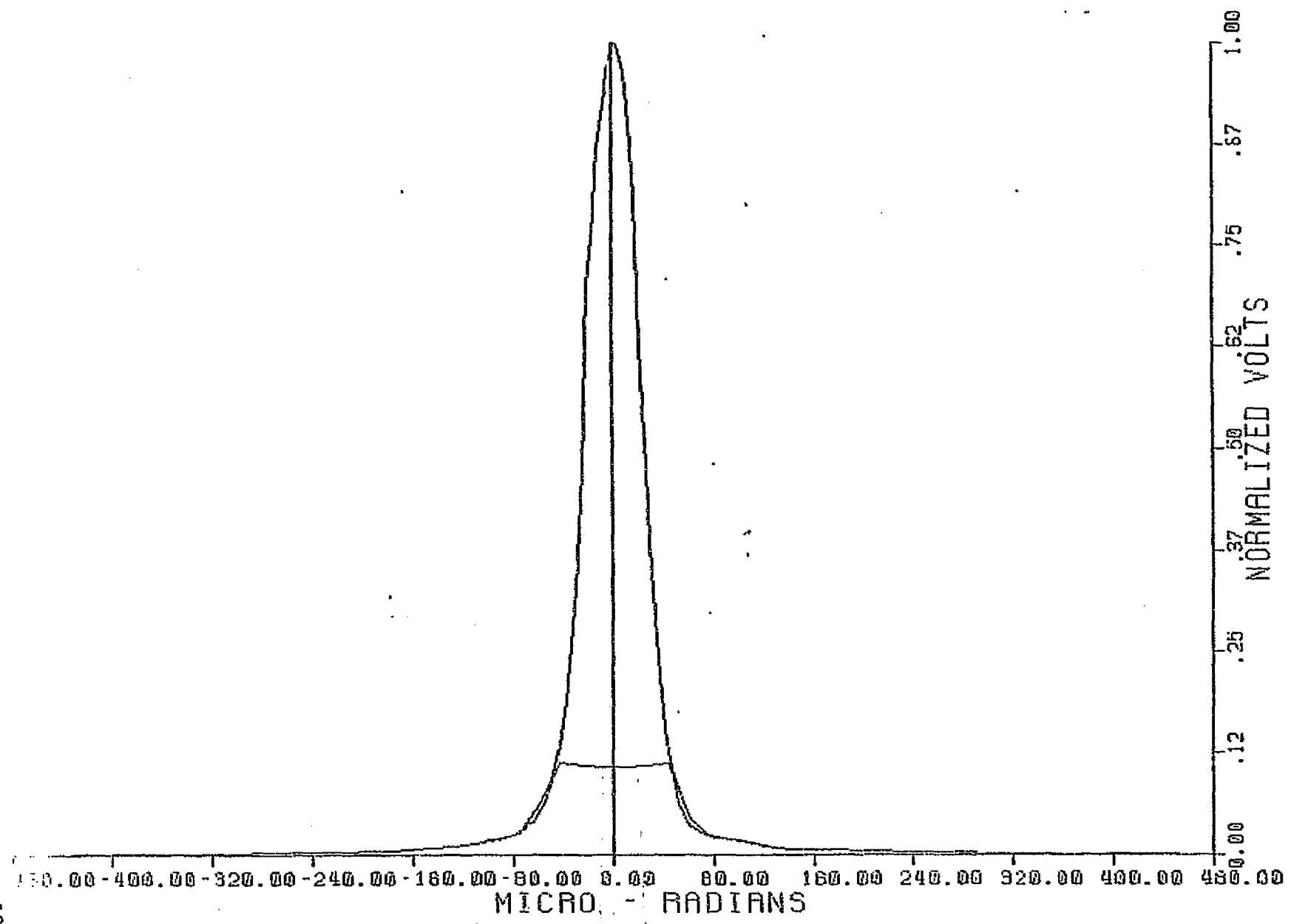

NEAR AND FAR FIELD DATA FOR

Y - AXIS, BAND 7 CHANNEL 1

12-JUN-82

22:37:23

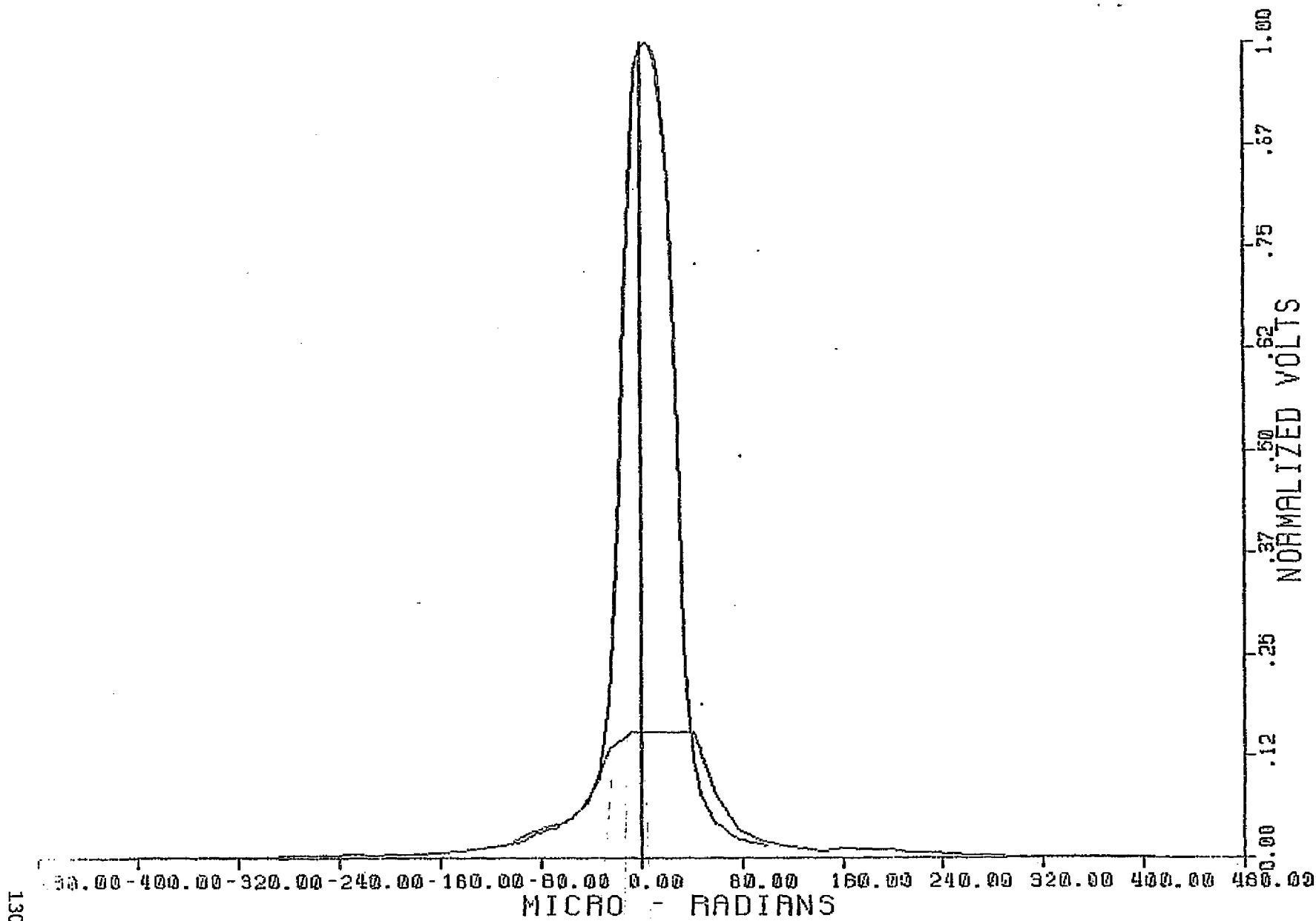

NEAR AND FAR FIELD DATA FOR

X - AXIS, BAND 7 CHANNEL 1

12-JUN-82

21:11:25

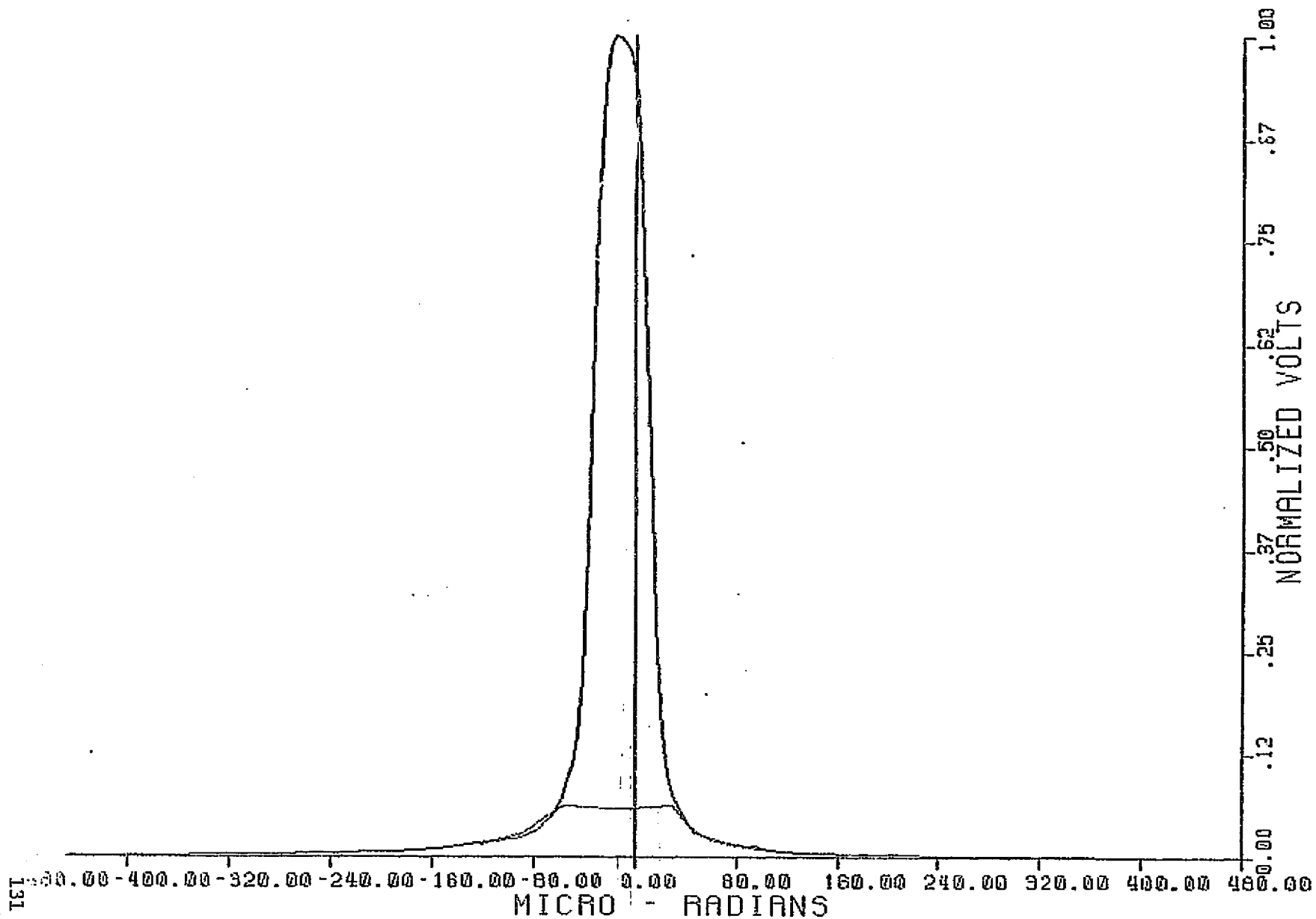

NEAR AND FAR FIELD DATA FOR

Y - AXIS, BAND 7 CHANNEL 2

12 JUN 82

22:39:08

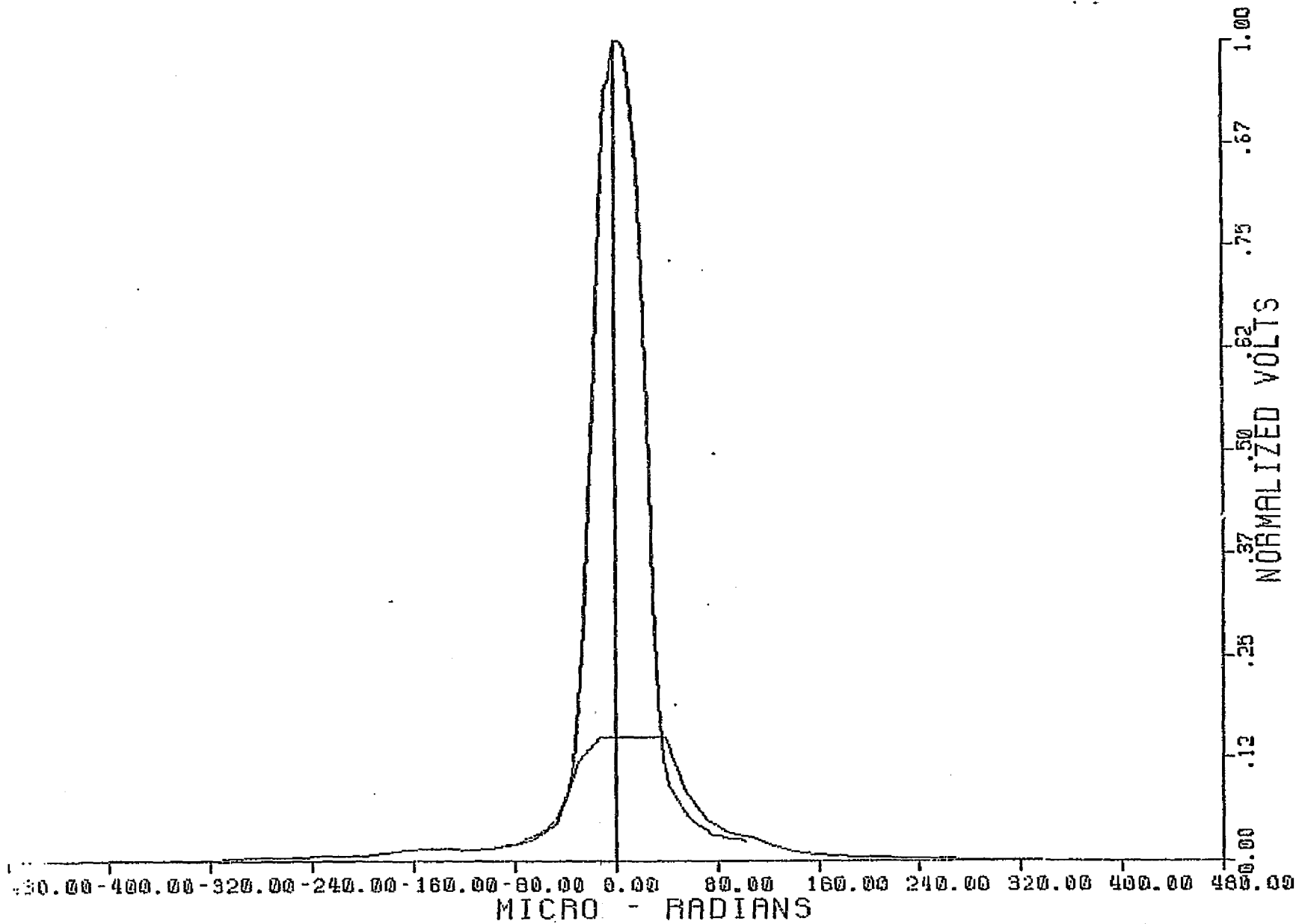

NEAR AND FAR FIELD DATA FOR

X - AXIS, BAND 7 CHANNEL 2

12-JUN-82

21:11:33

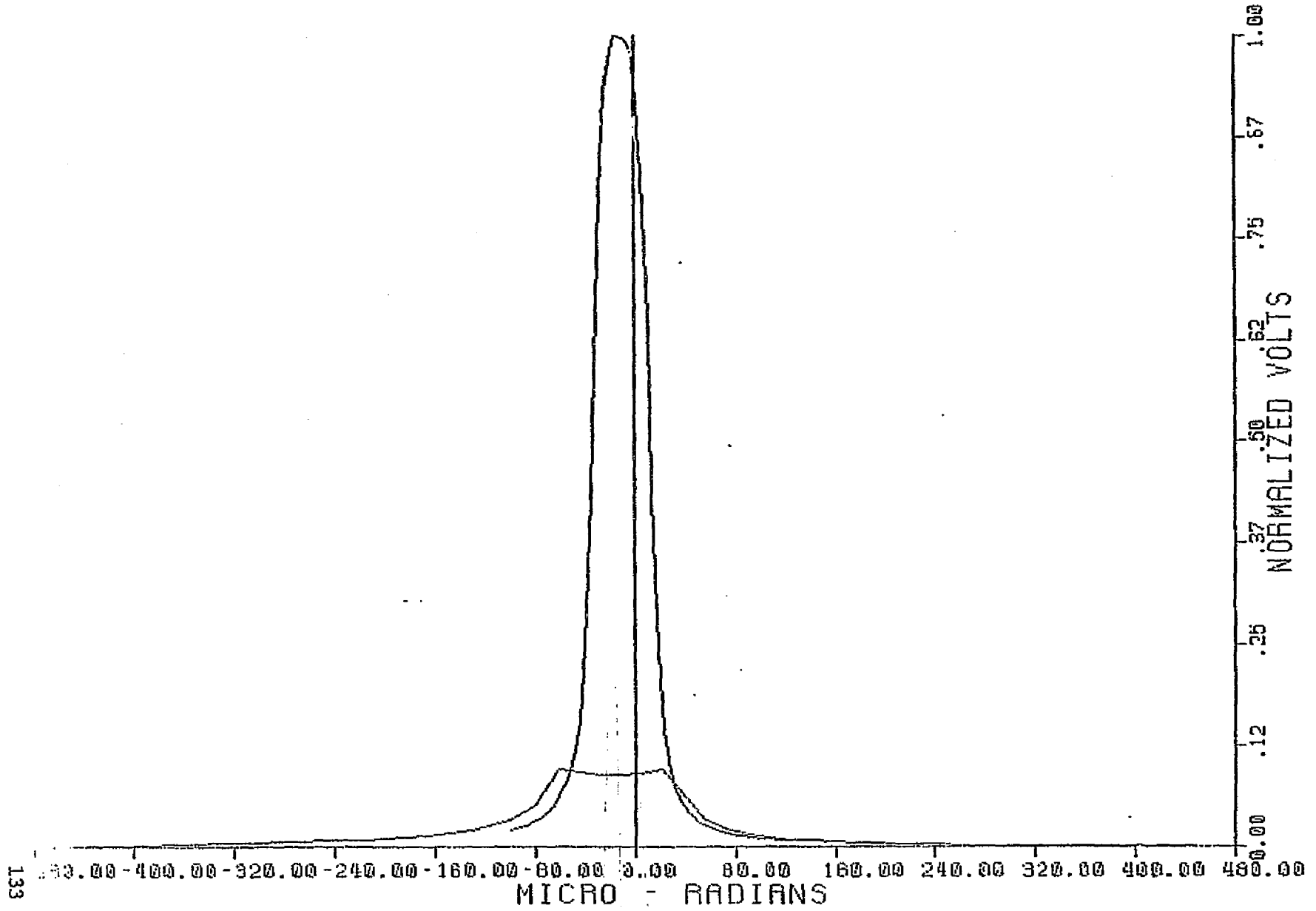

NEAR AND FAR FIELD DATA FOR

Y - AXIS, BAND 7 CHANNEL 15

12-JUN-82

22:37:32

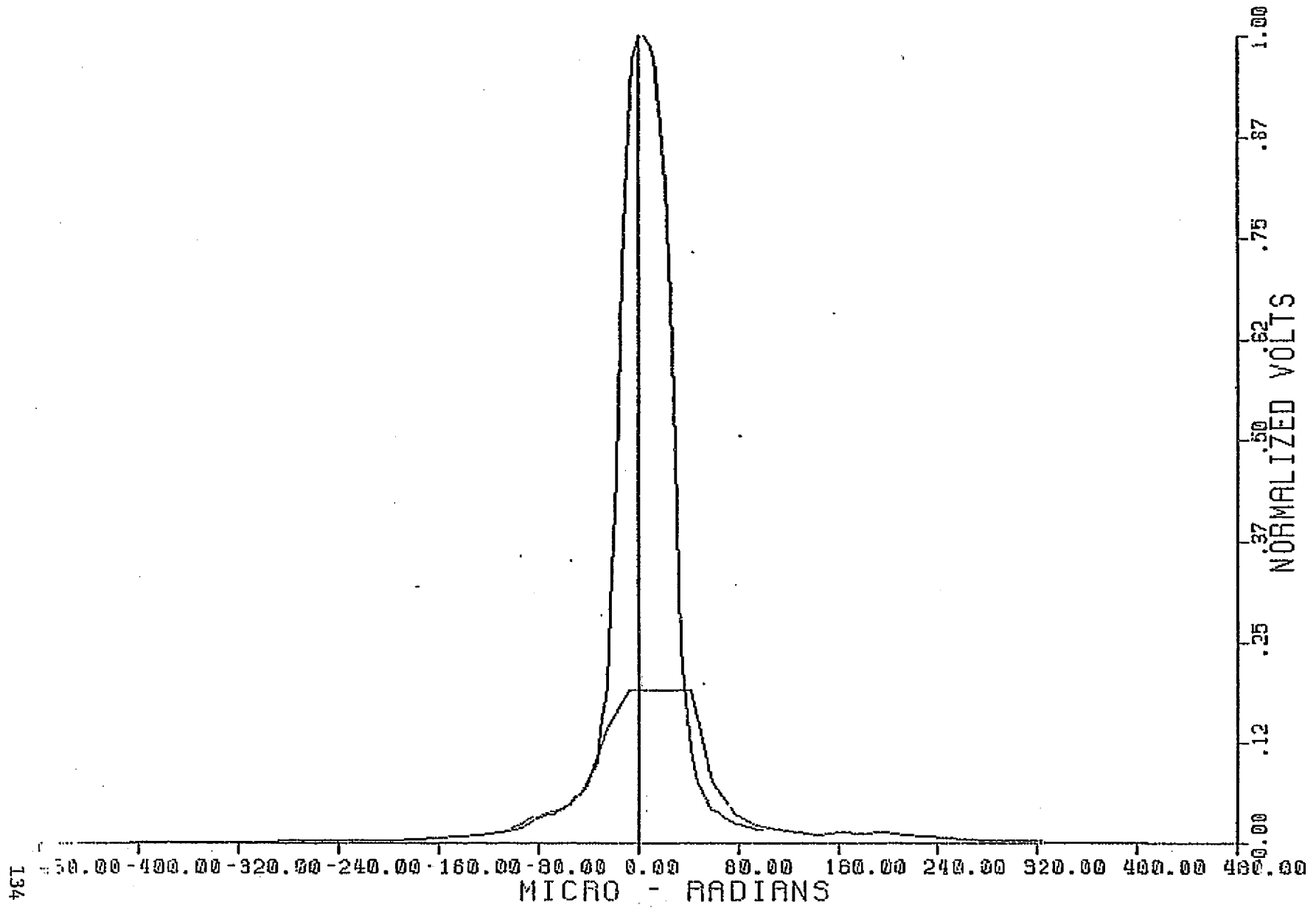

NEAR AND FAR FIELD DATA FOR

X - AXIS, BAND 7 CHANNEL 15

12-JUN-82

21:10:34

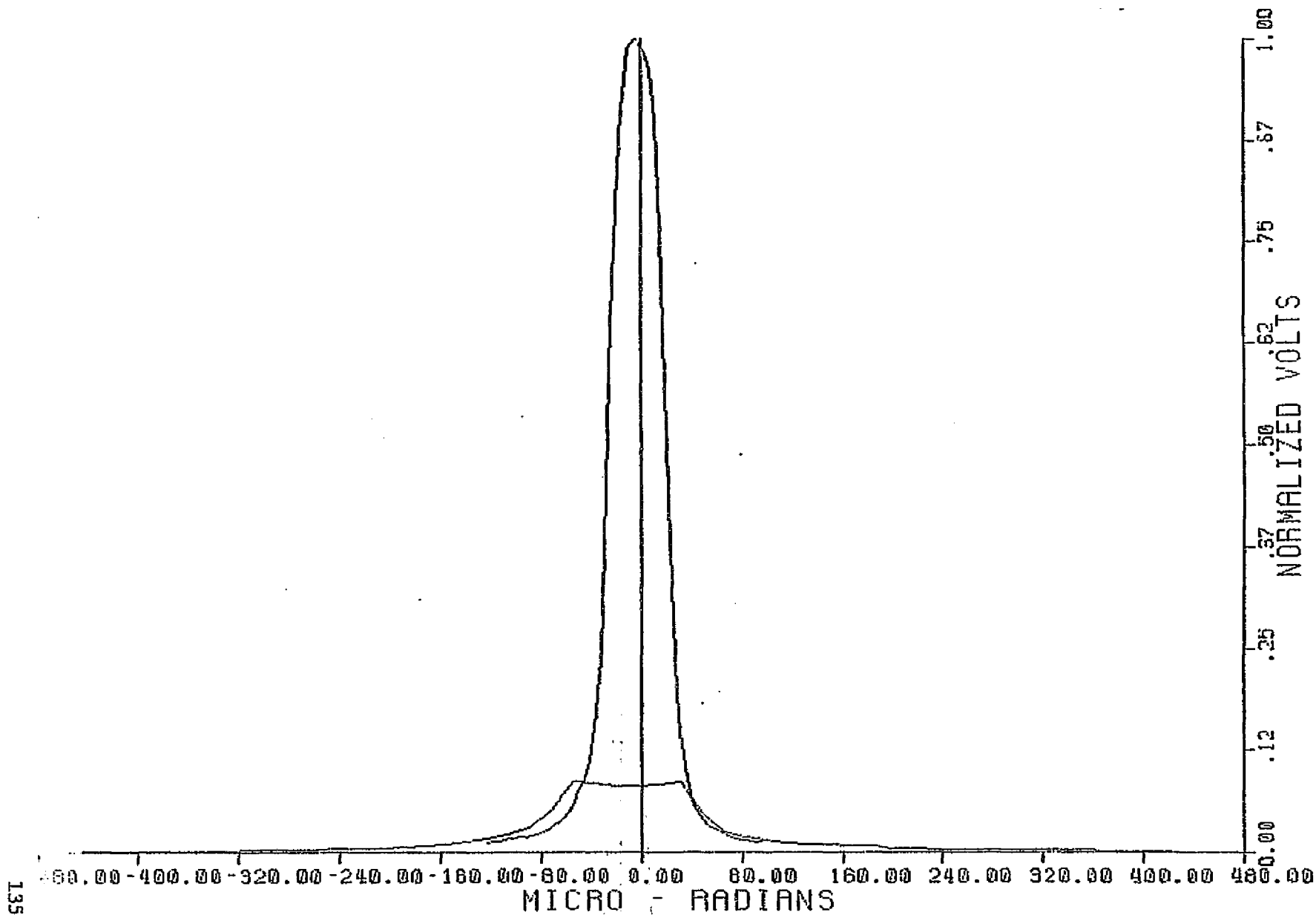

NEAR AND FAR FIELD DATA FOR

Y - AXIS, BAND 7 CHANNEL 16

12-JUN-82

22:39:15

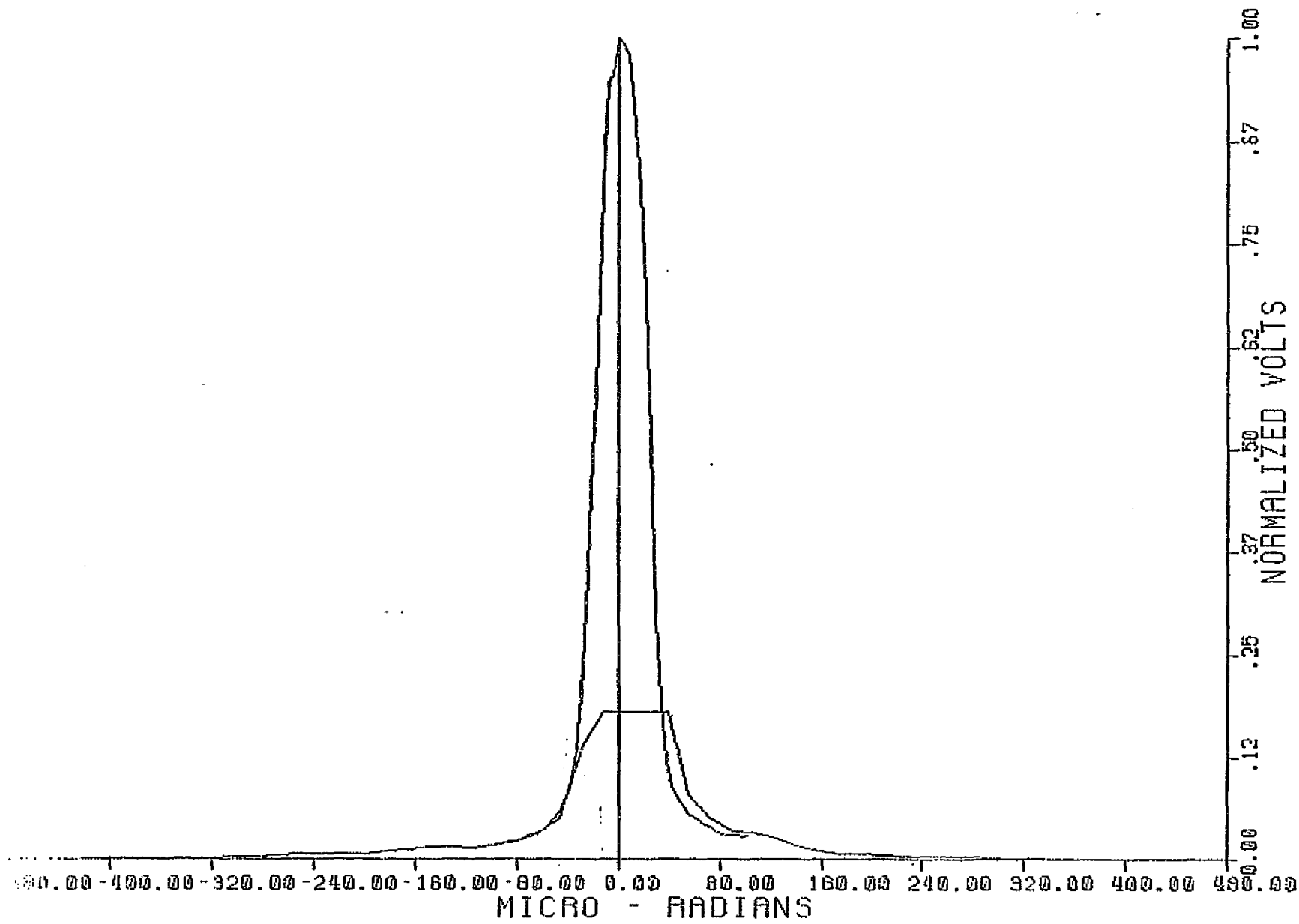

NEAR AND FAR FIELD DATA FOR

X - AXIS, BAND 7 CHANNEL 16

12-JUN-82

21:10:41

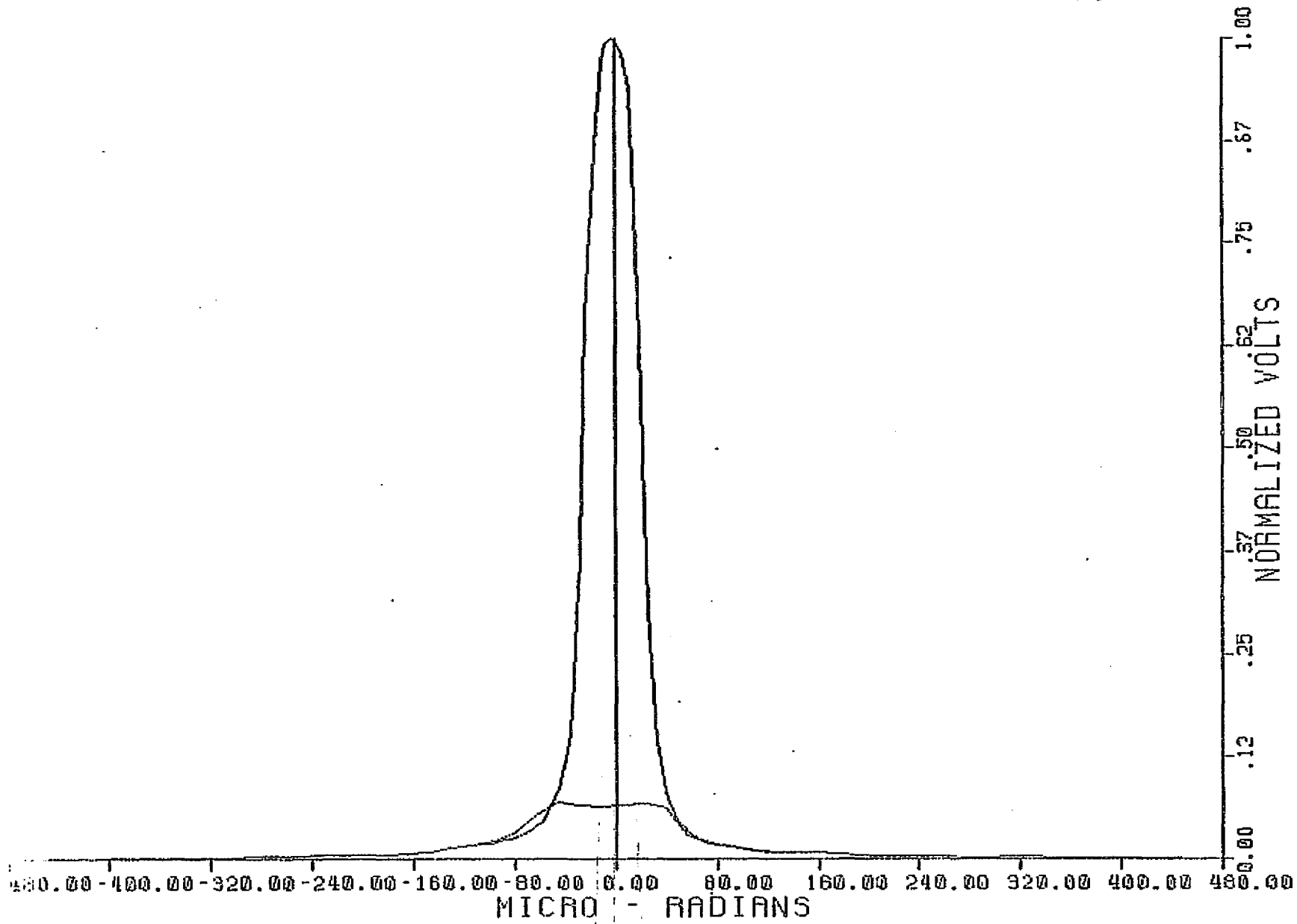

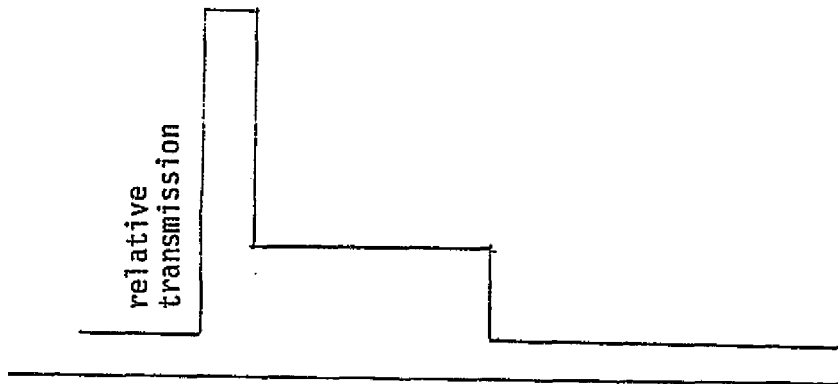
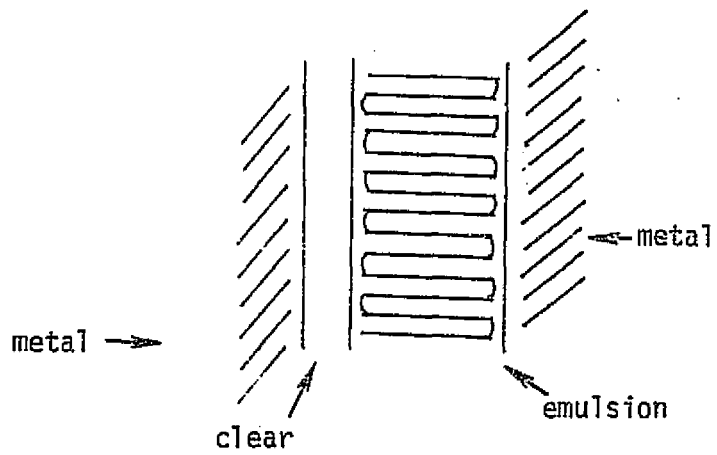
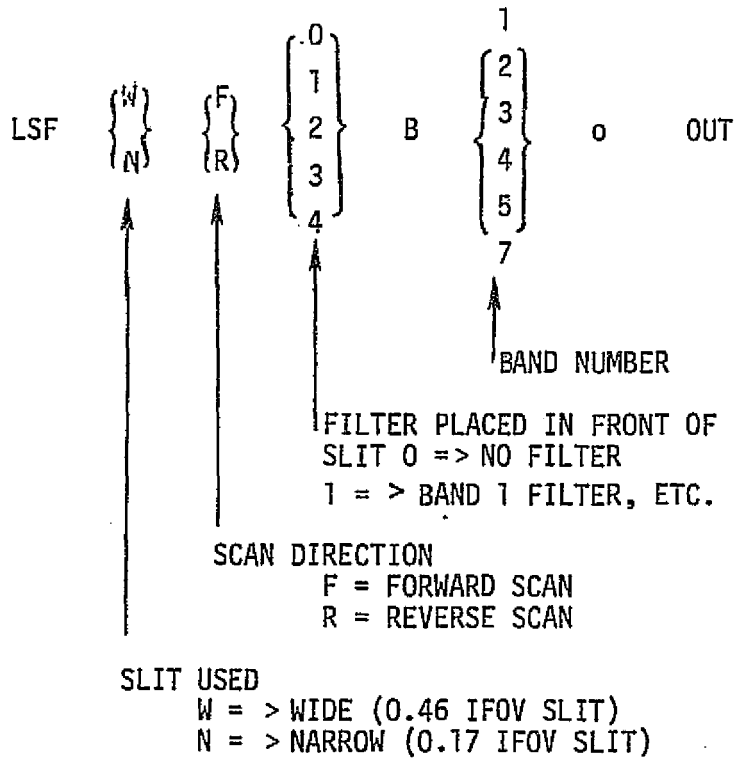

Figure 6.2 - Slit construction and a model of the slit transmission to be used in interpreting data for bands 5 and 7.

Figure 6.3



EXAMPLE:

File LSFWF1B4. OUT contains band 4 data taken during the forward scan. The wide (0.46IFOV) slit was used. A filter, similar to the band 1 bandpass filter was placed in front of the slit.

Figure 6.3

Interpretation of file names on the line spread function data tapes.

BAND 1
 NO FILTER
 FORWARD SCAN
 Ø.46 IFOV SLIT

MF+CP	SCANS	DET 1	DET 2	DET 3	DET 4	DET 5	DET 6	DET 7	DET 8	DET 9	DET 10	DET 11	DET 12	DET 13	DET 14	DET 15	DET 16	
1	Ø	1Ø2	2.86	2.58	2.43	2.48	2.45	2.67	2.35	2.72	2.3Ø	2.17	2.Ø5	2.28	2.25	2.54	2.1Ø	2.58
1	1	7Ø	2.83	2.36	2.49	2.39	2.63	2.7Ø	2.19	2.83	2.23	2.26	2.24	2.19	2.13	2.4Ø	1.93	2.49
1	2	91	2.84	2.55	2.51	2.41	2.31	2.48	2.45	2.63	2.21	2.49	2.1Ø	2.24	2.14	2.51	2.12	2.41
1	3	86	2.8Ø	2.5Ø	2.37	2.31	2.34	2.5Ø	2.24	2.65	1.99	2.4Ø	2.16	2.4Ø	2.2Ø	2.47	2.14	2.45
1	4	93	2.84	2.65	2.45	2.44	2.4Ø	2.54	2.32	2.68	2.16	2.28	2.Ø5	2.44	2.2Ø	2.31	2.13	2.49
1	5	1Ø1	3.Ø6	2.49	2.54	2.52	2.27	2.5Ø	2.26	2.85	2.26	2.11	2.18	2.45	2.26	2.37	1.98	2.49
1	6	92	2.84	2.47	2.58	2.46	2.32	2.58	2.33	2.67	2.32	2.35	2.23	2.32	2.3Ø	2.27	2.11	2.37
1	7	89	2.84	2.6Ø	2.37	2.3Ø	2.37	2.47	2.48	2.61	2.39	2.19	2.22	2.3Ø	2.29	2.4Ø	2.19	2.39
1	8	98	2.9Ø	2.53	2.58	2.38	2.42	2.68	2.33	2.82	2.14	2.42	2.16	2.27	2.17	2.24	2.Ø7	2.47
1	9	92	2.9Ø	2.43	2.51	2.29	2.53	2.59	2.36	2.8Ø	2.3Ø	2.24	2.18	2.22	2.24	2.67	2.14	2.43
1	1Ø	92	2.84	2.51	2.77	2.38	2.32	2.53	2.42	2.8Ø	2.33	2.4Ø	2.27	2.35	2.38	2.52	2.16	2.37
1	11	111	2.86	2.61	2.53	2.39	2.38	2.62	2.46	2.7Ø	2.27	2.3Ø	2.Ø9	2.47	2.17	2.33	2.19	2.27
1	12	79	2.82	2.35	2.35	2.51	2.3Ø	2.49	2.25	2.86	2.22	2.37	2.15	2.66	2.23	2.58	2.Ø6	2.27
1	13	94	2.94	2.49	2.59	2.46	2.44	2.67	2.3Ø	2.73	2.31	2.23	2.Ø6	2.15	2.18	2.48	2.Ø1	2.3Ø
1	14	94	2.84	2.62	2.6Ø	2.43	2.38	2.7Ø	2.33	2.63	2.37	2.37	2.15	2.23	2.32	2.7Ø	2.15	2.6Ø
1	15	98	2.73	2.65	2.39	2.41	2.45	2.54	2.42	2.68	2.35	2.24	1.99	2.3Ø	2.36	2.52	2.Ø5	2.36

FIGURE 6.5 -- A short section of file LSFNFØB1.OUT

LSFNFØB4.OUT;1	LSFNFØB1.OUT;1	LSFNFØB2.OUT;1	LSFNFØB3.OUT;1
LSFNROB3.OUT;1	LSFNFØB5.OUT;1	LSFNROB1.OUT;1	LSFNROB2.OUT;1
LSFWFØB .OUT;1	LSFNROB4.OUT;1	LSFNROB5.OUT;1	LSFWFØB1.OUT;1
LSFWFØB' OUT;1	LSFWFØB3.OUT;1	LSFWFØB4.OUT;1	LSFWFØB5.OUT;1
LSFWF1B4.OUT;1	LSFWF1B1.OUT;1	LSFWF1B2.OUT;1	LSFWF1B3.OUT;1
LSFWF2B4.OUT;1	LSFWF2B1.OUT;1	LSFWF2B2.OUT;1	LSFWF2B3.OUT;1
LSFWF3B4.OUT;1	LSFWF3B1.OUT;1	LSFWF3B2.OUT;1	LSFWF3B3.OUT;1
LSFWF4B4.OUT;1	LSFWF4B1.OUT;1	LSFWF4B2.OUT;1	LSFWF4B3.OUT;1
LSFWRØB4.OUT;1	LSFWRØB1.OUT;1	LSFWRØB2.OUT;1	LSFWRØB3.OUT;1
	LSFWRØB5.OUT;1	LSFWRØB7.OUT;1	

TABLE 6.4 - List of files on line spread function data tape.

LSFNFØB4.OUT;1	LSFNFØB1.OUT;1	LSFNFØB2.OUT;1	LSFNFØB3.OUT;1
LSFNRØB3.OUT;1	LSFNFØB5.OUT;1	LSFNRØB1.OUT;1	LSFNRØB2.OUT;1
LSFWFØB2.OUT;1	LSFNRØB4.OUT;1	LSFNRØB5.OUT;1	LSFWFØB1.OUT;1
LSFWFØB7.OUT;1	LSFWFØB3.OUT;1	LSFWFØB4.OUT;1	LSFWFØB5.OUT;1
LSFWF1B4.OUT;1	LSFWF1B1.OUT;1	LSFWF1B2.OUT;1	LSFWF1B3.OUT;1
LSFWF2B4.OUT;1	LSFWF2B1.OUT;1	LSFWF2B2.OUT;1	LSFWF2B3.OUT;1
LSFWF3B4.OUT;1	LSFWF3B1.OUT;1	LSFWF3B2.OUT;1	LSFWF3B3.OUT;1
LSFWF4B4.OUT;1	LSFWF4B1.OUT;1	LSFWF4B2.OUT;1	LSFWF4B3.OUT;1
LSFWRØB4.OUT;1	LSFWRØB1.OUT;1	LSFWRØB2.OUT;1	LSFWRØB3.OUT;1
	LSFWRØB5.OUT;1	LSFWRØB7.OUT;1	

TABLE 6.4 - List of files on line spread function data tape.

BAND 1
 NO FILTER
 FORWARD SCAN
 0.46 IFOV SLIT

MF+CP	SCANS	DET 1	DET 2	DET 3	DET 4	DET 5	DET 6	DET 7	DET 8	DET 9	DET 10	DET 11	DET 12	DET 13	DET 14	DET 15	DET 16	
1	0	102	2.86	2.58	2.43	2.48	2.45	2.67	2.35	2.72	2.30	2.17	2.05	2.28	2.25	2.54	2.10	2.58
1	1	70	2.83	2.36	2.49	2.39	2.63	2.70	2.19	2.83	2.23	2.26	2.24	2.19	2.13	2.40	1.93	2.49
1	2	91	2.84	2.55	2.51	2.41	2.31	2.48	2.45	2.63	2.21	2.49	2.10	2.24	2.14	2.51	2.12	2.41
1	3	86	2.80	2.50	2.37	2.31	2.34	2.50	2.24	2.65	1.99	2.40	2.16	2.40	2.20	2.47	2.14	2.45
1	4	93	2.84	2.65	2.45	2.44	2.40	2.54	2.32	2.68	2.16	2.28	2.05	2.44	2.20	2.31	2.13	2.49
1	5	101	3.06	2.49	2.54	2.52	2.27	2.50	2.26	2.85	2.26	2.11	2.18	2.45	2.26	2.37	1.98	2.49
1	6	92	2.84	2.47	2.58	2.46	2.32	2.58	2.33	2.67	2.32	2.35	2.23	2.32	2.30	2.27	2.11	2.37
1	7	89	2.84	2.60	2.37	2.30	2.37	2.47	2.48	2.61	2.39	2.19	2.22	2.30	2.29	2.40	2.19	2.39
1	8	98	2.90	2.53	2.58	2.38	2.42	2.68	2.33	2.82	2.14	2.42	2.16	2.27	2.17	2.24	2.07	2.47
1	9	92	2.90	2.43	2.51	2.29	2.53	2.59	2.36	2.80	2.30	2.24	2.18	2.22	2.24	2.67	2.14	2.43
1	10	92	2.84	2.51	2.77	2.38	2.32	2.53	2.42	2.80	2.33	2.40	2.27	2.35	2.38	2.52	2.16	2.37
1	11	111	2.86	2.61	2.53	2.39	2.38	2.62	2.46	2.70	2.27	2.30	2.09	2.47	2.17	2.33	2.19	2.27
1	12	79	2.82	2.35	2.35	2.51	2.30	2.49	2.25	2.86	2.22	2.37	2.15	2.66	2.23	2.58	2.06	2.27
1	13	94	2.34	2.49	2.59	2.46	2.44	2.67	2.30	2.73	2.31	2.23	2.06	2.15	2.18	2.48	2.01	2.30
1	14	94	2.34	2.62	2.60	2.43	2.38	2.70	2.33	2.63	2.37	2.37	2.15	2.23	2.32	2.70	2.15	2.60
1	15	98	2.73	2.65	2.39	2.41	2.45	2.54	2.42	2.68	2.35	2.24	1.99	2.30	2.36	2.52	2.05	2.36

FIGURE 6.5 -- A short section of file LSFNF0B1.OUT

```

220      READ (2,210) N(I), CURV(I), CURX(I), CURZ(I), CURR(I)
210      FORMAT (1X,I4,4(2X,F11.6))
          IF (N(I) .EQ. 0) THEN
              GO TO 220
          ENDIF
          PRINT 230, N(I), CURV(I), CURX(I), CURZ(I), CURR(I)
230      FORMAT (1X,I4,4(2X,F11.6))
C       WRITE (3,240) N(I), CURV(I), CURX(I), CURZ(I), CURR(I)
C 240    FORMAT (1X,I4,4(2X,F11.6))
200    CONTINUE
C
C DO THE COMPUTATIONS
C
          PRINT 250, NUM1
250    FORMAT (/,' THE FOLLOWING ARE THE OFFSET VALUES FOR SURFACE ',I4)
          PRINT 60, NUM2
          PRINT*, ' SURF          Y          X          Z          R'
          PRINT*, '
C
C       WRITE (3,50) NUM1
C       WRITE (3,60) NUM2
C       WRITE (3,250)
C 250    FORMAT (' SURF          Y          X          Z          R')
C
          DO 260 I = NUM1, NUM2
              CURV(I) = REFY(I) - CURV(I)
              CURX(I) = REFX(I) - CURX(I)
              CURZ(I) = REFZ(I) - CURZ(I)
              CURR(I) = REFR(I) - CURR(I)
              PRINT 270,N(I),CURV(I),CURX(I),CURZ(I),CURR(I)
C       WRITE (3,270) N(I),CURV(I), CURX(I), CURZ(I), CURR(I)
270    FORMAT (1X,I4,4(2X,F11.6))
260    CONTINUE
C
450    CONTINUE
          PRINT*, 'ALL RAYS HAVE BEEN COMPUTED'
C
C       ENDFILE (UNIT = 3)
C       CLOSE (2)
500    END

```

```

60 PRINT 60, NUM2
   FORMAT (' THROUGH ',I4)
   PRINT*, ' SURF          Y          X          Z          R'
   PRINT*, ' '

C
C
C   WRITE (3,50) NUM1
C   WRITE (3,60) NUM2
C   WRITE (3,70)
C 70  FORMAT (' SURF          Y          X          Z          R')
C
C READ, WRITE AND PRINT DATA FOR EACH SURFACE REQUESTED (REFERENCE RAYS)
C
C   DO I = NUM1, NUM2
90   READ (2,80) N(I), REFY(I), REFX(I), REFZ(I), REFR(I)
80   FORMAT (1X,I4,4(2X,F11.6))
      IF (N(I) .EQ. 0) THEN
          GO TO 90
      ENDIF
      PRINT 100, N(I), REFY(I), REFX(I), REFZ(I), REFR(I)
100  FORMAT (1X,I4,4(2X,F11.6))
C   WRITE (3,120) N(I), REFY(I), REFX(I), REFZ(I), REFR(I)
C 120  FORMAT (1X,I4,4(2X,F11.6))
      END DO

C
C SEARCH FOR STARTING SURFACE NUMBER OF CURRENT RAY
C
C   TEST FOR "SURF"
C
C   DO WHILE (END .NE. END)
      CONTINUE
   END DO

C   KEY = A
C   DO WHILE (KEY .NE. 'SURF')
      READ (2,10) KEY
      PRINT 20, KEY
   END DO

C
C FIND SURFACE NUM1
C
C   N(SURF) = 0
C   DO WHILE (N(SURF) .LT. NUM1-1)
150  READ (2,150) N(SURF)
      FORMAT (1X,I4)
      PRINT 160, N(SURF)
160  FORMAT (1X,I4)
   END DO

C
C READ, WRITE AND PRINT APPLICABLE SURFACES PLUS DATA (CURRENT RAYS)
C
C   PRINT 165, NUM1
165  FORMAT (/,' THE FOLLOWING ARE THE CURRENT RAYS FOR SURFACE ',I4)
      PRINT 60, NUM2
      PRINT*, ' SURF          Y          X          Z          R'
      PRINT*, ' '

C
C
C   WRITE (3,165) NUM1
C   WRITE (3,60) NUM2
C   WRITE (3,170)
C 170  FORMAT (' SURF          Y          X          Z          R')
C
C 145 DO 200 I = NUM1, NUM2

```

```

C THIS FILE FINDS THE CORRECT SURFACES TO BE COMPUTED AND
C PRINTS THE END MESSAGE....BUT IT ONLY GOES THROUGH THE
C FIRST SET OF DATA
C
C THIS PROGRAM WILL SUBTRACT ONE GROUP OF DATA FROM ANOTHER GROUP OF
C DATA, LINE BY LINE. IT CONSISTS OF COLUMNS X, Y, Z, AND R (WITH
C SURFACE NUMBERS INCLUDED)
C
    INTEGER NUM1, NUM2, TOTAL, SURF, I, KEY
    PARAMETER (SURF=75)
    INTEGER N(SURF)
    REAL CURX(SURF), CURV(SURF), CURZ(SURF), CURR(SURF)
    REAL REFV(SURF), REFY(SURF), REFZ(SURF), REFR(SURF)
C
C ENTER SURFACES TO BE COMPUTED
C
    PRINT*, 'ENTER THE FIRST SURFACE YOU WOULD LIKE TO COMPUTE'
    READ*, NUM1
    PRINT*, 'ENTER THE LAST SURFACE YOU WOULD LIKE TO COMPUTE'
    READ*, NUM2
    PRINT*, ' '
C
    IF (NUM1 .GE. NUM2) THEN
        PRINT*, 'THE FIRST SURFACE IS LARGER THAN THE LAST...'
        PRINT*, 'CANNOT COMPUTE OFFSETS'
        GO TO 500
    ELSE
        CONTINUE
    ENDIF
C
    TOTAL=NUM2 - NUM1 + 1
C
C OPEN AND READ THE FILE PRINTER.LIS
C
    OPEN (UNIT=2, NAME='PRINTER.LIS', TYPE='OLD')
C
C LOCATE FIRST SURFACE - NUM1 - BY USING SUBROUTINE SEARCH
C
C TEST FOR "SURF"
C
    DO WHILE (KEY .NE. 'SURF')
        READ (2,10,END=450) KEY
    10     FORMAT (1X,A4)
        PRINT 20, KEY
    20     FORMAT (1X,A4)
    END DO
C
C FIND SURFACE NUM1
C
    DO WHILE (N(SURF) .LT. NUM1-1)
        READ (2,30) N(SURF)
    30     FORMAT (1X,I4)
        PRINT 40, N(SURF)
    40     FORMAT (1X,I4)
    END DO
C
C OPEN THE FILE OFFSET.DAT
C
    OPEN (UNIT = 3, NAME='OFFSET', TYPE='NEW')
C
    PRINT 50, NUM1
    50     FORMAT (/, ' THE FOLLOWING ARE THE REFERENCE RAYS FOR SURFACE ',I4)

```

SANTA BARBARA RESEARCH CENTER
A Subsidiary of Hughes Aircraft Company
INTERNAL MEMORANDUM

TO: J.L. Engel

DATE: November 19, 1982
REF: HS236-8163 SED 230

SUBJECT: Light Leaks in the Prime Focal
Plane Assembly - II

FROM: D. Brandshaft
BLDG: B11 MS: 40
EXT: 6343

Reference 1: Light Leaks in Prime Focal Plane Assembly HS236-8115

A family of light leaks was discovered in the F-1 prime focal plane assembly during ACO7 testing. Since then, they have been examined in special tests conducted at SBRC (STR #017) and GE (8-Oct-82). This memo describes our current understanding of the light leak data. It includes a restatement of the relevant data in ref. 1 and a report on a partial analysis of the data taken at GE. (Full analysis of the data has been delayed by computer scheduling conflicts.) There is every reason to believe that a similar, but as yet undetected, set of light leaks exists in the PF model TM.

The light leaks are thought to have the following properties:

1. They do not affect the cooled focal plane.
2. They affect all four bands in the prime focal plane
3. They appear a secondary maxima in the scan direction line spread function (see figures 1 and 2 and computer plots). There may be as many as four such maxima associated with each band - two on each side of the principle maximum.
4. The scan direction coordinates of the light leaks are given in table 2. Their position is the same for both the odd and even half-bands. (The odd and even detectors are displaced from each other by 2.5 IFOV's. There are no corresponding displacements among the light leaks). The light leaks ROUGHLY 20 IFOV's wide in the track direction by 1 IFOV in the scan direction.
5. They are white light leaks in the sense that the leaked radiation does not pass through the filters which define the spectral responses of the prime focal plane bands. However, the channel response to leaked radiation does depend on the particular light leak involved. (See table 3).
6. The magnitude of the leaks is the same for all detectors in a given half-band but varies from half-band to half-band. The best available estimates of the magnitudes of the leaks are given in Table 2. Roughly speaking, this table can be interpreted as saying that if the TM is looking at a uniform scene for which all detectors in all bands should have an output of 100 counts, then the even channels of band 1 will actually have an output of 100.7 counts, the odd channels in band 1 147

will have an output of 101.4 counts, the even channels in band 2 will have an output of 100.2 counts, etc. .

The light leaks were discovered during testing for ACO7 (spatial coverage). In this test a line source (actually a slit with the image of a lamp filament focused on it) in the collimator focal plane is projected onto the TM focal plane. With the scan mirror locked, the slit, and hence its image in the TM focal plane, is moved in order to map out the line spread function of selected TM detectors. Figures 1 and 2 show the scan direction line spread functions for detectors 8 of bands 1 and 4. A relatively wide (0.9 IFOV) slit was used in order to maintain an adequate signal-to-noise ratio. The small peaks numbered 1-4 are the white light leaks. Similar leaks were visible in quick scans of bands 2 and 3. No leaks were observed in bands 5 and 7.

In order to investigate the spectral properties of the leaks, the band 4 witness filter was placed between the lamp and the slit. Thus, only light in the band 4 bandpass region reached the slit. The output of detector 8 of band 1 was observed. The amplitude at the central peak was reduced by a factor of 100, while the amplitude at the leaks was reduced by about a factor of four. When detector 8 of band 4 was observed, the amplitudes of its leaks were also reduced by about a factor of four, although its central peak was only reduced by a factor of 1.2. This shows that the light responsible for the leaks does not travel through the TM's bandpass filters.

When the band 5 witness filter was placed in the beam, both the leaked signals and the signals in the central peaks disappeared. This is as expected, since silicon detectors are insensitive to long wavelength radiation.

For a given detector, the ratio of the area of the central peak in the line spread function to the area of the secondary peaks provides a measure of the magnitude of the leaks. (The shapes of the leak peaks and central peaks are similar. Thus, it suffices to compare amplitudes instead of areas.) Since the light contribution to the central peak must pass through the detector bandpass filter while the leaked light does not, this ratio depends on the spectral shape of the source being observed. The spectrum of the source used to generate figures 1 and 2 was unrealistically red and poorly known. Furthermore, there were other experimental uncertainties (involving phase settings of a lock-in amplifier) which may have distorted the shape of the observed line spread function. As a result, these curves cannot be used to quantify to size of the leaks.

The required data was obtained during a special test run at GE. For this test, a 0.46 IFOV-wide slit was placed in the calibrator's BBR & GA reticle wheel. The scan mirror was used to scan the slit and mux output data was collected in the normal manner. The mux only samples data once every minor frame. Hence a single scan provides a seriously undersampled line spread function. There is, however, a large scan-to-scan jitter when the scan mirror is operated in air. Thus it is possible to use the line length error codes associated with each scan to piece together a well-sampled line spread function from several separate scans. Since we are interested in signals as small as 0.1 counts, approximately 2000 scans were averaged to obtain sufficient signal-to-noise.

The averaged responses to the slit are shown on the attached computer plots. These plots were used to create the "no filter" column in table 1 and all of table 2. The DSU/DEMUX in the bench test equipment was operating poorly when this data was taken. As a result some of the data for bands 3 and 4 was garbled. It is unclear whether the uneven curves for these bands are real or due to the inclusion of bad data.

In order to examine the spectral dependence of the light leaks, the tests were re-run with each of the four prime focal plane witness filters in front of the slit. The low signal to noise of these measurements limits the usefulness of the data to the three largest leaks. The results are displayed on table 3. Notice that the data for the band 1 light leak disagrees with that for the leaks in bands 3 and 4. While this is annoying in principle, the low signal to noise ratio of these measurements after averaging 2000 scans illustrates a lack of any need for a detailed knowledge of the spectral response.

The various slit responses indicate the light leaks are about 1 IFOV wide in the scan direction. By moving a slit of limited length in the track direction, we could determine that the leaks are roughly 20 IFOV's high and in line with the detectors. (The vast majority of the track direction data has yet to be analyzed. The quoted result is an rough estimate made while the data was being taken.)

The long thin shape of the light leaks and their positions relative to the band centers, suggests that they are associated with the slots at the sides of the individual band assemblies, (see figure 3).

TABLE 1

PEAK DETECTOR RESPONSE (MUX LEVEL)
TO SLIT SOURCE

BAND	NO FILTER	FILTER 1	FILTER 2	FILTER 3	FILTER 4
1	130.	120.	6.6	0.0	1.2
2	90.	2.7	82.	1.2	0.2
3	120.	<0.2	1.5	105.	<0.2
4	125.	~0.2	~0.2	<0.1	115.
AVG	116.				

TABLE 2

LEAK SIZES AND POSITIONS

HALF-BAND	LEAK POSITION RELATIVE TO CENTRAL MAX. (IFOV'S)	LEAK AMPLITUDE (MUX LEVELS)	SUM OF LEAK AMPLITUDES AS A % OF AVERAGE RESPONSE (SEE TABLE 1)
1-even	-13.1	.45	0.7%
	-9.1	.1	
	12.4	<.1	
	17.2	.2	
		0.85	
1-odd	-15.6	1.3	1.4%
	-11.6	.1	
	9.9	.15	
	14.7	.1	
		1.65	
2-even	-14.5	.1	0.2%
	13.3	.1	
		.2	
2-odd	-12.0	.2	0.4%
	11.8	.15	
	14.2	.1	
		.45	
3-even	-14.8	.25	0.6%
	9.7	.3	
	12.4	.15	
		.7	
3-odd	-12.0	.3	1.2%
	12.3	.9	
	14.9	.15	
		1.35	
4-even	-14.0	.6	1.1%
	-7.4	.3	
	10.1	.2	
	12.4	.15	
		1.25	
4-odd	-11.7	.3	0.4%
	12.6	.2	
		.5	

TABLE 3
SPECTRAL RESPONSE OF LARGEST
LIGHT LEAKS

EAK	FILTER COVERING SLIT	RESPONSE AS % OF NO-FILTER RESPONSE	RESPONSE AS % OF RESPONSE FOR CENTRAL PEAK OF FILTER'S BAND
BAND 1-ODD	1	9%	0.1%
	2	19%	0.3%
	3	22%	0.3%
	4	17%	0.2%
BAND 3-ODD	1	9%	0.05%
	2	Not measured, poor S/N	
	3	21%	0.2%
	4	35%	0.3%
BAND 4-EVEN	1	Not measured-poor S/N	
	2	Not measured-poor S/N	
	3	Not measured-poor S/N	
	4	36%	0.2%

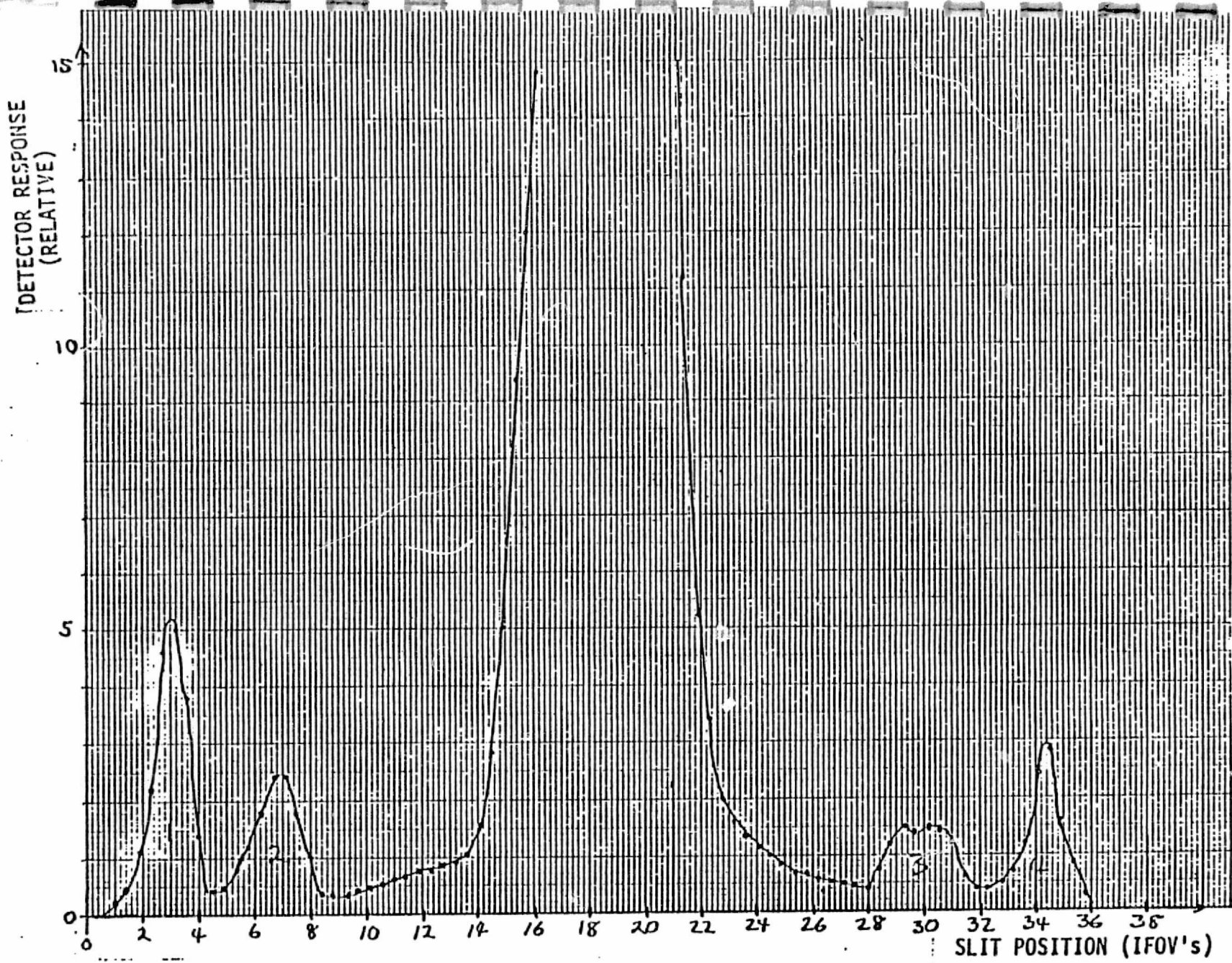

ORIGINAL PAGE IS
OF POOR QUALITY

Figure 1: Static line spread function for band 1, detector 8. Data was taken using the collimator and a 0.9 IFOV-wide slit.

DETECTOR RESPONSE (RELATIVE)

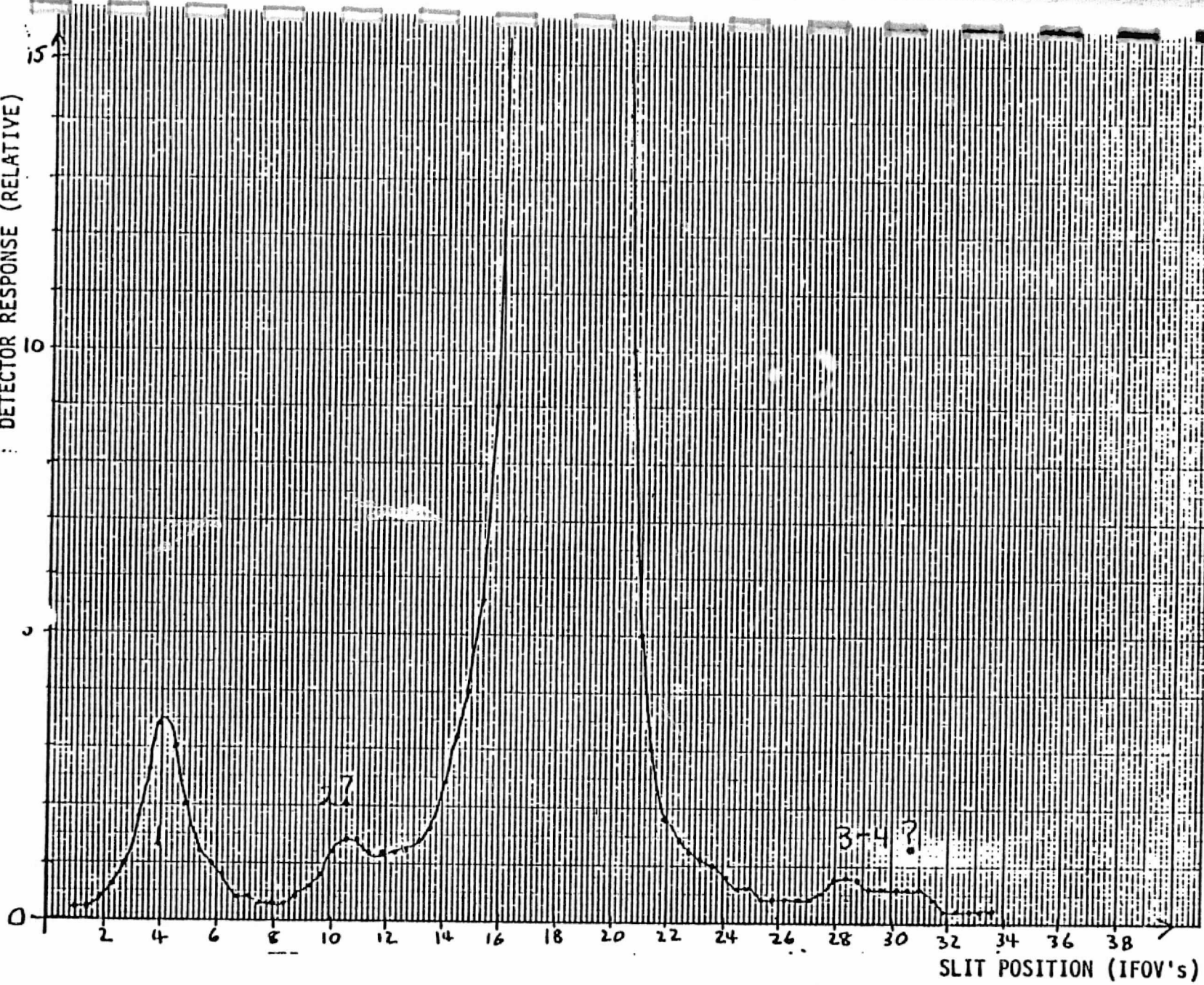

SLIT POSITION (IFOV's)

Figure 2: Static line spread function for band 4, detector 8. Data was taken using the collimator and a 0.9 IFOV-wide slit.

ORIGINAL PAGE IS
OF POOR QUALITY

7 - COHERENT NOISE

Coherent noise in the TM output data was measured using Fourier transform techniques. Measurable coherent noise exists at only two frequencies, the first and second harmonics of the power supply frequency. (The F1 model TM uses a free-running switching mode power supply. Its oscillator frequency is near 9.2 KHz). Table 7.1 provides a summary of the measured noise amplitudes at these frequencies.

Noise Amplitudes (in peak counts) for the worst case channel in each band

Band	Worst Case Channel	Amplitude @ 9.2 KHz	Amplitude @ 18.5 KHz
1	2	.36	.14
2	15	.14	.27
3	5	.30	.17
4	---	<.05	<.05
5	7	1.29	.63
5*	5	.34	.31
5*	9	.43	.18
7	10	.35	.30

Band average noise amplitudes (in peak counts)

Band	Amplitude @ 9.2 KHz	Amplitude @ 18.5 KHz
1	.26	.07
2	.08	.13
3	.18	.11
4	<.05	<.05
5	.35	.23
5*	.27	.20
7	.18	.19

*Excluding channel 7

TABLE 7.1. OBSERVED COHERENT NOISE

In all bands, the worst case channel at 9.2 KHz was also the worst case channel at 18.5 KHz.

8 - SCAN PROFILES AND BAND TO BAND REGISTRATION

The most thorough measurements of the scan mirror's scan profile were made during the scan mirror assembly (SMA) unit level acceptance tests. The results of these tests were reported in reference 8.1. The scan mirror can be driven by either of two redundant sets of scan mirror electronics (SME's). The SME's can be operated in either of two modes, the scan angle monitor (SAM) mode or the bumper mode. (The bumper mode is a backup mode which would only be used if the SAM's fail.) Figures 8.1 through 8.8 are taken from reference 8.1. They show the along-scan and cross-scan scan profiles for the four cases. (Note that all angles in are in mirror space. The TM's scan geometry is such that an along-scan mirror space angle corresponds to a cross-track object space angle 2θ . Similarly, a cross-scan mirror space angle θ corresponds to an along-track object space angle $2\theta \cos 35^\circ$).

The scan mirror's along scan profile can be thought of as the sum of three terms; a linear ramp, a 5th degree polynomial, and a parabolic correction. Table 8.9 provides the calibration constants necessary to compute these terms. Reference 8.2 discusses a variety of issues concerning the scan profile in general and the parabolic correction term in particular. (Computation of the scan profile requires knowledge of the line length error information obtained from the SAM. Spacecraft roll affects the measured values of these errors. This "roll effect" must be backed out of the raw SAM data using spacecraft attitude data. As a result it is almost impossible for an end user to compute scan profiles).

During thermal vacuum testing, an attempt was made to measure the system level scan profile. These measurements were compromised by the presence of vibrations in the TM-calibrator system. The dominant vibrational mode was at the 15th harmonic of the scan frequency. The following paragraphs describe the results of these measurements together with an assessment of their reliability.

The scan line corrector's (SLC) scan profile was measured and found to be nearly ideal, i.e., within $\pm 2.5 \mu\text{rad}$ (object space) of a $9.610 \mu\text{rad}/\text{sec}$ linear ramp over the entire active scan. This result held when the SLC was driven by either of its redundant drivers. There was little evidence of vibration in these measurements and they are considered to be reliable (see figure 8.10).

The scan mirror's along-track (cross-scan) scan profile was also measured. The measured profile can be approximated by a parabola 11 object space μrad 's high. (This data was taken using SME-1. We would expect SME-2 data to be nearly identical). The curve implies that the TM points too far backward at the center of scan. Vibrational effects are clearly visible in the data. However, the fit displayed in figure 8.11 appears convincing. The magnitude of the observed nonlinearity is about 2 1/2 times as big as that observed in the SMA acceptance test profiles. It is unclear which profile is more reliable.

Measurement of the scan mirrors cross-track (along-scan) profile yielded irregular and irreproducible results.

Tables 8.12 and 8.13 present data on the apparent cross-track (along-scan) position of the detector relative to channel 9 of band 4. Conceptually, the data is a combination of three factors; the physical distance between the detectors, the relative time delays in the electronics, and the scan velocity. The sign of the effect of the electronics delays on the apparent detector position changes with scan direction. This is the major reason for the change in the apparent detector displacements between forward and reverse scans. The data was taken near the center of scan, where, in the absence of vibrations, the scan velocity is expected to be very close to the nominal scan velocity. The effect of the vibrations on the apparent detector displacements is probably small, i.e., less than .05 IFOV. The data is thought to be reliable at this level.

Along track (cross scan) misregistrations among detectors in the prime focal plane appear to be quite small, i.e., less than $\pm .03$ IFOV. Similarly, the along track misregistrations of detectors in the cold focal plane also appears to be less than $\pm .02$ IFOV. The prime and cold focal planes are misaligned by about 0.09 IFOV in the track direction (see figure 8.14).

Note that the .inchworms may move as a result of vibrations during launch. This would result in a change of the relative positions of the prime and cold focal planes.

Figure 8.1

DATA SHEET 4.3.4-1
SCAN PROFILES
ALONG SCAN

TS 32015-004
8 March 1980

90725 22

SMA Designation F-1 ENG DATA

SAM MODE S/N 4

SME (1) or (2) 1 28.9 -28.8 7.1
(Nominal Voltages)

T2 T3 T4 T5 T6 T7 T8 T9
25.6 24.6 24.8 25.2 24.8 26.3 29.2 24.4 24.4

SMOOTHING POLYNOMIAL COEFFICIENTS				
ORDER (T)	FWD	REV	SPEC	P/F
0	4.6812e-07	6.1556e-09		
1	-2.0927e-03	2.5213e-03		
2	2.4365e-01	-3.0669e-01		
3	-1.1042e 01	1.3025e 01		
4	2.1349e 02	-2.3212e 02		
5	-1.4560e 03	1.4747e 03		
INFLECTION POINTS	3	3	<3	P
MAX*+ MAX -	6.0 -5.5	6.6 -3.9	+ - 17.5	P
AVERAGED TO SMOOTHED*	0.2	0.2	<2.1 RMS	P

SAM ANGLES USED (MRAD) -67.171 67.159
IFAR COUNTS K = 0.500091
CALIBRATION

FAST SCAN

BUMPER A 3527
P2 P3 328379 328385 328382
MID P1 P4 164218 164233 164223
PO P5 -2 4 4
BUMPER B -3215 5

OFFSET-CORRECTED SCAN ANGLES (REF PO), μRAD.

P2 134330 P3 134329
P1 67174 P4 67170
PO 0 P5 0
NEXT PO 0

5.50e-01 TORR PRESSURE *MICRO RADIAN

MIDSCAN PRESSURE CORRECTION: 0.28 URAD

SAM OFFSET, urad

2.3 1.1
6.0 1.9
2.6 2.6

NON-LINEARITY, μRAD

17.5 SPEC

10

-10

-17.5 SPEC

-20

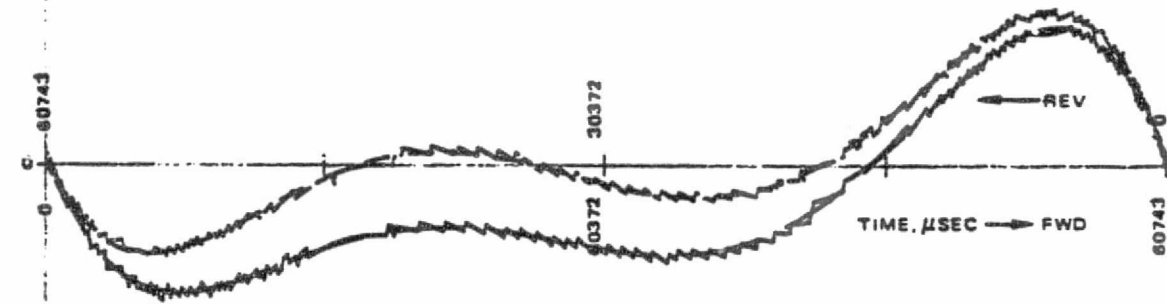

data for smoothed profile : NORM
data for measured profile : NORM

Run No. 31081.0918

Test Flow Event H-2 seq 7

Comments test no. 2

QA Stamp

Date 31081

Tested By

Figure 8.2

DATA SHEET 4.3.4-1
SCAN PROFILES
ALONG SCAN

TS 32015-004
8 March 1980

77.57706

SMA Designation F-1 ENG DATA

SAM MODE S/N 4

SME (1) or (2) 2 28.9 -28.8 7.1
(Nominal Voltages)

T1 26.2 T2 24.9 T3 25.3 T4 25.8 T5 25.4 T6 26.8 T7 29.9 T8 24.6 T9 24.6

SMOOTHING POLYNOMIAL COEFFICIENTS

ORDER (T)	FWD	REV	SPEC	P.F
0	4.3144e-07	-2.1578e-07		
1	-1.6538e-03	3.1184e-03		
2	2.4464e-01	-3.2331e-01		
3	-1.1422e 01	1.3313e 01		
4	2.1987e 02	-2.3650e 02		
5	-1.4945e 03	1.4991e 03		
INFLECTION POINTS	3	3	<3	P
MAX*+ MAX -	9.3 -3.0	9.9 -1.9	+ - 17.8	P
AVERAGED TO SMOOTHED*	0.2	0.2	<2.1 RMS	P

SAM ANGLES USED (MRAD) -67.182 67.160

IFAR COUNTS K = 0.500080

FAST SCAN

BUMPER A 3514
P2 P3 328423 328430 328418
MID -P1 P4 164237 164248 164235
PO P5 -1 3 0
BUMPER B -3188 3

OFFSET-CORRECTED SCAN ANGLES (REF PO), μRAD

P2 134343 P3 134338
P1 67185 P4 67180
PO 0 P5 -1
NEXT PO 0

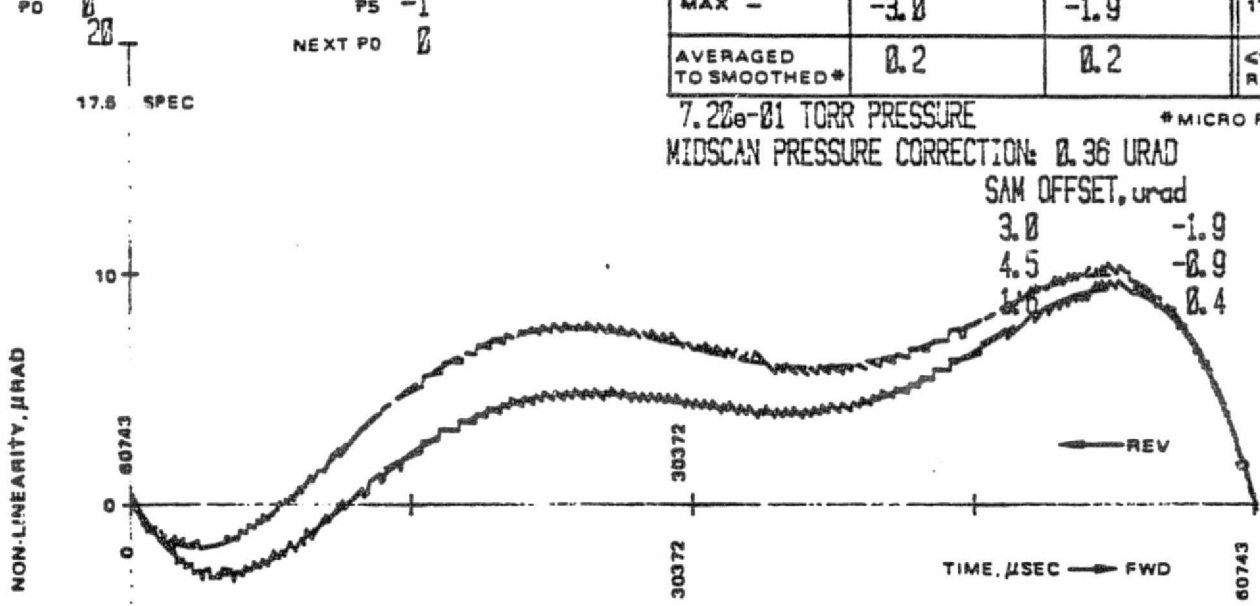

7.20e-01 TORR PRESSURE # MICRO RADIAN

MIDSCAN PRESSURE CORRECTION: 0.36 URAD

SAM OFFSET, urad

3.0 -1.9
4.5 -0.9
1.0 0.4

-17.8 SPEC

data for smoothed profile : NORM
data for measured profile : NORM

Run No. 31081.0950
Test Flow Event H-14 seq 7
Comments test no. 14



QA Stamp  Date 31081
Tested By 

Figure 8.3

DATA SHEET 4.3.4-1
SCAN PROFILES
ALONG SCAN

TS 32015-004
8 March 1980

90725 22

SMA Designation F-1 ENG DATA

BUMPER MODE
SN 4

SME (1) or (2) 1

28.9 -28.8 7.1
(Nominal Voltages)

T2 T3 T4 T5 T6 T7 T8 T9
25.9 24.7 25.0 25.4 25.0 26.6 29.6 24.5

SMOOTHING POLYNOMIAL COEFFICIENTS

SAM ANGLES USED (MRAD) -67.2 67.2
IFAR COUNTS K = 0.500000
CALIBRATION

FAST SCAN

BUMPER A
P2 P3

MID -P1 P4 FROM TFEQ RUN 31081.0931
P0 P5

BUMPER B
OFFSET-CORRECTED SCAN ANGLES (REF P0), μ RAD.

P2 P3
P1 P4
P0 P5
NEXT P0

ORDER (T)	FWD	REV	SPEC	P/F
0	5.5119e-08	2.4379e-07		
1	-1.9550e-03	2.3769e-03		
2	2.4116e-01	-2.9430e-01		
3	-1.1179e 01	1.2650e 01		
4	2.1896e 02	-2.2760e 02		
5	-1.5077e 03	1.4566e 03		
INFLECTION POINTS	3	3	<3	-
MAX*+ MAX -	7.1 -5.2	6.4 -4.2	+ - 17.6	-
AVERAGED TO SMOOTHED*	0.1	0.1	<2.1 RMS	-

6.00e-01 TORR PRESSURE
MIDSCAN PRESSURE CORRECTION: 0.30 URAD

*MICRO RADIANS

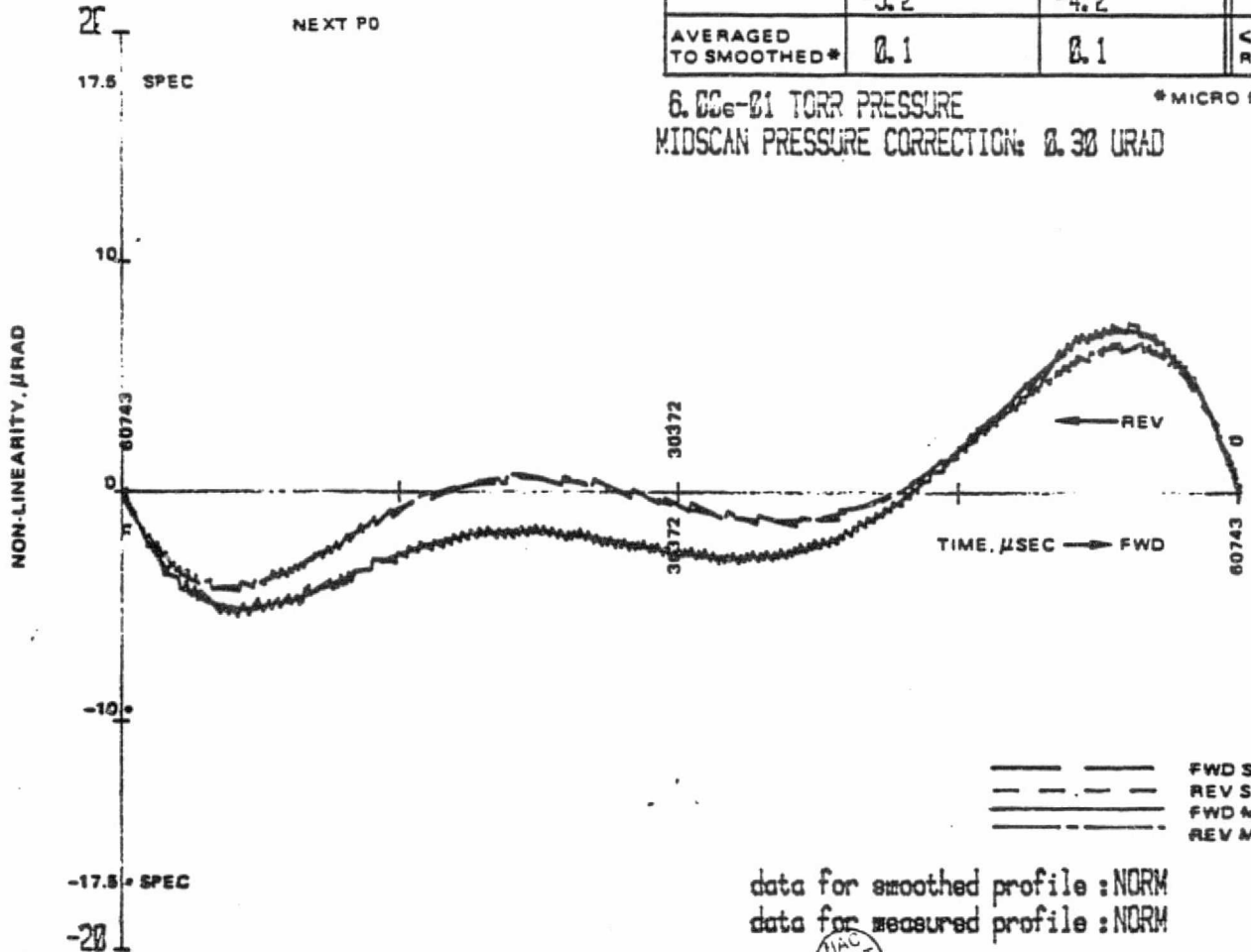

==== FWD SMOOTHED
---- REV SMOOTHED
==== FWD MEASURED
---- REV MEASURED

data for smoothed profile: NORM
data for measured profile: NORM

Run No. 31081.0931

Test Flow Event H-3 seq 7

Comments test no. 3

QA Stamp

Date 31081

Tested By

□

Figure 8.4

DATA SHEET 4.3.4-1
SCAN PROFILES
ALONG SCAN

TS 32015-004
8 March 1980

90725 22

SMA Designation F-1 ENG DATA

BUMPER MODE SW 4

SME (1) or (2) 2

28.9 -28.8 7.1
(Nominal Voltages)

T2 T3 T4 T5 T6 T7 T8 T9
26.3 25.0 25.4 25.9 25.6 26.9 30.3 24.7

SMOOTHING POLYNOMIAL COEFFICIENTS

SAM ANGLES USED (MRAD) -67.2 67.2
IFAR COUNTS K - 0.500077
CALIBRATION

FAST SCAN

BUMPER A
P2 P3

MID P1 P4 FROM TFEG RUN 31081.1011
PO P5

BUMPER B
OFFSET-CORRECTED SCAN ANGLES (REF PO), μRAD.

P2 P3

P1 P4

PO P5

NEXT PO

20
17.5 SPEC

ORDER (T)	FWD	REV	SPEC	P/F
0	-1.1849e-07	6.1555e-08		
1	-1.3525e-03	2.8591e-03		
2	2.1910e-01	-2.9687e-01		
3	-1.0534e 01	1.2396e 01		
4	2.0726e 02	-2.2361e 02		
5	-1.4352e 03	1.4364e 03		
INFLECTION POINTS	3	3	<3	-
MAX*+ MAX -	10.6 -2.7	9.4 -2.0	+ - 17.5	-
AVERAGED TO SMOOTHED*	0.2	0.2	<2.1 RMS	-

0.00e-01 TORR PRESSURE *MICRO RADIAN
MIDSCAN PRESSURE CORRECTION: 0.40 URAD

NON-LINEARITY, μRAD

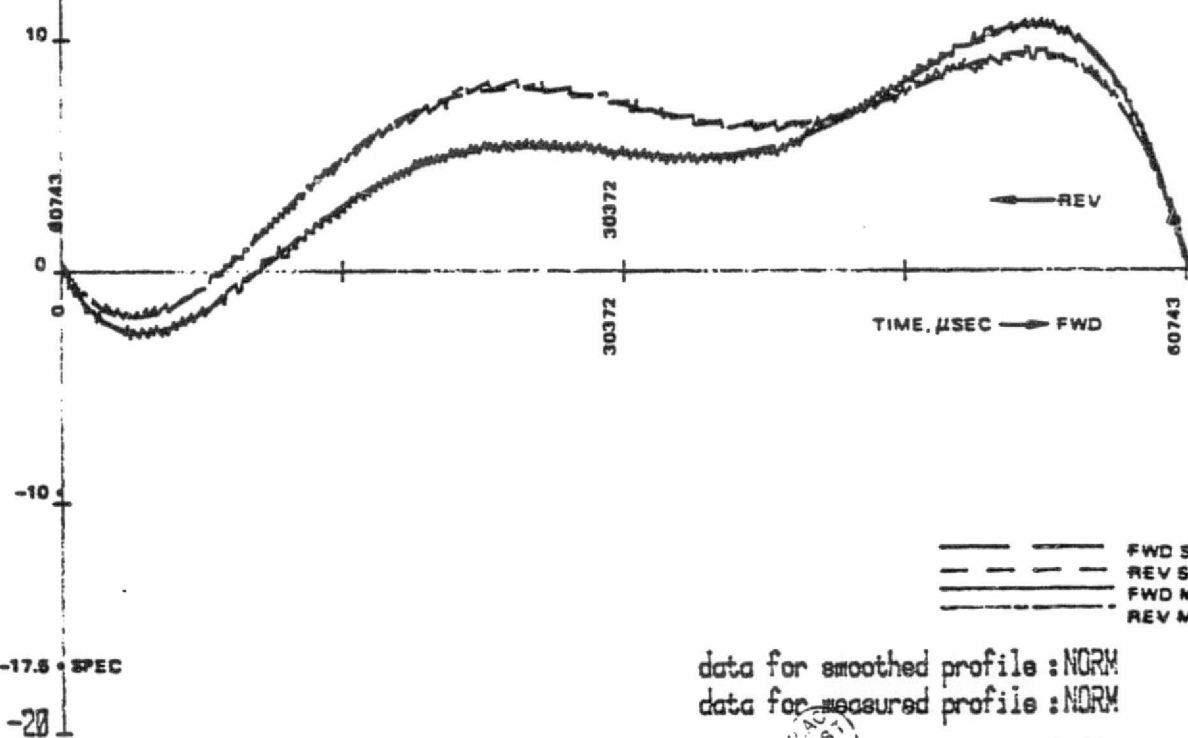

data for smoothed profile: NORM
data for measured profile: NORM

Run No. 31081.1011
Test Flow Event H-15 seq 7
Comments test no. 15

QA Stamp _____ Date 31081
Tested By _____

Figure 8.5

DATA SHEET 4.3.4.4
SCAN PROFILES
CROSS SCAN

TS 32015-004
8 March 1980

02/17/80

SMA Designation **F-1 ENG DATA**

SAM MODE

S/N 4

SME (1) or (2) 1

28.9 -28.8 7.1
(Nominal Voltages)

FORWARD LINEAR TERM
REMOVED TO CORRECT FOR
IFAR ALIGNMENT (REV TERM
--FWD TERM). 96.78 urad

SMOOTHING POLYNOMIAL COEFFICIENTS**

ORDER (T)	FWD	REV	SPEC	P/F
0	-1.4496e-07	1.8833e-07		
1	-1.2690e-04	-9.9974e-05		
2	3.5212e-03	2.6935e-03		
3	-4.8660e-02	-6.8859e-02		
4	5.4476e-01	1.4509e 00		
5	-2.2877e 00	-9.9468e 00		
INFLECTION POINTS	0	1	<3	P
MAX + MIN -	-0.1 -1.7	0.2 -1.3	+ - 20	P
AVERAGED TO SMOOTHED*	0.3	0.3	<2.6 RMS	P

0.6 TORR PRESSURE

*MICRORADIANS
**AFTER REMOVING LINEAR
IFAR-ALIGNMENT TERM

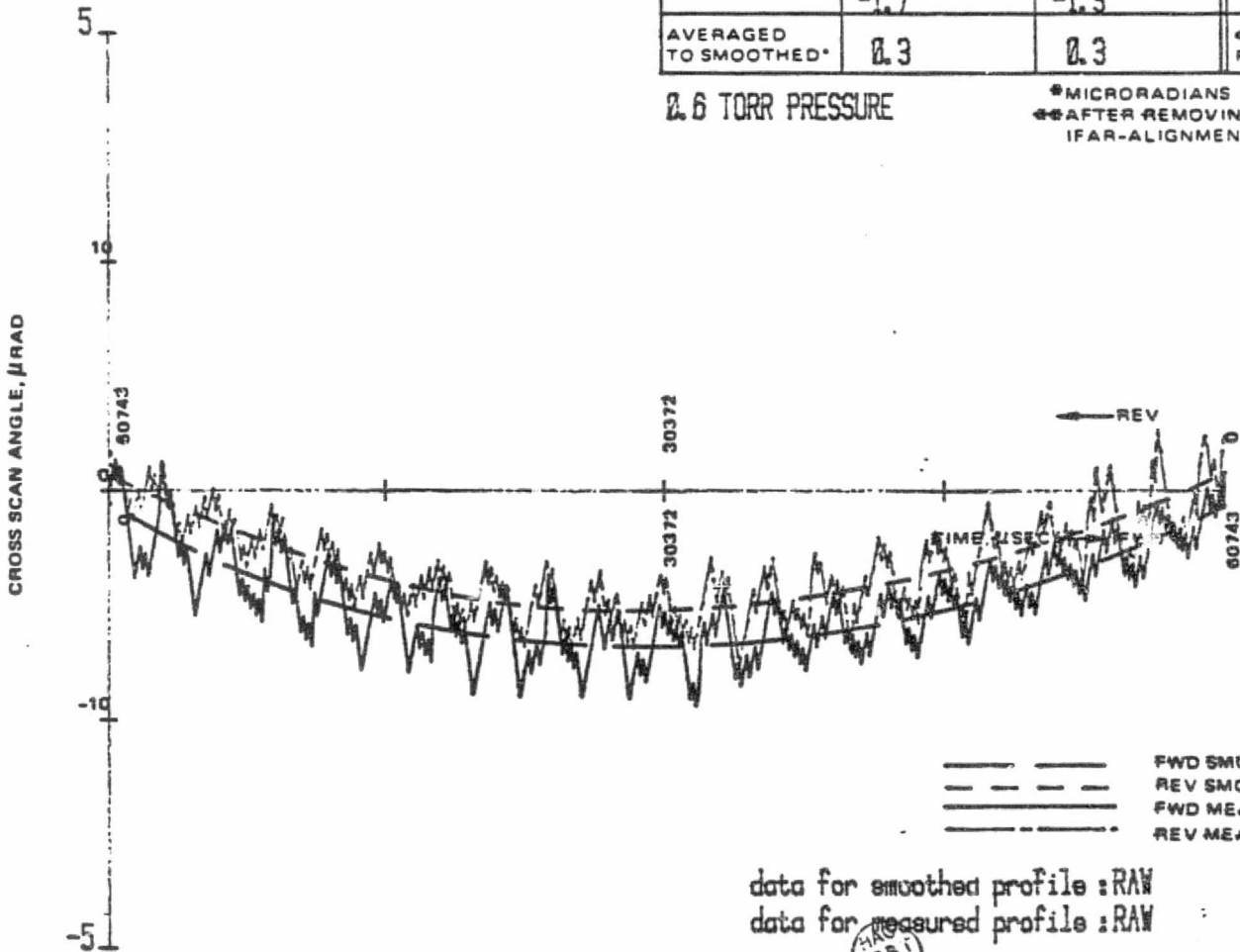

Run No. 31081.0918

Test Flow Event H-2 seq 7

Comments test no. 2

QA Stamp _____ Date 31081

Tested By B

Q

Figure 8.6

TS 32015-004

8 March 1980

DATA SHEET 4.3.4-4
SCAN PROFILES
CROSS SCAN

SAM MODE

S/N 4

SME (1) or (2) 2 28.9 -28.8 7.1
(Nominal Voltages)

SMA Designation F-1 ENG DATA

FORWARD LINEAR TERM
REMOVED TO CORRECT FOR
IFAR ALIGNMENT (REV TERM
-FWD TERM): 96.74 urad

SMOOTHING POLYNOMIAL COEFFICIENTS**

ORDER (I)	FWD	REV	SPEC	P F
0	-1.1935e-07	2.3227e-07		P
1	-1.2148e-04	-9.2625e-05		
2	2.9221e-03	1.5799e-03		
3	-2.9348e-02	-1.3242e-02		
4	3.3941e-01	2.9615e-01		
5	-1.7827e-00	-1.6706e-00		
INFLECTION POINTS	0	0	<3	P
MAX* + MIN -	-2.1 -1.7	0.2 -1.3	+ - 20	P
AVERAGED TO SMOOTHED*	0.3	0.3	<2.5 RMS	P

0.7 TORR PRESSURE

*MICRORADIANS
**AFTER REMOVING LINEAR
IFAR-ALIGNMENT TERM

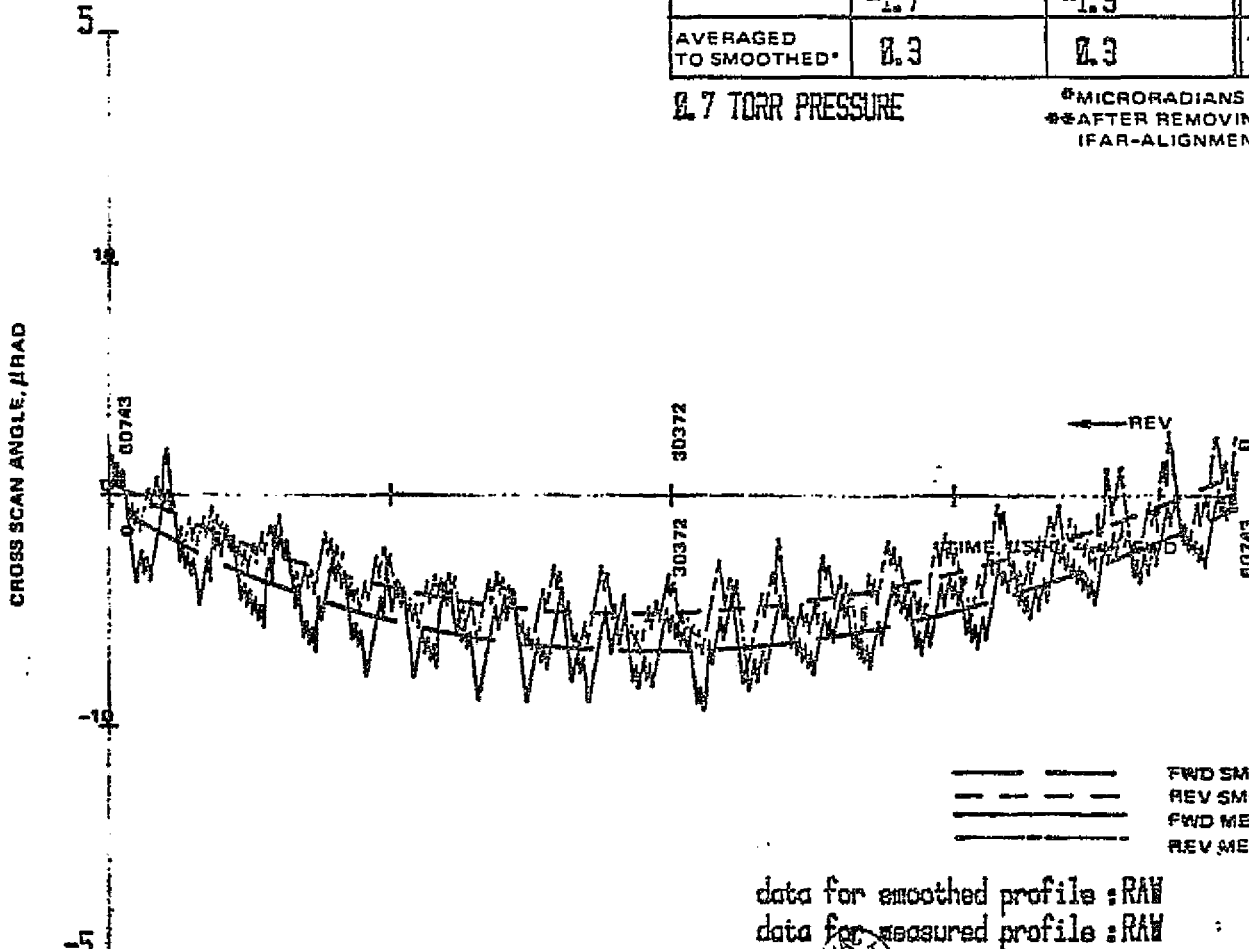

data for smoothed profile : RAW
data for measured profile : RAW

Run No. 31081.0950
Test Flow Event H-14 seq 7
Comments test no. 14

QA Stamp _____ Date 31081
Tested By _____

Figure 8.7

TS 32015-004
8 March 1980

DATA SHEET 4.3.4.4
SCAN PROFILES
CROSS SCAN

BUMPER MODE

SMA Designation F-1 ENG DATA

S/N 4

SME (1) or (2) 1 28.9 -28.8 7.1
(Nominal Voltages)

SMOOTHING POLYNOMIAL COEFFICIENTS**

FORWARD LINEAR TERM
REMOVED TO CORRECT FOR
IFAR ALIGNMENT (REV TERM
- FWD TERM): 97.21 μ rad

ORDER (T)	FWD	REV	SPEC	P F
0	-5.3389e-07	-1.3054e-06		
1	-1.0153e-04	-0.2386e-05		
2	1.6723e-03	2.0573e-03		
3	9.1868e-03	-3.4992e-02		
4	-2.6238e-01	7.5536e-01		
5	1.9039e 00	-4.9939e 00		
INFLECTION POINTS	0	0	<3	-
MAX* + (MIP) -	-0.5 -2.0	-1.0 -2.7	+ - 20	-
AVERAGED TO SMOOTHED*	0.3	0.3	<2.6 RMS	-

0.6 TORR PRESSURE

*MICRORADIANS
**AFTER REMOVING LINEAR
IFAR-ALIGNMENT TERM

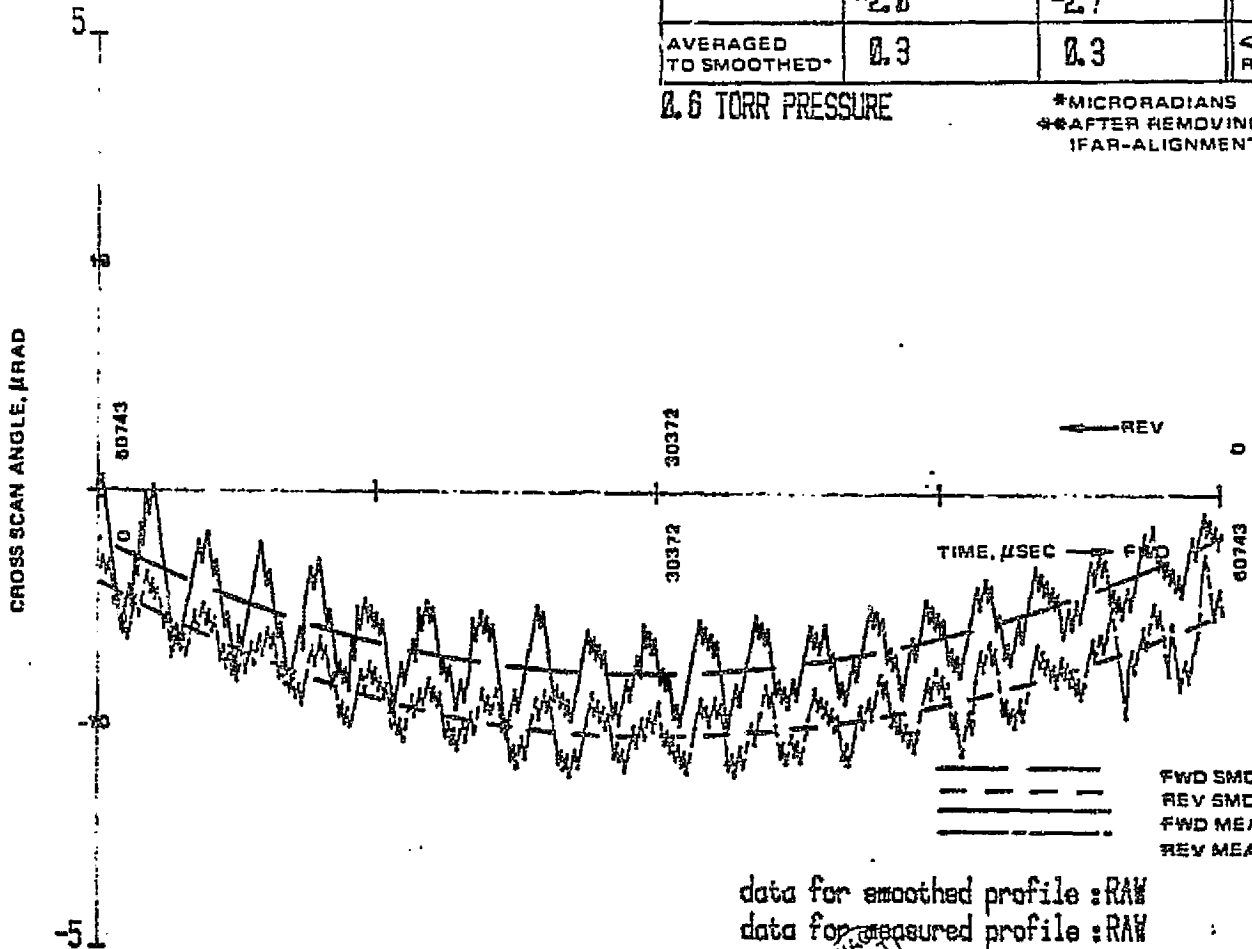

data for smoothed profile : RAW
data for measured profile : RAW

Run No. 31081.0931

Test Flow Event H-3 889 7

Comments test no. 3

QA Stamp _____ Date 31081

Tested By _____

Figure 8.8

TS 32015-004
8 March 1980

DATA SHEET 4.3.4.4
SCAN PROFILES
CROSS SCAN
BUMPER MODE

90225-25

SMA Designation F-1 ENG DATA

S/N 4

SME (1) or (2) 2 28.9 -28.8 7.1
(Nominal Voltages)

FORWARD LINEAR TERM
REMOVED TO CORRECT FOR
IFAR ALIGNMENT (SMA TERM
= -FWD TERM): 97.00 urgd

SMOOTHING POLYNOMIAL COEFFICIENTS**

ORDER (T)	FWD	REV	SPEC	P/F
0	-6.0671e-07	-1.4473e-06		
1	-1.3039e-04	-1.0187e-04		
2	4.2157e-03	2.4976e-03		
3	-9.3982e-02	-3.6994e-02		
4	1.6260e 00	5.8693e-01		
5	-1.0634e 01	-2.9295e 00		
INFLECTION POINTS	1	0	<3	-
MAX +	-0.6	-1.2	+	-
MIN -	-2.2	-2.9	20	-
AVERAGED TO SMOOTHED*	0.3	0.3	<2.8 RMS	-

0.9 TORR PRESSURE

*MICRORADIANS
**AFTER REMOVING LINEAR
IFAR-ALIGNMENT TERM

CROSS SCAN ANGLE, URAD

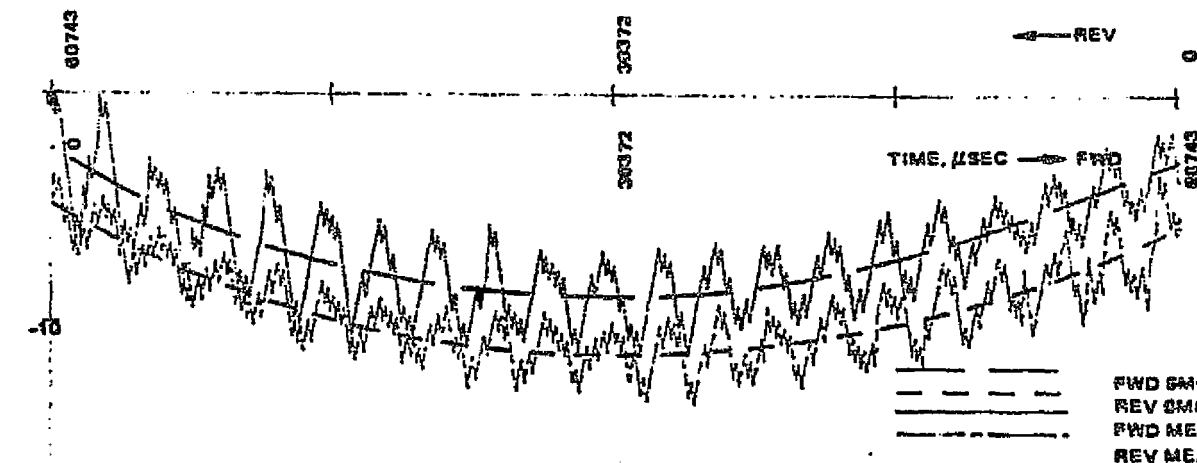

data for smoothed profile : RAW
data for measured profile : RAW

Run No. 31081.1011
Test Flow: Event H-15 seq 7
test no. 15
Comments _____

QA Stamp _____ Date 31081
Tested By _____



	SME-1 SAM MODE (Page 331)	SME-1 BUMPER MODE (Page 342)	SME-2 SAM MODE (Page 353)	SME-2 BUMPER MODE (Page 366)	
FORWARD SCAN	a_0 rad	4.6812E-7	5.5119E-8	4.3144E-7	-1.1849E-7
	a_1 rad/sec	-2.0927E-3	-1.9550E-3	-1.6538E-3	-1.3525E-3
	a_2 rad/sec ²	2.4365E-1	2.4116E-1	2.4464E-1	2.1910E-1
	a_3 rad/sec ³	-1.1042E+1	-1.1179E+1	-1.1422E+1	-1.0534E+1
	a_4 rad/sec ⁴	2.1349E+2	2.1896E+2	2.1987E+2	2.0726E+2
	a_5 rad/sec ⁵	-1.4560E+3	-1.5077E+3	-1.4945E+3	-1.4352E+3
	θ_{po} rad	-5.46E-6	--	4.55E-6	--
REVERSE SCAN	b_0 rad	6.1556E-9	2.4379E-7	-2.1578E-7	6.1555E-8
	b_1 rad/sec	2.5213E-3	2.3769E-3	3.1184E-3	2.8591E-3
	b_2 rad/sec ²	-3.0669E-1	-2.9430E-1	-3.2331E-1	-2.9687E-1
	b_3 rad/sec ³	1.3025E+1	1.2650E+1	1.3313E+1	1.2396E+1
	b_4 rad/sec ⁴	-2.3212E+2	-2.2760E+2	-2.3650E+2	-2.2361E+2
	b_5 rad/sec ⁵	1.4747E+3	1.4566E+3	1.4991E+3	1.4364E+3
	θ_{ro} rad	-2.43E-6	--	6.08E-6	--
K_0'	.500045	--	.500082	--	

$$K_0' = \frac{-\theta_{PoP5}}{\theta_{P2P3} - \theta_{PoP5}}$$

Table 8.9 - Summary of along scan scan profile parameters from Reference 8.1.
ALL ANGLES ARE IN MIRROR SPACE

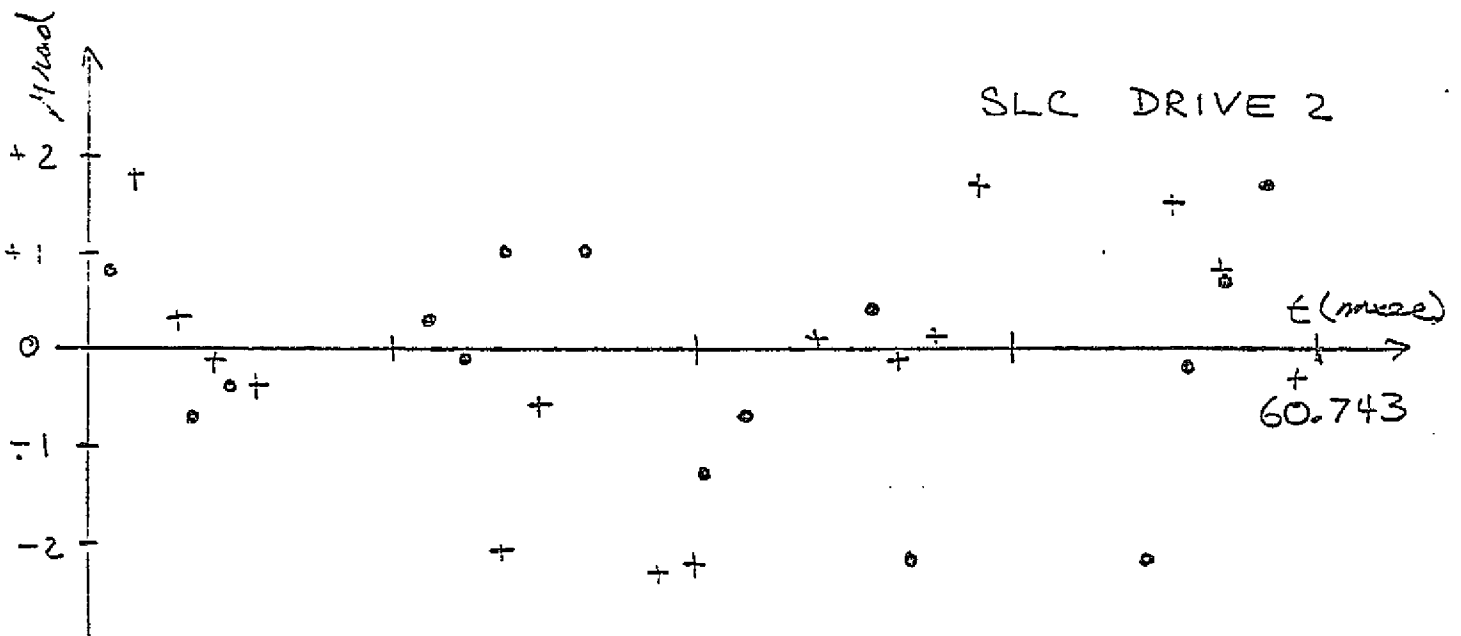
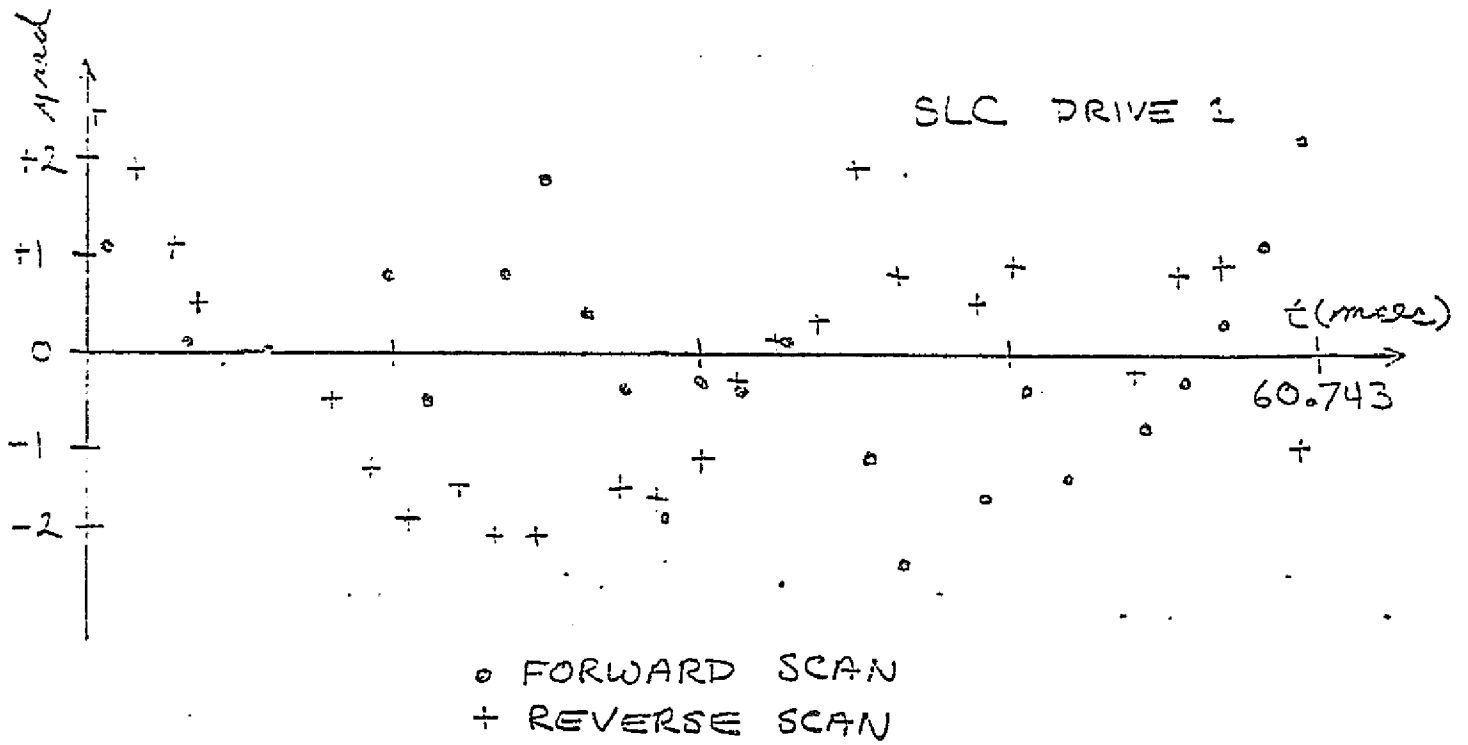

Figure 8.10 - Deviation of the scan line corrector (SLC) scan profile from a 9.610 mrad/sec linear ramp. All angles are in object space. The observed deviations are thought to be within the measurement accuracy.

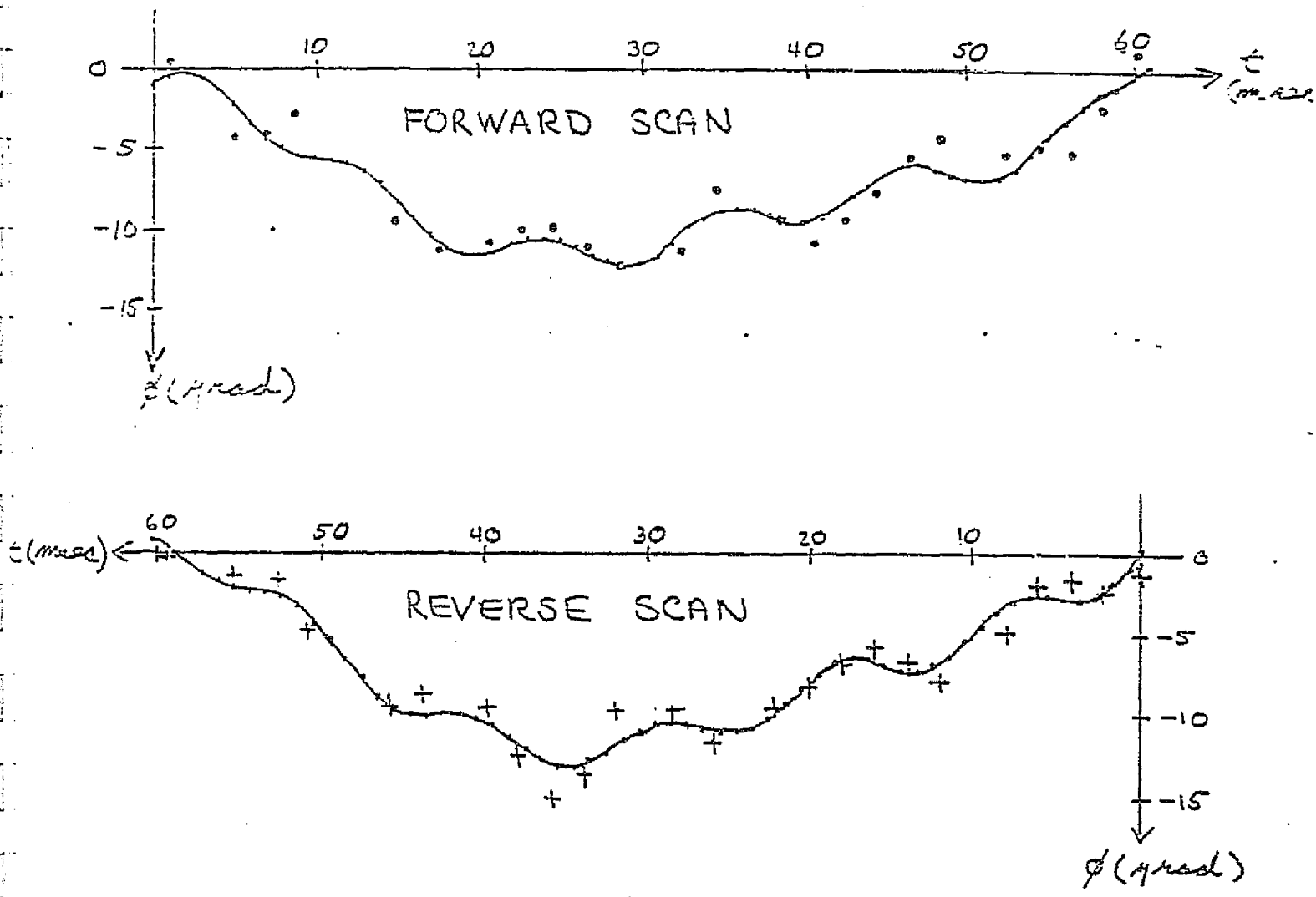

Figure 8.11 - Scan mirror cross scan profile for SME-1 in SAM mode. Solid curves are the sum of a 5th degree polynomial and a sine wave at the 13th harmonic of the scan frequency, i.e., $91 H_z$. Angles are in object space.

Table 8.12

Along scan registration data for forward scans. Tabulated values are the difference between the nominal and apparent detector positions relative to detector 9 of band 4. All values are in minor frames. For example, during a forward scan detector 9 of band 1 will see an object 75.22 minor frames after the object is seen by detector 9 of band 4 rather than the nominal 75.00 minor frame delay. Values marked with * are uncertain.

FORWARD SCAN

CHANNEL	1	2	3	4	5	7
1	.23	-.05	-.02	.03	.29	-.03
2	.24*	.01	-.01	.02	.10	-.17
3	.22	-.05	-.01	.03	.26	-.09
4	.24	-.04	-.01	.02	.12	-.11
5	.25	-.01	-.04	.02	.15	-.07
6	.20	-.01	-.05	-.03	.19	-.12
7	.21*	-.04	0	-.01	.17	-.05
8	.19	-.04	-.06	0	.19	-.10
9	.22	-.05	-.04	0	.20	0
10	.20	-.03	-.03	-.02	.21	-.12
11	.22	-.07	0	0	.17	-.04
12	.23	-.02	-.03	-.02	.12	-.19
13	.27	-.03	.04	.02	.17	-.11
14	.20	.01	-.02	0	.14	-.18
15	.28	-.03	.04	.06	.13	-.10
16	.23	-.03	-.02	.03	.13	-.15

Table 8.13

Along scan registration data for reverse scans. Tabulated values are the difference between the nominal and apparent detector positions relative to detector 9 of band 4. All values are in minor frames. For example, during a reverse scan detector 9 of band 1 will see an object -75.21 minor frames after (75.21 minor frames before) the object is seen by detector 9 of band 4 rather than the nominal -75.00 minor frame delay. Values marked by * are uncertain.

REVERSE SCAN

BAND

Channel	1	2	3	4	5	7
1	-.15	.10	.09	.06	.01	.17
2	-.14	.16	.14	.06	.07	.31
3	-.19	.08	.10	.06	.03	.16
4	-.13	.12	.13	.07	.08	.34
5	-.17	.12	.06	.04	-.05	.21
6	-.18	.14	.11	.01	.16	.33
7	-.22*	.09	.11	0	-.03	.25
8	-.19	.11	.09	.03	.16	.37
9	-.21	.06	.06	0	.01	.32
10	-.18	.12	.12	.01	.19	.38
11	-.21	.06	.10	.01	0	.29
12	-.16	.12	.11	.01	.13	.33
13	-.16	.08	.15	.03	0	.23
14	-.18	.15	.13	.03	.17	.36
15	-.15	.08	.13	.06	-.05	.22
16	-.17	.10	.12	.05	.21	.44

HUGHES

INTERDEPARTMENTAL CORRESPONDENCE



TO: A. B. Marchant cc: Distribution
ORG:

DATE: September 4, 1980

REF. 7735.2/430
HS236-1891

SUBJECT: Thematic Mapper SMA Along-scan
Profile Review - Meeting of July 17, 1980

FROM: P. R. Prince
ORG. 77-32-11

BLDG. 12
LOC. CC

MAIL STA. V133
EXT. 3201

The attached document contains the viewgraphs that were presented at the meeting referenced above. A brief discussion accompanies each viewgraph for the benefit of those who are interested but who were unable to attend.

The meeting concluded with a mutual agreement between the HAC Program Office and Goddard that a parabolic midscan correction be incorporated to solve the along-scan linearity profile variations, and the appropriate SMA design specification paragraphs were modified accordingly.



P. R. Prince

PRP/nd

**SCAN MIRROR ASSEMBLY
ALONG-SCAN PROFILE REVIEW**

JULY 17, 1980

HUGHES

ALONG-SCAN PROFILE REVIEW AGENDA

The agenda will serve as a table of contents. After an introduction that summarizes the along-scan linearity requirements and the solution to profile shifting, the characteristics of the profile shift and "wander" phenomena are covered. Details of the measurement techniques are presented in support of the measured results and to ensure confidence in these results. The parabolic correction of the along-scan profile by using telemetered midscan time information is explained in detail, and life test model data is presented to illustrate its application. The thermal sensitivity of the profile is also presented; this discussion is followed by the conclusions and recommendations. Please consult the indicated reference for further information and additional reference material.

ALONG-SCAN PROFILE REVIEW AGENDA

JULY 17, 1980

HUGHES

I. INTRODUCTION	AB MARCHANT	
II. SMA ALONGSCAN PROFILE	PR PRINCE	
△ <u>PROBLEM</u>		PAGE:
● SCAN PROFILE LAUNCH, THERMAL SHIFTS		
● WANDER		11
△ <u>MEASUREMENT CONFIDENCE</u>		20
● SCAN PROFILE GENERATION		
△ <u>SOLUTION</u>		
● PARABOLIC CORRECTION		31
● LTM TEST DATA		33
● DETAILS OF MIDSCAN GROUND CORRECTION METHOD*		41
III. CONCLUSIONS AND RECOMMENDATIONS	AB MARCHANT	
IV. SMA DESIGN SPECIFICATION – REV C	PR PRINCE	

*REFER TO HS236-1880 FOR FURTHER DETAILS AND FOR
EXAMPLES OF MIDSCAN LINEARITY CORRECTION

JULY 1980

INTRODUCTION

Throughout the development phase and now in the final flight manufacturing phases of the TM SMA program, the along-scan variation from a true linear angle as a function of time has been found to change slightly (about $\pm 5 \mu\text{rad}$ maximum) on a test-to-test (a separation of 15 minutes or more) basis, and it has been found to shift several tens of microradians during exposure to thermal cycling and vibration. The profile review meeting afforded an opportunity to present an organized summary of the findings, to discuss instrumentation precision, to present evidence that all profile shifting and "wander" are parabolic (and hence correctable by ground-based processing), and to discuss details for employing the midscan correction. Redesign within any practical time/cost framework appears to be impractical and it would probably not solve the problem (part of which may be due to a basic metallurgical flexure pivot characteristic). Since the specification values seem to be firm, the recommended practical and effective solution is to retain the specified parameters but allow the scan profile to be corrected in order to achieve the performance required.

INTRODUCTION

HUGHES

PROBLEM: SMA FAILS THREE BASIC SPECIFICATIONS

- 1. ALONG-SCAN LINEARITY
- 2. BAND-TO-BAND REGISTRATION (SCAN RATE)
- 3. GEOMETRIC REPEATABILITY

SOLUTIONS:

- REDESIGN
- CHANGE SPECIFICATION VALUES
- ✓ ● RETAIN SPECIFIED VALUES BUT ALLOW SCAN PROFILE CORRECTION

LIFE TEST MODEL SCAN MIRROR ASSEMBLY

On the facing page is a photograph of the front of the life test model SMA. The central cut-out (obscuration region) provides room for an on axis-torque motor. A vibration damper (for use in the scan mirror doming vibration mode) is mounted on the armature. The turnaround springs and striker plates are located at each end of the assembly. The beryllium scan mirror is a two-piece machined eggcrate design in which the front and back are brazed together along the webs in the center. The scan mirror is shown resting against the bumpers of turnaround "B".

LIFE TEST MODEL SCAN MIRROR ASSEMBLY

HUGHES

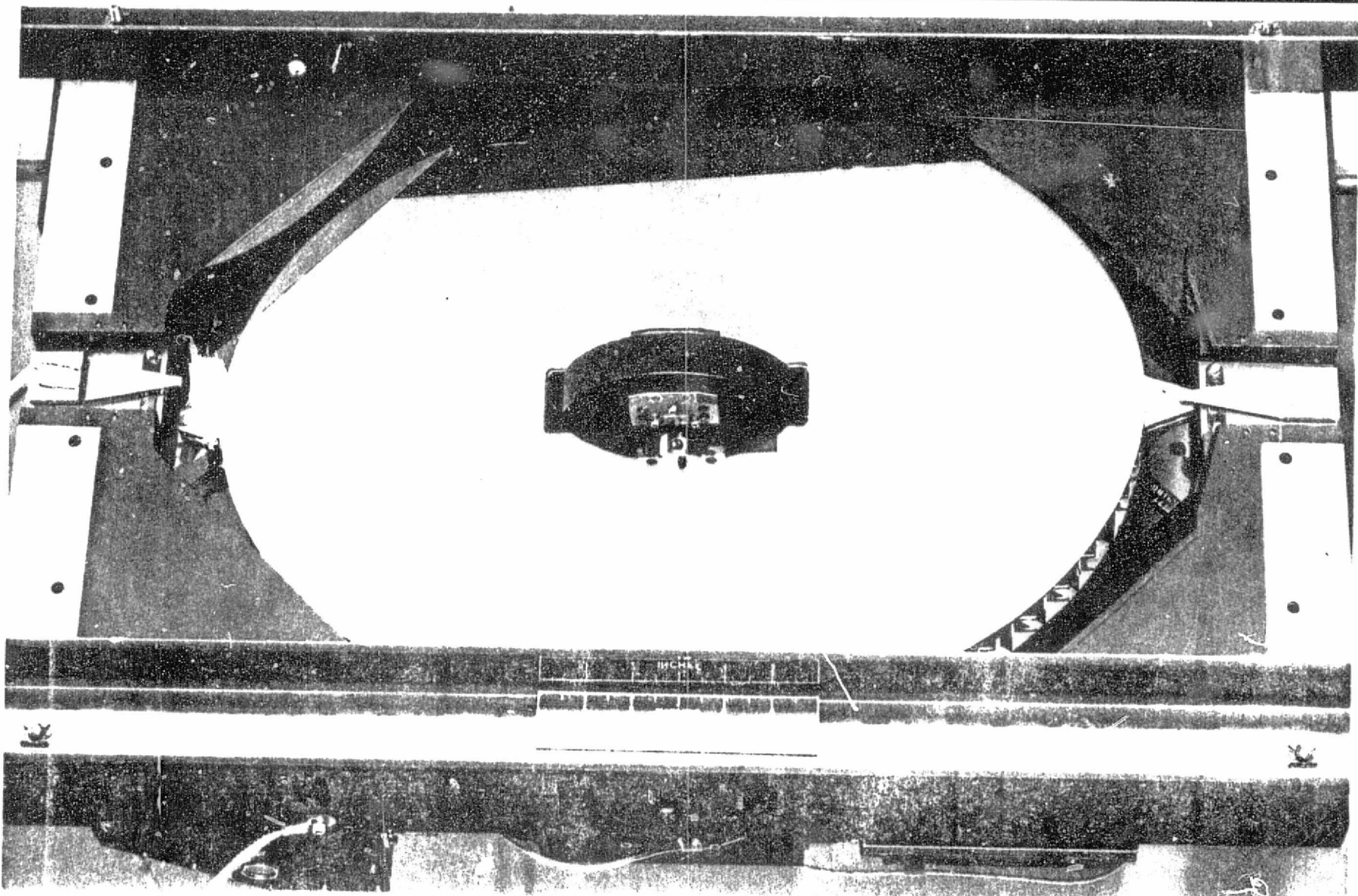

ORIGINAL
OF POOR QUALITY

On the facing page is a photograph of the back of the SMA. The frame and bridge are made of beryllium. The scan angle monitor (SAM) at the upper left-hand corner directs the energy from a solid-state laser to the polished back of the scan mirror by means of a relay mirror that is attached to the bridge structure. After two reflections between the three-faceted wing mirror and the scan mirror, the laser beam crosses a split diode pair to create precision angular reference pulses at the scan extremes and at midscan.

Precision temperature sensors are located near each bumper, each flexure pivot, and on the center of the bridge.

The scan mirror electronics (SME) dissipates about 18 watts of power in an aluminum housing. The glass corner cubes shown are permanently mounted in the scan mirror. They are used in various unit level tests for accurately measuring the angular position of the scan mirror. This mirror is shown resting against the bumpers of turnaround "B" (it is at "B" that the scan mirror is nearest the SAM).

LIFE TEST MODEL SCAN MIRROR ASSEMBLY

HUGHES

DTS
T8

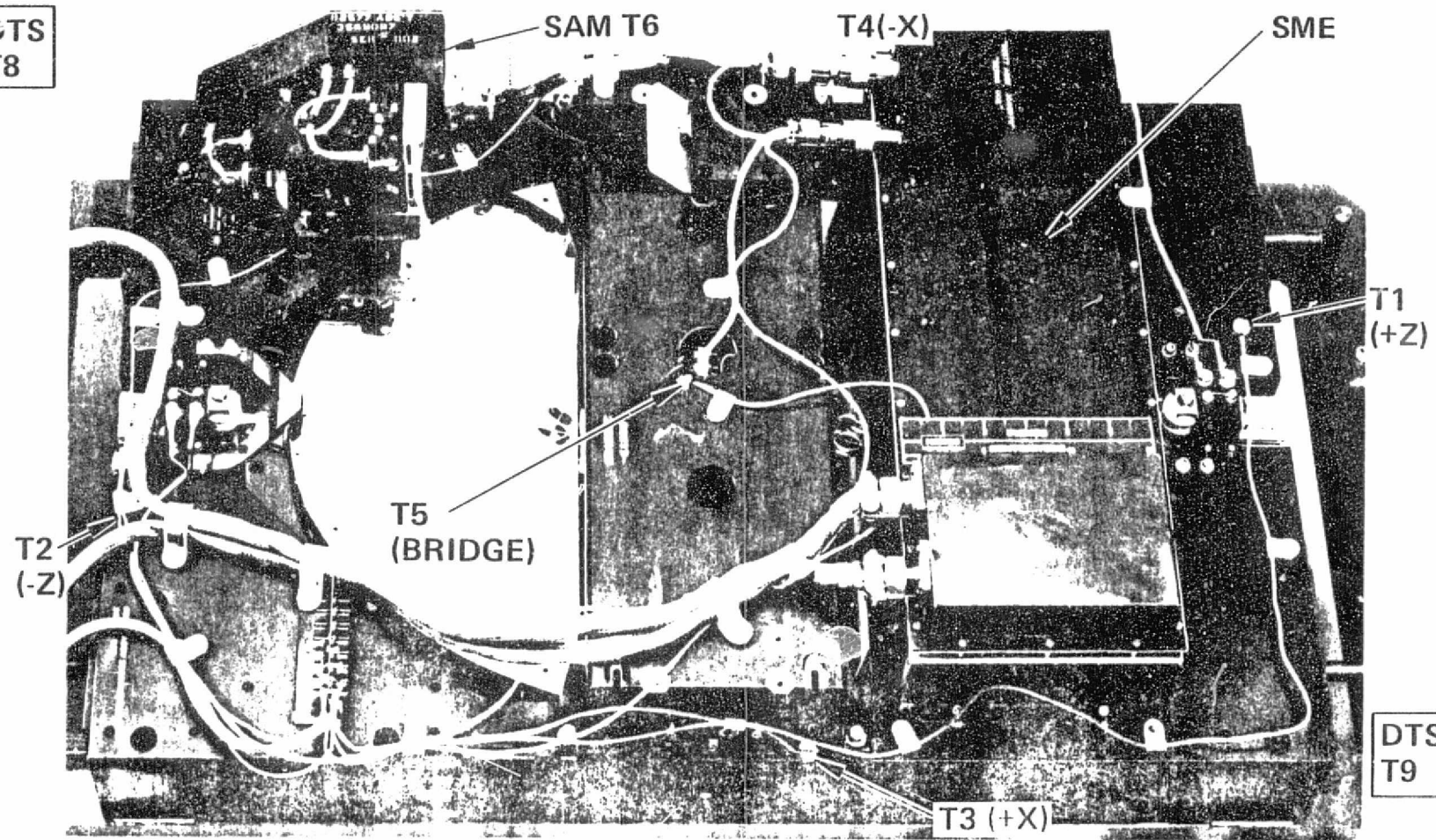

Copyright © 1964
OF FOUR

The facing figure defines the forward and reverse scans with respect to turnarounds "B" and "A". The start of the forward scan is defined as P_0 , when the scan mirror is leaving the "B" turnaround (closest to the scan angle monitor).

Angles $\theta_{P_0P_5}$, $\theta_{P_1P_4}$, and $\theta_{P_2P_3}$ represent the static condition in which the scan mirror is "locked" onto the corresponding SAM station by means of SAM-LOCK (not scanning). In this condition, no vibrations or time delays occur and there is no distinction between forward and reverse scan. A theodolite (DMK-2) measures these angles at the beginning of the unit acceptance test. A proportionality constant K'_0 is defined as the ratio of the midscan to the full-scan angle as measured with the theodolite.

When the SMA is made to scan, time delays and small vibrations occur that cause the dynamic SAM pulses (P_0 through P_5) to shift slightly from the static SAM stations. These small shifts, which are called SAM offsets, must be very stable if the midscan linearity correction is to be effective. A modification incorporated in the life test model (effectivity S/N 002 and up) was adapted in order to stiffen the SAM primary mirrors and thereby stabilize the SAM offsets.

ALONG SCAN DEFINITIONS

HUGHES

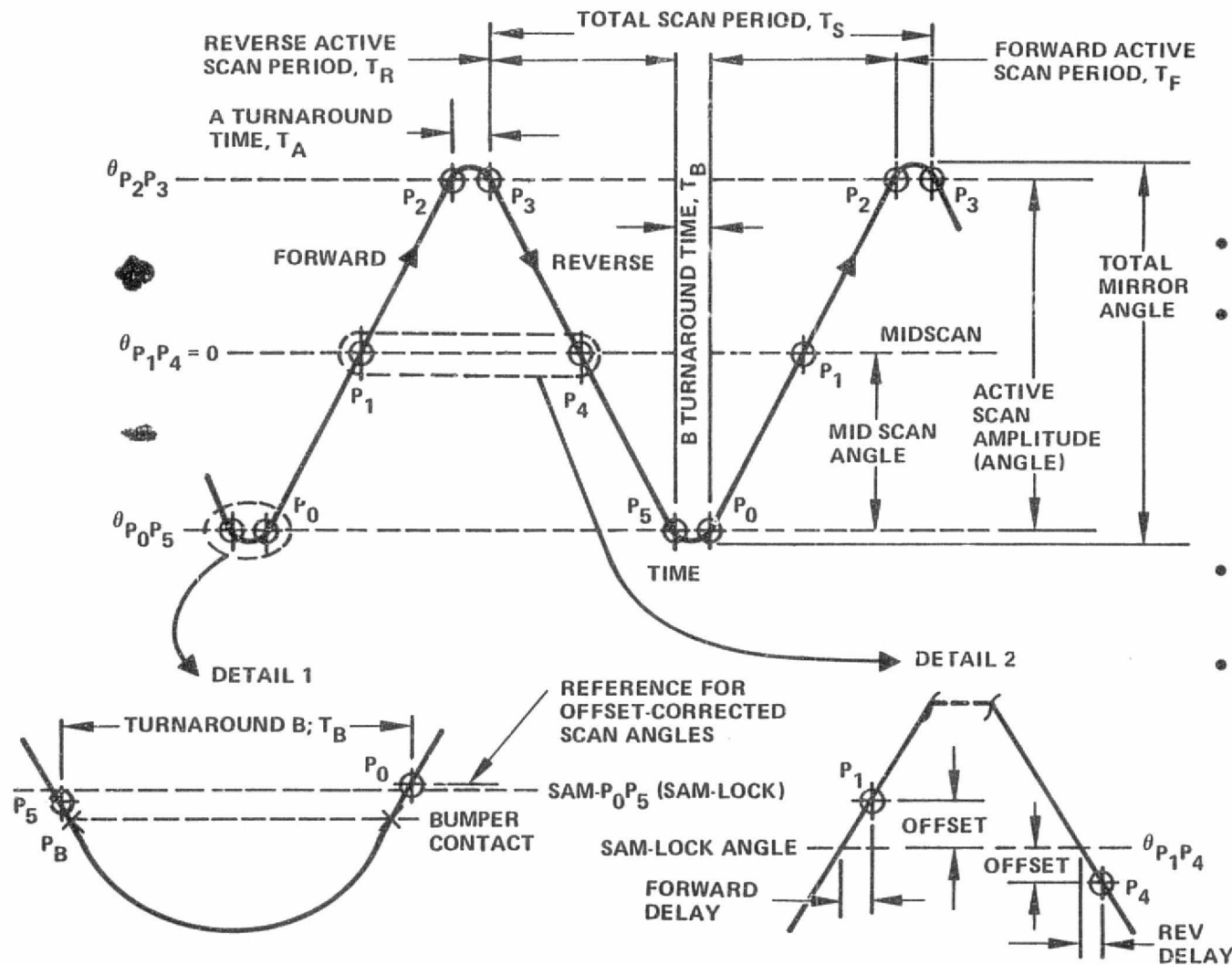

- SAM-LOCK MIDSCAN POSITION REFERENCE
- THEODOLITE USED TO MEASURE $\theta_{P_0P_5}$ (NEG) AND $\theta_{P_2P_3}$ (POS)

$$K'_0 = - \frac{\theta_{P_0P_5}}{\theta_{P_2P_3} - \theta_{P_0P_5}} \approx 0.500000$$

- SAM OFFSETS INCLUDE TIME DELAY AND VIBRATION
- SAM OFFSETS STABLE (LTM SAM PRIMARY MIRROR STIFFENERS)

The curve on the opposite page shows the deviation from a perfectly linear scan for the "vibration engineering model" (aluminum eggcrate STM scan mirror mounted in the engineering model frame); the data on which it is based was taken before the installation of the magnetic compensator assembly. The ± 500 - μ rad "sinusoidal" shape is characteristic of a linear spring force (flexure pivots) acting on the scan mirror. The curve has been described as "sinusoidal" but it is actually cubic. The small parabolic curve labeled non-nested represents the component of the scan profiles due to eddy current drag; this, rather than a linear torque on the scan mirror, is a constant torque on the mirror. The deviation from a previous scan profile that results from a constant torque is parabolic.

The locus of points consisting of the averages of the forward and reverse scans is termed nested since it is the component common to both the forward and the reverse profiles (they "nest" when folded onto each other). The nested component is caused by conservative (non-lossy) torques acting on the scan mirror. The components of each profile that do not nest (i.e., are of opposite sign when the reverse scan is folded onto the forward scan) are caused by non-conservative lossy mechanisms, such as eddy current drag, air drag, etc.

Equations for nested and non-nested are indicated on the curve.

VEM NONLINEARITY WITHOUT MAGNETIC COMPENSATION

HUGHES

Date: 61878
Time: 921

ALONG SCAN LINEARITY
Case: NO DESPRINGER, RUN 12 POSIT HIT
Temperature
S
F
C

Turnaround
Tau A
Tau B 10278.9
P5-P8
P3-P2 11201.4

FIXT 23.80
23.56

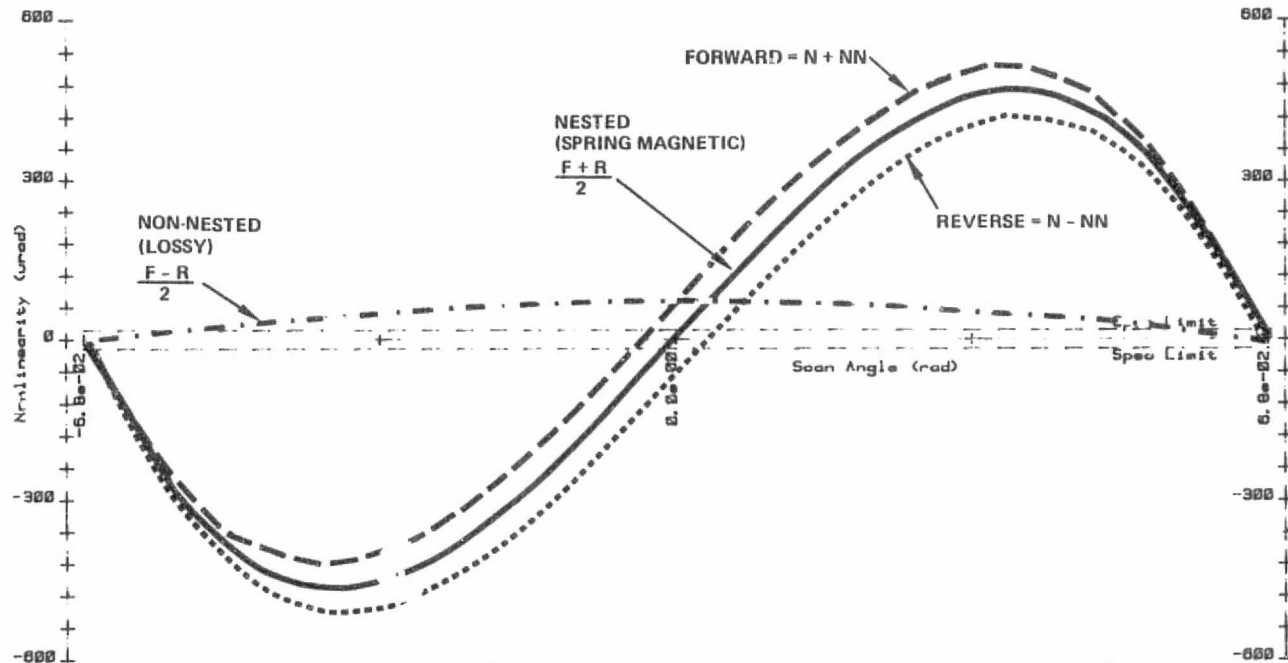

Fast SAMs
0
163917
327867
327826
163883
-39

Calibration
0.0
163936.0
327891.0
SAM Lock SAM 1
K = 0.4899/7
Bumper A 0
Bumper B 0

	Max	Min
Forward	516.3	-416.0 urad
Nested	489.2	-481.5
Non-Nested	69.1	1.0
Sample 100 (ML03.0, 4)		

When a constant torque acts on the scan mirror, it causes a parabolic nonlinearity. A small incremental constant (within a scan) torque (shown dotted) superimposes a small parabolic modification onto the profile. Such torques can be caused by changes in eddy current drag and in eddy current compensation current sources, rotations in the flexure pivot or magnetic compensator with respect to each other, or changes in the mechanical hysteresis of the flexure pivots. If the constant (within a scan) torque alternates in sign between forward and reverse scans, the parabolic change will be non-nested, and the forward and reverse scan separation will change. If the sign of the torque does not alternate, the parabolic change will be nested, and the forward and reverse scans will increase or decrease together.

An incremental change in torque that is linear (shown dashed) superimposes a small "sinusoidal" component onto the profiles.

When the SMA is operated at significant temperature differences from that of SMA assembly (and adjustment), a small "sinusoidal" nonlinearity ($-0.5 \mu\text{rad}/^\circ\text{C}$ peak to peak) is observed. This nonlinearity appears to be due to a larger temperature coefficient in the flexure pivot spring rate than in the magnetic compensators. The "sinusoidal" component disappears as the temperature returns to normal.

All shifts due to vibration, shock, and thermal cycling have been substantially parabolic.

FORCES INVOLVED IN ALONG SCAN NONLINEARITY

HUGHES

NET TORQUE

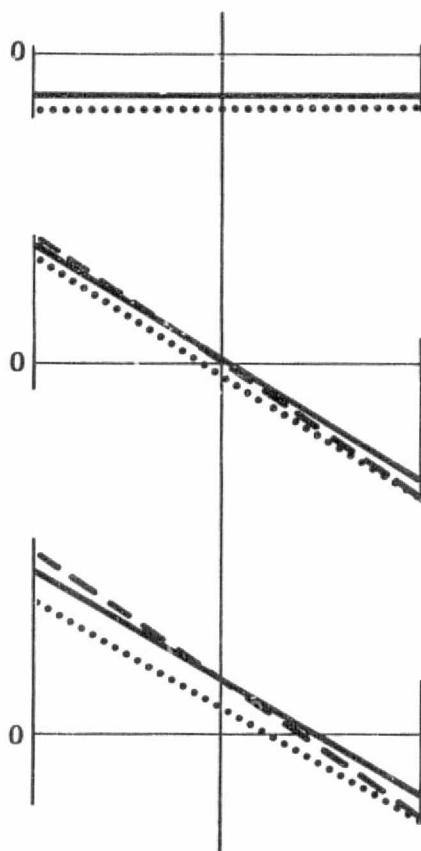

THERMAL VIBRATION SHIFTS HAVE BEEN PARABOLIC

RESULTING NONLINEARITY

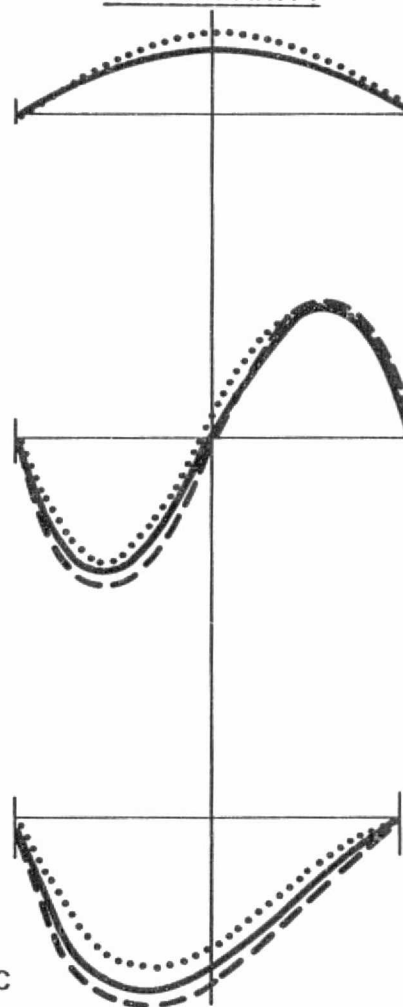

PARABOLIC

- EDDY CURRENT
- COMPENSATION CURRENT SOURCES
- CONSTANT (ANGLE INDEPENDENT) TORQUES
- INTENTIONAL CURRENT SOURCES

THIRD-ORDER (AND HIGHER)

- ANGLE DEPENDENT TORQUES -
- FLEXURE PIVOT;
- MAGNETIC COMPENSATOR

COMPLEX

- OFFSET BORESIGHT OF FLEXURE PIVOTS AND COMPENSATORS
- COMPLEX SHIFT
- PARABOLIC SHIFT

SEE HS236-0802
-1603

FEBRUARY 1980

VG 7

VEM PREVIBRATION 2 NESTED NONLINEARITY

In an attempt to isolate the mechanically induced profile shifting and "wander", most of the SMA developmental tests were conducted without electronic active scan eddy current compensation (to remove the small known variations in current source).

The profile shown illustrates the nested component (unaffected by eddy currents) for the VEM SMA before the second series of exposures to vibration in May 1979.

VEM PRE-VIB 2 NESTED NONLINEARITY

HUGHES

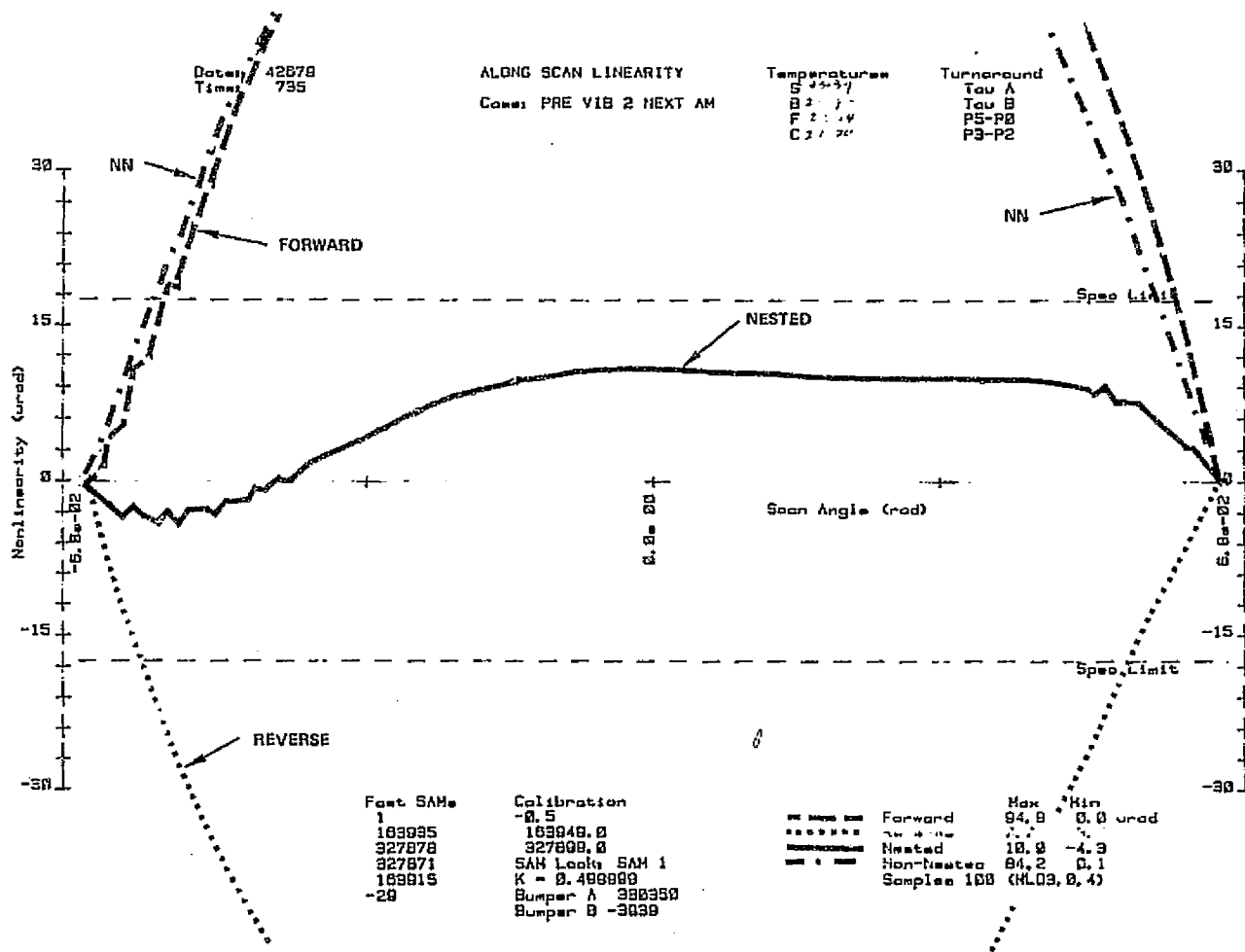

C-3

OF POOR QUALITY

After vibration, a 31- μ rad net midscan shift was observed that was found to be parabolic (discussed with viewgraph 16). Investigations followed as various SMA models became available. Four engineering model configurations evolved, i. e., EM-A and EM-B, which are similar to the VEM except that the scan mirror is made of beryllium and the scan angle monitor was converted from a four-bounce to a two-bounce optical system. EM-C and EM-D included Eastman 910 cement between the flexure pivots and their mounting blocks.

EM-A and EM-C did not include the bridge half of the magnetic compensator, whereas EM-B and EM-D included all of the SMA components. These configurations were measured and exposed to vibration in an attempt to isolate what appeared at the time to be rotations of the flexure pivots or magnetic compensators.

VEM POST-VIB 2 NESTED NONLINEARITY

HUGHES

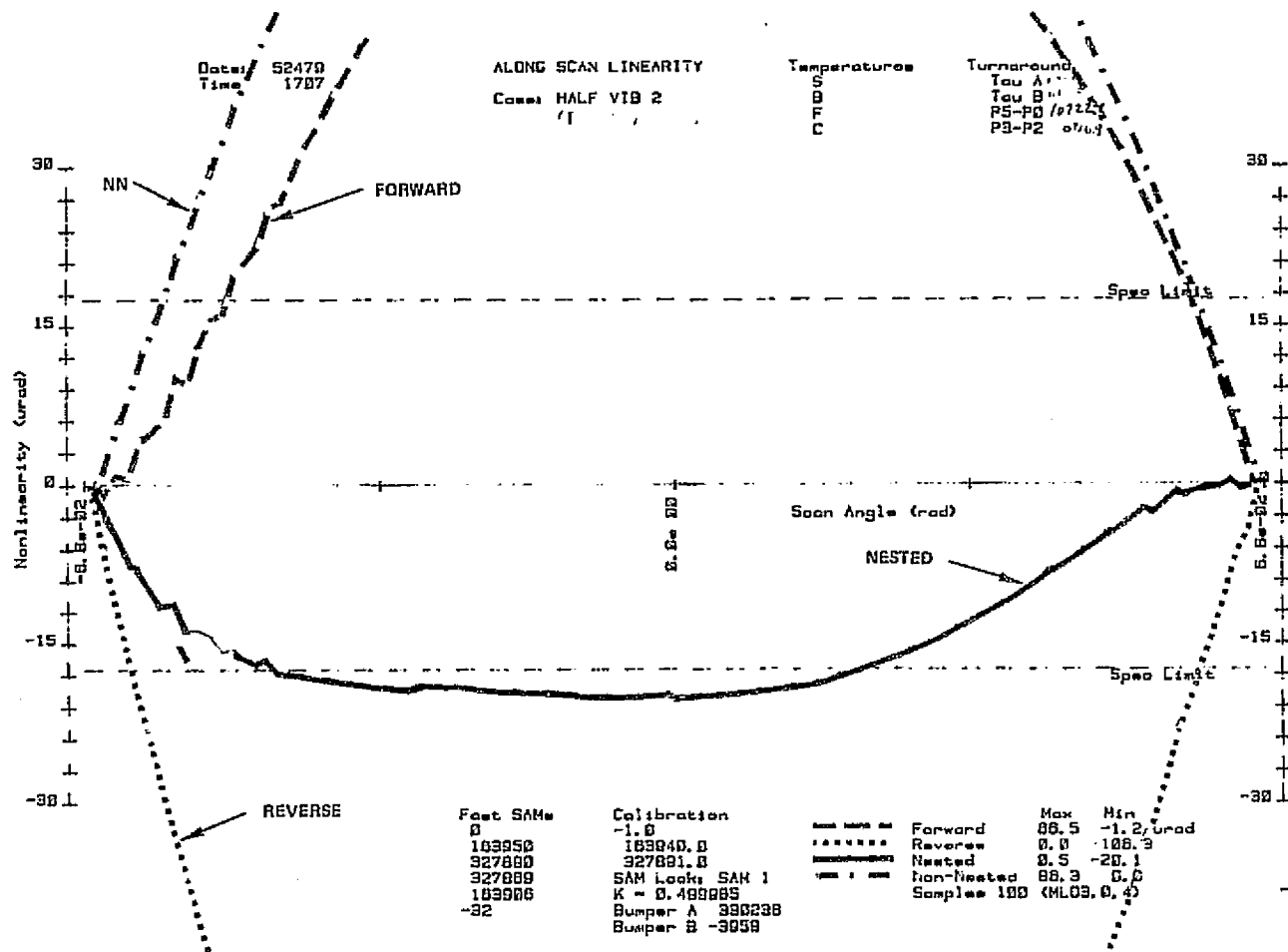

ORIGINAL OF POOR QUALITY

SAM #001's OK
 -6.78...
 6.702...

The shifting of the nested profile has in some cases been cumulative, and in one case (multiple vibration exposures) it totaled 54 μ rad. Profile "wander", i. e., variation from test to test, has generally remained within ± 5 μ rad. These observations include the STM, VEM, and all configurations of the EM and life test model. SAM offset variations, 93 Hz main-frame modes, a 118-Hz IFAR fixture resonance, and small variations in the active scan control (ASC) eddy current compensation current sources have all been identified and eliminated in one way or another. In spite of these problems throughout the SMA development, profile "wander" has been clearly evident in all configurations. Although an orbital "warm-up" profile variation has been seen, profile wander occurs after many hours of continuous operation at constant temperature.

The shifting of the profile (from vibration and thermal cycle exposures) has been parabolic and must therefore be caused by rotations of the flexure pivots, metallurgical (hysteresis) changes in these pivots, motion of the magnetic compensator elements, or changes in structural stress. Although parallel investigations of flexure pivots and compensator mounting are continuing, it is now generally believed that the shifting is a metallurgical effect.

Wander may be caused by variations in thermal gradients, changes in eddy currents or in current source with temperature and possibly by gravitational effects (changes in the granite slab rest position).

POTENTIAL CAUSES OF PROFILE SHIFTING AND WANDER

HUGHES

△ PROFILE SHIFTS -- 0 TO 54 μ RAD; WANDER -- $\approx \pm 5 \mu$ RAD

△ VIBRATION AND THERMAL CYCLE SHIFTING

- FLEXURE PIVOT ELEMENTS (MOUNTING AND PIVOTS THEMSELVES)
- MAGNETIC COMPENSATOR ELEMENTS
- STRUCTURAL STRESS CHANGES

△ WANDER

- THERMAL GRADIENT VARIATIONS
- EDDY CURRENT CHANGES
- CURRENT SOURCE CHANGES (TEMPERATURE)
- GRAVITY

SUMMARY OF ALONG-SCAN PROFILE SHIFT

The facing chart depicts all of the profile shifts observed with the various SMA configurations (noted at the top). Every new configuration or adjustment is indicated by a small square that is referenced to zero. The open circles indicate detailed IFAR/DAS measurements in the TM Laboratory, and the solid dots indicate relative shifts of midscan time measurements on the vibration fixture (nested component). Vibration 10 caused a 23- μ rad shift, which occurred in the presence of the magnetic compensator. However, removing the compensator and measuring linearity in relation to the previous EM-C configuration indicated that the shift that occurred was associated with the flexure pivots.

ALONG-SCAN PROFILE SHIFT SUMMARY

HUGHES

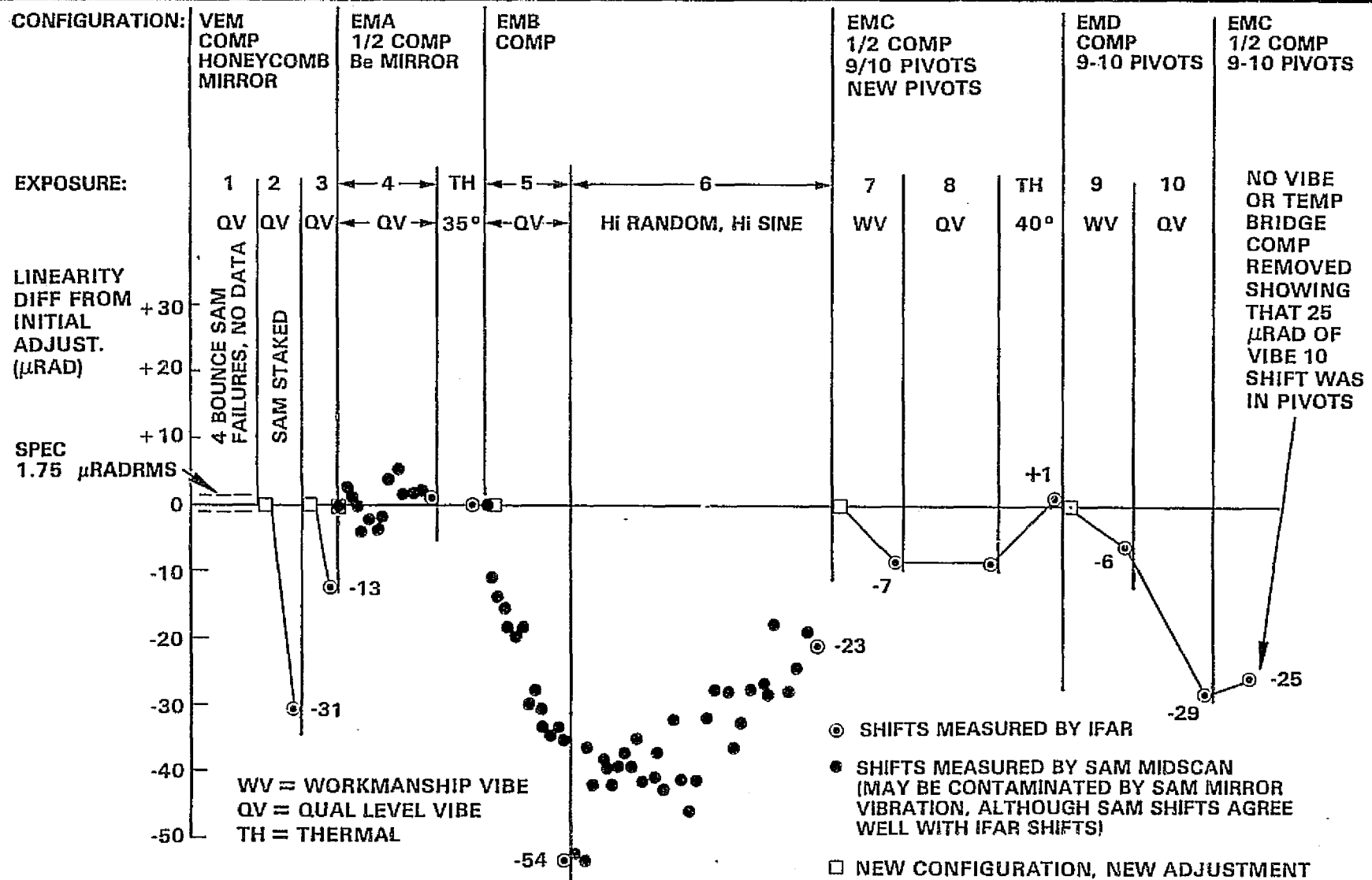

VG 11

ALONG-SCAN PROFILE WANDER

The facing viewgraph indicates observations of the linearity "wander". During the life test, midscan times will be monitored and plotted to determine if there is any long-term trend in the "wander" effect.

ALONG-SCAN PROFILE WANDER

HUGHES

- VEM: OBSERVED WANDER ON DTS
 - ≈ ±2 μRAD ELECTRONICS
 - ≈ ±3 μRAD NON-ELECTRONICS
- EM: SEVERAL SETS OF 20 RUNS INDICATED THE SAME, AND POSSIBLY SOME GRADUAL LONG-TERM DRIFT
- EM: WANDER RUNS SHOW ≈ 4 μRAD NESTED VARIATION AND ≈ -1.5 μRAD NON-NESTED VARIATION AFTER 40-MINUTE ORBIT OPERATION
- WANDER CONCLUSIONS:
 - Δ -1.5 μRAD NON-NESTED TURN-ON VARIATION DUE TO CURRENT SOURCE TEMPERATURE RISE
 - Δ 4 μRAD NESTED TURN-ON VARIATION DUE TO THERMAL STRESSES ON FLEXURE PIVOTS OR COMPENSATORS
 - Δ DIRECTIONS OF SHIFTS PROBABLY DEPEND ON INITIAL TEMPERATURE
- LTM: WILL BE MONITORED FOR STATISTICS AND LONG-TERM DRIFT

These simulated orbit data runs (on the structural model main frame) represent Engineering Model quarter-, mid-, and three-quarter linearity points as measured by the data acquisition system (DAS) and also the midscan correction indicated in the line length code (Curve 1). Since the correction follows the measured data and the quarter points follow parabolically, this fact indicates that the correction scheme works for the turn-on component of the profile "wander".

In some data runs, the turn-on profile variation decreased rather than increased. A small portion of this variation is in the ASC current sources, but the source of the dominant effect is not known.

45-MINUTE OPERATION FROM STANDBY CONDITION

HUGHES

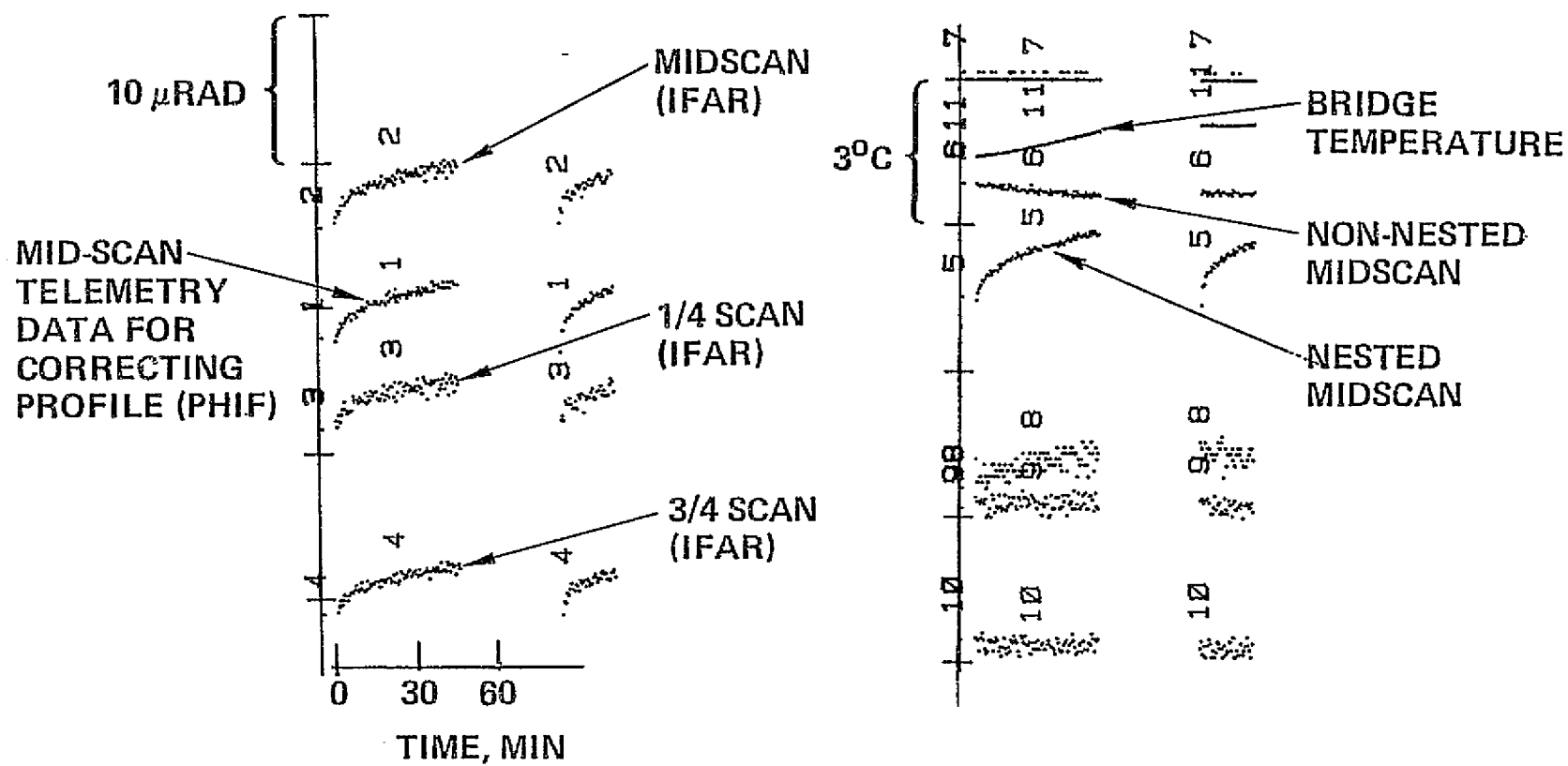

MID-SCAN
TELEMETRY
DATA FOR
CORRECTING
PROFILE (PHIF)

EM; SME ON SMA

The ASC current source temperature dependence was measured on the EM circuit board. The positive and negative current sources are used to compensate the reverse and forward scans, respectively. Over the expected operating temperature range of the circuit board, less than one-microradian variation is seen. Hence the dominant variations seen in simulated orbit runs of viewgraph 12 are not due to ASC current source variation.

SME ACTIVE SCAN CONTROL CURRENT SOURCE STABILITY

HUGHES

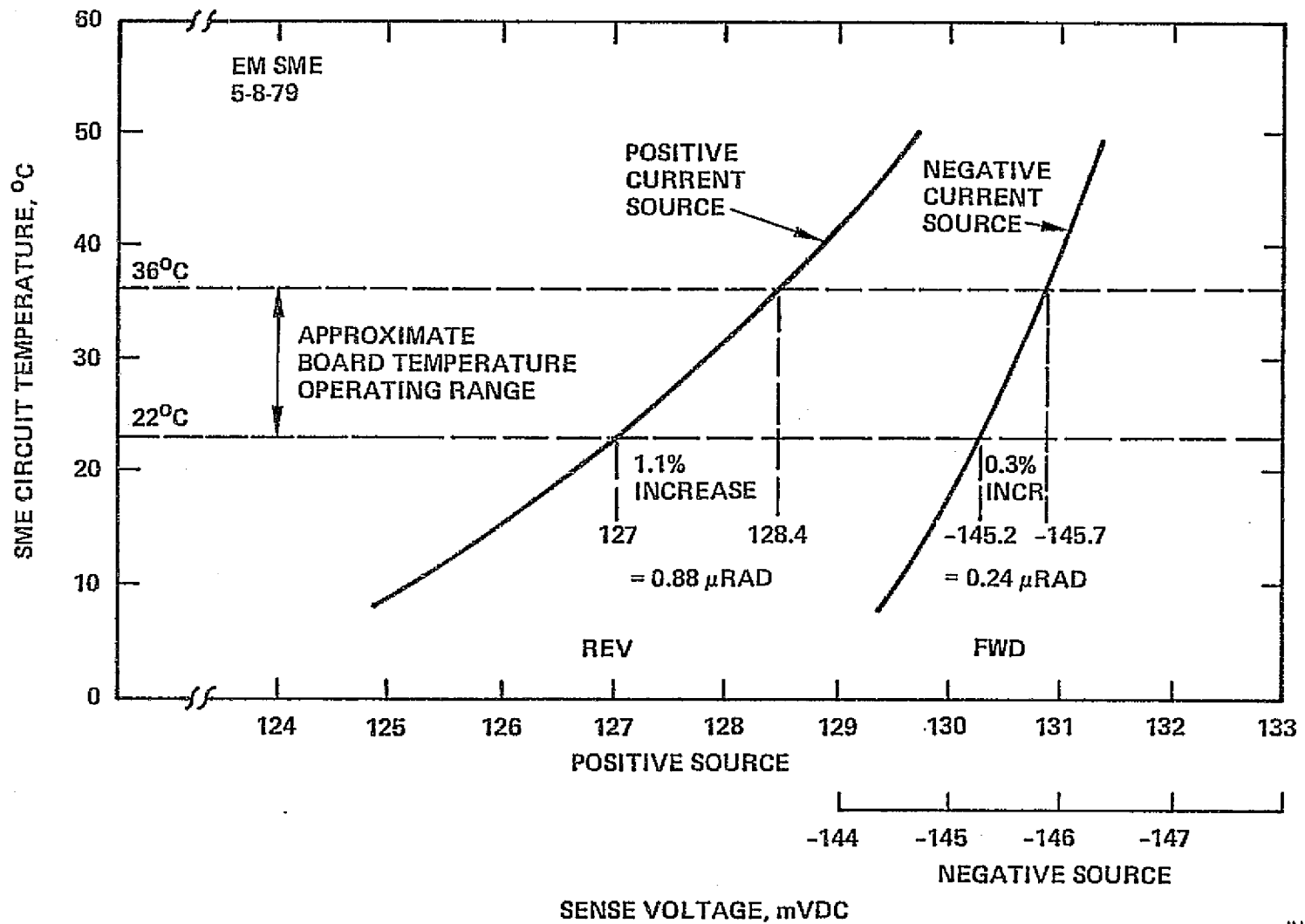

With a four-bolt mount on the DTS fixture, the life test model SMA was operated at 12°, 24°, and 36°C. This interface is considerably different than that of the main frame. Under these conditions, it was found that both nested and non-nested relative thermal variations were similar for the three configurations shown.

NESTED AND NON-NESTED VARIATIONS WITH TEMPERATURE

HUGHES

- LIFE TEST MODEL (ON DTS) OPERATED WITH SME INSIDE CHAMBER
(WITH ACTIVE SCAN CONTROL):
 - Δ NESTED = 7.9 μ RAD/12⁰C
 - Δ NON-NESTED = -5.4 μ RAD/12⁰C

- LTM, BB2 (OUTSIDE CHAMBER), WITH ACTIVE SCAN CONTROL:
 - Δ NESTED = 8.1 μ RAD/12⁰C
 - Δ NON-NESTED = -6.2 μ RAD/12⁰C

- LTM, BB2 (OUTSIDE CHAMBER), NO ACTIVE SCAN CONTROL
 - Δ NESTED = 8.5 μ RAD/12⁰C
 - Δ NON-NESTED = -5.8 μ RAD/12⁰C

- CONCLUSIONS
 - Δ DOMINANT NESTED AND NON-NESTED TEMPERATURE EFFECTS
ARE NOT CURRENT SOURCE VARIATIONS
 - Δ NESTED VARIATION APPARENTLY IS NOT DUE TO SME THERMAL
EXPANSION
 - ∴ EDDY CURRENTS AND CONSERVATIVE TORQUES VARY WITH
TEMPERATURE

This chart identifies the requirements that must be met if the midscan profile correction is to work. The first two items are discussed in the following four viewgraphs. The SMA offsets are now expected to remain stable after the stiffening of the SAM primary mirrors on the Life Test Model. Line length telemetry, which includes midscan information, is explained in Viewgraph 41. The line length is issued as error signals from an ideal linear scan (the time to midscan from start and the time from midscan to stop). These signals overflow when either half-scan error exceeds 11 clock bits ($\pm 385 \mu\text{sec}$).

Viewgraphs 31 through 43 explain the ground-based processing parameters and how to modify the smoothed profile polynomial equations to incorporate the parabolic midscan correction.

PARABOLIC SCAN PROFILE CORRECTION

HUGHES

- ALL SIGNIFICANT SHIFTS AND WANDER MUST BE PARABOLIC
- TO MEASURE MIDSCAN ACCURATELY REQUIRES STABLE WING MIRROR
- REQUIRES STABLE SAM OFFSETS (STABLE, NON-RESONANT SAM OPTICS)
- REQUIRES MIDSCAN INFORMATION IN LINE LENGTH TELEMETRY
- REQUIRES GROUND-BASED PROCESSING

VG 16

VEM POST-VIBRATION 2 WITH NESTED CORRECTION (CURRENT)
TO RE-ESTABLISH PRE-VIBRATION 2

The 31- μ rad shift which occurred in vibration 2 was shown to be substantially parabolic by applying a constant torque to the scan mirror in one direction; this was done by using the ASC current sources.

If the original data plot of pre-vibration 2 (see viewgraph 7) is overlaid with the data plotted in this figure, it is seen that throughout the scan the nested profiles overlay within about one micro-radian. This fact demonstrates empirically that this shift is parabolic.

VEVI POST-VIB 2 WITH NESTED CORRECTION (CURRENT) TO RE-ESTABLISH PRE-VIB 2

HUGHES

Date: 53879
Time: 1925

ALONG SCAN LINEARITY
Post v 2 WITH:
Case: MANUAL NESTED WITH NON-N: 030.328
(0.44) Plus (-0.11), (-0.14)

Temperature Turnaround
SUBC Tau A
T Tau B
P5-P8
P3-P2

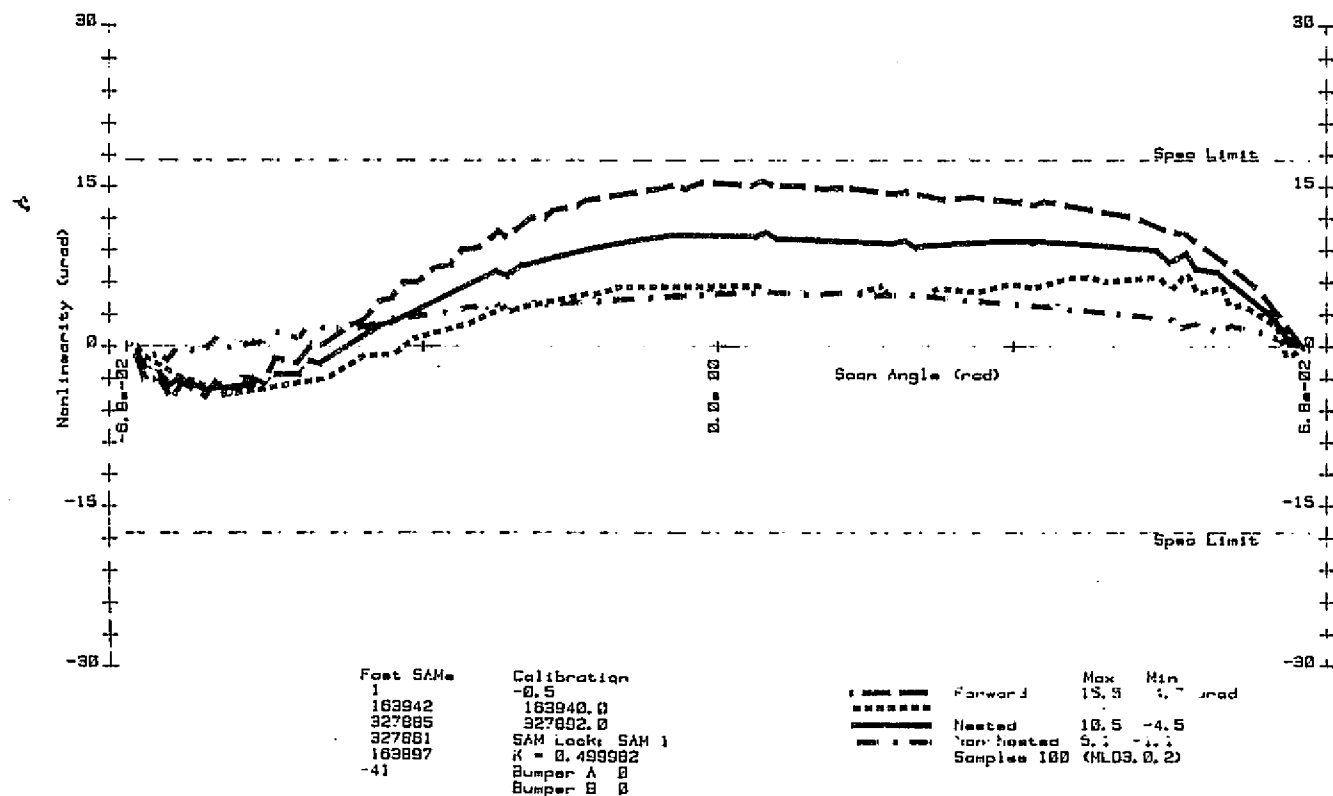

These figures illustrate that the gravitational effect on the EM profile is parabolic. The upper left-hand figure includes the fifth-order smoothed profile polynomial fitted to a normal SMA linearity run and the smoothed profile polynomial fitted to an inverted SMA linearity run. The lower left-hand figure illustrates the parabolas needed to bring both profiles to zero at midscan. The upper right-hand curves are the modified profiles after the corresponding parabolic terms have been subtracted. At the lower right-hand is an expansion of the one above (10- μ rad total scale on the ordinate). There are two curves, one solid, one dashed; both are substantially the same, hence that the normal and inverted profiles are related parabolically.

PARABOLIC SHIFT OF INVERTED SMA (EM)

HUGHES

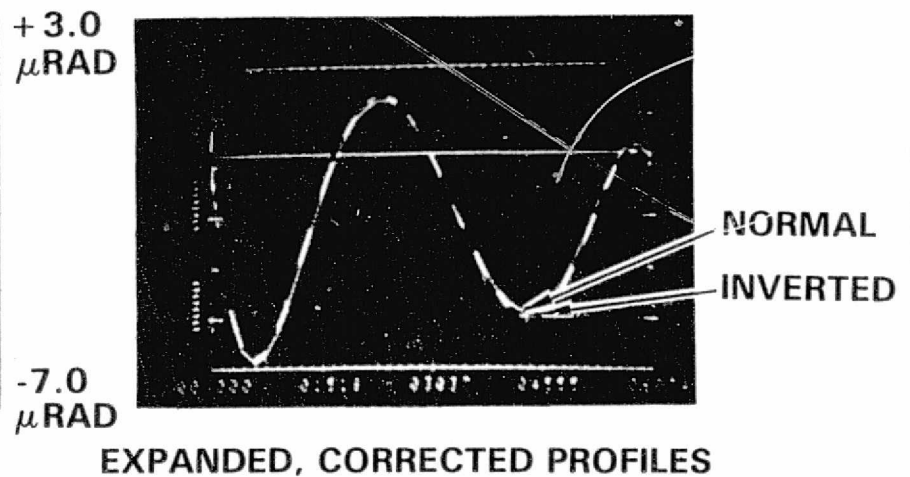
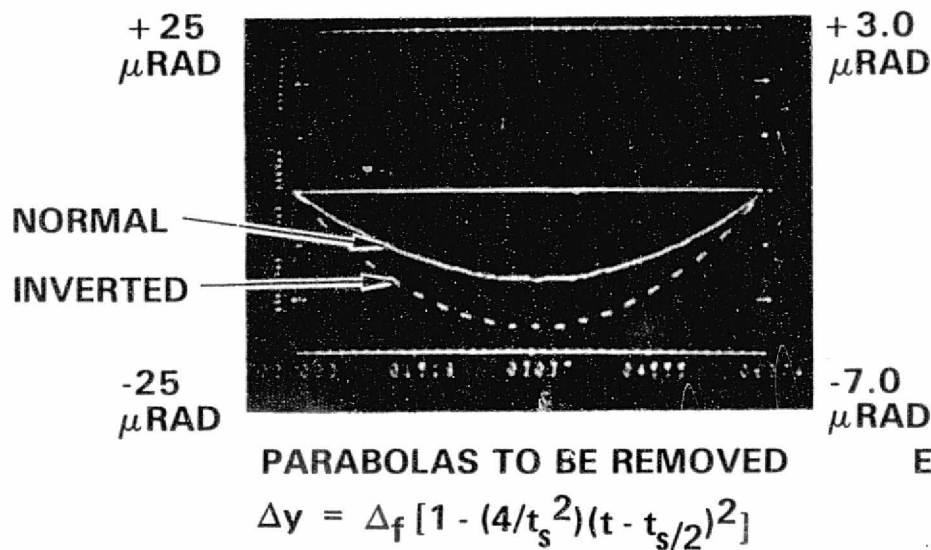
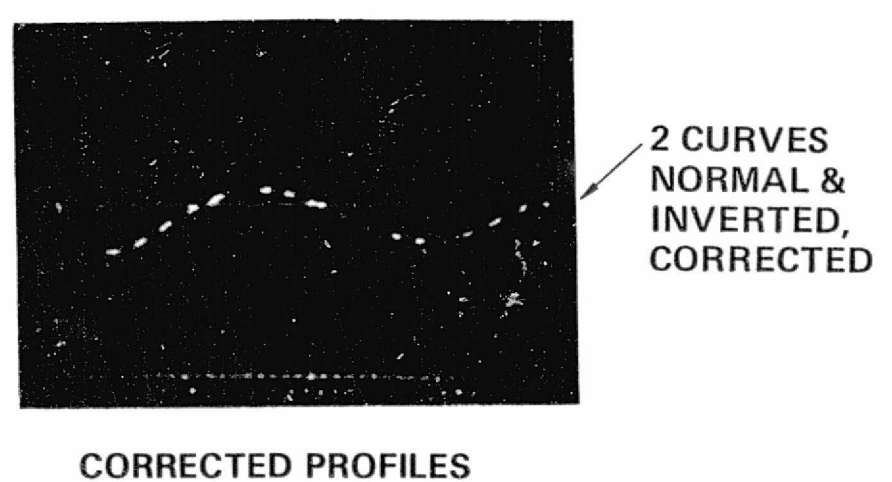
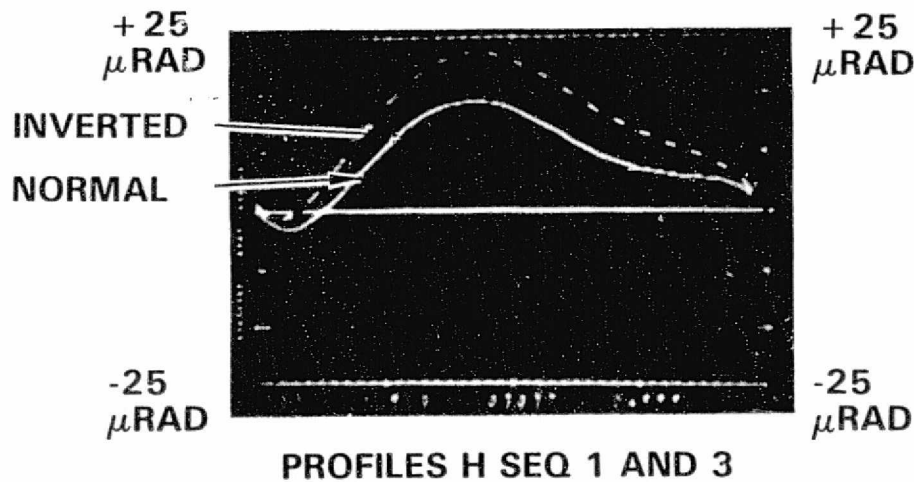

ORIGINAL PROFILE OF POOR QUALITY

For the midscan correction to be effective, it is important that the SAM wing mirror remain stable. The facing figure illustrates all linearity curves taken for SAM (1) during two months of test (VEM) in which IFAR calibrations were taken. The IFAR SAM angle proportionality constant K represents the wing mirror stability. The upper curve illustrates variations in mid-scan linearity in these tests, many of which intentionally stressed the SMA by placing shims under portions of the frame. The time period also includes vibration No. 1. Throughout these tests the K factor remained within the equivalent of $\pm 2 \mu\text{rad}$.

The interferometric angle resolver (IFAR) is discussed in viewgraph 23. The intrinsic pointing angle of this instrument with respect to the SMA (at midscan) α_0 affects the value of the wing mirror proportionality constant K . If α_0 is large (milliradians), there will be a discrepancy between K and K'_0 (K'_0 is the wing mirror proportionality constant as measured with a theodolite). When the SMA is inverted, α_0 changes sign and its effect on K is opposite. Hence we can define K_0 as the average of NORMAL K and INVERTED K . K_0 should be equal to K'_0 . All life test model K_0 values found are plotted and indicate exceptional stability of the wing mirror.

LTM K_0 STABILITY

HUGHES

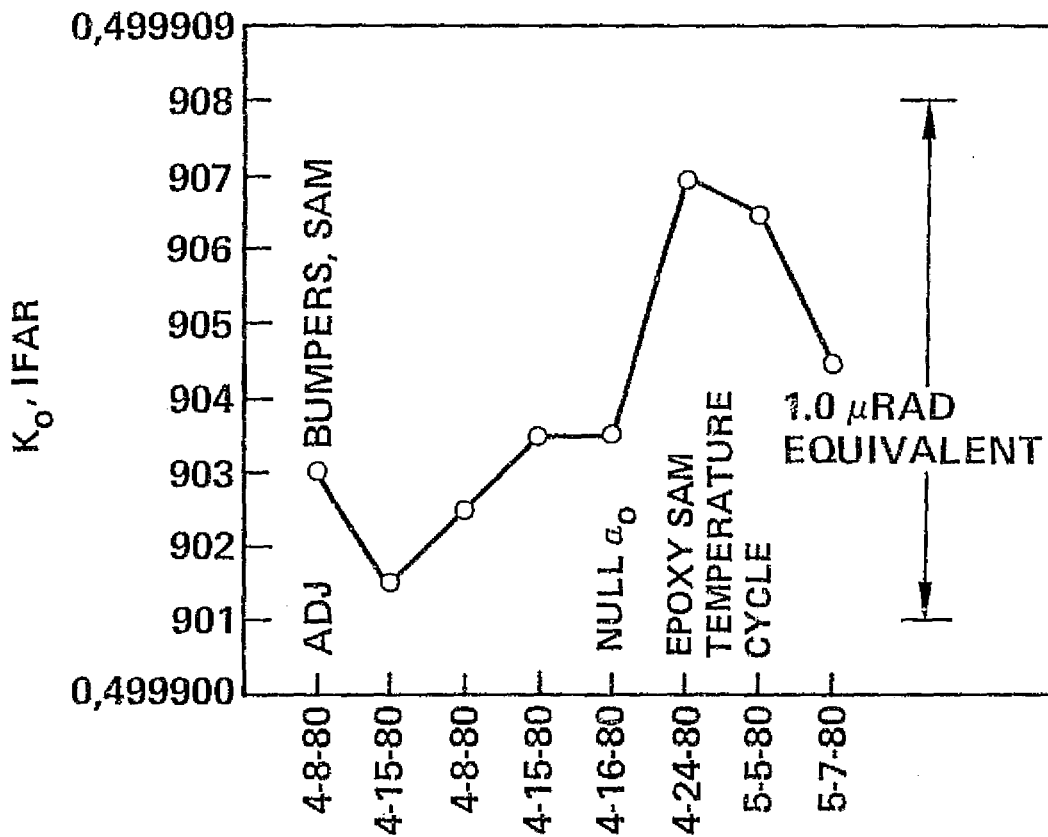

- INVERT SMA AND CHANGE SIGN OF α_0

- $$K_0 = \frac{K_{NORM} + K_{INV}}{2}$$

- DATA INDICATES WING MIRROR IS STABLE TO MEASUREMENT CAPABILITY

VG 20

SCAN PROFILE GENERATION

The next ten viewgraphs describe the equipment and methods used in generating along-scan profiles. Data is presented that indicates the accuracy of the instrumentation.

SCAN PROFILE GENERATION

HUGHES

- TEST CONFIGURATION
- IFAR OPERATION AND EQUATIONS
- WHERE IFAR CAN GO WRONG; PREVENTIVE TESTS
- SAM-LOCK/IFAR STABILITY
- DATA COLLECTION
 - CALIBRATION
 - SCAN DATA
- SAM OFFSETS
- POLYNOMIAL FIT TO 400-POINT DATA; SMOOTHED PROFILE

JULY 1980

The present acceptance test station (ATS) consists of a rigid aluminum SMA mounting fixture (DTS) that is within a stainless-steel vacuum chamber and that is mounted on an isolated granite slab. The DTS fixture is thermally controlled. The IFAR instrument is attached to a rigid aluminum fixture. A theodolite can be set up to view the front surface of the scan mirror through a port in the DTS fixture.

Signals from the IFAR and the SMA interface with the data acquisition system (DAS) which formats high-speed IFAR digital data and directs it (DMA) to the HP 9825A computer. A time clock can be sampled and a DVM/scanner combination monitors temperatures and voltages. The computer interfaces with a printer and highly precise plotter.

ALONG-SCAN PROFILE TEST CONFIGURATION

HUGHES

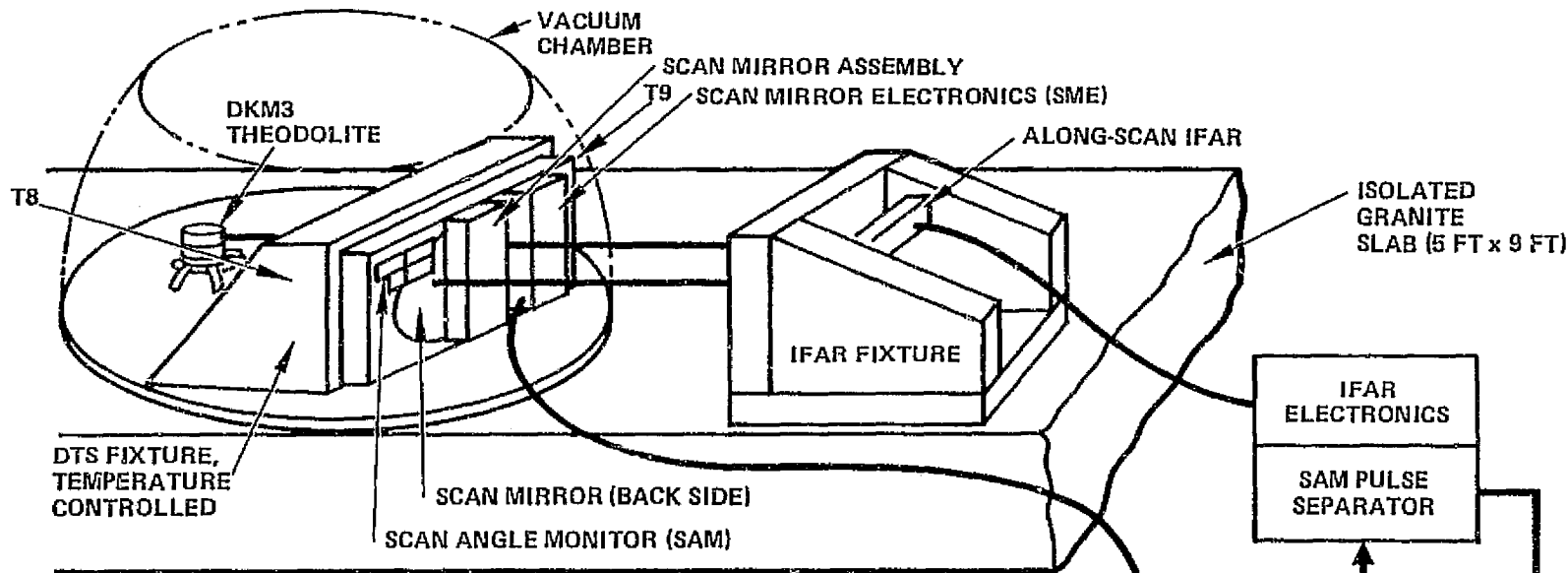

THEODOLITE MEASURED ANGLES:

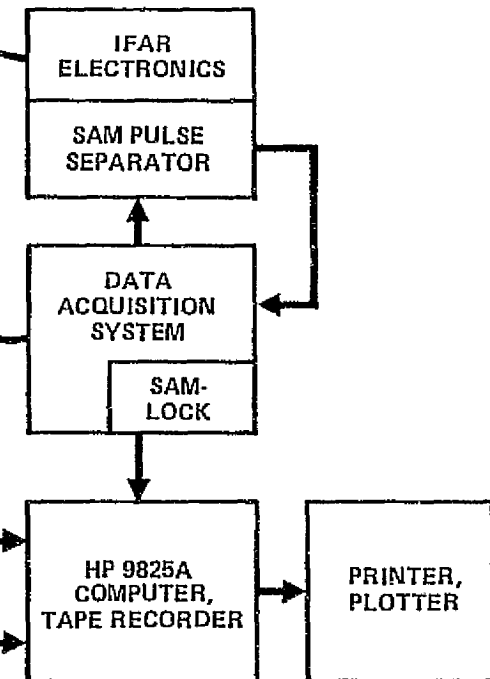
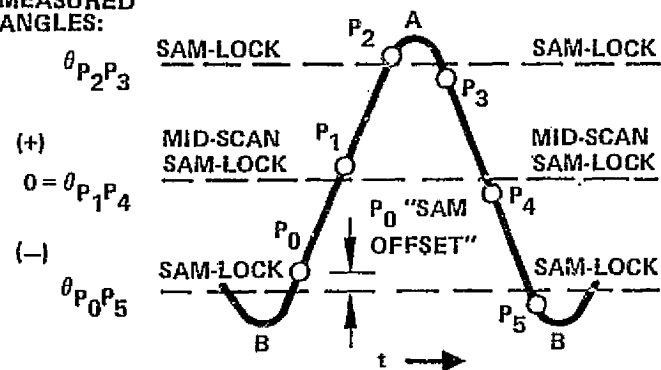

ELECTRONIC ZERO-LOCK (SAM-LOCK)

A requirement was established to lock the SMA to midscan for system level optical alignment. Mechanical locks were investigated and found to be undesirable. An electronic means was found to locate the scan mirror at either bumper (by using currents in the torque motor) or electronically lock it onto the dc-coupled SAM preamplifier signal by using a Type I integrating control loop to remove the effects of residual spring forces. This scheme has become key to the calibration of IFAR for linearity tests. It is used to locate the scan mirror precisely at the three angles that are measured with IFAR and that were previously measured with a theodolite. In this way, the nonlinear IFAR equations can be solved in order to relate interference fringe count with angle.

ELECTRONIC ZERO-LOCK (SAM-LOCK)

HUGHES

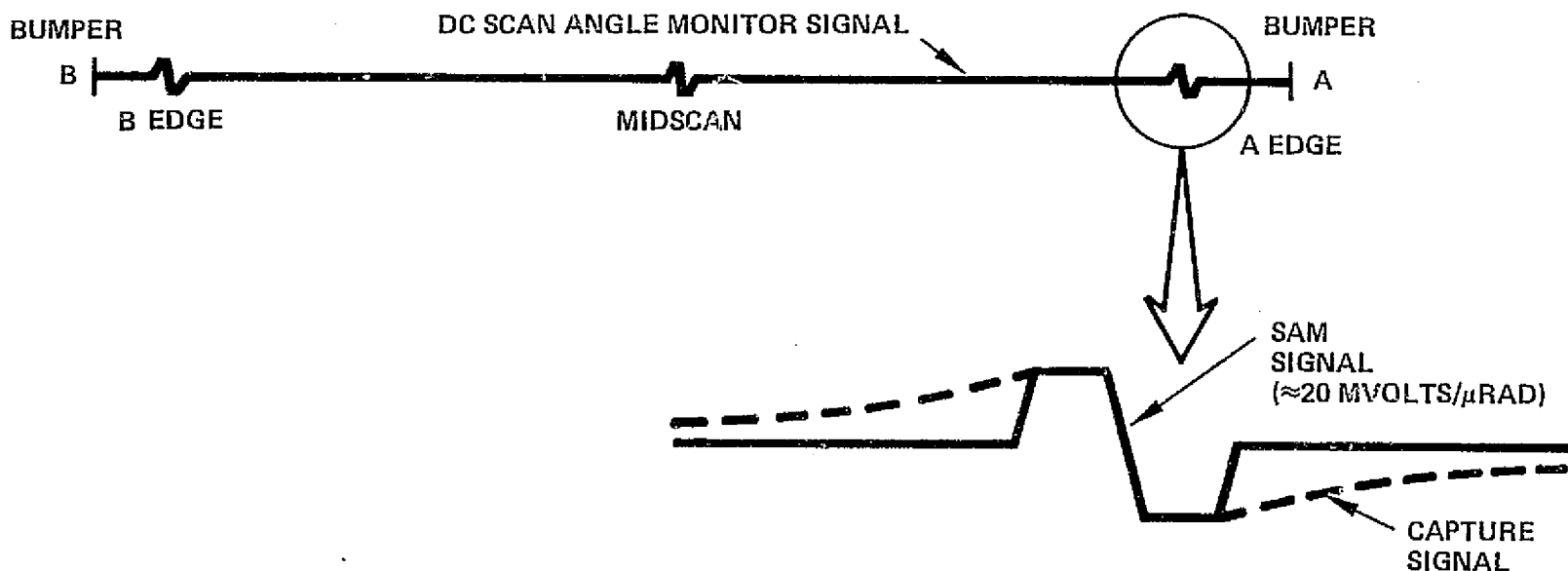

- SIMPLE, ACCURATE OPTICAL ALIGNMENT
- SYSTEM TEST AID
(SIMPLE BORESIGHT AND EDGE CHECK)
- $< 1 \mu\text{RAD}$ PRECISION POINTING AT TRUE SYSTEM REFERENCE ANGLES (LINE START, MIDSCAN, LINE STOP ANGLES)

INSTRUCTIONS

1. SELECT A OR B BUMPER
2. SELECT INTEGRATOR - OUT
3. SELECT MIDSCAN OR EDGE
4. ADJUST KNOB CCW TO CAPTURE
5. SWITCH TO SAM; WAIT 5 SECONDS
6. SLOWLY TURN KNOB CW TO LOCK
7. SELECT INTEGRATOR - IN

JULY 1980

The facing figure presents simplified IFAR equations that result from eliminating negligible terms (see HS236-1334). Since the corner cube spacing A depends on temperature, the calibration must be done for each test. The wavelength of light varies with pressure in the chamber, and the intrinsic pointing angle of the IFAR fixture with respect to the midscan pointing angle of the scan mirror can vary. It is important that in each linearity test these variables be accounted for. The technique used involves assigning the known static SAM angles (from theodolite measurements) to the measured IFAR counter readings at the three angles. With this data, the values of N_0 , a , and b can be determined directly.

Three problems are occasionally encountered with the system. Laser instabilities can occur whereby coherence fluctuates and can upset the fringe signal generation. Optical alignment must be carefully adjusted and monitored. Finally, during calibration the integrator switch for SAM-LOCK can be inadvertently placed in the OFF condition. The characteristics of these problems are now well known, and traps are set in the test software to catch all of these situations, alerting the operator to the problem and requiring a repeat of the test. All of these tests have been used (manually in the early days) since the beginning of the engineering model testing. They are now incorporated into the test software.

IFAR CALIBRATION AND EQUATIONS

HUGHES

$$N = N_0 + a \sin(\theta) - b \sin^2(\theta/2)$$

$$a = D \cos \alpha_0$$

$$b = 2D \sin \alpha_0$$

$$D = 8A/\lambda$$

(SEE HS236-1334)

SAM-LOCK
LOCATIONS

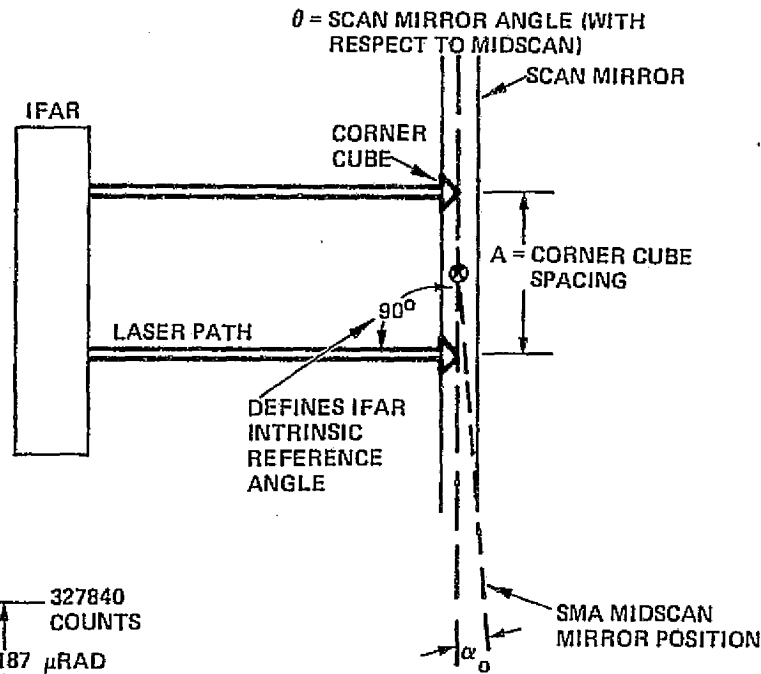
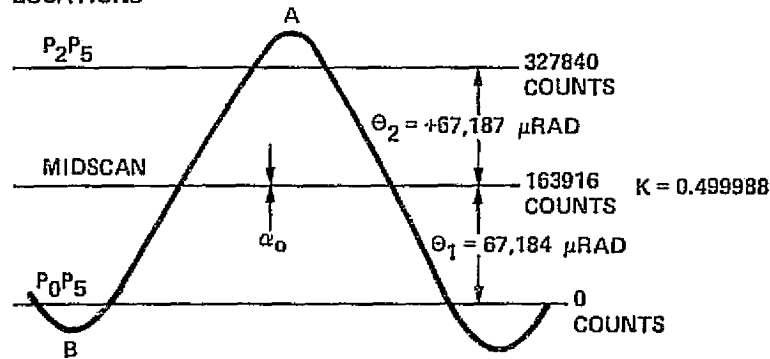

Δ CORNER CUBE SPACING IS TEMPERATURE--DEPENDENT

Δ N_0, a, b GENERATED FROM $\theta_1, \theta_2,$ AND IFAR COUNTS

Δ α_0 FOUND TO HAVE TWO COMPONENTS (LTM)

- CORNER CUBE ALIGNMENT IN SM
- IFAR FIXTURE ALIGNMENT WITH SMA

Δ ΔN VS θ SHOWN TO BE BOTH CORRECT AND CORRECTLY IMPLEMENTED IN SOFTWARE

Δ IFAR MISBEHAVIOR

- LASER
- ALIGNMENT
- INTEGRATOR SWITCH

$$K = \frac{N_1 - N_0}{N_2 - N_0} \quad (\text{NORM OR INV})$$

$$K_0 = \frac{(K_{\text{NORM}} + K_{\text{INV}})}{2}$$

$$K'_0 = \text{THEODOLITE RATIO}$$

DATA SHOWING IFAR AND THEODOLITE AGREEMENT

The 31 measurements plotted were carefully taken by positioning the scan mirror (LTM) at various positions within the scan field. Theodolite and IFAR measurements were made at each location. The end points and midscan values were used in calibrating the IFAR equations, which were then used to compute the angle for each data point. The difference between the resulting IFAR measurement and the corresponding theodolite measurement is shown in the facing figure. The statistical uncertainty normally observed with the theodolite used is approximately 1 arc-sec rms. These data points had a 0.58 arc-sec rms (one sigma) uncertainty. This data confirms that all significant nonlinear terms in the IFAR equations have been accounted for.

DATA SHOWING IFAR AND THEODOLITE AGREEMENT

HUGHES

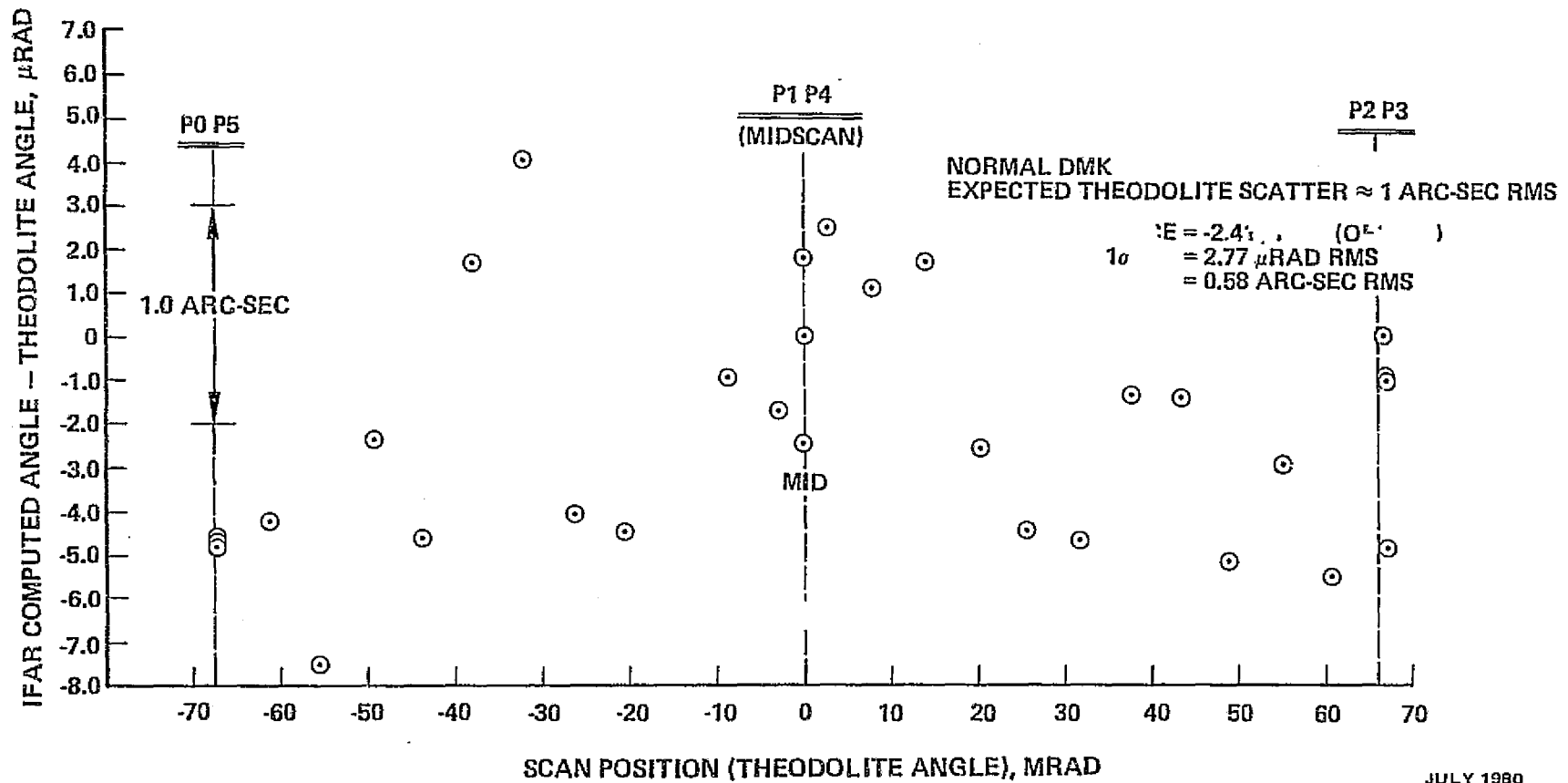

JULY 1980

LONG-TERM SAM-LOCK STABILITY TEST (SEVEN HOURS)

To demonstrate the stability of the electronic zero-lock (SAM-LOCK) in meeting the repeatability requirements (Para 3.1.1.8 of DS32015-004) of ± 1 arc-sec, the data shown on the facing page was collected. This represents a combination of long-term IFAR stability, DTS and IFAR fixture stabilities, d-c SAM stability, and SAM emitter/detector effects. Each data point is the mean of ten samples of the IFAR counter, taken about 0.5 second apart. This process was repeated every 5 seconds overnight. Clearly, the SAM-LOCK meets its stability requirements. The major variations are believed to occur in the relative pointing of the IFAR fixture (not thermally controlled) and the DTS fixture (controlled to 24.0°C).

LONG-TERM SAM-LOCK STABILITY TEST (7 HOURS)

HUGHES

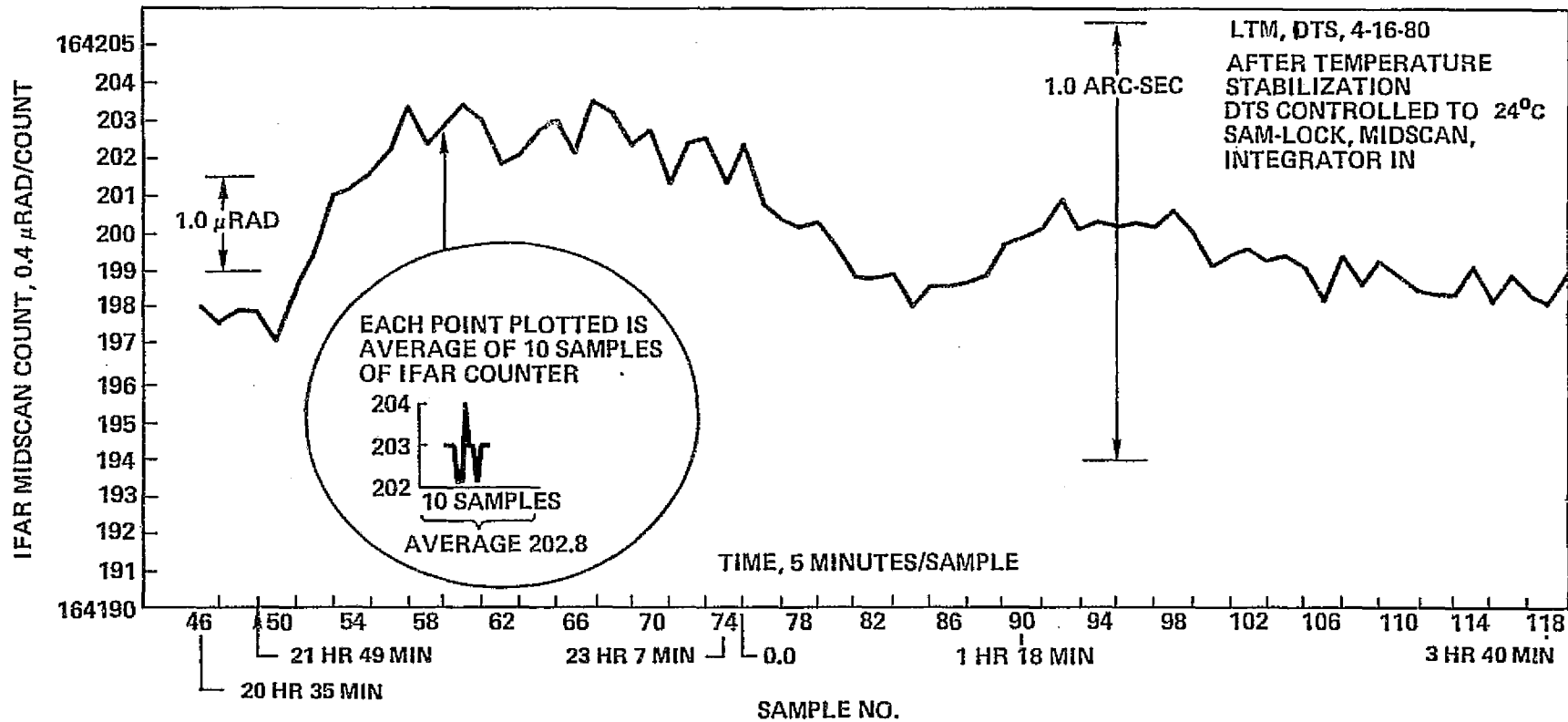

This flow diagram illustrates the process followed during acceptance tests when calibrating the IFAR for each linearity test. The first measurement involves the mean of five separate theodolite readings that are taken once for each scan mirror before the profiles are generated. The remaining steps are self-explanatory.

ALONG-SCAN PROFILE GENERATION PROCESS (CALIBRATION)

HUGHES

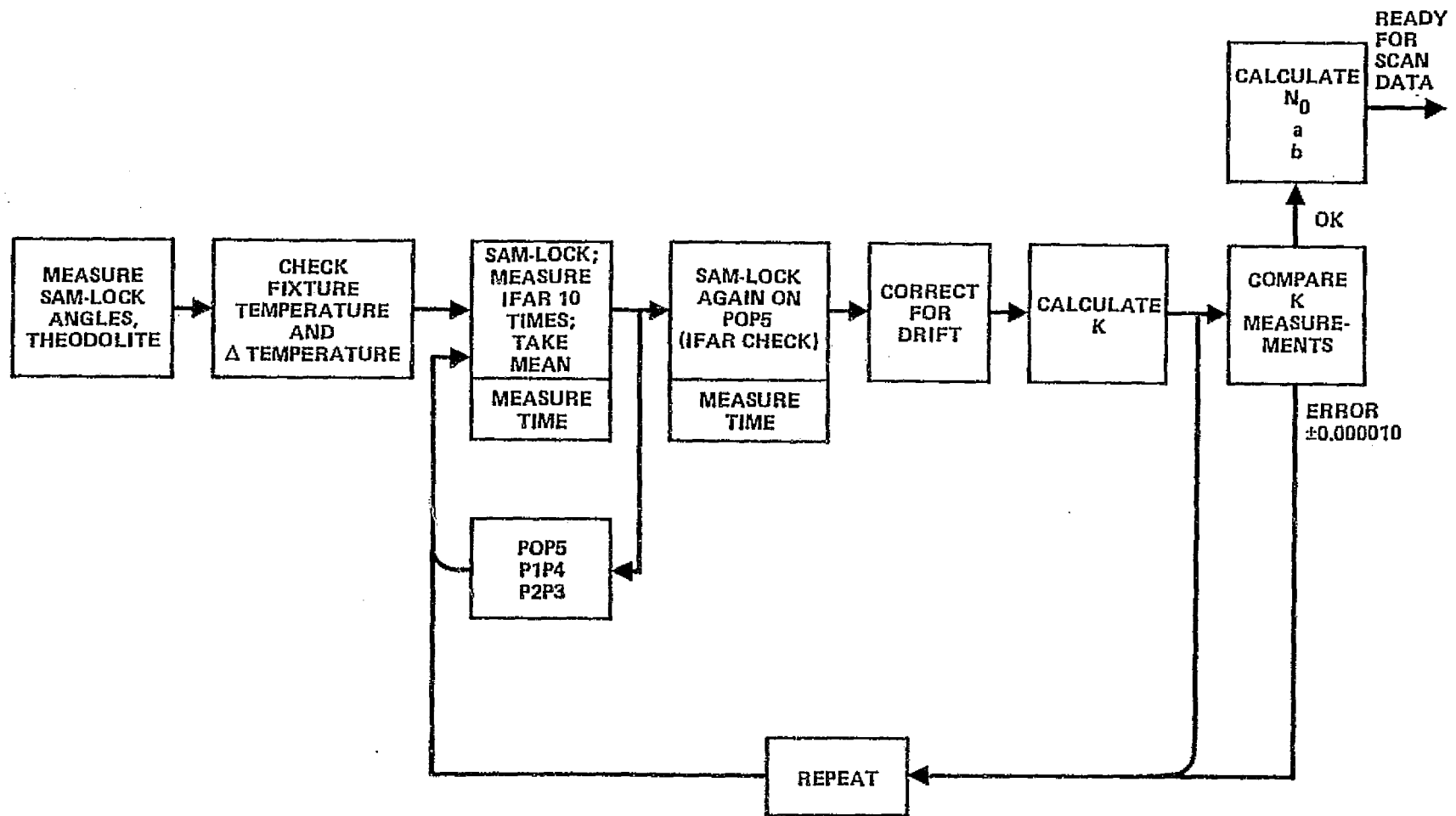

IFAR CALIBRATION TECHNIQUE

The facing viewgraph is a typical computer printout for a calibration. The scan mirror is SAM-LOCKED onto P_0P_5 , and ten samples of the IFAR counter are read (each count corresponds to about $0.41 \mu\text{rad}$). A value is then obtained for bumper B, followed by midscan and bumper A. After the SAM station at P_2P_3 is measured, the scan mirror is returned to P_0P_5 to determine if there were any laser problems and to obtain thermal drift corrections. At the end of the data collection period, the IFAR equation parameters N_0 , a and b are determined for the upcoming scan data. As can be seen, this process takes about three minutes. The scan data is then collected within about two minutes.

IFAR CALIBRATION TECHNIQUE

HUGHES

CALIBRATE: SAM/SME: 1

Along	Cross	Octal A	B
-1.00	1.00	007401	007777
0.00	4.00	007404	010000
-1.00	5.00	007405	007777
-1.00	4.00	007404	007777
P _{0P5} -1.00	3.00	007403	007777
-2.00	2.00	007402	007776
-2.00	2.00	007402	007776
-3.00	1.00	007401	007775
-1.00	2.00	007402	007777
-1.00	2.00	007402	007777
-1.00	2.00	007402	007777
Average	-1.30	Minutes:	610.62

Along	Cross	Octal A	B
327810.00	6.00	057406	010202
327810.00	5.00	057405	010202
327810.00	4.00	057404	010202
327810.00	3.00	057403	010202
P _{2P3} 327810.00	5.00	057405	010202
327809.00	5.00	057405	010201
327810.00	6.00	057406	010202
327810.00	6.00	057406	010202
327810.00	5.00	057405	010202
327810.00	6.00	057406	010202
327811.00	5.00	057405	010203
Average	327810.00	Minutes:	612.35

1σ = 0.7 COUNT
TYP
= 0.3 μRAD

Along	Cross	Octal A	B
-3363.00	1.00	007401	001335
-3364.00	1.00	007401	001334
-3364.00	1.00	007401	001334
-3364.00	0.00	007400	001334
Average	-3364.00	Minutes:	611.00

Along	Cross	Octal A	B
-1.00	6.00	007406	007777
-1.00	4.00	007404	007777
-1.00	5.00	007405	007777
-1.00	6.00	007406	007777
P _{0P5} -1.00	7.00	007407	007777
AGAIN 0.00	7.00	007407	010000
-1.00	7.00	007407	007777
-1.00	6.00	007406	007777
-1.00	6.00	007406	007777
-1.00	5.00	007405	007777
-2.00	7.00	007407	007776
Average	-1.00	Minutes:	613.00

Along	Cross	Octal A	B
163904.00	2.00	027402	110100
163904.00	1.00	027401	110100
163904.00	1.00	027401	110100
163904.00	1.00	027401	110100
163904.00	2.00	027402	110100
163904.00	4.00	027404	110100
163903.00	5.00	027405	110077
163903.00	4.00	027404	110077
163903.00	4.00	027404	110077
163903.00	4.00	027404	110077
163902.00	4.00	027404	110076
Average	163903.40	Minutes:	611.32

MIDSCAN

Along Scan Calibration

Facet	IFAR Counts	Preset Angles	No. a,b
P0P5	-1.00	-6.7184000E-02	1.6390361E 05
P1P4	163903.61	0.0000000E 00	2.4414333E 06
P2P3	327810.08	6.7187000E-02	2.4155637E 03

K = 0.499997

Bumper A: 331507.78
Bumper B: -3363.75

Along	Cross	Octal A	B
331507.00	4.00	057404	017363
331508.00	8.00	057410	017364
331508.00	9.00	057411	017364
331507.00	8.00	057410	017363
Average	331507.67	Minutes:	612.10

CROSS SCAN conversion factor: 0.410urad/IFAR count

ALONG-SCAN PROFILE GENERATION PROCESS
(SCAN DATA AND PROFILES)

This flow diagram illustrates the processes involved in scan data collection immediately after calibration. After the panel switch settings are checked (by computer), data on a pair of scans is collected, and the IFAR count at the P_0 time of the third scan is compared with that of the first. This test ensures that optical adjustments of IFAR and of the laser are proper. Each sample is then compared with its neighbors to determine if there are any discrepancies in the data. The data is then processed for plotting and testing against the design specification requirements.

ALONG-SCAN PROFILE GENERATION PROCESS (SCAN DATA AND PROFILES)

HUGHES

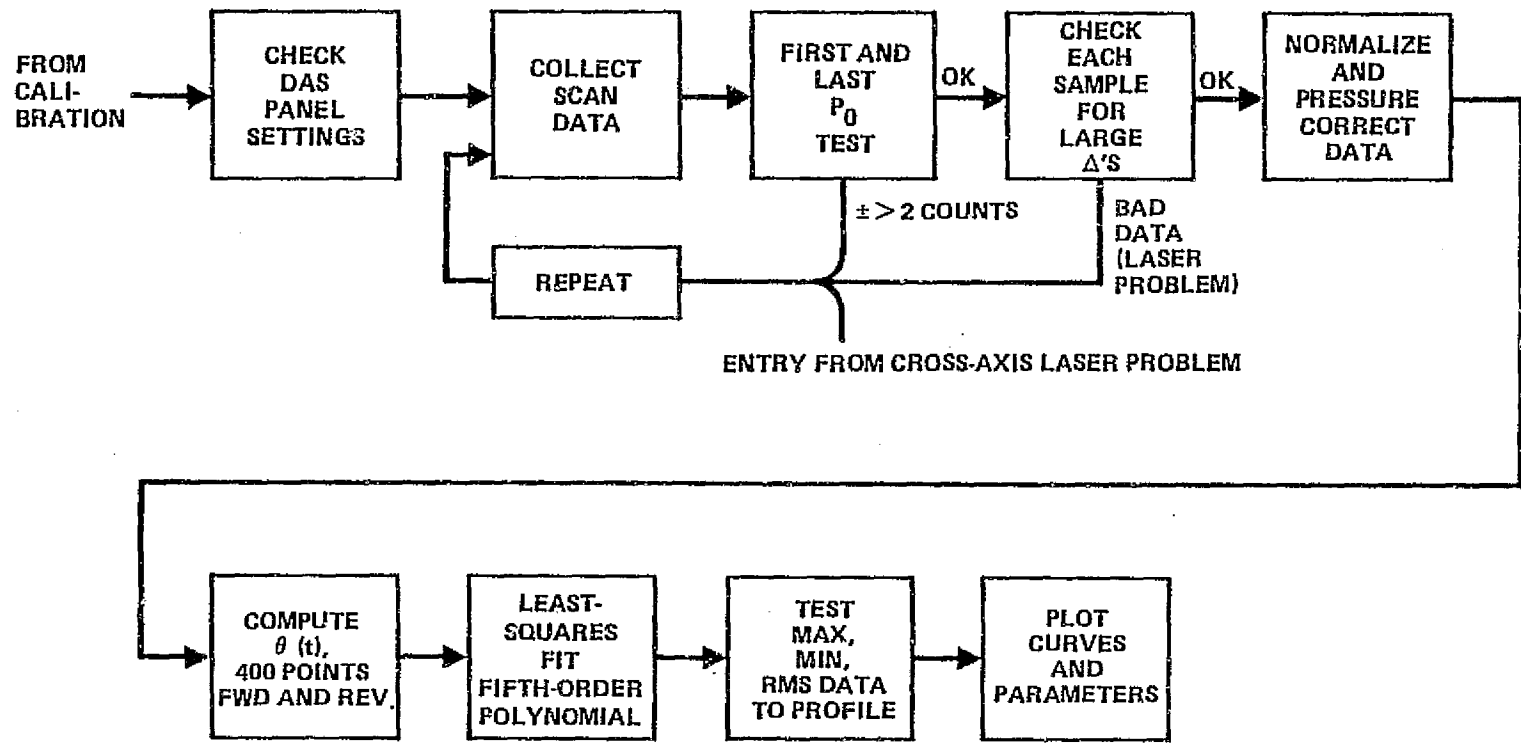

Two basic types of along-scan data sets are taken in the course of SMA acceptance tests, i. e., original high-resolution data for generating the smoothed profile polynomials, and multiple-scan lower-resolution geometric repeatability test data.

For the reference smoothed profile, a data set of one forward scan and one reverse scan, each with 400 angular points, is taken. The sample rate is sufficient to resolve the highest frequencies encountered with SMA profiles. Since short-term operation (e. g., 4000 scans) is known to be stable and since any wander is known to be parabolic, it is sufficient to generate a profile from a single scan provided that proper tests are employed to ensure that the data is good. The typical fit of a fifth-order polynomial along the 400 points is 0.2 μ rad rms.

For the geometric repeatability tests, the SMA laboratory computer memory limits the short-term data capacity. The number of scans obtainable should be sufficient to demonstrate that geometric repeatability is within specifications. Developmental tests of the LTM have shown that the line length repeatability to midscan is half the line length repeatability (typically $<0.5 \mu$ sec, one sigma) over 2000 forward and 2000 reverse scans. Hence over this time period, geometric profile wander was negligible. To alternately sample peaks and nulls of the torsional resonance, about 75 samples are needed across the scan. This number ensures that within any group of several torsional resonance peaks (ten), at least one sample will occur near a positive peak and near a negative peak and that on the basis of known profile characteristics, it will reliably indicate the worst-case deviation from the smoothed polynomial, within a small fraction of 1 μ rad.

OPTIMIZING HP 9825A MEMORY LIMITS

HUGHES

REFERENCE SMOOTHED PROFILE (1 FWD, 1 REV; 400 POINTS EACH)

- △ MUST PROVIDE HIGH RESOLUTION ON ALL MIRROR MOTION – INCLUDING 1050 Hz (TORSIONAL RESONANCE) AND BEYOND
- △ HIGH RESOLUTION REQUIRED TO MEASURE BAND-TO-BAND REGISTRATION (SCAN RATE)
- △ NUMBER OF SCANS UNIMPORTANT FOR CURVE FIT SINCE SHORT-TERM SCAN-TO-SCAN REPEATABILITY IS $< 0.4 \mu\text{RAD } 1\sigma$
- △ 6585 SAMPLES/SEC (6.3 SAMPLES PER TORSIONAL RESONANCE PERIOD)
- △ RMS OF CURVE FIT ALONG THE PROFILE TYPICALLY $0.2 \mu\text{RAD RMS (2.1 SPEC)}$

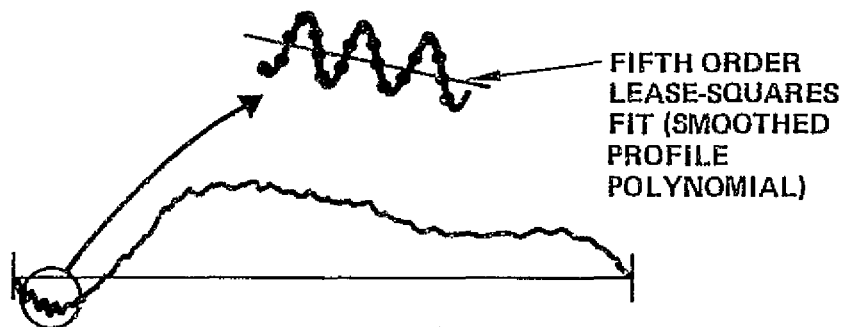

GEOMETRIC REPEATABILITY PROFILES (19 FWD, 19 REV; 75 POINTS EACH)

- △ RESOLUTION SHOULD BE SUFFICIENT TO SAMPLE POSITIVE AND NEGATIVE PEAKS OF TORSIONAL RESONANCE (THEY ARE FARTHEST FROM PROFILE)
- △ NUMBER OF SCANS SHOULD BE SUFFICIENT TO DEMONSTRATE THAT PERFORMANCE IS WITHIN SPECIFICATIONS
- △ THESE REQUIREMENTS LEAD TO:
 - NO. SCANS ≥ 20
 - NO. POINTS ≥ 128
- △ NO. SCANS CHOSEN = 19
- △ NO. POINTS POSSIBLE = 75

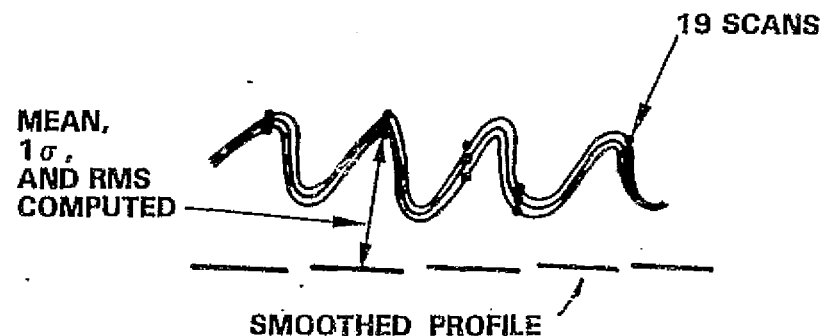

The facing table lists the individual sources of error involved in generating scan profiles. The values shown can be used in an error analysis to determine the fixed and scan-to-scan geometric uncertainties. On the radiometer, main frame errors would have to be determined for baseplate motion (negligible on the DTS).

The remaining viewgraphs deal with the method to be used for correcting parabolic profiles and with early LTM example data.

SCAN PROFILE ERROR SOURCES (ON DTS FIXTURE)

HUGHES

IFAR CALIBRATION

μRAD RMS

SAM LOCK	≈0.3
WING MIRROR THEODOLITE MEASUREMENT*	2.0

SCAN

SAM QUANTIZATION (5 MHz) 0.42 μRAD	0.12
IFAR QUANTIZATION, EACH POINT 0.41 μRAD	0.12

DYNAMICS

TORSIONAL RESONANCE~/ μRAD P-P (START OF SCAN)	0.42
SAM VIBRATION	≈0.1
WANDER**	≈2.0
BASEPLAT MOTION	(NEGLIG ON DTS)

*ABSOLUTE PROFILE UNCERTAINTY; NOT A REPEATABILITY PARAMETER

**CORRECTABLE BY USING MIDSCAN TELEMETRY

The facing figures explain how a parabola can be added to a smoothed profile polynomial to create a ground-calibrated profile polynomial that very closely describes an actual scan (scan "i") whose midscan telemetry data was used to determine the size of the parabola.

The upper curve illustrates an original smoothed profile. Its midscan value is defined as the profile (reference) offset angle ϕ_{fo} . This value is found during the data collection for the scan used when the original profile is taken. The second figure illustrates the actual profile for scan "i" in relation to the smoothed profile. The offset angle ϕ_{fi} is found from line length telemetry. The "ith" scan differs from the smoothed profile by a parabola where the midscan amplitude is $(\phi_{fi} - \phi_{fo}) = \Delta F_i$.

The lowest figure illustrates the original smoothed profile, the parabola $\Delta(t)$, and the ground-calibrated profile which is the parabola added to the original profile.

HUGHES

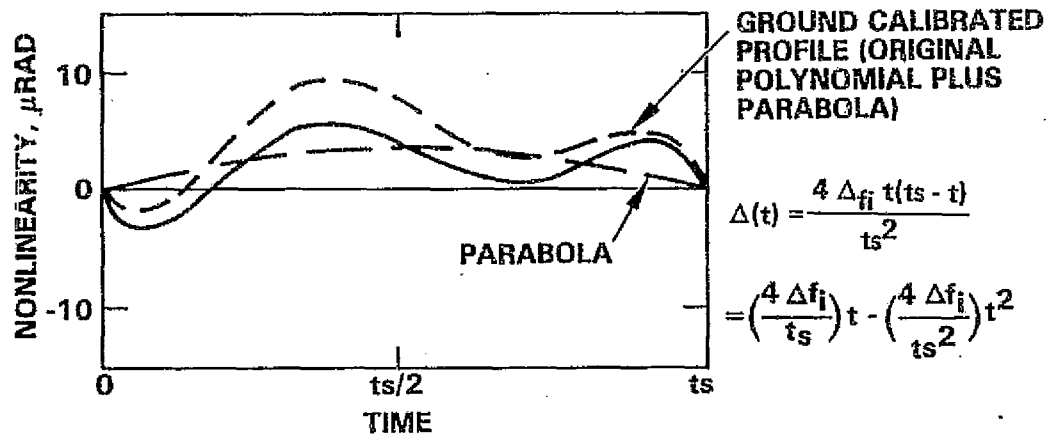
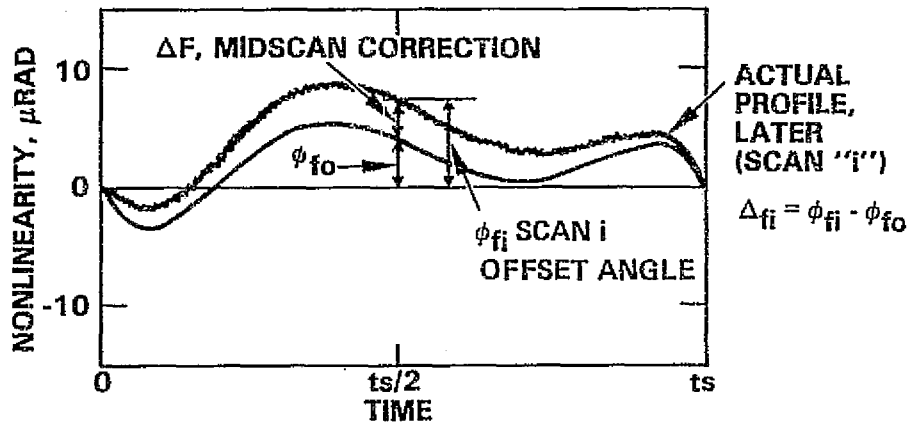
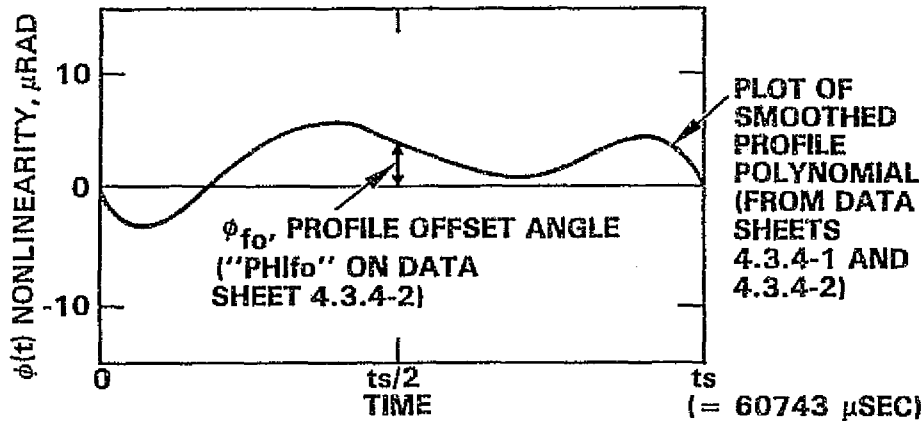

PROFILE POLYNOMIAL MODIFICATION CURVES

The forward profile is a fifth-order power series with coefficients a_0 through a_5 . The parabola for scan "i" is a second-order power series consisting of two terms, $a'_{1,i}$ and $a'_{2,i}$. The ground-calibrated profile is defined as a fifth-order power series with $a_{1,i} = a_1 + a'_{1,i}$ and $a_{2,i} = a_2 + a'_{2,i}$. The equation used to obtain Δ_{fi} from line length code is discussed with viewgraph 41.

HUGHES

● INITIAL SMOOTHED PROFILE POLYNOMIAL:

$$\phi(t) = a_0 + a_1t + a_2t^2 + a_3t^3 + a_4t^4 + a_5t^5$$

(FROM DATA SHEET 4.3.4-1)

● PARABOLA ASSOCIATED WITH LATER SCAN "i"

$$\Delta(t) = \left(\frac{4\Delta f_i}{t_s}\right) t - \left(\frac{4\Delta f_i}{t_s^2}\right) t^2$$

● GROUND CALIBRATED PROFILE POLYNOMIAL:

$$a_{0,i} = a_0$$

$$a_{1,i} = a_1 + \left(\frac{4\Delta f_i}{t_s^2}\right)$$

$$a_{2,i} = a_2 - \left(\frac{4\Delta f_i}{t_s^2}\right)$$

$$a_{3,i} = a_3$$

$$a_{4,i} = a_4$$

$$a_{5,i} = a_5$$

● Δf_i IS OBTAINED FROM LINE LENGTH CODE

PROFILE
POLYNOMIAL
MODIFICATION
EQUATIONS

JULY 1980

VG 33

LIFE TEST MODEL (AF) -- BASIC PROFILES
WITH FIFTH-ORDER POLYNOMIALS

The facing figure is an example data sheet taken on the LTM before it underwent final acceptance tests. Both the 400-point measured profiles and the smoothed fifth-order polynomials are plotted on a 20- μ rad scale. The theodolite angles are circled and indicated as $\theta_{P_0P_5}$ and $\theta_{P_2P_3}$. These angles are used to compute Δ_{fi} and Δ_{ri} . The box at the top right indicates the polynomial coefficients. In the lower left-hand corner, the run number indicates the date and time.

DATA SHEET 4.34-1
SCAN PROFILES
ALONG SCAN

TS 32015-004

$b_0 = b_5$

HUGHES

SMA Designation LTM, AF, NORM, RT, SAM MODE S/N 2
T1 T2 T3 T4 T5 T6 T7 T8 T9
25.9 24.7 24.9 25.3 25.8 26.8 28.9 28.8 28.7

SME (1) or (2) 2V 28.9 - 28.8 8.7 (Nominal Voltages)

SAM ANGLES USED (MRAD) 67.176 67.177 - 0P2P3
IFAR COUNTS K - 0.499973

SMOOTHING POLYNOMIAL COEFFICIENTS

ORDER (I)	FWD	REV	SPEC	P/F
0	a_0 8.7464e-09	-8.1495e-07		
1	a_1 -1.7947e-03	1.8782e-03		
2	a_2 2.7264e-01	-2.4193e-01		
3	a_3 -1.2527e 01	1.1793e 01		
4	a_4 2.3000e 02	-2.3194e 02		
5	a_5 -1.4762e 03	1.5646e 03		
INFLECTION POINTS	3	3	<3	P
MAX* MAX -	-5.5 -3.5	8.7 -2.8	+ - 17.5	P
AVERAGED TO SMOOTHED*	0.2	0.2	<2.1 RMS	P

FAST SCAN
BUMPER A 1676
PZ P3 328445 328458 328445
MID -P1 PA 164214 164231 164211
PD P5 1 17 0
BUMPER B -2586 16
OFFSET-CORRECTED SCAN ANGLES (REF PD), MRAD:
P2 134952 P3 134946
P1 67176 P4 67168
PD 0 P5 -7
NEXT PD -0

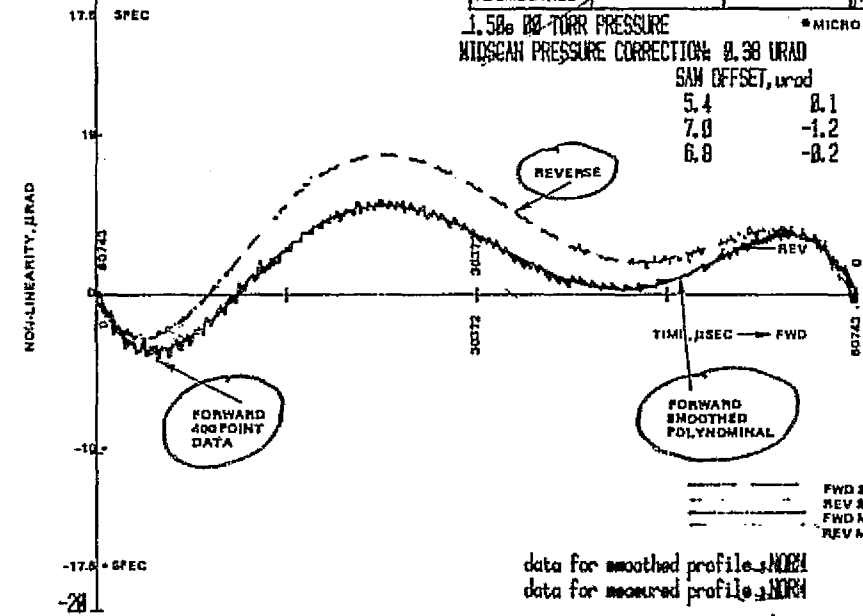

BASIC PROFILES
WITH FIFTH-ORDER
POLYNOMIALS

Run No. 61888 1858 OA Stamp _____ Date 61888
Test Flow Event H-1 seq 9 Tested By _____
Comments test no. 1 1 FWD/1 REV SCAN, 400 POINTS EACH
□ *

This figure is a second sheet of smoothed profile data. Line length telemetry information is indicated at the top, and ϕ_{f0} , ϕ_{r0} (PHIf0, PHIRO) are pointed out; they are to be used in computing the midscan correction. For engineering information, the nested and non-nested components of the forward and reverse profiles are plotted.

TS 32015-004

DATA SHEET 4.3.4.2
SCAN PROFILES
ALONG SCAN SMOOTHED
SAM MODE

□

HUGHES

SMA Designation LTM, AF, NORM, RT,

S/N 2

SME (1) or (2) 2
(Nominal Voltages)
28.9 -28.8 6.7

8.489973

K -
FWD MIDSCAN
REV MIDSCAN
NESTED, MIDSCAN:
NON-NESTED, MIDSCAN

3
1.42

from SMOOTHED PROFILES

PERIOD

1st HALF

2nd HALF

PHI₁

PHI_{1f}, PHI_{1r}

FWD
68742.81
38374.68
38368.48
4.31
4.14

REV
68743.88
38374.68
38368.48
6.36
6.74

LINE LENGTH
TELEMETRY
INFORMATION

--- FWD SMOOTHED
--- REV SMOOTHED
--- NESTED, SMOOTHED
--- NON-NESTED SMOOTHED

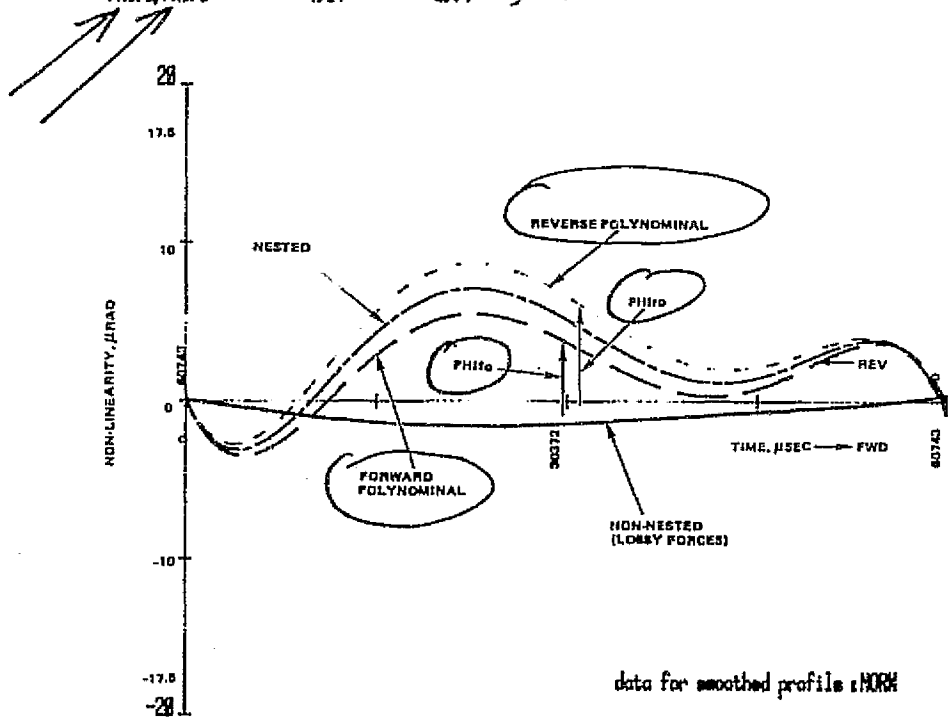

LIFE TEST MODEL (AF)

BASIC PROFILES (CONT.)

Run No. 61888.1858
 Test Flow Event R-1 004 8
 Comments test no. 1

QA Stamp _____ Date 61888
 Tested By _____

VG 35

LTM TEST DATA

The 400 point profiles and the least-squares fitted fifth-order polynomials have already been shown. The following three viewgraphs represent one set of data from a 75-point, 19-scan geometric repeatability test that is plotted normal, ground-calibrated and that shows the deviation between ground-calibrated polynomials and the actual measured average profile.

LTM TEST DATA

HUGHES

- 400-POINT PROFILES AND POLYNOMIAL FIT
- GEOMETRIC REPEATABILITY TESTS
 - NORMAL
 - GROUND-CALIBRATED
 - DEVIATION PLOTS
- ACTIVE SCAN CORRECTION REMOVED
- LOW-TEMPERATURE TEST

VG 36

LIFE TEST MODEL (AF) - GEOMETRIC
REPEATABILITY (-24°C)

At the top of this data sheet, the title "NORMAL" means that the smoothed profile used in the plot and specification tests was the original polynomial. The theodolite angles are pointed out, and right below them the run number of the original data for the smoothed profiles is indicated. The midscan correction that was computed (but not used) is also indicated. The plots show the 75 connected points (averages of 19 scans) both for forward and reverse scans, along with the original smoothed profiles. In the box at the lower right, the time from the start of scan to the sample that is farthest from the smoothed profile (largest rms) is indicated together with its mean error (see viewgraph 19), one-sigma spread of the 19 points from the mean, and the rms of the 19 points from the smoothed profile, which must be less than 1.75 μ rad in order to pass.

TS 32015-004
8 March 1980

DATA SHEET 4.3.5-3
OPERATIONAL PERFORMANCE
ALONG SCAN GEOMETRIC REPEATABILITY
SAM MODE NORMAL

SMA Designation: LTM AF INV SN2 SMC 111 of 121 2 Voltage: High _____, Nom _____, Low _____

IFAR COUNTS: CALIBRATION: K * 0.498840 TEMPS: T1 T2 T3 T4 T5 T6 T7 T8 T9 T0

BUMPER A P2 P3 25.1 24.5 24.0 25.0 25.1 26.1 26.5 24.0 24.0

MID - P1 P4 P0 P8 SAM ANGLES USED (MRAD) -57.170 67.177
0P0P5 0P2P3

SCANNING SAM OFFSETS, μ RAD
P2 0.2 P3 -0.8
P1 0.5 P4 -2.0
P0 0.0 P6 -0.8
LAST P0 0.2

FWD SMOOTHED PROFILE (FROM TFE-11 RUN NO. 01000, 1200)
REV SMOOTHED PROFILE
MEASURED AVG, FWD
MEASURED AVG, REV

FWD REV
MIDSCAN OFFSET ANGLES, PHIT, PHIR
rms 0.45 0.82
sigma 0.34 0.48
MIDSCAN GROUND CORRECTION
rms 4.31 3.18
 Δ_{ij} Δ_{ij}

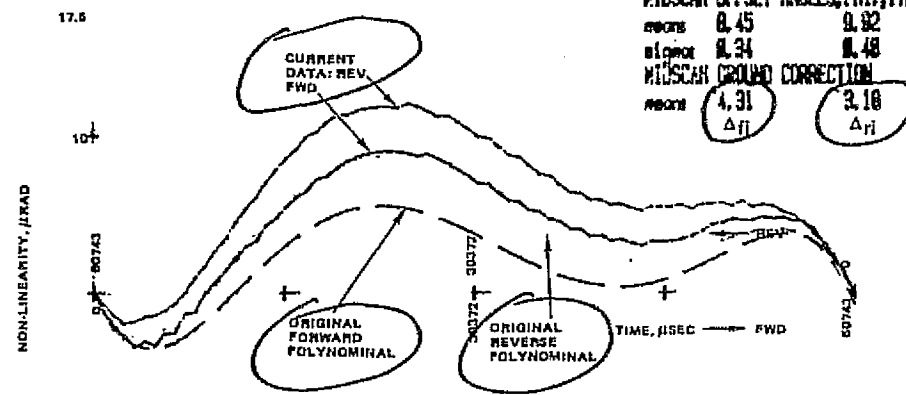

data for smoothed profile: NORM
data for measured/avg profile: NORM/AVG

0.20-01 TORR PRESSURE
MIDSCAN PRESSURE CORRECTION: 0.28 μ rad

WORST CASE DEVIATIONS OF AVERAGES FROM PROFILES

	SCAN TIME (μSEC)	MEAN ERROR*	ONE SIGMA*	RMS*	RMS SPEC*	P/F
FWD	26700.00	3.77	0.35	3.79		
REV	28310.01	4.06	0.38	4.08	<1.75	F

Run No. 01000.1205 QA Stamp _____ Date 01000
Test Flow Event R-5 seq 0 Tested By _____
Comments test no. 5, 10 FWD/10 REV SCAN, 75pts each

NOTE

NOTE

HUGHES

LIFE TEST MODEL (AF)

GEOMETRIC REPEATABILITY

24°C

ORIGINAL PAGE IS OF POOR QUALITY

VG 37

LIFE TEST MODEL (AF) - GEOMETRIC
REPEATABILITY (24°C) GROUND-CALIBRATED

At the top of this data sheet, the title "GND CALIBRATED" indicates that the smoothed profile used has been modified with the midscan ground correction before plotting and testing for worst-case deviation in the box. It can be seen that after the application of the correction, the specified value of $\leq 1.75 \mu\text{rad rms}$ is obtained.

TS 32015-004

DATA SHEET 4.2.5
 OPERATIONAL PERFORMANCE
 ALONG SCAN GEOMETRIC REPEATABILITY
 SAM MODE (GND CALIBRATED)
 S/N2 SRE (1) or (2) 2

HUGHES

SMA Designation LTM; AF; INV; Voltage: High, Nom, Low

IPAR COUNTS: CALIBRATION K = 0.409848 TEMPS. T1 T2 T3 T4 T5 T6 T7 T8 T9 T0
 BUMPER A 1674 28.9 -20.8 6.8
 P2 P3 326720 25.1 24.5 24.9 25.0 25.1 28.1 28.5 24.0 24.0
 MID - P1 P4 164169 SAM ANGLES USED (MKRAD) -67.176 67.177
 P2 P3 BUMPER B -2500

SCANNING SAM OFFSETS, μ RAD
 P2 6.2 P3 -0.8
 P1 8.5 P4 -2.0
 P0 8.6 P6 -0.8
 LAST P0 8.2

FWD SMOOTHED PROFILE
 (FROM TEST RUN NO. 61888, 1975)
 REV SMOOTHED PROFILE
 MEASURED AVE, FWD
 MEASURED AVG, REV

FWD REV
 MIDSCAN OFFSET ANGLES, PHI_F, PHI_R
 mean 8.45 9.02
 sigma 0.34 0.40
 MIDSCAN GROUND CORRECTION
 mean 4.31 3.18
 THESE APPLIED TO POLYNOMIALS

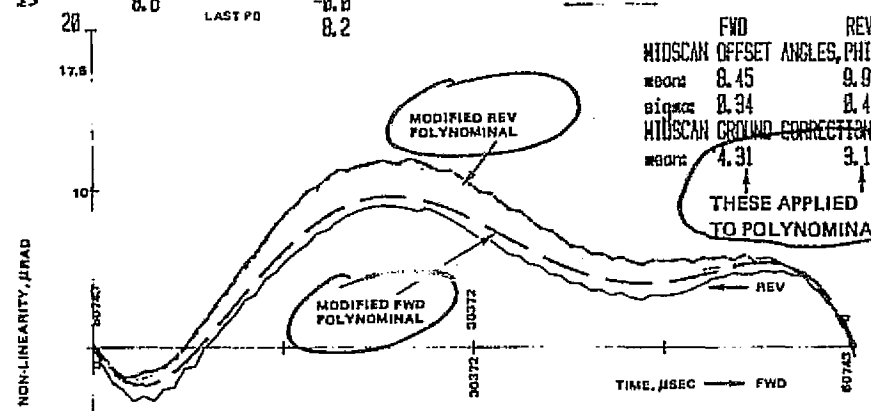

data for smoothed profiles: NORM
 data for measured/avg profile: NORM/AVG
 0.00-01 TORR PRESSURE
 MIDSCAN PRESSURE CORRECTION: 0.20 μ rad

WORST CASE DEVIATIONS OF AVERAGES FROM PROFILES

	SCAN TIME (μSEC)	MEAN ERROR*	ONE SIGMA*	RMS*	RMS SPEC*	P/F
FWD	4054.67	-0.92	0.24	0.95		
REV	13754.98	1.08	0.36	1.13	<1.75	P

Run No. 61888.1205 QA Stamp _____ Date 61888 NOTE
 Test Flow Event R-5 seq 9 Tested By _____
 Comments test no. 5, 19 FWD/19 REV SCAN, 75pts each

GEOMETRIC REPEATABILITY

24°C

GND CALIBRATED

ORIGINAL PAGE IS OF POOR QUALITY

VG 38

LIFE TEST MODEL (AF) - GEOMETRIC
REPEATABILITY (24°C) DEVIATION PLOTS (EXPANDED SCALE)

At the top of this data sheet, the title "GND CALIB DEVIATION" indicates that the midscan ground correction has been applied. The only difference is the plot and the scale. What is plotted is a point-by-point difference between the ground-calibrated smoothed profile polynomial and the mean of the 19 scans, for each of the 75 points across the scan. Note that the scale is $\pm 5 \mu\text{rad}$. This and the previous two viewgraphs refer to the same set of data.

TS 32015-004

DATA SHEET 4.3.6-3
OPERATIONAL PERFORMANCE
ALONG SCAN GEOMETRIC REPEATABILITY

SAM MODE (and calibrated) deviation profile GND CALIB DEVIATION
LTM: AF; INV; S/N 2 SME (1) or (2) 2 Voltage: High, Nom, Low

SMA Designation
IPAR COUNTS: CALIBRATION
BUMPER A P2 P3
MID - P1 P4 P0 P5
BUMPER B
SCANNING
MEAN VALUES
F2
P1
P0
K - 0.489040
TEMP. T1 T2 T3 T4 T5 T6 T7 T8 T9
28.9 28.8 28.8
25.1 24.5 24.9 25.0 25.1 26.1 28.5 24.8 24.8
SAM ANGLES USED (MRAD) -87.176 67.177
FWD SMOOTHED PROFILE (FROM THE-41 RUN NO. 1)
REV SMOOTHED PROFILE
MEASURED AVE, FWD
MEASURED AVG, REV
FWD REV
MIDSCAN OFFSET ANGLES, PHIF, PHIR
mean 8.45 9.92
sigma 0.34 0.48
MIDSCAN GROUND CORRECTION
mean 4.91 3.18

HUGHES

LIFE TEST
MODEL
(AF)

GEOMETRIC
REPEATABILITY

24°C

DEVIATION PLOTS
(EXPANDED SCALE)

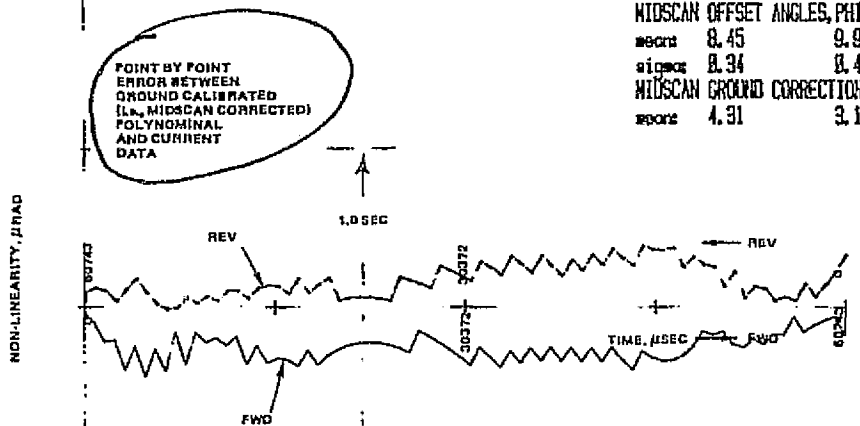

data for smoothed profile : NORM
data for measured/avg profile : NORM/AVG
0.00-01 TORR PRESSURE
MIDSCAN PRESSURE CORRECTION 0.20 unad

WORST CASE DEVIATIONS OF AVERAGES FROM F PROFILES

	SCAN TIME (μSEC)	MEAN ERROR*	ONE SIGMA*	RMS*	RMS SPEC*	P/F
FWD	4854.67	-0.92	0.24	0.95		
REV	13754.99	1.08	0.36	1.13	<1.76	P

* MICRO-RADIANS

Run No. 61808.1285
Test Flow Event R-5 seq 9
Comments test no. 5, 10 FWD/10 REV SCAN, 75 pts each
QA Stamp _____ Date 61808 NOTE
Tested By _____

ORIGINAL SOURCE OF POOR QUALITY

VG 39

LIFE TEST MODEL (AF) - GEOMETRIC REPEATABILITY (24°C)
BB2 ELECTRONICS; NO ACTIVE SCAN CONTROL CURRENT

The facing figure is a ground-calibrated profile with midscan corrections of more than $\pm 80 \mu\text{rad}$ that meets the $1.75\text{-}\mu\text{rad}$ requirement at all angles in both directions of scan. The original profile used was taken with the LTM electronics using active scan current (see view-graph 33) whereas the measured profile was taken with a different electronics controller (bread-board 2) and with the active scan current disabled. Hence probably SME (1) and SME (2) profiles could be reduced to one profile with the corresponding ϕ_{f0} .

TS 32015-004

DATA SHEET 4.3.3
OPERATIONAL PERFORMANCE
ALONG SCAN GEOMETRIC REPEATABILITY
SAM MODE (GND CALIBRATED)

HUGHES

SMA Designation LTM 882 HD ASC S/N 2

Voltage: High _____, Nom _____, Low _____

IFAR COUNTS:

CALIBRATION

BUMPER A

P2 P3

MID - P1 P4

P2 P3

BUMPER B

SCANNING

P2

P1

P0

MEAN VALUES

28

17.5

10

NON-LINEARITY, μ RAD

-10

-17.5

-28

K = 0.499978

17.00

16.212

2.54

SAM OFFSETS, μ RAD

P2 0.4

P1 0.4

P0 0.0

LAST P0 0.0

P3 1.5

P4 0.0

P5 1.3

0.0

DATA AND GROUND CALIBRATED POLYNOMIALS

FWD

REV

30372

30372

TIME, μ SEC

FWD

REV

TEMP: T1 T2 T3 T4 T5 T6 T7 T8 T9

24.9 25.1 25.1 25.9 25.8 18000.8 18000.8 24.5

SAM ANGLES USED (MRAD) -57.176 67.177

FWD SMOOTHED PROFILE
 (FROM TPE-II RUN NO. 01900.1931)
 REV SMOOTHED PROFILE
 MEASURED AVE, FWD
 MEASURED AVG, REV

FWD REV
 MIDSCAN OFFSET ANGLES, PHI, PHI-
 mean 90.83 -75.96
 sigma 0.18 0.15
 MIDSCAN GROUND CORRECTION
 mean 66.68 -62.64
 CORRECTIONS APPLIED

data for smoothed profile: NORM
 data for measured/avg profile: NORM/AVG

1.00% Torr Pressure
 MIDSCAN PRESSURE CORRECTION: 0.45 μ rad

WORST CASE DEVIATIONS OF AVERAGES FROM PROFILES

	SCAN TIME (USEC)	MEAN ERROR*	ONE SIGMA*	RMS*	RMS SPEC*	P/F
FWD	22055.12	0.93	0.46	1.03		
REV	0.00	0.81	0.06	0.81	-1.75	P

Run No. 01900.1931

QA Stamp _____ Date 01/08/88

Test Flow Event R7 seq 0

Tested By _____

Comments test no. 7, 19 FWD/18 REV SCAN, 75pts each

NOTE

LIFE TEST MODEL (AF)

GEOMETRIC REPEATABILITY

24°C

BB2 ELECTRONICS
NO ACTIVE SCAN
CONTROL CURRENT

ORIGINAL QUALITY OF POOR QUALITY

VG 40

LIFE TEST MODEL (AF) - GEOMETRIC
REPEATABILITY (24°C) BB2 ELECTRONICS;
NO ACTIVE SCAN CONTROL; DEVIATION PLOTS (EXPANDED SCALE)

The facing plot corresponds to the difference between the ground-calibrated smoothed profile and the average measured profile of the previous viewgraph in which more than ± 80 - μ rad corrections were used. Note the vertical scale and that throughout the scan performance is well within 1 arc-sec.

TS 32015-004

DATA SHEET 4.3.5-3
OPERATIONAL PERFORMANCE
ALONG SCAN GEOMETRIC REPEATABILITY

SMA Designation LTM BB2 NO ASC S/R2 **SAM MODE** (and calibrated) (deviation profile) Volts, Nom , Low
SME (1) or (2) 2

TEMP: T1 T2 T3 T4 T5 T6 T7 T8 T9 T10
24.9 25.1 25.1 25.9 25.8 18000.0 18000.0 24.5 24.5

IFAR COUNTS
CALIBRATION
BUMPER A 1700 EL 409037M
P2 P3
MID - F1 P4 3200
P0 P5 164212
BUMPER B 251
SCANNING
SWEEP OFFSETS, μ RAD
P2 P3
P1 P4
P0 P5
LAST P0
MEAN VALUES
5
6.4 1.5
8.8 8.8
6.8 1.3
6.8

FWD SMOOTHED PROFILE
(FROM TFE-H RUN NO. 61908.1831)
REV SMOOTHED PROFILE
MEASURED AVG, FWD
MEASURED AVG, REV

FWD REV
MIDSCAN OFFSET ANGLES, PHIT, PHIR
mean 86.83 -75.86
sigma 8.18 8.15
MIDSCAN GROUND CORRECTION
mean 86.83 -82.84

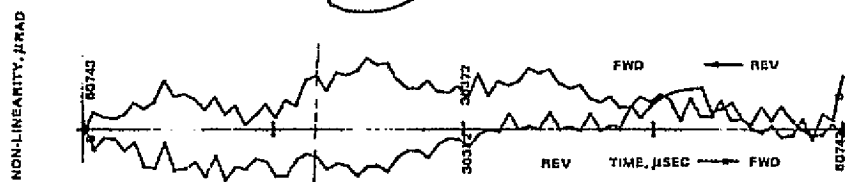

data for smoothed profile : NORM
data for measured/avg profile : NORM/AVG
1.88 $\times 10^{-6}$ TORR PRESSURE
MIDSCAN PRESSURE CORRECTION: 8.45 μ rad

WORST CASE DEVIATIONS OF AVERAGES FROM PROFILES

	SCAN TIME (μSEC)	MEAN ERROR*	ONE SIGMA*	RMS*	RMS SPEC*	T/F
FWD	22055.12	8.93	8.46	1.93		
REV	8.86	8.81	8.88	8.81	<1.75	P

Run No. 61908.1831 QA Stamp _____ Date 61908 NOTE
Test Flow Event R-7 Tested By _____
Comments test no. 7, 10 FWD/10 REV SCAN 75 pts each

HUGHES

**LIFE TEST
MODEL
(AF)**

**GEOMETRIC
REPEATABILITY**

24°C

BB2 ELECTRONICS

**NO ACTIVE SCAN
CONTROL**

**DEVIATION PLOTS
(EXPANDED SCALE)**

ORIGINAL
OF POOR QUALITY

LINE LENGTH CODING (SAM MODE)

The reader may wish to refer to viewgraph 31. To provide midscan correction, the values of Δ_{fi} and of Δ_{ri} must be found. These values are calculated on the next viewgraph from the data presented here. The line length code contains first-half and second-half scan errors E1 and E2, which are defined as R1-T1 and R2-T2, respectively, where R and T represent references and half-scan times. Reference 1 = 30371.4 μ sec and Reference 2 = 30371.6 μ sec (they total the ideal scan time of 60743.0 μ sec). First-half scan error (FHSERR) and second-half scan error (SHSERR) have the units of 5 MHz clock periods (0.18845 μ sec). These represent the errors (in clock counts) from the references in clock counts (161164 and 161165), and they are transmitted from the SMA to the mux in binary 2's complement format as indicated. Note the example of decoding, wherein midscan time errors E1 and E2 are found after which first- and second-half scan times T1 and T2 can be determined.

LINE LENGTH CODING (SAM MODE)

HUGHES

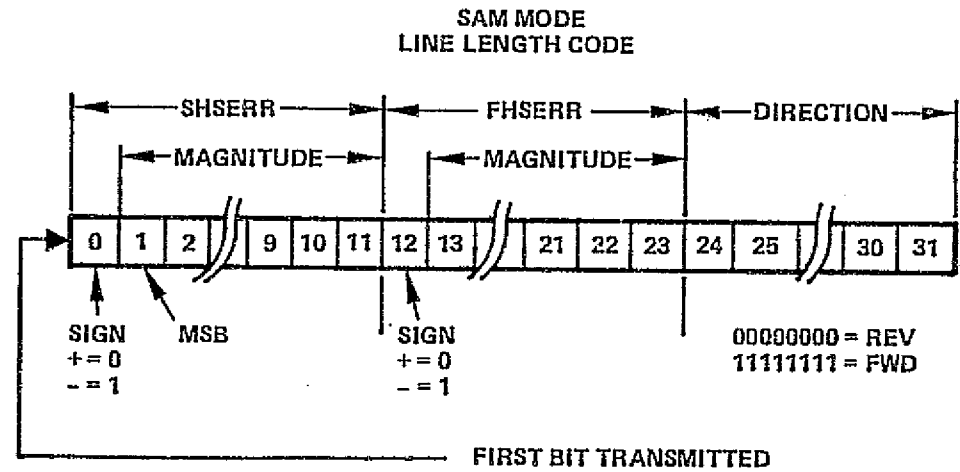
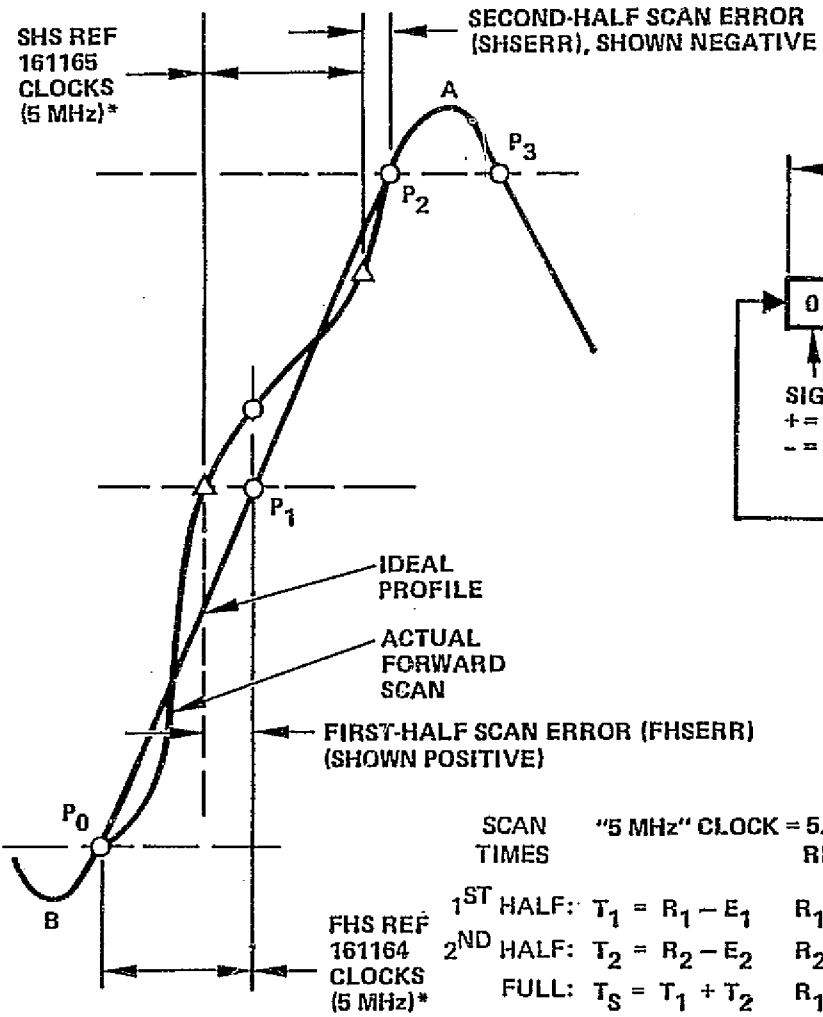

MAGNITUDES ARE IN 2'S COMPLEMENT AND INDICATE 5 MHz CLOCK PERIODS OF 188.45 NSEC

EXAMPLE

00000100100	11111011101	00000000
-------------	-------------	----------

DECIMAL = 36 DECIMAL = -35 REVERSE

$E_2 = 36 (0.18845 \mu\text{SEC}) = 6.784 \mu\text{SEC}$

$E_1 = -35 (0.18845 \mu\text{SEC}) = -6.596 \mu\text{SEC}$

At the top right of the facing figure is a triangle involving the first-half scan error E_1 , the midscan offset angle ϕ_{mf} , and the scan rate. The offset angle is approximately equal to the time error multiplied by the scan rate. When the actual wing mirror proportionality constant K'_0 and first- and second-half scan times are taken into account, the midscan offset angle ϕ_{mf} is as indicated, where K'_0 involves theodolite measurements from the original data sheet (viewgraph 33).

The forward offset angle is then found, and it differs from ϕ_{mf} only if there is a partial atmospheric drag associated with scan "i".

Finally, $\Delta_{fi} = \phi_{fi} - \phi_{fo}$, where ϕ_{fo} was previously identified on the second data sheet of the original profiles (viewgraph 34). Δ_{fi} can then be applied (viewgraph 32) to the original smoothed profile polynomial to obtain the desired ground-calibrated polynomial.

FORWARD OFFSET ANGLE

HUGHES

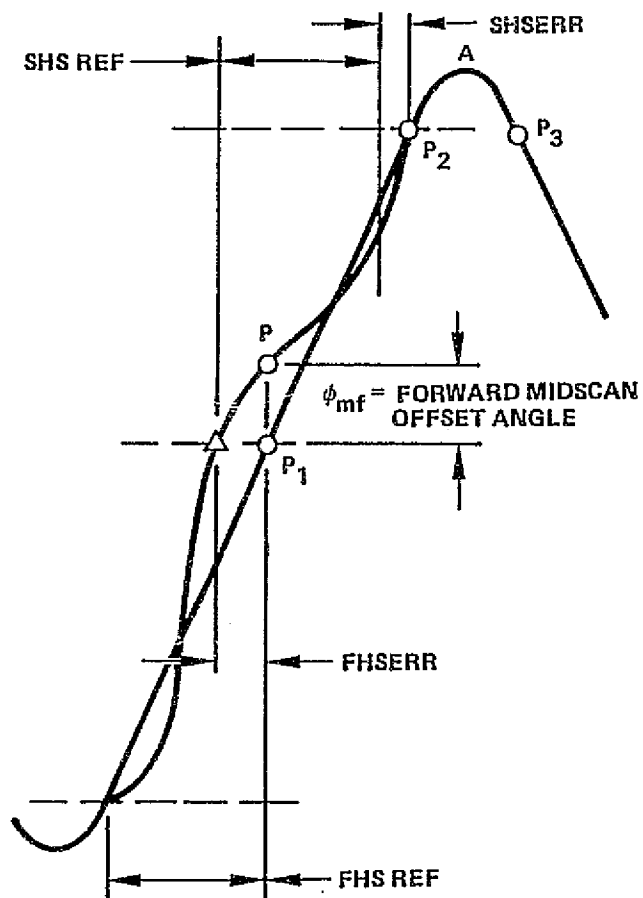

FORWARD MIDSCAN OFFSET ANGLE:

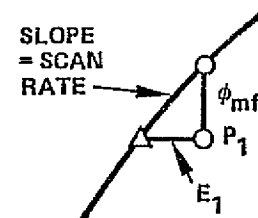

$$\phi_{mf} \approx E_1 \cdot (\text{SCAN RATE})$$

TAKING INTO ACCOUNT ACTIVE SCAN TIME (T_S) AND SAM WING MIRROR RATIO (K'_0):

$$\phi_{mf} = [T_1(K'_0 - 1) + T_2(K'_0)] \left(\frac{\theta_{P_2 P_3} - \theta_{P_0 P_5}}{T_S} \right)$$

$$K'_0 = \frac{-\theta_{P_0 P_5}}{\theta_{P_2 P_3} - \theta_{P_0 P_5}}$$

FORWARD OFFSET ANGLE, SCAN i

$$\phi_{fi} = \phi_{mf,i} + \phi_p \quad \nearrow \text{0 IN HARD VACUUM}$$

FORWARD MIDSCAN CORRECTION, SCAN i

$$\Delta_{fi} = \phi_{fi} - \phi_{fo}$$

PARABOLIC MIDSCAN CORRECTION SUMMARY

The facing viewgraph is a step-by-step summary of the operations required for applying the midscan correction. A summary profile data sheet will be supplied with the SMA test data in which all of the values of the parameters associated with the smoothed profiles (Rev. B) are presented.

PARABOLIC MIDSCAN CORRECTION SUMMARY

HUGHES

1. DECODE FIRST AND SECOND-HALF SCAN ERRORS E_1 AND E_2 , FROM LINE LENGTH CODE; COMPUTE T_1 , T_2 , AND T_S
2. COMPUTE OFFSET ANGLE (ϕ_f) FROM T_1 , T_2 , T_S , AND K'_0 , $\theta_{P_0 P_5}$, $\theta_{P_2 P_3}$ (FROM SMA DATA SHEET)
3. COMPUTE MIDSCAN CORRECTION (Δ_{fi}) FROM OFFSET ANGLE AND ϕ_{f0} (PHI_{f0} OF SMA DATA SHEET)
4. COMPUTE a'_1 AND a'_2 FROM MIDSCAN CORRECTION
5. ADD a'_1 TO a_1 AND a'_2 TO a_2 FOR $a_{1,i}$ AND $a_{2,i}$ IN THE SMOOTHED PROFILE POLYNOMIAL

The coefficients of spring force variation with temperature shown on the facing page were determined by raising and lowering the various model SMAs 10 to 20 degrees and noting the variation in the peak-to-peak "sinusoidal" component of the scan profile. They are sufficiently small to be ignored. However, if desired, a correction could be implemented on the basis of temperature telemetry.

SCAN PROFILE THERMAL DEPENDENCE

HUGHES

△ EM-A WITHOUT MAGNETIC COMPENSATORS

$$\Delta = - 0.6 \mu\text{RAD PP}/^{\circ}\text{C}$$

△ EM-C, INCLUDING MAGNETIC COMPENSATOR

$$\Delta = - 0.5 \mu\text{RAD PP}/^{\circ}\text{C}$$

△ LTM WITH COMPENSATOR

$$\Delta = - 0.4 \mu\text{RAD PP}/^{\circ}\text{C}$$

△ ALL ~ SINUSOIDAL; NEGLIGIBLE

△ CORRECTABLE IF REQUIRED BY USING SIMPLE THIRD-ORDER TERMS WITH INTERFACE TEMPERATURE TELEMETRY

VG 45

LIFE TEST MODEL (AF) - GEOMETRIC
REPEATABILITY (12°C) BB2 ELECTRONICS;
NO ACTIVE SCAN CONTROL CURRENT

The facing figure is the ground-calibrated profile plotted with the average measured profile
for an interface temperature of 12°C.

TS 32014-004
8 March 1980

DATA SHEET 4.3.6.3
OPERATIONAL PERFORMANCE
ALONG SCAN GEOMETRIC REPEATABILITY

SAN MODE (and calibrated)
SME (1) or (2) 2

HUGHES

SMA Designation LTM BB2 NO ASC S/N 2
IFAD COUNTS CALIBRATION K = 0.499979
BUMPER A 1800
P2 P3 23759
MID-P1 P4 164172
Po P6
BUMPER B -2300

Voltage: High _____ Nom _____ Low _____
28.9 48.8 7.7
TEMP: T1 T2 T3 T4 T5 T6 T7 T8 T9 T10
13.9 14.8 14.2 14.4 15.9 18000.0 18000.0 12.6 11.8
SAM ANGLES USED (MRAD) -67.178 67.177

SCANNING SAM OFFSETS, μ RAD
P2 5.7 P3 -0.6
P1 7.0 P4 -0.6
P0 6.0 P5 -0.4
LAST P0 0.4

FWD SMOOTHED PROFILE
-IPROM TEST RUN NO. 62008
REV SMOOTHED PROFILE
MEASURED AVG, FWD
MEASURED AVG, REV

FWD REV
MIDSCAN OFFSET ANGLES, PHIG, PHIR
mean 88.17 -88.25
sigma 0.18 0.19
MIDSCAN CORRECTION
mean 84.83 -88.99

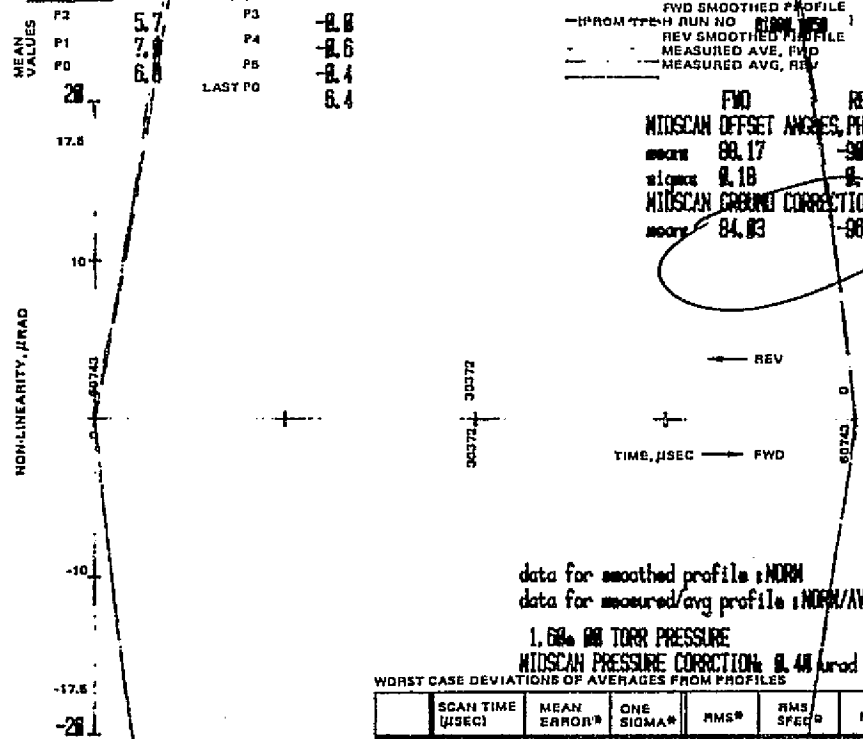

data for smoothed profile : NORM
data for measured/avg profile : NORM/AVG
1.6% @ 10 TORR PRESSURE
MIDSCAN PRESSURE CORRECTION: 0.48 μ rad

WORST CASE DEVIATIONS OF AVERAGES FROM PROFILES

	SCAN TIME (USEC)	MEAN ERROR*	ONE SIGMA*	RMS*	RMS SPEC*	P/P
FWD	18000.57	2.59	0.32	2.61		
REV	45318.25	2.28	0.41	2.24	<1.3s	F

Run No. 62008 0042
Test Flow Event 1-9 seq 9
Comments test no. 9, 19 FWD/19 REV SCAN, 75pts each

QA Stamp _____ Date 62008
Tested By _____

NOTE (LOW TEMP)

LIFE TEST MODEL (AF)
GEOMETRIC REPEATABILITY
12°C

BB2 ELECTRONICS,
NO ACTIVE SCAN CONTROL CURRENT

VG 46

LIFE TEST MODEL (AF) -- GEOMETRIC
REPEATABILITY (12°C) BB2 ELECTRONICS;
NO ACTIVE SCAN CONTROL; DEVIATION PLOTS (EXPANDED SCALE)

The data on the facing page should be compared with that on viewgraph 36 at 24°C. It can be clearly seen here that there is a "sinusoidal" component of nonlinearity caused by the flexure pivot temperature coefficient on spring constant (plus any effect of magnetic compensator thermal dependence). Although the requirement specified was not quite met, the interface temperature was four times the expected worst-case value used.

TS 32015-004

DATA SHEET 4.3.5-3
OPERATIONAL PERFORMANCE
ALONG SCAN GEOMETRIC REPEATABILITY

SMA Designation LTH, BB2, NO ASC SM 2

SME (1) or (2) 2 Voltage: High, Nom, Low
28.9 -28.8 7.7

IFAN COUNTS: CALIBRATION K - 0.499979

TEMPS: T1 T2 T3 T4 T5 T6 T7 T8 T9
13.9 14.8 14.2 14.4 15.9 18888.8 18888.8 12.6 13.8

BUMPER A 1888
P2 P3 1841.72
MID - P1 P4
P0 P5
BUMPER B -2363

SCAN ANGLES USED (M/RAD) -67.176 67.177

SCANNING: SCAN OFFSETS, M/RAD
P2 5.7 P3 -0.8
P1 7.8 P4 -0.8
P0 8.8 P5 -0.4
5 LAST P0 6.4

FWD SMOOTHED PROFILE
(FROM THE N RUN NO. 02908.0942)
REV SMOOTHED PROFILE
MEASURED AVG, FWD
MEASURED AVG, REV

FWD REV
WIDSCAN OFFSET ANGLES, PHI₁, PHI₂
mean 83.17 -98.25
sigma 0.18 0.19
WIDSCAN GROUND CORRECTION
mean 84.83 -98.99

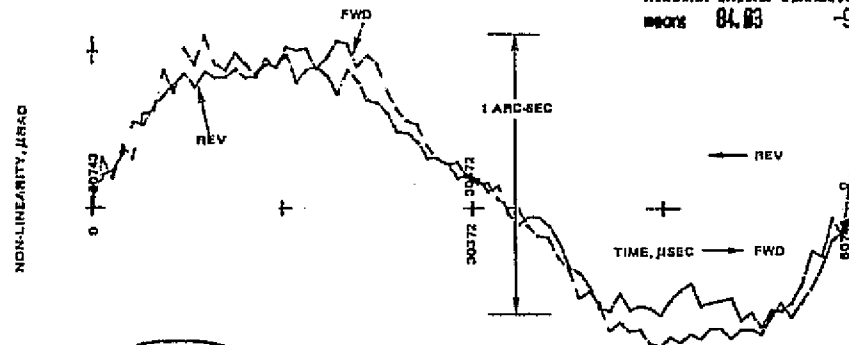

NOTE FLEX PIVOT 0.4 M/RAD/°C "SINUSOIDAL" NONLINEARITY CONTRIBUTION

data for smoothed profile: NORM
data for measured/avg profile: NORM/AVG

1.00 Torr PRESSURE
WIDSCAN PRESSURE CORRECTION: 0.43 umad

WORST CASE DEVIATIONS OF AVERAGES FROM PROFILES

	SCAN TIME (M/SEC)	MEAN ERROR*	ONE SIGMA*	RMS*	RMS SPEC*	P/P
FWD	18083.57	2.58	0.32	2.81		
REV	45318.25	2.28	0.41	2.24	<1.75	F

Run No. 02908.0942

QA Stamp _____ Date 02908

Test Flow Event R-9 seq 8

Tested By _____

Comments test no. 8, 19 FWD/19 REV SCAN, 75pts each

NOTE DUE TO 12° TEMP

HUGHES

LIFE TEST MODEL (AF)

GEOMETRIC REPEATABILITY

12°C

BB2 ELECTRONICS, NO ACTIVE SCAN CONTROL

DEVIATION PLOTS (EXPANDED SCALE)

VG 47

RECOMMENDATIONS

The recommendations offered on the basis of the data presented in this package are summarized on the facing page.

RECOMMENDATIONS

HUGHES

1. RETAIN LINEARITY REQUIREMENTS BUT REVISE DESIGN SPECIFICATION TO ALLOW MIDSCAN CORRECTION

2. CONSIDER MODIFICATIONS OF F-1 AND POSSIBLY A PF RETROFIT
 - CULVER CITY TO PROPOSE CANDIDATE ON-BOARD CORRECTION SCHEMES

 - CULVER CITY TO EVALUATE DESIGN MODIFICATIONS NEEDED TO REDUCE VIBRATION-INDUCED SHIFTS

 - SBRC TO EVALUATE INTERRELATIONS OF MIDSCAN CORRECTIONS AND ADS JITTER CORRECTIONS

3. CONDUCT SYSTEM ANALYSIS BY USING PRESENT COMPUTER MODEL TO VALIDATE LINEARITY REQUIREMENTS

9 - TELEMETRY AND COMMAND

The TM's telemetry and command functions are described in the "Thematic Mapper Telemetry Handbook" and the "Thematic Mapper Command Handbook," references 9.1 and 9.2. The following four two-sided pages are errata to those handbooks.

Tables 9.1 - 9.4 are telemetry snaps made during thermal vacuum testing. Tables 9.1 - 9.3 show the TM in picture mode at progressively higher temperature. Table 9.4 shows the TM in standby mode. Note that some of the parameters shown in these tables refer to the external calibrator. The TM telemetry points are listed in the Telemetry Handbook.

TABLE 1. TELEMETRY COEFFICIENT SUMMARY

IS No.	Parameter	Nomenclature	A ₀	A ₁	A ₂
1	001	Power supply 1 current	-0.01	0.02	
2	002	Power supply 2 current	-0.01	0.02	
—	003	SMA -Z HOUSING TEMP.			
3	004	+19 V (high current)	-0.55556 E-1	0.11111	
4	005	-19 V (high current)	0.55557 E-1	-0.11111	
—	006	SMA -Z HOUSING ₁ TEMP.			
5	007	+8 V	-0.23809 E-1	0.47619 E-1	
6	008	SPARE			
7	010	+33 V shutter drive	-0.71428 E-1	0.14285	
8	011	All cal lamps ON	-0.01	0.02	
9	025	Band 1 +19 V	-0.55554 E-1	0.11111	
10	026	Band 1 -19 V	0.55555 E-1	-0.11111	
11	028	Band 2 +19 V	-0.55554 E-1	0.11111	
12	029	Band 2 -19 V	0.55555 E-1	-0.11111	
13	031	Band 3 +19 V	-0.55554 E-1	0.11111	
14	032	Band 3 -19 V	0.55555 E-1	-0.11111	
15	034	Band 4 +19 V	-0.55554 E-1	0.11111	
16	035	Band 4 -19 V	0.55555 E-1	-0.11111	
17	037	Band 5/7 +19 V	-0.55554 E-1	0.11111	
18	038	Band 5/7 -19 V	0.55555 E-1	-0.11111	
19	040	Band 6 +19 V	-0.55554 E-1	0.11111	
20	041	Band 6 -19 V	0.55555 E-1	-0.11111	
21	043	Isolated +19 V	-0.55554 E-1	0.1111	
22	044	Isolated -19 V	0.55555 E-1	-0.11111	
23	046	CDVU +9 V	-0.16129 E-1	0.32258 E-1	
24	013	Power supply 1 SMA +6.8 V	-0.2381 E-1	0.47619 E-1	
25	016	Power supply 1 MSA +27 V	-0.71431 E-1	0.14285	
26	019	Power supply 1 SMA -27 V	0.71431 E-1	-0.14285	
27	014	Power supply 2 SMA +6.8 V	-0.2381 E-1	0.47619 E-1	
28	017	Power supply 2 SMA +27 V	-0.71431 E-1	0.14285	
29	020	Power supply 2 SMA -27V	0.71431 E-1	-0.14285	
30	022	Multiplexer +30 V	-0.58823 E-1	0.11764	
31	110	Multiplexer input current	-0.92905 E-2	0.1858 E-1	
32	102	Multiplexer bit density	7.2254	-0.23958 E-1	-0.86562 E-5
33	105	Multiplexer +5 V (+5.2 VF status)	-0.11736 E-1	0.23473 E-1	
34	104	Multiplexer +18 V (+18.8 VF status)	-0.42493 E-1	0.84983 E-1	
35	106	Multiplexer -3 V (-2.3 VF status)	0.52584 E-2	-0.10517 E-1	
36	108	Multiplexer -5 V (-5.2 VF status)	0.11869 E-1	-0.23738 E-1	

Table 1 (Continued)

Command	Nomenclature	Opposite Command
TM:046	Band 5 OFF	TM:045
TM:047	Band 6 ON	TM:048
TM:048	Band 6 OFF	TM:047
TM:049	Band 7 ON	TM:050
TM:050	Band 7 OFF	TM:049
TM:051	Serial command receiver 1 ON/2 OFF	TM:052
TM:052	Serial command receiver 2 ON/1 OFF	TM:051
TM:053	Macrodiscrete command generator A primary ON/A redundant OFF	TM:057
TM:054	Macrodiscrete command generator A redundant ON/A primary OFF	TM:057
TM:055	Macrodiscrete command generator B primary ON/B redundant OFF	TM:057
TM:056	Macrodiscrete command generator B redundant ON/B primary OFF	TM:057
TM:057	Macrodiscrete command generators OFF	TM:053/TM:054/ TM:055/TM:056
TM:058	Power supply 1 OFF	TM:001
TM:059	Power supply 2 OFF	TM:002
TM:060	Multiplexer ON (power supply 2)	TM:061
TM:061	Multiplexer OFF (power supply 2)	TM:060
TM:062	DC restore ON	TM:006
TM:063	SME 2 select SAM/SME 1 select bumper	TM:012
TM:064	Not used	
TM:065	SMA +Z heater controller ON	TM:066
TM:066	SMA +Z heater controller OFF	TM:065
TM:067	SMA -Z heater controller ON	TM:068
TM:068	SMA -Z heater controller OFF	TM:067
TM:069	Cooler intermediate stage outgas heater enabled	TM:071
TM:070	Cooler intermediate stage outgas heater controller ON	TM:071
TM:071	Cooler intermediate stage heater controller OFF/heater disabled	TM:070/TM:069
TM:072	Cooler door fusible link switch B CLOSE	TM:096
TM:073	Shutter fusible link switch B CLOSE	TM:096
TM:074	Scan line corrector 1 ON/2 OFF	TM:076
TM:075	Scan line corrector 2 ON/1 OFF	TM:076
TM:076	Scan line correctors OFF	TM:074/TM:075
TM:077	Calibration lamp sequencer ON	TM:078
TM:078	Calibration lamp sequencer OFF	TM:077
TM:079	Inchworm power ON	TM:080
TM:080	Inchworm power OFF	TM:079
TM:081	Cold stage telemetry OFF	TM:088
TM:082	Cooler door motor ON	TM:083
TM:083	Cooler door motor OFF	TM:082
TM:084	Baffle heater control ON	TM:086
TM:085	Baffle heater backup ON	TM:086
TM:086	Baffle heater control OFF/backup OFF	TM:084/TM:085
TM:087	Cold stage outgas heater enable	TM:089

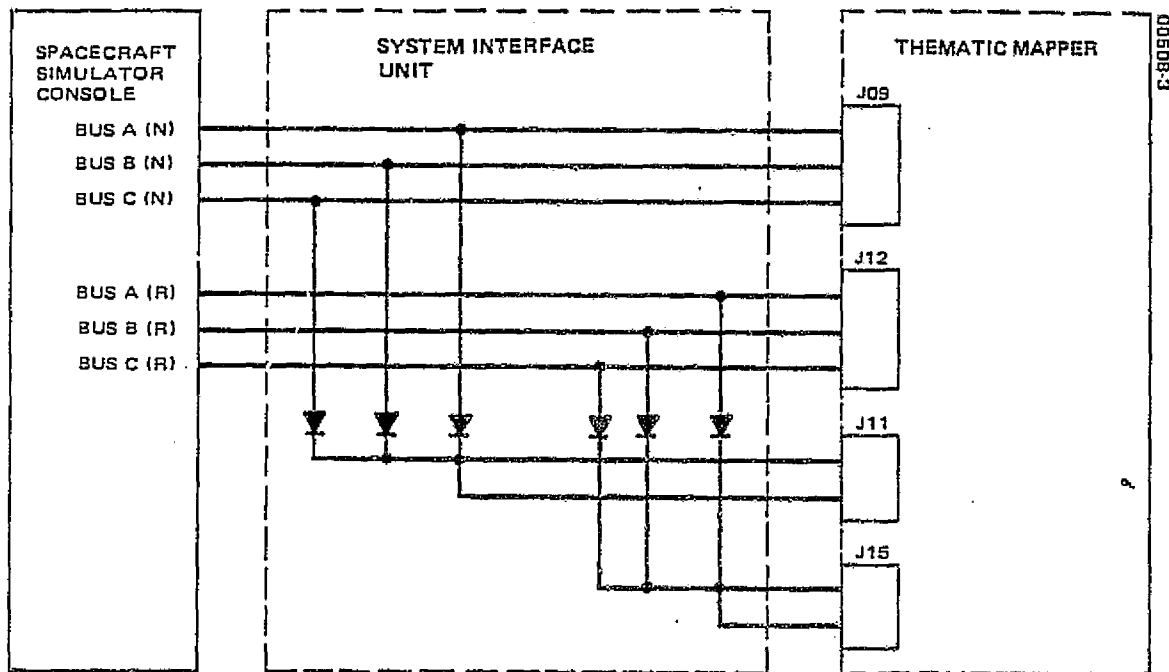

00508-3

a) BTCE 28-VOLT COMMAND BUS INTERFACE

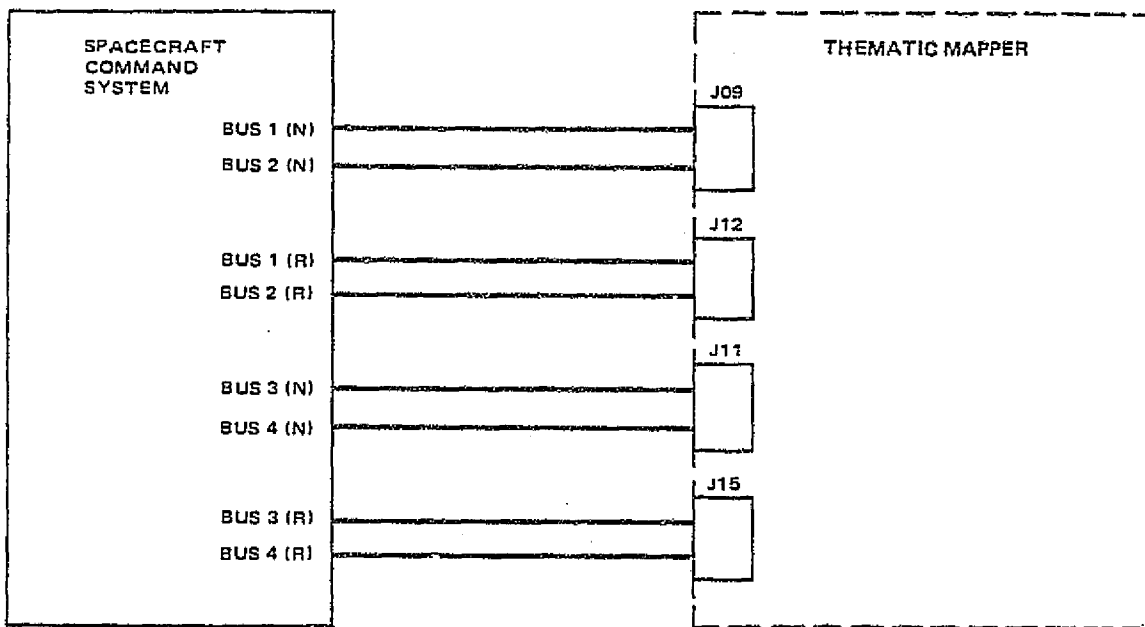

b) SPACECRAFT 28-VOLT COMMAND BUS INTERFACE

FIGURE 3. BTCE AND SPACECRAFT COMMAND BUSES

PRECEDING PAGE BLANK NOT FILMED

00500-11A

INCHWORM CONTRACT

TM: 143
SERIAL WORD 3
BIT 9

THIS COMMAND SETS BIT 9 OF WORD 1 TO A LOGIC 1. THIS BIT IN CONJUNCTION WITH BIT 8 DETERMINES THE INCHWORM STEP SIZE AND DIRECTION AS SHOWN IN THE TABLE BELOW.

COMMAND VERIFICATION: INCHWORM CONTRACT TELEMETRY = LOGIC 1.

DIRECTION COMMAND STATES

COMMANDS	BIT 8	BIT 9	NOMINAL MOTION
TM: 145, TM: 144	0	0	NONE*
TM: 145, TM: 143	0	1	CONTRACT
TM: 145, TM: 144	1	0	EXTEND
TM: 145, TM: 143	1	1	-

*AT POWER ON BITS 8 AND 9 ARE "0".

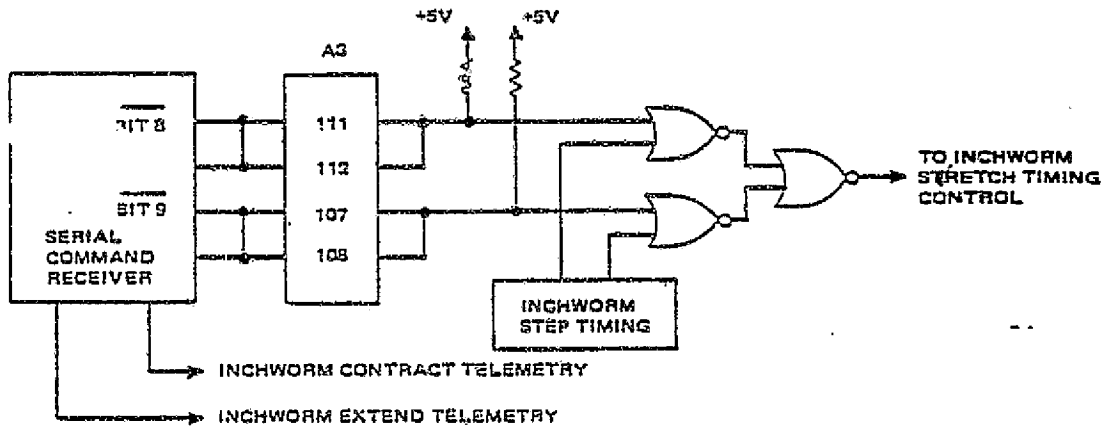

INCHWORM NOT CONTRACT

TM: 144
SERIAL WORD 2
BIT 9

THIS COMMAND SETS BIT 9 OF WORD 1 TO A LOGIC 0. THIS BIT IN CONJUNCTION WITH BIT 8 DETERMINES THE INCHWORM STEP SIZE AND DIRECTION AS SHOWN IN THE TABLE BELOW.

COMMAND VERIFICATION: INCHWORM CONTRACT TELEMETRY = LOGIC 0.

DIRECTION COMMAND STATES

COMMANDS	BIT 8	BIT 9	NOMINAL MOTION
TM: 145, TM: 143	0	0	NONE*
TM: 145, TM: 143	0	1	CONTRACT
TM: 145, TM: 144	1	0	EXTEND
TM: 145, TM: 143	1	1	-

*AT POWER ON BITS 8 AND 9 ARE "0".

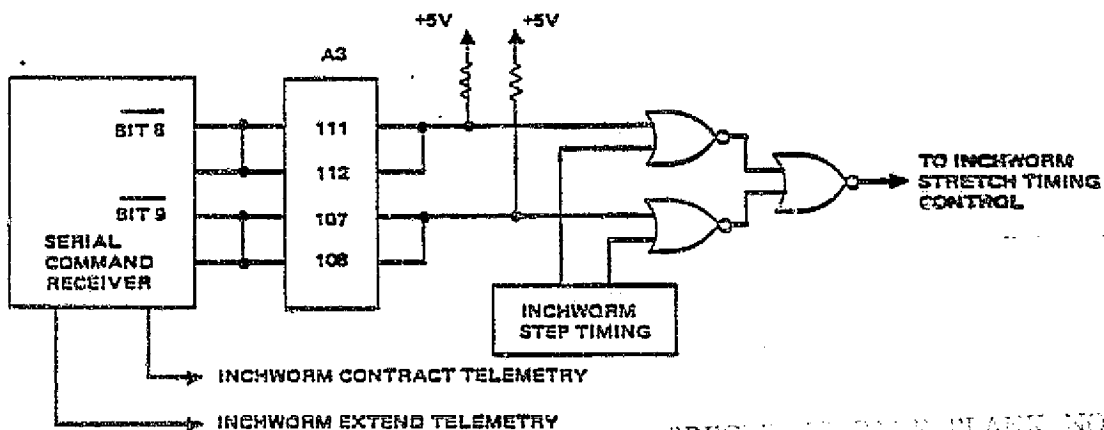

THIS PAGE IS BLANK NOT FILLED

COLLECT NUMBER 1
 COLLECTION VIDEO ERROR FLAG 0
 NUMBER OF COLLECTS, FIRST COLLECT ONLY 1
 TOTAL NUMBER OF BLOCKS IN COLLECTION 288
 NUMBER OF BYTES IN LAST VIDEO DATA BLOCK 128
 HEADER/TRAILER LENGTH IN BLOCKS 3

TIME IN YEAR MONTH DAY HOUR:MIN:SEC TIC
 TIME OF COLLECT 82 9 7 4: 40: 20 24
 NUMBER OF SCANS IS 20
 VECTOR OF BANDS /DETECTORS COLLECTED
 1 2 3 4 5 6 7 8 9 10 11 12 13 14 15 16
 BANDS E E E E E E E E E E E E E E E E
 DETEC T T T T T T T T T T T T T T T T

START NF, END ME, BYTES/NF
 2935 3385 16

COLLECTED FORWARD SCANS ONLY

DUMP OF DSU REGISTERS (IN HEX)

0004	0108	02FF	03FF	0414	0580	0680	0700	0800	0900	0A00	0B00	0C00	0D00	0E00	0F00
1000	1100	1200	1300	1400	1500	1600	1700	1800	1900	1A00	1B00	1C00	1D00	1E00	1F00
2000	2100	2200	2300	2400	2500	2600	2700	2800	2900	2A00	2B00	2C00	2D00	2E00	2F00
3000	3100	3200	3300	3400	3500	3600	3700	3800	3900	3A00	3B00	3C00	3D00	3E00	3F00
4001	415D	4200	43C1	445D	4500	4600	4700	4800	4900	4A00	4B00	4C00	4D00	4E00	4F00
5000	5100	5200	5300	5400	5500	5600	5700	5800	5900	5A00	5B00	5C00	5D00	5E00	5F00
6000	6100	6200	6300	6400	6500	6600	6700	6800	6900	6A00	6B00	6C00	6D00	6E00	6F00
7000	7100	7200	7300	7400	7500	7600	7700	7800	7900	7A00	7B00	7C00	7D00	7E00	7F00
8077	8132	82AB	83B4	8498	854F	863F	877F	88F4	89BF	8AF4	8BB4	8CBF	8DF4	8EF4	8F4E
9008	910C	9218	9359	945B	955F	965F	975F	9854	991F	9A5F	9B14	9C14	9D14	9E14	9F5F
A039	A14B	A20A	A3E9	A43B	A52C	A6B5	A77F	A8FF	A97E	AAF6	ABB4	ACF6	ADFE	AE9F	AFFF
B08D	B18C	B218	B319	B49C	B586	B69F	B71F	B89B	B999	BA0C	BB9F	BC84	BD06	BE06	BF9F
C001	C128	C2AB	C364	C480	C5F6	C6FF	C7FF	C8F7	C9AF	CA1F	CB07	CC0D	CD0F	CE07	CEFF
D040	D14C	D210	D359	D45B	D556	D657	D75F	D81E	D91E	DA1F	DB0F	DC0F	DD5F	DE1F	DF5F
E005	E140	E20A	E304	E4E4	E5D7	E68F	E7FF	E88F	E9BF	EAF6	EB3F	ECB7	EDFF	EEF7	EFF7
F000	F10C	F218	F31A	F49B	F50C	F616	F707	F89F	F99F	FA9F	FB9F	FC9F	FD9F	FE97	FF9F

RECORDING PAGE FLANK NOT FILLED

TELEMETRY SNAPSHOT

STREAM TIME= 250:04:48:17:38Z

1 PWR SUP 1 CRNT	1,960	TVTS	142	2 PWR SUP 2 CRNT	.0000	TVTS	0	3 SMA +2 HSN TMP	24.10	DEGC	153
4 +19V SUPPLY	21.67	VDC	302	5 -19V SUPPLY	-22.1	VDC	301	6 SMA -2 HSN TMP	23.86	DEGC	154
7 +8V SUPPLY	8,397	VDC	346	8 SPARE TLM	.0000	N/A	26	9 SAM TEMP	24.11	DEGC	153
10 +33V SMTR DRV	34.24	VDC	322	11 +80V HTR SUPL	102.5	VDC	377	12 SMA ELEC TMP	24.64	DEGC	64
13 SMA +6.8V #1	7,300	VDC	351	14 SMA +6.8V #2	.0000	VDC	0	15 SMA FLX P+X T	23.37	DEGC	156
16 SMA +27V #1	30.37	VDC	320	17 SMA +27V #2	.0000	VDC	0	18 SMA FLX P-X T	23.61	DEGC	155
19 SMA -27V #1	-26.6	VDC	257	20 SMA -27V #2	.0000	VDC	0	21 SUNSHLD TEMP	23.39	DEGC	213
22 MUX +30V SUP	29.84	VDC	321	23 SPARE TLM	.0000	N/A	21	24 SPARE TLM	.0000	N/A	377
25 BAND 1 +19V	20.66	VDC	274	26 BAND 1 -19V	-20.1	VDC	270	27 ODD ANB PA TEM	22.13	DEGC	217
28 BAND 2 +19V	20.38	VDC	273	29 BAND 2 -19V	-20.1	VDC	270	30 RELAY OP TMP	117.4	DEGC	2
31 BAND 3 +19V	20.59	VDC	274	32 BAND 3 -19V	-20.1	VDC	271	33 EV ANB PRA TP	21.50	DEGC	221
34 BAND 4 +19V	20.48	VDC	273	35 BAND 4 -19V	-20.2	VDC	272	36 CAL SHT HB TEM	13.73	DEGC	252
37 BAND 5-7 +19V	19.68	VDC	264	38 BAND 5-7 -19V	-19.5	VDC	262	39 SLC TEMP	19.65	DEGC	305
40 BAND 6 +19V	19.60	VDC	265	41 BAND 6 -19V	-20.1	VDC	265	42 CAL LP FLT TMP	14.04	DEGC	251
43 ISOLATED +19V	22.33	VDC	314	44 ISOLATED -19V	-22.3	VDC	314	45 SPARE TLM	.0000	N/A	377
46 CDVU +8V	7,425	VDC	320	47 SPARE TLM	.0000	N/A	34	48 SPARE TLM	.0000	N/A	377
49 INT CAL BB TMP	34.23	DEGC	202	50 SI EPA TEMP	18.10	DEGC	164	51 MUX ELCT TMP	32.26	DEGC	76
52 CAL SHT FG TMP	15.52	DEGC	206	53 BKUP SMTR TMP	15.52	DEGC	206	54 BAFFLE TEMP	26.25	DEGC	312
55 MUX PS TEMP	30.82	DEGC	101	56 SPARE TLM	.0000	N/A	0	57 SPARE TLM	.0000	N/A	0
58 CLD STG TMP A	-176.	DEGC	215	59 PRI NIR HSK TP	15.28	DEGC	245	60 CLD STG TMP B	-174.	DEGC	325
61 INT STG TMP A	-129.	DEGC	220	62 INT STG TMP B	-131.	DEGC	276	63 SPARE TLM	.0000	N/A	377
64 CLD ST FPA TMP	-175.	DEGC	202	65 CLD ST CNTRL T	-175.	DEGC	200	66 CFPA HTR CRNT	-.014	MA	0
67 POWER SUP TEMP	20.25	DEGC	225	68 SPARE TLM	.0000	N/A	0	69 SPARE TLM	.0000	N/A	1
70 SLC 1 DR CRNT	.2040	AMPS	144	71 BND 6 PSTA TMP	19.00	DEGC	231	72 SLC 2 DR CRNT	.9400	AMPS	10
73 SLC 1 +/-15V	2,520	CNTS	176	74 SLC 2 +/-15V	.0000	CNTS	0	75 CAL LMP DR TMP	23.39	DEGC	213
76 SLC 1 +5V	5,000	VDC	175	77 SLC 2 +5V	.2000	VDC	5	78 BLK BDY CRNT	41.15	MA	73
79 SEC NIR TEMP	20.25	DEGC	225	80 SPARE TLM	.0000	N/A	5	81 CAL LMP1 CRNT	101.7	MA	230
82 CAL LMP2 CRNT	.0000	MA	0	83 CLD PAMP TEMP	.6368	DEGC	323	84 CAL LMP3 CRNT	104.4	MA	234
85 BEL HTR CRNT	.5985	AMPS	377	86 CLD STG HRT I	35.64	MA	22	87 PRI MR TEMP	14.66	DEGC	247
88 ICHWRM 1 POS	-.014	INCH	1	89 ICHWRM 2 POS	-.014	INCH	1	90 ICHWRM 3 POS	-.015	INCH	0
91 SEC MR HSK TMP	20.25	DEGC	225	92 BAND 1 A/D REF	2,000	VDC	144	93 BAND 2 A/D REF	1,980	VDC	143
94 BAND 3 A/D REF	1,980	VDC	143	95 TEL HSG TEMP	18.07	DEGC	234	96 BAND 4 A/D REF	2,000	VDC	144
97 BAND 5 A/D REF	2,000	VDC	144	98 BAND 7 A/D REF	2,000	VDC	144	99 TEL BP TEMP	-18.5	DEGC	377
100 SPARE TLM	.0000	N/A	11	101 SPARE TLM	.0000	N/A	0	102 MUX BIT DENVS	2,862	CNTS	304
103 CLR AMB ST TMP	-8.06	DEGC	352	104 MUX +18V	17.59	VDC	317	105 MUX +5V	4,905	VDC	321
106 MUX -3V	-2.00	VDC	277	107 CLR DR TEMP	37.14	DEGC	142	108 MUX -5V	-5.12	VDC	330
109 MUX -15V	-12.5	VDC	323	110 MUX INP CRNT	3,511	AMPS	275	111 +Y RAD FIN TMP	-15.1	DEGC	371
112 SPARE TLM	.0000	N/A	0	113 TIME	448,1600	XXX		114 SMA OPSTAT N	134.0	STUS	206
115 SMA SCNLR N	168.0	RFEQ	250	116 SMA TRNERR N	59.75	USEC	XXX	117 SMA TORPLS N	-801.	FILS	XXX
118 SMA SHSERR N-1	34.68	USEC	XXX	119 SMA FHSERR N-1	-33.7	USEC	XXX	120 SMA SUMERR N-1	-802,2560	SUM	XXX
121 SMA SCNCTR	2352.	CNTS	XXX	122 SMA SCNLR N-1	88.00	RFEQ	130	123 SMA TRNERR N-1	179.0	USEC	XXX
124 SMA TORPLS N-1	-787.	PULS	XXX	125 SMA SHSERR N-2	-26.0	USEC	XXX	126 SMA FHSERR N-2	23.56	USEC	XXX
127 SMA SUMERR N-2	-785,2910	SUM	XXX	128 SMA SCNTYM N-2	60761.47	CONT	XXX	201 TIME	448,1700	XXX	XXX
202 TB BUS VOLTAGE	34.24	VDC	XXX	203 TB BUS CURRENT	7.260	AMPS	XXX	204 +18V VOLTS	.0000	VDC	XXX
205 -18V VOLTS	.0000	VDC	XXX	206 +20V VOLTS	.0500	VDC	XXX	207 -20V VOLTS	.4000	VDC	XXX
208 +18V CURRENT	.0000	AMPS	XXX	209 -18V CURRENT	.0000	AMPS	XXX	210 +20V CURRENT	.1200	AMPS	XXX
211 -20V CURRENT	.1600	AMPS	XXX	212 SPARE TLM	.0000		314	213 SNSR 1 REF BB	49,0000	DEGC	XXX
214 SNSR 2 REF BB	48,8000	DEGC	XXX	215 MTF BR TMP	45,7000	DEGC	XXX	216 SNSR 2 VAR BB	45,9000	DEGC	XXX
217 STUS 1 SBS LVR	-190,700	DEGC	XXX	218 REF BB TEMP	-189,900	DEGC	XXX	219 STUS 3 SBS LVR	-189,900	DEGC	XXX
220 SPARE TLMS LVR	224,500	XXX		221 STUS 1 SBS CLR	-191,600	DEGC	XXX	222 STUS 2 SBS CLR	-191,100	DEGC	XXX
223 I-F Y POSITION	.00000000	XXX		224 RETROREFLECTOR	.00000000	XXX		225 I/F X POSITION	.00000000	XXX	
226 I/F Z POSITION	.00000000	XXX		227 SPARE I/FITON	.00000000	XXX		228 STUS 3 SBS CLR	-191,600	DEGC	XXX
229 STUS 4 SBS CLR	-192,100	DEGC	XXX	230 ITG SPH 1 FT	49,5000	DEGC	XXX	231 ITG SPH 2 FT	8,40000	DEGC	XXX
232 ITG SPH 1 ST	266,500	DEGC	XXX	233 ITG SPH 2 ST	2,60000	DEGC	XXX	234 FWD GUST FWD R	24,8600	DEGC	XXX
235 FWD GUST MID R	24,4900	DEGC	XXX	236 FWD GUST TOP R	24,6200	DEGC	XXX	237 FWD GUST FWD L	23,4600	DEGC	XXX

HEADER.DAT1240

FROM UTLRVH TASK 04:49:01 07-SEP-82

TELEMETRY SNAPSHOT

238	FWD GUST MID L	23.5200	DEGC XXX	239	FWD GUST TOP L	23.2300	DEGC XXX	240	AFT GUST AFT R	24.9300	DEGC XXX
241	AFT GUST MID R	24.9700	DEGC XXX	242	AFT GUST TOP R	24.7800	DEGC XXX	243	AFT GUST AFT L	24.0900	DEGC XXX
244	AFT GUST MID L	24.0100	DEGC XXX	245	AFT GUST TOP L	23.5600	DEGC XXX	246	HOR FLT FWD	24.7600	DEGC XXX
247	HOR FLT MID	24.7400	DEGC XXX	248	HOR FLT AFT	25.0600	DEGC XXX	249	TELSCP TUB FWD	19.6100	DEGC XXX
250	TELSCP TUB AFT	23.1900	DEGC XXX	251	SNDRY MIRROR	21.1100	DEGC XXX	252	SNDRY MIR SUP	20.9000	DEGC XXX
253	ROT MIR SUP	26.3900	DEGC XXX	254	BB 1 BASE	22.0800	DEGC XXX	255	BB 2 BASE	21.2100	DEGC XXX
256	SPARE TLM	-999.990	XXX	257	SPARE TLM	-999.990	XXX	258	ITG SPH 1 BR T	47.5600	DEGC XXX
259	ITG SPH 2 BR 2	7.74000	DEGC XXX	260	FLD LMP HT	23.1300	DEGC XXX	261	SPARE TLMT	-999.990	XXX
262	SPARE TLMT	-999.990	XXX	263	SPARE TLMT	-999.990	XXX	264	SPARE TLMT	-999.990	XXX
265	SPARE TLMT	-999.990	XXX	266	MTF LMP CRNT	=.764000	AMPS XXX	267	BBR/GA LMP CRT	-.001000	AMPS XXX
268	FLOOD LMP CRNT	.000000	AMPS XXX	269	INDEX TABLE	466.0	DEGS XXX	270	6 POS MIRROR	.0000	CONT XXX
271	MTF WHEEL	10600	CONT XXX	272	NDF WHEEL	10799	CONT XXX	273	BBR/GA WHEEL	.0000	CONT XXX
274	IRMT WHEEL	.0000	CONT XXX	501	THERM SHUTDOWN	ENAB	1	502	SMA +Z HT CNTR	ON	1
503	SMA -Z HT CNTR	ON	1	504	CMO RCVR ON	ONE	1	505	SHTR FL SW A	OPEN	0
506	SHTR FL SW B	OPEN	0	507	SHTR FL SW C	OPEN	0	508	BAND 1	ON	1
509	BAND 2	ON	1	510	BAND 3	ON	1	511	BAND 4	ON	1
512	BAND 5	ON	1	513	BAND 6	ON	1	514	BAND 7	ON	1
515	CLR DOOR	OPEN	0	516	CLR DOOR OUTGS	NO	0	517	CLR DR FUL UPN	NO	0
518	CLR DR MAG	OFF	0	519	CLR DR MTR	OFF	0	520	CD FUS LK SW A	OPEN	0
521	CD FUS LK SW B	OPEN	0	522	CD FUS LK SW C	OPEN	0	523	CAL LAMP 1	ON	1
524	CAL LAMP 2	ON	1	525	CAL LAMP 3	ON	1	526	CAL LP 1 OVRD	OFF	0
527	CAL LP 2 OVRD	OFF	0	528	CAL LP 3 OVRD	OFF	0	529	CAL SEQNCR	ON	1
530	MUX PWR BK TLM	ON	1	531	INCHWRM PW	OFF	0	532	LVDT PW	OFF	0
533	BLACK BODY HTR	ON	1	534	BLACK BODY T2	OFF	0	535	BLACK BODY T3	ON	1
536	BLKBD BKP HTR	OFF	0	537	SM ELEC 1	ON	1	538	SM ELEC 2	OFF	0
539	BAF HTR CNTRLR	ON	1	540	BAF HTR BKUP	OFF	0	541	MAC DSC GEN AP	ON	1
542	MAC DSC GEN AR	OFF	0	543	MAC DSC GEN BP	ON	1	544	MAC DSC GEN BR	OFF	0
545	MUX POWER	ON	1	546	MDSCAN PULSE	OFF	0	547	SLC 1 POWER	ON	1
548	SLC 2 POWER	OFF	0	549	CAL SHUTTER	ON	1	550	CAL SH PHS	LOCK	1
551	CAL SH AMP	LUCK	0	552	BKUP SHUTTER	OFF	0	553	BKP SH PHS	UNLK	0
554	BKP SH AMP	UNLK	0	555	CLD STG HT CNT	OFF	0	556	CS UVIGAS PWR	OFF	0
557	INTR ST HT CNT	ON	1	558	INTER STG HTR	OFF	0	559	CLD FPA HT CT	ON	1
560	COLD FPA T2	ON	1	561	COLD FPA T3	OFF	0	562	COLD FPA TLM	ON	1
563	INCHWRM CNTRT	OFF	0	564	INCHWRM 3 ENBL	DISA	0	565	INCHWRM 2 ENBL	DISA	0
566	INCHWRM 1 ENBL	DISA	0	567	CLR DR MOVE	OFF	0	568	CLR DOOR O-C	OPEN	0
569	MDSCAN PULSE B	DISA	0	570	MDSCAN PULSE A	DISA	0	571	INCHWRM MOVE	OFF	0
572	INCHWRM EXTND	OFF	0	573	DC RESTORE	ON	1	574	FRM DC RES SEL	OFF	0
575	SPARE TLMS SEL	ON	1	576	CLD STG TLM	ON	1	577	ALL CAL LAMPS	OFF	0
578	SMA MODE	SAM	0	579	SMA CIRCUIT	SME1	0	580	TLM SCALING	ON	1
581	SMA +Z HEATER	ENAB	1	582	SMA -Z HEATER	ENAB	1	583	MIDSCAN P BKUP	OFF	0
584	SME 1 SACT SAM	ON	1	585	SMA DIRECTIONM	REV	1				

STREAM TIME= 250:04:48:17:38?

COLLECT NUMBER 1
 COLLECTION VIDEO ERROR FLAG 0
 NUMBER OF COLLECTS, FIRST COLLECT ONLY 1
 TOTAL NUMBER OF BLOCKS IN COLLECTION 318
 NUMBER OF BYTES IN LAST VIDEO DATA BLOCK 488
 HEADER/TRAILER LENGTH IN BLOCKS 3

TIME IN YEAR MONTH DAY HOUR:MIN:SEC TIC
 TIME OF COLLECT 82 9 2 8:43:0 26
 NUMBER OF SCANS IS 10
 VECTOR OF BANDS /DETECTORS COLLECTED
 1 2 3 4 5 6 7 8 9 10 11 12 13 14 15 16
 BANDS T T T T T T T T T T T T T T T T
 DETEC T T T T T T T T T T T T T T T T

START MF, END MF, BYTES/MF
 1 7 102
 7064 7224 96

REVERSE SCAN INFORMATION
 START MF, END MF, BYTES/MF
 1 7 102
 6500 6660 96

COLLECTED FORWARD AND REVERSE SCANS

DUMP OF DSU REGISTERS (IN HEX)

0004	015F	02FF	03FF	040A	0500	0601	0700	0800	0900	0A00	0B00	0C00	0D00	0E00	0F00
1000	1100	1200	1300	1400	1500	1600	1700	1800	1900	1A00	1B00	1C00	1D00	1E00	1F00
2000	2100	2200	2300	2400	2500	2600	2700	2800	2900	2A00	2B00	2C00	2D00	2E00	2F00
3000	3100	3200	3300	3400	3500	3600	3700	3800	3900	3A00	3B00	3C00	3D00	3E00	3F00
40FD	4167	4200	43FD	4467	4500	4600	4700	4800	4900	4A00	4B00	4C00	4D00	4E00	4F00
5000	5100	5200	5300	5400	5500	5600	5700	5800	5900	5A00	5B00	5C00	5D00	5E00	5F00
6000	6100	6200	6300	6400	6500	6600	6700	6800	6900	6A00	6B00	6C00	6D00	6E00	6F00
7000	7100	7200	7300	7400	7500	7600	7700	7800	7900	7A00	7B00	7C00	7D00	7E00	7F00
8001	8198	8298	83B4	8498	852F	86BF	87DF	88F4	89B4	8AF4	8BB4	8CB4	8DF4	8EF4	8F04
9040	911B	921B	9359	945B	951F	965F	975F	9814	9915	9A57	9B14	9C14	9D14	9E14	9F04
AD07	A13B	A23B	A3E8	A43B	A520	A6B4	A776	ABFF	A976	AAF6	ABB4	ACF6	ADF6	AE95	AFFF
B000	B19C	B29C	B319	B49C	B506	B697	B707	B89B	B999	BA0C	BB1D	BCB4	BD06	BE06	BF9F
C001	C164	C280	C364	C4B0	C5B7	C6FF	C7FF	C837	C92F	CA1F	CB07	CC0F	CD0F	CE07	CFFF
D040	D119	D21B	D359	D45B	D516	D65F	D75F	D81E	D91F	DA1F	DB0F	DC0F	DD1F	DE1F	DF5F
E007	E104	E2E4	E304	E4E4	E5B7	E6BF	E7FF	E8BF	E9BF	EAFF	EB3F	ECB7	EDFF	EEF7	EFFF
F000	F19A	F29B	F31A	F49B	F504	F616	F707	F89F	F99F	FA9F	FB9F	FC9F	FD9F	FE97	FF9F

HEADER.DAT7132

FROM UTLVNH TASK 08:44:48 02-SEP-82

TELEMETRY SNAPSHOT

STREAM TIME= 245:08:43:06:05?

1 PWR SUP 1 CRNT 2,480	TVTS 174	2 PWR SUP 2 CRNT ,0000	TVTS 0	3 SMA +Z HSN TMP 23,13	DEGC 157
4 +19V SUPPLY 23,24	VDC 320	5 -19V SUPPLY -23,4	VDC 314	6 SMA -Z HSN TMP 23,37	DEGC 156
7 +9V SUPPLY 8,470	VDC 350	8 SPARE TLM ,0000	N/A 24	9 SAM TEMP 22,66	DEGC 161
10 +33V SHIR DRV 33,91	VDC 320	11 +80V HTR SUPL 102,5	VDC 377	12 SMA ELEC TMP 23,14	DEGC 70
13 SMA +6,8V #1 7,300	VDC 351	14 SMA +6,8V #2 ,0000	VDC 0	15 SMA FLX P-X T 22,18	DEGC 163
16 SMA +27V #1 30,37	VDC 320	17 SMA +27V #2 ,0000	VDC 0	18 SMA FLX P-X T 22,41	DEGC 162
19 SMA -27V #1 -28,8	VDC 275	20 SMA -27V #2 ,0000	VDC 0	21 SUNSHLD TEMP 23,08	DEGC 214
22 MUX +30V SUP 29,84	VDC 321	23 SPARE TLM ,0000	N/A 23	24 SPARE TLM ,0000	N/A 377
25 BAND 1 +19V 20,77	VDC 275	26 BAND 1 -19V -20,1	VDC 270	27 ODD AMB PA TEM 10,94	DEGC 263
28 BAND 2 +19V 20,38	VDC 273	29 BAND 2 -19V -20,1	VDC 270	30 RELAY OP TMP 121,2	DEGC 0
31 BAND 3 +19V 20,48	VDC 273	32 BAND 3 -19V -20,1	VDC 271	33 EV AMB PREA TP 10,63	DEGC 264
34 BAND 4 +19V 20,59	VDC 274	35 BAND 4 -19V -20,2	VDC 272	36 CAL SHT HB TEM 8,129	DEGC 274
37 BAND 5-7 +19V 19,79	VDC 265	38 BAND 5-7 -19V -19,5	VDC 262	39 SLC TEMP 13,25	DEGC 325
40 BAND 6 +19V 19,60	VDC 265	41 BAND 6 -19V -20,1	VDC 265	42 CAL LP FLT TMP 8,757	DEGC 272
43 ISOLATED +19V 22,22	VDC 313	44 ISOLATED -19V -22,3	VDC 314	45 SPARE TLM ,0000	N/A 377
46 CDVU +8V 7,461	VDC 321	47 SPARE TLM ,0000	N/A 34	48 SPARE TLM ,0000	N/A 377
49 INT CAL BB TME 34,23	DEGC 202	50 SI FPA TEMP 10,94	DEGC 67	51 MUX ELCT TMP 19,64	DEGC 140
52 CAL SHT FG TMP 9,470	DEGC 254	53 BUUP SHIR TMP 9,311	DEGC 255	54 BAFFLE TEMP 26,85	DEGC 315
55 MUX PS TEMP 20,25	DEGC 136	56 SPARE TLM ,0000	N/A 0	57 SPARE TLM ,0000	N/A 0
58 CLD STG TMP A -180,	DEGC 241	59 PRI MIR MSK TP 10,94	DEGC 263	60 CLD STG TMP B -176,	DEGC 330
61 INT STG TMP A -135,	DEGC 263	62 INT STG TMP B -136,	DEGC 304	63 SPARE TLM ,0000	N/A 377
64 CLD ST FPA TMP -179,	DEGC 252	65 CLD ST CNTRL T -179,	DEGC 247	66 CFFA HTR CRNT -.014	MA 0
67 POWER SUP TME 17,45	DEGC 236	68 SPARE TLM ,0000	N/A 0	69 SPARE TLM ,0000	N/A 2
70 SLC 1 DR CRNT ,0840	AMPS 163	71 BND 6 PSTA TMP 10,94	DEGC 263	72 SLC 2 DR CRNT ,9480	AMPS 7
73 SLC 1 +/-15V 2,460	CNTS 173	74 SLC 2 +/-15V ,0000	CNTS 0	75 CAL LMP DR TMP 14,04	DEGC 251
76 SLC 1 +5V 5,000	VDC 175	77 SLC 2 +5V ,1200	VDC 3	78 BLK HDY CRNT 47,43	MA 104
79 SEC MIR TEMP 17,76	DEGC 235	80 SPARE TLM ,0000	N/A 5	81 CAL LMP1 CRNT ,0000	MA 0
82 CAL LMP2 CRNT 105,1	MA 235	83 CLD PAMP TEMP -5,59	DEGC 344	84 CAL LMP3 CRNT ,6694	MA 1
85 DEL HTR CRNT ,0000	AMPS 0	86 CLD STG HRT I ,0000	MA 0	87 PRI MR TEMP 10,00	DEGC 266
88 ICHWRM 1 POS -.015	INCH 0	89 ICHWRM 2 POS -.015	INCH 0	90 ICHWRM 3 POS -.015	INCH 0
91 SEC MR MSK TMP 17,76	DEGC 235	92 BAND 1 A/D REF 1,980	VDC 143	93 BAND 2 A/D REF 1,980	VDC 143
94 BAND 3 A/D REF 1,980	VDC 143	95 TEL HSG TME 14,97	DEGC 246	96 BAND 4 A/D REF 2,000	VDC 144
97 BAND 5 A/D REF 1,980	VDC 143	98 BAND 7 A/D REF 2,000	VDC 144	99 TEL BP TEMP -18,5	DEGC 377
100 SPARE TLM ,0000	N/A 12	101 SPARE TLM ,0000	N/A 1	102 MUX BIT DEMS 3,131	CNTS 267
103 CLR AMB ST TMR -13,6	DEGC 366	104 MUX +18V 17,59	VDC 317	105 MUX +5V 4,905	VDC 321
106 MUX -3V -2,01	VDC 300	107 CLR DR TEMP 37,14	DEGC 142	108 MUX -5V -5,15	VDC 331
109 MUX -15V -12,5	VDC 323	110 MUX INP CRNT 3,493	AMPS 274	111 +V RAD FIN TMP -18,5	DEGC 377
112 SPARE TLM ,0000	N/A 0	113 TIME 843,0600	XXX	114 SMA OPSTAT N 6,000	STUS 6
115 SMA SCNLIN N 88,00	RFEQ 130	116 SMA TRNERR N 162,1	USEC XXX	117 SMA TORPLS N -743,	PULS XXX
118 SMA SHSERR N-1 -20,6	USEC XXX	119 SMA FHSERR N-1 26,76	USEC XXX	120 SMA SUMERR N-1 -741,7475	SUM XXX
121 SMA SCNCJR 1216,	CONT XXX	122 SMA SCNLIN N-1 168,0	RFEQ 250	123 SMA TRNERR N-1 75,40	USEC XXX
124 SMA TORPLS N-1 -757,	PULS XXX	125 SMA SHSERR N-2 34,49	USEC XXX	126 SMA FHSERR N-2 -33,5	USEC XXX
127 SMA SUMERR N-2 -758,1470	SUM XXX	128 SMA SCNTYM N-2 60758,07	CONT XXX	201 TIME 843,0600	XXX
202 TM BUS VOLTAGE 27,32	VDC XXX	203 TM BUS CURRENT 11,71	AMPS XXX	204 +10V VOLTS ,0200	VDC XXX
205 -18V VOLTS ,0100	VDC XXX	206 +20V VOLTS ,6000	VDC XXX	207 -20V VOLTS ,5700	VDC XXX
208 +18V CURRENT ,0000	AMPS XXX	209 -18V CURRENT ,0000	AMPS XXX	210 +20V CURRENT ,2300	AMPS XXX
211 -20V CURRENT ,3000	AMPS XXX	212 SPARE TLM ,0000	314	213 SNR 1 REF BB 51,2000	DEGC XXX
214 SNR 2 REF BB 51,1000	DEGC XXX	215 MIF BB TMP -22,4000	DEGC XXX	216 SNR 2 VAR BB -22,2000	DEGC XXX
217 STUS 1 SBS LVR -191,100	DEGC XXX	218 REF BB TEMP -190,200	DEGC XXX	219 STUS 3 SBS LVR -190,200	DEGC XXX
220 SPARE TLMS LVR 220,200	XXX	221 STUS 1 SBS CLR -191,800	DEGC XXX	222 STUS 2 SBS CLR -191,200	DEGC XXX
223 I-F Y POSITION ,00000000	XXX	224 RETROREFLECTOR ,00000000	XXX	225 I/F X POSITION ,00000000	XXX
226 I/F Z POSITION ,00000000	XXX	227 SPARE I/FITION ,00000000	XXX	228 STUS 3 SBS CLR -242,400	DEGC XXX
229 STUS 4 SBS CLR -243,100	DEGC XXX	230 ITG SPH 1 FT 17,8000	DEGC XXX	231 ITG SPH 2 FT 6,20000	DEGC XXX
232 ITG SPH 1 ST 15,5000	DEGC XXX	233 ITG SPH 2 ST 1,10000	DEGC XXX	234 FWD GUST FWD R 21,2700	DEGC XXX
235 FWD GUST MID R 20,7000	DEGC XXX	236 FWD GUST TOP R 20,1000	DEGC XXX	237 FWD GUST FWD L 20,0400	DEGC XXX

TELEMETRY SNAPSHOT

238 FWD GUST MID L 19.9200	DEGC XXX	239 FWD GUST TOP L 18.8700	DEGC XXX	240 AFT GUST AFT R 21.3300	DEGC XXX
241 AFT GUST MID R 21.2600	DEGC XXX	242 AFT GUST TOP R 20.5400	DEGC XXX	243 AFT GUST AFT L 20.7800	DEGC XXX
244 AFT GUST MID L 20.4700	DEGC XXX	245 AFT GUST TOP L 19.5400	DEGC XXX	246 HOR PLT FWD 21.5300	DEGC XXX
247 HOR PLT MID 21.3100	DEGC XXX	248 HOR PLT AFT 21.8400	DEGC XXX	249 TELSCP TUB FWD 16.4500	DEGC XXX
250 TELSCP TUB AFT 19.1100	DEGC XXX	251 SDRY MIRROR 18.2300	DEGC XXX	252 SDRY MTR SUP 18.1700	DEGC XXX
253 ROT MTR SUP 21.2500	DEGC XXX	254 BB 1 BASE 17.7600	DEGC XXX	255 BB 2 BASE 17.4500	DEGC XXX
256 SPARE TLM -999.990	XXX	257 SPARE TLM -999.990	XXX	258 ITG SPH 1 BK I 16.6300	DEGC XXX
259 ITG SPH 2 BK 2 5.63000	DEGC XXX	260 FLD LMP HT 20.0500	DEGC XXX	261 SPARE TLMT -999.990	XXX
262 SPARE TLMT -999.990	XXX	263 SPARE TLMT -999.990	XXX	264 SPARE TLMT -999.990	XXX
265 SPARE TLMT -999.990	XXX	266 MTF LMP CRNT -.013000	AMPS XXX	267 BBR/GA LMP CRT -.001000	AMPS XXX
268 FLOOD LMP CRNT .000000	AMPS XXX	269 INDEX TABLE .0000	DEGS XXX	270 6 POS MIRROR 21600	CONT XXX
271 MTF WHEEL .0000	CONT XXX	272 NDF WHEEL .0000	CONT XXX	273 BBR/GA WHEEL .0000	CONT XXX
274 IRMTE WHEEL .0000	CONT XXX	501 THERM SHEDWN ENAB	1	502 SMA +Z HT CNTR ON	1
503 SMA -Z HT CNTR ON	1	504 CMD RCVR ON ONE	1	505 SHTR FL SW A OPEN	0
506 SHTR FL SW B OPEN	0	507 SHTR FL SW C OPEN	0	508 BAND 1 ON	1
509 BAND 2 ON	1	510 BAND 3 ON	1	511 BAND 4 ON	1
512 BAND 5 ON	1	513 BAND 6 ON	1	514 BAND 7 ON	1
515 CLR DOOR OPEN	0	516 CLR DOOR OUTGS NO	0	517 CLR DR FUL UPN NO	0
518 CLR DR MAG OFF	0	519 CLR DR MTR OFF	0	520 CD FUS LK SW A OPEN	0
521 CD FUS LK SW B OPEN	0	522 CD FUS LK SW C OPEN	0	523 CAL LAMP 1 OFF	0
524 CAL LAMP 2 ON	1	525 CAL LAMP 3 OFF	0	526 CAL LP 1 OVRD OFF	0
527 CAL LP 2 OVRD ON	1	528 CAL LP 3 OVRD OFF	0	529 CAL SEQNCR OFF	0
530 MUX PWR BK TLM ON	1	531 INCHWRM PW OFF	0	532 LVDT PW OFF	0
533 BLACK BODY HTR ON	1	534 BLACK BODY T2 ON	1	535 BLACK BODY T3 ON	1
536 BLKBD BKP HTR OFF	0	537 SM ELEC 1 ON	1	538 SM ELEC 2 OFF	0
539 BAF HTR CNTRLR ON	1	540 BAF HTR BKUP OFF	0	541 MAC DSC GEN AP ON	1
542 MAC DSC GEN AR OFF	0	543 MAC DSC GEN BP ON	1	544 MAC DSC GEN BR OFF	0
545 MUX POWER ON	1	546 MDSCN PULSE OFF	0	547 SLC 1 POWER ON	1
548 SLC 2 POWER OFF	0	549 CAL SHUTTER ON	1	550 CAL SH PHS LOCK	1
551 CAL SH AMP LOCK	1	552 BKUP SHUTTER OFF	0	553 BKP SH PHS UNLK	0
554 BKP SH AMP UNLK	0	555 CLD STG HT CNT OFF	0	556 CS OUTGAS PWR OFF	0
557 INTR ST HT CNT ON	1	558 INTER STG HTR OFF	0	559 CLD FPA HT CT ON	1
560 COLD FPA T2 OFF	0	561 COLD FPA T3 OFF	0	562 COLD FPA TLM ON	1
563 INCHWRM CONTRT OFF	0	564 INCHWRM 3 ENBL DISA	0	565 INCHWRM 2 ENBL DISA	0
566 INCHWRM 1 ENBL DISA	0	567 CLR DR MOVE OFF	0	568 CLR DOOR O-C OPEN	0
569 MDSCAN PULSE B DISA	0	570 MDSCAN PULSE A DISA	0	571 INCHWORM MOVE OFF	0
572 INCHWORM EXTND OFF	0	573 DC RESTORE ON	1	574 FRM DC RES SEL OFF	0
575 SPARE TLMS SEL ON	1	576 CLD STG TLM ON	1	577 ALL CAL LAMPS OFF	0
578 SMA MODE SAM	0	579 SMA CIRCUIT SHE1	0	580 TLM SCALING ON	1
581 SMA +Z HEATER ENAB	1	582 SMA -Z HEATER ENAB	1	583 MIDSCAN P BKUP OFF	0
584 SME 1 SLCT SAM ON	1	585 SMA DIRECTIONM FWD	0		

STREAM TIME= 245:08:43:06:05?

COLLECT NUMBER 1
 COLLECTION VIDEO ERROR FLAG 0
 NUMBER OF COLLECTS, FIRST COLLECT ONLY 1
 TOTAL NUMBER OF BLOCKS IN COLLECTION 179
 NUMBER OF BYTES IN LAST VIDEO DATA BLOCK 416
 HEADER/TRAILER LENGTH IN BLOCKS 3

TIME IN YEAR MONTH DAY HOUR:MIN:SEC TIC
 TIME OF COLLECT 82 9 7 13:13:6 39

NUMBER OF SCANS IS 40

VECTOR OF BANDS / DETECTORS COLLECTED

1 2 3 4 5 6 7 8 9 10 11 12 13 14 15 16

BANDS T T T T F F F F

DETECT T T T T T T T T T T T T T T T T

START ME, END ME, BYTES/ME

1 7 102
 3217 3242 64

COLLECTED FORWARD SCANS ONLY

DUMP OF DSU REGISTERS (IN HEX)

0004	010E	02FF	03FE	042B	058D	0681	0700	0800	0900	0A00	0B00	0C00	0D00	0E00	0F00
1000	1100	1200	1300	1400	1500	1600	1700	1800	1900	1A00	1B00	1C00	1D00	1E00	1F00
2000	2100	2200	2300	2400	2500	2600	2700	2800	2900	2A00	2B00	2C00	2D00	2E00	2F00
3000	3100	3200	3300	3400	3500	3600	3700	3800	3900	3A00	3B00	3C00	3D00	3E00	3F00
409B	4139	4200	439B	4439	4500	4600	4700	4800	4900	4A00	4B00	4C00	4D00	4E00	4F00
5000	5100	5200	5300	5400	5500	5600	5700	5800	5900	5A00	5B00	5C00	5D00	5E00	5F00
6000	6100	6200	6300	6400	6500	6600	6700	6800	6900	6A00	6B00	6C00	6D00	6E00	6F00
7000	7100	7200	7300	7400	7500	7600	7700	7800	7900	7A00	7B00	7C00	7D00	7E00	7F00
8001	8191	82AB	83B4	8498	854F	863F	877F	88F4	898F	8AF4	8BB4	8CBF	8DF4	8EF4	8F4E
9040	910C	9218	9359	945B	955F	965E	975F	9854	991E	9A5F	9B14	9C14	9D14	9E14	9F5F
A007	A1AA	A2BA	A3E8	A43B	A52C	A685	A77F	A8FF	A97F	AAF6	ABBA	ACF6	ADFE	AE9F	AFFF
B000	B18C	B218	B319	B49C	B586	B69F	B71F	B89B	B999	BA0C	BB9F	BC94	BD06	BE06	BF9F
C001	C128	C2AB	C364	C48D	C5E6	C6FE	C7FF	C8F7	C9AE	CA1F	CB07	CC00	CD0E	CE07	CEFF
D040	D14C	D218	D359	D45B	D556	D657	D75F	D81F	D91F	DA1F	DB0F	DC0F	DD5F	DE1F	DF5F
E005	E140	E2BA	E304	E4E4	E5B7	E6BF	E7FF	E8BF	E9BF	EAF6	EB3F	ECB7	EDFF	EEF7	EFFF
F000	F10C	F218	F31A	F49B	F50C	F616	F707	F89F	F99E	FA9F	FB9F	FC9F	FD9F	FE9F	FF9F

HEADER.DAT:J315

FROM UTLNVH TASK 13:33:45 07-SEP-82

TELEMETRY SNAPSHOT

STREAM TIME= 250:13:12:26:80Z

1	PWR SUP 1 CRNT	.0000	TVIS	0	2	PWR SUP 2 CRNT	2.460	TVIS	173	3	SMA +Z HSN TMP	24.10	DEGC	153
4	+19V SUPPLY	23.57	VDC	323	5	-19V SUPPLY	-23.5	VDC	315	6	SMA -Z HSN TMP	23.86	DEGC	154
7	+8V SUPPLY	8.434	VDC	347	8	SPARE TLM	.0000	N/A	25	9	SAM TEMP	24.61	DEGC	151
10	+33V SHTR DRV	34.89	VDC	326	11	+80V HTR SUPPL	102.1	VDC	376	12	SMA ELRC TMP	25.79	DEGC	61
13	SMA +6.8V #1	.0000	VDC	0	14	SMA +6.8V #2	-7.338	VDC	353	15	SMA FLX P-X T	23.37	DEGC	156
16	SMA +27V #1	.1460	VDC	1	17	SMA +27V #2	31.03	VDC	325	18	SMA FLX P-X T	23.86	DEGC	154
19	SMA -27V #1	.0000	VDC	0	20	SMA -27V #2	-30.8	VDC	300	21	SUNSHLD TEMP	23.08	DEGC	214
22	MUX +30V SUP	29.84	VDC	321	23	SPARE TLM	.0000	N/A	30	24	SPARE TLM	.0000	N/A	377
25	BAND 1 +19V	21.10	VDC	300	26	BAND 1 -19V	-20.4	VDC	273	27	ODD AMB PA TEM	28.85	DEGC	172
28	BAND 2 +19V	20.71	VDC	276	29	BAND 2 -19V	-20.3	VDC	272	30	RELAY OP TMP	121.2	DEGC	0
31	BAND 3 +19V	20.59	VDC	274	32	BAND 3 -19V	-20.3	VDC	273	33	EV AMB PREA TP	27.87	DEGC	175
34	BAND 4 +19V	20.92	VDC	277	35	BAND 4 -19V	-20.6	VDC	275	36	CAL SHT HB TEM	13.73	DEGC	252
37	BAND 5-7 +19V	19.79	VDC	265	38	BAND 5-7 -19V	-19.5	VDC	262	39	SLC TEMP	22.68	DEGC	275
40	BAND 6 +19V	19.82	VDC	267	41	BAND 6 -19V	-20.2	VDC	266	42	CAL LP FLT TMP	14.66	DEGC	247
43	ISOLATED +19V	22.44	VDC	315	44	ISOLATED -19V	-22.7	VDC	317	45	SPARE TLM	.0000	N/A	377
46	CDVU +8V	7.639	VDC	326	47	SPARE TLM	.0000	N/A	35	48	SPARE TLM	.0000	N/A	377
49	INT CAL BB TMP	34.23	DEGC	202	50	SI FPA TEMP	20.02	DEGC	203	51	MUX ELCT TMP	41.36	DEGC	57
52	CAL SHT FG TMP	15.99	DEGC	203	53	BKUP SHTR TMP	15.83	DEGC	204	54	BAFFLE TEMP	26.45	DEGC	313
55	MUX PS TEMP	36.07	DEGC	67	56	SPARE TLM	.0000	N/A	0	57	SPARE TLM	.0000	N/A	0
58	CLD SIG TMP A	-176.	DEGC	215	59	PRI MIR MSK TP	15.28	DEGC	245	60	CLD STG TMP B	-173.	DEGC	324
61	INT STG TMP A	-129.	DEGC	220	62	INT STG IMP B	-131.	DEGC	276	63	SPARE TLM	.0000	N/A	377
64	CLD ST FPA TEMP	-175.	DEGC	202	65	CLD ST CNTRL T	-175.	DEGC	200	66	CFPA HTR CRNT	-.014	MA	0
67	POWER SUP TEMP	22.13	DEGC	217	68	SPARE TLM	.0000	N/A	0	69	SPARE TLM	.0000	N/A	1
70	SLC 1 DR CRNT	1.004	AMPS	0	71	BND 6 PSTA THP	20.56	DEGC	224	72	SLC 2 DR CRNT	-.084	AMPS	210
73	SLC 1 +/-15V	.0000	CNTS	0	74	SLC 2 +/-15V	2.400	CNTS	170	75	CAL LMP DR TMP	26.90	DEGC	200
76	SLC 1 +5V	.2000	VDC	5	77	SLC 2 +5V	4.880	VDC	172	78	BLK BDY CRNT	41.15	MA	73
79	SEC MIR TEMP	19.63	DEGC	227	80	SPARE TLM	.0000	N/A	6	81	CAL LMP1 CRNT	.0000	MA	0
82	CAL LMP2 CRNT	103.7	MA	233	83	CLD PAHP TEMP	2.660	DEGC	315	84	CAL LMP3 CRNT	104.4	MA	234
85	BEL HTR CRNT	.0000	AMPS	0	86	CLD STG HRT I	1.980	MA	1	87	PRI MR TEMP	14.66	DEGC	247
88	ICHWRM 1 POS	-.015	INCH	0	89	ICHWRM 2 POS	-.015	INCH	0	90	ICHWRM 3 POS	-.014	INCH	1
91	SEC MR MSK TMP	19.63	DEGC	227	92	BAND 1 A/D REF	1.980	VDC	143	93	BAND 2 A/D REF	1.980	VDC	143
94	BAND 3 A/D REF	1.980	VDC	143	95	TEL HSG TEMP	18.07	DEGC	234	96	BAND 4 A/D REF	1.980	VDC	143
97	BAND 5 A/D REF	2.000	VDC	144	98	BAND 7 A/D REF	1.980	VDC	143	99	TEL BP TEMP	-18.5	DEGC	377
100	SPARE TLM	.0000	N/A	13	101	SPARE TLM	.0000	N/A	2	102	MUX BIT DENS	2.965	CNTS	277
103	CLR AMB ST TMP	-8.06	DEGC	352	104	MUX +18V	17.67	VDC	320	105	MUX +5V	4.929	VDC	322
106	MUX -3V	-2.01	VDC	300	107	CLR DR TEMP	37.14	DEGC	142	108	MUX -5V	-5.15	VDC	331
109	MUX -15V	-12.5	VDC	324	110	MUX INP CRNT	3.511	AMPS	275	111	+Y RAD FIN TMP	-15.7	DEGC	372
112	SPARE TLM	.0000	N/A	0	113	TIME	1312.270	XXX		114	SMA OPSTAT N	134.0	STUS	206
115	SMA SCNLIN N	168.0	RFEQ	250	116	SMA TRNERR N	56.36	USEC	XXX	117	SMA TORPLS N	-800.	PULS	XXX
118	SMA SHSERR N-1	34.49	USEC	XXX	119	SMA FHSERR N-1	-34.1	USEC	XXX	120	SMA SUMERN N-1	-800.5595	SUM	XXX
121	SMA SCNCTR	5039.	CNT	XXX	122	SMA SCNLIN N-1	88.00	RFEQ	130	123	SMA TRNERR N-1	181.1	USEC	XXX
124	SMA TORPLS N-1	-186.	PULS	XXX	125	SMA SHSERR N-2	-23.7	USEC	XXX	126	SMA FHSERR N-2	23.94	USEC	XXX
127	SMA SUMERN N-2	-786.0450	SUM	XXX	128	SMA SNTYM N-2	60758.83	CNT	XXX	201	TIME	1312.260	XXX	
202	TM BUS VOLTAGE	27.88	VDC	XXX	203	TM BUS CURRENT	10.28	AMPS	XXX	204	+18V VOLTS	.0000	VDC	XXX
205	-18V VOLTS	.0000	VDC	XXX	206	+20V VOLTS	.0500	VDC	XXX	207	-20V VOLTS	.2900	VDC	XXX
208	+18V CURRENT	.0000	AMPS	XXX	209	-18V CURRENT	.0000	AMPS	XXX	210	+20V CURRENT	.2800	AMPS	XXX
211	-20V CURRENT	.3300	AMPS	XXX	212	SPARE TLMNT	.0000	XXX	314	213	SNSR 1 REF BB	50.9000	DEGC	XXX
214	SNSR 2 REF BB	50.8000	DEGC	XXX	215	MTF BB TMP	-22.1000	DEGC	XXX	216	SNSR 2 VAR BB	-21.9000	DEGC	XXX
217	STUS 1 SBS LVR	-190.500	DEGC	XXX	218	REF BB TEMP	-189.900	DEGC	XXX	219	STUS 3 SBS LVR	-189.900	DEGC	XXX
220	SPARE TLMS LVR	-255.600	XXX		221	STUS 1 SBS CLR	-191.600	DEGC	XXX	222	STUS 2 SBS CLR	-191.100	DEGC	XXX
223	I-F Y POSITION	.00000000	XXX		224	RETRORFLECTOR	.00000000	XXX		225	I/F X POSITION	.00000000	XXX	
226	I/F Z POSITION	.00000000	XXX		227	SPARE I/FITION	.00000000	XXX		228	STUS 3 SBS CLR	-191.500	DEGC	XXX
229	STUS 4 SBS CLR	-192.100	DEGC	XXX	230	ITG SPH 1 FT	55.1000	DEGC	XXX	231	ITG SPH 2 FT	9.00000	DEGC	XXX
232	ITG SPH 1 ST	270.400	DEGC	XXX	233	ITG SPH 2 ST	3.40000	DEGC	XXX	234	FWD GUST FWD R	23.9200	DEGC	XXX
235	FWD GUST MID R	23.4400	DEGC	XXX	236	FWD GUST TOP R	23.5300	DEGC	XXX	237	FWD GUST FWD L	22.4900	DEGC	XXX

HEADER.DAT:1315

FROM UTLWVH TASK 13:33:45 07-SEP-82

TELEMETRY SNAPSHOT

238 FWD GUST MID L 22,5000	DEGC XXX	239 FWD GUST TOP L 22,2100	DEGC XXX	240 AFT GUST AFT R 23,8700	DEGC XXX
241 AFT GUST MID R 23,9000	DEGC XXX	242 AFT GUST TOP R 23,6800	DEGC XXX	243 AFT GUST AFT L 23,1100	DEGC XXX
244 AFT GUST MID L 22,9800	DEGC XXX	245 AFT GUST TOP L 22,5500	DEGC XXX	246 HOR PLT FWD 23,8400	DEGC XXX
247 HOR PLT MID 23,7100	DEGC XXX	248 HOR PLT AFT 24,0300	DEGC XXX	249 TELSCP TUB FWD 19,0000	DEGC XXX
250 TELSCP TUB AFT 22,1300	DEGC XXX	251 SNDRY MIRROR 20,6600	DEGC XXX	252 SNDRY MIR SUP 20,4400	DEGC XXX
253 ROT MIR SUP 25,6300	DEGC XXX	254 BB 1 BASE 21,0800	DEGC XXX	255 BB 2 BASE 19,8100	DEGC XXX
256 SPARE TLM -999,990	XXX	257 SPARE TLM -999,990	XXX	256 ITG SPH 1 BK T 52,6400	DEGC XXX
259 ITG SPH 2 BK 2 8,35000	DEGC XXX	260 FLD LMP HT 22,4600	DEGC XXX	261 SPARE TLMT -999,990	XXX
262 SPARE TLMT -999,990	XXX	263 SPARE TLMT -999,990	XXX	264 SPARE TLMT -999,990	XXX
265 SPARE TLMT -999,990	XXX	266 MTF LMP CRNT -7,763000	AMPS XXX	267 BBR/GA LMP CRT -7,001000	AMPS XXX
268 FLOOD LMP CRNT 0,000000	AMPS XXX	269 INDEX TABLE 466,0	DEGS XXX	270 6 POS MIRROR 0,0000	CONT XXX
271 MTF WHEEL 0,0000	CONT XXX	272 NDF WHEEL 10801	CONT XXX	273 BBR/GA WHEEL 10792	CONT XXX
274 IRMTE WHEEL 0,0000	CONT XXX	501 THERM SH'DWN	ENAB	502 SMA +Z HT CNTR	ON
503 SMA -Z HT CNTR	UN	504 CMD RCVR	ON	505 SHTR FL SW A	OPEN
506 SHTR FL SW B	OPEN	507 SHTR FL SW C	OPEN	508 BAND 1	ON
509 BAND 2	ON	510 BAND 3	ON	511 BAND 4	ON
512 BAND 5	ON	513 BAND 6	ON	514 BAND 7	ON
515 CLR DOOR	OPEN	516 CLR DOOR OUTGS	NO	517 CLR DR FUL OPN	NO
518 CLR DR MAG	OFF	519 CLR DR MTR	OFF	520 CD FUS LK SW A	OPEN
521 CD FUS LK SW B	OPEN	522 CD FUS LK SW C	OPEN	523 CAL LAMP 1	ON
524 CAL LAMP 2	UN	525 CAL LAMP 3	ON	526 CAL LP 1 OVRD	OFF
527 CAL LP 2 OVRD	OFF	528 CAL LP 3 OVRD	OFF	529 CAL SEONCR	ON
530 MUX PWR BK TLH	ON	531 INCHWRM PW	OFF	532 LVDT PW	OFF
533 BLACK BODY HTR	ON	534 BLACK BODY T2	OFF	535 BLACK BODY T3	ON
536 RLKBD BKE HTR	OFF	537 SM ELEC 1	ON	538 SM ELEC 2	OFF
539 BAF HTR CNTRLR	ON	540 BAF HTR BKUP	OFF	541 MAC DSC GEN AP	ON
542 MAC DSC GEN AR	OFF	543 MAC DSC GEN BP	ON	544 MAC DSC GEN BR	OFF
545 MUX POWER	UN	546 HDSCAN PULSE	OFF	547 SLC 1 POWER	OFF
548 SLC 2 POWER	UN	549 CAL SHUTTER	ON	550 CAL SH PHS	LOCK
551 CAL SH AMP	LOCK	552 BKUP SHUTTER	OFF	553 BKP SH PHS	UNLK
554 BKE SH AMP	UNLK	555 CLD STG HT CNT	OFF	556 CS OUTGAS PWR	OFF
557 INTR ST HT CNT	UN	558 INTER STG HTR	OFF	559 CLD FPA HT CT	ON
560 COLD FPA T2	ON	561 COLD FPA T3	OFF	562 COLD FPA TLM	ON
563 INCHWRM CONTRT	OFF	564 INCHWRM 3 ENBL	DISA	565 INCHWRM 2 ENBL	DISA
566 INCHWRM 1 ENBL	DISA	567 CLR DR MOVE	OFF	568 CLR DOOR O-C	OPEN
569 HDSCAN PULSE B	DISA	570 HDSCAN PULSE A	DISA	571 INCHWRM MOVE	OFF
572 INCHWRM EXTND	OFF	573 DC RESTORE	ON	574 FRM DC RES SEL	OFF
575 SPARE TLMS SEL	ON	576 CLD STG TLM	ON	577 ALL CAL LAMPS	OFF
578 SMA MODE	SAM	579 SMA CIRCUIT	SME1	580 TLM SCALING	ON
581 SMA +Z HEATER	ENAB	582 SMA -Z HEATER	ENAB	583 HDSCAN P BKUP	OFF
584 SME 1 SLCT SAM	ON	585 SMA DIRECTIONM	REV		

STREAM TIME= 250:13:12:26:807

COLLECT NUMBER 1
 COLLECTION VIDEO ERROR FLAG 0
 NUMBER OF COLLECTS, FIRST COLLECT ONLY 1
 TOTAL NUMBER OF BLOCKS IN COLLECTION 117
 NUMBER OF BYTES IN LAST VIDEO DATA BLOCK 160
 HEADER/TRAILER LENGTH IN BLOCKS 3

TIME IN YEAR MONTH DAY HOUR:MIN:SEC TIC
 TIME OF COLLECT 82 9 7 11:52:5 12
 NUMBER OF SCANS 15 40
 VECTOR OF BANDS / DETECTORS COLLECTED
 1 2 3 4 5 6 7 8 9 10 11 12 13 14 15 16
 BANDS F F F F T F T F
 DETECT T T T T T T T T T T T T T T T T

START MF, END MF, BYTES/MF
 1 7 102
 3122 3147 32

COLLECTED FORWARD SCANS ONLY

DUMP OF DSU REGISTERS (IN HEX)

0004	0150	02FF	03FE	042B	0580	06B1	0700	0800	0900	0A00	0B00	0C00	0D00	0E00	0F00
1000	1100	1200	1300	1400	1500	1600	1700	1800	1900	1A00	1B00	1C00	1D00	1E00	1F00
2000	2100	2200	2300	2400	2500	2600	2700	2800	2900	2A00	2B00	2C00	2D00	2E00	2F00
3000	3100	3200	3300	3400	3500	3600	3700	3800	3900	3A00	3B00	3C00	3D00	3E00	3F00
4098	4139	4200	439B	4439	4500	4600	4700	4800	4900	4A00	4B00	4C00	4D00	4E00	4F00
5000	5100	5200	5300	5400	5500	5600	5700	5800	5900	5A00	5B00	5C00	5D00	5E00	5F00
6000	6100	6200	6300	6400	6500	6600	6700	6800	6900	6A00	6B00	6C00	6D00	6E00	6F00
7000	7100	7200	7300	7400	7500	7600	7700	7800	7900	7A00	7B00	7C00	7D00	7E00	7F00
8001	8132	82AB	83B4	8498	854F	863F	877F	88F4	898F	8AF4	8BB4	8CBF	8DF4	8EF4	8F4E
9040	910C	921B	9359	945B	955E	965E	975E	9854	991E	9A5F	9B14	9C14	9D14	9E14	9F5F
A007	A14B	A2BA	A3C8	A438	A52C	A6B5	A77F	A8FF	A97F	AAF6	ABB4	ACF6	ADFE	AE9F	AFFF
B000	B18C	B21B	B319	B49C	B586	B69F	B71F	B89B	B999	BA0C	BB9F	BC8A	BD06	BE06	BF9F
C001	C12B	C2AB	C364	C4B0	C5E6	C6FF	C7FE	C8F7	C9AE	CA1F	CB07	CC0D	CD0E	CE07	CEFF
D040	D14C	D21B	D359	D45B	D556	D657	D75F	D81F	D91F	DA1F	DB0F	DC0F	DD5F	DE1F	DF5F
E005	E14D	E28A	E304	E4E4	E5B7	E6BF	E7FF	E8BF	E9BF	EAF6	EB3F	ECB7	EDFF	EEF7	EFFF
F000	F10C	F21B	F31A	F49B	F50C	F616	F707	F89F	F99E	FA9F	FB9F	FC9F	FD9F	FE97	FF9F

TELEMETRY SNAPSHOT

STREAM TIME= 250:11:51:25:202

1	PWR SUP 1 CRNT	.0000	TVTS	0	2	PWR SUP 2 CRNT	2.500	TVTS	175	3	SMA +2 HSN TMP	24.35	DEGC	152
4	+19V SUPPLY	23.35	VDC	321	5	+19V SUPPLY	-23.4	VDC	314	6	SMA -2 HSN TMP	23.61	DEGC	155
7	+8V SUPPLY	0.434	VDC	347	8	SPARE TLM	.0000	N/A	26	9	SAM TEMP	25.11	DEGC	147
10	+33V SHTR DRV	34.56	VDC	324	11	+80V HIR SUPL	102.5	VDC	377	12	SMA ELEC TMP	26.57	DEGC	57
13	SMA +6.8V #1	.0313	VDC	1	14	SMA +6.8V #2	7.370	VDC	354	15	SMA FLX P+X T	23.37	DEGC	156
16	SMA +27V #1	.0000	VDC	0	17	SMA +27V #2	30.89	VDC	324	18	SMA FLX P-X T	23.86	DEGC	154
19	SMA -27V #1	.0000	VDC	0	20	SMA -27V #2	-30.6	VDC	277	21	SUNSHLD TEMP	23.39	DEGC	213
22	MUX +30V SUP	29.99	VDC	322	23	SPARE TLM	.0000	N/A	30	24	SPARE TLM	.0000	N/A	377
25	BAND 1 +19V	20.99	VDC	277	26	BAND 1 -19V	-20.3	VDC	272	27	ODD AMB PA TEM	36.77	DEGC	143
28	BAND 2 +19V	20.71	VDC	276	29	BAND 2 -19V	-20.3	VDC	272	30	RELAY OP TMP	121.2	DEGC	0
31	BAND 3 +19V	20.70	VDC	275	32	BAND 3 -19V	-20.3	VDC	273	33	EV AMB PREA TP	34.61	DEGC	151
34	BAND 4 +19V	20.81	VDC	276	35	BAND 4 -19V	-20.6	VDC	275	36	CAL SHT HB TEM	13.73	DEGC	252
37	BAND 5-7 +19V	19.79	VDC	265	38	BAND 5-7 -19V	-19.5	VDC	262	39	SLC TEMP	26.38	DEGC	263
40	BAND 6 +19V	19.82	VDC	267	41	BAND 6 -19V	-20.3	VDC	267	42	CAL LP FLT TMP	15.28	DEGC	245
43	ISOLATED +19V	22.44	VDC	315	44	ISOLATED -19V	-22.5	VDC	316	45	SPARE TLM	.0000	N/A	377
46	CDVU +8V	7.639	VDC	326	47	SPARE TLM	.0000	N/A	34	48	SPARE TLM	.0000	N/A	377
49	INT CAL BB TMP	34.23	DEGC	282	50	SI FPA TEMP	21.89	DEGC	221	51	MUX ELCT TMP	50.90	DEGC	44
52	CAL SHT FG TMP	16.15	DEGC	202	53	BKUP SHTR TMP	15.67	DEGC	205	54	BAFFLE TEMP	27.05	DEGC	316
55	MUX PS TEMP	40.64	DEGC	60	56	SPARE TLM	.0000	N/A	0	57	SPARE TLM	.0000	N/A	0
59	CLD STG TMP A	-176.	DEGC	215	59	BRI HIR MSK TP	14.97	DEGC	246	60	CLD STG TMP B	-173.	DEGC	324
61	INT STG TMP A	-129.	DEGC	220	62	INT STG TMP B	-130.	DEGC	275	63	SPARE TLM	.0000	N/A	377
64	CLD ST FPA TMP	-175.	DEGC	201	65	CLD ST CTRL T	-175.	DEGC	177	66	CFPA HTR CRNT	-.014	MA	0
67	POWER SUP TEMP	24.03	DEGC	211	68	SPARE TLM	.0000	N/A	0	69	SPARE TLM	.0000	N/A	0
70	SLC 1 DR CRNT	1.004	AMPS	0	71	BND 6 PSTA TMP	20.88	DEGC	223	72	SLC 2 DR CRNT	.2440	AMPS	137
73	SLC 1 +/-15V	.0000	CNTS	0	74	SLC 2 +/-15V	2.400	CNTS	170	75	CAL LMP DR TMP	29.18	DEGC	171
76	SLC 1 +5V	.2000	VDC	5	77	SLC 2 +5V	4.840	VDC	171	78	BLK BDY CRNT	41.85	MA	74
79	SEC MIR TEMP	19.63	DEGC	227	80	SPARE TLM	.0000	N/A	10	81	CAL LMP1 CRNT	.0000	MA	0
82	CAL LMP2 CRNT	102.4	MA	231	83	CLD PAMP TEMP	5.270	DEGC	305	84	CAL LMP3 CRNT	.0000	MA	0
85	BFL HTR CRNT	.0000	AMPS	0	86	CLD STG HRT I	1.980	MA	1	87	PRI MR TEMP	14.66	DEGC	247
88	ICHWRM 1 POS	-.015	INCH	0	89	ICHWRM 2 POS	-.015	INCH	0	90	ICHWRM 3 POS	-.015	INCH	0
91	SEC MR MSK TMP	19.94	DEGC	226	92	BAND 1 A/D REF	1.980	VDC	143	93	BAND 2 A/D REF	2.000	VDC	144
94	BAND 3 A/D REF	2.000	VDC	144	95	TEL HSG TEMP	17.76	DEGC	235	96	BAND 4 A/D REF	1.980	VDC	143
97	BAND 5 A/D REF	1.980	VDC	143	98	BAND 7 A/D REF	2.000	VDC	144	99	TEL BP TEMP	-18.5	DEGC	377
100	SPARE TLM	.0000	N/A	12	101	SPARE TLM	.0000	N/A	1	102	MUX BIT DENS	2.739	CNTS	312
103	CLR AMB ST TMP	-8.06	DEGC	352	104	MUX +18V	17.67	VDC	320	105	MUX +5V	4.929	VDC	322
106	MUX -3V	-2.01	VDC	300	107	CLR DR TEMP	37.14	DEGC	142	108	MUX -5V	-5.12	VDC	330
109	MUX -15V	-12.5	VDC	324	110	MUX INP CRNT	3.530	AMPS	276	111	+Y RAD FIN TMP	-15.7	DEGC	372
112	SPARE TLM	.0000	N/A	0	113	TIME	1151.260	XXX		114	SMA UPSTAT N	198.0	STUS	306
115	SMA SCNLIN N	168.0	RFEQ	250	116	SMA TRNERR N	45.80	USEC XXX		117	SMA TORPLS N	-792.	PULS XXX	
118	SMA SHSERR N-1	33.17	USEC XXX		119	SMA FHSERR N-1	-31.8	USEC XXX		120	SMA SUMERR N-1	-793.0195	SUM XXX	
121	SMA SCNCTR	12181	CNT XXX		122	SMA SCNLIN N-1	88.00	RFEQ	130	123	SMA TRNERR N-1	204.3	USEC XXX	
124	SMA TORPLS N-1	-779.	PULS XXX		125	SMA SHSERR N-2	-22.6	USEC XXX		126	SMA FHSERR N-2	23.56	USEC XXX	
127	SMA SUMERR N-2	-780.0130	SUM XXX		128	SMA SCNTYM N-2	60758.07	CNT XXX		201	TIME	1151.250	XXX	
202	TM BUS VOLTAGE	27.88	VDC XXX		203	TM BUS CURRENT	10.63	AMPS XXX		204	+18V VOLTS	.0000	VDC XXX	
205	-18V VOLTS	.0000	VDC XXX		206	+20V VOLTS	.0000	VDC XXX		207	-20V VOLTS	.0000	VDC XXX	
208	+18V CURRENT	.0000	AMPS XXX		209	-18V CURRENT	.0000	AMPS XXX		210	+20V CURRENT	.2600	AMPS XXX	
211	-20V CURRENT	.2500	AMPS XXX		212	SPARE TLMENT	.0000	314		213	SNSR 1 REF BB	50.6000	DEGC XXX	
214	SNSR 2 REF BB	50.5000	DEGC XXX		215	MTF BB TMP	-22.1000	DEGC XXX		216	SNSR 2 VAR BB	-21.9000	DEGC XXX	
217	STUS 1 SBS LVR	-190.700	DEGC XXX		218	REF BB TEMP	-189.900	DEGC XXX		219	STUS 3 SBS LVR	-189.900	DEGC XXX	
220	SPARE TLMS LVR	220.200	XXX		221	STUS 1 SBS CLR	-191.600	DEGC XXX		222	STUS 2 SBS CLR	-191.100	DEGC XXX	
223	I-F Y POSITION	.00000000	XXX		224	RETRORFLECTOR	.00000000	XXX		225	I/F X POSITION	.00000000	XXX	
226	I/F Z POSITION	.00000000	XXX		227	SPARE I/FITION	.00000000	XXX		228	STUS 3 SBS CLR	-191.500	DEGC XXX	
229	STUS 4 SBS CLR	-192.100	DEGC XXX		230	ITG SPH 1 FT	52.7000	DEGC XXX		231	ITG SPH 2 FT	10.6000	DEGC XXX	
232	ITG SPH 1 ST	277.000	DEGC XXX		233	ITG SPH 2 ST	4.70000	DEGC XXX		234	FWD GUST FWD R	23.8900	DEGC XXX	
235	FWD GUST MID R	23.3500	DEGC XXX		236	FWD GUST TOP R	23.2400	DEGC XXX		237	FWD GUST FWD L	22.4800	DEGC XXX	

HEADER.DAT:1307

FROM UTLWVH TASK 11:52:50 07-SEP-82

TELEMETRY SNAPSHOT

238 FWD GUST MID L 22,4600	DEGC XXX	239 FWD GUST TOP L 22,0000	DEGC XXX	240 AFT GUST AFT R 23,8300	DEGC XXX
241 AFT GUST MID R 23,8300	DEGC XXX	242 AFT GUST TOP R 23,5000	DEGC XXX	243 AFT GUST AFT L 23,1100	DEGC XXX
244 AFT GUST MID L 22,9600	DEGC XXX	245 AFT GUST TOP L 22,4600	DEGC XXX	246 HOR PLT FWD 23,8800	DEGC XXX
247 HOR PLT MID 21,7000	DEGC XXX	248 HOR PLT AFT 24,0400	DEGC XXX	249 TELSCP TUB FWD 18,9000	DEGC XXX
250 TELSCP TUB AFT 22,2400	DEGC XXX	251 SDRY MIRROR 20,7400	DEGC XXX	252 SDRY MIR SUP 20,4800	DEGC XXX
253 ROT MIR SUP 25,4200	DEGC XXX	254 BB 1 BASE 20,7800	DEGC XXX	255 BB 2 BASE 19,8300	DEGC XXX
256 SPARE TLM -999,990	XXX	257 SPARE TLM -999,990	XXX	258 ITG SPH 1 BK 1 50,6200	DEGC XXX
259 ITG SPH 2 BK 2 9,98000	DEGC XXX	260 FLD LMP HT 22,3100	DEGC XXX	261 SPARE TLMT -999,990	XXX
262 SPARE TLMT -999,990	XXX	263 SPARE TLMT -999,990	XXX	264 SPARE TLMT -999,990	XXX
265 SPARE TLMT -999,990	XXX	266 MTF LMP CRNT -7,763000	AMPS XXX	267 BBR/GA LMP CRT -.001000	AMPS XXX
268 FLOOD LMP CRNT .000000	AMPS XXX	269 INDEX TABLE 466,0	DEGS XXX	270 6 POS MIRROR .0000	CONT XXX
271 MTF WHEEL 37801	CONT XXX	272 NDF WHEEL 37801	CONT XXX	273 BBR/GA WHEEL 10192	CONT XXX
274 IRMTF WHEEL .0000	CONT XXX	501 THERM SHTDWN ENAB	1	502 SMA +Z HT CNTR ON	1
503 SMA -Z HT CNTR ON	1	504 CND RCVR ON ONE	1	505 SHTR FL SW A OPEN	0
506 SHTR FL SW B OPEN	0	507 SHTR FL SW C OPEN	0	508 BAND 1 ON	1
509 BAND 2 ON	1	510 BAND 3 ON	1	511 BAND 4 ON	1
512 BAND 5 ON	1	513 BAND 6 ON	1	514 BAND 7 ON	1
515 CLR DOOR OPEN	0	516 CLR DOOR OUTGS NO	0	517 CLR DR FUL OPN NO	0
518 CLR DR MAG OFF	0	519 CLR DR HTR OFF	0	520 CD FUS LK SW A OPEN	0
521 CD FUS LK SW B OPEN	0	522 CD FUS LK SW C OPEN	0	523 CAL LAMP 1 ON	1
524 CAL LAMP 2 ON	1	525 CAL LAMP 3 ON	1	526 CAL LP 1 OVRD OFF	0
527 CAL LP 2 OVRD OFF	0	528 CAL LP 3 OVRD OFF	0	529 CAL SEQNCR ON	1
530 MUX PWR BK TLM ON	1	531 INCHWRM PW OFF	0	532 LVDT PW OFF	0
533 BLACK BODY HTR ON	1	534 BLACK BODY T2 OFF	0	535 BLACK BODY T3 ON	1
536 BLKBD BKP HTR OFF	0	537 SH ELEC 1 OFF	0	538 SH ELEC 2 ON	1
539 BAF HTR CNTRLR ON	1	540 BAF HTR BKUP OFF	0	541 MAC DSC GEN AP ON	1
542 MAC DSC GEN AR OFF	0	543 MAC DSC GEN BP ON	1	544 MAC DSC GEN BR OFF	0
545 MUX POWER ON	1	546 MDSCAN PULSE OFF	0	547 SLC 1 POWER OFF	0
548 SLC 2 POWER ON	1	549 CAL SHUTTER ON	1	550 CAL SH PHS LOCK	1
551 CAL SH AMP LOCK	1	552 BKUP SHUTTER OFF	0	553 BKP SH PHS UNLK	0
554 BKP SH AMP UNLK	0	555 CLD STG HT CNT OFF	0	556 CS OUTGAS PWR OFF	0
557 INTR ST HT CNT ON	1	558 INTER STG HTR OFF	0	559 CLD FPA HT CT ON	1
560 COLD FPA T2 ON	1	561 COLD FPA T3 OFF	0	562 COLD FPA TLM ON	1
563 INCHWRM CONTRI OFF	0	564 INCHWRM 3 ENBL DISA	0	565 INCHWRM 2 ENBL DISA	0
566 INCHWRM 1 ENBL DISA	0	567 CLR DR MOVE OFF	0	568 CLR DOOR O-C OPEN	0
569 MDSCAN PULSE B DISA	0	570 MDSCAN PULSE A DISA	0	571 INCHWORM MOVE OFF	0
572 INCHWORM EXTND OFF	0	573 DC RESTORE ON	1	574 FRM DC RES SEL OFF	0
575 SPARE TLMS SEL ON	1	576 CLD STG TLM ON	1	577 ALL CAL LAMPS OFF	0
578 SMA MODE SAM	0	579 SMA CIRCUIT SME2	1	580 TLM SCALING ON	1
581 SMA +Z HEATER ENAB	1	582 SMA -Z HEATER ENAB	1	583 MIDSCAN P BKUP OFF	0
584 SME 1 SLCT SAM OFF	0	585 SMA DIRECTIONM REV	1		

STREAM TIME= 250:11:51:25:207

C-4