

NASA-CP-2422 19860016322

*NASA Conference Publication 2422*

# Applications of Tethers in Space

*Workshop  
Proceedings  
Volume 2*

LIBRARY COPY

1985  
LANGLEY RESEARCH CENTER  
LIBRARY, NASA  
HAMPTON, VIRGINIA

*Proceedings of a workshop held in  
Venice, Italy  
October 15-17, 1985*

**National Space Plan**

**NASA**



*NASA Conference Publication 2422*

# Applications of Tethers in Space

*Workshop  
Proceedings  
Volume 2*

William A. Baracat, *Compiler*  
*General Research Corporation*  
*McLean, Virginia*

Proceedings of a workshop sponsored  
jointly by the Italian National Space  
Plan, CNR, and NASA and held in  
Venice, Italy  
October 15-17, 1985

**NASA**  
National Aeronautics  
and Space Administration  
**Scientific and Technical  
Information Branch**

1986





## PREFACE

The Applications of Tethers in Space Workshop was held in Venice, Italy during the period October 15-17, 1985. The Hotel Excelsior, located on the island of Lido, provided outstanding accommodations for the workshop, which was jointly sponsored by the Italian National Space Plan, National Research Council, and the National Aeronautics and Space Administration, Office of Space Flight, Advanced Programs Division. Workshop coordination was provided by the Centro Internazionale Congressi and General Research Corporation. Aeritalia generously provided a gala dinner banquet for the workshop attendees and their guests, and the office of the Mayor of Venice hosted a reception at the city hall.

General Research Corporation would like to thank and commend everyone who organized, coordinated, and participated in the workshop. The panel co-chairmen are especially noteworthy in fulfilling their roles of directing and summarizing their respective panels. We are proud to have participated in the workshop and be a part of the advancement of this exciting and challenging field which, as is evident in these proceedings, is evolving into a technically sophisticated and mature science. The complete documentation of this workshop is contained in the Workshop Proceedings, Volumes 1 and 2. The Executive Summary, which contains an abbreviated compilation of the panel summaries, is also provided.

William A. Baracat  
McLean, Virginia  
March 1986



## FOREWORD

The Tethers in Space Workshop held in Venice, Italy, follows by only two years the one held in Williamsburg, Virginia, in June 1983. Yet, much has happened. The most significant events are: (1) the passing of our beloved leader, Giuseppe Colombo, (2) the announcement by President Reagan of the Space Station as a national goal, and (3) the initiation of several tether demonstration missions, already in hardware development or design phases.

Bepi, whom we call the "Father of Tethers," would be pleased at the pace of this emerging technology. The development of the Tethered Satellite System (TSS), a joint U.S. - Italy project, is on a firm course, with the first launch scheduled for 1988. The announcement of the Space Station goal by the President has provided an anchor for serious studies of the use of tethers on the Space Station. A whole panel session was devoted to this subject at this workshop, and was the second best attended. NASA, Italy, and industry continue to examine the benefits and technological problems associated with placing a tether system on the Space Station. We fully expect to see this happen, although it may be after the Initial Operational Capability (IOC).

Are there other tether and tether related missions that can be flown in the next few years on the Shuttle in addition to the TSS? The answer is yes. NASA, with Italy's involvement, will be verifying the principles of electromagnetic tethers in space to produce power or drag. A series of flight experiments are either hardware ready, or in hardware development. These experiments should enhance the TSS-1 mission, and may use at some point the disposable tether, which itself will require a preliminary demonstration. Looking to the future, there is much interest in the tethered platform, with the tether assisting in platform pointing. NASA's Ames Research Center, again with the Italians, are engaged in a definition study on this, called the Kinetic Isolation Tether Experiment (KITE).

Our reach in this workshop has not only been to Earth orbit but also to the planets. Serious attention to tether operations near the Moon, Mars, and other planets is underway. Some of these ideas are presented in the workshop proceedings. Although it may sometimes seem that we are getting ahead of ourselves, these applications may be here sooner than we think.

Paul A. Penzo  
March 1986

APPLICATIONS OF TETHERS IN SPACE  
WORKSHOP COORDINATION

GENERAL CO-CHAIRMEN

Ivan Bekey, Director  
Advanced Programs  
Office of Space Flight  
NASA Headquarters  
Washington, DC

Prof. Luciano Guerriero, Director  
National Space Plan  
National Research Council  
Rome, Italy

TECHNICAL PROGRAM CO-CHAIRMEN

Dr. Paul A. Penzo  
Advanced Programs  
Office of Space Flight  
NASA Headquarters  
Washington, DC

Dr. Gianfranco Manarini  
Program Manager  
Tethered Satellite System  
National Space Plan  
National Research Council  
Rome Italy

ADMINISTRATIVE CO-CHAIRMEN

Edward J. Brazill  
Advanced Programs  
Office of Space Flight  
NASA Headquarters  
Washington, DC

Marinella Ercoli  
National Space Plan  
National Research Council  
Rome, Italy

WORKSHOP COORDINATION

Terrence G. Reese  
General Research Corporation  
McLean, VA

Marisa Adduci  
Centro Internazionale Congress  
Bari, Italy

WORKSHOP PROCEEDINGS

William A. Baracat  
General Research Corporation  
McLean, VA

Terrence G. Reese  
General Research Corporation  
McLean, VA

WORKSHOP PANEL CO-CHAIRMEN

Science Applications

Prof. Franco Mariani  
University of Rome

Dr. Paul Coleman  
University of California

Electrodynamics

Prof. Marino Dobrowolny  
National Research Council

Mr. Joseph Kolecki  
NASA/Lewis Research Center

Transportation

Dr. Ernesto Vallerani  
Aeritalia

Mr. Joseph Carroll  
California Space Institute

Controlled Gravity

Prof. Luigi G. Napolitano  
University of Naples

Dr. Charles A. Lundquist  
University of Alabama

Constellations

Dr. Gianfranco Bevilacqua  
Aeritalia

Dr. Enrico Lorenzini  
Smithsonian Astrophysical Observatory

Technology and Test

Prof. Carlo Buongiorno  
Minister of Research

Mr. Paul Siemers  
NASA/Langley Research Center

Space Station

Prof. Gianfranco Manarini  
National Research Council

Dr. Georg von Tiesenhausen  
NASA/Marshall Space Flight Center

TABLE OF CONTENTS

	<u>PAGE</u>
<u>WORKSHOP PROCEEDINGS - VOLUME 1</u>	
PREFACE	111
FOREWORD	v
WORKSHOP COORDINATION	vii
WORKSHOP PANEL CO-CHAIRMEN	viii
I INTRODUCTION	1
Opening Addresses	3
Orientation and Purpose, Luciano Guerriero	5
Welcome, Augusto Salvadori	11
Opening Address, Luigi Granelli	13
Keynote Address, Ivan Bekey	15
Guest Speaker, James Arnold	21
General Presentations	35
Tethered Satellite System, J. Sisson	37
Tethered Satellite Design, G. Manarini	63
Tether Fundamentals, J. Carroll	81
A Review of Tether Induced Dynamical Features, S. Bergamaschi	103
Science Applications, F. Mariani	117
Applications of Tethers for Planetary Missions, P. Penzo	127
Electrodynamic Interactions, M. Dobrowolny	153
Electrodynamic Interactions, J. McCoy	161
Transportation, G. von Tiesenhausen	185
Controlled Gravity, L. Napolitano	221
U.S. Gravity Utilization of Tethers Activity, K. Kroll	223
Tether Applications for Space Station, W. Nobles	239
The Science and Applications Tethered Platform (SATP) Project, P. Merlina	269
Technology and Test, P. Siemers	279
Tethered Constellations, E. Lorenzini	285
Tether Dynamics Movie, J. Loftus	309
II PANEL SUMMARIES AND PRESENTATIONS	311
Science Applications	313
Summary Report, F. Mariani and P. Coleman	315
"SATP Project Inquiry on Users Requirements," A. Ansemli	335
"High Resolution Remote Sensing Missions of a Tethered Satellite", S. Vetrella and A. Moccia	349
Future Applications of Tethers for Basic Scientific Research," H. Mayer	365

TABLE OF CONTENTS (CONT.)

	<u>PAGE</u>
<u>WORKSHOP PROCEEDINGS - VOLUME 1 (CONT.)</u>	
Electrodynamics	369
Summary Report, M. Dobrowolny and J. Kolecki	371
"Electrodynamic Tether Power and Thrust Generation Applications," report from the Subcommittee on Electrodynamic Applications	383
"Hollow Cathode Experiments and Technology Developments," report from the Subcommittee on Hollow Cathodes and Electron Guns	387
"Use of Electrodynamic Tethers as ULF/ELF Antennas," report from the Subcommittee on Tether Antennas	395
"Electrodynamic Interactions Priorities," 18 October 1985 Panel Co-Chairman Meeting Summary	399
"Laboratory Simulation of the Electrodynamic Interactions of a Tethered Satellite With An Ionospheric Plasma," C. Bonifazi, et al.	401
"Natural ELF Noise Evaluation for TSS Emissions Detection on the Earth's Surface," G. Tacconi	421
"Spontaneous Radiation Emitted by Moving Tethered Systems," M. Dobrowolny	431
"Tethered Satellite System Core Equipment," C. Bonifazi	441
"Program Review of Electrodynamic Tether Related Activities at NASA Lewis Research Center," J. Kolecki	471
"Plasma Contactor Performance Characterization," P. Wilbur	483
"Theory of Plasma Contactors for Electrodynamic Tethered Satellite Systems," D. Parks, I. Katz	499
Electrodynamics Panel Presentation, J. McCoy	547

WORKSHOP PROCEEDINGS - VOLUME 2

PREFACE	iii
FOREWORD	v
WORKSHOP COORDINATION	vii
WORKSHOP PANEL CO-CHAIRMEN	viii



TABLE OF CONTENTS (CONT.)

	<u>PAGE</u>
<u>WORKSHOP PROCEEDINGS - VOLUME 2 (CONT.)</u>	
II PANEL SUMMARIES AND PRESENTATIONS	1
Transportation	3
Summary Report, E. Vallerani and J. Carroll	5
"Small Expendable Deployment System (SEDS),"	
J. Carroll	15
"Tethered OTV Operations," M. Henley	31
"Centaur and Shuttle Tether Technology Demonstration	
Package," M. Henley	47
Controlled Gravity	53
Summary Report, L. Napolitano and C. Lundquist	55
"Tethered Constellations, Their Utilization as	
Microgravity Platforms and Relevant Features," L.	
Napolitano, F. Bevilacqua	65
"Artificial or Variable Gravity Attained by	
Tether Systems" C. Lundquist	79
Remarks to the Controlled Gravity Panel, J. Arnold	87
"Tethered Orbital Refueling Study," D. Fester	89
"Tethers and Gravity in Space," P. Penzo	125
"Tethered Elevator: A Unique Opportunity for	
Space Processing," R. Monti	137
"Gravity Utilization Issues," K. Kroll	147
Constellations	149
Summary Report, G. Bevilacqua and E. Lorenzini	150
"Dynamics of Tethered Constellations in Earth	
Orbit," E. Lorenzini	167
Technology and Test	205
Summary Report, C. Buongiorno and P. Siemers	207
"Shuttle Continuous Open Wind Tunnel (SCOWT),"	
G. Carlomagno, et al.	225
"Shuttle Tethered Aerothermodynamics Research	
Facility (STARFAC) Instrumentation Requirements,"	
G. Wood, et al.	251
"Shuttle Tethered Aerothermodynamics Research	
Facility (STARFAC)," P. Siemers, et al.	265
"Tether Pointing Platform and Space Elevator	
Mechanisms Analysis of the Key Concepts for	
SATP and Scaled SATP," E. Turci	287
"The Development of Optimal Control Laws for	
Orbiting Tethered Platform Systems," P. Bainum	325

TABLE OF CONTENTS (CONT.)

	<u>PAGE</u>
<u>WORKSHOP PROCEEDINGS - VOLUME 2 (CONT.)</u>	
Technology and Test (Cont.)	
Recommendations to the Technology and Test Panel, P. Bainum	355
"Effects of Damping on the Control Dynamics of the Space Shuttle Based on Tethered Systems," V. J. Modi	357
"Electrodynamic Tether Technology Considerations," J. Kolecki	383
"COMLINK Proposal for Future Missions of Tethered Satellite," F. Sciarrino	387
"Input to Technology and Test Panel from P. Magnani"	395
"Input to Technology and Test Panel from G. Marone"	397
Space Station	399
Summary Report, G. Manarini and G. von Tiesenhausen	401
"Tethered Elevator and Platforms as Space Station Facilities System Studies and Demonstrative Experiments," P. Merlina	413
"Roles for Tethers on an Evolving Space Station," J. Carroll	457
III WORKSHOP SUMMARY OF RECOMMENDED APPLICATIONS AND DEMONSTRATIONS	473
APPENDICES	
A PANEL MEMBERS	479
B WORKSHOP PARTICIPANTS	489
C WORKSHOP AGENDA	509
D BIBLIOGRAPHY	513

II

PANEL SUMMARIES AND PRESENTATIONS



**TRANSPORTATION PANEL**



## TRANSPORTATION PANEL SUMMARY REPORT

The transportation panel has discussed the following applications and has ranked them. The ones having the best potential near-term payoffs are listed first. The rest depend increasingly on future developments, either in tether technology itself or in the remainder of the space infrastructure.

1. The Small Expendable Deployment System for boosting payloads from the shuttle
2. Electrodynamic propulsion for small and large orbit changes within LEO
3. Boosting of OTVs from the Shuttle, to reduce the delta-V needed to reach GEO
4. Launch vehicle capture & release by tethers hanging from permanent facilities
5. Artificial gravity on manned deep-space expedition vehicles during transit
6. Multi-pass remote aerobraking of planetary orbiters, to simplify navigation
7. An equatorial "staircase" or "fire brigade" to high orbits and escape
8. "Slings" of various sorts:
  - a. Spinning lunar-orbiting rock collector/pro prospector
  - b. Lunar-surface-based sling to throw rocks into low lunar orbit
  - c. Asteroid-based sling (to throw rocks, or to move the asteroid itself)
  - d. Hoops or solenoids with electromagnetic assist to the tether strength

The proceedings for the session are organized as follows:

- 1) General presentations (by Loftus and Vallerani).
- 2) Concept presentation and discussion summaries (1-8D).
- 3) Viewgraph presentations on selected concepts.

Joe Loftus, JSC

Space initiatives have moved away from single mission optimization. Space Shuttle and Space Station are complementary parts of a new, general-use infrastructure. With Space Shuttle launches normalized (e.g., to the 1st and 15th of the month), the Space Station becomes a temporary cargo storage facility, holding various satellites until their peculiar insertion windows open. As an accumulator, in this manner, Space Station almost becomes the equivalent of a 5th orbiter. The point is that Space Shuttle and Space Station are only parts of a total set, and all other space hardware and capabilities should be considered as complementary parts of a greater whole.

Ernesto Vallerani, Aeritalia

- o Utilization of tethers for docking
- o Explore advantages for use of tethers for planetary explorations

(A review of Chris Purvis' idea of multiple-pass tether aerobraking)



1. Joe Carroll - Shuttle Expendable Tether System or SETS

(Presented at the miniworkshop)

Initially, expendable tethers were considered in conjunction with the external tank of Space Shuttle. Since less than 1 lb. tension is needed to downward deploy the external tank, low tension deployment captured attention. A proposal for a study resulted. Deploy-only mode for expendable tethers with low (but not zero) tension means you do not need a take-up capability. The system that results is a low-tension high-braking capability system that can be used to deboost payloads by a pendulum swing release. A project to launch a 50 lb. payload from a GAS can is in the initial hardware development stage, and could fly before TSS. SETS has been approved for experimentation.

Critical Issues:

- Operations
- Hardware
- Safety
- Reliability

Priority: Near Term, High

Recommended Flight Tests:   o In works  
                                  o Deboost  
                                  o Preferred for 1st test

2. Bill Loftus - Electrodynamic Propulsion of Tethers for Transport

Critical Issues:

- TSS one mission & success of other early tests
- **IMPORTANT** Value of electrodynamic propulsion is considered to be of such high priority that all possible methods should be looked at during early tether tests
- Dynamics of orbital elements

Priority: Near Term, High

Recommended Flight Tests:   o TSS I & other plasma contactor experiments needed

### 3. Mark Henley - Tethered OTV Operations

OTV is considered a Space Station element. OTV tether boost combined with stage and propulsive burn is the concept. Hanging and swinging tether options being considered, and Shuttle, E.T., and Space Station as launch mass options. Relative payload gains noted for all three OTV options: reusable; air propulsive; reusable aerobraked; or expendable (in decreasing order). Swinging tethers offer improved capabilities over hanging tethers without noticeable penalties. Expendable tethers are preferred over reusable tethers. Command and Control issues examined.

### Mark Henley - Tether Boost Technology Demo Package

Using a Centaur to demonstrate potential to augment OTV deployment by tether. Demo in 1990s. After Centaur returns to LEO by aerobrake, it would rendezvous with Orbiter for tether demo. Called Centaur and Shuttle Tether (CAST) tether demonstration package.

#### Critical Issues:

- Shuttle based v. Space Station launch
  - maximize commonality
- Attitude control of end mass
- Release operations of end mass
- TSS vs. expendable tether
  - TSS Robust but instrumented

Priority: Near Term, High

Recommended Flight Tests: o Centaur & Shuttle Demo  
Shuttle Demo  
o TSS One & Other  
Electrodynamic  
(Plasma experiments)

### 4. Joe Carroll - Tethered Docking and Release of Shuttle with Space Station

Results in slightly lower apogee, much lower perigee, tethered deboost, and propellant scavenging (for transfer to an OMV).

#### Critical Issues:

- Space Station SCAR design impact
- Operation precision
- Temporary S.S. orbit effects
- Loads on Space Station

Priority: Near Term, High

Recommended Flight Tests: o Can be demo  
by SETS or TSS  
o Capture

5. Mark Henley - Low RPM Spinning Tethers for Artificial Gravity for Manned Planetary Excursions

Critical Issues:

- Can it also be used in LEO?
  - Proof of concept?
- How much gravity is needed by human physiology?
- Can it be Shuttle/TSS tested? Concept demonstration during TSS mission one or two?

Priority: Near Term, High

Recommended Flight Tests: o Some TSS I data  
applicable  
o TSS I in a spin  
mode  
o Future TSS or  
SETS experiments

6. Chris Purvis - Multiple-Pass Aerobraking Tethers

Using 100 km, 1 mm dia. tether hanging from a 2000 kg space probe circularized above a planet with an atmosphere, to reduce orbit height Saves mass over a "hard shield" aerobrake.

Critical Issues:

- Material options
- Scheduling/control options
- Meteoroid risk
  - Ribbon is better?
  - Multiple strands
- Failure
- Dynamics for tether
  - Elliptical orbit?
- How deep into atmosphere do requirements of science want probe to go?
- Flow fields
- Specular vs. diverse flow

Priority: Near Term, High

Recommended Flight Tests: o SETS or TSS II  
Demo  
o TSS II should  
yield data  
applicable

7. Mark Henley - Use of Series of Equatorial Plane Tethers as a Stairway to Escape Velocity

Critical Issues:

- Need equatorial or polar plane launch
- Nodes vs. Van Allen Belt

Priority: Later Development

Recommended Flight Tests: o Other flight experiments should cover

8A. Joe Carroll - Spinning Tethers to Pick Up Lunar Material

Critical Issues:

- Dynamics
- Releasing-aiming-catching (especially core grabber)
- Deployer hardware
- Mass concentrations - lunar

Priority: Later Development

Recommended Flight Tests: o Ground based tests  
o TSS should be considered

8B. Joe Carroll - Lunar-Surface Based Sling

Launching 10 kg payloads, by a rotating sling on the lunar surface. An Apollo lander sized vehicle lands and anchors itself to the lunar surface. A rover retrieves materials and passes them to the anchored sling, which throws 10 kg into lunar orbit. A lunar orbital tether station then slings payload into a lunar-Earth transfer.

Critical Issues:

- Could it be scaled and tested in a vacuum chamber?
- Does this have a customer? Are lunar materials needed?
- Bearing loads
- Release mechanisms
- Can they be caught?
- "Safety" issues
- Shape of spinning tethers? Dynamics?
- Manufacturing techniques for tapered tethers

Priority: Later Development

Recommended Flight Tests: o Ground tests (vacuum)

8C. Chris Purvis - Rotating Constellation With A Center Reel, To Be Used To Sling Material From Asteroid Belt Without Landing

Critical Issues:

- Basic design
- On asteroid or in space?
- Release, aiming, etc.?

Priority: Later Development

Recommended Flight Tests: o Ground tests

8D. Chris Purvis - Rotating Hoop of Tether Material, Under Magnetic Field to Reduce Tension, to be Used as a Method of Slingshotting Material from Lunar Surface

- Critical Issues:

- Super-magnetic technology
- Supplement the tensile properties of the material
- Dynamics
- Releasing-aiming-catching (especially core grabber)
- Deployer hardware
- Mass concentrations - lunar
- Electrical energy
- Throughput potential
- 

Priority: Later Development

Recommended Flight Tests: o Ground tests seem  
in order  
o Further examination

**Transportation Concept 8c.**

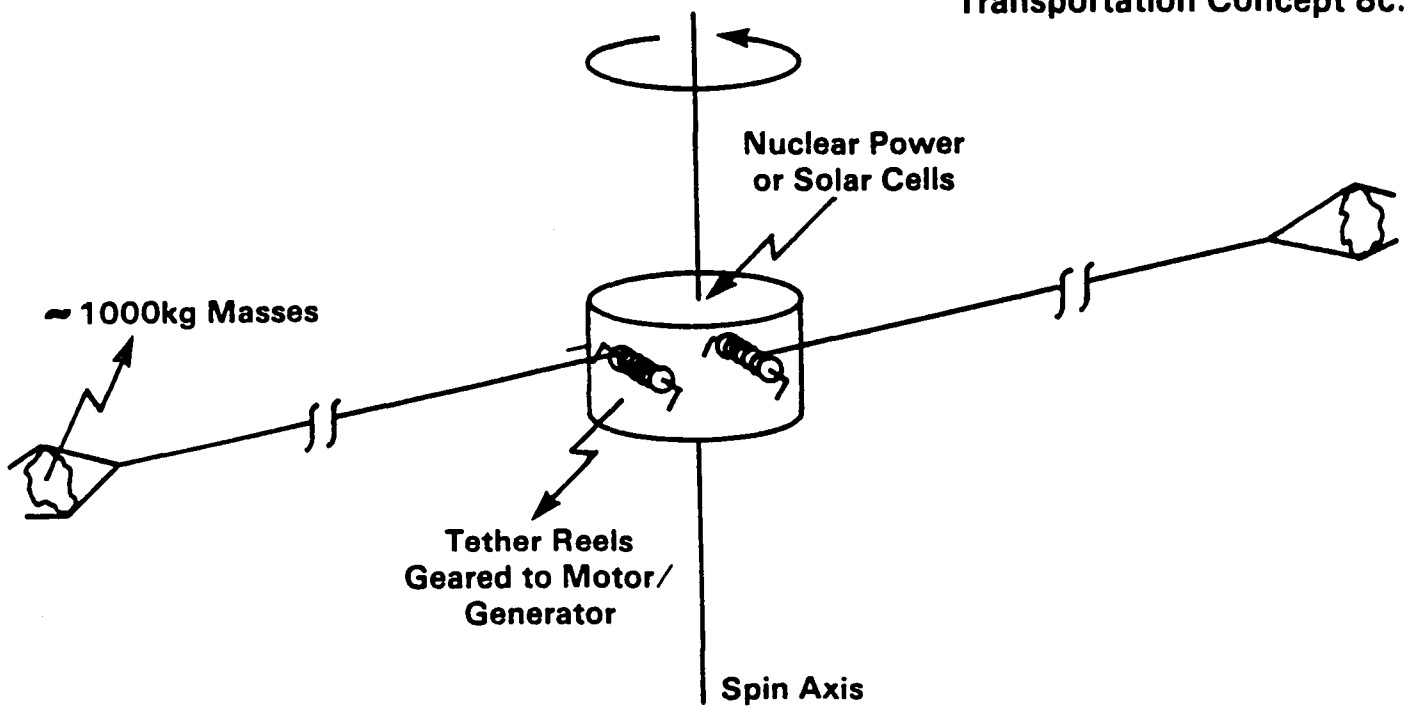

**Symmetric Rotating Tether System For Returning Material From Near-Earth Asteroids  
(Can be in Free Flight or Bolted to Asteroid)**

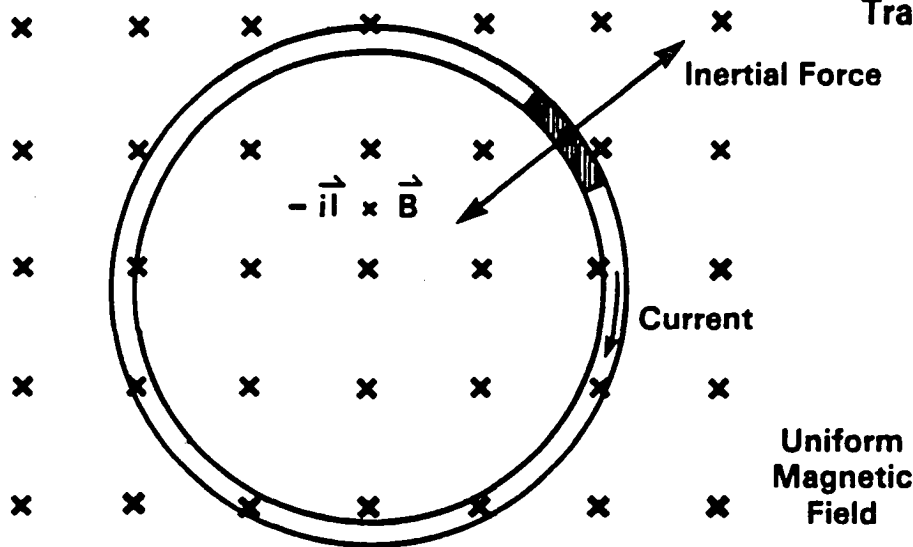

• Rotating Hoop Tether

Can Have Rim Velocities in Excess of Material Characteristic Velocity

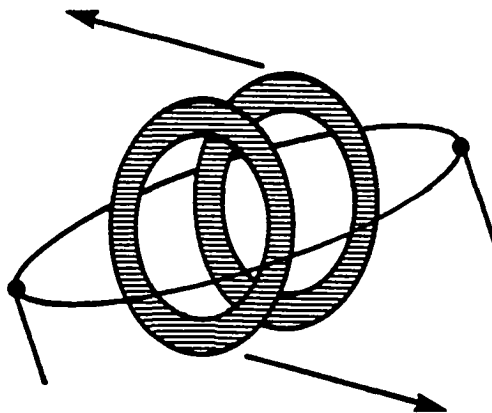
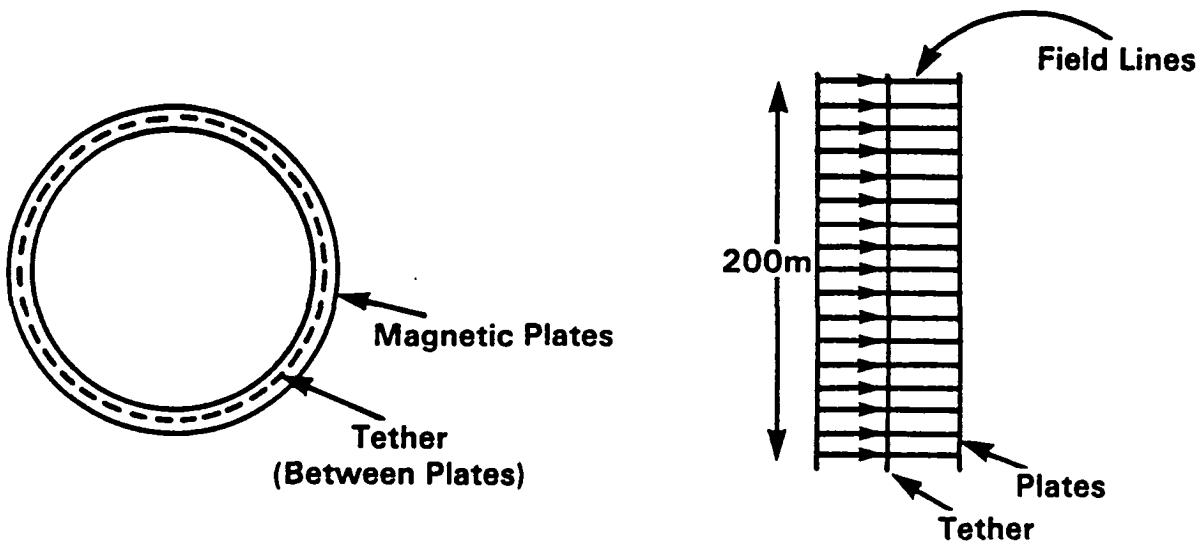

**SPINNING TETHER** 1cm in diameter in very strong  $100\text{w}/\text{m}^2$  field can experience no tension at  $\triangleright 2\text{kms}^{-1}$  rim velocity could fling payloads capable of withstanding 4000g's (Current power  $\sim 1000\text{ w}$ )





**SMALL EXPENDABLE DEPLOYMENT SYSTEM (SEDS)**

Joseph A. Carroll  
Energy Science Laboratories, Inc.  
11404 Sorrento Valley Rd., #113  
San Diego, CA 92121  
619/452-7039

## OUTLINE OF PRESENTATION:

- Introduction to Basic Concept
- Summary of Phase I Findings
- Summary of Phase II Status
- Potential Applications
- Conclusions & Recommendations

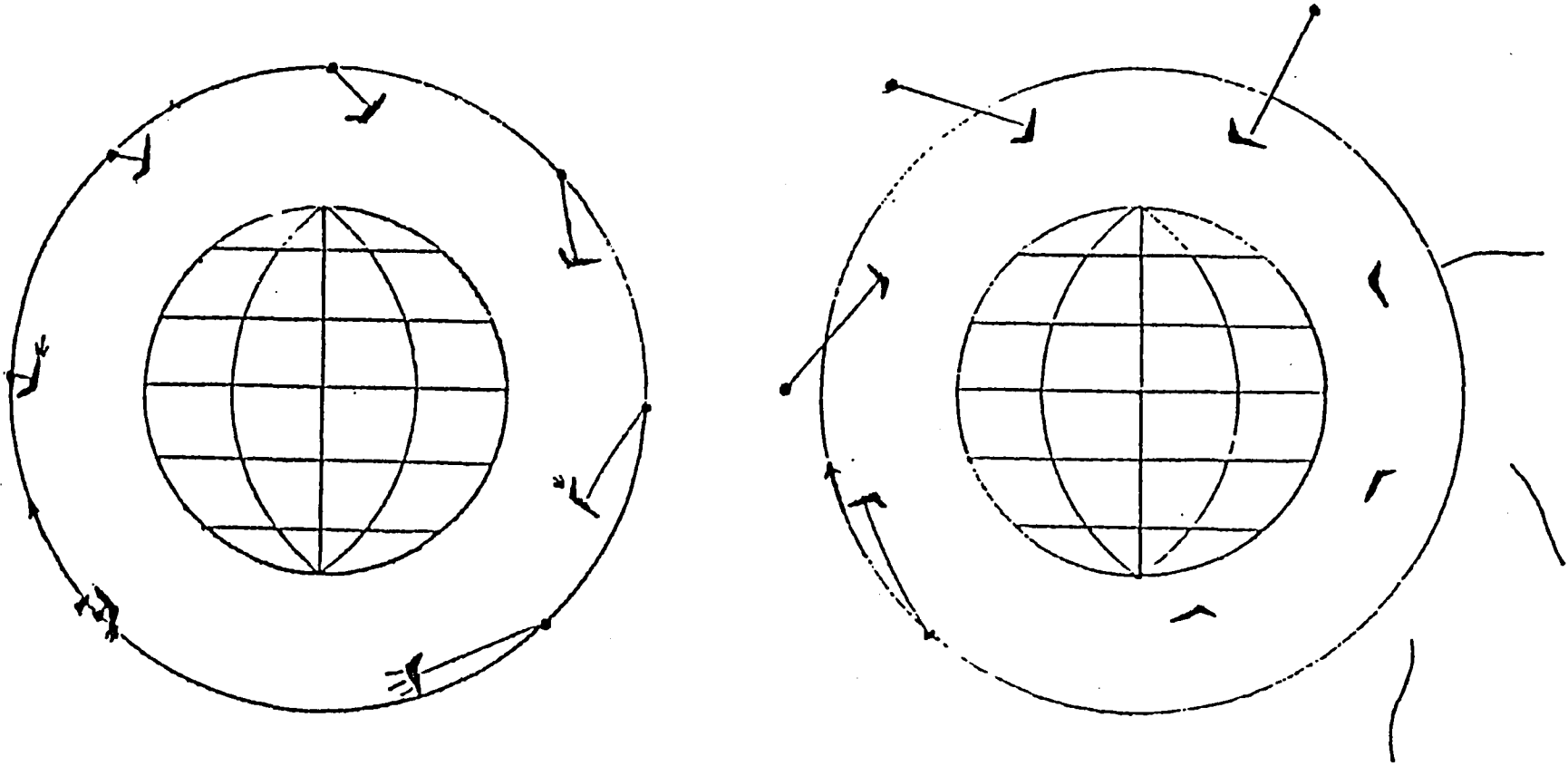

Low-Tension Deployment Followed by Pendulum Swing & Release

What is special about this deployment concept?

Low tension deployment & swinging release

Disposable tether

Comparison of hanging and swinging releases  
for equal energy and momentum transfer:

Swing amplitude	0°	35°	85°
Tether length	1	.67	.54
Maximum loads	1	1.33	1.69
Tether mass	1	.89	.91
μmeteoroid hazard	1	.27	.12
Power dissipation	1	.30	.002

What advantages does a disposable tether have?

- Eliminates time-consuming retrieval operation
- Simplifies deployer: no motors or level-winders needed
- Eliminates need for TSS-like boom & docking gear
- Minimizes tether degradation (new tether each time)

What have we studied during the SBIR Phase I study?

Control strategies

STS operational impacts

Safety & reliability

Deployer locations

Prototype hardware

New concepts

Early applications

Range of performance benefits

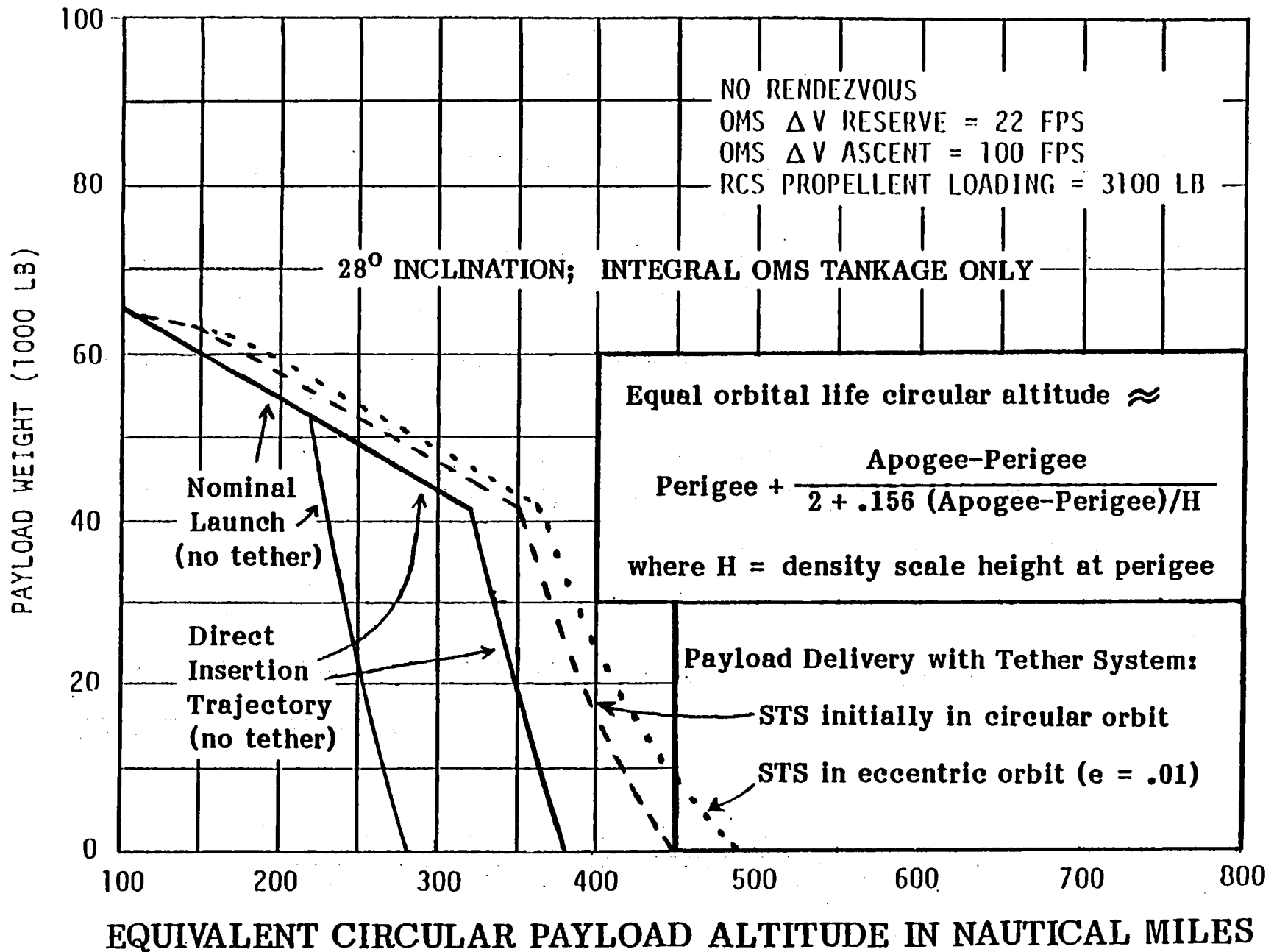

Benefits of GAS-sized Tether System to STS (Preliminary)



SUMMARY OF SBIR PHASE II EFFORT  
(April 1985 — March 1987)

Primary objective:

- To bring our concept to flight-test-ready status

Secondary objectives:

- To determine the range of potential users & benefits;
- To make the test system similar to the operational one;
- To benefit the TSS & TAS programs.

Phase II Tasks & Fraction of Effort:

- Design, develop, test, & evaluate hardware: 40%
- Analyze systems integration, safety, & reliability: 25%
- Study control options & improve simulations: 20%
- Identify early applications & performance benefits: 15%

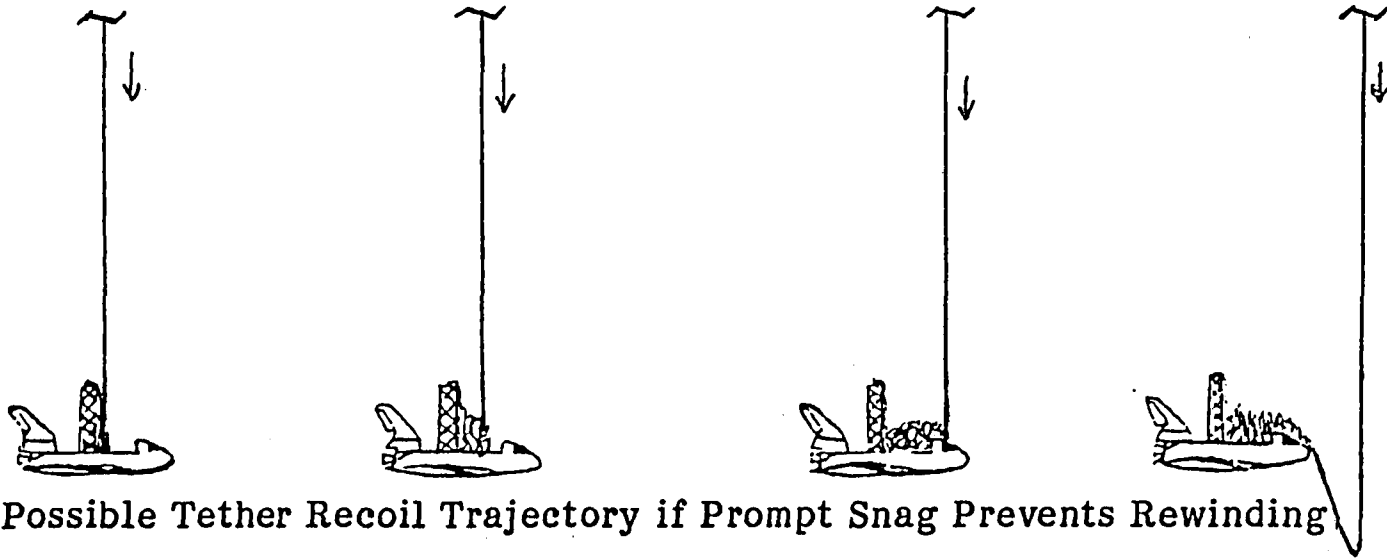

Possible Tether Recoil Trajectory if Prompt Snag Prevents Rewinding

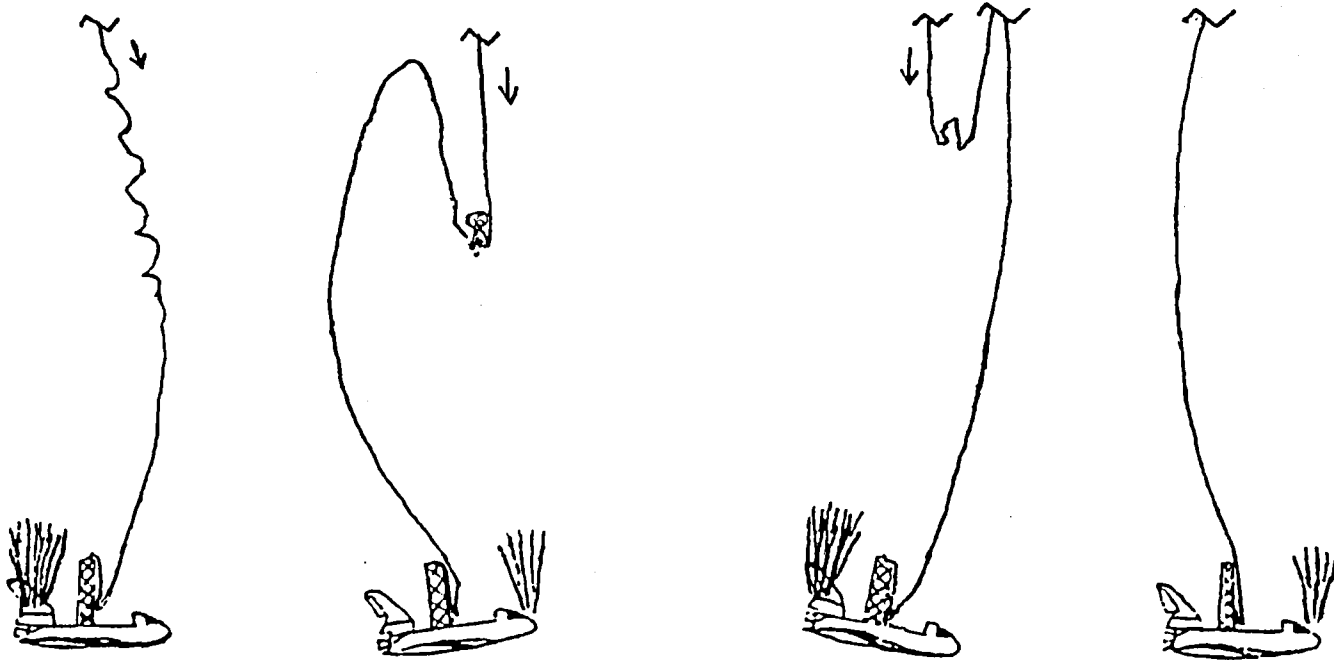

Possible Tether Trajectory With RCS Use & "Rocking-Horse" Strategy

## A TYPICAL INTEGRATION ISSUE:

"All nonmetallic materials exposed to the payload bay shall be selected for low outgassing characteristics. Material selection criteria of 1 percent, or less, total mass loss and 0.1 percent, or less, Volatile Condensable Material (VCM) as defined in NASA/JSC Specification SP-R-0022A, or its equivalent, shall be used."

ICD 2-19001, section 10.6.2

Kevlar 29 contains up to about 7% water at 55% RH, and that water comes out rather slowly in a vacuum.

Possible solutions to this problem include:

- Seek waivers (& hope other users don't object);
- Keep the deployer sealed until ready for use;
- Dry out the tether before launch & keep it sealed;
- Use non-hygroscopic tethers (e.g., Spectra 900).

## CONTROLS & SIMULATION STUDIES

- Identify the most important design & operation parameters; (e.g., effects of payload mass, tether tension, etc.)
- Enhance & use simulation programs to support other analyses; (We plan to enhance our 2-D simulation program to run on a MacIntosh with simple input & real-time graphic output. We plan to use GTOSS for most detailed simulations, and maybe SLACK2 for severed-tether simulations.)
- Refine operations & controls for best-early-candidate users. (Some new applications require new control strategies.)

## POTENTIAL APPLICATIONS OF SEDS

- Dilemma: "Useful" tests are desired with real payloads, but reliability worries, integration time, and payload problems may delay early tests.
- Response: Use cheap payloads that don't REQUIRE a boost:
  - Deployable GAS for calibrating airport radar;
  - Other "We'll take whatever we can get" STS users";
  - Controlled-reentry test for station priority cargo;
  - Chemical release experiments;
  - Dedicated passive payloads.
- Later operational uses:
  - Electrodynamic power tether for extended STS missions;
  - (Re)boosting major payloads (LDEF, AXAF, SolarMax, etc.)
  - Boosting supply caches for future use on space station.

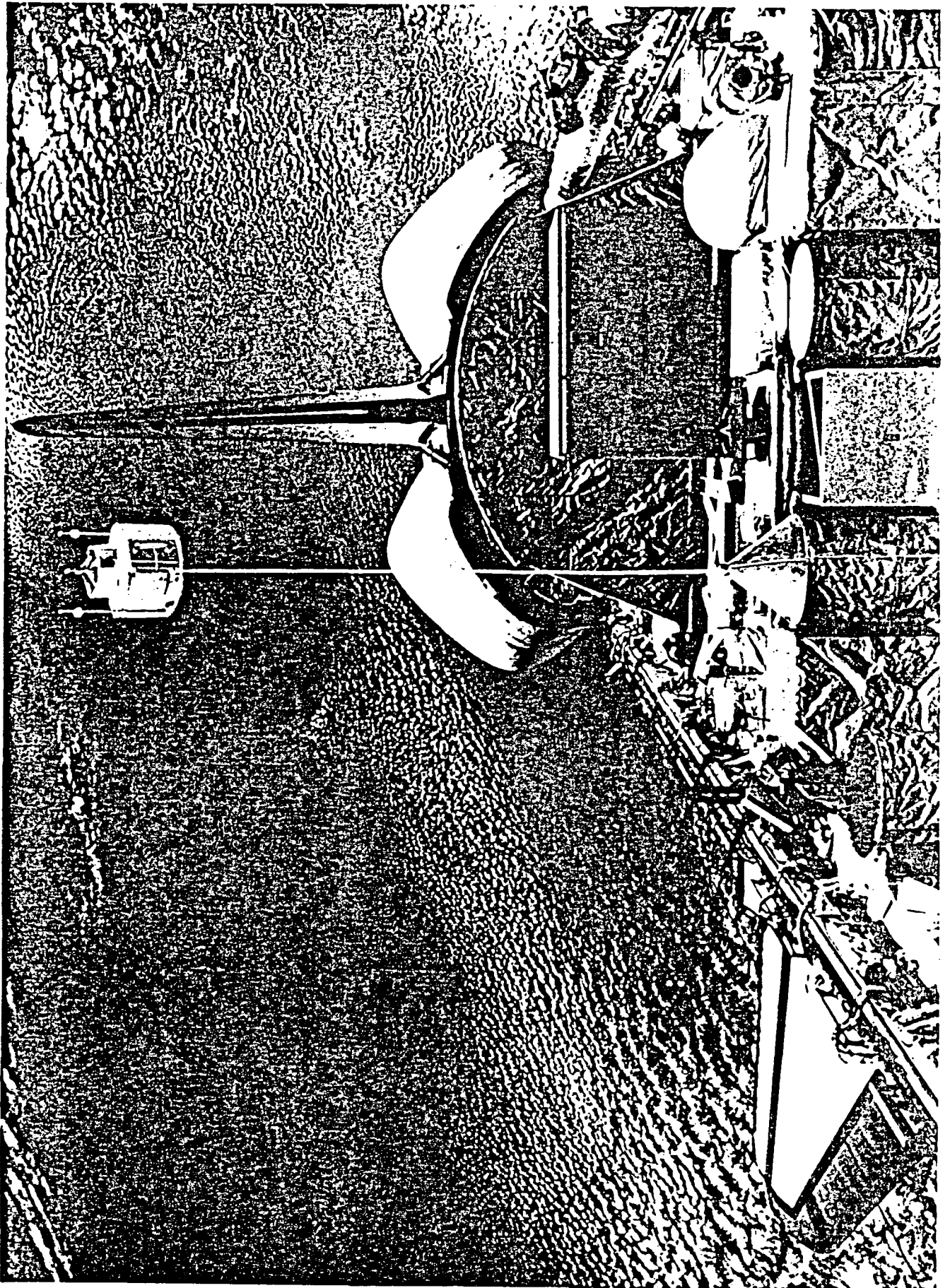

## CONCLUSIONS:

- SEDS may provide larger benefits than most STS enhancements, at radically lower cost.
- SEDS & TSS have complementary capabilities & roles.
- SEDS may facilitate quick-turnaround tether experiments.

## RECOMMENDATIONS:

- NASA fund one or more early flight tests of SEDS.
- STS users consider what "cheap boosts" can do for them.





# TETHERED OTV OPERATIONS

Mark W. Henley  
General Dynamics  
Space Systems Division

## INTRODUCTION

Do tethers make sense for the Orbital Transfer Vehicle? This question is addressed here, as a part of OTV flight operations, as the operational issues of tether launch for the OTV are considered to be more significant even than technical issues. The answer to this question is that tether boost is an attractive option for OTV in spite of the significant operational issues. Expendable shuttle-based swinging tether boost is recommended for near term applications requiring a moderate (~20%) increase in OTV payload capability. Heavier reusable tether systems are recommended for far term applications from the Space Station or other orbiting facilities, further improving OTV payload capacity, and with a corresponding increase in operational complexity.

## TETHER PRINCIPALS

The concept of a tether boost for the OTV is based upon the exchange of momentum between the OTV and a lower orbiting object, such as the Space Station, Space Shuttle or External Tank. The OTV is given a small delta V upon release, which can be subtracted from the total delta V requirements of the mission, as illustrated to scale for the trajectory of a static vertical tether in figure 1. Because of the exponential relationship between delta V and payload delivery capability, a substantial payload gain is realized by a relatively small delta V reduction.

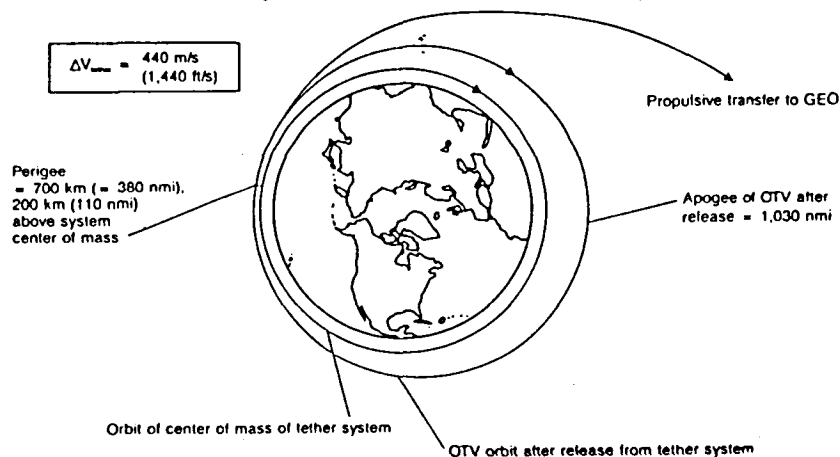

Figure 1. Tether boost for OTV is illustrated in an example trajectory.

## TETHERED OTV OPERATIONS

For any action, there is an equal and opposite reaction. The reaction, in this case, is a loss of orbital velocity by the lower mass in the tethered system. Momentum (mass x velocity) gained by the OTV equals that lost by the lower mass, and thus a heavier lower mass will have a smaller change in velocity than the OTV (a lighter, upper mass).

A tether is acted upon by the gradient in the gravitational potential of the earth. The higher mass is farther from the earth's center of mass and experiences less gravitational attraction than the lower mass. This difference in gravitational attraction results in a tension in the tether which is proportional to the vertical displacement between the orbiting masses. A tether system which is vertically oriented with respect to the earth will actually make one rotation per orbit in an inertial frame of reference, adding a centrifugal term (half that from the gravity gradient) to the tension in the tether. A vertically oriented tether system is in a stable configuration, whereas a system with a component of horizontal displacement will not remain in that orientation, but will swing in response to gravitational forces (and initial velocity conditions). Both of these systems are considered here for OTV boost.

Figures 2 a and b illustrate the trajectories resulting from release of an OTV from static (vertical) and swinging tether systems. The lower mass in these illustrations is considerably heavier than the OTV, causing less change in its orbit than the boost to the OTV upon release from the tether tip. The swinging tether strategy, as noted, results in a substantially greater apogee increase for a given tether length. Operations in the swinging strategy are simplified somewhat by the reduced tether length, but involve more complicated dynamics. The static case may actually be more difficult to achieve than the swinging case, as orbital dynamics cause a swinging motion upon extension of a tether in the vertical direction.

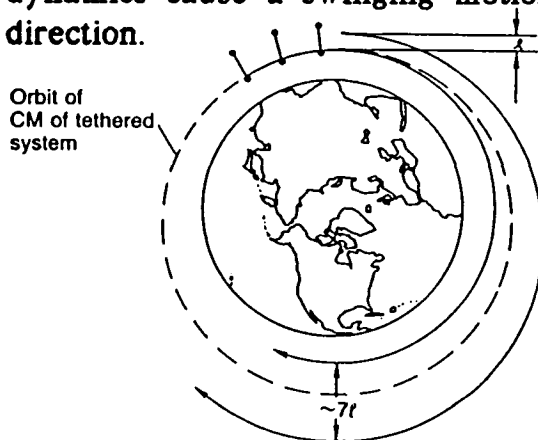

Figure 2a. Static tether boost

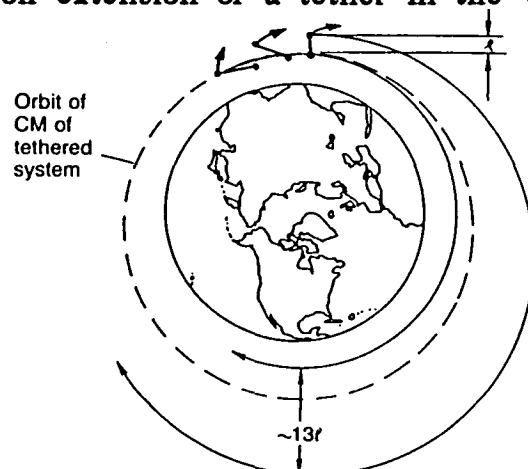

Figure 2b. Swinging tether boost

**TETHERED OTV OPERATIONS**

**TETHER BOOST SYSTEM OPTIONS**

OTV boost through tether operations may utilize a variety of lower masses for momentum exchange. The options of using the Space Shuttle, External Tank, and Space Station as the lower mass are illustrated in figure 3. Additional far term options are possible, such as a dedicated orbiting transportation node, similar to the Space Station in its transportation function, but without the constraints upon tethered operations imposed by Space Station users.

**TETHERED OTV BOOST SYSTEM OPTIONS**

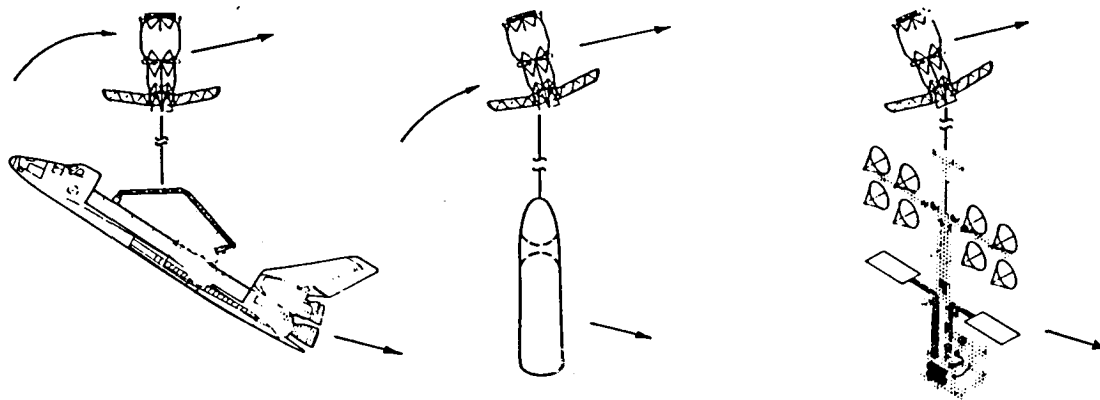

**OTV-NSTS**

**OTV-ET**

**OTV-SS**

Launch option	Swinging OK	Swinging OK	Hanging only
OTV mass	30 tons	30 tons	30 tons
Other mass	90 tons	35 tons	200 tons
OTV boost	10 × length	7 × length	6 × length
Other deboost	3 × length	6 × length	1 × length
Deboost effect	Lower Orbit	Re-entry	Undesireable
Accelerations	Inconsequential	Inconsequential	Undesireable

11105700-3

Figure 3. Several options exist for the lower mass in tethered OTV boost .

## TETHERED OTV OPERATIONS

Momentum exchange is desirable for reducing the orbital energy of the Space Shuttle and External Tank, but may be detrimental to the Space Station. Space Station orientation constraints also limit the tether operations to near vertical deployment, and the microgravity environment on the Space Station is expected to exceed 10-5 g during tether operations. Space Station operational considerations are noted below in figure 4.

**GENERAL DYNAMICS**  
*Space Systems Division*

## TETHERED OTV BOOST FROM SPACE STATION

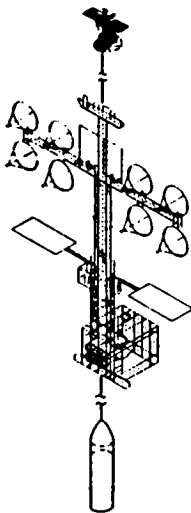

### Considerations for tether-launched OTV

- Momentum of OTV launched must be balanced by an opposite reaction to maintain Space Station altitude:
  - Use Space Station propulsion
  - De-orbit mass (ET, Shuttle, etc)
- Change in Space Station altitude must remain within acceptable limits
- Acceleration levels aboard the Space Station will exceed  $10^{-5}g$  during tether operations (may exceed allowable limits for materials processing)

11105700-4

Figure 4. Space Station operations would be constrained by OTV boost.

**TETHERED OTV OPERATIONS**

**PERFORMANCE BENEFITS**

OTV payload capability improvement is the object of tether boost scenarios. This increase in payload capability may be utilized in baseline OTV launch strategies, or in special circumstances when payload mass exceeds normal OTV capabilities. Relative payload gain from tether boost for a reference OTV is plotted in figure 5 as a function of initial delta V supplied by the tether. Payload improvement is illustrated for this vehicle in an all propulsive, aerobraked, and expendable mode of operation. The dramatic difference in percent payload improvement between these modes of operation is not duplicated on an absolute scale (pounds of payload gained). Total payload of this reference vehicle without the tether boost varies substantially depending upon mode of operation (all-propulsive, aerobraked, or expendable).

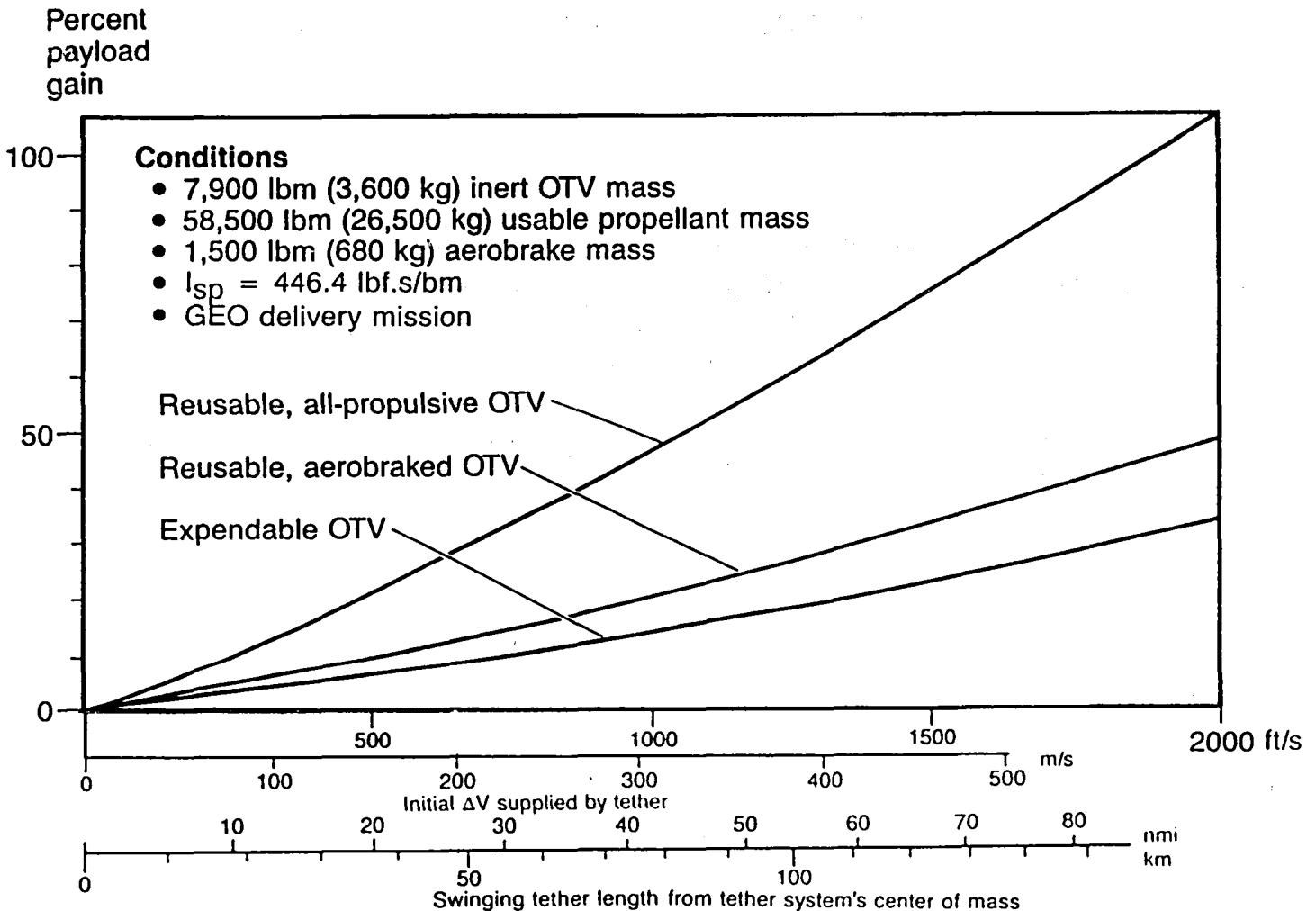

Figure 5. Relative payload gain depends upon OTV type.

**TETHERED OTV OPERATIONS**

**STATIC vs SWINGING TETHER BOOST**

The pros and cons of static and swinging tether boost systems are noted in figure 6. The static tether is in a lower energy state than the swinging tether, and must dissipate (or store / use) the energy generated during tether deployment. The swinging tether converts this energy, instead, to motion of the tether system (resulting in an approximately doubled tether delta V for a given tether length); the swinging tether apparatus is expected to suffice with a friction brake for low level energy dissipation, as opposed to the more elaborate devices required for the static tether system. System weight is reduced by the simpler energy dissipation mechanism, and the tether itself is approximately 12% lighter than that required for an equal delta V using a static tether. Reuse of either system would be operationally complex, probably requiring a tether tip satellite which assists in system control during the reeling in operation. The static tether system, however, is expected to be more amenable to reuse.

<b>Issue</b>	<b>Hanging*</b>	<b>Swinging</b>
Deployment	Vertical	Horizontal
Power dissipation	Needed	Not required
System weight	Heavier	Lighter
System volume	Greater	Lesser
Tether weight	10% heavier	10% lighter
Tether length	Longer (~double)	Shorter (~1/2)
OPS duration	Similar	Similar
OPS complexity	Similar	Similar

\*Some swinging motion is generated (& damping operations needed) with vertical tether deployment & retraction

Figure 6. Swinging tether issues compare well to static (hanging) issues.

**TETHERED OTV OPERATIONS**

**EXPENDABLE vs REUSABLE TETHER SYSTEM**

Expendable and reusable tether systems both show potential benefits for OTV. A trade between these two alternatives, figure 7, shows that an expendable system is operationally more desirable, primarily because of the absence of retrieval operations. System mass is also a major issue-the reusable system is expected to be substantially heavier, due to the increased mass of the apparatus (which includes a tether tip satellite), and the substantial electrical power is required for the retrieval operations. An expendable tether may remain temporarily in LEO, as is suggested below, or may be released directly into a re-entry trajectory.

<b>Issues</b>	<b>Expendable</b>	<b>Reusable</b>
Timelines	Shorter duration	Longer duration
Complexity	Simpler operation	Added operation
Reliability	Affected by duration & complexity	
Weight	Lighter system	Heavier system
Control	Shuttle/OTV RCS	Sub-satellite
Debris	Tether stays in orbit (Rapid orbital decay)	No debris release

Figure 7. Expendable tethers may simplify OTV tether boost operations.

**TETHERED OTV OPERATIONS**

An expendable system is only beneficial if the tether system is less massive than the propellant required for an equivalent payload increase. In figure 8, payload increase is plotted against tether mass. From the approximation that the tether mass is one half that of the expendable tether system, a limit is derived to the practical extent of an expendable tether. In the event that an OTV is insufficiently sized for a particular payload, expendable tether launch may be worthwhile beyond the approximate limit shown here. Note that the regimes below refer to a particular OTV design and do not necessarily indicate limits for other vehicle designs.

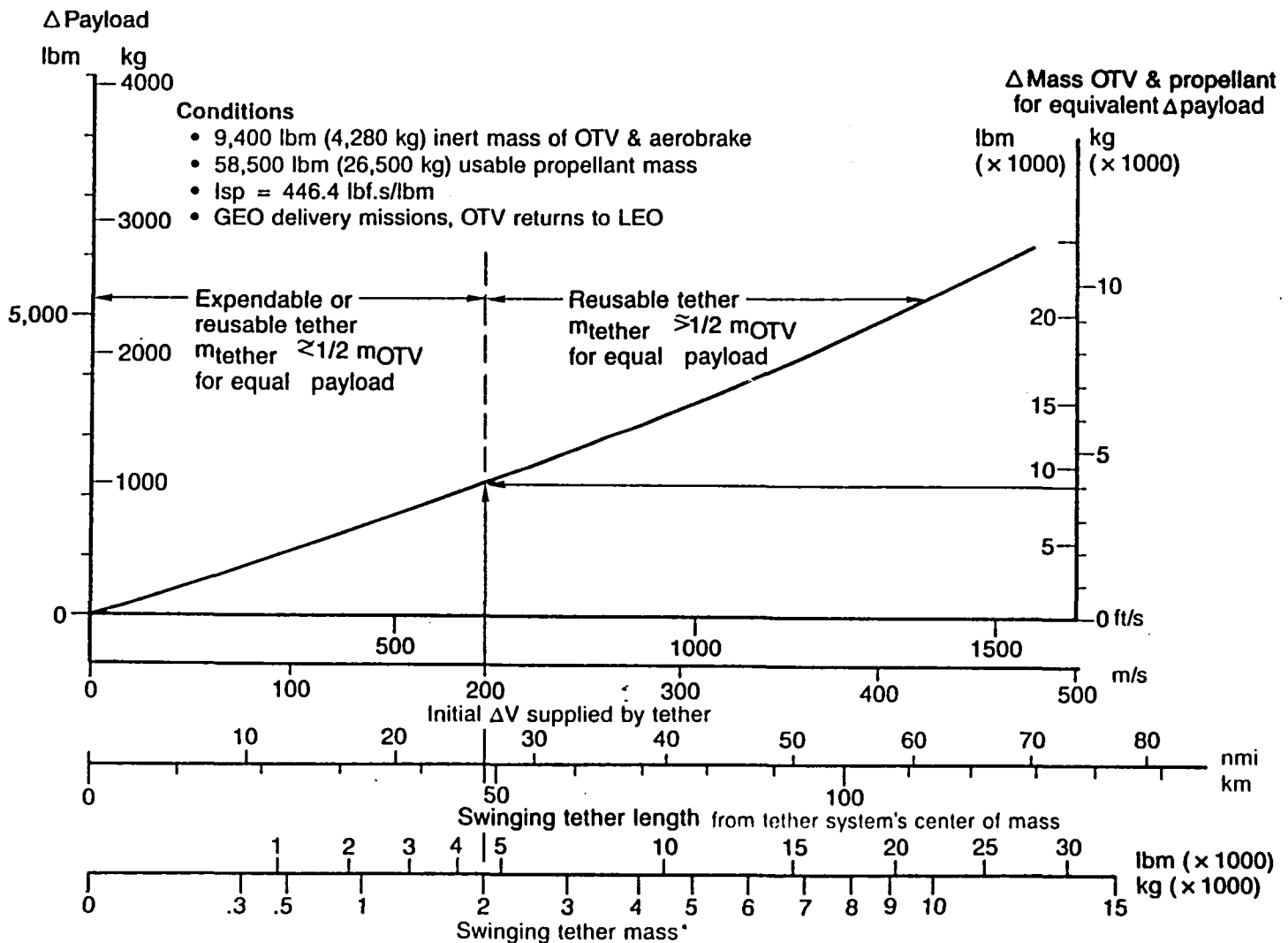

\*Based upon equations for Kevlar from J. Carroll in "Guidebook for Analysis at Tether Applications"

Figure 8. Expendable tether boost for OTV is limited in scope.



## TETHERED OTV OPERATIONS

### EXPENDABLE SHUTTLE-BASED TETHER OPERATIONS

A swinging, expendable tether system is suggested for Space Shuttle operations. Operation of this system (figure 9) is divided into four time periods, deployment, swinging, release, and post-release operations. In this scenario, the tether is either left in a low orbit (with an orbital lifetime on the order of days, so that orbital debris hazard generation is minimal), or is released from the OTV into a re-entry trajectory.

**GENERAL DYNAMICS**  
*Space Systems Division*

### SHUTTLE-BASED EXPENDABLE TETHER BOOST OPERATIONS

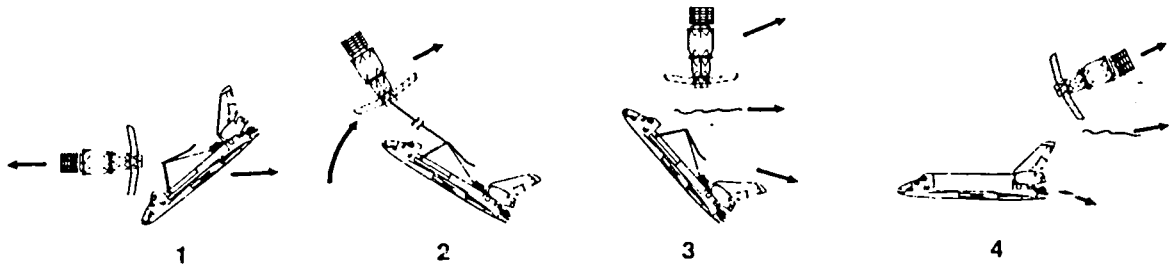

**1) Tether deployment**

- NSTS RCS initiates deployment
- Brake controls deployment rate

**2) Tether swinging**

- Brake halts deployment
- Gravity gradient causes swing

**3) Tether release**

- Timed for maximum Delta V gain
- Vehicles enter new orbits

**4) Mission complete**

- NSTS prepares for reentry
- OTV prepares for first burn
- Tether orbit decays rapidly

11105700-9

Figure 9. An expendable tether is recommended for Shuttle-based OTV boost.

## TETHERED OTV OPERATIONS

A more detailed view of a candidate tether system apparatus is shown in figure 10. The first member of the RMS arm is utilized as a part of the system, and is supported by two lines in order to spread the tether's tensional load across the Space Shuttle's center of mass. The tether itself resides within a protective sleeve running the length of the first RMS member; this serves to protect both the tether, by shielding it, and the orbiter, by preventing any potential tether breakage in this region from possible entanglement with the RMS arm. A remote disconnect mechanism is shown at the OTV, which is to be activated after a guillotine mechanism within the tether canister/deployer releases the Space Shuttle from the lower end of the tether. The canister/deployer suggested is a derivative of a predecessor currently being developed under MSFC funding. The system illustrated is not necessarily a final recommendation, but represents the best of several alternatives traded on the basis of weight and volume minimization.

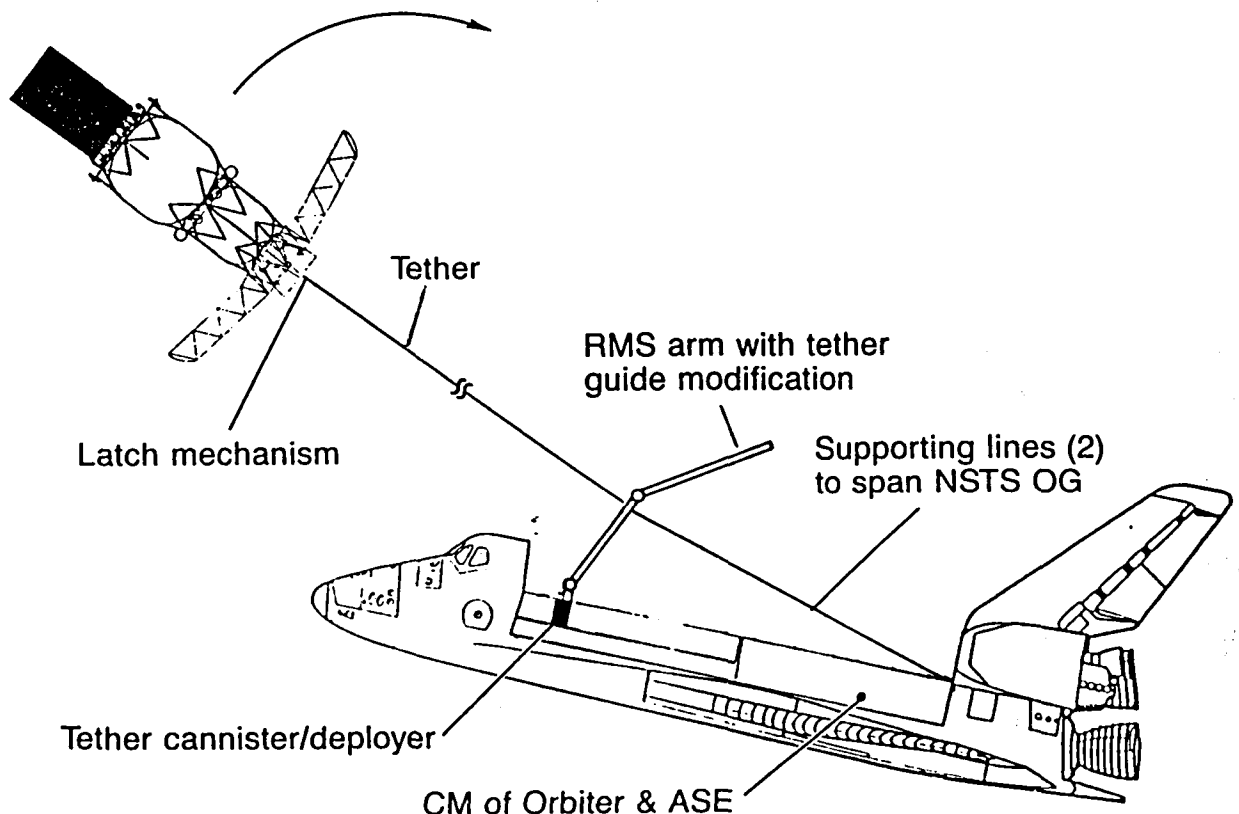

Figure 10. Shuttle-based tether boost may use a system such as this.

**TETHERED OTV OPERATIONS**

**COMMAND and CONTROL**

Three options are explored in figure 11 for the command and control of shuttle-based tether boost operations for OTV. The primary difference between these alternatives of passive, assisted, and active control is the inclusion of operations by a tether tip satellite or the OTV itself for the latter two options, respectively. A sufficient degree of control is expected through passive operations, in which the Space Shuttle supplies the delta V for initial separation and subsequent corrections, and the OTV acts as a dumb mass, becoming activated after release from the tether tip. Assisted and active control options are desirable, but not mandated for tether operations.

	<b>Passive</b>	<b>Assisted</b>	<b>Active</b>
Tether tip control	None	Sub-satellite	OTV RCS
Shuttle RCS control	Primary	Back-up	Back-up
Deployment rate	Tether brake	Tether brake	Tether brake
Libration damping	None/NSTS	Sub-satellite	OTV/NSTS RCS
Release at Shuttle	Guillotine	Guillotine	Guillotine
Release at OTV	Tether tip	Sub-satellite	OTV control
<b>Degree of control</b>	<b>Sufficient</b>	<b>Precise</b>	<b>Precise</b>

Figure 11. Control may be passive, active (sub-satellite), or through OTV RCS.

## **TETHERED OTV OPERATIONS**

### **SAFETY CONSIDERATIONS**

Tether entanglement and breakage hazards must be minimized, with thorough contingency planning if tether boost operations are to be considered a realistic option for the OTV. Figure 12 lists a number of precautions against these hazards. Hazards to Space Shuttle operations are more critical than to Space Station operations due to the more limited time and resources available for repair. Safety issues must be considered in depth in the design of tether boost systems for such.

## **Safety Considerations**

<b>Hazard</b>	<b>Precautions</b>
Tether entanglement	<ul style="list-style-type: none"><li>• Ensleeve tether in low abrasion tubing between reel &amp; "rod" tip</li><li>• Make system jettisonable</li><li>• Supply EVA tools &amp; training for contingency extrication</li></ul>
Tether breakage	<ul style="list-style-type: none"><li>• Minimize exposure period to micrometeoroids &amp; orbital debris</li><li>• Monitor tether tension &amp; integrity (e.g., fiber optics)</li><li>• Jettison tether in event of break</li><li>• Use RCS to maneuver away from jettisoned tether system</li><li>• Keep Shuttle altitude high enough to prevent re-entry</li></ul>

Figure 12. Safety issues must be resolved for tethered OTV operations.

**TETHERED OTV OPERATIONS**

**TETHERED PROPELLANT DEPOT**

The concept of a tethered propellant depot for OTV propellant storage and acquisition on the Space Station has been traded against that of an attached depot in figure 13. The Bond number ( $B_0$ , the ratio of gravity gradient forces to surface tension forces) associated with a propellant depot located at the bottom of the Space Station is sufficient for the settling of OTV propellants in large diameter tanks, removing part of the rationale for such a depot. Safety would be improved by the more distant location of potentially hazardous propellant supplies on a tethered depot, but safety would also be enhanced by a contingency supply of oxygen and water from OTV propellant supplies attached to the Space Station. Operations in general would be more difficult with a tethered depot, and the microgravity environment would be disrupted unless (and perhaps even if) a second tethered mass were extended from the Space Station in the opposite direction.

**OTV PROPELLANT DEPOT AT SPACE STATION  
 TETHERED VS ATTACHED**

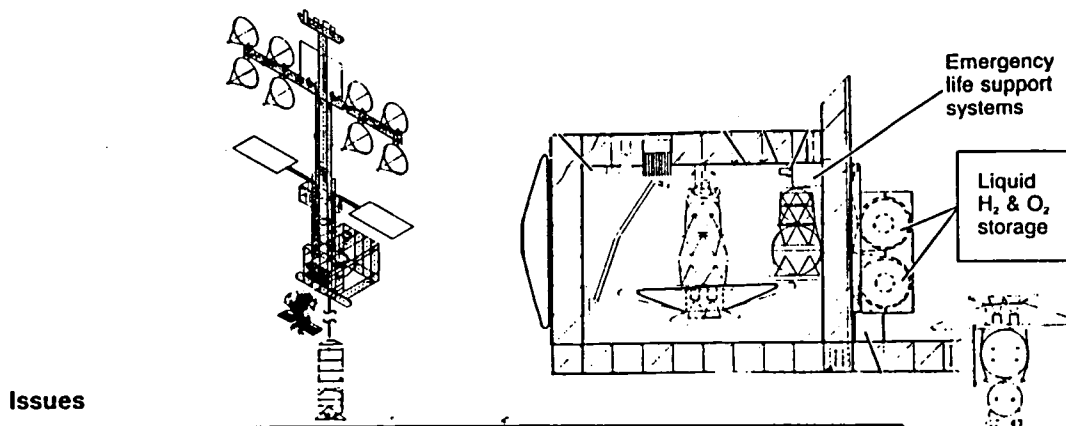

**Issues**

Operations	Difficult rendezvous Tether launch difficult Impacts Space Station prox. ops.	Normal rendezvous Tether launch ok  Normal SS prox. ops.
Safety Commonality Microgravity	Distant propellants  More than $10^{-5}g$	Contingency $O_2$ & $H_2O$ Propulsion, ECLSS Less than $10^{-5}g$
Propellant settling	$LH_2$ settles ( $B_0 \gg 50$ )	$LH_2$ settles ( $B_0 > 50$ )

11105700-13

Figure 13. A tethered OTV propellant depot is not necessarily recommended.

## TETHERED OTV OPERATIONS

### ADVANCED TETHER APPLICATIONS

Advanced applications of tethers for OTV extend as far as ones imagination wishes. Several of these potential applications are worthy of further study. Figure 14 illustrates the use of a tether to exchange momentum between the OTV and its payload, the scenario shown here is that of payload delivery to the moon, but the same concept can be applied to put a payload in an approximate final orbit. A rotating tether system might be useful for the creation of an artificial sense of gravity for manned OTV missions of long duration, such as would be expected in the exploration of Mars. Earlier it was mentioned that a separate orbital transportation node might be desirable in LEO, such a facility could use techniques beyond those already discussed for improving OTV payload capability. For example, rotational tether systems are feasible in addition to the static and swinging system alternatives which have been discussed. These are but a few of the potential applications of tethers which the OTV might evolve to use in the long term.

### ADVANCED TETHER APPLICATION EXAMPLE

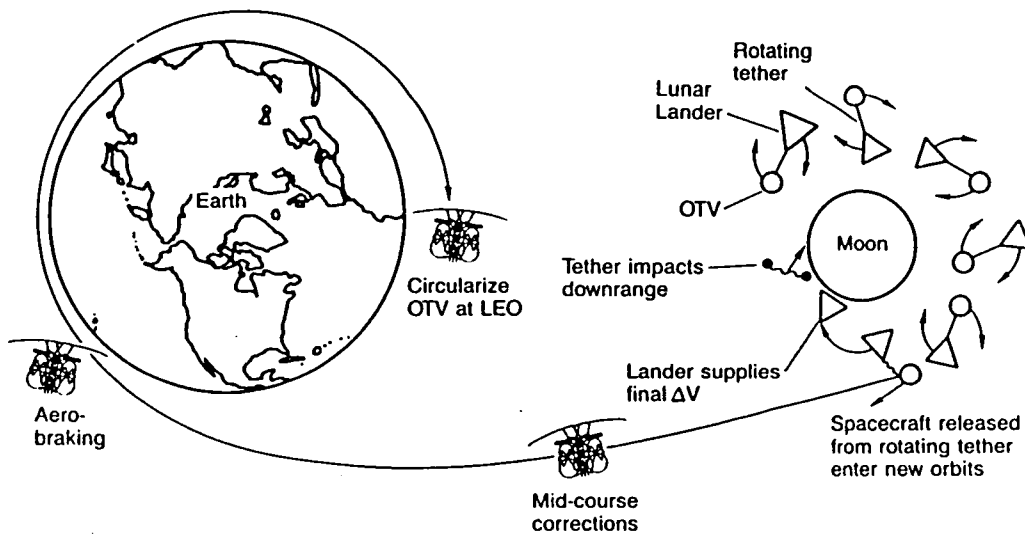

- Momentum transfer via rotating tether can supply part of the  $\Delta V$  required for delivery of mass to the lunar surface
  - Less  $\Delta V$  needed for Lunar Lander
  - Less  $\Delta V$  needed for OTV return to Earth
- Similar strategy may be used for GEO delivery

11105700-14

Figure 14. Lunar delivery illustrates the evolution of tethered OTV operations.

## **TETHERED OTV OPERATIONS**

### **SUMMARY**

The preceding discussion has centered upon the operational aspects of tether boost for the OTV. Major conclusions from this discussion are listed in figure 15. Tether boost for the OTV is recommended as an option which deserves increased emphasis in the future. Swinging, expendable Shuttle-based operations have received little, if any, attention in the past, but have been identified here to have a potential for OTV payload improvement. Reusable, space-based tether systems are considered to be more feasible for long term applications involving larger delta V gains. Development and demonstration of OTV-associated tether technology and operations should be given a high priority by NASA.





## Centaur And Shuttle Tether Technology Demonstration Package

Tether assisted OTV launch from an orbiting facility (Shuttle, Space Station, Platform, etc.) can supply an initial velocity boost and substantially increase OTV payload. Technology for tether boost of the OTV is relatively simple compared to other technology advancements with similar performance benefits, such as aerobraking or advanced engine development. The basic technology for tether assisted launch can be demonstrated early and effectively by the use of the Shuttle-Centaur as a mock OTV, as is suggested in figure 1.

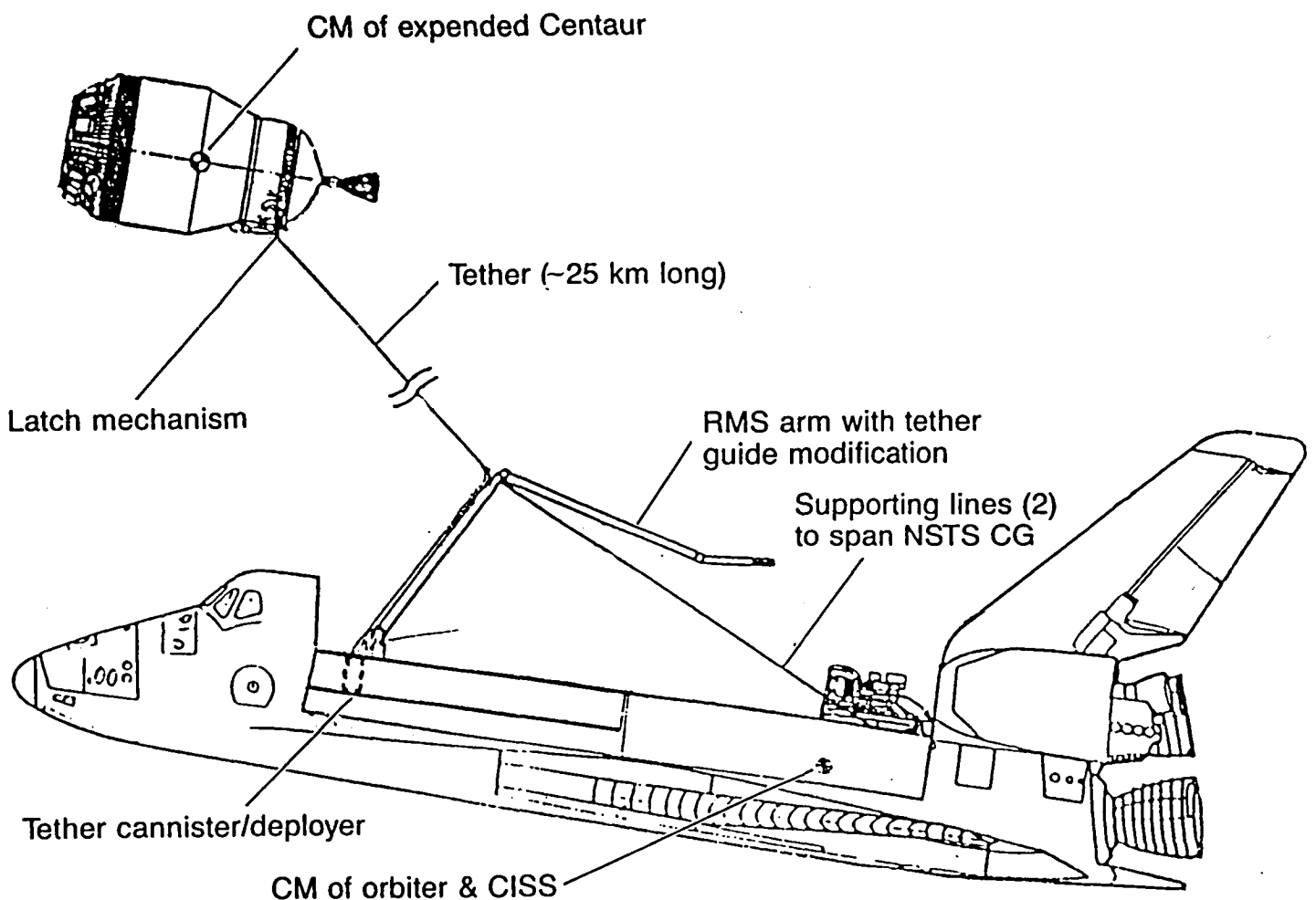
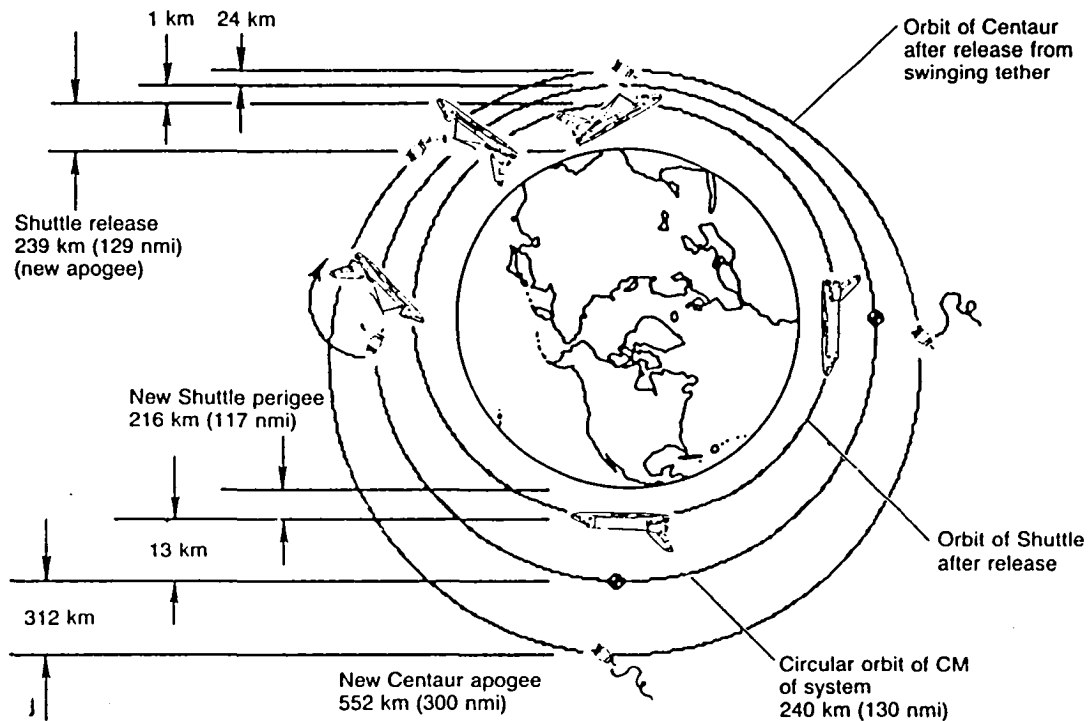

Figure 1. An expended Shuttle-Centaur may be used to demonstrate the technology required for tethered boost operations for the OTV.

## CAST TDP

The proposed Centaur and Shuttle Tether Technology Demonstration Package (CAST TDP) can test the operations and hardware for tethered launch of an OTV from the Shuttle, and can demonstrate an initial velocity boost achieved upon release of the tether (figure 2).

### CENTAUR & SHUTTLE TETHER TECHNOLOGY DEMONSTRATED PACKAGE Trajectory



11105700 19

Figure 2. The CAST TDP trajectory simulates that of a tethered OTV boost.

The CAST TDP is a scaled-down simulation of an actual tethered OTV launch. The large size of the expended Shuttle-Centaur (Shuttle-Centaur) reasonably represents the OTV. Tether length, mass and tension, and "OTV" mass and delta V boost for this demonstration are a modest fraction of those occurring in an actual OTV launch. The deboost delta V received by the shuttle, a potential secondary benefit from a tethered OTV launch, is also less significant for the CAST TDP. Estimates of these parameters are listed in the following table for both the CAST TDP and a tethered OTV launch.

## CAST TDP

	Technology Demonstration	Technology Application
Lower vehicle	Shuttle	Shuttle
Upper vehicle	Expend Centaur	Orbit Transfer Vehicle
Tether length	14 n.mi. (~25km)	40 n.mi. (~75km)
Tether tension	150 lbf (680 N)	4,000 lbf (18,000 N)
Tether mass	50 lbm (23 kg)	4,000 lbm (1,800 kg)
V gain of upper mass	330 ft/s (100 m/s)	750 ft/s (230 m/s)
V loss of lower mass	10 ft/s (3 m/s)	250 ft/s (76 m/s)
Tether guide system	RMS arm attachment	RMS arm attachment
Tether container	Small canister	Compact pallet or canister

Interfaces for the CAST TDP include both data transmission and physical connections (Figure 3). The Shuttle-Centaur must return to LEO after fulfilling its primary mission, requiring avionics modifications identical to those found in other proposed TDPs which return the Shuttle-Centaur to LEO. Additional power may be required in order for the Shuttle-Centaur to collect and transmit experimental data such as accelerometer and inertial attitude readings. Data interfaces aboard the Shuttle include visual and radar observation, and the monitoring/control of tether tension, attitude, and deployment velocity.

### Interface

### Requirements

#### Shuttle/Centaur

- Avionics
- RCS
- Grapple fixture

As per aerobrake TDP for return to NSTS  
Replace double by quad thrusters  
Point through CM of expended Shuttle/Centaur

#### Tether system

- Tether tip
- Tether cannister
- Supporting lines
- RMS attachment
- Tether controls

EVA or RMS attachment to Shuttle/Centaur  
Contain & deploy tether  
Spread load across NSTS CM  
Constrain tether relation to NSTS CM  
Control tension, velocity, release time

#### NSTS

- Visual
- Ku-band radar
- RCS

Monitor position, attitude, dynamics  
Monitor distant Shuttle/Centaur motions  
Initiate deployment & control attitude

Figure 3. CAST interfaces require minor modifications of existing systems.

## C A S T T D P

Physical interfaces consist of the connections between the tether system and the end masses (Shuttle and Shuttle-Centaur), and of the mechanisms which control tension and release. Tether tension must be transmitted directly through the Shuttle's center of mass (CM) in order to avoid the introduction of a torque upon the Shuttle during tether operations; supporting lines are used here to effect the spreading of the tensional load across a region which includes the Shuttle's CM. For the CAST TDP, the tether interface with the upper vehicle does not necessarily need to remotely disconnect, as it would in actual practice, it is desirable, however, to include a remote disconnect capability in order to accurately simulate a tethered OTV launch. A redundant tether release mechanism at the Shuttle is required both for the experiment and in practice, with EVA backup and jettisoning of tether apparatus available as contingency options to ensure separation of the tether from the Shuttle.

The CAST TDP offers a relatively lightweight and low cost method of demonstrating OTV tether launch operations and delta V gain upon tether release (Figure 4). The TDP achieves minimal weight through the selection of an expendable, rather than reusable, tether system, and by using the RMS arm in a dual role (for both manipulating the mock OTV and for spreading tether tension across the Shuttle's CM). The volume required for the package is also minimal, allowing an essentially a full Shuttle Cargo Bay Envelope for the primary Shuttle-Centaur mission. Dimensions of the tether deployment canister are those of a Get Away Special canister, and would be scaled up for the tethered launch of an OTV and its payload. Other hardware designed for the CAST TDP is capable of later use in a tethered OTV launch.

### Tether system

• Tether tip mechanism	25	11
• RMS attachment	100	45
• Supporting lines	20	9
• Tether canister	150	68
• Tether & controls	200	91
• Shuttle RCS propellant	+ 200	91
• Subtotal; additional weight on Shuttle	695	315
• Contingency (= 15%)	+ 105	48
<b>Total</b>	<b>800 lbm</b>	<b>363 kg</b>

Figure 4. The CAST TDP offers a lightweight and low cost method of testing tether boost operations and hardware for OTV.

## CAST TDP

Timelines for the CAST TDP are dependent upon mission selection and comanifestation of other TDPs on the same mission. The CAST TDP requires the return of the expended Shuttle-Centaur to LEO, which is accomplished by several other proposed TDPs. Timelines (Figure 5) therefore begin after the return of the Shuttle-Centaur to LEO, in a reference scenario which uses an aerobraking technology demonstration to bring the Shuttle-Centaur back to the vicinity of the Shuttle.

### TIMELINE FOR CAST TECHNOLOGY DEMONSTRATION

Event title	Start	Duration	Finish
Aerobrake TDP (returns expended Centaur to LEO)	00:00:00	34:20:00	34:20:00
Centaur phasing	34:20:00	06:00:00	40:20:00
Remaining Centaur propellants dumped	34:20:00	01:00:00	35:20:00
<b>Tethered OTV TDP</b>	40:20:00	00:00:00	40:20:00
Centaur co-orbits with Shuttle Orbiter	40:20:00	00:10:00	40:30:00
Orbiter maneuvers close to Centaur	40:30:00	00:30:00	41:00:00
Centaur captured with RMS	41:00:00	00:15:00	41:15:00
Visual inspection of Centaur/aerobrake	41:15:00	00:15:00	41:30:00
EVA to tether Orbiter to Centaur	41:30:00	04:00:00	45:30:00
Remove thermal material samples from Centaur	41:30:00	00:30:00	42:00:00
Tethered Centaur deployment	45:30:00	06:00:00	51:30:00
Release Centaur & tether	51:30:00	00:00:00	51:30:00

Figure 5. CAST TDP timelines follow completion of the primary mission.

The CAST TDP timeline is of a relatively short duration, with tether system connection and tether deployment encompassing most of the operational time. EVA is used in this reference timeline partly for simplicity in making tether apparatus connections - alternatively, the RMS may be able to perform this function, shortening timelines and reducing costs. Tether deployment is expected to require approximately 90 minutes for extension and 30 minutes for swinging; a wide margin of excess time is allotted in this reference timeline, which might be shortened considerably in the actual mission.

The reference timeline estimates, while of relatively short duration, may be further shortened in order to reduce power storage requirements associated with longer mission durations. Shuttle-Centaur power availability during the CAST TDP can be omitted at the expense of the absence of data transmission from the Shuttle-Centaur. We recognize the value of active Shuttle-Centaur avionics throughout the CAST TDP however, and hence measures are being considered to reduce timelines and improve time-dependent power supplies.

## **CAST TDP**

Many issues remain for the CAST Technology Demonstration Package, as summarized below in figure 6. It is hoped that a variation of the package discussed in the preceding pages can be flown in the relatively near future, in order to make this technology available for OTV applications

### **ISSUES**

#### **Centaur & Shuttle Tether TDP**

- Should avionics remain activated for TDP?
  - Three-axis accelerometer data desirable
  - Shuttle/Centaur RCS maneuvers possible
  - Requires additional power provision
- Should TDP scope be increased?
  - Current scope limited by selected mission
  - Larger TDP weight allocation desirable
- Is RMS modification appropriate?
  - Requalification required
  - Other options may be better suited to TDP
- Are alternate missions available for TDP?
  - Requires return of Centaur to Shuttle
- Several hardware elements required are TBD
  - Attach points on CISS, Centaur & RMS
  - Suitable deployer in early development
- Disposal of Centaur & aerobrake after TDP
  - Can RCS initiate re-entry?
  - Is downward tether boost alternative preferable?

**CONTROLLED GRAVITY PANEL**





## CONTROLLED GRAVITY PANEL SUMMARY REPORT

During its deliberations, this Panel formulated a significant class of opportunities that the panel denoted as "controlled gravity". This capability offered by tether systems has unique aspects that seem not to have been fully appreciated or articulated previously. These topics reach to the very foundations of fundamental science and still have immediately apparent practical possibilities. In the experience of the Panel members this is a rare and precious circumstance deserving serious and careful attention. Therefore this report seeks first to convey the concepts of controlled gravity that the Panel found so intriguing and promising.

A parallel between electromagnetic and gravitational fields may be instructive. Man's control and use of electromagnetic fields is the very basis of modern technology. The same is not as true of gravitational fields or their equivalent acceleration fields (The equivalence of gravitational and acceleration fields is a fundamental tenet of relativistic mechanics). Most of man's experience is in a familiar and comfortable gravity field of about  $9.8 \text{ m/s}^2$ . To be sure, higher acceleration fields can be produced in centrifuge apparatus, and these have widespread practical applications. The advent of spacecraft gave the first possibility of appreciable durations of near-zero acceleration fields.

The vicinity of the center of mass of a small body in a free-fall gravitational orbit experiences very small acceleration fields. The term microgravity environment has come into common usage for this situation, although the actual accelerations may vary by at a factor  $\pm 10^2$  from the  $10^{-6}g$  implied by a literal interpretation of the term, ( $g$  = the acceleration on the equator at mean sea level on the Earth surface). The possibility to perform experiments in microgravity and prospects for subsequent commercial operations is the motivation for serious scientific and development efforts in several national space programs.

Tether systems offer the new possibility of controlled acceleration fields, or controlled gravity, in the range from  $10^{-1}g$  to values below  $10^{-6}g$ , perhaps even  $10^{-8}g$ . Still smaller accelerations require other techniques, as developed

for investigations of fundamental gravitational physics (See, for example, Robert L. Forward, "Flattening spacetime near the Earth," Phys. Rev. D 26 pp 735-744, 15 Aug 1982). Tether systems achieve their control through placing experiments at significantly large displacements from the orbit center or zero acceleration position of an orbiting system. The system may either be in a gravity gradient stabilized configuration (rotating once per orbit in an inertial frame), or it may be rotating more rapidly.

As used in the previous paragraph, controlled has broad interpretation. It includes not only the magnitude of the acceleration field, but also its vector properties, its time dependence, and the uncertainty or noise associated with them. For example, by varying the length of a tether in accordance with a prescribed control law, a desired time dependent acceleration field can be imposed on an experiment system. This changing field could be a step function of increasing or decreasing magnitude, it could be a periodic function or it could have some other pattern. As another example, the tether length could be varied to compensate for field variations due to orbital eccentricity, the oblateness of the Earth or thermal expansion displacements. Thus the applied acceleration fields might be held constant within tight uncertainty limits. These are only two examples from many that could be given to illustrate the manner in which the space tether concept can be used to provide a controlled gravity environment. In its range of applicability, this is a unique capability. It makes possible controlled gravity operations of great interest, in the same way that controlled magnetic and electric fields opened new vistas a century earlier.

The Panel in joint sessions with the Constellations Panel spent some time reviewing the specific modes in which tether systems can be employed to provide controlled acceleration fields. These fall conveniently into two cases: 1) gravity gradient stabilized configurations and 2) rotating configurations. The equilibrium acceleration field obtained in case 1) for various numbers of bodies and tethers and at different places in the system are given in subsequent sections of this document (Napolitano and Belivacqua; Lundquist).

For time-varying gravity gradient configurations, the control laws, motions and resulting acceleration fields are more complicated but amenable to analysis.

The radial acceleration field produced by a rotating system, as in case 2), is well known. The use of a long tethered system has the advantage that the relative change in acceleration with radial distance can be small (i.e. the field is more uniform across the dimensions of an experiment). Again a time varying tether length is a more involved but tractable situation.

Circumstances in which controlled gravity might be applied usefully are so diverse that the Panel had neither time nor composition to evaluate them in depth. The Panel did hear presentations and received written statements on several applications. The presentation and written materials are tabulated below and reproduced in subsequent parts of this report. Also the Panel as a group discussed other applications. From these considerations some broad observations can be drawn.

#### PRESENTATIONS TO THE CONTROLLED GRAVITY PANEL

Luigi G. Napolitano and Franco Bevilacqua	Tethered Constellations, Their Utilization as Microgravity Platforms and Relevant Features
Charles A. Lundquist	Artificial or Variable Gravity Attained by Tether Systems
James R. Arnold	Remarks to Controlled Gravity Panel
Dale A. Fester	Tethered Orbital Refueling Study
Enrico Lorenzini	Dynamics of Tethered Constellations in Earth Orbit (this appears in the Constellations Panel section)
Paul A. Penzo	Tethers and Gravity in Space
R. Monti	Tethered Elevator: A Unique Opportunity for Space Processing
Kenneth R. Kroll	Gravity Utilization Issues

Biological response to different fixed magnitudes of gravity or to varying acceleration fields is a topic of significant interest. The organisms of concern range from microscope specimens to man himself. In the range from  $10^{-1}g$  to  $10^{-9}g$ , little is known about threshold values for biological phenomena. Measuring these is a fundamental scientific contribution. It also has practical implications for extended space missions such as a manned expedition to Mars. Is some level of artificial gravity necessary or desirable during such a trip? If so, what level is required or optimum? These issues could be explored on tethered platforms in orbit about the earth. If necessary, a mission to Mars could employ a rotating tethered configuration to supply the desired artificial gravity.

Fluid mechanics plays ubiquitous roles in space operations. These range from practical applications, such as propellant handling, to scientific applications, such as separation of organic molecules or living cells. In all these operations, the presence or absence of an acceleration field is a crucial matter. In some instances even a small acceleration field is advantageous, for example to settle propellants in the desired end of a tank. In other circumstances some stringent upper limit of acceleration must be respected, as may be the case in electrophoretic separation of biological materials. In each of these examples, a tether system can be applied beneficially. However, in many cases the optimum acceleration field is just not known. In growing some crystal from a solution, the dominant mass transport mechanism for the depositing material may change from turbulent flow, to laminar flow, to diffusion if the applied acceleration field is reduced over several orders of magnitude. The quality and quantity of the growing crystal presumably changes also, but where is the optimum? How sensitive is the product to noise or other unwanted variation of the field? Do important thresholds exist? Such questions can be answered definitively only if experiments can be done with different controlled acceleration fields. This control is again an appropriate role for a tether mechanism.

The answer to these optimization and threshold questions can have important fiscal implications both for anticipated commercial operations and for facilities such as the Space Station. The imposition of an unnecessarily restrictive

acceleration requirement on the Space Station can be very costly (Arnold, this report). On the other hand, refurbishment to correct for inadequate initial requirements is also costly. Tether systems can not only facilitate answers to these questions, but also they can provide a versatile mechanism for control of the acceleration field at desired positions within the Station.

The tether length to some auxiliary body or bodies can be adjusted to maintain the required environment at the position of a microgravity laboratory module when masses move about the station complex or when masses are added or removed from the station. In addition, active control should provide more precise placement of the acceleration field and allow a vertical distribution of microgravity experiments to be performed sequentially. An artificial intelligence system coupled with acceleration sensors on the station could prescribe continuous adjustment to accomplish these objectives.

The tethered auxiliary body could benefit as well from the greater acceleration field it will experience. This could be the case for a propellant management depot, which could have a fixed, non-zero, gravity field. These gravity control functions are but some of those discussed by the Space Station Panel.

An additional implication of a tether for controlled gravity is the isolation it provides from disturbances. A tether acts as a low frequency bypass filter to lateral disturbances, while work with tether weaves may also provide some damping of disturbances along the tether. This advantage can be achieved by moving the disturbances off the space station or moving the microgravity laboratory off the space station. The later option would minimize the acceleration level seen by the laboratory, but would hamper manned involvement with experiments.

When more complex, or constellation configurations of three or more bodies are examined, controlled gravity is a natural consideration. Perhaps the first example of this class will be an elevator mechanism that attaches to the tether between two primary bodies and carries a third body upward or downward along the tether. The acceleration field in the third body thus can be easily controlled by moving it up or down the tether.

Finally, the Panel noted that the orbital mechanics of tethered systems and the gravity control by them is a rapidly developing discipline for which little standard terminology or notation has evolved. In the interest of more efficient communication, the Panel recommended the nomenclature in the following diagram.

#### RECOMMENDED TERMINOLOGY

Microgravity	$10^{-4}$ g and smaller	} reduced gravity
Low Gravity	$10^{-1}$ g to $10^{-4}$ g	
Earth Gravity	1 g	
Hypergravity	greater than 1 g	} enhanced gravity

#### RECOMMENDATIONS

The Panel was asked to organize its conclusions and recommendations as they pertain to three eras: 1) the Tethered Satellite System period extending through the first few TSS flights, 2) the period of Space Station Initial Orbital Capability embracing its first few years of operation, 3) a post-IOC period when the Space Station becomes mature and facilities are added systematically to it. The recommendations also should include a priority list of tether uses and of economical demonstrations of tether capabilities.

To accommodate this desired reporting format, the Panel prepared the matrix below. Its vertical columns indicate the three eras. The two horizontal divisions represent, respectively, 1) the controlled gravity uses or objectives that the Panel judged to be appropriate for each era and 2) the demonstrations and experiments that would address these objectives.

TSS ERA  
PRE-IOC

IOC ERA  
FOR SPACE STATION

POST-IOC ERA

	TSS ERA PRE-IOC	IOC ERA FOR SPACE STATION	POST-IOC ERA
OBJECTIVES  AND  USES	Objective is to master the concept and technology of gravity control.  Gravity control would be applied to: Life Sciences Materials Science Fluid Science Engineering Uses	Gravity Controlled experimentation in Space Station applied to: Life Sciences Materials Science Fluid Science Engineering Uses	Fully exploit gravity control in Space missions.
DEMONSTRATIONS  AND  EXPERIMENTS	Demonstrate gravity profile generation, measurement and use, including appropriate analysis and evaluation.  Recommended Opportunities for early demonstrations: Spinning Orbiter Mission Orbiter experiments during tether missions Elevator on a tether.	Science and application experiments, possibly using TSS deployer	Processes and applications.

The demonstrations of gravity control during the TSS era are of great importance to future applications. They fall in two general classes: 1) gravity-stabilized tethered systems and 2) rotating systems. These demonstrations deserve more detailed discussion than can be given in the matrix. This can best be done individually for some anticipated missions.

Disposable Deployer Mission, (1987). This mission may allow a measurement of the acceleration field change and particularly the associated acceleration noise at positions in the shuttle while the tether and payload are deployed. Appropriate instrumentation for these measurements needs to be identified and scheduled for the mission.

Spinning Shuttle Mission, (1987-8). This mission provides the first opportunity to begin investigations of controlled gravity and threshold phenomena in the low gravity range ( $10^{-1}$  to  $10^{-6}$ ). Although a tether is not involved in this demonstration, the rotation principles for achieving low gravity are the same as for a rotating tethered system. Therefore the mission is included here. The experiment currently planned has attitude control thrusters firing for a 3 hour period; however, the spin may be extended for a longer period for those experiments that are sensitive to thruster firings. Maximum yaw spin rate is planned to be approximately 5 degrees per second. The acceleration level, of course, varies with position in the shuttle. Fluid science and applications are particularly pertinent for this mission. Necessary instrumentation and demonstration equipment should be planned.

TSS-1, (1988)

The first TSS mission provides a fine opportunity to demonstrate and analyze the resulting acceleration field on the Orbiter including the associated acceleration noise, during all phases of tether operations. These measurements should be correlated with other data such as accelerations on the satellite, tether length and tether tension. This mission should provide the necessary



information to extrapolate performance of a tether gravity control system for Space Station.

#### TSS-2

The controlled gravity experiments on the Orbiter for TSS-1 should be repeated and expanded with the greater deployment length planned for this mission. This mission may provide an opportunity to test an "elevator" that moves along the tether between the Orbiter and the Satellite. Such testing would determine the precision with which the elevator can be placed at a desired gravity level and would help map the acceleration noise resulting from desired gravity level profiles.

#### KITE

The disturbance isolation aspects of this proposed mission may make it particularly suited to studies of the uncertainties or noise levels that accompany the obtained acceleration fields.

#### TSS-3

The controlled gravity objectives for this mission would be similar to those for TSS-2, except that improved demonstrations should be expected based on experience with earlier missions.



TETHERED CONSTELLATION, THEIR UTILIZATION AS MICROGRAVITY  
PLATFORMS AND RELEVANT FEATURES

Luigi G. Napolitano  
University of Naples (Italy)

Franco Bevilacqua  
Aeritalia, Space Division - Turin (Italy)

Abstract

This paper summarizes the characteristics of the artificial gravity field acting on tethered platforms. The main characteristics of microgravity environments are identified and the improvements of tethered platforms over the classical platform gravity configuration are emphasized. The new microgravity environment gives the possibility of studying a very large number of phenomena offering new potentialities to microgravity sciences.

A simplified analytical investigation is performed to point out the effects of three causes that affect the artificial gravity field, namely: the orbital eccentricity, the tether thermal field and the docking of space vehicles with the main platform. The eccentricity effects are due to the deviation of the tethered system from the ideal nominal circular orbit. A periodical variation of the tether length is induced from the change of tether temperature during each orbit, with a consequent effect on the gravity field. The docking of a space vehicle to the main platform can introduce on the global system of the tethered platforms a dynamical perturbation.

Ultimately, the order of magnitude of these effects are investigated and compared with each other.

1. Characterization of the gravity field

The space evolution introduced by the Tethered Satellite and represented by the very large constellation of already studied complex tethered platforms cannot be forgotten, as more and more times underlined, a new field of science such as microgravity.

Since the new kind of microgravity environment offered by Tethers is substantially different from the "classical" one, it seems necessary and appropriate at this stage to individuate the characteristics of the gravity field.

Obviously, the first parameter characterizing a gravity field is its level (Fig. 1) ranging, at present, from the ground value ( $g/g_0=1$ ) to  $g/g_0=10^{-2}$  of the aircrafts flying parabolic Klapenian orbits, to  $10^{-5}$  for Sounding Rockets, to  $10^{-6}$  of the terrestrial Drop Towers, to  $10^{-7}$  of Spacelab and to  $10^{-8}$  of the Automatic Platforms (Free Flyers). It must be recognized that, apart from the variability around them, these values define a discrete range of gravity levels.

One of the parameters never taken into account is the direction of the "residual" gravity vector; in the following paragraphs the reason of that is clarified.

Once the level and the direction of  $g$  have been considered and hopefully controlled, the time dependence of  $g$  represent further parameters. In particular, the duration and the quality of the chosen  $g$  level and direction must be analyzed, being the quality characterized in terms of persistence of the nominal value throughout the duration and of gravity pollution.

2. Microgravity environments of classical and tethered platforms and importance of g-variations.

The coming of the tethered platforms has changed the way of thinking about the gravitational conditions obtainable in space; in particular the concept of g-variations is changed. In fact, the classical platform gravity configuration is characterized by:

- single point nominal g-value
- unknown direction
- time independent or quasi-steady nominal g-value
- different g-quality

All this means that g-variations are neither considered nor controlled and, in any case, represent disturbing parameters.

On the contrary, tethered platforms allow to look at g-variations as a system performance and, such as that, they can be continuously controlled. Thus, the main characteristics of tethered platforms microgravity environment are:

- continuous function of nominal g-values (both in intensity and direction)
- controllability
- g-quality higher than classical one
- possible time dependent nominal g-value (both in intensity and direction)

Apart from the quality and controllability effects, the addition of the time dimension appears to be the most important and promising parameters offered by the tether constellations.

The new microgravity environment gives the possibility of studying a very large number of phenomena not yet investigated; an absolutely not complete list of them is reported below in order to give an idea on the possibilities offered by tethers:

- parametric g-value (intensity and direction) investigations in order to obtain a continuous E(g) curve (E represents any experimental parameter)
- imposed and controlled g-level time profiles; a particular case is represented by a periodic, both in intensity or direction, function of g(t), in order to study the effects of frequency and amplitude
- analysis of the g-jitters by simulating them; up to now g-jitters have been only measured
- effects of g-intermittencies or, in general, effects at g(t) step functions
- effects of g(t) hysteresis on different phenomena
- controllability of g-noise

3. New potentialities offered by tethers to microgravity sciences

The potentialities presented in the last paragraph are self-explanatory and the importance of them with respect to the different field of science should be self-evident. However, it is interesting to enter explicitly the three main fields of science involved with microgravity conditions: Life Sciences, Material Sciences, Fluid Sciences. For each of them it is easily possible to individuate a number of typical examples of user's needs:

- Life Sciences
  - Determination of threshold g values for biological processes
- Material Sciences
  - determination of the level-frequency acceptability regions for crystal growth processes
  - solidification front geometry any dynamics as function of g(t)
- Fluid Sciences
  - g-jitters
  - contact angle hysteresis
  - dynamic wetting
  - spreading
  - influence of g-history on critical point phenomena
  - stability enhancing by means of time variation of g-levels

The influence of a g-variation capability on processes is also important, for example, for the optimization of the process itself by means of the so-called g-tuning.

4. Main performances and Characteristics of a tethered platform

During our study on this argument we convinced ourselves on the opportunity to concentrate our effort on the dynamics issues related to these off-standard scientific platforms instead to distribute our attention on different aspects like configuration, architecture and mission, in order to clearly identify the main characteristics of this attractive microgravitational solution before to approach more general aspects.

It is clear that a tethered platform exhibits a net acceleration proportional to the

distance from the center of gravity of the global tethered space system and vertically oriented when in stationary stabilised conditions.

This net acceleration opposed by the tether tension can be viewed as an "artificial gravity" that, at the end of a static vertical tether, can be tuned at different values by controlling the tether length: L i.e.:

$$\frac{g}{g_0} = 3 \frac{R_0^2}{(R_0+H)^3} \cdot L$$

where:

g/g<sub>0</sub>: artificial gravity referred to Earth  
Surface gravity

R: Earth Surface Radius

H: Altitude of Tethered System Center of gravity.

In the Table 1 a preliminary evaluation on artificial gravity levels offered by a tethered platform for different altitudes and tether lengths is shown:

Tab. 1 - Artificial Gravity as function of altitude and tether length

Altitude:H (km)	Artificial Gravity: g/g <sub>0</sub>			
	L <sub>min</sub> = 100 m		L <sub>max</sub> = 100.000 m	
463	3.81	10 <sup>-5</sup>	3.81	10 <sup>-2</sup>
1.000	3.04	10 <sup>-5</sup>	3.04	10 <sup>-2</sup>
10.000	2.78	10 <sup>-6</sup>	2.78	10 <sup>-3</sup>
35.786	1.63	10 <sup>-7</sup>	1.63	10 <sup>-4</sup>

In particular, limiting our attention on low orbit, we can evidenciate that the micro gravity performances offered by tethers cover all the range between Automatic Platforms and Aircraft performances.

In Fig. 1 we have shown three scales, relevant to low orbit (H = 463 km), medium orbit (H = 10.000 km) and geostationary orbit (H = 35.786 km), relating the tether length to the obtained artificial gravity levels.

It is important to say that the possibility to modify the artificial gravity level by modifying and controlling the tether length, unavoidably induces disturbing accelerations effects due to a quite complex orbital transient dynamics.

So an imposed and controlled g-level time profile is to be considered taking into account this transient disturbing effects.

Another important aspect affecting a tethered platform performance is the g-noise induced by different perturbing reasons like residual orbital eccentricity of the tethered system, thermal behaviours inducing tether length variation, rendez-vous and docking manoeuvres of the main station inducing dynamic perturbation on the tethered platforms. These different aspects will be analysed in a preliminary approach in the next paragraphs.

### The dynamics model

Since the objective of this paper was to outline some aspects of microgravity environment, the analysis was based on a rather simplified dynamic model of the system.

The most significant simplifications were the omission of lateral tether dynamics and the use of only one normal mode for the elastic expansion of the tether.

The tether was assumed to have a constant diameter of 2.3 mm and uniform mass distribution per unit length.

The microgravity platform was assumed to have a mass of 10 ton.

From Lagrange's theory the stretch equation can be expressed in the following form:

$$\left(M + \frac{mt}{3}\right) \ddot{z} + \left(M + \frac{mt}{3}\right) \ddot{\rho} = \left(M + \frac{mt}{3}\right) L \left[ \dot{\varphi}^2 + (\dot{\varphi} - \dot{\theta})^2 \cos^2 \vartheta + \frac{\mu}{R^2} (3 \cos^2 \vartheta \cos^2 \varphi - 1) \right] - K Z \quad (1)$$

Where the two Euler angles  $\vartheta$  and  $\varphi$  describe the platform motion, M and mt are the platform and the tether masses, Z is the tether elongation, l the unstretched tether length and L the tether length.  $\dot{\varphi}$  represents the angular velocity of orbital reference frame.

In this equation as generalized forces were assumed only first order gravity gradient field and elastic tether force.

Aerodynamic forces were neglected.

The elasticity was represented by a linear spring whose spring constant K is:

$$K = \left( \frac{\pi d^2}{4} \right) \frac{E}{l}$$

where d is the diameter of tether and E is Young's modulus.

The energy dissipation due to frictional losses in the tether material is in general small, and the damping was assumed to be null.

### 5.1 The dynamic effect of the thermal environments

The effect of the thermal field generated along the tether is one of the most interesting parameter to be considered in order to investigate the dynamic behaviour of a system compound by two bodies connected to this tether.

The main parameters which affect the tether temperature are the following:

- Solar Radiation
- Albedo
- Infrared Radiation
- Aerodynamic Heating

At the orbital altitudes that are interesting for the analysis of the microgravity phenomena, the effect of the atmospheric heating is negligible, therefore it has not been introduced in this analysis. The simulations considered during these preliminary thermal analysis have been performed assuming a tether default length of L = 100 Km (measured at a temperature of 20°C) and placing the tether in a circular orbit where its center of mass altitude, with respect to the earth surface, is of 400 Km.

A trade off about two different tether materials has been considered:

- 302 Stainless Steel
- Kevlar 29

Table 2 shows the main properties of the two tethers considered for the calculations.

Table 2 - Characteristics of Analyzed Tethers

	302 STAINLESS STEEL	KEVLAR-29 (BARE)
CONFIGURATION	1x19 Standed Wire Rope	Bare braided (no Jacket)
EXTERNAL DIAMETER	0.89 mm	2.00 mm
DENSITY	4.05 Kg/Kg	4.00 Kg/Km
ABSORPTIVITY	0.44	0.44
EMISSIVITY	0.12	0.83
EXPANSION THERMAL COEFF.	20.0x10 <sup>-6</sup>	-2.5x10 <sup>-6</sup>

A thermal mathematical model has been developed in which the 100 Km tether has been subdivided in 100 nodes. The energy balance equations have been solved using the SINDA thermal analyzer.

The analyses have been conducted considering the two extreme orbital conditions under a thermal point of view, as shown in Fig. 2.

A particular subroutine was improved to exactly simulate the twilight effect during the tether entry and exit from the earth shadow. With the knowledge of the temperature behaviour of all tether nodes during one orbit, it is possible to quantify the tether total expansion/contraction and the relevant velocities and accelerations with the hypotheses of considering a completely free tether.

The results obtained during the above mentioned analyses can be summarized as following:

- the maximum thermal gradient between the two tether ends both for the stainless steel and for the kevlar is always lower than 15°C, during all the orbital phases
- the tether average temperature behaviour as function of the orbit time is shown in Fig. 3 for all the analyzed cases
- the tether length variation, the relevant velocities and accelerations are respectively shown in Figs 4, 5 and 6.

The analysis of the previous results shows the following conclusions:

- the maximum tether length variation during one orbit due to thermal loads variation is of approximately 300 meters for the stainless steel tether and of 25 meters for the kevlar tether;
- the maximum speed corresponding to the above variation is of approximately 0.5 m/s for the stainless steel and of 0.04 m/s for the kevlar;
- the maximum acceleration impulse obtained during the simulation is of 0.015 m/s<sup>2</sup> (1.5x10<sup>-3</sup> g) for the stainless steel and of 0.008 m/s<sup>2</sup> (0.8x10<sup>-3</sup> g) for the kevlar.

To analyse the effective dynamic response of the system to thermal field generated by entry and exit from the earth shadow the eq. /1/ was used.

As additional simplifications the tether mass was neglected and the assumption of null in-plane and out-of-plane librations was made.

The system orbit was circular with semi-major axis  $a = 6778$  Km and the unstretched tether length (at a temperature of  $20^{\circ}\text{C}$ ) was assumed  $l = 100$  km.

The basic elastic properties of two tether materials were considered.

For Kevlar 29 a spring constant  $K = 5.55$  N/m was considered with basic mode frequency  $f_{kv} = 3.75 \cdot 10^{-3}$  Hz.

For 302 Stainless steel a spring constant  $K = 8.78$  N/m was found with natural frequency  $f_{st} = 4.72 \cdot 10^{-3}$  Hz.

The system was assumed stretched but in equilibrium as initial condition.

The tether thermal behaviour (described in the previous par.) was applied to the system, and the dynamic response was found by numerical integration of eq. / 1 /.

The fig's 7 and 8 show the tether elongation and the dynamic radial acceleration for the Kevlar and Stainless materials and for the two beta values of 0 and 52 degrees.

For the Kevlar tether the equilibrium elongation results of about 697 m.

The thermal environment causes elongation oscillations of about 4 m peak to peak amplitude over one orbital period.

The global acceleration disturbance results of about  $+ 1.3 \cdot 10^{-3}$  m/s<sup>2</sup>.

The Stainless tether presents an equilibrium elongation of about 440 m. The thermal transient induces elongation oscillations of about  $\pm 30$  m amplitude during one orbit. The acceleration disturbance results of about  $\pm 2.5 \cdot 10^{-2}$  m/s<sup>2</sup>.

The Stainless material induces perturbations of one order of magnitude greater than the Kevlar one.

Kevlar seems suitable material for micro-gravitational environment.

## 5.2 The dynamic effect of orbital eccentricity.

To evaluate the microgravity disturbances due to small eccentricity of the system orbit the eq. / 1 / was used.

As additional simplification the tether mass was neglected and the assumption of null in-plane and out-of-plane librations was made. In addition the elastic properties of the tether were neglected because this kind of disturbances is not expected to excite the elastic expansion mode of the tether.

The orbit semi-major axis was fixed at 6778 km and the orbital eccentricity was varied from  $3 \cdot 10^{-3}$  to  $15 \cdot 10^{-3}$ .

The Fig. 9 shows the orbital radius, the angular velocity and the radial acceleration in function of the true anomaly for five values of orbital eccentricity.

The gravity gradient acceleration relevant to a tether length,  $L = 100$  km, for circular orbit is  $0.384$  m/s<sup>2</sup>. Small orbit eccentricities

cause a disturbance of orbital periodicity and amplitude function of eccentricity. For a typical circular error of about  $5 \cdot 10^{-3}$  the disturbance results of about  $1.5 \cdot 10^{-2}$  m/s<sup>2</sup> peak to peak amplitude.

## 5.3 The dynamic effects of docking

This section is devoted to give a preliminary assessment of the g-variations induced by a docking manoeuvre on a tethered platform. The simplified model, adopted to represent the system dynamics, considers the motion of the subsatellite as unidimensional along the z-axis of the tether. Both the geometrical and structural characteristics of the system components (namely, subsatellite, tether and upper platform) were assumed according to the definitions given in the previous sections; here, an additional system component (i.e. the shuttle) is considered to model the docking manoeuvre with the upper platform.

Basically, the effect of a docking manoeuvre on the subsatellite acceleration levels is twofold; one is a short-term effect representing the subsatellite dynamic response to an external impulse due to the docking and the other is a long-term effect due to the change of the overall system centre of mass.

The first effect was assessed by considering the target (that is, upper platform, tether and subsatellite) to be in a circular orbit with its centre of mass at 6778 Km altitude, and the shuttle approximating to the upper platform with relative velocity along the z-axis.

By assuming a mass ratio  $M/m = 100$  between the upper platform and the subsatellite, 100 Km for the tether length (in Kevlar 29) whose longitudinal stiffness was previously estimated as  $K = 5.55$  N/m, and the worst case of impact in the range of the allowable conditions for the rendez-vous and docking manoeuvre, the maximum variation of acceleration induced on the microgravity platform was about  $1.10^{-4}$  m/s<sup>2</sup>. That is, the  $0.15$  m/s<sup>2</sup> of acceleration induced on the upper platform were damped via the tether flexibility until the above mentioned small value at the lower platform.

The long term effect arises because, when the shuttle docks with the upper platform, the overall system will change. In conditions of soft impact the velocities of the various parts of the composite system will all be the same as immediately before the docking, while the center of mass will be different and so the orbit of the new centre of mass. Energy and angular momentum preservation allow for calculating both the new semi-major axis and eccentricity of the orbit. Assuming that the velocity of the new centre of mass is greater than the local circular velocity, the composite system will be at the perigee of the new orbit immediately after the docking and so the maximum (negative) variation of acceleration on the microgravity will result after an orbital semiperiod. With the assumptions of the above simplified model, the variation of the centre of mass is restricted to a few meters along the negative z-axis and so negligible g-variations as resulting from the application of Eqn. / 1 /.

Thus, the g-variations induced by the

docking manoeuvre may be considered, in first approximation, very small when compared with those induced by the other already analyzed environments.

### Conclusions

Tethered platforms provide a unique multi-disciplinary facility for conducting research on microgravity sciences.

The potentialities offered by a tethered platform are clearly represented in Fig. 1 in which a comparison between artificial microgravity performances offered by different solutions as Aircraft, Rockets, Spacelab, Drop Towers, Automatic Platforms and a Tethered System, evidentiates its advantages in capability to cover an extended microgravity range:  $10^{-6} \leq g/g_0 \leq 10^{-2}$  for an indefinite time. The capability to perform a desired g-level time profile, acting on tether length with a suitable control law able to minimize transient disturbing effects, represents an important feature.

The results obtained by a preliminary analysis on g-noise induced by different perturbing reasons like residual orbital eccentricity, tether length thermal modification and docking induced dynamic effects are reasonably acceptable.

In particular, for a low orbit ( $H = 400$  km) and considering a tether length of 100 km, the microgravity disturbances due to orbital eccentricity ranging between:  $3 \times 10^{-3} \leq e \leq 15 \times 10^{-4}$  is limited to:  $4 \times 10^{-4} g \leq g \leq 20 \times 10^{-4} g$  i.e. from 1% to 5% of artificial gravity value:  $g/g_0 = 3.8 \times 10^{-2}$ .

The dynamic effects induced by tether length variation as a function of temperature behaviour are essentially concentrated in the two sun-eclipse transitions per orbit in which the temperature presents a derivative discontinuity. Two different tether materials have been considered: Stainless Steel and Kevlar having a coefficient of thermal expansion of  $20 \times 10^{-6} \text{ 1/C}^\circ$  and  $-2.5 \times 10^{-6} \text{ 1/C}^\circ$  respectively.

The global acceleration disturbance on a 100 km tethered platform in low orbit, as deduced by a simplified model neglecting damping effects, has been  $+ 2.5 \times 10^{-3} g$  for stainless steel tether and  $+ 1.3 \times 10^{-4} g$  for Kevlar tether i.e. of the order of 6% and 0.3% of artificial gravity respectively Kevlar seems a suitable material for microgravity tethered platforms.

The g-variation induced by a docking manoeuvre at the upper platform, assuming a mass ratio of 100 between this platform and the sub-satellite, 100 km of tether length, is of the order of  $1 \times 10^{-3} g$ , i.e. less than 1% of artificial gravity. This perturbation can be considered negligible with respect to the others, taking also into account the singularity of this event.

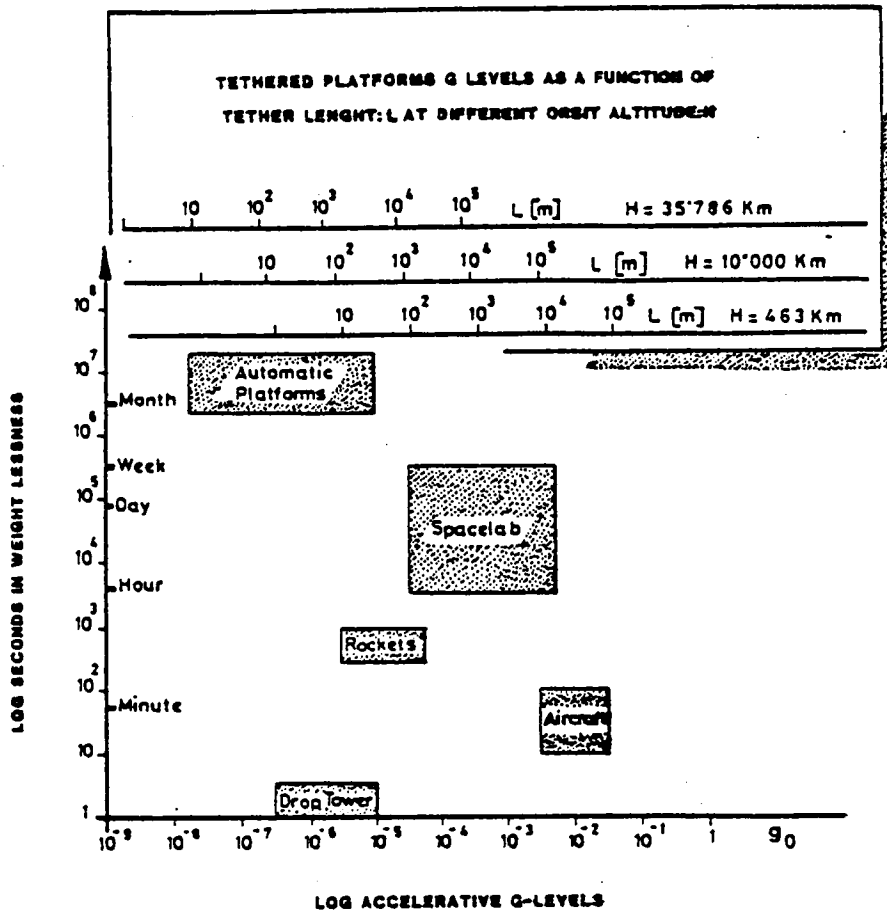

FIG. 1 NOMINAL GRAVITATIONAL LEVELS AS A FUNCTION OF DURATIONS ACHIEVABLE WITH THE MAIN AVAILABLE MICROGRAVITY PLATFORMS COMPARED WITH TETHERED PLATFORMS.

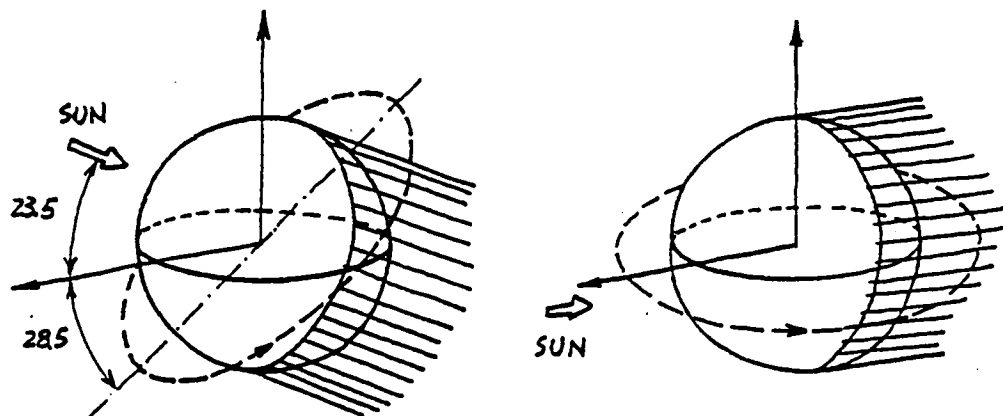
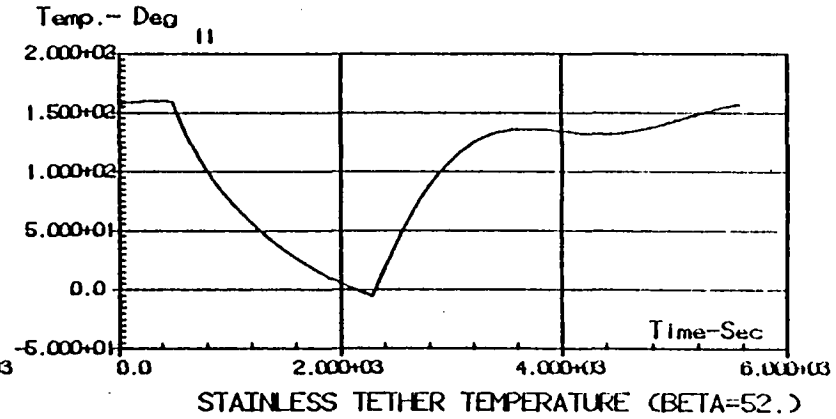
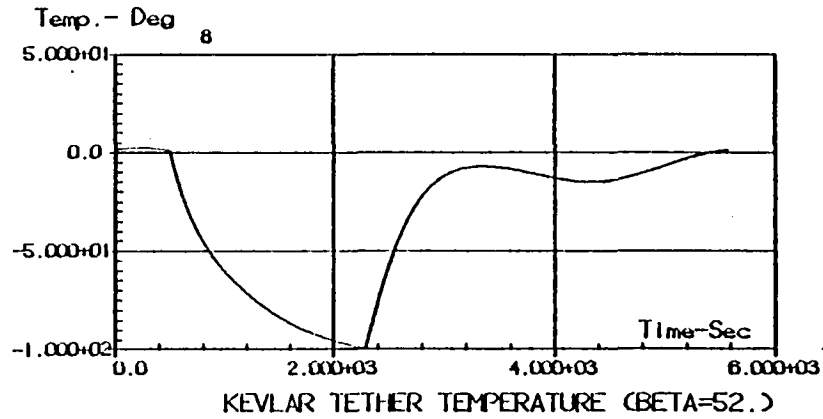
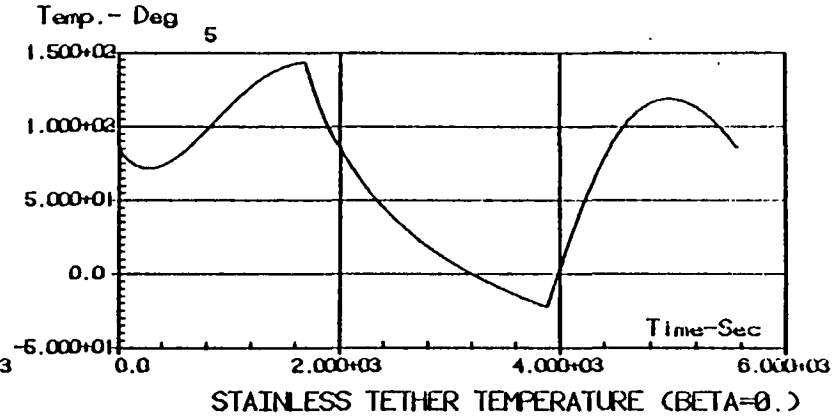
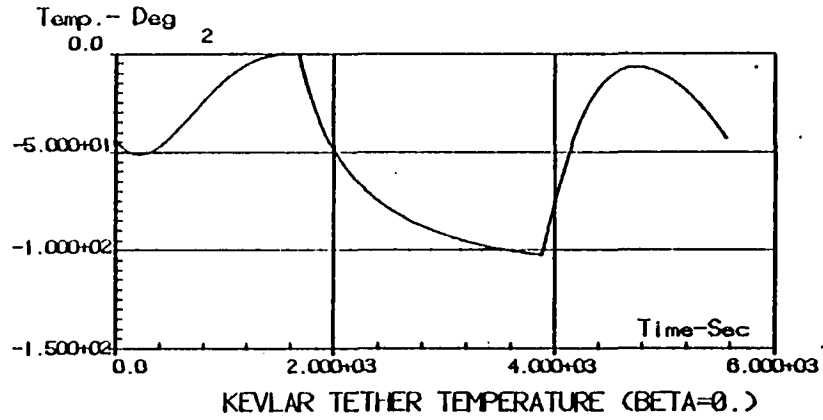

FIG. 2 ORBITAL CONDITIONS FOR TETHER THERMAL ANALYSIS





AERITALIA-SETTORE SPAZIO

FIG. 3 TETHERS AVERAGE TEMPERATURE DURING AN ORBIT PERIOD

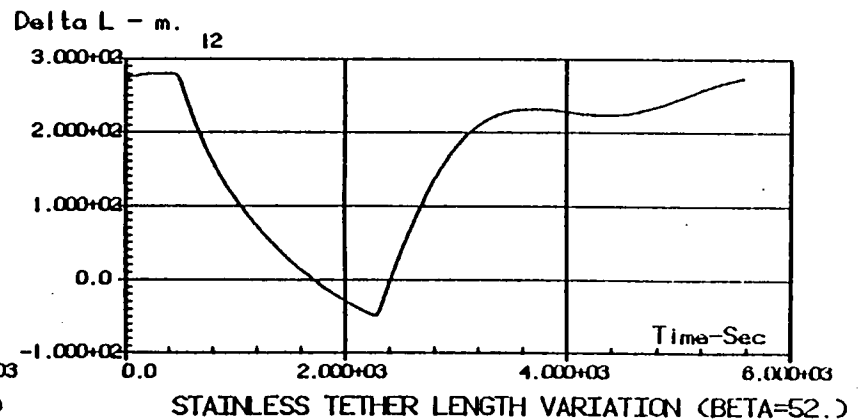
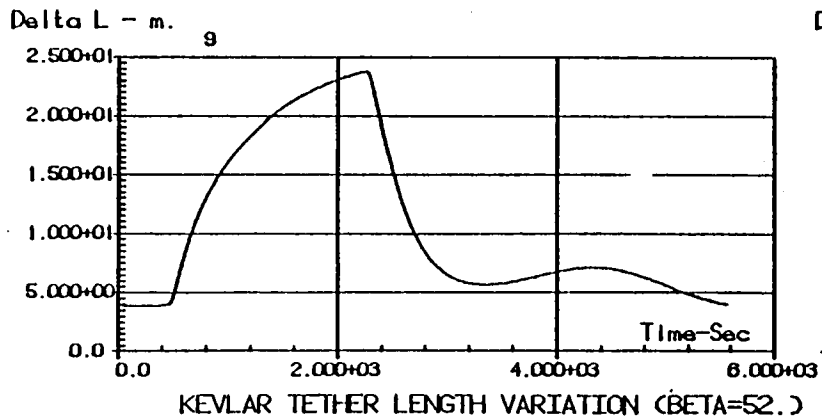
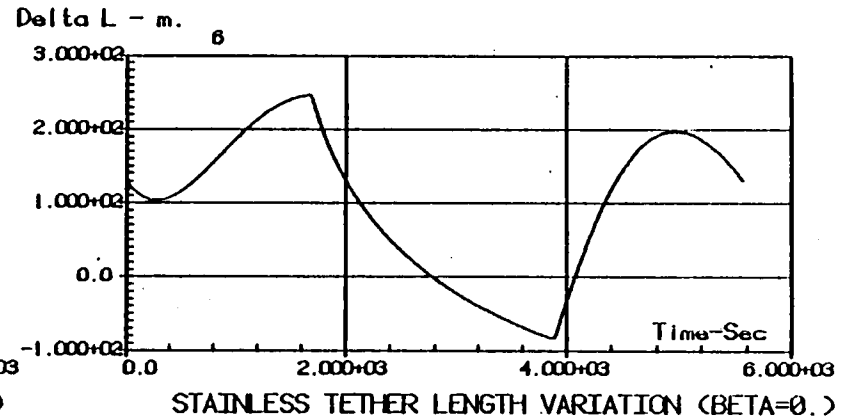
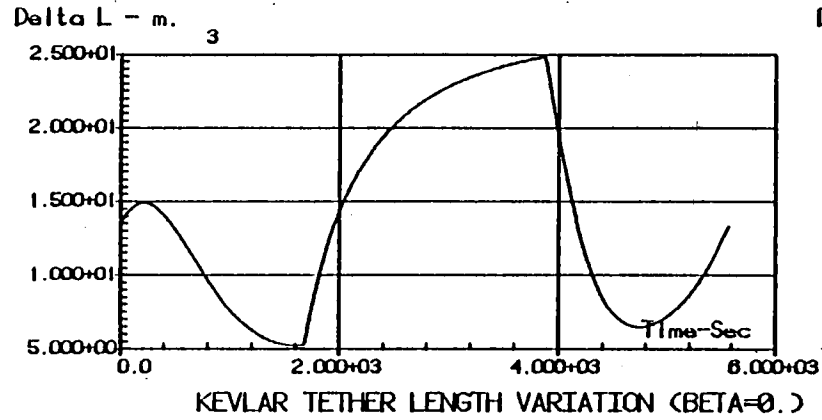

AERITALIA-SETTORE SPAZIO

FIG.4 TETHERS LENGTH VARIATION DUE TO TEMPERATURE

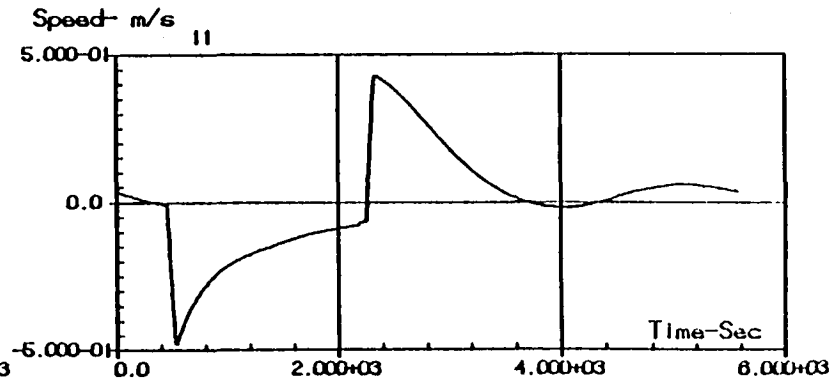
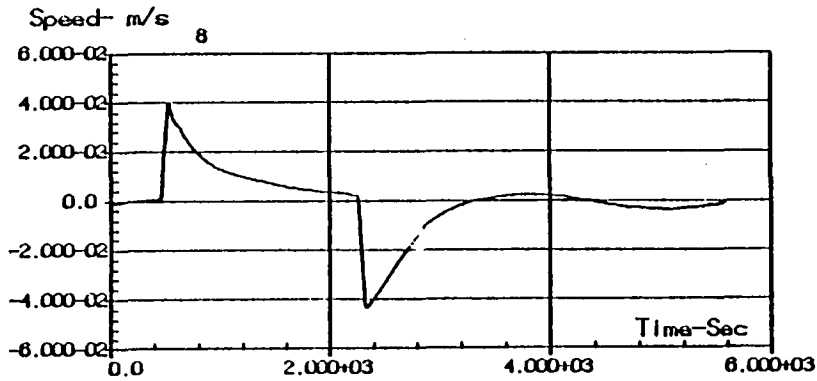
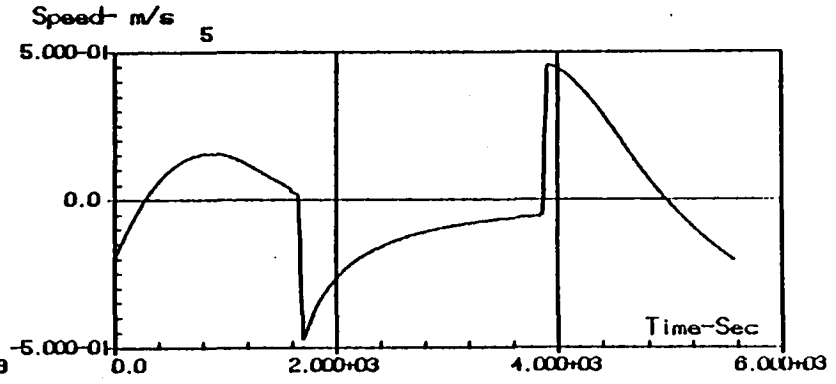
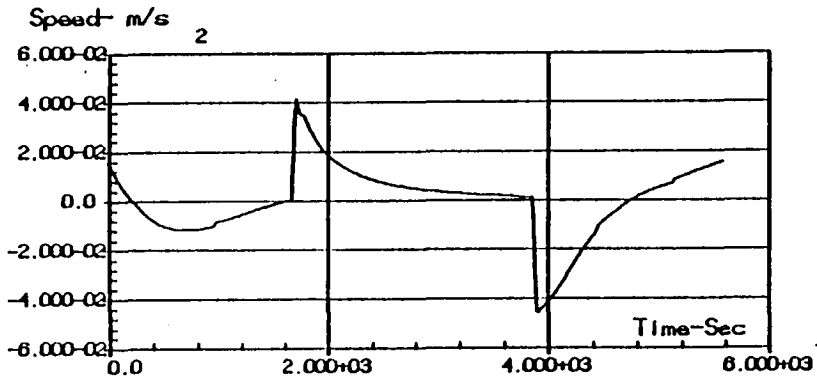

73

FIG. 5 TETHERS SPEED DUE TO TEMPERATURE VARIATIONS

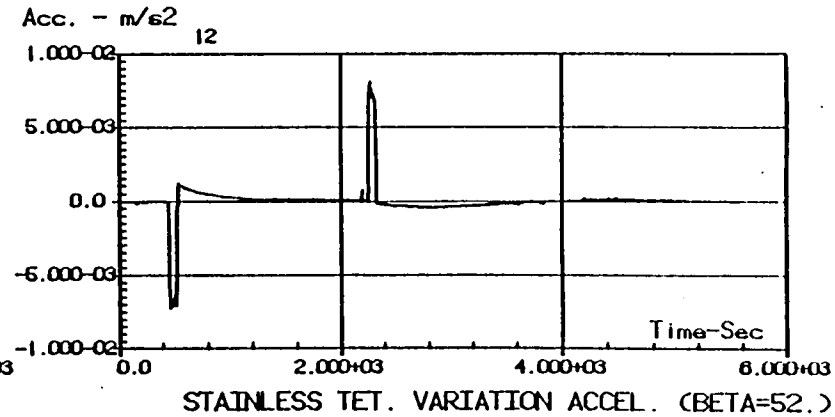
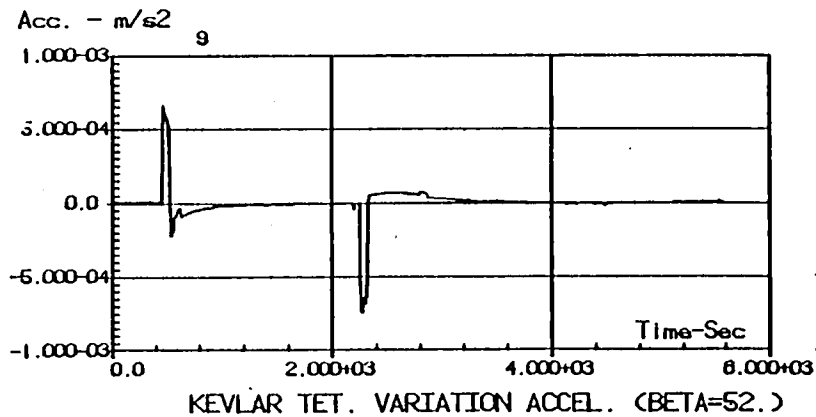
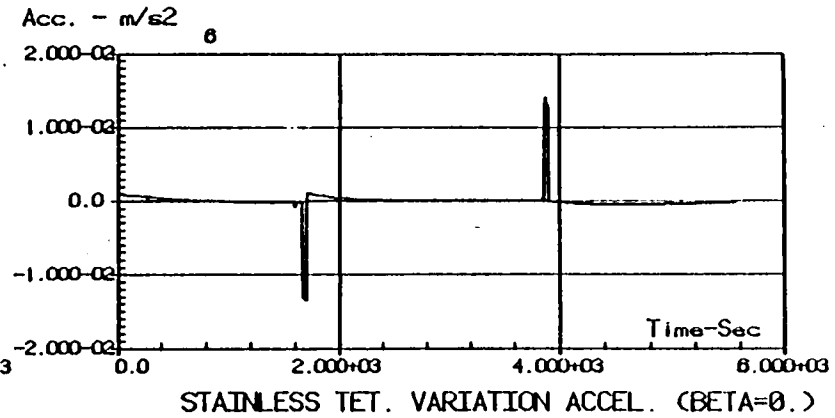
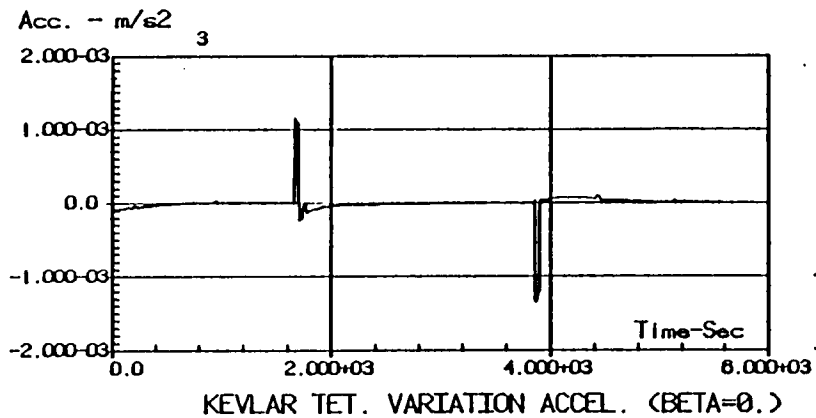

AERITALIA-SETTORE SPAZIO

FIG.6 TETHERS ACCELERATIONS DUE TO TEMPERATURE VARIATIONS

74

PLOTTING PROGRAM  
MICROGRAVITY STUDY

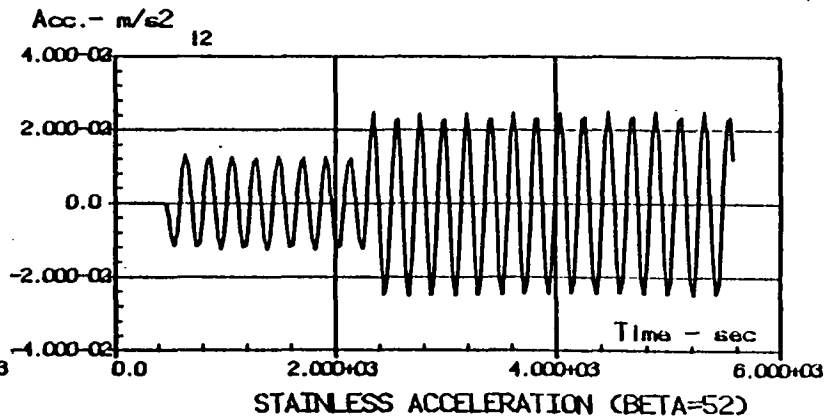
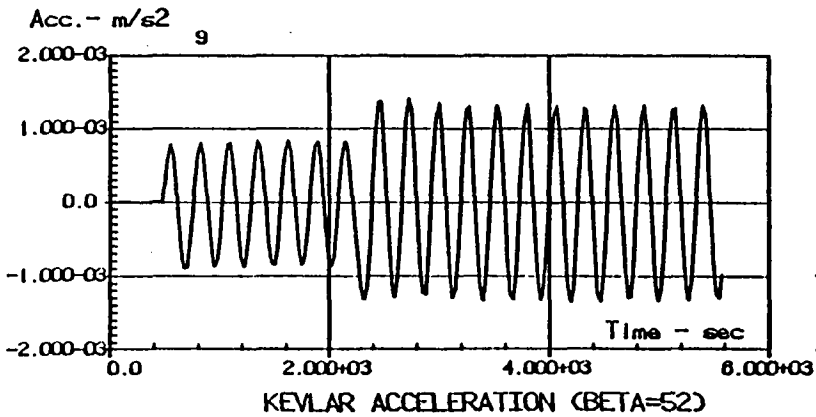
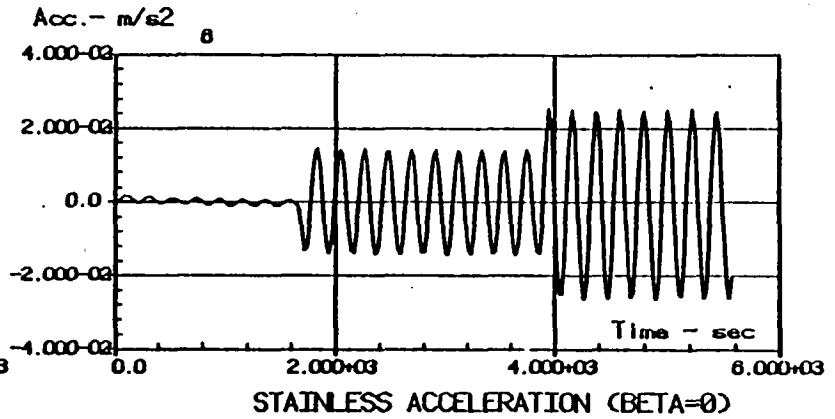
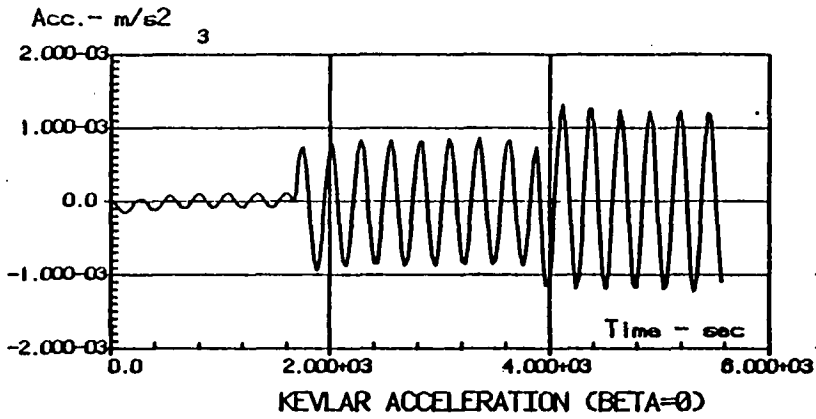

AERITALIA-SETTORE SPAZIO

FIG. 7 TETHERS ELONGATION DUE TO THE EFFECTIVE DYNAMIC RESPONSE OF THE SYSTEM

PLOTTING PROGRAM  
MICROGRAVITY STUDY

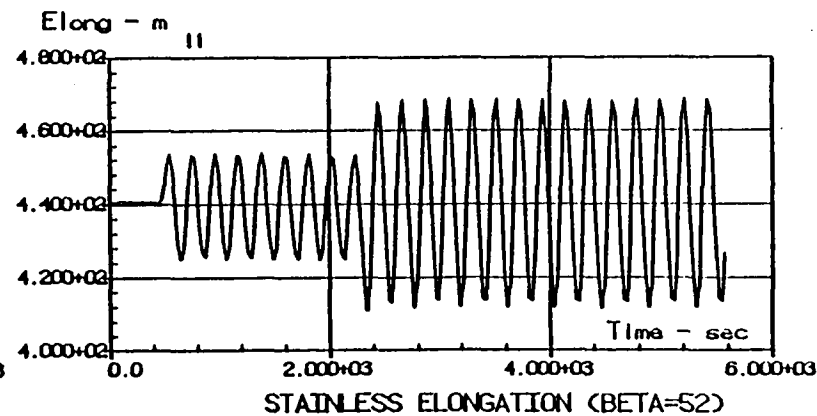
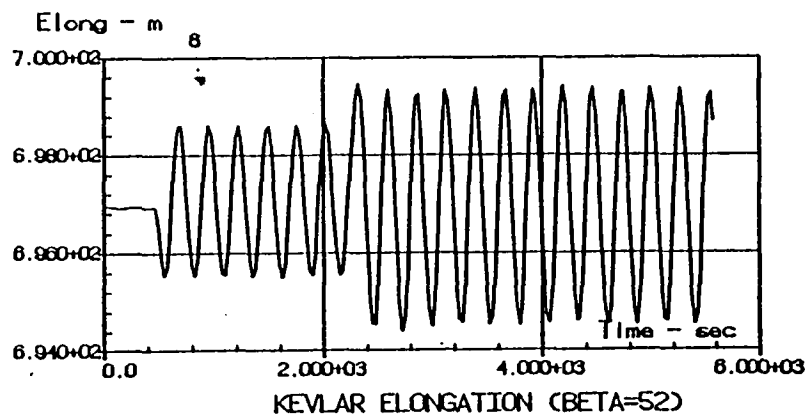
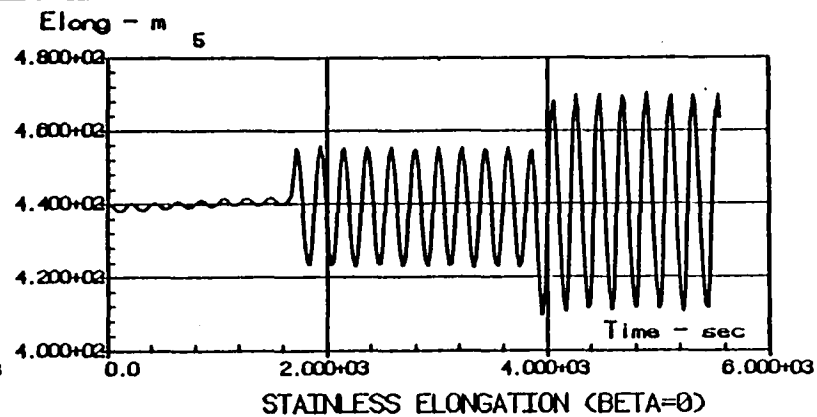
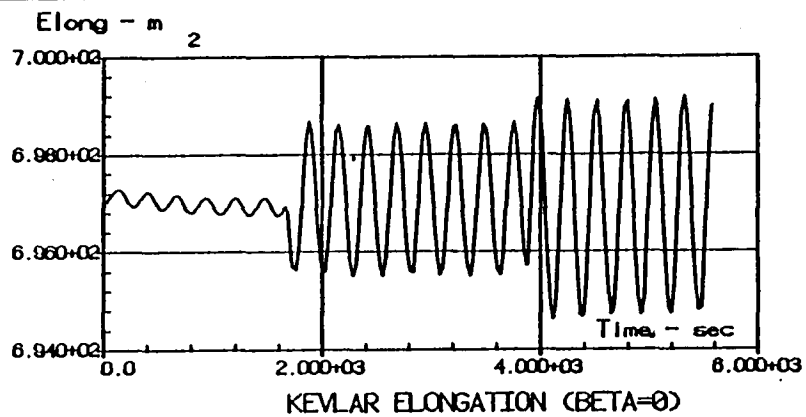

AERITALIA-SETTORE SPAZIO

FIG. 8 TETHERS RADIAL ACCELERATION DUE TO THE EFFECTIVE DYNAMIC RESPONSE OF THE SYSTEM

PLOTTING PROGRAM  
MICROGRAVITY STUDY

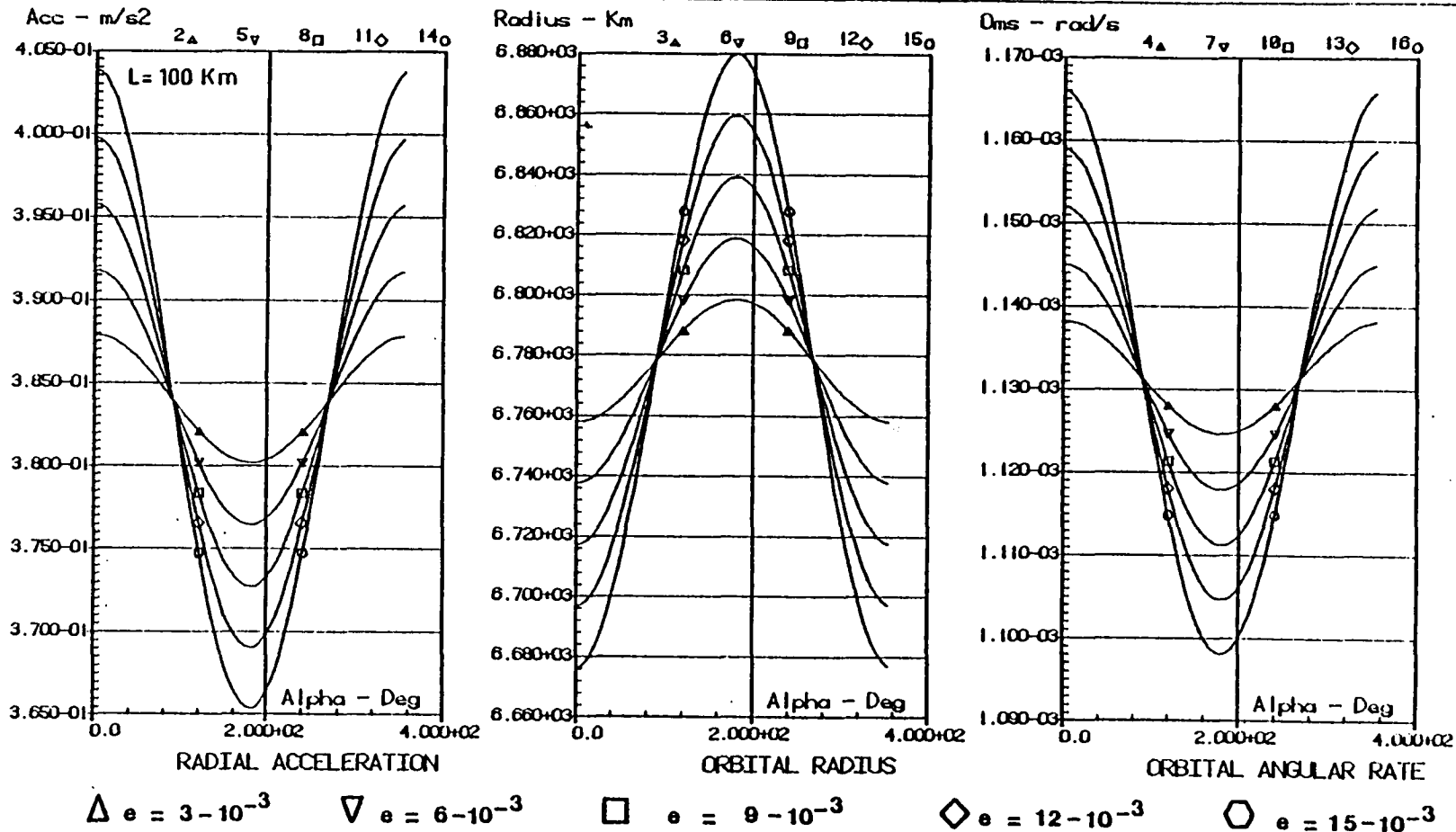

AERITALIA-SETTORE SPAZIO

FIG. 9 RADIAL ACCELERATION, ORBITAL RADIUS AND ORBITAL ANGULAR RATE DUE TO DIFFERENT RESIDUAL ECCENTRICITIES





# ARTIFICIAL OR VARIABLE GRAVITY ATTAINED BY TETHER SYSTEMS\*

Charles A. Lundquist

The University of Alabama in Huntsville

## I. MOTIVATION

The simplest orbiting tethered system demands for stability that the mass centers of two end bodies be displaced above and below the position of zero acceleration. Therefore, the contents of the end bodies are subjected necessarily to acceleration fields or "artificial gravity" whose magnitudes depend on the dimensions and masses of the system. If the length of the tether changes, so do the fields. Even for a fixed tether length, the acceleration field at a location in the system may be somewhat variable unless special means are employed to maintain a constant value.

These fundamental properties of a tethered system can be used to advantage if small or variable acceleration fields are desired for experimental or operational reasons. This potential use involves a few expressions from a formulation of tether system dynamics. Some of these formulae have been collected here for convenient reference.

A special application of acceleration field control using a tether system is attainment of near-zero gravity. In this application, even small variations about zero become a critical matter.

## II. THE TWO BODY EQUILIBRIUM CASE

The most rudimentary model of an equilibrium tethered system assumes that a body of mass,  $m_2$ , is connected to another body of mass,  $m_3$ , by a tether of negligible mass oriented along a geocentric radius, (See figure 1). As shown in Figure 1,  $Q$  is the geocentric distance to the center of mass of  $m_2$  and  $m_3$ , and  $S$  is the tether length between  $m_2$  and  $m_3$ . Further let  $G$  be the fundamental gravitational constant,  $m_1$  the mass of the Earth, and  $m = m_2 + m_3$ . The Earth is treated as a point mass, and the orbit of the tethered system is assumed to be circular. It is easily shown, for this simplistic case, that the orbital angular rate,  $\omega$ , is given by

$$\omega^2 = \frac{Gm_1}{Q^3} \left\{ \frac{m_2}{m} \left[ 1 - \frac{m_3}{m} \left( \frac{S}{Q} \right) \right]^{-2} + \frac{m_3}{m} \left[ 1 + \frac{m_2}{m} \left( \frac{S}{Q} \right) \right]^{-2} \right\} \quad (2.1)$$

For analytical treatments of tether dynamics, the use of  $\left( \frac{S}{Q} \right)$  as a small

---

\*Prepared for the Applications of Tethers in Space Workshop, Venice, Italy, October 15-17, 1985.

parameter for series expansions is useful. To second order in this small quantity, equation (2.1) can be rewritten approximately as

$$\omega^2 = \frac{Gm_1}{Q^3} \left\{ 1 + 3 \frac{m_2 m_3}{m^2} \left( \frac{S}{Q} \right)^2 \right\} \quad (2.2)$$

Likewise the tension is

$$\begin{aligned} \tau = \frac{Gm_1 m_2 m_3}{mQ^2} \left\{ \left[ 1 - \frac{m_3}{m} \left( \frac{S}{Q} \right) \right]^{-2} \left[ 1 + \frac{m_2}{m} \left( \frac{S}{Q} \right) \right] \right. \\ \left. - \left[ 1 + \frac{m_2}{m} \left( \frac{S}{Q} \right) \right]^{-2} \left[ 1 - \frac{m_3}{m} \left( \frac{S}{Q} \right) \right] \right\} \end{aligned} \quad (2.3)$$

To second order in  $\left( \frac{S}{Q} \right)$  this can be written

$$\tau = \frac{Gm_1 m_2 m_3}{mQ^2} \left\{ 3 \left( \frac{S}{Q} \right) + 3 \frac{(m_3 - m_2)}{m} \left( \frac{S}{Q} \right)^2 \right\} \quad (2.4)$$

The corresponding radial acceleration fields to second order are

$$\gamma_2 = - \frac{Gm_1}{Q^2} \frac{m_3}{m} \left[ 3 \left( \frac{S}{Q} \right) + \frac{3(m_3 - m_2)}{m} \left( \frac{S}{Q} \right)^2 \right] \quad (2.5)$$

$$\gamma_3 = \frac{Gm_1}{Q^2} \frac{m_2}{m} \left[ 3 \left( \frac{S}{Q} \right) + \frac{3(m_3 - m_2)}{m} \left( \frac{S}{Q} \right)^2 \right] \quad (2.6)$$

where the positive sense is radially outward. These are the fields  $\gamma_i$  sensed by an experiment at the body centers of mass respectively and in a coordinate system rotating with the orbit of the system.

An orbiting point mass with the same angular rate as equation (2.1), or its approximation, equation (2.2) would have a radial distance  $\bar{Q}$  given by

$$\omega^2 = \frac{Gm_1}{\bar{Q}^3} \quad \text{or} \quad \bar{Q}^3 = \frac{Gm_1}{\omega^2} \quad (2.7)$$

The radius  $\bar{Q}$  is in some sense a "center of motion" for the tether system. It is related to the center of mass by the expression

$$\frac{1}{\bar{Q}^3} = \frac{1}{Q^3} \left\{ \frac{m_2}{m} \left[ 1 - \frac{m_3}{m} \left( \frac{S}{Q} \right) \right]^{-2} + \frac{m_3}{m} \left[ 1 + \frac{m_2}{m} \left( \frac{S}{Q} \right) \right]^{-2} \right\} \quad (2.8)$$

or approximately by

$$\bar{Q} = Q \left\{ 1 - \frac{m_2 m_3}{m_2} \left( \frac{S}{Q} \right)^2 \right\} \quad (2.9)$$

The  $\bar{Q}$  also differs from the center of gravity of this simplistic tether system.

The center of gravity is defined as the radius,  $\bar{\bar{Q}}$ , at which a single body of mass  $m$  would be subject to the total gravitational force on bodies  $m_2$  and  $m_3$ ,

$$\frac{m}{\bar{\bar{Q}}^2} = \frac{m_2}{r_2^2} + \frac{m_3}{r_3^2} \quad (2.10)$$

The center of gravity,  $\bar{\bar{Q}}$ , to second order is

$$\bar{\bar{Q}} = Q \left\{ 1 - \frac{3}{2} \frac{m_2 m_3}{m_2} \left( \frac{S}{Q} \right)^2 \right\} = \bar{Q} \left\{ 1 - \frac{1}{2} \frac{m_2 m_3}{m_2} \left( \frac{S}{Q} \right)^2 \right\} \quad (2.11)$$

The three centers are also related by

$$\bar{Q}^3 = Q \bar{\bar{Q}}^2 \quad (2.12)$$

The pertinence of  $\bar{Q}$  is its role as the position at which acceleration is zero for the angular rate from equation (2.1) or (2.2). Acceleration is not zero at the system center of mass or the center of gravity.

### III. TETHER WITH SIGNIFICANT MASS

If the mass of the tether itself,  $m_T$ , is significant relative to the mass of the two end bodies, then the expressions of Section II must be modified. For a tether of uniform mass density, the orbital rate for the equilibrium configuration is given by

$$\omega^2 = \frac{Gm_1}{Qm} \left[ m_2 \frac{1}{r_2^2} + m_3 \frac{1}{r_3^2} + m_T \frac{1}{r_2 r_3} \right] \quad (3.1)$$

where the total mass is

$$m = m_2 + m_3 + m_T$$

and the center of mass,  $Q$ , is

$$Q = \frac{m_2}{m} r_2 + \frac{m_3}{m} r_3 + \frac{m_T}{m} \left( \frac{r_2 + r_3}{2} \right)$$

The last term in the equation for  $\omega^2$  corresponds to the gravitational force on the tether between bodies 2 and 3. Thus, the center of gravity,  $\bar{Q}$ , for the system is given by

$$\frac{m}{\bar{Q}^2} = \frac{m_2}{r_2^2} + \frac{m_3}{r_3^2} + \frac{m_T}{r_2 r_3} \quad (3.2)$$

and

$$\omega^2 = \frac{Gm_1}{\bar{Q}^2} = \frac{Gm_1}{\bar{Q}^3} \quad (3.3)$$

Equation 3.3 has the same form as 2.7.

To the second order in  $\left(\frac{S}{Q}\right)$ , equation 3.1 becomes

$$\omega^2 = \frac{Gm_1}{Q^3} \left[ 1 + \left\{ 3 \frac{m_2 m_3}{m^2} + \frac{m_T}{m} \left( \frac{m_2}{m} + \frac{m_3}{m} + \frac{m_T}{4m} \right) \right\} \left( \frac{S}{Q} \right)^2 \right] \quad (3.4)$$

Correspondingly, the position of zero acceleration is

$$\bar{Q} = Q \left[ 1 - \left\{ \frac{m_2 m_3}{m^2} + \frac{m_T}{3m} \left( \frac{m_2}{m} + \frac{m_3}{m} + \frac{m_T}{4m} \right) \right\} \left( \frac{S}{Q} \right)^2 \right] \quad (3.5)$$

Likewise, the tensions on body 2 and body 3 and the acceleration fields at their centers of mass are, respectively

$$\begin{aligned} T_2 = -m_2 \gamma_2 = \frac{Gm_1 m_2}{Q^2} \left\{ 3 \left[ \frac{m_3}{m} + \frac{m_T}{2m} \right] \left( \frac{S}{Q} \right) + \right. \\ \left. \left[ 3 \frac{m_3}{m} \left( \frac{m_3 - m_2}{m} \right) + \frac{m_T}{m} \left( \frac{m_3 - m_2}{m} \right) + \frac{m_T}{m} \left( \frac{m_3}{m} + \frac{m_T}{2m} \right) \right] \left( \frac{S}{Q} \right)^2 \right\} \quad (3.6) \end{aligned}$$

$$\begin{aligned}
-\tau_3 = m_3 \gamma_3 = \frac{Gm_1 m_3}{Q^2} \left\{ 3 \left[ \frac{m_2}{m} + \frac{m_T}{2m} \right] \left( \frac{S}{Q} \right) + \right. \\
\left. \left[ 3 \frac{m_2}{m} \left( \frac{m_3 - m_2}{m} \right) + \frac{m_T}{m} \left( \frac{m_3 - m_2}{m} \right) - \frac{m_T}{m} \left( \frac{m_2}{m} + \frac{m_T}{2m} \right) \right] \left( \frac{S}{Q} \right)^2 \right\} \quad (3.7)
\end{aligned}$$

#### IV. THREE AND MORE TETHERED BODIES

A radial configuration of three bodies connected by two tethers is the first constellation system of interest for its resulting acceleration fields. As a special case, the middle body can be put at the position of zero acceleration.

For the three body case, let  $m_2$  be the mass of the body closest to the Earth,  $m_3$  be the middle body and  $m_4$  be farthest from the Earth. The radial distances are  $r_2, r_3, r_4$ , respectively. Also for uniform linear mass densities, denote by  $m_{23}$  the total tether mass between bodies 2 and 3, and likewise use  $m_{34}$  for the tether between bodies 3 and 4. The tether tension pulling on body 2 due to the tether to body 3 will be denoted by  $\tau_{23}$ . Similarly, the tension at body 3 due to the tether to body 2 is  $\tau_{32}$ . By the same convention,  $\tau_{34}$  also acts on body 3 and  $\tau_{43}$  on body 4. Figure 4.1 illustrates these notations.

For the case in which the bodies execute circular orbits and the tethers lie along a geocentric radius, the force equilibria are specified by the equations below. Equation 4.1 pertains to body 2, Equation 4.2 to the tether between 2 and 3 etc.

$$\tau_{23} + m_2 r_2 \omega^2 - \frac{Gm_1 m_2}{r_2^2} = 0 \quad (4.1)$$

$$-\tau_{23} + \tau_{32} + m_{23} \left( \frac{r_2 + r_3}{2} \right) \omega^2 - \frac{Gm_1 m_{23}}{r_2 r_3} = 0 \quad (4.2)$$

$$-\tau_{32} + \tau_{34} + m_3 r_3 \omega^2 - \frac{Gm_1 m_3}{r_3^2} = 0 \quad (4.3)$$

$$-\tau_{34} + \tau_{43} + m_{34} \left( \frac{r_3 + r_4}{2} \right) \omega^2 - \frac{Gm_1 m_{34}}{r_3 r_4} = 0 \quad (4.4)$$

$$-\tau_{43} + m_4 r_4 \omega^2 - \frac{Gm_1 m_4}{r_4^2} = 0 \quad (4.5)$$

These five equations have five unknowns, namely  $\omega^2, \tau_{23}, \tau_{32}, \tau_{34}, \tau_{43}$ , where the radii and masses are considered as given.

Adding Equations (4.1) through (4.5) gives the solution for  $\omega^2$

$$\omega^2 = \frac{Gm_1}{\overline{Q}^2} = \frac{Gm_1}{\overline{Q}^3} \quad (4.6)$$

where

$$m\overline{Q} = m_2 r_2 + m_{23} \left( \frac{r_2 + r_3}{2} \right) + m_3 r_3 + m_{34} \left( \frac{r_3 + r_4}{2} \right) + m_4 r_4 \quad (4.7)$$

$$\frac{m}{\overline{Q}^2} = \frac{m_2}{r_2^2} + \frac{m_{23}}{r_2 r_3} + \frac{m_3}{r_3^2} + \frac{m_{34}}{r_3 r_4} + \frac{m_4}{r_4^2} \quad (4.8)$$

$$m = m_2 + m_{23} + m_3 + m_{34} + m_4 \quad (4.9)$$

Equation 4.6 has the same form as 2.7 and 3.3. In fact, it is clear from the derivation that the same result can be generalized directly to any number of bodies and uniform density tethers in a radial linear configuration in circular orbits.

Using Equation 4.6, the tensions are immediately derived from 4.1 through 4.6. The acceleration fields at the center of mass of each body likewise follow immediately.

$$\gamma_2 = -\frac{\tau_{23}}{m^2} = r_2 \omega^2 - \frac{Gm_1}{r_2^2} \quad (4.10)$$

$$\gamma_3 = \frac{\tau_{32}}{m_3} - \frac{\tau_{34}}{m_3} = r_3 \omega^2 - \frac{Gm_1}{r_3^2} \quad (4.11)$$

$$\gamma_4 = \frac{\tau_{43}}{m_4} = r_4 \omega^2 - \frac{Gm_1}{r_4^2} \quad (4.12)$$

If body 3 is to be positioned at the point of zero acceleration (i.e.,  $\gamma_3 = 0$ ) then as expected

$$r_3^3 = \overline{Q}^3 = \frac{Gm_1}{\omega^2} \quad (4.13)$$

But  $\omega^2$  is also a function of  $r_3$ , and therefore Equation 4.13 must be solved for  $r_3$ . A cubic equation in  $r_3$  results which can be solved analytically or numerically.

However, if the two tethers have the same linear mass density, the case reduces to that of Section 3. This can be seen intuitively because any third mass can be attached to the tether at the zero acceleration point between two

bodies without influencing the tension. The same result follows analytically from equations 4.1 through 4.5 using the uniform density condition,

$$\frac{m_{23}}{r_3 - r_2} = \frac{m_{34}}{r_4 - r_3} \quad (4.14)$$

and the condition for zero acceleration at body 3,

$$-\tau_{32} + \tau_{34} = 0 \quad (4.15)$$

Thus, in this case, Equation 3.5 can be written to second order,

$$r_3 = \bar{Q} = Q \left[ 1 + \left\{ \frac{m_2 m_4}{m} + \frac{m_{24}}{3m} \left( \frac{m_2}{m} + \frac{m_4}{m} + \frac{m_{24}}{4m} \right) \right\} \left( \frac{S}{Q} \right)^2 \right] \quad (4.16)$$

where

$$m = m_2 + m_{24} + m_4 \quad (4.17)$$

$$mQ = m_2 r_2 + m_{24} \left( \frac{r_2 + r_4}{2} \right) + m_4 r_4 \quad (4.18)$$

Figure 1

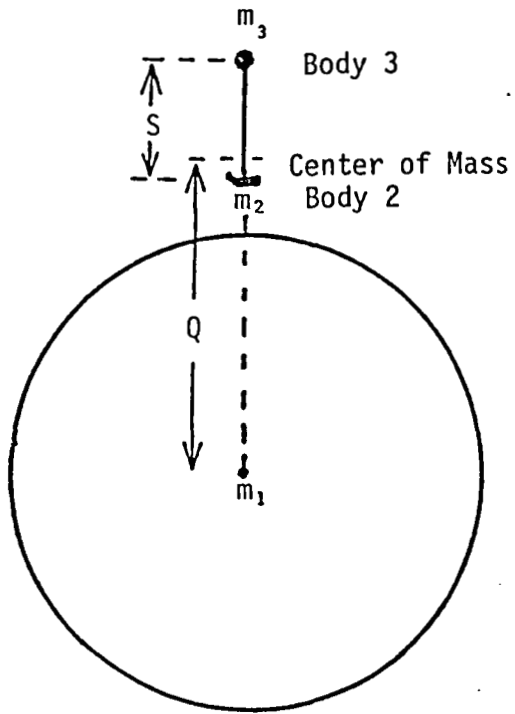
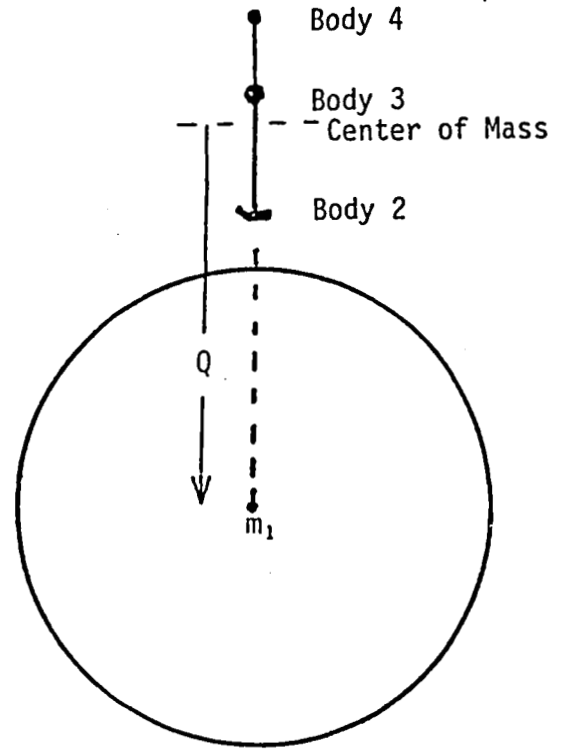

Figure 2





REMARKS TO THE CONTROLLED GRAVITY PANEL

James R. Arnold

The necessary level of acceleration for materials studies (microgravity) on the space station or other work platform in LEO is not now well defined. Some suggestions have placed this level as low as  $10^{-7}$ ,  $10^{-8}$  or even  $10^{-9}$  g.

Discussions yesterday made it clear that such levels can only be achieved if many subtle second-order and third-order effects are controlled.

My colleagues in the materials field, and especially just those persons most active in experimental programs, have convinced me of one basic point:

"The level of microgravity must not be allowed to be the cost driver for the first facilities put into use".

What should be done is to achieve what can be done with the use of tethers and intelligent design, but not to attempt highly complex and difficult technologies beyond that point. I have the impression (perhaps wrong) that accelerations on the order of  $10^{-5}$  g, or even perhaps better, can be achieved in this way. This will already allow a rich field of studies in materials science and related fields.

Venezia, 16 October, 1985



---

# TETHERED ORBITAL REFUELING STUDY

PRESENTED BY

DALE A. FESTER  
MARTIN MARIETTA DENVER AEROSPACE  
DENVER, COLORADO

PRESENTED TO  
APPLICATIONS OF TETHERS IN SPACE WORKSHOP  
VENICE, ITALY/OCTOBER 15-17, 1985

**MARTIN MARIETTA**

1 - 10/15/85

# PROGRAM OVERVIEW

---

PROGRAM TITLE: TETHERED ORBITAL REFUELING STUDY

CONTRACT: NAS9-17059

PROGRAM MANAGER: DALE FESTER (303) 977-8699

CUSTOMER: NASA-JSC  
KENNETH R. KROLL, TECHNICAL MONITOR

PROGRAM OBJECTIVES: EVALUATE THE FEASIBILITY AND LIMITATIONS OF FLUID ACQUISITION AND TRANSFER UNDER AN ACCELERATION INDUCED IN A TETHERED ORBITAL REFUELING FACILITY AND PROVIDE CONCEPTUAL DESIGNS

PERIOD OF PERFORMANCE: NOVEMBER 1983 TO AUGUST 1985

**MARTIN MARIETTA**

2 - 10/15/85

# PROGRAM TASKS

- 0 RECOMMEND THE FLUID TRANSFER METHOD AND PARAMETERS
- 0 EVALUATE DISTURBANCES, FLUID MOTION, AND DAMPING
  - ESTABLISH NECESSARY FACILITY CONFIGURATION DETAILS
  - DETERMINE TYPE, RELATIVE MAGNITUDE, AND SOURCES OF DISTURBANCES
  - DEVELOP DAMPING CRITERIA FOR EACH TYPE OF FLUID MOTION
  - DETERMINE ENVELOPE OF OPERATION IMPOSED BY THE DAMPING CRITERIA
- 0 SELECT PASSIVE DEVICES TO AUGMENT INHERENT FLUID DAMPING AND DETERMINE THE RESULTANT ENVELOPE OF OPERATION
- 0 ASSESS FACILITY IMPACTS ON SPACE STATION AND OTV DESIGN REQUIREMENTS
- 0 ASSESS THE EFFECT OF TETHER LENGTH ON HAZARDS ASSOCIATED WITH TANK OVERPRESSURE EXPLOSION AND CONTAMINATION DUE TO PROPELLANT LEAKAGE OR VENTING
- 0 IDENTIFY GROUND AND FLIGHT TESTS NECESSARY TO PROVE THE TETHERED ORBITAL REFUELING CONCEPT

# STUDY LOGIC FLOW

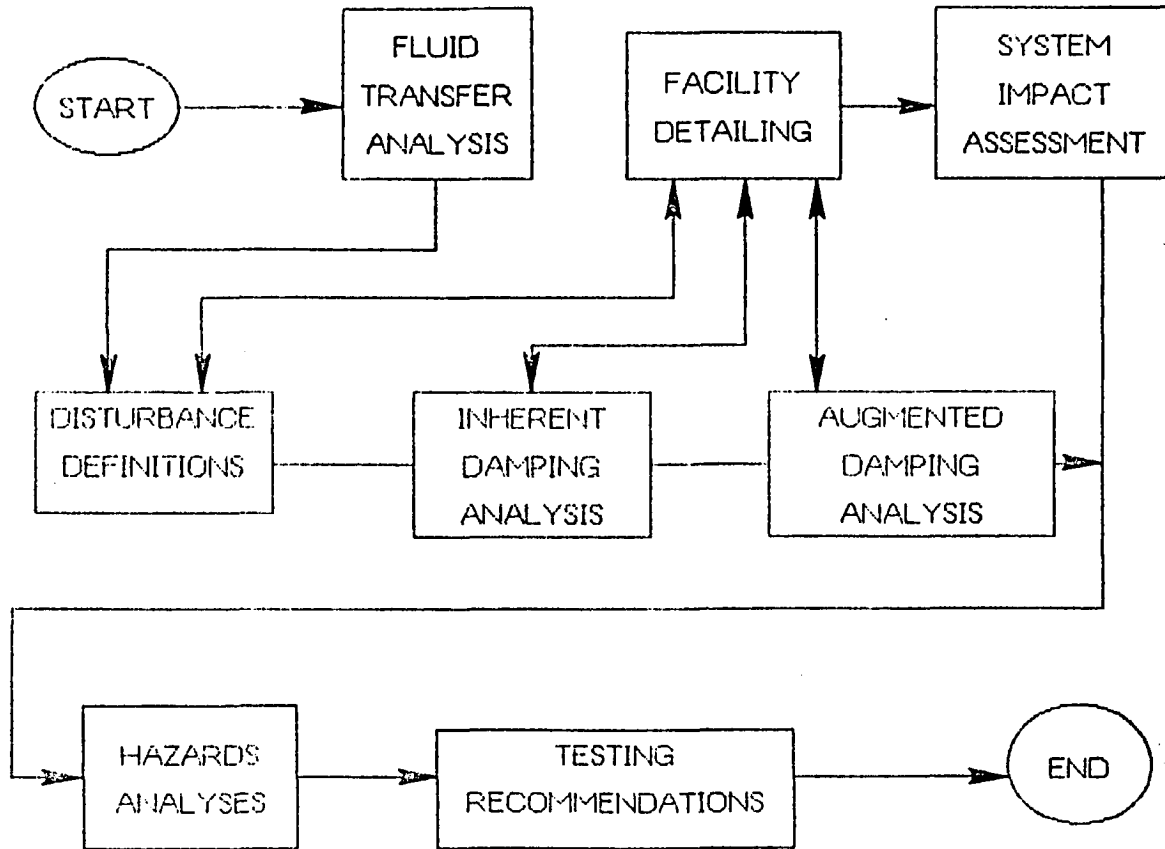

# WORK STATEMENT GROUNDRULES

0 3 TETHER CASES

- STATIC, VERTICAL TETHER WHERE MOTION IS DUE TO FLUID MOTION ONLY
- GENERAL PENDULUM MOTION THROUGH A FIXED ANGLE EITHER ALONG OR PERPENDICULAR TO THE ORBITAL PLANE

0 FACILITY C.G. IS MAINTAINED ALONG THE TETHER AXIS

0 PROPELLANTS: L<sub>2</sub>O<sub>2</sub>/LH<sub>2</sub>: 100,000 LBM STORAGE AND 45,000 LBM TRANSFERRED  
N<sub>2</sub>O<sub>4</sub>/MMH AND N<sub>2</sub>H<sub>4</sub>: CONSIDER ONLY IN A CURSORY SENSE

0 INDIVIDUAL TANKS ARE 14 FEET IN DIAMETER OR LESS AND 90%, 50% OR 10% FULL

0 TRANSFER METHODS: PRESSURE, PUMP, OR GRAVITY FEED

0 THE SPACE STATION, REFUELING FACILITY AND PROPULSION STAGE ARE LOCATED IN A NOMINAL ORBIT OF 250 NAUTICAL MILES

**MARTIN MARIETTA**

5 - 10/15/85

# MINIMUM TETHER LENGTH

## SYSTEM CONFIGURATION

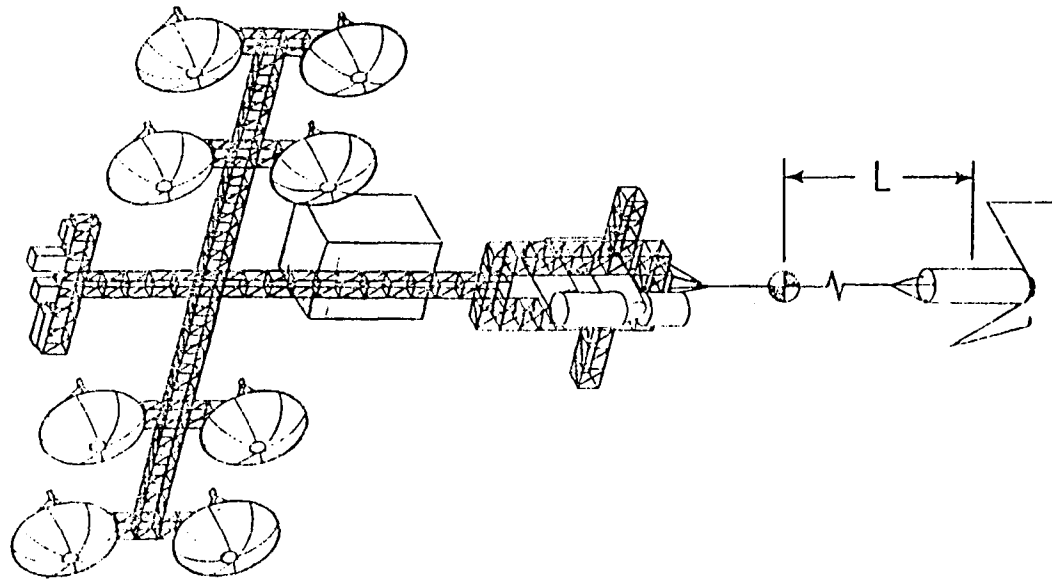

BOND NUMBER MUST BE OVER 50; THUS:

$$L \geq \frac{4 B_0 \sigma}{1.16 \times 10^{-7} \rho D^2}$$

PROPELLANT	L, FT	ACCELERATION, g
LO <sub>2</sub>	120	1.4 X 10 <sup>-5</sup>
LH <sub>2</sub>	280	3.2 X 10 <sup>-5</sup>

**MARTIN MARIETTA**

6 - 10/15/85



# GRAVITY DRIVEN TRANSFER

0 REQUIRED TETHER LENGTH WAS FOUND BY EQUATING LINE PRESSURE DROP TO GRAVITY HYDROSTATIC HEAD

0 LINE PRESSURE DROP IS BASED ON FANNING EQUATION

- ASSUMES NOMINAL 30 FT LINE LENGTH

- NEGLECTS VALVE AND FILTER PRESSURE DROPS

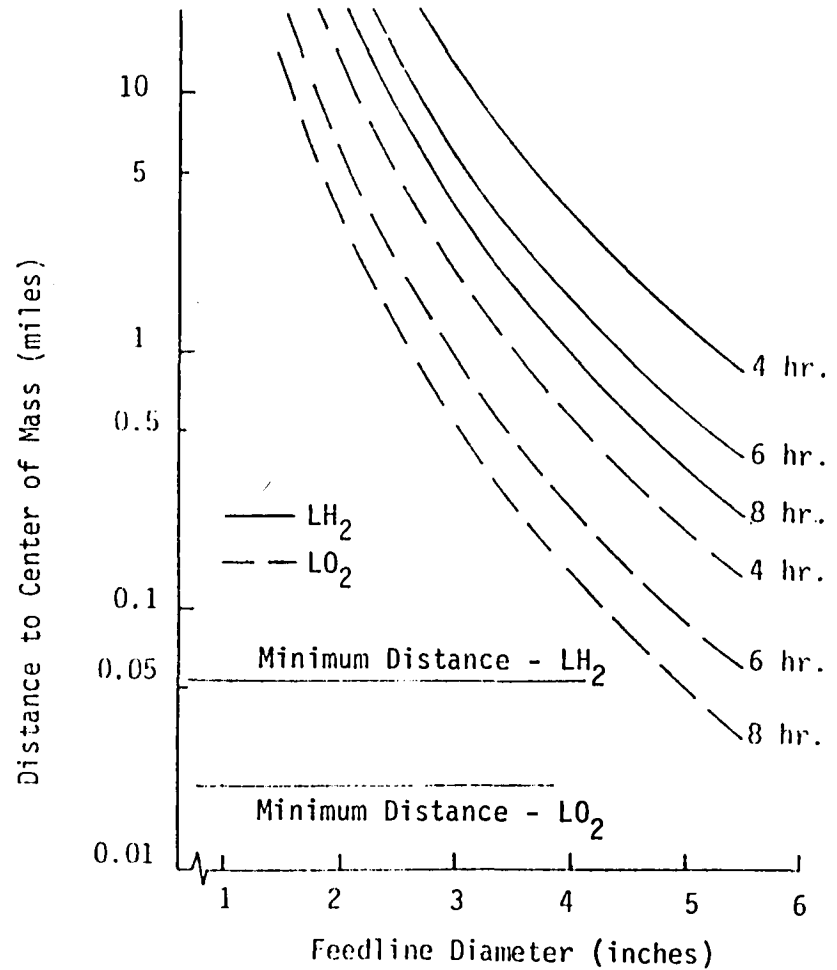

**MARTIN MARIETTA**

7 - 10/15/85

# FLUID TRANSFER METHOD SELECTION

## TANK FILL METHODS

- 0 VENT WHILE FILLING
- 0 EVACUATED FILL
- 0 ULLAGE RECOMPRESSION

## TRANSFER METHODS

- 0 PRESSURIZED
- 0 PUMPED
- 0 GRAVITY

## SELECTION FACTORS

- 0 ABILITY TO ACCOMPLISH FILL
- 0 VENTING REQUIREMENTS
- 0 RELIABILITY
- 0 TRANSFER TIME
- 0 MASS

AUTOGENOUS PRESSURIZED TRANSFER  
WAS CHOSEN FOR CRYOGENS

**MARTIN MARIETTA**

8 - 10/15/85

# TANK SHAPE ALTERNATIVES

## LH<sub>2</sub> TANKS (19,000 LBM)

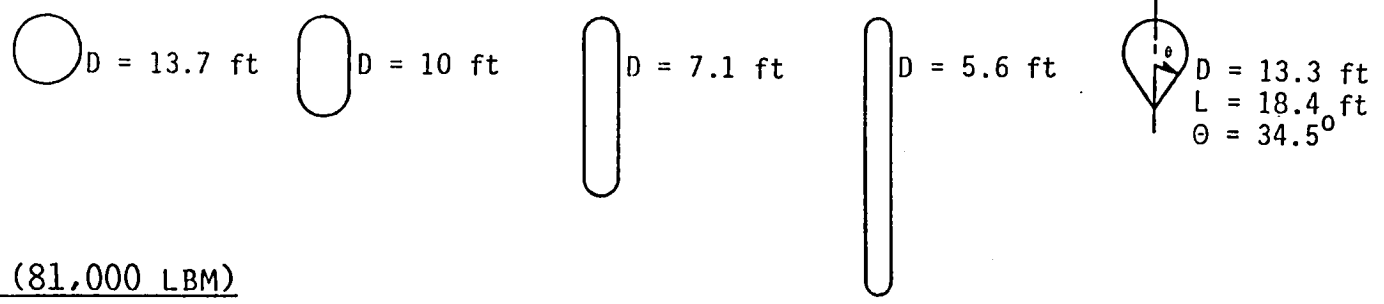
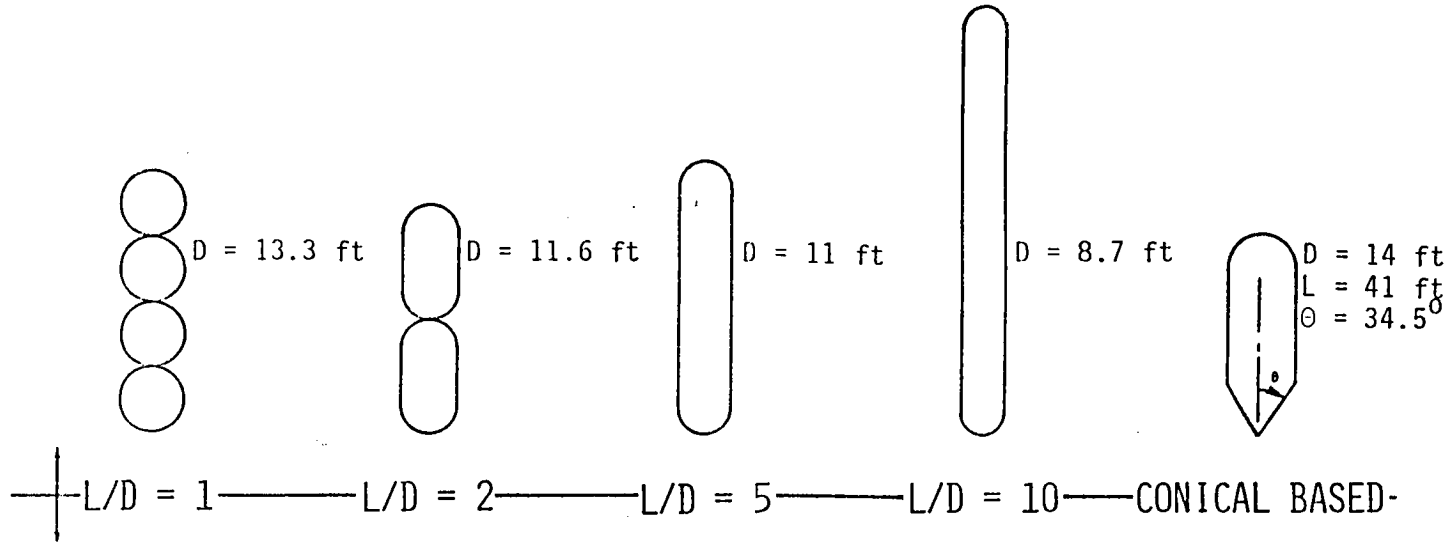

## LO<sub>2</sub> TANKS (81,000 LBM)

**MARTIN MARIETTA**

9 - 10/15/85

# ALLOWABLE SLOSH ENERGY

$$\Delta E = M \Delta G \Delta H$$

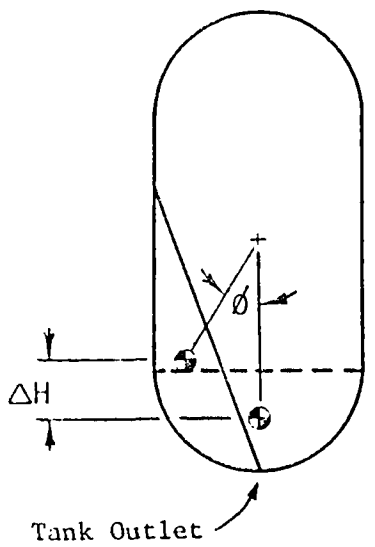

ENERGY for LH<sub>2</sub>, ft-lbf

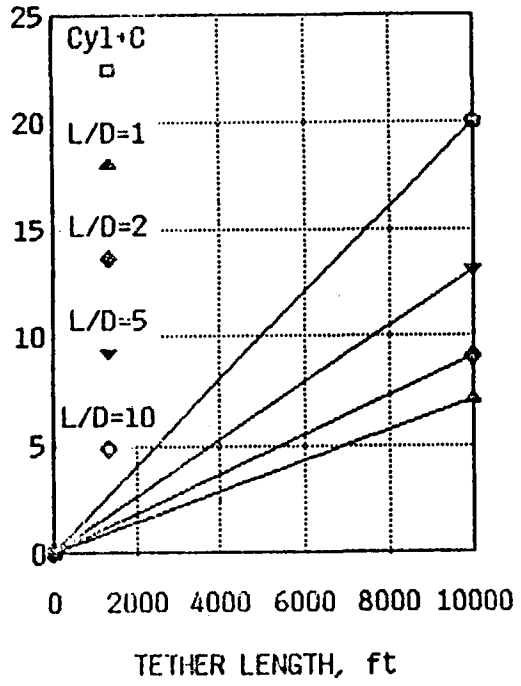

98

**MARTIN MARIETTA**

10 - 10/15/85

# TANK ANALYSIS RESULTS

	<u>L/D = 1</u>	<u>L/D = 2</u>	<u>L/D = 5</u>	<u>L/D = 10</u>	CONICAL BASED
<u>LH2</u>					
TANK AND MLI MASS, LBM	5,716	4,362	5,008	6,163	4,110
BOILOFF, LBM	28,768	21,900	25,230	31,010	20,674
TOTAL MASS, LBM	34,484	26,262	30,238	37,173	24,784
SLOSH ENERGY, FT-LBF (10% FILL, 3000 FT TETHER)	2	3	4	6	6
<u>L02*</u>					
TOTAL MASS, LBM	1,202	1,299	1,830	2,525	1,262
SLOSH ENERGY, FT-LBF (10% FILL, 3000 FT TETHER)	6	7	11	16	14

\* L02 BOILOFF IS ZERO; L02 VCS IS COOLED BY H<sub>2</sub>

**MARTIN MARIETTA**

11 - 10/15/85

# FACILITY DESIGN CHARACTERISTICS

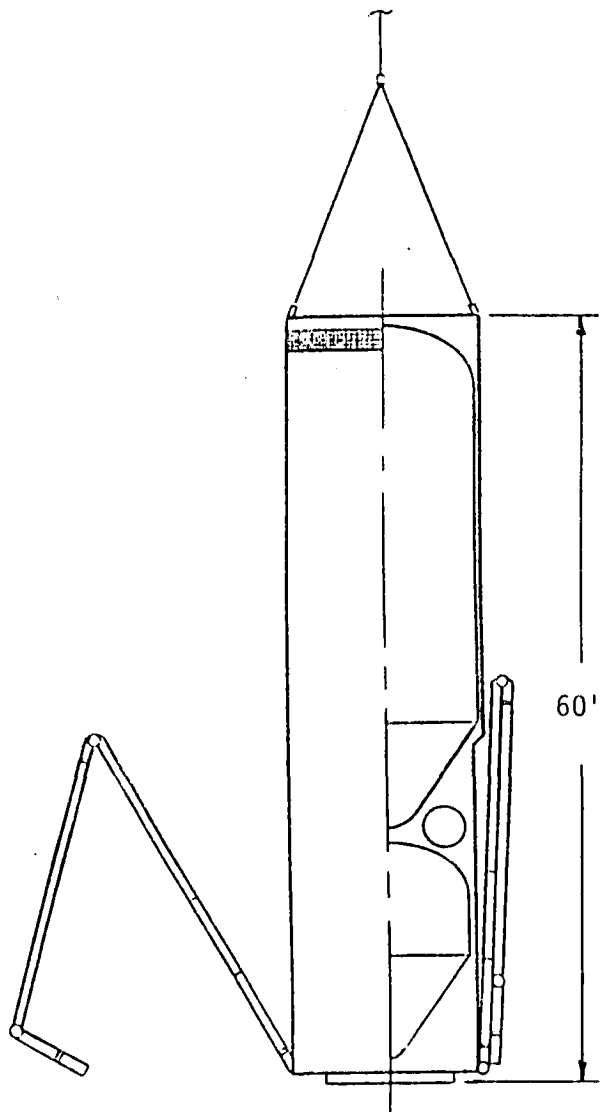

<u>ITEM</u>	<u>MASS, LBM</u>
TANKS/FEED SYSTEM	5,570
STRUCTURE AND DEBRI SHIELDING	11,000
THERMAL CONTROL	4,000
PRESSURIZATION SYSTEM	1,080
POWER/ENERGY STORAGE	1,700
ACS/PROPULSION	500
CONTROL/MONITORING	1,000
AVIONICS	500
GRAPPLING/DOCKING EQUIPMENT	<u>3,000</u>
DRY MASS	28,350
PROPELLANT	<u>100,000</u>
TOTAL MASS	128,350

**MARTIN MARLETTA**

# TORF LAUNCH CONFIGURATION

0 STS AVAILABLE PAYLOAD BAY IS 60 FT

- DEPLOYMENT IS VIA SPRING LOADED TRUNNIONS AND STS RMS
- DEPLOYMENT WILL BE IN PROXIMITY (<100 M) OF SPACE STATION

0 TORF RMS LAUNCH CONFIGURATION

- STOWED IN CHANNEL ALONG TORF SIDE
- WRIST AND GRAPPLE FIXTURE SECURED ON TORF AFT END
- 6.9 FT (2.1 M) TELESCOPING SECTION IN UPPER ARM STOWED IN RETRACTED POSITION

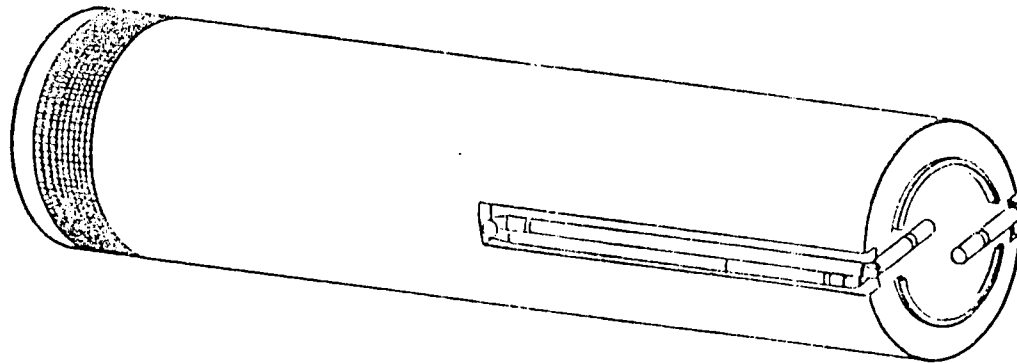

**MARTIN MARIETTA**

13 - 10/15/85

# FLUID SYSTEM SCHEMATIC

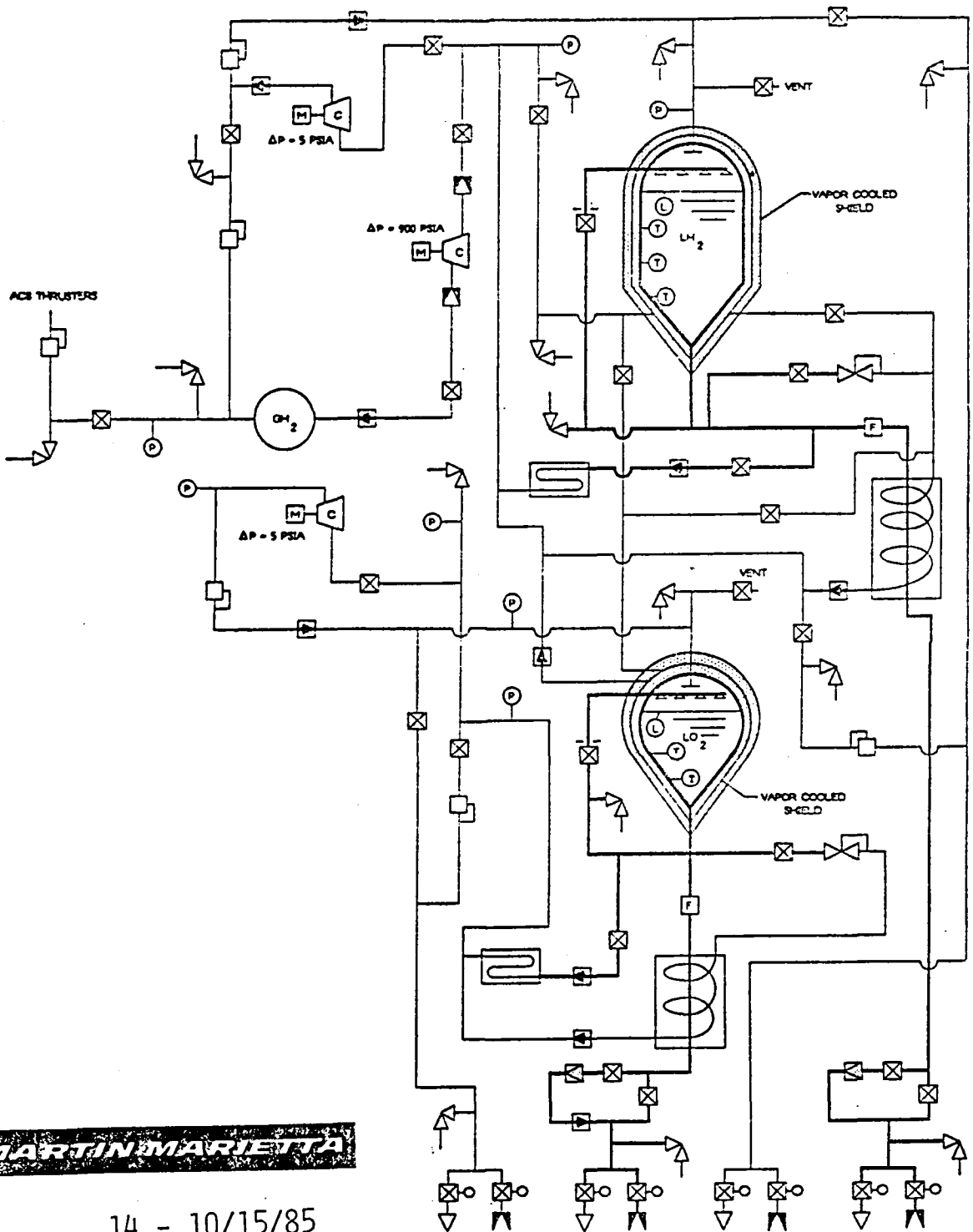

**MARTIN MARIETTA**

14 - 10/15/85



# AUXILIARY PROPULSION

- 0 REQUIREMENTS INCLUDE ATMOSPHERIC DRAG MAKE-UP, SHUTTLE BERTHING, AND OTV BERTHING
  - SHUTTLE AND OTV APPROACH VELOCITIES ARE ASSUMED TO BE 2 FT/S
- 0 CONTINUOUS DRAG MAKE-UP IS NECESSARY TO MINIMIZE THRUSTER INDUCED TORF LIBRATION
  - A SINGLE BURN OF A 30 DAY REBOOST INDUCES LIBRATION ANGLES OF OVER 30° WITH 25, 50 OR 100 LBF THRUSTERS
- 0 USING ONLY H<sub>2</sub> BOILOFF IN COLD GAS THRUSTERS, THE APS REQUIREMENT CAN BE MET WITH A SPECIFIC IMPULSE OF 220 s
  - BOTH TORF AND SPACE STATION DRAG MAKE-UP CAN BE DONE WITH A SPECIFIC IMPULSE OF 570 s
- 0 BASELINE 220 s SPECIFIC IMPULSE THRUSTERS FOR TORF AUXILIARY PROPULSION, EXCLUDING SPACE STATION DRAG MAKE-UP

# DEBRIS SHIELD DIMENSIONAL REQUIREMENTS

- 0 NASA SPECIFICATION - A 95% PROBABILITY OF NO PENETRATION OF SHIELD OR TANK IN A 10-YEAR PERIOD
- 0 TO MEET REQUIREMENT, AN ALUMINUM PARTICLE, 1 CM IN DIAMETER, MOVING AT 9 KM/S MUST BE STOPPED
- 0 BASELINE SHIELD DESIGN IS A TWO-WALL TYPE WITH BUMPER AND BACKWALL
- 0 SHIELD WALL THICKNESSES GIVEN BY EXPERIMENTAL CORRELATION AS A FUNCTION OF
  - PARTICLE MASS
  - PARTICLE VELOCITY
  - PARTICLE DENSITY
  - WALL YIELD STRENGTH
  - WALL DENSITY
  - BUMPER-TO-BACKWALL SPACING

(REF. ESA SP 153, PROTECTION FOR HALLEYS COMET MISSION, BURTON G. COUR-PALAIS)

**MARTIN MARIETTA**

16 - 10/15/85

# TORF DEBRIS SHIELD

- 0 ALUMINUM TANK WALL UTILIZED AS BACK WALL
  - DICTATED BY WELD LAND MINIMUM THICKNESS
  - REQUIRED THICKNESS IS 0.32 CM
- 0 ALUMINUM HONEYCOMB SUPPORT STRUCTURE OUTER SHEAR PANEL UTILIZED AS BUMPER
- 0 VCS, MLI, AND HONEYCOMB STRUCTURE INNER SHEAR PANEL PROVIDE ADDITIONAL PROTECTION
- 0 VCS TUBE EXPOSED AREA IS SMALL
  - HONEYCOMB STRUCTURE IS SUFFICIENT SHIELDING
  - MEETS NASA SPECIFICATION OF 95% PROBABILITY OF NO PUNCTURE

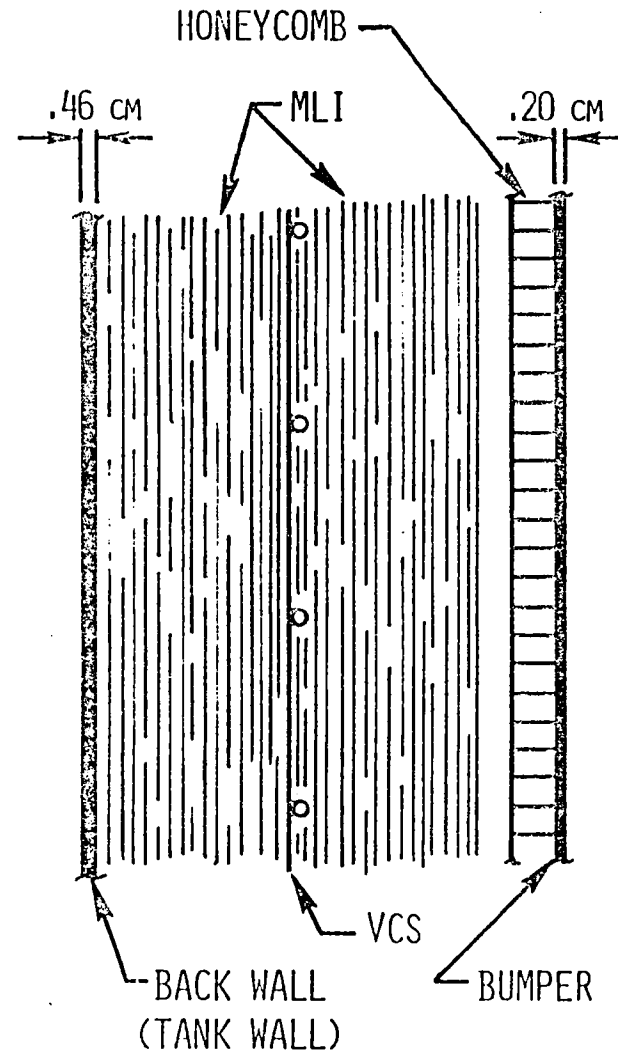

MARTIN MARIETTA

17 - 10/15/85

# FACILITY/FLUID DYNAMICS STUDY

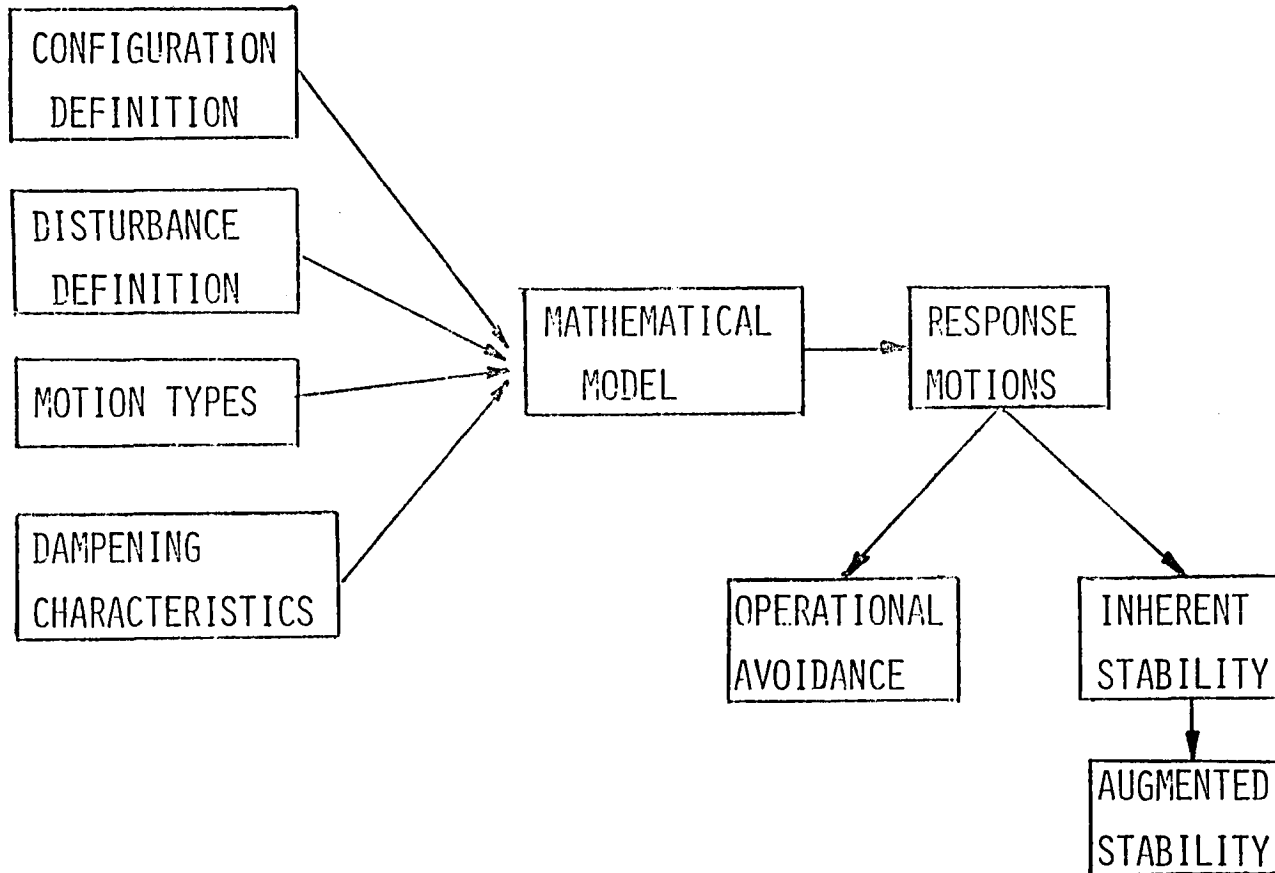

# DISTURBANCE TYPES AND MAGNITUDES

<u>TYPE</u>	<u>MAGNITUDE</u>	<u>DESCRIPTION</u>
IMPULSIVE	0-16000 LBF-SEC 0-100 IN LBF-SEC	BERTHING ATTITUDE CONTROL
RANDOM	0-10 LBF	CREW MOVEMENT
SINUSOIDAL	$2 \times 10^{-2}$ LBF, 90 MIN PERIOD $10^{-6}$ G, 90 MIN PERIOD	DRAG ON SOLAR ARRAYS LUNAR GRAVITY
STEADY STATE	$3 \times 10^{-3}$ LBF	ATMOSPHERIC DRAG
STEP	0.028 LBF 100 LBF, 10 MIN/30 DAYS	STATIONKEEPING REBOOST
TRANSIENTS	$10^{-3}$ LBF $10^{-2}$ LBF	FLUID TRANSFER STARTUP STEADY FLOW

**MARTIN MARIETTA**

19 - 10/15/85

# INITIAL DYNAMICS ANALYSES

0 SMALL-DISTURBANCE, LINEAR, PLANAR MODEL (2640 FT TETHER)

<u>MODE</u>	<u>MOTION</u>	<u>PERIOD, s</u>	<u>G<sub>0</sub>, RAD/LBF</u>	<u>G<sub>H</sub>, RAD/LBF</u>
1	TETHER PENDULUM	3190	$6 \times 10^{-5}$	$1.5 \times 10^{-4}$
2	FACILITY PENDULUM	181	$1.6 \times 10^{-3}$	$5.3 \times 10^{-3}$
3	FACILITY FLUIDS	124	$1.3 \times 10^{-2}$	$2.2 \times 10^{-2}$
4	FACILITY FLUIDS	113	$7 \times 10^{-3}$	$3.9 \times 10^{-2}$
5	OTV FLUIDS	95	$3.1 \times 10^{-4}$	$4.8 \times 10^{-4}$
6	OTV FLUIDS	76	$7.3 \times 10^{-4}$	$2.4 \times 10^{-4}$

0 FREQUENCY IS A LINEAR FUNCTION OF TETHER LENGTH

# MODEL APPROACH

---

THE MODEL IS A COLLECTION OF POINT MASS CONNECTED BY RIGID LINKS

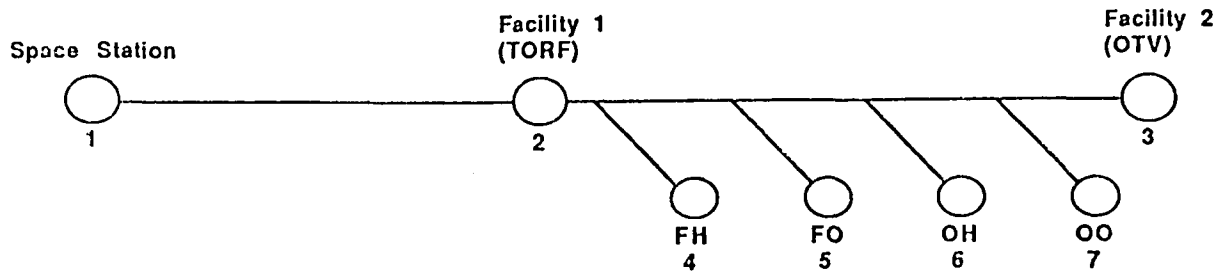

THE FACILITY AND OTV AS A SINGLE RIGID BODY IS REPRESENTED BY 2 MASSES WHICH ARE SEPARATED BY A DISTANCE WHICH GIVES THE SAME CENTER OF MASS AND THE SAME PITCH AND YAW INERTIAS. EACH FLUID MASS IS REPRESENTED AS A PENDULUM WHOSE LENGTH IS BASED ON TANK GEOMETRY

**MARTIN MARIETTA**

21 - 10/15/85

# ANALYSIS APPROACH

- 0 IDENTIFY WORST-CASE DISTURBANCES
- 0 EVALUATE LIMITS FOR ZERO DAMPING
  - FLUID SLOSH AMPLITUDE
  - FACILITY SWING ANGLE
- 0 EVALUATE LIMITS FOR DAMPING TIME CONSTANT
- 0 SYSTEM PARAMETERS
  - FACILITY FILL: 10%, 50%, 90%
  - OTV FILL: 10%, 50%, 90%
  - TETHER LENGTH: 500 FT, 1000 FT, 2000 FT, 4000 FT
  - FACILITY MAXIMUM SWING ANGLE: 0°, 15°, 30°

110



# DISTURBANCES

- 0 VARIOUS FORCING FUNCTIONS ORIGINATING ON THE SPACE STATION WERE CONSIDERED
  - IN PLANE
  - OUT OF PLANE
  - ALONG RADIUS
  - STATION DELTA = 1 FT/S (MAXIMUM).
- 0 DISTURBANCES ON TORF DURING FLUID TRANSFER ( $\sim .01$  LBF) ARE NEGLIGIBLE
- 0 THE WORST CASE DISTURBANCE WAS USED FOR ALL FOLLOWING ANALYSES

III

**MARTIN MARIETTA**

23 - 10/15/85

# RESULTS

COMPARISON OF DAMPED AND UNDAMPED SLOSH RESPONSES DUE TO A 1 FT/SEC VELOCITY CHANGE OF THE SPACE STATION. TETHER LENGTH = 1000 FT.

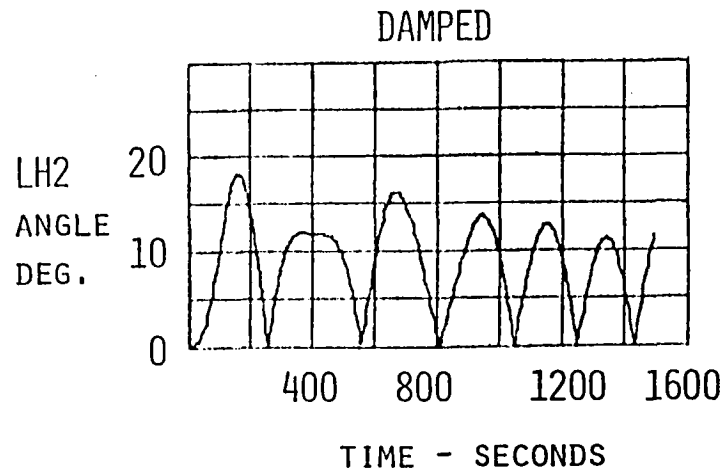
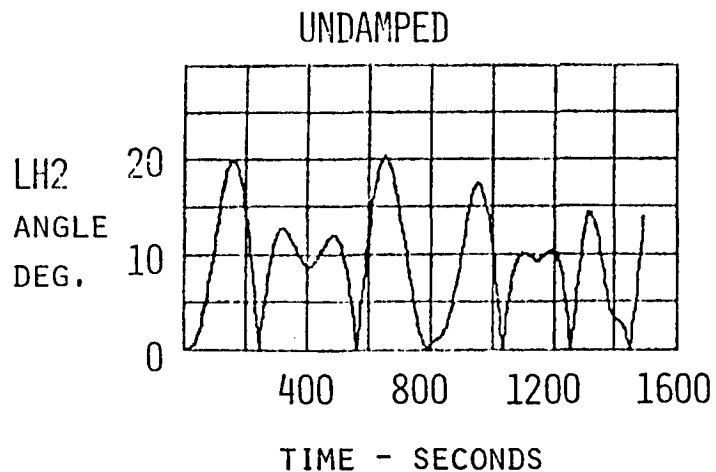

**MARTIN MARIETTA**

24 - 10/15/85

# RESULTS (CONTINUED)

TETHER AND FACILITY SWING ANGLES FOR THE UNDAMPED CASE OF A 1 FT/SEC VELOCITY CHANGE OF THE SPACE STATION

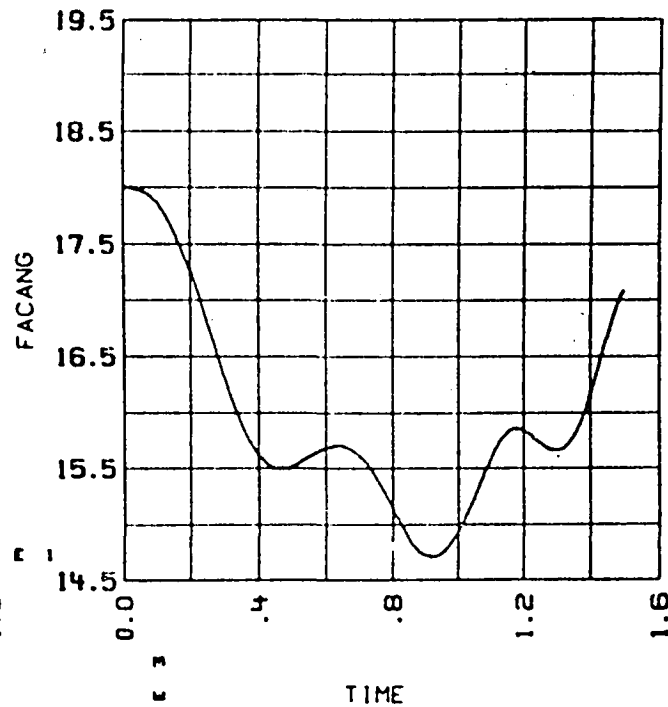
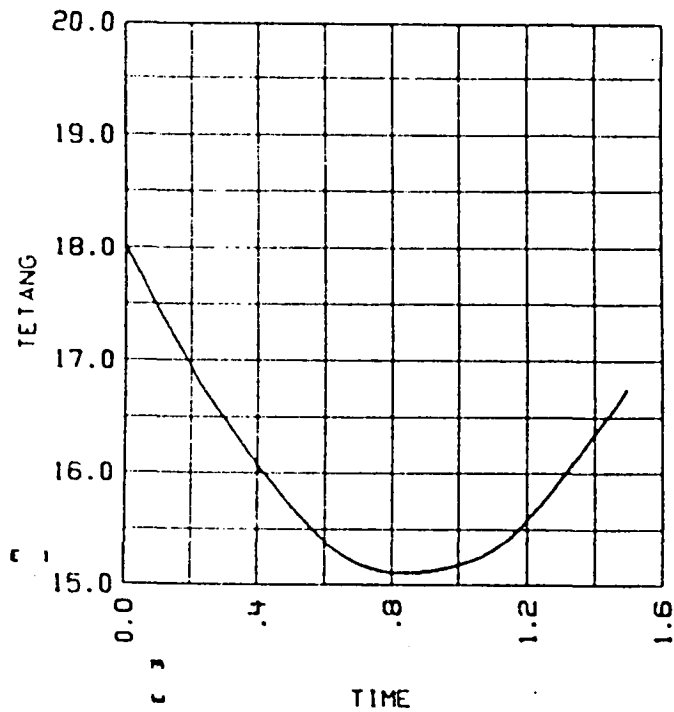

# RESULTS (CONCLUDED)

---

FLUID SLOSH ANGLE AS A FUNCTION OF TETHER LENGTH FOR A 1 FT/SEC VELOCITY CHANGE OF THE SPACE STATION

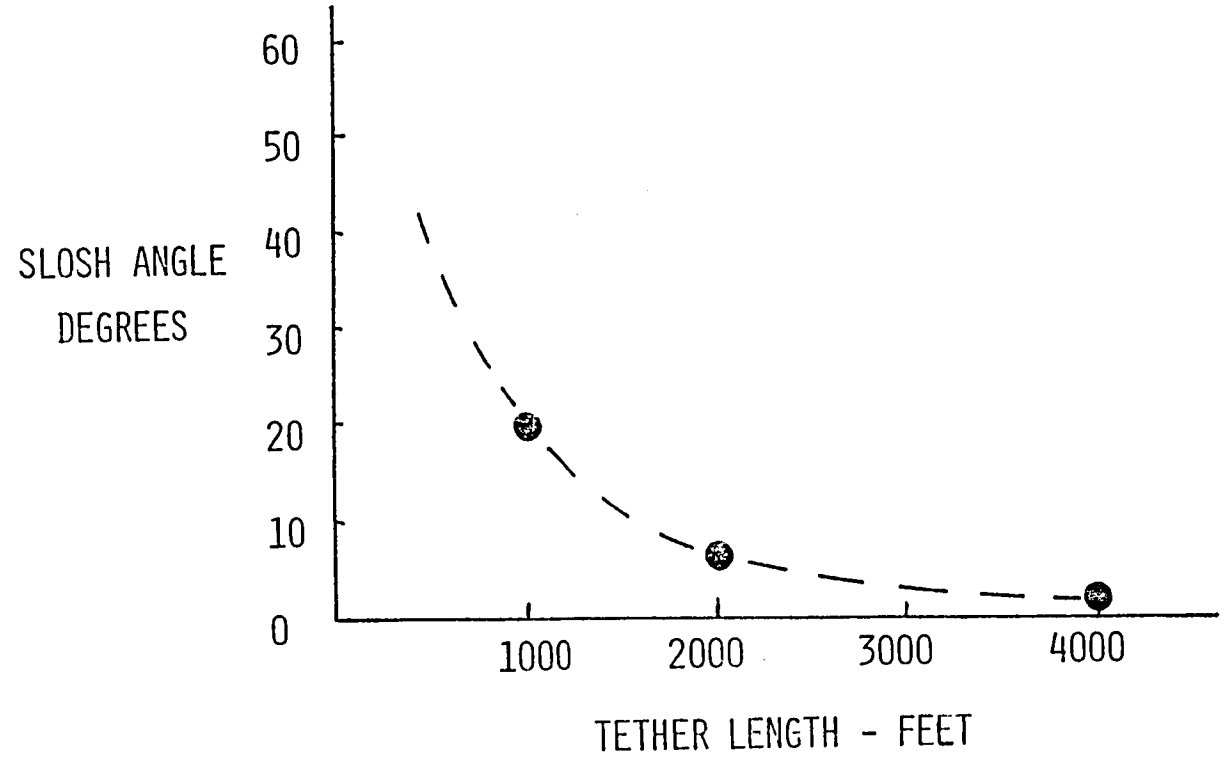

114

**MARTIN MARIETTA**

26 - 10/15/85

# CONCLUSIONS

---

- 0 WORST DISTURBANCES ARE IMPULSIVE
- 0 FLUID MOTION SENSITIVE TO TETHER LENGTH
- 0 DAMPING REQUIRED FOR MOTION PERSISTANCE
- 0 MAXIMUM MOTION INSENSITIVE TO DAMPING
- 0 MINIMUM DAMPING 5%
- 0 MINIMUM TETHER LENGTH 1000 FT

# POWER TOWER SPACE STATION DESIGN

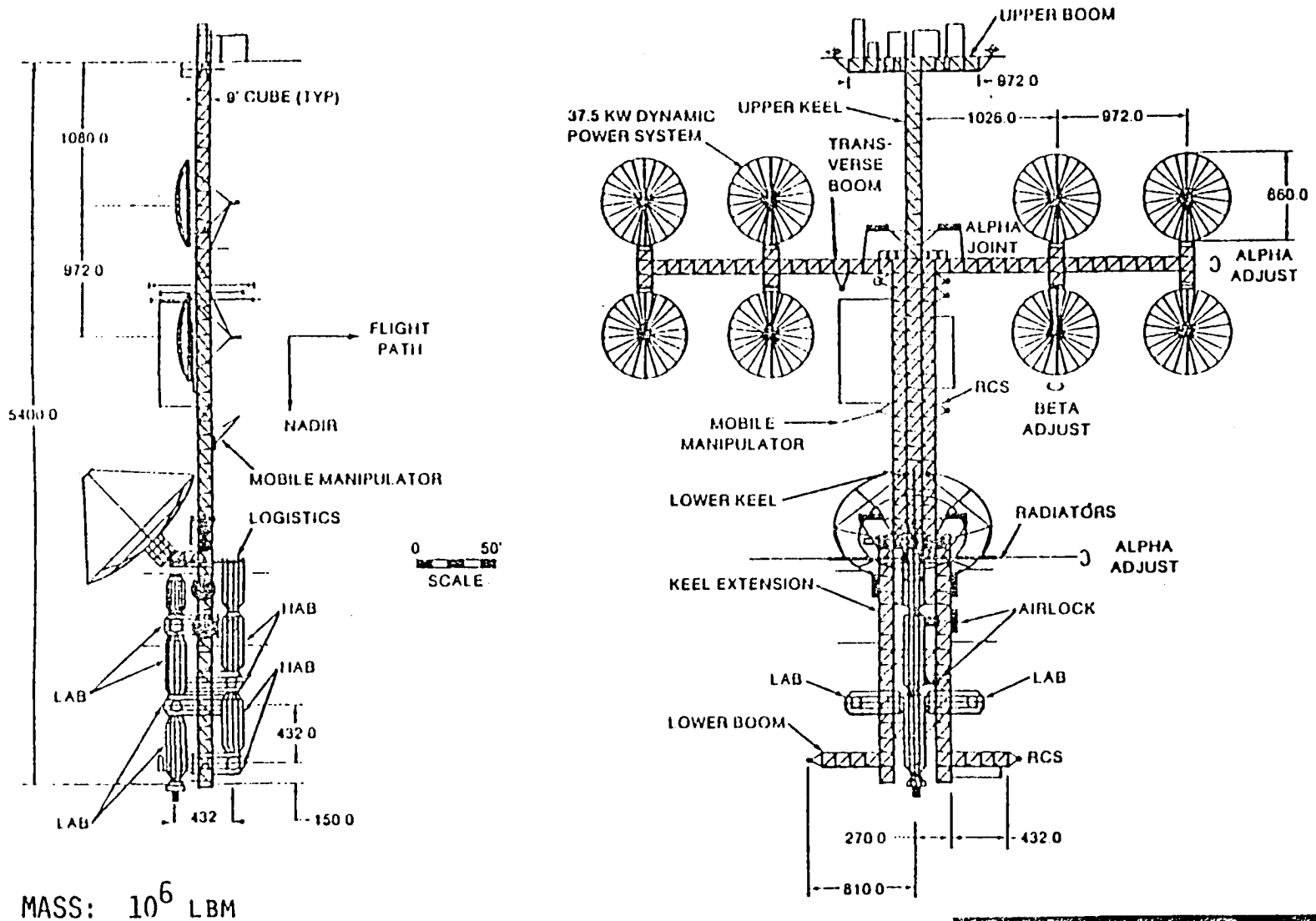

MASS:  $10^6$  LBM

**MARTIN MARIETTA**

28 - 10/15/85

# SPACE STATION IMPACT ASSESSMENT

- 0 SPACE STATION HARDWARE NECESSARY TO SUPPORT THE TORF INCLUDES
  - TETHER DEPLOYMENT PALLET
  - TETHER DEPLOYMENT BOOM
  - TORF BERTHING MECHANISM
  - TRACKING/RANGING ELECTRONICS
  
- 0 MAJOR TECHNOLOGICAL ADVANCES ARE NOT NECESSARY TO DEVELOP THIS HARDWARE
  
- 0 ACCELERATION OF OVER  $10^{-5}g$  ARE IMPOSED ON THE SPACE STATION
  
- 0 BERTHING THE ORBITER OFF-AXIS AT THE STATION WILL IMPOSE ATTITUDE TORQUES AND SHIFTS IN THE GRAVITY GRADIENT MAGNITUDE
  
- 0 PROXIMITY OPERATIONS MUST AVOID TETHER
  
- 0 RENDEZVOUS WITH EITHER THE TORF OR THE STATION INVOLVES NON-KEPLERIAN ORBITS AND MUST BE DONE "ON THE FLY"

117

**MARTIN MARIETTA**

29 - 10/15/85

# TORF/OTV OPERATIONS

- 0 SEVERAL OPTIONS EXIST FOR OTV DEPLOYMENT TO TORF
  - THE OMV MANEUVERS THE OTV/PAYLOAD PACKAGE TO THE TORF
  - A CRAWLER TRANSPORTS THE OTV/PAYLOAD DOWN THE TETHER TO THE TORF
  
- 0 THE OMV MANEUVER WAS BASELINED FOR THE BERTHING MANEUVER
  - RENDEZVOUS WITH OUTBOARD END OF DEPLOYED FACILITY APPEARS BEST
  
- 0 HARDWARE NECESSARY FOR VEHICLE DOCKING INCLUDES
  - STRONG RMSs
  - BERTHING RING WITH LATCHES
  - FLUID TRANSFER CONNECTOR
  
- 0 TIMELINE INCLUDES:
  - SIX OTV REFUELING PER YEAR
  - SIX OTV SCAVENGING (IF DESIRABLE) PER YEAR
  - SIX STS RESUPPLY PER YEAR



# PROXIMITY OPERATIONS

- 0 THE OMV MANEUVERS THE OTV AROUND THE SPACE STATION
  - MAXIMUM OTV/PAYLOAD DRY MASS IS 23,000 LBM
  
- 0 OMV ORBITAL MANEUVERING DEPENDS ON TORF DEPLOYMENT DIRECTION WITH RESPECT TO THE SPACE STATION
  - WITH THE TORF DEPLOYED TOWARDS THE EARTH, THE OTV/OMV/PAYLOAD PACKAGE RELEASES FROM THE SPACE STATION AND DROPS TO THE TORF. A MISDOCK RESULTS IN THE VEHICLE AND FACILITY DRIFTING AWAY FROM EACH OTHER
  
  - WITH THE TORF DEPLOYED AWAY FROM THE EARTH, THE OMV MUST FIRE TOWARDS THE STATION TO MOVE AWAY. A MISDOCK RESULTS IN THE VEHICLE AND FACILITY DRIFTING TOWARDS EACH OTHER

# GRAPPLE MANEUVER

## 0 GRAPPLING SCENARIO FOR OMV/OTV/PAYLOAD PACKAGE

- VEHICLE APPROACHES FACILITY.
- GRAPPLE ARM #1 ATTACHES TO OMV.
- GRAPPLE ARM #2 REACHES AROUND OTV AEROBRAKE AND ATTACHES TO OTV.
- GRAPPLE ARM #1 RELEASES OMV.
- OMV RELEASES OTV/PAYLOAD AND FLIES AWAY.
- GRAPPLE ARM #1 ATTACHES TO OTV.
- BOTH ARMS PULL OTV/PAYLOAD TO HARD DOCK ON TORF.
- FLUID TRANSFER LINES ATTACH.

## 0 A MODIFIED RMS IS BEING CONSIDERED FOR THE GRAPPLE ARM.

- LONGER AND STRONGER ARMS
- STRONGER JOINTS
- STRONGER ATTACH POINTS
- MODIFIED GRAPPLE FIXTURE

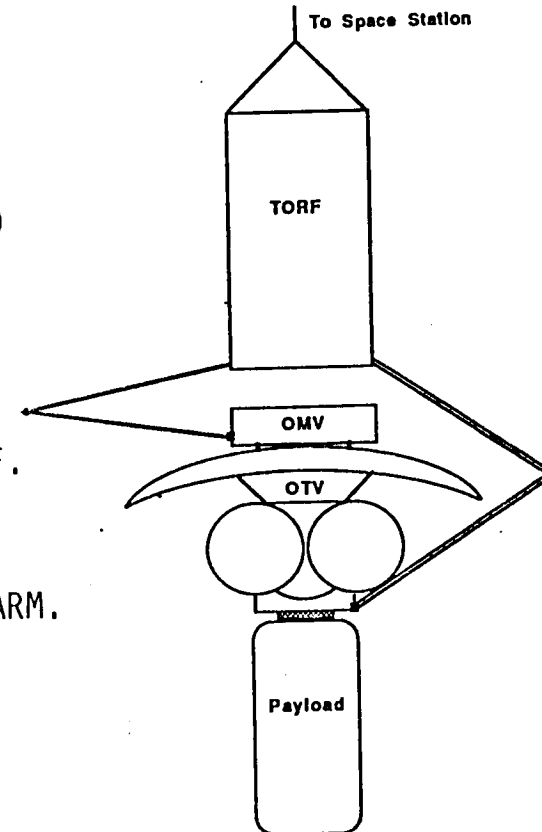

**MARTIN MARIETTA**

32 - 10/15/85

# TETHER BREAKING OR SEVERING

- 0 ASSUME
  - THE NOMINAL ORBIT ALTITUDE IS 250 NMI
  - THE FACILITY IS ABOVE THE SPACE STATION
  - THE FACILITY IS FULLY LOADED
  
- 0 FOR A 3000 FT DISTANCE FROM THE SPACE STATION TO THE CENTER OF MASS AFTER BREAKING:
  - THE RESULTING SPACE STATION ORBIT HAS A PERIGEE OF 249.6 NMI
  - THE RESULTING TORF ORBIT HAS AN APOGEE OF 251 NMI
  
- 0 FOR THE TETHER LENGTHS REQUIRED BY THE REFUELING FACILITY, IF THE TETHER BREAKS, THE SPACE STATION IS NOT IN DANGER OF DEORBITING

# MAJOR CONCLUSIONS

- 0 A TORF APPEARS TO BE TECHNICALLY FEASIBLE
- 0 THE MAJOR SYSTEM CONCERNS FOCUS AROUND THE COMPLEX OVERALL OPERATIONS REQUIREMENTS
- 0 THE ADVANTAGES OF A TORF INCLUDE:
  - POTENTIAL IMPROVED SPACE STATION STABILITY
  - POTENTIAL EASIER FACILITY FLUID MANAGEMENT
  - POTENTIAL IMPROVED SPACE STATION SAFETY
  - PROBABLE REDUCED SPACE STATION CONTAMINATION
- 0 FURTHER ANALYSES SHOULD COMPARE TETHERED TO ZERO-G PROPELLANT STORAGE TO QUANTIFY THESE ADVANTAGES

# CURRENT PROGRAM OVERVIEW

PROGRAM TITLE: TETHERED ORBITAL REFUELING STUDY

CONTRACT: NAS9-17422

PROGRAM MANAGER: DALE FESTER (303) 977-8699

CUSTOMER: NASA-JSC  
KENNETH R. KROLL, TECHNICAL MONITOR

PROGRAM OBJECTIVES: EVALUATE THE FACILITY'S COMPETITIVENESS WITH THE CRYOGENIC FLUID MANAGEMENT FACILITY (CFMF) ZERO-GRAVITY REFUELING TECHNOLOGY. THE PROGRAM SHALL EXAMINE THE INTERACTION OF FLUID AND TETHER MOTION, THE ASSOCIATED OPERATIONS AND COMPARE THE COSTS AND BENEFITS OF EACH FACILITY.

PERIOD OF PERFORMANCE: SEPTEMBER 1985 TO JUNE 1986

**MARTIN MARIETTA**

35 - 10/15/85



# TETHERS AND GRAVITY IN SPACE

Paul A. Penzo  
Jet Propulsion Laboratory  
Pasadena, California

Office of Space Flight  
Advanced Programs  
NASA Headquarters

**Life Science**

## **GRAVITY IN SPACE—LIFE SCIENCE OBJECTIVES**

- **EASE TRANSITION BETWEEN 0g IN SPACE AND 1g ON EARTH**
- **PROVIDE EARTH-LIKE HABITABILITY AT PARTIAL g**
- **STUDY EFFECTS OF PARTIAL g ON PLANT, ANIMAL DEVELOPMENT**
- **STUDY EFFECTS ON MAN: CARDIOVASCULAR, SKELETAL, VESTIBULAR SYSTEMS; PERFORMANCE**
- **STUDY EFFECTS ON INDIVIDUAL DEVELOPMENT**
- **SIMULATE GRAVITY CONDITIONS OF MOON, MARS**
- **PREPARE FOR POSSIBLE USE OF ARTIFICIAL GRAVITY FOR MANNED MISSIONS TO MARS, ASTEROIDS**



# PRODUCING VARIABLE GRAVITY IN SPACE

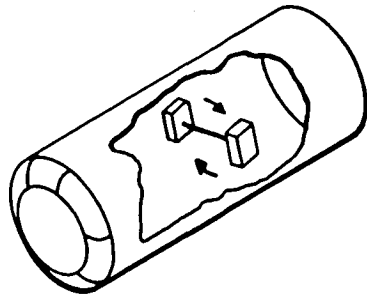

## CENTRIFUGE

- ANY g—LEVEL
- SMALL VOLUME
- LARGE CORIOLIS
- DYNAMIC DISTURBANCE

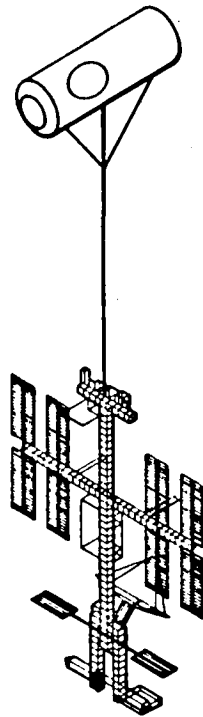

## TETHER

- LOW g—LEVEL (0.1)
- LARGE VOLUME
- LONG DURATION
- NEGLIGIBLE CORIOLIS

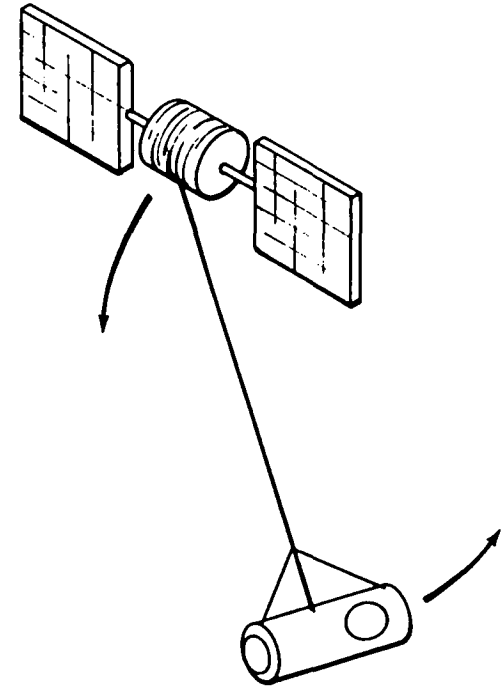

## ROTATION

- ANY g—LEVEL
- LARGE RADIUS
- LOW CORIOLIS
- PLATFORM, BUT POSSIBLY SPACE STATION

# FORCES IN TETHERED ORBITAL SYSTEM

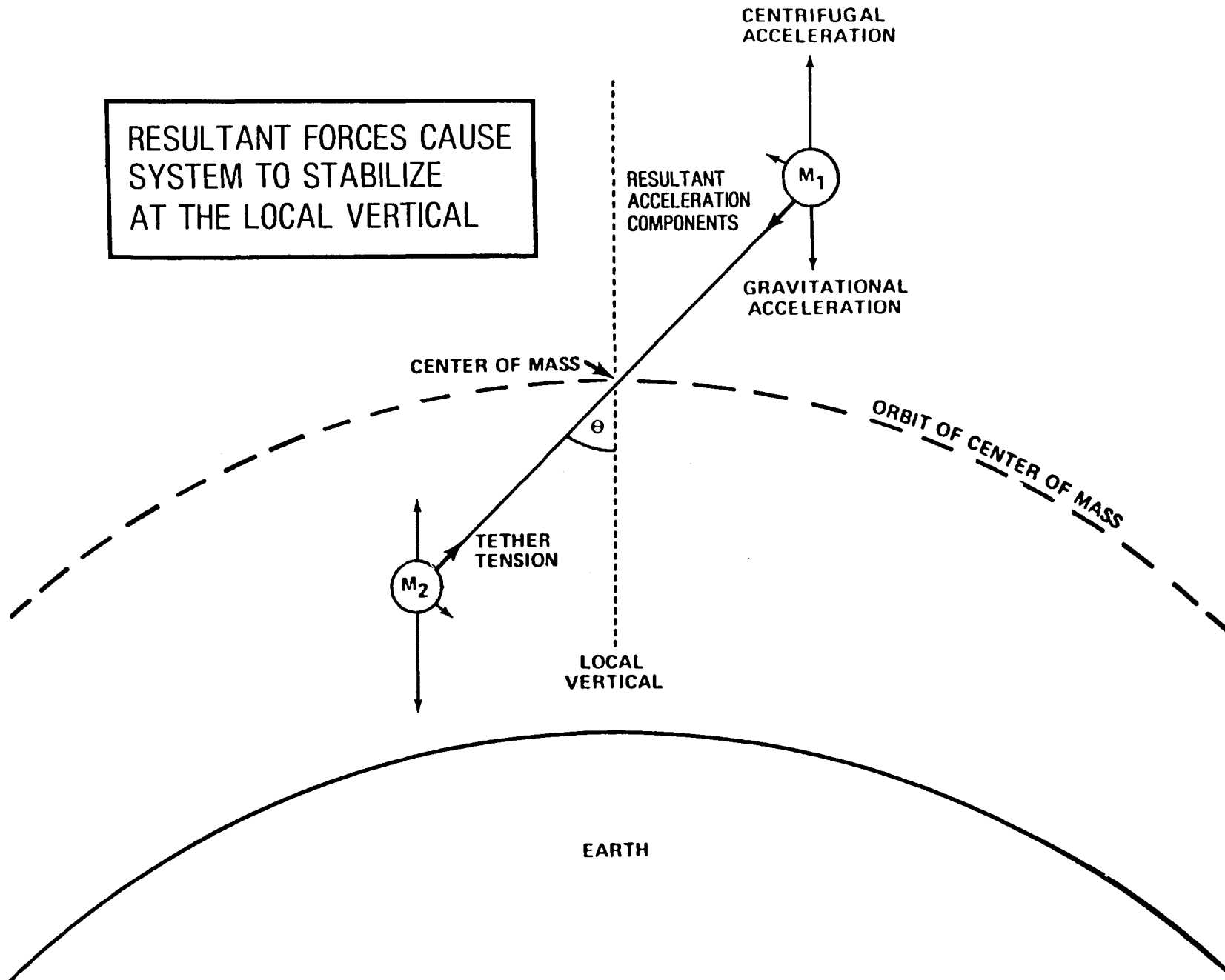

# TETHER MASS AS FUNCTION OF LENGTH

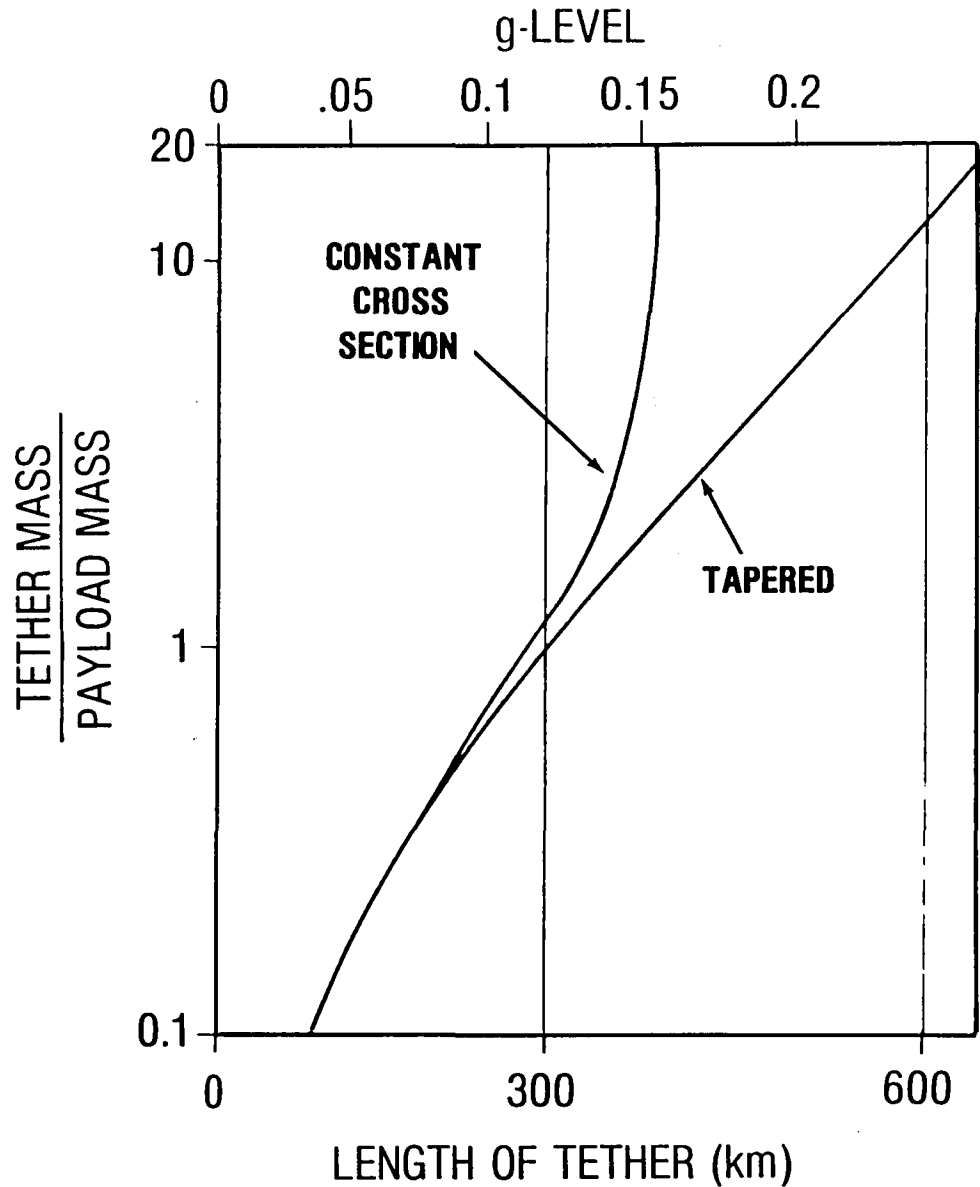

MATERIAL: KEVLAR 29  
 SAFETY FACTOR = 3.5  
 WORKING STRESS =  $0.7 \times 10^9 \text{ nm}^{-2}$   
 DENSITY =  $1450 \text{ kg m}^{-3}$   
 ALTITUDE = 500km  
 STEADY STATE

# TETHERED MICROGRAVITY FACILITY

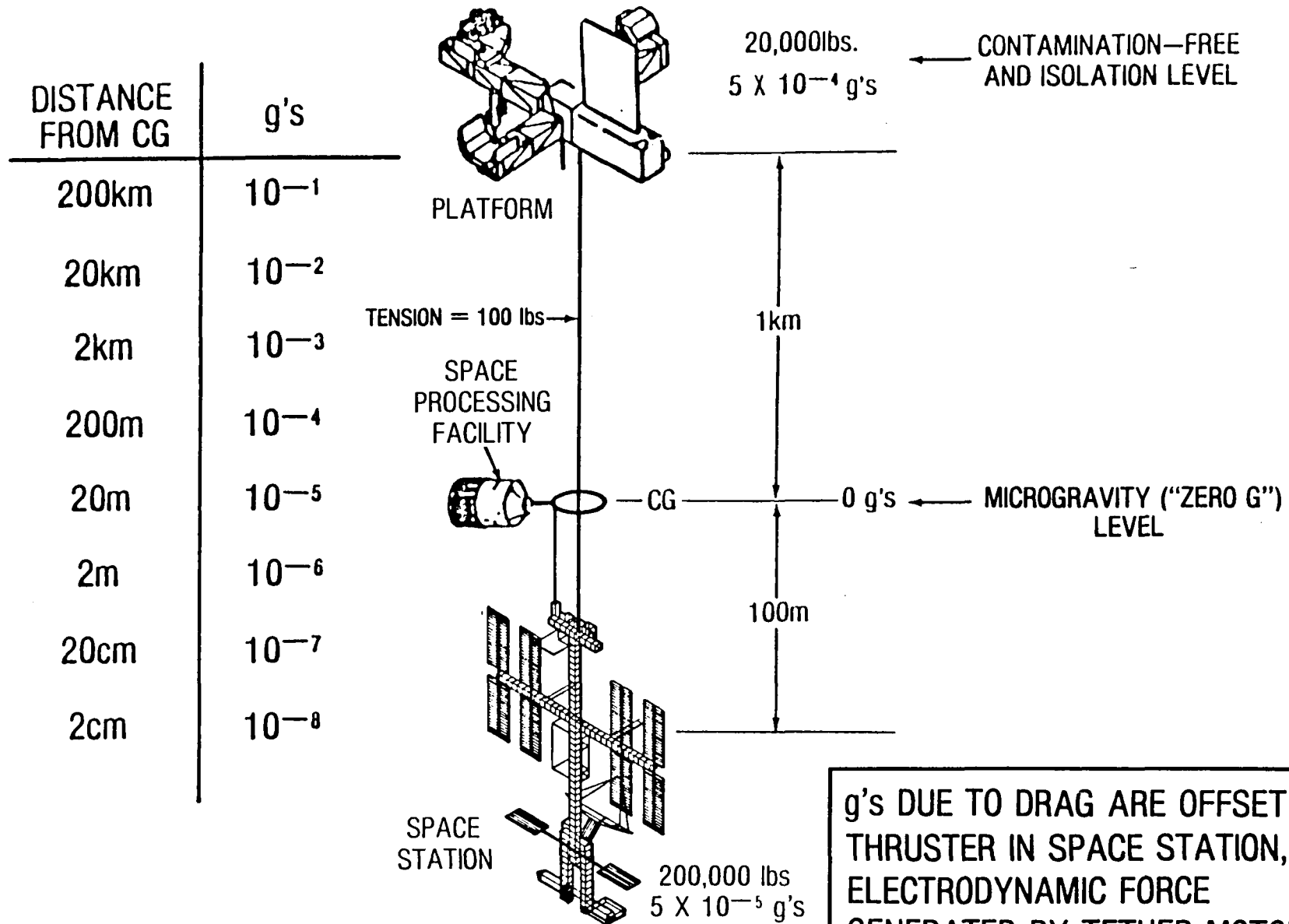

g's DUE TO DRAG ARE OFFSET BY THRUSTER IN SPACE STATION, OR ELECTRODYNAMIC FORCE GENERATED BY TETHER MOTOR

**LIFE SCIENCES GRAVITY LABORATORY  
(GRAVLAB)  
TECHNOLOGY READINESS POST IOC**

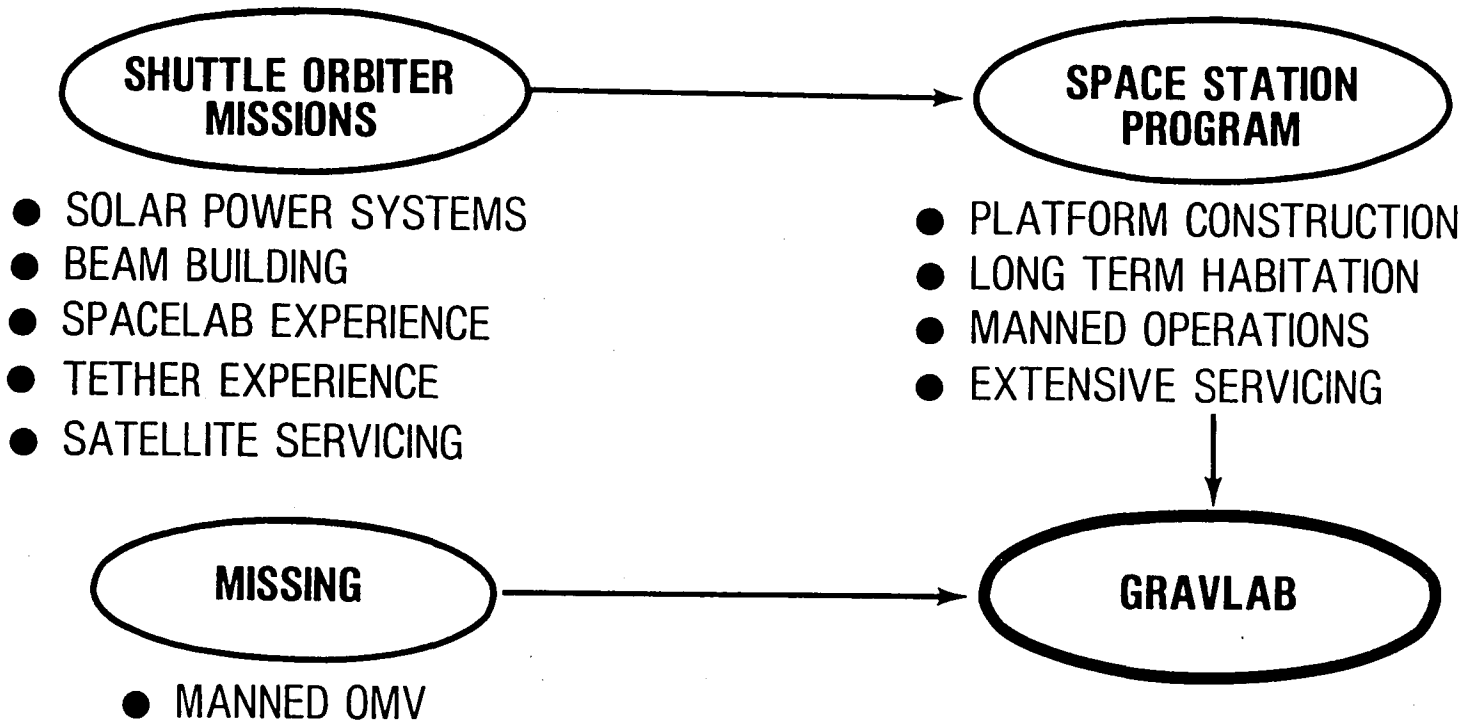

# GRAVLAB DESIGN—TETHER PLATFORM CONCEPT

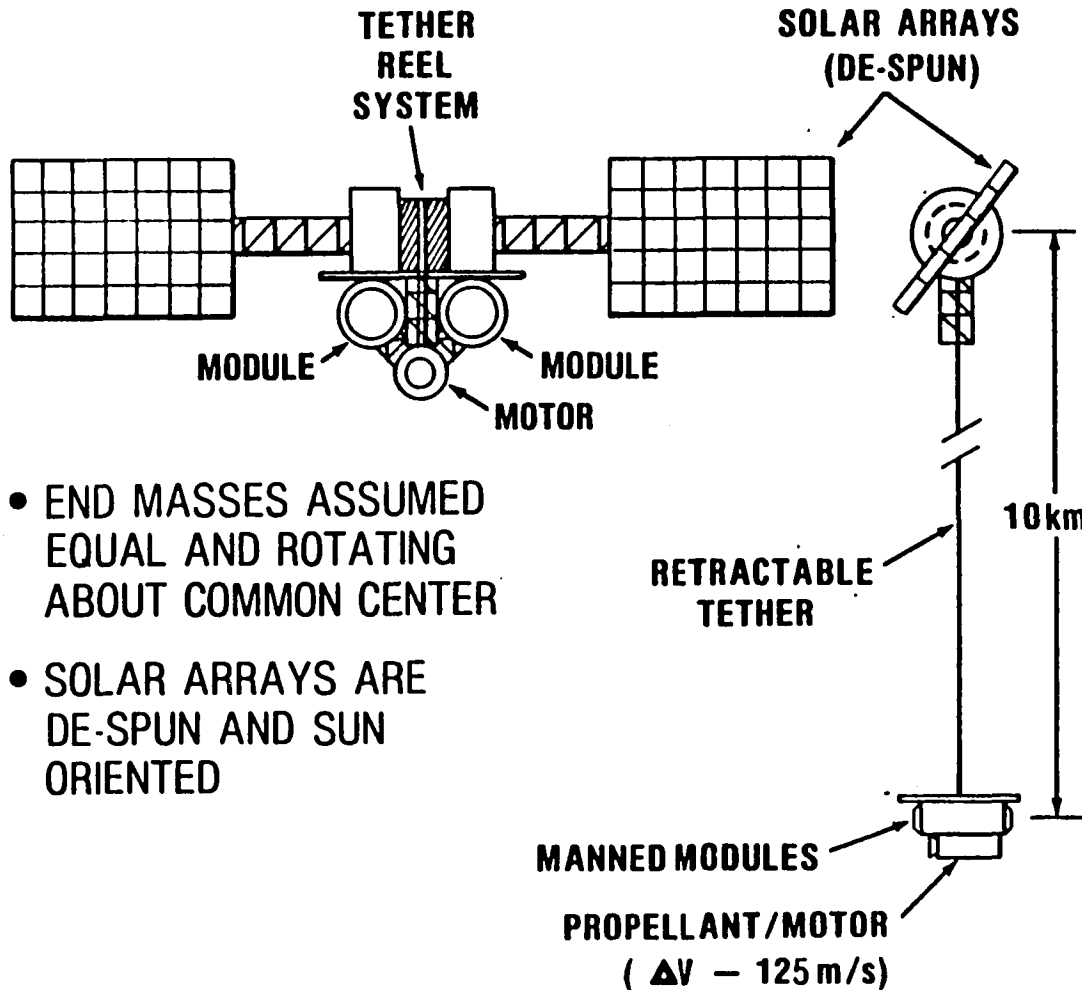

- END MASSES ASSUMED EQUAL AND ROTATING ABOUT COMMON CENTER
- SOLAR ARRAYS ARE DE-SPUN AND SUN ORIENTED

DEPLOYED LENGTH	RPM	g-LEVEL
4 km	0.75	1.25
5 km	0.48	0.65
6 km	0.33	0.38
8 km	0.20	0.16
10 km	0.12	0.08

# GRAVLAB DESIGN—STATION CONCEPT

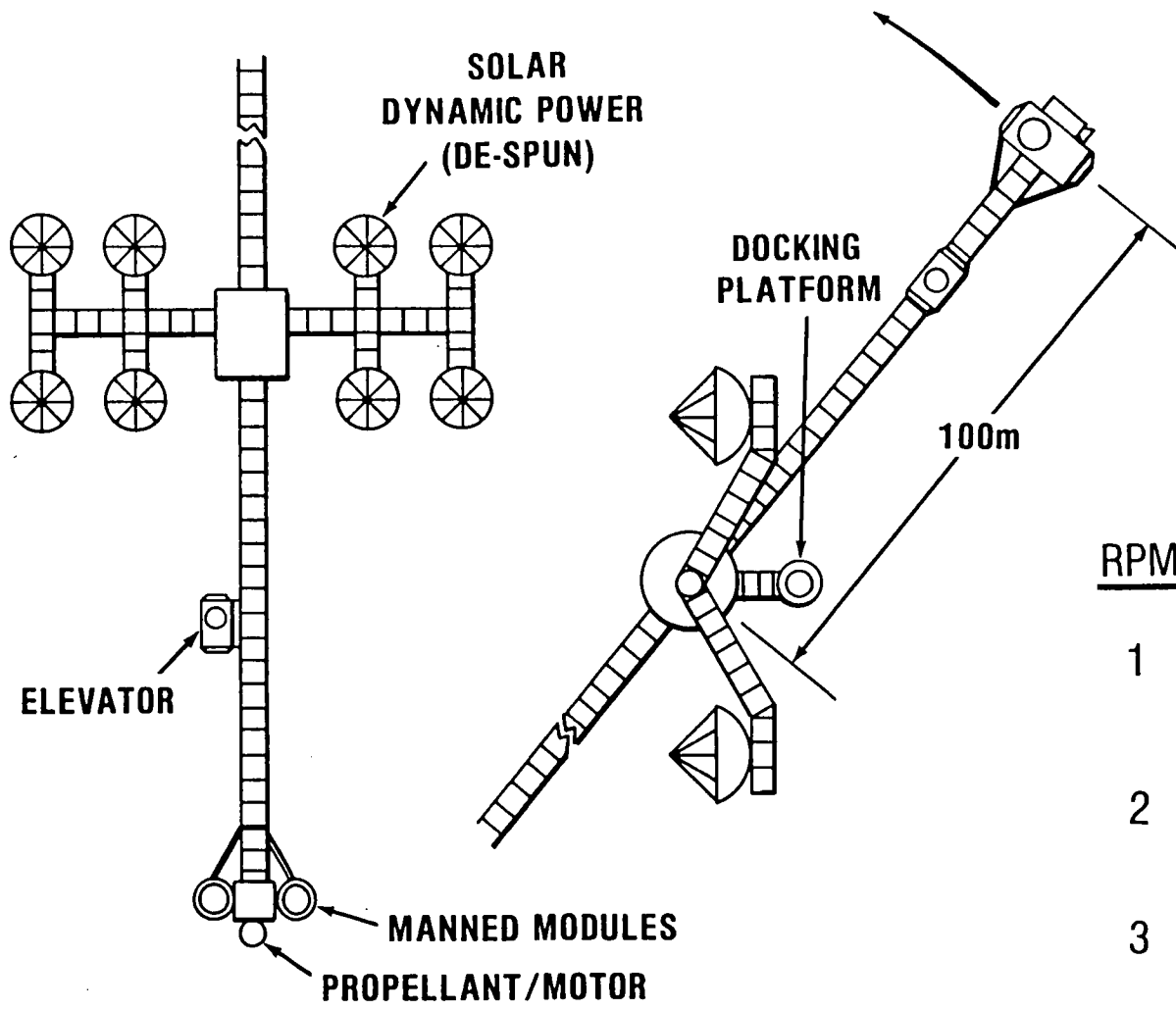

- 4 MODULES, 2 AT EACH END ROTATE ABOUT A COMMON CENTER
- ELEVATOR TRANSFERS MEN, SUPPLIES TO EITHER END

<u>RPM</u>	<u>ΔV</u>	<u>G-LEVEL</u>
1	10m/s	0.11
2	20 m/s	0.45
3	30 m/s	1.00

# GRAVLAB STATION DESIGN—TETHER ENHANCEMENT

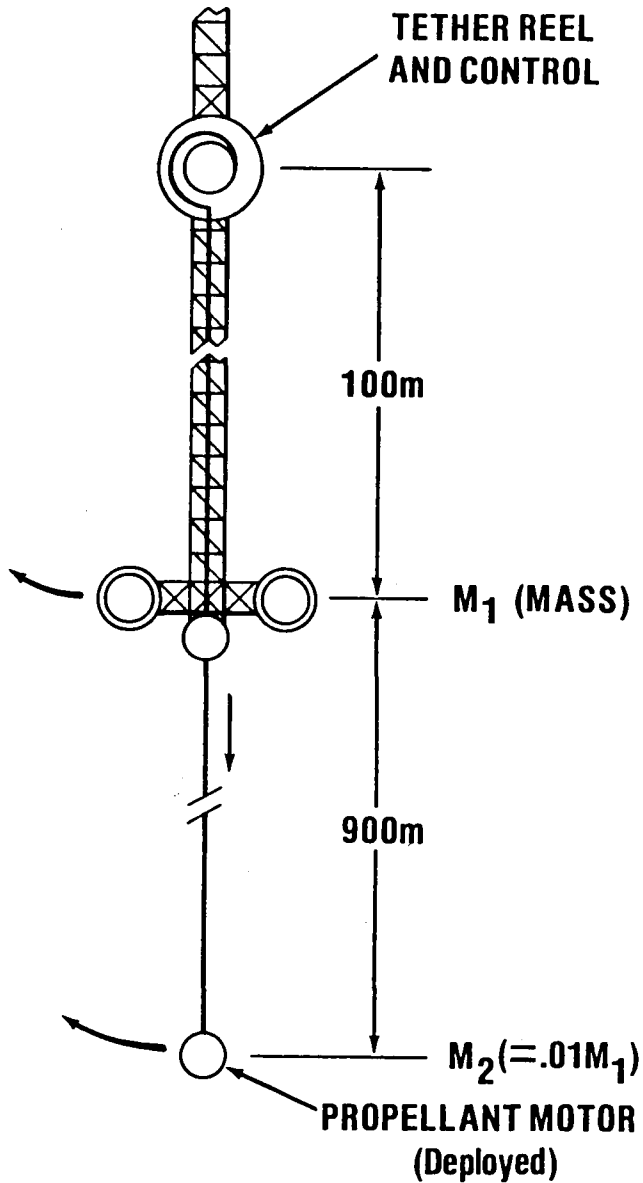

- TETHER MAY BE USED TO CONTROL ROTATION (HENCE G-LEVEL) WITHOUT USE OF PROPELLANT

<u>DEPLOYED LENGTH</u>	<u>RPM</u>	<u>G-LEVEL</u>
0	+2.0	0.45
400	1.6	0.30
700	1.2	0.16
900	1.0	0.11



## **CONCLUSIONS/RECOMMENDATIONS**

- **LIFE SCIENCES SHOULD CONSIDER UTILIZING THE LOW GRAVITY LEVEL AVAILABLE WITH THE SHUTTLE LAUNCHED TETHERED SATELLITE SYSTEM**
- **THIS SYSTEM CAN SUPPORT LONG DURATION EXPERIMENTS WHEN PLACED ON THE SPACE STATION**
- **POST IOC, SPACE STATION AND TETHER SYSTEMS WILL BE AVAILABLE TO BUILD A ROTATING SEPARATE VARIABLE GRAVITY LABORATORY**
- **FOR SUCH A LABORATORY, TETHERS CAN PROVIDE A LARGE AND EASILY VARIED RADIUS TO REDUCE CORIOLIS EFFECTS, AND VARY THE g—LEVEL**



# TETHERED ELEVATOR: A UNIQUE OPPORTUNITY FOR SPACE PROCESSING

R. MONTI

## 1. INTRODUCTION

Latest Fluidynamic and Material Science experiments in Microgravity Environment have emphasized the importance of the residual gravity level and of the g-jitter on Fluids Physics phenomena.

These studies point out at the importance of:

- 1) studying the combined steady residual g-level and/or the g-jitter on the different classes of experiments.
- 2) studying the non-linear effects on the fluid systems such as: accumulation during the experiment time, stability of fronts ( liquid-fluids interfaces, solidification fronts, diffusion fronts) and consequently evaluating the effects upon the processes under study.
- 3) separating the effects of the residual constant gravity-level from the effects of g-jitter.

The above points are of interest not only for a proper analysis of the experimental results and for a rational design of microgravity experiments, but also for allowing the Sponsoring Space Agencies and/or the Manufacturing Companies to adopt useful criteria in the design requirements of the platforms and of the microgravity laboratories. Sound requirements are in fact desperately sought about the residual gravity levels, below which scientific returns from the various experiments can be ensured; the danger is to make expensive and useless efforts

in reducing the gravity field at too low levels that are too demanding for Space hardware.

A number of the above questions could be resolved by experimenting at conditions of zero-gravity (say at levels of  $10^{-6}$  g) and by evaluating the effect of increasing gravity levels on single experiments, if the possibility exists of increasing at will the residual gravity.

## 2. G-LEVEL TOLERABILITY OF SPACE PROCESSING EXPERIMENTS

The strong reduction of the g-level ensured by the Space environments is not always sufficient to guarantee the thermofluidynamics fields wanted by the experimenters (that is the fields corresponding to real zero-gravity conditions).

For instance, the problems of the stability of the solidification fronts, of the stability of the symmetry conditions (spherical, cylindrical and plane) points out at the possibility that there might be a number of accumulation processes (memory of the system) particularly when the boundary conditions are somehow dependent on the thermofluidynamics fields themselves.

As an example we briefly analyze the application of a g-level step disturbance and its effect on the propagation of a plane solidification front.

In consequence of the g-level, buoyancy forces are produced; they induce a convective velocity field which distorts the concentration and/or temperature fronts ahead of the solidification front in the liquid where the process of

solidification takes place and which is mainly controlled by diffusion processes in absence of gravity.

This distortion depends on the level of the residual gravity, on the characteristics of the fluid and on the boundary conditions.

The relation between the order of magnitude of the induced convective speeds and of the diffusion speed can be taken as a measure of the disturbance.

The ratio between the convective speed and the diffusive speed can be very high, also for small values of the imposed g-level, and, consequently, also the distortion of the solidification front can be relevant. The return of the g-level to very small values, even if the boundary conditions have not changed, seldom allows a return to the conditions of a plane front within a reasonable time (the thermal and mass diffusion velocities, are typically very small).

Another important example is the effect of a g-level on the spherical symmetry of a thermofluidynamic field.

Let us consider a spherical drop of a liquid or a solid sphere that are dissolving or forming in a liquid matrix at condition of zero gravity; typical examples are those of the solution growth or of the drops formation (e.g. cooling through a miscibility gap).

Periodical g-jitter disturbances have different effects on the overall drop motion and on the thermofluidynamic field around the drop: the overall drop motion may be not relevant in a purely g-jitter field with zero average value (displacements of the drop relative to the liquid tend to

cancel out during a cycle) but the temperature and concentration field distortion could be of importance if some stability limits are trespassed.

The order of magnitude of the times necessary to cause the distortion, in comparison to those needed to return to spherical fronts, are in the same ratios as the (induced) convective velocities and the diffusion velocities:

$$V_c/V_d = gL^3 / \nu D \frac{\Delta \rho}{\rho}$$

where D is the thermal (or mass) diffusion coefficient and  $\rho$  is the density variation consequent to a temperature or to a concentration non uniformity.

Referring to typical values for the aqueous solutions it results (for  $g=10^{-4} g_0$ ):

$$t_n/t_d \simeq 10^3 \quad (\text{mass diffusion})$$

$$t_n/t_d \simeq 10^2 \quad (\text{thermal diffusion})$$

This would mean that it is necessary to wait a time of the order of 15 minutes for each of  $10^{-4} g_0$  disturbance that lasts one second only, in order to obtain the zero-g concentration conditions again, and to wait a time of the order of 2 minutes, in order to obtain the conditions again for the zero-g temperature distribution.

Of course the real situation is more complex insofar as the convective motion has to decay to a zero velocity condition (the decay is related to the viscous momentum propagation time  $L^2/\nu$ ) and the zero-g concentration and/or temperature fields must have time to reach purely diffusive conditions. The evolution towards those conditions strongly depends on

the problems under study and it is difficult to give general quantitative indications.

In the case of g-jitter with a certain frequency it is more difficult to anticipate what is the order of magnitude of the times involved, mainly because those caused during a semi-period might be compensated by that induced in the next semi-period.

The case becomes more difficult if limits of stability are trespassed, this occurs when, for instance, the g-disturbance is able to induce in the liquid sort of Benard cells that create a flow pattern that may be independent of the direction of the g-level during the semiperiod.

### 3. POTENTIALITIES OF A TETHERED ELEVATOR

It is desirable the realization of a platform able to: 1) set levels of zero gravity to certain payload, 2) allow a controlled change of this level within values of  $10^{-2} < g/g_0 < 10^2$  and 3) create accelerations with controlled amplitudes and frequency.

In fact application of controllable g-levels allows to answer a number of questions posed by recent results of the experimentation in microgravitational Fluidynamics.

The Tethered Elevator could have the possibility of providing variable g-levels (both steady and g-jitter) around a very low steady g-level (that can be realized when the Elevator is near the center of mass of the Space Station-Tether complex). Sliding the elevator at a distance (e) from the center of mass one gets a steady g-level that is approximatively equal to:  $g/g_0 = 3l/R$ ; R being the

distance of the center of mass from the center of the earth ( typically  $g/q = 4.4 \cdot 10^{-7}$  for each meter of the distance (1)).

When positioning a variable periodic oscillation to the Payload a clean g-jitter disturbance can be obtain that would not be otherwise obtainable by other systems. These two possibilities make the Elevator a unique facility to help resolving a number of still open questions.

#### 4. MODEL EXPERIMENTS

A number of experiments can be devised to ascertain the effect of the g-level on some class of experiments.

Two experiments falling within the fluidynamics problematics indicated in Section 2 are briefly described.

A) A copper sphere is suspended inside a transparent liquid matrix (See Fig.1) and is observed by holography or interferometry in order to visualize the isotherms. When heating the sphere by Joule heaters embedded in the copper sphere, starting from an isothermal spherical simmetry, (i.e. when locating the payload at the CG of the system, or very close to it) and before any interference occurs with non spherically-symmetric boundaries (if any) the isotherm pattern look as in Fig.2. The thermal field can then be disturbed either by moving the payload gently out of the CG (to a steady g-level) or inducing a preselected g-jitter. At those new conditions the isotherms (that will be axisymmetric along the induced g direction) will evolve towards another pattern due to the convective flow field induced by the thermal buoyancy forces (Fig.3). The



evolution time depends on the values of the flow velocities. After a quasi-steady pattern has been established, the zero-g conditions are reestablished on the payload: the system will then evolve towards the initial, spherical symmetric, diffusion controlled situation.

The time necessary to restore the zero-g thermal pattern will depend on the value of the flow field velocities and on the characteristic thermal diffusion time.

B) A very similar experiment can be devised for a mass diffusion controlled experiment in which a dissolving sphere of solid material is suspended in a solution and the iso-concentration fronts are visualized by a similar diagnostic apparatus. A spherical symmetry can be ensured for the diffusion controlled (zero-g) process by suitable boundary geometry and conditions.

The measurement of the times necessary to disturb the axisymmetry and to restore it at different steady and g-jitter levels will greatly help in the establishment of valid criteria for the g-level tolerability in a very important class of MS experiments (e.g. solution crystal growth and vapour crystal growth).

## 5. CONCLUSIONS

The Tethered Elevator will greatly contribute to the solutions of many still open problems that are preventing a much wider utilization of the Space environment in the Microgravity area.

Detailed study must be carried out to enable the Elevator to perform along the briefly described lines.

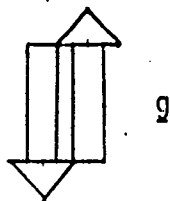
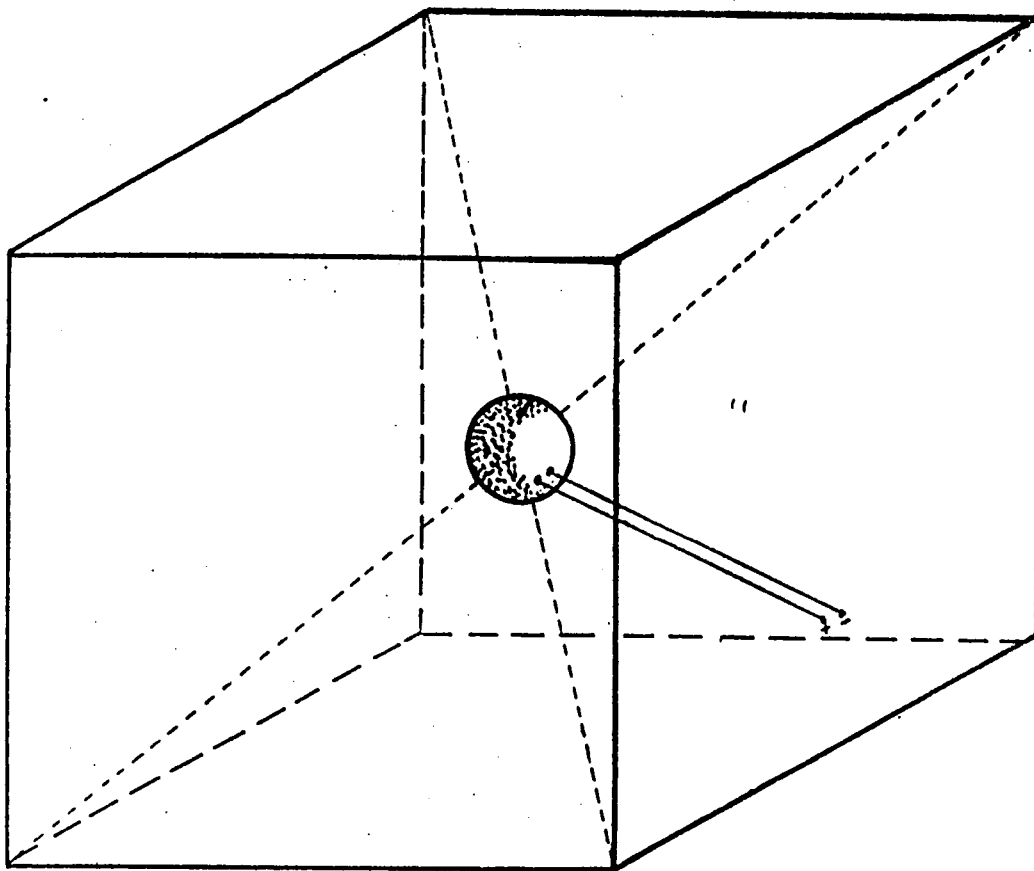

Fig. 1 - Spherical heater suspended in a transparent box

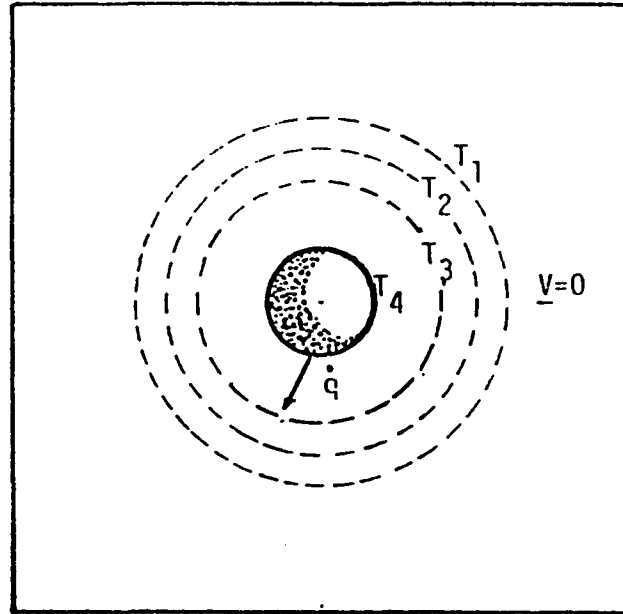

Fig. 2 - Temperature field and isotherms in a zero-g conditions

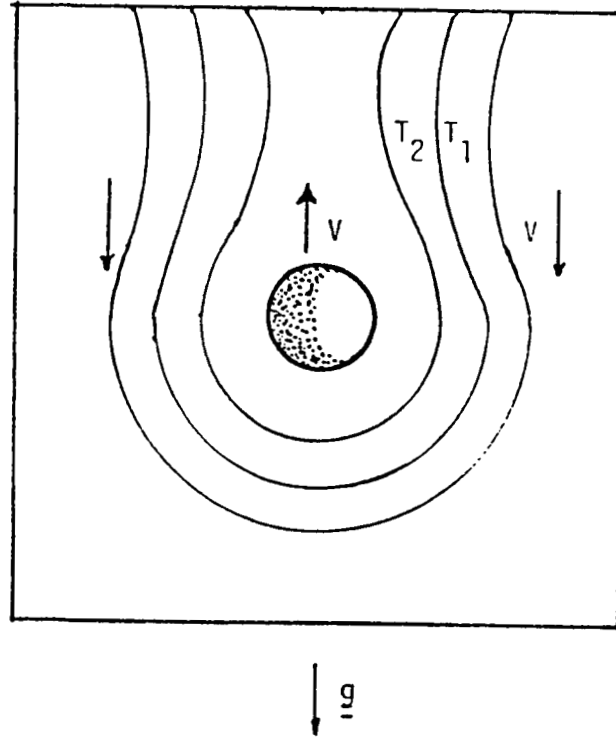

Fig. 3 - Distorted isotherms in micro-g environment

## GRAVITY UTILIZATION ISSUES

Kenneth R. Kroll

Johnson Space Center, NASA

- . Can the extra cost of a tether be justified?
- . Is movement of the space station center of gravity acceptable?
  - . should microgravity laboratory modules be moved to the tether?
  - . should balancing tether applications be used?
- . Is changing proximity operations procedures and hardware acceptable?
  - . Can a tether crawler be developed?
  - . Can docking be done at a center of gravity which is on the tether?
- . Will platforms be permanently deployed.
  - . Where will servicing be performed?
  - . Is tether movement to be limited?
  - . Can experiments be stopped for disturbances?
- . Which is more important: manned involvement      low disturbance levels?
  - . Can experiments be remotely controlled?
- . Can power and communications be supplied through the tether to a moving platform?
- . Will laboratory movement adversely affect experiments?
  - . What are the best procedures for limiting tether movement?
  - . Can disturbance sensitivity and variable gravity laboratory coexist?
- . Is liquid settling the primary use of gravity?
  - . Are long tether lengths for small sizes practical?
- . How can higher gravity level medical experiments be integrated into the space station system using a tether?

Venezia, 16 October, 1985



CONSTELLATIONS PANEL

## CONSTELLATIONS PANEL SUMMARY REPORT

### Introduction

The Constellations Panel, because of its limited number of attendees, shared its life during the Workshop in part with the Micro-gravity Panel and in part with the Space Station Panel. It could, therefore, benefit from the inputs of two different panels which are related to tethered constellations. Tethered constellations, in fact, can provide a valuable solution to projects such as the micro-g/variable-g laboratory, the multi-probe tethered system, and the centrifuge for low-gravity applications.

The following presentation highlights the versatility of tethered constellations and the various different configurations that have been conceived so far. The presentation is divided into three sequential timeframes which have, as a central reference point, the IOC (Initial Operating Capability) phase of the Space Station program. Therefore the demonstration flights of certain one-dimensional tethered constellations belong to the Pre-IOC-Era while the final, operational utilizations of the one-dimensional tethered constellations belong to the IOC-Era. All the other more complex configurations, such as the two-dimensional constellations and a couple of new ideas developed during the Workshop, have been listed under the Post-IOC-Era category.



## Pre-IOC-Era

1. Demo flight for the micro-g/variable-g (space elevator) with a modified TSS system (e.g., adding a down-scaled elevator to the TSS)
2. Shuttle-borne, multi-probe 1-D system for simultaneous data collection (e.g., measurement of spatial geophysical gradients with good time correlation)

1. DEMO MULTI-g/VARIABLE-g

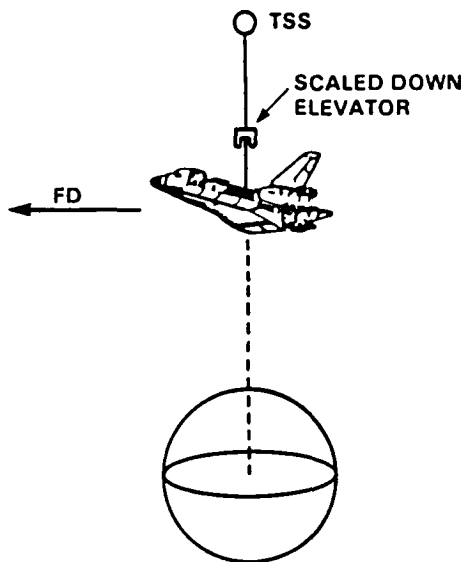

2. DEMO MULTI-PROBE SYSTEM (BEADS ON THE TETHER)

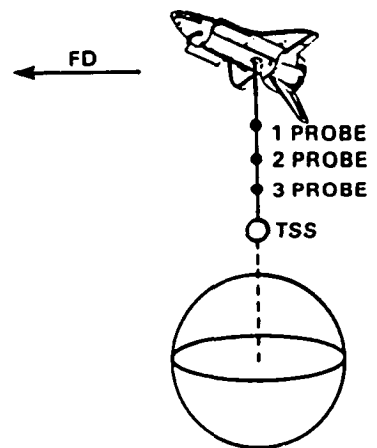

IOC-Era

3. Micro-g/Variable-g Lab (space elevator) Space Station-borne
4. Space Station c.o. (orbital center  $\approx$  center of mass) management
5. Space Station-borne multi-probe system

3. 1-D, 3-Mass, Vertical, Tethered Constellation (SS at one end)

PURPOSE - Multi-purpose system:

- micro-g/variable-g
- controlled g variations
- service to the end platform

NEED - Strongly requested by the micro-g community

- g-tuning
- g-jitter
- controlled-g time profile
- hysteresis cycles

BENEFITS - Unique capability of providing time varying g-profile from microgravity level to  $10^{-2}g$

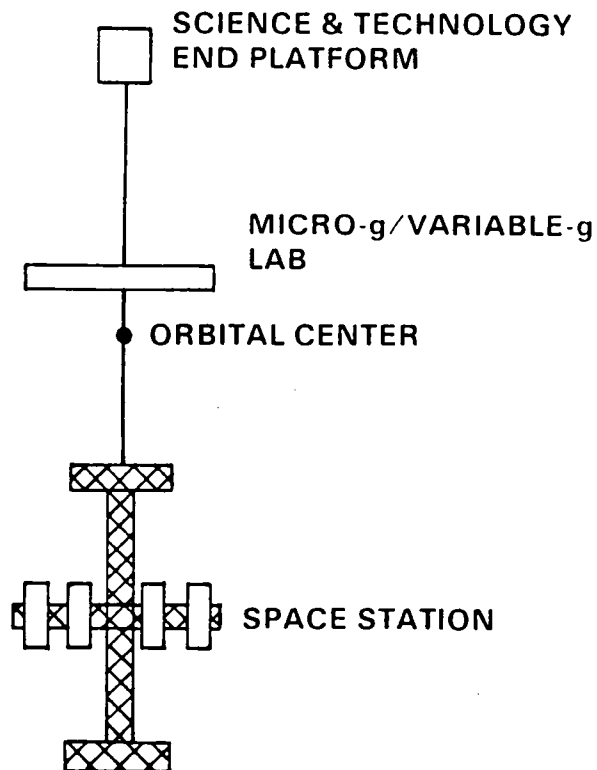

FEASIBILITY - high

PRACTICALITY - high

COST BENEFIT POTENTIAL - N/A for variable-g applications  
- TBD for micro-g applications

PRIORITY - 1st

REQUESTED TECHNOLOGY - Very accurate accelerometers for micro-g applications  
- Very smoothly operating reeling systems or crawlers

ALTERNATIVE APPROACHES - None for micro-g/variable-g combined  
OTHER THAN TETHERS applications

NEAR TERM APPLICATION - Demonstration flights with the Shuttle (modify TSS system by adding a simplified elevator)

FUTURE APPLICATIONS - Attached to the Space Station

4. 1-D, 3-Mass, Vertical, Tethered Constellation (SS in the middle)

PURPOSE - Management of the system's orbital center

NEEDS - Especially required if another payload is deployed on a tether and the micro-g lab is on the SS

BENEFITS - Greater operation flexibility w.r.t. micro-g experiment schedule

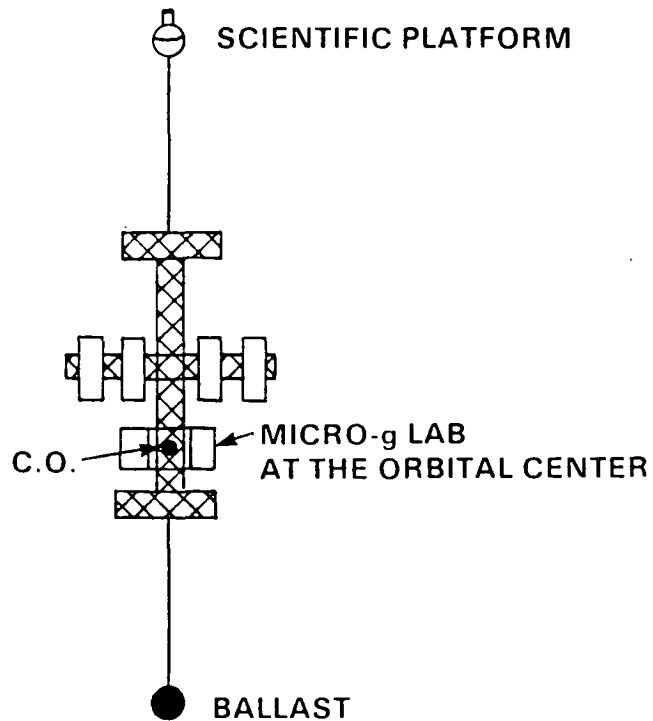

FEASIBILITY - high

PRACTICALITY - high

COST BENEFIT POTENTIAL - TBD

PRIORITY - 1st

REQUESTED TECHNOLOGY - Very accurate accelerometers

ALTERNATIVE APPROACHES - Alone if tethered systems are deployed on one  
OTHER THAN TETHERS side and simultaneous micro-g experiments have  
to be performed

FUTURE APPLICATIONS - Attached to the Space Station

5. 1-D, More Than 3-Mass, Vertical, Tethered Constellation (multi-probe tethered system)

PURPOSE - Measurement of spatial geophysical gradients

BENEFITS - The system can reach low altitude orbits that are not achievable otherwise

- It provides simultaneous data at different locations (good time correlation of the measurements)

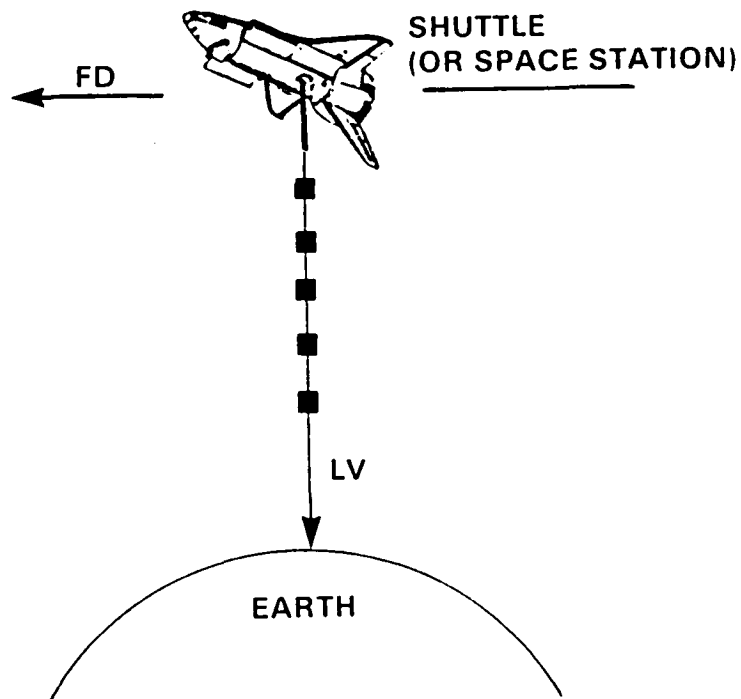



FEASIBILITY - high

PRACTICALITY - medium high

COST BENEFIT - N/A

PRIORITY - 1st

CRITICAL DESIGN AND REQUESTED TECHNOLOGY -

- o Dynamic analysis
- o Crawling system
- o Operational sequence for deployment and retrieval

ALTERNATIVE APPROACHES - None if simultaneous data collection is required  
OTHER THAN TETHERS

FUTURE APPLICATIONS - Space Shuttle flight (or Space Station)

Post-IOC-Era

All the following applications are supposed to be free-flying systems.

6. Quadrangular 2-D constellations electrodynamically stabilized.
7. Quadrangular 2-D constellations stabilized by differential air drag.
8. Pseudo-elliptical 2-D constellation, electrodynamically stabilized.
9. Centrifuge for low-g application:  $>10^{-3}g$ .
10. Torquing of a spinning station (or vehicle) for controlling the precession rate of the spin axis.

6. 2-D, Electrostatically Stabilized Constellation (ESC)

PURPOSE - Separation of junctions in a physically connected configuration

FEASIBILITY - Medium

PRACTICALITY - With complexities

PRIORITY - 2nd

CRITICAL DESIGN - o Multi-reel system control  
o Better dynamics analysis required

FUTURE APPLICATIONS - TBD

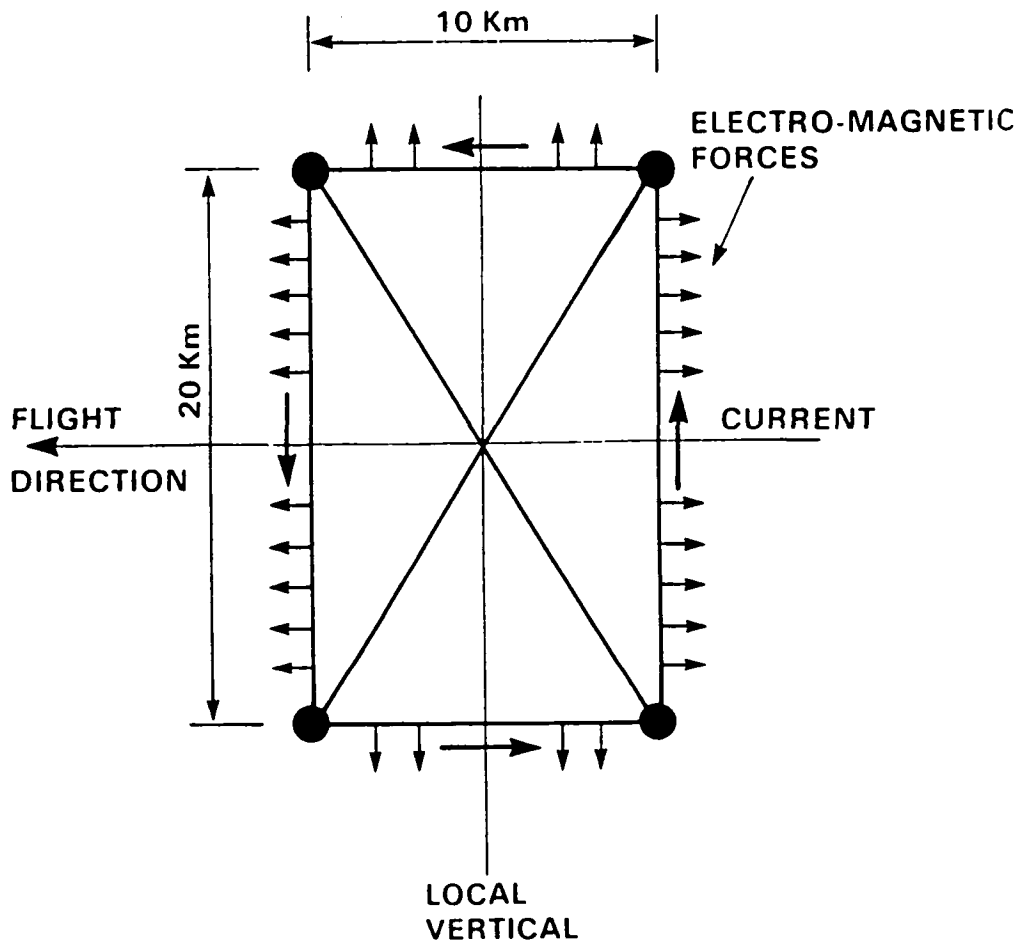

7. 2-D, Differential Drag Stabilized Constellations (DSC) (DSC)

PURPOSE - Separation of functions in a physically connected configuration

FEASIBILITY - Medium

PRACTICALITY - With complexities

PRIORITY - 2nd

CRITICAL DESIGN - o Multi-reel system control  
o Better dynamics analysis required

FUTURE APPLICATIONS - TBD

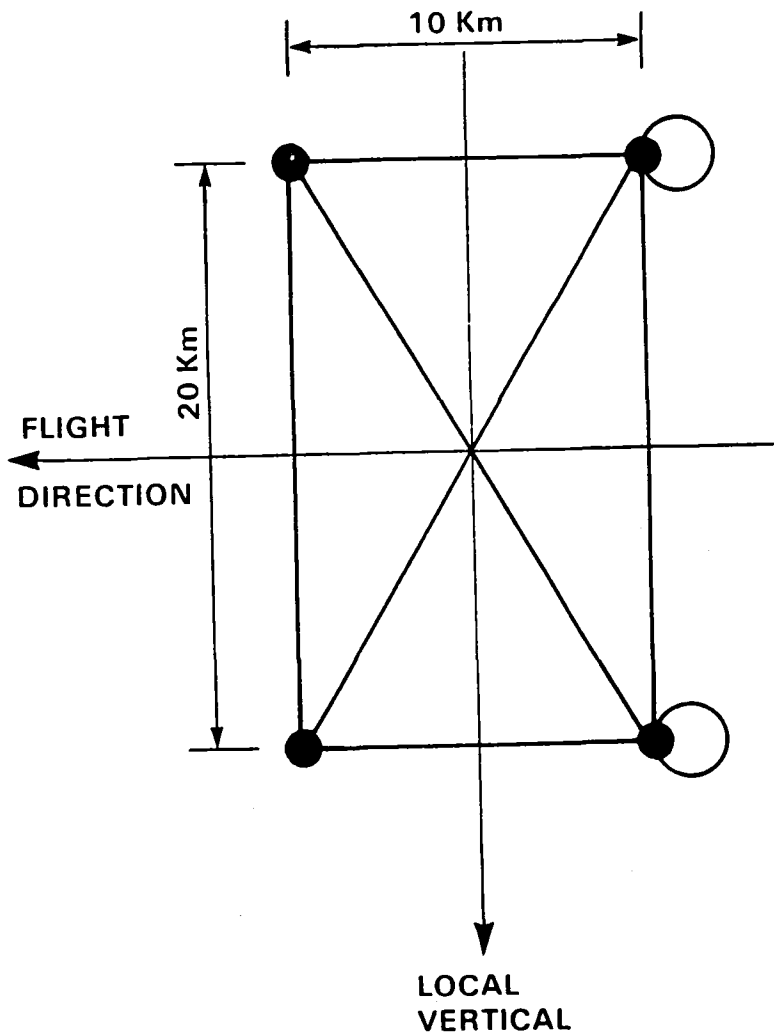

8. 2-D, Electrodynamically Stabilized, Pseudo-Elliptical Constellation (PEC)

PURPOSE - External frame for stabilizing light structures (e.g., reflectors, solar sails)

FEASIBILITY - High

PRACTICALITY - Medium high

PRIORITY - 2nd

CRITICAL DESIGN - Multi-reel system control

FUTURE APPLICATIONS - TBD

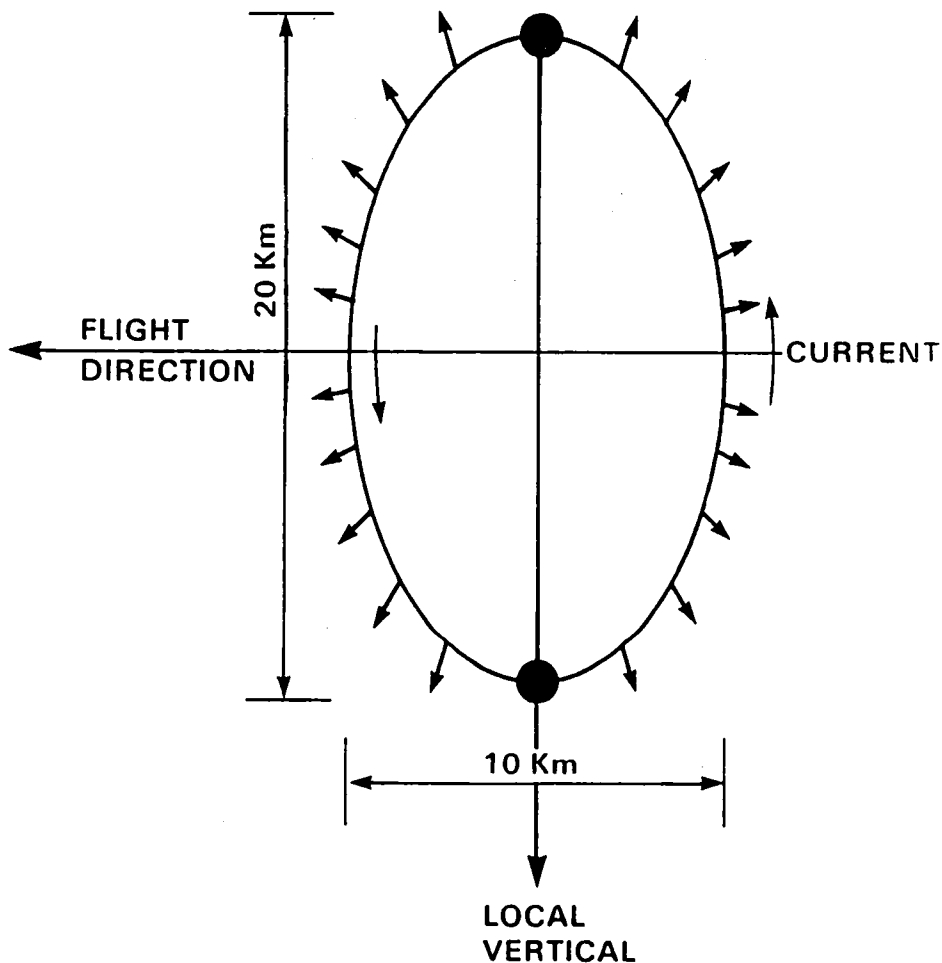

NEW IDEAS

9. CENTRIFUGE FOR LOW GRAVITY:  $>10^{-3}g$

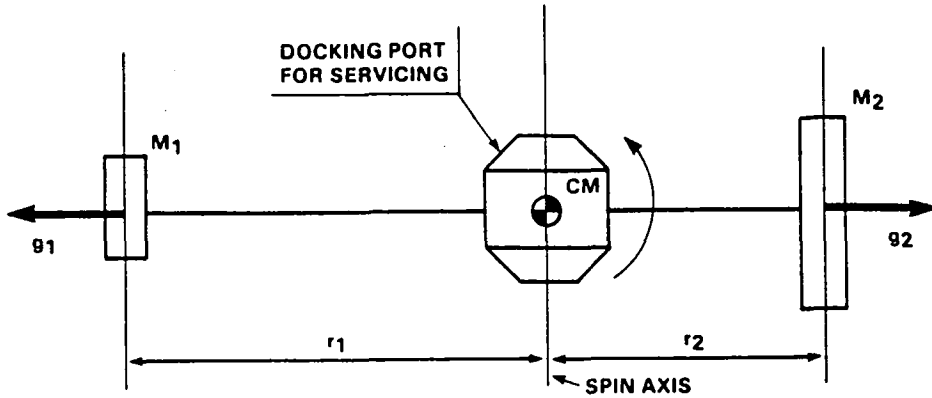

10. TORQUING OF A SPINNING STATION FOR CONTROLLING THE PRECESSION RATE OF THE SPIN AXIS: (e.g., Keeping the spin axis aligned with the local vertical)

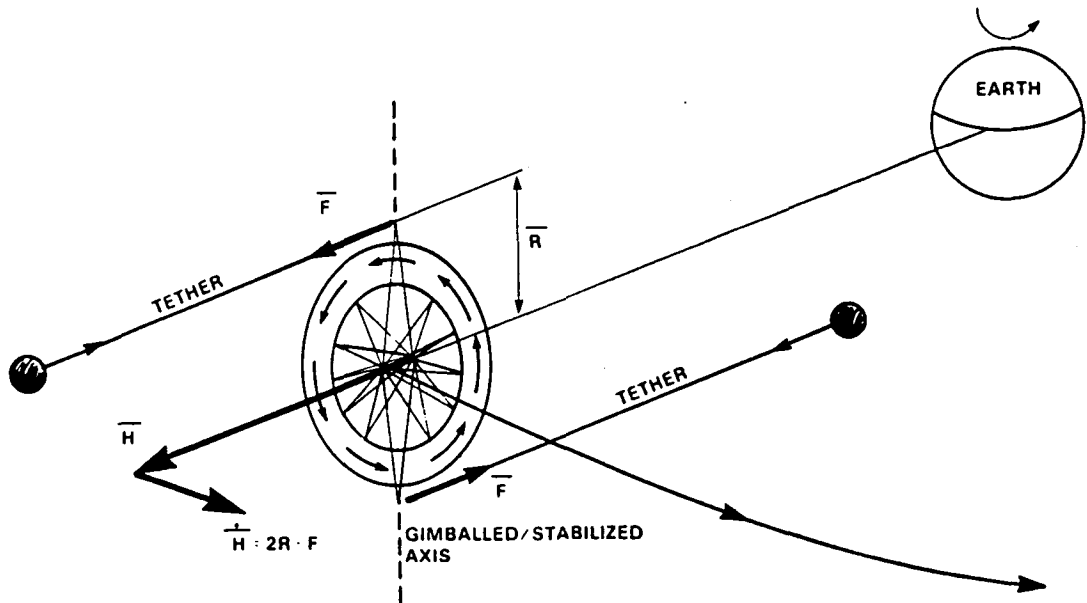

## CONCLUSIONS

1-D vertical constellations provide unique capabilities (1st priority)

- 3-mass system (space elevator) can provide variable-g environment from microgravity level to  $10^{-2}$ g.
- More-than-3-mass system provides simultaneous data collection at different locations.
- 3-mass system (SS in the middle) for SS orbital center management allows simultaneous micro-g experiments and other tether assisted experiments.

2-D constellations (2nd priority)

- Stable configurations proposed for providing a separation of functions among physically connected platforms.
- Pseudo-elliptical constellations provide an external 2-D frame for stabilizing light structures (e.g., reflectors, solar sails).

## RECOMMENDATIONS

Improve the fidelity of dynamics models, especially w.r.t. tether dynamics

Tether construction

- multi-function tether concept to be further developed
- tether physical characteristics; effects on the system dynamics

Ingenious design of crawling systems

Improve the knowledge of micro-g/variable-g requirements





SMITHSONIAN ASTROPHYSICAL OBSERVATORY  
60 GARDEN STREET  
CAMBRIDGE, MASSACHUSETTS 02138  
U.S.A.

WORK DONE UNDER CONTRACTS:  
NAS8-35497 NASA/MSEC  
NAS8-36606 NASA/MSEC  
RH4-394019 MMC

PANEL PRESENTATION  
ON  
DYNAMICS OF TETHERED CONSTELLATIONS  
IN EARTH ORBIT  
BY  
ENRICO LORENZINI

PRESENTED TO:

APPLICATIONS OF TETHERS IN SPACE WORKSHOP  
VENICE, ITALY  
15-17 OCTOBER 1985

SUMMARY OF PRESENTATION

• PHASE I STUDIES

STATION KEEPING OF SINGLE-AXIS AND TWO-AXIS CONSTELLATIONS

- WRAP-UP OF PHASE I STUDIES ALREADY PRESENTED TO NASA/MSEC
- FURTHER ANALYSIS CARRIED OUT ON TWO-DIMENSIONAL CONSTELLATIONS
- SINGLE-AXIS VERTICAL CONSTELLATIONS. LOW-G PLATFORM

• PHASE II STUDIES

DEPLOYMENT OF CONSTELLATIONS

- SINGLE-AXIS VERTICAL CONSTELLATIONS WITH THREE MASSES
  - DEPLOYMENT STRATEGY
  - DAMPING OF VIBRATIONAL MODES

## PHASE I STUDIES

### DYNAMICS AND STABILITY OF A HORIZONTAL TETHER

#### WITH A DOWNSTREAM BALLOON

- STABILITY CONDITION WHEN NEGLECTING THE TETHER DRAG CONTRIBUTION IS GIVEN BY:

$$\frac{1}{6} \rho \frac{a^2}{\ell} C_D \left( \frac{A_2}{m_2} - \frac{A_1}{m_1} \right) > 1$$

- THE SYSTEM DECAY BY:

$$\frac{da}{dt} = 2 C_D \frac{A_2 + A_1}{m_1 + m_2} \rho \sqrt{\mu a}$$

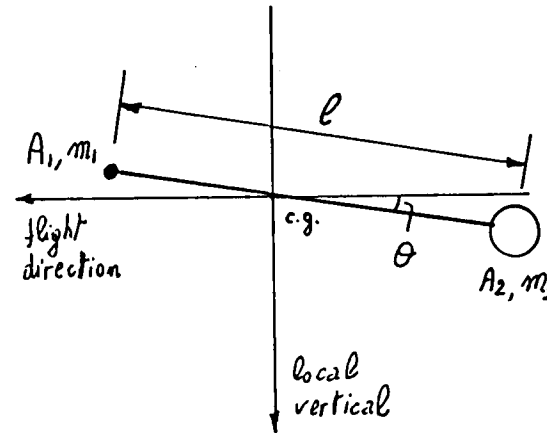

- STABILITY AND SYSTEM LIFETIME, WITHOUT REBOOSTING, ARE CONTRASTING REQUIREMENTS
- MAXIMUM HORIZONTAL TETHER LENGTH ACHIEVABLE STRONGLY LIMITED BY TECHNOLOGICALLY ATTAINABLE A/M RATIO OF THE BALLOON (MAXIMUM A/M = 10 ÷ 20 M<sup>2</sup>/KG)

# DRAG STABILIZATION LIMITS FOR SINGLE-AXIS HORIZONTAL CONSTELLATIONS

$$\text{AREA/MASS} = A/M_2 = 10 \text{ m}^2/\text{KG}$$

z (km)	Minimum Atmo. Density Exospheric Temp. = 600K		Maximum Atmo. Density Exospheric Temp. = 1100K	
	$h_{\text{max}}$ (m)*	$\frac{da}{dt}$ (km/day)**	$h_{\text{max}}$ (m)	$\frac{da}{dt}$ (km/day)
150.	$2.31 \times 10^5$	$2.84 \times 10^3$	$3.23 \times 10^5$	$3.97 \times 10^3$
200.	$1.89 \times 10^4$	$2.29 \times 10^2$	$4.79 \times 10^4$	$5.82 \times 10^2$
300.	$5.47 \times 10^2$	7.05	$4.51 \times 10^3$	$5.36 \times 10^1$
400.	$3.57 \times 10^1$	0.42	$7.58 \times 10^2$	8.80
500.	3.64	0.04	$1.61 \times 10^2$	1.83

\* $h_{\text{max}}$  = maximum horizontal length for stable configuration

\*\* $\frac{da}{dt}$  = orbital decay rate

## ORIGINAL "FISH-BONE" CONFIGURATION STABILITY ANALYSIS

• STABILITY CONDITION, WHEN NEGLECTING THE HORIZONTAL TETHER DRAG CONTRIBUTION, IS:

$$\frac{1}{6} \rho \frac{a^2}{h} C_D \left( \frac{3A_2 + dt_2 \ell_2}{M_2} - \frac{3A_1 + dt_1 \ell_1}{M_1} \right) > 1$$

- TETHER A/M RATIO INCREASES BY DECREASING ITS THICKNESS BUT IT IS NEVERTHELESS SMALL WHEN COMPARED TO THE BALLOONS.

- THE NECESSITY OF A MASSIVE DEPLOYER SYSTEM AT MASS  $M_{22}$  STRONGLY REDUCES THE MAXIMUM A/M RATIO OF THE DOWNSTREAM VERTICAL TETHER SUBSYSTEM.

• CONCLUSIONS

- THE "FISH-BONE" CONSTELLATION, WITHOUT ANY MODIFICATIONS, HAS A STABILITY (MAXIMUM ALLOWABLE HORIZONTAL TETHER LENGTH) LOWER THAN THE SINGLE AXIS HORIZONTAL CONSTELLATION.

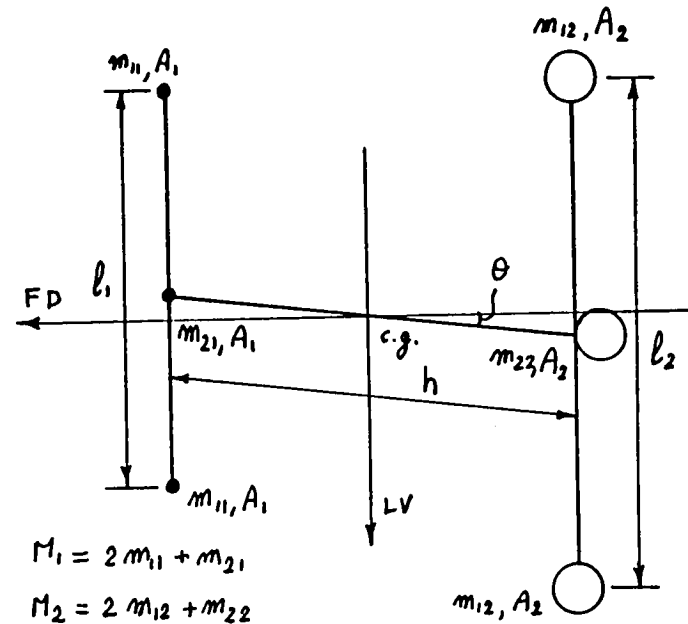

# STABILITY LIMITS FOR A "FISH-BONE" CONSTELLATION VS. ORBITAL ALTITUDE

## ASSUMPTIONS

$$l_2 = l_1 = 20 \text{ km}$$

$$A_2/m_{12} = 10 \text{ m}^2/\text{kg} ; \quad A_1/m_{11} = 4 \times 10^{-3} \text{ m}^2/\text{kg}$$

$$d_{t2} = 1 \text{ mm (kevlar)} ; \quad d_{t1} = 2 \text{ mm (kevlar)}$$

$$m_{11} = m_{12} = 200 \text{ kg}$$

$$m_{21} = 1000 \text{ kg} ; \quad m_{22} = 800 \text{ kg (deployer)} + 200 \text{ kg (balloon)} = 1000 \text{ kg}$$

z (km)	Minimum Atmo. Density Exospheric Temp. = 600K		Maximum Atmo. Density Exospheric Temp. = 1100K	
	$h_{\text{max}}$ (m)*	$\frac{da}{dt}$ (km/day)**	$h_{\text{max}}$ (m)	$\frac{da}{dt}$ (km/day)
150.	$9.54 \times 10^4$	$5.99 \times 10^4$	$1.33 \times 10^5$	$8.38 \times 10^4$
200.	$7.81 \times 10^3$	$4.83 \times 10^3$	$1.98 \times 10^4$	$1.23 \times 10^4$
300.	$2.26 \times 10^2$	$1.49 \times 10^2$	$1.86 \times 10^3$	$1.13 \times 10^3$
400.	$1.47 \times 10^1$	8.87	$3.13 \times 10^2$	$1.86 \times 10^2$
500.	1.50	0.84	$6.65 \times 10^1$	$3.86 \times 10^1$

\* $h_{\text{max}}$  = maximum horizontal length for a stable configuration

\*\* $\frac{da}{dt}$  = orbital decay rate

SOME CONCEPTUAL EXAMPLES OF TWO-DIMENSIONAL CONSTELLATIONS HORIZONTALLY STABILIZED BY AIR DRAG (DSC)

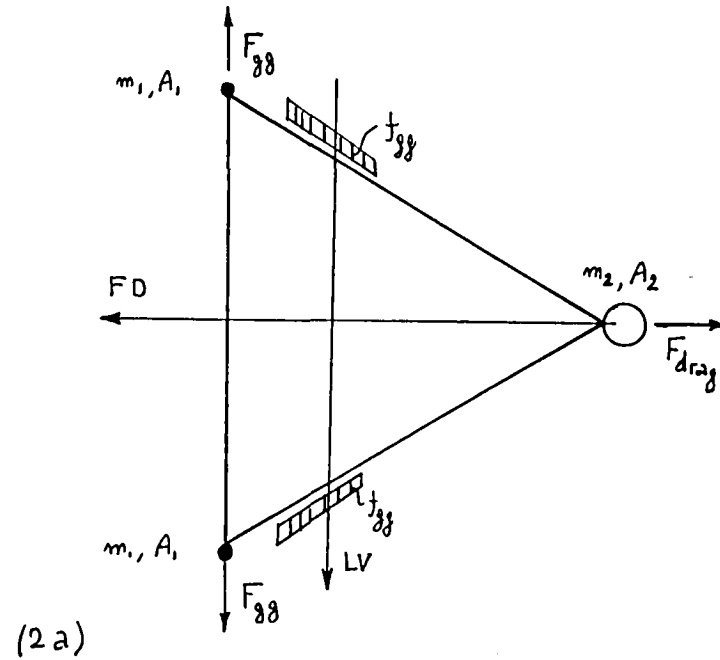
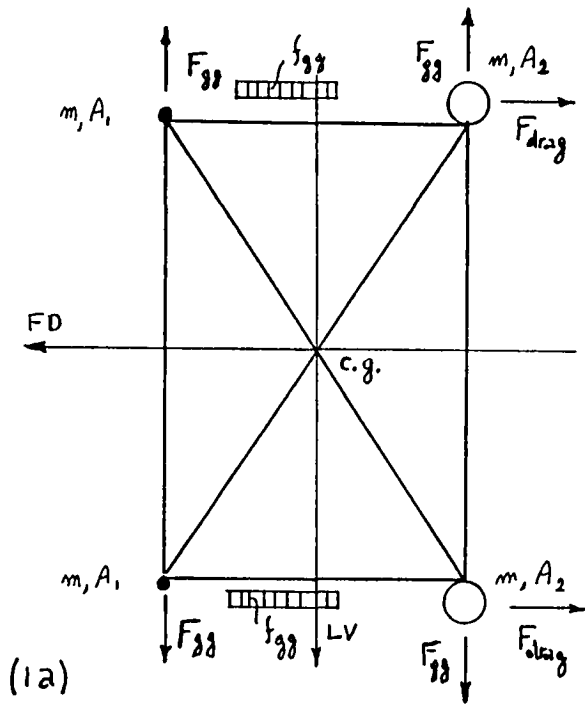

-WITH THIS CONFIGURATION THE DRAG FORCE IS FULLY EXPLOITED TO GUARANTEE THE MINIMUM TENSION LEVEL IN THE HORIZONTAL TETHERS AND NOT TO COUNTERACT GRAVITY GRADIENT.

• SOME CONCEPTUAL CONFIGURATIONS OF TWO-DIMENSIONAL CONSTELLATIONS WHERE SHAPE STABILITY IS PROVIDED BY ELECTRODYNAMIC FORCES (ESC).

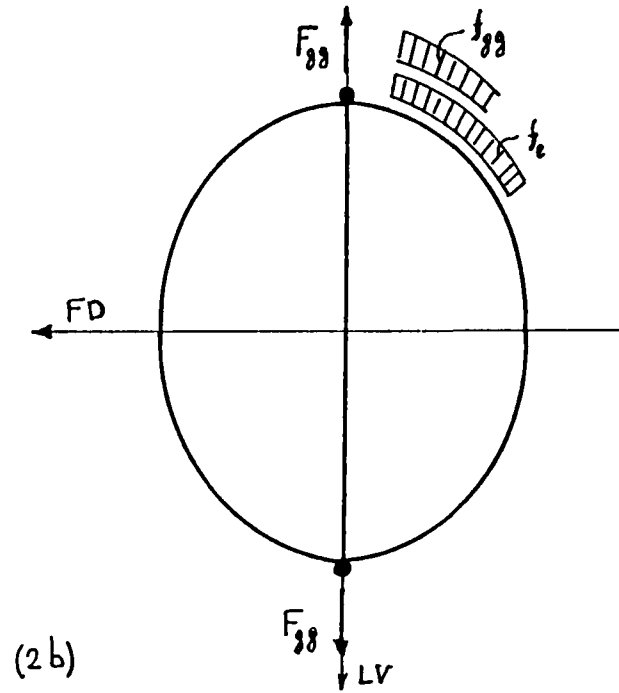
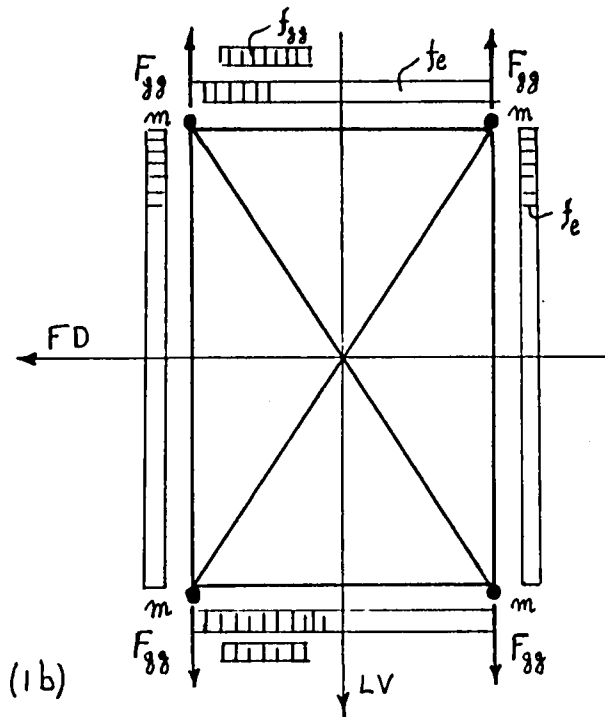

-ELECTRODYNAMIC FORCES STRETCH THE CONSTELLATION WHILE THE RESULTANT IS ZERO SO THAT THEY DON'T INCREASE THE ORBIT DECAY.



# DESIGN PARAMETERS FOR DSC AND ESC

## ASSUMPTIONS

Orbit Altitude = 500 km;  $m_{tot} = 4 \times 5000 \text{ kg} = 20 \text{ metric tons}$ ;  $h/l = 0.5$ ; Near Equatorial Orbit.

\*T = Tension in the horizontal tethers

\*\*Orbit decay rate computed for average atmo. density.

\*DSC WITH HORIZONTAL TETHER DIA. = .2 mm.

*T(N)	$T/3\rho\Omega^2$	Min. Atmo. Density Exosp. Temp. = 600K dia. balloon (m)	Aver. Atmo. Density Exosp. Temp. = 800K dia. balloon (m)	Max. Atmo. Density Exosp. Temp. = 1100K dia. balloon (m)	** Orbital Decay (km/day)	h(km)	l(km)
0.02	$1.21 \times 10^8$	137.92	51.78	20.72	0.62	9.	18.
0.04	$2.42 \times 10^8$	195.05	73.22	29.31	1.25	14.	28.
0.06	$3.63 \times 10^8$	238.88	89.68	35.90	1.87	23.5	47.

\*ESC (OPTION 1) ALL ALUMINUM TETHERS WITH THE SAME DIA.

*T(N)	V = Electro Motive Force (KV)	$\frac{B_l V}{3\delta\rho\Omega^2}$	h(km)	l(km)	Diameter Conductive Tether (mm)	Current (Amp)	Power (kw)	Solar Panel Area (m <sup>2</sup> )	** Orbit Decay (km/day)
0.06	↑	↑	↑	↑	0.21	0.2	2.76	20.	$1.61 \times 10^{-2}$
0.1	↑	↑	↑	↑	0.27	0.33	4.55	32.5	$1.83 \times 10^{-2}$
0.2	13.80	$10 \times 10^8$	10	20	0.38	0.67	9.23	66.0	$2.39 \times 10^{-2}$
0.3	↓	↓	↓	↓	0.47	1.01	13.80	98.6	$2.93 \times 10^{-2}$
0.6	↓	↓	↓	↓	0.67	2.03	27.98	199.9	$4.55 \times 10^{-2}$

\*ESC (OPTION 2) HORIZONTAL WIRES ALUMINUM, VERTICAL WIRES COPPER

- COMPARATIVE TABLE

T(N)	I(Amp)	V(KV)	Power(KW)	Comments
0.3	1.01	13.8	13.8	All wire aluminum
		10.6	10.6	Horizontal Al + .38 mm dia. copper vertical
		7.6	7.6	Horizontal Al + .54 mm dia. copper vertical

\*ESC (OPTION 3) HORIZONTAL WIRES KEVLAR VERTICAL WIRES COPPER

- FRONT VERTICAL WIRE AS ALFVEN ENGINE
- REAR VERTICAL WIRE AS POWER GENERATOR
- POWER TRANSFER (TRANSFER VOLTAGE 5kV, EFFICIENCY 90%)  
BIFILAR LINE TO DELIVER POWER MADE OF SAME COPPER WIRE

I(A)	T(N)	V <sub>delivered</sub> (KV)	V(KV)	P(KW)	Comments
0.2	0.06	2.96	2.44	.49	*
0.33	0.1	2.54	3.06	1.02	*
0.67	0.2	1.71	4.89	3.26	*
1.0	0.3	1.07	6.53	6.53	*
0.2	0.06	3.32	1.58	.316	**
0.33	0.1	3.08	1.93	.643	**
0.67	0.2	2.54	3.06	2.04	**
1.0	0.3	2.17	3.93	3.93	**

\*Vertical tether copper R = 3000Ω dia. = .38 mm

\*\*Vertical tether copper R = 1500Ω dia. = .54 mm

# PSEUDO ELLIPTICAL CONSTELLATION ELECTRODYNAMICALLY STABILIZED (PEC)

## ASSUMPTIONS

- ALUMINUM WIRE DIA. = .67 mm
- THIS KIND OF STRUCTURE CAN BE USED AS EXTERNAL FRAME TO STABILIZE A LIGHT TWO-DIMENSIONAL STRUCTURE (e.g. A REFLECTOR)

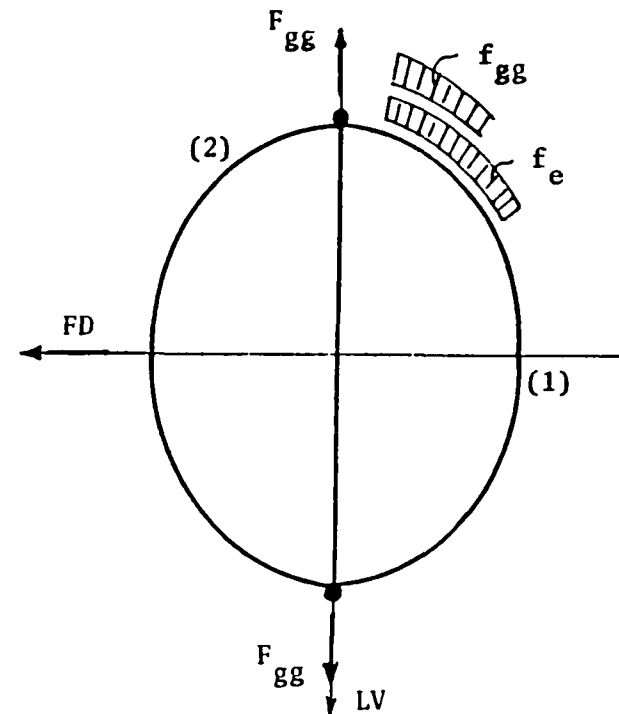

	Current (Amp)	Voltage (kV)	T <sub>1</sub> (N)	T <sub>2</sub> (N)	Perimeter
<b>Case 1</b>					
h = 2a = 20 km l = 2b = 40 km	1.130	12.4	1.35	.56	96.88
<b>Case 2</b>					
h = 2a = 10 km l = 2b = 20 km	.565	3.10	.339	.141	48.44

## TRIANGULAR CONSTELLATIONS STABILIZED BY AIR DRAG

### STABILITY ANALYSIS

#### - ASSUMPTIONS

ORBITAL ALTITUDE = 500 km

3-MASS 1000 kg EACH

BALLOON BALLISTIC COEFFICIENT =  $10 \text{ m}^2/\text{kg}$

BALLOON DIA. = 100 m

#### CONCLUSIONS

A SMALL PITCH ROTATION OF THE CONSTELLATION MAKES ONE OF THE INCLINED TETHERS GO SLACK.

Constellation Rotation (deg) that causes one of the inclined tether to go slack, as a function of geometrical parameters

	0.3	0.5	0.7	1.0	$h/l$
$h(\text{km})$					
5.	4.42	2.03	1.39	0.95	$\theta^\circ$
10.	2.22	1.01	0.69	0.47	$\theta^\circ$
15.	1.48	0.67	0.46	0.31	$\theta^\circ$

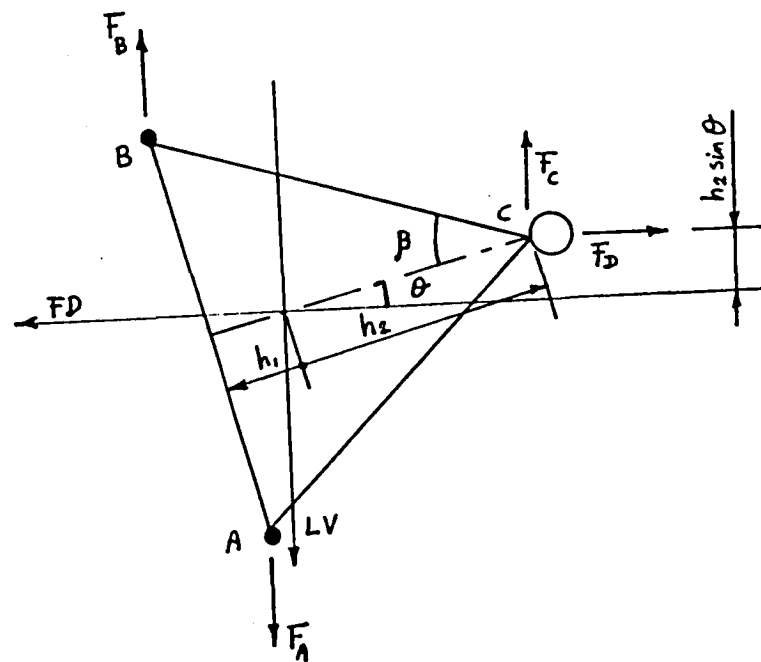

## PRELIMINARY CONCLUSIONS ON TWO-DIMENSIONAL CONSTELLATIONS

- ORIGINAL "FISH-BONE" CONSTELLATIONS ARE STABLE WITH VERY SHORT HORIZONTAL TETHERS (LESS THAN 100 M. AT 500 KM ALTITUDE).
- ALTERNATIVE SOLUTIONS ARE QUADRANGULAR DSC's AND ESC's AND, FOR SPECIAL APPLICATIONS, PEC's.
- IN ALL OF THEM ROTATIONAL STABILITY IS PROVIDED BY GRAVITY GRADIENT (SUITABLE MASS DISTRIBUTION) WHILE SHAPE STABILITY IS PROVIDED BY DRAG FORCES OR ELECTRODYNAMIC FORCES.
- SUITABLE DESIGN PARAMETERS CAN PROVIDE GOOD STABILITY WITH A REASONABLY LOW POWER REQUIREMENT FOR ESC's AND FEASIBLE BALLOONS FOR DSC's.
- ESC's HAVE A STRONGER TENSION IN THE HORIZONTAL TETHERS THAN DSC's AND AN ORBIT DECAY SMALLER BY AN ORDER OF MAGNITUDE.
- ESC's ARE SUITABLE FOR LOW INCLINATION ORBITS. AN OSCILLATION AROUND THE VERTICAL AXIS AT ORBITAL FREQUENCY IS UNAVOIDABLE BECAUSE ESC's TEND TO KEEP THEIR LONGITUDINAL PLANE PERPENDICULAR TO THE  $\vec{B}$  VECTOR.
- DSC's CAN FLY AT ANY ORBITAL INCLINATION. THE YAW OSCILLATION SHOWS UP AT HIGH INCLINATION ONLY DUE TO THE EARTH'S ROTATING ATMOSPHERE.

## SINGLE-AXIS, VERTICAL CONSTELLATION WITH THREE MASSES

- GOOD STABILITY
- MIDDLE MASS LOCATED AT THE SYSTEM ORBITAL CENTER FOR LOW-G APPLICATIONS
- ORBITAL CENTER IS 1.2 m LOWER THAN THE SYSTEM C.M. IN THE CONSTELLATION UNDER INVESTIGATION

### • DESIGN PARAMETERS ADOPTED

- ORBIT ALTITUDE = 500 km
- ORBIT INCLINATION =  $28.5^\circ$
- TETHER LENGTH = 10 km
- $m_1$  (S/S) = 90.6 TON
- $m_2$  (BALLAST) = 9.06 TON
- $m_3$  (LOW-G) = 4.53 TON

### • STATION KEEPING PHASE HAS BEEN SIMULATED

- $J_2$  GRAVITY TERM TAKEN INTO ACCOUNT
- TETHER TRANSVERSE MODES NEGLECTED
- LONGITUDINAL DAMPERS NOT INCLUDED IN THE SIMULATION

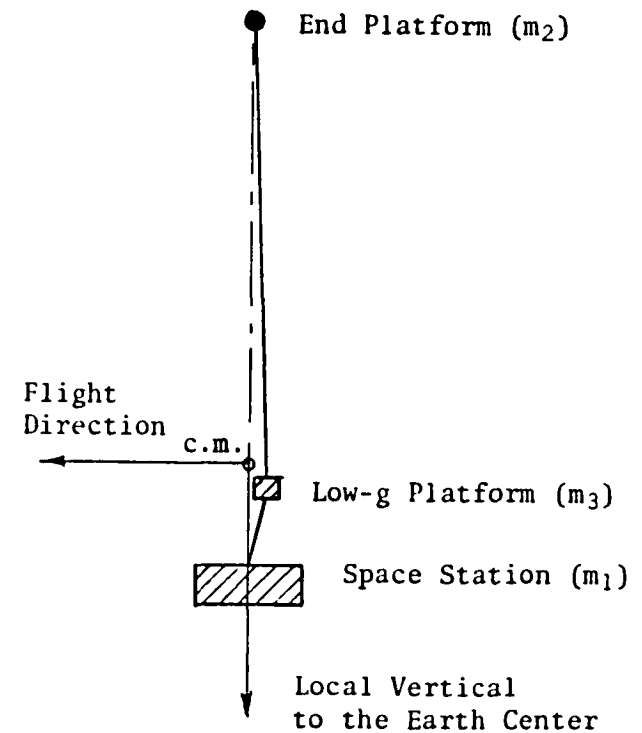

LOW-G APPLICATIONS, STATION-KEEPING PHASE

IN-PLANE COMPONENT VS. TIME

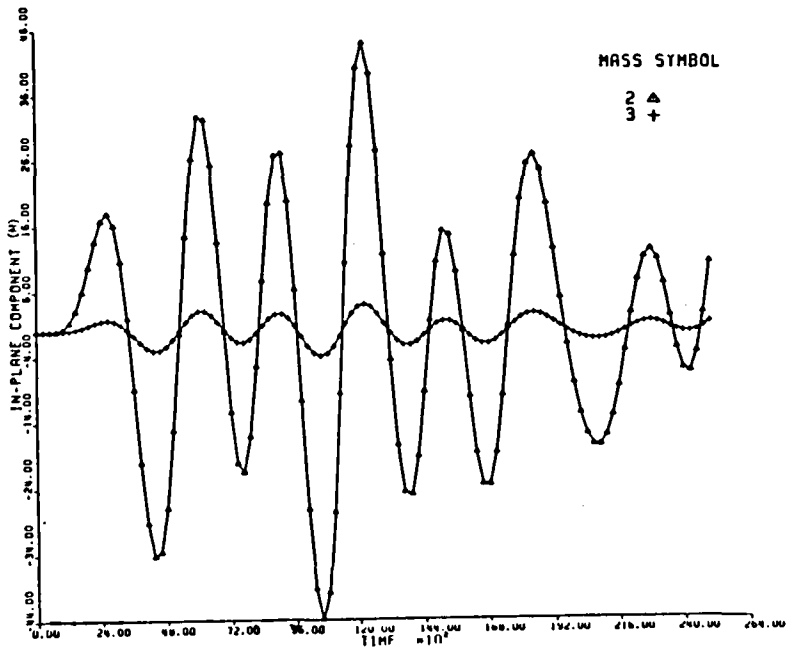

OUT-OF-PLANE COMPONENT VS. TIME

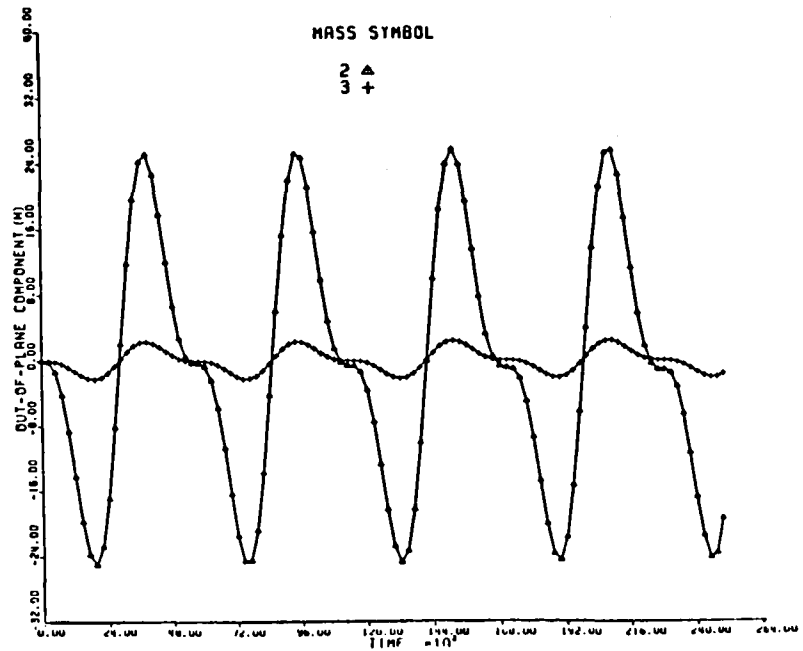

\*ACCELERATION LEVEL OF LOW-G PLATFORM PRELIMINARILY ESTIMATED TO BE AROUND  $10^{-8}g$ .

-RADIAL COMPONENT, SHOWN IN THE FIGURE, IS THE DOMINATING COMPONENT

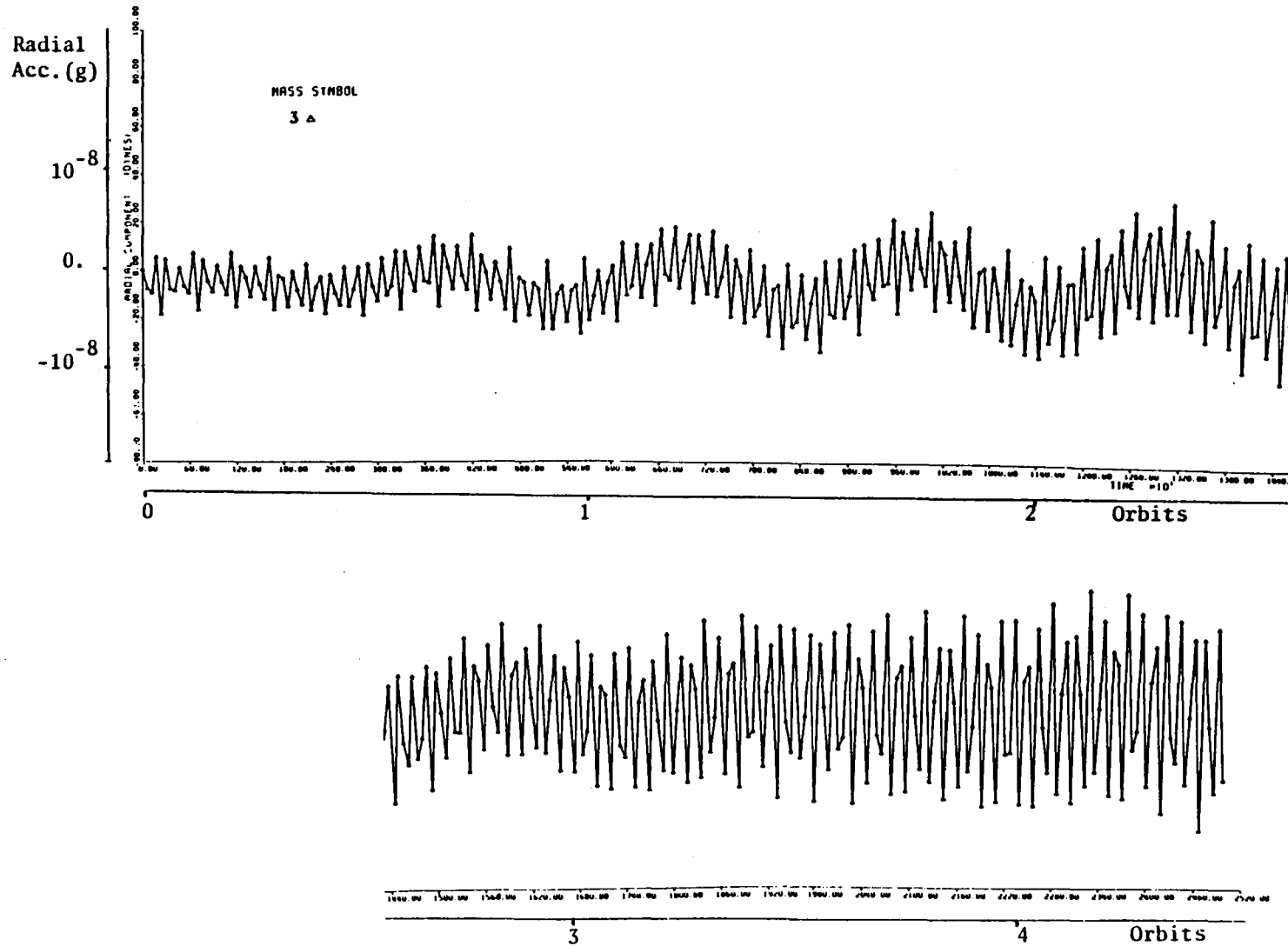

\*SINGLE-AXIS, VERTICAL CONSTELLATIONS APPEAR PROMISING FOR LOW-G/VARIABLE-G APPLICATIONS

\*HIGH FIDELITY ANALYSIS OF EXTERNAL PERTURBATIONS NECESSARY



## PHASE II STUDIES

- TWO-DIMENSIONAL MODEL IMPLEMENTED TO STUDY AND OPTIMIZE DEPLOYMENT MANEUVERS OF SINGLE-AXIS VERTICAL CONSTELLATIONS WITH THREE MASSES
  - SPECIALIZED SOFTWARE NECESSARY FOR PARAMETRICAL STUDY OF DEPLOYMENT
  - STUDY GOAL IS TO DEVISE A DEPLOYMENT STRATEGY WHICH MINIMIZES THE DISTURBANCES (ACCELERATION LEVEL) ON BOARD THE LOW-G PLATFORM
  - SAME DESIGN PARAMETERS AND ORBITAL CHARACTERISTICS AS IN STATION-KEEPING STUDIES THROUGHOUT DEPLOYMENT STUDIES

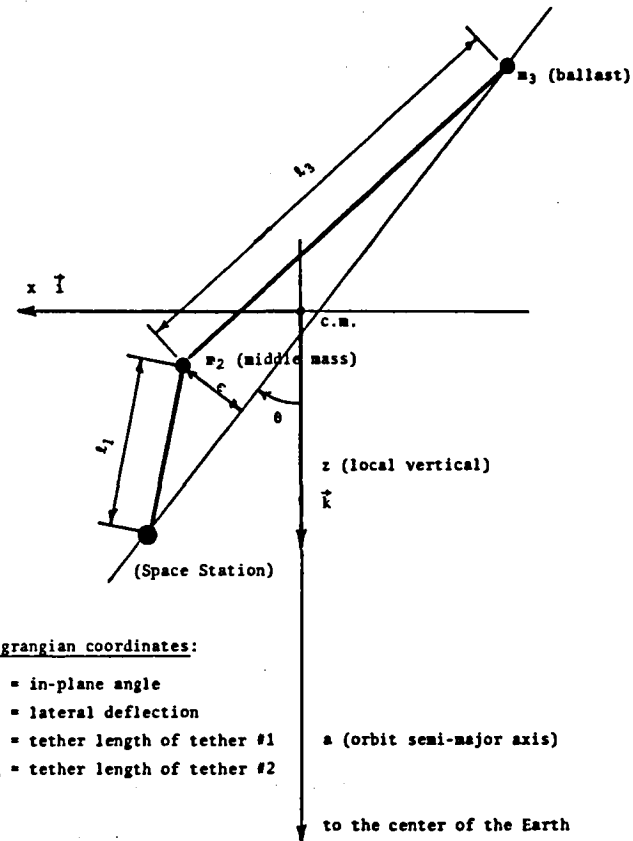

## SELECTION OF THE DEPLOYMENT STRATEGY

- ASSUMPTIONS

- NO DAMPERS
- UNSTRETCHABLE TETHERS
- INITIAL ALIGNMENT ERROR OF THE THREE MASSES:  $\epsilon = 5 \text{ CM}$

- DEPLOYMENT STRATEGY

- RATE CONTROL LAW DESIGNED IN ORDER TO KEEP THE MIDDLE MASS AT THE SYSTEM C.M. THROUGHOUT THE ENTIRE MANEUVER
- LATERAL DEFLECTIONS (AND ACCELERATIONS) OF THE MIDDLE MASS ARE KEPT LOW BY FOLLOWING THE ABOVE MENTIONED STRATEGY
- WHEN DEPLOYMENT IS COMPLETE THE MIDDLE MASS SHOULD BE MOVED TO THE ORBITAL CENTER

- DETAILS ON THE CONTROL LAW

- ACCELERATION PHASE (CONSTANT ANGLE)

$$l(t) = l_T \text{ EXP } (\alpha t) \quad 0 < t < t_T \text{ (TRANSITION TIME)}$$

- DECELERATION PHASE

$$l(t) = l_f - (l_f - l_T) \text{ exp } [-\beta(t-t_T)] \quad t_T < t < t_{sk}$$

$$\beta = \alpha l_T / (l_f - l_T)$$

- ALL THE CHARACTERISTIC LENGTHS ARE IN THE SAME RATIOS AS THE FULLY DEPLOYED TETHER LENGTHS.

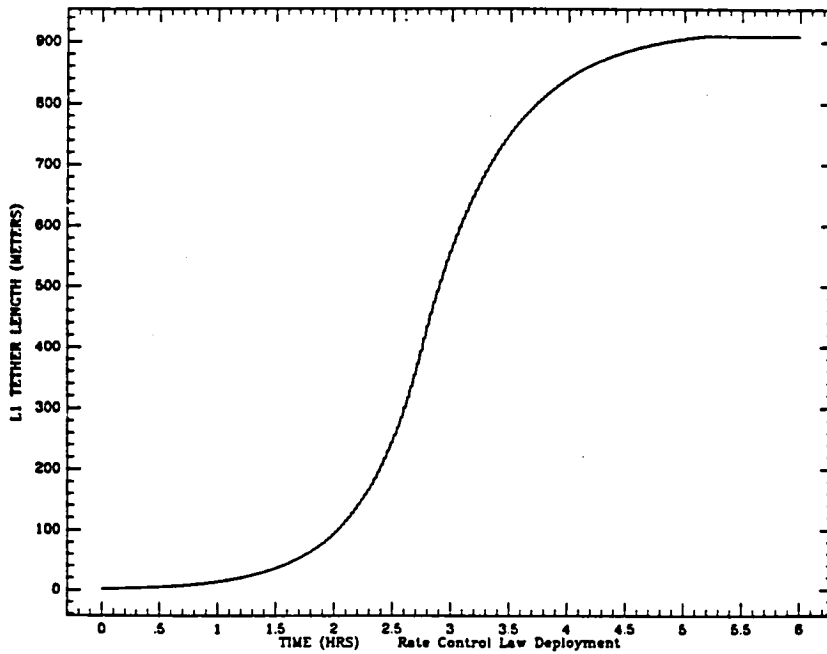

(a) Lower Mass  $m_1$

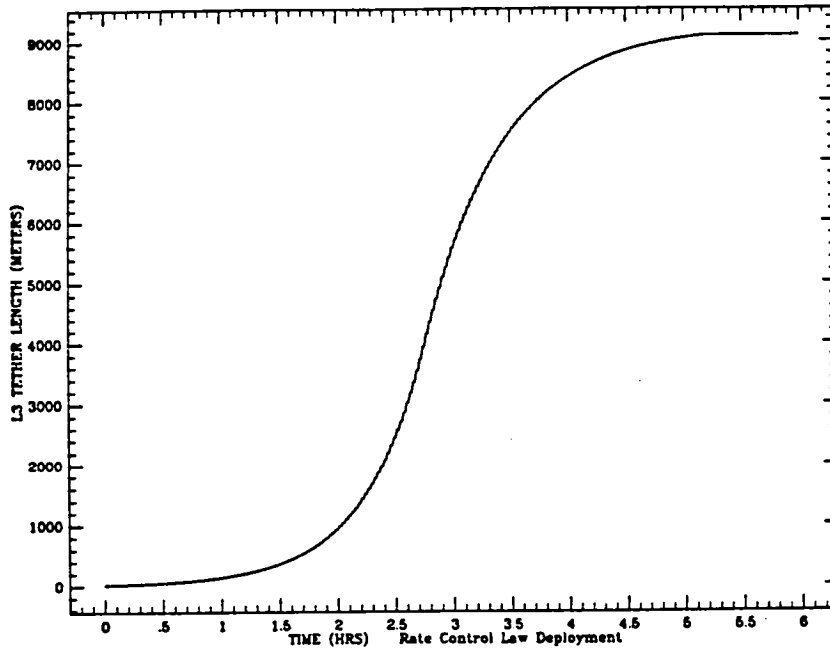

(b) Upper Mass  $m_3$

Figure 2.4.1 Tether length vs. time. DEPLOYMENT

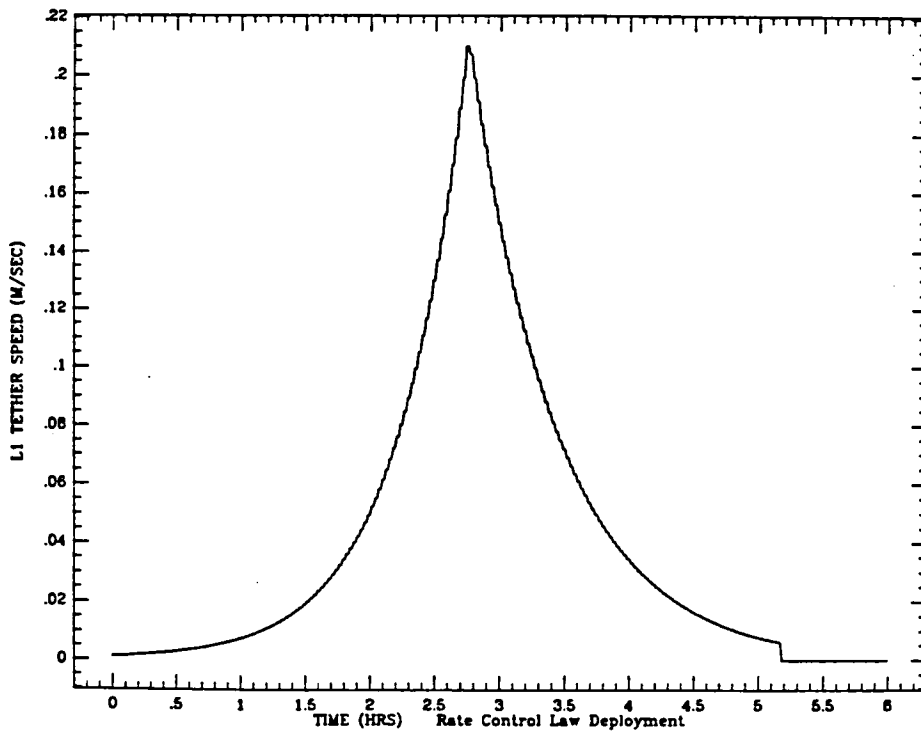

(a) Lower Mass  $m_1$

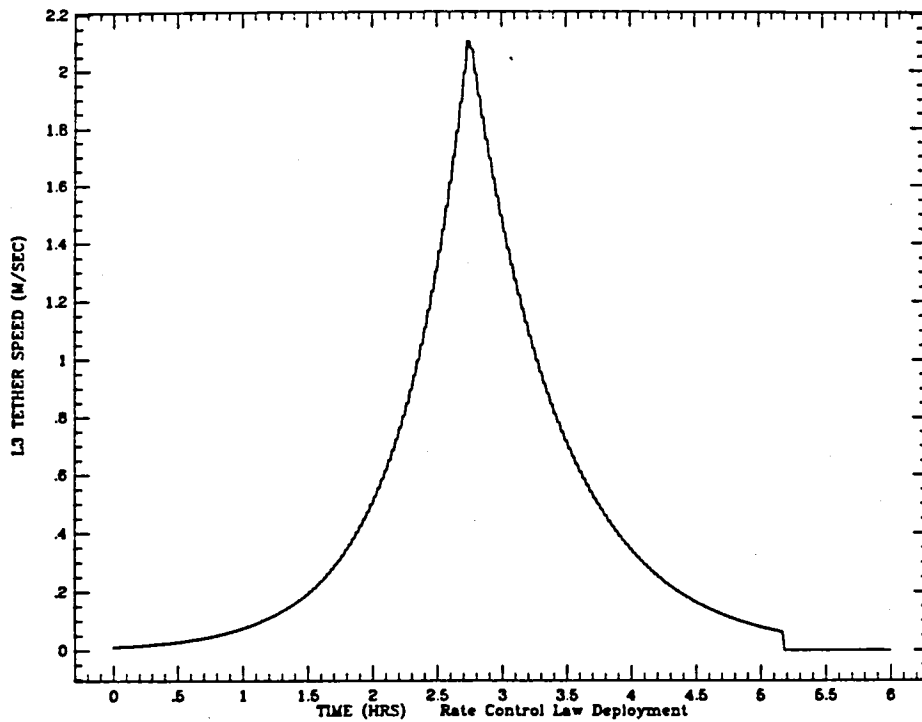

(b) Upper Mass  $m_3$

Figure 2.4.2 Tether speed vs. time. DEPLOYMENT

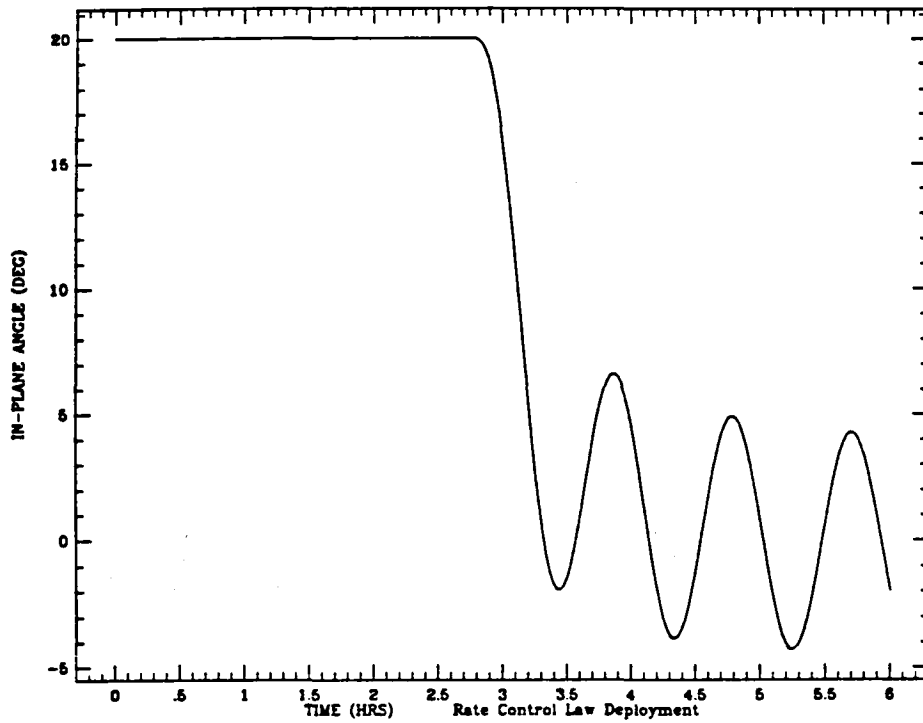

Figure 2.4.3 Constellation's in-plane angle vs. time.  
Initial value = 20°.

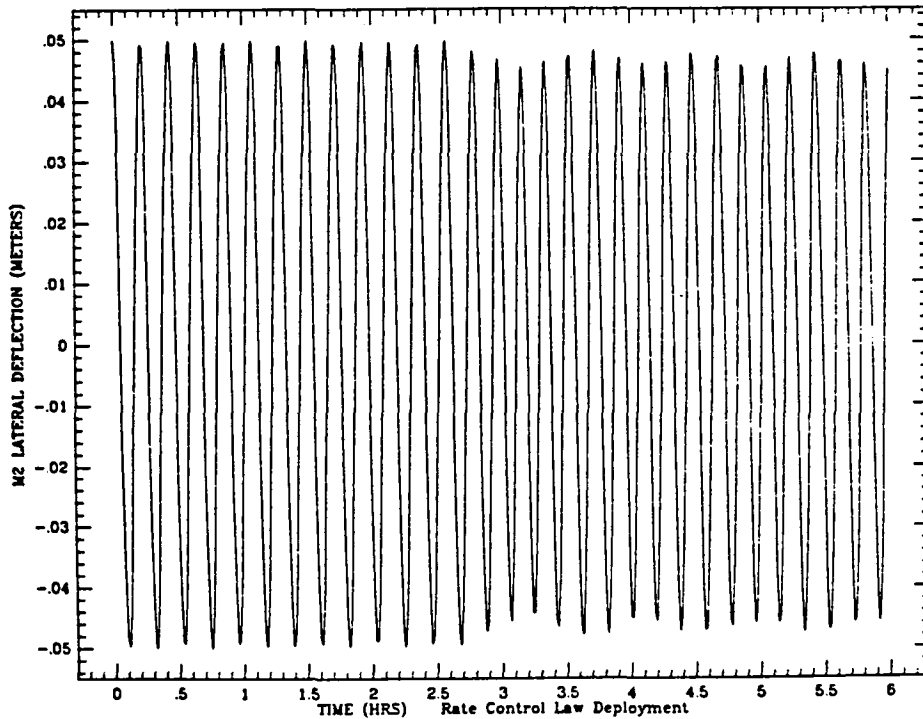
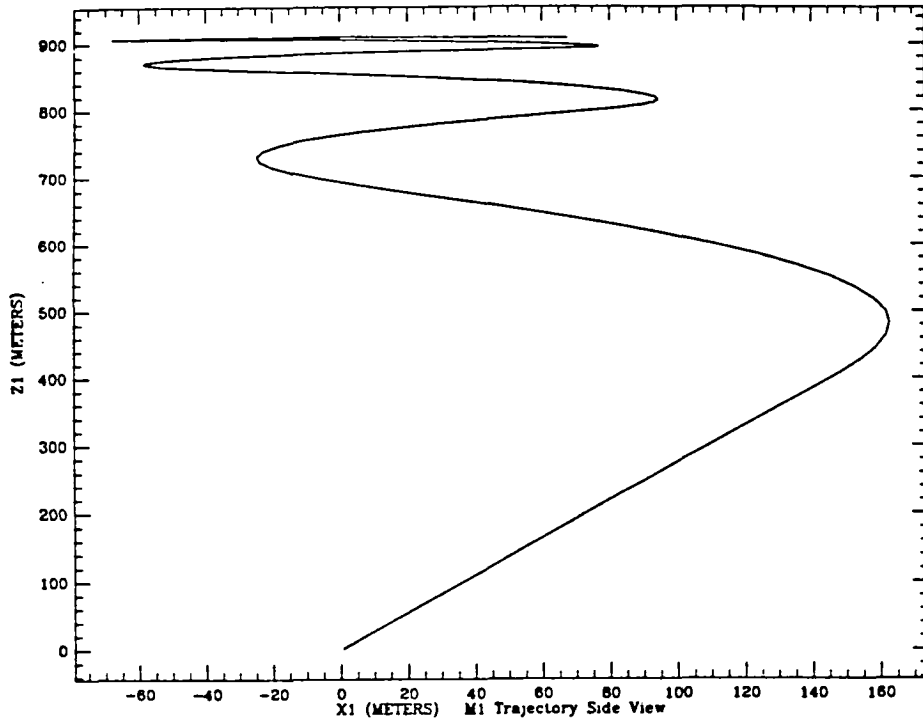
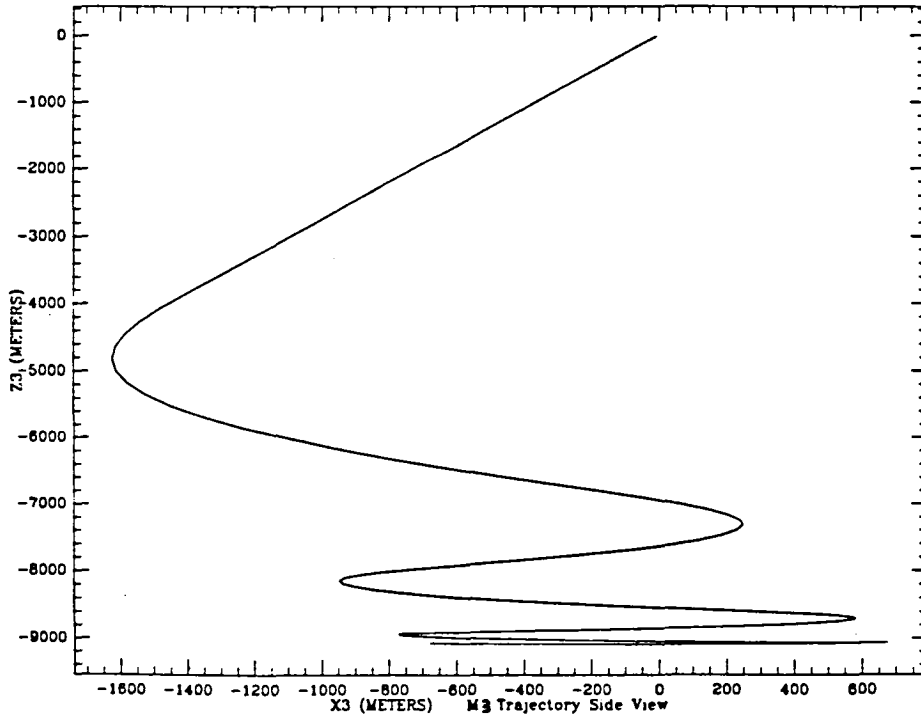

Figure 2.4.8 Lateral deflection of the middle mass vs. time.  
Initial value = 0.05 m. DEPLOYMENT



(a) Lower Mass  $m_1$



(b) Upper Mass  $m_3$

Figure 2.4.5 Trajectory's side view of the lower and upper mass

DEPLOYMENT

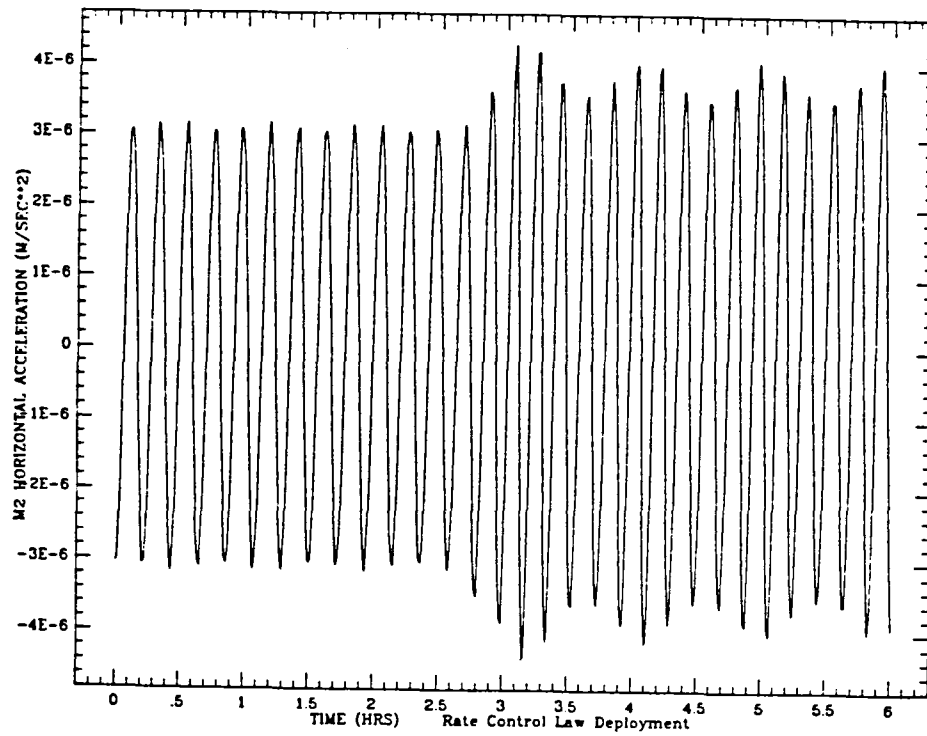

Figure 2.4.9 Horizontal acceleration component of the middle mass vs. time for an initial lateral deflection = 0.05 m.

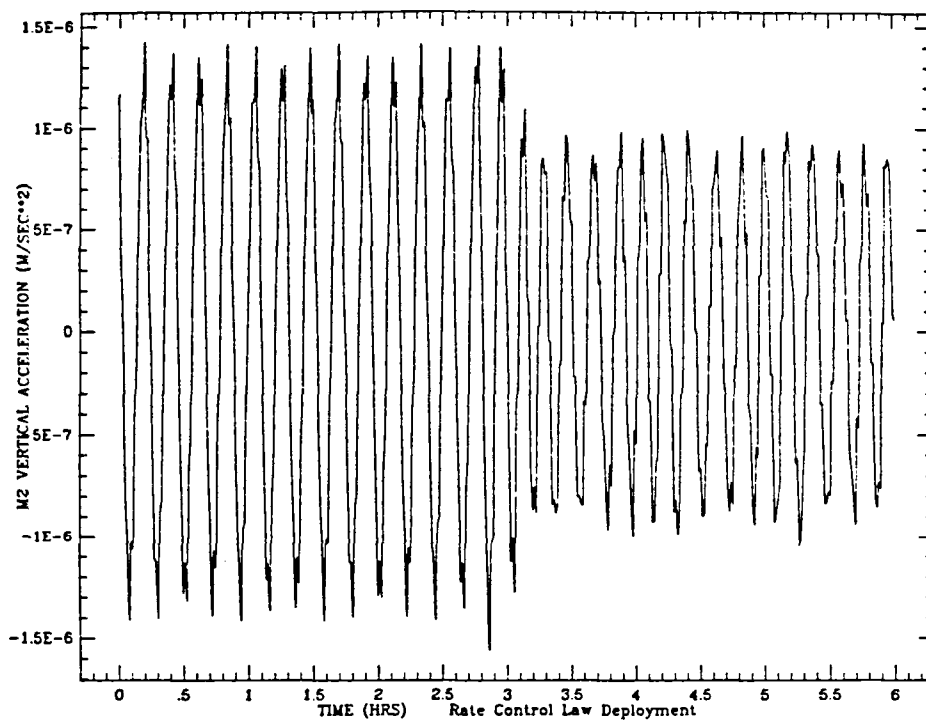

Figure 2.4.10 Vertical acceleration component of the middle mass vs. time for an initial lateral deflection = 0.05 m.

COMMENTS ON DEPLOYMENT SIMULATIONS WITHOUT DAMPERS

- BY MAINTAINING THE MIDDLE MASS AT THE SYSTEM C.M. THE PERTURBATIONS ON IT ARE MINIMIZED DURING DEPLOYMENT.
- THE ACCELERATION LEVEL, HOWEVER, DEPENDS ON THE INITIAL MISALIGNMENT ERROR OF THE THREE MASSES.
- AT THIS STAGE OF THE STUDY DAMPING OF LATERAL OSCILLATIONS APPEARS THE MOST DIFFICULT.
- THE MIDDLE MASS SHOULD BE MOVED TO THE ORBITAL CENTER (ZERO ACCELERATION POINT IN STEADY STATE CONDITION), WHEN THE DEPLOYMENT HAS BEEN COMPLETED.



## DAMPING OF VIBRATIONAL MODES

- IMPROVED TWO-DIMENSIONAL MODEL
  - ELASTIC TETHERS
  - LONGITUDINAL TETHER OSCILLATION DAMPERS
  
- MODIFIED TETHER CONTROL LAW
  - OPTIMIZED ANGULAR FEEDBACK FOR RATE CONTROL LAW
    - OVERALL LIBRATION CONTROL
    - EFFECTIVE ALSO IN DAMPING TRANSVERSE OSCILLATIONS
  
- THE ORBITAL VELOCITY STRONGLY AFFECTS THE IN-PLANE RESPONSE SO THAT THE BEST DAMPING CYCLE IS NO LONGER SHAPED LIKE A YO-YO CYCLE.
  
- THE BEST OSCILLATION CYCLE MAKES THE SATELLITE FOLLOW AN S-SHAPED TRAJECTORY WITH DECREASING TETHER LENGTH FOR RETROGRADE TETHER LIBRATION.

• TETHER LIBRATION DAMPING ( $\theta$ )

- ENERGY DISSIPATED PER CYCLE

$$E_D = 2 \int_0^T \ell \dot{\ell} (\dot{\theta} - \Omega) \dot{\theta} dt$$

- THE TERM DEPENDING ON  $\Omega$  (ORBITAL RATE) IS DOMINATING

- IN ORDER TO HAVE  $E_d \gg 0$  A GOOD CONTROL LAW IS

$$\ell_c = \ell_{SK} (1 - K_\theta \theta) \text{ so that } E_d \approx 2 \ell_{SK}^2 K_\theta \left[ \int_0^T \dot{\theta}^2 \Omega dt - \int_0^T \dot{\theta}^3 dt \right]$$

• TRANSVERSE OSCILLATION DAMPING ( $\epsilon$ )

- ANGULAR FEEDBACK THAT TAKES INTO ACCOUNT THE LATERAL DEFLECTION DAMPS OUT LATERAL OSCILLATIONS

$$\ell_{c1} = \ell_{SK1} \left[ 1 - K_{1\theta} (\theta - \epsilon / \ell_1) \right] \quad \text{tether \#1}$$

$$\ell_{c3} = \ell_{SK3} \left[ 1 - K_{3\theta} (\theta + \epsilon / \ell_3) \right] \quad \text{tether \#2}$$

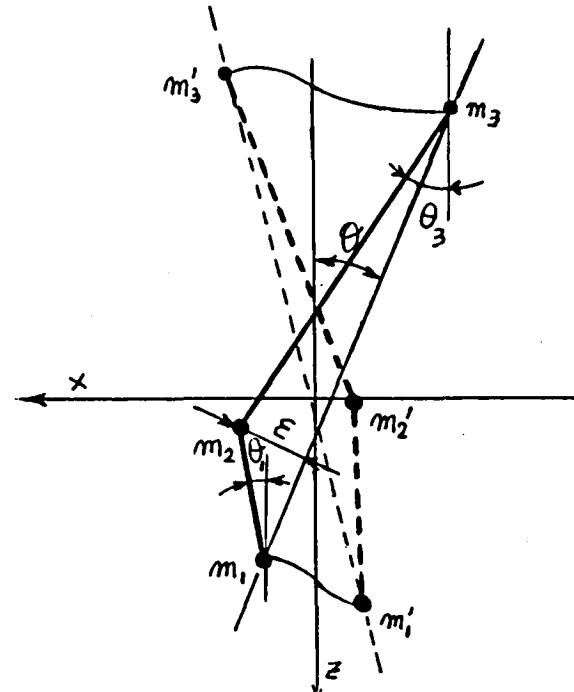

- TETHER LONGITUDINAL OSCILLATION AND TETHER LIBRATION HAVE FREQUENCIES DIFFERENT BY AN ORDER OF MAGNITUDE
- SIMULTANEOUS MULTI-FREQUENCY DAMPING BY REEL-CONTROL IS AN OPTION. REEL-CONTROL TUNED IN TIME SHARING TO FREQUENCIES THAT ARE TO BE DAMPED OUT IS ANOTHER OPTION
- A LONGITUDINAL DAMPER (SPRING + DASHPOT) PER EACH TETHER IS PROBABLY A SIMPLER SOLUTION
  - THIS SOLUTION IS ADOPTED IN THE FOLLOWING SIMULATIONS
  - EACH DAMPER IS TUNED TO THE RESPECTIVE TETHER'S LONGITUDINAL FREQUENCY
  - CRITICAL DAMPING FACTORS ARE MORE EFFECTIVE THAN SUBCRITICAL ONES
  - LONGITUDINAL DAMPERS STRONGLY REDUCE THE LIKELIHOOD OF SLACK TETHER

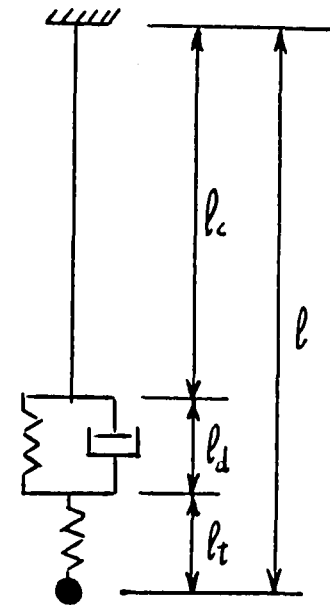

- MODIFIED DEPLOYMENT STRATEGY + DAMPERS

- LONGITUDINAL DAMPERS ACTIVE THROUGHOUT THE WHOLE MANEUVER
- ACCELERATION PHASE EQUIVALENT TO PREVIOUS DEPLOYMENT (CONSTANT ANGLE)
- WHEN TETHER VELOCITY OF PHASE I MATCHES TETHER VELOCITY REQUIRED BY ROTATIONAL DAMPER ON, ROTATIONAL AND TRANSVERSE DAMPERS ARE SWITCHED ON
  - A COSINUSOIDAL TRANSITION LAW IS USED TO MATCH THE TETHER LENGTHS
  - THE ROTATIONAL DAMPER DRIVES THE SYSTEM TO A COMPLETE DEPLOYMENT

$$l_c = l_i \exp(\alpha t) \quad \text{acceleration phase}$$

$$l_c = l_{sk} [1 - f_{tr} - k_\theta (\theta - \epsilon/l)] \quad \text{rotational damper on}$$

$$f_{tr} = (l_{ftr} - l_{itr}) \cos\left(\frac{\pi}{2} t/T_{tr}\right)$$

- MODIFIED DEPLOYMENT STRATEGY RESULTS IN A FAST MANEUVER
- THE ELASTIC TETHERS ASK FOR EXTRA CARE IN THE INITIAL PART OF THE MANEUVER
  - IN LINE THRUSTER RECOMMENDABLE
  - PRESENT SIMULATIONS START AT A TETHER LENGTH (20 M AND 200 M RESPECTIVELY) WHERE THE IN-LINE THRUSTERS ARE SUPPOSED TO GO OFF

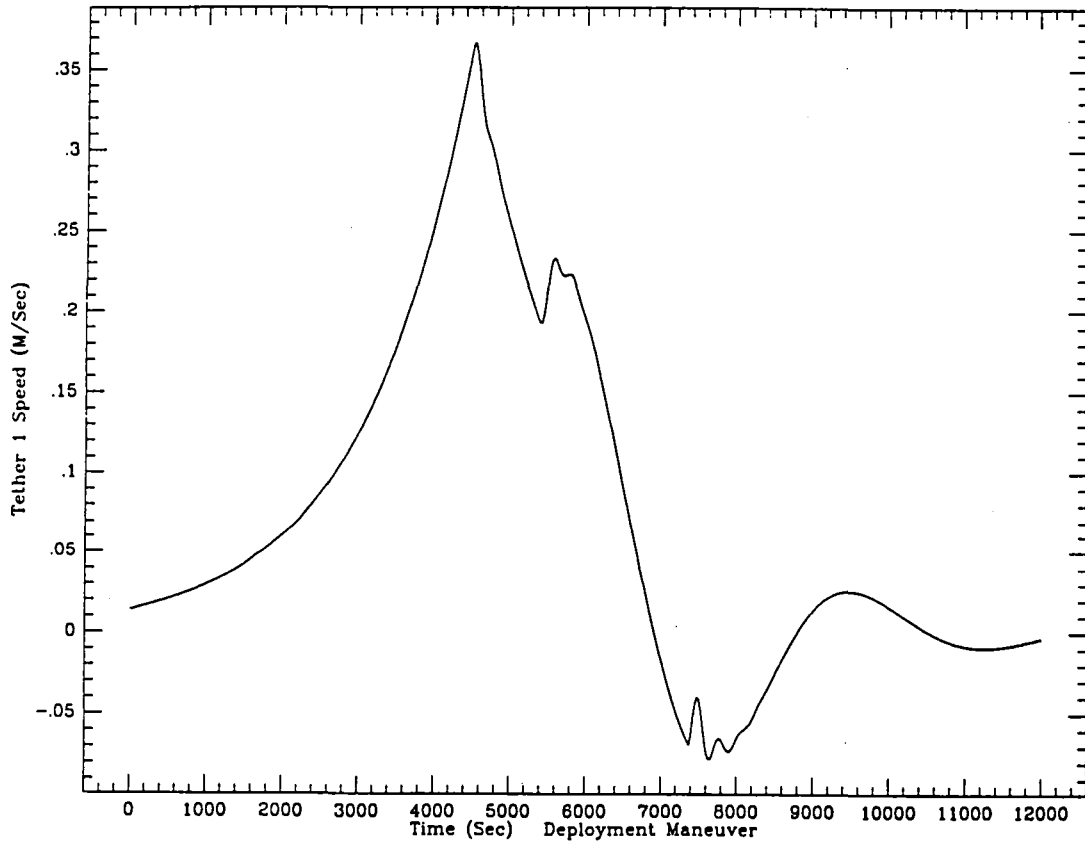
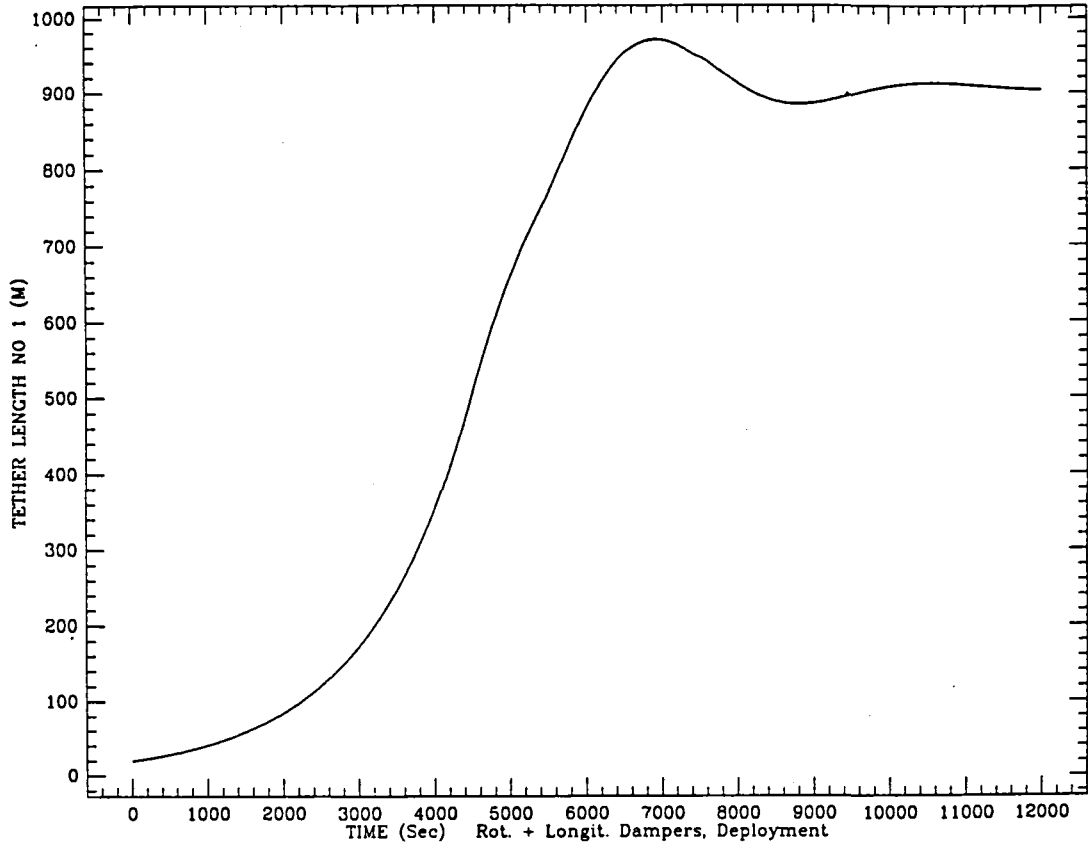

**DEPLOYMENT**

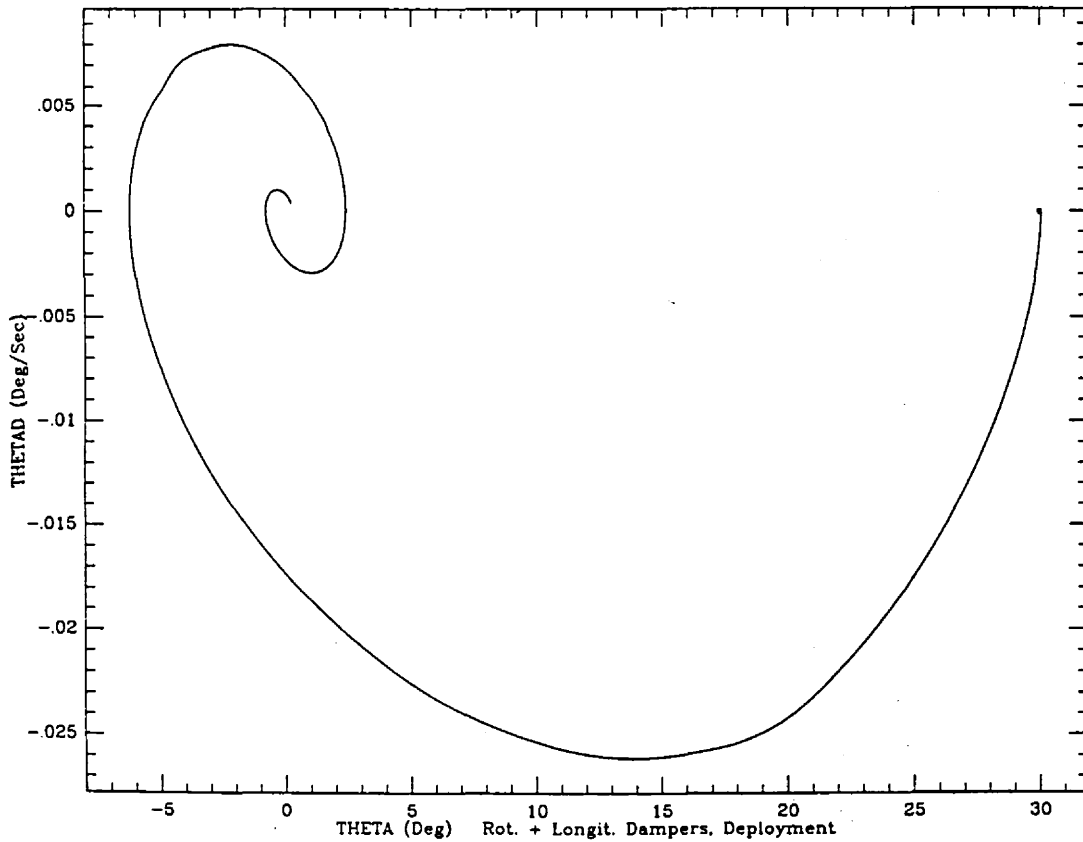
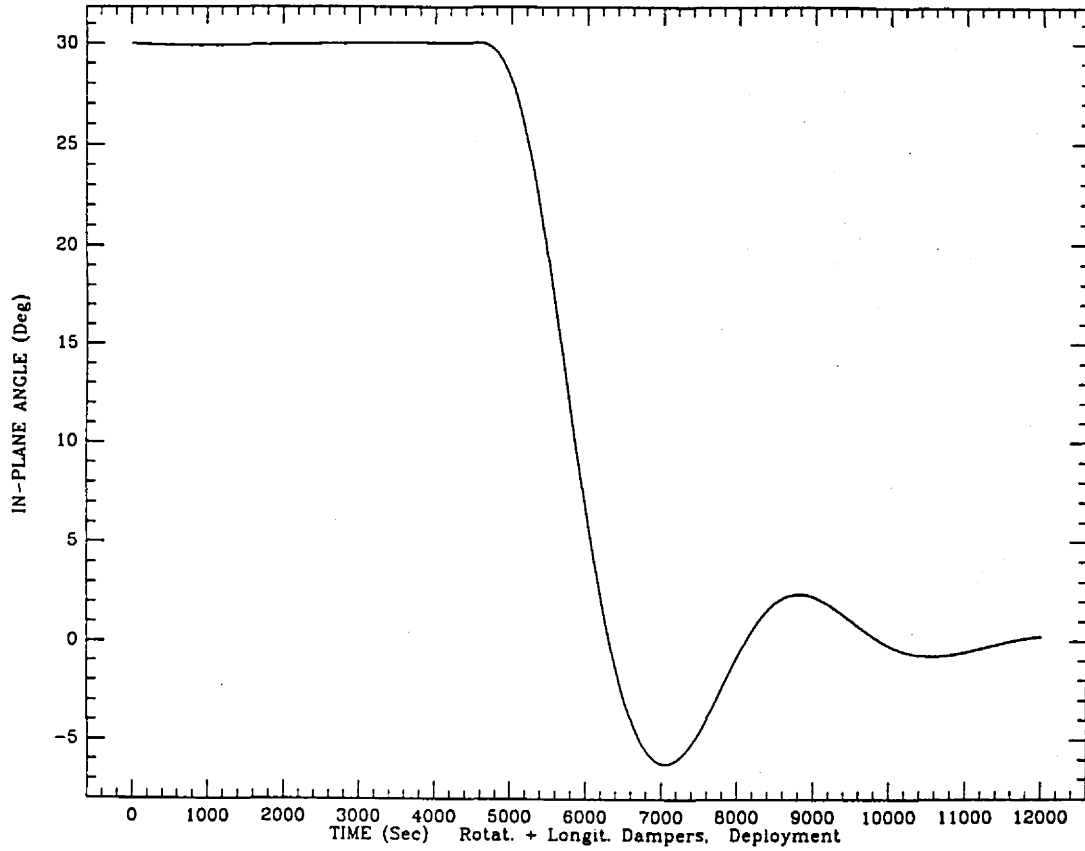

DEPLOYMENT

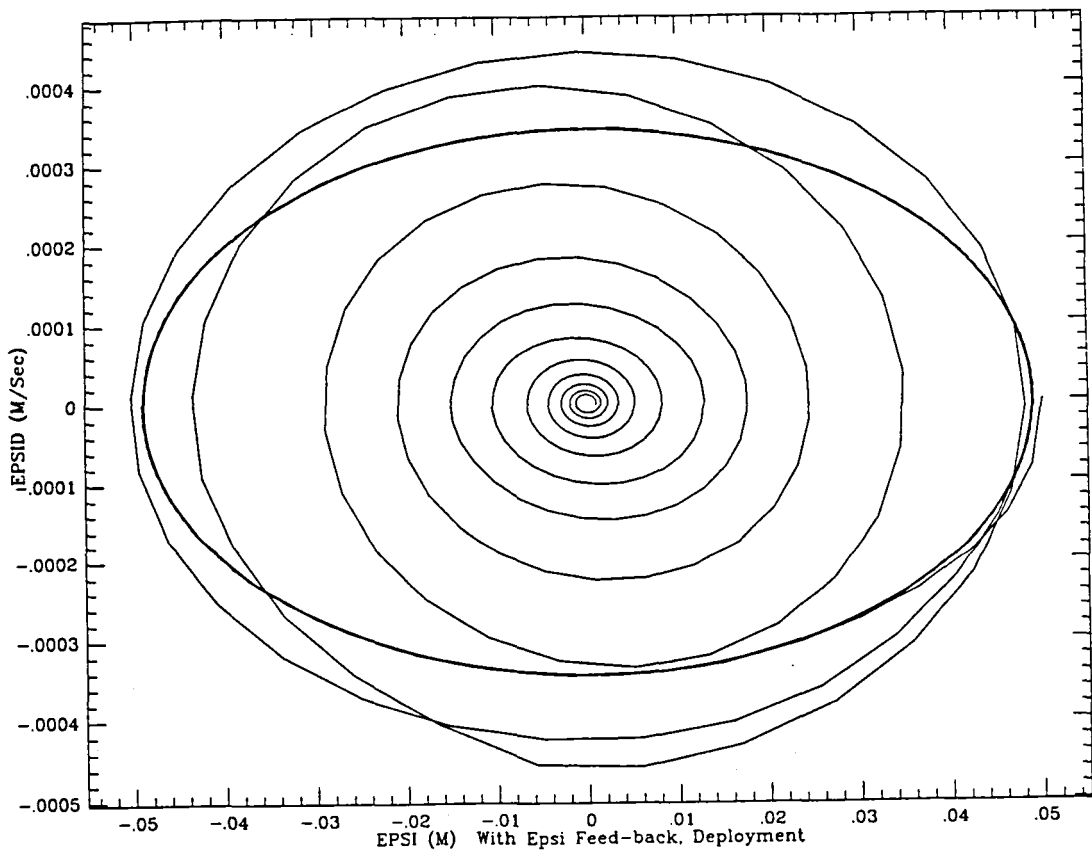
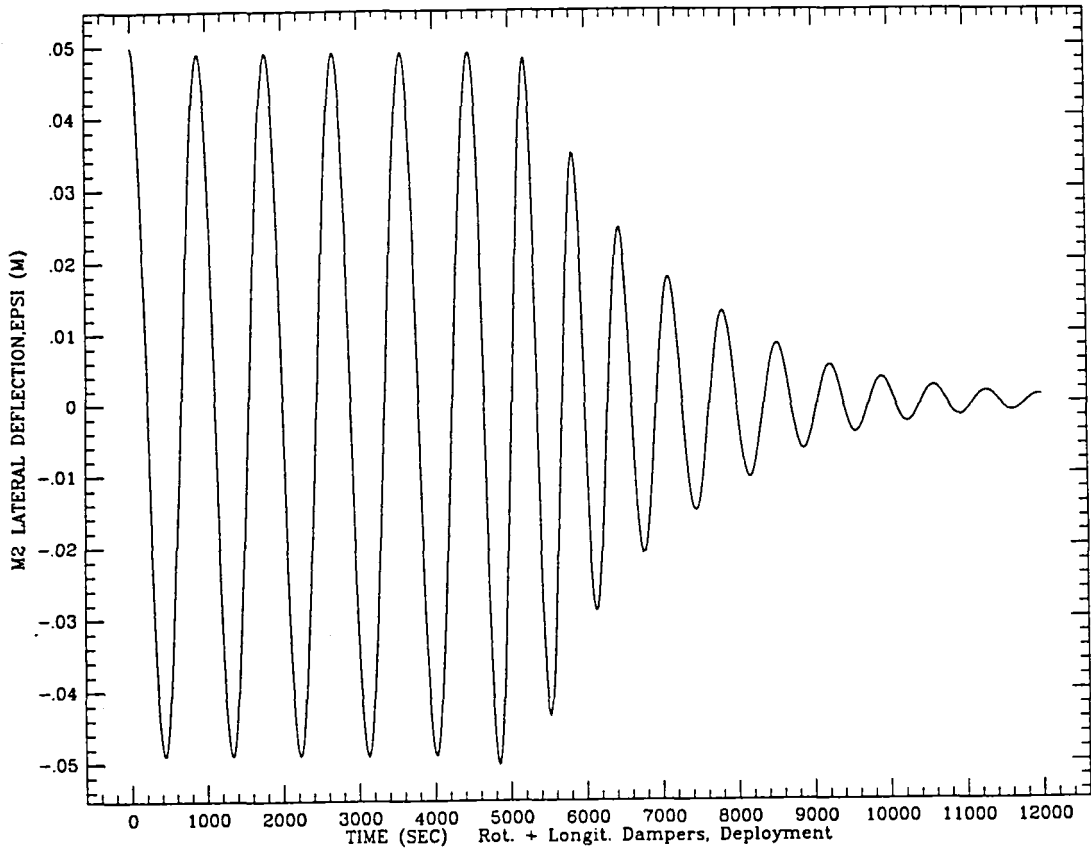

DEPLOYMENT

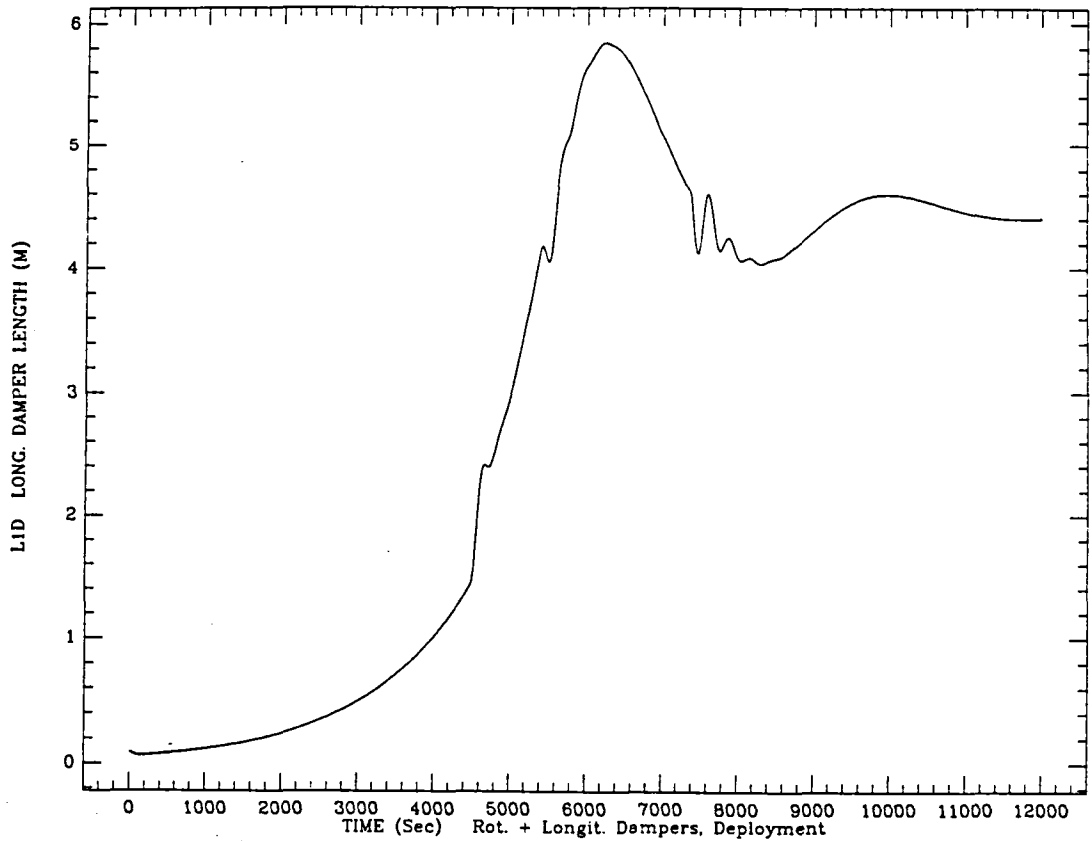
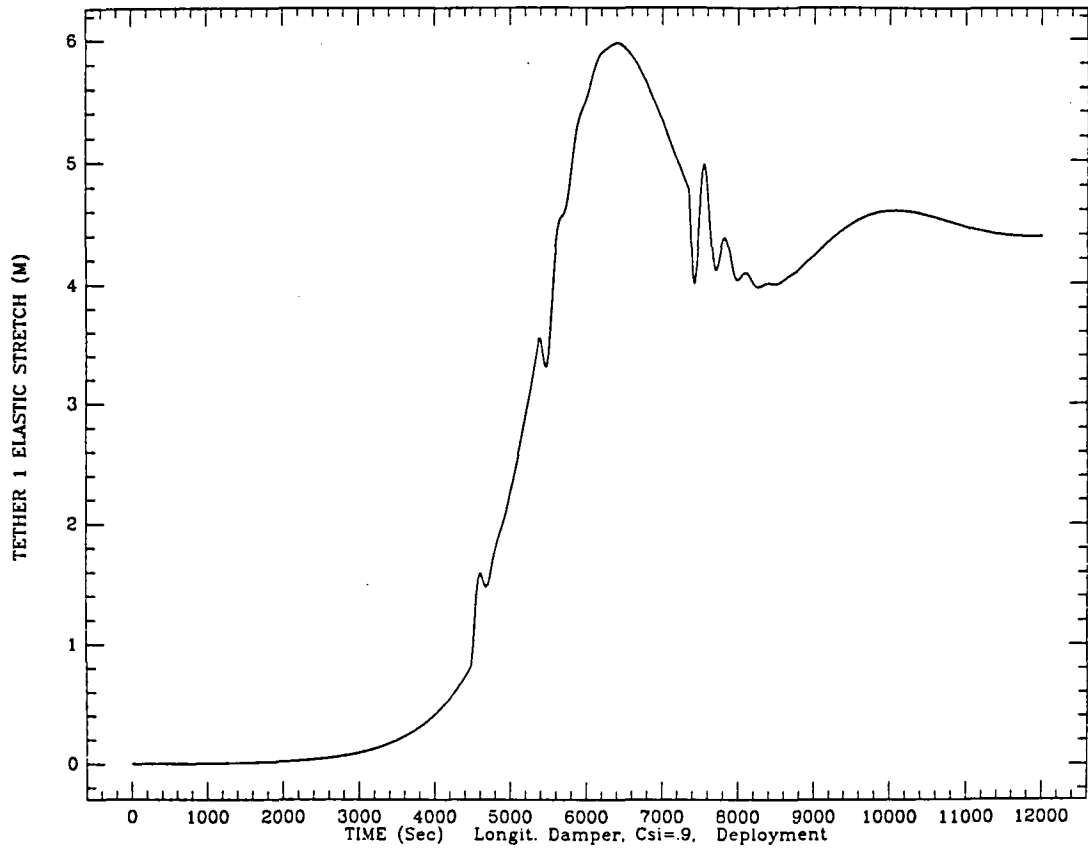

DEPLOYMENT



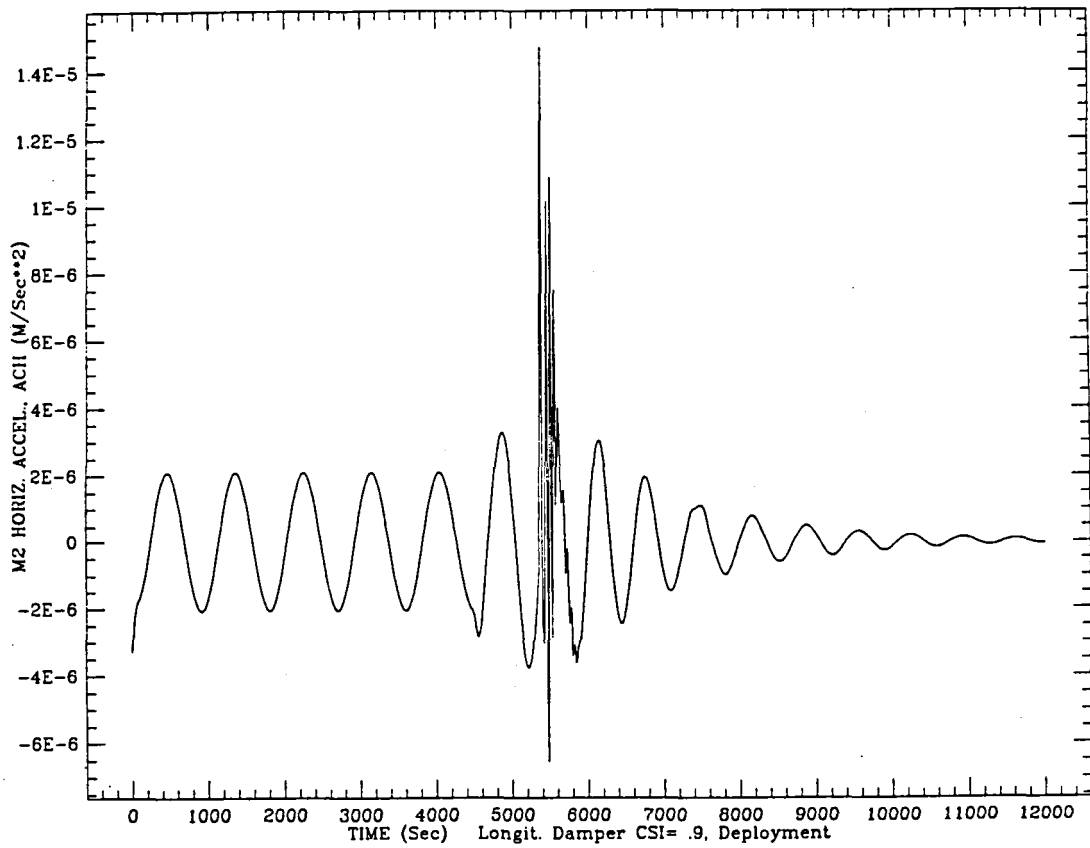
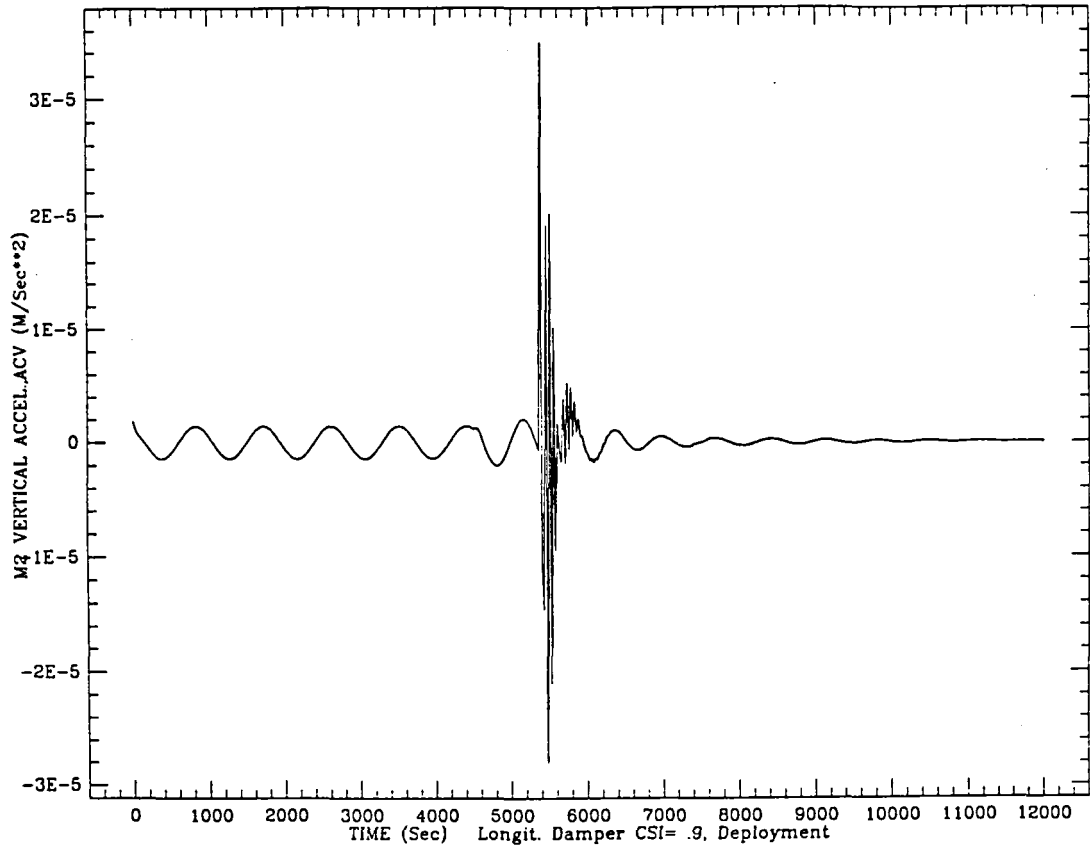

DEPLOYMENT

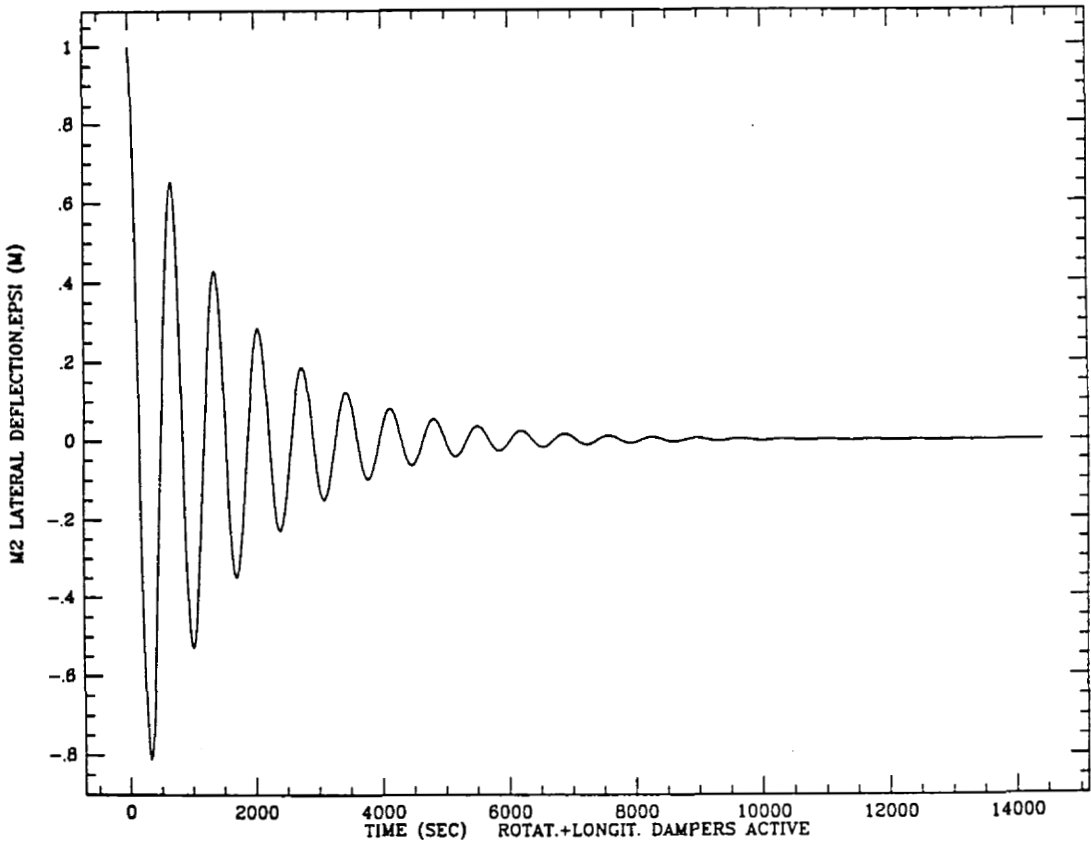
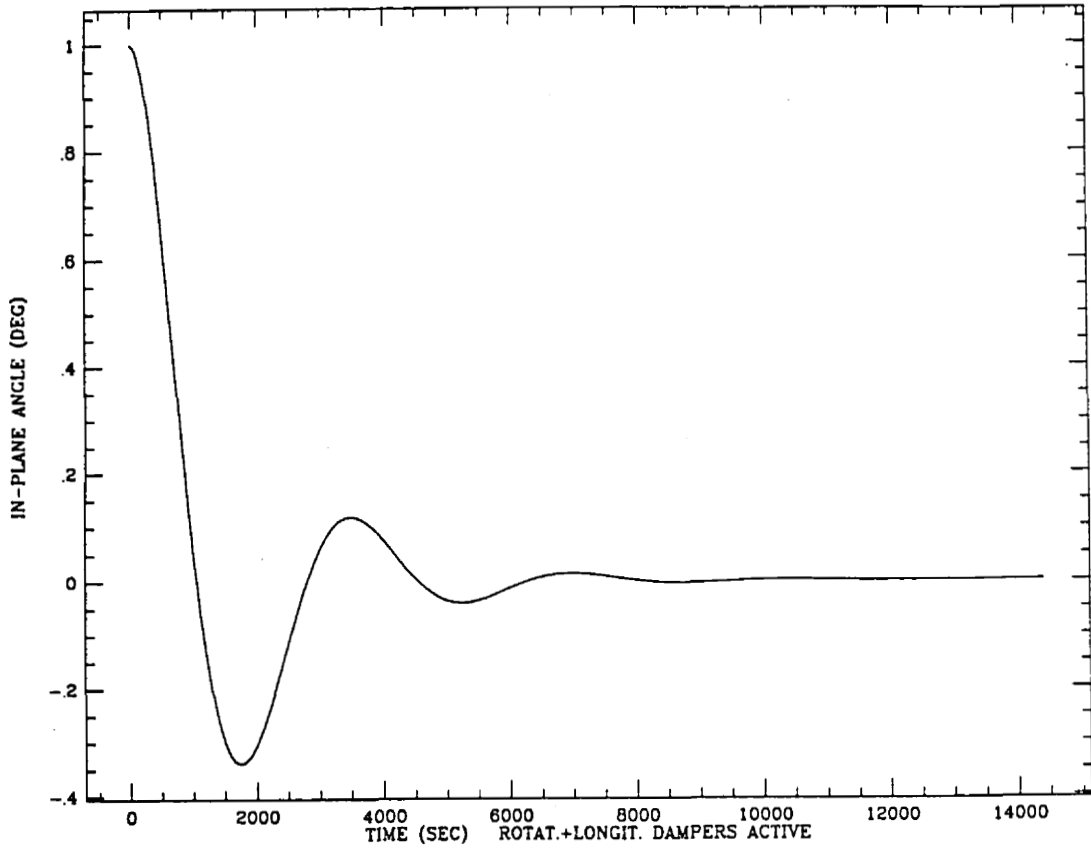

**STATION-KEEPING**

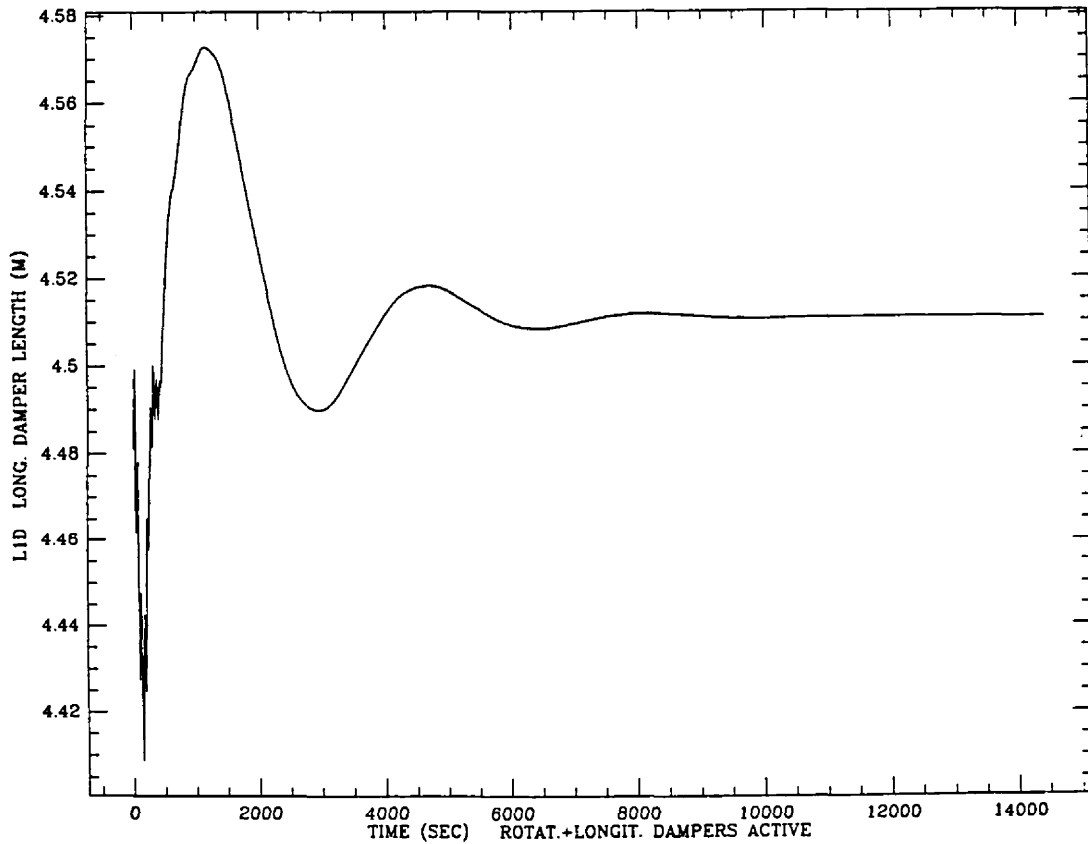
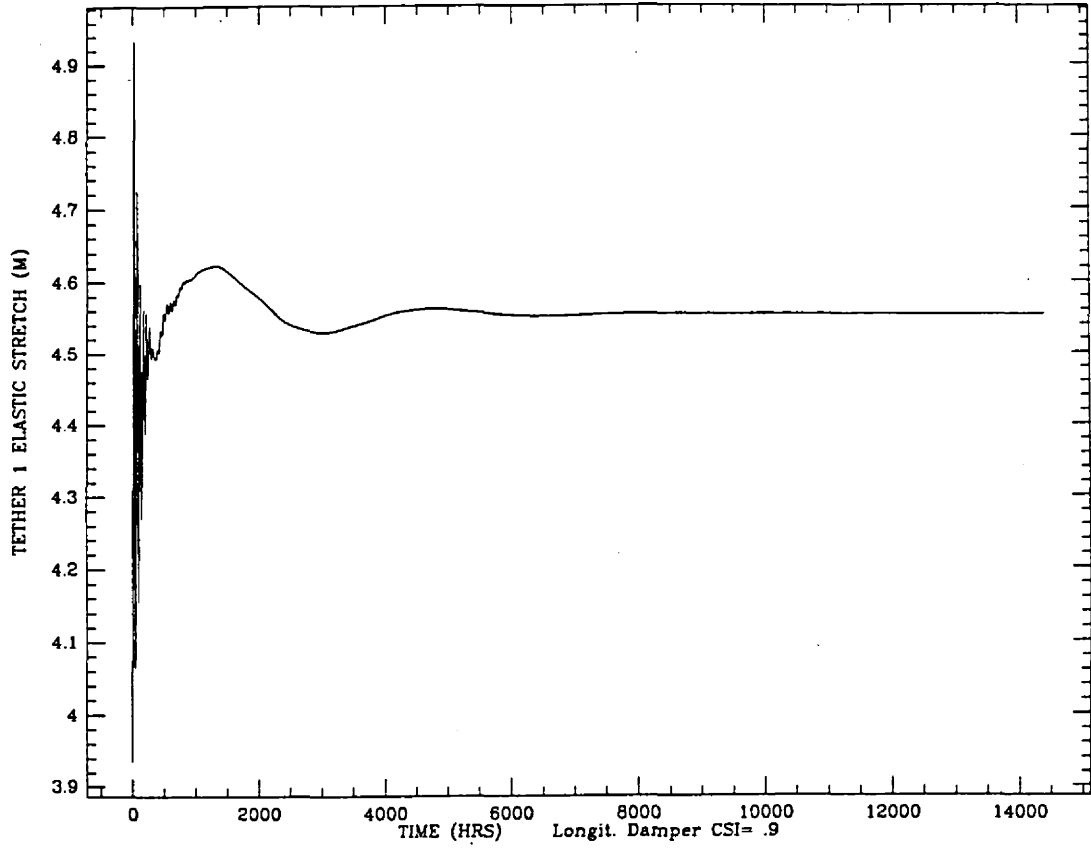

STATION-KEEPING

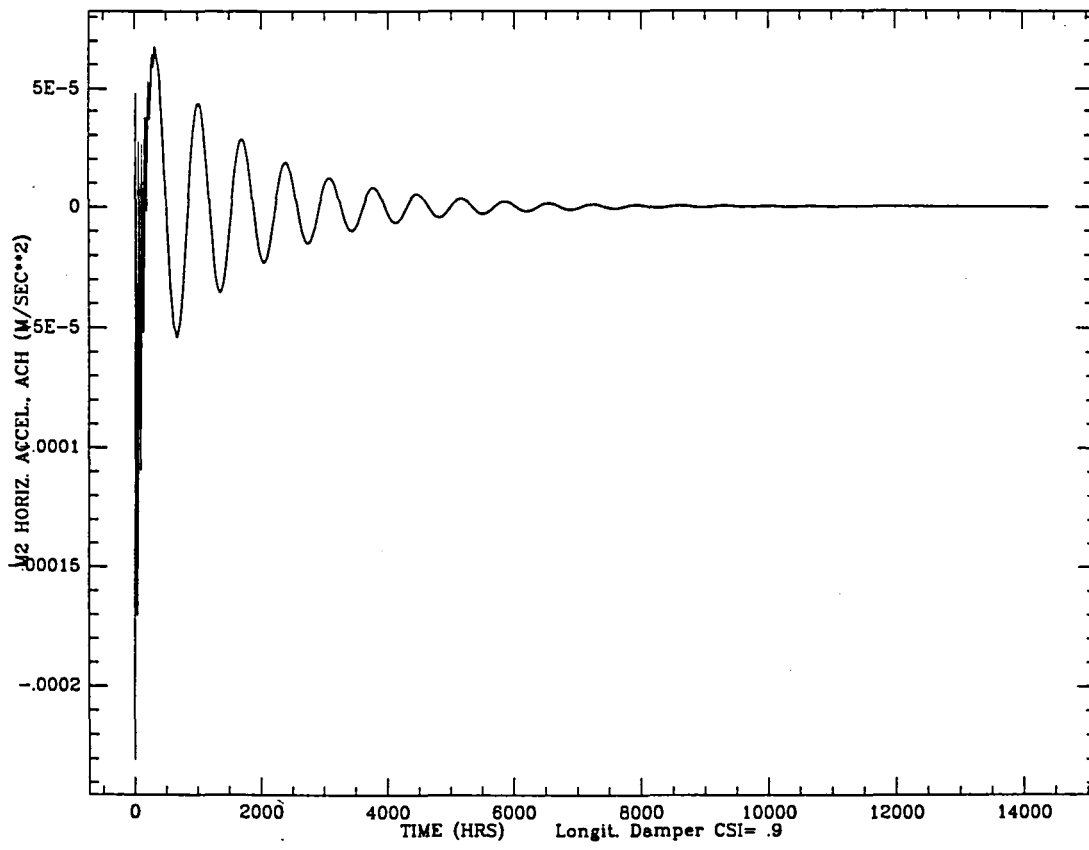
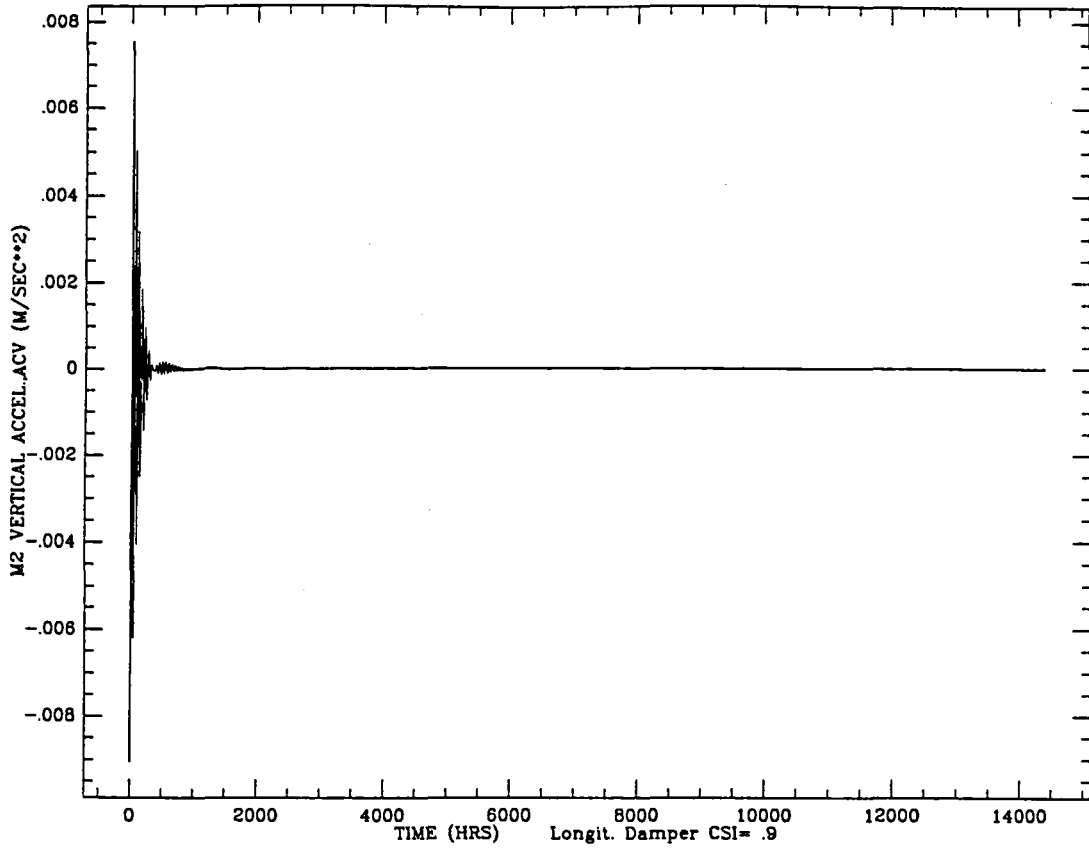

STATION-KEEPING

- COMMENTS ON DAMPING OF VIBRATIONAL MODES DURING DEPLOYMENT
  - EFFECTIVE WAY OF DAMPING LONGITUDINAL, LATERAL AND SYSTEM LIBRATIONS HAS BEEN DEvised
    - DAMPING OF LATERAL OSCILLATIONS REQUIRES A GOOD KNOWLEDGE OF THE THREE-MASS ALIGNMENT
    - ROTATIONAL ANGLE WITH RESPECT TO THE LOCAL VERTICAL ALSO REQUIRED. A LOWER ACCURACY THAN THAT FOR THE LATERAL DEFLECTION IS NECESSARY.
  - FAST DEPLOYMENT HAS BEEN ATTAINED
  - INITIAL OSCILLATIONS DAMPED OUT IN FEW HOURS SO THAT FINAL ACCELERATION LEVEL ON THE LOW-G PLATFORM IS LOWER THAN THAT ESTIMATED IN THE STATION-KEEPING STUDIES (THE FORCING TERMS ARE INACTIVE THIS TIME).



TECHNOLOGY AND TEST PANEL





APPLICATIONS OF TETHER  
IN SPACE WORKSHOP

VENICE, ITALY

OCTOBER 15-17, 1985

TECHNOLOGY AND TEST PANEL  
REPORT

**October 16th Summary**

Either the Technology and Test panel did an outstanding job at the Williamsburg workshop two years ago, or the same people are repeating the recommendations that were made then. In actuality, it is a combination of the two situations because the basic tether technology requirements have not changed nor have the people who were involved in 1983 changed all that much. In fact, the new panel members reinforce the position of the continuing members. As a result of this situation, the panel makes no new recommendation nor does it have any new applications to propose. This position is pending interfaces and inputs from the other discipline panels, but preliminary discussions indicate continuing technology concerns from the other panels also.

The Technology and Test panel spent the day in formal presentations and reviews of the ongoing technology related work. The morning session was spent reviewing the Atmospheric/Aerothermodynamic or tethered "wind tunnel" concept, specifically the TSS-2 proposal, and the Shuttle Tethered Aerothermodynamic Research Facility feasibility/definition study results. The panel endorses this work as an important near-term tether application and recommends an aggressive design and development program. (It was also brought to the panel's attention that a high priority recommendation of the S&A panel was a low atmosphere mission similar to that proposed by STARFAC).

The second technology area reviewed was tether mission (science) and system (engineering) instrumentation. Ongoing studies have concentrated on the definition of instrument requirements for the atmospheric/aerothermodynamic mission but have also touched on general tether applications system performance monitoring and control instrumentation such as satellite positioning laser systems to supplement GPS capabilities, tether temperature, and techniques for failure detection (fiber optic). An instrumentation issue surfaced as a result of a stated requirement for a tensiometer to be located at the satellite during TSS-2 and STARFAC missions to define system drag and support system control and post-flight dynamic modeling and performance analysis. If such a measurement is necessary for TSS-2, why shouldn't TSS-1 also have such a measurement to support similar analysis. As a result of discussions, the panel recommends that the inclusion of such a measurement be studied and implemented if possible.

The morning session was concluded with presentations, by Turci, relative to the status of Aeritalian studies: (1) Tether Pointing Platform, a system similar to that proposed by Lemke of NASA ARC to provide a controlled remote platform for TBD tether application; (2) Tether Space Elevator Mechanism Concepts, the development of which is an enabling technology for Variable Gravity Applications and transportation of platforms and systems along a tether.

The afternoon was spent reviewing various dynamic simulation/mission modeling capabilities. Although SKYHOOK and GTOSS were not formally presented, they were discussed and are considered the base simulation systems at this time.

The question being asked is "Is there a need for a 'universal' simulation capability and, if not, how can mission designs and analyses be regulated and controlled for consistency and reliability?" This subject will be discussed tomorrow, and a recommendation will be made.

Not included in today's summary because of a lack of interested or involved participants (which is probably a result of a lack of activity in the area) was the subject of tether materials and configurations. This lack of activity is of concern to the panel because a recommendation to initiate applications related tether requirements and development studies was made at the Williamsburg workshop. Tether materials and configurations is an enabling technology without which the tether application program cannot mature and evolve.

Tomorrow's activities will center around briefings from Joe Kolecki relative to Electrodynamics Technology and Joe Carol relative to Expendable Tether Capabilities. The latter will provide a method for accomplishing early technology related tether tests, as well as continued tests during the interim years between TSS-1 and TSS-2 which now may be as much as 3 years. Finally, the panel will review its activities and formulate its final recommendations.

**TECHNOLOGY & TEST**  
**OCTOBER 16, 1985 SUMMARY**

**REVIEWED:**

- **ATMOSPHERIC/AEROTHERMODYNAMIC (TETHERED WIND TUNNEL) CONCEPT**
  - TSS-2 PROPOSAL—CARLOMAGNO
  - STARFAC FEASIBILITY/DEFINITION—SIEMERS

PANEL ADVOCATES CONCEPT/RECOMMENDS CONTINUED DEFINITION AND DEVELOPMENT
  
- **INSTRUMENTATION—WOOD**
  - SCIENCE FOR ATMOSPHERIC/AEROTHERMODYNAMIC
  - ENGINEERING FOR TSS/TAS
    - TENSIOMETER REQUIREMENTS FOR TSS DYNAMICS MODELING AND CONTROL (?) MAJOR CONCERN RELATIVE TO INSTRUMENT AT SATELLITE
  
- **TETHER POINTING PLATFORM CONCEPT STUDIES—TURCI**
  - TECHNOLOGY SUPPORTING TAS MISSIONS TBD
  
- **TETHER SPACE ELEVATOR MECHANISM CONCEPT (CRAWLER)**
  - ENABLING TECHNOLOGY FOR VARIABLE GRAVITY
  - ENABLING TECHNOLOGY FOR TRANSPORTATION ALONG TETHER CONCEPTS
  
- **DYNAMIC MODELING**
  - "UNIVERSAL" SIMULATION CAPABILITY (?)

## TECHNOLOGY AND TEST

### Session IV

#### Final Oral Report

October 17, 1985

This is the final oral report of the Technology and Test panel. Whereas the other workshop panels are primarily concerned with the definition of tether applications, the Technology and Test panel's emphasis has been relative to the accomplishment of promising tether applications. It is the opinion of the panel's members that the early definition of the enabling technologies and the initiation of programs required to resolve the tether related technology issues is critical to the success of the TSS program as well as the growth and maturing of the tether concept. In addition to defining specific tether technology issues, the panel has defined a technology based application as well as several systems concepts requiring technology development to realize their potential. The technology issues, application, and systems defined are:

1. Tether Requirements/Materials Configuration
2. Tether Dynamics
3. TSS-2 Supporting Technology
4. Shuttle Tethered Aerothermodynamic Research Facility--Application
5. TSS-1/Electrodynamic Tethers
6. Space Elevator--System
7. Tether Pointing Platform--System
8. Time

#### Technology Issue--Tether Requirements/Materials/Configuration

In spite of a lack of participants with a specific interest in this technology area which concerned the panel, the panel expressed considerable concern relative to the issue with the conclusion that the definition and development of tethers is the singular most critical technology related to the implementation of the tether applications defined to date. It is imperative that the tether characteristics/requirements necessary to accomplish the various proposed applications be defined. One of the ongoing tether technology related activities which must be continued and expanded is the definition of potential tether environments and the development of tethers that are compatible with that environment. Issues such as temperature, atomic oxygen, ultraviolet and infrared radiation, micrometeoroid impact, and many others must be defined and addressed. An extremely important issue related to the Shuttle Tethered Aerothermodynamic Research Facility tether application is a high temperature tether capable of operating under large loads at temperatures in excess of 1000° K. Another significant tether characteristic that must be defined and will require considerable development is the requirement to be conductive in order to generate or transmit power or provide a communication link between tethered system and parent vehicle.

Another critical design consideration for future tethered applications is the incorporation of tether system redundancy to minimize or eliminate payload loss or parent vehicle damage due to tether damage or failure. A related

technology system recommended for design and definition is a system of instrument capability that would detect tether failure and provide early warning for system safety.

As a result of these tether issues, the Technology and Test panel recommends that (1) NASA and PSN initiate a coordinated program to define tether requirements and a development and test program to evaluate tether concepts and materials, (2) that, because of the importance of this issue and the lack of specific participation relative to this technology issue, a Tether Requirements/Materials/Configuration panel be established for the next workshop to generate interest and activity in the area.

#### Technology Issue--Tether Dynamics

The panel spent considerable time reviewing tether dynamic simulation capabilities. It is believed by the panel that the development of accurate dynamic simulation/mission modeling capabilities is critical to the acceptance of the tether concept. It is imperative that the dynamic characteristics of TSS-1 and TSS-2 be accurately predicted to ensure the acceptance of the concept. Nothing will do the program more damage than to have the flight dynamics differ from the predictions. With this in mind, the panel expressed concern that there are numerous special purpose simulation capabilities in existence and the number is growing at what seems to be an exponential rate. This lack of control of the dynamic modeling and simulation programs eliminates any basis for program comparison or checking relative to application feasibility studies and mission planning. This lack of a coordinated dynamics/mission simulation capability was of concern to the Technology and Test panel as was an inability, due to environment simulation capability, to generate a test case for evaluation of the various dynamic models. Even the major programs, SKYHOOK and the recently developed GTOSS, require verification.

As a result of the panel concerns, it is recommended that the existing Tether Dynamics Working Group's activity be expanded to include the design, development, implementation, and review of a dynamics "test case" incorporating the TSS-1 and TSS-2 missions for program verification. Concepts for earlier simulation tests should be seriously studied and considered. The Tether Dynamics Working Group should oversee and provide a peer review function of the results of the "test case" simulation results and, as a result, make recommendations relative to future development of dynamic/mission simulation capabilities as required for tether applications. As with the Tether Requirements/Materials/Configuration issue, the establishment of a Dynamics panel for future workshops is recommended. (As major technology issues evolve into significant work areas, their considerations by the Technology and Test panel is no longer productive except in overview capacity.)

#### Technology Issue--TSS-2 Supporting Technology Programs

The success of TSS-1 and TSS-2 is critical to the evolution and growth of the tether concept. While the TSS-1 mission will be discussed later, the successful accomplishment of TSS-2 has significant implications to future atmospheric tether missions and related programs. There are several TSS-2

related technology issues which concerned the Technology and Test panel, namely:

- Instrumentation
- Materials
- Aerothermal Analysis
- Dynamics
- Configuration (Satellite)

The issue of instrumentation relates to the design and development of both the mission control instrumentation; such as, tensiometers, which the panel recommends at each end of the tether for all the TSS missions for dynamic control and post-flight verification, and tether temperature sensing for mission control and tether performance verification as well as science related instrumentation. Relative to the science instrumentation, it is important to note that the TSS-2 mission will operate in a region of the upper atmosphere that imposes peculiar measurement requirements to define molecular species and determine ion and electron concentration at both the satellite surface as well as across the flow field; i.e. Mass Spectrometer and Rayleigh Scattering (laser systems), respectively. While Mass Spectrometers are flight qualified, their design is peculiar to each mission, and laser flow-field profiling is a ground-based capability requiring considerable study prior to flight certification. Finally of concern was the development of heat flux sensors for the satellite and the tether and the need for instrumentation capable of detecting tether failure.

The panel was also concerned about tether and satellite materials. Since the panel is interested in extending TSS-2's operating range (below 130 km altitude), studies relative to both tether and satellite materials that will perform at higher temperatures are recommended. The development of high temperature tether and satellite materials is a prerequisite to the accomplishment of aerothermodynamic research in the free-molecule and transition flow regimes proposed for TSS-2, as well as being of interest and value to the proposed STARFAC missions. These proposed TSS-2 studies are required to define thermal, as well as aerodynamic, design parameters for future atmospheric missions. Preliminary studies indicate rapid increases in tether temperature as well as significant increases in length of tether required to accomplish lower altitude missions. The increased tether requirement occurs as the aerodynamic drag on the tether and satellite approaches the gravity gradient force, and the tether deployment angle deviates significantly from the vertical. These aerothermodynamic phenomena result in requirements for considerable studies relative to tether/satellite dynamics as well as mission studies relative to the deployment, mission operations, and retrieval of the tethered system, specifically relative to communication, tracking and satellite/tether control. The TSS-2 mission, as well as extended capability baseline geometry missions, could significantly contribute to an understanding of the upper atmosphere and upper atmospheric aerothermodynamics.

Finally, the panel expressed considerable concern relative to the mission turn-around time between TSS-1 and TSS-2 and the lack of compatibility of the objectives of TSS-1 and TSS-2 satellite configurations. It is believed that such delays will considerably compromise the impact on the success of the first mission and thereby the potential growth of the concept and its

applications for space station particularly. Consideration should, therefore, be given to the development of two satellites--one for electrodynamic missions and one for atmospheric missions.

The primary recommendation relative to TSS-2 is the initiation of detailed system studies to define the mission limitations of the present TSS configuration and the definition of the modifications, both tether and satellite, required to extend the present capability to lower altitudes. Such studies would include all the previously discussed TSS-2 supporting technology issues.

#### Technology Issue--Shuttle Tethered Aerothermodynamic Research Facility - STARFAC

This is the Technology and Test panel's proposed tether application and is an extension of the proposals presented relative to TSS-2. STARFAC is a research proposal that would take advantage of the tether concept's peculiar capability to provide in-situ steady-state aerothermodynamic/atmospheric data. The proposal recommends the extension of the TSS-2 capability to an altitude of 90 km. While present studies indicate that a passive TSS-2 configured satellite may be limited to 100 km altitude, the inclusion of negative lift, propulsion, or tether configuration changes, could extend this capability. The supporting technologies as discussed relative to TSS-2 are:

- Instrumentation
- Materials (see Technology Issue--Tether Requirements/  
Materials/Configuration)
- Configuration
- Dynamics/Mission Design (see Technology Issue--Tether  
Dynamics)

The STARFAC proposal extends the research capability to include the transition and possibly slip flow regimes while the TSS-2 is probably limited to the free-molecule regime. This capability expands the studies required to support the development of the enabling technologies.

The panel recommends that studies be initiated as soon as possible relative to mission design and limitation definition, as well as the development and test of required hardware systems with emphasis on instrumentation and high temperature components. These recommendations are complimentary to the TSS-2 recommendations.

#### Technology Issue--TSS-1/Electrodynamic Technology

The interaction between the Electrodynamic and Technology and Test panels was initiated as a result of concerns expressed by Technology and Test panel members relative to TSS-1 success. The interaction resulted in a "charged" discussion about the success potential of the planned mission. As a result of this discussion, it was jointly agreed, the details of the agreement were included in the Electrodynamic panel's final report as given by Joe Kolecki, "that a plasma contactor (hollow cathode) should be included and operated on the Orbiter during the TSS-1 mission."



For the future of the electrodynamic tether concept, the development of tether conductors and insulators is critical. It is recommended that, as discussed in Technology Issue--Tether Requirements/Materials/Configurations, tether materials receive priority study with significant emphasis on electrodynamic applications. (Electrodynamic and atmospheric high-temperature tether configurations are of particular significance to the tether program because of the TSS program and the near-term potential of these two concepts.) Finally, the success of the electrodynamic tether concept depends on the generation of power in kilowatts which requires the development of high voltage power management and control hardware. (See Electrodynamic panel's report for details.)

#### Technology Issue--Space Elevator (Crawler)

The implementation of many tether applications requires the development of a tether crawler for tether inspection but primarily for the transport of materials and equipment between a space station, for example, and a tethered work station. Such a system capability requires the development of technology and then the design and development of the required mechanisms. The panel encourages continued design effort relative to the Space Elevator (Crawler) concept. Such work is presently underway by Aeritalia.

#### Technology Issue--Tether Pointing Platform

The Tether Pointing Platform is a system proposed by both NASA and Aeritalia for various applications relative to tether controlled operational missions. The Technology and Test panel recommends continued study of this concept leading to feasibility definition and demonstration.

#### Technology Issue--Time

The Technology and Test panel is concerned relative to the timely definition and development of the application's enabling technologies. The development of these technologies must be accomplished to allow the evolutionary growth of the tether concept. Technology will control the future of the tether (second only to dollars).

The only recommendation that can now be made is that the technology related programs discussed be implemented as soon as possible, quickly, NOW!

That concludes the final report of the Technology and Test panel--thank you.

# **TECHNOLOGY AND TEST**

## **SUMMARY**

**OCTOBER 17, 1985**

# TECHNOLOGY AND TEST

## TECHNOLOGY ISSUE :

- TETHER REQUIREMENTS / MATERIALS / CONFIGURATIONS
  - DEFINE TETHER CHARACTERISTICS TO SUPPORT TETHER APPLICATIONS
    - REDUNDANCY
    - ENVIRONMENT COMPATIBILITY
    - CONDUCTIVE / NON-CONDUCTIVE
    - HIGH TEMPERATURE
    - TRANSMISSION CAPABILITY
      - POWER
      - COMMUNICATION
    - FAILURE DETECTION

## RECOMMENDATIONS :

- INITIATE COORDINATED NASA/PSN PROGRAM TO DEFINE REQUIREMENTS AND INITIATE DEVELOPMENT AND TEST OF TETHER CONCEPTS AND MATERIALS
- ESTABLISH TETHER REQUIREMENTS / MATERIALS / CONFIGURATION PANEL FOR NEXT WORKSHOP TO GENERATE INTEREST / ACTIVITY

# TECHNOLOGY AND TEST

## TECHNOLOGY ISSUES :

- **ELECTRODYNAMICS**
  - **TETHER MATERIALS**
    - **CONDUCTORS**
    - **INSULATORS**
  - **POWER MANAGEMENT AND CONTROL**
    - **HIGH VOLTAGE**
  - **INCLUSION / OPERATION OF PLASMA CONTACTOR (HOLLOW CATHODE) ON ORBITER DURING TSS-1 MISSION**
  
- **SPACE ELEVATOR (CRAWLER)**
  - **MECHANISM DESIGN AND DEVELOPMENT**
  
- **TETHER POINTING PLATFORM**
  - **CONCEPT DEFINITION**

# TECHNOLOGY AND TEST

## TECHNOLOGY ISSUE :

- TSS-2 SUPPORTING TECHNOLOGY PROGRAMS
  - INSTRUMENTATION
    - TENSIOMETER
    - TETHER TEMPERATURE
    - HEAT FLUX SENSORS
    - FLOW FIELD PROFILING INSTRUMENTS (RAYLEIGH SCATTERING)
    - MASS SPECTROMETER INLETS
    - TETHER FAILURE DETECTION
  - MATERIALS
    - TETHER
    - SATELLITE
  - AEROTHERMAL ANALYSES - THERMAL CONSTRAINTS
  - DYNAMICS / MISSION STUDIES
    - COMMUNICATION
    - TRACKING
    - CONTROL
  - CONFIGURATION (TSS-2 AND TSS-1)

## RECOMMENDATIONS :

- DEFINE MISSION PLAN WITHIN CAPABILITIES OF PRESENT CONFIGURATION
- DEFINE MODIFICATIONS REQUIRED TO EXTEND PRESENT CAPABILITY

# TECHNOLOGY AND TEST

## TECHNOLOGY ISSUE :

- SHUTTLE TETHERED AEROTHERMODYNAMIC RESEARCH FACILITY  
CONCEPT TO EXTEND ATMOSPHERIC/AEROTHERMO CAPABILITY TO  
90 km ALTITUDE
  
- SUPPORTING TECHNOLOGY
  - INSTRUMENTATION
  - MATERIALS
  - CONFIGURATION
  - DYNAMICS/MISSION DESIGN

## RECOMMENDATIONS :

- INITIATE STUDIES RELATIVE TO STARFAC DESIGN DEVELOPMENT AND TEST  
WITH EMPHASIS ON :
  - INSTRUMENTATION
  - HIGH TEMPERATURE COMPONENTS

# TECHNOLOGY AND TEST

## TECHNOLOGY ISSUE :

- TETHER DYNAMICS
  - SPECIAL PURPOSE SIMULATION CAPABILITIES ARE NUMEROUS AND GROWING
  - NO BASIS FOR COMPARISON / CHECKING
  - NO COORDINATED DYNAMICS / MISSION STUDY CAPABILITY

## RECOMMENDATIONS :

- DEFINITION / DEVELOPMENT OF TSS-1 / TSS-2 DYNAMICS TEST CASE
- EXPAND DYNAMICS WORKING GROUP'S ACTIVITY TO INCLUDE IMPLEMENTATION AND REVIEW OF TEST CASE RESULTS AND PROVIDE PEER REVIEW FUNCTION - RECOMMEND FUTURE DEVELOPMENT FOR TETHER APPLICATIONS
- ESTABLISH DYNAMICS PANEL FOR FUTURE WORKSHOPS AND TAS REVIEWS

# **TECHNOLOGY AND TEST**

TECHNOLOGY ISSUE :

**T I M E**

RECOMMENDATION :

**IMPLEMENT TECHNOLOGY RELATED PROGRAMS QUICKLY**

**( NOW ! )**



REFERENCE-1

AN EXPERT SYSTEM FOR DEPLOYMENT, RETRIEVAL AND CONTROL OF  
TETHERED SATELLITES

by

W. Teoh  
M.C. Ziemke

The University of Alabama in Huntsville  
Huntsville, Alabama 35899

October 1985

## ABSTRACT

Within the next few years, there will be a Space Shuttle mission wherein a satellite on a conducting tether will be flown 20 km above the orbiter and a non-conducting tether satellite will be flown 100 km lower than the spacecraft orbit of 200 km to 240 km. These tethered satellites will be deployed by a system consisting of a precisely-controlled winch and an extendable boom-type projector. Once projected a distance above or below the spacecraft, the satellites will begin to feel the effects of the gravity gradient and pull away with increasing force, requiring winch braking to control deployment speed. For satellite retrieval, the winch will require power input. The process of optimum tethered satellite control obtained through braking and/or powering the winch can be rather complex and will require the development of a set of system control laws. This complexity arises from several factors of tethered satellite dynamics. The atmospheric drag on the satellite and its tether will vary with altitude, especially when the lower satellite moves down into the transition flow region below 130 km. It is also believed that the satellite will develop swinging motions which must be damped by precise tugging of the winch. Additional forces on the tether will result from the electrodynamic effects that occur when a current flows along the conducting tether. Other control complications arise from the use of moving subsatellite instrument packages deployed from the spacecraft or from the deployment of a subsatellite from the main tethered satellite.

It is believed that an expert system could be very beneficial to the optimum control of the tethered satellites by the winch and boom. The University of Alabama in Huntsville is currently developing an expert system (called DEX) that can be used for docking maneuvers of the OMV. A similar concept can be used to develop an expert system to control the tethered satellite system's reel and boom mechanism. The use of this expert system can substantially reduce the manpower requirements during the deployment and retrieval of tethered satellites. Additionally, it can maintain a stable configuration in the interim by introducing controlled damping through variation of the tether tension.

Because the only tethered satellite system data available to date is derived from simulation studies, it may not be initially possible to construct a complete knowledge base. Thus, the tethered satellite control laws, sensor signal processing, self-learning and manual over-ride capabilities must be built into this proposed expert system.

TECHNOLOGY AND TEST PANEL

PRESENTATION I

APPLICATION OF TETHERS IN SPACE

SHUTTLE CONTINUOUS OPEN WIND TUNNEL  
(SCOWT)

OCTOBER 15-17, 1985

GIOVANNI M. CARLOMAGNO, UNIVERSITY OF NAPLES

LUIGI de LUCA, UNIVERSITY OF NAPLES

PAUL M. SIEMERS, NASA / LaRC

GEORGE M. WOOD, NASA / LaRC

## SCIENTIFIC OBJECTIVES

- provide informations relative to the aerodynamic and heat transfer coefficients within the range of the thermo-fluid-dynamic conditions experienced by the satellite during TSS atmospheric flights.
- improve the understanding of the gasdynamic processes occurring downstream of the bow wave standing in front of the satellite.
- implement the knowledge of the chemistry and physics of the upper atmosphere related to satellite aerothermodynamics.
- check for the existence of an overshooting of the air drag coefficient of the sphere in the transition regime (Bird AIAA J. 1966, Kussoy & Stewart AIAA J. 1970).

## TECHNOLOGICAL OBJECTIVES

- define TSS capabilities with regard to atmospheric flights.
- exploit parallel feasibility studies concerning tether materials, aerodynamic stabilizers etc.
- provide valuable engineering informations on the TSS overall experimental envelope of operation.

## MOTIVATIONS

- current wind tunnel technology does not provide reliable thermo-fluid-dynamic data in the combined low Reynolds number and large Mach number regime.
- present computational methods cannot yield the required thermo-fluid-dynamic coefficients because of computational limitations and/or lack of an experimental data base.
- designers who need free-molecule/transition-flow regime data are forced to resort to empirical representations based upon sparse flight data and/or extrapolation of wind tunnel data.
- the research will give preliminary results on the feasibility of a tethered system mainly devoted to aerothermodynamic research.

## AIMS

- the present research yields a complete set of measurements within the extended range of flight conditions and/or the long time of operation encompassed by TSS.
- a proper instrumentation allows the execution of "in situ" measurements to characterize the upper atmosphere and provides the data base to develop and validate theoretical models of free molecule/transition flow fields.
- the comparison of computational data with flight measurements can produce a reliable design tool for future flight systems operating in this regime.
- in the first atmospheric mission the molecular mean free path of the free stream will vary by two orders of magnitude. Large variations are also present for temperature, pressure, density, molecular weight and speed ratio.

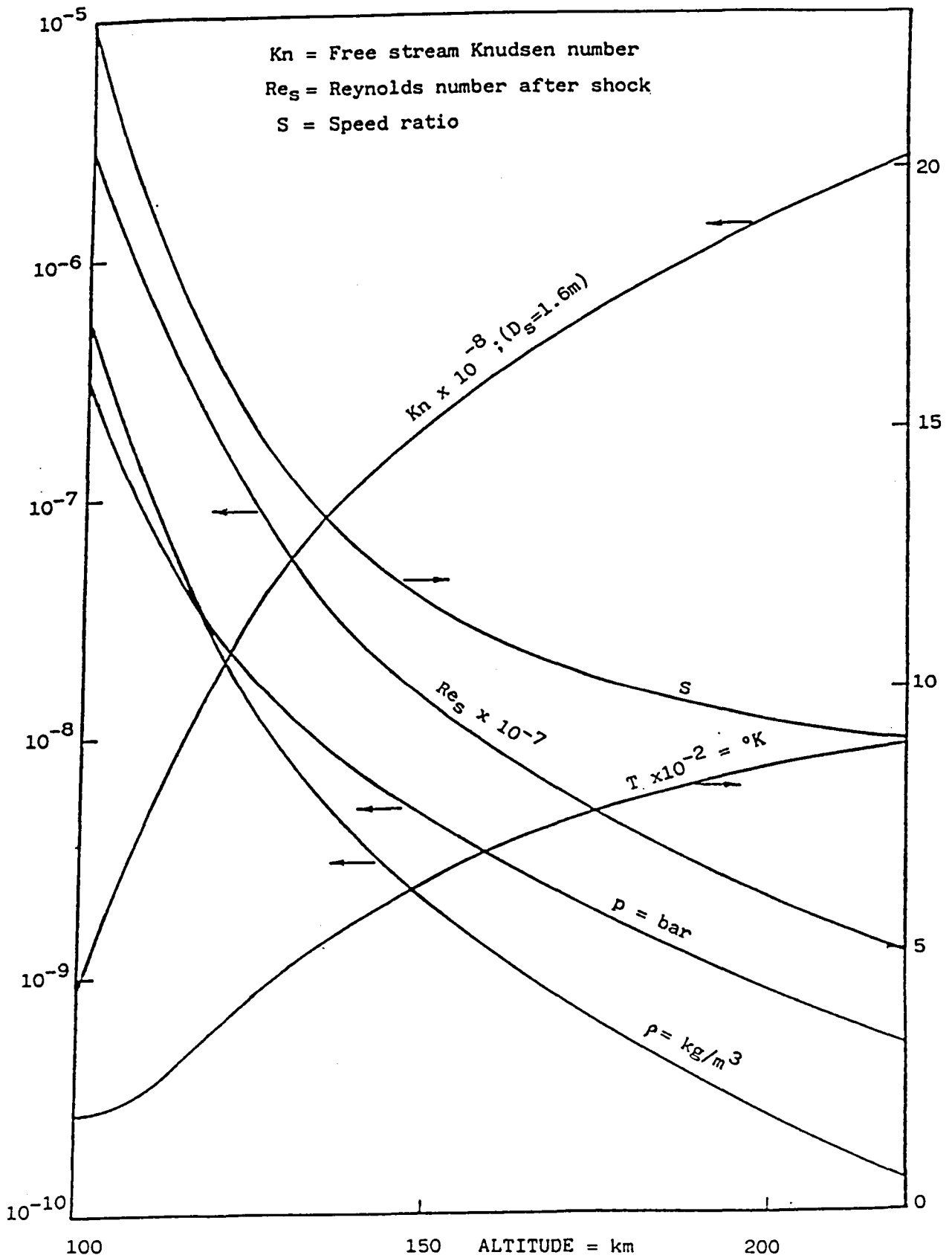



## RELATION TO OTHER ONGOING RESEARCH PROGRAMS

- research to define the Orbiter's aerothermodynamics in the free-molecule/transition flow regime is currently sponsored by the Office of Aeronautics and Space Technology (OAST) of NASA as part of the Orbiter Experiment (OEX) program.
- SCOWT is the first step toward development of the Shuttle Tethered Aerothermodynamic Research Facility (STARFAC)
- advanced hypersonic flight systems which operate in the rarefied atmosphere as Aeroassisted Orbiter Transfer Vehicle (AOTV) and Entry Research Vehicle (ERV) are presently under feasibility study.
- SCOWT supports the development of the computational models required in order to design the above flight systems and to reduce the development time and flight demonstration costs.

## INVESTIGATION APPROACH

A comprehensive set of measurements is performed to characterize:

- state vector of the satellite (position, velocity, attitude)
- free stream characteristics (composition, density, etc.)
- satellite/flow field interaction (forces, skin temperatures, heat fluxes, boundary layer composition)

CURRENTLY IDENTIFIED MEASUREMENTS	CANDIDATE METHODS UNDER CONSIDERATION	PROJECTED R&D REQUIREMENTS	
		EXTENDED	MODERATE
GROUND BASED SHUTTLE AND SATELLITE RELATIVE TO SHUTTLE TRACKINGS	N.A.		
TSS ATTITUDE	3-AXES GYRO-SYSTEM		*
TETHER TENSION	3-AXES TENSIO METER		*
SATELLITE ACCELERATION	3-AXES ACCELEROMETER		*
INTERNAL TEMPERATURES	GROUND ED JUNCTION THERMO-COUPLES		*
SURFACE TEMPERATURES	CO-AXIAL OR PARALLEL RIB-BON THERMOCOUPLES		*
HEAT FLUXES	STANDARD SENSORS AS THIN FILMS, CALORIMETERS, ETC.	*	
FREE STREAM GAS ANALYSIS	FREE STREAM MASS SPECTRO-METER	*	
BOUNDARY LAYER GAS ANALYSIS	BOUNDARY LAYER MASS SPEC-TROMETER	*	
FLOW-FIELD PROFILING	RAYLEIGH SCATTERING, IR, LASER FLUORESCENCE	*	

## STATE VECTOR OF THE SATELLITE

- the ground based Shuttle tracking and the satellite-relative-to-Shuttle tracking give the TSS Best Estimated Trajectory (BET).
- BET together with the outputs of the 3-axes accelerometer-gyro system give the complete state vector of the satellite (position, velocity and attitude).

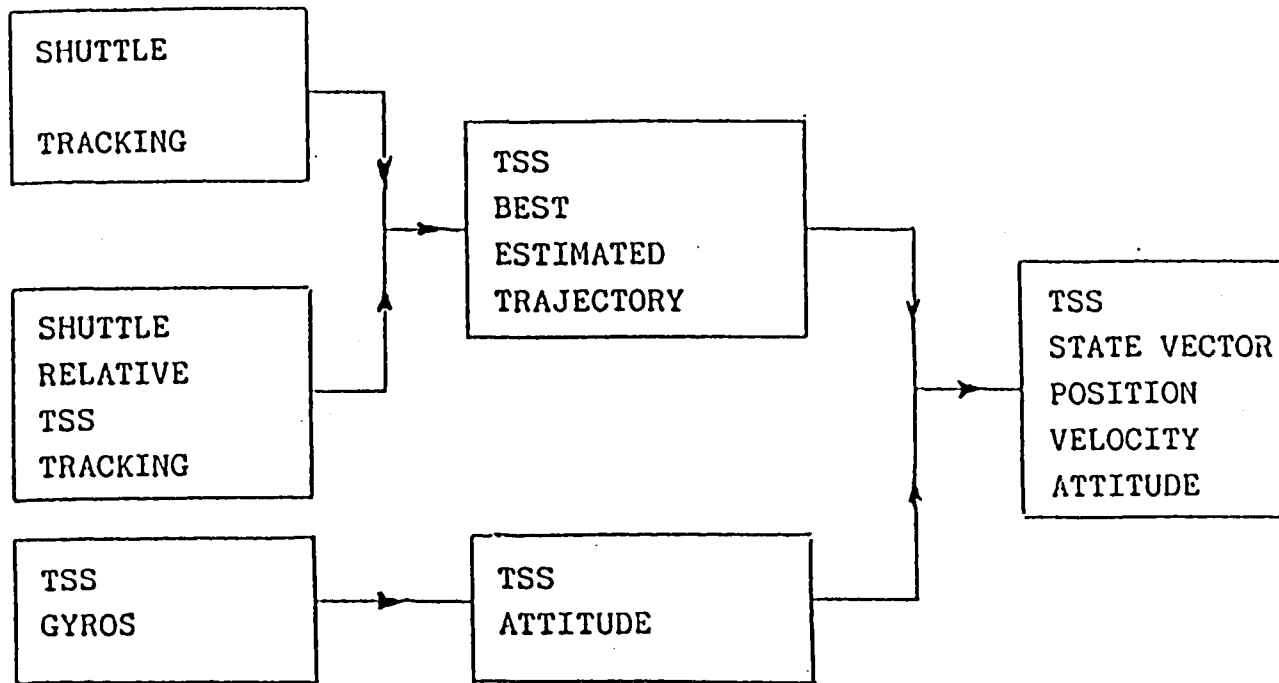

DERIVATION OF TSS STATE VECTOR

## TENSIOMETER

- the overall force exerted by the tether on the satellite is measured by a three component balance (tensiometer).
- the force measurement together with accelerometer data can provide the fluid dynamic drag.
- in the atmospheric mission the presence of tensiometer on the satellite will give valuable informations on tether dynamics.

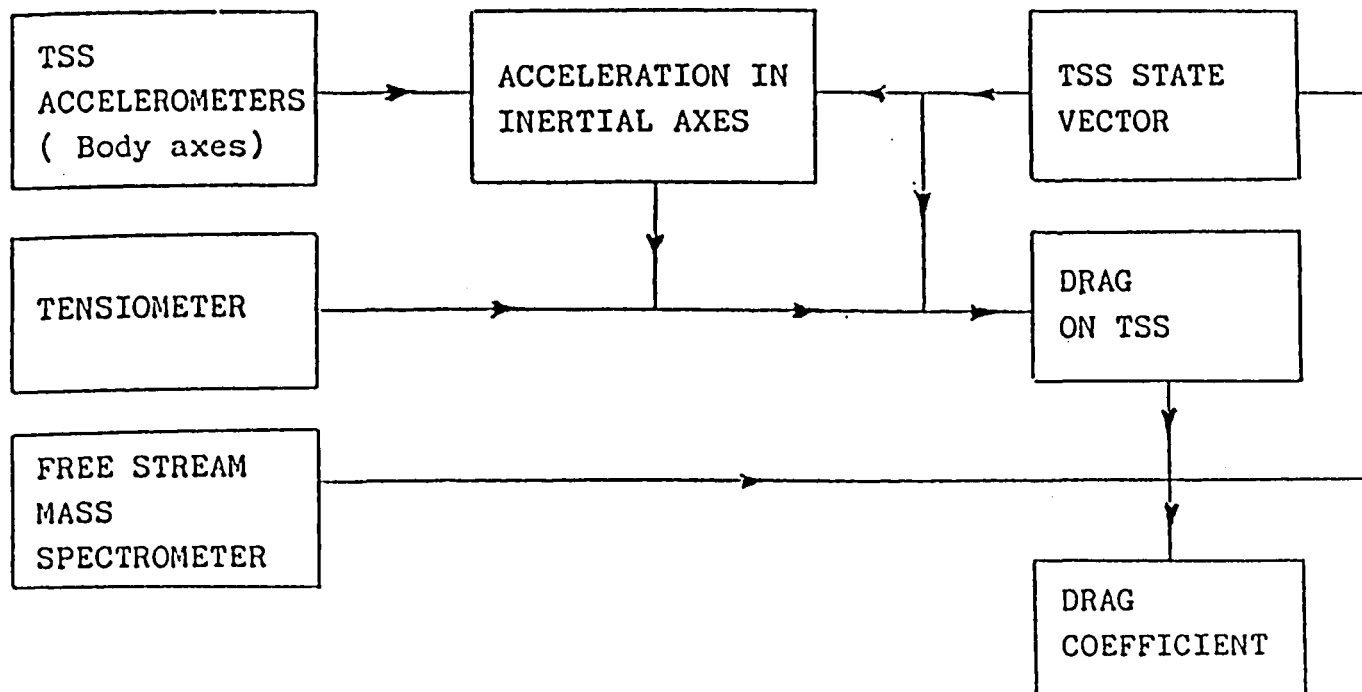

DERIVATION OF DRAG COEFFICIENT

## THERMAL MEASUREMENTS

- internal temperatures can be measured with grounded junction thermocouples. Present in-house thermocouple calibration facilities are adequate without further development.
- surface temperatures can be measured with either co-axial or parallel ribbon thermocouples. An experimental measurements verification program will be performed to insure that the sensors meet the accuracy requirements.
- heat flux measurements can be performed by one of the standards methods selecting the sensor by temperature level and heat rate level and frequencies considerations.



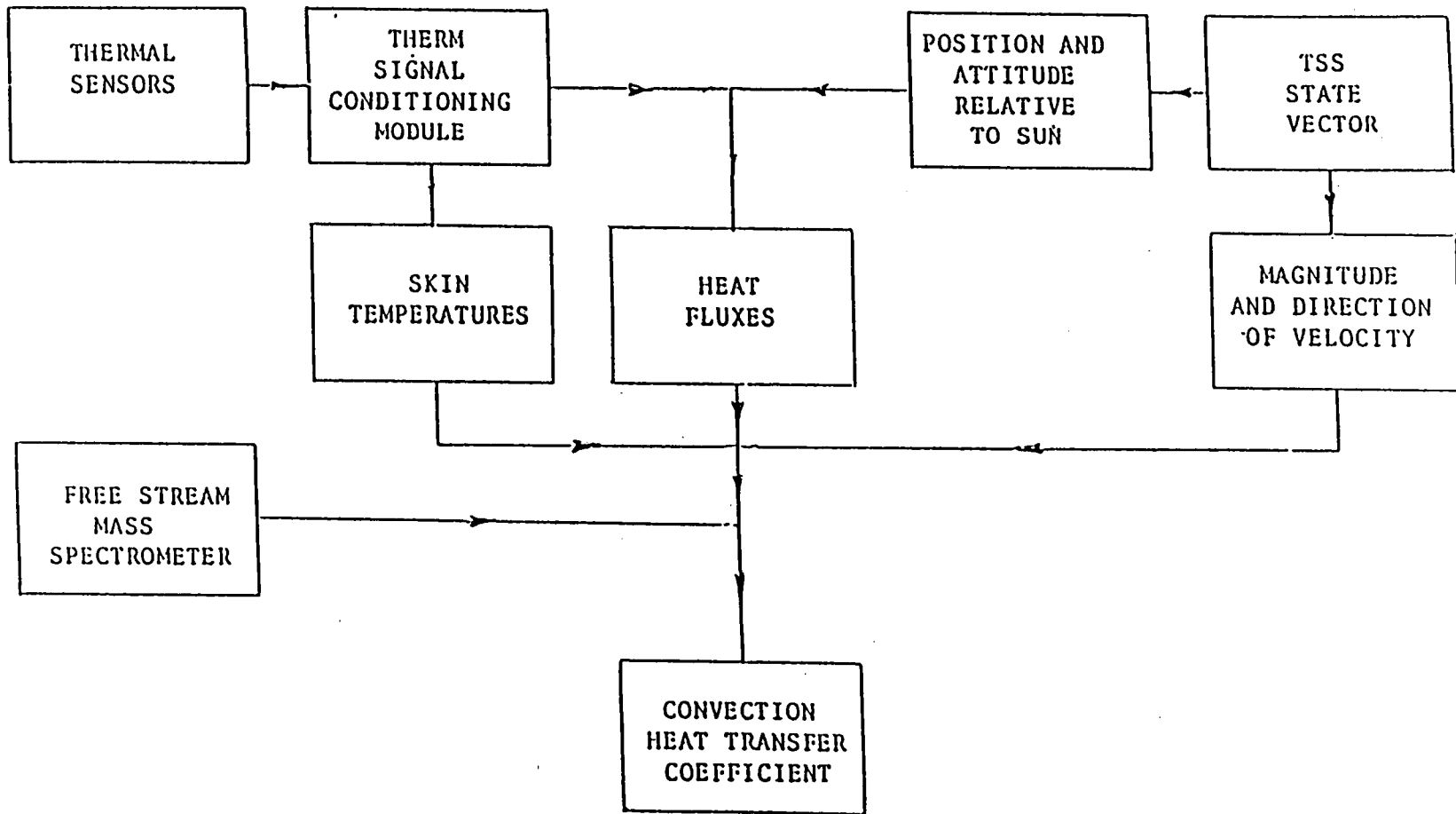

DERIVATION OF CONVECTION HEAT TRANSFER COEFFICIENT

## HEAT FLUX MEASUREMENTS

- heat flux sensors must be investigated with regard to their frequency response.
- heat flux sensors generally are bodies whose temperatures are measured at known points.
- four types of one-dimensional heat flux sensors have to be basically considered: thin film ( $T_1$ ); thick film ( $\bar{T}$ ); wall calorimeter ( $T_2$ ); gradient sensor ( $\Delta T$ ).
- the slab back face can be either insulated (adiabatic;  $Q_2=0$ ) or maintained at a given temperature (in contact with a heat sink;  $T_2=0$ ).
- amplitude and phase lag are dependent on frequency  $\omega$  and thermal diffusivity coefficient  $\alpha$ .

## NOTATION FOR ONE-DIMENSIONAL HEAT FLUX SENSORS

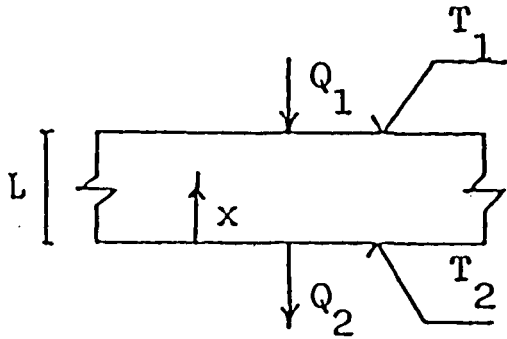

$$Q_1 = |Q_1| \sin \omega t$$

$$T = |T| \sin (\omega t + \phi)$$

$$\Delta T = T_1 - T_2$$

$$\bar{T} = \int_0^L T \, dx / L$$

# STARFAC EQUATORIAL CIRCULAR ORBIT SIMULATION

Orbiter Altitude (km)	Target Altitude (km)	Tether Length (km)		Satellite Altitude (km)	Tether Temperature (°K)	Tension Orbiter (Newtons)	Deploy Time (Sec)	Orbiter Altitude Maintenance	Tether Simulation Mass Points
		Target	Actual						
200	N/A	90	91.3	109.5	774	341	8803	Infinite Mass	2
200	"	90	100	102.3	909	353	8803	None	2
200	"	90						Infinite Mass	5
200	"	90	102	103.3	904	554	7243	"	8
200	"	90						"	10
200	"	95						"	2
200	"	100	138.5	100.1	934	1047	40000	"	2
200	"	110						"	2
220	125	N/A	94.8	125	572	721	11000	"	2
220	125	"	95.2	124.9	568	558	8857	"	6
220	120	"	100	120	613	762	11500	"	2
220	120	"	96.1	120	604	720	9000	None	2
220	115	"	105.5	115	706	802	12000	Infinite Mass	2
220	100	"	160.6	100.3	942	1251	40000	"	6
220	110	"	112.1	110	761	820	13000	"	2
220	110	"	107.4	110	758	802	9800	None	2
220	95	"	187.7	97.7	978	1614	40000	Infinite Mass	6
220	105	"	123.3	105	859	919	24000	"	2
220	100	"	152.9	100.2	944	1147	40000	"	2
220	115	"	101.4	115	704	781	9400	None	2
220	100	"	121.4	100.2	969	458	10000	"	2
220	100	"	151.3	100.4	941	377	40000	Low Thrust	2
220	95	"	206.3	96.6	990	1595	40000	Infinite Mass	2
220	95	"	143.8	95	1004	576	15000	None	2
220	110	"	111.9	110	760	275	19500	Low Thrust	2
240	N/A	130						Infinite Mass	2
240	110	N/A	126.7	110	761	470	12000	None	2
240	100	"	141.7	100.1	969	554	12600	"	2
240	95	"	159.1	95.1	1046	629	15800	"	2

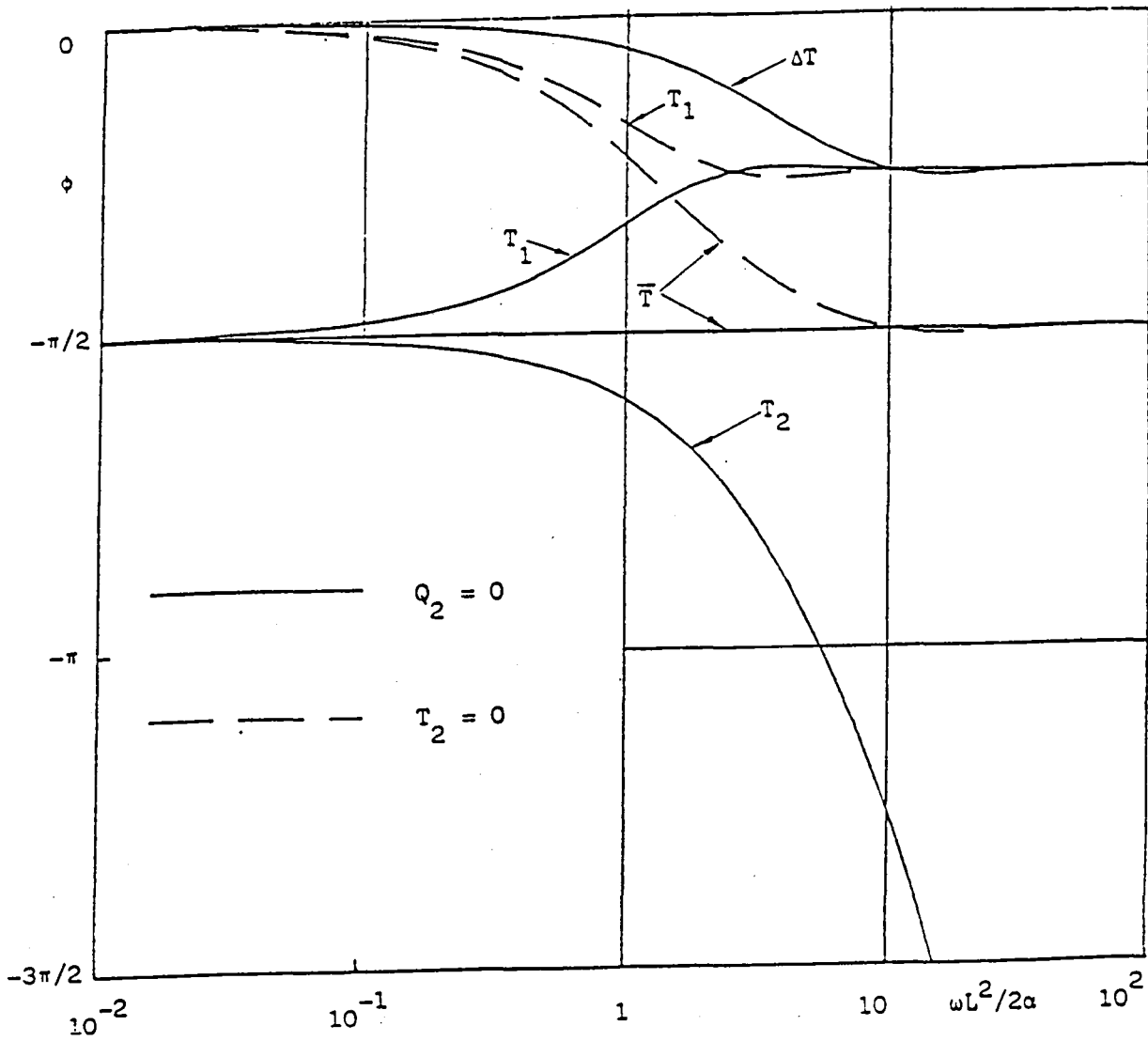

FREQUENCY RESPONSE OF ONE-DIMENSIONAL HEAT FLUX SENSORS (PHASE LAG)

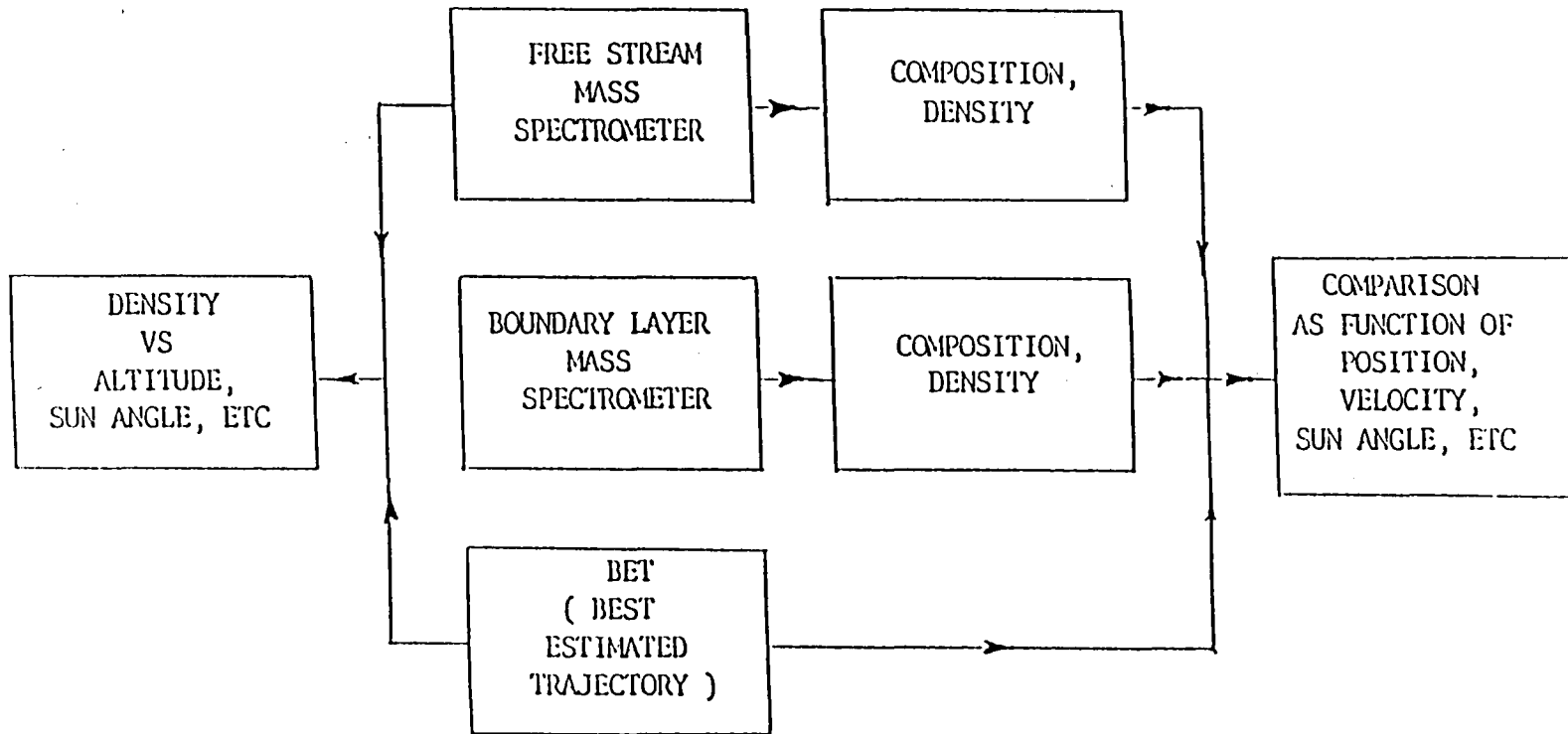

DATA REDUCTION OF MASS SPECTROMETERS MEASUREMENTS

## BOUNDARY LAYER MASS SPECTROMETER

- a "boundary layer" mass spectrometer is being developed to measure the gas composition and the ratio of neutral to charged molecules and atoms at the satellite surface (behind the bow wave).
- the instrument is a small double-focussing mass spectrometer projected to weigh on the order of few kgs.
- to have minimal effects on the flow, an "effusive" inlet is being developed based on a small disc containing parallel capillaries.

## THE DOUBLE FOCUSSED MASS SPECTROMETER

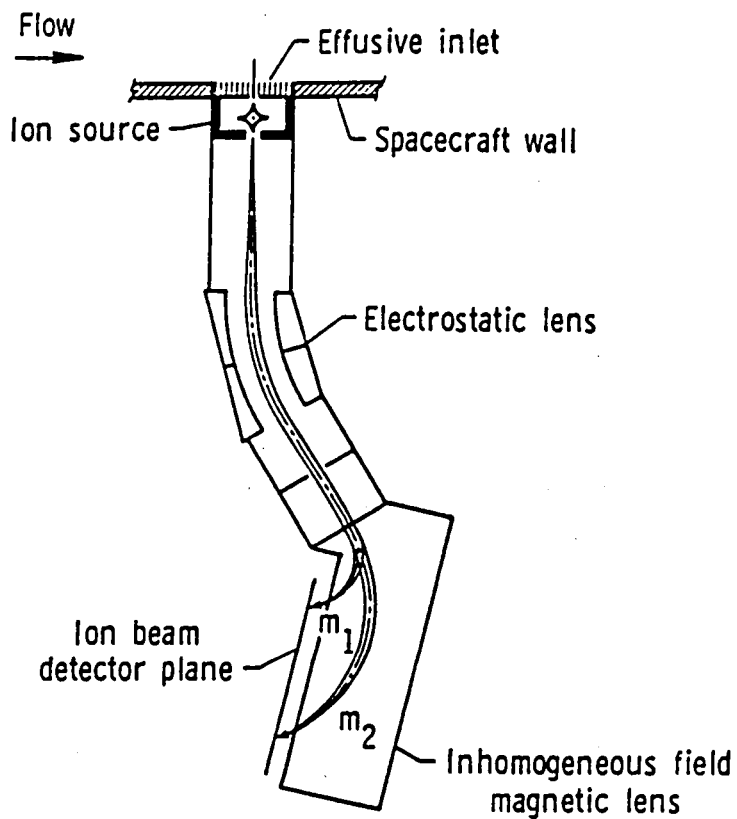

## THE EFFUSIVE INLET

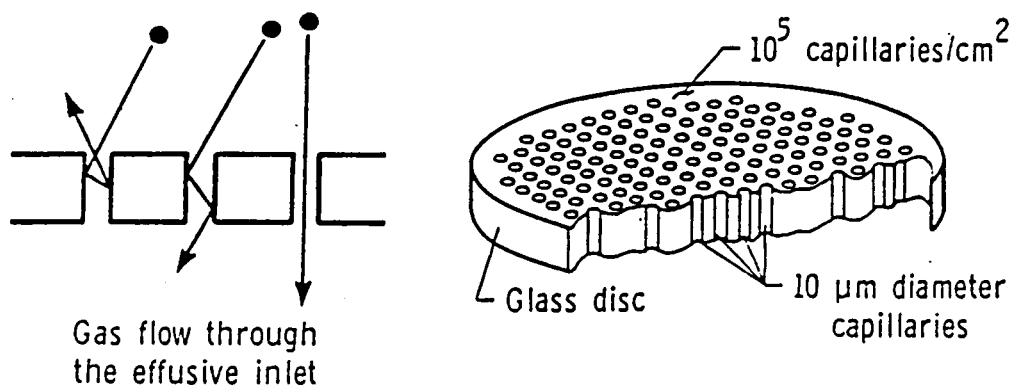



## SENSOR FOR CONCENTRATION PROFILE

- with regard to the interaction between the satellite surface and the flow field, the possibility of measuring the concentration profiles in the boundary layer by means of an infrared (IR) concentration profile sensor will be evaluated.
- this study will define boundary layer resolution, spectral bandwidths and level of concentrations which can be measured.
- alternatively the Rayleigh scattering and the laser fluorescence techniques will be investigated.

TSS - SECTION VIEW  
 TYPICAL MEASUREMENT LOCATIONS

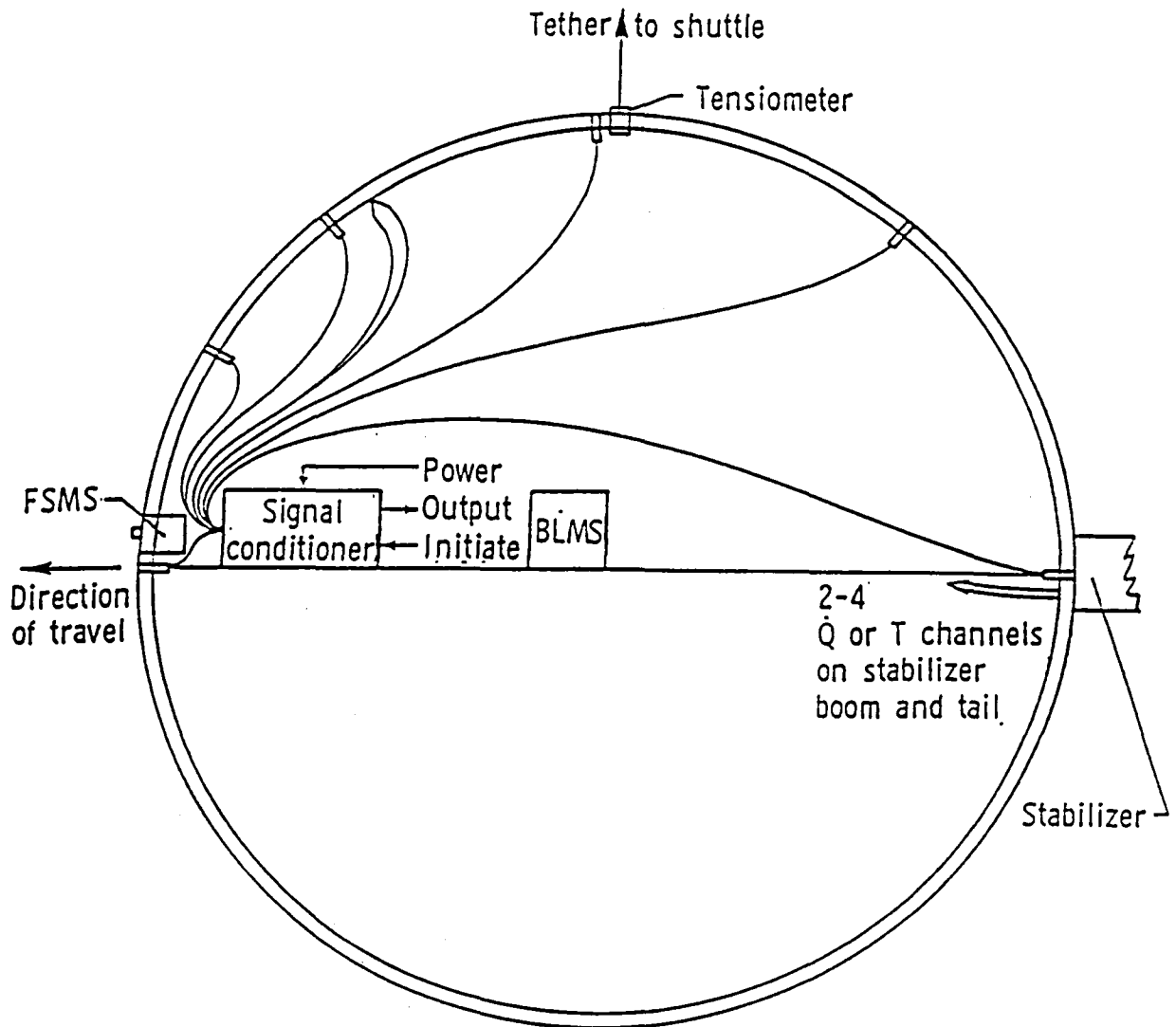

Legend

FSMS - Free stream mass spectrometer

BLMS - Boundary layer mass spectrometer at TSS surface

≡ - Surface temperature sensor or heat flux sensor,  
 not on same streamline as any other sensor

◁ - Housekeeping temperature sensor

## CONCLUSIONS

- SCOWT's primary objective is to perform "in situ" measurements to provide aerodynamic and heat transfer coefficients at the conditions experienced by the satellite during TSS atmospheric flights.
- a complete set of measurements is performed in order to provide the data base to develop and validate theoretical models of free-molecule transition flow fields.
- the research is well related to other ongoing programs such as STARFAC, AOTV and ERV presently being investigated.
- SCOWT supports the development of the models required to design the above flight systems and to reduce development time and flight demonstration costs.



TECHNOLOGY AND TEST PANEL

PRESENTATION II

SHUTTLE TETHERED AEROTHERMODYNAMICS

RESEARCH FACILITY

(STARFAC)

INSTRUMENTATION REQUIREMENTS

OCTOBER 15 - 17, 1985

GEORGE M. WOOD  
PAUL M. SIEMERS  
SSD / IRD / LaRC

GIOVANNI M. CARLOMAGNO  
UNIVERSITY OF NAPLES

JOHN HOFFMAN  
UNIVERSITY OF TEXAS - DALLAS

Typical Physical Properties of the Terrestrial Atmosphere

Regions	Altitude km	Temperature °K	Pressure torr	Number Density $N/cm^3$	Mean Molecular Weight	Research Vehicles
heterosphere (diffusive mixing)	600	1000	$2.1 \times 10^{-10}$		11.51	satellite
	400	990	$2.6 \times 10^{-9}$		15.98	
	300	976	$1.4 \times 10^{-8}$	$6.5 \times 10^8$	17.73	
	250	941	$1.6 \times 10^{-7}$	$1.9 \times 10^9$	19.19	
	200	854	$8.4 \times 10^{-7}$	$7.2 \times 10^9$	21.30	
	150	634	$2.7 \times 10^{-6}$	$4.9 \times 10^{10}$	24.10	
	140	520	$4.6 \times 10^{-6}$	$9.3 \times 10^{10}$	24.75	
	130	420	$8.5 \times 10^{-6}$	$2.0 \times 10^{11}$	25.44	
	120	355	$2.0 \times 10^{-5}$	$5.4 \times 10^{11}$	27.27	
	110	265	$5.8 \times 10^{-5}$	$2.1 \times 10^{12}$	27.90	
mesosphere	100	210	$2.4 \times 10^{-4}$	$1.1 \times 10^{13}$	28.40	sounding rocket
	95	193	$6.4 \times 10^{-4}$	$3.2 \times 10^{13}$	28.60	
	90	176	$1.4 \times 10^{-3}$	$7.6 \times 10^{13}$	28.77	
	85	160	$2.9 \times 10^{-3}$	$1.9 \times 10^{14}$	28.88	
	80	177	$7.9 \times 10^{-3}$	$4.2 \times 10^{14}$	28.96	
	75	194	$1.0 \times 10^{-2}$	$9.6 \times 10^{14}$		
	70	211	$4.4 \times 10^{-2}$	$2.0 \times 10^{15}$		
	65	232	$9.4 \times 10^{-2}$	$3.9 \times 10^{15}$		
	60	253	$1.9 \times 10^{-1}$	$7.2 \times 10^{15}$		
	55	273	$3.6 \times 10^{-1}$	$1.3 \times 10^{16}$		
stratosphere	50	274	$6.6 \times 10^{-1}$	$2.3 \times 10^{16}$		balloons, sounding rockets
	45	274	$1.2 \times 10^0$	$4.3 \times 10^{16}$		
	40	268	$2.2 \times 10^0$	$8.1 \times 10^{16}$		
	35	252	$4.3 \times 10^0$	$1.7 \times 10^{17}$		
	30	235	$8.6 \times 10^0$	$3.6 \times 10^{17}$		
	25	227	$1.8 \times 10^1$	$7.7 \times 10^{17}$		
	20	219	$3.9 \times 10^1$	$1.7 \times 10^{18}$		
	15	211	$8.5 \times 10^1$	$3.9 \times 10^{18}$		
	10	231	$1.3 \times 10^2$	$7.7 \times 10^{18}$		
	5	266	$3.7 \times 10^2$	$1.3 \times 10^{19}$		
troposphere	0	291	$7.6 \times 10^2$	$2.5 \times 10^{19}$	28.96	

from: Heicklen, J., "Atmospheric Chemistry,"  
Academic Press, 1972.

# REPRESENTATIVE ATMOSPHERIC DAYTIME ION CONCENTRATIONS

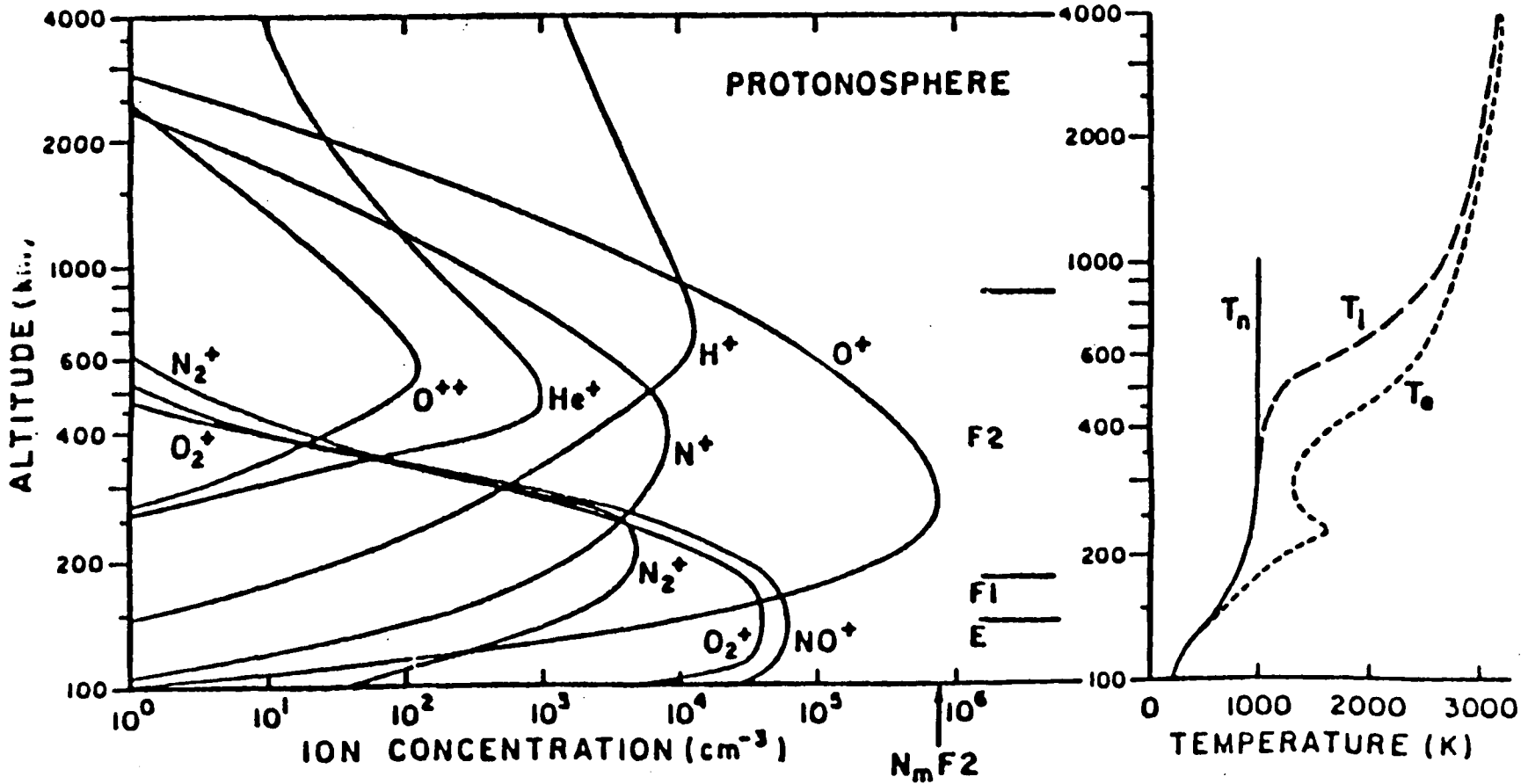

LaRC 7/18/85

# EQUILIBRIUM AND NONEQUILIBRIUM GAS PROPERTY COMPARISONS FROM AT POINT AWAY FROM THE WALL

Sphere cone at altitude = 58 km; Mach = 14; Angle of attack = 30°

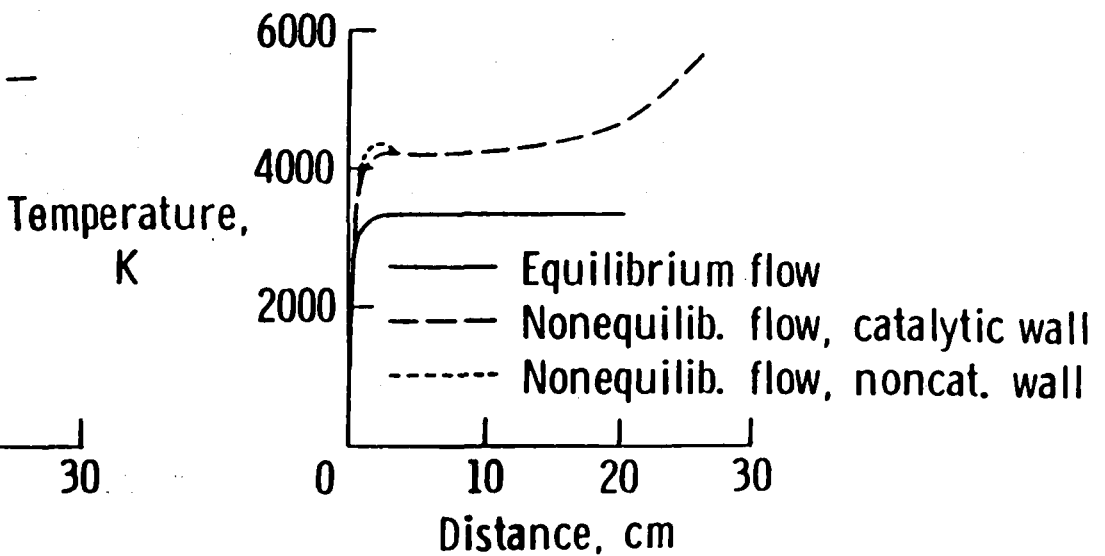
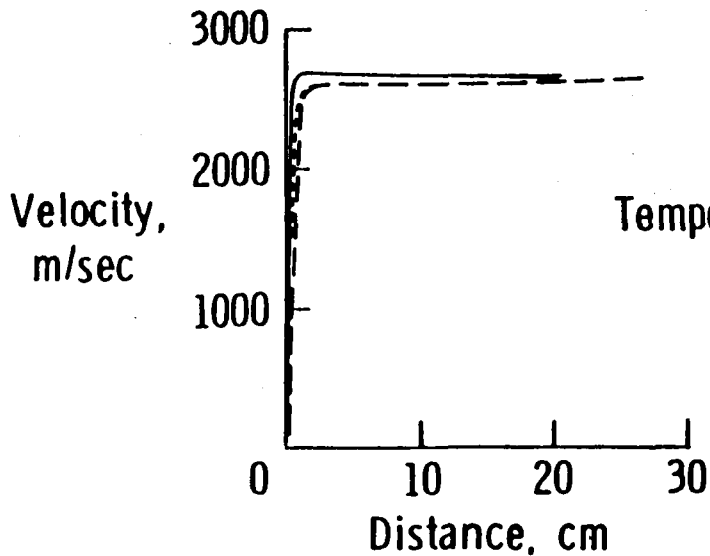
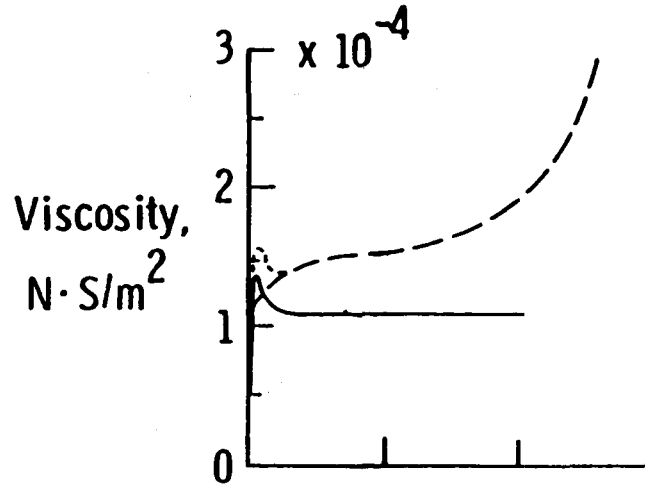
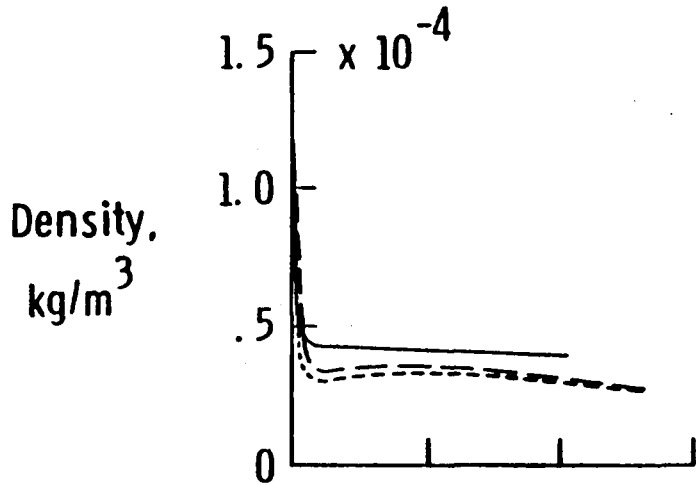



# **STARFAC**

## **AEROTHERMODYNAMIC MEASUREMENTS AND INSTRUMENTATION**

- **RESPONSIBILITY OF TSS (STARFAC) TECHNOLOGY AND TEST PANEL AT LaRC  
(SPACE SYSTEMS DIVISION; INSTRUMENT RESEARCH DIVISION)**
  - **DEFINE ENGINEERING MEASUREMENTS NECESSARY FOR  
CONTROL AND HOUSEKEEPING**
  - **DEFINE SCIENCE MEASUREMENTS NECESSARY TO INVESTIGATE  
AEROTHERMODYNAMIC ENERGY AND MOMENTUM TRANSFER**
  - **DEFINE INSTRUMENTATION REQUIREMENTS AND ASSESS  
STATE-OF-THE-ART**
  - **MEASUREMENT ADVISORY PANEL TO INTERFACE AEROTHERMO-  
DYNAMIC, ENGINEERING, AND MEASUREMENT SPECIALISTS**

LaRC  
7/18/85

# STARFAC

## SCIENCE MEASUREMENTS

CURRENTLY IDENTIFIED MEASUREMENTS	CANDIDATE METHODS UNDER CONSIDERATION	PROJECTED R&D REQUIREMENTS	
		EXTENDED	MODERATE
SURFACE TEMPERATURE DISTRIBUTION	THERMOCOUPLES		*
HEAT FLUX RATE	THERMOCOUPLES, CALORIMETERS	*	
SURFACE PRESSURE DISTRIBUTION	CAPACITANCE, VARIABLE RELUCTANCE		*
FREE STREAM GAS ANALYSIS	FREE STREAM MASS SPECTROMETER	*	
BOUNDARY LAYER GAS ANALYSIS	BOUNDARY LAYER MASS SPECTROMETER	*	
FLOW-FIELD PROFILING	RAYLEIGH SCATTERING, IR, LASER FLUORESCENCE	*	
GAS DENSITY	PRESSURE, TEMPERATURE, MASS SPECTROMETER MEASUREMENTS		*
BOUNDARY LAYER TRANSITION	PRESSURE, TEMPERATURE MEASUREMENTS		*
WALL CATALYSIS	MASS SPECTROMETER TEMPERATURE MEASUREMENTS		*

# STARFAC

## ENGINEERING MEASUREMENTS

CURRENTLY IDENTIFIED MEASUREMENTS	CANDIDATE METHODS UNDER CONSIDERATION	PROJECTED R&D REQUIREMENTS	
		EXTENDED	MODERATE
TETHER TENSION	TENSIOMETERS , ACCELEROMETERS		*
TETHER TEMPERATURE	REFLECTED ACOUSTIC WAVE PROPOGATION	*	
SATELLITE SURFACE TEMPERATURE	THERMOCOUPLES		*
HEAT TRANSFER RATE	THERMOCOUPLES, CALORIMETERS	*	
SATELLITE INTERNAL TEMPERATURE	THERMOCOUPLES, RADIOMETERS		*
DYNAMIC SURFACE PRESSURE	CAPACITANCE, VARIABLE RELUCTANCE		*
INTERNAL PRESSURE	THERMOPILE, CAPACITANCE		*
ACCELERATION (DRAG)	ACCELEROMETERS, GYROSCOPES		*
SATELLITE COORDINATES	LASER RADAR	*	
SATELLITE / STS COMMUNICATIONS	FIBER OPTICS, ELECTRONIC, LASER	*	

## **TSS- 2 FREE STREAM GAS ANALYSIS**

**Objectives:** Quantitatively determine neutral and ionized gas concentrations ( $N^0 \approx 10^9$ ,  $N^+ \approx 10^6/\text{cm}^3$ ), in order to relate global variations in free-stream composition to TSS-1 operational behavior and to electrodynamic measurements.

**Approach:** Modify and integrate an existing flight qualified Venus probe high resolution mass spectrometer for TSS use.

**Development:** Design and fabricate free-stream inlet; minor modification of electronics to optimize operation parameters for TSS mission, incorporate data storage system.

# THE DOUBLE FOCUSSED MASS SPECTROMETER

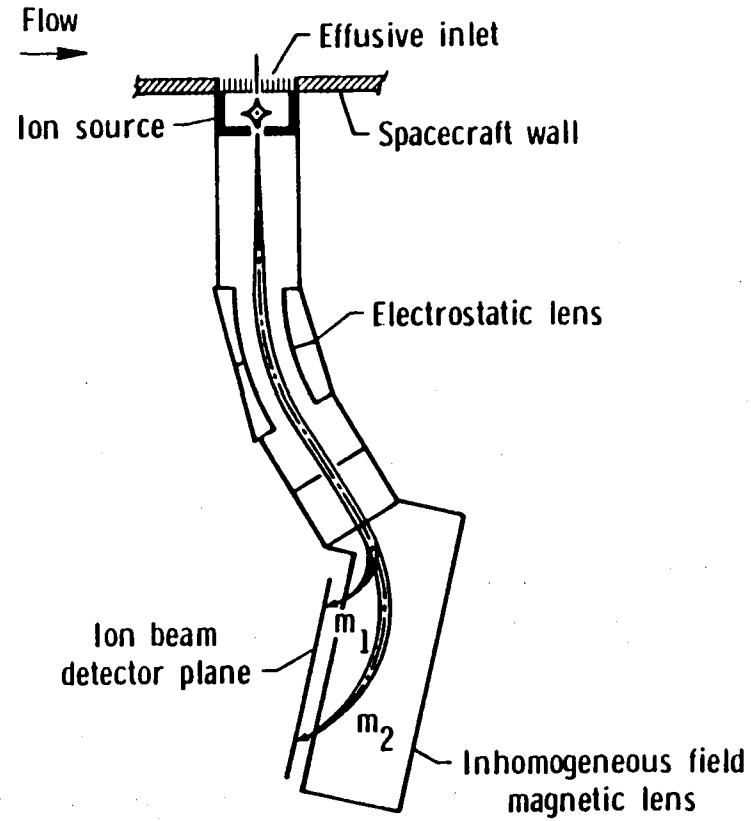

## THE EFFUSIVE INLET

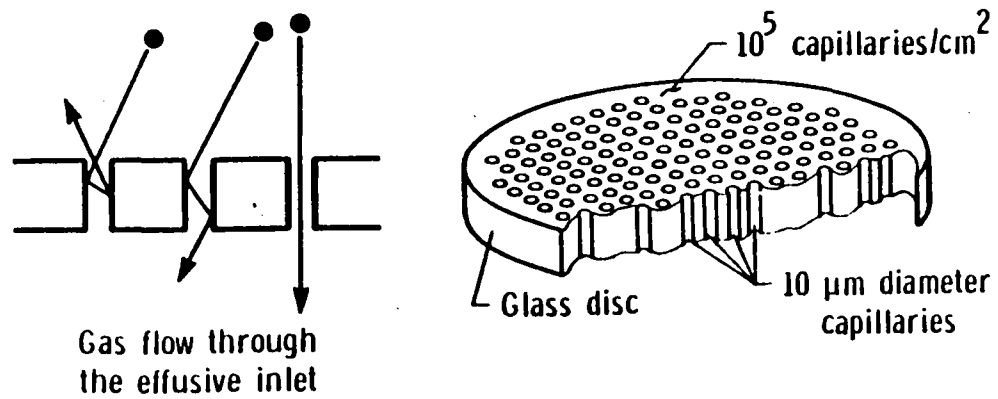

# POTENTIAL NON-INTRUSIVE MEASUREMENT TECHNIQUES FOR HYPERSONIC BOUNDARY-LAYER RESEARCH

<u>Technique</u>	<u>Measurement</u>	<u>Issues</u>
<u>Passive</u>		
Mass spectrometry	Species concentration	Sampling and collecting, single point measurement
Thermal emissions	Temperature, species identity	Poor spatial resolution with averaging effect
<u>Optical</u>		
Rayleigh scattering	Total density	Noise from stray light, particulates, and high fluorescent emissions behind shock
Raman scattering	Temperature, species concentration	Same as Rayleigh - limited to N <sub>2</sub> identification below 52 km, N <sub>2</sub> thermometry below 40 km

# QUANTITATIVE PHYSICAL MEASUREMENTS AND CANDIDATE MEASUREMENT METHODS FOR AEROTHERMODYNAMIC STUDIES

Currently Identified Measurements	Candidate Methods Under Consideration
Surface temperature	Thermocouples
Heat flux	Thermocouples, calorimeters
Internal temperature	Thermocouples, radiometers
Surface pressure	Capacitance, variable reluctance, thermopile
Acceleration	Accelerometers, gyros
Free-stream composition	Free stream neutral/charged particle mass spectrometer
Boundary-layer composition	Boundary-layer neutral mass spectrometer
Density	Pressure, temperature, mass spectrometer measurements
Flow-field profiling	IR, Rayleigh scattering, laser fluorescence
Boundary-layer transition	Surface temperature and pressure measurements
Wall catalysts	Determine from mass spectrometer measurements

# STARFAC

## MEASUREMENT AND INSTRUMENTATION DEFINITION STATUS

- MAJOR ENGINEERING AND SCIENCE MEASUREMENTS IDENTIFIED
- CANDIDATE MEASUREMENT METHODS IDENTIFIED, BUT NOT SELECTED FOR EACH, STATE-OF-THE-ART ASSESSMENT CONTINUING
- R & D REQUIRED : ALL METHODS WILL REQUIRE AT LEAST MODERATE ENGINEERING R & D TO MEET SPECIFIC TSS REQUIREMENTS
- DATA ACQUISITION REQUIREMENTS, USE OF ARTIFICIAL INTELLIGENCE, CONTROLLED DATA SYSTEM, AND COMMUNICATIONS METHODS BEING ASSESSED

LaRC  
7/18/85



# STARFAC

## EXAMPLES OF MEASUREMENTS REQUIRING R & D

- TETHER TEMPERATURE DISTRIBUTION – RECENTLY IDENTIFIED REQUIREMENT FOR 100 KM FLIGHT ; REFLECTED ACOUSTIC WAVE PROPAGATION BEING CONSIDERED FOR MEASUREMENT
- FLOW FIELD PROFILING – MAJOR LIMITATIONS ARE LOW SIGNAL DUE TO LOW DENSITY ( $N=10^{13}/\text{CM}^3$ ) , REQUIREMENT FOR SMALL, HIGH POWER SOLID STATE LASER AND DETECTOR ARRAYS; RALEIGH OR RAMAN SCATTERING, FLOURESENCE ARE CANDIDATES
- DENSITY AND GAS ANALYSIS – R & D REQUIRED FOR NON-INTRUSIVE, NON-PERTURBING SAMPLE SYSTEMS AND FOR MULTIPLE ION BEAM DETECTOR; CURRENT FLIGHT MASS SPECTROMETER TECHNOLOGY IS ADEQUATE FOR TSS APPLICATIONS

LaRC  
7/18/85



TECHNOLOGY AND TEST PANEL

PRESENTATION III

SHUTTLE TETHERED AEROTHERMODYNAMICS

RESEARCH FACILITY

(STARFAC)

OCTOBER 15 - 17, 1985

PAUL M. SIEMERS, LaRC

GEORGE M. WOOD, LaRC

HENRY WOLF, AMA

## STARFAC

The Earth's atmosphere from 90 km to 200 km provides the last aerothermodynamics frontier. This atmospheric region is taking on even more significance as man advances into space on a more routine basis with plans for a permanent presence requiring even more extensive capabilities to "fly" in and through this region. Present NASA programs which require but also can provide an understanding of the aerodynamics and aerothermodynamics of the free molecule and transition flows that exist at these altitudes are the Aeroassisted OTV, Entry Research Vehicle and the Tethered Satellite. Each of these programs provides a unique opportunity to do flight research in the rarefied upper atmosphere. However, the Tethered Satellite Program provides, because of its capability to obtain global, in-situ, steady-state data, the greatest potential to:

1. Define the performance of aerodynamic shapes as a function of environmental characteristics (free molecule, transition, slip flow regimes).
2. Define the characteristics of the upper atmosphere and the global variability of properties such as composition temperature, pressure and density.

Such data are required to accomplish the systematic development and verification of analytical prediction techniques required to support advance configuration designs.

LaRC  
1/22/85

# SHUTTLE TETHERED AEROTHERMODYNAMIC RESEARCH FACILITY

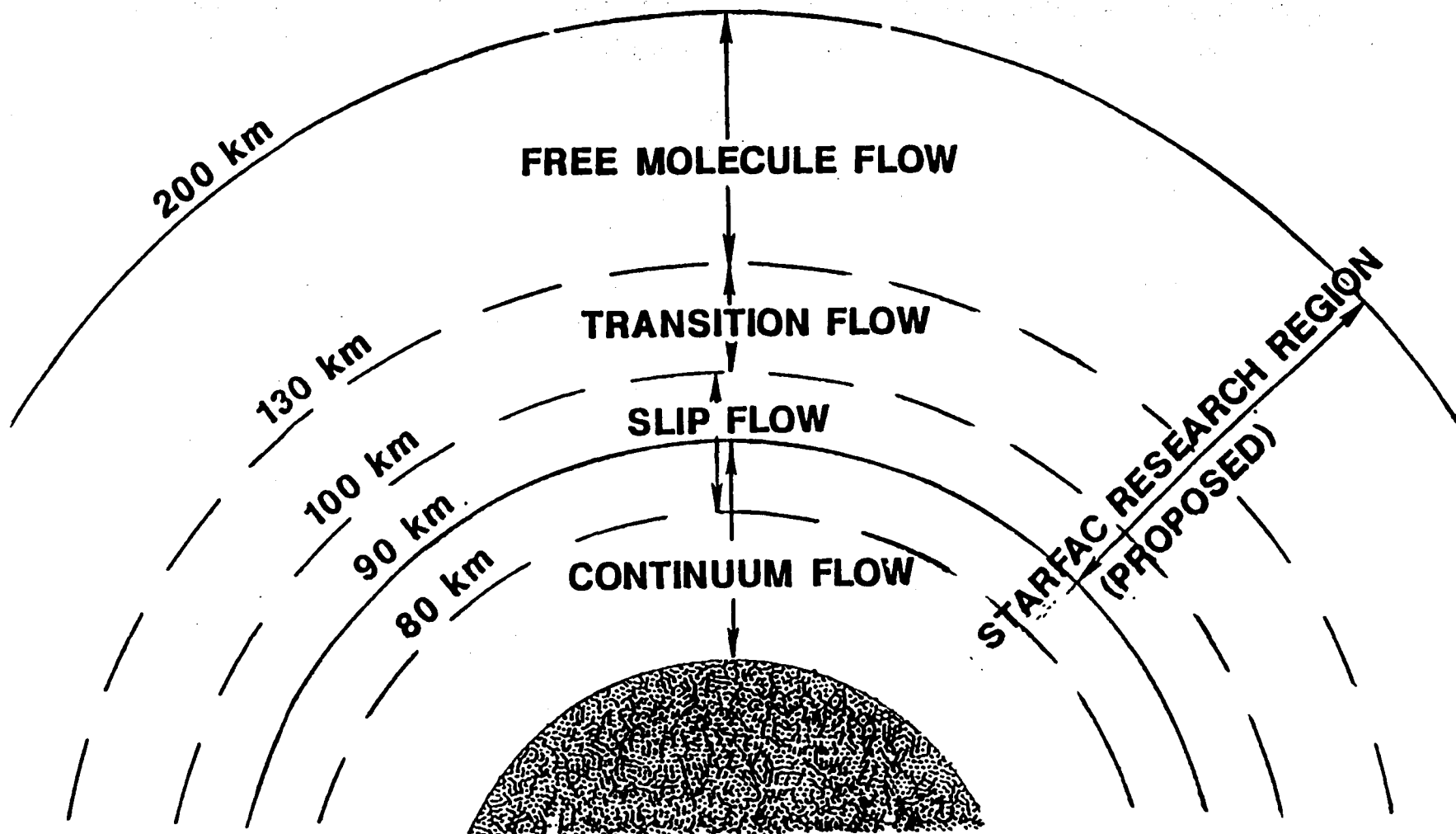

267

LaRC

1 / 22 / 85

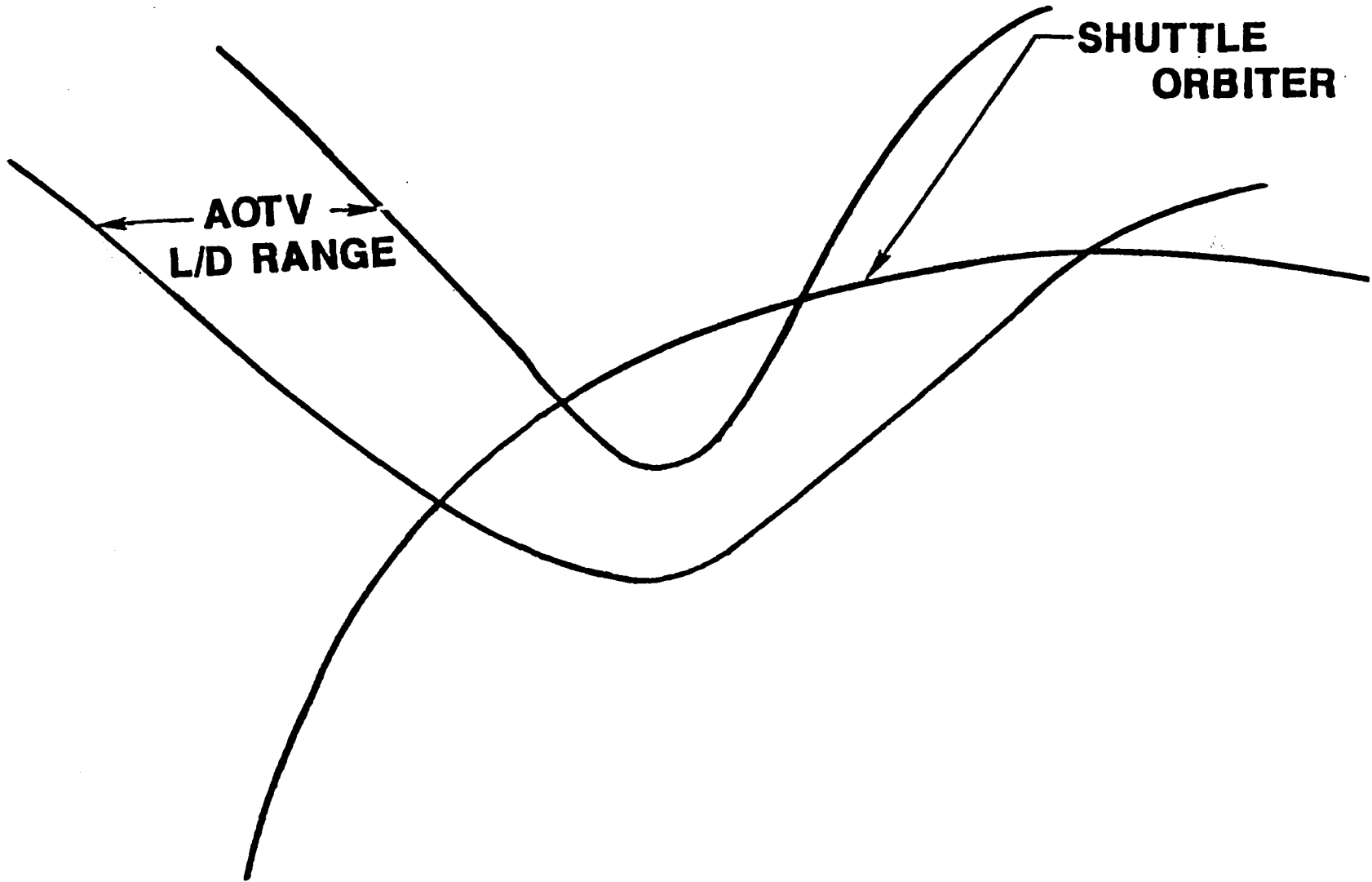



# STARFAC

## PROPOSED RANGE OF ATMOSPHERIC PROPERTIES

ALT, km	Temp °K	Pressure, $\rho$ torr	Density $\rho$ , kg/m <sup>3</sup>	M.W.	MFP, m	Kn
90	176	$1.4 \times 10^{-3}$	$3.63 \times 10^{-6}$	28.77	0.01	.01
100	210	$2.4 \times 10^{-4}$	$5.6 \times 10^{-7}$	28.40	0.1	0.1
125	410	$1.3 \times 10^{-5}$	$1.8 \times 10^{-8}$	25.10	10	10
150	634	$2.7 \times 10^{-6}$	$2.1 \times 10^{-9}$	24.10	50	50
200	854	$8.4 \times 10^{-7}$	$2.5 \times 10^{-10}$	21.30	100	100

413 8911 1985

LaRC  
7/18/85



# **STARFAC**

- **OBJECTIVE**

**ESTABLISH THE FEASIBILITY OF A TETHERED SATELLITE SYSTEM  
CAPABLE OF OPERATING FROM THE SPACE SHUTTLE ORBITER AND  
ACCOMPLISHING AEROTHERMODYNAMIC RESEARCH AT AN ALTITUDE  
BETWEEN 90 KM AND 200 KM**

**LaRC  
7/18/85**

# STARFAC

## APPROACH:

- DEVELOP OR MODIFY AS REQUIRED A TETHER SYSTEM SIMULATION PROGRAM TO STUDY SYSTEM ELEMENTS RELATIVE MOTION, STABILITY FORCES, TEMPERATURE, DEPLOYMENT, RETRIEVAL, ETC.
- DEVELOP CONTROL LAWS AND LOGIC AS REQUIRED TO MEET STARFAC MISSION OBJECTIVES
- PERFORM SYSTEM TRAJECTORY SHAPING STUDIES TO ESTABLISH OPERATIONAL CONSTRAINTS
- PERFORM MISSION SIMULATION TO DEFINE CONCEPT MISSION ENVELOPE
- DEFINE SYSTEM ENGINEERING AND SCIENCE DATA REQUIREMENTS AND ESTABLISH INSTRUMENT DEVELOPMENT REQUIREMENTS

LaRC  
7/18/85

# **STARFAC SIMULATIONS**

## **SIMPLIFIED MISSION**

- **EQUATORIAL , CIRCULAR ORBIT**
- **SHUTTLE ALTITUDE MAINTAINED**
- **SPHERICAL 500 kg SATELLITE**
- **STAINLESS STEEL TETHER ,  
1 1/2 mm DIAMETER**

**LaRC  
7/18/85**

# STARFAC

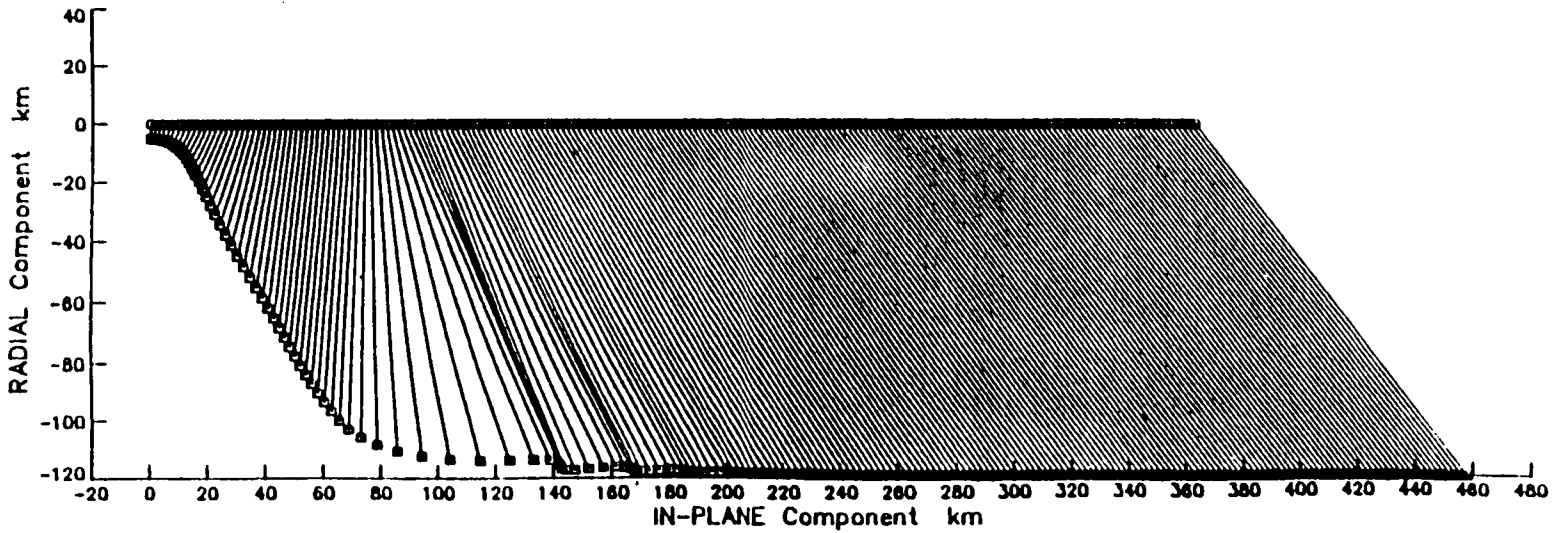
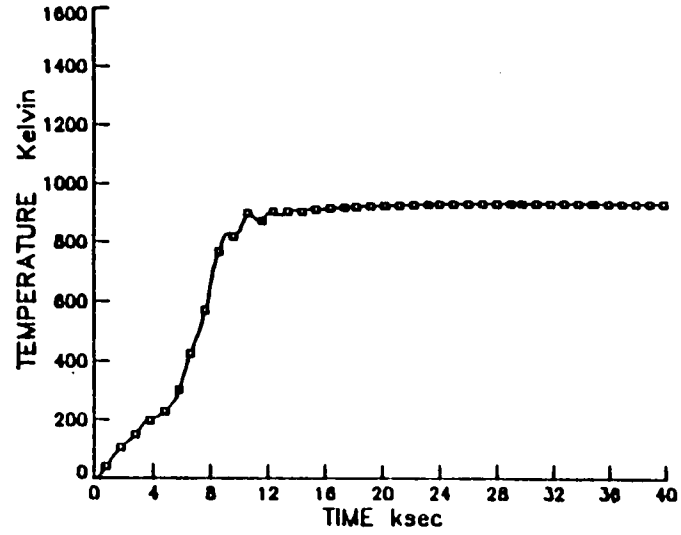
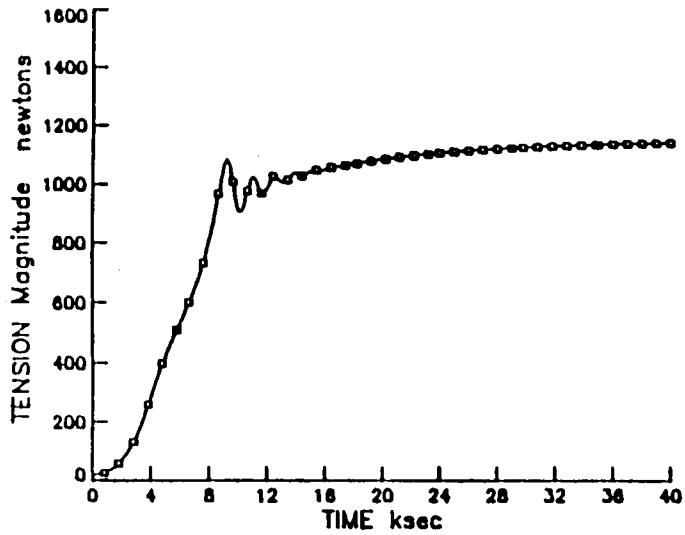

Satellite Ht. = 100 km

LaRC  
1/22/85

# STARFAC

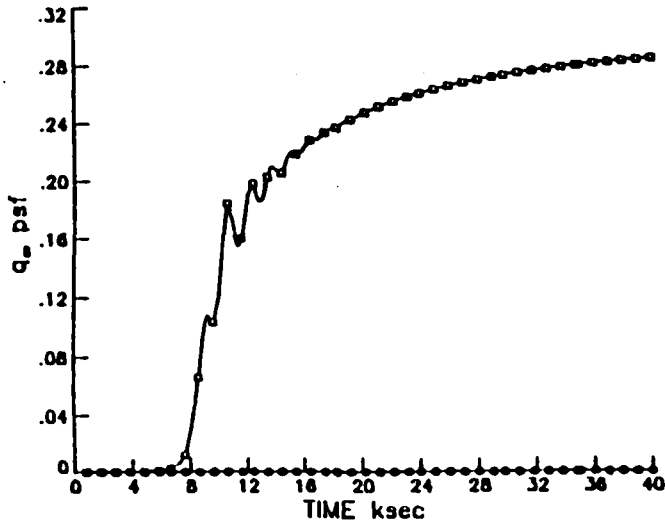
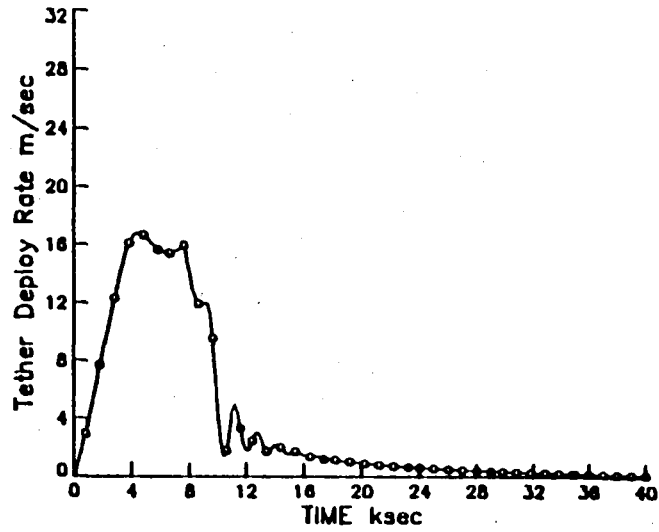
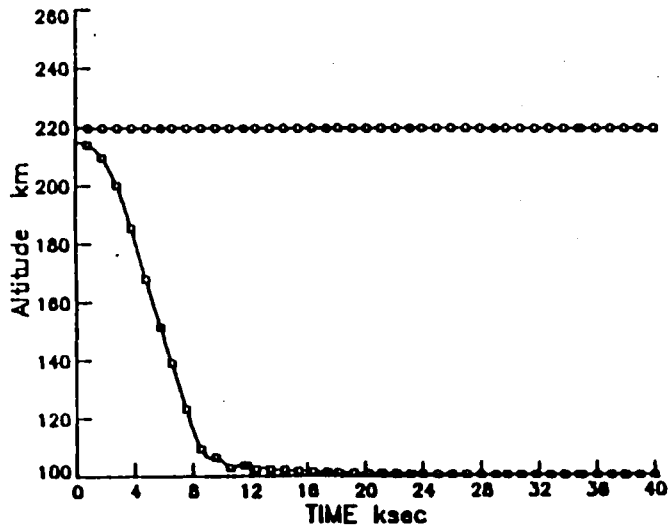

Satellite Ht. = 100 km

LaRC  
1/22/85

# STARFAC

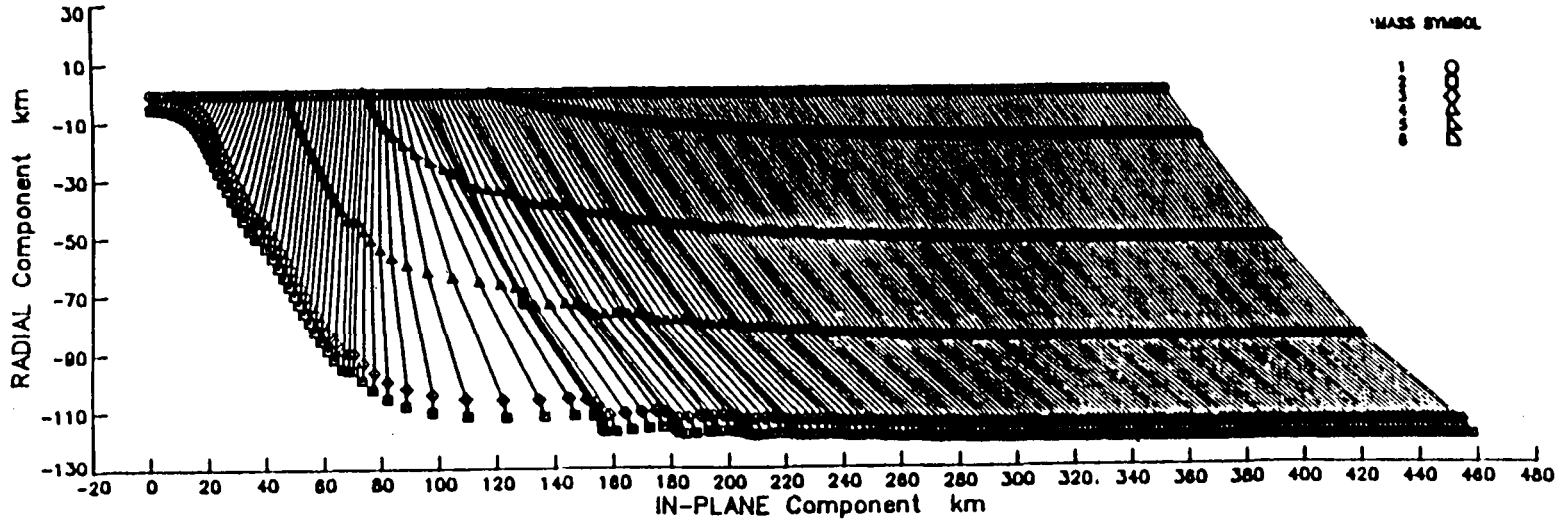
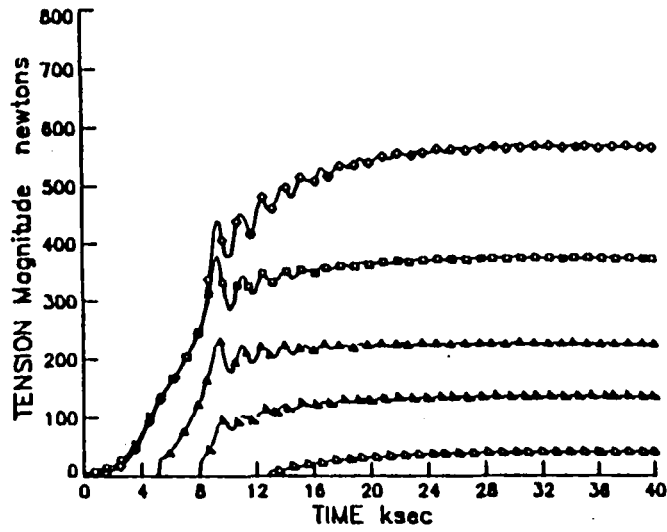
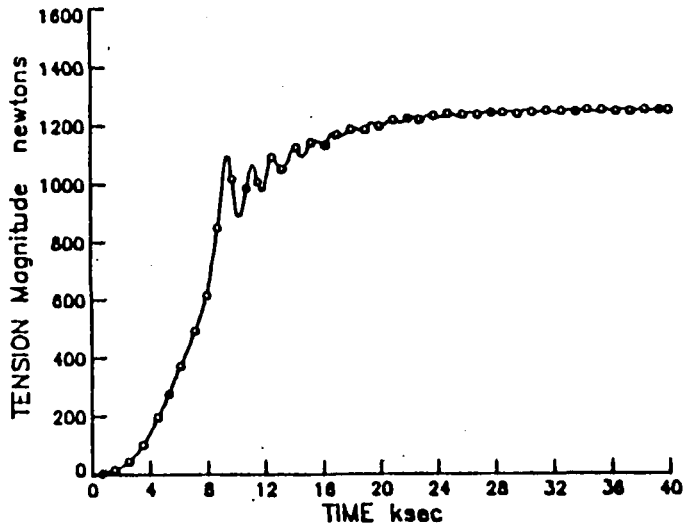

Satellite Ht. = 110 km

LARC  
1/22/85

# STARFAC

## SIMULATIONS

### ELLIPTICAL ORBIT MISSIONS

- PURPOSE : PROVIDE THERMAL RELIEF FOR TETHER

Tether Length (km)		Orbit Parameters (km)		Satellite Altitude (km)	Tether Temperature (°K)	Tension Orbiter (Newtons)	Deploy Time (sec)	Orbiter Altitude Maintenance
Target	Actual	Perigee	Apogee					
90	96.9	200	220	109.8	770	368	11346	Infinite Mass
90	101.8	200	240	115.0	709	250	11401	Infinite Mass
90	96.6	200	260	116.7	697	373	11436	Infinite Mass
90	96.6	200	260	113.8	730	376	11401	None
90	99.8	200	300	124.6	608	250	11504	Infinite Mass
90	97.7	200	400	137.2	551	253	11560	Infinite Mass
90	94.2	200	500	159.9	502	354	11730	Infinite Mass

### CONCLUSIONS

- NO THERMAL RELIEF
- REDUCED DATA PERIOD
- TETHER DYNAMICS PROBLEMS

LaRC  
7/18/85

# STARFAC

## SIMULATIONS

### ● INCLINED ORBIT (REAL) MISSIONS

Target Altitude (km)	Tether Length (km)	Satellite Altitude (km)	Tether Temperature (°K)	Tension Orbiter (Newtons)	Deploy Time (Sec)	Orbiter Altitude Maintenance	Tether Simulation 8 Mass Points	Orbit Inclination
120	94.6	120	770	298	7800	Infinite Mass	No	28°
120	85.7	120	618	240	7260	None	No	28°
110	110.6	110	763	366	11300	Infinite Mass	No	28°
110	99.6	109.9	762	325	11000	None	No	28°
100	146.7	100	940	402	28500	Infinite Mass	No	28°
100	162.1	100	936	1281	18354	Infinite Mass	Yes	28°
100	146.6	100	944	409	28000	None	No	28°
100	125.7	101.8	909	332	39500	Low Thrust	No	28°
100	140.6	99.8	976	421	15000	Infinite Mass	No	57°
100	132.5	100	983	319	12000	Low Thrust	No	57°



# STARFAC

## INCLINED ORBIT SIMULATIONS

279

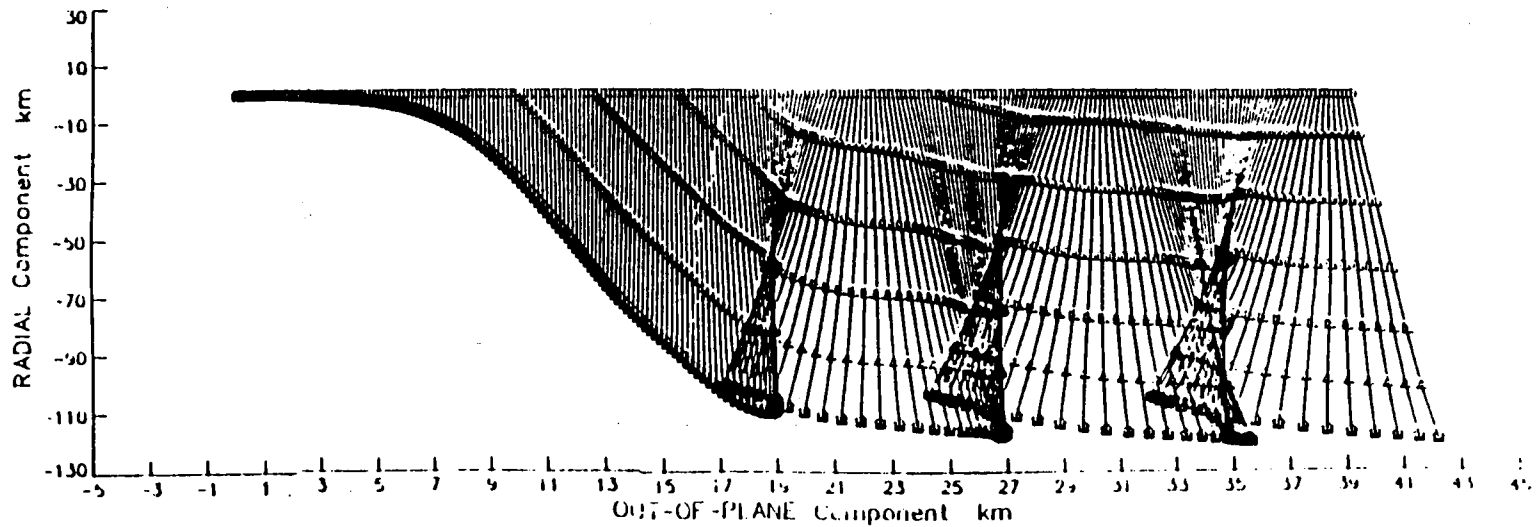
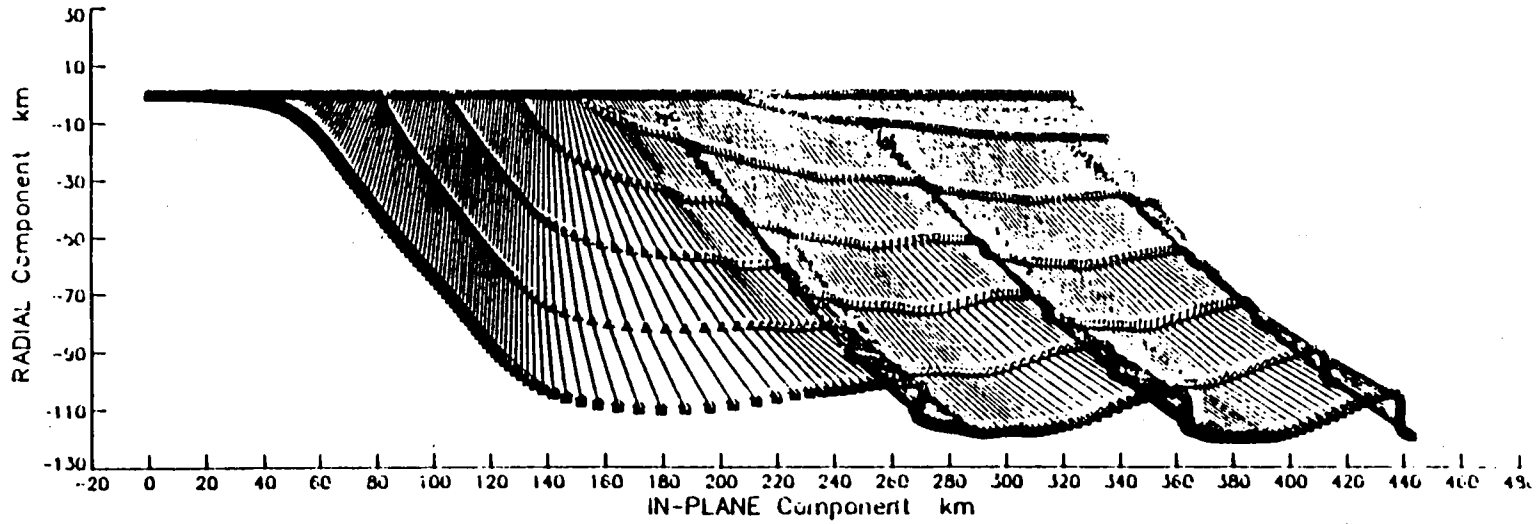

LaRC  
7/18/85

# STARFAC

## INCLINED ORBIT SIMULATIONS

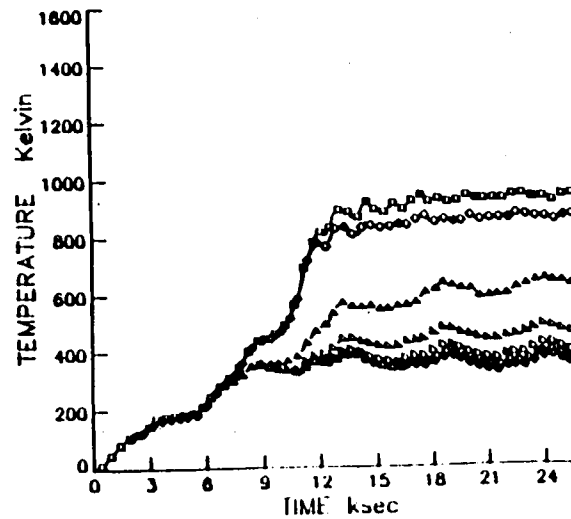
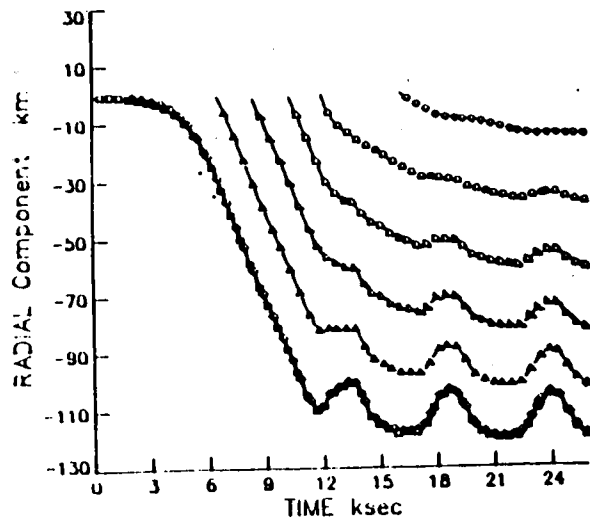
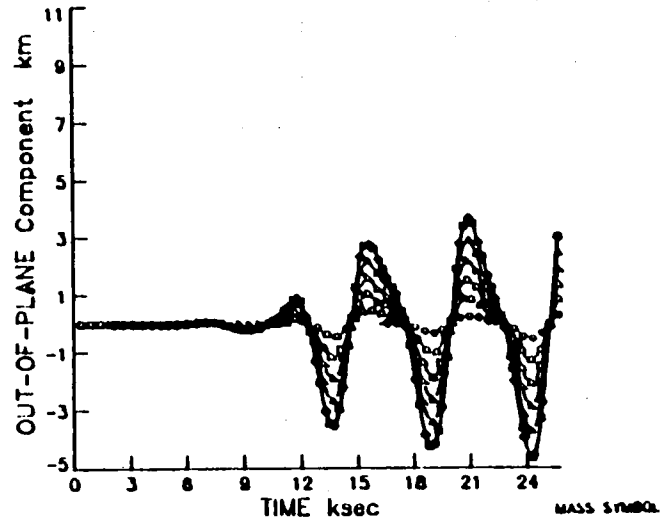
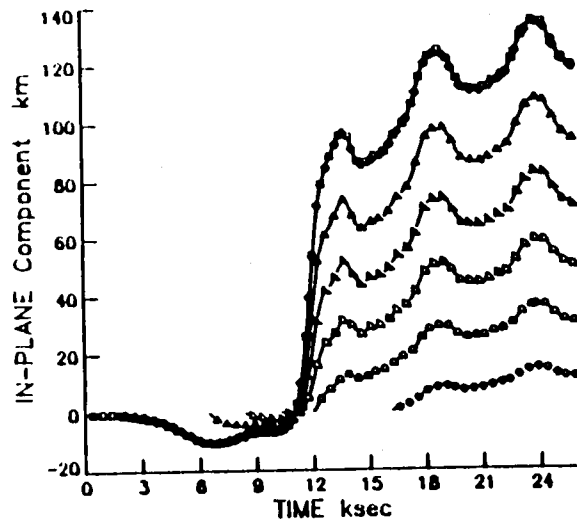

MASS SYMBOL  
1  
2  
3  
4  
5  
6  
7  
8  
9  
10  
11  
12  
13  
14  
15  
16  
17  
18  
19  
20  
21  
22  
23  
24

LaRC  
7/18/85

# STARFAC

## INCLINED ORBIT SIMULATIONS

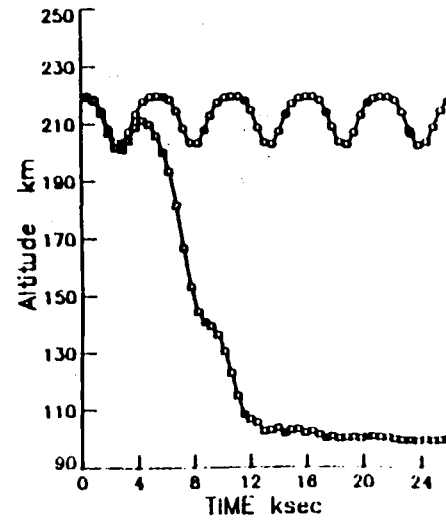
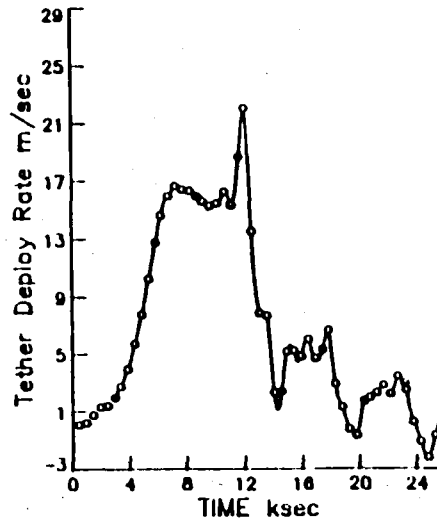
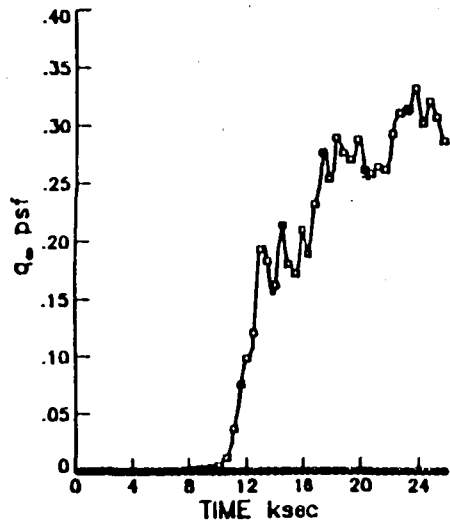
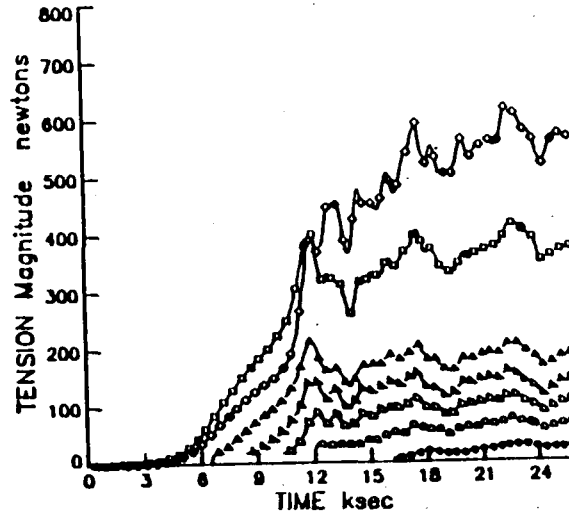
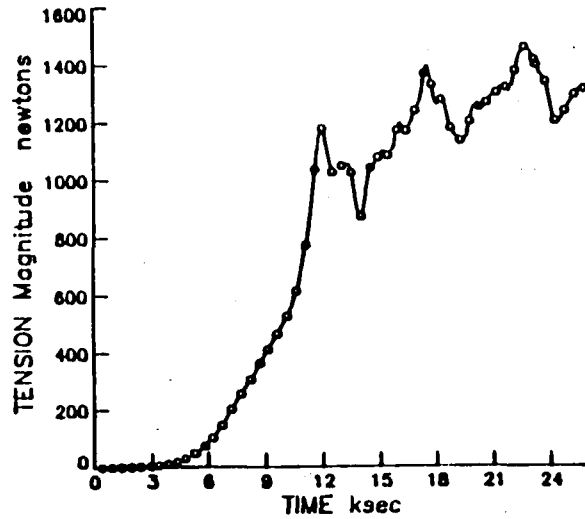

LaRC  
7/18/85

# STARFAC

## ORBITER ALTITUDE LOSS VERSUS STARFAC ALTITUDE

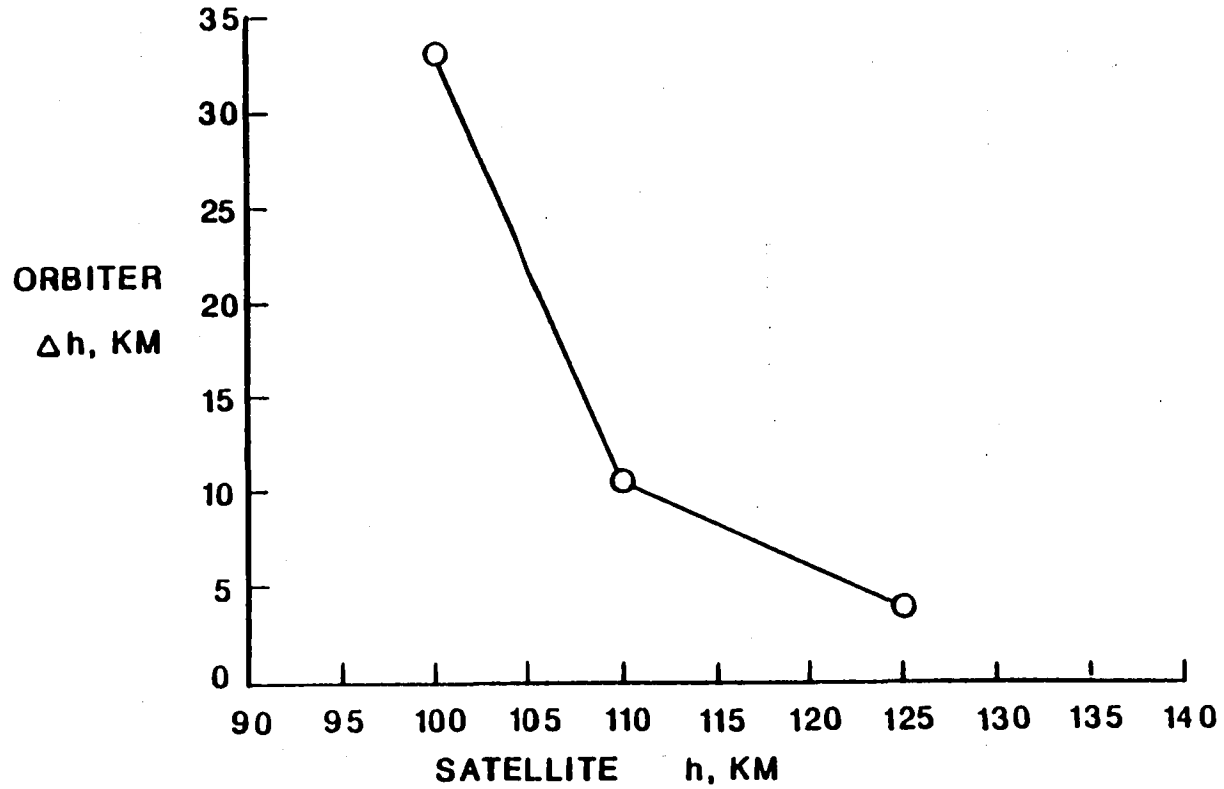

282

LaRC  
7/18/85

# STARFAC

## MISSION TIMELINE

### TYPICAL MISSION

- DEPLOY TO INITIAL TARGET ALTITUDE
- MAINTAIN SHUTTLE ORBITER ALTITUDE BY CONTINUOUS  $\Delta V$  MANEUVERS
- ACCOMPLISH MINIMUM OF ONE ORBIT DATA PERIOD
- DEPLOY SATELLITE TO SECOND ALTITUDE
- REPEAT SEQUENCE

Mission Time (Sec)	Altitude (km)		Tether			Total Orbit Revs.
	Satellite	Orbiter	Length (km)	Temperature ( $^{\circ}$ K)	Tension Orbiter (n)	
0	215	219	5	0	6	0.0
7177	125	209	84	510	230	1.3
14646	125	213	82	520	170	2.7
16799	120	217	98	620	270	3.2
24277	120	203	91	700	230	4.6
27564	115	217	104	701	294	5.2
35028	115	207	100	739	244	6.6
38535	110	218	112	754	281	7.2
46004	110	210	111	762	207	8.6
49264	105	217	116	830	280	9.2
56729	105	204	117	889	276	10.6
91611	100	208	142	944	375	17.2
99065	100	202	144	933	342	18.6

PROCESS MAY BE REPEATED UNTIL ORBITER MAINTENANCE  $\Delta V$  BUDGET DEPLETED (TBD)

LaRC  
7/18/85

# STARFAC

## CONCLUSIONS :

- THE FEASIBILITY OF DEPLOYING A TETHERED SATELLITE TO AN ALTITUDE OF 100 KM HAS BEEN ESTABLISHED
- THE FEASIBILITY OF DEPLOYING A TETHERED SATELLITE TO AN ALTITUDE BELOW 100 KM IS POSSIBLE BUT COSTLY
- THE ACCOMPLISHMENT OF AEROTHERMODYNAMIC RESEARCH AT ALTITUDES BETWEEN 100 AND 200 KM IS PRACTICAL
- CIRCULAR SHUTTLE ORBITS PROVIDE OPTIMUM MISSION TIMELINES
- MISSIONS BELOW 125 KM ALTITUDE REQUIRE THE DEVELOPMENT OF A HIGH TEMPERATURE TETHER
- TETHER MISSIONS ARE LIMITED TO ORBITAL SPEEDS

LaRC  
7/18/85

# STARFAC

## RECOMMENDATIONS:

- ACCOMPLISH DETAILED MISSION STUDIES
  - OPTIMIZE SKYHOOK
  - INCORPORATE GTOSS
- TSS BASELINE / MINI-MOD MISSIONS
  - FOREBODY MODIFICATIONS
    - CONICAL
  - RUDDER MODIFICATIONS
    - CONTROL
    - WAKE FLOW
- DISPOSABLE TETHER MISSIONS
- AERODYNAMIC (L/D) VEHICLE CONFIGURATIONS
- PROPULSION AUGMENTED MISSIONS
- INSTRUMENTATION DESIGN, DEVELOPMENT AND TESTING
- TETHER DEVELOPMENT

LaRC  
7/18/85





TECHNOLOGY AND TEST PANEL

PRESENTATION IV

TETHER POINTING PLATFORM AND SPACE ELEVATOR MECHANISMS

ANALYSIS OF THE KEY CONCEPTS FOR SATP AND SCALED SATP

OCTOBER 15 - 17, 1985

E. TURCI  
AERITALIA

ANALYSIS OF THE KEY CONCEPTS FOR SATP AND SCALED SATP

PANEL PRESENTATION

PREPARED BY : E. TURCI  
AERITALIA GSS: SPACE MECHANISMS LEADER

2ND APPLICATIONS OF TETHER IN SPACE WORKSHOPS

VENICE, ITALY

OCTOBER - 15,17 1985

# TETHER POINTING PLATFORM AND SPACE ELEVATOR MECHANISMS

## 1. TETHER POINTING PLATFORM MECHANISM

### 1.1 SCOPE

THE IDEA TO CONTROL AND STABILIZE THE ATTITUDE OF A PLATFORM BY MEANS OF A MOVABLE TETHER ATTACHMENT POINT WAS PROPOSED IN 1984 BY MR. LEMKE, L.G. -NASA-AMES.

CONTROLLED DISPLACEMENTS OF THE ATTACHMENT POINT GENERATE TORQUES ON THE PLATFORM PROVIDING THE STABILIZATION OF THE ROLL & PITCH AXES.

STABILIZATION ACCURACY AS HIGH AS FEW ARCSEC IS POSSIBLE IF THE MECHANISM REALIZES PRECISE ATTACHMENT POINT DISPLACEMENTS WITH A SUFFICIENTLY LARGE FREQUENCY BAND RESPONSE.

MECHANISM CONCEPTS AND TECHNOLOGICAL SOLUTIONS ARE GIVEN HERE FOR A SCALED SATP ; THE PROPOSED CONFIGURATIONS ASSUME THE FOLLOWING MAIN CONSTRAINTS :

## TETHER POINTING PLATFORM MECHANISMS

- TETHER TENSION : 100 N
- TETHER TILT ANGLE :  $\pm 4$  DEG.
- POINTING AREA IN X Y PLANE :  $\pm 2$  CM
- POSITION ACCURACY :  $< 0,1$  MM
- RESPONSE FREQUENCY BAND : MAX. OBTAINABLE
- OPERATIVE LIFETIME: LIMITED TO ONE MONTH

## 1.2 Candidate Concepts

The concepts evaluated in this study are described by the following sketches of fig 1.

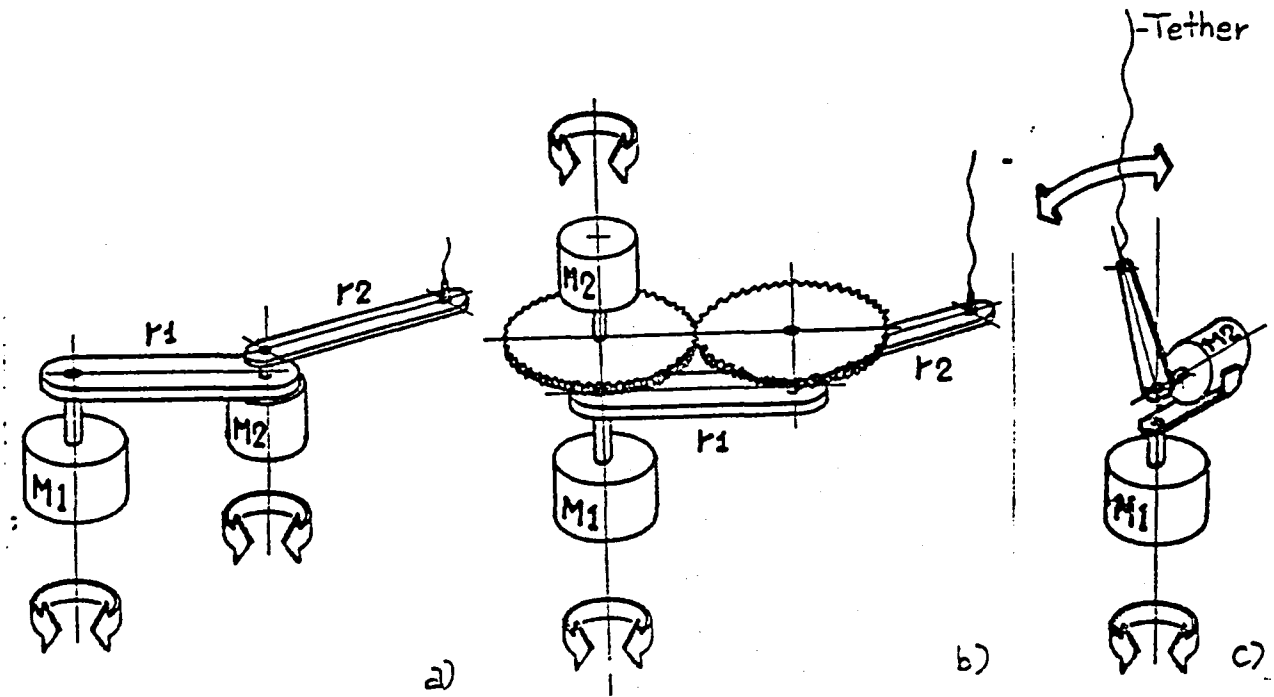

Fig.1 tethered pointing platform mechanism concepts a), b), c).

# TETHER POINTING PLATFORM MECHANISMS

1.2

## CANDIDATE CONCEPTS

THE CONCEPTS EVALUATED IN THIS STUDY ARE DESCRIBED BY THE FOLLOWING SKETCHES OF FIG.1 :

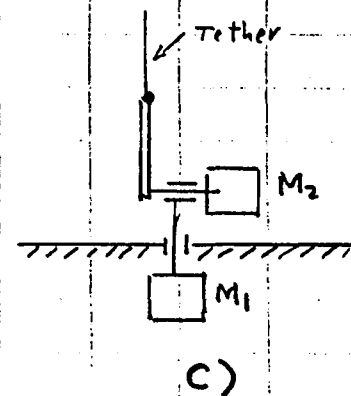
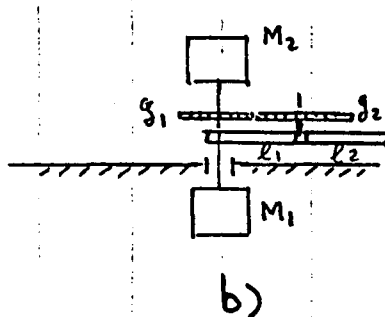
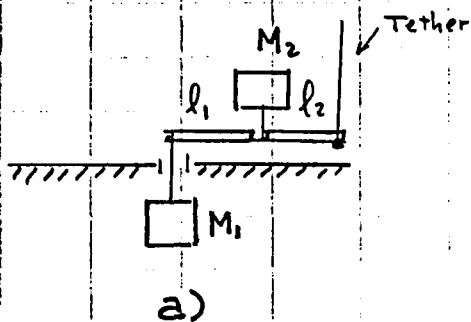

FIG.1 TETHERED POINTING PLATFORM MECHANISM CONCEPTS a), b), c)

## TETHER POINTING PLATFORM MECHANISMS

CONCEPT A) - THE POSITION OF  $P$  IS CONTROLLED BY THE ROTATIONS  $\theta_1, \theta_2$  (HINGES OF THE ARMS  $l_1, l_2$ ) -

THE RELATIONSHIP BETWEEN THE COMMANDED CARTESIAN COORDINATES  $X_P \text{ \& } Y_P$  AND THE ROTATIONS  $\theta_1, \theta_2$

$$\text{IS: } \begin{cases} X_P = l_1 \cos \theta_1 + l_2 \cos \theta_2 \\ Y_P = l_1 \sin \theta_1 + l_2 \sin \theta_2 \end{cases}$$

ROTATIONS,  $\theta_1, \theta_2$ ,

CONTROLLED BY  $M_1$  AND  $M_2$ , ARE TRIGONOMETRIC FUNCTIONS OF THE CARTESIAN COORDINATES.

THE DRAWBACK OF THE CONCEPT IS A TOO HIGH INERTIAL LOAD OF  $M_1$

CONCEPT B) - B) IS AN IMPROVEMENT OF A) WHERE  $M_2$  MOTOR IS AXIALLY ALIGNED WITH  $M_1$ ; THE IMPROVEMENT MINIMIZES THE INERTIAL LOAD OF  $M_1$  DUE TO  $M_2$  BUT DOES NOT AVOID HEAVY ARMS AND VERY TIGHT BALL BEARING ASSEMBLIES DUE TO CANTILEVER ARMS. THE TOOTHED GEARS  $G_1, G_2$  GENERATE FURTHER POINTING ERRORS. MOTOR CONTROL UNIT IS COMPLEX AND GENERATES ERRORS DUE TO TRIGONOMETRIC ALGORITHMS.

## TETHER POINTING PLATFORM AND SPACE ELEVATOR MECHANISMS

### CONCEPT C)

UTILIZES A COMPLETELY DIFFERENT APPROACH - MOTORS  $M_1$ ,  $M_2$  CONTROL DIRECTLY AZIMUTH AND ELEVATION OF THE TETHER ATTACHMENT POINT P; CANTILEVER IS AVOIDED; THE INERTIAL LOADS ON THE ROTATION AXES ARE MINIMIZED. COMMANDS SIGNALS ARE GIVEN IN POLAR COORDINATES; TRIGONOMETRIC ALGORITHMS ARE NO MORE NECESSARY.



## TETHER POINTING PLATFORM AND SPACE ELEVATOR MECHANISMS

### 1.3 BASELINE CONCEPT-DESCRIPTION

CONCEPT C) HAS BEEN ASSUMED AS BASELINE AND ANALYZED -  
THE ENGINEERING DRAWINGS IN FIG.2 ILLUSTRATE THE CONFIGURATION AND  
THE LAYOUT.

IDENTICAL ROTARY ACTUATORS CONTROL AZIMUTH AND ELEVATION ANGLES (STAN-  
DARDIZATION).

BOTH ACTUATORS CONSIST OF : MOTOR , SYNCHRO, OPTICAL ENCODER.

THE ELEVATION ACTUATOR IS AXIALLY ALIGNED WITH THE AZIMUTH ONE SO  
AS TO MINIMIZE ITS INERTIAL LOAD.

IRREVERSIBLE GEAR COUPLINGS ( WORM & WORMGEAR - SPROCKET TOOTHED  
SECTOR) -PROVIDE A FULL RANGE OF TILT ELEVATION ANGLES WHEN THE MOTOR  
TURNS A FULL ROTATION; THE RESPONSE TIME CAN BE DESIGNED IDENTICAL  
ON A BOTH CHANNELS, THE OVERALL ASSEMBLY IS RUGGED SO TO ENSURE GOOD  
ACCURACIES; BACKLASH IS MINIMIZED OR MADE NULL.

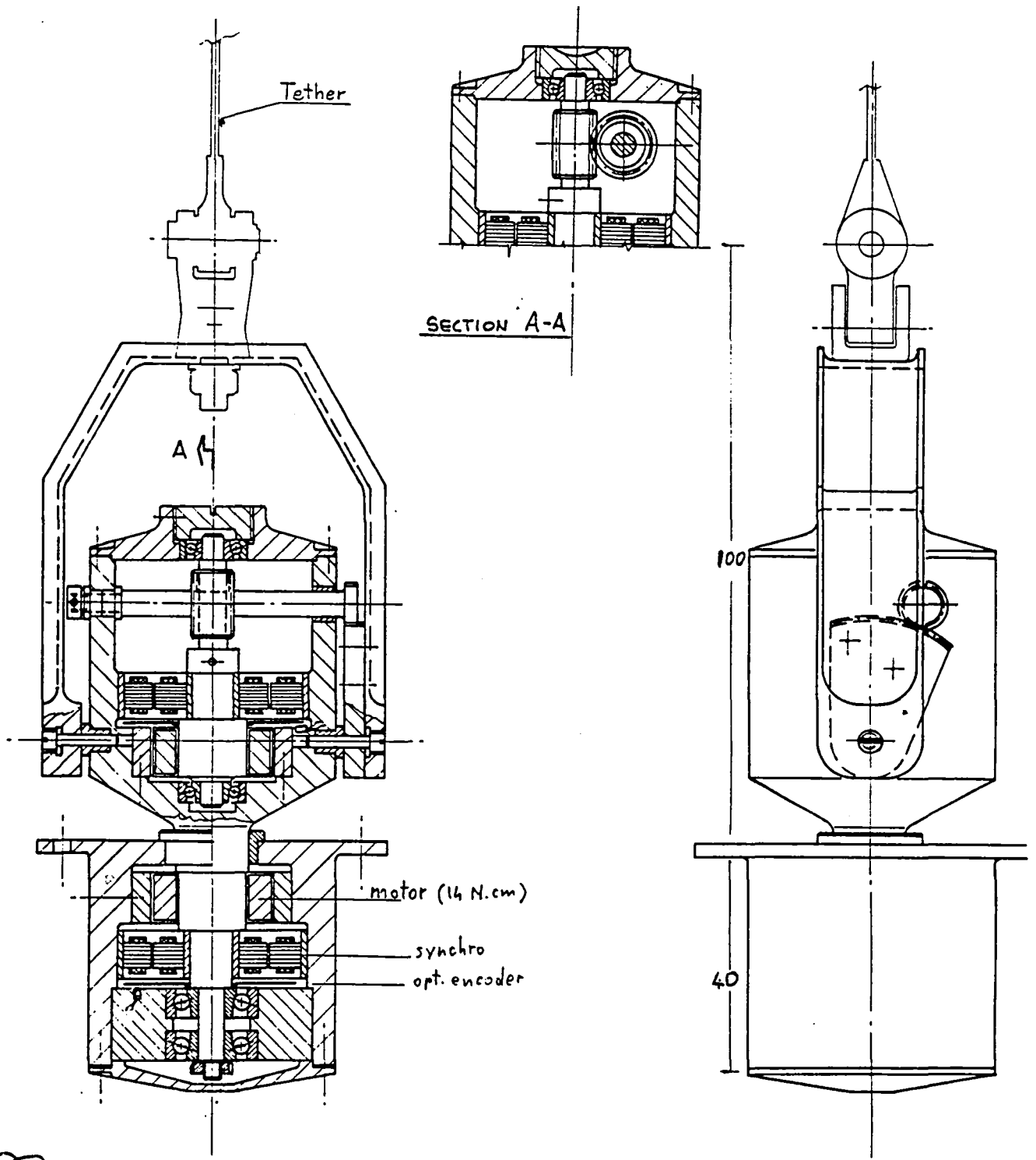

A FIG.2 TETHER POINTING PLATFORM MECHANISMS

## TETHER POINTING PLATFORM AND SPACE ELEVATOR MECHANISMS

### 1.4 BASELINE CONCEPT-CONTROL ANALYSIS

THE CONTROL BLOCK DIAGRAM FOR THE AZIMUTH CHANNEL IS ILLUSTRATED IN FIG.3.

TEMPORAL RESPONSES TO STEP COMMANDS ARE GIVEN (COMPUTER SIMULATIONS) IN FIG. 4 AND 5 WITHOUT AND WITH LEAD/LAG FILTER.

THE MOTOR HAS BEEN ASSUMED TO BE A D.C. BRUSHED MOTOR, THE ANGULAR TRANSDUCER A PLASTIC FILM POTENTIOMETER AND THE SPEED FEEDBACK TO BE AN IDEAL DERIVATIVE FUNCTION.

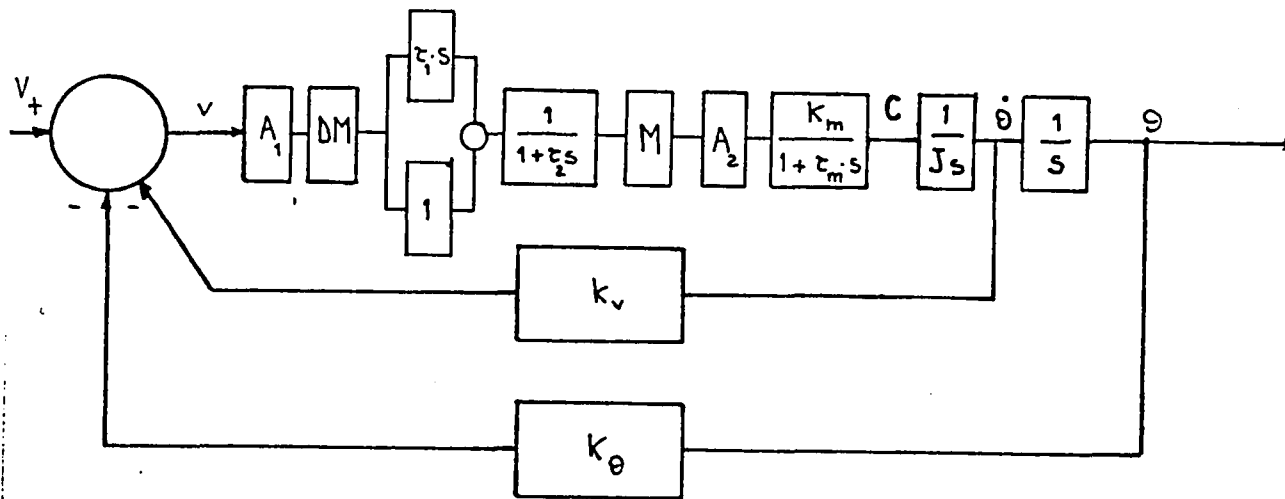

$A_1 A_2 = 100$   
 $K_m = 4.9 \cdot 10^{-2} \text{ N}\cdot\text{m}/\text{V}$   
 $K_v = 3.72 \cdot 10^{-2} \text{ V}\cdot\text{s}/\text{rad}$   
 $K_\theta = 118 \text{ V}/\text{rad}$

$J \approx 10^{-4} \text{ kg}\cdot\text{m}^2$   
 $\tau_m = 17.3 \text{ ms}$   
 $\tau_1 = 20 \text{ ms}$   
 $\tau_2 = 2 \text{ ms}$

FIG.3 AZIMUTH CHANNEL CONTROL BLOCK DIAGRAM

The system has a very high time constant so it is necessary to use the filter. If we assume  $\tau_1 = \tau_{E1}$ , we would only have a lag as high as  $\tau_2$ , but this procedure would cause unchecked modes.

It is so better to use an higher lead  $\tau_1$ , and a very little  $\tau_2$ .

In this way the system response is the following :

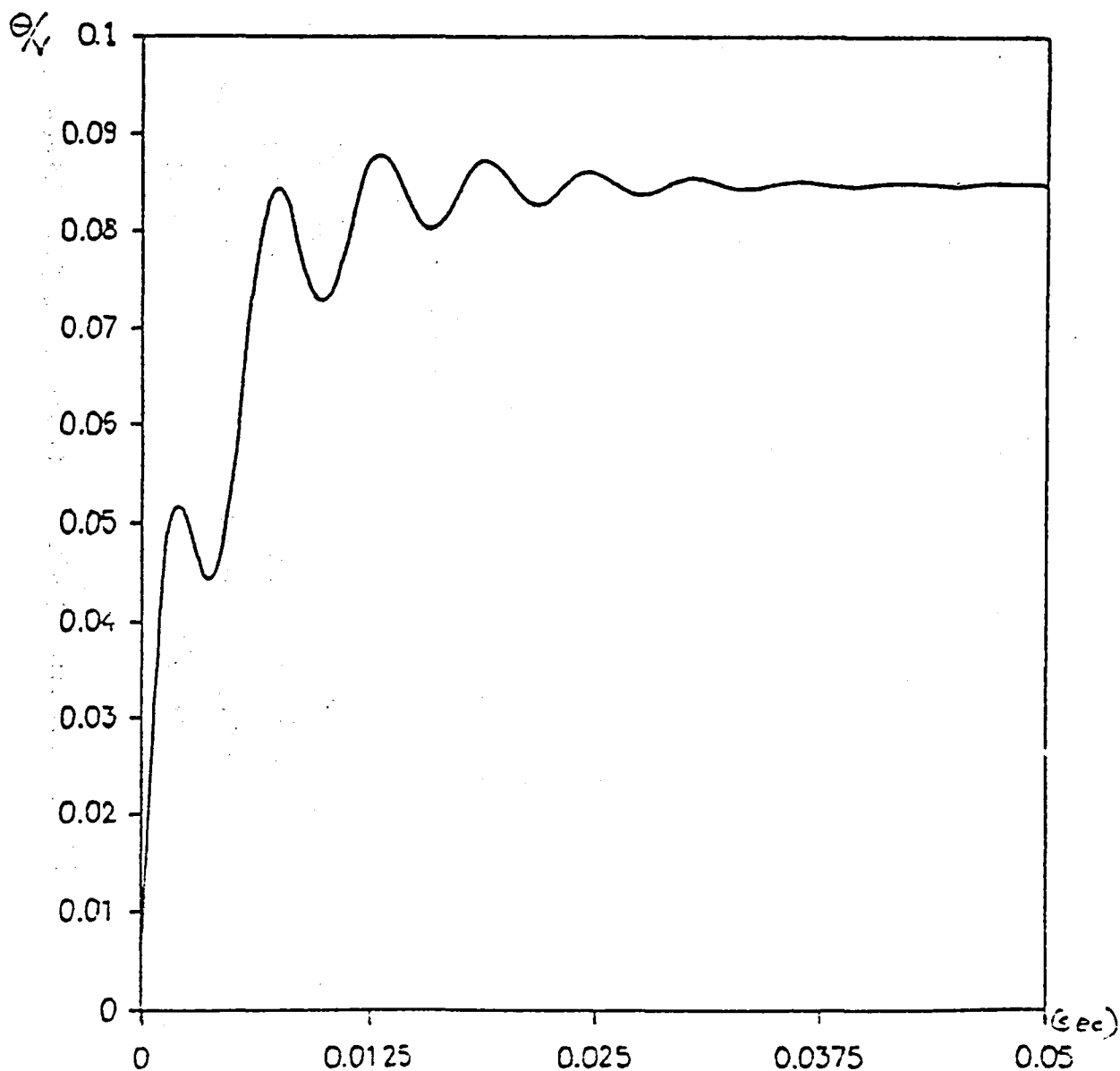

FIG. 5 - Response with lead/lag filter

It is so possible to evaluate the transient without or with the lead/lag filter simply imposing respectively  $\tau_1 = \tau_2 = \emptyset$  or  $\tau_1 = 20$  m sec and  $\tau_2 = 2$  m sec  
The response without the filter is shown in fig.4

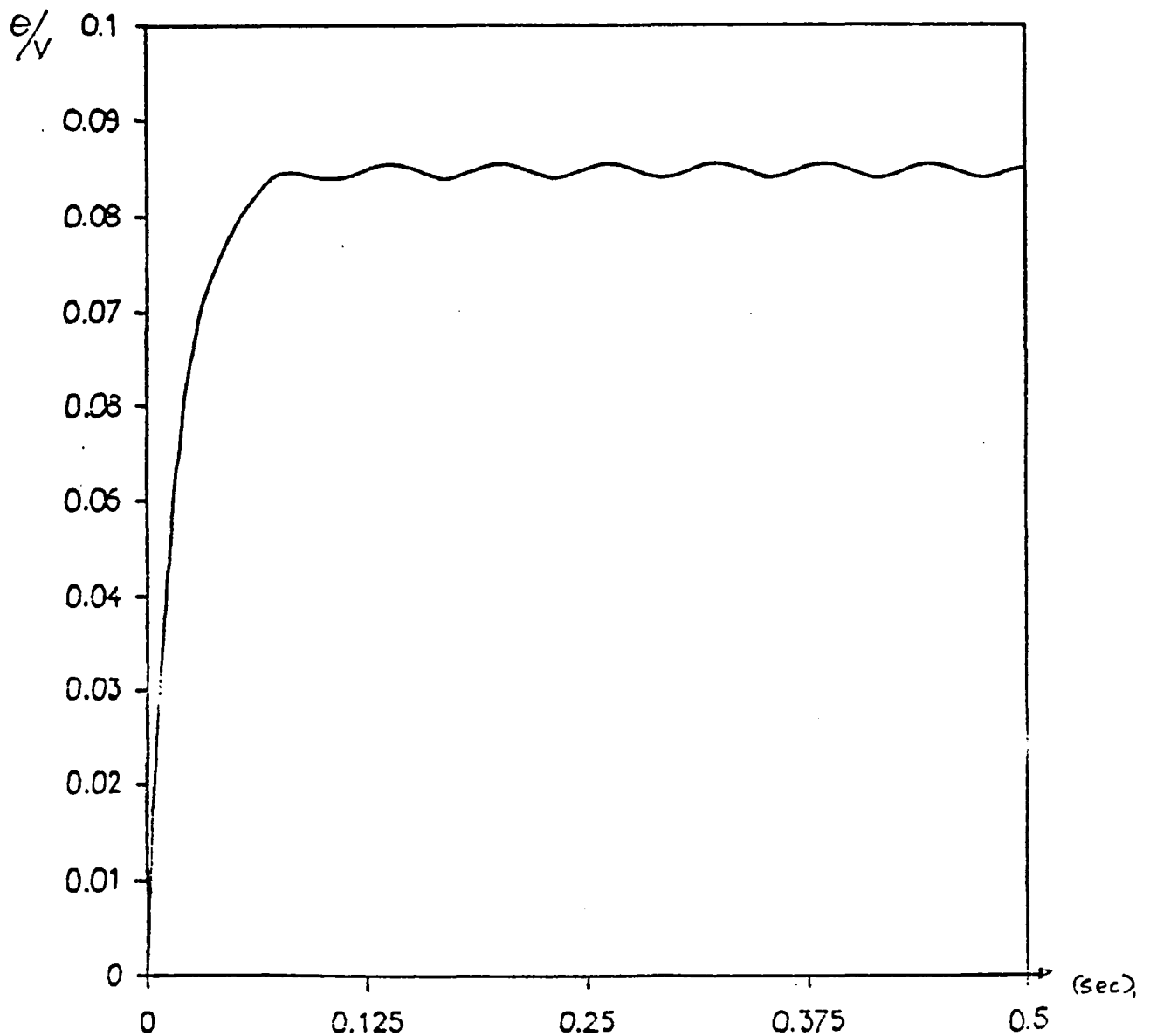

FIG.4 - Response without lead/log filter

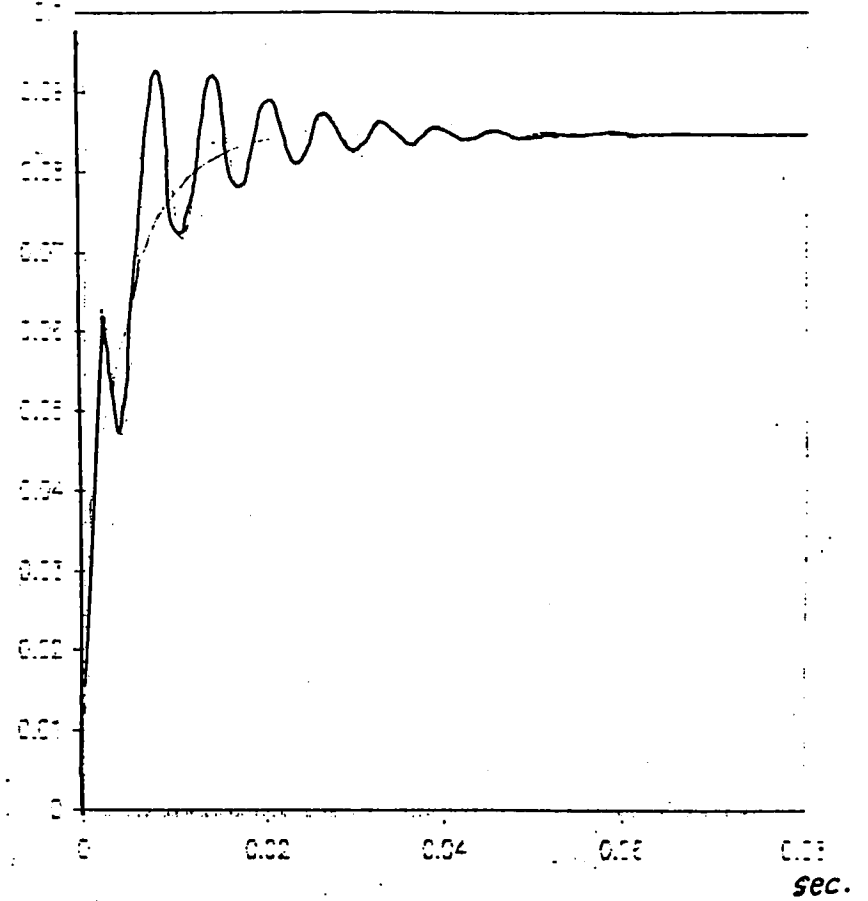
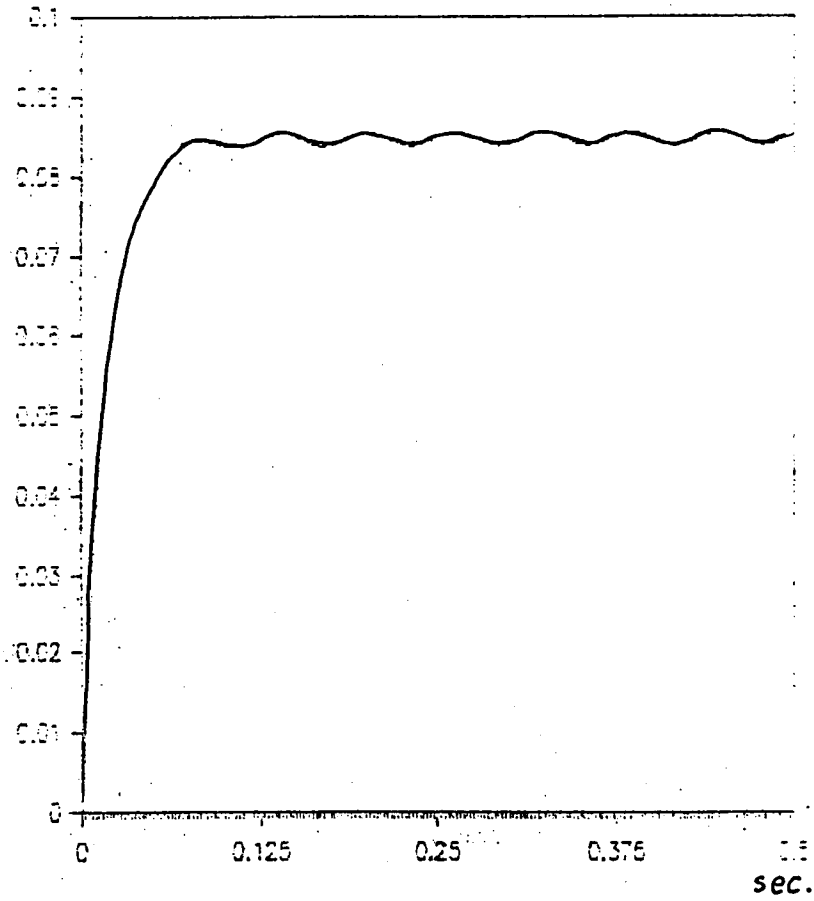

FIG.4 - TRANSIENT WITHOUT LEAD/LAG FILTER - FIG.5 -TRANSIENT WITH LEAD/LAG FILTER

## TETHER POINTING PLATFORM AND SPACE ELEVATOR MECHANISMS

### 1.5 BASELINE CONCEPT- COMPONENTS AND TECHNOLOGIES

TO MEET THE TORQUE REQUIREMENTS A BRUSHED SAMARIUM COBALT D.C. (14 cm.N) TORQUE MOTOR IS MANDATORY; THE FEEDBACKS CAN BE OBTAINED IN DIFFERENT WAYS.

ANGULAR TRANSDUCERS

{ PLASTIC FILM POTENTIOMETER

{ SYNCHRO

SPEED TRANSDUCERS

{ OPTICAL ENCODER

{ ELECTRONIC DERIVATE OF THE D.C. ANGULAR SIGNALS .

THE MOST SIMPLE SOLUTION UTILIZES : POTENTIOMETER AND ELECTRONIC DERIVATE. ALL CONTROLS ARE IN D.C. THE DRAWBACK IS CONSTITUTED BY THE NON CONTROLLED ANGLES OF THE POTENTIOMETER AT ITS EXTREMITIES.



## TETHER POINTING PLATFORM AND SPACE ELEVATOR MECHANISMS

THE MORE ACCURATE SOLUTION UTILIZES:

SYNCHRO AND OPTICAL ENCODER.

THIS SOLUTION REQUIRES A MORE  
SOPHISTICATED ELECTRONIC AND PROBABLY  
GIVES HIGHER RESPONSE TIMES.

THE DWG. IN FIG.2 UTILIZES SYNCHRO AND A FLAT DISC OPTICAL ENCODER  
FEEDBACKS.

## TETHER POINTING PLATFORM AND SPACE ELEVATOR MECHANISMS

### 2. SPACE ELEVATOR MECHANISM FOR SCALED SATP

#### 2.1 SCOPE

A MOVING ELEVATOR ALONG A TETHER DEPLOYED TO A FIXED LENGTH HAS BEEN ALREADY PROPOSED IN THE FRAME OF SYSTEM STUDIES AS A SPACE STATION FACILITY.

THE CONCEPT PROPOSED IN THIS CHAPTER IS REFERRED TO A SCALED SATP WHERE THE TETHER INTERACTION LENGTH IS LIMITED TO 1.0 (APPROX. METER), THE TETHER IS MADE OF KEVLAR ( $\phi \sim 2$  MM) AND THE INTERACTION MAX. FORCE IS 10 N. THE ELEVATOR WILL BE HOOKED TO THE TETHER BY MEANS OF THE RMS OF THE SHUTTLE.

THE SPEED RANGE IS ZERO TO 1.0 METER/SECOND OR MORE, IF POSSIBLE. THE MOVEMENT HAS TO BE SMOOTHED AND CONTROLLED BY PROGRAMMED SPEED PROFILES. THE OPERATIVE LIFETIME IS LIMITED TO ONE MONTH.

## TETHER POINTING PLATFORM AND SPACE ELEVATOR MECHANISMS

### 2.2 CANDIDATE CONCEPTS

THE IDEA TO DRAG THE TETHER GRIPPING IT BETWEEN TWO ROTATING WHEELS HAS BEEN EVALUATED BECAUSE OF ITS SIMPLICITY.

A DESIGN APPROACH, ON THE OTHER SIDE, REQUIRES INVESTIGATION ON FRICTION BETWEEN THE TETHER (KEVLAR,  $\phi \sim 2$  MM) AND THE MATERIAL (RUBBER) COVERING THE WHEELS.

IN FIG. 6 TEST SET-UP AND TEST RESULTS ARE GIVEN.

UTILIZING THE MEASURED COEFFICIENT OF FRICTION, A PRELIMINARY DESIGN HAS BEEN DONE. THE CONCEPT IS CONSIDERED THE BASELINE FOR THE SCALED SATP, WHILE OTHER SOLUTIONS PROPOSED FOR THE SATP (NEXT CHAPTER) WILL BE CONSIDERED APPROPRIATE CONFIGURATIONS ALSO FOR THE SCALED ONE.

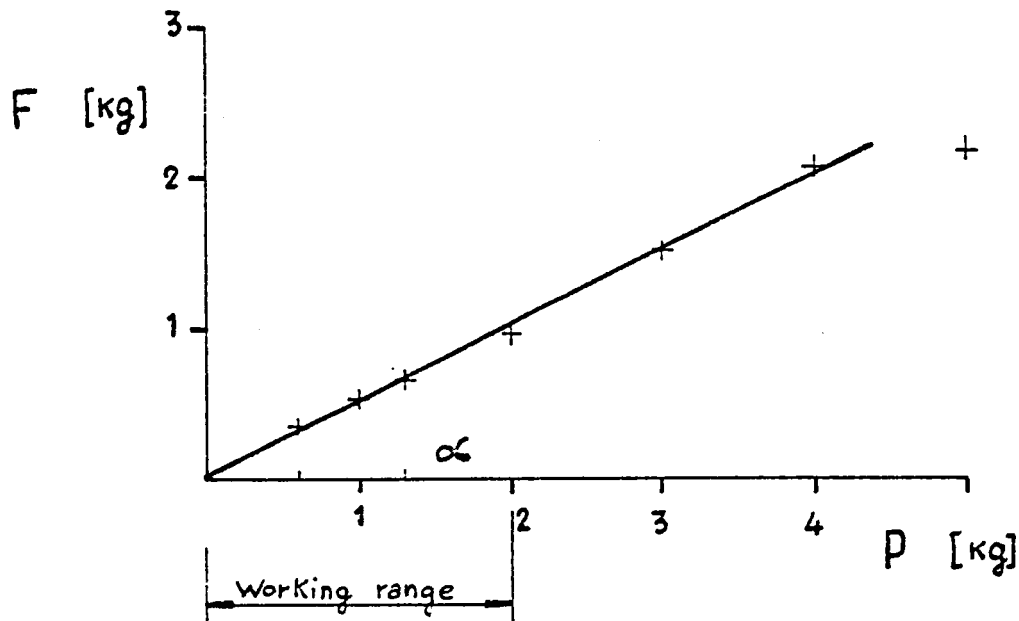

$$f = \operatorname{tg} \alpha \approx 0.5$$

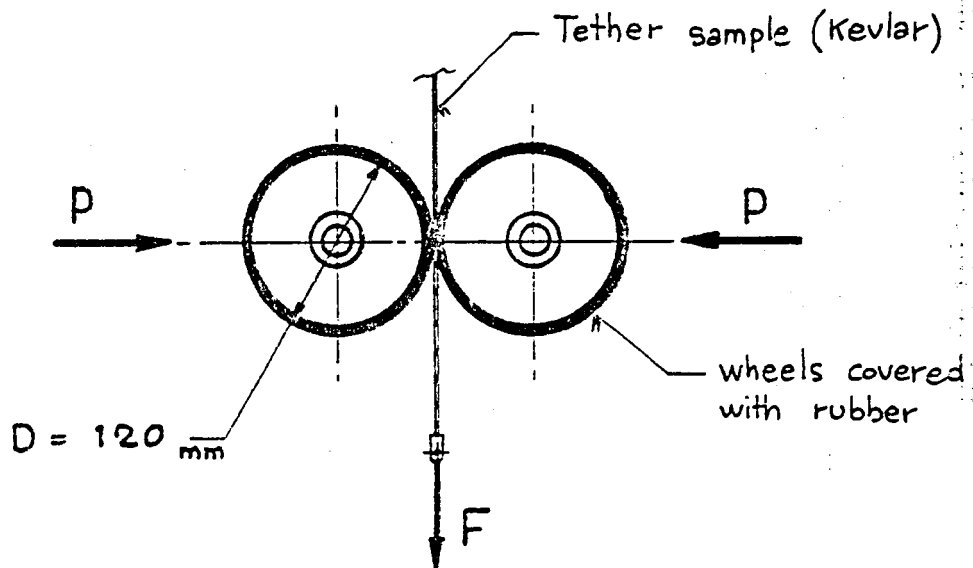
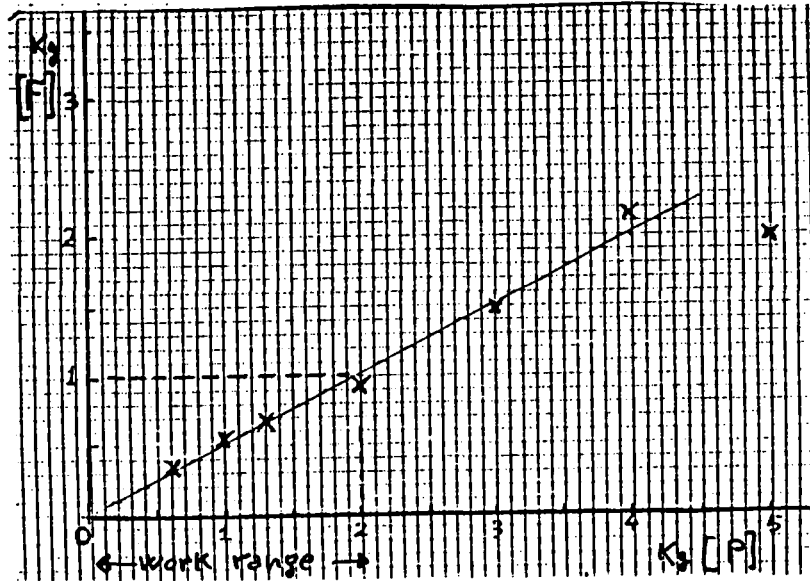

FIG. 6

TEST SET-UP FOR FRICTION MEASUREMENT AND TEST RESULTS.

# TETHER POINTING PLATFORM AND SPACE ELEVATOR MECHANISMS



mean measured coefficient of friction  $\mu \sim 0,5$

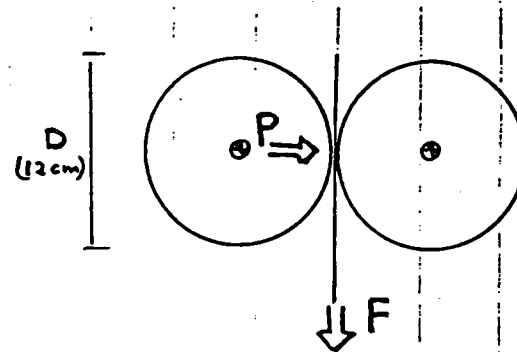

- tether: Kevlar 2mm
- wheels covered by rubber strip (1mm):  $D=12\text{mm}$
- F max force measured by dynamometer (kgf)
- P force measured by dynamometer (kgf)

FIG. 6

TEST SET-UP FOR FRICTION MEASUREMENT AND TEST RESULTS

## TETHER POINTING PLATFORM AND SPACE ELEVATOR MECHANISMS

### 2.3 SCALED SATP BASELINE CONCEPT DESCRIPTION

LOOKING AT FIG. 7 WE CAN SEE THAT THE ACTIVE WHEEL IS ROTATED BY A BRUSHED SAMARIUM COBALT D.C. TORQUE MOTOR (REDUNDED FOR RELIABILITY REASONS), THE SPEED CONTROL IS REALIZED BY A TACHOGENERATOR, THE TORQUE IS MEASURED BY A PIEZO-ELECTRIC TORQUE/AXIAL FORCE TRANSDUCER, THE WHEEL IS COVERED BY A STRIP OF APPROPRIATE FRICTION MATERIAL (RUBBER), THE PRESSURE OF THE ACTIVE WHEEL ON THE PASSIVE ONE IS CONTROLLED BY A SECOND (LINEAR) ACTUATOR UTILIZING A SCREW AND A SPRING; THE PUSHING FORCE IS MEASURED BY A SIMILAR TORQUE/AXIAL TRANSDUCER. THE ROTATION OF THE SCREW IS CONTROLLED BY (REDUNDED) BRUSHED D.C. TORQUE MOTORS, THE FEEDBACKS ARE: TACHOGENERATOR AND PIEZO-ELECTRIC TRANSDUCER. AN ELECTROMAGNETIC CLUTCH IS ALSO FORESEEN; THE WINDINGS ARE REDUNDED (FOR RELIABILITY REASONS).

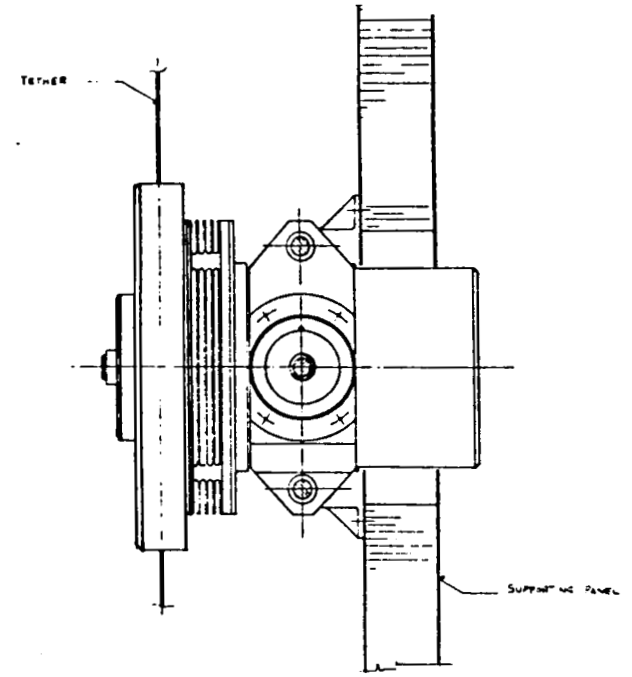
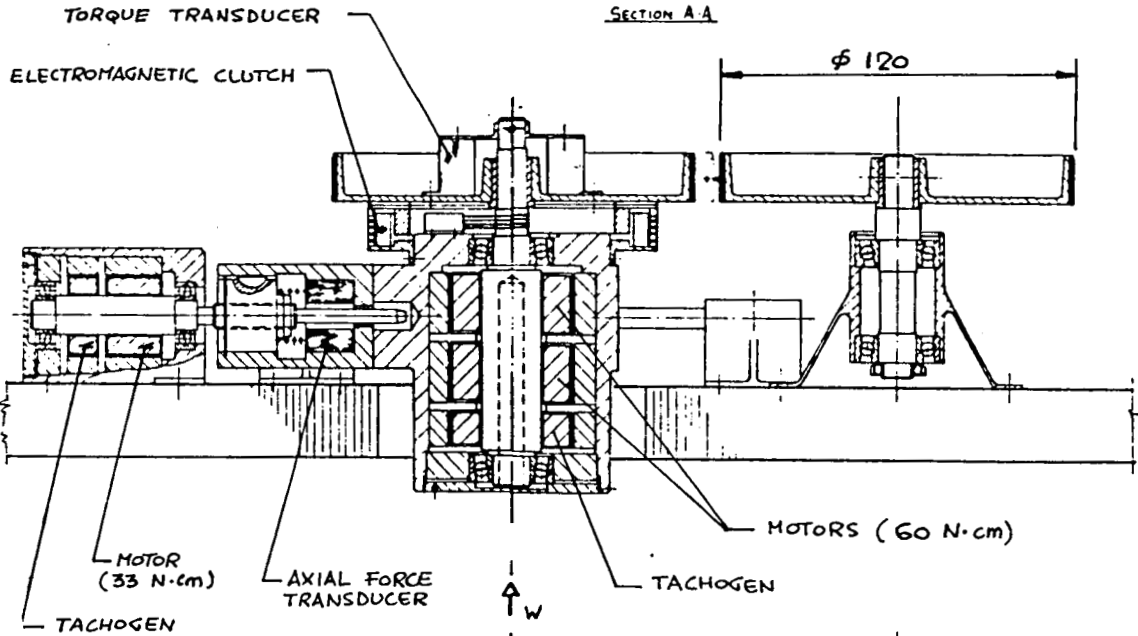

SECTION B-B

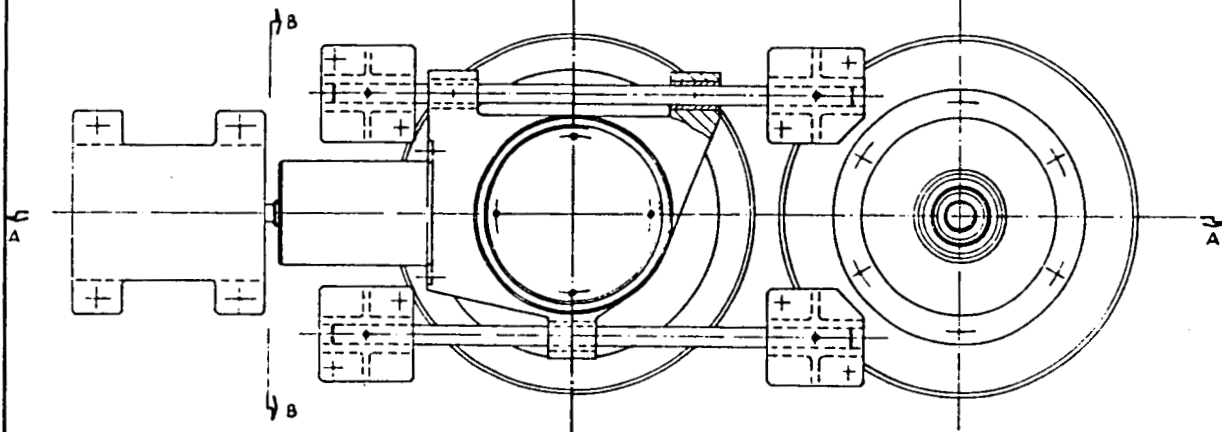

VIEW FROM 'W'  
(Supporting panel removed)

FIG. 7 - SPACE ELEVATOR MECHANISM FOR SCOLED SATP

DESIGNER: [Signature]		CHECKED: [Signature]	
DATE: OCTOBER 1967	SCALE: 1:1	DRAWING NO. 100-100-100	
PROJECT: SPACE ELEVATOR		SUBJECT: DRIVE MECHANISM FOR ELEVATOR (SCALED MODEL)	
REVISIONS:		REVISIONS:	
NO.	DESCRIPTION	NO.	DESCRIPTION
1	INITIAL DESIGN	1	INITIAL DESIGN
2	REVISED FOR SCOLED SATP	2	REVISED FOR SCOLED SATP

## TETHER POINTING PLATFORM AND SPACE ELEVATOR MECHANISMS

IF SLIPPINGS OCCUR .. THE TORQUE TRANSDUCER EVIDENCES THE EVENT AND AN INCREASE OF PUSHING FORCE IS COMMANDED TO THE LINEAR ACTUATOR. THE SIGNALS FROM THE PIEZO-ELECTRIC TRANSDUCERS AND FROM THE TACHOGENERATORS WILL BE USED ALSO AS MONITORS.

### 2.4 SCALED SATP BASELINE CONCEPT- COMPONENTS AND TECHNOLOGIES

AN ALTERNATIVE SOLUTION TO THE BRUSHED REDUNDED D.C. MOTORS IS THE BRUSHLESS SYNCHRONOUS TORQUE MOTOR (WITH REDUNDED WINDING AND REDUNDED E.C.U.) THIS MACHINE REQUIRES THE USE OF A ROTOR POSITION ENCODER (HALL SENSOR ENCODER) AND THREE PHASE BRIDGE COMMUTATION CIRCUIT (THREE PHASE CONFIGURATION) . THE SWITCHES ARE OPERATED SEQUENTIALLY AT INTERVALS ACCORDING TO THE SIGNALS GENERATED BY THE MAGNETIC ENCODER. THIS SOLUTION LOOKS TOO COMPLICATE FOR THE SCALED SATP WHEN THE OPERATIVE LIFE IS OF THE ORDER OF ONE MONTH. IN ALTERNATIVE TO THE PIEZO-ELECTRIC TRANSDUCERS STRAIN GAUGES CAN BE USED.



## TETHER POINTING PLATFORM AND SPACE ELEVATOR

### 3. SPACE ELEVATOR MECHANISM FOR SATP

#### 3.1 SCOPE

THIS SPACE STATION FACILITY REQUIRES A SPECIFIC CONCEPT AS THE MAIN REQUIREMENTS ARE COMPLETELY DIFFERENT FROM THE SCALED SATP. IN FACT THE TETHER HAS A DIAMETER OF  $\sim 17$  MM, THE INTERACTION MAX. FORCE IS  $\sim 150$  N, THE ELEVATOR MASS IS (PROBABLE OF)  $\sim 5$  TONS AND THE OPERATIVE LIFETIME IS, AS MINIMUM, AN ORDER OF MAGNITUDE LONGER THAN THE SCALED ONE.

## TETHER POINTING PLATFORM AND SPACE ELEVATOR

### 3.2 SATP ELEVATOR BASELINE CONCEPT DESCRIPTION

THE CONCEPT DESCRIBED IN CAP. 2.3 CANNOT BE USED ON SATP, FOR, AS MINIMUM, TWO REASONS :

- THE DRAGGING FORCE IS SO HIGH THAT THE GRIPPING BETWEEN THE TWO WHEELS CAN DAMAGE THE TETHER.
- THE SURFACE OF CONTACT BETWEEN THE TWO WHEELS AND TETHER IS TOO LIMITED AND SLIPPING EVENTS CANNOT BE AVOIDED.

THE CONCEPT PROPOSED IN THIS PARAGRAPH, WILL ENSURE AN UNIFORM SURFACE OF CONTACT UTILIZING TWO ENDLESS TOOTHED BELTS DRAGGING THE TETHER ALONG A LINEAR LENGTH. THE BELTS ARE PRESSED BY SLIDING BLOCKS. FIG. 8 DESCRIBES CLEARLY THE CONCEPT: THE ROTARY ACTUATOR UTILIZES TWO REDUNDED D.C. BRUSHED TORQUE MOTORS OF 0,92 N M AND TACHOGENERATOR, OR A SINGLE SYNCHRONOUS, BRUSHLESS TORQUE MOTOR WITH REDUNDED WINDINGS AND ECU; THE GEAR COUPLING (WORM & WORMGEAR) ENSURES IRREVERSIBILITY OF

## TETHER POINTING PLATFORM AND SPACE ELEVATOR

THE ROTATIONS, THE SLIDING BLOCKS PRESS THE TETHER WITH CONTROLLED FORCES UTILIZING A LINEAR ACTUATOR SIMILAR TO THE PROPOSED IN THE SCALED CONCEPT, A TORQUE TRANSDUCER ASSEMBLED ON THE ACTIVE WHEEL MEASURES THE DRAGGING PROVIDING A PROPORTIONAL CONTROL OF THE SLIDING BLOCK PRESSURES.

IF FURTHER ANALYSIS OR MORE DETAILED REQUIREMENTS WILL REJECT THE SLIDING BLOCKS BECAUSE OF THE WEAR AND DEBRITS, AN ARRAY OF NEEDLES CAN BE USED SATISFACTORY (SEE PART, FIG. 8B).

ACCURATE EVALUATION OF THE TOOTHED BELT TECHNOLOGY HAS STILL TO BE DONE; ANYHOW, METAL TAPES OR POSIDRIVE BELTS MADE OF NEOPRENE WITH THEETH COVERED BY NYLON, INTERNALLY REINFORCED WITH METALLIC CABLES CAN BE USED.

DETAILS OF THE DESIGN AND THE TECHNOLOGIES ARE REPRESENTED IN FIG. 8B.

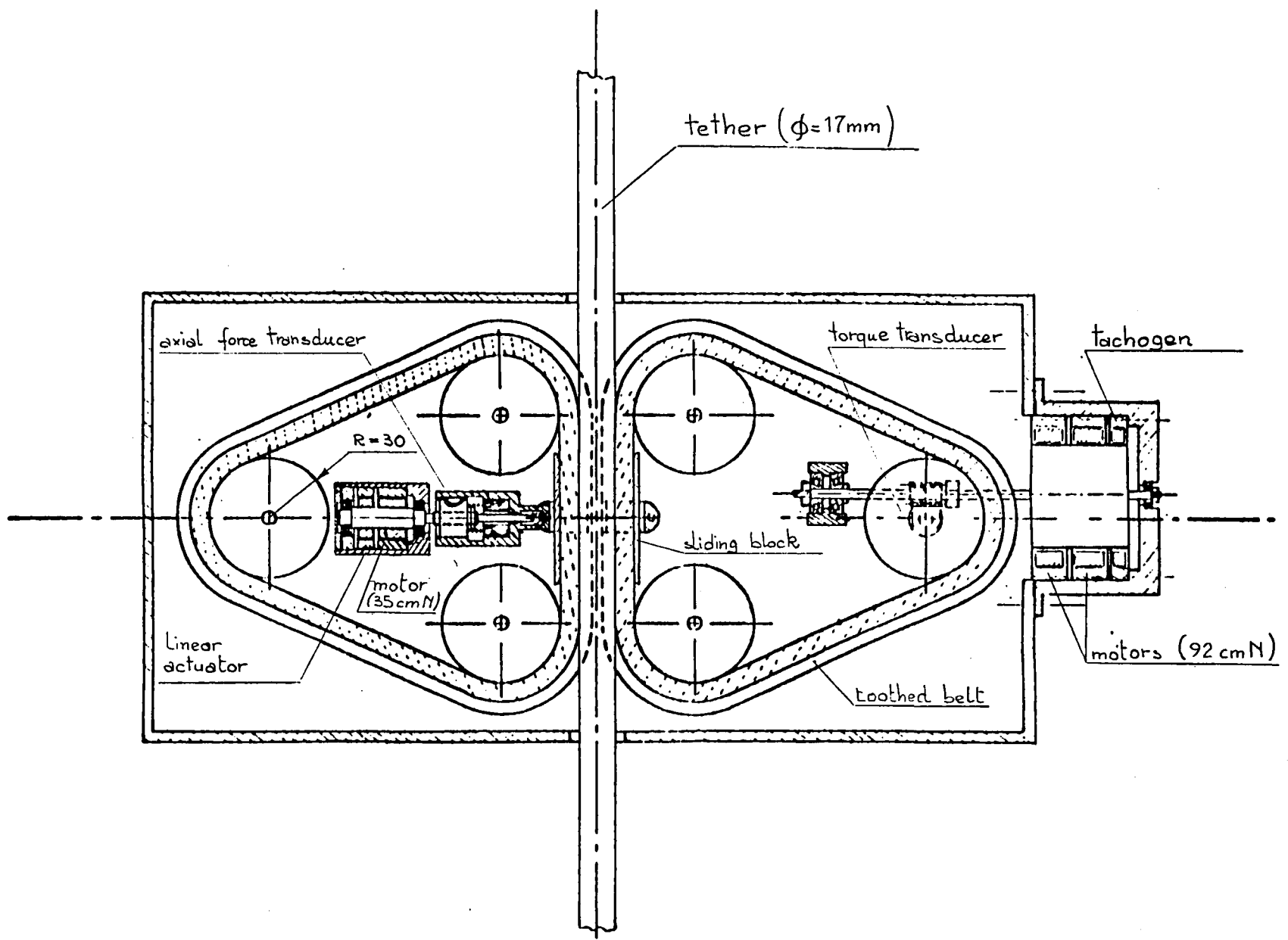
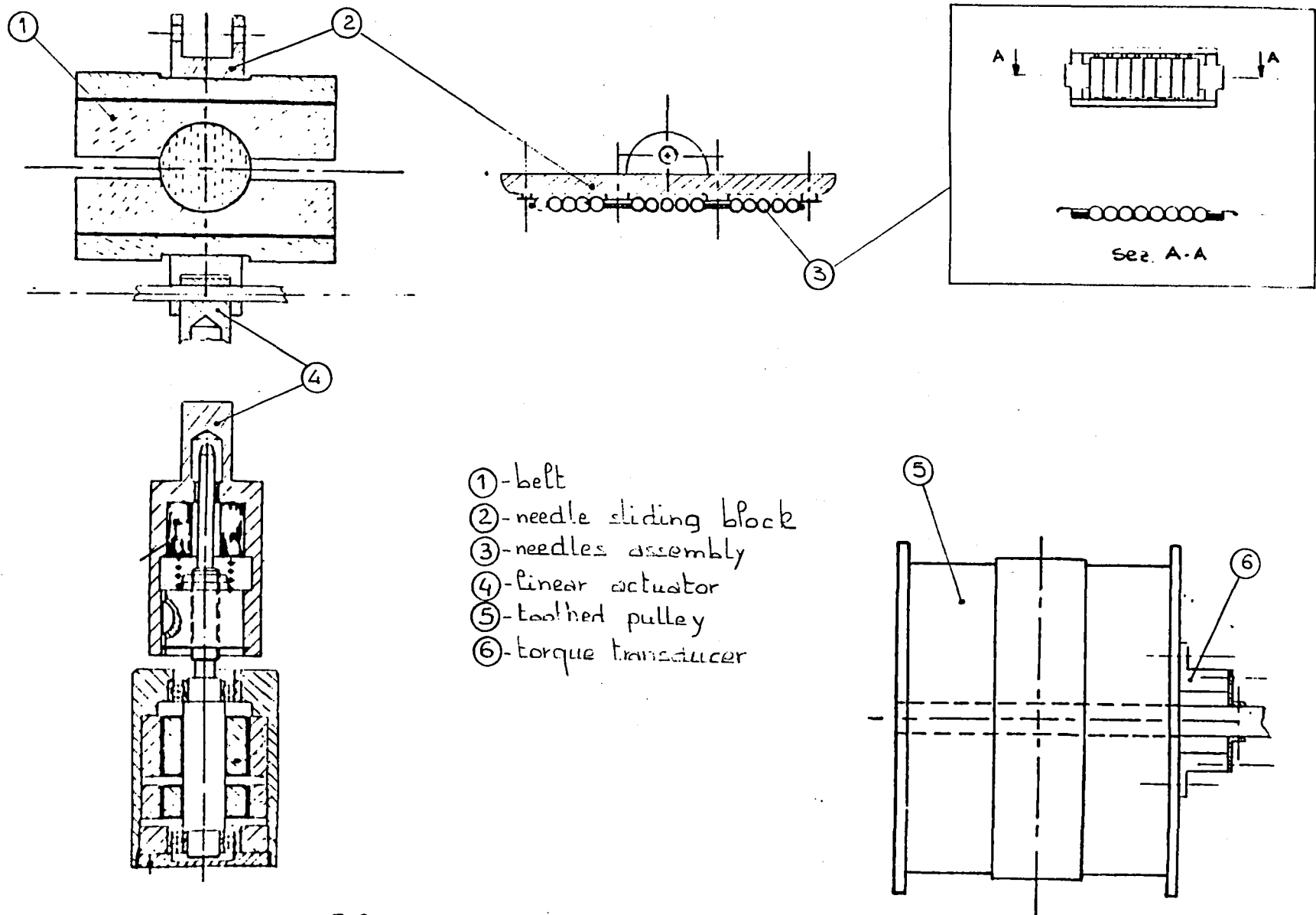

FIG.8a- SATP ELEVATOR MECHANISM (TOOTHED BELT CONCEPT)



- ① - belt
- ② - needle sliding block
- ③ - needles assembly
- ④ - linear actuator
- ⑤ - toothed pulley
- ⑥ - torque transducer

FIG. 8 B - SATP ELEVATOR MECHANISM - DETAILS AND TECHNOLOGIES

## TETHER POINTING PLATFORM AND SPACE ELEVATOR MECHANISMS

### 3.3 SATP ELEVATOR-ROBOTIC CONCEPT DESCRIPTION

THE POSSIBILITY TO DRAG THE TETHER UTILIZING TWO PINCERS AND AN ALTERNATIVE LINEAR MOTION HAS BEEN INVESTIGATED.

THE CONCEPT IS DESCRIBED IN FIG. 9 A)

TWO LONG SCREWS WITH RECIRCULATING BALL BEARINGS DRIVE, IN BOTH DIRECTIONS, TWO PINCERS. THE Pincer GRASPS THE TETHER AND DRAGS IT ALONG THE SCREW WHILE THE SECOND ONE (OPEN) RETURNS TO ITS INITIAL POSITION. CONTINUITY OF THE MOTION IS ENSURED BY A CONTEMPORARY DRAGGING OF BOTH PINCERS FOR A WHILE UNDER CONTROLLED IDENTICAL SPEEDS.

WHEN AT THE END OF ITS STROKE, THE Pincer OPENS, THE OTHER ONE STARTS ITS STROKES HAVING COMPLETED THE INVERSION OF MOTION AND INITIAL TRANSITORY.

# TETHER POINTING AND SPACE ELEVATOR MECHANISMS

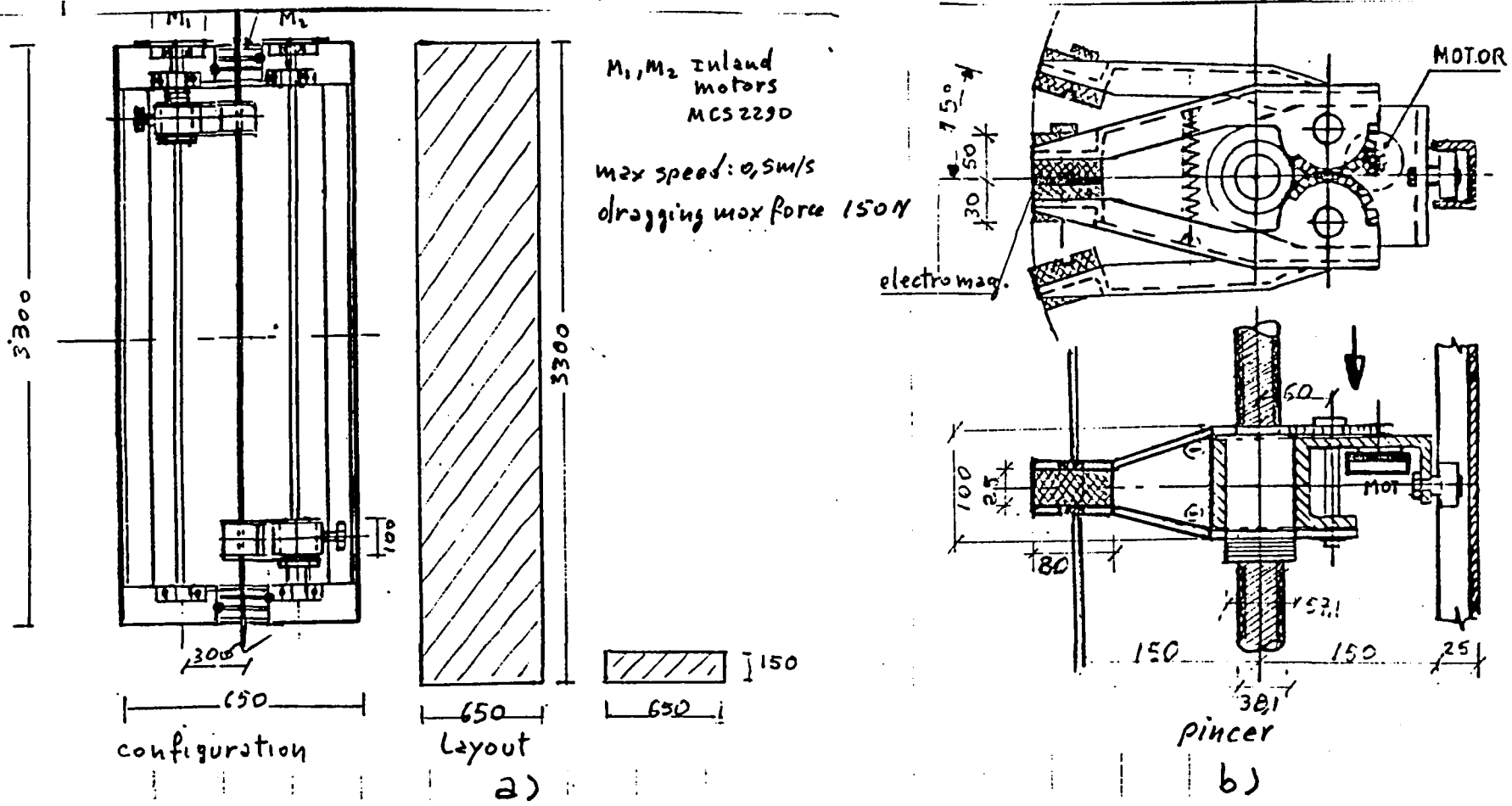

317

FIG. 9

ASTP ELEVATOR ROBOTIC CONCEPT CONFIGURATION AND PINCER

## TETHER POINTING AND SPACE ELEVATOR MECHANISMS

THE PINCHER IS DESCRIBED IN FIG. 9 B)

OPENING/CLOSURE OPERATIONS ARE REALIZED BY A SMALL D.C. BRUSHLESS TORQUE MOTOR, THE GRASPING BY AN ELECTROMAGNET ; CURRENT IS CONTROLLED BY THE DRAGGING FORCE MEASURED BY A PIEZO-ELECTRIC TRANSDUCER (OR STRAIN-GAUGES) (FIG.10 ).

WHEN A SLIPPING EVENT ARISES, AN INCREASE OF CURRENT IS COMMANDED TO THE ELECTROMAGNET.

THE SLEEPING EVENTS ARE TAKEN BY A PICK-OFF (DIFFERENTIAL TRANSFORMER) LOCATED INSIDE THE TWO JAWS GRASPING THE TETHER.



# TETHER POINTING PLATFORM AND SPACE ELEVATOR

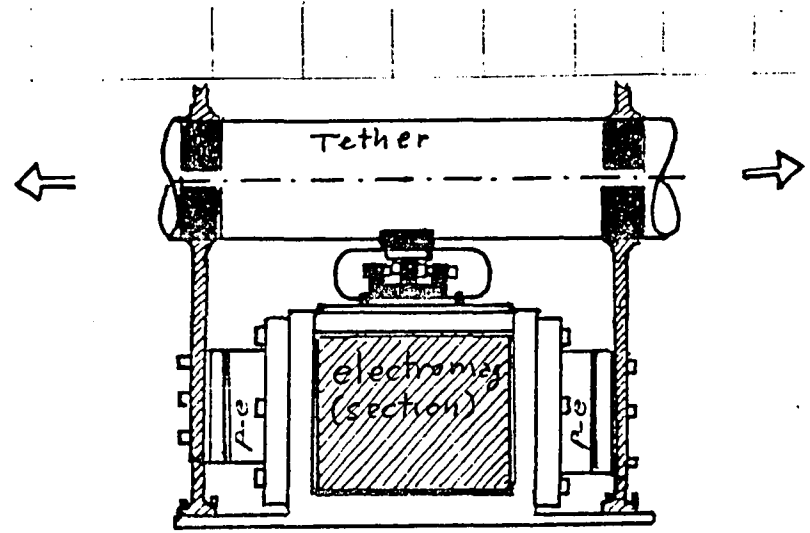
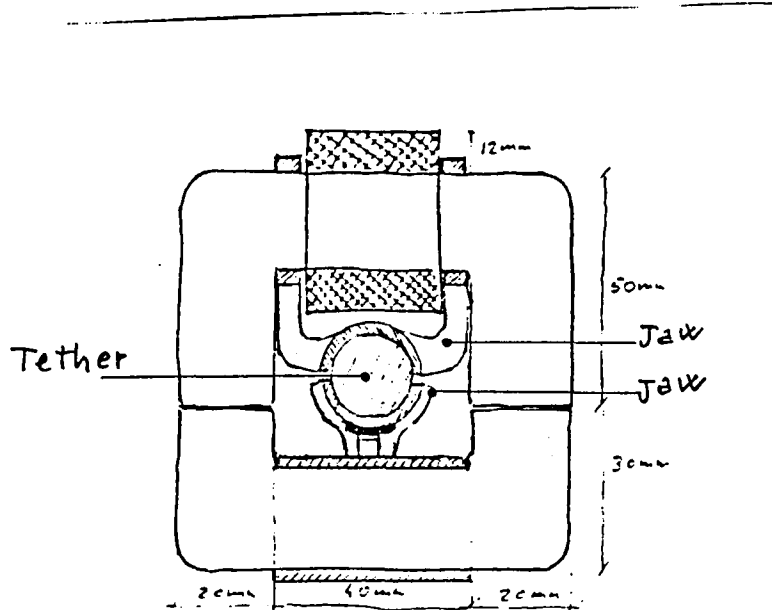

• electromagnet

• grasping assembly with  
 p-e = piezo-electric force transducer,  
 Jaws, differential transformer for slipping

FIG. 10

ELECTROMAGNET, JAWS GRASPING THE TETHER WITH MEASUREMENT TRANSDUCERS

## TETHER POINTING PLATFORM AND SPACE ELEVATOR

### 3.4 SATP ELEVATOR - ELECTROMAGNETIC PROPULSION CONCEPT DESCRIPTION

THE POSSIBILITY TO DRAG A MASS OF 500 KG. (ELEVATOR) ALONG A TETHER OF 17 MM. DIAMETER EXCHANGING A MAX. FORCE OF 150 N WITH A MAX. SPEED OF FEW METERS /PER SECOND UTILIZING ELECTROMAGNETIC FORCES HAS BEEN EVALUATED.

THE INVESTIGATED CONCEPT UTILIZES THE FORCE OF A CORE IMMERGED IN A MAGNETIC FIELD CREATED BY A COIL.

THE FORMULA OF THE FORCE IS :  $F = \frac{1}{2} I^2 \frac{dL}{dx}$  WHERE  $\frac{dL}{dx}$  IS THE VARIATION OF THE INDUCTION DUE TO THE CORE MOVEMENT. INSIDE THE COIL,  $I$  IS THE CURRENT OF THE COIL.

IN FIG. 11 IS INDICATED THE BEHAVIOUR OF A CORE MOVING INSIDE A COIL.

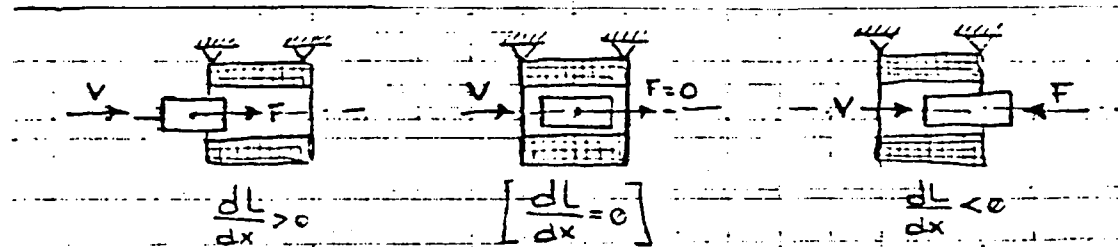

FIG. 11

## TETHER POINTING PLATFORM AND SPACE ELEVATOR

THE FORCE ACTING ON A CORE IMMERGED IN A SINGLE COIL INCREASES AND INVERTS ITS DIRECTION WHEN CROSSING THE COIL.

THE REALIZATION OF A HIGH MEAN FORCE AND MINIMUM RIPPLE IS POSSIBLE IF:

- MANY COILS ARE USED : THE COILS HAVE TO BE OPPORTUNELY OUT OF PHASE IN REFERENCE TO THE CORE POSITIONS.
- COILS ARE SWITCHED OFF WHEN CORES CROSS THE COILS: THIS AVOIDS BRAKING FORCES
- A SWITCHING PROCEDURE IS USED : IN SUCH A WAY TO REALIZE A CONTINUOUS MOVEMENT IN BOTH SENSES.

TAKING INTO ACCOUNT THE FORMER ASSUMPTIONS AND THE REQUIREMENTS, THE FOLLOWING GEOMETRIC CONFIGURATION HAS BEEN OBTAINED (SEE FIG. 12 ).

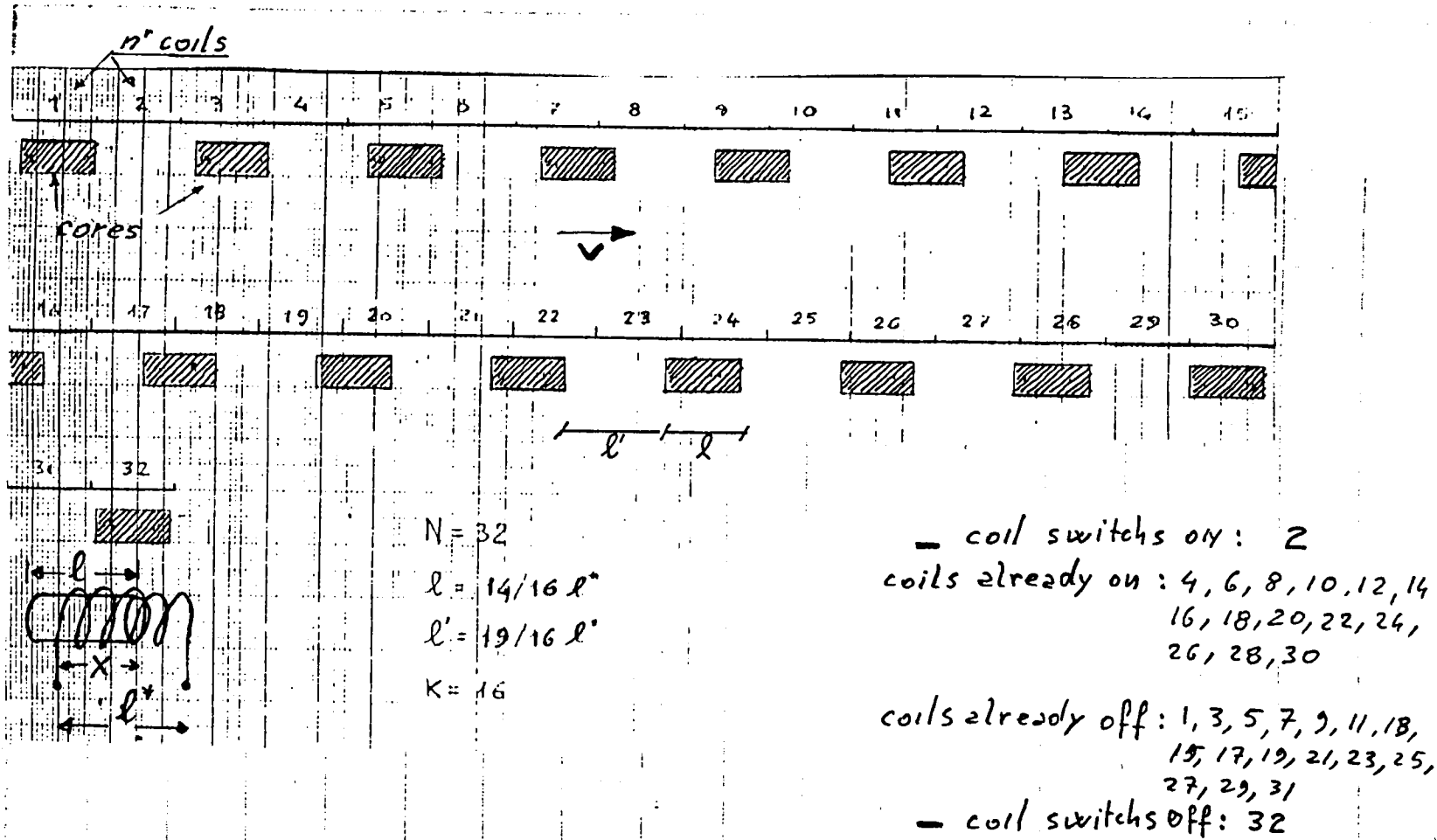

FIG. 12

- GEOMETRICAL ARRANGEMENT OF THE COILS AND CORES

# TETHER POINTING PLATFORM AND SPACE ELEVATOR

THE DIMENSIONS OF THE COIL PACKAGE ARE DEPENDENT ON MANY PARAMETERS, ANYHOW A CONGRUENT SET OF VALUES IS INDICATED IN FIG. 13 WHERE  
 $H = 2,0 \text{ m}$  ,  $D = 6,25 \text{ cm}$  ,  $\phi \sim 21 \text{ mm}$  ,  $l^* = 6,25 \text{ cm}$

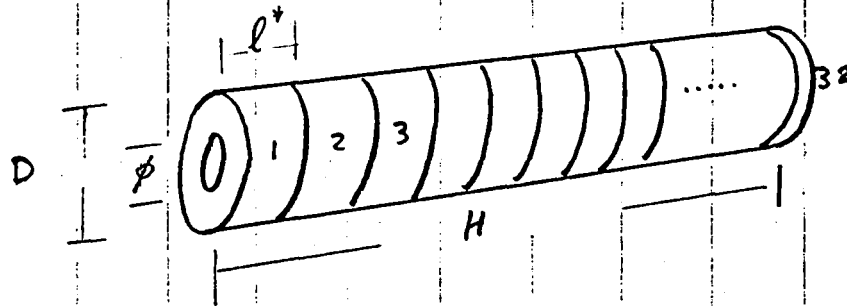

FIG. 13 COIL PACKAGE LAYOUT

# TETHER POINTING AND SPACE ELEVATOR

THE TETHER SECTION INCLUDING ELECTRICAL CABLES, CORES, AND STRUCTURAL SKIN IS SKETCHED IN FIG. 14

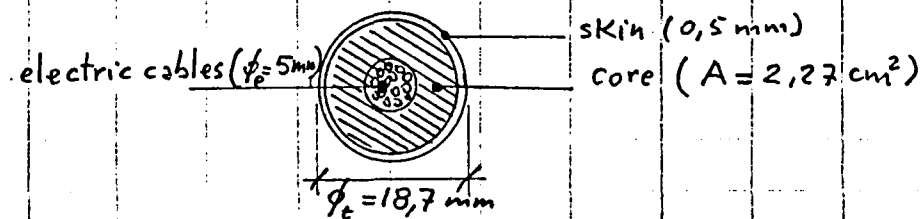

FIG. 14 TETHER SECTION

THE DYNAMIC BEHAVIOUR CAN BE INVESTIGATED UTILIZING THE FORMULA :

$$F_T(y) - F = M_{elev} \cdot \ddot{y} : \frac{\delta l^*}{K} \leq y \leq (\delta + l^*) \frac{l^*}{K} - \text{IF } F = 150 \text{ N}, \quad M_{elev} = 5000 \text{ KG}$$

THE PROPULSIVE FORCE  $F_T(y)$  IS VARIABLE INSIDE THE LIMITS

$F_{min} = 160 \text{ N}$ ,  $F_{max} = 267 \text{ N}$  - THE CURRENT IN THE COILS IS  $I = 5,34 \text{ A}$  AND THE TOTAL ELECTRIC POWER IS  $2860 \text{ W}$  WHERE THE MECHANICAL POWER IS  $P_m = 150 \text{ (N)} \cdot 5 \text{ (M/S)} = 750 \text{ W}$ . COOLING OF THE COILS RESULTS NECESSARY.

TECHNOLOGY AND TEST PANEL

PRESENTATION V

THE DEVELOPMENT OF OPTIMAL CONTROL LAWS  
FOR ORBITING TETHERED PLATFORM SYSTEMS

OCTOBER 15 - 17, 1985

PETER M. BAINUM  
PROFESSOR OF AEROSPACE ENGINEERING  
DEPARTMENT OF MECHANICAL ENGINEERING  
HOWARD UNIVERSITY

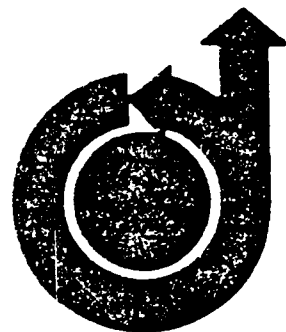

The Development of Optimal Control Laws  
for Orbiting Tethered Platform Systems

Peter M. Bainum  
Professor of Aerospace Engineering  
Department of Mechanical Engineering  
Howard University  
Washington, D.C. 20059

Stanley E. Woodard  
Graduate Research Fellow  
Department of Mechanical Engineering  
Howard University  
Washington, D.C. 20059

and

Jer - Nan Juang  
Aerospace Technologist  
Structural Dynamics Division  
NASA Langley Research Center  
Hampton, VA 23665

# **AAS/AIAA Astrodynamics Specialist Conference**

VAIL, COLORADO, AUGUST 12-15, 1985  
AAS Publications Office, P. O. Box 28130, San Diego, CA 92128



THE DEVELOPMENT OF OPTIMAL CONTROL LAWS  
FOR ORBITING TETHERED PLATFORM SYSTEMS

P. Bainum\*, S. Woodard<sup>XX</sup>, and Jer-Nan  
Juang<sup>+</sup>

A mathematical model of the open and closed loop in-orbit plane dynamics of a space platform-tethered-subsatellite system is developed. The system consists of a rigid platform from which an (assumed massless) tether is deploying (retrieving) a subsatellite from an attachment point which is, in general, offset from the platform's mass center. A Lagrangian formulation yields equations describing platform pitch, subsatellite tether-line swing, and varying tether length motions. These equations are linearized about the nominal station keeping motion. Control can be provided by both modulation of the tether tension level and by a momentum type platform-mounted device; system controllability depends on the presence of both control inputs. Stability criteria are developed in terms of the control law gains, the platform inertia ratio, and tether offset parameter. Control law gains are obtained based on linear quadratic regulator techniques. Typical transient responses of both the state and required control effort are presented.

---

\* Professor of Aerospace Engineer., Dept. of Mechanical Engr., Howard University, Washington, D.C. 20059

xx Graduate Research Fellow, Dept. of Mechanical Engr., Howard University, Washington, D.C. 20059

+ Aerospace Technologist, Structural Dynamics Div., NASA Langley Research Center, Hampton, VA 23665

## INTRODUCTION

The Smithsonian Astrophysical Observatory<sup>1</sup> proposed the Shuttle based "Skyhook" concept consisting of a tether of approximately 100km length to be deployed from the Shuttle Orbiter and transporting at its end a subsatellite experimental package. The subsatellite could be deployed either above or below the Shuttle for purposes of conducting a variety of upper atmospheric experiments; an in-orbit demonstration of the tethered satellite system could occur as early as 1987.<sup>2</sup>

The analyses of the dynamics and control of the tethered - subsatellite system (TSS) has been performed by a host of investigators; a recent survey article by Misra and Modi<sup>3</sup> describes over sixty papers treating various aspects of tether (or cable) connected orbiting two-body systems. A preliminary treatment of the TSS system was addressed by Rupp<sup>4</sup> who assumed that motion was restricted to the orbital plane and neglected the tether mass. A tether tension station keeping control law was proposed such that the tension would vary as a linear function of the tether line length, rate of change of length, and desired (commanded) length. For deployment/retrieval the commanded length could be varied according to a prescribed function of time. Subsequently, the three dimensional dynamics and control including the inertia effect of the tether mass and aerodynamic forces (and heating) on the tether and subsatellite was treated. It was noted that for local vertical station keeping, within the linear range, tether tension would not provide control of the out-of-orbit-plane swing motion (roll), but such control would be implemented in the non-linear system due to higher order coupling<sup>5</sup>, or by including nonlinear feedback terms in the tension control law.<sup>6</sup>

Bainum and Kumar<sup>7</sup> introduced a new tether tension control law (for a massless tether) where the tension was assumed to vary as a linear function of the in-plane length and angular variational coordinates and their rates based on an application of linear optimal control theory. By proper selection of the state and control penalty matrices it was possible to obtain faster responses with no increase in power levels during station keeping as compared with alternate control strategies. As an extension to this Diarra<sup>8</sup> showed that the effect of a massive but taut tether is to reduce the stability region in the

parametric space formed by the optimal control gains of Ref. 7.

Advanced space platform - based applications of the tethered satellite system were recently described by Laue and Manarini.<sup>9</sup> As an autonomous subsystem it could be used to deploy and recover payloads from the platform with advantages of higher payload mass and longer mission durations than would be possible with the original Shuttle based systems. Another application of tethered - platform systems could involve tethers attached to astronauts who would be servicing experiments which are designed to function at a pre-set distance from the platform monitoring deck.

The objective of the present paper is the development of a mathematical model for an advanced space platform-based application of the TSS and the synthesis of appropriate control laws based on an application of optimal control theory. To the authors' knowledge this is the first such development of a mathematical model based primarily on tethered-platform applications.

#### DEVELOPMENT OF THE SYSTEM EQUATIONS OF MOTION

The system is idealized as containing a rigid platform from which an assumed (massless) tether is deploying or retrieving a subsatellite (Fig. 1) at a distance,  $l$ , from a point on the platform which is offset by a distance,  $h$ , from the platform's mass center. The point of tether attachment is assumed to be along the platform's roll axis ( $h \geq 0$ ). The tether is considered to be massless and remains taut for all subsatellite motion.

For this study the mass of the subsatellite is assumed to be significantly less than that of the platform. Therefore, the composite system center of mass can be assumed to be coincident with the platform center of mass and shifts in the composite center of mass can be neglected.

Only the platform pitching motion and the subsatellite motion in the orbit plane will be

considered. Environmental disturbances such as solar pressure, aerodynamic drag and torques, and the dynamic effects due to the earth's oblateness are considered to be negligible.

A Lagrangian formulation is used to derive the system equations of motion. Figure 1 illustrates the system geometry. The body

axes  $\hat{e}_\xi$ ,  $\hat{e}_\zeta$ ,  $\hat{e}_\eta$  coincide with the platform principal

axes of inertia. The transformation between the body frame of reference and the orbit frame of reference is given by,  $[s \rightarrow \sin(\ )$  and  $c \rightarrow \cos(\ )]$

$$\begin{bmatrix} \hat{e}_\xi \\ \hat{e}_\zeta \\ \hat{e}_\eta \end{bmatrix} = \begin{bmatrix} c\psi & 0 & -s\psi \\ 0 & 1 & 0 \\ s\psi & 0 & c\psi \end{bmatrix} \begin{bmatrix} \hat{e}_x \\ \hat{e}_y \\ \hat{e}_z \end{bmatrix} \quad (1)$$

where  $\hat{e}_x$ ,  $\hat{e}_y$ ,  $\hat{e}_z$  are orbit frame axes, with  $\hat{e}_z$  in the direction of the local vertical and  $\hat{e}_y$  normal to the orbital plane. The angle  $\psi$  describes the orientation of the platform with respect to the local vertical. The position vector describing the location of the subsatellite is

$$\bar{R} = \bar{R}_0 + \bar{l} \quad (2)$$

Equation (2) may be further developed as:

$$R = -(R_0 s\psi + h + l s\theta) \hat{e}_\xi + (R_0 c\psi + l c\theta) \hat{e}_\eta \quad (3)$$

where  $R_0$  represents the distance between the center of the earth and the platform center of mass and  $l$  represents the length of the tether line. The distance,  $h$ , is the tether attachment offset from the platform center of mass. The angle,  $\theta$ , represents the angular displacement of the tether line relative to a local normal in the platform.

The subsatellite velocity is

$$\dot{\bar{R}} = \dot{\bar{R}}_0 = \dot{\bar{l}} \quad (4)$$

which, after expansion takes the form:

$$\begin{aligned} \dot{\bar{R}} = & [-(\dot{l}s\theta + \dot{\theta}lc\theta) + (\dot{\psi} + \omega)lc\theta + R_0\omega c\psi] \hat{e}_\xi + [(\dot{l}c\theta \\ & - \dot{\theta}ls\theta) + (\dot{\psi} + \omega)(h + ls\theta) + R_0\omega s\psi] \hat{e}_\eta \end{aligned} \quad (5)$$

where  $\omega$  is the orbital rate of the platform.

The total system kinetic energy can be represented in terms of the platform and subsatellite components:

$$T = T_p + T_s = T_p + (1/2)m (\dot{\bar{R}} \cdot \dot{\bar{R}}) \quad (6)$$

Expansion of Eq. (6) yields,

$$\begin{aligned} T = & (1/2) \{ [I_\zeta (\dot{\psi} + \omega)^2 + M\omega^2 R_0^2] + m[\dot{l}^2 + \dot{\theta}^2 l^2 \\ & - 2(\dot{\psi} + \omega)\dot{\theta}l^2 + 2\dot{l}R_0\omega s(\psi - \theta) - 2\dot{\theta}R_0l\omega c(\psi - \theta) + \dot{l}^2(\psi + \omega)^2 \\ & + R_0^2\omega^2 + 2(\dot{\psi} + \omega)R_0l\omega c(\psi - \theta) + (\dot{\psi} + \omega)^2(h^2 + 2lhs\theta) \\ & + 2(\dot{\psi} + \omega)hR_0\omega s\psi + 2(\dot{\psi} + \omega)h\dot{l}c\theta - 2(\dot{\psi} + \omega)\dot{\theta}lhs\theta] \} \end{aligned} \quad (7)$$

where  $M$ ,  $m$ , and  $I_\zeta$  are the platform mass, subsatellite mass, and platform pitch principal moment of inertia, respectively.

The subsatellite potential energy is given by:

$$V_s = -GM_0m/\sqrt{R} \quad (8)$$

where  $G$  and  $M_0$  are the Universal gravitational constant and mass of the Earth, respectively.

Substitution of Eq. (3) into Eq. (8) yields,

$$V_s = -GM_o m [R_o^2 + h^2 + \ell^2 + 2\ell h s \theta + 2R_o h s \Psi + 2R_o \ell c(\Psi - \theta)]^{-1/2} \quad (9)$$

Equation (9) can be rewritten as:

$$V_s = -(GM_o m/R_o) [1 + (h^2 + \ell^2 + 2\ell h s \theta)/R_o^2 + 2(hs\Psi + \ell c(\Psi - \theta))/R_o]^{-1/2} \quad (10)$$

Because  $h^2$ ,  $\ell^2$ , and  $\ell h \ll R_o^2$  the expansion of certain components of the second term inside the bracket yields higher order terms as compared with the remaining terms. With the binomial expansion, retaining terms of order  $(h/R_o)^2$ , etc. from the brackets,

$$V_s = -(GM_o m/R_o) \{1 - (hs\Psi + \ell c(\Psi - \theta))/R_o - (h^2 + \ell^2 + 2\ell h s \theta)/(2R_o)^2 + (3/2)[h^2 s^2 \Psi + 2h\ell s \Psi c(\Psi - \theta) + \ell^2 c^2(\Psi - \theta)]/R_o^2\} \quad (11)$$

Based on Kepler's third law

$$\omega^2 = GM_o/R_o^3, \text{ and} \quad (12)$$

therefore, Eq (11), becomes

$$V_s = -\omega^2 m [R_o^2 - hR_o s \Psi - \ell R_o c(\Psi - \theta) - (h^2 + \ell^2 + 2\ell h s \theta)/(2) + (3/2)h^2 s^2 \Psi + 3h\ell s \Psi c(\Psi - \theta) + (3/2)\ell^2 c^2(\Psi - \theta)] \quad (13)$$

The platform potential energy is denoted by,

$$V_p = -GM_o M/R_o + (3/2)\omega^2 (I_\eta - I_\xi) (s^2 \Psi - 1) \quad (14)$$

Where  $I_\eta$  and  $I_\xi$  are the platform yaw and roll principal moments of inertia, respectively. The second term represents the effects of a distributed massive rigid body under the influence of a gravitational gradient.<sup>10</sup> The total system potential energy is a combination of the platform and sub-satellite contributions as given in Eqs. (14) and (13),

$$V = V_p + V_s \quad (15)$$

The general form of Lagrange's equations

$$\frac{d}{dt} \left( \frac{\partial T}{\partial \dot{q}_i} \right) - \frac{\partial T}{\partial q_i} + \frac{\partial V}{\partial q_i} = Q_{q_i} \quad (16)$$

will be considered for the generalized coordinates:  $q_i = l, \theta, \psi$ ; where  $Q_{q_i}$  is the corresponding generalized force. Application of Eqs. (16) renders independent equations for each of the three generalized coordinates. After substitution and expansion these equations are:

Length (l) equation

$$\begin{aligned} \ddot{l} + \ddot{\psi} h c \theta - ((\dot{\psi} - \dot{\theta}) + \omega)^2 l - (\dot{\psi} + \omega)^2 h s \theta \\ + \omega^2 l (1 - 3c^2(\psi - \theta)) + \omega^2 h s \theta - 3\omega^2 h s \psi c(\psi - \theta) = Q_l / m \end{aligned} \quad (17)$$

Swing angle ( $\theta$ ) equation

$$\begin{aligned} (\ddot{\theta} - \ddot{\psi}) + 2(\dot{l}/l)[(\dot{\theta} - \dot{\psi}) - \omega] - \ddot{\psi}(h/l)s\theta \\ - (\dot{\psi}^2 + 2\omega\dot{\psi})(h/l)c\theta - 3\omega^2(h/l)s\psi s(\psi - \theta) \\ - (3/2)\omega^2 s(2(\psi - \theta)) = Q_\theta / ml^2 \end{aligned} \quad (18)$$

Pitch angle ( $\psi$ ) equation

$$\begin{aligned} \ddot{\psi} + (3/2)\omega^2 \lambda^2 s^2 \psi + (m/I_G)[-lh(\dot{\psi} - \dot{\theta} + \omega)^2 c\theta \\ + (\ddot{\psi} - \ddot{\theta})hls\theta + \ddot{\psi}h^2 + \ddot{l}hc\theta + 2h\dot{l}(\dot{\psi} - \dot{\theta} + \omega)s\theta \\ - (3/2)\omega^2 h^2 s^2 \psi - \omega^2 hlc(2\psi - \theta) - \omega^2 hlc\psi c(\psi - \theta)] = Q_\psi / I_G \end{aligned} \quad (19)$$

where

$$\lambda^2 = \frac{(I_\eta + I_\xi)}{I_\zeta}$$

### NON-DIMENSIONALIZATION OF SYSTEM EQUATIONS OF MOTION

The offset parameter, tether length, and time will be nondimensionalized using:  $\beta = h/l_c$ ;  $\xi = l/l_c$ ;  $\tau = \omega t$ ; where  $l_c$  is the nominal reference length. Eqs. (17) & (19) can be rewritten in the following non-dimensional form, which may be more appropriate for the subsequent numerical parametric studies.

#### Length

$$\begin{aligned} \xi'' &= [((\psi' + \theta') + 1)^2 + 3c^2(\psi - \theta) - 1] \xi \\ &+ [\psi' c \theta + (\psi' + 1)^2 s \theta + s \theta - 3s \psi c(\psi - \theta)] \beta = \\ &Q_l / (m \omega^2 l_c) \end{aligned} \quad (20)$$

#### Swing angle

$$\begin{aligned} (\theta'' + \psi'') + (2\xi'/\xi) [(\theta' + \psi') - 1] - (3/2)s[2(\psi - \theta)] \\ = (\beta/\xi) [\psi' s \theta + (\psi'^2 + 2\psi') c \theta - 3s \psi s(\psi - \theta)] = \\ Q_\theta / (m l^2 \omega^2) \end{aligned} \quad (21)$$

#### Pitch angle

$$\begin{aligned} \psi'' + (3/2)\lambda^2 s^2 \psi + (m/I_\zeta) \beta l^2 c \{ [ -((\psi' + \theta') + 1)^2 c \theta + (\psi' + \theta') s \theta - c \psi c(\psi - \theta) + c(2\psi - \theta) ] \\ + [\xi' c \theta - (3/2)\beta s^2 \psi + \psi' \beta + 2\xi'((\psi' - \theta') + 1)s \theta] \} = \\ Q_\psi / (I_\zeta \omega^2) \end{aligned} \quad (22)$$

### LINEARIZATION OF SYSTEM EQUATIONS OF MOTION

By assuming that the pitch and swing angles remain small (i.e.  $\theta \ll 1$ ,  $\psi \ll 1$ ) and also their rates, and by having  $\xi = 1 + \varepsilon$  where  $\varepsilon \ll 1$ , then  $\sin q = q$ ,  $\cos q = 1$  and Eqs. (20) & (21) can be approximated by the



following linear equations for length, swing angle, and pitch angle, respectively,

$$\epsilon'' + 2(\psi' + \theta') + 3\epsilon + \beta(\psi'' + 3\psi) = 3 + Q / (m\omega^2 l_c) - \Delta Q_l \quad (23)$$

$$\theta'' + \psi'' + \beta 3(\psi - \theta) + 2\epsilon' + 2\beta\psi' = Q_\psi / (m l_c^2 \omega^2) - \Delta Q_\psi \quad (24)$$

$$\psi'' + 3\lambda^2 \psi + (m/I_\zeta) \beta l_c^2 [\beta(3\epsilon + 2(\psi' - \theta'))$$

$$+ (\epsilon'' - 3\beta\psi + \psi'' \beta)] = Q / (I \omega^2) + 3(m/I) \beta l_c^2 = \Delta Q_\psi \quad (25)$$

The  $\Delta Q_i$  on the right hand side of Eqs. (23)-(25) represent potential control laws. The 3 on the right hand side of Eq. (23) represents the equilibrium tension required at length,  $l_c$ . This tension force may be provided by either the control system or the tether's natural elasticity or combinations of both. The  $3(m/I_\zeta) \beta l_c^2$  represents the equilibrium non-dimensional torque (acceleration) required for the platform pitch angle to be zero. Without any attachment offset ( $\beta=0$ , Eq. (25) decouples from the length and swing angle equations.

At equilibrium for  $Q_l = Q_\psi = Q_\psi = 0$ ,  $q''_i = q'_i = 0$ . By choosing  $l = l_c$  therefore  $\epsilon = 0$ . The equilibrium values of pitch angle and swing angle (in the absence of control) are:

$$\theta_{eq} = \psi_{eq} = (m/I_\zeta) \beta l_c^2 (\lambda^2 - h^2 m/I_\zeta)^{-1} \quad (26)$$

These equilibrium values are dependent on the physical properties of the platform such as its principal moments of inertia and on the attachment offset distance and the subsatellite mass. For the range of numerical parameters considered here, there are no singularity problems with the denominator terms in Eq. (26).

#### DEVELOPMENT OF SYSTEM CONTROL

In state variable form in the absence of external disturbances,  $Q_l$ ,  $Q_\psi$ ,  $Q_\psi$ , but in the presence of control, Eqs. (23) - (25) can be rewritten as:

$$\frac{dX}{dt} = AX + BU \quad (27)$$

where

$$X^T = [\epsilon \ \psi \ \theta \ \epsilon' \ \psi' \ \theta'] \quad (28)$$

and

$$A = \begin{bmatrix} 0 & 0 & 0 & 1 & 0 & 0 \\ 0 & 0 & 0 & 0 & 1 & 0 \\ 0 & 0 & 0 & 0 & 0 & 1 \\ 3 & 3\beta - 3\beta\lambda^2 & 0 & 0 & 2 & -2 \\ 0 & -3\lambda^2 & 0 & 0 & 0 & 0 \\ 0 & 3 - 3\lambda^2 & -3 & 2 & 2\beta & 0 \end{bmatrix} \quad (29)$$

where: A is the system state matrix; X is the system state vector; B is the control influence matrix and U is the control vector, respectively. Matrices X, A, B, and U have dimensions  $n \times 1$ ,  $n \times n$ ,  $n \times r$ ,  $r \times 1$ , respectively, where n is the order of the system and r is the number of control inputs. For the system under consideration  $n = 6$ .

For this application it is assumed that control could be realized through appropriate modulation of the tension in the tether line and the momentum-type controller for the platform pitching motion. Thus, the control influence matrix is given by,

$$B^T = \begin{bmatrix} 0 & 0 & 0 & 1 & 0 & 0 \\ 0 & 0 & 0 & 0 & 1 & 0 \end{bmatrix} \quad (30)$$

# CONTROLLABILITY AND OBSERVABILITY OF THE SYSTEM

Before the development of a suitable control law for U, it is necessary to show that the system satisfies the following controllability condition.<sup>11</sup> The system  $X' = AX + BU$  is controllable if and only if the rank of  $P = n$  where:

$$P = [B \mid AB \mid A^2B \mid \dots \mid A^{n-1}B] \quad (31)$$

In addition to B, the partitions of P (in transposed form) are:

$$(AB)^T = \begin{bmatrix} 1 & 0 & 0 & 0 & 0 & 2 \\ 0 & 1 & 0 & 2 & 0 & 2\beta \end{bmatrix} \quad (32)$$

$$(A^2B)^T = \begin{bmatrix} 0 & 0 & 2 & \neq 1 & 0 & 0 \\ 2 & 0 & 2\beta & \neq(\beta+3\beta\lambda^2) & (\neq 3\lambda^2) & (7\neq 3\lambda^2) \end{bmatrix}$$

$$(A^3B)^T = \begin{bmatrix} \neq 1 & 0 & 0 & 0 & 0 & \neq 8 \\ \neq(\beta+3\beta\lambda^2) & (\neq 3\lambda^2) & (7\neq 3\lambda^2) & \neq 8 & 0 & \neq(8\beta+12\beta\lambda^2) \end{bmatrix}$$

$$(A^4B)^T =$$

$$\begin{bmatrix} 0 & 0 & \neq 8 & 13 & 0 & 0 \\ \neq 8 & 0 & \neq(8\beta+12\beta\lambda^2) & (6\beta\lambda^2+13\beta+9\beta\lambda^4) & (9\lambda^4) & (9\lambda^4-37) \end{bmatrix}$$

$$(A^5B)^T =$$

$$\begin{bmatrix} 13 & 0 & 0 & 0 & 0 & 50 \\ (6\beta\lambda^2+13\beta+9\beta\lambda^4) & 9\lambda^4 & (9\lambda^4-37) & 50 & 0 & (50\beta+48\beta\lambda^2+36\beta\lambda^4) \end{bmatrix}$$

By using a particular submatrix of P, formed from its first, second, third, fourth, fifth and seventh

columns, (P') it can be verified that  $\text{Det } P' = 20 \neq 0$ ; therefore, the rank of P is 6 and the system is completely controllable. It can also be verified that with control generated by a single input represented only by tether tension modulation, then the system is uncontrollable. On the otherhand, for the case where only a platform pitch controller is used (except for possibly some singular values of the inertia ratio,  $\lambda$ ), and when  $\beta = 0$ , the system is controllable. For the general case with offset a further numerical analysis would be required, but due to the increased coupling it is thought the same results would prevail.

If all the state variables are available as measureable outputs, Y, the matrix, C, in the equation:  $Y = CX$  is an identity matrix (6x6) in which case the observability condition becomes trivial. But, if due to practical limitations only two of the state variables, length ( $\ell$ ) and length rate ( $\ell'$ ) are available as outputs, then, the output vector, Y, can be written as

$$Y = CX \tag{33}$$

where

$$C = \begin{bmatrix} 1 & 0 & 0 & 0 & 0 & 0 \\ 0 & 0 & 0 & 1 & 0 & 0 \end{bmatrix}$$

Through the rotation of a drum,  $\ell$  can be measured, and with a chronometer, an average  $\ell'$  can be determined at all instants of time. A linear control strategy, U, as based on linear state feedback of the form:  $U = -KX$ , requires the complete knowledge of all state variables at all instants of time.

In the system under consideration the swing angle,  $\theta$ , swing rate,  $\theta'$ , pitch,  $\psi$ , and pitch rate,  $\psi'$ , would then have to be estimated from the output measurements. This is possible only if the system equations satisfy the observability condition.<sup>11</sup> The system is observable if and only if the matrix

$$\bar{Q} = [C^T | A^T C^T | (A^T)^2 C^T | \dots | (A^T)^{n-1} C^T] \tag{34}$$

has rank = n

It can be verified that the rank of  $\bar{Q}$  is 6 and the system is completely observable. By measuring only the length ( $\ell$ ) and length rate ( $\ell'$ ) the other system state variables can be estimated. For many applications of the tethered platform system it will

be relatively easy to measure these two components of the state, whereas measurements of the other state components may require different types of sensors, which may be more difficult to implement.

#### APPLICATION OF THE LINEAR QUADRATIC REGULATOR PROBLEM TO DEVELOP CONTROL LAWS

In order to develop a control law based on linear state feedback, the linear quadratic regulator problem from optimal control theory will be applied.<sup>11</sup>

The optimal control,  $U$ , which minimizes the performance index

$$J = \int_0^{\infty} (X^T Q X + U^T R U) dt \quad (35)$$

is given by,

$$U = -(R^{-1} B^T P) X = -KX \quad (36)$$

where  $Q$  is the positive semi-definite state penalty matrix,  $R$  is the positive definite control penalty matrix which penalizes the system more severely for large control, and  $P$  is the positive definitive solution to the steady state Riccati matrix equation,<sup>11</sup>

$$-PA - A^T P + PBR^{-1}B^T P - Q = 0 \quad (37)$$

The linear control strategy,  $U$ , requires gains proportional to all positions and rates. The appropriate gain matrix,  $K$ , is given by

$$K = \begin{bmatrix} K_{\epsilon} & K_{\psi} & K_{\theta} & K_{\epsilon'} & K_{\psi'} & K_{\theta'} \\ C_{\epsilon} & C_{\psi} & C_{\theta} & C_{\epsilon'} & C_{\psi'} & C_{\theta'} \end{bmatrix} \quad (38)$$

This control scheme is suitable for a closed loop system having tension modulation on the tether line and a momentum-type device for controlling the pitching motion of the platform. A computer algorithm developed by Melsa and Jones<sup>12</sup> has been implemented for solving for the elements of the gain ( $K$ ) matrix, given the elements of the state and control penalty weighting matrices,  $Q$  and  $R$ , the state matrix,  $A$ , and control influence matrix,  $B$ , and

after the controllability of the system has been established.

### STABILITY CONDITIONS FOR THE LINEAR SYSTEM WITH LINEAR CONTROL

By assuming solutions for length, swing angle, and pitch angle to be, respectively:

$$\epsilon(\tau) = \epsilon e \quad ; \theta(\tau) = \gamma e \quad + \theta_{eq}; \psi(\tau) = \alpha e \quad + \psi_{eq}, \quad (39)$$

where  $\theta_{eq}$  (or  $\psi_{eq}$ ) is given by Eq. (26), the variational coordinates for the swing and pitch angles are used to bias the nonzero equilibrium values for the pitch angle, and the swing angle in Eqs. (23) - (25).

The linear control strategy, U, renders two separate control laws for controlling the tether tension and the platform pitch angle. The two control laws can be written as,

$$\Delta Q_{\ell} = -(K_{\epsilon} \epsilon + K_{\epsilon'} \epsilon' + K_{\theta} \gamma + K_{\theta'} \gamma' + K_{\psi} \alpha + K_{\psi'} \alpha') \quad (40)$$

$$\Delta Q_{\psi} = -(C_{\epsilon} \epsilon + C_{\epsilon'} \epsilon' + C_{\theta} \gamma + C_{\theta'} \gamma' + C_{\psi} \alpha + C_{\psi'} \alpha') \quad (41)$$

where  $\gamma$  and  $\alpha$  are the swing and pitch angle variational coordinates, respectively,

Eqs. (39) - (41) can be substituted into Eqs. (23) - (25) with the assumption that  $\Delta Q = 0$  to develop the closed-loop system characteristic equation.<sup>13</sup> In this process it is also noted that one of the subdeterminants also corresponds to that used to develop the characteristic equation for the TSS system.<sup>7, 13</sup> For the lower order system of Ref. 7 a graphical interpretation of the stability boundaries in terms of the gains in the tension control law was previously obtained (Ref. 7, Fig. 2.). For the case of zero offset ( $h = 0$ ) and where the platform mass distribution approximates that of a uniform sphere, this figure can still give insight into the stability of the more complex system studied here. For the present study the necessary and sufficient conditions have been fully developed in terms of the control law gains, tether offset parameter, platform inertia ratio, subsatellite mass, and desired tether length. Because of their complexity, a simple geometric

interpretation has not been successfully implemented, but these complex conditions appear in full in Ref. 13.

## NUMERICAL RESULTS

Three modes of operation are involved with the platform/subsatellite system. They are: deployment of the subsatellite; maintaining its position at some nominal location (station keeping); and subsatellite retrieval. Here attention focuses only on the station keeping phase of the operation. For the subsequent numerical work in this study the following platform and subsatellite properties are considered,

Platform mass,  $M = 10000.0$  Kg; Subsatellite mass,  $m = 100.0$  Kg

Platform pitch principal moment of inertia,  $I_S = 5.33 \times 10^6$  Kg-m<sup>2</sup>

Platform moment of inertia ratio,  $\lambda^2 = 1.200$ ;

Platform altitude = 500.0 Km;

Platform orbital rate,  $\omega = 1.1068 \times 10^{-3}$  rad/sec

Tether line reference length,  $l_c = 100.0$  m;

Platform length = 30.0m; Tether attachment offset = 20.0m

With the above system properties the equilibrium tether line swing angle,  $\theta_{eq}$  and platform pitch angle  $\Psi_{eq}$  are calculated (Eq. (26)), to be 0.0314 rad.

## PARAMETRIC STUDIES OF THE STATE AND CONTROL PENALTY MATRICES

Assuming that the information about all the state variables is available either through direct measurement or by estimation, only the feedback gains in Eq. (38) need to be computed for implementation of the control. Optimal feedback gains for a given set of state and control penalty weighting matrices,  $Q$  and  $R$ , respectively, in the performance index,  $J$ , are obtained by solving the nonlinear algebraic matrix Riccati equation for  $P^{11}$ . It is difficult to obtain an analytic expression for  $P$  in terms of the weighting matrices,  $Q$  and  $R$ , for a high order system. However, many numerical algorithms are available for solving

the matrix Riccati equation with the aid of a digital computer. The numerical procedure adopted in the present analysis is as given in Melsa and Jones 12 with inclusion of a subroutine from ORACLS<sup>14</sup>, which determines closed-loop system eigenvalues.

The matrices, Q and R, in the performance index, J, are selected such as to yield the desired system performance. For the present analysis it is desired to have the settling time as small as possible without excessive energy in the state or control. Only by trial and error can one arrive at suitable values for Q and R which result in the desired closed-loop system response. Figures 2-4 show typical variations of the real part of the least damped oscillatory mode with R and different components of the Q matrix. Figure 2 represents the case where the diagonal elements of Q are varied and the tether is assumed to be attached at the platform mass center. Figure 3 illustrates the effect of the same variations with a tether attachment offset of 20.0 meters.

The effect of the offset is to increase the natural coupling of the system. This increased coupling improves the performance in the least damped mode (i.e., shifts the curves upward). This tendency is more pronounced for the smaller values of weights in the state penalty matrix. Larger weighting elements in the state penalty matrix result in higher coupling from the control effort which overshadows that due to the attachment offset. Increases in the control penalty weighting result in more rapid damping of the system's oscillations (i.e., more negative values for the real part of the eigenvalue). This tendency is more apparent for smaller weighting elements in the state penalty matrix.

When only one of the diagonal elements of the state penalty matrix is varied at a time, the performance is improved when that element penalizes a position state as compared with the situation where the diagonal element being varied penalizes the corresponding rate state. As an example, Fig. 4 shows the effect of varying only the tether length penalty element in the Q matrix on the real part of the least damped mode while holding the other elements in the Q matrix constant where the offset parameter,  $h = 20\text{m}$ . From the results of the more extensive parametric study<sup>13</sup> it is seen that similar weighting of all states gives better results than split weighting, for the range of parameters considered here.



Table 1 lists the control system characteristics of the platform/subsatellite system with a 20.0 meter tether attachment offset. These control parameters render a desirable settling time without excessive energy in the state and control effort. Table 2 lists similar characteristics for the case of no offset.

TABLE 1

TETHER AND PLATFORM CONTROL CHARACTERISTICS AND CONTROL LAW GAINS

Offset = 20.0 m

Least Damped Modal Time Constant = 0.243 hr

State penalty matrix,  $Q=10\delta_{ij}$

Control penalty matrix,

$$R = \begin{bmatrix} 2 & 0 \\ 0 & 2 \end{bmatrix}$$

Gains,

$K_e = 8.03247$   
 $K_\psi = 1.56196$   
 $K_\theta = 3.44483$   
 $K_{e'} = 6.76085$   
 $K_{\psi'} = 1.43246$   
 $K_{\theta'} = 2.92402$

$C_e = 1.91681$   
 $C_\psi = 2.16826$   
 $C_\theta = 1.80729$   
 $C_{e'} = 1.43246$   
 $C_{\psi'} = 5.38079$   
 $C_{\theta'} = 1.17312$

TABLE 2

TETHER AND PLATFORM CONTROL CHARACTERISTICS AND  
CONTROL LAW GAINS

Offset = 0.0 m

Least Damped Modal Time Constant = 0.243 hr

State penalty matrix,  $Q=10^6 I_j$

Control penalty matrix,

$$R = \begin{bmatrix} 2 & 0 \\ 0 & 2 \end{bmatrix}$$

Gains,

$K_\epsilon = 7.99860$   
 $K_\psi = 1.48671$   
 $K_\theta = 3.37475$   
 $K_{\epsilon'} = 6.86226$   
 $K_{\psi'} = 1.19052$   
 $K_{\theta'} = 3.12771$

$C_\epsilon = 2.00348$   
 $C_\psi = 2.05478$   
 $C_\theta = 1.30765$   
 $C_{\epsilon'} = 1.19052$   
 $C_{\psi'} = 5.23986$   
 $C_{\theta'} = 0.083203$

## TRANSIENT RESPONSES

By using Euler integration techniques, Eqs. (23) & (25) were numerically integrated to give the transient response of the system states for different initial conditions. As an example, Fig. 5 shows the response of the differential length (from a desired reference length of 100m), the platform pitch, and the tether line swing angle for initial conditions of 101m in tether length and 0.01 rad in both the platform pitch angle and the tether line swing angle for a tether attachment offset of 20m. The tether and platform control law gains for this application are shown in Table 1. It is seen that the tether line swing motion is the most poorly damped requiring about 1.75 hr to reach the nominal value, whereas the platform pitch motion is damped out within approximately 1.0 hr.

## CONTROL EFFORTS

The two dimensional control laws for controlling tether tension and platform pitch angle are, respectively,

$$\Delta Q = -m\omega^2 l_c (K_\epsilon \epsilon + K_{\epsilon'} \epsilon' + K_\theta \theta + K_{\theta'} \theta' + K_\psi \psi + K_{\psi'} \psi') \quad (42)$$

$$\Delta Q = -I_y \omega^2 l_c (C_\epsilon \epsilon + C_{\epsilon'} \epsilon' + C_\theta \theta + C_{\theta'} \theta' + C_\psi \psi + C_{\psi'} \psi') \quad (43)$$

These control laws represent the control effort the designer must supply to ensure that the tether line remains taut at all times and that the local normal at the platform's center of mass remains aligned with the local orbit vertical. Equation (42) represents the tether tension added to the tether line's natural tension (represented by the 3 on the right hand side of Eq. (23)).

Figure 6 represents the time history of the tether tension and platform torque control efforts for the same initial conditions and attachment offset of Fig. 5. The transient responses of the tension control effort illustrate that at certain intervals of time the designer supplied tension amplitude becomes negative. However, when this level of tension is added to the system's natural tension (.037N) the total tension remains positive. Therefore, the tether line remains taut.

For all cases of initial conditions and offsets studied the settling time on the tension control effort was about 1.5 hour. The torque control effort has a settling time of approximately 1.0 hour. The attachment offset is associated with increases in the amplitudes of the control efforts but the order of magnitudes of the amplitudes do not change.

#### CONTROL POWER LEVELS

An important interest to the designer is the amount of power which must be supplied to control a given system in a desirable manner. As an example of the amount of power needed to supply tether tension and platform torque control for the case of increased initial conditions of 0.05 (dimensionless) and no offset, it was seen that the maximum (differential) tension power level was less than  $3 \times 10^{-4}$  watts and platform torque power level required was less than 0.08 watts.

#### CONCLUSIONS AND RECOMMENDATIONS FOR FUTURE INVESTIGATIONS

In this study of the in-plane dynamics and control of a space platform with a tethered subsatellite, it has been seen that:

- (1) within the linear range the system is controllable with momentum-type control on the platform and with tension modulation on the tether line;
- (2) equilibrium values of swing and pitch angles are dependent on the physical properties of the platform inertia, subsatellite mass, and tether attachment offset;
- (3) the linear system is observable with tether length and length rate measurements only;
- (4) tether attachment offset increases the system's natural coupling and improves transient performance in the least damped mode, but at the cost of slightly larger control force amplitudes;
- and (5) the linear quadratic regulator problem has been utilized for determining tether and platform control law gains which provide for stable closed-loop systems.

The authors suggest the following topics for future research;

- (1) development of a three dimensional model of the platform-subsatellite system;
- (2) development of a two dimensional model of the platform-subsatellite

system to include tether mass and platform flexibility. Include in this model an examination for resonance interaction between the flexible tether and the platform; (3) include disturbances in either model such as solar pressure, aerodynamics, and plant and measurement noise; and (4) examine effects of other control devices on the platform or subsatellite, such as active thrusters.

#### ACKNOWLEDGEMENT

This research was supported by the NASA/Howard University Large Space Structures Institute. The authors thank both Dr. Jerrold Housner, the NASA Technical Monitor and Dr. Taft H. Broome, Jr., the Howard University Director of the Institute for their interest and help. Finally, appreciation is extended to Dr. A.S.S.R. Reddy, Howard University, for his advice and assistance in the generation of the numerical results.

#### REFERENCES

1. G. Colombo, E.M. Gaposchkin, M.D. Grossi, and G.C. Weiffenbach "Shuttle-Born 'Skyhook': A New Tool for Low Orbital Altitude Research," Smithsonian Astrophysical Observatory Report, 1974.
2. "Martin Awaits Go - Ahead for Tethered Satellite," Aviation Week and Space Technology, December 20, 1982, pp. 60#63.
3. A.K. Misra, and V.J. Modi, "Dynamics and Control of Tethered Connected Two-Body Systems - a Brief Review," 33rd International Astronautical Congress, Paris, Sept. 27-Oct 2, 1982, Paper No. IAF 82-315.
4. C.C. Rupp, "A Tether Tension Control Law for Tethered Subsattelites Deployed along the Local Vertical," NASA TMX-64963, 1975.
5. W.P. Baker, et al, "Tethered Subsattellite Study," NASA TMX-73314, 1976.
6. V.J. Modi, G. Chang-fu, A.K. Misra, and D.M. Xu, "On the Control of the Space Shuttle-Based Tethered Systems," 32nd International Congress, Rome, Sept. 1981, Paper No. IAF 81-347.

7. P.M. Bainum and V.K. Kumar, "Optimal Control of the Shuttle Tethered Subsatellite System," Acta Astronautica, Vol. 7, 1980, pp. 1333-1348.
8. C.M. Diarra, "The Effect of Tether Mass on the Stability and the Controllability of the Shuttle Tethered Subsatellite System," 33rd International Astronautical Congress, Paris, Sept. 27-Oct. 2, 1982, Paper No. ST-82-06.
9. J.H. Laue and F. Manarini, "The Tethered Retrieval Platform Concept and Utilization," 33rd International Astronautical Congress, Paris, Sept. 27-Oct. 2, 1982, Paper No. IAF 82-13.
10. L. Meirovitch Methods of Analytical Dynamics, McGraw-Hill Book Company, 1970.
11. M. Athans and P.L. Falb, Optimal Control, An Introduction to Theory and Its Application, McGraw-Hill, New York, 1966.
12. J.L. Melsa and S.K. Jones, Computer Programs for Computational Assistance in the Study of Linear Control Theory, McGraw-Hill, New York, 1973.
13. S.E. Woodard, "The Dynamics and Control of a Space Platform with a Tethered Subsatellite", Master's Thesis, Howard University, Dept. of Mechanical Engineering, May 1985.
14. E.S. Armstrong, ORACLS-A Design System for Linear Multivariable Control, Marcel Dekker, Inc., New York and Basel, 1980.

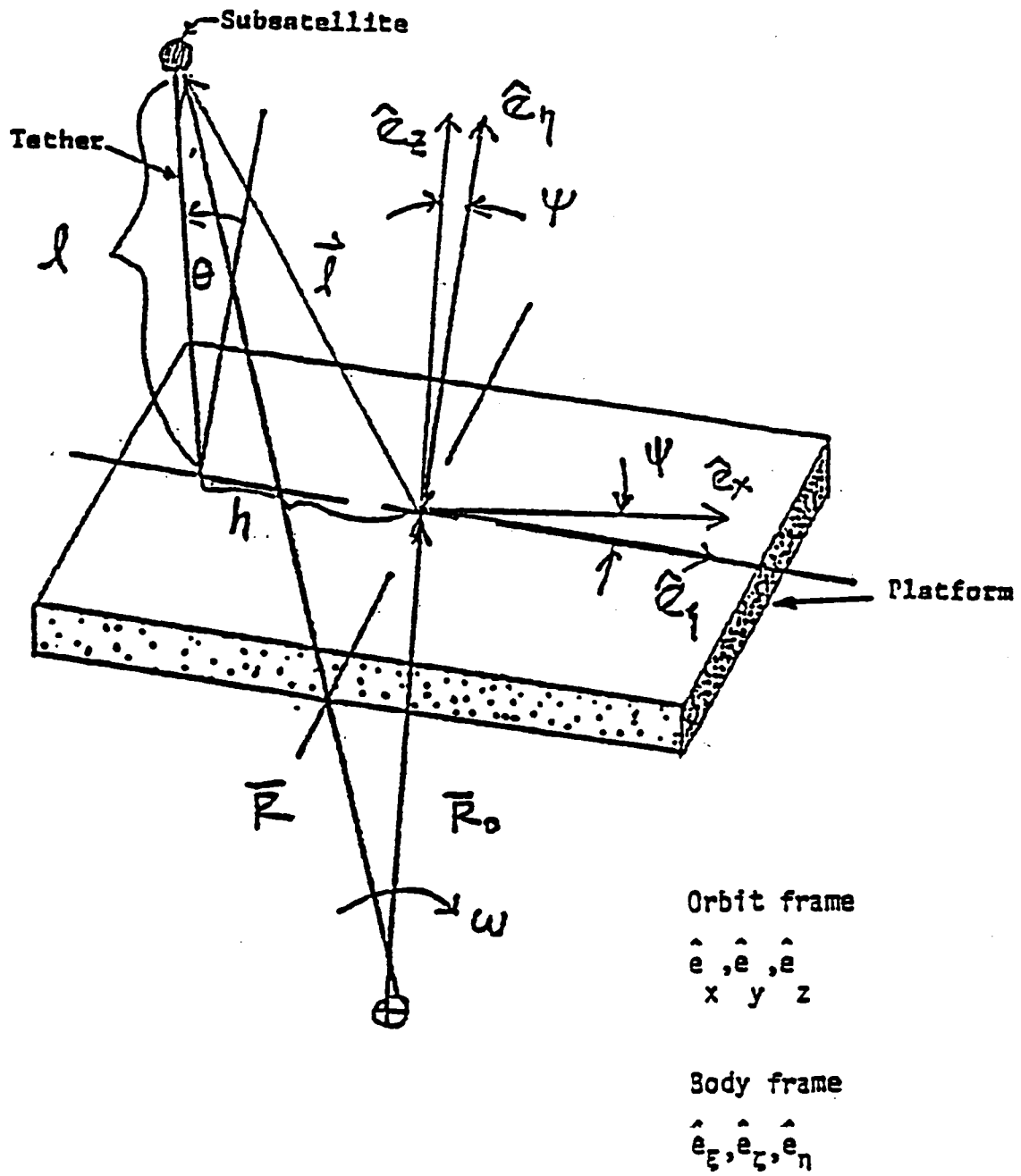

Figure 1

System Geometry

Figure 2

Variation of the Real Part of Least Damped Mode with R and Q with No Offset

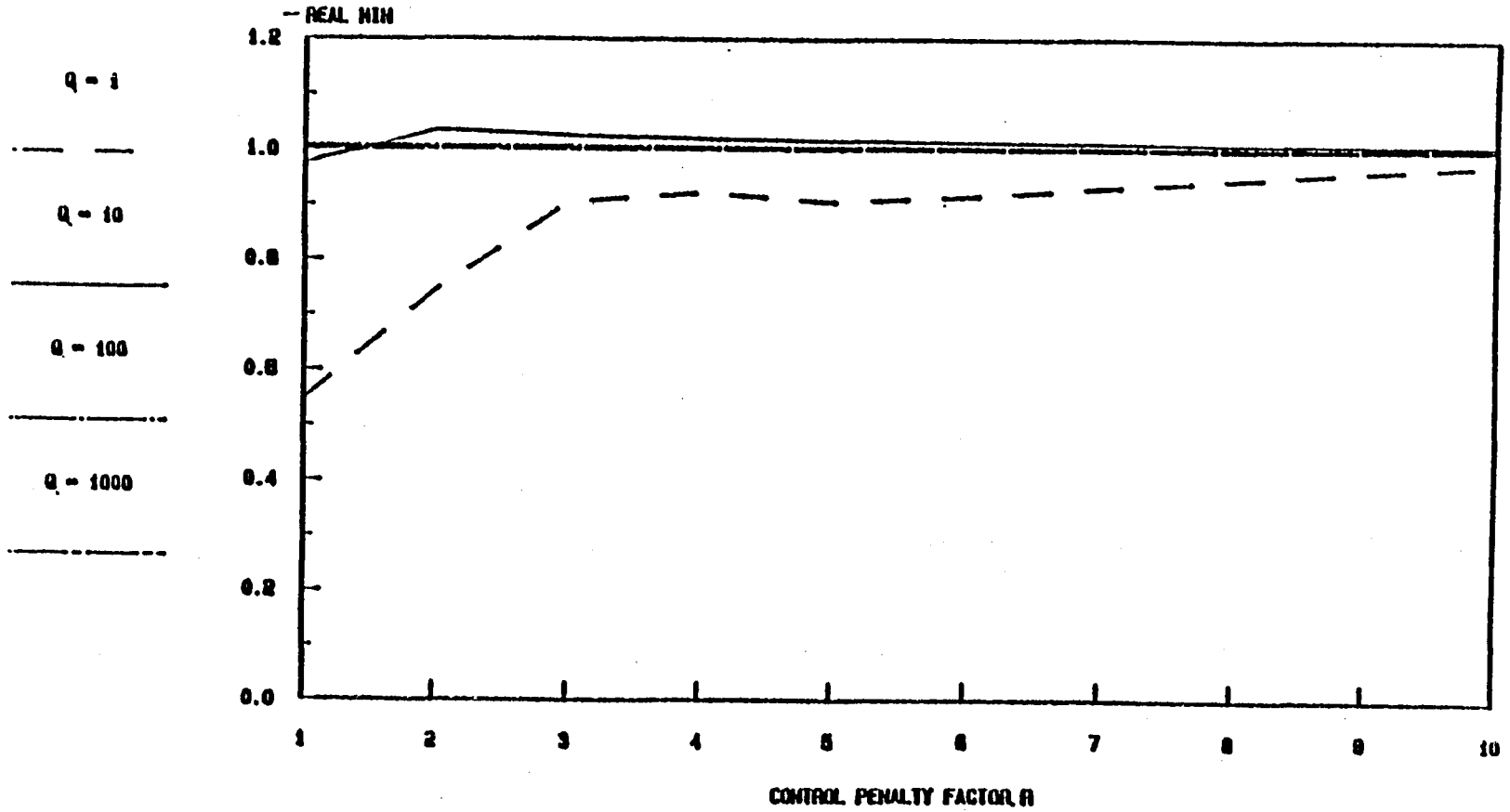
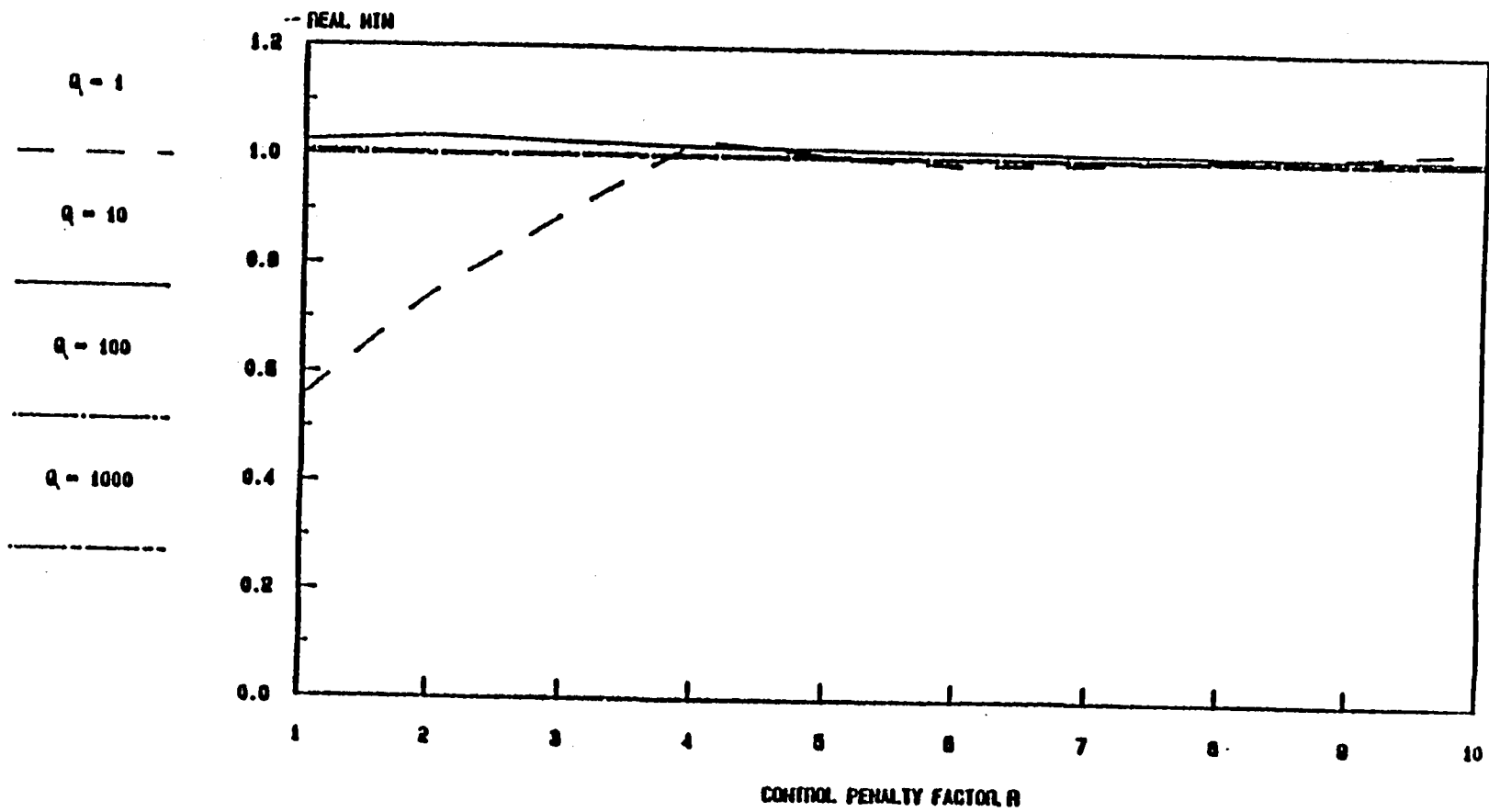

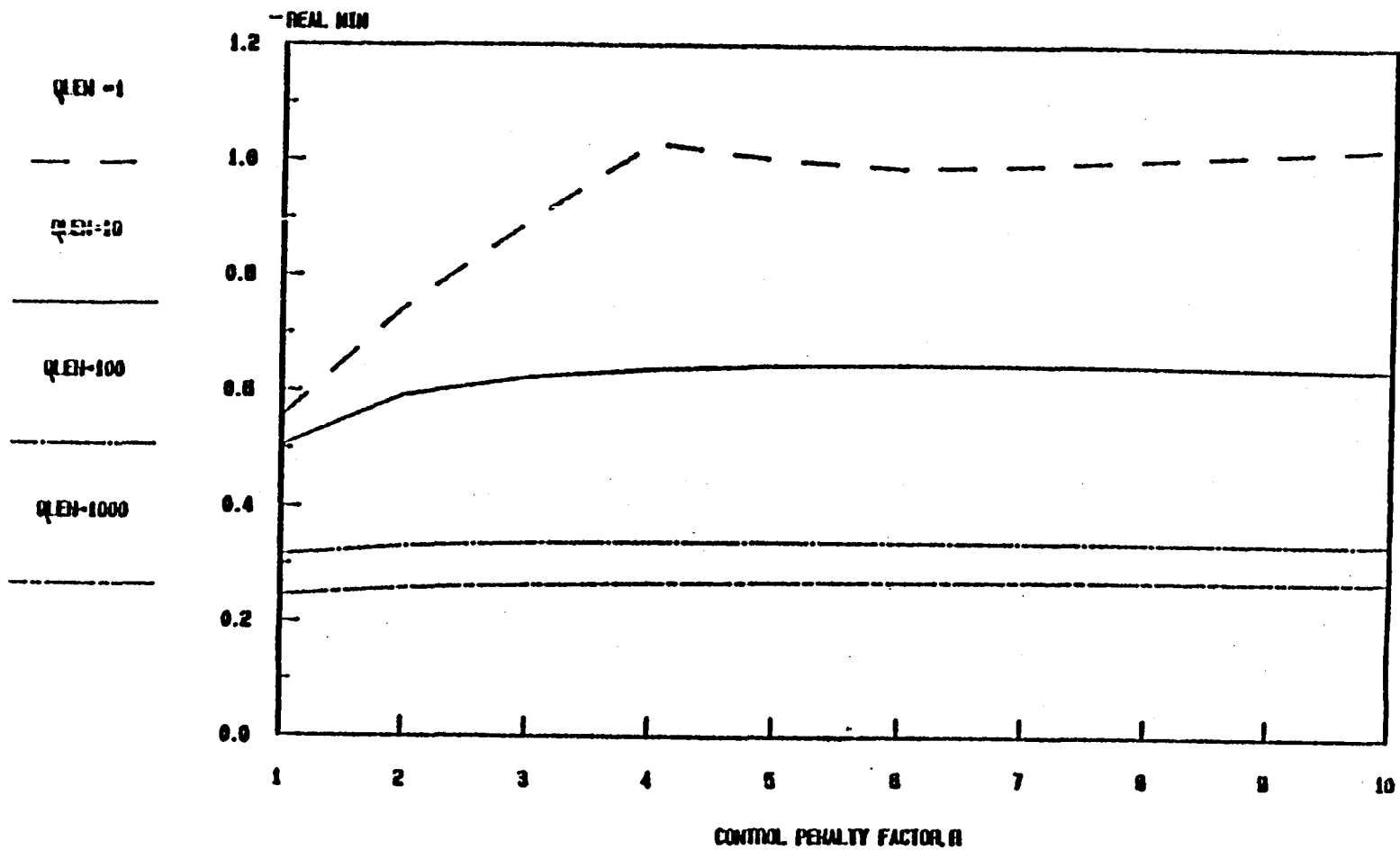

Figure 3 Variation of Real Part of Least Damped Mode with R and Q with Offset



351

Figure 4 Variation of Real Part of Least Damped Mode with R and  $Q_{\epsilon}$   
 (remaining  $Q_{ij}=1.0$ ); with Offset



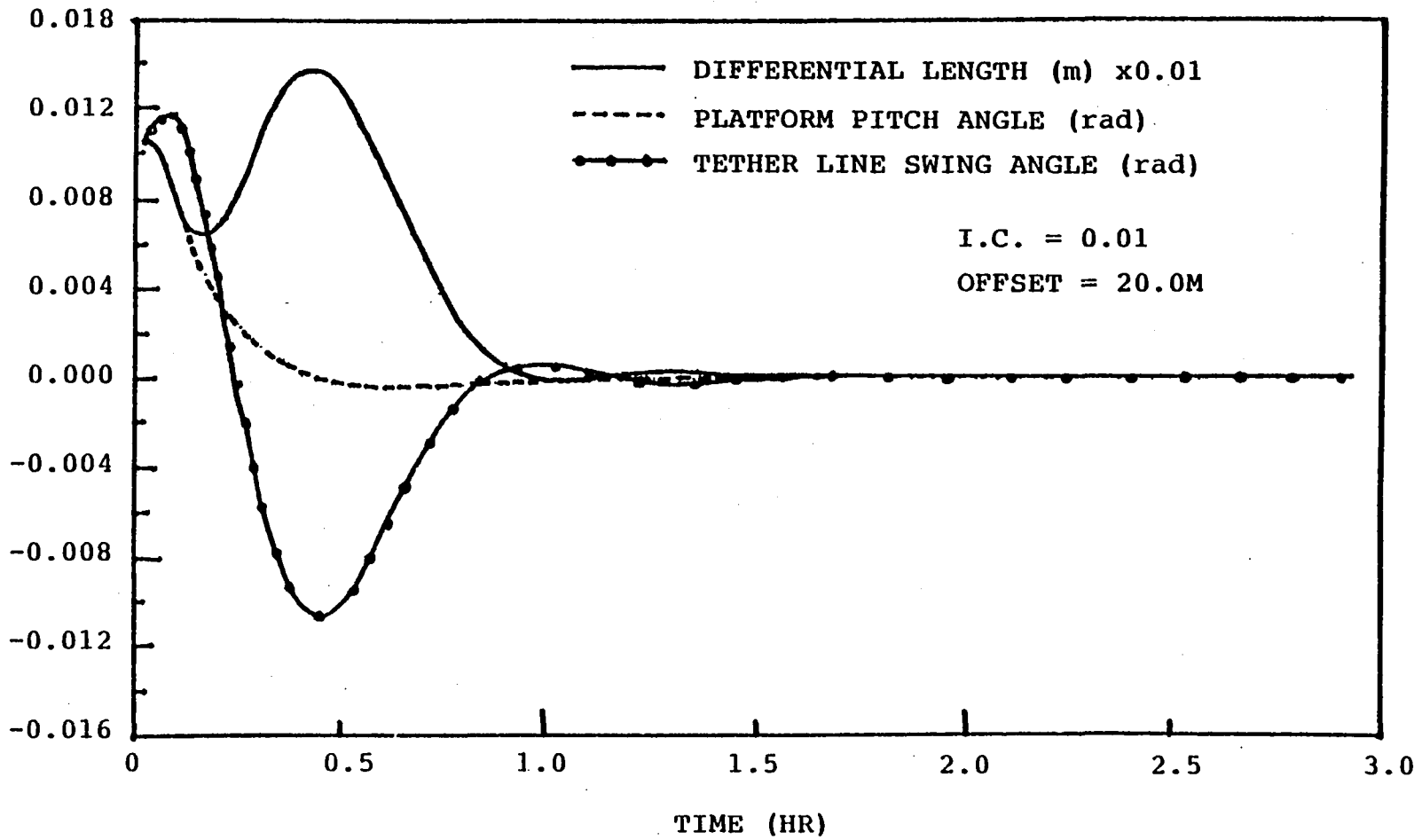

Fig. 5 Transient Response of  
Position Coordinates

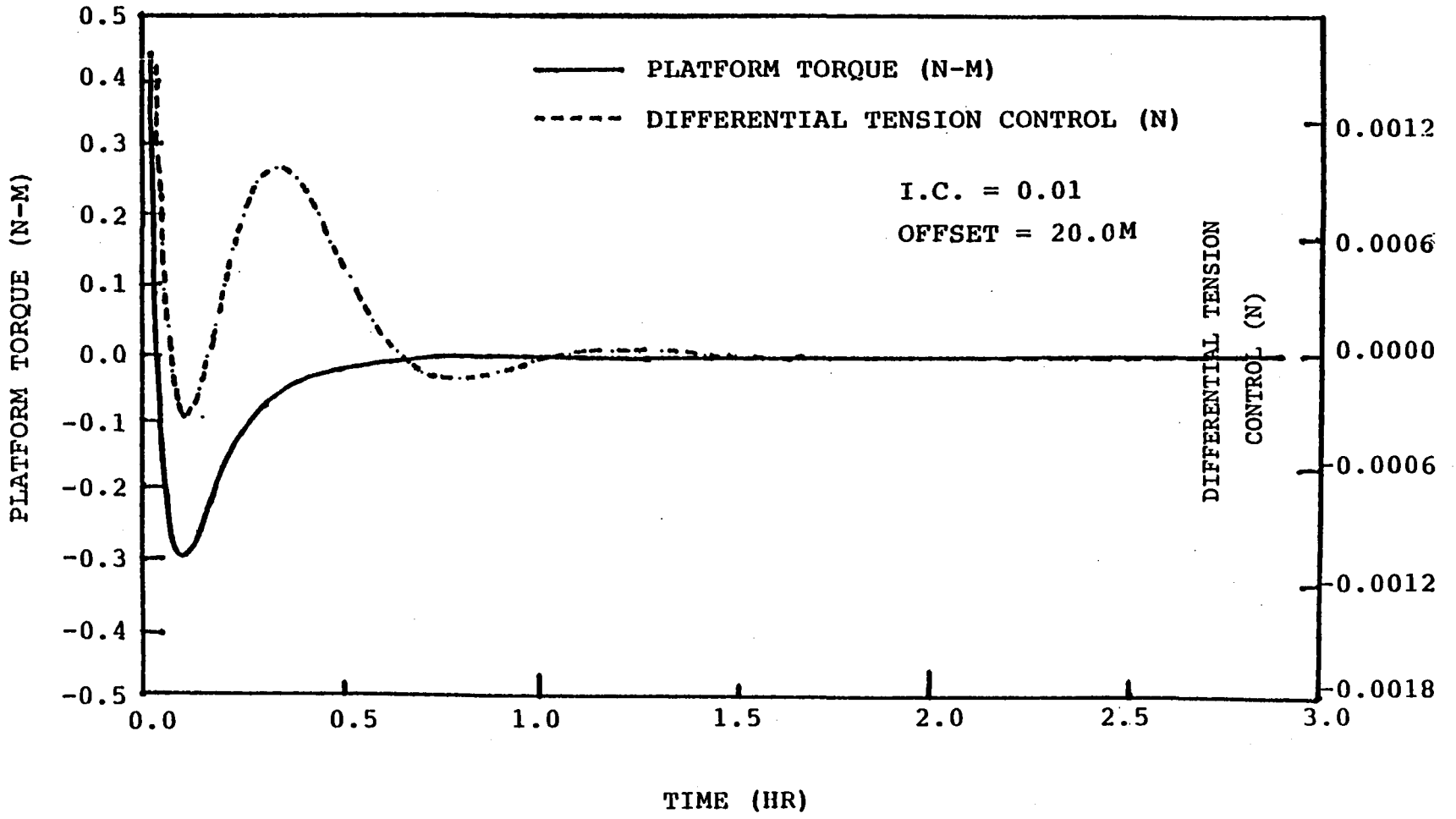

Fig. 6 Time History of Required Control Effort

RECOMMENDATIONS TO THE TECHNOLOGY  
AND TEST PANEL

Recommendations:

- 1) Recommendations of committee should be coordinated with those of the Space Station panel due to obvious overlay.
- 2) Regarding dynamic simulation capability, general purpose complete software programs should be used only after extensive preliminary design parametric studies are performed using simpler routines oriented toward a specific configuration, but often neglecting some of the physical effects. The general purpose and specific software routines should thus be used in a logical complimentary fashion.
- 3) There is an impending need to provide an in-orbit demonstration test of the validity of existing dynamic simulations. This should be done in three distinct phases: (a) during deployment; (b) during station-keeping; and (c) during retrieval operations. As a start, the TSS-1 mission in which atmospheric drag effects are expected to be small is suggested. A confidence in the accuracy of dynamic models will provide a significant boost to the more complex TSS-2 mission in which the effect of the rotating atmosphere will be important, especially if altitudes as low as 90 km will be considered. An experiment should also be designed for the TSS-2 mission to test the accuracy of the way in which atmospheric effects are modeled.

Needless to say, if either of the first two missions is not successful, or encounters partial dynamic problems, the potential jeopardy to the whole TSS concept and its many exciting applications should be obvious.

It would appear that some care in validating existing dynamic analysis (and making necessary changes) in this initial phase may pay greater dividends in the long run.

Respectfully submitted by

Peter M. Bainum  
Panel Member

Peter M. Bainum  
Dept. of Mechanical Engr.  
Howard University  
Washington, D.C. 20059

(202) 636-6612



TECHNOLOGY AND TEST PANEL

PRESENTATION VI

EFFECTS OF DAMPING ON THE CONTROL  
DYNAMICS OF THE SPACE SHUTTLE BASED ON  
TETHERED SYSTEMS

OCTOBER 15 - 17, 1985

V. J. MODI  
THE UNIVERSITY OF BRITISH COLUMBIA  
VANCOVER, B. C.  
CANADA

### LOW ALTITUDE SCIENCE APPLICATIONS

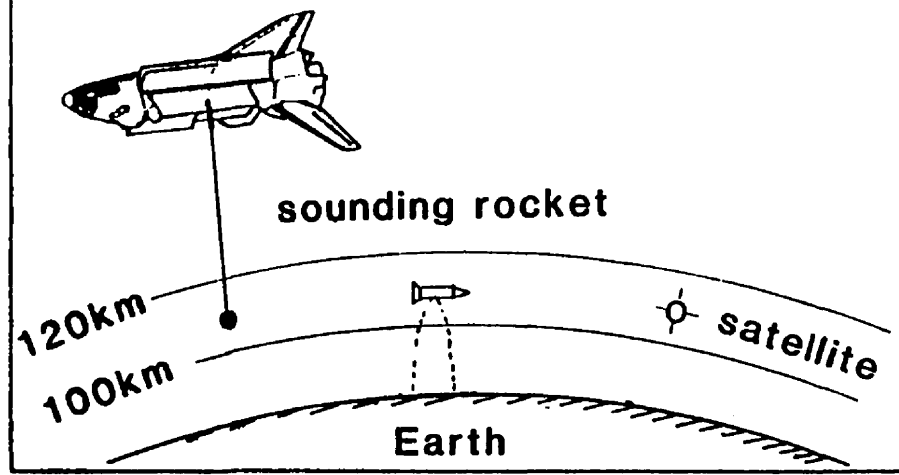

### RELEASE OF ARTIFICIAL METEORS

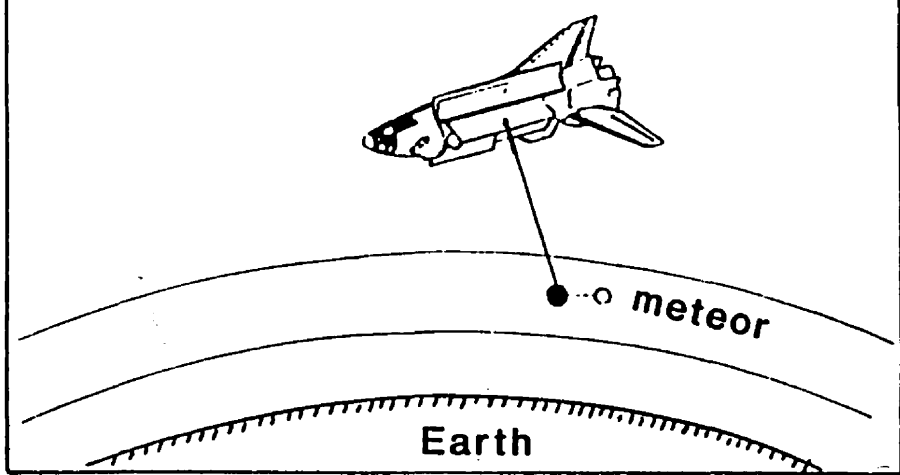

358

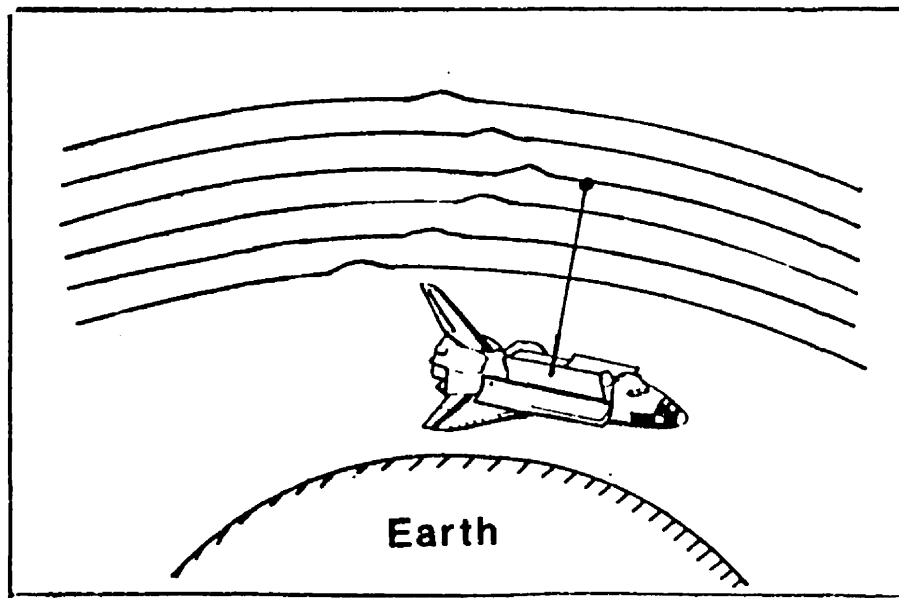

ALFVEN WAVE GENERATOR

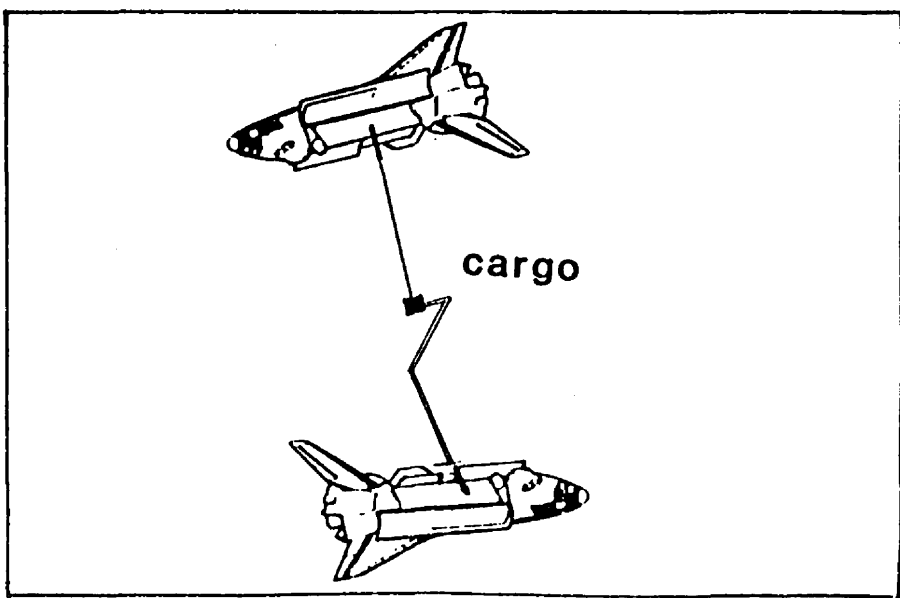

CARGO TRANSFER



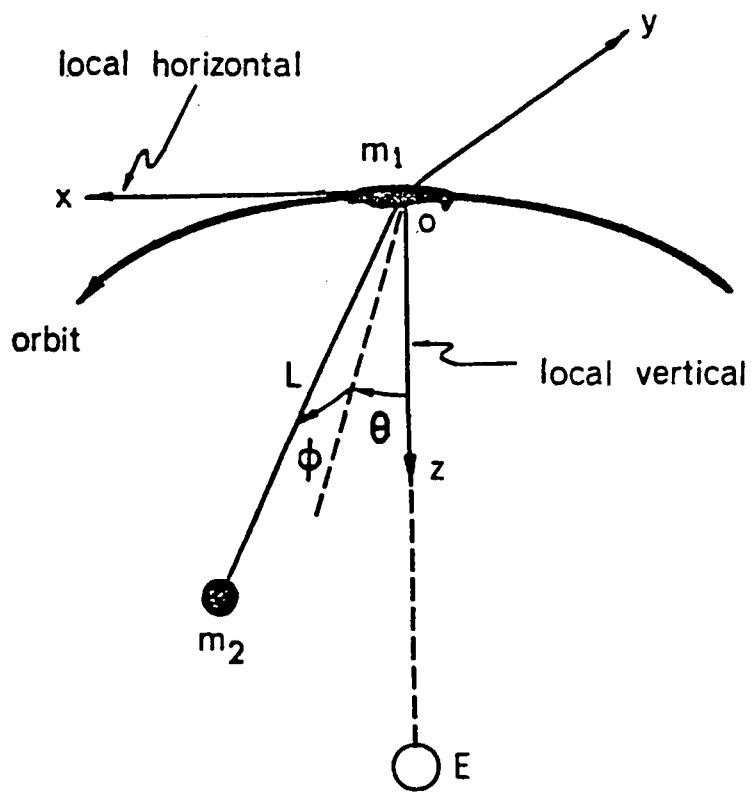

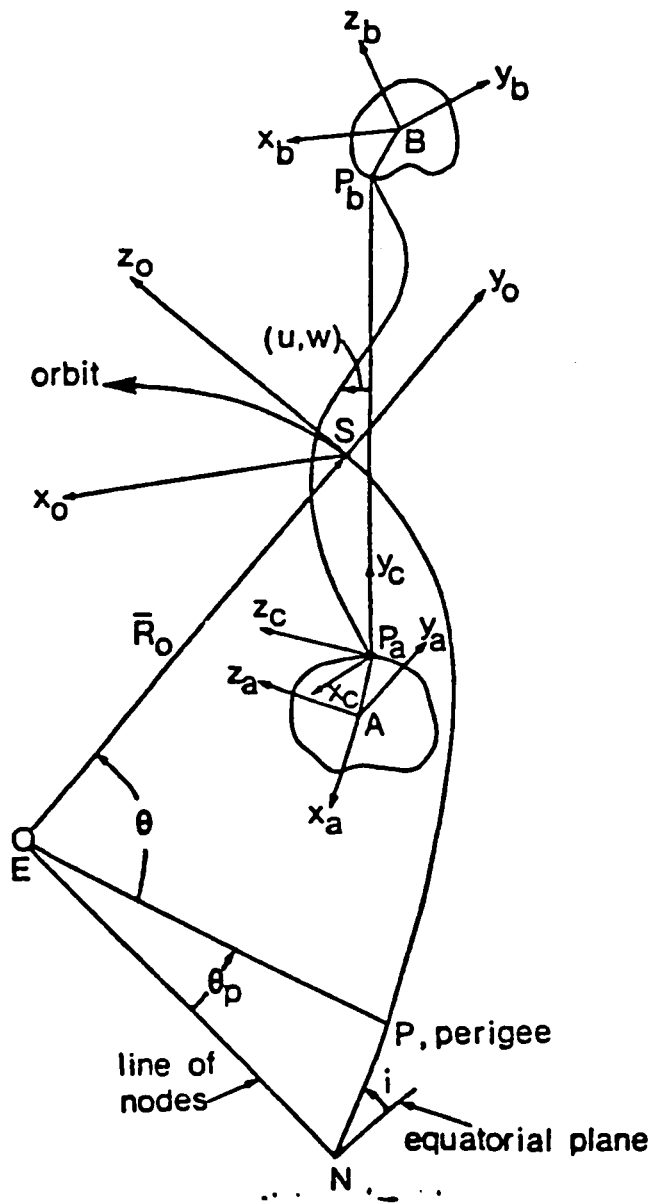

Figure 1. Geometry of motion.

## THE SPACE SHUTTLE BASED TETHERED SYSTEMS

In its utmost generality the problem is quite challenging as the system dynamics is governed by a set of ordinary and partial nonlinear, nonautonomous and coupled equations which account for\*:

- . three dimensional rigid body dynamics (librational motion) of the Shuttle and the subsatellite;
- . swinging inplane and out-of-plane motions of the tether, of finite mass and elasticity, with longitudinal and transverse vibrations superimposed on them;
- . offset of the tether attachment point from the Shuttle's center of mass;
- . aerodynamic drag in a rotating atmosphere.

- \* A.K. Misra, and V.J. Modi, "A General Dynamical Model for the Space Shuttle Based Tethered Subsattellite System," Advances in the Astronautical Sciences, Vol.40, Part II, 1979, pp.537-557.
- \* Misra, A.K., and Modi, V.J., "Dynamics and Control of Tether Connected Two-Body Systems," Invited Address, 33rd Congress of the International Astronautical Federation, Paris, France, Sept.1982, Paper No.IAF-82-316; also Space 2000, Selected Papers from the 33rd AIF Congress, Editor: L.G. Napolitano, AIAA Publisher, pp.473-514.
- \* Xu, D.M., Misra, A.K., and Modi, V.J., "On Thruster Augmented Active Control of a Tethered Subsattellite System During its Retrieval," AIAA/AAS Astrodynamics Conference, Seattle, Wash. August 1984, Paper No. 84-1993.

- \* ROTATIONS AND VIBRATIONS OF THE TETHER ARE INHERENTLY UNSTABLE DURING RETRIEVAL OF THE SUBSATELLITE.
- \* SCHEMES EXIST TO CONTROL ROTATIONAL MOTION SUCCESSFULLY.
- \* CONTROL OF LONGITUDINAL AND TRANSVERSE VIBRATIONS STILL REMAINS A PROBLEM.
- \* NONLINEAR COUPLING BETWEEN TRANSVERSE AND LONGITUDINAL VIBRATIONS IS IMPORTANT.

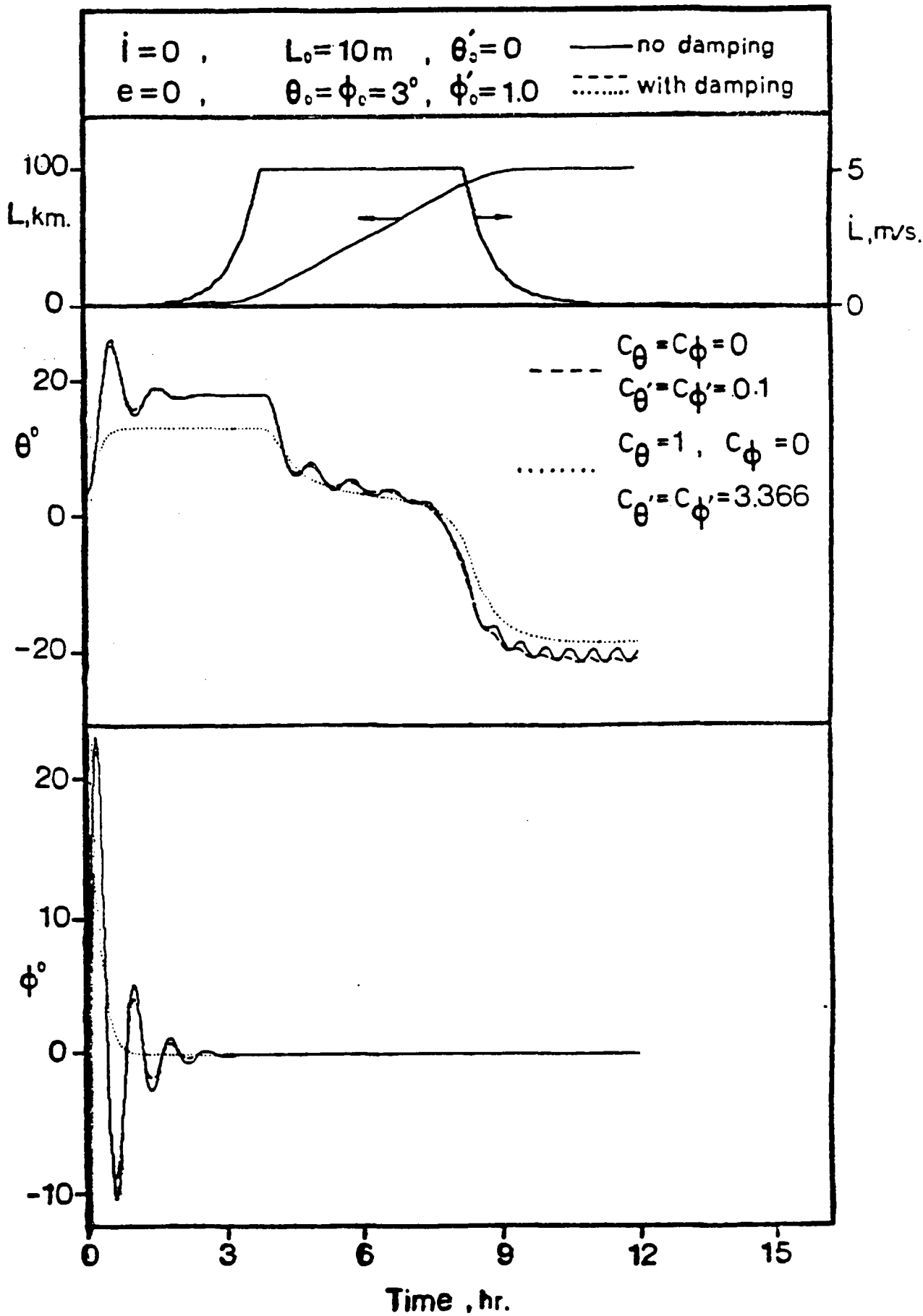

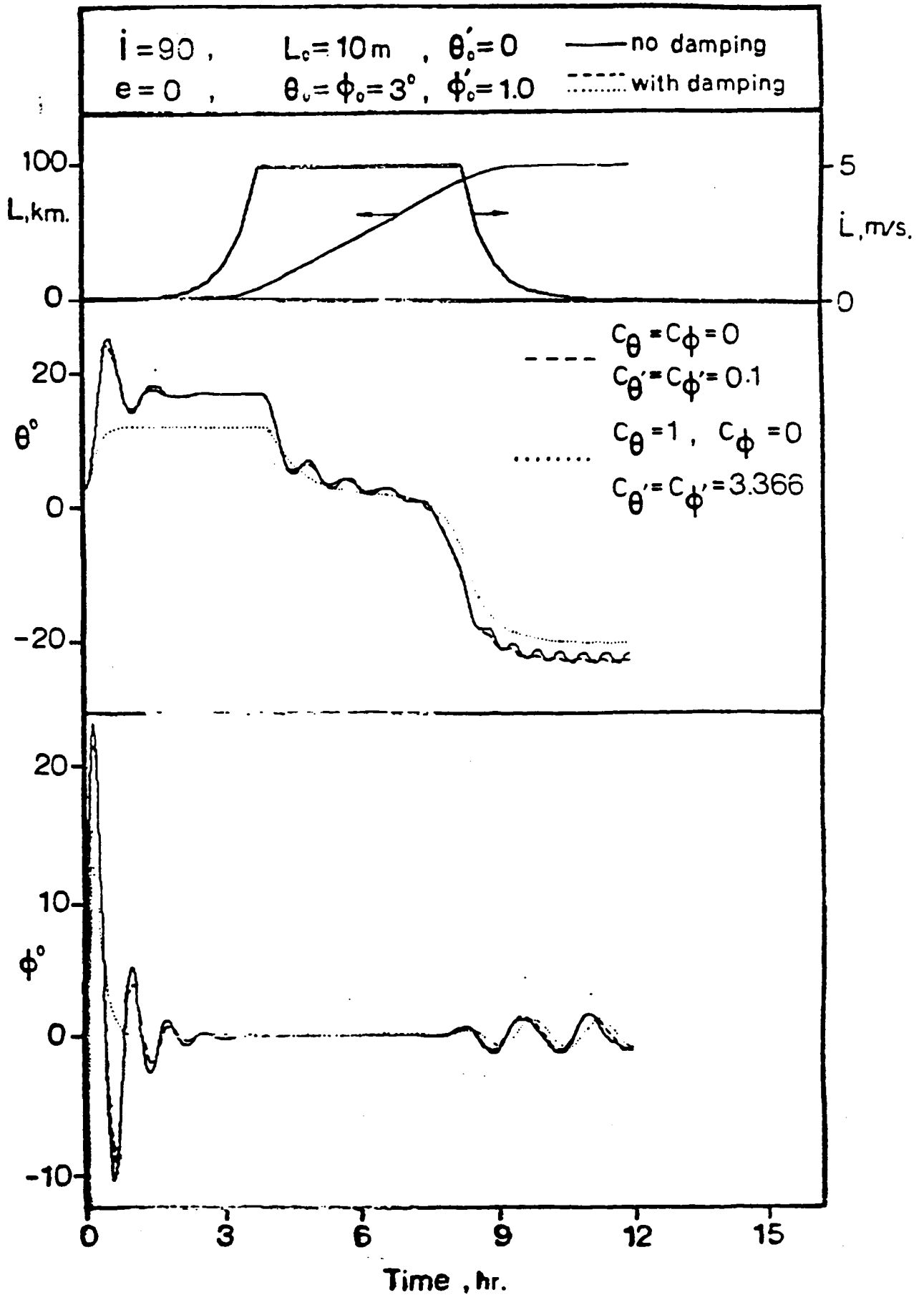

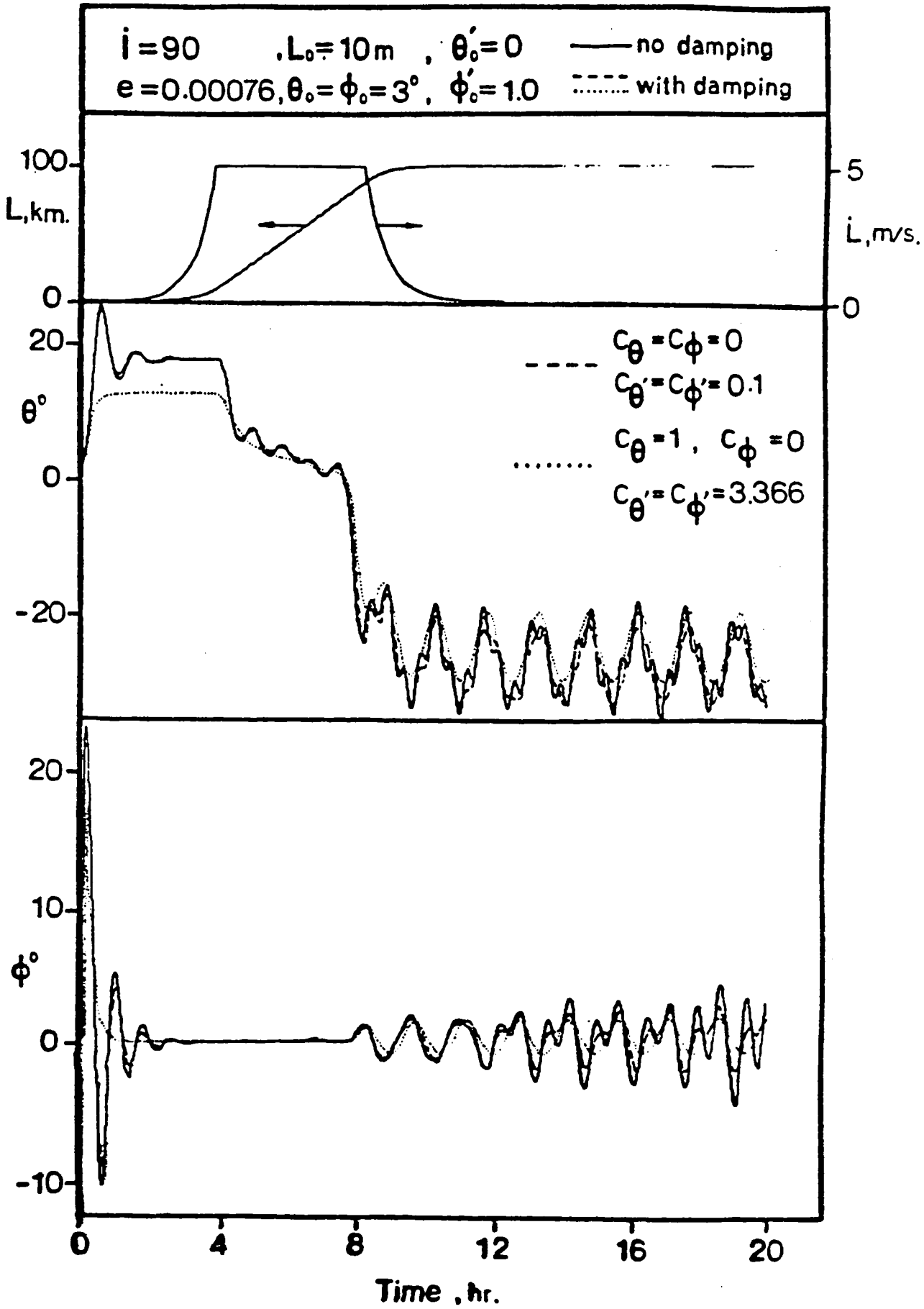

$$i=0, \quad \theta_0=0, \quad \phi_0=3^\circ, \quad L_0=100 \text{ km}$$

$$e=0, \quad \theta'_0=\phi'_0=0, \quad L=L_0 e^{-t/P}$$

$$P=5000 \text{ sec}$$

— no damping ,  
 .....with damping ,  $C_\theta=C_\phi=0$  ,  $C_{\theta'}=C_{\phi'}=0.1$

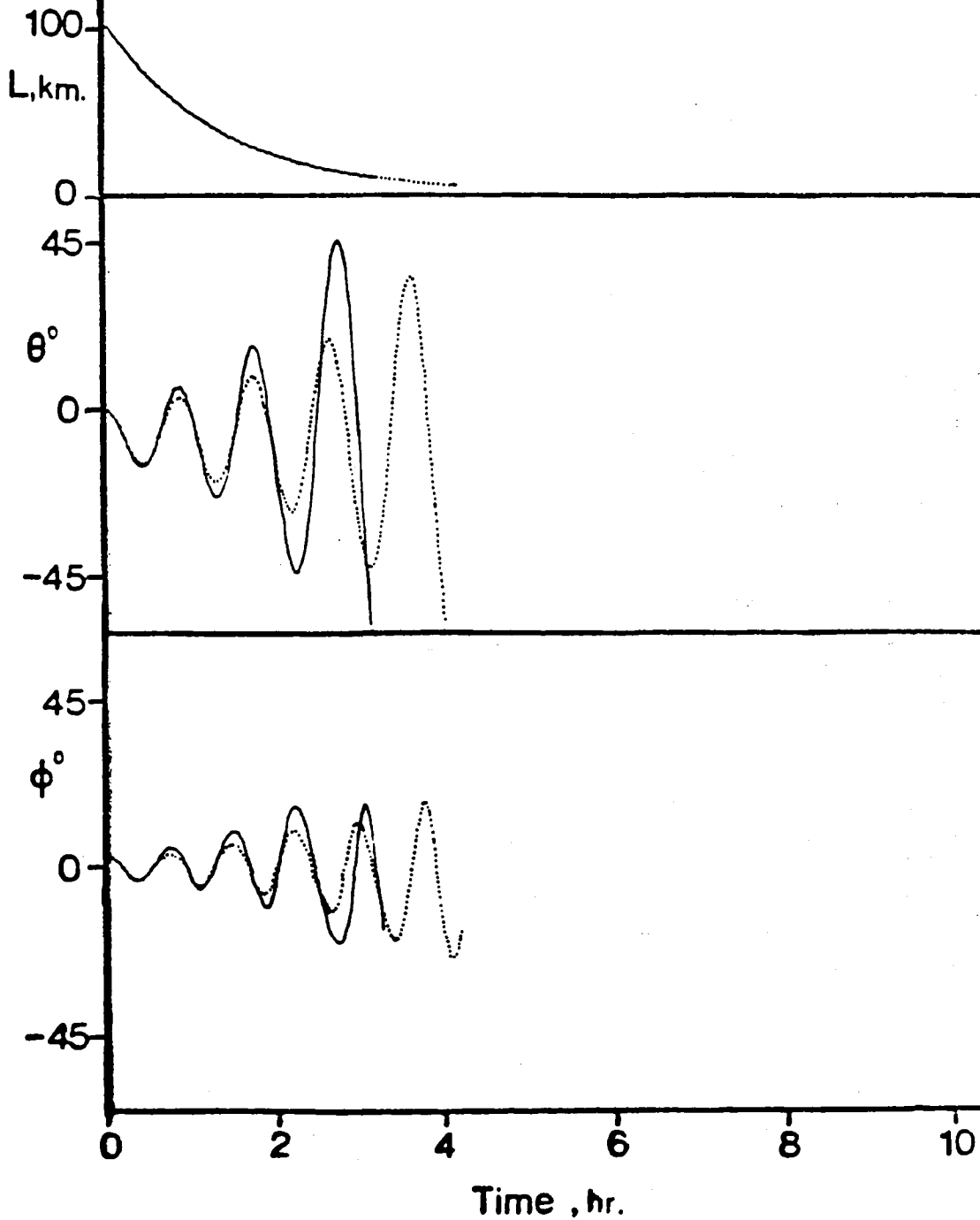



## CONTROL STRATEGIES

Tension control strategy as proposed by Kissel (Baker et al.)\*

optimal law based on an application of the linear regulator problem as proposed by Bainum and Kumar \*\*;

Several nonlinear control strategies sensitive to the tether length, length rate, librational and vibrational dynamics\*\*\*;

Nonlinear control strategies together with thrusters†.

\* P.W. Baker, et al., "Tethered Subsatellite Study," NASA TM X-73314, March 1976.

\*\* P.M. Bainum, and V.K. Kumar, "Optimum Control of the Shuttle-Tethered Subsatellite System," 30th Congress of the International Astronautical Federation, Rome, Italy, September 1981, Paper No. IAF-81-347; also Acta Astronautica, Vol.9, No.6-7, 1982, pp.437-443.

Xu, D.M., Misra, A.K., and Modi, V.J., "On Vibration Control of Tethered Satellite Systems," NASA/JPL Workshop on Application of Distributed System Theory to the Control of Large Space Structures, Jet Propulsion Laboratory, Pasadena, Calif., U.S.A., July 1982, NASA/JPL Publication 83-46, Editor: G. Rodrigues, pp.317-327.

† Xu, D.M., Misra, A.K., and Modi, V.J., "On Thruster Augmented Active Control of a Tethered Subsatellite System During Retrieval," AIAA/AAS Astrodynamics Conference, Seattle, Wash., U.S.A., August 1984, Paper No. AIAA-84-1993.

$i = 90^\circ$ ,  
 $e = 0$

$L_0 = 100 \text{ km}$ ,  
 $\theta_0 = -20^\circ$

$\phi_0 = 10^\circ$ ,  
 $\theta'_0 = \phi'_0 = 0$

— no aerodynamics  
 ..... with aerodynamics  
 - - - with aerodynamics and damping

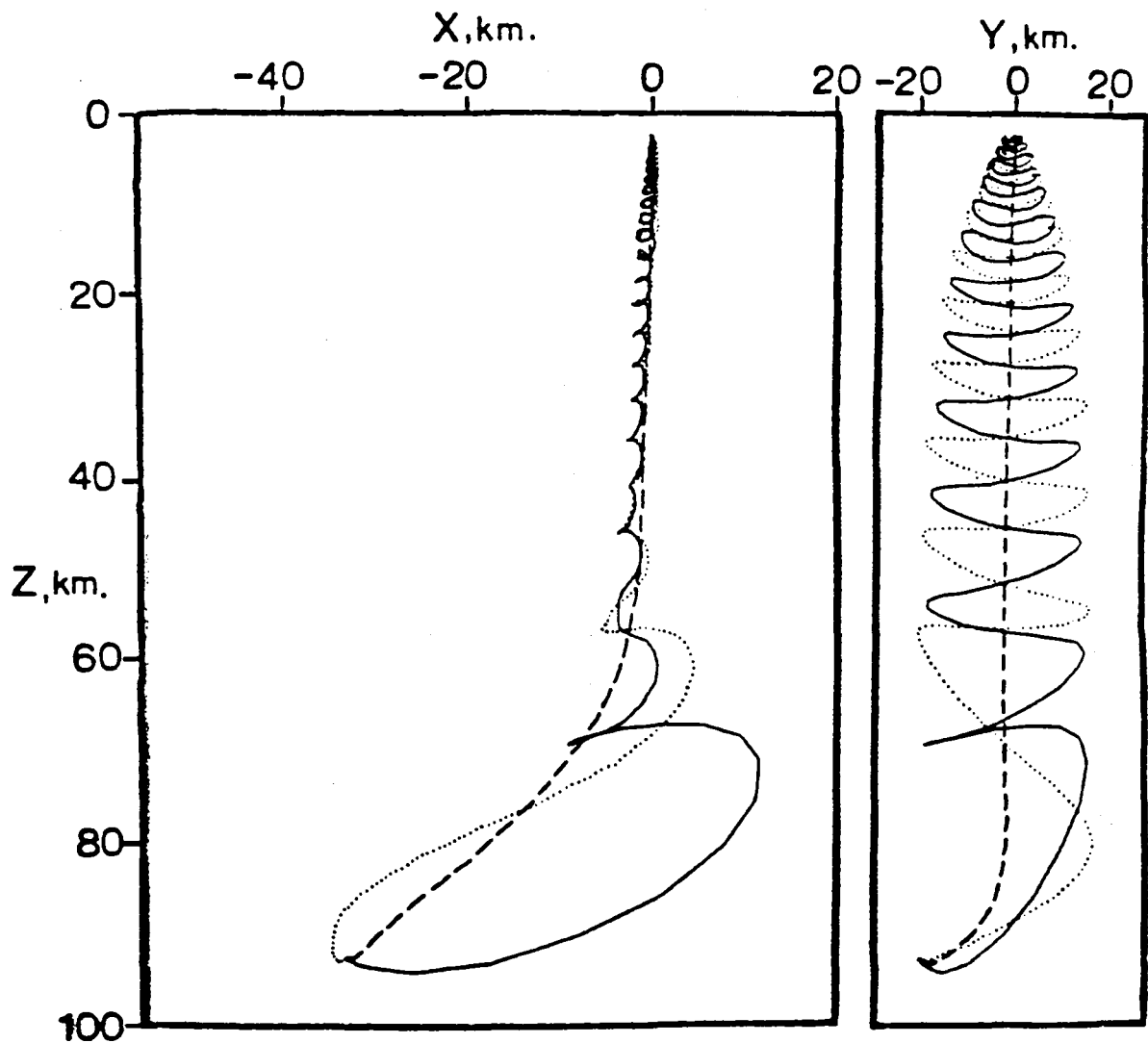
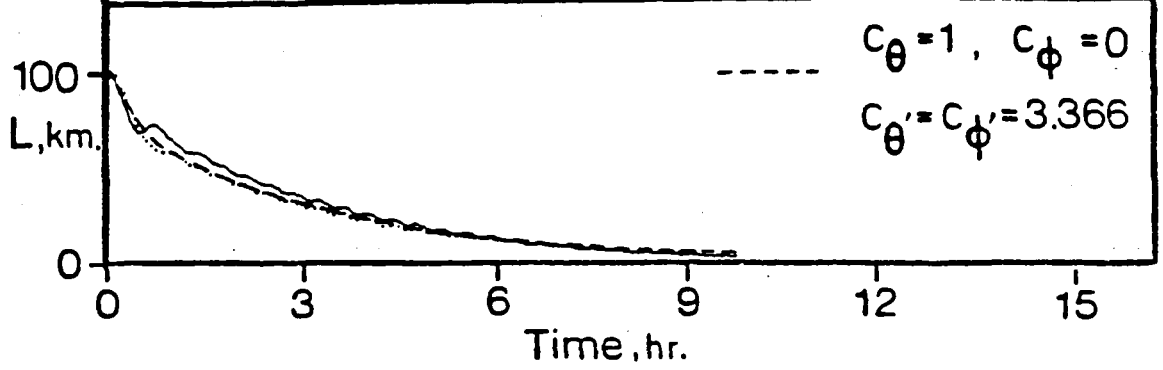

$i = 90^\circ$ ,  $L_0 = 100 \text{ km}$ ,  $\phi_0 = 10^\circ$ ,  
 $e = 0.00076$ ,  $\theta_c = -20^\circ$ ,  $\theta'_c = \phi'_c = 0$ .

— with aerodynamics  
 ..... with aerodynamics and damping

.....  $C_{\theta} = C_{\phi} = 0.1$

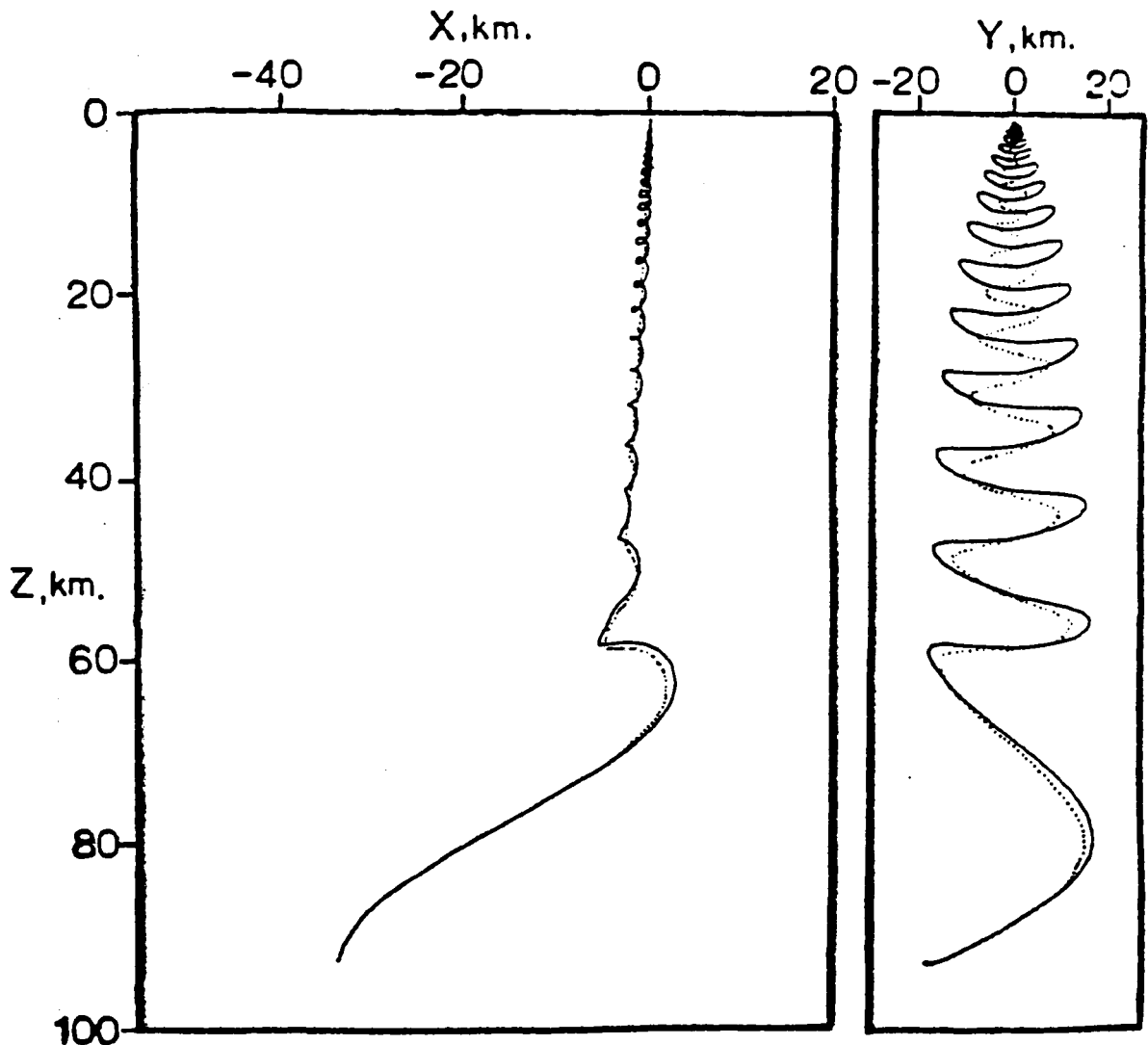
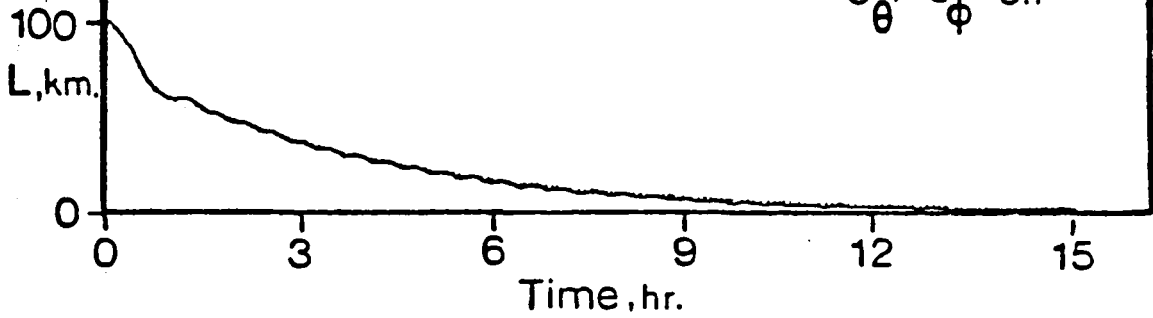

$i = 90^\circ$  ,  $L_0 = 100 \text{ km}$  ,  $K_2 = 7.0$   
 $e = 0$  ,  $L_c = L_0 e^{-t/P}$  ,  $K_2 = 4.0$   
 $\theta'_0 = \phi'_0 = 0$  ,  $P = 5000 \text{ sec}$  ,  
 .....  $\theta_0 = -8^\circ$  ,  $\phi_0 = 0$   
 —  $\theta_0 = -15^\circ$  ,  $\phi_0 = 3^\circ$

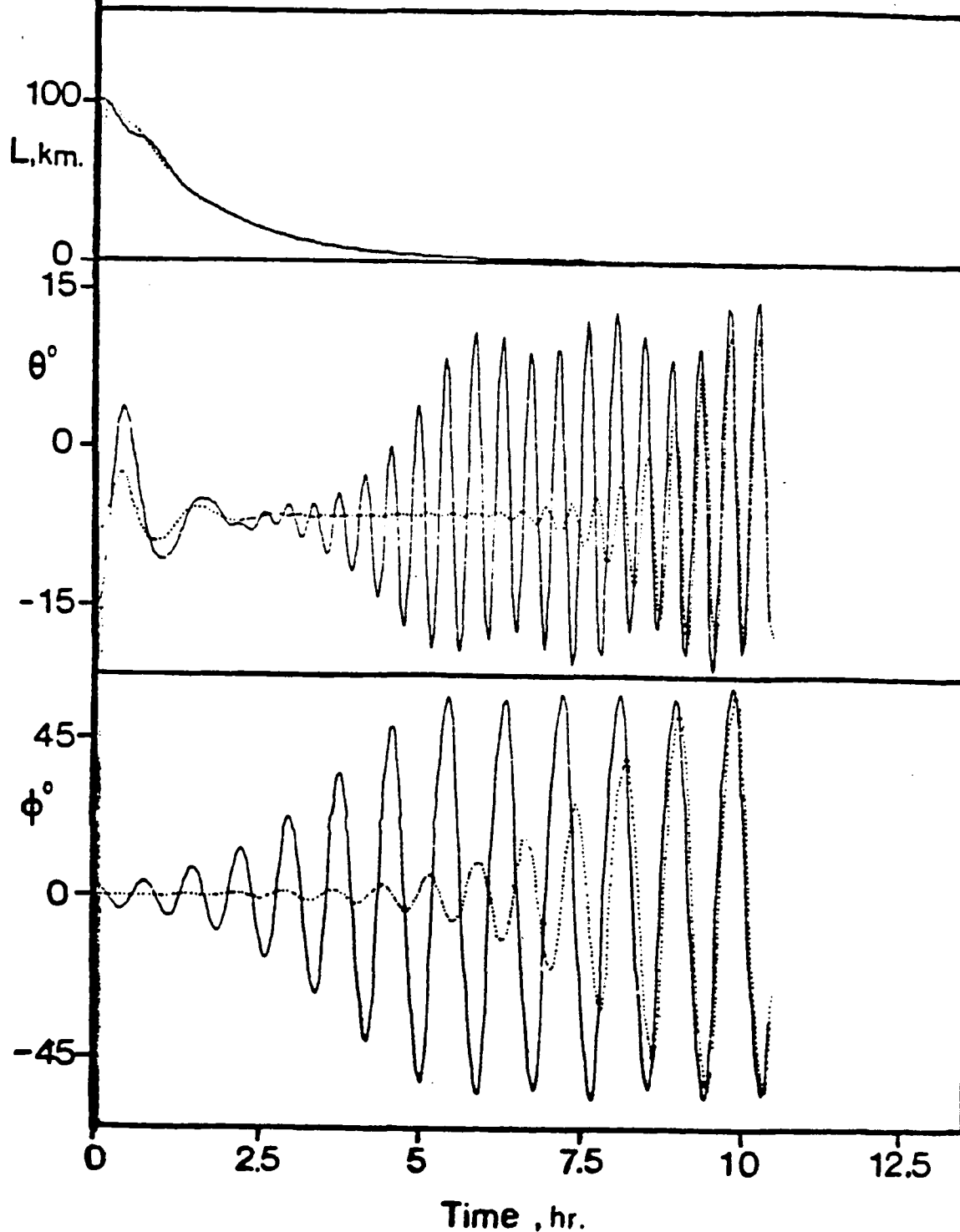

$i = 90^\circ$	,	$L_0 = 100 \text{ km}$	,	$K_L = 7.0$
$e = 0$	,	$L_c = L_0 e^{-t/P}$	,	$K_L = 4.0$
$\theta'_0 = \phi'_0 = 0$	,	$P = 5000 \text{ sec}$	,	$K_\phi = 100$
$\theta_0 = -15^\circ$	,	.....	no damping	
$\phi_0 = 3^\circ$	,	—	with damping, $C_\theta = C_\phi = 0.1$	

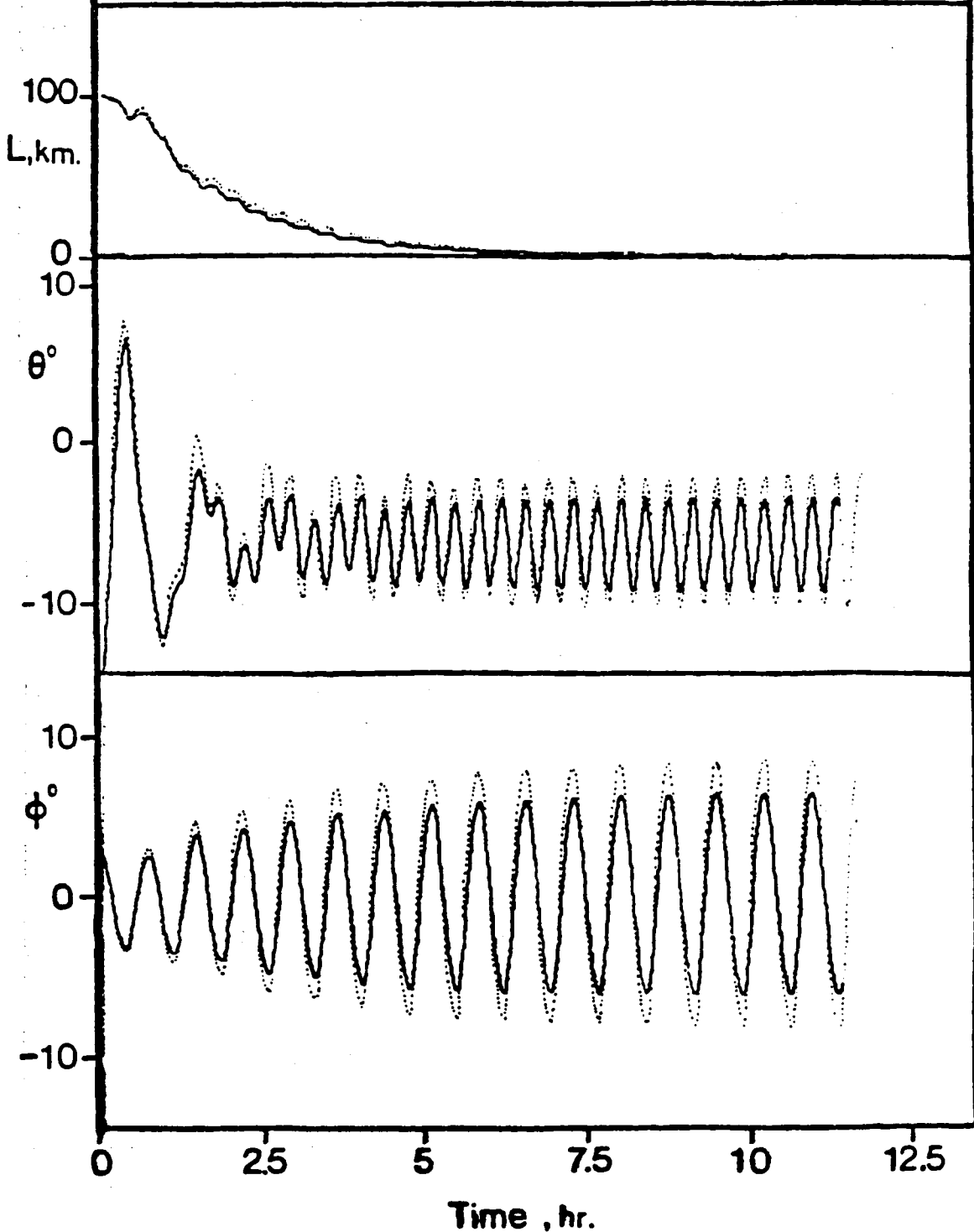

$i = 90^\circ$  ,  $L_0 = 100 \text{ km}$  ,  $K_L = 7.0$   
 $e = 0$  ,  $L_c = L_0 e^{-t/P}$  ,  $K_L = 4.0$   
 $\theta'_0 = \phi'_0 = 0$  ,  $p = 5000 \text{ sec}$  ,  $K_{\phi^2} = 100$   
 $\theta_0 = -15^\circ$  ,  $\phi_0 = 3^\circ$  ,  $\zeta_0 = 295 \text{ m}$  ,  $C_{\theta'} = C_{\phi'} = 0.1$

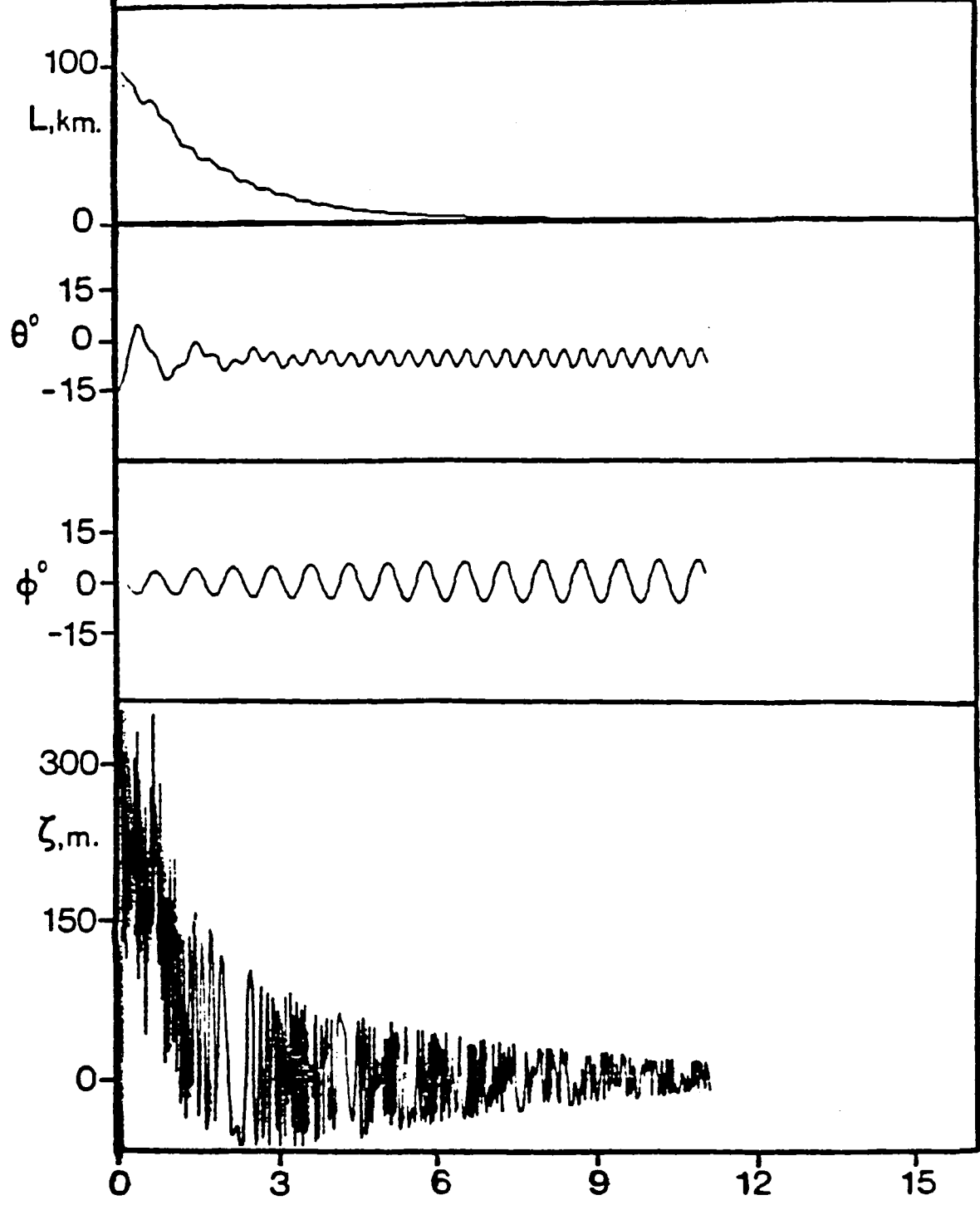

- Length Rate Control Law
- Thruster Augmented Active Control Law
  - Exponential Retrieval
  - Constant Velocity Retrieval

$$\bar{T} = \bar{i} T_y + \bar{j} T_c + \bar{k} T_x$$

Maximum thrust provided is limited to  $\pm 5N$

Example :

- Circular polar orbit
- Spherical satellite with projected area of  $1m^2$   
Mass =  $170\text{ kg}$
- $1\text{ mm}$  diameter Kevlar tether

- Initial Conditions

All the generalized co-ordinates excited

- transverse as well as longitudinal disturbances

- Pitch =  $15^\circ$

- Roll =  $1^\circ$

- Total Thrust Impulse Required

$$\approx 1 \times 10^4 \text{ Ns}$$

Retrieval Time from 100 km to 250 m  $\approx$  2 hrs.



$M_b = 170 \text{ kg}$  ;  $l_i = 100 \text{ km}$  ;  $l_{fin} = 0.25 \text{ km}$   
 $\rho_c = 0.658 \text{ kg/km}$  ;  $e = 0$  ;  $i = 90^\circ$  ;  $c = -4 \times 10^{-4} \text{ s}^{-1}$   
 $d_c = 0.325 \text{ mm}$  ;  $A_1'(0) = A_2'(0) = B_1'(0) = B_2'(0) =$   
 $H = 220 \text{ km}$  ;  $C_1(0) = C_2(0) = 0$  ;  $\eta'(0) = c/\omega$

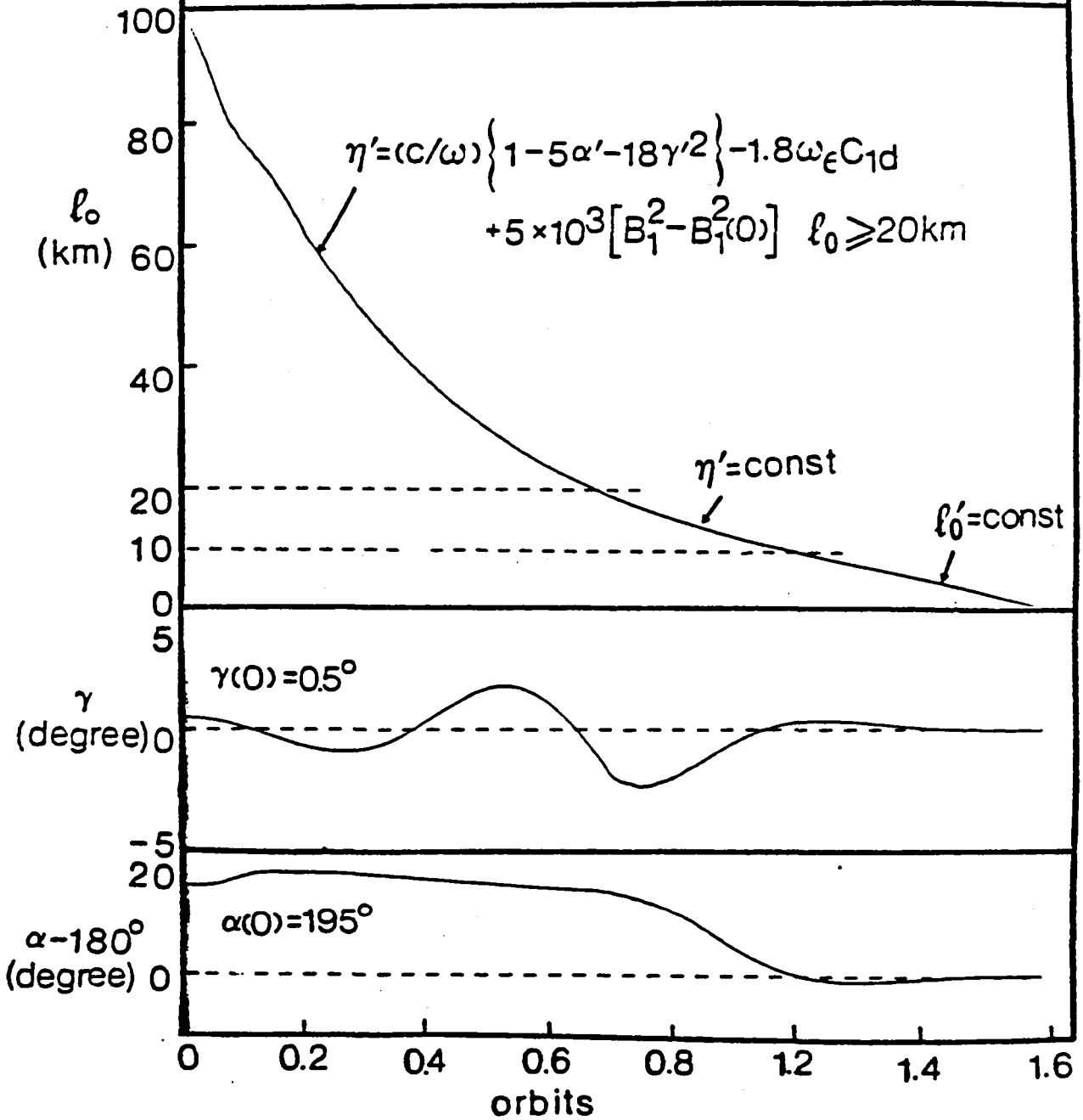

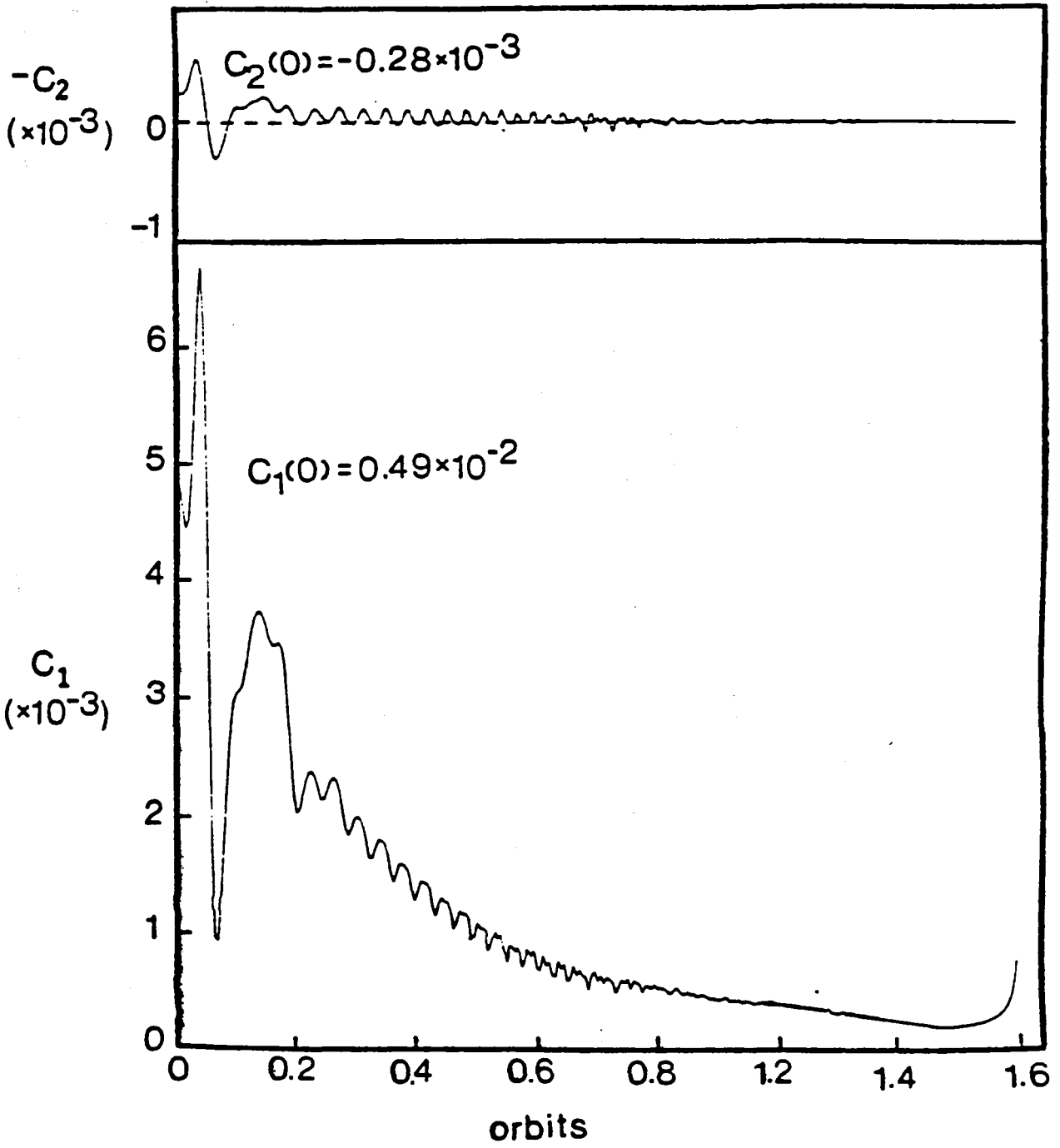

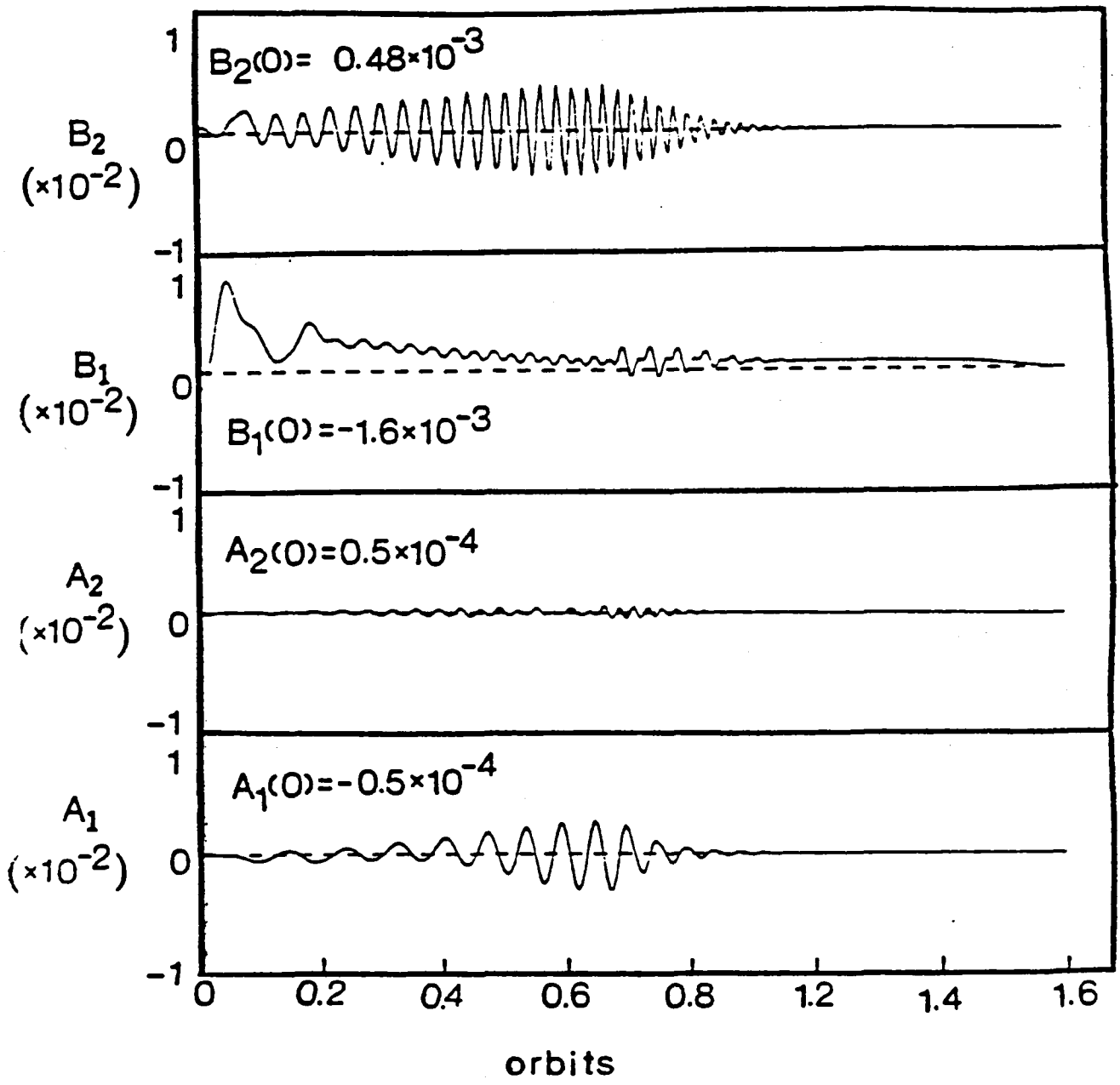

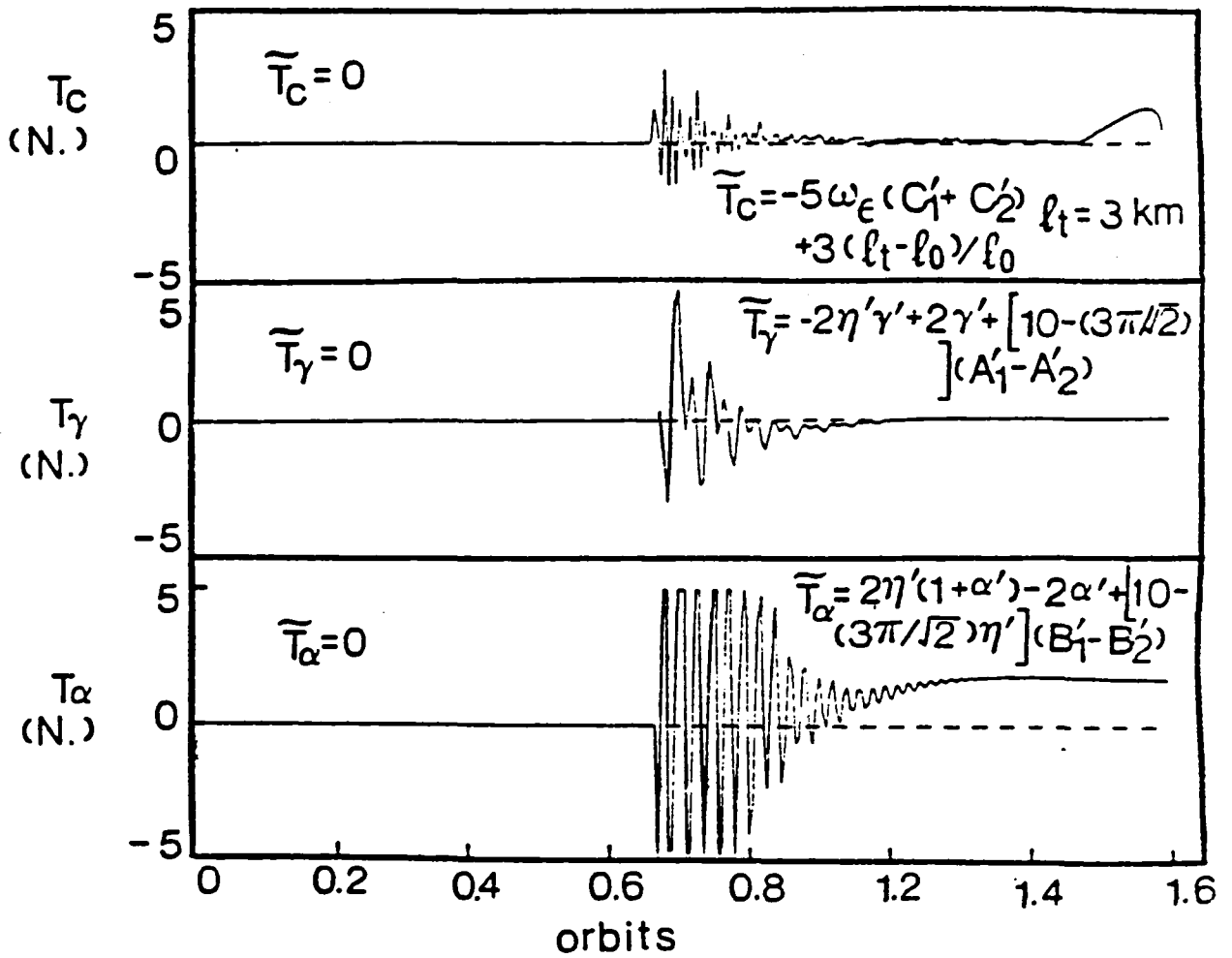

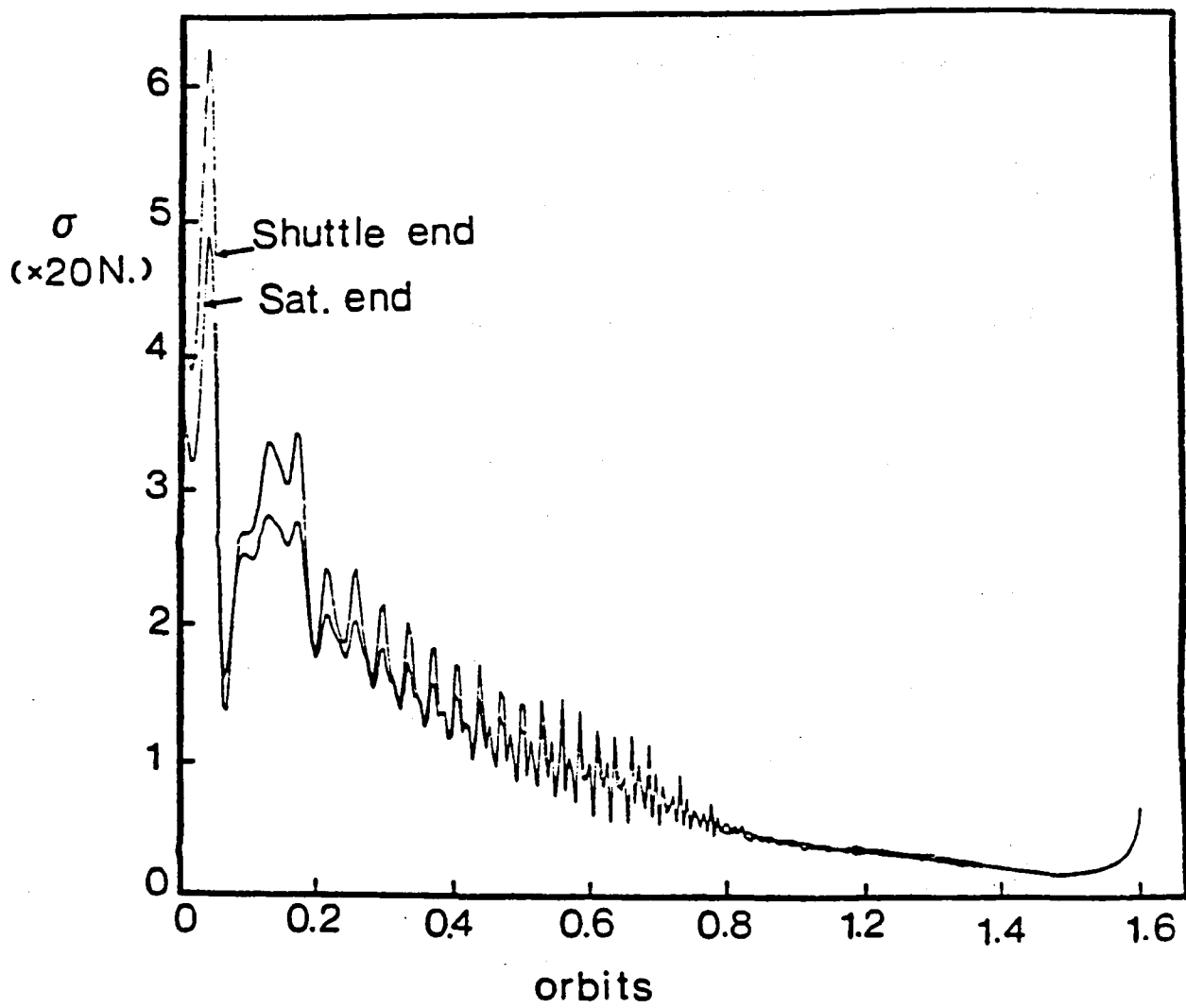

## SUMMARY OF RESULTS

- (i) The analysis suggests that a relatively simple point mass model can provide useful information concerning librational dynamics during deployment and retrieval of the Space Shuttle based tethered subsatellite system. The results show that a nonlinear tension control strategy of the form  $T = T(\ell, \ell', \phi'^2)$  in conjunction with a suitable choice of gains and realistic damping can lead to stable retrieval manoeuver with amplitudes in pitch and roll limited to acceptable values.
- (ii) Longitudinal and lateral vibrations of the tether are strongly coupled and can lead to the slackening of the tether.
- (iii) Tether vibrations can be controlled quite effectively by speeding up the retrieval at smaller tether length and/or using thrusters.

# COMMENTS

## GENERAL :

- IF ONE JUDGES FROM THE MATERIAL PRESENTED AT THIS CONFERENCE, THE PROGRESS MADE SINCE THE FIRST WORKSHOP APPEARS TO BE MINIMAL.
- TIME HAS COME TO GROW OUT OF THE INFANTILE PHASE OF ENUMERATING A WIDE VARIETY OF POSSIBLE TETHER APPLICATIONS AND SETTLE DOWN ON DETAILED STUDIES OF A FEW APPLICATIONS CONSISTENT WITH COMMITTED PROGRAMS AND AVAILABLE RESOURCES.

TO BE TAKEN SERIOUSLY BY ALLOCATORS OF FUNDS AND PROGRAM MANAGERS, THE WORKSHOP OF THIS NATURE SHOULD FOCUS ATTENTION, NOT DIFFUSE IT.

- WITH THE U. S. COMMITMENT TO A SPACE STATION, THE FUTURE OF THE TETHER CONCEPT HAS THE MAXIMUM PROMISE IN THAT AREA.. JUST AS THE SPACE STATION HAS A BASELINE CONFIGURATION, THIS WORKSHOP, OR THE FUTURE ONE, SHOULD IDENTIFY "BASELINE CONFIGURATIONS" FOR POSSIBLE TETHER PROJECTS. WHAT IS NEEDED IS A CONCERTED EFFORT IN A FEW WELL THOUGHTOUT PROJECTS RATHER THAN AN TORRENTIAL OUTPOUR OF CONCEPTS WHICH REMAIN CONCEPTS.

# COMMENTS

## SPECIFIC :

- SUCCESS OF MOST OF THE CONCEPTS TALKED ABOUT AT THIS WORKSHOP RELY ON THE FUNDAMENTAL REQUIREMENT OF DYNAMICS, STABILITY AND CONTROL OF TSS DURING DEPLOYMENT, STATIONKEEPING AND RETRIEVAL. MORE ATTENTION SHOULD BE DIRECTED TOWARDS NUMERICAL MODELING OF THE DYNAMICS AND CONTROL WITH PRE- TSS-1 EXPERIMENT(S) ABOARD THE ORBITER TO VALIDATE THE MODEL AND OBTAIN RELIABLE INFORMATION CONCERNING KEY INPUT PARAMETERS. IT SEEMS TO ME THAT THIS IS OF FUNDAMENTAL SIGNIFICANCE.
- FOCUS ATTENTION ON APPLICATIONS OF THE TETHER CONCEPT TO THE SPACE STATION "SPACE CRANE", MRMS BASED TETHERED SYSTEM FOR CONTROLLED GRAVITY EXPERIMENTS, AND DEPLOYMENT OF A PLATFORM AT A DESIRED DISTANCE ARE THE ONES WHICH SHOW PROMISE.

WE HAVE BEEN VISIONARIES TO DATE, AND RIGHTLY SO. THE TIME HAS COME TO BE PRAGMATIC.



TECHNOLOGY AND TEST PANEL

PRESENTATION VII

ELECTRODYNAMIC TETHER  
TECHNOLOGY CONSIDERATIONS

OCTOBER 15 - 17, 1985

JOSEPH C. KOLECKI  
LEWIS RESEARCH CENTER

## Electrodynamic Tether Operation

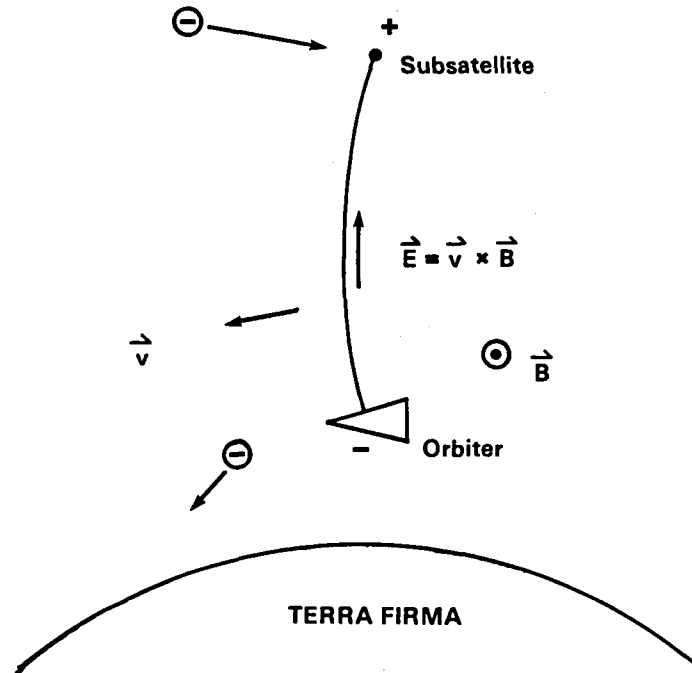

Figure 1. Electrodynamic Drag  $i\hat{l} \times B$ . Decrease in Orbiter Total Energy = Electric Energy in Electrodynamic Tether Circuit.

### Some Technology Areas

- o Plasma Contactors
  - Hollow Cathodes
  - Hollow Cathode Based Plasma Contactor
  - Electron Gun
  
- o Power Management and Conditioning
  - Interface Electronics Between End Of Tether And User
  - High Power Components
  - Switching
  - Storage

o Materials

- Any materials to be exposed in the LEO environment must be able to withstand a harsh atomic oxygen environment.

Status

o Plasma Contactors

- Study program which involves experimental and theoretical characterization of hollow cathodes and hollow cathode based plasma contactors

- Some early results: improved electron collection characteristics seem to occur with increased ion production efficiency.

For  $m_i/m_c \sim 300$ ,  $i_{i+} \sim 1/30 i_{e-}$ : ie., to collect x amps of electron current from the magnetoplasma, an ion current of  $\sim x/30$  amps is sufficient for an ion to electron mass ratio of 300.

- Advantage exists in the fact that a plasma contactor can "clamp" a spacecraft to within a few volts of plasma potential.

o Power Management and Conditioning

- There are no tether related activities in this area at present.
- Need to identify electrodynamic tether operational voltage and current ranges. This will be done in the System Studies presently underway.
- Need to identify state-of-the-art vs. advanced technology requirements.
- Need to begin the necessary component and circuit development programs early enough so as not to impact schedules later on.

o Materials

- Study program includes in-air and in-vacuo techniques for applying oxygen resistant, insulating coatings onto electrodynamic tethers.

### Summary

- o High power, i.e., multikilowatt electrodynamic tether systems need a variety of supporting technologies in order to be viable.
- o Study programs show that some of the necessary subsystems should prove workable.
- o The area of interface between the high voltage end of the electrodynamic tether and the user has not been addressed. This area is vital to the successful and safe operation of an electrodynamic tether system, and should begin to be addressed as operating ranges of multikilowatt systems are defined.

**TECHNOLOGY AND TEST PANEL**

**PRESENTATION VIII**

**COMLINK**

**PROPOSAL**

**FOR FUTURE MISSIONS  
OF TETHERED SATELLITE**

**OCTOBER 15 - 17, 1985**

**FILIPPO SCIARRINO**

**CONTRAVES ITALIANA**

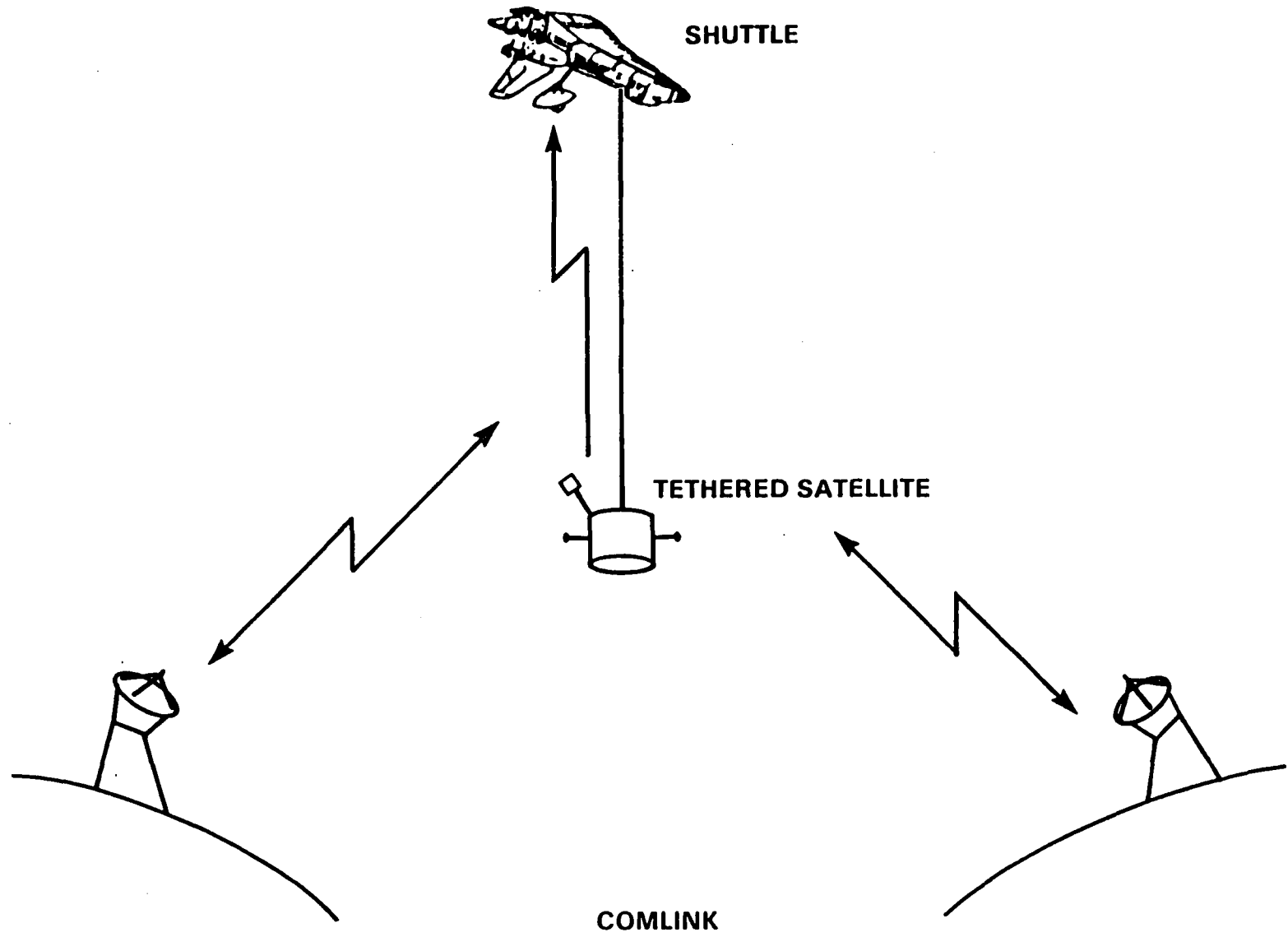

SHUTTLE

TETHERED SATELLITE

COMLINK

## **OBJECTIVES :**

- **TEST THE QUALITY OF THE COMMUNICATIONS LINKS BETWEEN SATELLITES**
- **INVESTIGATE THE INTERACTION BETWEEN THE VLF AND ELF WAVES, GENERATED BY THE CONDUCTING TETHER, AND THE SHF AND YHF ELECTROMAGNETIC WAVES, GENERATED BY THE 20/30 GHZ TRANSMITTER ON SATELLITE**
- **MEASUREMENT ON IONOSPHERIC ELECTRON DENSITY IRREGULARITIES BY MEANS OF PHASE-COHERENT RF TRANSMISSION BETWEEN THE TWO VEHICLES**
- **OBSERVE MOTION OF THE TETHERED SATELLITE, THROUGH THE DOPPLER LINK ESTABLISHED BETWEEN THE SHUTTLE AND THE SATELLITE**
- **TEST THE TECHNOLOGY AND DEPLOYMENT OF SPACE-BORN ANTENNAS OF LARGER DIAMETER**
- **DATA COLLECTION ON BOARD THE SHUTTLE**

**INSTRUMENTATION :**

**THE PAYLOAD WILL CONSIST OF A TEST ANTENNA AND RECEIVER, MOUNTED ON THE SHUTTLE PLATFORM AND A TRANSMITTER, PLACED ON THE SATELLITE, WHICH GENERATES MICROWAVE ELECTROMAGNETIC WAVES**



**32° RASSEGNA INTERNAZIONALE ELETTRONICA NUCLEARE ED AEROSPAZIALE**

---

Roma, 26 - 31 Marzo 1985

FILIPPO SCIARRINO

**A PAYLOAD FOR UTILIZATION OF SPACE PLATFORM IN THE  
FIELD OF COMMUNICATION AND EARTH OBSERVATION**



*Estratto dagli Atti del*

**25° CONVEGNO INTERNAZIONALE SULLO SPAZIO**

**26-27-28 Marzo 1985**

#### 4. PAYLOAD FOR COMMUNICATION LINK EXPERIMENT ON THE SHUTTLE-TETHERED SATELLITE

The Shuttle-Tethered Satellite System will utilize the Shuttle, in orbit to Earth at an altitude of approximately 200 Km in order to deploy, by means of a tether, a satellite up to a distance of 100 Km and hold it in a fixed position with respect to the Shuttle.

In this system, the long conducting tether with lengths of 10-100 Km would interact strongly with the ionosphere and magnetosphere. A number of space plasma perturbation experiments can be accomplished with the conducting tether and the instrumented electrodynamic satellite, deployed at a distance of 20 Km above the Shuttle. Operation of these electrodynamic experiments would require participation of Shuttle-Orbiter personnel and remote measurements from ground stations. But this measurement technique suffers the disadvantages of limited contact times and the disturbing effects due to the different orbital positions.

In this paper, this paper describes a payload which is suitable to create a measurement reference system for continued operation and with steady environmental parameters.

The proposed payload will perform an experiment on communication link (COMLINK) between the Shuttle and the tethered satellite.

##### 1 THE OBJECTIVES OF COMLINK

The objectives of the communication link experiment are as follows:

test the quality of the communication links between satellites in space;

investigate the interactions between the VLF and ELF waves, generated by the conducting tether, acting as antenna in near-toplasma, and the SHF and UHF electromagnetic waves, generated by the satellite;

make measurement on ionospheric electron density irregularities, by means of phase-coherent radiofrequency transmission between the two vehicles (Shuttle and sub-satellite);

observe motion of the tethered satellite, through the doppler link established between the Shuttle and sub-satellite;

test the technology and deployment of space borne antennas of larger diameter for communications application.

The Shuttle-Tethered Satellite Communication link is shown in Fig. 4.

##### 2 THE DESCRIPTION OF COMLINK PAYLOAD

The proposed payload consists of a test antenna, mounted on the Shuttle platform, and a transmitter, placed on the subsatellite which is wire suspended from the Shuttle and rotates around it in a space fixed orbital plan. The transmitter will establish plasma and electromagnetic waves, at a frequency above 10 GHz, varying with modulation techniques.

The type of antenna on the Shuttle platform, will be an offset fed parabolic reflector of about 3 mt. diameter.

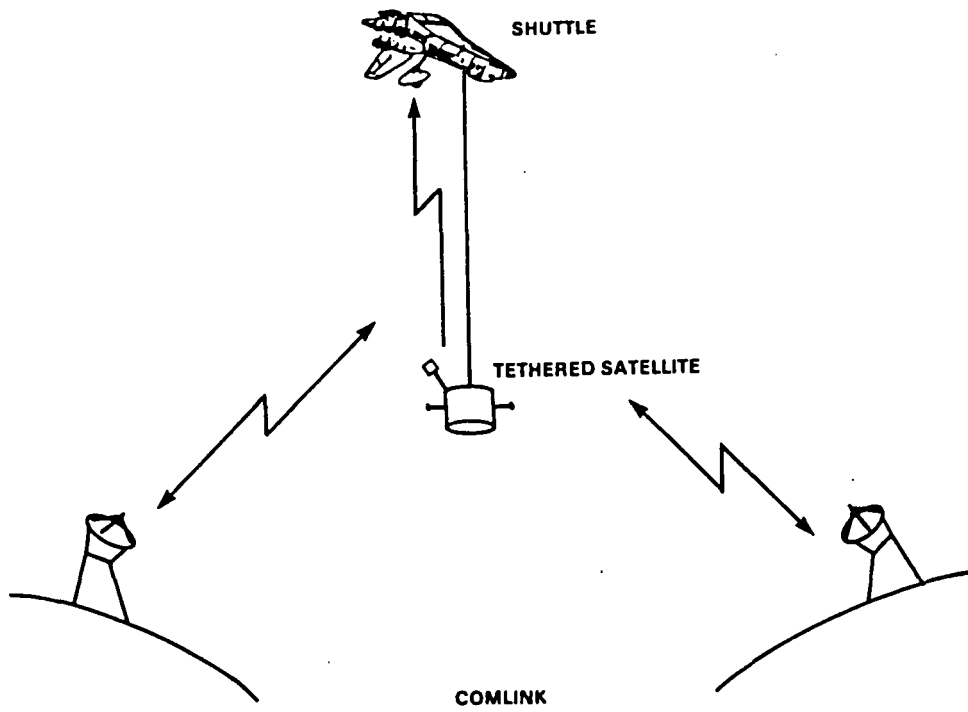

FIG. 4: SHUTTLE-TETHERED SATELLITE Communication link



**INPUT TO TECHNOLOGY AND TEST  
FROM PIERGIOVANNI MAGNANI  
(FIAR SP A - MILANE)**

● **TENSIOMETER :**

**IT IS DESIRABLE TO PERFORM A TECHNOLOGICAL / STATE OF  
THE ART SURVEY (OR ANALYSIS) IN ORDER TO ASSESS  
FEASIBILITY / AVAILABILITY**

**(SPACE QUALIFICATION IS NEEDED)**

● **'EQUATORIAL' ATTITUDE CONTROL OF TETHERED SATELLITE :**

**IN ORDER TO AVOID PLUME POLLUTION AROUND THE S/C, THE  
POSSIBILITY OF ATTITUDE STABILIZATION BY MEANS OF 'MAGNETIC  
DIPOLE' TECHNIQUE CAN BE INVESTIGATED**



**INPUT TO TECHNOLOGY AND TEST  
FROM GUALTIERO MARONE  
SOCIETA ITALIANA AVIONIOA (S.I.A.)**

**THE GROWING IN EXPERIMENT COMPLEXITY REQUIRE :**

- INCREMENT OF ENERGY AVAILABLE**
- INCREMENT OF COMMUNICATION BIT RATE**

**STUDIES ARE LOOKING AT THE POSSIBILITY TO USE THE TETHER AS :**

- POWER LINE TRANSPORTATION SYSTEM**
- COMMUNICATION LINK ( WITH OPTICAL FIBERS )**

**CRITICAL AREAS AND TECHNOLOGICAL ASPECTS THAT ARE TO BE  
INVESTIGATED ARE :**

**HIGH VOLTAGE POWER TRANSPORTATION**

- TETHER CONDUCTORS**
- TETHER INSULATORS**

**INPUT TO TECHNOLOGY AND TEST  
FROM GUALTIERO MARONE (con't)**

**POWER MANAGEMENT AND CONDITIONING**

- HIGH VOLTAGE POWER SUPPLY
- HIGH VOLTAGE ELECTRICAL INTERFACES

**COMMUNICATION WITH OPTICAL FIBERS**

- OPTICAL FIBERS CHARACTERISTICS (ELECTRICAL/THERMAL)
- OPTICAL TRANSMITTER/RECEIVER DEVICES

**TETHER CONFIGURATIONS**

- MECHANICAL / ELECTRICAL CONSTRAINTS
- TETHER MANUFACTURING ASPECTS



**SPACE STATION PANEL**



## SPACE STATION PANEL SUMMARY REPORT

### Table of Contents

1. Introduction and General Background
2. Tether Applications to Space Station
3. Space Station Benefits From Tether Applications
4. Flight Demonstrations
5. Required Technology Emphasis
6. Impact on Space Station Configuration and Operation
7. Space Station Tether Applications Priorities
8. Future Tether Applications
9. Conclusions and Recommendations

## 1. INTRODUCTION AND GENERAL BACKGROUND

It has not happened very often in space flight that a long dormant but radical new element of space flight is about to appear at the scene of space operations. The last several years have seen the advent and growth of a new avenue to space utilization: the tether. Well-organized and structured efforts of considerable magnitude have explored and defined the engineering and technological requirements of the use of tethers in space and have discovered their broad range of operational and economic benefits. The results of these efforts have produced a family of extremely promising candidate applications. The extensive efforts now in progress are gaining momentum and a series of flight demonstrations are being planned and can be expected to take place in a few years. This report is structured to cover the general and specific roles of tethers in space as they apply to NASA's planned Space Station.

The evolution of the tether concept into an engineering program is phased with the growth of the Space Station program. In such a way there is the possibility to have the tether applications compatible with the Space Station configuration and/or to be aware of what kind of tether related operations have to be eliminated due to evident conflict with respect to the Space Station requirements. Specific studies - started even before the Space Station program became officially approved - have been very useful in terms of a fast and efficient evaluation of what and how the tether concept could be of benefit to the Space Station program. In addition, the results of system investigation/dynamic studies/simulations and, later on, flight demonstration through the first TSS mission are major drivers for tether concept application, particularly to the Space Station. The success of early flight demonstrations will officially open a new door for the tether space activity, and the Space Station area will not be second to any other kind of application. Many attractive ideas have been generated so far on tether concept applications to Space Station. Therefore we are now in a position to start filtering out what, at present, is considered feasible and at the same time useful in terms of science, technology, and operation. The major final goal is to have tether concept application in conjunction with the IOC-phase Space Station. In that regard, after having assured/verified the compatibility

with the Space Station configuration, the associated benefits should automatically facilitate any final decision. It is anticipated that total or partial demonstration is required in order to complete the technical and safety scenario, considering also the technology and operation derived from the new proposed solutions. The major hope is that the impacts on the Space Station configuration can be easily accommodated. That can more probably become a reality if the specific issues are approached as soon as possible and in the most proper way.

## 2. TETHER APPLICATIONS TO SPACE STATION

### Fundamental Items

- o Specific Tether Applications
- o Issues and Concerns
- o Priorities
- o Flight Demonstrations
- o Application Priorities
- o Conclusions and Recommendations

Space Station Facilities and Capabilities (IOC era) - priorities will vary with program changes

- Tethered Orbiter Deployment (with OMS Propellant Scavenging)
- Tethered Launch of OTV
- IOC Tethered Space Station C.G. Vernier (C.G. Management)
- IOC Electrodynamic Reserve Power
- IOC Electrodynamic Thrust (Drag Make-up)
- IOC Tethered Platform (short mission)
- IOC "Zero G" Laboratory (soft suspension)
- IOC Tethered Elevator (soft suspension)
- Remote Docking of Orbiter
- IOC Deboosting Small Cargo Modules
- IOC Electrodynamic Tether (Research)
- Tethered Propellant Depot and Fuel Transfer
- Tethered Antenna Farm
- IOC Multi-Probe (beads on string)(short mission)
- Remote Wake Shield

### 3. SPACE STATION BENEFITS FROM TETHER APPLICATIONS

- o "Zero G" Laboratory
- o Reserve Power Generator
- o Halve Orbiter Deboost Propellant Requirement Through Tether Assisted Deboost
- o C.G. Management
- o Waste Disposal by Tether
- o Quick Sample Return
- o Eliminate OMV Propellant Tanker
  - Scavenge OMS Propellant During Tether Assisted Deorbit of Orbiter
- o Eliminate Instrument Contamination
  - Tethered Instrument Modules
- o Transfer of Hard Point For MRMS/Tether Operations From Orbiter to Space Station
- o Platform Useful to Settle Materials Before Processing
- o Periodic Supply of OMS Bi-Propellant for OMV and Platforms
- o Reduction of Stationkeeping Propellant Deliveries
- o Reduced Requirements for De-Orbit Logistic Through Tethered Waste Disposal
- o Tether Assisted Attitude Control (Contamination Reduction)
- o Combination of Center Mass Control Antenna Farm, Tether Assisted Attitude Control and Collision Avoidance Maneuver Capability by a Specific Tether System (Deployed Mass)
- o Maintenance of Constant Altitude Capability for Specific Earth Observations
- o Utilization of Power Surge Caused by Orbiter Deployment for Material Melting Coincident with the Generated G-Field for Settling the Melt
- o Tether is the Only Way to Maintain and Exercise Control Over Various Variable Gravity Fields ( $10^{-2}$  to  $10^{-5}$ ) and Thus Responding to an Urgent Scientific Requirement (Evolution of Gravity Maps)

#### 4. FLIGHT DEMONSTRATIONS

- o Tether Shape Measurements
- o KITE/Scaled-SATP
- o Disposable Tether System Verification
- o Fluid Transfer Experiments Under Various DC and AC Accelerations
- o Experiments Already Made to be Repeated Under Different G-Levels
- o Needed: Tether Mediated Rendezvous Demonstration
  - P/L Deployment and Subsequent Retrieval
- o Elevator/Crawler Demonstration (Gravity Field Mapping and Perturbation Determinations)
- o Verifying and Refining Dynamic Models in Flight Demos
- o Attachment/Detachment of Crawler to Tether
  - RMS
  - EVA
- o Drive Mechanism for Crawler
  - Electromechanical
  - Electromagnetic
- o Variable/Minimum Gravity
  - Accuracy
  - Duration
- o Attitude Control
  - Rotation About Tether
  - Stabilization for Instrument Pointing
- o Power Generation/Dissipation
- o C.G. Location and Maintenance for P/L's and Experiments Attached to Crawler
- o Degree of Automation/Robotics
- o Internal Suspension System



## 5. REQUIRED TECHNOLOGY EMPHASIS

- o Tether Technology
  - Materials and Configurations
  - Maintainability
  - Tension Control
  - Damping Characteristics
  - Environmental Compatibility
- o Deployer Technology
  - Motor/Generator
  - Motor/Reel Coupling
- o Electrodynamic Technology
  - Plasma Contactors
  - High Voltage Insulation
  - High Voltage Conversion and Control
  - Specific Tether Construction
  - Environmental Compatibility
- o Engineering Instrumentation
- o Science Instrumentation
- o Critical Systems Hardware (Mechanisms, Devices, etc.)

## 6. IMPACT ON SPACE STATION CONFIGURATION AND OPERATION

### Issues and Concerns

- o Space Station Collision Avoidance Maneuvers
  - 20 km Displacement in any Direction
  - Up to 24 Hours Notice
- o Space Station Quiet Periods Up to 30 Consecutive Days ( $10^{-6}$  g)
- o Proximity Operations
- o Debris Collision Probability of Long Duration Platform Tether
- o Platform May Have to be Retrievable Without Tether
- o Manned Zero G Laboratory
- o High G Levels During Orbiter and OTV Deployment ( $10^{-2}$  g)
- o Zero G Tether Module Should Also Serve as Transportation to Platform
- o On-Board Zero-G Laboratory Quite Massive ( 25,000 kg)
- o Platform May Have to Have An Autonomous Power System because Electrical Tethers Introduce Perturbations
- o Energy Supply and Dissipation for Elevator
- o Tethered Fuel Facility Has Severe Operational Problems
- o Thrust Generation Due to Punctured Tank Cannot Be Handled
- o Requirement to Support 20,000 N Longitudinal Force By Space Station Structure

## 7. SPACE STATION TETHER APPLICATIONS PRIORITIES

- Criteria:
- o IOC Space Station Applicability
  - o Improved Operational Capability
  - o Solution to Space Station Problems

Priorities:

- o Variable Gravity Laboratory (Controllable)
- o Deboosting Small Cargo Modules
- o Electrodynamic Reserve Power
- o Tether Space Station C.G. Control (Vernier)
- o Tethered Orbiter Deboost
- o Tethered Remote Docking of Orbiter
- o Tethered Science/Applications Platform

## 8. FUTURE TETHER APPLICATIONS

### A. Other Potential Tether Facilities in Earth Orbit

A-1 Electrodynamic OMV and Debris Collector

A-2 Spinning Facility for Simulating Lunar and Martian Gravity

A-3 Spinning Transport Node near GEO

### B. Potential Lunar, Martian, and Asteroidal Tether Facilities

B-1 Surface-Based Slings (on the Moon, Phobos, and Asteroids)(see Figure 1)

B-2 Transport Node in Low Lunar Orbit (See Figure 2)

B-3 Space Station in Low Mars Orbit

Lunar-Surface-Based Sling

- o "Minimal mass-driver" = fishing reel on Apollo 11
- o Launcher for 10 kg payloads should fit in 1 shuttle
  - 300 m tether @ 54 rpm imposes <1000 g on payloads;
  - bearing loads are similar to those on a train axle;
  - 1 launch/5 min. uses <100 kW, boosts 1,000 tons/yr
- o An orbiting tether facility collects launched payloads
- o Collision and debris generation may be a major problem

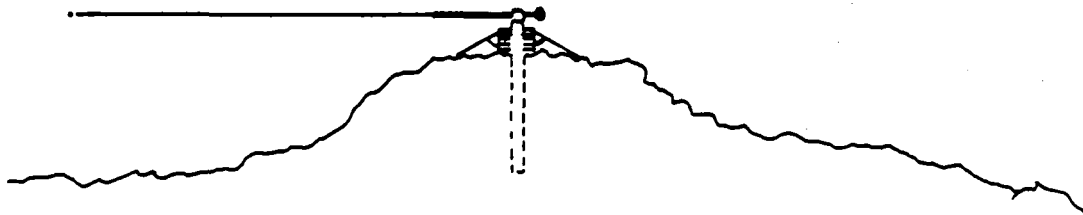

Figure 1

**EARTH-MOON TETHER-TRANSPORT INFRASTRUCTURE**

**AFV (AEROBRAKING FERRY VEHICLE)**

1. AEROBRAKES AND IS CAPTURED BY TAMPS
2. IS UNLOADED & REFUELED
3. IS TETHER/ROCKET BOOSTED TO MOON
4. IS CAPTURED & LOADED BY LOTS
5. IS SLUNG BACK TOWARDS EARTH BY LOTS

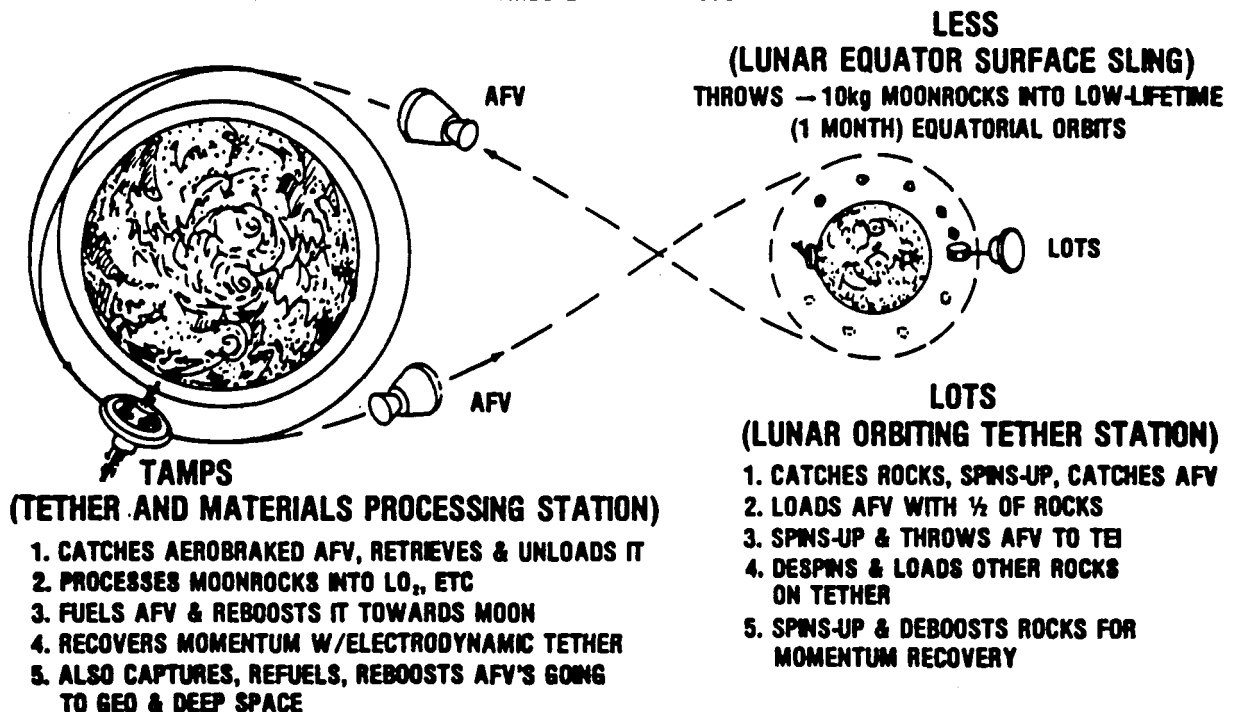

Figure 2

9. CONCLUSIONS AND RECOMMENDATIONS

- o Tethers can uniquely provide for the accomplishment of the Space Station basic objectives
- o Tether applications have solutions to significant Space Station problems
- o Tether applications can greatly improve Space Station capabilities and operational efficiencies
- o The complex interactions and interrelations of the many parameters of tether dynamics require improved understanding and an increased level of activity
- o Tether applications should be incorporated into Space Station design for use at IOC

TETHERED ELEVATOR AND PLATFORMS AS SPACE STATION FACILITIES

SYSTEM STUDIES AND DEMONSTRATIVE EXPERIMENTS

PANEL PRESENTATION

"2ND APPLICATIONS OF TETHERS IN SPACE WORKSHOP"

VENICE, ITALY, OCTOBER 15-17, 1985

413

## SCIENCE AND APPLICATIONS TETHERED PLATFORM

### WHAT TO DO IT

- SEVERAL PROMISING APPLICATIONS: KEY CONCEPTS
  - o MICROGRAVITY SCIENCE IN A CONTROLLED-G ENVIRONMENT
  - o HIGHLY STABLE POINTING PLATFORM FOR ASTRONOMY AND EARTH SCIENCE
  - o TRANSPORTATION TO AND FROM THE PLATFORM
  - o ACCESSIBILITY/UNCONTAMINATED ENVIRONMENT

### HOW TO DO IT

- AUTONOMY VS. SHARING OF SPACE STATION RESOURCES
- TETHER TECHNOLOGY: POWER LINE, COMMUNICATIONS LINK
- SPACE ELEVATOR AS MICROGRAVITY FACILITY
- POINTING PLATFORM BY MOVABLE ATTACHMENT POINT CONTROL
- SPACE ELEVATOR AS TRANSPORTATION FACILITY

### WHY DO IT

- COMPARISON WITH CONVENTIONAL SOLUTIONS.



## KEY CONCEPT - 1 - THE SPACE ELEVATOR

THE SPACE ELEVATOR IS AN ELEMENT ABLE TO MOVE ALONG THE TETHER IN A CONTROLLED WAY. THE MOST INTRIGUING TECHNOLOGICAL FEATURE IS THE ACTUATOR MECHANISM, DEVOTED TO CONTROL ELEVATOR MOTION ALONG THE TETHER. SEVERAL IDEAS ARE UNDER STUDY IN THE FOLLOWING TWO BROAD CLASSES:

- o MECHANICAL DEVICES (FRICTION INTERACTION WITH TETHER)
- o ELECTROMAGNETIC DEVICES (MAGNETIC INTERACTION WITH TETHER)

THE SPACE ELEVATOR MAY BE USED AS SPACE STATION FACILITY IN A TWO FOLD WAY.

- o MICROGRAVITY FACILITY TO TAP DIFFERENT LEVELS OF RESIDUAL GRAVITY
- o TRANSPORTATION FACILITY TO EASY ACCESS TETHERED PLATFORMS;

## THE MICROGRAVITY SPACE ELEVATOR

THE SPACE ELEVATOR AS MICROGRAVITY FACILITY SEEMS TO BE THE MOST PROMISING CONCEPT. IN FACT THE MICROGRAVITY SCIENTISTS HAVE CONSIDERED THIS CONCEPT VERY INTRIGUING BECAUSE OF THE UNIQUE CAPABILITIES THAT IT ALLOWS.

TO EVALUATE THE PERFORMANCE OF A MICROGRAVITY FACILITY TWO MAIN FEATURES HAVE TO BE CONSIDERED:

- o THE MICROGRAVITY ENVIRONMENT
- o THE RESOURCES/LOGISTIC SUPPORT

UP TO NOW AN UNMANNED FREE-FLYING PLATFORM OFFERS THE BEST MICROGRAVITY ENVIRONMENT, BUT A SPACE STATION MAY OFFER THE BEST RESOURCES/LOGISTIC SUPPORT.

WHAT IS THE ELEVATOR CONCEPT ROLE?

## THE MICROGRAVITY SPACE ELEVATOR (CONT'D)

### THE MICROGRAVITY ENVIRONMENT

THE ORDER OF MAGNITUDE OF THE MINIMUM GRAVITY ACCELERATION ATTAINABLE BY ELEVATOR CLOSE TO THE CENTER OF ORBIT OF A TETHERED SYSTEM HAS BEEN FOUND  $10^{-8}$  G. THIS RESULT NEEDS FURTHER ANALYSIS, MAINLY FOR THE DISTURBANCES COMING FROM THE SPACE STATION. HOWEVER THIS RESULT IS COMPARABLE WITH MINIMUM G-LEVEL BY FREE-FLYING PLATFORM.

TETHERED ELEVATORS ALLOW A NEW MICROGRAVITY ENVIRONMENT. THE NEW MAIN CHARACTERISTICS OF ELEVATOR MICROGRAVITY ENVIRONMENT ARE:

- o WIDE, CONTINUOUS RANGE OF G-VALUES OBTAINABLE
- o KNOWN G-DIRECTION
- o G-QUALITY HIGHER THAN CLASSICAL ONE
- o CONTROLLABILITY VS TIME BOTH IN INTENSITY AND DIRECTION

THE ADDITION OF THE TIME DIMENSION APPEARS TO BE THE MOST PROMISING FEATURE OFFERED BY ELEVATOR.

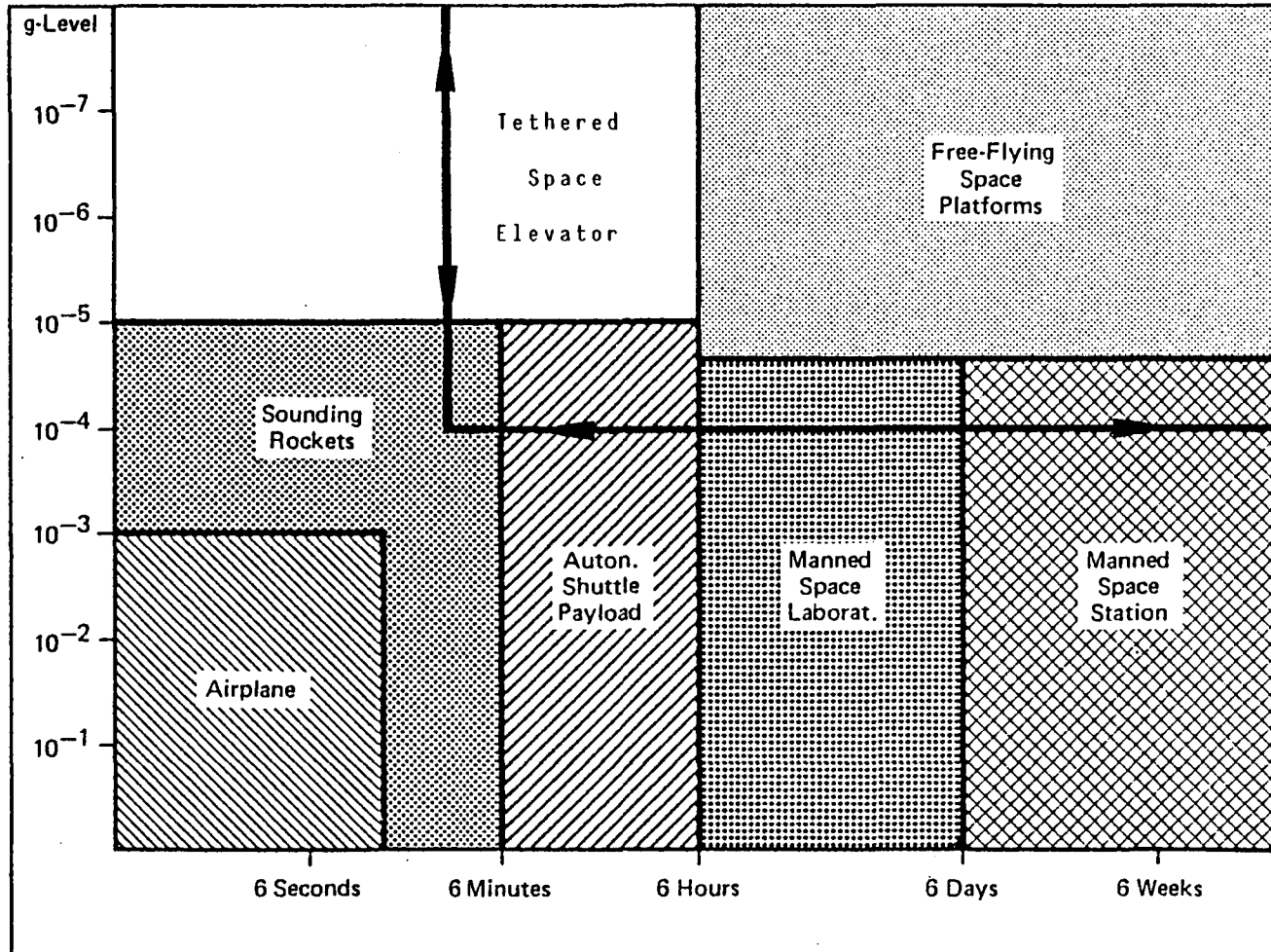

*Duration and level of reduced Microgravity*

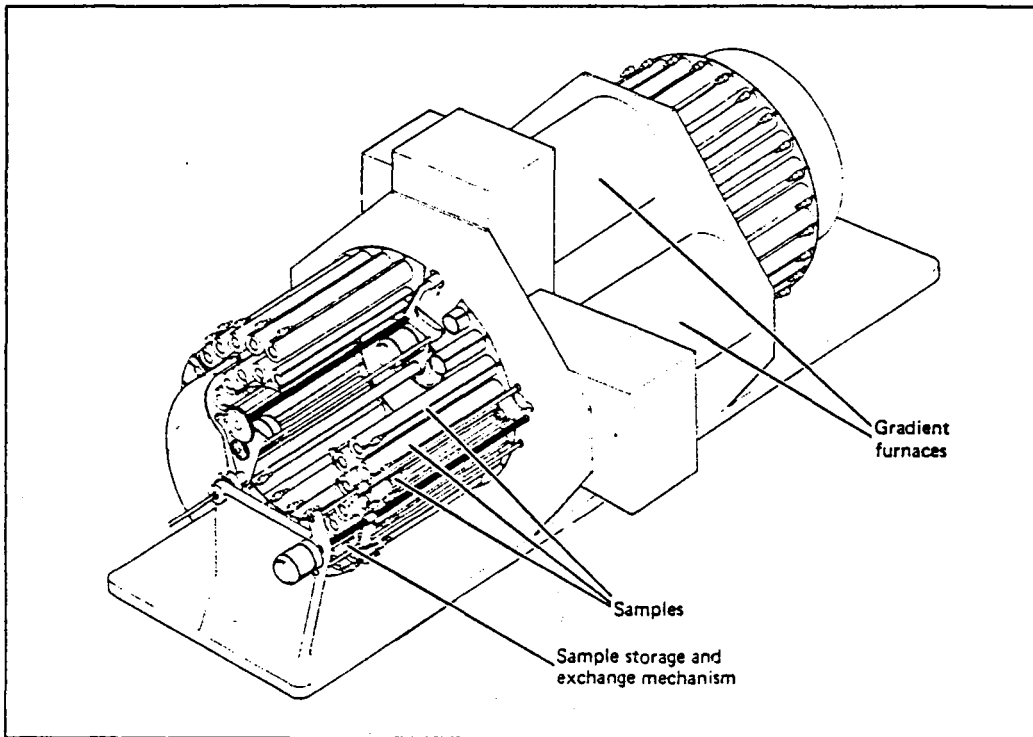

Example of a typical metallurgical candidate payload

Microgravity Facility Micro-G Environment	Free - Flying Space Platforms	Tethered Space Elevator
G-value	Single Point	Variable
Direction	Unknown	Known
Controllability Vs Time	NO	YES both in intensity and direction
G-Noise Control	NO	YES
G-Quality	Medium	High

Microgravity Environment Comparison

## THE MICROGRAVITY SPACE ELEVATOR (CONT'D)

### RESOURCES/LOGISTIC SUPPORT

THE MICROGRAVITY ELEVATOR WILL OPERATE NEAR THE SPACE STATION.  
A PROPOSED SYSTEM CONFIGURATION IS CONSTITUTED BY S/S, 10 KM TETHER,  
A SHUTTLE EXTERNAL TANK AS A BALLAST, AND THE ELEVATOR.  
IN THIS CONFIGURATION, THE ELEVATOR MOVES ALONG 1 KM OF TETHER FROM  
THE STATION; IT IS POSSIBLE WITH A SHORT AND SLACK CABLE TO USE SPACE  
STATION RESOURCES, INCLUDING:

- o ELECTRICAL POWER BY POWER LINE TRANSMISSION
- o DATA, CONTROL AND MONITORING BY OPTICAL FIBRE LINK

MOREOVER, THE ELEVATOR CAN BE RETRIEVED AT ANY TIME PROVIDING EASY AC  
CESS TO REPAIR MALFUNCTIONS AND EXCHANGE EXPERIMENTS, SAMPLES, ETC.

THE ELEVATOR IS ABLE TO FULLY UTILIZE THE SPACE STATION SUPPORT AND  
TO AVOID THE S/S CONTAMINATED ENVIRONMENT FROM A MICRO-G POINT OF  
VIEW BY TETHER MEDIATION.

THE MICROGRAVITY ELEVATOR

CONCEPT

SG-PB-AI-018

- 9 -

15-17/10/85

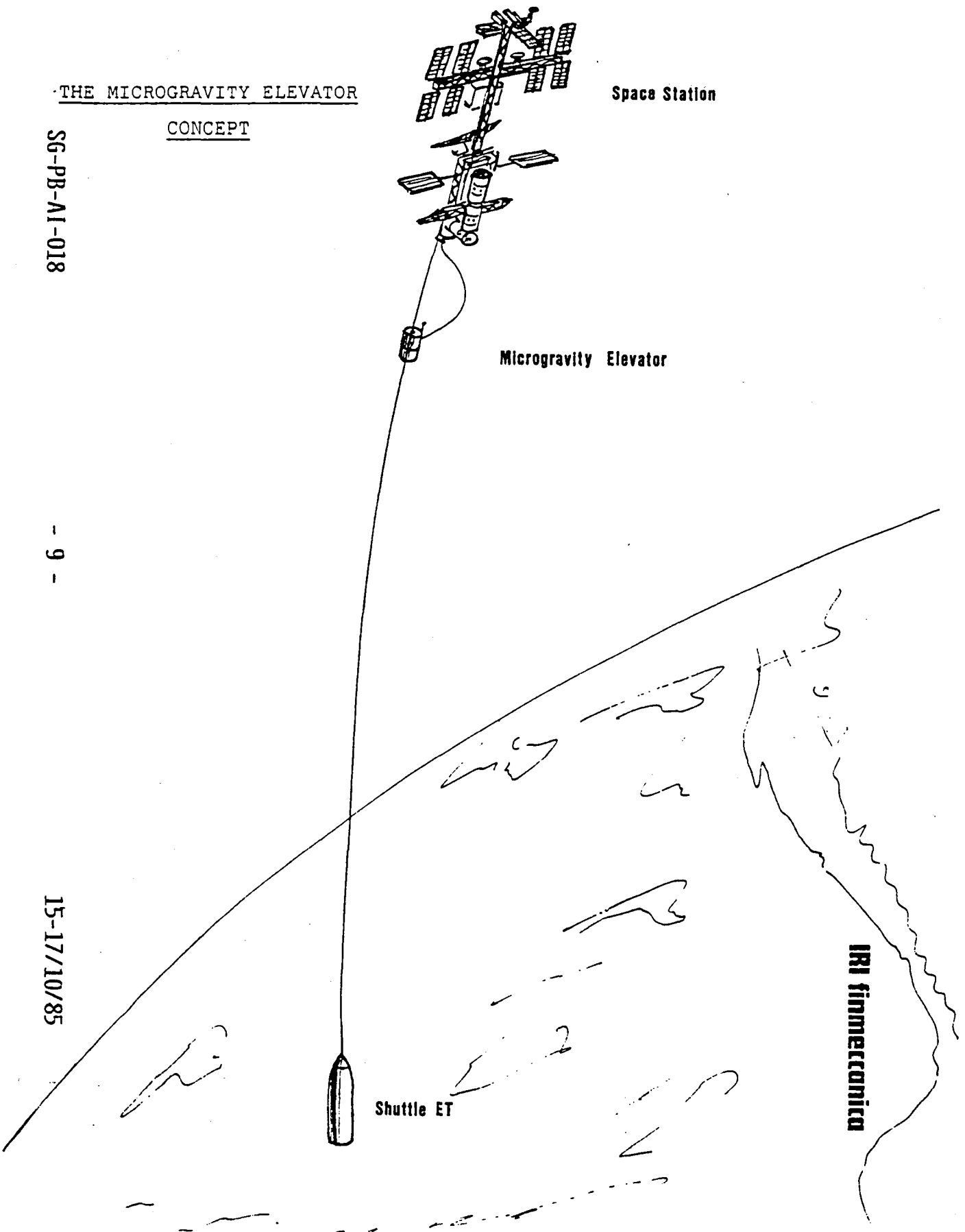

Space Station

Microgravity Elevator

Shuttle ET

IRI finmeccanica

## THE TRANSPORTATION SPACE ELEVATOR

THE IDEA OF USING LARGE TETHERED PLATFORMS CONNECTED TO THE SPACE STATION BY POWER LINE AND COMMUNICATIONS LINK (VIA TETHER TECHNOLOGY) MAKES UNREALISTIC FREQUENT OPERATIONS OF DEPLOYMENT AND RETRIEVAL.

ON THE OTHER HAND, THE PLATFORM MAY REQUIRE EASY ACCESS FOR MAINTENANCE, SUPPLY OF CONSUMABLES, MODULE AND EXPERIMENT EXCHANGE.

THE ELEVATOR, AS TRANSPORTATION FACILITY ABLE TO MOVE ALONG THE TETHER TO AND FROM THE PLATFORM, MAY BE THE TOOL FOR TETHERED PLATFORM EVOLUTION.

SEVERAL TECHNOLOGICAL PROBLEMS HAVE TO BE ANALYSED TO VALIDATE THE FEASIBILITY OF THIS IDEA, BUT THE FIRST STEP IS TO EVALUATE THE DYNAMICS OF THE SYSTEM DURING THE ELEVATOR MOTION.



## THE TRANSPORTATION SPACE ELEVATOR (CONT'D)

### DYNAMICS MODELS

TWO DIFFERENT MODELS WERE DEVELOPED TO SIMULATE THE SPACE ELEVATOR DY  
NAMICS:

- 5 D.O.F. MODEL TO SIMULATE SYSTEM C.G., SPACE STATION, PLATFORM AND ELEVATOR MOTION.

ASSUMPTIONS: o STATION, ELEVATOR AND PLATFORM ARE POINT MASSES  
o TETHER ELASTICITY IS NEGLECTED  
o ONLY IN-PLANE MOTION IS MODELLED

- CONTINUOUS MODEL TO SIMULATE TETHER LATERAL AND LONGITUDINAL VIBRA-  
TIONS ORIGINATED BY ELEVATOR MOTION.

ASSUMPTIONS: o ELASTIC AND ORBITAL EFFECTS ONLY WEAKLY COUPLED  
o TENSION CONSTANT ALONG THE TETHER  
o ELEVATOR MOTION SIMULATED AS AN EXTERNAL FORCE  
o ELEVATOR TRAVELS WITH CONSTANT VELOCITY.

## THE TRANSPORTATION SPACE ELEVATOR (CONT'D)

### SYSTEM DYNAMICS

#### SYSTEM PARAMETERS:

SPACE STATION MASS	= $10^6$ KG	ELEVATOR MASS	= $5 \cdot 10^3$ KG
PLATFORM MASS	= $5 \cdot 10^4$ KG	TETHER LENGTH	= 10 KM
INITIAL ORBIT	= CIRCULAR, 500 KM HEIGHT		

ELEVATOR FREE MOTION WAS INVESTIGATED BY IMPARTING THE NECESSARY IMPULSE TO REACH THE C.O.G. FROM THE SPACE STATION.

SYSTEM DYNAMICAL BEHAVIOUR SHOWS THAT VELOCITY CONTROL IS NEEDED.

CONTROLLED TRANSFER WAS ANALYSED FOR CONSTANT TRANSFER VELOCITY. FOR SMALL VELOCITIES, MOTION IS STABLE AND TETHER DEFLECTION IS BOUNDED. AS VELOCITY INCREASES PERTURBING OSCILLATIONS ARE EXCITED.

ELEVATOR - DYNAMICS OF FREE MOTION

425

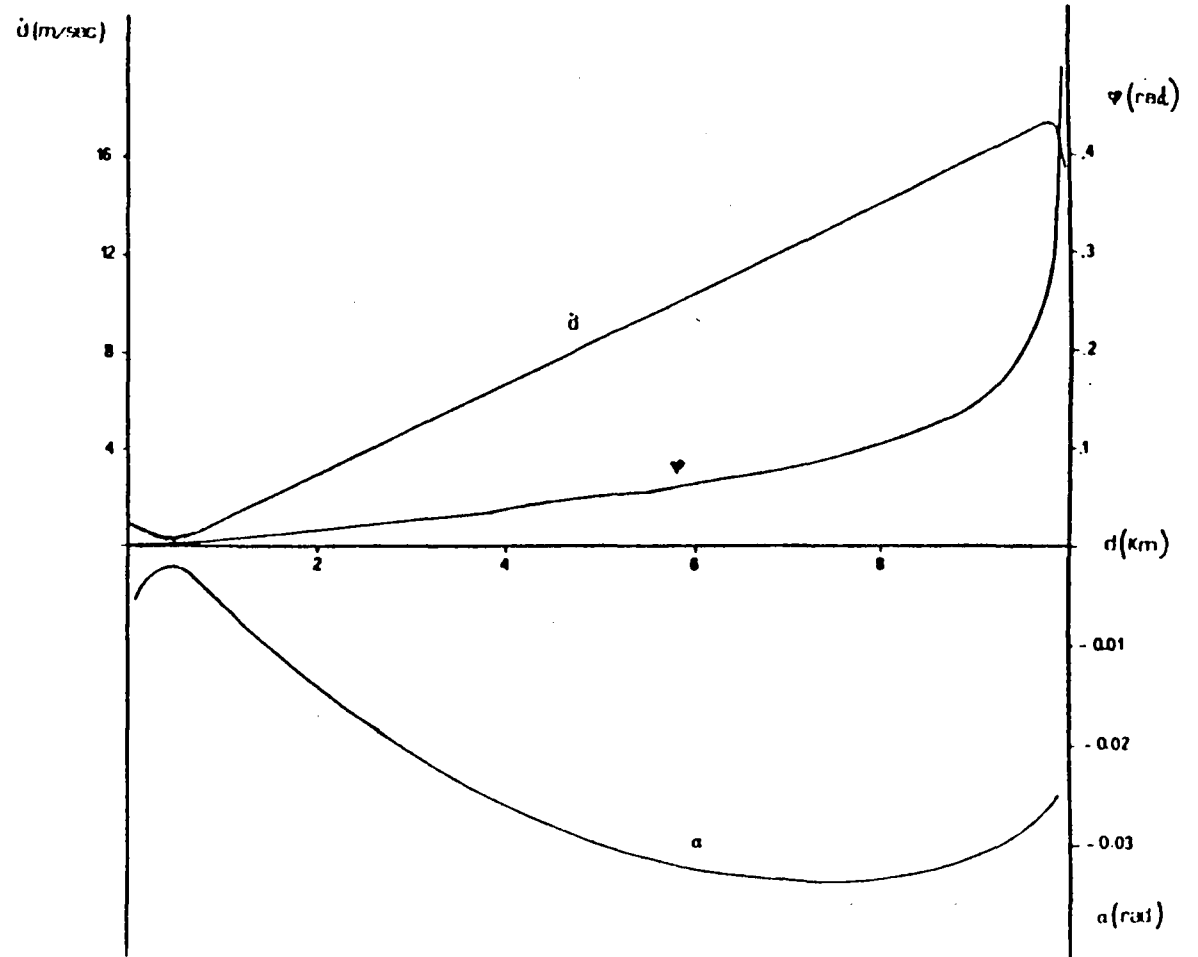
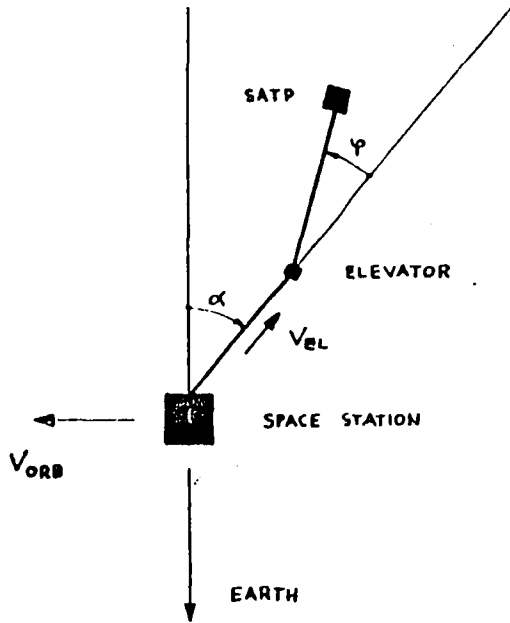

ELEVATOR - DYNAMICS OF CONTROLLED MOTION

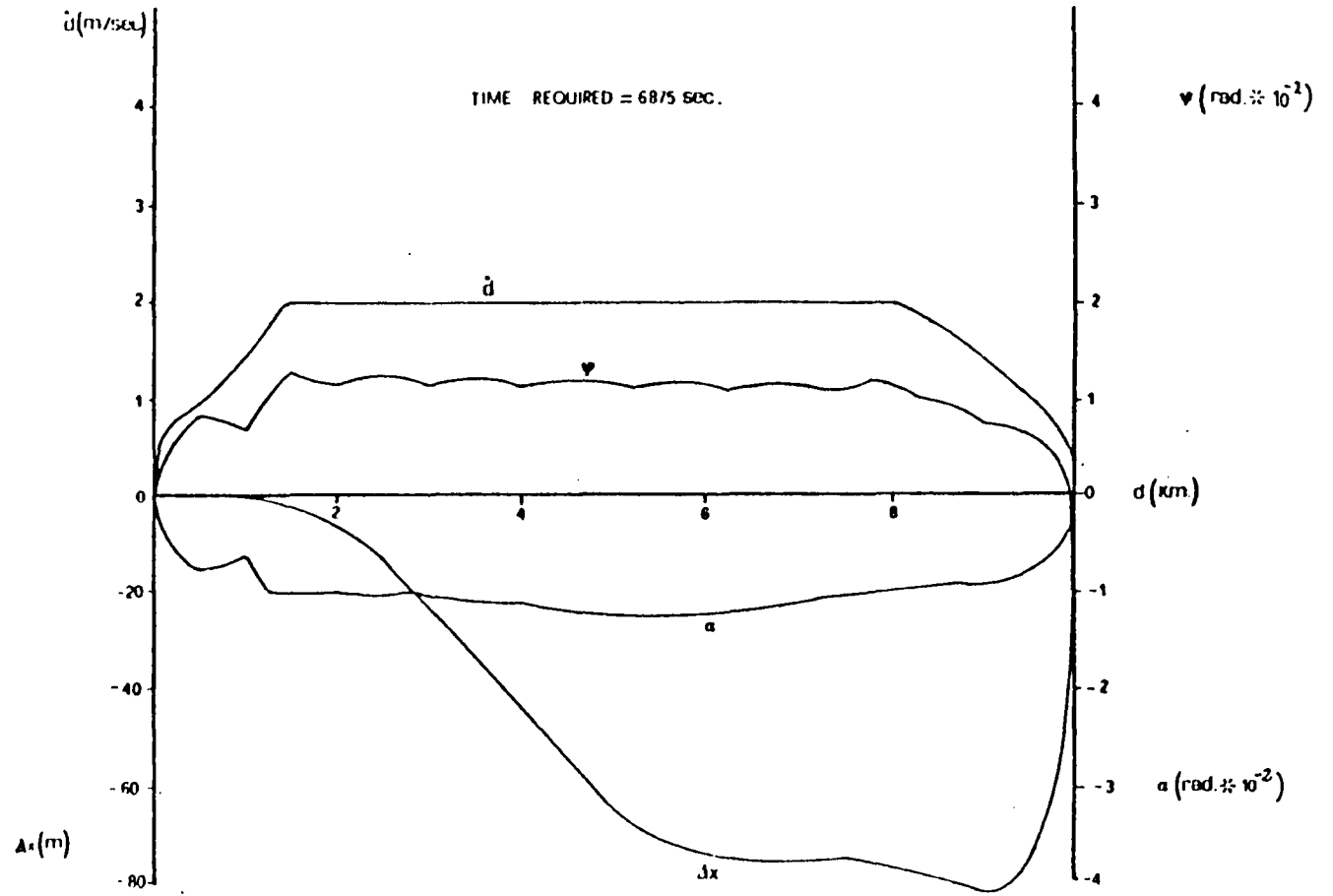
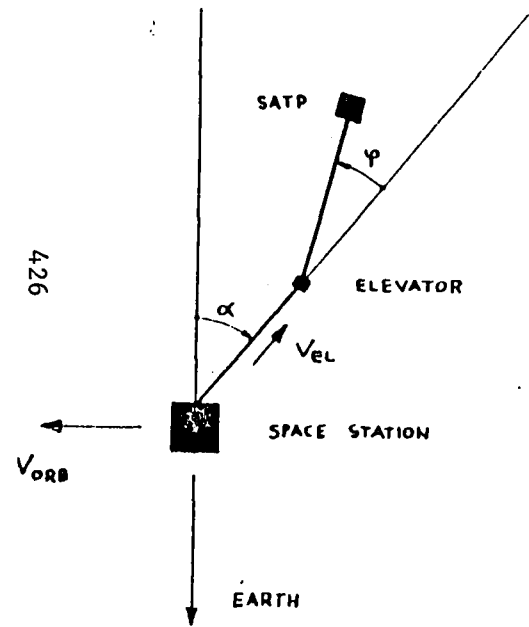

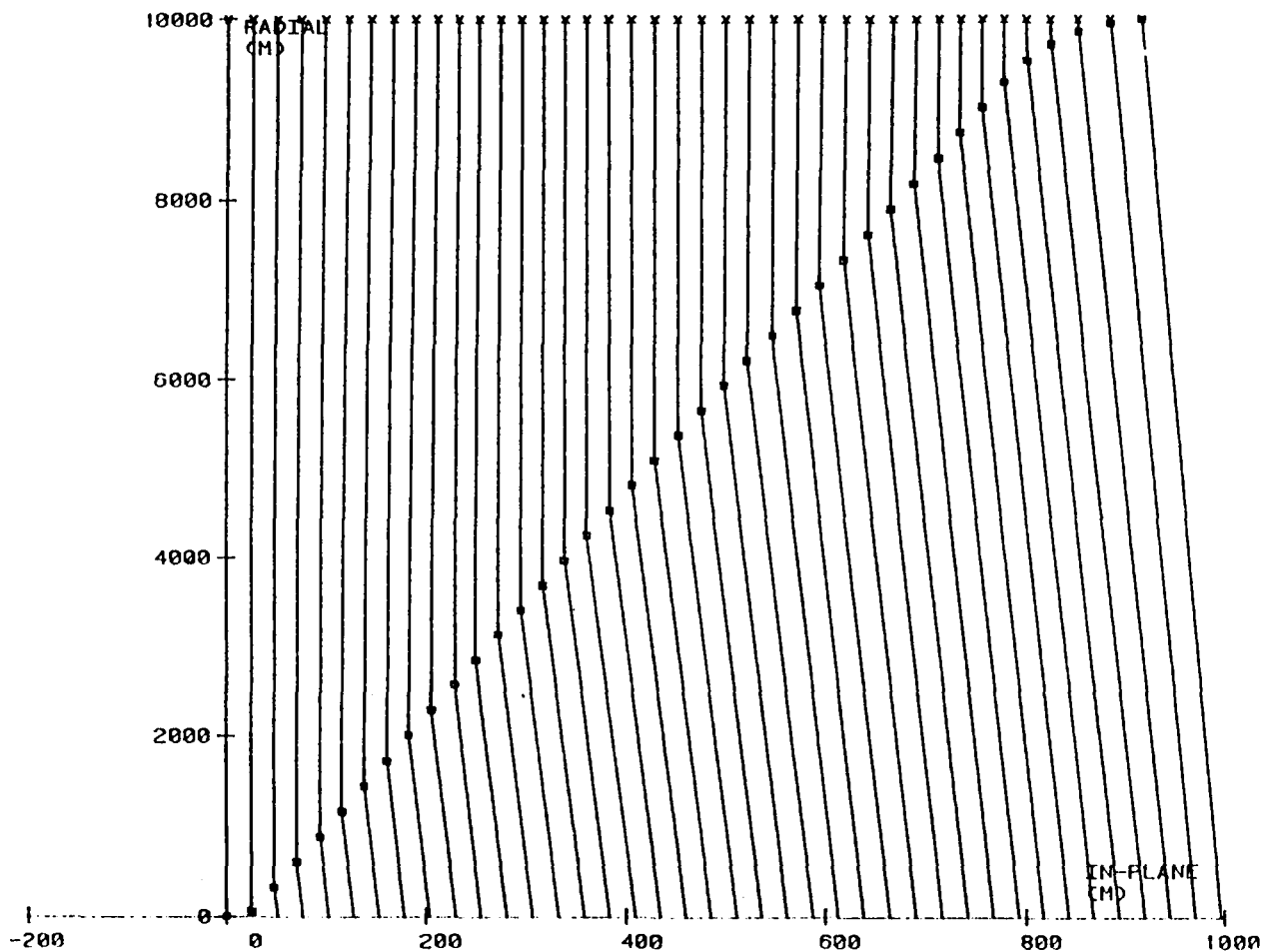

IN-PLANE-RADIAL DYNAMIC VIEW

427

## THE TRANSPORTATION SPACE ELEVATOR (CONT'D)

### TETHER LATERAL VIBRATIONS

#### SYSTEM PARAMETERS:

PLATFORM MASS =  $5 \cdot 10^4$  KG

ELEVATOR MASS =  $5 \cdot 10^3$  KG

TETHER LENGTH = 10 KM

ORBIT = CIRCULAR, 500 KM HEIGHT

TETHER LATERAL VIBRATIONS ARE INDUCED BY THE CORIOLIS FORCE ACTING ON THE ELEVATOR AS IT MOVES ALONG THE TETHER.

THE ELEVATOR WAS ASSUMED TO TRAVEL WITH 2 M/S CONSTANT VELOCITY, THE FIRST TWENTY MODES WERE INCLUDED AND THE TETHER DAMPING WAS NEGLECTED.

THE VIEWING OF THE VIBRATIONS OF SELECTED POINTS ALONG THE TETHER SHOWS THAT THE SMALLER THE DISTANCE FROM THE S/S THE GREATER THE EFFECT OF HIGHER MODES.

TETHER SHAPE AS A FUNCTION OF TIME IS TWO QUITE LINEAR SECTIONS WITH SLOPE CHANGE AT ELEVATOR POSITION.

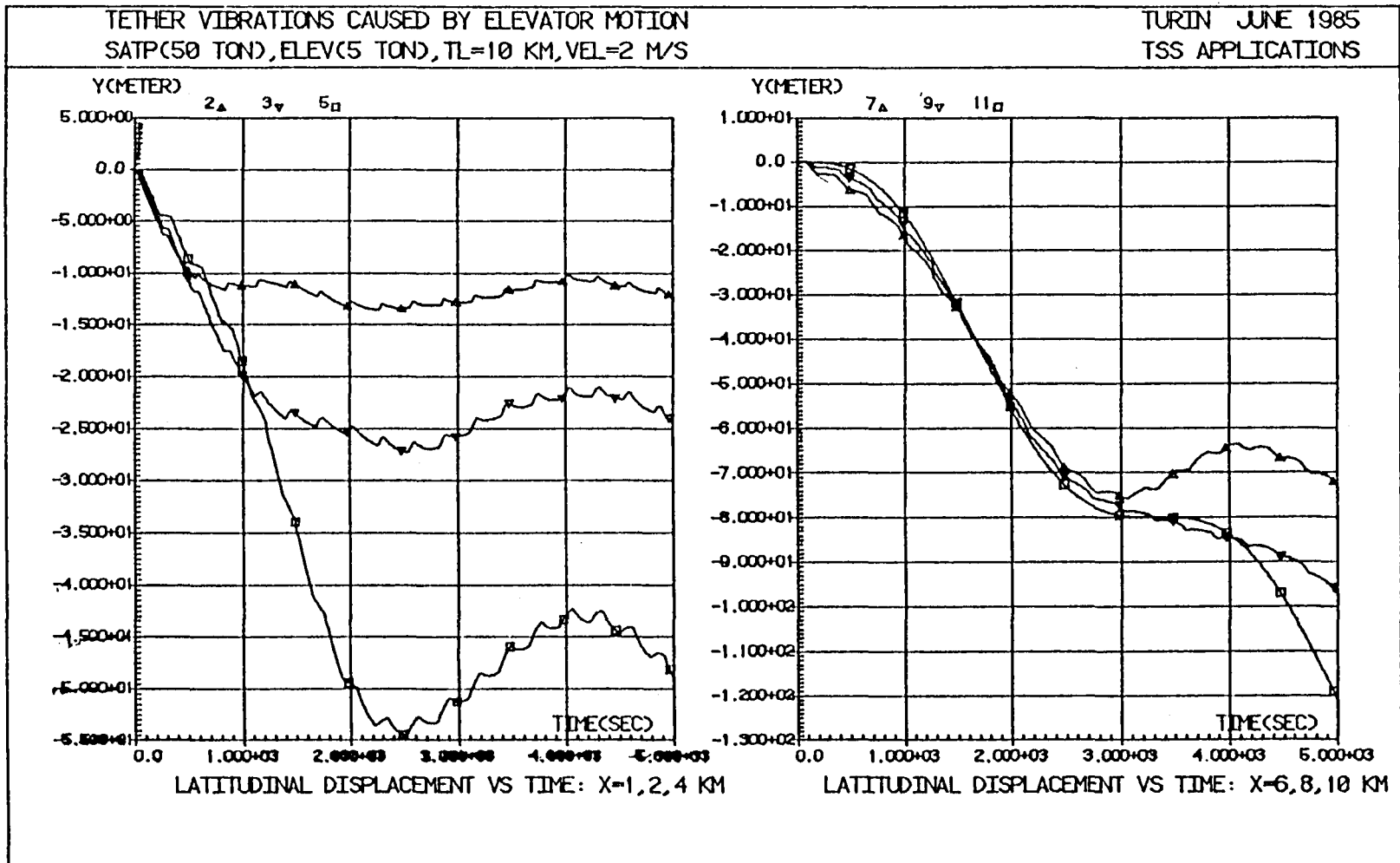

429

TETHER VIBRATIONS CAUSED BY ELEVATOR MOTION  
SATP(50 TON), ELEV(5 TON), TL=10 KM, VEL=2 M/S

TURIN JUNE 1985  
TSS APPLICATIONS

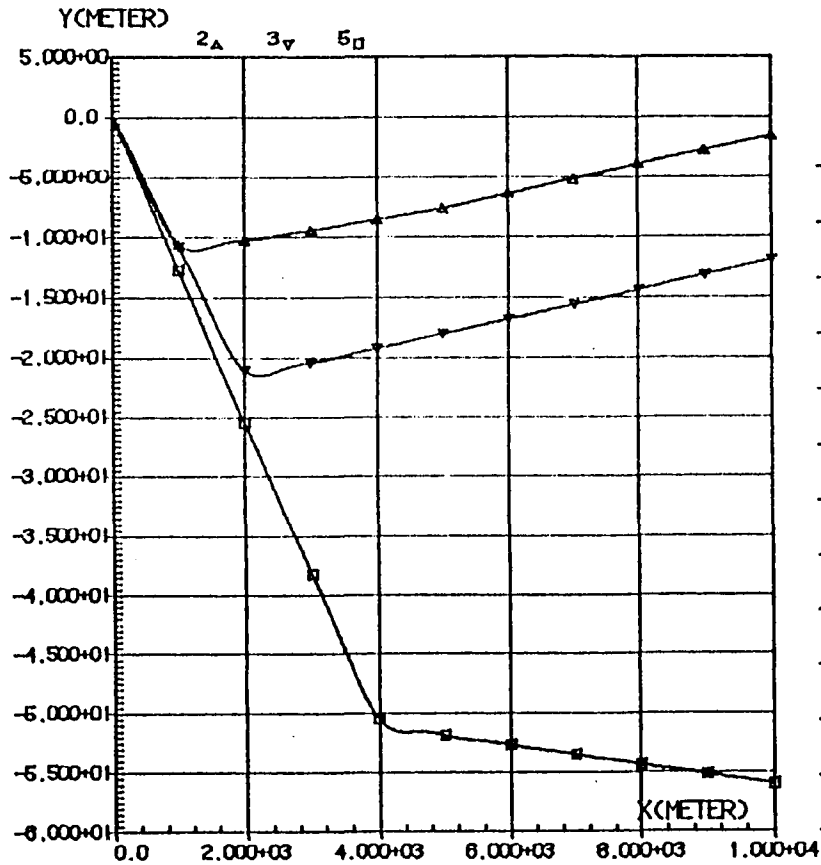

LAT. DISP. VS TETHER DIST. T=500, 1000, 2000 SEC

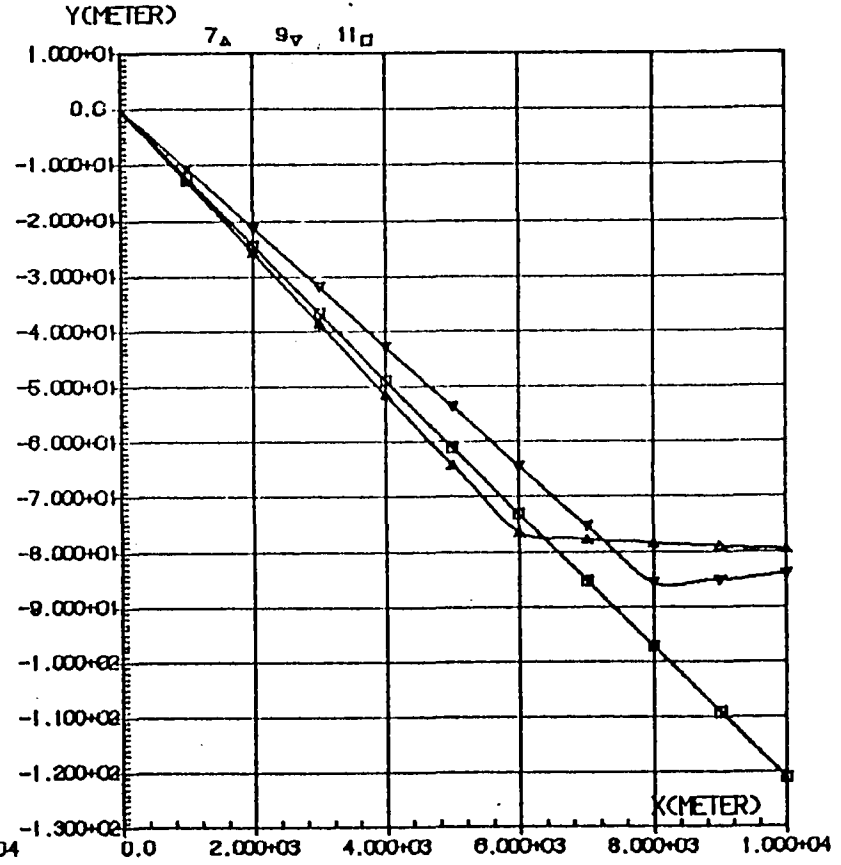

LAT. DISP. VS TETHER DIST. T=3000, 4000, 5000 SEC

430



THE TRANSPORTATION SPACE ELEVATOR (CONT'D)

TETHER LONGITUDINAL VIBRATIONS

SYSTEM PARAMETERS SAME AS FOR LATERAL VIBRATIONS.

TETHER LONGITUDINAL VIBRATIONS ARE INDUCED BY ELEVATOR CONTROL FORCES TO MAINTAIN CONSTANT VELOCITY OF 2 M/S.

THE FIRST TWENTY MODES WERE INCLUDED AND THE TETHER DAMPING WAS NEGLECTED.

THE DISPLACEMENTS ARE RELATIVE TO TETHER STRETCHED CONFIGURATION UNDER CONSTANT TENSION.

THE VIEWING OF DISPLACEMENTS FOR THE COMPLETE TRANSFER OF THE ELEVATOR FROM THE S/S TO THE SATP SHOWS ONLY DISPLACEMENTS CAUSED BY MASS TRANSFER. VIBRATIONS ARE NO APPRECIABLE.

THE PLOTS OF THE FIRST 250 SEC. OF THE MOTION CONFIRMS THAT VIBRATIONS ARE PRESENT BUT OF QUITE NEGLIGIBLE AMPLITUDE.

TETHER VIBRATIONS CAUSED BY ELEVATOR MOTION  
SATP(50 TON), ELEV(5 TON), TL=10 KM, VEL=2 M/S

TURIN JULY 1985  
TSS APPLICATIONS

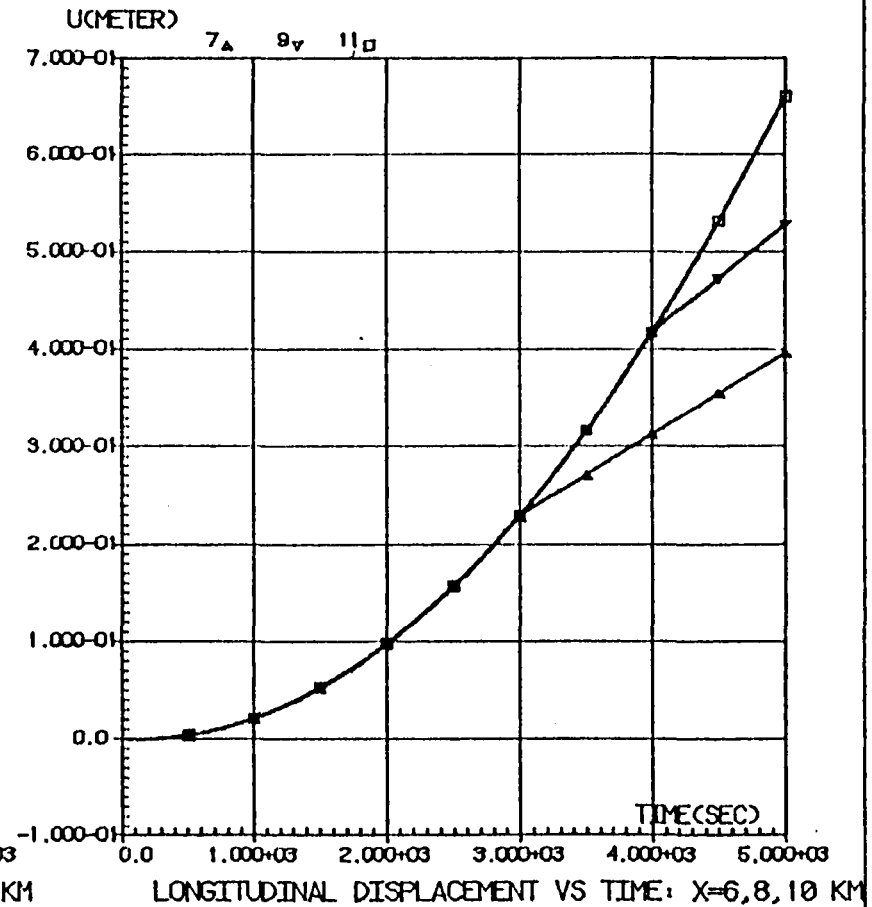
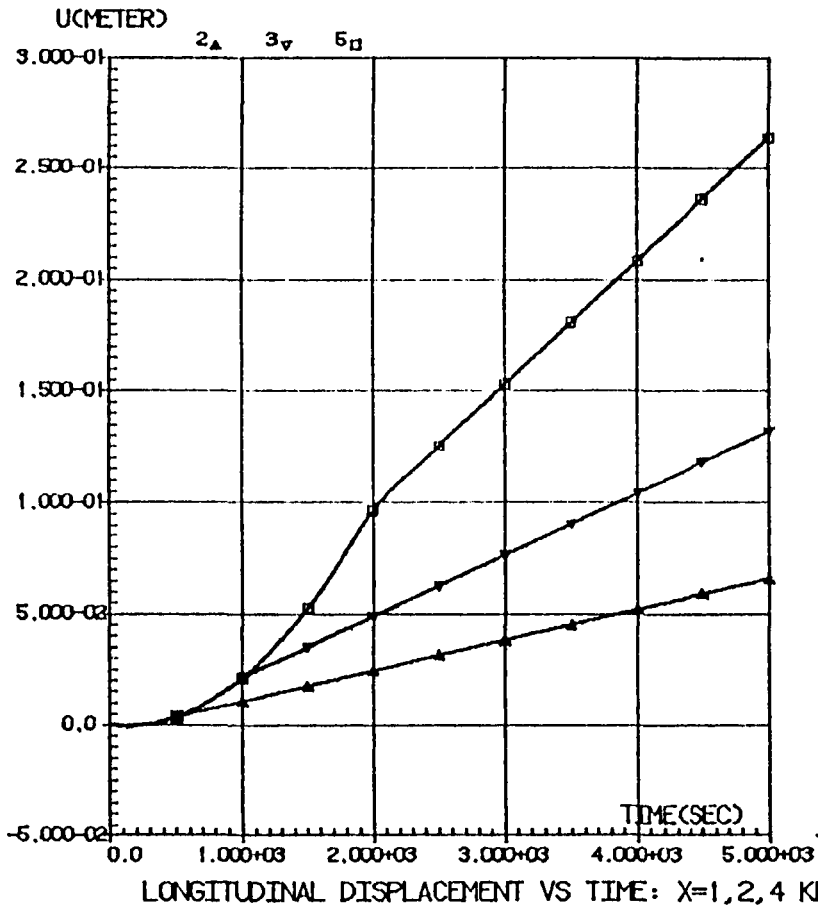

TETHER VIBRATIONS CAUSED BY ELEVATOR MOTION  
SATP(50 TON), ELEV(5 TON), TL=10 KM, VEL=2 M/S

TURIN JULY 1985  
TSS APPLICATIONS

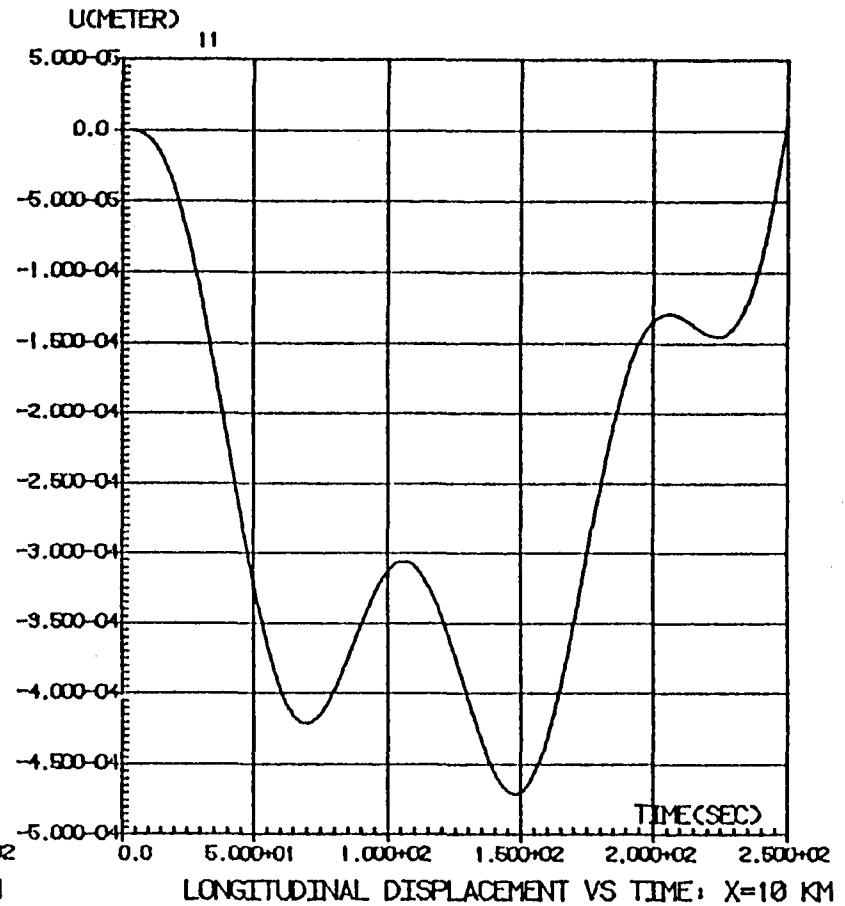
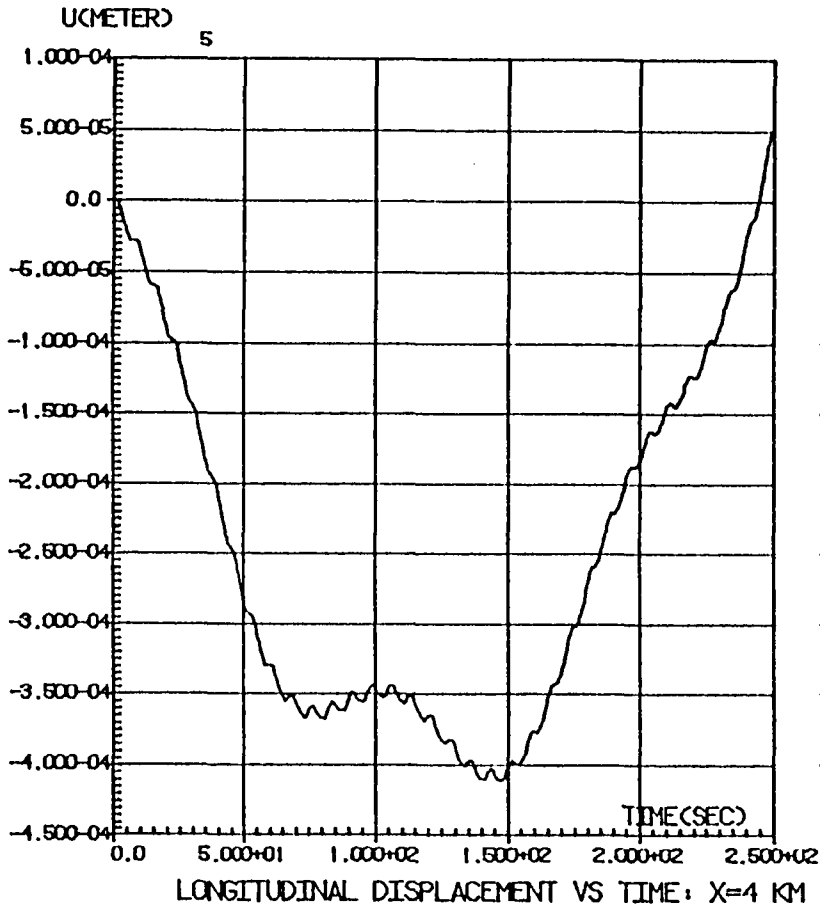

## KEY CONCEPT - 2 - THE POINTING PLATFORM

THE USE OF A TETHERED PLATFORM AS A SUPPORT FOR OPERATING ASTROPHYSICAL AND OTHER OBSERVATIONAL INSTRUMENTS REQUIRING PRECISION POINTING AND CONTROL PRESENTS SEVERAL ADVANTAGES:

- o ELECTRICAL POWER FROM SPACE STATION
- o HIGH CAPACITY OF DATA TRANSMISSION BY OPTICAL FIBRES
- o POSSIBILITY OF HUMAN INTERVENTION
- o EASE OF ACCESS
- o FREEDOM FROM CONTAMINATION

THIS CONCEPT COULD BECOME ATTRACTIVE ONCE IT IS DEMONSTRATED THAT A POINTING PERFORMANCE ON THE ORDER OF ARCSECONDS CAN BE REACHED BY THE COMBINATION OF DISTURBANCES ATTENUATION THROUGH TETHER AND ACTIVE CONTROL OF A MOVABLE ATTACHMENT POINT.

THIS IDEA REPRESENTS A NEW WAY TO CONTROL THE ATTITUDE OF A TETHERED BODY.

THE POINTING PLATFORM CONCEPT

SG-PB-A1-018

- 23 -

15-17/10/85

+

?

Pointing Platform

Space Elevator

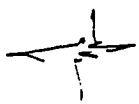

+

>

+

+

Space Station

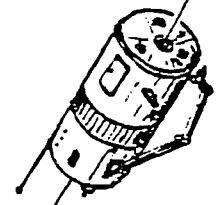
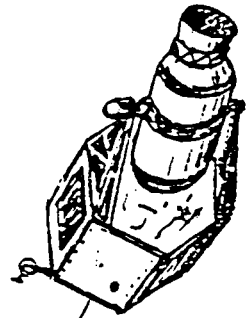
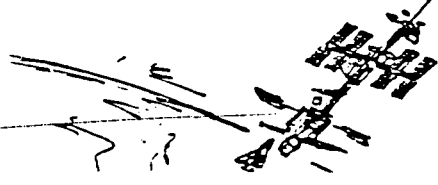

IRI finmeccanica

## THE POINTING PLATFORM (CONT'D)

### MOVABLE TETHER ATTACHMENT POINT

THEORETICAL CONTROL PHILOSOPHY WAS INVESTIGATED

- o INTRODUCTION OF DAMPING TERM PROPORTIONAL TO ATTITUDE ANGULAR RATE
- o ROUGH DETERMINATION OF CRITICAL DAMPING COEFFICIENTS
- o INTRODUCTION OF STABILIZATION TERM TO COMPENSATE DISTURBANCES DUE TO TETHER DYNAMICS.

CHECK SIMULATION WAS PERFORMED WITH DATA FROM TSS ELECTRODYNAMIC MISSION

- o HARDWARE AND CONTROL ERRORS WERE NEGLECTED
- o ATTITUDE (ANGLES, ANGULAR RATES) AND TETHER TENSION (3-AXIS) MEASUREMENT WERE ASSUMED
- o DRAG, ELECTRODYNAMIC FORCES (1 A), TETHER LIBRATIONS AND FIRST TWO LONGITUDINAL VIBRATIONS WERE INCLUDED IN THE MODEL.

THE POINTING PLATFORM (CONT'D)

MOVABLE TETHER ATTACHMENT POINT (CONT'D)

RESULTS ARE ENCOURAGING. THEORETICAL CONTROL ALLOWS STABILIZATION TO ARCSEC MAGNITUDE.

AREAS TO BE INVESTIGATED:

- o MECHANISM, SENSORS AND CONTROL ERROS
- o MOUNTING MISALIGNMENTS
- o THERMO-STRUCTURAL STABILITY.

SG-PB-AI-018

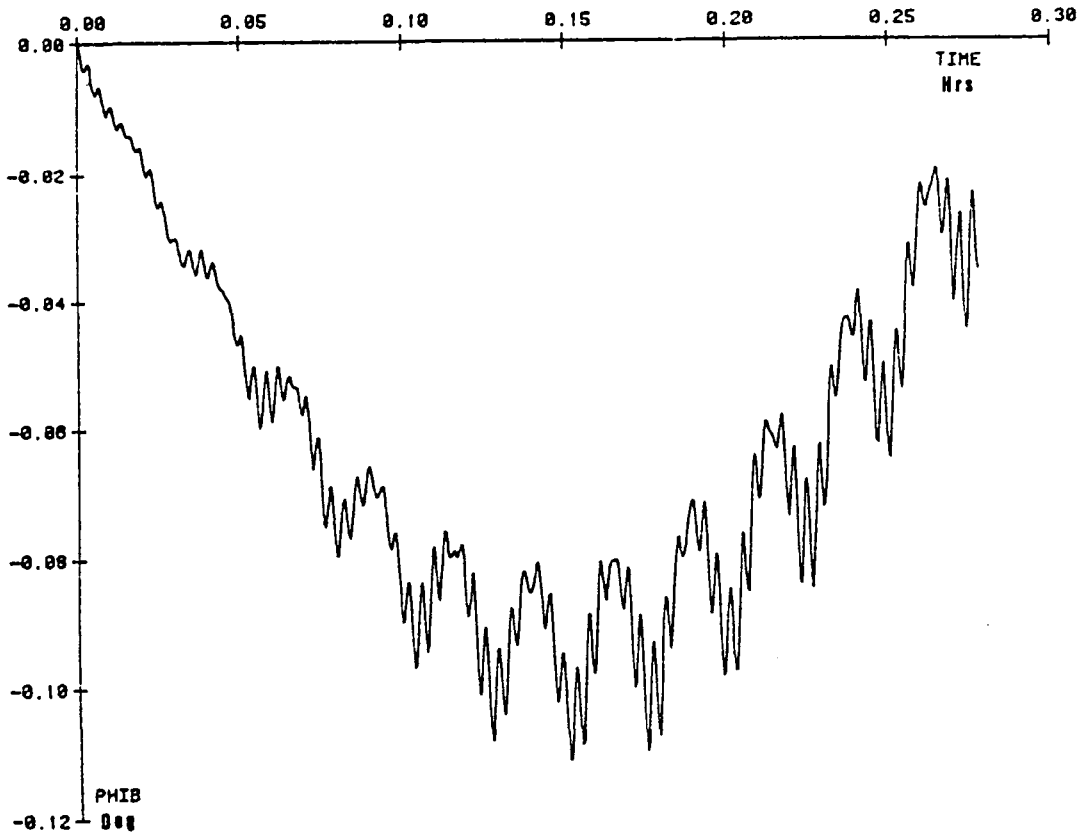

ROLL ANGLE (ATTACHMENT POINT AT THE REST)

- 26 -

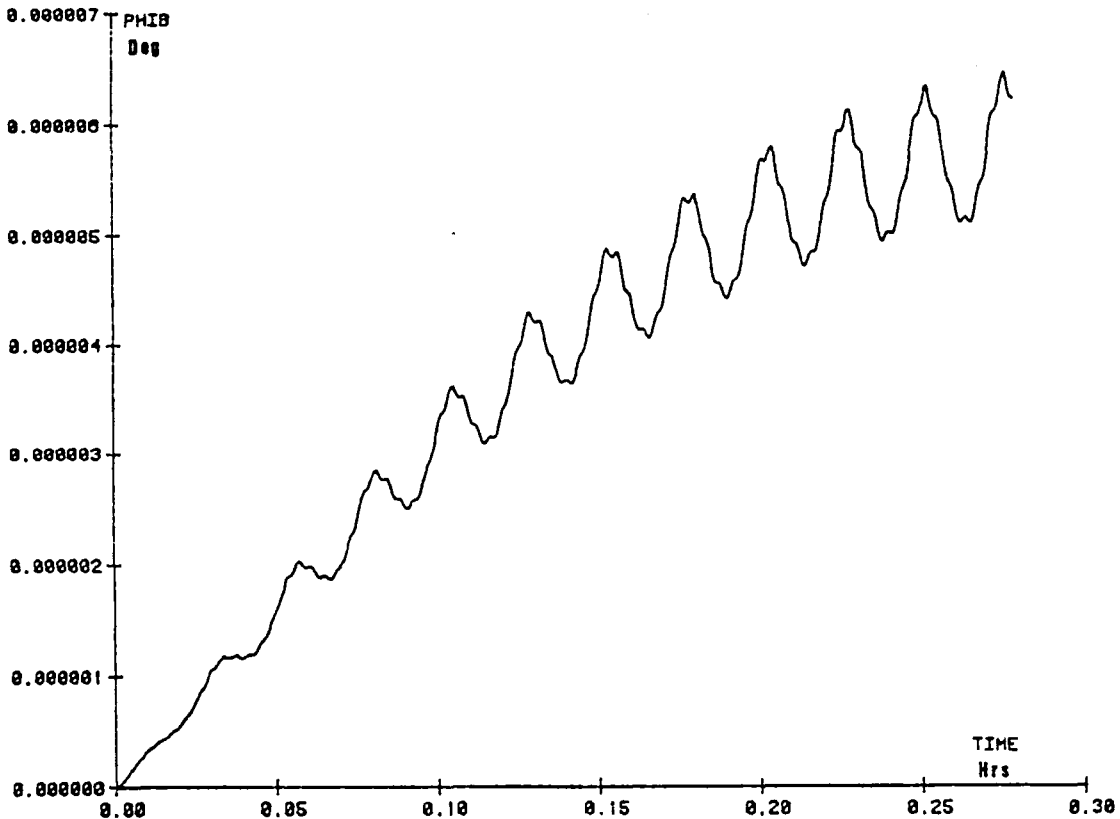

ROLL ANGLE (ATTACHMENT POINT CONTROL)

15-17/10/85

**AERITALIA**  
 Società  
 aerea  
 italiana  
 GRUPPO SISTEMI SPAZIALI

IRI fimeccanica



SG-PB-AI-018

- 27 -

15-17/10/85

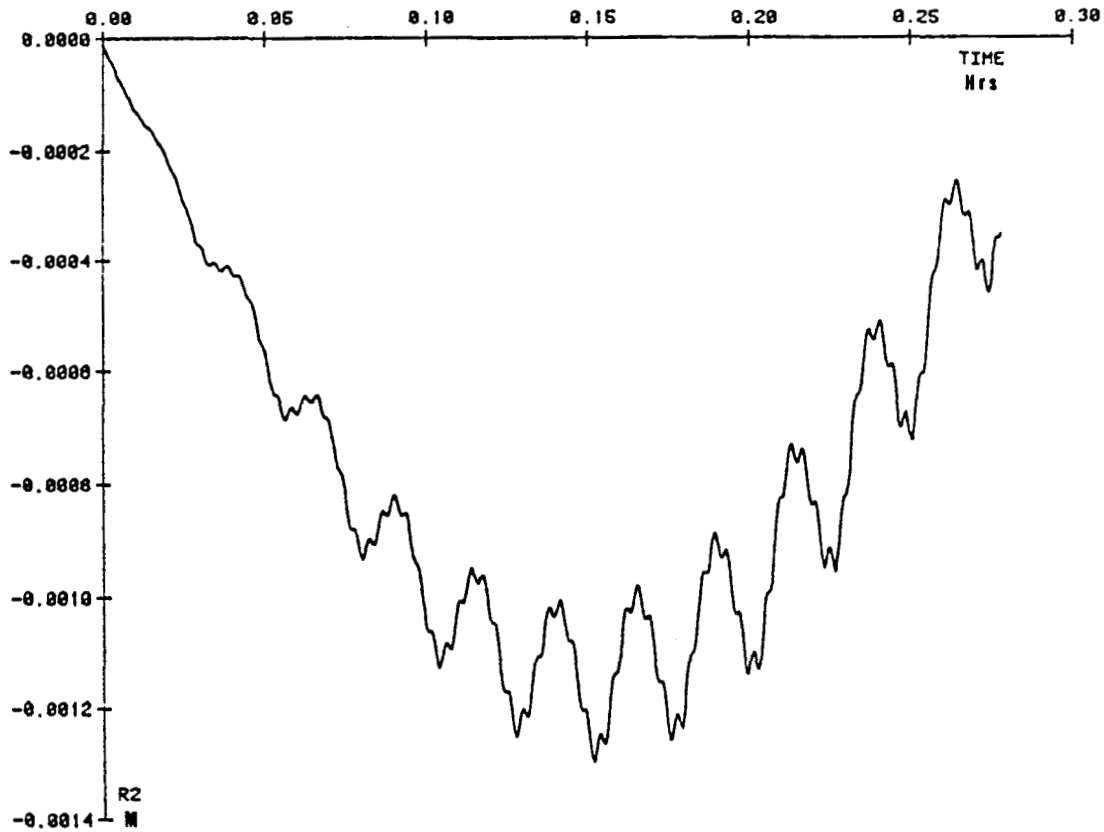

ATTACHMENT POINT POSITION CONTROL (Y AXIS)

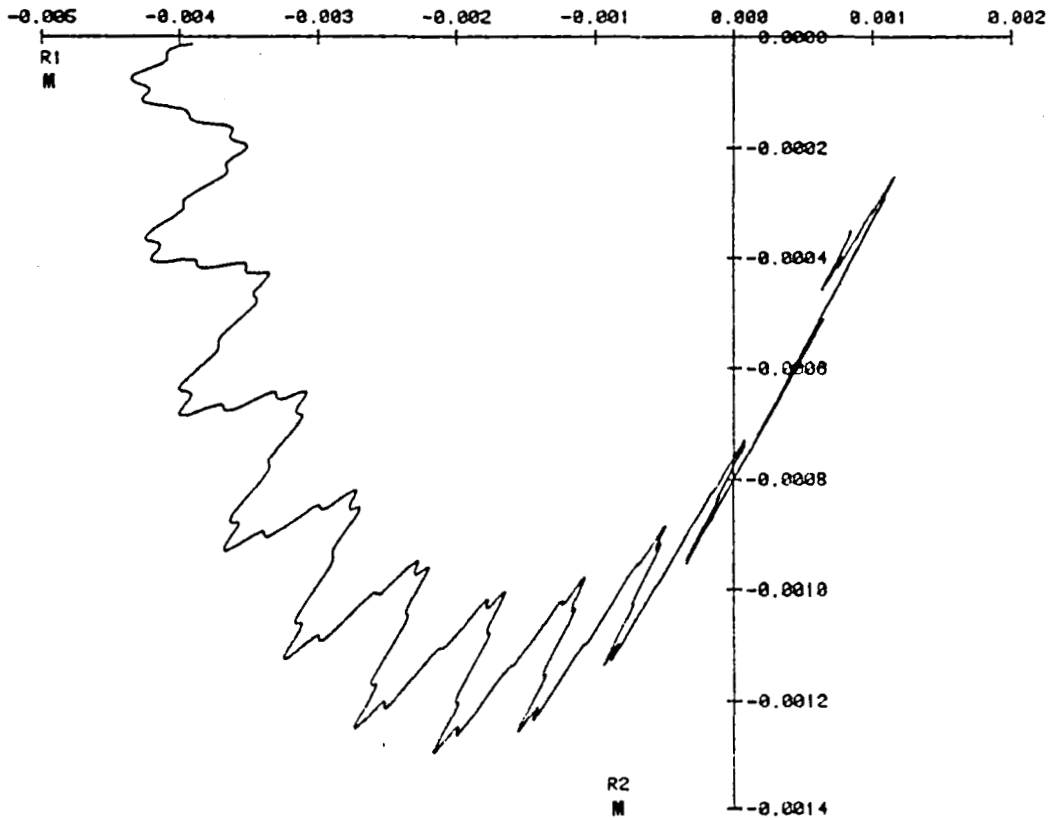

ATTACHMENT POINT TRAJECTORY - PLANE VIEW

## THE POINTING PLATFORM (CONT'D)

### INITIAL CONFIGURATION

AS INITIAL STEP TO TETHERED PLATFORMS EVOLUTION, A MEDIUM SIZE POINTING PLATFORM SEEMS THE MOST SUITABLE FACILITY FOR A CLASS OF OBSERVATIONAL APPLICATIONS.

IN FACT IF AMBITIOUS ASTROPHYSICAL PROJECTS JUSTIFY THE DESIGN OF A DEDICATED COMPLEX FREE-FLYER, MEDIUM OBSERVATIONAL APPLICATIONS OF RELATIVELY SHORT DURATION COULD TAKE ADVANTAGE OF A STANDARD POINTING FACILITY ABLE TO ARRANGE AT DIFFERENT TIME SEVERAL OBSERVATIONAL INSTRUMENTS.

THIS POINTING FACILITY COULD ALLOW GREAT REDUCTION OF COSTS, AVOIDING THE COST OF SEPARATE SERVICE FUNCTIONS FOR EACH APPLICATION.

PRELIMINARY CONFIGURATION STUDY OF THE POINTING PLATFORM IS IN PROGRESS.

## THE POINTING PLATFORM (CONT'D)

### PRELIMINARY GENERAL REQUIREMENTS

- o DEPLOYMENT TO 10 KM FROM THE SPACE STATION
- o POWER TRANSMISSION AND DATA LINK BY TETHER TECHNOLOGY
- o INERTIAL POINTING AND STABILIZATION ABOUT 3-AXIS
- o RESCUE OPERATION COMPATIBLE
- o MOUNTING OF PAYLOADS BOTH FOR ASTROPHYSICAL OBSERVATION AND FOR EARTH SURVEY
- o STANDARD SERVICE MODULE WITH CENTRALIZED FUNCTIONS:
  - ELECTRICAL POWER SUPPLY
  - DATA TRANSMISSIONS
  - ON-BOARD DATA HANDLING
  - AUXILIARY PROPULSION SYSTEM
  - ATTITUDE MEASUREMENT AND CONTROL
  - STANDARD PAYLOADS INTERFACE.

GRUPPO SISTEMI SPAZIALI

POINTING PLATFORM - PRELIMINARY CONFIGURATION

PLATFORM CONFIGURATION  
FOR PAYLOAD  
TO BE TILTED  
(e.g. space observation)

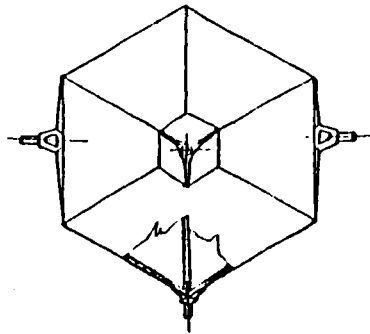

PLATFORM CONFIGURATION  
FOR FIXED PAYLOAD  
(e.g. earth observation)

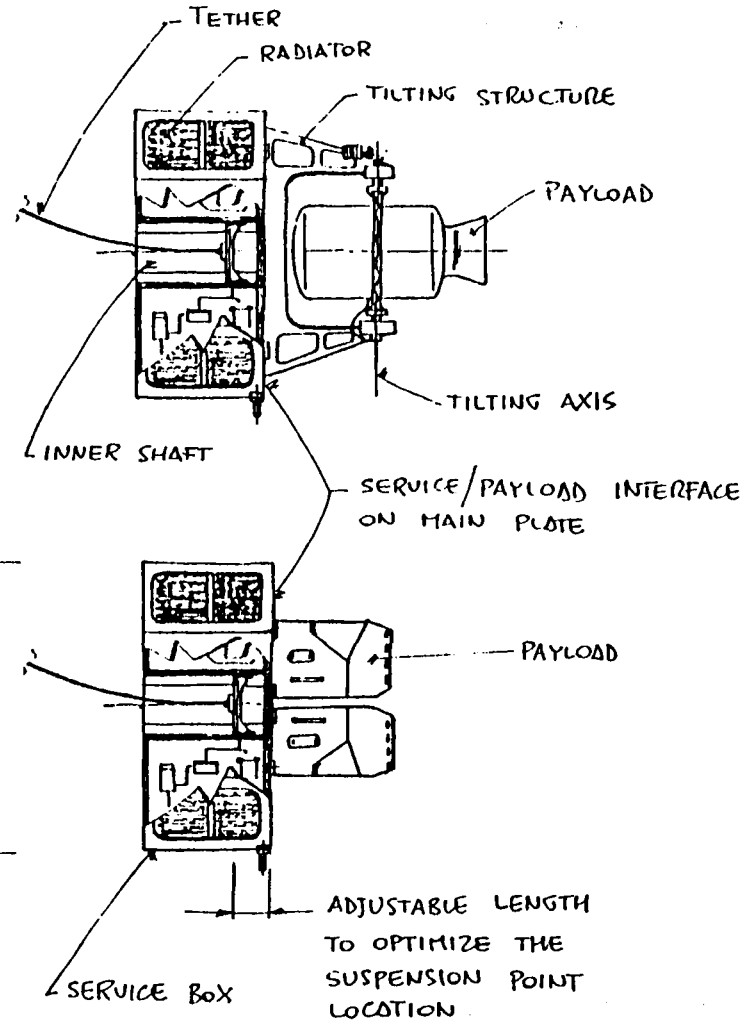
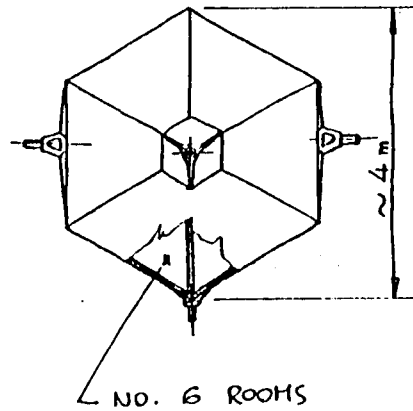

442

## TECHNICAL ISSUES

- o SPACE STATION IMPACTS
  - STATIC ACCELERATION LEVELS ( $10^{-4}$  g)
  - DEPLOYER SYSTEM LOCATION REQUIREMENTS
  - ELECTRICAL POWER SUPPLY REQUIREMENTS
  - DATA HANDLING REQUIREMENTS
  - OPERATIONS CONTROL
  
- o TETHER
  - DEBRIS COLLISION HAZARD
  - ELECTRICAL POWER LINE TECHNOLOGY
  - OPTICAL FIBRE TECHNOLOGY
  - DURABILITY
  - DESIGN FOR PERIODICAL RECOIL

TECHNICAL ISSUES (CONT'D)

- o DYNAMICS AND CONTROL
  - ELEVATOR MOTION DYNAMICS AND CONTROL
  - PLATFORM ATTITUDE DYNAMICS AND CONTROL
  - TETHER DYNAMICS
  
- o NEW SPACE TECHNOLOGY
  - MECHANISMS FOR ALONG TETHER MOTION
  - MECHANISMS FOR MOVABLE ATTACHMENT POINT CONTROL
  - DEPLOYER SYSTEMS
  - COMPLEX-MULTIFUNCTION TETHERS.

## BENEFITS ANALYSIS

- o THE SPACE ELEVATOR
  - UNIQUE CAPABILITY AS MICROGRAVITY FACILITY
  - THE BEST FACILITY TO ACCESS LARGE TETHERED PLATFORMS
  
- o THE POINTING PLATFORM
  - HIGH POINTING PERFORMANCE
  - HIGH CAPACITY OF DATA TRANSMISSION
  - ACCESS READINESS
  - FREEDOM FROM CONTAMINATION
  - COST EFFECTIVENESS FOR A LARGE CLASS OF OBSERVATIONAL APPLICATIONS.

## SHUTTLE-DEPLOYED "DOWN-SCALED PLATFORM"

DEMONSTRATION OF FEASIBILITY AND PERFORMANCE IS NEEDED BEFORE APPLICATION IS PROPOSED FOR THE SPACE STATION.

TO SAVE TIME AND LIMIT COSTS: USE OF STANDARD TSS DEPLOYER.

QUESTION TO BE ANSWERED:

- o TO WHAT EXTENT IS DOWN-SCALING MEANINGFUL ("SCALING LAWS")
- o WHAT FEATURES ARE TO BE MODELLED:
  - MICROGRAVITY ENVIRONMENT
  - STABILITY PROPERTIES
  - OTHER
- o IMPLEMENTATION OF CONCEPT
  - ELEVATOR
  - MOVABLE TETHER ATTACHMENT POINT



## SCALED-SATP CONCEPT

AN ASSESSMENT STUDY OF THE CAPABILITIES OF A SATP REDUCED-SIZE MODEL TO GIVE SATP FEASIBILITY AND PERFORMANCE DEMONSTRATION WAS PERFORMED.

PARTICULAR REFERENCE WAS MADE TO APPLICATIONS OF MICROGRAVITY AND OF VERY FINE INSTRUMENT POINTING. SPECIAL CARE WAS GIVEN TO THE ELEVATOR MOTION OUTLINE.

ON THE BASIS OF THIS ANALYSIS SOME CONSIDERATIONS CAN BE MADE ABOUT THE EXPERIMENTAL PROBLEM:

- FULL SIMILARITY OF ALL EFFECTS IS POSSIBLE ONLY FOR ONE-TO-ONE SCALE. IT SEEMS ALSO TO BE NOT NECESSARY.

SCALED-SATP CONCEPT (CONT'D)

- RESTRICTED SIMILARITY IS POSSIBLE.  
SCALED SATP KEEPS FULL EFFECTIVENESS FOR TESTING REFINED MODELS OF PHENOMENA (IT IS COMMON ATTITUDE IN THE FIELD OF COMPLEX MODELING).
  
- THE DIFFERENT ASPECTS DEALING WITH THE PROPOSED CONCEPTS AND THE COMPLEXITY OF PHENOMENA SEEMS TO MAKE ESSENTIAL THE IN-FLIGHT TESTS.

## CONFIGURATION STUDY

THE NECESSITY TO UTILIZE THE ON-GOING TETHERED SATELLITE SYSTEM APPEARS EVIDENT FOR COSTS AND SCHEDULE REASONS.

AS A GENERAL APPROACH:

- THE INTERFACES AND THE GENERAL REQUIREMENTS DEFINED FOR THE TSS CANNOT BE CHANGED.
- ONLY THE TSS-SATELLITE MUST BE CHANGED, AS LITTLE AS POSSIBLE IN ORDER TO MAXIMIZE THE EXISTING HARDWARE UTILIZATION.

A CONFIGURATION STUDY WAS PERFORMED IN ORDER TO EVALUATE THE SATELLITE DESIGN CHANGES REQUIRED TO LOCATE THE MOVABLE ATTACHMENT MECHANISMS AND THE ELEVATOR INSIDE THE SATELLITE.

THE MOVABLE ATTACHMENT POINT CONCEPT REQUIRES ONLY SMALL MODIFICATIONS OF THE CURRENT DESIGN.

THE ELEVATOR HOUSED IN THE SATELLITE REQUIRES LARGE DESIGN MODIFICATIONS (E.G., THE TANK HAVE TO BE SHIFTED).

PRESENT TSS-S  
CONFIGURATION

HYPHOTESIS FOR  
ELEVATOR  
ACCOMMODATION

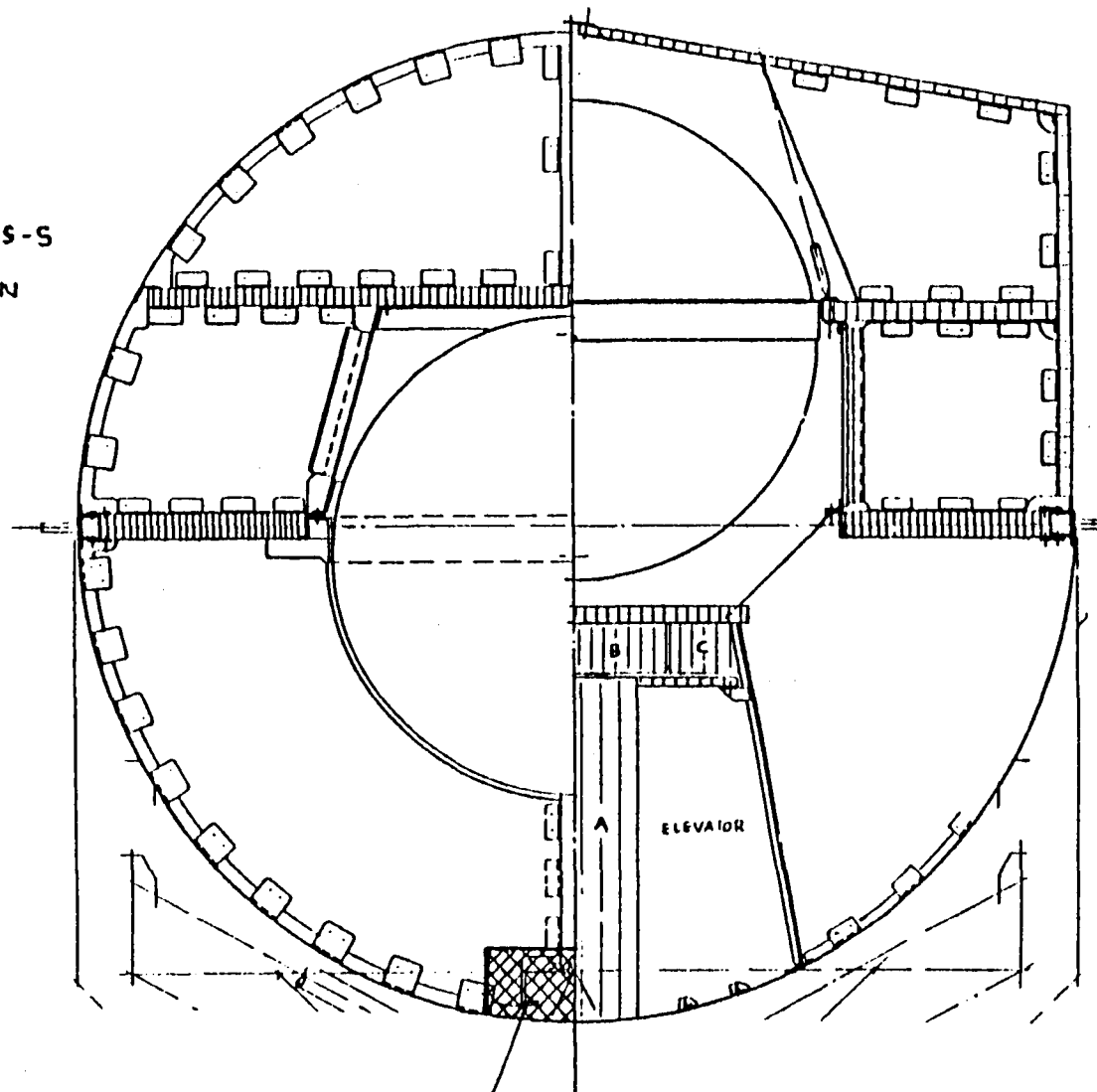

ROOM DEDICATED TO MOVABLE  
ATTACH. POINT MECHANISM

450

## PROPOSED CONFIGURATION

THE INTRODUCTION OF BOTH CONCEPTS (ELEVATOR AND MOVABLE ATTACHMENT POINT) ON THE PRESENT SATELLITE DESIGN APPEARS VERY CRITICAL BECAUSE OF THE VARIATION INDUCED ON THE STRUCTURE.

MOUNTING ONLY THE MOVABLE ATTACHMENT POINT HARDWARE ON THE SATELLITE SEEMS TO BE A VERY CHEAP SOLUTION CONSIDERING THAT THE DESIGN MODIFICATION COULD BE SIMPLE.

THE ELEVATOR COULD BE DESIGNED TO PERMIT ITS MOUNTING ON THE TETHER (BY MEANS OF THE SHUTTLE RMS) ONCE THE SATELLITE IS FAR OFF THE DEPLOYER AND RECOVERED BEFORE SATELLITE RETRIEVAL.

A PRELIMINARY STUDY OF THIS CONFIGURATION IS IN PROGRESS. THE SCALED ELEVATOR WILL BE DESIGNED TO PROVIDE:

- o RMS GRAPPLE FIXTURE
- o FRONT SLOT FOR THE POSITIONING ON THE TETHER
- o FINAL TETHER GUIDE-CAPTURE SENSORS AND MECHANISMS.

SG-PB-AI-018

- 40 -

SCALED ELEVATOR  
MOUNTING ON THE TETHER

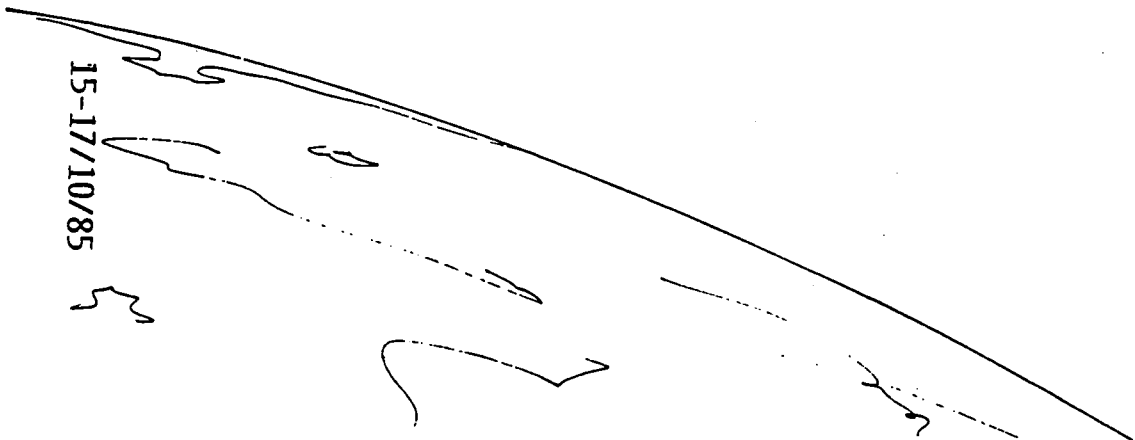
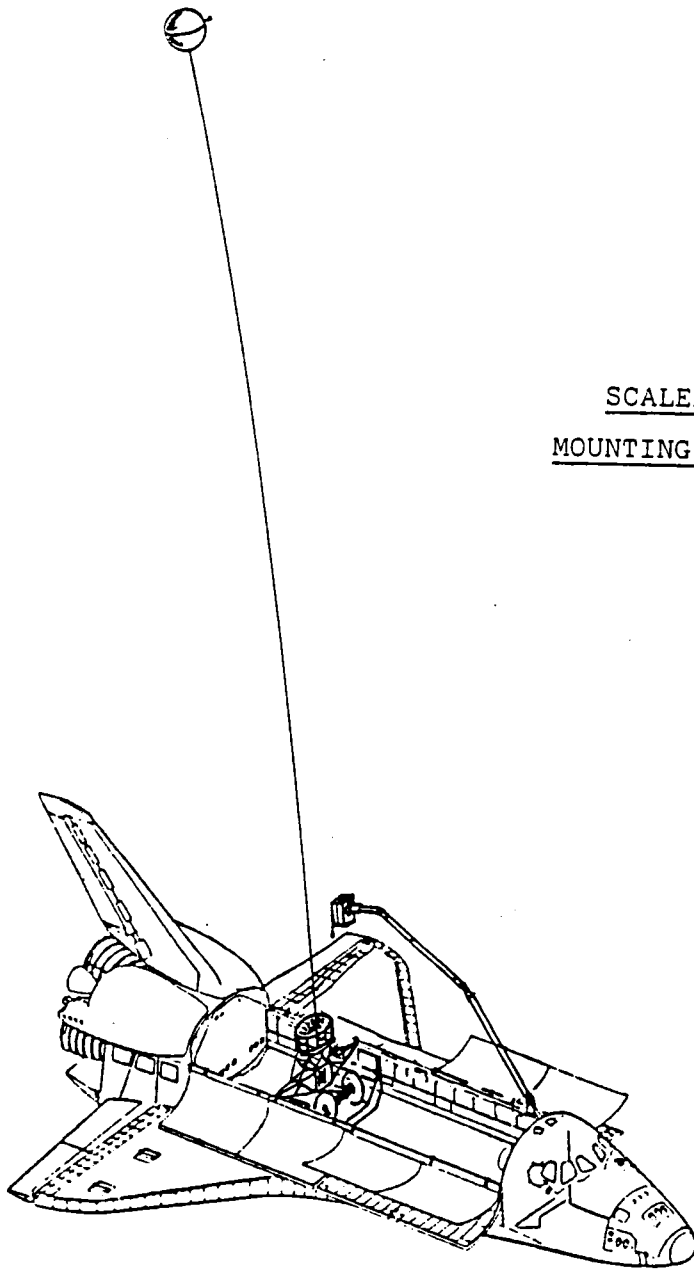

15-17/10/85

IRI finmeccanica

## PRELIMINARY ELEVATOR CHARACTERISTICS

- o DIMENSIONS : 0,65 x 0,65 x 1,05 m
- o MASS : 70 Kg
- o MAX VELOCITY : 2 M/S  
(TETHER REFERENCE FRAME)
- o POWER CONSUMPTION :  $\leq$  100 W
- o ONE-AXIS ATTITUDE CONTROL (YAW AXIS) BY MAGNETIC COILS
- o PASSIVE THERMAL CONTROL AND DEDICATED HEATERS
- o HYBRID STRUCTURE (COMPOSITES, AL ALLOYS)
- o FRICTION DRIVE MECHANISM
- o S-BAND COMMUNICATIONS (5 KB/SEC-TENTATIVE)

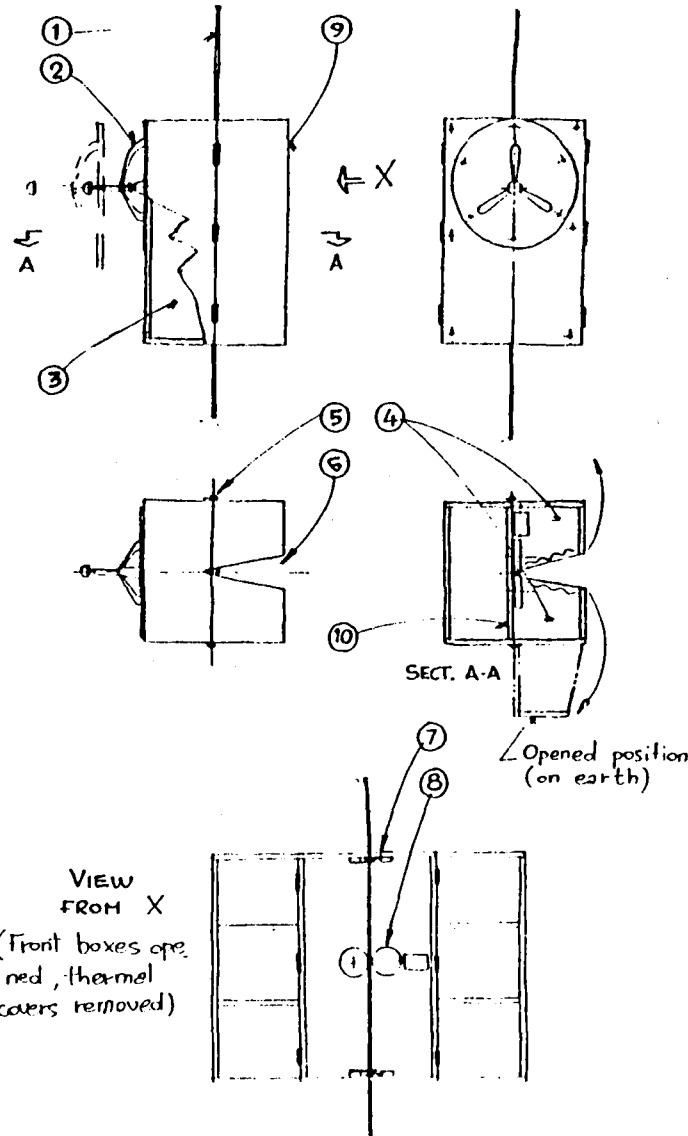

SCALED ELEVATOR - PRELIMINARY CONFIGURATION

LEGENDA :

- ① TETHER (WORKING POSITION)
- ② GRAPPLE FIXTURE MOUNTED ON REMOVABLE BACK COVER
- ③ BACK ROOM (P/L DEDICATED)
- ④ FRONT ROOMS (SERVICE DEDICATED)
- ⑤ HINGES FOR THE EQUIPMENT MOUNTING IN FRONT ROOMS
- ⑥ FRONT SLOT FOR THE ELEVATOR POSITIONING ON TETHER
- ⑦ FINAL TETHER CAPTURE AND GUIDE MECHANISM (TWO POSITIONS)
- ⑧ DRIVE MECHANISM
- ⑨ CARGO BAY JOINT POINTS (TRD) ON THIS SIDE
- ⑩ MAIN FRAME



## CONCLUSIONS

- o TETHERED ELEVATOR AND PLATFORMS COULD IMPROVE THE SPACE STATION SCIENTIFIC AND APPLICATIVE CAPABILITIES.
- o THE SPACE ELEVATOR PRESENTS UNIQUE CHARACTERISTICS AS MICROGRAVITY FACILITY AND AS A TETHERED PLATFORM SERVICING VEHICLE.
- o POINTING PLATFORMS COULD REPRESENT A NEW KIND OF OBSERVATION FACILITY FOR LARGE CLASS OF PAYLOADS.
- o THE DYNAMICAL, CONTROL AND TECHNOLOGICAL COMPLEXITY OF THESE CONCEPTS ADVISES DEMONSTRATIVE EXPERIMENTS.
- o THE ON-GOING TETHERED SATELLITE SYSTEM OFFERS THE OPPORTUNITY TO PERFORM SUCH EXPERIMENTS.
- o FEASIBILITY STUDIES ARE IN PROGRESS.  
THE MAJOR EFFORT WILL BE DEDICATED TO OUTLINE CONCEPTS AND TECHNIQUES OF SUCH A DEMONSTRATION.



ROLES FOR TETHERS ON AN EVOLVING SPACE STATION

Joseph A. Carroll  
California Space Institute  
SIO/UCSD, La Jolla, CA 92093  
619/459-7437

## SUMMARY OF CONTRACT WORK STATEMENT:

1. Develop a scenario for evolution of space station tether capabilities. Minimize tether-imposed constraints on station development & operations, but derive maximum benefit from a mutually compatible combination of:
  - Electrodynamic tethers for power, thrust, and libration control;
  - Momentum transfer operations involving the STS or upper stages;
  - Aeromaneuvering devices for space station orbital plane change;
  - Tethered constellations and tether/free-flyer combinations.
  
2. For advanced tether facilities orbiting the moon, determine:
  - Stationkeeping deltaVs to stay in precise equatorial or polar orbits;
  - Ratio of facility mass to maximum payload mass (surface-orbit-escape);
  - Electric-thruster power requirements & maximum rendezvous frequencies;
  - Overall capabilities and major constraints on such facilities.

## ATTRACTIVE ROLES IDENTIFIED DURING STUDY:

<u>Facility/Operation</u>	<u>Location:</u>	<u>Operational:</u>
1. Gravity-Gradient Fluid Settling	Near top & bottom	Usually
2. Tethered MicroGee Platform	Station CG	Usually
3. Tethered Earth-Viewing Platform	Bottom	Usually
4. Electrodynamic Power Management	Top or bottom	As needed
5. Electrodynamic OMV	LEO free-flyer	As needed
6. Payload Boosting, STS Deboosting	Top & bottom	Occasionally
7. Payload Juggling by Tether	Top & bottom	Occasionally
8. Tethered Docking of STS by SS	Bottom	Occasionally
9. Hazardous or contaminating ops.	Bottom	Occasionally
10. Lunar-Orbiting Tether Facility	Lunar orbit	When needed
11. Lunar-Surface-Based Sling	Lunar equator or pole	When needed
12. Mars-Orbiting Tether Facilities	Various Mars orbits	When needed

# 1. GRAVITY-GRADIENT FLUID SETTLING

- Gravity-gradient fluid settling need not be limited to propellants: Fluids are also used in science, materials processing, & habitation.
- Gravity-gradients of 20-30 microgee may often be enough for settling; when more is needed, all that is needed is to deploy ANY tethered mass.

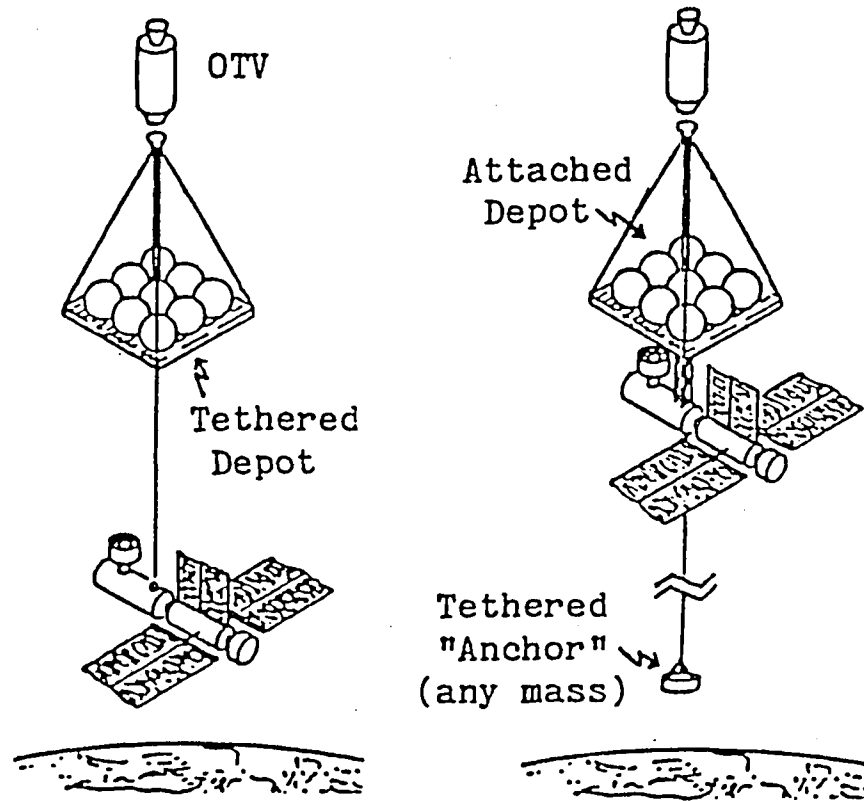

Two Propellant-Settling Options

## 2. TETHERED MICROGEE PLATFORM

- This facility can be moved when the station CG moves, or another tether can be adjusted to trim the station CG.

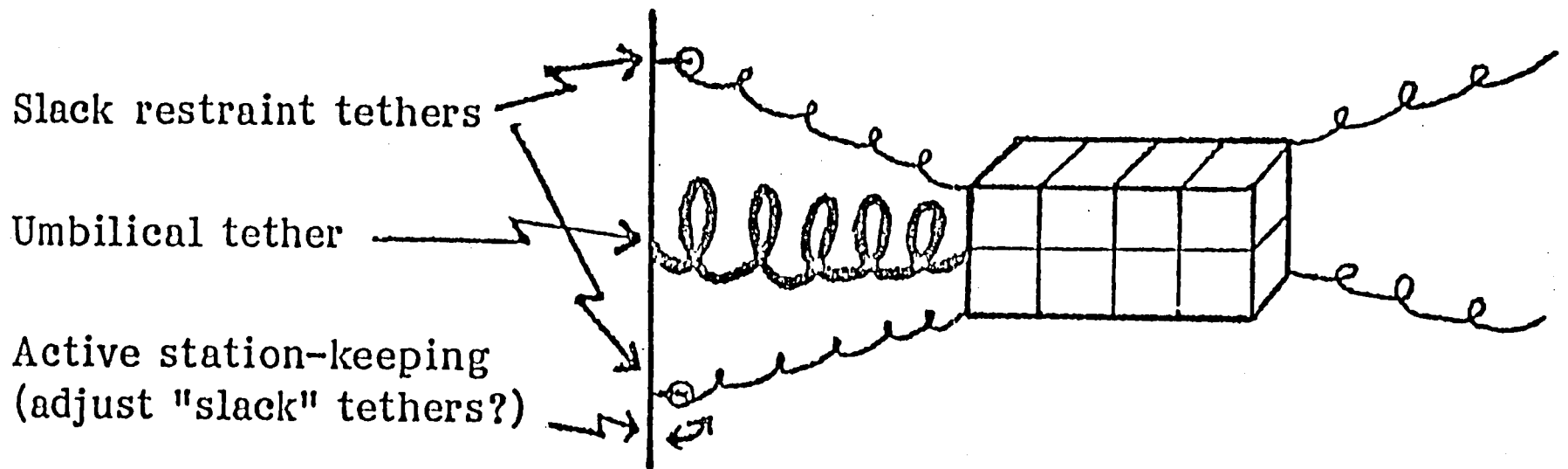

### 3. TETHERED EARTH-VIEWING PLATFORM

- Minimizes contamination & disturbances.
- Provides stationkeeping & attitude control.
- Allows convenient power & data transfer.
- Allows station CG adjustment (adjust length).

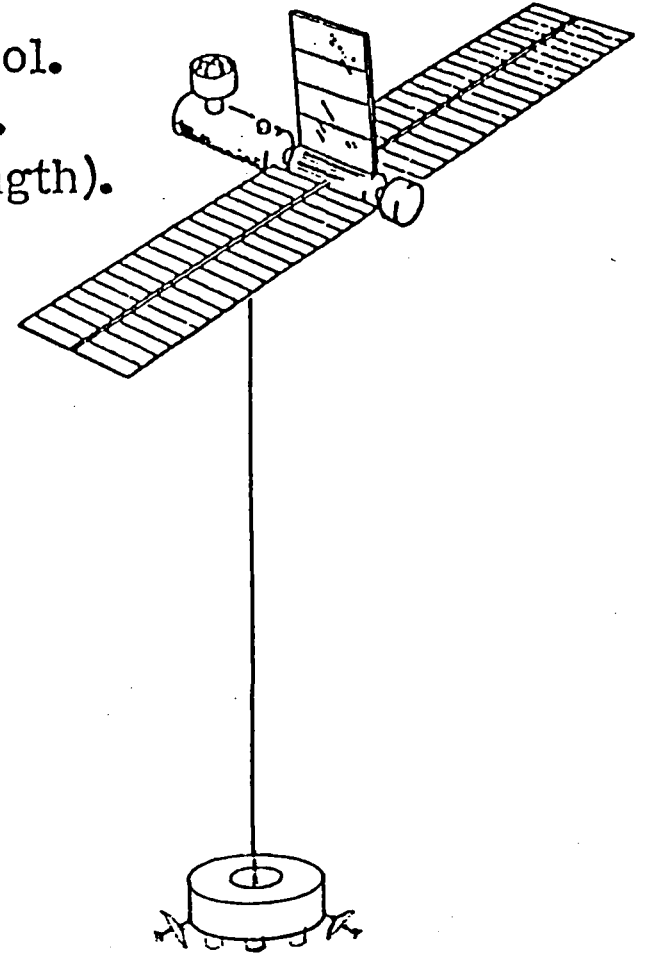



#### 4. ELECTRODYNAMIC POWER (& MOMENTUM) MANAGEMENT

- Off-peak power can be used for orbit boosting.
- Stored orbital energy can offset drag makeup, or can be recovered during peak-power times.

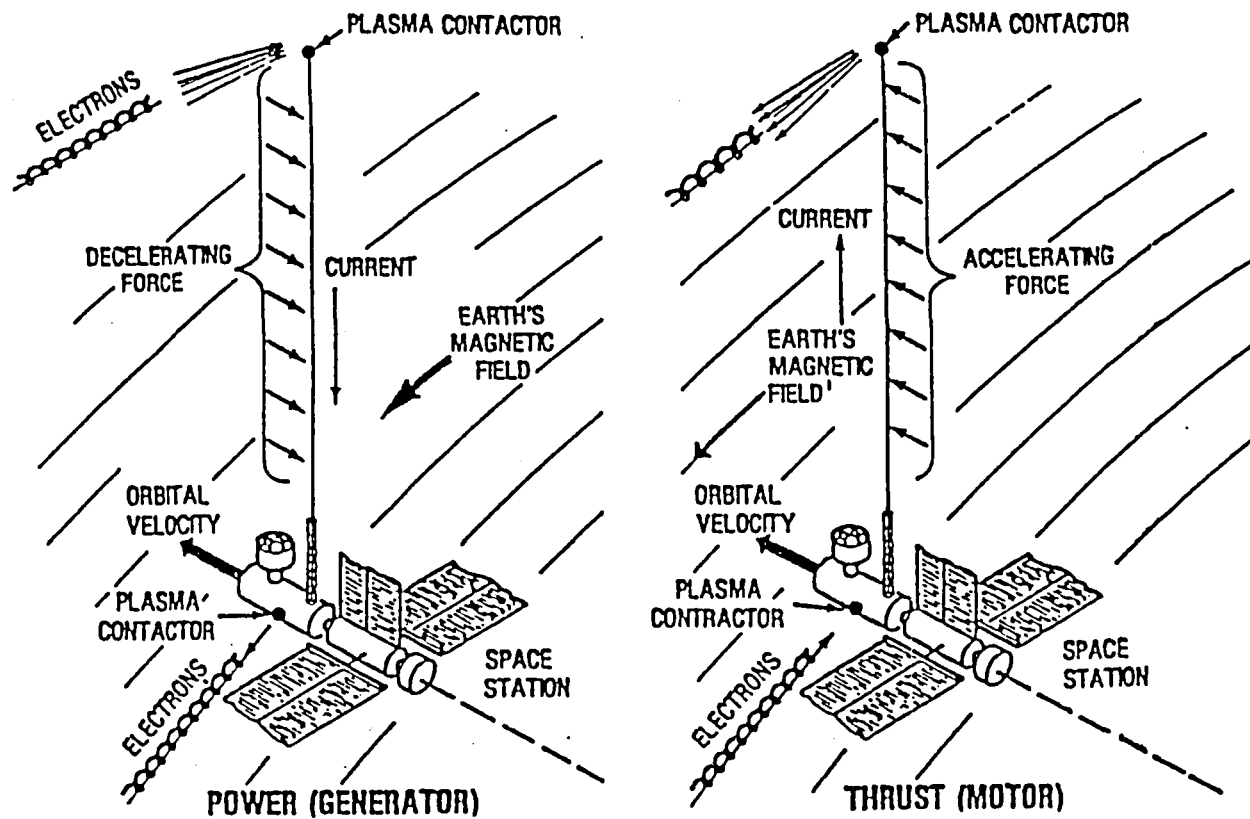

## 5. AN ELECTRODYNAMIC ORBITAL MANEUVERING VEHICLE

- ~10 km tether (1 cm diameter aluminum + 3 kV insulation)
- In the middle: OMV-like RCS, TV, end effectors, etc. →
- At each end: variable voltage DC power supply (0-3 kV)  
electron gun and large sail (or ion emitter) ↘
- DC & AC currents can alter all 6 orbital elements. In LEO:

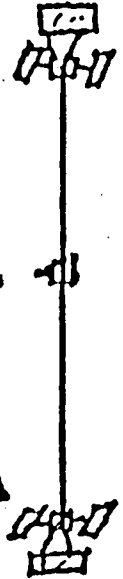

about 1.3 kWh is required per tonne.km altitude change

altitude changes over 100 km/day may be possible

inclination changes over .5 deg/day may be possible

## 6. PAYLOAD BOOSTING, STS DEBOOSTING

- Large boosts & deboosts must be paired so SS can return to formation. Pairing can also be with electrodynamic ops or tethered rendezvous.
- Propellant savings scale with station loads & orbit change: for each 100 lb load & 1 nmi delta-a, 200 lbs/op is saved. Questions:  
 What loads should the station be designed or scarred for?  
 What are maximum allowable short-term orbit perturbations?

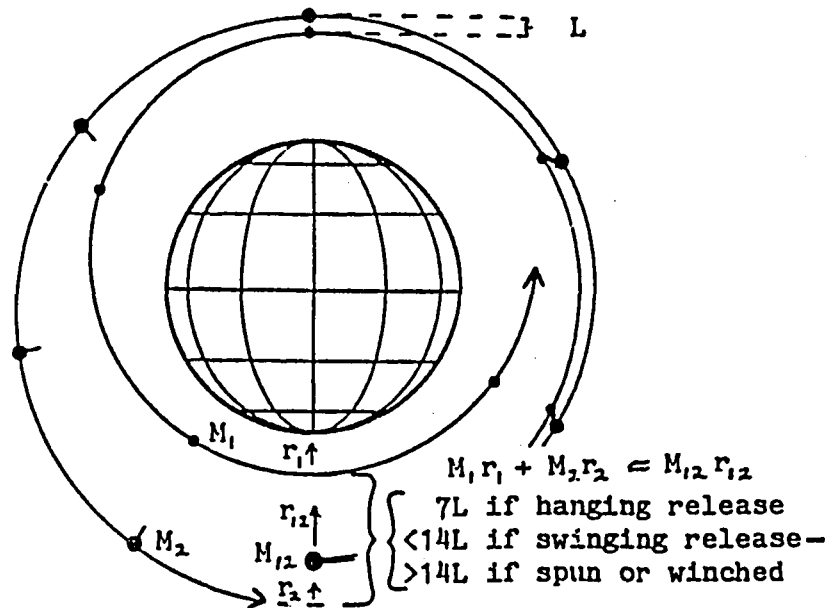

Effects of Tether Deployment and Release

## 7. PAYLOAD JUGGLING BY TETHER: NEAR & FAR-TERM POTENTIALS

### Using a Momentum Transfer Tether to "Juggle" Payloads:

#### Station-Tended Swarm of Free-Flyers:

466  
Payload is boosted & released by hanging or swinging tether;  
Released payload flies free for months while its orbit decays;  
When payload passes under station, tether recaptures it.  
Station does any necessary servicing & maintenance on payload.

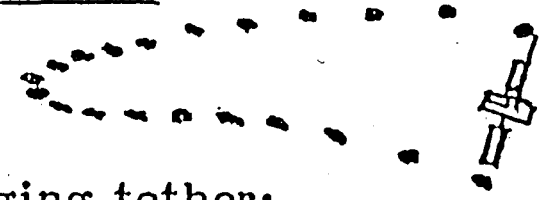

#### Single-orbit aerodynamic sensing, testing, or air collection:

Vehicle is slung upwards from station by spinning tether;  
Station damps tether spin by active length control;  
3/4 orbit after release, vehicle reaches perigee;  
1/4-1/2 orbit later, vehicle is recaptured from decayed orbit.

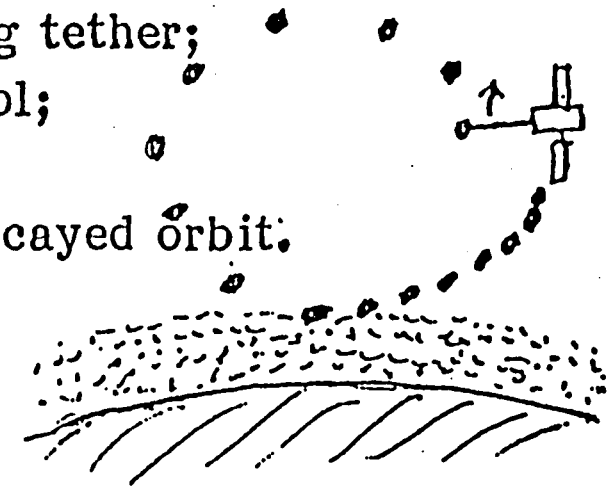

## 8. TETHERED DOCKING OF SHUTTLE WITH SPACE STATION

- Hardware & constraints mostly common w/STS deboost.
- Vary tether length with prop. needs & solar cycle.
- Savings scale with tether length up to about 60 km.
- Potential 60% increase in STS throughput!

Slightly lower apogee  
Much lower perigee  
Tethered deboost  
Cryo scavenging

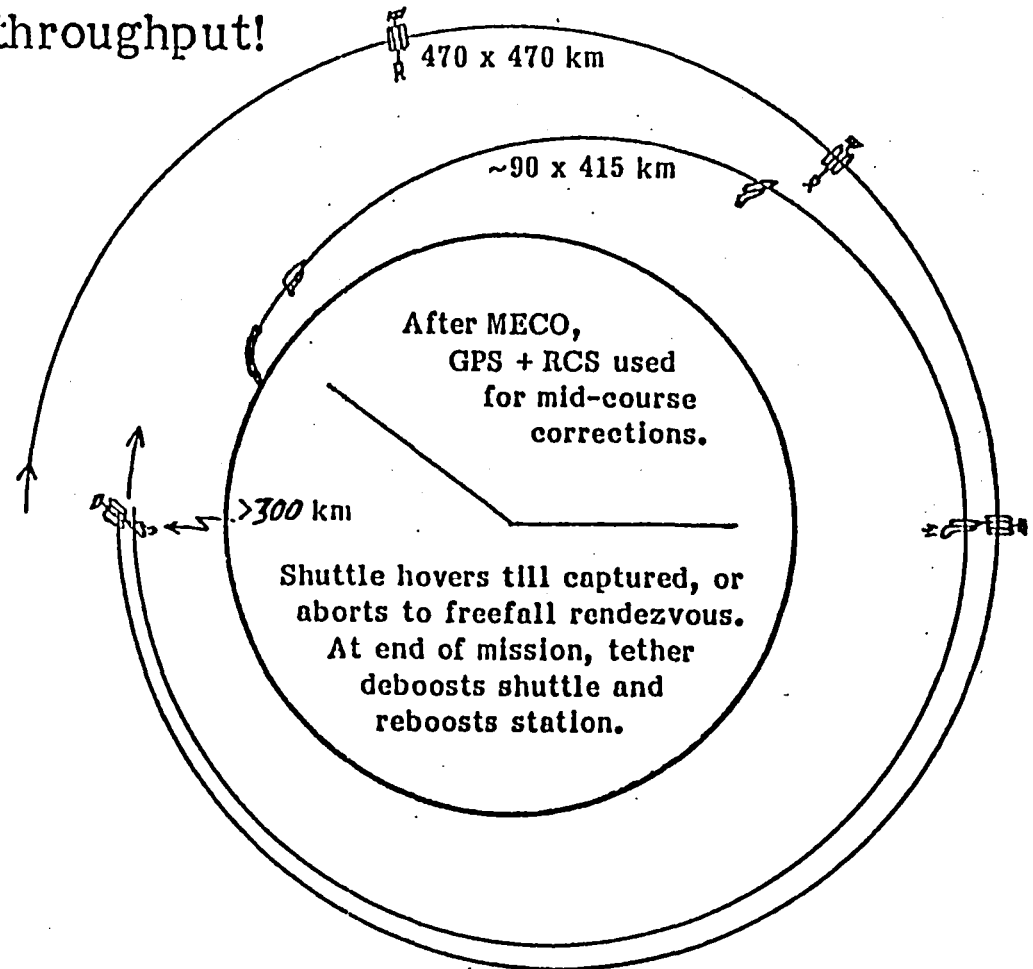

## 9. HAZARDOUS OR CONTAMINATING OPERATIONS

- Tether isolates contaminating & hazardous ops, while providing attitude, power, stationkeeping.
- Downward deployment shortens debris orbital life.
- An example: skin, cut up, & melt down ETs:

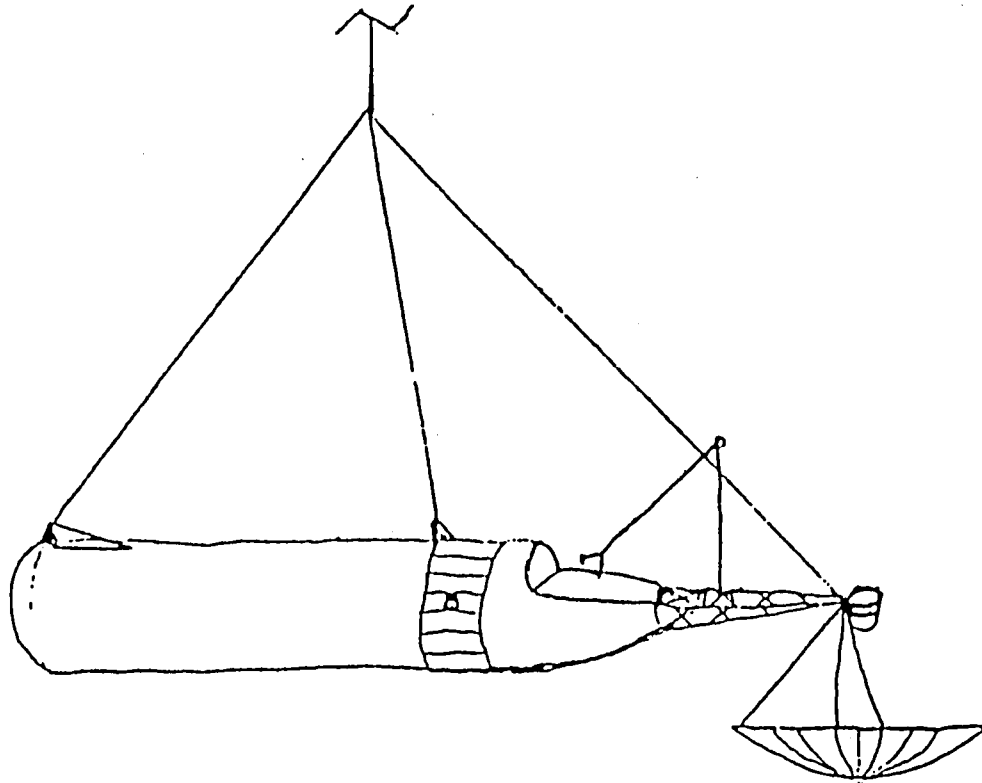

## 10. LUNAR-ORBITING TETHER FACILITY

- Long swinging tethers or short spinning ones?
- Three ranges of  $\Delta V$  have utility:

small, for capturing payloads in orbit ( $M_t \ll M_p$ )

850 m/s, to get 2/3 of surface-TEI  $\Delta V$  ( $M_t \approx M_p$ )

1700 m/s, to pick up objects on surface ( $M_t \approx 10M_p$ )

### Required Technology:

Advanced tether controls  
Powerful tether deployer  
Maneuverable tether tip  
Large power supply  
High-Isp propulsion  
Propellant extraction

### Transport Capabilities:

Surface-Orbit-Escape  
Handles large payloads  
Max g-loads  $< .3$  gee  
Rocket backup if desired  
Two-way mass flow is "free"  
Net boosting costs  $\sim 25$  MWH/tonne  
Polar orbit: frequent access to poles &  
infrequent access everywhere  
Equatorial: frequent access to equator

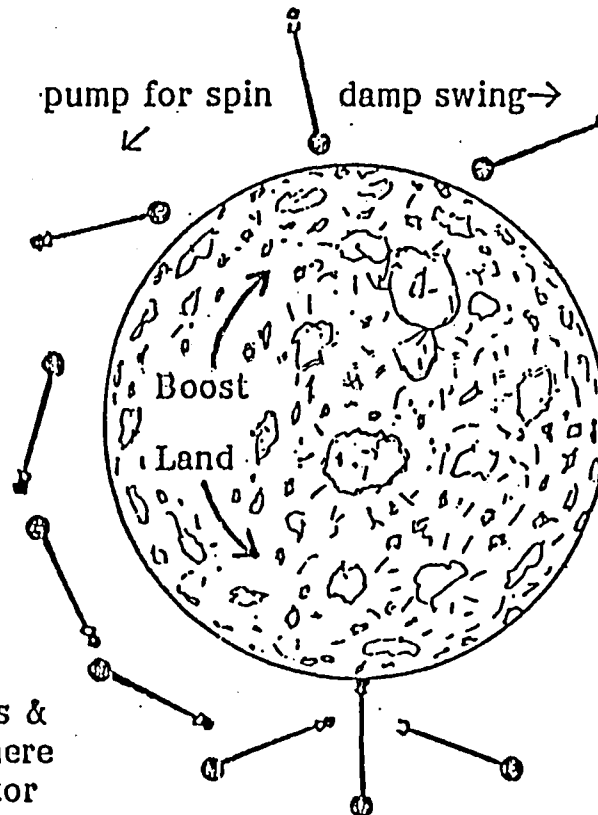

## 11. LUNAR-SURFACE-BASED SLING

- "Minimal mass-driver" = fishing reel on Apollo 11?
- Launcher for 10 kg payloads should fit in 1 shuttle.
  - 300 m tether @ 54 rpm imposes  $<1000$  gees on payloads;
  - Bearing loads are similar to those on a train axle;
  - 1 launch/5 min. uses  $<100$  kW, boosts 1,000 tonnes/yr.
- An orbiting tether facility collects launched payloads.
- Collision & debris generation may be a major problem.

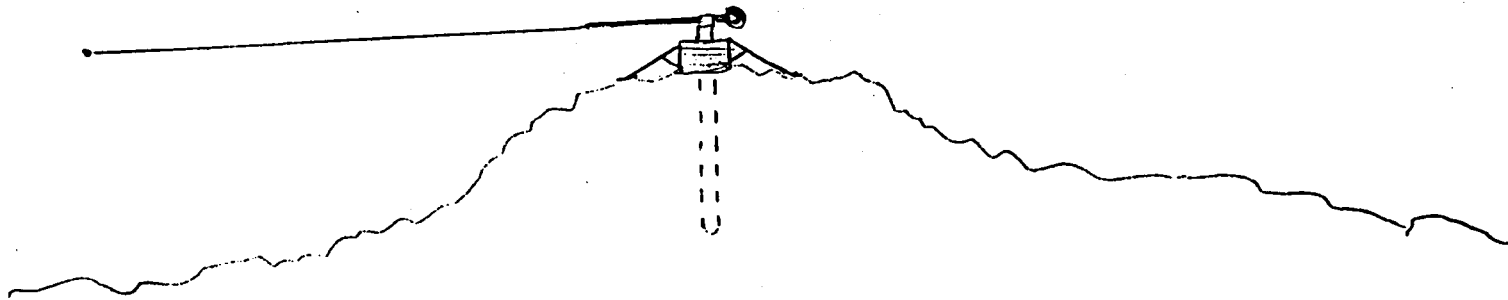



## 12. MARS-ORBITING TETHER FACILITIES

Mars & its moons are uniquely suited to tether operations:

- Both moons are in relatively low equatorial orbits;
- Most required deltaVs are well under 1 km/sec, so  $M_t < M_p$ .

A system of 3 facilities could have powerful capabilities:

- Sling on Phobos (inner moon) throws mass into low-periapsis orbits;
- Station in low orbit collects mass from Phobos & from atmosphere;
- Facility in eccentric orbit throws payloads to earth or asteroids.

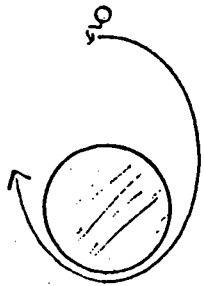

Phobos-Based Sling

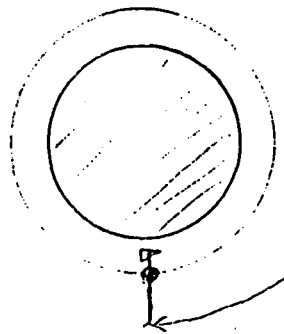

Mars Space Station

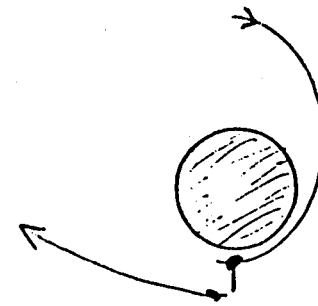

Tether "Upper Stage"

## CONCLUSIONS:

- Most proposed tether concepts on a space station are compatible: full-time operation is not needed, so time-sharing can be done.
- Many concepts are synergistic (e.g., STS deboost & rendezvous), so cost-benefit studies of single concepts understate the true benefits.
- Some concepts may require station scars IN THE DESIGN PHASE.

## RECOMMENDATIONS:

- NASA & Phase-B contractors should study concepts #1-#9 for relevance.
- Cost-benefit studies should include combinations of concepts #1-#9.
- Microgee tethered platforms should be built & tested on KC-135 & STS.
- Already-flown "micro-gee" experiments should be reflown on TSS-1, to see if 20-40 microgees (typical g.g. levels on station) make a difference.

III

WORKSHOP SUMMARY OF RECOMMENDED APPLICATIONS AND DEMONSTRATIONS

The Friday morning session of the Applications of Tethers in Space Workshop in Venice included the panel co-chairmen, and was devoted to listing those applications which would be appropriate for the following eras:

- A. Shuttle
- B. Space Station - IOC
- C. Space Station - Post IOC
- D. Post IOC - General

Some discussion was also devoted to demonstration and TSS missions, which would provide high science return and/or proof of an operational capability. This input is provided in outline form only. Detailed discussion of most of these applications may be found in the proceedings, or the attached references.

A. Operational Applications of Tethers for the Shuttle era.

- 1. Small Payload Placement
- 2. Electrodynamic Power Supply
- 3. Multiprobe (Constellation) System
- 4. Open Wind Tunnel
- 5. Gravity Controlled Experiments

B. Space Station Facilities and Capabilities in the IOC era.

- 1. Variable Length Tether for Space Station C.G. Management
- 2. Electrodynamic Power Supply
- 3. Electrodynamic Thrust (Drag Makeup)
- 4. Tethered Platform (Short Term Missions)
- 5. "Zero G" Laboratory using a Tethered Elevator
- 6. Deboosting Small Cargo Modules
- 7. Electrodynamic Tether for Research
- 8. Multi-probe "Beads on String" Constellation

C. Space Station in the Post IOC era.

1. Tethered Orbiter Deployment with OMS Propellant Scavanging
2. Tethered Launch of OTV
3. Remote Docking of Orbiter
4. Tethered Propellant Depot and Fuel Transfer
5. Tethered Antenna Farm
6. Remote Wake Shield

D. Post IOC - General

1. Spinning Manned Facility
2. Tethers on Platforms
3. Electrodynamic OMV
4. Remote Aerobraking
5. Two Dimensional Constellations
6. Station in LEO to Capture Launch Vehicles in Suborbital Trajectories (LEO Node)
7. Higher Orbit Tether Transfer Nodes
8. Rotating Tether (Sling) attached to the Moon or an Asteroid to Eject Surface Material into Orbit
9. Tether Facilities at other planets

In addition to these applications, some discussion was given to demonstration missions and their candidate objectives. The following are somewhat in chronological order of development.

A. Plasma Motor Generator (McCoy - 86)

- o Demonstrate feasibility and performance of hollow cathode
- o Dynamics and Temperature Response
- o Pulse Effects on Ambient Plasma
- o KU-Band Radar Tests

(Frequent reflights are planned)

- B. Disposable Deployer (Carroll - 87)
  - o Test Successful Release of Tether
  - o Vibration Dynamics
  - o Aerobraking Effects of Tether
  - o Aerothermal Effects using Balloon
  - o Tether Recoil and Shape
  - o Conduct low gravity experiments on orbiter during Tether deployment  
(Frequent reflights are planned)
  
- C. Spinning Orbiter with Tethered Satellite
  - o Test Fluid Settling and Slosh
  - o Conduct low-gravity science
  
- D. Tethered Satellite System (TSS-1)
  - o Accurate Dynamics Verification
  - o Data Collection for other applications
  - o Passive Electron/Ion Collection Efficiency
  - o Effectiveness of Hollow Cathode on Orbiter
  - o Test Accelerometers on Orbiter
  - o Test Tensiometers on Satellite
  - o Satellite Passive Retrieval mode for backup
  
- E. Shuttle released Dumbell Satellite
  - o Test Rendezvous Feasibility
  - o Dynamic Behavior
  - o Elevator attachment
  
- F. Tethered Centaur
  - o Test feasibility
  
- G. Kinetic Isolation Tether Experiment (KITE)
  - o Pointing Stability and accuracy
  - o Disturbance Isolation
  - o Test Extension Cord Concept
  - o Do low gravity experiment on orbiter

- H. Tethered Satellite System (TSS-2)
  - o Planned Aerodynamic Experiments
  - o Low Gravity on Orbiter
  - o Possible Elevator test
  
- I. Tethered Satellite System (TSS-3)
  - o (See TSS-1 Applications)
  - o Plasma Contactor on Orbiter and Satellite
  - o Test Spin Mode





**APPENDIX A**  
**PANEL MEMBERS**



SCIENCE APPLICATIONS PANEL MEMBERS

F. Mariani	II University Rome, Italy
D. Cobb	Los Alamos, USA
G. Carignan	University of Michigan, USA
R. Hudson	NASA Headquarters, USA
A. Anselmi	Aeritalia, Italy
M. Hechler	ESA/ESOC/MAO
W. Baracat	General Research Corporation, USA
P. Dickinson	Rutherford Appleton Lab, U.K.
A. Bonanni	Gavazzi Controls, Italy
A. C. Modugno	Opht. Clin. Rome University, Italy
M. Candidi	IFSI/CNR
H. Mayer	Jet Propulsion Laboratory, USA
C. Tang	Jet Propulsion Laboratory, USA
A. Moccia	University of Naples, Italy
S. Vetrella	University of Naples, Italy
N. Stone	Marshall Space Flight Center, USA
P. Coleman	University of California, USA
L. Gagliardi	PSN/CNR, Italy

ELECTRODYNAMICS PANEL MEMBERS

Joseph C. Kolecki  
Marino Dobrowolny  
Carlo Bonifazi  
Paul J. Wilbur  
Don Parks  
William J. Miller  
Kevin Rudolph  
John R. Beattie  
Jay Hyman  
James E. McCoy  
Bob Estes

Giorgio Tacconi  
Emilio Banfi  
Ludwik Celnikier  
J. P. Lebreton  
Jean Sabbaugh  
Efrem Rsuconi  
Wolfgang Westphal  
Manual Martinez-Sanchez  
Andrea Lorenzoni  
Francesco Giani

NASA/LeRC, USA  
IFSI/CNR, Italy  
IFSI/CNR, Italy  
Colorado State University, USA  
S-Cubed, USA  
Aeritalia, Italy  
Martin Marietta, USA  
Hughes Research Labs, USA  
Hughes Research Labs, USA  
NASA/JSC, USA  
Smithsonian Astrophysical  
Observatory, USA  
University of Genoa (DIBE), Italy  
Laben Si El, Italy  
Observatoire De Paris-Menfon  
SSD/ESA/ESTEC, The Netherlands  
CNR/PSN, Italy  
Carlo Gavazzi Controls, Italy  
AEG, Germany  
MIT, USA  
PSN, Italy  
Aeritalia SSG, Italy

TRANSPORTATION PANEL MEMBERS

Chris Purvis	JPL/Cal Tech, USA
Ed Bangsund	Boeing Aerospace, USA
Joseph Loftus	NASA/JSC, USA
Mark Henley	General Dynamics/SSD, USA
Tom Stuart	NASA/HQ, USA
Joe Carroll	Energy Science Labs, USA
Ernesto Vallerani	Aeritalia, Italy
Dave Moruzzi	Italian Advanced Industries, USA
Terry Reese	General Research Corporation, USA
Maxwell Hunter	Lockheed/MSD, USA
Mario Galantino	PSN/CNR, Italy
Harris Mayer	JPL, USA
Martin Hechler	ESA/ESOC, W. Germany

CONTROLLED GRAVITY PANEL MEMBERS

Charles A. Lundquist  
Luigi G. Napolitano  
James R. Arnold  
Giovanni Ahersini  
Dale E. Fester  
Faduesco Giani  
Vincero Guarnieri  
Jack W. Slowey

Rodelf Monsi  
Kenneth Kroll  
Ethu Outsua  
Alberto Passerone  
Giacomo C. Moduano  
Paul A. Penzo

University of Alabama, USA  
University of Naples, Italy  
University of California, USA  
Case, Mileu  
Martin Marietta, USA  
Aeritalia GSS, Italy  
Aeritalia GSS, Italy  
Smithsonian Astrophysical  
Observatory, USA  
University of Naples, Italy  
NASA/JSC, USA  
Politecuis of Tonius  
Iciam-CNR, Italy  
Eye Clinic, Rome University, Italy  
JPL USA

CONSTELLATIONS PANEL MEMBERS

Enrico Lorenzini

Franco Bevilacqua

Smithsonian Astrophysical  
Observatory  
Aeritalia, Italy

TECHNOLOGY & TEST PANEL MEMBERS

Paul Siemers  
Edmondo Turci  
Giovanni Carlomagno  
John Anderson  
P. G. Magnani  
G. Marone  
Don Crouch  
L. M. Palenzona  
Carlo Boccato  
Vittorio Giavotto  
Peter Bainum  
Vinod Modi  
George Wood  
John Hoffman  
Dick Diller  
G. Bianchini

NASA/LaRC, U.S.A.  
Aeritalia, Italy  
University of Naples, Italy  
NASA HQ, OAST, U.S.A.  
FIAR, Italy  
SIA, Italy  
Martin Marietta, U.S.A.  
ESA/ESTES  
Agusta  
Politecnico Milano, Italy  
Howard University, U.S.A.  
University of British Columbia, Canada  
NASA/LaRC, U.S.A.  
University of Texas at Dallas, U.S.A.  
NASA HQ, Code EE, U.S.A.  
University of Padova, Italy



SPACE STATION PANEL MEMBERS

Gianfranco Manarini	PSN/CNR, Italy
Georg von Tiesenhausen	MSFC/PS01, USA
Donald L. Jones	Ball Aerospace, USA
Bill Nobles	Martin Marietta, USA
B. Bischof	MBB/ERNO
N. W. Spencer	NASA/GSFC, USA
Pietro Merlina	Aeritalia, Italy
Fernando Grego	Selenia Spazio
Silvio Bergamaschi	Un. Padova, Italy
R. Ciardo	Aeritalia, Italy
Philip Chaneller	DFVLR/Koln-Porz
Dana Andrews	Boeing Aerospace, USA
Giuseppe Moneti	Martin Marietta, USA
Tom Mayfield	Martin Marietta, USA
Filippo Sciarrino	Contraves Italiana
Pietro Gervasini	Laben
Wolfgang Westphal	AEG, Germany
Gerald J. Whitman	American Embassy, Rome, Italy
E. Antonia	Politechnics di Torino, Italy
James Arnold	University of California, USA



APPENDIX B  
WORKSHOP PARTICIPANTS



Abba<sup>^</sup>, Stefano  
Aeritalia  
Via Archimede, 156  
00197 Roma  
Italy  
Ph. (06) 878425

Adduci, Marisa  
Centro Internazionale Congressi  
Viale Pio XII, 18  
70124 Bari - Italy  
Ph. (080) 514533  
Telex: 812259 CINTEC-1

Anderson, John L.  
NASA Headquarters  
Office of Aeronautics and Space Technology  
Mail Code RS  
Washington, DC 20546  
U.S.A.  
Ph. (202) 453-2756

Andrews, Dana  
2701 Avondale Ct., SE  
Decatur, AL  
U.S.A.  
Ph. (205) 895-7346

Anselmi, Alberto  
Aeritalia GSS  
Corso Marche, 41  
10146 Torino  
Italy  
Ph. (011) 3332356

Antona, Ettore  
Politecnico Di Torino  
Dipart. Ingegneria Aerospaziale  
Corso Duca degli Abruzzi, 24  
10146 Torino  
Italy  
Ph. (011) 5566807

Arnold, James  
California Space Institute  
University of California - San Diego  
La Jolla, CA 92093  
U.S.A.  
Ph. (619) 452-2908

Bainum, Peter  
Dept. of Mechanical Engr.  
Howard University  
Washington, DC 20059  
U.S.A.  
Ph. (202) 636-6612

Banfi, Emilio  
Laben  
SS Superiore 290  
Vimodrone (MI)  
Italy  
Ph. (02) 25075229

Bagsund, Edward L.  
Boeing Aerospace Co.  
PO Box 3999, M/S 8A 48  
Seattle, Washington 98124  
U.S.A.  
Ph. (206) 773-0636

Baracat, William  
General Research Corporation  
7655 Old Springhouse Road  
McLean, VA 22102  
U.S.A.  
Ph. (703) 893-5900, ext. 544  
Telex: 440543 FGI UI

Beattie, John  
Hughes Research Labs  
Mail Stop RL 57  
3011 Malibu Canyon Road  
Malibu, CA 90265  
U.S.A.  
Ph. (213) 317-5550

Bekey, Ivan  
NASA Headquarters  
National Aeronautics and Space Administration  
Office of Space Flight  
Mail Code MT  
Washington, DC 20546  
U.S.A.  
Ph. (202) 453-1148

Bergamaschi, Silvio  
Institute of Applied Mechanics  
Via Venezia 1  
35131 Padova  
Italy  
Ph. (049) 8071968

Bevilacqua, Franco  
Aeritalia  
Corso Marche 41  
10146 Torino  
Italy  
Ph. (011) 725089

Bianchini, Giannandrea  
Istituto Di Meccanica Applicata  
Via Venezia 1  
35100 Padova  
Italy  
Ph. (049) 20198

Bishop, Bernd  
Erno Raunfahrtechnik Gmbh RA 301  
Hunefeldstr. 1-5 Postf. 105909  
Bremen  
Germany  
Ph. (421) 3509248

Boccaato, Carlo  
Agusta Spa  
Via Caldera 21  
Milano  
Italy  
Ph. (02) 45275390

Bonanni Angelo  
Carlo Gavazzi Controls  
Via G. Ciardi 9  
Milano  
Italy  
Ph. (02) 4020212

Bonifazi Carlo  
PSN - CNR  
IFSI/CNR  
Via Regina Margherita, 202  
00198 Roma  
Italy  
Ph. (06) 40201  
TX 610261

Bozzo, Massimo  
Aeritalia  
Via Ortigara 3/13  
00100 Roma  
Italy  
Ph. (06) 67741

Buongiorno, Carlo  
P.S.N.  
Lungotevere Tamon De Revel, 76  
00100 Roma  
Italy

Candidi, Maurizio  
IFSI/CNR  
CP 27  
00044 Frascati  
Italy  
Ph. (06) 9423801

Carignan, George  
University of Michigan  
Space Physics Research Laboratory  
Department of Atmospheric and Oceanic Sciences  
Space Research Building  
2455 Hayward  
Ann Arbor, MI 48109  
U.S.A.  
Ph. (313) 764-9462

Carlomagno, Giovanni  
Istituto Di Gasdinamica  
P.le V. Tecchio, 80  
80125 Napoli  
Italy  
Ph. (081) 635355 - 616276

Carrol, Joseph  
Energy Science Labs  
421 Westbourne St.  
La Jolla, CA 92037  
U.S.A.  
Ph. (619) 452-7039

Celnikier Ludwik  
Oebservatoire De Paris Meudon  
92 Meudon  
France  
Ph. (01) 5347570

Chandler, Philip  
Space Station Program DFVLR  
Linden Hoehe  
D - 5000 Koeln 90 - FRG  
Ph. (49) 02203 6012856



Ciardo, Salvatore  
Aeritalia  
C.so Marche, 41  
10146 Torino  
Italy  
Ph. (011) 3332356

Cobb, Donald  
Los Alamos National Laboratory  
MS D446  
Los Alamos, NM 87545  
U.S.A.  
Ph. (505) 667-6722

Coleman, Paul  
Institute of Geophysics and Planetary Physics  
University of California  
Los Angeles, CA 90024  
U.S.A.  
Ph. (213) 825-1776

Cosmovici, Cristiano  
IFSI-CNR  
00044 Frascati  
Italy  
Ph. (06) 9423801

Crouch, Donald  
Martin Marietta Aerospace/MS 92071  
PO Box 179  
Denver, CO 80201  
U.S.A.

Dickinson, Paul  
Rutherford Appleton Laboratory  
Chilton Didcot  
Oxon Ox 11 0QX  
England  
Ph. Abingdon (0) 235 21900 ext. 6510

Diller, Dick  
NASA Headquarters  
National Aeronautics and Space Administration  
Code EE  
Washington, DC 20546  
U.S.A.  
Ph. (202) 453-1753

Dobrowolny, Marino  
Istituto Fisica Spazio Interplanetario CNR CP27  
00044 Frascati  
Italy  
Ph. (06) 9421017

Ercoli, Marinella  
Piano Spaziale Nazionale  
Viale Regina Margherita, 202  
00100 Roma  
Italy  
Ph. (06) 4767207

Estes, Robert  
Smithsonian Astrophysical Laboratory  
60 Garden Street  
Cambridge, MA 02144  
U.S.A.  
Ph. (617) 495-7261

Fester, Dale  
Martin Marietta Denver Aerospace  
PO Box 179  
Mail Stop MO441  
Denver, CO 80201  
U.S.A.  
Ph. (303) 977-8699

Fisette, Robert  
Martin Marietta International Office  
9 Avenue de la Colombie  
1050 Brussels  
Belgium  
Ph. (322) 660-2203

Forcella, Piero  
Aeritalia - Stampa  
Via Orti della Farnesina 102  
Roma  
Italy  
Ph. (06) 3686 3816

Foresta, Martin Franco  
Aeritalia - Stampa  
Via del Parlamento 9  
00186 Roma  
Italy  
Ph. (06) 77071

Frulli, Franco  
Ministero Ricerca Scientifica  
Lungotevere Thaon de Revel 78  
00100 Roma  
Italy  
Ph. (06) 394601

Gagliardi, Leonardo  
Piano Spaziale Nazionale  
Viale Regina Margherita 202  
00100 Roma  
Italy  
Ph. (06) 4767250

Galantino, Marco  
Piano Spaziale Nazionale  
Viale Regina Margherita 202  
00100 Roma  
Italy  
Ph. (06) 4767252

Gervasini, Pietro Luigi  
LABEN  
S.S. Panana Superiore 290  
22090 Vimodrone  
Italy  
Ph. (02) 250751

Ghersini, Giovanni  
Via Reggio Emilia, 39  
20090 Segrate (MI)  
Italy  
Ph. (02) 2167 2201

Giani Francesco  
Aeritalia  
Via Servais, 125  
10146 Torino  
Italy  
Ph. (011) 3332235/721345

Giavotto, Vittorio  
Dipartimento Di Ingegneria Aerospaziale  
Politecnico Di Milano  
Via Golgi 40  
20133 Milano  
Italy  
Ph. (02) 2364308

Granelli, Luigi  
Ministro Per La Ricerca Scientifica E Tecnologica  
Roma  
Italy  
Grego, Fernando  
Selenia Spazio  
Via Gaeta 70  
Roma  
Italy  
Ph. (06) 43682157

Guarnieri, Vincenzo  
Aeritalia - Saipa  
Via Servais 125  
10100 Torino  
Italy  
Ph. (011) 721345

Guerriero, Luciano  
Piano Spaziale Nazionale  
Viale Regina Margherita 202  
00100 Roma  
Italy  
Ph. (06) 8445107

Hechler, Martin  
Mission Analysis Office  
European Space Operation Center  
Robert Bosch Str. 5  
61 Darmstadt  
Germany  
Ph. 0044 6151886291

Henley, Mark  
General Dynamic Space Systems Div.  
PO Box 85990  
San Diego, CA 92138  
U.S.A.  
Ph. (619) 547-7309

Hoffman, John  
University of Texas at Dallas  
Physics Department  
PO Box 830688  
Richardson, TX 75143  
U.S.A.  
Ph. (214) 690-7840

Hudson, Robert  
NASA Headquarters  
National Aeronautics and Space Administration  
Mail Code EES  
Washington, DC 20546  
U.S.A.  
Ph. (202) 453-1676

Hunter, Maxwell  
Lockheed Missiles and Space Company  
3165 La Mesa Drive  
San Carlos, CA 94070  
U.S.A.  
Ph. (408) 742-6434

Hyman, Julius  
Hughes Research Labs  
3011 Malibu Canyon Road  
Mail Stop RL57  
Malibu, CA 90265  
U.S.A.  
Ph. (213) 317-5495

Iorio, Ciro  
Aeritalia  
Viale Petrolini 2  
00197 Roma  
Italy  
Ph. (06) 8778539

Jones, Donald  
Ball Aerospace  
Systems Division  
Mail Stop BE-9  
Box 1062  
Boulder, CO 80306  
U.S.A.  
Ph. (303) 939-4001

Kelly, Francis  
Dept. of the Navy  
Naval Research Lab  
Washington, DC 20375  
U.S.A.  
Ph. (202) 767-2941/(202) 767-2891

Kolecki, Joseph  
National Aeronautics and Space Administration  
Lewis Research Center  
21000 Brookpark Road  
Mail Stop 302-1  
Cleveland, OH 44135  
U.S.A.  
Ph. (216) 433-2296

Kroll, Kenneth  
National Aeronautics and Space Administration  
Johnson Space Center  
Mail Code EP4  
Houston, TX 77058  
U.S.A.  
Ph. (713) 483-5495

Letico, Enzo  
Italian National Space Plan  
950 L'Enfant Plaza  
Rm. 3163  
Washington, DC 20024  
U.S.A.  
Ph. (202) 863-1298

Lebretton, Jean Pierre  
Space Science Dept. of ESTEC  
Keperlaan 1  
Noordwijk  
The Netherlands  
Ph. (31) 171983600

Lippy, Lester  
Martin Marietta Corporation  
Denver Aerospace  
PO Box 179  
Mail Stop S8080  
Denver, CO 80201  
U.S.A.  
Ph. (303) 977-3678

Locatelli, Luigi  
Segretarion Ministro Granelli  
Via della Pila 2  
20100 Milano  
Italy

Loftus, Joseph  
National Aeronautics and Space Administration  
Johnson Space Center  
Office of the Director  
Mail Code AT  
Houston, TX 77058  
U.S.A.  
Ph. (713) 483-2194

Lorenzini, Enrico  
Smithsonian Astrophysical Observatory  
60 Garden Street  
Mail Stop 59  
Cambridge, MA 02138  
U.S.A.  
Ph. (617) 495-7211

Lorenzoni, Andrea  
Piano Spaziale Nazionale  
Viale Regina Margherita 202  
00195 Roma  
Italy

Lundquist, Charles  
University of Alabama  
Research Institute  
Box 209  
Huntsville, AL 35899  
U.S.A.  
Ph. (205) 895-6100

Magnani, Piergiovanni  
FIAR SPA  
Via Montefeltro 8  
20100 Milano  
Italy  
Ph. (02) 35790267

Manarini, Gianfranco  
Programma Spaziale Nazionale  
Viale Regina Margherita 202  
00198 Roma  
Italy

Mariani, Franco  
Dipartimento Fisica II Universita  
V.D. Raimondo  
00173 Roma  
Italy  
Ph. (06) 79792319

Markland, Chris  
ESA - ESTEC  
Noordwyk  
The Netherlands  
Ph. 1719 83841

Marone, Gualtiero  
SIA SPA  
Via Servais 125  
00100 Torino  
Italy  
Ph. (011) 794844

Martinez, Sanchez Manuel  
Dept. Aeronautics/Astronautics  
Massachusetts Institute of Technology  
Cambridge, MA 02139  
U.S.A.  
Ph. (617) 253-5613

Mayer, Harris  
30923 Cartier Drive  
Rancho Palos Verdes, CA 90274  
U.S.A.  
Ph. (213) 648-5426

Mayfield, Thomas  
Martin Marietta Overseas Co.  
PO Box 179 1140  
Denver, CO 80201  
U.S.A.  
Ph. (303) 971-5005

McCoy, James  
National Aeronautics and Space Administration  
Johnson Space Center  
Mail Code SN3  
Houston, TX 77058  
U.S.A.  
Ph. (713) 483-5171

Merlina, Pietro  
Aeritalia GSS  
Via Servais 125  
Torino  
Italy  
Ph. (011) 3332356

Miller, William  
Aeritalia Space System Group  
Cso Marche 41  
10146 Torino  
Italy  
Ph. (011) 3332356

Moccia, Antonio  
Istituto Di Gasdinamica  
Universita di Napoli  
Ple Tecchio 80  
80125 Italy  
Ph. (081) 616276

Modi, Vinod  
Department of Mechanical Engr.  
University of British Columbia  
2075 Wesbrook Mall  
Vancouver, B.C. V6T 1W5  
Canada  
Ph. (604) 228-2914

Modugno, Giacomo  
Via A. Ristori, 21  
00197 Roma  
Italy  
Ph. (06) 870510



Moneti, Giuseppe  
Multiconsult  
Via Porta Pinciana, 34  
00100 Roma  
Italy  
Ph. (06) 483505

Monti, Rodolfo  
Istituto Aerodinamica U. Nobile  
Universita' di Napoli  
Via Petrarca, 74  
80100 Napoli  
Italy

Montini, M.Barbara  
Piano Spaziale Nazionale  
V.le Regina Margherita, 202  
00100 Roma  
Italy  
Ph. (06) 4767261

Moruzzi, Dave  
Italian Advanced Industries (USA), Inc.  
1235 Jefferson Davis Highway  
Suite 500  
Arlington, VA 22202  
U.S.A.  
Ph. (703) 243-1700

Napolitano, Luigi  
Istituto Aerodinamica U. Nobile  
Via F. Russo, 29  
80123 Napoli  
Italy  
Ph. (081) 7690525

Nobles, William  
Martin Marietta Corporation  
Denver Aerospace  
PO Box 179  
Mail Stop S8071  
Denver, CO 80201  
U.S.A.  
Ph. (303) 977-4302

Palenzona, L.Marco  
ESA - ESTEC  
Kleperlaan 1, Postbus 299  
2200 AG Noordwijk  
The Netherlands  
Ph. (31) 171983651

Parks, Donald  
S-Cubed  
PO Box 1620  
La Jolla, CA 92038  
U.S.A.  
Ph. (619) 453-0060

Passerone, Alberto  
Istituto Di Chimica Fisica  
Applicata Dei Materiali (CNR)  
Lungo Bisagno Istria, 34  
16136 Genova  
Italy  
Ph. (010) 852951

Pellegrini, Pier Franco  
Dipartimento Di Fisica  
Via S. Marta, 3  
50139 Firenze  
Italy  
Ph. (055) 4796267

Penzo, Paul  
Jet Propulsion Laboratory  
Mail Code 156-217  
4800 Oak Grove Drive  
Pasadena, CA 91109  
U.S.A.  
Ph. (818) 354-2797 (FTS 792)

Pontiggia, Carlo  
Dipartimento Di Fisica  
Via del Bragone, 13  
16147 Genova  
Italy  
Ph. (010) 518184

Purvis, Christopher R.  
Jet Propulsion Lab  
Mail Code 156-246  
4800 Oak Grove Drive  
Pasadena, CA 91109  
U.S.A.  
Ph. (818) 354-8647

Raiola, Giulo  
Aeritalia Stampa  
Via Ermete Novelli, 6  
00100 Roma  
Italy  
Ph. (06) 874526

Reese, Terrence  
General Research Corporation  
7655 Old Springhouse Road  
McLean, VA 22102  
U.S.A.  
Ph. (703) 893-5900 ext. 680  
TELEX 440543 FGI UI

Ripp, Louis  
Martin Marietta Corporation  
PO Box 179  
Mail Stop S0561  
Denver, CO 80201  
U.S.A.  
Ph. (303) 977-4536

Rudolph, Kevin  
Martin Marietta Corporation  
PO Box 179  
Mail Stop M0482  
Denver, CO 80201  
U.S.A.  
Ph. (303) 977-8705

Ruffini, Remo  
Dipartimento di Fisica  
Universita' di Roma  
P.le Aldo Moro, 2  
00100 Roma  
Italy  
Ph. (06) 4976304

Rusconi, Efrem  
Carlo Gavazzi Controls  
Via Ciardi, 9  
20100 Milano  
Italy  
Ph. (02) 40201

Sabbagh, Jean  
Piano Spaziale Nazionale  
V.le Regina Margherita, 202  
00198 Roma  
Italy  
Ph. (06) 4767247

Sciarrino, Filippo  
Contraves Italiana  
Via Affile, 102  
00131 Roma  
Italy  
Ph. (06) 43672444

Siemers, Paul  
National Aeronautics and Space Administration  
Langley Research Center  
Mail Stop 366  
Hampton, VA 23665  
U.S.A.  
Ph. (804) 865-3031

Sisson, James  
National Aeronautics and Space Administration  
Marshall Space Flight Center  
Mail Code FA31  
Huntsville, AL 35812  
U.S.A.  
Ph. (205) 453-5310

Slowey, Jack  
Smithsonian Astrophysical Observatory  
60 Garden Street  
Cambridge, MA 02138  
U.S.A.  
Ph. (617) 495-7214

Spencer, Nelson  
National Aeronautics and Space Administration  
Goddard Space Flight Center  
Mail Code 610  
Greenbelt, MD 20771  
U.S.A.  
Ph. (301) 344-5001

Stone, Noble  
National Aeronautics and Space Administration  
Marshall Space Flight Center  
Mail Code ES53  
Huntsville, AL 35812  
U.S.A.  
Ph. (205) 453-0029

Stuart, Thomas  
NASA Headquarters  
National Aeronautics and Space Administration  
Office of Space Flight  
Mail Code MST  
Washington, DC 20546  
U.S.A.  
Ph. (202) 453-1562

Tacconi, Giorgio  
Dipartimento Dibe Universita' Genova  
Via dell'Opera Pia, 11 A  
16145 Genova  
Italy

Tang, Charles  
Jet Propulsion Laboratory  
4800 Oak Grove Drive  
Mail Code 156-248  
Pasadena, CA 91109  
U.S.A.  
Ph. (818) 354-6688

Tripodi, Carlo  
Aeritalia Stampa  
Via Bernini, 58  
80129 Napoli  
Italy

Turci, Edmondo  
Aeritalia  
Corso Marche 41  
10100 Torino  
Italy  
Ph. (011) 712923

Valente, Saverio  
Via Vittorio Emanuele 23  
80073 Capri  
Italy  
Ph. (081) 8370900

Vallerani, Ernesto  
Aeritalia  
C.so Marche 41  
10100 Torino  
Italy  
Ph. (011) 712923

Vetrella, Sergio  
Facolta Di Ingegneria Ist. Gasdinamica  
P.le Tecchini 80  
80125 Napoli  
Italy  
Ph. (081) 616276

von Tiesenhausen, Georg  
National Aeronautics and Space Administration  
Marshall Space Flight Center  
Mail Code PS01  
Huntsville, AL 35812  
U.S.A.  
Ph. (205) 453-2789

Westphal, Wolfgang  
Industriestrasse 29  
D-2000 Wedel  
Germany  
Ph. (04103) 702843

Whitaker, David  
Martin Marietta  
PO Box 179  
Denver, CO 80201  
U.S.A.  
Ph. (303) 977-5364

Whitman, Gerald  
American Embassy, Rome  
APO New York, NY 09784  
Ph. 46742375

Wilbur, Paul  
Colorado State University  
Department of Mechanical Engineering  
Fort Collins, CO 80523  
U.S.A.  
Ph. (303) 491-8564

Wood, George  
National Aeronautics and Space Administration  
Langley Research Center  
Mail Code 234  
Hampton, VA 23665  
U.S.A.  
Ph. (804) 865-2466

Wolff, Holger  
Messerschmitt Boelkow Blohn GMBH  
Postfach 801169  
D-8000 Muenchen 80  
West Germany  
Ph. (084) 6000 7762

**APPENDIX C**  
**WORKSHOP AGENDA**





APPLICATIONS OF TETHERS IN SPACE WORKSHOP

AGENDA

15-17 October 1985

14 October, 1985 - Monday

6:00pm -- 9:00am REGISTRATION

15 October, 1985 - Tuesday

8:00am -- 8:30am REGISTRATION

SESSION I - INTRODUCTION

8:30am -- 8:45am Orientation and Purpose...L. Guerriero

8:45am -- 9:00am Welcome...representing the Mayor of Venice, Mr. A. Salvadori

9:00am -- 9:30am Opening Address...Sen. Luigi Granelli, Minister of Scientific Research and Technology

9:30am -- 10:00am BREAK

10:00am -- 10:15am Keynote Address...I. Bekey

SESSION II - GENERAL PRESENTATIONS

10:15am -- 10:30am Tethered Satellite System...J. Sisson

10:30am -- 10:45am Tethered Satellite Design...G. Manarini, A. Lorenzoni

10:45am -- 11:15am Tether Fundamentals...J. Carroll/S. Bergamaschi

11:15am -- 11:45am Science Applications...F. Mariani/P. Penzo

11:45am -- 12:15pm Electrodynamic Interactions...M Dobrowolny/J. E. McCoy

12:15pm -- 12:45pm Transportation...G. von Tiesenhausen

12:45pm -- 2:30pm LUNCH

2:30pm -- 3:00pm Variable and/or Artificial Gravity... L. Napolitano/K. Kroll

3:00pm -- 3:30pm Space Station ... W. Nobles/P. Merlina

3:30pm -- 4:00pm Technology and Test ... C. Buongiorno/P. Siemers

4:00pm -- 4:30pm Constellations ... E. Lorenzini

4:30pm -- 5:15pm Tether Dynamics Movie ... J. Loftus

7:15pm RECEPTION HOSTED BY THE MAYOR OF VENICE

APPLICATIONS OF TETHERS IN SPACE WORKSHOP

AGENDA (CONT.)

15-17 October 1985

16 October, 1985 - Wednesday

SESSION III - PANEL MEETINGS

8:30am -- 12:00pm Panels Meet in Assigned Rooms  
12:00pm -- 2:00 pm LUNCH  
2:00pm -- 4:00pm Panels Meet in Assigned Rooms  
4:00pm -- 5:00pm Plenary Session - Preliminary Panel Reports  
8:00pm -- 11:00pm GALA DINNER...J. ARNOLD GUEST SPEAKER

17 October, 1985 - Thursday

SESSION III - PANEL MEETINGS (CONTINUED)

8:30am -- 12:00pm Panels Meet in Assigned Rooms  
12:00pm -- 1:30pm LUNCH

SESSION IV - WORKSHOP SUMMARY

1:30pm -- 3:30pm Final Report Preparation - Panel Chairmen Meet  
3:30pm -- 5:30pm Plenary Session - Summary of Workshop  
Recommendations

18 October, 1985 - Friday

8:30am -- 12:30pm Panel Chairmen Turn in Final Panel Reports,  
Legibly Prepared with Sketches, Diagrams and  
Reproducible Graphics as Available

APPENDIX D  
BIBLIOGRAPHY



VENICE WORKSHOP

APPLICATIONS OF TETHERS IN SPACE  
LIBRARY

1. Applications of Tethers in Space, Vols. 1 and 2, Executive Summary, Workshop Proceedings, 15-17 June 1983.
2. J. B. Eades and H. Wolf, "Tethered Body Problems and Relative Motion Orbit Determination," NAS-5-21453, Analytical Mechanics Association, Inc., August 1982.
3. G. Colombo, et al., "Shuttle-Borne 'Skyhook': A New Tool for Low-Orbital-Altitude Research," Smithsonian Institution Astrophysical Observatory, September 1974.
4. Unknown, "Shuttle/Tethered Satellite System Conceptual Design Study," NASA TM X-73365, Marshall Space Flight Center, December 1976.
5. C. Rupp and J. H. Laue, "Shuttle/Tethered Satellite System," Journal Astronautical Sciences, XXVI-1, January-March 1978.
6. Unknown, "Shuttle/Tethered Satellite System Definition Study," Final Study Report, NAS8-32854, Martin Marietta Aerospace, April 1979.
7. Shuttle/Tethered Satellite System Definition Study--Final Study Report, NAS8-32853, Ball Aerospace Systems Division, February 1979.
8. C. C. Rupp, A Tether Tension Control Law for Tethered Satellites Deployed Along Local Vertical, NASA TM X-64963, Marshall Space Flight Center, 1 September 1975.
9. Unknown, "The Tethered Satellite System," Final Report from the Facility Requirements Definition Team," sponsored by MSFC under NASA Contract NAS8-33383 to the Center for Atmospheric and Space Sciences, Utah State University, May 1980.
10. P. R. Williamson and P. M. Banks, "The Tethered Balloon Current Generator: A Space Shuttle-Tethered Subsatellite for Plasma Studies and Power Generation," Final Report, NOAA Contract 03-5-022-60, 16 January 1976.
11. William P. Baker, et al., "Tethered Subsatellite Study," NASA TMX-73314, MSFC, March 1976.
12. Unknown, "Report of the Plasma Physics and Environmental Perturbation Laboratory Working Groups," Program Development Contract NASA TM X-64856, March 1974.

13. Unknown, "Utilization of the External Tanks of the STS," draft of results from workshop held at the University of California, San Diego, 23-27 August 1982.
14. H. L. Mayer, "Swarms: Optimum Aggregations of Spacecraft," Aerospace Corporation ATR-80(7734)-1, 29 February 1980.
15. G. Colombo, et al., "Use of Tethers for Payload Orbital Transfer," Smithsonian Astrophysical Observatory, NAS8-33691, March 1982.
16. Maxwell W. Hunter, "Advanced Space Transportation Options," Lockheed, August 1982.
17. William P. Baker, J. A. Dunkin, et al., "Tethered Subsatellite Study," NASA TMX-73314, Marshall Space Flight Center, March 1976.
18. Arthur C. Clarke, The Space Elevator: 'Thought Experiment' or Key to the Universe, Address to the XXXth Astronautical Congress, Munich, 20 September 1979.
19. "The Process of Space Station Development Using External Tanks," Report by the External Tank Working Group of the California Space Institute, La Jolla, California, 11 March 1983.
20. David D. Lang and Roger K. Nolting, "Operations with Tethered Space Vehicles," Gemini Summary Conference, NASA SP-138.
21. W. C. Snoddy, "Scientific and Technical Applications of a Tethered Satellite System," 175th AIAA Aerospace Sciences Meeting, New Orleans, LA, 15-17 January 1979.
22. P. Roger Williamson, P. M. Banks, and K. Oyama, "The Electrodynamic Tether," Utah State University, Logan, Utah, NASA Contract NAS5-23837, 1978.
23. P. M. Kalaghan, et al., "Study of the Dynamics of a Tethered Satellite System (Skyhook)," Final Report Contract NAS8-32199, Smithsonian Astrophysical Observatory, Cambridge, MA, March 1978.
24. UAH/NASA Workshop on "The Uses of a Tethered Satellite System," Summary Papers, Huntsville, Alabama, May 1978.
25. M. Dobrowolny, G. Colombo, and M. D. Grossi, "Electrodynamics of Long Tethers in the Near-Earth Environment," Smithsonian Astrophysical Observatory, Cambridge, MA, October 1976.
26. Wei-Yuan Tang, "Comparison of Three Kinds of Possible Power Generators as Space Shuttle Power Extension Package," Smithsonian Institution, Cambridge, MA, 31 December 1981.
27. D. A. Arnold and M. D. Grossi, "Natural Damping in the Electrodynamic Tether," Smithsonian Institution, Cambridge, MA, 24 January 1983.

28. A. K. Misra and V. J. Modi, "Deployment and Retrieval of Shuttle Supported Tethered Satellites," University of British Columbia, Vancouver, B.C., Canada, 1980.
29. P. M. Banks, P. R. Williamson, and K. L. Oyama, "Shuttle Orbiter Tethered Subsatellite for Exploring and Tapping Space Plasmas," Aeronautics and Astronautics, February 1981.
30. Jerome Pearson, "Anchored Lunar Satellites for Cislunar Transportation and Communication," USAF Flight Dynamics Laboratory, WPAFB, Ohio, 1977.
31. J. H. Glaese and H. L. Pastrick, "Modal Synthesis Simulation of the Shuttle Orbiter Tethered Satellite System," Control Dynamics, Huntsville, Alabama, August 1982.
32. Tether System Applications To/With Space Station, Unmarked Document, Approx. 1982.
33. A Scenario for Evolution and Tether Uses in a Space Station, AIAA/NASA Space Systems Technology Conference, 5 June 1984, AIAA paper 84-1110-CP.
34. W. Nobles, Selected Tether Applications in Space, 31 July 1984, NASA Contract NAS8-35499.
35. Georg von Tiesenhausen, Tethers in Space--Birth and Growth of a New Avenue to Space Utilization, February 1984, NASA TM-82571.
36. Ivan Bekey, Tethers Open New Space Options, AIAA, April 1983.
37. J. A. Carroll, Guidebook for Analysis of Tether Applications, Contract RH4-394049, Martin Marietta Corporation, February 1985.
38. Tethered Satellite System, Advanced Concepts, STS, August 1981.
39. Dr. Mario Grossi, Engineering Study of the Electrodynamic Tether as a Spaceborne Generator of Electric Power, NASA Contract NAS8-35497, Smithsonian Institution Astrophysical Observatory, June 1984.
40. William B. Thompson, Electrodynamics of a Conducting Tether, Final Report to Martin Marietta Aerospace Corporation, Research Contract RH3-393855, California Space Institute and Department of Physics, University of California, San Diego, December 1983.
41. David A. Arnold, Orbital Pumping, NASA Contract NAS8-35036, Smithsonian Institution Astrophysical Observatory, 24 August 1984.
42. J. Tschirgi, Tether Deployed SSUS-A, NASA Contract NAS8-32842, McDonnell Douglas, April 1984.
43. Dr. Giuseppe Colombo, The Use of Tethers for Payload Orbital Transfer, NASA Contract NAS8-33691, Vol. II, March 1982.

44. The Process of Space Station Development Using External Tanks, California Space Institute of the University of California, Scripps Institution of Oceanography, La Jolla, CA, Report to Director of the Space Station Review Project, Office of Technology Assessment, 11 March 1983.
45. Joseph A. Carroll, Feasibility Study of a Disposable-Tether Payload Deploying System for the STS, NASA Contract NAS8-35843, 29 June 1984.
46. W. Nobles, Selected Tether Applications in Space, Martin Marietta, NASA Contract NAS8-35499, Final Report, February 1985.
47. Joseph A. Carroll, Tethers and External Tanks: Enhancing the Capabilities of the Space Transportation System, Research and Consulting Services, La Jolla, CA, 20 December 1982.
48. P. A. Penzo, Tethers and Gravity in Space, JPL, July 1985.
49. Study of an Orbiting Tethered Dumbbell System Having Positive Orbital Energy, Contract NAS8-35497, Smithsonian Institution, February 1985.
50. A Study of Transportation Applications of Space Tethers, Final Report, MIT Space Systems Laboratory, Contract No. RH4-394007 from Martin Marietta, February 1985.
51. Tether Applications for the Inertial Upper Stage, IUS Futures, The Boeing Company, January 1985.
52. P. A. Penzo, Tether for Mars Space Operation, JPL, 1984 Conference Paper, University of Colorado, Boulder, 10-14 July 1984.
53. Dr. Enrico Lorenzini, Analytical Investigation of Dynamics of Tethered Constellation in Earth Orbit, NASA Contract NAS8-35497, Final Report, Smithsonian Institution Astrophysical Observatory, December 1984.
54. Dr. Giuseppe Colombo, Tether Dynamics Software Review, High Resolution Tether Dynamics Studies, Advanced Tether Applications, Investigation of Electrodynamical Stabilization and Control of Long Orbiting Tethers, NASA Contract NAS8-35036, Smithsonian Institution Astrophysical Observatory, January 1984.
55. D. Fester, et al., Tethered Orbital Refueling Study, In Progress, NASA Contract NAS9-17059, January 1985.
56. P. A. Penzo and H. L. Mayer, Tethers and Asteroids for Artificial Gravity Assist in the Solar System, JPL, AIAA-84-2056, 1984.
57. Dr. Giuseppe Colombo, "Orbital Transfer and Release of Tethered Payloads," Final Report, Contract NAS8-33691, March 1983.



58. P. Roger Williamson, et al., "Measurements of Vehicle Potential Using a Mother-Daughter Tethered Rocket," Utah State University, NASA Grant NSG-6027, 1982.
59. Dr. Mario D. Grossi, "Theoretical Investigation of the Generation and Injection of Electromagnetic Waves in Space Plasma by Means of a Long Orbiting Tether," Final Report, Contract NAS8-33520, February 1981.
60. Mark Kammeyer and Carl Soderland, "Spinning Dumbbells in Orbit," NASA/JSC, July 1985.
61. Proceedings of Tether Applications in Space Program Review, McLean, VA, July 1985.
62. A Study of Transportation Applications of Space Tethers, MIT Space Systems Lab, Final Report, February 1985.
63. D. A. Fester, et al., "Tethered Orbital Refueling Study," Interim Report, Martin Marietta Aerospace prepared under contract NAS9-17059 to JSC, May 1985. (MCR-85-686)
64. P. A. Penzo, "Tethers for Mars Space Operations," presented at conference The Case for Mars II, University of Colorado, Boulder, July 10-14, 1984.
65. I. Bekey, "Space Station Operations Enhancement Using Tethers," IAF-84-43.
66. I. Bekey, "Applications of Space Tethers," IAF-84-436.









1. Report No. NASA CP-2422	2. Government Accession No.	3. Recipient's Catalog No.	
4. Title and Subtitle Applications of Tethers in Space - Workshop Proceedings Volume 2		5. Report Date June 1986	
		6. Performing Organization Code MT	
7. Author(s) William A. Baracat, Compiler		8. Performing Organization Report No.	
		10. Work Unit No.	
9. Performing Organization Name and Address Advanced Programs Division Office of Space Flight		11. Contract or Grant No. NASW-3921	
		13. Type of Report and Period Covered Conference Publication	
12. Sponsoring Agency Name and Address National Aeronautics and Space Administration Washington, DC 20546		14. Sponsoring Agency Code	
		15. Supplementary Notes William A. Baracat: General Research Corporation, McLean, Virginia.	
16. Abstract  <p>The proceedings of the second workshop on Applications of Tethers in Space, sponsored jointly by the Italian National Space Plan, CNR, and NASA, held in Venice, Italy, October 15-17, 1985, are presented here. The workshop was attended by persons from government, industry, and academic institutions to discuss the rapidly evolving area of tether applications in space.</p> <p>This volume contains the complete documentation of the workshop, including opening addresses, tether fundamentals, and panel reports and summaries.</p>			
17. Key Words (Suggested by Author(s)) tethers                      microgravity electrodynamic tethers space shuttle space station tethered satellite system		18. Distribution Statement  Unclassified - Unlimited  Subject Category 37	
19. Security Classif. (of this report) Unclassified	20. Security Classif. (of this page) Unclassified	21. No. of Pages 531	22. Price A23



**National Aeronautics and  
Space Administration  
Code NIT-4**

**Washington, D.C.  
20546-0001**

**Official Business  
Penalty for Private Use, \$300**

**SPECIAL FOURTH-CLASS RATE  
POSTAGE & FEES PAID  
NASA  
Permit No. G-27**

**NASA**

**POSTMASTER: If Undeliverable (Section 158  
Postal Manual) Do Not Return**

---

---

---