

NASA Technical Memorandum 100280

HOST Turbine Heat Transfer Program Summary

Herbert J. Gladden and Robert J. Simoneau
Lewis Research Center
Cleveland, Ohio

(NASA-TM-100280) HOST TURBINE HEAT TRANSFER
PROGRAM SUMMARY (NASA) 22 p CSCL 20D

N88-14320

Unclas
G3/34 0118106

Prepared for the
33rd International Gas Turbine and Aeroengine Congress and Exposition
sponsored by the American Society of Mechanical Engineers
Amsterdam, The Netherlands, June 5-9, 1988

NASA

HOST TURBINE HEAT TRANSFER PROGRAM SUMMARY

Herbert J. Gladden and Robert J. Simoneau
National Aeronautics and Space Administration
Lewis Research Center
Cleveland, Ohio 44135

ABSTRACT

The objectives of the HOST Turbine Heat Transfer subproject were to obtain a better understanding of the physics of the aerothermodynamic phenomena and to assess and improve the analytical methods used to predict the flow and heat transfer in high-temperature gas turbines. At the time the HOST project was initiated, an across-the-board improvement in turbine design technology was needed. A building-block approach was utilized and the research ranged from the study of fundamental phenomena and modeling to experiments in simulated real engine environments. Experimental research accounted for approximately 75 percent of the funding while the analytical efforts were approximately 25 percent. A healthy government/industry/university partnership, with industry providing almost half of the research, was created to advance the turbine heat transfer design technology base.

NOMENCLATURE

B_x airfoil axial chord

C blade tip gap

C_x axial flow speed

D jet diameter/blade tip cavity depth

d coolant channel hydraulic diameter

H heat transfer coefficient

H_o reference heat transfer coefficient

M_2 stator exit Mach number

Nu Nusselt number

NU_o reference Nusselt number

P_c coolant pressure

P_t gas stream pressure

R radius

Re_2 stator exit Reynolds number

Re_x local Reynolds number

T_c coolant temperature

T_G gas stream temperature

T_w airfoil temperature

T_u turbulence intensity

S surface distance

St Stanton number

St_o reference Stanton number

U gas stream velocity

U_m rotor wheel speed

U_w moving surface velocity

u' instantaneous velocity

V coolant velocity

W blade tip cavity width

X axial length

θ angle between mean velocity and major tip cavity axis

λ length scale

Ω rotational velocity

INTRODUCTION

Improved performance of aircraft gas turbine engines is typically accompanied by increased cycle pressure ratio and combustor exit gas temperature. The hot-section components of these turbojet/turbofan engines are subjected to severe aerothermal loads during the mission flight profile. Meeting the design goals of high cycle efficiency, increased durability of the hot-section components, and lower operating costs requires a multidisciplinary approach. Turbine Heat Transfer was one of the six disciplines addressed in the multidisciplinary Hot Section Technology (HOST) Project.

When the HOST Project was originally being planned, Stepka (1980), one of the originators of the project, performed an uncertainty analysis on the ability to predict turbine airfoil temperatures. He estimated that the then current ability to predict metal temperature in an operating engine was within 100 K and that by testing prototypes this could be refined to within 50 K. He also suggested that the uncertainty in heat flux was on the external or the hot gas side surface of the airfoil was a principle contributor to the inability to predict metal temperatures; however, both internal and external surface heat transfer were important. These levels of uncertainty in metal temperature can contribute to an order of magnitude uncertainty in component life.

A typical cooled aircraft gas turbine blade is illustrated in Fig. 1, showing the intricate internal flow passages and the variety of heat transfer mechanisms at work. These include: impingement cooling, serpentine passages with turbulator surfaces, and pin fins, all in very short (i.e., entrance length) distances and subject to strong rotational forces. In addition, since most blades are film cooled, the internal mass balance is a variable. The complexity of the external flow field over the turbine blade is illustrated in Fig. 2. Heat transfer in the external flow field is characterized by: high Reynolds number forced convection with rotation, high free-stream turbulence, strong pressure and temperature gradients, surface curvature, and an unsteady flow field. In addition, and most important, the internal and external surface heat transfer coefficients are coupled through the metal walls. In fact, the turbine airfoil is a very compact, very complex, and very efficient heat exchanger. This feature is particularly important in a durability program, such as HOST, where the real focus is on the thermal stress and fatigue of the structural elements.

Thus, in the HOST Turbine Heat Transfer Subproject it was important to direct research attention to both the internal and external surfaces of the turbine airfoil.

In the multidisciplinary HOST Project each participating discipline selected its own objective based on the greatest need in that particular area, rather than some common interdisciplinary goal. In Turbine Heat Transfer it was decided, based on evaluations of the type performed by Stepka (1980), that an across-the-board improvement in turbine heat transfer technology was needed. A ratcheting up of the overall technology; a moving from a correlation base to a more analytical base was identified as the Turbine Heat Transfer Subproject goal. It was also identified that the existing data base was insufficient to support this movement and increasing both the size and quality of the data base was essential. It was further recognized that HOST alone could not achieve this goal. It was hoped that HOST could be a sufficient catalyst and provide a sufficient forum to make this goal one that all of the partners; government, industry and universities; would find obtainable and worth pursuing.

This paper outlines the program directed at these goals. The paper will delineate progress towards the goals by reporting example results from each of the various research activities. It will summarize the major accomplishments and will make some observations on future needs.

TURBINE HEAT TRANSFER SUBPROJECT

The research program of the Turbine Heat Transfer Subproject was based on the idea that an across-the-board improvement in turbine design was needed. It was also based on an overall philosophy at NASA Lewis Research Center of taking a building block approach to turbine heat transfer, as shown in Fig. 3. The research ranged from the study of fundamental phenomena and modeling to experiments in real engine environments. Both experimental and analytical research were conducted.

Returning to Figs. 1 and 2, the range of phenomena addressed in the Turbine Heat Transfer Subproject are identified by numbers and arrows on these figures. The corresponding research programs are identified in Tables 1 and 2. One can see from these figures that the Turbine Heat Transfer Subproject covered most of the key heat transfer points on the turbine airfoil: film cooled airfoils, passage curvature, endwall flows, transitioning blade boundary layers, tip regions, and free-stream turbulence on the external surfaces. The subproject included impingement and turbulated serpentine passages on the internal surfaces. The program broke some new ground. An experiment was conducted, which obtained heat transfer data on the surfaces of the airfoils in a one and one-half stage large low speed rotating turbine. Another experiment acquired data on the internal turbulated serpentine passages subject to rotation at engine condition levels. Finally, vane heat transfer data were acquired in a real engine type environment behind an actual operating combustor.

Over the life of the HOST Project a little less than 5.5 million net research dollars were invested in the Turbine Heat Transfer Subproject. As shown in Fig. 4(a), there was a healthy government/industry/university partnership with industry providing almost half the research effort. Approximately three-fourths of the effort was experimental, as shown in Fig. 4(b). The majority of effort established a large number of major experimental datasets. These datasets have been well received and are expected to provide benchmarks for turbine heat transfer for many years to come. The analyses covered a wide range, including a three-dimensional Navier-Stokes effort; however, most of the analytic effort was focused on modeling local phenomena of key importance. The scope and range of the program is best seen by examining representative results.

EXPERIMENTAL DATABASE

The experimental part of the Turbine Heat Transfer Subproject consisted of six (6) large experiments and three (3) of somewhat more modest scope and was structured to address the phenomena identified in Figs. 1 and 2. Three (3) of the large experiments were conducted in a stationary frame of reference and three (3) were conducted in a rotating frame of reference.

Stationary Reference

One of the initial research efforts was the stator airfoil heat transfer program performed at the Allison Gas Turbine Division (Nealy et al., 1983; Hylton et al., 1983; Nealy et al., 1984; Turner et al., 1985; Yang et al., 1985). This research consisted of determining the effects of Reynolds number, turbulence level, Mach

number, temperature ratio, acceleration, and boundary layer transition on heat transfer coefficients for various airfoil geometries at simulated engine conditions. This research was conducted for nonfilm-cooled airfoils, showerhead film-cooled designs and showerhead/gill-region film cooling concepts. Typical results of this research are shown in Fig. 5. A typical cascade configuration is shown in the photograph (Fig. 5(a)). Two-dimensional midspan heat transfer coefficients and static pressure distributions were measured on the central airfoil of the three vane cascade. Nonfilm-cooled data are shown in Fig. 5(b) where the boundary layer transition is clearly identified as a function of Reynolds number on the suction surface. Figure 5(c) shows the effect on heat transfer in the downstream recovery region to the addition of showerhead film cooling. Data are presented as a Stanton number reduction. A detrimental effect is noted in the boundary layer transition region of the suction surface to the addition mass at the leading edge. Figure 5(d) shows a strong dependence on "gill-region" film cooling which is consistent with experience. However, when combining showerhead with gill-region film cooling more mass addition is not always better as indicated by the Stanton number reduction data on the pressure surface. This is a very extensive dataset which systematically shows the important effects of modern film cooling schemes on modern airfoils. It went beyond the traditional effectiveness correlations to provide actual heat transfer data. It should provide a valuable baseline for emerging analysis codes.

An investigation of secondary flow phenomena in a 90° curved duct was conducted at the University of Tennessee Space Institute (Crawford et al, 1985). The curved duct was utilized to represent airfoil passage curvature without the complexity of the horseshoe vortex. These data consist of simultaneous three-dimensional mean value and fluctuating components of velocity through the duct and compliment similar data in the literature. A schematic of the test facility and the three-dimensional laser velocimeter are shown in Fig. 6. The first phase of the research examined flows with a relatively thin inlet boundary layer and low free-stream turbulence. The second phase studied a thicker inlet boundary layer and higher free-stream turbulence. Typical experimental results of this research are shown in Fig. 6. The vector plot of cross-flow velocities clearly shows the development of a vortex in the duct corner near the low pressure surface. The analytical results will be mentioned in the Viscous Flow Analysis section. These data provide a comprehensive benchmark to verify codes at realistic flow conditions.

Two experiments were also conducted at NASA Lewis in the high-pressure facility (Gladden et al., 1985a; Gladden et al., 1985b; Gladden et al., 1987; Hippensteele et al., 1985). This facility was capable of testing a full-sized single-stage turbine at simulated real engine conditions. The tests, however, were limited to combined combustor/stator experiments. One experiment examined full-coverage film-cooled stator airfoils, while the second experiment utilized some of the advanced instrumentation developed under the instrumentation subproject. A comparison of experimental airfoil temperatures with temperatures obtained from a typical design system showed substantial differences for the full-coverage, film-cooled airfoils and suggests that models derived from low-temperature experiments are inadequate for "real-engine" conditions. The advanced instrumentation tests demonstrated the capability and the challenges of measuring heat flux and time-resolved gas temperature fluctuation in a real-engine environment.

Typical results are shown in Fig. 7 for thin film thermocouples and the dynamic gas temperature probe tested a simulated real engine condition. A comparison is made between steady state heat flux measurements and those determined from dynamic signal analysis techniques.

Stanford University has conducted a systematic study of the physical phenomena that affect heat transfer in turbine airfoil passages. Their recent experimental research has been concerned with high free-stream turbulence intensity and large turbulence scale that might be representative of combustor exit phenomena. A schematic of their free jet test facility and typical results are shown in Fig. 8. Data are measured on a constant temperature flat plate located at a specified radial and axial distance from the jet exit centerline. These data, presented as Stanton number ratios, indicate that heat transfer augmentation can be as high as 5X at a high value of free-stream turbulence intensity but only 3X if the length scale is changed. These results suggest that the designer must know a great deal more about the aerodynamic behavior of the flow field in order to successfully predict the thermal performance of the turbine components.

Prior to the advent of the HOST program, Arizona State University was pursuing a systematic study of impingement heat transfer with cross-flow characteristic of turbine airfoil cooling schemes. The work was initially sponsored by a NASA Lewis grant but was subsequently funded by the HOST program. The results of this research are summarized in Florschuetz et al. (1982a), Florschuetz et al. (1982b), Florschuetz et al. (1982c), Florschuetz et al. (1983), Richards et al. (1984), Florschuetz et al. (1984), Florschuetz et al. (1987), Florschuetz et al. (1985), Florschuetz et al. (1984). In addition to the many geometry variations, this research also investigated the effects of various jet-flow to crossflow ratios and differences between the jet-flow and the cross-flow temperature. Correlations were developed for both inline rows of impingement jets and staggered arrays of jets but without an initial cross-flow. The effects of cross-flow and temperature differences were then determined relative to the base correlations.

Rotating Reference

In the rotating reference frame, experimental aerodynamic and heat transfer measurements were made in the large, low-speed turbine at the United Technologies Research Center (Dring et al., 1987; Dring et al., 1986a; Dring et al., 1986b; Dring et al., 1986c; Blair et al., 1988; Blair et al., 1988). Single-stage data with both high and low-inlet turbulence were taken in phase I. The second phase examined a one and one-half stage turbine and focused on the second vane row. Under phase III aerodynamic quantities such as interrow time-averaged and rms values of velocity, flow angle, inlet turbulence, and surface pressure distributions were measured. A photograph of the test facility is shown in Fig. 9. Typical heat transfer data for both the first stator and rotor are also shown. These data show that an increase of inlet turbulence has a substantial impact on the first stator heat transfer. However, the impact on the rotor heat transfer is minimal. These data are also compared with Stanton numbers calculated by a boundary layer code and the assumption that the boundary layer was either laminar (LAM) or fully turbulent (TURB). These assumptions generally bracketed the data on the suction surface of both the stator and the rotor. However, the heat transfer on the pressure surface, especially for the high turbulence case, was generally above even fully turbulent levels on both airfoils. Pressure surfaces have traditionally received less

attention than suction surfaces. The high heat transfer on the pressure surface is not readily explainable and calls for additional research, especially modeling, on pressure surfaces.

The tip region of rotor blades is often a critical region and an area that suffers substantial damage from the high temperature environment. Arizona State University has experimentally modeled the blade tip cavity region and determined heat transfer rates by a mass transfer analogy with naphthylene (Chyu et al., 1987). A schematic of the test is shown in Fig. 10.

The blade tip cavity is a stationary model and the relative velocity of the shroud is represented by a moving surface at a specified "gap" spacing from the blade. Stanton number results for two different cavity aspect ratios are also shown in Fig. 10. The heat transfer on the surfaces next to the shroud are little changed by the aspect ratio which is not surprising. However, the heat transfer to the floor of the cavity is increased significantly on the downstream portion at the lower aspect ratio. Also shown in the figure is the flow angle effect on heat transfer. Because of the airfoil turning at the tip the cavity will be at different angles of attack to the mean crossflow direction. The data shows a minimal effect at an aspect ratio of 0.9 and a substantial effect at an aspect ratio of 0.23. This dataset is really quite a new addition to a traditionally neglected area and shows that with careful datasets and analyses one can obtain an optimal design for tip cavities.

The preceding studies were focused on the hot-gas side phenomena. Since the heat transfer phenomena is driven by the hot-gas side conditions, it is appropriate to concentrate resources on this area. However, the coolant-side heat transfer is also important. Therefore, coolant passage heat-transfer and flow measurements in a rotating reference frame were also obtained at Pratt & Whitney Aircraft/United Technologies Research Center (Kopper, 1984; Sturgess et al., 1987; Lord et al., 1987). Experimental data were obtained for smooth-wall serpentine passages and for serpentine passages with skewed and normal turbulators. The flow and rotation conditions were typical of those found in actual engines. This was a very realistic experiment. Data for both the smooth-wall and skewed turbulator passages are shown in Fig. 11 for radial outflow, representing only a tiny fraction of the total data involved in this very complex flow. Both datasets are shown correlated with the rotation number except for high rotation numbers on the high pressure surface. This is an area that requires additional research to understand and model the physical phenomena occurring in these passages.

ANALYTICAL TOOLS

The analytic parts of the turbine heat transfer subproject are characterized by efforts to adapt existing codes and analyses to turbine heat transfer. In general, these codes and analyses were well established before HOST became involved; however, the applications were not for turbine heat transfer, and extensive revision has often been required. In some cases the analytic and experimental work were part of the same contract.

Boundary Layer Analysis

The STAN5 boundary-layer code (Crawford et al., 1976) (which was developed on NASA contract at Stanford University in the mid-1970's) was modified by Allison Gas Turbine Division to define starting points and transition length of turbulent flow to accommodate their data, with and without film cooling, as well as

data in the literature. Specific recommendations are made to improve turbine airfoil heat transfer modeling utilizing a boundary layer analysis. These recommendations address the boundary conditions, the initial condition specification, including both velocity and thermal profiles, and modifications of conventional zero order turbulence models. The results of these improvements are shown in Fig. 12 where the start of transition and its extent on the suction surface are reasonably well characterized. For the case of shower-head film cooling, two empirical coefficients were utilized to modify the free-stream turbulence intensity and the gas stream enthalpy boundary conditions and permit a representative prediction of the Stanton number reduction in the recovery region. Boundary layer methods can be used for midspan analysis, however they require a realistic data base to provide the coefficients needed for proper reference.

In another boundary layer code effort United Technologies Research Center assessed the applicability of its three-dimensional boundary layer code to calculate heat transfer total pressure loss and streamline flow patterns in turbine passages. The results indicate a strong three-dimensional effect on a turbine blade, and agrees qualitatively with experimental data. The same code was modified for use as a two-dimensional unsteady code in order to analyze the rotor-stator interaction phenomena (Vatsa, 1985; Anderson et al., 1985a; Anderson et al., 1985b; Anderson, 1985c). These codes also needed data as input.

Finally, a fundamental study on numerical turbulence modeling, directed specifically at the airfoil in the turbine environment, was conducted at the University of Minnesota. A modified form of the Lam-Bremhorst low-Reynolds-number k-e turbulence model was developed to predict transitional boundary layer flows under conditions characteristic of gas turbine blades (Schmidt et al., 1987) including both free-stream turbulence and pressure gradient.

The purpose was to extend previous work on turbulence modeling to apply the model to transitional flows with both free-stream turbulence and pressure gradients. The results of the effort are compared with the experimental data of Allison Gas Turbine Division in Fig. 13. The augmentation of heat transfer on the pressure surface over the fully turbulent value is predicted reasonably well. In addition, when an adverse pressure gradient correction is utilized, the suction surface heat transfer data is also predicted reasonably well.

This was a reasonably good beginning to establishing a methodology for moving away from the heavy dependence on empirical constants. Although boundary layer methods will never solve the whole problem, they will always remain important analytic tools.

Viscous Flow Analysis

The three-dimensional Navier-Stokes TEACH code has been modified by Pratt & Whitney for application to internal passages and to incorporate rotational terms. The modified code has been delivered to NASA Lewis and tested on some simple geometric cases. The results of this effort indicate that the code is qualitatively adequate for simple geometries. For geometries of practical interest, much work remains to be done to bring the internal passage computational codes up to the level of proficiency of the free-stream codes. For the external airfoil surface important analytic progress is being made. By contrast, the work on internal passages is still primitive. The internal problem is substantially more complex.

A fully elliptic three-dimensional Navier-Stokes code has been under development at Scientific Research

ORIGINAL PAGE IS OF POOR QUALITY

Associates (SRA) for many years. This code was primarily directed at inlets and nozzles. SRA, Inc., has modified the code for turbine applications (Weinberg et al., 1985). This includes grid work for turbine airfoils, adding an energy equation and turbulence modeling, and improved user friendliness. The heat transfer predictions from the MINT code are shown in Fig. 14 compared to the data from the Allison Gas Turbine research. The analytical/experimental data comparison is good, however, the location of boundary layer transition was specified for the analytical solution.

The University of Tennessee Space Institute also developed a three-dimensional viscous flow analysis capability for the curved duct experiment utilizing the P.D. Thomas code (Thomas, 1979) as a base. Some analytical results from this code are shown in Fig. 6 where a vector plot of the cross-flow velocities are compared with the experiment. In addition, a stream sheet is shown as it propagates through the duct and is twisted and stretched. Additional comparisons of analysis and experiment show that the thin turbulent boundary layer results of this experiment are difficult to calculate with current turbulence models.

CONCLUDING REMARKS

Since this paper is an overview of the Turbine Heat Transfer aspects of the HOST program it has been presented as a cataloging and summarizing of the various activities. More importantly, the HOST program should be viewed as a catalyst bringing together the gas turbine community and building a technology momentum to carry advanced propulsion systems into the future. Specifically, the HOST Turbine Heat Transfer Subproject can point to the following accomplishments.

1. The impact of axial spacing and inlet turbulence on heat transfer and aerodynamics throughout the stator-rotor-stator of a stage and one-half axial turbine was measured. High-turbulence and post-transitional effects on the pressure surface of both stator and rotor can cause the Stanton number to be greater than the fully turbulent value.

2. Reynolds number, Mach number, curvature, and wall-to-gas temperature effects on boundary layer transition and heat transfer were determined for a stator airfoil.

3. Showerhead and "gill-region" film-cooling were shown to have both beneficial and adverse effects on the recovery region heat transfer at simulated engine conditions which depended on specific operating conditions.

4. Heat Transfer in both smooth-wall and turbulated-wall serpentine rotating coolant passages were correlated with a rotation number for the low-pressure surface. The high-pressure surface heat transfer was not well correlated.

5. Blade tip cavity heat transfer was shown to be strongly dependent on the cavity aspect ratio and angle-of-attack to blade tip flow direction.

6. Heat transfer measurements in high-turbulence intensity flow fields, simulating combustor exit phenomena, shows augmentation rates of 3X to 5X depending on the length scale of the turbulence.

7. Improved definition of the initial conditions and boundary conditions which are applicable to turbine airfoils was successful in improving the prediction of airfoil heat transfer for a wide range of geometries using the STAN5 boundary layer code.

8. The Lam-Bremhorst low-Reynolds number $k-\epsilon$ turbulence model was modified to also improve the predictions of airfoil heat transfer under transitional flows with both free-stream turbulence and pressure gradients.

9. A fully elliptic Navier-Stokes code was developed for turbine airfoils and includes turbulence modeling, an energy equation and improved user friendliness.

Frequently, heat transfer is a limiting factor in the performance and durability of an engine. However, as we continue to pursue higher and higher speeds, advancing technology becomes an interdisciplinary effort involving aerothermal loads definition and the structural response of advanced materials. This is especially true for hypersonic vehicles where the overall thermal management and design of the vehicle and the propulsion system become an integrated interactive entity. We now have, or are developing, tremendous analytical capabilities with which one can attack these very complex technology issues.

LOOK TO THE FUTURE

Many recent studies have been made to assess the aeropropulsion technology requirements into the 21st century. The consensus seems to suggest that significant technology advances are required to meet the goals of the future. Whether the goals are high speed sustained flight, single-stage-to-orbit or subsonic transport, the issues for the designer are improved fuel efficiency, high thrust-to-weight, improved component performance while maintaining component durability and reduced operating and maintenance costs. These issues will only serve to increase the "opportunities" available to the researcher in aerothermal loads and structures analysis. The verifiable predictions of unsteady flowfields with significant secondary flow phenomena and coupled thermal/velocity profiles is a fertile research area. Very little progress has been made to date in applying CFD techniques to the intricate and complex coolant channels required in the hot-section components. With the expected advances in high-temperature materials the components with significant aerothermal loads problems will expand beyond the airfoils and combustor liners to shrouds, rims, seals, bearings, compressor blading, ducting, nozzles, etc. The issues to be addressed and the technology advances required to provide the aeropropulsion systems of the 21st century are quite challenging.

REFERENCES

Anderson, O. L., 1985a, "Assessment of a 3-D Boundary Layer Analysis to Predict Heat Transfer and Flow Field in a Turbine Passage," NASA CR-174894.

Anderson, O. L., 1985b, "Calculation of Three-Dimensional Boundary Layers on Rotating Turbine Blades," Three Dimensional Flow Phenomena in Fluid Machinery, A. Hamed, J. Herring, and L. Povinelli, eds., ASME, New York, pp. 121-132.

Anderson, O. L., and Caplin, B., 1985c, "User's Manual for Three Dimensional Boundary Layer (BL3-D) Code," NASA CR-174899.

Blair, M. F., Dring, R. P., and Joslyn, H. D., 1988a, "The Effects of Turbulence and Stator/Rotor Interactions on Turbine Heat Transfer, Part II - Effects of Reynolds Number and Incidence," ASME Paper to be presented at the 33rd ASME Gas Turbine Conference, The Netherlands.

Blair, M. F., Dring, R. P., and Joslyn, H. D., 1988b, "The Effects of Turbulence and Stator/Rotor Interactions on Turbine Heat Transfer, Part I - Design Operating Conditions," ASME Paper to be presented at the 33rd ASME Gas Turbine Conference, The Netherlands.

- Chyu, M. K., Metzger, D. E., and Hwan, C. L., 1987, "Heat Transfer in Shrouded Rectangular Cavities," *Journal of Thermophysics and Heat Transfer*, Vol. 1, No. 2, pp. 247-252.
- Crawford, M.E., and Kay, W. M., 1976, "STAN5 - A Program for Numerical Computation of Two-Dimensional Internal and External Boundary Layer Flows," NASA CR-2742.
- Crawford, R. A., et al, 1985, "Mean Velocity and Turbulence Measurements in a 90° Curved Duct With Thin Inlet Boundary Layer," NASA CR-174811.
- Dring, R. P., Blair, M. F., and Joslyn, H. D., 1986a, "The Effects of Inlet Turbulence and Rotor Stator Interactions on the Aerodynamics and Heat Transfer of a Large-Scale Rotating Turbine Model. Vol. III, Heat Transfer Data Tabulation. 65% Axial Spacing," NASA CR-179468.
- Dring, R. P., Blair, M. F., and Joslyn, H. D., 1986b, "The Effects of Inlet Turbulence and Rotor/Stator Interactions on the Aerodynamics and Heat Transfer of a Large-Scale Rotating Turbine Model. Vol. IV, Aerodynamic Data Tabulation," NASA CR-179469.
- Dring, R. P., Blair, M. F., and Joslyn, H. D., 1986c, "The Effects of Inlet Turbulence and Rotor Stator Interactions on the Aerodynamics and Heat Transfer of a Large-Scale Rotating Turbine Model. Vol. II, Heat Transfer Data Tabulation. 15% Axial Spacing," NASA CR-179467.
- Dring, R. P., et al, 1987, "The Effects of Inlet Turbulence and Rotor/Stator Interactions on the Aerodynamics and Heat Transfer of a Large-Scale Rotating Turbine Model, Vol. I," NASA CR-4079.
- Florschuetz, L. W., and Isoda, Y., 1982a, "Flow Distributions and Discharge Coefficient Effects for Jet Array Impingement With Initial Crossflow," ASME Paper 82-GT-156.
- Florschuetz, L. W., et al, 1982b, "Jet Array Impingement Flow Distributions and Heat Transfer Characteristics - Effects of Initial Crossflow and Nonuniform Array Geometry - Gas Turbine Engine Component Cooling," NASA CR-3630.
- Florschuetz, L. W., Metzger, D. E., and Su, C. C., 1983, "Heat Transfer Characteristics for Jet Array Impingement with Initial Crossflow," ASME Paper 83-GT-28.
- Florschuetz, L. W., and Tseng, H. H., 1984a, "Effect of Nonuniform Geometries on Flow Distributions and Heat Transfer Characteristics for Arrays of Impinging Jets," ASME Paper 84-GT-156.
- Florschuetz, L. W., and Metzger, D. E., 1984b, "Effect of Initial Crossflow Temperature on Turbine Cooling With Jet Arrays," *Heat and Mass Transfer in Rotating Machinery*, D.E. Metzger and N. Afgan, eds., Hemisphere Publishing Corp., Washington, D.C., pp. 499-510.
- Florschuetz, L. W., and Su, C. C., 1985, "Heat Transfer Characteristics Within an Array of Impinging Jets," NASA CR-3936.
- Florschuetz, L. W., and Su, C. C., 1987, "Recovery Effects on Heat Transfer Characteristics Within an Array of Impinging Jets," *Heat Transfer and Fluid Flow in Rotating Machinery*, W.J. Yang, ed., Hemisphere Publishing Corp., Washington, D.C., pp. 375-387.
- Gladden, H. J., Yeh, F. C., and Fronek, D. L., 1985a, "Heat Transfer Results and Operational Characteristics of the NASA Lewis Research Center Hot Section Cascade Test Facility," ASME Paper 85-GT-82. (NASA TM-86890).
- Gladden, H. J., and Proctor, M. P., 1985b, "Transient Technique for Measuring Heat Transfer Coefficients on Stator Airfoils in a Jet Engine Environment," AIAA Paper 85-1471. (NASA TM-87005).
- Gladden, H. J., Yeh, F. C., and Austin, P. J. Jr., 1987, "Computation of Full-Coverage, Film-Cooled Airfoil Temperatures by Two Methods and Comparison With High Heat Flux Data," ASME Paper 87-GT-213. (NASA TM-88931).
- Hippensteele, S. A., Russell, L. M., and Torres, F. J., 1985, "Local Heat-Transfer Measurements on a Large Scale-Model Turbine Blade Airfoil Using a Composite of a Heat Element and Liquid Crystals," ASME Paper 85-GT-59. (NASA TM-86900).
- Hylton, L. D., et al, 1983, "Analytical and Experimental Evaluation of the Heat Transfer Distribution Over the Surfaces of Turbine Vanes," NASA CR-168015.
- Kopper, F.C., 1984, "Coolant Passage Heat Transfer With Rotation," *Turbine Engine Hot Section Technology*, NASA CP-2339, pp. 401-409.
- Lord, W. K., Pickett, G. F., Sturgess, G. J., and Weingold, H. D., 1987, "Application of CFD Codes to the Design and Development of Propulsion Systems," *Supercomputing in Aerospace*, NASA CP-2454, P. Kutler and H.Yee, eds., NASA, Washington, D.C., pp. 139-148.
- Nealy, D. A., et al, 1983, "Measurement of Heat Transfer Distribution Over the Surfaces of Highly Loaded Turbine Nozzle Guide Vanes," ASME Paper 83-GT-53,.
- Nealy, D. A., Mihelc, M. S., Hylton, L. D., and Gladden, H. J., 1984, "Measurements of Heat Transfer Distribution Over the Surfaces of Highly Loaded Turbine Nozzle Guide Vanes," *Journal of Engineering for Gas Turbines and Power*, Vol. 106, No. 1, pp. 149-158.
- Richards, D. R., and Florschuetz, L. W., 1984, "Forced Convection Heat Transfer to Air/Water Vapor Mixtures," NASA CR-3769.
- Schmidt, R. C., and Patankar, S. V., 1987, "Prediction of Transition on a Flat Plate Under the Influence of Free-Stream Turbulence Using Low-Reynolds-Number Two-Equation Turbulence Models," ASME Paper 87-HT-32.
- Stepka, F. S., 1980, "Analysis of Uncertainties in Turbine Metal Temperature Predictions," NASA TP-1593.
- Sturgess, G. J., and Datta, P., 1987, "Calculation of Flow Development in Rotating Passages for Cooled Gas Turbine Blades," *Computers in Engineering - 1987*, Vol. 3, ASME, New York, pp. 149-158.
- Thomas, P. D., 1979, "Numerical Method for Predicting Flow Characteristics and Performance of Nonaxisymmetric Nozzles Theory," NASA CR-3147.

ORIGINAL PAGE IS
OF POOR QUALITY

Turner, E. R., et al, 1985, "Turbine Vane External Heat Transfer, Vol. I - Analytical and Experimental Evaluation of Surface Heat Transfer Distributions With Leading Edge Showerhead Film Cooling," NASA CR-174827.

Weinberg, B. C., et al, 1985 "Calculations of Two- and Three-Dimensional Transonic Cascade Flow Fields Using the Navier-Stokes Equations," ASME Paper 85-GT-66.

Vatsa, V. N., 1985, "A Three-Dimensional Boundary Layer Analysis Including Heat-Transfer and Blade-Rotation Effects," 3rd Symposium on Numerical and Physical Aspects of Aerodynamic Flows, T. Cebeci, ed., California State University, pp. 10-45 to 10-59,

Yang, R. J., et al, 1985, "Turbine Vane External Heat Transfer, Vol. II - Numerical Solutions of the Navier-Stokes Equations for Two- and Three-Dimensional Turbine Cascades With Heat Transfer," NASA CR-174828.

TABLE I. - TURBINE HEAT TRANSFER SUBPROJECT SUMMARY

Figures 1 and 2	Work element	Results	Reference
Nonrotating experiments			
		Provide fundamental experimental data bases with focus on -	
1	Airfoil with film cooling ^a	Film cooling	2 to 6
11	Curved duct	Secondary flows	7
3	Impingement cooling	Impingement pattern correlations	12 to 19
5	Large-scale, high-intensity turbulence	Combustor exit simulation	
6	Real engine environment	The real environment	8 to 10
Rotating experiments			
8	Large low-speed turbine ^a	Rotor-stator interaction	20 to 25
2	Rotating coolant passage	Coriolis and buoyancy effects	27
4	Tip region simulator	Flow across moving airfoil tip	26
9	Warm core turbine	Vane and blade passage flow map fully scaled	
Analyses			
1	STAN5 modifications ^a	Enhance analytic tools for turbine application Adapt boundary layer code to current airfoil data	2 to 5
10	Three-dimensional boundary layer	Zoom focus on Three-dimensional regions	30 to 34
8	Unsteady boundary layer ^a	Account for rotor-stator interaction effects	28 to 29
2	Teach code with rotation ^a	Three-dimensional Navier-Stokes with rotation terms	
7	Low Reynolds number	Develop turbine airfoil specific turbulence model	35
12	Mint code ^b	Three-dimensional Navier-Stokes applied to turbine airfoil geometry	36

^aExperiment and analysis in the same contract.

^bWork done under two separate contracts.

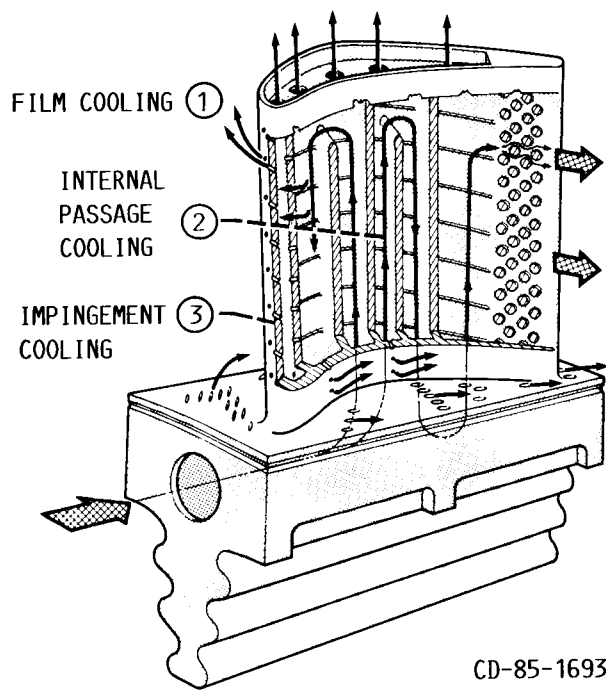

CD-85-16934

FIGURE 1. - TYPICAL COOLED AIRCRAFT GAS TURBINE BLADE. SEE TABLE I FOR DESCRIPTION OF NUMBERED FLOW PHENOMENA.

HIGHLY TURBULENT
REAL ENGINE FLOW SIMULATION

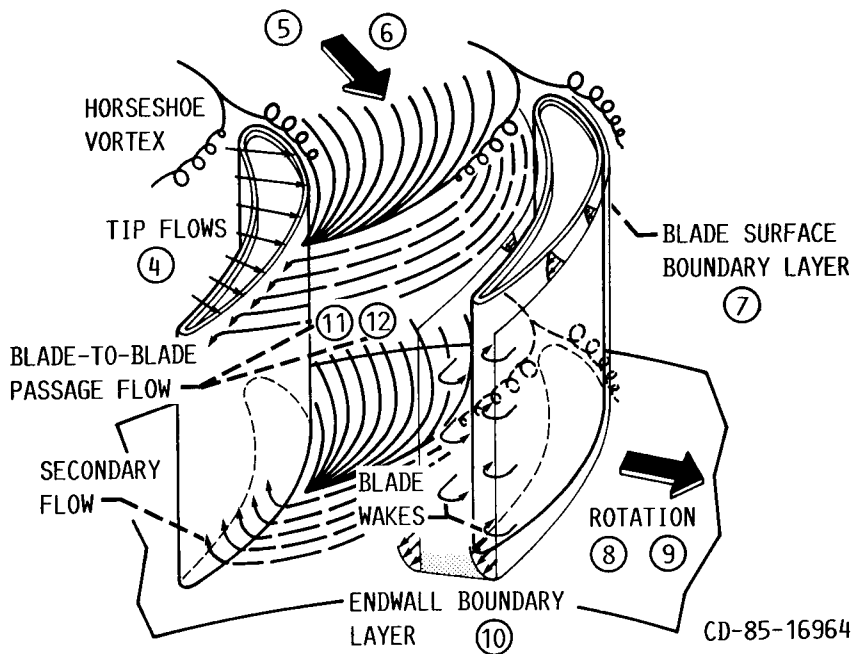

CD-85-16964

FIGURE 2. - COMPLEX FLOW PHENOMENA IN A TURBINE PASSAGE. SEE TABLE I FOR DESCRIPTION OF NUMBERED FLOW PHENOMENA.

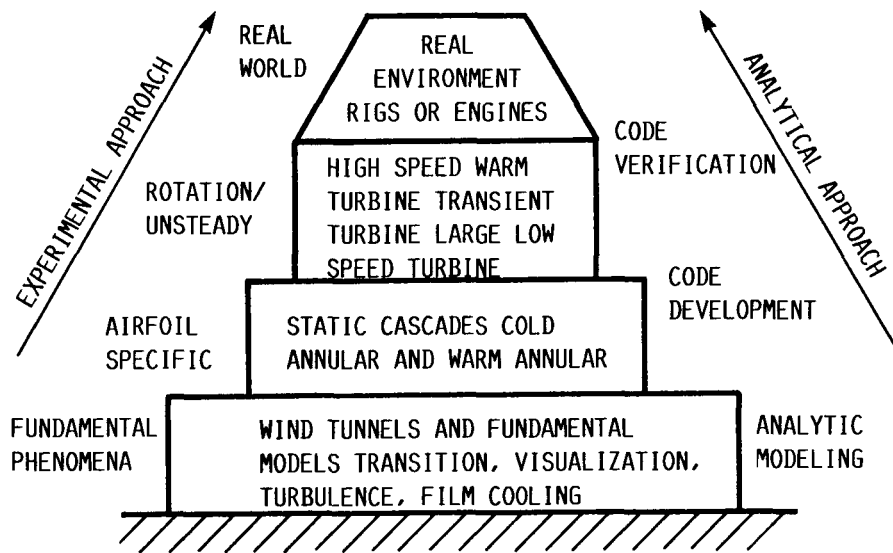
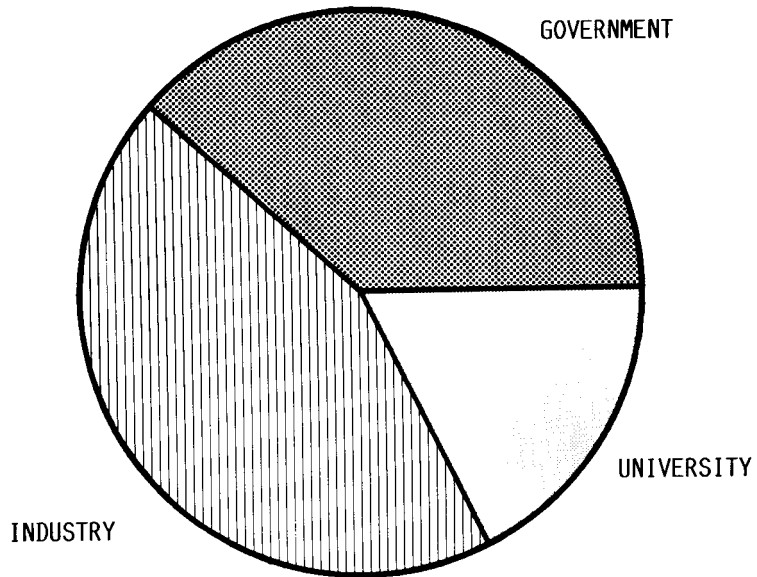

FIGURE 3.- BUILDING BLOCK APPROACH TO TURBINE AEROTHERMAL RESEARCH.

CD-85-16940

ORIGINAL PAGE IS
OF POOR QUALITY



(A) BY LOCATION OF RESEARCH.

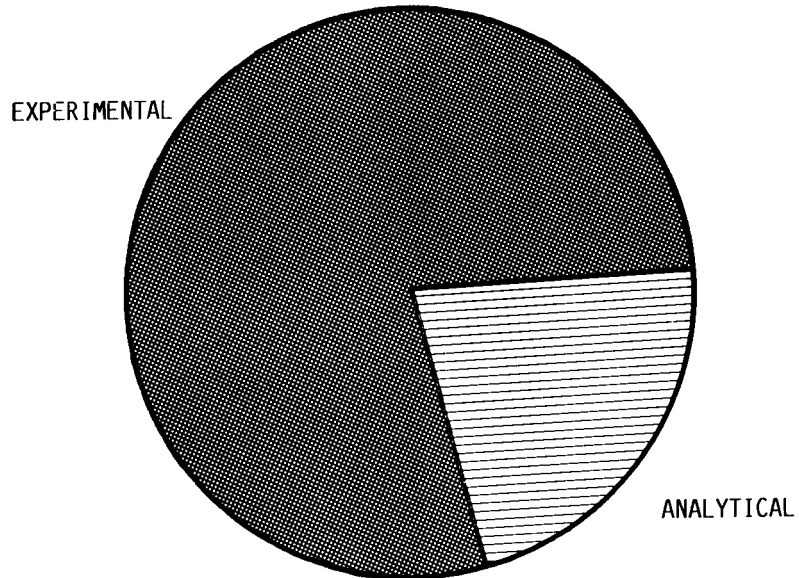

(B) BY TYPE OF RESEARCH.

FIGURE 4.- HOST TURBINE HEAT TRANSFER SUBPROJECT DISTRIBUTION
OF RESOURCES.

ORIGINAL PAGE IS
OF POOR QUALITY

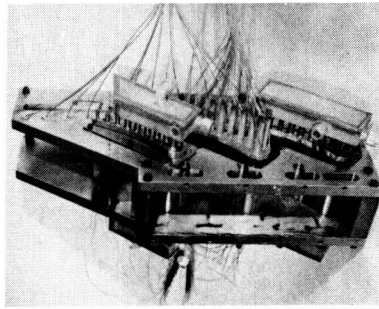

(A) THREE-VANE CASCADE.

NOMINAL RUN CONDITIONS
 $M_2 = 0.90$
 $T_W/T_G = 0.81$
 $T_u = 6.5\%$

EXIT REYNOLDS NUMBER
 $+ 1.51 \times 10^6$
 $\square 1.96 \times 10^6$
 $\diamond 2.49 \times 10^6$

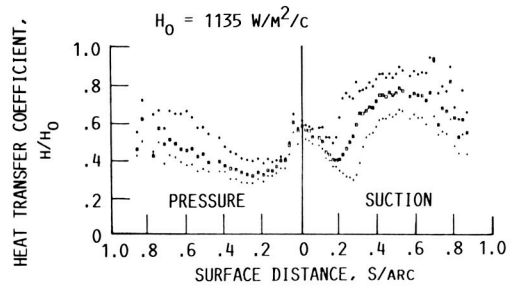

(B) NONFILM-COOLED AIRFOIL HEAT TRANSFER COEFFICIENTS.

DATA	M_2	RE_2	$P_{C,DS}/P_T$	$P_{C,LE}/P_T$	T_W/T_G
BASE	.75	2.00E6			
\diamond	.75	2.05E6	1.10	1.10	.67
\triangle	.74	2.00E6	1.10	1.05	.65
\circ	.75	2.01E6	1.10	1.02	.65
\square	.75	2.00E6	1.10	1.00	.66

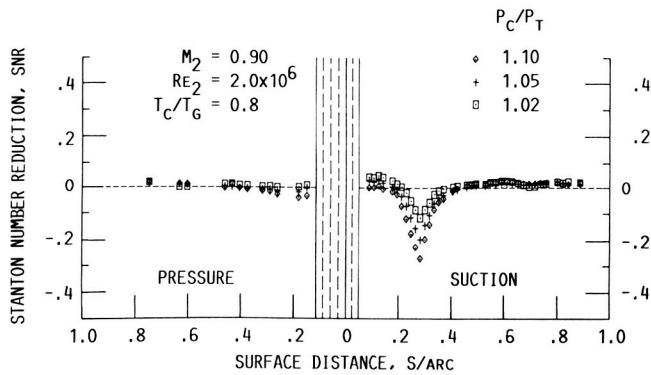

(C) INFLUENCE OF LEADING EDGE FILM-COOLING ON HEAT TRANSFER.

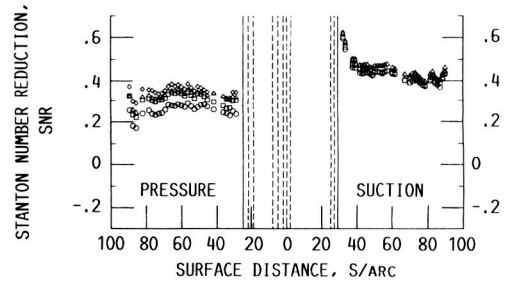

(D) COMBINED LEADING EDGE AND DOWN-STREAM FILM-COOLING.

FIGURE 5. - GAS-SIDE EXPERIMENTAL HEAT TRANSFER DATA FOR BOTH NON-FILM-COOLED AND FILM COOLED AIRFOILS. ALLISON GAS TURBINE DIVISION.

ORIGINAL PAGE IS
OF POOR QUALITY

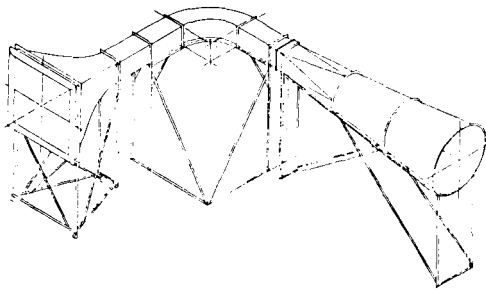

CURVED-DUCT FACILITY

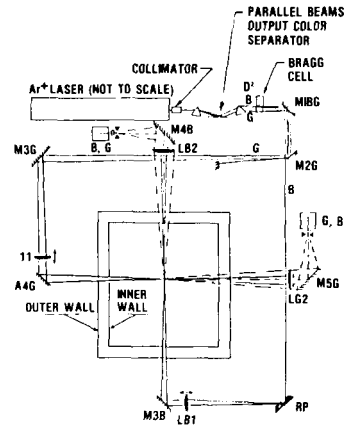

3-D LV OPTICAL SYSTEM

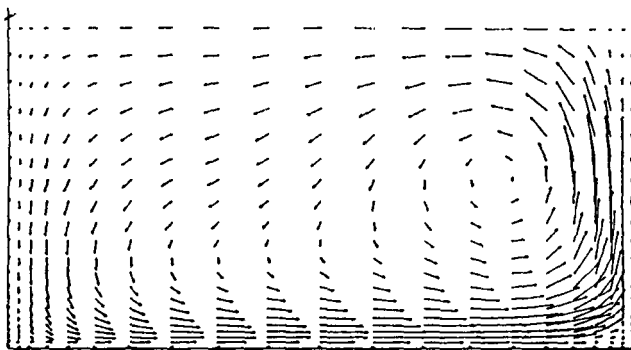

DUCT CROSS-FLOW PLOT P.D. THOMAS CODE
ANALYTICAL RESULTS

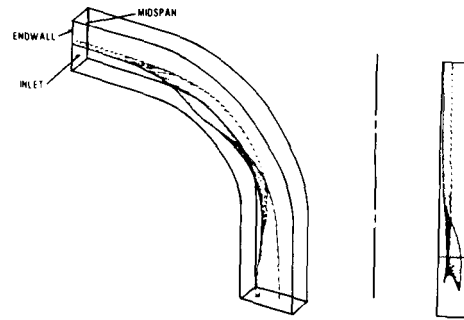

STREAM SHEET VELOCITY PATTERN THROUGH DUCT

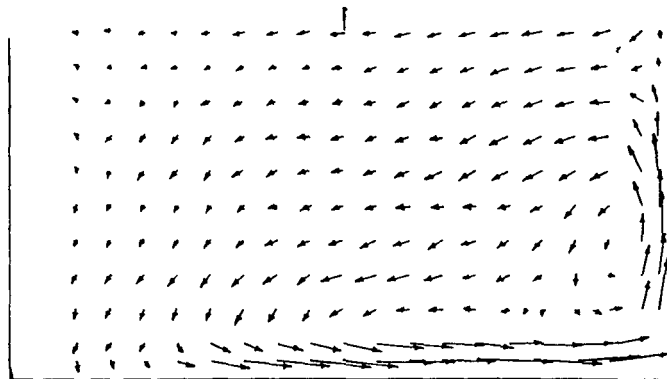

LOW REYNOLDS NUMBER DATA
EXPERIMENTAL RESULTS

FIGURE 6. - THREE-DIMENSIONAL FLOW-FIELD MEASUREMENTS IN A CURVED DUCT REPRESENTING AN AIRFOIL PASSAGE. UNIVERSITY OF TENNESSEE SPACE INSTITUTE.

ORIGINAL PAGE IS
OF POOR QUALITY

EXPERIMENTAL TEMPERATURE
MEASUREMENT

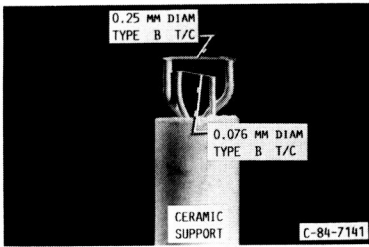
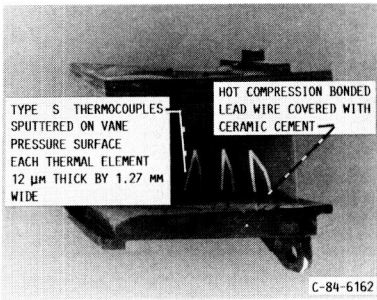

WALL TEMPERATURE RESPONSE TO
GAS TEMPERATURE RAMP

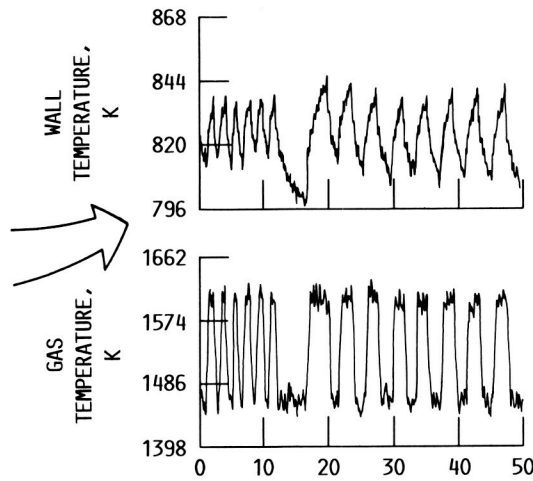

LOCAL HEAT TRANSFER
COEFFICIENTS DETERMINE FROM
DYNAMIC SIGNAL ANALYSIS

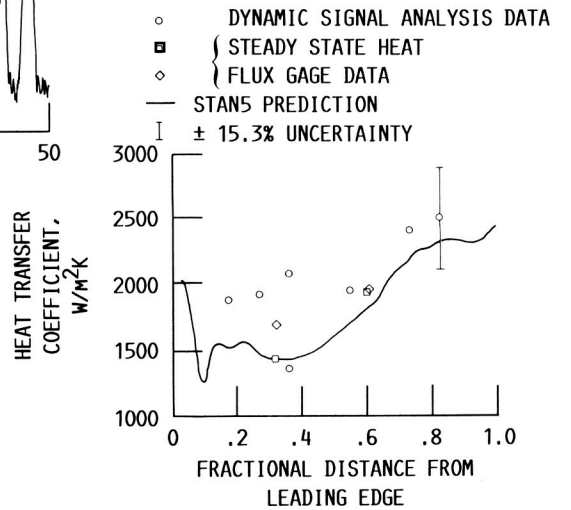

CD-85-17458

FIGURE 7. - HEAT FLUX MEASUREMENTS MADE IN A SIMULATED REAL ENGINE ENVIRONMENT ON STATOR AIRFOILS.
LEWIS RESEARCH CENTER.

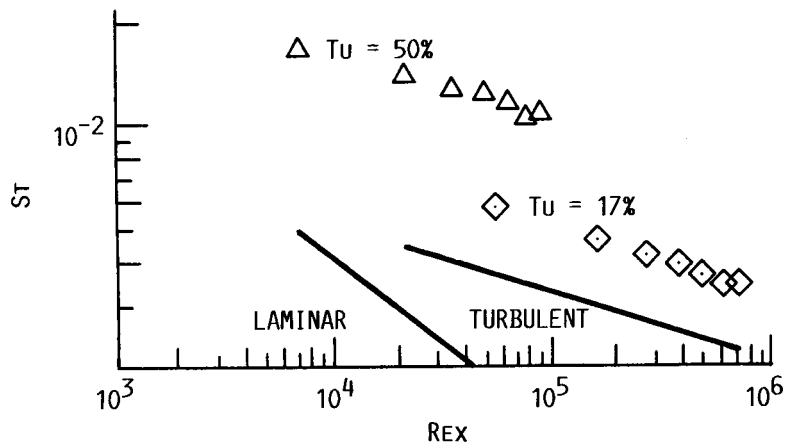
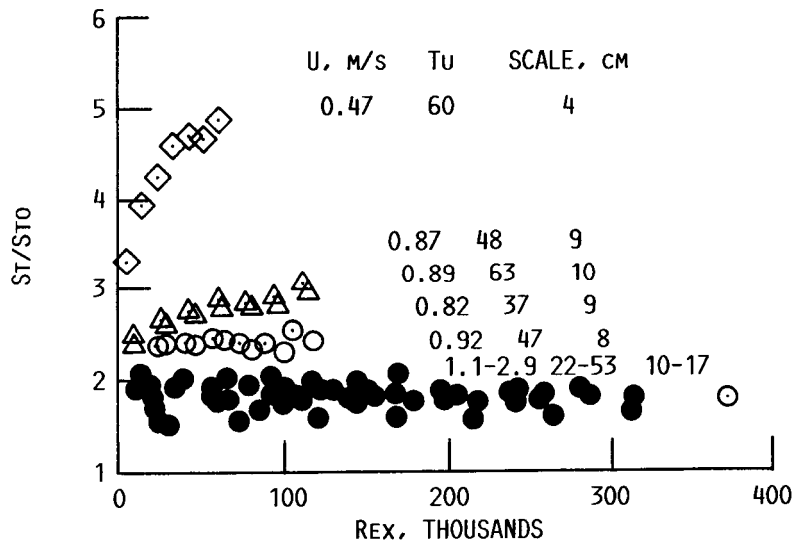
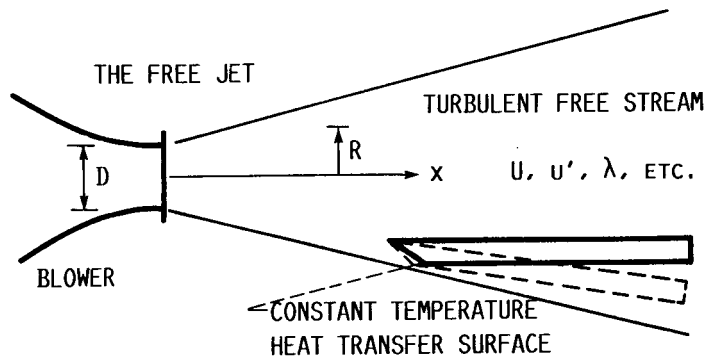
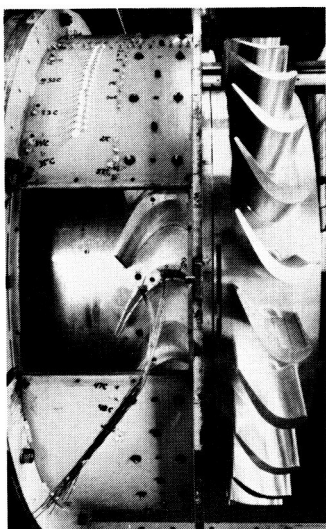

FIGURE 8. - HEAT TRANSFER AUGMENTATION RESULTING FROM HIGH FREE STREAM TURBULENCE AND SCALE. STANFORD UNIVERSITY.

ORIGINAL PAGE IS
OF POOR QUALITY



LARGE SCALE ROTATING RIG 1-1/2 STAGE
TURBINE CONFIGURATION FIRST VANE AND
ROTOR CASE REMOVED

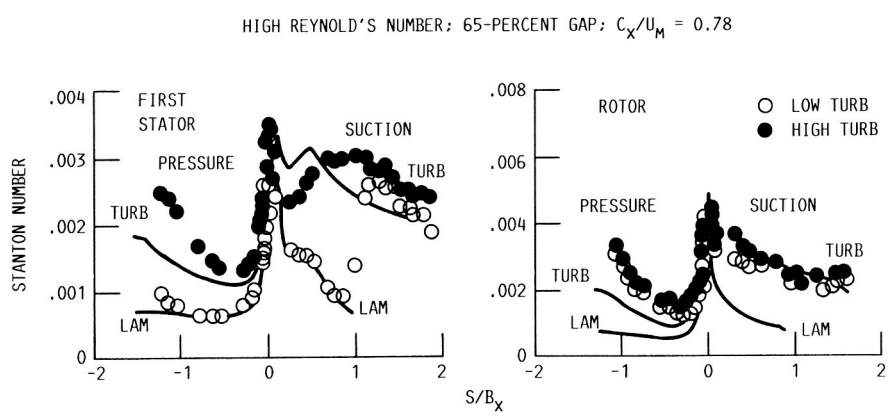

FIGURE 9. - ROTOR/STATOR INTERACTION AND THE AFFECT ON HEAT TRANSFER OF HIGH AND LOW FREESTREAM TURBULENCE. UNITED TECHNOLOGIES RESEARCH CENTER.

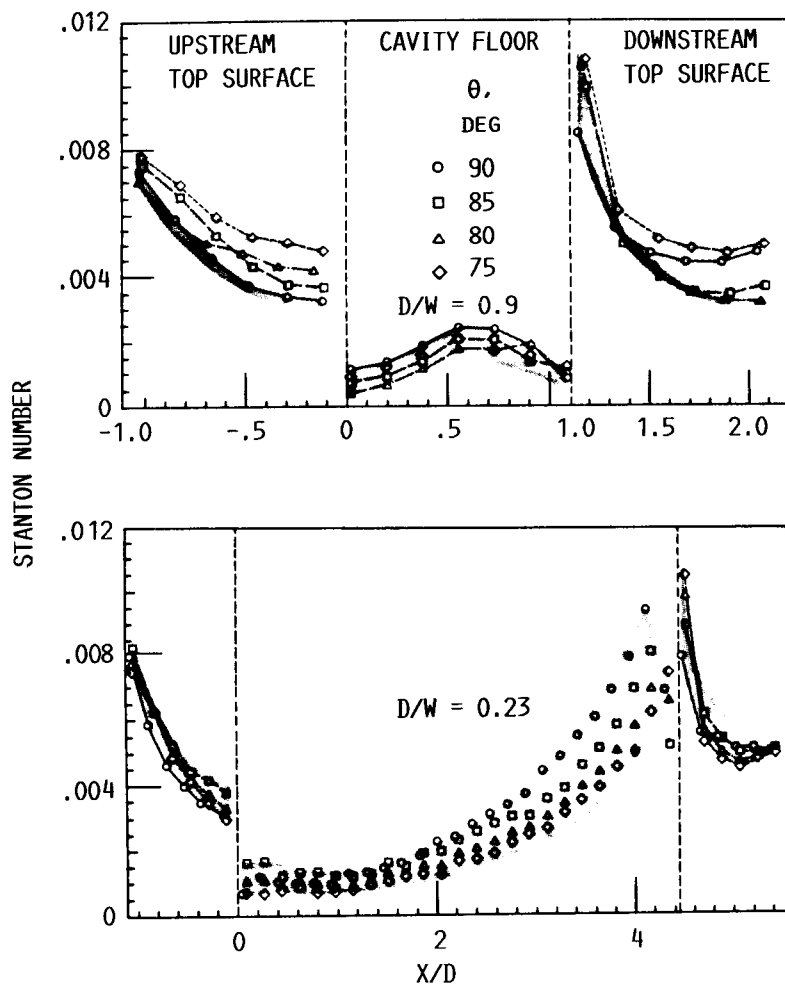
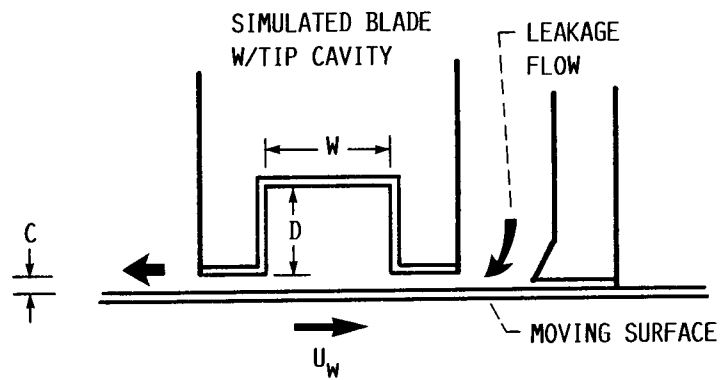

FIGURE 10. - EXPERIMENTAL HEAT TRANSFER RESULTS FOR A SIMULATED BLADE TIP CAVITY. ARIZONA STATE UNIVERSITY.

RE = 25 000

SYMBOL $\Delta T, \theta_f$
 FLAGS 40 80 120 160

OPEN SYMBOLS - SMOOTH WALL
 SOLID SYMBOLS - ROUGH WALL

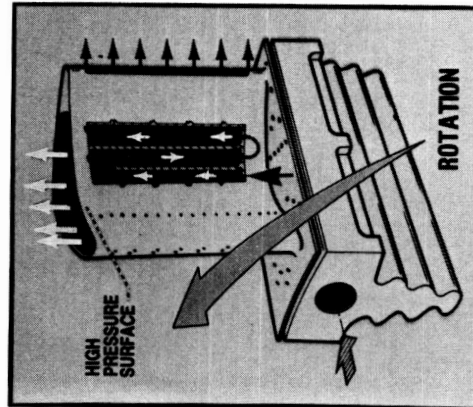
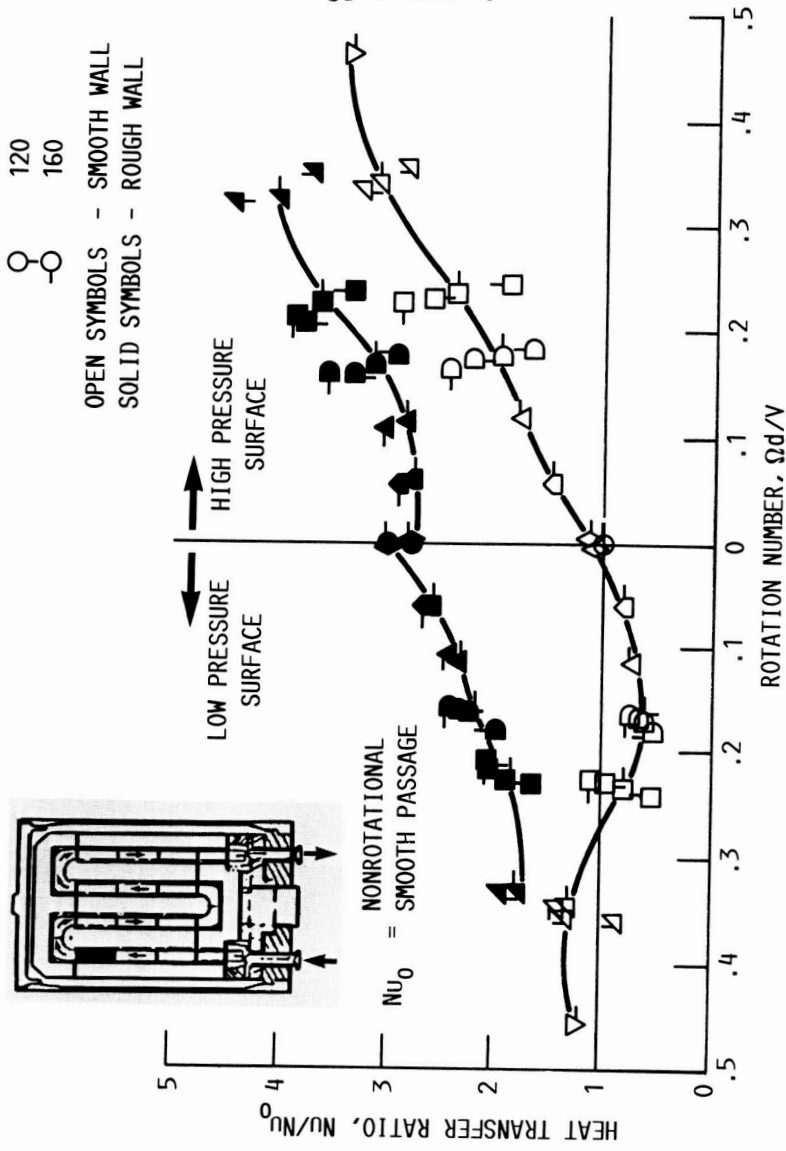

FIGURE 11. - THE EFFECTS OF ROTATION ON HEAT TRANSFER IN MULTIPASS COOLANT PASSAGES WITH AND WITHOUT TURBULATORS ARE SHOWN FOR AN OUTWARD FLOWING PASSAGE. PRATT AND WHITNEY AIRCRAFT.

TURBULENCE = 6.5 PERCENT; EXIT MACH NUMBER = 0.90

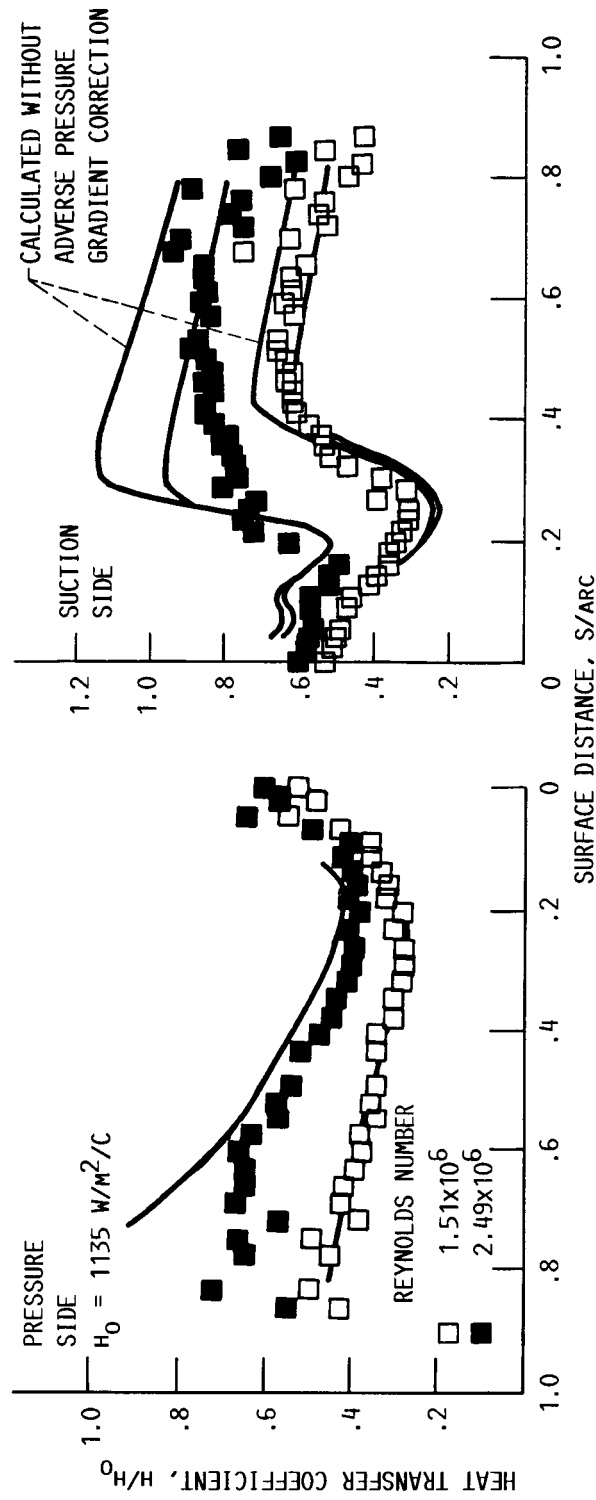

FIGURE 13. - A MODIFIED LOW REYNOLDS NUMBER K- ϵ TURBULENCE MODEL FOR A BOUNDARY LAYER ANALYSIS IS COMPARED WITH EXPERIMENTAL MEASUREMENTS. UNIVERSITY OF MINNESOTA.

CD-87-29102

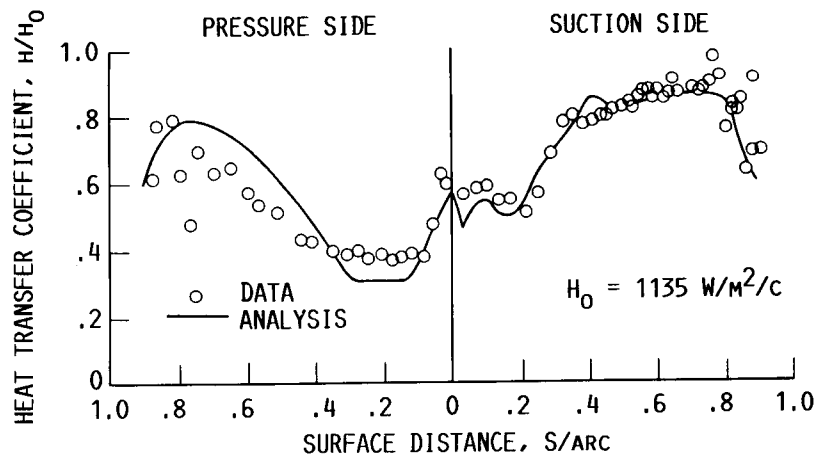
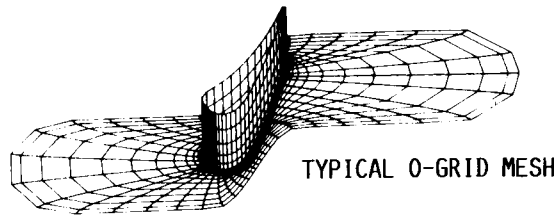

FIGURE 14. - A FULLY ELLIPTIC NAVIER-STOKES SOLUTION IS COMPARED WITH THE SAME EXPERIMENTAL MEASUREMENTS FOUND IN FIGURES 12 AND 13. SCIENTIFIC RESEARCH ASSOCIATE, INC.



Report Documentation Page

1. Report No. NASA TM-100280	2. Government Accession No.	3. Recipient's Catalog No.	
4. Title and Subtitle HOST Turbine Heat Transfer Program Summary		5. Report Date	
		6. Performing Organization Code	
7. Author(s) Herbert J. Gladden and Robert J. Simoneau		8. Performing Organization Report No. E-3876	
		10. Work Unit No. 505-31-04	
9. Performing Organization Name and Address National Aeronautics and Space Administration Lewis Research Center Cleveland, Ohio 44135-3191		11. Contract or Grant No.	
		13. Type of Report and Period Covered Technical Memorandum	
12. Sponsoring Agency Name and Address National Aeronautics and Space Administration Washington, D.C. 20546-0001		14. Sponsoring Agency Code	
		15. Supplementary Notes Prepared for the 33rd International Gas Turbine and Aeroengine Congress and Exposition, sponsored by the American Society of Mechanical Engineers, Amsterdam, The Netherlands, June 5-9, 1988.	
16. Abstract The objectives of the HOST Turbine Heat Transfer subproject were to obtain a better understanding of the physics of the aerothermodynamic phenomena and to assess and improve the analytical methods used to predict the flow and heat transfer in high temperature gas turbines. At the time the HOST project was initiated, an across-the-board improvement in turbine design technology was needed. A building-block approach was utilized and the research ranged from the study of fundamental phenomena and modeling to experiments in simulated real engine environments. Experimental research accounted for approximately 75 percent of the funding while the analytical efforts were approximately 25 percent. A healthy government/industry/university partnership, with industry providing almost half of the research, was created to advance the turbine heat transfer design technology base.			
17. Key Words (Suggested by Author(s)) Heat transfer Gas turbines Film cooling		18. Distribution Statement Unclassified - Unlimited Subject Category 34	
19. Security Classif. (of this report) Unclassified	20. Security Classif. (of this page) Unclassified	21. No of pages 21	22. Price* A02