

NBS TECHNICAL NOTE 1003

U.S. DEPARTMENT OF COMMERCE / National Bureau of Standards

Automatic Path Delay Corrections to GOES Satellite Time Broadcasts

C
73
003
37
4

NATIONAL BUREAU OF STANDARDS

The National Bureau of Standards¹ was established by an act of Congress March 3, 1901. The Bureau's overall goal is to strengthen and advance the Nation's science and technology and facilitate their effective application for public benefit. To this end, the Bureau conducts research and provides: (1) a basis for the Nation's physical measurement system, (2) scientific and technological services for industry and government, (3) a technical basis for equity in trade, and (4) technical services to promote public safety. The Bureau consists of the Institute for Basic Standards, the Institute for Materials Research, the Institute for Applied Technology, the Institute for Computer Sciences and Technology, the Office for Information Programs, and the Office of Experimental Technology Incentives Program.

THE INSTITUTE FOR BASIC STANDARDS provides the central basis within the United States of a complete and consistent system of physical measurement; coordinates that system with measurement systems of other nations; and furnishes essential services leading to accurate and uniform physical measurements throughout the Nation's scientific community, industry, and commerce. The Institute consists of the Office of Measurement Services, and the following center and divisions:

Applied Mathematics — Electricity — Mechanics — Heat — Optical Physics — Center for Radiation Research — Laboratory Astrophysics² — Cryogenics² — Electromagnetics² — Time and Frequency².

THE INSTITUTE FOR MATERIALS RESEARCH conducts materials research leading to improved methods of measurement, standards, and data on the properties of well-characterized materials needed by industry, commerce, educational institutions, and Government; provides advisory and research services to other Government agencies; and develops, produces, and distributes standard reference materials. The Institute consists of the Office of Standard Reference Materials, the Office of Air and Water Measurement, and the following divisions:

Analytical Chemistry — Polymers — Metallurgy — Inorganic Materials — Reactor Radiation — Physical Chemistry.

THE INSTITUTE FOR APPLIED TECHNOLOGY provides technical services developing and promoting the use of available technology; cooperates with public and private organizations in developing technological standards, codes, and test methods; and provides technical advice services, and information to Government agencies and the public. The Institute consists of the following divisions and centers:

Standards Application and Analysis — Electronic Technology — Center for Consumer Product Technology: Product Systems Analysis; Product Engineering — Center for Building Technology: Structures, Materials, and Safety; Building Environment; Technical Evaluation and Application — Center for Fire Research: Fire Science; Fire Safety Engineering.

THE INSTITUTE FOR COMPUTER SCIENCES AND TECHNOLOGY conducts research and provides technical services designed to aid Government agencies in improving cost effectiveness in the conduct of their programs through the selection, acquisition, and effective utilization of automatic data processing equipment; and serves as the principal focus within the executive branch for the development of Federal standards for automatic data processing equipment, techniques, and computer languages. The Institute consist of the following divisions:

Computer Services — Systems and Software — Computer Systems Engineering — Information Technology.

THE OFFICE OF EXPERIMENTAL TECHNOLOGY INCENTIVES PROGRAM seeks to affect public policy and process to facilitate technological change in the private sector by examining and experimenting with Government policies and practices in order to identify and remove Government-related barriers and to correct inherent market imperfections that impede the innovation process.

THE OFFICE FOR INFORMATION PROGRAMS promotes optimum dissemination and accessibility of scientific information generated within NBS; promotes the development of the National Standard Reference Data System and a system of information analysis centers dealing with the broader aspects of the National Measurement System; provides appropriate services to ensure that the NBS staff has optimum accessibility to the scientific information of the world. The Office consists of the following organizational units:

Office of Standard Reference Data — Office of Information Activities — Office of Technical Publications — Library — Office of International Standards — Office of International Relations.

¹ Headquarters and Laboratories at Gaithersburg, Maryland, unless otherwise noted; mailing address Washington, D.C. 20234.

² Located at Boulder, Colorado 80302.

BUREAU OF

1978

ACC

Automatic Path Delay Corrections to GOES Satellite Time Broadcasts

Technical Note, No. 1003

C 100

S 753

1003

78

J.V. Cateora

D.W. Hanson

D.D. Davis

Time and Frequency Division
Institute for Basic Standards
National Bureau of Standards
Boulder, Colorado 80303

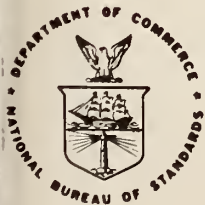

U.S. DEPARTMENT OF COMMERCE, Juanita M. Kreps, Secretary

Sidney Harman, Under Secretary

Jordan J. Baruch, Assistant Secretary for Science and Technology

NATIONAL BUREAU OF STANDARDS, Ernest Ambler, Director

Issued February 1978

NATIONAL BUREAU OF STANDARDS TECHNICAL NOTE 1003
Nat. Bur. Stand. (U.S.), Tech. Note 1003, 52 pages (February 1978)
CODEN: NBTNAE

U.S. GOVERNMENT PRINTING OFFICE
WASHINGTON: 1978

For sale by the Superintendent of Documents, U.S. Government Printing Office, Washington, D.C. 20402

Stock No. 003-003-01899-6 Price \$2.20 (Add 25 percent additional for other than U.S. mailing)

CONTENTS

1.	INTRODUCTION	1
2.	GOES SYSTEM DESCRIPTION	1
3.	TIME CODE SYSTEM	3
4.	RECEPTION	5
5.	DELAY COMPUTATION	7
6.	MATHEMATICAL CONSIDERATIONS	9
7.	SYSTEM HARDWARE	11
8.	SYSTEM SOFTWARE	16
9.	PERFORMANCE	27
10.	CONCLUSIONS	29
11.	REFERENCES	30
	APPENDIX	31

FIGURES

FIGURE 1	GOES COVERAGE	2
FIGURE 2	INTERROGATION MESSAGE FORMAT	2
FIGURE 3	TIME CODE GENERATION EQUIPMENT AT THE CDA WOLLOPS ISLAND, VIRGINIA	3
FIGURE 4	TIME CODE FORMAT	3
FIGURE 5	TRACKING NETWORK FOR THE GOES SATELLITES	4
FIGURE 6	INTERROGATION CHANNEL SIGNAL CHARACTERISTICS	5
FIGURE 7	INTERROGATION CHANNEL RECEIVER BLOCK DIAGRAM	5
FIGURE 8	INTERROGATION CHANNEL RECEIVER	6
FIGURE 9	DECODER CLOCK	7
FIGURE 10	SMART CLOCK	8
FIGURE 11	DELAY CALCULATOR	8
FIGURE 12	EARTH SATELLITE GEOMETRY FOR SLANT RANGE CALCULATION	9
FIGURE 13	AUTOMATIC DELAY CORRECTING SYSTEM BLOCK DIAGRAM	10
FIGURE 14	MICROPROCESSOR BLOCK DIAGRAM	11
FIGURE 15	MICROPROCESSOR WIRING DIAGRAM	12
FIGURE 16	RAM REGISTER MAP	13
FIGURE 17	SCIENTIFIC CALCULATOR CHIP INTERFACE	14
FIGURE 18	SCIENTIFIC CALCULATOR CHIP INPUT, DATA REQUEST AND OUTPUT CODES	15
FIGURE 19	PROGRAMMABLE DELAY GENERATOR	17
FIGURE 20	DELAY DISPLAY AND INPUT POSITION SWITCHES	18
FIGURE 21	MICROPROCESSOR/CALCULATOR COMPONENT LAYOUT	19
FIGURE 22	DISPLAY BOARD COMPONENT LAYOUT	19

FIGURE 23	MICROPROCESSOR/CALCULATOR BOARD (FRONT)	20
FIGURE 24	MICROPROCESSOR/CALCULATOR BOARD (BACK)	21
FIGURE 25	DISPLAY BOARD (FRONT)	22
FIGURE 26	DISPLAY BOARD (BACK)	23
FIGURE 27	SOFTWARE FLOWCHART	24
FIGURE 28	SOFTWARE FLOWCHART (CONTINUED)	25
FIGURE 29	MEASUREMENT OF UTC(NBS) - SAT/NBS	28
FIGURE 30	UTC(NBS) - GOES1/NBS (UNCORRECTED)	28
FIGURE 31	UTC(NBS) - GOES1/NBS (CORRECTED)	29
FIGURE 32	SATELLITE OUTPUT; CORRECTED AND UNCORRECTED	29

AUTOMATIC PATH DELAY CORRECTIONS TO GOES SATELLITE TIME BROADCASTS

J. V. Cateora, D. W. Hanson, and D. D. Davis

In support of the environmental data collection by the National Oceanic and Atmospheric Administration's (NOAA's) Geostationary Operational Environmental Satellites (GOES), a time code has been incorporated into an interrogation message from these satellites by the National Bureau of Standards (NBS). This message is directed to data-collection platforms engaged in seismic, tsunami, hydromet and other related monitoring activities. The NBS has developed this time-code system to serve environmental data users who require only a few tenths of a second accuracy as well as those who need a more accurate time reference.

The time code is available continuously from two geostationary satellites and provides a coverage of the Atlantic and Pacific Ocean Basins as well as the North and South American Continents. The time code includes the necessary information to compensate for free-space propagation delays between the master clock located at Wallops Island, Virginia, and the user. Preliminary results indicate a timing resolution of 10 μ s.

The time-code system is supported by atomic clocks maintained at Wallops Island, Virginia, the point of origin for all signals to be sent through the satellites. A data-logging system monitors three television networks and Loran-C to provide a comparison link between the Wallops Island clocks and reference standards at the NBS.

A microprocessor "smart" clock has been developed for the user that automatically corrects for path and equipment delays and places its recovered time in synchronism with Coordinated Universal Time (UTC) generated by NBS. This clock, associated recovery equipment, and measured results are discussed in detail in this report.

Key Words: Broadcast; delay correction; microprocessor; satellite; scientific calculations; time of year.

1. INTRODUCTION

A time code has been added by the National Bureau of Standards (NBS) into a communications channel between the National Oceanic and Atmospheric Administration's (NOAA's) Geostationary Operational Environmental Satellites (GOES) and remote environmental data-gathering platforms. The time code is continuously available throughout the entire Western Hemisphere, offering easy accessibility and moderately high accuracy at low cost. The time code contains Coordinated Universal Time (UTC) information and Universal Time (UT1) corrections. In addition to the time code, the satellite's position is included for free-space propagation time corrections. These position data are presently in the form of the satellite's longitude, latitude, and range from the earth's center. The UTC and UT1 information is a permanent feature of these satellites and will remain fixed in format. The satellite position information may undergo changes in form to improve its performance.

2. GOES SYSTEM DESCRIPTION

There are three GOES satellites in orbit, two in operational status and the third serving as an in-orbit spare. The two operational satellites are located at 135°W and 75°W with the spare at 105°W longitude. The earth coverages are shown in figure 1.

The mission for the GOES satellites includes (1) continuous photography of the earth's surface, (2) collection of data on the space environmental Sun/Earth interaction, and (3) collection of remote-sensor data including flood, rain, snow, tsunami, earthquake, and air/water pollution monitoring. It is in this third function that a need for a time code was realized since in many cases, the data are of greater value if labeled with the date as they are collected.

Some of these remote sensors are equipped with both a receiver and transmitter. Upon command from the satellite, these sensors, called data-collection platforms (DCP's), are activated to transmit stored data to the satellite. The satellite relays these data to the NOAA Command and Data Acquisition (CDA) station at Wallops Island, VA, for processing and dissemination to users. The communications channel used to activate this response is called the interrogation channel. This channel is continuously relaying interrogation messages through the satellites. Its format is shown in figure 2.

The interrogation message is exactly one-half second in length or 50 bits, the data rate being 100 b/s. The interrogation message is binary and phase modulates a carrier \pm 60 degrees after being Manchester-encoded; i.e., data and data clock are modulo-2 added before modulating the carrier. An interrogation message consists of the first four bits representing a BCD word of the time code beginning on the one-half second followed by a maximum length sequence (MLS) 15 bits in length for message synchronization and ending with 31 bits as an address for a particular DCP. When a DCP receives and recognizes its unique address, it transmits its data to the satellite. Sixty interrogation messages are required to send the 60 BCD time-code words constituting a time-code frame. The time-code frame begins on the one-half minute and requires 30 seconds to complete.

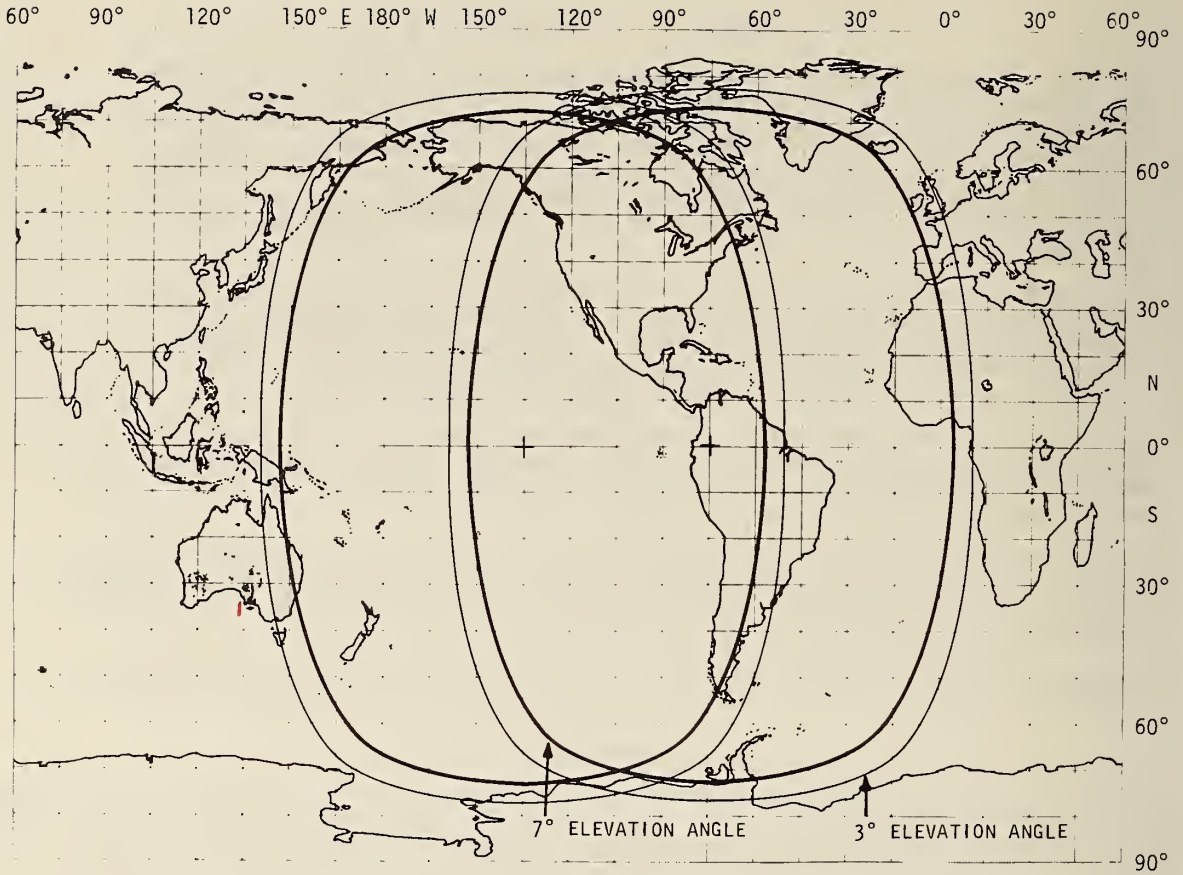

FIGURE 1. GOES COVERAGE

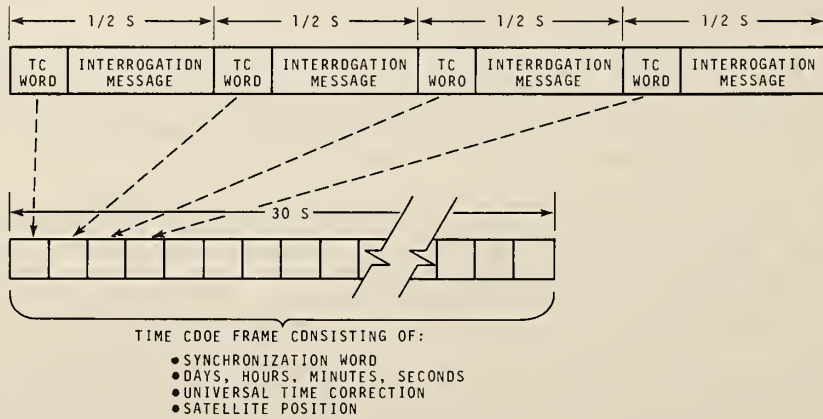

FIGURE 2. INTERROGATION MESSAGE FORMAT

3. TIME CODE SYSTEM

The time code is generated and integrated into the interrogation message at the CDA for transmission to the GOES satellites. The time-code generation system, shown in figure 3, is completely redundant and fully supported by an uninterruptable power supply. There is a communication interface between the equipment and NBS/Boulder using a telephone line. Over the telephone line, satellite position information is sent to the CDA and stored in memory for eventual incorporation with the time code and interrogation message. Data are also retrieved from the CDA via the telephone line to Boulder. These data include the frequency of the atomic oscillators and the time of the clocks relative to UTC as compared to TV transmissions from Norfolk, VA, and to the Loran-C transmissions from Cape Fear, North Carolina. These data are stored for retrieval in a data logger similar to that described in reference [1]. The data logger also measures and stores the time of arrival of the signals from both the Western and Eastern GOES satellites as received at the CDA. Besides the time and frequency monitoring functions, the data logger provides the information necessary for NBS staff at Boulder to remotely determine if and where malfunctions exist and how to correct for them by switching in redundant system components.

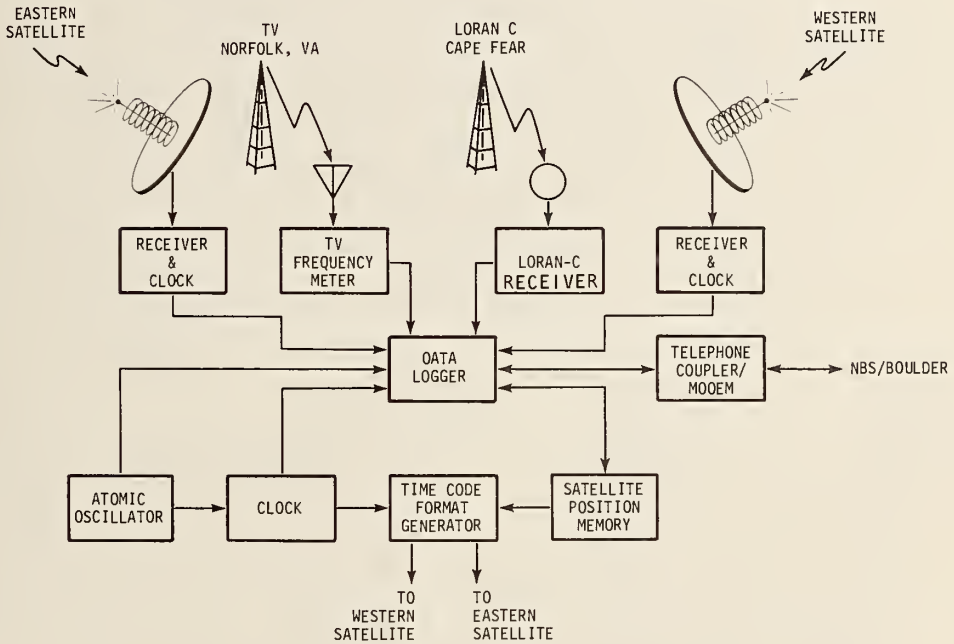

FIGURE 3. TIME CODE GENERATION EQUIPMENT AT THE CDA WALLOPS ISLAND, VIRGINIA

The interrogation message rate, 100 b/s, is generated by the atomic oscillators in the time-code system. The time-code frame repeats every 30 seconds and begins on the one-half minute as shown in figure 4. The time-code frame contains a synchronization word, a time-of-year word (UTC), the UT1 correction, and the satellite's position in terms of its longitude, latitude, and radius. The position information is presently updated only on the half hour.

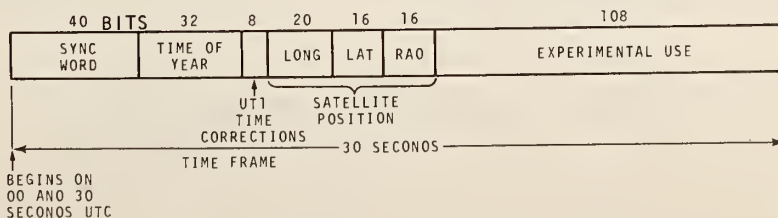

FIGURE 4. TIME CODE FORMAT

The satellite position information is generated at Boulder using a CDC 6600 computer and orbital elements furnished by NOAA's National Environmental Satellite Service (NESS). NESS generates these orbital elements weekly from data obtained from their trilateration range and range rate (R&RR) tracking network. This network is illustrated in figure 5. The tracking data are obtained by measuring the R&RR to the Western satellite from the CDA, and sites in the states of Washington and Hawaii. The Eastern satellite is observed from the CDA, Santiago, Chile, and Ascension Island in the South Atlantic. The sites used in the R&RR network other than the CDA are known as turn-around ranging stations (TARS).

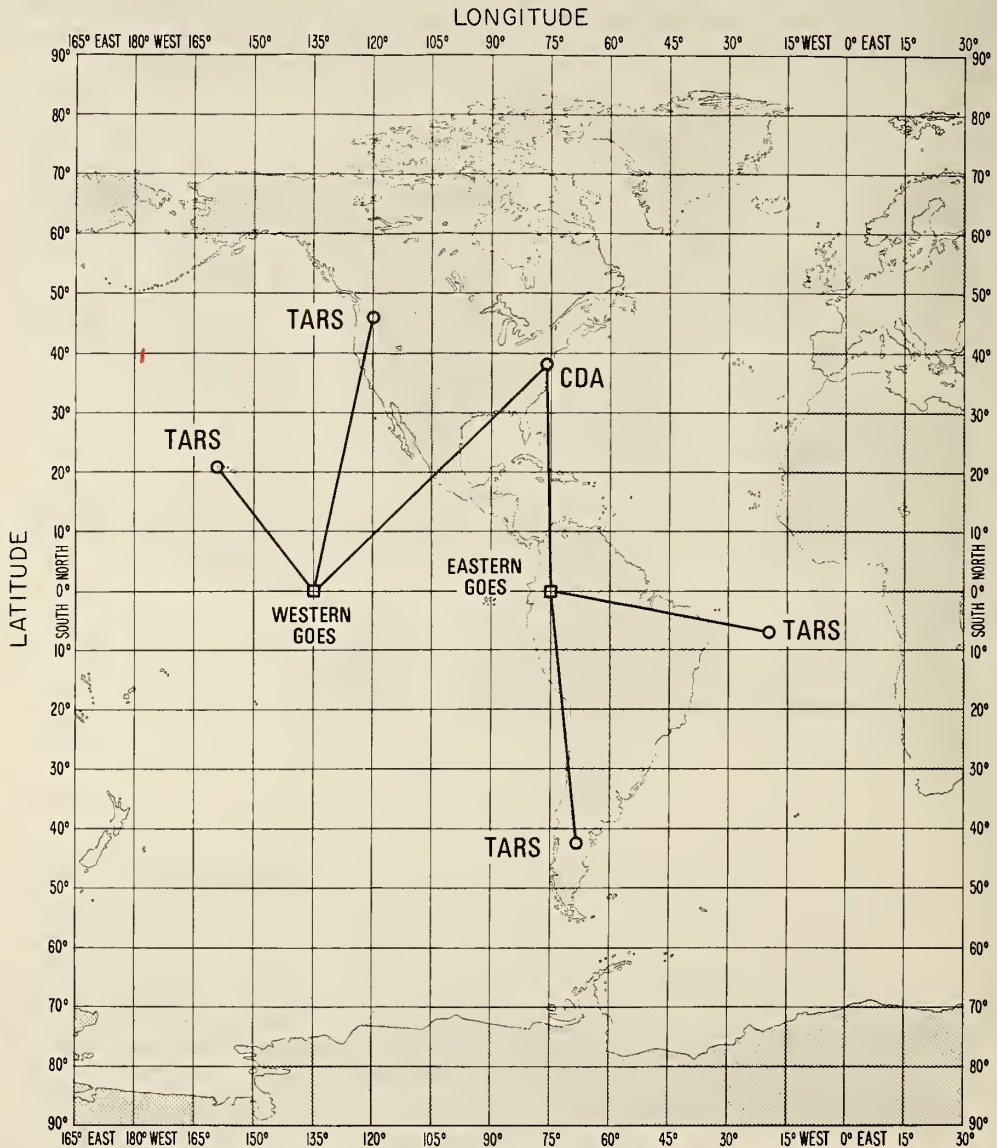

FIGURE 5. TRACKING NETWORK FOR THE GOES SATELLITES

4. RECEPTION

The interrogation channel signals are briefly characterized in figure 6. Typical antennas include simple low-gain helixes or yagis. A block diagram of the receiver is shown in figure 7. It is shown in figure 8 as three modules: an RF/IF module, an local oscillator injection module, and a demodulator module. This receiver is a coherent, synchronous digital receiver utilizing a phase-lock loop for demodulation and local oscillator generation and a bit synchronizer for detection purposes.

	WESTERN SATELLITE	EASTERN SATELLITE
FREQUENCY	468.8250 MHz	468.8375 MHz
POLARIZATION	RHCP	RHCP
MODULATION	CPSK (+ 60°)	CPSK (+ 60°)
DATA RATE	100 BPS	100 BPS
SATELLITE LOCATION	135° W	75° W
SIGNAL STRENGTH (OUTPUT FROM ISOTROPIC ANTENNA)	-139 dBm	-139 dBm
CODING	MANCHESTER	MANCHESTER
BANDWIDTH	400 Hz	400 Hz

FIGURE 6. INTERROGATION CHANNEL SIGNAL CHARACTERISTICS

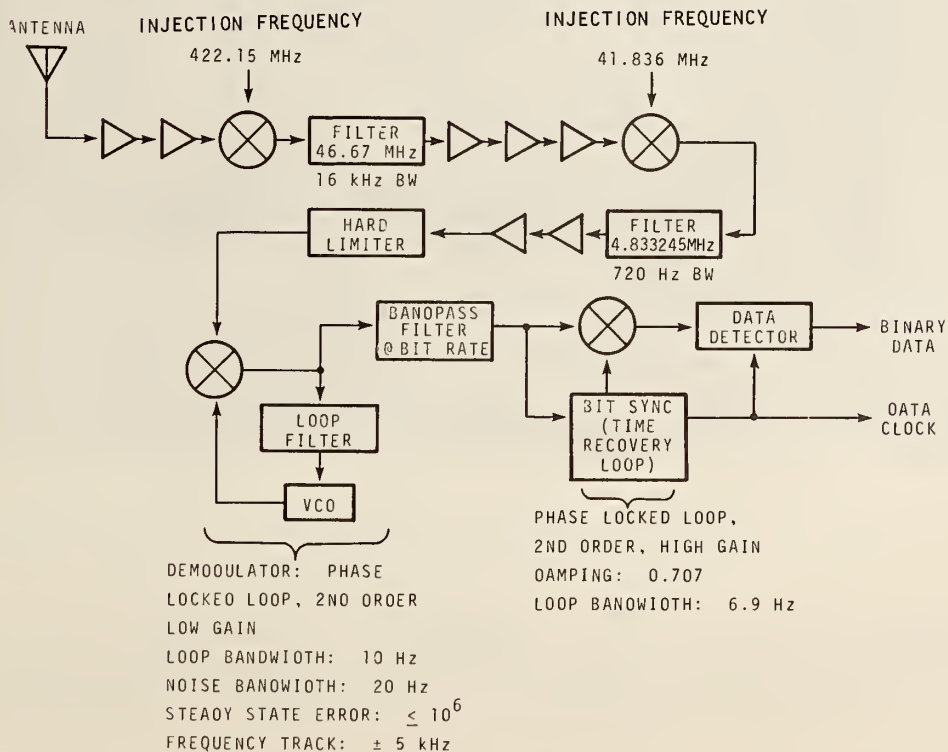

FIGURE 7. INTERROGATION CHANNEL RECEIVER BLOCK DIAGRAM

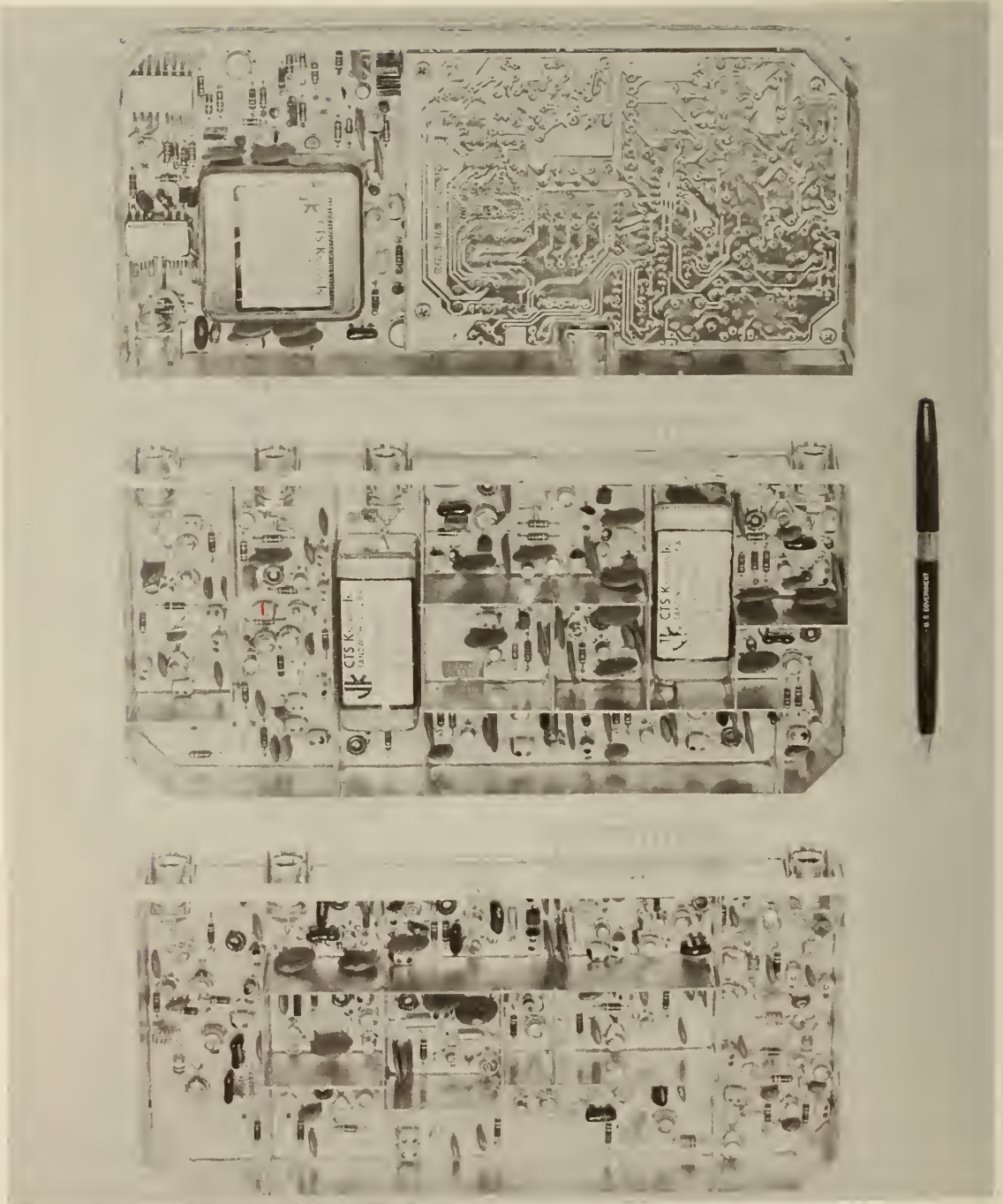

FIGURE 8. INTERROGATION CHANNEL RECEIVER

The outputs of the receiver data, and data clock are the inputs to a decoder clock (see reference [2] for a complete description of this clock). The decoder clock shown in figure 9 uses a four-bit microprocessor to demultiplex the data, extract the proper four bits of the time code every one-half second, and reconstruct the time-code frame. Once decoded, this time is loaded into Random Access Memory (RAM) and updated by incrementing the RAM clock in 10-ms steps by counting the data clock, a 100-Hz squarewave.

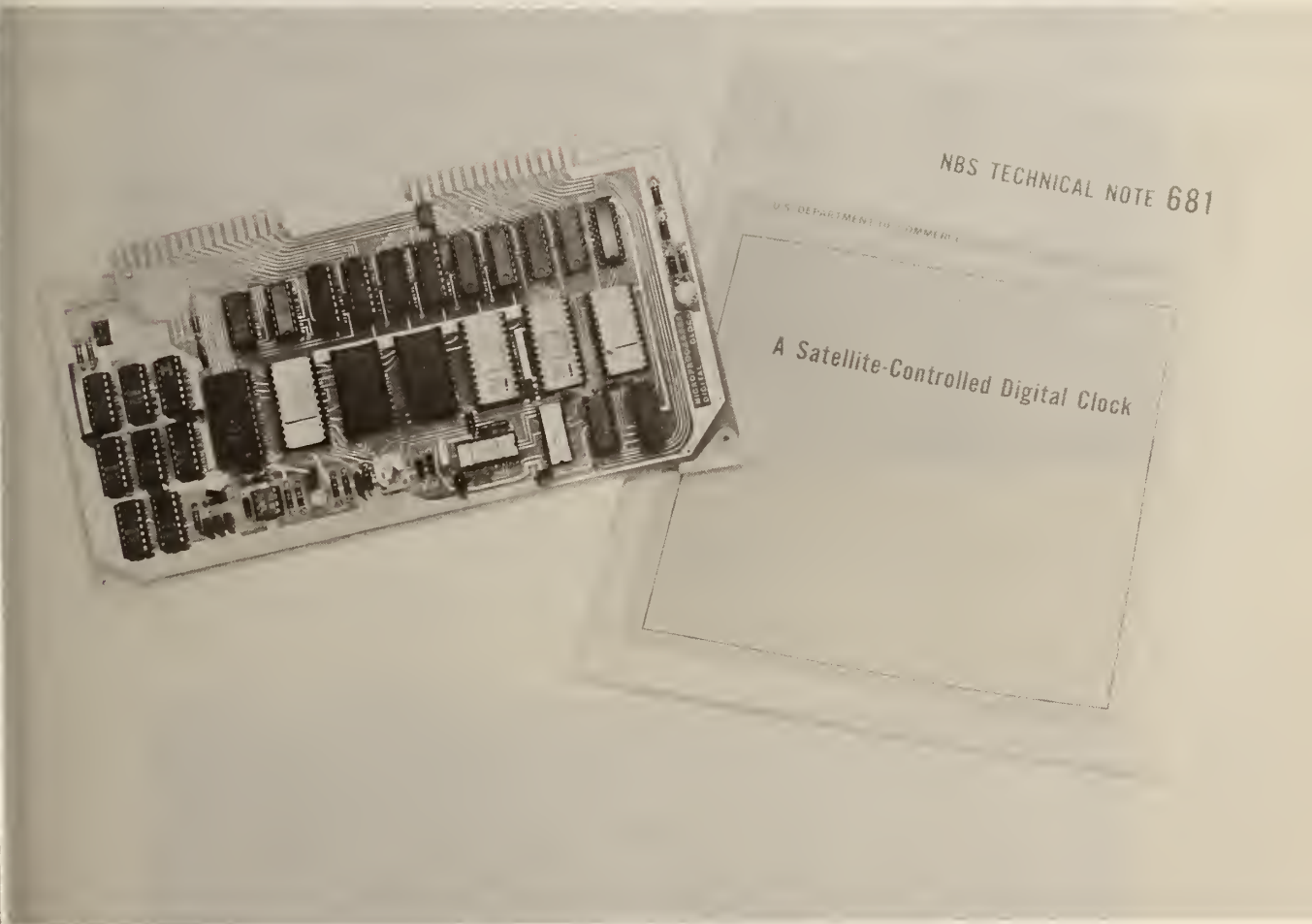

FIGURE 9. DECODER CLOCK

5. DELAY COMPUTATION

A prototype of a "smart" clock is shown in figure 10. The delay calculator is shown in figure 11. This is essentially an addition of a second microprocessor to the decoder clock for the calculation of the free-space propagation delay from the CDA to the clock via the satellite. This delay value is then used with a delay generator to compensate for the free-space path delay.



FIGURE 10. SMART CLOCK

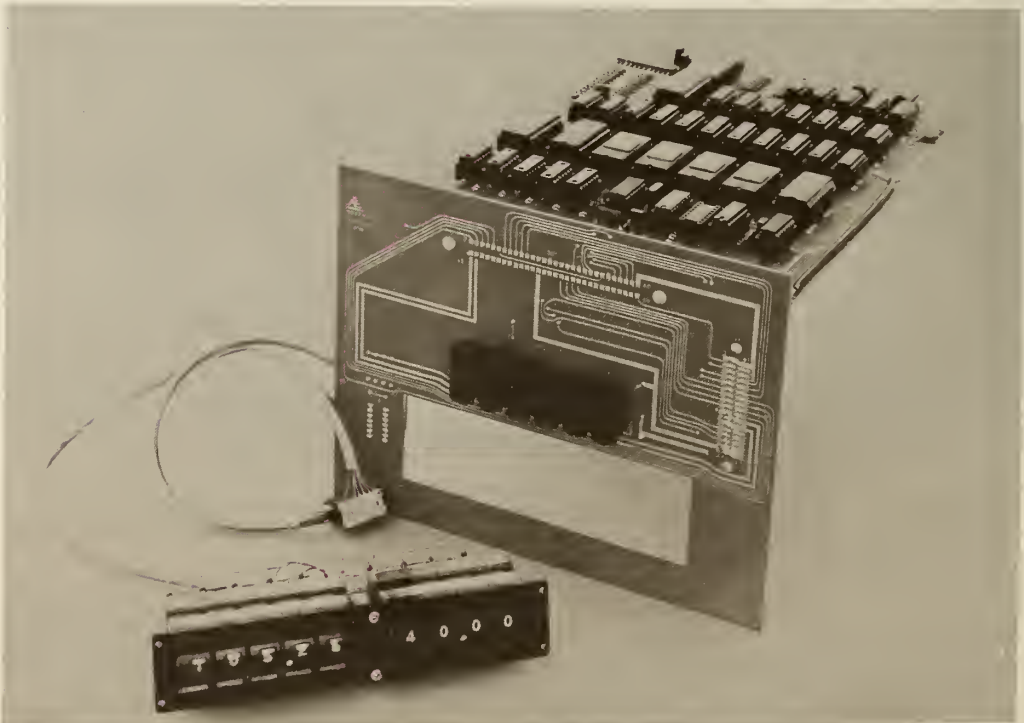

FIGURE 11. DELAY CALCULATOR

The "smart" clock uses the same type of four-bit microprocessor as the decoder clock. The microprocessor is interfaced to a large scale integration scientific calculator array (math chip) to provide the floating point arithmetic and mathematical functions required in the delay calculation. A 1-pps output and satellite position as longitude, latitude, and radial deviation from a reference orbit is obtained continuously from the decoder clock operating on the satellite's transmitted interrogation channel signal. User position is entered into the system via thumbwheel switches, and transmitter position (Wallops Island, VA) is contained in the microprocessor software. The computed delay drives a programmable delay generator to correct the 1 pps from the decoder clock. The resultant output from the programmable delay generator is a compensated 1 pps, adjusted to be in agreement with the master clock at Wallops Island, which is referenced to UTC(NBS). The hardware is a multiprocessor system consisting of two microprocessors plus a slaved scientific calculator chip and a delay generator.

The delay calculation is dependent on knowledge of the broadcasting satellite's position. This position is predicted in advance by a large scale scientific computer operating on orbital elements obtained from NOAA and sent to Wallops Island via telephone land line to be broadcast along with encoded time from each satellite. The delay correction system will work with any satellite in a synchronous orbit as long as the satellite's position is known. A calculation is made and the result is latched into the delay generator once per minute. A complete up and down delay calculation requires the execution of about 200 key strokes representing data and mathematical operations and functions under the control of the microprocessor and its associated transistor-transistor-logic (TTL) components.

6. MATHEMATICAL CONSIDERATIONS

The mathematics of the path-delay calculation require solving for length r in the geometry of figure 12; that is, the free-space propagation path between any point on the earth's surface and a geostationary satellite (see reference [3] for a more complete discussion of the calculation).

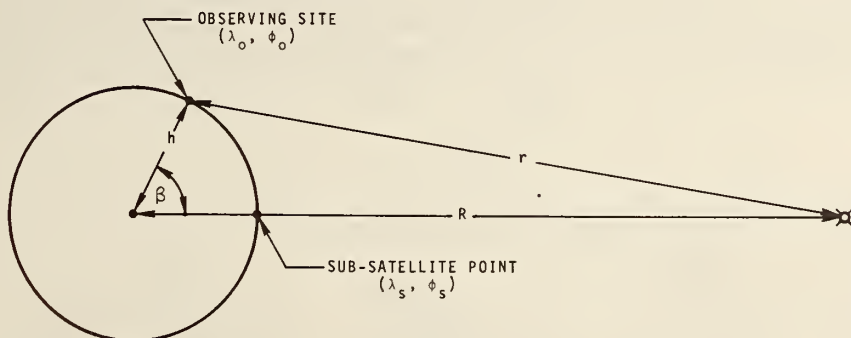

FIGURE 12. EARTH SATELLITE GEOMETRY FOR SLANT RANGE CALCULATION

Referring to figure 12 and using plane trigonometry:

$$r = \sqrt{R^2 + h^2 - 2Rh \cos \beta}, \quad (1)$$

where r is the range from any point on the earth's surface to the satellite, R is the distance from the satellite to the center of the earth, h is the distance from the receiver to the center of the earth, and β is the central angle between the subsatellite point and the given point. The quantity R is a component defining the satellite's position and is provided in the satellite time-code broadcast. The quantity h is related to the geodetic latitude ϕ of a site by the following equation:

$$h = a \sqrt{\frac{1 + \frac{b^4}{a^4} \tan^2 \phi}{1 + \frac{b^2}{a^2} \tan^2 \phi}}, \quad (2)$$

where $a = 6378.2064$ km, the earth's semi-major axis; and $b = 6356.5838$ km, the earth's semi-minor axis (see reference [4]).

The geocentric latitude, ϕ' is related to the geodetic latitude, ϕ , by the following equation.

$$\tan \phi' = \frac{b^2}{a^2} \tan \phi . \quad (3)$$

In the following discussion λ indicates longitude, and subscripts s and r denote subsatellite point and any other point on the earth's surface respectively.

Only $\cos \beta$ remains to be computed. The direct solution may be obtained from the triangle consisting of the subsatellite point, the observing point, and the intersection of the z-axis (i.e., the North Pole). Using spherical trigonometry and figure 12:

$$\cos \beta = \sin \phi'_r \sin \phi_s + \cos \phi'_r \cos \phi_s \cos (\lambda_s - \lambda_r). \quad (4)$$

These equations are programmed directly by storing key stroke sequences in programmable read-only memories (PROM's) and executing them in the scientific calculator array under microprocessor control. The calculation is repeated, first using the transmitter position for the up delay and then using the receiver position for the down delay. The two delays are summed and used in driving the delay generator.

The computed delay is subtracted from $300,000 \mu s^1$ and tens-complemented before being output to the delay generator. Tens-complementing is required because the programmable delay generator uses BCD counters which count in the up direction rather than the down direction. The delay generator setting is also multiplied by 1.024 because one count of the delay generator is equal to $1 \div 102,400$ Hz = $0.9765625 \mu s$. This frequency is derived from the satellite-controlled digital clock (see figure 13).

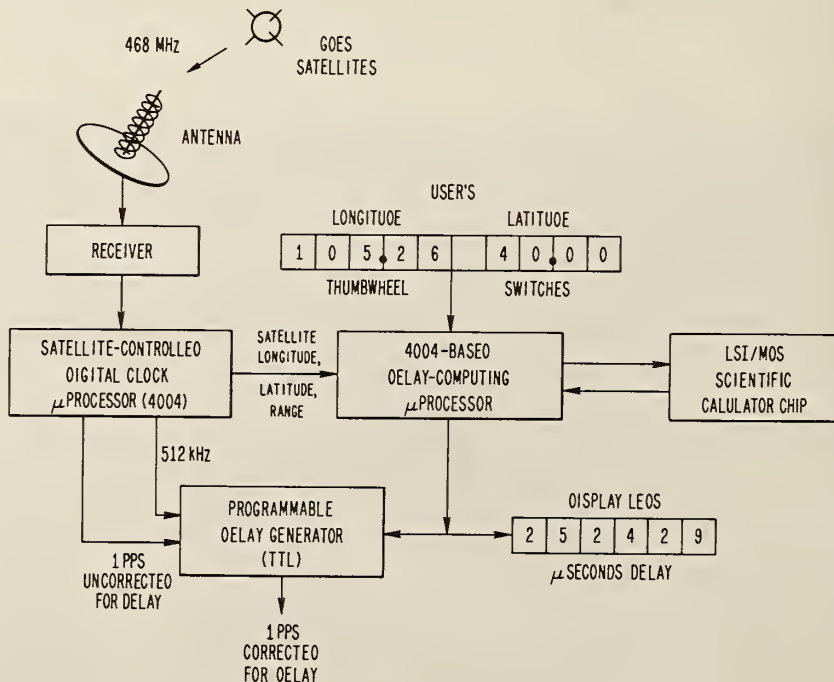

FIGURE 13. AUTOMATIC DELAY CORRECTING SYSTEM BLOCK DIAGRAM

¹The time at the CDA is advanced by $260,000 \mu s$ so it arrives nearly on time at the earth's surface. The delay generator is programmed to delay the decoder clock's 1 pps by $300,000 \mu s$ minus the computed free-space path delay, thus guaranteeing a positive (delay) value since negative values (an advance) cannot be implemented. Additional delay can be made through software to compensate for transmitter (CDA), satellite, receiver, and decoder-clock delays, when known, to place the corrected 1 pps in synchronism with the clock at the CDA.

7. SYSTEM HARDWARE

Early in the development effort a decision had to be made about the method to use for the delay calculation; that is, whether the calculation should be implemented through software or hardware. A software package for doing floating-point arithmetic and mathematical functions was available. Scientific calculators and their large scale integrated circuit chips were also available and their advantages were weighed against the software approach. Calculation execution times for multiply, divide, and the various mathematical functions were comparable in both methods and were not a factor in the decision. A software mathematical package for the four-bit microprocessor required about 750 eight-bit bytes or three programmable read-only memory (PROM) chips for program storage. This meant that even the software method would require extra hardware. The scientific calculator chip required extra hardware, but since it appeared to have more accuracy and range (scientific notation with dynamic range of 10^{99} to 10^{-99}), more mathematical functions, and looked to be generally more flexible, it was the method chosen. In addition, an existing hardware design was found for interfacing a scientific calculator chip to an eight-bit microprocessor that could also be used for a four-bit microprocessor. The software for this design could not be used, however, and new four-bit software had to be written. A four-bit microprocessor was used largely because of past experience with that type. The speed of a newer eight-bit microprocessor could not be used advantageously because of the slowness of scientific calculator chips in general. A four-bit word size was adequate since the task consisted largely of manipulating four-bit hexadecimal characters in and out of the calculator chip or RAM or to the delay generator and display board.

The decision was made to use the four-bit microprocessor and a large scale integration scientific calculator chip. The microprocessor is shown in figures 14 and 15. The system has been in operation at NBS for several months and its performance shows that the decision was more than satisfactory. The system has very powerful, accurate, and flexible computational capability at low cost and with high reliability. Key stroke codes must be entered into the math chip and held for 40 ms with a 40-ms delay between entries of key codes. Some of the mathematical functions such as sin and cos require about 1 1/2 seconds to perform. One complete calculation of the total up and down delay, the execution of about 200 key strokes, requires about 1 minute. Satellite position information is output from the decoder clock twice per minute at 0s and 30s. The delay microprocessor idles, waiting for the satellite position information. When the satellite position is available it is read by the delay microprocessor, stored in RAM, and the delay calculation finished. A complete calculation is performed and the delay generator is reset once per minute.

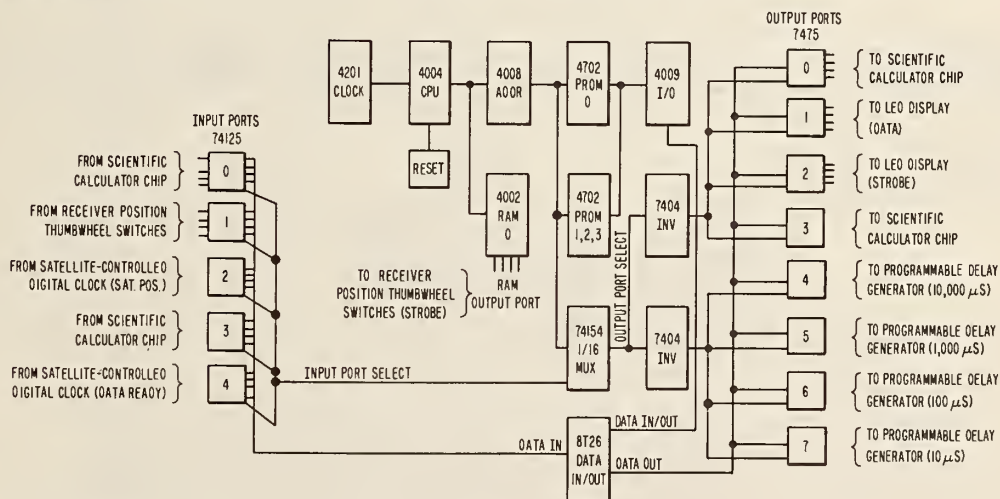

FIGURE 14. MICROPROCESSOR BLOCK DIAGRAM

Since the delay calculations always fall somewhere between 100,000 and 400,000 μ s, the decimal point is assumed to be between the seventh and eighth digits of the calculator chip output. The decimal point on the display board can therefore be wired.

Approximately once in every ten different computations, the result will contain one or more trailing zeros. If this happens, since the calculator chip doesn't output trailing zeros for display, the decimal point will be shifted. The software always checks for this condition and adds 0.01 to the result, thus forcing the decimal point back between digits seven and eight. The range of the programmable delay generator setting is always between 10,000 and 90,000, so if a decimal point shift occurs, 0.001 is added to the result to again put the decimal point back between digits seven and eight.

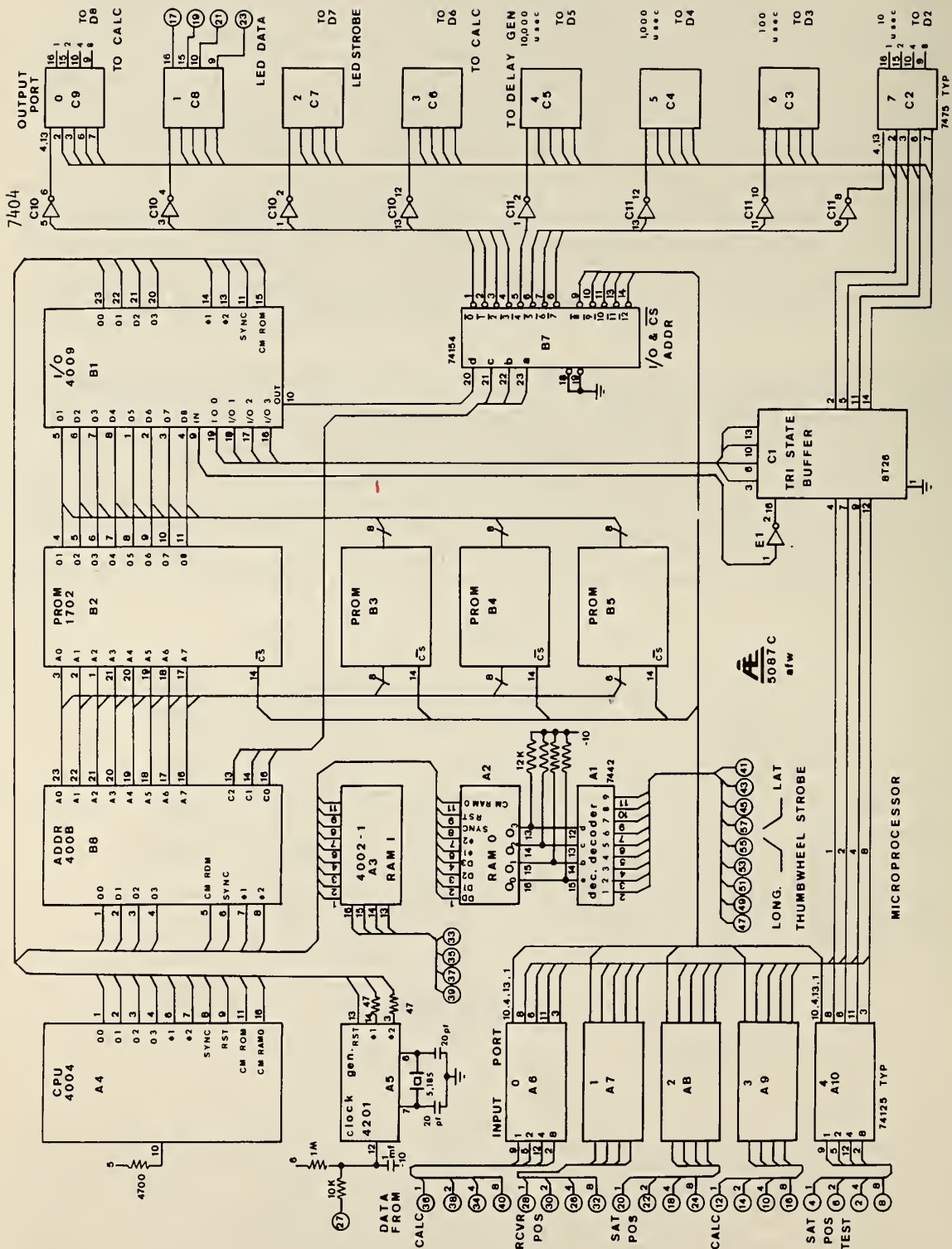

FIGURE 15. MICROPROCESSOR WIRING DIAGRAM

The delay microprocessor has five four-line input ports and nine four-line output ports, including one RAM output port, which are used as follows:

Output Port:

- 0 to scientific calculator chip (Least significant part of key code)
- 1 to LED delay display (data)
- 2 to LED delay display (strobe)
- 3 to scientific calculator chip (Most significant part of key code)
- 4 to programmable delay generator (10,000 μsec)
- 5 to programmable delay generator (1,000 μsec)
- 6 to programmable delay generator (100 μsec)
- 7 to programmable delay generator (10 μsec)

RAM Output Port:

- 0 to receiver position thumbwheel switches (strobe)

Input Port:

- 0 from scientific calculator chip (LED code)
- 1 from thumbwheel switches (user position)
- 2 from satellite-controlled digital clock (satellite position)
- 3 from scientific calculator chip (LED code)
- 4 from satellite-controlled digital clock (satellite position data ready)

One random access memory (RAM) chip is used for storage of transmitter, receiver, and satellite positions and for storage of math chip results. Figure 16 is the RAM register map showing how the RAM is organized. Total RAM storage available on the chip is 80 four-bit BCD characters.

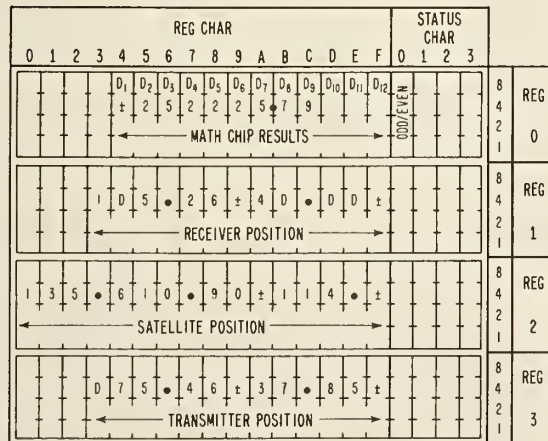

FIGURE 16. RAM REGISTER MAP

Figure 17 shows the scientific calculator chip microprocessor interface. The interface was designed by Dr. Robert Suding of the Digital Group, Denver, Colorado. The design requires two 4-bit input and two 4-bit output ports. The calculator chip is normally connected to a 12 x 4 matrix keyboard giving a 48 key input capability. Only 41 keys are actually used. Each key can be represented by a 2-digit hexadecimal key code as shown in figure 18. In normal operation with a keyboard,

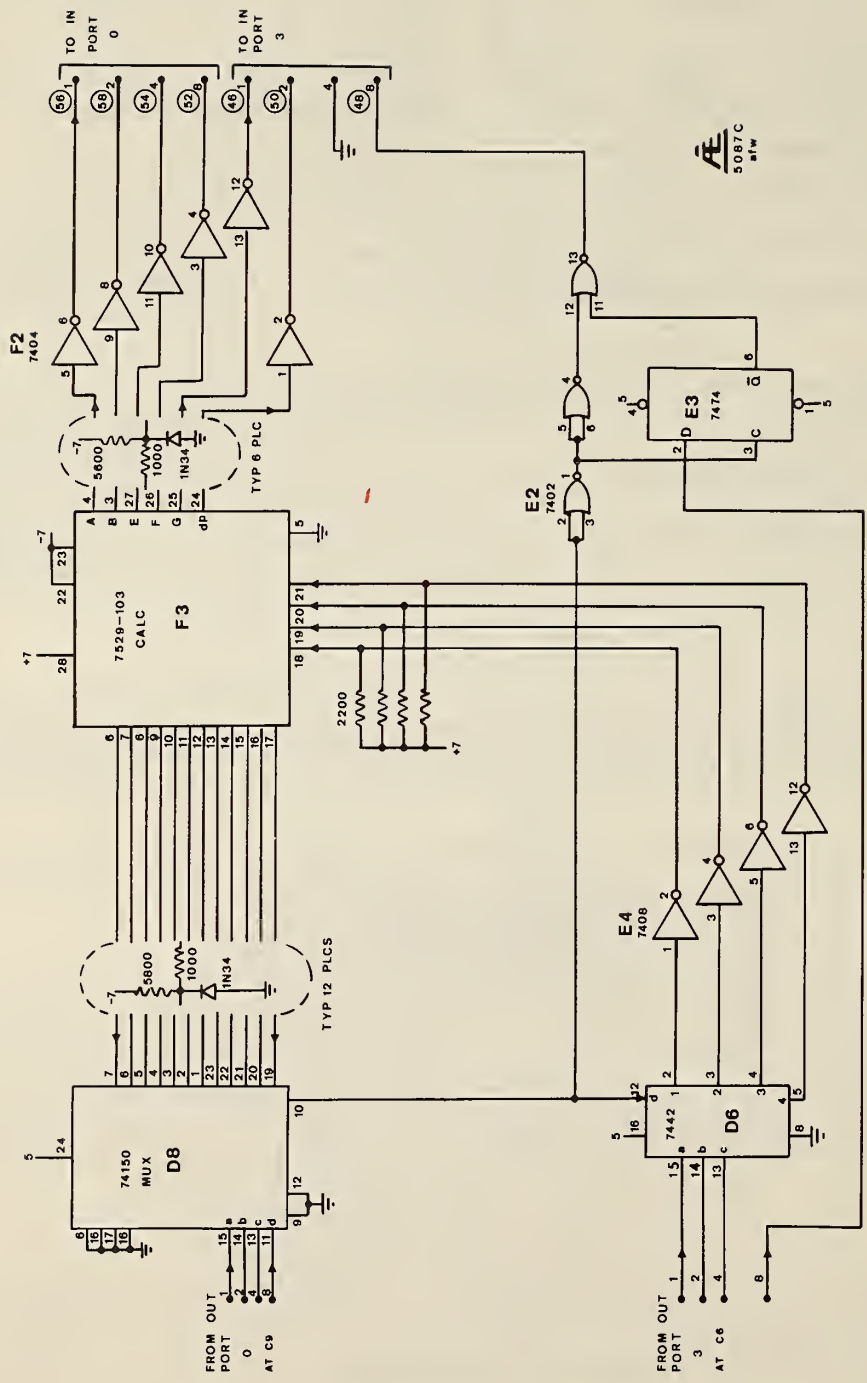

FIGURE 17. SCIENTIFIC CALCULATOR CHIP INTERFACE

the calculator chip outputs a time sequence of pulses on pins 6 through 17, one at a time. Then, depending on which key is depressed, one of the 12 pulses appears on one of the four Y input lines to the chip. The combination of a pulse at 1 of the 12 digit times on one of the four Y input lines provides the calculator chip with information on which one of the 48 possible keys has been depressed.

INPUT CODES FOR FUNCTION ENTRY							
FUNCTION	HEX	FUNCTION	HEX	FUNCTION	HEX	FUNCTION	HEX
0	11	ARC	1B	+	22	CA/CE	3C
1	12	SIN	31	-	23	CHS	2B
2	13	COS	32	x	24	EEX	2C
3	14	TAN	33	÷	25	y ^x	26
4	15	LN	34	=	27	{	28
5	16	LOG	35	π	2A	}	29
6	17	RCL	37	√	36	10 ^x	43
7	18	Σ	38	1/x	41	e ^x	44
8	19	x↔y	39	x ²	42	N!	45
9	1A	DGR	3A	No Op	00	Restore- Display	1C
.	21	STO	3B				

INPUT CODES FOR DIGIT DATA REQUEST							
DIGIT	HEX	DIGIT	HEX	DIGIT	HEX	DIGIT	HEX
1	81	4	84	7	87	10	8A
2	82	5	85	8	88	11	8B
3	83	6	86	9	89	12	8C

OUTPUT CODES FOR SEGMENT DECODE							
DIGIT ALONE	HEX	DIGIT AND DECIMAL PT	HEX	DIGIT ALONE	HEX	DIGIT AND DECIMAL PT	HEX
0	4F	0.	6F	7	43	7.	63
1	42	1.	62	8	5F	8.	7F
2	57	2.	77	9	5B	9.	7B
3	53	3.	73	-	50	-.	70
4	5A	4.	7A	ERROR	4D	ERROR.	6D
5	59	5.	79	ERROR	5D	ERROR.	7D
6	5C	6.	7C	BLANK	40	BLANK.	60

FIGURE 18. SCIENTIFIC CALCULATOR CHIP INPUT, DATA REQUEST AND OUTPUT CODES

The interface was designed to provide the same action as the keyboard but under microprocessor control. The least significant hexadecimal digit of the code is output by the microprocessor into the 1-2-4-8 input lines of the 74150 data selector to select one of 12 lines connected to the calculator chip. At the selected digit time the "8" line (pin 12) of the 7442 BCD-to-decimal converter goes low. At the same time the most significant digit of the hex key code, from output port 3, is going into the 7442 1-2-4 lines. Since the 7442 "8" is now low, one of its 1-2-3-4 decimal output lines, connected to the calculator Y inputs, can be high depending on the digit input. This provides the same effect as depressing a keyboard key, but it is now under microprocessor control. The "8" bit of output port 3 is used for requesting output data for a specific digit. For example, if data for digit 3 are desired, data request code 83 is output, the 8 from output port 3 and the 3 from output port 0. At the 3-digit time, pin 10 of the 74150 data selector goes low and is fed, through an inverter, to the clock input of a 7474 flip-flop. The "8" part of the data request code is connected to the data input of the 7474 and is clocked through at the 3-digit time. The 7474 \bar{Q} output and the 7474 clock input (through an inverter) are connected to a NOR gate which provides a positive pulse that stays high during all of the 3-digit time.

Now the microprocessor only needs to test the "8" bit of its 3 input port for high (negative logic 0) to know when the 7-segment LED data are valid for digit 3. The microprocessor then reads input port 0 and, with the other three bits of input port 3, has all the information necessary to decode the 7-segment LED data into a BCD character. Note that only 5 of the 7 LED segments are required to decode all 10 BCD characters. The decimal point output of the calculator chip is used only for detecting when the calculator chip is "DONE;" that is, when it is providing output. Since the digit 9 decimal point is always used for output, regardless of what the output might be, digit 9 is used for "DONE" testing. To test for "DONE," data request code 89 is output and the decimal point ("2" bit of input 3) is tested for-high. When the decimal point is high, the microprocessor knows that the calculator chip is finished and it either reads the 7-segment LED data for all the calculator chip output digits or it knows that entry of a key stroke is complete and enters the next key stroke.

The design of the calculator chip requires a key to be held down for at least 40 ms and when released no other key may be pressed for 40 ms. These delays have been implemented by the microprocessor software to provide the equivalent effect. Figure 18 shows the digit data request codes and the 7-segment LED output codes.

Figure 19 shows details of the programmable delay generator. The delay generator setting for the 10's of μs comes from output port 7 and the settings for 100's of μs and 10,000's of μs from output ports 6, 5 and 4 respectively. Half of a 7490 is used to divide the 512 kHz input by five. The 512 kHz comes from the satellite-controlled digital clock which is phase locked to the incoming satellite radio signal derived from the atomic clock standards at Wallops Island. The period of the 102.4 kHz from the divide by five counter is 9.765625 μs instead of exactly 10 μs . This difference is compensated in the microprocessor/calculator chip software by multiplying the delay generator setting by 1.024.

The delay generator uses five 74196 presetable decade up counters. The down-going edge of the 1-Hz pulse from the satellite-controlled digital clock loads four of the counters with the data latched into the four microprocessor output ports and starts the counters counting in the BCD up direction. The fifth counter is preset to "1" and its output (Q1, pin 5) is the 1-Hz output with the proper delay applied. The 1-Hz delayed output is also fed back to the first decade counter (10's of μs) to stop the counting.

A 7474 flip-flop was added to the satellite-controlled digital clock to make its 1-pps output coherent with the received 100 Hz satellite signal. Because the output from the digital clock is under microprocessor control, the exact number of instruction steps between the 1 pps varies. The 7474 allows the 1 pps into the delay generator only at rising edge times of the 100 Hz signal. A 74121 monostable multivibrator is used to give the 1 pps delayed output a constant 10 ms pulse width.

Figure 20 shows the 7-segment LEDs which display the calculation results, the uplink delay and the total uplink plus downlink delays. The display is a convenient monitor of the delays as they are computed. A programmable pocket calculator is used to check the calculations if there is any reason to doubt the displayed results.

The display uses a 7442 BCD-to-decimal converter, connected to output port 2, to strobe the TIL-308 LED display digits one at a time. BCD data from output port 1 are connected to all of the LED digits in parallel. Note that all decimal points are wired "off."

Figure 20 also shows the longitude and latitude thumbwheel switches for input of receiver position. RAM output port 0 is used to strobe the switches one by one and their setting is read into input port 1 and the data are stored in RAM. Five digits of longitude and four of latitude are entered. Figures 21-26 provide board layout and component location.

8. SYSTEM SOFTWARE

The software for the delay microprocessor/scientific calculator chip consists of a main program and 17 subroutines plus an area of PROM for storing the hexadecimal key code equivalents of key strokes. Program storage requires four 256 x 8 PROMs. The program was written to make the package as modular as possible; that is, to keep the main program simple and straightforward, using subroutines wherever practicable. Each program is discussed below in the order it is stored in PROM.

MAIN PROGRAM, 0-00 to 0-DF, uses about 240 bytes and controls the use of the subroutines as shown by the software flowchart, figures 27 and 28. Odd numbered passes through the main program compute the transmitter-to-satellite path delay in microseconds and store it in RAM register 0. Even passes compute the satellite-to-receiver delay. The two delays are then summed, giving the total delay over the path. The computation is identical for all passes through the program, but the up delay uses the transmitter position and the down delay uses the receiver position. RAM register 0 status character counts the number of passes through the program and is tested for odd or even. If odd the up delay is computed and if even the down delay is computed. Total delay is subtracted from the total clock advance of 300,000 μs and a programmable delay generator setting is computed and output.

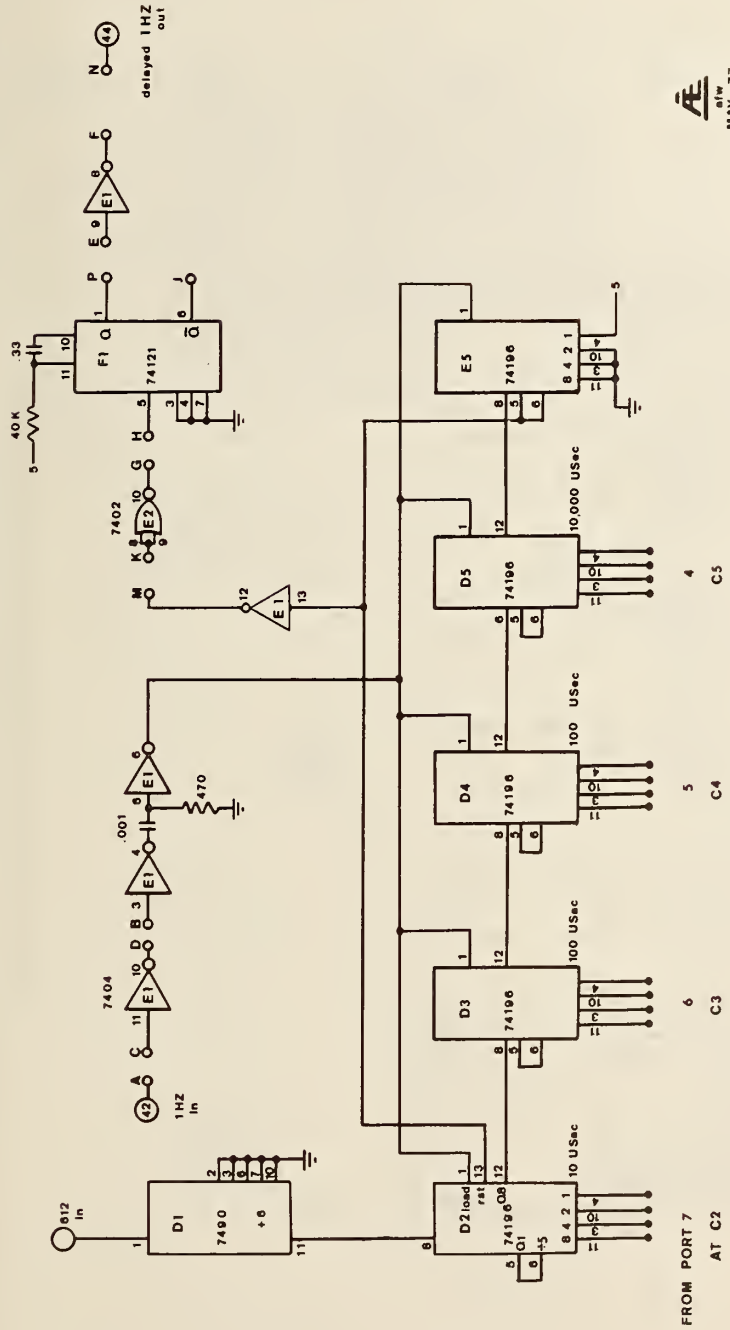

AE
 ofw
 MAY 77

FIGURE 19. PROGRAMMABLE DELAY GENERATOR

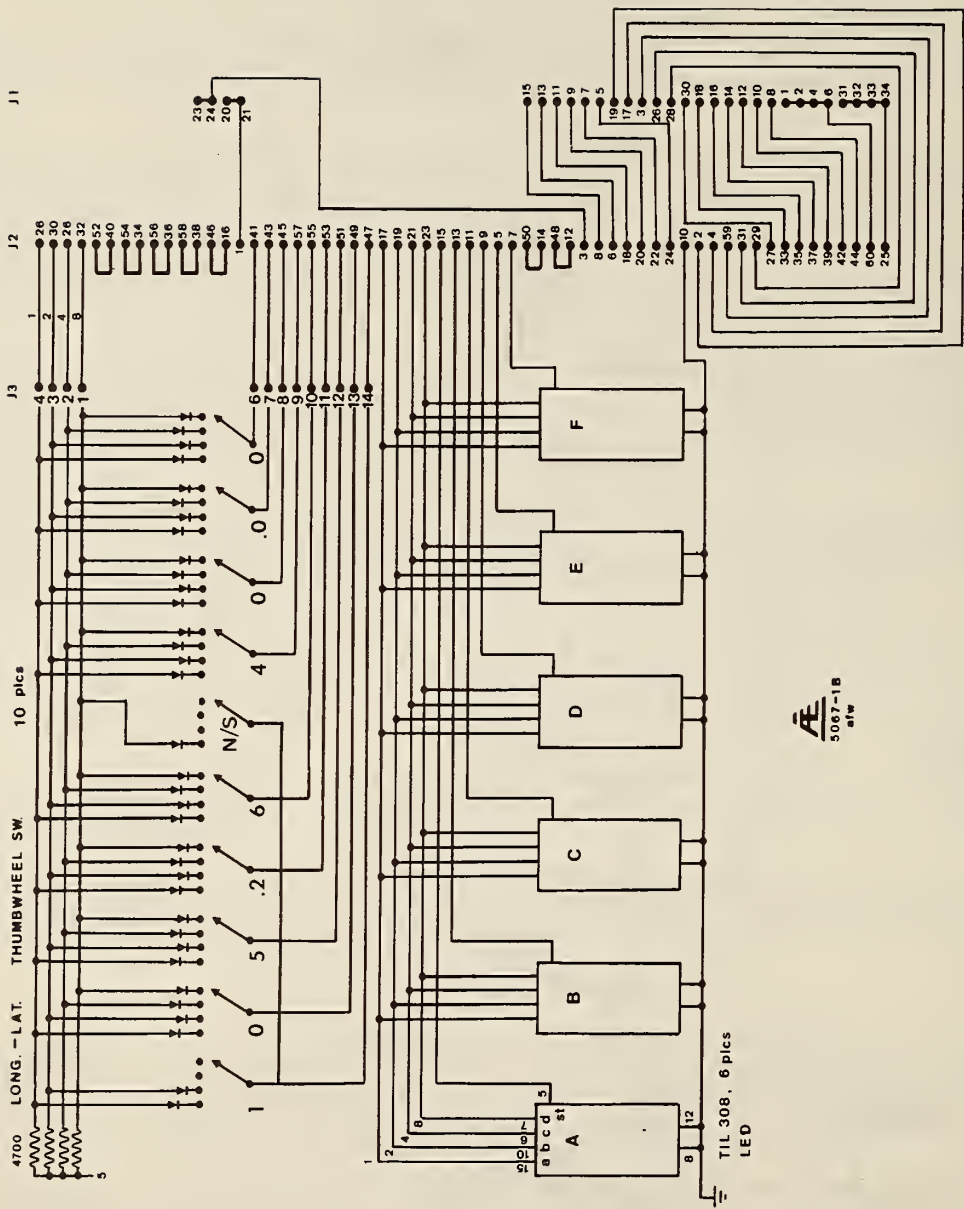

FIGURE 20. DELAY DISPLAY AND INPUT POSITION SWITCHES

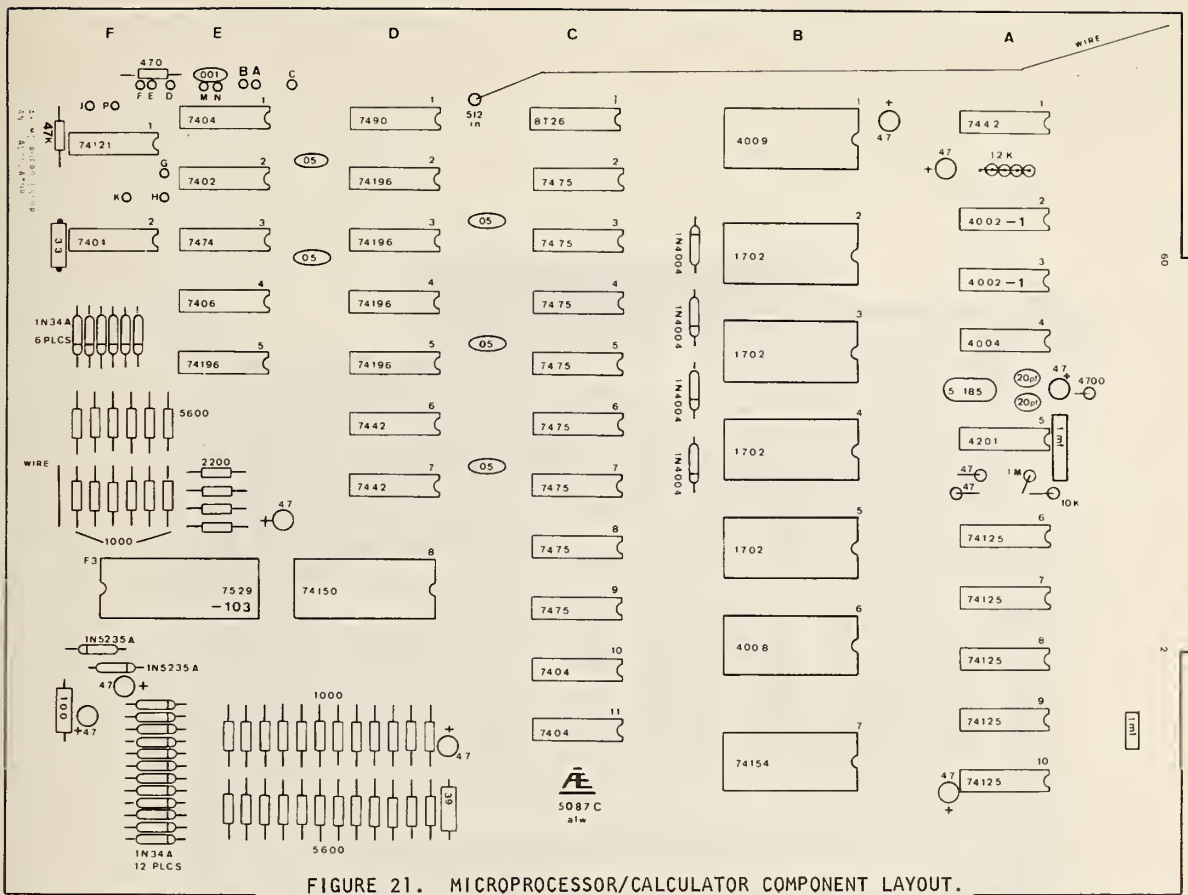

FIGURE 21. MICROPROCESSOR/CALCULATOR COMPONENT LAYOUT.

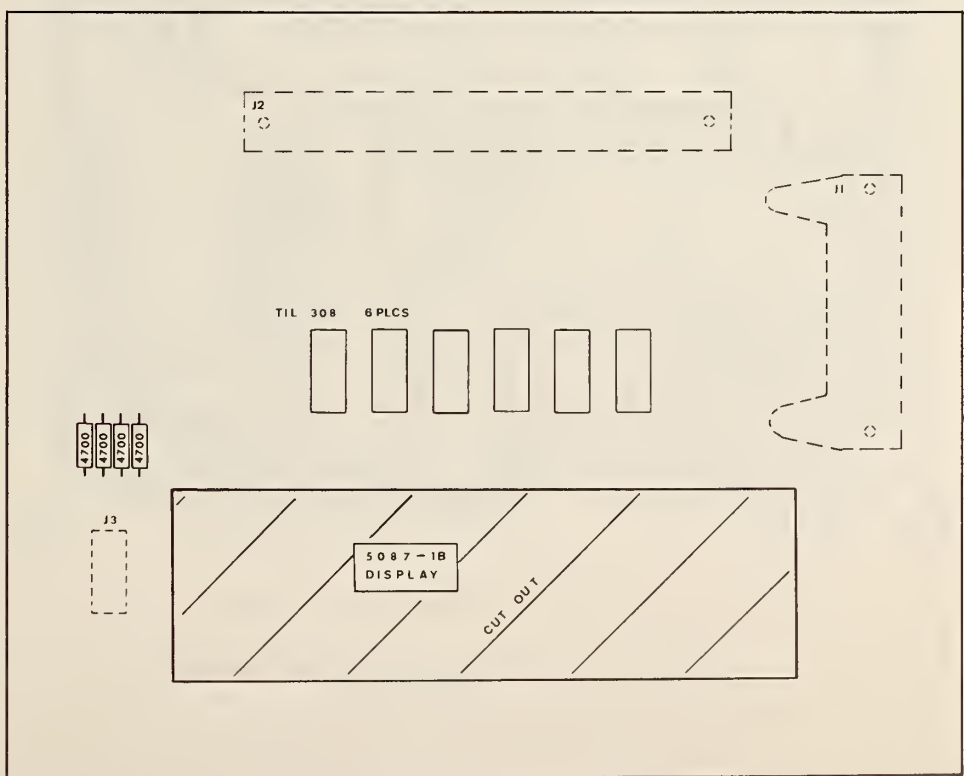

FIGURE 22. DISPLAY BOARD COMPONENT LAYOUT.

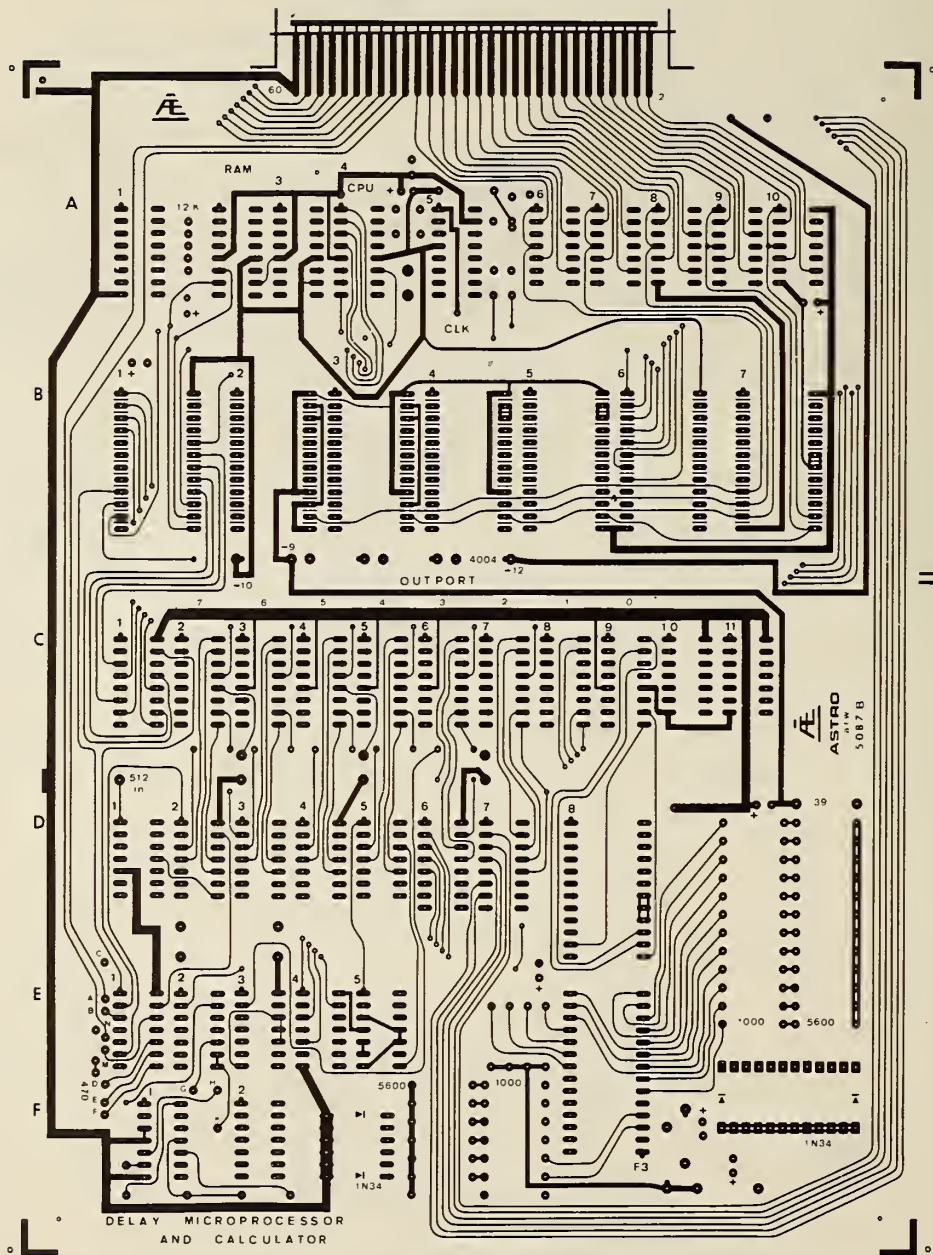

FIGURE 23. MICROPROCESSOR/CALCULATOR BOARD (FRONT).

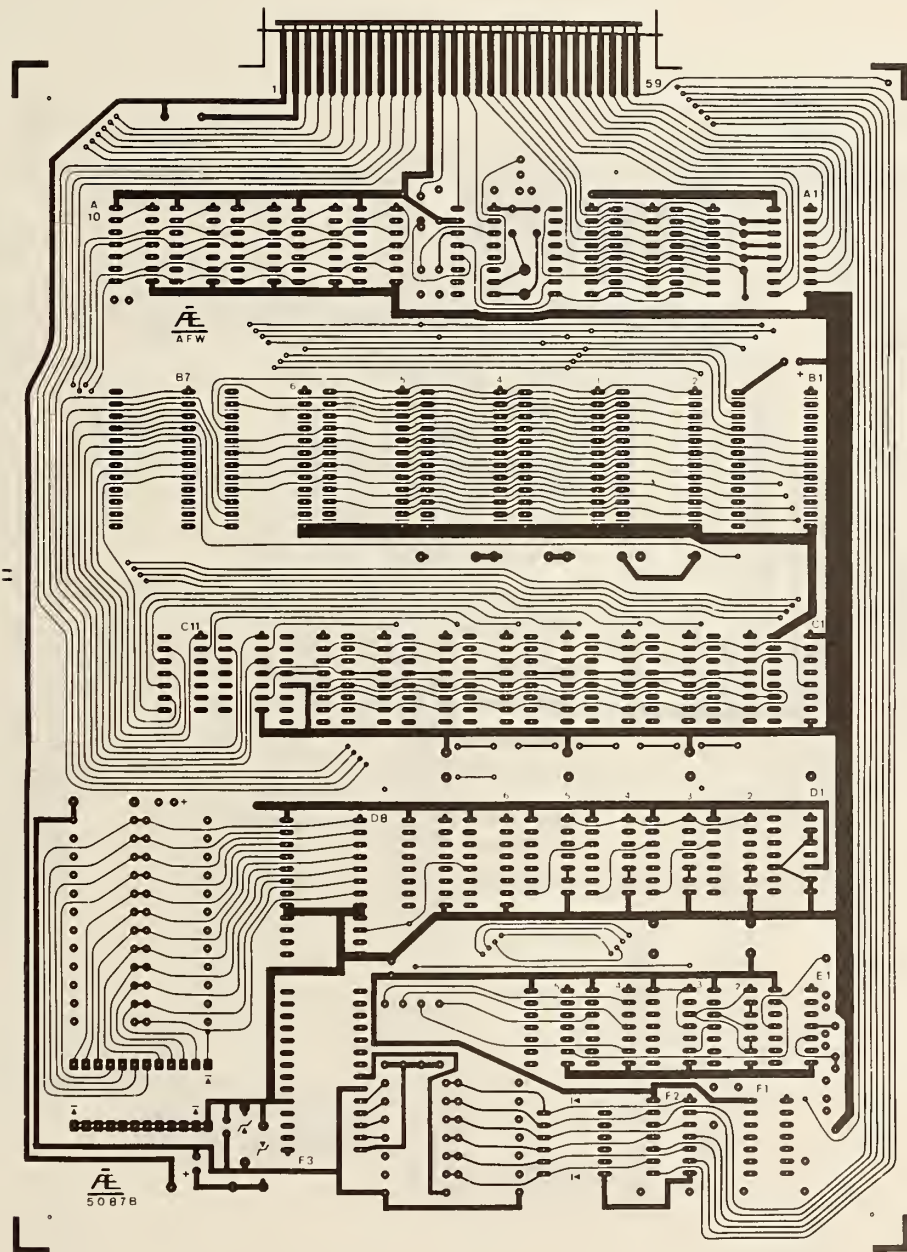
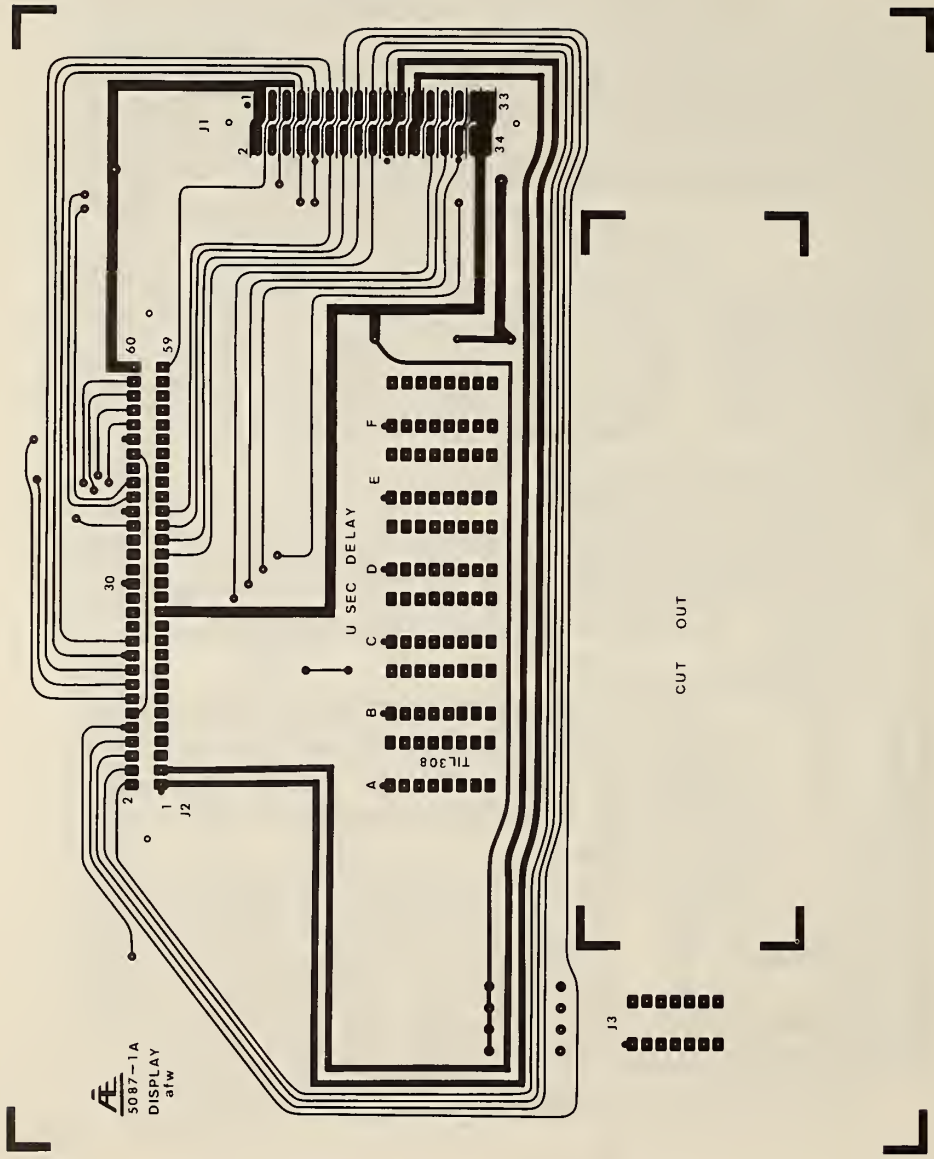

FIGURE 24. MICROPROCESSOR/CALCULATOR BOARD (BACK)



 5087-1A
 DISPLAY
 atw

FIGURE 25. DISPLAY BOARD (FRONT)

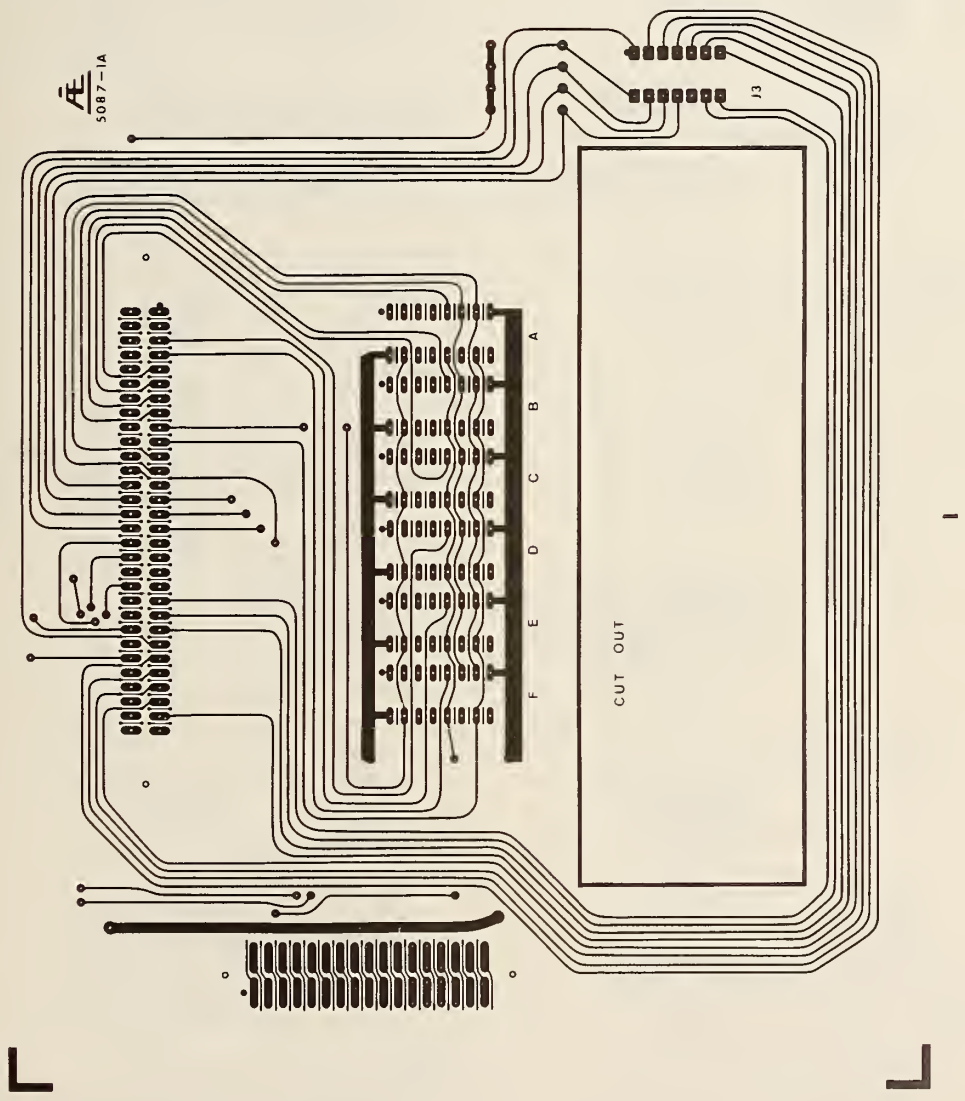

FIGURE 26. DISPLAY BOARD (BACK)

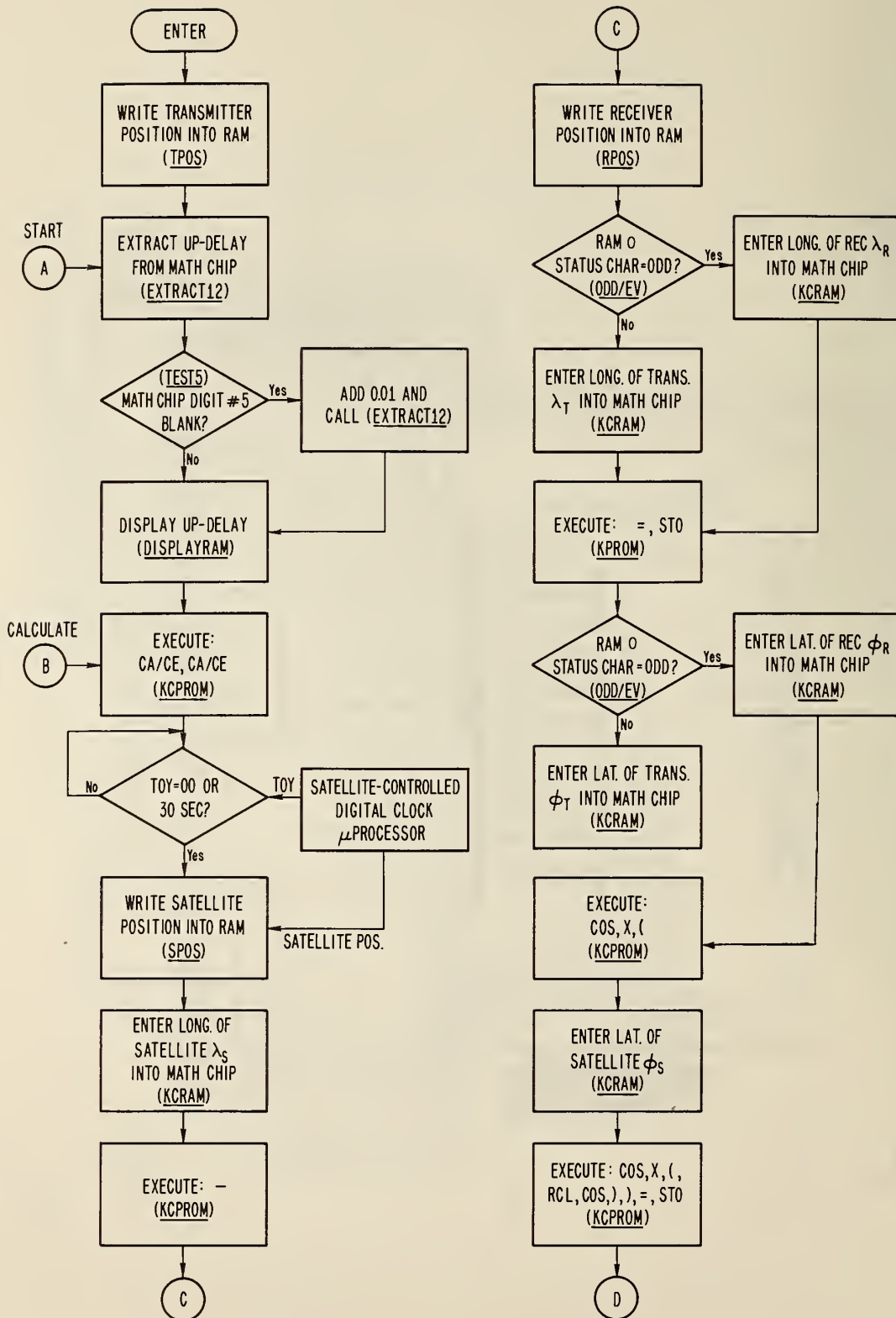

FIGURE 27. SOFTWARE FLOWCHART

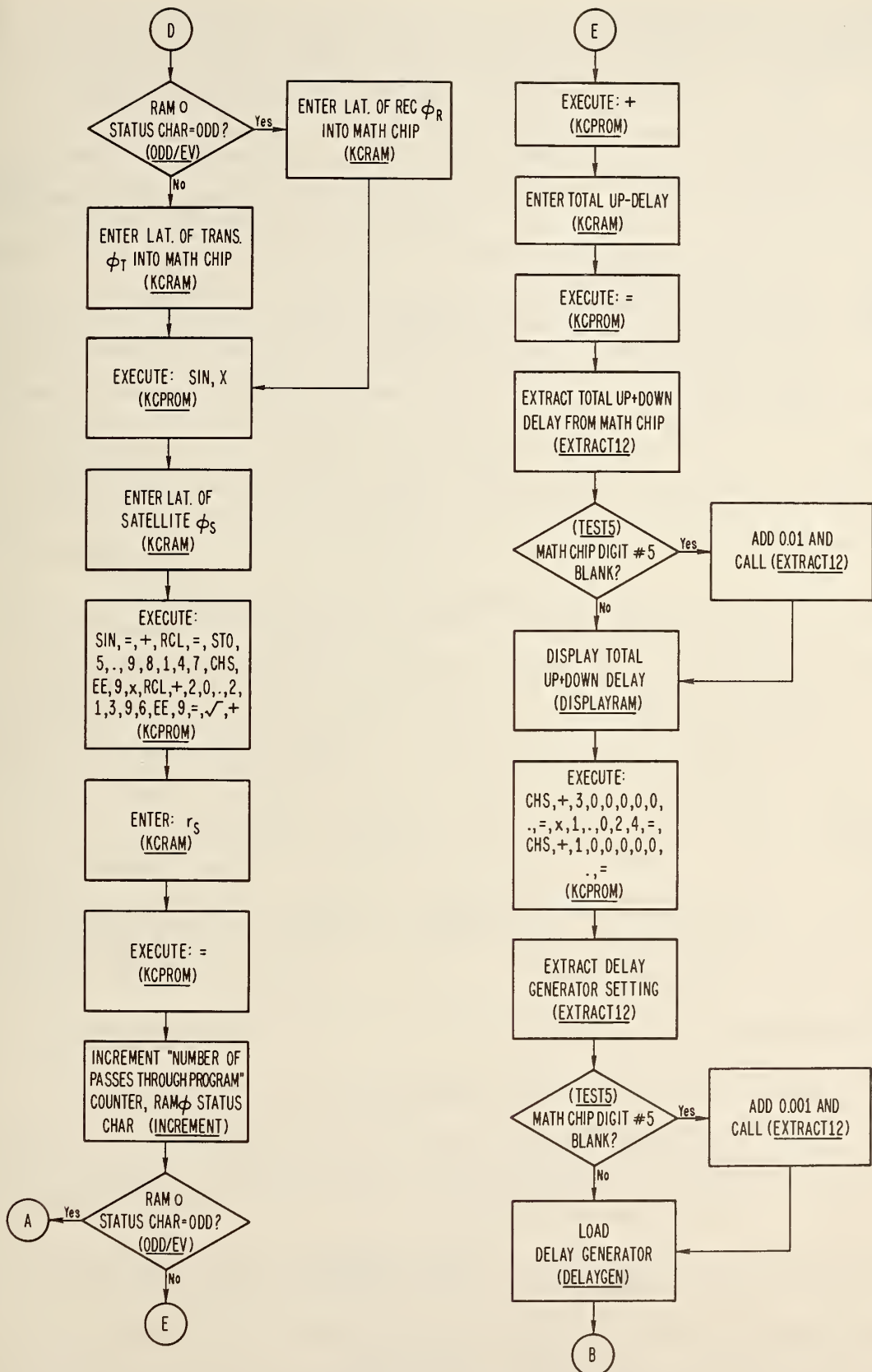

FIGURE 28. SOFTWARE FLOWCHART (CONTINUED)

TEST5, 0-F0 to 0-FF (16 bytes), is used for testing the math chip output 5 digit for blank. If found to be blank, then one or more trailing zeros have occurred in the result and 0.01 is added to the result to move the decimal point back to its assumed position between digits 7 and 8. Index register pair 0 and pair 4 are set up to add the 0.01, but the actual call to KCPR0M to do the addition must be made in the main program to avoid exceeding the limit of three levels of subroutines of the 4004.

KCRAM, 1-00 to 1-1B (28 bytes), reads specified BCD characters from RAM, encodes them into key codes, and calls INPUTKC to input the key codes to the math chip. KCRAM expects to find RAM/Reg./Character address in index register pair 4 and register A of pair 5 to contain the number of characters to be entered. Register A contains $F - (\text{number of characters}) + 1$. For example, if seven characters are to be entered: RA is set to $9 = F - 7 + 1$ using hexadecimal arithmetic. After reading the proper hexadecimal character from RAM into index register 1, and using P0 as an address, the FIN instruction puts the encoded equivalent of the hexadecimal character into P3. The key code contained in P3 is then entered into the math chip by subroutine INPUTKC.

INPUTKC, 1-20 to 1-3F (32 bytes), enters key codes into the math chip. First a no operation code (NOP = 00) is entered, and after 40 ms the key code is entered. After another 40 ms delay, the math chip is tested for "DONE" which is indicated by the appearance of a decimal point. The "DONE" indication may occur immediately after the second 40 ms delay if the key code for a single decimal digit is entered or as long as 1.5 s after the entry of a sin or cos function key code. Return to the calling program cannot happen until "DONE" occurs.

DECODE, 1-40 to 1-7F (64 bytes), is called by subroutine EXTRACT12 to convert the math chip 7-segment LED output code to BCD and store it in RAM. DECODE expects to find the most significant part of the segment code in R0 and the least significant part in R1. The FIN instruction using R0 and R1 as an address puts the decoded equivalent, or BCD character, into register pair 5 and it is then stored in RAM.

WRAM, 1-64 to 1-6C (9 bytes) is a subroutine called by TPOS and RPOS to write BCD characters into RAM.

TPOS, 1-80 to 1-9F (32 bytes), writes transmitter position into RAM0, register 3. In this case it is the latitude and longitude of Wallops Island, VA. TPOS calls subroutine WRAM to do the writing in RAM.

EXTRACT12, 1-A0 to 1-C0 (33 bytes), extracts the 12-digit mathematical result from the math chip in the form of 7-segment LED codes. DECODE is then called to convert the 7-segment LED codes to BCD characters and store them in RAM0, register 0. EXTRACT12 requests each of the 12 digits, one at a time, by outputting a digit request code and waiting for the "8" bit of input port 3 to become positive (negative logic "0"). When this happens, the most significant part of the segment code is available at input port 3 and the least significant part is available at input port 0. The digit request codes for digits 0 through 11 are 81 through 8B in hexadecimal notation. With the two-digit segment code contained in register pair 0, DECODE is called to decode and store the equivalent BCD character in RAM.

DISPLAYRAM, 1-C8 to 1-DC (21 bytes), displays the calculation result stored in RAM 0, register 0 on 7-segment LED displays. The display is used as an indication that the system is operating properly.

TESTN/S (1-E0 to 1-EE, 15 bytes), is called by subroutine RPOS to test the receiver position thumbwheel switches for a north or south latitude setting. Since the 8 bit of the longitude 100S position character is never used in a longitude setting is is wired to the north/south switch of the latitude switches. If the 8 bit = 0 north latitude is understood and if the 8 bit = 1 a minus sign (CHS key), indicating south latitude, is attached to the latitude reading.

DELAY40, 1-F2 to 1-FC (11 bytes) is called by INPUTKC to provide the 40 ms delay required by the math chip between the entry of key stroke codes.

INCREMENT, 2-08 to 2-0E (7 bytes), increments the RAM 0, register 0 status character which indicates the odd or even passes through the program; that is, the "up" delay and "down" delay passes.

ODD/EV, 2-0F to 2-1D (15 bytes), tests RAM 0, register 0 status character for odd or even numbered passes through the program and determines whether transmitter position data will be used for the "up" delay or receiver position data will be used for the "down" delay calculation. If odd, R8 is set equal to 1. If even, R8 is set equal to 3. Register pair 4, of which R8 is a part, is used by KCRAM to enter either the transmitter or receiver position into the math chip.

RPOS, 2-20 to 2-64 (69 bytes), reads the thumbwheel switches containing the receiver position and calls WRAM to write the data into RAM 0, register 1. RPOS calls READL/L to strobe the thumbwheel switches via RAM 0 output port and read in their data.

READL/L, 2-67 to 2-6F (9 bytes), is a subroutine called by RPOS to strobe and read receiver position data from thumbwheel switches.

DELAYGEN, 2-70 to 2-7D (14 bytes), reads the programmable delay generator setting from RAM 0, register 0 and outputs it to the delay generator.

SPOS, 2-80 to 2-D8 (89 bytes), waits for and reads satellite position data from the decoder clock. The position data are available only at 0s and 30s when the digital clock is updating its display hardware. Since the data are only present for a few machine cycles, they are read as quickly as possible into RAM 0, register 1 for temporary storage in RAM locations usually reserved for receiver position storage. After all 13 satellite position characters are read and stored in RAM, SPOS transfers them from RAM 0, register 1 to register 2 and inserts decimal point and CHS key codes wherever required. RAM 0, register 1 is then free to be used for its usual receiver position storage.

NCHARS, 2-E0 to 2-E9 (10 bytes) is a subroutine called by SPOS for writing BCD characters into RAM.

KEY CODE STORAGE, 3-00 to 3-DF (224 bytes), is an area used for storage of the key codes corresponding to the key strokes required by the calculation.

KCPROM, 3-E0 to 3-F4 (21 bytes) reads specified hexadecimal characters, representing key codes, that are stored in PROM and calls INPUTKC to enter the key codes into the math chip. When called, KCPROM expects to have the PROM address of the first key code in index register pair 0 and the last key code address + 1 in index register pair 4. The FIN instruction, with the PROM address in register pair 0, puts the key code into register pair 3. Pair 3 then transfers the key code to INPUTKC for entry into the math chip.

The appendix is a listing of the delay microprocessor's software. The program was punched into standard 80 column data processing cards only as a convenient method of documentation. The format of the listing is as follows:

Column	
1	Hexadecimal page or ROM chip number
2	Blank
3-4	Hexadecimal instruction address within ROM chip
5	Blank
6-7	Hexadecimal microprocessor instruction
8	Blank
9-18	1 to 10 character label
19	Blank
20-22	1 to 3 character operation mnemonic
23	Blank
24-33	1 to 10 character operand (data, register, condition, label, etc.)
34-37	Blank
38-80	Comments

Some 4004 instructions require two bytes, in which case the second line of the instructions may contain data or a jump address.

9. PERFORMANCE

The equation relating the time recovered from the satellite to the master clock at Wallops Island is given below.

$$\begin{aligned}
 \text{UTC(NBS)} - \text{SAT/NBS} &= (\text{UTC} - \text{CDA}) + (\text{CDA EQUIP DELAY}) + \\
 &\quad \left(\begin{array}{c} 3 \\ \text{FREE SPACE} \\ \text{PROPAGATION} \\ \text{DELAY} \end{array} \right) + \left(\begin{array}{c} 4 \\ \text{SATELLITE} \\ \text{TRANSPONDER} \\ \text{DELAY} \end{array} \right) + \\
 &\quad \left(\begin{array}{c} 5 \\ \text{IONOSPHERE \& } \\ \text{TROPOSPHERE} \\ \text{DELAY} \end{array} \right) + \left(\begin{array}{c} 6 \\ \text{RECEIVER \& } \\ \text{CLOCK} \\ \text{DELAY} \end{array} \right)
 \end{aligned}$$

Term 1 in this equation is known to better than 1 μ s using the data logger at the CDA which compares the CDA clocks to Loran-C and TV line-10. Using the measurement setups of figure 29, the smart-clock output on the chart recorder will draw a straight line if the orbit predictions are accurate and all equipment delays are constants; i.e., terms 2, 4, 5, and 6. Figure 30 shows raw data for 28 days. Each data point represents an average of measurements taken in one day at one-half hour increments totaling 48 measurements per day. Figure 31 shows the same data after removing the CDA clock drift and the two jumps in delay which have been attributed to equipment changes at the CDA. The orbit predictions used to generate these data were derived from three sets of orbital elements extrapolating as much as 22 days beyond their date.

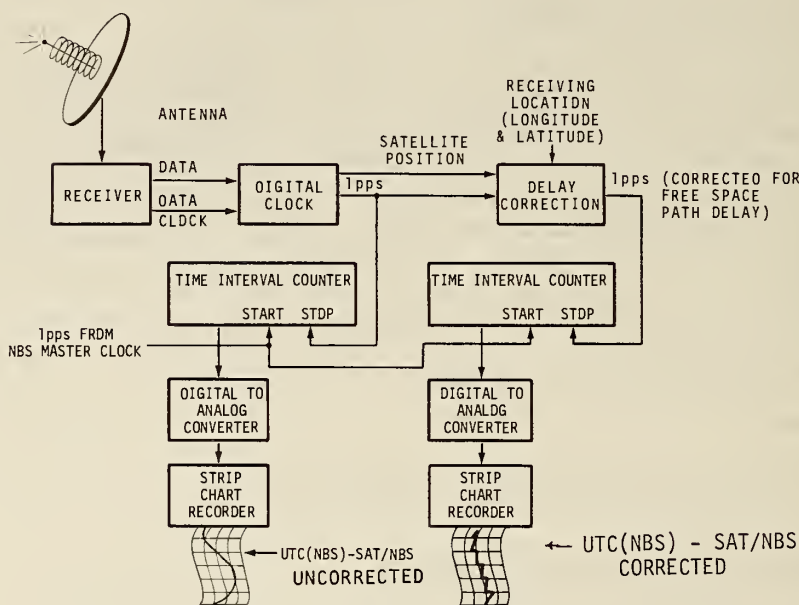

FIGURE 29. MEASUREMENT OF UTC(NBS) - SAT/NBS

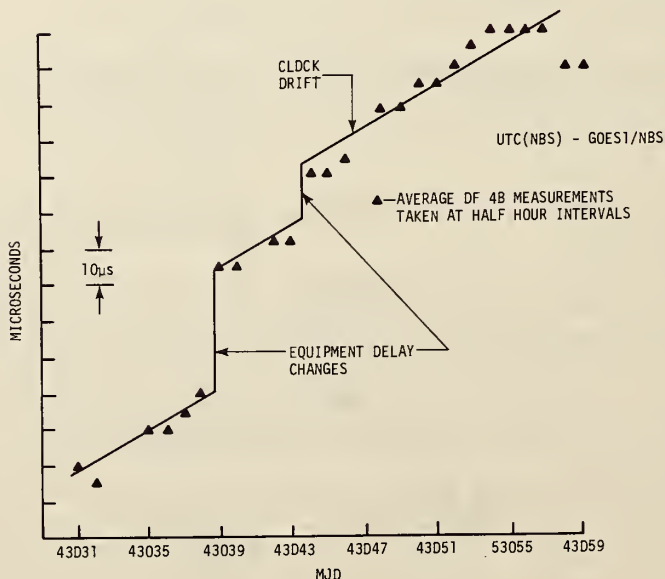

FIGURE 30. UTC(NBS) - GOES1/NBS (UNCORRECTED)

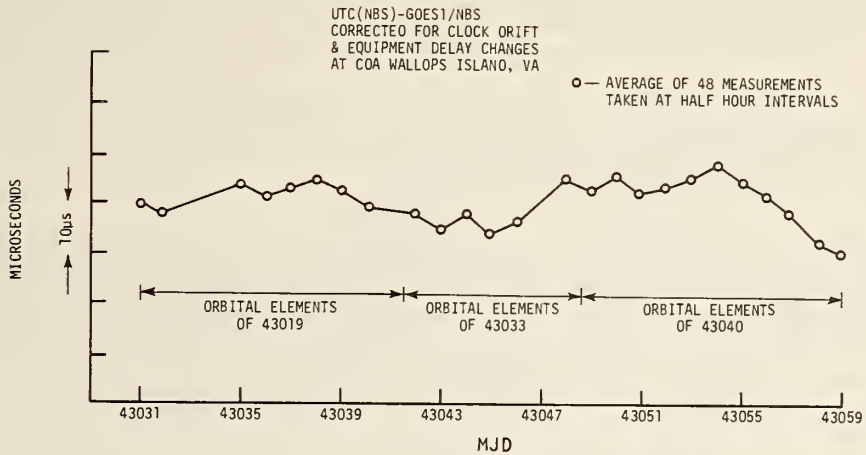

FIGURE 31. UTC(NBS) - GOES1/NBS (CORRECTED)

The results indicate a consistency in orbit determination and in the stability of equipment delays of about $10 \mu\text{s}$ for the period under study. A claim for accuracy cannot be made, however, until the equipment delays at the CDA and in the receiving equipment have been evaluated and more measurements of this type are taken at points separated by large geographical distances.

Portions of the actual charts producing the data just discussed are illustrated in figure 32. The output, uncorrected for the free-space delay, shows a 24-hour diurnal due to the satellite's orbit inclination and eccentricity. The corrected output, one point every half hour, lies in a straight line at least to a few microseconds on the average. Because the satellite-position data are updated only every half hour, the corrected output deviates from a straight line between the half-hour updates at the same rate shown for the uncorrected output.

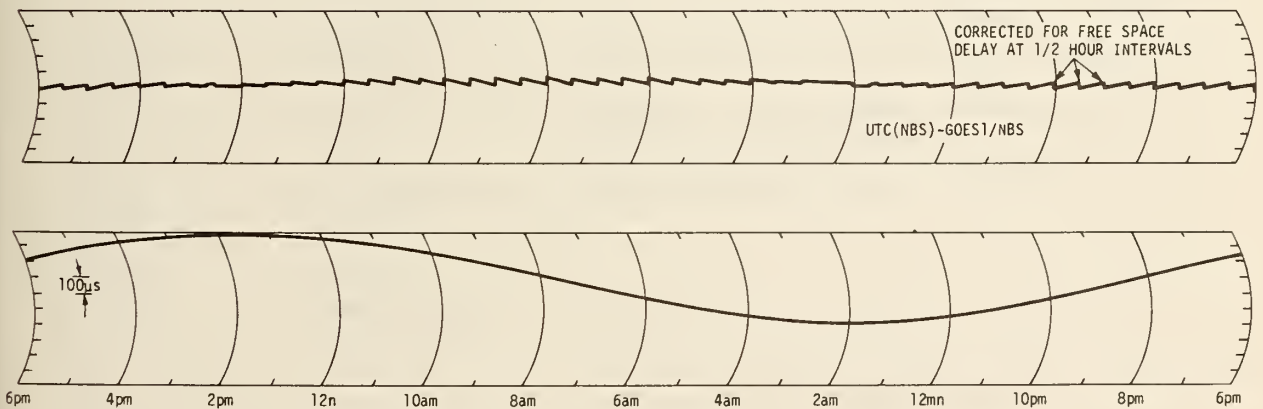

FIGURE 32. SATELLITE OUTPUT: CORRECTED AND UNCORRECTED

10. CONCLUSIONS

The time code has been broadcast from the two GOES satellites for more than one year. It has proven itself to be a reliable, low cost, and extremely simple system for moderately high-accuracy time. The time code is now considered a permanent feature of the GOES satellites and should see an expanding list of users for many purposes within the Western Hemisphere.

The results presented here indicate a potential accuracy of 10 to 20 microseconds. These figures need to be verified, however, by additional observations at widely separated geographical points. Equipment delays need further study. The clock drift and the effect of equipment changes at the CDA need to be offset or eliminated to make the time-code system a true one-way time transfer technique.

NBS plans to continue work toward the development of methods to increase the accuracy of the satellite time dissemination system. A more accurate satellite ephemeris generator has replaced an earlier one. Methods to provide the user with more accurate satellite position information over smaller time increments or on a continuous basis will be investigated.

11. REFERENCES

- [1]. Davis, D. D., A microprocessor data logging system for utilizing TV as a time/frequency transfer standard, (Proc. 8th Annual Precise Time and Time Interval (PTTI) Applications and Planning Meeting, Goddard Space Flight Center, Greenbelt, MD., Nov. 30 - Dec. 2, 1976, pp. 167-181).
- [2]. Cateora, J. V., Davis, D. D., and Hanson, D. W., A Satellite-Controlled Digital Clock, Nat. Bur. Stand. (U.S.), Tech. Note 681, 41 pages, (June 1976).
- [3]. Hamilton, W. F., and Hanson, D. W., A Synchronous Satellite Time Delay Computer, Nat. Bur. Stand. (U.S.), Tech. Note 638, 30 pages, (July 1973).
- [4]. Lewis, E. A., Parametric Formulas for Geodesic Curves and Distances on a Slightly Oblate Earth, Air Force Cambridge Research Laboratory Report, pp. 63-495, (April 1963).
- [5]. Hanson, D. W. and Hamilton, W. F., Experimental Time and Frequency Broadcasts from the ATS-3 Satellite, Nat. Bur. Stand. (U.S.), Tech. Note 645, 107 pages, (Nov. 1973).

APPENDIX

ROM ADDRESS	INSTRUCTION	MNEMONIC	COMMENTS
0 00			NBS DELAY MICROPROCESSOR/CALCULATOR - THIS
0 01 51		JMS -	4004 PROGRAM COMPUTES THE LINE OF SIGHT
0 02 80		- TPOS	RADIO PATH DELAY BETWEEN ANY TWO POINTS ON
0 03			EARTH VIA A SYNCHRONOUS SATELLITE --- ALL
0 04			PERFORMED BY A MOS TECHNOLOGY INC. MPS 7529-
0 05			103 LSI SCIENTIFIC CALCULATOR ARRAY INTERFACED TO THE MICROPROCESSOR.
0 06			THE SATELLITE POSITION DATA IS PROVIDED BY THE SATELLITE CONTROLLED
0 07			DIGITAL CLOCK ALSO INTERFACED TO THE MICROPROCESSOR. THE RECEIVER
0 08			POSITION IS ENTERED VIA THUMBWHEEL SWITCHES AND THE TRANSMITTER POSITION
0 09			IS WRITTEN INTO THE MICROPROCESSOR PROGRAM. THE OUTPUT CONTROLS THE
0 0A			DELAY OF A 1 HZ PULSE THROUGH A PROGRAMMABLE DELAY GENERATOR AND IS ALSO
0 0B			DISPLAYED ON LEDS. THE 1 PPS IS PROVIDED BY THE SATELLITE
0 0C			CONTROLLED DIGITAL CLOCK. J.V.CATEORA SEPT. 1976
0 0D			
0 0E 51	START	JMS -	EXTRACT 12 DIGIT RESULT FROM MATH CHIP
0 0F A0		- EXTRACT12	
0 10 50		JMS -	TEST RESULT FROM MATH CHIP FOR
0 11 F0		- TEST5	TRAILING ZEROS WHICH WILL CAUSE A DISPLACE-
0 12 14		JCN A0	MENT OF THE DECIMAL POINT
0 13 1A		- SKIP.01	
0 14 53		JMS -	IF DISPLACEMENT IS DETECTED ADD .01 AND
0 15 E0		- KCPR0M	EXTRACT NEW RESULT --- ELSE SKIP AND LEAVE
0 16 51		JMS -	THE RESULT ALONE
0 17 A0		- EXTRACT12	
0 18			
0 19			
0 1A 51	SKIP.01	JMS -	DISPLAY RESULTS STORED IN RAM
0 1B C8		- DISPLAYRAM	
0 1C 20	CALCULATE	FIM P0	ADDRESS OF FIRST KEY CODE TO BE EXECUTED
0 1D		0 0	
0 1E 28		FIM P4	ADDRESS OF LAST KEY CODE TO BE EXECUTED +1
0 1F 02		0 2	
0 20 53		JMS -	EXECUTE CA/CE
0 21 E0		- KCPR0M	CA/CE
0 22 52		JMS -	WRITE SATELLITE POSITION IN RAM
0 23 80		- SPOS	
0 24 28		FIM P4	FIRST CHARACTER IN RAM TO BE EXECUTED
0 25 20		2 0	
0 26 2A		FIM P4	F-NUMBER OF RAM CHARS+1 TO BE ENTERED INTO
0 27 A0		A 0	MATH CHIP, THAT IS F-6+1=A
0 28 51		JMS -	
0 29 00		- KCRAM	ENTER LONGITUDE OF SAT. INTO MATH CHIP
0 2A 20		FIM P0	
0 2B 02		0 2	
0 2C 28		FIM P4	
0 2D 03		0 3	
0 2E 53		JMS -	EXECUTE -
0 2F E0		- KCPR0M	
0 30			
0 31			
0 32 52		JMS -	WRITE RECEIVER POSITION INTO RAM
0 33 20		- RPOS	
0 34			
0 35			
0 36 52		JMS -	
0 37 6F		- ODD/EV	TEST NUMBER OF PASSES THRU PROGRAM (STATUS
0 38 03		LOM 3	CHARACTER) FOR ODD OR EVEN ---
0 39 B9		XCH R9	IF ODD ENTER LONGITUDE OF RECEIVER
0 3A 2A		FIM P5	IF EVEN ENTER LONGITUDE OF TRANSMITTER
0 3B 90		9 0	INTO MATH CHIP
0 3C 51		JMS -	
0 3D		- KCRAM	ENTER LONGITUDE OF TRANSMITTER OR RECEIVER
0 3E			INTO MATH CHIP
0 3F			

```

0 40 20      FIM P0
0 41 03      0 3
0 42 28      FIM P4
0 43 05      0 5
0 44 53      JMS - EXECUTE =
0 45 E0      - KCPROM - STO
0 46
0 47
0 48 52      JMS - TEST NUMBER OF PASSES THRU PROGRAM (STATUS
0 49 0F      - ODD/EV CHARACTER) FOR ODD OR EVEN ---
0 4A 0A      LD RA
0 4B 89      XCH R9 IF EVEN ENTER TRANSMITTER LATITUDE
0 4C 2A      FIM P5
0 4D A0      A 0
0 4E 51      JMS - ENTER LATITUDE OF TRANSMITTER OR RECEIVER
0 4F      - KCRAM INTO MATH CHIP
0 50
0 51
0 52 20      FIM P0
0 53 05      0 5
0 54 28      FIM P4 EXECUTE COS
0 55 08      0 8 X
0 56 53      JMS - (
0 57 E0      - KCPROM
0 58 28      FIM P4
0 59 26      2 6
0 5A 2A      FIM P5
0 5B B0      B 0
0 5C 51      JMS - ENTER LATITUDE OF SATELLITE INTO MATH CHIP
0 5D      - KCRAM
0 5E
0 5F
0 60 20      FIM P0 EXECUTE COS )
0 61 08      0 8 X =
0 62 28      FIM P4 ( STO
0 63 11      1 1 RCL
0 64 53      JMS - COS
0 65 E0      - KCPROM )
0 66
0 67
0 68 52      JMS - TEST NUMBER OF PASSES THRU PROGRAM (STATUS
0 69 0F      - ODD/EV CHARACTER) FOR ODD OR EVEN ---
0 6A 0A      LDM A IF ODD ENTER RECEIVER LATITUDE
0 6B 89      XCH R9 IF EVEN ENTER TRANSMITTER LATITUDE
0 6C 2A      FIM P5
0 6D A0      A 0
0 6E 51      JMS - ENTER LATITUDE OF TRANSMITTER OR RECEIVER
0 6F      - KCRAM INTO MATH CHIP
0 70
0 71
0 72 20      FIM P0
0 73 11      1 1
0 74 28      FIM P4
0 75 13      1 3
0 76 53      JMS - EXECUTE SIN
0 77 E0      - KCPROM X
0 78 28      FIM P4
0 79 26      2 6
0 7A 2A      FIM P5
0 7B B0      B 0
0 7C 51      JMS - ENTER LATITUDE OF SATELLITE INTO MATH CHIP
0 7D      - KCRAM
0 7E
0 7F

```

0 80 20	FIM P0	EXECUTE SIN 5	7	+	3	SQRT
0 81 13	1 3	=	.	CHS 2	9	+
0 82 28	FIM P4	+ 9	EE 0	6		
0 83 33	3 3	RCL 8	9	.	EE	
0 84 53	JMS -	= 1	X 2	9		
0 85 E0	- KCPROM	STO 4	RCL 1	=		
0 86 28	FIM P4		(32 KEY CODES)			
0 87 2B	2 8					
0 88 2A	FIM P5					
0 89 B0	B 0					
0 8A 51	JMS -					
0 8B	- KGRAM	ENTER NORMALIZED RANGE OF SATELLITE INTO				
0 8C 20	FIM P0	MATH CHIP				
0 8D 33	3 3					
0 8E 28	FIM P4					
0 8F 34	3 4					
0 90 53	JMS -	EXECUTE =				
0 91 E0	- KCPROM					
0 92 52	JMS -	INCREMENT RAM0/REG0 STATUS CHARACTER EACH				
0 93 08	- INCREMENT	PASS THROUGH PROGRAM				
0 94 52	JMS -					
0 95 0F	- ODD/EV	TEST NUMBER OF PASSES THRU PROGRAM (STATUS				
0 96 F0	CLB	CHARACTER) FOR ODD OR EVEN ---				
0 97 D1	LDM 1	IF ODD, R8 = 1 UP DELAY COMPUTED GO BACK				
0 98 98	SUB R8	TO START AND COMPUTE DOWN DELAY				
0 99 14	JCN A0	IF EVEN, R8 = 3 BOTH DELAYS HAVE BEEN				
0 9A 0E	- START	COMPUTED --- CONTINUE ON				
0 9B 20	FIM P0					
0 9C 34	3 4					
0 9D 28	FIM P4					
0 9E 35	3 5					
0 9F 53	JMS -	EXECUTE +				
0 A0 E0	- KCPROM					
0 A1 28	FIM P4					
0 A2 04	0 4					
0 A3 2A	FIM P5					
0 A4 90	9 0					
0 A5 51	JMS -	ENTER TOTAL UP DELAY INTO MATH CHIP				
0 A6	- KGRAM					
0 A7 20	FIM P0					
0 A8 35	3 5					
0 A9 28	FIM P4					
0 AA 36	3 6					
0 AB 53	JMS -	EXECUTE =				
0 AC E0	- KCPROM					
0 AD 51	JMS -	EXTRACT TOTAL UP DELAY + TOTAL DOWN DELAY				
0 AE A0	- EXTRACT12	FROM MATH CHIP				
0 AF						
0 B0 50	JMS -					
0 B1 F0	- TEST5					
0 B2 14	JCN A0					
0 B3 C0	- SKIP.01	TEST FOR TRAILING ZEROS AND ADJUST IF				
0 B4 53	JMS -	NECESSARY				
0 B5 E0	- KCPROM					
0 B6 51	JMS -					
0 B7 A0	- EXTRACT12					
0 B8						
0 B9						
0 BA						
0 BB						
0 BC						
0 BD						
0 BE						
0 BF						

0 C0 51	SKIP.01	JMS -	DISPLAY TOTAL UP + DOWN DELAY
0 C1 C8		- DISPLAYRAM	
0 C2 20		FIM P0	EXECUTE CHS 0 . + 0
0 C3 3B		3 8	DELAY + 0 0 1 .
0 C4 28		FIM P4	GENERATOR 3 . 2 0 =
0 C5 56		5 6	SETTING 0 = 4 0
0 C6 53		JMS -	0 X = 0
0 C7 E0		- KCIPROM	0 1 CHS 0
0 C8 51		JMS -	
0 C9 A0		- EXTRACT12	EXTRACT DELAY GENERATOR SETTING
0 CA 22		FIM P1	
0 CB 05		0 5	READ RAM0/REG0/CHARACTER 5 INTO R2 TO TEST
0 CC 23		SRC P1	FOR BLANK
0 CD E9		RDM	
0 CE B2		XCH R2	
0 CF DD		LDM 0	
0 D0 F1		CLC	IF RAM CHAR IS NOT = 0 (BLANK) SKIP
0 D1 92		SUB R2	
0 D2 1C		JCN A1	
0 D3 DC		- SKIP.001	
0 D4 20		FIM P0	
0 D5 56		5 6	IF RAM CHARACTER = 0 ADD .001 TO PREVENT
0 D6 28		FIM P4	TRAILING ZEROS FROM CAUSING A DECIMAL POINT
0 D7 5C		5 C	SHIFT
0 D8 53		JMS -	
0 D9 E0		- KCIPROM	
0 DA 51		JMS -	EXTRACT NEW RESULT
0 DB A0		- EXTRACT12	
0 DC 52	SKIP.001	JMS -	OUTPUT DELAY GENERATOR SETTING
0 DD 70		- DELAYGEN	
0 DE 40		JUN -	
0 DF 1C		- CALCULATE	
0 E0			
0 E1			
0 E2			
0 E3			
0 E4			
0 E5			
0 E6			
0 E7			
0 E8			
0 E9			
0 EA			
0 EB			
0 EC			
0 ED			
0 EE			
0 EF			
0 F0 22	TEST5	FIM P1	TEST5 TESTS FOR MATH CHIP OUTPUT DIGIT
0 F1 05		0 5	NUMBER 5 BLANK
0 F2 23		SRC P1	
0 F3 E9		RDM	READ RAM0/REG0/CHARACTER 5 INTO R2 TO TEST
0 F4 B2		XCH R2	FOR BLANK
0 F5 D0		LDM 0	
0 F6 F1		CLC	
0 F7 92		SUB R2	IF RAM CHARACTER IS NOT = 0 (BLANK) SKIP
0 F8 1C		JCN A1	
0 F9 FF		- SKIP.01	
0 FA 20		FIM P0	SET UP TO CALL KCIPROM TO ADD .01 ---
0 FB 36		3 6	HOWEVER MAIN PROGRAM MUST MAKE THE CALL OR
0 FC 26		FIM P4	ELSE THE LIMIT OF 3 LEVELS OF SUBROUTINES
0 FD 3B		3 B	WOULD BE EXCEEDED IF KCIPROM WERE CALLED
0 FE C1		BBL	FROM HERE. IF RAM CHAR = BLANK RETURN 1
0 FF C0	SKIP.01	BBL	IF RAM CHAR NOT = BLANK RETURN 0

1 00 20	KCRAM	FIM P0	FIRST KEY CODE ADDRESS FOR FIN INSTRUCTION
1 01 10		1 0	
1 02 22		FIM P1	TO SELECT I/O PORTS NUMBER 0
1 03		0 0	
1 04 24		FIM P2	TO SELECT I/O PORTS NUMBER 3
1 05 30		3 0	
1 06 29	ENCODE	SRC P4	P0 CONTAINS ADDRESS OF KEY CODE
1 07 E9		RDM	
1 08 B1		XCH R1	
1 09 36		FIN P3	PUT KEY CODE INTO P3
1 0A 51		JMS -	WRITE NOP AND KEY CODE TO MATH CHIP, WAIT
1 0B 20		- INPUTKC	FOR DONE
1 0C 69		INC R9	INCREMENT RAM CHARACTER ADDRESS IN R9
1 0D 7A		ISZ RA	INCREMENT NUMBER OF RAM CHARS COUNTER RA
1 0E 06		- ENCODE	
1 0F C0		BBL	RETURN TO MAIN PROGRAM
1 10 11	ZERO		
1 11 12	ONE		
1 12 13	TWO		
1 13 14	THREE		
1 14 15	FOUR		
1 15 16	FIVE		
1 16 17	SIX		
1 17 18	SEVEN		
1 18 19	EIGHT		
1 19 1A	NINE		
1 1A 21	DEC.PT.		
1 1B 2B	CHS		
1 1C			
1 1D			
1 1E			
1 1F			
1 20 D0	INPUTKC	LDM 0	INPUTKC INPUTS KEY STROKE CODES AND DATA
1 21 23		SRC P1	TO MATH CHIP ALONG WITH NOP AND WAITS FOR
1 22 F4		CMA	DONE --- NOP KEY CODE = 00
1 23 E2		WRR	
1 24 25		SRC P2	
1 25 F4		CMA	
1 26 E2		WRR	
1 27 51		JMS -	WAIT 40 MILLISECONDS
1 28 F2		- DELAY40	
1 29 A7		LD R7	R7 CONTAINS LEAST SIGNIFIGANT PART OF KEY
1 2A 23		SRC P1	CODE --- OUTPUT IT TO OUTPORT NUMBER 0
1 2B F4		CMA	
1 2C E2		WRR	
1 2D A6		LD R6	R6 CONTAINS MOST SIGNIFIGANT PART OF KEY
1 2E 25		SRC P2	CODE --- OUTPUT IT TO OUTPORT NUMBER 3
1 2F F4		CMA	
1 30 E2		WRR	
1 31 51		JMS -	WAIT 40 MILLISECONDS
1 32 F2		- DELAY40	
1 33 D6		LDM 6	WRITE OUT 89 FOR DONE TEST (NEG. LOGIC 76)
1 34 23		SRC P1	
1 35 E2		WRR	WRITE 9 TO OUTPORT NUMBER 0 (NEG. LOGIC 6)
1 36 D7		LDM 7	
1 37 25		SRC P2	WRITE 8 TO OUTPORT NUMBER 3 (NEG. LOGIC 7)
1 38 E2		WRR	
1 39 F0	DONETEST	CLB	
1 3A EA		RDR	INPORT NUMBER 3 STILL SELECTED --- READ IT
1 3B F6		RAR	
1 3C F6		RAR	ROTATE DECIMAL POINT LED SEGMENT INTO CARRY
1 3D 1A		JCN C0	POSITION TO TEST FOR DONE
1 3E 39		- DONETEST	
1 3F C0	DONE	BBL	IF DONE RETURN TO KCPROM OR KCRAM

```

1 40 D0 BLANK
1 41
1 42 10 ONE
1 43 70 SEVEN
1 44
1 45 3A DECODE      FIN P5
1 46 29             SRC P4
1 47 AA             LD RA
1 48 E0             WRM
1 49 69             INC R9
1 4A C5             BBL
1 4B
1 4C
1 4D E0 +OVERFLOW
1 4E
1 4F ZERO
1 50 B0 MINUS
1 51
1 52
1 53 30 THREE
1 54
1 55
1 56
1 57 20 TWO
1 58
1 59 50 FIVE
1 5A 40 FOUR
1 5B 90 NINE
1 5C 60 SIX
1 5D F0 -OVERFLOW
1 5E
1 5F 80 EIGHT
1 60 D0 BLANK.
1 61
1 62 10 ONE.
1 63 70 SEVEN.
1 64 A4 WRAM        LD R4
1 65 23             SRC P1
1 66 E0             WRM
1 67 63             INC R3
1 68 A5             LD R5
1 69 23             SRC P1
1 6A E0             WRM
1 6B 63             INC R3
1 6C C0             BBL
1 6D E0 +OVERFLOW.
1 6E
1 6F ZERO.
1 70 B0 MINUS.
1 71
1 72
1 73 30 THREE.
1 74
1 75
1 76
1 77 20 TWO.
1 78
1 79 50 FIVE.
1 7A 40 FOUR.
1 7B 90 NINE.
1 7C 60 SIX.
1 7D F0 -OVERFLOW.
1 7E
1 7F 80 EIGHT.

```

DECODE CONVERTS FROM 7 SEGMENT LED CODE TO BCD AND WRITES BCD INTO RAM0/REG0/CHARS 4 THRU F (THIS ROUTINE MUST BE LOCATED AT ADDRESSES 40 THRU 7F IN A PROM -- BECAUSE THE SEGMENT CODES ARE THE ADDRESSES)

USING SEGMENT CODE IN P0 AS ADDRESS FETCH INDIRECT BCD CHARACTER INTO RA OF P5 WRITE BCD CHARACTER INTO RAM INCREMENT RAM CHARACTER ADDRESS RETURN TO EXTRACT12

NOTE THAT IT IS ONLY NECESSARY TO USE 5 OF THE 7 SEGMENTS TO DECODE INTO BCD

WRAM IS CALLED BY SUBROUTINES TPOS AND RPOS TO WRITE TWO BCD CHARACTERS CONTAINED IN R4 AND R5 INTO RAM AND IS IMBEDDED INTO SUBROUTINE DECODE ONLY TO MAKE USE OF BLANK SPACES THAT ARE IN DECODE BY NECESSITY

RETURN TO TPOS OR RPOS

1 80 22	TPOS	FIM P1	TPOS WRITES POSITION OF TRANSMITTER INTO
1 81 33		3 3	RAM --- IN THIS CASE WALLOPS ISLAND, VA.
1 82			LONGITUDE = 75.46, LATITUDE = 37.85
1 83 24		FIM P2	
1 84 07		0 7	
1 85 51		JMS -	
1 86 64		- WRAM	WRITE 07 INTO RAM
1 87 24		FIM P2	
1 88 5A		5 A	
1 89 51		JMS -	
1 8A 64		- WRAM	WRITE 5. INTO RAM
1 8B 24		FIM P2	
1 8C 46		4 6	
1 8D 51		JMS -	
1 8E 64		- WRAM	WRITE 46 INTO RAM
1 8F 24		FIM P2	
1 90 03		0 3	
1 91 51		JMS -	
1 92 64		- WRAM	WRITE 03 INTO RAM
1 93 24		FIM P2	
1 94 7A		7 A	
1 95 51		JMS -	
1 96 64		- WRAM	WRITE 7. INTO RAM
1 97 24		FIM P2	
1 98 85		8 5	
1 99 51		JMS -	
1 9A 64		- WRAM	WRITE 85 INTO RAM
1 9B 24		FIM P2	
1 9C		0 0	
1 9D 51		JMS -	
1 9E 64		- WRAM	WRITE 00 INTO RAM
1 9F C0		BBL	RETURN TO MAIN PROGRAM
1 A0 22	EXTRACT12	FIM P1	EXTRACT12 EXTRACTS THE 12 DIGIT RESULT FROM
1 A1 04		0 4	THE MATH CHIP, DECODES IT AND STORES BCD
1 A2 24		FIM P2	CHARACTER IN RAM0/REG0
1 A3 30		3 0	
1 A4 26		FIM P3	DIGIT DATA REQUEST CODES 81, 82, 83, ETC.
1 A5 81		8 1	
1 A6 28		FIM P4	TO SELECT RAM0/REG0/CHARS4 THRU F FOR BCD
1 A7 04		0 4	STORAGE
1 A8 23	NEXTDIGIT	SRC P1	WRITE OUT DIGIT REQUEST CODES
1 A9 A7		LD R7	
1 AA F4		CMA	
1 AB E2		WRR	
1 AC 25		SRC P2	L.S.P. OF DIGIT REQUEST CODE TO OUTPUT 0
1 AD A6		LD R6	M.S.P. OF DIGIT REQUEST CODE TO OUTPUT 3
1 AE F4		CMA	
1 AF E2		WRR	
1 B0 F0	TESTDIGIT	CLB	
1 B1 EA		RDR	I/O PORTS 3 STILL SELECTED --- READ INPORT
1 B2 F4		CMA	NUMBER 3
1 B3 F5		RAL	IF 8 BIT IS POSITIVE (NEG. LOGIC 0) DIGIT
1 B4 1A		JCN C0	IS AVAILABLE --- IF NOT CONTINUE TESTING
1 B5 B0		- TESTDIGIT	
1 B6 EA		RDR	I/O PORTS 3 STILL SELECTED --- READ M.S.P.
1 B7 B0		XCH R0	OF SEGMENT CODE FROM INPORT 3 AND STORE IT
1 B8 23		SRC P1	IN R0
1 B9 EA		RDR	READ L.S.P. OF SEGMENT CODE FROM INPORT 0
1 BA B1		XCH R1	AND STORE IT IN R1
1 BB 51		JMS -	DECODE SEGMENT CODE AND STORE BCD CHARACTER
1 BC 45		- DECODE	IN RAM
1 BD 67		INC R7	INCREMENT L.S.P. OF DIGIT REQUEST CODE
1 BE 73		ISZ R3	
1 BF A8		- NEXTDIGIT	IF ALL 12 CODES HAVE BEEN SENT

1 C0 C0	BBL	RETURN TO MAIN PROGRAM
1 C1		
1 C2		
1 C3		
1 C4		
1 C5		
1 C6		
1 C7		
1 C8 22 OISPLAYRAM	FIM P1	DISPLAYRAM OISPLAYS MATH CHIP OUTPUT ON
1 C9 10	1 0	LEDS. OUTPUT IS STORED IN RAM0/REG0/CHARS
1 CA 24	FIM P2	4 THROUGH F
1 CB 20	2 0	TO SELECT OUTPORT NO. 2 FOR STROBE OUTPUT
1 CC 26	FIM P3	INITIALIZE STROBE TO ZERO
1 CO	0 0	
1 CE 28	FIM P4	TO SELECT RAM0/REG0/CHARACTERS 4 THRU F
1 CF 04	0 4	
1 00 25 RRAM	SRC P2	WRITE STROBE TO OUTPORT 2 --- STROBE IS
1 D1 A7	LD R7	OUTPUT BEFORE DATA BECAUSE OF LATCHED
1 02 F4	CMA	MICROPROCESSOR OUTPUT PORTS --- PREVENTS
1 03 E2	WRR	CHARACTERS FROM BEING SHIFTED ON OISPLAY
1 04 29	SRC P4	LEDS
1 05 E9	RDM	
1 06 23	SRC P1	
1 07 F4	CMA	
1 08 E2	WRR	SELECT, READ, WRITE RAM CHAR TO OUTPORT 1
1 09 67	INC R7	INCREMENT STROBE
1 0A 79	ISZ R9	
1 DB D0	- RRAM	INCREMENT RAM CHARACTER ADDRESS
1 DC C0	BBL	RETURN TO MAIN PROGRAM
1 DO		
1 OE		
1 DF		
1 E0 AA TESTN/S	LD RA	TESTN/S TESTS NORTH/SOUTH LATITUDE SWITCH
1 E1 F5	RAL	WHICH IS CONNECTED TO LONGITUDE 100S
1 E2 12	JCN C1	POSITION 8 BIT. IF = 0 LATITUDE IS NORTH
1 E3 E9	- SOUTH	IF = 1 LATITUDE IS SOUTH
1 E4 2A NORTH	FIM P5	SET RB, LATITUDE CHS CHAR. = 0 FOR NORTH
1 E5	0 0	
1 E6 F6	RAR	SHIFT LONG. 100S CHAR. BACK TO NORMAL AND
1 E7 BA	XCH RA	STORE BACK INTO RA
1 E8 C0	BBL	RETURN TO RPOS
1 E9 2A SOUTH	FIM P5	SET RB, LATITUDE CHS CHAR. = B FOR SOUTH
1 EA 0B	0 B	
1 EB F1	CLC	CLEAR SOUTH LATITUDE INDICATION
1 EC F6	RAR	SHIFT LONG. 100S CHAR. BACK TO NORMAL AND
1 E0 BA	XCH RA	STORE BACK INTO RA
1 EE C0	BBL	RETURN TO RPOS
1 EF		
1 F0		
1 F1		
1 F2 2C DELAY40	FIM P6	OELAY40 PROVIDES THE 40 MILLISECONOS
1 F3	0 0	DELAY REQUIRED BETWEEN ENTRIES OF KEY
1 F4 2E	FIM P7	STROKE COOES INTO MATH CHIP
1 F5 A0	A 0	
1 F6 7C FIRST	ISZ RC	
1 F7 F6	- FIRST	
1 F8 7D	ISZ RO	
1 F9 F6	- FIRST	
1 FA 7E	ISZ RE	
1 FB F6	- FIRST	
1 FC C4	BBL	RETURN TO INPUTKC
1 FO		
1 FE		
1 FF		

2 00			INCREMENT INCREMENTS THE NUMBER STORED IN
2 01			RAM0/REG0 STATUS CHARACTER WHICH RECORDS
2 02			NUMBER OF PASSES THRU PROGRAM --- ODD OR
2 03			EVEN PASSES DETERMINE WHETHER TRANSMITTER
2 04			OR RECEIVER POSITION WILL BE USED IN THE
2 05			DELAY CALCULATION
2 06			
2 07			
2 08 28	INCREMENT	FIM P4	
2 09		0 0	READ STATUS CHARACTER INTO ACCUMULATOR
2 0A 29		SRC P4	
2 0B EC		R00	
2 0C F2		IAC	INCREMENT ACCUMULATOR
2 0D E4		WR0	WRITE ACCUMULATOR BACK INTO STATUS CHAR
2 0E C0		B3L	RETURN TO MAIN PROGRAM
2 0F 26	ODD/EV	FIM P4	
2 10		0 0	READ STATUS CHARACTER INTO ACCUMULATOR
2 11 29		SRC P4	
2 12 EC		R00	
2 13 F6		RAR	
2 14 1A		JCN C0	TEST IF NUMBER IN STATUS CHARACTER IS ODD
2 15 1A		- EVEN	OR EVEN
2 16 F5	ODD	RAL	
2 17 D1		L0M 1	IF ODD SET R8 =1 CAUSES USE OF RECEIVER
2 18 B8		XCH R8	POSITION DATA STORED IN RAM
2 19 C0		B3L	RETURN TO MAIN PROGRAM
2 1A F5	EVEN	RAL	
2 1B D3		L0M 3	IF EVEN SET R8 =3 CAUSES USE OF TRANSMITTER
2 1C B8		XCH R8	POSITION DATA STORED IN RAM
2 1D CC		B3L	RETURN TO MAIN PROGRAM
2 1E			
2 1F			
2 20 22	RPOS	FIM P1	RPOS WRITES RECEIVER POSITION INTO RAM0/
2 21 13		1 3	REG1/CHARACTERS 3 THRU F AFTER READING IT
2 22 26		FIM P3	FROM THUMBWHEEL SWITCHES
2 23 01		0 1	TO SELECT RAM0 OUTPUT PORT --- R7 = STROBE
2 24 28		FIM P4	
2 25 10		1 0	TO SELECT INPORT 1 (LONG/LAT DATA)
2 26 52		JMS -	
2 27 67		- READL/L	
0 29 51		JMS -	TEST LONGITUDE 100S CHARACTER 8 BIT FOR 0
0 29 E0		- TESTN/S	OR 1 FOR NORTH OR SOUTH LATITUDE
2 2A AA		LD RA	
2 2B B4		XCH R4	READ 2 RECEIVER LONG/LAT SWITCHES AND STORE
2 2C 52		JMS -	2 POSITION CHARACTERS IN RAM
2 2D 67		- READL/L	
2 2E AA		LD RA	
2 2F B5		XCH R5	
2 30 51		JMS -	
2 31 64		- WRAM	
2 32 52		JMS -	
2 33 67		- READL/L	
2 34 AA		LD RA	STORE 1 POSITION CHARACTER + DECIMAL POINT
2 35 B4		XCH R4	IN RAM
2 36 DA		LDM A	
2 37 B5		XCH R5	
2 38 51		JMS -	
2 39 64		- WRAM	
2 3A 52		JMS -	
2 3B 67		- READL/L	
2 3C AA		LD RA	STORE 2 POSITION CHARACTERS IN RAM
2 3D B4		XCH R4	
2 3E 52		JMS -	
2 3F 67		- READL/L	

2 40	AA	LO	RA	
2 41	B5	XCH	R5	
2 42	51	JMS	-	
2 43	64	-	WRAM	
2 44	00	LDM	0	
2 45	B4	XCH	R4	
2 46	52	JMS	-	
2 47	67	-	REAOL/L	STORE CHS + 1 POSITION CHARACTER IN RAM
2 48	AA	LO	RA	
2 49	B5	XCH	R5	
2 4A	51	JMS	-	
2 4B	64	-	WRAM	
2 4C	52	JMS	-	
2 4D	67	-	READL/L	
2 4E	AA	LD	RA	STORE 1 POSITION CHARACTER + DECIMAL POINT
2 4F	B4	XCH	R4	IN RAM
2 50	0A	LDM	A	
2 51	B5	XCH	R5	
2 52	51	JMS	-	
2 53	64	-	WRAM	
2 54	52	JMS	-	
2 55	67	-	REAOL/L	
2 56	AA	LO	RA	
2 57	B4	XCH	R4	STORE 2 POSITION CHARACTERS IN RAM
2 58	52	JMS	-	
2 59	67	-	READL/L	
2 5A	AA	LO	RA	
2 5B	B5	XCH	R5	
2 5C	51	JMS	-	
2 5D	64	-	WRAM	
2 5E	AB	LO	RB	STORE LATITUDE CHS CHARACTER, WHICH WAS
2 5F	B4	XCH	R4	SAVED IN RB BY ROUTINE TESTN/S, IN RAM
2 60	00	LDM	0	
2 61	B5	XCH	R5	
2 62	51	JMS	-	
2 63	64	-	WRAM	
2 64	C0	BBL		RETURN TO MAIN PROGRAM
2 65				
2 66				
2 67	27	READL/L	SRC P3	READL/L WRITES STROBE TO RECEIVER LONGITUDE
2 68	A7	LO	R7	LATITUDE THUMBWHEEL SWITCHES VIA RAM0
2 69	F4	CMA		OUTPUT AND REAOS IN POSITION
2 6A	E1	WMP		
2 6B	29	SRC	P4	READ LONG/LAT CHARACTER FROM INPORT 1
2 6C	EA	ROR		
2 6D	BA	XCH	RA	TRANSFER LONG/LAT CHAR TO RPOS VIA RA
2 6E	67	INC	R7	INCREMENT STROBE
2 6F	C0	BBL		RETURN TO RPOS
2 70	22	OELAYGEN	FIM P1	OELAYGEN OUTPUTS 4 CHARACTER DELAY
2 71	05	0	5	GENERATOR SETTING TO DELAY GENERATOR
2 72	24	FIM	P2	TO SELECT OUTPUT 4 AND SET UP 4 CHARACTER
2 73	4C	4	C	COUNTER
2 74	23	NEXTCHAR	SRC P1	READ RAM CHARACTER
2 75	E9	ROM		
2 76	25	SRC	P2	
2 77	F4	CMA		WRITE CHARACTER TO OUTPUT 4
2 78	E2	WRR		
2 79	63	INC	R3	INCREMENT RAM CHARACTER ADDRESS
2 7A	64	INC	R4	INCREMENT NUMBER OF OUTPUT
2 7B	75	ISZ	R5	INCREMENT RAM CHARACTER COUNTER
2 7C	74	-	NEXTCHAR	
2 7D	C0	BBL		RETURN TO RPOS
2 7E				
2 7F				

2 80 22	SPOS	FIM P1	SPOS REAOS SATELLITE POSITION INFORMATION
2 81 20		2 0	FROM DECODER MICROPROCESSOR AND STORES IT
2 82 24		FIM P2	IN RAM0/REG1 TEMPORARILY THEN LATER
2 83 43		4 3	TRANSFERS IT TO REG2
2 84 26		FIM P3	
2 85 13		1 3	TO SELECT RAM0/REG1/CHARACTERS 3 THRU F
2 86 25	READS	SRC P2	
2 87 EA	REAOS+1	RDR	TEST DECODER MICROPROCESSOR RAM OUTPUT PORT
2 88 F1		CLC	FOR 3 --- IF NOT FOUND KEEP TESTING --- IF
2 89 95		SUB R5	FOUND READ DECODER OUTPORT 1 CONNECTED TO
2 8A 1C		JCN A1	JELAY MICROPROCESSOR INPORT 2
2 8B 87		- READS+1	
2 8C 23		SRC P1	READ SATELLITE POSITION DATA FROM INPORT 2
2 8D EA		ROR	
2 8E 27		SRC P3	WRITE SATELLITE POSITION DATA INTO RAM0/
2 8F E0		WRM	REG1
2 90 77		ISZ R7	IF 13 SATELLITE POSITION CHARACTERS HAVE
2 91 86		- READS	BEEN WRITTEN INTO RAM GO ON TO TRANSFER
2 92 22		FIM P1	THEM FROM REG1 TO REG2 AND INSERT DECIMAL
2 93 13		1 3	POINTS AND CHS WHERE NECESSARY
2 94 24		FIM P2	
2 95 20		2 0	TO SELECT RAM0/REG2/CHARACTERS 0 THRU F
2 96 0D		LDM 0	
2 97 86		XCH R6	TRANSFER 3 CHARACTERS FROM RAM REG1 TO REG2
2 98 52		JMS -	
2 99 E0		- NCHARS	
2 9A 0A		LDM A	
2 9B 25		SRC P2	WRITE DECIMAL POINT (A) INTO REG2
2 9C E0		WRM	
2 9D 65		INC R5	
2 9E 0E		LDM E	
2 9F 86		XCH R6	
2 A0 52		JMS -	TRANSFER 2 CHARACTERS FROM RAM REG1 TO REG2
2 A1 E0		- NCHARS	
2 A2 23		SRC P1	
2 A3 F0		CLB	
2 A4 E9		RDM	IF 6TH CHARACTER IN RAM REG1 1 BIT = 0 THEN
2 A5 63		INC R3	SIGN IS -
2 A6 F6		RAR	
2 A7 1A		JCN C0	
2 A8 AD		- MINUS	
2 A9 00	POSITIVE	LDM 0	IF 6TH CHARACTER IN RAM REG1 1 BIT NOT = 0
2 AA B8		XCH R8	SAVE R8 = 0 FOR + SIGN
2 AB 42		JUN -	
2 AC AF		- NEXT	
2 AD 0B	MINUS	LDM B	IF 6TH CHARACTER IN RAM REG1 1 BIT = 0
2 AE 88		XCH R3	SAVE R8 = B FOR - SIGN
2 AF DF	NEXT	LDM F	
2 B0 B6		XCH R6	TRANSFER 1 CHARACTER FROM RAM REG1 TO REG2
2 B1 52		JMS -	
2 B2 E0		- NCHARS	
2 B3 0A		LDM A	
2 B4 25		SRC P2	WRITE DECIMAL POINT (A) INTO RAM REG2
2 B5 E0		WRM	
2 B6 65		INC R5	
2 B7			
2 B8 0E		LDM E	TRANSFER 2 CHARACTERS FROM RAM REG1 TO REG2
2 B9 B6		XCH R6	
2 BA 52		JMS -	
2 BB E0		- NCHARS	
2 BC A8		LD R8	
2 BD 25		SRC P2	WRITE 0 OR B SAVED IN R8 INTO REG2 FOR + OR
2 BE E0		WRM	CHS
2 BF 65		INC R5	

2 C0 23		SRC P1	
2 C1 F0		CLB	
2 C2 E9		RDM	IF 10TH CHARACTER IN RAM REG1 1 BIT = 0 THEN
2 C3 63		INC R3	SIGN IS -
2 C4 F6		RAR	
2 C5 1A		JCN C0	
2 C6 CB		- MINUS	
2 C7 D0	POSITIVE	LDM 0	IF 10TH CHARACTER IN RAM REG1 1 BIT NOT = 0
2 C8 B8		XCH R8	SAVE R8 = 0 FOR + SIGN
2 C9 42		JUN -	
2 CA CD		- NEXT	
2 CB DB	MINUS	LDM 8	IF 10TH CHARACTER IN RAM REG1 1 BIT = 0
2 CC B8		XCH R8	SAVE R8 = 8 FOR - SIGN
2 CD DD	NEXT	LDM D	
2 CE B6		XCH R6	TRANSFER 3 CHARACTERS FROM RAM REG1 TO REG2
2 CF 52		JMS -	
2 D0 E0		- NCHARS	
2 D1 DA		LDM A	
2 D2 25		SRC P2	WRITE DECIMAL POINT (A) INTO RAM REG2
2 D3 E0		WRM	
2 D4 65		INC R5	
2 D5 A8		LD R8	
2 D6 25		SRC P2	WRITE 0 OR 8 SAVED IN R8 INTO REG2 FOR + OR
2 D7 E0		WRM	CHS
2 D8 C0		BBL	RETURN TO MAIN PROGRAM
2 D9			
2 DA			
2 DB			
2 DC			
2 DD			
2 DE			
2 DF			
2 E0 23	NCHARS	SRC P1	NCHARS TRANSFERS A SPECIFIED NUMBER OF
2 E1 E9		RDM	SATELLITE POSITION CHARACTERS FROM RAM0/
2 E2 F4		CMA	REG1 TO REG2
2 E3 25		SRC P2	
2 E4 E0		WRM	
2 E5 63		INC R3	INCREMENT RAM REG1 CHARACTER ADDRESS
2 E6 65		INC R5	INCREMENT RAM REG2 CHARACTER ADDRESS
2 E7 76		ISZ R6	
2 E8 E0		- NCHARS	INCREMENT NUMBER OF CHARACTERS COUNTER
2 E9 C0		BBL	RETURN TO SPOS
2 EA			
2 EB			
2 EC			
2 ED			
2 EE			
2 EF			
2 F0			
2 F1			
2 F2			
2 F3			
2 F4			
2 F5			
2 F6			
2 F7			
2 F8			
2 F9			
2 FA			
2 FB			
2 FC			
2 FD			
2 FE			
2 FF			

3 00 3C	CA/CE	PROM 3 IS USED FOR KEY STROKE CODE STORAGE
3 01 3C	CA/CE	ENTER LONGITUDE OF SATELLITE
3 02 23	-	ENTER LONGITUDE OF TRANSMITTER OR RECEIVER
3 03 27	=	
3 04 3B	STO	ENTER LATITUDE OF TRANSMITTER OR RECEIVER
3 05 32	COS	
3 06 24	X	
3 07 28	(ENTER LATITUDE OF SATELLITE
3 08 32	COS	
3 09 24	X	
3 0A 28	(
3 0B 37	RCL	
3 0C 32	COS	
3 0D 29)	
3 0E 29)	
3 0F 27	=	
3 10 3B	STO	ENTER LATITUDE OF TRANSMITTER OR RECEIVER
3 11 31	SIN	
3 12 24	X	ENTER LATITUDE OF SATELLITE
3 13 31	SIN	
3 14 27	=	
3 15 22	+	
3 16 37	RCL	
3 17 27	=	
3 18 3B	STO	
3 19 16	5	
3 1A 21	.	
3 1B 1A	9	
3 1C 19	8	$-2RH = -5.98147 \times 10^{**9}$
3 1D 12	1	
3 1E 15	4	
3 1F 18	7	
3 20 2B	CHS	
3 21 2C	EE	
3 22 1A	9	
3 23 24	X	
3 24 37	RCL	
3 25 22	+	
3 26 13	2	
3 27 11	0	
3 28 21	.	
3 29 13	2	
3 2A 12	1	$R^{**2} + H^{**2} = 20.21396 \times 10^{**9}$
3 2B 14	3	
3 2C 1A	9	
3 2D 17	6	
3 2E 2C	EE	
3 2F 1A	9	
3 30 27	=	
3 31 36	SQRT	
3 32 22	+	ENTER NORMALIZED RANGE OF SATELLITE
3 33 27	=	
3 34 22	+	ENTER TOTAL UP DELAY FROM RAM
3 35 27	=	
3 36 22	+	
3 37 21	.	
3 38 11	0	
3 39 12	1	
3 3A 27	=	
3 3B 28	CHS	
3 3C 22	+	SUBTRACT TOTAL COMPUTED DELAY FROM 300000.
3 3D 14	3	MICROSECONDS
3 3E 11	0	
3 3F 11	0	

3 40	11	0
3 41	11	0
3 42	11	0
3 43	21	.
3 44	27	=
3 45	24	X
3 46	12	1
3 47	21	.
3 48	11	0
3 49	13	2
3 4A	15	4
3 4B	27	=
3 4C	2B	CHS
3 4D	22	+
3 4E	12	1
3 4F	11	0
3 50	11	0
3 51	11	0
3 52	11	0
3 53	11	0
3 54	21	.
3 55	27	=
3 56	22	+
3 57	21	.
3 58	11	0
3 59	11	0
3 5A	12	1
3 5B	27	=
3 5C		
3 5D		
3 5E		
3 5F		
3 60		
3 61		
3 62		
3 63		
3 64		
3 65		
3 66		
3 67		
3 68		
3 69		
3 6A		
3 6B		
3 6C		
3 6D		
3 6E		
3 6F		
3 70		
3 71		
3 72		
3 73		
3 74		
3 75		
3 76		
3 77		
3 78		
3 79		
3 7A		
3 7B		
3 7C		
3 7D		
3 7E		
3 7F		

X 1.024 = RATIO BETWEEN OEC00ER
MICROPROCESSOR CLOCK AND DELAY
MICROPROCESSOR CLOCK FREQUENCIES, THAT IS
THE MINIMUM DELAY GENERATOR STEP IS
9.765625 MICROSECONOS AND NOT 10.
MICROSECONDS

10S COMPLEMENT DELAY GENERATOR SETTING
BECAUSE OF UP COUNTERS USED IN DELAY
GENERATOR

THESE STROKES ARE USED FOR DECIMAL POINT
ADJUSTMENT OF DELAY GENERATOR SETTING
CALCULATION

LOCATIONS 80 THRU BF ARE BLANK AND HAVE BEEN OMITTED
FROM THIS LISTING

3 C0			
3 C1			
3 C2			
3 C3			
3 C4			
3 C5			
3 C6			
3 C7			
3 C8			
3 C9			
3 CA			
3 CB			
3 CC			
3 CD			
3 CE			
3 CF			
3 D0			
3 D1			
3 D2			
3 D3			
3 D4			
3 D5			
3 D6			
3 D7			
3 D8			
3 D9			
3 DA			
3 DB			
3 DC			
3 DD			
3 DE			
3 DF			
3 E0 22	KCPROM	FIM P1	KCPROM ENTERS SPECIFIED KEY CODES STORED IN
3 E1		0 0	PROM
3 E2 24		FIM P2	TO SELECT I/O PORTS 3
3 E3 30		3 0	
3 E4 36	NOP	FIN P3	KEY CODE ADDRESS IS IN P0, KEY CODE WILL BE
3 E5 51		JMS -	STORED IN P3
3 E6 20		- INPUTKC	WRITE NOP, WRITE KEY CODE, WAIT FOR DONE
3 E7 71		ISZ R1	
3 E8 EA		- TESTADD	INCREMENT KEY CODE ADDRESS A2A1 FOR FIN
3 E9 60		INC R0	
3 EA F0	TESTADD	CLB	
3 EB A8		LD R8	
3 EC 90		SUB R0	
3 ED 1C		JCN A1	TEST KEY CODE ADDRESS IN P0 TO SEE IF LAST
3 EE E4		- NOP	KEY CODE HAS BEEN EXECUTED --- IF NOT
3 EF F0		CLB	EXECUTE NEXT ONE.
3 F0 A9		LD R9	
3 F1 91		SUB R1	
3 F2 1C		JCN A1	
3 F3 E4		- NOP	
3 F4 C0		BBL	RETURN TO MAIN PROGRAM
3 F5			
3 F6			
3 F7			
3 F8			
3 F9			
3 FA			
3 FB			
3 FC			
3 FD			
3 FE			
3 FF			

U.S. DEPT. OF COMM. BIBLIOGRAPHIC DATA SHEET	1. PUBLICATION OR REPORT NO. NBS TN-1003	2. Gov't Accession No.	3. Recipient's Accession No.	
4. TITLE AND SUBTITLE AUTOMATIC PATH DELAY CORRECTIONS TO GOES SATELLITE TIME BROADCASTS		5. Publication Date February 1978	6. Performing Organization Code 277.06	
7. AUTHOR(S) J. V. Cateora, D. W. Hanson, and D. D. Davis		8. Performing Organ. Report No.		
9. PERFORMING ORGANIZATION NAME AND ADDRESS NATIONAL BUREAU OF STANDARDS DEPARTMENT OF COMMERCE WASHINGTON, D.C. 20234		10. Project/Task/Work Unit No. 2776119	11. Contract/Grant No.	
12. Sponsoring Organization Name and Complete Address (Street, City, State, ZIP)		13. Type of Report & Period Covered	14. Sponsoring Agency Code	
15. SUPPLEMENTARY NOTES				
<p>16. ABSTRACT (A 200-word or less factual summary of most significant information. If document includes a significant bibliography or literature survey, mention it here.)</p> <p>In support of the environmental data collection by the National Oceanic and Atmospheric Administration's (NOAA's) Geostationary Operational Environmental Satellites (GOES), a time code has been incorporated into an interrogation message from these satellites by the National Bureau of Standards (NBS). This message is directed to data-collection platforms engaged in seismic, tsunami, hydromet and other related monitoring activities. The NBS has developed this time-code system to serve environmental data users who require only a few tenths of a second accuracy as well as those who need a more accurate time reference.</p> <p>The time code is available continuously from two geostationary satellites and provides a coverage of the Atlantic and Pacific Ocean Basins as well as the North and South American Continents. The time code includes the necessary information to compensate for free-space propagation delays between the master clock located at Wallops Island, Virginia, and the user. Preliminary results indicate a timing resolution of 10 μs.</p> <p>The time-code system is supported by atomic clocks maintained at Wallops Island, Virginia, the point of origin for all signals to be sent through the satellites. A data-logging system monitors three television networks and Loran-C to provide a comparison link between the Wallops Island clocks and reference standards at the NBS.</p> <p>A microprocessor "smart" clock has been developed for the user that automatically corrects for path and equipment delays and places its recovered time in synchronism with Coordinated Universal Time (UTC) generated by NBS. This clock, associated recovery equipment, and measured results are discussed in detail in this report.</p>				
<p>17. KEY WORDS (six to twelve entries; alphabetical order; capitalize only the first letter of the first key word unless a proper name; separated by semicolons)</p> <p>Broadcast; delay correction; microprocessor; satellite; scientific calculations; time of year.</p>				
<p>18. AVAILABILITY</p> <p><input checked="" type="checkbox"/> Unlimited</p> <p><input type="checkbox"/> For Official Distribution. Do Not Release to NTIS</p> <p><input checked="" type="checkbox"/> Order From Sup. of Doc., U.S. Government Printing Office Washington, D.C. 20402, SD Cat. No. C13, 46:1003</p> <p><input type="checkbox"/> Order From National Technical Information Service (NTIS) Springfield, Virginia 22151</p>	<p>19. SECURITY CLASS (THIS REPORT)</p> <p>UNCLASSIFIED</p>	<p>21. NO. OF PAGES</p> <p>52</p>	<p>20. SECURITY CLASS (THIS PAGE)</p> <p>UNCLASSIFIED</p>	<p>22. Price</p> <p>\$2.20</p>

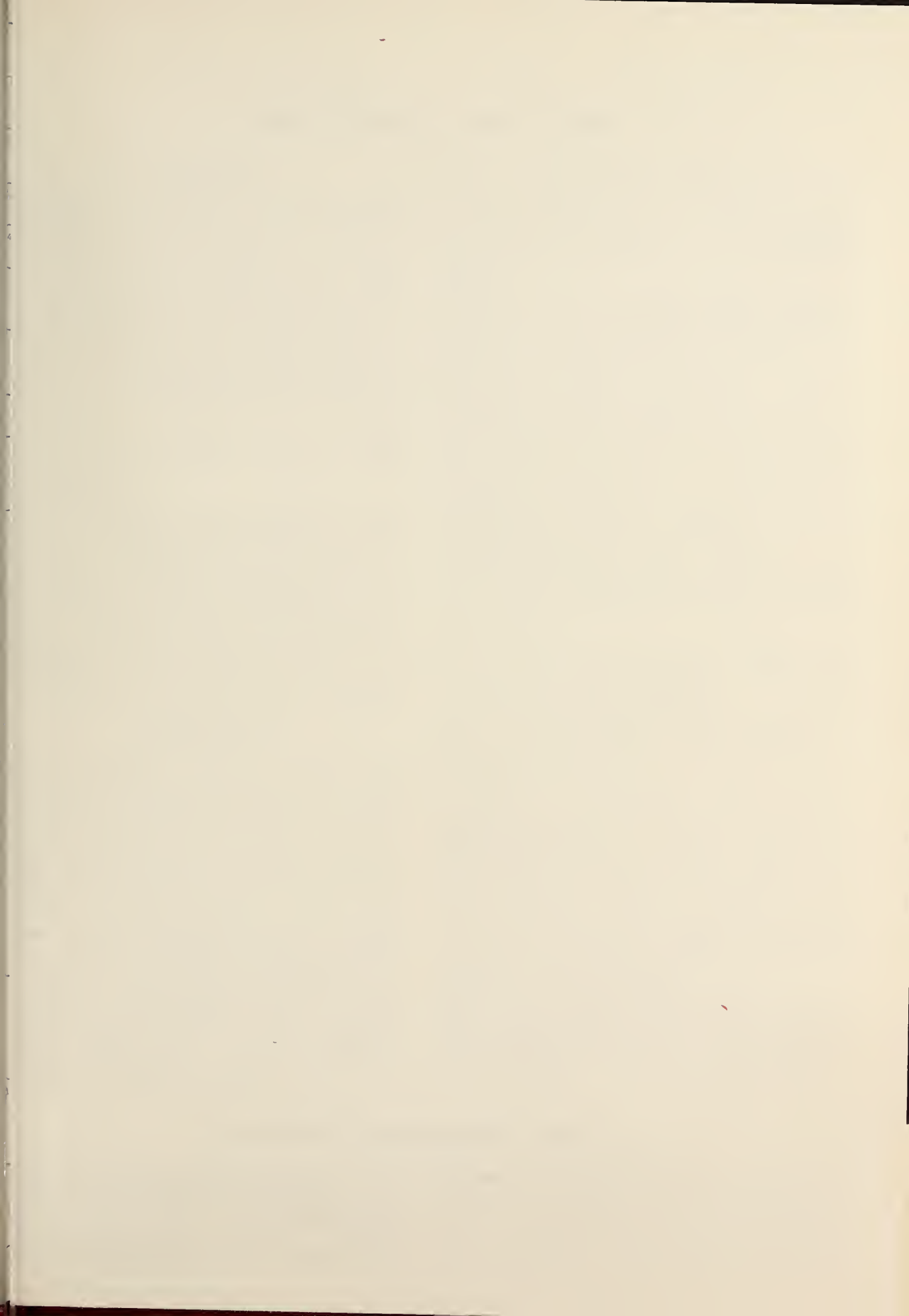

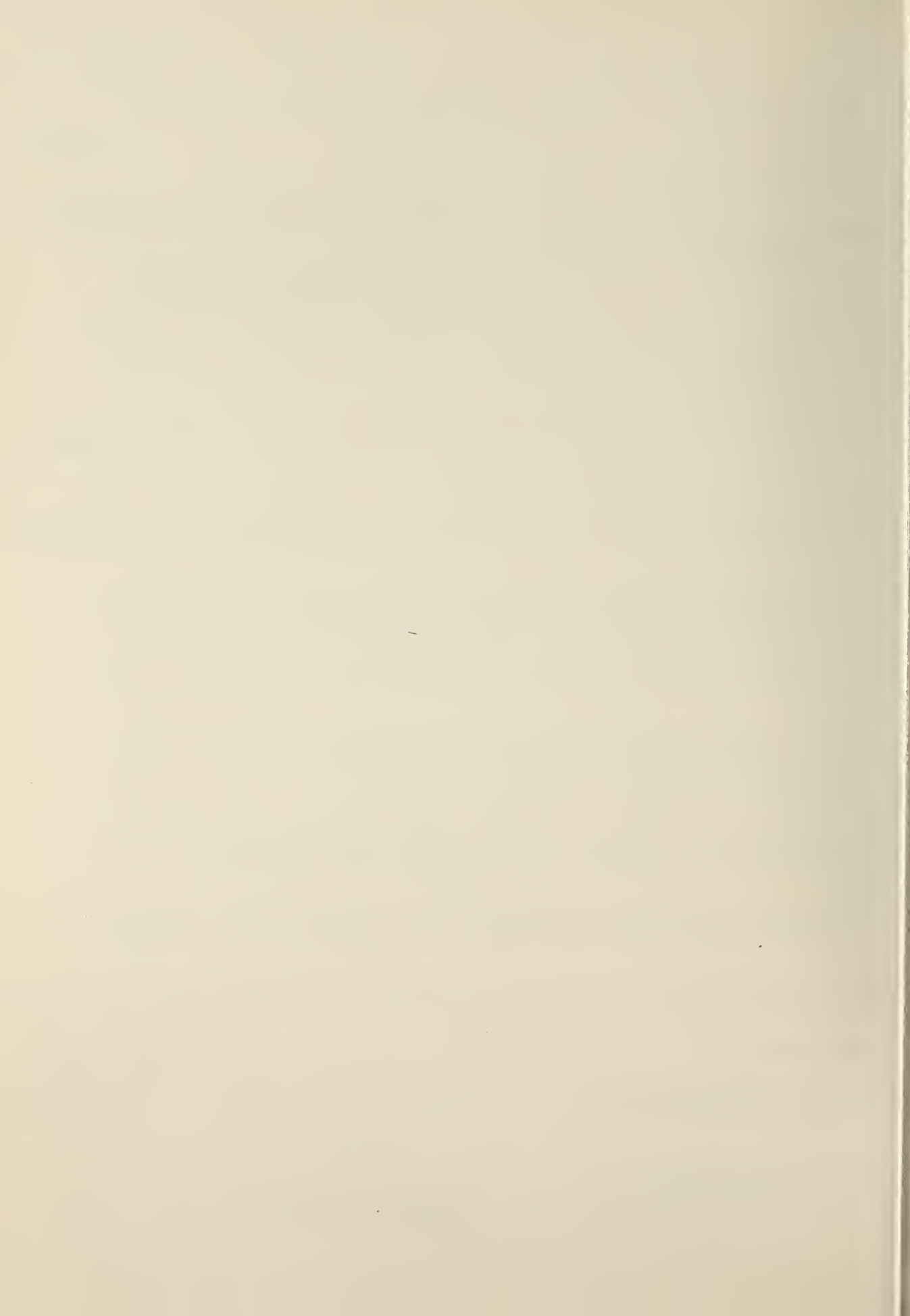

NBS TECHNICAL PUBLICATIONS

PERIODICALS

JOURNAL OF RESEARCH—The Journal of Research of the National Bureau of Standards reports NBS research and development in those disciplines of the physical and engineering sciences in which the Bureau is active. These include physics, chemistry, engineering, mathematics, and computer sciences. Papers cover a broad range of subjects, with major emphasis on measurement methodology, and the basic technology underlying standardization. Also included from time to time are survey articles on topics closely related to the Bureau's technical and scientific programs. As a special service to subscribers each issue contains complete citations to all recent NBS publications in NBS and non-NBS media. Issued six times a year. Annual subscription: domestic \$17.00; foreign \$21.25. Single copy, \$3.00 domestic; \$3.75 foreign.

Note: The Journal was formerly published in two sections: Section A "Physics and Chemistry" and Section B "Mathematical Sciences."

DIMENSIONS/NBS

This monthly magazine is published to inform scientists, engineers, businessmen, industry, teachers, students, and consumers of the latest advances in science and technology, with primary emphasis on the work at NBS. The magazine highlights and reviews such issues as energy research, fire protection, building technology, metric conversion, pollution abatement, health and safety, and consumer product performance. In addition, it reports the results of Bureau programs in measurement standards and techniques, properties of matter and materials, engineering standards and services, instrumentation, and automatic data processing.

Annual subscription: Domestic, \$12.50; Foreign \$15.65.

NONPERIODICALS

Monographs—Major contributions to the technical literature on various subjects related to the Bureau's scientific and technical activities.

Handbooks—Recommended codes of engineering and industrial practice (including safety codes) developed in cooperation with interested industries, professional organizations, and regulatory bodies.

Special Publications—Include proceedings of conferences sponsored by NBS, NBS annual reports, and other special publications appropriate to this grouping such as wall charts, pocket cards, and bibliographies.

Applied Mathematics Series—Mathematical tables, manuals, and studies of special interest to physicists, engineers, chemists, biologists, mathematicians, computer programmers, and others engaged in scientific and technical work.

National Standard Reference Data Series—Provides quantitative data on the physical and chemical properties of materials, compiled from the world's literature and critically evaluated. Developed under a world-wide program coordinated by NBS. Program under authority of National Standard Data Act (Public Law 90-396).

NOTE: At present the principal publication outlet for these data is the Journal of Physical and Chemical Reference Data (JPCRD) published quarterly for NBS by the American Chemical Society (ACS) and the American Institute of Physics (AIP). Subscriptions, reprints, and supplements available from ACS, 1155 Sixteenth St. N.W., Wash., D.C. 20056.

Building Science Series—Disseminates technical information developed at the Bureau on building materials, components, systems, and whole structures. The series presents research results, test methods, and performance criteria related to the structural and environmental functions and the durability and safety characteristics of building elements and systems.

Technical Notes—Studies or reports which are complete in themselves but restrictive in their treatment of a subject. Analogous to monographs but not so comprehensive in scope or definitive in treatment of the subject area. Often serve as a vehicle for final reports of work performed at NBS under the sponsorship of other government agencies.

Voluntary Product Standards—Developed under procedures published by the Department of Commerce in Part 10, Title 15, of the Code of Federal Regulations. The purpose of the standards is to establish nationally recognized requirements for products, and to provide all concerned interests with a basis for common understanding of the characteristics of the products. NBS administers this program as a supplement to the activities of the private sector standardizing organizations.

Consumer Information Series—Practical information, based on NBS research and experience, covering areas of interest to the consumer. Easily understandable language and illustrations provide useful background knowledge for shopping in today's technological marketplace.

Order above NBS publications from: Superintendent of Documents, Government Printing Office, Washington, D.C. 20402.

Order following NBS publications—NBSIR's and FIPS from the National Technical Information Services, Springfield, Va. 22161.

Federal Information Processing Standards Publications (FIPS PUB)—Publications in this series collectively constitute the Federal Information Processing Standards Register. Register serves as the official source of information in the Federal Government regarding standards issued by NBS pursuant to the Federal Property and Administrative Services Act of 1949 as amended, Public Law 89-306 (79 Stat. 1127), and as implemented by Executive Order 11717 (38 FR 12315, dated May 11, 1973) and Part 6 of Title 15 CFR (Code of Federal Regulations).

NBS Interagency Reports (NBSIR)—A special series of interim or final reports on work performed by NBS for outside sponsors (both government and non-government). In general, initial distribution is handled by the sponsor; public distribution is by the National Technical Information Services (Springfield, Va. 22161) in paper copy or microfiche form.

BIBLIOGRAPHIC SUBSCRIPTION SERVICES

The following current-awareness and literature-survey bibliographies are issued periodically by the Bureau:

Cryogenic Data Center Current Awareness Service. A literature survey issued biweekly. Annual subscription: Domestic, \$25.00; Foreign, \$30.00.

Liquefied Natural Gas. A literature survey issued quarterly. Annual subscription: \$20.00.

Superconducting Devices and Materials. A literature survey issued quarterly. Annual subscription: \$30.00. Send subscription orders and remittances for the preceding bibliographic services to National Bureau of Standards, Cryogenic Data Center (275.02) Boulder, Colorado 80302.

U.S. DEPARTMENT OF COMMERCE
National Bureau of Standards
Washington, D.C. 20234

OFFICIAL BUSINESS

Penalty for Private Use, \$300

POSTAGE AND FEES PAID
U.S. DEPARTMENT OF COMMERCE
COM-215



SPECIAL FOURTH-CLASS RATE
BOOK