



# **Pest Management in Stored Groundnuts**

Information Bulletin no. 22

International Crops Research Institute for the Semi-Arid Tropics

## Abstract

Dick, K.M. 1987. Pest management in stored groundnuts. Information Bulletin no. 22. Patancheru, A.P. 502 324, India: International Crops Research Institute for the Semi-Arid Tropics.

When groundnuts are stored, either as pods or kernels, they are susceptible to insect attack. The publication describes the main pest species and briefly outlines their ecology and behavior. The use of traps to detect pest populations in stores is discussed and methods of estimating quantitative losses are described. Recommended pest management techniques are outlined with emphasis on prevention of infestation by improving storage practices. The potential inputs to an integrated control program are examined. Screening for host-plant resistance to storage pests is discussed and general guidelines for these experiments given.

## Résumé

Dick, K.M. 1987. (La lutte contre les insectes dans les stocks d'arachide.) Pest management in stored groundnuts. Information Bulletin no. 22. Patancheru, A.P. 502 324, India : International Crops Research Institute for the Semi-Arid Tropics.

Les stocks d'arachides, qu'ils soient réalisés en coques ou en graines décortiquées, sont toujours susceptibles d'être attaqués par des insectes. Cet ouvrage décrit les principales espèces d'insectes et donne un bref aperçu de leur écologie et comportement. L'utilisation de divers pièges pour détecter les populations des ravageurs dans les magasins de stockage ainsi que les méthodes d'estimation des pertes quantitatives sont exposées. Les techniques recommandées de lutte contre les insectes sont esquissées tout en soulignant l'importance de la prévention de l'infestation à travers des pratiques de stockage améliorées. Les composantes potentielles d'un programme de lutte intégrée sont examinées. Le criblage pour la résistance des plantes-hôtes aux insectes des stocks est étudié, suivi par la présentation des procédés généraux et indications pour la réalisation de ces expériences.

The International Crops Research Institute for the Semi-Arid Tropics is a nonprofit scientific educational institute receiving support from donors through the Consultative Group on International Agricultural Research. Donors to ICRISAT include governments and agencies of Australia, Belgium, Canada, Federal Republic of Germany, Finland, France, India, Italy, Japan, Netherlands, Norway, People's Republic of China, Sweden, Switzerland, United Kingdom, United States of America, and the following international and private organizations: Arab Bank for Economic Development in Africa, Asian Development Bank, Deutsche Gesellschaft für Technische Zusammenarbeit (GTZ), Global 2000 Inc., International Development Research Centre, International Fertilizer Development Center, International Fund for Agricultural Development, The European Economic Community, The Ford Foundation, The Leverhulme Trust, The Opec Fund for International Development, The Population Council, The World Bank, United Nations Development Programme, and the University of Hohenheim. Information and conclusions in this publication do not necessarily reflect the position of the aforementioned governments, agencies, and international and private organizations.

*Correct citation:* Dick, K.M. 1987. Pest management in stored groundnuts. Information Bulletin no. 22. Patancheru, A.P. 502 324, India: International Crops Research Institute for the Semi-Arid Tropics.

**Cover:** Groundnut pods and kernels with characteristic damage caused by *Caryedon serratus* larvae. Note also eggs attached to pods and kernels, and distinctive pupal cocoons.

# **Pest Management in Stored Groundnuts**

**K. M. Dick**



ICRISAT

Information Bulletin no. 22

International Crops Research Institute for the Semi-Arid Tropics  
Patancheru, Andhra Pradesh 502 324, India

1987

# Contents

Introduction	3
Major Pests of Stored Groundnuts	3
<i>Caryedon serratus</i>	3
<i>Tribolium castaneum</i>	4
<i>Oryzaephilus mercator</i>	5
<i>Trogoderma granarium</i>	5
<i>Elasmolomus sordidus</i>	6
<i>Corcyra cephalonica</i>	6
<i>Ephestia cautella</i>	7
<i>Plodia interpunctella</i>	7
Other species	8
Detection of Insect Pest Populations	8
Sticky traps	8
Refuge traps	9
Light traps	10
Pitfall traps	10
Loss Assessment	11
Sampling	11
Quantitative loss determination	18
Insect Pest Management	21
Prevention of infestation	21
Control of established infestations	23
Integrated pest management	24
Breeding for resistance to storage pests	24
Suggested further studies	25
Bibliography	26

# Introduction

Groundnut, *Arachis hypogaea* L., is an important cash and food crop in many parts of the tropics, particularly in semi-arid areas. When stored before use the groundnut crop is susceptible to attack by insect pests. The degree of susceptibility depends largely on whether or not the groundnuts are shelled and the extent to which pods or kernels are damaged before being placed in store. Insect infestation causes loss in dry mass of the kernels, increased levels of free fatty acids in the oil (thereby lowering the quality) and, if the seeds are heavily damaged, reduction in germination potential. The heat and moisture generated by large insect populations within heaps or stacks of groundnuts may also increase the risk of mold growth.

In West Africa the extent of postharvest losses has prompted several studies of insect population development on groundnuts stored as pods and kernels. However, few attempts have been made to measure the extent of losses caused by insects either in farmers' stores or in large-scale commercial storage. Consequently, there is a lack of information on appropriate methods for assessing post-harvest losses.

This bulletin provides information on the major insect pests of stored groundnuts in the semi-arid tropics (SAT), methods of assessing the losses caused by these insects, and pest management practices that can help to reduce losses. The storage of groundnut products such as cake, meal, or oil is not discussed.

## Major Pests of Stored Groundnuts

Records list over 100 insect species that infest stored groundnuts (Redlinger and Davis, 1982). Only those species considered to be major cosmopolitan pests are described here.

### ***Caryedon serratus* (Olivier)**

**Coleoptera:Bruchidae**

Common names: groundnut borer,  
groundnut weevil

Synonyms: *Bruchus serratus* Olivier  
*Bruchus gonagra* Fabricius  
*Caryedon fuscus* (Goeze)  
*Caryedon gonagra* (Fabricius)

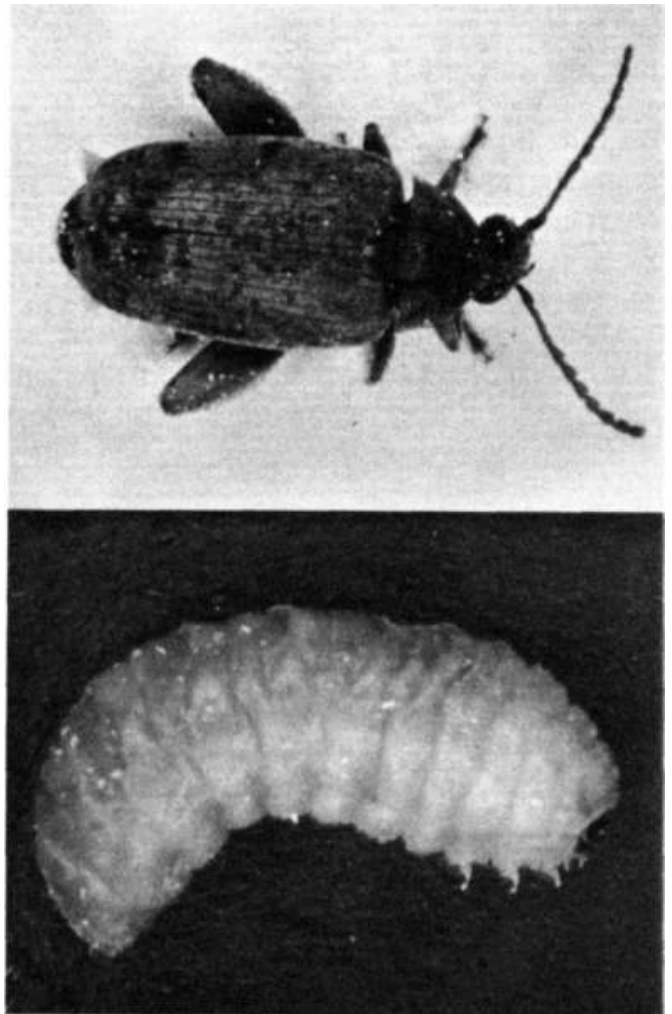

**Figure 1. Groundnut borer (*Caryedon serratus*) adult ( $\times 10$ ) and larva ( $\times 10$ ).**

This species is found in many parts of tropical Asia and Africa, breeding on common tree legumes such as *Tamarindus indica* L. (tamarind) as well as on harvested groundnuts. It is generally regarded as the only species that can penetrate intact pods to infest the kernels. The adult is 4-7 mm long and reddish-brown, with dark irregular markings on the elytra (Fig. 1). It has large, prominent eyes and can be easily distinguished from other storage pests by its broad hind femur, which bears a conspicuous comb of spines.

Infestation of harvested groundnuts can occur while the crop is drying in the field or when it is stored near infested stocks or crop residues. Adult females attach their eggs to the outside of pods or kernels. When the first instar larva hatches it burrows directly through the pod wall to reach the kernel. Each larva feeds solely within a single kernel (Plate a). When mature, larvae may partially or completely emerge from the pod, leaving a characteristic round hole approximately 3 mm in diameter. Larvae often migrate to the bottom of a stack or heap before pupating in distinctive ovoid cocoons (see cover). Damage caused by subsequent generations is, therefore, often heaviest in this part of the stock.

Under optimal conditions, 30-33°C and 70-90% relative humidity (RH), the mean development period is approximately 40 d, but there is likely to be wide variation round the mean within each individual population.

***Tribolium castaneum* (Herbst)**  
**Coleoptera:Tenebrionidae**

**Common name: rust-red flour beetle**

This species is found throughout the tropics and is regarded as a major pest of shelled groundnuts. The adults are 3-4 mm long, chestnut-brown in color (Fig. 2), and have a lifespan of several months. The beetles are strong fliers and are often the first species to colonize stored groundnuts. The females lay their eggs in cracks in the testa or in holes in the kernels created by the adult while feeding (Plate b). Thus the first instar larvae, which cannot penetrate intact testae, are able to feed directly on the cotyledons.

The larvae are cylindrical in shape with two prominent 'horns' on the last abdominal segment. They pupate inside damaged kernels without forming a cocoon. The adults and larvae are facultative predators of eggs and pupae of other storage pests and are also cannibalistic. The mean development period from egg to adult is approximately 32 d at 30°C and 90% RH but is twice as long at 70% RH.

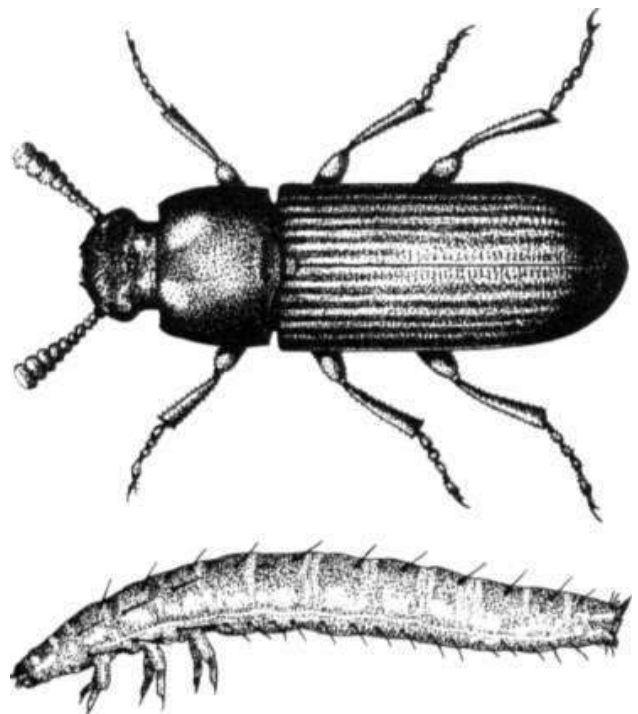

**Figure 2. Rust-red flour beetle (*Tribolium castaneum*) adult ( $\times 15$ ) and larva ( $\times 10$ ).**

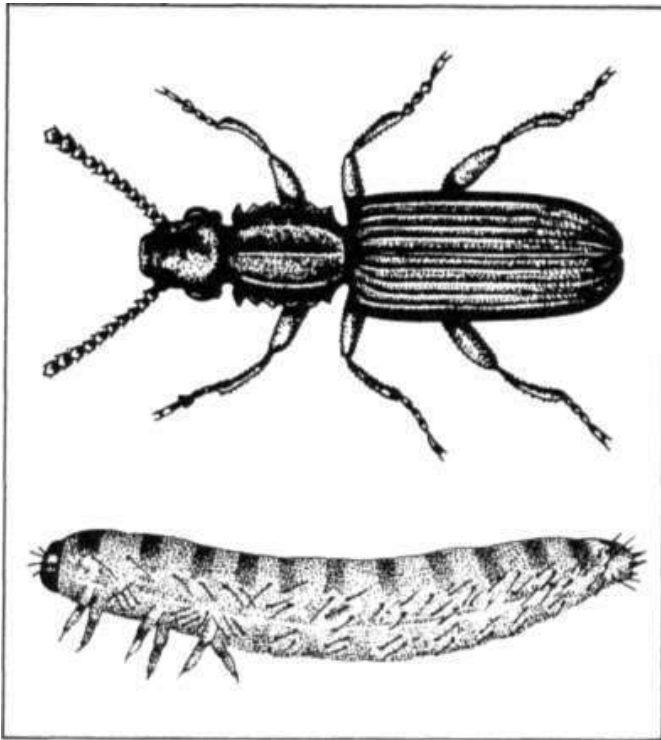

**Figure 3. Merchant grain beetle (*Oryzaephilus mercator*) adult (x20) and larva (x15).**

***Oryzaephilus mercator* (Fauvel)  
Coleoptera:Silvanidae**

**Common name: merchant grain beetle**

This cosmopolitan species has similar ecology and behavior to *Tribolium castaneum*. The adults are 2.5-3.5 mm long with a distinctive ridged prothorax bearing six large teeth on either side (Fig. 3). The larvae are cream-colored and possess more prominent thoracic legs than those of *T. castaneum*. The first instar larvae cannot penetrate intact testae and must feed on kernels damaged by the adults or by other storage pests. Under optimal conditions, 30-33°C and 70% RH, the life cycle is completed in 28-35d.

*O. mercator* is difficult to distinguish morphologically from its sibling species *O. surinamensis*, the saw-toothed grain beetle, but the latter is more usually associated with cereal products.

***Trogoderma granarium* Everts  
Coleoptera:Dermeestidae**

**Common name: khapra beetle**

This species is tolerant of hotter, drier conditions than many other storage pests and is commonly found in semi-arid areas of Africa, West Asia and northern India. It has not been recorded from Southeast Asia, South America, or Australasia. The adults are oval in shape, 2-3 mm long, and dark brown with black mottling (Fig. 4). Their dorsal surface is covered with fine hairs. Adults live for about 14 d and do not feed or fly. The larvae are straw-colored and from the 4th instar onwards have dense tufts of hair on each abdominal and thoracic tergite.

The bionomics of this species on groundnut have not been rigorously examined in the laboratory, and the optimal conditions for its development are still a matter for debate. Its more common occurrence in hot, dry areas is generally attributed to its inability to compete with faster-breeding species in more humid environments.

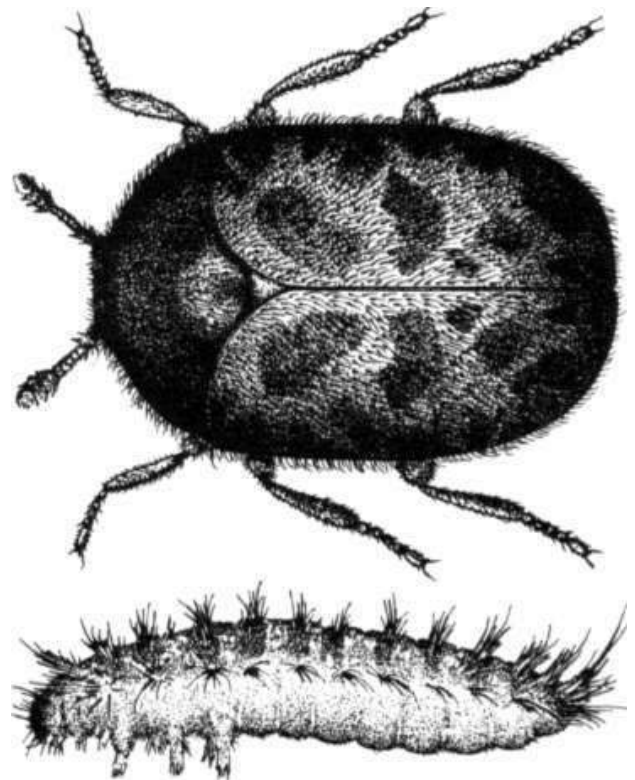

**Figure 4. Khapra beetle (*Trogoderma granarium*) adult (x20) and larva (\*10).**

Some larvae of certain strains can enter diapause in response to adverse conditions, e.g., extremes of temperature or overcrowding. When almost mature, the prediapause larvae often leave the stored commodity to enter crevices in the storage structure where they can remain without feeding for many months. In this state, metabolic activity is low and the larvae are extremely resistant to insecticides. Complete disinfection is difficult and for this reason many countries reject consignments of a commodity found to be infested by this species.

**Elasmolomus sordidus (Fabricius)**  
**Hemiptera:Lygaeidae**

**Synonym: Aphanus sordidus (Fabricius)**

This bug is widespread in tropical Africa and India, occurring on pods left drying in the field and in store. The adult is dark brown, approximately 10-mm long, and 2-mm wide (Fig. 5). In the field females lay their eggs in the soil or on groundnut haulms but, in store, eggs are laid loosely among the groundnuts or in sacking. The first instar nymphs have a bright red abdomen; later instars become progressively darker. All stages feed on kernels, perforating the pod with their rostrum. This causes the kernels to shrivel (Plate c) and increases the free fatty acid content of the oil, producing a rancid flavor.

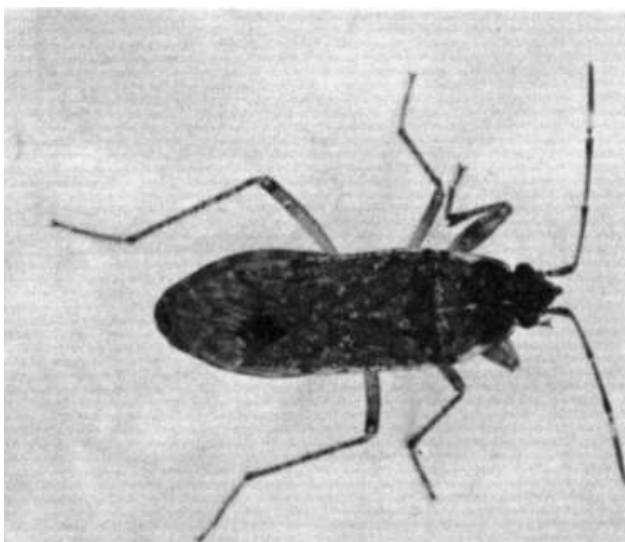

**Figure 5. Elasmolomus sordidus adult (x5).**

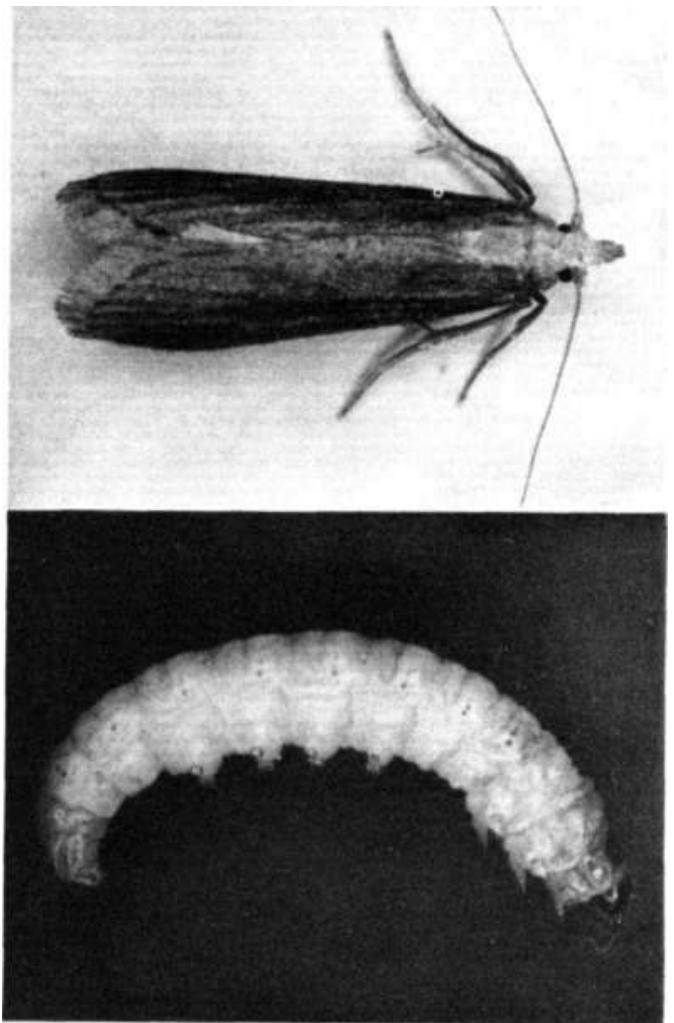

**Figure 6. Rice moth (Corcyra cephalonica) adult (x5) and larva (x5).**

**Corcyra cephalonica (Stainton)**  
**Lepidoptera:Pyralidae**

**Common name: rice moth**

This species has the ability to develop at low humidities (< 20% RH). This may account for its prevalence in the SAT over other stored product lepidopteran pests. The adult is brown and 12-15 mm long with its wings folded (Fig. 6). The labial palps point directly forward and are long and pointed in the female, but short and inconspicuous in the male. The adults do not feed. Females live for 1-2 weeks and scatter their eggs among the produce. The larvae are capable of damaging intact kernels and feed both on the surface and within seeds. They spin a tough silken fibre,



webbing together kernels, frass, and cast larval skins (Plate d). This type of contamination, easily distinguished from the fine dust that results from beetle infestation, may be of greater economic importance than the weight loss caused by larval feeding.

Pupation takes place either within the food source, in sacking, or in crevices in storage structures. At 28°C and 70% RH the life cycle from egg to adult takes 40-50 d. Male moths emerge, on average, 1-2 d before females.

**Ephestia cautella (Walker)**

**Lepidoptera:Pyralidae**

Common names: tropical warehouse moth, almond moth

Synonym: *Cadra cautella* (Walker)

This is a pest of many stored commodities throughout the tropics but is less common in arid areas. The adults are greyish-brown with an

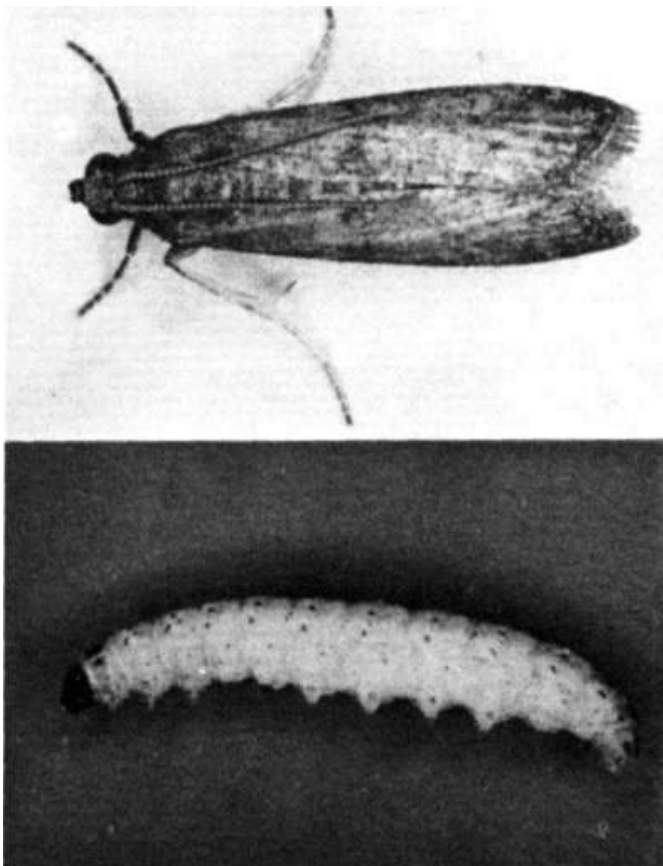

**Figure 7. Tropical warehouse moth (*Ephestia cautella*) adult (x8) and larva (x6).**

indistinct pattern on the forewings (Fig. 7). This moth is smaller than *C. cephalonica*, being 6-9 mm long at rest. The labial palps in both the male and female point upwards. Its life cycle is similar to that of other moths infesting stored products. The larvae are extremely mobile and move freely through the produce, contaminating it with fine silk webbing. At 28°C and 70% RH the life cycle takes 40-50 d.

**Plodia interpunctella (Hubner)**

**Lepidoptera:Pyralidae**

**Common name: Indian meal moth**

This species appears to be more prevalent in cooler areas of the tropics, e.g., highland regions. Its habits and life history are similar to those of the moth species already described. The adult larvae are easily recognized by the markings on their forewings: the basal third is cream-colored while the rest is reddish-brown. Adults are 8-12 mm long at rest, with labial palps that point directly forwards (Fig. 8). Under adverse conditions, e.g., extreme temperatures or overcrowding, the life cycle may be prolonged by a larval diapause. During diapause, normal applications of insecticides, especially fumigants, may prove ineffective.

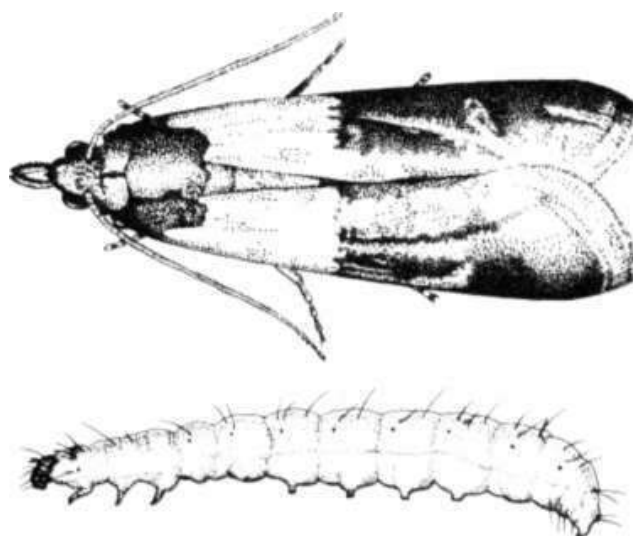

**Figure 8. Indian meal moth (*Plodia interpunctella*) adult (x6) and larva (x5).**

## Other species

*Tenebroides mauritanicus* (L.)  
Coleoptera:Trogossitidae

*Lasioderma serricorne* (F.)  
Coleoptera:Anobiidae

*Latheticus oryzae* Waterhouse  
Coleoptera:Tenebrionidae

*Cryptolestes* spp  
Coleoptera:Cucujidae

*Alphitobius* spp  
Coleoptera:Tenebrionidae

*Carpophilus* spp  
Coleoptera:Nitidulidae

These species occasionally infest stored groundnuts but are only considered to be of minor importance. They usually occur in association with one or more of the major pests described above. Illustrated keys for their identification can be found in TDRI (1984) and Freeman (1980).

## Detection of Insect Pest Populations

It is very important to detect low-level infestations of storage pests if control measures are to be implemented in sufficient time to prevent losses. The use of traps for this purpose often requires less time and effort than more conventional methods of inspection, such as 'spear' sampling. Traps cause less damage to the commodity, and will often provide the first evidence of an infestation that has developed between store inspections. Although insect traps are effective in detecting infestations, it is difficult to estimate insect population density from trap catches. A variety of traps are available differing in cost, sophistication, and in the range of insects attracted to them.

## Sticky traps

Any surface coated with a sticky substance (such as petroleum jelly, or the polybutene gel usually sold as bird repellent) that prevents an insect from leaving after landing on it can be used as a sticky trap. Several trap designs include the use of a pheromone source. Although these may vary in shape, the basic design (similar to that shown in Figure 9) has a pheromone source suspended near a surface covered in a sticky substance. A 'fly paper' baited with the sex pheromone component common to *Ephestia* spp. and *P. interpunctella*, is available. (Moth Indicator® from Detia, P.O. Box 10, 6941 Laudendbach/Bergstrasse, Federal Republic of Germany.)

Sticky traps should be suspended from the store roof, to hang above or between stacks or heaps of groundnuts. One problem with the use of these traps in stores is the short effective life of the sticky surface which soon becomes covered in dust. This will be a particular problem if a trap is placed near a groundnut decorticating unit.

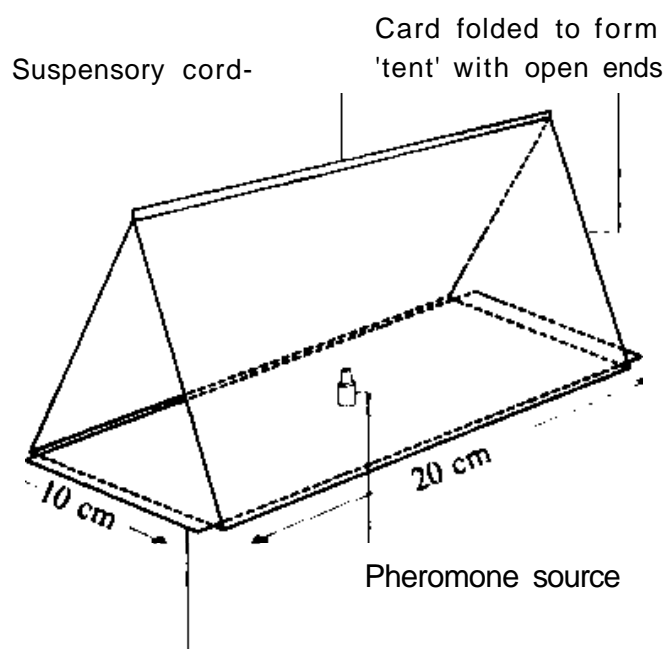

Removable card coated on upper surface with sticky polybutene gel

Figure 9. Sticky trap for flying insects. Adapted from Figure 11, Anon. 1983. Courtesy of TDRI.

## Refuge traps

These traps can be made from waste material such as cardboard packaging. They provide a refuge for insects such as moth larvae which habitually leave the food source to pupate in sacking or in crevices in the storage structure. Refuge traps should be placed around the base of sack stacks and between surface sacks. Insects will be prevented from leaving the trap if the

interior is sprayed with insecticide. These traps can also be made more attractive to a given species by baiting them with the appropriate aggregation pheromone. A trap similar to that shown in Figure 10, baited with the aggregation pheromone of *T. granarium*, is commercially available. (Trogotrap® from Degesch AG, 32-40 Weissmüllerstrasse, D-6000 Frankfurt, Federal Republic of Germany.)

Folded trap,  
corrugations inside,  
held together with rubber band

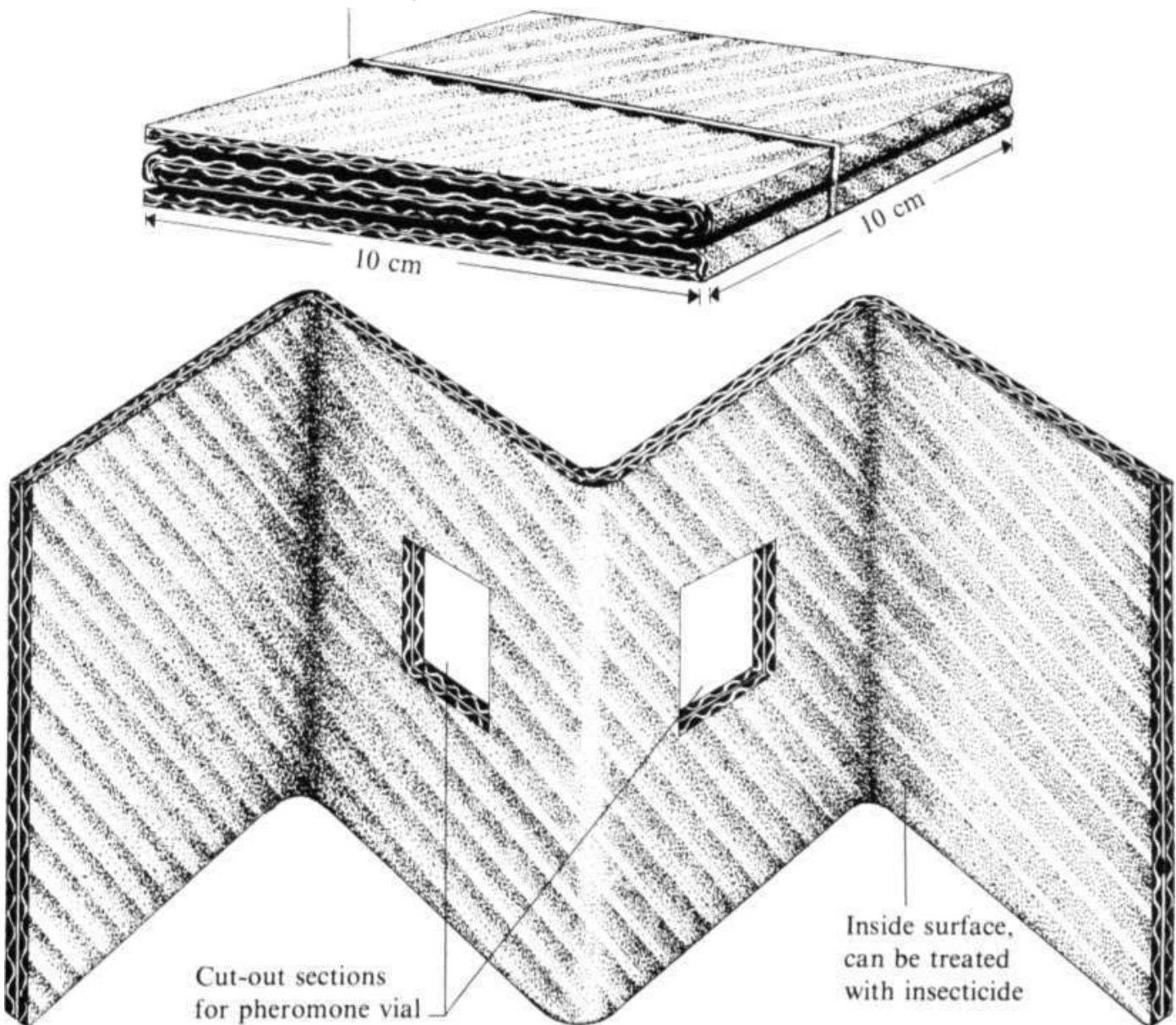

Figure 10. Refuge trap made from corrugated cardboard that can be baited with a pheromone. Adapted from Figure 2, Anon. 1983. Courtesy of TDRI.

## Light traps

These traps are most efficient at detecting moth infestations since the adults are attracted to the light when they leave the produce in order to fly and mate. This is not the case with stored product beetles, however, which often remain deep within the commodity for generations and leave only when conditions become unsuitable, e.g., as a result of high population density or high temperature.

Light sources of high intensity but low wattage are most suitable for attracting insects inside a food store. Ultraviolet (300-400 nm) and green light (500-550 nm) appear to be the wavelengths most attractive to storage pests. Ultraviolet (uv) tubes of suitable size and wattage (6, 15, or 32 W) are commercially available. Tubes or bulbs that

emit green light are less easy to obtain but can be made by covering white light sources with a heat-resistant green filter. These light sources can be operated at 110/240 V AC (mains electricity) using a choke, or 12 V DC (car battery). To save power they need only be operated when insects within the store are most likely to be flying, i.e., for 2-3 h around dusk.

In stores, unidirectional traps are most convenient since these can be wall- or ceiling-mounted, to avoid interference in stock movements. A simple trap of this type, developed at the Tropical Development and Research Institute (TDRI, Storage Department, London Road, Slough, UK) consists of two baffles of wood or metal, painted white and positioned on either side of a straight 6 W uv light tube (Fig. 11). Polythene sleeves coated on one side with sticky polybutene gel are placed over the baffles. Insects are attracted to the light, collide with the baffles, and are caught on the glue. The plastic sleeves can be easily removed to examine the catch.

Lightproofing the store will prevent large numbers of other species being attracted to the trap from outside. The efficiency of a light trap can also be improved by mounting a fan with a collecting funnel behind the light source. However, such a trap may prove impractical in many storage situations in the tropics as it requires a mains electricity supply and regular maintenance.

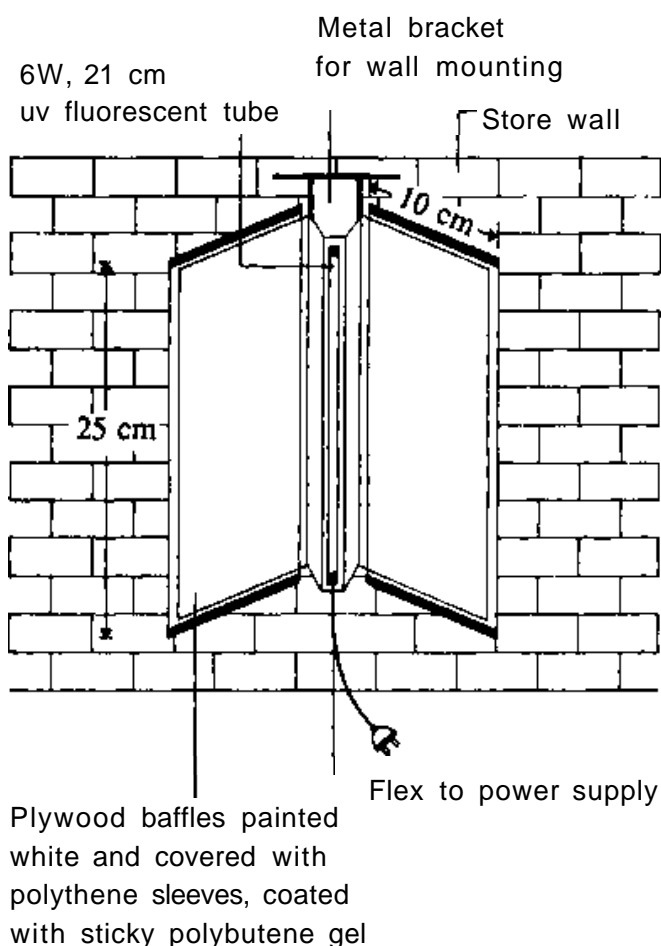

**Figure 11.** Simple, wall-mounted, unidirectional light trap developed by TDRI for use in stores. Adapted from Figure 7, Anon. 1983. Courtesy of TDRI.

## Pitfall traps

Some pests of stored products, for example, *Tribolium* spp, cannot climb smooth surfaces such as glass. Therefore, a small glass test tube or vial buried up to its lip in a bulk of groundnuts will trap adult *Tribolium* which fall into it while walking across the surface of a heap of pods or kernels. A pitfall trap has also been developed for insertion into bulked commodities (Fig. 12). This consists of a metal tube 20-cm long, the top half of which is perforated with holes that allow insects, but not the commodity, to fall into the tube. Insects passing through the holes fall into a glass tube in the lower half of the trap, which

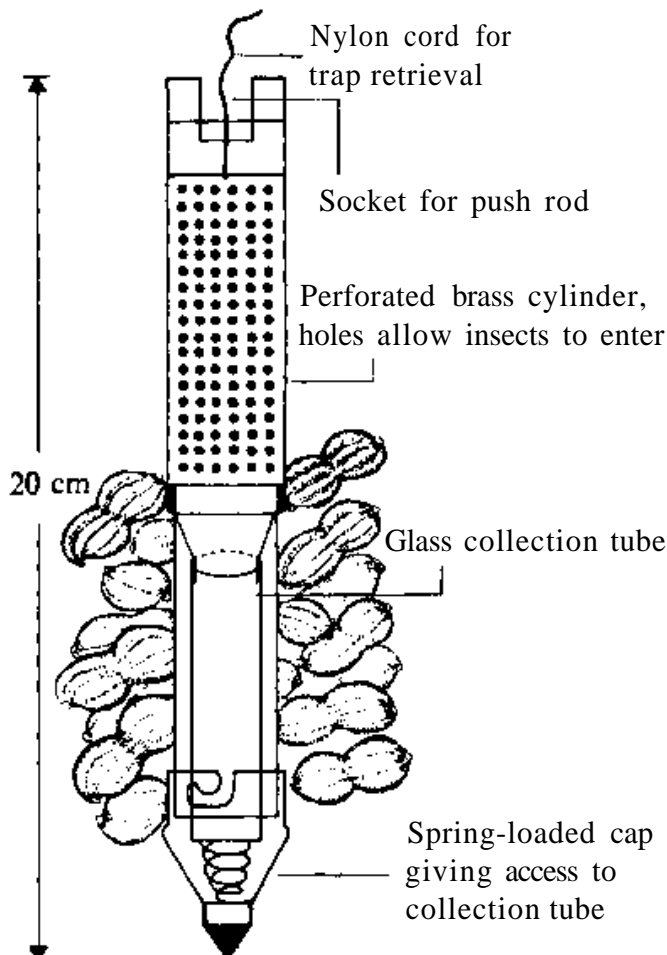

**Figure 12. Pitfall trap suitable for use in bulk groundnuts. Adapted from Loschiavo and Atkinson 1973.**

could contain a small pheromone source. The trap is inserted into the grain with a pushrod and retrieved using a cord attached to the top of the trap.

### Loss Assessment

If any of the pest species described above are found, either in traps or in stored groundnuts, it is likely that some damage will have been caused to the kernels. Methods of estimating the extent of storage losses are outlined here, with particular emphasis on standard techniques that require a minimum of equipment. Only quantitative loss is dealt with because the techniques presently available for assessment of qualitative loss are less well defined. Where the methods described are applicable to a number of different crops, the term 'grain' is used synonymously with groundnut 'pod' or 'kernel'.

### Sampling

In estimating the losses caused by insect pests to a consignment of any stored commodity, it is not practical to examine every grain. Measurement of the loss to the commodity as a whole has to be based on the loss recorded from a number of samples. These samples cannot simply be removed from the commodity where it is most accessible, e.g., from the top of a sack, or from the surface of a large heap. Insect infestations are seldom uniformly or even randomly distributed within a stock of stored grain. Thus, to obtain samples that give a true indication of the loss, methods must be used which ensure that every grain has an equal chance of selection.

The theoretical principles of representative sampling should be applied to all types of groundnut storage regardless of the scale of the storage operation. However, the practical problems involved will differ with the storage situation.

**Sack storage.** Sampling from grain stored in sacks usually involves numbering all the sacks in a stack or warehouse, and using random numbers to decide which of the sacks are to be sampled on any one occasion. With large consignments, the conditions of storage may vary markedly between the sacks, e.g., the temperature at the center of a stack may be different from that at the surface. These differences should be taken into account by using a 'stratified' sampling procedure. At its simplest, this involves the division of a single stack into a number of layers (or strata), each containing the same number of sacks. A given number of sacks in each layer is then chosen at random for sampling.

As a practical guide, the optimum number of sacks to be sampled from consignments of differing size is as follows:

- 10 sacks or less, sample each sack;
- between 11 and 100 sacks, sample 10 sacks;
- more than 100 sacks, the number to be sampled equals the square root of the total.

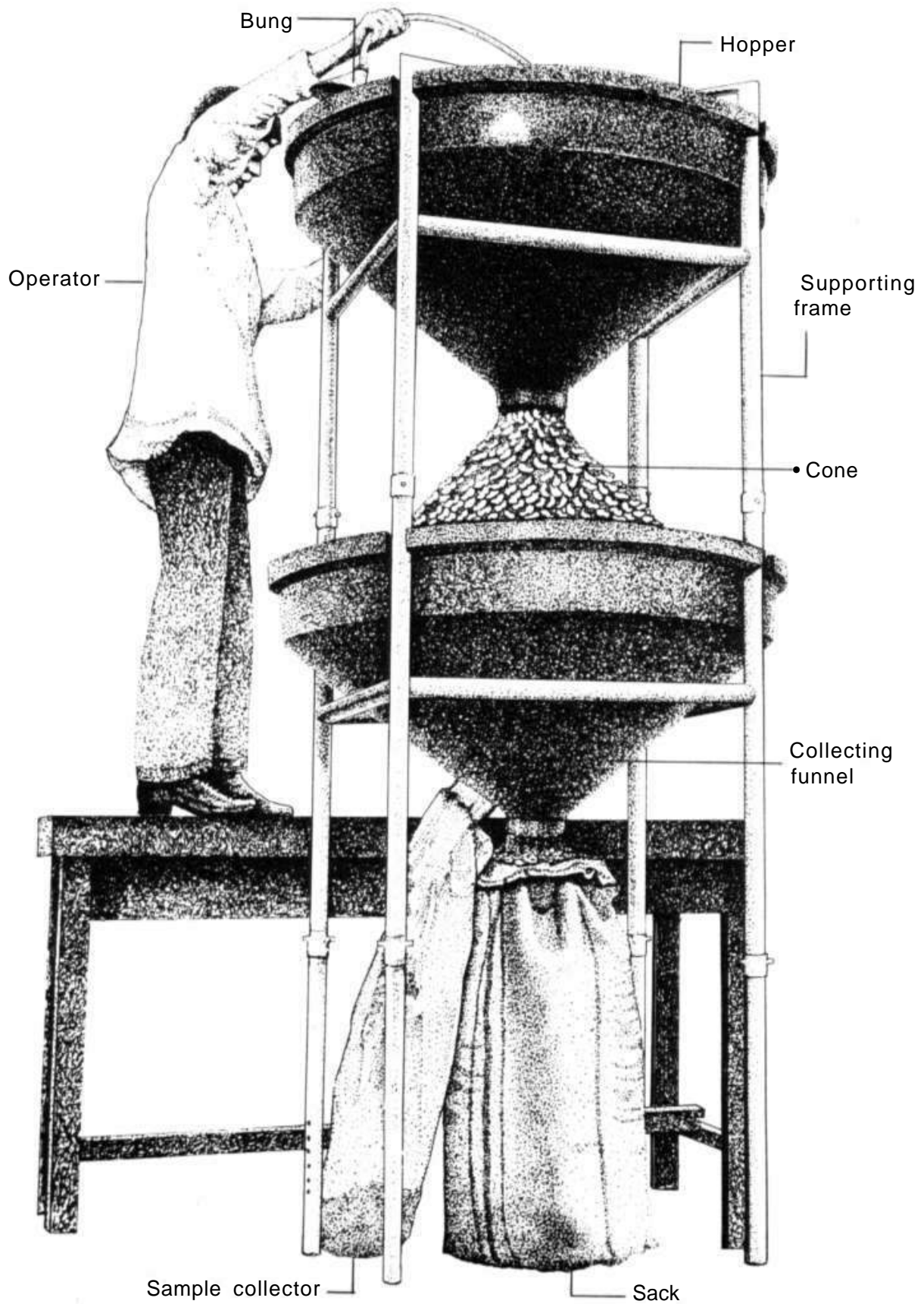

Figure 13. TDRI Produce Flow Sampler used for sampling bagged groundnuts. Adapted from Ashman 1973. Courtesy of TDRI.

Ideally, the sacks will be numbered and the first samples removed, when the consignment is being placed in storage. This provides a baseline measure against which the losses recorded in subsequent samples can be compared. Once the sacks have been stacked many of them are inaccessible. To obtain representative samples, the stack must be dismantled and this will inevitably involve some expenditure on labor and disruption of normal stock movements within the store. When stacks are broken down for sampling, the sacks should be replaced in their original positions so that the distribution of insects within the stacks is affected as little as possible. It is stressed that if samples are taken only from the most accessible sacks then the loss measurements obtained only represent that part of the total bulk from which they were collected. Similarly, if stocks are removed during the survey then loss levels in subsequent samples must be applied only to that part of the original material still in store.

Just as each sack to be sampled must be selected without bias, every grain within a sack must have an equal chance of inclusion in the final sample. Specialized equipment is available for removing representative samples from sacks of groundnuts, e.g., the TDRl Produce Flow Sampler (Fig. 13), or for reducing the size of large samples without bias in the laboratory, e.g., Boerner or Garnet® dividers (Fig. 14a and 14b). However, some sampling devices in widespread use, such as sack 'spears' or probes, do not provide representative samples and can give misleading results (Golob, 1976).

If no suitable equipment is available then representative samples can be obtained by 'coning and quartering'. This involves emptying a sack onto a smooth surface, thoroughly mixing the pods or kernels by hand and forming a cone-shaped heap which is then divided into quarters using a flat board. Two opposite quarters are returned to the sack. The remaining two are recombined and the process is repeated until a sample of the appropriate size is obtained (Fig. 15).



**Figure 14a. Boerner divider, approximately 1 m high, used in laboratory sampling.**

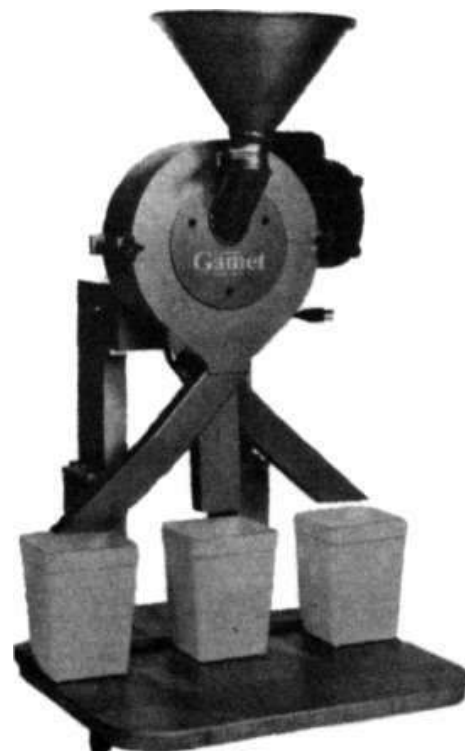

**Figure 14b. Garnet® divider, approximately 1m high, used in laboratory sampling.**

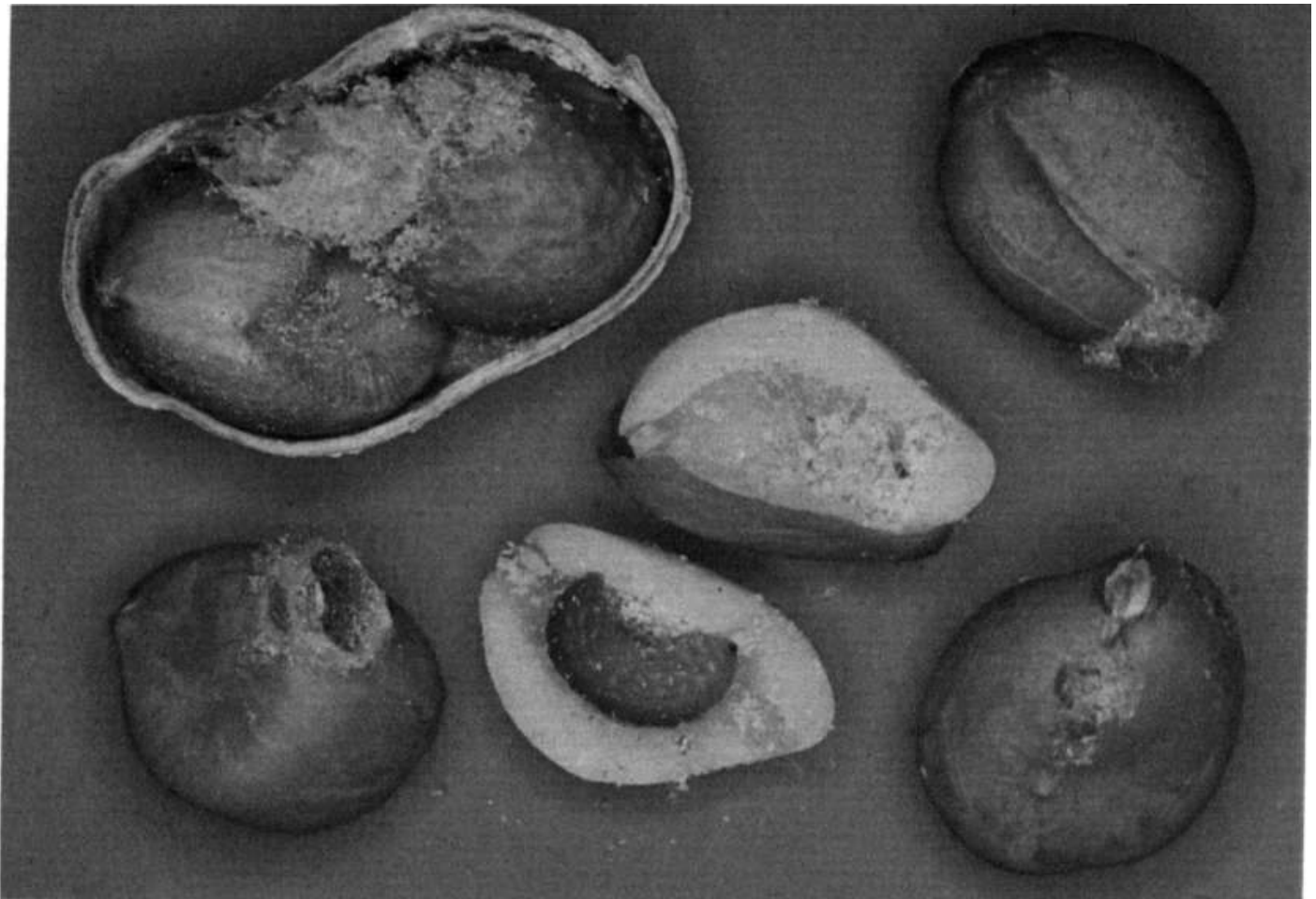

**Plate a.** Groundnut kernels damaged by *Caryedon serratus*. Note larval feeding site inside cotyledons, pupal cocoons formed largely inside kernels, and cocoon between kernel and pod wall.

**Plate b.** Groundnut kernels damaged by *Tribolium castaneum*. Note holes in testae and fine dust-like frass typical of beetle infestations.

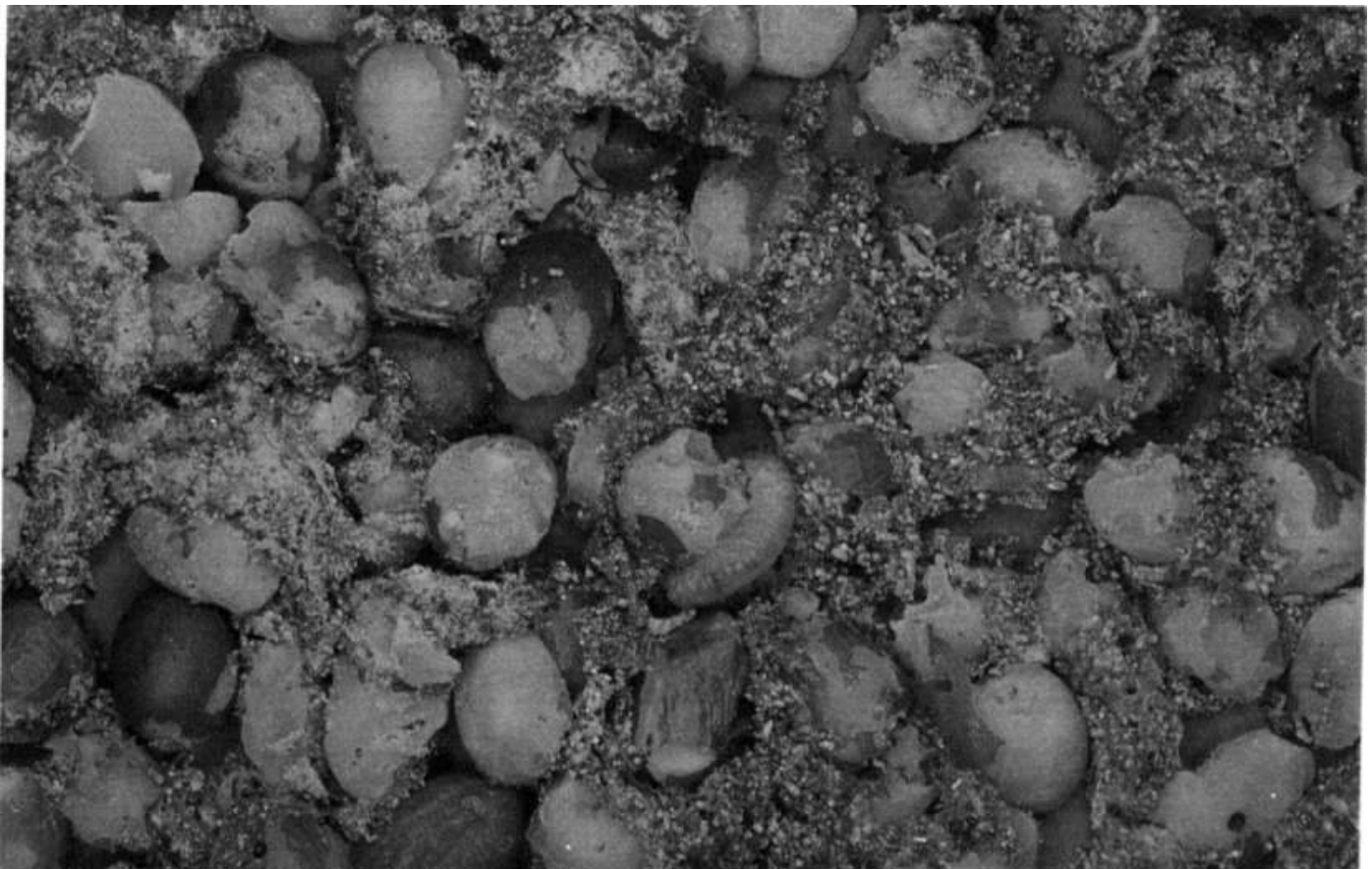





**Plate c.** Groundnut kernels (left) shrivelled as a result of feeding by *Elasmolomus sordidus*. Fungal invasion is common where the bug has penetrated the testa.

**Plate d.** Groundnut kernels damaged by *Corcyra cephalonica*. Exposed cotyledons, coarse frass and masses of webbing are typical of moth infestations.



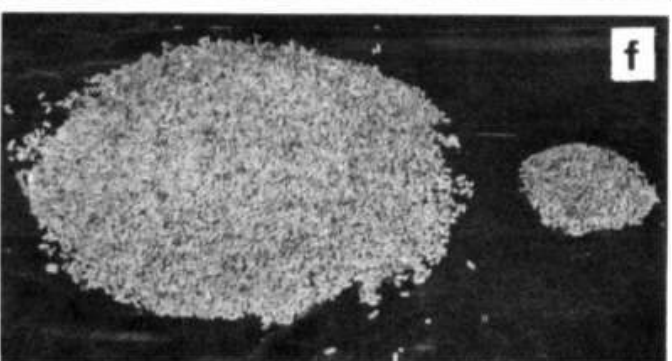
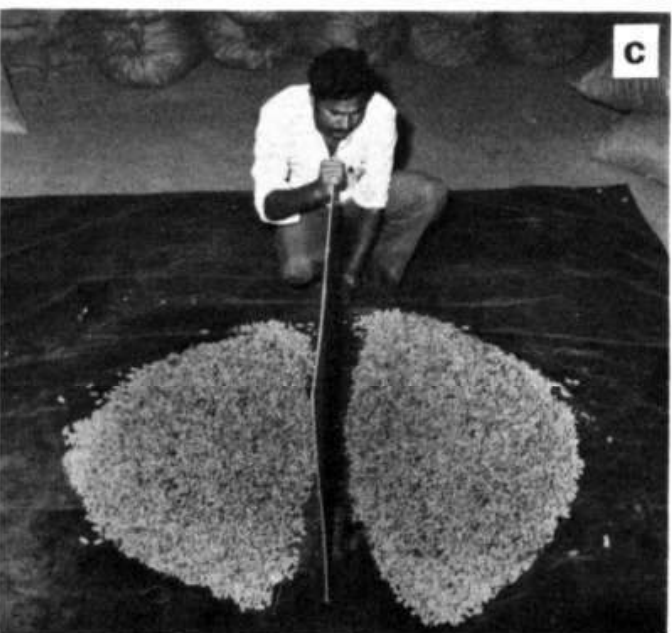
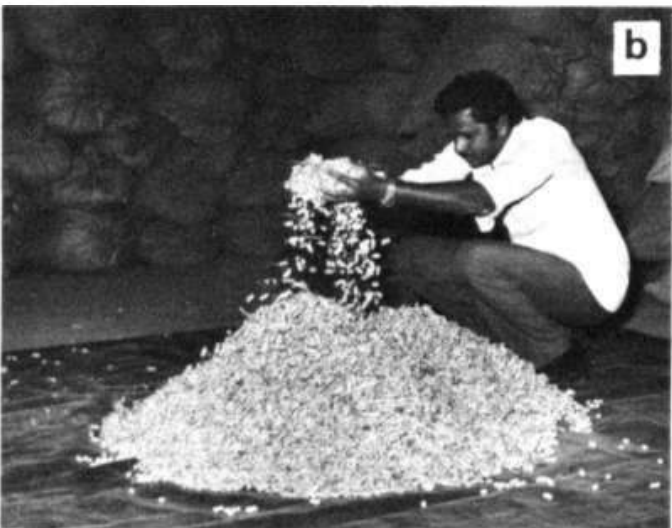

Figure 15. Coning and quartering technique for representative sampling without equipment; a. forming cone; b. mixing pods; c. halving; d. quartering; e. returning opposite quarters to sack; f. remaining quarters remixed (left), and approximate size of final sample (right).

**Bulk storage.** Representative samples can be accurately taken from groundnuts in sacks, because the consignment to be examined can be divided into easily identifiable units (the sacks) which can then be numbered and sampled at random. To some extent, this can also be done with bulk storage, when the store is being filled. The containers used to transport the crop to the store can be designated as the sampling units, these can be numbered and then selected at random for sampling. Thereafter, this division of the bulk into readily defined units is lost and it is not practical to use the same methodology as that recommended for sack stores.

Where the dimensions of the bulk store are known, it may be possible to use a systematic sampling procedure similar to that recommended for the inspection of railway wagons (Fig. 16). Such a sampling procedure is of little value, however, unless samples can be obtained

Container < 15 tonnes capacity :  
five sampling points (middle, and  
approximately 50 cm from sides).



Container 15 to 30 tonnes capacity  
eight sampling points.

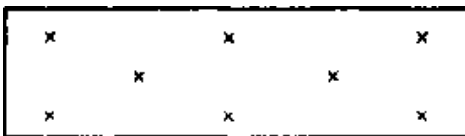

Container 30 to 50 tonnes capacity :  
eleven sampling points.



**Figure 16. Recommended sampling positions in bulk grain containers. Based on Anon. 1983. Courtesy of TDRI.**

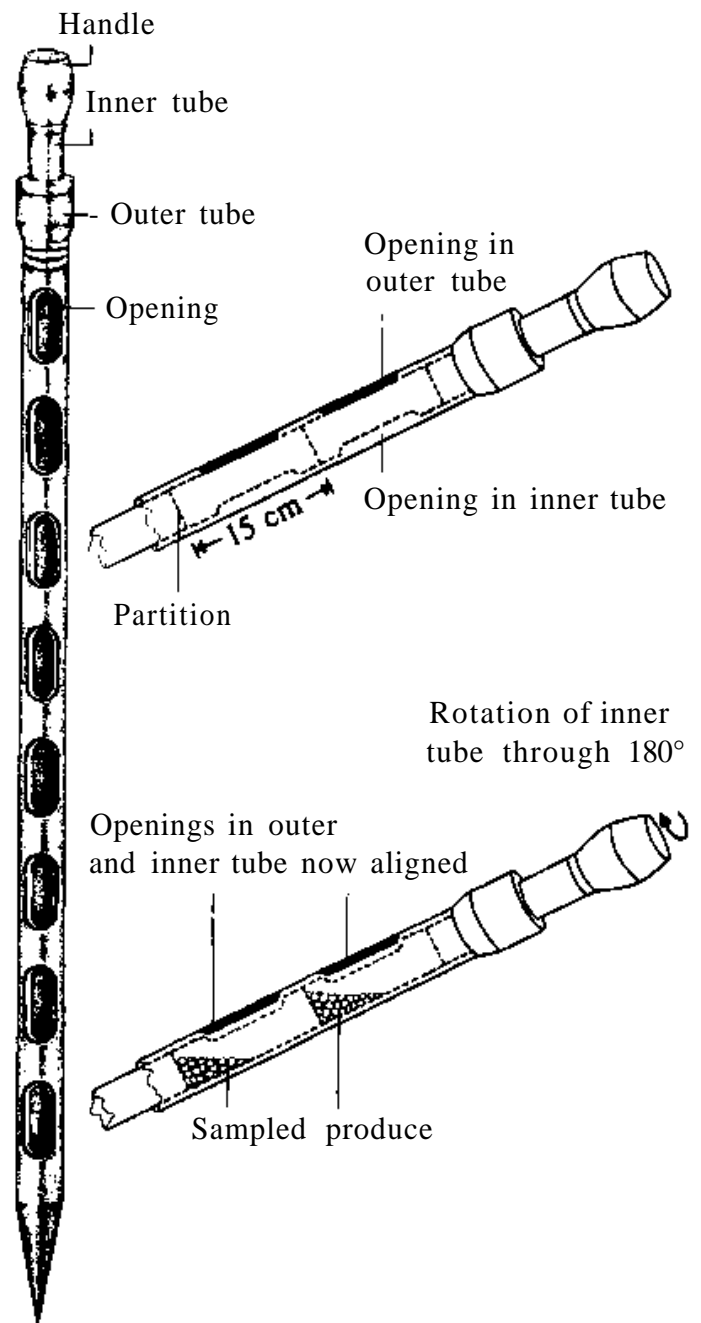

**Figure 17. Double-tube sampling spear designed for use with small-grained commodities.**

from below the surface of the bulk. This can be done using a variety of devices. The simplest of these is the double-tube sampling spear (Fig. 17). These can be up to 3.7-m long, and as the collecting tube is divided into a number of compartments it is possible to record the depth from which each part of the sample was removed.

However, even with this equipment it may not be possible to reach the bottom of a large heap or container, where some insect species tend to accumulate, and where damage can be most severe. Thus, the samples obtained with the spear may not be representative and data so collected can only be applied to that part of the produce from which samples were removed.

Most of the devices available for sampling from deep bulk stores were designed for use with small-grained commodities such as wheat and rice. It is doubtful whether they would work effectively for in-shell groundnuts without adapting the standard design.

### Quantitative loss determination

Experience has shown that sampling at monthly intervals is generally sufficient. When a delay between sample collection and analysis is expected the samples should be placed in plastic bags with a drop of liquid fumigant such as carbon tetrachloride in order to prevent further development of the insect population in the sample.

There are several acceptable methods for estimating the mass (weight) loss to stored cereals and pulses caused by insect infestation. There is, however, little experience in using any of these methods with groundnuts. The procedure selected depends on factors such as the availability of equipment and the estimated number of samples to be collected. Whichever method is chosen, groundnut samples must be shelled before mass loss can be assessed. As the wet mass of groundnuts will change with the ambient RH it is usually necessary to perform the calculations using the dry mass of each sample. This can be obtained either by placing a subsample of the groundnut kernels in a suitably calibrated moisture meter, or by drying a number of subsamples (5 x 10 g) in an oven at 103 ± 2°C for 16 h.

**Standard volume/mass method.** The accuracy of this method depends on obtaining an exact standard volume of grain using a simple apparatus called a chondrometer (Fig. 18), that drops an amount of grain from a fixed height into a

container of precise volume. The technique relies on the assumption that the volume occupied by the same number of damaged or nondamaged grains will be identical, but the mass of this standard volume will decrease as the level of damage increases.

The relationship between the dry mass and the moisture content of the standard volume of non-damaged grain at the time of storing is plotted on a graph. The dry mass of standard volumes of grain from later samples can then be compared to that of the initial sample, and the percentage mass loss calculated as follows:

$$\% \text{ dry mass loss} = \frac{D1 - DX}{D1} \times 100$$

where:

D1 = dry mass of the standard volume at the beginning of the experiment (read from the graph using the same moisture content as that obtained for DX), and

DX = dry mass on occasion X.

In large-scale surveys, which may include numerous sampling sites and different crop varieties, grain size often varies markedly between samples and a single volume/mass relationship cannot be applied to all the samples.

The standard volume/mass method can be adapted to allow for situations where baseline samples could not be collected. Each sample can be divided into damaged and apparently non-damaged portions. The mass loss is the difference in dry mass between the nondamaged and damaged portions. With this 'adapted' method relatively large samples (> 1 kg) may be required in order to obtain enough damaged or nondamaged grain to measure the mass of the standard volume.

Use of a chondrometer will only provide accurate results if damage does not affect the packing of grains in the measuring container. If packing is affected, the mass of the standard volume may actually increase as the damage levels increase.

When the 'adapted' method is used, 'hidden' infestation, e.g., by *C. serratus*, can result in an underestimation of losses because grains with such an infestation are included in the nondam-

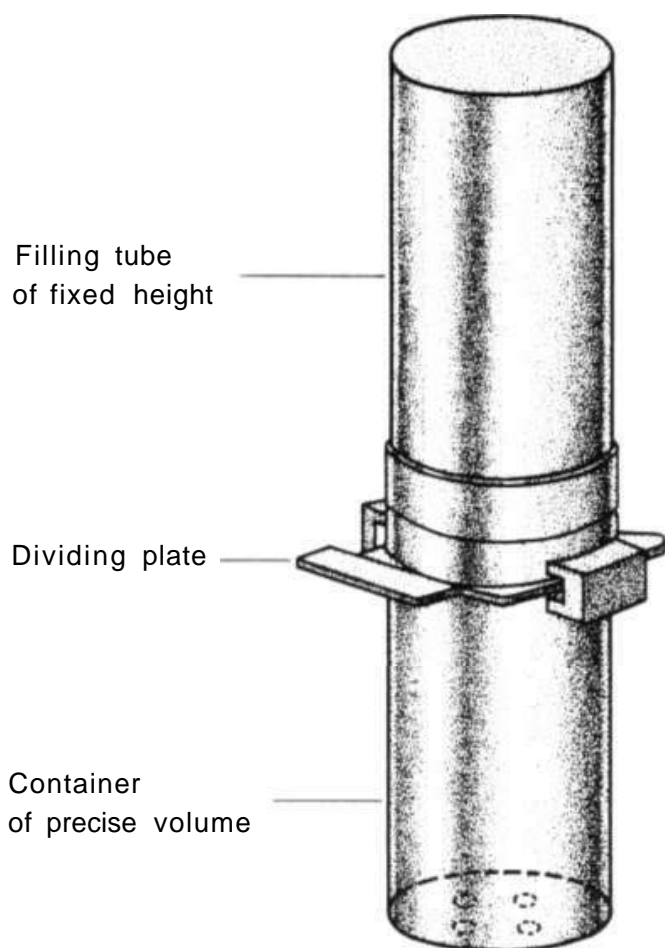

**Figure 18. Chondrometer for use in standard volume/mass method of quantitative loss assessment, approximately 30 cm high.**

aged portion of the sample. Use of this method introduces another source of error because it assumes that insects select grains at random either for feeding or oviposition or both; an assumption known to be invalid for certain species.

**Thousand-grain mass (TGM) method.** In this method, a sample taken when the commodity was placed in store is weighed, the number of grains counted and their moisture content determined. The dry mass of 1000 grains is then obtained using the formula:

$$\text{TGM} = \frac{1000 \times m \times (100-H)}{N \times 100}$$

where:

m = wet mass of the working sample;

H = percentage moisture content of the grain;

and

N = number of grains in the working sample.

The mass loss to subsequent samples as a result of infestation is calculated by using the formula:

$$\% \text{ dry mass loss} = \frac{M1 - MX}{M1} \times 100$$

where:

M1 = TGM of the grain at the beginning of the study; and

MX = TGM of the grain on occasion X.

This method resembles, in part, other procedures that relate numbers to mass of grains but does not involve separation of 'damaged' and 'nondamaged' grains or adjustment of the working sample to an exact mass or volume. It thus avoids several possible sources of error or bias.

**Count-and-weigh method.** This method involves weighing and counting only, and generally requires smaller samples than the standard volume/mass method. Each sample is divided into damaged and nondamaged portions. The grains in each portion are then counted and weighed, and the moisture content of the sample determined. Mass loss is calculated as:

$$\% \text{ dry mass loss} = \frac{(UNd) - (DNU)}{U(Nd + Nu)} \times 100$$

where:

Nu = number of nondamaged grains;

Nd = number of damaged grains;

U = dry mass of nondamaged grains; and

D = dry mass of damaged grains.

As this method involves the separation of damaged and nondamaged grains, the same sources of error are present as in the shortened standard volume/mass method. However, it does have an advantage over the other methods described here in that it allows damage by different species to be separately assessed. The information thus obtained could be of importance in determining the most effective control measures.

The count-and-weigh method was used to assess losses to in-shell groundnuts stored in sacks at an oil mill warehouse near Kurnool in Andhra Pradesh, India. The full procedure

employed in the laboratory analysis is given in Figure 19. After 5 months in store there was a 20% loss in dry mass of kernels. This was almost entirely due to damage caused by *C. serratus*.

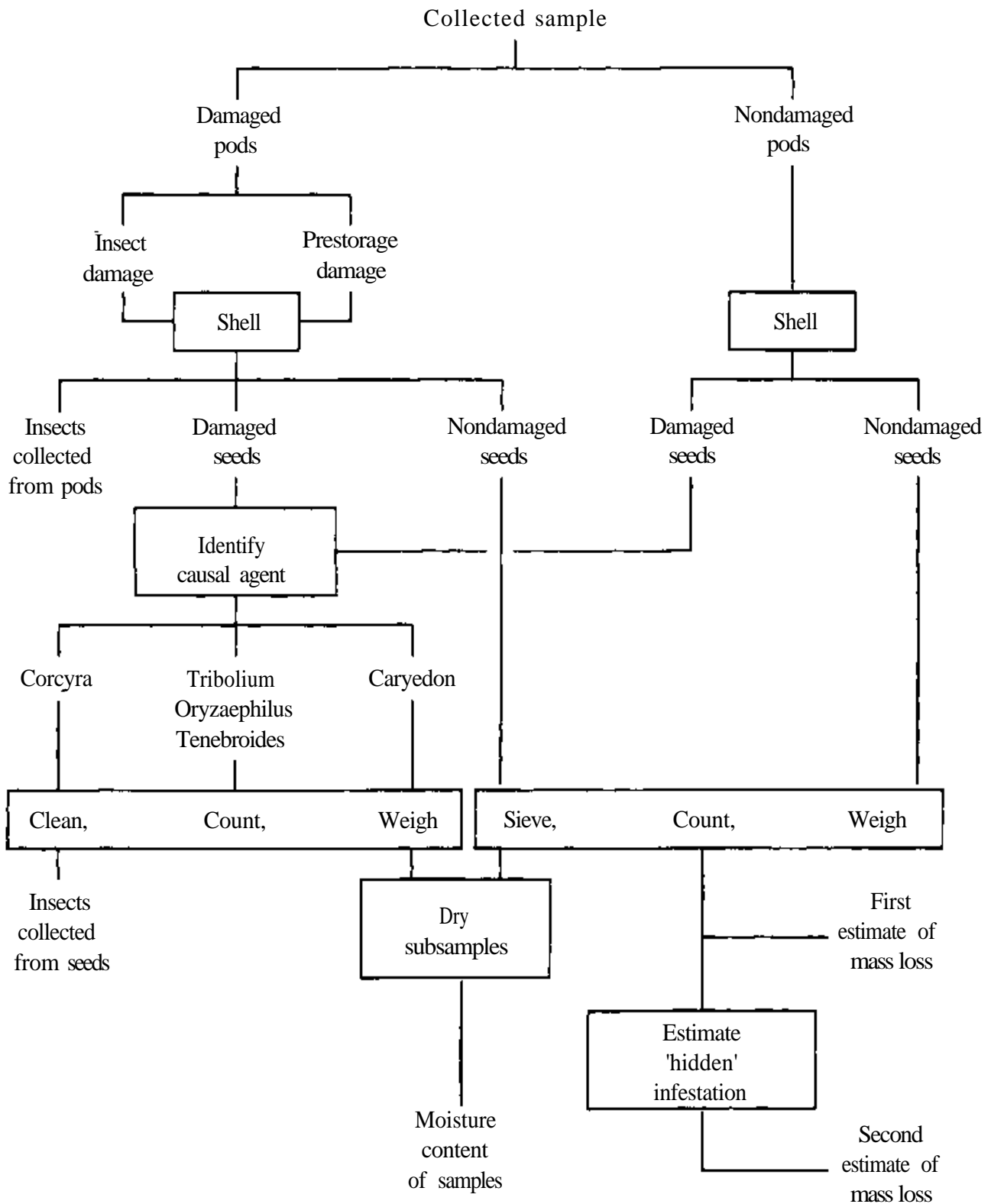

**Figure 19.** Flow chart of laboratory analysis procedure used to assess losses to in-shell groundnuts by count-and-weigh method.

The mass loss caused by early instar larvae (hidden infestation) was estimated by dissecting subsamples of kernels initially classed as non-damaged and recording the numbers containing larvae. The mean mass of kernels containing hidden infestation was obtained by taking an average of the masses of 'damaged' and 'non-damaged' kernels. These values were used to estimate the total number and mass of kernels with hidden infestation and the mass loss caused was calculated using the formula given above. The results showed that if hidden infestation was ignored, losses were underestimated by 1-2% of the initial dry sample mass.

## Insect Pest Management

In the SAT the high cost of insecticides, the frequent nonavailability of suitable formulations and packaging, and the increasing incidence of insecticide resistance necessitates an approach to postharvest pest management based on good storage practice. When determining the need for insecticide application, the economically acceptable level of insect infestation must be considered. This will depend on whether the groundnuts are destined for oil production, local consumption, resale as seed, or export.

### Prevention of infestation

Good storage management and hygiene are of great importance in preventing insect infestation of stored produce. Groundnuts must be dried properly after harvest, to reduce the moisture content of the kernels to below 7%, the upper limit for safe storage. At high moisture levels, insect populations develop more rapidly and there is an increased risk of invasion by toxigenic fungi, with a consequent danger of aflatoxin contamination.

Before stores are refilled they should be thoroughly cleaned and the residues from the previous crop removed and preferably burned. If the store or container is known to have held infested stocks then it is advisable to apply an

insecticide to the interior surfaces of the store after it has been cleaned (Table 1). Alternatively, empty stores that can be made relatively gas-tight can be disinfested using dichlorvos as a space treatment. Aerosol formulations of this insecticide are available but these require the use of an aerosol generator. Strips of PVC impregnated with dichlorvos are cheaper and more convenient for use in small stores. Placed in a store at a rate of 1 strip 30 nr<sup>3</sup> these strips should control stored-product moths for 3 to 4 months.

Used gunny sacks should be checked for the presence of insects before they are filled again. If necessary, sacks can be disinfested by rolling them up together and placing them in a sealed oil drum with a single phosphine tablet.

In sack stores, stacks should be constructed on wooden pallets to reduce the possibility of ground water seeping into the bottom sacks. This would cause the groundnuts in these sacks to become moldy. To facilitate fumigation, the stacks should be of a uniform size, and a space of at least 1 m should be left between stacks. In oil mills or transit warehouses, consignments of different ages should be stacked separately and removed in sequence for processing or shipment, even if this involves extra expenditure on labor costs of stock movements.

**Pod storage.** As most postharvest groundnut pests are unable to penetrate intact pods, leaving the crop in the shell for as long as possible during storage is an effective method of limiting damage. *C. serratus* will, however, attack groundnuts stored as pods. Since infestation of clean stocks will usually begin in the surface layers of a stack or bulk of groundnuts, the application of an insecticide spray or dust will provide some measure of protection against this pest. In sack stores, the sacks on the surface of each stack can be sprayed with any of the insecticides recommended for residual application on store walls etc, although at a lower rate of application (Table 1). Spraying stacks layer by layer is likely to be more effective than a single surface spray but involves greater expenditure on insecticide and labor, and causes considerable interference with routine sack-stacking and stock movement.

**Table 1. Summary of chemical control measures for protection of stored groundnuts.**

Control operations	Insecticide common name and formulation <sup>1</sup>	Application rate of whole product with specified a.i. concentration <sup>2</sup>
Prevention of infestation		
Application of insecticidal spray to interior surfaces of infested stores before refilling	Malathion (w.p.) Fenitrothion (e.c.) Chlorpyrifos-methyl (e.c.) Pirimiphos-methyl (e.c.) Iodofenphos (s.c.) Deltamethrin (w.p.)	250 g 25% a.i. in 5L water 100 m <sup>-2</sup> 200 ml 50% a.i. in 5l. water 100 nr <sup>2</sup> 200 ml 50% a.i. in 5L water 100 nr <sup>2</sup> 200 ml 50% a.i. in 5L water 100 m <sup>-2</sup> 200 g 50% a.i. in 5L water 100 m <sup>-2</sup> 50 g 2.5% a.i. in 3.3L water 100 nr <sup>2</sup>
Space treatment of empty stores before refilling	Dichlorvos (resin strips)	1 strip 30 m <sup>-3</sup>
Direct application of spray to pods or to sacks containing pods or kernels	Malathion (w.p.) Fenitrothion (e.c.) Chlorpyrifos-methyl (e.c.) Pirimiphos-methyl (e.c.) Iodofenphos (s.c.) Deltamethrin + piperonyl butoxide (e.c.)	Apply at half the rate recommended above     10 ml in 990 ml water t <sup>-1</sup>
Surface application to, or admixture of insecticidal dust with pods	Malathion (dust) Deltamethrin (dust) Fenitrothion + carbaryl (dust) Bromophos (dust)	500 g 2% a.i. t <sup>-1</sup> 500 g 0.2% a.i. t <sup>-1</sup> 500 g 1.2% + 0.8% a.i. t <sup>-1</sup> 200 g 2% a.i. m <sup>-2</sup> of surface area
Control of established infestation		
Fumigation of bagged or bulk stocks in gas-tight stores, or under gas-tight sheeting	Methyl bromide + chloropicrin (gas) Phosphine (solid aluminium phosphide)	10-15 g m <sup>-3</sup> for 24 h (dosage increased for control of <i>T. granarium</i> ) 3-5 tablets or 15-25 pellets 57% a.i. t <sup>-1</sup> for 7-10 d.
Fumigation of small quantities of pods or kernels in polythene-lined sacks or containers such as oil drums	Phosphine (solid) Ethylene dibromide (liquid) Ethylene dibromide + carbon tetrachloride, 1:8 mixture (liquid)	2-3 pellets 100 kg <sup>-1</sup> for 7-10 d. 3 ml 100 kg <sup>-1</sup> 12 ml 100 kg <sup>-1</sup>

1. a.i. = active ingredient; e.c. = emulsifiable concentrate; s.c. = suspension concentrate; w.p. = wettable powder.

2. If other formulations are used with a.i. concentrations differing from those given above, the amount of whole product used must be changed accordingly.

The same insecticides can be applied to the surface layer of pods in bulk stores. Alternatively, dust formulations of insecticides such as malathion, fenitrothion + carbaryl, or bromophos can be applied to the surface (Table 1). Bromophos dust (2% a.i.) applied at a rate of 200

g m<sup>-2</sup> to the surface and base of large heaps of pods in the open air, effectively controlled *C. seratus* in Senegal (Pointel, Deuse and Hernandez, 1979). If necessary, small quantities of pods can be protected by the admixture of insecticidal dust. This should be done by emptying the



groundnuts onto a smooth surface, then adding the insecticide and thoroughly mixing the two with a shovel or similar implement.

**Kernel storage.** The decision on when to shell groundnut stocks is often based on factors other than good storage practice, e.g., the economics of transporting a crop destined for export. Groundnuts destined for confectionary use or for seed are often shelled soon after harvest so that imperfect or damaged kernels can be discarded. This increases their susceptibility to attack by a number of insect pests. The direct application of insecticides to shelled groundnuts is not recommended as this can result in the presence of unacceptably high levels of toxic residues. However, kernels in sacks can be protected in the same way as nonshelled stocks by applying one of the recommended insecticides as a spray or dust, to the outside surface of the sacks.

### **Control of established infestations**

If stocks are already infested when placed in storage then insects may be present in the center of a heap or stack before they are detected by trapping or inspection. When this occurs, the only effective method of disinfestation is by fumigation. This involves the introduction of an insecticidal gas into a gas-tight space around the infested produce. The chemicals used in these operations are volatile and highly toxic to man. It is essential that they are used correctly and that those performing the fumigation are properly trained, and aware of the hazards involved.

**Large-scale storage (>1t).** Some storage structures can be effectively sealed to prevent leakage of gas during fumigation. The entire contents of the store can therefore be fumigated at one time. In the majority of cases, however, the infested material must be covered with a gas-proof sheet (PVC, at least 0.25-mm thick; or polythene, at least 0.13-mm thick). Where more than one sheet is needed to cover a single stack, the sheets should be joined by tightly rolling

together at least 0.5 m of overlap. The edges of the sheeting round the base should be weighted down with sand bags to prevent gas escaping.

The most suitable fumigants for the treatment of large, bagged or bulk consignments are methyl bromide and phosphine (Table 1). Methyl bromide is usually applied from large cylinders under high pressure, and therefore requires specialized equipment. The recommended dosage is 10-15 g m<sup>-3</sup> for 24 h. In order to effectively control *T. granarium*, this dose should be increased to 15-25 gm<sup>-3</sup>.

There are drawbacks in using methyl bromide to protect stored groundnuts. Inorganic bromide is retained in the oil of groundnut kernels, so treated stocks must be promptly ventilated on completion of the operation, in order to minimize residues. Repeated application of methyl bromide can reduce the germination potential of groundnuts kept for seed, particularly if their moisture content is high.

Phosphine is usually formulated as tablets or pellets of aluminium phosphide that release phosphine gas when in contact with moisture in the air. Ideally, to achieve good control in bulk stores, phosphine should be added to the groundnuts as the store is filled at a rate of 3-5 tablets or 25 pellets t<sup>-1</sup>. However, this is safe only if the operation is completed within 1-2 h of exposure of the first phosphine tablets. If this is not possible, tablets can be scattered over the surface or introduced into the bulk produce using a special applicator. Similarly, with sack storage, tablets can be added to each layer of sacks as they are being stacked, provided the operation is completed within 1-2 h. Alternatively, the tablets can be placed around the base of the stack, or squeezed between sacks at the sides and top of the stack.

After a fumigation period of 5-10 d the produce should be aired thoroughly and if possible the spent fumigant should be removed. This is more easily done if the tablets are enclosed in paper envelopes when they are placed in position.

**Small-scale storage (<1t).** Phosphine can also be used to treat small quantities of infested

groundnuts, if these can be placed in gas-tight containers. One pellet (0.6 g) placed on top of groundnuts in polythene-lined sacks gave satisfactory control of insects infesting confectionary grade kernels awaiting export (Proctor and Ashman, 1972). Used oil drums, sealed with aluminium tape or strips of polyurethane foam, could also be used for this purpose.

One drawback to using phosphine for small-scale operations is that once the sealed container in which tablets or pellets are supplied is opened, all the tablets have to be used immediately. If not, the remaining tablets may start to decompose, giving off phosphine gas.

Liquid fumigants such as ethylene dibromide (EDB), carbon disulphide, and carbon tetrachloride (CTC) can be used instead of phosphine to fumigate small quantities of produce. In West Africa, CTC has been recommended for single-sack fumigations and is marketed for that purpose in 10 ml plastic ampules. However, CTC is more commonly used in admixture with other fumigants to increase their penetration of the commodity. In India, a 1:8 mixture of EDB: CTC (12 mL 100 kg<sup>-1</sup>) has been recommended for fumigating a wide range of commodities (Webley and Harris, 1977).

Owing to sorption of chemicals onto the commodity, fumigant dispersal can be a problem. Better results will be achieved if the liquid is applied at several points while the container is being filled. Great care should be exercised when dispensing these chemicals, as they are believed to be carcinogenic. Their use has been restricted in certain western countries resulting in a reluctance to recommend their use on stored commodities in the tropics.

If properly carried out, fumigation should give complete control of those insects exposed to the gas. However, it offers no residual protection and reinfestation can rapidly occur.

## **Integrated pest management**

The need for alternatives to chemical control methods for the protection of stored products has been indicated in the past but is now seen as

increasingly urgent. In particular, the discovery of insect resistance to methyl bromide and phosphine (the two most common fumigants) has intensified the pressure to minimize use of conventional insecticides against postharvest pests. This in turn has encouraged research into alternative control techniques. These include:

- control of temperature, humidity, and atmospheric gases in storage facilities to create conditions unsuitable for insect development;
- admixture of abrasive materials such as fine sand, kaolin, or wood-ash to protect grain in farmer-level storage;
- use of certain plant materials such as crushed neem seed, neem leaves, or neem oil which have an antifeedant or repellent effect on storage pests. Vegetable oils have also been used to protect stored pulses against attack by bruchid beetles;
- dissemination of insect pathogens of stored product moths, e.g., the bacterium *Bacillus thuringiensis* Berliner or nuclear polyhedrosis and granulosis viruses, either by direct application onto the stored commodity or by attracting insects to traps containing a source of the disease;
- control of pests by natural enemies. This may require modifications both to conventional control procedures and to some aspects of the storage environment, to favor indigenous predators and parasites; and
- use of genotypes resistant to attack by the main postharvest pests.

The integration of biological, physical, and chemical control measures is still in its infancy and the relative cost of integrated pest-management programs cannot easily be predicted at this stage of their development. There is an urgent need to establish the potential and practicality of this approach in order to reduce the problems created by reliance on synthetic insecticides.

## **Breeding for resistance to storage pests**

Breeding groundnut cultivars resistant to post-harvest insect infestation is one possible way of

reducing losses during storage. It is a strategy particularly well-suited to improving storage in the SAT where the financial resources and technical expertise required for the effective use of chemical control methods are often lacking. Unfortunately, breeding for resistance to storage pests is often antagonistic to selection for increased yield. New high-yielding varieties have frequently proved to be more susceptible to insect attack during storage than the indigenous genotypes grown by the small-scale farmer. With the large number of new varieties now being developed it is important that there is some collaboration between breeders and storage entomologists to ensure that their release will not exacerbate storage problems.

**Basic procedures for resistance screening.** The assessment of the inherent susceptibility of crops to attack by storage insects usually involves the measurement of parameters such as length of development period, mortality of juvenile stages, amount of food consumed, and oviposition rate. To ensure that any differences in the values of these parameters obtained in a screening trial reflect genuine differences between genotypes, both the grain and the insects used in the experiment should be as uniform as is practical.

Before insects are placed on samples of the genotypes to be examined, the grain should be preconditioned to the experimental temperature and humidity levels for a period of at least 2 weeks to ensure that the moisture contents of the different genotypes are as similar as possible. The moisture content of a subsample of each genotype should be determined (as described above) at the start of the experiment. If mass loss is being assessed, then the moisture content should also be determined at the end of the experiment so that loss can be expressed as dry mass of grain.

Ideally the experiment should be performed in a room or chamber with controlled temperature and humidity. If this is not possible then the range of temperature and humidity should be recorded. This is essential when reporting the length of the insects' development period.

Cultures maintained to supply insects for screening should be of relatively constant density so that the size of adults, and therefore their likely egg-laying capacity is comparable. If the screening technique involves placing adults on the experimental material then they should be of identical age and reproductive status (mated or virgin). Whatever stage of the life cycle is used (adult, larva, or egg) a range of insect population densities per unit of grain mass should be examined in a preliminary experiment to determine the density at which differences between genotypes are most obvious and to check for any interaction between density and genotype.

### **Suggested further studies**

In a study of the development of pest populations on stored groundnuts in a warehouse in Andhra Pradesh, India, ICRISAT entomologists recorded serious losses by the groundnut bruchid, *C. serratus*. Reports of damage to groundnuts by this species had previously been confined to West Africa. The findings of the ICRISAT study highlight the need for more information on postharvest pests of groundnuts, particularly from groundnut-growing areas other than West Africa. These data will be of increased value if they include a measure of the mass loss caused by insect pests obtained using one of the accepted methods outlined in this bulletin.

There is also a need for more accurate information on the effect of insect infestation on the quality of groundnut oil. This might eventually allow the determination of economic thresholds for the main pests attacking stored groundnuts in the SAT.

## Bibliography

Publications listed here include those references not given in full in the text, and papers selected to provide further reading, and more in-depth treatment of specific topics.

**Adams, J.M.** 1976. A guide to the objective and reliable estimation of food losses in small scale farmer storage. *Tropical Stored Products Information* 32:5-12.

**Anon.** 1970. Methyl bromide dosage schedules. *Tropical Stored Products Information* 20:27-30.

**Anon.** 1983. Traps for use in detecting insect infestation in stored products. *Storage Training Notes*. Slough, UK: Tropical Development and Research Institute. (Limited distribution.)

**Ashman, F.** 1973. Methods and techniques of assessing quality in stored products. *Tropical Stored Products Information* 25:33-35.

**Banks, H.J.** 1977. Distribution and establishment of *Trogoderma granarium* Everts (Coleoptera: Dermestidae): climatic and other influences. *Journal of Stored Products Research* 13:183-202.

**Bell, C.H.** 1975. Effects of temperature and humidity on development of four pyralid moth pests of stored products. *Journal of Stored Products Research* 11:167-175.

**Blatchford, S.M., and Hall, D.W.** 1963. Methods of drying groundnuts. 1. Natural methods (literature survey). *Tropical Science* 5(1): 6-33.

**Surges, H.D.** 1962. Studies on the dermestid beetle *Trogoderma granarium* Everts. V. Reactions of diapause larvae to temperature. *Bulletin of Entomological Research* 53(1): 193-213.

**Burges, H.D.** 1963. Studies on the dermestid beetle *Trogoderma granarium* Everts. VI. Factors inducing diapause. *Bulletin of Entomological Research* 54(3): 571-587.

**Conway, J.A.** 1976. The significance of *Elasmolomus sordidus* (F.) (Hemiptera: Lygaeidae) attacking harvested groundnuts in The Gambia. *Tropical Science* 18(3): 187-190.

**Conway, J.A.** 1983. Notes on the biology and ecology of the groundnut seed beetle (*Caryedon serratus*) (01.) under field conditions in Senegambia. *Tropical Stored Products Information* 45:11-13.

**Davey, P.M.** 1958. The groundnut bruchid, *Caryedon gonagra* (F.). *Bulletin of Entomological Research* 49(2): 385-404.

**Davey, P.M., Hall, D.W., Coveney P.L., and Raymond, W.D.** 1959. The effect of insect infestation on the quality of decorticated groundnuts with special reference to storage at low and high humidities. *Tropical Science* 1:296-307.

**Delbosc, G.** 1966. Les parasites des stocks d'arachide. *Oleagineux* 21:293-296.

**Dobie, P.** 1984. Biological methods for integrated control of insects and mites in tropical stored products. I. The use of resistant varieties. *Tropical Stored Products Information* 48:4-8.

**Dobie, P.** 1984. Biological methods for integrated control of insects and mites in tropical stored products. VI. Integrated control: the role of biological methods. *Tropical Stored Products Information* 48:37-45.

**Feakin, S.D.(ed)** 1973. Pest control in groundnuts. PANS Manual No. 2. London, UK: Centre for Overseas Pest Research. 197 pp.

**Freeman, P.** 1980. Common insect pests of stored products. British Museum (Natural History) Economic Series No. 15. London, UK: British Museum (Natural History).

**Gillier, P., and Bockelee-Morvan, A.** 1979. La protection des stocks d'arachide contre les insectes. *Oleagineux* 34(3): 131-137.

**Golob, P.** 1976. Techniques for sampling bagged produce. *Tropical Stored Products Information* 31:37-48.

- Colon, P.** 1981. A practical appraisal of on-farm storage losses and loss assessment methods in Malawi. 2. The Lilongwe land development programme area. *Tropical Stored Products Information* 41:5-12.
- Green, A.A.** 1959. The control of insects infesting groundnut after harvest in The Gambia. I. A study of the groundnut borer *Caryedon gonagra* (F.) under field conditions. *Tropical Science* 1(3):200-205.
- Green, A.A.** 1960. The control of insects infesting groundnuts after harvest in The Gambia. II. Field trials on the control of the groundnut borer, *Caryedon gonagra* (F.). *Tropical Science* 2(1):44-54.
- Haines, C.P.** 1984. Biological methods for integrated control of insects and mites in tropical stored products. III. The use of predators and parasites. *Tropical Stored Products Information* 48:17-25.
- Harris, K.L., and Lindblad, C.J.** (eds.) 1978. Postharvest grain loss assessment methods. St. Paul, Minnesota, USA: American Association of Cereal Chemists. 193 pp.
- Heseltine, H.K.** 1973. A guide to fumigation with phosphine in the tropics. *Tropical Stored Products Information* 24:25-36.
- Hodges, R.J.** 1979. A review of the biology and control of the rice moth *Corcyra cephalonica* Stainton (Lepidoptera: Galleriinae). *Tropical Products Institute G. Report* 125. London, UK: Tropical Development and Research Institute. 20 pp.
- Hodges, R.J.** 1984. Biological methods for integrated control of insects and mites in tropical stored products. II. The use of pheromones. *Tropical Stored Products Information* 48:9-17.
- Hodges, R.J.** 1984. Biological methods for integrated control of insects and mites in tropical stored products. IV. The use of insect diseases. *Tropical Stored Products Information* 48:27-32.
- Howe, R.W.** 1956. The biology of the two common storage species of *Oryzaephilus* (Coleoptera, Cucujidae). *Annals of Applied Biology* 44(2):341-355
- Howe, R.W.** 1956. The effect of temperature and humidity on the rate of development and mortality of *Tribolium castaneum* (Herbst) (Coleoptera, Tenebrionidae). *Annals of Applied Biology* 44(2):356-368.
- Howe, R.W.** 1965. Losses caused by insects and mites in stored foods and feeding staffs. *Nutrition Abstracts and Reviews* 35:285-293.
- Loschiavo, S.R., and Atkinson, J.M.** 1973. An improved trap to detect beetles (Coleoptera) in stored grain. *Canadian Entomology* 105:437-440.
- Narain, P., and Khosla, R.K.** 1984. Estimation of post-harvest foodgrain losses. *Journal of the Indian Society of Agricultural Statistics* 36(1):127-142.
- Pointel, J.G., Deuse, J.P.L., and Hernandez, S.** 1979. Evaluation et évolution de l'infestation de stocks expérimentaux d'arachides en coque au Sénégal par *Caryedon gonagra* F. (Coleoptera: Bruchidae). *Agronomie Tropicale* 34(2):196-207.
- Prevert, P.F.** 1964. The distribution of insects in stacks of bagged groundnuts in northern Nigeria. *Bulletin of Entomological Research* 54:689-713.
- Proctor, D.L., and Ashman, F.** 1972. The control of insects in exported Zambian groundnuts using phosphine and polyethylene lined sacks. *Journal of Stored Products Research* 8:127-137.
- Proctor, D.L., and Rowley, J.Q.** 1983. The thousand grain mass (TGM) method: a basis for better assessment of weight losses in stored grain. *Tropical Stored Products Information* 45:19-23.
- Redlinger, L.M., and Davis, R.** 1982. Insect control in postharvest peanuts. Pages 520-571 in *Peanut science and technology* (Pattee, H.E.,

and Young, C.T., eds.). Yoakum, Texas, USA: American Peanut Research and Education Society, Inc..

**Rees, D.P.** 1985. Review of the response of stored product insects to light of various wavelengths, with particular reference to the design and use of light traps for population monitoring. *Tropical Science* 25(3): 197-215.

**Smith, K.G.** 1963. The study of an insect population living on bagged groundnuts stored in southern Nigeria with particular reference to the behaviour of *Trogoderma granarium* Everts (Col., Dermestidae). *Journal of the West African Science Association* 8(1): 44-51.

**Srivastava, A.S.** 1970. Important insect pests of stored oilseeds in India. *International Pest Control* 12(3): 18-20.

**Tropical Development and Research Institute.** 1984. Insects and arachnids of tropical stored products, their biology and identification (a training manual). Slough, UK. TDRI.

**Tyler, P.S., and Boxall, R.A.** 1984. Post-harvest loss reduction programmes: a decade of activities; what consequences? *Tropical Stored Products Information* 50:4-13.

**U.S. National Academy of Sciences.** 1978. Post-harvest food losses in developing countries. Washington D.C., USA: National Academy of Sciences. 207 pp.

**Webley D.J., and Harris, A.H.** 1977. A comparison of fumigants for in-bag fumigation. *Tropical Stored Products Information* 33:9-18.

**RA-00102**



**ICRISAT**

**International Crops Research Institute for the Semi-Arid Tropics  
Patancheru, Andhra Pradesh 502 324, India**