

### HP ProDesk 600 G3 Desktop Mini Business PC

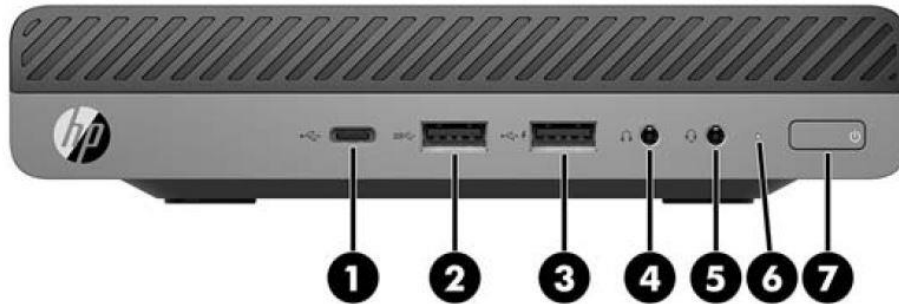

- |  |                              |
|--|------------------------------|
| 1. USB Type-C™ charging port                         | 5. Headset Connector         |
| 2. USB 3.1 Gen 1 port (5 Gbit/s data speed)          | 6. Hard drive activity light |
| 3. USB 3.1 Gen 1 charging port (5 Gbit/s data speed) | 7. Dual-state power button   |
| 4. Universal Audio Jack with CTIA headset support    |                              |

### HP ProDesk 600 G3 Desktop Mini Business PC

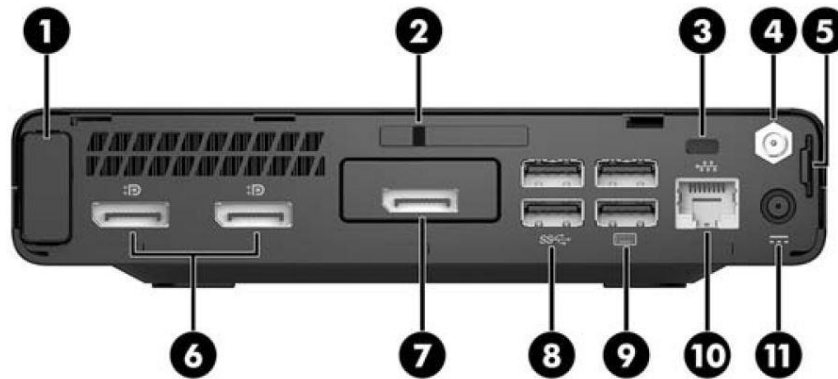

- |  |  |
|--|--|
| <ol style="list-style-type: none"> <li>1. Antenna cover</li> <li>2. Cover lock switch</li> <li>3. Cable lock slot</li> <li>4. External antenna connector</li> <li>5. Padlock loop</li> <li>6. (2) Dual-Mode DisplayPort™ 1.2 (DP++)</li> </ol> | <ol style="list-style-type: none"> <li>7. Choice of port (DisplayPort™ 1.2, HDMI, VGA, Serial or USB-C™) (USB-C™ option has alt mode DisplayPort™ 1.2 or 15W output)</li> <li>8. (2) USB 3.1 Gen 1 (5 Gbit/s data speed) (black)</li> <li>9. (2) USB 3.1 Gen 1 (5 Gbit/s data speed) (black), allows for wake from S4/S5 with keyboard/mouse when connected and enabled in BIOS</li> <li>10. RJ-45 Network connector</li> <li>11. Power connector</li> </ol> |
|--|--|

#### Not Shown

**Slots** (1) internal M.2 PCIe 2230 connector for optional wireless NIC  
 (1) internal M.2 SSD storage (2230 or 2280 connector)

**Bays** (1) 2.5" internal storage drive bay

**VESA** Support for VESA 100 mounting system on bottom of PC chassis

### Overview

#### HP ProDesk 600 G3 Small Form Factor Business PC

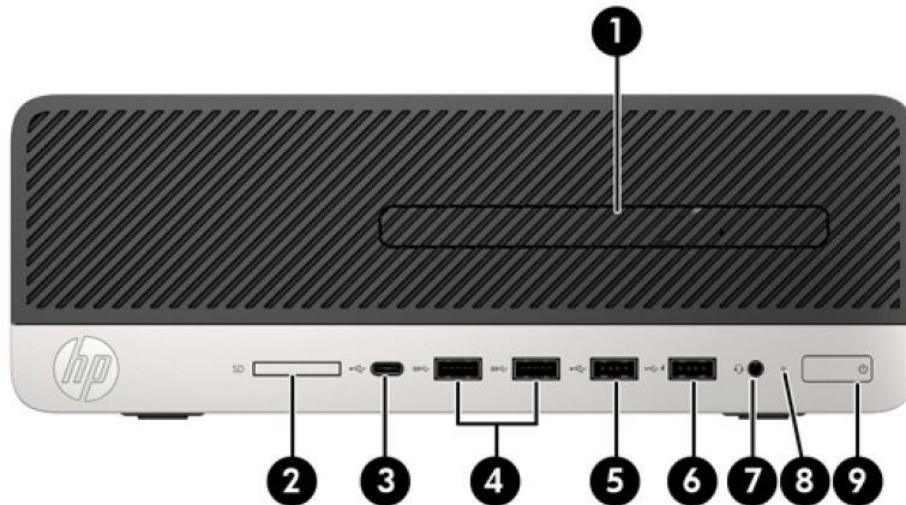

- |                                  |   |
|----------------------------------|---|
| 1. Slim Optical Drive (optional) | 6. USB 2.0 (fast charging port)                   |
| 2. SD card 4.0 reader (optional) | 7. Universal Audio Jack with CTIA headset support |
| 3. USB Type-C™ charging port     | 8. Hard drive activity light                      |
| 4. (2) USB 3.1 Gen1 ports        | 9. Power button                                   |
| 5. USB 2.0 port                  |   |

### Overview

#### HP ProDesk 600 G3 Small Form Factor Business PC

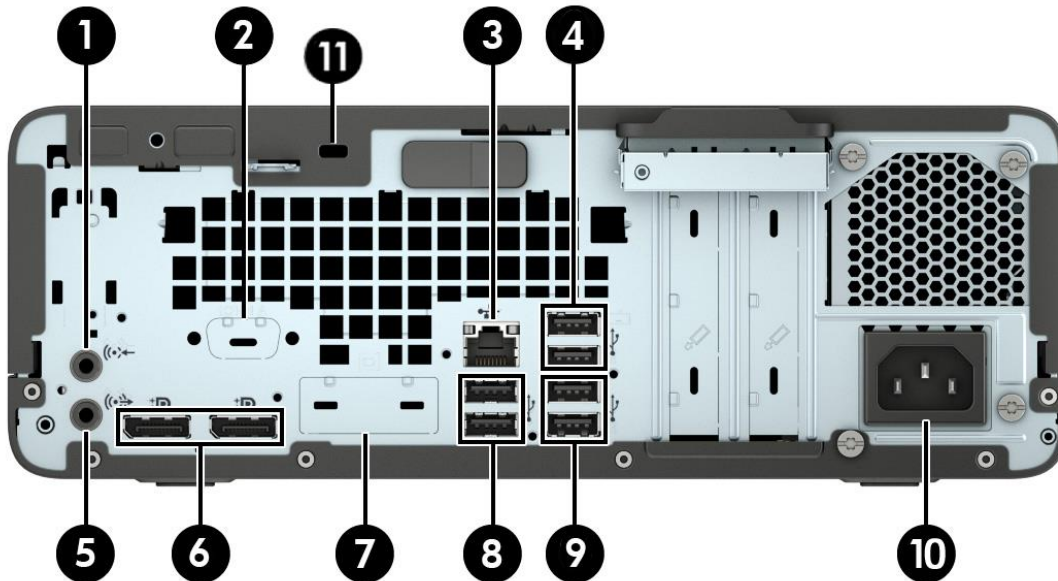

- |  |  |
|--|--|
| <ol style="list-style-type: none"> <li>1. Audio-in connector</li> <li>2. Optional serial port available</li> <li>3. RJ-45 (network) jack</li> <li>4. (2) USB 3.1 Gen1 ports</li> <li>5. Audio-out connector for powered audio devices</li> <li>6. (2) Dual-Mode DisplayPort™ (DP++)</li> </ol> | <ol style="list-style-type: none"> <li>7. Optional port (DisplayPort™, HDMI, VGA, or USB-C™) (USB-C™ option has alt mode DisplayPort™ or 15W output)</li> <li>8. (2) USB 2.0 ports with wake from S4/S5 feature</li> <li>9. (2) USB 3.1 Gen1 ports</li> <li>10. Power cord connector</li> <li>11. Cable lock slot</li> </ol> |
|--|--|

**NOTE:** The serial port is no longer standard to the chassis but is available as an option. A second serial port and PS/2 port PCIe combination are available.

#### Not Shown

- |  |
|--|
| <p>Slots</p> <ul style="list-style-type: none"> <li>(1) PCI Express x 16 graphics connector</li> <li>(1) PCI Express x 4 connector</li> <li>(1) internal M.2 PCIe x1 connector for optional wireless NIC</li> <li>(1) internal M.2 PCIe x4 connector for optional Turbo Drive SSD</li> </ul> <p>Bays</p> <ul style="list-style-type: none"> <li>(1) 3.5" internal storage drive bay or 2.5" internal storage drive bay (2.5" drive needs adapter)</li> <li>(1) 9.5mm slim optical drive bay</li> </ul> |
|--|

### Overview

### HP ProDesk 600 G3 and 680 G3 Microtower Business PC

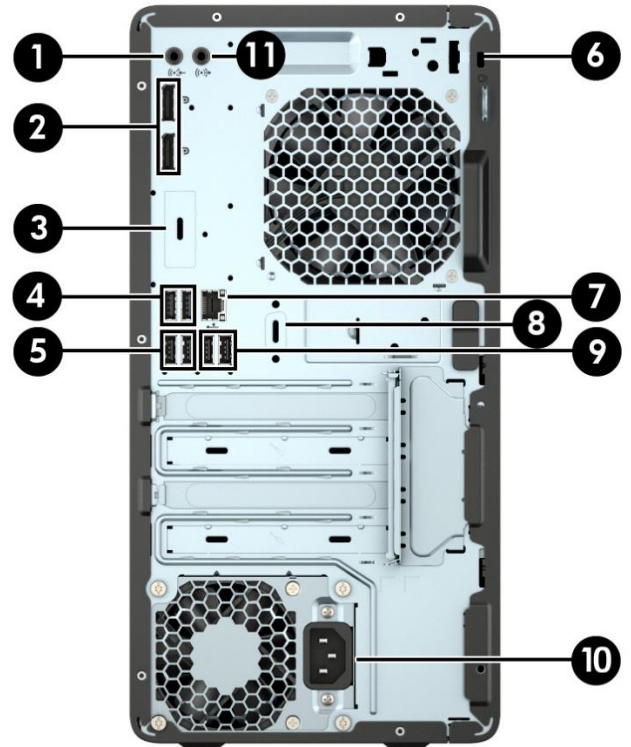
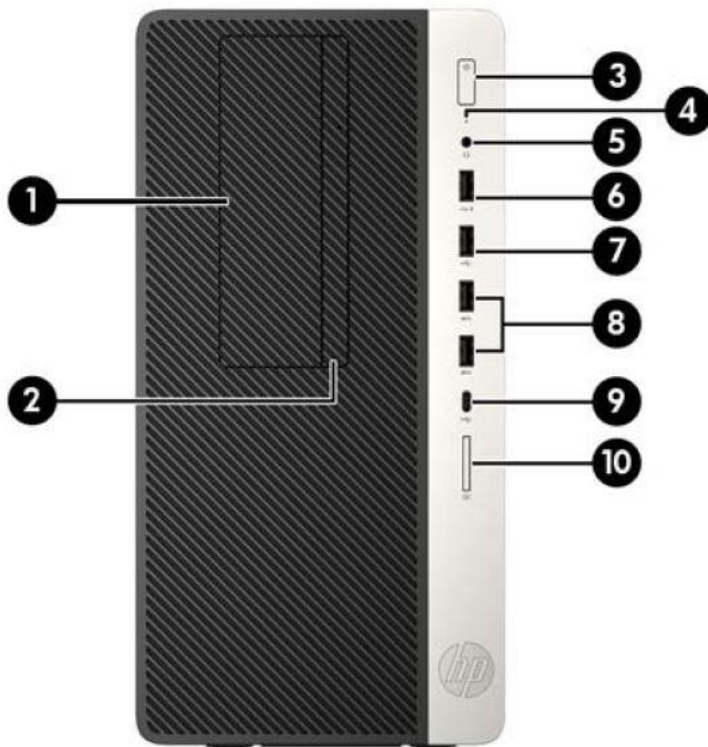

1. 5.25-inch drive bay (behind bezel)
2. Slim optical drive (optional)
3. Dual-state power button
4. Hard drive activity light
5. Universal Audio Jack with CTIA headset support
6. USB 2.0 (fast charging port\*)
7. USB 2.0 port
8. (2) USB 3.1 Gen1 ports
9. USB Type-C™ charging port
10. SD card 4.0 reader (optional)

1. Audio-in connector
2. Dual-Mode DisplayPort™ 1.2 (DP++) (2)
3. Optional port (DisplayPort™ 1.2, HDMI, VGA, or USB-C™) (USB-C™ option has alt mode DisplayPort™ 1.2 or 15W output)
4. (2) USB 2.0 Ports with Wake from S4/S5 feature
5. (2) USB 3.1 Gen1 ports
6. Cable lock slot
7. RJ-45 (network) jack
8. Optional serial port available
9. (2) USB 3.1 Gen1 ports
10. Power cord connector
11. Audio-out connector for powered audio devices

\*This port connects a USB device, provides high-speed data transfer, and even when the computer is off, charges products such as a cell phone, camera, activity tracker, or smartwatch.

NOTE: When a device is plugged into the headset jack, a dialog box will open asking if you want to use the connector for a microphone line-in device or a headphone. You can reconfigure the connector at any time by double-clicking the Audio Manager icon in the Windows® taskbar.

The serial port is no longer standard to the chassis but is available as an option. A second serial port and PS/2 port PCIe combination are available.

### Overview

#### Not Shown

- Slots (2) PCI Express x16 graphics connectors; one wired as an x4  
(1) PCI Express x1 accessory connector  
(1) PCI Express x1 accessory connector or PCI x1 accessory connector  
(1) internal M.2 PCIe x1 connector for optional wireless NIC  
(1) internal M.2 PCIe x4 connector for optional Turbo Drive SSD

**NOTE:** Select models will offer (1) PCI Express x1 accessory connector and (1) PCI connector instead of (2) PCI Express x1 accessory connectors

**NOTE:** Maximum total of 4 PCI slots supported on MT.

- Bays (1) 5.25" internal half-height drive bay or (2) 2.5" internal storage drive bays  
(1) 3.5" internal storage drive bays  
(1) 9.5mm internal optical drive bay

## Overview

### HP ProOne 600 G3 21.5-inch All-in-One Business PC



1. Webcam Microphone
2. Webcam LED
3. Webcam shutter

4. Webcam lens
5. Speakers

### Overview

#### HP ProOne 600 G3 21.5-inch All-in-One Business PC

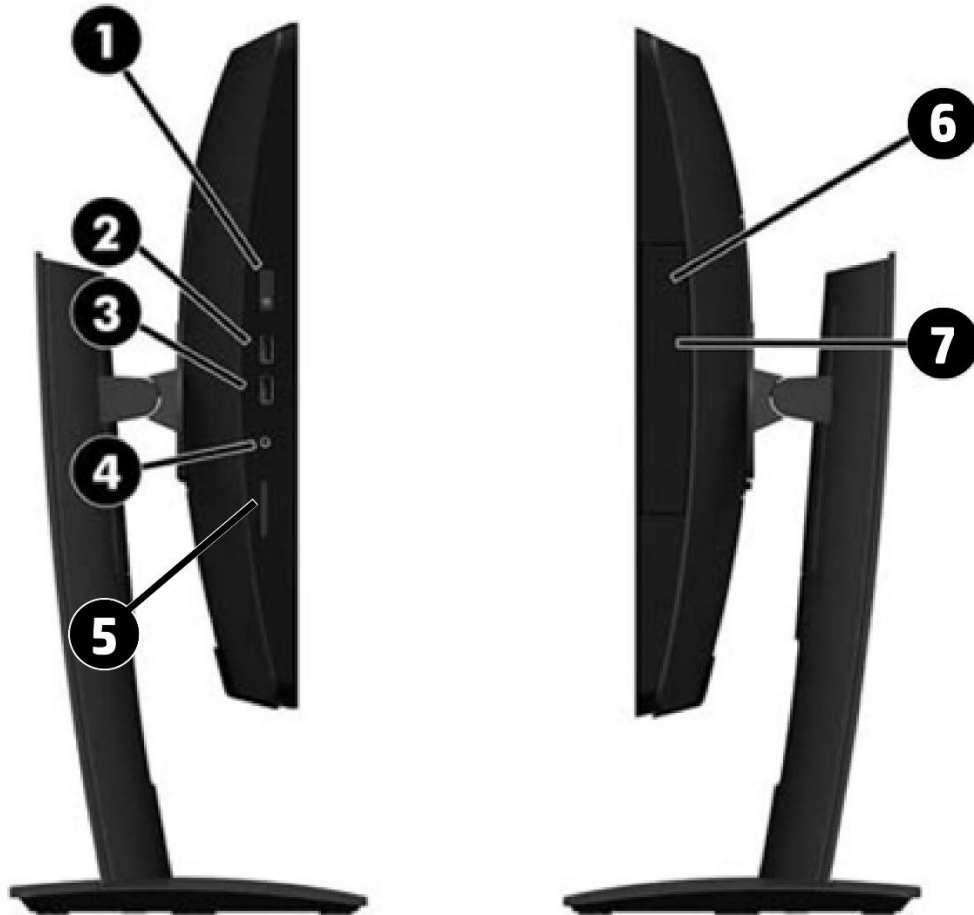

1. Power button
2. USB 3.1 Gen 1 charging port (5 Gbit/s data speed)
3. USB 3.1 Gen 1 port(5 Gbit/s data speed)

4. Headset jack
5. Media card reader
6. Optical disc drive
7. Optical disc drive eject button



Overview

## HP ProOne 600 G3 21.5-inch All-in-One Business PC

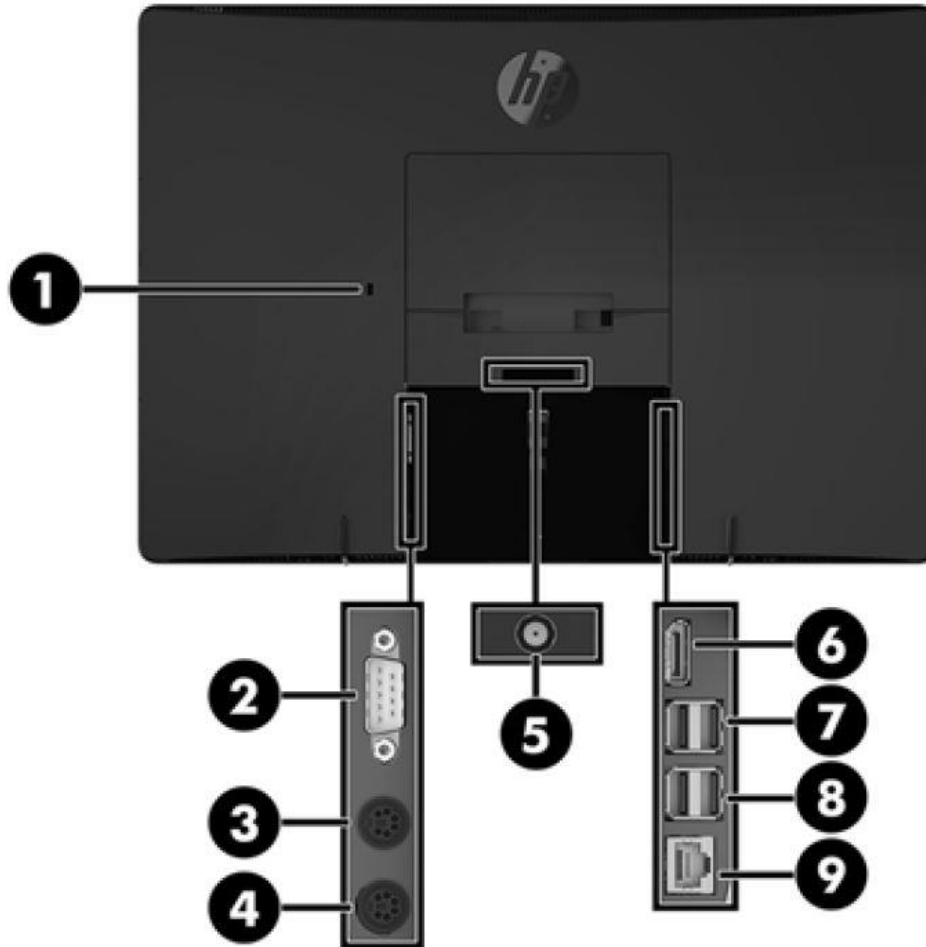

### REAR/PORTS (BEHIND SECURITY COVER)

- |    |                                    |    |  |
|----|------------------------------------|----|--|
| 1. | Security cable slot                | 6. | Dual-Mode DisplayPort™ 1.2 (DP++) connector            |
| 2. | Serial port (optional)             | 7. | (2) USB 3.1 Gen 1 charging ports (5 Gbit/s data speed) |
| 3. | PS/2 keyboard connector (optional) | 8. | (2) USB 2.0 Type-A ports with Wake from S4/S5 feature  |
| 4. | PS/2 mouse connector (optional)    | 9. | RJ-45 (network) jack                                   |
| 5. | Power connector                    |    |  |

#### Not Shown

- Slots (1) internal M.2 PCIe x1 connector for optional wireless NIC  
(1) internal M.2 PCIe x4 connector for optional Turbo Drive SSD
- Bays (1) 2.5" internal storage drive bay
- VESA Support for VESA 100 mounting system on bottom of PC chassis\*

## Overview

\*Mounting hardware sold separately (see Accessories section).

### Overview

## AT A GLANCE

- Choice of four form factors: Desktop Mini, Small Form Factor, Microtower and All-in-One Non-Touch only
- New commercial design on Desktop Mini, Small Form Factor, Microtower
- HP developed- and engineered UEFI BIOS supporting security, manageability and software image stability
- Intel® Q270 chipset supporting both Intel® 7 Generation and Intel® 6th generation Core™ processors, featuring integrated Intel® HD Graphics and optional Intel® vPro™ Technology (vPro is optional and requires factory configuration, available with Core i5 and Core i7 processors only)
- Processor support up to 65W (MT/SFF/AiO), 35W (DM)
- Support for Windows 10 to Windows 7 Downgrade with Intel® 6th Generation processors
- Intel® Ethernet Connection I219LM GbE LOM integrated network connection
- DDR4 Synchronous Dynamic Random Access Memory (SDRAM)
- Support for up to three monitors (on MT/SFF/DM form factors) via two standard DisplayPort™ 1.2 connectors and an optional third video port connector which provides the following choices: HDMI, VGA, DisplayPort™ 1.2, or USB Type-C™ with DisplayPort™ 1.2 (see Ports section or pages 1-8 for port availability by platform).
- Configurable 3rd rear I/O video port (HDMI, DisplayPort™ 1.2, VGA, Type-C with DisplayPort™ 1.2) (except AiO)  
NOTE: Multiple data drives setup in a RAID array is optional and requires product to be configured with vPro at purchase
- HP BIOSphere Gen3
- HP Manageability Integration Kit
- HP WorkWise
- Standard and high efficiency energy saving power supply options (Standard AiO power supply is high efficiency, energy saving)
- ENERGY STAR® certified. EPEAT® Gold registered where applicable/supported. Registration may vary by country. See [www.epeat.net](http://www.epeat.net) for registration status by country.
- CCC, CECP & SEPA Certified
- Optimized for Skype for Business (AiO only)
- TCO AiO and TCO Edge (AiO only)
- PC chassis and all internal components and modules are manufactured with low halogen content<sup>3</sup>
- Arsenic-free
- Dust filter available for Desktop Mini, Small Form Factor, Microtower
- Protected by HP Services, including limited warranties up to 3-3-3 (terms and conditions vary by country; certain restrictions and exclusions apply); Care Packs available with up to 5 years Next Business Day Onsite Hardware Support
- Lengthy purchase lifecycles and image stability

**NOTE: See important legal disclosures for all listed specs in their respective features sections.**

1. Multi-Core is designed to improve performance of certain software products. Not all customers or software applications will necessarily benefit from use of this technology. Performance and clock frequency will vary depending on application workload and your hardware and software configurations. Intel's numbering is not a measurement of higher performance.
2. DisplayPort™ multi-stream monitors 'daisy-chained' together.
3. External power supplies, power cords, cables and peripherals are not low halogen. Service parts obtained after purchase may not be low halogen.

### Standard Features and Configurable Components

## OPERATING SYSTEMS

### Preinstalled

- Windows 10 Pro 64<sup>1</sup>
- Windows 10 Pro 64 (National Academic License)<sup>3</sup>
- Windows 10 Home 64<sup>1</sup>
- Windows 10 Home Single Language 64<sup>1</sup>
- Windows 7 Professional 64 (available through downgrade rights from Windows 10 Pro)<sup>2, 4</sup>
- Windows 7 Professional 32 (available through downgrade rights from Windows 10 Pro)<sup>2, 4</sup>

### Pre-installed (other)

- FreeDOS 2.0
- NeoKylin Linux<sup>®</sup> 64

### Web-supported only

- Windows 10 Enterprise 64<sup>1</sup>
- Windows 7 Enterprise 64<sup>4</sup>

1. Not all features are available in all editions or versions of Windows. Systems may require upgraded and/or separately purchased hardware, drivers, software or BIOS update to take full advantage of Windows functionality. Windows 10 is automatically updated, which is always enabled. ISP fees may apply and additional requirements may apply over time for updates. See <http://www.windows.com>.
2. This system is preinstalled with Windows 7 Pro software and also comes with a license and media for Windows 10 Pro software. You may only use one version of the Windows software at a time. Switching between versions will require you to uninstall one version and install the other version. You must back up all data (files, photos, etc.) before uninstalling and installing operating systems to avoid loss of your data.
3. Some devices for academic use will automatically be updated to Windows 10 Pro Education with the Windows 10 Anniversary Update. Features vary; see <https://aka.ms/ProEducation> for Windows 10 Pro Education feature information.
4. Only available with 6<sup>th</sup> generation (Intel) processors.

## CHIPSET

Intel<sup>®</sup> Q270

## PROCESSORS\*, \*\*

\*NOTE: In accordance with Microsoft's support policy, HP does not support the Windows<sup>®</sup> 8 or Windows 7 operating system on products configured with Intel and AMD 7th generation and forward processors or provide any Windows<sup>®</sup> 8 or Windows 7 drivers on <http://www.support.hp.com>

\*\*Note: Multi-Core is designed to improve performance of certain software products. Not all customers or software applications will necessarily benefit from use of this technology. Performance and clock frequency will vary depending on application workload and your hardware and software configurations. Intel's numbering is not a measurement of higher performance.

### Intel<sup>®</sup> 7th Generation Core™ i7 Processors

	<u>DM</u>	<u>SFF</u>	<u>MT</u>	<u>AiO</u>
<b>Intel<sup>®</sup> Core™ i7-7700 Processor</b> 65W Up to 4.2 GHz Max. Turbo Frequency (3.6 GHz base frequency) 8 MB cache, 4 cores, 8 threads Intel <sup>®</sup> HD Graphics 630 Supports DDR4 memory up to 2400 MT/s data rate Supports Intel <sup>®</sup> vPro™ Technology and Intel <sup>®</sup> Stable Image Platform Program (SIPP)		<b>X</b>	<b>X</b>	<b>X</b>

### Standard Features and Configurable Components

<b>Intel® Core™ i7-7700T Processor</b> 35W Up to 3.8 GHz Max. Turbo Frequency (2.9 GHz base frequency) 8 MB cache, 4 cores, 8 threads Intel® HD Graphics 630 Supports DDR4 memory up to 2400 MT/s data rate Supports Intel® vPro™ Technology and Intel® Stable Image Platform Program (SIPP)	<b>X</b>			
--	----------	--	--	--

### Intel® 7th Generation Core™ i5 Processors

	<b><u>DM</u></b>	<b><u>SFF</u></b>	<b><u>MT</u></b>	<b><u>AiO</u></b>
<b>Intel® Core™ i5-7500 Processor</b> 65W Up to 3.8 GHz Max. Turbo Frequency (3.4 GHz base frequency) 6 MB cache, 4 cores, 4 threads Intel® HD Graphics 630 Supports DDR4 memory up to 2500 MT/s data rate Supports Intel® vPro™ Technology and Intel® Stable Image Platform Program (SIPP)		<b>X</b>	<b>X</b>	<b>X</b>
<b>Intel® Core™ i5-7500T Processor</b> 35W Up to 3.3 GHz Max. Turbo Frequency (2.7 GHz base frequency) 6 MB cache, 4 cores, 4 threads Intel® HD Graphics 630 Supports DDR4 memory up to 2400 MT/s data rate Supports Intel® vPro™ Technology and Intel® Stable Image Platform Program (SIPP)	<b>X</b>			
<b>Intel® Core™ i5-7600 Processor</b> 65W Up to 4.1 GHz Max. Turbo Frequency (3.5 GHz base frequency) 6 MB cache, 4 cores, 4 threads Intel® HD Graphics 630 Supports DDR4 memory up to 2400 MT/s data rate Supports Intel® vPro™ Technology and Intel® Stable Image Platform Program (SIPP)		<b>X</b>	<b>X</b>	<b>X</b>
<b>Intel® Core™ i5-7600T Processor</b> 35W Up to 3.7 GHz Max. Turbo Frequency (2.8 GHz base frequency) 6 MB cache, 4 cores, 4 threads Intel® HD Graphics 630 Supports DDR4 memory up to 2400 MT/s data rate Supports Intel® vPro™ Technology and Intel® Stable Image Platform Program (SIPP)	<b>X</b>			

### Intel® 7th Generation Core™ i3 Processors

	<b><u>DM</u></b>	<b><u>SFF</u></b>	<b><u>MT</u></b>	<b><u>AiO</u></b>
<b>Intel® Core™ i3-7100 Processor</b> 51W 3.9 GHz base frequency 3 MB cache, 2 cores, 4 threads Intel® HD Graphics 630 Supports DDR4 memory up to 2400 MT/s data rate		<b>X</b>	<b>X</b>	<b>X</b>
<b>Intel® Core™ i3-7100T Processor</b> 35W 3.4 GHz base frequency	<b>X</b>			

### Standard Features and Configurable Components

3 MB cache, 2 cores, 4 threads Intel® HD Graphics 630 Supports DDR4 memory up to 2400 MT/s data rate				
<u>Intel® Core™ i3-7300 Processor</u> 51W 4.0 GHz base frequency 4 MB cache, 2 cores, 4 threads Intel® HD Graphics 630 Supports DDR4 memory up to 2400 MT/s data rate		X	X	X
<u>Intel® Core™ i3-7300T Processor</u> 35W 3.5 GHz base frequency 4 MB cache, 2 cores, 4 threads Intel® HD Graphics 630 Supports DDR4 memory up to 2400 MT/s data rate	X			
<u>Intel® Core™ i3-7320 Processor</u> 51W 4.1 GHz base frequency 4 MB cache, 2 cores, 4 threads Intel® HD Graphics 630 Supports DDR4 memory up to 2400 MT/s data rate		X	X	X

### Intel® 7th Generation Pentium® Processors

	<u>DM</u>	<u>SFF</u>	<u>MT</u>	<u>AiO</u>
<u>Intel® Pentium® G4560 Processor</u> 54W 3.5 GHz Base Frequency 3 MB cache, 2 cores, 4 threads Intel® HD Graphics 610 Supports DDR4 memory up to 2400 MT/s data rate		X	X	X
<u>Intel® Pentium® G4560T Processor</u> 35W 2.9 GHz Base Frequency 3 MB cache, 2 cores, 4 threads Intel® HD Graphics 610 Supports DDR4 memory up to 2400 MT/s data rate	X			
<u>Intel® Pentium® G4600 Processor</u> 51W 3.6 GHz Base Frequency 3 MB cache, 2 cores, 4 threads Intel® HD Graphics 610 Supports DDR4 memory up to 2400 MT/s data rate		X	X	X
<u>Intel® Pentium® G4600T Processor</u> 35W 3.0 GHz Base Frequency 3 MB cache, 2 cores, 4 threads Intel® HD Graphics 610 Supports DDR4 memory up to 2400 MT/s data rate	X			
<u>Intel® Pentium® G4620 Processor</u> 51W 3.7 GHz Base Frequency 3 MB cache, 2 cores, 4 threads Intel® HD Graphics 610 Supports DDR4 memory up to 2400 MT/s data rate		X	X	X

### Standard Features and Configurable Components

#### Intel® 7th Generation Celeron® Processors

	<u>DM</u>	<u>SFF</u>	<u>MT</u>	<u>AiO</u>
<u>Intel® Celeron® G3930 Processor</u> 51W 2.9 GHz Base Frequency 2 MB cache, 2 cores, 2 threads Intel® HD Graphics 610 Supports DDR4 memory up to 2133 MT/s data rate		X	X	X
<u>Intel® Celeron® G3930T Processor</u> 35W 2.7 GHz Base Frequency 2 MB cache, 2 cores, 2 threads Intel® HD Graphics 610 Supports DDR4 memory up to 2133 MT/s data rate	X			
<u>Intel® Celeron® G3950 Processor</u> 51W 3.0 GHz Base Frequency 2 MB cache, 2 cores, 2 threads Intel® HD Graphics 610 Supports DDR4 memory up to 2133 MT/s data rate		X	X	X

#### Intel® 6th Generation Core™ i7 Processors

	<u>DM</u>	<u>SFF</u>	<u>MT</u>	<u>AiO</u>
<u>Intel® Core™ i7-6700 Processor</u> 65W Up to 4.0 GHz Max. Turbo Frequency (3.4 GHz base frequency) 8 MB cache, 4 cores, 8 threads Intel® HD Graphics 530 Supports DDR4 memory up to 2133 MT/s data rate Supports Intel® vPro™ Technology and Intel® Stable Image Platform Program (SIPP)		X	X	X
<u>Intel® Core™ i7-6700T Processor</u> 35W Up to 3.6 GHz Max. Turbo Frequency (2.8 GHz base frequency) 8 MB cache, 4 cores, 8 threads Intel® HD Graphics 530 Supports DDR4 memory up to 2133 MT/s data rate Supports Intel® vPro™ Technology and Intel® Stable Image Platform Program (SIPP)	X			

#### Intel® 6th Generation Core™ i5 Processors

	<u>DM</u>	<u>SFF</u>	<u>MT</u>	<u>AiO</u>
<u>Intel® Core™ i5-6500 Processor</u> 65W Up to 3.6 GHz Max. Turbo Frequency (3.2 GHz base frequency) 6 MB cache, 4 cores, 4 threads Intel® HD Graphics 530 Supports DDR4 memory up to 2133 MT/s data rate Supports Intel® vPro™ Technology and Intel® Stable Image Platform Program (SIPP)		X	X	X
<u>Intel® Core™ i5-6600T Processor</u> 35W Up to 3.5 GHz Max. Turbo Frequency (2.7 GHz base frequency) 6 MB cache, 4 cores, 4 threads Intel® HD Graphics 530 Supports DDR4 memory up to 2133 MT/s data rate	X			

### Standard Features and Configurable Components

Supports Intel® vPro™ Technology and Intel® Stable Image Platform Program (SIPP)				
<b>Intel® Core™ i5-6600 Processor</b> 65W Up to 3.9 GHz Max. Turbo Frequency (3.3 GHz base frequency) 6 MB cache, 4 cores, 4 threads Intel® HD Graphics 530 Supports DDR4 memory up to 2133 MT/s data rate Supports Intel® vPro™ Technology and Intel® Stable Image Platform Program (SIPP)		<b>X</b>	<b>X</b>	<b>X</b>
<b>Intel® Core™ i5-6500T Processor</b> 35W Up to 3.1 GHz Max. Turbo Frequency (2.5 GHz base frequency) 6 MB cache, 4 cores, 4 threads Intel® HD Graphics 530 Supports DDR4 memory up to 2133 MT/s data rate Supports Intel® vPro™ Technology and Intel® Stable Image Platform Program (SIPP)	<b>X</b>			

#### Intel® 6th Generation Core™ i3 Processors

	<u>DM</u>	<u>SFF</u>	<u>MT</u>	<u>AiO</u>
<b>Intel® Core™ i3-6100 Processor</b> 51W 3.7 GHz base frequency 3 MB cache, 2 cores, 4 threads Intel® HD Graphics 530 Supports DDR4 memory up to 2133 MT/s data rate		<b>X</b>	<b>X</b>	<b>X</b>
<b>Intel® Core™ i3-6100T Processor</b> 35W 3.2 GHz base frequency 3 MB cache, 2 cores, 4 threads Intel® HD Graphics 530 Supports DDR4 memory up to 2133 MT/s data rate	<b>X</b>			

#### Intel® 6th Generation Pentium® Processors

	<u>DM</u>	<u>SFF</u>	<u>MT</u>	<u>AiO</u>
<b>Intel® Pentium® G4400 Processor</b> 54W 3.3 GHz Base Frequency 3 MB cache, 2 cores, 2 threads Intel® HD Graphics 510 Supports DDR4 memory up to 2133 MT/s data rate			<b>X</b>	<b>X</b>

#### Intel® 6th Generation Celeron® Processors

	<u>DM</u>	<u>SFF</u>	<u>MT</u>	<u>AiO</u>
<b>Intel® Celeron® G3900 Processor</b> 51W 2.8 GHz Base Frequency 2 MB cache, 2 cores, 2 threads Intel® HD Graphics 510 Supports DDR4 memory up to 2133 MT/s data rate				<b>X</b>



### Standard Features and Configurable Components

## MEMORY\*

Form Factor	Type	Maximum	Number of Slots
Desktop Mini	DDR4-2400 (Transfer rates up to 2400 MT/s)	32 GB	2 SODIMM
Small Form Factor	DDR4-2400 (Transfer rates up to 2400 MT/s)	64 GB	4 DIMM
Microtower	DDR4-2400 (Transfer rates up to 2400 MT/s)	64 GB	4 DIMM
All-in-One	DDR4-2400 (Transfer rates up to 2400 MT/s)	32 GB	2 SODIMM

Memory modules available. Memory options vary by platform. All slots are customer accessible / upgradeable.

- 2,048 MB (2048 MB x 1) (AMO only)
- 4,096 MB (4096 MB x 1)
- 8,192 MB (8192 MB x 1)
- 16,384 MB (16,384 MB x 1)

\* Full availability of 4 GB or more of memory requires a 64-bit operating system. With Windows 32-bit operating systems, the amount of usable memory is dependent upon your configuration, so that above 3 GB all memory may not be available due to system resource requirements.

Memory modules support data transfer rates up to 2400 MT/s; actual data rate is determined by the system's configured processor. See processor specifications for supported memory data rate.

## STORAGE\*

### 2.5 inch 7.2k RPM Hard Disk Drives

	<u>DM</u>	<u>SFF</u>	<u>MT</u>	<u>AiO</u>
1TB SATA	X	X	X	X
500GB SATA	X	X	X	X

### 3.5" SATA 7.2k RPM Hard Disk Drives

	<u>DM</u>	<u>SFF</u>	<u>MT</u>	<u>AiO</u>
500GB 7200RPM 3.5in		X	X	
1TB 7200RPM 3.5in		X	X	
2TB 7200RPM 3.5in		X	X	

### 2.5 inch Solid State Hybrid Drives (SSHD)

	<u>DM</u>	<u>SFF</u>	<u>MT</u>	<u>AiO</u>
1TB 5400RPM 2.5in 8GB Hybrid	X	X	X	X
500GB 5400RPM 2.5in 8GB Hybrid	X	X	X	X

### 3.5 inch Solid State Hybrid Drives (SSHD)

	<u>DM</u>	<u>SFF</u>	<u>MT</u>	<u>AiO</u>
1TB 7200RPM 3.5in SSHD (SSHD)		X	X	

### 2.5 inch Self-encrypting Drives (SED HDD)

	<u>DM</u>	<u>SFF</u>	<u>MT</u>	<u>AiO</u>
500GB 5400RPM 2.5in Federal Information Processing Standard (FIPS) SED	X	X	X	X
500GB 7200RPM 2.5in SED OPAL2	X	X	X	X

### Standard Features and Configurable Components

#### 2.5 inch Self-encrypting Drives (SED SSD)

	<u>DM</u>	<u>SFF</u>	<u>MT</u>	<u>AiO</u>
256GB TLC SED SSD Opal 2 Drive	X	X	X	X
512GB TLC SED SSD Opal 2 Drive	X	X	X	X
256GB TLC SED SSD 2.5in Federal Information Processing Standard (FIPS) SED	X	X	X	X
512GB TLC SED SSD 2.5in Federal Information Processing Standard (FIPS) SED	X	X	X	X

#### PCIe NVMe SSD Drives

	<u>DM</u>	<u>SFF</u>	<u>MT</u>	<u>AiO</u>
HP 256GB Turbo Drive G2 PCIe TLC SSD Drive	X	X	X	
HP 512GB Turbo Drive G2 PCIe TLC SSD Drive	X	X	X	
HP 1TB Turbo Drive G2 PCIe TLC SSD Drive	X	X	X	
HP 256GB PCIe NVMe SSD Drive				X
HP 512GB PCIe NVMe SSD Drive				X
HP 256GB PCIe NVMe TLC SSD Drive				X
HP 512GB PCIe NVMe TLC SSD Drive				X
HP 1TB PCIe NVMe TLC SSD Drive				X

#### 2.5 SATA SSD Drives

	<u>DM</u>	<u>SFF</u>	<u>MT</u>	<u>AiO</u>
HP SATA 128GB SSD Drive	X	X	X	
HP SATA 256GB SSD Drive	X	X	X	
HP SATA 256GB TLC SSD Drive				X
HP SATA 512GB TLC SSD Drive				X

\*For storage drives, GB = 1 billion bytes, TB = 1 trillion bytes. Actual formatted capacity is less. Up to 30GB of system disk is reserved for system recovery software.

#### Optical Disc Drives

	<u>DM</u>	<u>SFF</u>	<u>MT</u>	<u>AiO</u>
HP 9.5mm G3 800/600 Tower DVD-Writer*			X	
HP 9.5mm G3 800/600 Tower DVD-ROM			X	
HP 9.5mm G3 800/600/400 SFF G4 400 Microtower DVD-Writer*		X		
HP 9.5mm G3 800/600/400 SFF G4 400 Microtower DVD-ROM		X		
HP 9.5mm ProOne AIO 600 G3 Ultra slim DVD-Writer Drive				X
HP 9.5mm ProOne AIO 600 G3 Ultra slim DVD-ROM Drive				X

\*HD-DVD discs cannot be played on this drive. No support for DVD-RAM. Actual speeds may vary. Don't copy copyright-protected materials. Double Layer discs can store more data than single layer discs. Discs burned with this drive may not be compatible with many existing single-layer DVD drives and players.

#### Removable

	<u>DM</u>	<u>SFF</u>	<u>MT</u>	<u>AiO</u>
HP 9.5mm Slim Removable SATA 500GB		X	X	X
HP 3.5" Removable SATA HDD Frame/Carrier			X	

### Standard Features and Configurable Components

#### Media Card Reader (optional)\*

	<b>DM</b>	<b>SFF</b>	<b>MT</b>	<b>AiO</b>
SD4 with 5-in-1 Interface from SD option to PCA is USB (Supports SD, SDXC, SDHC, UHS-I, UHS-II)		X	X	
SD3 with 4-in-1 Interface from SD option to PCIe (Supports SD, SDXC, SDHC, UHS-I)				X

\*Card sold separately

## GRAPHICS

#### System Integrated Graphics

	<b>DM</b>	<b>SFF</b>	<b>MT</b>	<b>AiO</b>
Intel® HD Graphics 530 (integrated on 6 <sup>th</sup> gen Core i7/i5/i3 processors)	X	X	X	X
Intel® HD Graphics 630 (integrated on 7 <sup>th</sup> gen Core i7/i5/i3 processors and Pentium G4620, 4600, 4600T)	X	X	X	X
Intel® HD Graphics 610 (integrated on Pentium G4560, G4560T, Celeron G3950, G3930, G3930T)	X	X	X	X

#### Optional Discrete Graphics Solutions

(optional and RX 460 devices and GT 730 1GB HDMI card, they must be configured at purchase)

	<b>DM</b>	<b>SFF</b>	<b>MT</b>	<b>AiO</b>
AMD Radeon™ R7 430 2GB LP 2DP PCIe x16 GF card		X	X	
AMD Radeon™ R7 450 4GB FH PCIe x16*			X	
AMD Radeon™ RX 460 2GB FH PCIe x16*			X	
NVIDIA® GeForce® GT 730 1GB PCIe x8 HDMI		X	X	
NVIDIA® GeForce® GT 730 2GB PCIe x8 DP		X	X	

\*Requires 250W chassis

<b>2<sup>nd</sup> Graphics Cards</b>	<b>DM</b>	<b>SFF</b>	<b>MT</b>	<b>AiO</b>
AMD Radeon™ R7 430 2GB LP 2DP PCIe x16 GF card 2 <sup>nd</sup> **			X	
AMD Radeon™ R7 450 4GB FH PCIe x16 G5 2 <sup>nd</sup> **			X	
NVIDIA® GeForce® GT 730 1GB PCIe x8 HDMI 2 <sup>nd</sup> ***			X	
NVIDIA® GeForce® GT 730 2GB PCIe x8 DP 2 <sup>nd</sup> ****			X	

\*\*Available only with AMD Radeon™ R7 450.

\*\*\*Available only with NVIDIA® GeForce® GT730 1GB.

\*\*\*\*Available only with NVIDIA® GeForce® GT730 2GB.

## Display (All-in-One models only)

21.5" diagonal IPS widescreen WLED backlit anti-glare LCD display

Orientation designed to operate in portrait or landscape mode (Additional stand or mount needed for AiO to be used in portrait mode.)

Non-touch

#### Display Panel

Type

IPS WLED Backlit LCD

Viewable image area (mm)

476.064 x 267.786

### Standard Features and Configurable Components

Screen opening (mm)	478.06 x 269.79
Native Resolution (HxV)	1920 x 1080
Aspect ratio	16:9
Pixel pitch (HxV)(mm)	0.247 x 0.247
Contrast ratio (typical)	1000:1
Brightness (typical)	Non-Touch 250nits (cd/m2)
Viewing angle (typical) (HxV)	178 ° x 178 °
Backlight lamp life (to half brightness)	30,000 hours minimum
Color support	Over 16 million colors
Color gamut (typical)	72%
Anti-glare	Yes
Default color temperature	Warm (6500K)
Response Time	14 ms

**NOTE:** All performance specifications represent the typical specifications provided by HP's component manufacturers; actual performance may vary either higher or lower.

<b>Easel Stand Adjustable Height Stand:</b>	Tilt Angle	-5° (+/-3°) to +70° (+/-3°)
	Height - vertical/landscape adjustment:	126.55 mm (±3 mm)
	Tilt Angle - Landscape	-5° to +20° (+/-3°)
	Title Angle – Low Position	-5° to +20° (+/-3°)
	Rotation(swivel)	None

## WEBCAM & MIC (All-in-One models only)

Optional integrated 1 MP webcam & microphone; maximum resolution of 1280 x 720; up to 30 frames/sec

Optional integrated 2 MP webcam & microphone; maximum resolution of 1920 x 1080; up to 30 frames/sec

## AUDIO/MULTIMEDIA

	<b>DM</b>	<b>SFF</b>	<b>MT</b>	<b>AiO</b>
Conexant CX20632 Audio Codec	X	X	X	
Conexant CX5001 Codec				X
Headset* front connector (3.5mm)	X	X	X	
Headphone front connector (3.5mm)	X			
Line-out rear connector* (3.5mm)		X	X	
Line-in rear connector* (3.5mm)		X	X	
Headset side port (3.5mm)				X
Multi-streaming capable*	X	X	X	

### Standard Features and Configurable Components

Internal speaker (standard)	X	X	X	
High performance integrated stereo speakers				X

\* The DM, SFF, MT front headset connector supports CTIA style headsets. The AIO front headset connector supports both CTIA and OMTP style headsets. Headset connectors are retaskable to function as a Line-In, Microphone-In, Line-out or Headphone-out port. Rear audio input ports are re-taskable as a Line-in or Microphone-in port. External speakers must be powered externally. Multi-streaming can be enabled in the audio control panel to allow independent audio streams to be sent to/from the front and rear jacks. This allows for different audio applications to use separate audio ports on the system. For example, the front jacks could be used with a headset for a communications application while the rear jacks are being used with external speakers and a multimedia application.

## NETWORKING/COMMUNICATIONS\*

### Ethernet (RJ-45) Integrated

	<u>DM</u>	<u>SFF</u>	<u>MT</u>	<u>AiO</u>
Intel® I219LM Gigabit Network Connection LOM (standard)	X	X	X	X

### Ethernet (RJ-45) Optional

	<u>DM</u>	<u>SFF</u>	<u>MT</u>	<u>AiO</u>
Intel® Ethernet I210-T1 PCIe x1 Gb Network Interface Card (optional)		X	X	

### Wireless LAN (optional and all except for 7265 for SFF/MT must be bought at purchase)

	<u>DM</u>	<u>SFF</u>	<u>MT</u>	<u>AiO</u>
Intel® 8265 802.11AC 2x2 Wi-Fi +Bluetooth® M.2 Combo Card vPro™ (802.11AC Wave 2 supported)	X	X	X	X
Intel® 8265 802.11AC 2x2 Wi-Fi +Bluetooth® M.2 Combo Card non-vPro™ (802.11AC Wave 2 supported)	X	X	X	X
Intel® 7265 802.11AC 2x2 Wi-Fi +Bluetooth® M.2 Combo Card non-vPro™	X	X	X	X
Intel® 7260 802.11 a,b,g,n 2x2 M.2 Bluetooth® Disabled NIC**	X			
Intel® 3168 802.11AC 2x2 Wi-Fi +Bluetooth® M.2 Combo Card non-vPro™	X	X	X	X

\* Wireless access point and Internet service required and not included. Availability of public wireless access points limited.

\*\*Wake on Lan feature is not available.

## SLOTS

	<u>DM</u>	<u>SFF</u>	<u>MT</u>	<u>AiO</u>
Turbo Drive (M.2 PCIe)	1 ea. M.2 PCIe x1-2230 (for WLAN)  1 ea. M.2 PCIe x4-2280/2230 (for storage)	1 ea. M.2 PCIe x1-2230 (for WLAN) 1 ea. M.2 PCIe x4-2280 (for storage)	1 ea. M.2 PCIe x1-2230 (for WLAN) 1 ea. M.2 PCIe x4-2280 (for storage)	1 ea. M.2 PCIe x1-2230 (for WLAN) 1 ea. M.2 PCIe x4-2280/2230 combo (for storage)
PCI Express x1 (v3.0)	N/A	N/A	2 ea.* (1 optional) 4.2" full height 6.6" length 10W max. power	N/A
PCI Express x4 (v3.0)	N/A	1 ea. 2.5" low profile 6.6" length 35W max. power	N/A	N/A

### Standard Features and Configurable Components

PCI Express x16 (v3.0) (wired as a x4)	N/A	N/A	1 ea. 2.5" low profile 6.6" length 35W max. power	N/A
PCI Express x16 (v3.0)	N/A	1 ea. 2.5" low profile 6.6" length 35W max. power	1 ea. 4.2" full height 6.6" length 75W max. power	N/A
Optional PCI	N/A	N/A	1 ea. 4.2" full height 6.6" length	N/A

\*Models configured with optional PCI slot with 1 PCI Express x1(v3.0) instead of 2.

NOTE: Maximum total of 4 PCI slots supported on MT.

## PORTS

	<b>DM</b>	<b>SFF</b>	<b>MT</b>	<b>AiO</b>
USB 2.0	N/A	2 (front) including 1 fast charging; 2 (rear)	2 (front) including 1 fast charging; 2 (rear)	2 (rear)
USB 3.1 Gen1	2 (front) including 1 fast charging; 4 (rear)	2 (front); 4 (rear)	2 (front); 4 (rear)	2 (side) including 1 fast charging, 2 (rear)
USB Type-C™3.1 Gen1 port	1 (front); 1 (optional) (rear)	1 (front); 1 (optional) (rear)	1 (front); 1 (optional) (rear)	N/A
Video	2 DisplayPort™ 1.2 with multi-stream 1 port (choice of DisplayPort™ 1.2, HDMI, VGA or USB-C™) (USB-C™ option has alt mode DisplayPort™ 1.2 or 15W output)	2 DisplayPort™ 1.2 with multi-stream 1 Optional port (DisplayPort™ 1.2, HDMI, VGA or USB-C™) (USB-C™ option has alt mode DisplayPort™ 1.2 or 15W output)	2 DisplayPort™ 1.2 with multi-stream 1 Optional port (DisplayPort™ 1.2, HDMI, VGA or USB-C™) (USB-C™ option has alt mode DisplayPort™ 1.2 or 15W output)	1 DisplayPort™ 1.2 with multi-stream
Audio	Front: 1 Headset and Headphone	Front: 1 Headset Rear: 1 Audio-out 1 Audio-in	Front: 1 Headset Rear: 1 Audio-out 1 Audio-in	Side: 1 Headset
Network Interface	RJ-45	RJ-45	RJ-45	RJ-45
Serial (RS-232)	1 (optional)*	1 (optional)	1 (optional)	N/A
Serial (RS-232) and (2) PS/2 combination*	N/A	1 (optional) (rear)	1 (optional) (rear)	N/A
Serial (RS-232), PS/2, and Hood sensor combination	N/A	N/A	N/A	1 (optional)(rear)

\*This card comes with a Serial Port and 2 PS/2 ports (3 ports total)

### I/O Ports — Internal ports

	<b>DM</b>	<b>SFF</b>	<b>TWR</b>	<b>AiO</b>
DM SATA storage connector	1	N/A	N/A	N/A
AiO SATA storage connector	N/A	N/A	N/A	2

### Standard Features and Configurable Components

Internal SATA storage connector(s)	N/A	2	4	N/A
------------------------------------	-----	---	---	-----

### BAYS

	<b>DM</b>	<b>SFF</b>	<b>MT</b>	<b>AiO</b>
5.25" Half Height **	N/A	N/A	1 ea.	N/A
9mm Slim ODD	N/A	1 ea.	1 ea.	1 ea.
Secure Digital (SD) 4 Reader	N/A	1 ea.	1 ea.	N/A
Secure Digital (SD) 3 Reader	N/A	N/A	N/A	1 ea.
2.5" internal storage drive	1 ea.	1 ea.*	2 ea.	1 ea.
3.5" internal storage drive	N/A	1 ea.*	1 ea.	N/A

\*SFF can be configured with either (1) 3.5" or (1) 2.5" internal storage drive (2.5 inch drive needs adapter)

\*\*The HP G2 5.25 ODD is also compatible with the G3 MT Chassis

### Standard Features and Configurable Components

#### KEYBOARDS AND POINTING DEVICES (optional)

<b>Keyboards</b>	<b>DM</b>	<b>SFF</b>	<b>MT</b>	<b>AiO</b>
HP Conferencing Keyboard	X	X	X	X
HP USB PS/2 Washable Keyboard*	X	X	X	X
HP USB Business Slim CCID SmartCard Keyboard	X	X	X	X
HP USB Business Slim Keyboard	X	X	X	X
HP PS/2 Business Slim Keyboard*		X	X	X
HP USB Business Slim Keyboard (China only)	X	X	X	X
HP USB Business Slim Grey Keyboard	X	X	X	X
<b>Mice</b>	<b>DM</b>	<b>SFF</b>	<b>MT</b>	<b>AiO</b>
HP PS/2 Mouse*		X	X	X
HP USB 1000dpi Laser Mouse	X	X	X	X
HP Grey V2 Mouse	X	X	X	X
HP USB Mouse	X	X	X	X
HP USB PS/2 Washable Mouse*	X	X	X	X
HP USB Mouse (China only)	X	X	X	X
HP USB Hardened Mouse	X	X	X	X
<b>Combo</b>	<b>DM</b>	<b>SFF</b>	<b>MT</b>	<b>AiO</b>
HP Wireless Business Slim Keyboard and Mouse	X	X	X	X
HP USB Keyboard and Mouse (China only)	X	X	X	X
<b>Other</b>	<b>DM</b>	<b>SFF</b>	<b>MT</b>	<b>AiO</b>
HP Mouse Pad	X	X	X	X

\*Optional HP Internal Serial/PS/2 Ports is required to support this device.

#### ADAPTERS AND CABLES (optional)

	<b>DM</b>	<b>SFF</b>	<b>MT</b>	<b>AiO</b>
HP DisplayPort™ 1.2 Cable	X	X	X	X
HP DisplayPort™ 1.2 to DVI-D Adapter	X	X	X	X
HP DisplayPort™ 1.2 to HDMI 4K Adapter	X	X	X	X
HP DisplayPort™ 1.2 to VGA Adapter	X	X	X	X
HP DVI Cable	X	X	X	X
HP 700mm DisplayPort™ 1.2 Cable Kit	X			
HP USB to Serial Port Adapter	X			X

#### I/O Devices

Optional Ports (only one can be chosen) must be configured at purchase except for PCIe x1 cards.

	<b>DM</b>	<b>SFF</b>	<b>MT</b>	<b>AiO</b>
HP DisplayPort™ 1.2 Port	X	X	X	
HP USB Type-C™ 1.2 Port	X	X	X	
HP HDMI Port	X	X	X	
HP VGA Port	X	X	X	



### Standard Features and Configurable Components

HP Internal Serial Port		X*	X*	
HP Internal Serial/PS/2 Ports		X*	X*	
HP Serial / PS/2 / Hood Sensor Module				X
HP PCIe x1 Parallel Port Card		X	X	
HP PCIe x1 SuperSpeed USB 3.1 Gen 2 Type-C Card		X	X	

### DUST FILTERS

	<u>DM</u>	<u>SFF</u>	<u>MT</u>	<u>AiO</u>
HP ProDesk 600 G3 Microtower Dust Filter			X	
HP ProDesk 600/400 G3 SFF Dust Filter		X		
HP G3 Mini Dust Filter	X			

\* Internal Serial Port and HP Internal Serial/PS/2 Ports can both be selected for MT and SFF

### DESKTOP MINI ACCESSORIES (optional)

	<u>DM</u>	<u>SFF</u>	<u>MT</u>	<u>AiO</u>
HP Desktop Mini DVD-Writer ODD Expansion Module	X			
HP Desktop Mini 500GB HDD/ I/O Expansion Module	X			
HP Desktop Mini I/O Expansion Module	X			
HP Desktop Mini Security/Dual VESA Sleeve	X			
HP DM VESA Power Supply Holder	X			
HP DM VESA Quick Deploy Adhesive	X			
HP Desktop Mini Vertical Chassis Stand	X			
HP Desktop Mini Port Cover Kit	X			
HP Quick Release Bracket	X			
HP DM Antenna/Wiring WLAN Kit	X			
HP PC Mounting Bracket for Monitors	X			

### AIO STANDS (optional)

	<u>DM</u>	<u>SFF</u>	<u>MT</u>	<u>AiO</u>
HP 600 G3 AIO no stand (Ships with cosmetic VESA cover)				X
HP 600 G3 AIO Adjustable Height Stand				X
HP 600 G3 AIO Easel Stand				X

### SOFTWARE COMPONENTS AND APPLICATIONS WITH WINDOWS

#### BIOS

HP BIOSphere Gen3<sup>1</sup>  
 HP DriveLock | HP Automatic DriveLock  
 BIOS Update via Network  
 Master Boot Record Security  
 Power On Authentication  
 Secure Erase<sup>2</sup>  
 Absolute Persistence Module<sup>3</sup>  
 Pre-boot Authentication

### Standard Features and Configurable Components

HP LAN-WLAN Protection  
HP Wireless Wakeup

#### **Multi Media**

CyberLink Power Media Player (select models only)  
CyberLink Power2Go (select models only)

#### **Communication / Connectivity**

Native Miracast Support<sup>4</sup>

#### **HP Value Add Software**

HP ePrint Driver + JetAdvantage<sup>5</sup>  
HP Hotkey Support - CMIT  
HP Recovery Manager  
HP Recovery Disc Creator (Windows 7 only)  
HP Jumpstart  
HP Support Assistant  
HP Noise Cancellation Software  
HP Velocity  
HP Notifications

#### **3rd Party**

Foxit PhantomPDF Express for HP (Windows 7 only)

#### **Microsoft Products**

Buy Office  
Bing Search  
Skype<sup>6</sup>

#### **Manageability**

HP Driver Packs<sup>7</sup>  
HP SoftPaq Download Manager (SDM)  
HP System Software Manager (SSM)<sup>7</sup>  
HP BIOS Config Utility (BCU)<sup>7</sup>  
HP Client Catalog<sup>8</sup>  
HP Manageability & Integration Kit (MIK)<sup>7</sup>  
LANDESK Management<sup>8</sup>

For more information on HP Client Management Solutions refer to: <http://www.hp.com/go/clientmanagement>

#### **Client Security Software**

HP Client Security

- HP Security Manager (including Credential Manager and Password Manager)
- HP Drive Lock
- HP Password Manager
- Absolute Persistence Module
- Power On Authentication

Microsoft Security Essentials<sup>9</sup> (Windows 7 only)  
Microsoft Defender (Windows 10 only)  
HP WorkWise (requires Bluetooth<sup>®</sup>)<sup>10</sup>

#### **Standard**

Trusted Platform Module (TPM) 2.0 (Infineon SLB9670). Common Criteria EAL4+ Certified.

## Standard Features and Configurable Components

Downgradeable to TPM 1.2. Convertible to FIPS 140-2 Certified mode. (TPM 2.0 is not available for Win 7 32-bit.) Restrictions apply; contact your account manager for more details.

For more information on HP Client Security Software Suite, refer to <http://www.hp.com/go/clientsecurity>.

1 HP BIOSphere Gen 3 requires Intel® or AMD 7th generation processors.

2 For the methods outlined in the National Institute of Standards and Technology Special Publication 800-88.

3 Absolute agent is shipped turned off, and will be activated when customers activate a purchased subscription. Subscriptions can be purchased for terms ranging multiple years. Service is limited, check with Absolute for availability outside the U.S. The Absolute Recovery Guarantee is a limited warranty. Certain conditions apply. For full details visit: <http://www.absolute.com/company/legal/agreements/computer-agreement>. Data Delete is an optional service provided by Absolute Software. If utilized, the Recovery Guarantee is null and void. In order to use the Data Delete service, customers must first sign a Pre-Authorization Agreement and either obtain a PIN or purchase one or more RSA SecurID tokens from Absolute Software.

4 Miracast is a wireless technology your PC can use to project your screen to TVs, projectors, and streaming media players that also support Miracast. You can use Miracast to share what you're doing on your PC and present a slide show. For more information:

<http://windows.microsoft.com/en-us/windows-8/project-wireless-screen-miracast>

5 Requires an Internet connection to HP web-enabled printer and HP ePrint account registration (for a list of eligible printers, supported documents and image types and other HP ePrint details, see [www.hp.com/go/eprintcenter](http://www.hp.com/go/eprintcenter)). Print times and connection speeds may vary.

6 Skype is not offered in China.

6 Not preinstalled, however available for download at <http://www.hp.com/go/clientmanagement>.

7 HP Management Integration Kit is available for download at <http://www.hp.com/go/clientmanagement>.

9 Opt in and internet connection required for updates.

10 HP WorkWise smartphone app is available as a free download on the App Store and Google Play. Requires Windows 10 Build 1607 or higher).

## HP BIOS

Key features of the HP BIOS include:

- Deployment and manageability – HP BIOS provides several technologies that help integrate the HP Pro 600 G3 Business PC into the enterprise, such as PXE, remote configuration, remote control, and F10 Setup support for 14 languages.
- Update your BIOS via the cloud or standardize on a BIOS version hosted on Enterprise network.
- Stability – HP BIOS supports the HP stable product roadmap by releasing only critical BIOS changes to the factory and advanced change notification.
- UEFI specification 2.5
- Absolute Persistence agent – For tracking and tracing services, available in select countries, separate software and purchase of a subscription is required.
- Thermal and power management – The HP BIOS provides and enables thermal and power management technologies so component temperatures are managed for high reliability and to assist in operating the HP Business Desktop computer in any enterprise environment.
- Acoustic performance – Industry leading acoustic emissions across the range of operating conditions.
- Serviceability – HP BIOS provides diagnostic and detailed service information.
- Upgrades and recovery – HP BIOS provides numerous ways to upgrade HP Business Desktop computers, including BIOS updates from within Windows (HPBIOSUPDREC), HP Client Manager, and fail-safe recovery. In addition, the HP Business Desktop BIOS Utilities tool enables replicated BIOS setup throughout the Enterprise; it is available from within the BIOS software and from the support website.
- HP BIOS uses PKI signing of the BIOS for trusted BIOS upgrades and recovery.

Additional HP BIOS Features:

- Power-On password – Helps prevent an unauthorized user from powering on the system.
- Administrator password – Also known as the setup password, this helps prevent unauthorized changes to the system configuration. If the administrator password is not known, the BIOS version cannot be changed and changes cannot be made to BIOS settings using F10 setup or under the OS.

## Standard Features and Configurable Components

- Advanced Configuration and Power Interface (ACPI) – Represents a significant innovation in power and configuration management, allowing operating systems and applications to manage power based on activity and usage. HP Pro models use ACPI to provide power conservation features.
- HP BIOS Protection - prevents unauthorized updates or changes to the BIOS due to malware, viruses, or malicious BIOS updates. Based on NIST SP800-147 policy guidelines.

S5 Max Power Savings setting supports EU Lot6 requirement and allows the computer to power down below 0.5W in S5 (when turned off). When S5 Max Power Savings feature is enabled below features are turned off:

- Power to slots
- Wake events other than power buttons (such as Wake on LAN)
- USB charging ports

## Core™ vPro™ Processors\*

### Intel® 6<sup>th</sup> & 7<sup>th</sup> Generation Core™ vPro™ Processors

All HP Pro 600 G3 Business PC models featuring this technology include processors that are part of the Intel® Stable Image Platform Program (SIPP) designed to ensure the stability promise inherent in the value proposition of the HP Pro 600 G3 Business PC, thus making these models the most stable, secure, and manageable platforms available to enterprises today.

**Intel® Advanced Management Technology (AMT) v11\*\*** – An advanced set of remote management features and functionality which provides network administrators the latest and most effective tools to remotely discover, heal, and protect networked client systems regardless of the system's health or power state. AMT 11 includes the following advanced management functions:

- Support for configuration of Intel® AMT 11.0 new capabilities
- No reset after provisioning
- Support changes to BIOS table 130
- Support for Microsoft Windows Server 2012 R2
- Support for New Microsoft SQL Server Versions including Standard and Enterprise editions
- Support for Intel® SSD Pro 2500 Series
- Support for Intel® Enterprise Digital Fence
- The Platform Discovery Utility can now discover these additional Intel® products:
- Intel® SSD Pro 2500 Series; Enterprise Digital Fence
- Intel® Identity Protection Technology with One Time Password; Public Key Infrastructure; Multi Factor Authentication
- Intel® Identity Protection Technology with Intel® WiGig
- New Profile Editor and Profile Editor Plugin Interface
- New Required Permissions for Solutions Framework

\*Some functionality of this technology, such as Intel Active management technology and Intel® Virtualization technology, requires additional 3rd party software in order to run. Availability of future "virtual appliances" applications for Intel vPro™ technology is dependent on 3rd party software providers. Compatibility with future "virtual appliances" is yet to be determined.

\*\* Intel® Active Management Technology requires an Intel® AMT-enabled chipset, network hardware and software, as well as connection with a power source and a corporate network connection. Setup requires configuration by the purchaser and may require scripting with the management console or further integration into existing security frameworks to enable certain functionality. It may also require modifications of implementation of new business processes.

## HARDWARE SECURITY

SATA 0,1 port disablement (via BIOS)

### Standard Features and Configurable Components

Serial, USB enable/disable (via BIOS)

Solenoid Lock/Intrusion Sensor (MT only)

Intrusion Sensor (Optional for SFF and AiO only)

Hood Sensor for DM (integrated in the PCA, can be enabled/disabled through BIOS)

Support for chassis padlocks and cable lock devices

### Standard Features and Configurable Components

#### POWER SUPPLY

	<u>DM</u>	<u>SFF</u>	<u>MT</u>	<u>AiO</u>
Standard Efficiency	65W EPS, 89% average efficiency at 115V & 230Vac	N/A	N/A	N/A
80 PLUS Bronze	N/A	180W active PFC 82/85/82% efficient at 20/50/100% load (115V)	180W active PFC 82/85/82% efficient at 20/50/100% load (115V) 250W active PFC 82/85/82% efficient at 20/50/100% load (115V)	N/A
80 PLUS Gold	N/A	N/A	N/A	160W active PFC 87/90/87% efficient at 20/50/100% load (115V) 88/91/88% efficient at 20/50/100% load (230V)
80 PLUS Platinum	N/A	180W active PFC 90/92/89% efficient at 20/50/100% load (115V) 91/93/90% efficient at 20/50/100% load (230V)	250W active PFC 90/92/89% efficient at 20/50/100% load (115V) 91/93/90% efficient at 20/50/100% load (230V)	N/A
Operating Voltage Range	90 – 264 VAC	90 – 264 VAC	90 – 264 VAC	90 – 264 VAC
Rated Voltage Range	100-240V AC	100-240V AC	100-240V AC	100-240V AC
Rated Line Frequency	50/60 HZ	50/60 HZ	50/60 HZ	50/60 HZ
Operating Line Frequency	47 – 63 Hz	47 – 63 Hz	47 – 63 Hz	47 – 63 Hz
Rated Input Current	N/A	N/A	N/A	N/A
Rated Input Current with Energy Efficient* Power Supply	65W/1.6A 90W/1.4A	180W/2.3A	180W/2.3A 250W Bronze/3.5A 250W Platinum/3A	2A
DC Output	+19.5V	+12.1V	+12.1V	+12.1V
Current Leakage (NFPA 99: 2102)	Less than 500 microamps of leakage current at 120 Vac with the ground wire disconnected, as	Less than 500 microamps of leakage current at 120 Vac with the ground wire disconnected, as required for Non-patient Electrical Appliances and Equipment used in a patient care facility or that		Less than 500 microamps of leakage current at 120 Vac with the ground wire disconnected, as

### Standard Features and Configurable Components

	required for Non-patient Electrical Appliances and Equipment used in a patient care facility or that contact patients in normal use. Per section 10.3.5.1.	contact patients in normal use. Per section 10.3.5.1.		required for Non-patient Electrical Appliances and Equipment used in a patient care facility or that contact patients in normal use. Per section 10.3.5.1.
	Less than 100 microamps of leakage current at 120 Vac with the ground wire intact with normal polarity, as required for Non-patient Electrical Appliances and Equipment used in a patient care facility or that contact patients in normal use. Per section 10.3.5.1.	Less than 100 microamps of leakage current at 120 Vac with the ground wire intact with normal polarity, as required for Non-patient Electrical Appliances and Equipment used in a patient care facility or that contact patients in normal use. Per section 10.3.5.1.		Less than 100 microamps of leakage current at 120 Vac with the ground wire intact with normal polarity, as required for Non-patient Electrical Appliances and Equipment used in a patient care facility or that contact patients in normal use. Per section 10.3.5.1.
Power Supply Fan	N/A	70mm variable speed	70mm variable speed	N/A
Power cord length	6.0 ft. (1.83 m)	6.0 ft. (1.83 m)	6.0 ft. (1.83 m)	6.0 ft. (1.83 m)
External Power Adapter	Yes	N/A	N/A	N/A
Dimensions	N/A	N/A	N/A	N/A
Total Cord Length	30mm x 113.5mm x 55mm	N/A	N/A	N/A

The harmonic input current requirements must be met under the following operating conditions:

Load Requirements: 50% and 100%

Input Voltage: 230Vac/50Hz.

For active power factor correction the power factor at 50% & 100% loads shall be greater than 0.9 over the entire nominal input voltage range (100-127VAC and 200-240VAC).

Condition	Standard Efficiency	82/85/82%	85/88/85%	87/90/87%	90/92/89%	Input Voltage
10% of Rated Load	-	75%	81%	84%	84%	115Vac/60HZ
20% of Rated Load	-	82%	85%	87%	90%	115Vac/60HZ
50% of Rated Load	-	85%	88%	90%	92%	115Vac/60HZ
	PF>0.9	PF>0.9	PF>0.9	PF>0.9	PF>0.95	
100% of Rated Load	70%	82%	85%	87%	89%	115Vac/60HZ
	PF>0.9	PF>0.9	PF>0.9	PF>0.9	PF>0.9	230Vac/50HZ

### Standard Features and Configurable Components

### WEIGHTS & DIMENSIONS

	<b>DM</b>	<b>SFF</b>	<b>MT</b>	<b>AiO</b>
Chassis (W x D x H) Not including bezel	6.97 x 6.88 x 1.35 in 177 x 174.7 x 34.2 mm	3.7 10.6 x 11.7 in 95 x 270 x 296 mm	6.69 x 10.79 x 13.3 in 170 x 274 x 338 mm	See table below.
System Volume	64 cu in 1.06 L	463 cu in 7.6 L	960 cu in 15.74 L	
System Weight*	2.67 lb 1.21 kg	9.98 lb 4.53 kg	15.77 lb 7.14 kg	
Max Supported Weight (desktop orientation)	N/A	77 lb 35 kg	77 lb 35 kg	
Packaging (W x D x H)	9.1 x 19.6 x 5.7 in 231.1 x 497.8 x 144.8 mm	15.71 x 9.06 x 19.65 in 399 x 230 x 499 mm	15.35 x 11.73 x 19.65 x in 390 x 298 x 499 mm	
Shipping Weight	6.1 lb 2.8 kg	16.12 lb. 7.32 kg	22.64 lb. 10.28 kg	
Packaging (with Expansion Pack, W x D x H)	10.0 x 19.6 x 7.8 in 255 x 497.8 x 198 mm			
Multi-Unit Packaging (10 units)	20.28 x 16.54 x 25 in 515 x 420 x 636 mm			
Shipping Weight	68 lbs /31 kg			
Shipping Weight (fully loaded)	11.5 lbs / 5.22 kg			
Palletization Profile	20-units per layer 4 layer max 80-units per pallet Footprint-39.21 x 46.61 in (996 x 1184 mm)	6-units per layer 10 layer max 60 per pallet 47.24 x 39.37 x 94.49 in (including pallet)	6-units per layer 7 layer max 42 per pallet 47.24 x 39.37 x 86.85 in (including pallet)	
	<i>Dependent on 40-Ft Std. Sea Container or 40-Ft High-cube Sea Container is used)</i>			

### ALL-IN-ONE WEIGHTS AND DIMENSIONS

<b>Weight</b>	<b>Without Stand</b>	<b>With Easel Stand</b>	<b>With Adjustable Height Stand (without VESA cover)</b>
System Weight	14.07 lb 6.38 kg	15.56 lb 7.06 kg	20.92 lb 9.49 kg
Shipping Weight	17.77 lbs 8.07kg	19.27 lbs 8.74 kg	27.15 lbs 12.31 kg

### Dimensions (W x D x H)



### Standard Features and Configurable Components

<b>Product Dimensions</b>	<b>Without Stand</b> 20.92 x 14.63 x 2.04 in 531.39 x 371.68 x 51.69 mm	<b>Easel Stand</b> 20.92 x 14.63 x 5.85 in 531.45 x 371.8x 148.72 mm	<b>Adjustable Height Stand (maximum)</b> 20.92 x 20.92 x 8.27 in 531.45 x 531.44 x 209.95 mm
			<b>Adjustable Height Stand (minimum)</b> 20.92 x 15.94 x 8.27 in 531.45 x 404.89 x 209.95 mm

### Shipping Dimensions

<b>Shipping Dimensions Boxed</b>	<b>Without Stand</b> 24.09x7.28x18.98(H) in 612x185x482(H) mm	<b>Easel Stand</b> N/A	<b>Adjustable Height Stand</b> 24.21 x 11.54 x 19.69 (H) in 615 x 293 x 500 (H) mm
<b>Shipping Dimensions Pallet</b>	<b>Without Stand (40 units)</b> 48 x 40 x 81.61 (H) in 1219 x 1016 x 2073 (H) mm	<b>Easel Stand (40 units)</b> 48 x 40 x 81.61(H) in 1219 x 1016 x 2073 (H) mm	<b>Adjustable Height Stand (24 units)</b> 48 x 40 x 84.44 (H) in 1219 x 1016 x 2145(H) mm

### Standard Features and Configurable Components

#### DESKTOP MINI DIMENSIONS

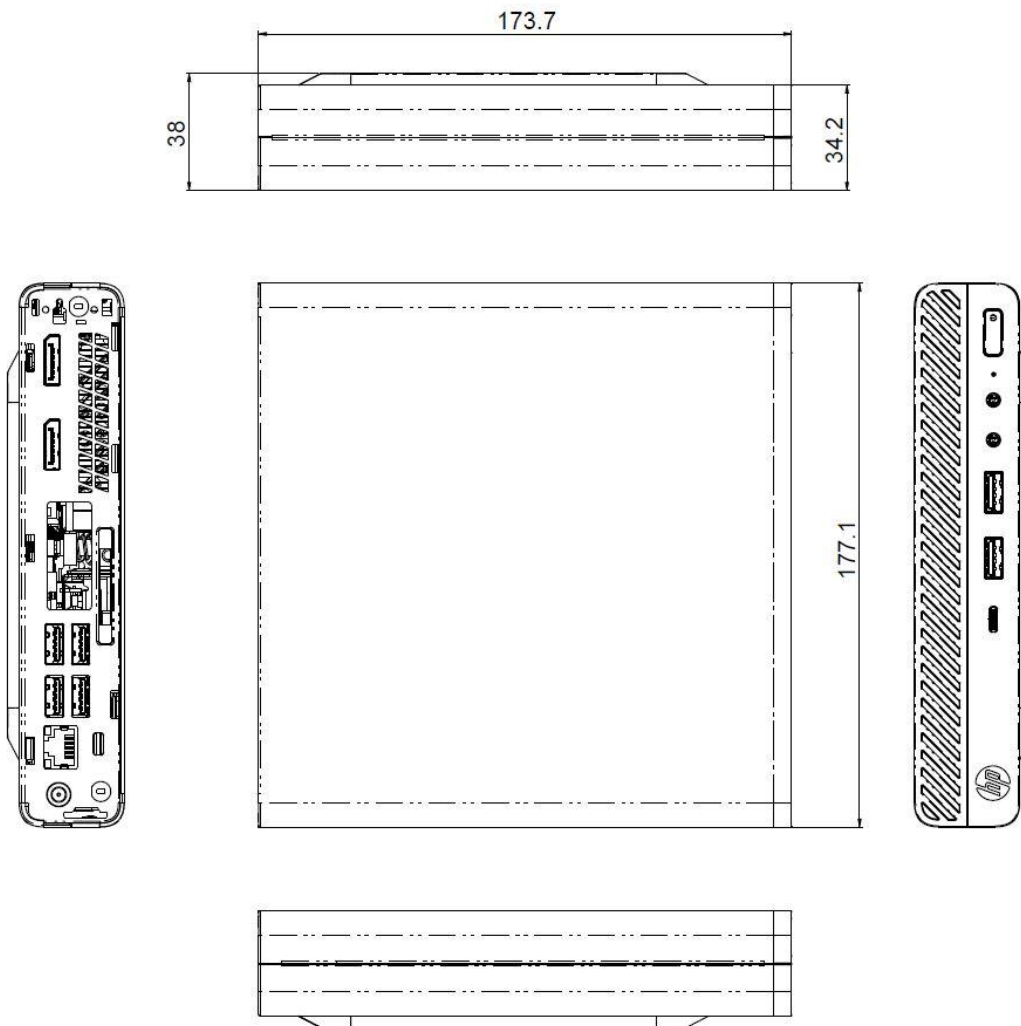

### Standard Features and Configurable Components

#### SMALL FORM FACTOR DIMENSIONS

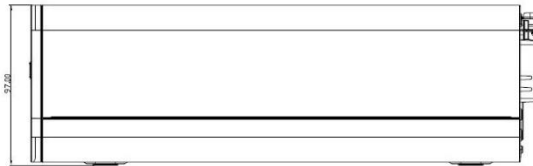
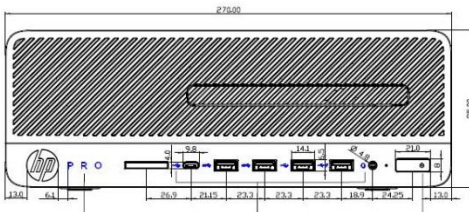
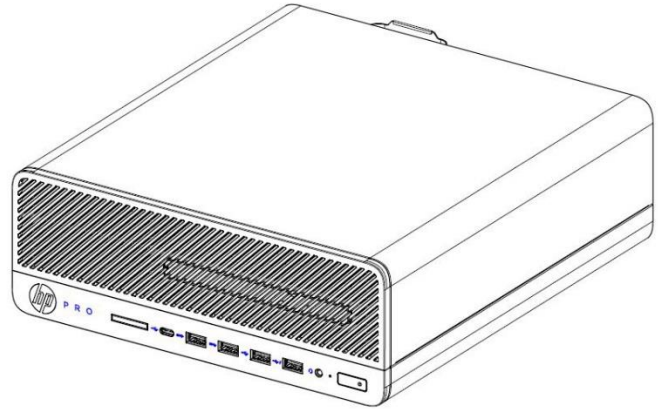
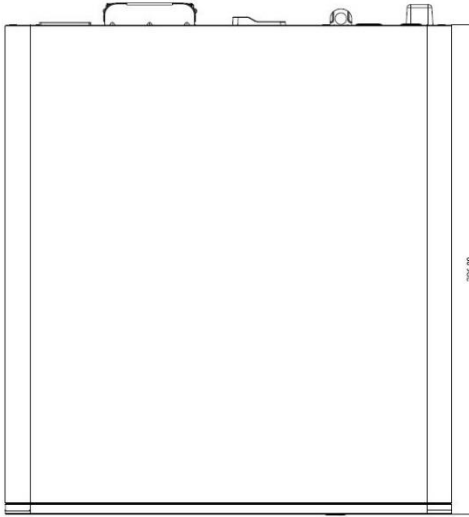

### Standard Features and Configurable Components

#### MICROTOWER DIMENSIONS

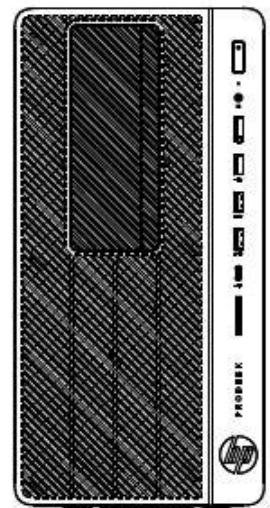
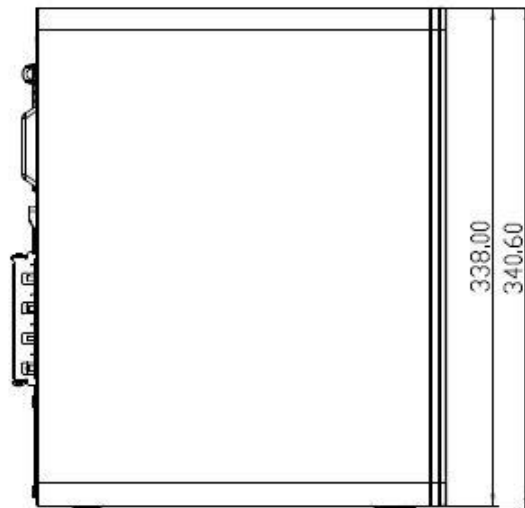
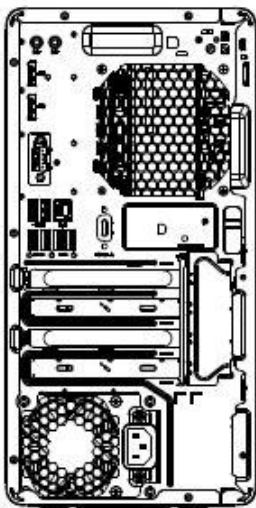
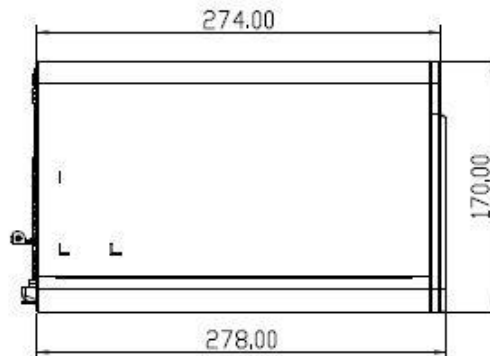

### Standard Features and Configurable Components

#### ALL-IN-ONE EASEL STAND DIMENSIONS

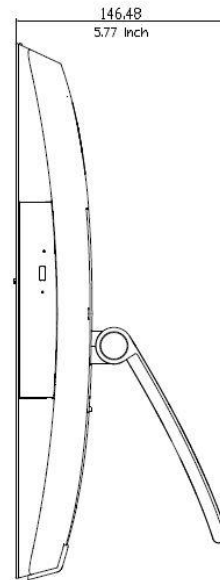
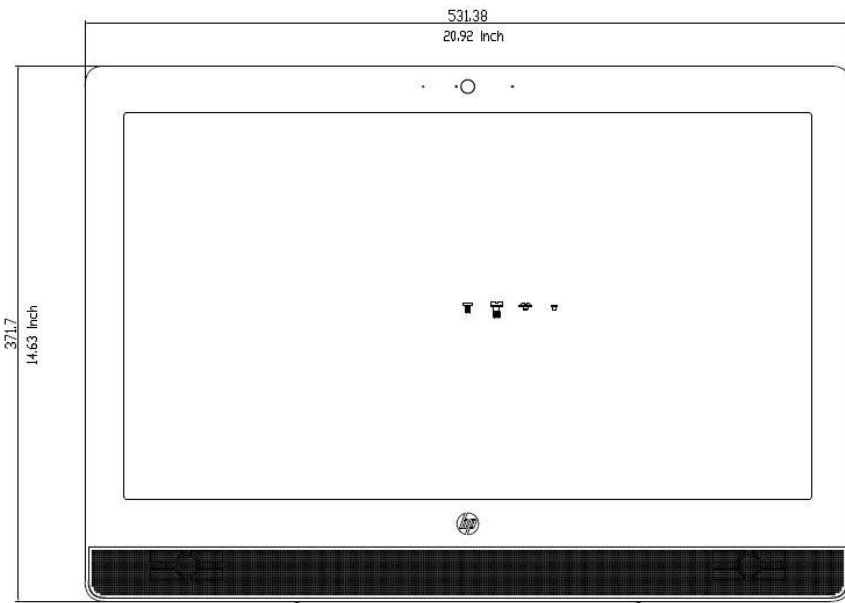
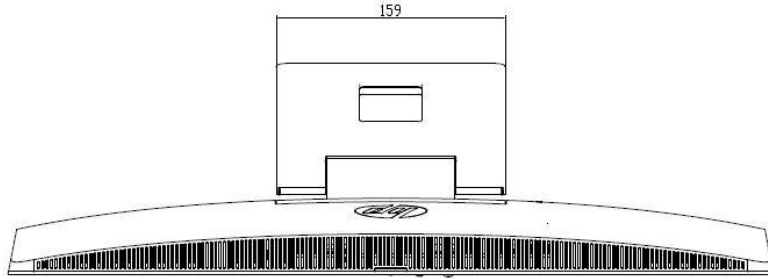

### Standard Features and Configurable Components

#### ALL-IN-ONE ADJUSTABLE HEIGHT STAND DIMENSIONS

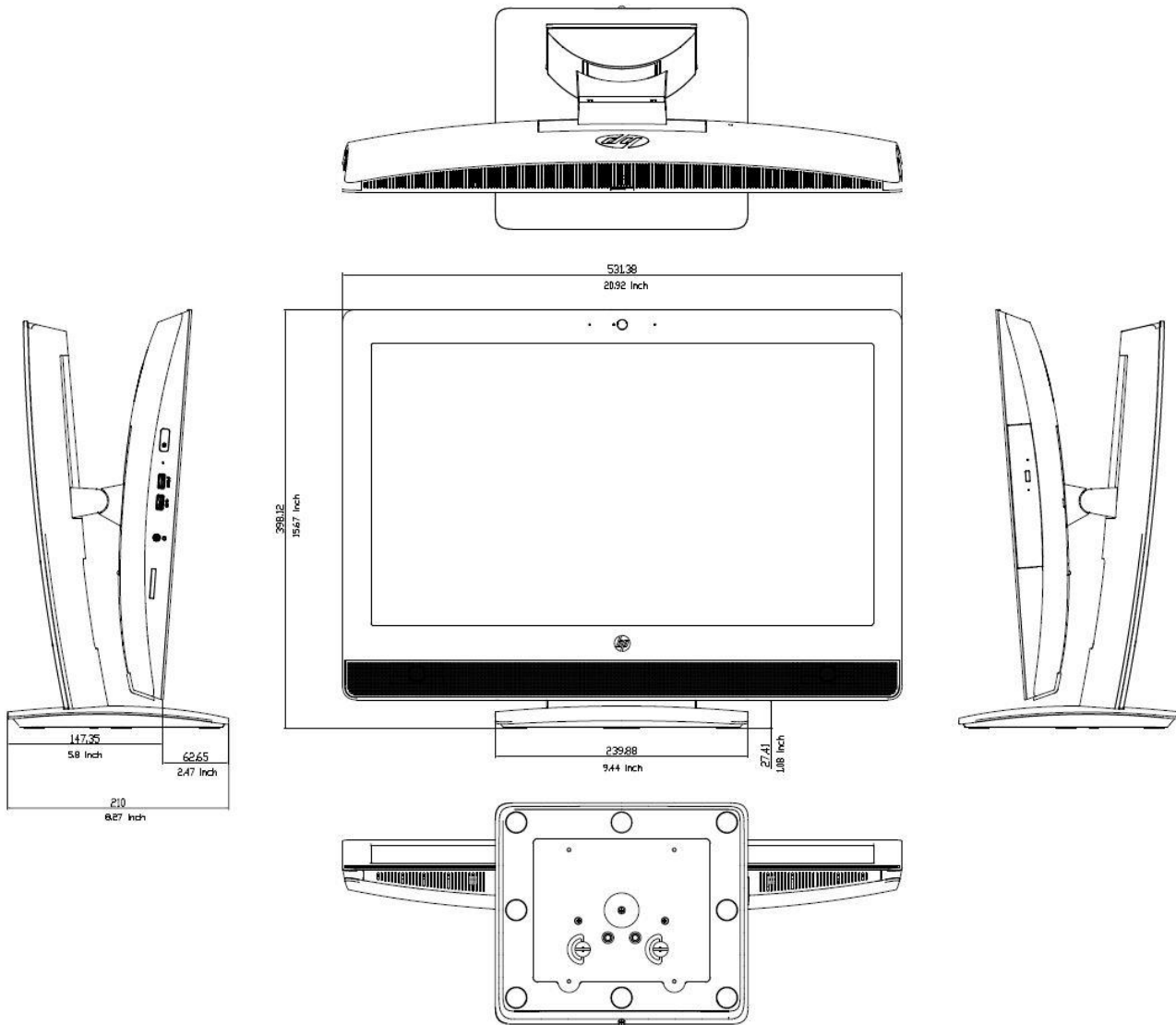

### Standard Features and Configurable Components

#### **ALL-IN-ONE NO STAND DIMENSIONS**

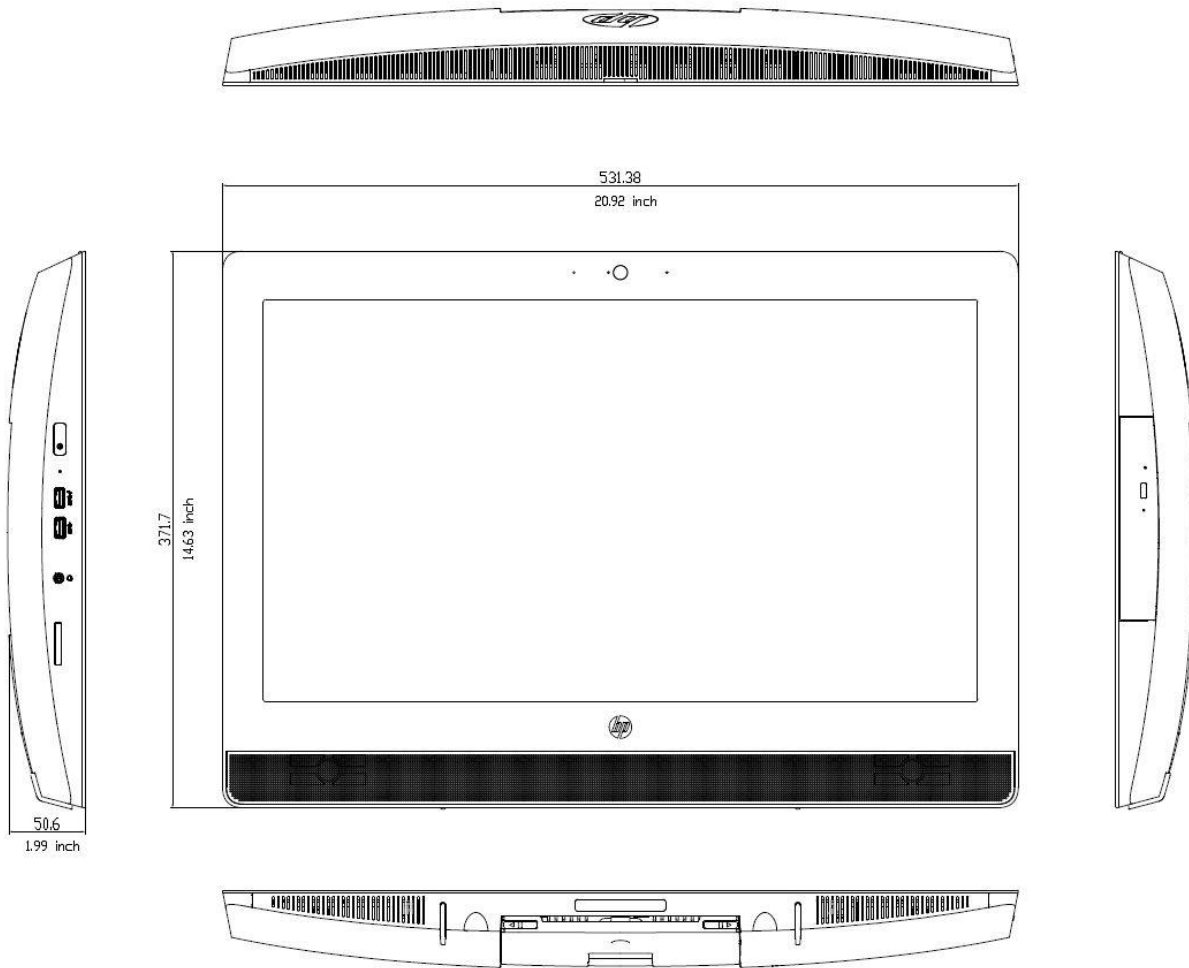

### Standard Features and Configurable Components

## ENVIRONMENTAL & INDUSTRY

### HP ProDesk 600 G3 Desktop Mini Business PC

<b>Eco-Label Certifications &amp; declarations</b>	<p>This product has received or is in the process of being certified to the following approvals and may be labeled with one or more of these marks:</p> <ul style="list-style-type: none"> <li>IT ECO declaration</li> <li>US ENERGY STAR®</li> <li>EPEAT Gold registered in the United States. See <a href="http://www.epeat.net">http://www.epeat.net</a> for registration status in your country.</li> </ul>		
<b>System Configuration</b>	<p>The configuration used for the Energy Consumption and Declared Noise Emissions data for the All-in-One PC model is based on a typically configured PC featuring a hard disk drive, a high efficiency power supply, and a Microsoft Windows® operating system.</p>		
<b>Energy Consumption (in accordance with US ENERGY STAR® test method)</b>	<b>115VAC, 60Hz</b>	<b>230VAC, 50Hz</b>	<b>100VAC, 50Hz</b>
Normal Operation (Short idle)	8.22 W	9.80 W	8.56 W
Normal Operation (Long idle)	7.66 W	7.69 W	7.70 W
Sleep	1.25 W	1.25 W	1.23 W
Off	1.03 W	1.03 W	1.10 W
	<p>Note: Energy efficiency data listed is for an ENERGY STAR® compliant product if offered within the model family. HP computers marked with the ENERGY STAR® Logo are compliant with the applicable U.S. Environmental Protection Agency (EPA) ENERGY STAR® specifications for computers. If a model family does not offer ENERGY STAR® compliant configurations, then energy efficiency data listed is for a typically configured PC featuring a hard disk drive, a high efficiency power supply, and a Microsoft Windows® operating system.</p>		
<b>Heat Dissipation*</b>	<b>115VAC, 60Hz</b>	<b>230VAC, 50Hz</b>	<b>100VAC, 50Hz</b>
Normal Operation (Short idle)	28 BTU/hr	34 BTU/hr	29 BTU/hr
Normal Operation (Long idle)	26 BTU/hr	26 BTU/hr	26 BTU/hr
Sleep	4 BTU/hr	4 BTU/hr	4 BTU/hr
Off	4 BTU/hr	4 BTU/hr	4 BTU/hr
	<p>*NOTE: Heat dissipation is calculated based on the measured watts, assuming the service level is attained for one hour.</p>		
<b>Declared Noise Emissions (in accordance with ISO 7779 and ISO 9296)</b>	<b>Sound Power (L<sub>WAd</sub>, bels)</b>	<b>Sound Pressure (L<sub>pAm</sub>, decibels)</b>	
Typically Configured – Idle	3.0	19	
Optical Drive – Sequential reads	3.1	20	
<b>Longevity and Upgrading</b>	<p>This product can be upgraded, possibly extending its useful life by several years. Upgradeable features and/or components contained in the product may include:</p> <ul style="list-style-type: none"> <li>8 USB ports</li> <li>2 memory slots</li> <li>1 internal M.2 PCIe 2230 connector for optional wireless NIC</li> <li>1 internal M.2 SSD storage (2230 or 2280 connector)</li> <li>1 2.5" internal storage drive bay</li> </ul> <p>Spare parts are available throughout the warranty period and or for up to "5" years after the end of production.</p>		
<b>Batteries</b>	<p>This battery(s) in this product comply with EU Directive 2006/66/EC</p>		



### Standard Features and Configurable Components

	<p>Batteries used in the product do not contain:                  Mercury greater than 1ppm by weight                  Cadmium greater than 20ppm by weight</p> <p>Battery size: CR2032 (coin cell)                  Battery type: lithium</p>		
<b>Additional Information</b>	<p>This product is in compliance with the Restrictions of Hazardous Substances (RoHS) directive - 2011/65/EC.                  This HP product is designed to comply with the Waste Electrical and Electronic Equipment (WEEE) Directive – 2002/96/EC.                  This product is in compliance with California Proposition 65 (State of California; Safe Drinking Water and Toxic Enforcement Act of 1986).                  This product is in compliance with the IEEE 1680 (EPEAT) standard at the Gold level, see <a href="http://www.epeat.net">www.epeat.net</a>                  Plastics parts weighing over 25 grams used in the product are marked per ISO11469 and ISO1043.                  This product contains 24.1% post-consumer recycled plastic (by wt.)                  This product is 91.4% recycle-able when properly disposed of at end of life.</p>		
<b>Packaging Materials</b>	<b>External:</b>	PAPER/Corrugated	443 g
	<b>Internal:</b>	PLASTIC/ Polyethylene Expanded - EPE	38 g
		PLASTIC/ Polyethylene high density - HDPE	4 g
	The plastic packaging material is made from 0% recycled content.		
	The paper material contains at least 25% recycled content.		
<b>Material Usage</b>	<p>This product does not contain any of the following substances in excess of regulatory limits (refer to the HP General Specification for the Environment at <a href="http://www.hp.com/hpinfo/globalcitizenship/environment/pdf/gse.pdf">http://www.hp.com/hpinfo/globalcitizenship/environment/pdf/gse.pdf</a>):</p> <ul style="list-style-type: none"> <li>Asbestos</li> <li>Certain Azo Colorants</li> <li>Certain Brominated Flame Retardants – may not be used as flame retardants in plastics</li> <li>Cadmium</li> <li>Chlorinated Hydrocarbons</li> <li>Chlorinated Paraffins</li> <li>Formaldehyde</li> <li>Halogenated Diphenyl Methanes</li> <li>Lead carbonates and sulfates</li> <li>Lead and Lead compounds</li> <li>Mercuric Oxide Batteries</li> <li>Nickel – finishes must not be used on the external surface designed to be frequently handled or carried by the user.</li> <li>Ozone Depleting Substances</li> <li>Polybrominated Biphenyls (PBBs)</li> <li>Polybrominated Biphenyl Ethers (PBBEs)</li> <li>Polybrominated Biphenyl Oxides (PBBOs) Polychlorinated Biphenyl (PCB)</li> <li>Polychlorinated Terphenyls (PCT)</li> <li>Polyvinyl Chloride (PVC) – except for wires and cables, and certain retail packaging has been voluntarily removed from most applications.</li> <li>Radioactive Substances</li> <li>Tributyl Tin (TBT), Triphenyl Tin (TPT), Tributyl Tin Oxide (TBTO)</li> </ul>		

### Standard Features and Configurable Components

<b>Packaging Usage</b>	<p>HP follows these guidelines to decrease the environmental impact of product packaging:</p> <ul style="list-style-type: none"> <li>• Eliminate the use of heavy metals such as lead, chromium, mercury and cadmium in packaging materials.</li> <li>• Eliminate the use of ozone-depleting substances (ODS) in packaging materials.</li> <li>• Design packaging materials for ease of disassembly.</li> <li>• Maximize the use of post-consumer recycled content materials in packaging materials.</li> <li>• Use readily recyclable packaging materials such as paper and corrugated materials.</li> <li>• Reduce size and weight of packages to improve transportation fuel efficiency.</li> <li>• Plastic packaging materials are marked according to ISO 11469 and DIN 6120 standards.</li> </ul>
<b>End-of-life Management and Recycling</b>	<p>Hewlett-Packard offers end-of-life HP product return and recycling programs in many geographic areas. To recycle your product, please go to: <a href="http://www.hp.com/go/reuse-recycle">http://www.hp.com/go/reuse-recycle</a> or contact your nearest HP sales office. Products returned to HP will be recycled, recovered or disposed of in a responsible manner.</p> <p>The EU WEEE directive (2002/95/EC) requires manufacturers to provide treatment information for each product type for use by treatment facilities. This information (product disassembly instructions) is posted on the Hewlett Packard web site at: <a href="http://www.hp.com/go/recyclers">http://www.hp.com/go/recyclers</a>. These instructions may be used by recyclers and other WEEE treatment facilities as well as HP OEM customers who integrate and re-sell HP equipment.</p>
<b>HP, Inc. Corporate Environmental Information</b>	<p>For more information about HP's commitment to the environment:</p> <p>Global Citizenship Report  <a href="http://www.hp.com/hpinfo/globalcitizenship/gcreport/index.html">http://www.hp.com/hpinfo/globalcitizenship/gcreport/index.html</a>          Eco-label certifications  <a href="http://www8.hp.com/us/en/hp-information/environment/ecolabels.html">http://www8.hp.com/us/en/hp-information/environment/ecolabels.html</a>          ISO 14001 certificates:  <a href="http://h20195.www2.hp.com/V2/GetDocument.aspx?docname=c04755842">http://h20195.www2.hp.com/V2/GetDocument.aspx?docname=c04755842</a>          and  <a href="http://www.hp.com/hpinfo/globalcitizenship/environment/pdf/cert.pdf">http://www.hp.com/hpinfo/globalcitizenship/environment/pdf/cert.pdf</a></p>

### HP ProDesk 600 G3 Small Form Factor Business PC

<b>Eco-Label Certifications &amp; declarations</b>	<p>This product has received or is in the process of being certified to the following approvals and may be labeled with one or more of these marks:</p> <ul style="list-style-type: none"> <li>• IT ECO declaration</li> <li>• US ENERGY STAR®</li> <li>• EPEAT &lt;Gold&gt; registered in the United States. See <a href="http://www.epeat.net">http://www.epeat.net</a> for registration status in your country.</li> <li>• TCO or TCO Certified Edge</li> </ul>		
<b>System Configuration</b>	<p>The configuration used for the Energy Consumption and Declared Noise Emissions data for the All-in-One PC model is based on a typically configured PC featuring a hard disk drive, a high efficiency power supply, and a Microsoft Windows® operating system.</p>		
<b>Energy Consumption (in accordance with US ENERGY STAR® test method)</b>	<b>115VAC, 60Hz</b>	<b>230VAC, 50Hz</b>	<b>100VAC, 50Hz</b>
Normal Operation (Short idle)	14.16 W	14.30 W	13.98 W
Normal Operation (Long idle)	13.39 W	13.43 W	13.29 W
Sleep	0.83 W	0.84 W	0.83 W
Off	0.72 W	0.72 W	0.72 W

### Standard Features and Configurable Components

	<p>Note: Energy efficiency data listed is for an ENERGY STAR® compliant product if offered within the model family. HP computers marked with the ENERGY STAR® Logo are compliant with the applicable U.S. Environmental Protection Agency (EPA) ENERGY STAR® specifications for computers. If a model family does not offer ENERGY STAR® compliant configurations, then energy efficiency data listed is for a typically configured PC featuring a hard disk drive, a high efficiency power supply, and a Microsoft Windows® operating system.</p>		
<b>Heat Dissipation*</b>	<b>115VAC, 60Hz</b>	<b>230VAC, 50Hz</b>	<b>100VAC, 50Hz</b>
Normal Operation (Short idle)	48 BTU/hr	49 BTU/hr	48 BTU/hr
Normal Operation (Long idle)	46 BTU/hr	46 BTU/hr	45 BTU/hr
Sleep	3 BTU/hr	3 BTU/hr	3 BTU/hr
Off	2 BTU/hr	2 BTU/hr	2 BTU/hr
	*NOTE: Heat dissipation is calculated based on the measured watts, assuming the service level is attained for one hour.		
<b>Declared Noise Emissions (in accordance with ISO 7779 and ISO 9296)</b>	Sound Power (L <sub>WAd</sub> , bels)	Sound Pressure (L <sub>pAm</sub> , decibels)	
Typically Configured – Idle	3.1	22	
Optical Drive – Sequential reads	3.2	22	
<b>Longevity and Upgrading</b>	<p>This product can be upgraded, possibly extending its useful life by several years. Upgradeable features and/or components contained in the product may include:</p> <ul style="list-style-type: none"> <li>• 11 USB ports</li> <li>• 2 PCIe half-length slot</li> <li>• 1 internal M.2 PCIe x1 connector for optional wireless NIC</li> <li>• 1 internal M.2 PCIe x4 connector for optional Turbo Drive SSD</li> <li>• 1 3.5" internal storage drive bay or 2.5" internal storage drive bay (HDD/SSD/SED/SSHD)</li> <li>• 1 9.5mm slim optical drive bay</li> </ul> <p>Spare parts are available throughout the warranty period and or for up to "5" years after the end of production.</p>		
<b>Batteries</b>	<p>This battery(s) in this product comply with EU Directive 2006/66/EC</p> <p>Batteries used in the product do not contain: Mercury greater the 1ppm by weight Cadmium greater than 20ppm by weight</p> <p>Battery size: CR2032 (coin cell) Battery type: lithium</p>		
<b>Additional Information</b>	<ul style="list-style-type: none"> <li>• This product is in compliance with the Restrictions of Hazardous Substances (RoHS) directive - 2011/65/EC.</li> <li>• This HP product is designed to comply with the Waste Electrical and Electronic Equipment (WEEE) Directive – 2002/96/EC.</li> <li>• This product is in compliance with California Proposition 65 (State of California; Safe Drinking Water and Toxic Enforcement Act of 1986).</li> <li>• This product is in compliance with the IEEE 1680 (EPEAT) standard at the gold level, see <a href="http://www.epeat.net">www.epeat.net</a></li> <li>• Plastics parts weighing over 25 grams used in the product are marked per ISO11469 and ISO1043.</li> <li>• This product contains 19.8% post-consumer recycled plastic (by wt.)</li> <li>• This product is 92.7% recycle-able when properly disposed of at end of life.</li> </ul>		
<b>Packaging Materials</b>	<b>External:</b>	PAPER/Paperboard	200 g

### Standard Features and Configurable Components

	<b>Internal:</b>	PLASTIC/Polyethylene Expanded - EPE	143 g
		PLASTIC/Polystyrene Expanded - EPS	118 g
		PLASTIC/Other	98 g
		PLASTIC/Polyethylene low density - LDPE	19 g
	The plastic packaging material is made from 80% recycled content.		
	The paper packaging materials contains at least 80% recycled content.		
<b>Material Usage</b>	<p>This product does not contain any of the following substances in excess of regulatory limits (refer to the HP General Specification for the Environment at <a href="http://www.hp.com/hpinfo/globalcitizenship/environment/pdf/gse.pdf">http://www.hp.com/hpinfo/globalcitizenship/environment/pdf/gse.pdf</a>):</p> <p>Asbestos            Certain Azo Colorants            Certain Brominated Flame Retardants – may not be used as flame retardants in plastics            Cadmium            Chlorinated Hydrocarbons            Chlorinated Paraffins            Formaldehyde            Halogenated Diphenyl Methanes            Lead carbonates and sulfates            Lead and Lead compounds            Mercuric Oxide Batteries            Nickel – finishes must not be used on the external surface designed to be frequently handled or carried by the user.            Ozone Depleting Substances            Polybrominated Biphenyls (PBBs)            Polybrominated Biphenyl Ethers (PBBEs)            Polybrominated Biphenyl Oxides (PBBOs) Polychlorinated Biphenyl (PCB)            Polychlorinated Terphenyls (PCT)            Polyvinyl Chloride (PVC) – except for wires and cables, and certain retail packaging has been voluntarily removed from most applications.            Radioactive Substances            Tributyl Tin (TBT), Triphenyl Tin (TPT), Tributyl Tin Oxide (TBTO)</p>		
<b>Packaging Usage</b>	<p>HP follows these guidelines to decrease the environmental impact of product packaging:</p> <ul style="list-style-type: none"> <li>• Eliminate the use of heavy metals such as lead, chromium, mercury and cadmium in packaging materials.</li> <li>• Eliminate the use of ozone-depleting substances (ODS) in packaging materials.</li> <li>• Design packaging materials for ease of disassembly.</li> <li>• Maximize the use of post-consumer recycled content materials in packaging materials.</li> <li>• Use readily recyclable packaging materials such as paper and corrugated materials.</li> <li>• Reduce size and weight of packages to improve transportation fuel efficiency.</li> <li>• Plastic packaging materials are marked according to ISO 11469 and DIN 6120 standards.</li> </ul>		
<b>End-of-life Management and Recycling</b>	<p>Hewlett-Packard offers end-of-life HP product return and recycling programs in many geographic areas. To recycle your product, please go to: <a href="http://www.hp.com/go/reuse-recycle">http://www.hp.com/go/reuse-recycle</a> or contact your nearest HP sales office. Products returned to HP will be recycled, recovered or disposed of in a responsible manner.</p> <p>The EU WEEE directive (2002/95/EC) requires manufacturers to provide treatment information for each product type for use by treatment facilities. This information (product disassembly instructions) is posted on the Hewlett Packard web site at: <a href="http://www.hp.com/go/recyclers">http://www.hp.com/go/recyclers</a>.</p>		

### Standard Features and Configurable Components

	These instructions may be used by recyclers and other WEEE treatment facilities as well as HP OEM customers who integrate and re-sell HP equipment.
<b>HP, Inc. Corporate Environmental Information</b>	<p>For more information about HP's commitment to the environment:</p> <p>Global Citizenship Report  <a href="http://www.hp.com/hpinfo/globalcitizenship/gcreport/index.html">http://www.hp.com/hpinfo/globalcitizenship/gcreport/index.html</a>            Eco-label certifications  <a href="http://www8.hp.com/us/en/hp-information/environment/ecolabels.html">http://www8.hp.com/us/en/hp-information/environment/ecolabels.html</a>            ISO 14001 certificates:  <a href="http://h20195.www2.hp.com/V2/GetDocument.aspx?docname=c04755842t">http://h20195.www2.hp.com/V2/GetDocument.aspx?docname=c04755842t</a>            and  <a href="http://www.hp.com/hpinfo/globalcitizenship/environment/pdf/cert.pdf">http://www.hp.com/hpinfo/globalcitizenship/environment/pdf/cert.pdf</a></p>

### HP ProDesk 600 G3 Microtower Business PC

<b>Eco-Label Certifications &amp; declarations</b>	<p>This product has received or is in the process of being certified to the following approvals and may be labeled with one or more of these marks:</p> <ul style="list-style-type: none"> <li>• IT ECO declaration</li> <li>• US ENERGY STAR®</li> <li>• EPEAT Gold registered in the United States. See <a href="http://www.epeat.net">http://www.epeat.net</a> for registration status in your country.</li> </ul>		
<b>System Configuration</b>	<p>The configuration used for the Energy Consumption and Declared Noise Emissions data for the All-in-One PC model is based on a typically configured PC featuring a hard disk drive, a high efficiency power supply, and a Microsoft Windows® operating system.</p>		
<b>Energy Consumption (in accordance with US ENERGY STAR® test method)</b>	<b>115VAC, 60Hz</b>	<b>230VAC, 50Hz</b>	<b>100VAC, 50Hz</b>
Normal Operation (Short idle)	12.45 W	12.11 W	12.29 W
Normal Operation (Long idle)	11.35 W	11.25 W	11.42 W
Sleep	1.20 W	1.17 W	1.20 W
Off	0.79 W	0.78 W	0.79 W
	<p>Note: Energy efficiency data listed is for an ENERGY STAR® compliant product if offered within the model family. HP computers marked with the ENERGY STAR® Logo are compliant with the applicable U.S. Environmental Protection Agency (EPA) ENERGY STAR® specifications for computers. If a model family does not offer ENERGY STAR® compliant configurations, then energy efficiency data listed is for a typically configured PC featuring a hard disk drive, a high efficiency power supply, and a Microsoft Windows® operating system.</p>		
<b>Heat Dissipation*</b>	<b>115VAC, 60Hz</b>	<b>230VAC, 50Hz</b>	<b>100VAC, 50Hz</b>
Normal Operation (Short idle)	43 BTU/hr	41 BTU/hr	42 BTU/hr
Normal Operation (Long idle)	39 BTU/hr	38 BTU/hr	39 BTU/hr
Sleep	4 BTU/hr	4 BTU/hr	4 BTU/hr
Off	3 BTU/hr	3 BTU/hr	3 BTU/hr
	<p>*NOTE: Heat dissipation is calculated based on the measured watts, assuming the service level is attained for one hour.</p>		

### Standard Features and Configurable Components

Declared Noise Emissions (in accordance with ISO 7779 and ISO 9296)	Sound Power ( $L_{WA}$ , bels)	Sound Pressure ( $L_{pAm}$ , decibels)	
Typically Configured – Idle	3.3	24	
Optical Drive – Sequential reads	3.3	25	
<b>Longevity and Upgrading</b>	This product can be upgraded, possibly extending its useful life by several years. Upgradeable features and/or components contained in the product may include:		
	<ul style="list-style-type: none"> <li>• 11 USB ports</li> <li>• 4 PCIe half-length slot</li> <li>• 1 internal M.2 PCIe x1 connector for optional wireless NIC</li> <li>• 1 internal M.2 PCIe x4 connector for optional Turbo Drive SSD</li> <li>• 2 2.5"/ 1 3.5" internal storage drive(HDD/SSD/SED/SSHD)</li> <li>• 1 5.25" external supporting optical drive</li> </ul> Spare parts are available throughout the warranty period and or for up to "5" years after the end of production.		
<b>Batteries</b>	This battery(s) in this product comply with EU Directive 2006/66/EC  Batteries used in the product do not contain: Mercury greater the 1ppm by weight Cadmium greater than 20ppm by weight  Battery size: CR2032 (coin cell) Battery type: lithium		
<b>Additional Information</b>	<ul style="list-style-type: none"> <li>• This product is in compliance with the Restrictions of Hazardous Substances (RoHS) directive - 2011/65/EC.</li> <li>• This HP product is designed to comply with the Waste Electrical and Electronic Equipment (WEEE) Directive – 2002/96/EC.</li> <li>• This product is in compliance with California Proposition 65 (State of California; Safe Drinking Water and Toxic Enforcement Act of 1986).</li> <li>• This product is in compliance with the IEEE 1680 (EPEAT) standard at the gold level, see <a href="http://www.epeat.net">www.epeat.net</a></li> <li>• Plastics parts weighing over 25 grams used in the product are marked per ISO11469 and ISO1043.</li> <li>• This product contains 19.8% post-consumer recycled plastic (by wt.)</li> <li>• This product is 92.7% recycle-able when properly disposed of at end of life.</li> </ul>		
<b>Packaging Materials</b>	<b>External:</b>	PAPER/Corrugated	1272 g
	<b>Internal:</b>	PLASTIC/Polyethylene Expanded - EPE	280 g
		PLASTIC/Polyethylene low density - LDPE	28 g
	The plastic packaging material is made from 75% recycled content		
	The paper packaging materials contains at least 47.5% recycled content.		
<b>Material Usage</b>	This product does not contain any of the following substances in excess of regulatory limits (refer to the HP General Specification for the Environment at <a href="http://www.hp.com/hpinfo/globalcitizenship/environment/pdf/gse.pdf">http://www.hp.com/hpinfo/globalcitizenship/environment/pdf/gse.pdf</a> ):  Asbestos Certain Azo Colorants Certain Brominated Flame Retardants – may not be used as flame retardants in plastics Cadmium Chlorinated Hydrocarbons Chlorinated Paraffins Formaldehyde Halogenated Diphenyl Methanes		

### Standard Features and Configurable Components

	<p>Lead carbonates and sulfates  Lead and Lead compounds  Mercuric Oxide Batteries  Nickel – finishes must not be used on the external surface designed to be frequently handled or carried by the user.  Ozone Depleting Substances  Polybrominated Biphenyls (PBBs)  Polybrominated Biphenyl Ethers (PBBEs)  Polybrominated Biphenyl Oxides (PBBOs) Polychlorinated Biphenyl (PCB)  Polychlorinated Terphenyls (PCT)  Polyvinyl Chloride (PVC) – except for wires and cables, and certain retail packaging has been voluntarily removed from most applications.  Radioactive Substances  Tributyl Tin (TBT), Triphenyl Tin (TPT), Tributyl Tin Oxide (TBTO)</p>
<p><b>Packaging Usage</b></p>	<p>HP follows these guidelines to decrease the environmental impact of product packaging:</p> <ul style="list-style-type: none"> <li>• Eliminate the use of heavy metals such as lead, chromium, mercury and cadmium in packaging materials.</li> <li>• Eliminate the use of ozone-depleting substances (ODS) in packaging materials.</li> <li>• Design packaging materials for ease of disassembly.</li> <li>• Maximize the use of post-consumer recycled content materials in packaging materials.</li> <li>• Use readily recyclable packaging materials such as paper and corrugated materials.</li> <li>• Reduce size and weight of packages to improve transportation fuel efficiency.</li> <li>• Plastic packaging materials are marked according to ISO 11469 and DIN 6120 standards.</li> </ul>
<p><b>End-of-life Management and Recycling</b></p>	<p>Hewlett-Packard offers end-of-life HP product return and recycling programs in many geographic areas. To recycle your product, please go to: <a href="http://www.hp.com/go/reuse-recycle">http://www.hp.com/go/reuse-recycle</a> or contact your nearest HP sales office. Products returned to HP will be recycled, recovered or disposed of in a responsible manner.</p> <p>The EU WEEE directive (2002/95/EC) requires manufacturers to provide treatment information for each product type for use by treatment facilities. This information (product disassembly instructions) is posted on the Hewlett Packard web site at: <a href="http://www.hp.com/go/recyclers">http://www.hp.com/go/recyclers</a>. These instructions may be used by recyclers and other WEEE treatment facilities as well as HP OEM customers who integrate and re-sell HP equipment.</p>
<p><b>HP, Inc. Corporate Environmental Information</b></p>	<p>For more information about HP’s commitment to the environment:</p> <p>Global Citizenship Report  <a href="http://www.hp.com/hpinfo/globalcitizenship/gcreport/index.html">http://www.hp.com/hpinfo/globalcitizenship/gcreport/index.html</a>  Eco-label certifications  <a href="http://www8.hp.com/us/en/hp-information/environment/ecolabels.html">http://www8.hp.com/us/en/hp-information/environment/ecolabels.html</a>  ISO 14001 certificates:  <a href="http://h20195.www2.hp.com/V2/GetDocument.aspx?docname=c04755842t">http://h20195.www2.hp.com/V2/GetDocument.aspx?docname=c04755842t</a>  and  <a href="http://www.hp.com/hpinfo/globalcitizenship/environment/pdf/cert.pdf">http://www.hp.com/hpinfo/globalcitizenship/environment/pdf/cert.pdf</a></p>



### Standard Features and Configurable Components

#### HP ProDesk 600 G3 Microtower Business PC (with PCI slot)

<b>Eco-Label Certifications &amp; declarations</b>	<p>This product has received or is in the process of being certified to the following approvals and may be labeled with one or more of these marks:</p> <ul style="list-style-type: none"> <li>• IT ECO declaration</li> <li>• US ENERGY STAR®</li> <li>• EPEAT Gold registered in the United States. See <a href="http://www.epeat.net">http://www.epeat.net</a> for registration status in your country.</li> </ul>		
<b>System Configuration</b>	<p>The configuration used for the Energy Consumption and Declared Noise Emissions data for the All-in-One PC model is based on a typically configured PC featuring a hard disk drive, a high efficiency power supply, and a Microsoft Windows® operating system.</p>		
<b>Energy Consumption (in accordance with US ENERGY STAR® test method)</b>	<b>115VAC, 60Hz</b>	<b>230VAC, 50Hz</b>	<b>100VAC, 50Hz</b>
Normal Operation (Short idle)	13.46 W	13.60 W	13.68 W
Normal Operation (Long idle)	12.53 W	12.26 W	12.44 W
Sleep	1.22 W	1.20 W	1.22 W
Off	0.81 W	0.80 W	0.81 W
	<p>Note: Energy efficiency data listed is for an ENERGY STAR® compliant product if offered within the model family. HP computers marked with the ENERGY STAR® Logo are compliant with the applicable U.S. Environmental Protection Agency (EPA) ENERGY STAR® specifications for computers. If a model family does not offer ENERGY STAR® compliant configurations, then energy efficiency data listed is for a typically configured PC featuring a hard disk drive, a high efficiency power supply, and a Microsoft Windows® operating system.</p>		
<b>Heat Dissipation*</b>	<b>115VAC, 60Hz</b>	<b>230VAC, 50Hz</b>	<b>100VAC, 50Hz</b>
Normal Operation (Short idle)	46 BTU/hr	47 BTU/hr	42 BTU/hr
Normal Operation (Long idle)	43 BTU/hr	42 BTU/hr	43 BTU/hr
Sleep	4 BTU/hr	4 BTU/hr	4 BTU/hr
Off	3 BTU/hr	3 BTU/hr	3 BTU/hr
	<p>*NOTE: Heat dissipation is calculated based on the measured watts, assuming the service level is attained for one hour.</p>		
<b>Declared Noise Emissions (in accordance with ISO 7779 and ISO 9296)</b>	<b>Sound Power (L<sub>WAd</sub>, bels)</b>	<b>Sound Pressure (L<sub>pAm</sub>, decibels)</b>	
Typically Configured – Idle	3.3	23	
Optical Drive – Sequential reads	3.3	23	
<b>Longevity and Upgrading</b>	<p>This product can be upgraded, possibly extending its useful life by several years. Upgradeable features and/or components contained in the product may include:</p> <ul style="list-style-type: none"> <li>• 11 USB ports</li> <li>• 3 PCIe half-length slot</li> <li>• 1 PCI half-length slot</li> <li>• 1 internal M.2 PCIe x1 connector for optional wireless NIC</li> <li>• 1 internal M.2 PCIe x4 connector for optional Turbo Drive SSD</li> <li>• 2 2.5"/ 1 3.5" internal storage drive (HDD/SSD/SED/SSHD)</li> <li>• 1 5.25" external supporting optical drive</li> </ul> <p>Spare parts are available throughout the warranty period and or for up to "5" years after the end of production.</p>		
<b>Batteries</b>	<p>This battery(s) in this product comply with EU Directive 2006/66/EC</p> <p>Batteries used in the product do not contain:</p>		



### Standard Features and Configurable Components

	<p>Mercury greater than 1ppm by weight Cadmium greater than 20ppm by weight</p> <p>Battery size: CR2032 (coin cell) Battery type: lithium</p>		
<b>Additional Information</b>	<ul style="list-style-type: none"> <li>• This product is in compliance with the Restrictions of Hazardous Substances (RoHS) directive - 2011/65/EC.</li> <li>• This HP product is designed to comply with the Waste Electrical and Electronic Equipment (WEEE) Directive – 2002/96/EC.</li> <li>• This product is in compliance with California Proposition 65 (State of California; Safe Drinking Water and Toxic Enforcement Act of 1986).</li> <li>• This product is in compliance with the IEEE 1680 (EPEAT) standard at the gold level, see <a href="http://www.epeat.net">www.epeat.net</a></li> <li>• Plastics parts weighing over 25 grams used in the product are marked per ISO11469 and ISO1043.</li> <li>• This product contains 19.6% post-consumer recycled plastic (by wt.)</li> <li>• This product is 95.1% recycle-able when properly disposed of at end of life.</li> </ul>		
<b>Packaging Materials</b>	<b>External:</b>	PAPER/Corrugated	1272 g
	<b>Internal:</b>	PLASTIC/Polyethylene Expanded - EPE	280 g
		PLASTIC/Polyethylene low density - LDPE	28 g
	The plastic packaging material is made from 75% recycled content		
	The paper packaging materials contains at least 47.5% recycled content.		
<b>Material Usage</b>	<p>This product does not contain any of the following substances in excess of regulatory limits (refer to the HP General Specification for the Environment at <a href="http://www.hp.com/hpinfo/globalcitizenship/environment/pdf/gse.pdf">http://www.hp.com/hpinfo/globalcitizenship/environment/pdf/gse.pdf</a>):</p> <p>Asbestos Certain Azo Colorants Certain Brominated Flame Retardants – may not be used as flame retardants in plastics Cadmium Chlorinated Hydrocarbons Chlorinated Paraffins Formaldehyde Halogenated Diphenyl Methanes Lead carbonates and sulfates Lead and Lead compounds Mercuric Oxide Batteries Nickel – finishes must not be used on the external surface designed to be frequently handled or carried by the user. Ozone Depleting Substances Polybrominated Biphenyls (PBBs) Polybrominated Biphenyl Ethers (PBBEs) Polybrominated Biphenyl Oxides (PBBOs) Polychlorinated Biphenyl (PCB) Polychlorinated Terphenyls (PCT) Polyvinyl Chloride (PVC) – except for wires and cables, and certain retail packaging has been voluntarily removed from most applications. Radioactive Substances Tributyl Tin (TBT), Triphenyl Tin (TPT), Tributyl Tin Oxide (TBTO)</p>		

### Standard Features and Configurable Components

<b>Packaging Usage</b>	<p>HP follows these guidelines to decrease the environmental impact of product packaging:</p> <ul style="list-style-type: none"> <li>• Eliminate the use of heavy metals such as lead, chromium, mercury and cadmium in packaging materials.</li> <li>• Eliminate the use of ozone-depleting substances (ODS) in packaging materials.</li> <li>• Design packaging materials for ease of disassembly.</li> <li>• Maximize the use of post-consumer recycled content materials in packaging materials.</li> <li>• Use readily recyclable packaging materials such as paper and corrugated materials.</li> <li>• Reduce size and weight of packages to improve transportation fuel efficiency.</li> <li>• Plastic packaging materials are marked according to ISO 11469 and DIN 6120 standards.</li> </ul>
<b>End-of-life Management and Recycling</b>	<p>Hewlett-Packard offers end-of-life HP product return and recycling programs in many geographic areas. To recycle your product, please go to: <a href="http://www.hp.com/go/reuse-recycle">http://www.hp.com/go/reuse-recycle</a> or contact your nearest HP sales office. Products returned to HP will be recycled, recovered or disposed of in a responsible manner.</p> <p>The EU WEEE directive (2002/95/EC) requires manufacturers to provide treatment information for each product type for use by treatment facilities. This information (product disassembly instructions) is posted on the Hewlett Packard web site at: <a href="http://www.hp.com/go/recyclers">http://www.hp.com/go/recyclers</a>. These instructions may be used by recyclers and other WEEE treatment facilities as well as HP OEM customers who integrate and re-sell HP equipment.</p>
<b>HP, Inc. Corporate Environmental Information</b>	<p>For more information about HP's commitment to the environment:</p> <p>Global Citizenship Report  <a href="http://www.hp.com/hpinfo/globalcitizenship/gcreport/index.html">http://www.hp.com/hpinfo/globalcitizenship/gcreport/index.html</a>          Eco-label certifications  <a href="http://www8.hp.com/us/en/hp-information/environment/ecolabels.html">http://www8.hp.com/us/en/hp-information/environment/ecolabels.html</a>          ISO 14001 certificates:  <a href="http://h20195.www2.hp.com/V2/GetDocument.aspx?docname=c04755842t">http://h20195.www2.hp.com/V2/GetDocument.aspx?docname=c04755842t</a>          and  <a href="http://www.hp.com/hpinfo/globalcitizenship/environment/pdf/cert.pdf">http://www.hp.com/hpinfo/globalcitizenship/environment/pdf/cert.pdf</a></p>

### HP ProOne 600 G3 21.5-inch All-in-One Business PC

<b>Eco-Label Certifications &amp; declarations</b>	<p>This product has received or is in the process of being certified to the following approvals and may be labeled with one or more of these marks:</p> <ul style="list-style-type: none"> <li>• IT ECO declaration</li> <li>• US ENERGY STAR®</li> <li>• EPEAT<sup>®</sup> Gold registered in the United States. See <a href="http://www.epeat.net">http://www.epeat.net</a> for registration status in your country.</li> <li>• TCO or TCO Certified Edge</li> </ul>		
<b>System Configuration</b>  <b>Energy Consumption (in accordance with US ENERGY STAR® test method)</b>	<p>The configuration used for the Energy Consumption and Declared Noise Emissions data for the All-in-One PC model is based on a typically configured PC featuring a hard disk drive, a high efficiency power supply, and a Microsoft Windows® operating system.</p>		
	<b>115VAC, 60Hz</b>	<b>230VAC, 50Hz</b>	<b>100VAC, 50Hz</b>
Normal Operation (Short idle)	19.37 W	19.44 W	19.44 W
Normal Operation (Long idle)	8.52 W	8.63 W	8.37 W

### Standard Features and Configurable Components

Sleep	0.76 W	0.78 W	0.77 W
Off	0.63 W	0.64 W	0.62 W
<p>Note: Energy efficiency data listed is for an ENERGY STAR® compliant product if offered within the model family. HP computers marked with the ENERGY STAR® Logo are compliant with the applicable U.S. Environmental Protection Agency (EPA) ENERGY STAR® specifications for computers. If a model family does not offer ENERGY STAR® compliant configurations, then energy efficiency data listed is for a typically configured PC featuring a hard disk drive, a high efficiency power supply, and a Microsoft Windows® operating system.</p>			
<b>Heat Dissipation*</b>	<b>115VAC, 60Hz</b>	<b>230VAC, 50Hz</b>	<b>100VAC, 50Hz</b>
Normal Operation (Short idle)	66 BTU/hr	66 BTU/hr	67 BTU/hr
Normal Operation (Long idle)	29 BTU/hr	30 BTU/hr	29 BTU/hr
Sleep	3 BTU/hr	3 BTU/hr	3 BTU/hr
Off	2 BTU/hr	2 BTU/hr	2 BTU/hr
<p>*NOTE: Heat dissipation is calculated based on the measured watts, assuming the service level is attained for one hour.</p>			
<b>Declared Noise Emissions (in accordance with ISO 7779 and ISO 9296)</b>	Sound Power (L <sub>WAd</sub> , bels)		Sound Pressure (L <sub>pAm</sub> , decibels)
Typically Configured – Idle	3.4		24
Optical Drive – Sequential reads	3.5		24
<b>Longevity and Upgrading</b>	<p>This product can be upgraded, possibly extending its useful life by several years. Upgradeable features and/or components contained in the product may include:</p> <ul style="list-style-type: none"> <li>• 6 USB ports</li> <li>• 2 memory slots</li> <li>• 1 Mini PCIe half-length slot</li> <li>• 1 MXM 3.0 Type A - 35W slot</li> <li>• 1 mSATA slot</li> <li>• 1 2.5" internal bay supporting up to Two 2.5" hard drives (HDD/SSD/SED/SSHD)</li> <li>• 1 5.25" external supporting optical drive</li> </ul> <p>Spare parts are available throughout the warranty period and or for up to "5" years after the end of production.</p>		
<b>Batteries</b>	<p>This battery(s) in this product comply with EU Directive 2006/66/EC</p> <p>Batteries used in the product do not contain:            Mercury greater the 1ppm by weight            Cadmium greater than 20ppm by weight</p> <p>Battery size: CR2032 (coin cell)            Battery type: lithium/manganese dioxide</p>		

### Standard Features and Configurable Components

<b>Additional Information</b>	<p>This product is in compliance with the Restrictions of Hazardous Substances (RoHS) directive - 2011/65/EC.</p> <p>This HP product is designed to comply with the Waste Electrical and Electronic Equipment (WEEE) Directive – 2002/96/EC.</p> <p>This product is in compliance with California Proposition 65 (State of California; Safe Drinking Water and Toxic Enforcement Act of 1986).</p> <p>This product is in compliance with the IEEE 1680 (EPEAT) standard at the Gold level, see <a href="http://www.epeat.net">www.epeat.net</a></p> <p>Plastics parts weighing over 25 grams used in the product are marked per ISO11469 and ISO1043.</p> <p>This product contains 38.7% post-consumer recycled plastic (by wt.)</p> <p>This product is 95.5% recycle-able when properly disposed of at end of life.</p>		
<b>Packaging Materials</b>	<b>External:</b>	PAPER/Corrugated	1320 g
	<b>Internal:</b>	PLASTIC/EPS (Expanded Polyethylene)	648 g
		PLASTIC/Polyethylene low density	40 g
		PLASTIC/Other	23 g
	The plastic packaging material contains at least 5% recycled content.		
	The corrugated paper packaging materials contains at least 30% recycled content.		
<b>Material Usage</b>	<p>This product does not contain any of the following substances in excess of regulatory limits (refer to the HP General Specification for the Environment at <a href="http://www.hp.com/hpinfo/globalcitizenship/environment/pdf/gse.pdf">http://www.hp.com/hpinfo/globalcitizenship/environment/pdf/gse.pdf</a>):</p> <ul style="list-style-type: none"> <li>Asbestos</li> <li>Certain Azo Colorants</li> <li>Certain Brominated Flame Retardants – may not be used as flame retardants in plastics</li> <li>Cadmium</li> <li>Chlorinated Hydrocarbons</li> <li>Chlorinated Paraffins</li> <li>Formaldehyde</li> <li>Halogenated Diphenyl Methanes</li> <li>Lead carbonates and sulfates</li> <li>Lead and Lead compounds</li> <li>Mercuric Oxide Batteries</li> <li>Nickel – finishes must not be used on the external surface designed to be frequently handled or carried by the user.</li> <li>Ozone Depleting Substances</li> <li>Polybrominated Biphenyls (PBBs)</li> <li>Polybrominated Biphenyl Ethers (PBBEs)</li> <li>Polybrominated Biphenyl Oxides (PBBOs) Polychlorinated Biphenyl (PCB)</li> <li>Polychlorinated Terphenyls (PCT)</li> <li>Polyvinyl Chloride (PVC) – except for wires and cables, and certain retail packaging has been voluntarily removed from most applications.</li> <li>Radioactive Substances</li> <li>Tributyl Tin (TBT), Triphenyl Tin (TPT), Tributyl Tin Oxide (TBTO)</li> </ul>		

### Standard Features and Configurable Components

<b>Packaging Usage</b>	<p>HP follows these guidelines to decrease the environmental impact of product packaging:</p> <ul style="list-style-type: none"> <li>Eliminate the use of heavy metals such as lead, chromium, mercury and cadmium in packaging materials.</li> <li>Eliminate the use of ozone-depleting substances (ODS) in packaging materials.</li> <li>Design packaging materials for ease of disassembly.</li> <li>Maximize the use of post-consumer recycled content materials in packaging materials.</li> <li>Use readily recyclable packaging materials such as paper and corrugated materials.</li> <li>Reduce size and weight of packages to improve transportation fuel efficiency.</li> <li>Plastic packaging materials are marked according to ISO 11469 and DIN 6120 standards.</li> </ul>
<b>End-of-life Management and Recycling</b>	<p>Hewlett-Packard offers end-of-life HP product return and recycling programs in many geographic areas. To recycle your product, please go to: <a href="http://www.hp.com/go/reuse-recycle">http://www.hp.com/go/reuse-recycle</a> or contact your nearest HP sales office. Products returned to HP will be recycled, recovered or disposed of in a responsible manner.</p> <p>The EU WEEE directive (2002/95/EC) requires manufacturers to provide treatment information for each product type for use by treatment facilities. This information (product disassembly instructions) is posted on the Hewlett Packard web site at: <a href="http://www.hp.com/go/recyclers">http://www.hp.com/go/recyclers</a>. These instructions may be used by recyclers and other WEEE treatment facilities as well as HP OEM customers who integrate and re-sell HP equipment.</p>
<b>HP, Inc. Corporate Environmental Information</b>	<p>For more information about HP's commitment to the environment:</p> <ul style="list-style-type: none"> <li>Global Citizenship Report <a href="http://www.hp.com/hpinfo/globalcitizenship/gcreport/index.html">http://www.hp.com/hpinfo/globalcitizenship/gcreport/index.html</a></li> <li>Eco-label certifications <a href="http://www8.hp.com/us/en/hp-information/environment/ecolabels.html">http://www8.hp.com/us/en/hp-information/environment/ecolabels.html</a></li> <li>ISO 14001 certificates: <a href="http://h20195.www2.hp.com/V2/GetDocument.aspx?docname=c04755842">http://h20195.www2.hp.com/V2/GetDocument.aspx?docname=c04755842</a> and <a href="http://www.hp.com/hpinfo/globalcitizenship/environment/pdf/cert.pdf">http://www.hp.com/hpinfo/globalcitizenship/environment/pdf/cert.pdf</a></li> </ul>

ENERGY STAR® certified models available

EPEAT® registered where applicable. EPEAT registration varies by country. See [www.epeat.net](http://www.epeat.net) for registration status by country. Search keyword generator on HP's 3rd party option store for solar generator accessories at [www.hp.com/go/options](http://www.hp.com/go/options)

TAA compliant models available

\* External power supplies, power cords, cables and peripherals are not Low Halogen. Service parts obtained after purchase may not be Low Halogen.

## Standard Features and Configurable Components

**UNIT ENVIRONMENT AND OPERATING CONDITIONS**

## General Unit Operating Guidelines

- Keep the computer away from excessive moisture, direct moisture and the extremes of heat and cold, to ensure that unit is operated within the specified operating range.
- Leave a 10.2 cm (4 in) clearance on all vented sides of the computer to permit the required airflow.
- Never restrict airflow into the computer by blocking any vents or air intakes.
- Do not stack computers on top of each other or place computers so near each other that they are subject to each other's re-circulated or preheated air.
- Occasionally clean the air vents on the front, back, and any other vented side of the computer. Lint, dust and other foreign matter can block the vents and limit the airflow.
- If the computer is to be operated within a separate enclosure, intake and exhaust ventilation must be provided on the enclosure, and the same operating guidelines listed above will still apply.

Temperature Range	Operating: 50° to 95° F (10° to 35° C)* Non-operating: -22° to 140° F (-30° to 60° C)
Relative Humidity	Operating: 10% to 90% (non-condensing at ambient) Non-operating: 5% to 95% (non-condensing at ambient)
Maximum Altitude (unpressurized)	Operating: 5000m Non-operating: 50000ft (15240 m)

\*Operating temperature is de-rated 1.0 deg C per 300 m (1000 ft) to 3000 m (10,000 ft) above sea level, no direct sustained sunlight. Maximum rate of change is 10 deg C/Hr. The upper limit may be limited by the type and number of options installed.

**SERVICE AND SUPPORT**

On-site Warranty <sup>1</sup>: Three-year (3-3-3) limited warranty delivers three years of on-site, next business day <sup>2</sup> service for parts and labor and complimentary limited technical support.<sup>3</sup> Three-year onsite and labor are not available in all countries. Service offers terms up to 5 years by choosing an optional HP Care Pack.<sup>4</sup> To choose the right level of service for your HP product, visit HP Care Pack Central: [www.hp.com/go/cpc](http://www.hp.com/go/cpc)

**NOTE 1:** Terms and conditions may vary by country. Certain restrictions and exclusions apply. Other warranty variations may be offered in your region.

**NOTE 2:** On-site service may be provided pursuant to a service contract between HP and an authorized HP third-party provider, and is not available in certain countries. Global service response times are based on commercially reasonable best effort and may vary by country.

**NOTE 3:** Technical telephone support applies only to HP-configured and third-party HP qualified hardware and software.

**NOTE 4:** Service levels and response times for HP Care Packs may vary depending on your geographic location. Service starts on date of hardware purchase. Restrictions and limitations apply. For details, visit [www.hp.com/go/cpc](http://www.hp.com/go/cpc). HP services are governed by the applicable HP terms and conditions of service provided or indicated to Customer at the time of purchase. Customer may have additional statutory rights according to applicable local laws, and such rights are not in any way affected by the HP terms and conditions of service or the HP Limited Warranty provided with your HP Product.

## Graphics

<b>Intel® HD Graphics (integrated)</b>			
DisplayPort™ 1.2	Multimode capable; supports HDCP, DisplayPort™ 1.2 Audio (2 streams), HBR2 link rates and Multi-Stream Technology for a maximum of 3 displays (including the integrated panel)		
Memory	The BIOS has options for selecting the dedicated memory size of 128MB, 256MB or 512MB Additional memory is allocated for graphics as needed using Intel's Dynamic Video Memory Technology (DVMT), to provide an optimal balance between graphics and system memory use.		
Maximum Graphics Memory	Microsoft Windows 7	Windows 8.1	Windows 10
	Up to 1.7GB	Up to 1.8GB	>4 GB
Note: the actual amount of maximum graphics memory can be less than the amounts listed above depending upon your computer's configuration.			
Maximum Color Depth	32 bits/pixel		
Graphics/Video API Support	6th Generation Core™ processors: <ul style="list-style-type: none"> <li>• Next Generation Intel® Clear Video Technology HD Support is a collection of video playback and enhancement features that improve the end user's viewing experience               <ul style="list-style-type: none"> <li>○ Encode/transcode HD content</li> <li>○ Playback of high definition content including Blu-ray Disc</li> <li>○ Superior image quality with sharper, more colorful images</li> </ul> </li> <li>• DirectX Video Acceleration (DXVA) support for accelerating video processing               <ul style="list-style-type: none"> <li>○ Full AVC/VC1/MPEG2/HEVC HW Decode</li> </ul> </li> <li>• Advanced Scheduler 2.0, 1.0</li> <li>• Windows 7, Windows 8.1, Windows 10, Linux OS Support</li> <li>• DirectX 12.1</li> <li>• OpenGL 4.4</li> <li>• Open CL 1.2 (Intel® HD Graphics 510)</li> <li>• Open CL 1.2/2.0 (Intel® HD Graphics 530)</li> </ul>		

### Supported Display Resolutions and Refresh Rates

Note: other resolutions may be available but are not recommended as they may not have been tested and qualified by HP. For All in One platforms, resolutions higher than the integrated panel resolution are not supported on the integrated panel.

Resolution	Refresh Rate	VGA	DisplayPort™ 1.2	HDMI	Standard
640 x 480	60, 75, 85	X	X	X	VESA DMT, CVT 0.31M3
720 x 400	70	X	X	X	IBM VGA
800 x 600	60, 75, 85	X	X	X	VESA DMT, CVT0.48M3

### Technical Specifications – Graphics

1024 x 768	60, 75, 85	X	X	X	VESA DMT, CVT 0.79M3
1152 x 864	60, 75, 85	X	X	X	VESA DMT, CVT 0.83MA
1280 x 720	60, 75, 85	X	X	X	VESA DMT, CVT 0.92M9, CEA-770.3
1280 x 768	60, 60RB, 75, 85	X	X	X	VESA DMT, CVT 0.98M9/0.98M9-R
1280 x 800	60, 75, 85	X	X	X	VESA DMT
1280 x 960	60, 75, 85	X	X	X	VESA DMT
1280 x 1024	60, 75, 85	X	X	X	VESA DMT, CVT 1.31M4
1366 x 768	60, 60RB	X	X	X	VESA DMT
1440 x 900	60, 60RB	X	X	X	VESA DMT
1600 x 900	60, 60RB, 75, 85	X	X	X	VESA DMT
1680 x 1050	60, 60RB, 75	X	X	X	VESA DMT, CVT 1.76MA/1.76MA-R
1920 x 1080	60	X	X	X	VESA DMT, CVT 2.07M9, SMPTE 274M
1920 x 1200	60, 60RB, 75, 85	X*	X	X	DMT, CVT 2.30MA/2.30MA-R
1600 x 1200	60, 75, 85	X*	X	X	VESA DMT, 1.92M3
1920 x 1440	60, 75, 85		X	X	VESA DMT, CVT 2.76M3
2048 x 1536	60,75		X	X	CVT 3.15M3
2560 x 1440	59.951		X	X	CVT 3.69M9-R
2560 x 1600	60, 60RB		X	X	VESA DMT, CVT 4.10MA/4.10MA-R
3840 x 2160	24		X	X	CVT-RBv1/v2 (8.29M9-R), SMPTE 274M
3840 x 2160	25		X	X	CVT-RBv1/v2 (8.29M9-R), SMPTE 274M
3840 x 2160	30		X	X	CVT-RBv1/v2 (8.29M9-R), SMPTE 274M
3840 x 2160	50		X	X	CVT-RBv1/v2 (8.29M9-R), SMPTE 274M
3840 x 2160	60		X	X	CVT-RBv1/v2 (8.29M9-R), SMPTE 274M
4096 x 2160	24		X	X	CVT-RBv1/v2 (8.85M-R), SMPTE 274M
4096 x 2160	25		X	X	CVT-RBv1/v2 (8.85M-R), SMPTE 274M
4096 x 2160	30		X	X	CVT-RBv1/v2 (8.85M-R), SMPTE 274M
4096 x 2160	50		X	X	CVT-RBv1/v2 (8.85M-R), SMPTE 274M
4096 x 2160	60		X	X	CVT-RBv1/v2 (8.85M-R), SMPTE 274M
1920 x 1080	60		X	X	VESA (SMPTE 274M)
1920 x 1080	50		X	X	SMPTE 274M
1920 x 1080	30		X	X	SMPTE 274M
1920 x 1080	24		X	X	SMPTE 274M
1280 x 720	60		X	X	VESA (CEA-770.3)
1280 x 720	50		X	X	SMPTE 296M



### Technical Specifications – Graphics

720 x 480	60		X	X	MHL (CEA-770.2)
720 x 576	50		X	X	ITU-R BT.1358
640 x 480	60		X	X	CEA (VESA DMT)
* 60Hz refresh rate only on VGA					

### AMD Radeon™ R7 430 2GB LP 2DP PCIe x16 GF card

<b>Memory</b>	1GB/2GB GDDR5 or 2GB/4GB DDR3
<b>Controller Clock Speed</b>	AMD® Radeon™ R7 430 GPU operating up to 780Mhz
<b>Multidisplay Support</b>	A maximum of 2 displays are supported by the card.
<b>Graphics /API support</b>	DIRECTX® 12, Mantle, OpenGL 4.4, Vulkan™
<b>Output Connectors</b>	2x DisplayPort

Resolution	Refresh Rate*	VGA (DVI-VGA adapter)	DisplayPort	Standard
640 x 480	60, 75, 85	X	X	VESA DMT, CVT 0.31M3
720 x 400	70	X	X	IBM VGA
800 x 600	60, 75, 85	X	X	VESA DMT, CVT0.48M3
1024 x 768	60, 75, 85	X	X	VESA DMT, CVT 0.79M3
1152 x 864	60, 75, 85	X	X	VESA DMT, CVT 0.83MA
1280 x 720	60, 75, 85	X	X	VESA DMT, CVT 0.92M9, CEA-770.3
1280 x 768	60, 60RB, 75, 85	X	X	VESA DMT, CVT 0.98M9/0.98M9-R
1280 x 800	60, 75, 85	X	X	VESA DMT
1280 x 960	60, 75, 85	X	X	VESA DMT
1280 x 1024	60, 75, 85	X	X	VESA DMT, CVT 1.31M4
1366 x 768	60, 60RB	X	X	VESA DMT
1440 x 900	60, 60RB	X	X	VESA DMT
1600 x 900	60, 60RB, 75, 85	X	X	VESA DMT
1680 x 1050	60, 60RB, 75	X	X	VESA DMT, CVT 1.76MA/1.76MA-R
1920 x 1080	60	X	X	VESA DMT, CVT 2.07M9, SMPTE 274M
1920 x 1200	60, 60RB, 75, 85	X	X	DMT, CVT 2.30MA/2.30MA-R
1600 x 1200	60, 75, 85	X	X	VESA DMT, 1.92M3
1920 x 1440	60, 75, 85	X	X	VESA DMT, CVT 2.76M3

### Technical Specifications – Graphics

2048 x 1536	60,75	X	X	CVT 3.15M3
2560 x 1440	59.951		X	CVT 3.69M9-R
2560 x 1600	60, 60RB		X	VESA DMT, CVT 4.10MA/4.10MA-R
3840 x 2160	24		X	CVT-RBv1/v2 (8.29M9-R), SMPTE 274M
3840 x 2160	25		X	CVT-RBv1/v2 (8.29M9-R), SMPTE 274M
3840 x 2160	30		X	CVT-RBv1/v2 (8.29M9-R), SMPTE 274M
3840 x 2160	50		X	CVT-RBv1/v2 (8.29M9-R), SMPTE 274M
3840 x 2160	60		X	CVT-RBv1/v2 (8.29M9-R), SMPTE 274M
4096 x 2160	24		X	CVT-RBv1/v2 (8.85M-R), SMPTE 274M
4096 x 2160	25		X	CVT-RBv1/v2 (8.85M-R), SMPTE 274M
4096 x 2160	30		X	CVT-RBv1/v2 (8.85M-R), SMPTE 274M
4096 x 2160	50		X	CVT-RBv1/v2 (8.85M-R), SMPTE 274M
4096 x 2160	60		X	CVT-RBv1/v2 (8.85M-R), SMPTE 274M
1920 x 1080	60		X	VESA (SMPTE 274M)
1920 x 1080	50		X	SMPTE 274M
1920 x 1080	30		X	SMPTE 274M
1920 x 1080	24		X	SMPTE 274M
1280 x 720	60		X	VESA (CEA-770.3)
1280 x 720	50		X	SMPTE 296M
720 x 480	60		X	MHL (CEA-770.2)

### AMD Radeon™ R7 450 4GB PCIe x16 Graphics Card

- Memory** 4GB 128-bit wide frame buffer operating at 1125MHz.
- Controller Clock Speed** AMD® Radeon™ R9 450 GPU operating at 925 MHz
- Multi-display Support** A maximum of 4 displays are supported by the card. A maximum of 2 legacy displays (Native VGA, DVI, or displays connected with passive DisplayPort™ 1.2 adapters are considered as legacy)
- Graphics /API support** DIRECTX 12, Open GL 4.3, Open CL1.2, UVD 3
- Output Connectors** 1 x Dual-Link DVI-I, 1x DisplayPort™ 1.2; 1x HDMI; Includes DVI to VGA adapter
- Supported Display Resolutions and Refresh Rates**

**Note:** other resolutions may be available but are not recommended as they may not have been tested and qualified by HP

Resolution	Refresh Rate*	VGA (DVI-VGA adapter)	DVI-D	DisplayPort™ 1.2	HDMI	Standard
640 x 480	60, 75, 85	X	X	X	X	VESA DMT, CVT 0.31M3
720 x 400	70	X	X	X	X	IBM VGA
800 x 600	60, 75, 85	X	X	X	X	VESA DMT, CVT0.48M3

### Technical Specifications – Graphics

1024 x 768	60, 75, 85	X	X	X	X	VESA DMT, CVT 0.79M3
1152 x 864	60, 75, 85	X	X	X	X	VESA DMT, CVT 0.83MA
1280 x 720	60, 75, 85	X	X	X	X	VESA DMT, CVT 0.92M9, CEA-770.3
1280 x 768	60, 60RB, 75, 85	X	X	X	X	VESA DMT, CVT 0.98M9/0.98M9-R
1280 x 800	60, 75, 85	X	X	X	X	VESA DMT
1280 x 960	60, 75, 85	X	X	X	X	VESA DMT
1280 x 1024	60, 75, 85	X	X	X	X	VESA DMT, CVT 1.31M4
1366 x 768	60, 60RB	X	X	X	X	VESA DMT
1440 x 900	60, 60RB	X	X	X	X	VESA DMT
1600 x 900	60, 60RB, 75, 85	X	X	X	X	VESA DMT
1680 x 1050	60, 60RB, 75	X	X	X	X	VESA DMT, CVT 1.76MA/1.76MA-R
1920 x 1080	60	X	X	X	X	VESA DMT, CVT 2.07M9, SMPTE 274M
1920 x 1200	60, 60RB, 75, 85	X	X	X	X	DMT, CVT 2.30MA/2.30MA-R
1600 x 1200	60, 75, 85	X	X	X	X	VESA DMT, 1.92M3
1920 x 1440	60, 75, 85	X	X	X	X	VESA DMT, CVT 2.76M3
2048 x 1536	60,75	X	X	X	X	CVT 3.15M3
2560 x 1440	59.951		X	X	X	CVT 3.69M9-R
2560 x 1600	60, 60RB		X	X	X	VESA DMT, CVT 4.10MA/4.10MA-R
3840 x 2160	24			X	X	CVT-RBv1/v2 (8.29M9-R), SMPTE 274M
3840 x 2160	25			X	X	CVT-RBv1/v2 (8.29M9-R), SMPTE 274M
3840 x 2160	30		X	X	X	CVT-RBv1/v2 (8.29M9-R), SMPTE 274M
3840 x 2160	50			X		CVT-RBv1/v2 (8.29M9-R), SMPTE 274M
3840 x 2160	60			X		CVT-RBv1/v2 (8.29M9-R), SMPTE 274M
4096 x 2160	24			X	X	CVT-RBv1/v2 (8.85M-R), SMPTE 274M
4096 x 2160	25			X	X	CVT-RBv1/v2 (8.85M-R), SMPTE 274M
4096 x 2160	30			X	X	CVT-RBv1/v2 (8.85M-R), SMPTE 274M
4096 x 2160	50			X		CVT-RBv1/v2 (8.85M-R), SMPTE 274M
4096 x 2160	60			X		CVT-RBv1/v2 (8.85M-R), SMPTE 274M
1920 x 1080	60		X	X	X	VESA (SMPTE 274M)
1920 x 1080	50		X	X	X	SMPTE 274M
1920 x 1080	30		X	X	X	SMPTE 274M
1920 x 1080	24		X	X	X	SMPTE 274M
1280 x 720	60		X	X	X	VESA (CEA-770.3)
1280 x 720	50		X	X	X	SMPTE 296M
720 x 480	60		X	X	X	MHL (CEA-770.2)

### Technical Specifications – Graphics

\* >60 refresh rates only for analog (VGA) signaling

#### AMD Radeon™ RX 460 2GB FH PCIe x16 Graphics Card

<b>Memory</b>	2GB 128-bit wide frame buffer operating at 1750MHz.
<b>Controller Clock Speed</b>	AMD® Radeon™ RX 460 GPU operating at up to 1.2GHz
<b>Multi-display Support</b>	A maximum of 4 displays are supported by the card.
<b>Graphics /API support</b>	DIRECTX 12, Open GL 4.5, Open CL 2.0, AMD Video Coding Engine (VCE) 3.4 and AMD Universal Video Decoder( UVD)
<b>Output Connectors</b>	1 x Dual-Link DVI-D, 1x DisplayPort™ 1.2; 1x HDMI

#### Supported Display Resolutions and Refresh Rates

**Note:** other resolutions may be available but are not recommended as they may not have been tested and qualified by HP

Resolution	Refresh Rate*		DVI-D	DisplayPort™ 1.2	HDMI	Standard
640 x 480	60, 75, 85		X	X	X	VESA DMT, CVT 0.31M3
720 x 400	70		X	X	X	IBM VGA
800 x 600	60, 75, 85		X	X	X	VESA DMT, CVT0.48M3
1024 x 768	60, 75, 85		X	X	X	VESA DMT, CVT 0.79M3
1152 x 864	60, 75, 85		X	X	X	VESA DMT, CVT 0.83MA
1280 x 720	60, 75, 85		X	X	X	VESA DMT, CVT 0.92M9, CEA-770.3
1280 x 768	60, 60RB, 75, 85		X	X	X	VESA DMT, CVT 0.98M9/0.98M9-R
1280 x 800	60, 75, 85		X	X	X	VESA DMT
1280 x 960	60, 75, 85		X	X	X	VESA DMT
1280 x 1024	60, 75, 85		X	X	X	VESA DMT, CVT 1.31M4
1366 x 768	60, 60RB		X	X	X	VESA DMT
1440 x 900	60, 60RB		X	X	X	VESA DMT
1600 x 900	60, 60RB, 75, 85		X	X	X	VESA DMT
1680 x 1050	60, 60RB, 75		X	X	X	VESA DMT, CVT 1.76MA/1.76MA-R
1920 x 1080	60		X	X	X	VESA DMT, CVT 2.07M9, SMPTE 274M
1920 x 1200	60, 60RB, 75, 85		X	X	X	DMT, CVT 2.30MA/2.30MA-R
1600 x 1200	60, 75, 85		X	X	X	VESA DMT, 1.92M3
1920 x 1440	60, 75, 85		X	X	X	VESA DMT, CVT 2.76M3

### Technical Specifications – Graphics

2048 x 1536	60, 75		X	X	X	CVT 3.15M3
2560 x 1440	59.951		X	X	X	CVT 3.69M9-R
2560 x 1600	60, 60 RB		X	X	X	VESA DMT, CVT 4.10MA/4.10MA-R
3840 x 2160	24			X	X	CVT-RBv1/v2 (8.29M9-R), SMPTE 274M
3840 x 2160	25			X	X	CVT-RBv1/v2 (8.29M9-R), SMPTE 274M
3840 x 2160	30		X	X	X	CVT-RBv1/v2 (8.29M9-R), SMPTE 274M
3840 x 2160	50			X	X	CVT-RBv1/v2 (8.29M9-R), SMPTE 274M
3840 x 2160	60			X	X	CVT-RBv1/v2 (8.29M9-R), SMPTE 274M
4096 x 2160	24			X	X	CVT-RBv1/v2 (8.85M-R), SMPTE 274M
4096 x 2160	25			X	X	CVT-RBv1/v2 (8.85M-R), SMPTE 274M
4096 x 2160	30			X	X	CVT-RBv1/v2 (8.85M-R), SMPTE 274M
4096 x 2160	50			X	X	CVT-RBv1/v2 (8.85M-R), SMPTE 274M
4096 x 2160	60			X	X	CVT-RBv1/v2 (8.85M-R), SMPTE 274M
1920 x 1080	60		X	X	X	VESA (SMPTE 274M)
1920 x 1080	50		X	X	X	SMPTE 274M
1920 x 1080	30		X	X	X	SMPTE 274M
1920 x 1080	24		X	X	X	SMPTE 274M
1280 x 720	60		X	X	X	VESA (CEA-770.3)
1280 x 720	50		X	X	X	SMPTE 296M
720 x 480	60		X	X	X	MHL (CEA-770.2)

## NVIDIA® GeForce® GT 730 1GB PCIe x8 HDMI Graphics Card

<b>Memory</b>	1GB GDDR5 64-bit wide frame buffer operating at 2.5GHz.
<b>Controller Clock Speed</b>	NVIDIA® Kepler™ GPU operating at 901 MHz
<b>Multi-display Support</b>	A maximum of 2 displays are supported by the card
<b>Graphics /API support</b>	Supports Microsoft DirectX 12, OpenGL 4.4 and OpenCL 2 API, Shade Model 5 and DirectCompute 11
<b>Output Connectors</b>	1 x Dual-Link DVI-I; 1x HDMI; Includes DVI to VGA adapter

### Supported Display Resolutions and Refresh Rates

**Note:** other resolutions may be available but are not recommended as they may not have been tested and qualified by HP

### Technical Specifications – Graphics

Resolution	Refresh Rate*	VGA (DVI-VGA adapter)	DVI-D	HDMI	Standard
640 x 480	60, 75, 85	X	X	X	VESA DMT, CVT 0.31M3
720 x 400	70	X	X	X	IBM VGA
800 x 600	60, 75, 85	X	X	X	VESA DMT, CVT0.48M3
1024 x 768	60, 75, 85	X	X	X	VESA DMT, CVT 0.79M3
1152 x 864	60, 75, 85	X	X	X	VESA DMT, CVT 0.83MA
1280 x 720	60, 75, 85	X	X	X	VESA DMT, CVT 0.92M9, CEA-770.3
1280 x 768	60, 60RB, 75, 85	X	X	X	VESA DMT, CVT 0.98M9/0.98M9-R
1280 x 800	60, 75, 85	X	X	X	VESA DMT
1280 x 960	60, 75, 85	X	X	X	VESA DMT
1280 x 1024	60, 75, 85	X	X	X	VESA DMT, CVT 1.31M4
1366 x 768	60, 60RB	X	X	X	VESA DMT
1440 x 900	60, 60RB	X	X	X	VESA DMT
1600 x 900	60, 60RB, 75, 85	X	X	X	VESA DMT
1680 x 1050	60, 60RB, 75	X	X	X	VESA DMT, CVT 1.76MA/1.76MA-R
1920 x 1080	60	X	X	X	VESA DMT, CVT 2.07M9, SMPTE 274M
1920 x 1200	60, 60RB, 75, 85	X	X	X	DMT, CVT 2.30MA/2.30MA-R
1600 x 1200	60, 75, 85	X	X	X	VESA DMT, 1.92M3
1920 x 1440	60, 75, 85	X	X	X	VESA DMT, CVT 2.76M3
2048 x 1536	60,75	X	X	X	CVT 3.15M3
2560 x 1440	59.951		X	X	CVT 3.69M9-R
2560 x 1600	60, 60RB		X	X	VESA DMT, CVT 4.10MA/4.10MA-R
3840 x 2160	24			X	CVT-RBv1/v2 (8.29M9-R), SMPTE 274M
3840 x 2160	25			X	CVT-RBv1/v2 (8.29M9-R), SMPTE 274M
3840 x 2160	30		X	X	CVT-RBv1/v2 (8.29M9-R), SMPTE 274M
3840 x 2160	50				CVT-RBv1/v2 (8.29M9-R), SMPTE 274M
3840 x 2160	60				CVT-RBv1/v2 (8.29M9-R), SMPTE 274M
4096 x 2160	24			X	CVT-RBv1/v2 (8.85M-R), SMPTE 274M
4096 x 2160	25			X	CVT-RBv1/v2 (8.85M-R), SMPTE 274M
4096 x 2160	30			X	CVT-RBv1/v2 (8.85M-R), SMPTE 274M

### Technical Specifications – Graphics

4096 x 2160	50				CVT-RBv1/v2 (8.85M-R), SMPTE 274M
4096 x 2160	60				CVT-RBv1/v2 (8.85M-R), SMPTE 274M
1920 x 1080	60		X	X	VESA (SMPTE 274M)
1920 x 1080	50		X	X	SMPTE 274M
1920 x 1080	30		X	X	SMPTE 274M
1920 x 1080	24		X	X	SMPTE 274M
1280 x 720	60		X	X	VESA (CEA-770.3)
1280 x 720	50		X	X	SMPTE 296M
720 x 480	60		X	X	MHL (CEA-770.2)

\* >60 refresh rates only for analog (VGA) signaling

### NVIDIA® GeForce® GT 730 2GB DP PCIe x8 Graphics Card

<b>Introduction</b>	Get impressive graphics and high resolution dual-display performance in a low profile, PCI Express x8 graphics add-in card based on the NVIDIA® Kepler™ Graphics Processor. Improve your everyday PC, Web conferencing, and video or photo editing.				
<b>Memory</b>	2GB GDDR5 64-bit wide frame buffer operating at 900 MHz				
<b>Controller Clock Speed</b>	NVIDIA® Kepler™ GPU operating at 902 MHz				
<b>Multi-display Support</b>	A maximum of 4 displays are supported by the card.				
<b>Graphics /API support</b>	Supports Microsoft DirectX 12, OpenGL 4.4 and OpenCL 2 APIs, Shade Model 5, UVD 4.2, VCE 2.0, and DirectCompute 11				
<b>Output Connectors</b>	1 x Dual-Link DVI-I, 1x DisplayPort™ 1.2; Includes DVI to VGA adapter Display Port output is multi-mode capable, support Audio, HBR2 and MST				
Resolution	Refresh Rate*	VGA (DVI-VGA adapter)	DVI-D	DisplayPort™ 1.2	Standard
640 x 480	60, 75, 85	X	X	X	VESA DMT, CVT 0.31M3
720 x 400	70	X	X	X	IBM VGA
800 x 600	60, 75, 85	X	X	X	VESA DMT, CVT0.48M3
1024 x 768	60, 75, 85	X	X	X	VESA DMT, CVT 0.79M3
1152 x 864	60, 75, 85	X	X	X	VESA DMT, CVT 0.83MA

### Technical Specifications – Graphics

1280 x 720	60, 75, 85	X	X	X	VESA DMT, CVT 0.92M9, CEA-770.3
1280 x 768	60, 60RB, 75, 85	X	X	X	VESA DMT, CVT 0.98M9/0.98M9-R
1280 x 800	60, 75, 85	X	X	X	VESA DMT
1280 x 960	60, 75, 85	X	X	X	VESA DMT
1280 x 1024	60, 75, 85	X	X	X	VESA DMT, CVT 1.31M4
1366 x 768	60, 60RB	X	X	X	VESA DMT
1440 x 900	60, 60RB	X	X	X	VESA DMT
1600 x 900	60, 60RB, 75, 85	X	X	X	VESA DMT
1680 x 1050	60, 60RB, 75	X	X	X	VESA DMT, CVT 1.76MA/1.76MA-R
1920 x 1080	60	X	X	X	VESA DMT, CVT 2.07M9, SMPTE 274M
1920 x 1200	60, 60RB, 75, 85	X	X	X	DMT, CVT 2.30MA/2.30MA-R
1600 x 1200	60, 75, 85	X	X	X	VESA DMT, 1.92M3
1920 x 1440	60, 75, 85	X	X	X	VESA DMT, CVT 2.76M3
2048 x 1536	60,75	X	X	X	CVT 3.15M3
2560 x 1440	59.951		X	X	CVT 3.69M9-R
2560 x 1600	60, 60RB		X	X	VESA DMT, CVT 4.10MA/4.10MA-R
3840 x 2160	24			X	CVT-RBv1/v2 (8.29M9-R), SMPTE 274M
3840 x 2160	25			X	CVT-RBv1/v2 (8.29M9-R), SMPTE 274M
3840 x 2160	30		X	X	CVT-RBv1/v2 (8.29M9-R), SMPTE 274M
3840 x 2160	60			X	CVT-RBv1/v2 (8.29M9-R), SMPTE 274M
4096 x 2160	24			X	CVT-RBv1/v2 (8.85M-R), SMPTE 274M
4096 x 2160	25			X	CVT-RBv1/v2 (8.85M-R), SMPTE 274M
4096 x 2160	30			X	CVT-RBv1/v2 (8.85M-R), SMPTE 274M
4096 x 2160	60			X	CVT-RBv1/v2 (8.85M-R), SMPTE 274M
1920 x 1080	60		X	X	VESA (SMPTE 274M)
1920 x 1080	50		X	X	SMPTE 274M
1920 x 1080	30		X	X	SMPTE 274M
1920 x 1080	24		X	X	SMPTE 274M
1280 x 720	60		X	X	VESA (CEA-770.3)
1280 x 720	50		X	X	SMPTE 296M
720 x 480	60		X	X	MHL (CEA-770.2)
720 x 576	50		X	X	ITU-R BT.1358
640 x 480	60		X	X	CEA (VESA DMT)

\* >60 refresh rates only for analog (VGA) signaling



### Technical Specifications – Hard Disk and Solid State Storage

#### HARD DISK AND SOLID STATE STORAGE

**NOTE:** For hard drives and solid state drives, GB = 1 billion bytes. TB = 1 trillion bytes. Actual formatted capacity is less. Up to 16 GB (for Windows 7) and 36 GB (for Windows 8.1/10) of system disk is reserved for the system recovery software.

<b>HP 1 TB 7.2K SATA 6.0Gb/s 2.5” Hard Disk Drive</b>		
<b>Capacity</b>	1,000,204,886,016 bytes	
<b>Rotational Speed</b>	7,200 rpm	
<b>Interface</b>	SATA 6 Gb/s	
<b>Buffer Size</b>	32 MB	
<b>Logical Blocks</b>	1,953,525,168	
<b>Seek Time</b> (typical reads, includes controller overhead, including settling)	Single Track:	2.0 ms
	Average:	12 ms
	Full-Stroke:	25 ms
<b>Height</b> (nominal)	0.374 in/9.5 mm	
<b>Width</b> (nominal)	Media diameter: 2.5 in/63.5 mm	
	Physical size: 2.75 in/70 mm	
<b>Operating Temperature</b>	41° to 131° F (5° to 55° C)	
<p>*NOTE: For hard drives and solid state drives, GB = 1 billion bytes. TB = 1 trillion bytes. Actual formatted capacity is less. Up to 36 GB (for Windows 10) of system disk is reserved for the system recovery software.</p>		

<b>HP 500 GB 7.2K SATA 6.0Gb/s 2.5” Hard Disk Drive*</b>		
<b>Capacity</b>	500,107,862,016 bytes	
<b>Rotational Speed</b>	7,200 rpm	
<b>Interface</b>	SATA 6 Gb/s	
<b>Buffer Size</b>	16 MB	
<b>Logical Blocks</b>	976,773,168	
<b>Seek Time</b> (typical reads, includes controller overhead, including settling)	Single Track:	2.0 ms
	Average:	12 ms

### Technical Specifications – Hard Disk and Solid State Storage

	Full-Stroke:	25 ms
<b>Height (nominal)</b>	0.267 in/6.8 mm	
<b>Width (nominal)</b>	Media diameter: 2.5 in/63.5 mm	
	Physical size: 2.75 in/70 mm	
<b>Operating Temperature</b>	41° to 131° F (5° to 55° C)	
<p>*NOTE: For hard drives and solid state drives, GB = 1 billion bytes. TB = 1 trillion bytes. Actual formatted capacity is less. Up to 36 GB (for Windows 10) of system disk is reserved for the system recovery software.</p>		

<b>500GB* 7.2K rpm SATA 6.0Gb/s 3.5" Hard Disk Drive</b>		
<b>Formatted Capacity</b>	500,107,862,016 bytes	
<b>Spindle Speed</b>	7,200 rpm	
<b>Interface</b>	Serial ATA 3.0 (6.0 Gb/s)	
<b>Buffer Size</b>	16 MB	
<b>Logical Blocks</b>	976,773,168	
<b>Seek Time (average)</b>	Single Track:	2.0 ms
	Average:	11 ms
	Full-Stroke:	21 ms
<b>Height (nominal)</b>	1 in/2.54 cm	
<b>Width (nominal)</b>	Media diameter: 3.5 in/8.89 cm	
	Physical size: 4 in/10.2 cm	
<b>Operating Temperature</b>	41° to 131° F (5° to 55° C)	
<p>*NOTE: For hard drives and solid state drives, GB = 1 billion bytes. TB = 1 trillion bytes. Actual formatted capacity is less. Up to 36 GB (for Windows 10) of system disk is reserved for the system recovery software.</p>		

<b>HP 1 TB* 7.2K rpm SATA 6.0Gb/s 3.5" Hard Disk Drive*</b>	
<b>Formatted Capacity</b>	1,000,204,886,016 bytes
<b>Rotational Speed</b>	7,200 rpm
<b>Interface</b>	Serial ATA 3.0 (6.0 Gb/s)
<b>Buffer Size</b>	32 MB

### Technical Specifications – Hard Disk and Solid State Storage

<b>Logical Blocks</b>	1,953,525,168	
<b>Seek Time (average)</b>	Single Track:	2.0 ms
	Average:	11 ms
	Full-Stroke:	21 ms
<b>Height (nominal)</b>	1 in/2.54 cm	
<b>Width (nominal)</b>	Media diameter: 3.5 in/8.89 cm	
	Physical size: 4 in/10.2 cm	
<b>Operating Temperature</b>	41° to 131° F (5° to 55° C)	
<p>* For hard drives and solid state drives, GB = 1 billion bytes. TB = 1 trillion bytes. Actual formatted capacity is less. Up to 36 GB (for Windows 10) of system disk is reserved for the system recovery software.</p>		

<b>HP 2 TB* 7.2K rpm SATA 6.0Gb/s 3.5" Hard Disk Drive*</b>		
<b>Formatted Capacity</b>	2 TB	
<b>Rotational Speed</b>	7,200 rpm	
<b>Interface</b>	SATA 6Gb/s NCQ	
<b>Cache, Multisegmented (MB)</b>	64 MB	
<b>Seek Time (average)</b>	Read	<8.5 ms
	Write	<9.5 ms
<b>Height</b>	1.028 in/26.11 mm	
<b>Width</b>	4.0 in/101.6 mm	
<b>Depth</b>	5.787 in/146.99 mm	
<b>Weight</b>	1.38 lb/626 g	
<b>Operating Temperature</b>	32° to 140° F (0° to 60° C)	
<p>*NOTE: For hard drives and solid state drives, GB = 1 billion bytes. TB = 1 trillion bytes. Actual formatted capacity is less. Up to 16 GB (for Windows 7) and 36 GB (for Windows 8.1/10) of system disk is reserved for the system recovery software.</p>		

<b>HP 1 TB* SATA 6G 2.5" 8GB Solid State Hybrid Drive (SSHD)*</b>	
<b>Formatted Capacity</b>	1 TB
<b>Spindle Speed</b>	5,400 rpm +/- 0.2%
<b>Drive Type</b>	Solid State Hybrid Drive (SSHD) technology with NAND Flash
<b>Interface</b>	SATA 6 Gb/s

### Technical Specifications – Hard Disk and Solid State Storage

<b>Cache Buffer</b>	64 MB	
<b>NAND Flash Commercial Multilevel Cell (cMLC)</b>	8 GB	
<b>Number of Sectors</b>	976,773,168	
<b>Seek Time (typical reads)</b>	Single Track:	2.0 ms
	Average:	12 ms
<b>Height</b>	0.374 +/- .008 in (9.5 +/- 0.2 mm)	
<b>Width</b>	2.750 +/- 0.010 in (69.85 +/- 0.25 mm)	
<b>Length</b>	3.951 +0.008 / -0.010 in (100.35 +0.20 / -0.25 mm)	
<b>Weight</b>	0.254 lb/115 g (max)	
<b>Operating Temperature</b>	32° to 140° F (0° to 60° C)	
* For hard drives and solid state drives, GB = 1 billion bytes. TB = 1 trillion bytes. Actual formatted capacity is less. Up to 16 GB (for Windows 7) and 36 GB (for Windows 8.1/10) of system disk is reserved for the system recovery software.		

<b>HP 500 GB SATA 6G 2.5" 8GB Solid State Hybrid Drive (SSHD)*</b>		
<b>Formatted Capacity</b>	500 GB	
<b>Spindle Speed</b>	5,400 rpm +/- 0.2%	
<b>Drive Type</b>	Solid State Hybrid Drive (SSHD) technology with NAND Flash	
<b>Interface</b>	SATA 6 Gb/s	
<b>Cache Buffer</b>	64 MB	
<b>NAND Flash Commercial Multilevel Cell (cMLC)</b>	8 GB	
<b>Number of Sectors</b>	976,773,168	
<b>Seek Time (typical reads)</b>	Single Track:	2.0 ms
	Average:	12 ms
<b>Height</b>	0.268 +/- .008 in (6.8 +/- 0.2 mm)	
<b>Width</b>	2.750 +/- 0.010 in (69.85 +/- 0.25 mm)	
<b>Length</b>	3.951 +0.008 / -0.010 in (100.35 +0.20 / -0.25 mm)	
<b>Weight</b>	0.209 lb/95 g (max)	

### Technical Specifications – Hard Disk and Solid State Storage

<b>Operating Temperature</b>	41° to 131° F (5° to 55° C)
*NOTE: For hard drives and solid state drives, GB = 1 billion bytes. TB = 1 trillion bytes. Actual formatted capacity is less. Up to 16 GB (for Windows 7) and 36 GB (for Windows 8.1/10) of system disk is reserved for the system recovery software.	

<b>HP 1-TB SATA 6G 3.5" 8GB Solid State Hybrid Drive (SSHD)*</b>		
<b>Formatted Capacity</b>	1 TB	
<b>Spindle Speed</b>	7,200 rpm	
<b>Drive Type</b>	Solid State Hybrid Drive (SSHD) technology with NAND Flash	
<b>Interface</b>	Serial ATA (SATA)	
<b>Cache Buffer</b>	64 MB	
<b>NAND Flash Multilevel Cell (MLC)</b>	8 GB	
<b>Number of Sectors</b>	1,953,525,168	
<b>Seek Time</b> (typical reads)	Single Track:	2.0 ms
	Average:	11 ms
<b>Height</b>	0.783 in / 2.01 cm	
<b>Width</b>	4 in / 10.2 cm	
<b>Length</b>	5.79 in / 14.7 cm	
<b>Weight</b>	0.88 lb/400 g	
<b>Operating Temperature</b>	41° to 131° F (5° to 55° C)	
*NOTE: For hard drives and solid state drives, GB = 1 billion bytes. TB = 1 trillion bytes. Actual formatted capacity is less. Up to 16 GB (for Windows 7) and 36 GB (for Windows 8.1/10) of system disk is reserved for the system recovery software.		

<b>500GB* 2.5" FIPS 140-2 SED Solid State Drive*</b>	
<b>Formatted Capacity</b>	500 GB
<b>Architecture</b>	Self-Encrypting (SED) Solid State Drive with SATA interface.
<b>Interface</b>	Serial ATA (6.0 Gb/s)

### Technical Specifications – Hard Disk and Solid State Storage

<b>Form Factor</b>	2.5 inch	
<b>Height</b>	6.80 mm ± 0.20	
<b>Width</b>	69.85 mm ± 0.25	
<b>Length</b>	100.35 mm ± 0.25/0.20	
<b>Weight (typical)</b>	<95 g (0.209 lb)	
<b>Bandwidth Performance</b>	Sustained data transfer rate OD	100 MB/s max
	I/O data-transfer rate	600 MB/s max
<b>Power</b>	Power consumption:	Spinup (max): 1.00A Idle, active: 0.70W Sleep 0.18W
<b>Environmental</b> (all conditions, non-condensing)	Operating Temperature:	32° to 140° F (0° to 60° C)
	Relative Humidity:	5% to 95%
	Shock:	Maximum 400 G/2 ms

\*NOTE: For hard drives and solid state drives, GB = 1 billion bytes. TB = 1 trillion bytes. Actual formatted capacity is less. Up to 16 GB (for Windows 7) and 36 GB (for Windows 8.1/10) of system disk is reserved for the system recovery software.

### 256GB\* TLC SED SSD 2.5" FIPS Drive\*

<b>Unformatted Capacity</b>	256 GB
<b>Architecture</b>	Self-Encrypting (SED) Solid State Drive with SATA interface.
<b>Interface</b>	Serial ATA (6.0 Gb/s)
<b>Form Factor</b>	2.5 inch
<b>Height</b>	7 mm
<b>Width</b>	69.85 mm
<b>Length</b>	100.45 mm
<b>Weight (typical)</b>	10 g (0.022 lb) max

### Technical Specifications – Hard Disk and Solid State Storage

<b>Bandwidth Performance</b>	Sequential read (128KB transfer)	530
	Sequential write (128KB transfer)	500
	Random read (4KB transfer)	55,000
	Random write (4KB transfer)	83,000
<b>Power</b>	SATA Power consumption	Sleep Typical: 2mW Idle, average: 55mW Active, average: 70mW Active maximum (128KB transfer): 3000 mW
<b>Environmental</b> (all conditions, non-condensing)	Operating Temperature	32° to 158° F (0° to 70° C)
	Relative Humidity	5% to 95%
	Non-operating Shock	1500 G/0.5ms
	Non-operating Vibration	5-800Hz @ 3.10G
<p><b>*NOTE:</b> For hard drives and solid state drives, GB = 1 billion bytes. TB = 1 trillion bytes. Actual formatted capacity is less. Up to 16 GB (for Windows 7) and 36 GB (for Windows 8.1/10) of system disk is reserved for the system recovery software.</p>		

### 512GB\* TLC SED SSD 2.5" FIPS Drive\*

<b>Unformatted Capacity</b>	512 GB
<b>Architecture</b>	Self-Encrypting (SED) Solid State Drive with SATA interface.
<b>Interface</b>	Serial ATA (6.0 Gb/s)
<b>Form Factor</b>	2.5 inch
<b>Height</b>	7 mm
<b>Width</b>	69.85 mm
<b>Length</b>	100.45 mm

### Technical Specifications – Hard Disk and Solid State Storage

<b>Weight (typical)</b>	10 g (0.022 lb) max	
<b>Bandwidth Performance</b>	Sequential read (128KB transfer)	530
	Sequential write (128KB transfer)	500
	Random read (4KB transfer)	92,000
	Random write (4KB transfer)	83,000
<b>Power</b>	SATA Power consumption	Sleep Typical: 2mW Idle, average: 55mW Active, average: 70mW Active maximum (128KB transfer): 4000 mW
<b>Environmental</b> (all conditions, non-condensing)	Operating Temperature	32° to 158° F (0° to 70° C)
	Relative Humidity	5% to 95%
	Non-operating Shock	1500 G/0.5ms
	Non-operating Vibration	5-800Hz @ 3.10G
<p>*NOTE: For hard drives and solid state drives, GB = 1 billion bytes. TB = 1 trillion bytes. Actual formatted capacity is less. Up to 16 GB (for Windows 7) and 36 GB (for Windows 8.1/10) of system disk is reserved for the system recovery software.</p>		

### 500 GB\* SATA 2.5" Self-Encrypting (SED) Opal 2 Solid State Drive\*

<b>Unformatted Capacity</b>	500GB
<b>Architecture</b>	Self-Encrypting (SED) Solid State Drive with 25nm MLC NAND Flash and SATA interface
<b>Interface</b>	Serial ATA 2.0 (3.0 Gb/s)
<b>NAND Flash</b>	25nm MLC NAND Flash
<b>Height</b>	.275 in/7mm
<b>Width</b>	2.75 in/69.85 mm



### Technical Specifications – Hard Disk and Solid State Storage

<b>Length</b>	3.95 in/100.5 mm	
<b>Weight</b>	0.161 lb (73 g)	
<b>Bandwidth Performance</b>	Sustained Sequential 128k Read:	Up to 450 MB/s
	Sustained Sequential 128k Write:	Up to 260 MB/s
	Random 4k Read:	Up to 46K IOPs
	Random 4k Write:	Up to 56K IOPs
<b>Latency</b>	Read:	55 $\mu$ s
	Write:	55 $\mu$ s
<b>Power</b>	SATA power consumption:	160 mW (active average); <85 mW (idle average)
<b>Useful Drive Life</b>	72TB written, up to 40GB/day for 5 years	
	Operating Temperature:	32° to 158° F (0° to 70° C)
<b>Environmental</b> (all conditions, non-condensing)	Relative Humidity:	5% to 95%
	Shock:	1,500 G/1 ms
<p>*NOTE: For hard drives and solid state drives, GB = 1 billion bytes. TB = 1 trillion bytes. Actual formatted capacity is less. Up to 16 GB (for Windows 7) and 36 GB (for Windows 8.1/10) of system disk is reserved for the system recovery software.</p>		

### 256 GB SATA 2.5" TLC SED SSD Opal 2 Drive\*

<b>Unformatted Capacity</b>	256 GB 500,118,192 (User Addressable Sectors)
<b>Architecture</b>	Self-Encrypting (SED) Solid State Drive with NAND Flash and SATA interface. Trusted Computing Group (TCG) OPAL 2.0 compliant encrypted solid state drive
<b>Interface</b>	Serial ATA (6.0 Gb/s)

### Technical Specifications – Hard Disk and Solid State Storage

<b>Form Factor</b>	2.5 inch	
<b>Height</b>	6.80 mm ± 0.20	
<b>Width</b>	69.85 mm ± 0.25	
<b>Length</b>	100.20 mm ± 0.25	
<b>Typical Weight</b>	37.4 g	
<b>Bandwidth Performance</b>	Sustained Sequential Read:	Up to 520 MB/s
	Sustained Sequential Write:	Up to 460 MB/s
<b>Power</b>	Power consumption:	Active: 3.891W; Idle: 0.085W
<b>Mean Time Between Failure (MTBF)</b>	1,500,000 hours	
<b>Environmental</b> (all conditions, non-condensing)	Operating Temperature:	32° to 158° F (0° to 70° C)
	Relative Humidity:	5% to 95%
	Shock:	1,500 G/0.5 ms
<p><b>*NOTE:</b> For hard drives and solid state drives, GB = 1 billion bytes. TB = 1 trillion bytes. Actual formatted capacity is less. Up to 16 GB (for Windows 7) and 36 GB (for Windows 8.1/10) of system disk is reserved for the system recovery software.</p>		

### 512 GB SATA 2.5" TLC SED SSD Opal 2 Drive\*

<b>Unformatted Capacity</b>	512 GB 1,000,215,216 (User Addressable Sectors)
<b>Architecture</b>	Self-Encrypting (SED) Solid State Drive with NAND Flash and SATA interface. Trusted Computing Group (TCG) OPAL 2.0 compliant encrypted solid state drive
<b>Interface</b>	Serial ATA (6.0 Gb/s)
<b>Form Factor</b>	2.5 inch
<b>Height</b>	7 mm ± 0.20
<b>Width</b>	69.85 mm ± 0.25
<b>Length</b>	100.20 mm ± 0.25

### Technical Specifications – Hard Disk and Solid State Storage

<b>Typical Weight</b>	37.4 g	
<b>Bandwidth Performance</b>	Sustained Sequential Read:	Up to 515 MB/s
	Sustained Sequential Write:	Up to 490 MB/s
<b>Power</b>	Power consumption:	Maximum active power: ≤4,400mW Average power: 70mW Slumber low power mode: 42mW – 52mW
<b>Mean Time Between Failure (MTBF)</b>	Up to 1,750,000 hours	
<b>Environmental</b> (all conditions, non-condensing)	Operating Temperature:	0°C to 70°C (32°F to 158°F)
	Non-operating temperature and storage	-55°C to +85°C (-67°F to 185°F)
	Operating and non-operating shock	1,500 G/0.5 ms

\*NOTE: For hard drives and solid state drives, GB = 1 billion bytes. TB = 1 trillion bytes. Actual formatted capacity is less. Up to 16 GB (for Windows 7) and 36 GB (for Windows 8.1/10) of system disk is reserved for the system recovery software.

### 256GB Turbo Drive G2 TLC Solid State Drive

<b>Unformatted Capacity</b>	256 GB
<b>Architecture</b>	Solid State Drive with TLC NAND Flash and PCIE interface. Complies with NVMe Standard Power Saving Modes: L1 substates support Multi Queue support
<b>Interface</b>	PCI-E Gen3 x 4
<b>Form Factor</b>	M.2 2280
<b>Height</b>	3.73 mm
<b>Width</b>	22.00 ± 0.15 mm
<b>Length</b>	80.00 ± 0.15 mm
<b>Weight</b>	Up to 8 g

### Technical Specifications – Hard Disk and Solid State Storage

<b>Bandwidth Performance</b>	Sustained Sequential Read:	Up to 2600 MB/s
	Sustained Sequential Write:	Up to 1000 MB/s
<b>Power</b>	Power consumption:	Active: Typical 6.1W; Idle: Typical 80mW L1.2: Typical 5mW
<b>Mean Time Between Failure (MTBF)</b>	1,500,000 hours	
<b>Environmental</b> (all conditions, non-condensing)	Operating Temperature:	32° to 158° F (0° to 70° C)
	Relative Humidity:	5% to 95%
	Shock:	1,500 G/0.5 ms

### 512GB Turbo Drive G2 TLC Solid State Drive

<b>Unformatted Capacity</b>	512 GB	
<b>Architecture</b>	Solid State Drive with TLC NAND Flash and PCIE interface. Complies with NVMe Standard Power Saving Modes: L1 substates support Multi Queue support	
<b>Interface</b>	PCI-E Gen3 x 4	
<b>Form Factor</b>	M.2 2280	
<b>Height</b>	3.73 mm	
<b>Width</b>	22.00 ± 0.15 mm	
<b>Length</b>	80.00 ± 0.15 mm	
<b>Weight</b>	Up to 8 g	
<b>Bandwidth Performance</b>	Sustained Sequential Read:	Up to 2600 MB/s
	Sustained Sequential Write:	Up to 1200 MB/s

### Technical Specifications – Hard Disk and Solid State Storage

<b>Power</b>	Power consumption:	Active: Typical 6.1W; Idle: Typical 80mW L1.2: Typical 5mW
<b>Mean Time Between Failure (MTBF)</b>	1,500,000 hours	
<b>Environmental</b> (all conditions, non-condensing)	Operating Temperature:	32° to 158° F (0° to 70° C)
	Relative Humidity:	5% to 95%
	Shock:	1,500 G/0.5 ms

### 1 TB Turbo Drive G2 TLC Solid State Drive

<b>Unformatted Capacity</b>	1 TB	
<b>Architecture</b>	Solid State Drive with TLC NAND Flash and PCIE interface. Complies with NVMe Standard Power Saving Modes: L1 substates support Multi Queue support	
<b>Interface</b>	PCI-E Gen3 x 4	
<b>Form Factor</b>	M.2 2280	
<b>Height</b>	3.73 mm	
<b>Width</b>	22.00 ± 0.15 mm	
<b>Length</b>	80.00 ± 0.15 mm	
<b>Weight</b>	Up to 8 g	
<b>Bandwidth Performance</b>	Sustained Sequential Read:	Up to 2600 MB/s
	Sustained Sequential Write:	Up to 1400 MB/s
<b>Power</b>	Power consumption:	Active: Typical 6.1W; Idle: Typical 80mW L1.2: Typical 5mW

### Technical Specifications – Hard Disk and Solid State Storage

<b>Mean Time Between Failure (MTBF)</b>	1,500,000 hours	
<b>Environmental</b> (all conditions, non-condensing)	Operating Temperature:	32° to 158° F (0° to 70° C)
	Relative Humidity:	5% to 95%
	Shock:	1,500 G/0.5 ms

#### HP 1 TB 7.2K SATA 6.0Gb/s 2.5” Hard Disk Drive

<b>Capacity</b>	1,000,204,886,016 bytes	
<b>Rotational Speed</b>	7,200 rpm	
<b>Interface</b>	SATA 6 Gb/s	
<b>Buffer Size</b>	32 MB	
<b>Logical Blocks</b>	1,953,525,168	
<b>Seek Time</b> (typical reads, includes controller overhead, including settling)	Single Track:	2.0 ms
	Average:	12 ms
	Full-Stroke:	25 ms
<b>Height</b> (nominal)	0.374 in/9.5 mm	
<b>Width</b> (nominal)	Media diameter: 2.5 in/63.5 mm	
	Physical size: 2.75 in/70 mm	
<b>Operating Temperature</b>	41° to 131° F (5° to 55° C)	

\*NOTE: For hard drives and solid state drives, GB = 1 billion bytes. TB = 1 trillion bytes. Actual formatted capacity is less. Up to 36 GB (for Windows 10) of system disk is reserved for the system recovery software.

#### HP 500 GB 7.2K SATA 6.0Gb/s 2.5” Hard Disk Drive\*

<b>Capacity</b>	500,107,862,016 bytes
<b>Rotational Speed</b>	7,200 rpm

### Technical Specifications – Hard Disk and Solid State Storage

<b>Interface</b>	SATA 6 Gb/s	
<b>Buffer Size</b>	16 MB	
<b>Logical Blocks</b>	976,773,168	
<b>Seek Time</b> (typical reads, includes controller overhead, including settling)	Single Track:	2.0 ms
	Average:	12 ms
	Full-Stroke:	25 ms
<b>Height</b> (nominal)	0.267 in/6.8 mm	
<b>Width</b> (nominal)	Media diameter: 2.5 in/63.5 mm	
	Physical size: 2.75 in/70 mm	
<b>Operating Temperature</b>	41° to 131° F (5° to 55° C)	
<p>*NOTE: For hard drives and solid state drives, GB = 1 billion bytes. TB = 1 trillion bytes. Actual formatted capacity is less. Up to 36 GB (for Windows 10) of system disk is reserved for the system recovery software.</p>		

### 500GB\* 7.2K rpm SATA 6.0Gb/s 3.5" Hard Disk Drive

<b>Formatted Capacity</b>	500,107,862,016 bytes	
<b>Spindle Speed</b>	7,200 rpm	
<b>Interface</b>	Serial ATA 3.0 (6.0 Gb/s)	
<b>Buffer Size</b>	16 MB	
<b>Logical Blocks</b>	976,773,168	
<b>Seek Time</b> (average)	Single Track:	2.0 ms
	Average:	11 ms
	Full-Stroke:	21 ms
<b>Height</b> (nominal)	1 in/2.54 cm	
<b>Width</b> (nominal)	Media diameter: 3.5 in/8.89 cm	
	Physical size: 4 in/10.2 cm	
<b>Operating Temperature</b>	41° to 131° F (5° to 55° C)	
<p>*NOTE: For hard drives and solid state drives, GB = 1 billion bytes. TB = 1 trillion bytes. Actual formatted capacity is less. Up to 36 GB (for Windows 10) of system disk is reserved for the system recovery software.</p>		

### Technical Specifications – Hard Disk and Solid State Storage

<b>HP 1 TB* 7.2K rpm SATA 6.0Gb/s 3.5" Hard Disk Drive*</b>		
<b>Formatted Capacity</b>	1,000,204,886,016 bytes	
<b>Rotational Speed</b>	7,200 rpm	
<b>Interface</b>	Serial ATA 3.0 (6.0 Gb/s)	
<b>Buffer Size</b>	32 MB	
<b>Logical Blocks</b>	1,953,525,168	
<b>Seek Time (average)</b>	Single Track:	2.0 ms
	Average:	11 ms
	Full-Stroke:	21 ms
<b>Height (nominal)</b>	1 in/2.54 cm	
<b>Width (nominal)</b>	Media diameter: 3.5 in/8.89 cm	
	Physical size: 4 in/10.2 cm	
<b>Operating Temperature</b>	41° to 131° F (5° to 55° C)	
<p>* For hard drives and solid state drives, GB = 1 billion bytes. TB = 1 trillion bytes. Actual formatted capacity is less. Up to 36 GB (for Windows 10) of system disk is reserved for the system recovery software.</p>		

<b>HP 2 TB* 7.2K rpm SATA 6.0Gb/s 3.5" Hard Disk Drive*</b>		
<b>Formatted Capacity</b>	2 TB	
<b>Rotational Speed</b>	7,200 rpm	
<b>Interface</b>	SATA 6Gb/s NCQ	
<b>Cache, Multisegmented (MB)</b>	64 MB	
<b>Seek Time (average)</b>	Read	<8.5 ms
	Write	<9.5 ms
<b>Height</b>	1.028 in/26.11 mm	
<b>Width</b>	4.0 in/101.6 mm	
<b>Depth</b>	5.787 in/146.99 mm	
<b>Weight</b>	1.38 lb/626 g	
<b>Operating Temperature</b>	32° to 140° F (0° to 60° C)	
<p>*NOTE: For hard drives and solid state drives, GB = 1 billion bytes. TB = 1 trillion bytes. Actual formatted capacity is less. Up to 16 GB (for Windows 7) and 36 GB (for Windows 8.1/10) of system disk is reserved for the system recovery software.</p>		



### Technical Specifications – Hard Disk and Solid State Storage

<b>HP 500 GB SATA 6G 2.5" 8GB Solid State Hybrid Drive (SSHD)*</b>		
<b>Formatted Capacity</b>	500 GB	
<b>Spindle Speed</b>	5,400 rpm +/- 0.2%	
<b>Drive Type</b>	Solid State Hybrid Drive (SSHD) technology with NAND Flash	
<b>Interface</b>	SATA 6 Gb/s	
<b>Cache Buffer</b>	64 MB	
<b>NAND Flash Commercial Multilevel Cell (cMLC)</b>	8 GB	
<b>Number of Sectors</b>	976,773,168	
<b>Seek Time (typical reads)</b>	Single Track:	2.0 ms
	Average:	12 ms
<b>Height</b>	0.268 +/- .008 in (6.8 +/- 0.2 mm)	
<b>Width</b>	2.750 +/- 0.010 in (69.85 +/- 0.25 mm)	
<b>Length</b>	3.951 +0.008 / -0.010 in (100.35 +0.20 / -0.25 mm)	
<b>Weight</b>	0.209 lb/95 g (max)	
<b>Operating Temperature</b>	41° to 131° F (5° to 55° C)	
<p>*NOTE: For hard drives and solid state drives, GB = 1 billion bytes. TB = 1 trillion bytes. Actual formatted capacity is less. Up to 16 GB (for Windows 7) and 36 GB (for Windows 8.1/10) of system disk is reserved for the system recovery software.</p>		

<b>HP 1 TB* SATA 6G 2.5" 8GB Solid State Hybrid Drive (SSHD)*</b>		
<b>Formatted Capacity</b>	1 TB	
<b>Spindle Speed</b>	5,400 rpm +/- 0.2%	
<b>Drive Type</b>	Solid State Hybrid Drive (SSHD) technology with NAND Flash	
<b>Interface</b>	SATA 6 Gb/s	
<b>Cache Buffer</b>	64 MB	

### Technical Specifications – Hard Disk and Solid State Storage

<b>NAND Flash Commercial Multilevel Cell (cMLC)</b>	8 GB	
<b>Number of Sectors</b>	976,773,168	
<b>Seek Time (typical reads)</b>	Single Track:	2.0 ms
	Average:	12 ms
<b>Height</b>	0.374 +/- .008 in (9.5 +/- 0.2 mm)	
<b>Width</b>	2.750 +/- 0.010 in (69.85 +/- 0.25 mm)	
<b>Length</b>	3.951 +0.008 / -0.010 in (100.35 +0.20 / -0.25 mm)	
<b>Weight</b>	0.254 lb/115 g (max)	
<b>Operating Temperature</b>	32° to 140° F (0° to 60° C)	
<p>* For hard drives and solid state drives, GB = 1 billion bytes. TB = 1 trillion bytes. Actual formatted capacity is less. Up to 16 GB (for Windows 7) and 36 GB (for Windows 8.1/10) of system disk is reserved for the system recovery software.</p>		

<b>HP 1-TB SATA 6G 3.5" 8GB Solid State Hybrid Drive (SSHD)*</b>		
<b>Formatted Capacity</b>	1 TB	
<b>Spindle Speed</b>	7,200 rpm	
<b>Drive Type</b>	Solid State Hybrid Drive (SSHD) technology with NAND Flash	
<b>Interface</b>	Serial ATA (SATA)	
<b>Cache Buffer</b>	64 MB	
<b>NAND Flash Multilevel Cell (MLC)</b>	8 GB	
<b>Number of Sectors</b>	1,953,525,168	
<b>Seek Time (typical reads)</b>	Single Track:	2.0 ms
	Average:	11 ms
<b>Height</b>	0.783 in / 2.01 cm	
<b>Width</b>	4 in / 10.2 cm	
<b>Length</b>	5.79 in / 14.7 cm	
<b>Weight</b>	0.88 lb/400 g	
<b>Operating Temperature</b>	41° to 131° F (5° to 55° C)	

### Technical Specifications – Hard Disk and Solid State Storage

\*NOTE: For hard drives and solid state drives, GB = 1 billion bytes. TB = 1 trillion bytes. Actual formatted capacity is less. Up to 16 GB (for Windows 7) and 36 GB (for Windows 8.1/10) of system disk is reserved for the system recovery software.

#### 500GB\* 2.5" FIPS 140-2 SED Solid State Drive\*

<b>Formatted Capacity</b>	500 GB	
<b>Architecture</b>	Self-Encrypting (SED) Solid State Drive with SATA interface.	
<b>Interface</b>	Serial ATA (6.0 Gb/s)	
<b>Form Factor</b>	2.5 inch	
<b>Height</b>	6.80 mm ± 0.20	
<b>Width</b>	69.85 mm ± 0.25	
<b>Length</b>	100.35 mm ± 0.25/0.20	
<b>Weight (typical)</b>	<95 g (0.209 lb)	
<b>Bandwidth Performance</b>	Sustained data transfer rate OD	100 MB/s max
	I/O data-transfer rate	600 MB/s max
<b>Power</b>	Power consumption:	Spinup (max): 1.00A
		Idle, active: 0.70W
		Sleep 0.18W
<b>Environmental</b> (all conditions, non-condensing)	Operating Temperature:	32° to 140° F (0° to 60° C)
	Relative Humidity:	5% to 95%
	Shock:	Maximum 400 G/2 ms

\*NOTE: For hard drives and solid state drives, GB = 1 billion bytes. TB = 1 trillion bytes. Actual formatted capacity is less. Up to 16 GB (for Windows 7) and 36 GB (for Windows 8.1/10) of system disk is reserved for the system recovery software.

#### 256GB\* TLC SED SSD 2.5" FIPS Drive\*

<b>Unformatted Capacity</b>	256 GB
-----------------------------	--------

### Technical Specifications – Hard Disk and Solid State Storage

<b>Architecture</b>	Self-Encrypting (SED) Solid State Drive with SATA interface.	
<b>Interface</b>	Serial ATA (6.0 Gb/s)	
<b>Form Factor</b>	2.5 inch	
<b>Height</b>	7 mm	
<b>Width</b>	69.85 mm	
<b>Length</b>	100.45 mm	
<b>Weight (typical)</b>	10 g (0.022 lb) max	
<b>Bandwidth Performance</b>	Sequential read (128KB transfer)	530
	Sequential write (128KB transfer)	500
	Random read (4KB transfer)	55,000
	Random write (4KB transfer)	83,000
<b>Power</b>	SATA Power consumption	Sleep Typical: 2mW Idle, average: 55mW Active, average: 70mW Active maximum (128KB transfer): 3000 mW
<b>Environmental</b> (all conditions, non-condensing)	Operating Temperature	32° to 158° F (0° to 70° C)
	Relative Humidity	5% to 95%
	Non-operating Shock	1500 G/0.5ms
	Non-operating Vibration	5-800Hz @ 3.10G
<p><b>*NOTE:</b> For hard drives and solid state drives, GB = 1 billion bytes. TB = 1 trillion bytes. Actual formatted capacity is less. Up to 16 GB (for Windows 7) and 36 GB (for Windows 8.1/10) of system disk is reserved for the system recovery software.</p>		

### 512GB\* TLC SED SSD 2.5" FIPS Drive\*

### Technical Specifications – Hard Disk and Solid State Storage

<b>Unformatted Capacity</b>	512 GB	
<b>Architecture</b>	Self-Encrypting (SED) Solid State Drive with SATA interface.	
<b>Interface</b>	Serial ATA (6.0 Gb/s)	
<b>Form Factor</b>	2.5 inch	
<b>Height</b>	7 mm	
<b>Width</b>	69.85 mm	
<b>Length</b>	100.45 mm	
<b>Weight (typical)</b>	10 g (0.022 lb) max	
<b>Bandwidth Performance</b>	Sequential read (128KB transfer)	530
	Sequential write (128KB transfer)	500
	Random read (4KB transfer)	92,000
	Random write (4KB transfer)	83,000
<b>Power</b>	SATA Power consumption	Sleep Typical: 2mW Idle, average: 55mW Active, average: 70mW Active maximum (128KB transfer): 4000 mW
<b>Environmental</b> (all conditions, non-condensing)	Operating Temperature	32° to 158° F (0° to 70° C)
	Relative Humidity	5% to 95%
	Non-operating Shock	1500 G/0.5ms
	Non-operating Vibration	5-800Hz @ 3.10G
<p><b>*NOTE:</b> For hard drives and solid state drives, GB = 1 billion bytes. TB = 1 trillion bytes. Actual formatted capacity is less. Up to 16 GB (for Windows 7) and 36 GB (for Windows 8.1/10) of system disk is reserved for the system recovery software.</p>		

### Technical Specifications – Hard Disk and Solid State Storage

<b>500 GB* SATA 2.5" Self-Encrypting (SED) Opal 2 Solid State Drive*</b>		
<b>Unformatted Capacity</b>	500GB	
<b>Architecture</b>	Self-Encrypting (SED) Solid State Drive with 25nm MLC NAND Flash and SATA interface	
<b>Interface</b>	Serial ATA 2.0 (3.0 Gb/s)	
<b>NAND Flash</b>	25nm MLC NAND Flash	
<b>Height</b>	.275 in/7mm	
<b>Width</b>	2.75 in/69.85 mm	
<b>Length</b>	3.95 in/100.5 mm	
<b>Weight</b>	0.161 lb (73 g)	
<b>Bandwidth Performance</b>	Sustained Sequential 128k Read:	Up to 450 MB/s
	Sustained Sequential 128k Write:	Up to 260 MB/s
	Random 4k Read:	Up to 46K IOPs
	Random 4k Write:	Up to 56K IOPs
<b>Latency</b>	Read:	55 $\mu$ s
	Write:	55 $\mu$ s
<b>Power</b>	SATA power consumption:	160 mW (active average); <85 mW (idle average)
<b>Useful Drive Life</b>	72TB written, up to 40GB/day for 5 years	
	Operating Temperature:	32° to 158° F (0° to 70° C)
<b>Environmental</b> (all conditions, non-condensing)	Relative Humidity:	5% to 95%
	Shock:	1,500 G/1 ms

### Technical Specifications – Hard Disk and Solid State Storage

\*NOTE: For hard drives and solid state drives, GB = 1 billion bytes. TB = 1 trillion bytes. Actual formatted capacity is less. Up to 16 GB (for Windows 7) and 36 GB (for Windows 8.1/10) of system disk is reserved for the system recovery software.

#### 256 GB SATA 2.5" TLC SED SSD Opal 2 Drive\*

<b>Unformatted Capacity</b>	256 GB 500,118,192 (User Addressable Sectors)	
<b>Architecture</b>	Self-Encrypting (SED) Solid State Drive with NAND Flash and SATA interface. Trusted Computing Group(TCG) OPAL compliant encrypted solid state drive	
<b>Interface</b>	Serial ATA (6.0 Gb/s)	
<b>Form Factor</b>	2.5 inch	
<b>Height</b>	6.80 mm ± 0.20	
<b>Width</b>	69.85 mm ± 0.25	
<b>Length</b>	100.20 mm ± 0.25	
<b>Weight</b>	Up to 73 g	
<b>Bandwidth Performance</b>	Sustained Sequential Read:	Up to 520 MB/s
	Sustained Sequential Write:	Up to 460 MB/s
<b>Power</b>	Power consumption:	Active: 3.891W; Idle: 0.085W
<b>Mean Time Between Failure (MTBF)</b>	1,500,000 hours	
<b>Environmental</b> (all conditions, non-condensing)	Operating Temperature:	32° to 158° F (0° to 70° C)
	Relative Humidity:	5% to 95%
	Shock:	1,500 G/0.5 ms

\*NOTE: For hard drives and solid state drives, GB = 1 billion bytes. TB = 1 trillion bytes. Actual formatted capacity is less. Up to 16 GB (for Windows 7) and 36 GB (for Windows 8.1/10) of system disk is reserved for the system recovery software.

#### 128GB SATA 2.5" Value (Non-SED) Solid State Drive

<b>Unformatted Capacity</b>	128 GB
-----------------------------	--------

### Technical Specifications – Hard Disk and Solid State Storage

<b>Architecture</b>	TLC NAND Flash	
<b>Interface</b>	SATA 3.2 (6.0 Gb/s)	
<b>Form Factor</b>	2.5 inch	
<b>Dimensions (W x H x D)</b>	6.98 x 0.7 x 10.05 cm	
<b>Weight</b>	31g	
<b>Bandwidth Performance</b>	Sustained Sequential Read:	Up to 510 MB/s
	Sustained Sequential Write:	Up to 330 MB/s
	Random Read:	Up to 38K IOPs
	Random Write:	Up to 70K IOPs
<b>Power</b>	DC power requirement:	5 VDC 5%-100 mV ripple p-p
	Total power consumption:	50mW (active); 20mW (idle)
<b>Useful Drive Life</b>	72TB written, up to 40GB/day for 5 years	
<b>Environmental</b> (all conditions, non-condensing)	Operating Temperature:	32° to 158° F (0° to 70° C)
	Relative Humidity:	5% to 95%
	Shock:	1,500 G/0.5 ms
<p><b>NOTE:</b> "For hard drives and solid state drives, GB = 1 billion bytes. TB = 1 trillion bytes. Actual formatted capacity is less. Up to 36 GB (for Windows 10) of system disk is reserved for the system recovery software."</p>		

### 256GB SATA 2.5" Value (Non-SED) Solid State Drive

<b>Unformatted Capacity</b>	256 GB
<b>Architecture</b>	TLC NAND Flash
<b>Interface</b>	SATA 3.2 (6.0 Gb/s)
<b>Form Factor</b>	2.5 inch



### Technical Specifications – Hard Disk and Solid State Storage

<b>Dimensions (W x H x D)</b>	6.98 x 0.7 x 10.05 cm	
<b>Weight</b>	31g	
<b>Bandwidth Performance</b>	Sustained Sequential Read:	Up to 510 MB/s
	Sustained Sequential Write:	Up to 330 MB/s
	Random Read:	Up to 38K IOPs
	Random Write:	Up to 70K IOPs
<b>Power</b>	DC power requirement:	5 VDC 5%-100 mV ripple p-p
	Total power consumption:	50mW (active); 20mW (idle)
<b>Useful Drive Life</b>	72TB written, up to 40GB/day for 5 years	
<b>Environmental</b> (all conditions, non-condensing)	Operating Temperature:	32° to 158° F (0° to 70° C)
	Relative Humidity:	5% to 95%
	Shock:	1,500 G/0.5 ms
<p><b>NOTE:</b> "For hard drives and solid state drives, GB = 1 billion bytes. TB = 1 trillion bytes. Actual formatted capacity is less. Up to 36 GB (for Windows 10) of system disk is reserved for the system recovery software."</p>		

### 256GB SATA 2.5" TLC Solid State Drive

<b>Formatted Capacity</b>	256 GB
<b>Architecture</b>	Solid State Drive with SATA interface; ATA 8 Compliant and SATA 2.6 compliant
<b>Interface</b>	Serial ATA 3 (6.0 Gb/s)
<b>Form Factor</b>	2.5 inch
<b>Height</b>	7 mm ± 0.20
<b>Width</b>	69.85 mm ± 0.25

### Technical Specifications – Hard Disk and Solid State Storage

<b>Length</b>	100.2 mm ± 0.25	
<b>Weight (typical)</b>	36.5 g (+2)	
<b>Data Transfer Rate (128k Sequential)</b>	Sequential Read	Up to 500 MB/s
	Sequential Write	Up to 455 MB/s
<b>Power Watts</b>	Power consumption (avg):	Read: 95 mW Write: 95 mW Standby: 70 mW DEVSLP: <7 mW
<b>Environmental</b> (all conditions, non-condensing)	Operating Temperature:	32° to 158° F (0° to 70° C)
	Relative Humidity:	5% to 95%
	Shock (2 m Sec half-sine):	1500 G peak 0.5ms (operating)

### 512 GB SATA 2.5" TLC Solid State Drive\*

<b>Formatted Capacity</b>	512 GB	
<b>Architecture</b>	Solid State Drive with SATA interface; ATA 8 Compliant and SATA 2.6 compliant	
<b>Interface</b>	Serial ATA 3 (6.0 Gb/s)	
<b>Form Factor</b>	2.5 inch	
<b>Height</b>	7 mm ± 0.20	
<b>Width</b>	69.85 mm ± 0.25	
<b>Length</b>	100.2 mm ± 0.25	
<b>Weight (typical)</b>	36.5 g (+2)	
<b>Data Transfer Rate (128k Sequential)</b>	Sequential Read	Up to 500 MB/s
	Sequential Write	Up to 455 MB/s
<b>Power Watts</b>	Power consumption (avg):	Read: 95 mW Write: 95 mW Standby: 70 mW

### Technical Specifications – Hard Disk and Solid State Storage

		DEVSLP: <7 mW
<b>Environmental</b> (all conditions, non-condensing)	Operating Temperature:	32° to 158° F (0° to 70° C)
	Relative Humidity:	5% to 95%
	Shock (2 m Sec half-sine):	1500 G peak 0.5ms (operating)
<p><b>*NOTE:</b> For hard drives and solid state drives, GB = 1 billion bytes. TB = 1 trillion bytes. Actual formatted capacity is less. Up to 36 GB (for Windows 10) of system disk is reserved for the system recovery software.</p>		

### Technical Specifications – Optical Drives

#### OPTICAL DRIVES

<b>HP 9.5mm G3 800/600 Tower DVD-Writer</b> <b>HP 9.5mm G3 800/600/400 SFF G4 400 SFF/MT DVD-Writer</b> <b>HP 9.5mm ProOne AIO 600 G3 Ultra slim DVD-Writer Drive</b> <b>HP 9.5mm ProOne AIO 600 G3 Ultra slim DVD-ROM Drive</b>		
<b>Height</b>	12.7mm height	
<b>Orientation</b>	Either horizontal or vertical	
<b>Interface type</b>	SATA/ATAPI	
<b>Disc recording capacity</b>	Up to 8.5 GB DL or 4.7 GB standard	
<b>Dimensions (W x H x D)</b>	5.04 x 0.5 x 5.0 in (128 x 12.7 x 127 mm) without bezel	
<b>Weight (max)</b>	0.42 lb (190 g)	
<b>Write speeds</b>	DVD-R DL	Up to 6X
	DVD+R	Up to 8X
	DVD+RW	Up to 8X
	DVD+R DL	Up to 6X
	DVD-R	Up to 8X
	DVD-RW	Up to 6X
	CD-R	Up to 24X
	CD-RW	Up to 24X
<b>Read speeds</b>	DVD-RW, DVD+RW	Up to 8X
	DVD-R DL, DVD+R DL	Up to 8X
	DVD+R, DVD-R	Up to 8X
	DVD-ROM DL, DVD-ROM	Up to 8X
	CD-ROM, CD-R	Up to 24X
	CD-RW	Up to 24X
	Random	DVD-ROM: 170 ms (typical), CD-ROM: 170 ms (typical)
<b>Access time</b> (typical reads, including settling)	Full Stroke	DVD-ROM: 320 ms (typical), CD-ROM: 320 ms (typical)
	Stop Time	6 seconds (typical)
	Source	Slimline SATA DC power receptacle
<b>Power</b>	DC Power Requirement	5 VDC ± 5%-100 mV ripple p-p
	DC Current	5 VDC (< 1000 mA typical, 1600 mA maximum)
	Temperature	41° to 122° F (5° to 50° C)
	Relative Humidity	10% to 80%

### Technical Specifications – Optical Drives

<b>Environmental conditions</b> (operating - non-condensing)	Maximum Wet Bulb Temperature	84° F (29° C)

## Technical Specifications – Memory

**SYSTEM MEMORY SUPPORT**

The HP ProDesk 600 G3 Business PC supports the 6<sup>th</sup> & 7<sup>th</sup> generation Intel® Core™ processor family. Based on a new PC micro-architecture, the processor is designed for a two-chip platform consisting of a processor and Platform Controller Hub (PCH). The 6<sup>th</sup> generation Intel® Core™ processor includes an Integrated Memory Controller (IMC). The IMC supports DDR4 protocols with two independent, 64-bit wide channels each accessing one or two DIMMs.

- Two channels of non-ECC DDR4 unbuffered dual in-line memory modules (UDIMM) or DDR4 unbuffered small outline dual in-line memory modules (SO-DIMM) with a maximum of two DIMMs per channel
- Single-channel and dual-channel memory organization modes
- Data burst length of eight for all memory organization modes
- Memory data transfer rates of up to 2400MT/s; actual supported data transfer rate determined by the configured processor.
- 64-bit wide channels
- DDR4 system memory I/O voltage of 1.25V
- Theoretical maximum memory bandwidth of:
  - 34 GB/s in dual-channel mode assuming 2400 MT/s

**PLATFORM MEMORY SUPPORT**

- The Small Form Factor (SFF) and Microtower (MT) platforms support up to four (4) industry-standard DDR4-SDRAM DIMMs.
- The Desktop Mini (DM) supports up to two (2) industry-standard DDR4-SDRAM SO-DIMMs.
- The All-in-One (AiO) platform supports up to two (2) industry-standard DDR4-SDRAM DIMMs.

**CAUTION:** You must shut down the computer and disconnect the power cord before adding or removing memory modules. Regardless of the power-on state, voltage is always supplied to the memory modules as long as the computer is plugged in to an active AC outlet. Adding or removing memory modules while voltage is present may cause irreparable damage to the memory modules or system board.

**NOTE:** For systems configured with more than 3 GB of memory and a 32-bit operating system, all memory may not be available due to system resource requirements. Addressing memory above 4 GB requires a 64-bit operating system.

### Technical Specifications – Networking and Communications

#### NETWORKING AND COMMUNICATIONS

<b>Intel® I219LM Gigabit Network Connection LOM (standard)</b>	
<b>Connector</b>	RJ-45
<b>System Interface</b>	PCIe + SMBus
<b>Controller</b>	Intel® I219LM Gigabit Ethernet Controller
<b>Data rates supported</b>	Supports operation at 10/100/1000 Mb/s data rates
<b>IEEE Compliance</b>	IEEE 802.3 Ethernet interface for 1000BASE-T, 100BASE-TX, and 10BASE-T applications (802.3ab, 802.3u, and 802.3i, respectively). EEE 802.3az support [Low Power Idle (LPI) mode] IEEE 802.3u auto-negotiation conformance
<b>Performance</b>	Jumbo Frames (up to 9 kB) 802.1Q & 802.1p Receive Side Scaling (RSS) Two Queues (Tx & Rx)
<b>Power</b>	<ul style="list-style-type: none"> <li>Ultra Low Power at cable disconnect (&lt;1 mW) enables platform support for connected standby</li> <li>Reduced power consumption during normal operation and power down modes</li> <li>Integrated Intel® Auto Connect Battery Saver (ACBS)</li> <li>Single-pin LAN Disable for easier BIOS implementation</li> <li>Fully integrated Switching Voltage Regulator (iSVR)</li> <li>Low Power Link-Up (LPLU)</li> </ul>
<b>MAC/PHY Interconnect</b>	<ul style="list-style-type: none"> <li>PCIe-based interface for active state operation (S0 state)</li> <li>SMBus-based interface for host and management traffic (Sx low power state)</li> </ul>
<b>Management Interface</b>	<ul style="list-style-type: none"> <li>MDC/MDIO management interface</li> </ul>
<b>Security &amp; Manageability</b>	<ul style="list-style-type: none"> <li>Intel® vPro™ support with appropriate Intel chipset components</li> </ul>

<b>Intel® Ethernet I210-T1 Gigabit Network Adapter</b>	
<b>Connector</b>	RJ-45
<b>System Interface</b>	PCI Express x1
<b>Controller</b>	Intel® I210 Gigabit Ethernet Controller
<b>Memory</b>	Integrated Dual 48K configurable transmit receive FIFO Buffers
<b>Data rates supported</b>	10/100/1000 Mbps

### Technical Specifications – Networking and Communications

<b>IEEE Compliance</b>	802.1P 802.1Q 802.2 802.3 802.3AB 802.3u 802.3x flow control	
<b>Bus architecture</b>	PCI-E 2.1	
<b>Data path width</b>	X1, 250 MB/s, Bi-directional interface	
<b>Data transfer mode</b>	Bus-master DMA	
<b>Hardware certifications</b>	FCC, B, CE, TUV-c, TUVus Mark Canada and United States, TUV-GS Mark for European Union	
<b>Power requirement</b>	Aux 3.3 V, 3.0 Watts in 1000 base-T and 1.0 Watts in 100 Base-T	
<b>Boot ROM support</b>	Yes 10BASE-T (half-duplex) 10 Mbps 10BASE-T (full-duplex) 20 Mbps	
<b>Network transfer rate</b>	10BASE-T (half-duplex) 10 Mbps	
	10BASE-T (full-duplex) 20 Mbps	
	100BASE-TX (half-duplex) 100 Mbps	
	100BASE-TX (full-duplex) 200 Mbps	
	1000BASE-T (full-duplex) 2000 Mbps (actual rate limited by PCI bus)	
<b>Environmental</b>	Operating Temperature:	32° to 132° F (0° to 55° C)
	Operating Humidity:	85% at 131° F (55° C)
<b>Management</b>	WOL, PXE, DMI, WFM 2.0	

### Intel® 8265 802.11ac 2x2 WiFi + Bluetooth® M.2 Combo Card\* (802.11AC Wave 2 supported)

	<b>Wireless LAN Standards</b>	IEEE 802.11a IEEE 802.11b IEEE 802.11g IEEE 802.11n IEEE 802.11ac
	<b>Interoperability</b>	Wi-Fi certified
	<b>Frequency Band</b>	802.11b/g/n • 2.402 – 2.482 GHz Note: The FCC has declared as of January 1, 2015 products that utilize passive scanning on channel 12/13 and are capable of transmitting



### Technical Specifications – Networking and Communications

	<p>must fully comply with requirements of 15.247 or otherwise disable those channels.</p> <p>802.11a/n</p> <ul style="list-style-type: none"> <li>• 4.9 – 4.95 GHz (Japan)</li> <li>• 5.15 – 5.25 GHz</li> <li>• 5.25 – 5.35 GHz</li> <li>• 5.47 – 5.725 GHz</li> <li>• 5.825 – 5.850 GHz</li> </ul> <p>Note: Indonesia no support this band)</p>
<b>Data Rates</b>	<ul style="list-style-type: none"> <li>• 802.11b: 1, 2, 5.5, 11 Mbps</li> <li>• 802.11g: 6, 9, 12, 18, 24, 36, 48, 54 Mbps</li> <li>• 802.11a: 6, 9, 12, 18, 24, 36, 48, 54 Mbps</li> <li>• 802.11n: MCS 0 ~ MCS 15, (20MHz, and 40MHz)</li> <li>• 802.11ac : MCS0 ~ MCS9, (1SS, and 2SS) (20MHz, 40MHz, and 80MHz)</li> </ul>
<b>Modulation</b>	<p>Direct Sequence Spread Spectrum</p> <p>BPSK, QPSK, CCK, 16-QAM, 64-QAM, 256-QAM</p>
<b>Security<sup>1</sup></b>	<ul style="list-style-type: none"> <li>• IEEE and WiFi compliant 64 / 128 bit WEP encryption for a/b/g mode only</li> <li>• AES-CCMP: 128 bit in hardware</li> <li>• 802.1x authentication</li> <li>• WPA, WPA2: 802.1x. WPA-PSK, WPA2-PSK, TKIP, and AES.</li> <li>• WPA2 certification</li> <li>• IEEE 802.11i</li> <li>• Cisco Certified Extensions, all versions through CCX4 and CCX Lite</li> <li>• WAPI</li> </ul>
<b>Network Architecture Models</b>	<p>Ad-hoc (Peer to Peer)</p> <p>Infrastructure (Access Point Required)</p>
<b>Roaming</b>	IEEE 802.11 compliant roaming between access points
<b>Output Power<sup>2</sup></b>	<ul style="list-style-type: none"> <li>• 802.11b : +16dBm minimum</li> <li>• 802.11g : +14dBm minimum</li> <li>• 802.11a : +14dBm minimum</li> <li>• 802.11n HT20(2.4GHz) : +14dBm minimum</li> <li>• 802.11n HT40(2.4GHz) : +12dBm minimum</li> <li>• 802.11n HT20(5GHz) : +14dBm minimum</li> <li>• 802.11n HT40(5GHz) : +12dBm minimum</li> </ul>
<b>Power Consumption</b>	<p>Transmit: 2.0 W (max)</p> <p>Receive: 1.6 W (max)</p> <p>Idle mode (PSP): 180 mW (WLAN Associated)</p> <p>Idle mode: 50 mW (WLAN unassociated)</p> <p>Connect Standby: 10 mW (WLAN+BT)</p> <p>Radio disabled: 30 mW</p>
<b>Power Management</b>	<p>ACPI and PCI Express compliant power management</p> <p>802.11 compliant power saving mode</p>
<b>Receiver Sensitivity<sup>3</sup></b>	<p>802.11b, 1Mbps : -94dBm maximum</p> <p>802.11b, 11Mbps : -86dBm maximum</p> <p>802.11g, 6Mbps : -88dBm maximum</p> <p>802.11g, 54Mbps : -74dBm maximum</p> <p>802.11a, 6Mbps : -88dBm maximum</p> <p>802.11a, 54Mbps : -74dBm maximum</p> <p>802.11n, MCS07 : -69dBm maximum</p> <p>802.11n, MCS15 : -66dBm maximum</p> <p>802.11ac, 1SS, MCS-0 : -86dBm maximum</p>

### Technical Specifications – Networking and Communications

	802.11ac, 1SS, MCS-9 : -61dBm maximum 802.11ac, 2SS, MCS-0 : -83dBm maximum 802.11ac, 2SS, MCS-9 : -58dBm maximum		
<b>Antenna type</b>	High efficiency antenna with spatial diversity, mounted in the display enclosure Two embedded dual band 2.4/5 GHz antennas are provided to the card to support WLAN MIMO communications and Bluetooth® communications		
<b>Form Factor</b>	PCI-Express M.2 MiniCard		
<b>Dimensions</b>	Type 2230 : 2.3 x 22.0 x 30.0 mm Or Type 1630 : 2.3 x 16.0 x 30.0 mm		
<b>Weight</b>	Type 2230 : 2.8g Or Type 1630 : 2g		
<b>Operating Voltage</b>	3.3v +/- 9%		
<b>Temperature</b>	Operating	14° to 158° F (–10° to 70° C)	
	Non-operating	–40° to 176° F (–40° to 80° C)	
<b>Humidity</b>	Operating	10% to 90% (non-condensing)	
	Non-operating	5% to 95% (non-condensing)	
<b>Altitude</b>	Operating	0 to 10,000 ft (3,048 m)	
	Non-operating	0 to 50,000 ft (15,240 m)	
<b>LED Activity</b>	LED Amber – Radio OFF; LED White – Radio ON		
	<ol style="list-style-type: none"> <li>1. Check latest software/driver release for updates on supported security features.</li> <li>2. Maximum output power may vary by country according to local regulations.</li> <li>3. Receiver sensitivity is measured at a packet error rate of 8% for 802.11b (CKK modulation) and a packet error rate of 10% for 802.11a/g (OFDM modulation).</li> </ol>		
	<b>HP Integrated Module with Bluetooth® 4.0/4.1/4.2 Wireless Technology</b>		
<b>Bluetooth® Specification</b>	4.0/4.1/4.2 Compliant		
<b>Frequency Band</b>	2402 to 2480 MHz		
<b>Number of Available Channels</b>	Legacy : 0~79 (1 MHz/CH) BLE : 0~39 (2 MHz/CH)		
<b>Data Rates and Throughput</b>	Legacy : 3 Mbps data rate; throughput up to 2.17 Mbps BLE : 1 Mbps data rate; throughput up to 0.2 Mbps Legacy : Synchronous Connection Oriented links up to 3, 64 kbps, voice channels		
<b>Transmit Power</b>	The Bluetooth® component shall operate as a Class II Bluetooth® device with a maximum transmit power of +4 dBm for BR and EDR.		
<b>Receiver Sensitivity</b>	<b>Modulation</b>	<b>0.01% BER</b>	<b>0.001% BER</b>
	GFSK	-80 dBm	-70 dBm
	π/4-DQPSK	-80 dBm	-70 dBm
	8DPSK	-80 dBm	-70 dBm
<b>Power Consumption</b>	Peak (Tx) 330 mW Peak (Rx) 230 mW Selective Suspend 17 mW		
<b>Range</b>	Legacy Up to 33 ft (10 m) BLE Up to 99 ft (30 m)		
<b>Electrical Interface</b>	USB 2.0 compliant		
<b>Bluetooth® Software Supported Link Topology</b>	Microsoft Windows Bluetooth® Software		
<b>Electrical Interface Bluetooth® Software Supported</b>	Point to Point, Multipoint Pico Nets up to 7 slaves Full support of Bluetooth® Security Provisions		

### Technical Specifications – Networking and Communications

	<b>Security</b>	
	<b>Power Management</b>	Microsoft Windows ACPI, and USB Bus Support
	<b>Power Management</b>	
	<b>Certifications</b>	Self-configurable to optimize power conservation in all operating modes, including Standby, Hold, Park, and Sniff
	<b>Security</b>	All necessary regulatory approvals for supported countries, including:
	<b>Certifications</b>	FCC (47 CFR) Part 15C, Section 15.247 & 15.249
	<b>Bluetooth® Profiles Supported</b>	
	<b>Power Management</b>	ETS 300 328, ETS 300 826
	<b>Certifications</b>	Low Voltage Directive IEC950
		UL, CSA, and CE Mark
	<b>Certifications</b>	UL, CSA, and CE Mark
	<b>Bluetooth® Profiles Supported</b>	Serial Port Profile (SPP)1,2 Service Discovery Application Profile (SDAP) Dial-Up Networking (DUN)1,1 Generic Object Exchange Profile (GOEP)1,2 Object Push Profile (OPP)1,2 Hard Copy Cable Replacement (HCRP)1,2 Personal Area Networking Profile (PAN)1.0 Human Interface Device Profile (HID)1.0 Hands Free Profile (HFP) 1.5/1.6 Advanced Audio Distribution Profile (A2DP) 1.3 Audio Video Remote Control Profile (AVRCP) 1.3/1.4
	<b>Bluetooth® V4.1/V4.2 support feature</b>	V4.1: ESR5/6/7 compliant V4.2: ESR8 compliant, LE Secure Connection – Basic
<p>*Wireless access point and internet access required. Availability of public wireless access points limited. The specifications for the 802.11ac WLAN are draft specifications and are not final. If the final specifications differ from the draft specifications, it may affect the ability of the notebook to communicate with other 802.11ac WLAN devices.</p>		

### Intel® 7265 802.11ac 2x2 DualBand Combo PCIe x1 Card

	<b>Wireless LAN Standards</b>	IEEE 802.11a IEEE 802.11b IEEE 802.11g IEEE 802.11n IEEE 802.11ac
	<b>Interoperability</b>	Wi-Fi certified
	<b>Frequency Band</b>	802.11b/g/n <ul style="list-style-type: none"> <li>2.402 – 2.482 GHz</li> </ul> <p>Note: The FCC has declared as of January 1, 2015 products that utilize passive scanning on channel 12/13 and are capable of transmitting must fully comply with requirements of 15.247 or otherwise disable those channels.</p> 802.11a/n <ul style="list-style-type: none"> <li>4.9 – 4.95 GHz (Japan)</li> <li>5.15 – 5.25 GHz</li> <li>5.25 – 5.35 GHz</li> <li>5.47 – 5.725 GHz</li> <li>5.825 – 5.850 GHz</li> </ul> <p>Note: Indonesia no support this band)</p>
	<b>Data Rates</b>	<ul style="list-style-type: none"> <li>802.11b: 1, 2, 5.5, 11 Mbps</li> <li>802.11g: 6, 9, 12, 18, 24, 36, 48, 54 Mbps</li> </ul>

### Technical Specifications – Networking and Communications

	<ul style="list-style-type: none"> <li>802.11a: 6, 9, 12, 18, 24, 36, 48, 54 Mbps</li> <li>802.11n: MCS 0 ~ MCS 15, (20MHz, and 40MHz)</li> <li>802.11ac : MCS0 ~ MCS9, (1SS, and 2SS) (20MHz, 40MHz, and 80MHz)</li> </ul>
<b>Modulation</b>	Direct Sequence Spread Spectrum BPSK, QPSK, CCK, 16-QAM, 64-QAM, 256-QAM
<b>Security<sup>1</sup></b>	<ul style="list-style-type: none"> <li>IEEE and WiFi compliant 64 / 128 bit WEP encryption for a/b/g mode only</li> <li>AES-CCMP: 128 bit in hardware</li> <li>802.1x authentication</li> <li>WPA, WPA2: 802.1x. WPA-PSK, WPA2-PSK, TKIP, and AES.</li> <li>WPA2 certification</li> <li>IEEE 802.11i</li> <li>Cisco Certified Extensions, all versions through CCX4 and CCX Lite</li> <li>WAPI</li> </ul>
<b>Network Architecture Models</b>	Ad-hoc (Peer to Peer) Infrastructure (Access Point Required)
<b>Roaming</b>	IEEE 802.11 compliant roaming between access points
<b>Output Power<sup>2</sup></b>	<ul style="list-style-type: none"> <li>802.11b : +16dBm minimum</li> <li>802.11g : +14dBm minimum</li> <li>802.11a : +14dBm minimum</li> <li>802.11n HT20(2.4GHz) : +13dBm minimum</li> <li>802.11n HT40(2.4GHz) : +13dBm minimum</li> <li>802.11n HT20(5GHz) : +12dBm minimum</li> <li>802.11n HT40(5GHz) : +12dBm minimum</li> <li>802.11ac 80MHz(5GHz) : +11dBm minimum</li> </ul>
<b>Power Consumption</b>	Transmit: 2.0 W (max) Receive: 1.6 W (max) Idle mode (PSP): 180 mW (WLAN Associated) Idle mode: 60 mW (WLAN unassociated) Radio disabled: 30 mW
<b>Power Management</b>	ACPI and PCI Express compliant power management 802.11 compliant power saving mode
<b>Receiver Sensitivity<sup>3</sup></b>	802.11b, 1Mbps : -94dBm maximum 802.11b, 11Mbps : -86dBm maximum 802.11g, 6Mbps : -88dBm maximum 802.11g, 54Mbps : -74dBm maximum 802.11a, 6Mbps : -86dBm maximum 802.11a, 54Mbps : -72dBm maximum 802.11n, MCS07 : -69dBm maximum 802.11n, MCS15 : -66dBm maximum 802.11ac, 1SS, MCS-0 : -86dBm maximum 802.11ac, 1SS, MCS-9 : -61dBm maximum 802.11ac, 2SS, MCS-0 : -83dBm maximum 802.11ac, 2SS, MCS-9 : -58dBm maximum
<b>Antenna type</b>	High efficiency antenna with spatial diversity, mounted in the display enclosure Two embedded dual band 2.4/5 GHz antennas are provided to the card to support WLAN MIMO communications and Bluetooth® communications
<b>Form Factor</b>	PCI-Express M.2 MiniCard
<b>Dimensions</b>	Type 2230 : 2.3 x 22.0 x 30.0 mm

### Technical Specifications – Networking and Communications

		Or Type 1630 : 2.3 x 16.0 x 30.0 mm	
<b>Weight</b>		Type 2230 : 2.8g Or Type 1630 : 2g	
<b>Operating Voltage</b>		3.3v +/- 9%	
<b>Temperature</b>	Operating	14° to 158° F (–10° to 70° C)	
	Non-operating	–40° to 176° F (–40° to 80° C)	
<b>Humidity</b>	Operating	10% to 90% (non-condensing)	
	Non-operating	5% to 95% (non-condensing)	
<b>Altitude</b>	Operating	0 to 10,000 ft (3,048 m)	
	Non-operating	0 to 50,000 ft (15,240 m)	
<b>LED Activity</b>		LED Amber – Radio OFF; LED White – Radio ON	
		<ol style="list-style-type: none"> <li>4. Check latest software/driver release for updates on supported security features.</li> <li>5. Maximum output power may vary by country according to local regulations.</li> <li>6. Receiver sensitivity is measured at a packet error rate of 8% for 802.11b (CKK modulation) and a packet error rate of 10% for 802.11a/g (OFDM modulation).</li> </ol>	
		<b>HP Integrated Module with Bluetooth® 4.2 Wireless Technology</b>	
<b>Bluetooth® Specification</b>		4.2 Compliant	
<b>Frequency Band</b>		2402 to 2480 MHz	
<b>Number of Available Channels</b>		79 (1 MHz) available channels	
<b>Data Rates and Throughput</b>		3 Mbps data rate; throughput up to 2.17 Mbps	
		Synchronous Connection Oriented links up to 3, 64 kbps, voice channels	
		Asynchronous Connection Less links 2178.1 kbps/177.1 kbps asymmetric or 1306.9 kbps symmetric	
<b>Transmit Power</b>		The Bluetooth® component shall operate as a Class II Bluetooth® device with a maximum transmit power of +4 dBm for BR and EDR.	
<b>Receiver Sensitivity</b>		<b>Modulation</b>	<b>0.01% BER</b>
		GFSK	-80 dBm
		π/4-DQPSK	-80 dBm
		8DPSK	-80 dBm
<b>Power Consumption</b>		Peak (Tx) 330 mW Peak (Rx) 230 mW Selective Suspend 17 mW	
<b>Range</b>		Up to 33 ft (10 m)	
<b>Electrical Interface</b>		USB 2.0 compliant	
<b>Bluetooth® Software Supported Link Topology</b>		Microsoft Windows Bluetooth® Software	
<b>Electrical Interface</b>		Point to Point, Multipoint Pico Nets up to 7 slaves	
<b>Bluetooth® Software Supported Security</b>		Full support of Bluetooth® Security Provisions	
<b>Power Management</b>		Microsoft Windows ACPI, and USB Bus Support	
<b>Power Management Certifications</b>		Self-configurable to optimize power conservation in all operating modes, including Standby, Hold, Park, and Sniff	
<b>Security</b>		All necessary regulatory approvals for supported countries, including:	
<b>Certifications</b>		FCC (47 CFR) Part 15C, Section 15.247 & 15.249	
<b>Bluetooth® Profiles Supported</b>			
<b>Power Management Certifications</b>		ETS 300 328, ETS 300 826	
		Low Voltage Directive IEC950	

### Technical Specifications – Networking and Communications

	<b>Certifications</b> <b>Bluetooth® Profiles Supported</b>	UL, CSA, and CE Mark Serial Port Profile (SPP) <sup>1</sup> Service Discovery Application Profile (SDAP) Dial-Up Networking (DUN) <sup>1,2</sup> Generic Object Exchange Profile (GOEP) <sup>1,2</sup> Object Push Profile (OPP) <sup>1,2</sup> File Transfer Profile (FTP) Synchronization Profile (SYNC) Hard Copy Cable Replacement (HCRP) <sup>1,2</sup> Personal Area Networking Profile (PAN) <sup>1,2</sup> Human Interface Device Profile (HID) <sup>1,2</sup> FAX Profile (FAX) Basic Imaging Profile (BIP) <sup>2</sup> Headset Profile (HSP) Hands Free Profile (HFP) Advanced Audio Distribution Profile (A2DP)
--	---	--

### Intel® 3168 802.11ac with PCIe x1 WLAN/ Bluetooth® Combo\*

<b>Wireless LAN Standards</b>	IEEE 802.11a IEEE 802.11b IEEE 802.11g IEEE 802.11n IEEE 802.11ac	
<b>Interoperability</b>	Wi-Fi certification	
<b>Frequency Bands</b>	802.11b/g/n	2.402 – 2.482 GHz  <b>Note:</b> The FCC has declared as of January 1, 2015 products that utilize passive scanning on channel 12/13 and are capable of transmitting must fully comply with requirements of 15.247 or otherwise disable those channels.
	802.11a/n	4.9 – 4.95 GHz (Japan) 5.15 – 5.25 GHz 5.25 – 5.35 GHz 5.47 – 5.725 GHz 5.825 – 5.850 GHz <b>Note: Indonesia only supports 5.725 - 5.825 GHz (CH149 - CH161)</b>
<b>Data Rates</b>	<ul style="list-style-type: none"> <li>802.11b: 1, 2, 5.5, 11 Mbps</li> <li>802.11g: 6, 9, 12, 18, 24, 36, 48, 54 Mbps</li> <li>802.11a: 6, 9, 12, 18, 24, 36, 48, 54 Mbps</li> <li>802.11n: MCS 0 ~ MCS 15, (20MHz, and 40MHz)</li> <li>802.11ac : MCS0 ~ MCS7, (1SS) (20MHz, 40MHz, and 80MHz)</li> </ul>	
<b>Modulation</b>	Direct Sequence Spread Spectrum	

### Technical Specifications – Networking and Communications

	BPSK, QPSK, CCK, 16-QAM, 64-QAM, 256-QAM
<b>Security<sup>1</sup></b>	<ul style="list-style-type: none"> <li>• IEEE and WiFi compliant 64 / 128 bit WEP encryption for a/b/g mode only</li> <li>• AES-CCMP: 128 bit in hardware</li> <li>• 802.1x authentication</li> <li>• WPA, WPA2: 802.1x. WPA-PSK, WPA2-PSK, TKIP, and AES.</li> <li>• WPA2 certification</li> <li>• IEEE 802.11i</li> <li>• Cisco Certified Extensions, all versions through CCX4 and CCX Lite</li> <li>• WAPI</li> </ul>
	<sup>1</sup> <a href="#">Check latest software/driver release for updates on supported security features.</a>
<b>Network Architecture Models</b>	Ad-hoc (Peer to Peer) Infrastructure (Access Point Required)
<b>Roaming</b>	802.11r Fast Roaming
<b>Output Power<sup>2</sup></b>	<ul style="list-style-type: none"> <li>• 802.11b : +16dBm minimum</li> <li>• 802.11g : +14dBm minimum</li> <li>• 802.11a : +14dBm minimum</li> <li>• 802.11n HT20(2.4GHz) : +14dBm minimum</li> <li>• 802.11n HT40(2.4GHz) : +12dBm minimum</li> <li>• 802.11n HT20(5GHz) : +14dBm minimum</li> <li>• 802.11n HT40(5GHz) : +12dBm minimum</li> <li>• 802.11ac 80MHz(5GHz) : +11dBm minimum</li> </ul>
	<sup>2</sup> <a href="#">Maximum output power may vary by country according to local regulations.</a>
<b>Power Consumption</b>	Transmit: 2.0 W (max) Receive: 1.6 W (max) Idle mode (PSP): 180 mW (WLAN Associated) Idle mode: 50 mW (WLAN unassociated) Connect Standby: 10 mW (WLAN+BT) Radio disabled: 5 mW
<b>Power Management</b>	ACPI and PCI Express compliant power management 802.11 compliant power saving mode
<b>Receiver Sensitivity<sup>3</sup></b>	802.11b, 1Mbps : -94dBm maximum 802.11b, 11Mbps : -86dBm maximum 802.11g, 6Mbps : -88dBm maximum 802.11g, 54Mbps : -74dBm maximum 802.11a, 6Mbps : -88dBm maximum 802.11a, 54Mbps : -74dBm maximum 802.11n, MCS07 : -69dBm maximum 802.11n, MCS15 : -66dBm maximum 802.11ac, 1SS, MCS-0 : -86dBm maximum 802.11ac, 1SS, MCS-9 : -61dBm maximum

### Technical Specifications – Networking and Communications

	802.11ac, 2SS, MCS-0 : -83dBm maximum 802.11ac, 2SS, MCS-9 : -58dBm maximum	
	<sup>3</sup> Receiver sensitivity is measured at a packet error rate of 8% for 802.11b (CKK modulation) and a packet error rate of 10% for 802.11a/g (OFDM modulation).	
<b>Antenna type</b>	High efficiency antenna with spatial diversity, mounted in the display enclosure Two embedded dual band 2.4/5 GHz antennas are provided to the card to support WLAN MIMO communications and Bluetooth® communications	
<b>Form Factors</b>	PCI-Express M.2 MiniCard	
<b>Dimensions</b>	Type 2230 : 2.3 x 22.0 x 30.0 mm Or Type 1630 : 2.3 x 16.0 x 30.0 mm	
<b>Weight</b>	Type 2230 : 2.8g Or Type 1630 : 2g	
<b>Operating Voltage</b>	3.3v +/- 9%	
<b>Temperature</b>	<b>Operating:</b>	14° to 158° F (-10° to 70° C)
	<b>Non-operating:</b>	-40° to 176° F (-40° to 80° C)
<b>Humidity</b>	<b>Operating:</b>	10% to 90% (non-condensing)
	<b>Non-operating:</b>	5% to 95% (non-condensing)
<b>Altitude</b>	<b>Operating:</b>	0 to 10,000 ft (3,048 m)
	<b>Non-operating:</b>	0 to 50,000 ft (15,240 m)
<b>LED Activity</b>	LED Amber – Radio OFF; LED White – Radio ON	
* Wireless access point and Internet service required and not included. Availability of public wireless access points limited.		
<b>HP Integrated Module with Bluetooth® 4.0/4.1/4.2 Wireless Technology</b>		
<b>Bluetooth® Specification</b>	4.0/4.1/4.2 Compliant	
<b>Frequency Band</b>	2402 to 2480 MHz	
<b>Number of Available Channels</b>	Legacy : 0~79 (1 MHz/CH) BLE : 0~39 (2 MHz/CH)	
<b>Data Rates and Throughput</b>	Legacy : 3 Mbps data rate; throughput up to 2.17 Mbps	
	BLE : 1 Mbps data rate; throughput up to 0.2 Mbps Legacy : Synchronous Connection Oriented links up to 3, 64 kbps, voice channels	



### Technical Specifications – Networking and Communications

	Legacy : Asynchronous Connection Less links 2178.1 kbps/177.1 kbps asymmetric (3-DH5) or 864 kbps symmetric (3-EV5)												
<b>Transmit Power</b>	The Bluetooth® component shall operate as a Class II Bluetooth® device with a maximum transmit power of + 4 dBm for BR and EDR.												
<b>Receiver Sensitivity Legacy</b>	<table border="1"> <thead> <tr> <th>Modulation</th> <th>0.01% BER</th> <th>0.001% BER</th> </tr> </thead> <tbody> <tr> <td>GFSK</td> <td>-80 dBm</td> <td>-70 dBm</td> </tr> <tr> <td><math>\pi/4</math>-DQPSK</td> <td>-80 dBm</td> <td>-70 dBm</td> </tr> <tr> <td>8DPSK</td> <td>-80 dBm</td> <td>-70 dBm</td> </tr> </tbody> </table>	Modulation	0.01% BER	0.001% BER	GFSK	-80 dBm	-70 dBm	$\pi/4$ -DQPSK	-80 dBm	-70 dBm	8DPSK	-80 dBm	-70 dBm
Modulation	0.01% BER	0.001% BER											
GFSK	-80 dBm	-70 dBm											
$\pi/4$ -DQPSK	-80 dBm	-70 dBm											
8DPSK	-80 dBm	-70 dBm											
<b>Power Consumption</b>	Peak (Tx) 330 mW Peak (Rx) 230 mW Selective Suspend 17 mW												
<b>Range</b>	Legacy Up to 33 ft (10 m) BLE Up to 99 ft (30 m)												
<b>Electrical Interface</b>	USB 2.0 compliant												
<b>Bluetooth® Software Supported Link Topology</b>	Microsoft Windows Bluetooth® Software												
<b>Electrical Interface Bluetooth® Software Supported Security</b>	Point to Point, Multipoint Pico Nets up to 7 slaves												
	Full support of Bluetooth® Security Provisions												
<b>Power Management Certifications</b>	Microsoft Windows ACPI, and USB Bus Support												
	Self-configurable to optimize power conservation in all operating modes, including Standby, Hold, Park, and Sniff												
<b>Security</b>	All necessary regulatory approvals for supported countries, including:												
<b>Certifications Bluetooth® Profiles Supported</b>	FCC (47 CFR) Part 15C, Section 15.247 & 15.249												
<b>Power Management Certifications</b>	ETS 300 328, ETS 300 826												
	Low Voltage Directive IEC950												
<b>Certifications Bluetooth® Profiles Supported</b>	UL, CSA, and CE Mark Serial Port Profile (SPP) <sup>1</sup> Service Discovery Application Profile (SDAP) Dial-Up Networking (DUN) <sup>1,2</sup> Generic Object Exchange Profile (GOEP) <sup>1,2</sup>												

### Technical Specifications – Networking and Communications

	<p>Object Push Profile (OPP)<sup>1,2</sup>          Hard Copy Cable Replacement (HCRP)<sup>1,2</sup>          Personal Area Networking Profile (PAN)<sup>1,2</sup>          Human Interface Device Profile (HID)<sup>1,2</sup>          Hands Free Profile (HFP)          Advanced Audio Distribution Profile (A2DP)</p>
	<p>Audio Video Remote Control Profile (AVRCP)</p>
<p><b>Bluetooth® V4.1/V4.2 support feature</b></p>	<p>V4.1: ESR5/6/7 compliant</p>
	<p>V4.2: ESR8 compliant, LE Secure Connection – Basic.</p>

### Technical Specifications - Audio

#### AUDIO

#### High Definition Audio – MT/SFF/DM

<b>Type</b>	Integrated
<b>HD Stereo Codec</b>	Conexant CX20632
<b>Audio I/O Ports</b>	Headset connector supports a CTIA style headset and is re-taskable as a Line-in, Line-out, Microphone-in or Headphone-out port
	Rear Line-In can be retasked to function as a microphone input
	Rear Line-Out
	All ports are 3.5mm and support stereo ( see above tables for system configurations)
<b>Internal Speaker Amplifier</b>	2W class D mono amplifier for the internal speaker only External speakers must be powered externally.
<b>Multi-streaming Capable</b>	Playback multi-streaming can be enabled in the audio control panel to allow independent audio streams to be sent to/from the front and rear jacks or integrated speaker.
<b>Sampling</b>	Independent sampling rates for DAC's and ADC's; supports resolutions from 16 to 24-bit; 44.1 kHz to 192 kHz for DAC and 44.1 kHz to 96 kHz for ADC
<b>Wavetable Syntheses</b>	Yes – Uses OS soft wavetable
<b>Analog Audio</b>	Yes
<b># of Channels on Line-Out</b>	Stereo (Left & Right channels)
<b>Internal Mono Speaker</b>	Yes

#### High Definition Audio - AIO

<b>Type</b>	Integrated
<b>HD Stereo Codec</b>	Conexant CX5001
<b>Audio I/O Ports</b>	Side Headset Jack (Universal Audio Jack 3.5mm) supports CTIA or OMTP style headsets and <a href="#">is re-taskable as a Line-in, Line-out, Microphone-in or Headphone-out port</a>
	All ports are 3.5mm and support stereo ( see above tables for system configurations)
<b>Internal Speaker Amplifier</b>	2W per channel Class D amplifier for the internal speaker only. External speakers must be powered externally.
<b>Multi-streaming Capable</b>	Playback multi-streaming can be enabled in the audio control panel to allow independent audio streams to be sent to/from the headset, external or integrated speakers.
<b>Sampling</b>	Independent sampling rates for DAC's and ADC's; supports resolutions from 16 to 24-bit; 44.1 kHz to 192 kHz for DAC and 44.1 kHz to 96 kHz for ADC
<b>Wavetable Syntheses</b>	Yes – Uses OS soft wavetable

## Technical Specifications - Audio

<b>Analog Audio</b>	Yes
<b>Internal Stereo Speakers</b>	Yes

### Technical Specifications - Input/Output Devices

#### INPUT/OUTPUT DEVICES

### HP Conferencing Keyboard

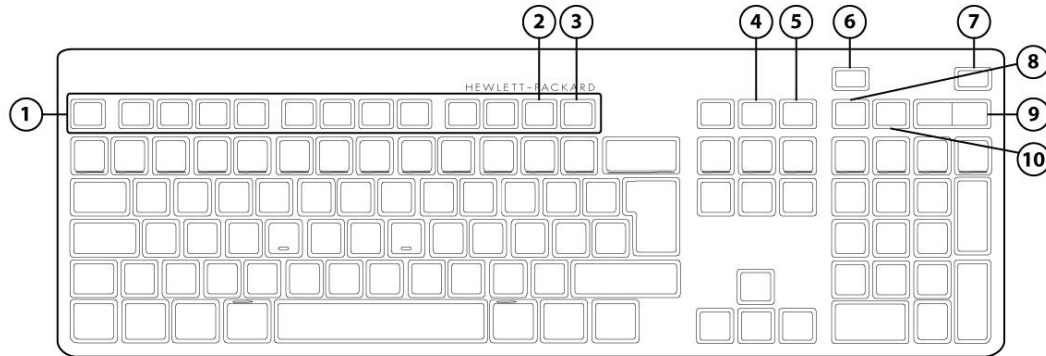

<b>1.</b>	Function Keys	<b>6.</b>	End/Decline a Call
<b>2.</b>	F11 Lync or Skype for Business Contact list *	<b>7.</b>	Answer a Call
<b>3.</b>	F12 Lync or Skype for Business Calendar **	<b>8.</b>	Microphone Mute
<b>4.</b>	Share Screen	<b>9.</b>	Volume Up/Down
<b>5.</b>	Stop Webcam	<b>10.</b>	Audio Mute

\*Microsoft Lync 2013, or Skype for Business, or Microsoft Outlook 2013 Contact list

\*\*Microsoft Lync 2013, or Skype for Business, or Microsoft Outlook 2013 Calendar

<b>Dimensions (H x L x W)</b>	0.85 x 17.34 x 6.10 in (2.16 x 44.05 x 15.50 cm)
<b>Weight</b>	24.69 oz. ( 700 g)
<b>Connectivity</b>	USB cable
<b>Keys</b>	110 (US) Layout, 111 (EU) Layout – depending upon country
<b>Feature Summary</b>	Full-size ultra-quiet keyboard with numerical pad and 12 function keys One-touch simplicity for Microsoft Lync or Skype for Business calls with dedicated keys and LED light indicators
<b>Illuminated keys</b>	Incoming Call – Blinks Green Call in progress –Green Microphone Mute – Orange Audio Mute – Orange Screen Sharing – Orange Stop Webcam – Orange
<b>Other Call control keys</b>	End/Decline Call

### Technical Specifications - Input/Output Devices

	Volume up and down rocker key
<b>Microsoft Lync/Outlook</b>	<p>Fn+F12 – Lync or Skype for Business Calendar will open. If Lync or Skype for Business is not available will bring Outlook Calendar *</p> <p>Fn+F11 – Lync or Skype for Business Contact will open. If Lync or Skype for Business is not available will bring Outlook Contact list *</p> <p>* Fn+11 and Fn+12 function keys are not supported in Microsoft Windows 8.x Metro mode</p>
<b>Functions Keys</b>	<p>Fn+F10 – System Settings</p> <p>Fn+F9 – Devices</p> <p>Fn+F8 – Search</p> <p>Fn+F7 – Blank</p> <p>Fn+F6 – Up Brightness Adjustment</p> <p>Fn+F5 – Down Brightness Adjustment</p> <p>Fn+F4 – Display Options</p> <p>Fn+F3 – File Explorer</p> <p>Fn+F2 – System Lock</p> <p>Fn+F1 – System Sleep</p>
<b>System requirements</b>	<p>Available USB port</p> <p>Windows 7, Windows 8.x, and Windows 10</p> <p>Server: Microsoft Lync Server 2010 or 2013 and Skype for Business Server 2015</p> <p>Client: Microsoft Lync 2013 version 15.0.46xx or newer or Skype for Business</p> <p>Notes:</p> <ul style="list-style-type: none"> <li>Limited support for Microsoft Lync 2010, Microsoft Lync 2013 Basic and Microsoft Metro Mode</li> <li>Screen brightness functions supported in select HP systems</li> </ul>
<b>Approvals EMC Product Safety</b>	<p>FCC; CE; ACA(C-tick); EAC</p> <p>UL, CE Mark</p>

### HP USB PS/2 Washable Keyboard

<b>Physical Characteristics</b>	Keys	104 (US) Layout, 105 (EU) layout – depending upon country
	Dimensions (L x W x H)	17.67x 6.62 x 1.38 in (449 x 168 x 35 mm)
	Weight	1.7 lb (0.77 kg) minimum
<b>Electrical</b>	Operating voltage	+ 5VDC ±5%
	Power consumption	50-mA maximum (with three LEDs ON)
	System interface	USB Type A plug connector
	ESD	CE level 4, 15-kV air discharge
	EMI - RFI	Conforms to FCC rules for a Class B computing device
	Microsoft PC 99 - 2001	Functionally compliant
<b>Mechanical</b>	Keycaps	Stepped -profile design

### Technical Specifications - Input/Output Devices

	Switch actuation	55-g nominal peak force with tactile feedback
	Switch life	20 million keystrokes
	Switch type	Contamination-resistant switch membrane
	Key-leveling mechanisms	For all double-wide and greater-length keys
	Cable length	7 ft (2.2 m)
	Microsoft PC 99 - 2001	Mechanically compliant
	Acoustics	43-dBA maximum sound pressure level
<b>Environmental</b>	Operating temperature	50° to 122° F (10° to 50° C)
	Non-operating temperature	4° to 149° F (-20° to 65° C)
	Operating humidity	10% to 95% (non-condensing at ambient)
	Non-operating humidity	0% to 95% (non-condensing at ambient)
	Operating shock	40 g, six surfaces
	Non-operating shock	80 g, six surfaces
	Operating vibration	2-g peak acceleration
	Non-operating vibration	4-g peak acceleration
	Drop (out of box)	26 in (66 cm) on carpet, six-drop sequence
	Drop (in box)	42 in (107 cm) on concrete, 16-drop sequence
<b>Operating system support</b>	Windows® 7, Windows Vista, Windows XP Professional	
<b>Approvals</b>	UL, cUL, FCC, CE, TUV GS, VCCI, BSMI, C-Tick, KCC, USB-IF, WHQL, EN/IEC 60601-1, IP66/NEMA4X	
<b>Ergonomic compliance</b>	ANSI HFS 100, ISO 9241-4, and TUVGS	
<b>HP USB Business Slim Smartcard Keyboard</b>		
<b>Physical Characteristics</b>	Keys	104, 105, 109 layout (depending upon country)
	Dimensions (H x W x D)	17.34 x 5.68 x 0.78 in (440.6 x 14.45 x 1.98 cm)
	Weight	1.32 lb (0.6± 0.1 kg)
<b>Electrical</b>	Operating voltage	5V
	Power consumption	200 mA
	System interface	USB Interface
	ESD	Air 12.5kV / Contact 8kV
	EMI - RFI	under 3dB
	Microsoft PC 99 - 2001	Conforms to FCC rules for a Class B computing device
<b>Mechanical</b>	Keycaps	Low-profile design
	Switch actuation	60±15g nominal peak force with tactile feedback
	Switch life	10 million keystrokes (Life tester)
	Switch type	Contamination-resistant switch membrane
	Key-leveling mechanisms	For all double-wide and greater-length keys
	Cable length	6 ft (1.8 m)
<b>Environmental</b>	Acoustics	43-dBA maximum sound pressure level
	Operating temperature	50° to 122° F (10° to 50° C)

### Technical Specifications - Input/Output Devices

	Non-operating temperature	-22° to 140° F (-30° to 60° C)		
	Operating humidity	10% to 90% (non-condensing at ambient)		
	Non-operating humidity	20% to 80% (non-condensing at ambient)		
	Operating shock	40 g, six surfaces		
	Non-operating shock	80 g, six surfaces		
	Operating vibration	2-g peak acceleration		
	Non-operating vibration	4-g peak acceleration		
	Drop (out of box)	26 in (66 cm) on carpet, six-drop sequence		
	Drop (in box)	30 in (76.2 cm) on concrete, 16-drop sequence		
<b>SmartCard Function</b>	Support	All ISO 7816 smart cards		
	Interface	Reads from and writes to all ISO7816-1, 2, 3, 4 memory and microprocessor smart cards (T=0, T=1)		
	Chipset	IDENTIVE CLOUD 2190 F		
	Standard APIs supported	PC/SC, EMV2000, CT-API		
	Power	USB Port		
		Short circuit detection (protects smart card and reader)		
		Power supply compliant with ISO7816 and EMV (5V, 60 mA)		
		Supports 3-V and 5-V cards		
	Power consumption	100-mA maximum draw		
	Communication	From card	9600 bps to 330,000 bps	
		From computer	12 Mbps (USB transfer speed)	
	Landing mechanism	Contact device	Friction contact	
		Card insertions rating	Up to 100,000 insertion cycles	
	Interface modes	CCID protocol		
Reader performance interface	USB connection			
Electro-magnetic standards	Europe	2004/108/EC		
	USA	USAFCC part 15		
<b>Approvals</b>	CE Marking; TUV; EAC; FCC; cULus/CSAus; ICES; RCM; VCCI; KCC; BSMI			
<b>Ergonomic Compliance</b>	ISO 9241-410, TUV GS			
<b>Kit Contents</b>	Keyboard, I/O Security and Documentation CD, warranty card			
<b>HP USB Business Slim Keyboard</b>				
<b>Physical characteristics</b>	Keys	104, 105, 106, 107, 109 layout (depending upon country)		
	Dimensions (L x W x H)	171.97 x 68.35 x 8.27 in (436.8± 1.5 x 137.6± 1.0 x 21.0± 1.0 cm)		
	Weight	1.32 lb (0.6± 0.08 kg)		
<b>Electrical</b>	Operating voltage	+ 4.4 – 5.25VDC		
	Power consumption	50-mA maximum (with 5 VDC power supplied and three LEDs ON)		



### Technical Specifications - Input/Output Devices

	System interface	USB Type A plug connector
	ESD	Contact Discharge: 2, 4,6,8KV Air Discharge: 2, 4, 8,10,12.5KV
	EMI - RFI	Conforms to FCC rules for a Class B computing device
	Microsoft® PC 99 - 2001	Functionally compliant
<b>Mechanical</b>	Keycaps	Low-profile design
	Switch actuation	60±12.5g nominal peak force with tactile feedback
	Switch life	10 million keystrokes (Life tester)
	Switch type	Contamination-resistant switch membrane
	Key-leveling mechanisms	For all double-wide and greater-length keys
	Cable length	6 ft (1.8 m)
	Microsoft PC 99 - 2001	Mechanically compliant
<b>Environmental</b>	Acoustics	43-dBA maximum sound pressure level
	Operating temperature	50° to 122° F (10° to 50° C)
	Non-operating temperature	-22° to 140° F (-30° to 60° C)
	Operating humidity	10% to 90% (non-condensing at ambient)
	Non-operating humidity	20% to 80% (non-condensing at ambient)
	Operating shock	40 g, six surfaces
	Non-operating shock	80 g, six surfaces
	Operating vibration	2-g peak acceleration
	Non-operating vibration	4-g peak acceleration
	Drop (out of box)	26 in (66 cm) on carpet, six-drop sequence
	Drop (in box)	30 in (76.2 cm) on concrete, 16-drop sequence
<b>Approvals</b>	UL, FCC, CE Mark, TUV, TUV GS, VCCI, BSMI, C-Tick, KC	
<b>Ergonomic compliance</b>	ANSI HFS 100, ISO 9241-4, and TUVGS	

### Technical Specifications - Input/Output Devices

<b>Kit contents</b>	Keyboard	Installation Guide
	Warranty Card	Safety and Comfort Guide
<b>HP PS/2 Business Slim Keyboard</b>		
<b>Physical Characteristics</b>	Keys	104, 105, 106, 107, 109 layout (depending upon country)
	Dimensions (L x W x H)	171.97 x 68.35 x 8.27 in (436.8± 1.5 x 137.6± 1.0 x 21.0± 1.0 cm)
	Weight	1.32 lb (600± 80 g)
<b>Electrical</b>	Operating voltage	+ 4.4 – 5.25VDC
	Power consumption	50-mA maximum (with 5 VDC power supplied and three LEDs ON)
	System interface	PS/2 6-pin mini din connector
	ESD	Contact Discharge: 2, 4, 6, 8KV Air Discharge: 2, 4, 8, 10, 12.5KV
	EMI - RFI	Conforms to FCC rules for a Class B computing device
	Microsoft PC 99 - 2001	Functionally compliant
	Keycaps	Low-profile design
	Switch actuation	60±12.5g nominal peak force with tactile feedback
	Switch life	10 million keystrokes (Life tester)
	Switch type	Contamination-resistant switch membrane
	Key-leveling mechanisms	For all double-wide and greater-length keys
	Cable length	6 ft (1.8 m)
	Microsoft PC 99 - 2001	Mechanically compliant
<b>Environmental</b>	Acoustics	43-dBA maximum sound pressure level
	Operating temperature	50° to 122° F (10° to 50° C)
	Non-operating temperature	-22° to 140° F (-30° to 60° C)
	Operating humidity	10% to 90% (non-condensing at ambient)

### Technical Specifications - Input/Output Devices

	Non-operating humidity	20% to 80% (non-condensing at ambient)
	Operating shock	N/A
	Non-operating shock	65 inch 2.9 ms, six surface; 30g 266 inch/second; 50g 266 inch/second six surface
	Operating vibration	2-g peak acceleration
	Non-operating vibration	Starting at 5 Hz, vary the frequency of vibration from 5 to 500 Hz and back to 5 Hz at a Logarithmic sweep rate of 1 octave per minute.
	Drop (out of box)	26 in (66 cm) on carpet, six-drop sequence
	Drop (in box)	29.93 in (76 cm) on concrete, 16-drop sequence
<b>Approvals</b>	UL, FCC, CE Mark, TUV, TUV GS, VCCI, BSMI, C-Tick, KC	
<b>Ergonomic compliance</b>	ANSI HFS 100, ISO 9241-4, and TUVGS	

### HP USB (Grey) Business Slim Keyboard

<b>Physical characteristics</b>	Keys	104, 105, 106, 107, 109 layout (depending upon country)
	Dimensions (L x W x H)	17.19 x 5.41 x 0.82 in (43.68±1.5 x 13.76±1.0 x 2.1 ±1.0 cm)
	Weight	1.32 lb (0.6± 0.08 kg)
<b>Electrical</b>	Operating voltage	+ 4.4 – 5.25VDC
	Power consumption	100-mA maximum (with 5 VDC power supplied and three LEDs ON)
	System interface	USB Type A plug connector
	ESD	Contact Discharge: 4, 6, 8 KV
	EMI – RFI	Air Discharge: 8, 10, 12 KV / 15 KV
	Microsoft PC 99 – 2001	Conforms to FCC rules for a Class B computing device; Functionally compliant
<b>Mechanical</b>	Keycaps	Low-profile design
	Switch actuation	Rubber dome + membrane
	Switch life	10 million
	Switch type	Rubber dome
	Key-leveling mechanisms	Link bar
	Cable length	For all double-wide and greater-length keys
	Microsoft PC 99 – 2001	Yes
<b>Environmental</b>	Acoustics	55-dBA maximum sound pressure level
	Operating temperature	10°C to 50°
	Non-operating temperature	-30°C to 90°
	Operating humidity	10% to 90% (non-condensing at ambient)
	Non-operating humidity	60% to 80% (non-condensing at ambient)
	Operating shock	40 g, six surfaces

### Technical Specifications - Input/Output Devices

	Non-operating shock	80 g, six surfaces
	Operating vibration	2-g peak acceleration
	Non-operating vibration	4-g peak acceleration
	Drop (out of box)	26 in (66 cm) on carpet, six-drop sequence
	Drop (in box)	30 in (76.2 cm) on concrete, 16-drop sequence
<b>Approvals</b>	FCC; CE; VCCI; BSMI; KC; EAC; RCM; TUV-GS; UL; RoHS; WEEE	
<b>Ergonomic compliance</b>	ANSI HFS 100; ISO 9241-4; and TUVGS	

### HP Wireless Business Slim Keyboard and Mouse

<b>Keyboard</b>	Dimensions ( L x W x H)	171.97 x 68.35 x 8.27 in (436.8± 1.5 x 137.6± 1.0 x 21.0± 1.0 cm)
	Weight – Without Two AA Alkaline Batteries	1.23 lb (560± 80 g)
<b>Mouse</b>	Dimensions (H x L x W)	1.46 x 4.53 x 2.47 in (37 x 115 x 62.9 mm)
	Weight – Without Two AA Alkaline Batteries	0.15 lb (67 g)
<b>Receiver</b>	Dimensions (H x L x W)	0.33x 1.79 x 0.72 in (8.4 x 45.5 x 18.4 mm)
	Weight	0.21 oz (5.9 g)
	Cable Length – Minimum	6 ft (1.8 m)
	Range	32.8 ft (10 m)
<b>System Requirements</b>	Available USB port for the receiver CD-ROM Drive *This system may require upgraded and/or separately purchased hardware and/or a DVD drive to install the Windows 7 software and take full advantage of Windows 7 functionality. See <a href="http://www.microsoft.com/windows/windows-7/">http://www.microsoft.com/windows/windows-7/</a> for details.	
<b>Approvals</b>	Product Safety	UL; CSA /TUV (Europe only); CE Mark; CB Report
	Ergonomics	ANSI; ISO (Europe only); GS Mark (Germany only)
	EMC	FCC; CE; ACA (-tick); BSMI; KC ; VCCI
	CE Mark	EN 55022:2010; EN 55024; EN 301489-1; EN 61000
	Design Guidelines for PCs	PC 99 – connector overmold colors; PC 2001 – full functionality
	Telecom	All local telecom requirements and approvals for intended markets
	USA	FCC Title 47 CFR, Par 15, Subpart C; other local requirements

### Technical Specifications - Input/Output Devices

	Country Support	US, Belgium, Switzerland, Spain, Denmark, Netherlands, France, Germany, Italy, Portugal, Sweden, Norway, Finland, UK, Poland, Czech Republic, Turkey, Greece, Austria, Bulgaria, Cyprus, Estonia, Hungary, Ireland, Latvia, Lithuania, Luxemburg, Malta, Romania, Slovakia, Slovenia, Vietnam, HK, Australia, NZ, Malaysia, Singapore, Indonesia, Philippines, Thailand, Canada, China, Japan, Korea, Taiwan, India, Venezuela, Ecuador, Russia, Ukraine, Israel, Croatia, United Arab Emirates, Peru, Brazil, Chile, Argentina, Mexico, South Africa, and up to 193 countries worldwide.
<b>Environmental</b>	Keyboard contains 25% post-consumer recycled plastic material.	

<b>HP PS/2 Mouse</b>		
<b>Dimensions</b> (H x L x W)	1.46 x 2.48 x 4.53 in (3.70 x 6.29 x 11.50 cm)	
<b>Weight</b>	3.53 oz (100g; +10g/- 5 g)	
<b>Environmental</b>	Operating temperature	-32° to 104°F (0° to 40° C)
	Non-operating temperature	-4° to 140°F (-20° to 60° C)
	Operating humidity	10% to 90% (non condensing at ambient)
	Non-operating humidity	10% to 90% (non condensing at ambient)
	Operating shock	40 g, 6 surfaces
	Non-operating shock	80 g, 6 surfaces
	Operating vibration	2 g peak acceleration
	Non-operating vibration	4 g peak acceleration
<b>Electrical</b>	Drop (out of box)	80 cm height onto asphalt tile over concrete or equivalent, 5-drop in 5 direction except the cable face
	Operating voltage	5 VDC ± 10%
	Power consumption	100mA
	System consumption	PS/2 mini-din connector
	ESD	CE level 4, 15 kV air discharge
	EMI-RFI	Conforms to FCC rules for a Class B computing device
<b>Mechanical</b>	Microsoft PC99 - 2001	Functionally compliant
	Resolution	800 DPI
	Tracking speed	10 in/s (25.4 cm/s) maximum
	Acceleration	±15%
	Switch actuation	65±20 gf
	Switch life	3,000,000 operations (using Hasco modified tester)

### Technical Specifications - Input/Output Devices

	Switch type	Low force micro-switches
	Tracking mechanism life	80 km
	Cable length	6 ft (1.8 m)
	Microsoft PC99 - 2001	Mechanically compliant
<b>Scroll wheel</b>	Width	6 mm
	Diameter	22.5 ± 0.2 mm
	Maximum rotation force	50 gf-cm
	Switch type	Light force micro-switch
	Switch life	1 million operations
	Mechanical life	Minimum 200,000 revolutions
<b>Regulatory Approvals</b>	UL/cUL, FCC, CE Mark, TUV/GS, VCCI, KCC, BSMI, C-Tick	

### HP USB 1000dpi Laser Mouse

<b>Dimensions</b> (H x L x W)	1.47 x 4.53 x 2.47 in (37.3 x 114.97 x 62.86 mm)	
<b>Weight</b>	3.360 oz (102g)	
<b>Cable length</b>	70.9 in (180 cm)	
<b>System requirements</b>	Available USB port	
<b>Environmental</b>	Operating Temperature	32° to 104° F (0° to 40° C)
	Non-operating Temperature	-4° to 140° F (-20° to 60° C)
	Operating Humidity	10% to 90% (non-condensing at ambient)
<b>Mechanical</b>	Resolution	1000dpi
	Tracking Speed	45 cm/sec
	Cable Length	70.9 in (180 cm)

### HP USB PS/2 Washable Mouse

<b>Dimensions</b> (H x L x W)	1.56 x 2.44 x 4.61 in (3.95 x 6.21 x 11.7 cm)	
<b>Weight</b>	4.44 oz (126 g)	
<b>Environmental</b>	Operating temperature	-32° to 104°F (0° to 40° C)
	Non-operating temperature	-4° to 140°F (-20° to 60° C)
	Operating humidity	10% to 90% (non-condensing at ambient)
	Non-operating humidity	10% to 90% (non condensing at ambient)
	Operating shock	40 g, 6 surfaces
	Non-operating shock	80 g, 6 surfaces
	Operating vibration	2 g peak acceleration
	Non-operating vibration	4 g peak acceleration

### Technical Specifications - Input/Output Devices

	Drop (out of box)	80 cm height onto asphalt tile over concrete or equivalent, 5-drop in 5 direction except the cable face
<b>Electrical</b>	Operating voltage	5 VDC $\pm$ 10%
	Power consumption	100mA
	System consumption	PS/2 mini-din connector
	ESD	CE level 4, 15 kV air discharge
	EMI-RFI	Conforms to FCC rules for a Class B computing device
	Microsoft® PC99 – 2001	Functionally compliant
<b>Mechanical</b>	Resolution	400 $\pm$ 20% DPI
	Tracking speed	10 in/s (25.4 cm/s) maximum
	Acceleration	100 in/s/s (2.54 m/s/s)
	Switch actuation	61 g nominal peak force
	Switch life	3,000,000 operations (using Hasco modified tester)
	Switch type	Low force micro-switches
	Tracking mechanism life	155 mi (250 km) at average speed of 10 in/s
	Cable length	6 ft (1.8 m)
	Microsoft PC99 – 2001	Mechanically compliant
<b>Scroll wheel</b>	Width	8 mm
	Diameter	1.01 in (25.6 mm)
	Maximum rotation speed	48 rats/sec
	Switch type	Light force micro-switch
	Switch life	1 million operations
	Mechanical life	Minimum 200,000 revolutions
<b>Regulatory approvals</b>	Compliant	UL, CSA, FCC, CE Mark, TUV, TUV GS, VCCI, BSMI, C-Tick, MIC

<b>HP USB Hardened Mouse</b>			
Mouse Type	Wired optical mouse		
Interface	USB 2.0		
Dimensions (H x L x W)	114.97 x 62.92 x 37.3 mm (+/-0.3 mm) (11.49 x 6.29 x 1.46 in)		
Weight	92 g (+/-10 g) (3.2 oz)		
Cable length	1.8 M		
Tracking	X-Y Positioning	X-Y Wheel Resolution	1000 DPI
		Tracking Speed	Up to 30 in/sec in either X or Y direction

### Technical Specifications - Input/Output Devices

	Z Axis Wheel	Z Wheel Revolution	24 counts per revolution
		Tracking Speed	0 ~ 120 rpm
Environmental	Operating temperature	0° - 40°C	
	Non-operating temperature	-40° - 65°C	
	Operating humidity	90%	
	Agency Approvals	CE FCC RCM VCCI EMC EAC BSMI UL ICES-003 Class B KCC TUV/GS	
Electrical	Input Voltage & Current	4.4 ~ 5.25 VDC / 100 mA	
	Power Consumption	Under nominal 5 VDC power supplied, max current consumption is 100mA with tracking speed up to 30 in/sec	
Color	Black		
System requirements	Windows 10, Windows 8.1 32/64bit, Windows 7 32/64bit		

<b>HP Grey V2 Mouse</b>		
<b>Dimensions</b> (H x L x W)	1.46 x 4.53 x 2.48 in (3.72 x 11.5 x 6.29 cm) ±1 mm	
<b>Weight</b>	3.53 oz (100g; +10g/- 5 g)	
<b>Environmental</b>	Operating temperature	50° to 122°F (10° to 50° C)
	Non-operating temperature	-22° to 140°F (-30° to 60° C)
	Operating humidity	10% to 90% (non condensing at ambient)
	Non-operating humidity	20% to 80% (non condensing at ambient)
	Operating shock	40 g, 6 surfaces
	Non-operating shock	80 g, 6 surfaces
	Operating vibration	2 g peak acceleration
	Non-operating vibration	4 g peak acceleration
<b>Electrical</b>	Operating voltage	4.75~5.25 Vdc
	Power consumption (typical)	10mA
<b>Mechanical</b>	Connector	USB 2.0



### Technical Specifications - Input/Output Devices

	Type	3D mouse (3 keys and wheel)
	Resolution	800 DPI
	Sensor	PixArt vendor Optical USB mouse sensor. DIP
	Tracking speed	30 inch/sec (max)
	Tracking acceleration	8G(max), 1G=9.8m/s <sup>2</sup>
	Cable length	6 ft (1.8 m)
<b>Color</b>	Grey	
<b>Regulatory Approvals</b>	FCC, CE, ICES, C-TICK, VCCI, KCC, BSMI, ISO9241, Part 4, Computer Work Station Ergonomics compliance, IEC 801-2, IEC 1000-4-2, EN 55024:1998 + A1:2001 + A2:2003, European Standard EN 55022: 2006 Class B, CE Mark	

<b>HP USB Mouse</b>		
<b>Dimensions</b> (H x L x W)	2.5 x 4.5 x 1.5 in (63.5 x 114.3 x 38.1 mm)	
<b>Weight</b>	0.22 lb (99.79 g)	
<b>Color</b>	Black	
<b>Connector</b>	USB	
<b>Mechanical</b>	Resolution	800 DPI sensitivity
	Buttons	Two primary buttons and clickable scroll wheel

## Technical Specifications – Miscellaneous Features

**MISCELLANEOUS FEATURES****Management Features**

- Advanced Configuration and Power Management Interface (ACPI). Allows the system to wake from a low power mode. Controls system power consumption, making it possible to place individual cards and peripherals in a low-power or powered-off state without affecting other elements of the system.
- Intel® Wired for Management support; industry wide initiative to make Intel® architecture based PCs, servers and mobile computers more inherently manageable out-of-the-box and over the network
- Dual State Power Button; acts as both an on/off button and a suspend-to-sleep button

**Serviceability Features**

- Dual colored power LED on front of computer to indicate either normal or fault condition
- Diagnostic LED Explanation Table:
  - Power LED will blink red 2 to 5 times, then blink white 2 or more times, then repeat (with beep tones for each blink initially):
    - 2 red + 2 white User must provide file for BIOS recovery (USB storage, typically)
    - 2 red + 3 white User must enter a key sequence to proceed with recovery by policy
    - 2 red + 4 white BIOS recovery is in progress
    - 3 red + 2 white Memory could not be initialized
    - 3 red + 3 white Graphics adapter could not be found
    - 3 red + 4 white Power supply failure / not connected
    - 3 red + 5 white Processor not installed
    - 3 red + 6 white Current processor does not support an enabled feature
    - 4 red + 2 white Processor has exceeded its temperature threshold / system thermal shutdown
    - 4 red + 3 white System internal temperature has exceeded its threshold
    - 5 red + 2 white System controller firmware is not valid
    - 5 red + 3 white System controller detected BIOS is not executing
    - 5 red + 4 white BIOS could not complete initialization / PCA failure
    - 5 red + 5 white System controller rebooted the system after a health or recovery timer triggered
- HP PC Hardware Diagnostics UEFI:
  - This utility enables hardware level testing outside the operating system on many components. The diagnostics can be invoked by pressing F2 at POST, and is available as a download from HP Support
- System/Emergency ROM
- Flash ROM
- CMOS Battery Holder for easy replacement
- BIOS recovery files are maintained on the local OS drive when updating with HP BIOS Update and Recovery utility (HPBIOSUPDREC) 5 Aux Power LED on System PCA
- Processor ZIF Socket for easy Upgrade
- Over-Temp Warning on Screen (Requires IM Agents)
- Clear Password Jumper
- DIMM Connectors for easy Upgrade
- Clear CMOS Button
- NIC LEDs (integrated) (Green & Amber)
- Dual Color Power and HD LED - To Indicate Normal Operations and Fault Conditions
- Color coordinated cables and connectors
- Tool-less Hood Removal
- Front power switch
- System memory can be upgraded without removing the system board or any internal components
- Tool-less Hard Drive, CD & Diskette Removal
- Green Pull Tabs, and Quick Release Latches for easy Identification

## Technical Specifications – Environmental

**Additional Features****Description****Towerable Orientation**

Product can be oriented as either a desktop (horizontal) or a tower (vertical)

**Drive Lock**

Implementation of the industry standard ATA Security feature set. When enabled, it prevents software access to user data on the drive until one or two user-defined passwords are provided.

**Boot Sectors Protection**

MBR or GPT boot sectors of the hard drive are critical to securely starting the operating system. By saving the MBR or GPT data (depending on the how the OS was installed), the BIOS will be able to monitor for changes and allow the user to override them with the backup copy at boot-up.

**Drive Protection System**

DPS Access through F10 Setup during Boot

A diagnostic hard drive self-test. It scans critical physical components and every sector of the hard drive for physical faults and then reports any faults to the user. Running independently of the operating system, it can be accessed through a Windows-based diagnostics utility or through the computer's setup procedure. It produces an evaluation on whether the hard drive is the source of the problem and needs to be replaced.

The system expands on the Self-Monitoring, Analysis, and Reporting Technology (SMART), a continuously running systems diagnostic that alerts the user to certain types of failures.

**SMART Technology (Self-Monitoring, Analysis and Reporting Technology)**

Allows hard drives to monitor their own health and to raise flags if imminent failures were predicted.

**SMART I - Drive Failure Prediction**

Predicts failures before they occur. Tracks fault prediction and failure indication parameters such as re-allocated sector count, spin retry count, calibration retry count.

**SMART II - Off-Line Data Collection**

By avoiding actual hard drive failures, SMART hard drives act as "insurance" against unplanned user downtime and potential data loss from hard drive failure.

**SMART III - Off-Line Read Scanning with Defect Reallocation**

IOEDC: I/O Error Detection Circuitry

Detects errors in Read/Write buffers on HDD cache RAM.

**SMART IV - End-to-End CRC for hard drives**

Interface in F10 setup provides confirmation of SMART IV support.

After-Market Options (availability may vary by region)

### After Market Options

<b>Business Monitors</b> (sample list)*	<b>SFF/MT</b>	<b>DM</b>	<b>AiO</b>	<b>Part Number</b>
HP ProDisplay P240va 23.8-inch Monitor	X	X		N3H14AA
HP ProDisplay P232 23-inch Monitor	X	X		K7X31AA
HP ProDisplay P222c 21.5-inch Video Conferencing Monitor	X	X		L4J08AA
*Additional models are available.				
<b>Communication Devices</b>	<b>SFF/MT</b>	<b>DM</b>	<b>AiO</b>	<b>Part Number</b>
Intel® Ethernet I210 - T1 Gbe NIC	X			E0X95AA
Intel® 7265 802.11ac 2x2 DualBand Combo PCIe x1 Card	X			N4G85AA
<b>Graphics Solutions</b>	<b>SFF/MT</b>	<b>DM</b>	<b>AiO</b>	<b>Part Number</b>
NVIDIA® GeForce® GT 730 2GB DP PCIe x8 Card	X			Z9H51AA
NVIDIA® GeForce® GT 730 1GB HDMI PCIe x8 Card	X			
AMD® Radeon™ R7 450 4GB PCIe x16 Card	MT Only			Z9H52AA
HP UHD USB Graphics Adapter	X	X	X	N2U81AA
HP DisplayPort™ 1.2 Cable Kit	X	X	X	VN567AA
HP DisplayPort™ 1.2 To DVI-D Adapter	X	X	X	FH973AA
HP DisplayPort™ 1.2 To VGA Adapter	X	X	X	AS615AA
HP DisplayPort™ 1.2 To HDMI 4k Adapter	X	X	X	K2K92AA
HP DVI to DVI Cable	X	X	X	DC198A
HP (Bulk) 700mm DisplayPort™ 1.2 Cable Kit		X		V8Y77A6
HP USB-C to VGA Adapter (when Type-C Port is installed)	X	X		N9K76AA
HP USB-C to HDMI Adapter (when Type-C Port is installed)	X	X		N9K77AA
HP USB-C to DisplayPort™ 1.2 Adapter (when Type-C Port is installed)	X	X		N9K78AA
<b>Data Storage Drives</b>	<b>SFF/MT</b>	<b>DM</b>	<b>AiO</b>	<b>Part Number</b>
HP 500GB 7200PRM SATA 6.0Gb/s 3.5" Hard Drive	X			QK554AA
HP 1TB 7200rpm SATA 6Gb/s 3.5" Hard Drive	X			QK555AA
HP 256GB SATA TLC Solid State Drive	X	X	X	P1N68AA
HP 512GB Turbo Drive G2 TLC M.2 SSD Drive	X	X	X	X8U75AA
HP 9.5mm Slim Removable SATA 500GB	X		X	T7G14AA
HP 256GB SATA Non-SED Solid State Drive	X	X	X	W0U55AA
HP 9.5mm G3 800/600 Tower DVD Writer	MT Only			1CA52AA
HP 9.5mm G3 8/4 SFF G4 400 SFF/MT DVD Writer	SFF Only		AiO Only	1CA53AA
<b>Input Devices</b>	<b>SFF/MT</b>	<b>DM</b>	<b>AiO</b>	<b>Part Number</b>
HP Conferencing Keyboard	X	X	X	K8P74AA
HP USB Business Slim Keyboard	X	X	X	N3R87AA

After-Market Options (availability may vary by region)

HP PS/2 Business Slim Keyboard	X			N3R86AA
HP Wireless Business Slim Keyboard and Mouse**	X	X	X	QY449AA
HP USB Business Slim Grey Keyboard (EMEA only)	X	X	X	Z9H49AA
HP USB Business Slim Smart Card CCID Keyboard	X	X	X	Z9H48AA
HP USB PS/2 Washable Keyboard and Mouse Kit**	X	X	X	BU207AA
HP USB Grey V2 Mouse (EMEA only)	X	X	X	Z9H74AA
HP USB Business Slim Keyboard and Mouse (China Only)	X	X	X	Z9H50AA
HP USB Hardened Mouse	X	X	X	P1N77AA
HP PS/2 Mouse	X			QY775AA
HP USB Mouse	X	X	X	QY777AA
HP USB 1000dpi Laser Mouse	X	X	X	QY778AA
** Keyboard contains 25% post-consumer recycled plastic material				
<b>Desktop Mini Accessories</b>	<b><u>SFF/MT</u></b>	<b><u>DM</u></b>	<b><u>AiO</u></b>	<b><u>Part Number</u></b>
HP Desktop Mini DVD Super Multi-Writer ODD Expansion Module		X		K9Q83AA
HP Desktop Mini 500GB HDD/ I/O Expansion Module		X		K9Q82AA
HP Desktop Mini Rack Mount Tray Kit		X		G1K21AA
HP Desktop Mini Security/Dual VESA Sleeve		X		G1K22AA
HP Desktop Mini 65W Power Supply Kit		X		L2X04AA
HP Desktop Mini 90W Power Supply Kit		X		L4R65AA
HP Desktop Mini Vertical Chassis Stand		X		G1K23AA
HP Desktop Mini Port Cover Kit		X		1ZE52AA
HP Desktop Mini I/O Expansion Module		X		K9Q84AA
HP Integrated Work Center Desktop Mini/Thin Clients		X		G1V61AA
HP Single Monitor Arm		X		BT861AA
HP Quick Release Bracket		X		EM870AA
HP PC Mounting Bracket for Monitors		X		N6N00AT
<b>System Memory</b>	<b><u>SFF/MT</u></b>	<b><u>DM</u></b>	<b><u>AiO</u></b>	<b><u>Part Number</u></b>
HP 4GB DDR4-2400 DIMM	X			Z9H59AA
HP 8GB DDR4-2400 DIMM	X			Z9H60AA
HP 16GB DDR4-2400 DIMM	X			Z9H57AA
HP 4GB DDR4-2400 SODIMM		X	X	Z9H55AA
HP 8GB DDR4-2400 SODIMM		X	X	Z9H56AA
HP 16GB DDR4-2400 SODIMM		X	X	Z9H53AA

After-Market Options (availability may vary by region)

<b>Multimedia Devices</b>	<b><u>SFF/MT</u></b>	<b><u>DM</u></b>	<b><u>AiO</u></b>	<b><u>Part Number</u></b>
HP Business Headset v2	X	X	X	T4E61AA
HP USB Business Speakers v2	X	X		N3R89AA
<b>Security Devices</b>	<b><u>SFF/MT</u></b>	<b><u>DM</u></b>	<b><u>AiO</u></b>	<b><u>Part Number</u></b>
HP 600 G3 SFF Intrusion Sensor	SFF only			J6L43AA
HP 600 G3 MT Solenoid Lock and Intrusion Sensor	MT only			J6L42AA
HP Business PC Security Lock v2 Kit	X			N3R93AA
HP Keyed Cable Lock 10mm Kit	X	X	X	T1A62AA
HP Dual Head Keyed Cable Lock Kit	X	X	X	T1A64AA
<b>Stands and Accessories</b>	<b><u>SFF/MT</u></b>	<b><u>DM</u></b>	<b><u>AiO</u></b>	<b><u>Part Number</u></b>
HP (10 Set) 600/800 G3 Tower Bezel Support Kit	Tower only			Z9H63A6
HP (10) 400 G4 600/800 G3 SFF G4 MT Bezel Support Kit	SFF only			Z9H64A6
HP Single Monitor Arm	X	X		BT861AA
HP 600 G3 800/705/600 G2 AIO Adjustable Height Stand			X	N7H08AA
HP ProOne 600 G3 Adjustable Height Stand			X	2GU06AA
<b>LANDESK Software (e-delivery)</b>	<b><u>SFF/MT</u></b>	<b><u>DM</u></b>	<b><u>AiO</u></b>	<b><u>Part Number</u></b>
Contact your HP representative for available options.				N/A

© Copyright 2018 HP Development Company, L.P. All rights reserved.

The information contained herein is subject to change without notice. The only warranties for HP products are set forth in the express limited warranty statements accompanying such products. Nothing herein should be construed as constituting an additional warranty. HP shall not be liable for technical or editorial errors or omissions contained herein. Microsoft and Windows are registered trademarks or trademarks of Microsoft Corporation in the U.S. and/or other countries. Intel, Celeron, Core, Pentium are registered trademarks or trademarks of Intel Corporation in the U.S. and/or other countries. Bluetooth® is a trademark of its proprietor, used by HP, Inc. under license. USB Type-C™ and USB-C™ are trademarks of USB Implementers Forum. NVIDIA, GeForce and NVS are trademarks and/or registered trademarks of NVIDIA Corporation in the U.S. and other countries. AMD and Radeon are trademarks of Advanced Micro Devices, Inc. ENERGY STAR is a registered trademark owned by the U.S. Environmental Protection Agency. DisplayPort™ and the DisplayPort™ logo are trademarks owned by the Video Electronics Standards Association (VESA®) in the United States and other countries.

### Change Log

Date of change:	Version History:		Description of change:
January 25, 2017	Version 1 to 2	Launch	QS launched
February 8, 2017	Version 2 to 3	Update	Weights & Dimensions Section: Chassis (W x H x D) Not including bezel MT inches value
February 13, 2017	Version 3 to 4	Update	Graphics Section updated
February 27, 2017	Version 4 to 5	Update	Bays section updated (5.25" Half Height text updated, footnote added)
March 2, 2017	Version 5	Update	Accessories section updated (accessory added), Environmental section updated
March 6, 2017	Version 5 to 6	Update	Security Devices updated and Hardware Security updated
March 9, 2017	Version 6 to 7	Update	After market section updated (added accessory)
March 14, 2017	Version 7 to 8	Update	Graphics section updated
March 21, 2017	Version 8 to 9	Update	Environmental Section updated
March 23, 2017	Version 9 to 10	Update	USB ports updated
April 5, 2017	Version 10 to 11	Update	Slots section updated & Dimensions nomenclature updated (W x D x H)
April 7, 2017	Version 11 to 12	Updated	HP Bios section updated (NIST 800-147 certification added)
April 17, 2017	Version 12 to 13	Updated	Overview Section updated
April 17, 2017	Version 13 to 14	Updated	Ports section updated
April 27, 2017	Version 14 to 15	Updated	Graphics section updated
May 22, 2017	Version 15 to 16	Update	Security Devices section: HP 600 G3 SFF Intrusion Sensor part number changed from 1CA50AA to J6L43AA
July 10, 2017	Version 16 to 17	Added	Added AiO form factor
July 17, 2017	Version 17 to 18	Updated	Desktop Mini Accessories updated: P3R65AA deleted and replaced by 1ZE52AA; I/O Ports – Internal ports section added.
July 21, 2017	Version 18 to 19	Updated	Slots footnote updated Environmental disclaimer updated
July 25, 2017	Version 19 to 20	Updated	“256GB Turbo Drive G2 TLC OPAL 2.0 SED Solid State Drive” removal updated
July 28, 2017	Version 20 to 21	Update	Webcam & mic resolution spec added.
August 3, 2017	Version 21 to 22	Update	Environmental section Table updated.
August 9, 2017	Version 22 to 23	Update	Dimensions and weight section updated
August 21, 2017	Version 23 to 24	Update	Added how many PS/2 ports are on the card with footnote, in the Ports section
August 25, 2017	Version 24 to 25	Update	Dimensions and weight section updated
September 1, 2017	Version 25 to 26	Update	Environmental for 600 G3 MD, 600 G3 SFF, 600 G3 MT and 600 G3 PCI MT added individually
October 5, 2017	Version 26 to 27	Update	DisplayPort™ version updated in the whole document
October 16, 2017	Version 27 to 28	Update	“Multi-unit packaging” and “Shipping weight” added to Weights and dimensions table
October 18, 2017	Version 28 to 29	Update	(5 Gbit/s data speed) added to each USB 3.1 Gen1 Port in all call outs
October 30, 2017	Version 29 to 30	Update	Power section updated
November 7, 2017	Version 30 to 31	Update	Intel® vPro™ Technology bullet corrected on AT A GLANCE section
November 20, 2017	Version 31 to 32	Update	New spec line added to WEBCAM & MIC (All-in-One models only)
December 4, 2017	Version 32 to 33	Update	Typo corrected in Intel Core i3-7300T Processor specs / And corrections in Aio SATA Storage connectors
December 12, 2017	Version 33 to 34	Update	Typo corrected in Slots section, Adjustable Height Stand specs updated
January 2, 2018	Version 34 to 35	Update	Serial port updated at 600 G3 SFF
January 3, 2018	Version 35 to 36	Update	Power factor information table added to Power supply section
January 4, 2018	Version 36 to 37	Update	Slot PCI Express x16 specified to to be designed on MT
January 24, 2018	Version 37 to 38	Update	HP Desktop Mini Lock Box removed from the Accessories section
February 7, 2018	Version 38 to 39	Update	PCI Express x 4 (v3.0) Row added to Slots section

### Change Log

February 12, 2018	Version 39 to 40	Update	HP ProOne 600 G3 21.5-inch All-in-One Business PC call out reference added to side view image
March 28, 2018	Version 40 to 41	Update	PCI ports updated
April 13, 2018	Version 41 to 42	Update	At a glance section updated
April 15, 2018	Version 42 to 43	Update	AMD Radeon™ R7 430 2GB LP 2DP PCIe x16 GF card specs added to MT and SFF
April 18, 2018	Version 43 to 44	Update	AMD Radeon™ R7 430 2GB LP 2DP PCIe x16 GF card specs updated