

---

## Project Report

# Organic Materials in Wall Paintings

---

Edited by Francesca Piqué  
and Giovanni Verri





Project Report

Organic Materials  
in Wall Paintings

Edited by Francesca Piqué and Giovanni Verri

THE GETTY CONSERVATION INSTITUTE  
LOS ANGELES

© 2015 J. Paul Getty Trust

The Getty Conservation Institute  
1200 Getty Center Drive, Suite 700  
Los Angeles, CA 90049-1684m USA  
Telephone 310-440-7325  
Email [gciweb@getty.edu](mailto:gciweb@getty.edu)  
[www.getty.edu/conservation](http://www.getty.edu/conservation)

Production editor: Gary Mattison  
Designer: Hesperheide Design

ISBN 978-1-937433-(online resource)

The Getty Conservation Institute works to advance conservation practice in the visual arts, broadly interpreted to include objects, collections, architecture, and sites. It serves the conservation community through scientific research, education and training, model field projects, and the broad dissemination of the results of both its own work and the work of others in the field. And in all its endeavors, it focuses on the creation and dissemination of knowledge that will benefit professionals and organizations responsible for the conservation of the world's cultural heritage.

Front cover: Tintori replica resample OL18BIS photographed in raking light. This is one of the wall painting replicas created by Leonetto Tintori and studied as part of the Organic Materials in Wall Painting project. The Tintori replicas are archived at the Laboratorio per Affresco di Vainella, Prato, Italy. Photo: OMWP.

# Dedication

This book is dedicated to the memory of Giorgio Torraca (1927–2010) and Leonetto Tintori (1908–2000) in recognition of their enormous contribution and inspiration for this project and for the field of wall paintings conservation.



# Contents

---

## **PART ONE**

---

### **Project Overview**

Project Description	7
Tintori's Replicas	10
Use of Tintori's Replicas for the Project	10
Evaluation of Techniques: Methodology, Levels, and Criteria	13

---

## **PART TWO**

---

### **Techniques Used for Identification of Organic Materials**

Noninvasive Techniques	
UV-Induced Fluorescence Photography	17
Time-Resolved Laser-Induced Fluorescence Spectroscopy (TR-LIF) and Fluorescence Lifetime Imaging (FLIM)	20
Integrated Multi-spectral Imaging Systems	25
Fiber Optic Reflectance Spectroscopy (FORS)	29
Fiber Optic Fluorescence Spectroscopy (FOFS)	32
Mid-FTIR Fiber Optic Spectroscopy	35
Invasive Techniques	
Cross-Section Preparation	38
UV Examination and Stain Tests on Cross Sections	39
FTIR Reflectance and FTIR–Attenuated Total Reflectance (ATR) Spectroscopy on Cross Sections	43
Micro-FTIR Spectroscopy	46
High-Performance Liquid Chromatography (HPLC)	49
Gas Chromatography–Mass Spectrometry (GC–MS)	52
Enzyme-Linked Immunosorbent Assay (ELISA) for Protein Identification	58

---

**PART THREE**

---

<b>Research Results</b>	62
Papers and Publications	63
• <a href="#">Wall Painting Replicas for the Scientific Study of Organic Binders (2015)</a> <i>Cristina N. Grandin and Giuseppe A. Centauro</i>	66
• <a href="#">Ultraviolet-Induced Luminescence Imaging (2015)</a> <i>Giovanni Verri, Annette T. Keller, Francesca Piqué, and Alfredo Aldrovandi</i>	76
• <a href="#">Time-Resolved Fluorescence Spectroscopy and Fluorescence Lifetime Imaging for the Analysis of Organic Materials in Wall Painting Replicas (2015)</a> <i>Daniela Comelli, Austin Nevin, Giovanni Verri, Gianluca Valentini, and Rinaldo Cubeddu</i>	83
• <a href="#">Noninvasive, In Situ Identification of Binding Media Using Reflection Mid-FTIR (2015)</a> <i>Costanza Miliani, Antonio Sgamellotti, Giovanni Verri, Paolo Benedetti, B. Giovanni Brunetti, Alessia Daveri, and Francesca Rosi</i>	97
• <a href="#">FTIR in Reflectance and Attenuated Total Reflectance for the Analysis of Stratigraphic Cross Sections of Wall Paintings Samples (2015)</a> <i>Austin Nevin and Charlotte Martin de Fonjaudran</i>	111
• <a href="#">Use of ELISA in Identifying Proteins in the Tintori Wall Painting Replicas</a> <i>Joy Mazurek and Jennifer Porter</i>	122
Appendix 1: <a href="#">Cataloging of the Wall Painting Replica Samples</a> <b>Images of Tintori replicas</b>	132
Appendix 2: <a href="#">Archive Sample of Replica OL18bis</a> <b>Sample data set</b>	136





## PART ONE

---

# Project Overview

### Project Description

Historically, there has been a widespread misconception that the majority of wall paintings are frescoes. In guidebooks and articles, the term *fresco* has been used interchangeably with *wall paintings* and *mural paintings*. *Fresco* (“fresh” in Italian) has a specific technical meaning: it indicates pigment particles (substances that add color) mixed in water and applied on a *fresh* lime-based plaster before the plaster has set. The pigments are bound to the surface of the wall through the carbonation process. This durable painting technique enjoyed brief periods of popularity among the ancient Romans and Italians, but in its purest form it was often rejected by artists as too limiting. Instead, painters from all periods and across the globe have relied on a wide range of organic materials (including egg, glue, oil, and resins) as binders (materials that hold pigments together and bond paint to a surface) for works of art on walls.

This lack of understanding of the nature and presence of the organic materials used in wall paintings has resulted in considerable damage brought on by misguided restoration interventions. Organic materials are particularly vulnerable during conservation intervention, and identifying their presence prior to treatment is critical to their survival. These materials deteriorate faster than inorganic components; often, only traces remain in centuries-old murals, making these organic components a challenge to identify and conserve.

Identifying inorganic components in wall paintings today is a relatively straightforward process. The challenge in identifying organic materials arises principally from four factors: (1) low binder-to-pigment ratio (as low as one-tenth of 1% of binder); (2) the unstable chemico-physical nature of organic materials, which may result in rapid and dramatic decay; (3) the number of large, often vast, heterogeneous, open, and porous wall painting systems, which are highly susceptible to degradation and contamination; and (4) the complex interactions between painting materials (typically pigments and binders but other materials as well), which can limit the ability of scientific instruments to identify these organic materials.

To enhance scientific support for the conservation of wall paintings, in 2003 the Getty Conservation Institute (GCI) partnered with a number of research groups (see sidebar) with varying degrees of expertise to create the Organic Materials in Wall Paintings (OMWP) project. The goal of the project was to evaluate various investigation techniques and assess their potential and limitations for organic materials identification in lime-based wall paintings.

For the assessment of investigation techniques, the OMWP project used a set of wall painting replicas selected from among hundreds made by Leonetto Tintori (1908–2000) at the Laboratorio per Affresco di Vainella (LAV), near Prato, Italy. Tintori, a renowned wall painting conservator, devoted much of his professional career to the study of organic materials in wall paintings. The replicas, which simulated various techniques and material combinations, were created to better understand the materials used in wall paintings. These were prepared using different types of binders and pigments applied on lime-based plaster. Each OMWP partner laboratory evaluated the analytical potential and limitations of one or more analytical techniques used on the Tintori replicas. The project team then set about developing an investigation methodology that started with approaches not requiring sampling (noninvasive), followed by investigations that required removal of material (invasive). Evaluation of the techniques was carried out by assessing both the level of information that a particular method would provide and the accuracy/repeatability of the result.

Research on the Tintori replicas concluded three years later, in 2006. Initial project results were presented at a symposium held at Centro Conservazione e Restauro La Venaria Reale, near Turin, Italy, in May 2006. The OMWP project concluded in 2010, and this project report summarizes some of the results of the collaboration.

## Project Background and Partners

The Organic Materials in Wall Paintings (OMWP) project was inspired by the need to improve conservation of wall paintings among conservation scientists and conservators with vast experience and vision. Most of these professionals have been directly or indirectly involved in the project through meetings and have provided significant input. Although many are not named as authors in the articles collected in this publication, each has played an important role in the development of the project. Of particular note are Giorgio Torraca (1926–2011), Mauro Matteini, Sharon Cather, and Leonetto Tintori (1908–2000).

## Project Partners & Team Members

### *The Getty Conservation Institute/Los Angeles*

Giacomo Chiari, project leader  
 Francesca Piqué  
 Michael Schilling  
 Arlen Heginbotham (J. Paul Getty Museum)  
 Joy Mazurek  
 Lorinda Wong  
 Gary Mattison  
 Giorgio Torraca, consultant  
 Giovanni Verri, consultant  
 Charlotte Martin de Fonjaudran, intern  
 Francesca Casadio, intern  
 Ivana Giangualano, intern

### *CNR-Istituto di Chimica Inorganica e delle Superfici, Padua*

Alessandro Vigato  
 Enrico Fiorin

### *CNR-Istituto di Conservazione e Valorizzazione Beni Culturali, Florence*

Mauro Matteini  
 Lucia Toniolo

### *CNR-Istituto di Fisica Applicata nello Carrara, Florence*

Andrea Casini  
 Marcello Picollo

### *CNR-Istituto di Scienze e Tecnologie Molecolari, Perugia*

Antonio Sgamellotti  
 Bruno Brunetti  
 Constanza Miliani

### *The Courtauld Institute of Art, Wall Painting Conservation Department, London*

Sharon Cather  
 Austin Nevin

### *Istituto Superiore Centrale per La Conservazione Ed il Restauro, Rome*

Fabio Talarico

### *Laboratorio per Affresco di Vainella, Prato*

Giuseppe Centauro  
 Cristina Grandin

### *Opificio delle Pietre Dure, Florence*

Alfredo Aldrovandi  
 Giancarlo Lanterna  
 Annette Keller

### *Politecnico di Milano, Milan*

Gianluca Valentini  
 Daniela Comelli

### *Scientific Research Laboratories of the Vatican Museums, Vatican City*

Ulderico Santamaria  
 Fabio Morresi

### *UCLA/Getty Master's Program on the Conservation of Ethnographic and Archaeological Materials, Los Angeles*

Ioanna Kakoulli

### *Università di Parma, Dipartimento di Chimica e Chimica Fisica, Parma*

Antonella Casoli  
 Elisa Campani

### *Università di Pisa, Dipartimento di Chimica e Chimica Industriale, Pisa*

Alessia Andreotti  
 Maria Perla Colombini  
 Gwenaelle Gautier

### *Università di Perugia, Dipartimento di Chimica, Perugia*

Aldo Romani  
 Catia Clementi  
 Francesca Rosi

\*This list includes project partners and team members as of 2006.

## Tintori's Replicas

The conservator Leonetto Tintori studied the presence and role of organic materials in wall paintings throughout his professional life. Over the course of his long career, Tintori encountered organic materials in wall paintings by different artists and in different environments. He grew to appreciate the role of these materials in the final painting and understand the need to be aware of their presence in thinking about conservation treatment.

Tintori used to say: “Garanzia di un corretto restauro in pittura murale, può essere offerta soltanto conoscendone a fondo la natura e la tecnica originale” (Only a profound knowledge of the nature and original technique can guarantee a proper restoration of mural paintings). He began to focus systematically on this subject in 1983, when he created a center at his home in Vainella, near Prato, Italy, to study this topic and to teach wall painting techniques.

In pursuit of this interest, Tintori made hundreds of wall painting replicas simulating different techniques and material combinations. Used in creating these samples were organic materials such as egg, oil, casein, and milk, in combination with different types of pigments and mortars. Many of these samples were then aged and exposed for different lengths of time indoors as well as outdoors. All samples were documented and cataloged in written, graphic, and photographic form. In 1988, Tintori donated the center, including the property and the collection of samples, to the city of Prato.

The research section, called Sezione studi e ricerche Leonetto Tintori, founded by Tintori and based on his knowledge and experience in treating wall paintings, is also the result of work by Tintori's collaborators. In particular, Cristina N. Grandin, professor of mural painting technique at the International University of Art (UIA), in Venice, worked side by side with Tintori at the LAV in making many of these replicas (see Grandin and Centauro, this volume).

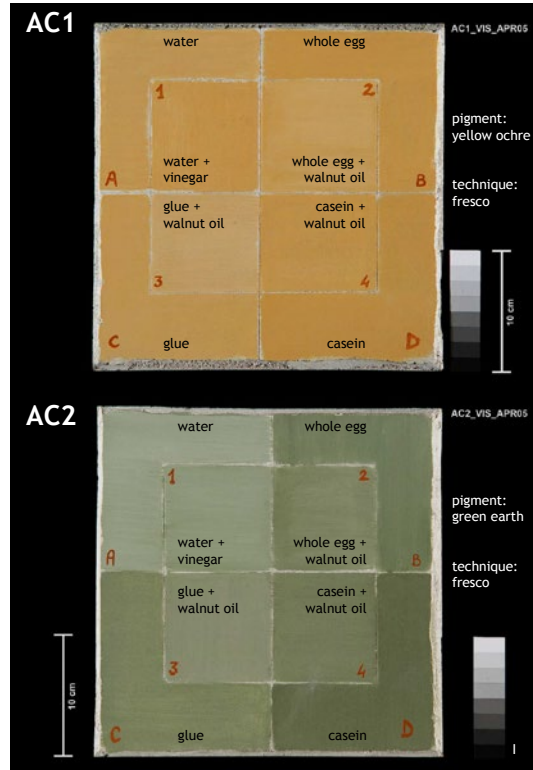
## Use of Tintori's Replicas for the Project

The objective of the OMWP project was to assess the potential of different investigation techniques for the identification of organic materials in wall paintings. Tintori's replicas were recognized as an excellent source of reference paints of known composition. They had had the time to age naturally and were, for the most part, well documented.

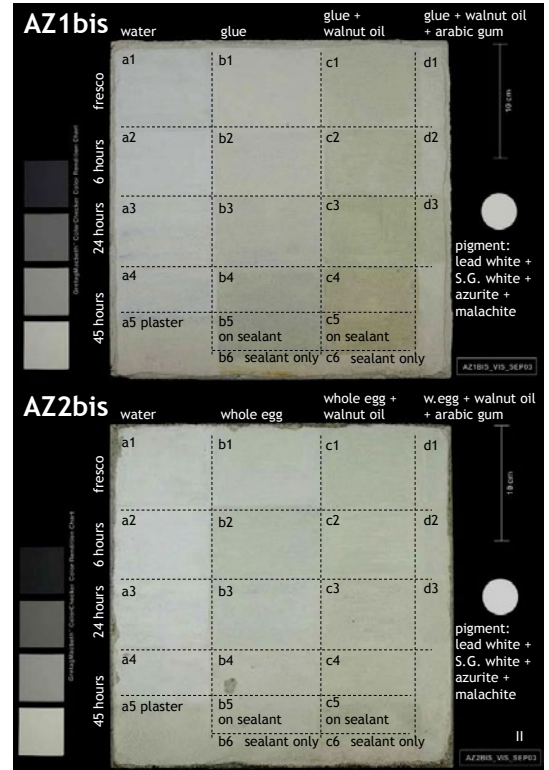
The Tintori replicas selected for the project (named per the classification of the LAV archive) are: AC1, AC2, AZ1bis, AZ2bis, M1bis, M2bis, M3bis, M4bis, N2, N3, N7, N11, N16, N25, N34, N20, N29, N38, OL17bis, OL18bis, Z8, and Z9. Figures 1–10 show each replica and note the pigments and binders used.

**Note:** As part of the OMWP project, a database was constructed in Microsoft Access to document the Tintori collection of replicas. The information entered was extremely detailed and included the type of pigment (lead white, red ocher, etc.), binder (linseed oil, rabbit-skin glue, etc.), and phase of application (elapsed time between application of the lime-based plaster substrate and application of the paint). The database was intended to provide rapid access to the vast amount of information available on the more than five hundred replicas prepared by Tintori.

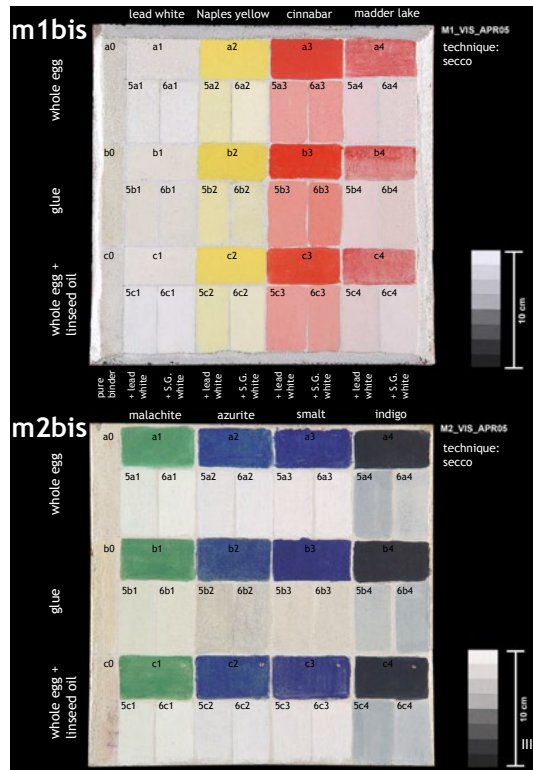
**FIGURE 1**  
Replicas AC1 and AC2, showing pigments and binders used.



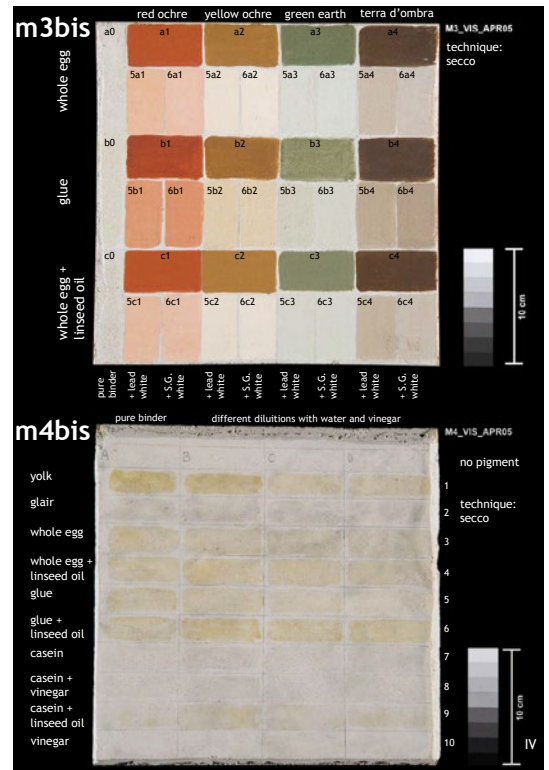
**FIGURE 2**  
Replicas AZ1bis and AZ2bis, showing pigments and binders used.



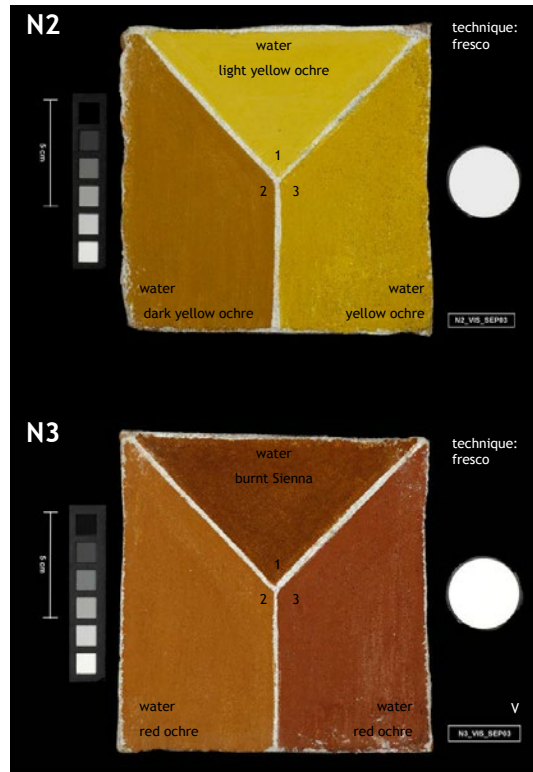
**FIGURE 3**  
Replicas M1bis and M2bis, showing pigments and binders used.



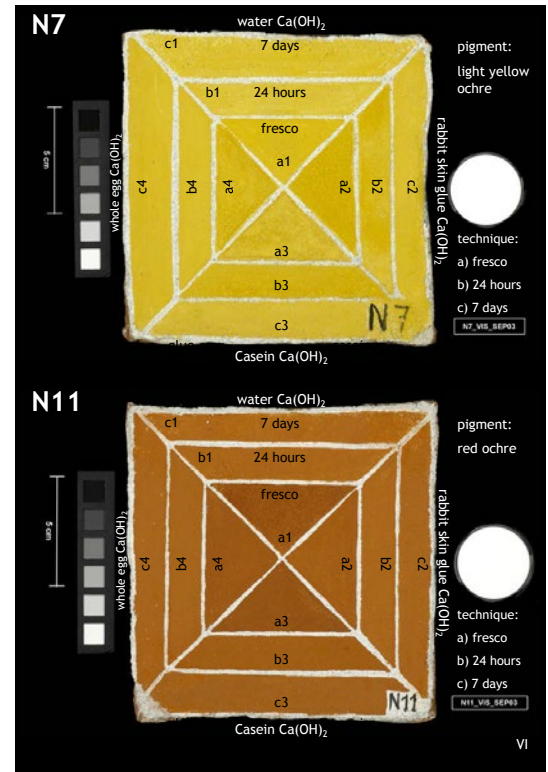
**FIGURE 4**  
Replicas M3bis and M4bis, showing pigments and binders used.



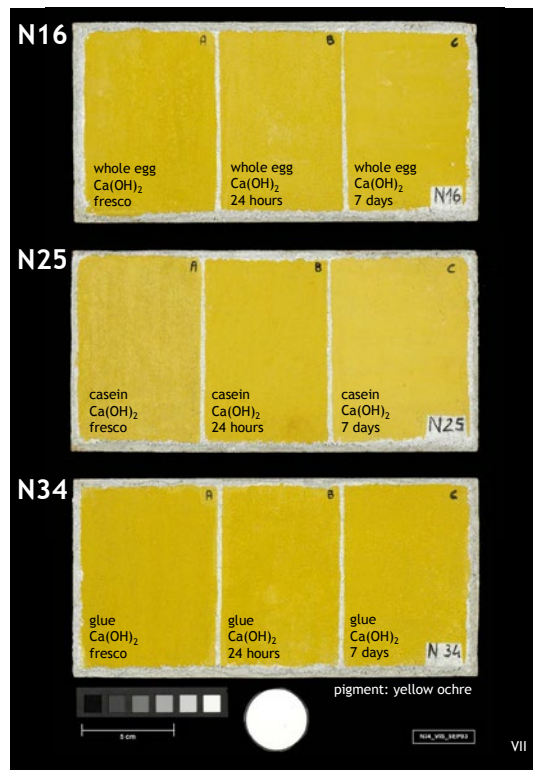
**FIGURE 5**  
Replicas N2 and N3, showing pigments and binders used.



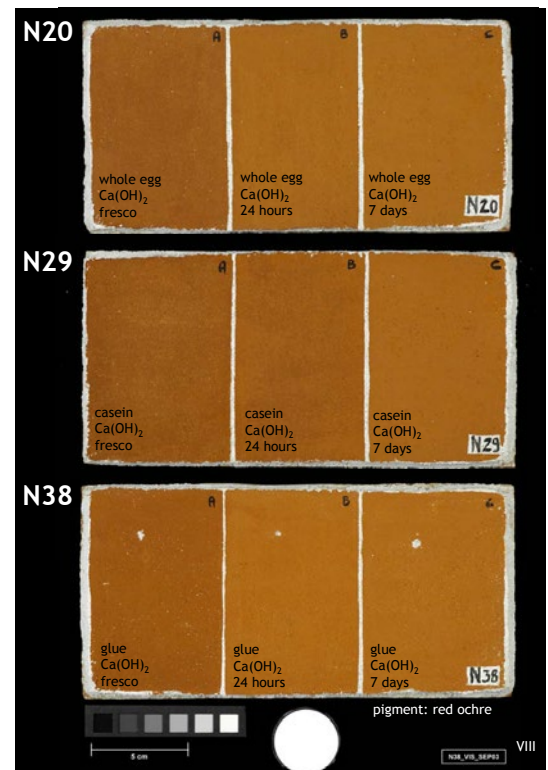
**FIGURE 6**  
Replicas N7 and N11, showing pigments and binders used.



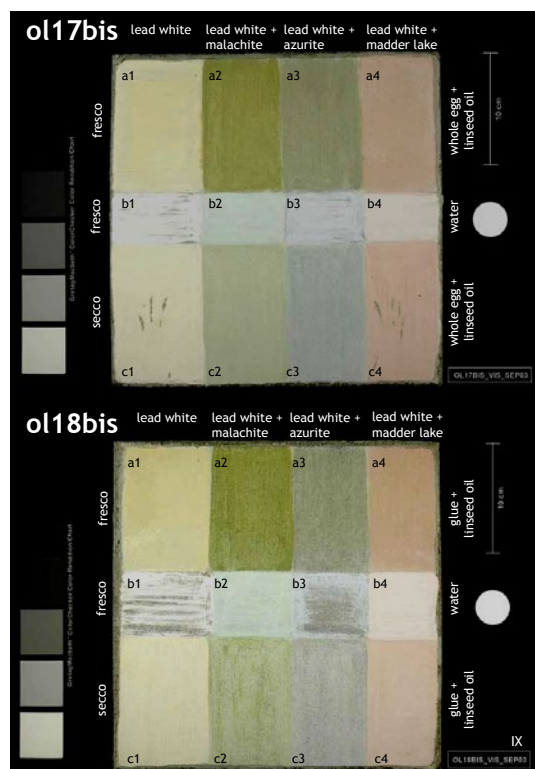
**FIGURE 7**  
Replicas N16, N25, and N34, showing pigments and binders used.



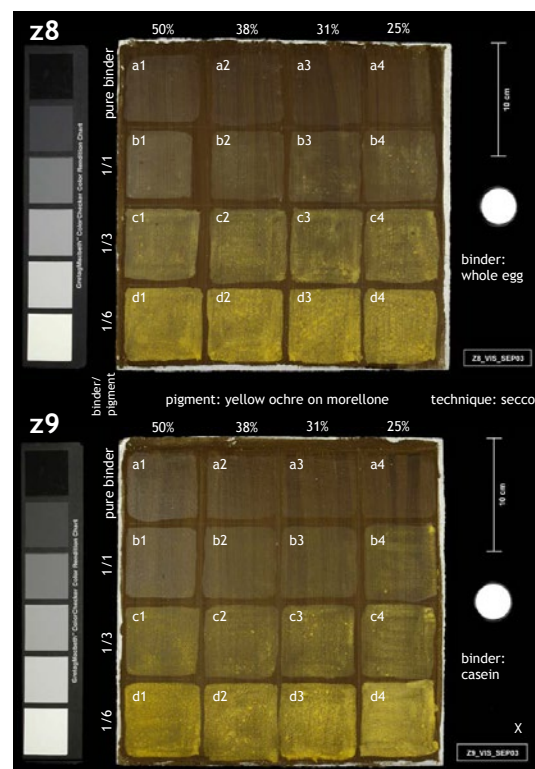
**FIGURE 8**  
Replicas N20, N29, and N38, showing pigments and binders used.



**FIGURE 9**  
Replicas OL17bis and OL18bis, showing pigments and binders used.



**FIGURE 10**  
Replicas Z8 and Z9, showing pigments and binders used.



## Evaluation of Techniques: Methodology, Levels, and Criteria

To evaluate the ability of each individual technique to detect organic materials in the set of replicas tested, the project partners examined a group of wall painting replicas of known composition (Tintori's replicas) with a number of different analytical techniques.

These reference standards were characterized by the use of different types of binders and pigments and by the timing of the application according to the level of carbonation of the plaster—fresh, partially carbonated, or fully carbonated (i.e., plaster that is wet, partially dry, or fully dry). More than 160 types of paint composition were studied using noninvasive methods; of these, about forty were sampled and studied using invasive techniques. The binders used to make the paint composition studied were: rabbit-skin glue, ammonium caseinate, whole egg, walnut oil, linseed oil, and gum arabic. Two organic pigments were also included: madder lake and indigo.

Evaluation of the techniques was based on the level of information obtained (sensitivity) and the correlation factor (accuracy) for the level of information. The following four levels of information regarding the presence of organic materials were defined:

**Level 1.** Presence of organic materials**Level 2.** Class of organic material

The classes tested were limited to proteins, lipids, gums, and organic pigments.

**Level 3.** Type of organic material

The types tested include:

- proteins: rabbit-skin glue, casein, whole egg;
- lipids: linseed oil, walnut oil, whole egg;
- gums: gum arabic; and
- organic pigments: madder lake, indigo.

**Level 4.** Organic materials in mixtures

The mixtures tested include:

- linseed oil, walnut oil, glue;
- linseed oil, walnut oil, whole egg;
- walnut oil, whole egg, gum arabic; and
- walnut oil, glue, gum arabic.

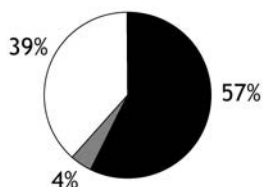
Obviously, not all of the techniques can provide information at each level. Evaluation consisted of determining the level of information that each technique would be able to provide. In addition, a set of specific criteria was used for individual techniques in order to determine the correlation factor. It is important to note that these criteria were developed specifically for the set of lime-based paint samples under investigation and were not intended for general application.

When significant, a correlation factor has been calculated for the level of information obtained and is expressed as % positive, % uncertain, and % negative correlation for the set of paint (replica sectors) studied.

- **Positive correlation:** The output of the technique corresponds to the composition of the paint measured.
- **Uncertain correlation:** The output of the technique is uncertain with respect to the composition of the paint measured.
- **Negative correlation:** The output of the technique does not correspond to the composition of the paint measured.

Where statistically significant, the correlation factor is represented in terms of percentage of positive, uncertain, and negative correlation, as in the following example:

■ Positive ■ Uncertain □ Negative



The correlation factor represents the capability of each individual technique to characterize the composition of the paint under investigation. This factor was evaluated for the highest level of information obtained.



## PART TWO

---

# Techniques Used for Identification of Organic Materials

As part of the three-year Organic Materials in Wall Paintings (OMWP) collaborative project, a number of investigative techniques were evaluated for their ability to provide information on the presence of organic materials in wall paintings. These techniques can be classified in two ways according to their impact on works of art: (1) noninvasive techniques (not requiring sampling) and (2) invasive techniques (requiring sampling).

### Noninvasive Techniques

The group of noninvasive techniques includes mainly analytical tools that are based on spectroscopic techniques that can provide a description of the components of the paint often without direct contact on the surface. These investigative methods are continuously improving and—significant for the study of wall paintings—many instruments are becoming portable. Portable noninvasive methods have proved to be important in the study of wall paintings, typically heterogeneous in nature and in condition, because they allow study in situ and in direct dialogue with conservators. Noninvasive investigations are a prerequisite to the development of a sampling strategy limited to specific and characteristic situations.

Noninvasive methods evaluated as part of the OMWP project were as follows:

- UV-Induced Fluorescence Photography;
- Fluorescence Lifetime Imaging (FLIM);
- Integrated Multispectral Imaging Systems;
- Fiber Optic Reflectance Spectroscopy (FORS);
- Fiber Optic Fluorescence Spectroscopy (FOFS); and
- Mid-FTIR Fiber Optic Spectroscopy.

## Invasive Techniques

The group of invasive techniques includes more traditional investigative methods that require a portion of the material for testing. Some techniques are used on the sample as taken and are nondestructive. Nondestructive techniques are typically spectroscopic exams and do not alter the sample, which remains available for further testing. Other techniques are performed on the sample mounted in a cross section to reveal the painting stratigraphy (layers). These are called *para-destructive* because the sample is modified irreversibly by being embedded in a polymeric resin, but several types of investigations can be carried out on the same sample. The techniques that consume the sample are called *destructive*.

Invasive methods used as part of the OMWP project were as follows:

- Cross-Section Preparation;
- UV Examination and Stain Tests on Cross Sections;
- FTIR Reflectance and FTIR–Attenuated Total Reflectance (ATR) Spectroscopy on Cross Sections;
- Micro-FTIR Spectroscopy;
- High-Performance Liquid Chromatography (HPLC);
- Gas Chromatography–Mass Spectrometry (GC–MS); and
- Enzyme-Linked Immunosorbent Assay (ELISA) for Protein Identification.

---

# UV-Induced Fluorescence Photography

## General Information

**Brief description:** Fluorescence emission of materials is characterized by parameters such as spectral features and emission intensity (amplitude), decay time, and polarization. These parameters are specific to the presence of a particular compound. Although fluorescence analysis finds wide application in material characterization, most applications of fluorescence are related to the study of organic compounds. In fact, molecules such as proteins, lipids, and more complex biopolymers often emit a perceivable fluorescence when excited by UV or visible electromagnetic radiation.

The CCD of a digital camera can record UV-induced fluorescence emission in the visible range (c. 400–700 nm) when a surface is irradiated by UV radiation (365 nm). Visible radiation can also be used to excite organic colorants, according to their absorption properties.

**Information provided:** The system provides spatial information on fluorescent materials.

## Technique Overview

**Type of analysis:** Noninvasive, mapping.

**Area measured:** The area is a function of the resolution of the digital camera, the type of lenses, and the intensity and distance of the illumination system. UV-induced fluorescence photography should be carried out initially on a large scale (approximately 0.2–1 m<sup>2</sup> painted surface) to identify areas with significant differences (in fluorescence properties), which can then be inspected in greater detail (5–10 cm<sup>2</sup>).

**Contact between instrument and object:** No contact is required.

**System specifications:** All recording for this project was done using a Nikon D100 digital camera with a Micro Nikkor 2,8/60 mm. The aperture is fixed on f/11 (max. MTF) and the recording mode is set on Av (automatic with aperture priority), ISO 200,  $\Delta EV = 0$ . The images are recorded as .tif (3000 × 2000 pixel a 24 bit; 18 Mb). A set of reflectance gray reference standards (Spectralon<sup>®</sup> 99%–2%, Labsphere) is included in the frame to evaluate ambient stray radiation. The UV component reflected from the object under investigation is blocked by a Schott KV418 filter positioned in front of the camera.

Weight: Camera, 1 kg; UV lights, 1.8 kg each.

Dimensions: Camera, 15 × 15 × 12 cm; UV lights, 25 × 18 × 10 cm.

UV light source: The illumination for UV-induced fluorescence multispectral imaging consists of a set of four Philips PL-S 9W double black light blue (BLB) tubes with high-frequency electronic ballasts, and a 11.9 × 11.9 cm Schott DUG11 window. The filters remove the parasitic blue light from the lamps. The lamps are

manufactured at Istituto di Fisica Applicata Nello Carrara (IFAC), Consiglio Nazionale per le Ricerche (CNR), Florence, Italy. Commercially available UV lamps mainly emit radiation at about 365 nm. However, a small component in the violet-blue range between 380 and 410 nm and another in the IR region above 700 nm are also emitted. This unwanted IR and violet-blue radiation is referred to here as *parasitic* because it is generated by the radiation source itself. Parasitic radiation should be distinguished from ambient stray light, which is by contrast generated from sources other than the UV radiation source (i.e., solar radiation from a window or from artificial light). Recent developments in the field of photo-induced luminescence imaging allow the capture of UV-induced fluorescence images using flashes, even in the presence of ambient stray radiation. For this project, images were captured in a darkened environment.

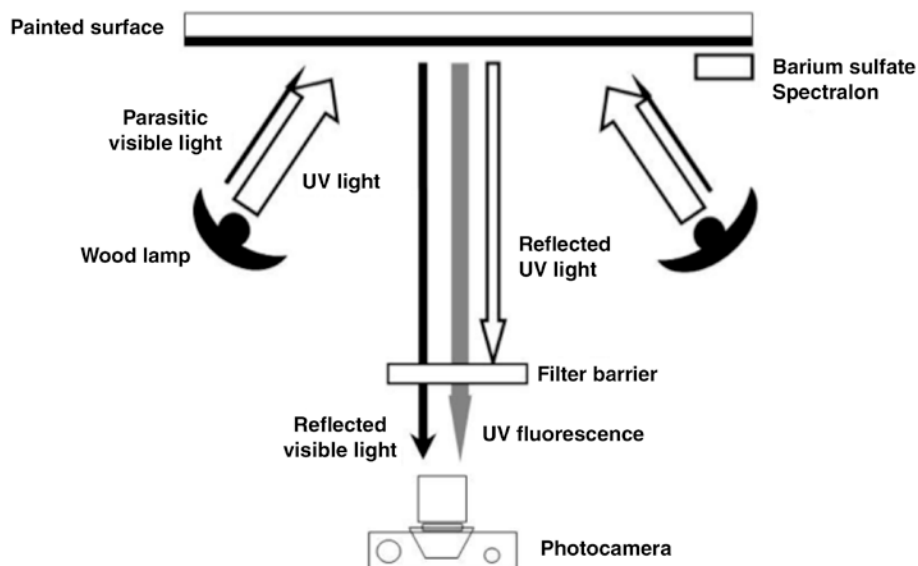
Type of power supply required and working power: No particular requirement.

Transportability: Good.

Health and safety: UV radiation protection for skin and eyes is required for the operator.

**FIGURE 1**

Schematic of the setup during measurement. Illustration courtesy of Giovanni Verri.



**Potential damage to the object:** The technique requires the irradiation of the object with UV light. The intensities involved are not normally harmful for the painting, but exposure must be kept to a minimum.

**Commercially available device or parts:** The device parts are commercially available. The UV source used in this study was manufactured at IFAC, CNR, Florence, Italy.

---

## Results and Interpretation

**Result type:** Image is digital sRGB file.

**Ease of interpretation:** UV-induced fluorescence radiation consists of the sum of the emission of several fluorophores with different properties of low specificity (amplitude and spectral features). Photography reduces the spectral information of such emissions into three bands: blue (400–500 nm), green (500–600 nm), and red (600–700 nm).<sup>1</sup> Interpretation of UV-induced fluorescence photography must be taken with great care.

**Applicability:** All surfaces.

**Result file type:** Images are recorded as .tif files of 3000 × 2000 pixels a 24 bit (18 MB).

## Notes

1. The wavelengths are only indicative.

## Bibliography

- Aldrovandi, Alfredo, Ezio Buzzegoli, Annette Keller, and Diane Kunzelman. 2005. “Investigation of Painted Surfaces with a Reflected UV False Colour Technique.” *Art '05*, 8th International Conference on “Non-destructive Investigations and Microanalysis for the Diagnostics and Conservation of the Cultural and Environmental Heritage,” Lecce, Italy, 15–19 May.
- Andrew, Sally R., and Dinah Eastop. 1994. “Using Ultra-violet and Infra-red Techniques in the Examination and Documentation of Historic Textiles.” *The Conservator* 18: 50–56.
- Mairinger, Franz. 2004. “UV-, IR- and X-ray Imaging.” In *Non-destructive Microanalysis of Cultural Heritage Materials*, edited by K. Janssens and R. Van Grieken, 15–66. *Comprehensive Analytical Chemistry*, vol. 42. Amsterdam: Elsevier.
- Verri, Giovanni, and David Saunders. 2014. “Xenon Flash for Reflectance and Luminescence (Multispectral) Imaging in Cultural Heritage Applications.” *The British Museum Technical Bulletin* 8: 83–92.

---

## Time-Resolved Laser-Induced Fluorescence Spectroscopy (TR-LIF) and Fluorescence Lifetime Imaging (FLIM)

### General Information

**Brief description:** The fluorescence emission of materials is characterized by parameters such as spectral features and emission intensity (or amplitude), decay time, and polarization. These parameters are specific to the presence of a particular compound. Although fluorescence analysis finds wide applications in material characterization, most applications of fluorescence are related to the study of organic compounds. In fact, molecules such as proteins, lipids, and more complex biopolymers, often emit a perceivable fluorescence when excited by UV or visible electromagnetic radiation. The characterization of organic compounds is achieved by irradiating the sample with UV excitation (337 nm; N<sub>2</sub> laser). The properties of the fluorescence emission (amplitude, spectral features, and lifetime) may offer the means for discrimination between different compounds. By subsequently recording delayed spectra with respect to the laser pulse, emission decay can be reconstructed per each wavelength (TR-LIF). Fluorescence lifetime imaging (FLIM) allows the determination of not only the presence of an organic fluorescent compound but also its spatial distribution. FLIM is based on the measurement of the decay kinetic properties of fluorescence emission at each spatial point of a sample, thus allowing the reconstruction of an averaged lifetime map of the region under investigation. The main advantage of this technique is that fluorescence lifetime is not sensitive to local variations of concentration. Moreover, it can provide effective means of discrimination between fluorophores (organic molecules exhibiting fluorescence properties) with spectrally overlapped emission.

**Information provided:** FLIM and TR-LIF may allow identification of the presence and spatial distribution of organic compounds showing fluorescence properties. They also allow the characterization and discrimination of organic compounds on the basis of their different spectral and temporal characteristics.

TR-LIF provides two outputs: (1) a spectrum of fluorescence emission intensity (a.u.) vs. wavelength (nm) and (2) a spectrum of fluorescence lifetime (ns) vs. wavelength (nm).

FLIM provides two outputs: (1) a fluorescence amplitude map (a.u.) of the surface under investigation and (2) a fluorescence lifetime map (ns), averaged over the full wavelength range of the analyzed surface.

### Technique Overview

**Type of analysis:** Noninvasive point analysis (TR-LIF) and noninvasive surface mapping (FLIM).

**Area measured:** TR-LIF analyzes small portions of surface (~20 mm<sup>2</sup>). FLIM, in the proposed configuration, can analyze circular surfaces of about 20 cm in diameter.

**Contact between instrument and object:** TR-LIF: Contact is not strictly required. FLIM: The measurement does not require contact.

**System specifications:** The TR-LIF setup is a spectroscopy unit that allows the acquisition of both fluorescence intensity spectra and fluorescence lifetime spectra. The excitation beam is provided by a pulsed nitrogen laser (VSL-337ND-S, Laser Science Inc.). The nitrogen ( $N_2$ ) source is based on a sealed plasma cartridge placed in the resonant cavity of the laser. No external flowing gas is required, making the laser extremely compact and easy to use. The main drawback associated with this configuration is the major length of the laser pulse (FWHM  $\sim 4$  ns). The maximum output power is about 5 mW at a maximum repetition rate of 30 Hz. The laser beam is sent in a fiber bundle that allows the illumination of a selected point of the sample. This bundle is made of a larger central fused silica fiber ( $\text{Ø} = 600 \mu\text{m}$ ) that delivers the excitation radiation to a desired area of a few millimeters in diameter, and of 20 fibers ( $\text{Ø} = 200 \mu\text{m}$ ) arranged in two circular rings, which collect the emitted fluorescence and deliver it to the detector. The detector is made of a time-gated Optical Multichannel Analyzer (OMA, EG&G Princeton Applied Research, Princeton, NJ) based on a reflective diffraction grating, which allows the measurement of fluorescence spectra in the visible range. The reflective grating can be slightly rotated by means of a precision micrometer to select the desired spectral band. At the exit of the spectrometer, the individual wavelengths of the radiation are read by an intensified silicon photodiode array that provides the amplification and the temporal gating of the signal: a multi-alkali photocathode, featuring maximum sensitivity in the range between 550 and 800 nm; a single-stage MCP and an output phosphor; the light emitted from the phosphor is finally coupled, through fiber optics, to a 512-elements linear photodiode array. The temporal gating of the spectrometer is obtained by means of a negative voltage pulse applied to the photocathode. Three possible gate widths, equal to 5, 10, and 20 ns, are allowed. A cutoff filter (B+W UV 010) placed before the entrance slit of the spectrometer is used to remove the excitation light from the recorded spectra.

During acquisition, the integration time of the linear photodiode array can vary depending on the intensity of the emission coming from the analyzed area. Typical exposure times vary from 100 ms for highly fluorescing samples to a few seconds. The main drawback associated with a long exposure time is electronic noise introduced by the photocathode. To reduce the noise component, the detector can be cooled down to 5 °C with an internal Peltier, thus reducing the dark charge spontaneously generated at the photocathode.

Furthermore, a background signal that takes into account this electronic noise can be subtracted from the collected data. A simple trigger unit based on a fast photodiode permits the synchronization of the detector with the laser pulse. Completing the apparatus is a delay generator capable of delays from 0 to 100 ns in 0.5 ns step. The automatic setting of all the instrumental parameters is controlled using a PC with dedicated software that was developed to drive all the instruments composing the system and to manage data acquisition. A user-friendly interface has been designed and implemented within the Labwindows environment (National Instruments, Austin, TX). Registered emission spectra are corrected for the detection efficiency in the selected spectral range (370–630 nm). To analyze the kinetics of the emission, a set of fluorescence spectra is acquired after different delays with respect to the excitation pulses and processed according to mono- and bi-exponential algorithms with an offline software developed using Matlab (MathWorks, Natick, MA).

The FLIM system records the fluorescence photons and their related decay kinetic at each spatial point of a surface. The principle is similar to the one described for TR-LIF devices. In this case, however, the fluorescence emitted by the sample is not separated in its spectral components. Nevertheless, the advantage offered by FLIM lies in its imaging capabilities. The basic elements of the system are a pulsed laser source and a time-gated image detector with high temporal resolution. Suitable, fast electronic equipment is also required for the synchronization of the two elements. The laser source required has to be pulsed and emit light pulses with a full width at half maximum (FWHM) several times shorter than the kinetics of the fluorescence emission. Depending on the application, the pulse width goes from around 1 ns to a few picoseconds or less for faster measurements.

In the present setup, a N<sub>2</sub> laser source (LN203C Laser Photonics, Orlando, FL) generates pulses shorter than 1 ns (FWHM) at 337 nm. The laser beam is coupled to an optical fiber with a core diameter of 600 μm and delivered to the object under investigation on a circular area of about 20 cm in diameter. Typically, the average power is kept under 1 mW in order to prevent any damage to the specimen. The image detector is a double MCP intensified camera designed to detect up to a single photon (ICCD225, Photek, St. Leonards-on-Sea, England, UK). The intensifier is optically coupled through a fiber optic taper to a common CCD (XC77CE, Sony). The double MCP stage allows a high intensification of the input signal with a maximum electron gain near 10<sup>6</sup>. The MCP can be gated with a gate rise-and-fall time of 2 ns. Minimum gate width is 5 ns, even though longer gate widths can be used—up to 100 ns—to collect a large fraction of the fluorescence emission, yielding better signal-to-noise ratio.

During the acquisition, a variable number of frames are averaged in real time to eliminate the noise generated by the image intensifier. Noise can severely affect the measurement when the MCP is operating close to the single photon limit. In normal conditions, when the gain of the image intensifier is <10<sup>4</sup>, a 16-frame average leads to a well-balanced image in terms of contrast and resolution, yet in the case of a very low signal, the image intensifier must be driven at the maximum gain and a 128-frame average is required. A homemade trigger unit allows synchronization of the image intensifier with the laser pulse. The electronic circuit, manufactured at the Politecnico di Milano, is a constant fraction discriminator unit that provides a trigger signal almost insensitive to possible fluctuations of the intensity of the laser source. A precision delay generator (Stanford Research Systems, Sunnyvale, CA) allows temporal sampling of the emitted fluorescence with delays from 1 to 100 ns. Dedicated software has been developed to drive all the devices that compose the system and to manage image acquisition. A user-friendly interface has been designed and implemented within the LabWindows environment (National Instruments, Austin, TX), while the images are recorded and processed by a high-performance image board (Genesis, Matrox Electronic Systems, Dorval, Canada). To calculate the fluorescence lifetime map of the region under investigation, two or more images are acquired after different delays with respect to the excitation pulses and mathematically processed. A powerful program for offline analysis has been developed using Matlab (MathWorks, Natick, MA). This program, featuring a graphic user interface, allows modification of the parameters involved in lifetime calculation, such as number of delayed images, type of regression, and color maps for data presentation.



Weight: ~30 kg.

Dimensions: Main body, 100 × 100 × 100 cm.;

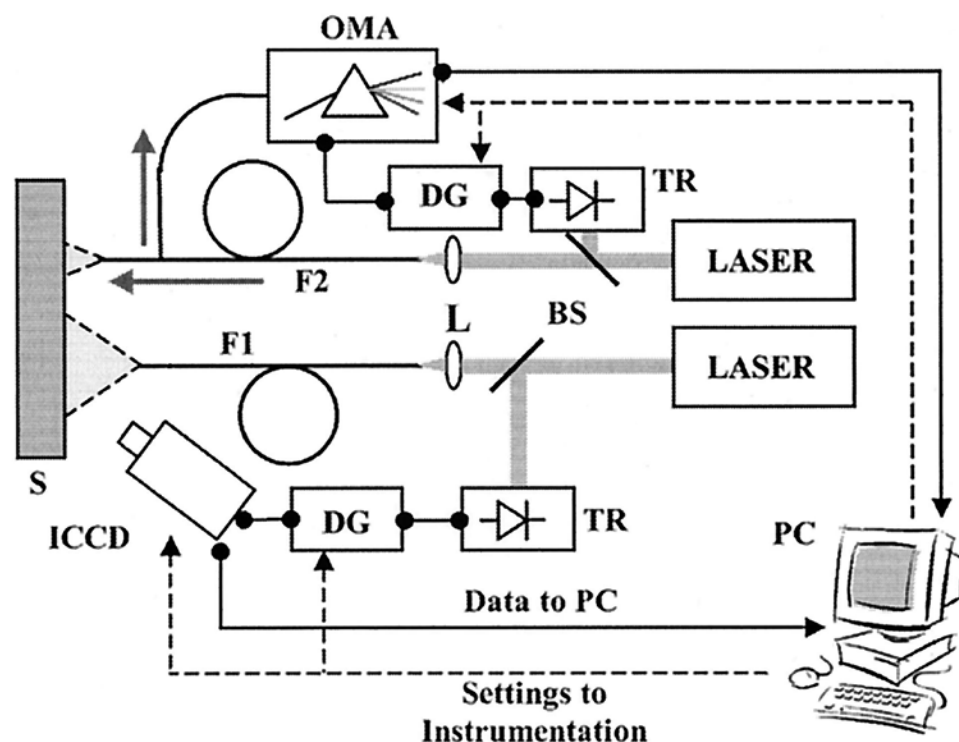
Type of power supply required and working power: No particular requirement.

Transportability: Averaged.

Health and safety: Protection required from UVA radiation for the operator.

**FIGURE 2**

Schematic of fluorescence devices used at the Politecnico di Milano. LASER = pulsed nitrogen laser; BS = beam splitter; L = focusing lens; F1 = silica fiber; F2 = silica fiber bundle, ICCD = time-gated intensified camera; OMA = time-gated spectrometer; TR = optical trigger circuits; DG = delay generators; S = Tintori replica surface; PC = personal computer. Illustration courtesy D. Comelli.



**System calibration process:** Wavelength scale of the TR-LIF system is calibrated by means of a mercury lamp before a set of measurements. The position of the mercury emission peaks is identified and inserted in the calibration section of the acquisition software. The spectral sensitivity of the detector is corrected by means of a calibrated black body halogen lamp.

FLIM does not require calibration.

**Potential damage for the object during measurement:** The technique requires irradiating the sample with UV radiation. According to the measuring time, the irradiation time varies according to the emittance of the sample (max ≈ 5 minutes for TR-LIF, usually shorter for FLIM). A shorter irradiation time would also reduce noise (dark current).

**Commercial availability:** The device is only partially commercially available.

---

## Results and Interpretation

**Result type:** Fluorescence time-resolved spectrum and FLIM.

**Ease in interpretation:** UV-induced fluorescence emission and lifetime spectra of a solid sample consist of the sum of the emission of several fluorophores with different absorption and emission properties. The specificity of fluorescence emission bands is limited, and the interpretation of the results requires a deep knowledge of fluorescence spectrometry.

**Applicability:** The technique can be easily applied to all surfaces even though different roughness of the surface can produce different results. In the present setup, fluorescence spectra are limited to 370–630 nm.

**Result file type:** TR-LIF: Spectra can be converted to a format readable by Microsoft Excel. FLIM: Image file is readable by dedicated software. The software can also generate a .jpg file.

## Bibliography

- Comelli, Daniela, et al. 2004. "Fluorescence Lifetime Imaging and Spectroscopy as a Tool for Nondestructive Analysis of Works of Art." *Applied Optics* 43 (10): 2175–83.
- \_\_\_\_\_. 2005. "Fluorescence Lifetime Imaging and Fourier Transform Infrared Spectroscopy of Michelangelo's *David*." *Applied Spectroscopy* 59 (9): 1174–81.
- \_\_\_\_\_. 2011. "Insights into Masolino's Wall Paintings in Castiglione Olona: Advanced Reflectance and Fluorescence Imaging Analysis." *Journal of Cultural Heritage* 12 (1): 11–18.
- \_\_\_\_\_. 2012. "On the Discovery of an Unusual Luminescent Pigment in Van Gogh's Painting 'Les bretonnes et le pardon de pont Aven'." *Applied Physics A* 106 (1): 25–34.
- Cubeddu, Roberto, et al. 2002. "Time-Resolved Fluorescence Imaging in Biology and Medicine." *Journal of Physics D: Applied Physics* 35: R1–R16.

---

## Integrated Multispectral Imaging Systems (MuSIS™ HS and SpectraCube™ SD 200)

### General Information

**Brief description:** Multispectral imaging systems allow the acquisition and capturing of black-and-white images at specific wavelengths across the electromagnetic spectrum. A full spectrum per image pixel is calculated from the captured spectral images (spectral cube) and displayed (imaging spectroscopy). Diffuse reflectance or UV-induced fluorescence images and spectra can be recorded according to the type of illumination used (halogen or UV). The most significant information on the presence of organic materials is provided by UV-induced fluorescence multispectral imaging.

The MuSIS™ HS system acquires digital real-time images at specific bandwidths using optical filters. Thirty-two images are recorded from 420 nm to 1000 nm at 20 nm intervals. RGB images can be obtained by combining incoming radiation intensity values from images in the green, red, and blue regions. The gray level (0–255) of each pixel represents the intensity of light at a specific bandwidth. Correction procedures are necessary in order to interpret the images and the spectra.

The SpectraCube™ SD 200 system acquires a set of interferometric images and reconstructs a “cube” of spectral images by means of the Fourier Transform algorithm. Single spectra can be plotted by clicking at any pixel of a reference image usually synthesized by means of the same spectral images (e.g., an RGB picture). Again, correction procedures are necessary in order to interpret the images and the spectra.

The bandwidth is conditioned by the types of filters used (in the case of the MuSIS™) and on the sensitivity of the detector.

**Information provided:** Multispectral imaging systems provide noninvasive mapping and characterization of materials with different optical and chemical properties. The output consists of a set of images at each individual wavelength interval that provides topographic information of superficial heterogeneity through reflectance and UV-induced fluorescence imaging spectroscopy.

### Technique Overview

**Type of analysis:** Visible % reflectance and UV-induced fluorescence imaging and spectroscopy (spatially resolved analysis).

**Area measured:** Surface mapping can be undertaken on areas comparable to those of photography, although spatial resolution is considerably inferior. Spatially resolved spectroscopic analysis is undertaken on a pixel of the reference RGB image or on a group of pixels.

**Contact between instrument and object:** Contact is not required.

**System specifications:** Both systems can record images and spectra of % diffuse reflectance and UV-induced fluorescence. A white reference standard is used to correct the acquired visible reflectance images at the given conditions of illumination. The correction related to the UV-induced fluorescence imaging is problematic because a calibrated light source was not available for this program.

MuSIS™ (Forth Photonics, Athens, Greece) cameras operate in the 370–1550 nm range. This is achieved with a combination of a CCD and an infrared-to-visible imaging converter. Digital images can be captured and displayed in real time on a computer monitor. Filters (32 spectral bands in the range of 370–1000 nm and 1 spectral band in the range of 1000–1550 nm), image acquisition, and analysis are controlled through dedicated software. Spectra per image pixel can be calculated following appropriate correction (the spectral range is, in this case, limited to 420–1000 nm).

SpectraCube™ SD 200 (Applied Spectral Imaging, Edingen-Neckarhausen, Germany) acquires a series of images by means of a Sagnac interferometer and a CCD camera. The setup records images of interference and, through Fourier Transform algorithm, calculates the optical spectra at any imaged point. In the case of diffuse reflectance the spectral cubes are corrected using as reference the reflectance spectra acquired on a white (or gray) standard plate (e.g., 99% reflectance Spectralon®).

If illumination dis-uniformity is ignored (small objects), reflectance spectra at any pixel may be rescaled by dividing with the spectrum taken on the standard plate. For large objects, both spectral and spatial scaling are achieved by dividing the whole cube by a whole cube acquired under the same conditions on a white plate covering the same field of view.

In the spectral analysis of emitted fluorescence—that is, in UV fluorescence spectral imaging—calibration is problematic as there are no “white” reference standards. Accurate calibration would require measuring the response of the system on an integrating sphere as a uniform illumination source with a known spectrum.

A rough estimation of the SD 200 spectral responsivity was performed using a 2900 K QTH lamp illuminating a certified 99% Spectralon plate from a distance. Due to the low sensitivity of the CCD at its spectral ends and to the low power emitted from a QTH in the blue region, the operating spectral range after the application of the spectral correction resulted narrowed with respect to 450–950 nm SD 200 operative region.

For simple discrimination of fluorescence spectral yields, calibration is not necessary, similar to common UV fluorescence photography, in which color calibration is not used. Instead, compensation for spatial dis-uniformity in the excitation irradiation can be easily obtained by means of a measurement, under the same acquisition conditions, of a homogeneously fluorescing plate (e.g., gray cardboard).

A clean reflectance reference standard (Spectralon® 99% by Labsphere, North Sutton, NH) is always included in the frame in order to evaluate the amount of ambient stray visible light. For further details, please go to: [www.spectral-imaging.com](http://www.spectral-imaging.com).

Weight: MuSIS™, 3 kg; SpectraCube™, 5.6 kg.

Dimensions: MuSIS™, 13.9 × 10.2 × 23.2 cm; SpectraCube™, 29 × 46 × 16 cm.

Type of power supply required and working power: No particular requirement.

Transportability: Good.

Health and safety: Protection required from UV radiation for the operator.

**Scheme of the setup during measurement:** The setup is comparable to the one used for technical photography.

UV light source: For this project, the illumination for UV-induced fluorescence multi-spectral imaging consists of a set of four Philips PL-S 9W double BLB tubes, with high-frequency electronic ballasts, and a 11.9 × 11.9 cm Schott DUG11 window. The filters remove the parasitic blue light from the lamps. The lamps are manufactured at IFAC, CNR, Florence, Italy.

The illumination for reflectance multispectral imaging consists of halogen bulbs.

**Potential damage to the object:** The technique requires the irradiation of the sample with UV radiation (365 nm). Irradiation time varies according to the emittance of the sample, the intensity of the UV source, and the sensitivity of the detector.

**Commercial availability:** Both instruments are commercially available.

## Results and Interpretation

**Result type:** Image and % diffuse reflectance or UV-induced fluorescence spectra.

**Ease of interpretation:** UV-induced fluorescence emission consists of the sum of the emission of several fluorophores with different absorption and emission properties. Specificity of fluorescence emission bands is limited, and interpretation requires a deep knowledge of fluorescence spectrometry. Moreover, the spectral range of both systems is inadequate for analysis and characterization of historical binding media, since an important part of the fluorescence emission in the UV range is not recorded. The spectra should therefore be interpreted with extreme care.

**Applicability:** The techniques can be easily applied to all surfaces even though different roughness of the surface can produce different results.

**Result file type:** MuSIS™: .bmp files readable and managed by dedicated software. Spectra can be converted to .txt files.

SpectraCube™: .cub files readable and managed by dedicated software. Spectra can be converted to .txt files.

## Bibliography

- Bacci, M., A. Casini, C. Cucci, F. Lotti, M. Picollo, B. Radicati, and L. Stefani. 2003. "A Fourier Transform Imaging Interferometer for Reflectance and Fluorescence Spectral Imaging." Paper presented at the Organic Materials in Wall Paintings Project Workshop, Prato and Florence, Italy, 17–19 June 2003.
- Balas, C., V. Papadakis, N. Papadakis, A. Papadakis, E. Vazgiouraki, and G. Themeli. 2003. "A Novel Hyper-spectral Imaging Apparatus for the Non-destructive Analysis of Objects of Artistic and Historic Value." *Journal of Cultural Heritage* 4 (1): 330–37.

- Casini, A., F. Lotti, M. Picollo, L. Stefani, and A. Aldrovandi. 2003. "Fourier Transform Interferometric Imaging Spectrometry: A New Tool for the Study of Reflectance and Fluorescence of Polychrome Surfaces." In *Conservation Science 2002: Papers from the Conference Held in Edinburgh, Scotland, 22–24 May 2002*, edited by J. H. Townsend, K. Eremin, and A. Adriaens, 249–53. London: Archetype Publications.
- Maravelaki-Kalaitzaki, P., V. Zafiropulos, P. Pouli, D. Anglos, C. Balas, R. Salimbeni, S. Siano, and R. Pini. 2003. "Short Free Running Nd:YAG Laser to Clean Different Encrustations on Pentelic Marble: Procedure and Evaluation of the Effects." *Journal of Cultural Heritage* 4: 77s–82s.
- Pouli, P., V. Zafiropulos, C. Balas, Y. Doganis, and A. Galanos. 2003. "Laser Cleaning of Inorganic Encrustation on Excavated Objects: Evaluation of the Cleaning Result by Means of Multi-spectral Imaging." *Journal of Cultural Heritage* 4: 338s–342s.
- Zafiropulos, V., C. Balas, A. Manousaki, Y. Marakis, P. Maravelaki-Kalaitzaki, K. Melesanaki, P. Pouli, et al. 2003. "Yellowing Effect and Discoloration of Pigments: Experimental and Theoretical Studies." *Journal of Cultural Heritage* 4: 249s–256s.

---

## Fiber Optic Reflectance Spectroscopy (FORS)

### General Information

**Brief description:** For this project, the system acquires % reflectance spectra vs. wavelength in the 270–820 nm range. Electromagnetic radiation in the 270–820 nm interval is projected through optical fibers onto the surface of the object, which responds according to its optical properties. The incident radiation will be transmitted, absorbed, or reflected by the surface under investigation. Reflection can be either diffused or specular. The diffused component is collected by fiber optics and delivered to a spectro-analyzer, where it is separated into components and analyzed to provide the % reflected.

**Information provided:** The system provides information on the optical properties of the components of the sample. This technique is commonly used for the characterization, and in particular cases the identification, of pigments and colorants. The output consists of a spectrum of diffuse % reflectance.

### Technique Overview

**Type of analysis:** Point analysis.

**Area measured:** Approx. 0.3 cm<sup>2</sup>.

**Contact between instrument and object:** Contact is not strictly required. Signal-to-noise ratio is increased when contact is allowed. The probe is provided with a rubber o-ring to minimize possible damage during contact.

**System specifications:** Percentage reflectance spectra are acquired using a Zeiss MCS501 spectro-analyzer. This portable device operates in the 200–1000 nm range with 0.8 nm/pixel acquisition step (1024 Si-diodes) and has its own internal source (a voltage-stabilized 20W tungsten-halogen lamp, model CLH500, working range 320–2500 nm). In addition, an external Xenon lamp (Zeiss model CLX500, working range 270–850 nm) can be used. Two bundles of pure fused quartz fibers (one bifurcated, for sending the incident light that illuminates the investigated area [about 3 mm in diameter] from two different symmetrical directions,  $2 \times 45^\circ$ ; the other linear, for receiving the diffused light) are used to convey the light onto the surface under investigation and to collect the diffused component of the light to the detector. Operating range of the fibers is 220–1100 nm. The probe-head (manufactured at IFAC, Florence, Italy) is a dark hemisphere, 3 cm in diameter, terminating with a flat base and having three apertures on the top. Reflectance spectra are recorded in the 270–820 nm range using the external Xenon light source and a Spectralon plate as a standard reference of 99% reflectance. Thanks to the rapid acquisition time of each single spectrum (a few dozen ms), each spectrum is the average of three independent acquisitions. The number of averaged spectra can be increased to improve the statistics of the measurement.

Weight: ~15 kg.

Dimensions: ~50 cm × 40 cm × 20 cm.

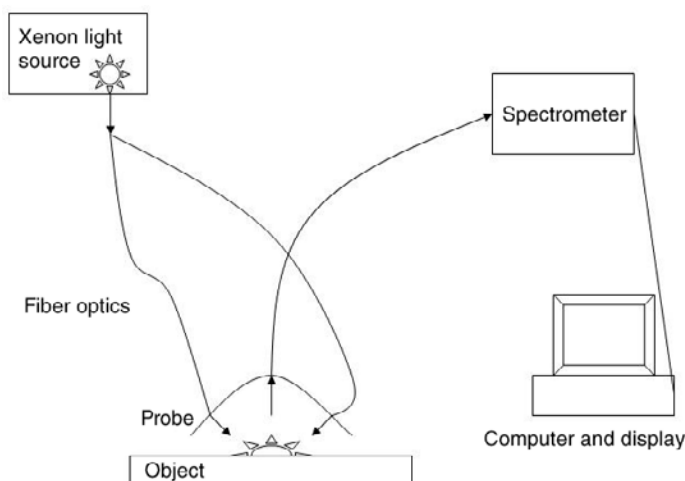
Type of power supply required and working power: No particular requirement.

Transportability: Good.

Health and safety: No particular protection required for the operator.

**FIGURE 3**

Scheme of the setup used for the measurement. Illustration courtesy of Giovanni Verri.



**System correction process:** The Xenon lamp needs to be turned on one hour before taking the actual measurement. The first step is the acquisition of a spectrum of a calibrated white Spectralon as a 99% reflectance reference surface. This procedure is fairly easy and quick but should be repeated every four or five measurements.

**Potential damage to the object:** The technique requires irradiation of the sample with light in the infrared, visible, and UV regions. Integration time is a few dozen ms per measurement and therefore not harmful to objects such as wall paintings.

**Commercial availability:** The device is partially commercially available.

## Results and Interpretation

**Result type:** Spectrum of % reflectance vs. wavelength (270–820 nm).

**Ease in interpretation:** The results are interpreted by comparison with reference standards. IFAC provides an online database of reference spectra: <http://fors.ifac.cnr.it/>.

**Applicability:** The technique can be easily applied to all surfaces even though different roughness of the surface can produce variable results.

**Result file type:** Dedicated software transforms spectra into .txt files.



---

## Bibliography

- Aldrovandi, A., M. L. Altamura, M. T. Cianfanelli, and P. Ritano. 1996. "I materiali pittorici: tavolette campione per la caratterizzazione mediante analisi multispettrale." *OPD Restauro* 8: 191–210.
- Bacci, M., F. Baldini, R. Carlà, and R. Linari. 1991. "A Color Analysis of the Braccacci Chapel Frescoes." *Applied Spectroscopy* 45: 26–31.
- Bacci, M., S. Baronti, A. Casini, F. Lotti, M. Picollo, and O. Casazza. 1992. "Non-destructive Spectroscopic Investigations on Paintings Using Optical Fibers." In *Materials Issues in Art and Archaeology III: Symposium Held April 27–May 1, 1992, San Francisco, California, USA*, edited by P. B. Vandiver, J. R. Druzik, G. S. Wheeler, and I. C. Freestone, 265–83. Materials Research Society Symposium Proceedings 267. Warrendale, PA: Materials Research Society.
- Bacci, M., A. Casini, C. Cucci, M. Picollo, B. Radicati, and M. Vervat. 2003. "Non-invasive Spectroscopic Measurements on the *Il ritratto della figliastra* by Giovanni Fattori: Identification of Pigments and Colourimetric Analysis." *Journal of Cultural Heritage* 4: 329–36.
- Bacci, M., M. Picollo, B. Radicati, A. Casini, F. Lotti, and L. Stefani. 1998. "Non-destructive Investigation of Wall Painting Pigments by Means of Fiber-Optic Reflectance Spectroscopy." *Science and Technology for Cultural Heritage* 7: 73–81.
- Barnes, N. F. 1939. "A Spectrophotometric Study of Artists' Pigments." *Technical Studies in the Field of the Fine Arts* 7 (3): 120–38.
- Bullock, L. 1978. "Reflectance Spectrophotometry for Measurement of Colour Change." *National Gallery Technical Bulletin* 2: 49–55.
- Saunders, D. 1986. "The Measurement of Colour Change in Paintings." *European Spectroscopy News* 67: 10–17.

---

## Fiber Optic Fluorescence Spectroscopy (FOFS)

### General Information

**Brief description:** The system acquires fluorescence emission (200–1100 nm) spectra by means of quartz fiber optics. Therefore, no contact between the probe and the object is strictly required. Molecular organic compounds, such as binding media, can absorb UV radiation and re-emit visible light. Molecules with such properties usually are referred to as fluorophores. The excitation wavelengths used are therefore in the UV range (254–333 nm) with the exception of organic pigments, for which the excitation wavelength is selected according to the absorption properties of the fluorescent compound under investigation. The excitation radiation from the Xenon light source is selected by a monochromator and is projected onto the surface through the input fiber bundle. Following absorption and emission from the specimen, the output signal is collected into an output bundle of fibers and analyzed using a CCD detector system.

**Information provided:** The system provides qualitative information mainly on the organic components of a solid sample. Output consists of a fluorescence emission spectrum.

### Technique Overview

**Type of analysis:** Point analysis (2 mm diameter).

**Area measured:** The instrument can analyze details (less than 10 mm<sup>2</sup>).

**Contact between instrument and object:** Contact is not strictly required. Ambient light can affect the measurement.

**System specifications:** Fiber optic fluorescence spectroscopy (FOFS) allows the acquisition of fluorescence emission spectra of solid materials (surface area of approximately 2 mm in diameter). Emission spectra are collected by a portable fluorimeter assembled as a prototype from separate individual components. The excitation light source (175 W Xenon lamp) is focused on a H-10 Jobin Yvon UV monochromator (linear dispersion 8 nm/mm) that enables the selection of the excitation wavelength. An excitation interferential filter is used to avoid the transmission of any spurious radiation. A Y-shaped fiber optic cable probe directs the excitation radiation onto the surface under investigation. Radiation emitted by the specimen is focused onto a second fiber optic cable and directed to a high-sensitivity (86 photons/counting) Avantes CCD spectrometer. An emission cutoff filter is used to exclude reflected light from the surface. The probe consists of two concentric arrays of fiber optics. The internal fibers transmit the excitation light, while the external fibers transmit the emission signal.

To confirm data reliability, the spectra collected with the portable fluorimeter are compared with spectra of the same samples measured using a Spex Fluorolog-2 1680/1 spectro-fluorimeter (bench equipment), controlled by Spex DM 3000F spectroscopy software and equipped with fiber optic accessories (Fluorolog-2).

Weight: ~20kg distributed in two separate cases.

Dimensions: Main body: two separated cases of  $\sim 40 \times 30 \times 20$  cm; optical fibers: 200 cm long. Flexibility of the quartz fiber optic system allows high versatility.

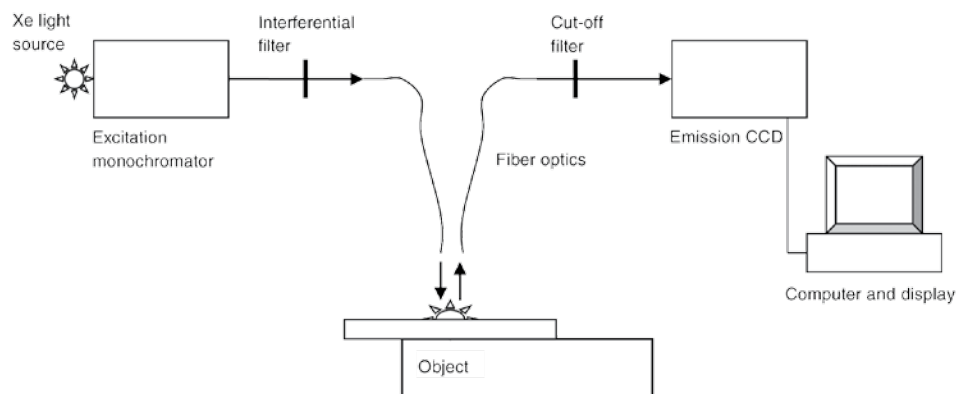
Type of power supply required and working power: No particular requirement.

Transportability: Good.

Health and safety: None.

**FIGURE 4**

Scheme of the setup used for the measurement. [FOFS] Illustration courtesy of Giovanni Verri.



**System calibration process:** Calibration is not required.

**Potential damage to the object:** The technique requires irradiation of the sample with UV light. Integration time can be selected, and more than one measurement on the same spot can be taken in order to improve the statistics of the measurement. This implies a longer exposition to UV light. Integration time of 1 s leads to a total exposure of about 5 minutes per measurement. Integration time is related to emittance of the sample.

**Commercial availability:** The device has been assembled by the chemistry department of the University of Perugia.

## Results and Interpretation

**Result type:** UV-induced fluorescence spectrum.

**Ease in interpretation:** UV-induced fluorescence emission spectra of a solid sample consists of the sum of the emission of several fluorophores with different absorption and emission properties. The specificity of such emission bands is limited and the interpretation of the results requires a deep knowledge of fluorescence spectrometry.

**Applicability:** The technique can be easily applied to all surfaces even though different roughness of the surface can produce variable results.

**Result file type:** Dedicated software allows conversion of the spectra into .txt files.

## Bibliography

Clementi, C., C. Miliani, A. Romani, and G. Favaro. 2003. "Spettrofluorimetria UV-VIS in riflettanza: Una tecnica non distruttiva per la diagnostica dei manufatti artistici." In *Conferenza nazionale sulle prove non distruttive monitoraggio diagnostica, Biennale PnD-MD: 10. Congresso nazionale dell'AIPnD: Ravenna '03, Palazzo De André, 2-4 aprile 2003*, 110-18. Brescia: Queriniana.

---

## Mid-FTIR Fiber Optic Spectroscopy

### General Information

**Brief description:** The system acquires molecular vibrational mid-FTIR (4000–900  $\text{cm}^{-1}$ ) spectra in reflectance mode by means of chalcogenide fiber optics. The input signal from the IR source is conveyed onto the surface through the input fiber bundle and, following reflection (reflection is both diffuse and specular, due to the particular  $0^\circ/0^\circ$  geometry of the system), the output signal is collected by the output fiber bundle and subsequently analyzed by the interferometric system. Both organic and inorganic compounds respond to mid-IR radiation according to the vibrational modes allowed by selection rules.

**Information provided:** The system is used for surface investigation and provides information on the presence of organic and inorganic compounds. The output consists of a spectrum of molecular IR pseudo-absorbance ( $\log(1/R)$ , where R is Reflectance) vs. wavenumber ( $\text{cm}^{-1}$ ).

### Technique Overview

**Type of analysis:** Noninvasive surface point analysis.

**Area measured:** The instrument analyzes a small portion of a surface ( $\sim 20 \text{ mm}^2$ ).

**Contact between instrument and object:** Contact is not strictly required. Signal-to-noise ratio is increased when contact is allowed.

**Applicability:** The technique can be applied to all surfaces. Limitations are related to physical accessibility to the surface due to size and weight of the instrument and to the extreme fragility of the chalcogenide fiber optics system.

**System specifications:** The portable spectrophotometer (JASCO VIR 9500) is made of a Midac Illuminator IR radiation source (1350  $^\circ\text{C}$ ), a Michelson interferometer, and a cryogenically cooled MCT detector. The system is equipped with a Remspec mid-infrared fiber optic sampling probe. The fibers, made of chalcogenide glass, have an excellent signal-to-noise ratio throughout the range of 900–4000  $\text{cm}^{-1}$  with the exception of the 2050–2200  $\text{cm}^{-1}$  region, due to the fiber Se-H stretching absorption. The Y-shaped probe consists of nineteen fibers, seven for the irradiation and twelve for the collection of the outcoming signal. The probe is kept perpendicular to the painting surface ( $0^\circ/0^\circ$  geometry) at a distance of 4–8 mm. Resolution and number of scans can be selected.

Weight:  $\sim 30 \text{ kg}$ .

Dimensions: Main body:  $\sim 50 \times 50 \times 50 \text{ cm}$ ; optical fibers: 140 cm. The instrument needs 2 m of space in front of the surface under investigation.

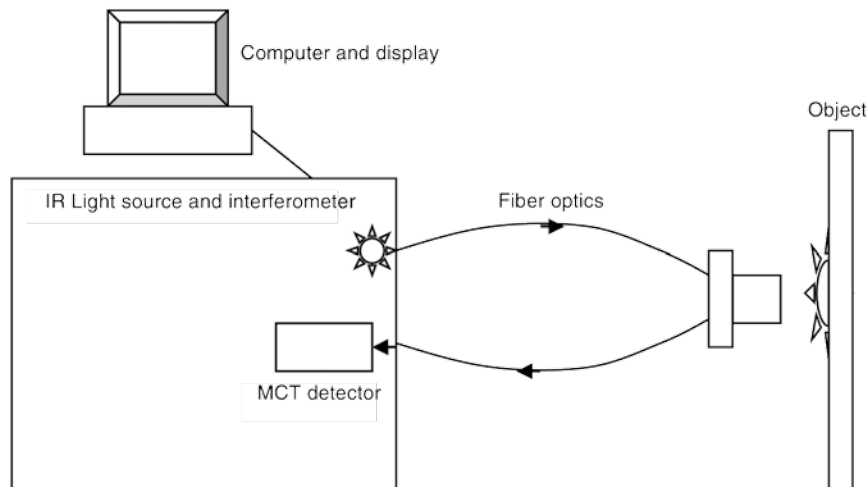
Type of power supply required and working power: No particular requirement.

Transportability: Good.

Health and safety: The MCT detector is cryogenically cooled with liquid nitrogen. Standard protection (goggles, gloves, and apron) for the operator is therefore required.

**FIGURE 5**

Scheme of the setup during measurement. [Mid-FTIR] Illustration courtesy of Giovanni Verri.



**Background correction:** The first step is the acquisition of a background spectrum of a specularly reflecting surface (usually a highly polished stainless-steel slab), carefully cleaned with acetone. Measurement of the background contains the signals of the vibrations due to environmental  $\text{CO}_2$  and  $\text{H}_2\text{O}$  and the optical distortions of the instrumentation. The background spectrum is subsequently automatically subtracted from the successively collected spectra. A new background measurement is needed each time the subtraction becomes unsatisfactory and corresponds to a change in the conditions of the environment.

**Potential damage to the object:** The technique requires the irradiation of the object with IR light; the intensities involved are not harmful to the painting.

**Commercial availability:** All components of the device are commercially available.

## Results and Interpretation

**Result type:** The output consists of a spectrum of molecular IR pseudo-absorbance ( $\log(1/R)$ , where  $R$  is Reflectance) vs. wavenumber ( $4000\text{--}900\text{ cm}^{-1}$ ). Dedicated software allows the conversion of the original file format into .txt or .dx.

**Ease of interpretation:** A deep knowledge of IR spectrometry together with a specific experience in fiber optics reflectance FTIR spectroscopy is required. As opposed to conventional transmission FTIR spectroscopy, the interpretation of fiber optics pseudo-absorbance spectra is fraught with difficulty. In fact, fiber optic reflectance spectra can exhibit significant differences (from the corresponding conventional FTIR spectra) due to the inhomogeneous distribution of particles on the surface (surface roughness and morphology) and/or to the experimental  $0^\circ/0^\circ$  opti-

cal geometry of the system. Because scattering is wavelength dependent, these differences vary with the wavenumber. Typically, disturbances appear as a severe baseline deformation, in which the degree of influence is more pronounced at longer wavelengths (at lower wavenumbers). Interpretation of vibrational modes characteristic of organic compounds is also critically influenced by the effects of the carbonate-based matrix, and by other types of spectral distortions such as the concentration of the analyte and presence of inorganic compounds. Because of these differences, conventional FTIR spectra are not immediately comparable with fiber optic reflectance spectra.

## Bibliography

- Carretti, E., F. Rosi, C. Miliani, and L. Dei. 2005. "Monitoring of Pictorial Surfaces by Mid-FTIR Reflectance Spectroscopy: Evaluation of the Performance of Innovative Colloidal Cleaning Agents." *Spectroscopy Letters* 38 (4–5): 459–75.
- Miliani, C., C. Ricci, F. Rosi, I. Borgia, B. G. Brunetti, and A. Sgamellotti. 2005. "Original and Fake Blue Pigments from the Church of S. Francesco in Montefalco Painted by Benozzo Gozzoli: A Spectroscopic Approach." In *Proceedings of the Sixth Infrared and Raman Users Group Conference (IRUG6): Florence, Italy, March 29th–April 1st, 2004*, edited by M. Picollo, 213–19. Padua: Il Prato.
- Miliani, C., A. Sgamellotti, B. G. Brunetti, I. Borgia, and C. Ricci. 2004. "Non-invasive Characterisation of Contamination and Alteration Materials by Fibre Optic FT-IR *in situ* Measurements." In *Exploring David: Diagnostic Tests and State of Conservation*, edited by S. Bracci, F. Falletti, M. Matteini, and R. Scopigno, 165–69. Florence: Giunti.

---

## Cross-Section Preparation

### General Information

**Brief description:** The preparation and examination of cross sections is fundamental to the study of painting samples. Cross sections can be examined and analyzed using different methods and techniques involving a variety of sources of energy (X-ray, visible light, IR, UV, electrons, etc.).

**Information provided:** Depending on the techniques and methods of examination, cross sections can provide important information on the stratigraphy.

### Sample Requirements and Preparation

**Sample size or weight:** Samples for cross sections are normally stratigraphic (containing all layers of a painting), generally weigh 10–100 µg, and can measure down to 50 × 50 µm or smaller.

**Sample preparation:** For this project, cross sections are prepared using two different embedding resins: Mecaprex™ polyester resin and Epofix (Streurs®) cold-mounting embedding resin. Resin is poured into cubic molds to fill half of the volume. The sample itself is then placed into the mold with the paint surface facing down. More resin is poured over the sample until it is completely covered. Once the resin is set, the samples are polished perpendicularly to the outer surface using different grades of abrasive silicon carbide paper and dry polished with Micromesh®.

### Bibliography

- Khandekar, N. 2003. "Preparation of Cross-Sections from Easel Paintings." *Reviews in Conservation* 4: 52–64.
- Wyplosz, Nicolas, René Koper, Jaap van der Weerd, Ron Heeren, and Jaap Boon. 2000. "Improvements in Surface Preparation of Paint Cross-Sections Necessary for Advanced Imaging Technique." In *Art et chimie, la couleur: Actes du congrès*, edited by Jacques Goupy and Jean-Pierre Mohen, 65–68. Paris: CNRS Editions.



---

## UV Examination and Stain Tests on Cross Sections

### General Information

**Brief description:** Many organic materials exhibit fluorescent properties when excited by UV radiation. Direct observation of fluorescence may be indicative of the presence of organic materials, but it is not sufficient to give precise information on their nature. Stain tests on cross sections using colored and/or fluorescent dyes can indicate the presence of broad classes of organic materials (proteins, lipids, or gums).

The mechanisms by which dyes react with organic (both natural and synthetic) and inorganic materials differ quite significantly. Fluorescent dyes, or fluorochromes, react with free amino groups of proteins through covalent binding. Diachromes (also called histochemical stains, biological stains, or acidic/basic dyes) associate with opposite-charged ions, depending on the pH of the environment and its impact on the overall electrical charge of the protein. Dyes for lipids tend to dissolve into materials of similar solubility parameters and will stain any oil-like hydrophobic material. Fluorescent dyes have specific excitation and emission spectra; thus, appropriate wavelength selection devices (filter cubes) should be used for optimum observation of staining patterns.

**Information provided:** UV examination and stain tests provide layer-specific information on the presence of broad classes of organic materials (proteins, lipids, and/or gums) within the painting cross section. Staining reaction is most commonly observed with an optical microscope, and results are interpreted by comparing photo-micrographs before and after staining.

### Sample Requirements and Preparation

**Sample size or weight:** Samples for cross section generally weigh 10–100 µg and can measure down to 10 × 50 µm or smaller.

**Sample preparation:** Tests were carried out on cross sections embedded in polyester resin and dry polished using abrasive cloths of various grit (see page 38 on cross-section preparation).

### Technique Overview

An Olympus PROVIS AX 70 microscope equipped with a 150W Olympus Highlight 3001 optical fiber illuminator was employed to observe cross sections in reflected visible light. Examination under UV was carried out using an ultra-high-vacuum mercury-vapor lamp as a light source and an Olympus U-MWU filter cube (excitation filter: 330–385 nm, dichroic mirror: 400 nm; emission filter: LP 420 nm).

**Description of the method:** Diachromes—exhibiting strong colors under visible light—and fluorescent dyes were applied to cross sections in various solvents. Four dyes—two diachromes and two fluorochromes—were selected for both protein and

lipid staining. Each dye was prepared with a specific solvent and concentration. The solution was applied to the surface of cross sections. Application time and rinsing procedure varied according to the selected dye (see procedures below). The cross section was observed and photographed before and after staining under visible and UV illumination.

## Reagents and Procedures

### 1. PROTEINS

#### 1a. Diachromes

*Brilliant Blue R* (CAS 6104-59-2)

**Preparation:** Saturated solution in distilled water.

**Procedure:** Staining solution applied for 2–3 minutes and washed with distilled water.

**Results:** Blue color.

*Fuchsine Acid* (CAS 3244-88-0)

**Preparation:** 1% in distilled water.

**Procedure:** Staining solution applied for 15 minutes and washed with distilled water.

**Results:** Pink color.

#### 1b. Fluorochromes

*Lissamine Rhodamine Sulfonyl Chloride (LISSA)* (CAS 3520-42-1)

**Center of the excitation/absorption bandwidth:** 575 nm.

**Center of the emission bandwidth:** 595 nm.

**Preparation:** Acetone (0.25 g/100 ml).

**Procedure:** Staining solution is applied and excess wiped immediately with a paper wipe.

**Results:** A pale red color is observed without filter cube. Bright red-orange fluorescence is observed with appropriate filter cube.

*Fluorescein Isothiocyanate (FITC)* (CAS 3326-32-7)

**Center of the excitation/absorption bandwidth:** 490 nm.

**Center of the emission bandwidth:** 525 nm.

**Preparation:** Acetone (0.25 g/100 ml).

**Procedure:** Staining solution is applied and excess wiped immediately with a paper wipe.

**Results:** A pale yellow color is observed without filter cube. Bright yellow-green fluorescence is observed with appropriate filter cube.

## 2. LIPIDS

### 2a. Diachromes

*Sudan Black B* (CAS 4197-25-5)

**Preparation:** Saturated solution in 2-propanol and distilled water (solvent ratio = 3:2).

**Procedure:** Staining solution applied for 30 minutes. Rinsing with 40 ml alcohol diluted with 60 ml distilled water, followed by a 30-minute wash with distilled water.

**Results:** Dark blue.

*Oil Red O* (CAS 1320-06-5)

**Preparation:** Saturated solution in a mixture of 60 ml ethyl alcohol and 40 ml distilled water.

**Procedure:** Staining solution applied for 30 minutes. Rinsing with 40 ml alcohol diluted with 60 ml distilled water, followed by a 30-minute wash with distilled water.

**Results:** Red.

### 2b. Fluorochromes

*Rhodamine B* (CAS 81-88-9)

**Center of the excitation/absorption bandwidth:** 540 nm.

**Center of the emission bandwidth:** 625 nm.

**Preparation:** Ethanol (10 mg/25 ml).

**Procedure:** Staining solution is applied and excess wiped immediately with a paper wipe.

**Results:** Red-orange fluorescence.

*2,7-Diclorofluorescein* (CAS 76-54-0)

**Center of the excitation/absorption bandwidth:** 512 nm.

**Center of the emission bandwidth:** 526 nm.

**Preparation:** Ethanol (10 mg/25 ml).

**Procedure:** Staining solution is applied and excess wiped immediately with a paper wipe.

**Results:** Yellow fluorescence.

## Results and Interpretation

**Result type:** The cross section is observed under visible and UV light, and a photomicrograph is taken before and after staining using appropriate filter cubes.

**Interpretation:** Interpretation of results is complicated by the fact that many dyes lack specificity and can interact with a wide variety of materials. This may cause a

false positive. Physical exclusion of the dye, lack of available reactive functional groups for protein staining, or disruption of the material under investigation—due to sample preparation or staining procedures—can in turn generate false-negative results. Sample pretreatment, counter-staining, and selective extraction of the materials under investigation can be included in the staining protocol to further corroborate results. Testing and interpretation of results require experience and understanding of staining mechanisms. Possible interference from synthetic embedding materials, pigments, or unspecific adsorption should also be taken into consideration.

## Bibliography

- Gay, M.-C. 1970. “Essais d’identification et de localisation des liants picturaux par des colorations spécifiques sur coupes minces” [Identification and location tests of painting media by thin-layer staining]. *Annales du laboratoire de recherche des Musées de France*: 8–24.
- Johnson, M., and E. Packard. 1971. “Methods Used for Identification of Binding Media in Italian Paintings of the XVth and XVIth Centuries.” *Studies in Conservation* 16: 145–64.
- Kockaert, L., and M. Verrier. 1978. “Application des colorations à l’identification des liants de Van Eyck” [Application of staining in the identification of Van Eyck’s paint media]. *Bulletin de l’Institut royal du patrimoine artistique* 17: 122–27.
- Messinger, J., II. 1992. “Ultraviolet-Fluorescence Microscopy of Paint Cross Sections.” *Journal of the American Institute for Conservation* 31: 267–74.
- Polysciences, Inc. 2014. *Technical Data Sheet 602: Periodic Acid Schiff’s Stain Kit (PAS)*. <http://www.polysciences.com/skin/frontend/default/polysciences/pdf/TDS%20602.pdf>
- Wolbers, R. 1989. *Notes for Workshop on New Methods in the Cleaning of Paintings*. Marina del Rey, CA: Getty Conservation Institute.
- Wolbers, R., and G. Landrey. 1987. “The Use of Direct Reactive Fluorescent Dyes for the Characterization of Binding Media in Cross Sectional Examinations.” In *Preprints of Papers Presented at the Fifteenth Annual Meeting: Vancouver, British Columbia, Canada, May 20–24, 1987*, 168–202. Washington, DC: American Institute for Conservation of Historic and Artistic Works.
- Zweig, Gunter, and Joseph Sherma, eds. 1972. *CRC Handbook of Chromatography*. 2 vols. 1st ed. Cleveland: CRC Press.

---

## FTIR Reflectance and FTIR–Attenuated Total Reflectance (ATR) Spectroscopy on Cross Sections

### General Information

**Brief description:** Micro-FTIR reflectance spectroscopy records molecular vibrations ( $4000\text{--}650\text{ cm}^{-1}$ ) of a sample in reflectance mode using a microscope and Cassegrain IR objective. Most organic and inorganic molecules absorb mid-IR radiation as governed by selection rules and can hence be analyzed by FTIR.

In micro-ATR, a crystal, transparent to infrared radiation, is brought into contact with the sample surface. An IR beam reflected within the crystal effectively probes the sample at the sample-crystal contact interface.

**Information provided:** Reflectance micro-FTIR is used for the investigation of any surface under the microscope and allows analysis of both organic and inorganic compounds. Data consist of a spectrum of reflectance or pseudo-absorbance ( $\log(1/R)$ , where  $R$  is Reflectance) vs. energy or wavenumber ( $\text{cm}^{-1}$ ). Within the context of the analysis of cross sections, micro-FTIR allows a localized analysis of particular areas of an embedded fragment (pigment particles, paint layers, etc.) that can be selected on the basis of visual examination with the same Cassegrain or alternative visual objectives. ATR yields IR absorption spectra similar to those recorded in traditionally used transmission FTIR.

### Sample Requirements and Preparation

**Sample size or weight:** Samples must be large enough to make a cross section ( $1\text{ mg}$ ,  $50 \times 50\ \mu\text{m}^2$ ). In addition, sample thickness or individual particle size, which can be analyzed, depends on the absorbance/reflectance of the analyte. However, theoretical limitations of the technique using traditional sources limit the analysis of areas on a sample to greater than  $7 \times 7$  micrometers. With ATR, the size of the micro-crystal determines the effective sampling area; for the OWMP project, crystals of 100 micrometer diameter were used.

**Sample preparation:** Samples were prepared in cross section using polymer-based embedding media to reveal the paint-layer stratigraphy. Samples were dry polished to avoid dissolution and removal of any organic material. Hand polishing using micromesh cloths was performed, taking care to polish in one direction and only once on the same area of the cloth, in order to limit smearing the embedding material onto the surface of the sample.

**Area measured:** Selected rectangular areas of the sample can be analyzed in the  $10 \times 10\ \mu\text{m}^2$  to  $250 \times 250\ \mu\text{m}^2$  range. In micro-ATR, areas of 100  $\mu\text{m}$  diameter on the surface of the cross section were analyzed.

**Contact between instrument and object:** No contact is necessary when measuring samples in reflectance. With ATR analysis, perfect contact is required. This procedure implies the application of significant pressure over the small area of contact. In the case of diamond ATR, this has the potential of significantly scratching

the cross section without damaging the instrument; the opposite is the case with ZnSe, which is soft and hence easily damaged.

## Technique Overview

**Type of analysis:** Invasive, nondestructive, point analysis.

**Applicability:** The technique can be applied to all IR reflective surfaces, but selection rules apply. Limitations are related to the selection of areas on a cross section that may be too thin or small for repeatable analysis and sufficient signal-to-noise ratio. Reflectance measurements are associated with a high signal-to-noise ratio when surfaces are more reflective. With ATR, fixed sample size is a limitation, but due to theoretical advantages regarding absorption at the crystal-sample interface, nonreflective and absorbent compounds can be effectively analyzed.

**System specifications:** Micro-FTIR in reflectance was carried out with a JASCO FTIR 470-plus spectrophotometer equipped with a nitrogen-cooled MCT detector and an IRT-30 optical microscope using the 16x Cassegrain objective for observation of the sample, reflectance measurements, and the ATR objective for surface analysis. Visual examination was carried out using the CCD attached to the IR microscope, which had a resolution of  $192 \times 192$  pixels. The instrument operated in a  $4000\text{--}650\text{ cm}^{-1}$  spectral range. All spectra were taken with between 100 and 400 acquisitions and a resolution of  $4\text{ cm}^{-1}$ . No corrections were applied. A variable area of the sample was selected for analysis using the operating software and was based on the shape and width of the paint layers as found in cross section.

Micro-ATR measurements were undertaken using the same system as described above, with an automated stage and ZnSe micro-ATR objective. Samples were brought into contact with the objective using an automated xyz stage and pressure gauge.

Additional diamond micro-ATR measurements were undertaken using the Thermo Nicolet Nic-Plan IR microscope connected to a Nicolet 560 IR spectrometer. Spectra were recorded with between 100 and 400 acquisitions at  $4\text{ cm}^{-1}$  resolution.

**Health and safety:** The MCT detector is cryogenically cooled with liquid nitrogen. Standard protection (goggles, gloves, and apron) for the operator is therefore required.

**Background correction:** It is necessary to subtract the background during reflectance measurements. Therefore, a background spectrum was recorded at the same resolution and number of acquisitions as used for recording spectra on the sample. A polished gold slide was used for measurement of the background. Focusing of the sample was carried out manually to maximize the number of counts recorded. ATR background readings were similarly carried out when the crystal was not in contact with the sample.

**Commercial availability:** All components of the device are commercially available.

---

## Results and Interpretation

**Result type:** Output consists of a spectrum of molecular IR pseudo-absorbance ( $\log(1/R)$ , where R is Reflectance) vs. the wavenumber (4000–650  $\text{cm}^{-1}$ ). Dedicated software allows the conversion of the original file format into ASCII format (.csv, .txt, .dx).

**Ease of interpretation:** Experience with the interpretation and use of IR spectrometry together with specific experience in the observation of cross sections is required. As opposed to conventional transmission FTIR spectroscopy, interpretation of reflectance spectra is not always straightforward. Reflectance spectra can exhibit significant differences from the corresponding conventional FTIR spectra due to the inhomogeneous distribution of particles on the surface (surface roughness and morphology) and/or to the experimental  $0^\circ/0^\circ$  optical geometry of the system. In fact, reflectance can be specular and diffuse. It should be mentioned that, in the case of highly polished cross sections, the specular component is usually predominant. Both components may contribute to the distortion of the spectrum. Application of mathematical data conversions such as Kramers-Kronig can aid in the interpretation of the spectra. In addition, scattering is wavelength dependent, and therefore these differences vary with the wavenumber. Typically, disturbances appear as a severe baseline deformation in which the degree of influence is more pronounced at longer wavelengths (at lower wavenumbers). Interpretation of vibrational modes characteristic of organic compounds is also critically influenced by the effects of the silicate- and carbonate-based matrix, by vibrational overtones and the interference with vibrations from aliphatic and carbonyl bonds in the embedding resin, and by the relative absorption of pigments, which limits the size of the area of analysis.

In contrast, ATR measurements are easier to interpret and are only slightly distorted with respect to transmission spectra due to lower absorption of IR at longer wavenumbers. Hence, comparison with spectral databases is more straightforward.

## Bibliography

- Derrick, M., D. Stulik, and J. M. Landry. 1999. *Infrared Spectroscopy in Conservation Science*. Los Angeles: The Getty Conservation Institute.
- Lanterni, G., and M. R. Nepoti. 1996. "Preparazione dei campioni con accessori specifici per la spettrofotometria IR e variazioni spettrali in rapporto al loro utilizzo." *OPD Restauro* 8: 165–70.
- Nevin, A. 2005. "The Use of Micro-FTIR with Attenuated Total Reflectance for the Analysis of Wall Painting Cross-Sections." *Zeitschrift für Kunsttechnologie und Konservierung* 2: 356–68.
- Van der Weerd, J., et al. 2004. "Preparation Methods and Accessories for the Infrared Spectroscopic Analysis of Multi-Layer Paint Films." *Studies in Conservation* 49: 193–216.

---

## Micro-FTIR Spectroscopy

### General Information

**Brief description:** The underlying physical-chemical principle of FTIR spectroscopy consists of the infrared absorption of molecular functional groups characteristic of organic or inorganic compounds. Both organic and inorganic compounds respond to mid-IR radiation according to the vibrational modes allowed by selection rules.

Micro-FTIR is an invasive technique that collects molecular vibrational mid-FTIR (4000–650  $\text{cm}^{-1}$ ) spectra on micro-areas of solid samples by means of an FTIR spectrometer coupled with an optical microscope. Micro-FTIR measurements can be carried out on a sample without pretreatment or on solvent-soluble and/or insoluble portions. Extraction with different solvents is useful as it separates components with different polarities. These components can be studied separately by FTIR analysis. In this way, the characterization of mixtures of organic materials, such as lipid and proteins, is more efficiently undertaken.

**Information provided:** Micro-FTIR spectroscopy is a powerful tool for the identification of the presence of organic materials and the characterization of the class of materials (e.g., proteins, lipids). Output consists of a spectrum of molecular IR % transmittance vs. wavenumber ( $\text{cm}^{-1}$ ).

The presence or absence of organic materials is the first level of information that is almost always achieved. The class or type of organic material is also often recognized.

### Sample Requirements and Preparation

**Sample size or weight:** Bulk analysis: a few  $\mu\text{g}$  or ng. Solvent extraction: a few  $\mu\text{g}$  or more.

#### Sample preparation:

Bulk analysis:

CNR-ICIS – The sample is preliminarily observed under an optical microscope, flattened on a slide with a metal roller, placed on a sodium chloride disc, and inserted into a sample holder.

CNR-ISTM – The sample must be pressed between two diamond windows to form a thin, transparent film. Spectral distortion can occur when samples are too thick. Dilution with an IR transparent medium such as KBr may be necessary. Sample preparation can be conducted under low magnification.

Solvent extraction:

CNR-ICIS – The sample is treated with solvents of different polarity in a 2 ml vial in order to separate different organic materials. Typically, water is a suitable solvent for the extraction of proteins (with the exception of casein) while chloroform is suitable for the extraction of lipids. The solution is placed in a sample holder made of a reflecting and nonabsorbing metal support (e.g., gold or aluminum mirror). The



support is warmed, and, following evaporation of the solvent, the solvent-soluble and/or the insoluble portions are analyzed separately in reflectance mode.

**Area measured:** CNR-ISTM – The instrument analyzes selected micrometric portions of the sample depending on the objective used. Generally, the 16x Cassegrain allows investigation in the range between  $625 \times 625 \mu\text{m}^2$  and  $10 \times 10 \mu\text{m}^2$ .

CNR-ICIS – The micro-FTIR spectrometer allows the investigation of very small areas of the sample down to  $20 \times 20 \mu\text{m}^2$ .

## Technique Overview

**Type of analysis:** The analysis is micro-invasive but not destructive.

**Applicability:** No restrictions.

**System specifications:** CNR-ISTM: The spectrophotometer (JASCO FTIR-470 Plus) is made of a Midac Illuminator IR radiation source (1350 °C), a Michelson interferometer, and a cryogenically cooled MCT detector (4000–650  $\text{cm}^{-1}$ ). The system is equipped with an IRT-30 microscope with a 16x Cassegrain objective. The area under investigation is observed and selected via software using a CCD camera with a 20 W halogen lamp.

Experiment setup: 400–1000 scans, resolution 4  $\text{cm}^{-1}$ , final format % transmittance, correction: none.

Sample holder: Diamond cell composed of two diamond windows between which the sample is pressed.

CNR-ICIS – The micro-FTIR instrument is composed of two units: a Nicolet Magna 560 FTIR spectrometer (optical bench) operating in the 4000–650  $\text{cm}^{-1}$  spectral range, and a Spectra-Tech Continuum microscope.

The main components of the instrument are: Nernst filament as an infrared radiation source, a KBr beam splitter, a Michelson interferometer, a laser He-Ne, a visible light illuminator system, a Cassegrain objective (SpectraTech Inc. Infinity Refflachromat™ 15X  $\infty/V$  N.A. 0.58), and an MCT detector cryogenically cooled with liquid nitrogen.

The system needs to be internally purged with a flux of nitrogen in order to strongly reduce IR absorptions by water vapor and carbon dioxide.

Experiment setup: 64 scans, resolution 4  $\text{cm}^{-1}$ , final format % transmittance, correction: none.

Health and safety: The MCT detector is cryogenically cooled with liquid nitrogen. Standard protection (goggles, gloves, and apron) for the operator is therefore required.

**System calibration process:** The detector calibration has to be periodically checked by collecting an infrared spectrum of a standard material (e.g., polystyrene film) and by ensuring that the infrared absorption bands lie at the correct positions.

Periodical controls of the microscope performance include optic microscope alignment of both infrared and the visible beams in transmitted and in reflected mode.

**Background correction:** The first step of any FTIR analysis is the acquisition of a background spectrum performed on the cleaned support (diamond cell, NaCl or Au plate). The background spectrum contains signals of molecular vibrations of environmental CO<sub>2</sub> and H<sub>2</sub>O and of optical distortions of the instrumentation. The background spectrum is subtracted from the successively collected spectra. A new background measurement is needed each time the subtraction becomes unsatisfactory.

**Potential damage to the object:** The technique is not destructive.

**Commercial availability:** All components of the devices are commercially available.

## Results and Interpretation

**Result type:** Output FTIR spectrum is a graph of the intensity of the transmitted infrared radiation versus wavenumbers (cm<sup>-1</sup>). Spectra presented for the OMWP project have not been manipulated: baseline correction, smoothing, and carbon dioxide automatic suppression are not applied.

**Ease of interpretation:** Interpretation of the micro-FTIR spectrum of a sample can be performed by comparing the position, intensity, and shape of the diagnostic infrared absorption bands with those tabulated for reference materials. FTIR reference libraries are available for organic and inorganic materials.

The interpretation of FTIR spectra may be difficult when more than one material is present due to band masking or superpositioning. This problem is typical of paint layers that are heterogeneous mixtures. Separation of components by chemical treatment can aid in the identification of low-concentration compounds.

## Bibliography

- Derrick, M., D. Stulik, and J. M. Landry. 1999. *Infrared Spectroscopy in Conservation Science*. Los Angeles: The Getty Conservation Institute.
- Humecki, H. J. 1995. *Practical Guide to Infrared Microspectroscopy*. New York: M. Dekker.
- Messerschmidt, R. G., and M. A. Harthcock, eds. 1988. *Infrared Microspectroscopy: Theory and Applications*. Practical Spectroscopy 6. New York: M. Dekker.

---

## High-Performance Liquid Chromatography (HPLC)

### General Information

**Brief description:** The analytical method is based on an automated sample treatment that separates the organic components into different soluble fractions, which are then analyzed using high-performance liquid chromatography (HPLC). For the OMWP project, HPLC was used for identification of proteins only, although this technique can be used very efficiently also for identification of organic colorants. The amino acid components of protein are dissolved in the liquid mobile phase and are separated during the chromatographic run due to the different affinity with the mobile phase and with the stationary phase (liquid column coating). The separated compounds are identified by retention time.

**Information provided:** HPLC provides qualitative and quantitative information on the amino acid-forming proteins.

### Sample Requirements and Preparation

**Type of analysis:** Invasive–destructive.

**Sample size or weight:** Sample weight: 1–2 mg.

**Sample preparation:** In order to obtain single amino acids, the samples must be hydrolyzed (see the next section). All the sample preparation derivatization reactions are made with a robot auto-sampler.

### Technique Overview

**Description of the analytical method:** After weighing and inserting the sample in a 2 ml vial (suitable for high temperatures), 0.5 ml of 6 M hydrochloric acid is added. The capped vial remains at 105 °C for 24 hours. After cooling, the content is evaporated to total dryness under a stream of nitrogen while heated to 60 °C, dissolved in 50 µl of 0.1 M hydrochloric acid, inserted into a vial suitable for HPLC, and capped. The method is based on automated online derivatization followed by an HPLC separation. The derivatization reactions are necessary to stain the amino acids and make them visible to the diode array detector (DAD). The reaction mixture is buffered at a pH of 10.2, allowing direct derivatization of acid hydrolyzed protein samples. Primary amino acids react first with OPA (orthophthalaldehyde) using 3-mercaptopropionic acid (3-MPA), which decreases their hydrophobicity. As a result, the OPA derivatives elute chromatographically before the FMOC (fluorenyl methoxychloroformate) derivatives. The secondary amino acids do not react with OPA but are then derivatized using FMOC.

**System specifications:** Instrument: Agilent 1100 HPLC: G1311A Quaternary pump with G1315A DAD, 6 mm flow cell.

Column: Zorbax Eclipse-AAA (inversed phase), 4.6 × 150 mm, 3.5 µm (porosity).

Mobile phase: A: 40mM Na<sub>2</sub>PO<sub>4</sub> pH 7,8  
B: ACN : MeOH : water (45/45/10,v/v/v)  
All mobile-phase solvents are HPLC grade.

Pump settings: Flow: 2 ml/min; stop time: 25 min; post time: off.

Auxiliary pump settings: Max. flow ramp: 100 µL/min<sup>2</sup>; compressibility A: 50 × 10<sup>-6</sup>; minimal stroke A: 20 µL; compressibility B: 115 × 10<sup>-6</sup>; minimal stroke B: auto: gradient.

Detector settings: Required lamps: UV lamp.

UV: 338 nm, 10 nm bandwidth (bw), reference: 390 nm, 20 nm bw (for OPA amino acids); 262 nm, 16 bw, reference: 324 nm, 8 nm bw (for FMOC amino acids); peak width: >0.03 min (0.5 s); slit: 4 nm.

Derivatization reagents:

Borate buffer: Agilent PN 5061-3339; 0.4 N in water, pH 10.2.

FMOC reagent: Agilent PN 5061-3337.

OPA reagent: Agilent PN 5061-3335.

Water: Deionized, HPLC grade.

**System calibration process:** For quantitative analysis, it is necessary to build calibration curves of amino acid standard solutions.

**Commercial availability:** All components of the device are commercially available.

## Results and Interpretation

**Result type:** HPLC data consist of chromatographs that report the abundance profile of free analytes (e.g., amino acids) vs. retention time (min). The area of the peaks allows evaluation of the amino acid relative percentage profiles.

**Ease of interpretation:** Experience with interpretation and use of the HPLC DAD signal is needed.

**Applicability:** Identification of proteins.

**Result file type:** Raw data are produced in .d format (Agilent format) and exported in .csv format. These files contain DAD signals and now the MSD signals.

## Bibliography

- Henderson, J. W., R. D. Ricker, B. A. Bidlingmeyer, and C. Woodward. 2000. *Rapid, Accurate, Sensitive, and Reproducible HPLC Analysis of Amino Acids*. Agilent Technologies Publication no. 5980-1193E. <http://www.chem.agilent.com/Library/chromatograms/59801193.pdf>
- Mills, J. S. 1966. "The Gas Chromatographic Examination of Paint Media. Part I, Fatty acid Composition and Identification of Dried Oil Films." *Studies in Conservation* 11 (2): 92–108.
- Schilling, M. R., and H. P. Khanjian. 1996. "The Gas Chromatographic Analysis of Amino Acid as Ethyl Chloroformate Derivates III. Identification of Proteinaceous Binding Media by Interpretation of Amino Acid Composition Data." In *ICOM Committee for Conservation Preprints, 11th Triennial Meeting, Edinburgh, Scotland, 1–6 September 1996*, edited by J. Bridgland, 211–19. London: ICOM.

---

## Gas Chromatography–Mass Spectrometry (GC–MS)

### General Information

**Brief description:** Gas chromatography–mass spectrometry (GC–MS) combines the efficient separation property of chromatography with the sensitive and specific identification of mass spectrometry. The analytical method consists of a multistep chemical treatment of the sample that separates the organic components into different volatile fractions. For the OMWP project, GC–MS was used for identification of proteins and lipids. (GC–MS is used also for identification of polysaccharides and natural resins.) Amino acids (proteins) or fatty acids (lipids) are separated in a capillary column because of their different affinity with the mobile phase (inert gas) and the stationary phase (column coating). The separated compounds are identified by retention time and by further mass spectrometry analysis.

**Information provided:** GC–MS allows qualitative and quantitative determination of amino acids and fatty acids. The areas of the chromatographic peaks allow the evaluation of the amino acid and fatty acid relative percentage profiles. The presence of markers, the evaluation of characteristic parameters, and multivariate statistical analysis allow identification of the type of protein (albumin, collagen, casein) and, in most cases, the type of lipid (linseed oil, walnut oil, egg).

This section describes the procedures and apparatuses used by three laboratories: University of Pisa (UniPI), the Getty Conservation Institute (GCI), and the University of Parma (UniPR).

### Sample Requirements and Preparation

**Sample size or weight:** For analysis of proteins and lipids, sample weight is in the order of hundreds of micrograms (~500 µg).

### Technique Overview

**Type of analysis:** Invasive–destructive.

**Applicability:** The technique can be applied to the analysis of proteins, lipids, polysaccharides, and natural resins. Limitations are related to the amount of organic materials contained in the sample and to the presence of copper-based pigments, which hamper sample preparation. Analytical procedures are not repeatable as the method is destructive.

**Apparatus specifications:**

UniPI: Sample preparation was carried out with a microwave oven model MLS-1200 MEGA Milestone (FKV, Sorisole, BG, Italy).

A 6890N GC System Gas Chromatograph (Agilent Technologies, Palo Alto, CA), coupled with a 5973 Mass Selective Detector (Agilent Technologies) single quadrupole mass spectrometer equipped with PTV (programmable temperature vaporizing) injector, was used. The mass spectrometer was operated in the EI posi-

tive mode (70 eV). The MS transfer line temperature was 280 °C; the MS ion source temperature was kept at 230 °C and the MS quadrupole temperature at 150 °C. For the gas chromatographic separation, an HP-5MS fused silica capillary column (5% diphenyl–95% dimethyl-polysiloxane, 30 m × 0.25 mm i.d., 0.25 μm film thickness, J&W Scientific, Agilent Technologies, Palo Alto, CA) with a deactivated silica pre-column (2 m × 0.32 mm i.d., J&W Scientific, Agilent Technologies, Palo Alto, CA) was used. The carrier gas was used in constant flow mode (He, purity 99.995%) at 1.2 ml/min.

For fatty acids, the PTV injector was used in splitless mode at 300 °C. The chromatographic oven was programmed as follows: 80 °C, isothermal for 2 minutes, 10 °C/min up to 200 °C, 200 °C, isothermal for 3 minutes, 10 °C/min up to 280 °C, 280 °C, isothermal for 3 minutes, 20 °C/min up to 300 °C, 300 °C, isothermal for 20 minutes.

For amino acid analysis, the PTV injector was used in splitless mode at 280 °C. The chromatographic oven was programmed as follows: initial temperature 100 °C, isothermal for 2 min, then 4 °C/min up to 280 °C, and isothermal for 15 min. MS spectra were recorded both in TIC (total ion current) and SIM (selected ion monitoring) mode.

GCI: An Agilent 5972 gas chromatograph/mass spectrometer was employed. A DB-5MS capillary column was used for the separation (30 m × 0.25 mm × 1 μm). Hydrogen carrier gas was set to a linear velocity of 66 cm/sec. The splitless injector was set to 300 °C with a 60-second purge-off time. The MS transfer line was set to 300 °C. MS spectra were recorded in TIC (mass range 45–700).

For the analysis of the TBDMS derivatives, the GC oven temperature program was: 105 °C for 1 minute, then ramped to 300 °C at 20 °C/min, followed by a 3-minute isothermal period. A solvent delay of 4 minutes was used. The mass spectrometer was used in selected ion monitoring mode. For the analysis of the Meth Prep derivatives, the GC oven temperature program was 50 °C for 1 minute; 10 °C/min to 320 °C; then isothermal for 20 minutes.

UniPR: A 6890N GC System Gas Chromatograph (Agilent Technologies), coupled with a 5973 Mass Selective Detector (Agilent Technologies) single quadrupole mass spectrometer, has been employed. A VF-5 fused-silica capillary column coated with a 0.25 μm film of methyl silicone (5% phenyl), FactorFour, Varian Inc. (USA), was used for the separation (30 m × 0.25 mm × 1 μm). Helium carrier gas was set to flow at 0.60 ml/min. The splitless injector was set to 280 °C with a 30-second purge-off time. The MS transfer line was set to 280 °C. MS spectra were recorded in TIC (mass range 45–450).

For fatty acids, the GC oven temperature program was 80 °C for 2 minutes, then ramped to 270 °C at 20 °C/min, followed by a 6-minute isothermal period. For analysis of the amino acid derivatives, the GC oven temperature program was 60 °C for 3 minutes; 25 °C/min to 260 °C; then isothermal for 6 minutes.

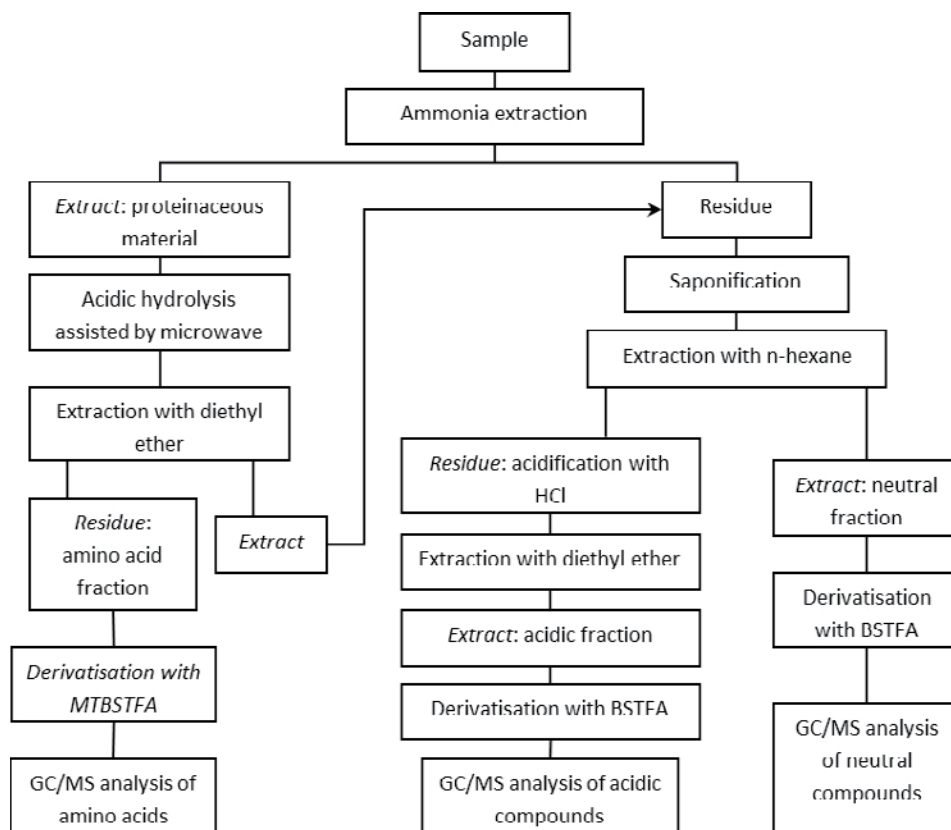
#### **Description of the analytical methods:**

UniPI: The analytical method used was based on an optimized GC–MS combined procedure for the simultaneous characterization of proteinaceous materials and drying oils (Andreotti et al. 2006). In this way, other lipidic materials, natural waxes, and plant and animal resins occurring in the same micro-sample from artworks also may be detected. The procedure is based on a multistep chemical

pretreatment of the sample, which includes acidic hydrolysis of proteins (Colombini, Modugno, and Giacomelli 1999; Rampazzi et al. 2002) and saponification of esters and triglycerides (Colombini, Modugno, Giacomelli, and Francesconi 1999): the method achieves separation of an aqueous fraction containing amino acids and of two organic fractions (acidic and neutral), which are all separately submitted to derivatization reactions and analysis by GC–MS. A scheme of the analytical procedure is shown in figure 6.

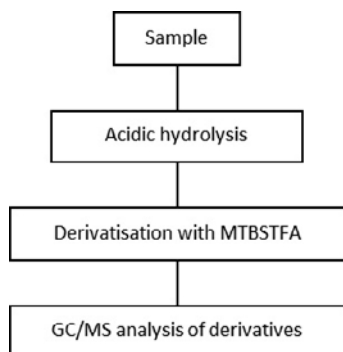
**FIGURE 6**

Scheme of the UniPI method. Courtesy G. Gautier.



**FIGURE 7**

Scheme of the GCI silylation method for protein identification. Courtesy G. Gautier.



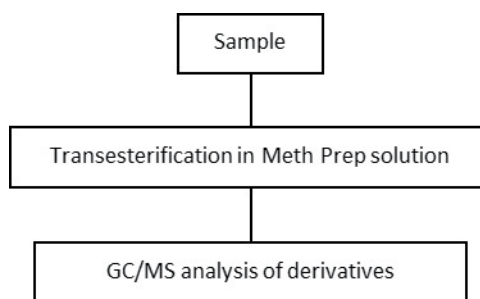
GCI: The GCI follows two procedures for identification of proteins and lipids. Identification of proteins is based on acidic hydrolysis of the sample followed by derivatization and GC–MS analysis, as indicated in figure 7 (Schilling 2005).

The GCI procedure for identification of lipids is based on transesterification to obtain the methyl esters of the fatty acids, which are analyzed by GC–MS; the procedure is reported in figure 8.



**FIGURE 8**

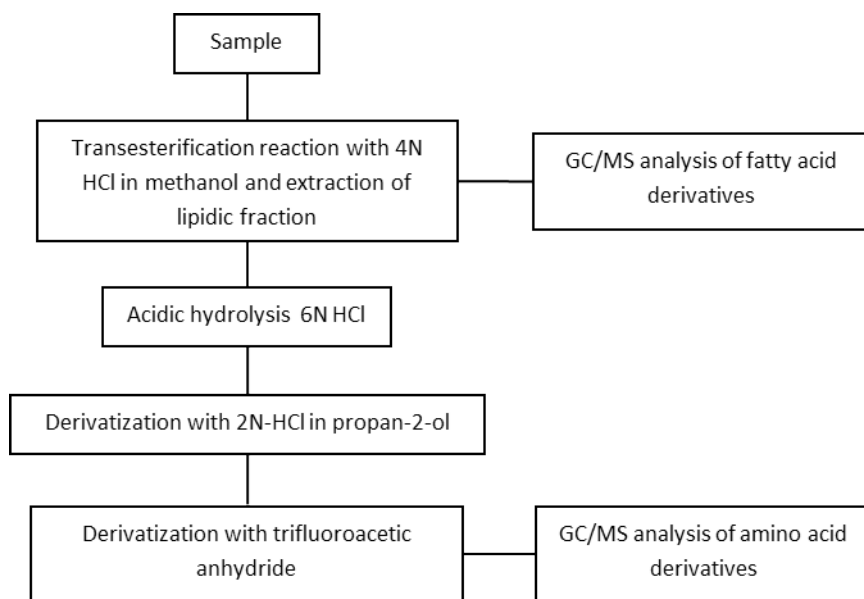
Scheme of the GCI Meth Prep method for lipids identification. Courtesy G. Gautier.



UniPR: The UniPR analytical method is based on a combined procedure for the characterization of drying oils (Casoli, Cauzzi, and Palla 1999) and proteinaceous materials (Casoli, Musini, and Palla 1996) on the same sample. To identify lipidic fraction, the paint sample was treated with 4N-HCl in methanol and n-hexane to obtain free fatty acids as methylesters. To identify protein fraction, the residue was hydrolyzed with 6N-HCl, and through derivatization with 2N-HCl in propan-2-ol and trifluoroacetic anhydride N-trifluoroacetyl-O-isopropil amino acid derivatives were obtained. See figure 9.

**FIGURE 9**

Scheme of the UniPR method for proteins and lipids identification. Courtesy G. Gautier.



**System calibration process:** For quantitative analysis, it is necessary to build calibration curves of amino acid and fatty acid standard solutions.

**Commercial availability:** All components of the device are commercially available.

## Results and Interpretation

**Result type:** GC–MS data consist of chromatographs and mass spectra. A chromatograph reports the abundance profile of free analytes (e.g., fatty acids) vs. retention time (min) and is characteristic of each chemical species. The peaks' areas allow evaluation of amino acid and fatty acid relative percentage profiles. MS spectra that characterized each analyte were recorded both in TIC and SIM mode. Mass spectral assignment was based on comparisons with mass spectra of pure compounds. In the absence of reference spectra, the peak assignment was based on mass spectra interpretation.

### Protein type identification

Principal component analysis (PCA), a multivariate statistical method of data clustering, is used for the identification of proteinaceous materials (Colombini, Modugno, and Giacomelli 1999; Colombini, et al. 1998; Casoli et al. 1998; Casoli, Montanari, and Palla 2001). In addition to the PCA, the correlation method was used. This scheme incorporates data analysis techniques employed in other studies: concentration tables (Halpine 1992; Ronca 1994) and correlation matrices (Sinkai and Sugisita 1990). The correlation coefficient is a useful tool for determining the degree of association between data sets.

### Lipid type identification

Fatty acid profiles are characteristic of drying oils and of lipids contained in egg. Characteristic parameters (palmitic vs. stearic acid [P/S] and azelaic vs. palmitic acid [A/P]) are calculated and used for the characterization of lipids. The sum of the relative percentage of the dicarboxylic acids (azelaic, suberic, and sebacic) aids in the differentiation between egg and siccative oils (Rampazzi et al. 2002).

**Ease of interpretation:** The use of the technique and interpretation of the data require extensive experience.

## Bibliography

- Andreotti A., I. Bonaduce, M. P. Colombini, G. Gautier, F. Modugno, and E. Ribechini. 2006. "Combined GC-MS Analytical Procedure for the Characterization of Glycerolipid, Waxy, Resinous, and Proteinaceous Materials in a Unique Paint Microsample." *Analytical Chemistry* 78 (13): 4490–4500.
- Casoli, A., D. Cauzzi, and G. Palla. 1999. "The Study of Binding Media in Polychrome Works of Art: The Drying Oils." *OPD Restauro* 11: 111–21.
- Casoli, A., M. Fichera, A. P. Fifi, G. Musumarra, and G. Palla. 1998. "Characterisation of Proteinaceous Binders by Multivariate Analysis of Their Amino Acid 'Fingerprint'." *Science and Technology for Cultural Heritage* 7 (1): 39–47.
- Casoli, A., A. Montanari, and L. Palla. 2001. "Painted Models Simulating Ancient Polychromies: A Statistical Analysis of Chemical Results." In *Proceedings of the 3rd International Congress on Science and Technology for the Safeguard of Cultural Heritage in the Mediterranean Basin*, edited by J. Alpuente, I. Bustamante, P. Lopez, and J. Sanz, 839–45. Alcalá De Henares, Spain: Servicio de Publicaciones.

- 
- Casoli, A., P. C. Musini, and G. Palla. 1996. "Gas Chromatographic – Mass Spectrometric Approach to the Problem of Characterizing Binding Media in Paintings." *Journal of Chromatography A* 731 (1–2): 237–46.
- Colombini, M. P., R. Fuoco, A. Giacomelli, B. Muscatello, and N. Fanelli. 1998. "Characterisation of Proteinaceous Binders in Samples of the 'Giudizio Universale' Wall Paintings at Florence Cathedral." *Science and Technology for Cultural Heritage* 7 (1): 49–58.
- Colombini, M. P., F. Modugno, R. Fuoco, and A. Tognazzi. 2002. "A GC–MS Study on the Deterioration of Lipidic Paint Binders." *Microchemical Journal* 73 (1–2): 175–85.
- Colombini, M. P., F. Modugno, and A. Giacomelli. 1999. "Two Procedures for Suppressing Interference from Inorganic Pigments in the Analysis by Gas Chromatography–Mass Spectrometry of Proteinaceous Binders in Paintings." *Journal of Chromatography A* 846 (1–2): 101–11.
- Colombini, M. P., F. Modugno, M. Giacomelli, and S. Francesconi. 1999. "Characterisation of Proteinaceous Binders and Drying Oils in Wall Painting Samples by Gas Chromatography–Mass Spectrometry." *Journal of Chromatography A* 846: 113–24.
- Halpine, S. 1992. "Amino Acid Analysis of Proteinaceous Media from Cosimo Tura's 'The Annunciation with Saint Francis and Saint Louise of Toulouse'." *Studies in Conservation* 37 (1): 22–38.
- Rampazzi, L., F. Cariati, G. Tanda, and M. P. Colombini. 2002. "Characterisation of Wall Paintings in the Sos Furrighesos Necropolis (Anela, Italy)." *Journal of Cultural Heritage* 3 (3): 237.
- Ronca, F. 1994. "Protein Determination in Polychromed Stone Sculptures, Stuccoes and Gesso Grounds." *Studies in Conservation* 39 (2): 107–20.
- Schilling, M. R. 2005. "Paint Media Analysis." In *Scientific Examination of Art: Modern Techniques in Conservation and Analysis*, 186–205. Sackler NAS Colloquium. Washington, DC: National Academies Press.
- Sinkai, T., and R. Sugisita. 1990. "Identification of Protein Containing Binding Media and Adhesives in Works of Art by Amino Acid Analysis" [in Japanese]. *Kobunkazai no Kagaku* 35: 1–12.

---

# Enzyme-Linked Immunosorbent Assay (ELISA) for Protein Identification

## General Information

**Brief description:** The enzyme-linked immunosorbent assay (ELISA) is an antibody-based technique commonly used in biological research to quickly and precisely identify small samples of protein or other biological macromolecules (often as tiny as a nanogram) using a reliable colorimetric assay. This relatively simple and inexpensive procedure can identify plant gums, glues, and other protein-based or polysaccharide-containing materials present in works of art and can be used to detect and differentiate four common binding media types: glue, casein, egg, and plant gums at concentrations in the nanogram range. This biological mechanism provides the basis of the technique used in this project for the identification of organic materials in wall paintings.

**Information provided:** The samples analyzed by ELISA allow simultaneous analysis of plant gum, egg, animal glue, and casein.

## Sample Requirements and Preparation

**Sample size or weight:** Samples must be 0.5–1 g.

**Sample preparation:** Place 10–500 µg of each sample into 2 mL micro-centrifuge tubes. Add 20 µL of elution buffer to each sample. Elution buffer consists of 5 mL of 1M tris(hydroxymethyl)aminomethane hydrochloride (tris-HCl), 1 mL of 0.5 M ethylenediaminetetraacetic acid (EDTA), 180 g urea, 25 mL of 20% sodium dodecyl sulfate (10 g in 50 mL deionized water), and deionized H<sub>2</sub>O to a final volume of 500 mL. Elution buffer is adjusted to pH 7.4 using NaOH. The solution may be stored at room temperature.

**Prepare positive controls:** Depending on the assay, add 10–50 µg each of egg white, rabbit-skin glue, animal glue (typically bovine), cow's milk (casein), or gum arabic into separate micro-centrifuge tubes. Add 20 µL elution buffer to each positive control and to a sterile “blank” tube containing no antigen. Allow samples, standards, and blank to elute by standing for 2–3 days at room temperature (minimum 12 hours).

Next, add 80 µL of 100 mM sodium bicarbonate to each tube; 100 mM sodium bicarbonate solution contains 0.42 g of NaHCO<sub>3</sub> brought to a total of 50mL with deionized H<sub>2</sub>O. The solution may be stored at room temperature. Mix well and let stand for 10 minutes, allowing particulate matter to settle to the bottom of the tube. Prepare ELISA plates for the samples by adding 40 µL of bicarbonate buffer to each of the wells in two separate 96-well polystyrene ELISA plates. ELISA plates are typically labeled with eight rows (A–H) and twelve columns (1–12).

Multiple dilutions for each sample are used to verify the results of the assay. Dilutions can be obtained by direct pipette transfer between rows or by adding 40 µL of eluent from the first sample to A1, 20 µL to B1, 10 µL to C1, and 5 µL to D1. A minimum of four dilutions is recommended. Repeat this procedure for all the sam-

ples, reserving column 12 for blanks and column 11 for positive controls. Next, add 40  $\mu\text{L}$  of blank eluent solution to all the wells in column 12. After the blanks, add the positive controls to column 11. Add bicarbonate buffer to each of the wells so that the final volume is 80  $\mu\text{L}$ .

Cover the plates with Parafilm™ and incubate at 4 °C for 24 hours. After incubation, allow the plates to come to room temperature and empty the contents of each well with a multichannel pipette (#L300S, Rainin Instrument, LLC, Oakland, CA). Be cautious, as it is possible to cross-contaminate nearby wells. If necessary, dry the pipette tips on clean absorbent paper between rows.

Rinse the wells by adding 300  $\mu\text{L}$  of phosphate-buffered saline (PBS) to each well and allow to stand for 2 minutes. All PBS solutions used in this procedure were diluted 1:10 with deionized water from standard commercial 10 $\times$  concentrate. PBS solutions may be stored at room temperature. Empty the wells into a waste receptacle by inverting the plate with a brisk shake. Repeat this rinsing operation two times. It is important to rinse thoroughly so that all unbound sample material, including particulate residue, is removed. Tap the plate on a paper towel between rinsing to remove all PBS from the wells. Add 300  $\mu\text{L}$  Sea Block™ buffer diluted 1:10 v/v in PBS to all the wells. Allow the trays to stand for 60 minutes at room temperature. Empty the wells into an appropriate receptacle and pat the inverted plate dry on a paper towel.

Next, add 80  $\mu\text{L}$  of the appropriate diluted primary antibody to each of the wells in the rows described in the box below. Dilutions of all the antibodies are prepared using Sea Block™ buffer solution. Allow the antibodies to bind for 2 hours at room temperature.

Empty the plates and rinse all wells three times with 300  $\mu\text{L}$  of PBS as above. Add 80  $\mu\text{L}$  of diluted secondary antibody to each row. Allow the antibodies to bind for 2 hours at room temperature. Empty the plates and rinse all wells three times as before, then add 80  $\mu\text{L}$  of p-nitrophenyl phosphate pNPP solution. Wait until the controls are fully developed while making sure that the blanks remain clear (up to one hour). If desired, stop the reaction by adding 80  $\mu\text{L}$  0.75 M NaOH to each of the wells. Measure the absorbance at 405 nm of the solution in each well.

**TABLE 1**

Primary and secondary antibodies used in ELISA. The numbers beneath each antibody are the dilution factors. For example, the collagen antibody is diluted 200 times (10  $\mu\text{L}$  antibody > 2 mL block solution). The block solution is Sea Block™ buffer diluted 1:10 v/v in PBS.

Source: Data from Joy Mazurek, Getty Conservation Institute (2006).

Primary Antibody Dilution Used	Secondary Antibody Dilution Used
Collagen #AB6577 200 (10 $\mu\text{L}$ > 2 mL)	Rabbit IgG #AP132A 500 (30 $\mu\text{L}$ > 15 mL)
Collagen #AB198111 400 (5 $\mu\text{L}$ > 2 mL)	Goat IgG #AB6742 400 (5 $\mu\text{L}$ > 2 mL)
Fish Collagen #T89171R 100 (20 $\mu\text{L}$ > 2 mL)	Rabbit IgG #AP132A 500 (30 $\mu\text{L}$ > 15 mL)
Casein, #RCAS-10A 800 (5 $\mu\text{L}$ > 4 mL)	Rabbit IgG #AP132A 500 (30 $\mu\text{L}$ > 15 mL)
Ovalbumin #AB1225 800 (5 $\mu\text{L}$ > 4 mL)	Rabbit IgG #AP132A 500 (30 $\mu\text{L}$ > 15 mL)
Phosvitin #SC-46681 66 (30 $\mu\text{L}$ > 2 mL)	Mouse IgG #AP124A 400 (5 $\mu\text{L}$ > 2 mL)
Plant gum #MAC207 50 (40 $\mu\text{L}$ > 2 mL)	Rat IgM KPL#05-16-03 100 (20 $\mu\text{L}$ > 2 mL)
Gum Tragacanth #MAC265 50 (40 $\mu\text{L}$ > 2 mL)	Rat IgG #AB6846 400 (5 $\mu\text{L}$ > 2 mL)

## Technique Overview

**Type of analysis:** Destructive, chemical assay.

**Applicability:** ELISA is limited to protein and to polysaccharide-containing media. Antibody labeling techniques were used as a standard analytical technique and are a complement to existing GC–MS and FTIR techniques. ELISA is a highly accurate and sensitive procedure, with detection limits down to the nanogram of protein and polysaccharides. It provides qualitative information on protein and on polysaccharide media.

**System specifications:** A spectrophotometer or automated plate reader such as Finstruments 341 96-well microplate spectrophotometer (MTX Lab Systems, Inc., Vienna, VA). In the case of strong responses, the results can be visually and qualitatively read.

**Health and safety:** The antibodies and reagents used are not classified as hazardous. Standard wet chemistry safety protocols should be followed.

**Background correction:** It is necessary to subtract the background during reflectance measurements. Measurement of several blanks for each antibody is needed. For each primary antibody, antigen-free negative control (blank) wells should be tested. Absorbance at 405 nm was determined and recorded. Standard deviation should be calculated from the absorbance reading blanks for each antibody. For ELISA tests, the results were scored positive if absorbance was greater than the value of the standard deviation of the blank multiplied by 3 (3s or 3sd). For our purposes, when absorbance readings were above 0.3 OD at 405 nm, results were positive.

**Commercial availability:** All components of the method are commercially available.

## Results and Interpretation

**Result type:** The sample data were interpreted as positive (+) when absorbance readings were above 0.3 OD at 405 nm.

**Ease of interpretation:** ELISA can yield false negatives even if the protein of interest is present. This occurs if the primary antibody does not recognize the epitope and bind to it. Other potential reasons for false negatives include chemical modification from age and cross-linking with pigments or if the protein cannot be extracted into solution.

## Bibliography

- Cartechini, L., M. Vagnini, M. Palmieri, L. Pitzurra, T. Mello, J. Mazurek, and G. Chiari. 2010. "Immunodetection of Proteins in Ancient Paint Media." *Accounts of Chemical Research* 43 (6): 867–76.
- Crowther, J. R. 2001. *The ELISA Guidebook*. Totowa, NJ: Humana Press.
- Getty Conservation Institute, 2010. "Antibody Research (2006–2010)." [www.getty.edu/conservation/our-projects/science/antibody](http://www.getty.edu/conservation/our-projects/science/antibody)
- Mazurek, J., M. Schilling, G. Chiari, and A. Heginbotham. 2008. "Antibody Assay to Characterize Binding Media in Paint." In *15th Triennial Conference, New Delhi, 22–26 September 2008: Preprints (ICOM Committee for Conservation)*, edited by J. Bridgland, 849–56. Paris: ICOM Committee for Conservation.
- Schultz, J., J. Arslanoglu, C. Tavzes, and K. Petersen. 2009. "Immunological Techniques: A Different Approach for the Analysis of Proteins in Cultural Heritage. Part 1, The Basics Explained." *Zeitschrift für Kunsttechnologie und Konservierung* 23 (1): 129–39.

## PART THREE

# Research Results

The aim of this project was to evaluate the effectiveness of various investigative techniques that could be used to determine the presence of organic materials in wall paintings. Results of the research have been published in a number of books, journals, and conference proceedings, which appear below in the list of Papers and Publications, organized by subject.

Several articles, featuring additional project information and results, are published for the first time in this volume:

- [“Wall Painting Replicas for the Scientific Study of Organic Binders.”](#) by Cristina N. Grandin and Giuseppe A. Centauro
- [“Ultraviolet-Induced Luminescence Imaging.”](#) by Giovanni Verri, Annette T. Keller, Francesca Piqué, and Alfredo Aldrovandi
- [“Time-Resolved Fluorescence Spectroscopy and Fluorescence Lifetime Imaging for the Analysis of Organic Materials in Wall Painting Replicas.”](#) by Daniela Comelli, Austin Nevin, Giovanni Verri, Gianluca Valentini, and Rinaldo Cubeddu
- [“Noninvasive, In Situ Identification of Binding Media Using Reflection Mid-FTIR.”](#) by Costanza Miliani, Antonio Sgamellotti, Giovanni Verri, Paolo Benedetti, B. Giovanni Brunetti, Alessia Daveri, and Francesca Rosi
- [“FTIR in Reflectance and Attenuated Total Reflectance for the Analysis of Stratigraphic Cross Sections of Wall Paintings Samples”](#) by Austin Nevin and Charlotte Martin de Fonjaudran
- [“Use of ELISA for Identifying Proteins in the Tintori Wall Painting Replicas.”](#) by Joy Mazurek and Jennifer Porter



## Papers and Publications

### Evaluation of Techniques: Methodology, Levels, and Criteria

Piqué, Francesca. 2006. "Il progetto Organic Materials in Wall Paintings: Risultati della prima fase." In *IV Congresso Nazionale IGIIC: Lo stato dell'arte 4: Volume degli atti: Siena, Santa Maria della Scala 28–30 settembre 2006*, 125–32. Florence: Nardini.

\_\_\_\_\_. 2007. "A Methodology for the Identification of Organic Materials in Wall Paintings." In *Safeguarded Cultural Heritage: Understanding and Viability for the Enlarged Europe: Proceedings of the 7th European Conference "Saveur": 31st May–3rd June 2006, Prague, Czech Republic*, edited by Miloš Drdáký and Michel Chapuis, 31–39. Prague: ITAM.

### General

Casadio, Francesca, Ivana Giangualano, and Francesca Piqué. 2004. "Organic Materials in Wall Paintings: The Historical and Analytical Literature." *Reviews in Conservation* (5): 63–80.

Piqué, Francesca, A. Aldrovandi, A. Andreotti, M. R. Lanfranchi, C. Miliani, and A. Romani. 2008. "Monitoring Cleaning Procedures on the Wall Paintings by Agnolo Gaddi in the Church of Santa Croce in Florence." In *In Situ Monitoring of Monumental Surfaces: Proceedings of the International Workshop SMW08, 27–29 October 2008, Florence, Italy*, edited by Piero Tiano and Carla Pardini, 261–68. Florence: Edifir.

Verri, Giovanni, Alfredo Aldrovandi, Giuseppe Centauro, Catia Clementi, Daniela Comelli, Costanza Miliani, Marcello Picollo, Francesca Piqué, and Lucia Toniolo. 2005. "Evaluation of Non-invasive Techniques for the Detection of Organic Material in Wall Painting." In *8th International Conference on "Non-destructive Investigations and Microanalysis for the Diagnostics and Conservation of the Cultural and Environmental Heritage," Lecce (Italy), 15–19 May 2005*, edited by C. Parisi, G. Buzzanca, and A. Paradisi. Brescia: Associazione Italiana Prove non Distruttive Monitoraggio Diagnostica.

### UV-Induced Luminescence Lifetime Spectroscopy and Imaging (OMA-FILM)

Nevin, A., A. Cesaratto, S. Bellei, C. D'Andrea, L. Toniolo, G. Valentini, and D. Comelli. 2014. "Time-Resolved Photoluminescence Spectroscopy and Imaging: New Approaches to the Analysis of Cultural Heritage and Its Degradation." *Sensors (Switzerland)* 14 (4): 6338–55.

### UV-Induced Luminescence Imaging

Verri, Giovanni, Daniela Comelli, Sharon Cather, David Saunders, and Francesca Piqué. 2008. "Post-capture Data Analysis as an Aid to the Interpretation of Ultraviolet-Induced Fluorescence Images." In *Computer Image Analysis in the Study of Art, Proceedings of SPIE 6810*, edited by D. G. Stork and J. Coddington, 681002-1–681002-12.

### Fiber Optic Fluorescence Spectroscopy (FOFS)

Verri, G., C. Clementi, D. Comelli, S. Cather, and F. Piqué. 2008. "Correction of Ultraviolet-Induced Fluorescence Spectra for the Examination of Polychromy." *Applied Spectroscopy* 62 (12): 1295–1302.

### Mid-FTIR Fiber Optic Spectroscopy

Daveri, A., G. Verri, F. Rosi, C. Miliani, P. Benedetti, and F. Piqué. 2008. "Principal Component Analysis of Reflectance Medium Infrared Spectra for the Non-invasive Identification of Organic Materials in Wall Paintings." In *CMA4CH: 2nd International Meeting on Application of Multivariate Analysis and Chemometry Applied to Cultural Heritage and Environment: Ventotene Island, Italy, Europe, 1–4 June 2008*.

**Note:** Selected papers presented at this conference were published in *Current Analytical Chemistry* 6, no. 1 (January 2010). This paper was not one of them. However, it is available on [Academia.com](http://www.academia.com) through G. Verri's profile:

[http://www.academia.edu/3550116/Principal\\_Component\\_Analysis\\_of\\_Reflectance\\_Medium\\_Infrared\\_Spectra\\_for\\_the\\_Non-Invasive\\_Identification\\_of\\_Organic\\_Materials\\_in\\_Wall\\_Paintings](http://www.academia.edu/3550116/Principal_Component_Analysis_of_Reflectance_Medium_Infrared_Spectra_for_the_Non-Invasive_Identification_of_Organic_Materials_in_Wall_Paintings) (occurred on July 20, 2015)

Rosi, F., A. Daveri, C. Miliani, G. Verri, P. Benedetti, F. Piqué, B. G. Brunetti, and A. Sgamellotti. 2009. "Non-invasive Identification of Organic Materials in Wall Paintings by Fiber Optic Reflectance Infrared Spectroscopy: A Statistical Multivariate Approach." *Analytical and Bioanalytical Chemistry* 395: 2097.

### Micro-FTIR on Cross Sections

Martin de Fonjaudran, Charlotte, Austin Nevin, Francesca Piqué, and Sharon Cather. 2008. "Stratigraphic Analysis of Organic Materials in Wall Painting Samples Using Micro-FTIR Attenuated Total Reflectance and a Novel Sample Preparation Technique." *Analytical and Bioanalytical Chemistry* 392 (1–2): 77–86.

Nevin, Austin. 2005. "The Use of Micro-FTIR with Attenuated Total Reflectance for the Analysis of Wall Painting Cross-Sections." *Zeitschrift für Kunsttechnologie und Konservierung* 19 (2): 356–68.

### Gas Chromatography–Mass Spectrometry (GC–MS)

Campani, Elisa, and Antonella Casoli. 2007. "The Problem of Organic Materials Identification in Wall Paintings: Testing Procedures." In *Safeguarded Cultural Heritage: Understanding and Viability for the Enlarged Europe: Proceedings of the 7th European Conference "Saveur": 31st May–3rd June 2006, Prague, Czech Republic*, edited by Miloš Drdáký and Michel Chapuis, 709–11. Prague: ITAM.

Gautier, Gwénaëlle, and Perla Colombini. 2007. "GC-MS Identification of Proteins in Wall Paintings Samples: A Fast Clean-up Procedure to Remove Copper-Based Pigment Interferences." *Talanta* 73: 95–102.

### Enzyme-Linked Immunosorbent Assay (ELISA) for Protein Identification

Mazurek, J., M. Schilling, G. Chiari, and A. Heginbotham. 2008. "Antibody Assay to Characterize Binding Media in Paint." In *15th Triennial Conference, New Delhi, 22–26 September 2008: Preprints (ICOM Committee for Conservation)*, edited by J. Bridgland, 849–56. Paris: ICOM Committee for Conservation.

Vagnini, M., L. Pitzurra, L. Cartechini, C. Miliani, B. G. Brunetti, and A. Sgamellotti. 2008. "Identification of Protein in Painting Cross-Sections by Immunofluorescence Microscopy." In *Analytical and Bioanalytical Chemistry* 392 (1-1): 57–64.

---

### Unpublished Research

- Chocan, Valeria. 2005. "Spettroscopia vibrazionale per lo studio non invasivo di superfici policrome." Degree in technologies for the conservation and restoration of cultural heritage, University of Perugia.
- Daveri, A. 2005. "Spettroscopia mid-FTIR in riflettanza per lo studio non invasivo dei dipinti murali." Degree in chemistry, University of Perugia.
- Gautier, Gwénaëlle. 2005. "A Reliable Analytical Procedure for the Characterization and Identification of Proteinaceous Binding Media in Wall Paintings." PhD diss., University of Pisa.
- Nevin, A. 2004. "ATR and Reflectance Micro-FTIR, an Exploration of Their Suitability for the Analysis of Wall Paintings Cross-Sections." Master's diss., Courtauld Institute of Art, University of London.
- Rosi, F. 2004. "Spectroscopic Studies for the Conservation of Mural Paintings." PhD diss., University of Perugia.

### GCI Newsletter Articles

- Piqué, Francesca. 2005. "Science for the Conservation of Wall Paintings." *Conservation: The GCI Newsletter* 20 (2). [http://www.getty.edu/conservation/publications\\_resources/newsletters/20\\_2/news\\_in\\_cons2.html](http://www.getty.edu/conservation/publications_resources/newsletters/20_2/news_in_cons2.html)
- "Project Updates: Organic Materials in Wall Paintings." 2003. *Conservation: The GCI Newsletter* 18 (3): 28. [http://www.getty.edu/conservation/publications\\_resources/newsletters/18\\_3/gcinews6.html](http://www.getty.edu/conservation/publications_resources/newsletters/18_3/gcinews6.html)
- . 2004. *Conservation: The GCI Newsletter* 19 (2): 23. [http://www.getty.edu/conservation/publications\\_resources/newsletters/19\\_2/gcinews1.html](http://www.getty.edu/conservation/publications_resources/newsletters/19_2/gcinews1.html)
- . 2006. *Conservation: The GCI Newsletter* 21 (2): 29. [http://www.getty.edu/conservation/publications\\_resources/newsletters/21\\_2/gcinews1.html](http://www.getty.edu/conservation/publications_resources/newsletters/21_2/gcinews1.html)
- "A Tribute to Leonetto Tintori." 2000. *Conservation: The GCI Newsletter* 15 (3): 28–29. [http://www.getty.edu/conservation/publications\\_resources/newsletters/15\\_3/gcinews8.html](http://www.getty.edu/conservation/publications_resources/newsletters/15_3/gcinews8.html)

# Wall Painting Replicas for the Scientific Study of Organic Binders

Cristina N. Grandin and Giuseppe A. Centauro

## Introduction

*A fresco* is a wall painting technique dating to antiquity (Cennini 1982; Vasari 1986; Boldrini 1991; Mora, Mora, and Philippot 1999). This technique has become the subject of a number of scientific investigations related to the conservation of internationally renowned wall painting cycles in Italy, including those by Giotto, Michelangelo, Piero della Francesca, Masaccio, Andrea Mantegna, Raphael, and Luca Signorelli (Centauro and Moriondo Lenzini 1993; Basile 2003; Mancinelli, Colalucci, and Gabrielli 1994; Fabjan, Cardinali, and De Ruggieri 2010). Though the experienced wall painting conservator Leonetto Tintori was not aware of these studies, he anticipated the results of most of this research through close observation of wall paintings and by conducting thorough experimentations in his atelier.

The main difficulties in analyzing *a fresco* painting lie in the complexity of the technique and in the degradation of the materials. Although this type of wall painting is widely considered to involve a lime-based plaster and inorganic pigments dispersed in water, it is often executed using small additions of organic binders such as casein, glue, or egg. The presence of an organic binder is a primary contributor to the overall effect when used in the original tempera or as a material for retouching by a conservator/restorator. In addition, original and added material may age differently because they are applied differently. For example, original organic materials were applied diluted and thus did not form coherent layers, whereas modern consolidation or retouching materials tend to form a coherent film (Tintori 1997). Unlike most inorganic components of the paintings, organic materials are prone to deterioration, making identification difficult.

Overlooked by art historians as well as scientists and conservators, organic materials in *a fresco* wall paintings were thoroughly studied by Tintori. In 1983, he founded the Laboratorio per Affresco di Vainella (LAV), near Prato, Italy, where he investigated the *a fresco* technique with a particular focus on the use of organic binders. Having the ultimate goal of improving the understanding of the use of these materials in wall paintings, the research section of LAV created a series of wall painting replicas—a combination of a lime-based substrate and a variety of painting materials. Each replica was composed of several sectors painted with three variable parameters: pigment(s), binder(s), and phase of application. The latter refers to the period of time between the application of the lime-based final plaster layer and the application of paint. Most replicas were based on historic recipes. LAV holds a rich collection of hundreds of replicas, some of which were made by Tintori himself, and others by his collaborators.

The collaboration between the research section of LAV and the Getty Conservation Institute (GCI) allowed the exploration of the ability of scientific

instrumentation and diagnostic protocols to identify organic materials in wall paintings. In addition, researchers reevaluated, in a critical sense, the primary and secondary literature on *a fresco* painting and tempera.

## Painting *a Fresco*

The *a fresco* technique is variable and complex. It requires preparation of the supporting wall (Cennini 1982; Vasari 1986; Mora, Mora, and Philippot 1999, 147–49), transfer of the preparatory drawing (Cennini 1982; Vasari 1986, 60–62; Pozzo 1977; Mora, Mora, and Philippot 1999, 420–26), application of plaster, and of paint while the plaster is fresh, from which the term *a fresco* is derived (Cennini 1982; Vasari 1986; Pozzo 1977, 420–22; Mora, Mora, and Philippot 1999, 85–172). First, the supporting wall is treated with water and covered entirely with a lime-based plaster typically composed of lime putty and sand (*arriccio*). A preliminary drawing, called *sinopia*, may then be executed over the *arriccio*. When the *arriccio* is dry, a thinner layer of plaster composed of lime putty and finer sand is applied on top. This thin layer covering the entirety of the wall width is referred to as *pontata* (scaffold length); smaller portions are called *giornate* (day of work). At this stage, and after the plaster has partially set, the preparatory drawing is transferred. This may be carried out in different ways, including the use of incised lines or cartoons (Procacci 1961; Procacci and Guarnieri 1975).

**FIGURE 1**

*A fresco* replica (ME5). The background, the garment, and the hand of the angel were painted using the *buon fresco* technique with water. Azurite was mixed with animal glue and subsequently applied on dry plaster, or *a secco*.



When done, the final painting may then be executed. Mineral pigments dispersed in water are applied to the wet plaster, a technique often referred to as *a buon fresco*, or “good fresco,” as the paint is applied without the aid of an organic binder; hence “good” or “pure.” Only inorganic pigments resistant to high alkalinity are suitable to be used *a buon fresco*. Depending on environmental conditions, the application of the mixture of pigments and binders must be done quickly, as the lime-based plaster sets, or carbonates, by encapsulating the pigment particles in a calcium carbonate matrix. Generally speaking, because of their inorganic origin, *buon fresco* paintings are considered stable and less subject to deterioration.

The use of organic tempera paints is reserved for the next stage. Once the plaster is dry (or drying), pigments that cannot be applied *a buon fresco* are mixed and applied with an organic binder. Cennini himself mentions that the final touches of *a fresco* are executed with pigments mixed with organic binders (Cennini 1982, 90)<sup>1</sup> (see fig. 1).

The genesis and development of painting on walls is not always ordered and predictable as described above. Many factors, both voluntary and accidental, may affect the regular process (Vasari 1986, 13).<sup>2</sup> The effects of the climate and microclimate in the area or room in which the painting is kept, the nature of the materials used, and the individual painting technique each contribute to the decisions the artist makes.

## Painting *a Secco*

The use of organic binders mixed with pigments and applied to dry plaster (*tempera a secco*) is a most common practice also explained in primary sources (Cennini 1982, 85–88; Vasari 1986, 66–70; Pozzo 1977). As mentioned, organic materials are prone to physical and chemical deterioration (Vasari 1986, 13–14). Therefore, the durability of some paintings seems to suggest that techniques in between *a fresco* and *a secco* might have been used. Such a clear-cut distinction did not exist in the past. Tintori was the first to hypothesize the use of paint on *stanco* plaster, and he concentrated his research on this topic.

## Painting *a Stanco*

Tintori hypothesized a more versatile and creative use of tempera, for example, on not fully set plaster—half dry, called *stanco*, or “tired,” the “weakened” state of the lime carbonation, and defined *auxiliar* as the organic binders added to the pigments to help them adhere (Tintori 1995). There is no reference in the literature to the use of *stanco* plaster or to *stanco* as a term used to define an incomplete state of carbonation of the lime plaster. Artists may have applied pigments mixed with an organic binder to a wet, semi-dry, or fully dry wall (Del Serra 1986, 59–68, 101–10; Angelini 1986, 95–110).

The combination of tempera with some pigments on wet or semi-dry plaster might result in a more adept, resistant paint layer. However, eminent sources such as Vasari criticized such practices as a mark of inexperience. The use of a mixed technique might explain some pictorial effects that would be difficult to reproduce using an orthodox or standard palette of pigments and an ordinary or *buon fresco* working method.

## The Replicas: Classification and Description

The research at LAV begun by Tintori had as its principal objective the understanding of *a fresco* painting and the experimentation of various techniques of its execution. The research dates back to 1988, when Tintori started experimenting with plasters and pigments at his atelier in Vainella (Tintori 1993, 65–135), and is based on his own observations while conserving wall paintings by Giotto in Padua,<sup>3</sup> Piero della Francesca in Arezzo (Matteini 1993, 233–38), Masaccio in Florence (Tintori 1990, 247–69), and others.<sup>4</sup> During this period, some of these painting cycles were again undergoing conservation. Tintori had been consulted, sparking in him a renewed interest in the painting technique used in these important cycles. According to Tintori, a successful conservation program could be achieved only through a deep understanding of the materials and the original painting technique. This knowledge helps limit the risks of inappropriate treatments that could alter the original execution of the artwork. The artistic matter is not the subject for just any study: its inclusion in the creative sphere of the work of art fixes it, by definition, in a unique and unrepeatably form over time. The original nature of the artistic matter is what is most exposed to loss, especially during conservation interventions (Centaurio and Grandin 2005).

Organic materials play multiple, important roles in wall painting. For example, they are functional elements, used as tempera to prepare a surface, especially for a

*secco* paintings. Prior to applying paint, the materials are combined with pigments to provide adhesion on plaster (Vasari 1879; Cennini 1859), or they are applied as protective layers or varnishes. Primary literary sources make reference to the use of tempera as final touches in wall paintings (fig. 2). However, Tintori determined that these finishing touches could have occurred shortly after the completion of a *giornata* with the intention to alter, unify, or soften the unpredictable variations of color that may occur when painting *a fresco*. This technique was used by Piero della Francesca in the cathedral of Arezzo and was dubbed an *episodio tecnico*, or “technical episode,” by Tintori (1993).

Organic materials also are expressive elements. The artist adds and uses organic materials while painting, making revisions or changes immediately on the semi-dry or dry plaster (Cennini 1982, 93),<sup>5</sup> or introduces brushstrokes at the end of the work, as in retouches and complements (Tintori 1993, 139–40) (fig. 3). According to Tintori, this expressive use of tempera was popular among artists of the Italian Renaissance, whose style was highly sophisticated in their attempts to use pigments normally “forbidden” *a fresco* (Tintori 1995). Skilled artists were able to use pigments dispersed in tempera on walls in such a way that would last for centuries; by using tempera, it was possible to avoid unwanted changes in the appearance of the colors (e.g., dark colors becoming lighter or light colors becoming duller).

From these simple technical considerations, LAV generated over many years a large collection of replicas that reproduce numerous wall painting techniques, colorful mixtures of pigments and binders, and recipes for *a fresco* painting ranging from antiquity to the present time. Each replica was made on a support of porous terracotta (a tile), prepared and plastered with lime putty and sand, and painted according to historical practices.

**FIGURE 2**

A *secco* replica (Z18), painted on dry plaster using egg tempera mixed with pigments that cannot be applied on highly alkaline lime-based plasters (e.g., lead white, cinnabar, malachite, lakes, Naples yellow).



**FIGURE 3**

Replica (BA8) with organic binders applied on fresh and semi-dry plaster. When applied correctly, it is difficult to distinguish this type of application from *buon fresco* painting.



Each series of replicas develops and illustrates one or more of the following:

1. supports and plasters;
2. applications of pure pigments or in combination on fresh plaster, on partially set plaster, and on set plaster;
3. different environmental conditions (humid or dry); and
4. natural aging (in controlled storage).

The most significant variables in the replicas were executed using organic binders: milk, animal glue, egg (whole egg, egg white, or egg yolk), gum arabic, casein, wax, and various types of oil (raw linseed oil, regular linseed oil, walnut oil, and poppy seed oil). Each of these binders was used alone or mixed in various combinations (e.g., *tempera grassa*, or the mixture of egg yolk and linseed oil or other oils to create an emulsion) (fig. 4).

**FIGURE 4**

Demonstrative replica (OL10). In this tile, experimentation was carried out using different organic binders, including *tempera grassa* and *magra* with azurite on fresh plaster.



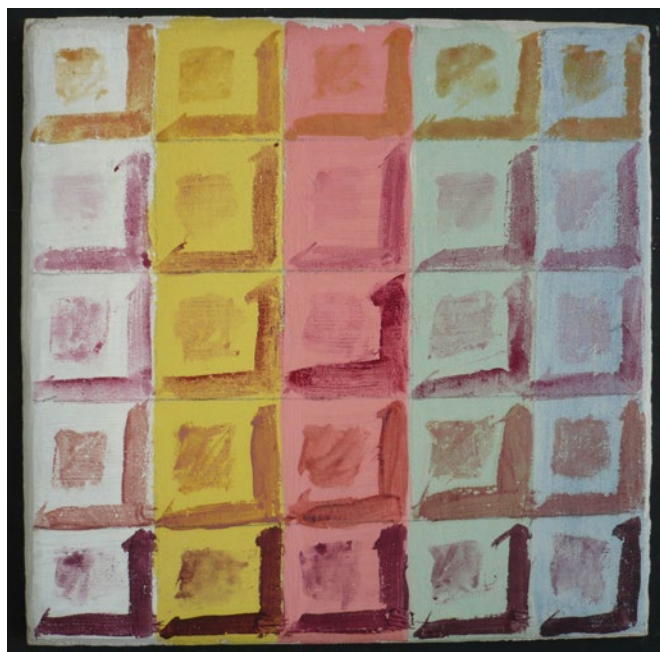
The replicas are of three types:<sup>6</sup>

1. Creative: those made by Tintori himself, which have a greater creative value (fig. 5);
2. Exemplative: those made with scientific rigor, measuring and noting the exact quantities of each ingredient used (fig. 6); and
3. Demonstrative: those alternating in aspects of quality or quantity depending on the original artistic intention (fig. 7).

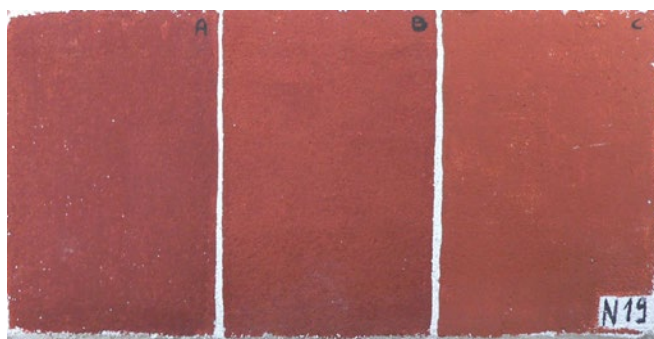


**FIGURE 5**

Creative replica (Z24), painted by Tintori, with alternating applications of pigments and binders on *stanco* plaster.

**FIGURE 6**

Exemplative replica (N19), suitable for scientific investigations and executed with known components and application methodologies.

**FIGURE 7**

Demonstrative replica (M7), a combination of red ocher, cinnabar, and madder lake, mixed with water and organic binders and applied on fresh and dry plaster.

For the purposes of the research coordinated by the GCI from 2003 to 2006, twenty-two replicas were chosen. The replicas follow the classification of the historic archive of LAV and are identified by the following initials: AC1, AC2, AZ1bis, AZ2bis, M1bis, M2bis, M3bis, M4bis, N2, N3, N7, N11, N16, N25, N34, N20, N29, N38, OL17bis, OL18bis, Z8, and Z9. Each series develops and investigates a research trend through a variety of painting techniques:

- AZ series: executed using mixtures of blue-green pigments based on technical hypotheses formulated on the skies painted by Piero della Francesca;

- OL series: illustrates the Renaissance techniques that made use of *tempera grassa* mixed with pigments difficult to apply on fresh plaster;
- Z series: compares the proportions of binders in glazes;
- N series: uses various temperas in an ordered sequence;
- AC series: shows the differences between *tempera grassa* and *magra*; and
- M/bis: use tempera and *tempera grassa* paint on set plaster or *a fresco*.

## Results and Advantages

Tintori's research was based on the execution of the replicas (Tintori 1993). The same experimental principle is still valid today for the development of new replicas. The creation of replicas is an empirical and simple method that allows for direct observation of the skills of the artists, tests working methods, and objectively evaluates the reliability of historical recipes. Tintori determined that an archive of replicas is essential in understanding the creativity and techniques used by artists and distinguishing them from other influences such as aging and decay.

The replicas are of critical importance not only to the understanding of the technical genesis of a wall painting but also to a better orientation of scientific study and analysis during conservation interventions, on the condition that these replicas possess certain qualities:

**FIGURE 8**

Replica (D4) painted with aged yellow ocher applied *a fresco*, *stanco*, and *secco* (top to bottom), mixed with water, milk, egg, and animal glue (left to right).



- the quality of the materials used in the making of the replicas;
- a significant selection of pigments, binders, and combinations of the two;
- the preparation of organic binders (egg, glue, oil, etc.);
- the sequence of application of the paint (on fresh, partially set, and set plaster);
- the comparison with other techniques (*a buon fresco*, *tempera ausiliare*, *tempera grassa*, etc.);
- a technical sheet for each replica with comprehensive information regarding materials, methods, observations, and techniques used in each replica's preparation;<sup>7</sup> and
- the periodic monitoring and selective testing on duplicates of the same replica.

Replicas of known composition are used for scientific research. This knowledge allows researchers to evaluate degradation phenomena on naturally aged organic materials and to distinguish aging processes from later additions and actions (fig. 8).

## Conclusions and Future Objectives

The collection of replicas started by Leonetto Tintori at LAV is an important archive of samples of wall paintings. It contains hundreds of technical and chromatic combinations according to traditional working methods or more unique artistic expression. The research carried out at LAV over a three-year period served to deepen the understanding of *a fresco* painting techniques with the final goal of improving conservation practices. If not recognized from the outset, such delicate original interventions in tempera may be effectively obliterated by aggressive conservation treatments.

A work of art is a combination of technical ability and artistry, both of which are at times difficult to quantify. Therefore, we must keep an open mind to the virtually endless number of permutations among the choice of pigments, binders, and plasters. The outcomes of this research will help promote the creation of new replicas in relationship to different kinds of scientific, technological, artistic, and historical research.<sup>8</sup> The next step is to promote the diffusion of the results to further stimulate the understanding of artistic techniques and to improve conservation practices.

*The presentation of this research is dedicated to the memory of Leonetto Tintori.*

*Cristina N. Grandin is professor of mural painting technique at the International University of Art, Venice, and collaborated with Leonetto Tintori at LAV. Giuseppe A. Centauro is associate professor in architectural conservation at the University of Florence and is affiliated with LAV, Sezione Ricerche 'L. Tintori'.*

## Notes

1. “E nota, che ogni cosa che lavori in fresco vuole essere tratto a fine e ritoccato in secco con tempera.”
2. “perchè l’occhio non vede i colori veri insino a che la calcina non è ben secca, nè la mano vi può aver giudizio d’altro che del molle o secco; di maniera che chi lo dicessi lavorare al buio o con occhiali di colori diversi dal vero, non credo che errasse di molto.”
3. The documentation related to the conservation interventions by Tintori on the paintings by Giotto in the Scrovegni Chapel, Padua, was collated by the authors of this paper and subsequently acquired by the Comune di Padova (Municipality of Padua) for the new conservation interventions to be carried out by the Istituto Centrale del Restauro ([www.giottoagliscrovegni.it](http://www.giottoagliscrovegni.it)).
4. A brief summary of the conservation interventions undertaken by Tintori can be found in Centauro 2001.
5. “Poi in fresco tolli azzurro della Magna lavato bene, . . . mettivi dentro un poco di colla stemperata. . . Ancora metti nel detto azzurro un rosse d’un ovo; . . . Quando l’hai ben campeggiato, e che sia asciutto, tolli un poco d’indaco e di negro, e va ombrando le pieghe.”
6. This distinction was made not by Tintori but by the teachers at LAV for didactic purposes.

7. The technical sheet contains qualitative information on the materials used and observations noted during the making of the replica. The entire LAV archive, consisting of more than five hundred replicas and hundreds of pictorial combinations, was digitized using Microsoft Access during the preparatory phase of this project. This database allows for quick identification of replicas containing similar combinations of particular materials.
8. To underscore the importance of the study of organic materials in wall paintings, especially those materials that enrich artistic expression, the LAV published in 2005 a Declaration of Intentions. It is available on request from the LAV ([info@laboratoriotintori.prato.it](mailto:info@laboratoriotintori.prato.it)).

## References

- Angelini, A. 1986. “La Loggia della Galatea alla Villa Farnesina a Roma: L’incontro delle scuole Toscana, Umbra e Romana (1511–14).” In *Tecnica e stile: Esempi di pittura murale del Rinascimento italiano*, edited by E. Borsook and F. Superbi Gioffredi, 95–110. Milan: Silvana; Los Angeles: J. Paul Getty Trust.
- Basile, G., ed. 2003. *Il restauro della Cappella degli Scrovegni: Indagini, progetti, risultati* [Restoration of the Scrovegni Chapel: Surveys, project, results]. Milan: Skira.
- Boldrini, S. 1991. *Materia e immagine: Fonti sulle tecniche della pittura* [Material and images: Sources on the techniques of painting]. Materiali della cultura artistica 2. Rome: Leonardo–De Luca editori.
- Cennini, C. 1859. *Il libro dell’arte, o, Trattato della pittura*. Edited by G. Milanesi and C. Milanesi. Florence: F. Le Monnier.
- . 1982. *Il libro dell’arte*. 2nd ed. Edited by F. Brunello. Venice: N. Pozza.
- Centauro, G. A., ed. 2001. *Leonetto Tintori: L’Arte attraverso: Antiche stanze di Santa Caterina (8 novembre 2001–28 febbraio 2002)*. Poggibonsi: Lalli.
- Centauro, G. A., and C. N. Grandin. 2005. *Per la salvaguardia della pittura murale*. Poggibonsi: Lalli. <http://www.laboratoriotintori.prato.it/attivita/ricerca/htm/salvaguardia.htm>
- Centauro, G. A., and M. Moriondo Lenzini, eds. 1993. *Piero della Francesca ad Arezzo: Atti del Convegno Internazionale di Studi, Arezzo, 7–10 marzo 1990*. Venice: Marsilio.
- Del Serra, A. 1986. “Sodoma e Monteoliveto Maggiore e discussioni su tecniche miste, pigmenti e cartoni (ca. 1505–08).” In *Tecnica e stile: Esempi di pittura murale del Rinascimento italiano*, edited by E. Borsook and F. Superbi Gioffredi, 59–68. Milan: Silvana; Los Angeles: J. Paul Getty Trust.
- Fabjan, B., M. Cardinali, and M. B. De Ruggieri, eds. 2010. *Materiali e tecniche nella pittura murale del Quattrocento: Storia dell’arte, indagini diagnostiche e restauro verso una nuova prospettiva di ricerca*. Rome: ENEA.
- Mancinelli, F., G. Colalucci, and N. Gabrielli. 1994. *Michelangelo, il giudizio universale*. Art Dossier, no. 88. Florence: Giunti.
- Matteini, M. 1993. “Notizie e precisazioni sul restauro Tintori degli anni Sessanta.” In *Piero della Francesca ad Arezzo: Atti del Convegno Internazionale di Studi, Arezzo, 7–10 marzo 1990*, edited by G. A. Centauro and M. Moriondo Lenzini, 233–38. Venice: Marsilio.
- Mora, P., L. Mora, and P. Philippot. 1999. “Le grandi tappe storiche della tecnica.” In *La conservazione delle pitture murali*, 85–172. Bologna: Editrice Compositori.

- 
- Pozzo, A. 1977. "Breve istruzione per dipingere a fresco." In *I principi della pittura figurativa nelle testimonianze degli artisti e degli scrittori d'arte*, edited by R. E. L. Panichi, 132–38. Collezione di cultura 23. Pisa: Giardini.
- Procacci, U. 1961. *Sinopie e affreschi* [Sinopie and frescoes]. Milan: Electa Editrice.
- Procacci, U., and L. Guarnieri. 1975. *Come nasce un affresco* [How a fresco is born]. Florence: Bonechi.
- Tintori, L. 1990. "Note sulla 'Trinità' affrescata da Masaccio nella chiesa di Santa Maria Novella in Firenze: III. Gli ultimi interventi di restauro." In *Le pitture murali: Tecniche, problemi, conservazione*, edited by C. Danti, M. Matteini, and A. Moles, 261–68. Florence: Centro Di.
- . 1993. *Nella tecnica della pittura murale: Rilievi sulla tecnica dei maestri Giotto, Simone Martini, Bonamico Buffalmacco, Piero Della Francesca, Masaccio, Filippo Lippi e raccolta di campionature in affresco, tempera ausiliare e tempera in secco*. Prato: Associazione laboratorio per affresco Elena e Leonetto Tintori.
- . 1995. *Il legante organico nell'affresco: Espressione e vitalità da salvaguardare: Ricerche, campionature, testimonianze*. Opus: Quaderni di conservazione e valorizzazione dei beni culturali e ambientali 4. Poggibonsi: Lalli.
- Vasari, G. 1878–85. *Le vite de' più eccellenti pittori, scultori ed architettori*. Edited by G. Milanesi. 9 vols. Florence: G. C. Sansoni. First published in 1550.
- . 1986. *Le vite de' più eccellenti architetti, pittori, et scultori italiani, da Cimabue insino a' tempi nostri: Nell'edizione per i tipi di Lorenzo Torrentino, Firenze 1550*. Edited by L. Bellosi and A. Rossi. Turin: Giulio Einaudi.

# Ultraviolet-Induced Luminescence Imaging

Giovanni Verri, Annette T. Keller, Francesca Piqué, and  
Alfredo Aldrovandi

## Introduction

When excited with electromagnetic radiation, materials may emit radiation at lower energy (Lakowicz 2006). This phenomenon is called photo-induced luminescence. UV-induced luminescence is a subset of photo-induced luminescence and can be described by its two main components: excitation and emission. Excitation is the radiation that is sent toward and absorbed by the object under investigation. Emission is the radiation that, following the absorption, is emitted by the object. In the case of artworks, the most commonly used excited radiation is in the UV range (365 nm), while emission occurs in the visible range (400–700 nm); however, other forms of excitation have been recently developed (Verri 2009; Accorsi et al. 2014). The emission of luminescence can be easily recorded using digital cameras. Many organic materials such as binders and colorants, as well as some inorganic materials such as mineral pigments, absorb UV radiation and re-emit it as colored, visible light. Most of the UV radiation is absorbed within the uppermost layers of organic matter, rendering UV radiation particularly useful in revealing the presence of superficial films made of organic materials and in highlighting differences between surfaces (Confalonieri et al. 1985; Mairinger 2004; Pinna, Galeotti, and Mazzeo 2009).

## UV-Induced Luminescence

In general terms, UV-induced luminescence is a “weak” phenomenon—that is, the quantum yield, or the proportion between emitted photons and incoming photons is low. Additionally, part of the excitation will be not absorbed but reflected by the object. If the process of absorption and emission is fast ( $<10^{-8}$  s), the phenomenon is called *fluorescence*; if slow ( $>10^{-8}$  s), it is called *phosphorescence* (Lakowicz 2006). The more generic term *luminescence*, independent of the speed of the process, is used in this paper.

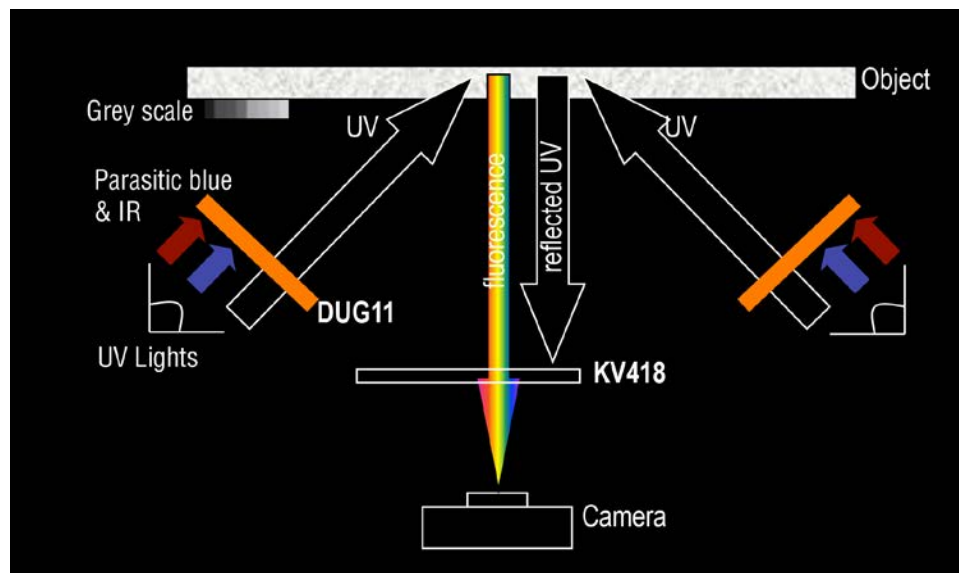
Organic materials usually show luminescence properties, but these may vary significantly in terms of both intensity and emission wavelengths according to their chemical and physical environment as well as their age. The setup used for UV-induced luminescence imaging consists of the following:

1. UV radiation sources
2. Excitation filter
3. Reflectance/luminescence standards
4. Emission filter
5. Camera

A schematic representation of the setup is shown in figure 1 (Autenrieth, Aldrovandi, and Turek 1992; Aldrovandi et al. 2005).

**FIGURE 1**

A schematic representation of the setup used for UV-induced luminescence imaging.



### UV Radiation Sources

The illumination for UV-induced luminescence imaging consists of a set of four Philips PL-S 9W double black light blue (BLB) tubes (365 nm), with high-frequency electronic ballasts, and a 11.9 × 11.9 cm Schott DUG11 excitation filter (see below), manufactured at Istituto di Fisica Applicata Nello Carrara (IFAC), Consiglio Nazionale per le Ricerche (CNR), Florence, Italy. Other UV radiation sources such as flashes have been suggested as an alternative to more conventional UV lamps (Verri and Saunders 2014).

### Excitation filter

In the early twentieth century, the American physicist Robert Williams Wood developed a type of glass based on nickel oxides. This glass can act as a band-pass filter capable of blocking visible radiation from, for example, a mercury vapor lamp. Black to the naked eye, the filter allows through radiation roughly between 320 and 400 nm and in the longest red-infrared range. UV lamps equipped with Wood's filters are commonly used to inspect museum objects and artifacts with the purpose of detecting the presence of materials not visible to the naked eye.

It is unwanted as it does not excite luminescence and is reflected by the object, possibly masking any weak emissions in the violet-blue range. Therefore, this radiation can have a considerable impact on interpretation of the luminescence phenomena; in other words, it is important to determine if violet or blue radiation from an object is derived from reflected parasitic radiation or is the result of a real UV-induced luminescence emission.

To minimize the amount of parasitic radiation that can reach the surface under study, other filters can be used. For example, DUG11 filters, manufactured by

Schott, show strong absorption in the violet-blue and IR ranges, hence considerably reducing the amount of parasitic radiation.

### **Reflectance/Luminescence Standards**

When recording luminescence emission by organic materials, it is advisable to evaluate the amount of parasitic and ambient stray radiation using a reference standard. The Spectralon 99% Reflectance Standard, manufactured by Labsphere, is a proprietary material that reflects 99% of the incoming radiation in the 200–2500 nm range and does not show luminescence properties. When such a standard is inserted in the image alongside the object under investigation, it is possible to measure the amount of reflected radiation and therefore assess the amount of both parasitic and ambient stray radiation. When illuminating with a UV source in the absence of parasitic or ambient stray visible light radiation, the 99% Reflectance Standard will appear black, and any light recorded on the object must be produced by luminescence. In the presence of ambient or parasitic radiation, the 99% Reflectance Standard will appear colored. The color and intensity of the radiation coming from the standard is related to the amount of incoming ambient and parasitic radiation. Thus, the standard can be used to assess how much radiation is the result of real luminescence and how much is due to the presence of reflected light. In the recorded image, any RGB values above those of the reference standard are assigned to real luminescence, as the standard does not have any luminescence properties.

### **Emission Filter**

Once emitted, luminescence is recorded with a digital camera as RGB values. To remove the reflected UV component and further reduce the parasitic component reflected from the lamp off the object, an emission filter is necessary. Kodak Wratten filters are commonly used for this purpose; however, because these filters show some luminescence properties, they were not used for this study. A cut-on Schott KV418 (with 50% transmission at 418 nm) was used instead.

### **Camera**

UV-induced luminescence images were captured using a Nikon D100, equipped with a Micro Nikkor, F=2.8/60mm, lens. The f-stop was 11 (max. MTF), aperture priority, ISO 100, delta EV=0, and white balance 5600 °k.

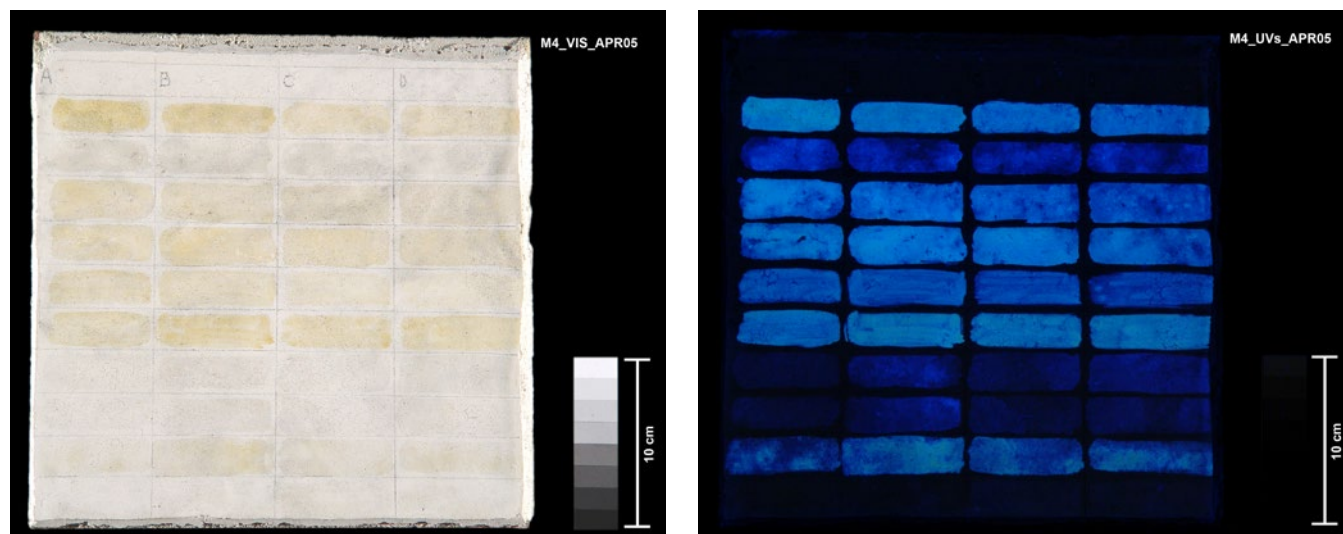
### **Limitations of the Technique**

Some organic materials such as paper, natural dyes, or fabric may be susceptible to photo-fading when exposed to UV radiation. In addition, UV radiation is damaging to the eye. It is therefore necessary to minimize the exposure time of artifacts to UV radiation and to wear protective gear.



**FIGURE 2**

Replica M4, painted with different binders at increasing dilutions with water (shown from left to right). (Left) Visible image; (right) UV-induced luminescence image. Binders include (top to bottom in each row) yolk, glair, whole egg, whole egg and linseed oil, animal glue, animal glue and linseed oil, casein, casein with vinegar, and casein with linseed oil. All binders show similar luminescence properties. Using UV-induced luminescence imaging, the distinction between the different types of binders is not possible.



## Results

### Pure Binders

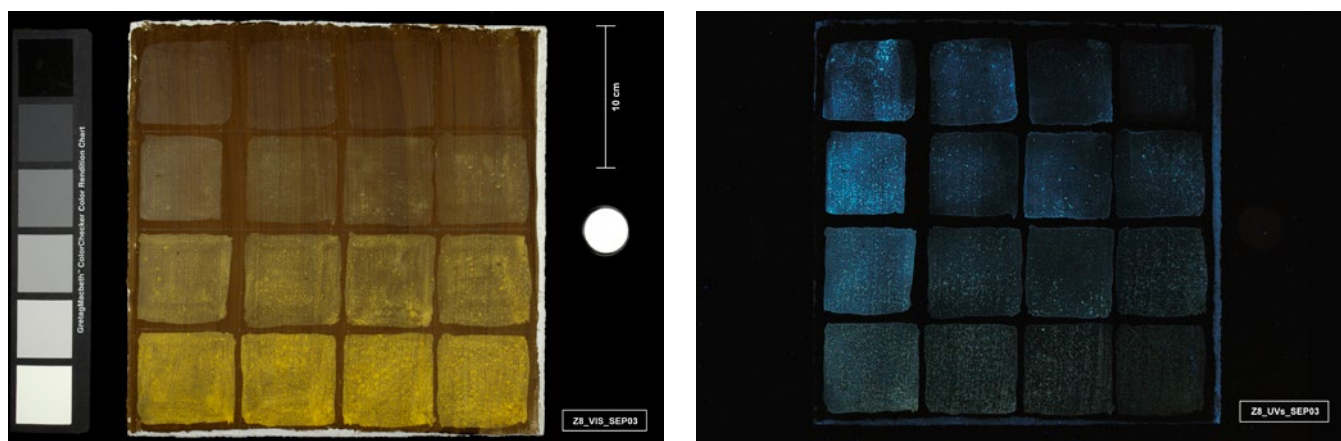
Figure 2 shows the visible (left) and UV-induced luminescence images of tile M4, on which a variety of organic binders were used over a white lime-based plaster with no addition of pigments. Though all sectors show luminescence properties, which confirm the presence of an organic binder, it is not possible to distinguish between the different binders, as all show an emission in the blue/cyan range. In some instances, the sectors painted with organic material rich in lipids, such as oil or egg yolk, seem to produce a slightly yellower emission, but this is not a consistent behavior.

### Binders and Pigments

In addition to chemical quenching, which corresponds to a decrease of luminescence caused by a variety of factors including the concentration of the emitting substance (Lakowicz 2006), another important phenomenon is the physical absorption of the emission by colored pigments, which do not show any luminescence properties (Verri, Comelli et al. 2008). When in isolation, for example, some organic binders emit a bluish/whitish light. If the same organic binder is mixed with a yellow pigment, the blue component of the bluish/whitish emission by the binder will be partially absorbed by the yellow pigment. The resulting emission will appear yellowish rather than bluish/whitish, making identification of the organic binder difficult.

**FIGURE 3**

Replica Z8, painted with whole egg and yellow ocher. (Left) Visible image; (right) UV-induced luminescence image showing the absorption of the blue emission by the pure egg (top left sector) caused by the presence of yellow ocher (bottom left).



This phenomenon has significant implications in the interpretation of UV-induced luminescence images. In the example described above, what is observed and recorded by the camera is a yellow luminescence, which could be misunderstood as the presence of fats or even an organic colorant. Regarding replica Z8 (fig. 3), the only luminescent material is egg yolk, which, as can be seen in the top left corner of the right-hand image of figure 3, emits a blue luminescence when applied alone. By contrast, when mixed with yellow ocher, which is not luminescent, the material appears to show a yellow emission, as can be seen in the bottom left. In extreme cases, dark pigments such as ochers or carbon-based pigments can absorb the luminescence of the binder entirely and cause a false-negative assessment of the results.

Some pigments such as those containing copper and iron, including azurite, malachite, and red ocher, may also act as quenchers and extinguish the luminescence from the binder before it is even emitted (Verri and Ambers 2010).

In some instances, it is possible to remove the influence of the absorbing pigment and retrieve information on the original luminescence emission by the binder. Aspects related to the physical absorption of radiation and its relation to photo-induced luminescence imaging protocols are discussed further in Verri, Clementi et al. 2008; Verri, Comelli et al. 2008; and Dyer, Verri, and Cupitt 2013.

## Levels of Identification

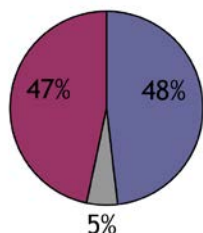
UV-induced luminescence imaging can be used to assess the presence of an organic binder (level 1) but not to distinguish between different binders. Criteria for assessing level 1 are as follows:

- Organic material present: RGB values in the UV-induced luminescence image are above those read on the 99% Reflectance Standard.
- Possible organic material present: RGB values are higher, but very close to those recorded on the 99% Reflectance Standard.

**FIGURE 4**

Results of the evaluation of 135 painted sectors with organic binders using UV-induced luminescence imaging.

■ Positive ■ Uncertain ■ Negative



- No organic material present: RGB values in the image are below those read on the 99% Reflectance Standard.

The chart in figure 4 shows the results of the evaluation of 135 painted sectors with organic binders: 48% of the sectors were correctly attributed, 5% were uncertain, and 47% were erroneously interpreted as without any organic material (false negatives).

## Conclusions

UV-induced luminescence imaging is particularly useful, as it provides distribution maps of luminescent materials. With this technique, however, it is possible to determine only whether an organic binder may be present, but not the type of binder (e.g., protein or lipid).

One main constraint of this technique is related to the intrinsic nonspecificity of luminescence emission, as well as the strong influence that some pigments may have, causing the absorption or quenching of the emitted luminescence.

*Giovanni Verri is a lecturer at the Courtauld Institute of Art, London. Annette T. Keller is an expert in multispectral imaging and director of artIMAGING, Berlin. Francesca Piqué is professor of science in conservation at SUPSI and is a consultant with the Getty Conservation Institute, Los Angeles. Alfredo Aldrovandi is head of the physics laboratory at the Opificio delle Pietre Dure, Florence.*

## References

- Accorsi, G., G. Verri, A. Acocella, F. Zerbetto, G. Lerario, G. Gigli, D. Saunders, and R. Billinge. 2014. "Imaging, Photophysical Properties and DFT Calculations of Manganese Blue (barium manganate(vi) sulphate) – A Modern Pigment." *Chemical Communications* 50 (97): 15297–15300.
- Aldrovandi, A., E. Buzzegoli, A. Keller, and D. Kunzelman. 2005. "Investigation of Painted Surfaces with a Reflected UV False Colour Technique." *Art '05*, 8th International Conference on "Non-destructive Investigations and Microanalysis for the Diagnostics and Conservation of the Cultural and Environmental Heritage," Lecce, Italy, 15–19 May.
- Andrew, S. R., and D. Eastop. 1994. "Using Ultra-violet and Infra-red Techniques in the Examination and Documentation of Historic Textiles." *The Conservator* 18: 50–56.
- Autenrieth, H. P., A. Aldrovandi, and P. Turek. 1992. "La tecnica di ripresa fotografica in fluorescenza ultravioletta: problemi ed esperienze." *Kermes* 5 (14): 50–67.
- Confalonieri, L., M. Milazzo, E. Paltrinieri, and A. Gallone. 1985. "X-ray Fluorescence, Infrared Radiography, and Infrared and Ultraviolet Photography of 'The Betrothal of the Virgin' by Raphael." In *Application of Science in Examination of Works of Art: Proceedings of the Seminar*, edited by P. England and L. van Zelst, 190–97, 7–9 September 1983. Boston: Museum of Fine Arts.
- Dyer, J., G. Verri, and J. Cupitt. 2013. "Multispectral Imaging in Reflectance and Photo-induced Luminescence Modes: A User Manual." European CHARISMA Project. <http://www.britishmuseum.org/pdf/charisma-multispectral-imaging-manual-2013.pdf>
- Lakowicz, J. R. 2006. *Principles of Fluorescence Spectroscopy*. 3rd ed. London: Springer.

- 
- Mairinger, F. 2004. "UV-, IR- and X-ray Imaging." In *Non-destructive Microanalysis of Cultural Heritage Materials*, edited by K. Janssens and R. Van Grieken, 15–72. Amsterdam: Elsevier.
- Pinna, D., M. Galeotti, and R. Mazzeo. 2009. *Scientific Examination for the Investigation of Paintings. A Handbook for Conservator-Restorers*. Florence: Centro Di.
- Verri, G. 2009. "The Spatially Resolved Characterisation of Egyptian Blue, Han Blue and Han Purple by Photo-Induced Luminescence Digital Imaging." *Analytical and Bioanalytical Chemistry* 394 (4): 1011–21.
- Verri, G., and J. Ambers. 2010. "Revealing Stratigraphy." In *Italian Renaissance Drawings*, edited by J. Ambers, C. Higgitt, and D. Saunders, 89–102. London: Archetype Books.
- Verri, G., C. Clementi, D. Comelli, S. Cather, and F. Piqué. 2008. "Correction of Ultraviolet-Induced Fluorescence Spectra for the Examination of Polychromy." *Applied Spectroscopy* 62 (12): 1295–1302.
- Verri, G., D. Comelli, S. Cather, D. Saunders, and F. Piqué. 2008. "Post-capture Data Analysis as an Aid to the Interpretation of Ultraviolet-Induced Fluorescence Images." In *Computer Image Analysis in the Study of Art, Proceedings of SPIE 6810*, edited by D. G. Stork and J. Coddington, 681002-1–681002-12.
- Verri, G., and D. Saunders, 2014. "Xenon Flash for Reflectance and Luminescence (Multispectral) Imaging in Cultural Heritage Applications." *The British Museum Technical Research Bulletin* 8: 83–92.

# Time-Resolved Fluorescence Spectroscopy and Fluorescence Lifetime Imaging for the Analysis of Organic Materials in Wall Painting Replicas

Daniela Comelli, Austin Nevin, Giovanni Verri, Gianluca Valentini, and Rinaldo Cubeddu

## Introduction

Photo-induced luminescence (PL) emission, defined as the spontaneous emission of radiation from an electronically excited species following excitation by electromagnetic radiation, has long been used for the examination of works of art as a simple photographic technique (Hansell 1968; Aldrovandi and Picollo 2001; Mairinger 2004). It is characterized by spectral features and emission intensity, decay time, and polarization (Lakowicz 2006). PL consists of fluorescence and phosphorescence, depending on the nature of the excited state: the former involves the fast radiative emission from a singlet excited state (with typical lifetimes from  $10^{-9}$  to  $10^{-7}$  s), whereas the latter involves the much less probable and slow transition from a triplet excited state (from  $10^{-6}$  to  $10^0$  s) (Lakowicz 2006).

With advances in technology and wider use of portable noninvasive luminescence spectroscopy and imaging devices (Comelli et al. 2004; Thoury et al. 2007; Comelli et al. 2008; Romani et al. 2008; Ricciardi et al. 2009; Verri 2009; Verri and Saunders 2014), there has been an increase in applications of laser-based PL spectroscopic techniques for analysis of cultural heritage (Raimondi et al. 2009; Romani et al. 2010; Comelli et al. 2011, 2012).

These applications are related to the analysis of intrinsically luminescent organic and inorganic materials employed in works of art, including proteins, oils, waxes, semiconductor pigments, resins, and varnishes (de la Rie 1982; Miyoshi et al. 1982; Bottiroli, Gallone-Galassi, and Bernacchi 1986; Larson, Shin, and Zink 1991; Anglos et al. 1996; Thoury et al. 2007; Nevin et al. 2007, 2009; Verri 2009; Verri and Ambers 2010).

For the Organic Materials in Wall Paintings (OMWP) project, the analysis of fluorescence emission of organic materials on Leonetto Tintori's replicas was performed by irradiating samples with ultraviolet radiation from a nanosecond-pulsed nitrogen laser emitting at 337 nm (alternative UV-pulsed laser sources include the third and fourth harmonic of a Q-switched Nd:YAG laser emitting light at 355 nm and 266 nm, respectively). The properties of the PL emission (amplitude, spectrum, and lifetime) offer a means of discriminating between some of the organic compounds and assessing the chemical and physical properties of the painted surfaces.

This research is focused on analysis that employed both a time-resolved fluorescence spectrometer and a fluorescence lifetime imaging (FLIM) unit (Comelli et al. 2004, 2005). Here, the main advantage is that the emission lifetime is insensitive to variations in concentration of organic material and independent of the intensity of the fluorescence emission. In addition, changes in fluorescence lifetime may be

related to composition and chemical modifications of organic materials, as well as to the influence of the microenvironment on the selected organic samples (e.g., pigments, varnishes).

It is recognized that *in situ* identification of organic materials used on painted surfaces using fluorescence spectroscopy is not straightforward (Verri et al. 2008; Romani 2010). This is due to intrinsic similarities in emission spectra of many of these materials. Also, the complex attenuation of emission by optical absorption from other non-emitting materials (e.g., some pigments) is a known problem and may significantly distort fluorescence spectra (Verri et al. 2008; Clementi et al. 2009). Nevertheless, UV-induced fluorescence can be employed as an effective technique for discriminating between different complex mixtures of painting materials. This is a particular advantage of FLIM, which is suited to analysis of large painted surfaces and to assessment of variation in fluorescence lifetime related to heterogeneities rather than to the specific identification of materials, which requires careful interpretation of data and can be better achieved by integration with complementary analysis.

## Context

Analysis of binding media used in paint has been performed with PL spectroscopy on a variety of model samples, films, and mock-ups of oil- and protein-based binding media. The most recently published results of fluorescence spectroscopy for binding media using a variety of laser sources are summarized in table 1 (Nevin, Spoto, and Anglos 2012). In contrast to the fluorescence of resins used for varnishes (Thoury et al. 2007), the fluorescence of proteins is better understood, and the identity of different fluorophores has been suggested (Nevin et al. 2006). Protein-based binding media contain many fluorophores; hence, the emission spectra of proteins are strongly dependent on excitation wavelength.

Spectroscopic discrimination between pure protein-based binding media (egg white and casein; egg yolk and animal glue) requires the use of excitation below 300 nm, which is sufficient to excite emissions from aromatic amino acids (see table 1). When excitation wavelengths greater than 300 nm are employed and emission is detected only above 380 nm, spectra recorded of protein-based media are generally similar in shape but may differ slightly in fluorescence lifetime (Nevin et al. 2007). Egg yolk films emit at 425 nm, whereas the addition of a drying oil causes a shift to 450 nm (Castillejo et al. 2002). The addition of linseed oil causes broad fluorescence emissions, which may shift from 492 to 683 nm (de la Rie 1982; Larson 1991) with prolonged natural aging. Generally, lifetimes of binding media are on the order of 3–6 ns.

The addition of pigments to protein-based and oil-based films may significantly modify the detected fluorescence from the binder (de la Rie 1982; Verri et al. 2008; Nevin et al. 2008). Results suggest that, with low binder-to-pigment ratio, the weak signal of intrinsic fluorescence may limit the application of fluorescence spectroscopy and imaging for the identification of organic binders. In some cases, the optical absorption or quenching effect by the pigment could be so strong as to completely obliterate the fluorescence emission by the binder and therefore produce false-negative results.

**TABLE 1**

Laser-induced fluorescence spectroscopy of protein-based binding media where Tryptophan (Trp) and Tyrosine (Tyr) attributions are given only when reported (Nevin et al. 2012).

Organic material	Excitation wavelength	Emission wavelength/ nm	Lifetime/ns	Attribution
Animal glues	248	305, 385		Tyr, pentosidine
	337	415	4.7	di-tyrosine
		430–440		
	355	440, 415, ~480		Pyridinoline, di-tyrosine, dihydroxyphenylalanine and related products
Calcium caseinate	337	460	6.0	
Casein	248	340, 420		Trp, di-tyrosine
	266	310, 330		Tyr, Trp
	355	435		Oxidation products
	363.8	456		
Egg white	248	340, 420		Trp, di-tyrosine
	266	310, 330		Tyr, Trp
	337	415	5.3	di-tyrosine
	363.8	588		
	355	435		Oxidation products
Egg yolk	248	515–440		Phospholipids
	266	310, 330		Tyr, Trp
	337	425	4.0	
Egg yolk – linseed oil – tempera	248	450		
Oil – Linseed—aged 1 year	363.8	492		
Oil – Linseed—aged 50 years	363.8	685		
Wax	337	500–550	6.0	

## Materials and Methods

Time-resolved laser-induced fluorescence spectroscopy and FLIM data were acquired from the surfaces of the replicas. Results from different replicas are presented in the following sections.

### Time-Resolved Laser-Induced Fluorescence Spectroscopy

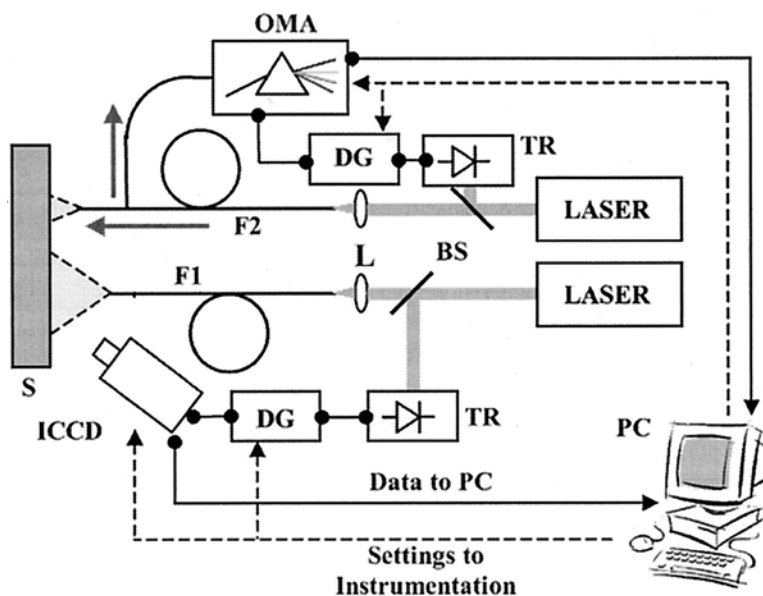
A time-gated visible spectrometer (Optical Multi-Channel Analyzer, EG&G Princeton Applied Research, Princeton, NJ) with sensitivity in the 370–650 nm

spectral range was employed for estimating the emission decay kinetic of each sample as a function of the emission wavelength (Comelli et al. 2004). A schematic of the device is shown in figure 1.

The spectrally and lifetime-resolved device is based on a time-gated detector in the nanosecond time range coupled to the visible spectrometer. UV-pulsed excitation (at 337 nm) is provided by a pulsed nitrogen laser (VSL-337ND-S, Laser Science Inc., Franklin, MA). The laser beam is sent in a fiber bundle that is placed in gentle contact with the sample through a metallic spacer covered with a Teflon ring. The fiber bundle is made of a central fused silica fiber ( $\text{\O}=600\ \mu\text{m}$ ) that delivers excitation radiation to the sample surface, and of 20 fibers ( $\text{\O}=200\ \mu\text{m}$ ) arranged in two circular rings, which collect the emitted fluorescence and deliver it to the detector. The time-gated detector is a linear intensified camera characterized by a fixed gate width of 10 ns and a temporal jitter close to 0.2 ns. To reduce the noise component, the detector is cooled down to  $5^\circ\text{C}$  with an internal Peltier. A cutoff filter (B+W UV 010) placed before the entrance slit of the detector is used to remove the excitation light from the recorded spectra. A simple trigger unit based on a fast photodiode permits synchronization of the detector with the laser pulse. Completing the apparatus is a delay generator capable of delays from 0 to 100 ns in 0.5 ns step. The automatic setting of all instrumental parameters during measurements is controlled using a PC with dedicated software, implemented within the LabWindows environment (National Instruments, Austin, TX). To analyze the kinetics of the emission, a set of fluorescence spectra is acquired after different delays with respect to the excitation pulses and processed according to a monoexponential decay model. A program for offline analysis has been developed using Matlab (MathWorks, Natick, MA).

**FIGURE 1**

Schematic of fluorescence devices used at the Politecnico di Milano. LASER = pulsed nitrogen laser; BS = beam splitter; L = focusing lens; F1 = silica fiber; F2 = silica fiber bundle, ICCD = time-gated intensified camera; OMA = time-gated spectrometer; TR = optical trigger circuits; DG = delay generators; S = Tintori replica surface; PC = personal computer.





## Fluorescence Lifetime Imaging

The FLIM system (Comelli et al. 2004) is based on a time-gated intensified camera (ICCD225, Photek, St. Leonards-on-Sea, England, UK) exhibiting a minimum gate width of 10 ns. A sequence of images is acquired by activating the gate of the image detector at different delays with respect to excitation pulses. In this way, the temporal behavior of the fluorescence emitted by each pixel is recorded. Then, by applying a suitable fitting procedure based on a monoexponential decay model, the fluorescence lifetime map of the field of view is reconstructed.

The UV excitation light ( $\lambda=337$  nm) is provided by a second nitrogen laser (LN203C, Laser Photonic, Orlando, FL) that generates 1-ns-long pulses, synchronous with the gated camera, at a repetition rate of 50 Hz. The excitation beam is coupled to an optical silica fiber having a core diameter of 600  $\mu\text{m}$  and delivered to the replica in a circular area of about 20 cm in diameter. Typical irradiance is kept below 3  $\mu\text{W}/\text{cm}^2$ . A custom-made trigger circuit and a precision delay generator (DG535, Stanford Research Systems, Sunnyvale, CA) allow temporal sampling of the emitted fluorescence. The entire system has been assembled in a portable rack of about 60  $\times$  60  $\times$  70 cm.

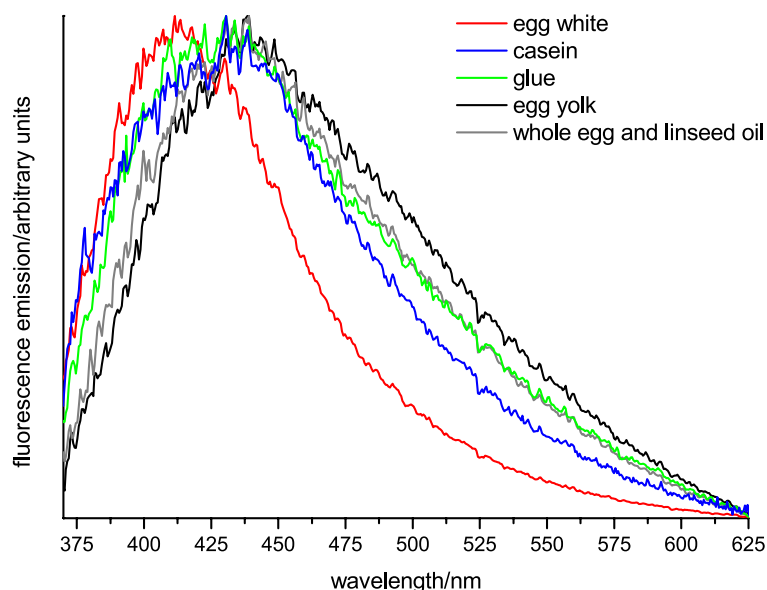
## Results and Discussion

### Analysis of Pure Binders: replica M4bis

Different sectors on replica M4bis (see appendix 1), prepared with egg, egg white, glue, and proteins mixed with oil, have been analyzed using time-resolved fluorescence spectroscopy. For binders, fluorescence excited at 337 nm is ascribed to the presence of different fluorophores in the binding media (see table 1 for published attributions). Figure 2 shows the normalized emission of the sectors painted with pure binder without the addition of a pigment. The fluorescence emission of pure egg white is hypsochromically shifted (at 410 nm) with respect to that of the other binding media; mixtures containing both protein and lipids (egg yolk, and egg mixed with linseed oil) yield the broadest fluorescence with maxima at approximately 435 nm. Collagen-based glue and casein are not easily distinguished from protein-lipid mixtures on the basis of the spectral emission at 337 nm excitation (Nevin et al. 2007).

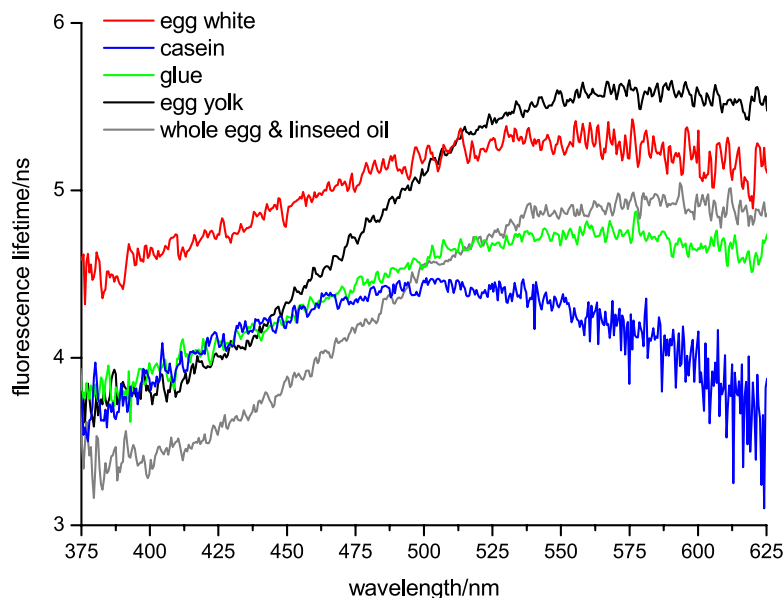
Fluorescence lifetime of the same binders shows a complex behavior varying with emission wavelength—that is, shorter lifetimes for shorter wavelengths and longer lifetimes for longer wavelengths—hence suggesting the presence of fluorophores with different decay kinetics in each binder. Focusing on the 375–500 nm spectral range, where all binders show a maximum fluorescence emission, egg white exhibits the longest lifetime (4.5 ns at 400 nm) and glue and casein have shorter lifetimes close to 4.2 ns at 430 nm. Egg yolk and whole egg mixed with oil show a similar trend in the spectral variation, which increases with emission wavelength for both binders. More specifically,

**FIGURE 2**  
Normalized fluorescence spectra of organic binder from replica M4bis (excitation wavelength 337 nm).



**FIGURE 3**

Fluorescence lifetime as a function of emission wavelength of different binding media from replica M4bis.



egg mixed with oil has the shortest lifetime (3.7 ns at 430 nm), while egg yolk exhibits a lifetime of 4.1 ns at 430. These observations are in agreement with the trends reported for the analysis of binding media on quartz substrates (Nevin et al. 2007). Results are shown in figure 3.

### Effects of Pigments on Fluorescence of Organic Media

The influence of pigments on fluorescence depends on a number of factors:

1. Optical absorption of the luminescence emission by the colored pigment (Verri et al. 2008; Clementi et al. 2009)
2. Possible luminescence of the pigment (Clementi 2009)
3. Modification of the binder microenvironment, which could induce quenching phenomena and chemical interactions or reactions between binder and pigment and between binder and substrate (Lakowicz 2006)

Binders mixed with other pigments: replicas Z- and N-

In the Z- series (see appendix 1), the addition of increasing concentrations of other pigment leads to a decrease in the intensity of the fluorescence of the various organic binders and to a modification of fluorescence spectra (see Verri 2008 for a detailed description of the fluorescence emission of replica Z8). This is caused by selective optical absorption of the fluorescence of egg (the binder used in Z8) by the yellow-colored pigment. However, no significant differences are observed in the fluorescence lifetime between the unpigmented and pigmented areas. This is ascribed to the lack of influence on the fluorescence decay from the inert yellow pigments (i.e., no influence of the microenvironment on the binder fluorophores). As observed for pure egg samples, replicas painted in egg yolk mixed with yellow other exhibit a dependence of fluorescence lifetime with wavelength, which increases from 4.0 ns at 380 nm to 5.0 ns at 580 nm. Casein mixed with the same pigment exhibits a smaller variation in lifetime with wavelength, while an average

fluorescence lifetime of approximately 4.9 ns is observed in the different sectors of replica Z9.

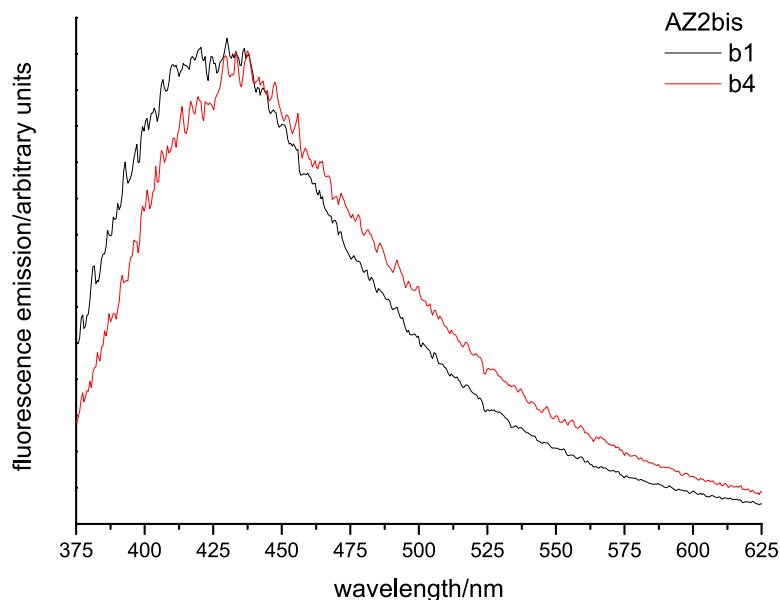
Interesting results have been observed on samples painted *a fresco*, *a stanco*, and *a secco*: for *stanco* replica N16, painted in yellow ochre mixed with egg yolk (see appendix 1), there is a decrease in fluorescence lifetime in comparison with the lifetime of samples painted *a fresco* and *a secco*. It is not known for certain the reason behind this phenomenon; however, it has been shown that calcium ions increase fluorescence lifetime of fluorophores (Ross et al. 1991). Therefore it may be suggested that the longer lifetime in sectors painted *a fresco* could be caused by the interaction between  $\text{Ca}^{2+}$  and fluorophores present in binding media. Chemical modifications of binding media (hydrolysis) due to the alkalinity of the plaster are also possible, but the fluorescence emission spectra of the sectors in N16 are the same. In sectors in replica N34 (see appendix 1) painted with animal glue, the average fluorescence lifetime increases to 4.6 ns (*fresco*) compared to 4.0 ns (*secco*); the same trend is found in sectors painted with casein in replica N25 (see appendix 1) with fluorescence lifetimes of 4.7 (*fresco*) and 4.5 ns (*secco*).

Binders mixed with lead white and copper carbonate pigments:  
replicas AZ- and OL-

The fluorescence spectrum and lifetime of lead white, calcium carbonate, malachite, and azurite (AZ) mixed with whole egg in replica AZ2bis (see appendix 1) are strongly influenced by the phase of application and show noticeable changes from *fresco* to *stanco* (48 hours). The *fresco* substrate contributes to a slight hypsochromic shift of the fluorescence spectrum in comparison with that of pure whole egg. This outcome could be the result of a chemical reaction between the alkaline substrate, pigments, and binding medium or optical absorption (fig. 4). Fluorescence lifetime varies, with binders applied *a fresco* exhibiting a longer emission with respect to those applied *a secco* (fig. 5). A similar effect was observed in samples containing ochre pigments (see appendix 1).

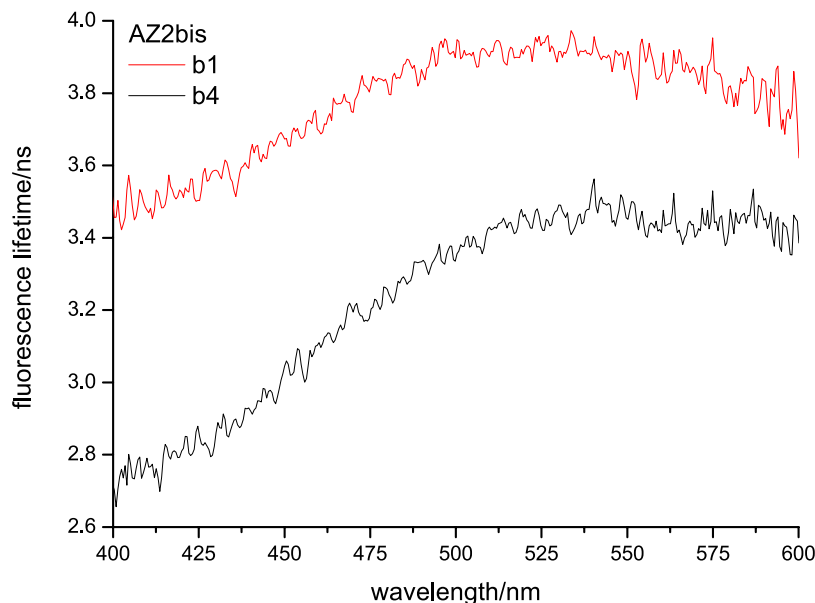
**FIGURE 4**

Normalized fluorescence spectra of sectors painted at different times from replica AZ2bis containing whole egg, b1 (*a fresco*), and b4 (*a secco*) (excitation wavelength 337 nm).



**FIGURE 5**

Fluorescence lifetime as a function of emission wavelength of sectors painted at different times from replica AZ2bis containing whole egg, b1 (*a fresco*), and b4 (*a secco*).



In the replica painted in glue with the same mixture of pigments used in replica AZ1bis (see appendix 1), smaller differences are observed in the average lifetime values for paint bound in glue and painted *a fresco* and *a secco*. However, the same trend is noted: fresco paint has a longer lifetime than the same paint applied *a secco*. In addition, the paint bound in glue mixed with the complex mixture exhibits a shorter lifetime than that observed in pure binder (M4bis), and it is possible that, in the AZ1bis replica, copper ions ( $\text{Cu}^{2+}$ ) from malachite and azurite act as possible quenchers for the fluorescence emission, giving rise to a decrease in fluorescence lifetime (Lakowicz 2006).

The addition of oil to the paint in AZ1bis also influences the detected fluorescence. For example, in sector b3 (painted with only glue) an average lifetime of 3.3 ns is observed, whereas glue mixed with oil in sector c3 exhibits a lifetime of 3.6 ns, suggesting that the addition of drying oil (which also fluoresces) leads to an increase in average lifetime. Fluorophores from fatty acid oxidation may contribute to this fluorescence (de la Rie 1982). It is also possible that fatty acid soaps formed upon reactions between basic lead carbonate and lipids could contribute to the fluorescence of the organic materials.

The most complex replica analyzed (see appendix 1) contains whole egg mixed with linseed oil as binder with several pigments (lead white, significant concentrations of copper-containing carbonate pigments—malachite and azurite—and madder lake), painted *a fresco* and *a secco*. The interpretation is complicated by several factors: copper (II) ions are well-known quenchers for fluorescence (Lakowicz 2006), and it has been shown that they influence the fluorescence spectrum of protein-based binding media (Nevin et al. 2008). Basic lead carbonate (lead white) can react with fatty acids to form lead soaps (Keune and Boon 2007). Madder is a fluorescent pigment that emits at around 610 nm (Clementi et al. 2008) and has a short lifetime (on the order of a few nanoseconds) (Romani et al. 2008, 2010).

Time-resolved fluorescence spectroscopy was employed to assess the influence of pigments on the fluorescence spectrum and fluorescence lifetime. FLIM was carried out to assess the technique for differentiating larger areas from the different sectors on the replica. The detected fluorescence emission depends on the presence of concentrated malachite and azurite, as well as fluorescent pigment madder. The emission spectra are reported in figure 6. For sectors containing malachite and azurite, the fluorescence spectrum of the binder is attenuated by both quenching and optical absorption by the green and blue pigment, causing a bathochromic shift in the detected emission (especially noticeable in the malachite sector, a2) and a general broadening of the spectrum (Verri et al. 2008). The emission from the sector painted with madder (a4) is clearly visible in the red range; madder absorbs UV radiation and part of the fluorescence from the binder between 350 and 450 nm. Both contribute to the overall fluorescent emission between 500 and 600 nm (Clementi et al. 2008), appearing as a shoulder in the fluorescence spectrum in shown in figure 6.

The fluorescence lifetime measurements of the OL- series (see appendix 1) are more difficult to interpret. Although the general shape of the spectral dependence of fluorescence lifetime of the different sectors containing the oil-egg mixture is similar, the lifetime is different for each sector. The presence of madder in sector a4 reduces the fluorescence lifetime above approximately 480 nm; this is ascribed to the contribution of emissions from the pigment, which, on its own, has a lifetime of approximately 1.5 ns (Romani et al. 2008). Copper-based pigments (sectors a2 and a3) significantly reduce the fluorescence lifetime, possibly due to the quenching of fluorescence by  $\text{Cu}^{2+}$  ions, which may occur by a Förster resonance energy transfer (FRET) mechanism (Hötzer et al. 2011). The fluorescence lifetime of the sector containing malachite is shorter than that observed in paint containing azurite. This may be related to the greater solubility of the pigment in the oil-egg mixture (Preis and Gamsjäger 2002). Finally, as observed in AZ- replicas, sectors

**FIGURE 6**

Fluorescence spectra of sectors painted *a secco* from replica OL17b (excitation wavelength 337 nm).

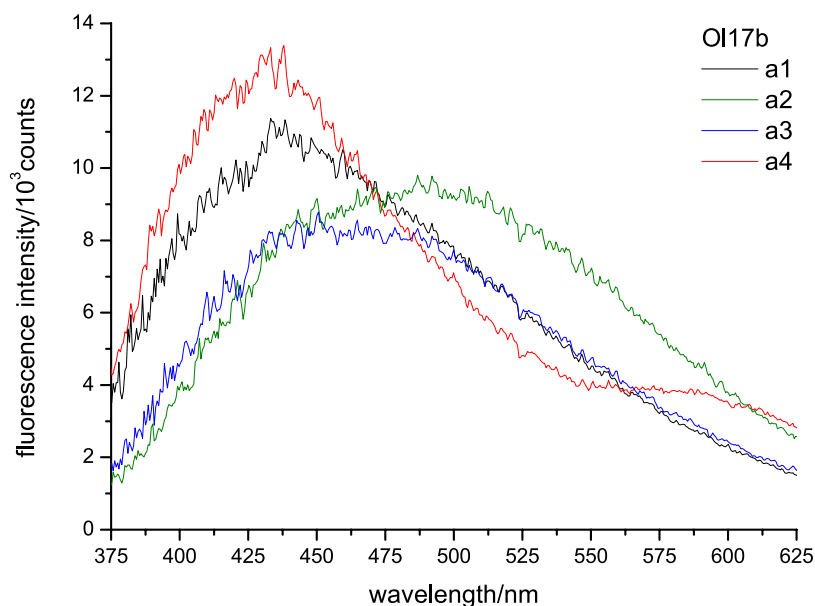


FIGURE 7

False-color FLIM of replica OL17b. The colors of the circles represent different lifetimes.



painted out *a fresco* have decreased fluorescence lifetime with respect to those painted out *a secco*.

Although FLIM analysis produces images calculated based on the decay in the amplitude of fluorescence integrated in the whole visible range, results acquired with this setup yield trends similar to those reported above for time-resolved fluorescence spectroscopy. False-color images of different sectors, shown as small circles in figure 7 and indicating average decay time, yield average lifetimes that decrease with the addition of copper-based pigments, following the trend observed in spectroscopy (see fig. 6). Furthermore, FLIM measurements suggest that sectors painted *a fresco* have longer fluorescence lifetimes.

FLIM has the advantage of providing spatial information for each measurement, as each pixel contains information related to the temporal decay of fluorescence; consequently, FLIM is less sensitive to the positioning of the fiber in comparison with time-resolved fluorescence spectroscopy. In addition, the technique can be used to rapidly detect differences between larger areas; this discriminating power is its strength. Results from complementary techniques, such as time-resolved fluorescence spectroscopy and multispectral fluorescence imaging (Comelli et al. 2008), can be used to further explain specific changes in fluorescence emission between different samples.

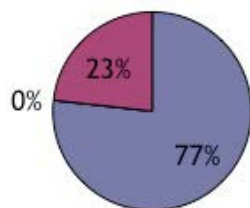
## Levels of Identification

Through fluorescence lifetime spectroscopy, it is possible to assess the presence of an organic binder (level 1). While the lifetime might provide some indications of the nature of the binder (level 2), more research is necessary to establish the potential of the technique. Therefore, the criteria used to identify the presence or absence of an organic binder in level 1 include the following:

**FIGURE 8**

Chart representing the correlation factors for the level of information obtained.

■ Positive ■ Uncertain ■ Negative



- Organic material present: presence of an emission band with a clearly defined maximum
- No organic material present: absence of an emission band

Figure 8 charts the results obtained after the evaluation of 142 sectors as blind tests and using the above criteria. Level 1 is reached with good confidence (77% of positive results). The negative results are attributed mainly to the presence of false negatives due to the absorption or quenching of fluorescence by pigments.

## Conclusions

Analysis of organic materials in wall paintings using fluorescence spectroscopy presents challenges based on the difficulty in interpreting variations in emission spectra, modifications in fluorescence lifetime, and interference from pigments and other materials present in and on the painted surface. Analysis of the naturally aged and well-characterized Tintori replicas suggests possible explanations for the observed fluorescence of different samples. In the absence of pigments, it may be possible to discriminate between different binding media on the basis of spectral lifetime and fluorescence emission. Nevertheless, the use of only one excitation wavelength limits the discrimination capabilities of the technique; excitation spectra recorded with various excitation wavelengths have been shown to be extremely useful in achieving this goal (Nevin et al. 2006). Moreover, complementary analysis of fluorescence lifetime using shorter UV excitation wavelengths (e.g., the fourth harmonic of an Nd:YAG laser at 266 nm), coupled with sensitivity in the UV range, would be advantageous and would allow detection of signal from amino acids.

When binding media are mixed with pigments, modifications of fluorescence spectra often occur due to optical absorption of the emitted radiation by the colored pigment. In some cases, this effect may be mathematically corrected on the basis of visible reflectance analysis (Verri et al. 2008; Clementi et al. 2009). Pigments may also interact chemically with binders. For example, from the analysis of fluorescence lifetime, it is evident that copper-containing pigments tend to reduce the lifetime of emissions. Finally, paint applied *a fresco* exhibits longer lifetime than paint *a secco*; this effect may be caused by the presence of calcium ions in the binding matrix/substrate.

This work has demonstrated the extreme sensitivity of fluorescence. However, its use as an analytical technique for the identification of binding media is not straightforward. Many unanswered questions remain regarding the fluorescence of organic materials, the influence of their preparation, their interaction with other painting materials, and aging and degradation. Another issue not investigated in this study is the interference of commonly used conservation materials and consolidants on the fluorescence of surfaces.

In conclusion, the attribution of fluorescence spectra to specific compounds is not possible at this stage of the research. However, complementary optical spectroscopic technique, including Raman spectroscopy and fiber optic reflectance spectroscopy (FORS), may provide key data for the interpretation of fluorescence.

FLIM analysis has the advantage of providing spatial information on variations in fluorescence lifetime, which is independent from its intensity. This has allowed

the detection of the same organic material irrespective of concentration (e.g., on N- and Z- replicas). One difficulty in applying the technique is the interpretation of results, which often requires integration with other complementary techniques, imaging, and statistical analysis (Comelli et al. 2011). The instrumentation could be improved, such as the use of more compact and transportable laser sources (Comelli et al. 2012) to make the application of FLIM more straightforward, even if the instrumentation itself is research grade and not commercially available.

When carefully interpreted, fluorescence and lifetime spectroscopy and imaging can thus provide useful information related to organic materials and their application in wall paintings.

*Daniela Comelli, Gianluca Valentini, and Rinaldo Cubeddu are professors in the Department of Physics, Polytechnic University of Milan. Austin Nevin is a researcher with the Institute of Photonics and Nanotechnology of the National Research Council (IFN-CNR), Milan. Giovanni Verri is a lecturer at the Courtauld Institute of Art, London.*

## References

- Aldrovandi, A., and M. Picollo. 2001. "Indagini in fluorescenza UV." In *Metodi di documentazione e indagini non invasive sui dipinti*. Padua: Il Prato.
- Anglos, D., M. Solomidou, I. Zergioti, V. Zafirooulos, T. G. Papazoglou, and C. Fotakis. 1996. "Laser-Induced Fluorescence in Artwork Diagnostics: An Application in Pigment Analysis," *Applied Spectroscopy* 50 (10): 1331–34.
- Bottiroli, G., A. Gallone-Galassi, and E. Bernacchi. 1986. "Microspectrofluorometric techniques as applied to the analysis of binding media and varnishes in color samples taken from paintings." In *Scientific Methodologies Applied to Works of Art: Proceedings of the Symposium*, 168–70. Florence, Italy, 2–5 May 1984. Milan: Montedison progetto cultura.
- Castillejo, M., M. Martin, M. Oujia, D. Silva, R. Torres, A. Manousaki, V. Zafirooulos, O. F. Van den Brink, R. M. Heeren, R. Teule, A. Silva, and H. Gouveia. 2002. "Analytical Study of the Chemical and Physical Changes Induced by KrF Laser Cleaning of Tempera Paints." *Analytical Chemistry* 74: 4662–71.
- Clementi, C., B. Doherty, P. L. Gentili, C. Miliani, A. Romani, B. G. Brunetti, and A. Sgamellotti. 2008. "Vibrational and Electronic Properties of Painting Lakes." *Applied Physics A* 92 (1): 25–33.
- Clementi, C., C. Miliani, G. Verri, S. Sotiropoulou, A. Romani, B. G. Brunetti, and A. Sgamellotti. 2009. "Application of the Kubelka–Munk Correction for Self-Absorption of Fluorescence Emission in Carmine Lake Paint Layers." *Applied Spectroscopy* 63 (12): 1323–30.
- Comelli, D., C. D'Andrea, G. Valentini, R. Cubeddu, C. Colombo, and L. Toniolo. 2004. "Fluorescence Lifetime Imaging and Spectroscopy as Tools for Nondestructive Analysis of Works of Art." *Applied Optics* 43: 2175–83.
- Comelli, D., A. Nevin, A. Brambilla, I. Osticioli, G. Valentini, L. Toniolo, M. Fratelli, and R. Cubeddu. 2012. "On the Discovery of an Unusual Luminescent Pigment in Van Gogh's Painting 'Les bretonnes et le pardon de pont Aven'." *Applied Physics A* 106 (1): 25–34.
- Comelli, D., A. Nevin, G. Valentini, I. Osticioli, E. M. Castellucci, L. Toniolo, D. Gulotta, and R. Cubeddu. 2011. "Insights into Masolino's Wall Paintings in Castiglione Olona:



- Advanced Reflectance and Fluorescence Imaging Analysis.” *Journal of Cultural Heritage* 12 (1): 11–18.
- Comelli, D., G. Valentini, R. Cubeddu, and L. Toniolo. 2005. “Fluorescence Lifetime Imaging and Fourier Transform Infrared Spectroscopy of Michelangelo’s *David*.” *Applied Spectroscopy* 59 (9): 1174–81.
- Comelli, D., G. Valentini, A. Nevin, A. Farina, L. Toniolo, and R. Cubeddu. 2008. “A Portable UV-Fluorescence Multispectral Imaging System for the Analysis of Painted Surfaces.” *Review of Scientific Instruments* 79 (8): 086112 [article no.].
- De la Rie, E. Rene. 1982. “Fluorescence of Paint and Varnish Layers.” Parts 1–3. *Studies in Conservation* 27 (1): 1–7; (2): 65–69; (3): 102–8.
- Hansell, P. 1968. “Ultraviolet and Fluorescence Recording.” In *Photography for the Scientist*, edited by C. Engel, 363–82. London and New York: Academic Press.
- Hötzer, B., R. Ivanov, S. Altmeier, R. Kappl, and J. Gregor. 2011. “Determination of Copper (II) Ion Concentration by Lifetime Measurements of Green Fluorescent Protein.” *Journal of Fluorescence* 21 (6): 2143–53.
- Keune, K., and J. J. Boon. 2007. “Analytical Imaging Studies of Cross-Sections of Paintings Affected by Lead Soap Aggregate Formation.” *Studies in Conservation* 52: 161–76.
- Lakowicz, J. R. 2006. *Principles of Fluorescence Spectroscopy*. 3rd ed. London: Springer.
- Larson, L. J., K. K. Shin, and J. I. Zink. 1991. “Photoluminescence Spectroscopy of Natural Resins and Organic Binding Media of Paintings.” *Journal of the American Institute of Conservation* 30 (1): 89–104.
- Mairinger, F. 2004. “UV-, IR- and X-ray Imaging.” In *Non-destructive Microanalysis of Cultural Heritage Materials, Comprehensive Analytical Chemistry*, edited by K. Janssens and R. Van Grieken, vol. 42, 15–66. Amsterdam: Elsevier.
- Miyoshi, T., M. Ikeya, S. Kinoshita, and T. Kushida. 1982. “Laser-Induced Fluorescence of Oil Colours and Its Application to the Identification of Pigments in Oil Paintings.” *Japanese Journal of Applied Physics* 21: 1032–36.
- Nevin, A., D. Anglos, S. Cather, and A. Burnstock. 2008. “The Influence of Visible Light and Inorganic Pigments on Fluorescence Excitation Emission Spectra of Egg-, Casein- and Collagen-Based Painting Media.” *Applied Physics A* 92 (1): 69–76.
- Nevin, A., S. Cather, D. Anglos, and C. Fotakis. 2006. “Analysis of Protein-Based Binding Media Found in Paintings Using Laser Induced Fluorescence Spectroscopy.” *Analytica Chimica Acta* 573: 341–46.
- Nevin, A., D. Comelli, G. Valentini, D. Anglos, A. Burnstock, S. Cather, and R. Cubeddu. 2007. “Time-Resolved Fluorescence Spectroscopy and Imaging of Proteinaceous Binders Used in Paintings.” *Analytical and Bioanalytical Chemistry* 388 (8): 1897–1905.
- Nevin, A., D. Comelli, G. Valentini, and R. Cubeddu. 2009. “Total Synchronous Fluorescence Spectroscopy Combined with Multivariate Analysis: Method for the Classification of Selected Resins, Oils, and Protein-Based Media Used in Paintings.” *Analytical Chemistry* 81 (5): 1784–91.
- Nevin, A., G. Spoto, and D. Anglos. 2012. “Laser Spectroscopies for Elemental and Molecular Analysis in Art and Archaeology.” *Applied Physics A* 106 (2): 339–61.
- Preis, W., and H. Gamsjäger. 2002. “Solid-Solute Phase Equilibria in Aqueous Solution. XVI. Thermodynamic Properties of Malachite and Azurite—Predominance Diagrams for the System  $\text{Cu}^{2+} - \text{H}_2\text{O} - \text{CO}_2$ .” *Journal of Chemical Thermodynamics* 34 (5): 631–50.

- 
- Raimondi, V., G. Cecchi, D. Lognoli, D. Palombi, R. Gronlund, A. Johansson, S. Svanberg, K. Barup, and J. Hallstrom. 2009. "The Fluorescence Lidar Technique for the Remote Sensing of Photoautotrophic Biodeteriogens in the Outdoor Cultural Heritage: A Decade of In Situ Experiments." *International Biodeterioration & Biodegradation* 63: 823–35.
- Ricciardi, P., J. K. Delaney, L. Glinsman, M. Thoury, M. Facini, and E. R. de la Rie. 2009. "Use of Visible and Infrared Reflectance and Luminescence Imaging Spectroscopy to Study Illuminated Manuscripts: Pigment Identification and Visualization of Underdrawings." In *Proceedings of SPIE*, edited by L. Pezzati and R. Salimbeni, vol. 7391, article no. 739106. Bellingham, WA: International Society for Optical Engineering (SPIE).
- Romani, A., C. Clementi, C. Miliani, B. G. Brunetti, A. Sgamellotti, and G. Favaro. 2008. "Portable Equipment for Luminescence Lifetime Measurements on Surfaces." *Applied Spectroscopy* 62: 1395–99.
- Romani, A., C. Clementi, C. Miliani, and G. Favaro. 2010. "Fluorescence Spectroscopy: A Powerful Technique for the Noninvasive Characterization of Artwork." *Accounts in Chemical Research* 43: 837–46.
- Ross, J. B. A., W. R. Laws, K. W. Rousslang, and H. R. Wyssbrot. 1991. "Tyrosine Fluorescence and Phosphorescence in Proteins and Polypeptides." In *Topics in Fluorescence Spectroscopy – Biochemical Applications*, edited by J. R. Lackowitz, 1–53. London: Springer.
- Thoury, M., M. Elias, J. M. Frigerio, and C. Barthou. 2007. "Nondestructive Varnish Identification by Ultraviolet Fluorescence Spectroscopy." *Applied Spectroscopy* 61 (12): 1275–82.
- Verri, G. 2009. "The Spatially Resolved Characterisation of Egyptian Blue, Han Blue and Han Purple by Photo-Induced Luminescence Digital Imaging." *Analytical and Bioanalytical Chemistry* 394 (4): 1011–21.
- Verri, G., and J. Ambers. 2010. "Revealing Stratigraphy." In *Italian Renaissance Drawings*, edited by J. Ambers, C. Higgitt, and D. Saunders, 89–102. London: Archetype Books.
- Verri, G., C. Clementi, D. Comelli, S. Cather, and F. Piqué. 2008. "Correction of Ultraviolet-Induced Fluorescence Spectra for the Examination of Polychromy." *Applied Spectroscopy* 62 (12): 1295–1302.
- Verri, G., and D. Saunders. 2014. "Xenon Flash for Reflectance and Luminescence (Multispectral) Imaging in Cultural Heritage Applications." *The British Museum Technical Bulletin* 8: 83–92.

# Noninvasive, In Situ Identification of Binding Media Using Reflection Mid-FTIR

Costanza Miliani, Antonio Sgamellotti, Giovanni Verri, Paolo Benedetti, B. Giovanni Brunetti, Alessia Daveri, and Francesca Rosi

## Description of the Technique

The spectrophotometric system acquires molecular vibrational mid-FTIR (7000–900  $\text{cm}^{-1}$ ) spectra in reflection mode using chalcogenide fiber optics. This system can be considered noninvasive, as no contact between the probe and the surface of the object is strictly required. The input signal from the infrared (IR) source is directed toward the surface through the input fiber bundle, and, following reflection (both diffuse and specular, due to the particular  $0^\circ/0^\circ$  geometry of the system), the output signal is collected by an output fiber bundle and subsequently analyzed by the interferometric system. Both organic and inorganic molecules may be responsive to mid-IR radiation, according to the vibrational modes allowed by selection rules (Miliani et al. 2012).

The portable spectrophotometer (JASCO VIR 9500) is made of a Midac Illuminator IR radiation source (1350 °C), a Michelson interferometer, and a cryogenically cooled mercury cadmium telluride (MCT) detector. The system is equipped with a Remspec mid-IR fiber optic sampling probe. The fibers, made of chalcogenide glass (As, Se, Te, mixture for the core and an As, Se, S mixture for the cladding), have an excellent signal-to-noise ratio throughout the 7000–900  $\text{cm}^{-1}$  range, with the exception of the 2200–2050  $\text{cm}^{-1}$  region, due to the fiber Se-H stretching absorption. The Y-shaped probe consists of nineteen fibers, seven for the irradiation and twelve for the collection of the outgoing signal. During the measurement, the probe is kept perpendicular to the surface of the object ( $0^\circ/0^\circ$  geometry) at a distance of about 4–8 mm. The resolution and number of scans can be selected using dedicated software.

The first step is the acquisition of a background spectrum of a specularly reflective surface (highly polished stainless steel), carefully cleaned with acetone to prevent contamination. Background measurement registers the vibrations of the environmental  $\text{CO}_2$  and  $\text{H}_2\text{O}$  and the spectral signals of the instrumentation. Subsequently, reflection spectra of the unknown samples are automatically converted into reflectance by rationing with the background measurement. Output consists of an IR pseudo-absorbance spectrum  $A'$  ( $A' = \log(1/R)$ , where R is percentage reflectance) vs. wavenumber ( $\text{cm}^{-1}$ ).

As opposed to conventional transmission FTIR spectroscopy, the interpretation of fiber optic pseudo-absorbance spectra is fraught with difficulty, as fiber optic reflection spectra can exhibit significant differences from conventional transmission FTIR spectra (Miliani et al. 2012). Comparisons between reflection and transmission spectra are not always possible. Therefore, existing transmission FTIR databases of materials cannot always be used successfully.

In general terms, both surface reflection (mainly generating specular reflected light) and volume reflection (mainly responsible for the diffuse component of the light) are active when analyzing painted surfaces (Miliani et al. 2012; Miliani et al. 2010). This behavior may affect spectral features to an extent that depends not only on the optical properties of the materials but also on the roughness of the surface. Therefore, several types of distortions (e.g., derivative, *reststrahlen* effect and intensity enhancement) can coexist in the same spectrum, making the application of Kramers-Kronig and Kubelka-Munk corrections impossible (Miliani et al. 2012; Griffiths and De Haseth 2007). As a result, the interpretation of pseudo-absorbance FTIR spectra is far from straightforward.

In this paper, the infrared reflection results are presented by pigment type: silicate-, carbonate- or sulphate-based. Representative spectra of the combinations of different pigments, binders and application techniques (*fresco*, *stanco*, or *secco*) are illustrated.

## Results

### Influence of the Calcium Carbonate Support

The presence of lime-based plaster can hinder or distort the characteristic bands of organic compounds in those regions of the spectrum where the vibrational bands of calcium carbonate are active (White 1974). Figure 1 shows the reflection spectra of lime-based plaster and the conventional transmission spectra of linseed oil, egg, glue, and casein. The  $\nu_3(\text{CO}_3^{2-})$  asymmetric stretching appears as an inverted band at about  $1400\text{ cm}^{-1}$ . This effect, called *reststrahlen*, is caused by the strong infrared absorption of  $\text{CO}_3^{2-}$  (Chalmers, Everall, and Ellison 1996). The other bands are associated with the combination bands of the carbonate anion (Bottcher, Gehlken, and Steele 1997):

1.  $\nu_1 + \nu_4$  at  $1800\text{ cm}^{-1}$ ;
2.  $\nu_1 + \nu_3$  at  $2500\text{ cm}^{-1}$ ; and
3.  $2\nu_3$  at about  $2900\text{ cm}^{-1}$ .

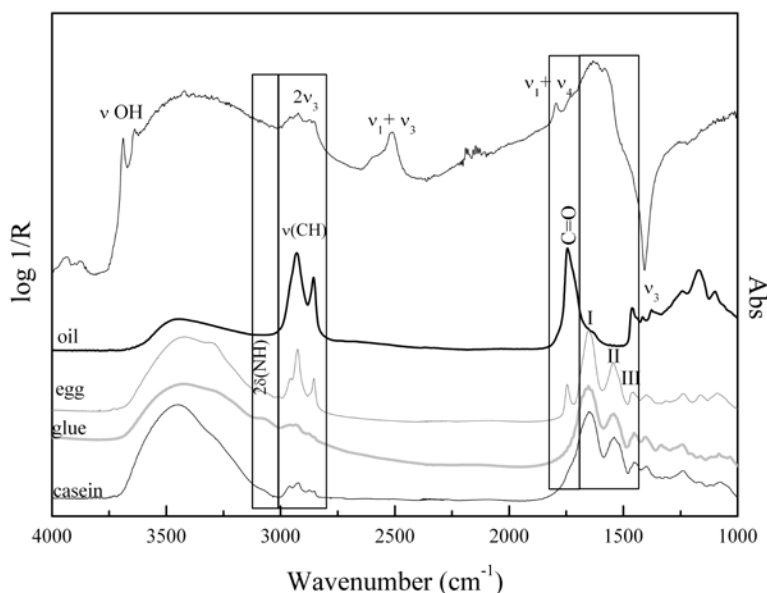
The doublet at  $3690$  and  $3640\text{ cm}^{-1}$  is related to the OH stretching of calcium dihydroxide in the plaster that is not completely carbonated into calcium carbonate with the interaction with  $\text{CO}_2$  in the air. The  $\nu_3$  *reststrahlen* band strongly distorts the spectral region between  $1750$  and  $1100\text{ cm}^{-1}$ , where the various carbonyl absorptions occur. In addition, its first overtone ( $2\nu_3$ ) may considerably affect the diagnostic region of C-H stretching modes.

Figure 1 shows transmission mid-FTIR spectra of pure protein characterized by the presence of the following:

1. Amide I (stretching C=O in the region of  $1700$ – $1600\text{ cm}^{-1}$ );
2. Amide II (C-N and N-H vibrations at about  $1550\text{ cm}^{-1}$ ); and
3. Amide III (C-H bending vibration near  $1450\text{ cm}^{-1}$ ).

**FIGURE 1**

Transmission infrared spectra of standard organic binders (linseed oil, egg, glue, casein) and reflection spectra of lime-based plaster. The boxes contain the spectral ranges of C-H, N-H, and C=O stretching modes. Labels I, II, and III indicate amide infrared vibrational modes.



The asymmetrical and symmetrical N-H stretchings occur near 3350 and 3180  $\text{cm}^{-1}$  respectively, and the first overtone of amide II at about 3090  $\text{cm}^{-1}$  (Derrick, Stulik, and Landry 1999).

The egg spectrum is characterized by spectral features belonging to proteinaceous (amide I, II, and III bands) and lipidic compounds. Lipids show vibrational bands due to ester groups: a strong, sharp carbonyl band at 1750–1730  $\text{cm}^{-1}$  and C-O bands at 1240, 1165, and 1103  $\text{cm}^{-1}$ . The lipids spectra are also characterized by strong absorption bands related to C-H stretching at about 2990  $\text{cm}^{-1}$  and weaker bands at 1464, 1379  $\text{cm}^{-1}$  assigned to C-H bending (see fig. 1). Pure oil was not present in any of Leonetto Tintori's replicas. Oil was mixed with egg, animal glue, and casein to create *tempera grassa*.

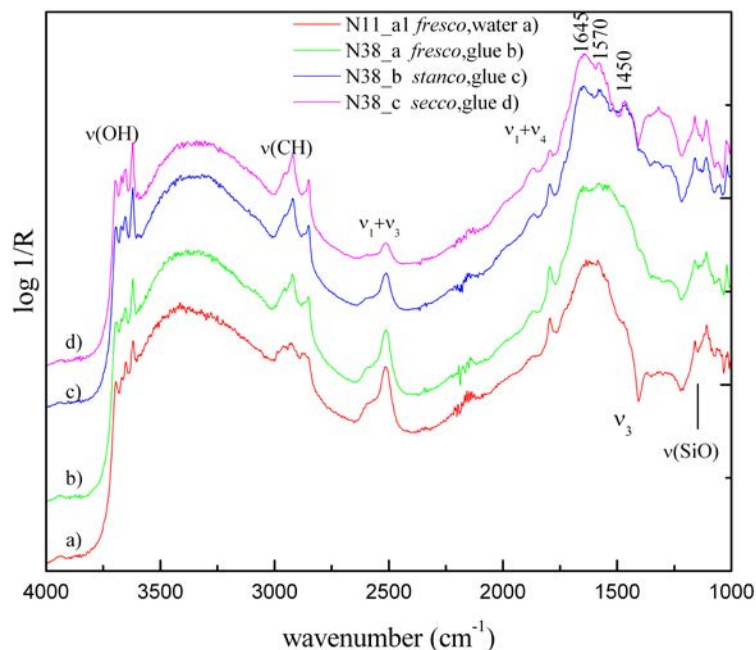
### The Influence of Silicate-, Carbonate- and Sulphate-Based Pigments on Binders

#### Silicate-based pigments and animal glue

Replicas painted with a combination of organic binders and pigments were analyzed to evaluate the influence of the latter on the spectral signature of the former. Figure 2 shows the FTIR spectra of a selection of sectors from tile N11 (see also fig. 6 in part 1) and tile N38 (see also fig. 8 in part 1), both showing red ocher applied with the aid of water or *a buon fresco* (N11\_a1) and with animal glue *a fresco* (N38\_a), *a stanco* (N38\_b), and *a secco* (N38\_c). Comparison between spectra allows the following considerations to be made:

**FIGURE 2**

Reflection mode FTIR spectra recorded on tile N38 and tile N11 (binder: animal glue; pigment: red ocher).



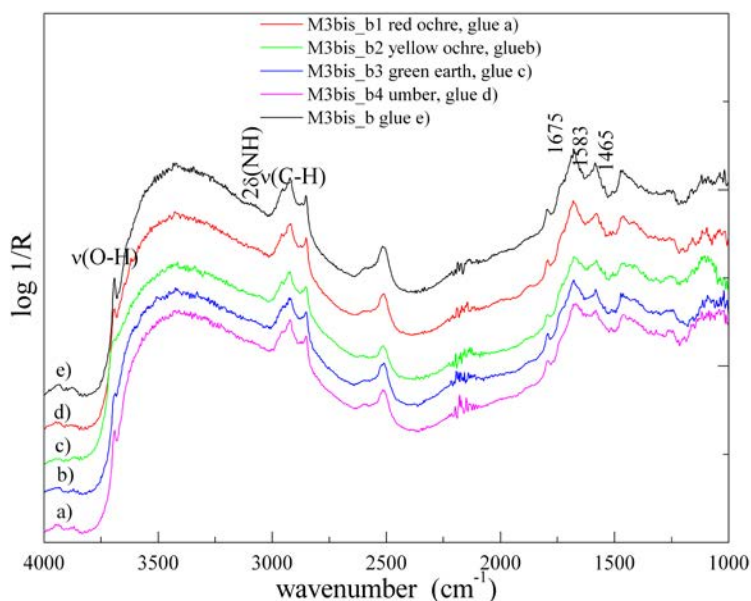
1. All spectra show features influenced by the combination bands of  $\text{CO}_3^{2-}$  at 1800, 2500, and 2900–3100  $\text{cm}^{-1}$ . The inverted  $\nu_3$  band is particularly strong in the sector painted without binder (N11\_a1) but less influential in all other sectors.
2. All spectra show features related to silicates: two peaks at 1037 and 1074  $\text{cm}^{-1}$ , assigned to the Si-O stretching of silicates within the red ocher; a peak at 3650  $\text{cm}^{-1}$ , related to kaolin, which is likely to have been added as a filler to hematite;
3. The peaks at 1465, 1580, 1645, and 2800–2900  $\text{cm}^{-1}$  can be associated with animal glue.

The intensity of these bands depends on the application phase. In the case of *fresco*, the N38\_a spectrum is similar to that of N11\_a1 without binder (water). By contrast, the spectra corresponding to *stanco* (N38\_b) and *secco* (N38\_c) increasingly show features corresponding to the presence of animal glue. The effect of the painting technique is evident in all tiles, independent of the type of binder or pigment present.

A possible explanation might involve the different physical properties of the sectors. For the *fresco* technique, the plaster, the pigment, and the binder are applied wet and therefore intimately bound to one another upon drying. As a consequence, the carbonate matrix strongly influences the spectral features of the binder by covering the weakest vibrational modes. Conversely, for the *stanco* and, overall, for the *secco* technique, the binder and pigment form a coherent layer separate from the set carbonate matrix. In this instance, the bands characteristic of the organic binder are less affected by those of the matrix. Decrease of the contribution due to the plaster substrate in the *stanco* and *secco* sectors is confirmed by the weakening of the plaster combination bands' intensity.

**FIGURE 3**

Reflection mode FTIR spectra recorded on tile M3bis (binder: animal glue and pigment).



The spectral features at 1465, 1583, and 1640–1645  $\text{cm}^{-1}$  can be assigned to amide III, II, and I of animal glue, respectively. Comparison between spectra collected on replicas N38 and N11 with those of the animal glue standard collected in transmission mode (see fig. 1) reveals a derivative-like shape of the amide I, II, and III broadened by the diffuse component of the light, thus appearing as maxima shifted by 15 and 30  $\text{cm}^{-1}$  with respect to the transmission bands for animal glue. In addition, the C-H stretchings of the animal glue standard are different from those observed on N38.

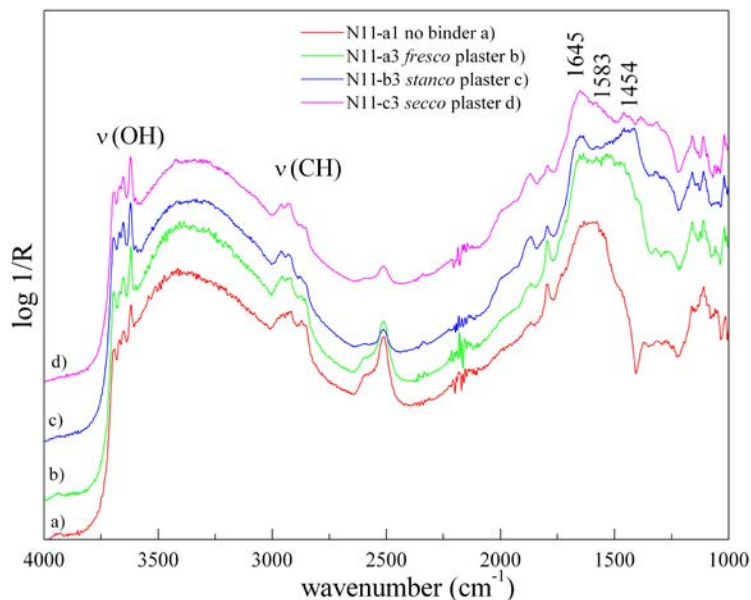
Further analysis of other replicas—M2bis (see also fig. 3 in part 1) and M3bis (see also fig. 4 in part 1)—painted with organic binders and silicate-based pigments (red, yellow and green earth, umber and smalt) provides additional clues for interpretation of the reflection mode spectra expressed in pseudo-absorbance units. In general terms, comparison between spectra collected on the sectors painted with glue (with and without pigment) shows that silicate-based pigments do not strongly modify the absorption bands characteristic of organic binders (fig. 3). The vibrational modes of the silicate components of the pigment are observed only in the case of smalt at 1069  $\text{cm}^{-1}$ . The multiplet at high wavenumbers, typical of kaolin, is absent from all spectra from tile M2bis and tile M3bis, indicating that in this case the white silicate was not used as a filler. The peaks at 3692  $\text{cm}^{-1}$  can be assigned to slaked lime,  $\text{Ca}(\text{OH})_2$ , not yet converted into calcium carbonate. The bands corresponding to organic binder are clear in all the samples with the exception of those painted with smalt, where the amide peaks are less intense and amide I is here placed at 1681  $\text{cm}^{-1}$ .

#### Silicate-based pigments and casein

An equivalent study was carried out on analogous replicas painted with casein and silicate-based pigments. The considerations resulting from the analysis of the sectors painted with animal glue can be extended to those painted with casein. Figure 4

**FIGURE 4**

Reflection mode FTIR spectra recorded on tile N11 (binder: casein; pigment: red ochre).



shows the spectra of tile N11; as observed in the case of animal glue, amide II and III have a derivative-like shape, while amide I is overlapping with the carbonate stretching and appears at  $1650\text{ cm}^{-1}$ , as in the casein reference standard (see fig. 1).

#### Silicate-based pigments and egg tempera

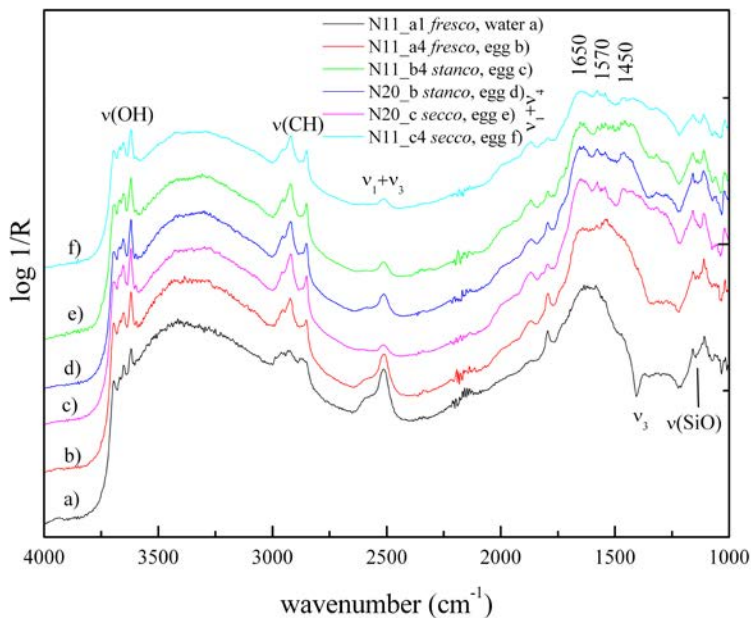
Figure 5 shows the FTIR spectra of a selection of sectors from tile N11 (see also fig. 6 in part 1) and tile N20 (see also fig. 8 in part 1). Both tiles show red ochre applied with the aid of water on fresh plaster or *a buon fresco* (N11\_a1), with egg on fresh plaster (N11\_a4), egg on *stanco*, (N11\_b4 and N20\_b), and egg on *secco* (N11\_c4 and N20\_c). Comparison between spectra allows the following considerations:

1. At low wavenumbers, the Si-O stretching of silicates contained in the pigment is less evident with respect to the corresponding spectra of the proteinaceous binding media previously discussed. Conversely, at high wavenumbers the OH stretching of kaolin is well observed;
2. The ester carbonyl group at about  $1740\text{ cm}^{-1}$ , characteristic of the lipidic component of egg, is not visible. This might be due to the strong influence of the carbonate band of the plaster substrate;
3. Amide I, II, and III at  $1653$ ,  $1577$ , and  $1460\text{ cm}^{-1}$ , respectively, characteristic of proteinaceous component of egg, are visible; and
4. CH stretchings of egg are clearly visible in the  $2800\text{--}3000\text{ cm}^{-1}$  range.



**FIGURE 5**

Reflection mode FTIR spectra recorded on tile N11 and tile N20 (binder: egg tempera; pigment: red ocher).



#### Silicate-based pigments and *tempera grassa*

The effect of the addition of a lipid to a proteinaceous binder—to create a *tempera grassa*—was studied using tile AC1 and tile AC2 (see also fig. 1 in part 1). These replicas are painted with yellow earth and green earth, respectively. Each tile is composed of eight sectors where the pigments were applied in egg, glue, and casein pure or in the form of *tempera grassa*, obtained by mixing the binders with walnut oil. Figure 6 shows the spectra of yellow and green ocher applied with pure animal glue and egg, with the addition of oil.

**FIGURE 6**

Reflection mode FTIR spectra collected on tile AC1 and tile AC2 (pigment: yellow earth and green earth, respectively).

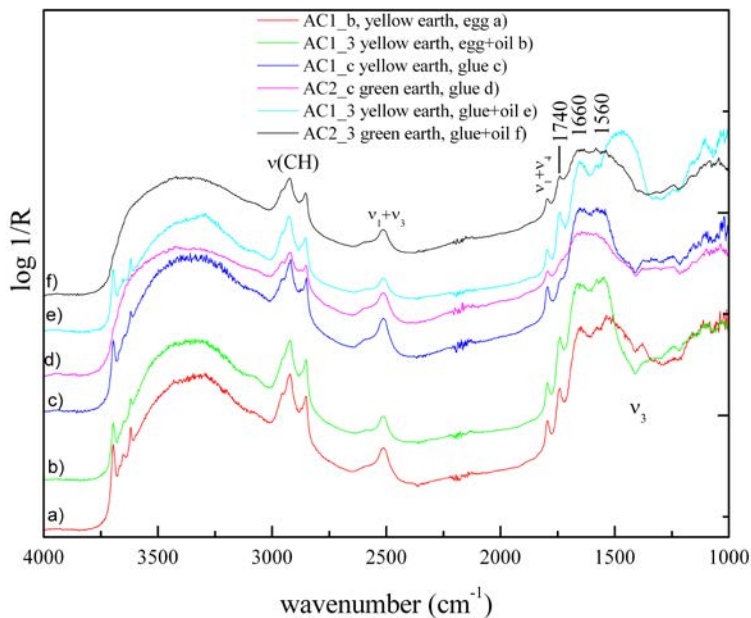
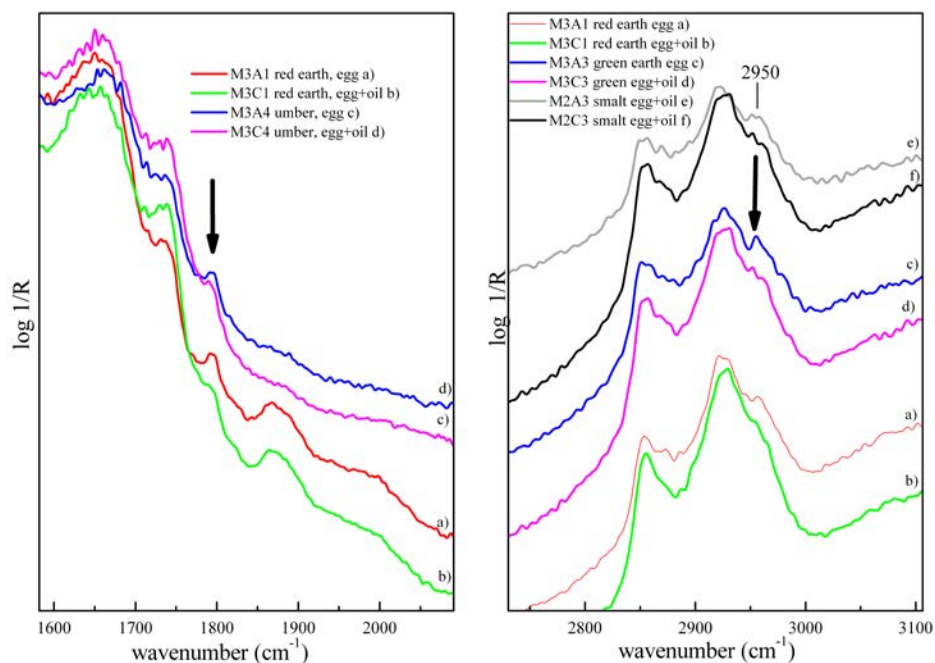


FIGURE 7

Reflection mode FTIR spectra collected for tile m3bis and tile m2bis: spectral differences between *tempera* and *tempera grassa*.



It is possible to distinguish the presence of *tempera grassa* (as opposed to a pure proteinaceous *tempera*) by the absorption at 1734–1740  $\text{cm}^{-1}$  due to the lipidic component. In addition, the CH stretchings are stronger in the presence of lipids. As observed above, the influence of the calcium carbonate substrate is very strong for the sectors where paint was applied *a fresco*, making amide I the only proteinaceous mode observed in all spectra containing a protein.

Because both pure egg and *tempera grassa* contain lipids, the distinction between them is not straightforward. However, when a consistent amount of lipids is present, such as for the sectors shown in figure 7, the carbonyl stretching of esters at 1740  $\text{cm}^{-1}$  is stronger. Moreover, in the presence of oil, the combination band of carbonate at 1800  $\text{cm}^{-1}$  decreases, probably due to the *tempera grassa* forming a thick film over the matrix and weakening the spectral contribution of the plaster substrate. In addition, when *tempera grassa* is present, the CH stretching at 2950  $\text{cm}^{-1}$  tends to be weaker (fig. 7). Finally, independent of the used pigment, the proteinaceous bands due to amide I (1660  $\text{cm}^{-1}$ ) and II are observable.

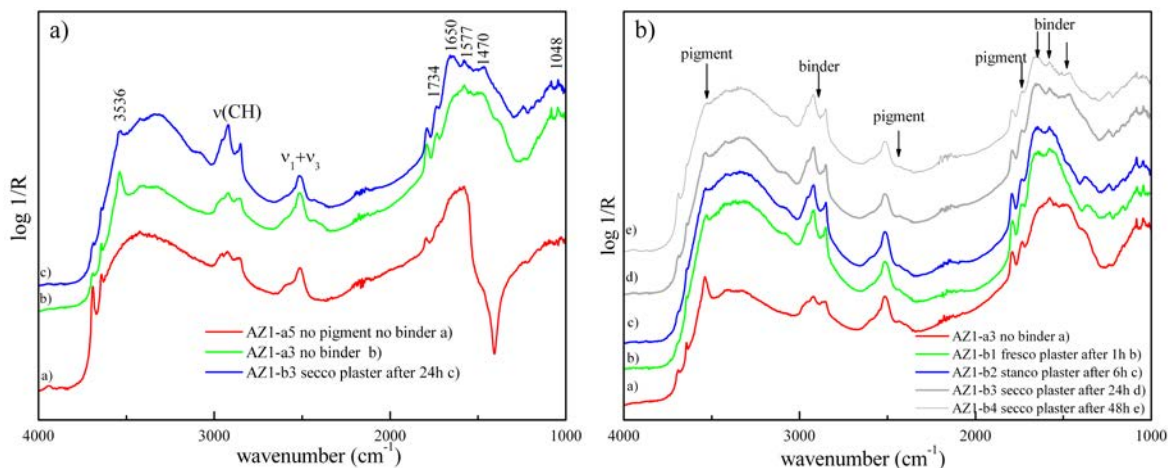
#### Carbonate-based pigments and organic binders

The observations made for the calcium carbonate substrate can be extended to the case of carbonate-based pigments—such as azurite, malachite, and lead white—all showing  $\text{CO}_3^{2-}$  vibrational modes similar to those of lime-based plaster. In most instances, the presence of carbonate-based compounds can make identification of organic binders difficult because, as mentioned above, the carbonate anion shows strong vibrational modes in the fingerprint region of the binder.

Tile AZ1bis (see also fig. 2 in part 1) is composed of a combination of carbonate-based pigments mixed in different application phases with animal glue and *tempera grassa*. Comparison between spectra of the plaster layer (AZ1bis\_a5)

FIGURES 8A, 8B

Reflection mode FTIR spectra of tile AZ1bis (binder: animal glue; pigment: miscellaneous carbonate pigments).



and of the pigments applied on *secco* plaster (AZ1bis\_a3) with no binder (only water was used to apply the pigments) in figure 8a reveals bands related to lead white: a sharp band at 1048,  $\text{cm}^{-1}$  ( $\nu_1$  stretching), a strong and distorted band ( $\text{CO}_3^{2-}$  asymmetric stretching) in the region 1500–1300  $\text{cm}^{-1}$ , and a sharp peak at 3536  $\text{cm}^{-1}$  (OH stretching). In addition, the reflection optical layout increases the carbonate combination bands at 1735  $\text{cm}^{-1}$  ( $\nu_1 + \nu_4$ ) and at 2400–2500  $\text{cm}^{-1}$  ( $\nu_1 + \nu_3$ ) (Miliani et al. 2012).

Comparison between the spectra of AZ1bis\_a3 and AZ1bis\_b3 (animal glue applied *a secco*) reveals the following:

1. CH stretching at 3000–2800  $\text{cm}^{-1}$  can be attributed to the organic binder; and
2. Amide I, II, and III at 1650, 1577, and 1470  $\text{cm}^{-1}$ , respectively, can be attributed to the binder even if they are partially hidden by the matrix effect due to the carbonate pigments and the plaster layer.

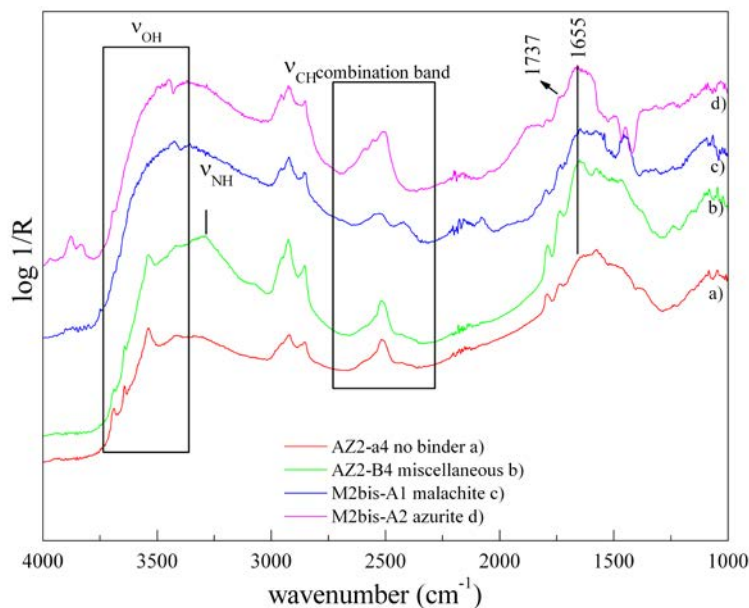
The spectra collected on sectors treated with animal glue with different carbonation phases (fig. 8b) show clearly how the painting technique influences the spectral features. As noted for N11 and N38, the contribution of the organic binder to the spectrum increases (amide I and C-H stretching) from *fresco* to *secco*, while at the same time the vibrational bands due to the pigment and matrix decrease (combination bands and OH stretching of lead white). Similar conclusions can be drawn for replicas painted with carbonate-based pigments and casein.

The replica studied for the evaluation of egg tempera applied with carbonate pigments is AZ2bis (see also fig. 2 in part 1). It has the same structure of AZ1bis but was painted using egg as a binder. The sectors characterized by a combination of carbonate-based pigments (azurite, malachite, lead white, and calcium carbonate) applied with egg in different phases are compared with those on M2bis, which contain pure malachite and azurite applied *a secco* with egg.

All spectra collected for various carbonate-based pigments show strong contributions of the  $\text{CO}_3^{2-}$  anion (fig. 9). The OH stretching absorptions of lead white (3544  $\text{cm}^{-1}$ ), malachite (3314 and 3407  $\text{cm}^{-1}$ ), and azurite (3420  $\text{cm}^{-1}$ ) are located at high wavenumbers. Carbonate combination bands are visible in the 2300–2660  $\text{cm}^{-1}$  range, 2423 and 2542  $\text{cm}^{-1}$  for malachite, 2410 and 2507  $\text{cm}^{-1}$  for lead white,

**FIGURE 9**

Reflection mode FTIR spectra collected on tile AZ2bis and tile M2bis (binder: egg tempera; pigment: carbonate pigments).



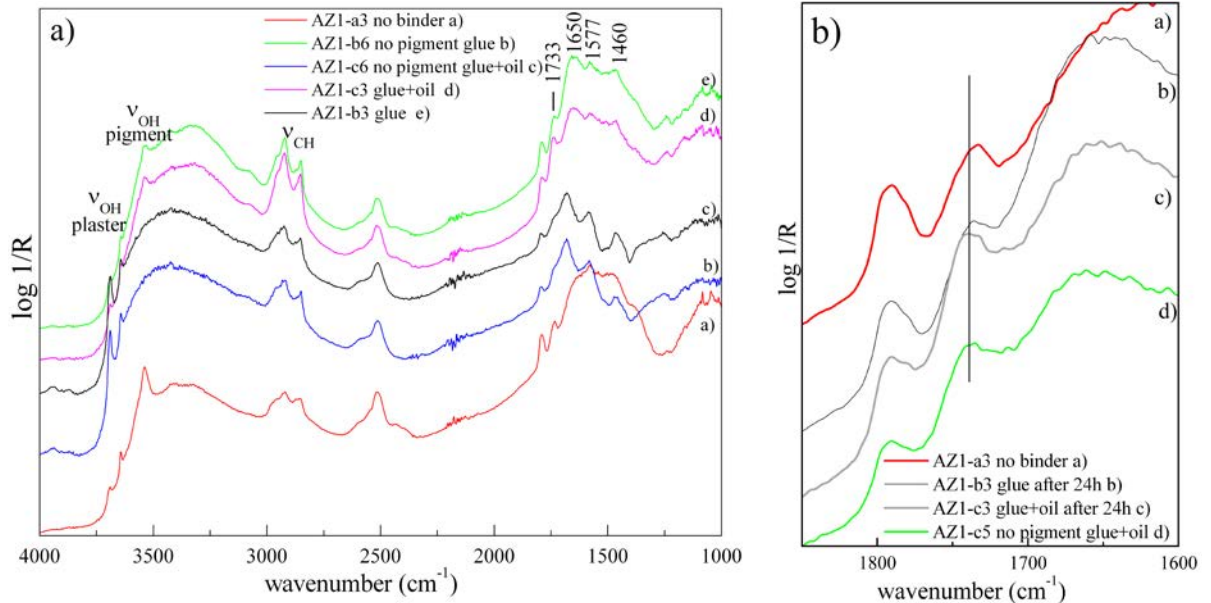
2553 and 2587  $\text{cm}^{-1}$  for azurite, and 2500  $\text{cm}^{-1}$  for calcium carbonate. Both the asymmetric stretching of carbonate anions (at about 1400  $\text{cm}^{-1}$ ) and the  $\nu_1 + \nu_4$  combination bands occur in the fingerprint region. The larger amount of lead white with respect to the other pigments in tile AZ2bis is proved by the intensity of the  $\nu_1 + \nu_4$  band (1735  $\text{cm}^{-1}$ ) of lead carbonate (see fig. 9).

The strongest contribution of carbonate-based pigments is the intense, distorted asymmetric stretching of the carbonate anion, making identification of amide II and III difficult. Amide I can be distinguished in the presence of lead white, but it is less evident when azurite and malachite are used in the paint mixture. The NH stretching at high wavenumbers is recognizable in the presence of lead white. In the case of malachite and azurite, the peak at about 1740  $\text{cm}^{-1}$  could be used for the identification of the lipidic component of egg. By contrast, in the presence of lead white, the combination band  $\nu_1 + \nu_4$  around 1735  $\text{cm}^{-1}$  makes identification of lipidic components more difficult.

The influence of carbonate-based pigments on *tempera grassa* (animal glue and egg) was also investigated using replica AZ1bis. As shown in figure 10a, the spectra obtained on sectors painted with *tempera grassa* are compared with those containing animal glue only. The presence of carbonate-based pigments, mainly lead white, covers the amide II band at 1577  $\text{cm}^{-1}$ , while the amide I peak shows a derivative-like peak whose maximum appears at 1680  $\text{cm}^{-1}$  in the sectors without pigment. Identification of the lipidic component is made difficult by the presence of lead white, which shows a  $\nu_1 + \nu_4$  combination band at 1735  $\text{cm}^{-1}$  (fig. 10b) coinciding with the carbonyl ester absorption. However, a close comparison between the spectra of lead white with and without a lipidic binder shows a different band shape and position (fig. 10b).

**FIGURES 10A, 10B**

Reflection mode FTIR spectra collected on tile AZ1bis (pigment: lead white, calcium carbonate, malachite, azurite). The detail in fig. 10b shows the effect of  $\nu_1 + \nu_4$  combination band of lead white on ester carbonyl identification.

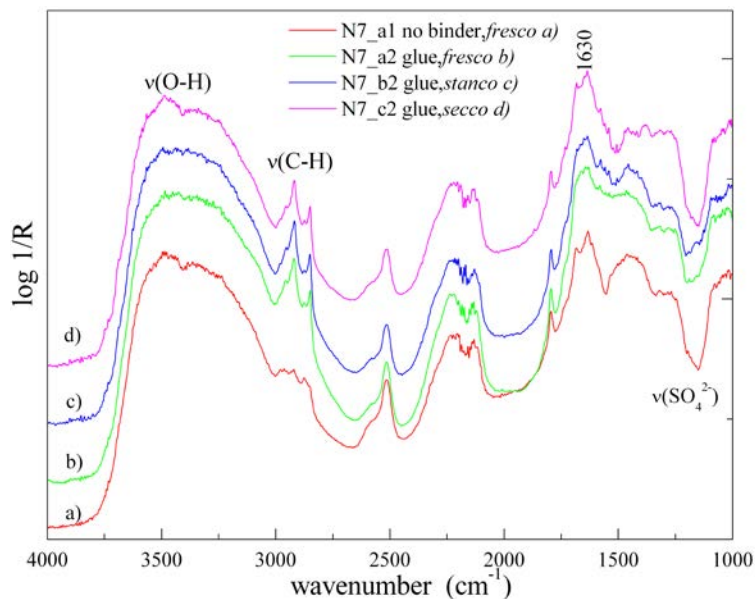


#### Sulfate-based pigments and organic binders

Tile N7 and tile N11 (see also fig. 6 in part 1) are characterized by a silicate pigment containing gypsum ( $\text{CaSO}_4 \cdot 2\text{H}_2\text{O}$ ) as filler. These replicas are considered here in terms of the effect of the presence of sulfates on binder identification. In figure 11, the band at 1146 cm⁻¹, coupled with the peaks at 1632 and at about 3400 cm⁻¹, can be

**FIGURE 11**

Reflection mode FTIR spectra collected on tile N7 (binder: animal glue; pigment: yellow ochre containing gypsum).



related to gypsum mixed with silicates in the yellow pigment (Rosi et al. 2010). The most intense absorption of gypsum (asymmetric stretching at  $1146\text{ cm}^{-1}$ ) is positioned in a spectral region free from binder signals. However, the OH bending and stretching ( $1632$  and  $3400\text{ cm}^{-1}$ ) of gypsum mask the proteinaceous amide I and N-H stretching, respectively. Strong CH absorption in the  $2900\text{--}2800\text{ cm}^{-1}$  range can be attributed to the presence of an organic material. However, it is obviously not possible to identify the nature of the organic binder from this single spectral feature.

## Level of Identification

By using reflection mid-FTIR spectroscopy, it is possible to assess the presence of an organic binder (level 1) and to determine whether the binder is a protein or a lipid (level 2). The spectral features used as criteria for level 1 and level 2 are as follows:

### Level 1

- Organic material present:  $\nu$  (CH) are visible.
- No organic material present:  $\nu$  (CH) are not visible.

### Level 2 proteins

- Proteins present:  $2\delta$  (NH) is visible or amide I and amide II are visible.
- Possible protein: amide I is visible.
- Proteins absent: amide I, amide II, and  $2\delta$  (NH) are not visible.

If gypsum is present, the following is valid:

- Protein present:  $2\delta$  (NH) is visible.
- Possible protein: amide II is visible.
- Proteins absent:  $2\delta$  (NH) and amide II are not visible.

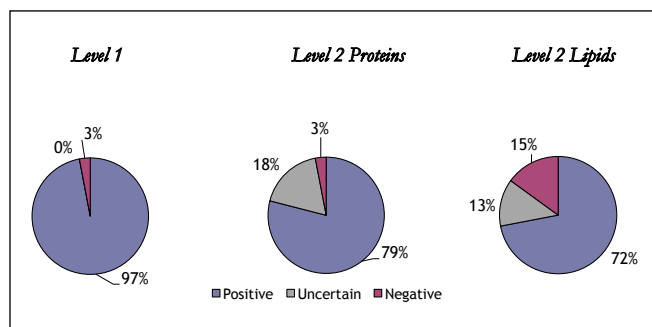
Finally, the following is valid for lipids:

- Lipids present:  $\nu$  C=O is resolved.
- Possible lipids:  $\nu$  (CH) are sharp and strong.
- Lipids absent:  $\nu$  (CH) are not sharp and strong and  $\nu$  C=O is not resolved.

Figure 12 shows the results obtained after evaluating 160 sectors as blind tests and using the above-mentioned criteria. Level 1 is reached with good confidence (97% of positive results). The reliability of reflection mid-FTIR with respect to Level 2 provides positive results for the identification of binding media with a percentage of 79 and 72 for proteins and lipids, respectively.

**FIGURE 12**

Charts representing the correlation factors for each level of information obtained.

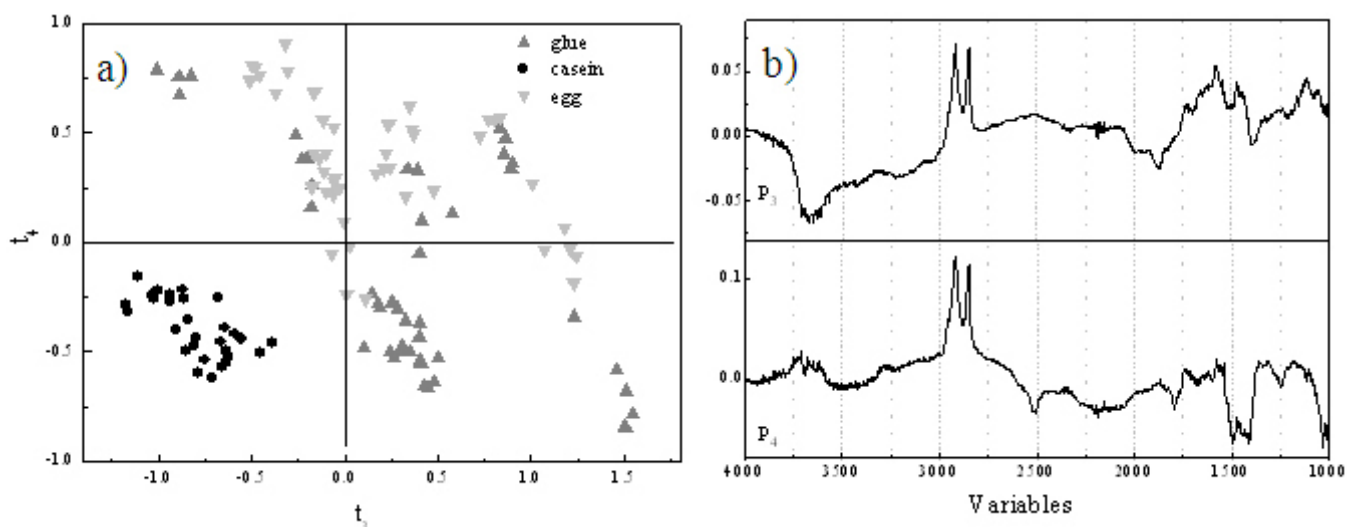


## Chemometry

In an attempt to differentiate between proteinaceous binding media, principal component analysis (PCA) was applied to spectra recorded from replicas painted with a silicate-based pigment: N11, N20, and N38 (egg, casein, and glue *a fresco*, *a stanco*, and *a secco*) (Rosi et al. 2009). Each spectrum was baseline corrected on the last 100 variable and divided by average value calculated on

**FIGURES 13A, 13B**

PCA scores and loadings plot on data set composed of 120 spectra collected on 15 sectors of replicas N11, N20, and N38 for a total of 11 different combinations. Fig. 13a:  $t_3$  vs.  $t_4$ , Fig. 13b:  $p_3$  and  $p_4$  profiles (explained variance %: PC3=8.7; PC4=4.1).



all spectra (Rosi et al. 2009) using GOLPE (Generating Optimal Linear PLS Estimations) (Baroni et al. 1993).

In the score plot  $t_3$  vs.  $t_4$  (fig. 13a), casein (bottom left) is separated from egg and glue, considering the third and fourth principal components that in fact contain the spectroscopic information of the organic binder as underlined in figure 13b, where the loading plot profiles are reported. Casein shows different and weaker CH stretching modes with respect to the other binders (see figs. 2–4) (Miliani et al. 2007). By contrast, glue and egg cannot be separated. As noted in figure 5, the vibrations relative to the lipidic components are not always visible.

## Conclusions

The spectral results suggest the effectiveness of fiber optic reflection mid-FTIR spectroscopy for the detection and identification of organic binders. The study of a large number of painted sectors from Tintori's replicas indicates a strong interaction between carbonate substrate, pigments, and binders used as paint. This interaction, which may make the identification of the binder difficult, is generally stronger for *fresco* replicas, where the contribution of the matrix is more evident. The following was observed:

1. Silicate-based pigments show absorption features far from those of organic binders and therefore do not interfere strongly in their identification;
2. Sulfate-containing pigments show absorption bands in close correspondence to those of the organic binders, making identification difficult; and
3. Carbonate-containing pigments show absorption features in the proximity of those of organic binders and may therefore interfere with identification.

The technique can distinguish between proteinaceous and lipidic binders. In addition, some slight differences are also observable among different proteinaceous binders, such as casein and animal glue.

Costanza Miliani is a faculty member of CNR-ISTM, Istituto di Scienze e Tecnologie Molecolari, Perugia, Italy. Antonio Sgamellotti is a full professor at CNR-ISTM. Giovanni Verri is a lecturer at the Courtauld Institute of Art, London. Paolo Benedetti is a consultant with Multivariate Infometric Analysis (MIA), Perugia, and with the Department of Chemistry at the University of Perugia. B. Giovanni Brunetti is professor of general and inorganic chemistry, Centro d' Eccellenza SMAArt (Scientific Methodologies applied to Archaeology and Art), University of Perugia. Alessia Daveri is affiliated with the Laboratorio di Diagnostica per i Beni Culturali di Spoleto. Francesca Rosi is a department member of CNR-ISTM.

## References

- Baroni, M., G. Costantino, G. Cruciani, D. Riganeli, R. Valigi, and S. Clementi. 1993. "Generating Optimal Linear PLS Estimations (GOLPE): An Advanced Chemometric Tool for Handling 3D-QSAR Problems." *Quantitative Structure-Activity Relationships* 12: 9–20.
- Bottcher, M. E., P. L. Gehlken, and D. F. Steele. 1997. "Characterization of Inorganic and Biogenic Magnesian Calcites by Fourier Transform Infrared Spectroscopy." *Solid State Ionics* 101: 1379–85.
- Chalmers, J. M., N. J. Everall, and S. Ellison. 1996. "Specular Reflectance: A Convenient Tool for Polymer Characterization by FTIR-Microscopy," *Micron* 27: 315–28.
- Derrick, M., D. Stulik, and J. M. Landry. 1999. *Infrared Spectroscopy in Conservation Science*. Los Angeles: The Getty Conservation Institute.
- Griffiths, P., and J. A. De Haseth. 2007. *Fourier Transform Infrared Spectrometry*. 2nd ed. New York: Wiley.
- Miliani C., F. Rosi, I. Borgia, P. Benedetti, B. G. Brunetti, and A. Sgamellotti. 2007. "Fiber-Optic Fourier Transform Mid-Infrared Reflectance Spectroscopy: A Suitable Technique for *In Situ* Studies of Mural Paintings." *Applied Spectroscopy* 61 (3): 293–99.
- Miliani, C., F. Rosi, B. G. Brunetti, and A. Sgamellotti. 2010. "In Situ Non-invasive Study of Artworks: The MOLAB Multi-technique Approach." *Account of Chemical Research* 43: 728.
- Miliani, C., F. Rosi, A. Daveri, and B. G. Brunetti. 2012. "Reflection Infrared Spectroscopy for the Non-invasive In Situ Study of Artists' Pigments." *Applied Physics A, Materials Science & Processing* 106: 295–307.
- Rosi, F., A. Daveri, B. Doherty, S. Nazzareni, B. G. Brunetti, A. Sgamellotti, and C. Miliani. 2010. "On the Use of Overtone and Combination Bands for the Analysis of the CaSO<sub>4</sub>-H<sub>2</sub>O System by Mid-Infrared Reflection Spectroscopy." *Applied Spectroscopy* 64: 956.
- Rosi, F., A. Daveri, C. Miliani, G. Verri, P. Benedetti, F. Piqué, B. G. Brunetti, and A. Sgamellotti. 2009. "Non-invasive Identification of Organic Materials in Wall Paintings by Fiber Optic Reflectance Infrared Spectroscopy: A Statistical Multivariate Approach." *Analytical and Bioanalytical Chemistry* 395: 2097.
- White, W. B. 1974. "The Carbonate Minerals." In *The Infrared Spectra of Minerals*, edited by V. C. Farmer, 227–84. Mineralogical Society Monograph 4. London: Mineralogical Society.



# FTIR in Reflectance and Attenuated Total Reflectance for the Analysis of Stratigraphic Cross Sections of Wall Painting Samples

Austin Nevin and Charlotte Martin de Fonjaudran

## INTRODUCTION

The sampling of wall paintings and the preparation of cross sections are fundamental for technical analysis. Light microscopy (under visible and UV light) and scanning electron microscopy are widely applied to the analysis of cross sections; more recently, nondestructive Fourier Transform Infrared Spectroscopy microscopy (micro-FTIR) has been introduced for the stratigraphic analysis of organic and inorganic materials in samples. Advances and developments in micro-FTIR have been evaluated for the analysis of various samples of cultural heritage, including wall painting cross sections (Martin de Fonjaudran et al. 2008).

This article focuses on the application of micro-FTIR as a routine method for the analysis of samples from works of art (Derrick, Stulik, and Landry 1999; Casadio and Toniolo 2001). While intrinsic limitations of the technique include a low sensitivity to materials in trace concentrations, as well as complexity in the spectral discrimination of mixtures, FTIR remains one of the most powerful, affordable, and commonly used methods for analysis. Within the context of this project, FTIR analysis has also been applied in reflectance (Rosi et al. 2009; Miliani, this volume) and for the analysis of extracts and microsamples.

Micro-FTIR spectroscopy is suitable for the analysis of microscopic samples, including stratified paint samples from medium-rich easel paintings (Gore 2003; Pilc and White 1995; Lanterna and Nepoti 1996). Following the project and the research carried out in 2003–5, the method has been extended to Attenuated Total Reflectance (ATR) mapping (Mazzeo et al. 2007; Spring et al. 2008). Infrared spectroscopic imaging (van der Weerd et al. 2003) has been employed for the analysis of organic and inorganic materials (van der Weerd, Heeren, and Boon 2004). In addition, the application of FTIR in reflectance to the analysis of wall paintings (Rosi et al. 2009) has demonstrated the potential of uncorrected reflectance spectroscopy for the assessment of the presence of organic materials in wall paintings. Another noteworthy application includes the coupling of micro-FTIR with Synchrotron radiation in the analysis of oil-based wall painting fragments from Bamiyan in Afghanistan (Cotte et al. 2008).

## DESCRIPTION OF THE TECHNIQUE

Micro-FTIR reflectance spectroscopy records molecular vibrations (4000–650  $\text{cm}^{-1}$ ) of a sample using a spectrometer, microscope, and a Cassegrain IR objective. No contact between the objective and sample is required, but reflectance spectra often exhibit distortions due to diffuse reflectance and scattering effects (Rosi et al. 2009). In micro-ATR, a crystal of different physical and chemical properties rang-

ing from diamond to ZnSe that is transparent to infrared radiation is brought into contact with the sample surface. An IR beam, reflected within the crystal, probes the sample at the sample–crystal interface. FTIR spectra recorded in ATR are similar to those recorded in transmission, with slight linear distortions due to the wavelength dependence of the penetration of IR radiation into the sample, which is on the order of less than 10 micrometers. Reflectance micro-FTIR spectroscopy can be used for the investigation of any surface under the microscope, but the technique is limited by sample reflectivity. Within the context of the analysis of cross sections, micro-FTIR allows the measurement of selected areas of an embedded fragment (pigment particles, paint layers, etc.).

Although micro-FTIR spectroscopy, operating in reflectance and ATR, is a method for nondestructive analysis of complex, necessarily small samples, significant challenges are associated with instrumental optimization, sample preparation, and spectral interpretation.

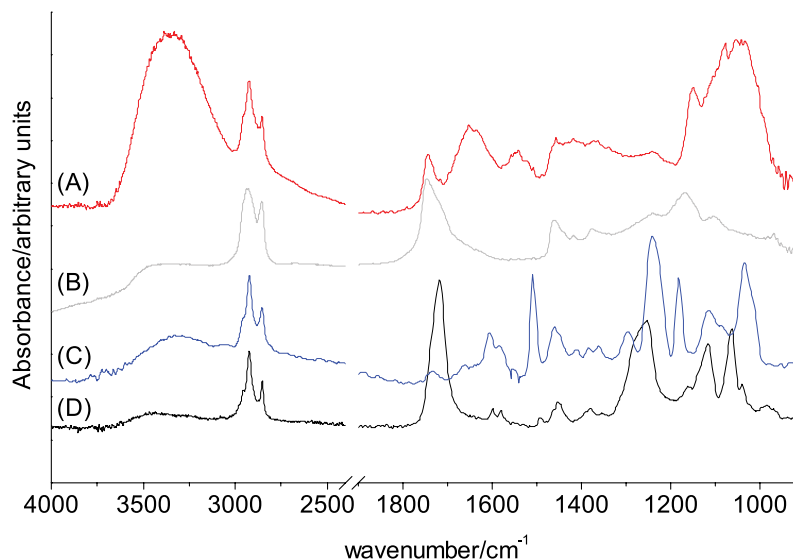
## SAMPLE PREPARATION

Preparation of cross sections remains a major issue for molecular analysis. Various novel methods have been proposed, often based on the use of isolation layers that protect porous samples from infiltration. Perhaps the most important aspect of the analysis of samples in FTIR is contamination by embedding materials, a problem recognized for the analysis of sections of easel paintings and analogous samples (van der Weerd et al. 2004; Derrick et al. 1994) and for the application of ATR to the analysis of cross sections from samples of wall paintings (Nevin 2005). Since this work was completed, other major developments have been published in the preparation of cross sections and thin sections for FTIR analysis (see, for example, Pouyet et al. 2014; Papliaka et al. 2015). Interpretation of FTIR spectra acquired on cross sections of wall paintings prepared with traditional methods is complicated by the presence of embedding materials. The absorption bands of synthetic polymers occur in the same frequency range as those of organic media commonly encountered as glue, egg, and oil binders in paint or plaster layers (fig. 1).

Careful polishing of samples characterized by their low porosity using an appropriate sample holder and an aqueous dispersion of alumina nanograins has been shown to overcome the smearing and contamination of the sample with embedding resins, greatly improving results of FTIR imaging (Wyplosz et al. 2000). However, complete infiltration of porous and leanly bound wall painting samples results in the penetration of synthetic resins into and throughout the sample, and no polishing or cutting procedures will yield a resin-free surface.

Alternative sample preparation procedures have been developed in an effort to overcome infiltration of embedding resins. The use of various barrier coatings has been tested and some procedures proven satisfactory (Derrick et al. 1994). Preventing infiltration of embedding resins, however, results in loss of original materials during polishing or microtoming of decohesive wall painting samples. IR-transparent materials such as potassium bromide or silver chloride have been used in the past for FTIR bulk analysis in transmission. More recently, layers of compressed potassium bromide salts have been proposed to sandwich a paint sample, which is subsequently polished to produce thin sections and cross sections (van der Weerd et al. 2004; Mazzeo et al. 2007), for stratigraphic FTIR without interference from any embedding material. As with barrier coatings, the absence of an infiltrating and consolidating medium may result in undesirable alterations and loss

**Figure 1.** FTIR spectra for the analysis of embedding media compared with binding media (A) egg yolk and linseed oil (lipid and protein), (B) linseed oil (lipid), (C) epoxy embedding medium, and (D) polyester embedding medium.



of the layered structure. Samples squeezed onto a diamond cell may retain their layer structure despite morphological alterations. Ion cutting offers an elegant alternative, but the availability of this technique precludes access for routine analysis (Boon and Asahina 2006).

This work focuses on the assessment of micro-FTIR for the analysis of cross sections prepared from samples of replicas from the Organic Materials in Wall Paintings project. Cross sections and thin sections were prepared using different methods. Analysis was carried out using micro-FTIR operating in reflectance, transmittance, and ATR and is reported below.

### Materials and Methods

Cross sections were prepared from small fragments, and two cold-mounting embedding media were used (Khandekar 2003). A polyester resin (Mecaprex SS<sup>®</sup>) and an epoxy resin (Epofix<sup>™</sup>) were employed to prepare duplicate cross sections. The polyester resin forms a softer, more transparent cross section, while the epoxy yields harder and slightly yellow cross sections and has a tendency to trap air bubbles.

Cross sections were then polished, yielding smear-free surfaces, with particular attention devoted to creating flat surfaces to optimize the positioning of the ATR crystal and avoid sample movement during analysis. Samples were manually dry-polished using Micro-mesh<sup>™</sup> cloths ranging from 1000 to 12000 mesh.

### Alternative Method for Preparation of Thin Sections

Cross sections of samples were prepared following an alternative procedure, described in detail in Martin de Fonjaudran et al. (2008).

Prior to embedding and microtoming, porous fragments were consolidated with a saturated solution of cyclododecane in toluene (80% w:v). This preliminary step ensures that porous samples will remain cohesive during microtoming. The samples were then thinly coated with melted cyclododecane to ensure complete encap-

sulation and prevent resin infiltration. A light-cured acrylic resin (Technovit LC2000®) and a custom-made mold were used to produce resin blocks adapted to the working distance of the IR microscope and the shape required for efficient microtoming. After curing by exposure to blue light (440 nm), the bullet-shaped resin block was microtomed to reveal a cross section of the sample. Three slices 10–20  $\mu\text{m}$  thick from the top of the cross section were sacrificed to ensure removal of the cyclododecane surface coating. After 24 hours at room temperature, complete sublimation of the cyclododecane coating occurred, sometimes leaving a thin gap around the resin-free sample.

### Micro-FTIR Spectroscopy

Two micro-FTIR instruments were employed during analysis. One was a JASCO FTIR 470-plus spectrophotometer equipped with a nitrogen-cooled MCT detector and an IRT-30 optical microscope using the 16x Cassegrain objective for observation of the sample, reflectance measurements, and a ZnSe ATR objective for surface analysis. Another was a Nicolet 560 IR spectrometer coupled to a Thermo Nicolet Nic-Plan IR microscope equipped with a 15x Cassegrain objective and a slide-on diamond ATR objective. All spectra were recorded between 4000 and 650  $\text{cm}^{-1}$  with between 100 and 400 acquisitions, resolution of 4  $\text{cm}^{-1}$ , and no corrections were applied to spectra. Variable areas of samples were selected for analysis using the operating software.

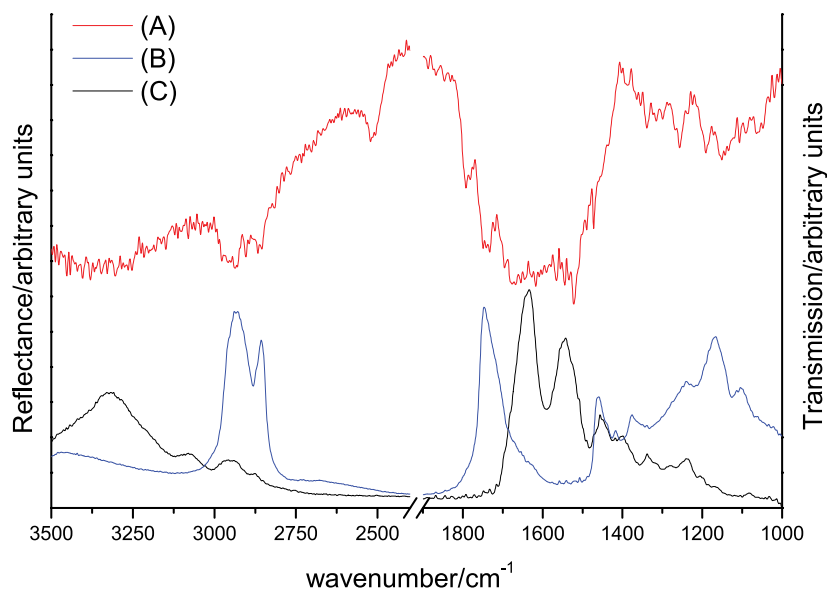
A polished gold slide was used for measurement of the background for reflectance. During analysis, the sample was focused manually to maximize the number of counts recorded. For ATR analysis, background readings were taken when the crystal was not in contact with the sample. Samples were brought into contact with the objective using an automated xyz stage and pressure gauge.

## RESULTS AND DISCUSSION

Qualitative information regarding the chemical composition of the materials found in cross sections was obtained using FTIR in reflectance and ATR. Specifically, micro-FTIR spectra of organic and inorganic materials from the embedding material, the paint layers, and the ground can be recorded, but final spectra depended on distribution of materials in the area examined. It is noted that cross sections of the group constituted by Z- replicas and the N- replica presented thin (less than 10 micrometers) layers of organic media mixed with other pigments. These layers were so thin that no useful signal could be acquired using micro-FTIR from the paint layer. The samples of wall painting replicas contained carbonates (calcium carbonate is found as a pigment, medium, ground, or inert; lead white is found as part of a ground or as a pigment). As signals from carbonates in reflectance measurements are broad in sectors AZ1b\_c1 (fig. 2) and OL18b\_a1, some bands in the fingerprint region from organic binding media are observed in the derivative band in reflectance; for example, the C=O stretching at approximately 1740  $\text{cm}^{-1}$  in sector AZ1b-c1. Other bands from C-H stretching, which are far from the carbonate band, are easily visible in reflectance analysis.

Criteria were established for the evaluation of FTIR spectra acquired with ATR and based on the presence of specific bands associated with proteins and lipids (table 1).

**Figure 2.** FTIR spectra for the analysis of the AZ- sample, compared with transmission reference spectra of (B) linseed oil and (C) rabbit-skin glue. A strong inflection found at approximately 1300  $\text{cm}^{-1}$  corresponds to the  $\nu\text{C-O}$  carbonate vibration; small bands corresponding to signal from protein and lipid are seen, as are others from the epoxy embedding resin.



**TABLE 1**

Key bands in FTIR spectra for the assessment of the presence of protein and lipid-based binding media

Wavenumber/ $\text{cm}^{-1}$	Assignment
3300	$\nu\text{NH}$ : amide NH stretching
3067–3090	2 $\delta$ : first overtone of NH bending
3000–2800	$\nu\text{CH}$ : aliphatic C-H stretching
1710–1770	$\nu\text{CO}$ : carbonyl stretching
1650	Amide I
1550	Amide II
1460–1400	Amide III, aliphatic C-H bending

Identification of the presence of organic materials (Level 1) was based on the detection of  $\nu\text{CH}$  in cross sections. Due to both infiltration and smearing of the polymer (and thus the constant presence of signal from C-H stretching), this criterion was applied only to the analysis of uncontaminated thin sections. For detection of specific classes of organic media,  $\nu\text{C=O}$ : carbonyl stretching, amide I, and amide II were considered for the evaluation of ATR spectra recorded from samples embedded in epoxy. With embedding in polyester, the C=O stretching was completely masked by that of the resin. Therefore, only ATR measurements on cross sections prepared with epoxy were considered. In reflectance, signal from  $\nu\text{NH}$  was sometimes detected, but decreased IR penetration and detected signal at longer wavenumbers inhibited the detection of signal in ATR analysis.

## ASSESSMENT OF REFLECTANCE MEASUREMENTS

Reflectance measurements are most successful when signals are large due to the low signal-to-noise ratio with most samples. Generally, the largest possible aperture was chosen according to the thickness of the layer analyzed.

In the analysis of all samples from the OL- and AZ- replicas, the main carbonate component is obvious; the derivative band shape with an inflection point at approximately  $1400\text{ cm}^{-1}$  is characteristic and a direct consequence of the reststrahlen effect (see Miliani, this volume; Rosi et al. 2009). However, in the spectrum acquired with the smaller aperture, no bands can be assigned to organic components of the paint layer. Only with the larger aperture and better signal-to-noise ratio are bands observed at approximately  $1740\text{ cm}^{-1}$  and (very weak) at  $1640\text{ cm}^{-1}$ , suggesting the presence of both amide and ester vibrations.

Analysis of AZ1b\_c1, which also contains carbonate pigments, is shown in figure 2.

Weak bands suggest the presence of ester functional groups in the sectors analyzed. This is probably due to the concentration of lipidic binders with respect to the much larger concentration of carbonates, a typical feature of the samples studied as part of the project. In some layers containing protein-based binding media, it is possible to observe bands corresponding to amide vibrations (at approximately  $1650\text{ cm}^{-1}$  and  $1580\text{ cm}^{-1}$ ). In the noisy spectrum of a lead carbonate layer with protein-based binding media, clear inflections are observed that correspond to infiltrated epoxy embedding material ( $1242$ ,  $1510$ , and  $2500\text{ cm}^{-1}$ ).

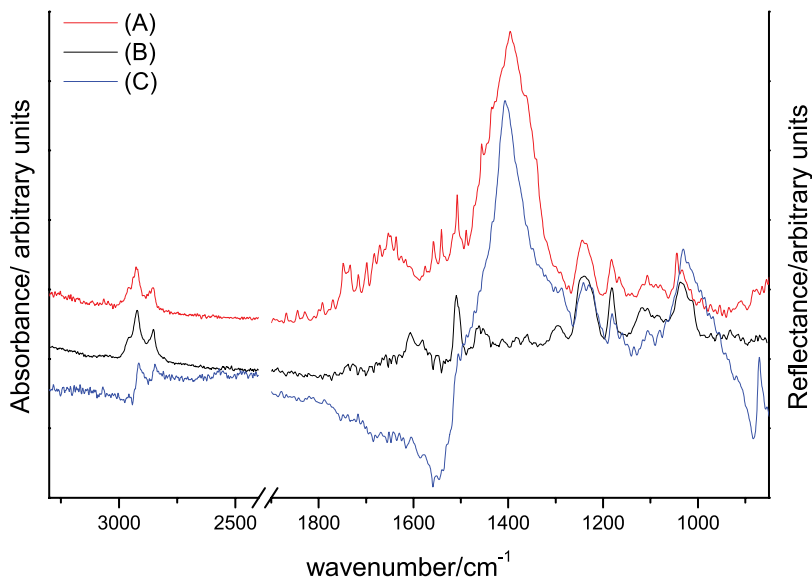
Even though reflectance measurements are often dominated by the carbonate inflection, bands ascribed to ester and amide vibrations are identified. Other bands in the reflectance spectrum, including those caused by combinations, are ascribed to the lead white and calcium carbonate matrix (pigments and embedding material (see fig. 1). Specifically, bands characteristic of carbonates are found at  $1500$ – $1397\text{ cm}^{-1}$ ,  $900$ – $800\text{ cm}^{-1}$ ,  $700$ – $680\text{ cm}^{-1}$ , and  $1100$ – $1000\text{ cm}^{-1}$ ); these bands are distorted in reflectance mode (Rosi et al. 2009).

## MICRO-ATR ANALYSIS

In comparison with micro-FTIR in reflectance, the use of ATR generates spectra that can be more easily interpreted but has the disadvantage of a less controllable sampling area governed by both crystal size and aperture of the beam. As shown in figures 3a and 3b, in cross sections containing thick carbonate layers, a protein-based compound can be observed with micro-ATR measurements due to the amide I band.

The micro-FTIR spectrum acquired in ATR from a paint layer containing linseed oil and rabbit-skin glue has clear bands corresponding to amide I, amide II, and  $\nu\text{C}=\text{O}$  (see fig. 3a). In contrast, with reflectance spectroscopy from an area of the sample indicated in red in figure 3b, the large band from the lead carbonate  $\nu\text{C}=\text{O}$  between  $\sim 1500$ – $1300\text{ cm}^{-1}$  masks signal from organic binding media. In both modes of acquisition, bands in spectra correspond to vibrations from the epoxy embedding material, indicating contamination with the polymer, probably attributable to infiltration of the embedding media into the paint and signal from the resin due to the reflectance window size

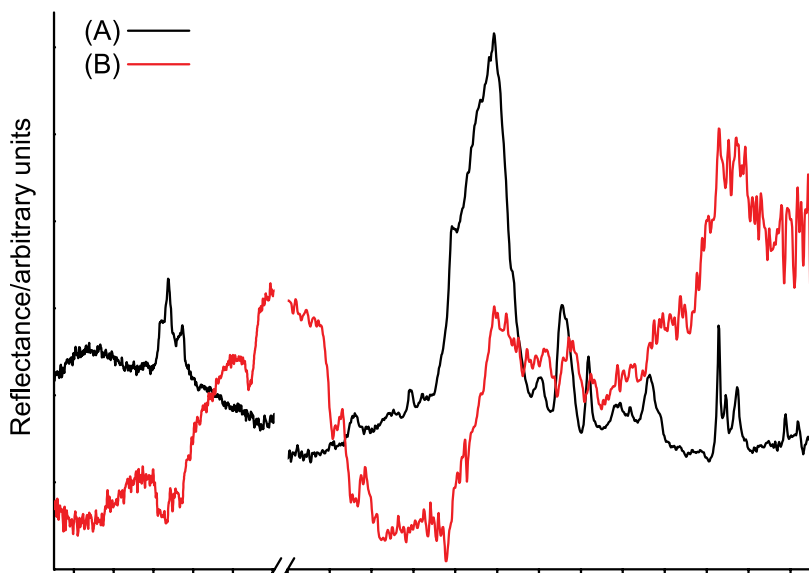
**Figure 3a.** FTIR spectra for a paint layer with linseed oil and rabbit-skin glue, showing clear bands corresponding to amide I, amide II, and  $\nu\text{C}=\text{O}$ , respectively.



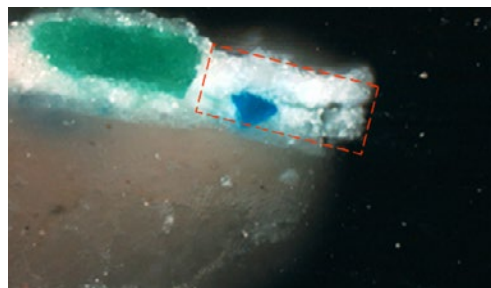
**Figure 3b.** Spectra in figure 3a were acquired from the area of the wall painting sample outlined in red.



**Figure 4a.** Comparison of micro-FTIR spectra and ATR spectra in the analysis of the AZ- sample.



**Figure 4b.** Spectra in figure 4a were acquired from the area of the AZ- sample outlined in red, measuring approx. 70 x 30 micrometers.



A comparison between micro-FTIR spectra acquired in reflectance and in ATR from the AZ- sample is shown in figure 4a. The spectroscopy is from an area measuring approximately  $70 \times 30$  micrometers, indicated in red in figure 4b. As occurs in the analysis of cross sections prepared with traditional embedding methods, bands from the embedding resin are visible; in the sample shown, other bands corresponding to amide I, amide II, and  $\nu\text{C}=\text{O}$  are evidence of the presence of protein

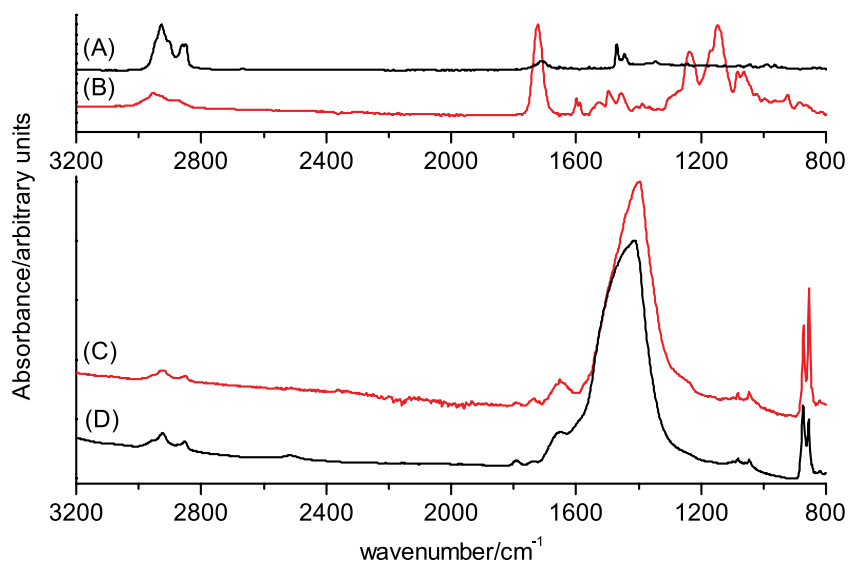
and lipids. In reflectance spectra, which are often associated with poor signal-to-noise ratio, only bands ascribed to C-O stretching are evident, which correspond to the same frequency of the combination bands of C-O stretching from the carbonate pigments (calcium carbonate and basic lead carbonate) in the paint layer. Identification of protein based on amide I vibrations is not possible due to the very noisy reflectance spectrum.

## ANALYSIS OF A MICROTOMED SAMPLE WITH CYCLODODECANE

Micro-FTIR ATR measurements were collected along with transmission (diamond cell) measurements obtained from a powdered portion of sample AZ1b\_c1 for comparison with a cross section of the same sample prepared using cyclododecane. Both the transmission and ATR spectra are similar, presenting a band of N-H stretching around  $3200\text{ cm}^{-1}$  and bands of C-H stretching around  $2800\text{--}3000\text{ cm}^{-1}$ , whereas the amide I band around  $1650\text{ cm}^{-1}$  is more apparent in the ATR spectrum than in the transmission spectrum (fig. 5).

Though absorption bands around  $3000\text{--}2800\text{ cm}^{-1}$  (C-H stretching) could be ascribed to the cyclododecane consolidant, the reduced intensity of C-H stretching bands and the absence of absorption bands around  $1715\text{--}1700\text{ cm}^{-1}$ , which are characteristic of cyclododecane, exclude interferences that could be attributed to the presence of the cyclic alkane. Similarly, the presence of acrylic resin within or over the sample is unlikely considering the lack of absorption bands characteristic of the embedding medium (e.g.,  $1729\text{ cm}^{-1}$ ,  $1241\text{ cm}^{-1}$ , and  $1151\text{ cm}^{-1}$ ). The exclusion of embedding materials would therefore facilitate the interpretation of the ATR spectrum and the identification of the organic components in cross sections.

**Figure 5.** Transmission and ATR spectra for the AZ- sample with references of (A) cyclododecane, (B) Technovit® embedding medium, (C) micro-ATR on AZ1b, and (D) transmission reference from the AZ- sample. The amide I band around  $1650\text{ cm}^{-1}$  is more apparent in the ATR spectrum than in the transmission spectrum.





## Advantages and disadvantages of Micro-FTIR

Incomplete contact between the sample and the ATR crystal can be a limiting factor for micro-FTIR ATR analysis. A significant issue is the impression left by the ATR crystal in the soft embedding material. Damage to the cross section following ATR analysis has been observed in samples of other wall paintings, which compromises the nondestructive nature of the technique.

Although such drawbacks are significant and thin layers (below 10 micrometers) could not be analyzed in cross sections using the tested instruments, micro-FTIR is still useful for the analysis of layers that are thick enough to give sufficient signal. The choice of embedding material is also critical. If FTIR analysis is foreseen, it is important to select resins appropriately. Polyester resins interfere with fatty acid identification in porous samples; epoxy resins, although less transparent, provide a viable alternative.

## CONCLUSIONS

In all instances, the level of information obtained depends on the degree to which it is possible to isolate the fragment from the embedding medium used for the preparation of the cross section. Conventional micro-FTIR is limited by poor spatial resolution and sensitivity; only the thickest paint layers of carbonate containing pigments mixed with lipid and protein yielded spectra that could be used to assess the presence and general indications of organic materials. Specific organic media were not identified, nor could egg tempera be differentiated from mixtures of oil and glue. Similarly, fish glue and rabbit-skin glue could not be differentiated. Nonetheless, the strength of micro-FTIR resides in its fast, inexpensive, widely available, and nondestructive analysis of cross sections.

In comparison with reflectance, analysis using ATR is promising, as spectra are more easily interpreted and wide bands associated with distortions from inorganic compounds are absent, improving resolution of organic compounds associated with binding media. However, uncorrected reflectance spectra of inorganic pigments still can yield important information regarding the presence of specific pigments or pigment mixtures. Combined with a suitable sample preparation method, these spectra could also provide indications of the presence of organic materials, provided that they occur in sufficiently high concentration.

The alternative method for the preparation of thin sections of samples is particularly useful when stratified analysis is required, as is common for samples of multilayer wall paintings. However, a critical choice in terms of sample preparation must be made depending on the type of microscopy and spectroscopy that will be carried out on the same sample.

## ACKNOWLEDGMENTS

At the Getty Conservation Institute, the authors warmly thank Giacomo Chiari for access to the analytical facilities, Herant Khanjian for instruction in FTIR microscopy, and Julie Arslanoglu (now at the Metropolitan Museum of Art) for suggesting the use of cyclododecane. Austin Nevin would like to thank Sharon Cather and Aviva Burnstock, both of Courtauld Institute of Art, for their guidance during his

MA research on FTIR ATR, and Giancarlo Lanterna and Daniela Pinna of Opificio delle Pietre Dure; Costanza Miliani, Francesca Rosi, and Antonio Sgamellotti of Consiglio Nazionale per le Ricerche, Istituto di Scienze e Tecnologie Molecolari (CNR-ISTM); and Bruno Brunetti of Università di Perugia for access to analytical facilities.

---

*Austin Nevin is a researcher at Consiglio Nazionale per le Ricerche (CNR) in Milan, where his work focuses on the analysis of paintings and painting materials. Charlotte Martin de Fonjaudran is a consultant conservator who has supervised conservation projects of wall paintings in Malta and India, as well as graduate student fieldwork in China, Cyprus, and India, since 2004.*

## REFERENCES

- Ajò, D., U. Casellato, E. Fiorin, and P. Vigato. 2004. "Ciro Ferri's Frescoes: A Study of Painting Materials and Technique by SEM-EDS Microscopy, X-Ray Diffraction, Micro FT-IR and Photoluminescence Spectroscopy." *Journal of Cultural Heritage* 5: 333–48.
- Boon J., and S. Asahina. 2006. "Surface Preparation of Cross Sections of Traditional and Modern Paint Using the Argon Ion Milling Polishing CP System." *Microscopy and Microanalysis* 12: 1322–23.
- Casadio F., and L. Toniolo. 2001. "40 Years of Infrared Spectroscopic Investigations." *Journal of Cultural Heritage* 2 (1): 71–78.
- Coombs, D. 1999. "The Use of Diamond as an ATR Material." *Internet Journal of Vibrational Spectroscopy* 2: 3–13.
- Cotte, M., P. Dumas, G. Richard, R. Breniaux, and P. Walter. 2005. "New Insight on Ancient Cosmetic Preparation by Synchrotron-Based Infrared Microscopy." *Analytica Chimica Acta* 553: 105–10.
- Cotte, M., J. Susini, V. Armando Solé, Y. Taniguchi, J. Chillida, E. Checroun, and P. Walter. 2008. "Applications of Synchrotron-Based Micro-Imaging Techniques to the Chemical Analysis of Ancient Paintings." *Journal of Analytical Atomic Spectrometry* 23: 820–28.
- Derrick, M., L. Souza, T. Kieslich, H. Florsheim, and D. Stulik. 1994. "Embedding Paint Cross-Section Samples in Polyester Resins: Problems and Solutions." *Journal of the American Institute for Conservation* 33 (3): 227–45.
- Derrick, M., D. Stulik, and J. Landry. 1999. *Infrared Spectroscopy for Conservation Science*. Los Angeles: The Getty Conservation Institute.
- Fiorin, E., C. Miliani, A. Nevin, F. Piqué, and G. Verri. 2006. "The Use of FTIR to Detect Organic Materials in Wall Paintings: A Comparative Study." Paper presented at the Infrared and Raman Users Group Conference, Museum of Modern Art, New York, 28–31 March.
- Gore, E. 2003. "A Study of the Interaction between Oil and Pigment through the Analysis of Cross-Sections from Paintings." Dissertation for postgraduate diploma in the conservation of easel paintings, Courtauld Institute of Art, University of London.
- Khandekar, N. 2003. "Preparation of Cross-Sections from Easel Paintings." *Reviews in Conservation* 4: 52–64.
- Lanterna, G., and M. Nepoti. 1996. "Preparazione dei campioni con accessori specifici per la spettrofotometria IR e variazioni spettrali in rapporto al loro utilizzo." *OPD Restauro* 8: 165–70.

- Martin de Fonjaudran, C., A. Nevin, F. Piqué, and S. Cather. 2008. "Stratigraphic Analysis of Organic Materials in Wall Painting Samples Using Micro-FTIR Attenuated Total Reflectance and a Novel Sample Preparation Technique." *Analytical and Bioanalytical Chemistry* 392 (1–2): 77–86.
- Mazzeo, R., E. Joseph, S. Prati, and A. Millemaggi. 2007. "Attenuated Total Reflection–Fourier Transform Infrared Microspectroscopic Mapping for the Characterisation of Paint Cross-Sections." *Analytica Chimica Acta* 599: 107–17.
- Nevin, A. 2005. "The Use of Micro-FTIR with Attenuated Total Reflectance for the Analysis of Wall Painting Cross-Sections." *Zeitschrift für Kunsttechnologie und Konservierung* 2: 356–68.
- Papliaka, Z. E., L. Vaccari, F. Zanini, and S. Sotiropoulou. 2015. "Improving FTIR Imaging Speciation of Organic Compound Residues or Their Degradation Products in Wall Painting Samples, by Introducing a New Thin Section Preparation Strategy Based on Cyclododecane Pre-treatment." *Analytical and Bioanalytical Chemistry* 407 (18): 5393–403.
- Pile, J., and R. White. 1995. "The Application of FTIR-Microscopy to the Analysis of Paint Binders in Easel Paintings." *National Gallery Technical Bulletin* 16: 73–95.
- Pouyet, E., A. Lluveras-Tenorio, A. Nevin, D. Saviello, F. Sette, and M. Cotte. 2014. "Preparation of Thin-Sections of Painting Fragments: Classical and Innovative Strategies." *Analytica Chimica Acta* 822: 51–59.
- Rizzo, A. 2008. "Progress in the Application of ATR-FTIR Microscopy to the Study of Multi-layered Cross-Sections from Works of Art." *Analytical and Bioanalytical Chemistry* 392 (1–2): 47–55.
- Rosi, F., A. Daveri, C. Miliari, G. Verri, P. Benedetti, F. Piqué, B. G. Brunetti, and A. Sgamellotti. 2009. "Non-invasive Identification of Organic Materials in Wall Paintings by Fiber Optic Reflectance Infrared Spectroscopy: A Statistical Multivariate Approach." *Analytical and Bioanalytical Chemistry* 395 (7): 2097–106.
- Shashoa, Y. 2002. "Degradation and Inhibitive Conservation of Baltic Amber in Museum Collections." PhD diss., Department of Conservation, National Museum of Denmark.
- Spring, M., C. Ricci, D. A. Peggie, and S. G. Kazarian. 2008. "ATR-FTIR Imaging for the Analysis of Organic Materials in Paint Cross Sections: Case Studies on Paint Samples from the National Gallery, London." *Analytical and Bioanalytical Chemistry* 392 (1–2): 37–45.
- Toniolo, L., A. Sansonetti, L. E. Depero, R. Pedrazzani, I. Viola, E. Pantos, and M. Tobin. 2006. "Characterization of Painting Materials by Micro-FTIR Measurements with Traditional and Synchrotron Radiation Source." Paper presented at the Infrared and Raman Users Group Conference, Museum of Modern Art, New York, 28–31 March.
- Urban, M. 1996. *ATR Spectroscopy of Polymers: Theory and Practice*. Washington, DC: American Chemical Society.
- van der Weerd, J., M. van Veen, R. Heeren, and J. Boon. 2003. "Identification of Pigments in Paint Cross Sections by Reflection Visible Light Imaging Microspectroscopy." *Analytical Chemistry* 75 (4): 716–22.
- van der Weerd, J., R. Heeren, and J. Boon. 2004. "Preparation Methods and Accessories for the Infrared Spectroscopic Analysis of Multi-layer Paint Films." *Studies in Conservation* 49: 193–216.
- Wyplosz, N., R. Koper, J. van der Weerd, R. Heeren, and J. Boon. 2000. "Improvements in Surface Preparation of Paint Cross-Sections Necessary for Advanced Imaging Techniques." In *Art et chimie, la couleur: Actes du congrès*, 65–68. Paris: CNRS Editions.

# Use of ELISA in Identifying Proteins in the Tintori Wall Painting Replicas

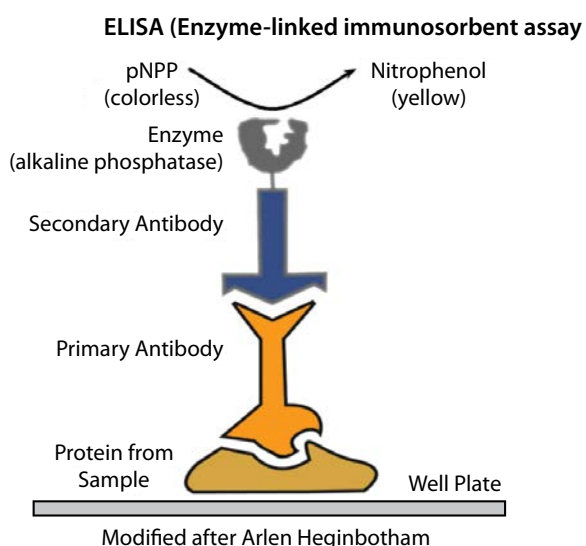
Joy Mazurek and Jennifer Porter

## DESCRIPTION OF THE TECHNIQUE

Enzyme-linked immunosorbent assay (ELISA) uses antibodies for the specific and simultaneous detection of molecules. This article discusses applying this technique to the identification of protein- and carbohydrate-based materials in wall painting samples from the collection of replicas created at the laboratory of the conservator Leonetto Tintori. The organic materials we identified are collagen from glue, ovalbumin from egg white, casein from milk, and polysaccharides from plant gums.

An organism produces antibodies when foreign agents such as viruses or bacteria attack it. The immune system has evolved to be able to recognize certain molecules on the surfaces of these foreign invaders. These molecules, called antigens, are usually proteins, but antibodies can recognize parts of many molecules. The immune system responds by generating antibodies that bind to the antigen at specific regions, called epitopes. Each epitope has a unique conformation that an antibody recognizes and binds to. For example, a virus will have various epitopes and a variety of antibodies are produced to attack it. This biological mechanism provides the basis of immunological techniques for ELISA. Antibodies are chemically modified by attaching or linking them to enzymes. When these modified antibodies recognize and attach to an antigen, they catalyze a color change in a solution of p-nitrophenyl phosphate (pNPP). The technique has several variants; the primary three are referred to as direct, indirect, and sandwich. For a detailed description of ELISA and its variants, see Crowther (2001) and Mazurek et al. (2008). In this article, only the indirect method is discussed (fig. 1).

**Figure 1.** Diagram showing the indirect method of ELISA. The protein is bound to the well plate and the primary antibody is bound to the protein. The secondary antibody, containing the enzyme alkaline phosphatase, then binds to the primary antibody. Finally, pNPP (p-nitrophenyl phosphate) is added. The enzyme cuts the phosphate group and turns pNPP into a yellow dye. The protein is positively identified if the solution turns yellow. (Heginbotham, 2004)



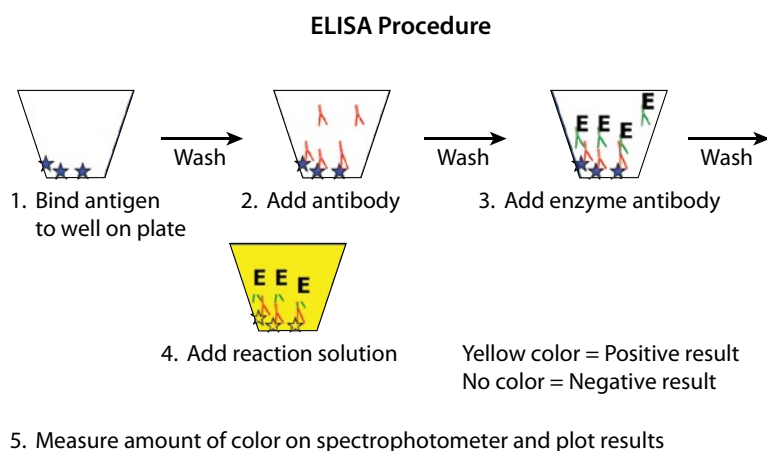
## TESTING PROCEDURE

A total of 28 Tintori wall painting replica samples were tested using ELISA; this technique allowed the correct identification of the binding media in the majority of samples. These promising results were the catalyst to developing and documenting a procedure that can be routinely applied to samples from works of art.

The Tintori samples are relatively well aged, have known compositions, and had been tested with many other complementary techniques. Some limitations of this study include small sample size (in some cases less than 0.1 mg of powder), which may have increased the possibility of contamination during handling, and the lack of a sample containing casein.

The testing procedure, outlined in figure 2, is as follows:

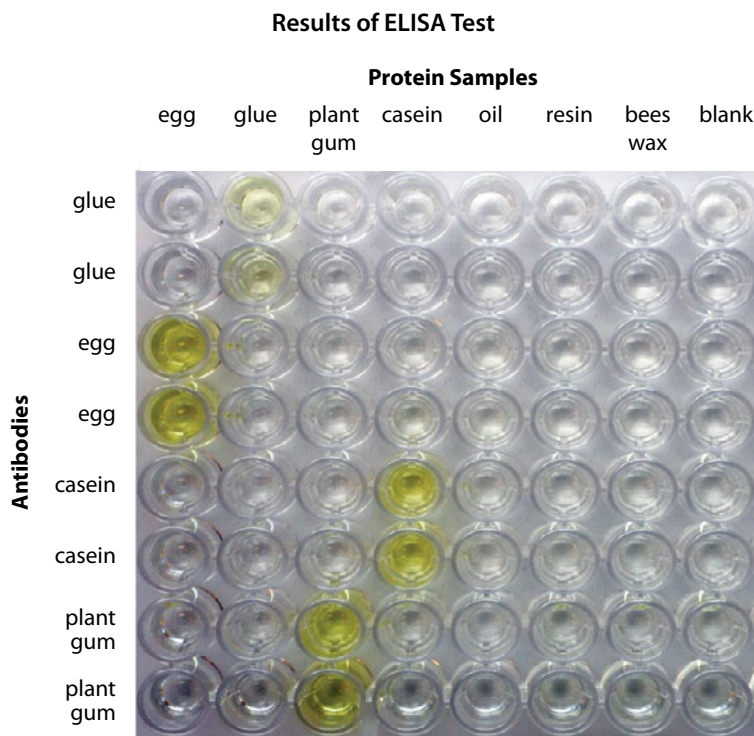
**Figure 2.** Flowchart of the ELISA procedure.



1. Paint samples are first dissolved in an extraction buffer, then diluted and added to the wells of an ELISA plate (fig. 3). The proteins and polysaccharides present in the samples bind to the walls of the well. Samples are run in duplicate with different dilutions in order to confirm results. Testing of up to 10 samples is possible.
2. A primary antibody targeted to the protein or polysaccharide is added to the well; and will bind to it if present. The well is thoroughly rinsed to remove any unbound primary antibody from the well plate.
3. An enzyme-conjugated secondary antibody, which is specific to the primary antibody source (e.g., rat, mouse, rabbit), is added to the well. The well is thoroughly rinsed to remove any unbound secondary antibody. At the end of this step, the secondary antibody will be present in the well only if the target protein (antigen) was present in the original sample. Detection of the antigen is then accomplished through enzymatic activity of the secondary antibody.

In the testing procedure, the secondary antibody is conjugated to alkaline phosphatase. Alkaline phosphatase catalyzes the hydrolysis of p-nitrophenyl phosphate (pNPP, which is colorless) to p-nitrophenol, a yellow dye (see fig. 3).

When pNPP is added to the well, the development of yellow color may or may not be observed. The development of color depends not only on the amount of antigen present in the well but also on the time during which the enzyme is left active. For qualitative results, a visual evaluation of the yellow color is sufficient

**Figure 3.** Results of the ELISA well-plate test.

to establish the presence of the targeted protein or carbohydrate. For semiquantitative results, the well plate is analyzed on a plate reader that measures absorbance at 405 nm.

## LEVEL OF INFORMATION

Tintori painted his replicas by combining pigments with and without binding media. He also would mix binders such as whole egg and drying oil, rabbit-skin glue and oil, egg, and gum arabic and drying oil, in various mixtures. A small subset of 28 samples from the replicas was tested to determine the presence of all of these binders in various mixtures with and without binders using different antibodies.

The level of information is not species specific; collagen can come from a variety of animal species and is generically reported as “glue.” If albumin is detected, it is generically reported as “egg.” If polysaccharides are detected, they are generically reported as “plant gum.” The technique is not quantitative because it does not give a ratio or an amount of each protein. This is due to the lack of data regarding possible protein/pigment interactions and how these might affect the amount of protein extracted into solution. The extraction solution (elution buffer) for ELISA is buffered at pH 8, which is a relatively gentle process. The elution buffer is 5 mL of 1 M tris (hydroxymethyl)aminomethane hydrochloride (tris-HCl), 1 mL of 0.5 M ethylenediaminetetraacetic acid (EDTA), 180 g urea, 25 mL of 20% sodium dodecyl sulfate (10 g in 50 mL deionized water), and deionized H<sub>2</sub>O final volume 500 mL. EB pH adjusted to 7.4 using NaOH. The solution may be stored at room tempera-

ture. To minimize alterations to the original conformation of proteins and polysaccharides, samples are not heated or sonicated but instead allowed to react slowly over several days at room temperature. Therefore, as the extraction is not controlled, ELISA can provide only semiquantitative information on the amount of binder present in the sample.

### **Collagen Antibody**

The main protein in animal glue is collagen, which is found in bones, tendons, cartilage, and the skin of animals (Gettens and Stout 1966). Animal glue also includes other proteins such as keratin, elastin, ucin, and chondrin; however, collagen is the most abundant. Collagen types differ by unique polypeptide chains. The most common are types I, II, and III. Type I is found in almost any tissue or organ (Nimni 1988, 3–4) and is therefore also abundant in animal glue.

Preliminary investigations were conducted using an antibody made by injecting Collagen type I from human and cow into a rabbit and harvesting the antibodies. The antibody mixture is polyclonal, meaning it contains various antibodies sensitive to a range of epitopes on that collagen molecule, so that the exact epitope is unknown. According to the antibody manufacturer ABCAM, the antibody mixture used in this study recognizes areas of the tertiary structure of Collagen I, and this makes it less sensitive to changes in the shape of the collagen molecule (i.e., denaturation). This antibody was chosen because animal glue is made by boiling skin and bone, resulting in denatured collagen.

However, these preliminary investigations were unsuccessful because the animal glue used in the Tintori replicas was rabbit-skin glue, and antibodies created by a rabbit cannot recognize collagen from a rabbit. Collagen I antibodies from a goat (ABCAM #AB19811) were used instead of the more commonly available rabbit antibodies. Of the four samples indicated in figure 4, two (OL18bisC1 and OL18bisA1) tested positive for Collagen I. However, glue was also detected in AZ2bisD1 and AZ1bisD1 (fig. 5) when glue should not have been present. This might have been due to false positives or to real contamination—for example, Tintori's sample containers might have had residual glue.

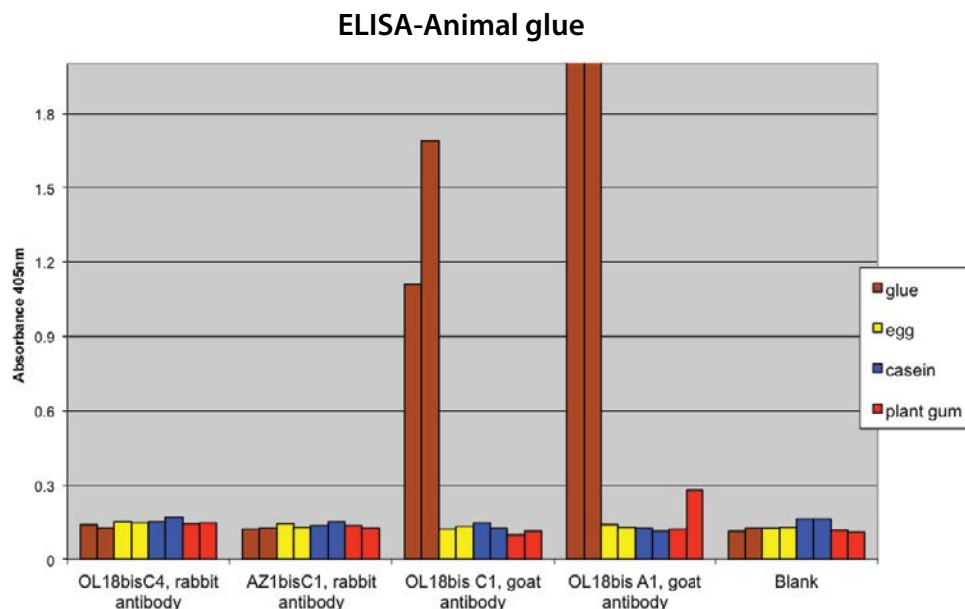
### **Plant Gum Antibody**

Plant gums are polysaccharides, but components of proteins such as the amino acid hydroxyproline are also common in many plant gums (Churms 1984). Therefore, plant gums can be considered protein/polysaccharide complexes. The protein is generally thought to be present as a central core within the gum molecule. Plant gums have been identified successfully using antibodies (Dewey 1997).

Gum arabic, from *Acacia senegal*, was used by Tintori as a binder on a number of replicas. This gum contains approximately 2% protein that is rich in the amino acids hydroxyproline, serine, and proline, which are linked to carbohydrates. Gum arabic can be identified with the plant gum antibodies MAC207 and JIM13. Both are monoclonal antibodies and recognize the epitope (beta) GlcA1->3(alpha) GalA1->2Rha of fruit tree gum, acacia gums (including gum arabic), and others. JIM13 is the most sensitive of the two antibodies. The antibodies, which recognize carbohydrate structures, appear only to bind to the carbohydrate part of the arabinogalactan proteins (M. G. Hahn, pers. comm., 2007, University of Georgia).

Six samples (from AZ2D1, AZ2bisD1, and AZ1bisD1) were painted with a binder mixture containing gum arabic using ELISA. These were very small

**Figure 4.** Results of the collagen antibody study, indicating the two samples that tested positive for Collagen type I.



samples—less than 0.1 mg—and are composed of a mixture of gum arabic, linseed oil, and egg. All three gave positive results for plant gum (see fig. 5).

### Egg Antibody

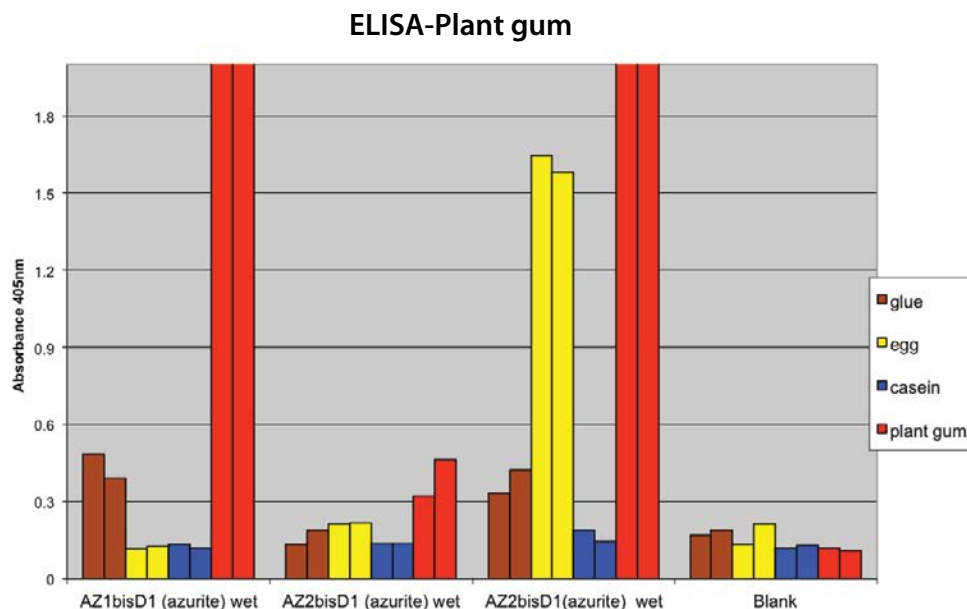
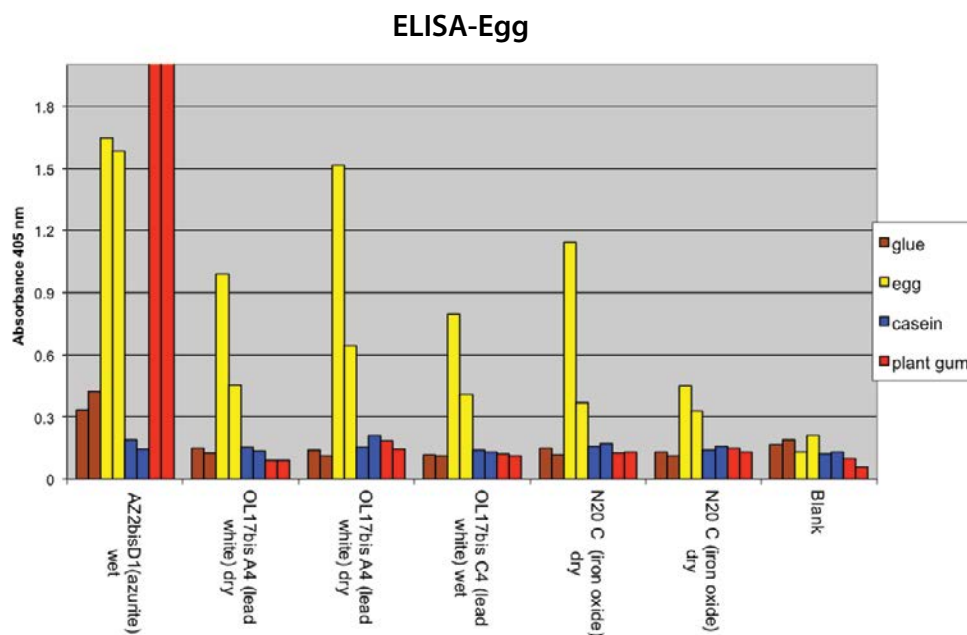
Historically, whole egg, egg white, and egg yolk have been common choices as binding media for paint (Gettens and Stout 1966). Ovalbumin, a protein found in egg white but not in egg yolk, is a glycoprotein consisting of a polypeptide that contains phosphorus, mannose, and glucosamine. There is reported homology in the amino acid sequences of hen ovalbumin and quail ovalbumin (Webster et al. 1981), and it was shown that the antibody used in this study for ovalbumin identifies egg from several different species of bird: quail, duck, and hen. Studies on the coexistence of egg proteins and copper- and mercury-based pigments have shown that the breakdown of egg proteins can occur, especially when pigments such as verdigris, vermilion, and azurite are present (Khandekar, Phenix, and Sharp 1994).

Tintori used azurite with whole egg to make some of his samples. Fifteen samples containing egg were tested with ELISA, and eight yielded positive results (fig. 6). The negative results could have been caused by limited sample size or the degradation of the egg proteins due to interaction with pigments. Of all the samples painted with copper-based pigments, only sample AZ2bisD1 gave a positive result. None of the Z8 series of samples, painted with yellow ochre and egg, were positive.

### Casein Antibody

Casein is the most dominant phosphoprotein found in milk. When combined with calcium, it forms calcium caseinate, an insoluble salt. The mixture of casein with lime confers good adhesive properties and water repellency (Gettens and Stout 1966). In milk, casein exists in large colloid lumps, called micelles, and does not



**Figure 5.** Results of the plant gum antibody study, showing the presence of glue.**Figure 6.** Results of the egg antibody study, showing the presence of egg.

have a crystalline structure. The fact that it lacks a well-defined three-dimensional structure supports the idea that it has a random quaternary structure. The casein antibody is polyclonal, made from highly purified bovine casein, and harvested from rabbits. None of the remaining Tintori replicas were painted with casein. However, a positive result for casein was obtained for one sample, OL17B1. According to records, the sample is a fresco and should not contain any binding media. Contamination is suspected, but it is hard to pinpoint the cause.

## INTERPRETATION OF RESULTS

When testing with antibodies, in order to clearly establish whether a positive result has been obtained, it is recommended that a baseline absorbance distribution be determined for each batch of antibodies provided by a manufacturer. Once this baseline has been established, it can be used to evaluate the results of all assays conducted with that antibody batch. To generate the baseline distribution, 20 blank wells (with no antigen added) were analyzed for each antibody following the procedure outlined above. Absorbance at 405 nm was measured for each well, and the standard deviation was calculated.

If a well in the plate turned yellow, it was an indication that it contained the protein recognized by the specific primary antibody, and therefore the result was positive. The 20 blanks tested showed how yellow each antibody became when no protein was present. A reasonable value for a negative result is between 0.1 and 0.2 absorbance. We have found for the assays described in this paper that positive results can be conclusive when the absorbance is 0.3 or higher. If blanks turned yellow or the positive control was clear, then the antibody tested for that analysis was unreliable and had to be repeated.

## ADVANTAGES AND DISADVANTAGES OF ELISA

Antibody binding to the antigen epitope is one of the most specific interactions known in biology, and this specificity is one of the major advantages of this approach. Performance of ELISA does not require expensive instrumentation or highly specialized chemists. Its common use in biological research to quickly and precisely identify very small samples of protein or polysaccharide (often as little as a nanogram) makes it a well-tested technique.

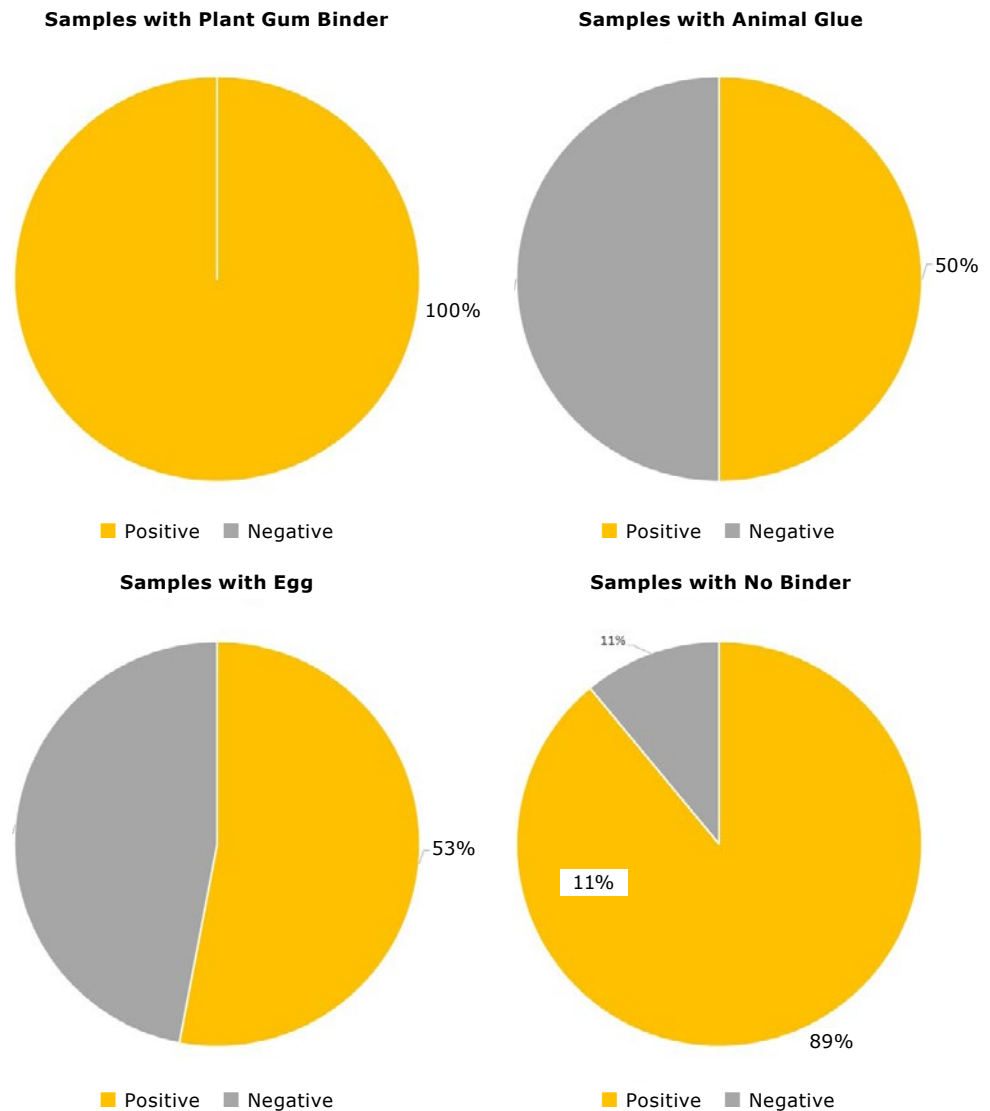
Although investigations of artists' materials have been somewhat limited to date, ELISA is reliable and extremely sensitive with samples containing complex mixtures of binding media.

ELISA can yield negative results even when the binder of interest is present. This will occur if the primary antibody does not recognize the epitope and therefore does not bind to it. Failure to recognize the epitope can result from chemical modification due to aging of the binder and cross-linking with pigments or support so that the molecule cannot be extracted and taken into solution. An advantage of techniques such as gas chromatography–mass spectrometry (GC–MS) is that the individual components of proteins (amino acids) or plant gums (carbohydrates) can be identified. ELISA does not identify other media; in the case of Tintori, this includes linseed oil. Because this is a relatively new technique to the field of conservation, the amount of data is limited and thus interpretation is not always straightforward.

## CONCLUSIONS

ELISA was moderately effective in the precise identification of proteins in the 28 Tintori samples tested. The charts in figure 7 provide a statistical description of the results obtained. Positive indicates the results are correct; negative indicates the results are incorrect.

**Figure 7.** Pie charts showing the percent correct for each paint media in the Tintori samples. Positive = correct; negative = incorrect.



The samples yielded good results. All six samples containing gum arabic tested positive and therefore provided a correct answer. For samples with egg and animal glue, results were mixed: only half of the egg and half of the animal glue samples tested correctly. The reason for the lower accuracy is not known; pigments are likely a factor.

When antibodies produced in goats were used, two of the four samples containing rabbit-skin glue tested positive. Casein analysis was not possible due to an insufficient sample remaining for testing. One of the samples with no binder tested positive for casein. It was a false positive, as it was painted a fresco (with no organic binder). All of the eight remaining fresco samples (with no organic binder) tested negative for the four binding media. This was the only false positive observed and may be due to contamination of the sample.

We can conclude that ELISA is an accurate and sensitive procedure, with detection limits down to the nanogram of protein (Heginbotham et al. 2004; Crowther 2001). However, it is sensitive to pigments and may produce false negatives. Nonetheless, positive results are very reliable, and ELISA provides qualitative information on binding media, most importantly on mixtures. With this relatively simple and inexpensive procedure, it is possible to detect plant gum, egg, and collagen-based binding media used historically in works of art.

## ACKNOWLEDGMENTS

Development and distribution of plant gum antibodies for this study were supported in part by National Science Foundation grants RCN0090281 and DBI 0421683.

---

*Joy Mazurek has worked as an Assistant Scientist at the Getty Conservation Institute since 1998. She specializes in the identification of organic materials by gas chromatography/mass spectrometry. She obtained her master's degree in biology, with emphasis in microbiology from California State University Northridge, and a bachelor of science degree in biology from University of California, Davis. Jennifer Porter received her MA in wall painting conservation in 2007 from the Courtauld Institute of Art, London. As a Graduate Intern at the Getty Conservation Institute, she researched ELISA methodology in conjunction with the OMWP project. Since that time, she has continued to work in conservation research and as a field conservator with a variety of institutions worldwide and is currently Assistant Lecturer in the Department of Conservation and Built Heritage at the University of Malta.*

## REFERENCES

- Churms, S. C., and A. M. Stephen. 1984. "Structural Studies of an Arabinogalactan-Protein from the Gum Exudate of *Acacia robusta*." *Carbohydrate Research* 133: 105–23.
- Crowther, J. R. 2001. *The ELISA Guidebook*. Totowa, NJ: Humana Press.
- Dewey, F., M. I. Thurston, and Q. C. B. Cronk. 1997. "Monoclonal Antibodies that Differentiate between Gum Arabic, Gum Seyal and Combretum Gum." *Food and Agricultural Immunology* 9: 123–34.
- Gettens, R., and G. Stout. 1966. *Painting Materials: A Short Encyclopaedia*. New York: Dover.
- Heginbotham, A., V. Millay, and M. Quick. 2004. "The Use of Immunofluorescence Microscopy (IFM) and Enzyme-Linked Immunosorbent Assay (ELISA) as Complementary Techniques for Protein Identification in Artists' Materials." In *Wooden Artifact Group (WAG) Postprints*, 32nd Annual Meeting of the AIC, Portland, OR. Washington, DC: AIC.
- Hodgins, G., and R. Hedges. 1999. "A Systematic Investigation of the Immunological Detection of Collagen-Based Adhesives." Paper presented at the 6th International

- Conference on Non-destructive Testing and Microanalysis for the Diagnostics and Conservation of the Cultural and Environmental Heritage, Rome, May 17–20.
- Khandekar, N., A. Phenix, and J. Sharp. 1994. "Pilot Study into the Effects of Solvents on Artificially Aged Egg Tempera Paint Films." *The Conservator* 18: 62–72.
- Kockaert, L., P. Gausset, and M. Dubi-Rucquoy. 1989. "Detection of Ovalbumin in Paint Media by Immunofluorescence." *Studies in Conservation* 34 (4): 183–88.
- Mazurek, J., A. Heginbotham, M. Schilling, and G. Chiari. 2008. "Antibody Assay to Characterize Binding Media in Paint." In *ICOM Committee for Conservation*, vol. 2, 678–85. New Delhi: Allied.
- Nimni, M. 1988. *Collagen*. Boca Raton, FL: CRC Press.
- Phenix, A. 1996. "The Composition and Chemistry of Eggs and Egg Tempera." In *Proceedings of the Symposium on Early Italian Painting: Techniques and Analysis, Maastricht, 9–10 October 1996*, edited by T. Bakkenist, R. Hoppenbrouwers, and H. Dubois, 11–20. Maastricht: Limburg Conservation Institute.
- Webster, D. M., W. K. Fisher, D. D. Koureas, and E. O. Thompson. 1981. "Amino Acid Sequences Containing Cysteine or Cystine Residues in Ovalbumin from Eggs of the Quail *Coturnix coturnix japonica*." *Australian Journal of Biological Sciences* 34 (5–6): 505–14.
- Yates, E., J. Valdor, S. Haslam, H. Morris, A. Dell, W. Mackie, and J. Knox. 1996. "Characterization of Carbohydrate Structural Features Recognized by Anti-arabinogalactan-protein Monoclonal Antibodies." *Glycobiology* 6 (2): 131–39.

## APPENDIX 1

# Cataloging of the Wall Painting Replica Samples

Throughout his professional life, the late Leonetto Tintori was engaged in the study of organic materials in wall paintings at the Laboratorio per Affresco di Vainella (LAV). In his extensive career as a wall painting conservator, Tintori realized the need for understanding the presence and the role of these materials in the preservation of wall paintings. He concentrated his work on this subject beginning in 1983, when he created a center at his home in Vainella, near Prato, Italy, to pursue his studies and teach wall painting techniques.

To this end, Tintori made hundreds of wall painting replicas simulating different techniques and material combinations. The replicas are painted in sectors—that is, an area completely covered using the same painting technique and phase of application. Organic materials such as egg, oil, casein, and milk were used in combination with different types of pigments and mortars. Tintori documented the materials and methods—and, in some instances, the relative amounts of binders and pigments—used in each replica. Each sector has been marked with a code identifying the materials used (fig. A1.1). (See Grandin and Centauro article for more information on Tintori’s preparation of the replicas.)

As part of the Organic Materials in Wall Paintings (OMWP) project, these replicas were cataloged in a Microsoft Access database to document the more than five hundred replicas in the Tintori collection and to enable sectors to be searched by binder, pigment, and phase of application.

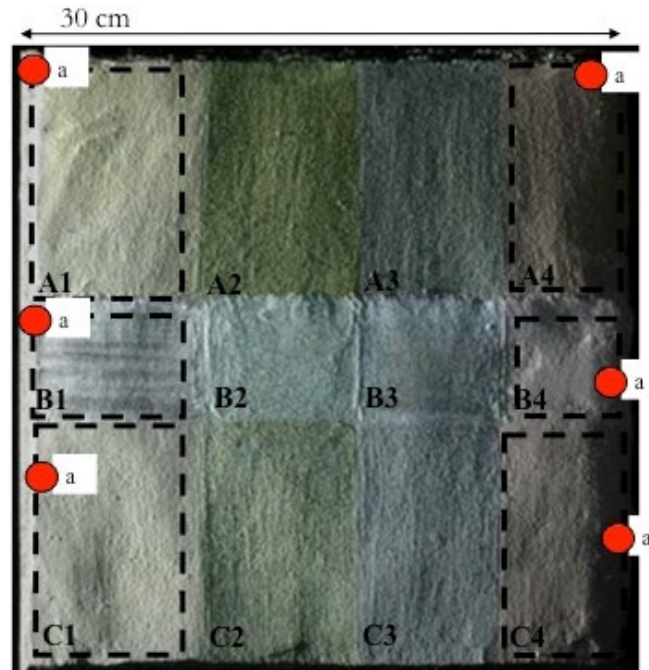
The information entered was extremely detailed and included the type of pigment (lead white, malachite, etc.), binder (linseed oil, rabbit-skin glue, etc.), and phase of application (elapsed time between application of the lime-based plaster substrate and application of the paint). As an example, see tables A1.1 and A1.2, which display information for replica OL18bis. Tintori’s original description, in Italian, of this replica was also included (table A1.3). The database was intended to provide rapid access to the vast amount of information available on Tintori’s replicas and is currently available only at the LAV.

A sample of the database can be accessed [here](#). This sample folder includes technical images (visible light photography, incident, and raking, as well as UV and IR photography) of twenty-two Tintori replicas selected for the OMWP project. (A screenshot is shown in fig. A1.2.) The document titled “Replicas description.ppt” provides a visual overview of each of the samples studied as part of the project.

Access to other samples may be available; contact the LAV Archives at: [info@laboratoriotintori.prato.it](mailto:info@laboratoriotintori.prato.it).

**FIGURE A1.1**

Sample with information for replica OL18bis, showing sectors studied. Tables A1.1 and A1.2 provide a detailed description of the replica including binders, pigments, and application time of each sector.



Organic Materials in Wall Paintings  
Replicas selected for 1st phase study

**TABLE A1.1**

Description of replica OL18bis as entered into the Access database.

Made on: November 18 1997
Support: Brick tile (30×30cm)
Arriccio: 60% river sand and 40% slaked lime, 1 cm thick
Intonaco: 50% river sand and 50% slaked lime, 0.2 cm thick
Pigments: Lead white, malachite, azurite, lake madder
Binders: rabbit-skin glue, linseed oil
12 sectors – selected 6:
OL18bis_a1*
OL18bis_b1
OL18bis_c1
OL18bis_a4
OL18bis_b4
OL18bis_c4*
*samples mounted as cross sections with embedding medium polyester resin (xsp) and with epoxy resin (xse) and studied as cross sections with FTIR

**TABLE A1.2**

Sectors studied of replica OL18bis, including binder, pigment, and application phase.

Sector name	Binder(s)	Pigment(s)	Application (time since plastering)
OL18bis_a1	rabbit-skin glue + linseed oil 30%	lead white	6 days
OL18bis_a2	rabbit-skin glue + linseed oil 30%	lead white + malachite	6 days
OL18bis_a3	rabbit-skin glue + linseed oil 30%	lead white + azurite	6 days
OL18bis_a4	rabbit-skin glue + linseed oil 30%	lead white + madder	6 days
OL18bis_b1	water	lead white	same day
OL18bis_b2	water	lead white + malachite	same day
OL18bis_b3	water	lead white + azurite	same day
OL18bis_b4	water	lead white + azurite	same day
OL18bis_c1	rabbit-skin glue + linseed oil 30%	lead white	same day
OL18bis_c2	rabbit-skin glue + linseed oil 30%	lead white + malachite	same day
OL18bis_c3	rabbit-skin glue + linseed oil 30%	lead white + azurite	same day
OL18bis_c4	rabbit-skin glue + linseed oil 30%	lead white + madder	same day

**FIGURE A1.2**

Screenshot of the contents of the folder titled "[Images of Tintori replicas AC1-Z11.](#)"

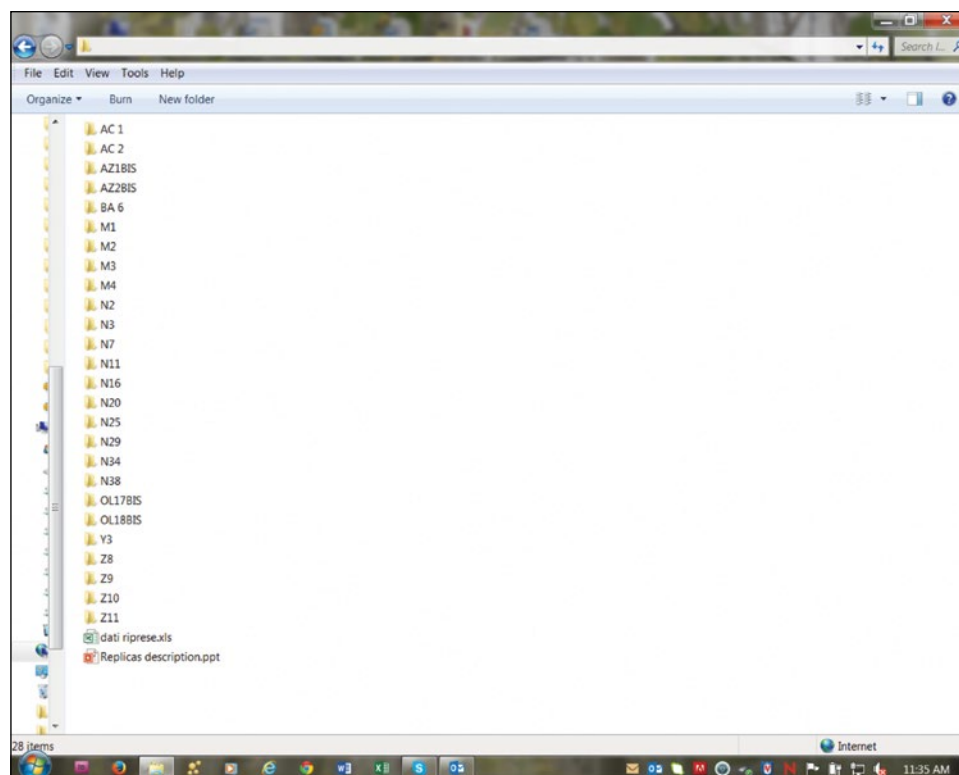




TABLE A1.3

Original description of the replica by Tintori, in Italian.

## LABORATORIO PER AFFRESCO DI VAINELLA SEZIONE RICERCHE

**SERIE OL  
TAV 18 Bis  
SCHEDA N. 436**

**data inizio campione:** 18-11-97

<b>supporto:</b>	mattonella terracotta cm. 30x30
<b>arriccio:</b>	sabbia di fiume 60%, calce 40%; spessore cm. 1
<b>intonaco:</b>	sabbia di fiume 50%, calce 50%; spessore cm. 0,2 A: steso il 12-11-97 B-C: steso il 18-11-97
<b>pigmenti:</b>	1: biacca, 2: biacca gr.5 + malachite gr.2 3: biacca gr.5 + azzurrite gr.2 4: biacca gr.5 + lacca di robbia gr.2
<b>leganti:</b>	A-C: tempera grassa: colla di coniglio secca gr. 15 +acqua gr.70 +olio di lino crudo decolora gr.10 + aceto gr.5 B: acqua
<b>stesura:</b>	A: su secco con t. grassa B: su fresco con acqua C: su fresco con t. grassa

### Osservazioni:

Lo scopo di tale campione risiede nell'osservare attraverso foto U.V. e dopo un adeguato invecchiamento naturale ed artificiale (sul campione duplicato), una possibile differenza tra l'ossidazione dell'olio e la sua saponificazione.

Per la preparazione delle mestiche, i vari pigmenti, nelle loro diverse percentuali di combinazione, sono stati precedentemente pesati e mescolati in polvere tra di loro. La proporzione è in funzione del peso e non del volume e corrisponde ad una parte di bianco (gr. 5) più metà parte di pigmento colorato (gr.2).

Dopo avere preparato il legante, le tempere sono state preparate tutte con la stessa quantità di colore mescolato a pari quantità di legante (es. gr.5 biacca più gr. 3 di tempera grassa più gr. 2 di acqua) diluito quanto basta in acqua (circa 50% di legante puro più 50% di acqua).

Per la preparazione della tempera grassa, l'olio di lino crudo è stato aggiunto poco alla volta miscelandolo a caldo con la colla sciolta a bagnomaria ma senza farlo bollire.

La differenza tra i campioni OL 17 e 17 BIS e questi due risiede nel fatto che nei primi due l'olio risulta in emulsione con il legante, mentre in questi rimane in sospensione. Anche qui l'acqua è stata aggiunta a parte preparando le mestiche dei colori ed è stata leggermente aumentata (50% legante puro più 50% acqua), a causa della maggiore forza adesiva della colla rispetto all'uovo e della minore scorrevolezza durante le stesure.

## APPENDIX 2

### Archive Sample of Replica OL18bis

The Organic Materials in Wall Paintings (OMWP) project team studied twenty-two Tintori replicas using documentation and a number of investigative techniques both invasive and noninvasive. The data are shown in table A2.1. These investigations yielded a wide range of results that were evaluated for their effectiveness in identifying organic materials in wall paintings.

The replicas selected for study (named per the classification of the archive at the Laboratorio per Affresco di Vainella) are: AC1, AC2, AZ1bis, AZ2bis, M1bis, M2bis, M3bis, M4bis, N2, N3, N7, N11, N16, N25, N34, N20, N29, N38, OL17bis, OL18bis, Z8, and Z9.

A sample data set can be accessed [here](#). This folder contains files on the type of data obtained by the OMWP team based on one of the replicas studied, OL18bis (fig. A2.1).

**TABLE A2.1**

Data filing system for the Tintori replicas, based on documentation and investigative techniques.

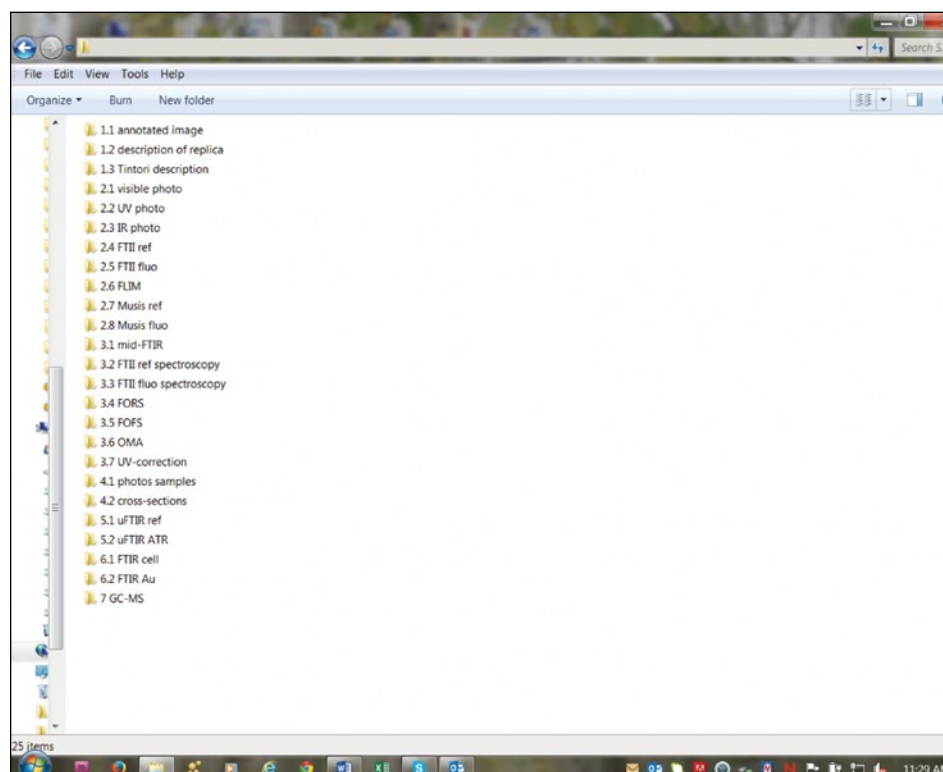
<b>Replica Information</b>
File name and description
1.1 Annotated image
1.2 Description of replica and sectors studied
1.3 Original description by Tintori (in Italian)
<b>Noninvasive: mapping</b>
File name and description
2.1 Visible light photography (incident and raking)
2.2 Ultraviolet (UV) induced fluorescence photography (unfiltered and filtered)
2.3 Infrared (IR) photography (black and white and false color)
2.4 Fourier Transform Imaging Interferometer (FTII) – Reflectance spectral imaging
2.5 FTII – UV-induced fluorescence spectral imaging
2.6 Fluorescence Lifetime Imaging (FLIM)
2.7 MuSIS – Reflectance spectral imaging
2.8 MuSIS – UV-induced fluorescence and UV reflectance spectral imaging
<b>Noninvasive: point analysis</b>
File name and description
3.1 Fourier Transform Mid-Infra-Red (mid-FTIR) fiber optic reflectance spectroscopy
3.2 FTII Reflectance spectroscopy
3.3 FTII UV-induced fluorescence spectroscopy
3.4 Fiber optic reflectance spectroscopy (FORS)

(continued)

<b>Noninvasive: point analysis (cont'd)</b>
3.5 Fiber optic UV-induced fluorescence spectroscopy (FOFS)
3.6 Optical Multi-channel Analyzer (OMA)
3.7 UV-induced fluorescence correction (FOFS, OMA, FORS)
<b>Invasive: stratigraphy mapping</b>
File name and description
4.1 Macro photography of samples
4.2 Cross-section microscopy examination and stain tests (visible and UV light)
<b>Invasive: stratigraphy point analysis</b>
File name and description
5.1 $\mu$ -FTIR reflectance spectroscopy
5.2 $\mu$ -FTIR Attenuated Total Reflectance (ATR) spectroscopy
<b>Invasive: nondestructive</b>
File name and description
6.1 $\mu$ -FTIR transmission spectroscopy – diamond cell
6.2 $\mu$ -FTIR reflectance spectroscopy – Au
6.3 $\mu$ -Raman spectroscopy
<b>Invasive: destructive</b>
File name and description
7.1 High Performance Liquid Chromatography – Diode Array Detector (HPLC-DAD)
7.2 Gas Chromatography – Mass Spectrometry

**FIGURE A2.1**

Screenshot of the contents of the folder titled "[Sample data set OL18bis](#)."





The Getty Conservation Institute