

SCANORA[®] 3Dx

Flexible
Easy
Competitive

 **SOREDEX**

SCANORA[®] 3Dx - The in-office large
field-of-view Cone Beam CT system for
Head and Neck imaging

SCANORA® 3Dx. The solution.

SCANORA® 3Dx makes advanced 3D imaging easy in the head and neck area. The system is ideal for ENT (Ear, Nose, Throat), dentomaxillofacial and cranial examinations in imaging centers, ENT offices, total care oral and maxillofacial clinics, hospitals and multispecialty dental practices.

3D imaging raises diagnostic possibilities to a new level compared to 2D imaging. Compared to medical CT imaging, CBCT imaging offers many benefits: lower dose as the FOV size and location can be optimized to avoid radiation sensitive organs, better spatial resolution in bony structures and lower cost of purchase, commissioning, maintenance and use. Examinations are fast and convenient for the patients.

A CBCT system is also a perfect addition to an existing medical CT. Both systems have their applications. A CBCT system can effectively perform, e.g. sinus studies and postoperative follow-up cases, that previously were handled with overdimensioned medical CT systems.

Summary of benefits

Flexible

- Six, plus two optional, fields-of-view from 50 x 50 mm to 240 x 165 mm
- The FOV can be freely located to different areas of the head and neck
- Comprehensive software offering

Easy

- Seated patient, head in normal position
- 12" HD clear touch control panel for ensuring easy workflow
- Compatible with leading navigation and surgical guide systems

Competitive

- DICOM®/PACS compatibility
- Optional CCD - RealPAN™ sensor for high quality dental panoramic imaging, with AutoSwitch™ 2D/3D mode change
- Small footprint

Right FOV for each task

A suitable imaging protocol can be defined for every diagnostic task by adjusting the field-of-view, resolution and dose. The FOV can be freely located to any region of interest in the head and neck area.

SCANORA® 3Dx fields-of-view (H×D in millimeters)



Small S (50x50)



Small S+ (50x100)



Medium M (80x100)



Medium M+ (80x165)



Large L (140x100)



Large L+ (140x165)



XL (180x165)
Optional



XL+ (240x165)
Optional

Excellent diagnostic performance

SCANORA® 3Dx system provides diagnostic tools for a wide area of applications. The system is very versatile. Special attention has been paid to the needs of ENT clinicians. The FOV selection, ease of use and the software features offer efficient solutions for diagnostic tasks.

ENT

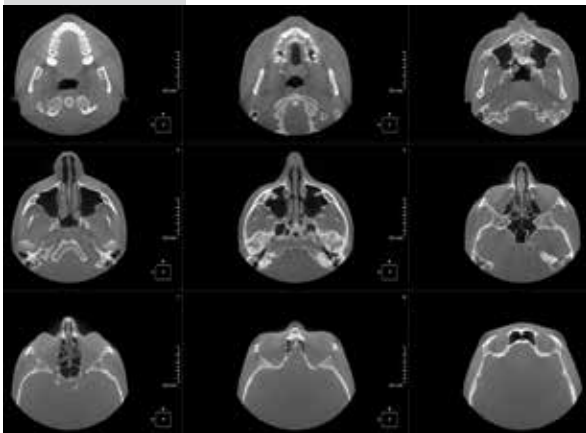

Axial, coronal and sagittal slice series are the most common way of diagnosing the image. The three basic views clearly show all the sinuses (L+).

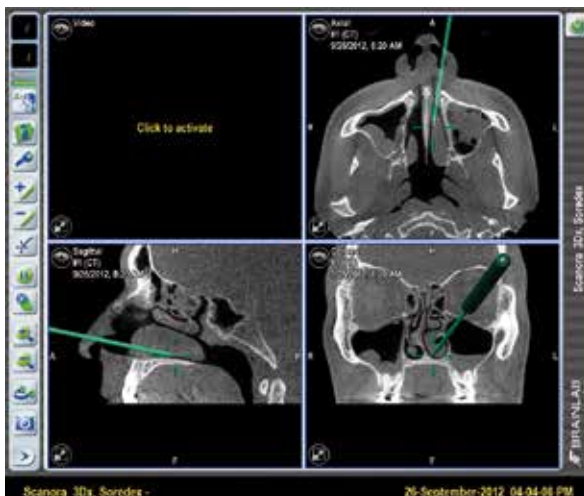
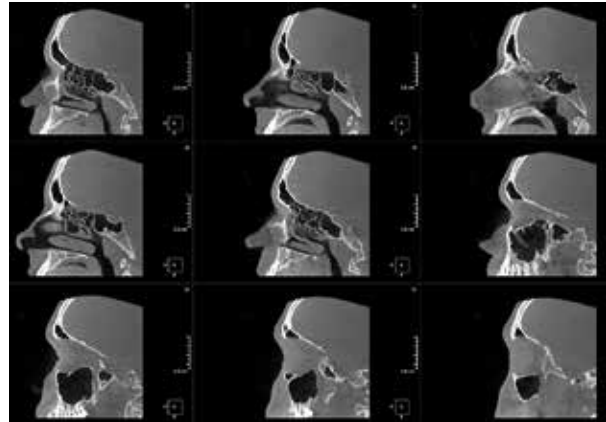
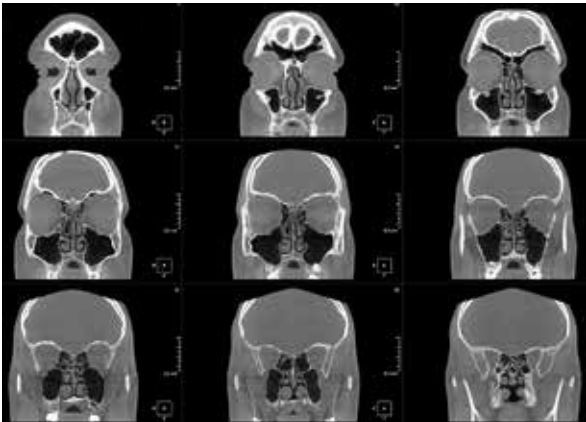

The datasets are compatible with leading surgical navigation systems.

The imaging tasks of otorhinolaryngology can be effectively carried out.

Temporal bone

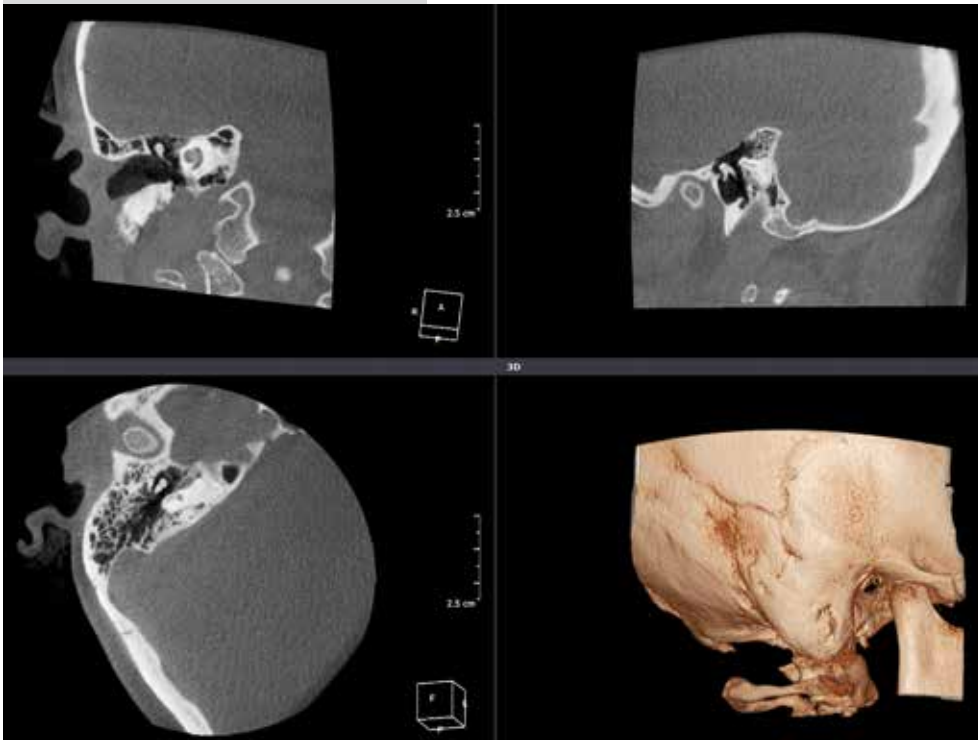

Temporal bone structures (M).

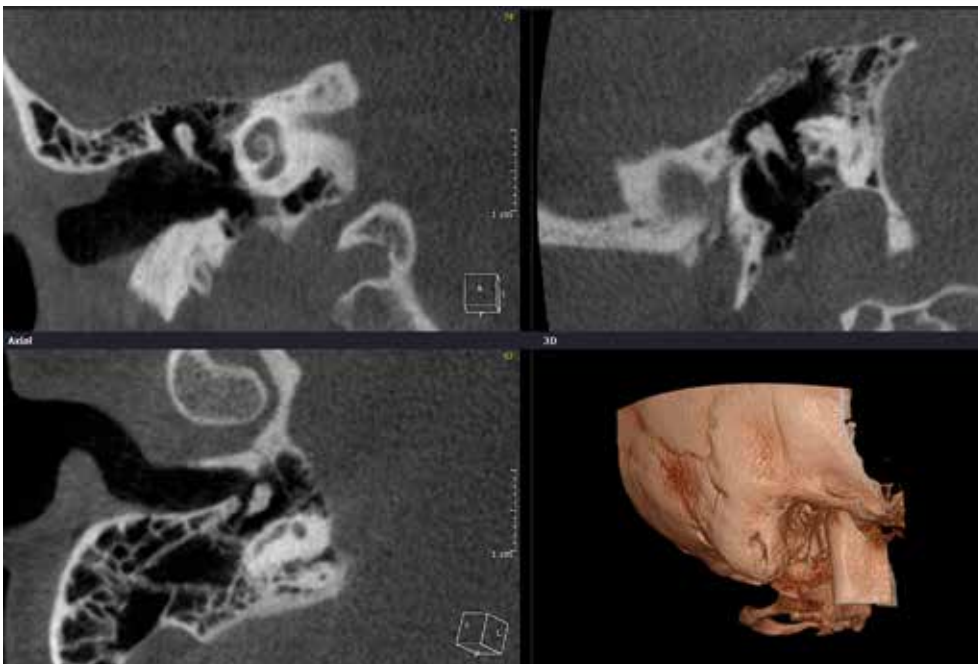

The above case zoomed in for showing the auditory ossicles more clearly.

Clear display of craniofacial conditions.

Craniofacial

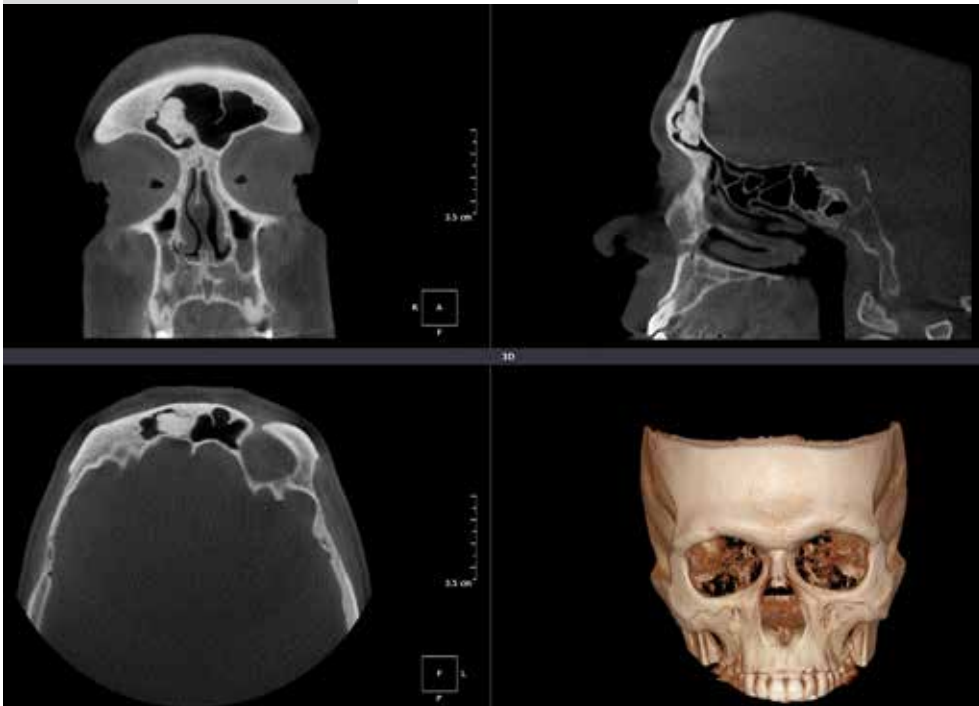

An osteoma in frontal sinus (L+). The sinonasal cavities are sound. No further treatment needed.

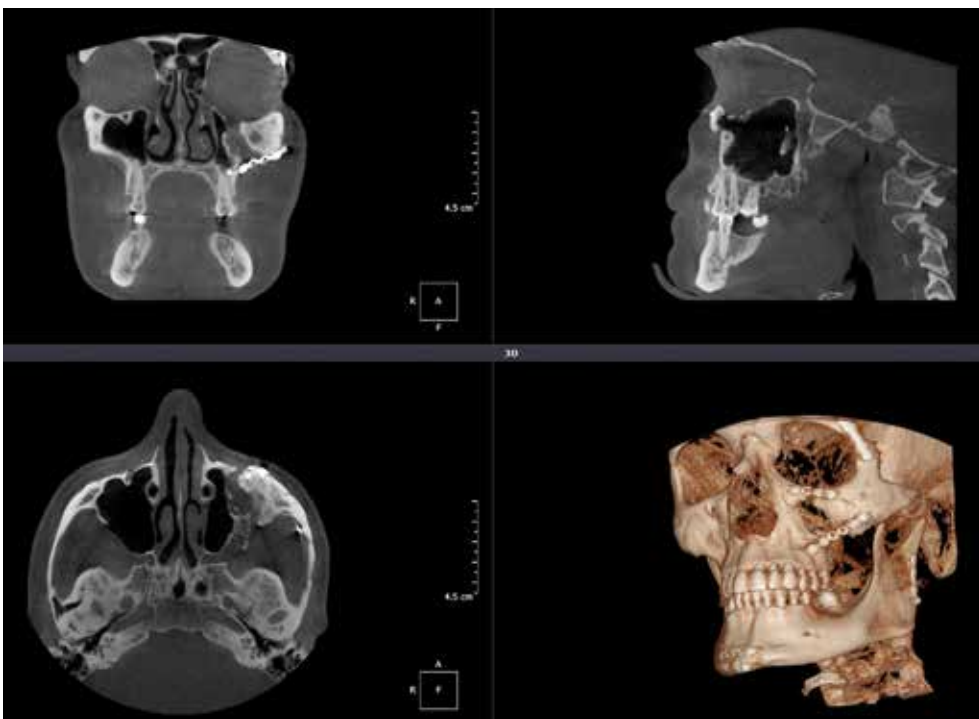

A postoperative trauma case (L+). Left side blow-out fracture. Assessment for orbital floor reconstruction.

The system is effective in surgical planning and follow-up.

Facial surgery



3D, coronal and oblique sagittal reformatted images (L+) of a 30 year old male after orbital floor and medial wall reconstruction and zygomatic fracture reposition.

The largest FOV (XL+) shows the whole facial complex.

Orthognathic surgery



3D, axial and synthetic panoramic reformatted images (XL+).

A postoperative study of a 38 year old male after bimaxillary osteotomy 2 months before. Swelling and pain in the left mandibular region, but in CBCT there were no signs of surgical complications in that area.

The FOV can be easily positioned in all the areas of the head and neck. The cervical area as an example.

Cervical spine



Coronal, axial and sagittal reformatted images of the cervical spine (L) in a 50 year old patient showing spondylotic osteophytes in the ventrolateral region at the level C5 – C6 and C6 – C7 and very small calcification of the posterior longitudinal ligament at level C5 – C6. No degeneration is seen at the level of facet joints.

Dental and TMJ applications

Dental

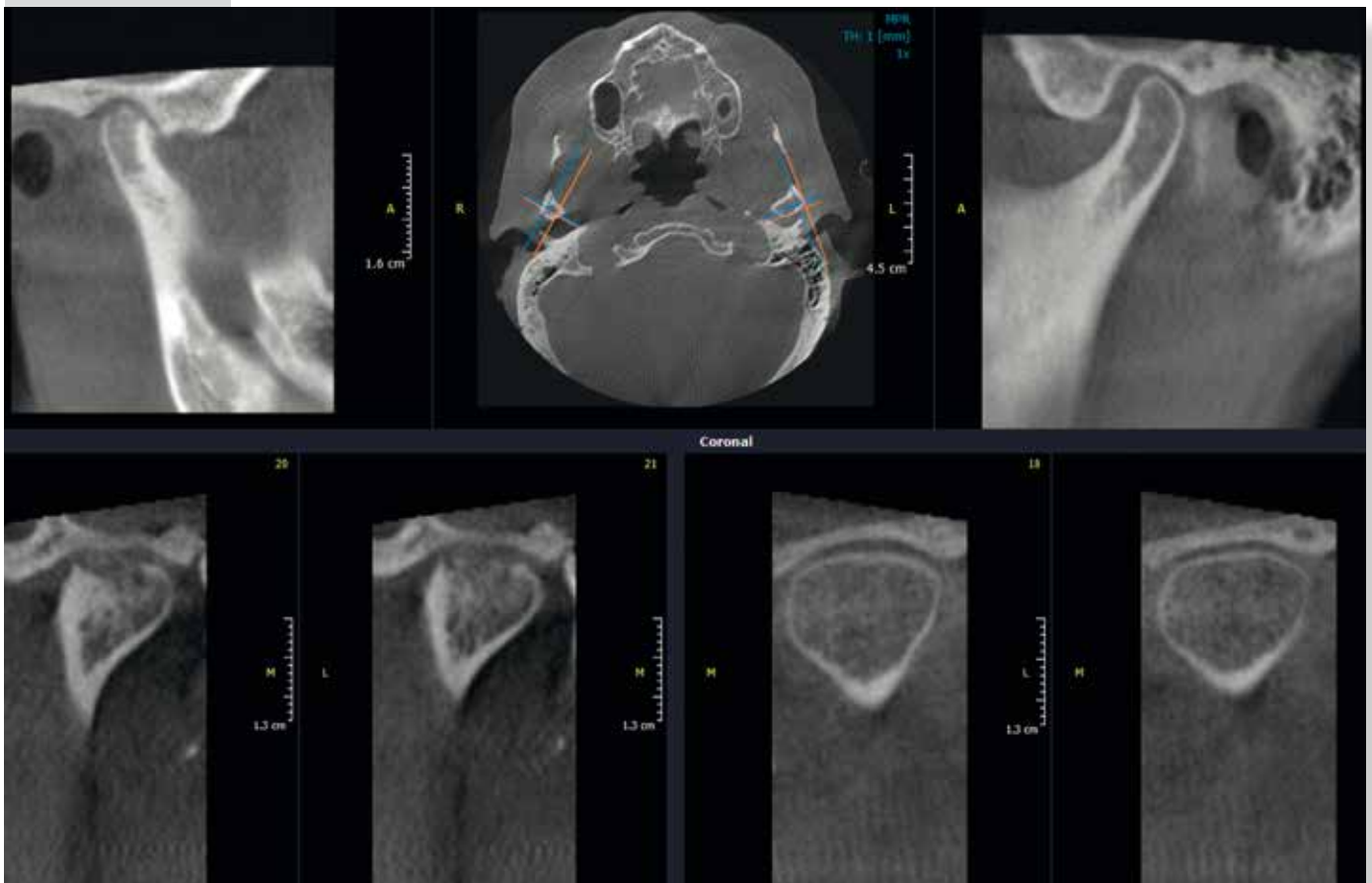

A temporo-mandibular joint study. Osteoarthritis in the right TMJ. (M+)

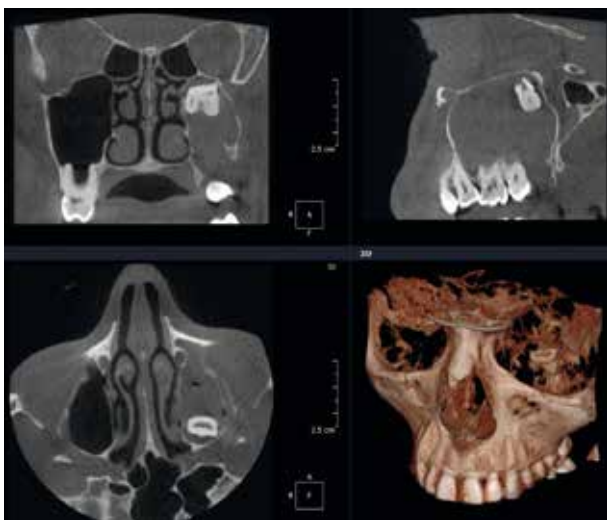

Odontogenic sinus problem. (L+).

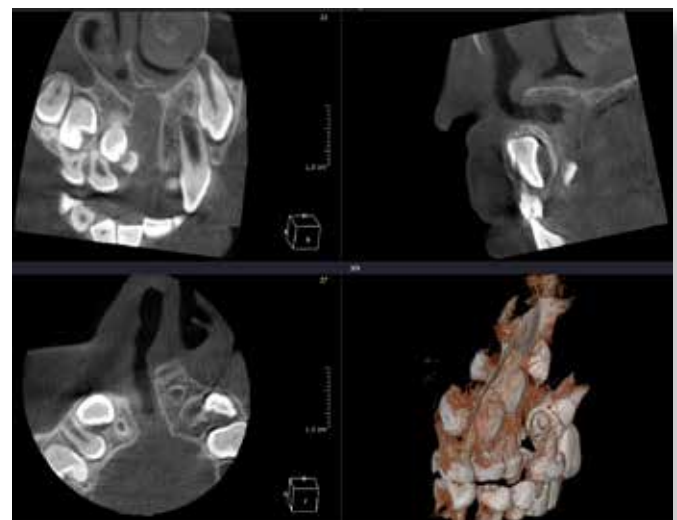

A study of the dental region. Right palatal cleft. (S).

RealPAN™ Panoramic imaging

SCANORA® 3Dx uses a dedicated CCD sensor for high resolution panoramic imaging. With the panoramic option SCANORA® 3Dx provides the speed and efficiency of a traditional panoramic unit. The dental panoramic image provides an overview of the dentition and jaw area.



The unique patented AutoSwitch™ feature changes detectors automatically between panoramic and 3D modes.



Comprehensive software offering

SCANORA® 3Dx produces image data in DICOM® format. With its open architecture it allows versatile and optimized software solutions to be tailored for your practice. The local area network (LAN) with several viewing stations is the solution for most practice applications allowing the system to be linked with the network and system server.

SCANORA® software is the main platform, including the local patient image database and panoramic image handling. The system comes with comprehensive patient management capabilities, a server enabled image database and comprehensive tools for 2D and 3D image processing, diagnostics, treatment planning and reporting.

Freely distribute clinical cases on CD/DVD to referring clinicians. Referring clinicians can utilize the free viewer without investing in special software or import the images in DICOM® format into their own 3D software.

** Digital Imaging and Communication in Medicine*

The software offering can be tailored for different specialties including for instance following features:

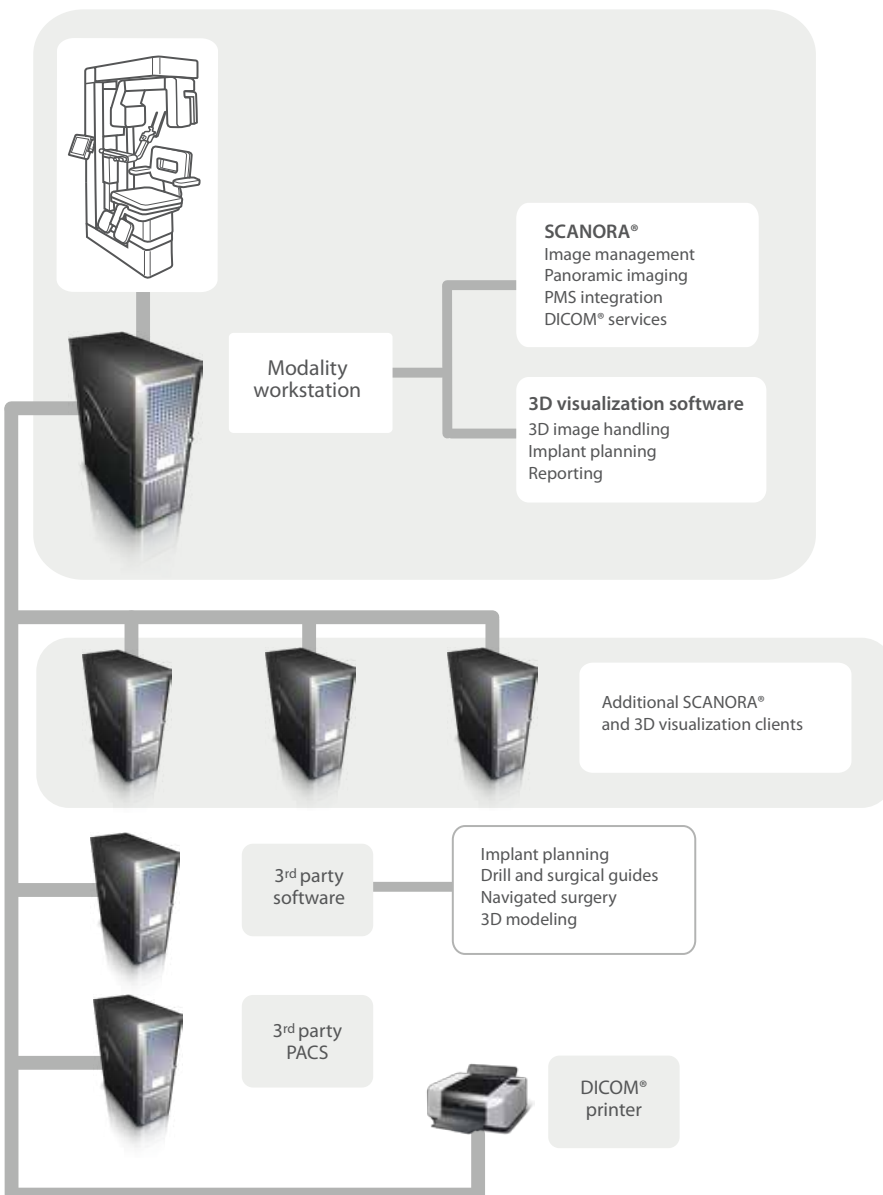

ENT

- Virtual endoscopy
- Airway analysis
- Segmentation

Radiology

- Reporting
- DICOM® printing
- PACS connectivity
- Radiology views
- Image fusion

Dental

- Implant planning
- 3D orthodontic analysis
- TMJ diagnostics

Low dose 3D imaging

X-ray imaging is a balance between image quality and x-ray dose by following the ALARA*) principle. With SCANORA® 3Dx this tradeoff has been successfully addressed by combining high image quality with low dose. The key factors in achieving this are sophisticated X-ray generation, selectable imaging modes, a state-of-the-art flat panel detector and innovative image reconstruction technology.

The minimum effective dose can be compared to one digital panoramic exposure and for a large field-of-view to a few panoramic exposures.

SCANORA® 3Dx gives you the ability to carefully minimize the dose according to the diagnostic task, whether it is a question of detailed primary diagnostics or a follow-up study.

*) ALARA = As Low As Reasonably Achievable

DOSE COMPARISON

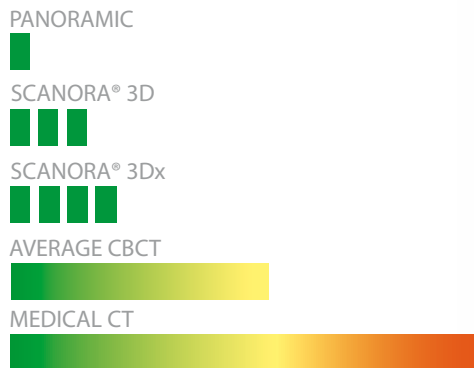

Technical data

SCANORA® 3Dx imaging programs

FOV(H × D) (mm)	Voxel sizes (mm)		Name	Application examples
	Std res	High res		
50 × 50	0.15	0.1	S	Single implants, wisdom tooth, localized problems, endo, perio
50 × 100	0.4	0.2	S+	Maxilla or mandible, implants, drill guides
80 × 100	0.25	0.15	M	Maxilla and mandible, implants, temporal bone
80 × 165	0.35	0.15	M+	Both temporal bones, jaws and TMJ's
140 × 100	0.35	0.25	L	Sinuses, cervical spine, airways
140 × 165	0.3	0.2	L+	Sinuses, orthognathic surgery, ENT, ortho
180 × 165 optional	0.5	0.3	XL	Trauma, facial and orthognathic surgery
240 × 165 optional	0.5	0.3	XL+	Trauma, facial and orthognathic surgery

3D imaging parameters

Scan time	18 - 34 s
Effective exposure time	2.4 - 6 s
3D image receptor type	Flat panel a-Si

Dedicated panoramic imaging (Optional)

Adult panoramic program
Child program
Five partial segments
Lateral TMJ program

X-ray generator

Tube	Fixed anode tube
Focal spot	0.5 mm
Target angle	15 degrees
kV	60-90
mA	4-10

General

Weight	310 kg (690 lbs)
Dimensions (HxWxD)	1973 mm × 1600 mm × 1400 mm (77.7" × 63" × 55.1")

Power requirements

Line voltage	220-240 VAC (±10 %), 50/60 Hz
--------------	----------------------------------

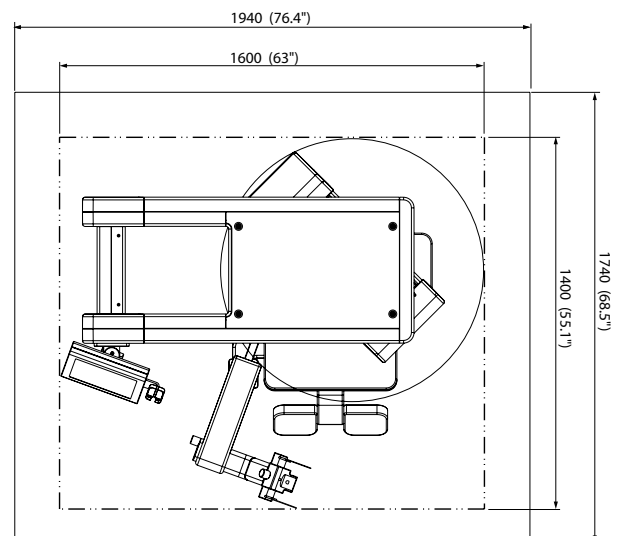
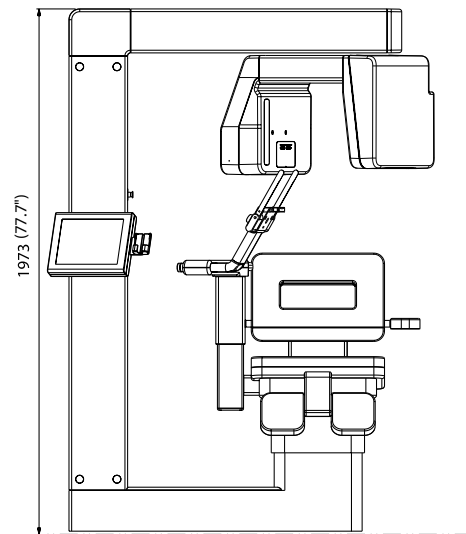



Head office and factory:

SOREDEX

Nahkelantie 160, Tuusula
P.O. Box 148, FI-04301 Tuusula
Finland
Tel. +358 10 270 2000
Fax +358 9 701 5261
info@soredex.com

SOREDEX USA

1245 W. Canal Street
Milwaukee, WI 53233
U.S.A.
Tel. +1 800 558 6120
Fax +1 414 481 8665
usainfo@soredex.com

SOREDEX Germany

Schutterstrasse 12
77746 Schutterwald
Germany
Tel: +49 (0) 781 28 41 98-0
Fax: +49 (0) 781 28 41 98-30
kontakt@soredex.de

Digital imaging made easyTM

www.soredex.com • www.soredex.de • www.soredex.com/usa

209231-2 10/12 Printed in Finland



Since 1977 SOREDEX has been a leader in providing innovative imaging solutions for demanding professionals. Through continuous evolution and refinement we have set the highest industry standards for Quality, Reliability and Efficiency.

We are committed to following this path today and in the future.

SCANORA®/AutoSwitch™/RealPAN™/Digital imaging made easy™ is a registered trademark / a common law trademark of SOREDEX. Other product names and trademarks are the property of their respective owners.

CE-marked, NB (CE) number 0537. Electrical safety meets the IEC 60601-1 standard. Manufacturing complies with ISO 13485:2003, ISO 9001:2008, and ISO 14001:2004.

DICOM® is the registered trademark of the National Electrical Manufacturers Association for its standards publications relating to digital communications of medical information

SOREDEX reserves the right to make changes in specifications and features shown herein at any time without notice or obligation. Contact your SOREDEX representative for the most up-to-date information.

© 2012 SOREDEX