

fi-6800 Image Scanner Getting Started

Thank you for purchasing fi-6800 Color Image Scanner (hereinafter referred to as "the scanner"). This manual describes the preparation required for use of the scanner. Follow the preparation procedures described in this manual.

Make sure to read the "Safety Precautions" document provided with the scanner before use. Read the Operator's Guide (PDF) included in the Setup DVD-ROM for information about the scanner's operation procedures, daily care, consumables replacement, and troubleshooting.

July 2013

<Trademarks and registered trademarks>

Microsoft, Windows, Windows Server, Windows Vista, and SharePoint are either registered trademarks or trademarks of Microsoft Corporation in the United States and/or other countries.

ISIS is a registered trademark or trademark of EMC Corporation in the United States.

PaperStream is a registered trademark of PFU LIMITED in Japan.

Other company names and product names are the registered trademarks or trademarks of the respective companies.

© PFU LIMITED 2009-2013

Checking the Components

Make sure that all items shown below are included in the package. If any other packaging is provided, make sure to store it as well. Make sure to handle the components with care.

The box and packaging materials are required for storage and transportation of the scanner. Do not throw them away. If anything is missing or damaged, contact your FUJITSU scanner dealer or an authorized FUJITSU scanner service provider.



Scanner (× 1)

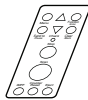

Operator Panel Overlay (× 6)



Power Cable (× 1)



USB Cable (× 1)



Safety Precautions (× 1)

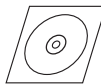

Setup DVD-ROM (× 1)

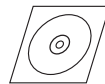

2D Barcode for PaperStream Setup CD-ROM (× 1)



fi-6800 Convenient Operation (× 1)
fi-6800 Maintenance Guide (× 1)



Note: The contents may vary depending on the country.

Safety Precautions

The provided "Safety Precautions" document contains important information about the safe use of the scanner. Before using the scanner, make sure to read and understand the information provided in the "Safety Precautions" document.

Symbols Used in This Manual

The following symbols are used in this manual.

Symbol	Description
	This symbol alerts operators to an operation that, if not strictly observed, may result in severe injury or death.
	This symbol alerts particularly important information. Be sure to read this information.
	This symbol alerts operators to helpful advice regarding operation.

Installing the Software

Bundled Software

The following software are bundled with the scanner:

- **PaperStream IP (TWAIN) Driver**
Conforms to the TWAIN standard. Used when you operate the scanner using TWAIN-compliant applications.
- **PaperStream IP (ISIS) Driver**
Conforms to the ISIS standard. Used when you operate the scanner using ISIS-compliant applications.
- **2D Barcode for PaperStream**
This option can recognize two dimensional codes. Can be used with the PaperStream IP (TWAIN) driver, the PaperStream IP (ISIS) driver, or PaperStream Capture. For details about the installation, refer to readme in the 2D Barcode for PaperStream Setup CD-ROM.
- **Software Operation Panel**
Configure various settings such as the operation of the scanner and managing the consumables. Installed together with the PaperStream IP (TWAIN) driver and PaperStream IP (ISIS) driver.

- **Error Recovery Guide**
Shows the error status and countermeasures when an error occurs. Installed together with the PaperStream IP (TWAIN) driver and PaperStream IP (ISIS) driver.
- **PaperStream Capture**
An image scanning application that supports the PaperStream IP (TWAIN) driver and PaperStream IP (ISIS) driver. By defining scan settings as document profiles, you can customize the settings according to your preference.
- **Manual**
Includes Safety Precautions, Getting Started and Operator's Guide.
- **Scanner Central Admin Agent**
Used to centralize the management of multiple scanners, by allowing you to apply firmware updates simultaneously, monitor the operating status, and check the scanner information. Note that required applications will differ depending on the form of operation. For details, refer to the Scanner Central Admin User's Guide.
- **Other Software (Legacy)**
Software that were bundled with older versions of scanners are also included.
 - **TWAIN Driver**
Conforms to the TWAIN standard. Used when you operate the scanner using TWAIN-compliant applications.
 - **ISIS Driver**
Conforms to the ISIS standard. Used when you operate the scanner using ISIS-compliant applications.
 - **Image Processing Software Option**
A software option featuring advanced binarization of scanned images. Can be installed together with the scanner drivers (TWAIN/ISIS).
 - **ScandAll PRO**
A TWAIN/ISIS-compliant image scanning software. You can define scanning settings as batch profiles, to suit your various operation requirements. By defining scanning settings as batch profiles, you can easily perform scans in accordance with various operation requirements.
 - **Scan to Microsoft SharePoint**
A software program that allows you to upload your files easily from ScandAll PRO to a SharePoint site. Can be installed together with ScandAll PRO.

System Requirements

The system requirements for fi-6800 are as follows.

Operating system	<ul style="list-style-type: none"> ● Windows® 2000 Professional (Service Pack 4 or later) (*1) (*2) ● Windows® XP Home Edition (Service Pack 3 or later) ● Windows® XP Professional (Service Pack 3 or later) ● Windows® XP Professional x64 Edition (Service Pack 2 or later) ● Windows Server® 2003, Standard Edition (*1) (*2) (*4) ● Windows Server® 2003, Standard x64 Edition (*1) (*2) (*4) ● Windows Server® 2003 R2, Standard Edition (Service Pack 2 or later) (*4) ● Windows Server® 2003 R2, Standard x64 Edition (Service Pack 2 or later) (*4) ● Windows Server® 2008 Standard (32-bit/64-bit) ● Windows Server® 2008 R2 Standard (64-bit) ● Windows Vista® Ultimate (32-bit/64-bit) (Service Pack 1 or later) ● Windows Vista® Home Premium (32-bit/64-bit) (Service Pack 1 or later) ● Windows Vista® Home Basic (32-bit/64-bit) (Service Pack 1 or later) ● Windows Vista® Business (32-bit/64-bit) (Service Pack 1 or later) ● Windows Vista® Enterprise (32-bit/64-bit) (Service Pack 1 or later) ● Windows® 7 Home Premium (32-bit/64-bit) ● Windows® 7 Professional (32-bit/64-bit) ● Windows® 7 Enterprise (32-bit/64-bit) ● Windows® 7 Ultimate (32-bit/64-bit) ● Windows Server® 2012 Standard (64-bit) ● Windows® 8 (32-bit/64-bit) (*3) ● Windows® 8 Pro (32-bit/64-bit) (*3) ● Windows® 8 Enterprise (32-bit/64-bit) (*3)
------------------	---

DVD drive	Essential for installing the software
Interface	<ul style="list-style-type: none"> ● Ultra-SCSI (50-pin) ● USB2.0 (High-Speed)

*1: Scanner Central Admin Agent is not supported.

*2: ScandAll PRO and Scan to Microsoft SharePoint are not supported.

*3: The software operates as a desktop application.

*4: PaperStream IP and PaperStream Capture are not supported.



Windows Vista® screen examples are used to explain the operations. The screens and operations may differ slightly depending on the operating system you are using. Where there is no distinction between the different versions of the above operating system, the general term Windows® is used.

Installing the Bundled Software

Install the bundled software from the Setup DVD-ROM in the following procedure.

Note that there are two ways to install the bundled software: select [Installation (Recommended)] to install all the software required to operate the scanner, or [Installation (Custom)] to select and install the software as needed.



- If an old version of the software is installed already, uninstall it first. For how to uninstall software, refer to "A.5 Uninstalling the Software" in the Operator's Guide.
- Log on as a user with "Administrator" privileges (Administrators).

■ Installation (Recommended)

The following software are installed:

- PaperStream IP (TWAIN) Driver
- Software Operation Panel
- Error Recovery Guide
- PaperStream Capture
- Manual
- Scanner Central Admin Agent

1. Turn on the computer and log onto Windows® as a user with Administrator privileges.

2. Insert the Setup DVD-ROM into the DVD drive.

⇒ The [fi Series Setup] screen appears.



If the [fi Series Setup] screen does not appear, double-click "Setup.exe" in the Setup DVD-ROM via Windows Explorer or [Computer].

3. Click the scanner model.
4. Click the [INSTALL (Recommended)] button.



5. Follow the instructions on the screen to proceed with the installation.

■ Installation (Custom)

1. Perform steps 1. to 3. in "Installation (Recommended)" (page 3).
2. Click the [Installation (Custom)] button.



3. Select the check box for the software to install and click the [Next] button.
4. Follow the instructions on the screen to proceed with the installation.

Installing the Scanner

Place the scanner at its installation site.

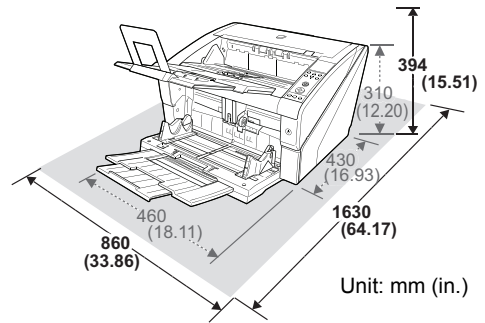

Unit: mm (in.)

..... Scanner's Dimensions

— Installation Space



- The scanner weight is 32 kg (70.56 lb). You must not carry it alone.
- Carry the scanner by supporting it from the bottom.

Connecting the Cables

The following describes how to connect the cables between the scanner and your computer.

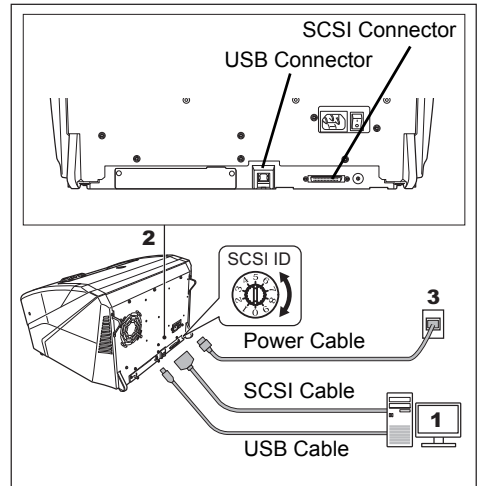

1. Make sure that the computer is turned OFF.

- 2.** Connect the scanner to your computer either with a USB or SCSI cable.



- You cannot make both USB and SCSI cable connections at the same time.
- You cannot connect multiple computers to the scanner at the same time.
- Turn off the scanner and your computer whenever you switch the interface cable.

The following describes the requirements for connecting with the respective cables.

● **USB cable**

- Be sure to use the USB cable which comes as an accessory with this scanner.
- When connecting to an USB hub, use the first stage USB hub that is closest to the computer. If you use the second or later hub stages, the scanner may not operate correctly.
- If you connect the scanner with USB 2.0, it is required that the USB port and the hub be compliant with USB 2.0. The scanning speed slows down when you connect the scanner with USB 1.1.

● **SCSI cable**



Be careful not to damage any pins of the SCSI connector when connecting the scanner to your computer.

- When using the scanner with a SCSI interface, the following types of SCSI cable and SCSI card must be purchased.

SCSI cable:

Use a SCSI cable whose connector on the computer side mates to the connector on the SCSI card installed on your computer. On the scanner side, use a 50-pin high-density type SCSI cable.

SCSI Connector 1: 50-pin high-density type
SCSI Connector 2: 68-pin high-density type

SCSI card:

Find the recommended SCSI card information on the Fujitsu website (FAQ):
<http://www.fujitsu.com/global/support/computing/peripheral/scanners/scsi/>

- In a SCSI daisy chain formation, connect the scanner so that it is the terminated device.
- The SCSI ID initially set at the factory is [5]. If the SCSI ID of another SCSI device is set to the same ID, change the scanner's SCSI ID to [0] through [6].

- 3.** Connect the power cable to the power connector of your scanner and to the power outlet.

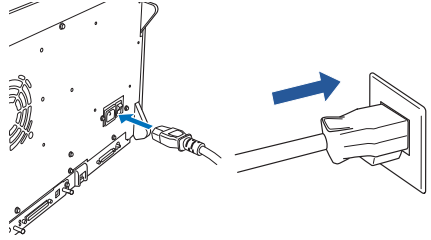

WARNING

Be sure to use the supplied power cable. The following cases may cause electrical shock or malfunction.

- Using a power cable other than that supplied
- Using the supplied power cable for other devices

Test-Scanning Documents

Using ScandAll PRO, you can test-scan documents to check if they are scanned correctly. For details about scanning documents by using PaperStream Capture and the PaperStream IP driver, refer to the help of each software. The following describes how to test-scan a document:

- 1.** Turn on the scanner.

1. Press the "I" side of the main power switch on the rear side of the scanner.
2. Press the power button on the front of the scanner. The scanner is turned ON, the power button lights in blue, and the liquid crystal display (LCD) shows [Ready].



If you see an error indication other than the above on the LCD, refer to "Chapter 8 Troubleshooting" in the Operator's Guide.

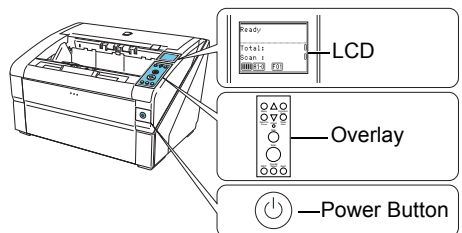

2. Replace the current operator panel overlay with the one for the language to be used, and specify the language to be shown on the LCD.

For how to replace the overlay and specify the language setting, refer to "Chapter 4 How to Use the Operator Panel" in the Operator's Guide.

3. Turn on your computer.



For a SCSI connection, turn on the scanner and confirm that the LCD shows [Ready]. Then, turn on your computer.

4. The scanner is automatically detected, and the [Found New Hardware] dialog box appears. Select [Locate and install driver software (recommended)] to install the driver, following the on-screen instructions.

5. Load a sheet into the scanner.

For loading a sheet, refer to "2.1 Loading Documents" in the Operator's Guide.

6. Launch ScandAll PRO.

Select the [Start] menu → [All Programs] → [Fujitsu ScandAll PRO] → [ScandAll PRO].

7. Select the [Tool] menu → [Preferences].

⇒ The [Setup] dialog box appears.

8. On the [Scan] tab, select a driver to use, and then click the [OK] button.

9. Select the [Scan] menu → [Select Scanner].

⇒ The [Select Scanner] dialog box appears.

10. Select the scanner you want to use, and then click the [Select] button.

Select the scanner model which is connected to your computer.

The list of scanner models varies depending on the scanner driver installed.

TWAIN	ISIS
FUJITSU fi-6800dj	Fujitsu fi-6800

11. Click the [Scan] menu → [Scan Settings].

⇒ The [Scan Settings] dialog box appears.

12. Clear the [Save to file] check box.

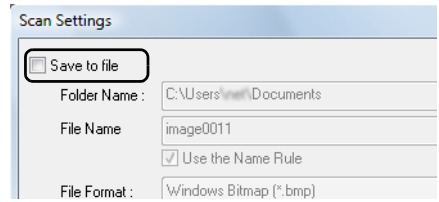

You only check the operation now, so you do not have to save to file.

13. Click the [Scanner Setting] button.

⇒ The scanner driver's setup dialog box appears.

14. Configure scanner settings such as the resolution and paper size.

- TWAIN/ISIS scanner drivers

Configure scan settings, and then click the [OK] button.



For a TWAIN scanner driver, the scanner driver setup dialog box may be displayed again after the [OK] button is clicked. If this occurs, click the [Scan] button in the dialog box.

15. In the [Scan Settings] dialog box, click the [Scan] button.

⇒ The scanned document images are displayed in the ScandAll PRO window.

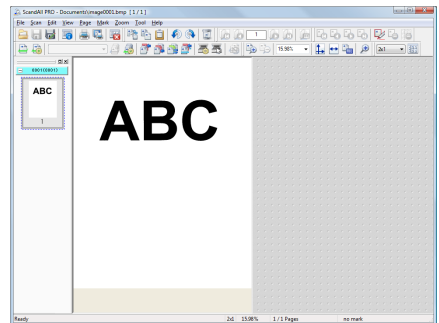

Refer to "Chapter 8 Troubleshooting" in the Operator's Guide, if you see any unexpected characters on the LCD.

For information about other scanning features, refer to "Chapter 5 Various Ways to Scan" in the Operator's Guide.

Contact for Inquiries

Refer to the contact list on the last page of the "Safety Precautions" document.