

HISTORIC PROPERTY DOCUMENTATION

Pond Eddy Bridge (All Veterans Memorial Bridge)

<u>PHMC Key #</u>	000397
<u>Location:</u>	The Pond Eddy Bridge crosses the Delaware River on Pennsylvania State Route 1011 between the village of Pond Eddy in Shohola Township, Pike County, Pennsylvania and the village of Pond Eddy in the Town of Lumberland, Sullivan County, New York. USGS Pond Eddy, Pennsylvania Quadrangle, UTM: 18 515013E 4597329N.
<u>Date of Construction:</u>	1904-1905
<u>Fabricator:</u>	Owego Bridge Company
<u>Present Owner:</u>	The present owner of the Pond Eddy Bridge is the Commonwealth of Pennsylvania.
<u>Present Use:</u>	The vehicular bridge is currently open with a 7 ton weight limit and a 10 M.P.H. Speed Limit.
<u>Significance:</u>	The Pond Eddy Bridge was listed in the National Register of Historic Places on November 14, 1988 as a representative example of a multiple span Pennsylvania (Petit) through truss bridge. This bridge is one of the few representative truss bridges located in northeastern Pennsylvania.
<u>Project Information:</u>	<p>The Pennsylvania Department of Transportation has proposed replacement of the Pond Eddy Bridge because of structural deficiencies, load restrictions, and limited roadway width. In accordance with the Memorandum of Agreement, this documentation was undertaken in September 2012 by the Pennsylvania Department of Transportation as a mitigation measure prior to demolition of the bridge.</p> <p>ASC Group, Inc. 801 E. Park Drive, Suite 102 Harrisburg, Pennsylvania 17111</p>

Description and History

The 1905 Pond Eddy Bridge, more recently known as the All Veterans Memorial Bridge, crosses the Delaware River between a former village known as Pond Eddy, Pennsylvania in Shohola Township, Pike County and a hamlet known as Pond Eddy, New York in the Town of Lumberland, Sullivan County. Pennsylvania State Route (S.R.) 1011 is known locally as Flagstone Road southwest of the bridge and Rosas Road southeast of the bridge. On the New York side of the Pond Eddy Bridge, S.R. 97 was constructed in the 1930s generally along the path of the former Delaware and Hudson Canal and runs roughly parallel to the Delaware River. Sullivan County Road (C.R.) 41, known as High Street, running southeast intersects with S.R. 97 at the Pond Eddy Bridge. Just west of C.R. 41, local Hollow Road runs southwest and intersects with C.R. 41 at S.R. 97 (Figure 1).

The Pond Eddy Bridge is a two-span, pin-connected steel Pennsylvania (Petit) through truss bridge. The trusses are supported on cut stone mortared abutments and a stone center pier. The upper chords of the trusses are at varying elevations giving the bridge a “camel-back” appearance. Each identical span is 252 feet long with an overall bridge length of 504 feet. The curb to curb width of the bridge is 14 feet 10 inches and it has a timber deck. The wooden deck is supported on longitudinal rolled steel stringers which are supported on steel built up riveted floorbeams.

Each span of the Pond Eddy Bridge has twelve equal panels measuring 21 feet each and the distance between the trusses is 17 feet, 3 5/8 inches, measured center to center. The top chords of each truss are comprised of two channel sections connected with a plate across the top flanges and with the bottom flanges laced together with flat bars. The bottom chords of each truss are made up of multiple eyebar links. The truss diagonal and vertical members provide for tension and compression and the truss members are connected with shear pins at each truss node.¹

No historic information is available regarding the foundations of the abutments or the center pier. There are no extant engineering drawings for the 1905 Pond Eddy Bridge and, although there is speculation that the abutments, wing walls, and center pier may be from the 1871 bridge in the same location, this cannot be confirmed.² The abutment and the wing walls on the Pennsylvania side of the bridge bear directly on the surface of a ledge of bedrock; they are not imbedded into the rock.³ All masonry support features are faced with mortared flagstone which was still mined locally when the Pond Eddy Bridge was constructed in the early twentieth century.⁴

In the early nineteenth century, a privately funded engineering feat transformed the economy and development of northeastern Pennsylvania and southwestern New York. In the early 1820s two Philadelphia businessmen understood the value of anthracite coal that was available in abundance in northeast Pennsylvania and recognized the need to develop an economical way to

transport the resource to markets in New York City and Canada. They hired Benjamin Wright, the engineer of the Erie Canal, to design a canal that would move goods from Honesdale, Pennsylvania to the Lackawaxen River, cross the Delaware River to run northwest along the bank of that river to the Neversink River, and travel on to the Hudson River and the Erie Canal. The estimated cost of the 32 foot wide canal was 1.2 million dollars which was raised through a private stock sale. Construction began on the Delaware and Hudson Canal (D&H Canal) in 1825. The grueling hand building of the 108 mile Canal eventually included the construction of 108 locks, 137 bridges, and 28 basins, dams, and reservoirs. By 1828 coal laden barges were pulled by mules along the towpath next to the Canal. In 1847 bridge engineer John Roebling was hired to design four suspension aqueducts (or bridges) to facilitate faster traffic flow at river crossings. One of these structures, the Delaware Aqueduct or the Roebling Bridge is extant and was restored by the National Park Service; it has been designated a National Historic Landmark and a National Civil Engineering Landmark.⁵

Along the D&H Canal, close to the former Lock No. 63, the current of the Delaware River runs contrary to its usual direction creating a small area of slow moving water that resembles a pond. This natural phenomenon gave the developing nearby hamlet the name of Pond Eddy, New York. After the opening of the D&H Canal in 1828, Pond Eddy became home to canalmen and their families and attracted hunters and fishermen. The hamlet, considered part of the town of Lumberland, soon included a small collection of homes, a school, a Methodist Church, and the 1835 Sportsmen Hotel.⁶

In the late 1840s transportation improvements came to the Pennsylvania side of the Delaware River with the construction of the Erie Railroad which crossed the river from New York into Pennsylvania north of Matamoras in Westfall Township, Pike County. The railroad generally followed the river west/northwest through Shohola Township and Lackawaxen Township before crossing into Wayne County, Pennsylvania (Figure 2). The construction of the Erie Railroad along the rocky heights of the Pennsylvania side of the Delaware River was difficult and dangerous requiring extensive use of dynamite. The constant blasting often sent tons of rock into the river disrupting and endangering canal traffic.⁷

Once the rail line was completed, a station at Pond Eddy, Pennsylvania and a quarry stop at Flagstone were constructed. Because of the rugged topography of the area, Pond Eddy, Pennsylvania grew more slowly than its counterpart in New York. However, the economic development in this section of Shohola Township was greatly increased by the advent of bluestone (also known as flagstone) mining in the late 1860s. James Kigour owned bluestone quarries in Pond Eddy, Pennsylvania and Pond Eddy, New York and the stone was shipped for use all over the country via the D&H Canal and the Erie Railroad. The presence of two major transportation opportunities, successful industries, and abundant natural resources brought prosperity to the communities of Pond Eddy in both states.

In the late nineteenth century, the Town of Lumberland, New York made the decision to finance the construction of a bridge across the Delaware River in the vicinity of the communities of Pond Eddy, Pennsylvania and Pond Eddy, New York. In 1869 the New York State Legislature authorized Lumberland to construct a bridge across the Delaware River at Decker's Dock in Pond Eddy. James Decker owned a home, a dock and other property on the Delaware River at the site of the proposed bridge. Decker was a former canal boat captain who settled in Pond Eddy and became involved in Lumberland and Sullivan County politics. In 1860 he became supervisor (or mayor) of Lumberland and was also active as a lumber and stone dealer and in farming. Decker was elected Sheriff of Sullivan County in 1870 and later served as a state congressman.⁸

Shortly after the legislation passed in 1869, the Town of Lumberland appointed Bridge Commissioners to oversee the process of constructing a bridge across the Delaware River.⁹ There is no other discussion in the Lumberland Town Records regarding the construction of the bridge but secondary sources indicate that a "Roebbling type suspension bridge" was constructed between 1870 and 1871 at a cost of \$19,600. John Roebbling was a noted bridge engineer who had designed the aqueducts/bridges for the D&H Canal in the 1840s. Construction was overseen by James D. Decker, who lived adjacent to the new structure. The two-span Pond Eddy Bridge was designed with wire cables and stringers, in some cases anchored to natural features on the steep Pennsylvania side. The bridge was 521 feet long and 12 feet wide and was elevated 28 feet above the low water level of the Delaware River at each abutment and 31 feet at the center pier. There were clapboard covered wooden towers on either side of both abutments and the center pier. On the New York side a small wooden bridge crossed over the D&H Canal and Towpath and led to the suspension bridge approach (Historic Photographs 1-3). The bridge became locally known as Decker's Bridge or the Bridge at Decker's Dock (Figure 3).¹⁰

According to the Lumberland Town Records, the first repairs to the 1871 bridge were made in 1876 with the replacement of the wooden deck planks with yellow pine and spruce through a lumber contract with James Decker.¹¹ In 1886 the town issued its first bond in the amount of \$1,000 to provide funds for repairing the pier and abutments of the bridge.¹² In the 1890s and early twentieth century, the Town Board of Lumberland repeatedly discussed problems with the suspension bridge, often meeting at the bridge site and usually ending with an appropriation for repairs.¹³

In the late nineteenth and early twentieth century the most typical type of vehicular bridge construction in the United States were various truss designs, constructed of iron and steel. After 1900 J.P. Morgan's American Bridge Company controlled much of the metal bridge fabrication market but smaller bridge companies, such as the Groton Bridge and the Owego Bridge Company continued to be active in northeastern Pennsylvania and throughout New York. The

Groton Bridge Company, located in the central New York town of the same name, was founded in 1877 and became a regionally well known company. Like many small bridge fabricators, it was absorbed into the American Bridge Company in 1900 but purchased from that entity in 1902 by the Congers Brothers. The Owego Bridge Company was established in 1892 by Ellery Colby who had previously been associated with the Groton Bridge Company. In 1902 Frank Congers also purchased the Owego Bridge Company and the two firms operated separately but under the same ownership for the next several decades.¹⁴

Southwestern New York and northeastern Pennsylvania, along the Delaware River, were not unaccustomed to flooding events but in October 1903 almost two days of rain precipitated a particularly destructive onslaught. The river crest was recorded just over 23 feet, four feet above flood stage; it became known as the Great Pumpkin Flood because much of that fall crop was seen floating down the river. Bridges on rivers and creeks close to the Delaware River sustained damage or were washed away entirely.¹⁵

The Town of Lumberland lost several bridges as a result of the 1903 Pumpkin Flood. During October and November of 1903 the Lumberland Highway (formerly Bridge) Commissioners awarded the Owego Bridge Company contracts to replace three bridges which had been damaged or destroyed by the flood.¹⁶ In late November the Town Board and the Highway Commissioners turned their attention to the Pond Eddy Bridge which had sustained damage in the October flood. The Town Board met on site and heard from a report from an Owego Bridge Company representative who recommended repairs to the bridge cables. The Town Board requested that the Highway Commissioners seek the opinion of a bridge engineer. The second expert agreed that repairs were necessary but he did not feel the bridge was unsafe. The Board took no action on repairs to the bridge and the matter did not come up again until the spring of 1904.¹⁷

In April of 1904 the Lumberland Town Board authorized the hiring of a State Engineer to inspect the Pond Eddy Bridge. The Board met at the bridge in May where the State Engineer informed them that the bridge cables were safe and further stated that a full report would be provided by the State to the Town Board. No documentation of that report appears in the town records but in June 1904 the Town Board resolved to refer the issue of the Pond Eddy Bridge to their legal counsel.¹⁸

On July 15, 1904 the Town Board once again met at Rixson's Hotel, adjacent to the Pond Eddy Bridge. They initially voted to repair the bridge but then apparently heard from representatives of various bridge companies. The Board resolved to have the "Bridge men" prepare estimates for repairs to the bridge according to plans drawn up by the Owego Bridge Company. The representatives of the bridge companies prepared their bids while the Board adjourned for lunch. Possibly following a review of the bids presented after lunch, the Town Board rejected the

morning's resolution and made a new resolution requesting two bids from each company; one for repair of the bridge and one for replacement of the bridge. The bids were again prepared immediately and presented to the Town Board. The bids were recorded as follows:

<u>Company</u>	<u>Repair Cost</u>	<u>New Bridge</u>
Groton Bridge Co.	\$19,100	\$31,000
Syracuse Bridge Co.	\$19,225	\$31,225
Rochester Bridge Co.	\$20,225	\$32,000
Owego Bridge Co.	\$18,400	\$28,900
Canton Bridge Co.	\$18,995	\$30,982

The Board agreed that replacement of the bridge was more cost effective and they resolved that, because the State Engineer had determined the bridge “known as the Decker Dock Bridge” was unsafe, a new bridge should be constructed according to the plans and specifications drawn up by the Owego Bridge Company. They further voted, on the same day, to accept the low bid of the Owego Bridge Company.¹⁹

The new Pond Eddy Bridge was to be a Pennsylvania through truss, a design often used for railroad bridges of moderate length. The steel trusses were fabricated in the Owego, New York shops of the Owego Bridge Company and transported via the Erie Railroad to Pond Eddy. During the summer of 1904 the existing Pond Eddy Bridge remained open but preparation work on the abutments and center pier likely also took place. The extent of the reuse or rebuilding of the existing abutments and center pier are unknown although a September 8, 1904 meeting of the Town Board included a discussion of changes to the contract for the north abutment of the bridge. At the same meeting a resolution instructed the Highway Commissioners to post signs that the bridge would be closing on or about October 15, 1904.²⁰ Construction was obviously proceeding in October 1904 when the Town Board authorized the Highway Commissioners to “... furnish native Pitch Pine plank necessary for the proposed New Iron Bridge at Pond Eddy”, as well as oak wheel guards.²¹

On January 13, 1905, the Town Board convened at Jacob Pontz' Mountain View Hotel in order to meet Charles Stowell, the New York State Engineer who was to inspect the nearly completed new bridge (Historic Photo 4). The content of Stowell's report is not documented in the Town Records but in late January the Board authorized payment to the Owego Bridge Company after Highway Commissioner George Paye approved their work. Paye recommended that \$900 be withheld from the final payment to cover uncompleted work.²² At the same meeting, Town Board members voted to have signs put on the new Pond Eddy Bridge and on the Carpenter Brook Bridge stating that there would be a “... Ten Dollar(s) fine for driving faster than a walk ...” (Historic Photo 5).²³

The financing for the new Pond Eddy Bridge was originally covered by 28 short term certificates for \$1,000 each, payable by the National Bank of Port Jervis. The bridge financing was reorganized in December 1905 when the Lumberland Town Board made application to the Sullivan County Board of Supervisors for the authority to issue \$1,000 bonds, maturing over a 17 year period.²⁴

The early twentieth century was a time of change in the Upper Delaware Valley and for the Pond Eddy communities in Pennsylvania and New York. The Delaware and Hudson Canal ceased operation in 1898 and the property was taken over by the Erie Railroad. Lumbering and bluestone mining had run their course and the natural resources were greatly diminished. The region had become well known as a tourist destination, specializing in hunting and fishing as well as more passive pursuits of boating, bird watching, and hiking (Historic Photo 6). Pond Eddy, New York was home to at least two hotels and a number of boarding houses. In Pond Eddy, Pennsylvania there were private summer homes and year-round residences. With easy access from the metropolitan centers of the northeast via the Erie Railroad, the Town of Lumberland also became a popular site for grand country estates

Over the next 22 years the Town of Lumberland struggled to maintain the Pond Eddy Bridge and keep it in good repair. The bridge accommodated automobile traffic as well as carriages and wagons. In the summer of 1908, the Lumberland Town Board appropriated funds for painting the bridge, replacing the plank deck, and making repairs to the stone center pier. The center pier was particularly susceptible to damage from winter ice and debris on the Delaware River. Highway Commissioner Andrew Paye appears to have been the contractor for many of the repairs to the Pond Eddy Bridge.²⁵ Three years later in 1911 the deck planks were once again replaced and the Town Board recommended that a Shohola, Pennsylvania stone mason be contacted about repairs to the abutments. The Board later authorized the sale of used bridge plank for \$2 per thousand feet.²⁶

In the summer of 1914, the Lumberland Town Board held a series of meetings to discuss the ongoing problem of damage to the center pier of the Pond Eddy Bridge. Experts present at the July 30 meeting recommended a 24 foot steel nose plate, 18 inches wide, and 9 feet of concrete on the upstream side; their estimate for these repairs was \$1,400. The Board took no action but agreed to meet at the bridge in August and examine the foundation of the center pier themselves. This was accomplished and the Highway Superintendent was instructed to draw up a repair plan with specifications and advertise for bids. At a meeting of the Town Board on August 6, 1914, three bids were opened with estimates ranging from \$400 to \$750. The repair contract was awarded on August 10 to Peter Caufield with the lowest bid of \$400. On September 18 the work on the center pier of the Pond Eddy Bridge was inspected by the Highway Superintendent and found to be satisfactory so payment was authorized.²⁷

Highway Superintendent Andrew Paye appeared before the Lumberland Town Board in June 1918 with concerns about damage to the center pier of the Pond Eddy Bridge and the loss of cribbing on the bridge over Carpenter Brook. The Board agreed to meet Paye at the Pond Eddy Bridge several days later where they secured a boat and examined the center pier from the water. The Board authorized Paye to complete repairs at a cost of no more than \$500.²⁸ In 1919 the deck planking on the bridge was again replaced.²⁹

In June 1921 the Town Board met again at a Pond Eddy Hotel, and examined the further damage to the center pier of the Pond Eddy Bridge. They passed a resolution that, due to the pier damage that compromised the safety of the entire structure, the Highway Superintendent should proceed with repairs to the pier and appropriated \$1,200 for the work. However, a note in the Town Records indicates that this payment certificate was issued but never used.³⁰

The Lumberland Town Records do not document whether repairs to the center pier were completed in 1921 but in the late summer of 1922 the Town Board was once again in a boat on the Delaware River inspecting the winter's damage to the Pond Eddy Bridge. They authorized the Highway Superintendent to draw up specifications for two types of repairs; covering the pier with large boulders and suitable fill to be paved on top and covering the pier with cribbing filled with concrete. They also authorized the public solicitation of bids to complete the work. Again, there is no documentation in the Town Records that this work ever began.³¹

The Lumberland Town Board met in June 1923 and again addressed the issue of repairs to the center pier of the Pond Eddy Bridge, authorizing the Highway Superintendent to post notices that bids on the repair work would be accepted. The contract specifications called for large rocks and two courses of rip rap at the front and sides of the pier. During their July meeting the Board opened the one bid received from Andrew Paye (former Highway Superintendent) and awarded him a contract to prepare a base for the pier repairs with one-half to one ton boulders and to rip rap the top with large flat boulders, paved with cement. The Town of Lumberland was to furnish the cement and the contractor all other materials and labor. Payment would be based on charges of \$4.50 per cubic yard for rock fill and \$5.50 per cubic yard for paving with a completion date of October 1, 1923.

When the work was finished in late September it was inspected by the current Highway Superintendent who found it satisfactory and acceptable but noted that there was a discrepancy between Paye's measurements of work completed and the Superintendent's measurements. When the Town Board compared the cost of the work based on the Superintendent's measurements to Paye's bill they found a difference of \$687 in their favor. Paye disputed this difference and the Board agreed to hire an independent engineer to take measurements of the completed work. The City Engineer of Port Jarvis, New York was engaged to examine and

measure the repairs. His report noted that Paye's bill was \$475.25 too high. Paye would not accept this assessment and the issue was tabled in October 1923.³²

There was no resolution of the payment issue for over a year. The Town Records thoroughly document Andrew Paye's claim that Lumberland owed him \$454.45 and his efforts, including legal representation, to receive payment for the work. In November 1924 there was a compromise agreement by which Paye received half of the amount he claimed was owed or \$227.23.³³

The Lumberland Town Board first discussed the possibility of selling the Pond Eddy Bridge to the State of New York and the Commonwealth of Pennsylvania in January 1925. They appointed a committee of one to study the issue and confer with the appropriate parties.³⁴ According to later documentation in the Town Records, part of the work involved an assessment of the current repairs needed for the bridge. Over a year later, in April 1926, the Board passed a resolution that confirmed an estimated \$10,000 in potential repair costs, noted that the Interstate Bridge Commission was unwilling to purchase the bridge but would take it over for \$1, and called for a special Town Meeting for the taxpayers of Lumberland to vote on whether or not to convey the bridge to the two states.³⁵ There were 24 votes cast on the issue and it passed 23-1 as certified by Franz V. Schwarz, Town Clerk.³⁶

After another ten months of legalities, the Lumberland Town Board met on May 25, 1927 and presented the following deeds to be conveyed jointly to the states of New York and Pennsylvania:

- Deed covering the Bridge
- Warrantee Deed covering the land on which the abutment stands in Pennsylvania
- Warrantee Deed covering the land on which the abutments stand in New York
- Quit Claim Deed covering the land on which the abutment stands in New York

A resolution to sell the Pond Eddy Bridge for \$3 to be paid equally by the State of New York and the Commonwealth of Pennsylvania passed unanimously and the Town of Lumberland, New York was no longer responsible for the 1905 Pond Eddy Bridge over the Delaware River.³⁷

In 1916 and 1917, respectively, New York and Pennsylvania formed the Joint Interstate Bridge Commission with the primary purpose of seeing that the ten bridges along the Delaware River between the two states were in good repair and free to the traveling public. Between 1922 and 1930 the Commission acquired ten bridges along the upper Delaware River between New York and Pennsylvania with the costs being equally divided between the two states. Pennsylvania is responsible for the five bridges between Matamoras and Milanville, Pennsylvania (including the Pond Eddy Bridge #2), and New York is responsible for the five bridges between Cohecton and

Pond Eddy Bridge
(All Veterans Memorial Bridge)
PA Key No. 000357
(Page 9)

Hancock, New York.³⁸ The Joint Interstate Bridge Commission meets annually, alternating between New York and Pennsylvania Department of Transportation locations. Each state's Department of Transportation serves as a designee of the Commission in maintaining, repairing, and replacing the ten bridges. All maintenance costs over \$10,000 are shared equally between New York and Pennsylvania, and each state is responsible for the bridge approaches on their side of the Delaware River. The cost of bridge replacement, including only the substructure and superstructure of the bridge, is to be divided equally between the two states.³⁹

As previously noted, the Pond Eddy Bridge was in need of repairs when it was acquired by the New York-Pennsylvania Joint Interstate Bridge Commission in 1927. No record of repairs to the bridge between 1927 and 1989 has been located. The last substantial repair to the Pond Eddy Bridge was in 2011 when 64 steel stringers were replaced in order to bring the allowable weight limit back to 7 tons.

BILBIOGRAPHY

Beers, F.W., *County Atlas of Sullivan, New York*. New York: Walker & Jewett Company, 1875.

Catskill Archive Web Site, *Erie Railroad: Through the Delaware Valley*. Accessed at <http://catskillarchive.com/home.htm>, September 2012.

Hatch Mott McDonald, *Study Report: SR 1011, Section 470, Pike County, Pond Eddy Bridge over the Delaware River, Shohola Township, Pike County, PA, Lumberland Township, Sullivan County, NY*. Millburn, New Jersey: February 2003.

Mead and Hunt Engineers, *1999 Contextual Study of New York's Pre-1961 Bridges*. Prepared for the New York State Department of Transportation, November 1999.

Meyers, Arthur N., *Crossing the Delaware River ... Via Toll Bridges*. Narrowsburg, New York: The Delaware Valley Press, no date.

Schwarz, Frank, *Town of Lumberland History Syllabus, Grades 5-8*. Lumberland, New York: Town of Lumberland, 2006.

Sullivan County, New York Historical Society, Various including historic photographs and obituaries.

The River Reporter, "October 3, 1903: The Great Pumpkin Flood", Volume XXX No. 40, Week of September 30-October 6, 2004, Narrowsburg, New York.

The River Reporter, "Bridge commission focuses on two bridges", March 26, 2006.

Town of Lumberland Council Records, 1849-1929, Lumberland Town Hall, Lumberland, New York.

Upper Delaware Scenic Byway Web Site, *History: The Delaware and Hudson Canal*. Accessed at: <http://upperdelaware scenicbyway.org>, September 2012.

Valley Forge Laboratories, *Reconnaissance Soils and Geological Engineering Report*. Devon, Pennsylvania: 2003.

Wakefield, Manville B., *Coal Boats to Tidewater*. Fleischmann's, New York: Purple Mountain Press, 1992.

Pond Eddy Bridge
(All Veterans Memorial Bridge)
PA Key No. 000357
(Page 11)
Bibliography (continued)

West, Dan, Pennsylvania Railroad Station Past and Present Web Site, accessed at
<http://www.west2k.com/pa.htm>, October 2012.

Pond Eddy Bridge
(All Veterans Memorial Bridge)
PA Key No. 000357
(Page 12)

Figure 1
Resource Location
Shohola Township, Pike County, Pennsylvania
Town of Lumberland, Sullivan County, New York
USGS 1997, Pond Eddy, Pennsylvania, 7.5' series quadrangle

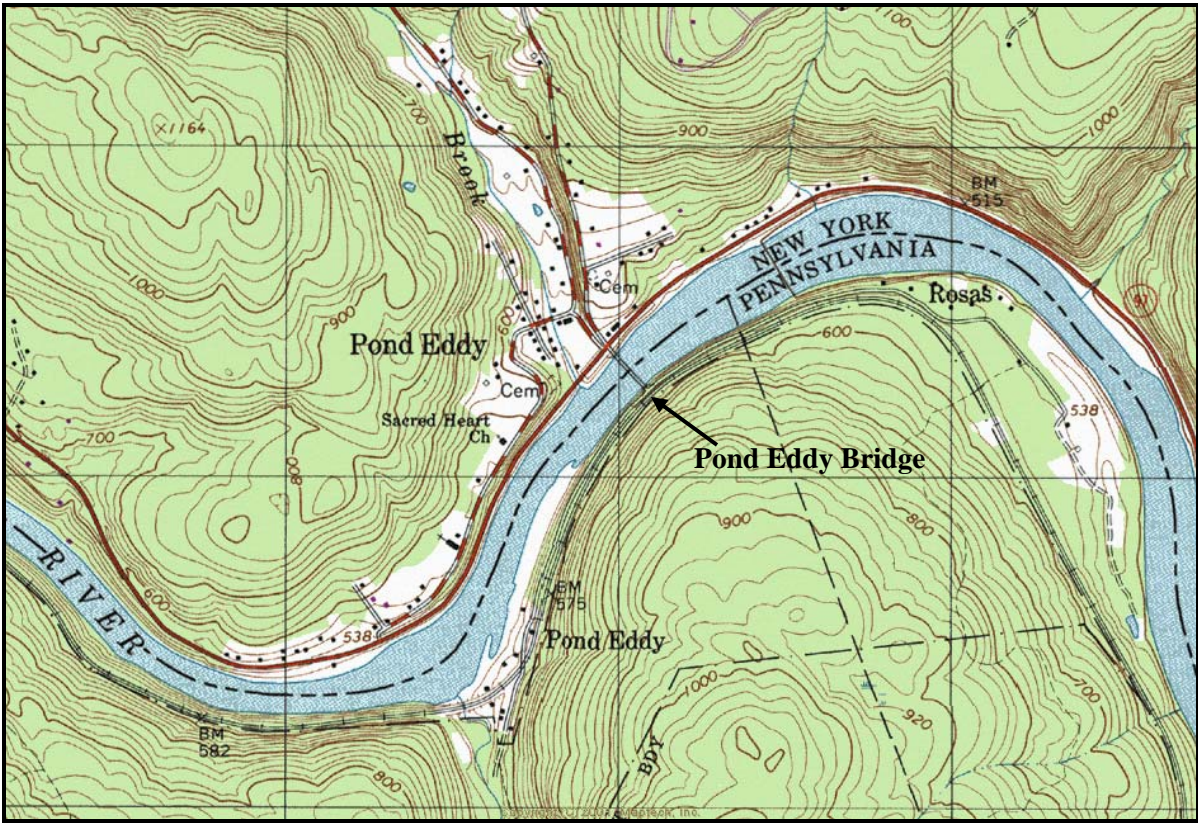

Pond Eddy Bridge
(All Veterans Memorial Bridge)
PA Key No. 000357
(Page 13)

Figure 2
1895 Pike County, Erie Railroad Map

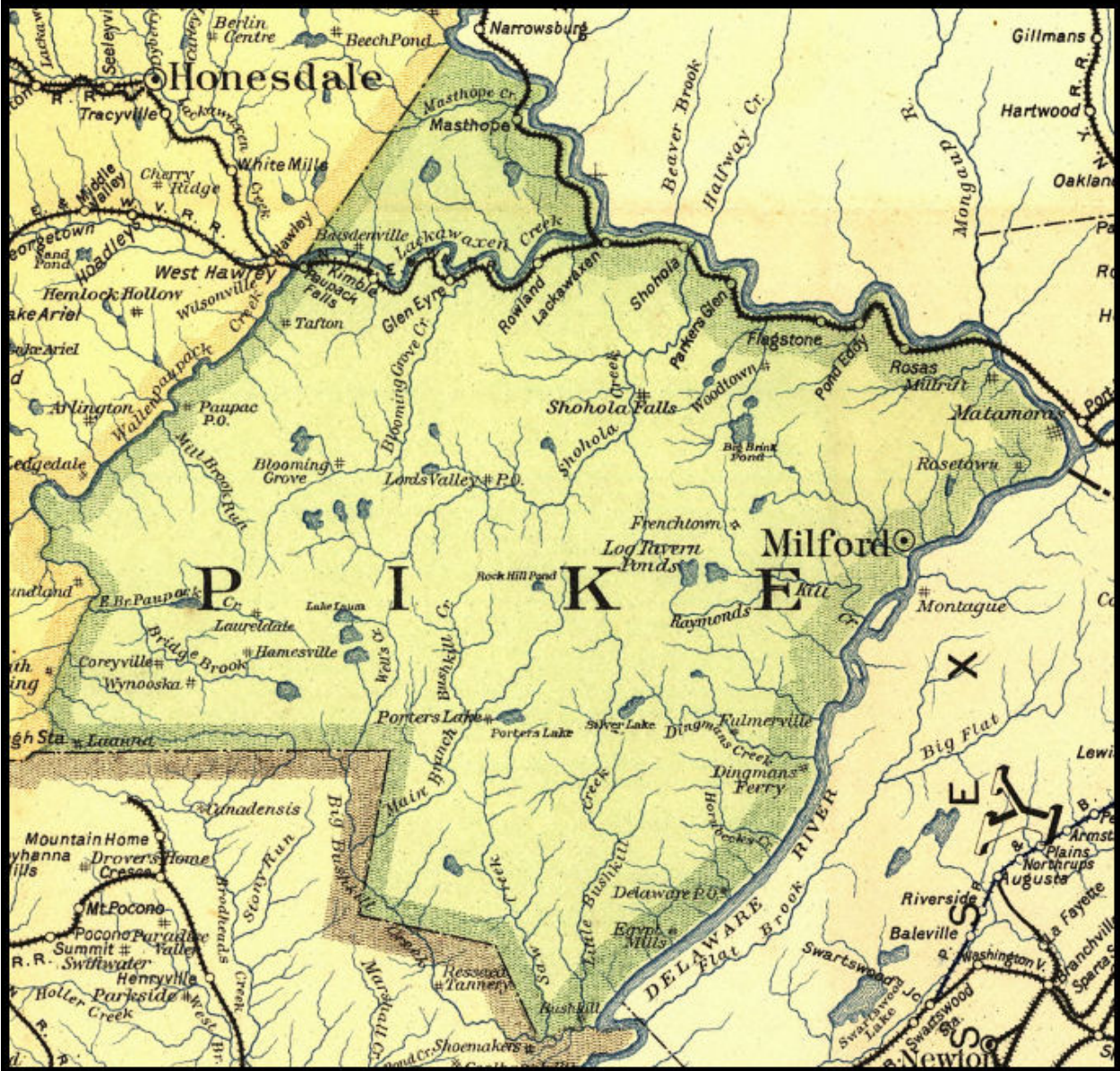

From Pennsylvania Railroad Station Past and Present Web Site at <http://www.west2k.com/pa.htm>.

Pond Eddy Bridge
(All Veterans Memorial Bridge)
PA Key No. 000357
(Page 14)

Figure 3
1875 *County Atlas of Sullivan, New York*
Town of Lumberland
Hamlet of Pond Eddy



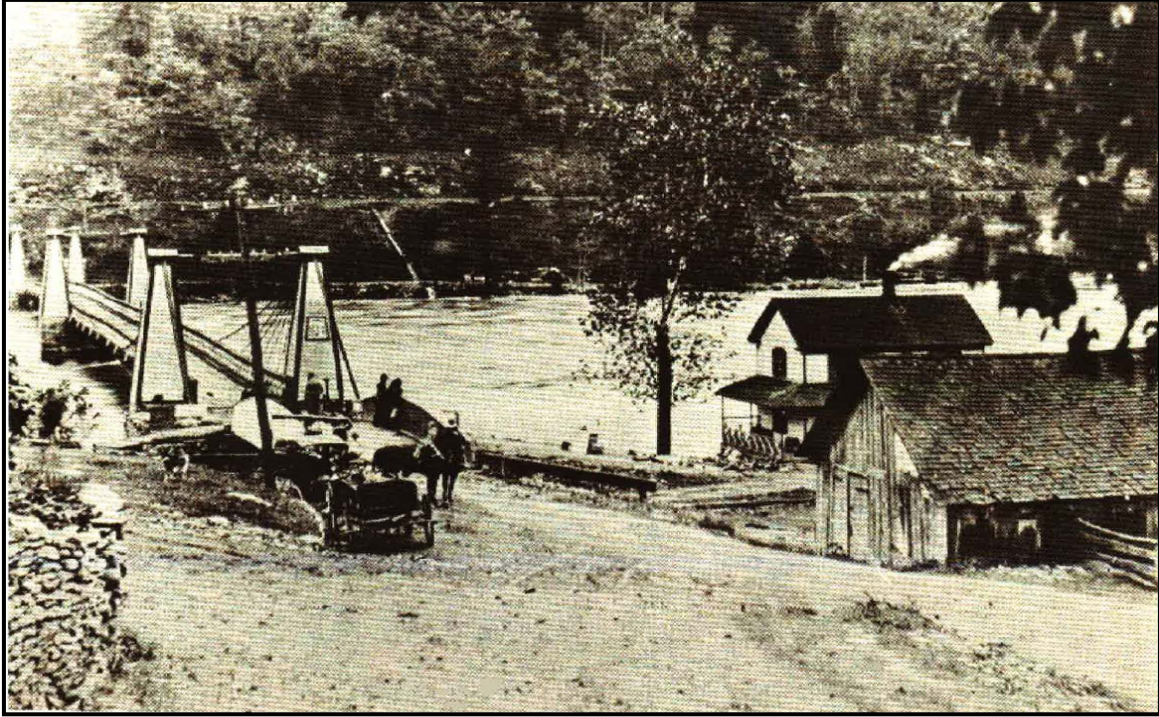

Historic Photo 1. The 1871 Pond Eddy Bridge at a time of high water on the Delaware River. A wooden bridge crossed the Delaware and Hudson Canal and the toll collector's house is at the right. Photo from *Coal Boats to Tidewater* by Manville B. Wakefield, Page 101.



Historic Photo 2. An undated and colorized postcard of the 1871 Pond Eddy Bridge. Postcard courtesy of the Sullivan County (New York) Historical Society



Historic Photo 3. A ca. 1885 view of Pond Eddy, New York showing the Delaware and Hudson Canal and Towpath and the 1871 Pond Eddy Bridge to the northeast. Postcard courtesy of the Sullivan County Historical Society



Historic Photo 4. An early twentieth century view of the Pond Eddy, New York Mountain View Hotel, owned by Jacob Pontz. Postcard courtesy of the Town of Lumberland History Museum

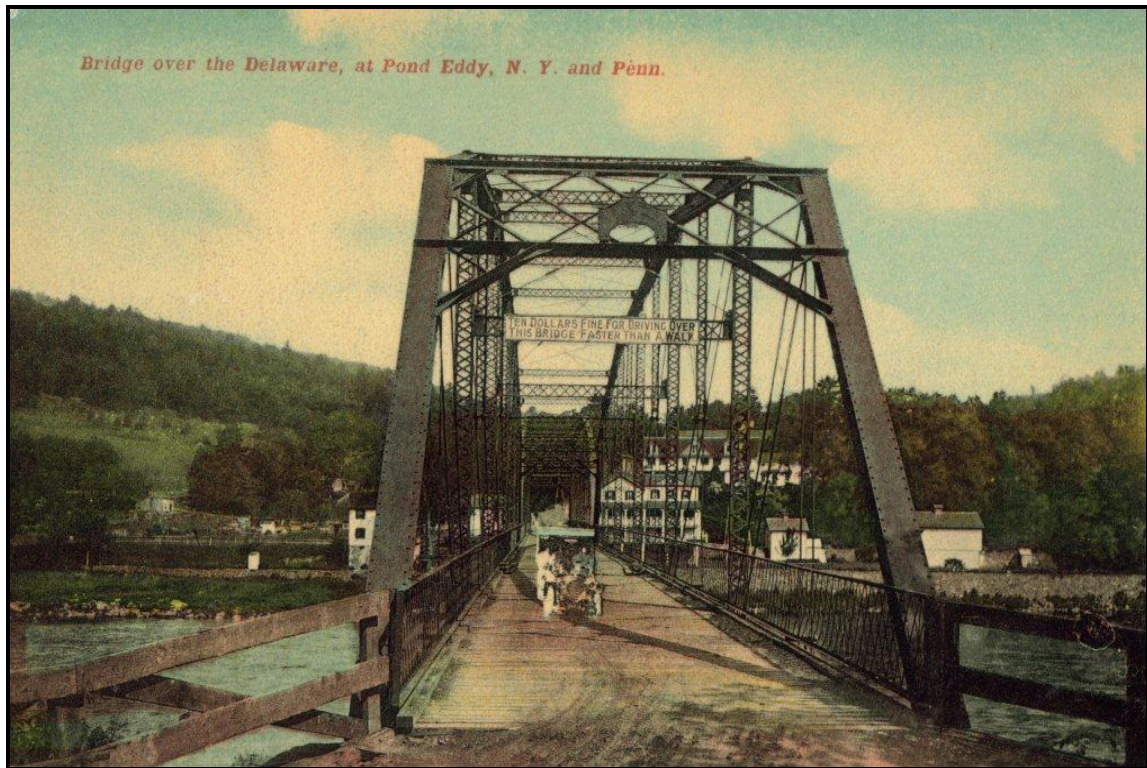

Historic Photo 5. A ca. 1910 view of the 1905 Pond Eddy Bridge looking northwest from Pennsylvania to Pond Eddy, New York. Postcard courtesy of the Sullivan County Historical Society



Close-up from the above postcard showing the sign originally placed at each entrance to the Pond Eddy Bridge by authorization of the Lumberland Town Board in 1905.



Historic Photo 6. A ca. 1908 view looking northwest of the 1905 Pond Eddy Bridge and Rixton's Riverside Hotel along the Delaware River. Postcard courtesy of the Sullivan County Historical Society



Historic Photo 7. An early twentieth century view looking southeast of the Pond Eddy Bridge and the Erie Railroad on the Pennsylvania side of the Delaware River. Postcard courtesy of the Sullivan County Historical Society.

NOTES

1. Hatch, Mott, McDonald, *Study Report: S.R. 1011, Section 470, Pike County, Pond Eddy Bridge over the Delaware River* (Study Report), P. 2.
2. Valley Forge Laboratories, *Reconnaissance Soils and Geological Engineering Report* (Geological Report), P. 1-2
3. Study Report, P. 23
4. Geological Report, P. 6-7
5. Upper Delaware Scenic Byway Web Site (Scenic Byway), History: the Delaware and Hudson Canal, accessed at <http://upperdelaware scenicbyway.org>, September, 2012.
6. Schwarz, Frank, Lumberland History Syllabus, No Page Number.
7. Catskill Archive Web Site (Catskill), Erie Page: Through the Delaware Valley, accessed at <http://catskillarchive.com/home.htm>, September, 2012.
8. Decker, James D. Obituary, on file at the Sullivan County Historical Society, Monticello, New York.
9. Town of Lumberland Council Records (Town Records), Volume 2, P. 148. The information for this report is primarily taken from three volumes of the original records of the Lumberland Town Council, currently housed at the offices of the Town of Lumberland, New York. Volume 2 covers 1849-1891, Volume 3 covers 1891-1910, and Volume 4 covers 1910-1929.
10. Myers, Arthur N., *Crossing the Delaware River ... Via Toll Bridges*, P. 14-15.
11. Town Records, V.2, P. 212.
12. Town Records, V.2, P. 352-354.
13. Town Records, V. 3, P. 24-26, 64, 89, 91, 203-4, 238.
14. Mead and Hunt, *1999 Contextual Study of New York State's Pre-1961 Bridges*, P. 88-95.
15. *River Reporter*, "Oct. 9, 1903: 'The Great Pumpkin Flood' ", from the Week of September 30-October 6, 2004.
16. Town Records, V.3, P. 341-354.
17. Town Records, V.3, P. 355-356.
18. Town Records, V.3, P. 376-389.

NOTES (Page 2)

19. Town Records, V.3, P. 390-394.
20. Town Records, V.3, P. 398-399.
21. Town Records, V.3, P. 401.
22. Town Records, V.3, P. 417-419.
23. Town Records, V.3, P. 421.
24. Town Records, V.3, P. 450.
25. Town Records, V.3, P. 510-512.
26. Town Records, V.4, P. 73-76.
27. Town Records, V.4, P. 139-141.
28. Town Records, V.4, P. 246-251.
29. Town Records, V.4, P. 289-296.
30. Town Records, V.4, P. 336.
31. Town Records, V.4, P. 379-380.
32. Town Records, V.4, P. 396-409.
33. Town Records, V.4, P. 439.
34. Town Records, V.4, P. 446.
35. Town Records, V.4, P. 471.
36. Town Records, V.4, P. 494.
37. Town Records, V.4, P. 506-508.
38. *River Reporter*, "Bridge commission focuses on two bridges", March 26, 2006.
39. Joint Interstate Bridge Commission, New York-Pennsylvania Revised General Agreement.

HISTORIC AMERICAN ENGINEERING RECORD

INDEX TO PHOTOGRAPHS

POND EDDY BRIDGE

PA Key No. 000397

(All Veterans Memorial Bridge)

S.R. 1011 Spanning Delaware River

Lumberland, New York and Shohola Township, Pennsylvania

INDEX TO BLACK AND WHITE PHOTOGRAPHS

Douglas Terpstra, Photographer, June 2012

- 000397-1 GENERAL VIEW OF BRIDGE WITHIN SETTING LOOKING NORTHEAST
- 000397-2 GENERAL VIEW OF BRIDGE WITHIN SETTING LOOKING SOUTHWEST
- 000397-3 APPROACH TO BRIDGE LOOKING NORTHEAST
- 000397-4 APPROACH TO BRIDGE LOOKING SOUTHWEST
- 000397-5 SOUTHWEST ELEVATION OF BOTH SPANS LOOKING NORTHEAST
- 000397-6 SOUTHWEST ELEVATION OF EAST SPAN LOOKING NORTHEAST
- 000397-7 SOUTHWEST ELEVATION OF WEST SPAN LOOKING NORTHEAST
- 000397-8 NORTHEAST ELEVATION OF EAST SPAN LOOKING WEST
- 000397-9 NORTHEAST ELEVATION OF WEST SPAN LOOKING WEST
- 000397-10 EAST PORTAL OF BRIDGE LOOKING NORTHWEST
- 000397-11 WEST PORTAL OF BRIDGE LOOKING SOUTHEAST
- 000397-12 WEST ABUTMENT OF BRIDGE LOOKING NORTHEAST
- 000397-13 CENTER PIER AND EAST ABUTMENT OF BRIDGE LOOKING SOUTHEAST
- 000397-14 FLOORBEAMS AND UNDERSIDE OF BRIDGE DECK WEST SPAN LOOKING SOUTH
- 000397-15 NORTHWEST FOOTER OF BRIDGE LOOKING SOUTHEAST

- 000397-16 DETAIL OF RAILING AND SIDE CONNECTIONS LOOKING SOUTHEAST

- 000397-17 DETAIL OF A TOP CHORD CONNECTION OF THE NORTH TRUSS OF
 THE WEST SPAN LOOKING NORTH

- 000397-18 DETAIL OF CONNECTION OF VERTICAL MEMBERS AND DIAGONAL
 MEMBERS WEST SPAN NORTH TRUSS THIRD PANEL FROM WEST
 LOOKING NORTH

- 000397-19 DETAIL OF VERTICAL MEMBER WITH “CARNEGIE” FOUNDRY MARK
 LOOKING NORTHEAST

- 000397-20 DETAIL OF MEMORIAL PLAQUE AT WEST PORTAL LOOKING
 SOUTHEAST

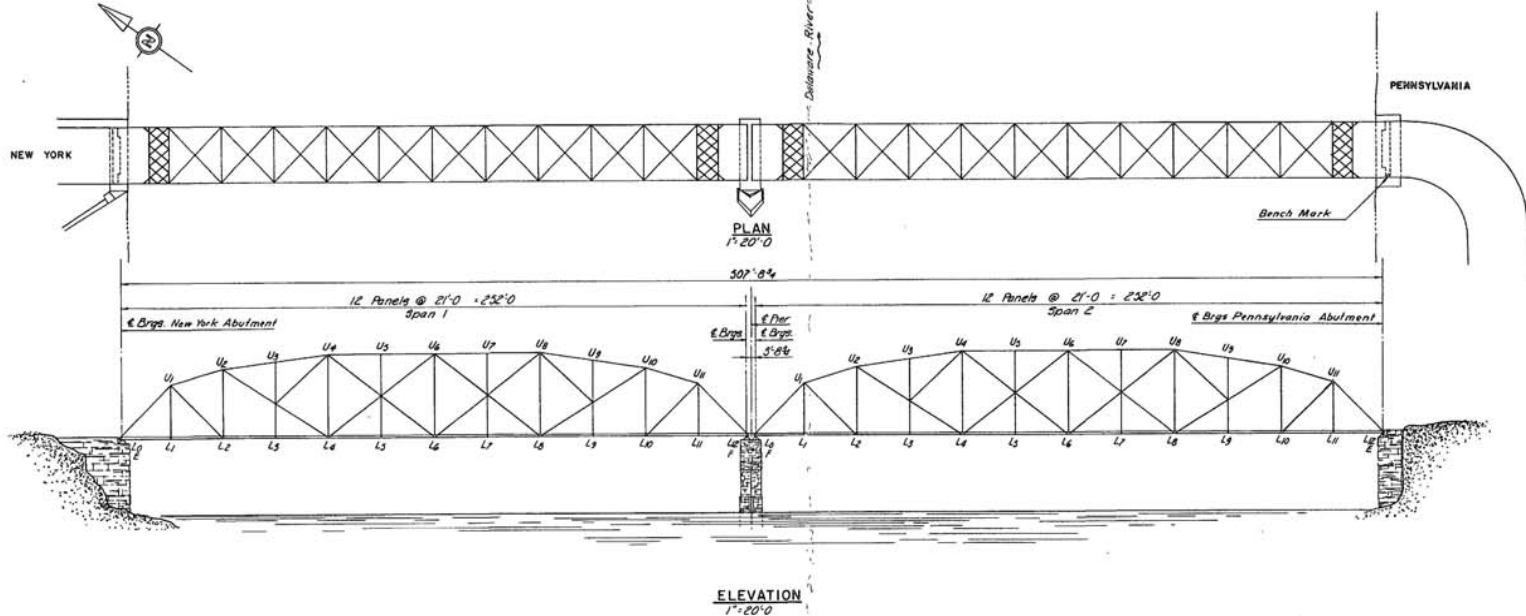

ELEVATION
1"=20'-0"

Note A:
The four bars shown are on 5' centers. The two interior bars and the two exterior bars run in opposite directions from a given floor beam. Only two bars are located on each side of the bridge in each panel, alternating between 5' and 9' centers.

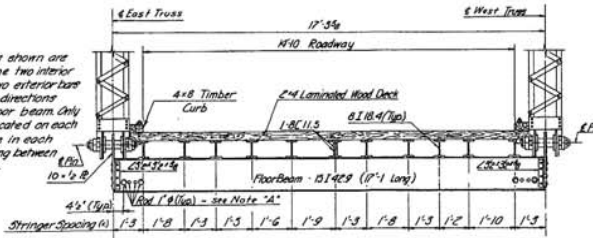

TYPICAL SECTION
6"=1'-0"

LOWER JOINT	SPAN 1		SPAN 2	
	EAST TRUSS	WEST TRUSS	EAST TRUSS	WEST TRUSS
L0	539.94	539.87	539.79	539.76
L1	539.99	539.92	539.82	539.77
L2	539.06	539.98	539.86	539.83
L3	539.06	539.99	539.88	539.83
L4	539.11	539.05	539.91	539.87
L5	539.09	539.00	539.91	539.87
L6	539.71	539.05	539.94	539.87
L7	539.07	539.01	539.88	539.85
L8	539.05	539.99	539.88	539.82
L9	539.18	539.93	539.80	539.77
L10	539.12	539.89	539.77	539.72
L11	539.83	539.80	539.69	539.62
L12	539.77	539.75	539.62	539.59

ELEVATIONS OF LOWER PINS ARE AT 6' PIN.

- NOTES
- ALL ELEVATIONS ARE REFERENCED TO AN ASSUMED B.M. EL. 539.00, LOCATED ON THE WEST SIDE OF THE PENNSYLVANIA ABUTMENT.
 - THE SUPERSTRUCTURE AND SUBSTRUCTURE WERE INSPECTED IN DEPTH FOLLOWING THE GENERAL CRITERIA FOR TYPE II INSPECTIONS, SET FORTH IN THE PENNSYLVANIA DEPARTMENT OF HIGHWAYS' CIRCULAR LETTER C-2523 TITLED "BRIDGE INSPECTION PROGRAM - GENERAL PROCEDURE FOR CURSORY AND IN-DEPTH INSPECTIONS" AND THE BUREAU OF PUBLIC ROADS - A. A. S. H. D. 'S PUBLICATION TITLED "AN INFORMATIONAL GUIDE FOR INSPECTION OF HIGHWAY BRIDGES," DATED MARCH, 1968.
 - NO REFERENCE PLANS FOR BRIDGE NO. 2 WERE AVAILABLE.

NEW YORK - PENNSYLVANIA
JOINT INTERSTATE
BRIDGE COMMISSION



THRU TRUSS BRIDGE
OVER DELAWARE RIVER
POND EDDY PA. TO POND EDDY N.Y.
IN DEPTH (TYPE II) INSPECTION
GENERAL PLAN AND ELEVATION

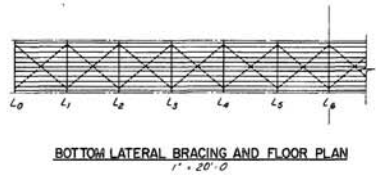
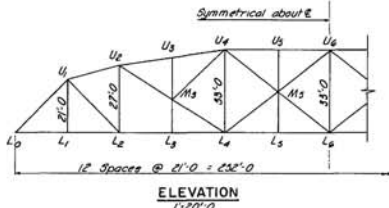
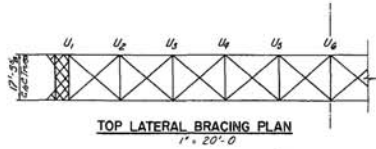

TRUSS MEMBERS	
Truss Members	Section
Top chord	
L0 U1	2-C 12 x 24, R 16 x 36
U1 U2	
U2 U3	
U3 U4	
U4 U5	
U5 U6	
Bottom chord	
L0 L1	2-Bars 3/4
L1 L2	
L2 L3	
L3 L4	2-Bars 4/4
L4 L5	
L5 L6	
Verticals	
U1 L1	2-Bars 1"Ø
U2 L2	
U3 L3	2-C 8 x 12 4
U4 L4	
U5 L5	
U6 L6	2-C 8 x 12 4
U1 M1	
U2 M2	
U3 M3	2-Bars 1"Ø
U4 M4	
U5 M5	
Diagonals	
U1 L2	2-Bars 2 1/4
U2 L3	
U3 L4	2-Bars 3/4
U4 L5	
U5 L6	2-Bars 2 1/4
U6 L0	
U1 M2	2-Bars 3/4
U2 M3	
U3 M4	2-Bars 2 1/4
U4 M5	
U5 M6	1-Bar 14"Ø
U6 M0	
U1 L4	2-Bars 14"Ø
U2 L5	
U3 L6	2-Bars 2 1/4
U4 L0	

TRUSS RATING									
MEMBER	AREA	CAPACITY C	DEAD LOAD		NSPO LIVE LOAD		HDO LIVE LOAD		RATING
			DL	DL	LL+I	DL+LL	STRESS LEVEL %	LL+I	
L0U1	-17.1	-206	-99	-101	-200	89	-	-	-
U1U2	-17.1	-206	-102	-97	-199	89	-	-	-
U2U3	-17.1	-242	-138	-132	-270	112	-	-	-
U3U4	-17.1	-242	-138	-132	-270	112	-	-	-
U4U5	-17.1	-242	-153	-147	-300	124	-	-	-
U5U6	-17.1	-242	-153	-147	-300	124	-	-	-
L0L1	+6.0	+108	+69	+66	+135	125	-	-	-
L1L2	+6.0	+108	+69	+66	+135	125	-	-	-
L2L3	+10.0	+180	+99	+93	+192	106	-	-	-
L3L4	+10.0	+180	+99	+93	+192	106	-	-	-
L4L5	+11.0	+198	+129	+122	+251	127	+122	19	-
L5L6	+11.0	+198	+129	+122	+251	127	+122	19	-
U1L1	+2.0	+36	+13	+38	+51	143	+33	14	-
U2L2	+6.7	-77	-16	-28	-44	57	-	-	-
M1L3	+2.0	+36	+13	+38	+51	142	+33	14	-
U4L4	-6.7	-65	0	-35	-35	54	-	-	-
M5L5	+2.0	+36	+13	+38	+51	142	+33	14	-
U1L2	+4.7	+86	+41	+47	+88	102	-	-	-
U2M3	+4.5	+81	+45	+39	+104	120	+59	19	-
M3L4	+4.7	+86	+35	+51	+86	100	-	-	-
M4U4	+1.5	+28	+11	+33	+44	157	+29	17	-
U4M5	+4.7	+86	+31	+55	+86	100	-	-	-
M5L6	+3.5	+63	+21	+46	+67	106	-	-	-
M6U6	+2.2	+41	+10	+31	+41	100	-	-	-

SIGN CONVENTION
 TENSION (+)
 COMPRESSION (-)
 AREA - NET (-)
 GROSS (+)

ALLOWABLE STRESSES

AXIALLY LOADED MEMBERS

TENSION (PSI): $F_A = 18,000$
 COMPRESSION (PSI): $F_C = 15,000 - \frac{1}{3} \left(\frac{L}{r}\right)^2$
 FOR PINNED ENDS.
 $F_A = 15,000 - \frac{1}{4} \left(\frac{L}{r}\right)^2$
 FOR RIVETED ENDS.

MEMBERS SUBJECTED TO BENDING

TENSION FLANGE (PSI): $F_B = 18,000$
 COMPRESSION FLANGE (PSI): $F_B = 18,000 - 3 \left(\frac{L}{r}\right)^2$

PINS

SHEAR (PSI): $F_V = 13,000$
 BENDING (PSI): $F_B = 26,000$
 BEARING (PSI): $F_{BRG} = 26,000$

P.D.M. RATING FORMULA:

RATING (IN TONS) = $\frac{C - D}{(L.L. + 1)_{HDO}} \times 20$

FOR DETAILED DESCRIPTION OF RATING PROCEDURE, SEE THE "SUMMARY OF STRUCTURAL ANALYSIS" SECTION OF THE WRITTEN REPORT.

NOTE:
 WHEN LANE LOADING COVERED, THE CAPACITY WAS INCREASED BY 25% FOR RATING.

PIN RATING				
JOINT		L0	U1	L3
PIN DIAMETER	IN.	4.00	3.50	3.25
PIN AREA	IN. ²	12.56	9.61	11.00
SECTION MODULUS	IN. ³	6.28	4.22	5.18
CAPACITY (C _p) - IN.KIPS		163	110	135
	DEAD LOAD (DL) - IN.KIPS	62	55	30
	LL+I (NSPO) - IN.KIPS	63	119	132
DL+LL+I-S - IN.KIPS		125	174	162
STRESS LEVEL %		77	158	120
LL+I (HDO) - IN.KIPS		-	119	-
RATING - TONS		-	9	-

SHEAR AND BEARING DO NOT GOVERN THE RATING OF PINS.

FLOOR SYSTEM RATING									
MEMBER	SECTION	SECTION MODULUS	CAPACITY C	DEAD LOAD		NSPO LIVE LOAD		HDO LIVE LOAD	
				DL	DL	LL+I	DL+LL	STRESS LEVEL %	LL+I
STRINGERS (SS)	8 I 18.4	14.2	20	5	40	43	200	40	8
FLOOR BEAMS	15 I 42.9	58.9	88	34	174	208	235	151	7

NEW YORK - PENNSYLVANIA
 JOINT INTERSTATE
 BRIDGE COMMISSION



THRU TRUSS BRIDGE
 OVER DELAWARE RIVER
 POND EDDY PA. TO POND EDDY N.Y.
 IN DEPTH (TYPE II) INSPECTION
 STRESS DATA

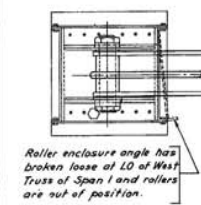
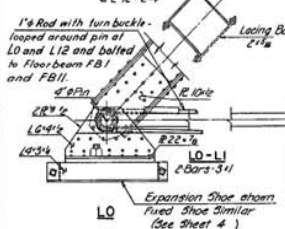
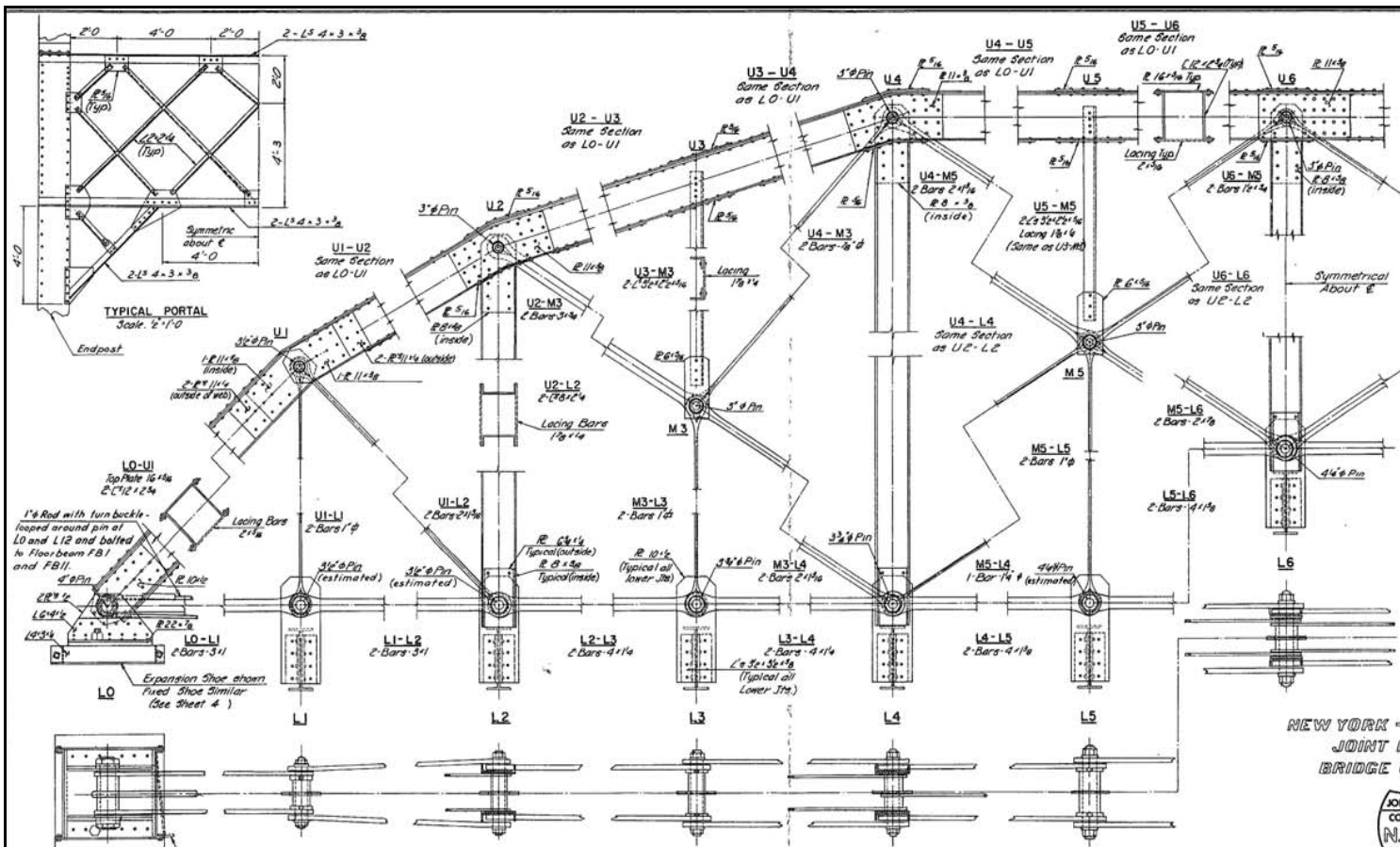

CONDITION OF TRUSS MEMBERS
 MOST OF THE MAIN AND SECONDARY TRUSS MEMBERS APPEAR TO BE IN GOOD CONDITION, WITH SOME RUST AND CORROSION PRESENT AT AND NEAR CONNECTIONS.
 CONNECTIONS BETWEEN TOP LATERAL BRACING AND TOP CHORDS ARE BADLY DETERIORATED, AS DETAILED ON SHEET 4.

CONDITION OF PINS
 PINS AT UPPER AND MIDDLE JOINTS APPEAR TO BE IN GOOD CONDITION, WITH ONLY SCATTERED CASES OF RUST AND CORROSION.
 SLEEVES ON LOWER PINS HAVE DETERIORATED BADLY IN MANY CASES AND HAVE EXPOSED SOME OF THE PINS TO CORROSION.

NEW YORK - PENNSYLVANIA
 JOINT INTERSTATE
 BRIDGE COMMISSION



THRU TRUSS BRIDGE
 OVER DELAWARE RIVER
 POND EDDY PA. TO POND EDDY N.Y.
 IN DEPTH (TYPE II) INSPECTION
 TRUSS DETAILS

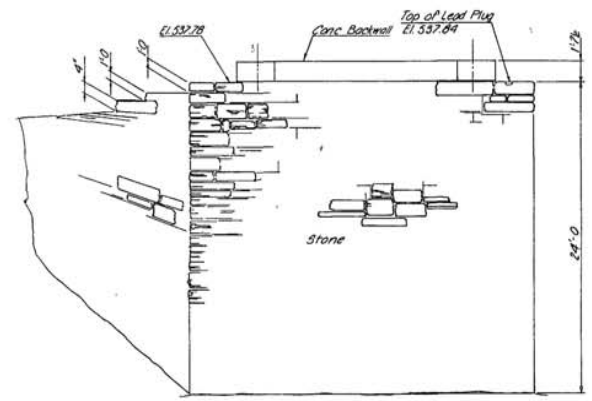
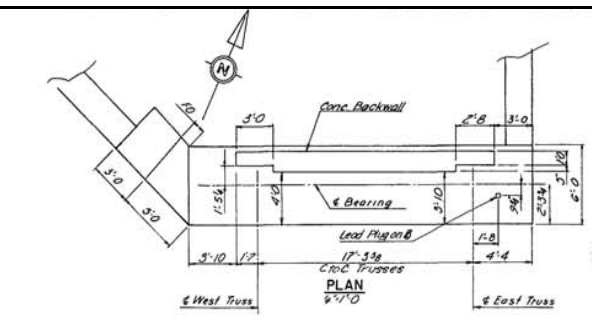

CONDITION OF ABUTMENTS
 BOTH ABUTMENTS APPEAR TO BE IN GOOD OVERALL
 CONDITION. LITTLE SURFACE DETEIORATION WAS
 OBSERVED ON EITHER THE STONE OR CONCRETE PORTIONS.
 FOR THE CONDITION OF THE PIER, SEE SHEET 6.

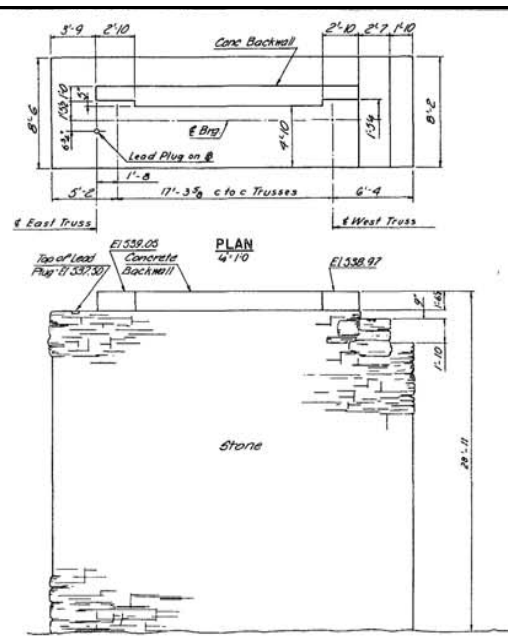
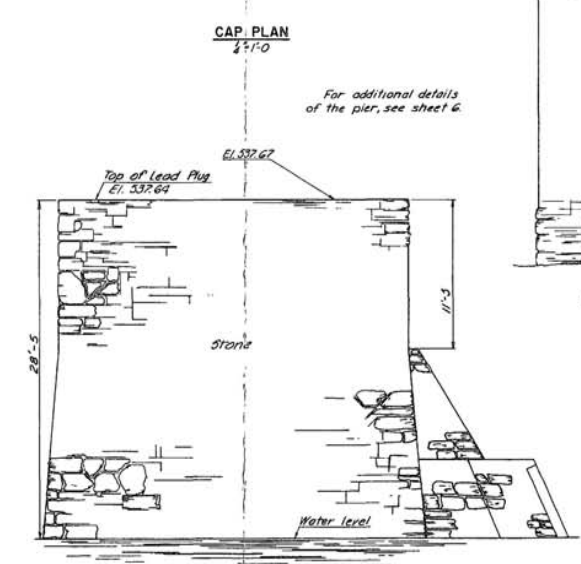
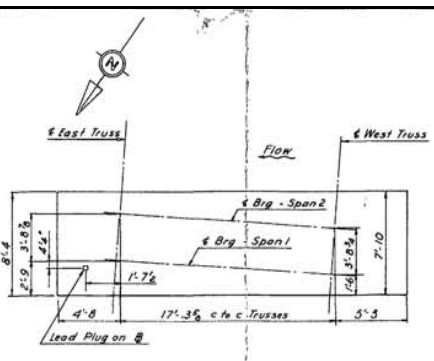

NEW YORK - PENNSYLVANIA
 JOINT INTERSTATE
 BRIDGE COMMISSION



THRU TRUSS BRIDGE
 OVER DELAWARE RIVER
 POND EDDY PA. TO POND EDDY N.Y.
 IN DEPTH (TYPE II) INSPECTION
 SUBSTRUCTURE DETAILS

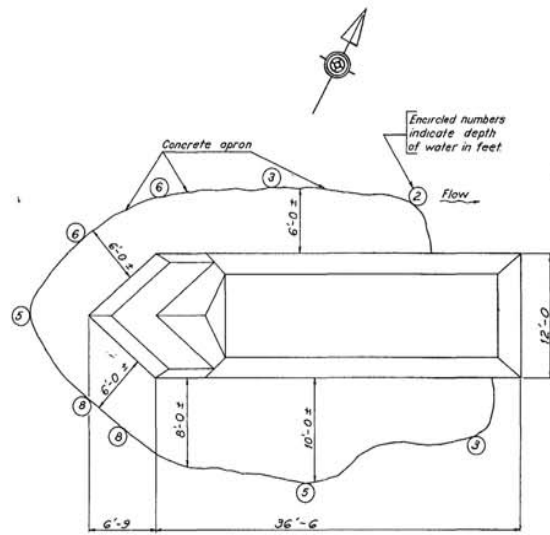

PLAN
1"=5'-0"

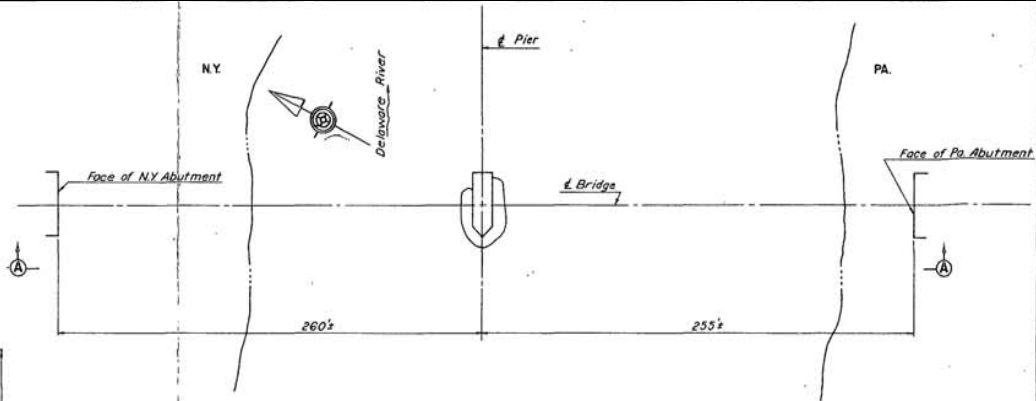

LOCATION PLAN
1"=30'-0"



SECTION A-A
1"=30'-0"

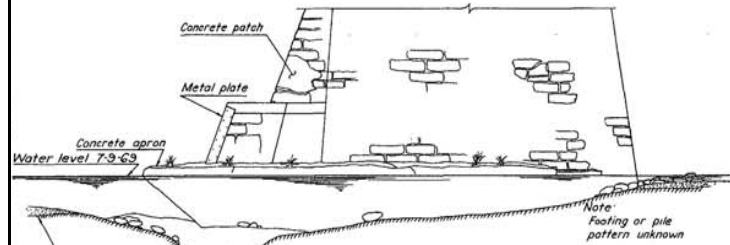

ELEVATION - PIER
1"=5'-0"

NEW YORK - PENNSYLVANIA
JOINT INTERSTATE
BRIDGE COMMISSION



THRU TRUSS BRIDGE
OVER DELAWARE RIVER
POND EDDY PA. TO POND EDDY N.Y.
IN DEPTH (TYPE II) INSPECTION
UNDERWATER INSPECTION

NOTES:
0 INSPECTION DATE: 7-9-69
ALL DIMENSIONS SHOWN ARE
FIELD MEASUREMENTS.