

SHIP FORM DEFINITION

The Shape of a Ship

The Traditional Way to Represent the Hull Form

- A ship's hull is a very complicated three dimensional shape. With few exceptions an equation cannot be written that fully describes the shape of a ship. Therefore, naval engineers have placed great emphasis on the graphical description of hull forms. Until very recently, most of this work was done by hand. Today high-speed digital computers assist the engineer with the drawings, but they are not substitutes for *imagination* and *judgment*.
- Traditionally, the ship's hull form is represented graphically by a lines drawing. The lines drawing consists of projections of the intersection of the hull with a series of planes. The planes are equally spaced in each of the three dimensions (x, y, z). Planes in one dimension will be perpendicular to planes in the other two dimensions. We say that the sets of planes are mutually perpendicular or orthogonal planes.

Lines Drawing- Lines Plan

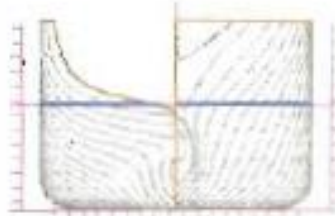
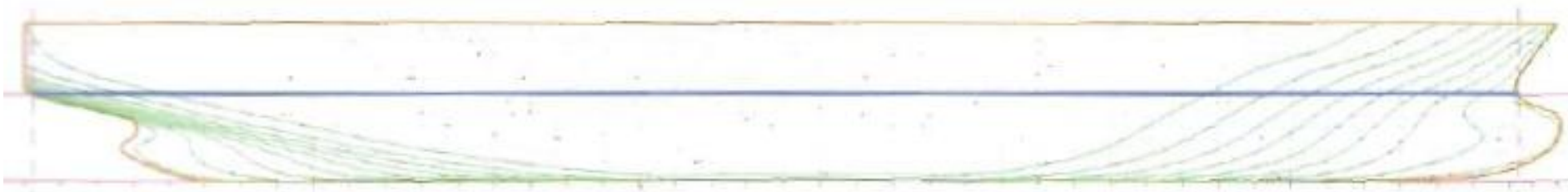

Length over all	210,345 [m]
Length over oak	212,000 [m]
Moulded breadth	32,240 [m]
Drift	12,240 [m]
Displacement	59279 [t]
Cb	0,691 [-]
Cp	0,707 [-]
Cm	0,978 [-]
LCR	0,343 [% Lpp]
Xb	102,561 [m]
KMtransverse	14,430 [m]

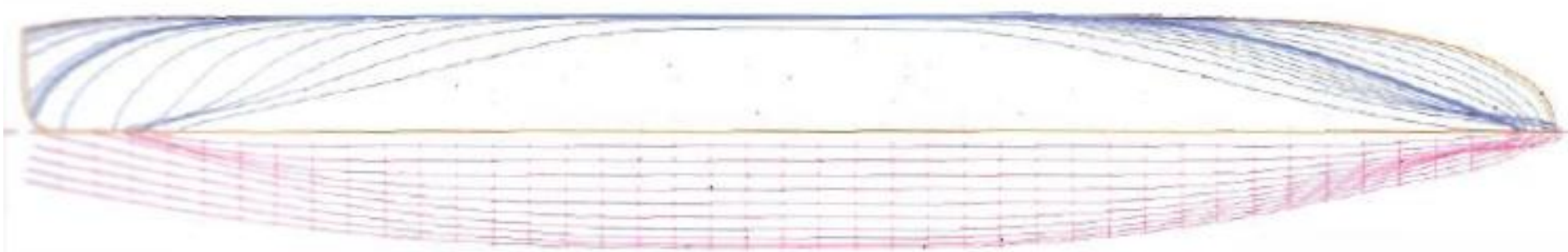

Linesplan	
Traffic name	Project 20-0-2
Leaf number: 20.0.002.1.010.00	Scale: 7/200

- The points of intersection of these planes with the hull results in a series of lines that are projected onto a single plane located on the front, top, or side of the ship. This results in three separate projections, or views, called the “**Half-Breadth Plan**”, “**Sheer plan**” and “**Body Plan**”.

The creation of the linesplan from 3D ship hull form

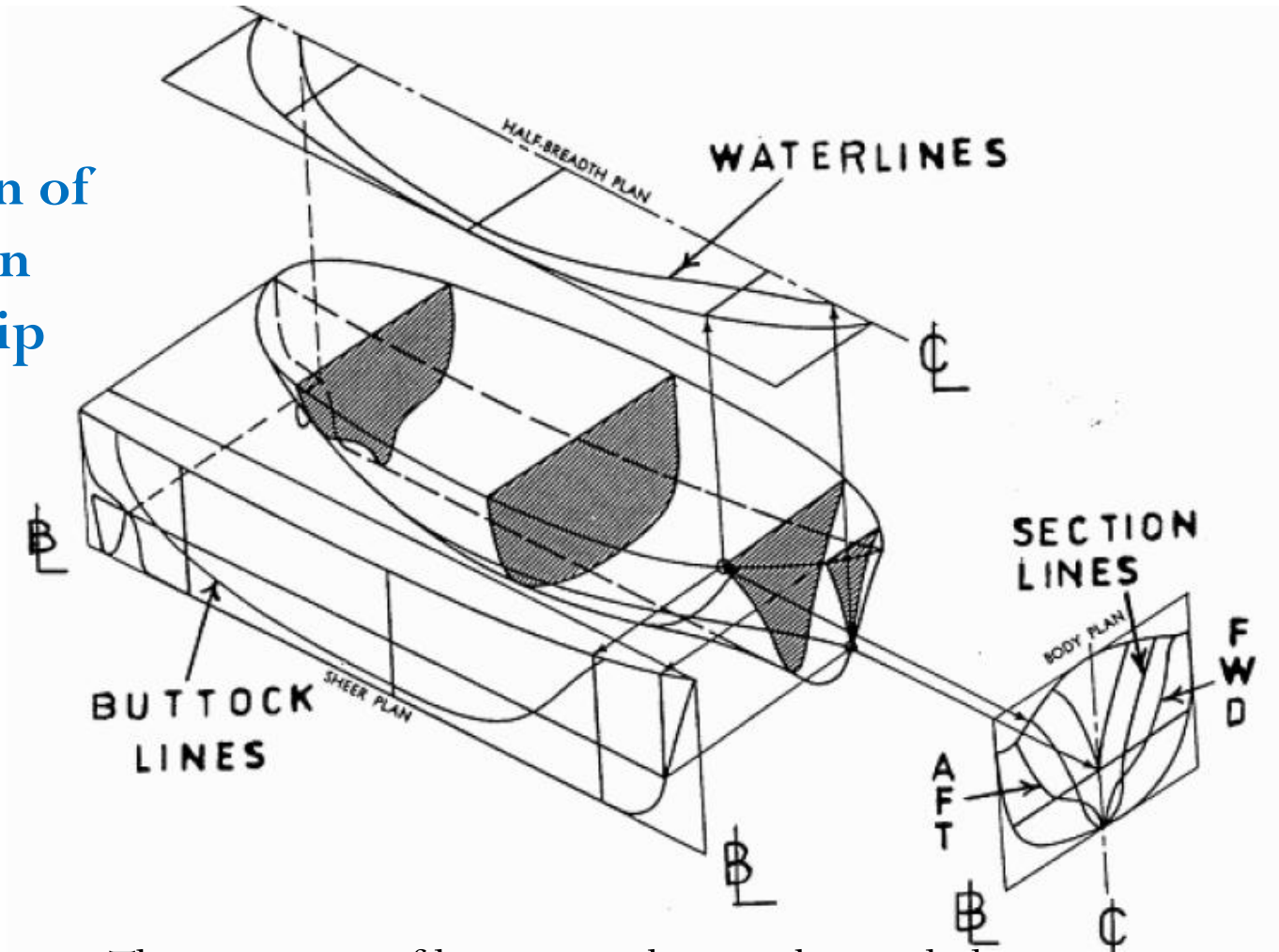

The projection of lines onto three orthogonal planes

- To visualize how a “lines drawing” works, place the ship in an imaginary rectangular box whose sides just touch the keel (baseline) and sides of the ship. The bottom, side and front of the box will serve as the basis for three orthogonal projection screens on which lines will be projected onto. The lines to be projected result from the intersection of the hull with planes that are parallel to each of the three orthogonal planes mentioned.

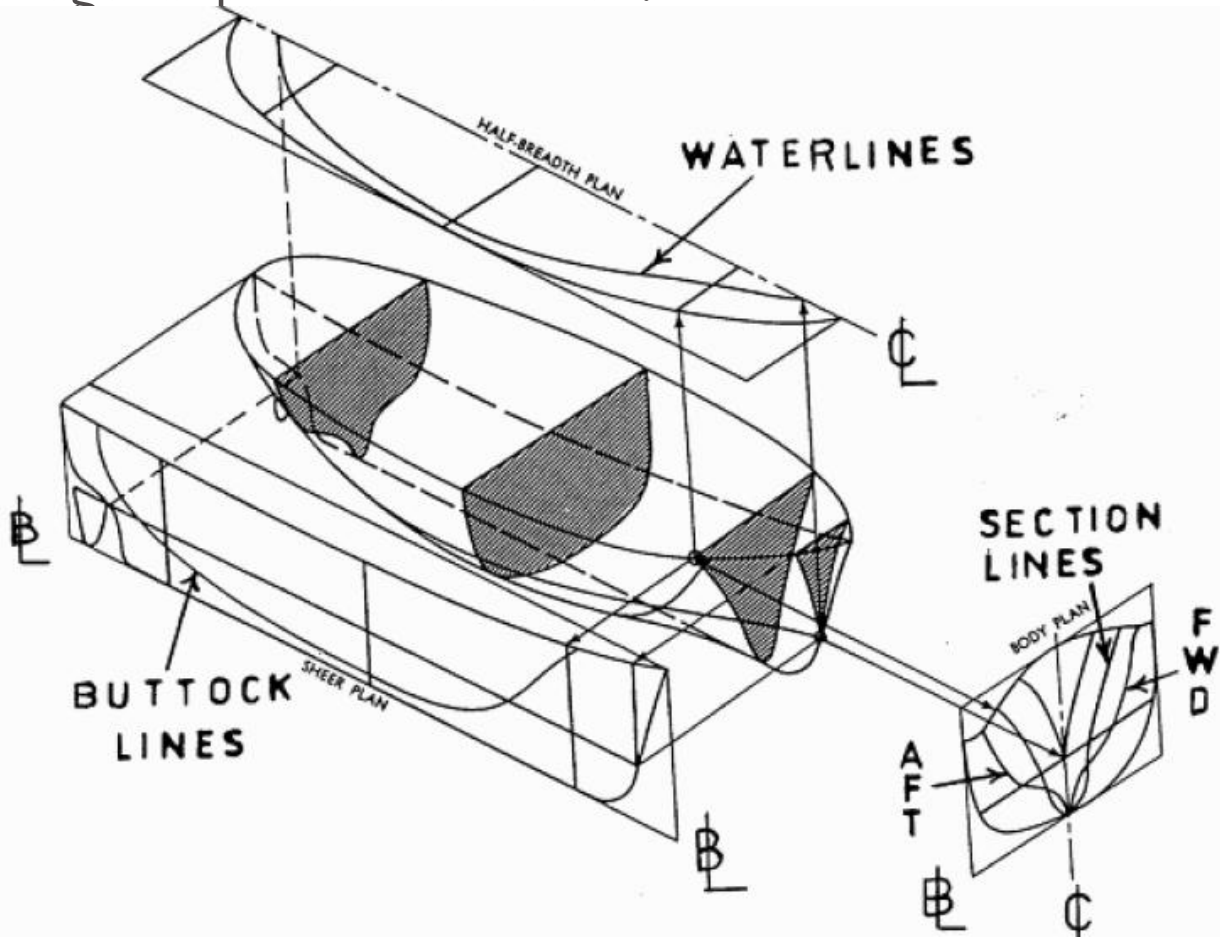

The Half-Breadth Plan-Waterline Plan-TOP VIEW

- Think about our imaginary box. The bottom of the box is a reference plane called the base plane. The base plane is usually level with the keel. A series of planes parallel and above the base plane are imagined at regular intervals. Each plane will intersect the ship's hull and form a line at the points of intersection. These lines are called “**waterlines**” and are all projected onto a single plane called the “Half Breadth Plan”.

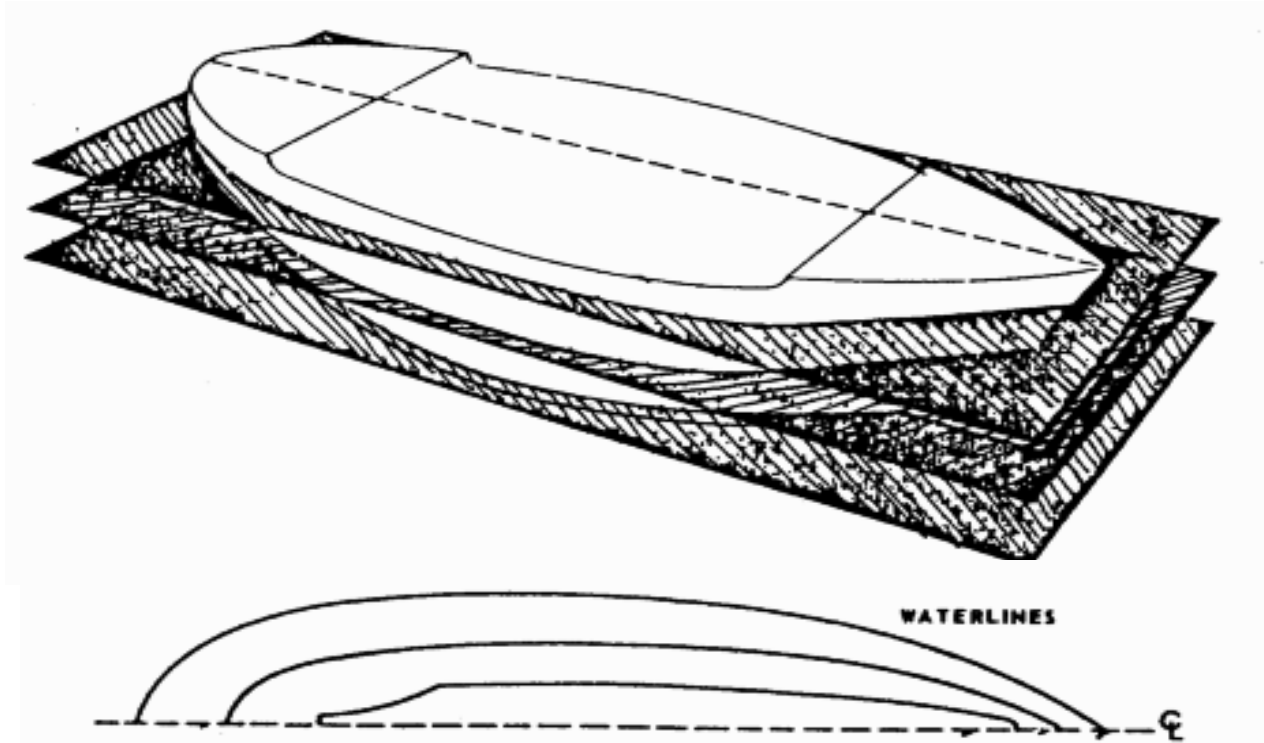

Creation of the half-breadth plan

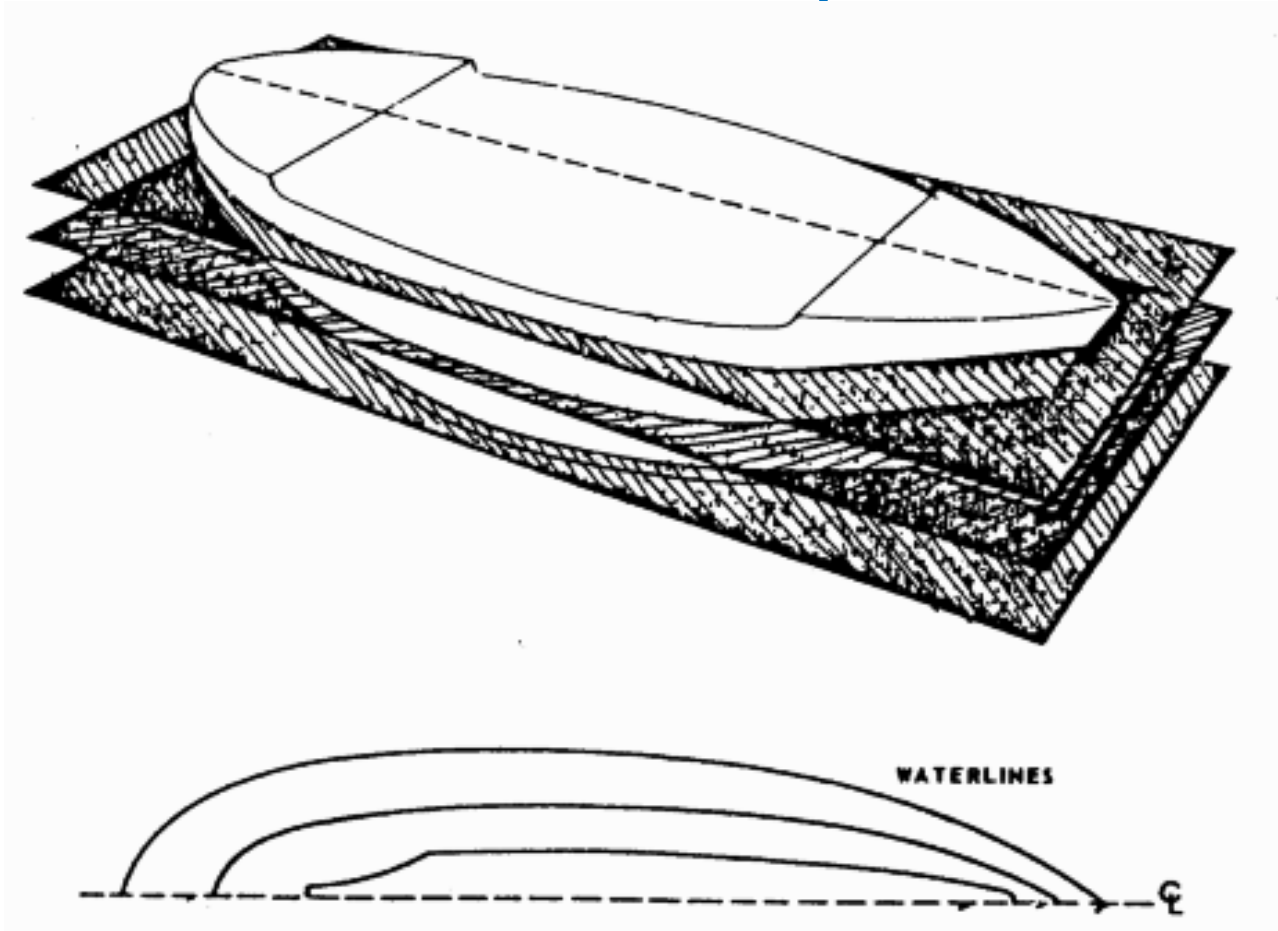

Each waterline shows the true shape of the hull from the top view for some elevation above the base plane which allows this line to serve as a pattern for the construction of the ship's framing.

- The waterlines referred to here have nothing to do with where the ship actually floats. These waterlines are the intersection of the ship's hull with some imaginary plane above the base plane. There will be one plane above the base plane that coincides with the normal **draft** (**draught**) of the ship, this waterline is called the “**Design Water Line** or **Loaded Waterline**”. This waterline is actually the waterline the ship floats. The design water line is often represented on drawings as “**DWL**”, “**LWL**” or “**∇**”.
- Since ships are symmetric about their centerline they only need be drawn for the starboard or port side, thus the name of “**Half Breadth Plan**”

The Sheer Plan -Profile plan – SIDE VIEW

- A plane that runs from bow to stern directly through the center of the ship and parallel to the sides of the imaginary box is called the centerline plane. A series of planes parallel to one side of the centerline plane are imagined at regular intervals from the centerline. Each plane will intersect the ship's hull and form a curved line at the points of intersection. These lines are called “buttocks” and are all projected onto a single plane called the “**Sheer Plan**”.

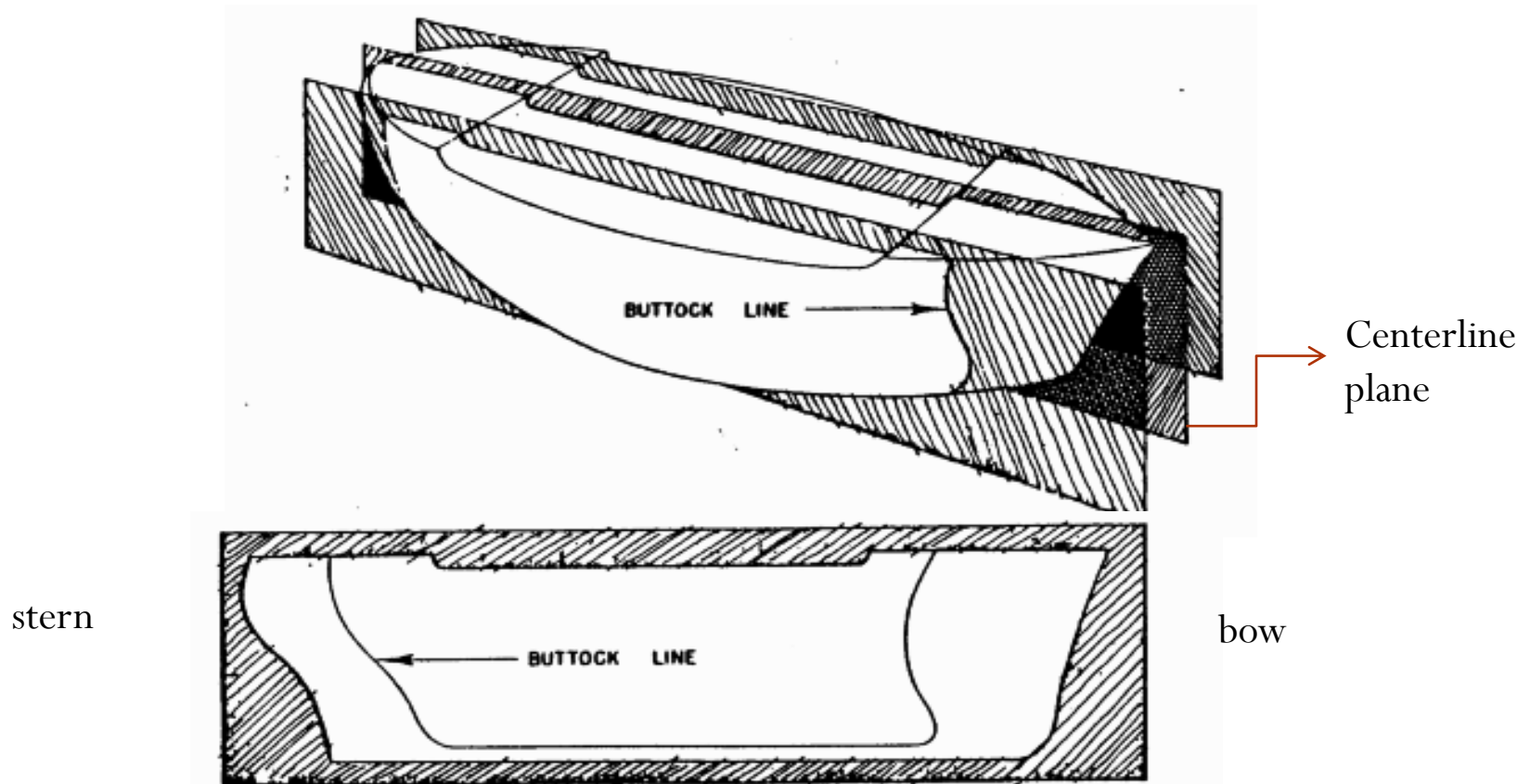

The creation of the sheer plan

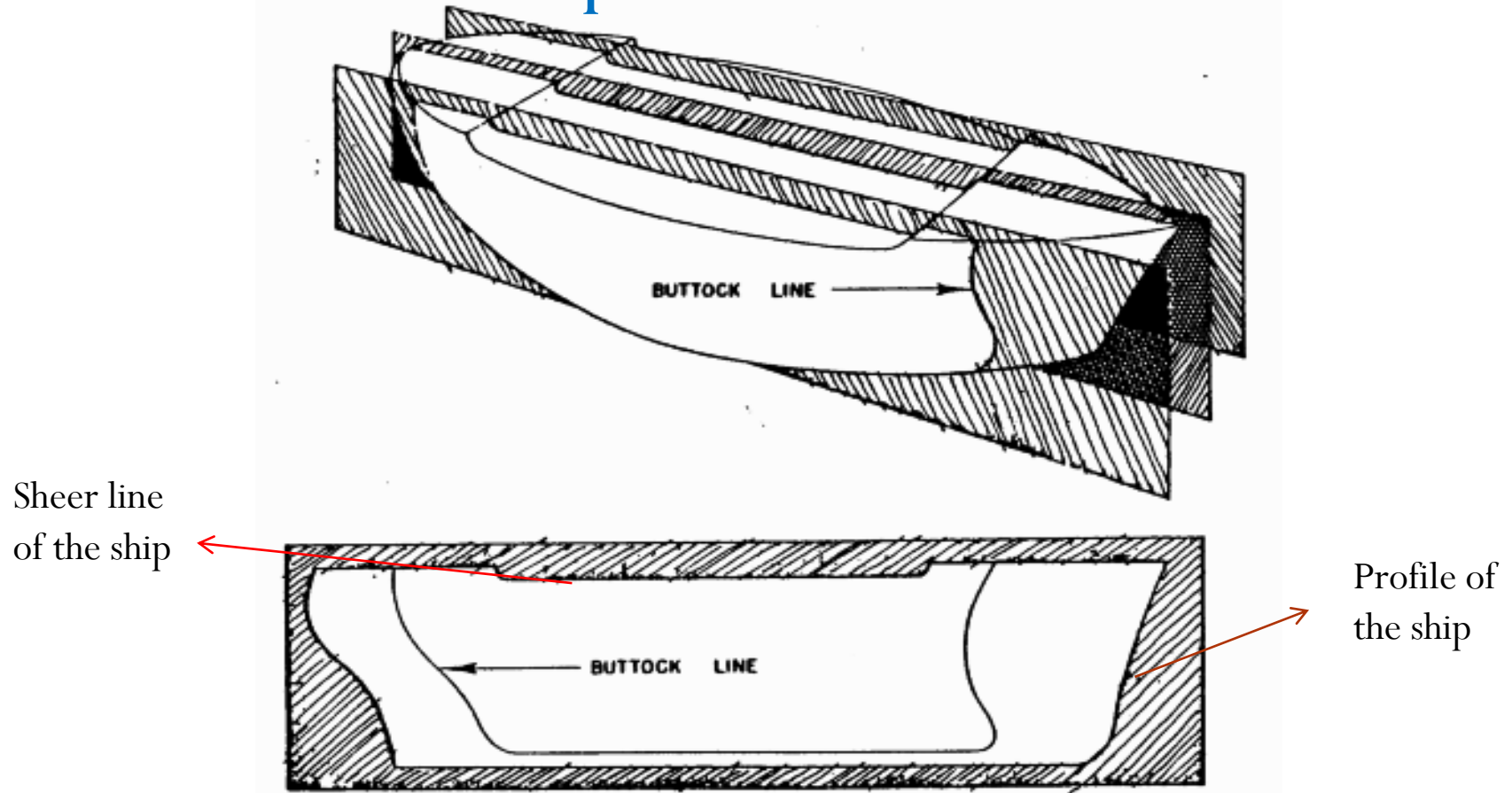

Each buttock line shows the true shape of the hull from the side view for some distance from the centerline of the ship. This allows them to serve as a pattern for the construction of the ship's **longitudinal** framing. The centerline plane shows a special buttock called the "**profile**" of the ship. The sheer plan gets its name from the idea of a sheer line on a ship. The sheer line on a ship is the upward longitudinal curve on ship's deck. It is the sheer line of the vessel which gives it a pleasing aesthetic quality.

The Body Plan - FRONT VIEW

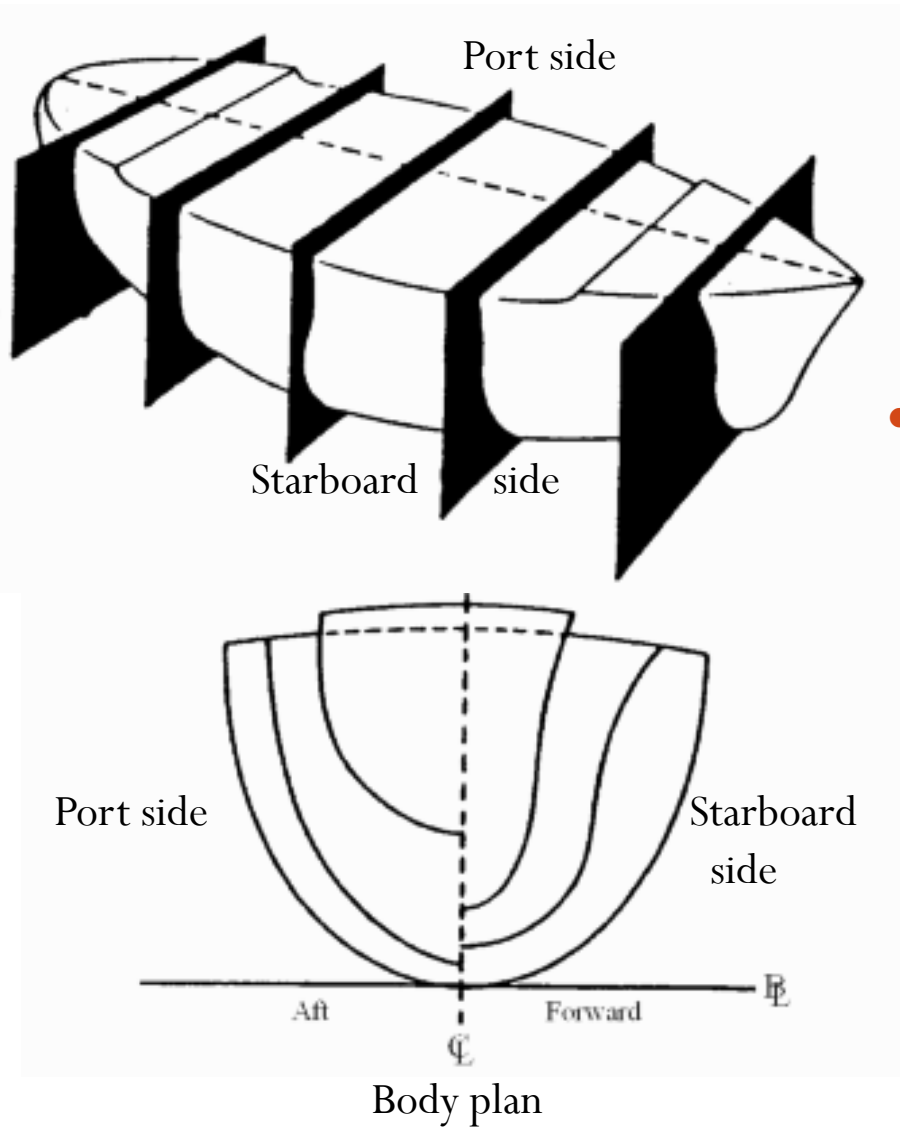

- Planes parallel to the front and back of the imaginary box running port to starboard are called **stations** or **sections**. A ship is typically divided into 11, 21, 31, or 41 evenly spaced stations. The larger the ship the more stations will be made. An odd number of stations results in an even number of equal blocks between the stations.
- The body plan takes advantage of the ship's symmetry. Only half of each section is drawn because the other half is identical. By convention, the sections forward of amidships are drawn on the right side, and the sections aft of amidships are drawn on the left side. The amidships section is generally shown on both sides of the body plan. The vertical line in the center separating the left and right half of the ship is called the centerline.

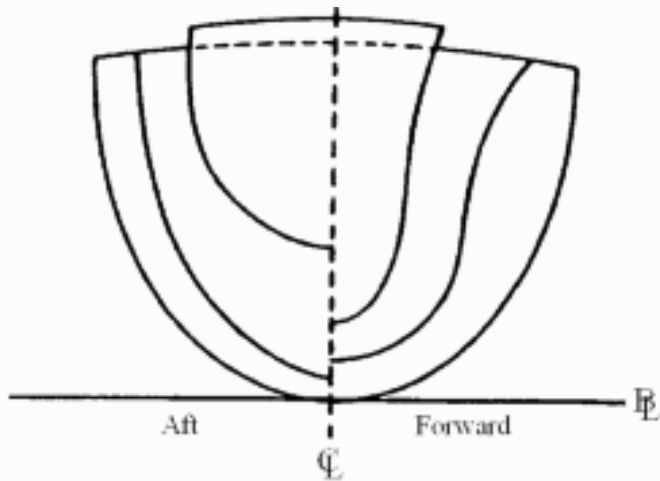
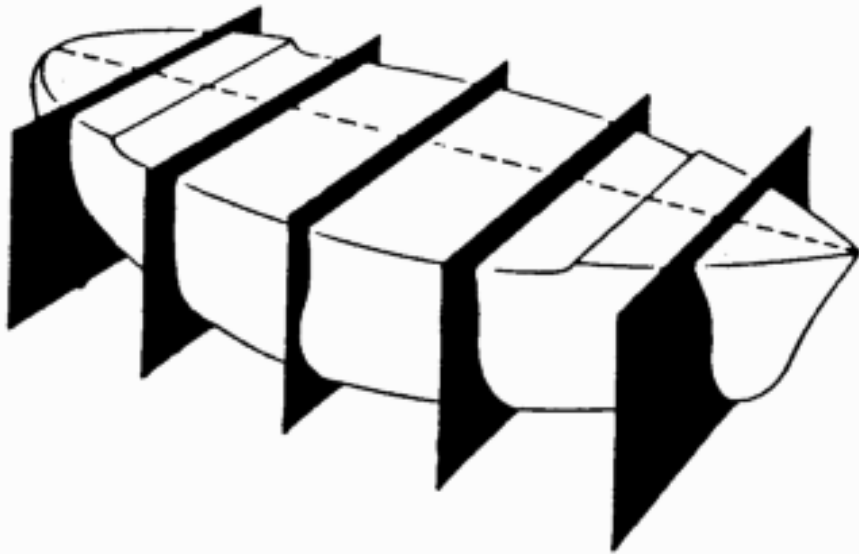

- Each section line shows the true shape of the hull from the front view for some longitudinal position on the ship which allows this line to serve as a pattern for the construction of the ship's **transverse** framing.
- Each station plane will intersect the ship's hull and form a curved line at the points of intersection. These lines are called “sectional lines” or “sections” and are all projected onto a single plane called the “**Body Plan**”

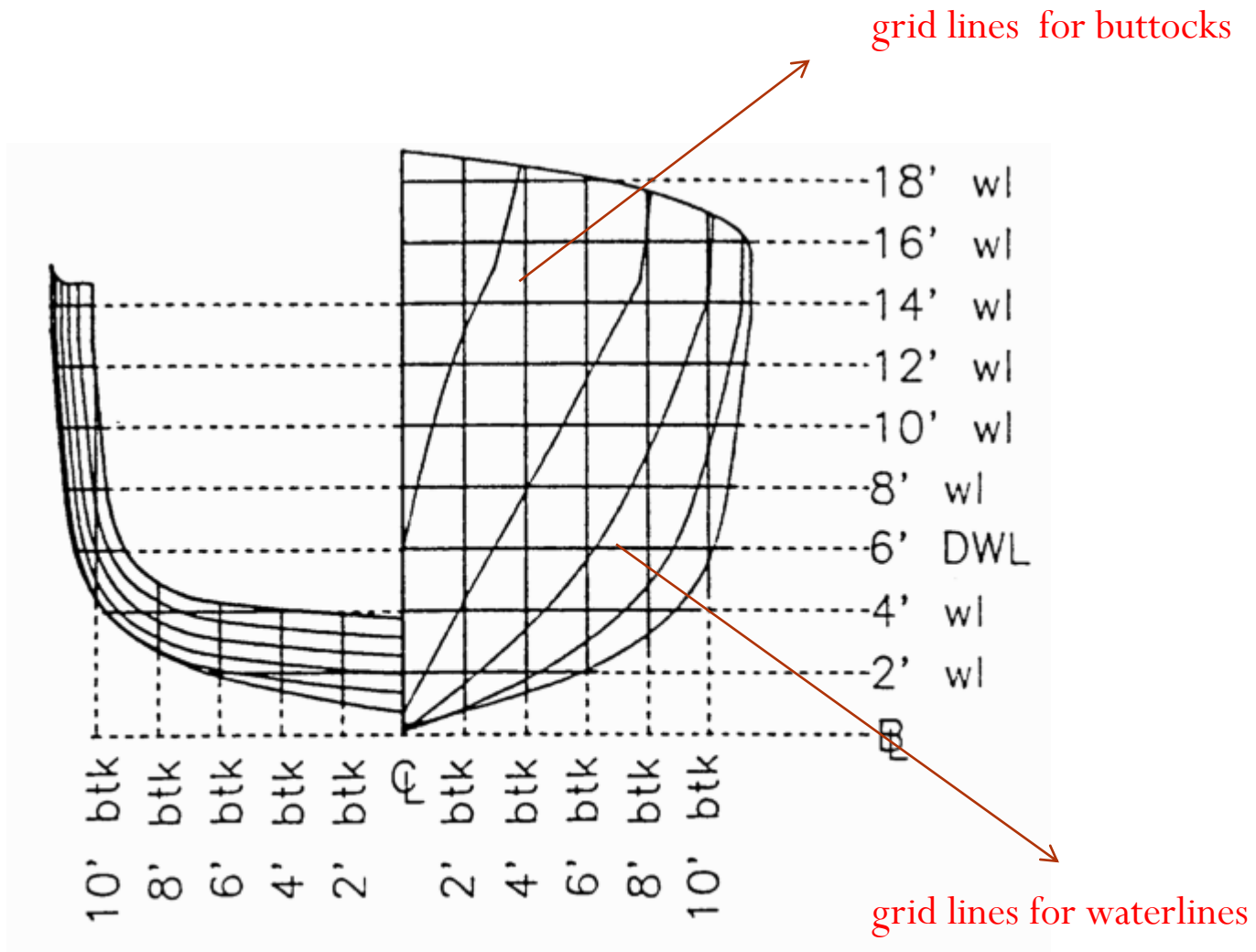

USNA Patrol Craft - Body Plan

Water lines.

Horizontal cross-sections of the hull are called water lines. One of these is the water lines/design draught. This is the water line used in the design of the ship when it is hypothetically loaded. When the water lines are projected and drawn into one particular view, the result is called a water line model.



Buttocks

Vertical cross-sections in fore and aft direction are called buttock lines. These cross-sections are parallel to the plane of symmetry of the ship. When the buttocks are projected and drawn into one particular view, the result is called a sheer plan.



Sections



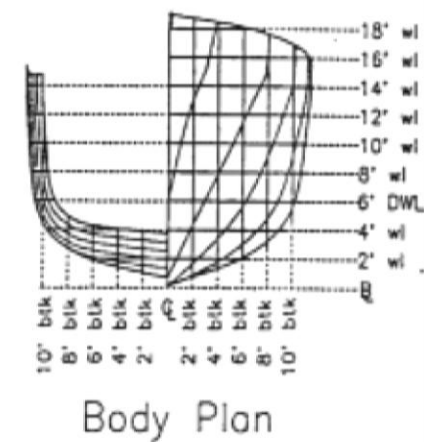
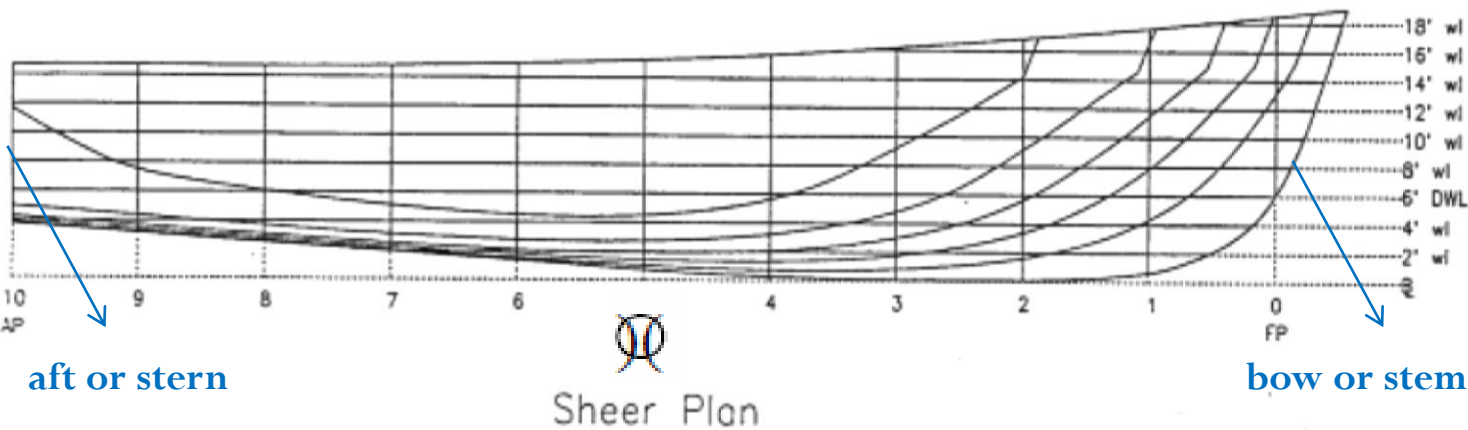

- The first forward station at the bow is usually labeled station number zero. This forward station is called the forward perpendicular (FP). By definition the FP is located at a longitudinal position as to intersect the stem of the ship at the DWL.

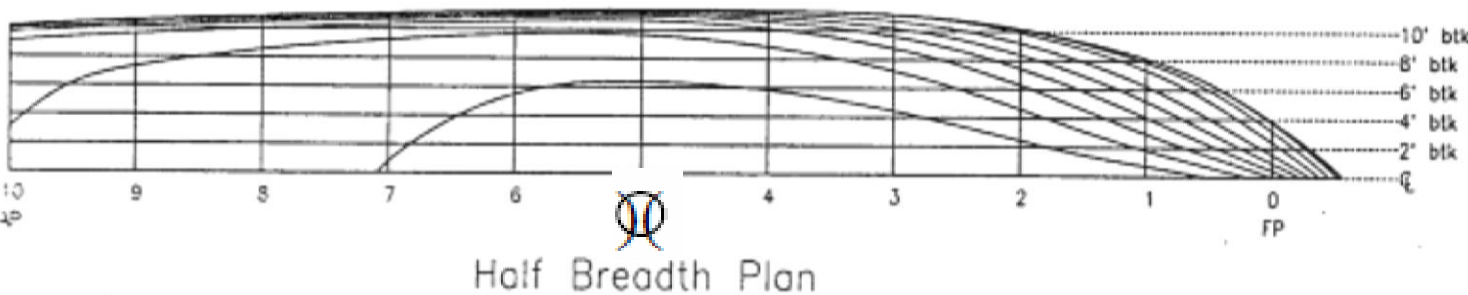

Principal Dimensions	
LOA	107' 4"
LPP	101' 8"
Beam Max	22' 9"
Station Spacing	10' 2"
Draft	6' 0"

- The after-most station is called the after perpendicular (AP). By definition the AP is located at a longitudinal position as to intersect the stern at the DWL for ships with a transom stern or alternatively through the rudder stock of the vessel.
- The station midway between the perpendiculars is called the midships station, usually represented by the O symbol. The length between these perpendiculars has the symbol "Lpp". Engineers typically use the Lpp for calculations. There is also an overall ship length "LOA" that might be a more useful number to use if you were docking the ship.

USNA Yard Patrol Craft
Modified Lines Plan
Scale 1:10
Des by H. Harbo 1/88

Nowadays the lines plans are being made with the aid of computer programs that have the possibility to transform the shape of the vessel automatically when modifications in the ship's design require this.

If the linesplan is ready, the programs may be used to calculate among other things the volume and displacement of the ship.

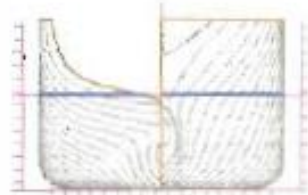

Length over all	: 210,345 [m]
Length over oal	: 212,000 [m]
Moulded breadth	: 32,240 [m]
Draft	: 12,240 [m]
Displacement	: 59279 [t]
Cb	: 0,661 [-]
Cp	: 0,707 [-]
Cm	: 0,978 [-]
LCB	: 0,340 [% Lpp]
Xb	: 102,561 [m]
KMtransverse	: 14,430 [m]



Hullform characteristics

- All aspects concerning the measurements of seagoing vessels are arranged in the certificate of registry act of 1982.
- **Perpendiculars** The forward and after perpendiculars shall be taken at the forward and after ends of the length (L_{pp}). The forward perpendicular shall coincide with the foreside of the stem on the water line on which the length is measured.
- **FP** – Fore perpendicular
- **AP** – Aft perpendicular
- **BL** - Base line

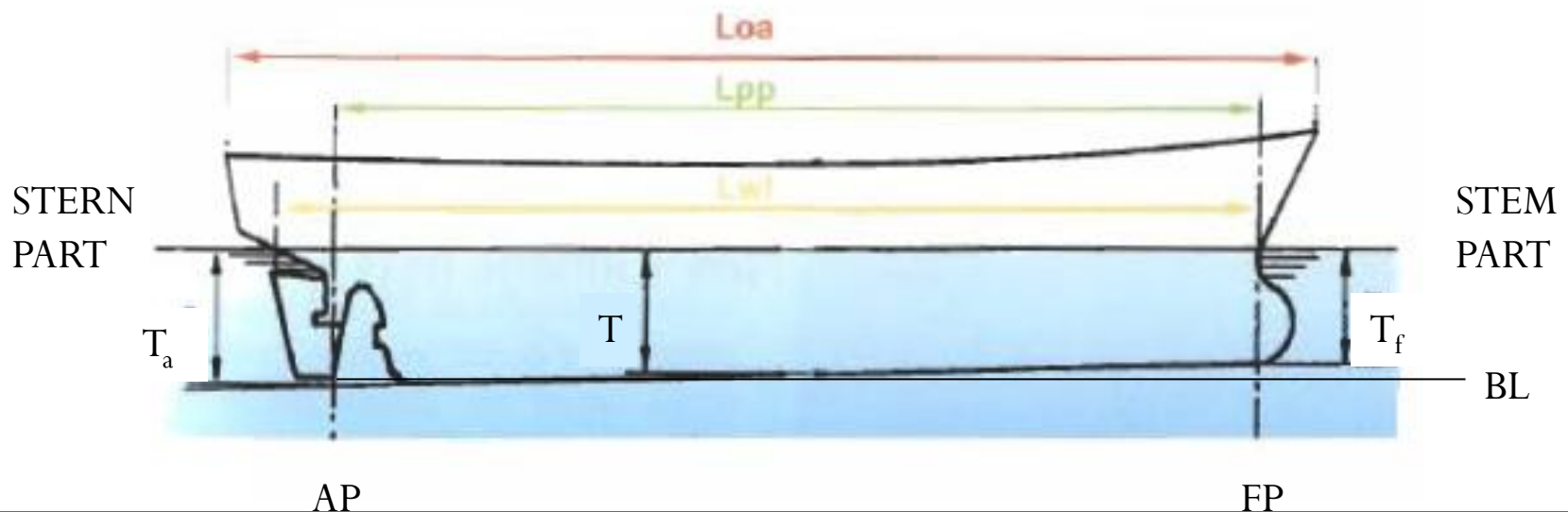

- **Length between perpendiculars (L_{pp})** – Distance between the fore and aft perpendicular
- **Length over all (Loa)** – The horizontal distance from stem to stern
- **Loaded waterline (Lwl)** – Horizontal distance between the stem and stern when the ship is on her summer mark. In other words the waterline of ship lying in the water.
- **Draught (T)** – The depth of a ship's keel below the waterline.
- **Trim** – The difference between the draught at the stem and stern

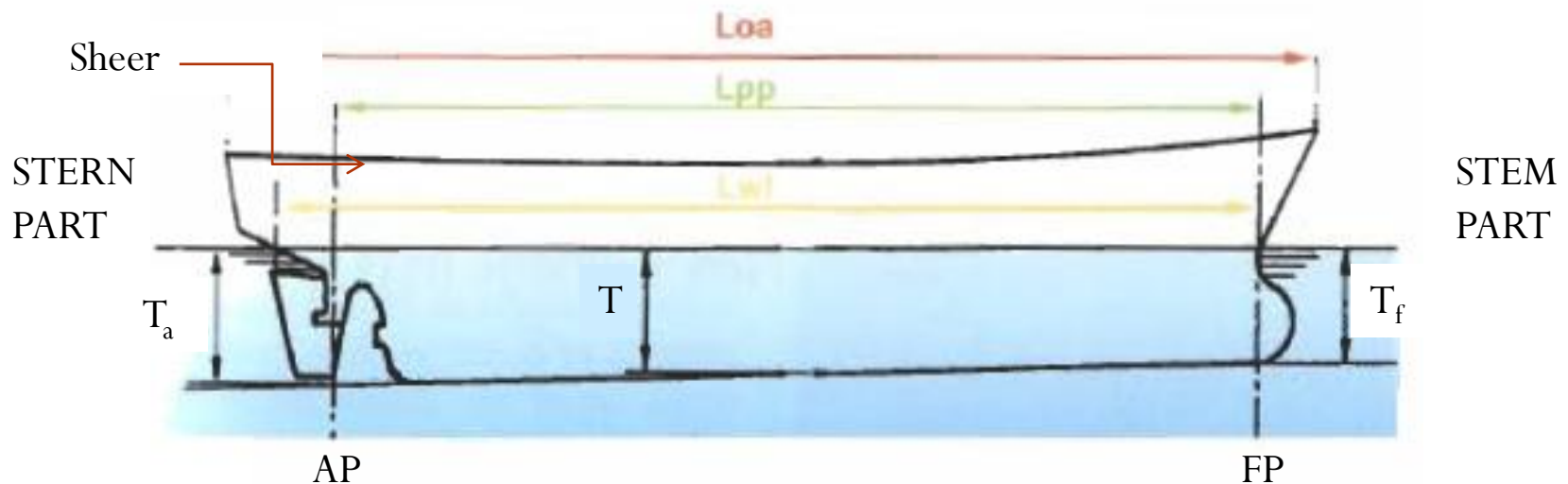

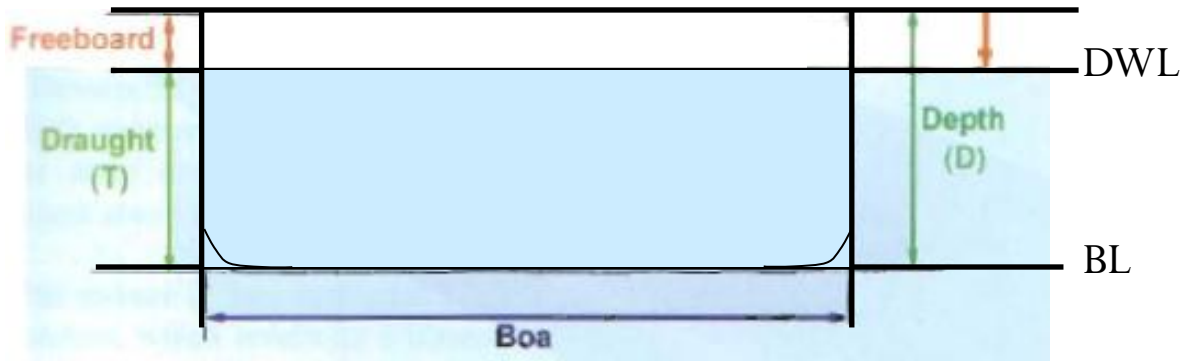

- **Breadth (B)** – The maximum breadth of the ship as measured from the outer hull on starboard to port side
- **Depth (D)** – The vertical distance between the base line and upper deck. The depth is measured at midships.

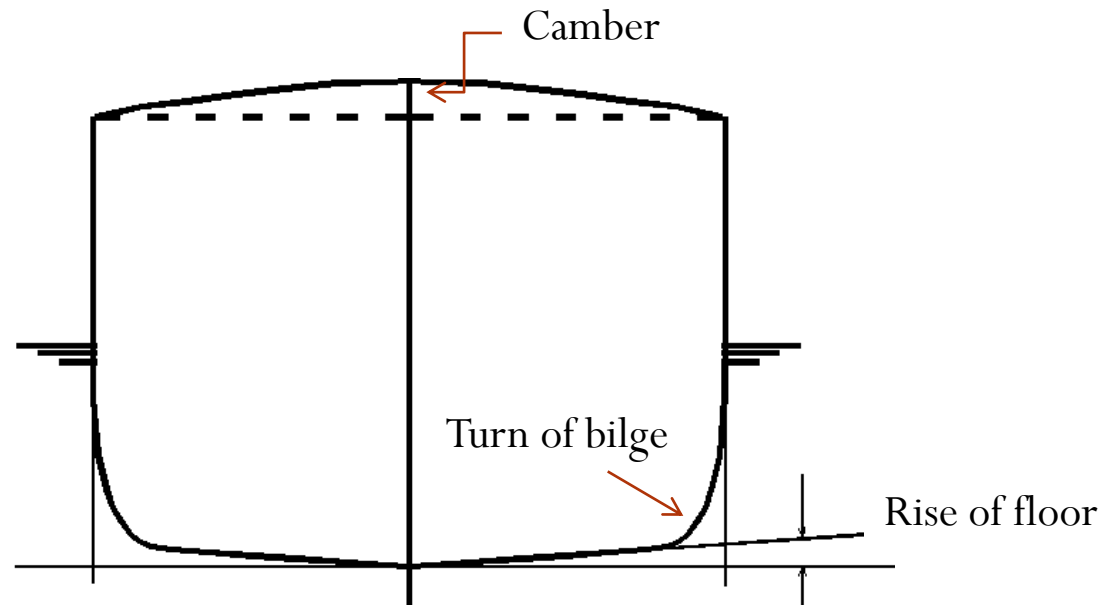

- **Sheer** – The upward rise of a ship's deck from amidships towards the bow and stern
- **Camber** – The curving of the weather deck which ensures drainage
- **Rise of floor** – Unique to some types of vessels like tugboats and fishing boats. This is the upwards rise of the lower edges of the floors from keel towards the bilges
- **Turn of bilge** – Gives the radius of the bilge of the ship

- **Freeboard.** The freeboard assigned is the distance measured vertically downwards amidships from the upper edge of the deck line to the upper edge of the related design waterline or loaded waterline.

● Call it a safety bulb !!

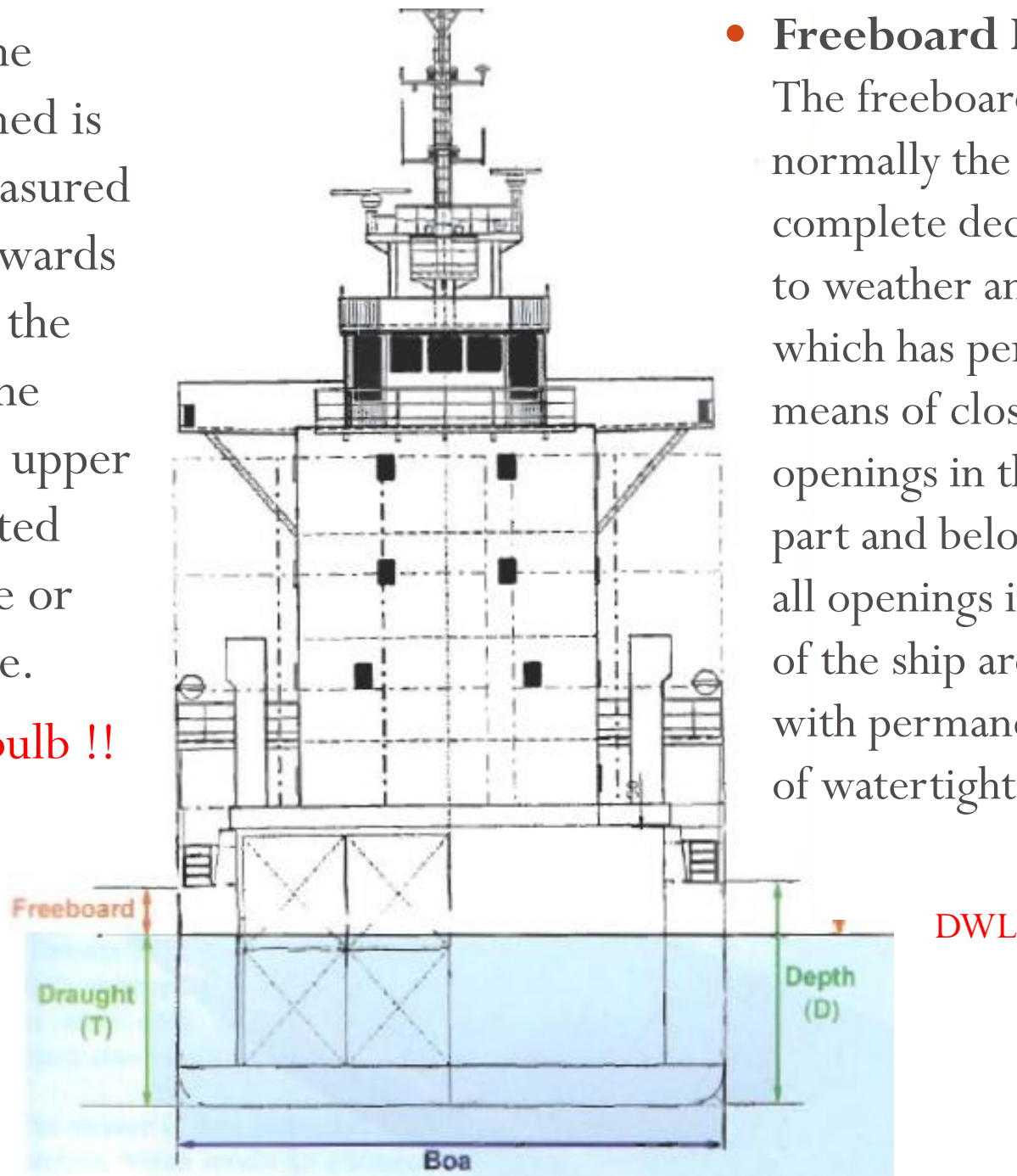

- **Freeboard Deck.** The freeboard deck is normally the uppermost complete deck exposed to weather and sea, which has permanent means of closing all openings in the weather part and below which all openings in the sides of the ship are fitted with permanent means of watertight closing.

Freeboard – Load line

- Safe loading, weight and balance have always been very serious issues for seafarers. In England, Samuel Plimsoll became the moving force to establish safe loading as a rule of law in 1875. Through his efforts, safe loading standards were adopted and forced by law. The first International Convention on Load Lines, adopted in 1930, was based on the principle of reserve buoyancy, although it was recognized then that the freeboard should also ensure adequate stability and avoid excessive stress on the ship's hull as a result of overloading.
- Load line conventions were conceived as instruments to assign the maximum safe draught for ships to operate at sea.

- The freeboard mark shall consist of a ring 300 mm in outside diameter and 25 mm wide which is intersected by a horizontal line 450 mm in length and 25 mm in breadth, the upper edge of which passes through the centre of the ring. The centre of the ring shall be placed amidships and at a distance equal to the assigned summer freeboard measured vertically below the upper edge of the deck line.



Proportions

The ratios of some of the dimensions discussed above can be used to obtain information on resistance, stability and manoeuvrability of the ship. Some widely used relations are:

L/B

The ratio of length and breadth can differ quite dramatically depending on the type of vessel. Common values:

Passenger ships	6-8
Freighters	5-7
Tug boats	3-5

A larger L/B value is favourable for speed, but unfavourable for manoeuvrability.

L/D

The length/depth-ratio. The customary values for L/D varies between 10 and 15. This relation plays a role in the determination of the freeboard and the longitudinal strength.

B/T (T = Draught)

The breadth/draught-ratio, varies between 2.3 and 4.5. A larger breadth in relation to the draught (a larger B/T-value) gives a greater initial stability.

B/D

The breadth / depth-ratio; varies between 1.3 and 2. If this value becomes larger, it will have an unfavourable effect on the stability (because the deck will be flooded when the vessel has an inclination) and on the strength.

Volumes and weights

The dimensions of a ship can be expressed by using terms which describe the characteristics of the ship. Each term has a specific abbreviation. The type of ship determines the term to be used. For instance, the size of a container vessel is expressed in the number of containers it can transport; a roll-on roll-off carrier's size is given by the total deck-area in square metres and a passenger ship in the number of people it can carry. At the IMO-conference in 1969 the new units "Gross Tonnage" and "Net Tonnage" were introduced, to establish a world-wide standard in calculating the size of a ship. In many countries the Gross Tonnage is used to determine port dues and pilotage, or to determine the number of people in the crew.



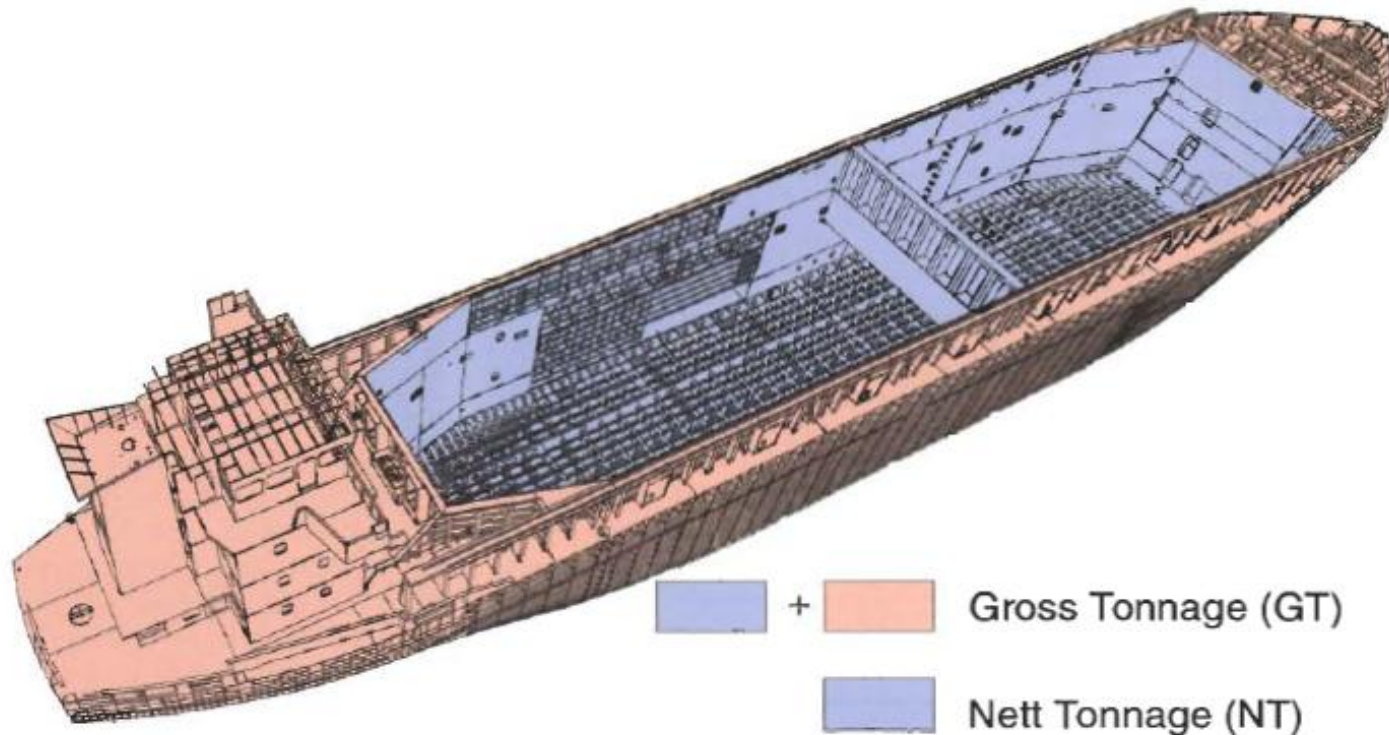

Gross Tonnage

The gross tonnage is calculated using a formula that takes into account the ship's volume in cubic metre below the main deck and the enclosed spaces above the main deck.

Nett Tonnage

The Nett Tonnage is also a dimensionless number that describes the volume of the cargo space. The NT can be calculated from the GT by subtracting the volume of space occupied by:

- crew
- navigation equipment
- propulsion equipment
- workshops

Displacement Δ (in t)

The displacement is the weight of the volume of water displaced by the ship. One could also say: the displacement equals the total mass of the ship.

$$\text{Displacement (t)} = \text{waterdisplacement (m}^3\text{)} * \text{density of water (t/m}^3\text{)}$$

Light displacement (in t)

This is the weight of the hull including the regular inventory. The regular inventory includes: anchors, life-saving appliances, lubricating oil, paint, etc.

Dead weight (in t)

This is the weight a ship can load until the maximum allowable submersion is reached. This is a constant, which is unique for every ship.

$$\text{Dead weight (t)} = \text{maximum weight } \Delta(t) - \text{light displacement (t)}$$

$$\text{Dead weight (t)} = \text{maximum weight } \Delta(t) - \text{actual weight } \Delta(t)$$

Cargo, carrying or dead weight capacity (in t)

This is the total weight of cargo a ship can carry. The cargo capacity (in t) is not a fixed number, it depends on the ship's maximum allowable submersion, which will include the capacity (in t) of fuel, provisions and drinking water. For a long voyage there has to be room for extra fuel, which reduces the cargo capacity.

Cargo capacity (t) = dead weight (t) - ballast, fuel, provisions (t).



The cargo capacity determines the amount of money the ship makes

Ship Hull Form Coefficients

Form coefficients give clues about the characteristics of the vessel's shape from the water line down into the water. This makes it possible to get an impression of the shape of the underwater body of a ship without extensive use of any data. However, the form coefficients do not contain any information on the dimensions of the ship, they are non-dimensional numbers.

Waterplane-coefficient C_w .

The waterplane-coefficient gives the ratio of the area of the water line A and the rectangular plane spanned by L_{pp} and B_{mld} . A large waterplane-coefficient in combination with a small block-coefficient (or coefficient of fineness) is favourable for the stability in both athwart and fore and aft direction.

$$\text{Waterplane-coefficient } (C_w) = \frac{A_w}{L_{pp} \times B_{mld}}$$

Midship section coefficient, C_m .

The midship-coefficient gives the ratio of the area of the midship section (A_m) and the area spanned by B_{mld} and T .

$$\text{Midship-coefficient } (C_m) = \frac{A_m}{B_{mld} \times T}$$

Block coefficient, coefficient of fineness, C_b .

The block coefficient gives the ratio of the volume of the underwater body and the rectangular beam spanned by L_{pp} , B_{mld} and T . A vessel with a small block coefficient is referred to as 'slim'. In general, fast ships have a small block coefficient.

Customary values for the block coefficient of several types of vessels:

Tanker	0.80-0.90
Freighter	0.70-0.80
Container vessel	0.60-0.75
Reefer	0.55-0.70
Frigate	0.50-0.55

$$\text{Block coefficient } (C_b) = \frac{V}{L_{pp} \times B_{mld} \times T}$$

$$\text{Block coefficient (Cb)} = \frac{V}{L_{pp} \times B_{mld} \times T}$$



Graphical representation of block coefficient



**A ship with a small block coefficient
but a large midship section coefficient**



**A ship with a large block coefficient
but a large midship section coefficient**

Prismatic coefficient

The prismatic coefficient gives the ratio of the volume of the underwater body and the block formed by the area of the midship section (A_m) and L_{pp} . The C_p is important for the resistance and hence for the necessary power of propulsion (if the C_p decreases, the necessary propulsion power also becomes smaller).

The maximum value of all these coefficients is reached in case of a rectangular beam, and equals 1. The minimal value is theoretically 0.

$$\text{Prismatic coefficient}(C_p) = \frac{V}{L_{pp} \times A_m}$$



Graphical representation of prismatic coefficient

Lets show a couple of lines plans that differ quite dramatically. The looker can tell from these lines plans that a ship would be slimmer with smaller coefficients and when the waterlines, section lines and buttocks are more closely spaced

Tug boat

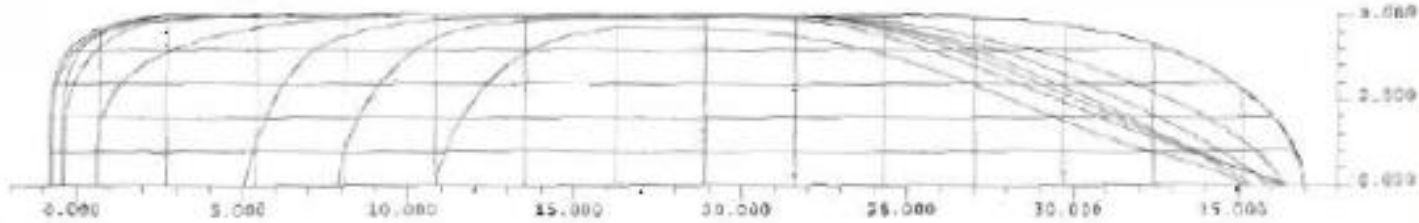
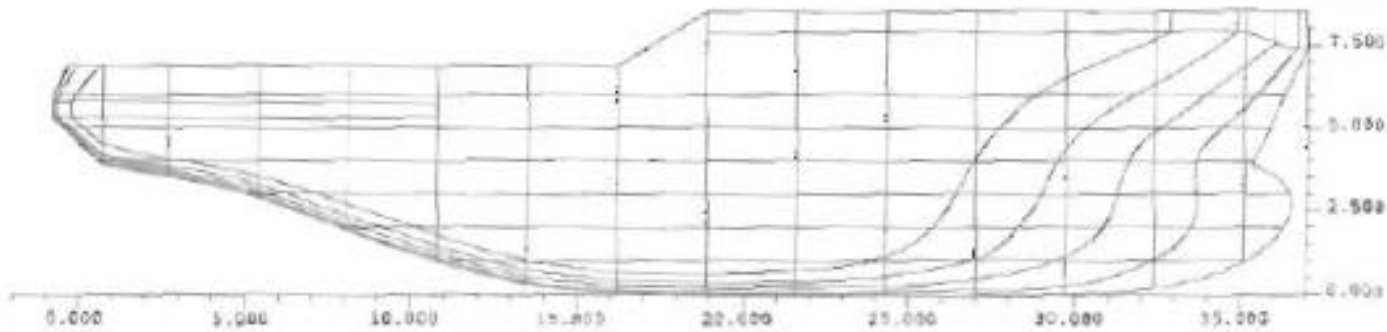
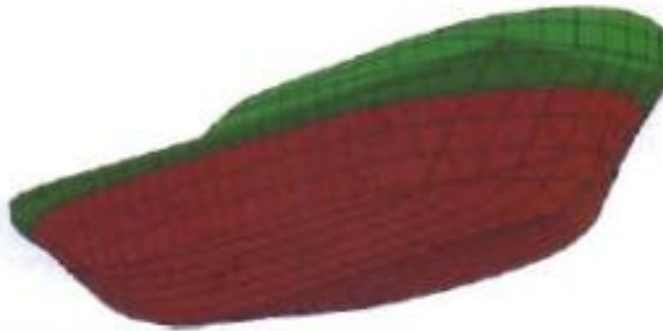
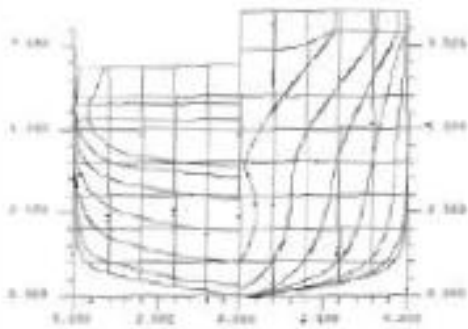

$$L_{pp} = 35.000 \text{ m}$$

$$C_b = 0.565$$

$$\text{Volume} = 896 \text{ m}^3$$

$$B_{mld} = 10.080 \text{ m}$$

$$C_m = 0.908$$

$$LCB = 2.90 \%$$

$$T_{mld} = 4.500 \text{ m}$$

$$C_p = 0.622$$

$$KM = 5.13 \text{ m}$$

Yacht

L_{pp} = 23.500 m

C_b = 0.157

Volume = 92 m³

B_{mld} = 6.250 m

C_m = 0.305

LCB = -3.16 %

T_{mld} = 4.000 m

C_p = 0.515

KM = 6.06 m

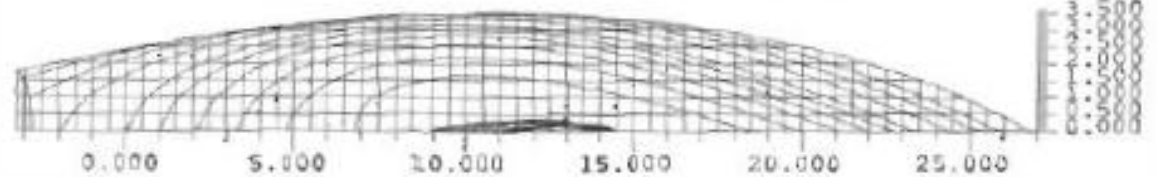
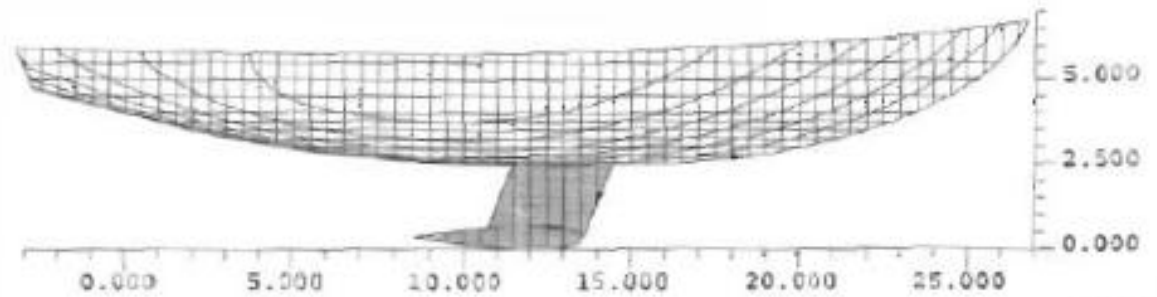

Coast guard ship with a somewhat exceptional underwater-shape.

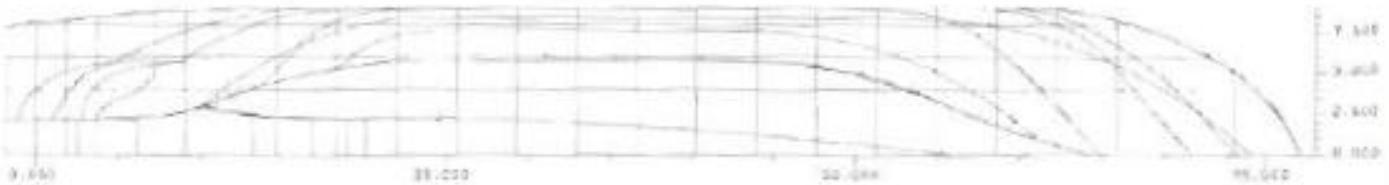
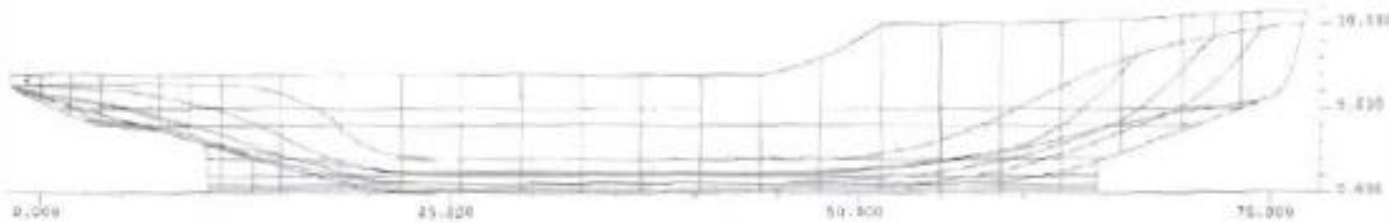
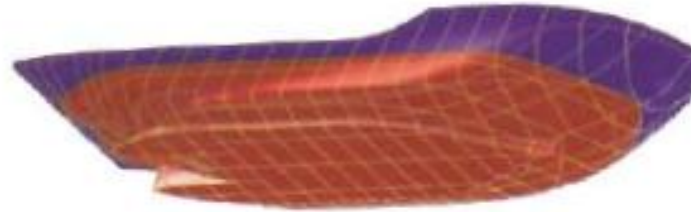
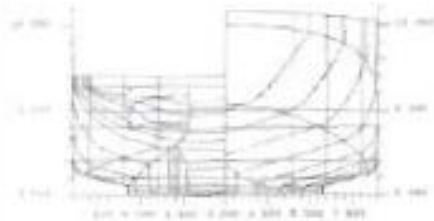

Lpp = 73.200 m
Cb = 0.637

Volume = 4196 m³
Bmld = 18.000 m

Cm = 0.933
LCB = -0.75 %

Tmld = 5.000 m
Cp = 0.683

KM = 8.67 m

Heavy cargo ship, multi-purpose.



Lpp	= 134.000 m
Cb	= 0.710
Volume	= 18644 m³
Bmld	= 28.000 m
Cm	= 0.992
LCB	= -2.24 %
Tmld	= 7.000 m
Cp	= 0.715
KM	= 14.46 m

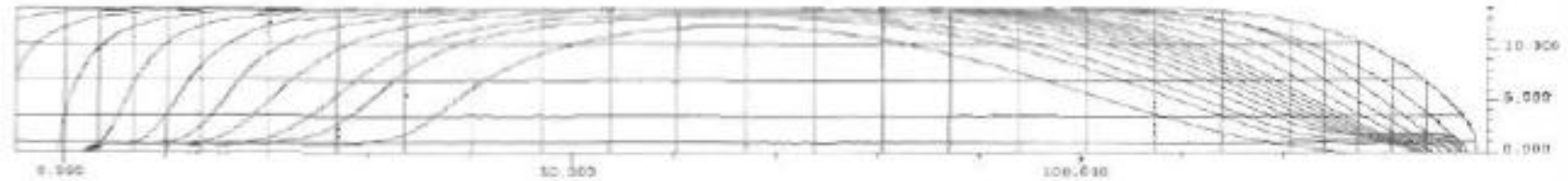
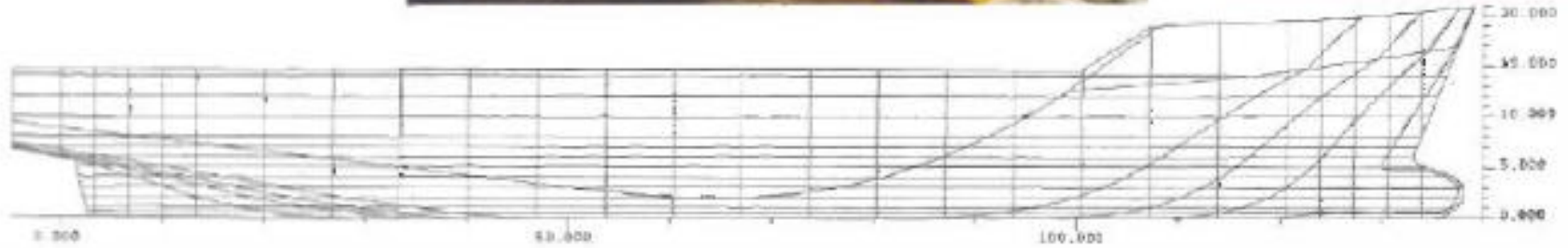
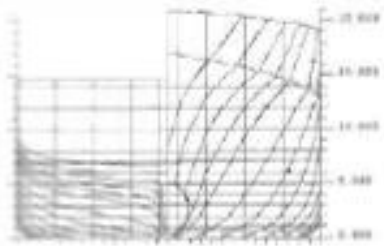

Frigate

L_{pp} = 96.000 m
 C_b = 0.452
Volume = 1620 m³
 B_{mld} = 11.500 m
 C_m = 0.752
LCB = -2.30 %
 T_{mld} = 3.250 m
 C_p = 0.601
KM = 6.17 m

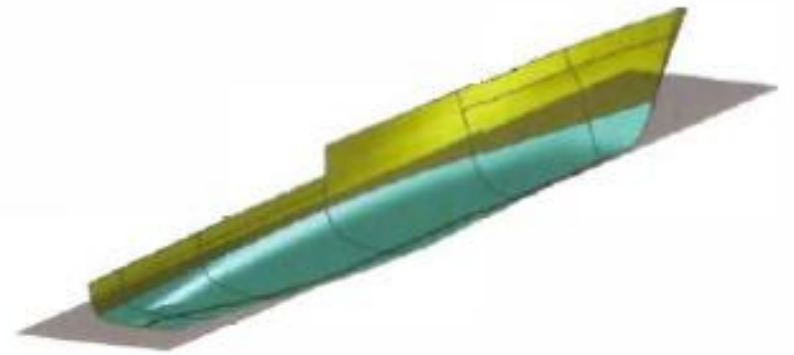
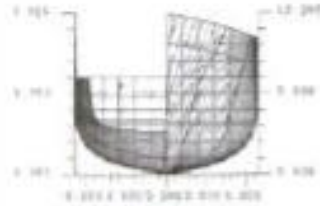

Frigate

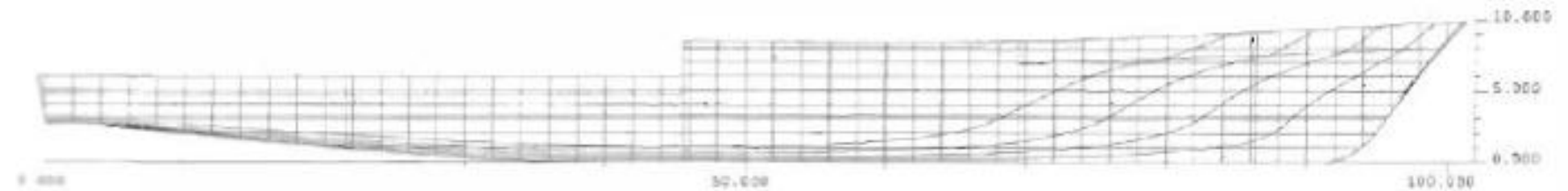

DRAWINGS

Of the many drawings, only the most important ones are mentioned here. In general, the following demands are made:

The general arrangement plan, safety plan, docking plan and capacity plan have to be submitted to the Shipping Inspectorate for approval.

The general arrangement plan, midship section drawing, shell expansion and construction plan (or sheer plan or working drawing) have to be submitted to the classification bureau for approval.

General arrangement plan

The general plan roughly depicts the division and arrangement of the ship. The following views are displayed:

- a (SB) side-view of the ship.
- the plan views of the most important decks.
- sometimes cross-sections, or a front and back view are included.

The views and cross-sections mentioned above, display among other things:

- the division into the different compartments (for example: tanks, engine room, holds)
- location of bulkheads.
- location and arrangement of the superstructures.
- parts of the equipment (for example: winches, loading gear, bow thruster, lifeboat).

Next to these, some basic data are included in the drawing like: principal dimensions, volumes of the holds, tonnage, dead weight, engine power, speed and class.

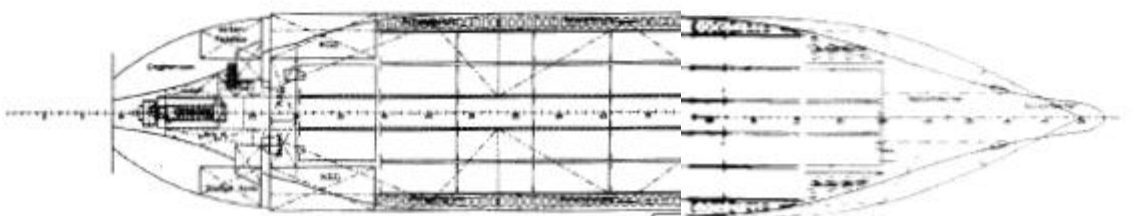
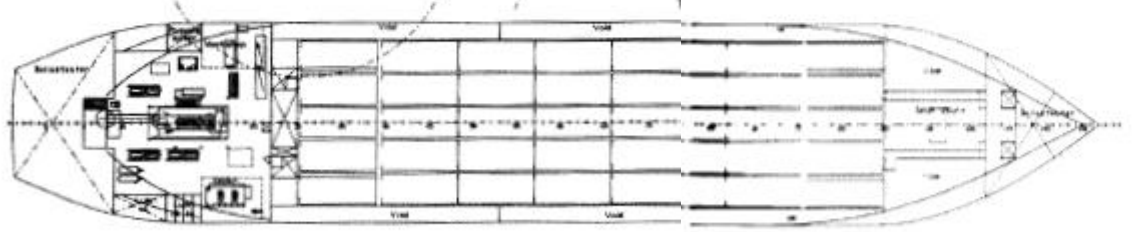
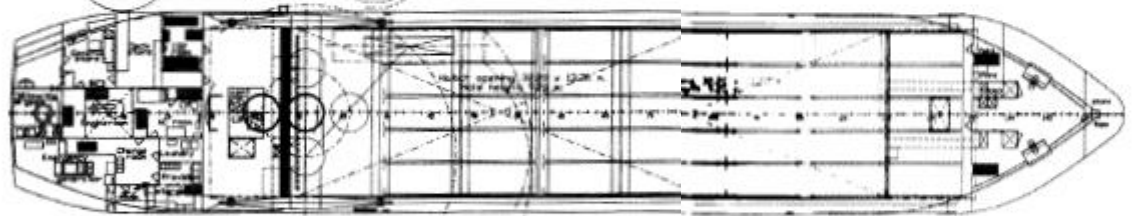
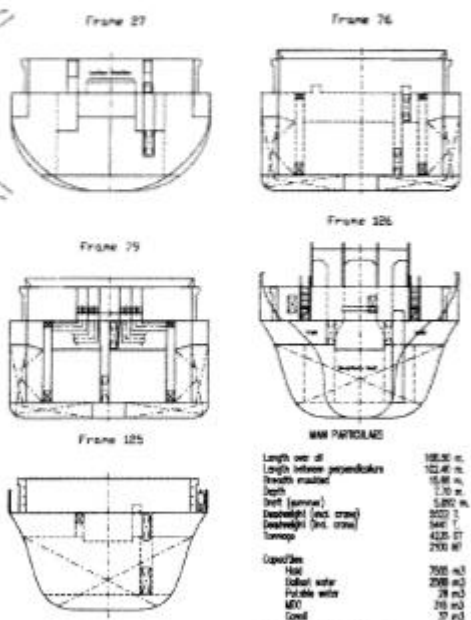
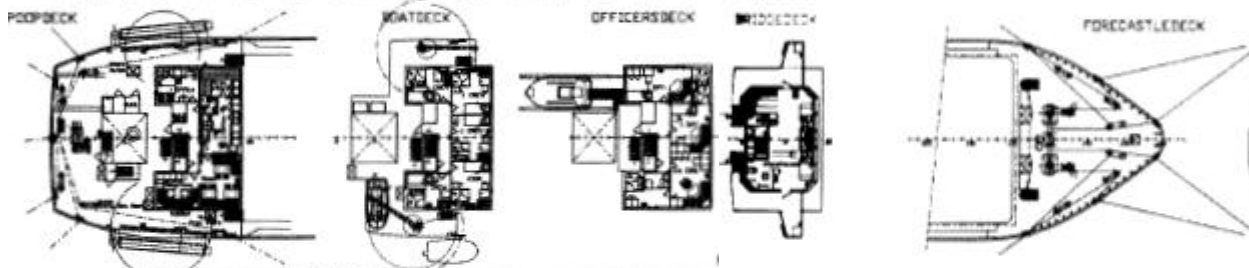
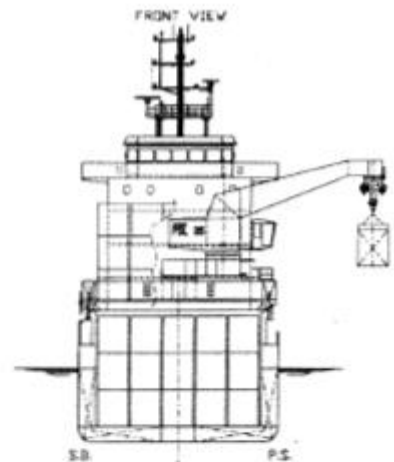
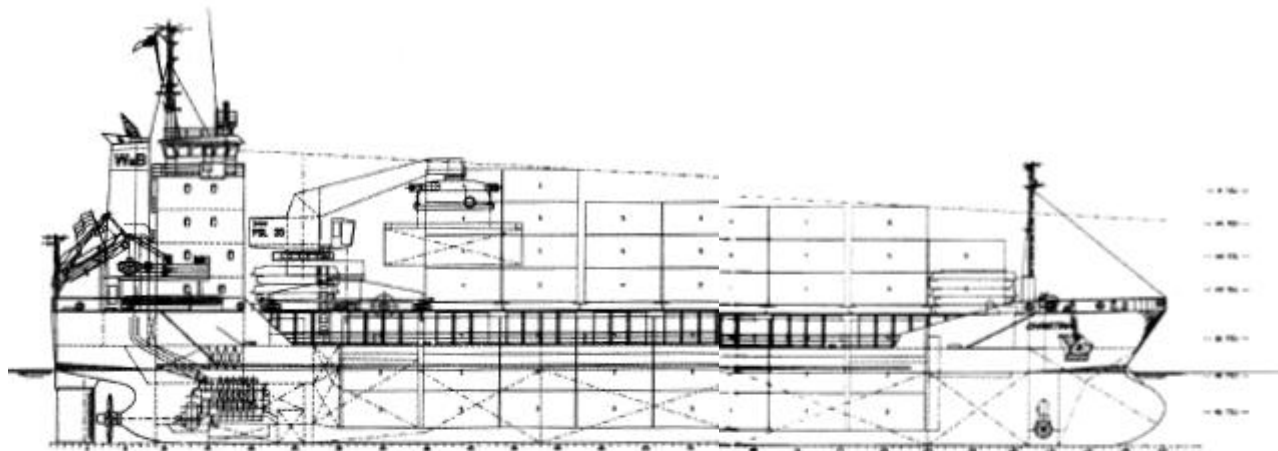

Length over all	126.35 m
Length between perpendiculars	122.40 m
Breadth moulded	18.80 m
Depth	11.70 m
Depth (summer)	11.800 m
Deckwidth (incl. crane)	20.22 m
Deckwidth (excl. crane)	18.47 m
Tonnage	4225 GT
	2300 RT
Capacity	
Net	7000 m ³
Global water	2000 m ³
Hot-ble water	78 m ³
MEO	110 m ³
Cond.	37 m ³

©E. van 't Ven / Swin

WV **HCC 5000**

WILNIE & BARENDS
ingenieurs- en architectenbureau

Nielster Sander bv
Rijkswaterstaat
Rijkswateringenbureau

COPYRIGHT RESERVED
CONSHIP INTERNATIONAL, BV - 1616 RM AM
ERDENEN - THE NETHERLANDS

HIGH CUBIC CONTAINER 5000

TYPE	SIZE	DATE	NO.	REVISED
1200	12-81-2340	1983-02	507	130

Midship Section

This cross-section shows one or more athwart cross-sections of the ship. In case of a freighter it is always a cross-section of the hold closest to the midship. Some of the data shows includes:

- principal dimensions
- engine power and speed
- data on classification
- equipment numbers
- maximum longitudinal bending moment.

Web Frame

Frame Spacing 700 mm

Web every 2nd Frame

Shell Expansion

A shell expansion drawing may be created from any workshop design. The drawing shows the girth (measurement around the plates) positions of all parts (plate edges, stringers, frames and decks) from a specified datum position (usually, but not always, the baseline)

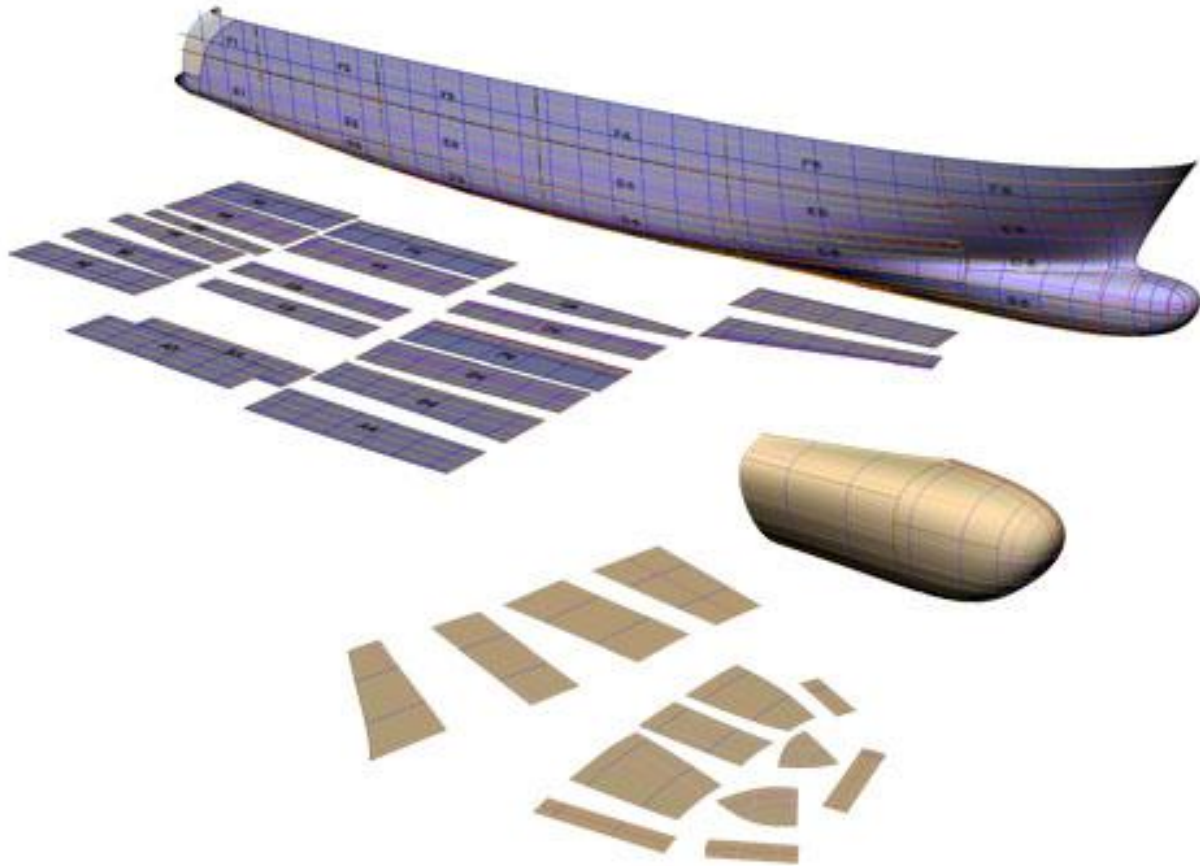

Shell Plating Aft P.S. ↙

Shell Plating Aft

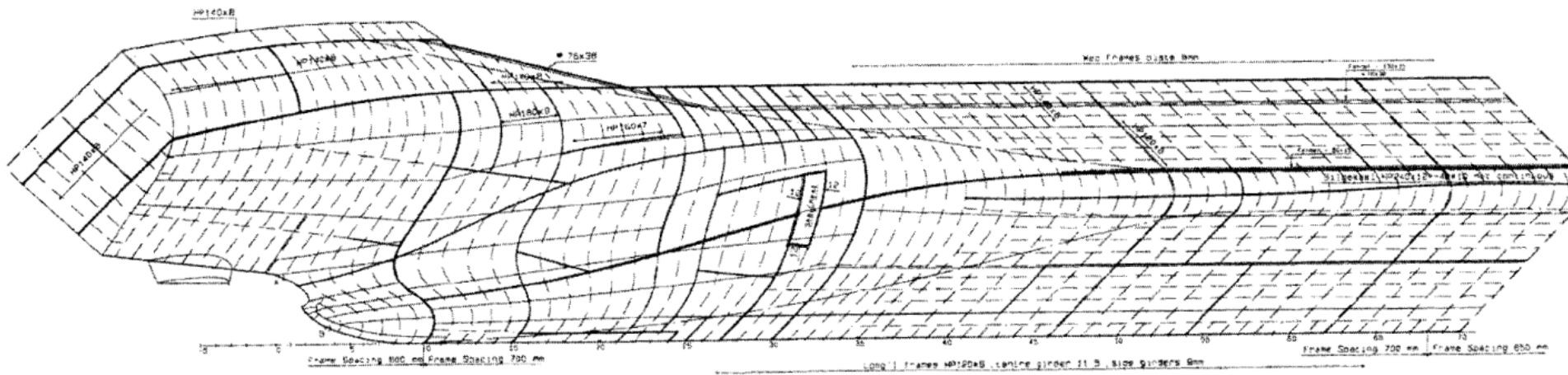
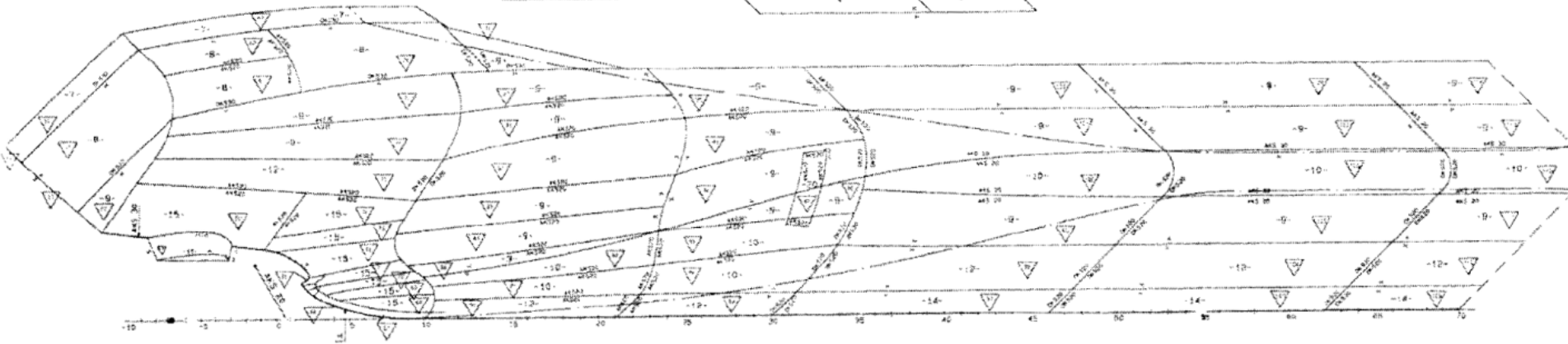

A typical shell expansion drawing

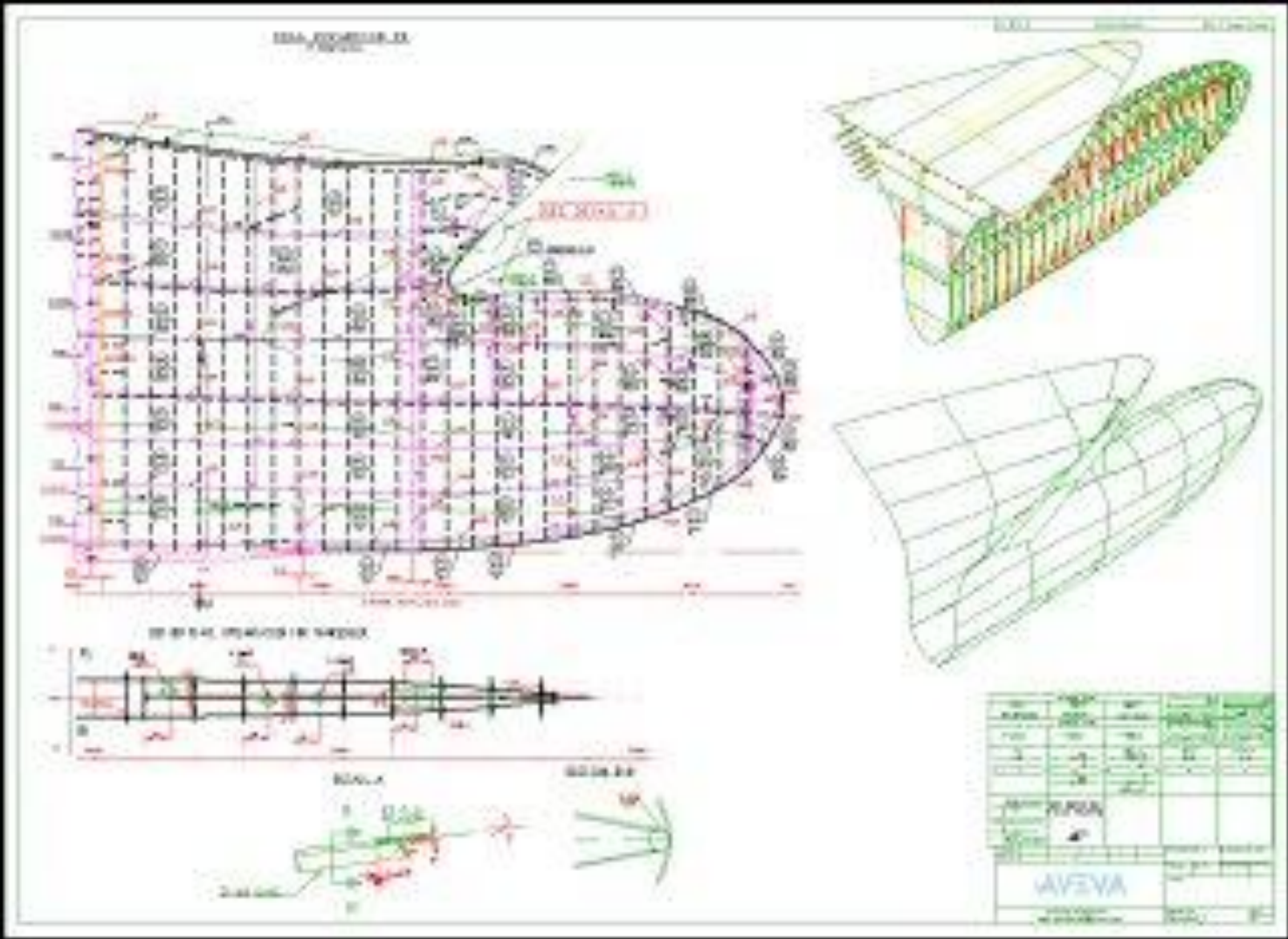

Other plans

- Construction plan
- Safety plan
- Docking plan
- Capacity plan

Important data on various ships

Ship owners have an interest in promoting their ships as much as possible, especially the types of cargo their ships can transport. Or to put it in another way: how they can earn money. The table on the next page contains data of a number of ships which differ very much in the type of cargo they can carry. The abbreviations and other information are explained, unless they have already been explained in the text.

Refrigerated vessel



Flag: panama
 Call sign: H.3.E.Y.
 Lloyds Nu: (1) 9167801
 Built: 2000
 DWT: (2) 12.902 mt

GT/NT: 11.382/6.408
 Loa: 155 m
 Beam: (3) 24 m
 Summer draught: 10,1 m
 Holds/Hatches/
 Compartments: (4) 4/4/15
 Ventilation/Air changes: (5) Vertical / 90
 Different temps: (6) 8/2 per hold
 Cranes: 2 x 40 t
 Pallet cranes: 2 x 8 t
 Container capacity: (7) 294 TEU plus 60 FEU
 or 207 FEU

Reefer plugs: (8) 185
 Speed banana laden: (9) abt. 21,5 knots
 Consumption (reefer plant): (10) abt. 49 MT IFO 380 RMG 35
 Aux: (11) abt. 6 MT IFO 380 RMG 35
 Tank capacity: (12) 1.800 MT IFO 380 RMG 35
 150 MT MDO DMA
 Additional Features: Bowthruster



Opened hold of the "Comoros Stream"



Hold of a reefer

Explanation on the specifications of the “Comoros Stream”

- (1) Lloyd’s number is also the IMO-registration number of the ship, even after a change of ownership, this number stays with the vessel.
- (2) Dead weight
- (3) Breadth
- (4) The number of holds, hatches and compartments. Most holds have three tween decks resulting in a hold which is divided into 4 compartments.
- (5) The ventilation is vertical. The entire hold capacity can be replenished 90 times per hour.
- (6) Number of isolated compartments where the temperature can be adjusted separately of the other compartments; two per hold.
- (7) The vessel can transport 294 TEUs + 60 FEUs or 207 FEUs.
- (8) Ship can supply 185 containers with electricity.
- (9) If the vessel is fully laden with bananas, the maximum speed is 21.5 knots.
- (10) The daily fuel consumption (including the refrigerating plant) is approximately 49 tons of Intermediate Fuel Oil 380 (old notation) or Residual Machine G35, the viscosity is 35 cst (at 100° C). G gives the quality of the viscosity.
- (11) The daily fuel consumption of the auxiliaries is 6 tons.
- (12) Capacity of the fuel tanks is 1800 tons RMG and 180 tons DMA (Distillate Marine Fuels, A is gas oil).

Coastal trade liner



Flag:	Dutch
Built:	1998 / 1999
Type:	boxed shape / sid
D.W.T.: (1)	2964 mt
D.W.C.C Summer: (2)	2800 mt
GT / NT:	2056 / 1168
L.O.A.:	88.95 m
B.O.A.:	12.50 m
Draught laden: (3)	04.34 m
Air draught: (4)	09.30 m
Classification: (5)	B.V. 1 3/3 E cargo- ship deepsea - BRG unrestricted waters incl. river Rhine
Trading area:	
Container intake (total):	108 teus
Cubic capacity GR / BA:	151.000 cbft
Movable bulkhead:	2
Tanktop strength:	15 mt/m ²
Hatch strength:	1 mt/m ²

Explanation on the specifications of the "Hansa Bremen"

- (1) Dead weight
- (2) Dead weight Cargo Capacity at Summer draught.
- (3) Maximum draught
- (4) Air draught at summer draught, if the (loaded) vessel is not at summer draught, additional ballast may be used.
- (5) Bureau Veritas, the ship satisfies the rules and requirements of the classification bureau for this type of ship.

Ventilation:	electrical, 6 airchanges p/h
Dimensions of holds (m) length/breadth/depth	
Hold 1:	62,40 x 10,24 x 6,75
Dimensions (m) of hatches	
Hatch 1:	62,40 x 10,24
Tank capacity	
Fuel:	217 cbm
Ballast:	1307 cbm
Fresh water	24 cbm
Engine equipment	
Main engine:	Wartsila 8L20
Output:	1320 bhp
Consumption:	Abt. 10,5 knots on abt. 5.500 litres MGO



Ferry



Length o.a.:	172.90 m
Length b.p.:	160.58 m
Breadth moulded:	25.70 m
Depth maindeck:	9.40 m
Depth upperdeck:	15.10 m
Design draught:	6.35 m
Total power at MCR: (1)	44,480 kW
Trial speed at design draught:	28 kts
Passenger capacity:	1,600
No of passenger cabins:	160
Dead weight:	4,500 T
Trailer lane length: (2)	1,780 m
Car lane length: (3)	450 m

Explanation on the specifications of the "Blue Star 2"

- (1) Power of the main engine. MCR = Maximum Continuous Rating.
- (2) Maximum total trailer length available.
- (3) Maximum total car length available.

Bitumen tanker



Present flag:	Dutch
Port of registry:	Rotterdam
Ship type:	LPG (1) Carrier S.P. (2) 9.3 bar -48C 2PG (3)
IMO number:	9031985
Dead weight (summer draft):	3566 tons
Cargo tank volume:	3200 m ³
Main engine:	Deutz SBV 9M 628 1690 kW at 900 r.p.m.
Aux. engines:	Deutz/MWM TBD (4) 234V8 3x331 kW
Type of fuel:	MDO
Total cabins:	10
Required minimum crew:	10

Explanation on the specifications of the "Corel Actinia"

- (1) Liquid Petroleum Gas
- (2) Safety Pressure
- (3) Classification Notation
- (4) Turbo Gasoil



After lengthening Anthony Veder's gas carrier "Coral Actinia" with 24.05 m enough space was provided to install a second cargo tank, increasing cargo capacity with 1000 m³ to 3200 m³.

Chemical tanker



Imo Type II, Marpol - Annex I & II (1)	
Built:	2000
Dwt m. tons:	6430 mt
GT:	4670
NT:	1679
Speed:	15,5 knots
L.o.a.	118,00 m
Breadth:	17,00 m
Draft:	6,45 m
Cargo cap. 98,5 %:	6871 cbm
Type steel: (2)	duplex stainless steel
Ice class:	1A
Exterior heating of cargo tanks up to 80 °C	
2 sloptanks cap. 206 cbm total (3)	

Explanation on the specifications of the “Dutch Aquamarine”

- (1) Marpol requirements, Annex I: oil products, Annex II: liquid chemicals.
- (2) The tanks are constructed of duplex stainless steel.
- (3) Sloptanks are tanks that collect the tank washing water.