

pavo

CATALOG

2019 - 2020

| | | | |
|-------------------------------------|-----------|---------------------------------|------------|
| About pavo | 2 | | |
| Pavo foundation | 3 | | |
| Green choice | 4 | | |
| Green choice | | | |
| Bio-degradable pp products | 6 | | |
| Eco binding covers | 7 | | |
| Pet Fabric - Bottle bags | 8 | | |
| Presentation | 10 | | |
| Binding | | | |
| Comb binding machines | 12 | | |
| Binding combs | 15 | | |
| - small office | | | |
| Binding combs | 16 | | |
| - office | | | |
| Wire machines | 17 | | |
| Wires | 19 | | |
| Slide binders | 20 | | |
| File strips | 21 | | |
| Metal binders | 21 | | |
| Green choice covers | 22 | | |
| Plastic binding covers | 23 | | |
| Paper binding covers | 24 | | |
| Binding kits | 26 | | |
| Thermocovers | 28 | | |
| Laminating | | | |
| Laminating machines | 29 | | |
| Laminating pouches | 35 | | |
| - small office | | | |
| Laminating pouches | 36 | | |
| - office | | | |
| Cold laminating sheets | 37 | | |
| - office | | | |
| Laminating film rolls | 38 | | |
| Book covering film | | | |
| Self adhesive book covering film | 39 | | |
| Overhead transparency sheets | | | |
| OHP foil | 40 | | |
| Identification | | | |
| Badges | 42 | | |
| Cutting | | | |
| Trimmers & guillotines | 45 | | |
| Cutting mats | 48 | | |
| Bundles | 50 | | |
| Dry wipe sheets | | | |
| Educational worksheet sleeves | 51 | | |
| Dry wipe notice boards | | | |
| White boards | 53 | | |
| Glass boards | 54 | | |
| Sign holder | | | |
| L-shaped sign holder | 55 | | |
| Magnetic products | | | |
| Various shapes | 56 | | |
| Mailroom | | | |
| Automatic letter folder | 57 | | |
| Security | 58 | | |
| Identification | | | |
| Badges | 60 | | |
| Signage | | | |
| French signs | 62 | | |
| French signs – braille | 64 | | |
| Design signs | 65 | | |
| Security camera | | | |
| Dummy cameras | 67 | | |
| Key solutions | | | |
| Key cabinets | 68 | | |
| Deluxe key cabinets | 70 | | |
| High security key cabinets | 72 | | |
| Design key cabinet | 76 | | |
| Key hook board | 77 | | |
| Key store safe | 78 | | |
| Key tags | 79 | | |
| | | Security | |
| | | Money solutions | |
| | | Cash boxes | 80 |
| | | Money managers & coin sorters | 86 |
| | | Counterfeit detection | 87 |
| | | Document solutions | |
| | | Security document box | 88 |
| | | Safes | |
| | | Security safes | 89 |
| | | Locks | |
| | | Padlocks | 94 |
| | | Shredding | |
| | | Shredders | 97 |
| | | Facility | 100 |
| | | Facility | |
| | | Ladders | 102 |
| | | Trolleys | 104 |
| | | Hand trucks | 106 |
| | | Step stools | 108 |
| | | - metal | |
| | | Step stools | 110 |
| | | - plastic | |
| | | Tool kits & cable fixing | 111 |
| | | Packaging tape dispensers | 112 |
| | | Packaging tape | 113 |
| | | Travel | 114 |
| | | On the road | |
| | | Carriers | 116 |
| | | Pet Fabric - Bottle bags | 117 |
| | | Conference | 119 |
| | | Clip boards | 120 |
| | | Locks | |
| | | Padlocks | 121 |
| | | At your desk | 124 |
| | | Desk top organisation | |
| | | Desk sets & accessories | 126 |
| | | Office stationery | |
| | | Compass | 129 |
| | | Scissors | 130 |
| | | Staples & pliers | 132 |
| | | Staples | 134 |
| | | Staple removers | 135 |
| | | Punchers | 136 |
| | | Tape dispensers | 139 |
| | | Tape | 140 |
| | | Glue sticks | 141 |
| | | Stamp pad | 141 |
| | | Correction tape | 142 |
| | | Rubber bands | 143 |
| | | Clips | 144 |
| | | Office interiors | 146 |
| | | Office interiors | |
| | | Desk lamps | 148 |
| | | Globes | 149 |
| | | Fan | 150 |
| | | Ergonomic supplies | 151 |
| | | Filing & storage | 152 |
| | | Filing & storage | |
| | | Bio-degradable pp products | 154 |
| | | Presentation ring binders | 155 |
| | | Ring binders | 156 |
| | | Presentation & storage products | 157 |
| | | Punched pockets | 158 |

Pavo is an **international manufacturer** in **workspace solutions**.

Pavo was co-founded in 1997 by Valentijn Jansen who started the business with production and distribution of binding combs.

Today our **product range** has expanded **over 1500 products!**

Our assortment contains products for conference, presentation, security, office stationery, desktop organisation & accessories, counterfeit, packaging, facilities supplies, mailroom supplies, warehousing & travel. We produce our products in our own **pavo brand** and various **private label brands**.

Our head office is based in Oss, The Netherlands. We **sell our products in more than 35 countries** to different types of distributors. Our international presence has made us able to see various local requirements and translate those into functions.

We want consumers **not only using our products but also enjoying** to use them. Over the past years, this has driven us to develop our products and made us where we are now.



Guided by the belief that every child has the right to education with equal value to succeed in life – and inspired by others – **Pavo Foundaton** was founded and registered in April 2015.

Pavo Foundation supports “TI GREN LAVI Haiti”. One of their projects is “Ecole du village’ a school located in Torbeck, Haïti. The school is founded for unprivileged children to give them a better chance in life. Schools in Haïti are relative expensive, just a few parents can afford their children to gain education. Currently 54% of the inhabitants is illiterate!

“Ecole du village a Torbeck’ provides free education and food for children between 2 and 14 years old. Today there are 96 elementary school students and the school continues to grow.



filex

pavo

GREEN CHOICE







Every year Millions Tons of plastic is wasted all over the world, 80% of this is sent to landfill where it can remain for decades.

Pavo is introducing a complete line of biodegradable PP filing and storage products. These products can biodegrade in two or three years wherever oxygene is present. So if the products are disposed of they will biodegrade fully until there is nothing more than CO₂, water and humus and no solid plastic waste will be left behind. The products can biodegrade because of a special formulation which is used in the production process. One special additive is used in this process.

This additive permits the living micro-organisms, such as bacteria and fungi, access to the carbon and hydrogen. This process is called OXO-degradation. It is therefore biodegradable. This OXO-biodegradable PP can also be recycled.

206 kilogram carbon footprint is reduced for every 1 kilogram additive into the PP production process.

| CODE | DESCRIPTION | QUANTITY |
|---------|---|----------|
| 8004799 | A4 punched pockets - 11 holes - 50 micron | 50 |
| 8004850 | A4 expanding file - 13 pocket (160 micron) - 700 micron | 1 |
| 8004911 | A4 2 button envelope - 450 micron | 1 |
| 8004638 | A4 2 flap report folder with metal clip | 1 |
| 8004683 | A4 ring binder - 2 rings - 900 micron | 1 |
| 8004676 | A4 ring binder - 4 rings - 900 micron | 1 |
| 8004645 | A4 cut flush folder - L folder - 130 micron | 50 |
| 8004713 | A3 document wallet with bungee - 600 micron | 1 |
| 8004706 | A4 document wallet with bungee - 600 micron | 1 |
| 8004928 | A4 expandable display book - 20 pockets - 700 micron | 1 |
| 8004669 | A4 lever arch file folder - 1100 micron | 1 |



punched pockets



expanding file
13 pockets



2 button envelope



2 flap report folder



ring binder
2 rings



ring binder
4 rings



cut flush folder



document wallet



expandable display
book - 20 pockets



lever arch file folder

Pavo gives you the possibility to choose for a green product.

The items below are made of 100% recycled material:
 - the RPET binding cover is made of recycled PET bottles
 - the eco binding cover is made of recycled paper

Make a conscious choice in the items below and combine them with a binding wire or binding comb.

| CODE | DESCRIPTION | QUANTITY |
|-----------|---|----------|
| A4 | | |
| 8048601 | RPET binding cover - 200 mic Tranparent glass clear | 100 |
| 8011117 | Eco binding cover - 250 gsm Cardboard - sand | 100 |
| 8011209 | Eco binding cover - 250 gsm Cardboard - sand | 25 |



bottle bags



bottle bags

Do you know our bottle bags?

Bags made off 100% recycled PET Fabric and are certified according Global Recycled Standard (GRS).
Make a conscious choice and combine responsibility with fashion.

Mix, match and combine these high quality products, fashionable for office, school and streetwear with nice added details.

| CODE | DESCRIPTION | QUANTITY |
|-----------|--|----------|
| A4 | | |
| 8005048 | Office bag - grey - 440 x 260 x 110 mm | 1 |
| 8005062 | Laptop sleeve - grey - 390 x 285 x 15 mm | 1 |
| 8005079 | Laptop backpack - grey - 445 x 300 x 95 mm | 1 |

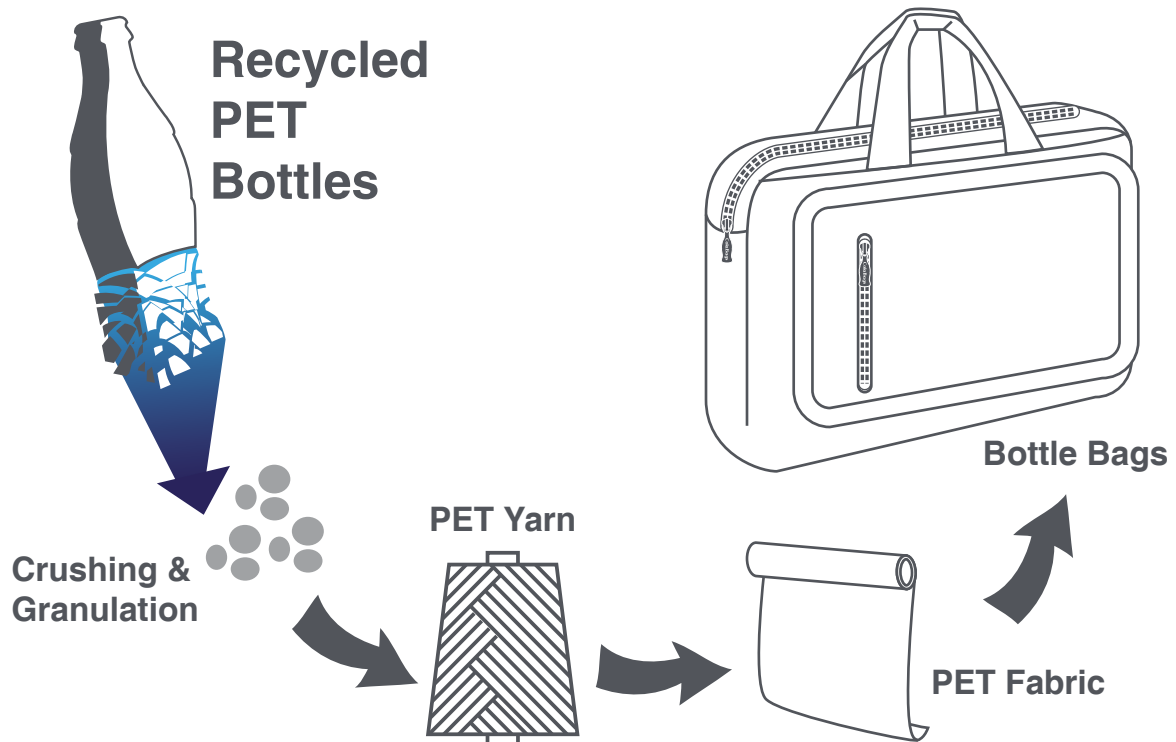

Global
Recycle
Standard

Drawing Textured yarn made with
recycled Polyester
100% post-consumer

pavo

PRESENTATION





pavo

Punching Entry Slot



MAX
A4
Size

comb binding machines

This overview gives you a quick insight into the possibilities for each device.

| | 8000012 sohomaster | 8030903 smartmaster 2 | 8031917 smartmaster plus | 8000043 bindmaster plus | 8000067 profmaster | 8032341 HD comb binder |
|----------------------------|-----------------------|--------------------------|-----------------------------|----------------------------|-----------------------|---------------------------|
| punch width | A4 | A4 | A4 | A4 | A4 | A4 |
| punch capacity | 3 - 4 sheets | 8 sheets | 12 sheets | 15 sheets | 20 sheets | 30 sheets |
| punch holes | 4 21 | 21 | 4 21 | 21 | 3/4 19/21 | up to 21 |
| bind capacity | 100 sheets | 150 sheets | 350 sheets | 500 sheets | 500 sheets | 500 sheets |
| adjustable paper guide | ✓ | ✓ | ✓ | ✓ | ✓ | ✓ |
| adjustable margin depth | ✗ | ✗ | ✗ | ✗ | 3 - 8 mm | 3 - 6 mm |
| removable paper tray | ✓ | ✓ | ✓ | ✓ | ✓ | ✓ |

comb binding machines



sohomaster

This compact machine has different functions, easy to use and easy to store. 3 functions : 21 holes, 3/4 holes for rings binders and binding combs.

- max punch width: A4
- max punching capacity: 3 - 4 sheets
- holes: 4 & 21
- binds up to: 100 sheets
- incorporated 4 holes punch
- adjustable paper guide
- removable waste paper tray
- warranty: 2 years
- machine size: 110 x 135 x 430 mm
- unit weight: 1.3 kg

| CODE | COLOR |
|---------|----------------|
| 8000012 | silver / black |



smartmaster 2 with kit: 25 binding combs, 25 pvc covers and 25 leather covers

This machine allows you to easily punch and bind your documents. Your thesis, projects, business plans will look pleasant and more professional.

- max punch width: A4
- max punching capacity: 8 sheets
- holes: 21
- binds up to: 150 sheets
- adjustable paper guide
- removable waste paper tray
- warranty: 2 years
- machine size: 215 x 353 x 223 mm
- unit weight: 1.56 kg

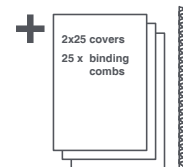

| CODE | COLOR |
|---------|--------------------|
| 8030903 | black / light grey |



smartmaster plus

This machine allows you to punch and bind your documents. Your thesis, projects, business plans will look pleasant and more professional.

- max punch width: A4
- max punching capacity: 12 sheets
- holes: 4 and 21
- binds up to: 350 sheets
- size indicator for plastic combs
- adjustable paper guide
- large removable waste paper tray
- warranty: 2 years
- machine size: 400 x 280 x 230 mm
- unit weight: 3.6 kg

| CODE | COLOR |
|---------|-------|
| 8031917 | grey |



bindmaster plus

This machine allows you to punch and bind your documents. Your thesis, projects, business plans will look pleasant and more professional.

- max punch width: A4
- max punching capacity: 15 sheets
- holes: 21
- binds up to: 500 sheets
- adjustable paper guide
- removable waste paper tray
- warranty: 2 years
- machine size: 370 x 140 x 230 mm
- unit weight: 4.8 kg

| CODE | COLOR |
|---------|-------------------|
| 8000043 | grey / light grey |

comb binding machines



profmaster

The high capacity of this machine allows you to punch and bind your documents. Your thesis, projects, business plans will look pleasant and more professional.

- max punch width: A4
- max punching capacity: 20 sheets
- holes: 3/4 & 19/21
- binds up to: 500 sheets
- 2 handles for easy operation
- size indicator for binding combs
- adjustable paper guide
- adjustable margin depth: 3 - 8 mm
- 7 disengageable punches
- incorporated 4 holes punch
- removable waste paper tray
- warranty: 2 years
- machine size: 440 x 220 x 400 mm
- unit weight: 9.5 kg

| CODE | COLOR |
|---------|----------------|
| 8000067 | silver / black |



HD comb binder

This professional machine allows you to punch and bind your documents. Your thesis, projects, business plans will look pleasant and more professional.

- max punch width: A4
- max punching capacity: 30 sheets
- holes: up to 21
- binds up to: 500 sheets
- 2 handles for easy operation
- size indicator for binding combs
- adjustable paper guide
- adjustable margin depth: 3 - 6 mm
- large removable waste paper tray
- warranty: 2 years
- machine size: 456 x 280 x 446 mm
- unit weight: 13 kg

| CODE | COLOR |
|---------|-------------------|
| 8032341 | grey / light grey |

binding combs - small office

Binding combs are easy to use, available in many different sizes. Use with a comb binding machine. The premium style combs have a structured and matt finish.

Binding is ideal to present your documents; a neat presentation, flat documents.



| CODE | DESCRIPTION | QUANTITY |
|----------------------|------------------------------------|----------|
| A4 - 21 rings | | |
| 8033935 | 6 mm Black | 25 |
| 8033942 | 8 mm Black | 25 |
| 8033959 | 10 mm Black | 25 |
| 8001477 | Assorted 8, 10, 12 and 14 mm Black | 25 |



binding combs - office

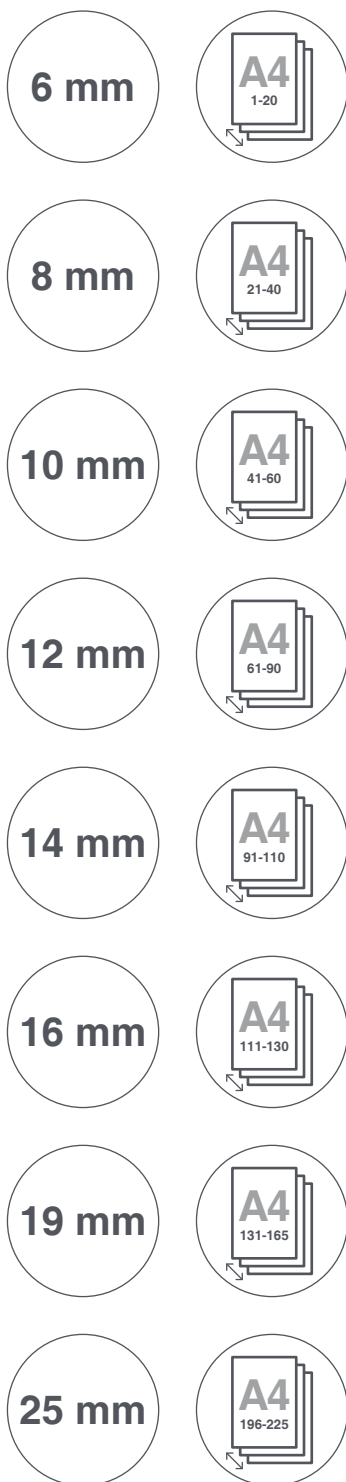

Binding combs are easy to use and available in many different sizes. Use with a comb binding machine. The premium style combs have a structured and matt finish.

Binding is ideal to present your documents; a neat presentation, flat documents.

| CODE | DESCRIPTION | QUANTITY |
|----------------------|-------------|----------|
| A4 - 21 rings | | |
| 8001576 | 6 mm White | 100 |
| 8001583 | 6 mm Black | 100 |
| 8001699 | 6 mm Blue | 100 |
| | | |
| 8001613 | 8 mm White | 100 |
| 8001620 | 8 mm Black | 100 |
| 8001637 | 8 mm Blue | 100 |
| | | |
| 8001798 | 10 mm White | 100 |
| 8001705 | 10 mm Black | 100 |
| 8001712 | 10 mm Blue | 100 |
| | | |
| 8001750 | 12 mm White | 100 |
| 8001767 | 12 mm Black | 100 |
| 8001811 | 12 mm Blue | 100 |
| | | |
| 8001934 | 16 mm White | 100 |
| 8001941 | 16 mm Black | 100 |
| 8001958 | 16 mm Blue | 100 |
| | | |
| 8001996 | 19 mm White | 100 |
| 8002009 | 19 mm Black | 100 |
| | | |
| 8000845 | 25 mm Blue | 50 |
| 8000869 | 25 mm Black | 50 |

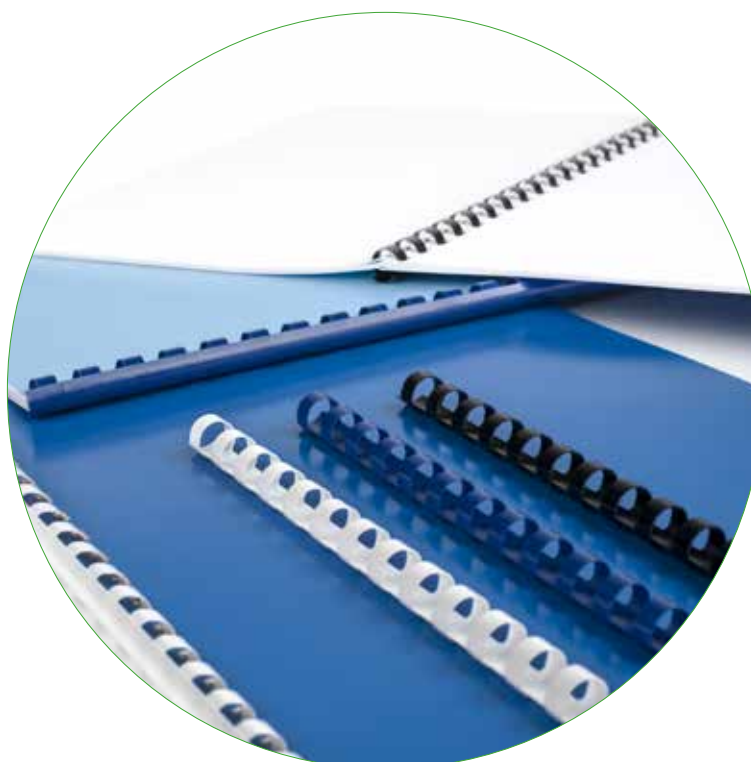

wire machines

This overview gives you a quick insight into the possibilities for each device.

| | 8001484 wiremaster | 8032822 HD wire binder | 8032907 HD wire binder |
|-----------------------------|-----------------------|---------------------------|---------------------------|
| punch size | □ 3:1 pitch | □ 3:1 pitch | ○ 3:1 pitch |
| punch width | A4 | A4 | A4 |
| punch capacity | 10 sheets | 15 sheets | 15 sheets |
| punch holes | 34 | 34 | 34 |
| bind capacity | 120 sheets | 130 sheets | 130 sheets |
| size indicator for wires | ✓ | ✓ | ✓ |
| adjustable wire closer | ✓ | ✓ | ✓ |
| adjustable paper guide | ✓ | ✓ | ✓ |
| removable paper tray | ✓ | ✓ | ✓ |

wire machines



wiremaster

This high capacity 3:1 pitch wire machine allows you to punch and bind your documents professionally. A 3:1 pitch machine punches 3 holes per inch paper (34 for A4).

- max punch width: A4
- max punching capacity: 10 sheets
- holes: 34 (size: 4 x 4 mm)
- binds up to: 120 sheets
- size indicator for wires
- adjustable wire closer
- adjustable paper guide
- wire comb holder
- removable waste paper tray
- warranty: 2 years
- machine size: 368 x 230 x 148 mm
- unit weight: 4.8 kg



| CODE | COLOR |
|---------|------------|
| 8001484 | light grey |



HD wire binder - rectangular punch

This high capacity 3:1 pitch wire machine allows you to punch and bind your documents professionally. A 3:1 pitch machine punches 3 holes per inch paper (34 for A4).

- max punch width: A4
- max punching capacity: 15 sheets
- holes: 34 (size: 4 x 4 mm)
- binds up to: 130 sheets
- 2 handles for easy operation
- adjustable wire closer
- adjustable paper guide
- wire comb holder
- removable waste paper tray
- warranty: 2 years
- machine size: 380 x 130 x 220 mm
- unit weight: 8.7 kg



| CODE | COLOR |
|---------|--------------------|
| 8032822 | black / light grey |



HD wire binder - round punch

This high capacity 3:1 pitch wire machine allows you to punch and bind your documents professionally. A 3:1 pitch machine punches 3 holes per inch paper (34 for A4).

- max punch width: A4
- max punching capacity: 15 sheets
- holes: 34 (size: ø 4 mm)
- binds up to: 130 sheets
- 2 handles for easy operation
- adjustable wire closer
- adjustable paper guide
- wire comb holder
- removable waste paper tray
- warranty: 2 years
- machine size: 380 x 130 x 220 mm
- unit weight: 8.7 kg



| CODE | COLOR |
|---------|--------------------|
| 8032907 | black / light grey |

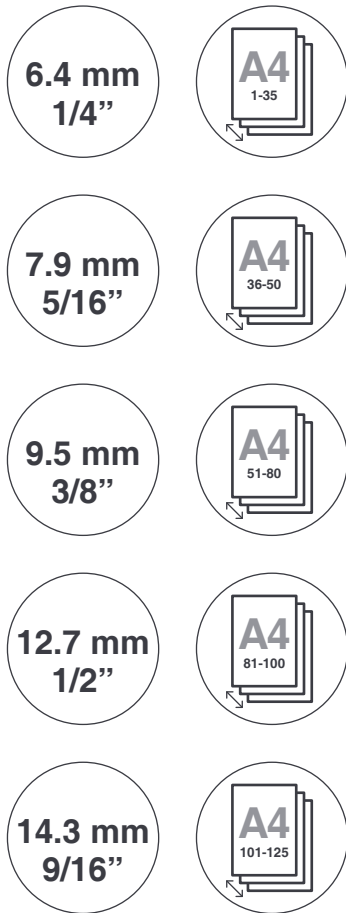

Binding is ideal to present your documents; a neat presentation, flat documents. These wires allow you to bind your documents, your thesis, projects, business plan will look pleasant and more professional. Use with a wire machine.

The Pavo 3:1 (34 loop) wires are for use with any 3:1 pitch wire binding machine.

| CODE | DESCRIPTION | QUANTITY |
|---------------------------------|------------------------|----------|
| A4 - 3:1 pitch (34 loop) | | |
| 8001651 | 6.4 mm - 1/4" White | 100 |
| 8001675 | 6.4 mm - 1/4" Black | 100 |
| 8001736 | 6.4 mm - 1/4" Silver | 100 |
| | | |
| 8001774 | 7.9 mm - 5/16" White | 100 |
| 8001897 | 7.9 mm - 5/16" Black | 100 |
| 8001859 | 7.9 mm - 5/16" Silver | 100 |
| | | |
| 8001095 | 9.5 mm - 3/8" White | 100 |
| 8001910 | 9.5 mm - 3/8" Black | 100 |
| 8001972 | 9.5 mm - 3/8" Silver | 100 |
| | | |
| 8002139 | 12.7 mm - 1/2" White | 100 |
| 8002153 | 12.7 mm - 1/2" Black | 100 |
| 8002214 | 12.7 mm - 1/2" Silver | 100 |
| | | |
| 8002351 | 14.3 mm - 9/16" White | 100 |
| 8002252 | 14.3 mm - 9/16" Black | 100 |
| 8002375 | 14.3 mm - 9/16" Silver | 100 |

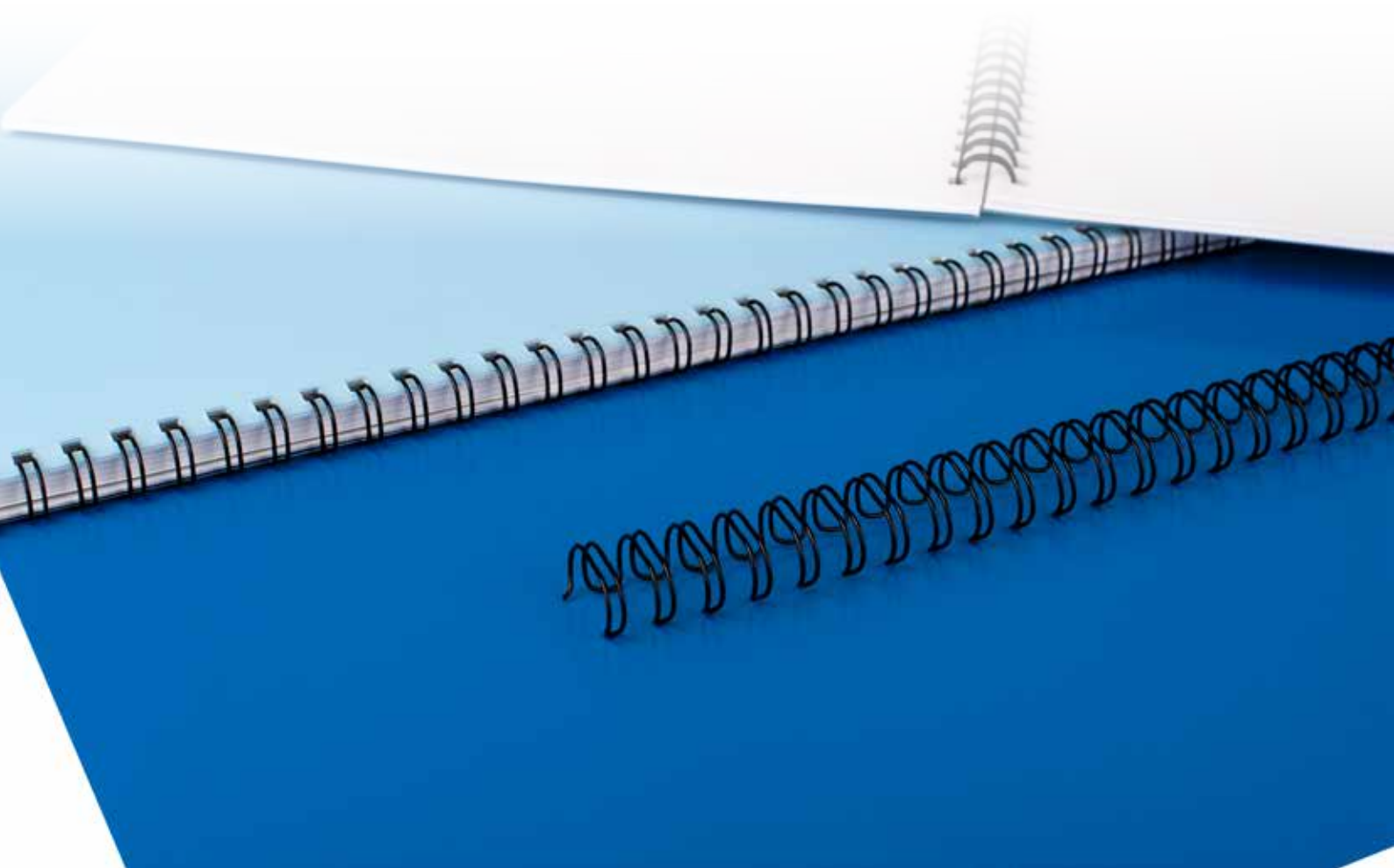

slide binders

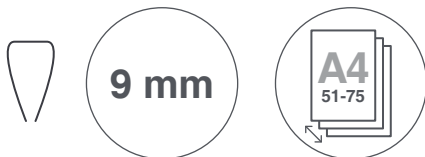

These slide binders allow you to bind your documents, your thesis, projects, business plan will look pleasant and more professional. Bind pages without the use of a machine.

Binding is ideal to present your documents; a neat presentation, flat documents.

| CODE | DESCRIPTION | QUANTITY |
|--------------------|-----------------------|----------|
| A4 - round | | |
| 8008872 | 3 mm Transparent | 25 |
| 8007097 | 3 mm Black | 25 |
| 8008261 | 3 mm Black | 100 |
| A4 - square | | |
| 8009015 | 6 mm Transparent | 25 |
| 8008117 | 6 mm Black | 25 |
| 8008308 | 6 mm Black | 100 |
| 8033973 | 8 mm Black | 25 |
| 8033980 | 10 mm Black | 25 |
| 8008322 | 10 mm Black | 100 |
| 8031337 | 9 mm Black | 25 |
| 8031351 | 12 mm Black | 25 |
| 8035984 | 15 mm Black | 25 |

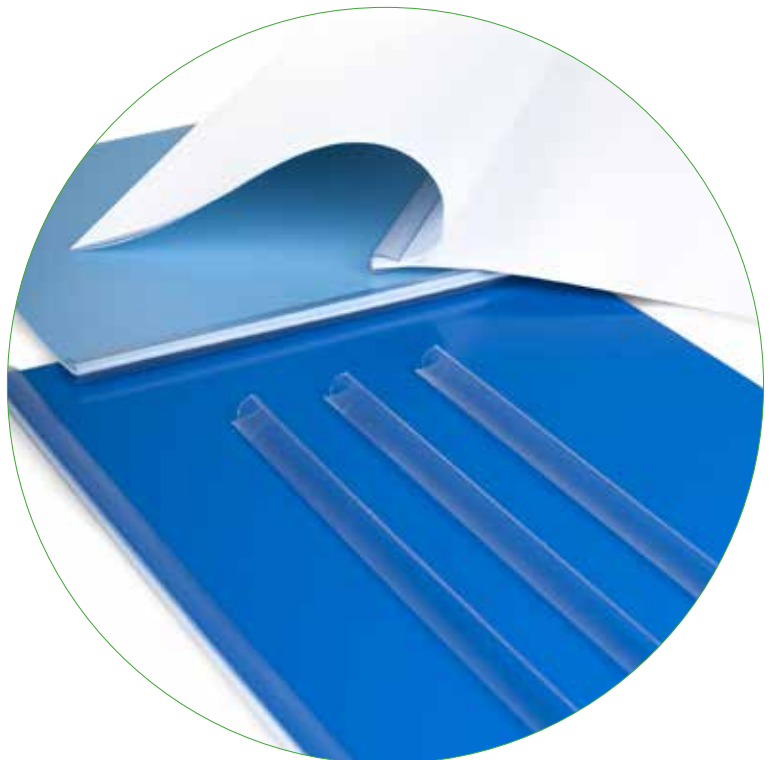

green choice covers

Pavo gives you the possibility to choose for a green product.
 The items below are made of 100% recycled material:
 - the RPET binding cover is made of recycled PET bottles
 - the eco binding cover is made of recycled paper

Make a conscious choice in the items below and combine them with a binding wire or binding comb.

| CODE | DESCRIPTION | QUANTITY |
|-----------|---|----------|
| A4 | | |
| 8048601 | RPET binding cover - 200 mic Tranparent glass clear | 100 |
| 8011117 | Eco binding cover - 250 gsm Cardboard - sand | 100 |
| 8011209 | Eco binding cover - 250 gsm Cardboard - sand | 25 |



plastic binding covers

These strong plastic covers are ideal to bind documents. Thesis, projects, business plans will look pleasant and more professional. Many colors available to fit any corporate identity or personal taste.

| CODE | DESCRIPTION | QUANTITY |
|-----------|---|----------|
| A4 | | |
| 8008568 | 150 mic PVC - transparent glass clear | 100 |
| 8008797 | 180 mic PVC - transparent glass clear | 25 |
| 8008803 | 180 mic PVC - transparent glass clear | 100 |
| 8009046 | 200 mic PVC - transparent glass clear | 100 |
| 8030675 | 200 mic PVC - green glass clear | 100 |
| 8008988 | 200 mic PVC - blue glass clear | 100 |
| 8009008 | 200 mic PVC - red glass clear | 100 |
| 8009060 | 200 mic PVC - yellow glass clear | 100 |
| 8039845 | 200 mic PVC - assorted colors glass clear | 100 |
| 8009282 | 250 mic PVC - transparent glass clear | 100 |
| 8009527 | 300 mic PVC - transparent glass clear | 100 |
| 8008209 | 200 mic PP - transparent glass clear prepunched | 100 |
| 8007882 | 200 mic PP - transparent glass clear | 100 |
| 8015283 | 280 mic PP - transparent glass clear | 100 |
| 8032327 | 300 mic PP - transparent matt | 100 |
| 8038121 | 300 mic PP - blue matt | 100 |
| 8038138 | 300 mic PP - ocean green matt | 100 |
| 8038145 | 300 mic PP - yellow matt | 100 |
| 8038152 | 300 mic PP - pink matt | 100 |
| 8002665 | 400 mic PP - white opaque | 100 |
| 8003204 | 400 mic PP - black opaque | 100 |
| 8003327 | 400 mic PP - dark blue opaque | 100 |
| A3 | | |
| 8009312 | 150 mic PVC - transparent glass clear | 100 |
| 8009329 | 200 mic PVC - transparent glass clear | 100 |
| 8011391 | 300 mic PVC - transparent glass clear | 100 |



paper binding covers

These covers are made of high quality paper ideal to bind documents. Thesis, projects, business plans will look pleasant and more professional. Many colors available to fit any corporate identity or personal taste.

| CODE | DESCRIPTION | | QUANTITY |
|-----------|-------------|--------------------------|----------|
| A4 | | | |
| 8011063 | 250 gsm | Coated - blue | 100 |
| 8011087 | 250 gsm | Coated - red | 100 |
| 8015351 | 250 gsm | Coated - green | 100 |
| 8011025 | 250 gsm | Coated - white | 100 |
| 8011049 | 250 gsm | Coated - black | 100 |
| 8038169 | 250 gsm | Coated - sky blue | 100 |
| 8038176 | 250 gsm | Coated - ocean green | 100 |
| 8038183 | 250 gsm | Coated - yellow | 100 |
| 8038190 | 250 gsm | Coated - pink | 100 |
| 8034949 | 250 gsm | Coated - assorted colors | 25 |
| 8011155 | 250 gsm | Linen look - blue | 100 |
| 8011179 | 250 gsm | Linen look - white | 100 |
| 8011353 | 250 gsm | Linen look - black | 100 |
| 8016617 | 250 gsm | Linen look - red | 100 |



paper binding covers

These covers are made of high quality paper ideal to bind documents. Thesis, projects, business plans will look pleasant and more professional. Many colors available to fit any corporate identity or personal taste.

| CODE | DESCRIPTION | QUANTITY |
|-----------|--|----------|
| A4 | | |
| 8011216 | 250 gsm Leather look - ivory | 100 |
| 8011100 | 250 gsm Leather look - white | 100 |
| 8011124 | 250 gsm Leather look - black | 100 |
| 8004324 | 250 gsm Leather look - black | 25 |
| 8011148 | 250 gsm Leather look - blue | 100 |
| 8036042 | 250 gsm Leather look - dark blue | 100 |
| 8011162 | 250 gsm Leather look - red | 100 |
| 8011186 | 250 gsm Leather look - forest green | 100 |
| 8032464 | 250 gsm Leather look - dark green | 100 |
| 8011230 | 250 gsm Leather look - yellow | 100 |
| 8034819 | 250 gsm Leather look - assorted colors | 25 |
| 8053353 | 250 gsm Leather look - assorted pastel colors | 100 |
| A4 | | |
| 8005215 | 230 gsm Glossy leather look - grey | 100 |
| 8005109 | 230 gsm Glossy leather look - grey | 25 |
| 8005239 | 230 gsm Glossy leather look - white | 100 |
| 8005123 | 230 gsm Glossy leather look - white | 25 |
| 8005253 | 230 gsm Glossy leather look - dark blue | 100 |
| 8005147 | 230 gsm Glossy leather look - dark blue | 25 |
| 8005277 | 230 gsm Glossy leather look - green | 100 |
| 8005291 | 230 gsm Glossy leather look - red | 100 |
| 8005185 | 230 gsm Glossy leather look - pink | 25 |
| 8005161 | 230 gsm Glossy leather look - black | 25 |
| 8003297 | 230 gsm Glossy leather look assorted colors - standard | 25 |
| 8013432 | 230 gsm Glossy leather look assorted colors: standard | 100 |
| 8018239 | 230 gsm Glossy leather look assorted colors - flash | 25 |
| A3 | | |
| 8017355 | 250 gsm Leather look - black | 100 |
| 8017362 | 250 gsm Leather look - white | 100 |



binding kits

Colorfull bindingkits, (semi)- transparant front covers, solid back covers + binding combs.

| CODE | DESCRIPTION | QUANTITY |
|-----------|---|----------|
| A4 | | |
| 8043750 | Trendy starterkit: PP covers, glossy cardboard covers; yellow, pink, sky blue, green, binding combs | 120 |
| 8013913 | Kit package: PVC covers (180 mic), leather look cardboard | 50 |
| 8002030 | Kit starter binding: PVC covers, glossy cardboard covers, binding combs | 75 |
| 8011483 | Kit mega starter binding: PVC covers, leather look cardboard - ivory, combs | 300 |

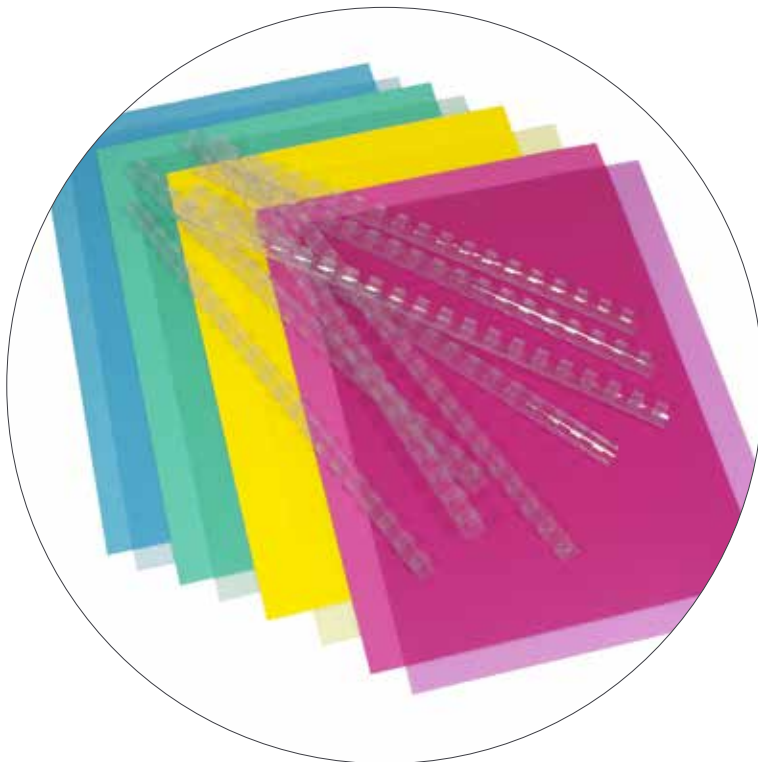



file strips



File strips are very useful and the solution for storing your document. It prevents losing or damaging concerning your valuable presentation.

| CODE | DESCRIPTION | QUANTITY |
|-----------|---------------------------------------|----------|
| A4 | | |
| 8026913 | 34 holes Transparent glass clear | 100 |
| 8026906 | 21 holes Transparent glass clear | 100 |

metal binders

Pavo metal binders are available in various sizes for various capacities.

The metal binders are made of steel; ideal for fastening any size document stack and keys and swatches.

| CODE | DESCRIPTION | QUANTITY |
|---------|------------------|----------|
| 8052639 | 25 mm Metal | 20 |
| 8052622 | 32 mm Metal | 20 |
| 8052653 | 38 mm Metal | 20 |
| 8052646 | 50 mm Metal | 10 |



thermocovers

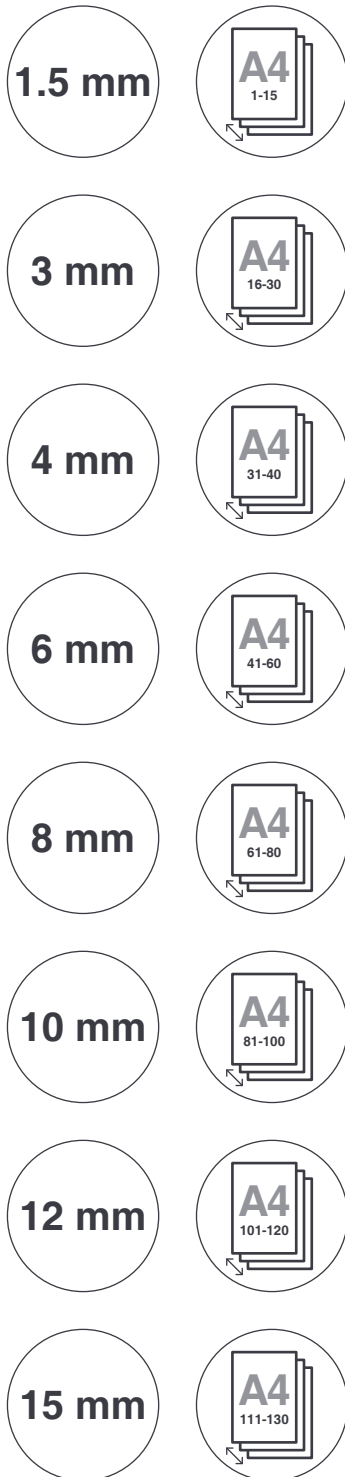

The high capacity of these thermocovers allows you to bind your documents, your thesis, projects, business plan will look pleasant and more professional.

Binding is ideal to present your documents; a neat presentation, flat documents.

| CODE | DESCRIPTION | | QUANTITY |
|-----------|-------------|-------------------------|----------|
| A4 | | | |
| 8003006 | 1.5 mm | Plain cardboard - white | 100 |
| 8011568 | 1.5 mm | Leather look - blue | 25 |
| 8003242 | 3 mm | Plain cardboard - white | 100 |
| 8011575 | 3 mm | Leather look - blue | 25 |
| 8003365 | 4 mm | Plain cardboard - white | 100 |
| 8011582 | 4 mm | Leather look - blue | 25 |
| 8003600 | 6 mm | Plain cardboard - white | 100 |
| 8011698 | 6 mm | Leather look - blue | 25 |
| 8003686 | 8 mm | Plain cardboard - white | 100 |
| 8025985 | 10 mm | Plain cardboard - white | 100 |
| 8036004 | 12 mm | Plain cardboard - white | 100 |
| 8036028 | 15 mm | Plain cardboard - white | 100 |





laminating machines

This overview gives you a quick insight into the possibilities for each device.

| | tbc A4 laminator | 8042920 colorado | 8053940 alaska ignite | 8045464 alaska vigor | |
|----------------------------------|-------------------------|-------------------------|--------------------------|-------------------------|--|
| lamination width | A4 9,3"/ 236 mm | A4 9,3"/ 236 mm | A4 9,3"/ 236 mm | A4 9"/ 230 mm | |
| laminating speed | 250 mm/min | 250 mm/min | 250 mm/min | 300 mm/min | |
| warm up | 2-4 min | 5 min | 60 sec | 60 sec | |
| max. pouches size | 2x100 microns | 2x100 microns | 2x125 microns | 2x250 microns | |
| max. laminating thickness | 0.6 mm (incl. paper) | 0.6 mm (incl. paper) | 0.6 mm (incl. paper) | 0.6 mm (incl. paper) | |
| rollers | 2 | 2 | 2 | 4 | |
| variable temperature | x | x | ✓ | ✓ | |
| cold laminating | x | ✓ | x | ✓ | |
| power consumption | 220 W | 220 W | 330 W | 880 W | |
| additional features & components | x | x | x | free pouches included | |

laminating machines

| | | 8053964 alaska ignite | 8045457 alaska swift | 8045471 alaska vigor | 8007585 HD laminator | 8007691 HD laminator |
|--|----------------------------------|--------------------------|-------------------------|-------------------------|-------------------------|-------------------------|
| | lamination width | A3 13"/ 330 mm | A3 13"/ 330 mm | A3 13"/ 330 mm | A3 13"/ 330 mm | A2 17"/ 450 mm |
| | laminating speed | 250 mm/min | 500 mm/min | 300 mm/min | 400 mm/min | 400 mm/min |
| | warm up | 90 sec | 90 sec | 60 sec | 3 min | 3 min |
| | max. pouches size | 2x125 microns | 2x125 microns | 2x250 microns | 2x250 microns | 2x250 microns |
| | max. laminating thickness | 0.6 mm (incl. paper) | 0.6 mm (incl. paper) | 0.6 mm (incl. paper) | n/a | n/a |
| | rollers | 2 | 4 | 4 | 4 | 4 |
| | variable temperature | ✓ | ✓ | ✓ | ✓ | ✓ |
| | cold laminating | ✗ | ✓ | ✓ | ✓ | ✓ |
| | power consumption | 550 W | 1210 W | 1210 W | 600 W | 600 W |
| | additional features & components | ✗ | free pouches included | free pouches included | ✗ | ✗ |

laminating machines



A4 laminator

- lamination speed: 250 mm/min
- warm up: 2-4 min
- max lamination width: 9,3" / 236 mm
- max pouches size: 2x100 microns
- max lamination thickness: 0,6 mm (incl. paper)
- rollers: 2
- warranty: 1 year
- power consumption: 220-260 V - 1.0 A
- ready light
- machine size: 330 x 58 x 110 mm
- unit weight: 1.1 kg

| CODE | COLOR |
|------|-------|
| tbc | black |



A4 alaska ignite laminator

The alaska ignite is a slim and compact design laminator with an attractive modern shape.

- lamination speed: 250 mm/min
- warm up: 90 sec
- max lamination width: 9,4" / 240 mm
- max pouches size: 2x125 microns
- max lamination thickness: 0,6 mm (incl. paper)
- variable temp control
- rollers: 2
- warranty: 2 years
- power consumption: 330 W
- ready light
- machine size: 380 x 100 x 65 mm
- unit weight: 0,8 kg

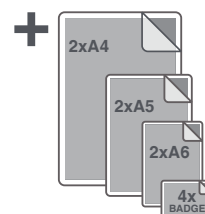

| CODE | COLOR |
|---------|---------------|
| 8053940 | white / black |



A4 colorado

The colorado laminator is characterized with a compact design.

- lamination speed: 250 mm/min
- warm up: 5 min
- max lamination width: 9,3" / 236 mm
- max pouches size: 2x100 microns
- max lamination thickness: 0,6 mm (incl. paper)
- rollers: 2
- warranty: 2 years
- power consumption: 220 W
- ready light
- machine size: 390 x 47 x 108 mm
- unit weight: 0,9 kg

| CODE | COLOR |
|---------|-------------------|
| 8042920 | white / dark grey |



A4 alaska vigor laminator with 10 free pouches - assorted sizes

The alaska vigor is characterized by the possibility to laminate up to 2x250 microns. A slim and compact design laminator with an attractive modern shape.

- lamination speed: 300 mm/min
- warm up: 60 sec
- max lamination width: 9" / 230 mm
- max pouches size: 2x250 microns
- max lamination thickness: 0,6 mm (incl. paper)
- variable temp control
- cold laminate
- rollers: 4
- warranty: 2 years
- power consumption: 880 W
- ready light
- machine size: 66 x 391 x 142 mm
- unit weight: 2,5 kg

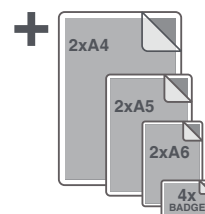

| CODE | COLOR |
|---------|-------------------|
| 8045464 | white / dark grey |

laminating machines



A3 alaska ignite laminator

The alaska ignite is a slim and compact design laminator with an attractive modern shape.

- lamination speed: 250 mm/min
- warm up: 90 sec
- max lamination width: 13" / 330 mm
- max pouches size: 2x125 microns
- max lamination thickness: 0.6 mm (incl. paper)
- variable temp control
- rollers: 2
- warranty: 2 years
- power consumption: 550 W
- ready light
- machine size: 470 x 100 x 65 mm
- unit weight: 1.1 kg

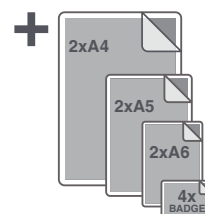

| CODE | COLOR |
|---------|---------------|
| 8053964 | white / black |



A3 alaska swift laminator with 10 free pouches - assorted sizes

The alaska swift is characterized by very fast laminating skills. A slim and compact design laminator with an attractive modern shape.

- lamination speed: 500 mm/min
- warm up: 90 sec
- max lamination width: 13" / 330 mm
- max pouches size: 2x125 microns
- max lamination thickness: 0.6 mm (incl. paper)
- variable temp control
- cold laminate
- rollers: 4
- warranty: 2 years
- power consumption: 1210 W
- ready light
- machine size: 66 x 491 x 142 mm
- unit weight: 3.5 kg

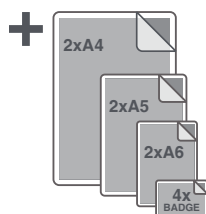

| CODE | COLOR |
|---------|-------------------|
| 8045457 | white / dark grey |



A3 alaska vigor laminator with 10 free pouches - assorted sizes

The alaska vigor is characterized by the possibility to laminate up to 2x250 microns. A slim and compact design laminator with an attractive modern shape.

- lamination speed: 300 mm/min
- warm up: 60 sec
- max lamination width: 13" / 330 mm
- max pouches size: 2x250 microns
- max lamination thickness: 0.6 mm (incl. paper)
- variable temp control
- cold laminate
- rollers: 4
- warranty: 2 years
- power consumption: 1210 W
- ready light
- machine size: 66 x 491 x 142 mm
- unit weight: 3.5 kg

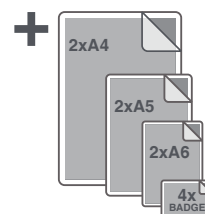

| CODE | COLOR |
|---------|-------------------|
| 8045471 | white / dark grey |

HD laminating machines



A3 HD laminator

The Pavo HD laminators features variable temperature settings and cold laminating. Suitable for high quality use.

- lamination speed: 400 mm/min
- warm up: 3 min
- max lamination width: 13" / 330 mm
- max pouches size: 2x250 microns
- variable temp control
- cold laminate
- rollers: 4
- warranty: 2 years
- power consumption: 600 W
- ready light
- machine size: 550 x 150 x 260 mm
- unit weight: 8 kg

| CODE | COLOR |
|---------|--------------|
| 8007585 | grey / beige |

A2 HD laminator

The Pavo HD laminators features variable temperature settings and cold laminating. Suitable for high quality use.

- lamination speed: 400 mm/min
- warm up: 3 min
- max lamination width: 17" / 450 mm
- max pouches size: 2x250 microns
- variable temp control
- cold laminate
- rollers: 4
- warranty: 2 years
- power consumption: 600 W
- ready light
- machine size: 680 x 160 x 285 mm
- unit weight: 11 kg

| CODE | COLOR |
|---------|--------------|
| 8007691 | grey / beige |

laminating pouches - small office

Pavo pouches are machine and user friendly. Made to precise standards they will pass more easily through your machine without leaving harmful glue residues.

Lamination pouches create a total seal and are ideal for giving lifetime protection against water, grease, dirt, tearing, creasing, fading. They also make colors more vivid. Suitable for use with all heat seal pouch laminators.

| CODE | DESCRIPTION | QUANTITY |
|--------------------|---------------------------------|----------|
| A3 | | |
| 8004607 | 2x75 mic | 25 |
| A4 | | |
| 8004522 | 2x75 mic | 25 |
| 8004287 | 2x75 mic Adhesive back | 25 |
| 8030859 | 2x80 mic Assorted classic frame | 25 |
| 8005703 | 2x125 mic | 25 |
| 8015405 | 2x180 mic | 25 |
| A5 | | |
| 8004461 | 2x75 mic | 25 |
| A6 | | |
| 8004447 | 2x75 mic | 25 |
| small sizes | | |
| 8030729 | Starterkit Assorted sizes | 55 |
| 8015443 | 2x180 mic 63 x 98 mm | 50 |

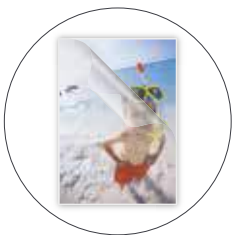

adhesive back



assorted classic frame



starterkit assorted sizes

laminating pouches - office

Pavo pouches are machine and user friendly. Made to precise standards they will pass more easily through your machine without leaving harmful glue residuals.

Lamination pouches create a total seal and are ideal for giving lifetime protection against water, grease, dirt, tearing, creasing, fading. They also make colors more vivid. Suitable for use with all heat seal pouch laminators.

| CODE | DESCRIPTION | QUANTITY |
|--------------------|---------------------------|----------|
| A1 | | |
| 8001156 | 2x125 mic | 25 |
| A2 | | |
| 8001163 | 2x75 mic | 200 |
| 8005857 | 2x125 mic | 50 |
| 8001170 | 2x125 mic | 200 |
| A3 | | |
| 8004331 | 2x75 mic | 100 |
| 8036639 | 2x75 mic Matt | 100 |
| 8005352 | 2x100 mic | 100 |
| 8029792 | 2x125 mic Matt | 100 |
| 8005895 | 2x125 mic | 100 |
| 8001446 | 2x200 mic | 50 |
| 8007233 | 2x250 mic | 50 |
| A4 | | |
| 8004270 | 2x75 mic | 100 |
| 8004553 | 2x75 mic Matt | 100 |
| 8004294 | 2x75 mic Adhesive back | 100 |
| 8005208 | 2x75 mic Fast | 100 |
| 8005376 | 2x100 mic | 100 |
| 8005413 | 2x100 mic Matt | 100 |
| 8005383 | 2x100 mic Adhesive back | 100 |
| 8005772 | 2x125 mic Filex (11holes) | 100 |
| 8029686 | 2x125 mic Matt | 100 |
| 8005710 | 2x125 mic | 100 |
| 8005727 | 2x125 mic Fast | 100 |
| 8005758 | 2x125 mic Adhesive back | 100 |
| 8006854 | 2x175 mic | 100 |
| 8007219 | 2x250 mic | 50 |
| A5 | | |
| 8004256 | 2x75 mic | 100 |
| 8001149 | 2x75 mic Matt | 100 |
| 8005659 | 2x125 mic | 100 |
| 8029679 | 2x125 mic Matt | 100 |
| A6 | | |
| 8004232 | 2x75 mic | 100 |
| 8005697 | 2x125 mic | 100 |
| A7 | | |
| 8004430 | 2x75 mic 80 x 111 mm | 100 |
| 8005574 | 2x125 mic 80 x 111 mm | 100 |
| small sizes | | |
| 8005536 | 2x125 mic 54 x 86 mm | 100 |
| 8005871 | 2x125 mic 65 x 95 mm | 100 |
| 8005994 | 2x125 mic 67 x 99 mm | 100 |
| 8006045 | 2x125 mic 75 x 105 mm | 100 |



adhesive back



filex

cold laminating sheets - office

When you need to laminate but the paper or ink can not stand high temperatures or your paper / photo needs to be flexible.
Can be used with a laminator with a cold (roller) function or a 'laminator press'.

| CODE | DESCRIPTION | QUANTITY |
|-----------|-----------------|----------|
| A3 | | |
| 8001071 | 90 mic Cold use | 50 |
| A4 | | |
| 8001088 | 90 mic Cold use | 50 |

cold laminating sheets

laminating pouches • pochettes à plastifier • laminiertaschen • lamineerhoezen • fundas para plastificación
• bolsas di plastificar • pouches per plastificatrici • bolsa de plastificação • folie laminacyjne • قورتل مليلدا عب قرحا • 塑封膜

Cold laminating in easy steps:

1. Make sure all the supplies are ready; cold laminating sheets, your personal (photo) document, a laminator with cold (roller) function and cutting materials.
2. Fold a small line on the top of the sheet. This way a part of the adhesive strip is uncovered.
3. Place the uncovered strip on the document that needs to be laminated.
4. Enter the pasted strip into the laminator.
5. Remove the paperback of the sheet and place the adhesive sheet over the top of the laminator backwards.
6. Turn the rollers of the laminator on. The document and adhesive sheet are automatically transported through the rollers so that the sheet is pressed on the document.
7. After the laminated document is released you can cut it to the required size.
8. Tadaa! Your document is finished.

<https://youtu.be/8S3BF4rZPCo>

laminating film rolls

The Pavo laminating film rolls are available in different sizes and thickness to match the level of protection you need. It will keep your machine running for the best results.

| CODE | DESCRIPTION | QUANTITY |
|---------|------------------------------------|----------|
| 8018833 | 125 mic 305 mm x 60 m - set of 2 | 1 |
| 8007066 | 75 mic 457 mm x 75 m - set of 2 | 1 |
| 8007073 | 75 mic 635 mm x 75 m - set of 2 | 1 |
| 8018840 | 42,5 mic 305 mm x 150 m - set of 2 | 1 |
| 8007035 | 37,5 mic 305 mm x 150 m - set of 2 | 1 |
| 8007042 | 37,5 mic 457 mm x 150 m - set of 2 | 1 |
| 8007059 | 37,5 mic 635 mm x 150 m - set of 2 | 1 |



self adhesive book covering film

The Pavo laminating film rolls are available in different sizes and thickness to match the level of protection you need. It will keep your machine running for the best results.

| CODE | DESCRIPTION | QUANTITY |
|---------|---|----------|
| 8000395 | Self adhesive book covering film matt clear - 10 m x 330 mm | 1 |
| 8000418 | Self adhesive book covering film matt clear - 10 m x 600 mm | 1 |
| 8000821 | Self adhesive book covering film gloss clear - 10 m x 450 mm | 1 |
| 8009411 | Self adhesive book covering film gloss clear - 10 m x 500 mm | 1 |
| 8010325 | Self adhesive book covering film gloss clear - 25 m x 250 mm | 1 |
| 8010349 | Self adhesive book covering film gloss - 25 m x 330 mm | 1 |
| 8010363 | Self adhesive book covering film gloss clear - 25 m x 500 mm | 1 |

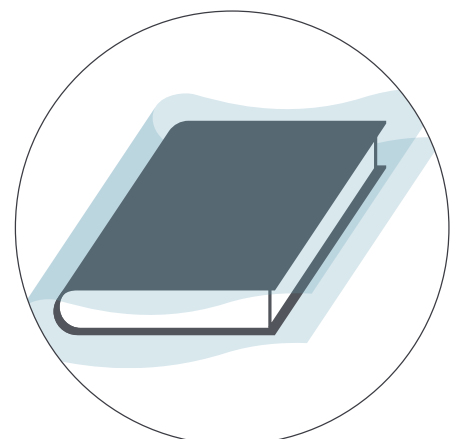

OHP foil

The Pavo OHP foil transparencies can be printed with various printers, to suit your wishes. Provide your presentations with very sharp, clear images. The A4 OHP transparencies have a thickness of 100 microns and are made of sturdy PET. Suitable for use with hydromarkers.

| CODE | DESCRIPTION | QUANTITY |
|-----------|---|----------|
| A3 | | |
| 8011902 | OHP foil Copier - 100 mic | 50 |
| A4 | | |
| 8011919 | OHP foil Copier - 100 mic | 100 |
| 8011926 | OHP foil Copier - 100 mic - Paper backed Long side | 100 |
| 8011933 | OHP foil Inkjet - 100 mic - Paper backed Short side | 50 |
| 8011940 | OHP foil Mono laser printer - 100 mic | 100 |
| 8011957 | OHP foil universal color laser printer - 100 mic | 50 |



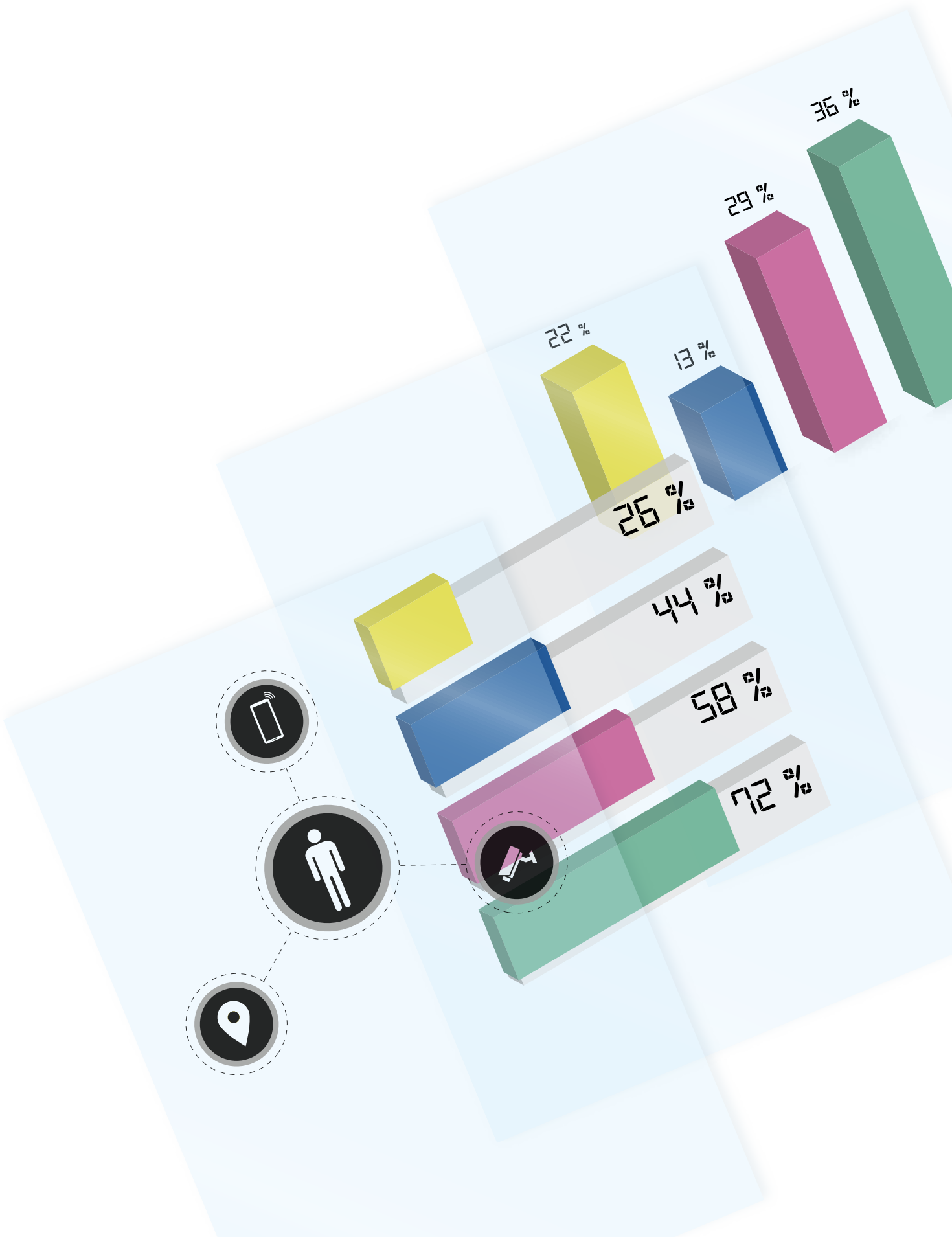

badges

From security to marketing your business, identification badges provide a countless of advantages. Whether you are at your office, a conference or a fair, it can be important to identify yourself. Identification badges contribute to corporate branding. Helps employees, participants and visitors address one another. Keeps areas ssecure and provides way for visitors and customers to identify employees and participants.

| CODE | DESCRIPTION | QUANTITY |
|--|--|----------|
| plastic - glass clear - thumb slot on the reverse | | |
| 8007776 | 40 x 60 mm Badge with pin | 50 |
| 8009299 | 40 x 75 mm Badge with pin | 100 |
| 8009176 | 40 x 75 mm Badge with combi clip | 50 |
| 8007899 | 55 x 86 mm Badge with combi clip | 50 |
| 8009206 | 54 x 90 mm Badge with pin | 50 |
| 8009183 | 54 x 90 mm Badge with combi clip | 50 |
| 8046850 | 57 x 91 mm Badge with combi clip | 50 |
| plastic - glass clear - opens at the top | | |
| 8009244 | 54 x 90 mm Self laminating with clip-on | 25 |
| 8007745 | 60 x 90 mm Visitor badge with clip-on | 50 |
| 8009213 | 60 x 90 mm Visitor badge - front cut away & clip-on | 25 |
| 8009220 | 60 x 90 mm Security badge with clip-on | 25 |
| hard PVC - matt transparent - opens on the side | | |
| 8046867 | 54 x 86 mm Security (hard PVC) badge with clip-on | 50 |
| 8009251 | 60 x 90 mm Security (hard PVC) badge with clip-on | 25 |
| accessories | | |
| 8009145 | Badge clip crocodile - metal | 25 |
| 8009275 | 850 mm Neck chain | 10 |
| 8006700 | 880 mm Textile lanyard (200 x 680 mm) with safety release - black | 10 |
| 8006724 | 880 mm Textile lanyard (200 x 680 mm) with safety release - blue | 10 |
| 8006748 | 880 mm Textile lanyard with badge with safety release - grey (lanyard: 2 x 440 mm / badge: 60 x 90 mm) | 10 |
| 8033058 | 800 mm Badge cord (2 x 400 mm) - black | 10 |
| 8033065 | 600 / 800 mm Badge reel with cord - black (reel: 600 mm / cord: 2 x 400 mm) | 10 |
| 8033041 | 600 mm Badge reel | 10 |
| 8003495 | 670 mm Badge reel HD - chrome | 10 |



8006700 - textile lanyard



8009275 - neck chain



8006724 - textile lanyard with badge



8033041 - badge reel



8003495 - badge reel HD

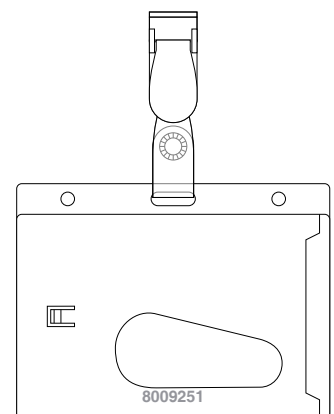
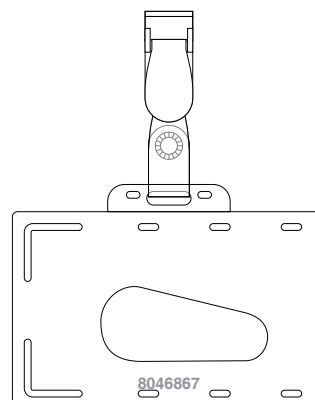
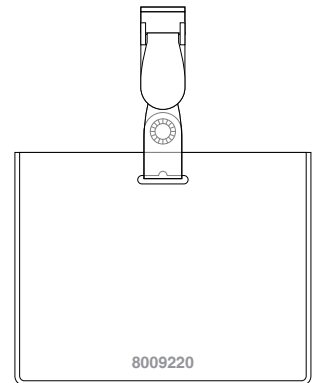
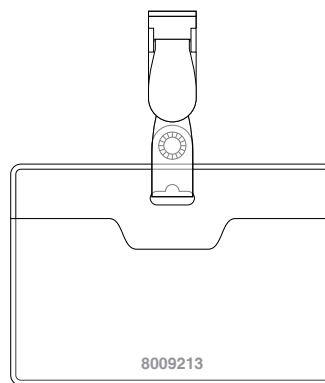
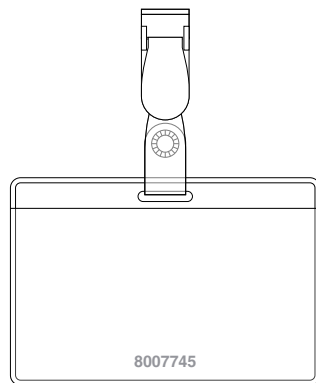
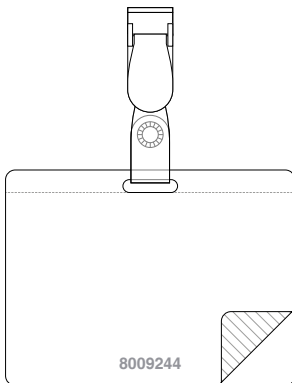
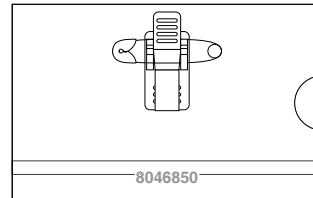
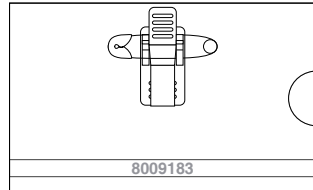
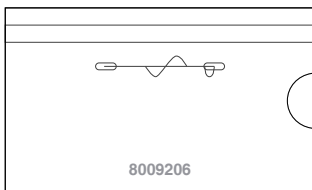
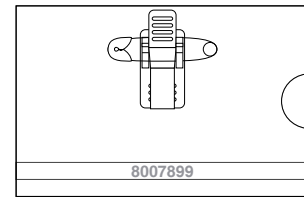
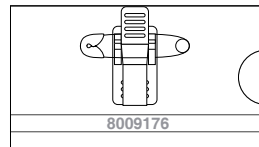
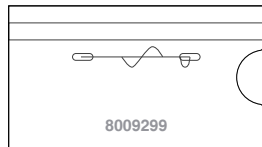
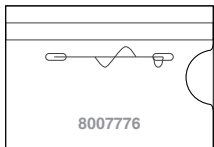



pavo



trimmers - guillotines

This overview gives you a quick insight into the possibilities for each device.

| | 8007783 1st paper cutter | 8007967 multicutter | 8007943 paper cutter II | 8007950 paper cutter II | 8008070 paper cutter II | 8007868 cutmaster 6 |
|--|-----------------------------|--|----------------------------|----------------------------|----------------------------|--------------------------|
| cutting width | A4 320 mm | A4 320 mm | A4 320 mm | A3 430 mm | A4 320 mm | A3 430 mm |
| cutting type | trimmer | trimmer | trimmer | trimmer | guillotine | guillotine |
| cutting capacity | 8 sheets | 12 sheets | 8 sheets | 15 sheets | 12 sheets | 15 sheets |
| paper size indicator | ✓ | ✓ | ✓ | ✓ | ✓ | ✓ |
| cutting table | ✗ | ✗ | ✓ | ✓ | ✓ | ✓ |
| cutting guard | ✗ | ✗ | ✗ | ✓ | ✓ | ✓ |
| additional features & components | ✗ | 6 x cutting blades | self sharpening blade | self sharpening blade | self sharpening blade | self sharpening blade |
| | | removable self healing cutting mat | | | fold away guard | |
| | | aluminum knife with spare blades | | | | |
| | | steel ruler | | | | |

trimmers & guillotines



A4 1st paper cutter - trimmer

An easy cutter to use. Press paper clamp and slide. Comfortable to hold, ideal for shapes and crafting. Perfect for paper cutting, scrapbooking, card making and more...

- max cutting capacity: 8 sheets
- cuts up to: 320 mm
- paper size indicators
- warranty: 2 years
- machine size: 420 x 140 x 50 mm
- unit weight: 0.36 kg

| CODE | COLOR |
|---------|-------|
| 8007783 | black |

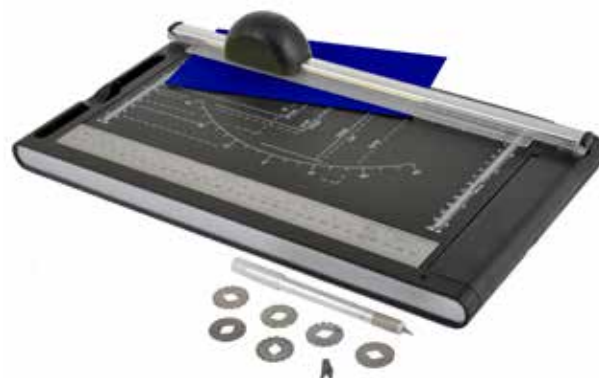

A4 multicutter - trimmer including components

No other cutter has this many uses. Press paper clamp and slide. Comfortable to hold, ideal for shapes and crafting. Perfect for paper cutting, card making and more...

- max cutting capacity: 12 sheets
- cuts up to: 320 mm
- paper size indicators
- including:
 - 6 different cutting blades
 - removable self healing cutting mat
 - aluminum knife with spare blades
 - steel ruler
- warranty: 2 years
- machine size: 235 x 85 x 450 mm
- unit weight: 1.44 kg

| CODE | COLOR |
|---------|-------|
| 8007967 | black |



A4 paper cutter II - trimmer

An easy cutter to use. Press paper clamp and slide. Perfect for paper cutting...

- max cutting capacity: 8 sheets
- cuts up to: 320 mm
- paper size indicators
- steel cutting table
- self sharpening blade
- paper size indicators
- warranty: 2 years
- machine size: 70 x 210 x 440 mm
- unit weight: 1.1 kg

| CODE | COLOR |
|---------|----------------|
| 8007943 | black / silver |



A3 paper cutter II - trimmer

An easy cutter to use. Press paper clamp and slide. Perfect for paper cutting...

- max cutting capacity: 15 sheets
- cuts up to: 430 mm
- steel cutting table
- self sharpening blade
- paper size indicators
- fully guarded
- warranty: 2 years
- machine size: 70 x 255 x 640 mm
- unit weight: 1.46 kg

| CODE | COLOR |
|---------|----------------|
| 8007950 | black / silver |

trimmers & guillotines



A4 paper cutter II - guillotine

This guillotine can be used to cut 12 pages at once.

- max cutting capacity: 12 sheets
- cuts up to: 320 mm
- steel cutting table
- self sharpening blade
- paper size indicators
- fully guarded (incl. fold away guard)
- warranty: 2 years
- machine size: 500 x 170 x 180 mm
- unit weight: 1.7 kg

| CODE | COLOR |
|---------|----------------|
| 8008070 | silver / black |



A3 cutmaster 6 - guillotine

This guillotine can be used to cut 15 pages at once.

- max cutting capacity: 15 sheets
- cuts up to: 430 mm
- steel cutting table
- self sharpening blade
- paper size indicators
- fully guarded
- warranty: 2 years
- machine size: 450 x 650 x 100 mm
- unit weight: 6.2 kg

| CODE | COLOR |
|---------|-------------------|
| 8007868 | light grey / blue |



paper cutter II - head

| CODE | COLOR |
|---------|-------|
| 8007769 | black |



spare blades for multicutter

1 set with spare blades for different cutting lines.

| CODE | COLOR |
|---------|-------|
| 8010455 | metal |

cutting mats

The Pavo cutting mats are self-healing and constructed using several layers of PVC plastics. This specialized formation allows cuts to disappear - which prolongs the life of the mat. Each cutting mat contains inch and metric measurements.

- one- and double-sided
- self healing qualities
- 3 & 5 layer PVC construction
- preprinted grid and degrees

| CODE | DESCRIPTION | QUANTITY |
|-----------|--|----------|
| A1 | | |
| 8002931 | 900 x 600 mm Self-healing - one-sided: blue 3 layers | 1 |
| 8004409 | 900 x 600 mm Self-healing - one-sided: green 3 layers | 1 |
| 8038732 | 900 x 600 mm Self-healing - one-sided: transparent 3 layers | 1 |
| 8004362 | 900 x 600 mm Self-healing - double-sided: pink/grey 5 layers | 1 |
| 8015498 | 900 x 600 mm Self-healing - double-sided: blue/black 5 layers | 1 |
| A2 | | |
| 8002924 | 600 x 450 mm Self-healing - one-sided: blue 3 layers | 1 |
| 8004386 | 600 x 450 mm Self-healing - one-sided: green 3 layers | 1 |
| 8004348 | 600 x 450 mm Self-healing - double-sided: pink/grey 5 layers | 1 |
| 8015511 | 600 x 450 mm Self-healing - double-sided: blue/black 5 layers | 1 |
| A3 | | |
| 8002917 | 450 x 300 mm Self-healing - one-sided: blue 3 layers | 1 |
| A4 | | |
| 8002900 | 300 x 220 mm Self-healing - one-sided: blue 3 layers | 1 |

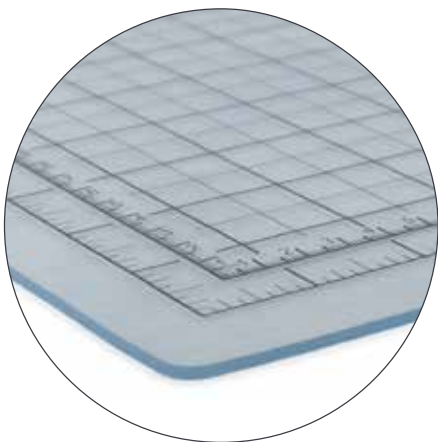

one-sided: transparent

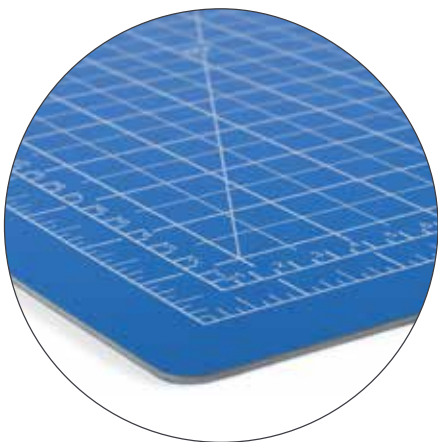

one-sided: blue

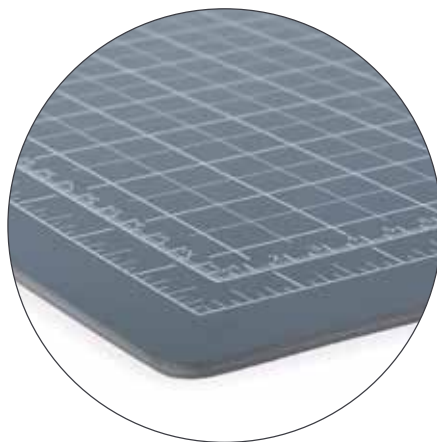

double-sided: grey front with pink back

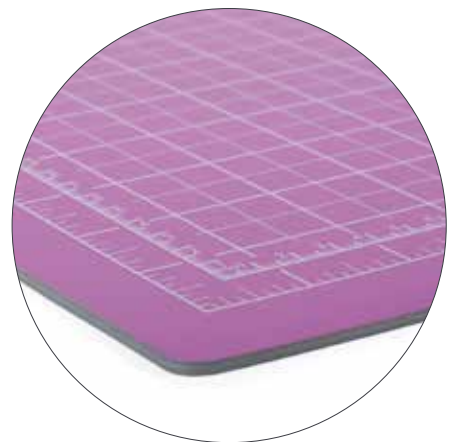

double-sided: pink front with grey back

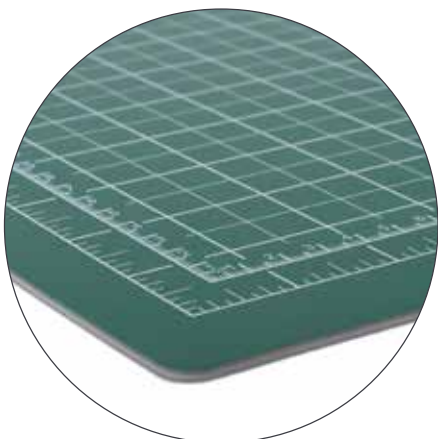

one-sided: green

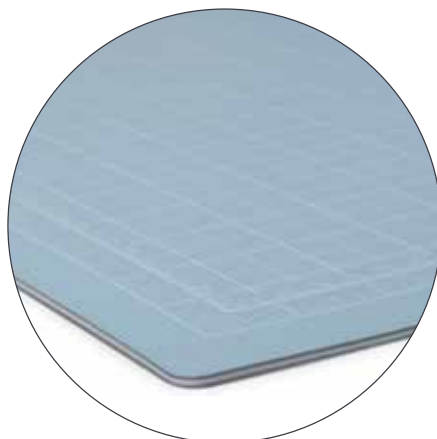

double-sided: blue front with black back

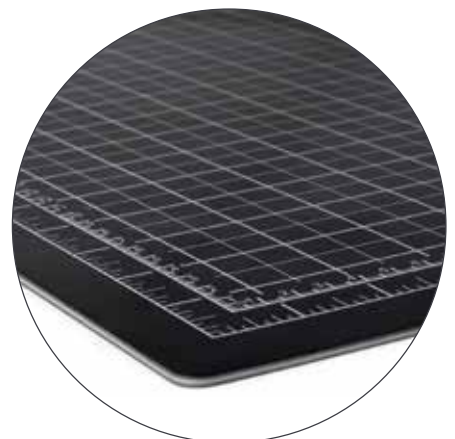

double-sided: black front with blue back

cutting mats



5 layers

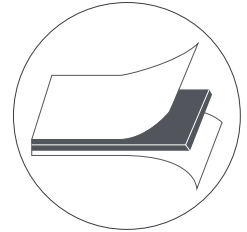

3 layers

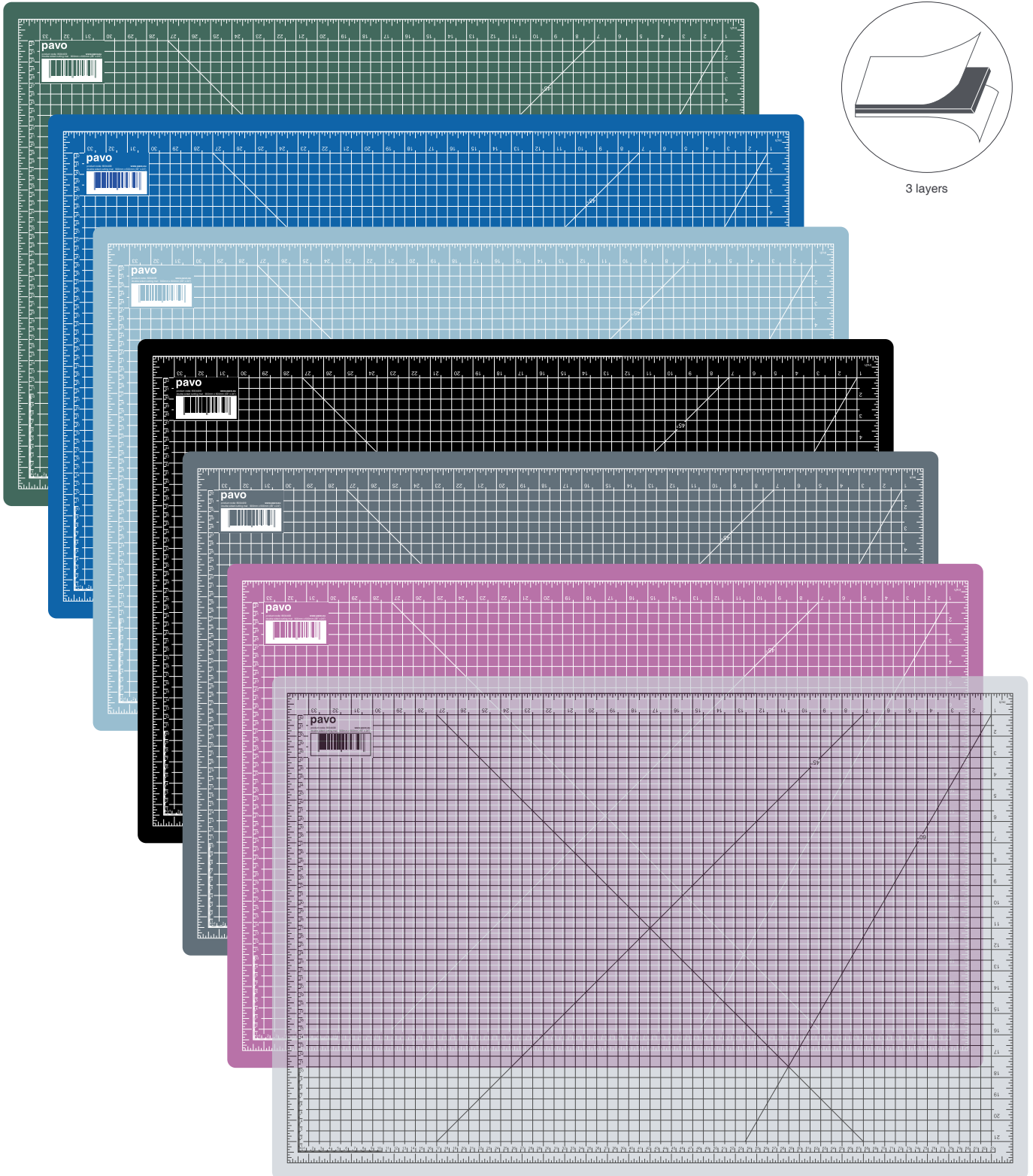



value pack: laminator + laminating pouches + trimmer

A promotion pack with a laminator, trimmer and laminating pouches in one box.

- A4 funlaminator
- assorted laminating pouches - 50
- A4 paper trimmer

| CODE | COLOR |
|---------|-------|
| 8014897 | black |

value pack: laminator + laminating pouches + cutter + corner cutter

A promotion pack with a laminator, laminating pouches, cutter and corner cutter in one box.

- A4 laminator
- assorted laminating pouches - 20
- A4 cutter
- corner cutter

| CODE | COLOR |
|---------|------------|
| 8005833 | black/blue |

[available on promo base](#)



special packaging requests
are available on promo base

educational worksheet sleeves

The Pavo dry wipe sleeves are made of durable, quality materials. These sleeves will add fun and variety to your activities.

- easy to use - write on and wipe off
- writable with a dry wipe marker
- available in a variety of colors

| CODE | DESCRIPTION | QUANTITY |
|-----------|--------------------|----------|
| A4 | | |
| 8011490 | A4 Assorted colors | 5 |
| 8011513 | A4 Black | 30 |

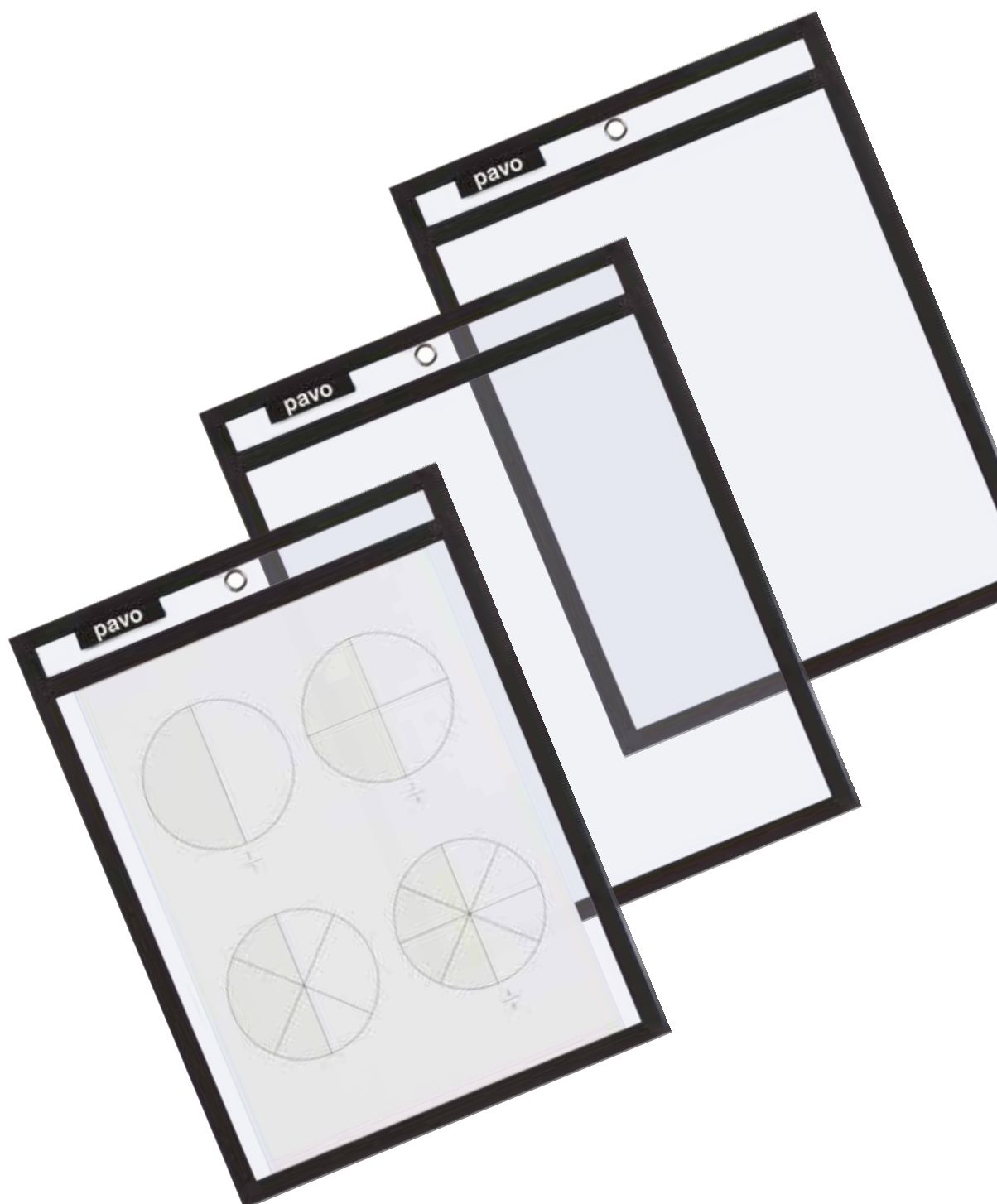



pavo

$\frac{1}{2}$ $\frac{2}{4}$

$\frac{3}{6}$ $\frac{4}{8}$

Pen not included.

High quality white boards for general use.

| CODE | DESCRIPTION | QUANTITY |
|---------|---|----------|
| 8037940 | 440 x 550 mm Cardboard | 1 |
| 8036066 | 400 x 300 mm MDF | 1 |
| 8036080 | 400 x 400 mm MDF | 1 |
| 8036189 | 600 x 450 mm MDF - aluminum frame rounded corners | 1 |



High quality glass boards for general use.



| CODE | DESCRIPTION | QUANTITY |
|---------|---------------------|----------|
| 8052196 | 450 x 450 mm Black | 1 |
| 8050680 | 350 x 350 mm White | 1 |
| 8048274 | 780 x 480 mm White | 1 |
| 8048281 | 1000 x 650 mm White | 1 |



L-shaped sign holder

Pavo L-shaped sign holders are made of clear acrylic and perfect to be used as a sign or picture frame or as a counter-top display.

- built-in base
- easy viewing
- easy insertion

| CODE | DESCRIPTION | QUANTITY |
|---------|--------------------------------|----------|
| 8019106 | A4 L-shape sign holder - clear | 1 |
| 8019113 | A5 L-shape sign holder - clear | 1 |



various shapes

Magnets are very useful for different utilities. In our assortment we have several type of magnets. Do you need normal, flexible or magnet hooks? It is all possible and they are available in different sizes.

| CODE | DESCRIPTION | QUANTITY |
|-------------------------|---|----------|
| magnets | | |
| 8056712 | 10 x 10 mm Super magnets for glassboards - silver | 6 |
| 8047680 | ø 11 mm Assorted colors | 16 |
| 8047666 | ø 15 mm Assorted colors | 12 |
| 8047505 | ø 20 mm Assorted colors | 7 |
| 8047437 | ø 25 mm Assorted colors | 5 |
| 8047369 | ø 30 mm Assorted colors | 4 |
| flexible magnets | | |
| 8052363 | 14 x 14 mm Adhesive magnets | 49 |
| 8052387 | 2500 x 35 mm Magnet band + 4 magnets - white | 1 |
| 8052400 | 500 x 30 mm Magnet band - white | 10 |
| 8052219 | 150 x 150 mm Magnet sheets - assorted colors | 6 |
| magnet hooks | | |
| 8047079 | ø 25 mm Max capacity: 4 kg - white | 3 |
| 8047055 | ø 36 mm Max capacity: 10 kg - white | 2 |
| 8047062 | ø 47 mm Max capacity: 18 kg - white | 2 |



10 x 10 mm magnet



assorted colors round magnets



magnet band

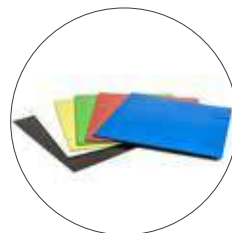

magnet sheets



ø 25 mm magnet hook

automatic letter folder

This automatic letter folder is ideal for mail rooms and offices.
It automatically feeds and folds documents.



| CODE | DESCRIPTION | QUANTITY |
|---------|--|----------|
| 8055821 | Automatic letter folder <ul style="list-style-type: none"> • 310 x 200 x 200 mm • compact folding machine with a collecting container • adjustable folding speed • four folding styles: half, fold, letter, double parallel fold • paper size: A4 and A5 • capacity of the paper tray: 100 sheets (80 g / m2) • LED display with integrated counter and preset counter • automatic shut off after 10 seconds | 1 |
| 8000333 | Letter folder roll cleaner - 1000 ml | 1 |



A photograph of a workspace. In the foreground, a white plastic chair with a complex, lattice-like backrest and a light-colored wooden base is positioned under a wooden desk. The desk has a thick, natural wood top and a metal frame. On the desk, there is a silver laptop, a blue notebook, and a pair of glasses. The background is a plain, light-colored wall.

pavo

SECURITY



badges

From security to marketing your business, identification badges provide a countless of advantages. Whether you are at your office, a conference or a fair, it can be important to identify yourself. Identification badges contribute to corporate branding. Helps employees, participants and visitors address one another. Keeps areas ssecure and provides way for visitors and customers to identify employees and participants.

| CODE | DESCRIPTION | QUANTITY |
|--|--|----------|
| plastic - glass clear - thumb slot on the reverse | | |
| 8007776 | 40 x 60 mm Badge with pin | 50 |
| 8009299 | 40 x 75 mm Badge with pin | 100 |
| 8009176 | 40 x 75 mm Badge with combi clip | 50 |
| 8007899 | 55 x 86 mm Badge with combi clip | 50 |
| 8009206 | 54 x 90 mm Badge with pin | 50 |
| 8009183 | 54 x 90 mm Badge with combi clip | 50 |
| 8046850 | 57 x 91 mm Badge with combi clip | 50 |
| plastic - glass clear - opens at the top | | |
| 8009244 | 54 x 90 mm Self laminating with clip-on | 25 |
| 8007745 | 60 x 90 mm Visitor badge with clip-on | 50 |
| 8009213 | 60 x 90 mm Visitor badge - front cut away & clip-on | 25 |
| 8009220 | 60 x 90 mm Security badge with clip-on | 25 |
| hard PVC - matt transparent - opens on the side | | |
| 8046867 | 54 x 86 mm Security (hard PVC) badge with clip-on | 50 |
| 8009251 | 60 x 90 mm Security (hard PVC) badge with clip-on | 25 |
| accessories | | |
| 8009145 | Badge clip crocodile - metal | 25 |
| 8009275 | 850 mm Neck chain | 10 |
| 8006700 | 880 mm Textile lanyard (200 x 680 mm) with safety release - black | 10 |
| 8006724 | 880 mm Textile lanyard (200 x 680 mm) with safety release - blue | 10 |
| 8006748 | 880 mm Textile lanyard with badge with safety release - grey (lanyard: 2 x 440 mm / badge: 60 x 90 mm) | 10 |
| 8033058 | 800 mm Badge cord (2 x 400 mm) - black | 10 |
| 8033065 | 600 / 800 mm Badge reel with cord - black (reel: 600 mm / cord: 2 x 400 mm) | 10 |
| 8033041 | 600 mm Badge reel | 10 |
| 8003495 | 670 mm Badge reel HD - chrome | 10 |



8006700 - textile lanyard

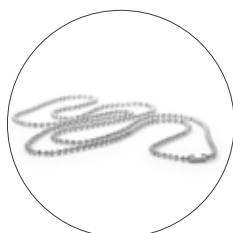

8009275 - neck chain



8006724 - textile lanyard with badge



8033041 - badge reel



8003495 - badge reel HD

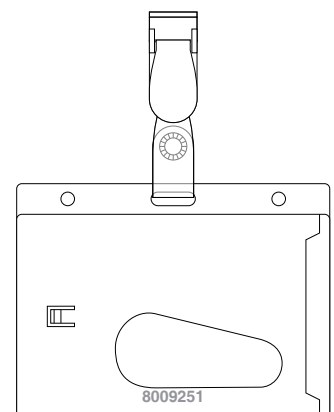
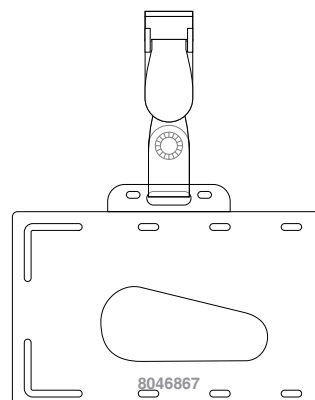
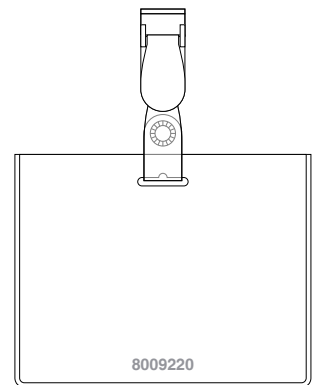
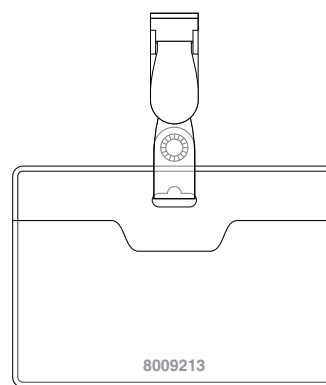
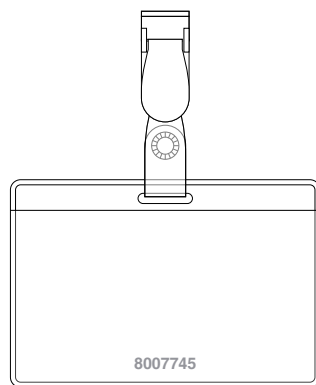
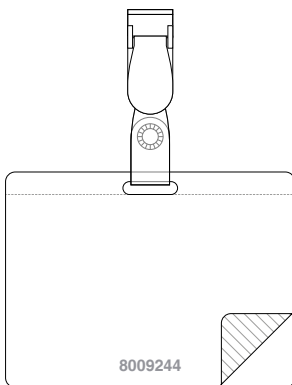
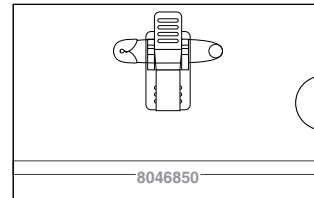
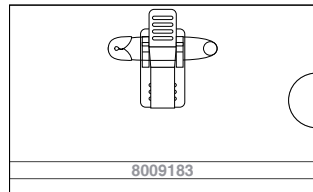
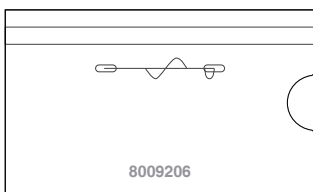
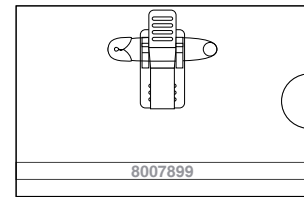
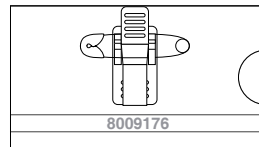
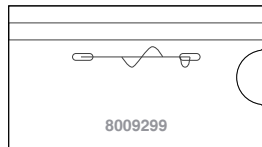
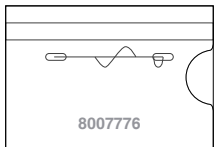

Signs provide information to help you and other users.

- material: metal
- adhesive tape on the back

| CODE | DESCRIPTION | QUANTITY |
|-----------|--------------------------------------|----------|
| A4 | | |
| 8046751 | Prière laisser les lieu 170 x 47 mm | 50 |
| 8046775 | Toilettes dames 170 x 47 mm | 50 |
| 8046782 | Toilettes hommes 170 x 47 mm | 50 |
| 8046829 | Toilettes mixte 170 x 47 mm | 50 |
| 8050178 | Toilettes handicapés 170 x 47 mm | 50 |
| 8046836 | Privé 170 x 47 mm | 50 |
| 8046768 | Entrée interdite 170 x 47 mm | 50 |
| 8046805 | Poussez 170 x 47 mm | 50 |
| 8046812 | Tirez 170 x 47 mm | 50 |
| 8046799 | Surveillance caméra 170 x 47 mm | 50 |
| 8046843 | Interdiction de fumer 150 x 210 mm | 50 |
| 8003655 | Interdiction de vapoter 150 x 210 mm | 50 |

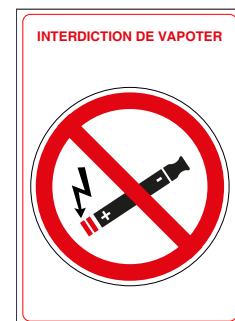
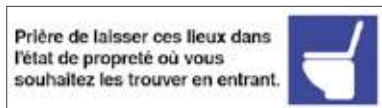

privé



french signs - braille

Signs provide information to help you and other users.

- material: 2 mm - 100% stainless steel
- round corners
- black print
- adhesive tape on the back
- french braille

| CODE | DESCRIPTION | QUANTITY |
|-----------|----------------------------------|----------|
| A4 | | |
| 8055913 | Toilettes hommes 150 x 150 mm | 50 |
| 8055937 | Toilettes femmes 150 x 150 mm | 50 |
| 8055951 | Toilettes mix 150 x 150 mm | 50 |
| 8055975 | Toilette handicapés 150 x 150 mm | 50 |
| 8055999 | Entree interdite 150 x 150 mm | 50 |

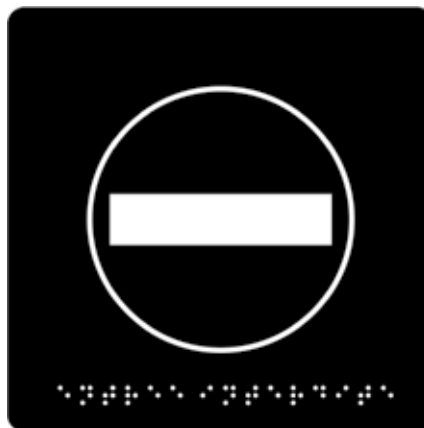

Signs provide information to help you and other users.

- material: 2 mm - 100% stainless steel
- round corners
- black (and red) print
- adhesive tape on the back

| CODE | DESCRIPTION | | QUANTITY |
|---------|--------------------|--------------|----------|
| 8054572 | Mixed toilets | 150 x 150 mm | 50 |
| 8054503 | No smoking allowed | 150 x 150 mm | 50 |







fake CCTV security camera

Protect your house, shop or office with a dummy camera.

- realistic CCTV
- 360° bracket
- with fake cables
- wall fixing: included
- power: 2xAAA batteries (not included)
- camera size: 120 x 260 x 100 mm
- unit weight: 0.325 kg



fake security dome camera

Protect your house, shop or office with a dummy camera.

- realistic CCTV
- LED light activation: ✓
- without cables
- ON / OFF switch
- wall fixing: included
- power: 2xAAA batteries (not included)
- camera size: ø120 mm x 80 mm
- unit weight: 0.15 kg

| CODE | COLOR |
|---------|-------|
| 8001125 | black |

| CODE | COLOR |
|---------|-------|
| 8001101 | black |





key cabinets

Don't have the worries for wondering where you have left the keys. Enjoy the perfectly organized and labeled keys, which are available for co-workers, customers etc.

All Pavo key cabinets are designed with a key return gap, which is easy for storing your key when the clerk has gone out. Very clever and absolutely unique! Available in different sizes, finish and locks.

Supplied with key fobs (8041923 excluded), self-adhesive number pad, label table and mounting wall fixings.

| CODE | DESCRIPTION | QUANTITY |
|---------|-----------------------|----------|
| 8027033 | 20 keys | 1 |
| 8014415 | 20 keys | 1 |
| 8036653 | 30 keys | 1 |
| 8014422 | 30 keys | 1 |
| 8041923 | 36 keys | 1 |
| 8027040 | 54 keys | 1 |
| 8014439 | 54 keys | 1 |
| 8027057 | 80 keys | 1 |
| 8014446 | 80 keys | 1 |
| 8027064 | 140 keys | 1 |
| 8014460 | 140 keys | 1 |
| 8032129 | 300 keys | 1 |
| 8038268 | 10 keys expansion bar | 1 |



8027033 - 20 keys



8036653 - 30 keys



8041923 - 36 keys



8027040 - 54 keys



8027057 - 80 keys



8027064 - 140 keys



8032129 - 300 keys



deluxe key cabinets

The Pavo Deluxe key cabinets are designed and have a nice solid metal base and come with a key return gap, which is easy for storing your key when the clerk has gone out.

Supplied with key fobs, self-adhesive number pad, label table and mounting wall fixings.

| CODE | DESCRIPTION | QUANTITY |
|---------|---|----------|
| 8047208 | Deluxe for 80 keys 80 x 380 x 450 mm Dark grey - matt finish with key return gap including key rings, tags, 2 keys and numbered hooks | 1 |
| 8047222 | Deluxe for 100 keys 90 x 380 x 550 mm Dark grey - matt finish with key return gap including key rings, tags, 2 keys and numbered hooks | 1 |
| 8047215 | Deluxe for 150 keys 110 x 380 x 450 mm Dark grey - matt finish with key return gap including key rings, tags, 2 keys and numbered hooks | 1 |
| 8047239 | Deluxe for 300 keys 220 x 380 x 530 mm Dark grey - matt finish with key return gap including key rings, tags, 2 keys and numbered hooks | 1 |



8047208 - deluxe for 80 keys



8047222 - deluxe for 100 keys



8047215 - deluxe for 150 keys



8047239 - deluxe for 300 keys



**DOOR
THICKNESS**
▶ 4 mm ◀

**BODY
THICKNESS**
▶ 2 mm ◀

electronic
lock

emergency
2keys

key tags

key
return gap

wall fixing
included

high security key cabinets

Don't have the worries for wondering where you have left the keys. Enjoy the perfectly organized and labeled keys, which are available for co-workers, customers etc. All Pavo key cabinets are designed with a key return gap, which is easy for storing your key when the clerk has gone out. Very clever and absolutely unique! Available in different sizes, finish and locks.

Supplied with key fobs, self-adhesive number pad, label table and mounting wall fixings.

| CODE | DESCRIPTION | QUANTITY |
|---------|---|----------|
| 8002696 | High security 20 keys 100 x 340 x 200 mm Dark grey - matt finish with electronic combination lock including key rings, tags, 2 emergency keys and numbered hooks | 1 |
| 8033911 | High security 50 keys 100 x 400 x 550 mm Dark grey - matt finish with electronic combination lock including key rings, tags, 2 emergency keys and numbered hooks | 1 |
| 8056019 | High security 100 keys 120 x 400 x 550 mm Dark grey - matt finish with electronic combination lock including key rings, tags, 2 emergency keys and numbered hooks | 1 |
| 8002719 | High security 150 keys 150 x 450 x 550 mm Dark grey - matt finish with electronic combination lock including key rings, tags, 2 emergency keys and numbered hooks | 1 |
| 8010905 | High security 300 keys 150 x 300 x 550 mm Dark grey - matt finish with electronic combination lock including key rings, tags, 2 emergency keys and numbered hooks | 1 |
| 8009022 | High security 50 keys 132 x 310 x 500 mm Suitable for sheltered outdoor use. Dark grey - matt finish with electronic combination lock including key rings, tags, 2 emergency keys and numbered hooks | 1 |
| 8006847 | High security 50 keys 100 x 300 x 465 mm With fingerprint lock . Dark grey - matt finish including key rings, tags, 2 emergency keys and numbered hooks | 1 |



8002696 - high security 20 keys



8033911 - high security 50 keys



8056019 - high security 100 keys



8002719 - high security 150 keys



8010905 - high security 300 keys



8009022 - high security 50 keys
suitable for sheltered outdoor use



8006847 - high security 50 keys
fingerprint lock

design key cabinet

The Pavo design key cabinet is designed with an inox front and a key return gap, which is easy for storing your key when the clerk has gone out. Very clever and absolutely unique!

Supplied with key fobs, self-adhesive number pad, label table and mounting wall fixings.

| CODE | DESCRIPTION | QUANTITY |
|---------|--|----------|
| 8018567 | Design for 54 keys 60 x 240 x 300 mm Inox / black - gloss finish with key return gap including key rings, tags, 2 keys and numbered hooks | 1 |



8018567 - 54 keys



8018567 - 54 keys



key hook board

The key hook board of Pavo is designed to be easily mounted on an wall - with the possibility to extend the board with an extra board (or more); above or below. Allowing multiple users quick access to your keys.

Enjoy the perfectly organized keys, which are available for co-workers, customers etc.

| CODE | DESCRIPTION | QUANTITY |
|---------|-----------------------------|----------|
| 8008582 | 50 keys 300 x 450 x 2 mm | 1 |

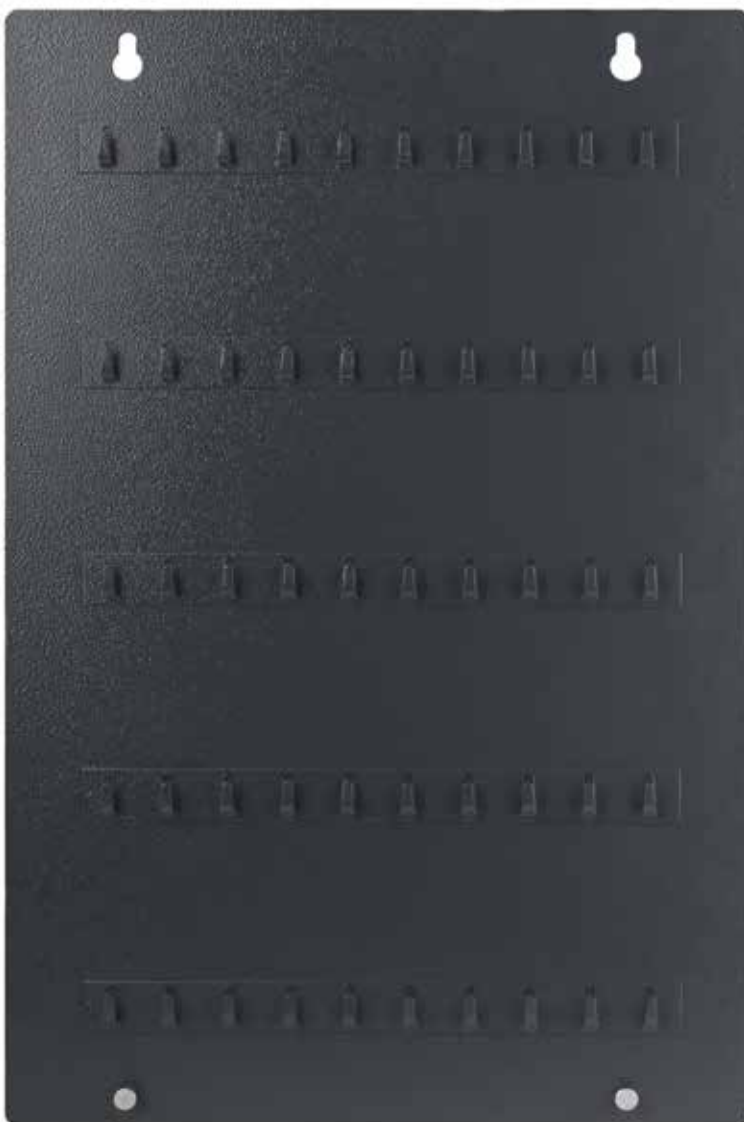

8008582 - 50 keys



8008582 - 50 keys - joint



key store safe

The Pavo key store safes gives you control of door keys, padlock keys, car keys etc. in an secure location that can be easily mounted to a wall.

- 3 digit combination lock
- fixable to walls (wall fixing included)

| CODE | DESCRIPTION | QUANTITY |
|---------|---|----------|
| 8016679 | Key store safe 145 x 100 x 57 mm Black - matt finish with 3 digit combination lock | 1 |



8016679 - key store safe

key tags

The Pavo key tags and sliding key fobs make it easy to label and identify your keys. The key tags and key fobs have a colorful design and come with a pre-cut paper insert label for marking and labelling your keys.

Sliding key fobs are easy to open & close.

- key tags label space: 29 x 14 mm
- key fobs label space: 40 x 24 mm

| CODE | DESCRIPTION | QUANTITY |
|---------|---|----------|
| 8046683 | Sliding key fobs - bag: 57 x 29 x 7 mm fob with 40 x 24 mm label - assorted colors | 5 |
| 8014569 | Sliding key fobs - bag: 57 x 29 x 7 mm fob with 40 x 24 mm label - assorted colors | 10 |
| 8046706 | Sliding key fobs - bag: 57 x 29 x 7 mm fob with 40 x 24 mm label - assorted colors | 50 |
| 8008889 | Sliding key fobs - box 57 x 29 x 7 mm fob with 40 x 24 mm label - assorted colors | 15 |
| 8046669 | Key tags - bag: 50 x 23 x 3 mm tag with 29 x 14 mm label - assorted colors | 20 |
| 8032174 | Key tags - bag: 50 x 23 x 3 mm tag with 29 x 14 mm label - assorted colors | 100 |
| 8008896 | Key tags - bag: 50 x 23 x 3 mm tag with 29 x 14 mm label - white | 100 |
| 8008902 | Key tags - bag: 50 x 23 x 3 mm tag with 29 x 14 mm label - black | 100 |
| 8008926 | Key tags - bag: 50 x 23 x 3 mm tag with 29 x 14 mm label - blue | 100 |
| 8008933 | Key tags - bag: 50 x 23 x 3 mm tag with 29 x 14 mm label - green | 100 |
| 8008940 | Key tags - bag: 50 x 23 x 3 mm tag with 29 x 14 mm label - yellow | 100 |
| 8008957 | Key tags - bag: 50 x 23 x 3 mm tag with 29 x 14 mm label - orange | 100 |
| 8008919 | Key tags - bag: 50 x 23 x 3 mm tag with 29 x 14 mm label - red | 100 |





cash boxes

Cash boxes are ideal for storing small valuables and cash.
All cash boxes come with a removable coin tray and are supplied with 2 keys.

Matt and glossy finish in trendy colours, 0,8 mm gauge steel.

| CODE | DESCRIPTION | QUANTITY |
|---------|--|----------|
| 8011827 | 6" Black - matt | 1 |
| 8008629 | 6" White - matt | 1 |
| 8011742 | 6" 115 x 150 Blue - matt | 1 |
| 8011861 | 6" x 80 mm Red - matt | 1 |
| 8011780 | 6" Dark grey - matt | 1 |
| 8011704 | 6" Assorted | 1 |
| 8011834 | 8" Black - matt | 1 |
| 8008643 | 8" White - matt | 1 |
| 8011759 | 8" 160 x 200 Blue - matt | 1 |
| 8011872 | 8" x 90 mm Red - matt | 1 |
| 8011896 | 8" Dark grey - matt | 1 |
| 8011711 | 8" Assorted - matt | 1 |
| 8011841 | 10" Black - matt | 1 |
| 8008667 | 10" White - matt | 1 |
| 8011766 | 10" 180 x 250 Blue - matt | 1 |
| 8011889 | 10" x 90 mm Red - matt | 1 |
| 8011803 | 10" Dark grey - matt | 1 |
| 8011728 | 10" Assorted - matt | 1 |
| 8011858 | 12" Black - matt | 1 |
| 8008681 | 12" White - matt | 1 |
| 8011773 | 12" 240 x 300 Blue - matt | 1 |
| 8011094 | 12" x 90 mm Red - matt | 1 |
| 8008704 | 12" Dark grey - matt | 1 |
| 8014408 | 12" Dark grey with combination lock - matt | 1 |



6" dark grey open



8" dark grey open



10" dark grey open



12" dark grey with combination lock open



6" dark grey closed



8" dark grey closed



10" dark grey closed



12" dark grey with combination lock closed



cash boxes - deluxe

The deluxe cash box distinguishes itself by opening with an automatic push button. Which makes the deluxe cash box very user-friendly as you can use it with one hand.

- equipped with a compartment cash tray
- cylinder lock with 2 keys
- easy to screw on a flat surface

| CODE | DESCRIPTION | QUANTITY |
|---------|-------------------|----------|
| 8009336 | 6" deluxe | 1 |
| 8008520 | 6" deluxe | 1 |
| 8007509 | 6" deluxe | 1 |
| | 115 x 150 x 80 mm | |
| | Red - matt | |
| | Blue - matt | |
| | White - matt | |
| 8009374 | 8" deluxe | 1 |
| 8009350 | 8" deluxe | 1 |
| 8007516 | 8" deluxe | 1 |
| | 160 x 200 x 90 mm | |
| | Red - matt | |
| | Blue - matt | |
| | Black - matt | |
| 8017058 | 10" deluxe | 1 |
| 8017034 | 10" deluxe | 1 |
| 8007523 | 10" deluxe | 1 |
| | 180 x 250 x 90 mm | |
| | Red - matt | |
| | Blue - matt | |
| | Silver - matt | |
| 8007530 | 12" deluxe | 1 |
| | 240 x 300 x 90 mm | |
| | Blue - matt | |



6" deluxe white - matt open



8" deluxe red - matt open



10" deluxe silver - matt open



12" deluxe blue - matt open

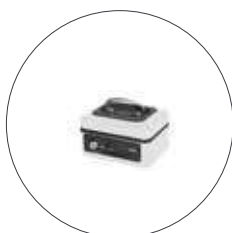

6" deluxe white - matt closed



8" deluxe red - matt closed



10" deluxe silver - matt closed



12" deluxe blue - matt closed



8007394 - cash box
green

cash boxes - trendy

Cash boxes are ideal for storing small valuables and cash.
 The 5" cash box has also a coin spare for fast coin storage when the cash box is locked.
 All cash boxes come with a removable coin tray and are supplied with 2 keys.

Matt finish in trendy colours, 0,8 mm gauge steel.

| CODE | DESCRIPTION | QUANTITY |
|-------------------|---|----------|
| 8007387 | 5" Light blue - glossy with coin spare | 1 |
| 8007394 | 5" Green - glossy with coin spare | 1 |
| 8007400 | 5" Pink - glossy with coin spare | 1 |
| 8007417 | 5" Kobalt blue - glossy with coin spare | 1 |
| 8007424 | 5" Silver - glossy with coin spare | 1 |
| 8007431 | 5" Yellow - glossy with coin spare | 1 |
| 8008377 | 5" Red - glossy with coin spare | 1 |
| 95 x 125 x 60 mm | | |
| 8007929 | 8" Light blue - glossy | 1 |
| 8002856 | 8" Yellow - glossy | 1 |
| 8005666 | 8" Green - glossy | 1 |
| 8002870 | 8" Pink -glossy | 1 |
| 8002177 | 8" Silver - matt | 1 |
| 160 x 200 x 90 mm | | |
| 240 x 300 x 90 mm | | |



8007387 - cash box light blue



8007400 - cash box pink



8007417 - cash box kobalt blue



8007424 - cash box silver



8007431 - cash box yellow



8007477 - cash box red

money managers & coin sorters

Store your money safe and organized in a money manager.

Matt epoxy coated, 0,8 mm gauge steel.

| CODE | DESCRIPTION | QUANTITY |
|---------|--|----------|
| 8014392 | 12" 238 x 300 x 90 mm Money manager Dark grey, with euro coin sorter | 1 |
| 8008742 | 12" 238 x 300 x 90 mm Money manager Red, with euro coin sorter | 1 |
| 8008766 | 12" 238 x 300 x 90 mm Money manager Blue, with euro coin sorter | 1 |
| 8047246 | 14" 368 x 115 x 280 mm Money manager Dark grey, with euro coin sorter | 1 |
| 8008728 | 14" 368 x 115 x 280 mm Money manager Dark grey, with gbp coin sorter | 1 |
| 8041077 | 12" Euro coin sorter - black | 1 |
| 8041084 | 14" Euro coin sorter - black | 1 |



12" red
open



12" bleu
open



14" dark grey
open

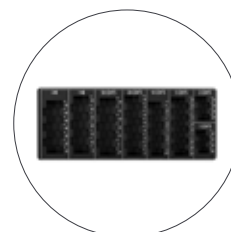

12" black
euro coin sorter



12" dark grey
closed



12" bleu
closed



14" dark grey
closed

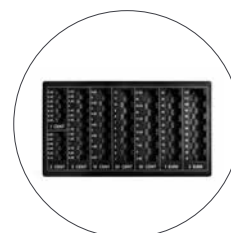

14" black
euro coin sorter

counterfeit detection



money check pro

Check easy to use counterfeit bills.

- method of detection: MT-MG-IR-2D
- banknote input: any direction
- detection speed: 0,55 SEC banknote
- 100 % ECB test.

| CODE | COLOR |
|---------|----------------|
| 8035717 | black / silver |



money check UV

Check easy to use counterfeit bills.

- UV detection
- watermark detection
- UV lamp: 1 x 9W
- fluorescent lamp: 1 x 9W

| CODE | COLOR |
|---------|-------|
| 8035731 | black |



money checker pen

Check easy to use counterfeit bills.

Simply press the tip of the pen to the bill if it turns yellow or clear the bill is good if it turns brown or black the bill is suspicious.

| CODE | COLOR |
|---------|-------|
| 8035755 | black |

security document box

The security document box from Pavo is ideal for secure storage of important documents and valuables in your car, (mobile) home and office.

- cylinder lock with 2 keys
- chrome handle
- easy to screw on a flat surface
- handles on both sides

| CODE | DESCRIPTION | QUANTITY |
|---------|--------------------------|-----------------------|
| 8008605 | 14" 370 x 280 x 90 mm | Dark grey - matt 1 |



security safes

Store your valuables in a safe. Included an electronic control panel, mastercode option and 2 emergency keys.



| CODE | DESCRIPTION | QUANTITY |
|---------|--|----------|
| 8040391 | 310 x 200 x 200 mm Dark grey content: 8.1 L | 1 |
| 8037483 | 350 x 250 x 250 mm Dark grey content: 15.7 L | 1 |
| 8054350 | 430 x 360 x 310 mm Dark grey content: 35 L | 1 |



8040391 - security safe
310 x 200 x 200 mm



8037483 - security safe
350 x 250 x 250 mm



8054350 - security safe
430 x 360 x 310 mm



8004690 - mini safe white

mini safes

Store your valuables in a safe. Included an electronic control panel, mastercode option and 2 emergency keys.



| CODE | DESCRIPTION | QUANTITY |
|---------|--|----------|
| 8004690 | 230 x 170 x 170 mm White inside dimension: 226 x 166 x 128 mm | 1 |
| 8005826 | 230 x 170 x 170 mm Blue inside dimension: 226 x 166 x 128 mm | 1 |
| 8005611 | 230 x 170 x 170 mm Red inside dimension: 226 x 166 x 128 mm | 1 |
| 8005680 | 230 x 170 x 170 mm Black inside dimension: 226 x 166 x 128 mm | 1 |



8005826 - mini safe blue



8005611 - mini safe red



8005680 - mini safe black

fingerprnt safe



Store your valuables in a safe. Included 2 emergency keys.

This unique model offers the ability to unlock the cabinet in 2 ways:
- Fingerprint (up to 100 different users can be set, quick easy and secure)
- Emergency Key

| CODE | DESCRIPTION | QUANTITY |
|---------|--|----------|
| 8016419 | 250 x 250 x 352 mm Black content: 15.7 L | 1 |



8016419 - fingerprint safe front



8016419 - fingerprint safe open

cross key safe

Store your valuables in a safe. Included 3 master keys.



| CODE | DESCRIPTION | QUANTITY |
|---------|--|----------|
| 8011247 | 250 x 250 x 352 mm Dark Grey content: 15.7 L | 1 |



8011247 - safe with cross key lock
3 keys



8011247 - safe with cross key lock
open

padlocks

Lock your valuables safely with a padlock.

A padlock has a steel case that can be closed with a hardened steel shackle and key or combination lock.

TSA locks are required for travelling to the USA. Nobody has access to your belongings only the customs, using a master key. After inspection the lock can be closed and your belongings are locked and safe again.

| CODE | DESCRIPTION | | QUANTITY |
|------------------|---|---|----------|
| locks | | | |
| 8034840 | Combination lock - brass | Base: 30 x 41 x 13 mm Diameter base <-> shackle: 28 mm Height product: 73 mm | 1 |
| 8037292 | Lock with 3 keys - brass | Base: 40 x 27 x 11 mm Diameter base <-> shackle: 23 mm Height product: 55 mm | 1 |
| 8006250 | Lock with 4 keys - wrapped iron | Base: 62 x 50 x 19 mm Diameter base <-> shackle: 23 mm Height product: 82 mm | 1 |
| TSA-locks | | | |
| 8046737 | TSA with 2 keys - brass | Base: 20 x 22 x 9 mm Diameter base <-> shackle: 13 mm Height product: 38 mm | 1 |
| 8046744 | TSA combination lock with cable - zink alloy | Base: 34 x 50 x 13 mm Diameter base - shackle: 40 / 36 mm Height product: 78 mm Cable length: 110 mm | 1 |
| 8046720 | TSA combination lock - plastic | Base: 34 x 41 x 14 mm Diameter base - shackle: 19 mm Height product: 66 mm | 1 |



combination lock
brass



lock with 3 keys
brass



lock with 4 keys
wrapped iron



TSA with 2 keys
brass



TSA combination lock with cable
zink alloy



TSA combination lock
plastic

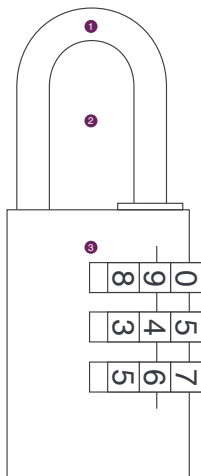

- 1 ø 5 mm steel shackle
- 2 26 mm space between base <-> shackle
- 3 combination lock

* size: 71 x 30 x 15 mm

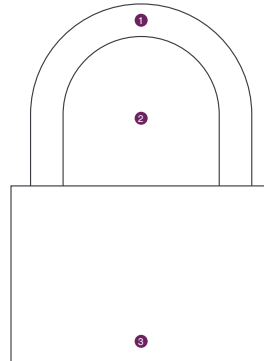

- 1 ø 5 mm steel shackle
- 2 23 mm space between base <-> shackle
- 3 key lock

* size: 55 x 40 x 11 mm

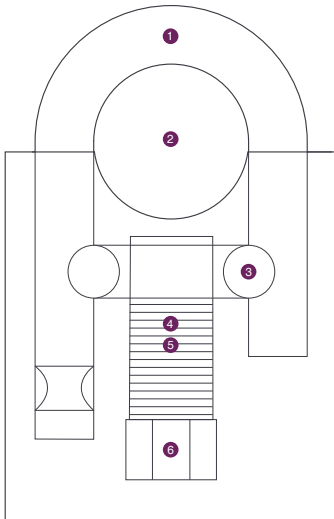

- 1 ø 10 mm chrome plated hardened steel shackle
- 2 ø 23 mm space between base <-> shackle
- 3 hardened double ball locking mechanism
- 4 disk lock mechanism
- 5 solid brass cylinder
- 6 movable chrome plated brass ring with hardened steel ring

* size: 82 x 50 x 19 mm

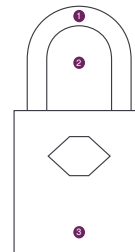

- 1 ø 3 mm steel shackle
- 2 13 mm space between base <-> shackle
- 3 key lock

* size: 38 x 20 x 9 mm

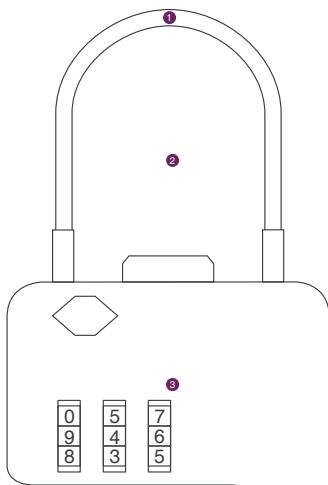

- 1 ø 2,5 mm flexible steel cable / shackle
- 2 36 mm space between base <-> shackle
- 3 combination lock

* size: 78 x 49,5 x 13 mm

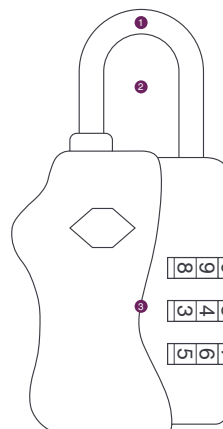





- 1 ø 4 mm chrome plated hardened steel shackle
- 2 19 mm space between base <-> shackle
- 3 combination lock

* size: 66 x 34 x 14 mm



strip & cross cut shredders

This overview gives you a quick insight into the possibilities for each device.

| | 8047086 cross cut 5 | 8003501 cross cut 6 | 8007790 cross cut 7 | 8053384 cross cut 12 | tbc strip cut | 8000784 strip cut 12 |
|---------------------|--|---|---------------------------|--|--|--|
| troath width | A4 220 mm | A4 220 mm | A4 220 mm | A4 220 mm | A4 220 mm | A4 220 mm |
| max. shred capacity | 5 sheets | 6 sheets | 7 sheets | 12 sheets | 6 sheets | 12 sheets |
| cut size | 4 x 33 mm | 4 x 33 mm | 4 x 39 mm | 5 x 38 mm | 6 mm | 7.9 mm |
| duty cycle | 2 min on 30 min off | 2 min on 40 min off | 2 min on 15 min off | 3 min on 30-40 min off | 2 min on 40 min off | 2 min on 40 min off |
| overheat protection | ✓ | ✓ | ✓ | ✓ | ✓ | ✓ |
| overload protection | n/a | n/a | n/a | n/a | n/a | ✓ |
| function | on / auto / off  | on / off  | on / auto / off / reverse | on / auto / off / reverse  | forward / off / reverse  | on / auto / off reverse  |
| basket volume | 15 L | 10 L | 17 L | 25 L | 10 L | 15 L |
| power consumption | 218.5 W | 253 W | 148 W | 300 W | 190 W | 253 W |
| decibel | 72 dB(A) | 72 dB(A) | 72 dB(A) | 68 dB(A) | 70 dB(A) | 72 dB(A) |



cross cut shredder 5

Shredder Easy to use, Plug & destroy. Absolute confidentiality.

- type: PE 15-5CC
- function on/auto/off
- throat width: 220 mm
- max shred capacity: 5 sheets A4
- cut size: 4 x 33 mm
- duty cycle: 2 min. on / 30 min. off
- overheat protection
- overload protection
- warranty: 2 years
- power consumption: 218.5 W
- decibel: 72 dB(A)
- machine size: 350 x 155 x 390 mm
- basket volume: 15 L
- unit weight: 3.54 kg



| CODE | COLOR |
|---------|----------------|
| 8047086 | silver / black |



cross cut shredder 6

Shredder Easy to use, Plug & destroy. Absolute confidentiality.

- type: PE 10-6CC
- throat width: 220 mm
- max shred capacity: 6 sheets A4
- cut size: 4 x 33 mm
- duty cycle: 2 min. on / 40 min. off
- overheat protection
- warranty: 2 years
- power consumption: 253 W
- decibel: 72 dB(A)
- machine size: 290 x 140 x 350 mm
- basket volume: 10 L
- unit weight: 3.25 kg



| CODE | COLOR |
|---------|-------|
| 8003501 | black |



cross cut shredder 7

Shredder Easy to use, Plug & destroy. Absolute confidentiality.

- type: PE 14-7CC
- function auto/off/reverse
- throat width: 220 mm
- max shred capacity: 7 sheets A4
- cut size: 4 x 39 mm
- duty cycle: 2 min. on / 15 min. off
- overheat protection
- overload protection
- warranty: 2 years
- power consumption: 148 W
- decibel: 74 dB(A)
- machine size: 360 x 180 x 308 mm
- basket volume: 14 L
- unit weight: 3.5 kg

| CODE | COLOR |
|---------|-------|
| 8007790 | black |



cross cut shredder 12

Shredder Easy to use, Plug & destroy. Absolute confidentiality.

- type: PE25-12CCCD
- function on/auto/off/reverse
- throat width: 220 mm
- max shred capacity: 12 sheets A4
- cut size: 5 x 38 mm
- duty cycle: 3 min on/30-40min off
- overheat protection
- warranty: 2 years
- power consumption: 300 W
- decibel: 68 dB(A)
- machine size: 361 x 375 x 420 mm
- basket volume: 25 L
- unit weight: 5.67 kg



| CODE | COLOR |
|---------|----------------|
| 8053384 | black / silver |



strip cut shredder

Shredder Easy to use, Plug & destroy. Absolute confidentiality.

- function forward/off/reverse
- throat width: 220 mm
- max shred capacity: 6 sheets A4
- cut size: 6 mm
- duty cycle: 2 min. on / 40 min. off
- overload protection
- overheat protection
- warranty: 2 years
- power consumption: 190 W
- decibel: 70 dB(A)
- machine size: 392 x 142 x 326 mm
- basket volume: 10 L
- unit weight: 1.5 kg



| CODE | COLOR |
|------|-------|
| tbc | black |



strip cut shredder 12

This stripcut shredder is compact and fast. It shreds 12 sheets in 1 minute. Easy to use; plug & destroy.

- function on/auto/off
- throat width: 220 mm
- max shred capacity: 12 sheets A4
- cut size: 7.9 mm
- duty cycle: 2 min. on / 40 min. off
- overload protection
- overheat protection
- warranty: 2 years
- power consumption: 253 W
- decibel: 72 dB(A)
- machine size: 165 x 330 x 400 mm
- basket volume: 15 L
- unit weight: 4.2 kg



| CODE | COLOR |
|---------|----------------|
| 8000784 | black / silver |





pavo

FACILITY



ladders



2-step household ladder

Easy for reaching higher cabinets or windows.

- material: steel
- steps: 2
- max loading: 150 kg
- space between rungs: 250 mm
- height top footplate: 470 mm
- folded size: 1130 x 160 x 465 mm
- overall size: 1075 x 470 x 465 mm
- unit weight: 4.7 kg

| CODE | COLOR |
|---------|---------------|
| 8041763 | black / white |



3-step household ladder 1.08 m

Stand alone ladder with storage tray on top.

- material: aluminum
- steps: 3
- max loading: 150 kg
- anti slip steps
- space between rungs: 200 mm
- height top footplate: 600 mm
- folded size: 1120 x 120 x 380 mm
- overall size: 1080 x 565 x 380 mm
- unit weight: 3.0 kg

| CODE | COLOR |
|---------|-----------------|
| 8037339 | aluminum / blue |



5-step household ladder 1.5 m

Stand alone ladder with storage tray on top.

- material: aluminum
- steps: 5
- max loading: 150 kg
- anti slip steps
- space between rungs: 210 mm
- height top footplate: 1000
- folded size: 1590 x 120 x 450 mm
- overall size: 1500 x 800 x 450 mm
- unit weight: 3.8 kg

| CODE | COLOR |
|---------|-----------------|
| 8037346 | aluminum / blue |



handtruck ladder combination

This ladder can be used as a handtruck and a ladder. The perfect all-in-one combination and easy to store.

- material: aluminum
- steps: 3
- max loading: 60 kg handtruck
150 kg ladder
- space between rungs: 200 mm
- height top footplate: 850 mm
- open trolley size: 360 x 450 x 1250 mm
- open ladder size: 360 x 820 x 1150 mm
- unit weight: 6.3 kg

| CODE | COLOR |
|---------|------------------|
| 8040902 | aluminum / black |

telescopic ladders



Telescopic ladders 8006298 & 8006304 are exclusively equipped with an automatic folding system and finger protection. Telescopic ladder 8006298 - 8006304 come with a foot for more stability.

<https://youtu.be/onZy92dOtnY>

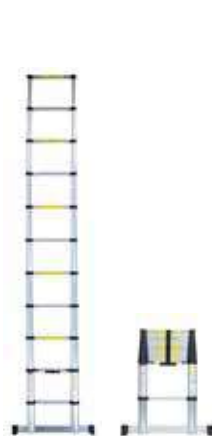

telescopic ladder 3.2 m

This telescope ladder is easy to store and light weight.

- material: aluminum
- steps: 10
- max loading: 150 kg
- space between rungs: 270 mm
- automatic folding system
- finger protection
- folded size: 840 x 800 x 90 mm
- overall size: 3200 x 800 x 90 mm
 - ↳ height top step: 3200 mm
- unit weight: 10.5 kg

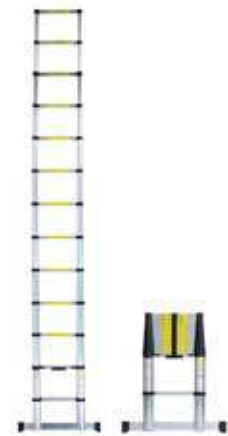

telescopic ladder 3.8 m

This telescope ladder is easy to store and light weight.

- material: aluminum
- steps: 12
- max loading: 150 kg
- space between rungs: 270 mm
- automatic folding system
- finger protection
- folded size: 900 x 800 x 100 mm
- overall size: 3800 x 800 x 100 mm
 - ↳ height top step: 3800 mm
- unit weight: 14.3 kg

| CODE | COLOR |
|---------|------------------|
| 8006298 | aluminum / black |

| CODE | COLOR |
|---------|------------------|
| 8006304 | aluminum / black |



foldable platform trolley

Trolleys are easy to use for the transport of goods.

- material: steel
- max loading: 150 kg
- folded size: 740 x 480 x 290 mm
- overall size: 740 x 480 x 830 mm
- unit weight: 7.2 kg

| CODE | COLOR |
|---------|--------------|
| 8037421 | beige / blue |



foldable platform trolley with brake

Trolleys are easy to use for the transport of goods.

- material: aluminum
- max loading: 137 kg
- folded size: 705 x 430 x 90 mm
- overall size: 705 x 430 x 950 mm
- unit weight: 5.5 kg

| CODE | COLOR |
|---------|------------------|
| 8055890 | black / aluminum |



hand trucks



heavy duty foldable hand truck - 250 kg

This heavy duty hand truck is easy to use and designed to cope with 250 kg. With inflatable wheels.

- material: steel
- max loading: 250 kg
- inflatable wheel
- folded size: 480 x 560 x 1120 mm
- overall size: 800 x 560 x 1120 mm
- unit weight: 14 kg

| CODE | COLOR |
|---------|-------|
| 8037469 | blue |



hand truck ladder combination - 60 / 150 kg

This ladder can be used as a hand truck and a ladder. The perfect all-in-one combination and easy to store.

- material: aluminum
- steps: 3
- max loading: 60 kg handtruck
150 kg ladder
- space between rungs: 200 mm
- height top footplate: 850 mm
- open trolley size: 360 x 450 x 1250 mm
- open ladder size: 360 x 820 x 1150 mm
- unit weight: 6.3 kg

| CODE | COLOR |
|---------|------------------|
| 8040902 | aluminum / black |



foldable hand truck - 70 kg

This heavy duty hand truck is easy to use and designed to cope with 70 kg.

- material: aluminum
- max loading: 70 kg
- TÜV / GS: ✓
- folded size: 57 x 392 x 635 mm
- overall size: 400 x 414 x 992 mm
- unit weight: 2.94 kg

| CODE | COLOR |
|---------|------------------|
| 8055876 | aluminum / black |



foldable hand truck - 120 kg

This heavy duty hand truck is easy to use and designed to cope with 120 kg. Including elastic strap.

- material: aluminum
- max loading: 120 kg
- TÜV / GS: ✓
- folded size: 490 x 55 x 900 mm
- overall size: 490 x 520 x 1190 mm
- unit weight: 5.7 kg

| CODE | COLOR |
|---------|------------------|
| 8001040 | aluminum / black |



foldable hand truck - 200 kg

This heavy duty hand truck is easy to use and designed to cope with 200 kg.

- material: aluminum
- max loading: 200 kg
- TÜV / GS: ✓
- folded size: 590 x 90 x 1075 mm
- overall size: 615 x 605 x 1310 mm
- unit weight: 13.1 kg

| CODE | COLOR |
|---------|------------------|
| 8005864 | aluminum / black |



step stools - metal

Step stools are ideal to use for reaching higher objects.
3 twin castors locks automatically when stepping up.

All Pavo step stools are TÜV certified.

| CODE | DESCRIPTION | QUANTITY |
|-------------------|---|----------|
| max weight 150 kg | | |
| 8041961 | Metal - H 420 mm x top ø 280 mm x base ø 440 mm - black | 1 |
| 8041978 | Metal - H 420 mm x top ø 280 mm x base ø 440 mm - blue | 1 |
| 8041985 | Metal - H 420 mm x top ø 280 mm x base ø 440 mm - red | 1 |
| 8041992 | Metal - H 420 mm x top ø 280 mm x base ø 440 mm - grey / beige | 1 |
| 8002825 | Metal - H 420 mm x top ø 280 mm x base ø 440 mm - anthracite | 1 |
| 8015115 | Metal - H 420 mm x top ø 280 mm x base ø 440 mm - vintage green | 1 |
| 8015122 | Metal - H 420 mm x top ø 280 mm x base ø 440 mm - flamingo pink | 1 |



step stools - plastic

Step stools are ideal to use for reaching higher objects.
3 twin castors locks automatically when stepping up.

All Pavo step stools are TÜV certified (except 8042968).

| CODE | DESCRIPTION | QUANTITY |
|-------------------|--|----------|
| max weight 150 kg | | |
| 8042005 | Plastic - H 420 mm x top ø 280 mm x base ø 440 mm - black | 1 |
| 8042012 | Plastic - H 420 mm x top ø 280 mm x base ø 440 mm - red | 1 |
| 8004560 | Plastic - H 420 mm x top ø 280 mm x base ø 440 mm - anthracite | 1 |
| 8042968 | Plastic - H 265 mm x top ø 280 mm x base ø 385 mm - black | 1 |





tool kit small

The Pavo tool kit contains the most reached tools used in household repairs and maintenance tasks.

- size: 290 x 53 x 208 mm
- material: plastic box
- including:
 - 1 combination plier 6"
 - 1 long nose plier 6"
 - 8 hex keys with holder
 - 1 utility knife
 - 1 adjustable wrench 6"
 - 4 precision screwdrivers
 - 1 bit holder
 - 1 claw hammer 8oz
 - 11 box with bits
 - 1 measure tape 3 m
- unit weight: 1.69 kg

| CODE | COLOR |
|---------|-------------|
| 8041039 | black / red |



tool kit large

The Pavo tool kit contains the most reached tools used in household repairs and maintenance tasks.

- size: 360 x 70 x 270 mm
- material: plastic box
- including:
 - 1 ratchet handle
 - 2 screwdriver - / +
 - 1 measure tape 3m
 - 1 utility knife
 - 4 precision screwdrivers
 - 1 mini saw
 - 1 electrical voltage tester: digital display
 - 10 bits and heads
 - 1 adjustable wrench 8"
 - 1 claw hammer 9oz
 - 9 sockets 1/4"
 - 60 assorted screws and plugs
 - 1 combination plier 6"
 - 1 long nose pliers 6"
 - 1 electrical tape 5m
 - 8 hex keys with holder
 - 1 tool case
- unit weight: 2.75 kg

| CODE | COLOR |
|---------|-------------|
| 8005635 | black / red |

cable fixings

High quality tie wraps and side cutter for general use.



| CODE | DESCRIPTION | QUANTITY |
|---------|--|----------|
| 8043712 | Sidecutter - for cutting off remains of tie wraps. | 1 |
| 8046485 | Tie wraps 2,5 x 100 mm | 100 |
| 8046447 | Tie wraps 3,5 x 180 mm | 100 |
| 8046461 | Tie wraps 4,5 x 180 mm | 100 |

packaging tape dispensers

Tapedispenser for fast and easy unwinding.
Uses up to 50mm core tapes.

| CODE | DESCRIPTION | QUANTITY |
|---------|--|----------|
| 8002092 | Packaging tape dispenser 50 mm x 66 m blue - with brake | 1 |



packaging tape

Pavo packaging tape is available in various sizes and colors.

For special requirements please feel free to contact us.

| CODE | DESCRIPTION | QUANTITY |
|---------|--|----------|
| 8000272 | Packaging tape - PP - 50mm x 66m - low noise brown | 6 |
| 8000319 | Packaging tape - PP - 50mm x 66m - low noise transparent | 6 |
| | Masking tape - 25mm x 50m | |
| | Double sided tape - 25mm x 33m | |
| | Duct tape - 50mm x 25m - silver | |
| | Packaging tape PP - 50mm x 66m - buff | |
| | Packaging tape PP - 50mm x 66m - buff low noise | |
| | Packaging tape PP - 38mm x 66m - buff | |
| | Packaging tape PP - 50mm x 66m - clear | |
| | Packaging tape PP - 50mm x 66m - clear low noise | |
| | Packaging tape PVC - 50mm x 66m - buff | |
| | Packaging tape PVC - 50mm x 100m - buff | |
| | Packaging tape PVC - 50mm x 66m - clear | |



pavo

TRAVEL







laptop bag 17"

Laptop bag with a front pocket and inside a large pocket and pen holder.

- material: PU
- size: 420 x 330 x 100 mm
- weight: 0.63 kg
- for 17" laptop
- including:
 - large inside pocket
 - front extra pocket
 - pen holder inside

| CODE | COLOR |
|---------|-------|
| 8047802 | black |



pilot case - 15"

Pilot case with an adjustable drawbar and 4 wheels with a rotation of 360°. Protected edges and corner protection and 2 zipped front pockets.

- material: PU
- max loading: 15 kg
- size: 410 x 390 x 230 mm
- overall height: 950 mm
- unit weight: 3.14 kg

| CODE | COLOR |
|---------|---------------|
| 8046409 | black / metal |



folding crate trolley - medium

- material: PP
- max loading: 20 kg
- folded size: 380 x 420 x 80 mm
- overall crate: 380 x 360 x 310 mm
- overall height: 880 mm
- unit weight: 2.3 kg

| CODE | COLOR |
|---------|---------------|
| 8053919 | black / metal |



folding crate trolley - large

- material: PP
- max loading: 35 kg
- folded size: 420 x 480 x 80 mm
- overall crate: 420 x 405 x 380 mm
- overall height: 1000 mm
- unit weight: 3.3 kg

| CODE | COLOR |
|---------|---------------|
| 8046126 | black / metal |



bottle bags

Do you know our bottle bags?

Bags made off 100% recycled PET Fabric and are certified according Global Recycled Standard (GRS).
Make a conscious choice and combine responsibility with fashion.

Mix, match and combine these high quality products, fashionable for office, school and streetwear with nice added details.

| CODE | DESCRIPTION | QUANTITY |
|-----------|--|----------|
| A4 | | |
| 8005048 | Office bag - grey - 440 x 260 x 110 mm | 1 |
| 8005062 | Laptop sleeve - grey - 390 x 285 x 15 mm | 1 |
| 8005079 | Laptop backpack - grey - 445 x 300 x 95 mm | 1 |

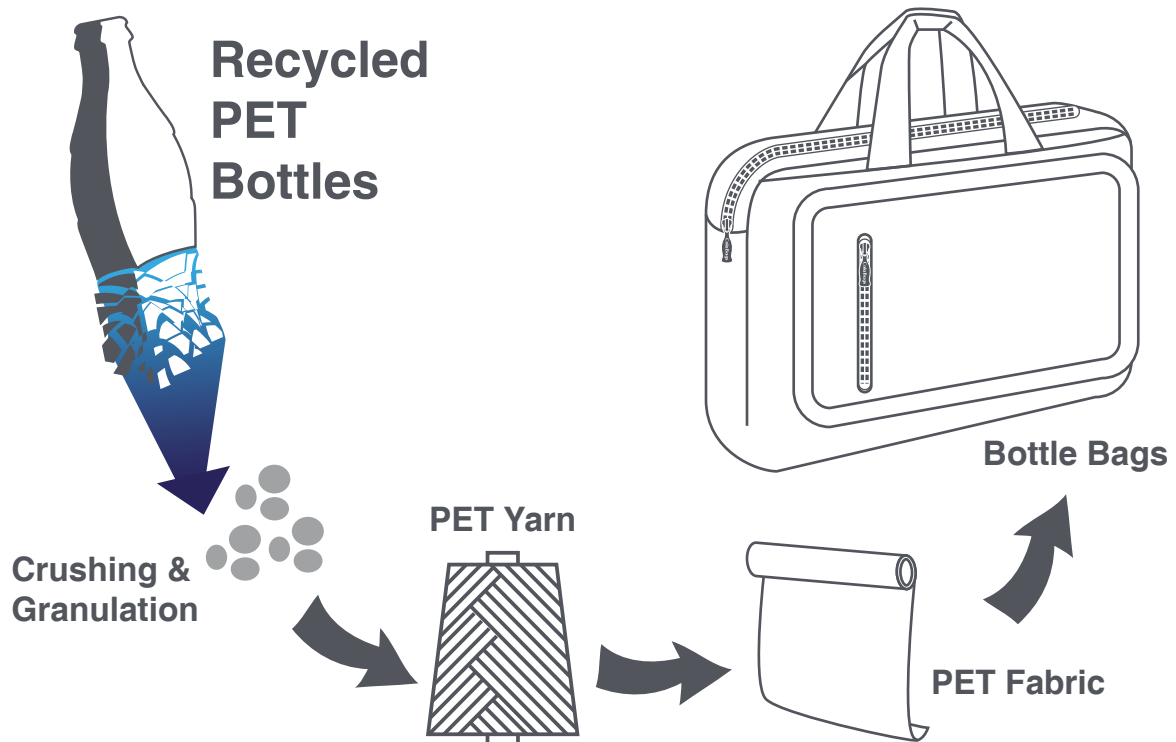

Global
Recycle
Standard

Drawing Textured yarn made with
recycled Polyester
100% post-consumer



conference folder with calculator

Conference folder leatherlook. Embossed with a Pavo logo.

- size: 320 x 245 x 20 mm
- material: PU leather
- weight: 0.6 kg
- including:
 - A4 writing pages
 - inside pocket
 - calculator
 - card holder
 - pen holder inside

| CODE | COLOR |
|---------|-------|
| 8046584 | black |



conference folder with calculator

Conference folder leatherlook.

- size: 345 x 255 x 25 mm
- material: PU leather
- weight: 0.7 kg
- including:
 - A4 writing pages
 - inside pockets: business card pockets, large pockets and large zippered pocket
 - calculator
 - card holder
 - pen holder inside
 - outside pocket

| CODE | COLOR |
|---------|-------|
| 8017621 | black |

foldover clipboard

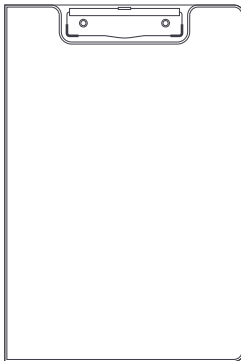

Pavo foldover clipboard made from tough, lightweight polypropylene with a strong metal clip holds sheets in place and a convenient pen holder.

| CODE | DESCRIPTION | QUANTITY |
|-----------|--|----------|
| A4 | | |
| 8013708 | Foldover PVC Clipboard A4 with inside pocket - blue | 1 |
| 8013715 | Foldover PVC Clipboard A4 with inside pocket - red | 1 |
| 8013722 | Foldover PVC Clipboard A4 with inside pocket - black | 1 |



padlocks

Lock your valuables safely with a padlock.

A padlock has a steel case that can be closed with a hardened steel shackle and key or combination lock.

TSA locks are required for travelling to the USA. Nobody has access to your belongings only the customs, using a master key. After inspection the lock can be closed and your belongings are locked and safe again.

| CODE | DESCRIPTION | | QUANTITY |
|------------------|---|---|----------|
| locks | | | |
| 8034840 | Combination lock - brass | Base: 30 x 41 x 13 mm Diameter base <-> shackle: 28 mm Height product: 73 mm | 1 |
| 8037292 | Lock with 3 keys - brass | Base: 40 x 27 x 11 mm Diameter base <-> shackle: 23 mm Height product: 55 mm | 1 |
| 8006250 | Lock with 4 keys - wrapped iron | Base: 62 x 50 x 19 mm Diameter base <-> shackle: 23 mm Height product: 82 mm | 1 |
| TSA-locks | | | |
| 8046737 | TSA with 2 keys - brass | Base: 20 x 22 x 9 mm Diameter base <-> shackle: 13 mm Height product: 38 mm | 1 |
| 8046744 | TSA combination lock with cable - zink alloy | Base: 34 x 50 x 13 mm Diameter base - shackle: 40 / 36 mm Height product: 78 mm Cable length: 110 mm | 1 |
| 8046720 | TSA combination lock - plastic | Base: 34 x 41 x 14 mm Diameter base - shackle: 19 mm Height product: 66 mm | 1 |



combination lock
brass



lock with 3 keys
brass



lock with 4 keys
wrapped iron



TSA with 2 keys
brass



TSA combination lock with cable
zink alloy



TSA combination lock
plastic

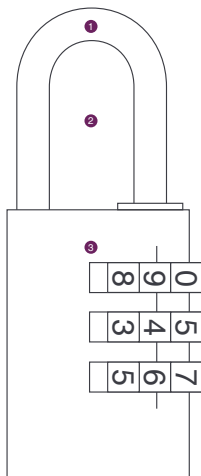

- 1 ø 5 mm steel shackle
- 2 26 mm space between base <-> shackle
- 3 combination lock

* size: 71 x 30 x 15 mm

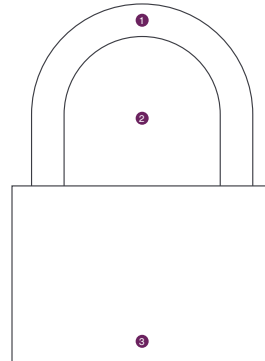

- 1 ø 5 mm steel shackle
- 2 23 mm space between base <-> shackle
- 3 key lock

* size: 55 x 40 x 11 mm

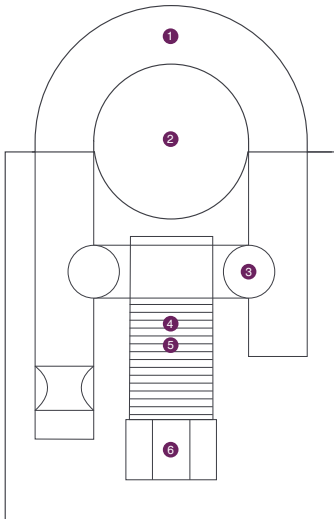

- 1 ø 10 mm chrome plated hardened steel shackle
- 2 ø 23 mm space between base <-> shackle
- 3 hardened double ball locking mechanism
- 4 disk lock mechanism
- 5 solid brass cylinder
- 6 movable chrome plated brass ring with hardened steel ring

* size: 82 x 50 x 19 mm

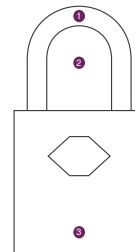

- 1 ø 3 mm steel shackle
- 2 13 mm space between base <-> shackle
- 3 key lock

* size: 38 x 20 x 9 mm

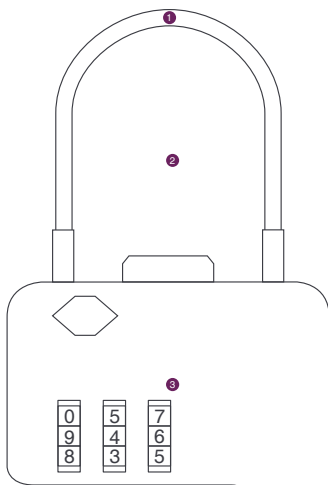

- 1 ø 2,5 mm flexible steel cable / shackle
- 2 36 mm space between base <-> shackle
- 3 combination lock

* size: 78 x 49,5 x 13 mm

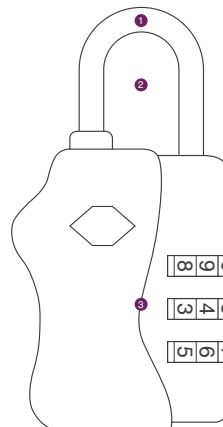

- 1 ø 4 mm chrome plated hardened steel shackle
- 2 19 mm space between base <-> shackle
- 3 combination lock

* size: 66 x 34 x 14 mm



pavo

AT YOUR DESK





pavo



correction fluid

white fluid • korrekturneuschweiß • corrector • corrector • corrector liquido • blanc

desk sets & accessories



folding desk mat

Folding desk mat in leather look. Embossed with a Pavo logo.

- size: 500 x 350 mm
- material: PU leather

| CODE | COLOR |
|---------|-------|
| 8046607 | black |



rotary desktop including all components on image

Holds your pens, rulers, mobile phone, etc. And keeps your things in place.

- size: Ø 161 x 84 mm
- material: plastic
- including:
 - scissors
 - stapler
 - staples
 - box cutter
 - ruler
 - pen
 - pencil
 - paper clips
 - eraser

| CODE | COLOR |
|---------|-------------|
| 8000173 | white/black |



rotary desktop including all components on image

Holds your pens, rulers, mobile phone, etc. And keeps your things in place.

- size: Ø 161 x 84 mm
- material: plastic
- including:
 - scissors
 - stapler
 - staples
 - box cutter
 - ruler
 - pen
 - pencil
 - paper clips
 - eraser

| CODE | COLOR |
|---------|------------|
| 8016716 | blue/black |



rotary desktop including all components on image

Holds your pens, rulers, mobile phone, etc. And keeps your things in place.

- size: Ø 150 x 110 mm
- material: plastic
- including:
 - scissors
 - stapler
 - staples
 - box cutter
 - ruler
 - pen
 - pencil
 - paper clips
 - eraser

| CODE | COLOR |
|---------|-------|
| 8046645 | black |



rolling paperclip dispenser

Rolling paperclip dispenser including paperclips.

- size: 90 x 85 x 45 mm
- material: plastic
- including:
 - 20 paperclips

| CODE | COLOR |
|---------|-------|
| 8046621 | black |



multifunctional desktop organizer

Holds your pens, rulers, mobile phone, etc. And keeps your things in place.

- size: 301 x 160 x 90 mm
- material: plastic
- including:
 - scissors
 - stapler
 - staples
 - box cutter
 - ruler
 - pen
 - pencil
 - paper clips
 - eraser
- extra feature: slidable middle section to personalize the tray sizes

| CODE | COLOR |
|---------|-------------|
| 8000197 | white/black |



trendy office set

Trendy office set, pen - tape - paper clips not included

- size: various (giftbox: 296 x 198 x 98 mm)
- material: plastic
- including:
 - paper clip dispenser
 - tape dispenser
 - pen holder
 - puncher
 - stapler
 - memo holder

| CODE | COLOR |
|---------|-------------|
| 8041121 | white/black |



desk tidy including all components on image

Holds your pens, rulers, mobile phone, etc. And keeps your desk tidy.

- size: 143 x 135 x 136 mm
- material: plastic
- including:
 - scissors
 - stapler
 - staples
 - box cutter
 - ruler
 - pen
 - pencil
 - paper clips
 - eraser

| CODE | COLOR |
|---------|-------|
| 8042944 | blue |



desk set 4 components

Desk set in leather look.

- size: 700 x 450 mm
- material: PU leather
- including:
 - desk mat
 - pen holder
 - phone holder
 - paper dispenser

| CODE | COLOR |
|---------|-------|
| 8047864 | brown |
| 8047871 | black |



desk set 3 components

Desk set in leather look.

- size: 700 x 450 mm
- material: PU leather
- including:
 - desk mat
 - pen holder
 - note holder

| CODE | COLOR |
|---------|-------|
| 8003013 | brown |
| 8002535 | black |



desk mat double side flaps

Desk mat in leather look.

- size: 700 x 450 mm
- material: PU leather

| CODE | COLOR |
|---------|-------|
| 8002986 | brown |
| 8002511 | black |



pencil case

Leather pencil case in leather look.

- size: 290 x 200 x 63 mm
- material: PU leather

| CODE | COLOR |
|---------|-------|
| 8002948 | brown |
| 8002474 | black |



pencil case - large

Leather pencil case in leather look.

- size: 295 x 155 x 155 mm
- material: PU leather

| CODE | COLOR |
|---------|-------|
| 8002962 | brown |
| 8002498 | black |



photo frame 10 x 15 cm

This photo frame in leather look is perfect to display your favourite picture in portrait or landscape.

- size: 205 x 158 mm
- material: PU leather

| CODE | COLOR |
|---------|-------|
| 8002801 | brown |
| 8002788 | black |

| CODE | DESCRIPTION | QUANTITY |
|---------|------------------------|----------|
| 8055517 | Plastic compass - blue | 500 |



scissors

High quality scissors for general office use.

| CODE | DESCRIPTION | QUANTITY |
|---------|---|----------|
| 8014187 | Scissors 8 1/4" Steel blade - recycled handle | 1 |
| 8014200 | Scissors 8 1/4" Steel blade - soft grip | 1 |
| 8007738 | Scissors 7" Full metal | 1 |
| 8007851 | Scissors 8 1/2" Full metal | 1 |





staplers & pliers

Make your choice in several variations of our staplers & pliers. We have a matching range in combination with our punchers.

| CODE | DESCRIPTION | QUANTITY |
|---------|--|----------|
| 8018055 | Plastic mini stapler - no. 10 - 10 sheets - yellow | 1 |
| 8053230 | Plastic stapler - 24/6 - 26/6 - 25 sheets - black - full strip | 1 |
| 8053209 | Plastic stapler - 24/6 - 26/6 - 25 sheets - black - half strip | 1 |
| 8053292 | Metal stapler - 24/6 - 26/6 - 25 sheets - black - full strip | 1 |
| 8053261 | Metal stapler - 24/6 - 26/6 - 25 sheets - black - half strip | 1 |
| 8055197 | Plastic stapler - 24/6 - 26/6 - 20 sheets - black - full strip | 1 |
| 8055166 | Plastic stapler - 24/6 - 26/6 - 20 sheets - black - half strip | 1 |
| 8055302 | HD stapler - 23/6 - 23/24 - 200 sheets - black | |
| 8040384 | Metal longarm stapler - 24/6 - 26/6 - 16 sheets - black | 1 |
| 8018062 | HD metal plier - 24/6 - 26/6 - 40 sheets - silver | 1 |
| 8005390 | Metal plier - 24/6 - 26/6 - 16 sheets - black | 1 |
| 8039128 | Metal plier - no. 10 - 16 sheets - black | 1 |
| 8052257 | Metal plier - 8/4 - 16 sheets - white | 1 |
| 8004478 | Metal plier - 21/4 - 12 sheets - blue | 1 |



8018055



8053230



8053261



8055197



8055302



8040384



8018062



8039128



8052257



8004478



staples

Staples in different sizes, suitable for common staplers.

| CODE | DESCRIPTION | QUANTITY |
|---------|----------------------------|----------|
| 8043095 | Staples 8/4 | 1000 |
| 8055067 | Staples 8/4 | 5000 |
| 8043057 | Staples no. 10 | 1000 |
| 8043071 | Staples no. 10 | 5000 |
| 8043118 | Staples 19 1/4 | 5000 |
| 8017720 | Staples 548E - 21/4 - 48/4 | 1000 |
| 8017737 | Staples 548E - 21/4 - 48/4 | 5000 |
| 8017775 | Staples 23/6 | 1000 |
| 8036615 | Staples 23/8 | 1000 |
| 8017782 | Staples 23/10 | 1000 |
| 8017799 | Staples 23/12 | 1000 |
| 8017805 | Staples 23/15 | 1000 |
| 8017812 | Staples 23/17 | 1000 |
| 8017829 | Staples 23/19 | 1000 |
| 8017836 | Staples 23/24 | 1000 |
| 8042975 | Staples 24/6 | 1000 |
| 8042999 | Staples 24/6 | 5000 |
| 8017744 | Staples 24/8 | 1000 |
| 8043019 | Staples 26/6 | 1000 |
| 8043033 | Staples 26/6 | 5000 |
| 8017751 | Staples 26/8 | 5000 |

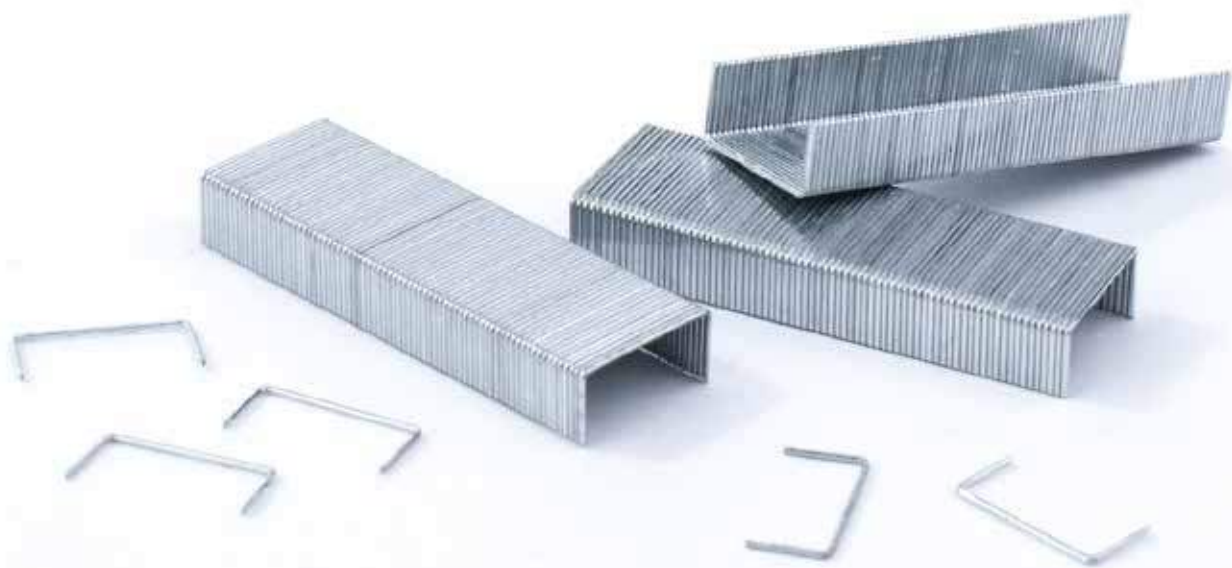

staple removers

Remove your staples easily with our staple removers.

| CODE | DESCRIPTION | QUANTITY |
|---------|------------------------------|----------|
| 8018192 | Staple remover | 1 |
| 8018208 | Staple remover - metal plier | 1 |



punchers

| CODE | DESCRIPTION | QUANTITY |
|---------|---|----------|
| 8053117 | 2 hole puncher - ensign - 10 sheets - black - with lock | 1 |
| 8053148 | 2 hole puncher - ensign - 20 sheets - black - with lock | 1 |
| 8055340 | 2 hole puncher - ensign - 30 sheets - black - with lock | 1 |
| 8053179 | 2 hole puncher - ensign - 40 sheets - black - with lock | 1 |



8053117 - ensign 10 sheets



80531418 - ensign 20 sheets



8055340 - ensign 30 sheets



8053179 - ensign 40 sheets

punchers

| CODE | DESCRIPTION | QUANTITY |
|---------|---|----------|
| 8017645 | ABS 2 hole puncher - endure - 20 sheets - black - with lock | 1 |
| 8017652 | ABS + metal 2 hole puncher - endure - 30 sheets - black - with lock | 1 |
| 8017669 | ABS + metal 2 hole puncher - endure - 40 sheets - black - with lock | 1 |
| 8017676 | ABS + metal 2 hole puncher - endure - 60 sheets - black - with lock | 1 |
| 8040285 | metal 4 hole puncher - endure - 22 sheets - black - with lock | 1 |



8017645 - endure 20 sheets



8017652 - endure 30 sheets



8017669 - endure 40 sheets



8017676 - endure 60 sheets



8040285 - endure 22 sheets

punchers

| CODE | DESCRIPTION | QUANTITY |
|---------|---|----------|
| 8018222 | 1 hole puncher - economic - 20 sheets - black - with lock | 1 |
| 8006786 | 2 hole puncher - economic - 10 sheets - black | 1 |
| 8006809 | 2 hole puncher - economic - 20 sheets - black | 1 |
| 8006823 | 2 hole puncher - economic - 35 sheets - black | 1 |
| 8036554 | 4 hole puncher - economic - 20 sheets - black - with lock | 1 |



8018222 - economic 20 sheets



8006786 - economic 10 sheets



8006809 - economic 20 sheets



8006823 - economic 35 sheets



8036544 - economic 20 sheets

tape dispensers

High quality tape dispensers for general office use.

| CODE | DESCRIPTION | QUANTITY |
|---------|--|----------|
| 8016730 | auto tape dispenser - 12-19 mm x 33 m - grey / white | 1 |
| 8048342 | heavy duty tape dispenser - 25 mm x 66 m - blue | 1 |
| 8048366 | heavy duty tape dispenser - 25 mm x 66 m - black | 1 |

| CODE | DESCRIPTION | QUANTITY PER BLISTER |
|---------|--|----------------------|
| 8000937 | Tape dispenser small: 2 tape rolls included - 12 mm x 10 m - black | 1 |
| 8056750 | Tape dispenser: 1 tape roll included - 19 mm x 33 m - transparent red | 1 |



High quality tape for general office use:

- easy tear
- available in blister packaging
- multipack and more sizes possible

| CODE | DESCRIPTION | QUANTITY |
|---------|--|----------|
| 8009947 | 12 mm x 33 m Clear tape - easy tear - 25 mm core | 12 |
| 8010004 | 12 mm x 66 m Clear tape - easy tear - 76 mm core | 6 |
| 8007103 | 12 mm x 66 m Clear tape - easy tear | 8 |
| 8009961 | 18 mm x 33 m Clear tape - easy tear - 25 mm core | 8 |
| 8010028 | 18 mm x 66 m Clear tape - easy tear - 76 mm core | 6 |
| 8007141 | 19 mm x 33 m Clear tape - easy tear | 8 |
| 8007004 | 19 mm x 66 m Clear tape - easy tear | 8 |
| 8009985 | 24 mm x 33 m Clear tape - easy tear - 25 mm core | 6 |
| 8010042 | 24 mm x 66 m Clear tape - easy tear - 76 mm core | 6 |
| 8007127 | 25 mm x 66 m Clear tape - easy tear | 6 |
| 8010066 | 25 mm x 33 m Double sided tissue tape - 76 mm core | 6 |
| 8006984 | 19 mm x 33 m Invisible tape - easy tear | 8 |

| CODE | DESCRIPTION | QUANTITY PER BLISTER |
|---------|--|----------------------|
| 8057788 | 19 mm x 20 m Transparent tape - 45 mic - easy tear | 1 |
| 8057801 | 19 mm x 7,5 m Invisible tape - 50 mic - easy tear | 1 |
| 8057818 | 19 mm x 33 m Invisible tape - 50 mic - easy tear | 1 |
| 8057825 | 19 mm x 33 m Clear tape - 50 mic - easy tear | 1 |



glue



Pavo glue goes on smooth and bonds fast. Works on a variety of surfaces.

- non toxic
- washable

| CODE | DESCRIPTION | QUANTITY |
|---------|-------------------|----------|
| 8000487 | Glue stick - 10 g | 1 |
| 8000494 | Glue stick - 21 g | 1 |
| 8000500 | Glue stick - 40 g | 1 |

| CODE | DESCRIPTION | QUANTITY PER BLISTER |
|---------|-----------------------------------|----------------------|
| 8000968 | Glue stick - 8 g | 5 |
| 8000999 | Glue stick - 21 g | 2 |
| 8002269 | Liquid glue - 30 ml - transparent | 1 |
| 8002283 | Liquid glue - 30 ml - white | 1 |

stamp pad

Pavo stamp pads are optimally adjusted for perfect imprints. The stamp pads are for general use and are re-inkable.

For more stamp pad colors and offers please feel free to contact us.



| CODE | DESCRIPTION | QUANTITY |
|---------|---|----------|
| 8019199 | Stamp pad - plastic - 70 x 110 mm - black | 1 |

correction tape

Use the Pavo correction fluid or roller for clean and precise correction on each type of paper.

- total white coverage
- non refillable
- suitable for all types of ink
- easy to write on

| CODE | DESCRIPTION | QUANTITY |
|---------|--|----------|
| 8000890 | Correction fluid bottle - 20 ml | 1 |
| 8017966 | Sideway correction roller - 4,2 mm x 8,5 m | 1 |
| 8017942 | Midway correction roller - 4,2 mm x 8,5 m | 1 |



rubber bands

Rubber bands:
 - color blond
 - contains 70% rubber
 - all sizes and colors possible
 - width from 1 mm - 10 mm
 - length from 40 - 200 mm

Also possible in red and assorted.



| CODE | DESCRIPTION | QUANTITY |
|---------|-------------------------------------|----------|
| 8018963 | Rubber bands - ø 100 x 1,2 mm - box | 100 g |
| 8018864 | Rubber bands - ø 150 x 1,2 mm - bag | 500 g |
| 8052943 | Rubber bands - ø 60 x 1,5 mm - bag | 1000 g |
| 8018871 | Rubber bands - ø 90 x 1,5 mm - bag | 500 g |
| 8013272 | Rubber bands - ø 40 x 1,8 mm - box | 100 g |
| 8013012 | Rubber bands - ø 40 x 1,8 mm - bag | 1000 g |
| 8013296 | Rubber bands - ø 60 x 1,8 mm - box | 100 g |
| 8013036 | Rubber bands - ø 60 x 1,8 mm - bag | 1000 g |
| 8013319 | Rubber bands - ø 80 x 1,8 mm - box | 100 g |
| 8013050 | Rubber bands - ø 80 x 1,8 mm - bag | 1000 g |
| 8013333 | Rubber bands - ø 100 x 1,8 mm - box | 100 g |
| 8013074 | Rubber bands - ø 100 x 1,8 mm - bag | 1000 g |
| 8013357 | Rubber bands - ø 120 x 1,8 mm - box | 100 g |
| 8013098 | Rubber bands - ø 120 x 1,8 mm - bag | 1000 g |
| 8013371 | Rubber bands - ø 150 x 1,8 mm - box | 100 g |
| 8013111 | Rubber bands - ø 150 x 1,8 mm - bag | 1000 g |
| 8013395 | Rubber bands - ø 180 x 1,8 mm - box | 100 g |
| 8013135 | Rubber bands - ø 180 x 1,8 mm - bag | 1000 g |
| 8013418 | Rubber bands - ø 200 x 1,8 mm - box | 100 g |
| 8013159 | Rubber bands - ø 200 x 1,8 mm - bag | 1000 g |
| 8018895 | Rubber bands - ø 180 x 2 mm - bag | 500 g |
| 8013173 | Rubber bands - ø 70 x 5 mm - box | 100 g |
| 8012879 | Rubber bands - ø 70 x 5 mm - bag | 1000 g |
| 8018888 | Rubber bands - ø 100 x 5 mm - bag | 500 g |
| 8013197 | Rubber bands - ø 90 x 6 mm - box | 100 g |
| 8012893 | Rubber bands - ø 90 x 6 mm - bag | 1000 g |
| 8012916 | Rubber bands - ø 110 x 8 mm - bag | 1000 g |
| 8018857 | Rubber bands - ø 125 x 8 mm - bag | 500 g |
| 8013210 | Rubber bands - ø 20 x 10 mm - box | 100 g |
| 8012930 | Rubber bands - ø 121 x 10 mm - bag | 1000 g |
| 8013234 | Rubber bands - ø 150 x 10 mm - box | 100 g |
| 8012954 | Rubber bands - ø 150 x 10 mm - bag | 1000 g |
| 8012978 | Rubber bands - ø 180 x 10 mm - bag | 1000 g |
| 8013258 | Rubber bands - ø 200 x 10 mm - box | 100 g |
| 8012992 | Rubber bands - ø 200 x 10 mm - bag | 1000 g |



High quality clips for general use.

| CODE | DESCRIPTION | QUANTITY |
|---------|-------------------------------------|----------|
| 8042067 | Foldback clips - 19 mm - black | 12 |
| 8042081 | Foldback clips - 25 mm - black | 12 |
| 8042104 | Foldback clips - 32 mm - black | 12 |
| 8042128 | Foldback clips - 41 mm - black | 12 |
| 8042142 | Foldback clips - 51 mm - black | 12 |
| 8042562 | Paperclips - 32 mm - pointed - zinc | 1000 |
| 8042760 | Paperclips - 77 mm - wavy - zinc | 100 |
| 8042906 | Push pins - assorted colors | 100 |



foldback clips - black

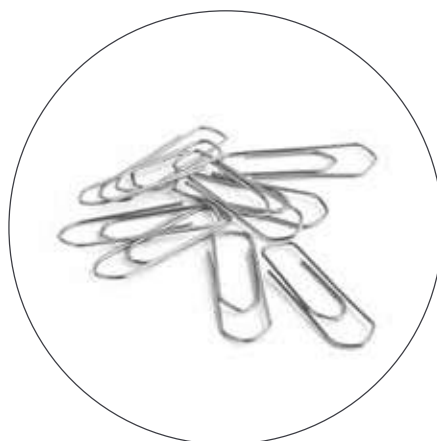

paper clips - pointed / zinc



push pins - assorted



pavo

OFFICE
INTERIORS





desk lamps



desk lamp flexible - halogen bulb included

Easy to use - plug & light

- material: metal / plastic
- cable length: 1.6 m
- energy label: C
- 1000 hours
- 2700 k
- 35 W ≈ 235 lumen
- light source: halogen: JC-GY6.35
- warranty: 1 year
- power consumption: 35-50 W / 220-240 V / AC 50-60 Hz
- base: 130 mm
- height: 500 mm
- unit weight: 1.75 kg



desk lamp - fluorescent bulb & clamp included

Easy to use - plug & light

- material: metal / aluminum
- cable length: 1.6 m
- energy label: A
- 6000 hours
- 6400 k
- 11 W ≈ 660 lumen
- light source: fluorescent: PL / 2G7 -11 W
- warranty: 1 year
- power consumption: 11 W / 220-240 V / AC 50-60 Hz
- base: 200 mm
- arms: 2 x 280 mm
- head: 310 mm
- unit weight: 2.0 kg

| CODE | COLOR |
|---------|-------|
| 8055715 | black |

| CODE | COLOR |
|---------|--------|
| 8055753 | silver |



desk lamp LED - with flexible arm

With this desk lamp you can light your desk and notebook by using the touch-dim function with 3 modes. Flexible in use with a rechargeable built-in battery.

- material: plastic
- cable length: 0.6 m
- energy label: A
- 20.000 hours
- 7000/8000 k
- 2 W ≈ 150 lumen
- battery capacity: 400mAh
- light source: LED: 5630 12 patch LED
- warranty: 1 year
- power consumption: 110-240 V / 50-60 Hz / 2 W / 0.1A
- base: 130 x 95 mm
- height: 435 mm
- unit weight: 0.19 kg

| CODE | COLOR |
|---------|-------|
| 8009398 | white |



desk lamp LED - with Qi charges

With this desk lamp you can light your desk by using dim function with various modes. On the base of the lamp you can charge your electronic devices wireless.

- material: plastic
- cable length: 1.8 m
- energy label: A - A++
- 30.000 hours
- 3000k/6000k/4500k
- 10 W ≈ 450 lumen
- working temperature: <50°
- light source: LED
- warranty: 1 year
- power consumption: 100-240 V / 50-60 Hz / 0.6A
- base: 185 x 125 x 13 mm
- height: 415 mm
- unit weight: 0.845 kg

| CODE | COLOR |
|---------|-------|
| 8000470 | black |



globe ø 20 cm with light bulb included

Detailed French topographical layout with all the countries and major cities.

- language: FRENCH (on request other languages available)
- material: plastic
- cable length: 1.75 m
- 15 W = C7
- light source: E14
- warranty: 1 year
- power consumption: 220-230 V - 0.68 A - 15 W
- base: ø 16 cm
- size: 290 x ø 20 x 21.5 cm
- unit weight: 0.42 kg



globe ø 20 cm

Detailed French topographical layout with all the countries and major cities.

- language: FRENCH (on request other languages available)
- material: plastic
- warranty: 1 year
- base: ø 16 cm
- size: 290 x ø 20 x 21.5 cm
- unit weight: 0.32 kg

| CODE | COLOR |
|---------|-------|
| 8016570 | black |

| CODE | COLOR |
|---------|-------|
| 8016556 | black |



16" plastic floor fan

Easy to use - plug & cool

- speed settings: 3
- adjustable height: 100 - 130 cm
- cross base: 60 cm
- blades: 3
- oscillation function
- safety mesh grill
- cable lenght: 1.8 m
- warranty: 2 years
- power consumption: 220-240 V - 44 W - 50 Hz
- size: 50 x 130 x 50 cm

| CODE | COLOR |
|---------|-------|
| 8053926 | white |

while stocks last



keyboard wrist support

Helps avoid injuries that can lead to repetitive stress disorder. Promotes upper hand and wrist movement. Memory foam cushioning for flexible support.

- material: memory foam
- anti-slip on the underside
- compatible with all keyboard types
- size: 460 x 20 x 85 mm
- unit weight: 0.18 kg

| CODE | COLOR |
|---------|-------|
| 8007172 | black |



mouse pad with wrist support

Helps avoid injuries that can lead to repetitive stress disorder. Promotes upper hand and wrist movement. Memory foam cushioning for flexible support.

- material: memory foam
- anti-slip on the underside
- compatible with all mouse types
- size: 252 x 20 x 230 mm
- unit weight: 0.16 kg

| CODE | COLOR |
|---------|--|
| 8007165 | gun metal while stocks last |



footrest

To increase the position of your legs feet. Increases the position of the legs for better blood circulation and less pressure on the upper legs. Adjustable heights and angles.

- material: plastic
- size: 343 x 95 x 465 mm
- unit weight: 1.56 kg

| CODE | COLOR |
|---------|-------|
| 8057726 | black |

pavo

**FILING &
STORAGE**



bio-degradable pp products



Every year Millions Tons of plastic is wasted all over the world, 80% of this is sent to landfill where it can remain for decades.

Pavo is introducing a complete line of biodegradable PP filing and storage products. These products can biodegrade in two or three years wherever oxygene is present. So if the products are disposed of they will biodegrade fully until there is nothing more than CO2, water and humus and no solid plastic waste will be left behind. The products can biodegrade because of a special formulation which is used in the production process. One special additive is used in this process.

This additive permits the living micro-organisms, such as bacteria and fungi, access to the carbon and hydrogen. This process is called OXO-degradation. It is therefore biodegradable. This OXO-biodegradable PP can also be recycled.

206 kilogram carbon footprint is reduced for every 1 kilogram additive into the PP production process.

| CODE | DESCRIPTION | QUANTITY |
|---------|---|----------|
| 8004799 | A4 punched pockets - 11 holes - 50 micron | 50 |
| 8004850 | A4 expanding file - 13 pocket (160 micron) - 700 micron | 1 |
| 8004911 | A4 2 button envelope - 450 micron | 1 |
| 8004638 | A4 2 flap report folder with metal clip | 1 |
| 8004683 | A4 ring binder - 2 rings - 900 micron | 1 |
| 8004676 | A4 ring binder - 4 rings - 900 micron | 1 |
| 8004645 | A4 cut flush folder - L folder - 130 micron | 50 |
| 8004713 | A3 document wallet with bungee - 600 micron | 1 |
| 8004706 | A4 document wallet with bungee - 600 micron | 1 |
| 8004928 | A4 expandable display book - 20 pockets - 700 micron | 1 |
| 8004669 | A4 lever arch file folder - 1100 micron | 1 |



punched pockets



expanding file
13 pockets



2 button envelope



2 flap report folder



ring binder
2 rings



ring binder
4 rings



cut flush folder



document wallet



expandable display
book - 20 pockets



lever arch file folder

presentation ring binders

16mm
capacity

30mm
SPINE

25mm
capacity

40mm
SPINE

38mm
capacity

55mm
SPINE

The Pavo presentation ring binders with 4D mechanism are ideal for storing documentation. Designed with outer and inner pockets for storing additional information.

- outer pockets on front, spine and back
- inner pockets on the left and right
- writable card for the spine

| CODE | DESCRIPTION | QUANTITY |
|-----------|--|----------|
| A4 | | |
| 8003976 | Presentation ring binder 4 D-ring - PP - 16 mm | 1 |
| 8003990 | Presentation ring binder 4 D-ring - PP - 25 mm | 1 |
| 8004010 | Presentation ring binder 4 D-ring - PP - 38 mm | 1 |



ring binders



The Pavo ring binders with 2 O mechanism are ideal for storing documentation.

- writable card for the spine

| CODE | DESCRIPTION | QUANTITY |
|-----------|--|----------|
| A4 | | |
| 8000913 | Ring binder 2 O-ring - blue - PP - 25 mm | 12 |
| 8000920 | Ring binder 2 O-ring - clear - PP - 25 mm | 12 |
| 8000975 | Ring binder 2 O-ring - assorted - PP - 25 mm | 12 |



presentation & storage products

The Pavo presentation & storage products will help to protect your documents.

| CODE | DESCRIPTION | QUANTITY |
|---------------------------|--|----------|
| A4 display book | | |
| 8012626 | Display Book PP - 40 pockets 40mic - black | 12 |
| 8012633 | Display Book PP - 40 pockets 40mic - blue | 12 |
| 8012640 | Display Book PP - 40 pockets 40mic - red | 12 |
| A4 document wallet | | |
| 8012312 | Document wallet with PP 11 reinforced holes 200 micro - clear | 5 |
| A5 | | |
| 8013760 | Document Box PP - 30mm - blue | 10 |
| 8013777 | Document Box PP - 30mm - transparent | 10 |



punched pockets

Punched pockets are embossed to reduce glare or they have a smooth glossy finish for better document clarity. They protect the content against moist, dirt and creases.

| CODE | DESCRIPTION | QUANTITY |
|-----------|---|----------|
| A3 | | |
| 8018987 | Portrait - Punched pockets 80 mic - 11 holes <ul style="list-style-type: none"> • orange peel finish • opening: top • material: PP • reinforced holes | 10 |
| 8000562 | Landscape - Punched pockets 80 mic - 11 holes <ul style="list-style-type: none"> • orange peel finish • opening: top • material: PP • reinforced holes | 10 |
| A4 | | |
| 8003150 | Portrait - Punched pockets 50 mic - 11 holes <ul style="list-style-type: none"> • glossy finish • opening: top • material: PP • reinforced holes | 100 |
| 8018956 | Portrait - Punched pockets 80 mic - 11 holes <ul style="list-style-type: none"> • glossy finish • opening: top • material: PP • reinforced holes | 100 |
| 8003174 | Portrait - Punched pockets 80 mic - 11 holes <ul style="list-style-type: none"> • orange peel finish • opening: top • material: PP • reinforced holes | 100 |
| A5 | | |
| 8018994 | Portrait - Punched pockets 80 mic - 7 holes <ul style="list-style-type: none"> • orange peel finish • opening: top • material: PP • reinforced holes | 100 |

