

# AUDIO

AUGUST, 1962

50¢

*...the original magazine about high fidelity!*

# ANNUAL

# PRODUCT

*Previewed*

# ISSUE 1962

#### LK-72 80 WATT AMPLIFIER

"... no effort has been spared to make the building job simple, a lot of fun, and yet have the builder end up with a unit that looks and works like factory-built equipment... Whizzed through the complete construction in only about 11½ hours. A conservatively designed, versatile, integrated stereo amplifier that should be a pleasure to build and a pleasure to use."

*Electronics World*

#### LT-110 FM MULTIPLEX TUNER

"... a fine stereo tuner and an unusually easy kit to build..."

*Audio, April, 1962*

"... If you have hesitated to go into stereo FM because of imagined complexities... fear no more. The LT-110 shows you how to enjoy stereo FM the easy way..."

*Electronics Illustrated, July, 1962*

"... The drift was the least I have ever measured on an FM tuner. Less than 2 or 3 kilocycles from a cold start..."

*Hi-Fi/Stereo Review, June, 1962*

#### LK-150 POWER AMPLIFIER

"... Checking my notebook for my feelings about the music capabilities — I find only two words, "immaculate sound"... This unit belongs to that very small group of components which allow you to "see" past the equipment into the performance itself..."

*American Record Guide, April, 1962*

#### LC-21 PREAMPLIFIER

"Noise is totally inaudible under any listening conditions... Listening to music with the LC-21 proves to be as rewarding as it was with the power amplifier. It impinges nothing of itself on the performance while providing positive control... both kits go together with no fuss at all. About a week's worth of evening work will provide a superb electronic control center..."

*American Record Guide, April, 1962*

Scott Kits win  
rave reviews  
from leading  
Hi-Fi experts

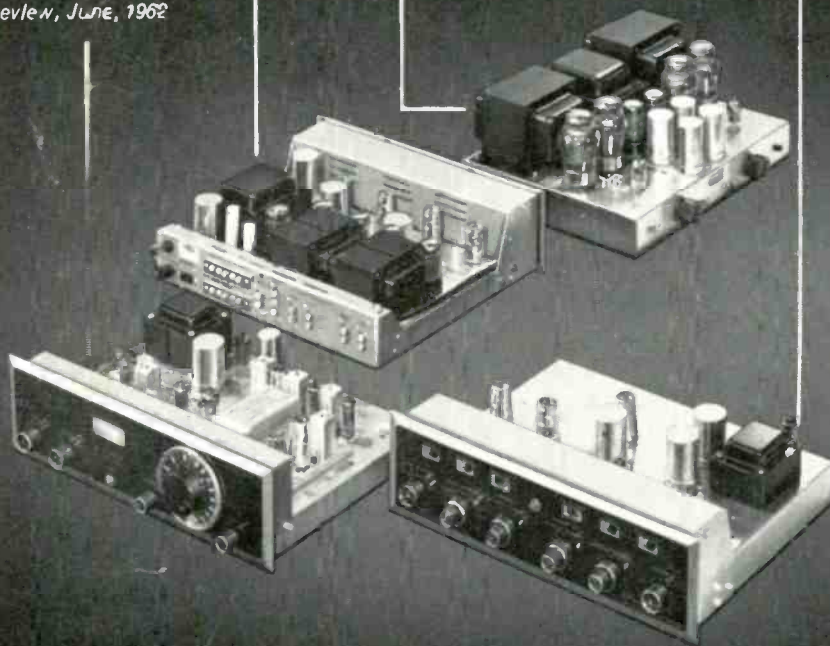

"The packaging and instruction manual for the Scott LK-72 kit help make the assembly and wiring of this amplifier painless and even pleasurable. Each stage of the work is carefully explained, with text and illustrations that leave little or no room for error, and which were obviously prepared with more than a passing sense of humor. There are no outside "blowups" to hang on the wall, but rather meticulously detailed drawings, in color, of each stage of the work, and all contained in the manual in the normal sequence of steps used by the builder. The instructions are prefaced with helpful hints on how to unpack the kit, what tools to select, correct soldering procedures, and so on. For those who are interested, there also is a section explaining how the amplifier operates, stage by stage. All told, this is a neat, attractive, very well-designed kit, and one which gives every assurance of successful completion even in the hands of the inexperienced or first-time builder."

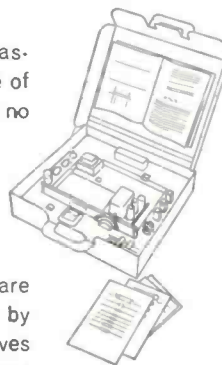

H. H. Scott, Inc., 111 Powdermill Rd.,  
Maynard, Mass. Dept. 035-08

Export: Morhan Exporting Corp., 458 Broadway, N. Y. C.  
Canada: Atlas Radio Corp., 50 Wingold Ave., Toronto

Rush me your new full-color folder  
showing the complete line of Scott  
Kits.

Name .....

Address .....

City ..... State .....

High Fidelity, April, 1962



# AUDIO

AUGUST, 1962 Vol. 46, No. 8

Successor to **RADIO**, Est. 1917

C. G. McPROUD • *Publisher*

DAVID SASLAW • *Editor*

JANET M. DURGIN  
*Production Manager*

## Contributing Editors

EDWARD TATNALL CANBY

JOSEPH GIOVANELLI

HAROLD LAWRENCE

CHARLES A. ROBERTSON

CHESTER SANTON

HENRY A. SCHOBEL  
*Business Manager*

SANFORD L. CAHN  
*Advertising Director*

EDGAR E. NEWMAN  
*Circulation Director*

*Representatives*  
Bill Pattis & Associates,  
4761 West Touby Ave.,  
Lincolnwood 46, Ill.  
James C. Galloway,  
6535 Wilshire Blvd.,  
Los Angeles 48, Calif.

## AUDIO Articles

- Transistorized FM Front Ends **19** *C. R. Gray and T. C. Lawson*  
Measuring and Matching the  
Phono Equalization Curve **24** *Mannie Horowitz*

## AUDIO Reviews

- Light Listening **8** *Chester Santon*  
Record Revue **78** *Edward Tatnall Canby*  
Jazz and All That **82** *Charles A. Robertson*

## PRODUCT PREVIEW SECTION 29

- Basic Power Amplifiers **29**  
Basic Amplifier Kits **30**  
Preamplifiers **31**  
Preamplifier Kits **32**  
Integrated Amplifiers **34**  
Integrated Amplifier Kits **35**  
Basic Tuners **36**  
Basic Tuner Kits **39**  
Tuner-Amplifiers—Receivers **40**

- Turntables with Arms **43**  
Turntables without Arms **46**  
Phono Cartridges **48**  
Tone Arms **52**  
Loudspeaker Mechanisms **56**  
Loudspeaker Systems in Enclosures **60**  
Tape Recorders **68**  
Microphones **75**  
Headphones **93**  
Miscellaneous **96**

## AUDIO in General

- Audioclinic **2** *Joseph Giovanelli*  
Letters **6**  
Audio ETC **12** *Edward Tatnall Canby*  
Editor's Review **16**  
About Music **88** *Harold Lawrence*  
Advertising Index **106**



AUDIO (title registered U. S. Pat. Off.) is published monthly by Radio Magazines, Inc., Henry A. Schober, President; C. G. McProud, Secretary. Executive and Editorial Offices, 204 Front St., Mineola, N. Y. Subscription rates—U. S. Possessions, Canada, and Mexico, \$4.00 for one year, \$7.00 for two years; all other countries \$5.00 per year. Single copies 50¢. Printed in U.S.A. at 10 McGovern Ave., Lancaster, Pa. All rights reserved. Entire contents copyrighted 1962 by Radio Magazines, Inc. Second Class postage paid at Lancaster, Pa.

RADIO MAGAZINES, INC., P. O. Box 629, MINEOLA, N. Y.  
Postmaster: Send Form 3579 to AUDIO, P. O. Box 629, Mineola, N. Y.



# SHERWOOD

only for those who want the ultimate



S-8000 FM/MX 64-watt Stereo Receiver \$299.50  
16¼" x 4½" x 14" deep. Combines Sherwood's brilliant FM stereo tuner design, two 32-watt amplifiers, two phono/tape pre-amplifiers, and all circuitry necessary to receive FM stereocasts.

RAVINIA Model SR3 3-way speaker system \$139.50. Walnut Cabinet 26¼" x 15" x 13¼" deep. 12" high-compliance woofer, 8" midrange, and 2½" ring-radiator tweeter. Features low intermodulation distortion, flat frequency response (± 2½ DB) to 17 KC.

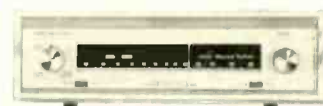

S-3000 FM/MX Stereo Tuner \$160.00. 14" x 4½" x 10½" deep. Identical tuner design to S-8000. Other tuners: S-2100 FM Stereo/AM Tuner \$199.50. S-2000 II FM/AM Tuner \$150.50. (Same but without FM stereo feature)

FM Stereo Multiplex Adapters may be used to convert Sherwood and other FM tuners for stereocast reception. \$49.50 to \$69.50.



S-5500 II 64-watt Stereo Preamplifier-Amplifier \$164.50. 14" x 4½" x 12¼" deep. Identical to amplifier used in S-8000. Other amplifiers: S-5000 II 80-watt Stereo Amplifier-Preamplifier \$199.50.

This typical room setting includes Sherwood's "Superb Stereo Starters,"—one S-8000 Receiver and two SR3 Loudspeakers. Sherwood Electronic Laboratories, Inc., 4300 N. California Ave., Chicago 18, Illinois. Write for complete technical details.



Write Dept. A-8

# Hear! Hear!

## 3 POWERFUL RECEPTION AIDS FOR FM AND FM MULTIPLEX STEREO

Set up for stereo or monaural FM? Either way, you'll bring in more stations... enjoy all stations more... with these powerful Jerrold FM accessories.

### FMX



#### FM RANGE EXTENDER

A must for multiplex, this high-gain (20 db) preamp really beefs up weak antenna signals. Brings in distant stations... eliminates unwanted noise... makes even low-cost tuners and radios sound great! Latest 6DJ8 frame-grid tube, "no-strip" twin-lead terminals. **\$29.95 list**

### TX-FM



#### FM/TV ANTENNA SPLITTER

Gives full FM reception from a broad-band TV antenna. Compact, triple-tuned band-pass filter splits FM and TV signals without loss to either. Complete isolation between FM and TV sets. Positive matching. Universal mounting, indoors or out. **\$6.95 list**

### MK-1



#### MAGIC CARPET ANTENNA

Hides under the rug, in the attic or closet. Exceptionally good for FM reception in apartment houses and suburban homes. **\$9.95 list**

Ask your hi-fi dealer for full information.

**JERROLD** ELECTRONICS CORPORATION

A subsidiary of  
The Jerrold Corporation  
Philadelphia 32, Pa.

## AUDIO CLINIC

Joseph Giovanelli



Send questions to:

Joseph Giovanelli  
3420 Newkirk Ave.  
Brooklyn 3, N. Y.

Include stamped, self-addressed envelope.

#### Measuring Turntable Performance

*Q. My question concerns a turntable I recently built—the hard way, not from a kit. I cannot be satisfied, however, until I measure the results. How are these measurements made? Rudolf Bohm, New York, New York.*

*A.* The main two criteria by which turntable performance is measured are its rumble content and its wow and flutter content. I naturally assume that the speed is accurate.

Rumble is measured with reference to a 1 kc tone recorded at 7 centimeters per second. The tone is impressed on a disc. The disc is played back and the output level produced by the tone is then measured. Then the tone ceases and the stylus passes over an unmodulated band of disc material. The rumble is noted as being so many db below the reference tone. In this test the RIAA compensation is used.

Wow and flutter are measured by means of a wow and flutter meter. This is a meter which has a discriminator circuit in its output. A tone is played again, and the meter will swing above and below a corresponding zero point (representing the tone's actual frequency). The meter pointer moves along a scale calibrated in terms of percentage of wow and flutter. The motion of the pointer will indicate which is present, and to what degree. This test is one which you probably cannot simulate in your own home.

#### What is Happening?

*Q. I have a component hi fi set consisting of a tuner, basic amplifier, and a speaker system. I have noticed that when I use my exterior TV antenna for FM reception, the signal increases over the non-antenna level, plus the fact that on one station only, there is an increase in noise. This noise sounds like wind (a rushing sound) and has no discernible audio components. When I disconnect one end of the 300-ohm twin lead, the noise becomes inaudible. When I have it connected, the noise comes back. Benrard Eisner, New York, New York.*

*A.* From what you write about the character of the noise, I suspect that the noise is the tuner going into oscillation, probably as a result of a defect in the front end. Certain tuners will do that, especially when the soldering of the braid associated with the variable condenser has been poorly done.

Before doing anything to the innards of the tuner, check the tubes, especially those

in the front end. If this check does not show a bad tube, you must then check all screen bypass capacitors and decoupling capacitors associated with the front end. A tube checker may not always show up such defects. The best thing to do is to replace these tubes with known good ones and note the performance of the tuner.) If this produces no results, resolder all ground connections, especially those associated with the variable capacitor. That should do it.

#### The Push-Pull Parallel Output Stage

*Q. I would like to operate the output tubes of Mr. Voss's amplifier ("Triode operation of KT88's", March, 1961 AUDIO) in a more conservative manner. Push-pull parallel operation suggests itself, but should I reduce the plate voltage to change the bias setting in order to maintain the same cathode current as for two tubes? In the event of the former, about how great a reduction in voltage is necessary? Would it be necessary to change the output transformer? Andrew H. Frank, San Francisco, California.*

*A.* When arranging a circuit for push-pull parallel operation there are several facts to keep in mind.

Let us assume that we are converting any amplifier for this type of operation. First, the impedance offered by this combination will be lower than it would be for a similar amplifier operated in the conventional push-pull arrangement. An output transformer having about half the impedance required for the push-pull configuration must be used in the circuit. Because such an amplifier is capable of giving you about twice the amount of power that could be delivered by the push-pull amplifier, you must use an output transformer having a greater power-handling capacity than would be required for the more standard circuit arrangement.

You would not adjust the bias so that the total cathode current taken by the four tubes is the same as would be required for two tubes. If you did that, the bias would be too great. Greater distortion would result. True, each tube would run cooler than it would in the push-pull circuit if the bias were reduced. However, this is not the manner by which cooler operation should be accomplished. If you want to run the tubes in a more conservative manner, you should reduce the plate and screen voltages, adjusting the total cathode current accordingly. (The correct procedures for doing this latter operation are shown either directly in the tube manual or can be worked out by means of the nomographs provided therein. Therefore, this procedure will not be discussed here.)

Even when the tubes are to be run more conservatively, it is likely that the total power consumed by the four tubes will be more than that consumed by the two tubes found in the original amplifier. Therefore, a power transformer having a greater

**This is where your investment  
in a Garrard  
Automatic Turntable  
pays off**

Chances are that sooner or later you will spend more on your records than you do on any record player. More, it may be, than the cost of your entire music system. Your listening enjoyment is dependent upon records and the unit that reproduces them. This is exactly why more GARRARD Type A's, for example, have been sold—and are being sold—than any other high fidelity record playing equipment, without regard to cost. Just consider this...

Most people today want to use one of the ultra sensitive cartridges developed originally for separately-sold tone arms because of high compliance. Garrard has integrated precisely such an arm in the Type A Automatic Turntable—dynamically-balanced, counterweight adjusted, designed and built with the same precision, the same balance, the same freedom from friction, the same playback characteristics and low resonance. This arm, operating in conjunction with the Type A's heavy, full-size, non-magnetic turntable—a laboratory-balanced, double-shielded motor; and (when you want it) the gentlest automatic record-handling mechanism ever designed; rewards you with the full measure of the magnificent reproduction you expect from the best recordings.

Garrard's Type A Automatic Turntable is proudly owned by a growing legion of highly critical people who, originally amazed at the \$79.50 price, have come to realize this completely integrated precision instrument could have been developed only by the Garrard Laboratories. For illustrated literature, write Dept. GK-12, Garrard Sales Corps., Port Washington, N. Y.



**Garrard**  
world's finest

# BOOK SHELF vs BIG SPEAKER IS REPRODUCTION vs RE-CREATION

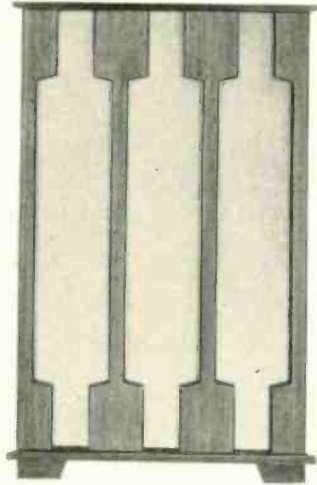

The majesty of a full symphony, the grandeur of a large chorus or the vibrant throbs of a mighty organ—these give the thrill and stir in a live performance. They produce big enveloping sounds. Just as their origin is in a large body, so their re-creation must come from a large body. As a miniature orchestra can never equal a full symphony in bigness of sound, so a small loudspeaker can never compare in fullness with that of a large one.

Bozak, pioneer exponent of big multiple unit speaker systems, offers the B-4000, also known as Symphony No. 1, for those who seek the grandeur of big, full sound but whose space does not permit the celebrated B-310A Concert Grand.

Used in matched pairs, the B-4000 has no peer for stereophonic re-creation of musical performances. Through a unique configuration of Bozak speakers, two B-4000 systems spread the music throughout the listening

room with true perspective, not only in width but also in depth. Instruments sound in their proper places, not just left, right and center, but closer or farther from the listener—as in the live performance. No truer reproduction has ever been achieved. The proof is in the hearing.

The speaker complement in each consists of two 16-ohm Bozak B-199A 12-inch woofers, one 8-ohm Bozak B-800 8-inch speaker used as a mid-range, four Bozak B-200Y dual tweeters in a vertical column array, and an N-105 LC crossover network with 6 db./octave crossover. Woofer roll-off is at 400 cycles, mid-range tweeter crossover at 1500 cycles. These are housed in a distinctly styled infinite type baffle of 8 cubic foot volume.

#### SPECIFICATIONS:

Useful frequency response: 35 to 20,000 cycles  
Impedance: 8 ohms  
Suggested amplifier power: 30-watts or greater  
Dimensions: 44" high x 27 $\frac{3}{4}$ " wide x 16" deep

current capacity must be employed, unless the one already used has the necessary reserve capacity.

It is possible that the rectifier originally used in this particular circuit cannot withstand the additional drain. Hence it may have to be paralleled by an additional rectifier. It is also possible that the current-handling capacity of the filter chokes must be increased.

It is possible also that you will have to redesign the feedback circuit. Because you are now using a different output transformer, its characteristics are likely to be different from those used in the original design of the amplifier.

When you operate the amplifier in this manner, you will obtain some increase in power. This increase, however, will depend upon whether or not you lowered the plate voltage to the output tubes. If you greatly lower the voltage, you are likely to come out with about the same power output that you would have obtained with the original circuit, and with somewhat less electrical efficiency. You would gain an amplifier whose output stage runs cooler per tube. Hence, you would have fewer output tube failures than would be true of the original design.

#### Starved Circuits

*Q. What is a starved amplifier? How does it work? What are its advantages and disadvantages? What design data is needed? L. Foisy, Brooklyn, New York.*

*A. When considering "starved" circuits, the thought arises as to what is being starved.*

The answer is that the tubes are starved for both plate and screen voltage. Most "starved" circuits employ pentodes. What happens in operation is that a high voltage is applied to the electrodes of the tube through ridiculously high screen and plate load resistors. Two megohm plate loads and 10 megohm screen resistors are not at all uncommon. The slightest change in plate current (created by a small change in grid voltage) will cause a considerable voltage change across the plate load resistor and hence, considerable voltage gain can be realized from the stage. Because of the high impedance of the entire circuit shut capacitors are extremely detrimental to high-frequency response. Some such amplifier circuits I have seen are flat to only 1000 cps.

Some correction of this deficiency can be achieved by the use of either negative or positive feedback. This feedback must be selective so as to boost the otherwise suppressed frequency band.

In 1958 AUDIO ran an article called "The Purple Cow Amplifier," in which the first stage was starved.

Other information concerning these circuits is available in the *Radiotron Designers' Handbook* and Terman's excellent book, *Radio Engineering*. AE



See your franchised Bozak dealer, or write  
Box 1166, Darien, Connecticut

Give



**NOW...A NORELCO  
'CONTINENTAL'  
TAPE  
RECORDER  
FOR  
EVERY PURSE  
AND PURPOSE**



WHETHER YOUR PARTICULAR REQUIREMENTS IN A TAPE RECORDER ARE SIMPLE OR COMPLEX  
... WHETHER THEY REFLECT THE DEMANDS OF YOUR HOBBY OR YOUR PROFESSION ...

WHETHER THEY STRESS LISTENING OVER RECORDING OR VICE VERSA, OR PROFESSIONAL  
QUALITY OVER PORTABILITY OR VICE VERSA, CHOOSING THE ONE RIGHT TAPE RECORDER  
FOR YOU HAS NOW BECOME AS SIMPLE AS A-B-C! FOR THERE ARE NOW FOUR  
NORELCO CONTINENTALS. ONE FOR EVERY PURSE. ONE FOR EVERY PURPOSE.

ALL GUILD-CRAFTED BY PHILIPS OF THE NETHERLANDS. EACH DESIGNED TO PROVIDE  
ITS OWNER WITH THOSE FEATURES BEST SUITED TO HIS SPECIAL REQUIREMENTS—WHETHER ON  
VACATION, ON LOCATION, IN THE HOME, STUDIO, OFFICE, CHURCH OR SCHOOL.

CONTINENTAL '100' (EL 3585) shown on top: transistorized, 7 lb., battery portable • records 2 hours on 4" reel, from any source • plays back thru self-contained speaker as well as radio, TV or record player • response: 100-6000 cps • tapes interchangeable with other 2-track 1 7/8 ips machines • constant-speed operation • complete with dynamic microphone.

CONTINENTAL '200' (EL 3541) shown bottom right: 4-track stereo head output direct to external stereo pre-amp for portable high fidelity tape-deck applications • completely self-contained for 4-track mono record and playback • mixing facilities • lightweight, compact, rugged • dynamic microphone.

CONTINENTAL '300' (EL 3542) second from top: 4-track stereo playback (tape head output) • self-contained 4-track mono record-playback • 3 speeds • dynamic microphone • ideal for schools, churches, recreation centers, etc. • choice of audio-philis seeking top quality at a sensible price.

CONTINENTAL '400' (EL 3536) bottom left: 4-track stereo and mono recording and playback • 3 speeds • completely self-contained, including dual recording and playback preamplifiers, dual power amplifiers, two loudspeakers and stereo dynamic microphone • frequency response: 50 to 18,000 cps at 7 1/2 ips • wow and flutter: less than .15% at 7 1/2 ips • signal-to-noise ratio: -48 db or better • cross-talk: -55 db.

For a convincing demonstration of these features and qualities, visit your favorite hi-fi or photo dealer . . . or write for brochure to:

A-5

**Norelco®**

**NORTH AMERICAN PHILIPS COMPANY, INC., High Fidelity Products Division, 230 Duffy Ave., Hicksville, L. I., N. Y.**

IN CANADA AND THROUGHOUT THE REST OF THE FREE WORLD, NORELCO CONTINENTAL IS KNOWN AS 'THE PHILIPS'.

## FOR THE ULTIMATE IN AUDIO TAPE RECORDING

**M**agnecord

... Known and used the world over to satisfy the most demanding requirements for performance and reliability in audio recording and reproduction.



**728 STEREO**  
The professional standard. 7½ and 15 ips. Superior performance in all areas.



**748 STEREO**  
The Olympian ... champion of recorders. 3¾ and 7½ ips. 4-track play and record.



**THE PT 6**  
The rugged, reliable "Workhorse" of the broadcast industry.



**THE P 75**  
"The Editor" ... includes all of the capabilities of the PT 6 plus extended performance and utility.



**THE M 90**  
"Mighty" in all performance characteristics. Magnecord's finest tape instrument.

Represented by leading audio dealers and industrial electronics distributors. Write today for additional information regarding your specific requirements.

WRITE TODAY FOR  
MORE INFORMATION



MAGNECORD SALES DEPARTMENT  
MIDWESTERN INSTRUMENTS  
P. O. BOX 7509 • TULSA 35, OKLAHOMA

# LETTERS

## Effects on Phase Shift

SIR:

Authors Klein and Tributsch of the article "Effect of Phase Shift on Hearing," in the July issue obviously did no research of literature, know little about hearing, and didn't try any frequencies below 1500 cps when they varied interaural phase difference. In my opinion the interaural phase difference decidedly shifts the apparent image from side to side when using signals below 1500 cps—as a matter of fact, 3 deg. is the DL at some frequencies. As references, see: *Measurement of Hearing*, by Hirsh; *Experiments in Hearing*, by von Bekesy; and *Handbook of Experimental Psychology*, by S. S. Stevens.

JACK F. CURTIS, Ph.D.,  
Research Associate,  
The C. W. Shilling Auditory  
Research Center, Inc.  
348 Long Hill Road,  
Groton, Conn.

## Headphones

SIR:

In all the discussion of speakers vs. earphones for stereo one point has been left out. To me it is so obvious that I must be wrong. When listening to stereo with speakers the sound comes from in front of you. If you turn your head, the sound will come from the side toward the speakers. With earphones, the sound always comes from the front no matter which way you face. This would not happen in a live performance.

ROBERT F. McDONALD,  
11 Vista Via,  
Lafayette, California

## Transistors

SIR:

In his discussion of transistor high-fidelity amplifiers in the May issue, Mr. Cooper omitted reference to the principle of very-low-impedance drive of an output stage using standard alloy transistors.

As a means of improving common-emitter frequency response, the principle is well known but the application of it to high-fidelity audio power amplification was first demonstrated, I believe, by D. W. Taylor at the last EIA/IRE Fall Meeting.

The technique lies in the use of a simple trifilar transformer to unity-couple a common-collector driver to the bases of the two output transistors. Even the most conservative design of the transformer results in one weighing a few ounces and easily hand-made or manufactured. The resulting cut-off frequency is many times the beta cutoff frequency.

Although this arrangement may not have been used commercially, the combination offers a functionally excellent and economically attractive means of obtaining high-fidelity audio power from alloy transistors.

W. BARRY CLARK, Engineering Division,  
Dominion Electrohome Industries Ltd.,  
Kitchener, Ontario

## Mixer Design

SIR:

I have just read Mr. Gerbracht's article on mixer design in the March issue. Despite the complicated circuitry and the elegant mathematics, I can't help but feel he is using a power hammer to crack a peanut. But then, components and tubes cost more

here, so we British tend to settle for rather more simple configurations.

But I will take him up on his dismissal of the "anode follower" mixer circuit. I checked my own four-channel unit and under the worst possible conditions (signal into one channel, the other three alternately open and short circuit) variation was not more than 0.25 db. Admittedly, the feedback loop is adjusted to give a gain of unity with one section of an ECC83, but by using instead a high- $\mu$  pentode (e.g., an EF86), the feedback can be reduced somewhat without degradation of this already low interaction figure.

The "anode follower" has another advantage, too—the output impedance is of the order of 3000 to 4000 ohms. In many cases, a cathode follower is unnecessary. I checked the total harmonic distortion of my particular example and the lowest reliable measurement I could obtain was 0.15 per cent at 5 volts output. Noise and response compare with Mr. Gerbracht's design.

Finally, if I did want a stereo mixer I would question the value of a design that only added the "sum" components in the "separation" control. Ideally, one should have control over both the "sum" and "difference" components. Such a circuit should be fairly easy to design.

REGINALD WILLIAMSON,  
78, Helena Road,  
Norwich, England

## Electronic Organs

SIR:

I am very pleased to see the articles on electronic organs in recent issues. I think there are enough organs and audio fans who own organs who will agree with me that there should be more of these articles or even a section devoted to them. There are so many interesting topics, such as accessory equipment, circuitry for additional voices, modifications of existing voices, percussion units, reverb units, and so on *ad infinitum*.

I have just completed a Schober Concert Organ, a project I enjoyed thoroughly, and one I have wanted to tackle for years. Technical knowledge is a help in building such a kit, but definitely not a necessity. For any audiofan readers who have tape recorders and like organ music, there is a tape club devoted to the organ exclusively. Drop a card to our secretary, Carl Williams, 152 Clizbe Ave., Amsterdam, N. Y. for particulars.

TOM CHRISTENSEN,  
Publicity, Organ Music Enthusiasts,  
130 Annatte Ave.,  
Smithtown, L. I., N. Y.

## FM Multiplex Tester

SIR:

I am anxious to learn if you are able to advise me as to the construction of a simple-as-possible signal generator for testing multiplex adapters or the adapter section of an FM stereo tuner. Is there any possibility of your publishing a constructional on such a device in the near future.

E. A. GARVEY,  
1658 No. 21st St.,  
Arlington 9, Va.

(Such a generator is not very simple, but one kit is announced currently in the advertisement on page 105. Ed.)



# SOUND TALK

...from the world's most experienced manufacturer of recording tapes

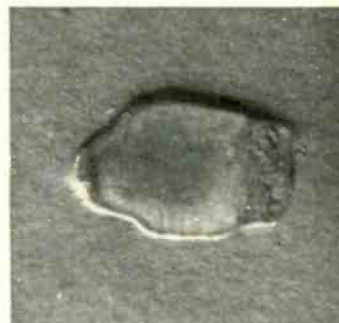

#### IMPERFECTIONS YOU AVOID WITH "SCOTCH" RECORDING TAPES!

Oxide flake (photo-micrograph, above) and backing defect (below) result in coating flaws that can interrupt the head contact of ordinary tape. Now, 4-track stereo makes the uniformity, the intimate head contact assured by "Scotch" Recording Tapes more important than ever!

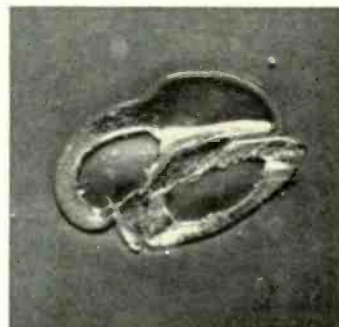

## How to avoid "signal spoilers" in 4-track stereo!

Make intimate head-to-tape contact a certainty with SCOTCH® BRAND Recording Tapes!

When you lose head-to-tape contact, the result can be distortion, loss of high frequency signal, even complete signal drop-out. Now, the narrower tracks involved in 4-track stereo magnify the danger of tiny tape irregularities becoming "signal spoilers"—make the assured uniformity of "SCOTCH" BRAND Recording Tapes more important than ever!

Oxide coating techniques used by 3M assure a smooth recording surface, with coating thickness microscopically precise. Similarly close tolerances are maintained for backing thickness, tape width. Result—identical recording properties, intimate head-to-tape contact are a certainty, inch after inch, reel after reel!

High-potency oxides permit thinner, more flexible coatings for sharp resolution, wide dynamic range, full frequency response. Exclusive Silicone lubrication assures smooth tape travel across heads, protects against head wear and extends tape life. To ensure brilliant, dependable sound reproduction whether making 4, 2 or full track recordings, *play the favorite . . . "SCOTCH" BRAND.*



For free descriptive literature, write Magnetic Products Division, Dept. MCT-82, 3M Company, St. Paul 19, Minn.

"SCOTCH" AND THE PLAID DESIGN ARE REGISTERED TRADEMARKS OF MINNESOTA MINING & MANUFACTURING CO., ST. PAUL 19, MINN. EXPORT 99 PARK AVE., NEW YORK, CANADA: LONDON, ONTARIO. © 1962, 3M CO.

Magnetic Products Division **3M** COMPANY



**David Rose: 21 Channel Sound  
M-G-M Tape STC 4004**

The running battle between disc and tape has gone through several phases as each medium has introduced its own improvements. Anyone following the struggle between stereo disc and quarter-track tape will find fresh material for argument and discussion in M-G-M's 21 Channel Sound Series. Depending on the playback equipment you use, it is still possible to "prove" that either medium is superior in A-B tests of stereo discs and four-track tapes containing the same material. It seems to me, in its latest relative standing, the disc still outperforms the tape in the matter of extreme highs. In a clear majority of cases, the highs on the record contribute more warmth and hall sound than those on the four-track tape. The earliest stereo records couldn't do this but discs (and pickups) have come a very long way. Four-track tapes, on the other hand, have changed far less since their introduction. All through the seesaw battle, quarter-track tape, though handicapped in signal-to-noise ratio, has provided good lows and a distinctive sense of freedom in the mid range.

This David Rose recording in 21 Channel Sound illustrates an interesting departure. It shows that a certain type of recording today sounds almost the same on tape or disc. Some difference is still discernible but it's far less than usual. The reason isn't too hard to find. With twenty-one microphones soaking up sound at close range in an average recording studio, the disc is somewhat at a disadvantage. In place of normal room sound, this recording makes heavy use of artificial reverberation. Since the strings cannot register natural warmth in the high end under these rather extreme circumstances, the disc manages to sound little better than the tape. As for pinpointing the individual instruments, it seems that you can do a passable job without the attributes of wide-range stereo if you use twenty-one mikes to locate each sound source. The record producer who is convinced that all listeners suffer uniform deficiencies in playback will always be tempted to substitute multi-channel techniques for conventional stereo that sounds great on a really good sound system.

The liner notes supplied with this recording contain an amusing nugget that proves once more how seldom the writers of such notes actually hear the releases they are talking about. Despite the vast amount of artificial reverberation that a child could spot, the notes speak of an acoustically perfect hall with a natural reverberation time of seven seconds having been used for this session. This tale really takes on the proportions of a whooper when you consider that the best concert halls providing recording facilities today rarely need more than two seconds acoustic delay.

**Marty Gold: The Music of Rodgers and Hart**

**RCA Victor LSP 2535**

**Melachrino Strings: The Music of Rodgers and Hammerstein**

**RCA Victor LSP 2513**

If your record dealer is typical of his tribe, much of his information about the sound on today's stereo discs has been gleaned from customers such as yourself. All too many dealers still haven't the foggiest notion how

## LIGHT LISTENING

**Chester Sington**

good some of their current stock can sound on the right equipment. In any case, you'll probably be doing your record merchant a favor if you tell him to keep the number 2535 in mind the next time he gets a call for an outstanding instrumental album capable of showing off a full-fledged sound system. Considerable experiment went into Marty Gold's album of Rodgers and Hart evergreens. Provided your stereo system can deliver the goods without the aid of tricked-up sound on the record, you'll find this one of the very first recording sessions to capture soloists in close-ups of astonishing quality without losing the room ambience of bona fide stereo recordings. Webster Hall acoustics and Marty Gold's inventive arrangements of some of the theatre's very greatest tunes are an unbeatable combination. Competent woofers will greet with particular relish the contra-bass clarinet of Stan Webb in *Dancing on the Ceiling* and *There's a Small Hotel*.

The Melachrino disc may appear a bit tame in comparison despite the fact that it happens to contain the best sounding collection of Rodgers and Hammerstein classics currently available. Everywhere you turn in this album, the top drawer show songs of the past two decades are a balm to the ear. Dick Rodgers has ample reason to be proud of his songs in these two albums.

**Bravo Giovanni (Original Broadway Cast)  
Columbia KOL 5800**

If an elaborate plot and a lot of fast action were the only requirements in a musical, this show would be one of the big hits of the decade. Not that the Broadway debut vehicle of opera star Cesare Siepi is seriously lacking in other ingredients that go into a good musical comedy. The total assets of this story (played at almost the tempo of a farce) add up to enough material to put together several of the slender-plot affairs we've had on Broadway this season. After eleven years as top basso at the Metropolitan, Cesare Siepi has earned the right to expect a musical with a score as rich as the one Ezio Pinza had when he first appeared on Broadway in "South Pacific." Instead, Siepi finds himself in a show that is stronger in story line than it is in the caliber of its music. I can't think of another voice or personality available in the theatre today better qualified to be entrusted with a solid bundle of good songs that we used to take for granted in musicals produced a decade ago. "Bravo Giovanni" would be an adequate vehicle for a run of the mill singing lead. Under the conditions we're considering, the music just misses the mark.

This show is on strongest ground as it digs its way, in more ways than one, into the restaurant business in present day Rome. Cesare Siepi is introduced as the struggling proprietor of a modest trattoria about to be engulfed by a branch of a mass-production chrome-plated restaurant chain. A novel by Howard Shaw provided the germ of the ideas that tumble forth in the book and lyrics of A. J. Russell and Ronny Graham as Siepi and his neighboring shopkeepers proceed to wreak their vengeance on the competing restaurant chain. Graham's agile wit, first noticed on Broadway when he served as composer, lyricist and sketch writer in "New Faces of 1952," points up every possibility for broad comedy as the "Siepi Gang" tunnels its way to the opposition kitchen and begins to divert their featured dishes to its own unsuspecting customers. The discovery, during the tunnel-

ing, of buried Etruscan treasures adds complications to an already busy plot.

Romantic interest is supplied by 19-year-old Michele Lee of Los Angeles, invading Broadway in her first sizable engagement. Her major moments occur during *I'm All I've Got* and *Steady, Steady*. In addition to his two love songs, *If I Were the Man* and *Miranda*, Siepi supplies the show's modest quota of Italian atmosphere in *Rome* and the title tune "Bravo Giovanni." George S. Irving, at one time the police inspector in "Irma La Douce" and now the competing restaurateur, shares comedy honors with David Opatoshu and Maria Karnilova. The best lines are fielded beautifully by this capable trio but a top composer would have given the singers equally challenging material.

**A Funny Thing Happened on the Way to the Forum (Original Broadway Cast)  
Capitol SWAO 1717**

This musical comes to records with a reputation that has already identified it as the season's second funniest show. "How to Succeed in Business," the top dog in humor this season, has little to fear however so far as the record audience is concerned. This Roman romp starring Zero Mostel cannot claim equal honors on records because so much of the new show's humor lies in its visual gags and uncurbed horseplay. Authors Burt Shevelove and Larry Gelbart based their farce on sure-fire material similar to that used in Roman comedies some two thousand years ago. Shevelove, while still at Yale, had made a pretty exhaustive study of the writings of Titus Maccius Plautus (a name that could easily have been at home in an old Fred Allen script). For assistance in building a new show around the ancient characters and plots of Plautus, Shevelove called in Stephen Sondheim—supplier of lyrics to such famous shows as "West Side Story" and "Gypsy." With veteran comedy director George Abbott at the helm, the stage production offers a field day for Zero Mostel in the juicy role of a coniving slave. At the microphone, Mostel is able to convey only a small fraction of the comedy talent that swamps the stage whenever he's sagging its beams. Not that the authors have not been generous in the amount of material they've given Zero. He appears in virtually every number in the album with the exception of the several attractive ballads scattered throughout the score. Even in the ballad department, he manages to appear in the reprise of the best tune in the show—*Lovely*—sung in its natural state by leading players, Brian Davies and Presley Marker. (The girl's name, incidentally, is not a typo, just the latest way to shorten precious.) Mostel leads the company in a stock "greeting and explanation" type song as the show opens to the strains of *Comedy Tonight*. The zany plot begins its tortuous path that finally ends in freedom for Mostel when Davies and Zero raise their voices in *Free*. David Burns, Zero, Jack Gilford and John Carradine contribute the most diverting moments in the show album when they take turns in the tandem lyrics of *Everybody Ought to Have a Maid*. This show may be a rather trifling effort on records but the score manages to dispense a higher percentage of melody than you find these days in shows that take themselves far more seriously.

**Mantovani: American Waltzes  
London Tape LPM 70051**

Whenever four-track tapes move forward in sound quality, a Mantovani reel is usually a good indicator of their progress. No other orchestra leader active in recording studios today pushes his string section in quite the way Mantovani does. It's possible that some of the "wiry" quality in his earlier quarter-track reels could be traced to the playing style of his strings as each man tried to hit full volume even in the upper registers. The style hasn't changed in London's latest Mantovani release yet the sound is definitely smoother. About halfway through the second waltz, I decided that memory alone shouldn't be asked to determine that the sound here was better than the earlier Mantovani reels. The only way to clinch the point was to dig out a previous tape near the current end of the shelf.

# Now there's no reason why anyone can't own a Fisher!



Introducing the new Fisher KX-100 StrataKit...

the 'basic Fisher' stereo control-amplifier anyone can build and anyone can afford.



There has never been anything like it. You invest \$129.50 plus a few evenings of highly entertaining work—and you are the owner of a Fisher amplifier rated at 50 watts stereo music power (IHFM Standard). Look again at the price and the power output figure. They are not typographical errors. You don't have to look again at the name. We know that you know what Fisher means.

But even if the KX-100 were not the most astonishing kit value of the stereo era, it would be worth building just because it is a StrataKit. The StrataKit method of kit construction is the exclusive Fisher development that enables a totally unskilled and inexperienced person to achieve the same end result as a professional laboratory technician. You can't help ending up with a faultless Fisher product when you build a StrataKit.

In addition to more watts per dollar than any other top-quality amplifier, the KX-100 features all the standard control and switching facilities plus a few remarkable extras: A front-panel headphone jack with speaker silencing switch... full tape monitoring facilities with the famous Fisher Tape-Play System... a High Filter switch... and a revolutionary new circuit that permits direct connection of a center-channel speaker without using an additional amplifier! Yes. All that for \$129.50.\*

\*Walnut or mahogany cabinet, \$24.95. Metal cabinet, \$15.95. Prices slightly higher in the Far West. Export: Fisher Radio International, Inc., Long Island City 1, N. Y. Canada: Tri-Tet Associates, Ltd., Willowdale, Ont.

FREE! \$1.00 VALUE! Just published! The Kit Builder's Manual: a new, illustrated guide to high-fidelity kit construction.

Fisher Radio Corporation  
21-29 44th Drive  
Long Island City 1, N. Y.

Please send me without charge The Kit Builder's Manual, complete with detailed information on all Fisher StrataKits.

The  
Kit Builder's  
Manual

Name \_\_\_\_\_

Address \_\_\_\_\_

City \_\_\_\_\_ Zone \_\_\_\_\_

State \_\_\_\_\_

03811

# GRADO

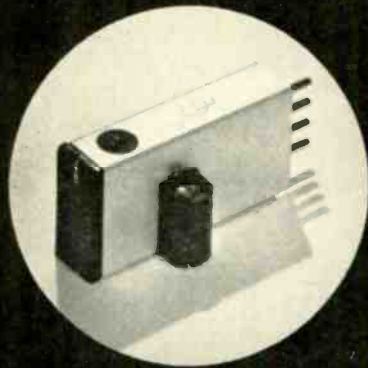

"Fantastic sound, equal to the finest tape I have ever heard."

The new GRADO STEREO CARTRIDGES represent a major step forward in bass depth and solidity, in mid range detail and in high frequency sweetness and smoothness. The complete lack of shrillness and stridency is most refreshing.

All GRADO cartridges are extremely rugged and not magnetically attractive. They are ideal for record changers.

Gentleness to records and the diamond stylus is proven by the following fact:

**ONLY GRADO GUARANTEES ITS DIAMOND STYLUS AGAINST NORMAL WEAR FOR A PERIOD OF 5 YEARS!!**

Senator Stereo Cartridge	\$24.95
Classic Stereo Cartridge	\$37.50
Laboratory Stereo Cartridge	\$49.50
Laboratory Series Tone Arm	\$39.50

For further details write to:

**GRADO LABORATORIES, INC.**

4614 7th Avenue Brooklyn 20, New York  
Export-Simonrice, 25 Warren St., N.Y.C.

Going back to an item released one year ago (Italia Mia, 70045) was a distinct revelation. The older reel immediately gave the impression that the playback head had been shoved a few degrees out of alignment during the minute or two it took to change reels. All that was needed to restore the sensation of an aligned head was to return to this present reel of unabashed sentiment in waltz time. There are far more accurate ways to check head alignment but this tape in a library containing any other Mantovani reel could put you on the alert. Whenever the two reels would begin to sound alike, you'd have ample warning to start getting matters upright again.

#### Stanley Black: Spain

London Tape LPL 74016

London's latest batch of Phase 4 stereo tapes goes in heavily for the travel motif noticeable on other labels this month. Proximity to the Continent may have little to do with it but the reels devoted to Italy (Roger Laredo Orchestra—London LPL 74014), France (Maurice Larcange and his Accordions—London LPL 74013) and the European cinema (Hit Themes from Foreign Films—London LPL 74020) give tape collectors an unusual opportunity to stock up on continental fare in one shopping trip. Of the entire group, Stanley Black's excursion to Spain will undoubtedly draw the most interest since his reputation is the only established one in the new crop of names. This same reputation, along with the position Black occupies on the roster of London artists, may account for the considerate treatment he receives at the hands of the Phase 4 recording crew. Unlike the lesser lights in this month's release, Black is accorded some degree of cohesion in the overall sound of his orchestra. A moderate amount of roll off in the treble will provide the proper equalization on full range equipment as the orchestra tackles such almost-Iberian favorites as *Valencia*, *Sevillanas* and *Ay-Ay-Ay*. An unexpected wrinkle in the interest of authenticity is the appearance of a Flamenco troupe with its own separate repertory sandwiched between the orchestral numbers. The twenty-channel console mixer gets its best workout in the famous "Ritual Fire Dance" by Manuel De Falla as the mikes pick out scattered accents in the string section that would have been lost in the concert hall.

#### Sound Tour: France

Verve V6 50000

Michele Arnaud: Paris in the Spring

Capitol ST 10317

If the record industry has anything to say in the matter, the dollar of the American tourist isn't going to be any safer upon his return home. We've always had plenty of records designed specifically to induce travel to far-off places. The latest trend in records attempts to tie in with the travel boom on a before and after basis. Verve Records has launched an ambitious series providing souvenirs in sound for those who've recently visited France, Italy, Spain or Hawaii. Richard Joseph, Travel Editor of *Esquire* magazine, has furnished a booklet for each country that covers far more than the usual album notes. Underpinning each musical selection on the record is a set of sound effects suggested by the tune. The only dubious effect is the sound of the pounding surf. It resembles the Jersey shore far more than it does a typical French beach.

The miking setup for the small orchestra is on the fussy side, providing a separate mike for virtually every instrument on the floor. The trouble with the 12-channel control boards such as the one used here seems to lie in the fact that their owners cannot resist the temptation to use every blessed channel when recording only thirteen or fourteen instruments.

The Capitol album offers the American record debut of the young French songstress, Michele Arnaud. Mlle. Arnaud belongs to the school of Parisian vocalists that favors an approach based on straightforward sophistication. Too young to rely on carefully developed mannerisms, Michele Arnaud offers a better glimpse of the Paris that is only sug-

gested in the Verve Sound Tour of France. No less an attraction is the engineering she receives in her debut record. Unburdened with extra channels, the recording is content to settle for a scrupulously clean account of what a dewy-fresh voice can do to the proper mike. The only thoroughly familiar item in this collection is *The Green Leaves of Summer*—the least expected sound is the suggestion of bagpipes in a song about a Highland wedding *Les Cornemuses*.

#### Pop Roundup

RCA Victor LSC 2595

Someone has decided to change the sound of the Boston Pops on records and I can't say the experiment is a wholly pleasing one. Arthur Fiedler's Bostonians have always enjoyed a good reputation among audiophiles. Few large orchestras specializing in light music have done as much as the Pops to champion recording techniques that made outstanding use of hall acoustics. During decades of recordings that go back to the Thirties (remember those 10-inch 78's with all the room sound?), the Boston Pops maintained a characteristic sound that instantly identified their efforts. When stereo came along, their sessions in Boston's Symphony Hall became an even more convincing proving ground for the virtues of big-hall sound. Some of their recent albums (*Viennese Nights*, *Music of Frank Loesser*, and *Hearts in 3/4 Time*) touch upon nearly everything that's been done to date in getting a big hall into the act during a stereo session.

Now along comes this collection of Western tunes arranged by Richard Hayman and Jack Mason and we find most of the regular Pops recording theories abandoned in favor of studio practices that have become a dime a dozen. Sections of the orchestra have been provided with their own mikes and then isolated by means of screens. The envelope of air that's been present in every Pops stereo recording since the Spring of '58 has been deflated to the minimum clearance of a typical studio. The weight of the orchestra is still there but the sound is now earthbound. Perhaps the most difficult readjustment in the new setup comes during the solo passages. The program of tunes featured is comprehensive enough to satisfy sagebrush fans of all ages. Nine TV Westerns are represented in the opening medley with remaining attention scattered among older fare such as *Cool Water*, *Riders in the Sky* and *Home on the Range*.

#### Cavalcade of the American Band

Capitol SW 1688

The Goldman Band is the logical choice for an album that attempts to outline the history of band music in America. Founded in 1911 by composer-conductor Edwin Franko Goldman, no other civilian group still active today can point to a comparable service record in the band field. Richard Franko Goldman, son of the founder, puts the band through its paces in an unusual album that will be required listening wherever interest in the development of American band music extends beyond the cursory. The early repertory of our pioneer bands has been a subject of considerable study by Richard Goldman. Going back to the American Revolution, he presents here a scoring for brass instruments of the patriotic hymn *Chester* by William Billings, probably the nation's first hit song—so popular in its day that it almost became a national anthem. *The Battle of Trenton* and the *Federal March* cover the rest of the 18th Century. Two Quicksteps represent the 1830's, the earlier example proving a fiendish challenge to cornet players Mel Brolles and James Burke. *Santa Ana's Retreat from Buena Vista*, Stephen Foster's only march, has the perky quality reminiscent of his minstrel tunes. *The Washington Greys*, one of the oldest American marches still in use, is the link to the Civil War era. Two marches by Victor Herbert and a polonaise by John Philip Sousa reveal new facets of familiar figures. The collection is brought up to date with Meacham's *American Patrol* and Morton Gould's *American Salute*. Capitol's sound fits in admirably with the intent of the collection, offering a uniformly uncolored sheet of glass through which to view the old documents in this showcase. **ZE**

## What does a nickel buy today?



### A chance to learn about the newest developments in loudspeakers, speaker systems, P.A. systems & microphones!

UNIVERSITY catalogs are unique. Each one is a complete and indispensable guide in its field, offering complete descriptions of the unusually wide range of UNIVERSITY products, plus sound advice on: how to select high fidelity speaker systems; how to buy hi-fi component speakers and build your own enclosure; how to plan Public Address systems; and how to choose the microphone best suited for your needs. Every music enthusiast and sound man should have these catalogs. Do you? Fill in the coupon and mail it to UNIVERSITY today.



#### UNIVERSITY LOUDSPEAKERS

A Division of Ling-Temco-Vought, Inc.  
Desk R-8.80 S. Kensico Ave., White Plains, New York

Please send me the new sound planning guide, or guides, checked below:

- Component Stereo High Fidelity Catalog  
 Public Address Catalog  Microphone Catalog

Name \_\_\_\_\_

Address \_\_\_\_\_

City \_\_\_\_\_ Zone \_\_\_\_\_ State \_\_\_\_\_



\*A four-cent stamp and a penny envelope.  
(If you want to save two cents, use a postcard.)

# AUDIO ETC.

Edward Tainall Canby



## 1. 100-MILE STEREO

Life in hi fi is dreadfully integrated these days. At long last, after integrating about 19 different factors, I was recently able to achieve a long-anticipated goal.

I listened to a perfect stereo broadcast at 100 miles.

First, there was my antenna. As previously reported, my rooftop rotating system began acting zanily last winter, receiving from the side and all that. It ended up later completely disconnected. The man went up to remove some of the accumulated frozen slush and the clear ice a foot thick that had formed around the edge of the roof and managed inadvertently to shovel the lead-in off. It was imbedded in the ice. Wasn't until a warm spring day that I got up on the roof and reconnected the 300-ohm ladder-type plastic lead. But still the old signal strength was missing. Something was tired.

Somebody said I needed a new lead-in. Plastic coated 300-ohm leads, I was told, don't stand up very long to outside weathering. Mine, I'll admit, looked pretty sad—the plastic was stretched and cracked, the spacing between the wires had narrowed (throwing off impedance values) and maybe the ultra-violet oxidation-by-weathering had added more unintended loss. Alas, I was busier than all get-out, so this job had to await my summer assistant, who is a whiz at getting things like that done pronto.

Then there was the little matter of the stereo tuner. As also reported, 'way back, I had figured on trading my Citation III for a stereo IIIX, pre-wired, and was awaiting same. Well, I finally got it—just in time to run into the winter's antenna difficulties. It was sensitive enough, however, to bring in the few stereo outlets within my range—I could hear WQXR in New York and WTFM at Lake Success (all-stereo) though with plenty of background noise. The stereo was thus not exactly pleasing. I found the relative silence of mono reception a relief, though the IIIX did show me one thing, that the quality of the fringe-area background noise on stereo differs from tuner to tuner. The Citation produces a plain white-noise hiss, not essentially different from the normal mono interstation hiss.

Then I returned the Citation for tuning adjustment, just to make sure it was in optimum condition. (As usual, I didn't want to get my fingers in where they shouldn't be. That took logistics. Things like big cardboard cartons full of inexplorable cardboard inserts that are supposed to fit in and around the set but never do—after the first unpacking. Necessary, of course, but an infernal headache to the man who ships his hi fi back "in the original carton!" I prefer old newspapers but generally make a brave attempt to figure out the inserts, on the theory that they are ideally better. . . .

So, many a moon later, back comes the IIIX from the factory and into my car and out to the country again. Alas, somebody must have juggled it in transit, probably the expressman who dropped it five or six feet onto his truck's flooring or, just maybe, me. So this time I figured we'd better adjust it ourselves, and my summer assistant got out his tools and did so in a jiffy. It takes only a moment—so I was in business.

Except for the antenna. It was hooked up, yet clearly not producing the signal it should. So, the weather being just wonderful, my assistant hopped up on the roof hauling the ladder after him, laid the antenna down on its side and re-wired the works, replacing the old ladder-type 300-ohm lead with a handy hank of the solid solid variety we happened to have at hand. Since the original installation had been led to the wrong part of the house—and extended, rather than rewired, we now took a shorter, more vertical path in to the tuner.

Well—that did it. Integration was complete, antenna, lead-in, and tuner, all in prime operating condition. And so when I tuned towards New York WQXR 100 miles away, the IIIX level meter shot up to maximum, 10 on its dial, and stereo boomed through with negligible background noise. Even the weaker signal of WTFM came through nicely in stereo, though my musical ear generally gets tired of the fare available on that station before very long.

Just to clinch the deal, I recorded a good piece of "Tristan und Isolde" in stereo on the Eico 4-track recorder (recently noted in our EQUIPMENT PROFILE). Thus I made my first tape of a stereo broadcast. On playing it back the next day, I was aware that it could be identified as a broadcast, rather than a direct copy of a recording, by the slight background noise, occasionally increasing, and once in awhile a wish-whish.

A test I've not been able to make yet is to record stereo off the air at 100 miles, then AB the tape with the original record out of my files played via the same audio. I'll have to monitor a broadcast that I can duplicate among my own records, and that may take a bit of waiting. My expectation is that on direct AB the combination of stereo transmission at the station, 100 miles of space and a record-and-playback operation out of my tuner should add up to some deterioration. I suspect, too, that the stereo itself may turn out to have been somewhat modified in the process—watered down is a good enough term. I thought I noticed a bit of instability and a general lack of impact in the stereo image as I did my 100-mile listening, but this needs to await further experience, for confirmation.

After all, you're not supposed to listen to multiplex stereo at 100 miles.

I am indebted to L. F. B. Carini's ex-

cellent little booklet on FM antennas, "Theme and Variations,"\* for a neat summing-up of the life expectancy—replace every 20 months—and the losses expected from the various types of lead-in line. Because of loss cross-wise through the plastic separating material, increased by age, the best type is the fancy open-wire arrangement, but it is the least practical for most of us. The ladder-style plastic is the best ready-made type, followed by the clear flat ribbon—but this is not for outdoor use. Then comes the hollow tubular air-core ribbon and the similar oval type, not commonly seen, and then the flat brown ribbon for outdoors. The open wire type gives 0.3 db insertion loss per 100 ft., the perforated 0.7 (ladder type), the flat brown ribbon 1.6 in dry condition and 7.3 db when wet. A lot.

I think maybe I'll replace my flat brown ribbon with the ladder type before next winter sets in.

## 2. STRAVINSKY ON STEREO

Igor Stravinsky is 80 this year. Suddenly, he's the grand old man of music, though to many of us more esoteric souls he has been a composer to reckon with for most of our lives.

My first Stravinsky recording, natch, was somebody's version of "Fire Bird"; but the next and the next were pretty esoteric: the original Stravinsky 78-rpm recordings for European Columbia of the "Oetet" and the "Symphony of Psalms"—made in the very early Thirties, with the ultra-dead acoustics that were then the normal rule for such recordings. I've had many dozens since.

Stravinsky has kept himself remarkably up to date. His musical aesthetics are positive, original and very seldom in line with the standard clichés about art and music we hear so often. His interests, similarly, tend to be unorthodox according to the popular conception of a composer. He has no long hair, of course; but then, few composers have, since the turn of the century. (Rachmaninoff introduced the crew cut to the company of great composers.) But there's more than mere hair involved.

For instance, most musicians and many composers take a fashionable musical point of view towards the low-brow but necessary business of recording: they make their living off it, sometimes, get their publicity through it, but they do not admit it through the front door into their proper musical society. The real thing—live music—is so very much better.

That is a remark that always annoys me by its sheer irrelevancy. So are fresh beans. But, come December, frozen beans are quite a blessing and, if you ask me, I'd rather eat frozen peas than shuck fresh ones. More important, they taste better most of the time, too.

Of course "live" music is "better" than recorded, in many senses! So what. Most of us do not maintain house orchestras and resident string quartets, not to speak of opera companies, in our modest homes. Few of us are able to "play our own." And in any case, recorded music has its own values, purely musical, that complement those of live music. A great deal of music is, in practice, far better realized on records than in the concert hall—for which it may not have ever been intended.

\* Apparatus Development Co., Inc., Wethersfield 9, Conn.

# SIMPLE ARITHMETIC:

Uncompromising engineering + moderate price = best buy



## New Eico Stereo FM Multiplex Tuner ST 97

Semi-Kit \$99.95    Wired \$149.95    Includes Metal Cover AND FET

### BUILDING THE SEMI-KIT:

The two most critical sections, the front end and 4 IF's through to the detector, are entirely pre-wired and pre-aligned for best performance on weak signals (fringe area reception).

For the third most critical section, the heart of the stereo demodulator, you simply mount and solder the components on a high quality circuit board. Pre-aligned coils eliminate all adjustments. The rest is non-critical and easily accomplished with the clearest pictorial drawings and most thorough-going step-by-step procedure in the industry.

### THE CIRCUIT

**the front end** Consistent and reliable printed circuit. Ultra-sensitive, stable, and low-noise. Wide-band design. Rugged plated steel housing for protection and shielding. Meets FCC radiation requirements. Precise temperature-compensation for freedom from drift without AFC. AFC provided with defeat for convenience. Indirect gear drive is backlash-free and eliminates possibility of microphony.

**the IF strip** Four IF amplifier-limiter stages (all that will do any good) and an ultra-wide-band ratio detector, all pre-wired and pre-aligned. Designed with the utmost practicality so that the simplest alignment is also the alignment for highest sensitivity and practically lowest distortion. (Important to you if a service alignment is ever required.) Output is flat to the limit of the composite stereo signal frequency spectrum to eliminate any need for roll-off compensation in the stereo demodulator.

**the stereo demodulator** Ten stages for unequalled performance capabilities. EICO's brilliantly-engineered zero phase-shift, filterless detection circuit

(patents pending) eliminates loss of separation due to phase-shift in the stereo sub-channel before recovery. Complete rejection of storecasting interference. Cathode follower driven, sharp cut-off 15kc low pass filters in each output channel.

### THE OPERATION

Two slide-rule dials in a line: one, a station frequency dial with the famous EICO "eye-ronic"® tuning-eye travelling along it to indicate the exact center of each broadcast channel; the other a logging dial with an automatic stereo indicator lamp travelling along it in tandem with the tuning-eye to indicate when the station tuned in is broadcasting stereo.

### THE LOOK

Massive extruded aluminum panel and side rails, exquisitely brushed and anodized pale gold, with baked epoxy brown, perforated steel cover.

### PERFORMANCE

Pre-production field tests brought back the report "Definitely a fringe-area stereo tuner," which is simply the meaning of our laboratory measurements. We know, for example, that full limiting is achieved at 10uV input signal, meaning that the low distortion and noise specifications (the full benefits of FM) will apply to all but the most distant and difficult-to-receive stations. The sharp selectivity you need when a tuner is that sensitive is here also (a strong local station and a low-power station 100 miles distant separated by only 0.4 mc, each had its own sharp tuning-in point on the dial). While signal levels as low as 2.5uV will produce phase-locking for full stereo separation, very strong local signals will pro-

duce no higher output from the FM detector than a 10uV signal and will not be degraded in quality by overloading the stereo demodulator. Distortion is very low, both in mono and stereo, so that the sound you hear has that sweetness, clarity, and freedom from grating harshness that results from absence of distortion. The stereo output signals are so clean that there is not a sign of the 19kc pilot carrier or the re-inserted 38kc sub-carrier visible on a scope presentation.

### SPECIFICATIONS

Antenna Input: 300 ohms balanced. IHFM Usable Sensitivity: 3uV (30db quieting), 1.5uV for 20db quieting. Sensitivity for phase-locking (synchronization) in stereo: 2.5 uV. Full limiting sensitivity: 10uV. IF Bandwidth: 280kc at 6db points. Ratio Detector Bandwidth: 1 megacycle peak-to-peak separation. Audio Bandwidth at FM Detector: Flat to 53kc discounting pre-emphasis. IHFM Signal-to-Noise Ratio: -55db. IHFM Harmonic Distortion: 0.6%. Stereo Harmonic Distortion: less than 1.5%\*. IHFM IM Distortion: 0.1%. Output Audio Frequency Response: ±1db 20cps-15kc. IHFM Capture Ratio: 3db. Channel Separation: 30db. Audio Output: 0.8 volt. Output Impedance: low impedance cathode followers. Controls: Power, Separation, FM Tuning, Stereo-Mono, AFC-Defeat. Tubes: 1-ECC85, 5-6AU6, 1-6AL5, 1-12AT7, 2-12AU7, 1-6D10 (triple triode), 1-DM70 (tuning-eye), 1-EZ80 rectifier, 6 signal diodes, 1 neon lamp. Power Source: 117V, 60cps; 60 watts drain; extractor post fuse. Size (HWD): 5 1/8" x 15 1/8" x 11 3/8". Weight 17 lbs.

\*Actual distortion meter reading of derived left or right channel output with a stereo FM signal fed to the antenna input terminals.



70-Watt Integrated Stereo Amplifier ST70  
Kit: \$99.95    Wired: \$149.95  
Includes Metal Cover

40-Watt Integrated Stereo Amplifier ST40  
Kit: \$79.95    Wired: \$129.95  
Includes Metal Cover



FM-AM Stereo Tuner ST96  
Kit: \$89.95    Wired: \$129.95  
Includes Metal Cover and FET



FM Multiplex Autodaptor MX99 (Patent Pending)  
Kit: \$39.95    Wired: \$64.95  
Cover Optional \$2.95

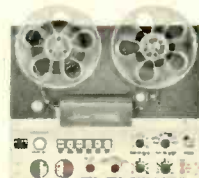

Transistorized Stereo/Mono 4-Track Tape Deck RP100 (Patents Pending)  
Semikit: \$299.95  
Wired: \$399.95  
Carrying Case \$29.95  
Rack Mount \$9.95



EICO, 3300 N. Blvd., L.I.C. 1, N.Y. A-8

Send free 32-page catalog & dealer's name.

Send new 36-page Guidebook to HI-FI for which I enclose 25¢ for postage & handling.

Name \_\_\_\_\_

Address \_\_\_\_\_

City \_\_\_\_\_ Zone \_\_\_\_\_ State \_\_\_\_\_

Add 5% in West.

© 1962 EICO Electronic Instrument Co., Inc.  
3300 Northern Boulevard, L. I. C. 1, N. Y.

Over 2 MILLION EICO Instruments in use. Most EICO Dealers offer budget terms.

Listen to the EICO Hour, WABC-FM, N. Y. 95.5 MC, Mon.-Fri., 7:15-8 P.M. • Export Dept., Roburn Agencies Inc., 431 Greenwich St., New York 13, N. Y.

FOR FULL QUALITY  
STEREO-MULTIPLEX  
OR MONOPHONIC  
FM RECEPTION

use

**FINCO**®

World's most  
Complete Line of  
Hi Fi Phased  
FM Antennas...

The "Top-Rated" "Best Buy"  
**FM ANTENNA LINE**

• No matter how well your FM unit is performing, you'll hear the difference a FINCO makes. Rich, luxurious distortion-free sound is yours when you pick just the right FM antenna from FINCO's complete line.

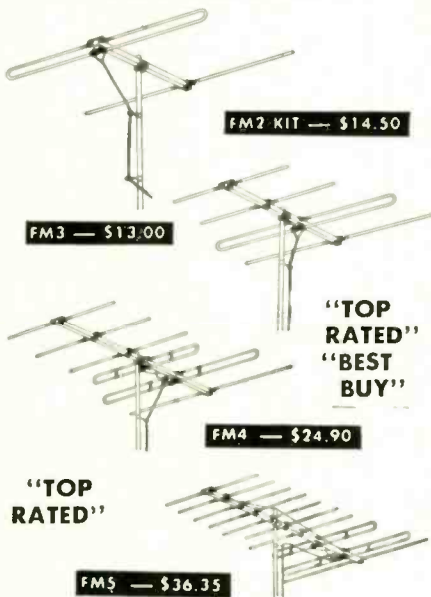

Plus FMT-1 Turnstile Kit — \$14.50

Write today for Catalog #20-213.

**FINCO**®  
THE FINNEY COMPANY  
Dept. A

34 W. Interstate Road Bedford, Ohio

This ability of the phonograph listener to "look in" imaginatively on all sorts of unlikely scenes, on widely varied musical surroundings, the ease with which he can accommodate to anything from an intimate solo recital to a grand symphony from his living room chair, counts for a great deal in our present music listening. But I could go on and on in this sort of defence. What I began to say was, Stravinsky has novel ideas on the most unexpected subjects, including this. Novel, that is, from an elderly and famous composer.

Stravinsky likes recording. He even likes stereo. Not only that, he can talk about it analytically. A while back, Columbia Records sent out a press release on him quoting, in turn, Stravinsky's remarks in a Record Supplement of the *New York Times*. How does "live" music compare with stereo? Here is his answer. Instead of the usual stereotypes about how much better live music is, he has this to say:

"Whereas the angle formed by a live orchestra and our two ears is about six inches, the angle at which the stereo microphone hears the same orchestra for us is sometimes as great as sixty feet." (Well, maybe there are other ways to put it, but this gets the idea over.) "We do not hear live performances 'stereophonically', therefore, and stereo, instead of giving us 'the best seat in the house' gives us, in fact, a kind of omnipresent seat not found in any house. Nor is it a seat in the orchestra; for an orchestra doesn't sound 'stereophonically' to itself.

"I do not say this to condemn stereo, however, but only to question the meaning of 'high fidelity', fidelity to what? If, as I say, the audition offered by stereo is, in any sense, unreal, it can be in another sense ideal and it is an idealization with important consequences. For one thing, it is a challenge to concert halls, though most concert halls are too bad to be worth challenging and since most concert halls are not ideal, or even good, I do not see why we should try to be 'real' or 'faithful' to them or why, in fact, we should not accept the stereophonic 'ideal'."

Take that from an old man! And this, mind you, was written only a few months after stereo was introduced on disc records. How many of your engineer friends were going along with stereo that soon?

Stravinsky went on, in this report, to talk about stereo separation in a novel way. Wagner, he pointed out, was mainly interested in a directional concentration of his huge orchestral sound, a minimum of separation—he was working for the very opposite of our stereo spread. (But stereo spread is only a part of the stereo effect, of course; the sense of "presence," the spatial feeling, the wall-bounce of the reverberation, are things that Wagner took for granted in his "live" music.)

On the other hand, Stravinsky points out, much music of a contrapuntal nature can benefit by the stereo spreading-out. (He says stereo has "no very serious ill effects" on such music, though Columbia unfortunately made a typo and had it "so very serious").

And with stereophony, he observes, we are also able to hear the true effect of many kinds of "live" spatial music which before could only be heard in very particular places. I can think of dozens of works which are more or less unsuitable for concert performances and yet turn out to be highly suitable for stereo. The backbone of good stereo material, in the classical area, is indeed found in such music.

Stereophony has already influenced existing music, says Stravinsky, in a superficial way "by a built-in exploitation of the

stereo effect, placing instruments near and far, on this side and that, so that one turns one's head to follow them." But, Stravinsky feels, a more profound influence will come "when composers see that in new music they have to construct "an independently interesting middle dimension". In other words, compose directly for the stereo space, rather than for the concert hall.

Stravinsky isn't happy about stereo recording techniques that separate the musicians so that, in the playing, an ensemble sound is very difficult for them to achieve. Unfortunate but necessary, some recording engineers will say.

As for separation, he observes very rightly that any "purely harmonic orchestral body"—i.e., one depending on the blend into a single sound—"will suffer from too much focus on its individual parts." There, he hits upon one of the biggest faults of much classical stereo. Too much separation, de-blending of instrumental sounds that were intended to fuse together, and do fuse together in the concert hall. The recording directors can play havoc with musical sense in this fashion, even though the outward sound may be stereophonically gorgeous. The art of recording in stereo, thus, is a more critical art than ever, depending crucially upon the musical judgment of those in charge of setting up the hall and the mikes within it.

Stravinsky, back when stereo was new, had the perception to write clearly on this subject. "In principle, of course, stereophonic recording should be able to fuse and achieve super-clear balances." (It can and does today, after four years of disc experience.) "In practice, however, we too often feel as though we were being made to follow the equivalent of "Arrow" scores to jump to the violins on their entrance, or follow a huge spotlight towards the trombones on theirs." The ping-pong effect, still very popular but now less evident in good classical stereo recording than in the early stereo period.

Stravinsky closes on a pleasant note of optimism. "With all my cautions about stereo, however, I expect that when I am accustomed to it, to its much greater volume and dynamic range, to its really remarkable ability to clarify orchestral doublings (that should have been left in the dark), to its ability to create the distance between a close instrument and a far-away instrument, I know I will soon be unable to listen to anything else."

I'm sure he hasn't, since.

I can clarify some of the above, perhaps. The "arrow scores" are standard miniature scores overprinted with huge black arrows that point to the things you are supposed to listen for—often in an arbitrary and unmusical fashion, oversimplifying. (Still—useful for score readers who "can't find the theme" in the welter of notes all over the page.)

As to "much greater volume and dynamic range" in stereo, I suspect that this was more apparent than real, i.e., Stravinsky heard it in the actual listening to stereo playback; his was not an engineering analysis and comparison, stereo versus mono. (He probably heard tape in the Columbia studios, anyhow.) However, if I am right, the maximum output from a stereo disc should be somewhat greater than that of an equivalent mono disc. (Not the same record played mono, merely removing the vertical response.) Groove geometry says so, anyhow, though perhaps recording engineers would suggest that considerations of stylus motion, tracking and compliance

(Continued on page 89)



**Let's listen in to a wonderful FM stereo!**

**32 (16/16) watts  
AM/FM Multiplex Tuner Amplifier  
SM-G 205**

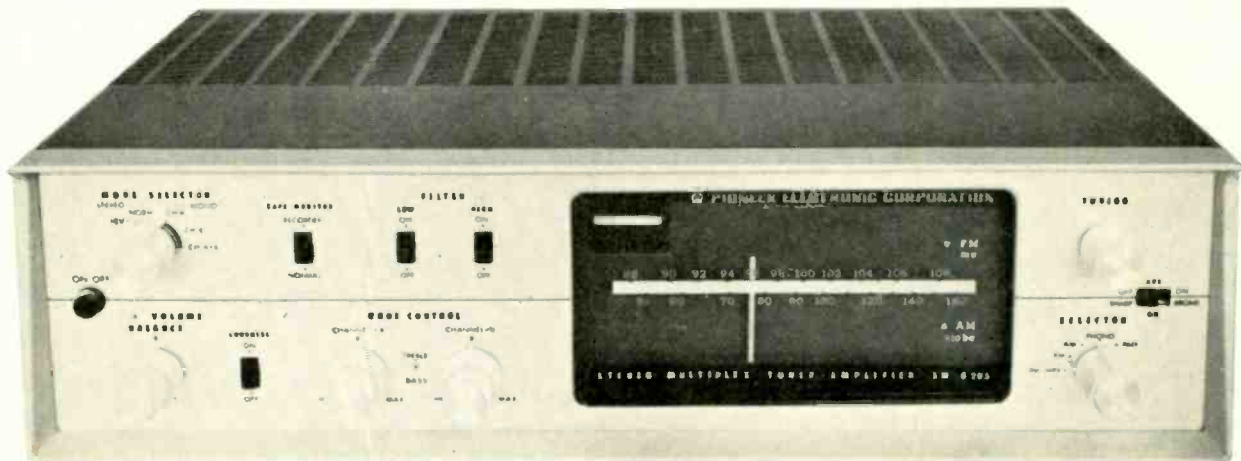

A new stereo amplifier that assures maximum performance in an FM multiplex stereo of wonderful tone quality — that's Pioneer's SM-G 205!

The SM-G 205 has both AM circuit and FM multiplex circuit for FM and FM stereo. The FM MPX tuner guarantees precise channel separation and perfect stereo reception, stabilized through the use of AFC. The phase reversion circuit produces stable and distortion-free output as high as 32W. Loudness control and high and low filters provide stereophonic reproduction of natural tone quality. And, the SM-G 205 is capable of reproducing a variety of program sources, including FM stereo, stereo discs, and stereo tapes — all with the same dynamic and rich tonal quality. The smartly modern design and clear-cut dial lines are sure to satisfy the most discriminating taste.

#### Specifications

Tuning Range: MW 535 to 1,605kc  
FM 88 to 108Mc

IF Band Width: MW Soft  $\pm 2.5$ kc, Hi-fi  $\pm 8$ kc  
FM  $\pm 100$ kc

Maximum Sensitivity: MW 19 $\mu$ V (at 1Mc, 500mW output; 30% modulation)  
FM 10 $\mu$ V (at 95Mc; 500mW output; S/N 30db; 30% modulation)

Inputs and Gain: MAG PU 2.5mV (For obtaining 11W output at 1kc)  
MTAL PU 28mV (For obtaining 11W output at 1kc)  
Tape (play) 165mV (For obtaining 11W output at 1kc)  
AUX 165mV (For obtaining 11W output at 1kc)

Output Terminal: 8 or 16 ohm for speaker (each channel)

Maximum Output: 16W x 2

Frequency Response: 20 cps - 5kc  $\pm 1$ db

Outside Dimensions: 18 $\frac{1}{4}$ "(W) x 13 $\frac{1}{4}$ "(D) x 5 $\frac{1}{2}$ "(H)



**PIONEER**

**PIONEER ELECTRONIC CORPORATION**

**5 Otowacho 6-chome, Bunkyo-ku, Tokyo, Japan**

**Distributors:**

Canada — IMPORTHOUSE OF CANADA 2939 Eglinton Ave. E., Scarboro, Ont.  
Singapore & Malaya — HWEE SENG & COMPANY 259 Beach Road, Singapore

# EDITOR'S REVIEW

## PLUG-IN TAPE HEADS

**I**N THIS DAY of rapid interchangeability being built into a wide variety of consumer products, it occurs to us that the same sort of feature could easily be provided with tape recorders. By now, the plug-in feature of record-playing equipment has become standard with every type of phonograph except the \$9.95 "hi-fi" models, and even in these it is usually possible to change the stylus. Actually, the only part of a phonograph pickup to wear out is the stylus itself, barring some accident which breaks or bends beyond repair the stylus-carrying element. So common is the expectation of being able to buy a replacement stylus that practically any price listing showing cartridges is followed by the line, "Replacement styli, \$x.xx," or possibly, "\$xx.xx."

Considering for a moment the difference between the wear on a stylus and that on a recording head, we come to an entirely different problem, and one for which no simple replacement "stylus" is offered that would bring performance back to that of a completely new instrument. Yet tape heads do wear, and as they do their high-frequency performance becomes poorer in most instances—more in some designs than in others. While the user can replace heads if he is physically competent enough, it still requires some rather intricate fumbling to make the change and it requires rather delicate soldering to get the usually fine leads properly in place on the new head without melting the insulation or even softening the head encapsulation. All of this could be eliminated if heads could be plugged in and out readily, with a well-designed mounting which would ensure accurate azimuth alignment. Since alignment must be done in any case when a head is replaced, it should present no hardship if alignment were also required every time a plug-in head were changed.

Even this would not be necessary if a complete head assembly—containing two to three heads as the case might be—were to be made to match up to a specific fixed point of registry on the recorder chassis. Once the heads were aligned on the individual mounting, the assembly could be changed at will without the need for further alignment. One other advantage of this arrangement appears to be that it would then be possible for the user to have say, two or three head assemblies—one for four-track tapes, one for two-tracks, and possibly one for full-track use. Most of us have occasion to record or reproduce both two- and four-track stereo tapes occasionally and such an arrangement would be a real windfall. As it is now, a four-track head will not give optimum performance with a two-track stereo tape; even though it may be possible to adjust the balance control to obtain approximately equal levels from the two channels, there is likely to be a difference in the signal-to-noise ratio on the two.

It is possible that there are good economic reasons why this idea is not practical, but it has been our experience that there is always a market for an improvement, even though it does cost a few dollars.

Anywhy, it is an idea that *we* would like in a machine for our own use.

## FM-STEREO FILTERS

Some readers have commented on the problems involved in recording FM-stereo broadcasts as a result of the presence in the tuner output of some 38- and/or 76-ke. Some months ago there was a newspaper report of one recordist who charged that radio stations were introducing spurious frequencies for the purpose of preventing the recording of their programs, but nothing more has been heard of it. Probably inaccurately reported, the named station indicated—according to the article—that it was experimenting with the idea. It is much more likely that it was a stereo broadcast, with the attendant 38-ke switching frequency appearing in the output.

It should be well known by now that the bias/erase oscillator in most non- or semi-professional tape recorders operates in the range of 70 to 80 ke, and the actual bias current in the head is comparatively high, so the presence of even a small amount of 76-ke in the signal being recorded will mix with the bias frequency giving the usual difference frequency of—in the typical bias-frequency-range—of 4000 to 6000 cps, and this appears in the playback as a continuing squeal which does act as an effective deterrent. What, if any, is the solution? Whose responsibility is it?

Some feel that the responsibility is that of the tuner manufacturer. From the audio standpoint, the 38- or 76-ke component does no damage whatever, and furthermore, it is usually at least 40 db down from the signal. It causes trouble only when the signal is recorded on a machine in which the bias frequency is close to 76 ke. We feel, therefore, that it is not the responsibility of the tuner manufacturer since he provides equipment which does what is intended of it. As we see it, the problem is up to the recorder manufacturer, and since it is relatively simple of solution, it would seem as though every recorder should be "FM-stereo proof." All that is necessary is to change the bias frequency to, say, 88 ke. This would make the major resultant signal 12,000 cps, which is not very likely to cause trouble. True, the fifth harmonic of 19 ke is 95, but very little 95-ke signal should be present in the tuner output, if any. There may be a little difficulty in raising the bias frequency in existing recorders, but a slight change in design could make it possible in future production.

The cure for anyone who now has a recorder which gives trouble lies in one of two methods—either increase the bias frequency so that it is in the range from 88 to 90 ke, or else introduce a low-pass filter between the tuner output and the recorder input. Since the highest frequency one is likely desirous of recording is 20,000 cps and the offending frequency is 38 ke, the filter should be relatively simple. In most instances a capacitor across the tuner output should suffice. Its value should be such that its reactance equals the impedance of the tuner output at about 20,000 cps. Try it out if you have this sort of a problem in recording stereo broadcasts.

# At Last!

A CARTRIDGE DESIGNED ESPECIALLY  
FOR AUTOMATIC TURNTABLES!

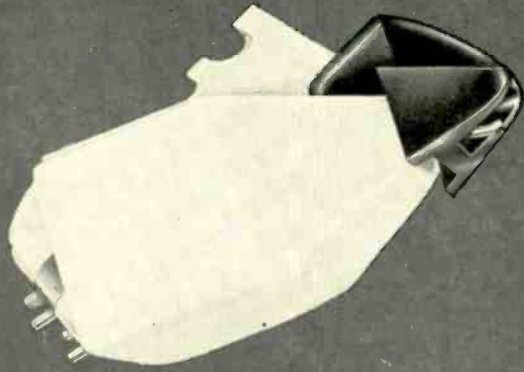

A NEW KIND OF CARTRIDGE FOR A TOTALLY NEW REQUIREMENT!

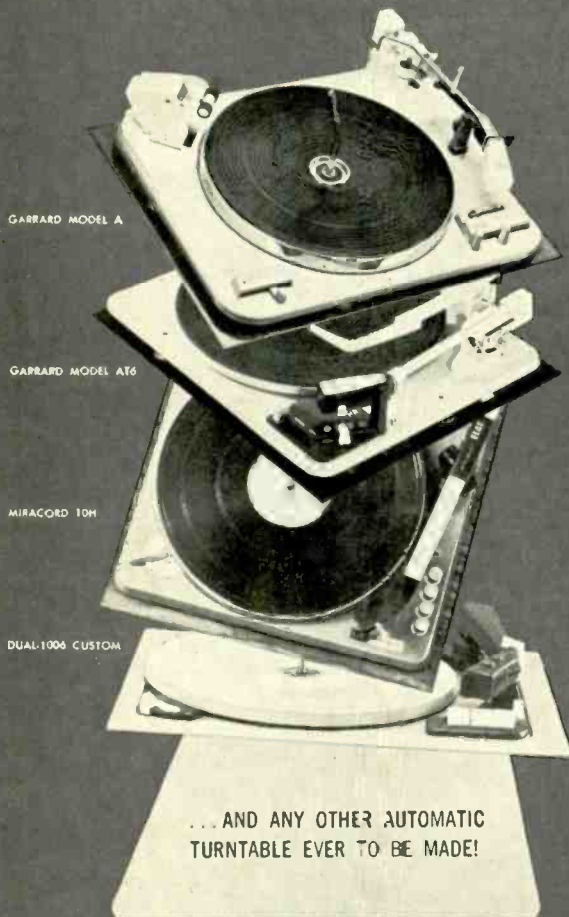

... AND ANY OTHER AUTOMATIC  
TURNTABLE EVER TO BE MADE!

The Pickering Model U38/AT is a cartridge designed especially for the new generation of automatic turntables. A true STANTON Stereo Fluxvalve, it combines excellent hum shielding with high output for unequalled signal-to-noise ratio.

High compliance is provided for the special turntable features while preserving the ruggedness demanded by automatic operation. Improved frequency response and lower inductance make the new Pickering U38/AT a truly universal cartridge to match the universal features of the automatic turntable.

**TECHNICANA:** PICKERING Model U38/AT is a STANTON Stereo Fluxvalve with a white body and black V-GUARD stylus assembly. Weight is 14 grams; Mounting centers: 7/16" to 1/2". Supplied with universal mounting hardware. \$46.50 AUDIOPHILE NET

**RESPONSE:**  $\pm 2$  db from 20 to 20,000 cycles.

**CHANNEL SEPARATION:** 35 db

**OUTPUT:** 10 mv each channel

**TRACKING FORCE:** 2 to 5 grams

**IMPEDANCE:** 47,000 to 100,000 ohms

**SHIELDING:** Complete mu-metal



" FOR THOSE WHO CAN HEAR THE DIFFERENCE "

**PICKERING & COMPANY, INC., Plainview, N. Y.**

The hermetically sealed STANTON Stereo Fluxvalve is warranted for a lifetime and is covered under the following patents: U.S. Patent No. 2,917,590; Great Britain No. 783,372; Commonwealth of Canada No. 605,673; Japan No. 261,203; and other patents are pending throughout the world.

# NOW RECORD FM STEREO FLAWLESSLY

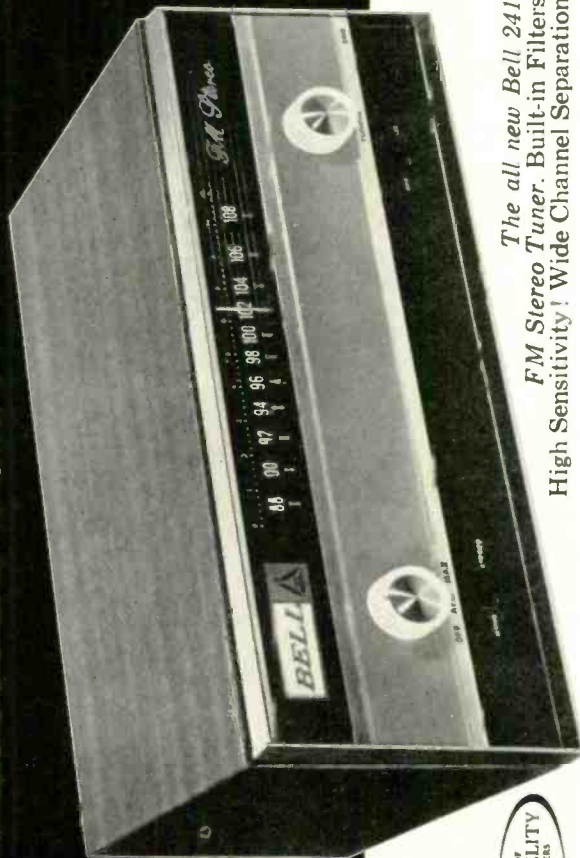

*The all new Bell 2419  
FM Stereo Tuner. Built-in Filters!  
High Sensitivity! Wide Channel Separation!*

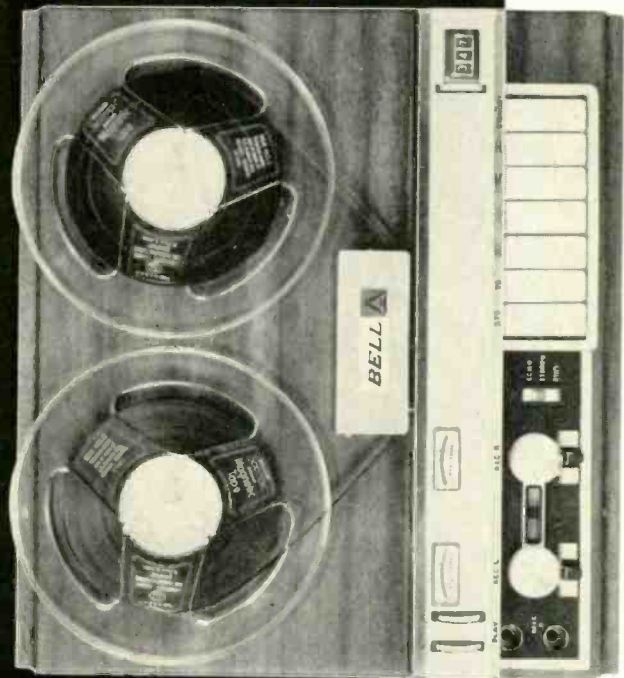

*The all new BELL T-347 4-Track Stereo Tape  
Deck. Off-the-tape monitoring! Sound on  
Sound! Echo Effect! Plus Duosound!*

Here's a matched pair of stereo components that lets you do an engineer-quality job of fine recording from FM stereo multiplex broadcasts

Special built-in filter circuits in the Bell 2419 FM Stereo Tuner provide interference-free recording. No squeal, whine or other noise that so often plagues made-in-the-home off-the-air stereo tapes.

This new Bell tuner is extremely sensitive; ideal for fringe area recording and listening. Its exceptionally stable multiplex circuits provide and maintain wide channel separation (30 db) for drift-free, consistently top quality FM reception.

The new Bell T-347 4-track stereo recorder is the obvious companion piece to the 2419 tuner. Three motor professional tape drive provides full control and safety for your tapes through all functions and at all speeds. And, separate play-back heads mean you always know that your recording is good, because you monitor off the tape giving you a constant check of the recorded program.

Additional features permit sound-on-sound recording, while built-in, variable echo provides many special dramatic effects. And, the sensational DUOSOUND . . . the most amazing recording feature you've ever heard . . . lets you put new dimension in monaural recordings! Re-record monaural records, tapes or broadcasts with such stereo effect that many ears will not detect the difference!

*Be sure to see and hear the new 2419 FM Stereo Tuner and the T-347 Tape Transport at your Bell Dealer soon! They are your answer to professional quality stereo recordings at a modest price.*

*You'll be absolutely thrilled by Bell's DUOSOUND!*

## BELL STEREO COMPONENTS

*Thompson Ramo Woolridge Inc.*

6325 Huntley Road Columbus 24, Ohio



# Transistorized FM Front Ends

C. R. GRAY and T. C. LAWSON\*

Development of transistorized FM tuners involves a whole new series of considerations no less complex than with vacuum tubes, but of entirely different types. Performance and reliability depend on the successful solution to all of the problems.

**M**ASS PRODUCTION of high-frequency transistors on automatic lines is now making it possible to design FM tuners for the consumer market at "consumer prices." This article discusses various transistor front ends used in FM tuners.

The term "front end" as used here refers to that portion of a tuner between the antenna and the first i.f. amplifier. This includes, where used, the r.f. amplifier and oscillator-mixer or converter. Much of the literature has referred to this part of the receiver as a tuner. However, the term tuner is often applied to the complete front end and i.f. amplifier, including the discriminator. For this reason, the term "front end" shall be used throughout this article.

The different types of configurations used in transistorized FM front ends are discussed along with the performance of each type. Also the influence that the choice of transistors has over the type of configuration used is discussed. Individual-stage circuit design considerations are also given.

## Basic Configurations

Figure 1 shows some of the basic configurations of an FM front end:

\* Philco Corporation, Lansdale Division

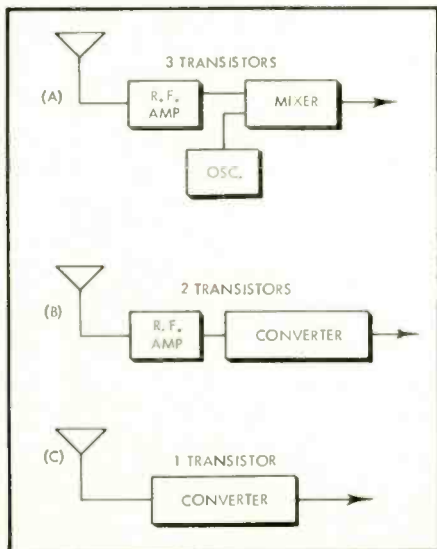
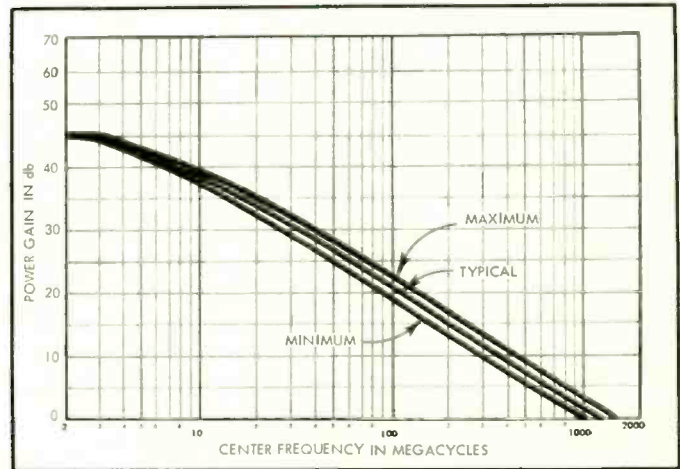

Fig. 1. Basic transistor FM front-end configurations.

Fig. 2. Typical matched-neutralized power gain vs. center frequency.



(A) is a three-transistor configuration using an r.f. amplifier, oscillator, and mixer; (B) is a two-transistor configuration using an r.f. amplifier and a single transistor as a converter; (C) is a one-transistor front end using only a converter. In the latter circuit, the r.f. amplifier has been eliminated and this configuration may consist of either a

single-transistor converter or a two-transistor oscillator-mixer combination. Before evaluating the basic configuration, some thought must be given to the choice of transistors used and also to the performance desired.

## Choice of Transistors

Transistors are available today whose gain and noise figure are comparable to the best tubes. Transistors such as the 2N1742 and the T2028 are intended for the best hi-fi applications.

Not only is proper circuit design necessary for good performance in an FM receiver, but the transistors must be in keeping with the desired performance and cost. In choosing a transistor for the r.f. amplifier, one important consideration is power gain. Since transistors are relatively low-impedance devices, power gain rather than voltage gain is important.

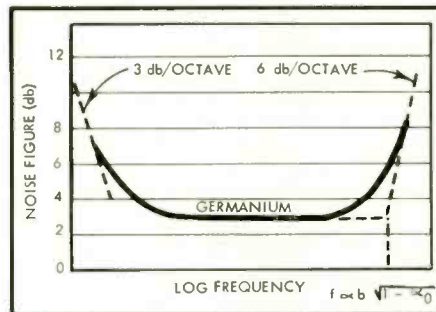
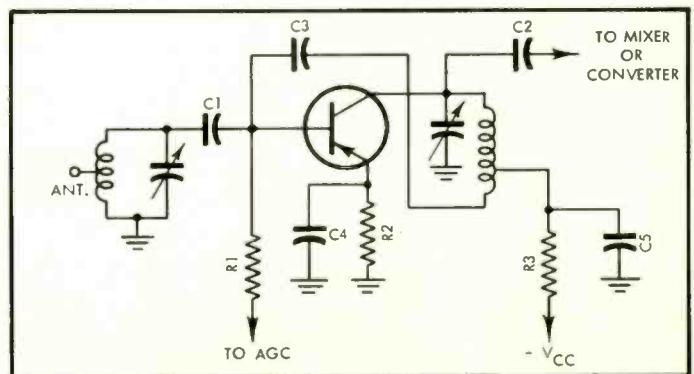

Fig. 3. Transistor noise figure vs. frequency.

Fig. 4. Common-emitter r.f. amplifier.



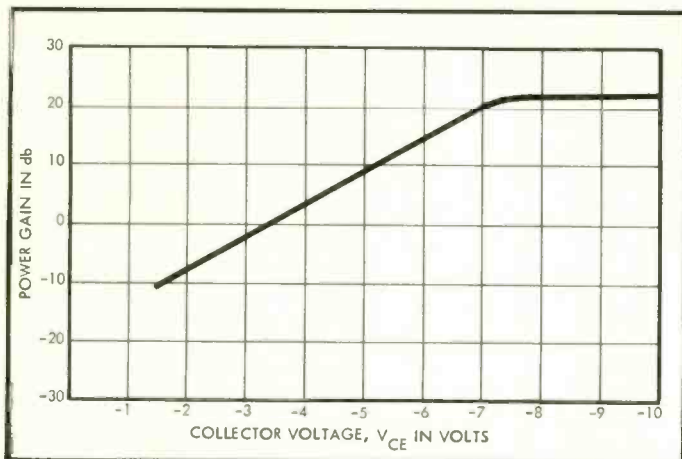

Fig. 5. Typical matched-neutralized power gain vs. collector-emitter voltage.

unit capable of at least 1 mw is sufficient.

**Circuit Considerations**

Before beginning consideration of the individual stages of a front end, a few general items must be considered. The supply voltage must not exceed the maximum ratings of the transistors and yet not be too low to affect the performance. A 12-volt supply is generally considered adequate.

The r.f. amplifier may be either a grounded-base or grounded-emitter configuration. At the FM frequencies, feedback which is inherent in the transistor is degenerative in the common-emitter connection and regenerative in the common-base connection. In a neutralized amplifier, the power gain will be identical in both connections. In an unneutralized amplifier more gain may be obtained from the common-base connection at some sacrifice in stability. When using a high-gain unit such as the 2N1742, sufficient gain may be obtained from the common-emitter connection. A unit with less gain, such as the 2N1745, may best be used in the common-base connection. Both of these connections have advantages and disadvantages. It has already been stated that more power gain can be obtained from an unneutralized common-base connection; however, the presence of regeneration causes a greater variation of power gain and bandwidth from transistor to transistor. Degeneration in the unneutralized common-emitter connection gives much better interchangeability. Best interchangeability is obtained from a neutralized common-emitter amplifier.

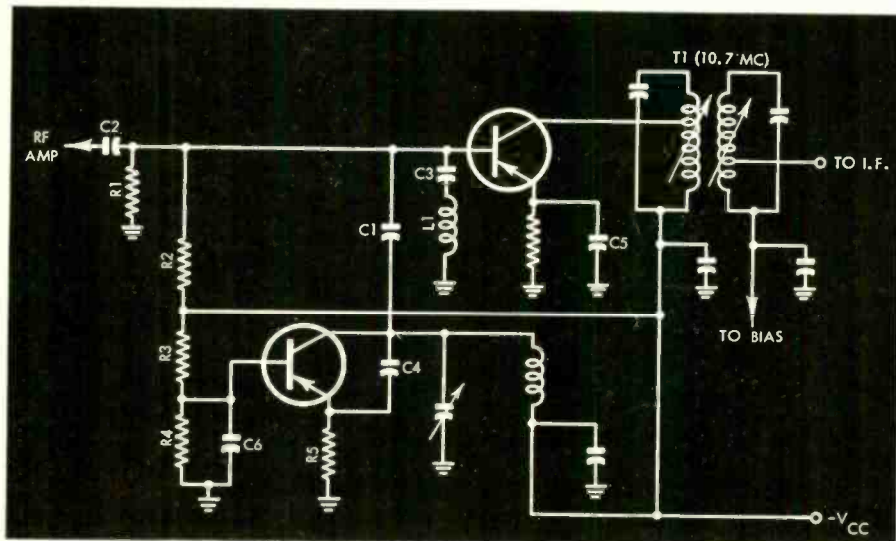

Fig. 6. Schematic of typical mixer and oscillator.

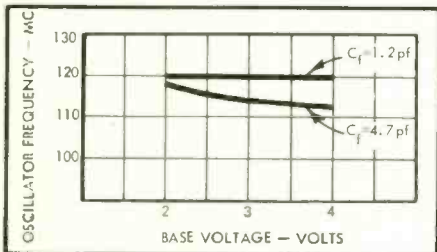

Fig. 7. A.f.c. characteristics—oscillator shift vs. base voltage for two values of feedback capacitance.

Figure 2 shows how the unilateralized power gain of most transistors varies with frequency. It can be seen that the power gain at any frequency can be determined if the power gain at another frequency is known since the slope of the curve in the high-frequency region is 6 db per octave. This means that if the power gain is a certain value at one frequency then it will be 6 db greater at one-half that frequency or 6 db less at twice that frequency.

Noise figure is also an important consideration in the r.f. amplifier. Figure 3 is a plot of transistor noise figure versus frequency. For any transistor in an FM r.f. amplifier, only the right portion of

this curve will be useful. Noise figure of the 2N1742 starts to increase at about 100 mc.

Conversion gain and noise figure are important parameters in a transistor for the converter or mixer stage. Noise figure, however, is not as important here as in the r.f. stage, although if it is excessively high, it can degrade the front-end performance.

The oscillator transistor must provide suitable output power at the FM-oscillator frequency for good mixer gain. A

Figure 4 is a circuit of a neutralized common-emitter amplifier.  $C_1$  and  $C_2$  are matching capacitors, to match the input and output resistance of the transistor. Impedance information is given by most semiconductor manufacturers in the form of short-circuit measurements for various frequencies and operating points. These values will be the same for a neutralized amplifier and will vary slightly in the unneutralized case, how-

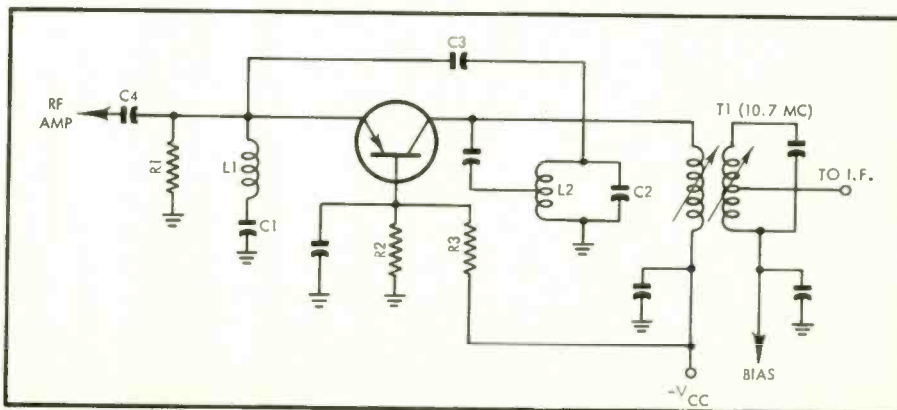

Fig. 8. Schematic of typical common-base FM converter.

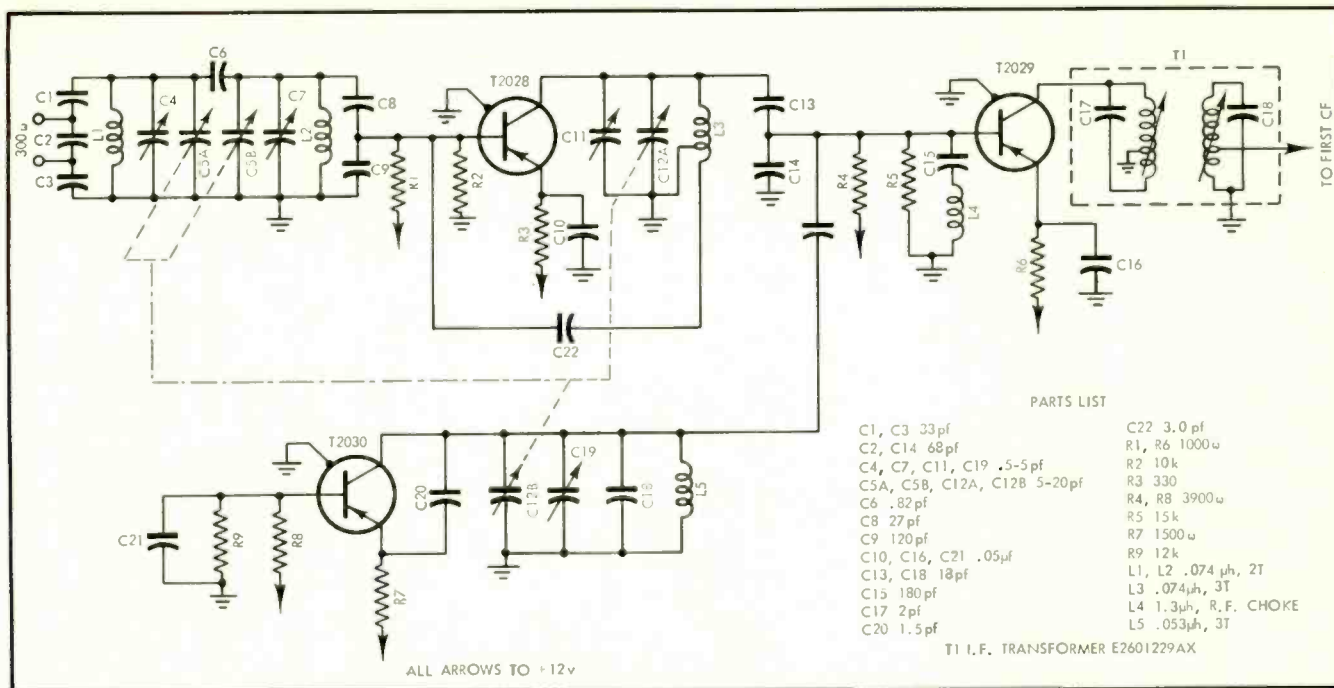

Fig. 9. Schematic of FM front end suitable for hi-fi applications.

ever, they will be sufficiently close for most initial designs.

Referring back to Fig. 4,  $C_3$  is the neutralizing capacitor which may or may not be used.  $R_2$ , which is bypassed by  $C_4$ , provides d.c. stability for temperature and beta variations.  $R_1$  provides the bias to the transistor base from the a.g.c. supply.  $R_3$  is inserted in the collector lead to provide the necessary voltage drop for forward a.g.c. As the a.g.c. voltage goes more negative, the resulting increase in collector current produces more voltage drop across  $R_3$  and  $R_2$ , thereby lowering the collector-to-emitter voltage. Figure 5 shows how the 100-mc power gain of the 2N1742 varies with the collector-to-emitter voltage.

Figure 6 is a circuit of a mixer and oscillator stage.  $C_2$  is the same matching capacitor shown in the r.f. amplifier and matches that stage to the input of the mixer. The input resistance presented here would be the same as the short-circuit resistance at the r.f. frequency.  $R_1$  and  $R_2$  provide bias voltage for the base.  $C_1$  couples the proper amount of oscillator injection voltage to the base. Approximately 150 mv is sufficient for good conversion gain. Emitter injection could also be used at this frequency with very little change in conversion gain or required injection power.

The matching capacitor,  $C_2$ , makes the base circuit a high impedance for the i.f. resulting in considerable degeneration.  $C_3$  and  $L_1$  are a series 10.7-mc tuned circuit to correct this problem, giving a considerable increase in conversion gain. It is imperative that the base-to-emitter impedance be low at the i.f. for good mixing action. This may also be accomplished with transformer

matching between the r.f. stage and mixer.

The oscillator is usually a common-base configuration as shown in Fig. 6.  $C_6$  places the base at r.f. ground and  $C_4$  provides feedback between collector and emitter to produce oscillation. A.f.c. does not seem to be necessary for frequency drift with temperature. However, for ease of tuning or where a varying supply voltage exists, some form of a.f.c. may be desired. By varying the d.c. base voltage, considerable variation in oscillator frequency can be obtained, depending upon the amount of feedback capacity used between the collector and

emitter. Figure 7 is a plot of oscillator shift versus base voltage for two values of feedback capacitance. With a little experimental work, a value of feedback capacitance could be determined to give the desired a.f.c. range.

Figure 8 is a circuit of a common-base converter, in which the oscillator and mixer have been combined in one stage. The same design considerations must be given to the converter as to the oscillator-mixer combination.  $C_1$  matches the r.f. amplifier to the input.  $C_3$  provides the oscillator feedback, and  $L_2$  plus  $C_2$  provide the oscillator tuned circuit.

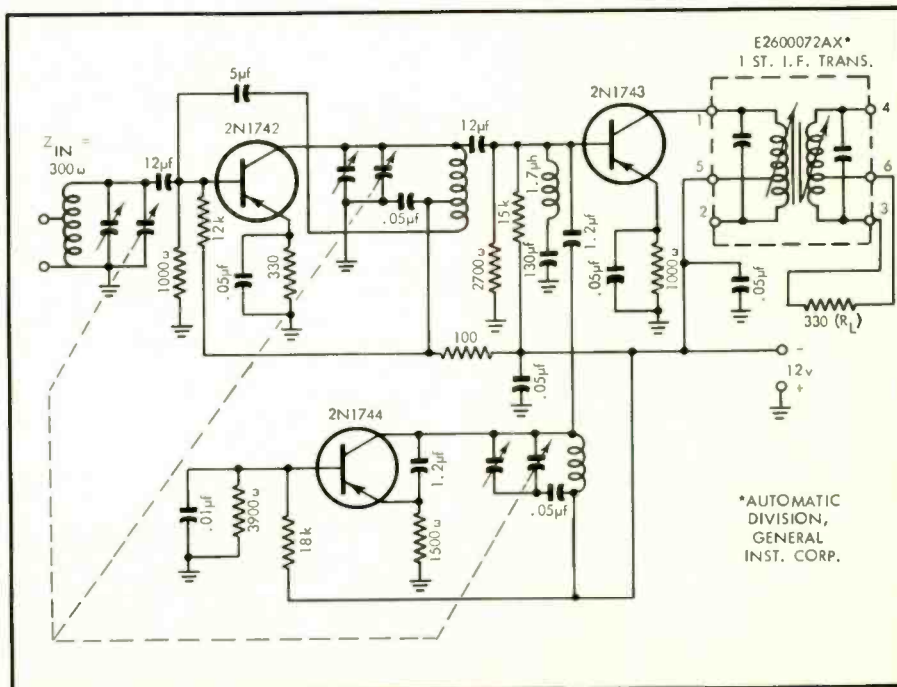

Fig. 10. Three-transistor FM front end.

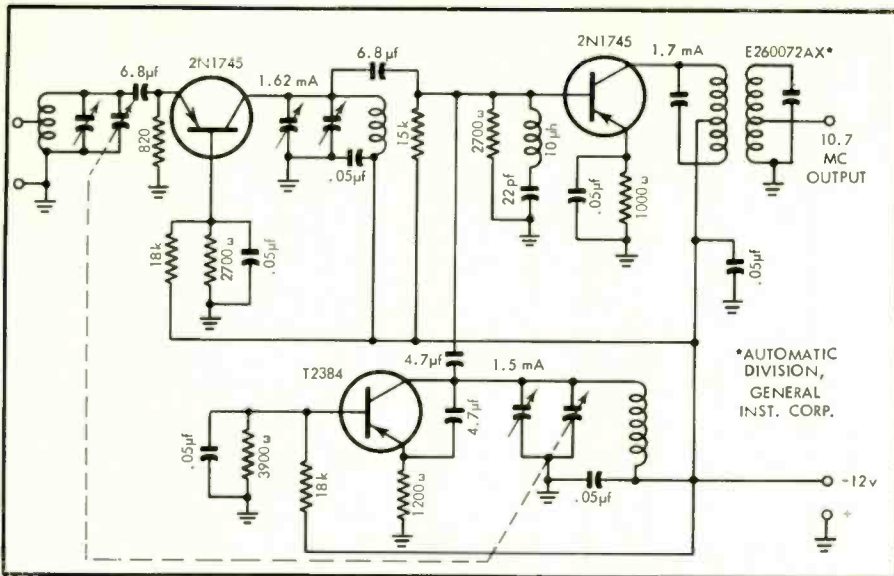

Fig. 11. Low-cost three-transistor front end.

$L_1$  and  $C_1$  compose the i.f. trap and  $R_1$ ,  $R_2$ , and  $R_3$  provide bias. The 10.7-mc output is taken from the double-tuned transformer,  $T_1$ .

**Performance**

Several basic tuners are described be-

low in order of performance and, in general, cost.

**1. Hi Fi Three-Transistor Front End**

A typical hi-fi front end is shown in Fig. 9. It has a double-tuned r.f. input and uses an r.f. transistor (T2028) whose

noise figure is about 3-3.5 db at 100 mc and whose typical  $f_{max}$  is 1800 mc. The r.f. and mixer are common-emitter; the oscillator common-base. The separate oscillator provides good stability and may be a.f.c.'d if desired.

The input 3-db bandwidth of the double-tuned circuit is about 1.5 mc and the input loss about 7 db. The output i.f. transformer has about 10 db loss. The over-all tuner gain is about 25 db giving a transistor gain of over 40 db.

**2. Three-Transistor Front End**

Figure 10 shows a conventional three-transistor arrangement for high-quality application. The 2N1742 has a typical noise figure of about 4 db at 100 mc and a typical  $f_{max}$  of 1200 mc. The gain is similar to the previous one (36 db) including the i.f. transformer. However, not as much care has been taken in designing for selectivity. The actual transistor gain of this complement is about 3-5 db less than the previous unit. The image and i.f. rejections are 38 and 60 db respectively.

**3. Three-Transistor Low-Cost Front End**

Figure 11 shows a three-transistor front end using transistors of slightly lower gain (2N1745 typical  $f_{max}$  900 mc). Neutralization is not used and the r.f. stage is run grounded base to improve the gain. As noted earlier, this sacrifices some uniformity. However, tuners such as this have been made in large quantities with no serious problems. The typical noise figure of the 2N1745 is about 4.5-5 db at 100 mc. The gain is about 28 db over the band including the loss in the first i.f. transformer. Image and i.f. rejection are 40 and 60 db respectively.

All of the above front ends use transistors which are functionally tested for the specific applications to insure interchangeability. Many manufacturers, including Philco, also sell transistors which are specified parametrically for low-cost applications. While these transistors do not have the control of parameters found in functionally tested units, it is possible to design sets with them if the design approach is conservative. Such a unit is described below.

**4. Two-Transistor Low-Cost Front End**

Figure 12 shows a two-transistor front end using the T2399 (typical  $f_T$  = 400 mc). This unit is designed for low-voltage (6-volt) operation. Both the r.f. and converter are common-base for extra gain. The typical noise figure of this transistor at 100 mc is 5 to 6 db. This arrangement will provide a gain of about 25 db including the loss in the first i.f. transformer.

Notice that the oscillator tank is in series with the i.f. tank and capacitive feedback is used for injection. In general, experience has shown that the gain of the converter is similar to the same

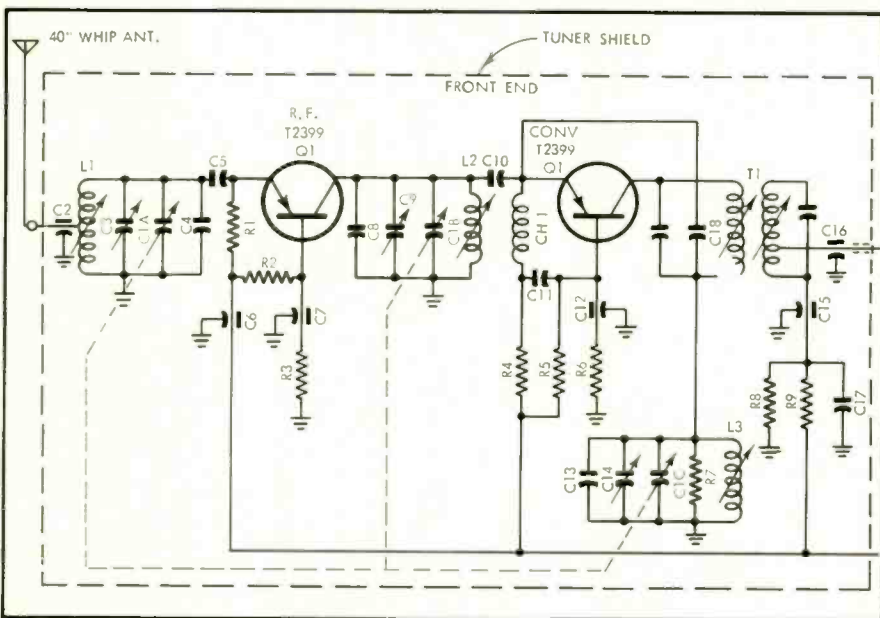

**PARTS LIST**

- |                                       |                                 |
|---------------------------------------|---------------------------------|
| C1 A, B, C 5-20 pf*                   | R1 390 OHM                      |
| C2, C16 1.5 pf FEEDTHROUGH            | R2 1500 OHM                     |
| C3, C9 0-18 pf TRIMMER ON TUNING GANG | R3, R9, R13, R17, R28 5600 OHM  |
| C5 8.2 pf DISC                        | R4 680 OHM                      |
| C4, C8, C10 5 pf DISC                 | R5 4300 OHM                     |
| C6, C7, C12, C15 2000 pf FEEDTHROUGH  | R6 47 k OHM                     |
| C11 330 pf DISC                       | R7 10 k OHM                     |
| C13 15 pf DISC                        | R8, R12, R16 2700 OHM           |
| C14 1-6 pf PISTON                     | R10, R14, R18 1000 OHM          |
| C17, C19, C20, C22 .05μf DISC         | R11, R15, R19, R26 220 OHM      |
| C23, C25, C26, C35 .05μf DISC         | R20, R21, R24 4700 OHM          |
| C18 2 pf DISC                         | R22 15 k OHM                    |
| C21, C24 5 pf SILVER MICA             | R23 10k, VOLUME CONT.           |
| C27, C28, C29 .005μf DISC             | R25 82 k OHM                    |
| C30 10μf, 15 WV ELECTROLYTIC          | R27 100 OHM                     |
| C31 .002 μf DISC                      | R29 82 OHM                      |
| C32 30μf, 15 WV, ELECTROLYTIC         | R30 2200 OHM, WIREWOUND, 1 WATT |
| C33 50μf, 15 WV, ELECTROLYTIC         |                                 |
| C34 100μf, 25 WV, ELECTROLYTIC        |                                 |

\*RADIO CONDENSER CO., #907588

Fig. 12. Low-cost two-transistor front end.



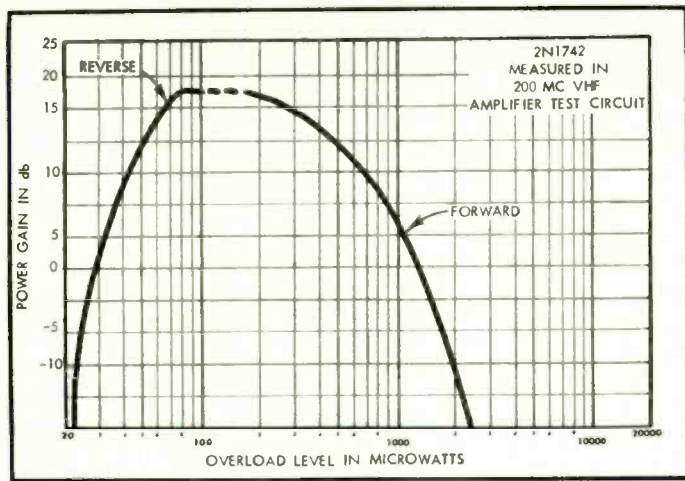

Fig. 13. Typical overload level vs. power gain for forward and reverse a.g.c.

unit as a mixer. However, while one less transistor is used in this arrangement it does have one serious disadvantage—the oscillator pulls on strong signals. In general, when the r.f. voltage applied to the emitter exceeds about 100–200k  $\mu$ v, the converter pulls badly and may become inoperative. Thus, depending on the gain of the r.f. stage, the converter will pull badly with input signals in the order of 10–30k  $\mu$ v. Two methods exist for correcting this. First, an overload diode in the collector circuit of the r.f. stage will limit the signal reaching the converter. Second, reverse a.g.c. may be applied to the r.f. stage to reduce the r.f. gain and thereby limit the signal. Forward a.g.c. cannot be used in this case because the low output impedance of the r.f. stage under full a.g.c. also causes oscillator pulling. The three-transistor tuner with the separate oscillator virtually eliminates the pulling and is therefore recommended wherever possible.

#### A.G.C.—Overload—Intermodulation

Two types of a.g.c. action are available to the transistorized FM circuit designer. The first, reverse a.g.c., is accomplished by reducing the current in the transistor. This is usually done by applying the a.g.c. voltage to the base. When the current is changed from the normal operating point down to about 50  $\mu$ a, the total a.g.c. range will be about 10 db more than the gain at the normal operating point. This type of a.g.c. in general provides less center-frequency shift, less bandwidth change (bandwidth reduces with a.g.c.), but also much worse overload performance.

The second, forward a.g.c., is accomplished by reducing the collector-to-emitter voltage. This is usually done by applying a signal to the base which increases the current and drops the supply voltage across bypassed series dropping resistors in either the collector or emitter circuits. This reduces the voltage across the transistor. Forward a.g.c. results in greater bandwidth and center-

frequency shift but also gives much better overload performance. Figure 13 shows a comparison of the overload performance of forward and reverse a.g.c. Reverse a.g.c. is useful with all transistors and will work at all frequencies

although it does not work well at low frequencies (audio). The MADT® amplifiers are the only VHF transistors designed to make use of the forward a.g.c. action. Forward a.g.c. is only effective in the high-frequency region (on the 6-db-octave slope). However, even with forward a.g.c., the overload performance and intermodulation in a transistor receiver are worse than a tube set. Subjective tests indicate transistors with forward a.g.c. are about 10 times worse, with reverse a.g.c. about 100 times. Herein lies the major problem in using transistors. However, with careful circuit design these problems may be minimized.

#### Reliability and Temperature

While intermodulation is a problem with transistors, improved reliability is an asset. Experience has indicated that most consumer products using transistors have line and field reject rates an order of magnitude better than vacuum tubes.

(Continued on page 104)

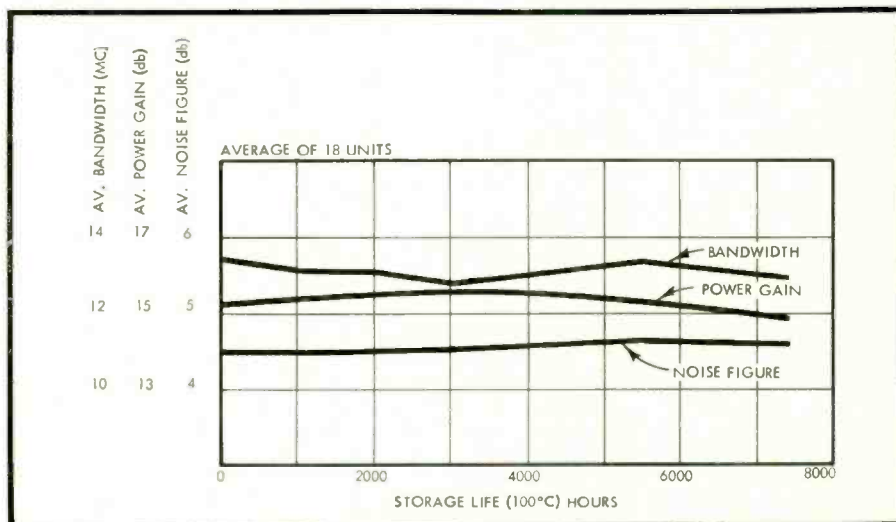

Fig. 14. Average curves of 2N1742 parameters vs. hours of life.

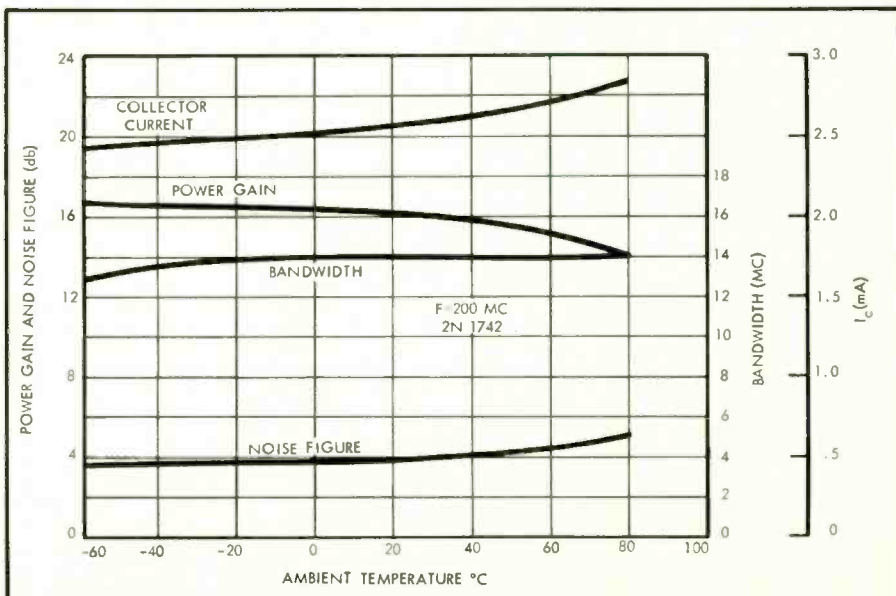

Fig. 15. Variations of power gain, noise figure, bandwidth, and collector current with temperature.

# Measuring and Matching the Phono Equalization Curve

MANNIE HOROWITZ\*

To ensure optimum performance from a phono cartridge, the response must be measured through the amplifier. Suitable equalizer circuits which depend on the cartridge characteristics, can then be introduced.

**P**HONOGRAPH CARTRIDGES may be divided into two major categories. One type produces an output voltage proportional to the amplitude of the signal recorded on a disc. The second, and probably the most popular with audiofans, provides a signal dependent upon the velocity of the stylus in the recorded groove. In each category there can be found good-quality and poor-quality units for both stereo and mono.

## Recordings and Cartridges

Group number 1 contains crystal and ceramic types. The output of these cartridges is proportional to the recorded

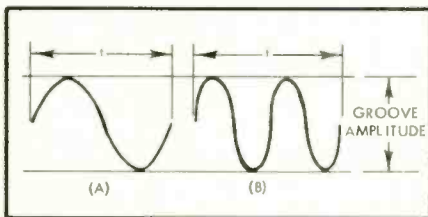

Fig. 1. Signal recorded in groove.

amplitude in the record groove. All frequencies recorded with equal amplitudes would theoretically produce constant voltages at the terminals of the cartridge. If the recorded amplitude were increased by a factor of two at any frequency, it would result in double the output voltage, depending upon the quality of the specific cartridge and the amplifier circuitry provided for reproduction.

Velocity-sensitive phonograph cartridges are exemplified by the magnetic (variable reluctance or moving coil) pickups. The output voltages produced by these types of cartridges can be understood with the help of Fig. 1.

Assume the frequency of recorded signal A is 1000 cps and that of recorded signal B is 2000 cps. Both signals have been recorded with equal amplitudes in the record groove. The stylus must travel twice the distance to trace curve B as it does in tracing curve A. The output from curve B will be double that of curve A

Fig. 2. Theoretical curves required to record and reproduce constant amplitudes. A-A, recording curve with constant-velocity cutter; B-B, playback curve using constant-velocity cartridge; C-C, constant-amplitude record and playback curve.

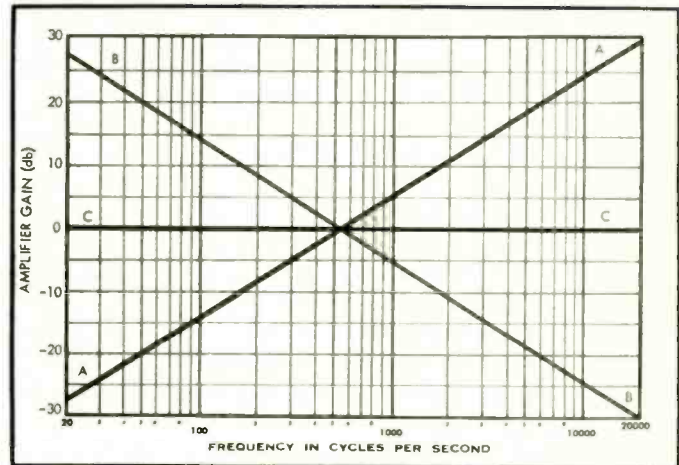

despite identical recorded amplitudes because the stylus traveled twice the distance during the same interval of time. From this it can readily be inferred that during reproduction, the output voltage is proportional to the frequency, assuming a constant recorded amplitude.

The velocity-type is generally used to record discs. When this type of cutter is being used, the voltage that must be applied to record signal B must be double that used for signal A, if both are to have the same groove amplitude on the recorded disc. Stated more analytically, to record a constant amplitude using a velocity-type recording head, the voltage applied to the head must vary directly with the recorded frequency.

Curve a-a in Fig. 2 shows the amplifier compensation required for recording a uniform amplitude with a velocity-type cutter while curve B-B shows the equivalent curve required to reproduce the constant recorded amplitude using a constant-velocity cartridge. One is the mirror image of the other about the zero axis. Note its 6-db-per-octave characteristic. For completeness, c-c is drawn as the recording and reproducing curve using constant-amplitude cartridges.

Recordings can be made using either the constant-amplitude or constant-velocity characteristic, or a combination of both. Assume for the moment that only the constant-velocity characteristic is used and that voltages equal in ampli-

Fig. 3. Groove amplitude resulting from applying a constant voltage to a velocity-type cutter.

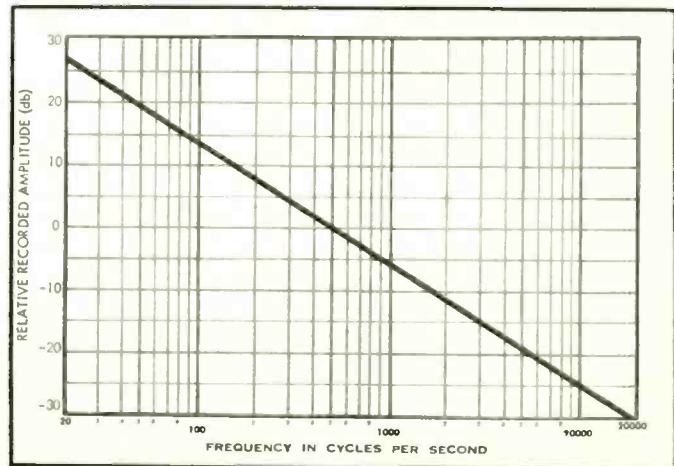

\* Project Engineer, Electronic Instrument Co., 3300 Northern Blvd., Long Island City 1, N. Y.

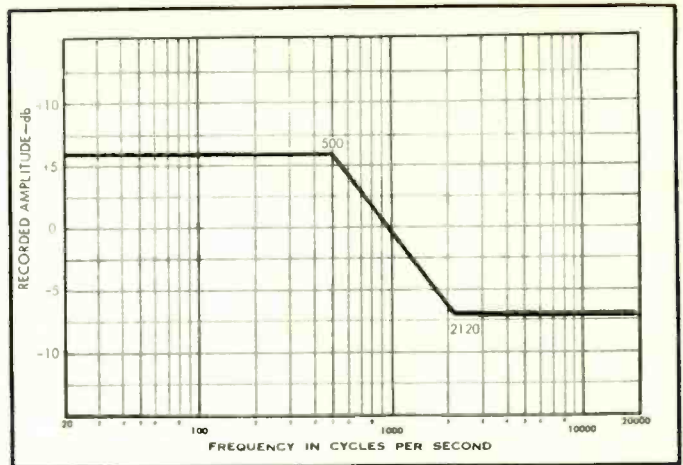
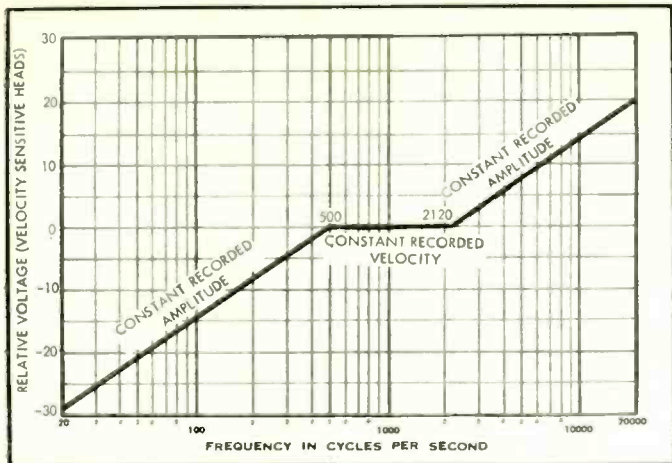

Fig. 4. (left) Curve adopted by RIAA for recording. Practical curves have rounded corners. Fig. 5. (right) Recorded amplitude resulting from constant-velocity cutter and RIAA recording curve.

tude at all frequencies were applied to this cartridge. The recorded groove swing would then vary inversely with frequency, as shown in Fig. 3. The amplitude in the record groove at the low frequencies would be much greater than it would be at high frequencies. Choosing two extremes of the audio band, the recorded amplitude at 30 cps is 500 times that at 15,000 cps.

This condition is intolerable for two reasons. At the extreme low frequencies, the record groove would be exceptionally wide. At the high frequencies, the recorded amplitude would be too low to override the record surface noise.

To overcome this, the RIAA (Recording Industry Association of America) adopted the recording curve shown in Fig. 4, which has become the standard of the industry. Assume that the record amplifier has been designed to produce a signal at the head having the frequency response of the curve shown in Fig. 4. Now apply a uniform signal to the recording amplifier. The resulting groove cut on the record will have the characteristics of constant-amplitude recordings up to 500 cps. This limits the groove swings at the low frequencies. The constant-velocity mode is used from 500 to 2120 cps. In this range, the groove swings decrease when a uniform signal is applied to the head. Above 2120 cps, the constant-amplitude characteristics take over to allow the high frequencies to override record noise. Here, as below 500 cps, a constant-amplitude groove is recorded for applied constant-amplitude voltages to the record head. The resultant excursions in the recorded groove are shown in Fig. 5.

Figure 5 results from the following considerations: The recording amplifier compensation curve required to produce uniform groove excursions at all frequencies using a velocity-type cartridge, must have the rising characteristic of A-A in Fig. 2. This is the slope of the constant-amplitude sections in Fig. 4. A constant-velocity section is drawn between the

two constant-amplitude sections. This requires no record amplifier compensation as it follows the natural characteristics of the velocity-type record head. In this range, recorded groove excursions vary inversely with frequency. The net recorded amplitude of the curve in Fig. 4 thus becomes the curve in Fig. 5.

Reproducing records using a constant-velocity cartridge requires a playback amplifier with the frequency-response curve being the mirror image around the 0-db axis, of the curve shown in Fig. 4. An exact curve, with the corners rounded off, is drawn in Fig. 6. Adding the curves in Fig. 4 and 6 (assuming the practical version of curve 4 has rounded corners) will result in a flat output along the 0-db axis. Obviously, to reproduce the input signal faithfully there must be a uniform output from the playback preamplifier for a uniform input to the record amplifier.

The setup shown in Fig. 7 is used for measuring the response of the amplifier. A more complete test would include employing the particular cartridge to be used with the amplifier, as an integral part of the test circuit.

#### Checking the Equalization Curve

A VTVM is shown monitoring the output from the signal generator. Greater accuracy can be achieved if the input

to the amplifier is monitored. The VTVM has been shown monitoring the generator not only because of simplicity in presentation, but also because of the smallness of the resulting error.

The unit under test is assumed to be a preamplifier. Because of its relatively high output impedance, the connecting leads to the output meter and scope should be of the low-capacitance shielded type. The test instruments should present a low capacitance to the preamplifier. If an integrated preamplifier-power amplifier is under test, all that would be required is the addition of a non-inductive load resistor at the output.

The AUX input is assumed to encompass that portion of the preamplifier exhibiting a flat response (i.e. no equalization). Other inputs with this characteristic may be labelled TUNER or MULTIPLEX.

The PHONO channel performs two functions. First it encompasses the amplification necessary for the low-voltage output from the constant-velocity cartridge. Next, it provides the equalization necessary for the particular cartridge.

In the test procedure, the output from the signal generator is first fed to the AUX input. A considerably reduced signal, attenuated by the action of the 1000-ohm to 10-ohm voltage divider is then fed to the PHONO input. If these resistive

Fig. 6. RIAA playback curve.

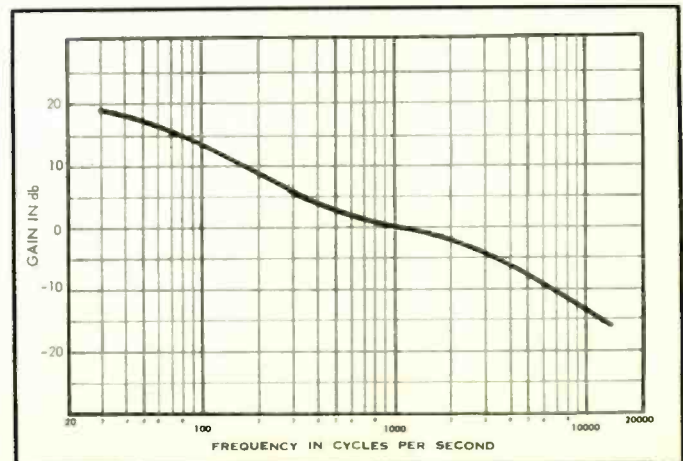

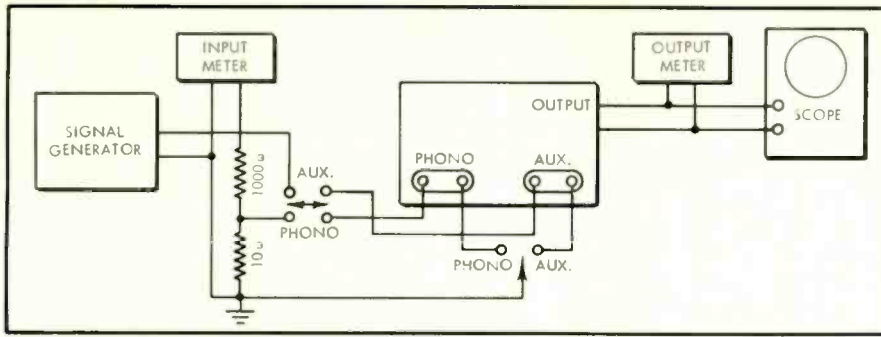

Fig. 7. Equipment set-up for measuring the phono equalization curve.

values load the audio generator excessively, the resistors in the dividing network may be increased proportionally. The desired signal level can be chosen using the DPDT switch shown in the drawing.

In most amplifiers, the PHONO and the AUX grounds on the preamplifier section are independent to prevent hum-sensitive loops from being formed between these inputs. To avoid any upset of this condition and to maintain the independent ground returns built into the amplifier, the ground lead from the signal generator should be switched when the specific input and signal level is chosen. This is accomplished using the DPDT switch.

The actual check should be accomplished using the following procedure to avoid false measurements: Feed the signal to the AUX input; adjust all frequency-compensating controls for a flat output; switch to 30 cps and turn up the level control to the point just before the preamplifier begins to distort; then make a note of this indication in db, on the output meter.

Now feed 1000 cps to the PHONO input. Set the level control on the signal generator so that the meter at the output of the preamplifier indicates some convenient point 19 to 25 db below the reading taken above at 30 cps. This is the reference or 0-db level. Measurements at other frequencies are referred to this figure in terms of the number of db above or below this 0-db level.

Select several frequencies on the curve

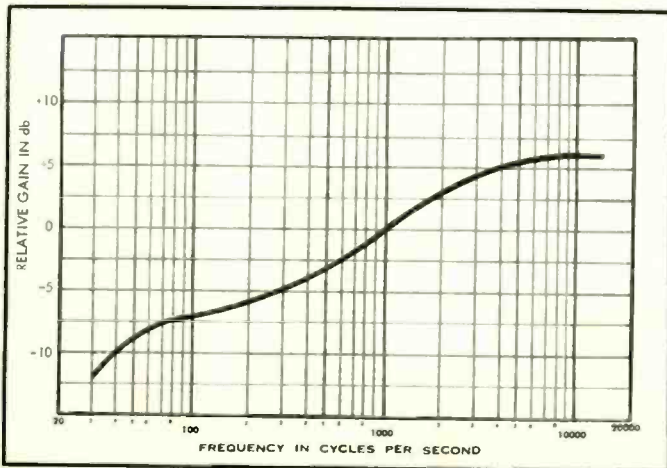

Fig. 8. RIAA curve for reproduction using a constant-amplitude cartridge.

in Fig. 6. Set the generator to each of these frequencies. The output from the generator must be maintained at a constant level, as read on the input-monitoring meter. Note the indication in db above and below the 1000-cps reference frequency. Compare these with the various points on the curve in Fig. 6. A good amplifier follows this curve with less than 2-db variation.

A more precise test includes the inductive effects of the cartridge to be used with the system. This factor becomes more critical when the cartridge is loaded by impedances other than that prescribed by the cartridge manufacturer. When the preamplifier under test is transistorized it is important that the cartridge be included.

Proper measurements will result only if the cartridge is placed in series with the PHONO input from the generator. Excessive high-frequency rolloff (possibly due to capacitance in the lead between the cartridge and the preamp) can then be adjusted reasonably well by increasing the input resistor to the PHONO preamplifier. Low-frequency inaccuracies may require redesign of the equalizing network.

#### Constant-Amplitude Cartridges

The output from these cartridges are theoretically proportional to the recorded amplitude as shown in Fig. 5. The playback curve must be the mirror image of this curve around the 0-db axis. An exact drawing of this curve, with corners

rounded off to reflect more accurately actual component characteristics, is drawn in Fig. 8.

The outputs from amplitude-sensitive cartridges are usually reproduced through linear amplifiers. For accurate performance, the cut at the low frequencies and the boost at the high frequencies must be built into the cartridge. The high-frequency boost is achieved by resonances purposely designed into the unit. Low-frequency cut is a function of the loading at the output of the cartridge.

The equivalent circuit of this type of cartridge is voltage source in series with a capacitance. The load resistor shown in Fig. 9 determines the loss at the low frequencies.

In this circuit,

$$V_{out} = V_{in} \frac{R}{R + X_c} \quad \text{Eq. (1)}$$

$$\text{or } \frac{V_{out}}{V_{in}} = \frac{R}{R + \frac{1}{j\omega C}} = \frac{j\omega RC}{j\omega RC + 1} \quad \text{Eq. (2)}$$

resulting in the gain curve shown in Fig. 10. The numerator indicates that at 0 cps, the output is zero, and rises from

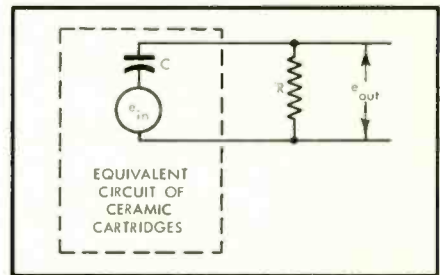

Fig. 9. Equivalent circuit of a ceramic cartridge feeding a resistive load.

there. The denominator indicates the frequency at which the output has dropped 3 db from the maximum flat output. The 3-db point is reached when, in the denominator,  $j\omega RC = j$ .

The capacitance of the cartridge is usually assumed to be 500 pf. The frequency where the output has fallen 3 db is, from Eq. (2),

$$f = 1/2\pi RC \quad \text{Eq. (3)}$$

for at this frequency, the  $j\omega RC$  term in the denominator Eq. (3) is equal to  $j$ .

Referring back to the curve in Fig. 8, the response is down about 12 db at 30 cps. Figuring back, it would be down 6 db at twice this, or 60 cps, and would be at the break point, which is already 3 db down, at 120 cps. Substituting this information into Eq. (3), yields a required load resistor,  $R$ , equal to

$$R = 1/2\pi fc = 1/6.28 \times 120 \times 5 \times 10^{-10} = 2.7 \text{ meg} \quad \text{Eq. (4)}$$

Unfortunately, few amplifiers have load impedances of that magnitude at the auxiliary inputs. A cathode follower at the input is required to provide this impedance. If the input impedance is 2.7 megohms, response at the AUX input

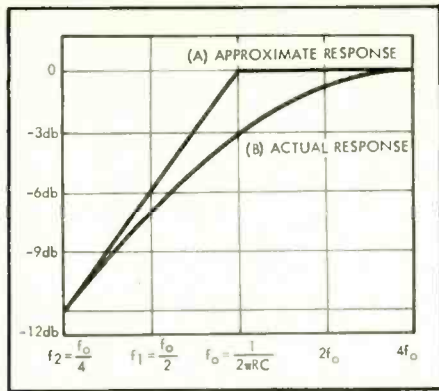

Fig. 10. Response of circuit of Fig. 9.

should be measured as described in the previous article. The output must be flat to enable the cartridge and pre-amplifier combination to provide the curve shown in Fig. 8.

It is frequently desirable to send the signal through the phono preamplifier when these cartridges are used. This serves the dual function of modifying

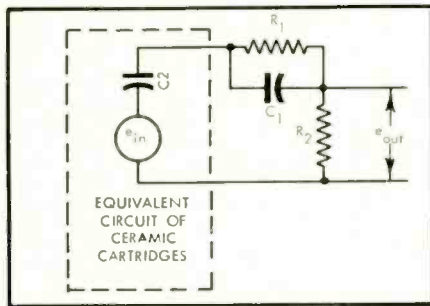

Fig. 11. Network used between ceramic cartridge and phono preamp with constant-velocity equalization.  $C_1 = 1000$  pf;  $C_2 = 500$  pf;  $R_1 = 68,000$  ohms;  $R_2 = 5000$  to 30,000 ohms.

the extreme requirements placed on  $R$  in Eq. (3) while permitting exact equalization for the different types of older records, when this is required. In the past, it has been the practice to provide these different equalizations in the phonograph preamplifier for velocity-type cartridges only. These equalization curves are not shown here. The modern amplifier seldom includes these, for all

record manufacturers have settled on the RIAA curve as standard. Older units may still incorporate the various equalizations.

One of the popular types of amplitude-sensitive cartridges is made by Sonotone. They recommend that the circuit shown in Fig. 11 be used between the ceramic cartridge and the velocity-equalized phono preamplifier. This network is used to modify the curve originally used with velocity-type cartridge to a curve suitable for use with ceramic amplitude-type cartridges.

An analysis of the circuit in Fig. 11 can become quite involved but is nonetheless worthwhile. The general sinusoidal solution can be applied to other constant-amplitude cartridges as well as to the Sonotone ceramic units for which the circuit was originated.

The equivalent circuit of the cartridge remains a voltage source,  $e_{in}$ , in series with a capacitor,  $C_2$ . The remainder of the circuit shown is designed to reproduce a record properly through an amplifier equalized for a velocity-type cartridge, while using one of the ceramic variety.

Considering the circuit as a voltage divider,

$$e_{out} = \frac{R_2}{X_{c2} + \frac{R_1 X_{c1}}{R_1 + X_{c1}} + R_2} (e_{in}) \quad (5)$$

where  $\frac{R_1 X_{c1}}{R_1 + X_{c1}}$  is the impedance of the parallel combination of  $R_1$  and  $C_1$ , while

$$X_{c2} = \frac{1}{j\omega C_2}. \text{ It also follows that } \frac{R_1 X_{c1}}{R_1 + X_{c1}} = \frac{R_1 / j\omega C_1}{R_1 + \frac{1}{j\omega C_1}} = \frac{R_1}{j\omega C_1 R_1 + 1}$$

Substituting this into Eq. (1), and dividing both sides of the equation by  $e_{in}$ , yields:

$$\frac{e_{out}}{e_{in}} = \frac{R_2}{R_2 + \frac{1}{j\omega C_2} + \frac{R_2}{j\omega C_1 R_1 + 1}}$$

Simplifying this,

$$\frac{e_{out}}{e_{in}} = \frac{R_2(j\omega C_2)(1 + j\omega C_1 R_1)}{R_2(j\omega C_2)(j\omega C_1 R_1 + 1) + j\omega C_1 R_1 + 1 + j\omega C_2 R_1} \quad \text{Eq. (6)}$$

Now, let  $k = C_2 R_1$ ,  $j\omega C_1 R_1 = S$ ,  $j\omega C_2 R_2 = S$  and  $S = j\omega$ . Substituting these into Eq. (6), and simplifying all terms inside the parenthesis, results in

$$\frac{e_{out}}{e_{in}} = \frac{S m (1 + S n)}{S^2 n m + S m + S n + 1 + S k} = \frac{S m (1 + S n)}{n m S^2 + S (m + n + k) + 1} \quad \text{Eq. (7)}$$

The two component factors in the denominator can be found by first letting the denominator be equal to zero. Thus

$$S^2 + S \left( \frac{m + n + k}{n m} \right) + \frac{1}{n m} = 0$$

Letting  $\frac{m + n + k}{n m} = \Sigma t$ , and solving<sup>1</sup> for the two values of  $S$ , namely  $S_1$  and  $S_2$ , yields:

$$S_1, S_2 = \frac{-(\Sigma t) \pm \sqrt{(\Sigma t)^2 - 4/nm}}{2} \quad \text{Eq. (8)}$$

Now letting  $\Delta = \sqrt{(\Sigma t)^2 - 4/nm}$ , the two solutions for  $S$  are

$$S_1 = \frac{-\Sigma t + \Delta}{2} \quad \text{Eq. (9)}$$

and

$$S_2 = \frac{-\Sigma t - \Delta}{2} \quad \text{Eq. (10)}$$

Substituting this back into Eq. (7), produces:

$$\frac{e_{out}}{e_{in}} = \frac{S m (1 + S n)}{\left( S + \frac{\Sigma t + \Delta}{2} \right) \left( S + \frac{\Sigma t - \Delta}{2} \right)}$$

<sup>1</sup>This type of solution can be found in most algebra books as a solution of the equation  $ax^2 + bx + c = 0$ . Here the two solutions of  $x$  are  $x_{1,2} = \frac{-b \pm \sqrt{b^2 - 4ac}}{2a}$

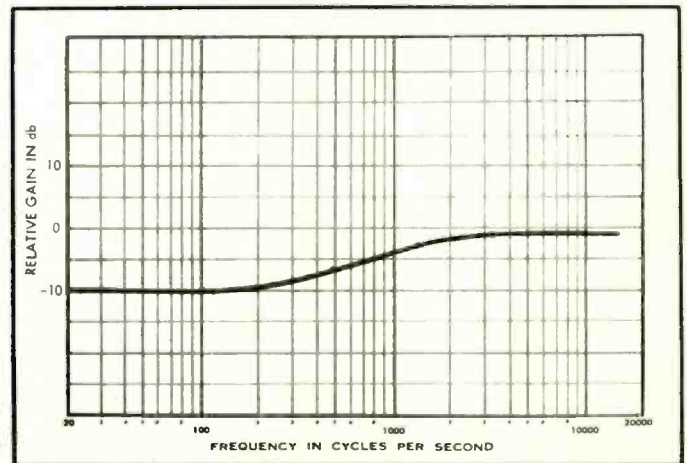
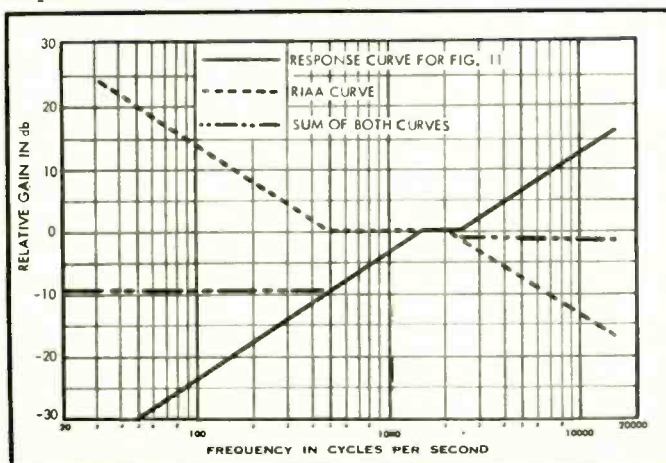

Fig. 12. (A), left, shows curves used to reproduce with a ceramic cartridge. A-A-A, response curve of Fig. 11; B-B-B, RIAA playback curve, built into preamp; C-C-C, the sum of curves A-A-A and B-B-B. (B), right, practical result of the C-C-C curve resulting from the circuit of Fig. 11.

$$\frac{j\omega m(1+j\omega n)}{\left(j\omega + \frac{\Sigma t + \Delta}{2}\right)\left(j\omega + \frac{\Sigma t - \Delta}{2}\right)}$$

$$= \frac{j\omega m}{\left(\frac{\Sigma t - \Delta}{2}\right)\left(\frac{\Sigma t + \Delta}{2}\right)} \times \frac{(1+j\omega n)}{\left(\frac{j\omega}{(\Sigma t + \Delta/2) + 1}\right)\left(\frac{j\omega}{(\Sigma t - \Delta/2) + 1}\right)}$$

Eq. (11)

Analyzing Eq. (11) results in the following four characteristics.

1.  $\frac{j\omega m}{\left(\frac{\Sigma t - \Delta}{2}\right)\left(\frac{\Sigma t + \Delta}{2}\right)}$  a constant factor

not affecting the frequency response any more than to show that at zero cps, the output is zero, and that the output rises at the rate of 6-db-per-octave from there.

2. The  $(1+j\omega n)$  indicates the point where the curve starts the second 6-db-per-octave rise. The frequency where the rise has advanced 3 db can be found by making  $j\omega = j$  or  $\omega = 1/n$ . Call this  $\omega_1$ .

3. and 4.  $1 + \frac{j\omega}{(\Sigma t + \Delta)/2}$  and  $1 + \frac{j\omega}{(\Sigma t - \Delta)/2}$  indicate the point where the curve starts dropping at the rate of 6-db-per-octave. The angular frequencies where the output has dropped 3 db from its former plateau, can be found by making the  $j$  terms in both factors equal to  $j$ .

Thus  $\frac{j\omega}{(\Sigma t + \Delta)/2} = j_1$  or  $\omega = \frac{\Sigma t + \Delta}{2}$ .

Call this  $\omega_2$  and  $\frac{j\omega}{(\Sigma t - \Delta)/2} = j_1$  or  $\omega = \frac{\Sigma t - \Delta}{2}$ . Call this  $\omega_3$ .

Using the constants called out in Fig. 11 to find  $\omega_1$  results in

$$\omega_1 = \frac{1}{n} = \frac{1}{C_1 R_2} = \frac{1}{(68 \times 10^3)(10^{-9})} = 14.7 \times 10^3$$

$$\text{and } f = \frac{\omega_1}{2\pi} = 2350 \text{ cps.} \quad \text{Eq. (12)}$$

To calculate  $f_2$  and  $f_3$ , it must first be noted that  $R_c$  can vary from 5000 to 30,000 ohms. It will be necessary to calculate  $f_2$  and  $f_3$  for both values of  $R_2$ . First, assume  $R_2 = 5000$  ohms. Then if  $n = 68 \times 10^{-6}$  (from previous calculations)

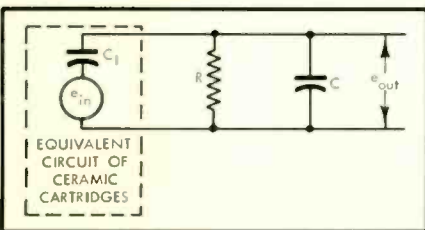

Fig. 13. Circuit used with a ceramic cartridge when feeding a relatively low impedance amplifier input.

$$k = C_2 R_1 = (5 \times 10^{-10})(68 \times 10^3) = 34 \times 10^{-6}$$

$$m = C_2 R_2 = (5 \times 10^{-10})(5 \times 10^3) = 2.5 \times 10^{-6}$$

$$k + m + n = 1.045 \times 10^{-4} \sim 1.05 \times 10^{-4}$$

$$mn = (68 \times 10^{-6})(2.5 \times 10^{-4}) = 1.70 \times 10^{-10}$$

$$\Sigma t = \frac{k + m + n}{mn} = \frac{1.05 \times 10^{-4}}{1.7 \times 10^{-10}} = 6.17 \times 10^5$$

$$\Delta = \sqrt{(\Sigma t)^2 - \frac{4}{mn}} = \sqrt{38 \times 10^{10} - \frac{4}{1.7 \times 10^{-10}}} = 5.97 \times 10^5$$

Substituting these figures into the equations for  $\omega_2$  and  $\omega_3$  gives

$$\omega_2 = \frac{6.17 \times 10^5 + 5.97 \times 10^5}{2} = 6.07 \times 10^5$$

$$\omega_3 = \frac{6.17 \times 10^5 - 5.97 \times 10^5}{2} = 10^4$$

so that  $f_2 = \frac{\omega_2}{2\pi} = 96,500$  cps Eq. (13)

and  $f_3 = \frac{\omega_3}{2\pi} = 1600$  cps Eq. (14)

while  $f_1 = 2350$  cps from Eq. (12).

Now assume the other extreme where  $R_2$  is equal to 30,000 ohms.

$$n = 68 \times 10^{-6}$$

$$k = 34 \times 10^{-6}$$

$$m = C_2 R_2 = (5 \times 10^{-10})(3 \times 10^4) = 15 \times 10^{-6}$$

$$k + m + n = 117 \times 10^{-6} = 1.17 \times 10^{-4}$$

$$mn = (68 \times 10^{-6})(15 \times 10^{-6}) = 1.02 \times 10^{-9}$$

$$\Sigma t = \frac{1.17 \times 10^{-4}}{1.02 \times 10^{-9}} = 1.17 \times 10^5$$

$$\Delta = \sqrt{(1.17 \times 10^5)^2 - \frac{4}{1.02 \times 10^{-9}}} = 0.99 \times 10^5$$

Substituting these values into the equation for  $\omega_2$  and  $\omega_3$  gives

$$\omega_2 = \frac{1.17 \times 10^5 + 0.99 \times 10^5}{2} = 1.08 \times 10^5$$

$$\omega_3 = \frac{1.17 \times 10^5 - 0.99 \times 10^5}{2} = 0.09 \times 10^5 = 9 \times 10^3$$

so that  $f_2 = \frac{\omega_2}{2\pi} = \frac{1.08 \times 10^5}{6.28} = 17,300$  cps Eq. (15)

and  $f_3 = \frac{\omega_3}{2\pi} = 1430$  cps Eq. (16)

while  $f_1 = 2350$  cps from Eq. (12).

The break points,  $f_2$  and  $f_3$  involve resistor  $R_2$ . It is interesting to note how insignificant a part the variation of  $R_2$  from 5000 to 30,000 ohms plays on the break points and consequently on the resulting frequency response of the network. When  $f_2$  was calculated for a value of  $R_2$  equal to 5000 ohms, the break point was at 96,500 cps, Eq. (13). Calculated for  $R_2$  equal to 30,000 ohms, it was 17,300 cps, Eq. (15). For all practical considerations, both frequencies are outside the audio spectrum.

However,  $f_3$  falls well within the audio spectrum. It is 1600 cycles when  $R_2$  is 5000 ohms and 1430 cps when it is 30,000

ohms. Audibly, it is at about the same frequency. We shall compromise and consider  $f_3$  to be 1500 cps.

$f_1$  does not involve  $R_2$  and remains at 2350 cps regardless of what  $R_2$  is. Variation of  $R_2$  will not affect frequency response to any noticeable degree. It will affect the voltage output from the network.  $R_2$  should be chosen so that a ceramic cartridge, when played through a velocity-equalized preamplifier, will provide sufficient output without overloading the preamplifier stages.

The response curve of this network, using a ceramic cartridge is shown in Fig. 12. The RIAA playback curve originally drawn in Fig. 6, is repeated in Fig. 12 with the corners squared off. This is an integral characteristic of the phonograph preamplifier in question. The sum of the two curves is the resultant curve necessary to reproduce the output from a ceramic cartridge properly.

Two things should be noted. First, the high-frequency boost from the network in Fig. 11 is just about cancelled by the built-in rolloff characteristic in the preamplifier at these frequencies. The resultant response at these frequencies is flat. At the lower frequencies, the curve conforms with that required to reproduce the output from a ceramic cartridge properly at these frequencies.

The flat response at high frequencies as shown in Fig. 12 does not prevent the boost shown in Fig. 8. The rise in response is still present due to the built-in resonances in the cartridge, as discussed previously.

Checking the preamplifier response using this network is straightforward. First check the preamplifier stage as previously described. Next, insert the network of Fig. 11 between the oscillator and the preamplifier. A 500-pf capacitor, representing the equivalent capacitance of the cartridge, should be inserted in series with the lead from the signal generator. The resultant output should follow the combined curve in Fig. 12, but with the corners rounded off, as shown in (B) of Fig. 12.

#### Ceramic Cartridges Feeding Medium Impedances

Any arrangement which results in a curve approximating that shown in (B) of Fig. 12 would result in proper reproduction from a disc recorded in accordance with the RIAA curve, when it is played with a constant-amplitude type of cartridge. Compensation is required only at the lower frequencies. The required high-frequency boost is controlled by resonances built in the cartridge.

Let us now assume that the input impedance at the amplifier is less than the 2.7 megohms recommended for  $R$  in Fig. 9 and determined by Eq. (4). In this instance, the circuit drawn in Fig. 13 may (Continued on page 87)

# PRODUCT PREVIEW SECTION

Presenting the annual compilation of the new—and some of the old standby—products that will be shown by your hi-fi dealer during the coming months, and at the Fall High Fidelity Music Show.

**W**HEN THE HI-FI MANUFACTURERS bring forth their annual crop of new and improved products, they are understandably anxious that everyone should know all about them. We are in full sympathy with this desire to the extent that we employ the August issue as a Product Preview, and then—to continue the service—we make the entire section available later in a handy-sized book for continued reference. This book, to be published September 15, is known as the AUDIOGUIDE.

In an attempt to arrive at some sort of uniformity in the descriptions of the products shown, we tried out a new scheme this year. Each manufacturer was furnished forms for each category

of products, with spaces for the information we think is important to the potential purchaser. This had, we opined, two advantages—one being that the manufacturer could choose which item he wished to feature in each category, and the other being the ultimate presentation of the material in a uniform order. The most important thing we learned was how to make forms, but we do believe that more information is provided about the products and in a more consistent form than heretofore.

We have continued the style of presentation, allowing a listing of up to five items in addition to the principal one, but without description in detail. Thus we have 38 pages of information

in this issue—and nearly 12 more of AUDIO size will be added in the AUDIOGUIDE. The additional material consists of more illustrations and a few items which had to be eliminated because of space. We hope, however, that the new form of data presentation meets with readers' approval.

The specifications given are those provided by the manufacturer. Prices quoted may vary between East and West, but only one price is shown. In any instance, for further information about any product described or listed but not described, just write to the manufacturer at the address given—he will be glad to hear from you.

## BASIC AMPLIFIERS

### ALTEC

● **351A Solid-State Power Amplifier.** The 351A is a 50-watt transistor amplifier for mono, stereo, third channel or hi fi music distribution use. It has the advantage of smaller size, lighter weight, less power consumption, and less heat generation than any vacuum tube counterpart. It provides 8 and 16 ohm speaker connections, plus an isolated 70 volt line (125 ohm) output for distributing sound to other speakers located throughout the house. The 351A represents an achievement in circuit design in that the rated power is developed over essentially the entire audio band at low distortion. Common power transistors become very "lossy" in the upper audio range and destroy themselves if operated continuously in that area. The 351A uses one of the most costly types, known as the "diffused-alloy transistor" to achieve its excellent high frequency performance.



**Specifications:** Transistor complement 9; Freq. resp. 20 to 20,000 cps  $\pm 1$  db; IHFM music power output, 50 watts; hum and noise, 90 db below rated watt output; sensitivity, input for rated output, 0.45 volts; damping factor, 7.5; output impedances, 4, 8, 16, 125 (70.7 v) ohms; weight, 14.5 lbs; dimensions: 9 $\frac{3}{8}$ " wide, 4 $\frac{3}{4}$ " high, 8 $\frac{1}{4}$ " deep; price, \$234.00. Altec Lansing Corp., 1515 S. Manchester Ave., Anaheim, California.

### FISHER

● **Model SA-300-B 90-Watt Stereo Power Amplifier.** Consisting of two identical basic amplifier channels for both stereophonic or monophonic reproduction, the SA-300-B offers laboratory quality at a fraction of the usual cost of equipment of this calibre. Hum and noise content is less than 1/1000th of 1% of full rated output! A center-channel output is included for connection to a third amplifier and loudspeaker system to fill the center of the stereophonic sound pattern.

**Specifications:** Tube/transistor complement 10 tubes and 1 selenium rectifier; freq. resp. 20 to 20,000 cps  $\pm 0.5$  db at 30 rms watts output; power bandwidth, 15 to 30,000 cps; IHFM music power output, 45 watts per channel; power output, rms, 38 watts per channel; harmonic distortion, 0.5% at 40 watts from



20 to 20,000 cps; IM distortion, 0.3% at 45 watts; hum and noise, 100 db below 1 watt output; sensitivity, input for rated output, 0.8 volts; damping factor, variable; output impedances, 4, 8, 16 ohms; controls, a.c. bal., bias adj, hum. separate input levels, d.c. bal.; switches, a.c. balance; convenience outlets, 1; weight, 32 lbs; dimensions, 16 $\frac{5}{8}$ " wide, 6 $\frac{1}{8}$ " high, 7 $\frac{1}{4}$ " deep. Price, \$199.50 assembled. Fisher Radio Corp., 21-21 44th Drive, L. I. C., N. Y.

1. Model SA-100 50-Watt Laboratory Standard Stereo Amplifier .....\$119.50

### LEAK

● **"Stereo 60" Amplifier.** Engineered for top-level performance, the Leak "Stereo 60" provides sufficient undistorted power to drive any modern speaker system.

**Specifications:** Tube complement (3) ECC83,

(4) EL34 (1) GZ34; Freq. Resp. 20 to 20k cps  $\pm 0.5$  db at 30 watts output; power output, rms, 30 watts per channel; harmonic

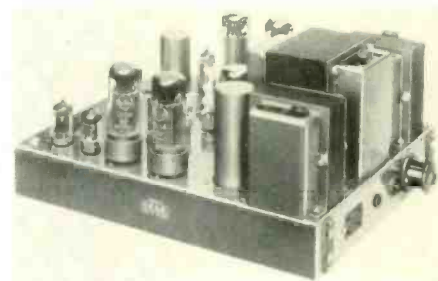

distortion, 0.1% at 30 watts; hum and noise, 80 db below 30 watt output; sensitivity, input for rated output, 120 mv; damping factor, 25; output impedances 4, 8, 16 ohms; convenience outlets 1; weight 27 $\frac{1}{2}$  lbs; dimensions: 10 $\frac{1}{2}$ " wide, 13 $\frac{1}{8}$ " high, 6 $\frac{1}{8}$ " deep; price, \$219.00. Ereona Corp., 16 W. 46th St., New York, N. Y.

1. "Stereo 20" Amplifier .....\$149.00

### MARANTZ

● **Model 8B Dual 35-watt Stereo Amplifier.** Long considered amongst the top as a stereo amplifier, the Model 8B offers more than per-



formance; it offers performance at top level for a long time. All components are used conservatively, as well as being of the finest quality. Construction practice is professional.

**Specifications:** Tube complement (2) 6BH6, (2) 6CG7, (4) EL-34; freq. resp. 20 to 20k

cps  $\pm 0.1$  db at 35 watts output; power bandwidth, 15 to 40k cps; power output, rms, 85 watts per channel; harmonic distortion, 0.5% at 35 watts from 20 to 20k cps; IM distortion, 0.5% at 35 watts; hum and noise, 80 db below 1 watt output; sensitivity, input for rated output, 1.3 volts; damping factor, 20; output impedances, 4, 8, 16 ohms; controls, bias adjust, meter; switches, test; weight, 50 lbs; dimensions, 13 $\frac{1}{2}$ " wide, 7 $\frac{1}{4}$ " high, 10 $\frac{1}{2}$ " deep; price, \$264.00. Accessories, 8G Grille \$9.00 Marantz Company, 25-14 Broadway, L.I.C., N.Y.

1. Model 9, 70-w mono power amp ... \$324.00
2. Model 9, 70-w, 70.7 volt output .... 354.00

## McINTOSH

• **Dual 75-watt Amplifier Model 275.** The reserve built into every "Mac" and the quality of component parts frees you from making critical adjustments. McIntosh has better performance with no bias controls and no balance controls. Of all amplifiers made and advertised, only McIntosh offers such low distortion with such reserve power. The patented McIntosh unity-coupled circuit makes this possible.



**Specifications:** Freq. resp. 16 to 60,000 cps  $\pm 0.25$  db; output, rms, 75 watts per channel; harmonic distortion, less than 0.5% at 75 watts from 20 to 20,000 cps; IM distortion, less than 0.5 at 75 watts; hum and noise, 90 db below rated output; sensitivity, input for rated output, 0.5 volts; output impedances, 4, 8, 16 ohms stereo, 2, 4, 8, 16, 32 mono; controls, 4 separate input gain; switches, power, stereo/mono; weight 67 lbs; dimensions, 17 $\frac{1}{4}$ " long, 8" high, 12 $\frac{1}{4}$ " wide; price, \$444.00, McIntosh Laboratory Inc., 2 Chambers St., Binghamton, N. Y.

1. MC 225, dual 25-w amp ..... \$198.00
2. MC 240, dual 40-w amp ..... 288.00
3. MC 75, mono 75-w amp ..... 229.50

## PIONEER

• **HF-90M, Monophonic Basic Amplifier.** The Model HF-90M is a power amplifier with a maximum output of 100 watts and is suited for use as a professional playback component when used in conjunction with a preamplifier. One use would be in a large auditorium or dining room.



**Specifications:** Tube complement (3) tubes, (3) silicon diodes; Freq. resp. 20 to 30,000 cps  $\pm 1$  db at 70 watts output; power bandwidth, 20 to 30,000 cps; IHFM music power output, 100 watts; power output, rms 80 watts; harmonic distortion, 1% at 80 watts at 1 k cps; IM distortion, 1% at 80 watts; hum and noise, 75 db below 1 watt output; sensitivity, input for rated output, 0.9 volts; output impedances, 4, 8, 16 ohms; controls,

level control; switches, power switch; weight, 26.5 lbs; dimensions, 14 $\frac{3}{4}$ " wide, 7 $\frac{1}{4}$ " high, 8 $\frac{1}{4}$ " deep. Pioneer Electronic Corp., 5 Otowacho 6-chome, Bunkyo-ku, Tokyo, Japan.

1. HF-90 MH, 200-ohms output

## QUAD

• **QUAD II Power Amplifier.** The QUAD II is designed to operate with the QUAD 22 control unit and therefore has no controls or switches. Stability and performance are independent of signal or load conditions so that this amplifier is suitable for use with any speaker system. A feature of this unit is its ability to maintain its specified performance even when tubes are replaced at random.

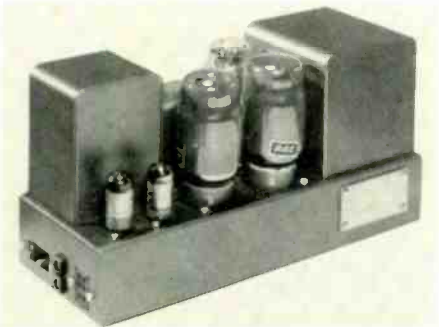

**Specifications:** Tube complement EF86(2), KT66(2), GZ32; Freq. resp. 10 to 50k cps  $\pm 0.5$  db at 1 watt output; power bandwidth, 20 to 15k cps; IHFM music power output, 11.5 watts per channel; power output, rms, 23 watts per channel; harmonic distortion, 2% at 23 watts; IM distortion, 1/2% at 25 watts; hum and noise, 80 db below 1 watt output; sensitivity, input for rated output, 1.4 volts; damping factor, 10; output impedances, 8, 16 ohms; weight, 18 $\frac{1}{4}$  lbs; dimensions, 13" wide, 4 $\frac{1}{2}$ " high, 6 $\frac{1}{2}$ " deep; price, \$125.00. Lectronics of City Lia Center, 7644 City Line Ave., Philadelphia, Pa.

## RAVENSWOOD

• **Model PA 800 Dual-45-watt Power Amplifier.** A high-power amplifier designed for the finest of systems and especially to drive heavy-duty speakers, the PA-800 is ideal for installation in systems which permit out-of-sight location and thus require no expensive housings for the amplifiers.

**Specifications:** Tube complement (2) 7199, (4) EL34; Freq. resp. 20 to 30,000 cps  $\pm 0.5$  db; IHFM music power output, 65 watts per channel; harmonic distortion, 0.6%; IM distortion, 1.1% rated output; hum and noise, 80 db below 1 watt output; dimensions: 16" wide, 5 $\frac{1}{2}$ " high, 6 $\frac{1}{4}$ " deep; price, \$199.95. RAVENSWOOD, Edgewood & McGuckian Sts., Annapolis, Md.

## H. H. SCOTT

• **208 80-Watt Stereo Power Amplifier.** A moderate power basic amplifier featuring low distortion. Well suited for most modern systems in conjunction with a preamplifier.

**Specifications:** Tube complement 6 tubes and selenium rectifier; Freq. resp. 20 to 20k cps  $\pm 1$  db at 10 watts output; power bandwidth 19 to 25k cps; IHFM music power output, 40 watts per channel; power output, rms, 36 watts per channel; harmonic distortion, 0.8% at 10 watts from 20 to 20k cps; IM distortion 0.5% at 10 watts; hum and noise, 80 db below 1 watt output; sensitivity, input for rated output, 1.5 or 2.5 volts; damping factor, 16.1; output impedance, 4, 8, 16 ohms; convenience outlets, 1; weight 27 lbs; dimensions, 16" wide, 5 $\frac{1}{4}$ " high, 7" deep; price, \$134.95. H. H. Scott, Inc., 111 Powdermill Rd., Maynard, Mass.

## SHERWOOD

• **S-360 40-Watt Basic Mono Amplifier.** The S-360 is a basic power amplifier with 40-watt music power output. Its long life and minimum distortion have won for it selection on such vital government installations as the Astronaut Project Mercury. Its compact size

makes it especially convenient for use as a 3rd-channel amplifier or as a booster amplifier (in pairs for stereo) for remote speaker installations.

**Specifications:** Tube complement (4) 7189, 12AX7, GZ34; freq. resp. 20 to 20k cps  $\pm 2$  db at 36 watts output; IHFM music power output, 40 watts per channel; power output, rms, 36 watts per channel; harmonic distortion, 0.7% at 36 watts from 25 to 20k cps; IM distortion, 1 $\frac{1}{2}$ % at 40 watts; hum and noise, 75 db below 1 watt output; sensitivity, input for rated output, 0.18 volts; damping factor, 10; output impedances, 4, 8, 16 ohms; controls, sensitivity, output tube balance; switches, output tube test; convenience outlets, 1; weight, 15 lbs; dimensions, 13 $\frac{1}{2}$ " wide, 6" high, 4 $\frac{3}{4}$ " deep; price \$59.50. Accessories: case, \$6.00. Sherwood Electronic Labs, Inc., 4300 N. California Ave., Chicago 18, Ill.

# BASIC AMPLIFIER KITS

## DYNACO

• **Stereo 70 Dual 35-watt Stereo Power Amplifier Kit.** Includes pre-assembled etched circuit for maximum reliability and ease of construction plus Dynaco output transformers. Stable with any loudspeaker, with excellent damping and square wave and pulse test performance. Output tubes operated at only 65% of capacity and filter capacitors at less than 85% of rated voltage—really conservative design.



**Specifications:** Tube complement: (4) EL34, (2) 7199, GZ34, selenium rectifier; Freq. Resp. 10 to 40 k cps  $\pm 0.5$  db at 1 watt output; power bandwidth, 20 to 20 k cps. IM distortion 1% at 35 watts; hum and noise, 74 db below 1 watt output; sensitivity, input for rated output, 1.3 volts; damping factor, 15; output impedances, 4, 8, 16 ohms; controls, biaset for each channel; switches on-off/stereo-mono; weight 28 lbs; dimensions, 13" wide, 9 $\frac{1}{2}$ " high 6 $\frac{1}{2}$ " deep. Price \$129.95 assembled, \$99.95 kit, including protective cover. Dynaco Inc. 3912 Powelton Ave., Philadelphia, Pa.

1. Mark III 60-watt mono amp kit ... \$ 79.95
2. Mark III-70 60-watt amp kit with usual and 70-70 output ..... 84.95
3. Mark III-500 60-watt amp kit with either 500 or 125 output ..... 89.95
4. Mark IV 40-watt mono amp kit ..... 59.95
5. Stereo 35, dual 17.5-watt amp kit (new Nov. 1962) ..... 59.95

## EICO

• **HF89 100-Watt Stereo Power Amplifier Kit.** Each power amplifier section of the HF89, conservatively rated at 50 watts, employs the proven cathode-coupled phase-inverter-driven circuit, preceded by a direct-coupled voltage amplifier. Fixed-biased, push-pull EL34's are used in the output stage and provision is made for both bias and d.c.-balance adjustments. The very-low-impedance characteristics of silicon diode rectifiers give the common power supply for the two amplifiers very good regulation, so that signal conditions in one amplifier have negligible effect



on operating conditions in the other. To ensure long life for the silicon diode rectifiers, electrolytics, and tubes, a surge resistor is included to limit the starting surge currents.

**Specifications:** Tube (1) *6CC83/12A X7*, (2) *6SN7GTB*, (4) *EL34*, silicon diode power supply; Freq. resp. 5 to 100k cps  $\pm 0.5$  db at 2 watts output; power bandwidth, 15 to 100k cps; power output, rms 50 watts per channel; harmonic distortion 1% at 50 watts from 20 to 20k cps; IM distortion, 0.5% at 100 watts; hum and noise 80 db below 1 watt output; sensitivity, input for rated output, 0.55 volts; damping factor, 12; output impedance, 4, 8,



16 ohms; controls, level set ch. 1, level set ch 2, bias dc bal. ch. 1, dc bal. ch. 2; switches, on-off; convenience outlets, 2; weight 40 lbs; dimensions, 15" wide, 6" high, 11" deep; price, \$139.50 assembled, \$99.50 kit. Accessories, matching metal enclosure, E-8, \$4.50. Electronic Instrument Co., Inc. 3300 Northern Blvd. L.I.C., N. Y.

1. HF-87 70-w stereo amp kit ..... \$74.95
2. HF-86 28-w stereo amp kit ..... 43.95

## HARMAN-KARDON

● **Citation II, 120-watt Stereo Power Amplifier Kit.** The Citation II is the top of the Harman-Kardon kit line insofar as power amplifiers are concerned. It offers sufficient power (undistorted) to drive any inefficient speaker extant and in addition it can handle the full dynamic range of a symphony orchestra.



**Specifications:** Tube complement, (4) 6550, (6) 12BY7A. Freq. resp. 2 to 80,000 cps  $\pm 0.5$  db at 1 watt output; power bandwidth, 18 to 40,000 cps; power output, rms, 60 watts per channel; harmonic distortion, 0.3% at 60 watts from 20 to 20,000 cps; IM distortion, 0.3% at 60 watts; hum and noise, 90 db below 60-watt output; sensitivity, input for rated output, 1.5 volts; damping factor, 18+; output impedances, 4, 8, and 16 ohms; controls, a.c. balance, bias adjust; switches, bias, a.c. balance selector; convenience outlets, 1, weight, 60 lbs; dimensions, 16 $\frac{3}{4}$ " wide, 9" high, 11 $\frac{1}{2}$ " deep. Price, \$229.95 assembled, \$159.95 kit. Accessories, ACU metal enclosure, \$7.95. Harman-Kardon, Inc., Plainview, N. Y.

1. Citation V, 80-w ster pwr amp kit .. \$119.95
2. Citation V, 80-w ster pwr amp wired. 179.95

## KNIGHT-KIT

● **KB-85 70-watt Stereo Amplifier Kit.** A basic stereo amplifier featuring 35 db of negative feedback per channel, a heavy chrome-plated chassis, and two printed circuit boards for easy assembly.

**Specifications:** Tube complement, (2) *EF86*, (4) *EL34*, (2) *GZ34*, (2) *ECC83*; freq. resp. 15 to 31,000 cps  $\pm 0.5$  db at 70 watts output; power bandwidth, 15 to 31,000 cps; power output, rms, 35 watts per channel; harmonic distortion, 0.5% at 70 watts from 30 to 31,000 cps; IM distortion, 0.5% at 70 watts; hum

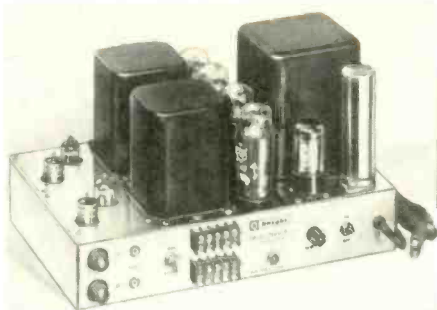

and noise, 90 db below rated output; sensitivity, input for rated output, 0.54 volts; damping factor, 17.4 to 290; stereo output impedances, 4, 8, 16, and 32 ohms; controls, input level; switches, on-off, stereo-mono, balance; weight, 39 lbs; dimensions, 14" wide, 8 $\frac{1}{4}$ " high, 9" deep; price, \$69.95 kit. Accessories, metal cover, \$6.50. Allied Radio Corporation, 100 N. Western Ave., Chicago 80, Ill.

## LAFAYETTE

● **KT-550 100-Watt Stereo Amplifier Kit.** An unusually high-quality high-powered amplifier utilizing military construction techniques. The kit is easy to assemble and contains bias and balancing provisions.



**Specifications:** Tube complement (4) 7027A, (4) 6CL6, (2) 6BR8A (5) silicon diodes; freq. resp. 14 to 45,000 cps  $\pm 0$ , -1 db at 50 watts output; power output, rms, 50 watts per channel; harmonic distortion, 0.75% at 50 watts from 20 to 20,000 cps; IM distortion, 0.5% at 50 watts; hum and noise, 90 db below 50 watts output; sensitivity, input for rated output, 1 volt; damping factor, 15; output impedances, 4, 8, 16 ohms; controls, bias and high-power balancing; switches, on-off; convenience outlets, 1; weight, 60 lbs; dimensions, 17" wide, 8 $\frac{1}{2}$ " high, 12 $\frac{1}{2}$ " deep. Price, \$184.50 assembled, \$134.50 kit. Lafayette Radio Electronics, 111 Jericho Turnpike, Syoset, L. I., N. Y.

## REALISTIC

● **HK-210 140-Watt Stereo Power Amplifier Kit.** The HK-210 is a high-powered high-quality basic amplifier utilizing the well-known Aero output transformers. Incorporating printed circuits, it is exceptionally easy to construct and provides performance equal to the laboratory model. Claimed to be the first commercially available amplifier which combines ultra-linear operation with hybrid feedback for unusually low distortion and high stability.

**Specifications:** Tube/transistor complement (1) selenium rect., (4) silicon diodes (4) *KT-77*, (2) *12AU7*, (2) *12AX7*; Freq. Resp. 5 to 80k cps. 0.5 db at 1 watt output; power bandwidth, 20 to 20k cps; IHFM music power output, 76 watts per channel; power output, rms, 70 watts per channel; harmonic distortion, 1% at 70 watts from 20 to 20k cps; IM distortion, 1% at 70 watts; hum and noise, 75 db below 1 watt output; sensitivity, input for rated output, 1.5 volts damping factor, 15 output impedances, 4, 8, 16 ohms; controls, meter selector, damping factor, bias balance, drive balance; switches, On-Off, variable damping on-off; weight 50 lbs; dimensions, 14" wide, 7" high, 10 $\frac{3}{4}$ " deep; price, \$179.95 assembled, \$139.95 kit. Radio Shack Corp., 730 Commonwealth Ave., Boston 17, Mass.

## H. H. SCOTT

● **LK-150 130-Watt Stereo Power Amplifier Kit.** Matched 6550 output tubes, rated at 100 watts, are used well below manufacturer's ratings to assure long operating life. Switchable subsonic filter permits the use of the LK-150 for laboratory applications where response below 5 cps is required. Input sensitivity is switchable between 2.5 volts (for the LC-21 and other Scott preamplifiers) and 1.5 volts for preamplifiers with lower output.



**Specifications:** Tube complement (2) 7199, (4) 6550, (2) *GZ34*; freq. resp. 4 to 65k cps  $\pm 1$  db at 10 watts output; power bandwidth, 19 to 25k cps; IHFM music power output 65 watts per channel; power output, rms, 60 watts per channel; harmonic distortion, 0.5% at 65 watts from 20 to 20k cps; IM distortion, 0.5% at 72 watts; hum and noise, 90 db below 1 watt output; sensitivity, input for rated output, 1.5 or 2.5 volts; damping factor, 16.1; output impedances, 4, 8, 16 ohms; controls, bias adjust with built in meter; switches, on/off, sensitivity, subsonic filter; convenience outlets, 1; dimensions, 15" wide, 6 $\frac{1}{2}$ " high, 11 $\frac{1}{4}$ " deep; price, \$169.95 kit. Accessories, cover \$19.95. H. H. Scott, Inc., 111 Powdermill Road, Maynard, Mass.

## PREAMPLIFIERS

### FISHER

● **Model 400-CX Stereo Preamplifier.** Designed to meet every possible audio control requirement, the 400-CX has twenty-eight controls and eighteen inputs, all simply arranged so that even a novice can operate them easily. The full-range stereo dimension control widens or narrows the apparent acoustic distance between stereo speakers. Jewel light system, visible from any listening position, indicates exact setting of mode selector switch. Center-channel output is provided for the connection of an additional amplifier and speaker to improve stereo sound distribution.



**Specifications:** Inputs: 4 phono, 2 micr, 2 tape head, 2 tuner, 2 tape amp, 2 aux. 1; 2 aux. 11 controls: Balance, Bass and Treble, Stereo Dimensions, Center Vol. Master Vol.; switches: Lo-Hi Filter, Phase, Mono-Stereo, 5 Selector Push Buttons; outputs: main, 30 ohms, 10 max. volts; recording 5000 ohms, 2.5 volts; freq. resp. 20 to 20,000 cps  $\pm 0.5$  db at 2 volts; harmonic distortion, 0.15% at 2 volts from 20 to 20,000 cps; sensi-

ivity, input for 1 volt output, phono, 1.4 mv tuner, 0.1 volts; hum and noise, 75 db below 1 volt output. Tube complement, (4)7247, (1)EZ80, (5)12AX7/ECC83; weight, 18 lbs; dimensions, 15 1/2" wide, 4 13/16" high, 12" deep. Price, \$199.50. Accessories: Cabinet—Wood (10-U) @ \$24.95; Metal in sim. leather (MC-2) @ \$15.95. Fisher Radio Corp., 21-21 44th Drive, L.I.C., N. Y.

## LAFAYETTE

● **LA-600A Stereo Preamplifier.** The LA-600A is a "no-compromise" preamp with twelve input jacks (six pairs) for program sources of any type or level.

**Specifications:** Inputs, mag. phono, ceramic phono, tape head, tuner, aux; controls—roll-off, turnover, 2 pair bass and treble, bridge; switches—on-off, tape monitor, rumble filter, scratch filter, presence, loudness, function;

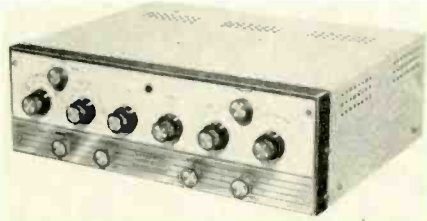

outputs—main, 1500 ohms, 4 max. volts; recording, 2700 ohms, 2 volts; freq. resp. 5 to 40,000 cps  $\pm 1$  db; harmonic distortion, 0.1% at 2 volts from 30 to 15,000 cps; IM distortion, .05% at 2 volts; sensitivity, input for 1-volt output—phono, 2.2 mv, tuner, 0.094 volts; hum and noise, 80 db below 2-volt output; tube complement, (7), 7025, (2) selenium rectifiers; weight, 16 lbs; dimensions, 14" wide, 4-13/16" high, 11 1/2" deep. Price, \$134.50 assembled, \$79.50 kit. Lafayette Electronics, 111 Jericho Turnpike, Syosset, L.I., N.Y.

## LEAK

● **"Point One" Stereo Preamp.** Impressive new styling enhances the appearance of the latest version of the well-known Leak "Point One" stereo preamplifier. Decorator-designed, the new front panel offers changeable color panels for both faceplate and knobs, enabling the user to match the decor of any room. The new escutcheon plate is interchangeable with the present one, permitting present owners the option of inexpensive conversion to the new styling. The "Point One" includes provisions for playing stereo, stereo reverse, left channel only, right channel only, and monophonically.

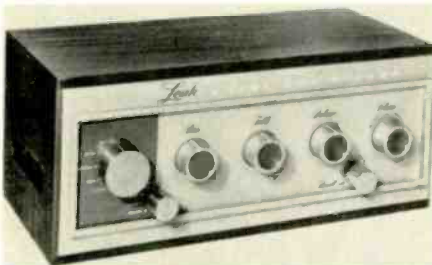

**Specifications:** Inputs: records, tape, mike, tuner, tape head; controls: bass, treble, balance, volume, rumble, filter; switches: function (5 position), input; freq. resp. 20 to 20k cps; harmonic distortion 0.01% at 125 mv; IM distortion 0.01% at 125 mv; sensitivity, input for 125 mv output, phono 3.5 mv, tuner, 35 mv; hum and noise, 60 db below 1 volt output. Tube complement (4)EF86; weight 5 1/2 lbs; dimensions: 10 1/2" wide, 3 3/4" high, 5" deep. Price \$119.50. Ercona Corp., 16 W. 46th St., New York, N. Y.

## MARANTZ

● **Model 7C Stereo Control Unit.** The Model 7C is a stereo control center with sufficient built-in flexibility to make it "up-to-date" for a long time to come. In addition it is built to last that long, using the professional cabling

and other construction techniques common to Marantz products.

**Specifications:** Inputs: mike, phono 1 and 2, tape head, FM-AM, FM-mpx, TV aux; controls: mode, selector, vol., balance, treble, bass; switches: on-off, hi and low cut, boost, tape monitor, record equal.; outputs: main, cathode follower, 100k and above (load), 10 max. volts;



freq. resp. 20 to 20k cps  $\pm 0.5$  db at 10 volts; IM distortion, 0.01% at 2 volts; sensitivity, input for 1 volt output, phono 0.6 mv tuner, 0.075 volts; hum and noise, 80 db below 10 mv on phono and hum below thermal noise. Tube complement, (6) ECC83/12AX7; weight, 20 lbs; dimensions, 14 3/8" wide, 5 3/8" high, 8 1/2" deep. Price, \$264.00 assembled. Accessories: wooden cabinet for above \$24.00. Marantz Company, 25-14 Broadway, L.I.C., N.Y.

## McINTOSH

● **C11 Stereo Preamplifier.** This preamplifier puts precision sound control at your fingertips, and increases the usefulness and enjoyment of any stereo system. Among its many features are: illuminated panel for important controls, simple rocker-action switches for secondary controls; floating panel for low-level inputs with single ground point to prevent induced hum loops from associated equipment; and shielding against TV and r.f. interference.



**Specifications:** Inputs: Aux, tape, tuner (2), phono (2), tape head, tape mon, mic; controls: selector, mode, volume, balance, 2 bass, 2 treble; switches: rec compensator, tape mon, reverse, power, rumble, scratch, loudness; outputs: main, 2.5 max. volts; recording, 0.25 volts; freq. resp. 20 to 20,000 cps  $\pm 0.5$  db; total distortion, less than .05% at 3 volts from 20 to 20,000 cps; sensitivity, input for 2.5-volt output, phono, 2 mv, tuner, 0.25 volts; hum and noise, less than 1.5  $\mu$ v input noise level; weight, 15 lbs; dimensions, 15 3/4" wide, 5 1/2" high, 12" deep. Price, \$229.50. McIntosh Laboratory, Inc., 2 Chambers St., Binghamton, N. Y.

## QUAD

● **QUAD 22 Stereo Control.** The QUAD 22 control unit features pushbuttons for selection of equalization or mode. The other front panel controls, in conjunction with the pushbuttons, provide all the controls and flexibility necessary to operate a modern stereo system. Plug-in units are available to match most available cartridges. The QUAD 22 is designed to operate with two QUAD II power



amplifiers for stereo although it can operate with only one for mono.

**Specifications:** Inputs: (2) phono, tape, (2) tuner, mic; controls: On-Volume, balance, treble, bass, filter slope, filter range; switches: stereo, mono, radio, mic, disc, tape; outputs: main, 0.25 meg ohms, 1.4 max. volts; recording, 0.25 meg ohms, 0.25 volts; freq. resp. 20 to 20k cps  $\pm 1/2$  db at 1.4 volts; harmonic distortion, 0.02% at 1.4 volts from 20 to 20k cps; IM distortion, 0.1% at 1.4 volts; sensitivity, input for 1 volt output, phono 4 mv, tuner, 0.25 volts; hum and noise, 70 db below 1 volt output. Tube complement, (2) EF86, (2) ECC83; weight, 6 lbs; dimensions, 10 1/2" wide, 3 1/2" high, 5 1/16" deep. Price, \$150.00. Electronics of City Line Center, 7644 City Line Ave., Philadelphia, Pa.

## SHURE

● **Series M61-1—Transistorized Stereo Preamplifier.** Compact, rugged, transistorized unit with choice of a.c. line or battery power supply. Unique design permits extreme flexibility of installation and use—can be mounted in vertical or upright position or upside down. Slide-selector switch offers three equalization inputs: (1) "phono" for conversion of ceramic phono inputs for use with magnetic cartridges; (2) "tape" for equalization of tape playback directly from tape head

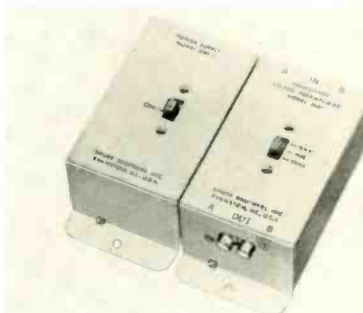

through hi-fi control preamplifier and (3) "microphone" for flat amplification wherever a boost in microphone output is required.

**Specifications:** Inputs: phono, tape, microphone; controls: None; switches: on-off positions; freq. resp. 25 to 15,000 cps  $\pm 2 1/2$  db; hum and noise, 50 db below 1 volt output; weight, 1 1/4 lbs; dimensions, 5 1/4" wide, 2" high, 5 1/4" deep. Price, \$27.50. Shure Bros., 222 Hartrey Ave., Evanston, Ill.

1. M61-3, same as above, with 30-volt battery supply ..... \$26.50
2. M65, stereo conversion preamplifier .. 24.00
3. M60, stereo line preamplifier ..... 19.95

## PREAMPLIFIER KITS

### DYNACO

● **PAS-2 Stereo Preamplifier Control Unit.** Includes preassembled etched circuit boards for maximum reliability and ease of construction. Complete feedback design, virtually incapable of overload.



**Specifications:** Inputs: tape head, phono, FM-AM, FM-MPX, spare. Special controls: selector, volume, balance, blend, bass, treble; switches: tape monitor, loudness, scratch, on-off; outputs: main, 5000 ohms, 4 max. volts; recording same as source, 0.4 volts; freq. resp. 10 to 40k cps +0.5 db at 2 volts; harmonic distortion, 0.02% at 2 volts from 20 to 20k cps; IM distortion, 0.05% at 2 volts; sensitivity, input for 1 volt output, phono 1 mv, tuner, 0.1 volts; hum and noise, 70 db below 10 mv phono input. Tube complement (4) 12AX7, 12X4, selenium rectifier; weight 10 lbs; dimensions, 13" wide, 4" high, 8" deep. Price, \$99.95 assembled, \$59.95 kit, including cover. Accessories: PM-3 panel mount kit, \$4.95. PK-30 deluxe panel kit with knobs, \$13.95. Dynaco, Inc., 3912 Powelton Ave., Philadelphia, Pa.

1. PAM-1 mono preamplifier kit ..... \$ 34.95
2. Above, wired ..... 59.95

## EICO

● **ST 84 Stereo Preamplifier Kit.** For all functions of the ST 84 all types of distortion are down to 0.05% at all levels. This is true not only at average input levels and when tone controls are set close to flat, but also at peak input levels and when tone controls are set at extreme positions.



**Specifications:** Inputs: mag ph a, mag ph r, tape hd, mic, tuner (3) aux; controls: level, balance, bass chan 1, bass chan 2, treble chan 1, treble chan 2; switches: Input, mode, tape mon, loudness, scratch filter, rumble filter, tape speed equal; outputs: main 8 k ohms, 4 max. volts; recording, 1400 ohms, 4 volts; freq. resp. 5 to 25 k cps ± 0.3 db at 2 volts; harmonic distortion, 0.05% at 2 volts from 20 to 20k cps; IM distortion 0.04% at 2 volts; sensitivity, input for 1 volt output, phono 1.6 mv, tuner, 0.17 volts; hum and noise 70 db below 1 volt output. Tube complement, (5) ECC83/12AX7, (1) 6X4; weight, 8½ lbs; dimensions, 15½" wide, 5½" high, 8¾" deep. Price \$89.95 assembled, \$59.95 kit. Electronic Instrument Co., Inc., 3300 Northern Blvd., L.I.C., N. Y.

1. HF 85 stereo preamp ..... \$39.95

## HARMAN-KARDON

● **Citation I, Stereophonic Control Preamplifier Kit.** A professional quality preamp kit with full facilities to handle about any combination of signal sources and program material.



**Specifications:** Stereo inputs—aux, tape, amp, tuner, phono 1, phono 2, tape head; controls—4 stepped tone controls, blend, rolloff, turnover, loudness, balance, mode, function, and low-cut; switches—contour, phasing, tape mon., stereo reverse, power push button; outputs, main, 1500 ohms, 15 max. volts; recording, 1500 ohms, 0.5 volts; freq. resp. 5 to 80,000 cps ± 0.5 db at 2 volts; harmonic distortion, 0.05% at 2 volts from 20 to 20,000 cps; IM distortion, 0.2% at 2.0 volts; sensitivity, input for 1-volt output, phono, 2.5 mv, tuner, 0.5 volts; hum and noise, 85 db below

rated output. Tube complement, (4) 12AX7, (5) 12AT7, (6) silicon diodes; weight, 32 lbs; dimensions, 14¾" wide, 6" high, 12¼" deep. Price, \$249.95 assembled, \$159.95 kit. Harman-Kardon, Inc., Plainview, N. Y.

1. Citation IV, ster control preamp kit... \$119.95
2. Citation IV, ster control, preamp, wired ..... 189.95
3. Citation A, ster control preamp kit... 249.95

## HEATH

● **Model AA-11 Stereo Preamplifier Kit.** Professional quality and clean-lined design. All basic controls are in open view and all secondary controls used to set the initial conditions are hidden behind the hinged lower front panel. Nine pushbutton input switches select any of five stereo inputs, any of three monophonic inputs, and an on-off switch. All input and output jacks are conveniently located on the rear chassis apron for easy installation in any stereo system. A controlled-output derived center channel provides stereo center fill-in or mono power to other rooms using an extra amplifier.



**Specifications:** Inputs: mono—AM, FM, aux; stereo—phono, tape head mic, mp, aux; controls: bass, treble, blend, volume, input level, balance; switches: scratch filter, rumble filter, stereo-mono, channel reverse, phase reverse, volume-loudness, 8 input selectors; outputs, main, 1800 ohms, 2.5 max. volts; recording, 1800 ohms, 0.5 volts; freq. resp. 20 to 20,000 cps ± 0.5 db at 2.5 volts; harmonic distortion, 0.05% at 2.5 volts from 20 to 20,000 cps; IM distortion, 0.09% at 2.5 volts; sensitivity, input for 2.5-volt output—phono, 2.5 mv, tuner, 0.1 volts; hum and noise, 65 db below 2.5-volt output. Tube complement, (8) 12AX7, (2) 12AT7; weight, 19 lbs; dimensions, 15¾" wide, 5½" high, 11½" deep. Price, \$84.95 kit. Heath Company, Benton Harbor, Mich.

1. AA-141 ster preamp kit ..... \$ 34.95

## KNIGHT-KIT

● **KP-50 Stereo Preamp Kit.** A complete and compact stereo preamp utilizing d.c. on filaments and incorporating six equalization positions to permit handling older LP's. Dual-concentric clutch-type controls are used for bass, treble, and level controls.

**Specifications:** Inputs—mag phono, ceramic phono, tape head, tuner, aux; controls—bass,

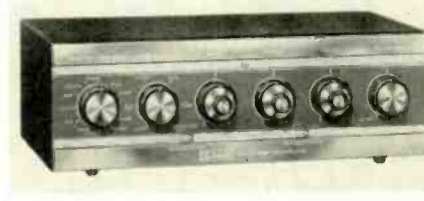

treble, level, loudness; switches—selector, mode, rumble filter, scratch filter, on-off, treble; outputs—main, 600 ohms, 3 volts; recording, 10 megohms; freq. resp., 7 to 120,000 cps ± 0.5 db at 1 volt; harmonic distortion, less than 0.25% at 1 volt from 20 to 20,000 cps; IM distortion, 0.7% at 1 volt; sensitivity, input for 1-volt output, phono, 2.5 mv; tuner, 0.15 volts; hum and noise, 80 db below 1-volt output. Tube complement, (2) 12AY7, (4) ECC82/12AU7, (2) selenium rectifiers; weight, 14 lbs; dimensions, 13¼" wide, 4¾" high, 7¾" deep. Price, \$59.95 kit. Allied Radio Corporation, 100 N. Western Ave., Chicago 80, Ill.

## R-A-E

● **Model 400, Stereo-Mono Preamplifier Kit.** A new high-quality preamp kit with many advanced features. Designed as a kit, the Model 400 features easy assembly and excellent performance.

**Specifications:** Inputs: mikes, phono high, phono low, tape; FM; controls: AM-TV, switches: stereo, stereo reverse, Channel A, Channel B, outputs: main, 0.1 megohms, 1 max. volts; recording, 0.1 megohms; 0.5 volts; freq. resp. 30 to 30,000 cps ± 1 db at 0.4 volts; harmonic distortion, 0.5% at 0.4 volts; IM distortion, 0.4% at 0.4 volts. Tube complement, (6) 12AX7; weight, 8 lbs; dimensions, 8" wide, 8¾" high, 11" deep. Price, \$97.50. kit. R-A-E Equipment, Inc., Central Bank Bldg., Great Barrington, Mass.

## REALISTIC

● **HK-212 Stereo Preamplifier Kit.** An easy-to-assemble stereo preamp kit with 14 panel controls plus stereo tape recorder and headphone jacks. Printed circuit construction.



**Specifications:** Inputs: tape head, phono 1, phono 2, tuner (2) aux; controls volume, balance, (2) treble, (2) bass, 3rd channel output lever; switches: input sel., function, tape monitor, rumble, scratch, loudness, phase; outputs: main, 5k ohms, 30 max. volts; recording 20k ohms, 1 volt; freq. resp. 10 to 60k cps ± 1 db at 1 volt; harmonic distortion, 0.05% at 1.5 volts from 20 to 20k cps; IM distortion, 0.05% at 1.5 volts sensitivity, input for 1.5 volt output, phono 2 mv, tuner, 0.35 volts; hum and noise, 60 db below 1 volt output. Tube complement, (4) 12AX7 (1) 6X4; weight, 15 lbs; dimensions, 15½" wide, 5¾" high, 6¾" deep. Price \$99.95 assembled, \$69.95 kit. Radio Shack, 730 Commonwealth Ave., Boston, Mass.

## H. H. SCOTT

● **LC-21 Stereo Control Center Kit.** Distortion is below the limits of even the finest test equipment. Hum is completely inaudible even in the magnetic positions due to the all-aluminum chassis, shielded power supply, and d.c.-heated tubes. The LC-21 can be used for laboratory applications where frequency response below 10 cps is desired. Among the 16 front panel controls are complete tape monitor switching facilities, front panel "derived" center channel level control, and phase-reverse switch. The LC-21 is an ideal companion to the LK-150 stereo power amplifier kit.

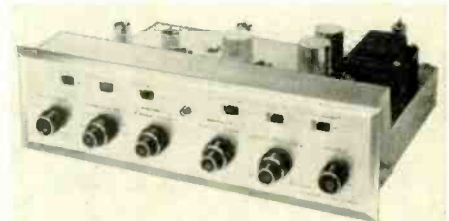

**Specifications:** Inputs: mag Ht, mag Lo, tape, extra, tuner, mike; controls: bass, treble, balance, volume, center chan. level; switches: input selector, stereo selector, rumble, scratch, monitor, loudness, phase; outputs: main, 100k ohms, 10 max. volts; recording, 0.5 volts; freq. resp. 10 to 55 cps ± 1.0 db at 2.5 volts; harmonic distortion, 0.1% at 2.5 volts from 20 to 20k cps; IM distortion, 0.1% at 2.5 volts; sensitivity, input for rated output, phono, 0.3 mv, tuner, 0.5 volts; hum and noise, 85 db below 1 volt. Tube complement, (6) 12AX7, (1) 6X4; weight, 13 lbs; dimensions, 15½" wide, 5¼" high, 13¼" deep. \$99.95 kit. Accessories: cases in various woods and metal from \$13.95. H. H. Scott, Inc., 111 Powdermill Road, Maynard, Mass.

# INTEGRATED AMPLIFIERS

## ALTEC

• **Stereo Amplifier-Preamplifier.** The Altec-Lansing Model 353-A, is a complete amplifying system, embodying two 25-watt stereo channels which may be combined for 50-watt monophonic operation when desired. Among its features is a matrixing network for "three-channel" stereo. Circuitry includes feedback-type equalization plus feedback around all tubes for minimum distortion. All low-level tubes have d.c. on heaters. Fourteen inputs include two each for magnetic cartridge, ceramic cartridge, tape head, tape recorder, tuner, microphone, and multiplex.



**Specifications:** Tube complement (5) 12AX7, (4) 6L6GC; freq. resp. 20 to 20,000 cps  $\pm 1$  db at 25 watts output; power output, rms, 25 watts per channel; harmonic distortion, 1% at 20 watts from 30 to 15,000 cps; hum and noise, 82 db below rated output; sensitivity, input for rated output—phono, 2.5 mv, tuner, 0.29 volts; damping factor, 4; output impedances, 4, 8, 16 ohms; inputs—4 phono, 2 tape head, 2 tape amp, 2 radio, 2 mic, 2 mp; weight, 35 lbs. Dimensions, 15" wide, 5 $\frac{7}{8}$ " high, 11 $\frac{1}{4}$ " deep. Price, \$225.00. Altec Lansing Corp., 1515 S. Manchester Ave., Anaheim, Calif.

## BELL

• **Model 2440 44-watt Stereo Amplifier System.** This compact unit offers all the features anyone needs for the home reproduction of music from a wide variety of sources.

**Specifications:** Freq. resp. 20 to 20,000 cps  $\pm 1$  db at 1 watt output; power bandwidth, 35 to 20,000 cps; IHFM music power output, 22 watts per channel; power output, rms, 20 watts per channel; harmonic distortion, 1% at 20 watts from 50 to 15,000 cps; IM distortion, 1% at 20 watts; hum and noise, 63 db below 1 watt output; sensitivity, input for rated output—phono, 3 mv, tuner, 0.1 volts; damping factor 4; output impedances, 4, 8, 16 ohms and high Z for recorder; inputs—4 phono, 2 tape head, 2 tape amp, 2 aux, 2 ceramic phono; weight, 28 lbs. Dimensions: 17 $\frac{3}{16}$ " wide, 5 $\frac{7}{16}$ " high, 10 $\frac{3}{8}$ " deep. Bell Sound Division, Thompson Ramo Wooldridge, Inc., 6325 Huntley Rd., Columbus, Ohio.

## BOGEN

• **AP250 Stereo Amplifier.** This unit offers control flexibility for stereo and mono sound sources. 50-watt output (25 per channel). Special blend control light indicates maximum or minimum stereo balance. New, special front-end tubes keep noise and hum at an unusually low level. The AP250, as all Bogen hi-fi stereo components, is finished in brushed gold.

**Specifications:** Tube/transistor complement 10 tubes plus 2 silicon rectifiers and 1 selenium rectifier; Freq. resp. 20 to 30,000 cps  $\pm 1$  db at 2.5 watts output; power bandwidth, 50 to 15,000 cps; IHFM music power output, 25 watts per channel; power output, rms 22 watts per channel; harmonic distortion, 0.6% at rated output; IM distortion 0.3% at 2.5 watts; hum and noise, 50 db below 1 watt; output sensitivity, input for rated output—phono, 4.5 mv, tuner, 0.5 volts; output impedances, 4, 8, 16 ohms; inputs—1 set phono, 1 set tape head, 1 set aux, 1 set tuner; weight, 20 lbs. Dimensions, 15" wide, 4 $\frac{3}{4}$ " high, 11 $\frac{1}{4}$ " deep. Price \$154.95. Accessories: EN-9 metal enclosure \$11.95; WE-9 walnut cabinet \$26.95. Other features: tape monitor facili-

ties, stereo headphone jack, stereo indicator light, 3rd channel output. Bogen Communication Div., Lear Siegler, Inc., Paramus, N. J.

1. AP30 Stereo Amplifier ..... \$99.95

## ERIC

• **"Dual Twenty" Amplifier Model 3160T.** This all-new Eric Stereo Amplifier is a masterpiece of performance and design. It features a transistorized preamplifier for magnetic cartridges to eliminate hum and microphonics, along with the normal complement of tone, loudness, and balance controls. Phono equalization compensates for RIAA, EUR, and LP records.

**Specifications:** Tube/transistor complement (2) 12AX7, (2) 7247, (4) 6BQ5, (1) G234, (2) 2N448. Freq. resp. 20 to 20,000 cps  $\pm 1$  db at 1 watt output; power output, rms, 20 watts per channel; harmonic distortion, 1% at 20 watts; IM distortion, 0.4% at 17 watts; hum and noise, 70 db below rated output; sensitivity, input for rated output—phono, 2.0 mv, tuner, 0.5 volts; output impedances, 4, 8, 16 ohms; inputs—2 phono, 2 tape amp, 2 aux, 2 tuner; weight, 17 lbs. Dimensions, 13 $\frac{3}{4}$ " wide, 4 $\frac{5}{16}$ " high, 11" deep. Price \$106.20. Eric Electronics Corp., 1823 Colorado Ave., Santa Monica, Calif.

1. "Dual Ten" Model 3460P, 10/10-w amp ..... \$ 79.95  
2. Model 3560T, 25/25-w amp ..... 149.95  
3. Model 3459T, 17-w mono amp ..... 69.95

## FISHER

• **Model X-101-C 60-Watt Integrated Stereo Amplifier.** Featuring design for simplicity of operation, the new Fisher X-101-C has all controls which are not commonly used behind a handsome panel, thus allowing even the uninitiated to operate this control center without confusing them with the large variety of controls.

**Specifications:** Tube complement 10 tubes, 2 silicon rect.; Freq. resp. 20 to 20,000 cps.  $\pm 1$  db at 1 watt output; power bandwidth, 16 to 30,000 cps; IHFM music power output, 30 watts per channel; power output, rms, 27



watts per channel; harmonic distortion, 0.5% at 27 watts at 1 kc; IM distortion, 0.8% at 30 watts; hum and noise, 88 db below full output; sensitivity, input for rated output—phono 3.5 mv, tuner 0.3 volts; damping factor 10; output impedance 4, 8, 16 ohms; inputs—2 phono, 2 tape head, 2 tape amp, 2 aux, 2 tuner; weight 24 lbs. Dimensions: 15 $\frac{1}{4}$ " wide, 4 $\frac{13}{16}$ " high, 12 $\frac{1}{2}$ " deep. Price \$199.50. Fisher Radio Corp., 21-21 44th Drive, L.I.C., N. Y.

1. X-100-B, ster audio control w. 50-w ster amp ..... \$169.50  
2. X-202-B, ster audio control w. 80-w ster amp ..... 249.50  
3. X-1000, ster audio control w. 110-w ster amp ..... 339.50

## GROMMES

• **Model 70PG Integrated Amplifier.** New compact high powered stereo amplifier with 70 watts of music power and featuring new RCA 7863 power tubes, silicon power supply and voltage regulation. Wide-range bass and treble controls, feedback loops for each stage and oversize output transformers result in clean, distortion-free sound. Provision for center-channel speaker.

**Specifications:** Tube/transistor complement 6-6EU7, 4-7868, 1-7868 regulator, 5-silicon rectifiers. Freq. resp. 20 to 20,000 cps  $\pm .5$  db at 1 watt output; power bandwidth, 30 to 20,000 cps; IHFM music power output, 35 watts per channel, power output, rms, 30 watts per channel; harmonic distortion, 2% at 30 watts



from 30 to 15,000 cps; IM distortion, 1% at 30 watts; hum and noise, 66 db below 1 watt output; sensitivity, input for rated output—phono, 3 mv, tuner, .25 volts; damping factor 10; output impedances, 4, 8, 16 ohms; inputs—1 Mag phono, 1 tape head, 1 tuner, 1 aux; weight, 27 lbs. Dimensions 14" wide, 4 $\frac{1}{2}$ " high, 11" deep. Price, \$199.95 assembled; accessories, cover, \$7.50. Precision Electronics, Inc., 9101 King St., Franklin Park, Ill.  
1. 36PC, dual 20-w amp ..... \$129.95  
2. 24PC, dual 12-w amp ..... 89.95

## HARMAN-KARDON

• **Award Amplifier, Model A500.** An integrated amplifier with complete flexibility to handle the full variety of program sources required of the modern system. Power output is sufficient to handle even an inefficient speaker system.



**Specifications:** Tube complement, (4) 7355, (1) 12AU7, (4) 12AX7. Freq. resp. 12 to 70,000 cps  $\pm 1$  db at 1 watt output; power bandwidth, 20 to 20,000 cps; IHFM music power output, 25 watts per channel; power output, rms, 20 watts per channel; harmonic distortion, 0.5% at 20 watts from 20 to 20,000 cps; IM distortion, 0.5% at 20 watts; hum and noise, 85 db below rated output; sensitivity, input for rated output—phono, 1.5 mv, tuner, 0.25 volts; damping factor 10+; output impedances, 4, 8, and 16 ohms; inputs—4 phono, 2 tape head, 2 tape amp, 2 aux; weight, 32 lbs. Dimensions, 15 $\frac{1}{4}$ " wide, 5 $\frac{7}{16}$ " high, 12" deep. Price, \$159.95 assembled. Accessories, WW50 cabinet, \$29.95; CX50 cage, \$12.95. Harman-Kardon, Inc., Plainview, N. Y.

1. A300, AWARD 30-w ster amp ..... \$ 99.95  
2. A10, mono 10-w amp ..... 49.95

## OMEGA

• **Model 1600 All Transistor Integrated Stereo Amplifier.** Embodying many fine features, as well as being transistorized, the Model 1600 is designed to operate in the finest audio systems. Some of the features include a patented bridge output circuit which delivers more power into the load; a system of balancing the volume, bass, and treble of the two stereo channels so that only one master control need be used thenceforth. In addition, the Model 1600 is extremely handsome in appearance.

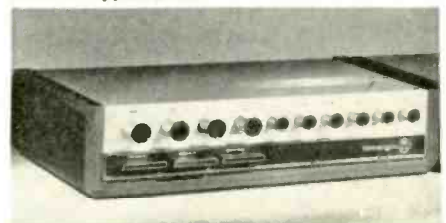

**Specifications:** Transistor complement 31 transistors, 7 diodes; Freq. resp. 18 to 20 k cps  $\pm 0.3$  db at 30 watts output per channel; power bandwidth, 18 to 20 k cps; IHFM music power output, 30 watts per channel; power output, rms, 25 watts per channel; harmonic distortion, 1% at 30 watts at 1 kc; IM dis-

tortion, 1% at 30 watts; hum and noise, 75 db below rated output; sensitivity, input for rated output—phono, 1/2 mv, tuner, 0.3 volts; output impedance, 8, 16 ohms; inputs—1/4 phono, 2 tape head, 2 tape amp, 2 aux, 2 TV; weight, 12 lbs. Dimensions: 15 1/2" wide, 5" high, 9" deep. Price, \$249.00. Omega Electronics Corp., 10017 North 19th Ave., Phoenix 21, Arizona.

## PILOT

● **Model 240, 30-Watt Integrated Stereo Amplifier.** This rugged, extremely versatile component is one of the most popular instruments Pilot has ever offered. The five pairs of stereo inputs can accommodate virtually every source of stereo music. Eleven front panel controls assure complete operational flexibility. The instrument even has a speaker selector for control of extension speakers in other rooms. In addition to the usual speaker outputs, the 240 has a special pair of outputs for connecting to a center speaker, for three-speaker stereo, or for monophonic listening in another room.

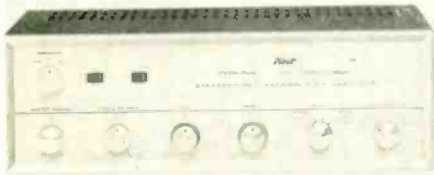

**Specifications:** Tube complement (4) EL84, (2) 7025/12AX7, (3) 12AX7, (1) GZ34; Freq. resp. 10 to 30,000 cps  $\pm 1$  db at 1 watt output; power bandwidth, 50 to 10,000 cps; IHFM music power output, 15 watts per channel; power output, rms, 12 watts per channel; harmonic distortion 1% from 70 to 8000 cps; IM distortion, 2% at 8 watts; hum and noise, 70 db below 1 watt output; sensitivity, input for rated output—phono, 3 mv, tuner, 0.1 volts; damping factor 4; output impedances, 4, 8, 16 ohms; inputs—2 phono, 2 tape head, 2 tape amp, MX, FM-AM; weight, 23 lbs. Dimensions, 14 3/4" wide, 5 1/4" high, 11 3/4" deep. Price, \$134.50. Pilot Radio Corp., 37-06 86th St., L.I.C. 1, N. Y.

1. Model 230, 24-watt stereo amplifier with cover ..... \$ 89.50
2. Model 246, 60-watt stereo amplifier with cover ..... 199.50
3. Model 248B, 74-watt stereo amplifier less cover ..... 269.50

## PIONEER

● **SM-801, Integrated Stereo Amplifier.** The newly announced Pioneer Model SM-801 is a professional quality stereophonic amplifier incorporating on one chassis two power amplifiers—each channel with a maximum rated output of 45 watts—and two extremely sensitive and highly versatile preamplifiers. With its high output, it is ideally suited for use in large concert halls, auditoriums, or other similar applications that call for a large amount of driving power.

**Specifications:** Tube complement 10 tubes and 4 diodes; Freq. resp. 20 to 100,000 cps  $\pm 1$  db at 500 mw output; power bandwidth, 20 to 100,000 cps; IHFM music power output, 45 watts per channel; power output, rms 35 watts per channel; harmonic distortion, 1% at 35 watts at 1 k cps; IM distortion, 1% at 35 watts; hum and noise,  $\pm 50$  db below 1 watt output; sensitivity, input for rated output—phono, 37 mv, tuner, 2.40 mv; damping factor 8; output impedance, 8, 16 ohms; inputs—7 phono, 2 tape head, 1 tape amp, 1 mic, 1 tuner; weight, 34.2 lbs. Dimensions, 16 7/8" wide, 5 11/16" high, 12 11/16" deep. Pioneer Electronic Corp., 5 Otowacho, 6-chome, Bunkyo-ku, Tokyo, Japan.

1. SM-C 800, 90-w professional amp

## RAVENSWOOD

● **Model CCP-700 Dual-30 Integrated Amplifier.** A complete control center for the home system, combined with a dual-30-watt power amplifier with adequate inputs and control facilities for the finest installations. Physical configuration of the unit makes it possible to mount in a variety of positions.

**Specifications:** Tube complement (2) ECC83, (2) ECC81, (1) ECC82, (2) 7199, (4) 7189, (6) silicon rectifiers; Freq. resp. 20 to 30,000 cps  $\pm 1$  db; IHFM music power output, 30 watts per channel; harmonic distortion, 0.8% at rated output; IM distortion, 1.2%; hum and noise, 75 db below 1 watt; output impedances, 4, 8, 16 ohms; dimensions: 13 1/2" wide, 11" high, 9" deep. Price, \$169.95. RAVENSWOOD, Edgewood & McGuckian Sts., Annapolis, Md.

1. CCP-600 20/20-w int amp ..... \$139.95

## H. H. SCOTT

● **299-C Complete Stereo Amplifier.** Features include: rugged 80-watt output stage assuring low-distortion reproduction of even the lowest frequencies; special signal lights make it easy for any number of the family to operate the system; stereo selector switch for choosing stereo or monophonic program sources; separate scratch and rumble filters; front panel stereo headphone output; and "derived" center-channel level control.

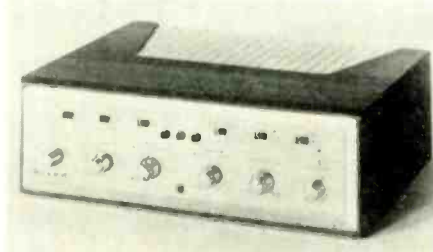

**Specifications:** Tube complement 11 tubes; freq. resp. 20 to 20k cps  $\pm 1$  db; power bandwidth, 19 to 25k cps; IHFM music power output, 40 watts per channel; power output, rms, 36 watts per channel; harmonic distortion, 0.8% from 20 to 20k cps; IM distortion, 0.5%; hum and noise, 80 db below 1 watt output; sensitivity, input for rated output—phono, 3 mv, tuner, 0.5 volts; damping factor 16; output impedance, 4, 8, 16 ohms; inputs—5 phono, 1 tape head, 1 tape amp, 1 aux, 1 Mic; weight, 30 lbs. Dimensions: 15 1/2" wide, 5 1/4" high, 13 1/4" deep. Price, \$229.95. Accessories: wood and metal cases, \$13.75. H. H. Scott, Inc., 111 Powdermill Road, Maynard, Mass.

1. 222-C, 48-watt stereo amp. .... \$169.95
2. 296, 100-watt ..... 299.95

## SHERWOOD

● **S-5500II 64-Watt Amplifier and Preamplifier.** The S-5500II features all the important controls and facilities of the S-5000II and was designed to offer full power requirements for most home music systems at economical cost. Controls include friction-locked bass and treble controls, scratch and rumble filters, stereo normal/reverse switch, phase-invert switch and tape-monitor switch. A total of 8 high-level and 4 low-level inputs are provided for maximum flexibility.



**Specifications:** Tube/transistor complement (4) 7868, (5) 12AX7, (4) sil. rect. Freq. resp. 20 to 20k cps  $\pm 1/2$  db at 30 watts output; IHFM music power output 32 watts per channel power output, rms, 30 watts per channel; harmonic distortion, 1/2% at 30 watts from 26 to 20k cps; IM distortion, 1 1/2% at 32 watts; hum and noise, 75 db below 1 watt output; sensitivity, input for rated output—phono, 1.2 mv, tuner, 1/4 volts; damping factor 5; output impedances, 4, 8, 16 ohms; input—2 phono, 2 tape head, 2 tape amp, 2 aux, 2 (other); weight, 27 lbs. Dimensions 14" wide, 4" high, 13 1/2" deep. Price, \$164.50. Accessories: case, \$7.50. Sherwood Electronic Labs, Inc., 4300 N. California Ave., Chicago 18, Ill.

1. S-5000II, 80-watt amp-preamp ... \$199.50

# INTEGRATED AMPLIFIER KITS

## EICO

● **ST-70 Stereo Amplifier Kit.** The ST-70 is a complete stereophonic control center plus two separate 35-watt amplifiers all on one chassis. Mode switches on front panels enable you to play either amplifier alone or use both amplifiers together for normal stereo, or for reverse stereo. It is also possible to use both amplifiers together for enhanced mono listening through two speaker systems.

**Specifications:** Tube complement (3) ECC83/12AX7, (2) 12DW7, (2) 6SN7GTB, (4) 7591, (1) GZ34. Freq. Resp. 10 to 50k cps  $\pm 0.5$  db at 2 watts output; power bandwidth, 15 to 90,000 cps; IHFM music power output, 37.5 watts per channel; power output, rms, 35 watts per channel; harmonic distortion 1% at 30 watts from 25 to 20k cps; IM distortion, 1% at 70 watts; hum and noise 63 db below 1 watt output; sensitivity, input for rated output—phono 4 mv, tuner, 0.5 volts; damping factor 11; output impedance, 4, 8, 16 ohms; inputs—1/4 phono, 2 tape head, 2 tape amp, 1/4 aux. Dimensions, 15 1/2" wide, 5 1/2" high 15" deep. Price \$149.95 assembled, \$99.95 kit, metal cover included. Electronic Instrument Co., Inc., 330 Northern Blvd., L.I.C., N. Y.

1. ST-40 watt integrated stereo amp kit \$79.95
2. HF-81, 28-watt integrated stereo amp kit ..... 69.95

## FISHER

● **Model KX-200 StrataKit 80-watt Integrated Stereo Amplifier.** An easy building, high-quality, integrated stereo amplifier kit. The instructions are explicit and "marbled" with humor.

**Specifications:** Tube complement 10 tubes, 4 silicon diodes; Freq. resp. 20 to 20,000 cps  $\pm 1$  db at 1 watt output; power bandwidth, 16 to 28,000 cps; IHFM music power output, 40 watts per channel; power output,



rms, 35 watts per channel; harmonic distortion, 0.4% at 35 rms watts at 1 k cps; IM distortion, 0.8% at 35 rms watts per channel; hum and noise, 90 db below full power output; sensitivity, input for rated output—phono, 3.5 mv, tuner, .35 volts; damping factor 10; output impedances, 4, 8, 16 ohms; inputs—2 phono, 2 tape head, 2 tape amp, 2 aux, 2 tuners; weight, 26 lbs. Dimensions, 15 1/8" wide, 4 13/16" high, 12 1/2" deep. Price, \$169.50 kit. Accessories: Cabinet 10-U, \$24.95, MC-2, \$15.95. Fisher Radio Corp., 21-21 44th Drive, L.I.C., N. Y.

1. KX-100, 50-w integrated amplifier StrataKit ..... \$129.50

## HARMAN-KARDON

● **Model A30K 30-watt Stereo Amplifier Kit.** An unusually well designed kit, the A30K features the most comprehensive and well thought out construction procedure. The instrument itself is equally well designed in terms of performance.

**Specifications:** Tube complement, (4) 7408, (4) 12AX7, (1) 12AU7; freq. resp. 15 to 70,000 cps  $\pm 1$  db at 1 watt output; power bandwidth, 30 to 20,000 cps; IHFM music power output, 15 watts per channel; power output, rms, 12 watts per channel; harmonic distortion, 0.5% at 5 watts from 20 to 20,000 cps; IM distortion, 1% at 15 watts; hum and noise, 80 db below rated output; sensitivity,

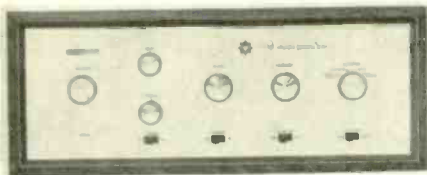

input for rated output—phono, 2.0 mv, tuner, 0.25 volts; damping factor, 8+; output impedances, 8 and 16 ohms; inputs 1/4 phono, 2 tape head, 2 tape amp., 2 aux.; weight, 25 lbs; dimensions, 15 1/4" wide, 5 7/16" high, 11 1/2" deep. Price, \$79.95 in kit form. Accessories, WW50 walnut enclosure, \$29.95; CX50 cage, \$12.95. Harman-Kardon, Inc., Plainview, N. Y.

1. A50K, 50-watt ster amp kit .....\$119.95

## HEATH

● **Model AA-21 Transistor Stereo Amplifier Kit.** Featuring 28 transistors and 10 diodes, the Heathkit AA-21 provides transformerless output circuit and multiple feedback loops. All controls are front-panel mounted for operating convenience. A hinged lower front panel conceals the tape-monitor input switch, speaker phase-reversal switch, loudness switch, and all input level controls. The lower right section of the front panel is a unique on/off switch, touch to turn on, touch to turn off. All input and output connections are conveniently located on the rear chassis panel. Circuit safety is assured through the use of five new, fast-acting bimetal circuit breakers—no fuses to replace. Kit assembly is fast and simple through the use of five circuit boards which eliminate most of the conventional point-to-point wiring. Preampifier circuits are "capsulated" in six epoxy-covered modules containing seventy resistors and capacitors, all factory wired and sealed, ready for installation on the preamp circuit board.



**Specifications:** Transistor complement, (28), diodes (10); freq. resp. 20 to 20,000 cps  $\pm 1$  db at 70 watts output; power bandwidth, 8 to 40,000 cps; IHFM music power output, 50 watts per channel; power output, rms, 35 watts per channel; harmonic distortion, less than 2% at 70 watts from 20 to 20,000 cps; IM distortion, less than 1.5% at 70 watts; hum and noise, 60 db below 1 watt output; sensitivity, input for rated output—phono, 2.5 mv, tuner, 0.3 volts; damping factor, unity; output impedances, 4, 8, and 16 ohms; inputs—mag phono, tape head, tape amp, aux, tuner; weight, 25 lbs., dimensions, 15 1/4" wide, 5" high, 13 1/2" deep. Price, \$134.95 kit. Heath Company, Benton Harbor, Mich.

1. AA-100, 50-w ster amp kit .....\$ 84.95  
2. AA-151, 28-w ster amp kit ..... 59.95

## KNIGHT-KIT

● **KG-60 Transistorized 50-watt Amplifier Kit.** Featuring the exclusive Knight-Kit thermal feedback circuit, the KG-60 offers high power at low distortion with all the advantages of a transistor amplifier.

**Specifications:** Transistor complement, (20), diodes (2), rectifier diodes, (4); freq. resp. 20 to 20,000 cps  $\pm 1$  db at 50 watts output; power bandwidth, 20 to 20,000 cps; IHFM



music power output, 25 watts per channel; power output, rms, 18 watts per channel; harmonic distortion, 1% at 25 watts at 1000 cps; IM distortion, 2% at 15 watts; hum and noise, 90 db below rated output; sensitivity, input for rated output—phono, 2.5 mv, tuner, 0.5 volts; output impedance, 4 ohms; inputs—phone, tape head, ceramic, aux; weight, 8 lbs; dimensions, 11" wide, 2 3/4" high, 9 1/4" deep. Price, \$89.95 kit. Accessories—metal case, \$4.95, wood case, \$9.95. Allied Radio Corporation, 100 N. Western Ave., Chicago 80, Ill.

## PACO

● **SA-40 Integrated Stereo Amplifier Kit.** The Paco SA-40 is a 40-watt (20 per channel) stereo integrated amplifier, with a low price and distortion. Encompassing the latest innovations, it is suitable for many future developments as well as the existing. In addition, it is flexible enough to accommodate most existing needs.



**Specifications:** Tube complement (9) tubes, (2) silicon rect; freq. resp. 30 to 90,000 cps  $\pm 1$  db at 1 watt output; power bandwidth, 50 to 15,000 cps; IHFM music power output, 25 watts per channel; power output, rms, 20 watts per channel; harmonic distortion, 2% at 20 watts from 50 to 15,000 cps; IM distortion, 2% at 20 watts; hum and noise, 57 db below 1 watt output; sensitivity, input for rated output—phono, 5 mv, tuner, 0.75 volts; damping factor 22; output impedance, 4, 8, 16, 32 ohms; inputs—phono, 47k $\Omega$ , tape head, 47k $\Omega$ , tape amp, 270k $\Omega$ , aux, 270k $\Omega$ ; weight, 25 lbs. Dimensions: 15 3/8" wide, 5 1/8" high, 11 3/4" deep. Price, \$129.95 assembled, \$79.95 kit. Paco Electronics Company, Inc., 70-31 84th St., Glendale, L. I., N. Y.

## H. H. SCOTT

● **LK-72 Complete Stereo Amplifier Kit.** Typical assembly time is approximately 15 to 20 hours. Full-size full-color instruction manual. Front panel "derived" center channel level control, switching facilities that enable simultaneous connection of both a stereo tape deck and stereo cartridge, and a full 40-watt-per-channel (IHFM) over the entire audio range make this amplifier kit an outstanding value.

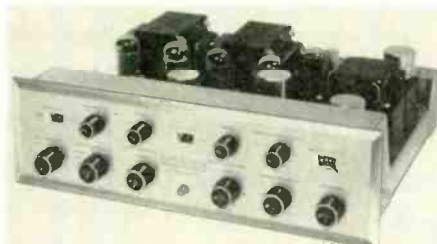

**Specifications:** Tube complement 11 tubes; Freq. resp. 20 to 20k cps  $\pm 1$  db at 10 watts output; power bandwidth, 19 to 25k cps; IHFM music power output, 40 watts per channel; power output, rms, 36 watts per channel; harmonic distortion 0.8% from 20 to 20k cps; IM distortion 0.5% at 10 watts; hum and noise, 80 db below 1 watt output; sensitivity, input for rated output—phono, 3 mv, tuner, 0.5 volts; damping factor 16; output impedances, 4, 8, 16 ohms; inputs—5 phono, 1 tape head, 1 tape amp, 1 aux, 1 tuner; weight 30 lbs. Dimensions: 15 1/2" wide, 5 1/4" high, 13 1/4" deep. Price, \$159.95. Accessories: Cases in wood or metal from \$13.95. H. H. Scott, Inc., 111 Powdermill Road, Maynard, Mass.

1. LK-48, 48-watt complete stereo amp. \$124.95

## REALISTIC

● **TA-208 80-Watt Transistor Stereo Amplifier.** An advanced design transistor amplifier with several unique features. All basic elements are mounted on the front part of the circuit board while the output section is on the rear to avoid cross coupling. Special attention has been paid to ventilation and air flow.

**Specifications:** Transistor complement (18) transistors. Freq. Resp. 10 to 20k cps  $\pm 1$  db at 80 watts output; IHFM music power output, 50 watts per channel (4 ohms); power output, rms 40 watts per channel (4 ohms); harmonic distortion, 0.4% at 25 watts (8 ohms) from 20 to 2k cps, less than 3% from 2k to 20k at 25 watts; IM distortion 1% at 25 watts; hum and noise, 50 db below 1 watt output; sensitivity, input for rated output—phono, 2 mv, tuner, 0.25 volts; damping factor 40 (8 ohms); output impedance matches any spkr 2 ohms or greater, inputs 1/4 phono, 1/4 tape head, 2 aux, 2 tuners; weight, 28 lbs. Dimensions, 15 1/2" wide, 5 3/4" high, 12 3/4" deep. Price, \$189.95 assembled, \$139.95 kit. Radio Shack Co., 730 Commonwealth Ave., Boston 17, Mass.

## TRANSIS-TRONICS

● **S-15 Stereo Amplifier.** The TEC all-transistor stereo amplifier, S-15, is claimed to be the first medium power hi-fi amplifier-preamp ever produced. Features output transformerless design. Unit is free from heat, hum, and microphonics. Also operates on 12-28 d.c. from battery.



**Specifications:** Transistor complement (22) transistors, (7) diodes; freq. resp. 20 to 20,000 cps  $\pm 1$  db at 3 watts output; IHFM music power output, 20 watts per channel; harmonic distortion, 0.5% at 20 watts at 1000 cps; IM distortion, 0.9% at 20 watts; hum and noise, 85 db below 1 watt output; sensitivity, input for rated output—phono, 3 mv, tuner, 0.14 volts; damping factor 32; output impedances, 4 ohms; inputs—1 phono, 1 tape amp, 2 aux, 1 tuner; weight, 9 lbs. Dimensions: 10 1/8" wide, 3" high, 8 1/2" deep. Price, \$139.50. Transis-Tronics, Inc., 1601 Olympic Blvd., Santa Monica, Calif.

## BASIC TUNERS

### BOGEN

● **TP250 FM-Stereo Tuner.** From the design simplicity of the "Simple-Scanner" dial to tuner features such as the "Stereo-Minder" indicator, quick-acting electronic tuning eye, and tape recording filter, the TP250 compares well with more costly tuners.



**Specifications:** FM Tube/transistor complement 10 plus 3 crystal diodes; type of

front end grounded grid; no. of i.f. stages 3; type of detector ratio detector; type of tuning indicator electronic eye; output signal 0.75 volts; no. of outputs 2; controls mode, tuning; switches a.f., power; freq. resp.  $\pm 5$  db from 30 to 15,000 cps; signal-to-noise ratio 60 db; IHFM volume sensitivity 0.5  $\mu$ v; capture ratio 4 db; selectivity 40 db; IHFM usable sensitivity 2.  $\mu$ v; AM suppression 50 db; harmonic distortion (100% mod.) 0.5%; stereo separation 20 db; type of stereo circuit matrix; type of a.f.c. circuit reactance tube; drift 20 kc; dimensions: 12 $\frac{3}{8}$ " wide, 4 $\frac{1}{4}$ " high, 11" deep; weight, 16 lbs. Other features "Stereo-Minder" indicator, tape recording filter, agc, i.f. Price \$159.95. Accessories: EN18 metal enclosure, \$11.95; WE-8 walnut cabinet \$26.95. Bogen Commun. Div., Lear Siegler, Inc., Paramus, N. J.

## ERIC

• **Model 3457 MX Deluxe FM Multiplex Tuner.** This Eric model features built-in multiplex circuitry, with front panel separation control. It employs a new C.E. Compactron tube for more efficient chassis construction.

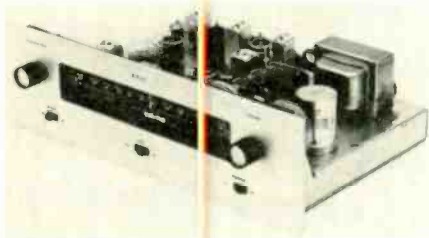

**Specifications:** FM: Tube complement (1) 6CL8, (1) 12AV7, (1) 6BZ6, (1) 6AU6, (2) 6EW6, (1) 6AL5, (1) 6D10, (1) EM84; type of front end, tuned r.f. stage; type of detector Foster-Seely; type of tuning indicator electron tube; no. of output 3—FM, L, R; controls, tuning, separation; switches, mode, a.v.c. defeat, power; freq. resp.  $\pm 1$  db from 50 to 15,000 cps; sensitivity 1  $\mu$ v for 20 db quieting; dimensions: 15 $\frac{1}{4}$ " wide, 4 $\frac{5}{16}$ " high, 8 $\frac{1}{4}$ " deep; weight, 8 lbs. Price \$119.95.

- 3157 MX—FM/AM trn ..... \$149.95
- 3357 FM trn ..... 72.95
- MX 600D MX Adapter ..... 59.95

## FISHER

• **Model R-200 FM-AM Multiplex Tuner.** High quality FM-Stereo and AM tuners on one compact chassis. The quality of both sections is appropriate for the best music listening.

**Specifications:** FM: Tube complement, 15 tubes, 15 diodes, 1 selenium rectifier; type of front end neutroie; no. of i.f. stages 5; type of detector ratio; no. of audio stages 2 each channel; type of tuning indicator meter; output signal 2 volts rated output; no. of outputs 2 each channel; controls, front panel; tuning, muting; Rear: 2 level; switches, front panel: stereo filter, selector. AM bandwidth, FM antenna; freq. resp.  $\pm 1$  db from 20 to 15,000 cps; signal-to-noise ratio 70 db; IHFM volume sensitivity below noise level; capture ratio 1.8 db; selectivity 65 db; IHFM usable sensitivity 1.6  $\mu$ v; AM suppression 60 db; harmonic distortion (100% mod) 0.4%; stereo separation 35 db; type of stereo circuit time division switching; type



of a.f.c. circuit none; drift less than 10 kc; dimensions 15 $\frac{1}{2}$ " wide, 4 $\frac{13}{16}$ " high, 12 $\frac{3}{4}$ " deep; weight 20 lbs. Other features: 3 jewel indicators for Stereo, Beacon, AM, and FM, 10-kc filter on AM; flywheel tuning. Accessories: Cabinets—wood (10-U) \$24.95; metal (MC-2) \$15.95.

AM: Tube complement see above; type of

circuit superhet with tuned r.f. and 2 i.f. stages; 3-gang tuning capacitor; type of detector diode; IHFM usable sensitivity 5  $\mu$ v; IHFM volume sensitivity below noise level; freq. resp. 0-3 db from 50 to 7500 cps; harm dist. 1%. Other features: 3-position AM bandwidth selector, jewel indicator for AM, 10-kc filter, loopstick antenna. Price \$299.50. Fisher Radio Corp., 21-21 44th Drive, L. I. C., N. Y.

- MPX-100, universal MPX adapter ... \$119.50
- FM-1000, network relay FM-stereo tuner ..... 429.50
- FM 200B, wide-band FM-stereo tuner 299.50
- FM 100B, wide-band FM-stereo tuner 249.50
- FM 50B, wide-band FM-stereo tuner... 199.50

## GROMMES

• **Model 101BM Stereo FM tuner with "Stereo Sentry"** that activates the bar tuning indicator when stereo is broadcast. Super sensitive front end has 3-gang capacitor, cascode r.f. and silver plated coils. I.f. has wide-band high gain 6HS6 tubes, tube and diode limiting and balanced diode detector. Cool silicon power supply and advanced compensation eliminate drift so that no afc is required. Multiplex section has trouble-free balanced-diode bridge switching circuit.



**Specifications:** FM: Tube complement (2) 6DT8, (3) 6HS6, 6FG6, 6EU7, 12AU7, (8) diodes, silicon rectifier; type of front end cascode—3 gang capacitor; no. of i.f. stages 3; type of detector balanced diode; no. of audio stages 0; type of tuning indicator eye tube; output signal, 1 volt; no. of outputs L and R (2); controls tuning and power off, stereo-mono (2); freq. resp.  $\pm 5$  db from 20 to 20,000 cps; signal-to-noise ratio 60 db; capture ratio 6 db; selectivity 250kc; IHFM usable sensitivity 2  $\mu$ v; AM suppression 60 db; harmonic distortion (100% mod.) 0.5%; stereo separation 30 db; type of stereo circuit bal. diode bridge switching; type of a.f.c. circuit none; drift 10 kc; dimensions 14" wide, 4 $\frac{1}{2}$ " high, 9" deep, weight 17 lbs. Price \$139.95; accessories, cover, \$7.50. Precision Electronics, Inc., 9101 King St., Franklin Park, Ill.

- 102DM, FM-AM with multiplex ster. \$159.95
- E104M, FM-AM with multiplex ster. . 129.95

## HARMAN-KARDON

• **Model T300X, AM-FM-FM Stereo Tuner.** A complete AM-FM tuner with built-in facilities for receiving FM stereo. Although modest in price, it certainly is not modest in performance.

**Specifications:** FM: tube complement (1) EZ81, (1) 6AJ3, (1) 6A08, (2) ECF80, (1) 6EQ7, (1) 6BN6, (1) 12AU7, (1) 6C4; type of front end, tuned grounded-grid r.f.; no. of i.f. stages, 4; type of detector Foster-Seely; output signal, 1.75 volts; no. of outputs, 2; controls, tuning; switches, a.f.c.



AM/FM, FM/FM Stereo, power on/off, noise filter; freq. resp.  $\pm 1$  db from 10 to 35,000 cps; signal-to-noise ratio, 65 db; capture ratio, 5 db; selectivity, 240 kc bandwidth 6 db down; IHFM usable sensitivity 32  $\mu$ v; harmonic distortion (100% mod.) 0.1%; stereo

separation, 30+ db; type of stereo circuit, switching; type of a.f.c. circuit reactance tube; drift  $\pm 20$  kc; dimensions, 15" wide, 6" high, 11 $\frac{1}{2}$ " deep; weight 25 lbs.

AM section: type of circuit, low-noise, high-gain r.f. pentode, 3-gang tuning capacitor; type of detector, high-perveance diode; no. of i.f. stages, 2; IHFM usable sensitivity, 25  $\mu$ v; freq. resp.  $\pm 1$  db from 20 to 5000 cps; harm dist. less than 1%. Price, \$149.95. Harman-Kardon, Inc., Plainview, N. Y.

- F500X, FM-stereo tuner ..... \$169.90
- F10, FM (mono) tuner ..... 69.95

## KARG

• **Stereo FM tuner, Model FMX-9.** Featuring a wideband i.f. and discriminator, the Karg FMX-9 incorporates advanced multiplex circuitry. Separate jacks are provided for mono and FM-stereo output. The 9-in. slide rule dial is calibrated each megacycle.

**Specifications:** FM: Tube 9 tubes; type of front end variable cap., r.f. amp., osc-mix, no. of i.f. stages 3; type of detector Foster-Seely discrim; no. of audio stages 1/chan; type of tuning indicator eye tube; output signal 1.5 volts; no. of outputs 3: A and B mono; controls tuning, volume (combined w. power switch); switches 1. Mode (Stereo, mono, standby). 2. Subchannel filter. 3. AVC; freq. resp.  $\pm 1$  db from 40 to 15,000 cps; signal-to-noise ratio 48 db; IHFM volume sensitivity 2.2  $\mu$ v; capture ratio 3 db; IHFM usable sensitivity 2.2  $\mu$ v; AM suppression 32 db; harmonic distortion (100% mod.) 1%; stereo separation 33 db; type of stereo circuit time division; drift 10 kc; dimensions: 15 $\frac{1}{2}$ " wide, 5" high, 5 $\frac{1}{2}$ " deep; weight, 11 lbs. Price, \$199.95. Karg Laboratories, 162 Ely Ave., S. Norwalk, Conn.

- CT-3, mono FM tuner ..... \$119.95
- MX-3, FM-stereo adapter ..... 99.30
- MX-5, FM-stereo adapter ..... 39.95
- MX-2, FM-stereo adapter, plug-in for Karg tuners ..... 44.50
- XT-1A, crystal-controlled 12 channel tuner ..... 229.95

## LAFAYETTE

• **LT-81 FM-Stereo Tuner.** The LT-81 is a moderately priced FM tuner with built-in multiplex provisions. The performance, however, features sensitivity and low distortion. It integrates well with many of the Lafayette systems, as well as with others.



**Specifications:** FM: Tube complement (8) tubes, (4) diodes; type of front end grounded grid; no. of i.f. stages 4; type of detector ratio; no. of audio stages 1; type of tuning indicator meter; output signal 1 volt; no. of outputs 2; controls tuning; switches selector, noise filter, a.f.c., power; freq. resp.  $\pm 2$  db from 20 to 20,000 cps; IHFM usable sensitivity 6  $\mu$ v; harmonic distortion (100% mod.) 1%; stereo separation 35 db; dimensions: 13 $\frac{1}{2}$ " wide, 5 $\frac{3}{4}$ " high, 9 $\frac{1}{4}$ " deep; weight, 12 lbs. Other features 3-gang tuning capacitor. Price, \$76.50. Lafayette Radio Electronics, 111 Jericho Turnpike, Syosset, L. I. N. Y.

## LEAK

• **MK11 FM-Stereo Tuner.** An ideal companion for the "Point One" stereo preamplifier.

**Specifications:** FM: Tube complement (2) ECF80, ECC84, ECC85, EF80, EM84, EZ80 (2) OA79; no. of i.f. stages 2; type of detector Foster Seely; type of tuning indicator maximum closure; output signal 1 volt; no. of outputs 2; controls tune, volume, on-off; switches a.f.c., local-distance; IHFM usable sensitivity 2 $\mu$ v; drift 15 kc; dimensions: 10 $\frac{1}{4}$ " wide, 3 $\frac{3}{4}$ " high, 7 $\frac{3}{4}$ " deep; weight, 11 lbs. Other features: cathode follower—sensitivity switch for locations of high signal strength. Accessories: Supplied with color inserts to

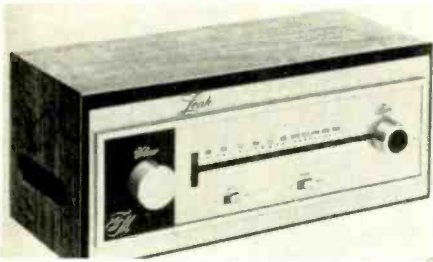

match room decor. Price \$149.00 Ercona Corp., 16 W. 46th St., New York, N. Y.

## McINTOSH

● **MX110 Tuner-Preamp Stereo Combination.** The MX110 combines in one convenient instrument an FM tuner, a multiplex decoder, and a stereo preamplifier. You mount only this one unit, connect it to your power amplifier and speakers, and listen. The preamp is similar to the C11, while the tuner has increased sensitivity and stability so that a.f.c. is no longer needed. The MX indicator lights up whenever the tuner is centered on an FM stereo broadcast.



**Specifications:** FM: Tube complement (1) 6BN4A, (2) 12AT7, (1) 6AB4, (3) 6AU6, (1) 6CS6, (3) 12AX7, (3) 6U8, (1) EM84A; (16) semiconductors; type of front end r.f. stage; no. of i.f. stages 4; type of detector, discriminator; type of tuning indicator electron tube; output signal 3 volts; no. of outputs 2 each channel, L+R, tape; controls tuning, selector, mode, dual concentric bass and treble, balance; switches muting, scratch, rumble, loudness, tape mon, reverse; freq. resp.  $\pm 1$  db from 20 to 20,000 cps; sensitivity 2.5  $\mu$ v; harmonic distortion (100% mod.) less than 0.6%; drift less than 25 kc; Freq. resp. 20 to 20,000 cps  $\pm 0.5$  db; output, 3 volts per channel; IM distortion 0.2% at 3 volts; hum and noise, 80 db below 3-volt output on high-level inputs; sensitivity, input for rated output — phono, 3 mv, aux. 0.3 volts; inputs—4 phono, 2 tape head, 2 tape amp, 2 aux; dimensions, 15 $\frac{1}{2}$ " wide, 5 $\frac{1}{4}$ " high, 13" deep; weight, 20 lbs. Price, \$347.50. Accessories, cabinet, \$25.00. McIntosh Laboratory, Inc., 2 Chambers St., Binghamton, N. Y.

## MONARCH

● **Model FM-100 Budget FM Tuner.** An economically priced FM tuner with high sensitivity, automatic frequency control, attractive solid brass panel, and slide rule dial. Compact, drift-free, and distortionless, the FM-100 is incomparable in its price class.



**Specifications:** FM: Tube complement, (2) 6AQ8, (3) 6BA6, (1) 6AL5, (1) 6X4; output signal 0.5 volts; no. of outputs 1; controls power, tuning; switches a.v.c. on/off; sensitivity 2.5  $\mu$ v for 20 db quieting; harmonic distortion (100% mod.) 1%; dimensions: 11 $\frac{1}{2}$ " wide, 3 9/16" high, 5 $\frac{3}{8}$ " deep. Price, \$39.95. Monarch Electronics International, Inc., North Hollywood, California.

1. FM-100X FM-MPX trn .....\$74.95

## OMEGA

● **Model 1650 FM/FM-Stereo Tuner.** The latest addition to the Omega line of transistorized equipment, the Model 1650 FM-stereo tuner is designed to complement the Model 1600 amplifier. Incorporating a new type of multiplex circuitry, the 1650 is capable of receiving relatively weak stereo signals because of its sensitivity and wide-band design.



**Specifications:** FM: Transistor complement 28 transistors; type of front end MADT transistor; no. of i.f. stages 5; type of detector wide-band ratio; type of tuning indicator balanced eye; output signal 0.8 volts; no. of outputs 5; controls on-off, a.f.c., quieting threshold, output, level, tuning, local-distant, stereo noise filter; freq. resp.  $\pm 1$  db from 30 to 15 k cps; capture ratio 3 db; IHFM usable sensitivity 1.8  $\mu$ v; harmonic distortion (100% mod.) 0.4%; stereo separation 33 db; type of stereo circuit switching; drift 15 kc; dimensions: 15 $\frac{1}{2}$ " wide, 3" high, 9" deep; weight, 10 $\frac{1}{2}$  lbs. Other features stereo broadcast indicator, built-in antenna. Price \$249.00. Omega Electronics Corp., 10017 North 19th St., Phoenix, Arizona.

## QUAD

● **Compact FM Tuner.** The Quad FM tuner is a compact unit designed to be used with Quad amplifiers. It is an attractive companion to the Quad 22 or II. Special features are a positive tuning indicator; drift-free temperature-compensated a.f.c. circuitry; low distortion; and high noise rejection.

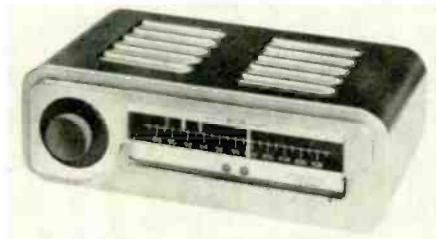

**Specifications:** FM: Tube complement 6AL5; 12AX7; 6BJ6; 12AT7; 6BH6(2); 6AU6; type of front end variable capacitor; no. of i.f. stages 3; type of detector phase discriminator; type of tuning indicator 2 neon lights; output signal 100 mv; no. of outputs two; controls tuning; freq. resp. from 20 to 20k cps; IHFM volume sensitivity 100  $\mu$ v; usable sensitivity 3  $\mu$ v for 20 db of quieting; type of a.f.c. circuit temp. comp.; dimensions: 10 $\frac{1}{2}$ " wide, 3 $\frac{1}{2}$ " high, 6" deep; weight, 6 lbs. Price, \$125.00. Lectronics of City Line Center, 7644 City Line Ave., Philadelphia 31, Pa. Pa.

## RAVENSWOOD

● **TX-700 FM Stereo Tuner.** The TX-700 tuner is designed to provide high-quality FM stereo signals to any control amplifier and power amplifiers and speakers or to any integrated amplifier with complete assurance of distortion-free and drift-free performance. Similar in form is the TAX-700, which provides the same facilities as the TX-700 and in addition, an AM tuner of exceptional performance.

**Specifications:** FM: Tube/transistor complement (1) AF114, (1) AF115, (4) AF116; type of front end, autodyne; no. of i.f. stages 4; no. of audio stages 1; type of tuning indicator meter; output signal 1 volt; IHFM usable sensitivity 2.9  $\mu$ v; stereo separation 29 db; dimensions: 13 $\frac{1}{2}$ " wide, 11" high, 4" deep. Price, \$159.95. Also available with AM, Model TXA 700 \$189.95. AM: Tube complement (1) ECH81, (1) 6BA6, (1) 6AU6; type

of circuit superhet; 2-gang tuning capacitor; type of detector, diode; type of tuning indicator meter.

1. TX600 FM ster trn tuning eye .....\$129.95
2. TAX600 AM-FM ster trn, tuning eye 169.95
3. TCCX700 FM ster trn/preamp .... 249.95
4. TCCAXP700 AM-FM ster trn/preamp 279.95

## REALISTIC

● **AM-FM/MLPX Stereo Tuner, TM-8.** TM-8 AM-FM-MPX Tuner, an all-in-one AM-FM tuner with built-in multiplex for FM stereo. Meter tuning is utilized for both AM and FM.

**Specifications:** FM: Tube complement (1) 6X4, (5) 6AQ8, (1) 6BA6, (3) 6AU6; type of front end grounded grid, t.r.f.; no. of i.f. stages 2; type of detector ratio; no. of audio stages 2; type of tuning indicator meter; output signal 2 volts; no. of outputs 2; controls tuning, dimension; switches on-off a.f.c. on-off, noise filter on-off, function selector; freq. resp.  $\pm 2$  db from 30 to 15 k cps; signal-to-noise ratio 50 db; IHFM usable sensitivity 2.5  $\mu$ v; AM suppression 25 db; harmonic distortion (100% mod.) 0.7%; stereo separation 27 db; type of stereo circuit carrier injection; type of a.f.c. circuit reactance tube; dimensions: 14 $\frac{1}{4}$ " wide, 5" high, 10" deep; weight 20 lbs. AM: Tube complement (2) 6BA6, (1) 6BE6, (1) OA81; type of circuit superheterodyne; 3-gang tuning capacitor; type of detector diode— $\frac{1}{2}$  wave; no. of i.f. stages 1; type of tuning indicator meter; IHFM usable sensitivity 70  $\mu$ v; freq. resp.  $\pm 1$  db from 20 to 7k cps. Other features t.r.f. stage. Price \$99.95. Radio Shack, 730 Commonwealth Ave., Boston 17, Mass.

## H. H. SCOTT

● **350-B Wideband FM Multiplex Stereo Tuner.** Built-in multiplex circuitry receives FM-stereo broadcasts without an adaptor. The 350B also receives regular monophonic FM broadcasts. Scott's new Sonic Monitor tells you automatically when stereo is on the air. Simply turn the switch and tune to the tone. Wide-band design assures IHFM sensitivity of 2.2  $\mu$ v and stereo separation that matches FCC transmission specifications. Exclusive Scott filtering circuits permit good results with any tape recorder.



**Specifications:** FM: Tube complement 9 tubes, 11 diodes, selenium rectifier; type of front end cascode; no. i.f. stages 3; type of detector ratio; no. of audio stages 3; type of tuning indicator meter; output signal 1.5 volts; no. of outputs 2 sets; controls vernier tuning, individual level controls (rear panel); switches "Sonic Monitor," a.g.c., stereo noise filter; freq. resp.  $\pm 1$  db from 20 to 20 k cps; signal-to-noise ratio 60 db; capture ratio 6.0 db; selectivity 55 db; IHFM usable sensitivity 2.2  $\mu$ v; AM suppression 55 db; harmonic distortion (100% mod.) 0.8%; stereo separation 35 db; type of stereo circuit time switching; drift 0.02%; dimensions: 15 $\frac{1}{2}$ " side, 5 $\frac{1}{4}$ " high, 13 $\frac{1}{4}$ " deep; weight, 13 lbs. Other features: sub-channel noise filter, switchable a.g.c., front panel tape output, individual level controls for each channel. Price, \$219.95. H. H. Scott, Inc., 111 Powdermill Road, Maynard, Mass.

1. 333 AM/FM multiplex stereo tuner
2. 314 FM mono tuner

## SHERWOOD

● **S-2100 FM-MPX-AM Stereo Tuner.** The Model S-2100 enables you to enjoy modern stereocasts via FM multiplex in your area.



Front-panel controls and complete FM-multiplex stereo circuitry are furnished to provide low-distortion stereo reception. The S-2100/MX also features the reception of AM broadcasts with the excellent fidelity afforded by the 15-kc wide "hi-fi" band pass. A sharply selective 5-kc pass-band is also selectable on the front panel for "pulling-in" weaker AM broadcasts. Stereo-MX programs are each identified on the S-2100 by the instant indication on Sherwood's new Stereo-lite.

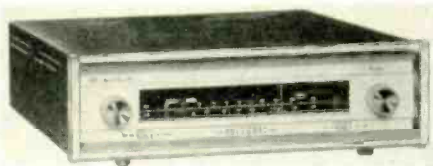

**Specifications:** FM: tube complement 12 tubes, 7 diodes, rectifier; type of front end cascade r.f. amp; no. of i.f. stages 2; type of detector balanced; type of tuning indicator tuning eye; output signal 1.4 volts; controls tuning, selector; switches off-on, a.f.c.; freq. resp.  $\pm 0.5$  db from 20 to 20,000 cps; signal-to-noise ratio 60 db; selectivity 220 kc at -3 db; IHFM usable sensitivity 1.8  $\mu$ v; harmonic distortion (100% mod.)  $\frac{1}{2}$ %; drift 25 kc; dimensions: 1 $\frac{1}{2}$ " wide, 4" high, 12 $\frac{1}{2}$ " deep; weight, 2 $\frac{1}{2}$  lbs. AM: Type of circuit superhet; type of detector diode; no. of i.f. stages 1; type of tuning indicator tuning eye; usable sensitivity 2  $\mu$ v at 60% mod. for 0.5 v. out, 6 db S/N; freq. resp. (wide) -6 db from 20 to 7500 cps. Price, \$199.50. Sherwood Electronic Labs, 4300 N. California Ave., Chicago 18, Ill.

## TRANSIS-TRONICS

● **FM-15MX FM-Stereo Multiplex Tuner.** All-transistor FM multiplex tuner has advanced circuitry. Circuit is sensitive and has maximum stability of tuning.

**Specifications:** FM: Transistor complement (20) transistors, (9) diodes; no. of i.f. stages 4; type of detector discriminator; no. of audio stages 1; type of tuning indicator meter; out-



put signal 1 volt; no. of outputs 2 pair; controls tuning, muting level; switches a.f.c., muting, power, MX; freq. resp.  $\pm 1$  db from 20 to 20,000 cps; signal-to-noise ratio 66 db; IHFM volume sensitivity 0.9  $\mu$ v; capture ratio 5.1 db; IHFM usable sensitivity 3.5  $\mu$ v; stereo separation 30 db; type of stereo circuit switching; drift 15 kc; dimensions: 10 $\frac{1}{8}$ " wide, 3" high, 8 $\frac{1}{2}$ " deep; weight, 8 lbs. Other features exceptional bandwidth—270 kc, 6 db down. Price, \$199.50. Transis-Tronics, Inc., 1601 Olympic Blvd., Santa Monica, Calif.

## BASIC TUNER KITS

### DYNACO

● **FM-1 Tuner.** The basic FM-1 monotuner features etched circuit design for exact reproducibility, and a complete system for customer alignment without instruments. To the basic tuner may be added either the FMX-3 multiplex integrator or the FMA-2 10-watt

mono amplifier, which fits in the same space as the adapter providing maximum versatility from a single unit.

**Specifications:** FM: type of front end cathode coupled; no. of i.f. stages 4; type of detector balanced bridge; no. of audio stages 2; type of tuning indicator eye tube; output signal 2 volts; no. of outputs 2; controls volume tuning; switches on-off; freq. resp. 0.5 db from 10 to 40k cps; signal-to-noise ratio 70db; IHFM volume sensitivity infinite; capture ratio 5 db; selectivity 54 db; IHFM usable sensitivity 4  $\mu$ v; AM suppression 63 db; harmonic distortion (100% mod.) 0.5%; stereo



separation (with FMX-3) 30 db; type of stereo circuit envelope detection and doubler; type of a.f.c. circuit none; drift less than 2.5 kc; dimensions: 13" wide, 4" high 8" deep; weight 11 lbs. Other features: FMX-3 multiplex integrator fits inside chassis. Price (FM-1) \$119.95 assembled, \$79.95 kit. Accessories PM-4 panel mount kit \$4.95, PK-40 deluxe panel, knobs \$9.95. Dynaco, Inc. 3912 Powelton Ave., Philadelphia, Pa.

1. FMX-3 multiplex adapter kit .....\$ 29.95
2. FMA-2 mono amp kit ..... 29.95

## EICO

● **ST-97 FM-Stereo Tuner Kit.** New from EICO is this FM-Stereo tuner kit which features a sensitive tuner combined with the exclusive EICO multiplex circuitry.

**Specifications:** FM: Tube (1) ECC85, (1) 12AT7, (1) DM70, (5) 6AU6 (2) 12AU7, (1) EZ80 rect., (1) 6AL5, (1) 6D10, (6) signal diodes; type of front end r.f. amp and self oscillating mixer; no. of i.f. stages 4; types of detector ratio; no. of stereo demod. stages 10; type of tuning indicator combination tuning eye-station indicator; output signal 0.7

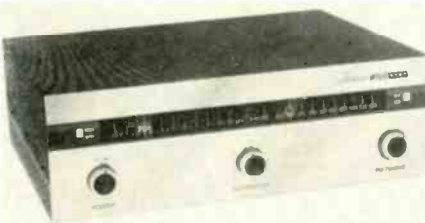

volts; no. of outputs (2) stereo, (1) FM det; controls on-off, tuning, separation; switches Stereo-Mono, a/c-defeat; freq. resp. 1 db from 20 to 15,000 cps; signal-to-noise ratio -55 db; capture ratio 3 db; IHFM usable sensitivity 3  $\mu$ v; harmonic distortion (100% mod.) 0.5%; stereo separation 30 db; type of stereo circuit matrix; drift 20 kc; dimension: 15 $\frac{1}{8}$ " wide, 5 $\frac{1}{8}$ " high, 11 $\frac{1}{8}$ " deep; weight 17 lbs. Other features: Stereo broadcast indicator (neon lamp) pre-wired and pre-aligned front end and i.f. strip in kit. Price, \$149.95 assembled; \$99.55 kit. Electronic Instrument Co., Inc., 3300 Northern Blvd., L.I.C., N. Y.

## FISHER

● **KM-60 Wide-Band FM-Stereo Tuner Kit.** A tuner kit with built-in and preassembled multiplex circuitry, the KM-60 features "Stereo Beam" which indicates when a stereo program is being broadcast. The kit is easy to build and represents a substantial financial saving.

**Specifications:** FM: Tube/transistor complement 11 tubes, 12 diodes, 1 selenium rect. type of front end Golden Cascade; no. of i.f. stages 4; type of detector ratio; no. of audio stages 1 each channel; type of tuning indicator meter; output signal 2 volts; no. of out-



puts 2 each channel; controls on face panel: tuning; on rear: left and right level; switches Selector, Stereo, Filter, Power (Meter selector on top of chassis for alignment); freq. resp.  $\pm 1$  db from 20 to 15,000 cps; signal-to-noise ratio 70 db; IHFM volume sensitivity below noise level; capture ratio 2.5 db; selectivity 60 db; IHFM usable sensitivity 1.8  $\mu$ v; AM suppression 55 db; harmonic distortion (100% mod.) 0.5%; stereo separation 35 db; type of stereo circuit time-division switching; type of a.f.c. circuit none; drift 15 kc max; dimensions: 15 $\frac{1}{8}$ " wide, 4 13/16" high, 13" deep; weight, 18 lbs. Other features stereo beam indicator. Price, \$219.50 assembled; \$169.50 kit. Accessories Cabinets: Wood (10-U) 24.95; Metal-simulated leather \$15.95. Fisher Radio Corp., 21-21 44th Drive, L.I.C., N. Y.

## HARMAN-KARDON

● **Citation III Professional FM-Stereo Tuner Kit.** Now with built-in multiplex, the Citation III remains the top of Harman-Kardon kit tuner line—a goodly amount. Famous for the role it played in opening the kit field for the highest-quality FM tuners the III is still in the forefront.

**Specifications:** FM: Tube complement (1) 6CW4, (1) ECC85, (2) ECF80, (2) 6AU6, (2) 6BN6, (2) 12AX7, (1) EZ81, (1) 12AT7 (8) diodes; type of front end Nuviator triode; no. of i.f. stages 5; type of detector Foster-Seely;



no. of audio stages 3; type of tuning indicator (2) level, center-of-channel, meters; output signal 3 volts; no. of outputs 2; controls tuning, loudness; switches a.f.c., interchannel muting, local/distance, power/stereo function; freq. resp.  $\pm \frac{1}{2}$  db from 1 to 52,000 cps; signal-to-noise ratio 75 db; capture ratio 3 db; selectivity 240 kc bandwidth 6 db down; IHFM usable sensitivity 1.65  $\mu$ v; harmonic distortion (100% mod) less than 0.1%; stereo separation 30 db; type of stereo circuit switching; type of a.f.c. circuit solid state; drift less than 15 kc; dimensions 14 $\frac{1}{8}$ " wide, 6" high, 12 $\frac{1}{4}$ " deep; weight 30 lbs. Price \$299.95 assembled, \$219.95 kit. Accessories: WCI walnut cabinet, \$29.95. Harman-Kardon, Inc., Plainview, N. Y.

1. F50XK, FM-ster tuner kit .....\$129.95

## HEATH

● **Model AJ-41 AM/FM Stereo Tuner.** In addition to AM or FM reception, the AJ-21 features a built-in stereo converter. A neon light indicator shows when an FM-stereo signal is received and individual tuning meters for AM and FM permit precise station settings. An FM squelch circuit eliminates noise between stations when tuning across the FM band. Cathode follower outputs provide low line impedance to minimize hum and high-frequency losses in the interconnecting audio cables. In mono AM or FM modes of operation the output stages are tied together to supply the same information to both the left and right channel amplifiers of a stereo system.

In FM stereo position both channels function separately. A multiplex phase control permits fine tuning for maximum separation.

**Specifications:** FM—tube complement, (9); type of front end, r.f. amp, osc, and mixer; no. of i.f. stages, 5; type of detector, discriminator; type of tuning indicator, meter; output signal, 0.5 volts; no. of outputs, 3; controls, power and afc, FM-stereo, phase, mode, AM fidelity and FM squelch, FM tuning, AM tuning, FM meter calibrate, AM meter calibrate, channel separation, left level, right level; freq. resp.  $\pm 2$  db from 20 to 20,000 cps; capture ratio, 12 db; IHFM usable sensitivity, 5  $\mu$ v; AM suppression, 25 db; harmonic distortion (100% mod.) 1%; stereo separation, 30 db; type of stereo circuit, matrix; type of a.f.c. circuit, reactance tube; dimensions, 15 $\frac{1}{4}$ " wide, 5 $\frac{1}{4}$ " high, 14 $\frac{1}{4}$ " deep; weight, 18 $\frac{1}{2}$  lbs.

AM: tube complement, 3; diodes, 2; type of circuit, r.f. amp superhet; 3-gang tuning capacitor; type of detector, voltage doubler; no. of i.f. stages, 1; type of tuning indicator, meter; controls (see above); IHFM usable sensitivity, 4  $\mu$ v; freq. resp.  $\pm 3$  db from 20 to 8000 cps; harm. dist. 1%. Other features: 10-kc whistle filter, switchable bandwidth. Price, \$189.95 assembled, \$119.95 kit. Heath Company, Benton Harbor, Mich.

1. AJ-30 Deluxe AM/FM tuner kit ....\$ 99.95
2. AJ-11 economy AM/FM tuner kit ... 69.95

## KNIGHT-KIT

• **KF-75 FM-Stereo Tuner Kit.** Featuring wide-band i.f. circuitry and printed circuit boards for easy assembly, the KF-75 is intended for the economy-minded kit builder who desires fine FM-stereo reproduction.

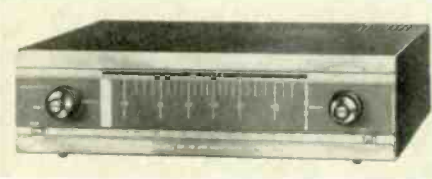

**Specifications:** Tube complement, (2) 6AU6, 12AU7, 6AL5, (2) 6CB6, (2) 6AQ8, EM84, EZ81; type of front end, t.r.f.; no. of i.f. stages, 4; type of detector, discriminator; no. of audio stages, 2; type of tuning indicator, eye; output signal, 10 volts; no. of outputs, 2; controls, FM tuning, dimension; switches, on-off, DSR, a.f.c., selector; freq. resp.  $\pm 1$  db from 20 to 20,000 cps; selectivity,  $\pm 3$  db; IHFM usable sensitivity, 1.5  $\mu$ v; AM suppression, 40 db; harmonic distortion (100% mod.) 1%; stereo separation, 30 db; type of stereo circuit, matrix; dimensions, 15 $\frac{1}{4}$ " wide, 4 $\frac{1}{2}$ " high, 15" deep; weight, 26 lbs. Price, \$84.95 kit. Allied Radio Corporation, 100 N. Western Ave., Chicago 80, Ill.

## PACO

• **Model ST45 AM/FM Tuner Kit.** Available in a variety of ways—as a full kit, as a semi-kit, and factory wired—the Paco ST-45 is a sensitive AM-FM tuner at a very moderate price. The AM and FM sections are independent so that simulcasts may be received or different programs may be sent simultaneously to different locations.

**Specifications:** FM: Tube complement 7 tubes, 6X4 rectifier, and EM84; type of front end, three-gang tuning capacitor grounded grid r.f.; no. of i.f. stages 4; type of detector Foster-Seely discriminator; type of tuning indicator eye tube; output signal 2 volts; no. of outputs 2; controls "FM level," AM tuning, FM tuning; switches power, a.f.c., function selector; freq. resp.  $\pm \frac{1}{2}$  db from 20 to 20,000 cps; sensitivity 2  $\mu$ v for 30 db quieting; harmonic distortion (100% mod.) 1%; type of a.f.c. circuit reactance tube; dimensions: 15 $\frac{3}{8}$ " wide, 5 $\frac{1}{8}$ " high, 11 $\frac{3}{4}$ " deep; weight, 19 lbs. Other features dual limiters, cathode followers output, complete FM circuitry on one printed-circuitboard, flywheel tuning, provision for addition of FM-stereo adapter. AM: Tube complement 3 tubes and crystal diode; type of circuit superhet with 3 stages a.v.c.; 3-gang tuning capacitor; controls AM level; switches same as above; freq.

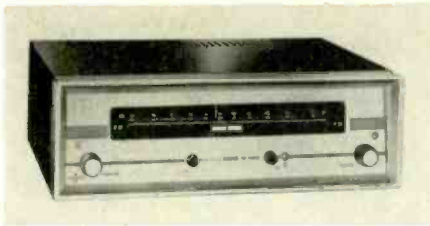

resp.  $\pm 3$  db from 20 to 5000 cps; harm. dist. 1%. Other features, tuned r.f. stage, 10 kc whistle filter, cathode follower output, complete AM circuitry on one printed circuit board, rotatable built-in ferrite antenna, flywheel tuning. Price \$134.95 assembled; \$84.95 kit. Paco Electronics Co., 70-31 84th St., Glendale 27, L. I., N. Y.

1. ST35MX, FM-stereo tuner kit .....\$99.95
2. ST25, FM tuner kit ..... 42.95
3. ST26, FM tuner plus amplifier kit .... 54.95
4. MX-100, multiplex adapter kit ..... 49.95

## R-A-E

• **Model 250 Stereo-Mono Tuner Kit.** Another new kit product from R-A-E featuring kit design for easy construction plus a good performing instrument.

**Specifications:** FM: Tube complement (2) 6AU6, 6AU5, 6BN6, 6AV6, 6X4, (2) ECC85, (2) 6AU6; type of front end Tetrode; no. of i.f. stages 3; types of tuning indicator EM84; output signal 0.5 volts; no. of outputs mono & stereo; controls: tuning, mono volume, stereo volume; IHFM usable sensitivity 0.7  $\mu$ v; AM suppression 20 db; stereo separation 30 db; type of stereo circuit gate switch; dimensions: 9" wide, 8 $\frac{3}{4}$ " high, 11" deep; weight, 9 lbs.

Other features: four parts boards and three decks are assembled and wired separately, and then mounted on the chassis. Price, \$129.95 kit. R-A-E Equipment, Inc., Central Bank Bldg., Great Barrington, Mass.

## H. H. SCOTT

• **LT-110 Wide-Band FM Multiplex Stereo Tuner Kit.** The new LT-110 utilizes the same front end used in the famous Scott 310D Broadcast Monitor tuner. The front end and multiplex sections are pre-wired and pre-aligned at the factory assuring ideal reception and stereo quality even in weak signal areas, and eliminating the need for elaborate test equipment in alignment. The silver-plated front end, copper-bonded-to-aluminum chassis, and wide-band design all contribute to an IHFM sensitivity of 2.2 microvolts. The LT-110 uses an even more simplified Ez-A-Line method than that used so successfully by builders of thousands of LT-10 tuners.



**Specifications:** FM: type of front end cascade; no. of i.f. stages 3; type of detector ratio; no. of audio stages 3; type of tuning indicator meter; output signal 1.5 volts; no. of outputs 2 sets; controls vernier tuning, level; switches a.g.c., independent on/off; freq. resp.  $\pm 1$  db from 20 to 20k cps; signal-to-noise ratio 60 db; capture ratio 6.0 db; selectivity 3.5 db; IHFM usable sensitivity 2.2  $\mu$ v; AM suppression 55 db; harmonic distortion (100% mod.) 0.8%; stereo separation 35 db; type of stereo circuit time switching; drift 0.02%. Other features sub-channel noise filter, switchable a.g.c. circuitry to permit tape recording, front panel audio output for taping. Price, \$159.95 kit. Accessories, cases in various woods & metal from \$13.95. H. H. Scott, Inc., 111 Powdermill Road, Maynard, Mass.

1. LT-10 FM mono tuner kit .....\$99.95

## TUNER-AMPLIFIERS OR RECEIVERS

### ALTEC

• **"Astro" AM-FM-MPX Receiver.** Five integrated stereo components are packaged in a compact 6" x 15" x 13 $\frac{1}{2}$ " cabinet: FM, FM multiplex, AM, dual-channel preamplifiers, dual-channel power amplifiers. The wide-band FM tuner features sensitivity to assure highest gain, lowest noise. A built-in FM multiplex tuner provides 30 db stereo separation between channels over the entire audio range. To take all guesswork out of tuning, a monitor light flashes automatically when stereo signal is received. The AM tuner provides excellent image and i.f. rejection. The amplifier section features a complete complement of controls and includes facilities for everything from record and tape player to the stereo headphones. Powerful dual-channel amplifiers.

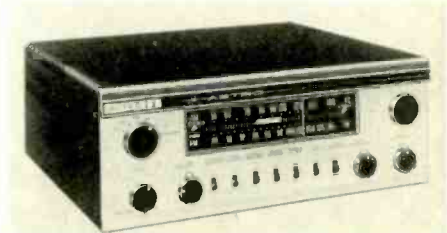

**Specifications:** FM: Tube/transistor complement (entire rec.) (12) transistors, (5) diodes, (18) tubes, type of front end cascode; type of tuning indicator eye tube; freq. resp.  $\pm 1$  db from 20 to 20,000 cps; IHFM usable sensitivity 2  $\mu$ v; stereo separation 30 db; type of stereo circuit time division; AM: IHFM usable sensitivity 2.9  $\mu$ v.

Amplifier: Freq. resp. 20 to 20,000 cps  $\pm 1$  db at 1 watt output; IHFM music power output 27.5 watts per channel; harmonic distortion, 1% at 20 watts from 25 to 10,000 cps; hum and noise, 60 db below 20 watts output; sensitivity, input for rated output—neg. phono, 4 mv, cer. phono .25 volts; damping factor 10; output impedances 8, 16 ohms; inputs—4 phono, 2 tape head, 2 tape amp; dimensions: 15" wide, 5 $\frac{3}{4}$ " high, 14 $\frac{1}{4}$ " deep. Price, \$597.00 Altec Lansing Corp., 1515 S. Manchester Ave., Anaheim, Calif.

### BELL

• **Model 2445 Stereo Amplifier-Tuner Combination.** Offering such unusual features as cancellation of vertical components when the mode switch is in mono position, and the provision of two phono inputs so that two recording sources may be left connected at all times, the 2445 offers complete stereo-mono control for a high-quality home system.

**Specifications:** FM: Tube complement (1) 6BN8, (2) ECC85, (1) 6AB4, (3) 6AU6; type of front end, neutralized cascode; no. of i.f. stages 3; type of detector, ratio; type of tuning indicator meter; output signal 1.5 volts; no. of outputs 3; switches, a.f.c.; freq. resp.  $\pm 1$  db from 30 to 53,000 cps; signal-to-noise ratio 55 db; IHFM volume sensitivity 1.5  $\mu$ v; capture ratio 2 db; selectivity -6 db 250 kc; IHFM usable sensitivity 1.8  $\mu$ v; AM suppression 40 db; harmonic distortion (100% mod.) 1%; stereo separation 28 db; type of stereo circuit, time switching; type of a.f.c. circuit, reactance tube. Other features, Stereo Sentry—indicator light for stereo FM. AM: Tube complement (2) 6BA6, (1) 6BE6, (1) 6BN8, (1) EZ80; type of circuit t.r.f., delayed a.v.c.; 3-gang tuning capacitor; type of tuning indicator diode; IHFM usable sensitivity 25  $\mu$ v; IHFM volume sensitivity 3  $\mu$ v; freq. resp.  $\pm 1$  db from 30 to 4000 cps; harm. dist. 1%. Freq. resp. 20 to 20,000 cps  $\pm 1$  db at 1

watt output; power bandwidth, 35 to 20,000 cps; IHFM music power output 22 watts per channel; power output, rms, 20 watts per channel; harmonic distortion, 1% at 20 watts from 50 to 15,000 cps; IM distortion 1% at 20 watts; hum and noise, 63 db below 1 watt output; sensitivity, input for rated output—phono, 3 mv, aux. 0.1 volts; damping factor 4; output impedances 4, 8, 16 ohms high Z for recorder; inputs—4 phono, 2 tape head, 2 tape amp, 2 aux, 2 cer phono; dimensions: 17 3/16" wide, 5 7/16" high, 13 3/4" deep; weight, 35 lbs. Bell Sound Division, Thompson Ramo Wooldridge, Inc., 6325 Huntley Rd., Columbus, Ohio.

## BOGEN

● **RP60 FM-AM Stereo Receiver.** Combining an FM-AM stereo tuner with an integrated stereo preamplifier and 60-watt amplifier, the RP60, represents great flexibility in a single unit. For FM broadcasts, the RP60 is equipped with a "Stereo-Minder" indicator that lights up when a station is transmitting in FM stereo. For private enjoyment of stereo, the RP60 has an outlet on the front panel for stereo headphones. Elegant brushed gold finish adds the decorator look to blend perfectly with any decor.



**Specifications:** FM: Tube/transistor complement 10 tubes and 6 diodes; type of front end grounded grid; no. of i.f. stages 3; type of detector ratio detector; type of tuning indicator electronic eye; no. of outputs 5; controls program selector, mode, volume, balance, bass, treble, power, tuning; switches rumble filter, scratch filter, loudness, tape monitor, dynamic a.f.c. stereo filter; freq. resp.  $\pm 1$  db from 20 to 20,000 cps; signal-to-noise ratio 60 db; IHFM volume sensitivity  $\pm 5 \mu\text{v}$ ; capture ratio 4 db; selectivity 40 db; IHFM usable sensitivity 2.5  $\mu\text{v}$ ; AM suppression 50 db; harmonic distortion (100% mod.), 0.5%; stereo separation 30 db; type of stereo circuit time division; type of a.f.c. circuit reactance; drift 20 k.c.; dimensions: 15 15/16" wide, 5 1/4" high, 15" deep; weight, 28 lbs.

Other features: tape recording filter, age, avc, whistle filter. AM Tube/transistor complement 4 tubes and 1 diode; type of circuit super-het; 3 gang tuning capacitor; type of detector diode; no. of i.f. stages 2; type of tuning indicator electronic eye; IHFM usable sensitivity 10  $\mu\text{v}$ ; IHFM volume sensitivity 10  $\mu\text{v}$ ; freq. resp.  $\pm 3$  db from 30 to 5000 cps; harm. dist. 1%.

**Amplifier:** Freq. resp. 20 to 30,000 cps  $\pm 1$  db at 2.5 watts output; power bandwidth, 50 to 15,000 cps; IHFM music power output 30 watts per channel; power output, rms, 27 watts per channel; harmonic distortion, 0.6% at rated output; IM distortion 0.3% at 2.5 watts; hum and noise, 50 db below 1 watt output; sensitivity, input for rated output—phono 4.5 mv, aux 0.5 volts; output impedances 4, 8, and 16 ohms; inputs 1 phono; 1 tape head, 1 aux. Price, \$299.95. Accessories: EN-7 metal enclosure, \$12.95; WE-7 Walnut enclosure, \$27.95. Bogen Communications Div. Lear Siegler Inc., Paramus, N. J.

1. RPF60 Stereo Receiver ..... \$279.95
2. RP100-BM Monophonic Receiver .. 186.60

## ERIC

● **Model 5761 MX Deluxe AM/FM Stereo Receiver.** Featuring a highly sensitive wide-band tuner with built-in multiplex circuitry combined with a dual 30-watt low-distortion amplifier. It is sturdily built on a heavy-gauge chassis, and components are worked well within their rated capacity. It is styled for flush-panel cabinet mounting, or in enclosures which are available for table top placement.

**Specifications:** Tubes, 19; transistors, 2; diodes, 2; pwr diodes, 2; FM; 1 tuned r.f. stage; no. of i.f. stages, 3; type of detector,



discriminator; type of tuning indicator, dual electron tube; controls, tuning, loudness, function, separate bass, treble, and loudness for each channel; switches, stereo/mono, reverse, visual balance, a.f.c., presence; freq. resp.  $\pm 1$  db from 20 to 20,000 cps; sensitivity, 1  $\mu\text{v}$  for 20 db quieting; separation, 35 db; type of stereo circuit, sampling. AM: type of circuit, superhet; type of tuning indicator, electron tube; freq. resp., 20 to 8,000 cps; freq. resp. 20 to 25,000 cps  $\pm 1$  db at 25 watts output; power output, rms, 30 watts per channel; harmonic distortion, 1% at 25 watts; inputs—2 phono, 2 tape amp, 4 aux; dimensions, 16" wide, 5 1/2" high, 13 1/2" deep; weight, 25 lbs. Price \$319.95. Eric Electronics Corp., 1832 Colorado Ave., Santa Monica, California.

1. Model 5760 MX, 10/10-w receiver.. \$199.95

## FISHER

● **Model 500-B 65-Watt FM-stereo Receiver.** Here on one integrated chassis is a wide-band FM tuner, with built-in multiplex; a stereophonic master control center; and a 65-watt stereophonic amplifier. Simply add two speaker systems to be ready for regular or stereo FM broadcasts. Add a record player or tape recorder to round out the system. A switchable filter reduces hiss and background noise on FM-stereo programs without affecting the frequency response.



**Specifications:** FM: Tube complement 19 tubes, 12 diodes, 2 silicon rectifiers; type of front end double triode; no. of i.f. stages 4; type of detector ratio; no. of audio stages 14; type of tuning indicator cathode ray; no. of outputs 2 for recording plus speakers; controls—Front: Vol., Bal., Bass & Treble, Tuning; Rear: Level, Phase Reverse; switches—Selector, MPX Filter, Hi & Lo Filter, Tape monitor Mono-Stereo, Loudness; freq. resp.  $\pm 1.0$  db from 20 to 15,000 cps; signal-to-noise ratio 70 db. r.f.; IHFM volume sensitivity below noise level; capture ratio 2.5 db; selectivity 55 db; IHFM usable sensitivity 2.2  $\mu\text{v}$ ; AM suppression 55 db; harmonic distortion (100% mod) 0.5%; stereo separation 35 db; type of stereo circuit time-division switching; drift 15 kc.

**AMPLIFIER:** Freq. resp. 20 to 25,000 cps  $\pm 1.5$  db at 2 watts output; power bandwidth, 16 to 32,000 cps; IHFM music power output 32.5 watts per channel; power output rms, 27 watts per channel; harmonic distortion 0.8% at 27 watts rms at 1000 cps; hum and noise, 80 db below full output; sensitivity, input for rated output—phono 3.3 mv, aux. 0.23 volts; damping factor 10; output impedances 4, 8, 16 ohms; inputs, 2 phono, 2 tape head, 2 tape amp, 2 aux; dimensions; 17 1/2" wide, 5 1/2" high, 23 1/2" deep; weight 31 lbs. Price \$359.50. Accessories: Wood or Mahogany cabinets, \$24.95. Fisher Radio Corp., 21-21 44th Drive, L.I.C., N. Y.

1. 800-B, AM-FM MPX 65-w rec ..... \$429.50

## GROMMES

● **Model 500 Receiver.** Stereo FM tuner with AM, preamp and 70-watt power amplifier on one compact chassis. Has all of the new fea-

tures of models 70PG stereo amplifier and 101BM multiplex tuner plus high performance AM. Eight panel controls and 5 slide switches include concentric bass and treble, blend control and dual contour switches. Provision for center-channel speaker.

**Specifications:** FM: Tube (2) 6DT8, (3) 6HS6, 6BA6, 6BE6, 6FG6, 12AU7 (7) 6EU7, (5) 7868, 6AB4, (8) diodes, (6) silicon rect.; type of front end cascade—3 gang capacitor; no. of i.f. stages 3; type of detector balanced diode; type of tuning indicator eye tube; controls tuning, selector, blend, bal., loudness, bass, treble, pwr sw; switches Lo filter, Hi filter, FM-stereo, contour-1, contour-2; freq. resp.  $\pm 0.5$  db from 20 to 20,000 cps; signal-to-noise ratio 60 db; capture ratio 6 db; selectivity 250kc; IHFM usable sensitivity 2  $\mu\text{v}$ ; AM suppression 60 db; harmonic distortion (100%



mod.) 0.5%; stereo separation 30 db; type of stereo circuit bal. diode bridge switching, type of a.f.c. circuit none; drift 10 kc.

AM: Tube complement see above; type of circuit super het; 3 gang; tuning indicator eye tube; controls see above; switches see above; IHFM sensitivity 3  $\mu\text{v}$ ; freq. resp.  $\pm 3$  db from 20 to 6500 cps; harm. dist. 1%.

**AMPLIFIER:** Freq. resp. 20 to 20,000 cps  $\pm .5$  db at 1 watt output; power bandwidth, 30 to 20,000 cps; IHFM music power output 35 watts per channel; power output, rms, 30 watts per channel; harmonic distortion, 2% at 30 watts from 30 to 15,000 cps; IM distortion 1% at 30 watts; hum and noise, 66 db below 1 watt output; sensitivity, input for rated output—phono, 3 mv aux 0.25 volts; damping factor 10; output impedances 4, 8, 16 ohms—1 mag. phono, 1 tape head, 1 aux. Dimensions: 16 3/4" wide, 6" high, 15" deep; weight, 35 lbs. Price \$299.95. Precision Electronics, Inc., 9101 King St., Franklin Park, Ill.

1. 502M, 24-w ster receiver ..... \$239.95
2. 510, 12-w FM mono receiver ..... 159.95
3. 511, 12-w FM-AM mono receiver ... 179.95

## HARMAN-KARDON

● **TA5000X, Stereo Festival 11.** The TA5000X combines an AM and FM-stereo tuner with a 50-watt stereo amplifier on the same chassis. The FM tuner is essentially the same as the F500X "Award" FM-stereo tuner. The amplifier, however, is not shared, and its specifications are shown.



**Specifications:** Freq. resp. 12 to 70,000 cps  $\pm 1$  db at 1-watt output; power bandwidth, 20 to 20,000 cps; IHFM music power output, 25 watts per channel; power output, rms, 20 watts per channel; harmonic distortion, 0.5% at 10 watts from 20 to 20,000 cps; IM distortion, 0.9% at 25 watts; hum and noise, 85 db below rated output; sensitivity, input for rated output—phono, 2.0 mv, aux, 0.25 volts; damping factor, 10 +; output impedances, 4, 8, and 16 ohms; inputs—2 phono, 2 tape head, 2 tape amp, 2 aux; dimensions, 16" wide, 6 1/4" high, 13 1/2" deep; weight, 40 lbs. Price, \$299.95. Accessories, WW80 walnut enclosure, \$29.95; CX80 cage, \$12.95. Harman-Kardon, Inc., Plainville, N. Y.

1. Model TA3000 X, "Stereo Recital II" 30-w rec ..... \$239.95
2. FA10, mono 10-w rec ..... 114.95

## KENWOOD

• **KW60 Stereo Receiver.** This stereo tuner-amplifier faithfully reproduces the entire audio range and provides a compact and versatile unit for the most critical audiophile. With AM, FM, and FM stereo available, together with all the requirements for audio control, the user has a wide range of sources at his command.



**Specifications:** Tube complement (2) 6CA4, (2) 6BA6, (5) 6AU6, (1) 6AL5, (3) 12AU7, (2) 6AQ8, (4) 12AX7, (1) 6BE6, (4) 7189, (3) OA81 diodes; FM: type of tuning indicator meter; controls, FM tuning, AM tuning, AM selectivity, volume, bass, treble, balance, selector, mode; switches, a.f.c. off/on, loudness, scratch filter, rumble filter, speaker on/off; sensitivity 2  $\mu$ v; other features, headphone jack on front panel. AM sensitivity 40  $\mu$ v.

**Amplifier:** Freq. resp., IHFM music power output 50 watts per channel; power output, rms, 24 watts per channel; harmonic distortion, 1% at 24 watts; sensitivity, input for rated output—phono, 3 mv, aux. .07 volts; inputs—2 phono, 2 tape head, 2 aux; dimensions, 19 $\frac{3}{4}$ " wide, 6" high, 13 $\frac{1}{2}$ " deep; weight, 37 $\frac{1}{2}$  lbs. Price \$279.95. Kenwood Electronics, Inc., 212 Fifth Ave., New York 10, N. Y.

## KLH

• **Model 8 FM Receiving System.** Housed on two solid walnut cabinets—one for the tuner and amplifier and the other for the speaker system, the KLH Model 8 is a complete FM receiving system, in spite of its compactness and simplicity. The tuner is extremely sensitive and stable, and the amplifier—though low-powered—is more than adequate in capacity, and is low in distortion. By designing the amplifier to complement the frequency response of the speaker, the entire performance can be engineered for optimum quality.

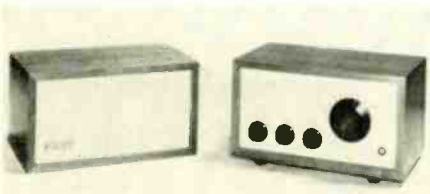

**Specifications:** Tuned r.f. stage, three i.f. stages, wideband detector; a.f.c. and tuning indicator not necessary because of circuitry; IHFM usable sensitivity, 2.5  $\mu$ v; distortion for 100% mod., 1%. Amplifier: output, 3 watts rms; controls, power, tuning, volume, and high-cut; frequency response, matched for flat acoustic output from the system's loudspeaker. Speakers: 2, high-excursion, in 4-in. frame; enclosure Fibreglas filled, sealed. Furnished with 30-ft. cord between speaker and tuner-amplifier unit. Dimensions of each cabinet: 10 $\frac{3}{4}$ " wide, 5 $\frac{7}{8}$ " high, 6 $\frac{5}{8}$ " deep. Price, \$159.00. KLH Research and Development Corp., 30 Cross St., Cambridge 39, Mass.

## KNIGHT-KIT

• **KN-45 AM-FM Stereo Receiver Kit.** A single low-cost unit containing a control center, a 32-watt stereo amplifier, and an AM-FM stereo tuner.

**Specifications:** Tube complement—(1) 6BE6, (2) 6BA6, (2) 6AU6, (1) 6AL5, (1) EM84, (1) 7025, (5) 12AX7, (4) 7189, (1) GZ34, (1) 6GY8; FM—no. of i.f. stages, 3; type of detector, ratio; type of tuning indicator, eye tube; controls—dual concentric bass and treble, balance, volume, tuning; switches—selector, power, stereo reverse, a.f.c.; freq. resp.  $\pm 1$  db from 20 to 20,000 cps; selectivity,  $\pm 3$  db; IHFM usable sensitivity, 2.5  $\mu$ v; AM

suppression, 40 db; harmonic distortion (100% mod.) 1%; stereo separation, 25 db; type of stereo circuit, matrix; dimensions, 16-7/16" wide, 4 $\frac{3}{4}$ " high, 13" deep; weight, 39 lbs. AM—type of circuit, superhet with r.f. amp; 2-gang tuning capacitor; type of detector, infinite impedance; no. of i.f. stages, 1; type of tuning indicator, eye tube; switches—bandwidth selector; IHFM usable sensitivity, 3  $\mu$ v; freq. resp.  $\pm 3$  db from 20 to 10,000 cps; harm. dist., 2%. Amplifier: freq. resp. 35 to 16,000 cps  $\pm 1$  at 16 watts output; power bandwidth, 35 to 16,000 cps; power output, rms, 16 watts per channel; harmonic distortion, 1.5% at 16 watts from 25 to 15,000 cps; IM distortion, 0.35% at 1 watt; hum and noise, 75 db below rated output; sensitivity, input for rated output—phono, 2 mv, aux, 0.2 volts; output impedances, 4, 8, and 16 ohms; inputs—2 phono, 2 tape head, 4 aux; dimensions, 16-7/16" wide, 4 $\frac{3}{4}$ " high, 13" deep; weight, 39 lbs. Price, \$129.95 kit. Allied Radio Corporation, 100 N. Western Ave. Chicago 80, Ill.

## LAFAYETTE

• **LA-226 40-Watt FM-AM-FM Stereo Receiver.** A completely integrated receiver, the LA-226 combines AM, FM, FM-stereo, and an amplifier to make almost a complete system at an unusually moderate price.

**Specifications:** FM: Tube complement 20 tubes plus 7 diodes; no. of i.f. stages 4; type of detector ratio; type of tuning indicator meter; no. of outputs 4 pair; controls off/on, blend, volume, concentric bass and treble, balance, tuning; switches selector, rumble filter, loudness, FM, noise, scratch; freq. resp.  $\pm 1/2$  db from 20 to 20k cps; IHFM usable sensitivity 3.5  $\mu$ v; harmonic distortion (100%



mod.) .7%; stereo separation 30 db. Other features: stereo headphone jack, speaker phase switch. AM: Tube complement (1) 6BA6, (1) 6BE6, (1) diode; 3-gang tuning capacitor; type of detector diode; type of tuning indicator meter; Ampl: freq. resp. 20 to 20,000 cps  $\pm 2$  db at 20 watts output; IHFM music power output 20 watts per channel; harmonic distortion, 1.5% at 20 watts from 20 to 20,000 cps; hum and noise, 60 db below 1 watt output; sensitivity, input for rated output—phono, 2 mv, aux. 0.1 volts; output impedances 8, 16 ohms; inputs—mag. phono, crystal phono; dimensions: 17 $\frac{1}{2}$ " wide, 5 $\frac{1}{4}$ " high, 15" deep; weight, 45 lbs. Price, \$189.95 assembled. Lafayette Radio Electronics, 111 Jericho Turnpike, Syosset, L. I., N. Y.

## MONARCH

• **Series 200MX AM-FM-Stereo Receiver.** Compact tuner-amplifier with complete control center for home stereo systems. Features built-in AM and FM antennas, "center" channel output, and transistor preamps, and housed in sparkling black metal cabinet with gold finished escutcheon.

**Specifications:** Tube/transistor complement (2) 6AQ8, (1) 6BE6, (5) 6BA6, (4) 6BMS, (1) 12AX7, (1) 12AU7, (1) 5AR4, (1) 6RE13, (4) 2SB75, (3) OA70, (2) OA79; FM: type of detector Foster-Seely; controls, dimension, mode, selector, bass, treble, balance, volume, tuning; switches, power, phase reverse, loudness, scratch, rumble; sensitivity 2  $\mu$ v for 20 db quieting, (100% mod.) AM: sensitivity 13  $\mu$ v; Freq. resp. 20 to 50,000 cps  $\pm 1$  db; power outputs, rms, 16 watts per channel; hum and noise, phono, 65 db; tuner, 70 db sensitivity, input for rated output—phono, 3.5 mv, aux. 170 mv; output impedances 4, 8, 16 ohms and center; inputs—4 phono, (2 low, 2 high) 2 tape amp, 2 aux, 2 mic; dimensions, 16 $\frac{3}{4}$ " wide, 5 $\frac{3}{4}$ " high, 13 $\frac{1}{4}$ " deep; weight, 26.4 lbs. Price, \$199.95. Mon-

arch Electronics International, Inc., North Hollywood, California.

1. STA-260, 30/30-w ster rec .....\$249.95
2. MAT-120, 12-w mono AM/FM rec . . . 109.95

## PILOT

• **Model 610, 24-Watt FM-mpx Stereo Receiver.** Connect two speaker systems, turn on the unit, and in seconds enjoy music broadcast in FM-stereo. The 610 utilizes Pilot's signal-sampling multiplex circuit that assures perfect stereo separation. Make stereo tapes off the air using the tape output connections (and tape recorders). The 610 has a tape monitor for making instantaneous comparison between the program being taped and the tape itself. For FM listeners, probably the most useful feature is the automatic FM-stereo indicator that immediately alerts you when a station is broadcasting stereo. In black and brushed gold styling, complete with cover.



**Specifications:** FM: Tube complement (1) EM84, (1) ECC85, (1) 6GM6, (1) 6EW6; no. of i.f. stages 2; type of detector ratio; no. of audio stages 8; type of tuning indicator eye tube; detector output signal 0.1-2 volts; controls tuning; freq. resp.  $\pm 1$  db from 20 to 15,000 cps; capture ratio 8 db; alt. channel selectivity 22 db; IHFM usable sensitivity 4  $\mu$ v; AM suppression 40 db; harmonic distortion (100% mod.) 1/2%; stereo separation 30 db; type of stereo circuit signal sampling; drift  $\pm 30$  kc; Other features: built-in linear antenna.

**AMPLIFIER:** Freq. resp. 10 to 25,000 cps  $\pm 1$  db at 1 watt output; power bandwidth, 50 to 9000 cps; IHFM music power output 12 watts per channel; power output, rms 10 watts per channel; harmonic distortion, 1% at 10 watts from 70 to 7000 cps; IM distortion 2% at 6 watts; sensitivity, input for rated output—phono, 4 mv, aux, 0.1 volts; damping factor, 3; output impedances, 8, 16 ohms; inputs—2 phono, 2 tape amp; dimensions, 14 $\frac{1}{2}$ " wide, 4 $\frac{1}{2}$ " high, 10" deep. Price, \$199.50. Pilot Radio Corp., 37-06 36th St., L.I.C., N. Y.

1. Model 602MA, FM-mpx stereo receiver with cover .....\$249.50
2. Model 602SA, FM-mpx-AM stereo receiver with cover ..... 299.50
3. Model 654M, FM-mpx stereo receiver with cover ..... 329.50
4. Mark III, FM tuner with cover ..... 49.95
5. Model 280B, FM-stereo tuner with cover ..... 99.95

## PIONEER

• **SM-Q 300 Receiver.** The newly announced Model SM-Q 300 is a deluxe model designed with care. It includes such features as tuners capable of receiving all types of radio broadcasting, output of 40 (20+20) watts, many auxiliary circuits, and so on.

**Specifications:** FM: Tube complement 19 tubes, 6 diodes; no. of i.f. stages 3; type of detector Foster-Seely; no. of audio stages 5; type of tuning indicator eye tube; output signal 10 volts; no. of outputs 2; controls bass, treble, mode, blend, balance, volume, loudness; switches power, selector A, selector B, rumble filter, scratch, whistle; signal-to-noise ratio 30 db; IHFM usable sensitivity 10  $\mu$ v; harmonic distortion (100% mod.) 1%; stereo separation 45 db.

**AM:** Tube complement, 6 tubes 2 diodes; type of circuit Superhet.; 2-gang tuning capacitor; type of detector diodes; no. of i.f. stages 2; type of tuning indicator eye tube; IHFM usable sensitivity 100  $\mu$ v.

**AMPLIFIER:** Freq. resp. 20 to 50,000 cps  $\pm 1$  db at .05 watts output; power bandwidth, 20 to 50,000 cps; IHFM music power output 20 watts per channel; power output, rms, 15 watts per channel; harmonic distortion, 1% at 35 watts at 1 k cps; IM distortion 1% at

15 watts; sensitivity, input for rated output—phono, 3.4 mv, aux. 160 mv; output impedances 4, 8, 16 ohms; inputs per channel 5 phono, 2 tape head, 1 aux. 1 mic; dimensions, 18¼" wide, 5½" high, 13¼" deep; 35.3 lbs. Pioneer Electronic Corp., 5 Otowaku 6-chome, Bunkyo, Tokyo, Japan.

1. AFT-12, FM-AM-SW stereo tuner
2. SM-B 200A, 28-w stereo
3. SM-G 204, 32-w stereo
4. SM-W 203, OTL stereo
5. FM-B 100, 10-w mono

## REALISTIC

● **STA-7 FM-Mpwr 24-Watt Stereo Receiver.** FM-stereo reception plus a 24-watt stereo amplifier characterize the STA-7 as a complete receiver for FM broadcasting.

**Specifications:** FM: Tube complement (4) 6AQ8, (3) 6BA6, (2) 12AX7, (4) 6BM8, (1) 5A4; type of front end grounded-grid r.f. amp.; no. of i.f. stages 2; type of detector ratio; no. of audio stages 12; controls tuning, tone, volume, balance, blend, separation, hum, balance; switches a.f.c.—on/off, power, loudness, function selector, phase; freq. resp. ± 2 db from 30 to 15k cps; signal-to-noise ratio 50 db; IHFM volume sensitivity 4 μv; IHFM usable sensitivity 5 μv; harmonic distortion (100% mod.) 0.8%; stereo separation 27 db; type of stereo circuit carrier injection; type of a.f.c. circuit reactance diode; dimensions: 16" wide, 5" high, 11¾" deep; weight, 32 lbs. Other features: convenience outlet, stereo headphone jack on front panel, center-channel output.

**Amplifier:** Freq. resp. 20 to 20k cps ± 1 db at 1 watts output; power bandwidth, 40 to 15 cps; IHFM music power output 13 watts per channel; power output, rms, 12 watts per channel; harmonic distortion 1% at 8 watts from 40 to 15k cps; IM distortion 1% at 12 watts; hum and noise, 51 db below 1 watt output; sensitivity, input for rated output—phono, 5 mv, aux. 0.65 volts; damping factor 10; output impedances 4, 8, 16 ohms; inputs 4 phono, 2 aux; dimensions as above. Price \$124.95. Radio Shack Co., 730 Commonwealth Ave., Boston 17, Mass.

## H. H. SCOTT

● **340 60-watt Stereo Multiplex Tuner/Amplifier.** A sensitive wide-band FM-Multiplex tuner, a complete stereo control center, and 60-watt power amplifier all on one compact chassis. Unique "Sonic-Monitor" tunes to the tone to tell you audibly when FM-stereo programs are on the air. If you do not require AM, the 340 provides all the outstanding performance of the 350 and an amplifier providing full power down to 20 cps. The 340 offers superb performance and amazing flexibility at modest cost.

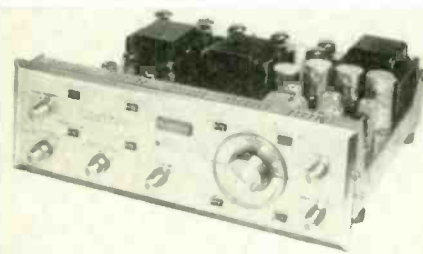

**Specifications:** FM: Tube complement 18 tubes, 13 diodes; type of front end cascode; no. of i.f. stages 3; type of detector ratio; no. of audio stages 3; type of tuning indicator meter; controls tuning; switches "Sonic Monitor," a.g.c.; freq. resp. ± 1 db from 20 to 20k cps; signal-to-noise ratio 60 db; capture ratio 6.0 db; selectivity 35 db; IHFM usable sensitivity 2.5 μv; AM suppression 55 db; harmonic distortion (100% mod.) 0.5%; stereo separation 35 db; type of stereo circuit time switching; drift 0.02%. Other features sub-channel noise filter, switchable a.g.c.

**Amplifier:** Freq. resp. 20 to 20 k cps ± 1 db at 10 watts output; power bandwidth, 19 to 25 k cps; IHFM music power output 30 watts per channel; power output, rms, 26 watts per channel; harmonic distortion 0.8% at 10 watts from 20 to 20 k cps; IM distortion 0.5% at 10 watts; hum and noise 80 db below 1 watt output; sensitivity, input for rated output—phono, 3 mv, aux. 0.5 volts; damp-

ing factor 16; output impedances 4, 8, 16 ohms; inputs—4 phono, 1 tape head, 1 tape amp, 1 aux. 1 (other); dimensions, 17½" wide, 6¼" high, 16¼" deep, weight, 37 lbs. Price, \$379.95. Accessories: cases in various woods and metal from \$17.95. H. H. Scott, Inc., 111 Powdermill Road, Maynard, Mass.

1. 355 AM-FM Multiplex tuner, preamp \$334.95

## SHERWOOD

● **S-8000 FM-Stereo 64-watt Receiver.** This unit contains all of the electronics for a complete home-music system on a single compact chassis. The S-8000 features two 32-watt amplifiers, complete with dual preamplifiers for phono and tape plus a highly sensitive FM tuner with complete wired-in circuitry for receiving FCC-approved FM multiplexed stereocasts. Just add speakers to complete your stereo home hi-fi music system.

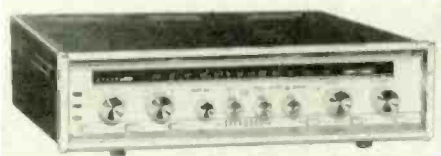

**Specifications:** FM: Tube/transistor complement 21 tubes, 4 silicon rect., 4 diodes; type of front end cascode; no. of i.f. stages 2; type of detector discrim; no. of audio stages 2; type of tuning indicator EM8; split bar eye; output signal 1.5 volts; no. of outputs stereo pair; controls FM-tuning, loudness, stereo balance, hush, bass, treble, phono gain; switches a.f.c. off-on, hi-filter, lo-filter, phanse rev, tape monitor, loudness contour; freq. resp. ± ½ db from 20 to 20k cps; signal-to-noise ratio 55 db; capture ratio 4 db; IHFM usable sensitivity 1.9 μv; harmonic distortion (100% mod.) ½%; stereo separation 40 db; type of stereo circuit phase loaded osc. and bal. synchron. detector; type of a.f.c. circuit reactance tube; drift 25 kc. Other features, "interchannel hush" or noise squelch, fly-wheel tuning.

**Amplifier:** Freq. resp. 20 to 20k cps ± ½ db at 30 watts output; IHFM music power output 32 watts per channel; power output, rms, 30 watts per channel; harmonic distortion, ½% at 30 watts; hum and noise, 75 db below 1 watt output; sensitivity, input for rated output—phono, 1.2 mv, aux. ¼ volt; damping factor 5; output impedances 4, 8, 16 ohms; inputs—stereo phono, stereo tape head, stereo tape amp, stereo aux. Dimensions, 16¼" wide, 4½" high, 14" deep; weight, 34 lbs. Price \$299.50. Accessories, case, \$7.50. Sherwood Electronic Labs, 4300 N. California Ave., Chicago 18, Ill.

# TURNTABLES WITH ARMS

## ACOUSTIC RESEARCH

● **Single-Speed Turntable.** This turntable is Acoustic Research's first product outside of the loudspeaker field. A single-speed (33½-rpm) turntable, it comes complete with arm, oiled walnut base, transparent dust cover, cables, and even an overhang adjustment device and stylus-force gauge. Manufacturer states that a condition of sale is that these turntables meet NARTB specifications for broadcast equipment on wow, flutter, rumble and speed accuracy.

**Specifications:** Speeds 33½ rpm, belt drive permanent magnet synchronous motor; turntable diameter, 11 11/16"; turntable weight, 3.3 lbs; shaft diameter .375"; turntable material aluminum; mat polyurethane; wow, 0.15%; flutter, 0.05%; dimensions of chassis, 12½" × 16½"; clearance required above mounting board, 2 9/32"; below, 2¾"; type of mounting, spring; controls, on-off; pickup head, universal; material, Acrylic;



number of mounting screws for cartridge, 2 plus spares; mounting dimensions, adjustable; number of leads to head, 4; number of leads to chassis, 5. Price \$58.00. Acoustic Research, Inc., 24 Thorndike St., Cambridge, Mass. Miscellaneous 19A1

## BOGEN

● **B61 Turntable.** Precision made to give noiseless, studio-quality performance. Complete with integrated tone arm, tracks as low as 1.5 grams. Precise automatic cueing and continuously variable speed are two features of the B61.

**Specifications:** Speeds 78, 45, 33½, 16 rpm plus continuously variable 29-86 rpm; drive, four-pole motor; turntable diameter, 12"; turntable weight, 7¼ lbs.; spindle shaft diameter, 9/32"; turntable material zinc alloy;

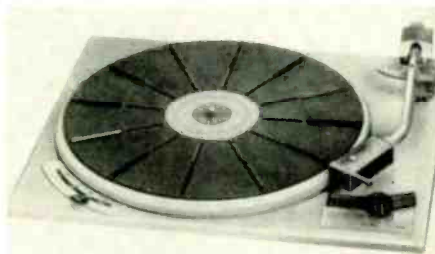

mat, rubber; wow, less than 0.2%; flutter, less than 0.2%; dimensions of chassis, 15¼" × 13¼"; clearance required above mounting board, 2½"; below, 2¼"; type of mounting, spring; controls, speed, on-off play; pickup head plug-in; material, aluminum; number of mounting screws for cartridge, 8 screws enclosed; mounting dimensions, 15" w × 13" d; number of pins (plug-in) to head, 4; number of leads to chassis, 3 (2 shielded); accommodation for different record sizes, 45-rpm adapter. Price \$59.95. Accessories: extra heads, \$4.00; PB8 wood base \$5.25. Bogen Communications Div. Lear Siegler Inc., Paramus, N. J.

## DUAL

● **Four-Speed Changer-Turntable.** The Dual-1006 "Custom" is a combination record changer and turntable offering four-speed operation. The "roller-feeler" record indexing action permits intermixing of any size records for completely automatic operation. A shaded four-pole induction motor is used which goes from rest to correct speed in one-quarter of a revolution. The platter is laminated and concentrically girded for increased rigidity. The one-piece tone arm tracks and trips at 2 grams and is adjustable for a wide range of tracking forces. The arm has a built-in tracking-force gauge. A lock-in cartridge holder is provided for use with all standard cartridges. Built-in stereo mono switch.

**Specifications:** Speeds 16½, 33½, 45, 78 rpm; idler drive; 4-pole motor; turntable diameter, 10.6"; turntable weight, 3.75 lbs; shaft diameter ¾"; turntable material steel; wow, 0.25%; flutter 0.25%; dimensions of chassis, 13¼" × 10½"; clearance required above mounting boards, 3½"; below 3"; type of mounting spring; controls (3) pushbuttons; automatic cycling time, 12 secs at 33½ rpm, 12 secs at 78 rpm; type of pickup head interchangeable cartridge holder; material plastic; number of mounting screws for cartridge, 2; mounting dimensions, std; number of leads to head, 4; number of leads to chassis, 4; accommodation for different record sizes, all sizes intermixed 7"-12". Price \$79.95. Accessories: extra cartridge holders \$2.10, 45-rpm auto spindle \$4.80. United Audio Products, 12 W. 18th Street, N.Y. 11, N. Y.

## ESL

● **Type 71 Concert Series Playback Unit.** This superb system consists of an ESL T200 Gyro/Spenston 4-speed turntable, an ESL S2000 Gyro/Balance arm, and an ESL Redhead cartridge wired and assembled on a lustrous oiled walnut base, ready to play.

**Specifications:** Speeds—78, 45, 33½, 16½ rpm; type of mounting, oiled walnut base; pickup head, plug-in; material, aluminum. Price, \$119.45. Electro-Sonic Laboratories, Inc., 627 Broadway, New York 12, N. Y.

1. Type 71H, same as 71, with hys/sync motor .....\$139.45
2. "Jewel Box" dust cover ..... 19.95

## GARRARD

● **Type A Automatic Turntables.** A dynamically balanced (counterweight adjusted) tone arm with a turntable, the Garrard Type A Automatic Turntable provides the convenience of a changer. The turntable platter is cast, weighted, and polished. The tone arm is adjustable by means of a sliding counterweight. At this point the arm is in gyroscopic balance. Tracking force is adjusted by means of a calibrated gauge on the side of the arm. Utilizing the pusher-platform changing mechanism exclusive with Garrard, the Type A operates as a fully automatic changer when desired.



**Specifications:** Speeds—33, 45, 78, 16½ rpm; rim drive; 4-pole shaded motor; turntable diameter, 10½"; turntable weight, 6 lbs; turntable material, aluminum; mat, rubber ribbed; dimensions of chassis, 16¾" x 14½"; clearance required above mounting board, 6"; below 2½"; type of mounting, adjustable leveling springs; controls, manual and auto on/off; automatic cycling time, 10 secs at 33½ rpm, 3½ sec at 78 rpm; type of pickup head, plug-in 4 pin; material plastic; number of mounting screws for cartridge, 4; mounting dimensions, ½"; number of leads to head, 4; number of leads to chassis, 5; accommodation for different record sizes, yes. Price \$79.50. Accessories extra heads \$1.50. Garrard Division, British Industries Corp., Port Washington, N. Y.

1. AT6 Automatic turntable, 4-speed dynamically balance tonearm ..... \$54.50
2. Autoslim/P Auto-manual, intermix changer ..... 39.50

## GLASER-STEERS

● **GS77T Record Changer.** Featuring the exclusive "Turntable Pause" which allows a pause during the change cycle and resumes action only after the next record has come into play position and stylus is in lead-in groove of record. This eliminates record surface wear caused by grinding action of record dropping on moving disc.

**Specifications:** Speeds, 16½, 33½, 45, 78 rpm; idler rim drive; 4-pole induction motor; turntable diameter, 11"; turntable weight 2½ lbs; shaft diameter ½"; turntable material steel; mat rubber; wow, 0.15% flutter, 0.03%; dimensions of chassis, 13½" x 12"; clearance required above mounting board, 5½", below 3"; type of mounting spring; controls, concentric knob and lever; automatic cycling time, 9 secs at 33½ rpm, 9 secs at 78 rpm; number of mounting screws for cartridge 2; mounting dimensions, ½"; number of leads to head 4; number of leads

to chassis, 5; accommodation for different record sizes, 7, 10, 12". Price \$59.50. Accessories; extra heads, double \$4.81; single \$2.43. Glaser Steers Inc., 155 Oraton St., Newark, N. J.

1. CSB, base ebony finish .....\$ 9.60
2. CSBW, base, oil finish, solid walnut .. 13.20
3. CSC, lucite cover ..... 9.75
4. CSS, automatic 45-rpm spindle ..... 2.95

## KLH

● **Model Eleven Stereophonic Portable Phonograph.** Comprising some of the engineering features of the well-known KLH loudspeaker systems with some newly engineered transistorized amplifier equipment and a Garrard AT-6 record changer with a Pickering 380C magnetic cartridge, the Model Eleven brings console quality into the portable



field for the first time. The detachable speakers may be separated up to 40 feet with the cables furnished. The case is molded of high-impact vinyl-clad "Contourlite," and is small enough to fit under the seat of a jetliner. The two loudspeaker enclosures attach firmly to the ends of the case for transport. The transistorized amplifier has an output of 15 watts (total) music power. Dimensions: 24" long, 14" deep, 7" high; weight, 26 lbs. Price, \$199.00. KLH Research and Development Corp., 30 Cross St., Cambridge 39, Mass.

## LAFAYETTE

● **PK-449WX Turntable and Tone Arm.** Designed and built to meet professional standards, the PK-449 combines on a single mounting plate a four-speed turntable and tone arm designed to complement each other. The turntable is constructed with a permanently lubricated oilite bronze bearing and the speed control allows 0.7% speed variation. The arm starts the motor when it is lifted.

**Specifications:** Speeds—16½, 33½, 45, 78 rpm; rim drive; 4-pole induction motor; turntable diameter, 12"; turntable weight, 3 lbs; turntable material, aluminum; mat, rubber; wow, 0.2%; flutter, 0.2%; dimensions of chassis, 16¼" x 12½"; clearance required below mounting board, 4"; controls, power (on arm), speed; type of pickup head, plug-in; material, aluminum; number of mounting screws for cartridge, std; mounting dimensions, std; accommodations for different record sizes, 45-rpm adapter. Price, \$49.50. Accessories; extra heads, \$1.69; PK-504W wood base \$9.95. Lafayette Radio Electronics, 111 Jericho Turnpike, Syosset, L. I., N. Y.

1. PK-160 SW, 4-speed turntable w/arm . \$26.95

## MIRACORD

● **Studio H Model 10H.** Featuring a hysteresis motor for accurate speed control, the Miracord "Studio-H" is intended to combine the convenience of a record changer with the accuracy of a turntable. In addition, the tone arm is of the quality normally found on turntables. The one-piece turntable platter is dynamically balanced. Automatic changing is accomplished by means of the "Magic Wand" spindle. Record-size selection and actuation of automatic operation is accomplished by means of pushbuttons.

**Specifications:** Speeds—78, 45, 33½, 16½ rpm; puck drive; hysteresis motor; turntable diameter, 12"; turntable weight, 6 lbs; turntable material, non-ferrous; mat, rubber; wow, less than 0.1%; flutter, less than 0.1%; dimensions of chassis, 14½" x 12½"; clearance required above mounting board, 5½"; below, 3½"; type of mounting, spring; controls, pushbutton; pickup head, plug-in; material, plastic shielded; number of mounting screws for cartridge, 2; mounting dimensions, stand-



ard"; number of leads to head, 5; number of leads to chassis, 4; accommodation for different record sizes, 7", 10", 12". Price \$99.50. Accessories: extra heads, \$3.50; auto 45 spindle, \$3.00. Benjamin Electronic Sound Corp., 97-03 43 Avenue, Corona 68, N. Y.

1. Miracord Studio, Model 10, 4-pole motor ..... \$89.50
2. Walnut base for above ..... 9.95
3. Miracover, dust cover ..... 14.95
4. Carrying case ..... 29.50

## NEUMANN

● **PA-2a Turntable and Automatic arm.** Designed as a playback system for the Neumann record-cutting lathe, the PA-2a is a fully professional integrated turntable and arm. Some unusual features are its small size, automatic cueing and cut-off.

**Specifications:** Speeds—33½, 45 rpm; belt and puck drive; hysteresis motor; turntable diameter 12"; turntable weight 8 lbs; shaft diameter ⅝"; turntable material aluminum; mat rubber; wow and flutter peak to peak 0.15%; dimensions of chassis, 14.5" x 12"; clearance required above mounting board 4.5", below 3.25"; type of mounting 4 rubber shocks; controls, speed, arm lower and lift; type of pickup head Neumann DST-62 plug-in; number of leads to head 5; number of leads to chassis, 3; accommodation for different record size, up to 13¼". Price \$450.50. Accessories, extra head, \$79.50. Gotham Audio Corp. 2 West 46th Street, N. Y. 36, N. Y.

## REK-O-KUT

● **Rondine 2, Model R320A.** The model R320A is a single-play turntable with fully automatic operation. It combines the single-play turntable with Rek-O-Kut's automatic tonearm, the "Auto-Poise." Two motors, each of which has a separate and distinct function, are used. A custom-built hysteresis-synchronous motor drives the turntable. The sole function of this motor is to drive the turntable at absolutely constant and accurate speed. A second synchronous "Auto-Poise" motor actuates the tonearm.



**Specifications:** Speeds—33½ rpm; belt drive; hysteresis-synchronous motor; turntable diameter, 12"; turntable weight, 4¼ lbs; shaft diameter, ⅝"; turntable material, cast aluminum; mat, ridged rubber; wow and flutter, 0.15%; dimensions of chassis, 14½" x 14½"; clearance required above mounting board, 3½"; below, 4¼"; type of mounting, springs; controls, pushbutton; type of pickup head, universal; material, cast aluminum; number of mounting screws for cartridge, 2; mounting dimensions, ½"; number of leads to head, 4; number of leads to chassis, 5; accommodation for different record sizes, standard 12" discs only. Price, \$169.95. Rek-O-Kut Co., Inc., 38-19 108th St., Corona 68, N. Y.

1. R 320, with manual tonearm .....\$129.95

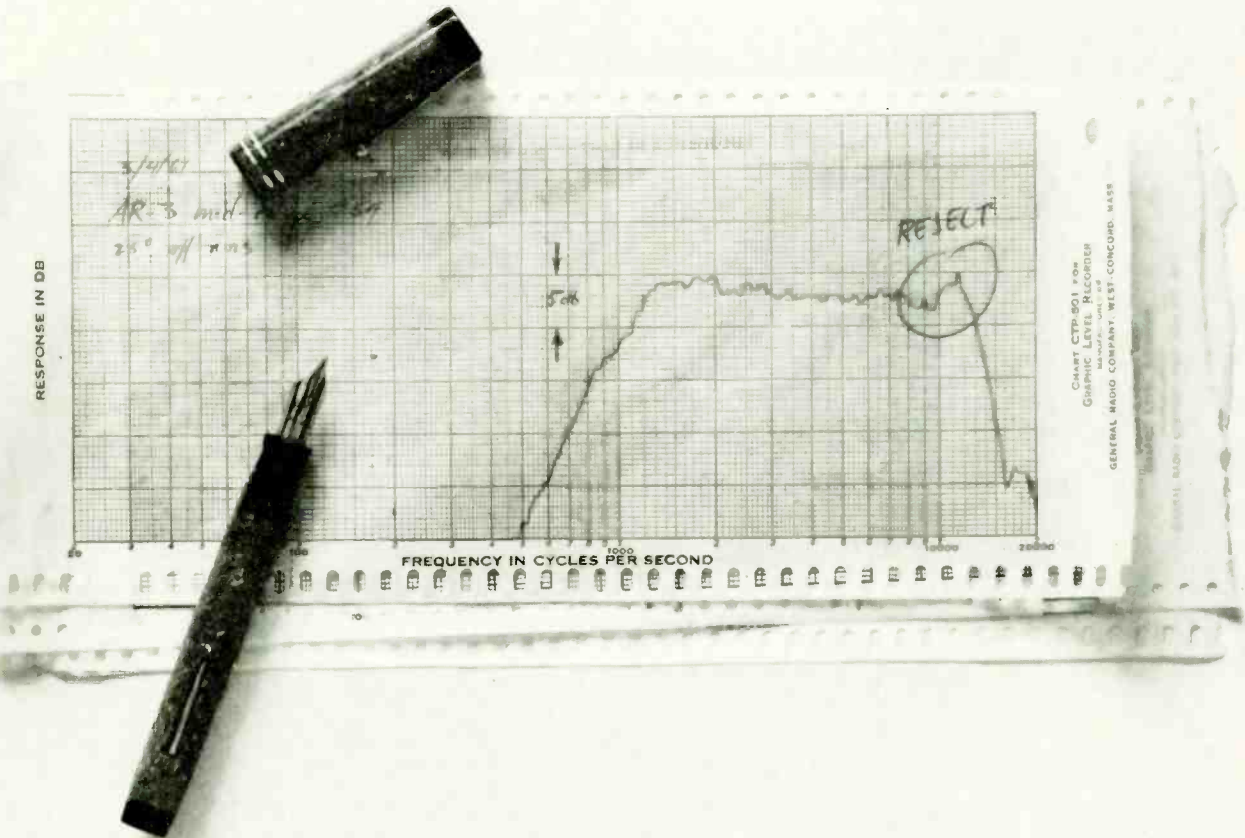

**THIS IS THE RECORDED FREQUENCY RESPONSE CURVE OF A REJECTED AR-3 MID-RANGE TWEETER**

Although this curve does not depart from the ideal by more than 2 decibels at any point, the sharp peak at 11,500 cycles is evidence of transient distortion.

The frequency response of all AR-3 tweeters and AR-2a super-tweeters is recorded and examined critically before installation. One out of fifteen never makes it to the cabinet.

AR speakers are priced from \$89 to \$225. They may be heard at AR Music Rooms, on the west balcony of Grand Central Terminal in New York City, and at 52 Brattle Street in Cambridge, Massachusetts. No sales are made or initiated at these showrooms.

Literature, including a list of AR dealers in your area, is available for the asking.

**ACOUSTIC RESEARCH, INC., 24 Thorndike Street, Cambridge 41, Massachusetts**

## THORENS

● **TD-135 Turntable and Arm.** For the first time Thorens makes available a new professional quality 4-speed turntable with a professional type (Model BT-D-12S) tone arm mounted as an integral part. Now enjoy the finest sound reproduction almost immediately after opening the box. A simple installation is required to install the cartridge and plug the leads into your amplifier. The TD-135 incorporates all the precision workmanship and design that has made Thorens turntables famous the world over.



**Specifications:** Speeds—16, 33, 45, 78 rpm; belt and idler wheel drive; induction 4-pole motor; turntable diameter, 12"; turntable weight, 8 lbs; shaft diameter,  $\frac{3}{8}$ "; turntable material, zinc; mat, rubber; wow and flutter, below NAB specs; dimensions of chassis, 15" x 12"; clearance required above mounting board, 3"; below 2 $\frac{1}{2}$ "; type of mounting, rubber grommets; controls, 4; type of pickup head, metal, plug-in; material, aluminum; number of mounting screws for cartridge, assorted; mounting dimensions, standard; number of leads to head, 4; number of leads to chassis, 5. Price, \$110.00. Accessories, extra heads, \$3.00; wood base \$7.00. Elpa Marketing Industries, Thorens Bldg., New Hyde Park, N.Y.

## TURNTABLES WITHOUT ARMS

### EMPIRE

● **Model 208 "Troubador" 3-speed turntable.** The Empire "Troubador," Model 208 is a belt driven 3-speed turntable. Each motor and each turntable are individually adjusted to perfect dynamic balance. Complete rumble isolation is provided by the motor suspension, flexible belt driven and the resilient nylon "seat" which supports and cushions the thrust of the main bearing. A case-hardened, lapped steel shaft fits precisely into the bearing well (honed to a micro finish)—a hard steel polished ball on the underside of the shaft rests on the nylon seat.



**Specifications:** Speeds 33 $\frac{1}{3}$ , 45, 78 rpm; belt drive; hysteresis motor; turntable diameter, 12"; turntable weight, 6 lbs; shaft diameter,  $\frac{1}{2}$ "; turntable material aluminum; mat rubber; wow, 0.03%, flutter 0.02%; dimensions of chassis, 14 11/16 x 16 11/16";

clearance required above mounting board 2 $\frac{7}{8}$ ", below 3 $\frac{1}{2}$ "; type of mounting brackets and shack mounts; controls power; provision for arm mounting pre-drilled; over-all weight, 20 lbs. Price \$100.00. Accessories, walnut base BW/208, \$15.00. Empire Scientific, 1075 Stewart Ave., Garden City, N. Y.

1. Empire 398 Troubador System (turntable, arm walnut base) .....\$175.00
2. Empire 388 Troubador System (turntable arm) less base ..... 160.00
3. Empire 498 Troubador System (turntable arm, walnut base) ..... 165.00
4. Empire 488 Troubador System (turntable arm) less base ..... 150.00

## FAIRCHILD

● **Single-Speed Turntable, Model 412-1A.** The 412 has a double-belt drive system for reducing rumble and wow and flutter to the lowest possible levels. Also the double-belt system allows more gradual step-down ratios between motor and turntable. The double-belt 412 has two step-down ratios of 1:4 and 1:13.5. These two gradual step-down ratios, instead of one severe stepdown, account for the wow and flutter characteristics of the 412.



**Specifications:** Speeds 33 $\frac{1}{3}$  rpm; belt drive; synchronous motor; turntable diameter 12" turntable weight 8 lbs; shaft diameter,  $\frac{1}{2}$ " turntable material aluminum, densite filled; mat moulded; wow, 0.10% flutter; 0.20% dimensions of chassis, 15" x 17 $\frac{1}{4}$ "; clearance required above mounting board, 1 $\frac{1}{4}$ ", below 5 $\frac{1}{2}$ "; type of mounting wood screws; controls ON-OFF; over-all weight, 15 lbs. Price \$95.00 assembled; \$74.95 kit. Accessories, 412BF Walnut base formica top, \$23.95. Fairchild Recording Equipment Corp., 10-40 45th Ave., L. I. C., N. Y.

1. 440 two-speed 4-pole motor turntable \$ 69.95
2. 440 kit ..... 58.00
3. 750 professional 3-speed turntable... 485.00
4. 530G professional 3-speed gear-driven table ..... 725.00

## GRAY

● **PK-33 Turntable Kit.** The Gray PK-33 utilizes a hysteresis-synchronous drive motor for speed constancy and a polyurethane belt to reduce wow and flutter. Rumble is reduced by the use of oilite bearings with lifetime lubrication. The manual is clearly written to facilitate assembly by even the inexperienced.

**Specifications:** Speeds—33 $\frac{1}{3}$  rpm; belt drive; hysteresis synchronous motor; turntable diameter, 11 $\frac{3}{4}$ "; turntable weight, 4 lbs; shaft diameter, 1"; turntable material, aluminum; mat, latex-cork; wow, 0.2%; flutter, 0.08%; dimensions of chassis, 9 by 9"; clearance required above mounting board, 2"; below, 5" type of mounting, screws; controls, on-off; provision for arm mounting, none required; over-all weight, 8 $\frac{3}{4}$  lbs. Price, \$49.50 kit. Accessories, TBA-Base \$19.95. Gray Research and Development Co., Box 12, Elwood, Conn.

## LAFAYETTE

● **PK-240W 4-Speed Transcription Player.** Well suited for stereo, the PK-240W is a 4-speed transcription player with a rim-weighted turntable and a rumble and noise figure 50 db below average recorded level. Each speed is variable within 7% of the nominal value through a magnetic eddy-current brake.

**Specifications:** Speeds—16 $\frac{2}{3}$ , 33 $\frac{1}{3}$ , 45, 78 rpm; rim drive; 4-pole induction motor; turntable diameter, 12"; turntable weight, 5 lbs; turntable material, aluminum; mat, rubber; wow, 0.2%; flutter 0.2%; dimensions of chassis, 12 $\frac{1}{4}$ " x 10 $\frac{1}{2}$ "; clearance required above mounting board, 1 $\frac{1}{2}$ "; below, 4"; controls, speed, power; provision for arm mounting, none; over-all weight, 14 lbs. Price, \$37.50. Lafayette Radio Electronics, 111 Jericho Turnpike, Syosset, L. I., N. Y.

## NEAT

● **P-88 Four-Speed Transcription Turntable.** The Neat P-88 is a four-speed turntable with a rugged induction motor. A separate board is provided on which the tone arm can be mounted, and this board is replaceable so that it is possible to interchange or upgrade tone arms easily. Neat products are available through a variety of sources in the United States—write to the manufacturer for information.



**Specifications:** Speeds—78, 45, 33 $\frac{1}{3}$ , 16 $\frac{2}{3}$  rpm; rim drive; C-start induction motor; turntable diameter, 13"; turntable weight, 5.6 lbs; shaft diameter, std.; turntable material, pressed aluminum, cast iron; mat, rubber; wow, 0.2%; flutter, 0.2%; dimensions of chassis, 18 $\frac{3}{4}$ " x 15"; clearance required above mounting board, 2.5"; below, 3 $\frac{3}{4}$ "; type of mounting, round head screw fitting; controls, magnetic brake; provision for arm mounting, mounting board; over-all weight, 11 lbs. Neat Onkyo Denki Co., Ltd., No. 4, 1-chome, Kanda Hatago-cho, Chiyoda-ku, Tokyo, Japan.

## REALISTIC

● **Mark 12 Professional Turntable.** The Mark 12 is a single-speed turntable driven by two hysteresis-synchronous motors. Because of its suspension it is not affected by extreme vibration.

**Specifications:** Speeds—33 $\frac{1}{3}$  rpm, direct drive; 2 hysteresis synchronous motors; turntable diameter, 12"; turntable weight, 1 $\frac{1}{2}$  lbs; shaft diameter,  $\frac{3}{8}$ "; turntable material aluminum; mat ribbed rubber; wow, 0.05% dimensions of chassis, 15" x 16"; clearance required above mounting board, 1 $\frac{1}{2}$ "; below 2"; type of mounting sponge rubber suspension; controls power; provision for arm mounting yes; over-all weight, 6 lbs. Price \$49.95. Radio Shack, 730 Commonwealth Ave., Boston 17, Mass.

## REK-O-KUT

● **Rondine 2, Model R Turntable.** The Rondine 2 is a single-play turntable driven by a hysteresis-synchronous motor at constant speed through a belt—to reduce wow and flutter.

**Specifications:** Speeds—33 $\frac{1}{3}$  rpm; belt drive; hysteresis-synchronous motor; turntable diameter, 12"; turntable weight, 4 $\frac{1}{4}$  lbs; shaft diameter,  $\frac{5}{8}$ "; turntable material, cast aluminum; mat, ridged rubber; wow, and flutter 0.15%; dimensions of chassis, 14 $\frac{7}{8}$ " x 14 $\frac{7}{8}$ "; clearance required above mounting board, 3 $\frac{1}{2}$ "; below, 4 $\frac{1}{4}$ "; type of mounting, spring-mounts; controls, pushbutton; provision for arm mounting, predrilled; over-all weight, 20 lbs. Price, \$79.95. Rek-O-Kut Co., Inc., 38-19 108th St., Corona 68, N. Y.

1. B-12H, 3-speed professional .....\$149.95
2. B-12CH, 3-speed ..... 109.95
3. N-34H, 33 1/3 and 45 rpm ..... 89.95
4. K-34H, 33 1/3 and 45-rpm kit ..... 69.95
5. K-33H, 33 1/3-rpm kit ..... 59.95



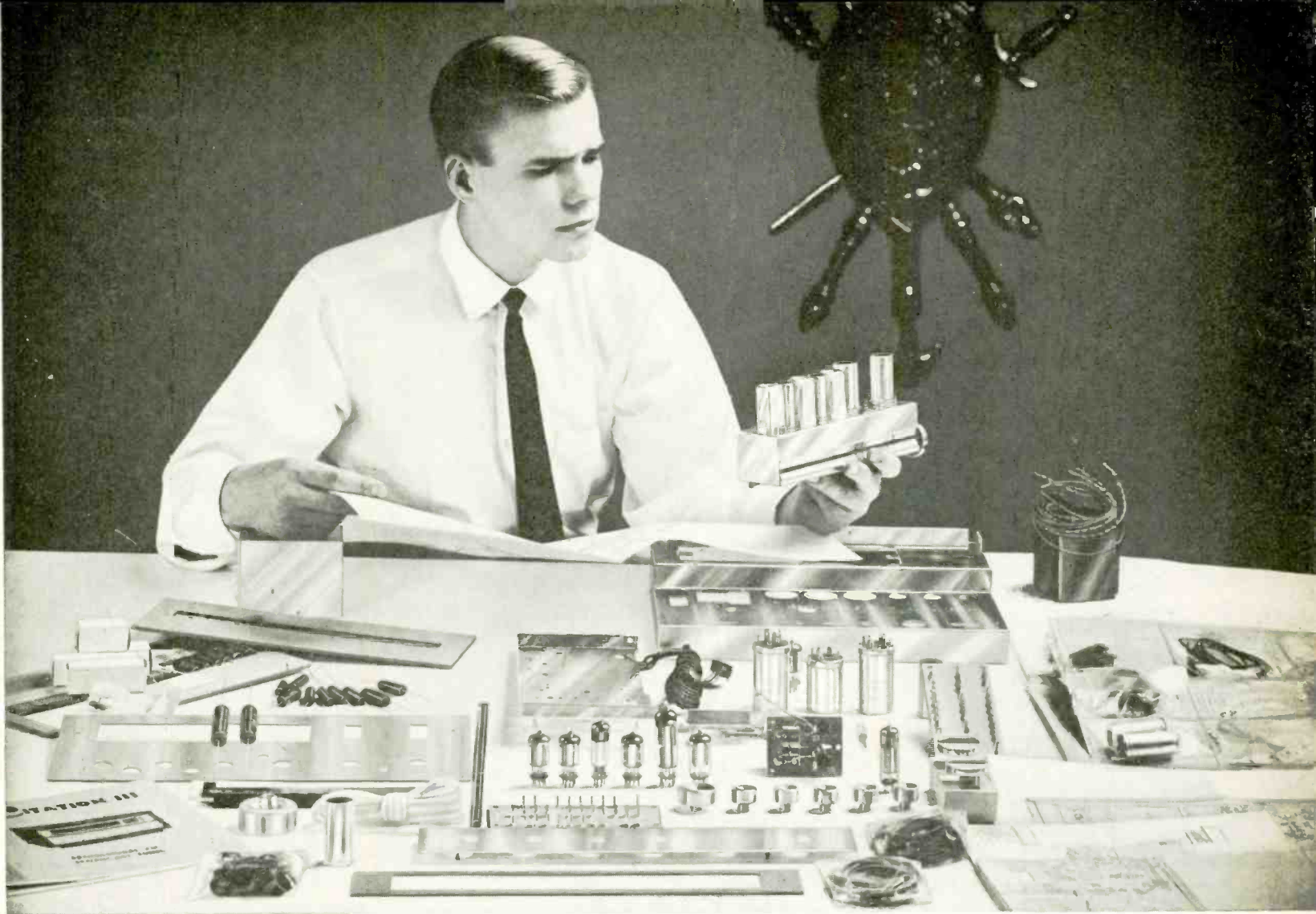

## Can You Afford 15 Hours to Build The World's Best FM/Multiplex Tuner?

Fifteen hours. That's all it takes to build the world's best FM/Multiplex tuner.

Citation has the "specs" to back the claim but numbers alone can't tell the story. On its real measure, *the way it sounds*, Citation III is unsurpassed. And with good reason.

After years of intensive listening tests, Stew Hegeman, director of engineering of the Citation Kit Division, discovered that the performance of any instrument in the audible range is strongly influenced by its response in the non-audible range. Consistent with this basic design philosophy—the Citation III has a *frequency response three octaves above and below the normal range of hearing*. The result: unmeasurable distortion and the incomparable "Citation Sound."

The qualities that make Citation III the world's best FM tuner also make it the world's best FM/Multiplex tuner. The multiplex section has been engineered to provide wideband response, exceptional sensitivity and absolute oscillator stability. It mounts right on the chassis and the front panel accommodates the adapter controls.

What makes Citation III even *more* remarkable is that it can be built in 15 hours without reliance upon external equipment.

To meet the special requirements of Citation III, a new FM cartridge was developed which embodies every critical tuner element in one compact unit. It is completely assembled at the factory, totally shielded and perfectly aligned. With the cartridge as a standard and the two D'Arsonval tuning meters, the

problem of IF alignment and oscillator adjustment are eliminated.

Citation III is the *only* kit to employ military-type construction. Rigid terminal boards are provided for mounting components. Once mounted, components are suspended tightly between turret lugs. Lead length is sharply defined. Overall stability of the instrument is thus assured. Other special aids include packaging of small hardware in separate plastic envelopes and mounting of resistors and condensers on special component cards.

For complete information on all Citation kits, including reprints of independent laboratory test reports, write Dept. A-8, Citation Kit Division, Harman-Kardon, Inc., Plainview, N. Y.

*The Citation III FM tuner—kit, \$149.95; wired, \$229.95. The Citation III MA multiplex adapter—factory wired only, \$79.95. The Citation III X integrated multiplex tuner—kit, \$219.95, factory wired, \$299.95. All prices slightly higher in the West.*



The  
Citation  
III

Build the Very Best **CITATION KITS** by **harman kardon**

## THORENS

• **Transcription Turntable.** Engineered for the finest music systems, the Thorens Model TD-124 is a four-speed machine featuring a full 12-inch, 1 1/2-lb. table for lowest wow and flutter. The main table is made of cast iron to provide shielding against hum pickup. A cover table made of aluminum, plus an attractive rubber mat, mitigates the attraction of magnetic pickups. Precision-machined, the Thorens Roto-Drive is adjustable  $\pm 3.0$  per cent for exact musical pitch. A built-in illuminated strobe allows setting to exact speed while record is playing. Easy levelling is accomplished by means of a built-in level-bubble and easily accessible levelling screws. The precision 4-pole motor is equipped with a compliant belt-plus-idler arrangement which provides excellent motor-vibration isolation.

**Specifications:** Speeds—16, 33, 45, 78 rpm; belt and idler wheel drive; induction 4-pole motor; turntable diameter, 12"; turntable weight, 1 1/2 lbs; shaft diameter, 9/16" turntable material, cast iron, aluminum cover; mat, rubber; wow and flutter below NAB specs; dimensions of chassis, 15 x 12 1/2" clearance required above mounting board, 2 1/2"; below, 3"; type of mounting, rubber grommets; controls, 3; provision for arm mounting, replaceable board; over-all weight, 22 lbs. Price, \$110.00. Accessories. Wood bases \$10.00 to \$40.00. Elpa Marketing Industries, Thorens Bldg., New Hyde Park, N. Y.

- |                       |         |
|-----------------------|---------|
| 1. TD-121 .....       | \$85.00 |
| 2. TD-111 .....       | 60.00   |
| 3. TDK-101, kit ..... | 47.50   |

## WEATHERS

• **Synchromatic "66" Turntable.** A high-performance turntable of unusual design, for rumble-free constant-speed reproduction of stereo and mono LP records. Synchronous drive motors, direct drive, and smooth, low-friction platter bearings hold wow, flutter, and rumble well below audibility. Entire light-weight system is shock-mounted on 3-cycle suspension system to prevent acoustic feedback or groove skipping due to floorborne vibrations. Seismic platform accommodates any lightweight tone arm of average length.

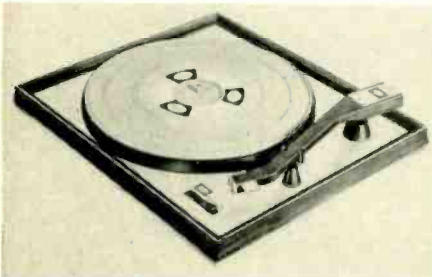

**Specifications:** Speeds—33 1/3 rpm; direct rim drive; (2) hysteresis- asynchronous motors; turntable diameter, 12"; turntable material, mat, rubber; wow, 0.02%; flutter 0.04%; dimensions of chassis, 16" w x 14" d x 2" h; type of mounting, 5 neoprene mounts; controls, on-off. Price, \$66.00 with base as shown. Weathers Div. of TelePrompser Corp., 50 W. 44th St., New York 36, N. Y.

- |   |         |
|---|---------|
| 1. ML-1-LB, 33 1/3 rpm turntable .....          | \$49.95 |
| 2. ML-234-LB, 33 1/3 and 45 rpm turntable ..... | 64.50   |

## PHONO CARTRIDGES

### ADC

• **ADC-1.** Designed for use with tone arms and turntables of the highest quality, the ADC-1 is individually calibrated and comes with complete performance report card. The

stylus can be replaced in less than 10 seconds and comes out with a flick of your finger—no tools or special skill are required.

**Specifications:** Type moving magnet; freq. resp. 10 to 20,000 cps  $\pm 2$  db; output, 1.25 mv/cm rec. velocity; channel separation, 33 db at 1 kc, 29 db at 10 kc; recommended load, 47k ohms; recommended tracking force—professional arms, .75–1.5 gms, effective stylus mass, 0.5 mg; compliance—lateral,  $20 \times 10^{-6}$  cm/dyne, vertical,  $20 \times 10^{-6}$  cm/dyne; no. of terminals, 4; mounting dimensions, std; weight, 6.8 gms, stylus radius, 0.6 mil. Price, \$49.50. Audio Dynamics, Inc., Pickett District Road, New Milford, Conn.

- |                              |         |
|------------------------------|---------|
| 1. ADC-2, for changers ..... | \$37.50 |
|------------------------------|---------|

## DUAL

• **DMS-900 Magnetic Stereo Cartridge.** Featuring excellent performance with tracking force of less than 2 grams, the Dual DMS-900 is constructed so that stylus can be easily replaced—just lift out the easily grasped assembly.

**Specifications:** Type variable reluctance; freq. resp. 20 to 20,000 cps  $\pm 3$  db; output, 1 mv/cm rec. velocity; channel separation, 28 db at 1 kc; recommended load, 12–47 k ohms; recommended tracking force—professional arms, 1.5–5 gms, changers 2–5 gms; compliance—lateral  $4 \times 10^{-6}$  cm/dyne, vertical,  $3 \times 10^{-6}$  cm/dyne; inductance, 250 mh, d.c. resistance 800 ohms/channel; no. of terminals, 4; mounting dimensions, std; weight 14 gms; Price, diamond \$34.50; replacement stylus \$17.25. United Audio Products, 12 W. 18th Street, New York 11, N. Y.

## DYNACO

• **Stereodyne II.** Features a symmetrical moving-iron (variable reluctance) design utilizing a quadri-coil push-pull system for exceptional distortion cancellation. Hum pickup is almost non-existent with complete mu-metal shielding, plus the hum-bucking push-pull design.

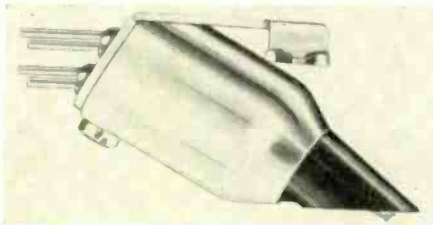

**Specifications:** Type, moving iron; freq. resp. 30 to 15,000 cps  $\pm 2$  db; output, 1.4 mv/cm rec. velocity; channel separation, 26 db at 1 kc, 15 db at 10 kc; recommended load 47 k ohms; recommended tracking force—professional arms, 1–2 1/2 gms, changers 2–3 gms; effective stylus mass, 0.8 mg; compliance—lateral  $5 \times 10^{-6}$  cm/dyne, vertical  $5 \times 10^{-6}$  cm/dyne; inductance, 200 mh; d.c. resistance 1250 ohms; no. of terminals 4; mounting dimensions std. weight 10 gms. Additional features: 0.5-mil and 3.0-mil stylus available. Price diamond \$29.95, replacement stylus \$14.95. Dynaco, Inc., 3912 Powelton Ave., Philadelphia, Pa.

## ELAC

• **Stereotwin STS-220.** The Model STS-220 is a moving-magnet cartridge with 0.7-mil diamond stylus designed for mono as well as stereo records. Frequency range is from 20 to 20,000 cycles with effective inter-channel separation over the entire band. Supplied with extra, replacement diamond stylus.

**Specifications:** Type moving magnet; freq. resp. 20 to 20,000 cps  $\pm 2$  db; output, 2.0 mv/cm rec. velocity; channel separation, 24 db at 1 kc, 24 db at 10 kc; recommended load, 33k–51k ohms; recommended tracking force—professional arms, 3 gms, changers, 3–5 gms, effective stylus mass, 2.2 mg; compliance—lateral,  $5.1 \times 10^{-6}$  cm/dyne, vertical  $5.1 \times 10^{-6}$  cm/dyne; d.c. resistance, 1000 ohms; no. of terminals, 4; mounting dimensions, standard; Price, diamond \$34.50; replacement diamond stylus \$12.50. Benjamin Electronic Sound Corp., 97-03 43 Ave., Corona 68, N. Y.

- |  |         |
|--|---------|
| 1. Stereotwin STS-310, with 0.5 mil stylus ..... | \$45.00 |
|--|---------|

## ELECTRO-VOICE

• **31D Ceramic Stereo Cartridge.** Employing ceramic elements in connection with a special printed circuit which is an integral part of the cartridge, the 31D is designed to be fed into the usual magnetic pickup inputs of stereo preamps. The cartridge is also available for ceramic inputs.

**Specifications:** Type ceramic; freq. resp. 20 to 20,000 cps  $\pm 2$  db; output, 1.2 mv/cm rec. velocity; channel separation, 28 db at 1 kc; recommended load, 22–47 k ohms; recommended tracking force—professional arms, 2–4 gms, changers, 6 gms; compliance—lateral,  $3/5 \times 10^{-6}$  cm/dyne, vertical,  $3/5 \times 10^{-6}$  cm/dyne; mounting std; no. of terminals, 4; mounting weight 9 gms. Price, diamond \$37.50 with 0.7 mil stylus. Electro-Voice, Inc., Buchanan, Michigan.

- |   |         |
|---|---------|
| 1. 32D, ceramic, 0.7 mil diamond stylus | \$40.00 |
| 2. 34D, ceramic, 0.5 mil diamond stylus | 40.00   |

## EMPIRE

• **880P Mono-Stereo Cartridge.** Intended for use in the highest quality tone arms, the 880P features an extended frequency range and unusual smoothness of response.

**Specifications:** Type moving magnet; freq. resp. 6 to 30,000 cps  $\pm 1 1/2$  db; output, 8.0 mv; channel separation, 35 db at 1 kc, 30 db at 10 kc; recommended load, 47k ohms; recommended tracking force—professional arms 0.5 gms, changers 3 gms, effective stylus mass 0.3 mg; compliance—lateral  $30 \times 10^{-6}$  cm/dyne, vertical  $30 \times 10^{-6}$  cm/dyne inductance 500 mh; d.c. resistance 850 ohms; no. of terminals, 4; mounting dimensions, 7/16 or 1/2"; weight 12 gms. Additional features: 0.6-mil hand polished diamond stylus. Price, diamond \$47.50, replacement stylus \$22.50. Empire Scientific 1025 Stewart Ave., Garden City, N. Y.

- |   |          |
|---|----------|
| 1. Empire 108, mono stereo cartridge    |          |
| 7-mil diamond .....                     | \$ 35.00 |
| 2. Replacement stylus for Empire 108 .. | 17.50    |

## ESL

• **"Redhead" Stereo Ceramic Cartridge.** The newest of the well-known ESL phonograph cartridges, the Redhead was developed to bring the trouble-free reproduction of an ESL cartridge within the reach of every critical listener. It features low distortion, wide frequency range, and excellent transient response.

**Specifications:** Type, ceramic; freq. resp. 20 to 20,000 cps  $\pm 2$  db; output, 50 mv/cm rec. velocity; channel separation, 20 db at 1 kc; recommended load, 2.2 megohms or more; recommended tracking force—3 gms min.; effective stylus mass, 2.5 mg; compliance—lateral,  $3 \times 10^{-6}$  cm/dyne, vertical,  $3 \times 10^{-6}$  cm/dyne; capacitance, 450 pf; no. of terminals, 4; mounting dimensions, 1/2"; weight, 5 gms.

Additional features: two plug-in networks provided which convert to electrical equivalent of magnetic cartridge. Price, diamond, \$14.95; replacement stylus, \$10.00. Electro-Sonic Laboratories, Inc., 627 Broadway, New York 12, N. Y.

## FAIRCHILD

• **SM-2 Stereo Cartridge.** Designed for professional applications, the SM-2 can be used in home high fidelity arms. The stylus utilizes a 0.7-mil polished diamond.

**Specifications:** Type moving magnet; freq. resp. 20 to 15 k cps  $\pm 2$  db; output 5 mv; channel separation 20 db at 1 kc, 20 db at 10 kc; recommended load, 47,000 ohms; recommended tracking force—professional arms 2.5 gms, changers 3–4 gms, effective stylus mass 1 mg; compliance—lateral  $5 \times 10^{-6}$  cm/dyne, vertical  $4.5 \times 10^{-6}$  cm/dyne; inductance, 500 mh, d.c. resistance 2000 ohms; capacitance 120 pf; no. of terminals 4; mounting dimensions 1/2"; weight 11 gms. Additional features: linear separation, low hum, low distortion (Barkhausen effect eliminated), replaceable stylus assembly. Price, diamond, \$37.50; replacement stylus \$15.00. Fairchild Recording Equipment Corp. 10–40 45th Ave., L. I. C., N. Y.

- |  |          |
|--|----------|
| 1. SM-1, stereo cartridge .....                | \$ 34.95 |
| 2. 225A, 225B (1.0G/2.5) mono cartridges ..... | 37.50    |

# all-transistorized New Sony Sterecorder 777

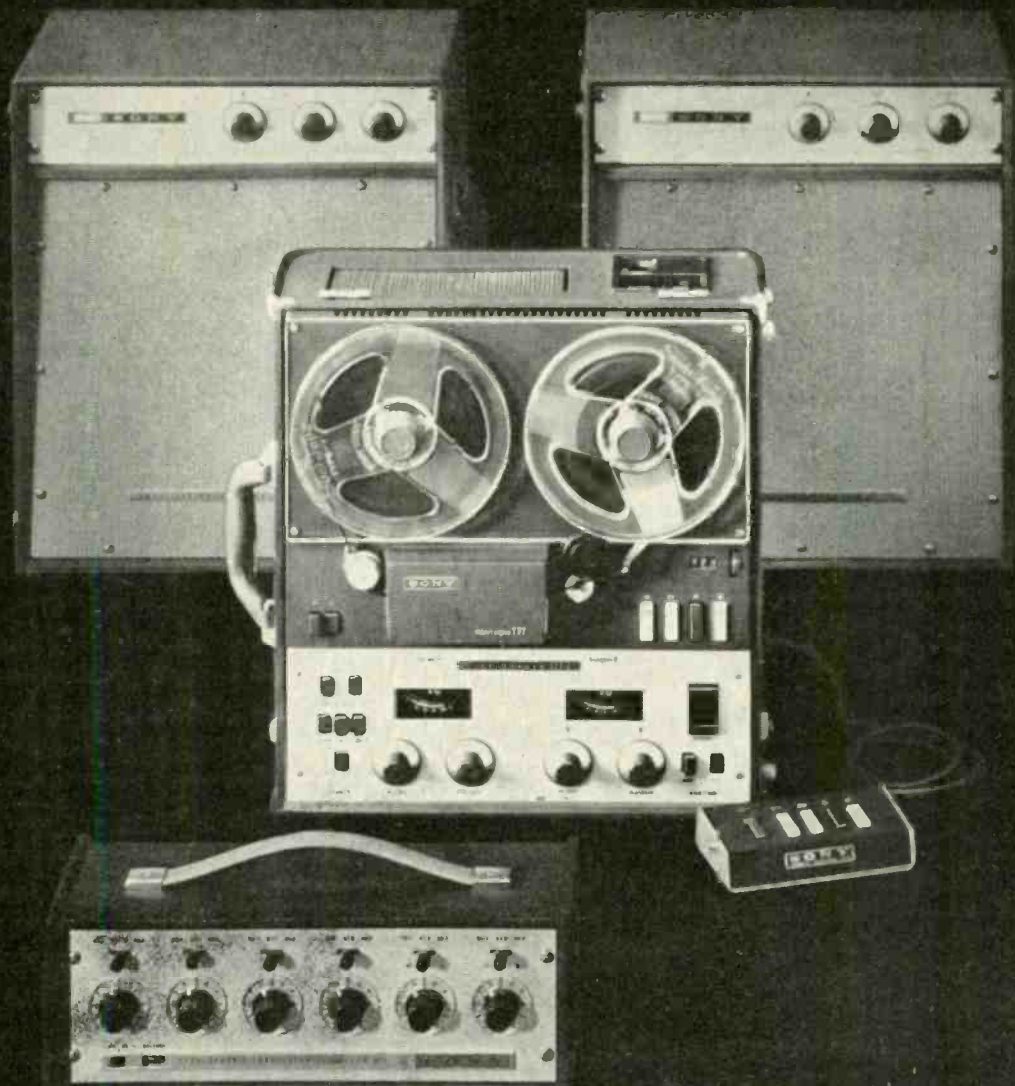

**the first/complete/portable/all-transistorized/high fidelity PROFESSIONAL RECORDING & PLAYBACK SYSTEM**

The most advanced achievement in recorder engineering to date, the superb new remote-controlled professional Sterecorder 777 series features the exclusive and patented Sony Electro Bi-Lateral 2 & 4 track playback Head a revolutionary innovation that permits the playback of 2 track and 4 track stereophonic or monophonic tape without track width compromise—through the same head!

Included in an array of outstanding features are individual erase/record/playback heads, professional 3" VU meters, automatic shut-off, automatic tape lifters, an all-solenoid, feather-touch operated mechanism, electrical speed change, monitoring of either source or tape, sound on sound facilities, and an all-transistorized military plug-in type circuitry for simple maintenance. The three motors consist of one hysteresis synchronous drive motor and two hi-torque spooling motors.

Unquestionably the finest professional value on the market today, the 777 is available in two models, the S-2 (records 2 track stereo) and the S-4 (records 4 track stereo). Both models can reproduce 2 and 4 track tapes \* And the Sterecorder 777 models will integrate into any existing component system. \$595 complete with portable case and remote control unit.

*\*Through the exclusive Sony Electro Bi-Lateral 2 and 4 track playback head.*

*Sony has also developed a complete portable all-transistorized 20 watt speaker/amplifier combination, featuring separate volume, treble and bass controls, mounted in a carrying case that matches the Sterecorder 777. \$175 each.*

*Also available is the MX-777, a six channel all-transistorized stereo/monophonic mixer that contains six matching transformers for balanced microphone inputs and recorder outputs, individual level controls and channel selector switches, Cannon XL type receptacles, a switch to permit bridging of center staging solo mike. \$175 complete with matching carrying case.*

*The first/complete/portable/all-transistorized/high fidelity/professional recording & playback system: \$1120 complete.*

*Sold only at Superscope franchised dealers. The better stores everywhere.*

*For additional literature and name of nearest franchised dealer write Superscope, Inc., Dept 7 Sun Valley, California.*

**All Sony Sterecorders  
are Multiplex ready!**

**SUPERSCOPE**

**The Tapeway to Stereo**

3. 230, Micro-7, 0.7-mil mono cartridge 42.50  
 4. 216A, vertical cartridge ..... 85.00

## GENERAL ELECTRIC

● **VR-1000-5 Stereo Cartridge.** This latest entry by GE into the magnetic cartridge field reflects their many years of experience in making cartridges for high fidelity applications. A feature, besides its performance, is the easy replacement of the stylus.

**Specifications:** Type magnetic; freq. resp. 20 to 20,000 cps  $\pm 3$  db; output, 1 mv/cm rec. velocity; channel separation, 25 db at 1 kc, 15 db at 10 kc; recommended load, 47k ohms; recommended tracking force—professional arms, 1-3 gms, changers, 3 gms; effective stylus mass 1.2 mg; compliance—lateral,  $6 \times 10^{-6}$  cm/dyne, vertical,  $9 \times 10^{-6}$  cm/dyne; inductance 400 mh; d.c. resistance 1100 ohms; no. of terminals 4; mounting dimensions,  $\frac{1}{2}$  inch; weight 11 gms. Price diamond, \$29.95; replacement stylus \$14.95. General Electric Co., Audio Products Dept., 2200 N. 22nd St., Decatur, Ill.

1. VR 22-5, ster cartridge ..... \$ 18.95  
 2. VR 22-7, ster cartridge ..... 16.95  
 3. VR 1000-7, ster cartridge ..... 24.95  
 4. VR 2, mono cartridge .....

## GRADO

● **"Classic" Stereo Cartridge.** The Classic cartridge uses the same basic design as the superior Laboratory Series cartridge, and is manufactured on a small assembly line basis with extremely close tolerances. The bass response in the Laboratory and Classic Series is identical, imparting a sweeping effortless quality to the over-all sound. The midrange is very close, and the high frequency response differs but slightly.

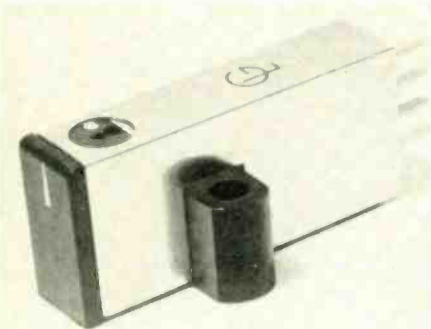

**Specification:** Type, moving coil; freq. resp. 15 to 28,000 cps  $\pm 1$  db; output, 0.9 mv/cm rec. velocity; channel separation, 25 db at 1 kc; recommended load, above 5,000 ohms; recommended tracking force—professional arms, 3 gms; effective stylus mass, 0.5 mg; compliance,  $12 \times 10^{-6}$  cm/dyne; d.c. resistance, 1100 ohms; no. of terminals, 4.

Additional features: no magnetic attraction to steel turntables; one year unconditional guarantee, plus four additional years for stylus against normal wear. Price, diamond, \$37.50. Grado Laboratories, Inc., 4614 Seventh Ave., Brooklyn 20, N. Y.

1. "Senator" cartridge ..... \$24.95  
 2. "Laboratory" cartridge ..... 49.50

## KNIGHT

● **KN-505X Stereo Cartridge.** A high-quality stereo cartridge for the most critical audio requirements. Highly compliant and with relatively high output, the 505X is suited for the rigors of stereo.

**Specifications:** Type, magnetic; freq. resp. 15 to 30,000 cps  $\pm 3$  db; output, 7.5 mv; channel separation, 28 db at 1 kc, 25 db at 10 kc; recommended load, 47,000 ohms; recommended tracking force—professional arms, 1 gm, changers, 4 gms; effective stylus mass, 0.6 mg; compliance—lateral,  $15 \times 10^{-6}$  cm/dyne, vertical,  $15 \times 10^{-6}$  cm/dyne; no. of terminals, 4; mounting dimensions, 7/16" or  $\frac{1}{2}$ " ; weight, 12 gms. Price, diamond, \$17.95; replacement stylus, \$9.95. Allied Radio Corporation, 100 N. Western Ave., Chicago 80, Ill.

## NEAT

● **VS-1000D, Moving-Coil Cartridge.** A high quality moving-coil cartridge featuring easily replaceable stylus assembly for this kind of cartridge. The output is relatively high for a moving coil and, as expected, the frequency range is relatively wide. And smooth too. Available from various sources in the United States—write the manufacturer.

**Specifications:** Type moving coil; freq. resp. 10 to 20,000 cps  $\pm 3$  db; output, 5 mv; channel separation, 30 db at 1 kc, 20 db at 10 kc; recommended load, 100-100k ohms; recommended tracking force—professional arms, 2 gms; compliance—lateral,  $10 \times 10^{-6}$  cm/dyne, vertical,  $10 \times 10^{-6}$  cm/dyne; d.c. resistance, 80 ohms; no. of terminals, 4; mounting dimensions, 12.7 mm; weight, 13.5 gms. Additional features: interchangeable stylus, high output voltage. Neat Onkyo Denki Co., Ltd., No. 4, 1-chrome, Kanda Hatago-cho, Chiyoda-ku, Tokyo, Japan.

## NEUMANN

● **DST-62 Stereo Cartridge.** This is the latest model and development of the already well-known DST unit. Improvements include elimination of rubber membrane complete enclosure of cartridge bottom. Torsion bar re-enforced making mis-alignment impossible even with long time lapse.

**Specifications:** Type dynamic; freq. resp. 30 to 15 k cps  $\pm 2$  db; output, .1 mv/cm rec. velocity; channel separation, 25 db at 1 kc, 25 db at 10 kc; recommended load, 50 (min) ohms; recommended tracking force—professional arms, 6 gms, effective stylus mass, 1 mg; compliance—lateral,  $3.6 \times 10^{-6}$  cm/dyne, vertical,  $3.6 \times 10^{-6}$  cm/dyne; d.c. resistance, 18 ohms; no. of terminals, 5; mounting dimensions, special; weight, 30 gms. Price, diamond, \$79.50; replacement stylus, \$20.00. Gotham Audio Corp., 2 West 46th St., New York 36, N. Y.

## ORTOFON

● **SPU-T Cartridge.** The Ortofon stereo cartridge, Model SPU, has extremely high compliance and low inertia of the stylus armature to give undistorted reproduction of stereo recordings. The meticulous craftsmanship of this component is immediately recognizable both in sight and sound. The electromagnetic elements are wound with an extra pure copper wire into long thin coils. Thus, the inertia and directional forces are reduced to a minimum and consequently the force required for tracking at both ends of the audio spectrum is very small. The stylus arm is composed of a special thin and light alloy strip to ensure compliance in both planes. "Prime diamonds" are used for the stylus so that under normal use they will last indefinitely and most certainly minimize record wear.

**Specifications:** Type moving coil; freq. resp. 20 to 20,000 cps  $\pm 2$  db; output, 14 mv; channel separation, 25 db at 1 kc, 20 db at 10 kc; recommended load, 50 k ohms; recommended tracking force—professional arms, 1-2 gms effective stylus mass, 1 mg; compliance—lateral,  $10 \times 10^{-6}$  cm/dyne, vertical,  $10 \times 10^{-6}$  cm/dyne; d.c. resistance, 1.8 ohms; no. of terminals, 4; mounting dimensions, standard; weight, 17 gms with transformer. Additional features: minimum of 20-db channel separation is maintained throughout audible range. Price, diamond, \$49.95; replacement stylus, \$15.00. Elpa Marketing Industries, New Hyde Park, N. Y.

1. SPU/GT, Mounted in Ortofon shell ... \$49.95  
 2. SPU/ESL, mounted in Ortofon shell for ESL arms ..... 49.95

## PICKERING

● **Pickering Model U38/AT Stereo Fluxvalve.** It is designed especially for the new generation of automatic turntables. It combines hum shielding with high output for high signal-to-noise ratio. High compliance is retained for turnable performance while providing the ruggedness demanded by automatic operation. Improved frequency response and low inductance make the new Pickering U38/AT a truly universal cartridge.

**Specifications:** Type moving magnet; freq. resp. 20 to 17,000 cps; output, 2 mv/cm rec. velocity; channel separation, 35 db; tracking force—professional arms, 2-5 gms; no. of terminals, 4; mounting dimensions, std; weight, 14 gms. Price, diamond, \$46.50. Pickering and Co., Plainview, N. Y.

## SHURE

● **M33 Stereo Dynetic Phonograph Cartridge.** Shure's finest cartridge for the very finest sound systems. Available with either .0005" stylus or .0007". Compliance of .0005" stylus permits tracking at less than one gram; .0007" at from 1.5 to 3 grams. Completely new, super-rugged stylus assembly is encased in plastic "grip", making stylus changing as easy as plugging in an electric cord. Special high efficiency Mumetal shielding prevents pick-up of hum.

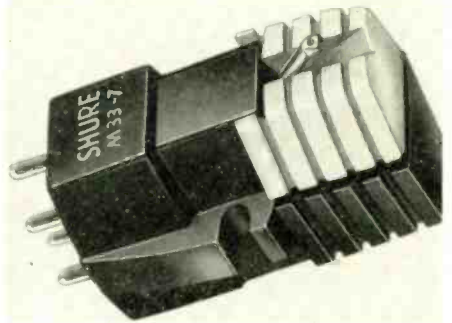

**Specifications:** Type magnetic; freq. resp. 20 to 20,000 cps  $\pm 2\frac{1}{2}$  db; output, 1 mv/cm rec. velocity; channel separation, 22.5 db at 1 kc, 10 db at 10 kc; recommended load per channel, 47,000 ohms; effective stylus mass, 1.3 mg; compliance—lateral,  $22 \times 10^{-6}$  cm/dyne (for M33-5) vertical,  $22 \times 10^{-6}$  cm/dyne (for M33-5); inductance, 600 mh; d.c. resistance, 750 ohms; capacitance, 70 pf; no. of terminals, 4; mounting dimensions, std; Price, diamond, \$36.50; replacement stylus, \$19.50. Shure Bros., 222 Hartrey Ave., Evanston, Ill.

1. M-77 (4-6 gms tracking) ..... \$27.50  
 2. M-3D (3-6 gms tracking) ..... 45.00  
 3. M-7D (4-7 gms tracking) ..... 24.00  
 4. M3N21D (2 1/2 gms maximum tracking) 47.25  
 5. M7N21D (2 1/2 gms maximum tracking) 36.75

## SONOTONE

● **9TA Series Cartridge and Velocitone "Mark II."** With Velocitone, the ceramic cartridge output can be plugged directly into the magnetic phono inputs of your amplifier. The 9TA is a high-quality stereo cartridge which utilizes a ceramic element and is thus hum free.

**Specifications:** Type ceramic; freq. resp. 20 to 17,000 cps  $\pm 2$  db; output, 11 mv (equalized); channel separation, 25 db at 1 kc; recommended load, 2 megohms; recommended tracking force—professional arms, 24 gms, changers, 3-5 gms; compliance—lateral,  $5.5 \times 10^{-6}$  cm/dyne, no. of terminals, 4; mounting dimensions,  $\frac{1}{2}$ " and  $\frac{3}{8}$ " ; weight, 3.2 gms. Price, diamond, \$13.00; sapphire, \$8.35; replacement stylus, \$2.75; \$5.75. Sonotone Corp., Elmsford, N. Y.

1. Velocitone "Mark II" with equalizers ..... \$14.75-22.75  
 2. 16TA-18TA series ..... 6.00- 9.75  
 3. 8TA series ..... 8.75-13.00  
 4. 916TA series ..... 6.00- 9.75

## SONOVOX

● **Moving Magnet Stereo Cartridge.** The Sonovox SX-1 represents a refinement in moving magnet cartridges. The magnet is spherical in shape thus achieving a uniform field. Extremely low mass and high compliance of the vibrating system produce minimum record wear.

**Specifications:** Type moving magnet; freq. resp. 20 to 20,000 cps  $\pm 1$  db; output, 4 mv; channel separation, 20 db at 1 kc, 20 db at 10 kc; recommended load, 50k ohms; recommended tracking force—professional arms, 3 gms; compliance—vertical,  $3 \times 10^{-6}$  cm/dyne;

**INTRODUCING A  
NEW SERIES OF  
COMPONENTS BY  
PILOT**

**The only thing more impressive than the sound  
is the price.**



**Model 280B FM Stereo Tuner**  
—For those who demand performance and value from a high-fidelity component. With PILOT's unique signal sampling Multiplex circuit: separation, 30 db or better. With enclosure.....**99.50**



**Model 230 Stereo Amplifier**  
—A 24-watt integrated stereophonic amplifier designed for maximum control flexibility. Frequency response ( $\pm 1$  db): 10-30,000 cps; harmonic distortion: 1%. Complete with enclosure.....**89.50**



PILOT also offers two other series of components, as well as a variety of 3-way speaker systems. See and hear them all at your PILOT dealer. For literature, write address below.



**Model 610 Stereo Receiver**—A complete stereo preamplifier, 24-watt stereo amplifier and FM Multiplex stereo tuner... all on one compact chassis. Equipped with an Automatic FM Stereo Indicator. In brush gold and black. With enclosure.....**199.50**

**PILOT RADIO CORPORATION 37-38 36TH STREET, LONG ISLAND CITY 1, N. Y.**

d.c. resistance, 150 ohms; no. of terminals, 4; weight, 12.5 gms.

Additional features: stylus, 0.7 mil diamond. Price, diamond, \$30.00. Sonovox Co., Ltd., 101 Tokiwamatsu-cho, Shibaya-ku, Tokyo, Japan.

## STANTON

• **Model 481AA Stanton Stereo Fluxvalve.** An ultra-linear professional pickup for use with ultra-lightweight tone arms capable of tracking within the range from 1/4 to 3 grams. Supplied with the D4005AA V-GUARD diamond stylus assembly.

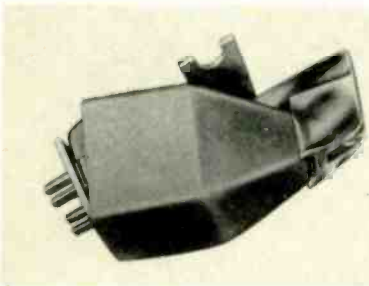

**Specifications:** Type moving magnet; freq. resp. 20 to 20k cps  $\pm 2$  db; output, 0.5 mv/cm rec. velocity; channel separation, 35 db recommended tracking force—professional arms, 1/4–3 gms; no. of terminals, 4; mounting dimensions, std; weight, 11 gms. Price, diamond, \$49.50; replacement stylus, \$19.50 Pickering and Co., Prof. Prod. Div., Plainview, N. Y.

## TONEARMS

### ADC

• **Pritchard Pickup System, ADC-85.** A dynamically balanced tone arm with the heavy adjustable counterweight occupying a minimal amount of space behind the mounting. To adjust stylus tracking force, you simply move the counterweight until the arm is in perfect balance. A fine adjustment allows the system to track at the precise force required by the cartridge design. With the ADC-1, the Pritchard system tracks at 1/4 gram.

Because of its low inertia, the system tracks each side of the groove perfectly, even if the record is warped. To stabilize the force created between the disc and the arm, a side thrust compensator permits the stylus to maintain even force on both sides of the groove wall. A signal ball-bearing mount minimizes friction.

**Specifications:** Over-all length of arm, 10 1/2"; distance from arm axis to turntable spindle, 9"; type of suspension, gimbal; stylus force, 3/4 up gms; type of pickup head, plug-in; material, plastic; arm material, walnut; pickup mounting, screw; screws, various; spacing, std; overhang, 0.7"; additional features, skating-force compensation; arm resonance—6 cps, lateral; 6 cps, vertical; Price, \$85.00. Accessories: extra pickup heads, \$6.95. Audio Dynamics Corp., Pickett District Road, New Milford, Conn.

### DYNACO

• **TA-12 12" Integrated Arm and Cartridge.** Integrated arm and cartridge with the same cartridge as the Stereodyne II in a plug-in arrangement. Single-hole mounting, dynamically balanced system utilizing "Isodyne" principle of dynamic equilibrium which maintains equal pressure on each groove wall at any stylus force.

**Specifications:** Over-all length of arm, 12" distance from arm axis to turntable spindle, 8 1/2" height range of turntable, 1/4" to 2" type of suspension, gimbal; stylus force range, 1 to 4 gms; type of pickup head, integrated with SDII cartridge; arm material, aluminum; pickup mounting plug-in; offset angle 21 deg.

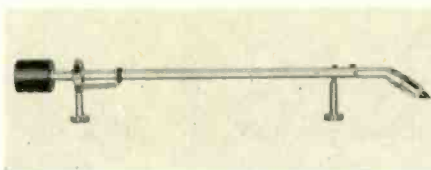

overhang 1/2"; maximum tracking error, 8 deg; additional features, dynamic balance, plug-in cartridge, adjustable arm rest; arm resonance—15 cps lateral 15 cps vertical; over-all weight 1 lb mounting dimensions, 8 1/2" radius from spindle. Price \$49.95. Dynaco Inc., 3912 Powelton Ave., Philadelphia, Pa.

1. TA-16, 16" version of above ..... \$ 59.95

### EMI

• **Model EPU 100, Integrated Tone Arm and Stereo Cartridge.** This new pickup was introduced to meet the demands of audio engineers and hi-fi enthusiasts for a precision instrument designed as a single unit. With the cartridge and arm designed in the same laboratories and made in the same factory, all the requirements for perfect reproduction can be met.

**Specifications:** Over-all length of arm, 10 1/2"; type of suspension, pivot; stylus force 2.5 gms; type of pickup head, integral; material aluminum; arm material aluminum and steel; spacing, std; additional features, designed to give minimum distortion toward center of record; Price, \$99.75. Scope Electronics Corp., 10 Columbus Circle, New York, N. Y.

### EMPIRE

• **Model 980 Playback Arm.** Available in Satin chrome (980) or Satin gold (980G) finish, the new Empire 980 arm combines free suspension and dynamic balance, the latter being achieved by locating the pivot points at the center of the arm's mass. The exclusive new "Dyna-Lift" lifts the arm away from the record automatically at the end of play.

**Specifications:** Over-all length of arm 12 3/4"; distance from arm axis to turntable spindle 9"; height range of turntable, 1 3/8"; type of suspension, ball bearing; stylus force range, 0 to 8 gms; arm material aluminum; pickup mounting interchangeable cartridge mount; screw spacing 7/16 or 1/2"; offset angle, 23.8 deg; overhang 3/4" range of cartridge weights for zero adjustment, 2 to 25 gms; maximum tracking error,  $\pm 0.65$  deg; additional features, plug-in cable assembly, calibrated force adjustment; arm resonance 6 cps lateral, 6 cps vertical. Price \$50.00. Accessories: cartridge mounting brackets, \$1.95. Empire Scientific, 1075 Stewart Ave., Garden City, N. Y.

1. Empire 980L, Dyna-Lift for 98 arm .. \$ 10.00

### ESL

• **S2000 Gyro/Balance Arm.** Every practical adjustment in the state of the phonograph art has been efficiently incorporated in the S2000 Gyro/Balance arm. The arm has a clearly calibrated vertical stylus-force adjustment using dual balanced hair springs, lineal and temperature compensated, a continuously variable indexed base overhang adjustment for all cartridges, and internal stability adjustments in all three planes. Eliminates the need for turntable leveling.

**Specifications:** Over-all length of arm, 13"; distance from arm axis to turntable spindle, 8"; height range of turntable, 1/2" to 2 1/2"; type of suspension, spring balance; stylus force range, 0.5 to 7 gms; type of pickup head, plug-in; material, aluminum; pickup mounting, 4 screws; spacing, 1/2"; overhang, 39/64"; eccentric mounting permits compensation for different pickups. Price, \$34.95. Electro-Sonic Laboratories, Inc., 627 Broadway, New York 12, N. Y.

### FAIRCHILD

• **Model 500 Anti-Skating Arm Transport.** The Model 500 Arm-Transport includes the Fairchild SM-2 stereo cartridge in combination with an arm. The Fairchild 500 is designed specifically to overcome the special

problems encountered in reproducing the stereo groove with its two different walls of information. It overcomes this problem by means of the anti-skating device incorporated in the arm.

**Specifications:** Over-all length of arm, 11 1/2"; distance from arm axis to turntable spindle, 8 1/2" height range of turntable, 3/8" to 2.0"; type of suspension, sharp pivots; stylus force range, 0 to 10 gms; arm material, aluminum; pickup mounting screw-in, leads supplied; screws 3/48, spacing 1/2"; offset angle 21.5 deg; overhang 3/8"; range of cartridge weights for zero adjustment, 5 to 12 gms; maximum tracking error, -1 1/2 deg; additional features, anti-skating device, isolated counterweight, dynamically balanced for 3 gram force, plug-in cables included; arm resonance 15 cps lateral, 1 1/2 cps vertical; over-all weight, 0.5 lbs; mounting, 1/8" dia hole and 3 wood screws. Price, \$58.00. Fairchild Recording Equipment Corp., 10-40 45th Ave., L. I. C., N. Y.

- 500A anti-skating arm with removable head ..... \$ 29.95
- 501, 16" anti-skating arm with removable head ..... 37.50
- SA-12, 12" stereo arm with cartridge slide ..... 39.95
- SA-16, 16" stereo arm with two cartridge slides ..... 60.00

### GRADO

• **Laboratory Tone Arm.** The Grado tone arm incorporates features never before found outside of the laboratory. It has separate balance adjustments for the vertical and lateral planes of arm movement, so the user can adjust the arm for perfect vertical balance and then adjust the arm for perfect lateral balance, regardless of weight and mass variations. The result of balance is a sharply reduced susceptibility to mechanical shock and acoustic feedback.

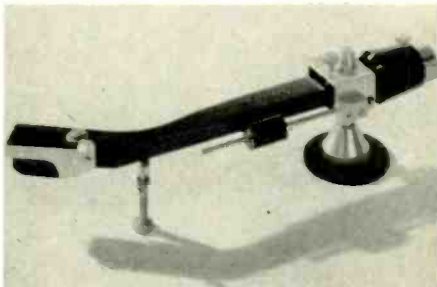

**Specifications:** Over-all length of arm, 1 1/4"; distance from arm axis to turntable spindle, 8 3/16"; type of suspension, balance, with spring; stylus force, 1/2 gm min.; type of pickup head, slide mounts; arm material, walnut; pickup mounting, standard on slide; overhang, 3/4"; maximum tracking error,  $\pm 0.5$  deg; additional features, stylus overhang adjustable, interchangeable cartridge slides; arm resonance—11 cps. Price, \$39.50. Accessories: extra cartridge slides, \$2.95. Grado Laboratories, Inc., 4614 Seventh Ave., Brooklyn 20, N. Y.

- Same, w Laboratory cartridge ..... \$55.00
- Same, w Classic cartridge ..... 75.00
- Same, w Senator cartridge ..... 63.00

### GRAY

• **SAK-12G Tone Arm Kit.** The SAK-12G is a 12" tone arm with the well-known Gray viscous damping principle and offered as a kit. Another feature of the arm is the interchangeable cartridge slide assembly.

**Specifications:** Over-all length of arm, 13"; distance from arm axis to turntable spindle, 8 5/16"; height range of turntable, 1 1/4" to 3"; type of suspension, sealed viscous damped; stylus force range, 0 to 10 grams; type of pick up head, modular—plug in frame; arm material, aluminum; pickup mounting screws; screws, 3-48; spacing, 1/2"; overhang 0.682"; range of cartridge weights for zero adjustment, 0 to 12 grams; maximum tracking error 2 degrees; additional features, dynamically balanced; arm resonance, 10 cps lateral, 20 cps vertical; over-all weight

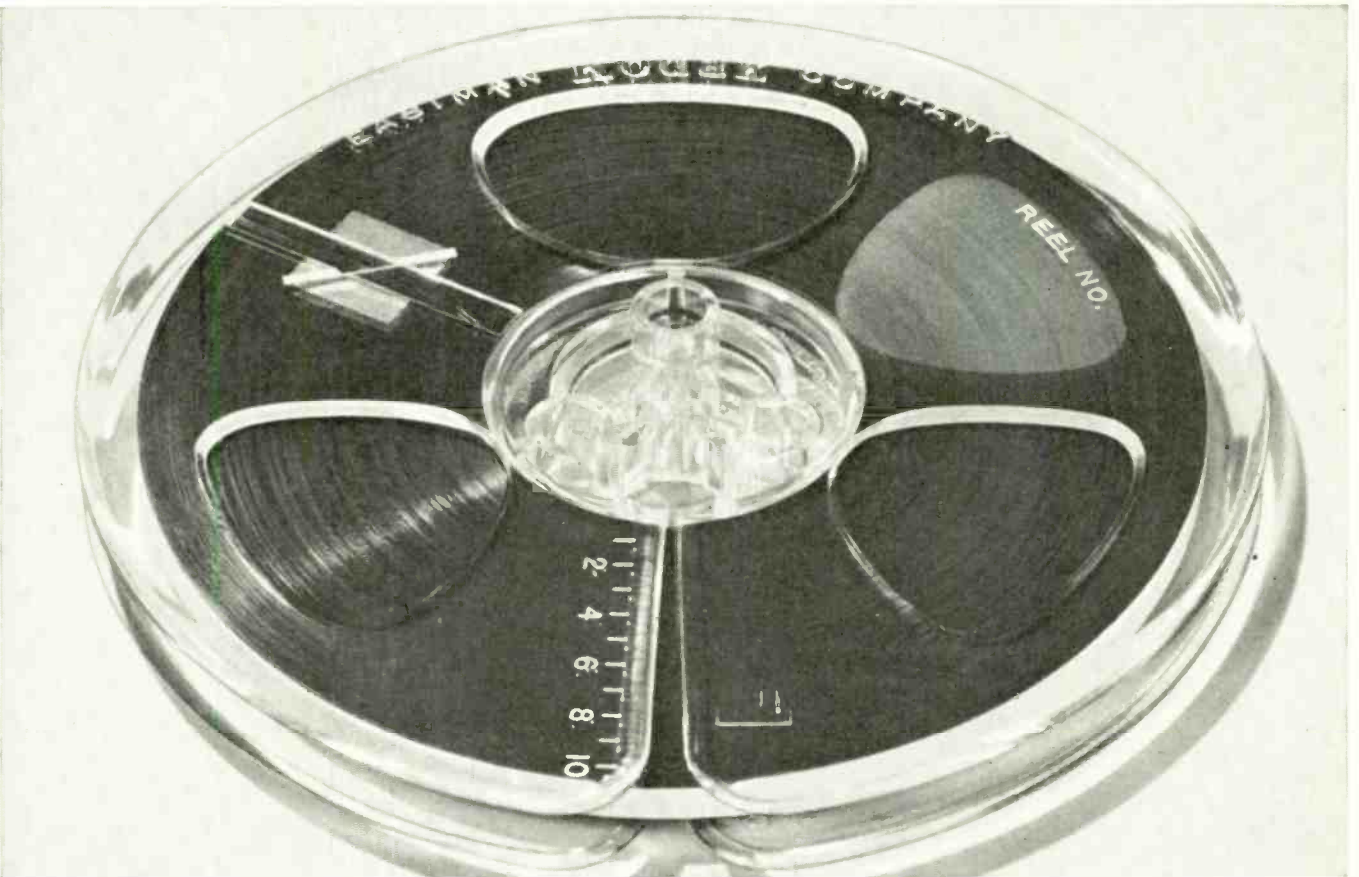
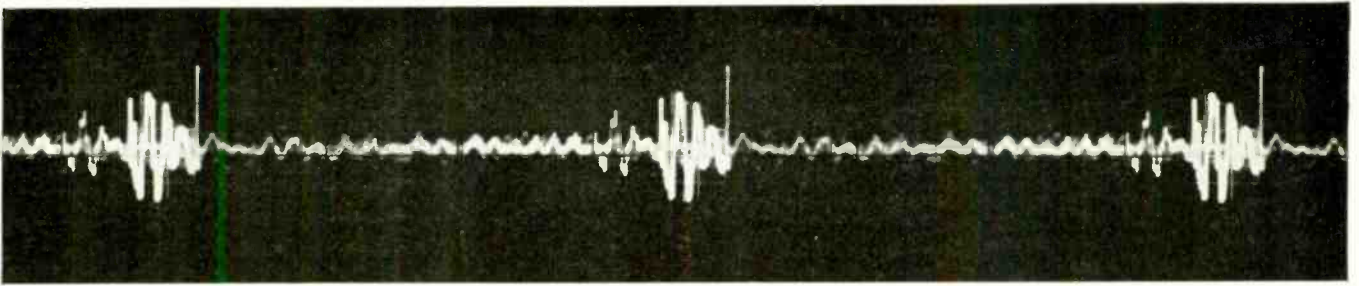

## HEAR TODAY! NEW KODAK TAPE!

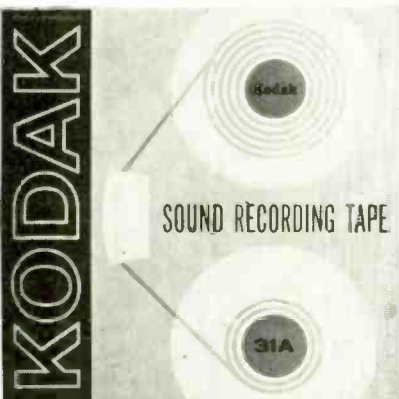

What's new about new KODAK Sound Recording Tape? Plenty. The oxide coating on this new tape is more uniform. Plus or minus 14 millionths of an inch. Magnetic domains are tighter, finer. This means an almost complete freedom from dropout. It also means superior frequency response in the high range.

But most important, new KODAK Sound Recording Tape will provide a uniformity both in response *and* sensitivity that makes it the most dependable recording material yet developed. Other benefits? Superb signal-to-noise ratio. Head-clinging suppleness. Lubrication that prevents both head and tape wear. And convenience, too. It comes on a KODAK Thread-Easy seven-inch reel with unique built-in splicer. Uniformity, frequency response, low distortion and high sensitivity. Doesn't it make sense to switch to new KODAK Sound Recording Tape today?

EASTMAN KODAK COMPANY, ROCHESTER 4, N. Y.

1½ lbs; mounting dimensions to clear arm, 13½" by 3". Price, \$24.95 kit, \$32.50 assembled; accessories, extra pickup heads \$4.60. Gray Research and Development Co., Box 12, Elwood, Conn.

1. SAK-12N, (kit) same as above except finished in aluminum .....\$ 28.60
2. 212-TN same as SAK-12N assembled. 35.50
3. 208-S, 16" prof stereo tone arm .... 49.50

## NEAT

● **GA-15P 16" Professional Arm Balanced Type.** Designed to perform professional functions, the GA-15P is a sturdy and well constructed tone arm incorporating the most recent advances. The plug-in head utilizes 5-terminal wiring with an independent chassis ground. Mounting dimensions for cartridges are standard EIA so that it will accept all standard cartridges. Arm resonance is unusually low, and is achieved by attention to detail in manufacturing and careful design.

**Specifications:** Over-all length of arm, 14½"; distance from arm axis to turntable spindle, 10¾"; height range of turntable, 1¼" to 1¾"; type of suspension, miniature ball bearing; stylus force range, 0 to 10 gms; type of pickup head, plug-in; material, plastic; arm material, aluminum; pickup mounting, screws; screws, 2; spacing, std; offset angle, 22 deg; overhang, ¾"; range of cartridge weights for zero adjustment, 5 to 20 gms; maximum tracking error, 1 deg; additional features, stylus-force adjustment 0-10 gm with scales for direct reading; arm resonance 3 cps, lateral; 5 cps, vertical; over-all weight, 1.5 lbs; mounting dimensions, 23 mm. Neat Onkyo Denki Co., Ltd., No. 4, 1-chome, Kanda Hatago-cho, Chiyoda-ku, Tokyo, Japan.

## ORTOFON

● **RMG-212 Tone Arm.** Precision ball bearings are used for both horizontal and vertical planes assuring perfect tracking at even minimum stylus force. Lateral balance by the special shape of the Duralumin tube arm enables perfect record tracking even up to 30° out of level. Resonance of the arm is minimized to a sub-audible 8 cps and the counterweight is calibrated in grams from 0 to 10. The plug-in shell accepts any cartridge and is adjustable for cartridge overhang.



**Specifications:** Over-all length of arm, 12"; distance from arm axis to turntable spindle, 9¾"; height range of turntable, 2¾" to 3¾"; type of suspension, gimbal; stylus force range, 0 to 7 gms; type of pickup head, plug-in; material, plastic; arm material, Duralumin; pickup mounting, adjustable; screws, assorted; spacing, assorted; offset angle, 22.7 deg; overhang, ¾"; range of cartridge weights for zero adjustment, preset to 51 gms; maximum tracking error, 1.19 deg; additional features, audio cables plug into socket in arm; arm resonance—8 cps, lateral; 8 cps, vertical; over-all weight, 1 lb. Price, \$54.95; accessories: extra pickup heads, \$5.00. Elpa Marketing Industries, New Hyde Park, N. Y.

1. RMG-309, 16" arm .....\$59.95
2. SMC-212, 12" arm ..... 29.95
3. SKC-212, 12" arm ..... 19.95

## REK-O-KUT

● **Automatic Tonearm, Model AP-320.** "Auto-Poise" can meet the critical requirements of the new, very high compliance cartridges. It does this with a mechanism which completely eliminates the need for manual handling of the tonearm. "Auto-Poise" features its own synchronous motor which provides fully auto-

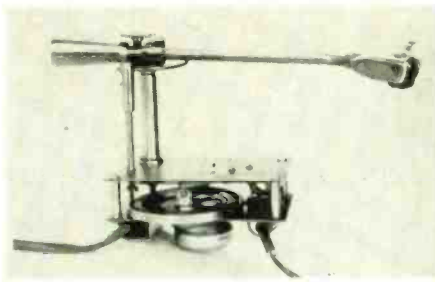

matic operation of the arm. At the touch of a button, "Auto-Poise" lifts the arm from the rest and places it on the record as the turntable starts; disconnects completely from the tonearm during play so that the arm is completely independent; lifts the arm and returns it to the rest after the record is finished; and shuts off the turntable.

**Specifications:** Over-all length of arm, 12½"; distance from arm axis to turntable spindle, 8¼"; height range of turntable, 1¾" to 2¾"; type of suspension, pivot bearings; stylus force range, 0 to 6 gms; type of pickup head, universal; material, aluminum; arm material, aluminum; pickup mounting, screws; screws, 2; spacing, ½"; offset angle, 21 deg; overhang, 31/64"; range of cartridge weights for zero adjustment, 0 to 1¼ gms; maximum tracking error, 1 deg; arm resonance—13 cps, lateral; 13 cps, vertical; over-all weight, 3 lbs; mounting dimensions, 3½" above, 4¼" below. Price, \$74.95; accessories: extra pickup heads, \$5.95. Rek-O-Kut Co., Inc., 38-19 108th St., Corona 68, N. Y.

1. S-320, manual tonearm .....\$34.95
2. APK converter (makes S-320 tonearm automatic) ..... 49.95
3. S-260, professional 16" tonearm ..... 36.95

## H. H. SCOTT

● **1000 Integrated Arm & Cartridge.** Featuring an arm length of 12.5-in. The arm is adjustable in height from 1¾-in. to 2¼-in.

**Specifications:** Type magnetic; freq. resp. 20 to 20k cps ± 2 db; channel separation, 30 db at 1 kc, 20 db at 10 kc; recommended load, 47k ohms; recommended tracking force—professional arms, 3.5 gms, effective stylus mass, 1 mg; compliance—lateral, 6×10<sup>6</sup> cm/dyne, vertical, 3.5×10<sup>6</sup> cm/dyne. Additional features: connecting cables to amplifier moulded to arm; all mounting hardware and instructions supplied. Price, diamond, \$89.95; replacement styli, \$20.00. H. H. Scott Inc., 111 Powdermill Road, Maynard, Mass.

## S.M.E.-SHURE

● **Model 3009 Pickup Arm (Series II).** An instrument of truly unrivaled quality and precision, the S.M.E. Tone Arm features an unprecedented combination of adjustments and inherent accuracy of manufacture that absolutely assure the user that he is tracking at the correct weight, at all times, with the least possible tracking error—regardless of the cartridge used. Among its manifold construction features are: accurate longitudinal and lateral balance adjustment; virtually frictionless knife-edge mounting of tone arm; rendering of tone arm non-resonant by use of internal fibre wood lining; totally enclosed bearings and an arm control lever operated through hydraulic damper.

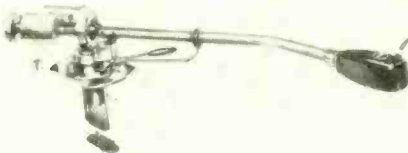

**Specifications:** Over-all length of arm, 12¼"; distance from arm axis to turntable spindle, 8.43" adjustable; height range of turntable, 2¾" to 3¼"; type of suspension, knife-edge; stylus force range, ¼ to 6 gms; type of pickup head, removable-locking collar; material, plastic; arm material, stainless steel; pickup mounting, standard; spacing, ½"; range of cartridge weights for zero adjustment, 5 to 20 gms; additional features, Arm raised and

lowered thru hydraulic damping lever; arm resonance—15 cps, lateral; 15 cps, vertical; over-all weight, 1½ lbs. Price, \$89.50. Shure Bros., 222 Hartrey Ave., Evanston, Ill.

1. M232A, professional 12" tone arm ...\$29.95
2. 236, professional 16" tone arm ..... 31.95
3. 212 "Stereo Dynetic" 12" integ arm and cartridge ..... 79.50
4. 212, "Stereo Dynetic" 16" integ arm and cartridge ..... 79.50

## STANTON

● **Model 200 Stanton Unipoise Arm.** The ultra-lightweight Model 200 leads a trend to featherweight tracking—extending life of both stylus and record. The Model 200 has the patented STANTON single pivot bearing for friction free motion in all planes. Ultra-lightweight construction gives lowest possible mass. Its design is classically simple, yet incorporates exclusive features for highest performance standards and dependability: simple adjustments balance the arm in all

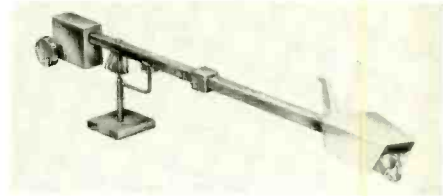

planes; a sensitive calibrated stylus-force adjustment has a range of 0 to 3 grams; single-hole installation requires no tools; no soldering needed; plug-in sockets provided; built-in arm rest; entire moving assembly weighs only 6 ounces; mounts in minutes, supplied with template and complete instructions.

**Specifications:** Over-all length of arm, 11¾"; distance from arm axis to turntable spindle, 8 11/16"; type of suspension, single pivot; stylus force range, 0 to 3 gms; pickup mounting, screw; screws, 2; spacing, std; over-all weight, 2 lbs. Price, \$16.00. Pickering and Co., Prof. Prod. Div., Plainview, N. Y.

## THORENS

● **BTD-12S Tone Arm.** This tone arm has been built to match perfectly the high performance of Thorens precision turntables for which it is specially adapted. It will equally give outstanding results on any other turntable presenting a sufficiently low vibration level.

**Specifications:** Over-all length of arm, 12¾"; distance from arm axis to turntable spindle, 7½"; height range of turntable, 2" to 3¼"; type of suspension, bearings; stylus force range, 0 to 8 gms; type of pickup head,

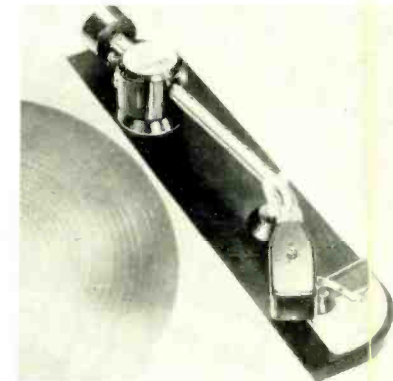

plug-in; material, alum.; arm material duralumin; pickup mounting, adjustable; screws, assorted; spacing, standard; offset angle, 25° 15' deg; overhang, 11/16"; range of cartridge weights for zero adjustment, 5 to 19 gms; maximum tracking error, 0.5 deg inch; additional features, stylus remains in vertical plane for any height adjustment; arm resonance—16 cps, lateral; 16 cps, vertical; over-all weight, 1 lb. Price, \$50.00; accessories: extra pickup heads, \$5.00. Elpa Marketing Industries, Thorens Bldg., New Hyde Park, N. Y.



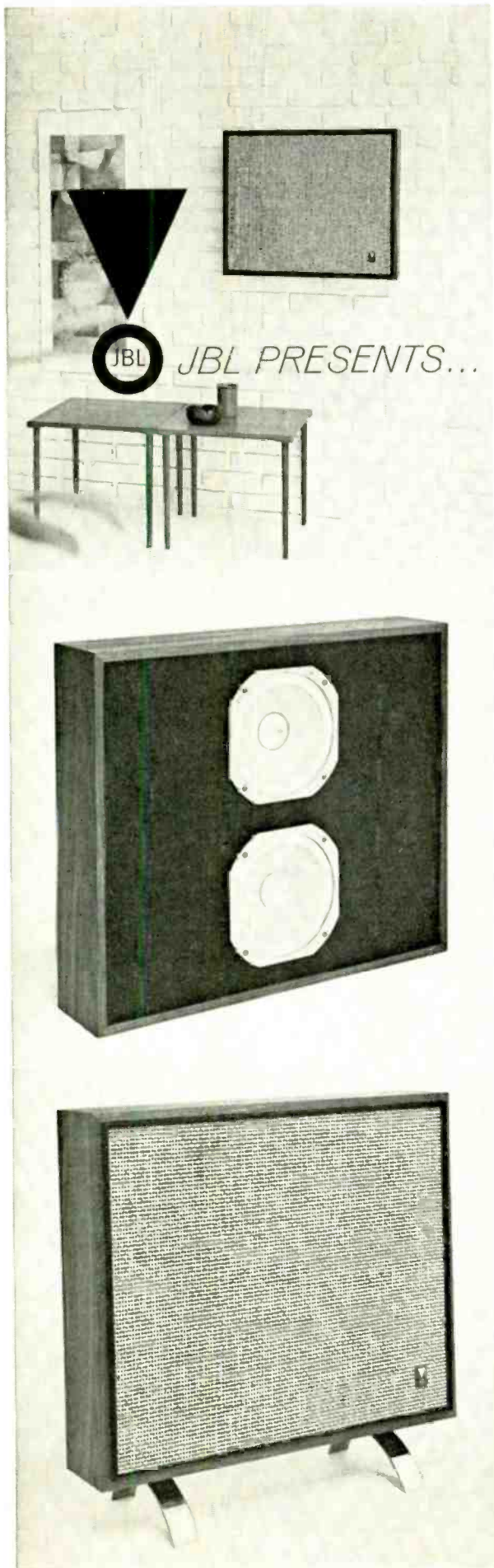

---

*THE TRIMLINE 54....*

---

**NEW PASSIVE  
LOW FREQUENCY  
RADIATOR GIVES  
FULL, TRUE BASS  
IN LESS THAN  
A CUBIC FOOT  
OF SPACE!**

Decor-conscious listeners want small speaker systems for their stereo installations. They have shown great enthusiasm for the thin-silhouette enclosure. They also demand full bass, bass without compromise. Yet, up to this point, they have not been able to get it from a reflex, folded horn, or "infinite baffle" system this small. Now JBL has found the right way to meet this need. The Trimline 54 is a precision loudspeaker system only 5 1/4" deep, 23 3/4" wide, 20" high. It contains two radiators, one dynamic, one passive. The dynamic unit is the 8" Linear-Efficiency model LE8T, a loudspeaker that reproduces the complete audio spectrum with a linearity unprecedented in a transducer of this size. The new passive 8" low frequency radiator is almost identical to the LE8T. It has the same treated cone, same frame and Lans-a-loy suspension; but it does not have a voice coil or magnet assembly. The passive radiator reacts to the dynamic driver at low frequencies exactly the way air mass and port react in a full-size reflex system. The passive cone doubles the effective piston area for fundamental bass tone reproduction. By providing optimum loading it also prevents distortion and increases power handling capacity. The Trimline 54 is solidly built, is given the rich JBL oiled walnut finish on all four sides. Back is recessed and provided with hangers so the unit may be suspended tight against a wall. A set of decorator-designed brass legs is optional. Again JBL solves a critical acoustical problem by coming up with the right idea at the right time.

PRODUCTS OF JAMES B. LANSING SOUND, INC., ARE MARKETED BY JBL INTERNATIONAL, LOS ANGELES 38, CALIF.

# LOUDSPEAKER MECHANISMS

## ALTEC

• **605A Duplex Loudspeaker.** An improved version of the famous 604 series, the new 605A provides unusually smooth response in the highs, extremely high linearity, and clean transient response in the lows.

**Specifications:** Type, duplex; power handling capacity 35 watts; impedance 16 ohms; frequency response, from 20 to 22,000 cps; magnet weight, l.f., 40 oz., h.f., 2 1/2 oz.; voice coil diameter, l.f., 3", h.f., 1 3/4"; free air resonance frequency 25 cps. Dimensions: 15 5/16" dia. 10" deep; weight, 37 lbs. with network. Price \$177.00. Altec Lansing Corporation, 1515 S. Manchester Ave., Anaheim, Calif.

1. 602B Duplex, 25-w, 15-in. spkr ... \$143.00
2. 601B Duplex, 20-w, 12-in. spkr ... 120.00
3. 803B bass spkr, 30-w, 15-in. spkr ... 66.00
4. 408A "Biflex" 15-w, 2-in. spkr ... 31.00

## BOZAK

• **B-207A Coaxial Speaker.** The B-207A is a 2-way speaker intended for infinite-baffle enclosures and "large" sound. It is capable of handling modern, high-powered amplifiers.

**Specifications:** Type 2-way; power handling capacity 20-60 watts; impedance 8 ohms; frequency response  $\pm 3$  db from 40 to 20,000 cps; magnet weight 40 oz; voice coil diameter

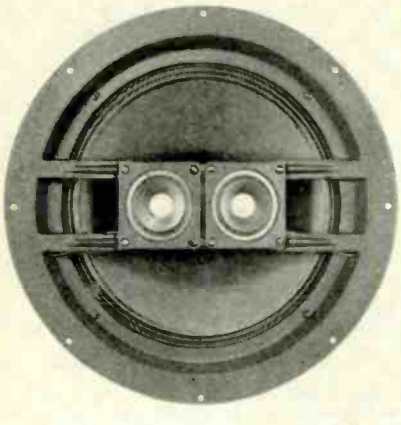

1 1/2"; free air resonance frequency 36 cps; recommended enclosure volume 5 cu ft minimum. Dimensions 15" diameter 7" deep; mounting dimensions, 8 1/4-in. holes on 1 1/2" circle; cutout diameter 12 1/4"; weight 13 lbs. Price \$89.50. Other features: Designed for infinite-baffle mounting. R. T. Bozak Mfg. Co., P. O. Box 1160, Danvers, Conn.

1. B-199A woofer, 12-inch ... \$52.00
2. B-209A midrange speaker, 6 1/2 inch. ... 51.00
3. B-200Y dual tweeter ... 32.00
4. B-800 8-inch wide-range speaker ... 45.00
5. M-108 8-inch wide-range weather-proof speaker ... 49.50

## ELECTRO-VOICE

• **12 TRXB, 3-Way Speaker.** Incorporating the design advantages of the Electro-Voice Radax Coaxial principle, the Electro-Voice Model 12 TRXB integrated 3-way loudspeaker includes, also, the latest developments in the reproduction of the highest audible frequencies through the use of an integral Super Sonax VHF driver. The 12 TRXB employs the Model T35B vhf driver. Bass response is excellent, affording pleasing musical balance without masking effects.

**Specifications:** Type 3-way loudspeaker; power handling capacity 20 watts; impedance

16 ohms; frequency response, from 35 to 18,000 cps; EIA sensitivity 52 db; magnet weight, woofer 1 lb. 6 oz. ceramic, tweeter 3.16 oz. Alnico V; voice coil diameter, woofer 2 1/2", tweeter 1 in.; recommended enclosure volume 20 cu ft. Dimensions: 12 1/4" dia. 7" deep; mounting dimensions, 4 9/32 in. holes on 1 1/2" circle; cutout diameter 10 1/2"; weight 16 1/2" lbs. Price \$70.00. Other features: Integral Sonophase vhf Driver, viscous damped cloth suspension; Electro-Voice, Inc., Buchanan, Michigan.

1. 12 TRX, 3-way speaker ... \$130.00
2. 15 TRXB, 3-way speaker ... 85.00
3. 15 TRX, 3-way speaker ... 155.00

## GOODMANS

• **Triaxiom No. 175C 12-inch 3-Way Loudspeaker.** Triaxiom 175C consists of a 3-way speaker with three independent concentrically placed radiators, each designed for maximum performance and efficiency within its portion of the audio spectrum. The new low-resonance free-floating piston cone handles 25 watts of audio power in the bass region from 20 to 2000 cps. An electrical crossover provides maximum efficiency from 2000 to 5000 cps. for the mid-range transducer. The hypipilliptical pressure-driven horn tweeter handles frequencies from 5000 cps. to 35000 cps. Complete with electrical crossover and variable acoustical control over a 30" cable.

**Specifications:** Type 3-way triaxial; power handling capacity 50 watts; impedance 16 ohms; frequency response, from 20 to 20,000 cps; sensitivity (watts input for +85-db level 10 feet on axis) 1/4 watts; magnet weight 1 3/4 lbs.; voice coil diameter 1 3/4 in.; free air resonance frequency 32 cps; recommended enclosure volume 5 cu ft. Dimensions 12" dia. 5" deep; mounting dimensions, 1 1/2-in. holes on 1 1/4" circle; cutout diameter 1 1/2"; weight, 1 1/4 lbs. Price \$49.50. Rockbar Corp., 650 Halstead Ave., Mamaroneck, N. Y.

1. Triaxiom 8, 8" triaxial ... \$29.50
2. Triaxiom 208C, 8" triaxial, 3" voice coil ... 54.50
3. Triaxiom 100C, 12" triaxial ... 34.50
4. Twinaxiom 200C, 12" twin cone ... 24.50
5. DL#2, ultra-high frequency tweeter and 5kc crossover ... 12.95

## HARTLEY

• **Hartley-Luth 220 MS Speaker.** This speaker features the tri-polymer cone and magnetic suspension under U. S. Patent #3,003,191. The magnet is 16,000 gauss, frame of cast aluminum. Outer surround of polysilastic for freedom of excursion, voice coil wound portion isolated from the shorted turn and damped by a dipped coating of polysiloxane. All the above impervious to conditions of high humidity and moisture. Wide dispersion of high frequencies plus excellent transient response. No crossovers or networks.

**Specifications:** Type full-range; power handling capacity 25 watts; impedance 8 ohms; frequency response,  $\pm 3$  db from 20 to 20,000 cps; magnet weight 5 3/4 lbs; voice coil diameter 1 in.; free air resonance frequency 42 cps; recommended enclosure volume 4 cu. ft. Dimensions 10 3/4" dia. 5 1/2" deep; mounting dimensions, (4) 3/16-in. holes on 9 3/4" circle; cutout diameter 9 1/2"; weight, 7 lbs. Price \$135.00. Other features, resonance fully damped by shorted turn in coil. Hartley Products Co., Inc., 521 E. 162 St., New York 51, N.Y.

1. Model 312, 12" full-range spkr ... \$ 99.95
2. Model 310, 10" full-range spkr ... 85.00
3. Model "XP" 10" full-range spkr ... 75.00

## IMF

• **IMF Styrene Pressure Drivers.** Uses polystyrene mass cone, for high accuracy in dynamic loudspeakers. Treble handled by phase-loaded pressure unit, providing very wide dispersion and smooth response. In cabinet of suitable dimensions, will provide smooth, clear reproduction of orchestral range.

**Specifications:** Type 2-way; power handling capacity 30 watts; impedance 16 ohms; frequency response, from 25 to 16k cps; free air resonance frequency woofer 20 cps; recommended enclosure volume 1.5 to 2.5 cu. ft. Dimensions: 12 1/2" and 3 3/16" and 2 1/2" dia.

5 7/16" deep; mounting woofer & tweeter 9" center to center of openings; weight, 10 3/4 lbs. Price \$145.00 woofer & tweeter. Lectronics of City Line Center, 7644 City Line Ave., Philadelphia, Pa.

1. IMF ribbon system, ribbon tweeter, Crossover special woofers ... \$130.00
2. IMF Standard-Pressure system, 12" woofer/pressure tweeters ... 55.00

## JENSEN

• **G-600 3-Way Loudspeaker.** The Jensen G-600 is a 3-way system with three electrically and acoustically independent l.f., m.f. and h.f. channels for utmost balance, efficiency, smoothness and range extension to upper hearing limit. M.f. and h.f. sections both employ compression-driver horn-loaded units for low distortion and wide-angle dispersion of highs. Separate dual crossover network. M.f. and h.f. balance controls, fully wired.

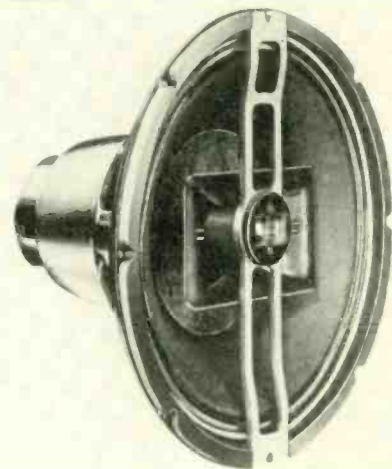

**Specifications:** Type 3-way; power handling capacity 35 watts; impedance 16 ohms; frequency response, from 30 cps to upper hearing limit; magnet weight 3 1/2 lb.

Dimensions: 15" dia., weight, 33 lbs. Price, \$134.50. Jensen Mfg. Co., 6601 S. Laramie St., Chicago 38, Ill.

1. G-610B, 15" triaxial ... \$252.75
2. H-223F, 12" coaxial ... 72.50
3. H-222, 12" coaxial ... 62.50
4. DX-120, 12" 2-element ... 27.50
5. DXF-80, 8" 2-element ... 24.50

## LAFAYETTE

• **SK-58 12-inch 2-Way Speaker.** The SK-58 is a 2-way speaker with a 12-in. free-edge woofer plus a 3-in. cone-type tweeter, with the tweeter mounted on the same axis as the woofer. A built-in LC network distributes the frequencies to the appropriate speaker. The free edge of the woofer is connected to the speaker basket by means of sheepskin.

**Specifications:** Type coaxial; power handling capacity 20 watts; impedance 8 ohms; frequency response, from 30 to 15,000 cps; magnet weight 20 oz; free air resonance frequency 40 cps; recommended enclosure volume 6 cu. ft. Dimensions: 12 1/4" dia., 6 3/8" deep; cutout diameter 10 1/2"; weight, 11 lbs. Price \$27.00. Other features: brilliance level control, 3" cone tweeter. Lafayette Radio Electronics, 111 Jericho Turnpike, Syosset, L. I., N. Y.

1. SK-180, 10" 3-way ... \$32.50
2. SK-210, 12" 3-way ... 49.50
3. SK-128, 8" biaxial ... 19.50

## JBL

• **LE14C, Full-Range 2-Way Coaxial Speaker.** The LE14C is designed to give optimum performance in minimum volume enclosures. The unique stepped-frame design permits the use of 14-inch low-frequency cone. The 4-inch diameter voice coil is constructed from edge-wound copper ribbon.

**Specifications:** Type 2-way coaxial; power handling capacity 30 watts; impedance 16 ohms; voice coil diameter 4 in.; free air re-

"The ONLY Professional Tape Recorder for Me,"  
 says GIL STRATTON, well known TV Sportscaster.  
 "You'll see what I mean when you try the  
 FULLY PROFESSIONAL ROBERTS 192."



## ONLY THE '192' ROBERTS PROFESSIONAL Monophonic Tape Recorder

gives you . . . Fulltrack or Halftrack ★ Hi/Lo Impedance input switching ★ 8/600 Ohm Balanced Output  
 ★ Self Contained Speaker ★ Frequency Response: 40 to 15,000 cps at 7½ ips, ± 2db; 40 to 9500 cps at 3¾ ips, ± 3db.  
 ★ Signal to Noise Ratio: 50 db below recorded "0" level. ★ Tape Speeds: 7½" or 3¾" per second. ★ Wow and Flutter: Less than  
 0.18% RMS. ★ Heads: Inline record/playback head in shielded housing; full track or ½ track available. ★ Motor and Drive: Pre-  
 cision balanced hysteresis-synchronous motor, to speed stabilized flywheel/capstan tape drive. ★ Amplifier: Professional terminal  
 board wiring used; cast front panel; 6 watts undistorted output. ★ Equalization: Amplifier record and playback equalization based  
 on broadcast (NAB) standards. ★ Inputs and Outputs: Jacks provided for low level, high impedance microphone input; high level  
 input; auxiliary speaker or line output; input/output jacks for connecting directly to either or both channels. ★ Index Counter:  
 Accurate, three digit type. ★ V. U. Meter: Illuminated, calibrated -10 to +3db. ★ Operating Position: Vertical or horizontal. ★ Reel  
 Size: 7" maximum (up to 2400" of tape). ★ Dimensions and Weight: 15¼" x 14½" x 9½" overall 28 lbs. ★ Interlocking Controls:  
 Prevent accidental erasure of recorded tapes; instantaneous start and split second acceleration. ★ Pause Lever: Permits instant  
 stops during recording, simplifies editing and facilitates setting volume level before recording. ★ Power Requirements: 95 to 120  
 volts, 60 cycles, 50 W.

\$349<sup>50</sup>

10½" Reel Adaptor Now Available—\$49.50



**ROBERTS ELECTRONICS, INC.**  
 5920 BOWCROFT AVENUE, LOS ANGELES 16, CALIFORNIA  
 MFRS. OF ROBERTS SONIC-THESIA, MEDICAL EQUIPMENT, STEREO HEAD PHONES,  
 NEGATIVE ION GENERATORS, AUDIO EQUIPMENT AND MAGNETIC RECORDING TAPE

ROBERTS ELECTRONICS, INC., Dept. A-8-C  
 5920 Bowcroft Ave., Los Angeles 16, Calif.

Please send me:

Roberts Stereo Tape Instruction Manual  
 containing stereo and monaural applications.  
 I enclose 25¢ (cash, stamps) for postage and  
 handling.

The name of my nearest dealer.

Name \_\_\_\_\_

Address \_\_\_\_\_

City \_\_\_\_\_ State \_\_\_\_\_

sonance frequency 25 cps; recommended enclosure volume 1.7 cu. ft. Dimensions 15" dia. 5 1/4" deep; cutout diameter 12 1/16"; weight, 2 1/2 lbs. Price \$150.00. James B. Lansing Sound, Inc., 3249 Casitas Ave., Los Angeles 39, Calif.

1. LEBT .....\$66.00

## MONARCH

• **Model SP-120XX Co-axial Speaker.** A 12-in. coaxial speaker with dual tweeters supported on a frame in front of the woofer cone and angled to project highs over a broad angle. Heavily constructed on a die cast aluminum frame.

**Specifications:** Type Coaxial; power handling capacity 15 watts; impedance 16 ohms; frequency response, 40 to 16,000 cps. Dimensions 12" dia. Price, \$24.95. Other features—dual tweeters mounted in front of woofer at divergent angles. Monarch Electronics International, Inc., North Hollywood, California.

1. SP-800X 8-in. coaxial spkr .....\$12.95
2. SP-300A 8-in. foll range spkr ..... 12.50
3. SP-412 12-in. Tri-plex (3-way) spkr.. 46.95
4. SP-200 6 1/2-in. full-range spkr ..... 7.95

## NORELCO

• **Speaker Series.** Illustrated is Model AD-5277M, the most powerful in the new T-7 series of twin-cone speakers manufactured by Philips of The Netherlands, and featuring Ticonal 7, a high-coercivity alloy which provides the highest possible concentration of flux densities in the voice-coil air gap. Weight for weight, Ticonal 7 is said to be about 30 per cent more powerful than any of the conventional magnet materials used in speaker construction. Voice-coil impedance of the new T-7 speakers is held constant throughout the entire frequency range by means of a copper ring fitted into the air gap. The ring acts as a shorted turn which induces a current opposite in polarity to that flowing through the voice coil, which reduces that current, thereby lowering the impedance to its proper level. The resonant frequency of the T-7 speakers is very low, resulting in an extremely straight response curve in the bass region. In addition to the cone for low and middle notes, the speakers are equipped with a high-note cone which extends the upper frequency range. Model AD-5277M is a 12-in. speaker with a frequency range of 35 to 18,000 cps and 20-watt continuous power handling capacity when properly housed. Cone resonance is 45 cps. High Fidelity Products Division, North American Philips Company, Inc., Hicksville, N. Y. User net price, \$59.50.

1. AD-4277M 12" spkr .....\$39.00
2. AD-4877M 8" spkr ..... 26.00
3. AD-3877M 8" spkr ..... 9.90

## OXFORD

• **HM12K5 12-inch Hidden Magnet Speaker.** Not an inverted magnet design, but rather a new design wherein the magnet and cone are both included within the basket. This permits the use of dual cones for extending the range of the speaker.

**Specifications:** Type 12"; power handling capacity 15 watts; impedance 8 ohms; frequency response,  $\pm 3$  db from 40 to 14,000 cps; sensitivity (watts input for +85-db level 10 feet on axis) 2.5 watts; magnet weight 12 oz; voice coil diameter 1.25 in.; free air resonance frequency 55 cps; recommended enclosure volume infinite baffle. Dimensions: 12 5/32" dia. 3 1/8" deep; mounting dimensions, (4) 3/8-in. holes on 1 1/8" circle; cutout diameter 11 1/16"; weight, 5 lbs. Price \$19.95. Other features: flush mounting instructions available for \$0.15 or part of HM box. Oxford Components, 3911 S. Michigan Ave., Chicago 53, Ill.

1. HM80H4, 8-in speaker .....\$16.50

## PERMOFLUX

• **"Royal" Speaker Line.** The Permoflux "Royal" speaker line includes 8- and 12-inch speakers in deluxe and standard configurations. The speaker cone in this series is flexible, slotted, thin at the edge, and coated with a permanently soft and resilient formula which together with an extra-large low-

resonance suspension at the cone apex gives very high compliance. The stiffened cone apex and special voice coil provide a smooth distribution of high frequencies.

**Specifications:** Type 12"; power handling capacity 20 watts; impedance 8 ohms; frequency response, from 30 to 12,000 cps; magnet weight 16 oz; dimensions: 12 7/32" dia., 6 1/8" deep; weight, 5 1/4 lbs. Price \$32.50. Permoflux Corp., 4111 San Fernando Road, Glendale, California.

1. Royal Standard 12 .....\$25.00
2. Royal Deluxe 8 ..... 22.50
3. Royal Standard 8 ..... 17.50
4. Royal 8 ..... 15.00

## PIONEER

• **PAX-20G, 2-Way Speaker System.** The Pioneer PAX-20G is a 2-way speaker containing an 8-in. woofer and a horn-type tweeter, mounted coaxially.

**Specifications:** Type coaxial type; power handling capacity 15 watts; impedance 8 or 16 ohms; frequency response,  $\pm 10$  db from 40 to 20,000 cps; sensitivity (watts input for

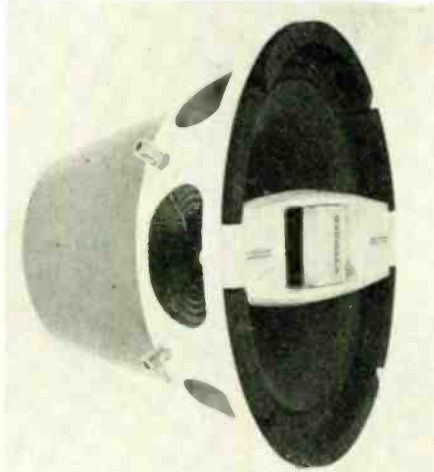

$\pm 85$ -db level 10 feet on axis) 0.185 watts; magnet weight i.f. 9 oz. h.f. 1.35 oz.; voice coil diameter i.f. 1 3/4 in., h.f. 5/8 in.; free air resonance frequency 50-70 cps; Dimensions 5 1/2" deep; cutout diameter 6 3/4"; weight, 4.4 lbs. Pioneer Electronic Corp., 5 Otowacho 6-chome, Bunkyo-ku, Tokyo, Japan.

1. PAX-20 A, 8" coaxial speaker
2. PAT-30 X, 12" 3-way speaker
3. PW-25 C, 10-inch woofer
4. PM-12 A, 5 mid
5. PT-6, horn tweeter

## R & A

• **Coaxial Speaker Series.** Manufactured by a well-known British speaker manufacturer, the 700 series Mark IV models are a group of high-quality woofer/midrange speakers. Although they vary in fundamental resonance they all provide smooth frequency response up to 18,000 cps. All feature Alcomax III Anisotropic magnet systems with a flux density of 12,000 gauss (10,000 gauss in 5-in. unit). The magnet assembly is easily removable without demagnetization and has zero external field. Power handling capacity is 10, 20, 25, and 30 watts respectively for Model 750 (5"), Model 780 (8"), Model 7100 (10"), and Model 7120 (12") speakers. Voice-coil impedance is 8 ohms for all models. Distributed in the United States by Ercona Corporation, 16 W. 46th St., New York 36, N. Y. User net price, Model 750 \$9.95, Model 780 \$14.95, Model 7100 \$16.95, Model 7120 \$18.95.

## REALISTIC

• **Nova 212 3-way 12" Speaker.** A 12" 3-way speaker intended for modest-sized enclosures. It utilizes a whizzer midrange and horn tweeter with level control.

**Specifications:** Type permanent magnet; power handling capacity 20 watts; impedance 16 ohms; frequency response, from 35 to

18,000 cps; magnet weight 13.47 oz.; voice coil diameters—2" woofer, 1" tweeter; free air resonance frequency 60 cps; recommended enclosure volume 4 cu. ft. Dimensions: 12 1/2" dia. 5 1/2" deep; mounting dimensions, 4 1/4" holes on std circle; cutout diameter 10 1/2"; weight, 10 lbs. Price \$29.95. Radio Shack, 730 Commonwealth Ave., Boston 17, Mass.

1. Nova 112 .....\$18.95
2. Nova 312 ..... 49.95

## STENTORIAN

• **HF1012U Extended Range 10-in. Loudspeaker.** The "Stentorian" extended range loudspeaker features a cambric cone with mid-range stabilizers and universal impedance voice coil for 4, 8 or 16 ohms.

**Specifications:** Type permanent magnet; power handling capacity 10 watts; impedance 4, 8, or 16 ohms; frequency response,  $\pm 2$  db from 30 to 14,000 cps; magnet weight 32 oz; voice coil diameter 1 in.; free air resonance frequency 35 cps; recommended enclosure volume 2-8 cu ft. Dimensions 10.187" dia. 4.593" deep; mounting dimensions, 4 holes on 10 25/32" circle; cutout diameter 9 1/4"; weight, 6 1/2 lbs. Price \$18.95. Barker Sales Co., 339 Broad Ave., Ridgefield, N. J.

1. HF812U, 8-in. speaker ..... \$14.95

## STEPHENS

• **Model 80CX.** Compact 8" coaxial loudspeaker combines qualities of the 80FR and the new RT-1 tweeter. Special mounting of tweeter does not increase speaker depth. Complete with crossover and brilliance control.

**Specifications:** Type 8" coaxial; power handling capacity 50 watts peak; impedance 16 ohms; freq. resp.,  $\pm 5$  db from 40 to 25,000 cps; magnet weight 16 oz; voice coil diameter 2 in.; free air resonance frequency 50 cps; recommended enclosure volume 1.5 cu. ft. Dimensions, 8 1/4" dia., 4 1/2" deep; mounting dimensions, (4) 1/4-in. holes on 7 5/8" circle; cutout diameter 7"; weight, 8 lbs. Price \$55.50. Other features electronic crossover. Stephens Trusonic, Inc., 8538 Warner Drive, Culver City, Calif.

1. 80FR, 8" full range .....\$33.50
2. 120FR, 12" full range ..... 60.00
3. 120LX, 12" coaxial ..... 99.50
4. 120W, 12" woofer ..... 60.00
5. 150FR, 15" full range ..... 87.00

## TANNOY

• **15" 'Monitor' Dual Concentric Loudspeaker.**

The new "Monitor" dual concentric incorporates many unique features including the revolutionary patented Tannoy magnetic shunt. By the use of this device, the magnetic flux may be accurately distributed between the low-frequency and high-frequency voice coil gaps with magnetic losses reduced considerably and useful flux increased by as much as 20%. Results are smoother response, better damping, improved transient response, higher efficiency.

**Specifications:** Type dual concentric; power handling capacity 50 watts; impedance 16 ohms; frequency response,  $\pm 3$  db from 30 to 20,000 cps; magnet weight 6 1/2 lbs.; voice coil diameter h.f. 2", l.f. 2"; free air resonance frequency 32 cps; recommended enclosure volume depends on enclosure type. Dimensions: 15 1/4" dia. 9" deep; mounting dimensions, holes P.C.D. on 14 1/2" circle; cutout diameter 13 1/4"; weight, 20 lb., 13 oz. Price \$179.00. Other features integrated sound source with high-frequency horn-loaded diaphragm, and curvilinear l.f. diaphragm. Crossover: 1000 cps. Tannoy (America) Ltd., P. O. Box 177, East Norwich, L. I., N. Y.

1. 12" 'Monitor' dual concentric, same principle .....\$138.00
2. 10" 'Monitor' dual concentric (type III LZ) same principle ..... 112.75

## UNIVERSITY

• **Model 812 3-Way Speaker.** Model 312 Series 200 12" high-compliance 3-way speaker is capable of response from 28-40,000 cps. Award-winning die-cast design, high-compliance woofer. Mid-range provided by patented Diffusicone for uniform dispersion of the 1000 to 3000-cps frequencies. The coaxially mounted Sphericon Super Tweeter

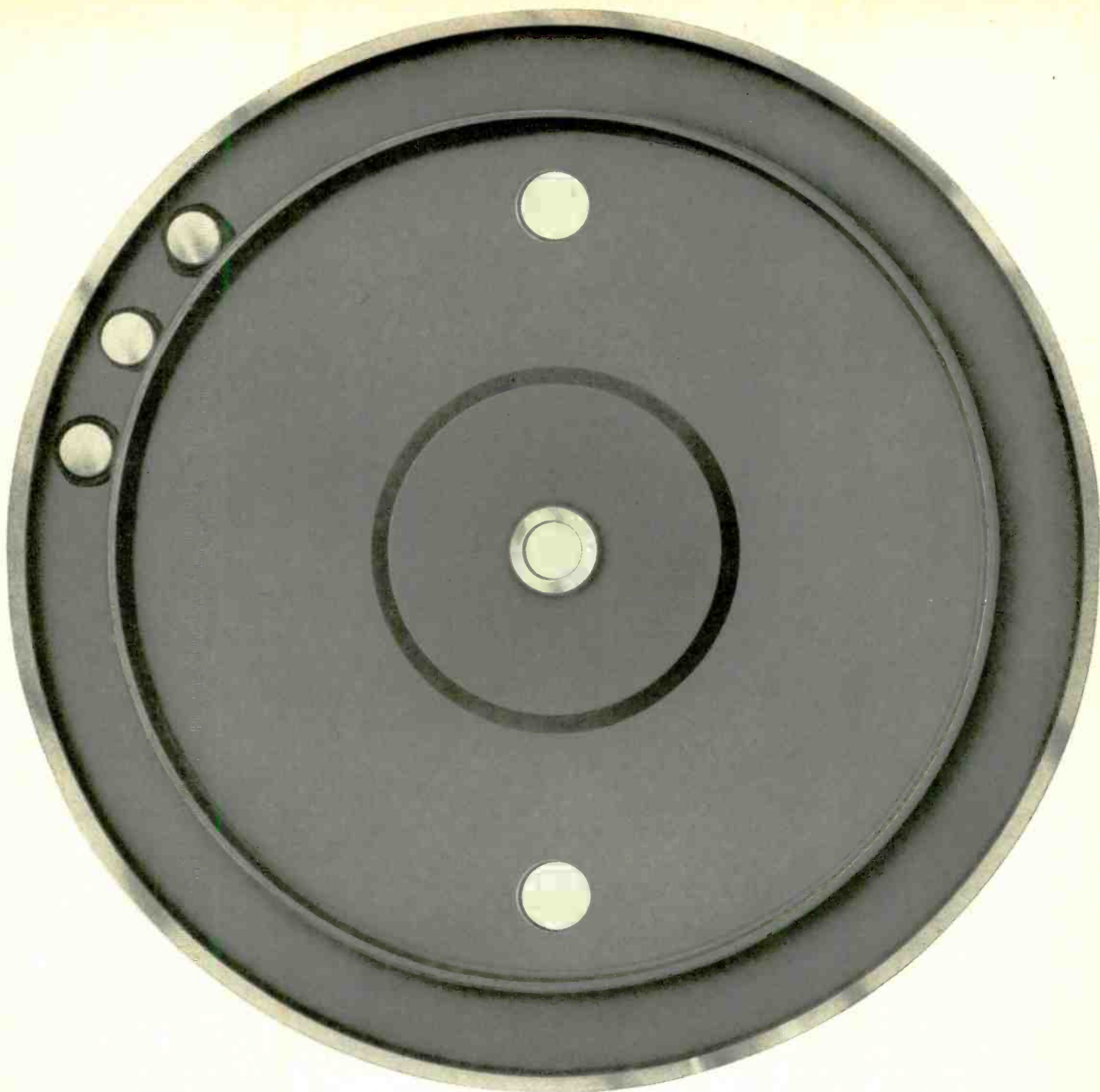

## no two are alike

Look at a row of Miracords, and take note of the turntable platters. They appear as identical as peas in a pod. Yet, no two are alike. They all started out as heavy, one-piece aluminum alloy castings bearing only slight resemblance to the finished product. Each was then secured to a precision lathe, and cut to shape. Layer after layer of metal was shaved from the form until the precise design dimensions were obtained.

At this point, the turntables were as identical in shape, size, weight, finish and appearance as modern technology can achieve. We could have stopped here, pleased as punch with the smooth, glistening results of our efforts. But, the standards of Miracord performance demand more than apparent quality—greater accuracy than dimensional measurements alone can reveal.

And so, each individual gleaming platter was put to test for dynamic balance. And each was individually corrected to assure the balanced distribution of mass

that gives the Miracord turntable its smooth, unwavering motion. Remove the turntable of any Miracord, and examine the under-side. You will see where metal discs were affixed, adding just a little more weight to one point or another to achieve this perfect balance in motion. Now, look at another Miracord platter. This one may have more or fewer discs, and at different points. You can look at a thousand. Each will reveal the individual attention it received. No two will be alike.



The Miracord is a modern, high quality record playing instrument—the only one with dynamically balanced turntable and mass-balanced transcription arm which you can play manually or as automatically as you please. The 10H with hysteresis-synchronous motor is \$99.50; model 10 with 4-pole induction motor, \$89.50. Prices do not include cartridge or base.

# MIRACORD

Make it a point to see the Miracord at your high fidelity dealer soon. For complete details, write to:

has its own reflector baffle to prevent acoustic interference from woofer and provides 120 deg. dispersion. Built-in electrical crossover network and adjustable brilliance control.

**Specifications:** Type 3-way; power handling capacity 35 watts; impedance 8-16 ohms; frequency response, from 28 to 40,000 cps; voice coil diameter 2 in.; recommended enclosure volume 1.5 cu. ft. min. Dimensions: 13" dia. 6 5/8" deep; mounting dimensions, 7/32-in. holes on 12 1/2" circle; cutout diameter 11 1/8"; weight, 10 1/4 lbs. Price \$73.00. University Loudspeakers, 80 South Kensico Ave., White Plains, N. Y.

- 315-C, Series 200, 15" 3-way ..... \$156.00
- 6201, Series 200, 12" coaxial ..... 57.75
- Diffusicone-12, Series 200, 12" 2-way 39.75
- 308, Series 200, 8" 3-way ..... 42.00
- Diffusicone-8, Series 200, 8" 2-way .. 28.00

## UTAH

● **8-in. Uni-Drive Speaker, Model D81A.** An 8-in. speaker with good performance at a moderate price.

**Specifications:** Type dual-cone; power handling capacity 18 watts; impedance 8 ohms; frequency response, from 40 to 16,000 cps; magnet weight 10.0 oz.; voice coil diameter 1 1/4 in. Dimensions 8 3/32" dia. 4" deep; mounting dimensions, (8) 1/4"-in. holes on 7 11/16" circle; cutout diameter 7 13/16"; weight, 4 lbs. Price \$24.30. Other features has dual-diameter magnet. Utah Electronics Corp., Huntington, Ind.

- D8SP, 8" 16.0 oz. magnet, 1 1/2" v.c. ... \$32.50
- D8J, 8" 6.8 oz. magnet, 1" v.c. .... 17.50

- D12J, 12" 6.8 oz. magnet, 1" v.c. .... 20.55
- D12LA, 12" 10.0 oz. magnet, 1 1/4" v.c. 27.60
- D12P, 12" 21.5 oz., magnet, 1 1/2" v.c. 40.00

## WHARFEDALE

● **Super 12RS/DD Full-range 12" Loudspeaker.** A full range 12" speaker with an unusually powerful magnet system.

**Specifications:** Type full range; power handling capacity 40 watts; impedance 12-15 ohms; frequency response, from 25 to 15,000 cps; magnet weight 256 oz.; voice coil diameter 1 1/4 in.; free air resonance frequency 28-33 cps; recommended enclosure volume 2 cu. ft. or more. Dimensions 12 1/2" dia. 7" deep; mounting dimensions, 4 3/16-in. holes on 12 1/2" circle; cutout diameter 10 1/2" weight, 22 lbs. Price \$89.50. Other features 190,000 gauss total flux, density 17,000 gauss, roll surround for small enclosures, cast basket, aluminum voice coil. Wharfedale Div. British Industries Corp., Port Washington, N. Y.

- Super 8" full-range speaker ..... \$26.50
- Super 10" full-range speaker ..... 47.50
- Super 3 treble speaker ..... 26.50
- W15 15" woofer ..... 89.50
- W12 12" woofer ..... 52.50

## WIGO

● **Model CX-212 12" Coaxial.** The CX-212 consists of a 12" extended range woofer, plus a twin-tweeter array with a built-in crossover network.

**Specifications:** Type 2-way; power handling capacity 30 watts; impedance 16 ohms; fre-

quency response from 30 to 15,000 cps; magnet weight 29 oz.; free air resonance frequency 40 cps. Price \$79.50. Other features: flux density 12,500 gauss. United Audio Products, 12 W. 18 St., New York, N. Y.

- ERD-2 extended range (12") ..... \$ 59.50
- CX-2 twin-tweeter array ..... 20.00
- ER-85 extended-range (8") ..... 21.00
- TW-400 tweeter (4") ..... 12.50
- WD-155 super woofer (16") ..... 169.50

## WILDER

● **Twin-Stereo, Model 808-A Loudspeaker.** An 8-in. speaker sold in matched pairs for stereo. The 808-A has a rugged die-cast basket and close-tolerance cone.

**Specifications:** Type 8" with whizzer; power handling capacity 25 watts; impedance 8 ohms; frequency response from 30 to 17,000 cps; magnet weight 16 oz.; voice coil diameter 2 in.; free air resonance frequency 44 cps; recommended enclosure volume 3 cu. ft. Dimensions: 8 1/2" dia. 4 3/4" deep; mounting dimensions, 3/4-in. holes on 7 7/8" circle; cutout diameter 6 3/4"; weight, 11 1/4 lbs. Price \$64.75 net. Wilder Engineering Products, 2013 N. Halsted St., Chicago, Ill.

- 1208, 12" matched twin stereo speakers ..... \$79.75
- 12200-A, 12" biaxial, full-range speaker ..... 39.95
- 12145, 12" biaxial, wide-range speaker 23.95
- 8220-A, 8" biaxial full-range speaker. 32.45
- 8172-A, 8" biaxial, wide-range speaker 21.95

# LOUDSPEAKER SYSTEMS IN ENCLOSURES

## ACOUSTIC RESEARCH

● **AR-3.** The AR-3 is a three-speaker full-range system utilizing the patented acoustic-suspension principle. In this principle the woofer cone is mounted on very free suspensions, so compliant that they are unable to provide the elastic restoring force normally required of them. The elastic restoring force is supplied by the pneumatic spring formed by the air within the cabinet. Both the 2-in. mid-range and the 1 3/8 in. tweeter utilize hemispherically shaped diaphragms as direct radiators.

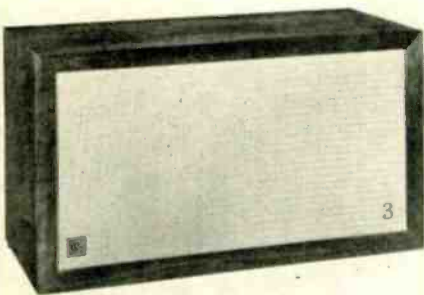

**Specifications:** Type of enclosure sealed; speakers 12" l.f., 2" m.f., 1 3/8" h.f.; type of crossover network L-C; impedance 4 ohms; sensitivity (watts input for +85-db level 10 feet on axis) 1.39 watts; magnet weights: l.f., 53 oz.; m.f., 53 oz.; h.f. 17 oz.; voice coil diameters: l.f., 2" m.f., 2" h.f. 1 3/8"; Dimensions: 25" wide, 14" high 11-3/9" deep; weight, 52.5 lbs.; finishes available and prices Mahogany or natural birch, \$216.00; unfinished pine \$203.00; Walnut, oiled walnut, cherry, korina, or teak \$225.00. Accessories: Speaker stand \$30.00; speaker base \$7.50, Acoustic Research, Inc., 24 Thorndike St., Cambridge, Mass.

- AR-2a, mahogany or birch ..... \$122.00
- AR-2, mahogany or birch ..... 96.00

## ALTEC

● **Model 831A "Capistrano."** The elegant simplicity of the Capistrano, selected for its excellence of design in the California Design exhibit, is an ideal complement to the precision-engineering sound components it encloses. The Capistrano is equally appealing to the decorator and the audiophile.

**Specifications:** Type of enclosure, reflex; speakers—1 l.f., 1 h.f. on horn; power handling capacity 30 watts; impedance 16 ohms; frequency response from 35 to 22,000 cps. Dimensions: 47" wide, 30" high, 23 1/2" deep; 120 lbs.; finishes available and prices: walnut, mahogany \$399.00. Altec Lansing Corporation, 1515 S. Manchester Ave., Anaheim, Calif.

- 830A "The Laguna"—2 woofers, h.f. horn ..... \$599.00
- 832A "The Corona"—cor spkr, similar to "Capistrano" ..... 399.00
- 833A "The Verde"—with 602B "Duplex" spkr ..... 309.00
- 700B "The Melodist"—2-spkr bookshelf ..... 126.00

## ARGOS

● **PHF-18 Petite.** The Petite is a very small, slim profile (only 3 3/4" deep) two-speaker system. It incorporates a new Jensen high-compliance woofer, designed especially for Argos. The Petite may be used anywhere—shelf, table, wall, or floor. Construction is of 3/4" hand rubbed oiled walnut with cane grill cloth.

**Specifications:** speakers 1 l.f., 1 h.f.; power handling capacity 10 watts; type of crossover network capacitor; impedance 8 ohms; frequency response ± 5 db from 50 to 15,000 cps; other features volume control, hanger brackets for wall, solid brass attachable legs. Dimensions: 18" wide, 12" high, 3 3/4" deep; weight, 8 1/2 lbs.; finishes available and prices: hand rubbed oiled walnut, \$24.95; Argos Products Co., 301 Main Street, Genoa, Illinois.

- TSE-1S 2-speaker shelf, fabric covered ..... \$24.95
- TSE-2AS 2-speaker shelf, oiled walnut ..... 39.95
- TSE-3AS 3-speaker shelf, fabric covered ..... 39.95
- TSE-4AS 3-speaker shelf, oiled walnut ..... 59.95

## AUDIO-TECH

● **ME-12 Loudspeaker System.** This unit has a continuously adjustable tweeter output from zero to maximum. Color coded binding posts for easy stereo connection. Guaranteed for 2 years against defective materials and for workmanship.

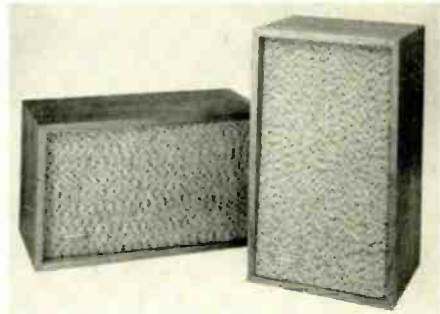

**Specifications:** Type of enclosure infinite baffle; speakers 12" l.f., 3" h.f.; power handling capacity 30 watts; type of crossover network, capacitor; impedance 16 ohms; frequency response from 40 to 20,000 cps; magnet weights: l.f. 32 oz.; h.f. 1.47 oz.; voice coil diameters: l.f., 2"; h.f. 1 1/2"; other features fused to protect against overload. Dimensions: 14" wide, 24" high, 12" deep; weight, 35 lbs.; finishes available and prices: hand rubbed oiled walnut, \$129.00. Audio Tech Laboratories, 3420 Newkirk Avenue, Brooklyn, N. Y.

- JA-15 loudspeaker system ..... \$250.00

## BOZAK

● **B-302A Urban Speaker System.** Although small in size, the Bozak B-302A possesses the same musical sensitivity featured by all Bozak speaker systems. It is ideal for small listening rooms or in pairs for stereo. The B-302A contains one Bozak 207A two-way speaker, one B-209A midrange speaker and one 10102 crossover network to provide crossover at 875 cps.

**TR-1 15 watt mobile transistorized p.a. amplifier**



**Plug-in-accessories**

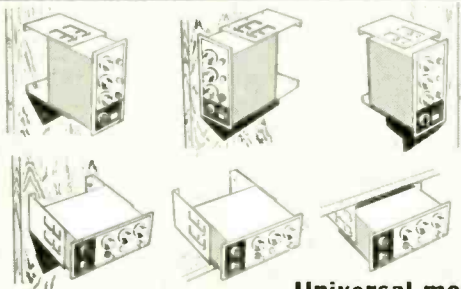

**Universal mounting**

**TR-2 30 watt portable transistorized DC or AC/DC p.a. amplifier**



**Plug-in-accessories**



**with LC-5 Carrying Cover**

**Harman-Kardon offers more operating features, more application versatility, more value than any other mobile or portable public address amplifier ever made... and they're transistorized!**

With the new Troubador Series, Harman-Kardon introduces exciting new potentials for mobile and portable p.a. amplifiers. Never before has there been equipment offering the extra value, the operating facilities and the flexibility of these advanced new units. For rentals, for regular and unusual applications, the TR-1 and TR-2 provide dramatic performance and economy benefits. The TR-1 will find use in police, fire, marine, military, construction and other mobile commercial applications where battery or ignition power is available but AC is not. The TR-2, in addition, includes on-chassis provision for optional AC-to-DC converter to give it limitless applications in schools, hospitals, stores... anywhere an amplifier is needed regardless of power source. Automatic switch-over to DC in event of AC power failure makes this the only amplifier to offer uninterrupted service. It is also the long-awaited answer for emergency control work.

**TR-1** • Simultaneous 2-channel operation: 1 mic, 1 music • Plug-in preamplifier module with equalization for tape head and mag phono • Universal mounting—TR-1 is free standing, also mounts flush on dashboards, panels, etc. Mounting brackets

permit installation on all surfaces in all positions. Removable without disturbing brackets • Provision to turn amplifier on or off from remote location or microphone • Constant voltage output in addition to voice coil impedances • Can't damage amplifier by grounding chassis or incorrect polarity • 4-position filter for maximum tone and acoustical control • And many other flexible operating features.

**TR-2** • Simultaneous 4 channel operation—2 mic, 2 music • Provision for on-chassis AC-to-DC solid state converter • On-chassis facilities for operation from AC with optional plug-in converter • Plug-in accessory provides automatic switchover to DC in event of AC power failure • Plug-in preamplifier module with built-in equalization for tape head and mag phono • Facility to turn amplifier on or off from microphone or remote location • Master Volume Control • Separate Bass and Treble Controls • Constant voltage output (25v & 70v balanced & unbalanced) and variety of voice coil impedances • Can't damage amplifier by grounding chassis or incorrect polarity • De Luxe Carrying Cover • Many other valuable operating and installation features.

Built by Sound Men for Sound-Men

**harman kardon**

For full details, write: Commercial Sound Div.

Desk, B-8, Plainview, L. I., New York

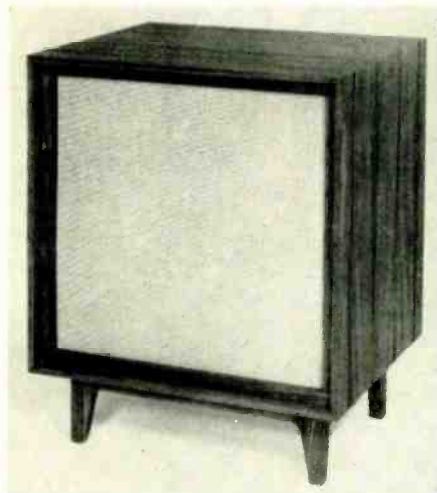

**Specifications:** Type of enclosure *infinite baffle*; speakers one l.f., one m.f., two h.f.; power handling capacity 20-60 watts; type of crossover network *three-way LC, 6 db/octave at 800 and 2500 cps*; impedance 8 ohms; frequency response  $\pm 3$  db from 40 to 20,000 cps; magnet weights: l.f., 2 1/2 oz.; m.f., 2 1/2 oz.; h.f., 16 oz.; voice-coil diameters; l.f., 1 1/2" m.f., 1 1/2" h.f. 3/4"; other features *full three-way speaker system in fine furniture cabinet*. Dimensions: 24" wide, 30" high, 20" deep; weight 80 lbs.; finishes available and prices: *walnut, mahogany, ebony \$254.50; French Provincial cherry \$290.00*. Accessories: *C-305U matching equipment cabinet \$285.00*. R. T. Bozak Mfg. Co., P.O. Box 1166, Darien, Conn.

- |  |       |          |
|--|-------|----------|
| 1. B-305 Urban speaker system          | ..... | \$397.50 |
| 2. B-305 Provincial speaker system     | ..... | 440.00   |
| 3. B-4000 speaker system               | ..... | 495.00   |
| 4. B-310A speaker system               | ..... | 770.00   |
| 5. B-3001 small two-way speaker system | ..... | 174.50   |

## CABINART

● **Mark 3.** An 8" extended-range loudspeaker system using bass reflex principle of operation with a unique horn coupling to the air. This principle enables the total back radiation to be effectively used thus maintaining critical damping while increasing the bass response.

**Specifications:** Type of enclosure *bass reflex-horn*; speakers 8" l.f. power handling capacity 10 watts; impedance 8 ohms; frequency response  $\pm 7$  db from 70 to 19,000 cps; sensitivity (watts input for +85-db level 10 feet on axis) 1/4 watt; magnet weights; l.f. 6.8 oz.; voice coil diameters; l.f., 1"; other features *3" whizzer cone, resonant frequency of speaker (free air) 65 cps, dual-diameter Alnico 5 magnet*. Dimensions: 23" wide, 11" high, 9 1/2" deep; weight, 27 lbs.; finishes available and prices: *unfinished \$18.00; oiled walnut \$30.00*. Cabinart Acoustical Dev. Corp., 34 Geyer St., Haledon, N. J.

## DUKANE

● **Ionovac Speaker System.** Utilizing ionized air instead of the conventional speaker diaphragm for converting electrical pulsations into sound, the "Ionovac" high-frequency speakers are available either separately or as part of a complete speaker system such as the Duke-20 full-range system shown. Heart of the speaker is a small open-end quartz cell, no larger than the eraser on a pencil, in which air is confined in a chamber which narrows down to a tiny aperture. Within the small space air molecules are bombarded with a high-frequency, high-voltage current which knocks sufficient electrons free to ionize the air. The ionic cloud is modulated by signals from the amplifier and is then fed into a small horn which delivers them efficiently to the room as sound waves. The "Ionovac" has a frequency range from 3500 to 20,000 cps. The Duke-20 includes two midrange speakers and a 12-in. high-compliance woofer in addition to the "Ionovac." Dukane Corp., St. Charles, Ill. User net price \$187.50.

- |                              |       |          |
|------------------------------|-------|----------|
| 1. Duke-10 tweeter           | ..... | \$ 79.50 |
| 2. Duke-30 wide-range system | ..... | 199.50   |
| 3. Duke-40 wide-range system | ..... | 149.50   |
| 4. Duke-50 bookshelf system  | ..... | 139.50   |

## EICO

● **HFS-5 2-Way Speaker System.** The Model HFS-5 provides fine bass from a bookshelf-size enclosure. It is a two-way system including an 8" bellows-suspension woofer and a 3 1/2" closed-back tweeter. Frequency division is accomplished by a high-pass capacitor filter at 2000 cps; a level control is provided for the tweeter.

The enclosure is constructed of 3/4" stock and is tuned to 45 cps by a tubular ducted port. A system Q of 1/2 means that the speaker is critically damped when used with any modern amplifier of normal damping factor (7-20). Critical damping gives the smoothest possible frequency response and the best transient response.

**Specifications:** Type of enclosure *ducted-port reflex*; speakers 8" l.f., 3 1/2" h.f.; power handling capacity 25 watts; type of crossover network *bridging capacitor and h.f. level control*; impedance 16 ohms; frequency response  $\pm 5$  db from 52 to 14,000 cps; magnet weights: l.f. 10.7 oz.; h.f., 1.47 oz.; voice coil diameters: l.f. 2"; h.f. 1/2"; dimensions: 12 1/2" wide, 2 1/2" high, 10" deep; finishes available and prices: *unfinished birch \$47.50 kit, \$56.50, wired; oiled walnut \$59.50 kit, \$69.50 wired*. Electronic Instrument Co., Inc., 3300 Northern Blvd., L.I.C., N. Y.

## ELECTRO-VOICE

● **Regina Ultra-Compact System.** The Regina was developed in answer to the demand of discriminating listeners for a system with minimum depth. This thin speaker is made possible by a refinement of E-V wide-range, low resonance systems. Less than six inches in depth, the Regina delivers performance equal to that of larger systems and may be used with the E-V Leyton depending upon the requirements of the room setting.

**Specifications:** Speakers 10" l.f. 5" h.f.; power handling capacity 20 watts; impedance 8 ohms; frequency response from 50 to 15,000 cps; EIA sensitivity 43 db; magnet weights: l.f. 22 oz. Dimensions: 16 3/4" wide, 2 1/2" high, 5 1/2" deep; weight, 22 lbs.; finishes available and prices: *oiled walnut, \$89.50*. Electro-Voice, Inc., Buchanan, Michigan.

- |                                   |       |          |
|-----------------------------------|-------|----------|
| 1. Princess, 2-way system, walnut | ...   | \$ 53.00 |
| 2. Leyton, 2-way system, walnut   | ..... | 89.50    |
| 3. Esquire, 3-way system, walnut  | ..... | 136.00   |
| 4. Regal, 3-way system, walnut    | ..... | 179.00   |
| 5. Royal, 3-way system, walnut    | ..... | 249.50   |

## EMI

● **EMI Model DLS 529 Bookshelf Loudspeaker System.** The Model DLS 529 features a hand-made 13 1/2" x 8 1/4" elliptical woofer with patented aluminum cone and plastic suspension and two 3 1/2" high-frequency units with hand-made curvatures. The 3/4" thick hardwood cabinet has specially treated internal damping to eliminate cabinet resonances, standing waves, or any other parasitic vibrations. In genuine figured walnut veneer and handsome, practical metal grille.

**Specifications:** Type of enclosure *sealed*; speakers one l.f., two h.f.; power handling capacity 15 watts; crossover 4500 cps; impedance 4 ohms; frequency response from 40 to 15,000 cps. Dimensions: 13" wide, 2 1/4" high, 12 1/4" deep; weight, 50 lbs.; finishes available and prices: *oil and satin walnut, \$159.00*. Scope Electronics Corp., 10 Columbus Circle, New York, N. Y.

## ERA DYNAMICS

● **"Minnie" Bi-Phonic Coupler.** A miniature version of the bi-phonic coupler speaker system wherein the front panel (wood) is used as the cone of the woofer.

**Specifications:** Type of enclosure *bi-phonic*; speakers, 1, l.f., 1 b.f.; power handling capacity 20 watts; type of crossover network *LC*; impedance 8 ohms; frequency response  $\pm 3$  db from 35 to 20 k cps; magnet weights: l.f., 10 oz.; h.f. 1.47 oz.; voice coil diameters: l.f., 1" h.f., 3/8"; dimensions: 13 3/8" wide, 18" high, 2" deep; weight 5 1/2 lbs. Price

\$60.00. ERA Dynamics Inc., 67 Factory Place, Cedar Grove, N. J.

- |                                   |       |          |
|-----------------------------------|-------|----------|
| 1. Wafaire, Bi-Phonic Coupler     | ..... | \$ 80.50 |
| 2. 440, Bi-Phonic coupler, walnut | ..... | 134.40   |

## FISHER

● **Model XP-4A Bookshelf Speaker System.** The XP-4A is a four-speaker, three-way system of bookshelf size requiring only 10 watts of amplifier power to give full volume in the average room.

**Specifications:** Type of enclosure *high resistance ducted port*; speakers—12" l.f. (2) 5" m.f., *hemispherical h.f.*; power handling capacity 60 watts; type of crossover network *LC*; impedance 8 ohms; frequency response

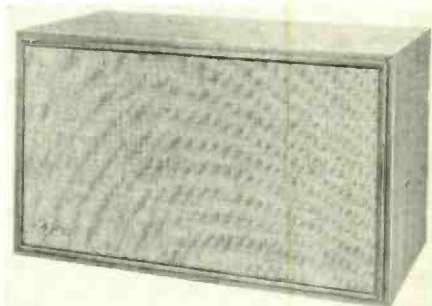

from 28 to over 20,000 cps; magnet weights; l.f., 22 1/2 oz. m.f., 3 1/2 oz.; h.f. 17 oz.; voice coil diameters: l.f., 2" m.f., 1" h.f., 2"; other features—unit construction eliminates need for metal speaker frame. Also features self-damping long-travel bass speaker. Dimensions: 24 1/2" wide, 14" high, 12 1/2" deep; weight, 50 lbs.; finishes available and prices: *mahogany, walnut, cherry, \$199.50. Unstained birch \$189.50*. Accessories: *LE-1 Univ. Base \$9.95*. Fisher Radio Corp., 21-21 44th Drive, L.I.C., N. Y.

- |  |       |          |
|--|-------|----------|
| 1. XP-1A, 3-way speaker system, mah.                 | ..    | \$129.50 |
| 2. XP-2A, 3-way speaker system, mah.                 | ..    | 84.50    |
| 3. KS-1, 3-way speaker system kit, unfinished walnut | ..... | 64.50    |

## GOODMANS

● **Model G-5 "Dekorator" Cabinet System.** The Model G-5 is a 5-speaker 4-way system. Employs the new 12" Superfoam Floating Piston Cone, which has sufficient stiffness and added mechanical resistance to provide uniform response within the woofer range of 20 to 2000 cps. Crossing over at 500 cps, a heavy-duty 8" closed-back free-edged speaker handles the frequencies from 500 to 2500 cps. Two new heavy-duty shielded closed-back 3 1/2" tweeters uniformly re-enforce the mid-range from 2500 to 7500 cps. The new hemispherical dome-lens omnidirectional compression ultra-high-frequency horn tweeter takes over to handle frequencies from 7500 up.

**Specifications:** Type of enclosure *infinite baffle*; speakers—1 l.f., 1 m.f., 3 h.f., power handling capacity 60 watts; impedance 16 ohms; frequency response  $\pm 8$  db from 30 to 20,000 cps; sensitivity (watts input for +85-db level 10 feet on axis) 1/4 watt; magnet weights: l.f., 1 1/4 lbs.; m.f., 1/2 lb.; h.f., 11 oz.; voice coil diameters: l.f., 3"; m.f., 1"; h.f., 1". Dimensions: 20" wide, 28" high, 6 3/4" deep; weight, 60 lbs.; finishes available and prices: *oiled walnut, \$139.50*. Rockbar Corp., 650 Halstead Ave., Mamaroneck, N. Y.

- |   |    |         |
|---|----|---------|
| 1. G-1, three-speaker system, 30 watts. | .. | \$56.50 |
| 2. G-2, three-speaker system, 40 watts. | .. | 59.50   |
| 3. G-3, five-speaker system, 45 watts   | .. | 79.50   |
| 4. G-4, five-speaker system, 60 watts   | .. | 89.50   |

## HARTLEY

● **Hartley-Luth Holton Type "B".** A fine furniture type of enclosure featuring, as in all Hartley cabinets, the Soundsorber for acoustic treatment of the rear wave and cabinet resonance. Front grille of Raffia for transparent sound. Total materials used for Soundsorber over 70 square feet. For the modern or contemporary home. Type "A" for the traditional or conservative surrounding. Utilizes any of the full-range Hartley speakers. No crossovers or networks needed.



**THE  
FINEST  
STEREO  
HEADPHONES  
YOU'VE  
EVER  
HEARD**



**jensen** MANUFACTURING COMPANY  
Division of The Muter Co.

Jensen's new HS-1 Stereo Headphones are ready for you. We think you will agree with the experts who say they are the finest ever. Reasons? They cover the frequency range with extra smoothness because they have new fluid-damped transducers developed by Jensen. And they are good to look at, easy to adjust, comfortable to wear. Cord comes out one side . . . you don't get tangled up. Impedance 8 ohms. Complete with Jackbox for connecting to any stereo amplifier. Write for Brochure MH.

HS-1 With 3 conductor plug and accessory jack box. . . . . Net \$24.95  
HS-1L With 4 spade lug terminals . . . . . Net 22.50

Jensen Manufacturing Co., 6601 S. Laramie Ave., Chicago 38, Ill. / Canada: Radio Speakers of Canada, Ltd., Toronto

**Specifications:** Type of enclosure *infinite*; power handling capacity 25 watts; type of crossover network, *none*; impedance 8 ohms; frequency response  $\pm 3$  db from 20 to 20,000 cps; magnet weights, 5 $\frac{3}{4}$  lbs. Dimensions: 2 $\frac{1}{2}$ " wide, 3 $\frac{1}{4}$ " high, 13" deep; weight, 80 lbs.; finishes available and prices: *oil walnut, mah, \$245.00*. Hartley Products Co., Inc., 521 E. 162 St., New York 51, N. Y.

- Hartley-Luth Holton style "A" with 220MS spkr .....\$245.00
- Hartley-Luth Holton style A or B w. 312 spkr ..... 215.00
- Hartley-Luth Holton style A or B w. 310 spkr ..... 195.00
- Holton Jr. oiled walnut w. 220MS spkr ..... 195.00
- Holton Jr. oiled walnut w. 312 spkr. 155.00

## HEATH

• **Model AS-22 "Profile" Speaker System.** "Profile" is a slim new Heathkit 3-way system speaker—just 5 in. deep. Versatile in performance, it uses a special 10-in. woofer of inverted design, plus a 6-in. midrange and a 3 $\frac{1}{2}$ -in. tweeter with closed backs for perfectly balanced, natural sound. Factory assembled cabinets are available in walnut finish or in unfinished white hardwood suitable for the finish of your choice.

**Specifications:** Type of enclosure, *tubed*; speakers, 10" l.f., 6" m.f., 3 $\frac{1}{2}$ " h.f.; power handling capacity, 25 watts; type of crossover network, *series capacitor*; freq. resp.  $\pm 5$  db from 55 to 12,500 cps; magnet weights—l.f., 16.1 oz; m.f., 2.16 oz; h.f. 2.15 oz; voice coil diameters—l.f. 2"; m.f.,  $\frac{3}{4}$ "; h.f., 9/16"; factory assembled cabinets of  $\frac{3}{4}$ " furniture-grade plywood. Dimensions: 19 $\frac{1}{2}$ " wide, 25" high, 5" deep; weight, 31 lbs; AS-22U, unfin. white hardwood, \$49.95; AS-22W walnut, \$54.95. Heath Company, Benton Harbor, Mich.

- AS-81 miniature speaker sys .....\$ 17.50
- AS-51 speaker sys ..... 39.95
- Acoustic suspension speaker sys ..... 59.95
- "Legato Compact" deluxe speaker sys 239.95

## IMF

• **IMF Styrene-Pressure Loudspeaker System.** Uses polystyrene mass cone for accuracy in a dynamic loudspeaker. Treble handled by phase-loaded pressure unit, providing very wide dispersion and smooth response.

**Specifications:** Type of enclosure *resistive loaded*; speakers—1 l.f., 1 h.f.; power handling capacity 30 watts; type of crossover network *capacitive*; impedance 16 ohms; frequency response from 25 to 16k cps. Dimensions: 16 $\frac{1}{2}$ " wide, 26 $\frac{1}{2}$ " high, 11 $\frac{1}{2}$ " deep; weight, 30 lbs., approx.; finishes available and prices: *oiled walnut \$200.00*. Others to be announced. Lectronics of City Line Center, 7644 City Line Ave., Philadelphia, Pa.

- IMF ribbon speaker system .....\$190.00
- IMF Standard-Pressure system ..... 90.00
- IMF-Radford System ..... 500.00
- IMF Orthophase (price to be announced)

## ISOTONE

• **EROICA.** Continuously-folded, extended, air column with constant-impedance air-mass loading.

**Specifications:** Type of enclosure *3-way patented*; speakers—12" l.f. 8" m.f., *compression* h.f.; power handling capacity 40 watts; impedance 8 ohms; frequency response  $\pm 2$  db from 30 to 16,000 cps; magnet weights: l.f., 80 oz.; m.f., 2 $\frac{1}{2}$  oz.; h.f., *normal* oz.; voice coil diameters: l.f., 1 $\frac{1}{2}$ "; m.f., 1"; other features pneumatically controlled transducer assembly action.

Dimensions: 15" wide, 40" high, 22" deep; weight, 140 lbs.; finishes available and prices: *oiled oak, mahogany \$299.00*. Isotone Associates, 3402 Third Ave., New York 56, N. Y.

- "Cellini," 2-spkr, 1 cu. ft. ....\$ 65.00
- "Egmont," 2-spkr, 2 cu. ft. ....110.00

## JANZEN

• **Z-500 Speaker System.** The Z-500 uses the well-known JanZen Electrostatic mid/high-range tweeter in a single-radiator version that reduces cost and cabinet size. The electrostatic tweeter is acoustically paired in the Z-500 with a special 11-in. Model 350A dynamic woofer. Frequency range from 30

to 30,000 cps. Dimensions, 24 $\frac{3}{4}$ " wide, 13 $\frac{1}{2}$ " high, 11 $\frac{3}{8}$ " deep. Available in walnut, mahogany, and birch, \$124.95. Neshaminy Electronic Corp., Neshaminy, Pa.

## JENSEN

• **Trk-9 Slim 3-way Loudspeaker System.** This new Jensen speaker system has slim proportioning and will adapt to almost any decor.

**Specifications:** Type of enclosure, *ducted port*; speakers—10" l.f., 8" m.f., *dome* h.f. power handling capacity, 25 watts; impedance, 8 ohms; frequency response from 30 cps to

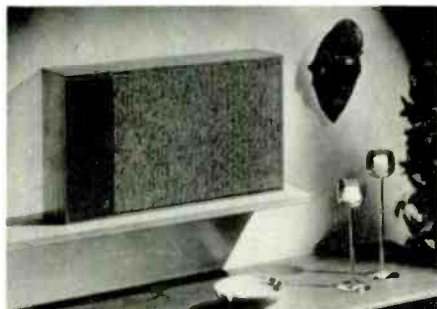

*beyond audibility.* Dimensions, 23 $\frac{3}{4}$ " wide, 13 $\frac{1}{2}$ " high, 5 $\frac{3}{8}$ " deep; weight, 25 lbs; finish available, walnut. Price, \$89.95. Jensen Manufacturing Company, 6601 S. Laramie Ave., Chicago 38, Ill.

- 3-P, 4-way sys ..\$119.50, \$139.50, \$159.50
- TF-3, 4-speaker 3-way sys, walnut.. 99.50
- TF-2, unfinished 3-speaker 2-way sys 64.50
- X-20, 3-speaker 2-way sys ..... 39.95
- X-10, 2-way sys ..... 29.75

## KLH

• **Model Six Compact Loudspeaker System.** Combining an acoustic suspension woofer of unusual design, in which the frame and magnet assembly become integral with the baffle panel, with a tweeter comprising a thin Bakelitized diaphragm with a maximum excursion of 1/16 in., the over-all performance belies the small size of the enclosure.

**Specifications:** Type of enclosure, *acoustic suspension*; speaker, 1 l.f., 1 h.f.; power handling capacity, 75 watts; type of crossover network, *L-C*; impedance, 8 ohms; freq. resp. 32 to 16,000 cps; crossover point, 1500 cps; dimensions: 23 $\frac{1}{2}$ " high, 12 $\frac{1}{2}$ " wide, 11 $\frac{1}{4}$ " deep, weight, 35 lbs. Available in mahogany, \$129.00; oiled walnut, \$134.00; unfinished, \$119.00. KLH Research and Development Corp., 30 Cross St., Cambridge 39, Mass.

- Model 7, 2.6 cu. ft. spkr sys .....\$189.00 to \$196.00
- Model 10, similar to Mod. 6, thinner ..... 86.00 to 94.00

## KLIPSCH

• **KB-100 Klipschorn.** A horn is a different structure and serves a different purpose than an enclosure. The Klipschorn is thus distinct from an enclosure in that the diaphragms are loaded for lower distortion, higher acoustic output, and more nearly perfect transient response.

**Specifications:** Type, *3-way horn*; speakers—15" l.f. *compression* m.f. and h.f.; power capacity, 3 acoustic watts output for 0.1% maximum FM distortion; crossover network, balancing; impedance, 16 ohms; frequency response,  $\pm 5$  db from 30 to 19,000 cps; sensitivity (watts input for +85-db level 10 feet on axis), approx. 0.1 watts; dimensions, 31" wide, 51" high, 29" deep; weight, 170 lbs., available in mahogany, walnut, and maple, \$852.00; unfinished fir, \$514.00. Klipsch and Associates, Hope, Arkansas.

- Cornwall, 3-way speaker sys .....\$408.00
- Model H, 3-way speaker sys ..... 221.00

## LAFAYETTE

• **"Elliptoflex" Enclosure with SK-58 Speaker.** The Elliptoflex enclosure is a ducted port system wherein the port is elliptical in shape and is located directly in front of the speaker. This unique system is designed to improve

low-frequency response by providing a smooth transition from front to rear (cone) radiation.

**Specifications:** Type of enclosure *ducted port*; speakers—12" l.f., 3" h.f.; power handling capacity 20 watts; type of crossover network *LC*; impedance 8 ohms; frequency response from 40 to 15,000 cps; magnet weights: l.f., 20 oz. Dimensions: 23 7/16" wide, 14" high, 13 5/16" deep; weight, 35 lbs; finishes available and prices: *mahogany, walnut, blonde \$64.50*; *oil walnut, unfin. birch \$59.50*. Lafayette Radio Electronics, 111 Jericho Turnpike, Syosset, L. I., N. Y.

- Elliptoflex with SK-210 spkr .....\$82.50
- Elliptoflex with SK-180 spkr ..... 66.50

## JBL

• **Trimline 54 Speaker System.** The JBL Trimline 54 couples the LE8T speaker and an 8" woofer to a new enclosure. The new enclosure is designed to double the effective radiating area at low frequencies. The 54 is of the new thin speaker genre and may be free standing or hung from a wall. Hanging brackets are provided. The enclosure is finished on four sides and may be used either vertically or horizontally.



**Specifications:** Type of enclosure *reflex*; speakers—8" l.f., 8" m.f./h.f.; power handling capacity 25 watts; impedance 8 ohms magnet weights: l.f., 6 $\frac{1}{2}$  lbs; voice coil diameters: l.f., 2". Dimensions: 23 $\frac{3}{4}$ " wide, 20" high, 5 $\frac{3}{8}$ " deep; weight, 29 lbs.; finishes available and prices: *walnut, mahogany, ebony \$117.00*. Accessories: *solid brass legs (pair) \$12.00*. James B. Lansing Sound, Inc., 3240 Casitas Ave., Los Angeles, Calif.

- Lancer 33 .....\$ 93.00
- Lancer 66 ..... 147.00

## LEAK

• **"Piston-Action" Sandwich Speaker System.** The Leak piston-action speaker system is a new concept in speaker design. The cone is polyfoam which is given 200 times the structural strength by a "sandwich" of aluminum skins. It thus behaves in the manner of the theoretical piston.

**Specifications:** Type of enclosure *sealed*; speakers 1 l.f., 1 h.f.; power handling capacity 50 watts; type of crossover network (2)  $\frac{1}{2}$ -sections with additional elements on tweeter; impedance 15 ohms; frequency response  $\pm 2.5$  db from 30 to 18,500 cps; voice coil diameters: m.f., 2"; h.f. 1"; other features: *special 13" polyfoam girder construction sandwich cone eliminates breakup distortions*. Dimensions: 15" wide, 26" high, 12" deep; weight, 49 lbs.; finishes available and prices: *Scandinavian walnut, \$199.00*. Ercona Corp., 16 W. 46th Street, New York, N. Y.

## MONARCH

• **Controlled-Resonance 2-way System.** This small cabinet size is made possible by the use of the "controlled resonance" principle employing plastic tubes of varied lengths and shapes to reduce unwanted resonance to inaudible levels. The cabinet is finished on four sides, and is fitted with a tweeter control.

**Specifications:** Type of enclosure *ducted reflex*; speakers—1 l.f., 2 h.f.; power handling capacity 30 watts; impedance 16 ohms; fre-



Perhaps two years from now the quality of this tape may be duplicated... perhaps never! **Soundcraft Golden Tone**—a physically perfect tape... a musically perfect sound. A bold claim? Yes.

Warranted? Yes. Here's why. Golden Tone is a very special tape... designed just for those who demand the finest performance from today's advanced recorders. Unless you have the discerning ear and the exacting equipment which ordinary tapes can't satisfy, there is no reason for you to buy Golden Tone.

A special magnetically-active FA-4 oxide formulation increases Golden Tone's high frequency output by 25%. Its signal-to-noise ratio is 7 db better than other brands, to give your recordings **the greatest dynamic range possible with a tape**. Precision-slit Golden Tone is free of edge burrs and skew. These physical defects can be cruelly exposed by the narrower tracks in 4-track recording. Microscopic burrs prevent the tracks on the edge of the tape from making intimate head contact, resulting in loss of "highs."

Skew, another hidden defect, produces cross-talk and loss of recording level. Golden Tone's oxide formulation and base are balanced to prevent cupping or curling, an effect which can also prevent tape to head intimacy. Golden Tone's oxide surface is Micropolished. This patented Soundcraft process removes any surface irregularity, prevents drop-outs, protects high frequency response and minimizes head wear.

From this physically perfect tape, comes musically perfect sound. Golden Tone costs more, but it is worth more. It is produced in small quantities with infinite care and rigid quality control. It is the world's finest tape for those who demand the ultimate in sound reproduction. Offered for the first time anywhere—a long play Golden Tone tape on 1 mil Mylar\*, TENSILIZED by DuPont—will not stretch or break. Also on ½ mil "Mylar" and 1½ mil Acetate Bases.



GOLDEN TONE BY REEVES SOUNDRAFT CORP

\*DuPont TM

quency response 25 to 18,000 cps. Dimensions: 23½" wide, 11" high, 11¾" deep. Finished in Swedish walnut, \$69.95. Monarch Electronics International, Inc., North Hollywood, California.

1. SP-CR1 deluxe controlled-resonance 3-way sys .....\$84.95
2. SP-80C 8-in. plus tweeter, 2-way sys. 49.95

## NORDIC

● *Nordic 1 Speaker System.* Compact, high-frequency design with clean response. Features patented 8" speaker with multi-layer free-floating cone; distortion 1%, 100–10k cps, 1.5% 10k–15k cps.

*Specifications:* Type of enclosure *bookshelf*; speakers 8" l.f.; 5" h.f.; power handling capacity 20 music power watts; impedance 8 ohms; frequency response from 45 to 18,000 cps. Dimensions: 22¾" wide, 10¾" high, 7½" deep; weight 18¼ lbs. Finishes available and prices: *Scandinavian walnut or teak*, \$59.50. Ercona Corp., 16 W. 46th St., New York 36, N. Y.

## PILOT

● *PSV-4 3-Way Speaker System.* This three-way bookshelf speaker system is a handsome addition to any room. The solid bass response is produced by a 12" Air Flex heavy-duty woofer which is front mounted in an Orton fiber-filled enclosure designed to yield maximum performance. Two 3½" cone-type speakers produce the crisp mid-frequencies. High frequencies are produced by a specially designed super tweeter. This four-speaker combination, plus a crossover network, gives unparalleled performance.

*Specifications:* Type of enclosure *infinite baffle*; speakers—12" l.f., (2) 3½" m.f., 3½" h.f.; power handling capacity 30 watts; type of crossover network(s) *air core inductor-capacitance, 6-db/octave*; impedance, 8 ohms; frequency response ± 6 db from 40 to 16,000 cps; magnet weights: l.f., 27 oz.; m.f., 1.47 oz.; h.f., 1.47 oz.; voice coil diameters: l.f., 2½"; m.f., ¾"; h.f., ¾"; other features *mid-range and tweeter level controls, finished on 4 sides*. Dimensions: 25¾" wide, 14½" high, 12" deep; weight 42 lbs.; finishes available and prices: *lacquered walnut, oiled walnut, mahogany*, \$119.50. Pilot Radio Corp., 37-06 36th St., New York, N. Y.

1. PSV-2 .....\$69.50
2. PSV-3 ..... 64.50

## PIONEER

● *CS-30 A Bookshelf Speaker System.* A compact 2-way speaker system which is appropriate for stereo in today's compact home.

*Specifications:* Type of enclosure *bookshelf*; speakers—12" l.f., 2 2.5" h.f.; power handling capacity 20 watts; type of crossover network *C-type attenuation 6 db/octave*; im-

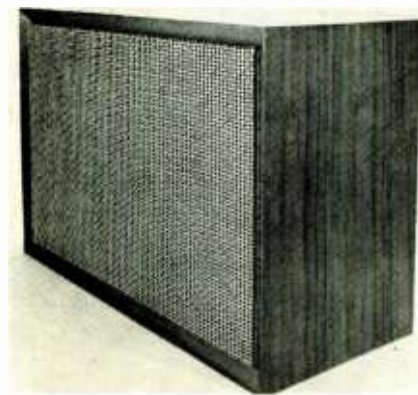

pedance 16 ohms; frequency response ± 7.5 db from 60 to 18,000 cps; sensitivity (watts input for +85-db level 10 feet on axis) 0.3 watts; magnet weights: l.f., 24 oz.; h.f., 2×2 oz.; voice coil diameters: l.f., 1 15/16" h.f., ¾". Dimensions: 24½" wide, 16½" high, 10¾" deep; weight, 34.2 lbs.; finishes available: *Teak*. Pioneer Electronic Corp., 5 Otowacho 6-chome, Bunkyo-ku, Tokyo, Japan.

1. CS-20 A, 8-inch 2-way speaker

2. CS-20 B, 8-inch coaxial speaker
3. CS-16 A, 6½-inch mechanical 2-way speaker
4. CS-183, Woofer 3¼-inch, tweeter 2¾-inch

## QUAD

● *Full-Range Electrostatic Speaker.* Perhaps the first full-range electrostatic speaker in the world, this speaker may herald the future for the industry. Completely free-standing and non-critical as to placement, it radiates from both sides in a figure-eight pattern which minimizes reflections from the walls and ceiling. Frequency range of the speaker is 45 to 18,000 cps and its impedance is 16 ohms. Dimensions are 31" high, 34½" wide, 10½" deep at bottom. Manufactured in England, exclusive United States distributor is Leetronics of City Line Center, 7644 City Line Ave., Philadelphia 31, Pa. User net price, \$345.00.

## RAVENSWOOD

● *M-8 Reflection Coupler.* One of a series of loudspeaker systems which depend upon the wall surface behind the speaker to distribute sound waves so that they appear to originate at a point somewhere beyond the wall. The new Dynamic Port Phase Inverter\* principle provides a form of variable damping which is unique and extremely effective in controlling speaker and cabinet resonances and adapting the entire system to room environments.

*Specifications:* Type of enclosure, *Dynamic Port Phase Inverter*; speakers—2 l.f., 1 m.f., 1 h.f.; power handling capacity 50 watts; type of crossover networks *half-section m-derived*; impedance 8 ohms; magnet weights: l.f., 27 oz.; m.f., 10 oz.; h.f., 1.45 oz.; voice coil diameters: l.f., 1½"; m.f., 1"; h.f., 9/16"; other features *variable damping*. Dimensions: 31" wide, 16½" high, 7" deep. Finishes available and prices: *walnut* \$144.95; *unfinished* \$124.95. RAVENSWOOD, Edgewood & McGuckian Sts., Annapolis, Md.

1. M-9 Reflection Coupler, bookshelf .....\$124.95–\$149.95
2. M-7 Reflection Coupler, 3-8", 1-3½" ..... 74.95– 84.95
3. M-6 Reflection Coupler, 2-8", 1-3½" ..... 49.95– 55.95

## REALISTIC

● *Electrostat Two-Speaker System.* An electrostatic high-frequency unit combined with a cone-type woofer.

*Specifications:* Type of enclosure *acoustic suspension*; speakers 1 l.f., (4) *electrostatic elements* h.f.; power handling capacity 20 watts; type of crossover network *LC*; impedance 8 ohms; frequency response from 45 to 25,000 cps; voice coil diameters: l.f., 1"; other features *power for electrostatic tweeters derived from power line, a.c. switch furnished, Has tweeter level control*. Dimensions: 13" wide, 22½" high 12" deep; weight, 27 lbs.; finishes available and prices: *mahogany* \$59.95; *oiled walnut and teakwood* \$62.95. Radio Shack, 730 Commonwealth Ave., Boston 17, Mass.

1. Electrostat 5, oiled walnut .....\$49.95
2. Electrostat 4A Mahogany ..... 84.95

## REK-O-KUT

● *Sonotone Speaker System.* A series of high style, 5-speaker, 3-way systems in fine furniture cabinets featuring figure eight radiation pattern from front and rear. Available in contemporary, provincial, and modern styles, in walnut, fruitwood, and ebony finishes respectively.

*Specifications:* Type of enclosure *slimline*; speakers—2 l.f., 2 m.f., 1 h.f.; power handling capacity 45 watts; type of crossover network *filter network*; impedance 8 ohms; frequency response +3-6 db from 40 to 18,000 cps; sensitivity (watts input for +85-db level 10 feet on axis) 0.20 watts (at 500 cps); magnet weights: l.f., 6.2 oz.; m.f., 6.2 oz.; h.f., 2.5 oz.; voice coil diameters: l.f., 1"; m.f., 1"; h.f., ¾"; dimensions: 24" wide, 23" high, 4" deep; weight, 18 lbs.; finishes available and prices: *solid walnut* \$79.95; *fruitwood, ebony* \$89.15. Rek-O-Kut Co., Inc., 38-19 108th St., Corona 68, N. Y.

1. CA 60, bookshelf 3-sprk sys, wal .....\$59.95

## THE RUS LANG

● *Rus-Lang 1+2 Speaker System.* Flexible cabinet end panels (bass resonators) constructed of stiff laminated materials and mounted on sponge rubber surrounds are utilized to extend low-frequency response with an 8 db gain over conventional enclosures of the same size. This is achieved by utilizing the back-wave energy of the speaker itself, the net result being an over-all improvement in system efficiency while retaining the convenience of compact design. This allows for drastic reduction in size of cabinet and produces a low-cost speaker system equal in quality and tone to costlier systems.

*Specifications:* Type of enclosure *infinite baffle*; speakers—8"; power handling capacity 20 watts; type of crossover networks *none*; impedance 8 ohms; frequency response ± 8.4 db from 40 to 14,000; magnet weight: 6.8 oz.; voice coil diameter: 1"; dimensions: 18" wide, 9¾" high, 9½" deep; weight, 14 lbs.; finishes available and prices: *oiled walnut* \$44.95. Rus Lang Corp., 138 Hand Ave., Bridgeport 4, Conn.

## H. H. SCOTT

● *S-3, 3-Way Loudspeaker System.* Only 9¾" deep, it is of true bookshelf size. The S-3 consists of a 10" low-resonance high-excursion woofer, and separate wide-dispersion mid-range and tweeter units, all contained within a strikingly handsome cabinet. The 3-way crossover network blends the separate speakers into a single sound source. Testing techniques pioneered by H. H. Scott assure virtually ideal matching from speaker to speaker for exact stereo balance.

*Specifications:* Type of enclosure *bookshelf*; speakers—10" l.f., 5" m.f., 1" h.f.; power handling capacity 50 watts; type of crossover network *air coil 3-way*; impedance 16 ohms; sensitivity (watts input for +85 db level 10 feet on axis) 12 watts; dimensions: 23½" wide, 11¾" high, 9¾" deep; weight, 37 lbs.; finishes available and prices: *Un, Pine* \$119.95; *Un, hardwood* \$129.95; *walnut or mahogany* \$134.95. H. H. Scott, Inc., 111 Powdermill Road, Maynard, Mass.

1. S-2, 3-way loudspeaker system from \$179.95
2. SK-4, 3-way loudspeaker system kit, unf. pine ..... 79.95

## SHERWOOD

● *Ravinia 3-Way System.* The Ravinia 3-way speaker system is based on a rigidly constructed enclosure, fabricated of one-inch, solid-core veneered side walls and one-inch resin-filled flakeboard speaker baffle. A front-to-back reinforcement strut eliminates possibility of panel vibration. The grille panel is easily removable for grille-cloth replacement or access to speakers. All speakers are replaceable from the front, and the crossover network is accessible through speaker openings.



*Specifications:* Type of enclosure *tube port*; speakers 12" l.f., 8" m.f., 3" h.f.; power handling capacity 50 watts; type of crossover network *12-db/octave at 600 cps and 3500 cps*; impedance 16 ohms; frequency response ± 2½ db from 45 to 17,500 cps; magnet weights: l.f., 1.66 lb.; m.f., 6.8 oz.; h.f., 9.0 oz.; voice coil diameters: l.f., 1½"; m.f., 1"; h.f., 1"; other features *high-compliance woofer annulus*. Dimensions: 26½" wide, 15" high, 13¼" deep; weight, 35 lbs.; finishes available and prices: *walnut* \$139.50; *birch unf.* \$129.50; *fir*, \$119.50. Accessories *console legs* \$19.95. Sherwood Electronic Labs, 4300 N. California Ave., Chicago 18, Ill.

# VERSATILE



## A SUPERB MONO FM TUNER

FM-1 kit—\$79.95; semi-kit—\$99.95 FM-1/A factory wired—\$119.95

## A MATCHLESS STEREO TUNER

FMX-3 stereomatic multiplex integrator kit—\$29.95; semi-kit—\$39.95.  
FM-3/A factory wired stereomatic multiplex tuner—\$169.95

## A QUALITY FM RECEIVER

FMA-2 insert amplifier kit—\$29.95. FM-2/A factory wired receiver—\$169.95

# DYNATUNER

To the four Dyna attributes

**QUALITY**  
**RELIABILITY**  
**SIMPLICITY**  
**ECONOMY**

the Dynatuner adds a fifth:

**VERSATILITY**

It is the Dyna policy always to provide extras — finer performance, more conservative operation, higher quality components, easier construction, simpler operation, and greater economy. Dyna owners have come to expect these qualities in every Dynakit. They know that Dyna specifications are down-to-earth, conservative ratings, easily attained by the kit builder. They know that each new Dyna product evidences a quality of thoroughness in design and execution (we call it "distillation") not found in the most expensive and elaborate component systems.

The Dynatuner is an excellent example of the versatility of a *completely* engineered design.

Initially designed as a superior quality mono FM tuner, our designers included certain basic performance capabilities which were invaluable bases on which to build a completely automatic, self-contained multiplex integrator of matchless performance. Every Dynatuner owner can now convert his mono tuner into a STEREO MATIC multiplex Dynatuner whenever he chooses. No extra space is required, there are no new knobs to confuse you, and the cost is under \$30.

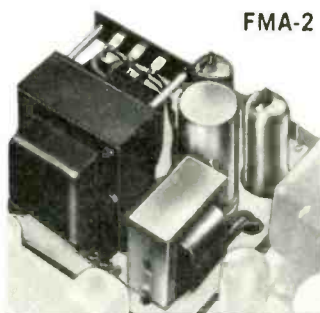

FMA-2

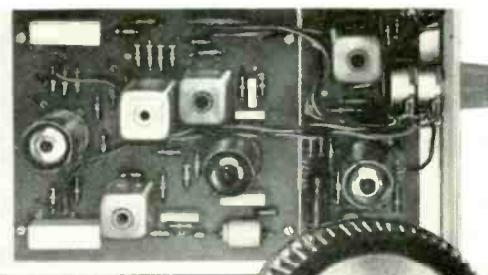

FMX-3

**STEREO**  
■■■■■■■■■■

96  
98

The FMX-3-equipped STEREO MATIC tuner requires no more effort than tuning a station. Silent, electronic switching provides either stereo or mono reception automatically, with more than 30 db stereo separation. The presence of a stereo broadcast lights the exclusive STEREOCATOR above the tuning eye. There are no problems with off-the-air recordings, mono broadcasts come through both low-impedance outputs at the same level as stereo; the volume control adjusts both channels; construction and alignment are as simple and positive as in the Dynatuner—fully equal to laboratory alignment methods; and the superior Dynatuner performance is retained in stereo.

If you don't need a stereo tuner, the extra space on the Dynatuner chassis has another \$30 option: a 10 watt insert amplifier of outstanding performance. With only a speaker you have an ideal FM companion for the bedroom, kitchen, back yard, swimming pool, Doctor's office, or for a starter components system for the college student. You've never heard 10 watts sound so good before, and this lightweight, compact, rugged unit is a natural for portable use, yet so versatile you can always use it as an independent tuner.

Don't let the modest cost and deceptively simple appearance fool you; this is professional-grade equipment in every sense, and we encourage direct comparison on any basis without reservation. In addition to easy-to-build kits, all of this equipment is also available in factory wired and tested form, and the tuner and multiplex integrator may also be obtained as time-saving semi-kits with factory-assembled etched circuit boards. In semi-kit form, only a couple of hours are needed for completion—still with significant savings.

Write for more complete information on these and other Dynakits.

**DYNACO, INC., 3912 POWELTON AVENUE, PHILADELPHIA 4, PENNSYLVANIA**  
CABLE ADDRESS DYNACO PHILA.

## TANNOY

● "GRF" Sidewall Horn-Loaded Enclosure and Speaker System. The 15" 'Monitor' Dual Concentric loudspeaker forms the heart of the system, while the 'GRF' enclosure provides a compound expanding sound source, an exclusive feature first introduced in the Auto-graph enclosure. The effect of this is that the wave-front area varies with frequency, giving an outstanding illusion of realism to both solo and orchestral music. In addition, the system has all of the well-known advantages of horn loading, e.g. excellent bass radiation and transient response, but none of the special distribution defects associated with conventional horns of multi-speaker systems.

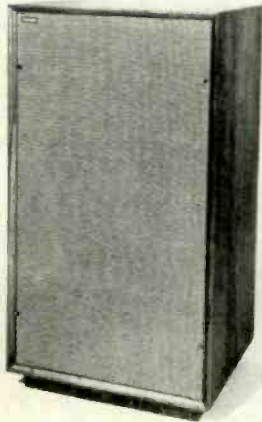

The low-frequency diaphragm of the 15" 'Monitor' Dual Concentric loudspeaker is rear horn loaded below 350 cycles, while between 350 and 1,000 cycles per second a new acoustic coupling device gives much improved front radiation. Above this frequency the non-directional horn-loaded high-frequency unit, which forms an integral part of the Dual Concentric loudspeaker, takes over, serving to preserve the impression of location so necessary to ensure realistic reproduction of vocal and solo instrumental music.

**Specifications:** Type of enclosure: horn; speakers: 15" 'Monitor' Dual Concentric; power handling capacity: 50 watts; type of crossover network: RLC crossover point 1000 cps; impedance: 16 ohms; frequency response: 30 to 20,000 cps,  $\pm 3$  db; efficiency, approx. 8%; magnet weight: 6½ lbs. (dual magnet); voice coil diameters: both 2". Dimensions: 23½" wide, 42" high, 17½" deep. Finishes available and prices: oiled walnut only, \$385.00. Tannoy (America) Ltd., P. O. Box 177 East Norwich, L. I., N. Y.

1. 'Belvedere Senior' bass reflex; finish oiled walnut \*
  2. 'Belvedere' bass reflex; finish oiled walnut \*
  3. 'Dalton' infinite baffle; finish oiled walnut \*
  4. 'Cadet' infinite baffle; finish oiled walnut \*
- \* all enclosure prices depend upon speaker installed

## UNIVERSITY

● **Classical Mark II 15" 3-Way High-Compliance Speaker System.** The Classic Mark II is the bridge between the giant mono speaker systems of yesterday and the compact bookshelf types of today. Its remarkable frequency range of from 20 to 40,000 cps is made possible by the use of University top-line components and engineering. A special, heavy duty 15" high-compliance woofer with a high energy Uniferrox-7 magnet and thick, very rigid diaphragm; a deluxe 8" high-compliance midrange with reserve excursion and power handling capacity for lowest distortion; and the famous Sphericon Super Tweeter for top end performance. All in a handsome oiled walnut cabinet compact enough to fit effortlessly into any modern environment.

**Specifications:** Type of enclosure ducted port; speakers—15" l.f., 8" m.f., ¾" h.f.; power handling capacity 10–60 watts; type of crossover network 3-way L/C network



w/balance controls; impedance 8 ohms; frequency response from 20 to 40,000 cps; voice coil diameters: l.f., 2"; m.f., 2"; h.f., ¾". Dimensions: 35" wide, 28¼" high, 17½" deep weight, 98 lbs.; finishes available and prices: oiled walnut \$295.00; University Loudspeaker, Inc., 80 South Kensington Ave., White Plains, N. Y.

1. Medallion XII, 12" 3-way system, walnut .....\$139.95

## UTAH

● **SH-4 Thin Bookshelf "Sorcerer."** A handsome, compact, good-sounding speaker system.

**Specifications:** Type of enclosure bass reflex; speakers—8" l.f., 3½" h.f.; power handling capacity 12 watts; type of crossover network capacitor; impedance 8 ohms; frequency response from 45 to 17,000 cps; magnet weights: 6.8 oz.; h.f., 1.47 oz.; voice coil diameters: l.f., 1"; h.f., 9/16"; other features walnut veneer, extremely thin, can be wall mounted. Dimensions: 20" wide, 12" high, 4 15/16" deep; finishes available and prices: walnut \$49.95. Unfinished \$46.95. Utah Electronics Corp., Huntington, Ind.

## WHARFEDALE

● **W60 Achromatic Full Range 2-Speaker System and Sand-Filled enclosure.** The original Achromatic unit. Though built to the dimensions of a "compact" system, is an integrated full-range speaker system in all respects.

**Specifications:** Type of enclosure sand filled ported duct; speakers 12½" l.f., 5" m.f. and h.f.; power handling capacity 60 peak watts; type of crossover network LC 1500 cps crossover; impedance 8 ohms; magnet weights: l.f. 152 oz.; m.f. and h.f. 20 oz.;

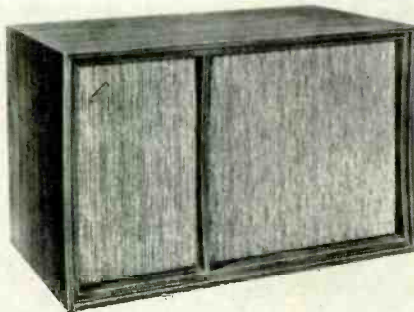

voice coil diameters: l.f. 2"; m.f. and h.f. ¾"; other features sand filled panel to eliminate cabinet resonance, wire wound "C" pad to balance high frequencies. Dimensions: 24" wide, 14¼" high, 13" deep; weight 50 lbs.; finishes available and prices: oiled and polished walnut and polished mahogany \$116.50. Polished fruitwood \$134.50. Unfinished sanded birch \$101.50. Accessories B67 Universal mounting base, finished as above \$9.95. Wharfedale Div., British Industries Corp., Port Washington, N. Y.

1. W40 Full range 2-speaker system walnut and mahogany ..... \$ 79.50
2. W40 Full range 2-speaker system, unfinished sanded birch ..... 69.50
3. W70 Full range 3-speaker system, walnut and mahogany ..... 164.50

4. W70 Full range 3-speaker system, unfinished sanded birch ..... 146.50
5. W70PR Provincial full range 3-speaker system ..... 189.50

## WILDER

● **The "Playmate" Speaker System.** The Wilder "Playmate" is a 2-way speaker system in a compact enclosure finished on all sides in furniture-grade veneers.

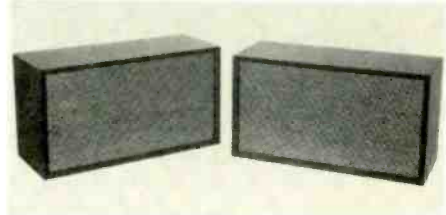

**Specifications:** Speakers—(2) 6" l.f., (1) ¾" h.f.; power handling capacity 25 watts; input impedance 8 ohms; frequency response from 40 to 18,000 cps. Dimensions: 18" wide, 10" high, 8" deep; weight, 14 lbs.; finishes available and prices: walnut \$39.75 net. Wilder Engineering, 2013 N. Halsted St., Chicago, Ill.

1. ES-81, walnut or blond .....\$79.75 net

## TAPE RECORDERS

### AMPEX

● **Tape Recorder Player, Model 1260.** A portable 4-track stereo and mono recorder player in attractive grey luggage—with record electronics and playback preamplifiers. It can be used in a fixed music system, or easily transported for on-the-spot recording or playback over one or two 2012 portable amplifier speakers. The 1260 is ideal for semi-professional recording and long-life service in education, business, theater, church or audio-visual systems.



**Specifications:** Speeds 7½, 3¾ ips; heads 2 ¼-track; records 4 track stereo, 4 track mono; plays 4 track stereo, 4 track mono (also half and full track mono); reel size 7 in.; no. of motors 1; timing accuracy ¼ of a half tone; freq. resp. 7½ ips,  $\pm 2$  db from 50 to 15,000 cps; 3¾ ips  $\pm 2$  db from 50 to 8000 cps; signal-to-noise ratio 55 db; wow and flutter, 0.2% at 7½ ips (measured by ASA standards), 0.3% at 3¾ ips (measured by ASA standards); rewind time, 1200 ft reel, 90 secs. Inputs 2 microphone, impedance 2.2 megohms, sensitivity 600 mv; 2 high level, impedance 250 k ohms, sensitivity 0.25 volts; amplifier outputs 2, type cathode follower, impedance 250 k or more ohms; Dimensions, 17½" wide, 9¼" high, 14" deep; weight, 36 lbs. Other features: 3 separate heads in metal cases, micro-milled, die cast frame, auto-set shut-off. Price \$545.00. Accessories: 2012 Amplifier-Speaker \$199.50.

1. Model 1250, unmounted tape deck .....\$499.50
2. Model 1270, portable low-level amps and speakers ..... 645.00



Swiss precision  
makes  
the  
difference



# THORENS

## MODEL TD-124 TRANSCRIPTION TURNTABLE

**CRAFTSMANSHIP** — unique in its precision — superlative in its design and style with more built in versatility, more conveniences and features than any other Turntable available today — on these the THORENS TD-124 has built its reputation.

As with the SWISS watchmakers renowned throughout the world for their precision made parts, some almost microscopic in size, all to microscopic tolerances. No one surpasses the SWISS in precision manufacturing.

No one has surpassed the precision crafted THORENS

Turntables either. A mere glance beneath the table tells you why; machined parts, precision balanced, polished to mirrorlike finishes — no mere metal stampings these! The drive system offers you the finest features of belt *plus* idler drive, *plus* a 10 pound table, machine balanced — no holes or slugs are ever used to balance this table!

We invite you to visit a franchised dealer. See the TD-124 and all the family of fine Thorens Turntables... then make a one minute comparison test with *any* other turntable (that's all you'll need) *or write us direct.*

**Guaranteed for One Full Year.**

**THORENS TD-124 — \$110 net BASES from \$10 to \$35**

THORENS DIVISION  
**ELPA MARKETING INDUSTRIES, Inc.**  
New Hyde Park, N. Y.



*In Canada: Tri-Tel Associates Ltd., Willowdale, Ont.*



**Thorens TD-121 — \$85 net**  
... an unexcelled Swiss-precision Thorens for those requiring 33 1/2 rpm only (convertible to other speeds). There's a Thorens model to fit every purse and turntable application.

## AMPLIFIER CORP.

• **Stereo-Transflyweight, Series 312-ST.** Battery operated, portable, Stereo-Transflyweight, Series 312-ST includes several models which meet NAB standards. Designed to meet need for compact, lightweight professional stereophonic recorders for unrestricted field use. Utilizes two clear channels for stereophonic recordings. Provides independent gain adjustment for each channel. Recordings may be fed into any dual-channel amplifier for stereophonic loudspeaker playback; or two channel stereo-recordings may be "non-stereo" played on any half-track recorder. Electric-motor, battery operated; operates anywhere from small dry replaceable or rechargeable batteries. Fully transistorized (20 transistors).

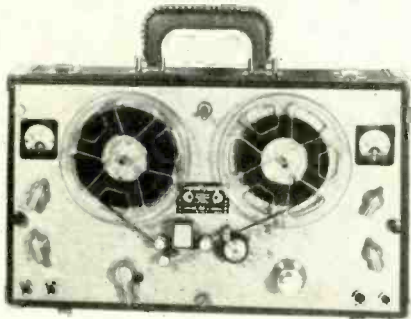

**Specifications:** Speeds 15/16, 1 7/8, 3 3/4, 7 1/2, 15 ips; heads 1 full track, 1 1/4-track; records 2 track stereo; plays 2 track stereo, reel size 5 in.; no. of motors 2; freq. resp. 7 1/2 ips  $\pm$  2 db from 50 to 10,000 cps; 3 3/4 ips,  $\pm$  2 db from 50 to 7500 cps; signal-to-noise ratio, 55 db; wow and flutter, 0.1% at 7 1/2 ips, 0.15% at 3 3/4 ips; rewind time, 900 ft. reel, 180 secs. Inputs 2 microphone. Impedance 50/200 ohms, sensitivity 4uv; amplifier outputs 1, type hi-impedance 15,000 ohms; output 2.5 volts. Dimensions, 15 1/2" wide, 5 1/2" high, 9" deep; weight, 11 1/2 lbs.

Other features: 2 built-in VU meters self contained, rechargeable batteries. Price \$624-684. Amplifier Corp. of America, 306 Broadway, New York 13, N. Y. Accessories: 110v a.c. Power Pack \$30.00

1. Transflyweight, Series 312 ..... \$438-529
2. Transmagnemite, Series 612 ..... 445-505
3. Weatherite Transmagnemite, Series 612 ..... 365-475
4. Secret Recorder, Series 212 ..... 475-535

## BELL

• **Model T-347 Stereo Tape Transport.** This new version of the popular Bell Stereo tape transport offers all the most desirable features for tape recording and playback. It mounts anywhere and plays in any position. It has an Auto-Stop mechanism for convenience, and a matching stereo preamplifier is included for professional quality playback and recording.

**Specifications:** Speeds 7 1/2, 3 3/4 ips; heads—3 1/4 track; records 1/4-track stereo, 1/2-track mono; plays 1/4-track stereo, 1/2-track mono; reel size 7 in.; no. of motors 3; timing accuracy  $\pm$  2%; freq. resp.—7 1/2 ips,  $\pm$  3 db from 18 to 16,500 cps; 3 3/4 ips,  $\pm$  3 db from 18 to 15,000 cps; signal-to-noise ratio, 50 db; wow and flutter, 0.2% at 7 1/2 ips, 0.25% at 3 3/4 ips; rewind time, 1200-ft. reel, 40 secs. Inputs—2 microphone, impedance 3 megohms, sensitivity 2.5 mv; 2 high level, impedance 100k ohms, sensitivity 0.1 volts; amplifier outputs—2, type hi-Z, impedance 20,000 ohms; dimensions: 15 1/4" wide, 7" high, 13 1/2" deep; weight, 21 lbs. Bell Sound Div., Thompson Ramo Wooldridge, Inc., 6325 Huntley Rd., Columbus, Ohio.

## CONCORD

• **Concord Model 880 Stereo Recorder.** Features four-track stereo record playback unit with three separate heads. Has three speeds and separate 7" speaker in lid for best stereo effect. Complete with 2 dynamic microphones, stands and necessary connecting cords.

**Specifications:** Speeds 1 7/8, 3 3/4, 7 1/2 ips; heads 3 1/4-track; records 1/2 track stereo, 1/4 track mono; plays 1/2 track stereo and 1/4 track mono; reel size 7 in.; no. of motors 1; timing accuracy .18%, freq. resp. 7 1/2 ips  $\pm$  2 db from 40 to 16,000 cps; 3 3/4 ips  $\pm$  2 db from 40 to 12,000 cps; signal-to-noise ratio, 60 db; wow and flutter, 0.15% at 7 1/2 ips, .23% at 3 3/4 ips; Inputs 2 microphone impedance 20 k ohms, sensitivity 3 mv; 2 high level, impedance 100 k ohms, sensitivity 3 volts; amplifier outputs 2, type hi-level impedance 2.2 k ohms; speaker outputs 2 impedance 8 ohms; output power 10 watts. Dimensions, 15 1/2" wide, 11" high, 17" deep; weight, 43 lbs. Price \$399.95. Concord Electronics Corp., 809 N. Cahuenga Blvd., Los Angeles 38, California.

1. Concord Model 220 ..... \$169.95
2. Concord Model 401 ..... 199.95
3. Concord Model 550 ..... 299.95

## CROWN

• **BX801 Full Track Record and Play.** Direct off-the-tape third head monitor. "Touch" control with all-electric relay and solenoid operation. Remote control facilities. Photo-cell automatic stop in all functions. Three motor transport, patented differential magnetic braking, hysteresis capstan motor, forced-air cooling, straight-line threading. Bias read and adjust, non-magnetic capstan. Satin anodized depth-engraved panels. All aluminum construction. Standard rack mount.

**Specifications:** Speeds 15, 7 1/2, 3 3/4 ips; heads 3 full track; records full track mono; plays full track mono; reel size 10 1/2 in., no. of motors 3; timing accuracy 99.8%; freq. resp. 7 1/2 ips, 2 db from 30 to 16,000 cps; 3 3/4 ips 3 db from 30 to 8000 cps; signal-to-noise ratio, 60 db; wow and flutter, .09% at 7 1/2 ips, .18% at 3 3/4 ips; rewind time, 1200 ft reel, 38 secs. Inputs: 1 microphone, impedance 50-250 ohms; amplifier outputs 1, type line, impedance 600 ohms. Dimensions, 19" wide 14" high 7 1/2" deep, weight 48 lbs. Other features: 1 1/2 ips available. Price, \$1035.00. Accessories: 30-watt amplifier, \$107.00. Crown International 1718 West Mishawaka Road, Elkhart, Indiana.

1. BX802, record and play half-track mono ..... \$945.00
2. BX822, 2-track stereo record and playback ..... 1395.00
3. BX824, four-track stereo record and playback ..... 1340.00

## EICO

• **RP/100 Stereo Tape Recorder Kit.** Designed for professional and home use, the EICO Model RP-100 tape deck has many features found in the most expensive models. The RP-100 includes a 14-transistor playback and record amplifier, electronic push-pull rectifier; a hysteresis-synchronous capstan drive motor, and two heavy-duty, four-pole induction motors to drive the reels. Each head is provided with a four-point professional mount, and the record and play heads have laminated mumetal pole pieces, interchannel mumetal shielding, and mumetal outer shielding. Use of separate record and playback heads and amplifiers permit, off-the-tape

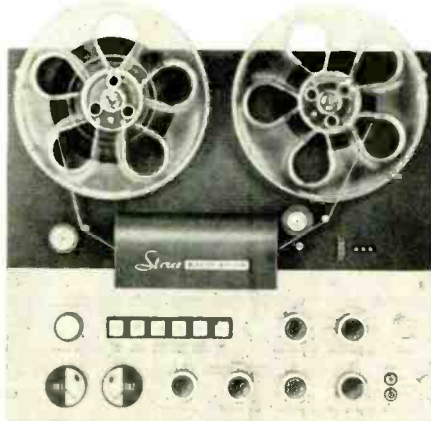

monitoring, and selected sound-on-sound operation without changing connections.

**Specifications:** Speeds 7 1/2, 3 3/4 ips; heads 3 1/4-track; records 1/4-track stereo, 1/4-track mono; plays 1/4-track stereo, 1/4 and 1/2-track mono; reel size 7 in.; no. of motors 3; timing accuracy 0.3%; freq. resp. 7 1/2 ips,  $\pm$  2 db from 30 to 15,000 cps; 3 3/4 ips  $\pm$  2 db from 30 to 10,000 cps; signal-to-noise ratio, 55 db; wow and flutter, 0.15 at 7 1/2 ips, 0.2% at 3 3/4 ips; rewind time, 1200 ft. reel, 45 secs. Inputs 2 microphone, impedance 8000 ohms sensitivity 0.5 mv; 2 high level, impedance 100 k ohms, sensitivity 0.1 volts; amplifier outputs 2, impedance 5000 ohms. Dimensions, 15 1/4" wide, 13 5/16" high, 7 1/4" deep. Other features: Studio quality hysteresis-synchronous capstan motor; completely electrical, pushbutton control of the transport using two solenoids; automatic end-of-tape stop switch; no pressure pads and sweep loading achieves extremely low-tape tension and head wear, free of tape bounce or slurring on starting; transistor record and playback electronics (independent) off-the-tape monitor panel; selected sound-on-sound. Price \$299.95 kit; \$399.95 wired; Carrying Case, \$29.95; Rack mount, \$9.95. Electronic Instrument Co., Inc., 3300 Northern Blvd., L.I.C., N. Y.

## FERROGRAPH

• **Model 424 Stereo Tape Recorder.** The 424 is an all-purpose mono and stereo recording and playback professional quality tape recorder. It has dual inputs per channel for full-depth recording. Output (each track) 1.5v rms max into not less than 100k ohms (impedance approx. 5000 ohms). Special recording-level meter.

**Specifications:** Speeds 3 3/4  $\times$  7 1/2 ips; heads 3 full track 1 1/4 track, 1 1/4 track; records 2 track stereo, 1/2 track mono; plays 1/4 or 1/2 track stereo, 1/2 or full track mono; reel size 8 1/4 in.; no. of motors 3; freq. resp. 7 1/2 ips,  $\pm$  3 db from 40 to 15,000 cps; 3 3/4 ips,  $\pm$  3 db from 40 to 10,000 cps; signal-to-noise ratio 52 db; wow and flutter, 0.2% at 7 1/2 ips; rewind time, 1200-ft reel, 40 secs. Inputs dual microphone, impedance 0.5 megohms; sensitivity 400 mv; amplifier outputs—2, impedance 5000 ohms; output power 1.5v at 5000 ohms. Dimensions: 18 1/2" wide, 9 3/4" high, 17 1/2" deep; weight 48 lbs. Other features: 3 motors, 4 preamps (2 record, 2 playback), each channel may be used separately without affecting other, automatic stop. Price, \$595.00. Ereona Corp., 16 W. 46th St., New York 36, N. Y.

1. 808 stereo, 3 3/4 and 7 1/2 ips ..... \$595.00
2. 4A/N mono record playback 3 3/4 and 7 1/2 ips ..... 399.50
3. 4A/H mono record 7 1/2 and 5 ips ..... 425.00

## HEATH

• **Model AD-22 4-Track Stereo Tape Recorder.** The new Heathkit AD-22 4-track stereo tape recorder is easy to assemble and simple to operate. It contains all the features needed for fine tape recordings and playback of stereo and mono tapes. The simplicity of the precision-machined mechanism and circuit-board construction assures fast, easy assembly and stable circuit performance. Features push-pull bias/erase oscillator, individual bias adjust and meter calibrate controls, VU-type meters, record interlock, input mixing controls.

**Specifications:** Speeds 7 1/2 and 3 3/4 ips; heads—2 1/4 track; records 1/4-track stereo, 1/2-track mono; plays 1/4-track stereo, 1/2-track mono; reel size 7 in.; no. of motors 1; freq. resp.—7 1/2 ips,  $\pm$  3 db from 40 to 15,000 cps; 3 3/4 ips,  $\pm$  3 db from 40 to 10,000 cps; signal-to-noise ratio, 45 db; wow and flutter 0.2% at 7 1/2 ips, 0.3 at 3 3/4 ips; rewind time, 1200-ft. reel, 100 secs. Inputs—2 microphone, impedance 1 meg. ohm, sensitivity 5 mv; 2 high level, impedance 250k ohms, sensitivity 160 mv; amplifier outputs—2, type cathode follower, impedance 6000 ohms; output power 1 + volt. Dimensions, 12" wide, 8" high, 15" deep; weight, 23 lbs.

Other features: Two VU-type record-playback meters, digital counter, push-pull bias/erase oscillator, circuit board const. Price, \$179.95. Heath Company, Benton Harbor, Mich.

1. AD-12, mechanism only for playback. \$124.95



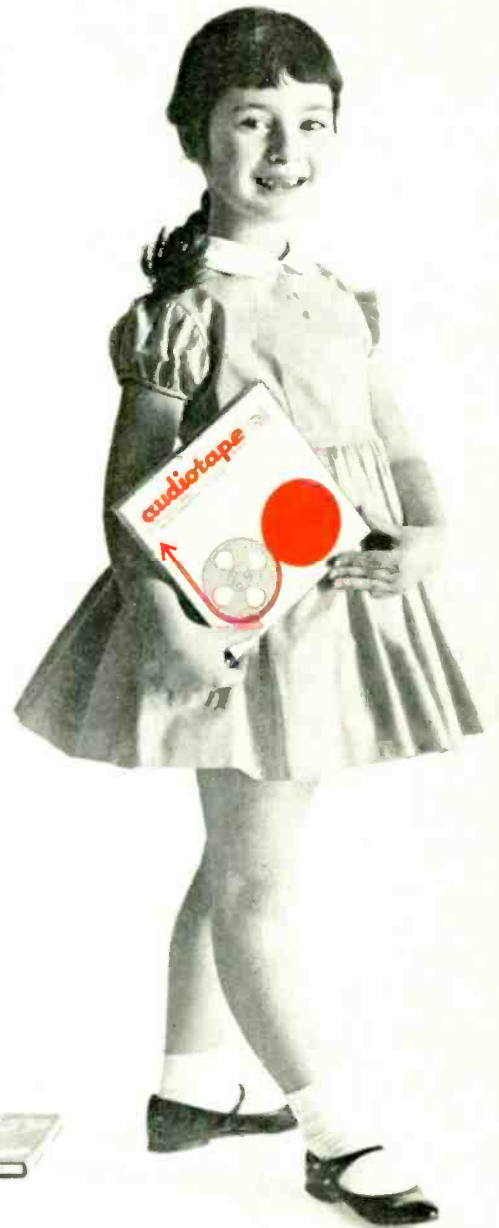

## Pardon us while we change our face

Some say that only women are privileged to change their minds, and their faces, whenever they choose. We disagree. And we have the courage of our convictions, because—from this day forward—Audiotape will be wearing a bright new face you've never seen before.

We think you'll like the new Audiotape look, not only because it's fresh, clean and attractive but because it will now be easier than ever to select the type of Audiotape you need. We've assigned a distinct, highly visible color to each of the eight types so that you can locate your favorite immediately. We've also printed a description of the contents on every package—brief, simple and in large, clear letters. (No matter which Audiotape you favor, you're getting the tape that quality made famous.)

Look for the new family of Audiotape packages. They're well worth your attention.

**audiotape**  
TRADE MARK

AUDIO DEVICES INC., 444 Madison Ave., New York  
Offices in Los Angeles, Chicago, Washington, D. C.

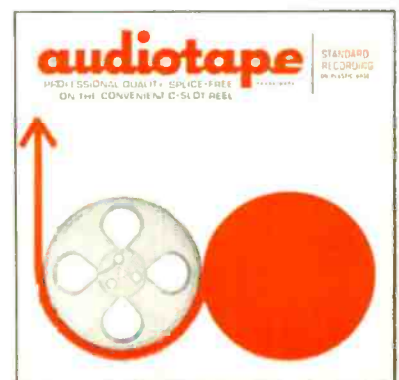

## KNIGHT

● **KN4310A Stereo Tape Recorder.** The Knight 4310A is a versatile stereo and mono tape recorder and playback system integrated into a single handsome package. Included are two 8-watt playback amplifiers and two 6-in. speakers.



**Specifications:** Speeds  $7\frac{1}{2}$ ,  $3\frac{3}{4}$ ,  $1\frac{1}{2}$  ips; heads—2  $\frac{1}{4}$  track; records  $\frac{1}{4}$ -track stereo, 2-track mono; plays  $\frac{1}{4}$  and  $\frac{1}{2}$ -track stereo,  $\frac{1}{4}$  and  $\frac{1}{2}$ -track mono; reel size 7 in.; no. of motors 1; timing accuracy  $1\frac{1}{2}\%$ ; freq. resp.— $7\frac{1}{2}$  ips,  $\pm 3$  db from 50 to 15,000 cps;  $3\frac{3}{4}$  ips,  $\pm 3\frac{1}{2}$  db from 50 to 10,000 cps; signal-to-noise ratio, 45 db; wow and flutter, 0.2% at  $7\frac{1}{2}$  ips, 0.3% at  $3\frac{3}{4}$  ips; rewind time, 1200-ft. reel, 90 secs. Inputs—2 microphones, impedance 1 meg ohm, sensitivity 1 mv; 2 high level, impedance 250,000 ohms, sensitivity 5.0 volts; amplifier outputs—2, type Hi-Z, impedance 250,000 ohms; speaker outputs 2, impedance 3.2 ohms; output power 8 watts per channel. Dimensions: 18" wide, 9 $\frac{1}{2}$ " high,  $14\frac{1}{2}$ " deep; weight, 35 lbs. Price, \$239.95. Allied Radio, 100 N. Western Ave., Chicago, Ill.

## KORTING

● **Model 158S Professional.** Hysteresis motor, electronic echo chamber and reverber effect, synchronized dubbing—sound with sound—electronic speed change. Fully self-contained stereo record and playback transistorized input stage for low noise level. Separate volume controls for recording and playback.

**Specifications:** Speeds  $7\frac{1}{2}$ ,  $3\frac{3}{4}$  ips; heads  $\frac{3}{4}$  track; records  $\frac{1}{4}$ -track stereo; plays 2 and  $\frac{1}{4}$ -track stereo,  $\frac{1}{4}$ -track mono; reel size 7 in.; no. of motors 1; freq. resp.— $7\frac{1}{2}$  ips,  $\pm 3$  db from 30 to 20,000 cps;  $3\frac{3}{4}$  ips,  $\pm 3$  db from 40 to 15,000 cps; signal-to-noise ratio, 50 db; wow and flutter, 0.2% at  $7\frac{1}{2}$  ips, 0.2% at  $3\frac{3}{4}$  ips; rewind time, 1200-ft. reel 120 secs. Inputs—2 microphone, impedance 200 ohms, sensitivity 0.07 mv; 2 high level, sensitivity 0.1 volts; amplifier outputs—2, type cath. foll.; speaker output impedance 4 ohms; output power 3.5 watts. Dimensions:  $16\frac{1}{2}$ " wide, 13" high,  $7\frac{3}{4}$ " deep; weight, 29 lbs. Other features: All connections for use as deck; automatic tape stop; digital tape counter; lock pause for cueing and editing. Price, \$369.50 with two mikes. Korting Recorder Sales Corp., 346 W. 44th St., New York, N. Y.

1. 114, prof. Deck, incl patch cords . . . \$279.50
2. 138S, self-contained stereo record and play . . . 279.50
3. 136, "Broadcaster" mono recorder . . . 219.50
4. 2243, 4-track mono record, stereo play 239.50

## LAFAYETTE

● **RK-137 2-Speed Tape Recorder.** A two-speed tape recorder which will record mono and play back stereo as well as mono. In addition it has built-in audio amplifier and



speaker so that the machine can play back what it has recorded, or prerecorded tapes. The price is surprisingly low for all of this.

**Specifications:** Speeds  $7\frac{1}{2}$ ,  $3\frac{3}{4}$  ips; heads— $\frac{1}{4}$  track; records  $\frac{1}{4}$ -track mono; plays  $\frac{1}{4}$  track stereo,  $\frac{1}{4}$ -track mono; reel size 7 in.; freq. resp.— $7\frac{1}{2}$  ips, from 40 to 15,000 cps;  $3\frac{3}{4}$  ips, from 40 to 9000 cps; signal-to-noise ratio, 42 db; wow and flutter, 0.3% at  $7\frac{1}{2}$  ips. Inputs—1 microphone; 1 high level; amplifier outputs—3; speaker outputs 1. Dimensions:  $13\frac{1}{2}$ " wide,  $6\frac{1}{2}$ " high,  $10\frac{5}{8}$ " deep; weight, 22 lbs. Other features: rugged lever shift for fast rewind, fast forward, play, and record functions. Price, \$89.50. Accessories: include mic, patch cords and carrying case. Lafayette Radio Electronics, 111 Jericho Turnpike, Syosset, L. I., N. Y.

1. RK-141, 2-speed stereo-playback tape deck . . . \$59.50

## LUXOR

● **Portable Model MP-424 Magnefon.** Now available in a completely portable vinyl-covered steel carrying case, the MP-424 offers the same high-quality performance of the earlier MP-410 which is supplied on a wooden base. All inputs and outputs are accessible at a terminal board at the front of the recorder, and both amplifier output and high-level recorder feed circuits are carried through the same plug, using four separate shielded leads. Left and right speaker outputs are accessible separately, and another pair of terminals provides left plus right for center-fill use.

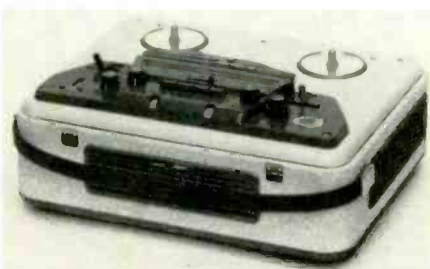

**Specifications:** Speeds  $7\frac{1}{2}$ ,  $3\frac{3}{4}$ ,  $1\frac{1}{2}$  ips; heads—2  $\frac{1}{4}$  track; records  $\frac{1}{4}$ -track stereo, 4-track mono; plays  $\frac{1}{4}$ -track stereo, 4-track mono; reel size 7 in.; no. of motors 1; freq. resp.— $7\frac{1}{2}$  ips,  $\pm 2$  db from 30 to 18,000 cps;  $3\frac{3}{4}$  ips,  $\pm 3$  db from 40 to 12,000 cps;  $1\frac{1}{2}$  ips,  $\pm 4$  db from 50 to 8000 cps; signal-to-noise ratio, 49 db; wow and flutter, 0.15% at  $7\frac{1}{2}$  ips, 0.20% at  $3\frac{3}{4}$  ips; rewind time, 1200-ft. reel, 120 secs. Inputs—2 microphone, impedance 1 megohm, sensitivity 3 mv; 2 high level, impedance 1 megohm, sensitivity 0.4 volts; amplifier outputs—2, impedance 56k ohms; speakers, 2; speaker outputs 3, (L, R, and L+R) impedance 4 ohms; output power  $2 \times 2$  watts. Dimensions,  $14\frac{3}{16}$ " wide  $11\frac{17}{16}$ " high,  $4\frac{7}{8}$ " deep; weight, 29 lbs. Other features: tone control switch, speaker switch (int, ext, both), two electron eye tubes for level indication. Price, \$319.00. AmeLux Electronics Corporation, 60 E. 42nd St., New York 17, N. Y.

1. MP410A Magnefon, walnut base . . . \$289.00
2. Magnefon deck . . . 234.00

## NEWCOMB

● **Model SM-310-4B Stereo  $\frac{1}{4}$ -Track Tape Recorder.** The  $\frac{1}{4}$ -track Model SM-310-4B as well as the earlier  $\frac{1}{2}$ -track Model SM-310, is "cybernetically engineered for intuitive operation." Control of the tape transport is centered in a "joy stick" which is sensibly moved to the left to rewind, to the right for fast forward, and toward the operator for record and play modes. Both models will operate either vertically or horizontally and take from 3" to  $10\frac{1}{2}$ " reels, as well as NAB hubs.

**Specifications:** Speeds  $3\frac{3}{4}$ ,  $7\frac{1}{2}$  ips; heads— $\frac{1}{4}$ -track; records  $\frac{1}{4}$ -track stereo,  $\frac{1}{4}$ -track mono; plays  $\frac{1}{4}$  or  $\frac{1}{2}$ -track stereo or mono; reel size  $10\frac{1}{2}$ " ; no. of motors 1; timing accuracy  $\frac{1}{2}\%$ ; freq. resp.  $7\frac{1}{2}$  ips,  $\pm 2$  db from 50 to 15,000 cps;  $3\frac{3}{4}$  ips,  $\pm 3$  db from 40 to 10,000 cps; signal-to-noise ratio, 50 db; wow and flutter, 0.2% at  $7\frac{1}{2}$  ips, 0.25% at  $3\frac{3}{4}$  ips; rewind time, 3600-ft. reel, 120 secs. In-

puts—2 microphone, impedance hi or lo by use of plug-in transformer sensitivity  $\frac{1}{2}$  mv; 2 high level, impedance 0.5 meg ohms, sensitivity 29 mv; amplifier output—2, type cathode follower. Dimensions:  $16\frac{3}{4}$ " wide,  $9\frac{1}{2}$ " high,  $12\frac{3}{4}$ " deep; weight, 34 lbs. Price, \$569.50. Newcomb Products Co., 6824 Lexington Ave., Hollywood 38, Calif.

## NORELCO

● **Continental "100" Fully Portable Tape Recorder.** Completely transistorized and battery operated, the Norelco Continental "100" is the logical extension of the Norelco Continental series of tape recorders. Because it is completely self-contained, and weighs only 8 pounds, the Continental "100" is ideal for use in on-the-spot interviews and away-from-the-office record keeping. Carefully designed, the "100" operates at such constant speed that tapes recorded on this machine can be played on any tape machine with  $1\frac{1}{4}$ -ips speed.



**Specifications:** Speeds  $1\frac{1}{4}$  ips; heads— $\frac{1}{2}$  track; records  $\frac{1}{2}$ -track mono; plays  $\frac{1}{2}$ -track mono; reel size 4" max; no. of motors 1; freq. resp.  $1\frac{1}{4}$  ips,  $\pm 3$  db from 100 to 6000 cps; signal-to-noise ratio 40 db; wow and flutter, 0.5% at  $1\frac{1}{4}$  ips; rewind time, 300-ft. reel, 100 secs. Inputs—1 microphone, impedance 500 ohms, sensitivity 0.3 mv; 1 high level, impedance 1 meg ohms, sensitivity 1 volt; amplifier outputs—1 at 1v., impedance 1000 ohms; speaker outputs 1, impedance 3 ohms; output power 250 mw. Dimensions:  $10\frac{1}{2}$ " wide,  $7\frac{1}{2}$ " high,  $3\frac{3}{4}$ " deep; weight, 8 lbs. Price, \$129.50. Accessories: carrying case \$9.95. North American Phillips Co., High Fidelity Prod. Division, 230 Duffy Ave., Hicksville, L. I., N. Y.

1. A.C. power supply, EL3766/54 . . . \$24.95

## ROBERTS

● **Model 990  $\frac{1}{4}$ -Track Stereo Tape Recorder.** A high-quality stereo tape recorder with built-in provisions for most stereo recording needs.

**Specifications:** Speeds  $3\frac{3}{4}$ ,  $7\frac{1}{2}$ , 15 ips; heads—2  $\frac{1}{4}$  track; records  $\frac{1}{4}$ -track stereo

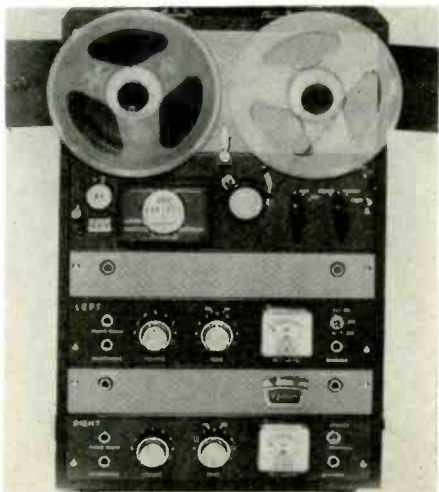

**SEE EVERYTHING IN  
STEREO HI-FI and RECORDING**  
*including Exclusive New Transistorized Equipment*

**FREE**

**SEND TODAY FOR YOUR  
MONEY-SAVING 464-PAGE**

mail  
now

**ALLIED**

**1963 CATALOG**

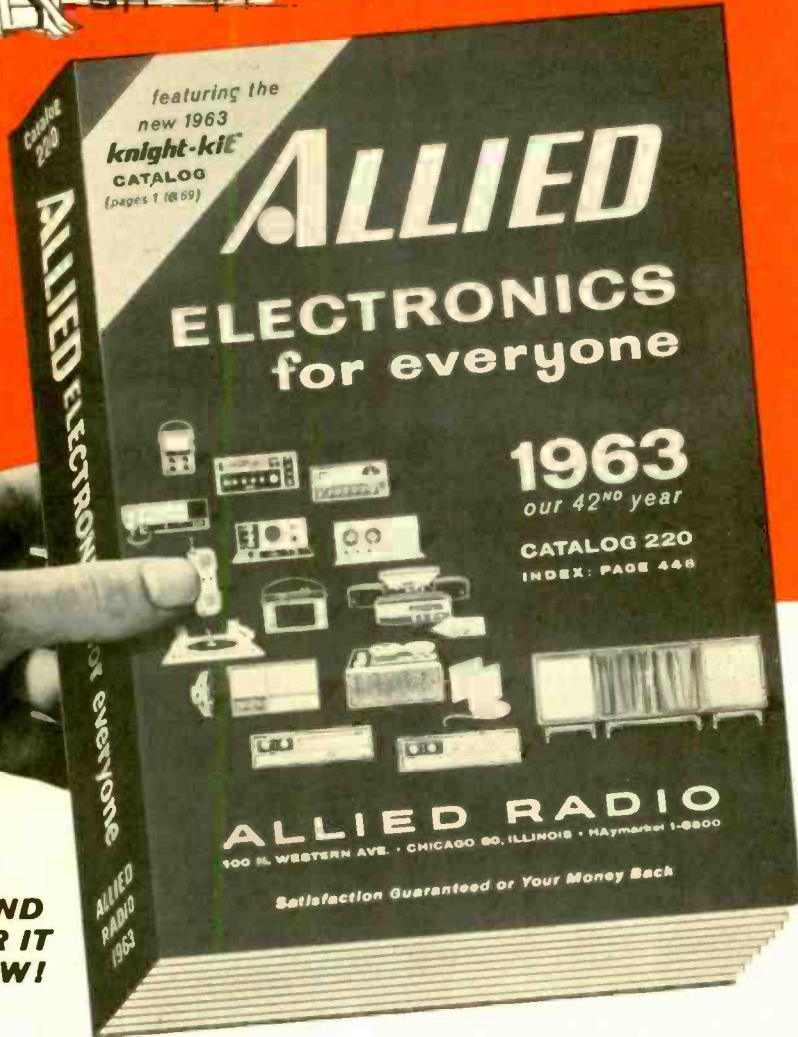

**SEND  
FOR IT  
NOW!**

**WORLD'S LARGEST HI-FI-ELECTRONICS CATALOG**  
**BIGGEST SELECTION • BIGGEST SAVINGS!**  
*satisfaction guaranteed or your money back!*

**NO MONEY DOWN:** OVER 50% MORE BUYING POWER WITH  
YOUR ALLIED CREDIT FUND PLAN

**SEE  
OTHER  
SIDE**

For your FREE 1963 ALLIED Catalog,  
fill in card, detach and mail. (Please  
give second card to an interested  
friend.)

**SEND  
CARD  
TODAY**

mail  
now

Name  
PLEASE PRINT

Address

City Zone

State

461H



**YOUR FREE  
ALLIED  
1963 CATALOG**

Name  
PLEASE PRINT

Address

City Zone

State

461H



**YOUR FREE  
ALLIED  
1963 CATALOG**

mail  
now

**FREE** SEND CARD  
FOR YOUR  
464-PAGE

# ALLIED 1963 CATALOG

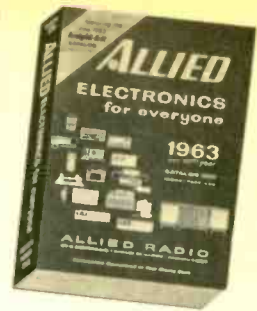

**WORLD'S LARGEST · BIGGEST SELECTIONS · BIGGEST SAVINGS!**

**NEW**

### Best Buys in Stereo Systems, Components & Records



Choose from the world's largest selection of components and complete systems. See the latest All-Transistor Stereo hi-fi and Stereo Multiplex FM. Save most on amplifiers, tuners, speakers and enclosures, record changers and players. Amazing discounts on famous-brand records. Get our unbeatable price on a hi-fi system of your own choice.

**NEW**

### Tape Recorders, Tape and Recording Accessories



Largest selection of complete recorders, including latest Stereo and professional types, tape decks, tape record/play preamplifiers and recording accessories. Unbelievable buys in quality recording tapes. Finest pre-recorded tapes at substantial savings. No greater recording values anywhere.

**NEW**

### MONEY-SAVING **Knight**® STEREO



Fastest-growing value name in hi-fi. KNIGHT components and systems are equal to the very best in quality and performance, yet they're far lower in cost, give you most for your money.

### NEWEST **Knight-Kits**®



Build your own—build the best at big savings. It's easy, it's enjoyable to assemble your own KNIGHT-KIT stereo hi-fi—and you get absolutely professional performance and appearance.

**NEW**



### More for Your Money in Beautiful HI-FI Cabinetry

Widest selection in contemporary and authentic period-styles—finest woods, construction and finish—at incomparable low cost. Includes complete equipment cabinetry, speaker enclosures of all types, special room-dividers and unique, economical shelf units.

**Save**

### Everything in Electronics for Everyone

- Transistor & FM-AM Radios • Phonographs
- Citizens Band 2-Way Radios • Amateur Equipment
- TV Tubes, Antennas, Accessories • Tools & Hdwe.
- Test & Lab Instruments • PA Systems & Intercoms
- Parts, Tubes, Transistors, Books

**NO MONEY DOWN:**  
Over 50% More Buying Power with Allied's Credit Fund Plan—Up to 24 Months to Pay!

*satisfaction guaranteed or your money back!*

**FREE** MAIL CARD TODAY FOR YOUR  
COPY OF THE 1963 ALLIED CATALOG  
AND GIVE THIS CARD TO A FRIEND

mail  
now

TO:

**ALLIED RADIO**  
100 N. WESTERN AVE.  
CHICAGO 80, ILL.

PLACE  
STAMP  
HERE

TO:

**ALLIED RADIO**  
100 N. WESTERN AVE.  
CHICAGO 80, ILL.

PLACE  
STAMP  
HERE

¼-track mono; plays ¼-track stereo, ¼-track mono; reel size 7 in.; no. of motors 1; timing accuracy 0.2%; freq. resp.—7½ ips, ±2 db from 40 to 15k cps; 3¾ ips, ±3 db from 40 to 12k cps; wow and flutter, 0.12% at 7½ ips, 0.2% at 3¾ ips; rewind time, 1200-ft. reel, 90 secs. Inputs—2 microphone, impedance 500k ohms, sensitivity 1.2 mv; 2 high level, impedance 1 meg ohm, sensitivity 0.120 volts; amplifier outputs—2, type cathode follower, impedance 10k ohms; speaker outputs 2, impedance 8 ohms; output power 6 watts. Dimensions, 14" wide, 21" high, 9¼" deep; weight, 47 lbs. Price, \$399.50 Roberts Electronics, Inc., 829 N. Highland Ave., Los Angeles, Calif.

## SCULLY

● **Model 270 Long-Play Professional Tape Reproducer.** A professional machine for use with well-known Scully record-cutting lathe. **Specifications:** Speeds 3¾-7½ or 7½-15 ips; plays ½ or ¼-track stereo, ½ or full-track mono; reel size 1¼ in.; no. of motors 3; timing accuracy 99.8%; freq. resp.—7½ ips ±1½ db from 50 to 15,000 cps; signal-to-noise ratio, 60 db; wow and flutter, 0.1% at 7½ ips, 0.2% at 3¾ ips; rewind time, 4800-ft. reel, 105 secs. amplifier outputs—type solid-state plug-in, impedance 600 ohms; dimensions: 19" wide, 24" high, 8¾" deep; weight, 79 lbs. Other features: disc brakes, 5-year amplifier guarantee. 1 year unit guarantee mono. Price, \$1395.00 mono; \$1530.00 stereo. Scully Recording Inst. Co., 280 Bunnell St., Bridgeport, Conn.

## SONY

● **Model 777 Stereorecorder (777 S-2 & 777 S-4).** The 777 S-2 is a 2-track stereo/mono recorder with 2 and 4-track playback; the 777 S-4 is a 4-track stereo-mono recorder with 2 and 4-track playback. An advanced achievement in recorded engineering, the new all-transistorized professional Sony 777 Stereorecorder series features the exclusive and patented Sony Electro Bi-Lateral 2- and 4-track playback head permitting the playback of 2-track and 4-track stereo or monophonic tapes without track-width compromise—through the same head. Other features include individual erase/record/playback heads, professional 3" VU meters, automatic shut-off, an all-solenoid feather-touch-operated mechanism, electrical speed change, hysteresis-synchronous drive motor and two high torque spooling motors.

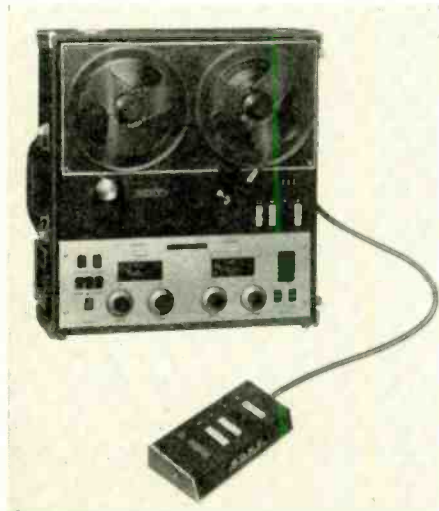

**Specifications:** Speeds 7½ and 3¾ ips; heads—1 ½ track, 1 ¼ track; records 2- or 4-track stereo, 2 or 4-track mono; plays 2 and 4-track stereo, 2 and 4-track mono; reel size 7 in.; no. of motors 3; freq. resp.—7½ ips, ±2 db from 40 to 15,000 cps; 3¾ ips, ±2 db from 40 to 8000 cps; signal-to-noise ratio, 50 db; wow and flutter, 0.15% at 7½ ips, 0.2% at 3¾ ips; rewind time, 1200-ft. reel, 60 secs. Inputs—2 microphone, impedance 250 ohms balanced, sensitivity -60 db; -10 db high level, impedance 100 ohms; amplifier outputs—2, type preamp, impedance 600 and hi-Z; dimensions: 16" wide, 17¾" high, 9"

deep; weight, 43 lbs. Other features: Includes remote control; all-transistorized electronics. Price, \$595.00. Accessories: AS-777-10 watt speaker/amplifier combination \$175.00 each. Superscope Inc., 8150 Vineland Ave., Sun Valley, Calif.

## TANDBERG

● **Model 6-44 3-Speed 4-Track Stereo Record-Playback Deck.** The Model 6-44 features a hysteresis-synchronous motor drive, micro-switch, automatic cut-off, easy tape threading position, superb recording and playback frequency response at all three speeds; separate FM-multiplex input to eliminate any beep tones. It is pushbutton operated, with built-in solenoid for remote control. Furnished in an attractive teak cabinet.

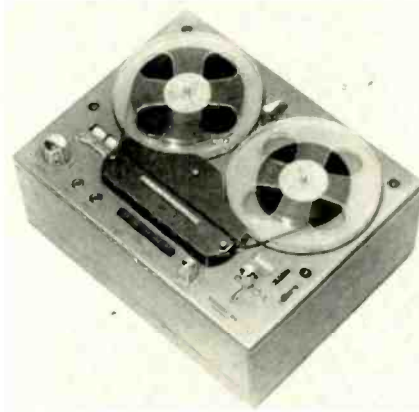

**Specifications:** Speeds 1½, 3¾, 7½ ips; heads—3 ¼-track; records 4-track stereo, 4-track mono; plays 2 and 4-track stereo, 2 and 4-track mono; reel size 7 in.; no. of motors 1; timing accuracy ±1%; freq. resp.—7½ ips, ±2 db from 30 to 16,000 cps; 3¾ ips, ±2 db from 40 to 11,000 cps; signal-to-noise ratio, 55 db; wow and flutter, 0.1% at 7½ ips, 0.15% at 3¾ ips; rewind time, 1200-ft. reel, 60 secs. Inputs—2 microphone, impedance 10,000 ohms, sensitivity 5 mv; high level impedance 10,000 ohms, sensitivity 0.05 volts; amplifier outputs—1.5v; speaker outputs 2. Dimensions: 12" wide, 6" high, 16" deep; weight, 25 lbs. Price, \$498.00. Accessories: TO56 carrying case, \$24.50, DP411 dynamic mic, \$49.50. Tandberg of America, Inc., 8 Third Ave., Pelham, N. Y.

1. Model 8 series, 2-speed mono \$219.50-287.50
2. Model 7 series, 3-speed stereo

## UHER

● **Model "4000 Report" Portable Tape Recorder.** The Uher "4000 Report" combines the recording quality of fine a.c.-powered recorders with the compactness and portability of battery-operated equipment. It works anywhere and in any position. Its all-metal housing contains a novel drive system and advanced electronics. Its four constant tape speeds offer choices ranging from maximum tonal fidelity to maximum recording time. Use the "4000 Report" for exceptionally fine recordings of live music or record up to 8½ hours on a 5" reel at the super slow speed of 15/16 ips.

**Specifications:** Speeds 7½, 3¾, 1½, 15/16 ips; heads—2 ½-track; records ½-track mono; plays ½-track mono; reel size 5 in.; no. of motors 1; timing accuracy 99.8%; freq. resp.—7½ ips, ±2 db from 50 to 22,000 cps; 3¾ ips, ±2 db from 50 to 18,000 cps; signal-to-noise ratio, 50 db; wow and flutter, 0.15% at 7½ ips, 0.2% at 3¾ ips. Inputs—1 microphone, impedance 1k ohms, sensitivity 0.1 mv; amplifier outputs—2, impedance 15k ohms; speaker outputs 1, impedance 4 ohms; output power 1 watt. Dimensions: 10½" wide, 3¾" high, 8½" deep; weight, 7 lbs. Martel Electronics, 7400 Melrose Ave., Los Angeles 46, Calif.

## VEGA

● **Model V-30 Transistorized Professional Magneto Tape Recorder-Reproducer.** Completely transistorized, with the solid-state

electronics on easily removable plug-in cards. Constant-tape-tension system allows use of thin-base, double-length tapes, without tape deformation. Start-stop action so fast it can cleanly split syllables. Wow and flutter exceptionally low (see specs).

Pushbutton, relay, and solenoid operation (actuate button is illuminated). Top-loading heads with wide access for cleaning, editing. Simplified servicing and interchangeability of many parts to minimize spare parts inventory. Small physical size. Rack mounting style or in portable case.

**Specifications:** Speeds, 7½ and 3¾ ips (other 2:1 ratio speed combinations on special order); heads: three 2-track heads; reel size: 8 in.; no. of motors: 3; tape speed accuracy: 0.03-0.6%; freq. resp.: 7½ ips, ±2 db from 50 to 18,000 cps; 3¾ ips, ±2 db from 65 to 10,000 cps; signal-to-noise ratio, 55 db; wow and flutter 0.09% rms at 7½ ips, 0.12% rms at 3¾ ips; rewind time, 1200 ft. reel 40 secs. Inputs: High-Z dynamic, or crystal microphone (50/250 ohm microphone with plug-in xmf. access.), bal./unbal. line bridge (100 k), -10 db, min. Outputs: Bal./unbal. 600 ohm, ±4 db, monitor jacks (for crystal phones). Dimensions (in case), 20" wide, 15" high, 14" deep; weight, 61 lbs. Price: \$1675 without case, \$1718 with case. Vega Electronics Corp., 1078 N. Highway, Cupertino, Calif.

## VIKING

● **86 Stereo-Compact.** Available with several head configurations, the Model RMQ is the quarter-track version containing 3 separate heads: one each for recording, playback, and erase. The deck is essentially the well-known Viking 85 with new electronics, functions, and heads.

**Specifications:** Speeds: 3¾, 7½ ips; heads—3¼ track; records ¼-track stereo, ¼-track mono; plays ¼ or ½-track stereo, ¼ or ½-track mono; reel size 7 in.; no. of motors 1; timing accuracy 0.5%; freq. resp.—7½ ips,

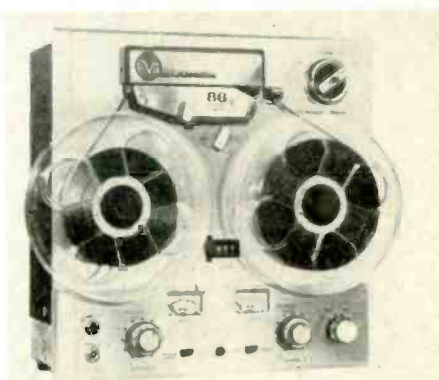

±3 db from 25 to 18,000 cps; 3¾ ips, ±3 db from 25 to 12,000 cps; signal-to-noise ratio, 55 db; wow and flutter, 0.2% at 7½ ips; rewind time, 1200-ft. reel, 90 secs. Inputs—2 microphone, impedance 1 meg. ohm, sensitivity 1 mv; 2 high level, impedance 180k ohms, sensitivity 0.1 volts; amplifier outputs—2, 1 volt, impedance 45k ohms; monitor outputs 2, impedance 4500 ohms. Dimensions: 13" wide, 13" high, 6¼" deep; weight, 22 lbs. Price, \$299.50. Viking of Minneapolis, 9600 Aldrich Ave., So. Minneapolis, Minn.

1. 76 compact, ¼-track rec and play . . . \$199.50
2. 76 deck, model HQ . . . 114.00
3. 86 super Pro RMQ . . . 394.00
4. 86 deck, model RMQ . . . 179.50

## MICROPHONES

### AKG

● **C-60 Miniature Transistorized Condenser Microphone System.** A professional condenser microphone system in an extremely small package.

**Specifications:** Type condenser; dir. pattern cardioid omni; diaphragm material Mylar and Gold; case anodized metal; finish satin; output impedance 50/200/500 ohms; freq. resp.  $\pm 2.5$  db from 30 to 20,000 cps; sensitivity 1.3 mv/microbar; cable connection Preh; length of cable furnished 15 ft.; type of plug Customer; dimensions micr.  $\frac{5}{8}$ " dia. by  $\frac{1}{4}$ ", power unit  $\frac{1}{4}$ " x  $3$ " x  $2$ "; weight micr. 2 oz.—power unit, 1 lb; type of mounting socket/suspension/gooseneck option; other features: studio quality in a portable condenser mike system featuring rechargeable cells. Price \$259.50. Accessories: a.c. power supply, fishpole, windscreen. Electronic Applications, 94 Richmond Hill Ave., Stamford, Conn.

1. AKG D-19U, dynamic cardioid multi-Z outputs ..... \$ 58.00
2. AKG D-24B, dynamic professional cardioid, 60 or 200 ohms ..... 165.00
3. AKG D-58, dynamic differential close talk, 290 ohms ..... 42.00
4. AKG Dyn 200, studio dynamic omni 60 and 200 ohms ..... 110.00
5. AKG C-12A professional condenser, remote switching 50 or 200 ohms ... 585.00

## ALTEC

● **Polyester Film Microphone.** One of a new line of modestly priced professional-quality microphones, the Altec model 683A features a polyester film diaphragm and a sintered bronze filter. The use of polyester film as the diaphragm material, instead of aluminum, greatly increases the ruggedness of the diaphragm

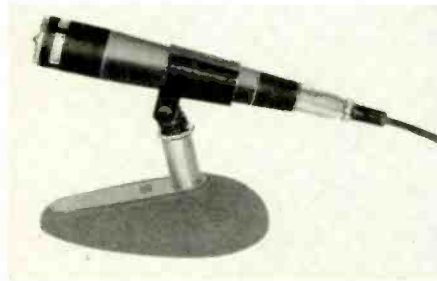

thus taking it out of the delicate, easily damaged category. The sintered bronze filter placed in front of the diaphragm protects it from foreign particles such as ferrous filings, dust, and water.

**Specifications:** Type dynamic; dir. pattern cardioid; diaphragm material polyester film; case metal; finish various; output impedance 30/50, 150/250, 20k ohms; freq. resp. from 45 to 15,000 cps; length of cable furnished 15 ft.; weight 11 oz.; type of mounting  $\frac{5}{8}$ "-27 thread mic stand. Price, \$72.00 Altec Lansing Corp., 1515 S. Manchester Ave., Anaheim, Calif.

## AMERICAN

● **Model D76 Cardioid Dynamic Microphone.** The new D76, with improved Mylar diaphragm, is a professional high-quality version of the D55. Each microphone is a custom job tailored to your response requirements, and assembled in our engineering Lab from start to finish. Finest workmanship and the most careful attention to detail are guaranteed.



**Specifications:** Type, dynamic; dir. pattern cardioid; diaphragm material, Mylar; finish, satin black or Roman gold; freq. resp. from 40 to 18,000 cps; sensitivity, -60 db re 1

mv/10 dynes/cm<sup>2</sup> (50 ohms); length of cable furnished 25 ft.; dimensions: 7 $\frac{1}{2}$ " long, 1 $\frac{3}{8}$ " dia.; weight 11 oz.; available in any required impedance. Price, \$195.00; with on/off switch, \$199.75. American Microphone Mfg. Co., Gallon, Ohio.

1. D55 cardioid dynamic, lo, med, hi-Z. \$ 89.50
2. D22 omnidirectional dynamic, lo, med, hi-Z ..... 99.50
3. D33 dynamic, 50 or 250 ohms Z ... 130.00

## BEYER

● **M-160 Double-ribbon Cardioid Microphone.** This unit is the smallest ribbon microphone of broadcast quality that has been marketed in some time. It is highly cardioid patterned as a result of construction featuring two ribbons, one behind the other.

**Specifications:** Type ribbon dynamic; dir. pattern cardioid; diaphragm material aluminum; case brass; finish sanded chrome; output impedance 50/200 ohms; freq. resp.  $\pm 3$  db from 50 to 20,000 cps; sensitivity .07 mv/bar; cable connection 6-pole Tuchel male; length of cable furnished 15 ft.; type of plug mating for above, tinned other end; dimensions 1.5" x 6"; weight 5.5 ozs; type of mounting swivel stand coupling; other features: jewelers' case. Price, \$195.00. Gotham Audio Corp., 2 West 46th St., New York, N.Y.

1. M-130 Ribbon—same as above but figure 8 pattern ..... \$165.00
2. M-100 Dynamic—Similar to above but omni-directional ..... 165.00

## CAPPS

● **Capps Condenser Microphone CM 2001.** A professional microphone for use in recording applications.

**Specifications:** Type condenser; dir. pattern omni-directional diaphragm material titanium; case aluminum; finish black; output impedance high; freq. resp. 3 db from 20 to 15,000 cps; sensitivity .55 mv/bar; cable connection Amphenol 79-08M; length of cable furnished 20 ft.; weight 8 oz. Price \$190.00. Capps Co., 20 Addison Place, Valley Stream, N. Y.

## DYNACO

● **B&O 200 Stereo Microphone.** Dual ribbon professional-quality mike which features quick conversion to mono microphone by unplugging the top ribbon housing. Features the ideal stereo point pickup which is necessary for compatible mono-stereo multiplex broadcasts. Included are a phasing switch for the two ribbons, and a Talk-Music-off switch. (Talk is for a rolled off low end for close mike speech.)

**Specifications:** Type ribbon; dir. pattern figure 8; diaphragm material aluminum; case steel; finish aluminum; output impedance 200 ohms; freq. resp. 2 db from 30 to 15,000 cps; sensitivity GM-156 db; cable connection 5-pin single connection supplied length of cable furnished 20 ft.; type of plug open end; dimensions—10 $\frac{1}{2}$ " x 1 $\frac{13}{16}$ "; weight 1 lb; type of mounting std.  $\frac{5}{8}$ " x 27 thread in quick-disconnect clip; other features: adjustable separation by rotation of the top ribbon with respect to the bottom ribbon. Price \$149.95 Accessories MT-2 dual 200 or HI-Z transformer \$24.95. Dynaco Inc., 3912 Powelton Ave., Philadelphia, Pa.

1. BGO 50, mono ribbon mike 50 ohm impedance ..... \$ 49.95
2. BGO 53, mono ribbon mike 50/250/Hi-Z ..... 59.95
3. SS-1, stereo spacer for 2 BGO mono mikes ..... 14.95

## ELECTRO-VOICE

● **Electro-Voice Model 633 General Purpose Omnidirectional Microphone.** Modern two-tone design dynamic microphone. High output level, wide-range response. For public address, home recording, communications, electronic teaching aids, paging systems. Integral on-off switch.

**Specifications:** Type dynamic; dir. pattern omnidirectional; die cast zinc case; finish chrome plate; output impedance hi-z or bal 150 ohms; freq. resp. from 70 to 10,000 cps; Sensitivity -57 db; length of cable furnished 6 ft.; weight 1 lb.; type of mounting  $\frac{5}{8}$ "-27

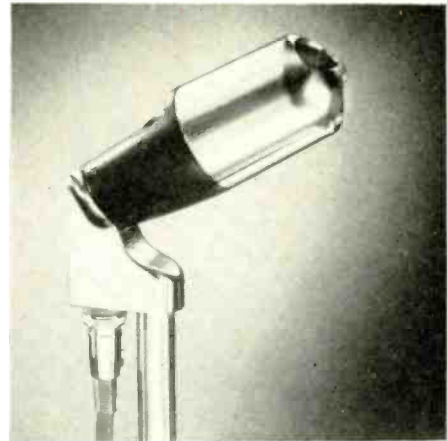

stand connector. Price, \$35.00. Electro-Voice, Inc., Buchanan, Michigan.

1. 634, omni dynamic ..... \$31.50
2. 636, omni dynamic ..... 72.50
3. 647A, lavalier moni dynamic ..... 82.50
4. 630, high output omni dynamic ..... 52.50
5. 615, home recording omni dynamic . 25.50

## LAFAYETTE

● **PA-263 Dynamic Stereo Microphone.** Featuring two microphone elements in a single case, with their axes at right angles to each other, the PA-263 will record excellent stereo even for the non-professional. Because of the disposition of the elements, just the right amount of reverberation will be recorded.

**Specifications:** Type stereo dynamic; dir. pattern (2) omni, 90° apart; case metal; finish satin chrome; output impedance 50 k ohms; freq. resp. from 50 to 15,000 cps; weight 6 lbs; type of mounting gland type swivel joint; other features: switch for either mono or stereo operation. Price, \$17.95. Lafayette Radio Electronics, 111 Jericho Turnpike, Syosset, L. I., N. Y.

1. PA-49, studio dynamic ..... \$11.95
2. PA-29, slim dynamic ..... 9.95
3. PA-46, dual impedance slim dynamic . 11.95

## NEUMANN

● **Model U-67 Condenser Microphone.** This newest in the line of Neumann Condenser Studio Microphones was especially designed to be a studio recording microphone adaptable to numerous different situations and, particularly, close microphone pickups. Its Voice-Music switch and overload protection switch make it ideally suitable to multiple mike techniques. It uses an EF-86 tube readily replaced by the user. The Model M-269 is identical to the U-67 except that it offers the possibility of remote controlling any of the three main patterns and an infinite resolution between patterns.

**Specifications:** Type condenser; dir. pattern omni, cardioid, figure-8, diaphragm material Mylar; case brass; finish sanded chrome; output impedance 50/200 ohms; freq. resp.  $\pm 2$  db from 8 to 20,000 cps; sensitivity 2.2 mv/bar; cable connection 7-pole male Tuchel; length of cable furnished 25 ft.; type of plug Cannon XLR 3-32 on output of NU-67 Power Supply; dimensions 7 $\frac{7}{8}$ " x 2 $\frac{1}{4}$ "; weight 1 lb; type of mounting swivel stand or elastic suspension; other features: Voice-Music switch; Overload Protection switch. Price, \$435.00. Accessories: Full Elastic Suspension Z-48, \$32.50, Wind and Close Talking Guard Z-67, \$32.50. Gotham Audio Corp., 2 West 46th St., New York 36, N.Y.

1. M-269, condenser mic ..... \$495.00
2. SM-2, double-stereo M-S mic, remote controlled ..... 795.00
3. KM-56, miniature, 3-pattern condenser mic ..... 435.00
4. KM-54a, miniature, cardioid condenser mic ..... 435.00
5. M-49b, remote-controlled pattern studio mic ..... 495.00

(Continued on page 92)



**GOOD HEADS  
PREFER  
TARZIAN TAPE**

ITEM	Reel Size	Length (Feet)	Code Number	Approximate Recording Time		
				1 1/2 I.P.S.	3 3/4 I.P.S.	7 1/2 I.P.S.
Standard Play 1.5 Mil Acetate Tape	3"	150	1131-01	30 mins.	15 mins.	7 1/2 mins.
	5"	600	1131-06	2 hrs.	1 hr.	30 mins.
	7"	1200	1131-12	4 hrs.	2 hrs.	1 hr.
	Reel Hub	2400	1131-24R	8 hrs.	4 hrs.	2 hrs.
	Hub	2400	1131-24H	8 hrs.	4 hrs.	2 hrs.
Long Play 1.0 Mil Acetate Tape	3"	225	1121-02	48 mins.	24 mins.	12 mins.
	5"	900	1121-09	3 hrs.	1 1/2 hrs.	45 mins.
	7"	1800	1121-18	6 hrs.	3 hrs.	1 1/2 hrs.
	Reel Hub	3600	1121-36R	12 hrs.	6 hrs.	3 hrs.
	Hub	3600	1121-36H	12 hrs.	6 hrs.	3 hrs.
Long Play 1.0 Mil Mylar Tape	3"	225	1321-02	48 mins.	24 mins.	12 mins.
	5"	900	1321-09	3 hrs.	1 1/2 hrs.	45 mins.
	7"	1800	1321-18	6 hrs.	3 hrs.	1 1/2 hrs.
	Reel Hub	3600	1321-36R	12 hrs.	6 hrs.	3 hrs.
	Hub	3600	1321-36H	12 hrs.	6 hrs.	3 hrs.
Empty Reels and Boxes	3"			NOTE: These figures are for monaural 2-track, and stereophonic 4-track recording. Divide by 1/2 to find recording time for single-track monaural and two-track stereophonic systems. I.P.S. indicates speed of tape past recording head in inches per second.		
	5"					
	7"					
Premium Package			1131-12RM6			

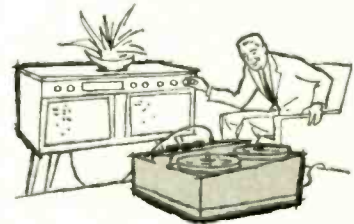
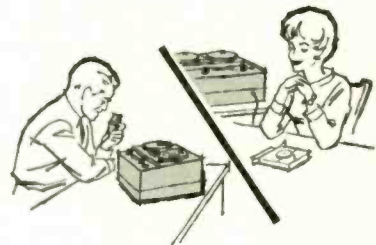

**Engineered for Highest Fidelity**

Sarkes Tarzian, Inc., a leading manufacturer in the electronics and communications industry, guarantees that every reel of Tarzian Tape is manufactured to identical professional quality standards. Three types of Tarzian Tape satisfy virtually every recording requirement: Standard Play 1.5 mil acetate, Long Play 1.0 mil acetate, and Long Play 1.0 mil Mylar\*. The 1 mil tapes give 50% more recording time on the same size reel.

**Try a Reel Today**

Let your own ears prove the sound reproduction superiority of Tarzian Tape over any other brand—of lower, equal, or higher price. Discover for yourself that, while Tarzian Tape's price is competitive, its quality is unchallenged. Write for your free copy of Sarkes Tarzian's 16-page booklet, "The Care and Feeding of Tape Recorders"—a handy guide to increased benefit and enjoyment from your tape equipment.

**Typical Tape Applications ...  
Have You Tried Them?**

- Recording TV, AM and FM radio programs
- Taping valuable records, both old 78's and newer 45's and 33 1/2's to preserve record quality
- Recording family events, such as weddings, birthdays, reunions, children's activities
- Taped letters—to family, friends, business and club acquaintances
- Practicing speeches, language, shorthand, music, many other learning activities
- Recording "live" concerts, lectures, party activities, theatrical events, special sound effects
- Adding sound to home movies and slide programs



\*DuPont trademark for its polyester film



**SARKES TARZIAN, Inc.**

World's Leading Manufacturers of TV and FM Tuners • Closed Circuit TV Systems • Broadcast Equipment • Air Trimmers • FM Radios • Magnetic Recording Tape • Semiconductor Devices  
**MAGNETIC TAPE DIVISION • BLOOMINGTON, INDIANA**  
 Export: Ad Auriema, Inc., N. Y. • In Canada, Cross Canada Electronics, Waterloo, Ont.

# RECORD REVUE

Edward Tatnall Canby \*

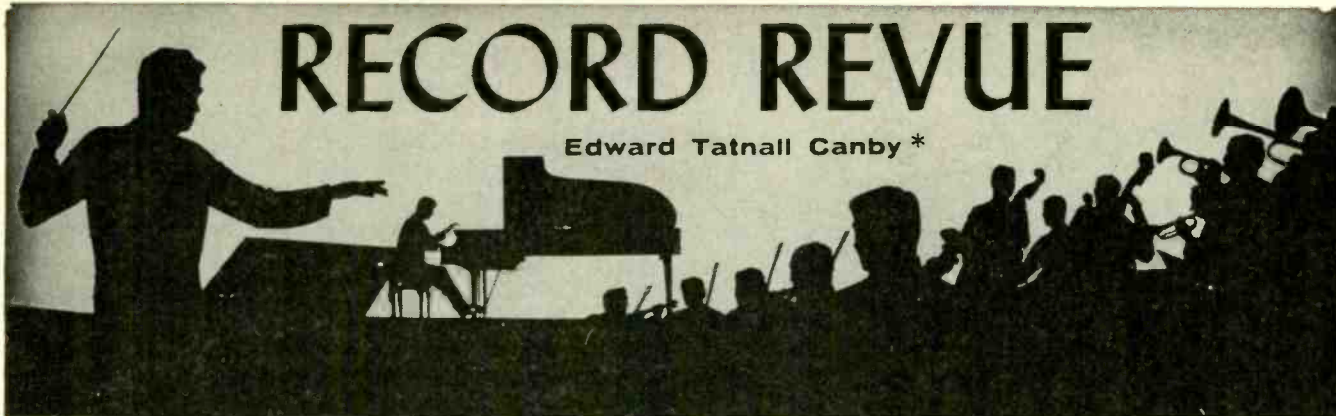

**Berlioz: Symphonie Fantastique.** Orch des Concerts Lamoureux, Markevitch. Deutsche Gramm. 138712 stereo

Of all the recent versions of this French war horse, this is surely the outstanding recording. For my taste, and for my hi-fi ear too, no other approaches it. Where so many performers are somehow perfunctory—the same old music, so tired and outdated—this one is alive like a first performance. (Well, maybe a tenth performance; the first is usually pretty bad!) And the recording is as startling in its realness as the performance.

Markevitch, though Russian born, was educated in Paris, another of the many students of the famed Nadia Boulanger, and thus has a thoroughly French background, heightened—as with so many of the Franco-Russians—by his Russian-style fire of temperament. He was one of the last protégés of the great Diaghilev of ballet fame, following upon such as Stravinsky.

## STRAVINSKY IS EIGHTY

**Stravinsky: Dumbarton Oaks; Danses Concertantes; Concerto in D for Strings.** English Chamber Orch., Davis.

L'Oiseau-Lyre SOL 60050 stereo

**Stravinsky: Concerto for Strings in D; Concerto in E Flat "Dumbarton Oaks".**

**Bartok: Divertimento for Strings.** Zurich Chamber Orch., de Stoutz.

Vanguard VSD 2112 stereo

I'm glad Stravinsky is eighty. His anniversary has started a flood of earlier Stravinsky on its way back where it ought to be, and in particular the mass of "middle period" Stravinsky that for so many years was thought of as the ultimate in dry, tasteless modernity by people who loved the "Fire Bird" music and maybe "Petrouchka."

Here are two excellent recordings of two such works and one of a third, with a complementary Bartok thrown in. I use to know these pieces after a fashion; I heard "Dumbarton Oaks" performed in 1942, only four years after its composition—and the place was Dumbarton Oaks in Washington, where it had first been heard. Gorgeous spot, the concert outdoors amid gardens and trees. The other works, too, I knew and I felt that maybe someday I'd understand them.

Now—I find them absolutely lovely, and wonderfully nostalgic, for times gone by! Music has moved so far, so fast, since then. Tape music. Serial music, Zen, set for pianos with broken bottles, hammers, pieces of colored string. Geometrical, mathematical computer music. The latest Stravinsky—which now borrows from them all. Phew!

The mid-period Stravinsky, you see, had lost the brittle, self-conscious show-off sound of the noisy Twenties, softened down the raucousness, tempered the brass and even the piano to quieter tones—yet the new, jazzy tempo is wholly of the time, seemingly full of indignity yet—as we now can hear—actually of great dignity and expressiveness.

Can you hear this? I think so, for two

reasons. First is that, today, the performances themselves are easy-going, familiar, intelligible. The musicians "speak the language" and can communicate it to you. Secondly, we—all of us—have moved ahead. Our ears are automatically conditioned to hear this music as already "old". It is a style that is absolutely gone forever now. And it should bring back its own period to all who are old enough to have lived then. Youngsters will enjoy it, of course, with fresh ears that hear it as really antique! Say, like Rachmaninoff or Tchaikowsky when we were young.

These two recordings? Both excellent. The Zurich group is more intimate, the sound less expansive but the music played with a fine smoothness and accuracy. The British group sounds bigger, is somewhat more flamboyant. You could almost choose by the differing contents—Bartok or more Stravinsky.

**Stravinsky: Concerto for Two Solo Pianos (1935); Sonata for Two Pianos (1944/5); Eight Easy Pieces (1915).** Gold and Fiddale. Columbia MS 6333 stereo

Here is Stravinsky for four hands—on one piano for the eight snazzy little pieces from the 'teens, on two grandis for the more pretentious and longer big works.

The Concerto, like Bach's "Italian Concerto" for harpsichord solo, achieves the sound and dimension of an orchestral work within the framework of four-hand piano tone. The Sonata is a more intimate work, not at all orchestral. An interesting study in careful styling, these pieces.

Middle-period Stravinsky on the piano at first sounds harsher than similar music for orchestra, and these pianists are not of the Romantic sort either. It seems to me that they exaggerate the percussive, steely qualities in the music, miss some of its really lyric, contemplative effects. They are of the hard-touch school of their pianistic generation (now replaced by "soft" and Romantic playing among the young) and so we should take this in our stride—for they do a technically expert job except for a few nervous places in the tougher fast parts.

You'll find the eight "Easy Pieces," at one piano, absolutely delightful—the nose-thumbing spoofiness that was so popular in France in the pre-War I days, and on through the Twenties. The Concerto is a big, serious piece out of the Great Depression, when music everywhere turned away from the brittle noisiness of the twenties. Europe as well as the U.S.A. The Sonata is a really lovely miniature, very "classical" à la Mozart, with ingratiatingly gentle rhythms and tune-fragments of the sweetest sort.

**Magnificent Two-Piano Performances.** (Mozart, Mendelssohn, Schubert). Hambro and Zayde.

Command CC 11010 SD stereo

As any reader ought to know, I am highly allergic to review-titles, the LP with the built-in review on its cover. Sonically, these pieces are indeed magnificent, even if their names aren't specified. (Why should I, if the album cover doesn't?) Hambro is one of the most competent of piano technicians around: he and Zayde have been performing for WQXR

listeners in the New York area, with considerable impact.

Musically, my reaction is slightly chilly. All the notes are there and with a vengeance, hard, precise, glittering. But the glassy-chrome styling is not good for Mozart, Schubert nor even Mendelssohn. Darned little "poetry" in this playing, by which I guess I mean, not enough phrasing, emotional contrast, contrast of harmony and key, of tension and relaxation. Complaints on a relatively high plane, to be sure—these players really play and Command really records.

**Schubert: Grand Duo for Piano Four Hands, Op. 140.** Gold and Fiddale.

Columbia MS 6317 stereo

Gold and Fiddale's twenty fingers added to the twenty shared by another team, Hambro and Zayde, sum up in forty steel-sprunged, trigger-action mechanisms a generation of pianists, those who were the "young" pianists just before the war and just after. It was the time of the hardened touch, the high-tension, teeth-gritting, percussive technique, enormously accurate, cat-like, and never by any chance sentimental. This was the great reaction to an older and sentimental generation—the long-hairs who kept their hair on their head and, in a few remaining living examples, still do. These youngsters were marvelous pianists—of their sort. They still are.

But now they are sandwiched in the middle of a strange juxtaposition. The young of today have gone all Romantic, soft, delicate, swooning right and left. The oldsters are still out of the *echt*-Romantic period tracing directly back to Liszt, Brahms. Thus the hard-touch pianists are cut off on both sides, and tend to sound increasingly metallic as their "style" loses ground.

So it is, here. This lovely, poetic big Schubert piece just doesn't come off right as played by these men. Not for my ears, anyhow. Two deadpan, too accurate in a literal sense, lacking the great poetic line, the ineffable Schubertian contrasts of harmony and mood, that were so important in Romantic playing.

**Britten: Noye's Fludde.** Solos, English Chamber Orchestra, E. Suffolk Children's Orch., Chorus of Animals, etc., Norman Del Mar. London OS 25331 stereo

**Stravinsky: The Flood.** A Biblical Allegory. L. Harvey, S. Cabot, Elsa Lanchester, etc., Columbia Symphony Orch. and Chorus, Stravinsky and Craft. (TV: June 14, 1962).

Columbia MS 6357 stereo

Well, well—what would old Noah think! Here he is in several spellings, two dramatic productions with music, one intended for "mystery play" production with numerous amateurs and children, the other highly professional and intended for TV. In both there is a Mrs. Noah and in both she sets up an awful row when Mr. N. tries to persuade her to get into the ark; she will not go aboard that silly contraption. Even the Noah kids can't persuade her, though the Big Storm sets in. Both recordings have a Big Storm, of course, and both bring the story to its dryland ending.

Beyond this, Messrs Britten and Stravinsky



# HEAR! HEAR!

...the Stereophonic  
Curtain of Sound\*  
recording technique!

on **AF** **AUDIO FIDELITY**

## Catalog of Hits!

Recognized for years by discriminating listeners for true stereophonic reproduction and the highest standard in high fidelity!



AFLP1927 / AFSD5927



DFM3011 / DFS7011



AFLP1924 / AFSD5924



AFLP1955 / AFSD5955



AFLP1973 / AFSD5973



AFLP1830 / AFSD5830



AFLP1966 / AFSD5966

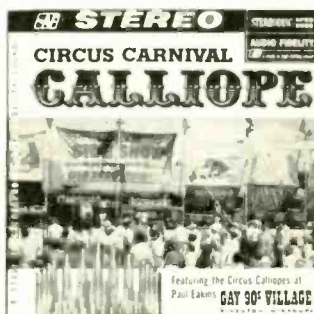

AFLP1958 / AFSD5958



AFLP1959 / AFSD5959



AFLP702 (mono only)



AFLP1953 / AFSD5953



AFLP1961 / AFSD5961



FCS50,006 (stereo only)

SUGGESTED LIST: MONO—\$4.98 / STEREO—\$5.95  
• AFLP, DFM (Mono) • AFSD, DFS, FCS (Stereo)

AVAILABLE AT YOUR RECORD STORE, OR WRITE:  
**AUDIO FIDELITY RECORDS**  
Dept. AB, 770 Eleventh Avenue, New York 19, N. Y.

**NEW! FREE!** ▶▶  
Complete illustrated catalogs.  
Records (mono and stereo)  
and Stereo Mastertapes.  
Full selection listings  
for each recording.



take off in different directions, decidedly. Britten's work, in the British manner, in both "conservative" and traditional, intended for those stalwarts of British vocalism the amateur performer and, especially, the boy soprano and alto. Never a Britten work without them.

There is much singing of solid old congregational hymns, with mildly modern accompaniment, and the boy singers are innocently in evidence. Also the children's orchestra. Text is given in the original spelling, which is nice, too. It's the Chester Miracle Play, out of the Middle Ages. When Mrs. Noye refuses to board the ark, tho' the storm his begun, Noah says "Come in, wife, by the twenty devils! Or else stay there and get left behind." So the sons have to haul her aboard bodily. In the olde Englysshe, though, it goes like this:

*"Come in, wife, in twenty devilles way!  
Or elles stand there without." . . .  
"Mother! we praye you all together,  
For we are heare, your owne childer,*

*Come into the shippe for feare of the  
weither. . . .  
"That will not I, for alle your call. . . ."  
"In faith, mother, yett you shalle,  
Wheither thou wylte or nought."  
—And in she goes, like a sack of meal.*

As for Stravinsky's newest opus, it is remarkably easy to follow considering that the musical idiom is serial—twelve tone—and the skips and jumps, without key-sense, are violent, all over the place. Elsa Lanchester is Mrs. Noah, and she makes herself felt all right. There's a voice of God, a chorus that sings in Latin, and the whole of Creation gets thrown in before the flood, including Eve and her Serpent. My main feeling here is that the pro performers under, the old man himself, are too restrained, too tense and formal.

Can't exactly blame them, for this was a Big Occasion, with human brass clattering up the place. But it doesn't help the story, nor the music. Later performances, more relaxed, should bring out more sparkle, punch, and vim.

**Stravinsky: Le Rossignol.** Reri Grist, Donald Gramm, Loren Driscoll, etc., Chorus, Orch. Opera Society of Washington, Stravinsky. Columbia KS 6327 stereo

I first heard this early opera of Stravinsky in the lovely Angel recording of 1956, done in French by the French Radio with an all-French cast which included the incomparable Janine Micheau as the Nightingale and a superb Jean Graudeau as the contemplative fisherman, whose lonely, moonlit song ties the operatic scenes together. You can guess from this that I find this new version somewhat of a shock. It isn't the old opera I used to know at all.

To be sure, the earlier version was 100% Frenchified, as blandly as only the French can manage it. French singing, language, French impressionist music. French orchestra and conductor, French instruments. It did, though, have a unity of style that was overwhelming. Its musicianship was fabulous all the way through. Moreover, the Angel performance was imaginative, poetic, dramatic, full of life and pathos, marvelous in its delicate contrasts of poetry and satire.

Well, Stravinsky wrote it, and here he is, conducting his own performance, though every aspect of it was not necessarily under his control. It is sung in Russian, which means, alas, that it is mostly mumbled, correctly or no; the cast is largely American and not at all Russian. And here we find a forthright, square, highly professional "oratorio style" rendition, for my ear largely lacking in subtlety, Stravinsky or no.

The singers sing well, but they just sing, too often. The orchestra plays well and forthrightly under Stravinsky's solid, obstinate beat. The contrasts between poetic, moonlit fantasy—the nightingale's spell—and hard, satiric superficiality—the preposterous court of the Chinese emperor—are simply not made dramatic. Everything runs together, colorlessly.

My rather sorry thought is that, in the first place, the old man doesn't really like his early work; or rather, he is not now able to re-create, in his still so vibrantly progressive personality, that youthful mood of post-impressionism that was so wonderfully clear in the original. He has gone far. He is not the re-creative type, after all, but the new creator, and today he creates very differently.

Moreover, alas, there is an incongruously real feeling here of the very thing that Stravinsky decried in the opera, back in 1907 and 1913, when the two parts of the work were composed. Then, he poked satire at the sycophants around the emperor. Now, he himself is surrounded with such an aura of sycophancy that we can almost hear it in these recent performances. I note it "The Flood"; I hear it too clearly in this recording too. Stiff, tense, wooden-faced performing under the nose of the Great One himself and all his big-brass accompanying cohorts. It doesn't flow, it isn't natural.

Nobody's fault, and least of all Stravinsky's. After all, the man has ripened to eighty and Columbia Records finds itself with the biggest prize it ever hoped to own; can the big-brass stuff be avoided? Not easily. And Stravinsky himself, one suspects, lives a reasonably human life even so, though like most of the great he surrounds his daily life with the attentions of a few who can play up to him with the right imagination and brain-power, serving as foils to his every wish and thought. Inevitable, again.

So—the Nightingale, Le Rossignol, has sung for yet another emperor, to find once again that poetry and beauty are at the beck and call of the Imperial power. I recommend the Angel recording, in plain old-fashioned mono. It's a much more poetic, more imaginative performance.

## ODDIANA

**Handel: Royal Fireworks Music. Woodcock: Recorder Concerto in C; Oboe Concerto in E minor.** Telemann Society, Richard Schulze, Theodora Schulze.

Vox STDL 500.750 stereo

Ah, the perils of authenticity! This recording of the well known "Fireworks Music" is, as its producer puts it, "authentic to the nth degree." Not only are their oboes with



## THE BEYER DT-48 DYNAMIC HEADPHONES...

are not and never will be mass produced. In fact, only 450 sets will be available for U.S.A. customers this year. Can you imagine the cost of hand machining every component part, including the outer housing, from solid metal? Only in this way can the dimensional stability which is required for such precision, be assured. Inevitably, the DT-48 had to be the most expensive headphone on the market today; but the thrill of hearing fidelity and low distortion, which no speaker system at any price can match . . . justifies the investment many times over. Readily connects to any power amplifier output with accessories supplied. Guaranteed for 6 months.

### SPECIFICATIONS:

FREQUENCY RANGE: 16-18,000 cps.

SENSITIVITY: 114 dB-SPL/mW at 400 cps, usable with 600 ohm line levels. (TR-48 required as accessory)

DISTORTION: Unmeasurable above 100 cycles and less than 0.3% RMS below 100 cycles.

DT-48 OWNERS! New cushions available as replacement for \$3.90

For more information write for Bulletin #5-a and include name of your dealer.

GOTHAM AUDIO CORPORATION

2 WEST 46 ST., NEW YORK 36, N. Y. (212) CO 5-4111



old-type reeds, valveless hunting horns and 18th century trumpets, also valveless, but a military cavalry serpent is heard—a contraption made of leather that sounds vaguely cow-like. But most important of all, and most controversial, is the *pitch*. The natural valveless brass instruments here play the natural high overtones; some notes are so out of tune as to be literally halfway between one "ordinary" pitch and another. Vox says that Handel expected the music to sound that way. The performers, New Yorkers and Bostonians, wrestle manfully with the old instruments but if you didn't know ahead of time you might wonder whether this was a musical nut house. Especially those trumpets and horns, EEOOW! They hurt.

Well, the arguments are generally convincing as propounded on a special illustrative band by the recording director. On paper—on plastic—yes. It is true that Handel's brass had no valves and is supposed to have been able to play only the natural harmonics, the upper partials of which are violently out of tune according to our civilized ideas of music. In theory, there was no way in which these higher notes could be brought into line. (I should think that a hunting horn, somewhat in the manner of later valveless orchestral horns, might be stopped to some extent to true up the pitch.)

But what really hits me, as I listen to this music, is that, authentic or no, it *could not* have sounded this way. Men, artists, performers, have done incredible things with instruments, seemingly defying ordinary analysis. I just do not believe, on aesthetic grounds, that Handel wrote music to be played with as grossly untuned a sound as some passages here—where the out-of-tune instruments double notes that are being played on other in-tune instruments. Why double them up?

On similar grounds, I suspect that, specific tones aside, the techniques of playing the old instruments as here demonstrated (and also in other Vox recordings) is simply not the polished technique of the expert in Handel's day. These men may be fine modern musicians but they are amateurs at the cavalry serpent and the hunting horn, any way you look at it. The extraordinary improvement in the playing of other old instruments in recent years, as techniques have been restored, goes to prove the point.

Generally speaking, playing of the Telemann group under the Schulzes—conductors and soloists alternately—is of a certain dogmatic, inflexible character, reflected in the simple Woodcock concerti, where there are no pitch problems at all, as well as in the Handel. A peculiar hiccup at the cadence, the end of a phrase or end of a movement, is an annoyingly persistent mannerism that even appears in the scale and chord passages of the demonstration band.

Much enthusiasm, a lot of very hard work and immense amounts of energy went into this project. It was a worthy one, even with some faults and a lingering doubt.

**Frank Martin: Ballade. Hindemith! Sonata. Roger Geob: Concertino for Trombone and Strings. Davis Shuman, trombone, Leonid Hambro, pf.**

**Golden Crest RE 7011 mono**

This recording is for trombonists, not people—like an RCA tube manual for engineers. It is part of a whole "Recital" series, offered for cryptic reasons by Golden Crest, which nominally runs to more popular fare. Each disc in the series will be of very special interest to people who play or like the instrument involved, but not for most others.

As a matter of fact, the music here is quite interesting and Mr. Shuman is an impeccable blower of his trombone, a specially modified type of his own design. But the whole atmosphere of the recording is educational-professional. Acoustics utterly dead, as of an old-style sound studio. The trombone about a foot from your nose. The piano, musically of equal importance, relegated distinctly to the background—this is a trombone record, after all.

It's a worthy series, this, but I don't recommend it to the general listener.

# The superiority of new Altec Dynamic Microphones is all the more amazing when you discover their moderate price!

There are six dynamic microphones in Altec's new professional studio series. Each sets new standards of performance and durability in its class. Each offers distinctive features of significant value to the professional user, especially since the highest price model is yours for under \$100.00! Let's take a look at some of these features:

## PROOF of Superior Performance

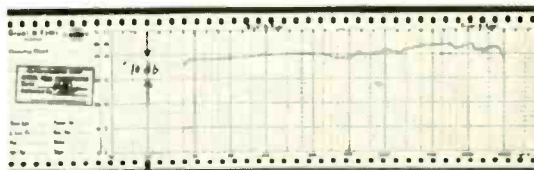

Each Altec 684A Omnidirectional and 685A Cardioid Microphone comes to you with its own certified calibration curve made on a Bruel & Kjaer Graphic Recorder. In the entire professional field, this practice is unique with Altec. The one shown here is typical of the 684A. The curve you receive gives visual proof of the remarkably smooth response provided by your Altec Microphone.

**BALANCED PAIRS FOR STEREO:** For stereo work, any pair of 684A or 685A Microphones is perfectly matched in performance characteristics. The calibration curves offer rapid means of assuring yourself of this balance.

**DESIGNED FOR RIGOROUS PROFESSIONAL USAGE:** The exclusive sintered bronze filter positively bars all foreign matter. These Altec Microphones may be used safely in any situation the professional engineer finds himself; not only in a protected studio, but anywhere—a

metals grinding mill if need be. Only Altec offers this absolute protection against the gradual degradation of quality common in ordinary microphones that can't prevent dust, moisture, and minute ferrous particles from restricting diaphragm movement.

Also featured are diaphragms of indestructible polyester that cannot be damaged by blasts, shock, impact—designed specifically for rigorous usage in any professional applications.

**EXCLUSIVE ALTEC MICROPHONE EXCHANGE POLICY:** After expiration of normal full year guarantee, you may exchange an inoperative microphone for a comparable new unit at a fraction of original cost. This Altec policy is unique in the industry; offered to better serve microphone users.



**ALTEC 684A OMNIDIRECTIONAL MICROPHONE**  
Frequency Response: 35 to 20,000 cycles • Output Impedance: 30/50, 150/250, 20,000 ohms • Output Level: -55 dbm/10 dynes/cm<sup>2</sup> • Hum: -120 db (Ref.: 10<sup>-3</sup> Gauss) Price: \$78.00 net

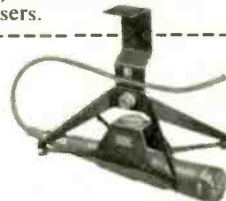

**ALTEC 685A CARDIOID MICROPHONE**  
SHOWN IN ALTEC 181A BOOM MOUNT  
Frequency Response: 40 to 16,000 cycles • Output Impedance: 30/50, 150/250, 20,000 ohms • Output Level: -54 dbm/10 dynes/cm<sup>2</sup> • Discrimination: Average front-to-back, 20 db • Hum: -120 db (Ref.: 10<sup>-3</sup> Gauss) Price \$96.00 net



**ALTEC 686A LAVALIER MICROPHONE**  
Frequency Response: 70 to 20,000 cycles • Output Impedance: 30/50, 150/250 ohms • Output Level: -55 dbm/10 dynes/cm<sup>2</sup> • Hum: -120 db (Ref.: 10<sup>-3</sup> Gauss) Price: \$45.00 net

For specific engineering details, call your nearest Altec Distributor (listed in your Yellow Pages) or write Dept. ABM

## ALTEC LANSING CORPORATION

A SUBSIDIARY OF LING-TEMCO-VOUGHT, INC.  
1515 South Manchester Avenue, Anaheim, California

© 1962  
Altec  
Lansing  
Corp.



OTHER ALTEC DYNAMICS PRICED FROM \$42.00 • ALTEC MINIATURE CONDENSER MICROPHONE SYSTEMS: Omnidirectional, \$236.00; Cardioid, \$275.00. • Altec offers a complete line of microphone accessories including desk and floor stands, switches, wall and boom mounts.

# JAZZ and all that

CHARLES A. ROBERTSON



## STEREO

**Ted Heath: Big Band Bash**

London Stereo SP44017

**Manny Albam: I Had The Craziest Dream**

RCA Victor Stereo LSA2508

**Billy Byers: Impressions Of Duke Ellington**

Mercury Stereo PPS6028

While astronauts receive thorough instruction before heading into outer space, the new breed of arrangers commissioned to place sound spectaculars into orbit often went on early ascents without much briefing in advance. The trio at work on the current launchings all made initial trips at a time when even engineers had trouble finding the way, and their knowledge of jazz and prior experience plotting the course of big bands undoubtedly kept everyone from losing a sense of direction. Each is a veteran test pilot by now, fully capable of showing off the added booster power and latest controls developed by the engineering staffs of the respective labels for this autumn's series of flights. Nobody is ready to try a moon shot as yet, and rhythmically they all keep at least one foot safely on the ground.

Johnny Keating calls signals during Ted Heath's first journey in a British craft bearing the mysterious letters I.M.20C.R., a new addition to London's Phase 4 stereo trademark signifying nothing less than "individually monitored 20 channel recording". Double-fold album covers contain a more graphic explanation, including a photo of the huge control panel on the new custom built console mixer itself. Warner Bros. recently demonstrated the flexibility of a sixteen channel console in introducing its Stereo Workshop Series, so the next mark for some company to shoot at is an even two dozen. One refinement provided on the London console is both chamber and electronic echo facilities on each channel. This method of applying individual reverberation permits any instrument or entire section to be moved to the front or rear in depth at will, aside from the greater scope for movement across the stereo stage. Warner Bros. boasts only of electronic reverberation, but the secret of echo is that it should either sound natural or pass unnoticed. By the same token, twenty channels are no better than a lonely ace in the hole unless handled with imagination and the good taste shown here.

A regular on the band's arranging staff for many years, Keating knows both Heath's brand of showmanship and the solo strength of each member. Now established as a freelancer, he directs stereo fantasies of his own when not busy on commissions from his former boss. Of course, no big band in history ever sounded the way the Heath crew does when it charges through the mazes of Phase 4 plus. Percussive effects turn up anywhere at anytime, and even Chick Webb never thought of using finger cymbals on *A-Tasket A-Tasket*. A Parisian hansom cab jogs along on *Clopin-Clopant*, and an entire camel caravan moves through *In A Persian Market*. Mandolin and guitar joust with a walking bass line on *Capuccina*, and the old Glenn Miller sound is revisited on *Out Of Nowhere*. While the Londoners enjoy nothing so much as a good bash, a few quiet moments do provide dynamic contrast. Steady hands at the controls keep reverberation from becoming obtrusive, but many an ear will be strained trying to detect the amount and type of echo employed to create various effects. Little effort should be required to fol-

low the roundabout trail of warlike tom-toms on *Cherokee*.

Manny Albam's last stereo action exploit was to juggle two tunes at once, so interpreting a dozen dreams is just the psychological cure needed to repair a split personality. Not that the word dream in every title means variety is lacking, as three different studio ensembles browse among the assorted reveries. I'll Woods, alto sax, and trombonist Bob Brookmeyer weave solos in and out among fourteen strings, percussion and regulation rhythm section on *Street Of Dreams*, and *I Can Dream, Can't I*. They also share featured roles with trumpeters Joe Newman and Clark Terry during a lively outing with full band on *Wrap Your Troubles In Dreams*, and *Someone's Rocking My Dreamboat*. Albam boosts the trumpet section a notch or so higher by voicing Bill Slapin's piccolo in with the section. The third group surrounds soprano obligatos of Miriam Workman with the same close orchestral support that Duke Ellington gives a vocalist, as harp, tympani and french horns add extra splashes of color on *Darn That Dream*, and *A Kiss To Build A Dream On*. Liner diagrams show the starting positions of each group, but the action Albam dreams up for engineers Bob Simpson, Dick Gardner and Ernest Oelrich must be heard before it can be imagined.

Billy Byers returns to the stereo wars after sojourning in Paris several years, during which time he worked with Ellington as technical advisor on the film "Paris Blues." Meeting the double challenge of the composer and his orchestra should be big enough for any arranger without the extra load of channel switching and other effects. Byers avoids a head-on collision by taking a different route whenever possible, starting right out with a 5/4 detour through Spanish Harlem on *Take The A Train*. Another example is Sol Schlinger's baritone sax solo on *Solitude*, which offers an interesting contrast to Harry Carney and the rest of the original sax section instead of inviting comparisons. The 21-piece studio band does afford a trumpet section capable of stopping all competition, as it includes Ernie Royal, Joe Newman, Clark Terry, and a certain Doctor Christian who might be Doc Severinsen in disguise. The increased booster strength in this case is the 35 mm magnetic film which Bob Fine uses at the former Everest studios in Bayside, L. I., and the greater signal to noise ratio pays off when a select bunch doubles on pursed lips to blow up a windstorm on *Caravan*. Also when Osie Johnson borrows pianist Patti Bown's shoes and manipulates them on a box covered with sand to reproduce the sound of Baby Lawrence's dancing feet on *Don't Get Around Much Anymore*. Additional percussive touches are supplied by Eddie Shaughnessy and Eddie Costa, but some label should persuade Sonny Greer to bring back his chimes and collections of traps for *Sophisticated Lady*, *Mood Indigo*, and other Ellington classics. Rather than movement from front to back, Mercury offers the enticement of "infinite depth," obtained by providing each section with an extra pair of overall microphones.

Fall is the traditional season for removing the veil of silence from new developments, and other companies will undoubtedly bring out spectaculars in time for the round of audio shows. On the basis of these three samples, it is safe to say that the various engineering staffs will advance stereo frontiers some distance further in space. Meanwhile, the jazz arrangers and soloists involved are gradually altering and expanding the usual

sound of big bands. This threesome is completely at home working with tympani, piccolo, bass clarinet, flutes, french horns or any odd paraphernalia that turns up in the studio. The word big no longer covers the subject adequately, and some inventive soul should come with an adjective like sputnik, multiplex or polyactive to describe both the hands and the scoring.

**Shelly Manne & His Men: Checkmate**

Contemporary Stereo S7599

As the heroic threesome in charge of this television crime series never stoops to ordinary private-eye tactics, the original Johnny Williams' score is too fancy and formal to be called jazz. Holding down the percussion chair in the studio orchestra was Shelly Manne, a seasoned veteran of the battles between Hollywood cops and robbers, having served valiantly under both "Mr. Lucky" and "Peter Gunn." Henry Mancini provided distinctive jazz scores for these shows, and the resulting albums paid off much better than crime ever did. This amount of loot is too tempting for a mere operative to resist, and Manne enlists four compatriots in an effort to outdo Mancini at his own game. Everyone is allotted plenty of solo space to cover the various themes and bring about a conversion to mood jazz. Richie Kamuca, tenor sax, and Conte Candoli, trumpet, do the preliminary investigation, but the case is finally broken by the rhythm team of Russ Freeman, piano, Chuck Berghofer, bass, and the boss himself. Devotees of Mancini's thrillers will enjoy this suspense story just as much, and Howard Holzer sets each colorful episode in roomy stereo.

**Art Farmer-Benny Golson Jazztet: Here And Now**

Mercury Stereo SR60698

**Dave Pell: I Remember John Kirby**

Capitol Stereo ST1687

Fond memories of the John Kirby sextet, one of the most successful little bands of the swing era, are recalled on both these recordings. The Art Farmer-Benny Golson Jazztet has arrived at the same pinnacle by following the methods, if not the style, of the earlier group. Careful planning, original writing, unique arrangements and hard work all went into the hopper, along with the considerable solo talents of the co-leaders. The climb to the top was swift, but staying there requires constant improvement and a fund of ideas. The other members have all been replaced more than once over a three-year period, and this session marks the arrival of four new faces, including trombonist Grachan Moncur III, Harold Mabern, piano, Herbie Lewis, bass, and drummer Roy McCurdy. The program touches all bases on today's jazz scene, and the commodity is highly vendable in clubs and on records, starting with the gospel driven *Tonk*. Moncur and Mabern join the leaders in contributing originals, and the standards include *Just In Time*, and *In Love In Vain*. Tommy Nola engineered the date, and the Jazztet will definitely be remembered twenty years from now.

Dave Pell heard the Kirby crew perform at its prime, but the records are around to serve as a reminder. Some arrangements are copied note for note, while others undergo a slight refurbishing. Marty Paich and pianist Johnny Williams composed new tunes reminiscent of the band's style, and they take a place beside *Rose Room*, *Anitra's Dance*, *Undecided*, and *Coquette*. Finely turned solos on alto sax from Benny Carter are mainstays, with Pell playing clarinet and Ray Linn on trumpet. Among the missing, unfortunately, is an example of O'Neil Spencer's extemporaneous vocalizing, when Kirby threw away the book and played the blues.

**Presenting The Buddy DeFranco-Tommy Gumina Quartet**

Mercury Stereo SR60685

With the continuing popularity of tenor sax and organ in combination, it was inevitable that a clarinetist would get together with an accordionist before long. Being less massive and unwieldy, this spanking team trots out with a lighter tread and swifter

“Brings out sound from records that more expensive cartridges do not”

Preston McGraw  
United Press  
International Hi-Fi  
equipment reviewer

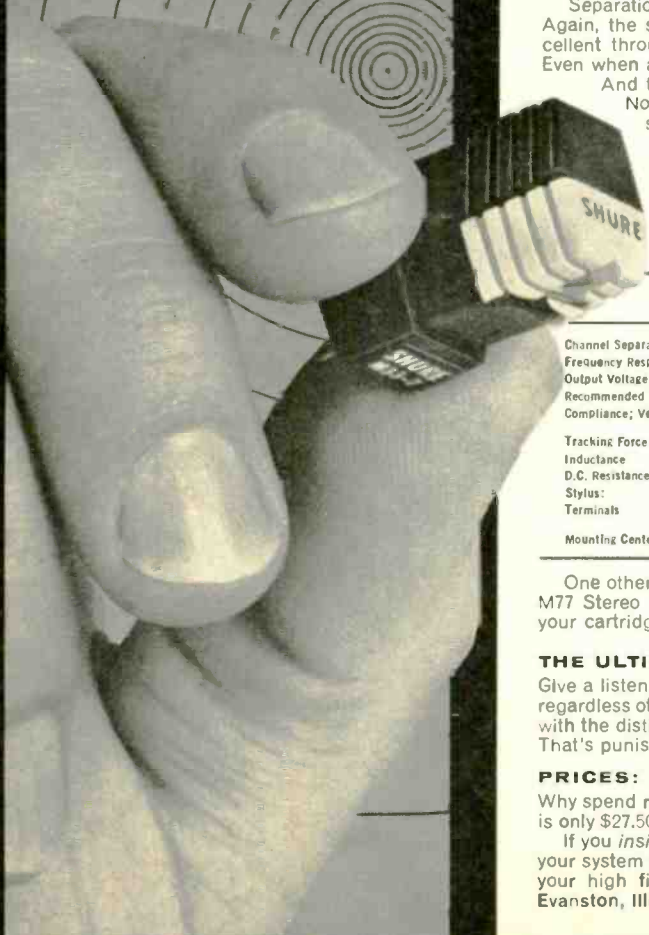

the incomparable new

# SHURE SERIES M33

*Stereo Dynetic®*

HIGH FIDELITY PHONOGRAPH CARTRIDGES

**NOT HOW MUCH? BUT HOW GOOD?**

According to United Press' Preston McGraw, the Shure series M33 cartridges are "so good that a hard-shelled listener might suspect Shure engineers of not knowing what they had when they hung a price tag on them."

We knew, all right, Mr. McGraw. It's just that we don't believe the best sounding cartridge need be the most expensive. The new Series M33, after all, was developed by the same team of engineers who developed the redoubtable Shure M3D series . . . the world's first truly high fidelity stereo cartridge. Numerically, Shure has made more highest-quality stereo cartridges than any other manufacturer—and they're used by more critics and independent hi-fi authorities than any other. Chronologically, Shure had a two year head start on the others. In short, Shure has learned how to make these critical components in the kind of quantities that result in lower prices.

**THE SOUND OF SPECIFICATIONS**

Again quoting Mr. McGraw: "Professional engineers are largely impressed by specifications, and the specifications of the M33 (except for compliance) are not unprecedented. But the way it sounds is something else again. The M33 puts flesh and bones on specifications. It brings out sound from records that more expensive cartridges do not."

He's right. To begin with, Shure specifications (as published) are not theoretical laboratory figures, or mere claims . . . they are actual production standards. 20 to 20,000 cps. response may appear average. But what the bare specifications don't show is that the M33 series goes right through the audible spectrum without a hint of the break-up prevalent in most other cartridges. Also, it is remarkably free from disconcerting peaking at this frequency or that. Result: absolutely smooth, transparent, natural sound re-creation. (Incidentally, where would you find a record that goes from 20 to 20,000 cps. with genuine music on it?)

Separation is over 22.5 db. at 1000 cps. Much more than necessary, really. Again, the separation figure doesn't show that the M33's separation is excellent throughout the audible spectrum. No cross-talk between channels. Even when an oboe plays.

And the matter of compliance:  $22 \times 10^{-6}$  cm. per dyne for the M33-5. Now there's a specification! According to Mr. McGraw, the Shure stylus feels like a "loose tooth." And so it should. The incredible compliance of the M33-5 gives it: the ability to respond instantly to the manifold and hyper-complex undulations of the record groove. Superior sound is one outcome of the superb compliance.

Another is the ability to track the record at low force. The M33-5 will track at forces as low as any other cartridge on the market today.

SPECIFICATIONS	M33-5	M33-7
Channel Separation (at 1000 cps)	Over 22.5 db	Over 22.5 db
Frequency Response	20 to 20,000 cps	20 to 20,000 cps
Output Voltage (per channel, at 1000 cps)	6 mv	6 mv
Recommended Load Impedance (per channel)	47,000 ohms	47,000 ohms
Compliance; Vertical & Lateral	$22.0 \times 10^{-6}$ cent. per dyne	$20.0 \times 10^{-6}$ cent. per dyne
Tracking Force	$\frac{1}{4}$ to 1.5 grams	1.5 to 3 grams
Inductance	600 millihenrys	600 millihenrys
D.C. Resistance	750 ohms	750 ohms
Stylus:	.0005" diamond	.0007" diamond
Terminals	4 terminal. (Furnished with adapters for 3-terminal stereo of monaural use.)	
Mounting Centers		Fits Standard $\frac{1}{2}$ "

One other item: if your tracking force is 4 to 6 grams, the even lower cost M77 Stereo Dynetic will deliver the best sound you can possibly get from your cartridge-arm combination.

**THE ULTIMATE TEST**

Give a listen. In fact, compare the Shure M33 series with any other cartridge, regardless of price, in A-B tests (we do it all the time). If you are not impressed with the distinct difference and greater naturalness of the Shure, don't buy it. That's punishment enough for us.

**PRICES:**

Why spend more than you must? M33-5 and M33-7 net for \$36.50 The M77 is only \$27.50

If you insist on Shure when you buy, you can demand more from the rest of your system when you play . . . write for literature, or still better, hear them at your high fidelity showroom: Shure Brothers, Inc., 222 Hartrey Avenue, Evanston, Illinois.

change of pace. Buddy DeFranco claims the partnership came about while he was looking for a pianist to fill out his quartet, and the move proves to be one of the happiest and most rewarding possible. A poll winner since 1945, the clarinetist came under frequent critical fire for coldness of tone and a calculated technique, but all that is changed now. Tommy Gumina voices his accompaniments to ensure a full, warm sound and presents enough of a challenge while improvising to keep anyone on the alert. Rarely has DeFranco been quite so responsive to another player, and together they engage in rapid interplay or create a unique blend. Next to be heard from will be flute and harmonica joined in harness. The group's original theme, *Never on Friday*, a rocking blues written by Gumina, tops a program containing such standards as *When Lights Are Low*, *S'Wonderful*, and *You Are Too Beautiful*. Bill Plummer, bass, and drummer Johnny Guerin complete the quartet. Bruce Swedden of Chicago's Universal Recording Studios engineered the

date, and the stereo version is well worth obtaining for the wide dynamics and subtle voicings.

**Harry Belafonte: The Midnight Special  
RCA Victor LSP2449**

Influence is perfectly capable of flowing in either direction, even though not many established artists admit the fact or even confess to reversing the flow. Of all the attempts by young singers to hit the mark Harry Belafonte set with his debut album, one of the few to come really close was the effort last season of Oscar Brown, Jr. Besides scoring almost as high in the charm and personality division, the Chicago youth introduced original material and tried a more modern approach. For once the hot breath of new talent singed Belafonte's heels enough to produce a reaction, and his latest album sounds even fresher and more lively than the first. While Belafonte would never deign to copy rival styles, his

performance does show a greater concern for contemporary trends, gathering into the fold recent developments in gospel singing, soul jazz, and the country blues revival. Belafonte also bestirs himself to forge verses and create new dramatic interludes on *Crowdad Song*, *Muleskinner*, *Michael Row The Boat Ashore*, and *Did You Hear About Jerry?* Besides such jazz luminaries as Don Lamond, Joe Wilder and Jerome Richardson, the assisting force includes Bob Dylan, harmonica, and guitarist Millard Thomas. The independent deal made on this release consolidates the singer's dominant position still further. While again selecting Bob Simpson as trusty engineer and remaining with RCA Victor for distribution, Belafonte negotiated a cheaper rate with Columbia for the pressings.

**Olguita: Latinville!  
World-Pacific Stereo 1801  
Tino Contreras: Percusiones Mexicanas  
Capitol Stereo ST10310**

To follow up the success of an album of authentic pachangas in an intimate setting for World-Pacific, Olguita turns to the big band sound of George Hernandez and a collection of new rhythm songs written to show off her vocal antics. The uptempo arrangements call for an assisting vocal group to answer her ad-lib chanting, a pastime at which she is especially adept. According to Oliver Berliner, who produced the session and wrote the notes, a girl with the ability to chant effectively is called a "montunera" or "guarachera" in the Caribbean, and the pace is both demanding and exhausting. Only expert dancers need apply. Two boleros composed by Arturo Castro provide an enjoyable respite.

Tino Contreras, a virtuoso drummer in the Afro-Cuban tradition from Chihuahua, made a reputation at home before casting his eyes across the border. His first album to be released here is designed to catch the tourist trade or attract the attention of booking agents for a trip north. The small combo includes trumpet, saxes, and a rhythm section with a spare bongo player. Latin rhythms and jazz are combined in a style suitable for smart cocktail lounge or hotel bar, and the tunes consist of such gringo favorites as *Night Train*, *Ebb Tide*, *Perfidy*, and *Matilda*. Just the same, the album is a sonic treat and will rate high with dancers.

**Edith Piaf: Potpourri par Piaf  
Capitol Stereo ST10295  
Shoshana Damari  
Vanguard Stereo VSD2103**

Although these singers represent different ethnic backgrounds, certain similarities in tone and style emerge on hearing one perform after the other, and playing their latest releases in tandem can be an interesting experiment. Often faint and indefinable, the resemblance is most noticeable during songs dealing with the joys or agonies of love. Guessing whether they both endured equally tremendous love affairs, or just developed that way, is part of the game. Edith Piaf's romantic trials are well known, but direct comparison also brings out Near Eastern qualities not always so easily observed in her singing. One of the factors that distinguishes her from the run-of-the-mill Parisian chanteuse could well be a deeper feeling for exotic sounds from lands along the Mediterranean. As though to emphasize the point, Miss Piaf departs briefly from her usual program of French chansons to include Ernest Gold's theme from the motion picture "Exodus." The song becomes just as much her own as the characteristic tales of the boulevards related on *Marie Trotter*, *Dans Leur Baiser*, and *La Bella Histoire D'Amour*. None of her great vitality seems to be diminished by recent sieges of illness, and stereo keeps her from towering over the orchestra conducted by Robert Chauvigny.

Shoshana Damari divides her attention between older traditional Hebrew music and folk material gathered by the new wave of Israeli composers, including four songs of Moshe Wilensky. A native of Yemen, she offers five ancient tales from that region, written by the poet Shalom Shabazi in the seventeenth century. Elyakum Shapira provides the arrangements and conducts the spirited little orchestra. Religious themes are treated

# AUDIBLY SUPERIOR..

... **TRANSIENT RESPONSE**—Unique low inertial single metal diaphragm system results in superior transient response and crystal clear definition at highest levels. Especially obvious when recording cymbals, trumpets or piano.

... **FREQUENCY RESPONSE**—AT LAST, a condenser microphone WITHOUT high frequency peaks. Piano and voice are reproduced without shrillness.

... **LACK OF DISTORTION**—Significantly lower distortion, never exceeding 0.3% at sound pressure levels to 115dB above 0.0002 microbar. Impossible to overload condenser capsule.

... **FRONT-TO-BACK RATIO**—Highest wideband rejection over the important midrange; at least 26dB. Since directional patterns are varied acoustically rather than electrically, frequency and sensitivity characteristics are not disturbed.

**UNEQUALLED PERFORMANCE**

The unique feature that makes Schoeps microphones superior to all others is its patented multiple-pattern, single metal diaphragm construction. Pattern switching is achieved by altering the acoustical chambers behind the diaphragm. This system guarantees the smoothest high frequency response and highest front-to-back discrimination in the cardioid pattern.

**GREATEST VERSATILITY**

Schoeps microphones are available in two series. The CM 60 series uses a standard 6AU6 plug-in tube. The smaller M221B series (illustrated) features a number of interchangeable condenser capsules. A full range of accessories, including a unique MS stereo adapter, makes Schoeps the most versatile microphone in the world.



Actual Size

Schoeps is the only condenser microphone approved for use by the entire French radio and television broadcasting system.

**COMPARE THE SCHOEPS**

You are cordially invited to try the Schoeps microphone on location or in your own studio. We are confident that you will find the Schoeps system vastly superior to any condenser microphone. Write or phone for a demonstration. Literature is available on request.

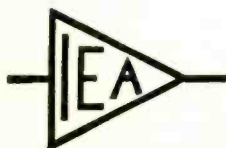

**INTERNATIONAL ELECTROACOUSTICS INCORPORATED**  
333 SIXTH AVENUE NEW YORK 14, N. Y. 212 WA 9-8364

as rhapsodically as songs of love, and it seems likely that Miss Piaf shares a corresponding knowledge of religious chant tradition. Whatever a study of the two singers together reveals, the project is bound to sharpen listener's wits and hearing.

**Stan Getz: Focus**  
**Verve VSTC260 (UST 3-track tape)**

Because the recording of this collaboration between Stan Getz and Eddie Sauter rates as one of the most important of the year, its preservation on four-track stereo tape is thoroughly warranted, and the presence of an eighteen piece string orchestra under Hershey Kay only makes owning a tape copy that much more desirable. Getz, who had asked the composer to write an extended work for him, was somewhat surprised to find the tenor-sax part omitted in the final score. All seven sections were conceived to fit the Beaux-Arts Quartet, which forms the nucleus of the orchestra, on the theory that Getz could develop solos from the lead sheet. Getz depended upon his ear instead, listening to Kay rehearse the strings and then improvising in the studio. The stereo tape and Ray Hall's engineering show clearly how Getz finds his way among the strings, or thrusts himself free to create counter melodies and bold, original lines. The basic rhythm is that of the string quartet, even during the section on which drummer Roy Haynes assists, but Getz plays before, after and on the beat, or at times heeds an independent rhythm of his own in the manner of Sonny Rollins. Admirers of both men will be delighted to hear Sauter experimenting again—and Getz making it work.

**Ella Fitzgerald: Clap Hands, Here Comes Charlie!**

**Verve VSTC265 (UST 4-track tape)**

Every so often someone drops innuendos about Ella Fitzgerald's ability as a jazz singer, causing her to reaffirm her superiority once again as she does on this four-track tape. If a little unkindness produced the performance heard here, then critics are welcome to cast all the aspersions they want. In fact, the program in chronological order could easily serve as a short history of jazz singing, starting with the tune which by reasons of seniority titles the album. No attempts are made to grab applause by tricks, and the singer aims straight to the color plexus in reverting to the swing era with *My Reverie*, and *Jersey Bounce*. Billy Holiday is saluted on *Good Morning Heartache*, and *You're My Thrill*, and the 1940s are recalled on *'Round Midnight*, and *Night In Tunisia*. The recent past is represented by *Cry Me A River*, and *Spring Can Hang You Up The Most*. If anyone at the close still clings to doubts as to the jazz content of the vocals, there can be no such reservations about the accompanying quartet. The notes fail to mention the names of Lou Levy, piano, Herb Ellis, guitar, Joe Mondragon, bass, and drummer Stan Levey, but stereo makes up for the omission by throwing an extra spotlight on each supporting member.

**Kenny Ball: Midnight In Moscow**  
**Kapp KTL41039 (UST 4-track tape)**

It takes an outstanding hit to transport a British traditional band across the Atlantic, and enthusiasts on this side can be thankful that the Muscovite title tune struck public fancy. In reaching a large teenage audience, the adaptation from an old Russian melody will introduce many new listeners, via this four-track tape, to such New Orleans standbys as *Tin Roof Blues*, *High Society*, and *Savoy Blues*. Kenny Ball, who regarded the music with affection long before it became so popular at home, adheres closely enough to "Trad" strictures to please righteous fans over here. His trumpet playing commands respect, and his vocalizing is always enjoyable. Despite another Russian salute on *Dark Eyes*, the septet owes everything to this country and acknowledges the debt with *American Patrol*. Anyone too old for the Moscow trip can revisit *You Must Have Been a Beautiful Baby*, and *Puttin' On The Ritz*. No "Trad" band is complete without a banjo, and Paddy Lightfoot's joyous beat is one of the reasons why.

# Grommes / MULTIPLEX

Grommes announces a completely new concept in mechanical and electronic engineering excellence to provide Multiplex Stereo with performance and "presence" never before accomplished heretofore. Owners of Grommes FM Tuners will be pleased to know that Grommes Tuners are adaptable for receiving FM Multiplex Stereo broadcasts through the use of Grommes low cost Multiplex adapters. Your Grommes equipment is never obsolete as Grommes engineers always plan ahead for things to come. Remember, when you buy Grommes, you buy the finest in FM-Stereo, regardless of price. Ask your high fidelity dealer to demonstrate Grommes. You will hear music with the new Grommes extra-"presence".



## Grommes

### MT MULTIPLEX (FM-STEREO) ADAPTER

Converts any high quality FM tuner to receive FM stereo programs. Connects to multiplex output of tuner and to auxiliary inputs of stereo amplifier. NO CONTROLS TO CRITICALLY ADJUST. Has full frequency response, separation and noise filter switch for fringe areas. Low heat silicon power supply.

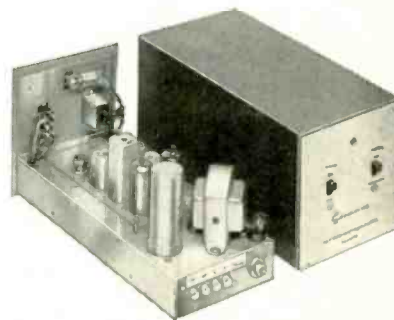

Send coupon today for complete details on Grommes equipment.

Name.....  
Street.....  
City.....Zone.....State.....

## Grommes

DIVISION OF PRECISION ELECTRONICS, INC.  
9101 King Avenue, Franklin Park, Illinois, Dept. TJ

Stereo places the band, ready for dancers, on the stage of a large hall. Let's hope the State Department decides to bring over the band itself.

**Oscar Peterson Trio: West Side Story**  
**Verve USTC268 (UST 4-track tape)**

With the release of the film, Leonard Bernstein's score is well into the second heat of recordings, and it was inevitable that a new jazz version by a piano trio would be in the running. Andre Previn teamed with Shelly Manne to place a Contemporary entry high on the list while the show was still on Broadway. A late start never leaves Oscar Peterson with anything less imaginative to say than those first off the mark. His main problem is editing a performance down to reasonable length, and the ideas left over after the session would undoubtedly fill a pleasurable hour or so beyond the thirty-seven minutes allotted on this four-track tape. The tunes are thoroughly seasoned by now, so the pianist gives a slight Latin twist to *Maria*, and finds a perky tempo for *I Feel Pretty*. Ray Brown plays idyllic bowed bass on *Somewhere*, and

then plucks furiously on *Jet Song*. Tape allows every stroke of Ed Thigpen's elegant brushwork to come through crisp and clear, while Bob Simpson's intimate stereo setting shows off the trio to best advantage. By way of an encore, all the themes are tied together in a well organized and swinging resumé of the score.

**The Weavers' Almanac**  
**Vanguard VTC1641 (UST 4-track tape)**

The young, carefree folk groups now so popular among the college crowd never knew what hard times are like, and panhandling for anything besides folding money would never enter their minds. Any worries they may have stem from automation, nuclear fission, and the hazards of travel on the Boston subway. Depressions are dealt with in sociology and history classes, and not at fraternity song fests. The Weavers, or at least the senior members, know from experience, and earnest students can learn from this four-track tape what the subject is all about by listening to E. Y. Harburg's lyrics for *Brother Can You Spare A Dime*. Today's stock market plungers

will be reassured as to this country's resiliency by two other depression songs, *We're All Dodgin'*, and *Which Side Are You On*, which are served up with meat and potatoes. The quartet also remembers when gospel singing was more apt to take place in tentshows than at Carnegie Hall, and stereo gives them a chance to raise the roof with *Fight On*, and *True Religion*. Fresh arrangements and additional words are the only concessions to modernity, but the Weavers are still tops for all that.

**Southern Tropical Harmony Steel Band:**  
**Limbo Party Audio Fidelity AFSD5967**  
**Calypto Exposed**

**Cook 1189**

While conga and bongo drums are adequate for most Latin rhythms, nothing generates greater excitement at a limbo party than an authentic steel band. Sid Frey recorded the Southern Tropical Harmony group on location in Trinidad, giving the ping and crash of mallets on metal the full benefit of stereo. The program gets underway with an exhibition for the tourist trade, as the first side consists of such popular items as the *Pachanga*, *Cachita*, and *Never On Sunday*. The reverse side contains all the abandon of Carnival time, being wholly turned over to almost fifteen minutes of uninterrupted limbo rhythms. This reduces chances of any break in the music during crucial moments of the dance, which involves passing face forward under a suspended bamboo pole at progressively lower levels. Instructions for making the limbo pole set-up are detailed on the liner, but the problem of how best to reach the other side without disturbing the pole is left unsolved. The steel band, with its five octave range of tenor, guitar and bass drums, is no easy subject for the microphone. This is one of the best recordings yet of the 55 gallon monsters in native surroundings.

Emory Cook explored the land of calypso and steel bands several years ago, and his field recordings from the West Indies deserve to be represented in every collection. The concoction offered here comes from his own private stock, which yields up selections too censorable to be issued before. The tapes are all pre-stereo, and a few sound as though the microphone was concealed beneath a shirt front. The lyrics of Mighty Cypher, Lord Melody Herbert Howard and other calypso kings are definitely not for the ears of children, but they should fill rest periods between limbo sessions very nicely.

**Gerry Mulligan: At The Village Vanguard**  
**Verve VSTC267 (4-track UST tape)**

About the only thing Gerry Mulligan's Concert Jazz Band lacked was enough of the right places to play. Many of its best arrangements are hardly suited to ballrooms, and only during the last months together did the members work up the amount of steam required to fill a large auditorium or outdoor arena. While the jazz clubs were highly receptive, rooms the size of the Village Vanguard are too small to accommodate all the customers a band needs to show a profit. Actually, the band was eminently suited to locations the dimensions of Town Hall, and they are in plentiful supply in high schools and on college campuses throughout the country. But until band managers and booking agents join in forming an organization similar to the Community Concert groups, some of the most desirable halls in the nation will be closed to jazz units. Record companies sell jazz to many of the people who patronize Community Concerts, and various folk singers are successfully tapping the same audience. Perhaps record companies had better take over this part of the business as well, but more intelligent packaging than is applied to the average jazz road show will be imperative from the start.

Meanwhile, stereo equipment in the home is an ideal medium for the band, and this just released four-track UST tape reveals how spontaneously it reacted to a live audience. On this recording, at least, the band sounds better and makes a more favorable impression than it did in some of the places it was forced to work. Among the high points are *Blueport*, *Lady Chatterley's Lover*, and the leader's switch to piano on *Let My People Be*.

# "No Echo"

## Why Burgess Magnetic Recording Tape is 8 ways better:



**Lower print-through** — Revolutionary Burgess dispersion processes greatly reduce possibility of magnetic transfer from layer to layer. "NO ECHO" with Burgess tape — after months of storage.



**Greater tensile strength** — new Burgess processes and formulas make Burgess tape "tough" tape. Tensile strength is important wherever tape is given rough handling, as in schools and colleges.



**Lower noise level** — New dispersion techniques eliminates "clumps" of oxide on Burgess tape. You get a lower noise level and eliminate "hissing" or "popping".



**Higher frequency response, greater sensitivity** — Burgess uses only acicular oxide particles (and disperses them evenly) to achieve finer sensitivity and top frequency response. Burgess wide bias latitude produces professional results on all types of recorders.

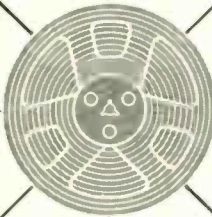

**Freedom from flake-off** — New Burgess precoat formula eliminates flake-off, cuts the amount of head-cleaning necessary, and gives constant true-tone qualities.



**Consistent satisfaction** — Burgess' new processes, monitored by rigid quality control, assure the user that Burgess tape is uniform from reel to reel. You get the same high reproduction quality today, tomorrow or next month.



**Superior built-in lubricant** — Enables tape to glide smoothly, without friction or squeaking over recorder head and guides. Prolongs the life of tape recorder heads.

**Erases clean** — Burgess tape erases clean and evenly on home recorders. No bulk eraser needed!

No other line of Magnetic Tapes offers you such **VERSATILITY, ADAPTABILITY** to your needs, or gives you all the advantages cited above

### BURGESS BATTERY COMPANY



DIVISION OF SERVEL, INC.  
**MAGNETIC TAPE DIVISION**  
 FREEPORT, ILLINOIS NIAGARA FALLS, CANADA



## PHONO CURVES

(from page 28)

be used. Here,  $R$  is the resistance at the AUX input of the amplifier. As you may recall, this section of the amplifier provides an output with a uniform frequency response when a constant voltage is applied at the input.  $C_1$  is the capacitance in the equivalent circuit of the cartridge. A capacitor,  $C$ , must be chosen to shunt the resistive input impedance

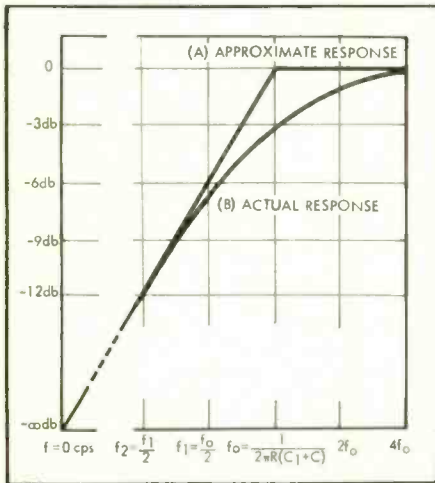

Fig. 14. Response of circuit of Fig. 13.

of the amplifier,  $R$ . The equation characterizing this network is

$$\frac{e_{out}}{e_{in}} = \frac{R/(1+j\omega RC)}{R/(1+j\omega RC) + 1/j\omega C_1} \quad \text{Eq. (17)}$$

where  $R/(1+j\omega RC)$  is the impedance of the parallel  $RC$  combination and  $1/j\omega C_1$  is the impedance of  $C_1$ . Simplifying Eq. (17) gives

$$\frac{e_{out}}{e_{in}} = \frac{j\omega RC_1}{j(\omega RC_1 + \omega RC)} \quad \text{Eq. (18)}$$

The frequency when the output has rolled off 3 db is:

$$j(\omega RC_1 + \omega RC) = j$$

$$\text{or } \omega = \frac{1}{RC_1 + RC}$$

$$\text{and } f = \frac{1}{2\pi R(C_1 + C)} \quad \text{Eq. (19)}$$

The  $j\omega RC_1$  term in the numerator indicates that the output is zero at d.c. with a steady rise of 6 db per octave. The curve fitting Eq. (17) is shown in (A) of Fig. 14. The output drops approximately 6 db per octave beginning at the frequency  $f = 1/2\pi R(C_1 + C)$ , and is equal to zero when  $f = 0$ .

It should be noted that (A) of Fig. 14 is an approximation to the actual curve. The output is actually 3 db down from its maximum when  $f_0 = 1/2\pi R(C_1 + C)$ ; it is down 7 db when  $f_1 = f_0/2$ ; it is down 12 db at  $f_2 = f_1/2$ ; and it drops 6 db per octave from there on, as shown in (B) of Fig. 14. If the curve with the

6-db-per-octave slope were extended back to the 0-db reference axis, it would intersect it at  $f_0$ . Thus curve (A) of Fig. 14 is used as an approximation for this curve, plotting  $f_0$  on the 0-db axis rather than 3-db below this axis. This approximation has been, and will continue to be applied through the article for convenience and ease of illustration.

As an example in the use of Eq. (17), assume  $R = 5 \times 10^5$  and  $C_1 = 5 \times 10^{-10}$ . A good approximation to the required curve in Fig. 8 would let  $f = 120$  cps. This was discussed above when referring to Fig. 9 and Eq. (4). Substituting these constants into Eq. (19) would make  $C$  approximately equal to 2200 pf.

Whatever the values of  $C_1$  and  $R$  may

be, the capacitor required to shunt  $R$  for a reasonably flat response can be readily calculated from Eq. (19). It should be remembered that these results fit the curve to a fair approximation only. In all practical situations, reproduction will be satisfactory.

The capacitor can be built into the amplifier, shunting the input resistor. If the frequency response is checked, it should not alter the response of the amplifier. This is especially true if the output impedance from the signal generator is low. Should a high-impedance signal source be used, some rolloff at the high frequencies may be noted. This rolloff will be a function of the impedance of the generator. Æ

# Build the finest professional color TV Set ever designed

## WITH color

### TV KITS by TRANSVISION

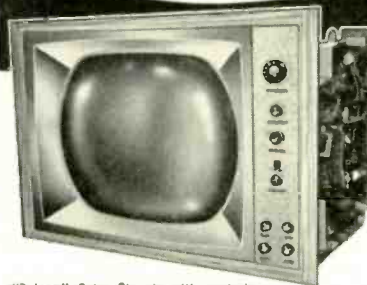

"DeLuxe" Color Chassis with controls mounted on panel in a vertical position.

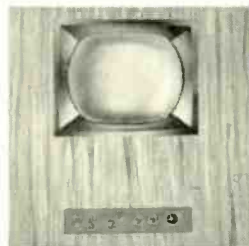

Custom wall installation of "DeLuxe" Color Chassis with horizontal controls separated from chassis.

**LEARN AS YOU BUILD:** Learn Color TV Theory, Practice, and Servicing. Complete course of study available for use in conjunction with the Kit—no technical background required to understand it.

**INSTRUCTION MANUAL:** Send \$5 for complete Assembly Manual, so that you can see how easy it is to build and service the Transvision TV Color Kit. Cost of manual refundable upon purchase of Kit.

## TRANSVISION ELECTRONICS, Inc.

Grey Oaks Avenue, Yonkers, N. Y. Dept. AC-8  
Telephone: (914) Yonkers 5-6900

This Color TV Kit is designed around the most expensive, thoroughly engineered and newest RCA TV Color Receiver.

Transvision has added improvements, features, and heavy-duty parts to this RCA licensed receiver in order to accommodate those who seek better quality than is commercially available.

#### WITH or WITHOUT REMOTE CONTROL

All critical circuitry is wired, aligned, and pre-tested by RCA.

Anyone Can Assemble—No Special Knowledge Required Buy Assembly Manual and See Easy, Complete Instructions.

**Exclusive Features:** All controls are mounted separately from chassis for flexibility in custom installation. . . . Only the finest quality oversized, extra heavy-duty parts are used for long, trouble-free use, and they are FULLY GUARANTEED for ONE FULL YEAR.

The 21" Color Tube is RCA's newest and best tube. The safety glass is bonded to the tube face to reduce reflections and eliminate dust accumulation. . . . NEVER OBSOLETE—Your Transvision TV Color Kit is always up-to-date because circuit improvements in Kit form are passed on to the Kit builder as they occur.

Buy on Installment Plan. **PAY AS YOU WIRE:** \$50 gets you started on this fascinating TV Color Kit project.

#### CHOICE OF MODELS:

- With Hi-Fidelity Sound System, complete with Color Tube . . . . . \$439.00.
- With Special Circuit (no audio) for connecting into your Hi-Fi System, complete with Color Tube . . . \$419.00.
- Remote Control optional . . . . . \$60.00 additional.

Also available as WIRED CHASSIS . . . Full line of Cabinets.

--- START NOW --- MAIL THIS COUPON ---

- Send FREE Catalog on Color TV Kits. . .  I enclose \$5 for Assembly Manual, refundable on purchase of TV Color Kit.  
 I enclose \$50 for Starting Package on pay-as-you-wire plan. (Complete Kits range from \$419 to \$499.) Dept. AC-8

Name \_\_\_\_\_  
Address \_\_\_\_\_  
City \_\_\_\_\_ Zone \_\_\_\_\_ State \_\_\_\_\_

# problem solving micro- phones

by  
**SHURE**



\$85<sup>00</sup>  
list  
model 55SW  
with switch

**PROBLEM:**  
Feedback

**SOLUTION:**  
Unidyne II  
UNIDIRECTIONAL  
DYNAMIC MICROPHONE

The most widely used and most requested high quality P.A. system microphone in the world. Dependable, rugged—indoors or out. Ultra-cardioid pick-up pattern (15 db down at rear) suppresses feedback superbly, yet picks up every subtle shading of sound. High output—can be used with low-gain systems. Multi-impedance switch (high-medium-low). Frequency response 50 to 15,000 cps. With or without on-off switch.

Shure Microphones for  
**TOTAL COMMUNICATIONS**

Total  
Communications . . .  
enables you to sell 6  
microphones with ease  
where you formerly  
sold only one.  
Write for literature:  
Dept. 44-F,  
Shure Brothers, Inc.,  
222 Hartrey Avenue,  
Evanston, Illinois



## ABOUT MUSIC

Harold Lawrence

### Record Making in the U.S.S.R.

**T**HE HEADQUARTERS of the U.S.S.R. record industry is located in a tall, gray building in Katchalova Street, about halfway between Moscow State University and the Tchaikovsky Conservatory. From this center flow the decisions that result in an annual output of 1200 new LP releases and more than 100,000,000 records, with an expected rise to the 200-million mark in 1963.

In view of these impressive figures, one would not be surprised to see the corridors and offices of *Fsyessayuznaya Studia Gramzapici* bustling with activity. The activity is there all right, but in muted tones. Following the receptionist through the studios, we passed a trio of technicians surrounding an Ortofon cutter and exchanging whispered comments; in another we caught a glimpse of a young woman in a white smock gazing at the meters of a Bruel and Kjaer Spectrum Recorder; and we looked in on a quality-control worker carefully lowering the pickup on a metal part. All was hushed intensity.

Finally, we arrived at our host's office. Mr. B. D. Vladimirovsky might be described as the classical artists-and-repertoire chief for the Soviet Union. Striking in appearance—his shock of gray hair contrasts vividly with his swarthy complexion and dark eyes—he is affable, soft-spoken, and, unlike many of his Western A. and R. counterparts, calm. There is a plausible explanation for his apparent serenity. Here is an executive whose roster includes such artists as Sviatoslav Richter, Emil Gilels, David Oistrakh, Mstislav Rostropovitch, Galina Vishnevskaya, the Leningrad Philharmonic, the Moscow Philharmonic, Kyril Kondrashin, Eugen Mravinsky; in fact, any and every Soviet musician or musical organization worth recording. No competitive Soviet record company threatens to lure any of these artists away from his label. He is in a position to plan the "dream" programs for his nation's outstanding performers. As might be expected, the selection of classical symphonic, vocal, and instrumental repertory is made in Moscow. However, not all Soviet recording is centralized. In the fields of folk and popular music, each of the "distributors," or local branches, makes recommendations to the capital for repertory and artists, and often records special material. Since Russia is merely one of sixteen Soviet republics, a wide variety of non-Russian music is taped throughout the U.S.S.R. from the Outer Mongolia to the Ukraine.

How are records sold in the U.S.S.R.? Although a few shops deal exclusively in phonograph discs, reported Mr. Vladimirovsky, most sales are made in the department stores, or "universal" shops, as they are called. Only four purely record outlets

exist in Moscow, for example. Has the stereo record made any headway in the U.S.S.R.? No, only a small number of stereo discs have been manufactured, although the Soviets are now recording nearly all their classical works on two-channel tape and have recently built their first consumer stereo phonograph. Unfortunately, Mr. Vladimirovsky was unable to demonstrate the player for us—no cartridge.

At this point, Mr. Vladimirovsky turned to Mr. A. I. Archinov, the chief audio engineer of the U.S.S.R. Gramophone Recording Studios. A gentle, balding, bespectacled man, Mr. Archinov speaks English fluently, his school training having been supplemented by a trip to the U.S.A. twenty-five years ago. Here, the interview shifted gears as both men fired queries at us regarding American techniques of sound reproduction in general, and those employed by Mercury Records in particular. (The American firm was then recording at the Tchaikovsky Conservatory's Great Hall with its own staff and recording truck. Its presence in Moscow naturally aroused extraordinary interest on the part of Soviet sound engineers since this was the first time the authorities had granted a Western company permission to record there with its own equipment.) By the manner in which the Russians absorbed our replies it was obvious that they were well acquainted with many of the latest developments in recording techniques. Mr. Archinov, a faithful *AUDIO* reader, makes frequent trips throughout Europe, inspecting components, meeting with colleagues in the field, and generally keeping his finger on the pulse of the audio industry. In recent years, he has purchased quantities of new equipment for the U.S.S.R. studios from Hungary, France, Denmark, Germany, and England. In addition, he informed us, the Soviets have come up with a professional tape recorder of their own. Not yet in full production (only thirty exist), the new machines are in service in the radio and recording studios and in various concert halls in Moscow. Conspicuous by its absence is American-made equipment. The only U. S. product spotted by us was a roll of Scotch brand splicing tape. Some Soviet editors still use ordinary cellophane tape.

The major portion of classical recording is done in four cities: Moscow, Leningrad, Odessa, and Riga. Three of the Soviet halls used for recording are internationally known—the Bolshoi Hall of the Tchaikovsky Conservatory and the Kolony Hall, both in Moscow, and the Leningrad Philharmonic Hall, which countless artists have praised for its near-perfect acoustics. Mr. Archinov also singled out a new recording site: a Riga Church in which he plans to record Bach's *Mass in B Minor* this fall. While on the subject of acoustics, both men stated their preference for concert halls

\* 26 W. Ninth St., New York 11, N. Y.

over studios for recording classical works, even though studios in the same building had been originally designed and built for multi-purpose recording.

Soviet engineers employ the MS system exclusively for their stereo recordings, thus producing a compatible stereo tape. On Katchalova Street, tape-to-disc transfer is made on Ortofon equipment, with 60 watts per channel driving the cutting mechanism. The monitor speakers which had been used previously had proved unsatisfactory. According to Mr. Archinov, they were bass-heavy and caused the cutting engineer to engrave his master lacquers with too little bass. Two speaker systems are now in operation: "ML" (Hungarian), and Pathe-Marconi (French). Disc playback amplifiers are 15 watts per channel.

An interesting feature of the Moscow studios is the use of rugs for acoustical treatment. From both the sound and esthetic standpoints, this is a most effective idea.

Two artificial reverberation systems are used by the Soviets in re-recording. The first is the E.M.T. sheet reverberator, made in West Germany; the second, a magnetic reverberator manufactured in Russia. The latter unit has the advantage of eliminating "repeats" the bugbear of units of this type.

Pressing facilities exist in Moscow, Riga, Leningrad, and Odessa. Two quality standards are maintained: one for domestic consumption, the other for export. Like books, records are inexpensive in the Soviet Union, but are on a lower technical level than equivalent Western discs and tend to wear out rapidly. (This may be partly due to the vinyl compound, and to the record players, of course.) That the Soviet public is quality-conscious, however, is proven by the fact that American stereo records are in intense demand among discophiles.

To round out our visit, Mr. Archinov played some recent, unreleased stereo tapes for us of John Ogden, the Moscow Chamber Orchestra under Rudolf Barshai, the Moscow Philharmonic directed by Kyril Kondrashin, and Galina Vishnevskaya. Then, with characteristic Russian hospitality, he took us downstairs, helped us hunt for a cab, found one, gave our address to the driver, and warmly invited us to visit him again and stay longer. Æ

## AUDIO ETC.

(from page 14)

actually hold the practical top output of a stereo groove not too far from the top mono output.

As to those orchestral doublings, Stravinsky refers, again, to the "color" mixtures of instrumental timbres, numerous instruments "doubling" on the same notes, at the same pitch or in various octaves, which go to make up a large part of modern orchestral sound. (They are much rarer in old music, Mozart and back.) It is true that close-up stereo recording can separate the individual strands of these sounds, for the "de-blend" mentioned above. Woodwinds in octaves, flute doubling strings, a thousand other combinations, were intended to sound as one, just as blended organ pipes play one melody. (The same de-blending often occurs in organ recording done too close to the pipes.)

On the other hand, many inner details,

get those highs

COMPARISONS SHOW THAT NEWCOMB PUTS ON TAPE THE HIGHS THAT OTHERS MISS AND REPRODUCES THEM FLAT AT FULL RATED OUTPUT

with

# NEWCOMB

Want an ear opener? Take your best source material, something rich in high frequencies. Record it on a Newcomb SM-310B (two track) or SM-310-4B (four track). A-B the results. Yes, you can hear the difference. You can measure the difference with instruments. Newcomb holds up perfectly; meets published specs at full rated output of 2.5 volts. This gives you a far better signal-to-noise ratio. Another feature that makes it possible to get those elusive highs on tape—Newcomb recorders are built with receptacles for Newcomb Humfree Plug-in Transformers. So equipped you can use long cords and low impedance microphones, preserve every tweet, twitter, transient, and overtone. Another feature the pros like—Cannon sockets are used for mike inputs.

The Newcomb new Series B models are the most foolproof, most dependable machines in their class. They are also easiest on tape, handle your precious recordings with maternal gentleness. Easiest to operate, too. Cybernetically engineered; operation is intuitive. They are still the only machines in their class that take 10½" reels, have four-digit counters, pointer-to-pointer recording level meters, mixing controls for both channels, blend control, ganged volume control, complete preamplification. For the perfectionist. Definitely.

Each Newcomb stereophonic tape recorder meets these specifications:

	RESPONSE	SIGNAL-TO-NOISE RATIO	OUTPUT
At 7½ ips	+2 db 30-15,000 cps	Better than 50 db	Average approx. 2.5 volts from cathode follower, each channel
At 3¾ ips	+3 db 40-10,000 cps	Better than 45 db	

Write for a complete description.

Cannon sockets for mike inputs, and receptacles for Newcomb Humfree Plug-in Transformers are accessible from side of case.

NEWCOMB AUDIO PRODUCTS CO., DEPT. T-G, 6824 LEXINGTON AVE., HOLLYWOOD 38, CALIF.

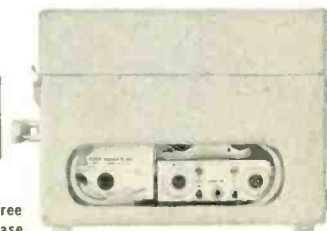

# STILL AVAILABLE!

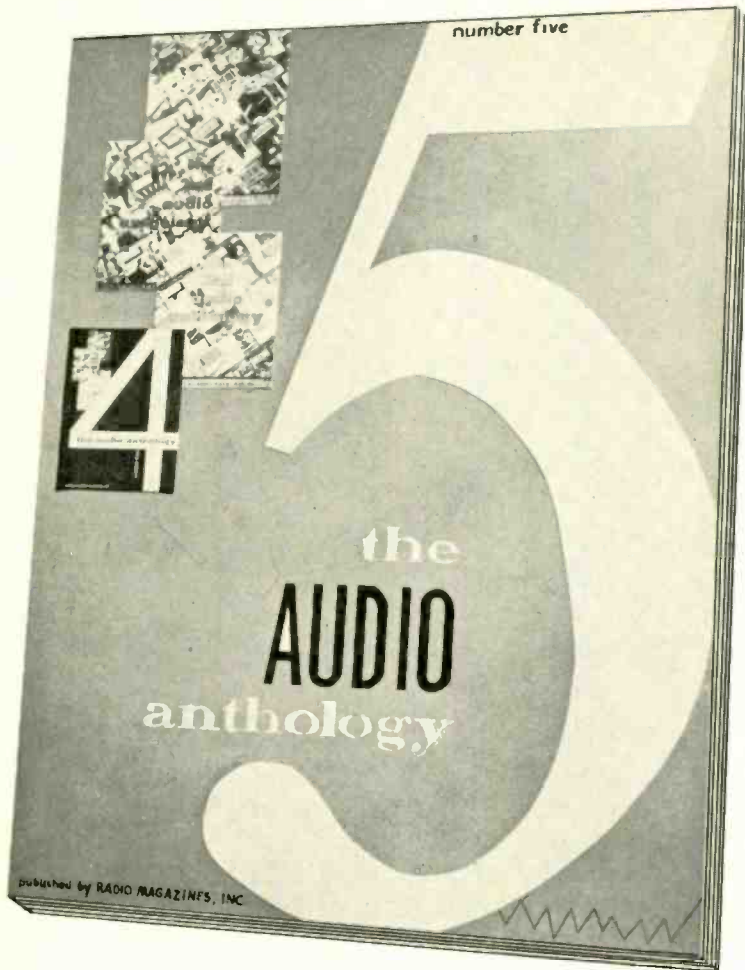

- THE BIGGEST AND BEST VOLUME EVER!
- MORE THAN 50 ARTICLES COVERING STEREO RECORDING AND REPRODUCTION; STEREO MULTIPLEX; MEASUREMENTS; STEREO HIGH FIDELITY TECHNOLOGY; CONSTRUCTION AND THEORY; etc.
- 144 PAGES WITH COMPLETE ARTICLES BY WORLD FAMOUS AUTHORITIES IN THE AUDIO AND STEREO HIGH FIDELITY FIELD.
- ATTRACTIVELY PRINTED AND BOUND FOR EVERLASTING USE. AN IMPORTANT STEREO HIGH FIDELITY REFERENCE BOOK.

Order The 5th AUDIO ANTHOLOGY NOW-ONLY \$3.50

RADIO MAGAZINES, INC., Dept. A  
P.O. Box 629, Mineola, New York

Enclosed is my remittance for \$..... I understand that my copy of the 5th Audio ANTHOLOGY will be mailed to me.

Use handy order form. We pay postage anywhere in the U.S. add 50¢ for Foreign orders.

Name.....

Address.....

City..... Zone..... State.....

I am: Engineer  Student  Audio Enthusiast   
Musician  Other.....

though not usually audible in live performance—at least, at normal concert distances—still are worth hearing and, when brought forward by stereo, can add unexpected new supra-concert-hall interest.

The musical judgment as to which elements in a piece of music can be brought forward, made to stand out for extra musical interest, which elements are better left inconspicuous and in the background, is the keenest and most demanding sort in the whole business of recording stereo. The best stereo records today are those in which careful judgment of this kind has been integrated with the more usual judgments of overall "stereo effect."

Now you can go out and buy some of the dozens of Stravinsky stereo discs that have been issued to commemorate his 80th birthday, not to mention plenty more made by him in person since he wrote the remarks quoted here. A grand old man, in truth, and a perceptive audio listener.

### 3. GROUNDS, SHIELDS AND LIQUID SHORTS

I've learned, over the years, that it is always the obvious that is least obvious. Trees that can't be seen because of forests. Things that lie close under the nose, but somehow are invisible and maybe unsmellable.

Grounds, for instance. A real audio amateur homebody like myself should never have to think about such matters as grounding. There are laws, rules, principles, and anybody who knows beans about electronics should be able to ground what needs to be grounded with his eyes closed. Ah yes.

And so when my various systems unaccountably provide me with annoying quantities of hum, I just take it in stride. One of those things.

On the other hand, my varying assistants have shown varying degrees of persistence in their attempts to remove the unremovable. There's *gotta* be a reason for it, one of them will say as he sails into my stereo disc playing system. A couple of hours later I'll hear him muttering faintly under his breath—*gotta be a reason*. As one grows older, one becomes either more adaptable, or more cynical. I tend to close my ears mentally to all such sounds of 60 or 120 cps, and let it go at that.

And yet—once in awhile, a miracle happens. One just did. Since yesterday, a fine and persistent hum that had been bothering the lower levels of my subconscious for months—I no longer noticed it out loud, so to speak—is gone. Utterly gone. Well, darned near it, anyhow. And I'm sitting here in bewilderment, trying to get used to the new sound, out of the same old place. It isn't that I notice the hum, or lack of it, concretely. Instead, my mind hears a *suddenly cleaner signal*. Fresh, newly washed, like the sound of a new stylus after you replace the old worn one.

The moral is simple. Hum is hum, but you can, if your mind is willing, put it out of your consciousness, like the sound of your furnace, or air conditioner or refig. On the other hand, what you can't do is to ignore the intermodulation effects of the hum upon the music you are listening to with your conscious ears. You may not notice the 60- or 120-cps sound itself and its persistent relatives. Rather, you hear a musical sound that is subtly distorted—not continuously, but intermittently according to the instantaneous combinations of musical signal and hum.

It's easy to adapt to a steady sound, that does not change. It is next to impossible to

adjust to a *dynamically changing* species of distortion. That's the worst thing that a slight hum does to good music. It does it even when the hum seems to be drowned out by the overriding musical signal. So—get rid of the unheard hum and you hear a cleaner musical sound.

How many pickups, loudspeakers, radio tuners, tape recorders, have been unknowingly misjudged on this basis? Plenty, I'll bet.

Add this to my moral: there are some nice and practical home-style hum removers that ought to be mentioned, if only for the record. Some are professional, most are strictly amateur—and just as good.

Yesterday, for instance, we wrapped a whole strip of high-impedance terminal board contacts with some sticky cloth tape, then crunched a hunk of Reynolds' best, standard aluminum foil for sandwiches, on top of the sticky stuff. Grounded it with a few twists and another hunk of sticky stuff to keep it in place. (I used to wind lengths of rosin-core solder around exposed "hot" leads, as a temporary and very effective ground. Temporary for years, of course. Not as good as foil.)

Everybody knows that tin cans make fine shields, but not enough people use them. A much easier and less corrosable material is the aluminum pie plate. Worth buying a brace of frozen pot pies, just to get hold of the stuff. It is much stronger, of course, than foil, and will sustain a physical load nicely, keeping its shape after a fashion.

Then, on a somewhat more professional level, there is the kind of conducting tape that is sticky on one side and metallic-conducting on the other. I have hanks of this on hand, in case I run out of tin cans. But look out for ordinary "silver" tape. Even that shiny Xmas sticky metallic wrapping tape isn't too trustworthy. It may turn out to offer a nice insulating plastic surface, over the metallic shine. Get the pro stuff, then, and use it liberally on phono connections and such that are exposed and unshielded.

Somewhere, of course, you'll connect all this sticky and crunchy stuff to ground—to the ultimate ground, if you have several levels of grounding. (We all do in stereo.) That's a different problem. There, my present solution, for example, is a piece of old bell wire that runs from my phono chassis to the preamp chassis. It works. (Most arms now provide an extra grounding wire; but you may have to hook the motor itself to your ground system as well.)

My newest wrinkle in shield-ground materials is expensive and I haven't got to try it very extensively yet. I bought a small bottle of it for a large price, out of sheer curiosity. Conducting "silver" paint.

Yes, it looks rather like a poor quality of ordinary silver or aluminum paint, with a dirty brownish cast to it. You would not think it could conduct. Most metallic paints don't. Each little bit of metal is neatly surrounded by a sea of liquid insulation that cures to solid insulation. Hence, I suppose, the cost of the conducting variety. It should be worth it. Use it for painting a fine coating of non-insulator over all sorts of things that need plain metallic shielding.

But look out for liquid shorts! They can be nasty. Liquid solder at least is hot and warns you when it is about to pour where it oughtn't to pour. Conducting paint will slither any old place and you can't wipe it off without leaving a subtle resistance-leak behind. It spreads, it infiltrates. And a cold liquid short that turns into a viscous-solid one is apt to be your last straw. Throw out the equipment and get new. Probably about time, anyhow.  $\text{\textcircled{A}}$

**The Mullard**  
*Master 10M Series*  
**ELECTRON TUBES**



**TUBE-TO-TUBE UNIFORMITY**  
For the Balance  
Originally Designed into the Circuit

*The Master 10M Series is a special range of selected tubes, ideal for today's technically-advanced and exacting electronic equipment.*

- Each tube Individually Laboratory-Tested
- Tube-to-Tube Uniformity and Section-to-Section Uniformity Assured
- Guaranteed Performance
- Long Life

*The Master 10M Series . . . guaranteed for 10,000 hours of effective performance, within two years from date of purchase . . . now available from 10M distributors or write direct for literature.*



**IEC**

*International Electronics Corporation*

81 Spring Street, New York 12, N. Y.



## The perfect companion for professional recording

Foster's dynamic DF-1 is an omnidirectional bar-type microphone for both professional and home use. This versatile mike weighs only 1/4 lb. including cord, and is just 3/4" long and 7/8" in diameter. Yet it has a range of 100 to 12,000 c.p.s. and sensitivity of  $-58\text{dB}$  ( $50\text{K}\Omega$ )  $\pm 3\text{dB}$  at 1,000 c/s ( $\text{OdB}=1\text{V}/\mu\text{bar}$ ). Your choice of 600 ohm, 10,000 ohm, or 50,000 ohm impedances.

Rugged and precision made, the DF-1 assures professional results right in your living room. Used with hi-fi, stereo, or tape recorder it faithfully recreates a broad band of audio frequencies — and takes up less space doing it. The DF-1 can be hand held, suspended from its neck cord, or clipped to your lapel. A strong diecast frame gives it complete protection for long trouble-free service.

You can get this outstanding all-new microphone now at popular prices. For further information write directly to the address below.



## FOSTER ELECTRIC CO., LTD.

384 Shimo-Renjaku, Mitaka, Tokyo, Japan  
CABLE: FOSTERELECTRIC MUSASHINOMITAKA

## PRODUCT PREVIEW SECTION

(from page 76)

### PEARL

● *C8 Professional Condenser Microphone Series.* This microphone meets studio specifications for noise, sensitivity, and directivity, Polar pattern changed from cardioid to (figure 8) bidirectional with flip of switch. Directivity: cardioid 15–20 db, bidirectional 20–25 db.

*Specifications:* Type condenser; dir. pattern cardioid and figure 8; diaphragm material gold foil; case metal; finish chrome; output impedance 200 ohms; freq. resp.  $\pm 2.5$  db from 20 to 20,000 cps; sensitivity 45 db cardioid, 48 db bidirectional; cable connection Cannon; length of cable furnished 20 ft; type of plug Cannon XLR; dimensions 5"  $\times$  29/32"; other features: S/N at 2k cps—65 db cardioid, 58 db bidirectional; sound volume range, 107 db cardioid, 111 db bidirectional. Price \$269.00  
Accessories: Type 3000 power supply, \$125.00  
Ercona Corp., 16 W. 46th Street, New York 36, N. Y.

1. Model C-K cardioid and omnidirectional ..... \$260.00
2. Model C-12 (cinema type bass and treble attenuation) ..... 250.00
3. Model ST-6 stereo ..... 695.00
4. Model C-2 omnidirectional ..... 259.00

### SCHOEPS

● *Professional Condenser Microphone.* The Schoeps CM-66 is designed with a patented multiple-pattern single diaphragm made of metal; pattern switching is achieved by altering the acoustical chambers behind the diaphragm. The switchable 15-db attenuator between the capsule and the preamplifier prevents overloading and distortion.

*Specifications:* Type condenser; dir. pattern cardioid, omni, figure 8; diaphragm material solid nickel; case matte satin chrome; output impedance switchable 30/50, 150/250 ohms; freq. resp. from 50 to 19,000 cps; cable connection Cannon XLR-3; length of cable furnished 33 ft. Price \$45.00. Accessories: with AGO elastic suspension (shown) \$470.00. International Electroacoustics, Inc., 333 6th Ave., New York 14, N. Y.

1. M221/26 condenser mic ..... \$460.00
2. CM 640 condenser mic ..... 415.00
3. M221/24 condenser mic ..... 440.00
4. EST 60, M-S stereo adapter ..... 84.00

### SHURE

● *Unidirectional Microphone.* The new Shure Model 546 "Unidyne III" was developed primarily for the broadcast market but is also ideal for top-quality public address installations and recording. The Unidyne III features vibration isolation, improved performance, and a Cannon connector.

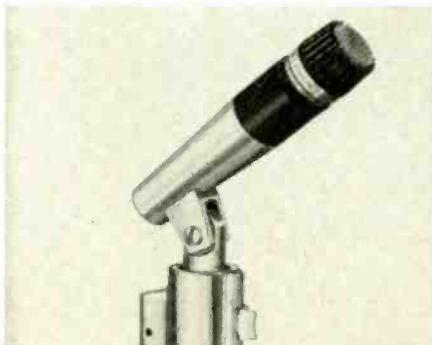

*Specifications:* Type dynamic; dir. pattern cardioid; case zinc; finish satin chrome and black; output impedance 30–100, 100–250 ohms; freq. resp. from 50 to 15,000 cps; output  $-55$  db; cable connection 2 conductor shielded; length of cable furnished 20 ft.; type of plug Cannon XL-3-11; dimensions:

1 15/64" dia., 5 7/16" long; weight 1 lb; type of mounting stand. Price, \$135.00. Shure Bros., 222 Hartrey Ave., Evanston, Ill.

### SONOTONE

● *Matched Microphones.* Introduced for stereo recording, Sonotone paired "Ceramikes" are acoustically matched at the factory to a tolerance of 2.0 db. Plugged into any quality stereo recorder, the CM-T10A feeds the tape a substantially flat signal. The heart of every Ceramike is a rugged, rubber-encased ceramic transducer which is immune to extremes of both temperatures and humidity. Controlled response is assured by an all-metal damping grid of a new design. The one-piece die-cast metal case is designed for easy hand use. For table and floor use there are matching stands.

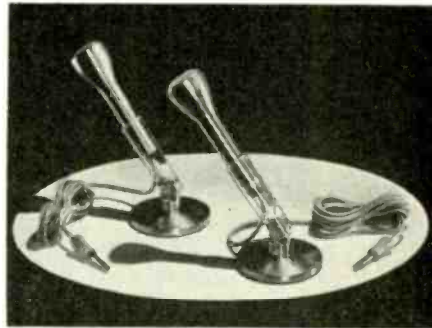

*Specifications:* Type ceramic; dir. pattern omni; diaphragm material ceramic; case metal; finish satin; output level 56 db  $\pm$  2db freq. resp.  $\pm 2$  db from 50 to 11,000 cps; length of cable furnished 7 ft; type of plug phone; mounting swivel stand. Price \$36.75 (matched pairs). Sonotone Corp., Elmsford, N. Y.

1. CM-11A, matched pair ..... \$36.75
2. CM-12A, low Z ..... 29.50

### TURNER

● *New Microphone Series.* The Turner 400 Series are broadcast type microphones which feature adjustable impedance and response. All four microphones in the Series (401, 402, 403, and the 404) are wide-response moving-coil dynamics and essentially non-directional. They can be mounted on 5/8" desk or floor stand. Positive grip camlock allows instant insertion or removal of microphone without disconnecting. Adapter supplied.

*Specifications:* Type dynamic; dir. pattern omnidirectional; diaphragm material dynaflex plastic; case aluminum; finish chrome epoxy; output impedance hi or 150 ohms; freq. resp. from 50 to 20,000 cps; sensitivity 60 db below 1 v/microbar; cable connection 3-pin Cannon insert; length of cable furnished 20 ft.; type of plug XLR3110 (Cannon); dimensions: 10 1/2 inches  $\times$  1-3/16; weight 7 oz.; type of mounting positive grip stand; other features: The Model 401 has a screwdriver frequency-cutoff adjustment. Price, \$125.00. Accessories shock mount desk stand #J022 \$8.00. The Turner Co., 1909 17th St., N.E., Cedar Rapids, Iowa.

1. 403, P.A. version ..... \$ 80.00
2. 220A, Lavalier ..... 125.00
3. 58, Lavalier ..... 57.00

### UNIVERSITY

● *Model 401 Professional Omnidirectional Dynamic Modular Microphone.* A professional dynamic microphone featuring exceptionally wide and smooth characteristics and application flexibility. Five different adaptors enable the 401, as well as the other three modular microphones (402S, 501, 502S), to meet almost any recording or broadcasting application requirements in seconds. No tools are required. Adaptors screw on and impedance change is effected by means of simple push-on connectors.

*Specifications:* Type dynamic; dir. pattern omnidirectional; diaphragm material polyester film; case, Zamac Alloy, finish gray and matte black; output impedance 30/50; 150/250; 20,000 ohms; fre. resp. from 30 to 20,000 cps; sensitivity (Lo Z)  $-55$  db/1mvo/10  $\mu$ bar; cable connection Amphenol or Can-

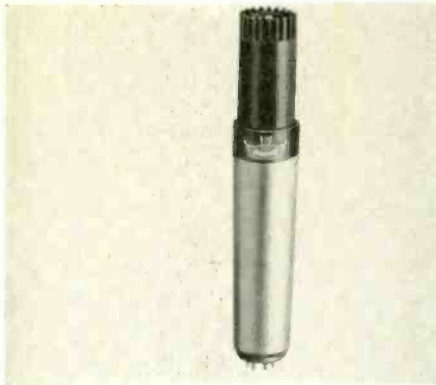

non plugs; length of cable furnished 18"; type of plug tinned wire termination; dimensions: 1 1/4" dia. x 6 3/8" long; weight 2 lbs.; type of mounting permanent or slide-on stand with adaptors. Price, \$43.50. University Loudspeakers, 80 South Kensico Ave., White Plains, N. Y.

1. 402S, omni dynamic modular .....\$47.70
2. 501, cardioid dyn. mod. .... 75.00
3. 502S, cardioid dyn. mod. .... 87.00
4. 403L, television dyn. omni lavalier.... 52.50
5. 404L, broadcast dyn. omni lavalier ... 57.00

## VEGA

• **Vega-Mike Wireless Microphone System.** The user of a Vega-Mike wireless microphone system has complete mobility to walk freely anywhere in the auditorium, even out into the audience with no trailing cable yet have every word amplified through the PA system, captured by a tape recorder, or channeled to a control board. A basic Vega-Mike wireless microphone system consists of a lightweight one-piece microphone-FM transmitter units,

and a specially designed Vega receiver to pick up the signal from the transmitter. Prices: Lavalier or hand-held Vega-Mike microphone-transmitter with receiver, \$517.50. Vega Electronics, 1078 N. Highway, Cupertino, Calif.

# HEADPHONES

## AKG

• **K-50 Dynamic Headphones.** K-50 headphones are designed for high quality mono and stereo applications. The K-50 is easily connected to the voice-coil terminals (or to preamplifier outputs of the cathode follower type, with the U-50 transformer). The diaphragm system of the K-50 is designed for no overshoot, no doubling, and no disturbing resonances. The headphones are lightweight, for no listening fatigue, and rugged, for long life. All components are also given tropic-resistant treatment.

**Specifications:** Impedance 15 or 200 or 400 ohms; range 30 through 25,000 cps; sensitivity 0.156 milliwatt per unit for output at ear of 95 db SPL; max undistorted level 127 db SPL at input of 90 milliwatts (4.25 volts rms); 1/2 wire cable, tinned ends; untermintated 6.5 ft. long leads. Ear cups clear plastic; 3.85 oz. net weight; impedance of each either one half or double by connecting terminals in series or parallel. Price \$22.50. Ear cushions for exclusion of extraneous noise, Z-50, per pair \$1.80. Electronic Applications, 194 Richmond Hill Ave., Stamford, Conn.

1. AKG K-58 boom headset featuring DK58 microphone plus choice headset impedance, balanced or unbalanced microphone output cable ..... \$46.80

## BEYER

• **DT-48 Dynamic Headphones.** These are one of the highest priced and highest performance phones on the market. They are used primarily by research laboratories and audiometer users. They are now available for hi-fi use with new cup-type cushions.

**Specifications:** Response: 16 to 18,000 cps; sensitivity: 114 db/mw above 2x10<sup>-4</sup> microbar at 400 cps; impedance: 5 ohms each side in stereo, 10 ohms mono; weight: 360 gram; maximum power handling, approx. 200 mw or 1 volt; voltage requirements approx. 2.5 mv per side; cushions, cup type C-48a (flat type C-48 on request). Price \$79.50. Accessories: TR-48 bridging transformer for 600-ohm lines complete with plugs. Price \$18.50. Gotham Audio Corp., 2 West 46th Street, N. Y., 36, N. Y.

1. DT-508S, lightweight twin phones, dynamic .....\$ 27.50
2. DT-507, miniature, hearing-aid type, dynamic ..... 12.85

## JENSEN

• **HS-1 Stereo Headphones.** Jensen HS-1 stereo headphones offer advanced features which contribute to acoustic performance and comfort. The moving coil driver units are of a new special design, matched to close tolerances for accurate stereo balance. Exclusive fluid damping of moving system yields superior response smoothness. Protective screens cover the diaphragms. Cases are marproof, breakage-proof nylon. Contoured soft cushions will retain their resilience and ability to achieve a close fit without pressure sensation indefinitely; they may be removed for cleaning. Yokes and headband springs are stainless steel. Ear cups rotate both horizontally and vertically for precise accommodation to the head. A total headband adjustment of 4 3/4" is provided (2 3/8" each side). Cord comes out one side—you don't get tangled up. For convenience in wiring, an accessory jack panel is furnished. When used, an input of approxi-



# C 60

## WORLD TRAVELER, ALL CLASSES

Now AKG's C-60 Miniature Condenser Microphone System is travelling all-classes everywhere with the B-60 Transistorized Power Supply.

Time was when a condenser mike was studio-bound. But AKG has liberated this highest-class microphone from the AC outlet. B-60 is at home wherever needed. Slung smartly over the shoulder it weighs less than many a telephoto lens, and includes space for the microphone and cables.

C-60/B-60's versatility is guaranteed by the quick change-over from cardioid to omni capsule. In seconds you can get the "musici," the pigeons alone, or the atmosphere of the whole Piazza.

(In Canada, George McCurdy, Radio Industries Ltd., 22 Front Street West, Toronto).

If you make ethnic recordings, or sound tracks, or background music for business or pleasure — make sure C-60/B-60 is entered in your passport. Its studio condenser quality makes a Tourist-Class recorder sound like First!

No other studio-quality condenser mike is so small, so light, so travel-wise, so inexpensive. The mike, with cable and power supply, fit in a leather case smaller than 3 x 4 x 6 inches. On a neckstrap you have no baggage burden. C-60 mike, B-60 Power Supply, L-60 Charger, \$259.50.

For data and name of the AKG dealer nearest you, write V. J. Skee at Electronic Applications, Inc., Wilton, Connecticut. Or phone 203-PO2-5537 (TWX WILT 426).



*exclusive in U.S.A.*

BRITISH PRECISION WORKMANSHIP  
GUARANTEES  
FINEST HI-FI REPRODUCTION

*Partridge  
output  
Transformers*



The secondary is brought out as four separate sections which may be connected in series or parallel to match speaker impedances of 0.95, 3.8, 8.5 and 15 ohms by this arrangement.

Each half primary is brought out to terminals as separate windings and is tapped for ultra linear performance. Latest grain orientated cores. Fully interleaved.

5200 Series—for use in 20 or 35 watt amplifiers with distortion less than 1%.

Available in 4 models

Model #	Plate to Plate Load	Tapped At	
P5201	9-12K ohms	43%	<b>\$3000</b> NET
P5202	7- 9K ohms	43%	
P5203	3- 7K ohms	43%	
P5204	3- 5K ohms	20%	

5300 Series—for use in 35 to 50 watt amplifiers with distortion less than 1%.

Available in 4 models

Model #	Plate to Plate Load	Tapped At	
P5351	9-12K ohms	43%	<b>\$3500</b> NET
P5352	7- 9K ohms	43%	
P5353	5- 7K ohms	43%	
P5354	3- 5K ohms	20%	

**ULTRA ELECTRONICS, INC.**

235 EAST 60th ST. • NEW YORK 22, N.Y.

CIRCLE 94A

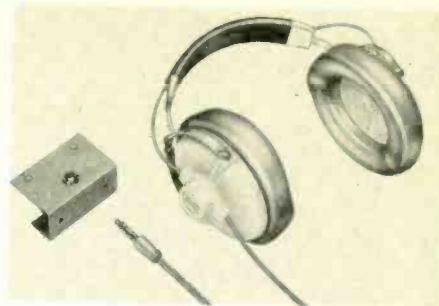

mately 1 watt per channel to the jack panel is required and improved signal-to-hum ratio is provided.

**Specifications: Drivers**—high-compliance, curvilinear, moisture resistant with Alnico magnet. Frequency Range: 20-15,000 cps. Power Requirements: 1/10 milliwatt. Impedance: 8 ohms each channel (may be connected to 4, 8 or 16 ohm amplifier outputs). Sensitivity: 95 db sound pressure level for 1 milliwatt. Plug: standard 3 contact headphone plug. Cord 8 ft. long. Net weight: 16 oz. Jensen Manufacturing Company, 6601 S. Laramie Avenue, Chicago 38, Illinois. User net price \$24.95.

1. CC-1, stereo headphone control center \$39.75
2. CFN-1, headphone cross-feed network 19.50

**KOSS**

• **Professional Headset, Model Pro-4.** The Professional Headset is engineered to meet the most rigid requirements. It is very rugged, shatter-proof, and shock-proof. Fluid filled ear cushions are designed to fit head contour and thus form a more perfect seal.

**Specifications:** Freq. resp. 30 to 20,000 cps; maximum input. 10 watts per channel, 60 watts per channel of normal music program source; distortion, less than 1% at maximum output of 125 db S. P. L.; impedance, 4 ohms; cord 8-ft. four-conductor; removable cushions can be cleaned with soap and water. Equipped for boom mike attachment. Price \$45.00. Koss Electronics, 2227 North 31st., Milwaukee, Wisconsin.

1. SP-3, stereophones ..... \$24.95
2. SP-5NS, dual-mode stereophones .... 24.95
3. SP-5SM, stereo/mono stereophones ... 24.95
4. SP-5VW, dual-input stereophones .... 24.95

**PERMOFLUX**

• **Headphone Series.** Available in a variety of impedances, the Permoflux DIIS series of binaural headphones achieve the full depth and presence available in binaural sound. The close coupling of the earpieces eliminates the adverse factors of improper room acoustics and poor speaker placement. Available with several styles of ear-cushions, the DIIS series is adaptable to a wide variety of circumstances. In addition various adapters are available which permit connecting up to four sets of headphones to one program source. Permoflux Products Co., 4111 San Fernando Road, Glendale, Calif. User net price, \$42.50-52.50.

**PIONEER**

• **Stereo Headquarters.** Usable for either stereophonic or monophonic listening, the Pioneer Model SE-1 features foam ear pieces, which are comfortable and also provide an excellent seal. The lightweight ear pieces and padded headband are completely adjustable to give a "custom fit" for utmost comfort. Only one conveniently long plastic cord is attached to the earphone. The cord is terminated in a final plug which may be plugged directly into the source, or into a four-way switch box connected to the speakers. This switchbox is provided. Impedance is 8 to 16 ohms. Monarch Electronics International Inc., 7035 Laurel Canyon Blvd., N. Hollywood, Calif. User net price \$19.95.

**REALISTIC**

• **Stereo Headphones.** For home use. The Realistic stereo headphones have 8-ohms impedance, frequency range from 20-20,000 cps,

**The First Book of its Kind—No Other Like It!**  
**SOUND in the THEATRE**

by Harold Burris-Meyer and Vincent Mallory

Nothing like SOUND in the THEATRE has ever been published. It is the first book to set forth in authoritative detail what you can do with sound by electronic control, and how to do it whenever the source (singer, musician, speaker, etc.) and the audience are present together. The book develops the requirements for electronic sound control from the necessities of the performance, the characteristics of the audience (hearing and psychoacoustics), and the way sound is modified by environment, hall, and scenery. Sound sources are considered for their susceptibility of control and need for it, and the many techniques for applying electronic sound control are described and illustrated in thirty-two specific problems. From these problems are de-

rived systems and equipment specifications. Complete procedures are given for: Planning, assembling, and testing sound control installations—Articulating sound control with other elements of production—Rehearsals and performances—Operation and maintenance of sound control equipment.

**THE AUTHORS**

During the past thirty years, the authors have developed the techniques of sound control in opera, open-air amphitheatres, theatres on Broadway, theatres on-the-road and off-Broadway, in concert halls and night clubs, in Hollywood and in the laboratory. Some of their techniques are used in broadcast and recording as well as in performances where an audience is present. From their laboratory have come notably successful applications of sound control to psychological warfare and psychological screening.

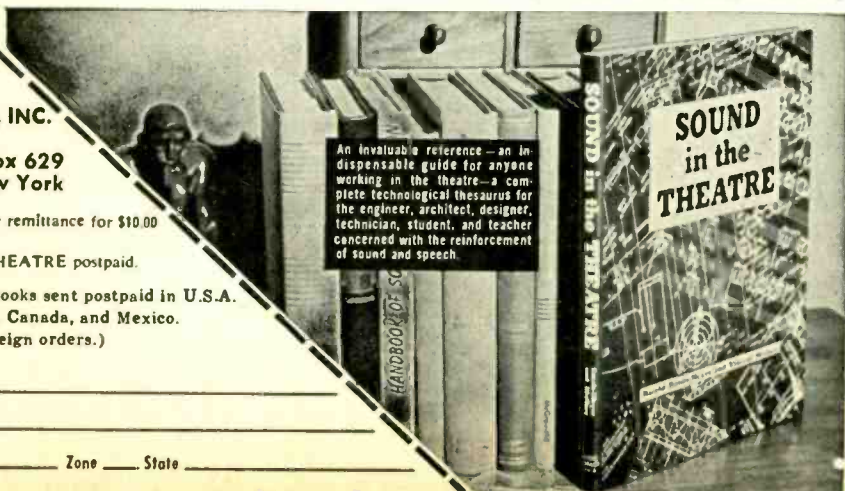

**RADIO  
MAGAZINES, INC.**  
Dept. AG-1  
Post Office Box 629  
Mineola, New York

I am enclosing my remittance for \$10.00  
Send my copy of  
SOUND in the THEATRE postpaid.

(No C.O.D., all books sent postpaid in U.S.A.  
and possessions, Canada, and Mexico.  
Add 50c for Foreign orders.)

Name \_\_\_\_\_  
Address \_\_\_\_\_  
City \_\_\_\_\_ Zone \_\_\_\_\_ State \_\_\_\_\_





silicone-rubber ear cushions, and a spring steel headband covered with wear-resistant fabric. Price \$14.95. Radio Shack, 730 Commonwealth Ave., Boston 17, Mass.

### E. J. SHARPE

• **HA-10 Stereo Phones.** Featuring a response from 20-20,000 cps flat from 30 to 10,000 cps  $\pm 3$  db. Noise-excluding ear pieces to remove outside disturbance. Plastic and metal construction to permit cleaning. Fits around ear rather than on the ear reducing fatigue. Price \$43.50. E. J. Sharpe Inst. Co., 965 Maryvale Dr., Buffalo 25, N. Y.

### TELEX

• **ST-10 Stereo-Twin Headset.** The Telex Stereo-Twin headset has been specifically designed to provide exceptional stereo private listening for the music lover. The rugged construction will provide years of listening enjoyment while allowing ample adjustment for maximum comfort and ambient noise rejection. Deluxe foam rubber cushions provide a superior acoustic seal even when wearing glasses. The Stereo-Twin is designed to provide maximum performance when connected to an amplifier output impedance of  $\frac{1}{2}$  to 16 ohms; 16 to 15,000 cps frequency response; two watts maximum power input; weight 13 oz. High yield-stress spring-type stainless steel headband, sleeved for maximum comfort. Price \$40.65. Telex, Inc., 1633 Eustis St., St. Paul 1, Minn.

### TURNER

• **Model 270 Headset with Optional Boom Microphone.** Moving coil dynamic phones are used on the Turner Model 270 Headset to give the user the finest possible reproduction of voice and recorded music. The Model 270 is available with 8-ohm, 250-ohm, and high-im-



pedance phones. The Model 270 headset has a flat response from 30 to 9000 cps, with good fidelity for an extended range up to 13,000 cps. The moving-coil phones have diaphragms of "dynaflex" plastic. Twin headbands are designed to accommodate modern hairdos and to be more comfortable than single-band units. Price, \$35.00. The Turner Co., 909 17th St., N.E., Cedar Rapids, Iowa.

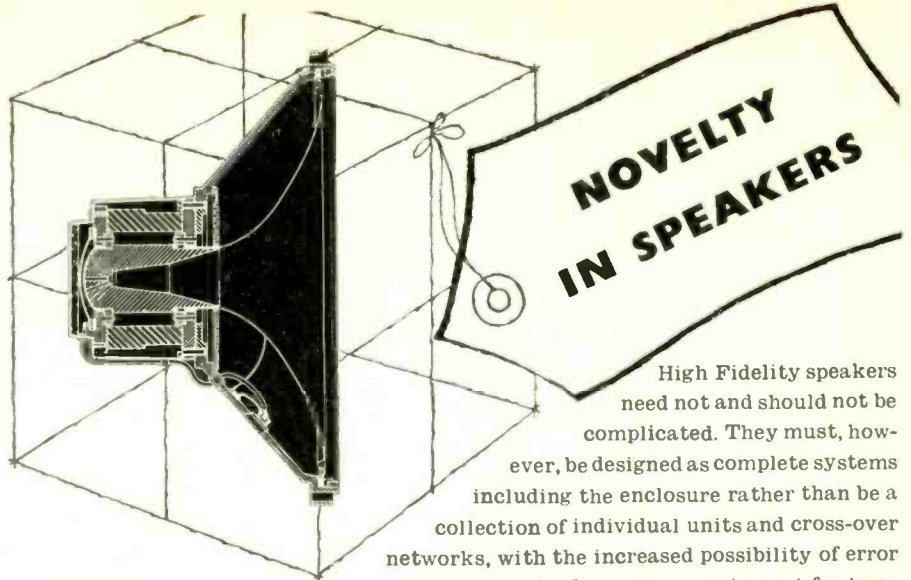

### BASIC SPECIFICATION

"Monitor" Dual Concentric Models

10", 12", and 15"

Frequency response 30-20,000 cps  $\pm 3$ db

Polar Distribution for 60° inc. angle - 3db at 10,000 cps

Write for full details.



**DUAL CONCENTRIC SPEAKERS**

TANNOY (AMERICA) LTD. P.O. BOX 177, EAST NORWICH, N.Y., U.S.A.  
TANNOY (CANADA) LTD. 36 WELLINGTON STREET EAST, TORONTO 1, ONTARIO, CANADA  
CIRCLE 95A

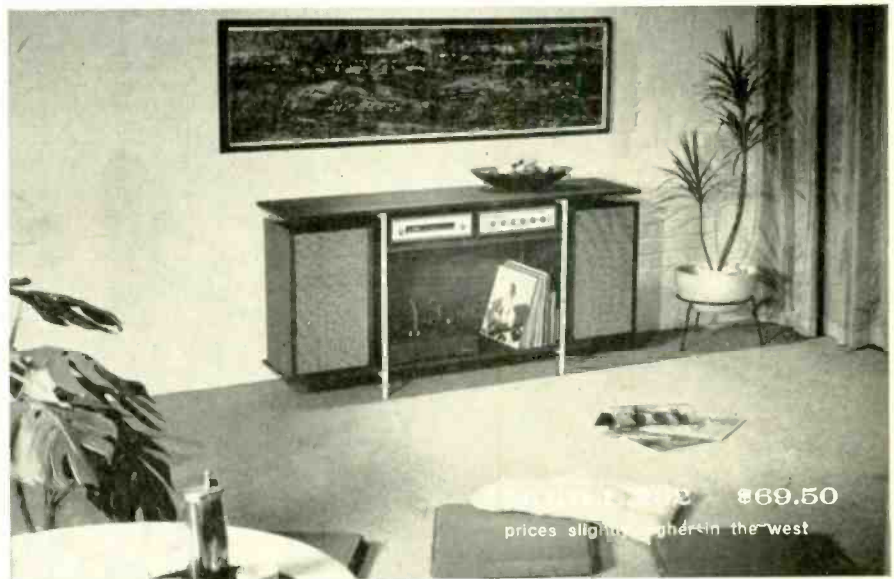

### elegant stereo cabinetry...

The new look in "bookshelf" speakers. Place a speaker on each end, amplifier and tuner on the adjustable shelf, and your components are transformed into a striking stereo cabinet which will highlight every interior and accent your fine components. Naturally, crafted from the finest of hardwoods in a choice of finishes. see your dealer or write for free brochure of the complete line.

**A**udio  
**O**riginals

474 SOUTH MERIDIAN STREET • INDIANAPOLIS 25, INDIANA  
CIRCLE 95B

# MISCELLANEOUS

## ACOUSTIC RESEARCH

• *Needle Force Gauge.* Balance type, with weights to 1/4 gram. Accuracy ± 5 per cent. Price \$1.00.

## ALTEC

• *500D Dividing Network.* Designed for use with 802 h.f. driver and 511 horn, the 500D has smooth 12-db-per-octave slope. Externally mounted high-frequency shelving control has four steps of 1 1/2 db for precise adjustment to individual room acoustics.

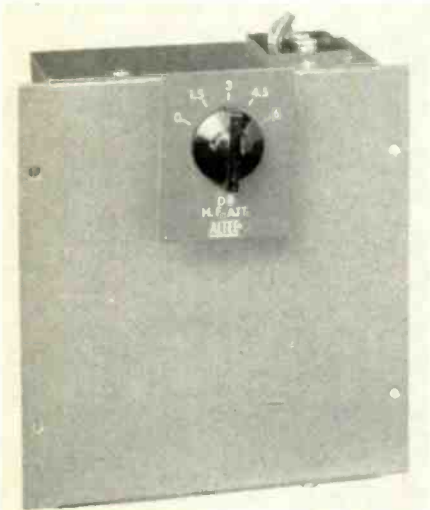

*Specifications:* Impedance, 16 ohms; h.f. attenuation, 6 db in 1 1/2-db steps; crossover

frequency, 500 cps; dimensions: 8" wide, 5 1/4" high, 2 5/8" deep; weight, 12 lbs. Price, \$60.00. Altec Lansing Corporation, 1515 S. Manchester Ave., Anaheim, Calif.

1. 800E dividing network, 800 cps . . . . \$46.50
2. 3000B dividing network 3000 cps . . . 22.50

## AMERICAN

• *New Professional Length.* American's new Professional Length breaks existing tape traditions by offering up to 25% more tape on the standard 7-inch reel. American's new "Professional Length" will increase 1 1/2-mil acetate to 1500 feet. 1-mil acetate to 2000 feet, 1-mil mylar to 2000 feet and 1/2-mil mylar to 3000 feet. The purpose of course is to offer the tape-it-yourself customer an opportunity to record more music on a 7-inch reel of tape regardless of the base material he prefers. The new Professional Length will retail for the same price as other quality tape of standard lengths. Greentree Electronics, Los Angeles, Calif.

## AMPEREX

• *Type 6GW8/ECL86 Triode Pentode.* The Amperex 6GW8/ECL86 is a triode-pentode with separate cathodes. The pentode section is designed for audio output in audio amplifiers or TV receivers. The triode section is suitable for amplification in these applications using a supply voltage of around 250 volts for both sections.

*Specifications:* Heater voltage, 6.3 v.; current, 700 ma; Noval base, T6 1/2 bulb, height 2 13/16" seated. Pentode section: 300 v. max; dissipation, plate, 9 watts, screen, 1.8 watts; cathode current 55 ma. Typical operation, plate-to-plate load, 9100 ohms, power output 14.3 watts per pair. Triode section: 300 v. max, dissipation, 0.5 watts; voltage gain 66 to 80. Amperex Electronic Corporation, 230 Duffy Ave., Hicksville, L. I., N. Y.

1. 6BQ5/EL84, med pwr output pentode . \$1.30
2. 6CA7/EL34, high pwr output pentode . 2.90
3. 5AR4/GZ34, power rectifier . . . . . 2.20
4. 12AU7/ECC82, med gain dual triode . . 1.23
5. 12AX7/ECC83, high gain dual triode . . 1.28

## AMPEX

• *AmpeX 500 Series Magnetic Recording Tape.* AmpeX 500 Series is a premium quality audio recording tape with exclusive Ferro-Sheen oxide surface for maximum frequency response, clean operation and low head wear. It is available on 5- or 7-inch plastic reels and is for semi-professional and first-rate home recording. It is designed for optimum performance on AmpeX recorders. An AmpeX "Signature Binding" and gold foil title tab is included with each reel of AmpeX tape so the finished recording will have an attractive library binding with a personalized title. Price varies. AmpeX Corporation, Magnetic Tape Products, 934 Charter St., Redwood City, California.

1. AmpeX-Irish 300 Magnetic Tape, economical quality.

## AMPLIFIER CORP.

• *"Magneraser" Model 200C and 220C.* Designed to serve a dual function, the new "Magneraser" completely erases tape on the reel, without rewinding, and also demagnetizes record-playback and erase heads. Wear and tear on the tape and equipment is reduced because erasure is effected on the reel.

*Specifications:* Switch, momentary, pushbutton. Field intensity 800 gauss. Line voltage, 117 volts nominal. Power consumption 60w. Current 3.05 amperes. Power factor 0.12. Construction, bakelite case. Size: 2 1/2-in. high x 4-in. diameter. Weight 3 1/2 lbs. Model 200C for 100-130 v; Model 220C for 200-260 v. Price \$18.00. Amplifier Corp. of America, 396 Broadway, New York 13, N. Y.

## ARTISAN

• *"York" Two-manual Organ Kit.* Although only 25" deep and 50" wide, the York offers more features than are found in any other organ of similar size: full 61-note manuals, 25-note concave pedal keyboard, dual expression pedals, and 40 stops—plus the authentic sound of a giant organ. The handsome theatre-styled console with "horseshoe" stopboard and multicolored stop tablets is impressive in any



# SLASH SWITCH COSTS

## Boost Performance and Sales Appeal

Improve product design. Add operating convenience. Cut production time and costs. Stackpole Slide Switches do the trick. Available in over 15 basic types, they give you ratings and features to meet your needs in appliances, power tools, electronic devices.

- 0.5 to 10-amp U.L. Ratings.
- Priced from \$.039 each.
- 11 Attractive Knob Colors.
- 1 to 4 poles—1 to 4 positions.
- Lug, printed circuit, or Quick Connect terminals.
- Maintained or momentary contact.
- Slide or pushbutton-operated types.

### 10-Amp Switch—less than 10¢

Specifically designed for modern appliances. Nylon-insulated, low-profile Type SS-37 with Q-C terminals. SPST or SPDT.

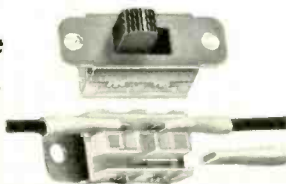

# STACKPOLE

WRITE FOR SWITCH BULLETIN

Electro-Mechanical Products Div., STACKPOLE CARBON CO. • Johnsonburg, Pa.

# SAVE 25%

## This is our GROUP SUBSCRIPTION PLAN

Now you, your friends and co-workers can save \$1.00 on each subscription to **AUDIO**. If you send 6 or more subscriptions for the U.S., Possessions and Canada, they will cost each subscriber \$3.00 each, 1/4 less than the regular one year subscription price. Present subscriptions may be renewed or extended as part of a group. Remittance to accompany orders.

(Please print)

Name \_\_\_\_\_  
Address \_\_\_\_\_  
 New  Renewal

Name \_\_\_\_\_  
Address \_\_\_\_\_  
 New  Renewal

Name \_\_\_\_\_  
Address \_\_\_\_\_  
 New  Renewal

Name \_\_\_\_\_  
Address \_\_\_\_\_  
 New  Renewal

Name \_\_\_\_\_  
Address \_\_\_\_\_  
 New  Renewal

Name \_\_\_\_\_  
Address \_\_\_\_\_  
 New  Renewal

U. S., Possessions, and Canada only

## RADIO MAGAZINES, INC.

P.O. Box 629, Mineola, N.Y.

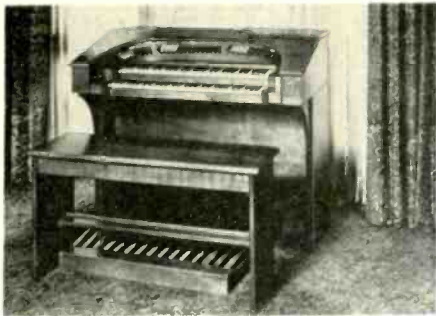

setting. It can be purchased in a complete 2-manual kit, or started with a single manual and later expanded. Prices start from \$1500 to \$2250. Independent oscillators are employed on every key of every manual and even in the pedal. This achieves a rich chorus tone. Artisan Organ Division. Electronic Organ Arts, 4949 York Boulevard, Los Angeles 42, Calif.

1. "Concert," 3-manual organ kit ..... \$3500 to \$5500
2. "Regal," small 3-manual organ kit ..... 1750 to 3750
3. "Theater," 2-manual horseshoe console organ kit ..... 1750 to 3000

### AUDIO DEVICES

• **AUDIOTAPE for Magnetic Recording:** Audiotape has an improved, bright new package design with eight distinct colors being used to identify all eight types of Audiotape. Simple and direct product descriptions are combined with the color-coding technique making Audiotape type selection easier than ever before. New Audiotape nomenclature includes: Standard Recording, for 1½-mil base materials; Longer Recording, for the 1-mil base materials; Double Recording for the ½-mil base materials; and Master Recording for tapes with special low-print-through oxide formulations. New products added to the Audiotape line include packaging on 5¼-in. reels and tapes with Colored Leader Reversal Strips for use on automatic stop-reversal machines. Audio Devices, Inc., 444 Madison Ave., New York 22, N. Y.

### AUDIO ORIGINALS

• **Model 303 Equipment Cabinet.** Concentrating on designs for the compact speaker, Audio Originals has created a series of designs which will accommodate a variety of standard components in an over-all integrated design. This Scandinavian design features convenient pull-out changer or turntable shelf, two adjustable component shelves, space for hundreds of records and a tape deck too. It is 72½-in. long, 32½-in. high and 16-in. deep. The speaker compartment is 25¾ x 16¾. The Model 303 is available in oiled Walnut, Mahogany, Cherry and Fruitwood. It is shipped knocked down and assembles in minutes. It weighs 85 pounds. Price \$99.50. Audio Originals, 474 S. Meridian, Indianapolis, Ind.

1. Model 202 Stereo Cabinet ..... \$69.50

### BOZAK

• **N-10102 Convertible Crossover Network.** The N-10102 is convertible for 8- to 16-ohm three-way speaker systems with 6-db-per-octave crossovers at 800 and 2500 cps. It is non-

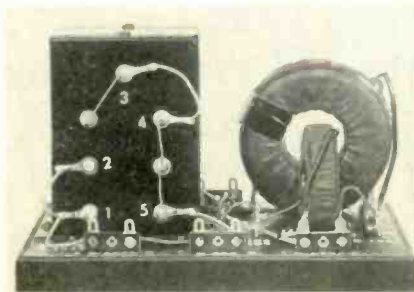

## Hear the newest stereo development . . .

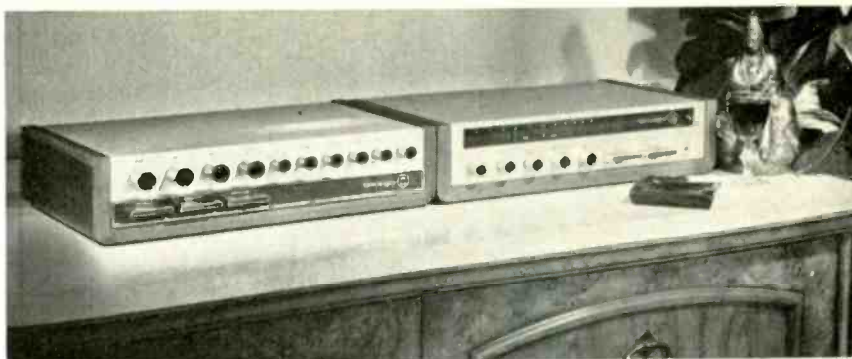

### The Omega all-transistor FM/multiplex tuner and 60-watt stereo amplifier . . .

You'll thrill to breath-taking concert hall reproductions with the totally-new all-transistor Omega FM/Multiplex Tuner and 60 watt Stereo Amplifier. These solid-state units represent a major "breakthrough" in electronic design. Exclusive transistor circuitry eliminates disturbing tube hum, microphonic noise and excess heat. Meticulously engineered, Omega provides you with flawless sound. The amplifier develops a full 60 watts (30 watts per channel) . . . the tuner gives you positive channel separation for unmatched stereo enjoyment. Other performance and styling features will also delight the most discriminating audiophile.

For complete information, contact your local Omega dealer or write directly to Omega.



**omega** ELECTRONICS CORPORATION

10017 North 19th Avenue • Phoenix 21, Arizona

Have You Heard The . . .

# PLAYMATES



### Matching Stereo Hi-Fi Speaker System

The Playmate is beautifully styled in Walnut Finished Veneer. Finished on all four sides permitting vertical or horizontal use and specially dimensioned for Book Shelf, Highboy or Lowboy Floor installation. It is ideal for use as a single unit by itself, perfect in pairs for stereo or as an addition to your present system. Truly superb performance, compact, in tasteful design to compliment in quiet elegance.



#### Equipped with 2 - 6" Speakers and 1 - 4" Tweeter!

The Playmate is specially designed with matched Woofer, Midrange and Tweeter Speakers plus suitable Crossover. Full base response to below 40 c.p.s. with clean and clear brilliance to 18,000 c.p.s. Capacity 25 watts—Impedance 8-16 ohms.

WILDER Engineering Products / 1253 W. DIVERSEY PKWY. CHICAGO 14, ILLINOIS

SEND COUPON FOR COMPLETE DETAILS ON NEW PLAYMATES AND OTHER HI-FI SPEAKERS

NET EA. 3995

Name \_\_\_\_\_  
Street \_\_\_\_\_  
City \_\_\_\_\_ Zone \_\_\_\_\_ State \_\_\_\_\_





## NEW... FROM FAIRCHILD MODEL 663

### COMPACT COMPRESSOR

Now you can have a compressor for every mike channel with this miniature low cost Fairchild Compact Compressor... no larger than a slide type attenuator (actual size 1½x7x4½ inches). This Fairchild Model 663 Compact Compressor will provide up to 20 db of compression with no increase in distortion. And the attack time of 40 milliseconds with a variable threshold and variable release time of .3 to 7 seconds offers complete compressor flexibility and performance. The Fairchild 663 Compact Compressor can be easily integrated into your present console to provide the ultimate answer to all level control problems.

Fairchild Model 663: \$158.00

Write today for complete details

## FAIRCHILD

RECORDING EQUIPMENT CORPORATION  
10-40 45th Ave., Long Island City 1, N. Y.

CIRCLE 98A

## CROWHURST BURSTEIN FIDELMAN

the experts help you  
get the most out of hi-fi

by Norman H. Crowhurst.

**FM STEREO MULTIPLEXING** "... a detailed description of the FCC standards for FM stereo broadcasting ..." — ELECTRONIC WORLD, #282, \$1.50.

**STEREOPHONIC SOUND (2nd Ed.)** "... valuable to those who like their 'fidelity' high and 'realistic' ..." — ELECTRONIC WORLD, #209, \$2.90.

**BASIC AUDIO, 3-VOLUME LEARN BY PICTURES COURSE** "... experimenters and more experienced hobbyists will find no other syllabus more richly informative or authoritative." — HIGH FIDELITY MAGAZINE, 3 vols., soft covers, #201, \$8.70; cloth, #201-H, \$9.95.

by Herman Burstein

**GETTING THE MOST OUT OF YOUR TAPE RECORDER** "... Written for the users of tape recorders, in his language... Indeed a contribution to the audio field." — DESIGN NEWS, #251, \$4.25.

**FUNDAMENTALS OF HIGH FIDELITY**. Tells you how to select the best equipment for the money and achieve the best performance from it. #226, \$2.95.

**REPAIRING HI-FI SYSTEMS** by David Fidelman. Save money! "Deals authoritatively... with test gear and techniques, the major troubles encountered in various system components." — HIGH FIDELITY MAGAZINE, #205, \$3.90.

### 10 DAY MONEY BACK GUARANTEE

JOHN E. RIDER PUBLISHER INC.  
A division of Hayden Publishing Co., Inc. A8  
116 West 14th St., New York 11, N. Y.

Enclosed is \$\_\_\_\_\_ Please send:  
 #282, \$1.50  #209, \$2.90  
 #201, \$8.70  #201-H, \$9.95  
 #251, \$4.25  #226, \$2.95  #205, \$3.90

Name \_\_\_\_\_

Address \_\_\_\_\_

City \_\_\_\_\_ Zone \_\_\_\_\_ State \_\_\_\_\_

CIRCLE 98B

ringing and causes no peaks or "holes" in response. Price \$27.50. R. T. Bozak Mfg. Co., P.O. Box 1166, Darien, Conn.

1. N-103 network, 16 ohms, crossovers at 400 and 2500 cps ..... \$37.50

### BURGESS

• **Burgess Magnetic Recording Tape on the new 1500' "LP Reel."** Burgess Magnetic recording tape on the new 1500' "LP Reel," is just the right amount of tape to record both sides of an LP record on one side of the tape at 7½ ips. Thus it is possible to get two complete records (four sides) on one reel of tape. This tape is one of a complete line of magnetic recording tape. 150-15 (1 mil, extra play Mylar), Price \$5.15; 190-15 (1 mil extra play plastic) \$4.50. Burgess Battery Co., Magnetic Tape Div., Freeport, Ill.

### CBS LABS

• **STR 100 Stereophonic Frequency Test Record.** Detailed instruction in two parts permit use of this record by audio engineers as a laboratory tool or by high fidelity enthusiasts for evaluating and adjustment of complete phonograph reproducer system.

**Specifications:** Separate test bands measure sweep frequency response; spot frequency response (includes voice announcements); channel separation; tone arm, cabinet, and loudspeaker resonance; wavelength loss and stylus wear; lateral and vertical compliance; and channel phasing. Other features: Triggering and reference level tones permit use of this record with graphic level recorders for automatic measurements of frequency response and crosstalk. Price \$8.50. CBS Laboratories, High Ridge Rd., Stamford, Conn.

### COUSINO

• **Audio Announcer AA-7320.** Basic playback unit for recorded Echo-Matic tamperproof cartridges with three-stage transistor amplifier output to dynamic headset, handset, or input to "Power-Matic" speaker Model PS 4177 or other power amplifiers, public address system or intercom. Features include automatic shutoff from metallic foil or painted stop on tape loop. May be restarted by remote cord, footmat switch, clock, photoelectric cell, and other switching devices.

**Specifications:** Transformer powered; flutter and wow less than 0.4% rms; signal-to-noise ratio, 45 db; response, 80 to 10,000 cps; operating speed 3¾ ips (1¼-ips available); operating power requirements—20 watts, 117 volts, 60 cps a.c., no standby power; motor and amplifier operational from 105-120 volts. Dimensions: 5¾" wide x 9" deep x 5¾" high; weighs 9 lbs. Various accessories available. Price, \$99.75. Cousino Electronics Corp., 1941 Franklin Ave., Toledo, Ohio.

1. PR-2331 Mag-matic tape repeater ... \$297.00
2. PS-4177 Power-Matic speaker ..... 39.00
3. MS-4547 Footmat start switch ..... 22.50
4. PC-4541 Remote start pushbutton ... 4.50

### ESL

• **Automatic Record Cleaner.** Cleaning the record as it is played, the ESL "Dust Bug" solves the problems of dust, lint, and static build-up on phonograph records and pickup stylus. The Dust Bug cleans records thoroughly and safely, and it is easily installed on turntables. It removes dust and lint immediately before the moment of playing by means of a



tuft of individually pointed soft nylon fibers in front of a cylindrical push pad, the latter being moistened with a harmless anti-static fluid which is supplied in a replaceable dispenser. Price, \$5.75 for model shown, for use on turntables. The Changer Dust Bag is designed for attachment to the pickup head of changers and serves the same purpose. Price, \$4.75. Electro-Sonic Laboratories, Inc., 627 Broadway, New York 12, N. Y.

### FAIRCHILD

• **Componder.** The Fairchild Componder is an auto-dynamic range expander-compressor. It is passive, introduces no distortion, for stereo-mono, noise-free expander-compressor; 6 db expansion, 10 db compression; input impedance 0-47k, output 47-500k. Four visual expansion-



compression indicators. Instant switching from compression-off-expansion. Two dynamic sensing controls. Price: factory assembled, Model 510, \$75.00; kit, Model 510K, \$59.95. Fairchild Recording Equipment Corp., 10-40 45th Ave., L.I.C., N. Y.

1. 661 Auto-Ten, a professional equipment ..... \$125.00

### FERRODYNAMICS

• **Magnetic Recording Tape, Brand Five.** The properties of Brand Five include a dry-synthetic lubricant, a hard scratch-resistant formulation, improved output and uniformity, and a one-piece quick threading reel. Available in 5", 7", and 10½" reels in both Mylar and acetate. Price varies. Ferrodynamics Corp., Lodi, N. J.

### FINCO

• **FM-4 FM Antenna.** The Finco FM-4 antenna is obtainable in both silver aluminum or exclusive soft gold corrodized (FM-4G).

The FM-4 features a high front-to-back ratio, coupled with high db gain, and is designed on Finco's patented extra-high geometric antenna principles, using twin-drive elements having impedance control "T" match stubs. Extra wide-space element, heavy duty special square boom, exclusive lock-tite-tilt saddle mounting with box girder snap-out, self-aligning brackets, completely pre-assembled with double wall reinforced all-aluminum elements. Aluminum, \$24.90. Gold Corrodized. Price \$27.75. The Finney Company, Bedford, Ohio.

1. FMT-A ..... \$14.50
2. FMT-1, kit ..... 14.50
3. FM-2, kit ..... 14.50
4. FM-3 ..... 13.00
5. FM-5 ..... 36.35

### FM/Q

• **Broadband Very High Gain FM Yagi.** FM/Q "Super Special" two-bay stacked array is a multiple element broadband FM yagi antenna designed especially for extended range reception of the 88 to 108 mc band. Design features heavy duty construction employing burnished seamless drawn aluminum tubing and stainless steel rustproof hardware. Two 12-element antennas are stacked together at full wave spacing for optimum gain and directivity. Exceptionally high signal output is obtained without the use of troublesome amplifying devices and attendant noise factor, for permanent high-level response. The array includes two antennas, stacking harness, mast terminal insulator, and a special 14½-ft. aircraft alloy (steel) for mounting. Normally supplied for standard 300-ohm impedance, the system is easily converted to 72 ohms as required. Price \$149.96. Apparatus Development Co., Inc., Drawer 153, Wethersfield, Conn.

1. "FM/Q" Super Special Broadband Yagi (single) ..... \$49.96
2. "FM/Q" Senior Broadband Yagi ..... 29.96
3. "FM/Q" Junior Broadband Yagi ..... 22.96
4. "FM/Q" Metropolitan Broadband Yagi . 14.95
5. "FM/Q" Long Ranger Single Frequency Yagi ..... 49.96

## GENALEX

● *KT77 Beam Powered Tetrode.* Intended as a replacement for the 6L6GB, the EL34/6CA7, and the 7581, the Genalex KT77 permits 32 watts of anode dissipation maximum, and an output of 72 watts per pair. Grids are gold plated and optically aligned to ensure freedom from grid emission. The KT77 is built to very exact specifications, and in addition is quite rugged. It is one of several specialized audio tubes. The KT77 may be used in triode, pentode or ultra-linear push-pull circuit. Price, \$5.50. British Industries Corp., Post Washington, N. Y.

- |  |        |
|--|--------|
| 1. KT88 Beam Power Tetrode Replaces 6550, 7027A, 6L6CC | \$6.95 |
| 2. KT66 Beam Power Tetrode Replaces EL35, 5881, 6L6    | 4.50   |
| 3. N709 Output Pentode, replaces 6BQ5, EL84            | 3.80   |
| 4. B759 Double Triode, replaces 12AX7, ECC83, 7025     | 3.00   |
| 5. U-77 Full Wave Rectifier, replaces CZ34, 5V4        | 3.70   |

## GRADO

● *"Dustat" Velvet Touch Record Cleaner.* This cleaner substantially reduces the electrostatic charge in records and completely re-

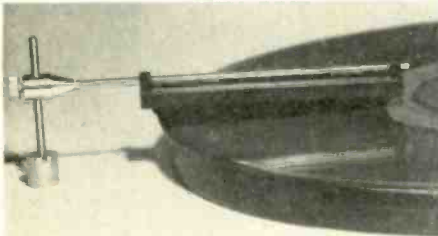

moves dirt and grit. The Dustat is easy to install and is fully adjustable for any turntable. The device does not contain radioactive materials, nor does it use any fluids. Price, \$6.95. Grado Laboratories, Inc., 4614 Seventh Ave., Brooklyn 20, N. Y.

## JERROLD

● *FM Range Extender, Model FMX.* The new Jerrold FM Range Extender, Model FMX is an FM antenna amplifier designed to overcome limitation of FM-multiplex broadcasting. The FMX provides a minimum gain of 20 db over the entire FM band. This one-tube antenna amplifier eliminates background noise and "drifting," can be mounted in an attic, closet, or on any convenient wall or flat surface where a 117-volt 60-cps outlet is available. Used with Jerrold's Model MF-2 or MF-4 multi-set couplers, the FMX can feed signal to two, three, or four receivers. The amplifier is extremely compact, weighing slightly over 2 lbs. It incorporates the latest 6DJ8 frame grid tube, insuring stable, high-level performance. Current used by the equipment is comparable to that used by an electric clock. It has a shut-off switch. Price \$29.95. Jerrold Electronics Corp., 15th and Lehigh Ave., Philadelphia, Pa.

- |   |        |
|---|--------|
| 1. TX-FM antenna splitter for TV-FM                   | \$5.95 |
| 2. MKI Magic carpet antenna (printed-circuit antenna) | 9.95   |

## KARG

● *Stereo Multiplex Signal Generator Kit, Model MX-1G.* Generates composite FM-multiplex stereo signal for service and advanced audio hobbyists.

*Specifications:* Oscillator, crystal controlled, 19,000, kc  $\pm$  2 cps. modulation, internal 1000-cps or external generator (requires 10 v. rms for full output); composite output, vari-

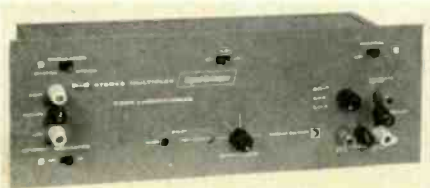

able 0-15 v. peak-to-peak; pilot signal, screw-driver adjust, variable 0 to 15% of composite, may be switched off, and is phase adjustable  $\pm$  45 deg. from zero phase with respect to carrier; separation, 40 db minimum, carrier suppression, in absence of modulation, carrier is down 40 db minimum from maximum composite output; output signal mode, switchable. L=R modulation (monophonic) L=-R modulation (full stereo), or L or R only; 'scope sync signals, audio modulation or pilot signal sync. Dimensions, 16" wide, 5 1/2" high, 5 1/2" deep; weight, 12 lbs. Price, kit including tubes and 19-kc crystal, \$149.95. Karg Laboratories, 162 Ely Ave., South Norwalk, Conn.

## KERSTING

● *Built-in Combination Hi-Fi Equipment and Record Storage Cabinet, Model BER.* Featuring tambour doors of solid walnut hardwood, with hand-rubbed satin finish and 1 1/2" solid walnut hardwood face moulding attached. Interiors are finished in blended colors. Unseen portions of the cabinets are of 3/4"



Douglas fir plywood, primed, ready for painting. Easily installed. Cut opening in wall—slide in and fasten. Contains two Quick-See Retractable Album Files, allowing front view flip through selection of records. Price, \$179.95. Kersting Mfg. Co., 504 S. Date St., Alhambra, Calif.

- |   |          |
|---|----------|
| 1. BE, equipment cabinet                | \$ 79.95 |
| 2. BR, record storage cabinet           | 99.95    |
| 3. BTR, tape and record storage cabinet | 149.95   |
| 4. BS, speaker cabinet                  | 69.95    |
| 5. BTV, TV cabinet                      | 119.95   |

## KODAK

● *Sound Recording Tape.* On the market only since March of this year, Kodak Sound Recording Tape is a general-purpose magnetic tape featuring low noise, high sensitivity, high output, full audio-frequency range, and consistent uniformity, both within each roll and from roll to roll. These properties enhance the performance of any tape recorder and permit recordings of highest fidelity with fine recording equipment. Lubrication of both base and oxide layer is combined with precise slitting to provide for smooth transport and precise tracking in tape recorders. Kodak Sound Recording Tape is available in five popular sizes: 1.5-mil Triacetate, standard play, in 1200-, 600- and 150-ft. reels of 7-, 5-, and 3-in. diameter, respectively, and in 1-mil Triacetate Extra Play in 1800- and 900-ft. reels of 7- and 5-in. diameter. A unique feature of all 1200- and 1800-ft. rolls of Kodak Tape is the Kodak Thread-Easy Reel, which is also available separately, and which makes possible quick and sure threading of the take-up reel. A special "splicing slot" is also provided on the face of the Thread-Easy Reel. Eastman Kodak Co., Rochester 4, N. Y.

## MARK-Q-MATIC

● *Model MQM-1 Slide Tape Synchronizer.* The MQM-1 is a simple device which synchronizes a tape recorder to a slide projector so that coordinated shows are possible. It installs simply beside the tape recorder. Synchroniza-

## SWITCHCRAFT AUDIO CONNECTORS

# Audio Connectors

With  
"CAPTIVE  
DESIGN"



INSERT SCREWS

From Switchcraft!



Screws remain in inserts when removed for cable installation. EXCLUSIVE "GROUND TERMINALS" provide complete grounding provisions. Many other unique features in this 3-pin line.

- |   |        |
|---|--------|
| A3F—Female Plug—U.S.A. List                       | \$2.25 |
| A3M—Male Plug—U.S.A. List                         | \$1.90 |
| B3M—Male Single Hole Mount Receptacle—U.S.A. List | \$2.90 |
| C3M—Male Panel Mount Receptable—U.S.A. List       | \$1.40 |

See Your Dealer Today or Write Us  
for Dealer Nearest You

# SWITCHCRAFT

5525 N. Elston Ave., Chicago 30, Ill.  
CIRCLE 99A

without question  
the finest\*



ask your dealer  
for a  
demonstration

\* IN HIGH FIDELITY SPEAKER SYSTEMS

IONOVAC DIVISION  
DUKANE CORPORATION  
DEPT. A-82 / ST. CHARLES, ILL.

- Where can I hear a demonstration?  
 Please send me available information

NAME \_\_\_\_\_  
FIRM (if dealer) \_\_\_\_\_  
ADDRESS \_\_\_\_\_  
CITY \_\_\_\_\_ STATE \_\_\_\_\_

CIRCLE 99B

# LOOK... THIS PHOTO

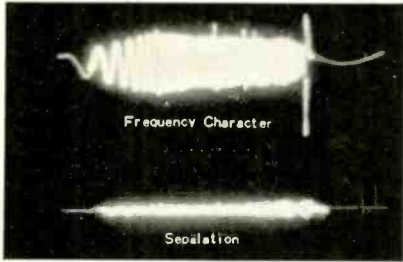

STEREO CARTRIDGE  
MODEL SX-1

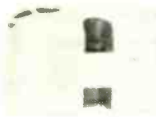

**SONOVOX CO., LTD.**  
101 Tokiwamatsu cho, Shibuya, Tokyo, Japan

CIRCLE 100A



When KLIPSCH speaks  
even PAGLIACCI listens!

For he knows original sound when he hears it... he's made it!

If you have ears like Pagliacci's, you'll appreciate the Klipsch CORNWALL, a speaker you can place against a wall as well as in a corner. Yet its performance is second only to the KLIPSCHORN corner horn speaker. Ideal for stereo.

Ask your dealer to challenge your Pagliacci ears with a Klipsch speaker system. Or write for information.

**KLIPSCH & ASSOCIATES, INC.**  
POST OFFICE BOX 96A HOPE, ARKANSAS  
CIRCLE 100B

tion of Mark-Q-Matic is accomplished by using "Cueing" pencil on tape. Erasing the cue mark does not influence program quality. It does not have transistors or tubes. Simple to install, and may be used with any reel-to-reel tape recorder. Has built-in work pilot light. Price, \$49.95. General Techniques, 50 Hancock Place, Valley Stream, N. Y.

## MICHIGAN MAGNETICS

• **Half-Track Head for Micro-Miniaturization.** Because of its small size and excellent performance, the new 3K17 half-track mono recording head should prove of great interest and benefit to manufacturers of the micro-miniaturized tape recorders. This new head is a revolutionary concept in a performance-proven mono applications, and can be adapted to entertainment or industrial recorders.

**Specifications:** Impedance, 2000 ohms; recording level, -12 db from saturation; audio current, .043 ma; bias current, 1.0 ma; bias frequency, 70 kc; inductance, 300 mh; playback level, 1000 cps. 2.0 mv ± 3 db; 10,000 cps, -8 db ± 3 db; dimensions: 0.387 in. high, 0.340 in. wide, 0.225 in. deep; mounting, 6/32 stud, 3/16 in. long. Michigan Magnetics, Inc., Vermontville, Michigan.

## MICROTRAN

• **Bulk Magnetic Tape Eraser.** The Microtran Model HD-11M bulk tape eraser is used to erase recorded signal and noise from magnetic tape without rewinding. The field intensity is sufficient to erase up to ½-in. tapes. The erase coil is encapsulated in high-impact epoxy so that it is permanently sealed against



the elements. The HD-11M may also be used for demagnetizing recording heads, watches, and other metal objects. The spindle mount for tape reels permits rapid and thorough erasing of reeled tape. It will handle reels from 5-in. to 10½-in. It requires 117 v.a.c. at 5 amps; it is 7-in. long, 3½-in wide, and 3¼-in. high; it weighs 9 lbs. Price, \$18.95. Microtran Company, 145 E. Mineola Ave., Valley Stream, N.Y.

## MULLARD

• **Master 10M Series.** A special range of selected tubes ideal for high fidelity and stereophonic equipment as well as the full range of today's technical advanced and exacting electronic equipment. Tube-to-tube uniformity and section-to-section uniformity assured. Each tube individually laboratory tested and performance guaranteed. Life guaranteed for 10,000 hours of effective performance within two years from the date of purchase. International Electronics Corp., 81 Spring St., New York 12, N.Y.

## PARTRIDGE

• **Output Transformer.** The latest entry from this well-known British manufacturer is the P4160 output transformer. Regarded by them as one of their biggest steps forward for many years, the P4160 is a C-core transformer in a seamless steel case, and weighs a total of 10½ lbs. Primary impedance is 6600 ohms with Ultra-Linear taps at forty per cent of primary turns. On the secondary there are eight sections of 0.95 ohms each. This will give 60 ohms when all sections are in series. Power rating is 20 wats from 20 to 50,000 cps, and 35 wats from 25 to 30,000 cps. Primary resonant frequency is 120,000 cps. Partridge Transformers, Ltd., Roebuck Rd., Chessington, Surrey, England. User net price in U. S. \$48.00. U. S. Dist., Ultra Electronics, Inc., 235 E. 60th St., New York 22, N. Y.

1. P4200, 15 wats output .....\$ 35.00
2. P4170, 100 wats output ..... 75.00
3. P4190, 150 wats output ..... 105.00

## R-A-E

• **Model 100 Variable Crossover Network.** Variable crossover is fed from preamp. Low-range output drives woofer amplifier; high-range output drives tweeter amplifier. Low-range switch limits highest frequency fed to woofer at 150, 200, 350, 500, 700, 1,000, 1,500 or 3,500 cps. Separate low-range and high-range level controls for exact balance between woofer and tweeter. Outputs are cathode followers. Tubes: three 12AX7. Four parts boards, two decks and front panel are assembled and wired separately, then mounted on the chassis. 6-in. wide, 8¾ in. deep. Kit Price \$74.95. R-A-E Equipment Inc., Central Bank Bldg., Great Barrington, Mass.

## ROBINS

• **Gibson Girl "Stereo 4" Tape Splicer, Model #TS-8D.** New "Stereo 4" tape splicer permits close tape trimming tolerances to protect vulnerable outside tracks of four-track tape. It handles all ¼" tapes equally well, including one- and two-track recordings. Produces new streamlined waist that leaves tape edges free of adhesive. The tape splicer features a two-



stage selector knob with "look-thru" windows that indicate to the user when blades are in precise "cut" and "trim" positions. Factory pre-set blades can be adjusted for lifetime accuracy. A pair of holding fingers secure tape during splicing. Unit has integrated tape dispenser with easy threading and is supplied with a roll of ½" x 100" splicing tape. Has a safety lock to prevent accidental damage when splicer is not being used. Price, \$11.50. Robins Industries Corp., Flushing, N. Y.

1. Standard "Stereo 4" tape splicer .....\$8.50
2. Junior "Stereo 4" tape splicer ..... 6.50

## ROCKFORD

• **Model 700-701 Danish Modern Ensemble, Equipment Cabinet and Two Speaker Enclosures.** Adds the pleasure of fine furniture to the joy of listening to good music. Enables you to achieve a beautiful music center with your own choice of separate famous-name high fidelity components for finer mono or stereo reproduction. Acoustically engineered and furniture crafted of selected woods with genuine walnut veneer, in rich oil walnut finish.



Equipment cabinet and free-standing speaker enclosures may be placed together or separate, as you desire. Sturdy construction assures long-life stability. Individual cabinets are also available separately. Price: equipment cabinet, \$113.00; speaker enclosure, \$58.00. Rockford Special Furniture Co., 2024 23 Ave., Rockford, Ill.

1. 600, Italian Provincial equip. cab. ...\$107.00
2. 500, Contemporary equip. cab. .... 128.00
3. 800, Early American equip. cab. .... 118.00
4. 120, Modern (20" wide) equip. cab. 63.00

## ROYCE

● "Audio Robot" Remote Control System. The new Royce Audio Robot remote control system, Model RCS-1, consists of the RC-1 control located at the music system, and a remote control pedestal with indicator light and switch at the extension speaker. It can be installed by anyone in a few minutes without any special tools—only a screwdriver is needed. The Audio Robot turns on or off any mono or stereo component or console music system from the extension speaker with-



out additional wiring. It eliminates unnecessary steps between the equipment and remote speakers, and is ideal for enjoyment in the bedroom before retiring. It will extend the life of your music system by reminding you visually that the equipment is on even after records are finished or the radio station is off the air.

**Specifications:** Power control capacity, up to 500 watts; power requirements, 0.1 watt; dimensions: Robot control, 5½" wide, 2½" high, 3½" deep; remote control, 3½" wide, 1" high, 3" deep. Price, \$32.95 complete; additional remote controls, \$5.49. Royce Electronic Developments, Inc., P. O. Box 321, Valley Stream, N. Y.

## SARKES-TARZIAN

● **Magnetic Tape.** Three types of Tarzian Tape satisfy virtually every requirement for sound recording. Include standard-play 1.5-mil acetate, long-play 1.0-mil acetate, long-play 1.0-mil Mylar. Each type is available in choice of 3, 5, and 7-inch reels, and on professional-size reels and bubs. Each reel is packed in protective carton and plastic. Prices begin at 65¢ for 150 feet of standard play 1.5-mil acetate. Sarkes-Tarzian, Inc., Magnetic Tape Div., Bloomington, Ind.

## SCHOBER

● **Electronic Organ Reverberation Unit.** The Schober Reverbatape Unit is the first reverberation device which can be installed successfully in any electronic organ, regardless of brand or size. Employing no springs, it contains a small tape-recorder mechanism which a continuous loop of tape and several playback heads, along with special circuitry on which patents are pending. The reverberation effect, which can be compared to that of a big pipe organ played in a large church

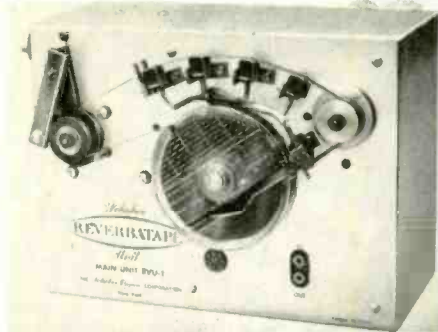

or theatre, is obtained from a series of carefully-spaced repetitions of the sound which blend to give the characteristics, gradual delay. Since the spacing of the repetitions is long enough and the system lacks self-resonances, the effect is startlingly realistic. Dimensions: Main Unit, containing tape recorder and electronic circuitry, 9¾" wide, 7¼" high, 5½" deep; power supply, 6½" wide, 2½" high, and 2" deep; control, a 3-gang potentiometer which may be mounted anywhere on the organ console. Price, \$299.95. The Schober Organ Corporation, 43

West 61st St., New York 23, N. Y.

1. Spinnet Organ Kit, complete .....\$ 550.00
2. Consolette Organ Kit, complete ..... 800.00
3. Concert Organ Kit, complete ..... 1200.00

## SCOTCH

● "Scotch" Brand No. 290 Magnetic Recording Tape. Providing 600 feet of ¼-inch tape on a 3¼-inch reel, the new Scotch 290 is fabricated from ½-mil tensilized polyester backing with a new oxide coating. Incorporated in the coating is a dry silicone compound to provide lubrication of the heads thus reducing wear. This reel provides an hour of recording time at 3¾ ips, utilizing two tracks. Price, \$2.95. 3M Company, St. Paul 19, Minn.

## SHURE

● **Shure-Quick Disconnect Microphone Isolation Units.** These microphone mounts are designed for use with microphones normally mounted on desk or floor stands, but which must be periodically removed for hand-held or carry-around use. Flanged, live rubber insert provides instant, non-swaying connection with microphone stand; effectively isolates the microphones from mechanical vibration, shocks, and noises carried to the microphone



through stand. Disconnect operation is easy, silent and instant. Made of aluminum and anodized for beauty and long wear. Model A45 is designed for microphones incorporating an isolation assembly. Model A47 is designed for microphones with connectors of standard 9/8"-27 thread. Dimensions of A45—3½" high × 1-5/16" diam. assembled; A47—5¼" high × 1-5/16" diam. assembled. Weight added to hand-held microphone: A45—2.3 oz., A47—3.6 oz. Net weight: A45—8.3 oz.; A47—4.6 oz. Price \$12.00 (either model). Shure Bros., 222 Hartrey Ave., Evanston, Ill.

## SOUNDCRAFT

● **New "Golden Tone" Premium Tape Line.** Soundcraft "Golden Tone" is a more expensive tape because it uses only the most magnetically active oxide particles in the coating for the finest sound reproduction and is manufactured to close tolerance precision for physical perfection. It has been produced to meet the exacting demands of today's advanced recorders which standard tapes cannot satisfy. "Golden Tone" is the tape for people who appreciate fine sound reproduction and have the equipment to produce it. "Golden Tone" is available in the following sizes: 1-mil Mylar\* Tensilized, GTM-18T, 1800 ft. 7-in. reel, \$7.50; ½-mil Mylar\* Tensilized, GTM-24T, 2400 ft., 7-in. reel, \$11.40; ½-mil acetate base, GTA-12, 1200-ft. 7-in. reel, \$4.70. Reeves Soundcraft Corp., Great Pasture Road, Danbury, Conn.  
\* Dupont T.M.

## STANTON

● **Model 604 Stanton Stereo Cable Kit.** A low-cost stereo cable assembly quickly converts automatic mono changers or manual tone arms to stereo. Fully shielded harness has plugs and connector clips already soldered. Length of harness is 4 feet. Supplied with cable retention clips. Price, \$3.98. Pickering and Co., Prof. Prod. Div., Plainview, N. Y.

TOP ALLOWANCE  
FOR YOUR USED COMPONENTS

AT  
**audio exchange**

WHEN YOU PURCHASE  
The SHERWOOD S-3000 IV

FM/MX STEREO TUNER

with "Acro-beam" Tuning

Features 7" expanded slide-rule tuning scale, Automatic Frequency Scale, special inter-channel hush system which eliminates noisy "hash" between FM channels.

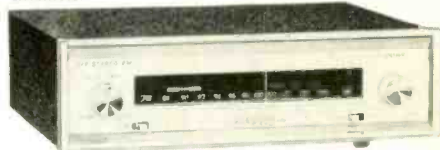

## TRADE 4 WAYS

- TRADE Hi-fi for hi-fi
- TRADE Amateur radio\* for hi-fi
- TRADE Hi-fi for amateur radio
- TRADE Amateur radio\* for amateur radio\*

\*Includes HAM; SWL; Citizen's Band; Test Equipment

## AUDIO EXCHANGE EXCLUSIVES:

Trade-Back Plan • New Equipment from over 100 manufacturers • Used Equipment sold on 10-day unconditional money-back guarantee . . . plus 90-day service warranty • Special GE credit plan • Custom Installation for stereo and monaural equipment. • HI FI service laboratory.

Get more! Pay less when you trade at

**audio exchange**

For Trading info., write dept. AG.  
PLEASE MAIL ALL ORDERS AND INQUIRIES TO JAMAICA  
153-21 Hillside Ave., Jamaica 32, N. Y. • Axtel 7-7577  
WHITE PLAINS, N. Y. BROOKLYN, N. Y. MANHASSET, N. Y.  
203 Mamaroneck Ave. 1065 Flatbush Ave. 451 Plandome Rd.

CIRCLE 101A

Chief Fidelitone  
ingredient:



QUALITY

We don't use just diamonds—we use gem stone quality diamonds.

And it's the same with each component of each Fidelitone diamond needle. The finest materials, engineering talent, and workmanship—all combine to assure you of quality needles for quality sound reproduction equipment.

When you need a needle, get quality—specify Fidelitone—on top since 1929.

**Fidelitone**

"Best buy on records"  
Chicago 26, Illinois  
CIRCLE 101B

# Wharfedale



**W60** In the streamlined look of fine modern furniture or handsomely crafted provincial, this full-range two speaker system continues to provide superlative performance—making it the automatic choice when the finest reproduction is desired. True Wood \$116.50. Unfinished, in sanded birch hardwood, without curved molding or dividers \$101.50.

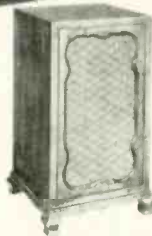

**W60 PR** Provincial in genuine Fruitwood \$134.50

Superb... because Wharfedale Achromatic Speaker Systems are crafted to reproduce music—as music really is. No spurious resonances, no artificial colorations mar the fidelity of reproduction. Listen to your favorite musical work on a Wharfedale—hear, perhaps for the first time, the clear transparent highs, the rich mid-tones, the fullness of a superb low-range.

## Sand Filled Panel

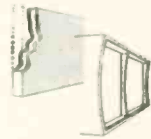

The inert sand filled panel (exclusive in all Wharfedale Systems) damps all vibrations, eliminates false resonances. The speakers perform with the enclosure as a single unit. The full range of sound is exceptionally smooth; transient response in bass and treble is exceptionally clean. A perfectly pure "Achromatic" musical image is achieved without acoustical coloration.

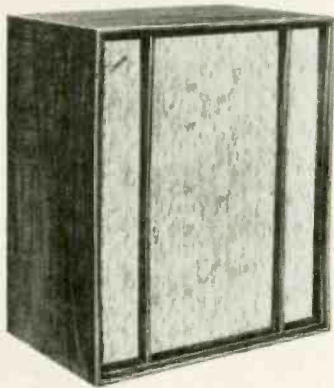

## W70

A three-speaker system—the ultimate in complete units—handsome by itself, yet still sufficiently compact for shelf or wall integration. The beauty and excellence of performance of this remarkable system makes it unusually attractive to experts and laymen alike. True Wood \$164.50. Unfinished in sanded birch hardwood, without curved molding or dividers. \$146.50.



## W70 PR

Provincial in genuine Fruitwood \$189.50

## W40

Ultra-compact (24" x 12" x 10") full-range system at a most attractive price. Two superior speakers. A newly developed 8½ inch low frequency driver with an extremely high flux density magnet—and Wharfedale's outstanding 5 inch tweeter—the same used in the larger W60 system. True Wood \$79.50. Unfinished in sanded birch hardwood, without curved molding \$69.50.

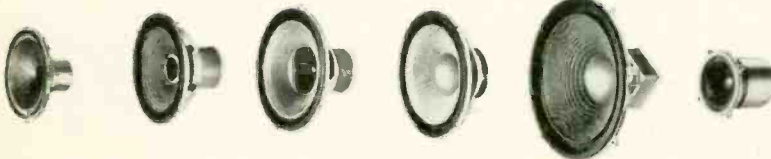
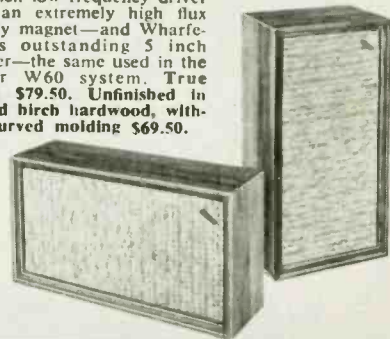

Full Range 8" Super 8 FS/AL \$26.50

Full Range 10" Super 10 RS/DD \$47.50

Full Range 12" Super 12 RS/DD \$89.50

Woofer W 12/RS \$52.50

Woofer W 15/RS \$89.50

Tweeter Super 3 \$26.50



## B67

Universal mounting base in matching woods for W60 and W70 systems. Easily installed to enhance the beauty of these enclosures.

True Woods \$9.95.  
Utility model in sanded birch hardwood \$8.95.



For illustrated literature write: Dept. WK12  
Wharfedale, a Division of British Industries Corp., Port Washington, N.Y.



## STATICMASTER

• **Record Brush.** The Staticmaster record brush Model 3R500 employs a polonium strip as a static neutralizer to make cleaning rec-

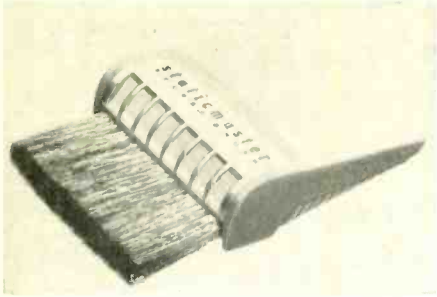

ords rapid and simple. The brush of the Staticmaster is made of genuine Jaguar hair which is both strong and soft. Nuclear Products Co., 10173 East Rush St., El Monte, Calif. User net price, \$14.95.

## SWITCHCRAFT

• **Model 306TR Stereo-Mono Microphone Mixer.** The 306TR is a 4-channel, high-impedance mixer. It feeds 4 signals (mono) or 2 signals (stereo) into a single output to a tape recorder. Accepts signals up to 1.5 volts. Transistorized amplifiers provide 6-db gain.



Response 20 to 20,000 cps. Each channel has separate volume control. Lever switch permits easy switching from mono to stereo. Price, \$37.50. Switchcraft, Inc., 5555 N. Elston Ave., Chicago 30, Ill.

1. 306, 4-channel stereo-mono mixer . . . \$22.50
2. 301TR, 4-channel mono mixer . . . 30.00
3. 301, 4-channel mono mixer . . . 19.50
4. 310, 2-channel mixer . . . 7.95
5. 311, 2-channel mixer . . . 8.95

## TACO

• **"LARK" FM Antenna Ad-A-Kit Model KG626A.** The Lark Ad-A-Kit (Model KG626-A) was designed for the do-it-yourselfer. When mounted on an existing TV antenna mast, it adds properties of a separate FM antenna. The kit provides Taco's "Lark" S-type FM antenna, with 50 ft. lead-in, woodscrew and mast-type standoffs. The antenna is omnidirectional, providing reception, without rotation, from all directions, up to 25 miles from the transmitter. The Lark antenna is anodized (gold color) and cannot rust or deteriorate. The kit lists for \$8.95. Technical Appliance Corp., Taco Ave., Sherburne, N. Y.

1. Bi-directional multiplex antenna (No. 615) . . . \$12.95
2. C-666 FM turnstile . . . 9.70
3. Fringe Yagi (644B) . . . 21.20
4. Deep fringe Yagi (Model 610) . . . 30.70

## TERADO

• **Transistorized Power Inverter.** The Terado Atlas, #50-200, changes 12-volt battery current to regular 110 volts, 60-cps a.c. Has capacity of 175 watts continuous; intermittent 200 watts, 60-cps maintained within 1 cycle plus or minus regardless of changing input or load. Excellent for operation of tape recorders, television sets, sound cameras, amplifiers, and so on. Will also operate hand power tools, vacuum cleaners, a.c.-d.c. motors, universal type up to 1/4 h.p., test equipment. Ideal for mobile truck displays of office equipment, and service trucks. Comes complete with remote control, cables and battery leads. Price, \$129.50. Terado Corp, 1064 1/2 Raymond Ave., St. Paul 8, Minn.

## TRANSVISION

• **23" TV Kit with 10-Watt Push-Pull Amplifier for Audio System.** Featuring a unique system of built-in-sections wherein one can buy the kit in sections as money and time

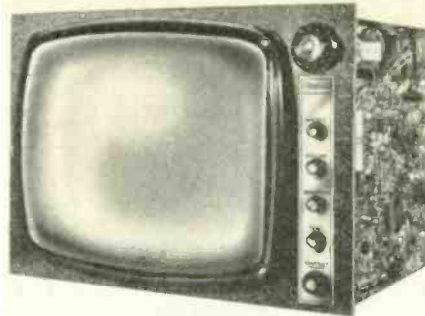

dictate. The unit shown, KG-10, includes a 10-watt audio amplifier although the kit may be purchased without it. Basically these are custom TV kits. Price \$199.00. Transvision Electronics Inc., Grey Oaks Ave., Yonkers, N. Y.

## ULTRAUDIO

• **Model M-5 "Customizer."** Professional high-fidelity mixer accepting up to 5 microphones or other sound sources. Will feed tape recorders, telephone line and sound system. Features real VU meter, straight-line volume controls,



self-contained power supply. All amplifier stages are plug-in, eliminating chance of failure. Hi and Low Z. Price \$288.00. Ultraudio, Box 921, Beverly Hills, Calif.

1. D-4, stereo Customixer, 4 inputs, 2 VU's . . . \$288.00
2. C-1, decorative Customixer carrying case . . . 39.50
3. S-90472, plug-in preamplifier . . . 12.50
4. S-90487, plug-in tone generator oscillator . . . 30.50
5. P-16, plug-in multi-impedance input xfmr . . . 11.40

## WINEGARD

• **PF-8 "Stereo-Tron" Electronic FM Antenna.** The PF-8 Stereo-Tron, when used with a rotor, gives good reception on at least 85% of all FM stations within a 200 mile radius. This is a super powerful electronic FM yagi with a built-in transistor amplifier. It has a minimum 25-db gain over a folded dipole and is recommended whenever the

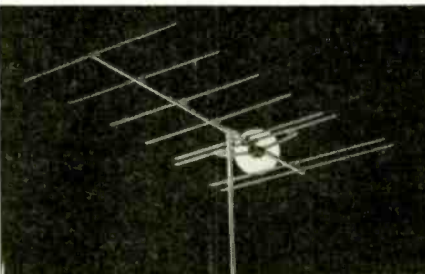

very finest installation is desired. Ideal for home use as well as in large distribution systems: motels, hotels, apartments, hospitals, etc. 300-ohm twin lead is used. Price \$64.25 including amplifier and power supply. Winegard Co., 3000 Kirkwood St., Burlington, Iowa.

1. FM-8 . . . \$23.65
2. FM-3T, FM antenna . . . 12.25
3. K2-FM, antenna . . . 5.05
4. CA-FM, TV-FM antenna coupler-splitter . . . 4.50

# Permoflux

Dynamic

## HEADPHONES



Standard of the World  
Unexcelled for —

- Quality
- Frequency Response Range
- Durability & Ruggedness
- Comfort
- Noise Exclusion

PERMOFLUX headphones  
carry a life-time warranty!

Write for catalog

PERMOFLUX CORPORATION

P.O. Box 1449, Glendale, Calif.  
CIRCLE 103A

# Audio Robots are for Sleeping

... or, for simple relaxing ... or, for any capricious whim we elect to exercise when we listen to high fidelity music. Audio Robots add an important measure of leisure to high fidelity — learn more about the newest development since the stereo record. Send for your free copy of ... "Audio Robots Are For Sleeping"

ROYCE ELECTRONIC DEVELOPMENTS, INC.  
50 Hancock Place  
Valley Stream, Long Island, N. Y.

Please send me Free copy of AUDIO ROBOTS ARE FOR SLEEPING

Name \_\_\_\_\_

Address \_\_\_\_\_

City \_\_\_\_\_ Zone \_\_\_\_\_ State \_\_\_\_\_



CIRCLE 103B

# YOU SAVE MONEY!

RUSH US YOUR  
LIST OF HI-FI  
COMPONENTS  
FOR A SPECIAL  
QUOTATION

WRITE FOR FREE  
AUDIO DISCOUNT  
CATALOG A-15

*New low prices on ampli-  
fiers, tuners, tape record-  
ers, speakers, etc.*

**KEY** ELECTRONICS CO.  
120 LIBERTY ST.  
NEW YORK 6, N.Y.



Erases an entire reel  
in seconds!

NEW

## ROBINS LOW-COST BULK TAPE ERASER model ME-77

At last! A professional quality bulk eraser for the amateur recordist. The ME-77 completely removes recorded and unwanted signals from reels of tape up to 1/4" wide and 7" in diameter. Seconds after you switch it on—you have a fresh—sound-free and noise-free tape ready for recording. And since the ME-77 reduces background noise 2 to 4 db below normal erase head levels, future recordings will be as clear as the original. Easy to use, the compact ME-77 comes in a durable bakelite housing.

Only \$22.00

At dealers or write:

ROBINS INDUSTRIES CORP. Flushing 56, N. Y.

## TRANSISTOR FRONT-ENDS

(from page 23)

One interesting question which is often raised is how do transistor noise figure and gain vary with life. *Figure 14* shows a plot of power gain, noise figure, and bandwidth on a group of 2N1742's as a function of hours of life at maximum rating. Note that these units were tested in a fixed-matched, fixed-biased and fixed-neutralized circuit and are therefore representative of actual circuit operation. Note there is a very little change to 7000 hours, or nearly one year of continuous operation. As a result of these measurements, we are convinced that it is safe to say the high-frequency characteristics of transistors do not change with life until after the transistor has failed normal static end-of-life conditions. There are two observations which may be made from this statement. First, the use of static characteristic to define end of life is useful even for high-frequency parameters and second, one should not expect the gradual slumping in gain and noise figure normally encountered in vacuum tubes under typical operating conditions.

Another question which is often raised is how do gain, noise figure, and so on vary with temperature. *Figure 15* shows a plot of the 2N1742 gain, noise figure, bandwidth, and collector current in the fixed-matched, fixed-neutralized, and fixed-biased test circuit over a temperature range of -60°C to +80°C. The transistor was inserted into the circuit and tuned for maximum gain at room temperature. Only the temperature of the transistor was changed, no further tuning was allowed. Thus, the changes are representative of the variation which might be expected in a practical circuit as a result of the transistor changes alone.

### Conclusion

The transistors described and the circuits presented indicate that transistor front ends are truly practical for FM receivers. Sensitivities and quieting levels equal to, or better than, tube receivers are possible. While transistors have only just begun to enter the FM field, indications are that they will continue to be used in increasing quantities not only in portable receivers but in many other applications.

Intermodulation is a major problem which remains to be solved. At present, the solutions are primarily of a circuit nature. For most applications careful circuit designs can solve most of the problems. The improved reliability and the possibility of portable FM receivers provide two important advantages which are possible with transistors. Æ

## CLASSIFIED

Rates: 10¢ per word per insertion for noncommercial advertisements; 25¢ per word for commercial advertisements. Rates are net, and no discounts will be allowed. Copy must be accompanied by remittance in full, and must reach the New York office by the first of the month preceding the date of issue.

HIGH FIDELITY SPEAKERS REPAIRED  
AMPRITE SPEAKER SERVICE  
168 W. 23rd St., New York 11, N. Y. CH 3-4812

ENJOY PLEASANT SURPRISES? Then write us before you purchase any hi-fi. You'll be glad you did. Unusual savings. Key Electronics, 120 Liberty St., New York 6, N. Y. CLOverdale 8-4288

PROFESSIONAL RECONDITIONING all audio and recording equipment. Low prices on components with service. Best trade-in deal in the country. Dick Simms. Audio Trading Post, Inc., 2nd Floor, 58 W. 48 St., New York 36, N. Y. JUDson 2-2356

SALE ITEMS—tapes—recorders—component quotes. Bayla, Box 131-O, Wantagh, N. Y.

FAIRCHILD STEREO CUTTING SYSTEM WITH HEAD, 100 hours' use plus unused spare heads. List price \$9,300. Price for immediate sale \$6,500. Hamilton Audio Electronics, 45 West 45th Street, New York City. CI 5-3430

WANTED: Stephens 425H horn. Paul Montgomery, 40 NE Tenth Street, Oklahoma City, Okla.

MAGNETIC TAPE, 4800' on broadcast 14' reel. Used, excellent. Postpaid, \$6.00. SueJoy Productions, 45 Hartland Rd., Rochester 17, N. Y.

WANTED: THORDARSON power transformer, model T-15R05. Must be perfect. J. J. Keane, 713 W. 47 St., Chicago 9, Ill.

LP RECORDS FROM YOUR TAPE. 40 minutes, \$6.00, p.p. Write for quantity prices. Quick service. Custom Recording, 923 Kansas Avenue, Kansas City, Kansas.

HARPSICHORD, \$150, in kit form for easy home workshop assembly. Write for brochure: Zuckermann Harpsichords, Dept. R, 115 Christopher St., New York 14, N. Y.

WANTED: Three used James B. Lansing 537-509 horns-lens assemblies. N. Metal, 1947 W. 7th Avenue, Vancouver 9, B. C.

SELL: Ampex 400 in portable case, \$390. Concertone 20/20 in portable cases, \$245, both in perfect condition. Don Warnock, 117 West 67 St., Kansas City, Mo.

WE RENT STEREO TAPES: both 2- and 4-track; all labels. Over 2500 different. FREE BROCHURE. Stereo-Parti, 811R Centinela Ave., Inglewood, California.

## BOUND VOLUMES

1961 Issues

Audio Magazine

Order Now

LIMITED NUMBER  
AVAILABLE

\$10.00 EACH POSTPAID  
U. S. DELIVERY ONLY

Send Order  
and Remittance Today

Book Division

Radio Magazines, Inc.  
P.O. Box 629  
Mineola, N. Y.

## ELECTRONIC WORLD HI-FI RECORDING TAPE

Splice Free—Guaranteed 1st Quality  
15-day Money Back Guarantee

			3-23	24+
22A	3"	225' Acetate	.45	.39
60A	5"	600' Acetate	.74	.67
90M	5"	900' Mylar	1.11	.99
12A	7"	1200' Acetate	1.09	.99
12M	7"	1200' Mylar	1.19	1.09
18A	7"	1800' Acetate	1.59	1.45
18M	7"	1800' Mylar	1.99	1.85
24M	7"	2400' Mylar	2.59	2.49

Add 15¢ Per Reel Postage & Handling—10¢ 24+ Reels  
Any ass't. permitted For 24+ price.  
Don't Buy Any HI-FI Components or Tape Recorders  
until you get our Low, Low Return Mail Quotation.  
Generous Trade-in on Old Equipment. **WE GUARANTEE WE WILL NOT BE UNDERSOLD.** Easy Pay  
Plan Up to 24 mos. to Day.  
CATALOG AND BEST BUY LIST FREE.

## ELECTRONIC FAIR

Dept. U—1797 1st Ave., New York 28, N.Y.

Circle 105C

## AUDIO unlimited

Specializes in SAVING YOU MONEY

- ✓ FACTORY FRESH COMPONENTS
- ✓ LOWEST POSSIBLE QUOTATIONS
- ✓ FAST DELIVERY

We are FRANCHISED DEALERS for most Hi-Fi  
lines. Most orders SHIPPED PROMPTLY from  
stock. RECORDING TAPE at LOWEST PRICES.  
FREE 95 Page STEREO CATALOG.

190-A Lex. Ave., Cor. 32  
St., New York 16, N. Y. Visit Our Showroom

Circle 105D

## COMPONENTS, TAPE RECORDERS

Write for our low quotes on your choice of com-  
ponents. Save more on "pkgs." All factory sealed.  
Send for "Monthly Specials" bulletin.

### HI-FI RECORDING TAPE

Splice Free (except 2400') freq. resp.  
20-20,000 cps. 15 day money back guarantee.

		3-11	12-23	24+
1200' 7"	acetate	\$1.29	\$1.17	\$ .99
1800' 7"	acetate	1.79	1.59	1.40
1800' 7"	mylar	1.95	1.85	1.83
2400' 7"	mylar	2.69	2.59	2.45
2400' 7"	tensitized mylar	2.99	2.95	2.90

Can Be Assorted. Add 15¢ Postage Per Reel  
10¢ For 24 Lots

125-N East 88 St., New York 28, N. Y.  
**CARSTON Studios**  
Circle 105E



## ARTISAN ORGAN

"King of Kits"

- The ultimate in organ  
tone & styling
- Skip dealer profits and  
factory labor
- Pay as you build &  
play as you build
- No previous technical  
skill required
- The original build-it-  
yourself organ

• Choice of models from \$1750 to \$5500  
Write today for details

4949-A York Blvd., Los Angeles 42, Calif.

Circle 105F

CANADA  
High Fidelity Equipment  
Complete Lines • Complete Service  
Hi-Fi Records — Components  
and Accessories

## ELECTRO-VOICE SOUND SYSTEMS

126 DUNDAS ST. WEST. TORONTO. CANADA

Circle 105G

## TOPS IN HI-FI!

BRITISH EQUIPMENT from the United Kingdom  
Hi-Fi Mail Order Specialists.

Send us details of your needs!

- AMPLIFIERS • MOTORS • TUNERS
- SPEAKERS • PICK-UPS

All goods carefully packed, insured and  
shipped promptly at minimum cost.

C. C. GOODWIN (SALES) LTD. (Dept. A)  
7, The Bdwy., Wood Green, London, N.22., Eng.  
Circle 105H

## Industry Notes...

**AUDIO EXCHANGE**—New York area  
"chain" of hi-fi stores—celebrated its  
eleventh anniversary on June 28. Cere-  
mony was marked by presentation of a  
framed proclamation from Jamaica (N. Y.)



Chamber of Commerce. Photo shows State  
Senator Seymour R. Thaler (center) look-  
ing on as Jamaica C.C. official Hughes,  
(left), makes presentation to William Col-  
bert, Audio Exchange prexy.

William A. Harrison was elected treas-  
urer of Allied Radio Corporation, reliev-  
ing Arthur Davis, executive vice presi-  
dent and company director of the duties  
as treasurer to devote full time to his  
other managerial duties. Mr. Harrison  
will continue to serve as controller and  
assistant secretary.

Altec Lansing Corporation, a subsidiary  
of Ling-Temco-Vought, Inc. appointed  
Charles L. Range as Regional Sales Man-  
ager for the company's line of stereo con-  
sumer products, commercial and indus-  
trial sound system equipment, telephone,  
microphone, and broadcast equipment in  
the Mid-Atlantic states. William E.  
Yeager was also promoted to the newly  
created post of Engineering Information  
Manager.

The E. T. Bozak Manufacturing Com-  
pany, South Norwalk, Conn., recently in-  
creased total production facilities by dou-  
bling the size of their No. 2 furniture  
plant, ensured uniformity of output by  
installing what is believed to be the in-  
dustry's first complete climate control,  
and further speeded production by a re-  
arrangement of the main plant layout.

**FLASH!** Just in time for this issue, Herb  
Horowitz, president of Empire Scientific Cor-  
poration announced the winner of Empire's 1st  
Annual Round the World Music Festival.  
Lucky man is Pat Nail, of Sunnyvale, Califor-  
nia. Mr. and Mrs. Nail will make the three-  
week trip through Europe, visiting Athens,  
Dubrovnik, Rome, Bregenz, Salzburg, Munich,  
Bayreuth, Hamburg, Paris, and Edinburgh.  
Winning dealer is MacDaniels Hi-Fi, of Menlo  
Park and salesman Ron Dorsey. Congratulations  
to all of them.

Alfred M. Zuckerman, formerly Chief  
Engineer of David Bogen Company, and  
Jules J. Rubin, professional musician,  
audio merchandiser and marketer, joined  
in formation of Royce Electronic Develop-  
ments, Inc., with offices and plant at 50  
Hancock Place, Valley Stream, N. Y. Line  
will be shown to public at the N. Y. High  
Fidelity Show in October.



\$2.50  
each

## SAVE YOUR COPIES OF AUDIO

- Each file holds a  
full year's copies.
- Jesse James Vol-  
ume Files for every  
publication.
- Covered in durable  
leather like Kivar,  
title embossed in 16  
Kt gold.

Satisfaction guaranteed

Attractive and  
practical for your  
home or office

3 for \$7.00  
6 for \$13.00

ORDER NOW — send  
check or money order  
MAGAZINE FILE CO.  
520 FIFTH AVENUE  
NEW YORK 36, N. Y.

**FREE** DESCRIPTIVE FOLDER  
UPON REQUEST

# KARG

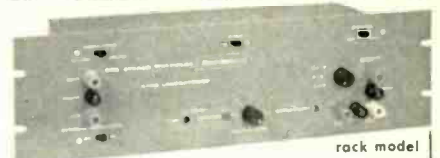

## FM Stereo Multiplex Signal Generator

Produces the FCC specified  
composite Stereo Multiplex  
signal.

Production alignment and test-  
ing of Stereo Adaptors, Tuners  
and Receivers.

Servicing and alignment  
of Tuners and Adaptors.

Model MX-1G cabinet \$250.  
Model MX-1G rack \$255.

**SAVE \$100.** Build your own  
Precision MX-1G Generator  
—kit \$150.

Send complete data and specs.

For prepaid shipment in U.S.A., send check  
or money order to: **KARG LABORATORIES**  
162 ELY AVENUE, S. NORWALK, CONN.

Circle 105A

# ISOTONE

acoustical tone equalizing music system  
AN ACOUSTICAL LANDMARK

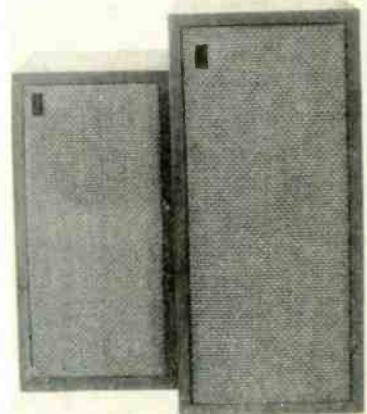

Listening to music with content is an indul-  
gence of the genteel, an introspective pastime  
that must be unimpeded in order, adequately,  
to resolve the message conveyed in otherwise  
flawless tonality. In high fidelity, especially,  
distraction is barbarous. Quiet, Please! is an  
insistence. "Quiet" is the Hall Mark of su-  
perior performance in a music system. "Quiet"  
inheres in Isotone's long, continuously folded,  
air-cushion design. Listen to Isotone's air-  
mass-controlled bass! Ask your distributor  
about us. Send for brochure.

**ISOTONE ASSOCIATES**

3402 Third Avenue New York 56

Circle 105B

**The New  
Lafayette  
2 Speed  
Stereo  
Playback  
Tape Deck  
Complete with  
Built-in  
6 Transistor  
Dual Playback  
Preamps**

*The Magnificent  
Fidelity  
of  
Stereo-Tape*

Now you can enjoy the superlative reproduction and fidelity of prerecorded tape at the price you'd expect to pay for a record changer. Precision engineered, the RK-141 is equipped with its own 6-transistor stereo preamplifiers designed to play back ¼ track and ½ track stereo plus ½ track and full track monaural tape with true NARTB hi-fi tape equalization. Its tape handling mechanisms and heads are of a type found in costlier units. Accepts all size reels to 7". Measures 10¾"Dx14¾"Wx 5"H. Complete with cables. Shpg. wt., 17 lbs.

RK-141WX .....	Net 59.50
Furniture Grade Walnut Base. Wt., 4 lbs.	
RK-148W .....	Net 6.95
Portable Carrying Case. Wt., 5 lbs.	
RK-147W .....	Net 9.95

**SPECIFICATIONS**

Frequency Response:  
@ 7½ IPS, 50-15,000 CPS ± 2.5db;  
@ 3¾ IPS, 50-9,000 CPS ± 2.5 db  
Wow and Flutter:  
0.15% @ 7½ IPS, 0.2% @ 3¾ IPS  
Cross Talk & Stereo  
Channel Separation: 50db  
Signal To Noise Ratio: 50db  
Playback Output with  
Built-In Stereo Playback  
Preamplifiers: 0.5V  
AC operation 110-120V, 60 cycles



Nothing Else To Buy!  
Includes Stereo  
Playback Preamps

**59<sup>50</sup>**  
NO MONEY DOWN

**LAFAYETTE  
RADIO**

Dept. AH-2, P.O. Box 10, Syosset, L. I., N. Y.

Name \_\_\_\_\_ FREE  
Address \_\_\_\_\_ Lafayette  
City \_\_\_\_\_ Zone \_\_\_\_\_ State \_\_\_\_\_ Summer Catalog  
Supplement

Mail Order Sales Center Syosset, Long Island, N. Y. New York 13, N. Y./Jamaica 33, N. Y./Bronx, 58, N. Y. Newark 2, N. J./Paramus, N. J./Plainfield, N. J./Boston 10, Mass.



**ADVERTISING  
INDEX**

Acoustic Research, Inc. ....	45
Allied Radio .....	73, 74
Altec Lansing Corporation .....	81
Artisan Organs .....	105
Audio Devices, Inc. ....	71
Audio Exchange .....	101
Audio Fidelity Records .....	79
Audio Originals .....	95
Audio Unlimited .....	105
Bell Stereo Components .....	18
Benjamin Electronic Sound Corp. ....	59
Bozak Speakers .....	4
British Industries Corporation .....	3, 102
Burgess Battery Company .....	86
Carston Studios .....	105
Classified .....	104
Dukane Corporation .....	99
Dynaco, Inc. ....	67
Eastman Kodak Company .....	53
EICO .....	13
Electronic Applications Inc. ....	93
Electro-Voice, Inc. ....	Cov. IV
Electro-Voice Sound Systems .....	105
Fairchild Recording Equipment Corp. ...	98
Fidelitone .....	101
Finney Company .....	14
Fisher Radio Corporation .....	9
Foster Electric Co., Ltd. ....	92
Garrard Sales Corp. ....	3
Goodwin, C. C. (Sales) Ltd. ....	105
Gotham Audio Corp. ....	80
Grado Laboratories, Inc. ....	10
Grommes, Division of Precision Electron- ics, Inc. ....	85
Harman-Kardon .....	47, 61
Hi Fidelity Center .....	105
International Electroacoustics Incorpo- rated .....	84
International Electronic Sales Corp. ....	91
Isotone Associates .....	105
Jensen Manufacturing Co. ....	63
Jerrold Electronics Corp. ....	2
Karg Laboratories, Inc. ....	105
Key Electronics Company .....	104
Klipsch and Associates .....	100
Lafayette Radio .....	106
Lansing, James B., Sound, Inc. ....	55
Magnecord Division of Midwestern In- struments .....	6
3M .....	7
Newcomb Audio Products Co. ....	89
North American Philips Co., Inc. ....	5
Omega Electronics Corporation .....	97
Permotflux Corporation .....	103
Pickering & Company, Inc. ....	17
Pilot Radio Corporation .....	51
Pioneer .....	15
Reeves Soundcraft Corporation .....	65
Rider, John F., Publisher .....	98
Roberts Electronics, Inc. ....	57
Robins Industries Corp. ....	104
Royce Electronic Development, Inc. ....	103
Sarkes-Tarzian, Inc. ....	77
Scott, H. H., Inc. ....	Cov. 11
Sherwood Electronic Laboratories, Inc. ...	1
Shure Brothers, Inc. ....	83, 88
Sonovox Co., Ltd. ....	100
Stackpole Carbon Co. ....	96
Superscope, Inc. ....	49
Switchcraft, Inc. ....	99
Tannoy (America) Ltd. ....	95
Thorens Division, Elpa Marketing Indus- tries, Inc. ....	69
Tansvision Electronics, Inc. ....	87
Ultra Electronics, Inc. ....	94
University Loudspeakers .....	11
Viking of Minneapolis .....	Cov. III
Wharfedale .....	102
Wildner Engineering Products .....	97

TYPICAL INSTALLATION? Maybe yes, maybe no, but with Viking Tape Components you choose the performance you need for the installation you have planned. Write for full facts!

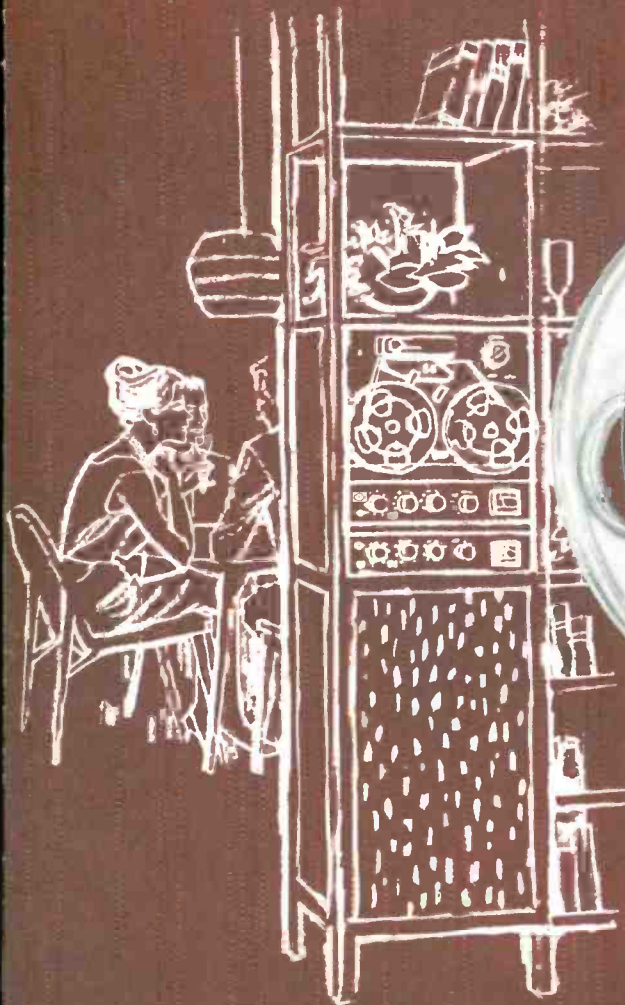

a critical  
look at  
Quality  
Tape  
Equipment

*accent on flexibility...*

**The new Viking 86 Series Transport...**

High performance guaranteed from the laminated, metal-faced heads to the reliable 2-motor, flutter-filter drive. Available with a variety of stereo and mono head configurations to meet individual needs. Playback capability 20-20,000 cps  $\pm$  2 db. Tape run-out switch; 3 $\frac{3}{4}$  and 7 $\frac{1}{2}$  ips; head shift; tape lifters. Erase-Protek, of course. Priced from \$132.00, varies with quantity and type of heads.

**The RP83 Recording/Playback Amplifier...**

Styled to match in appearance and performance with the 86 Series Transport. 80 kc bias frequency for full fidelity extended range recordings. One-volt output (playback) to music system. Mixing controls on "Mix" and "Hi-Level" inputs. Large VU meters, operable in recording and playback modes. Recording indicator. Net Price \$87.50 (two required for stereo recording).

For complete technical literature, visit your franchised Viking dealer or write to:



**Viking** OF MINNEAPOLIS, INC.

600 ALDRICH AVE. SO., MINNEAPOLIS 20, MINNESOTA

**PRETTY  
as a picture**

**...TOUGH  
as nails!**



Model 633



SETTING NEW STANDARDS IN SOUND

### THE NEW ELECTRO-VOICE MODEL 633 AND 634 UTILITY MICROPHONES

Now! An exciting new answer to your most demanding microphone needs! The Electro-Voice Model 633 and 634 utility microphones. Handsome new style wedded to rugged, dependable performance. Looks good anywhere... sounds great everywhere!

Specify the Model 633 for floor or desk stand use in school sound systems, tape recorders or industrial applications. Choose the Model 634 for custom mounting on boom or gooseneck in language laboratories, paging systems or wherever semi-permanent mounting is required.

Identical except for mounting, the 633 and 634 both feature a precision dynamic element with remarkable E-V Acoustalloy® diaphragm for smooth, peak-free response and unparalleled reliability despite high shock, moisture or heat. The generous diameter plus a high-energy magnetic structure offers excellent sensitivity for every application.

The precision dynamic element is carefully "packaged" in modern, unbreakable Cyclo-lac\* plastic combined with a satin-chromium finished, high-density die casting that soaks up abuse yet stays attractive for years. Handy on-off switch is included. Choice of high- or balanced low-impedance models.

In every way these fresh new dynamics set new standards of appearance and performance... yet the price is surprisingly low! The result of advanced engineering plus the most modern and efficient production facilities in the industry! Make the Electro-Voice Models 633 and 634 your new standards of utility microphone excellence, today!

\*T. M. Borg-Warner



Model 634

**SPECIFICATIONS:** Response 70-10,000 cps. Omni-directional. Sensitivity -57 db (Hi-Z, ref. 0 db = 1 volt/dyne/cm<sup>2</sup>). Available Hi-Z or balanced 150 ohms. 633: 5/8"-27 mounting, 6-foot cable with connector at microphone. \$35.00 List. 634: 5/8"-27 thread at back, 6-foot cable coaxial with mounting thread. \$31.50 List. (Normal trade discounts apply).

**Electro-Voice®**

**ELECTRO-VOICE, INC.**  
Commercial Products Div., Dept. 822A  
Buchanan, Michigan