

POWER-GATE™ Solid-State Devices

Uni-Directional DC Relay

Specification Sheet

Generation 3.0



ABSOLUTE MAXIMUM RATINGS⁽¹⁾

All devices, all voltages referenced to relay ground, unless otherwise specified.

Symbol	Parameter	Min.	Max.	Units
V _S	Source Voltage, RYxxxA	-0.3 ⁽²⁾	21 ⁽³⁾	Vdc
	Source Voltage, RYxxxB	-0.3 ⁽²⁾	39 ⁽⁴⁾	
V _L	Load Voltage (relay off)	-0.3 ⁽⁵⁾	V _S + 0.3 ⁽⁶⁾	Vdc
T _A	Ambient Temperature	-45	110	°C
V _{TRIG}	Trigger Voltage ⁽⁷⁾	-39 ⁽⁸⁾	39 ⁽⁴⁾	Vdc
V _{OVERRIDE}	Override Trigger Voltage	-39 ⁽⁸⁾	39 ⁽⁴⁾	Vdc

RECOMMENDED OPERATING CONDITIONS

All devices, all voltages referenced to relay ground, unless otherwise specified.

Symbol	Parameter	Min.	Max.	Units
V _S	Source Voltage, RYxxxA	6.5	18	Vdc
	Source Voltage, RYxxxB	6.5	36	
T _A	Ambient Temperature	-40	105	°C
V _{TRIG}	Trigger Voltage ⁽⁷⁾	0	36	Vdc
V _{OVERRIDE}	Override Trigger Voltage	0	36	Vdc

MECHANICAL SPECIFICATIONS

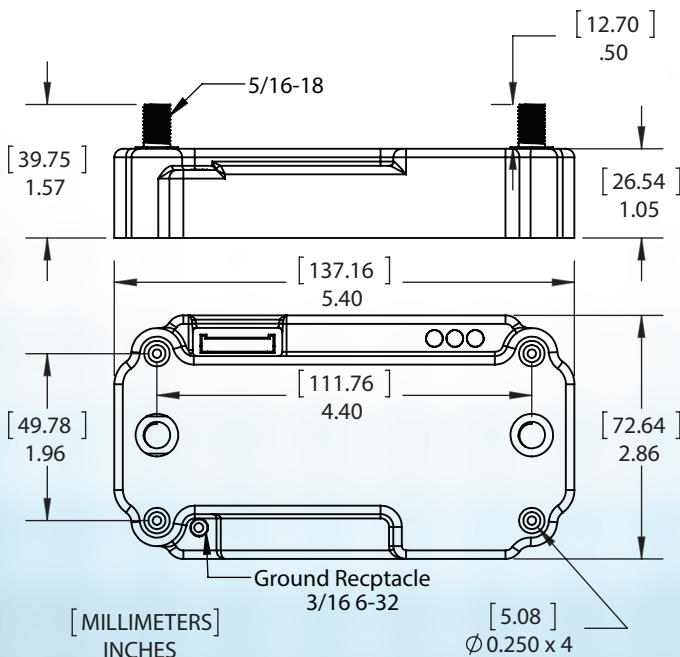

ADDITIONAL INFORMATION

Autonomous devices fitted with a master on/off switch for safe installation and master reset purposes. (exact switch may differ from picture)

Electronic assembly inserted into ABS encapsulation shell then backfilled with black, flame retardant, filled epoxy specifically developed for the potting of electronic modules.

Four integrated mounting holes pre-drilled to .250" Mounting torque not to exceed 60 inch-pounds or 7 newton-meters

Mounting posts, 5/16-18 x .50" with provided brass washers and nylon insert 5/16-18 nuts. Mounting torque not to exceed 75 inch-pounds or 8.5 newton-meters.

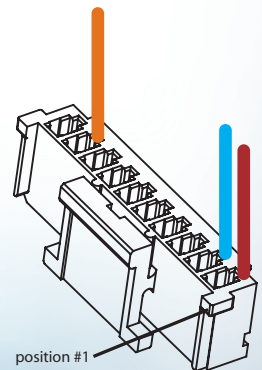

- | | | |
|----|--------------|--------|
| 1 | OVERRIDE - * | Brown |
| 2 | OVERRIDE + * | Blue |
| 3 | Empty | |
| 4 | Empty | |
| 5 | Empty | |
| 6 | Empty | |
| 7 | Empty | |
| 8 | TRIGGER - ** | Black |
| 9 | TRIGGER + | Orange |
| 10 | Empty | |

Harness 500492 Rev E
Connector housing Molex 355071000
Terminals Molex 50212-8000
Control harness, one meter, 24AWG wires

* Override trigger is non-isolated.
OVERRIDE - is internally connected to relay ground. Override enabled only when under-voltage or over-voltage are enabled.

** Only required for isolated trigger

Perfect Switch, LLC
(858) 720-1339
(858) 530-8656 fax
www.perfectswitch.com

ELECTRICAL SPECIFICATIONS

All devices, $T_A = 25 \pm 3^\circ\text{C}$, $6.5\text{ V} \leq V_S$ (RYxxxA) $\leq 18\text{ V}$, $6.5\text{ V} \leq V_S$ (RYxxxB) $\leq 36\text{ V}$,
all LEDs enabled, non-isolated trigger, all voltages referenced to relay ground, unless otherwise specified.

Symbol	Parameter	Min.	Typ.	Max.	Units	Conditions
$I_{L,MAX}$	Maximum Continuous Load Current	-	-	50	A	RY050x, $-40^\circ\text{C} \leq T_A \leq 105^\circ\text{C}$
		-	-	100		RY100x, $-40^\circ\text{C} \leq T_A \leq 105^\circ\text{C}$
		-	-	150		RY150x, $-40^\circ\text{C} \leq T_A \leq 105^\circ\text{C}$
		-	-	200		RY200x, $-40^\circ\text{C} \leq T_A \leq 105^\circ\text{C}$
		-	-	250		RY250x, $-40^\circ\text{C} \leq T_A \leq 105^\circ\text{C}$
		-	-	300		RY300x, $-40^\circ\text{C} \leq T_A \leq 105^\circ\text{C}$
$I_{L,SURGE}$	Maximum Surge Load Current	-	-	$5 \times I_{L,MAX}$	A	
V_{DROP}	Input-to-Output Voltage Drop	-	25	30	mV	RY050x, RY100x, RY150x, Load Current = $I_{L,MAX}$
		-	30	35		RY200x, RY250x, Load Current = $I_{L,MAX}$
		-	35	40		RY300x, Load Current = $I_{L,MAX}$
		-	-	80		Load Current = $I_{L,MAX}$, $T_A = +105^\circ\text{C}$
$I_{S,OFF}$	Operating Current, Relay Triggered Open	20.0	20.5	21.0	mA	$V_S = 6.5\text{ V}$, $V_{TRIG} = 0\text{ V}^{(7)}$
		10.7	11.2	11.7		$V_S = 6.5\text{ V}$, $V_{TRIG} = 0\text{ V}^{(7)}$, All LEDs disabled
		19.7	20.2	20.6		$V_S = 12\text{ V}$, $V_{TRIG} = 0\text{ V}^{(7)}$
		10.3	10.9	11.5		$V_S = 12\text{ V}$, $V_{TRIG} = 0\text{ V}^{(7)}$, All LEDs disabled
		21.1	21.4	21.7		$V_S = 18\text{ V}$, $V_{TRIG} = 0\text{ V}^{(7)}$
		11.3	12.2	13.0		$V_S = 18\text{ V}$, $V_{TRIG} = 0\text{ V}^{(7)}$, All LEDs disabled
		21.1	21.4	21.8		RYxxxB, $V_S = 24\text{ V}$, $V_{TRIG} = 0\text{ V}^{(7)}$
		11.9	12.2	12.5		RYxxxB, $V_S = 24\text{ V}$, $V_{TRIG} = 0\text{ V}^{(7)}$, All LEDs disabled
		21.2	21.5	21.9		RYxxxB, $V_S = 36\text{ V}$, $V_{TRIG} = 0\text{ V}^{(7)}$
		12.0	12.3	12.7		RYxxxB, $V_S = 36\text{ V}$, $V_{TRIG} = 0\text{ V}^{(7)}$, All LEDs disabled
$I_{S,ON}$	Operating Current, Relay Triggered Closed	33.0	35.0	37	mA	$V_S = 6.5\text{ V}$, $V_{TRIG} = 10\text{ V}^{(7)}$
		15.7	16.6	17.4		$V_S = 6.5\text{ V}$, $V_{TRIG} = 10\text{ V}^{(7)}$, All LEDs disabled
		34.2	35.4	36.6		$V_S = 12\text{ V}$, $V_{TRIG} = 10\text{ V}^{(7)}$
		16.1	17.0	18.0		$V_S = 12\text{ V}$, $V_{TRIG} = 10\text{ V}^{(7)}$, All LEDs disabled
		34.7	36.0	37.3		$V_S = 18\text{ V}$, $V_{TRIG} = 10\text{ V}^{(7)}$
		16.7	17.7	18.7		$V_S = 18\text{ V}$, $V_{TRIG} = 10\text{ V}^{(7)}$, All LEDs disabled
		35.5	36.4	37.3		RYxxxB, $V_S = 24\text{ V}$, $V_{TRIG} = 10\text{ V}^{(7)}$
		17.4	18.1	18.9		RYxxxB, $V_S = 24\text{ V}$, $V_{TRIG} = 10\text{ V}^{(7)}$, All LEDs disabled
		35.8	37.2	38.6		RYxxxB, $V_S = 36\text{ V}$, $V_{TRIG} = 10\text{ V}^{(7)}$
		18.1	19.0	19.9		RYxxxB, $V_S = 36\text{ V}$, $V_{TRIG} = 10\text{ V}^{(7)}$, All LEDs disabled
$I_{S,LP}$	Low Power Sleep Mode Supply Current ⁽⁹⁾	-	-	1.3	mA	RYxxxA
		-	-	1.5		RYxxxB
I_{LEAK}	Relay Off Leakage Current	-	193	220	μA	RYxxxA, $V_S = 6.5\text{ V}$, Load shorted to relay ground
		-	204	230		RYxxxA, $V_S = 12\text{ V}$, Load shorted to relay ground
		-	253	330		RYxxxA, $V_S = 18\text{ V}$, Load shorted to relay ground
		-	193	210		RYxxxB, Load shorted to relay ground
$I_{LEAK,LP}$	Low Power Sleep Mode Output Leakage Current ⁽⁹⁾	-	-	5		Load shorted to relay ground, relay in low power sleep mode
$V_{TRIG,ON}$	Trigger On Voltage	-	0.83	-	V	
		-	2.0	-		Isolated Trigger ⁽⁷⁾
$V_{TRIG,OFF}$	Trigger Off Voltage	-	0.82	-	V	
		-	1.6	-		Isolated Trigger ⁽⁷⁾
I_{TRIG}	Trigger Current	-	34	-	μA	$V_{TRIG} = 3.3\text{ V}^{(7)}$
		-	172	-		$V_{TRIG} = 12\text{ V}^{(7)}$
		-	413	-		$V_{TRIG} = 24\text{ V}^{(7)}$
		-	654	-		$V_{TRIG} = 36\text{ V}^{(7)}$
		-	2.1	-	mA	Isolated Trigger, $V_{TRIG} = 3.3\text{ V}^{(7)}$
		-	2.9	-		Isolated Trigger, $V_{TRIG} = 12\text{ V}^{(7)}$
		-	4.1	-		Isolated Trigger, $V_{TRIG} = 24\text{ V}^{(7)}$
		-	5.3	-		Isolated Trigger, $V_{TRIG} = 36\text{ V}^{(7)}$

ELECTRICAL SPECIFICATIONS (continued)

All devices, $T_A = 25 \pm 3^\circ\text{C}$, $6.5\text{ V} \leq V_S$ (RYxxxA) $\leq 18\text{ V}$, $6.5\text{ V} \leq V_S$ (RYxxxB) $\leq 36\text{ V}$,
all LEDs enabled, non-isolated trigger, all voltages referenced to relay ground, unless otherwise specified.

Symbol	Parameter	Min.	Typ.	Max.	Units	Conditions
V_{OVERRIDE}	Override Trigger Open Circuit Voltage	-	5 ⁽¹⁰⁾	-	V	
f_{TRIG}	Trigger Frequency	-	-	2	Hz	
I_{OVERRIDE}	Override Trigger Leakage Current	-	50	-	μA	OVERRIDE+ and OVERRIDE- ⁽¹¹⁾ shorted
I_{O1}	Overcurrent Threshold - Level 1	$1.02 \times I_{L,\text{MAX}}$	$1.2 \times I_{L,\text{MAX}}$	$1.38 \times I_{L,\text{MAX}}$	A	
t_{O1}	Overcurrent Threshold Shutdown Delay - Level 1	-	60	-	s	
I_{O2}	Overcurrent Threshold - Level 2	$1.7 \times I_{L,\text{MAX}}$	$2 \times I_{L,\text{MAX}}$	$2.3 \times I_{L,\text{MAX}}$	A	
t_{O2}	Overcurrent Threshold Shutdown Delay - Level 2	-	5	-	s	
I_{SC}	Short Circuit Threshold	$3.4 \times I_{L,\text{MAX}}$	$4 \times I_{L,\text{MAX}}$	$4.6 \times I_{L,\text{MAX}}$	A	
t_{SC}	Short Circuit Threshold Shutdown Delay	-	7	-	ms	
T_{OFF}	Internal Overtemp Shutdown	-	135	-	$^\circ\text{C}$	
T_{RESET}	Internal Overtemp Reset	-	130	-	$^\circ\text{C}$	
$\Delta V_{\text{UV/OV}}$	Under- and Over-voltage Threshold Tolerance ⁽¹²⁾	-1	± 0.5	1	%	
Δt	Timing Tolerance ⁽¹³⁾	-2	± 1	2	%	

NOTES:

- Stresses beyond those listed under absolute maximum ratings may cause permanent damage to the device. Exposure to any absolute maximum rating condition for extended periods may affect device reliability and lifetime.
- Larger negative voltages will blow internal fuse. If fuse blows, as long as V_S is not more negative than -21/-39 V for RYxxxA/RYxxxB, respectively, and is greater than V_L , no damage to device will occur. Call manufacturer to replace blown fuse.
- Transient-protected to 40 V. Additional external protection may be required in some applications.
- Transient-protected to 60 V. Additional external protection may be required in some applications.
- Larger negative voltages will blow internal fuse. If fuse blows, as long as $V_S - V_L$ is less than -21/-39 V for RYxxxA/RYxxxB, respectively, no damage to device will occur. Call manufacturer to replace blown fuse.
- Exceeding this rating will cause current to flow through the MOSFET body diodes, leading to MOSFET failure.
- Non-isolated trigger: V_{TRIG} equals difference between TRIGGER + and relay ground; Isolated trigger: V_{TRIG} equal difference between TRIGGER + and TRIGGER -. Isolated trigger non-standard. Call manufacturer for more information.
- Transient protected to -60 V. Additional external protection may be required in some applications.
- Low power sleep mode non-standard. Call manufacturer for more information.
- 100 k Ω (typical) between OVERRIDE+ and internal 5 V.
- OVERRIDE- is internally connected to relay ground.
- Under- and over-voltage shutdown features non-standard. Call manufacturer for more information.
- Applies to over-current, short-circuit, circuit-break, under-voltage, and over-voltage shutdowns.

TYPICAL PERFORMANCE

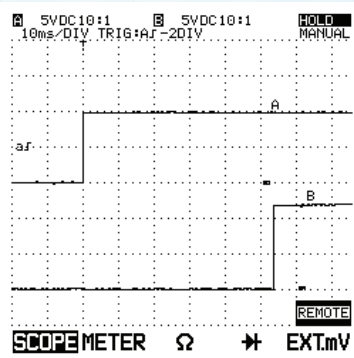

Figure 1: RYxxxA Turn-On Time
Top Trace: Trigger Voltage
Bottom Trace: Output Voltage

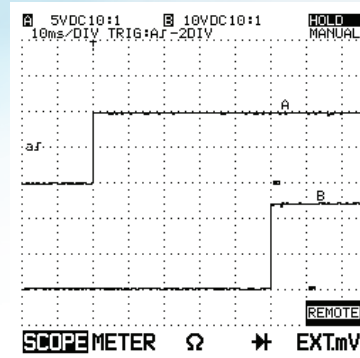

Figure 2: RYxxxB Turn-On Time
Top Trace: Trigger Voltage
Bottom Trace: Output Voltage

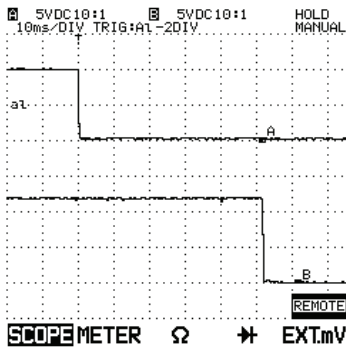

Figure 3: RYxxxA Turn-Off Time
Top Trace: Trigger Voltage
Bottom Trace: Output Voltage

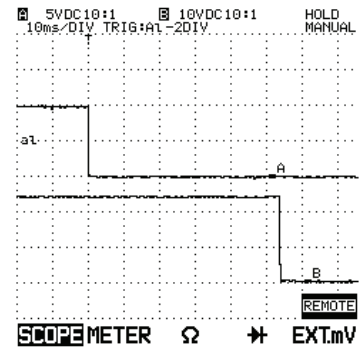

Figure 4: RYxxxB Turn-Off Time
Top Trace: Trigger Voltage
Bottom Trace: Output Voltage

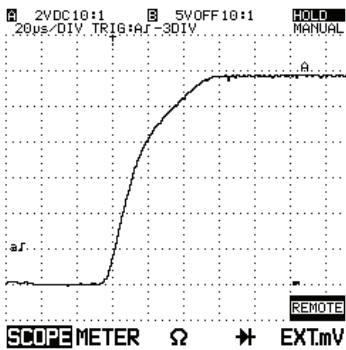

Figure 5: RYxxxA Output Rise Time

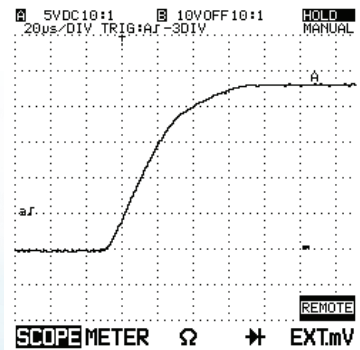

Figure 6: RYxxxB Output Rise Time

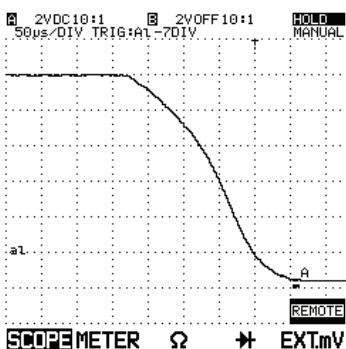

Figure 7: RYxxxA Output Fall Time

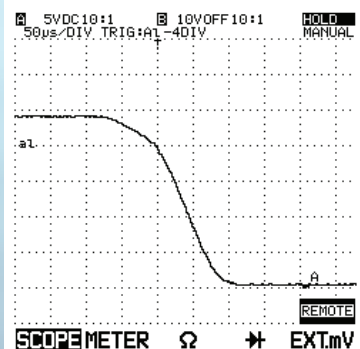

Figure 8: RYxxxB Output Fall Time

TYPICAL PERFORMANCE (continued)

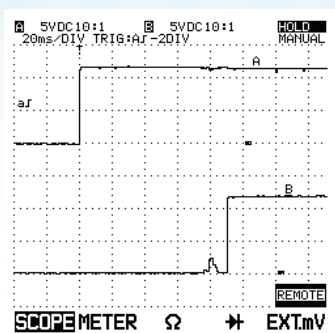

Figure 9: Start-up Output Turn-On Delay
Top Trace: Source Voltage
Bottom Trace: Output Voltage

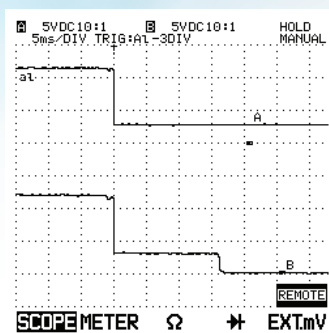

Figure 10: Source Voltage Drop to Output Off Delay
Top Trace: Source Voltage (12 V to 3 V)
Bottom Trace: Output Voltage

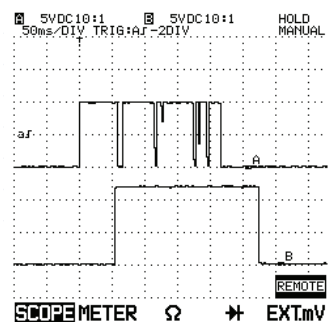

Figure 11: RYxxxA Trigger Noise Immunity
Top Trace: Trigger Voltage
Bottom Trace: Output Voltage

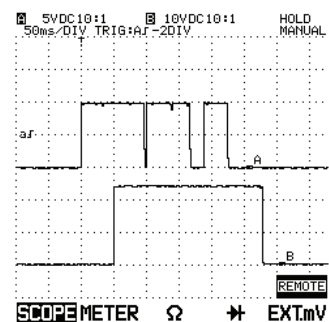

Figure 12: RYxxxB Trigger Noise Immunity
Top Trace: Trigger Voltage
Bottom Trace: Output Voltage

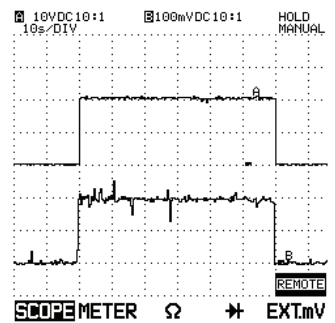

Figure 13: Overcurrent Level 1 Shutdown (RY150B shown)
Top Trace: Output Voltage
Bottom Trace: Output Current (100 A/div)

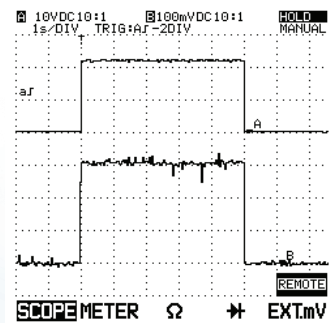

Figure 14: Overcurrent Level 2 Shutdown (RY150B shown)
Top Trace: Output Voltage
Bottom Trace: Output Current (100 A/div)

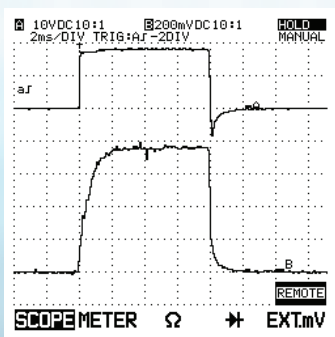

Figure 15: Short Circuit Shutdown (RY150B shown)
Top Trace: Output Voltage
Bottom Trace: Output Current (200 A/div)

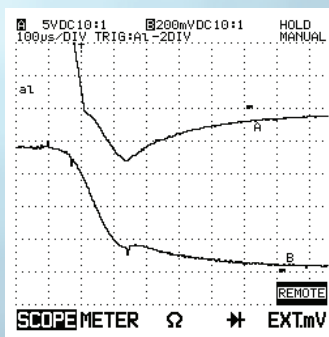
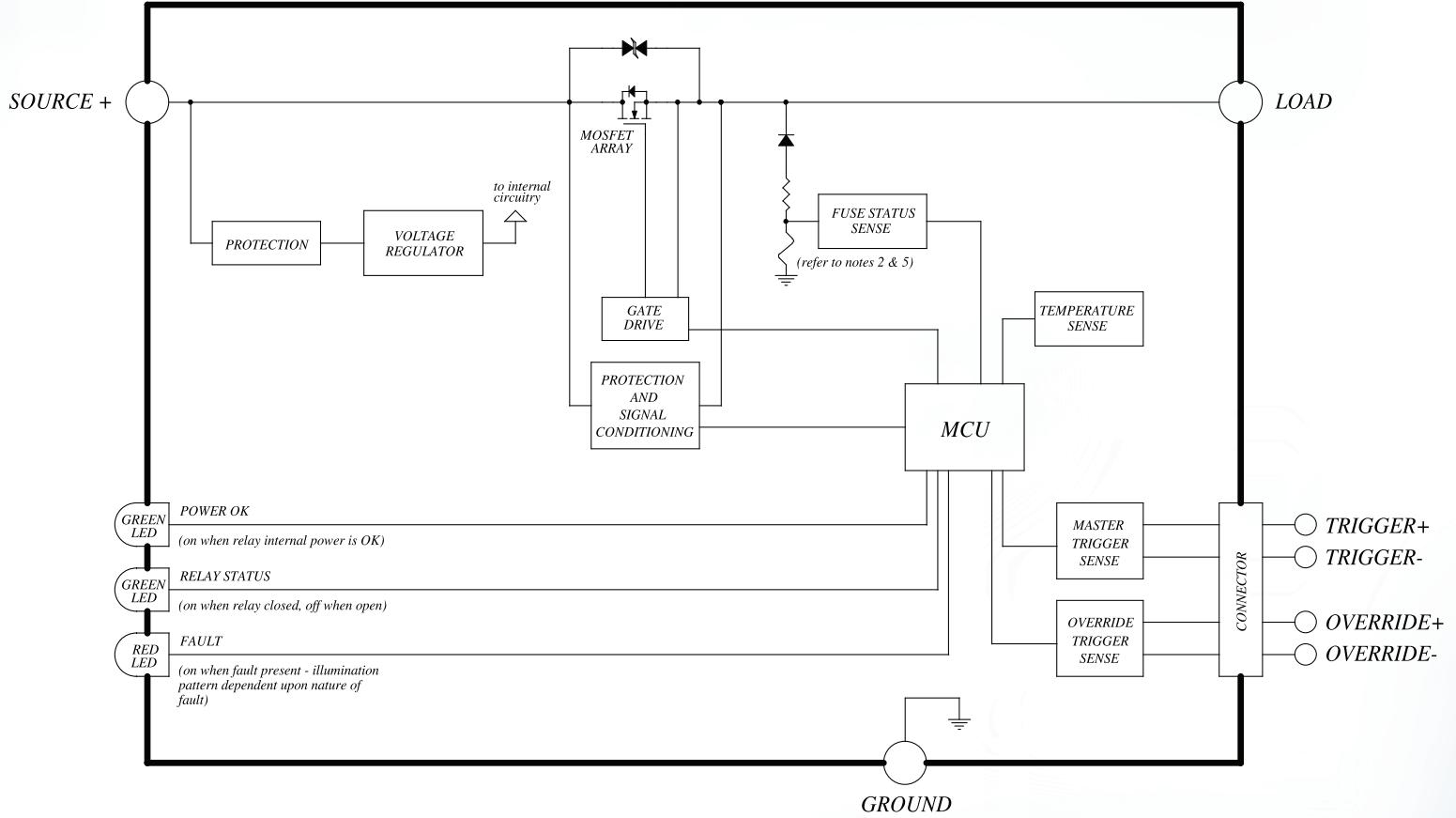
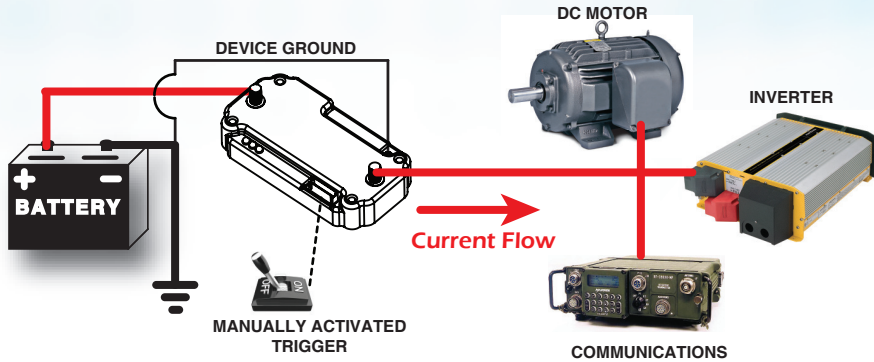

Figure 16: Inductive Load Shutdown - Current Decay (RY150B shown)
Top Trace: Output Voltage
Bottom Trace: Output Current (200 A/div)

FUNCTIONAL BLOCK DIAGRAM





POWER-GATE Uni-directional relay can be manually activated or ignition-switched to power or de-power all high and low current accessories including motors, inverters, communications equipment, lighting, refrigerators/freezers, and sensitive computer equipment.

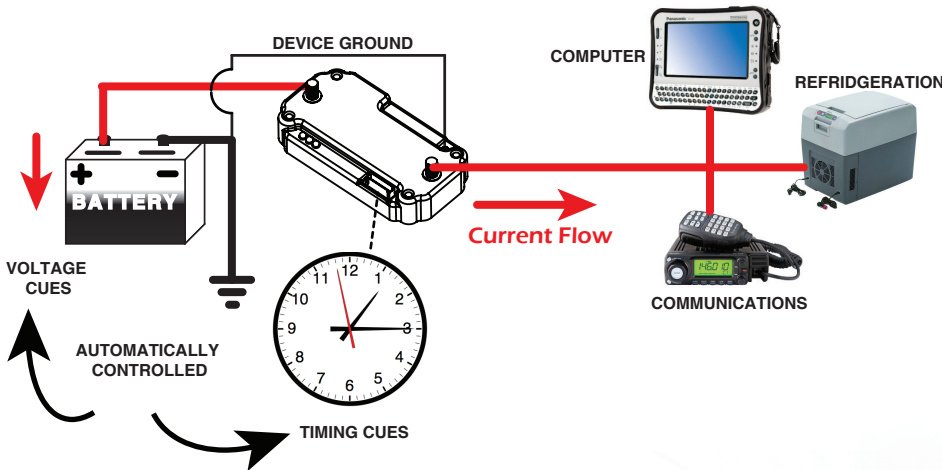

POWER-GATE Uni-directional relay can be programmed to automatically respond to low-voltage or high voltage battery conditions, and various timing cues making the device highly customizable. The ability to handle both high and low current in a single, easy-to-install module makes **POWER-GATE** a compelling choice when programmed to behave as a low voltage disconnect and preserve battery health.

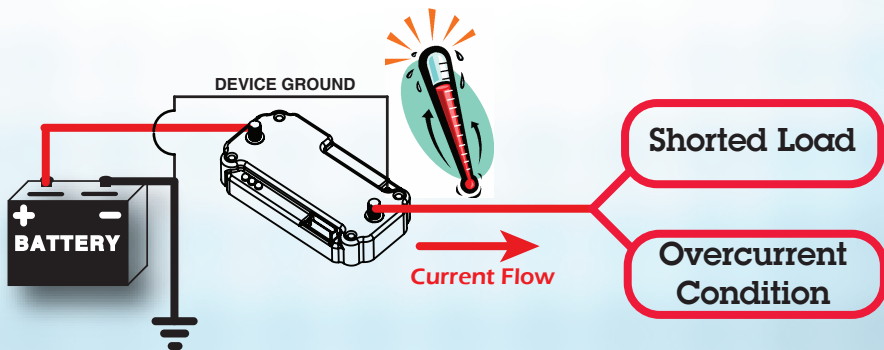

POWER-GATE Uni-directional relay can be programmed to respond as a precision circuit breaker. If the device senses a shorted load or an overcurrent condition, the device will “open” and de-power the output.

The device will also respond to over temperature conditions by sensing strategically placed sensors within the sealed module.

REVISION HISTORY

REV	DATE	DESCRIPTION	PAGE NUMBER (S)
0	02/28/14	Original Release	
1	03/13/14	Comprehensive Update	
2	04/30/14	Comprehensive Update	
3	05/23/14	Added torque specification for enclosure mounts	1

 DANGER / PELIGRO / DANGER /GEFAHR / PERICOLO / PERIGO					
<p>HAZARD OF ELECTRIC SHOCK, EXPLOSION, OR ARC FLASH.</p> <ul style="list-style-type: none"> Disconnect all power before installing or working with this equipment. Verify all connections and replace all covers before turning on power. <p>Failure to follow these instructions will result in death or serious injury.</p>	<p>RIESGO DE DESCARGA ELECTRICA O EXPLOSION.</p> <ul style="list-style-type: none"> Desconectar todos los suministros de energia a este equipo antes de trabajar con este equipo. Verificar todas las conexiones y colocar todas las tapas antes de energizer el equipo. <p>El incumplimiento de estas instrucciones puede provocar la muerte o lesiones serias.</p>	<p>RISQUE DE DESCARGE ELECTRIQUE OU EXPLOSION</p> <ul style="list-style-type: none"> Eteindre toutes les sources d'énergie de cet appareil avant de travailler dessus de cet appareil Vérifier tous connections, et remettre tous couverts en place avant de mettre sous <p>De non-suivi de ces instructions provoquera la mort ou des lésions sérieuses sérieuses.</p>	<p>GEFAHR EINES ELEKTRISCHE N SCHLAGES ODER EINER EXPLOSION.</p> <ul style="list-style-type: none"> Stellen Sie jeglichen Strom ab, der dieses Gerät versorgt, bevor Sie an dem Gerät Arbeiten durchführen Vor der Inbetriebnahme alle Anschlüsse überprüfen und alle Gehäuseteile montieren. <p>Unterlassung dieser Anweisungen können zum Tode oder zu schweren Verletzungen führen.</p>	<p>RISCHIO DI SCOSSA ELETTRICA O DELL'ESPLOSIONE.</p> <ul style="list-style-type: none"> Spenga tutta l'alimentazion e che fornisce questa apparecchiatura prima del lavorare a questa apparecchiatura Verificare tutti i collegamenti e sostituire tutte le coperture prima della rotazione sull'alimentazione <p>L'omissione di seguire queste istruzioni provocherà la morte o di lesioni serie</p>	<p>RISCO DE DESCARGA ELÉTRICA OU EXPLOSÃO</p> <ul style="list-style-type: none"> Desconectar o equipamento de toda a energia antes de instalar ou trabalhar com este equipamento Verificar todas as conexões e recolocar todas as tampas antes de religar o equipamento <p>O não cumprimento destas instruções pode levar á morte ou lesões sérias.</p>