

GENERAL CATALOGUE ²⁰¹⁹/₂₀₂₀

HEATING · COOLING · LIGHTING
SOUND · MODULAR · CONTROL



io-homecontrol® with somfy. Remote



Valid from September 2019.
(Changes and errors excepted)

BURDA WORLDWIDE TECHNOLOGIES GMBH

Rudolf-Diesel-Strasse 18 · D-65760 Eschborn · tel +49 6173 / 324 24 0 · fax +49 6173 / 324 24 24 · email info@burdawtg.de · www.burdawtg.com

Foreword

JIRI BURDA



DEAR BURDA PARTNERS AND CUSTOMERS,

I am pleased to introduce our General Catalogue 2019/2020 featuring our latest special products. Allow me to start with a brief review of the current business year, which has been characterised by international awards.

International Awards

Following its 2018 R+T Innovation Award, our patented MODULAR SYSTEM for heating, cooling and illuminating outdoor areas was honoured with three internationally renowned awards this year: the **RED DOT DESIGN AWARD 2019** for excellent product design, the **GERMAN DESIGN AWARD 2019** and the **INNOVATION AWARD R+T ASIA**, highly esteemed in Asia. We are very proud!

Pp. 22 onwards

SMART HOME with BURDA io-homecontrol® & Somfy

The concept of a SMART HOME with modern control systems has long since arrived in the outdoor sector for awnings and sun protection. In addition to shutters and awnings, weatherproof BURDA infrared heaters featuring the latest io-homecontrol® can be remote controlled simply via one or multi-channel Somfy Remote. Pp. 4 onwards

Terrace feeling with sound

The terrace is increasingly becoming the second living room, even in this part of the world. Our heating, lighting and cooling systems already contribute to your perfect ambiance, which is now complemented by a sound system. Available, with immediate effect, **as a standalone Bluetooth speaker or as a modular extension of our TERM2000 and RELAX GLASS heater series.**

Pp. 18 and p. 32

Only at BURDA: 4000 Watt Bluetooth dimmer

We are pleased to introduce a new **BTD4 Bluetooth dimmer with a very classy aluminium case**, which can be used to conveniently control heaters with a total POWER of up to 4000 Watt via the free BURDA APP on your Smartphone, or via the standard enclosed remote. Pp. 6 onwards

Flexibility trumps everything at BURDA

Furnish and decorate as you desire! On top of the new sound modules our successful RELAX GLASS series can also be extended with **lighting and cooling modules.**

The new 3000 Watt **RELAX GLASS MULTI** double heater for instant heat is just perfect for those who require a lot of heat quickly. Also, our new 4500 Watt long-wave heater RELAX DARK is optimally suited for large, windless areas – for all those who prefer a dark heater without light. Pp. 8 onwards

Enjoy browsing through our innovative product range!
Yours,

A handwritten signature in black ink, appearing to read 'Jiri Burda'.

Jiri Burda
CEO
Burda Worldwide Technologies GmbH

Content

io-homecontrol® with SOMFY REMOTE	page 4-5
BLUETOOTH	page 6-7
RELAX! SERIES	page 8-13
TERM2000 SERIES	page 14-17
TERM2000 LIGHT & HEAT	page 18-19
SMART SERIES	page 20-21
MODULAR SERIES	page 22-27
PERFECTCLIME® SERIES	page 28-32
HEATER ACCESSORIES	page 33-37
HEATPANELS	page 38-39
HEATPANELS THERMOSTATS AND ACCESSORIES	page 40
MORE SALES THROUGH SALES PROMOTION	page 41
GOOD TO KNOW	page 42-43





io-homecontrol® with Somfy Remote

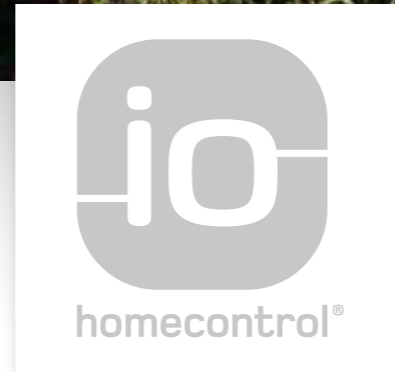

The **io-homecontrol® wireless technology** is the benchmark in many connected households worldwide for the cordless control of shutters, awnings and, **as of now, also series TERM2000 and RELAX GLASS BURDA heaters.**

An incorporated io transmitter/board in the heater corresponds, via radio, with an especially developed radio **remote control by Somfy**, via which our io infrared heaters can be turned on and off and dimmed in multiple stages. Somfy wireless hand transmitters with one or more channels are optional.



2 kW

74 cm

TERM2000 io IP67

Slow blow fuse 16 Amp (C16) recommended



CODE	EAN	POWER (in watt)	COLOR	PROTECTION CLASS	DIMENSIONS (w x h x d in cm)	WEIGHT (in g)	CABLE	CONNECTION
IOURCAC200V9010	4260409696570	2000	White	IP67	74 x 10 x 12.5	2500	1.9 m 3-wire, 1.5 mm ² , Schuko plug	L/N/PE, 230-240 V ~ 50 Hz
IOURCAC200V9005	4260409696587	2000	Black	IP67	74 x 10 x 12.5	2500	1.9 m 3-wire, 1.5 mm ² , Schuko plug	L/N/PE, 230-240 V ~ 50 Hz
IOURCAC200V7016	4260409696594	2000	Anthracite	IP67	74 x 10 x 12.5	2500	1.9 m 3-wire, 1.5 mm ² , Schuko plug	L/N/PE, 230-240 V ~ 50 Hz

RELAX GLASS io IP65

Extremely light reduced with tinted ceramic-glass SCHOTT NEXTREMA®

- 1.5 kW
- 1.8 kW
- 2.2 kW
- 3 kW



90 cm

CASE COLORS



GLASS SCREEN



128.6 cm

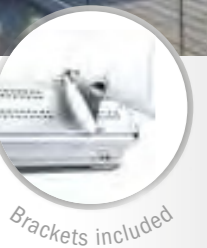

INFRARED HEATER

CODE	EAN	POWER (in watt)	COLOR (Case/Glass)	PROTECTION CLASS	DIMENSIONS (w x h x d in cm)	WEIGHT (in g)	CABLE	CONNECTION
IOBRELG1500-3	4260409696358	1500	Silver/Black	IP65	90 x 17 x 15.5	5400	1.8 m 3-wire, 1.5 mm ² , Schuko plug	L/N/PE, 230-240 V ~ 50 Hz
IOBRELG1500-3W	4260409696365	1500	Silver/White	IP65	90 x 17 x 15.5	5400	1.8 m 3-wire, 1.5 mm ² , Schuko plug	L/N/PE, 230-240 V ~ 50 Hz
IOBRELG1500-1	4260409696341	1500	Black/Black	IP65	90 x 17 x 15.5	5400	1.8 m 3-wire, 1.5 mm ² , Schuko plug	L/N/PE, 230-240 V ~ 50 Hz
IOBRELG1800-3	4260409696372	1800	Silver/Black	IP65	90 x 17 x 15.5	5400	1.8 m 3-wire, 1.5 mm ² , Schuko plug	L/N/PE, 230-240 V ~ 50 Hz
IOBRELG1800-3W	4260409696389	1800	Silver/White	IP65	90 x 17 x 15.5	5400	1.8 m 3-wire, 1.5 mm ² , Schuko plug	L/N/PE, 230-240 V ~ 50 Hz
IOBRELG1800-1	4260409696396	1800	Black/Black	IP65	90 x 17 x 15.5	5400	1.8 m 3-wire, 1.5 mm ² , Schuko plug	L/N/PE, 230-240 V ~ 50 Hz
IOBRELG2200-3	4260409696419	2200	Silver/Black	IP65	90 x 17 x 15.5	5400	1.8 m 3-wire, 1.5 mm ² , Schuko plug	L/N/PE, 230-240 V ~ 50 Hz
IOBRELG2200-3W	4260409696426	2200	Silver/White	IP65	90 x 17 x 15.5	5400	1.8 m 3-wire, 1.5 mm ² , Schuko plug	L/N/PE, 230-240 V ~ 50 Hz
IOBRELG2200-1	4260409696402	2200	Black/Black	IP65	90 x 17 x 15.5	5400	1.8 m 3-wire, 1.5 mm ² , Schuko plug	L/N/PE, 230-240 V ~ 50 Hz
IOBRELG3000-3	4260409696501	3000	Silver/Black	IP65	128.6 x 17 x 15.5	7100	1.8 m 3-wire, 1.5 mm ² , Schuko plug	L/N/PE, 230-240 V ~ 50 Hz
IOBRELG3000-3W	4260409696686	3000	Silver/White	IP65	128.6 x 17 x 15.5	7100	1.8 m 3-wire, 1.5 mm ² , Schuko plug	L/N/PE, 230-240 V ~ 50 Hz

SOMFY WIRELESS HANDHELD TRANSMITTERS

CODE	EAN	DESCRIPTION	COLOR	PROTECTION CLASS	DIMENSIONS (w x h x d in mm)
IOSIT1VP	4260409696716	Situo 1 VAR io Pure II	White	IP30	38 x 145 x 16
IOSIT5VAMP	4260409696723	Situo 5 VAR AM io Pure II	White	IP30	38 x 145 x 16





BLUETOOTH

The tried and tested infrared heaters of the **TERM2000** and **SMART** series are the basis of the BLUETOOTH heaters. Upgraded with a Bluetooth interface, the new BT heaters allow for convenient, wireless control of the infrared heater via your Smartphone or tablet. Our **BURDA APP**, which is compatible with all iOS and Android device is available to download free of charge. In addition to wireless control via the Smartphone App, Bluetooth heaters can be controlled as usual with the proven infrared remote control, with a range of 6 m, or operated manually with an integrated switch on the device. The infrared remote control that comes with the set is un-coded and compatible with all BURDA Bluetooth heaters. Alternatively, by pressing the incorporated switch on the device once or multiple times, the heater can be switched on, dimmed or switched off.

BLUETOOTH DIMMER

With a BLUETOOTH DIMMER you can conveniently control one or more heaters with a total power of up to 4000 Watt via the free BURDA APP with your Smartphone or tablet. The dimmers are available with 3000 and 4000 Watt power at 230 V.

APPLICATIONS

In all private, commercial, public, gastronomic or industrial outdoor areas.

Available for Burda Bluetooth heater and Bluetooth dimmer.



To download the App please scan the QR-Code.

For free for Android and iOS devices.

- ✓ Regulation for up to eight heaters
- ✓ Range: 50 m (no line of sight required)
- ✓ Timer function

Remote Control included

For an easy control of your Bluetooth heater or dimmer without smartphone.

71 cm

2 kW

Ultra Low Glare

Waterproof

All colors available!

Mounting bracket included (T-Bracket)

- ✓ Colors: Anthracite, white and black
- ✓ Ultra Low Glare tube
- ✓ Waterproof IP67

TERM2000 BLUETOOTH IP67

Slow blow fuse 16 Amp (C16) recommended

CODE	EAN	POWER (in watt)	COLOR	PROTECTION CLASS	DIMENSIONS (w x h x d in cm)	WEIGHT (in g)	CABLE	CONNECTION
BTURCAC200V9010	4260409692442	2000	White	IP67	71 x 10 x 12.5	2500	1.9 m 3-wire 1.5 mm ² , Schuko plug	1/N/PE ~ 230 V 50 Hz
BTURCAC200V7016	4260409692459	2000	Anthracite	IP67	71 x 10 x 12.5	2500	1.9 m 3-wire 1.5 mm ² , Schuko plug	1/N/PE ~ 230 V 50 Hz
BTURCAC200V9005	4260409692435	2000	Black	IP67	71 x 10 x 12.5	2500	1.9 m 3-wire 1.5 mm ² , Schuko plug	1/N/PE ~ 230 V 50 Hz

- ✓ Colors: Silver, white and black
- ✓ Splash water protection IP24

2 kW



Remote Control included

For an easy control of your Bluetooth heater or dimmer without smartphone.

SMART BLUETOOTH IP24

Slow blow fuse 16 Amp (C16) recommended



CODE	EAN	POWER (in watt)	COLOR	PROTECTION CLASS	DIMENSIONS (w x h x d in cm)	WEIGHT (in g)	CABLE	CONNECTION
BTBHS2024	4260409693135	2000	White	IP24	48 x 14.5 x 9.5	2500	1.9 m 3-wire 1.5 mm ² , Schuko plug	1/N/PE ~ 230 V 50 Hz
BTBHS2024-1	4260409693142	2000	Black	IP24	48 x 14.5 x 9.5	2500	1.9 m 3-wire 1.5 mm ² , Schuko plug	1/N/PE ~ 230 V 50 Hz
BTBHS2024-3	4260409693159	2000	Silver	IP24	48 x 14.5 x 9.5	2500	1.9 m 3-wire 1.5 mm ² , Schuko plug	1/N/PE ~ 230 V 50 Hz



48 cm

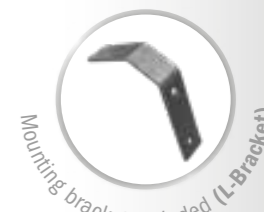

INFRARED HEATER

126 cm

3 kW

- ✓ Colors: Silver, white and black
- ✓ Splash water protection IP24

SMART TOWER BLUETOOTH IP24

Slow blow fuse 16 Amp (C16) recommended



CODE	EAN	POWER (in watt)	COLOR	PROTECTION CLASS	DIMENSIONS (w x h x d in cm)	WEIGHT (in g)	CABLE	CONNECTION
BTBHST3024	4260409694002	2 x 1500	White	IP24	29 x 126 x 32	7300	1.9 m 3-wire 1.5 mm ² , Schuko plug	1/N/PE ~ 230 V 50 Hz
BTBHST3024-1	4260409694026	2 x 1500	Black	IP24	29 x 126 x 32	7300	1.9 m 3-wire 1.5 mm ² , Schuko plug	1/N/PE ~ 230 V 50 Hz
BTBHST3024-3	4260409694019	2 x 1500	Silver	IP24	29 x 126 x 32	7300	1.9 m 3-wire 1.5 mm ² , Schuko plug	1/N/PE ~ 230 V 50 Hz



Remote Control included

For an easy control of your Bluetooth heater or dimmer without smartphone.



RELAX!

OUTDOOR & INDOOR

DESIGNSTRONG INFRARED HEATER WITH SHORT-, MEDIUM- AND LONG-WAVE

RELAX! is the new product group by BURDA PERFECTCLIME® featuring extremely powerful design heaters that operate with short-, medium- and long-wave infrared (IRA, IRB, IRC).

RELAX GLASS IP65 – infrared heater with Schott Nextrema® glass ceramics

The first water-protected infrared heater by BURDA PERFECTCLIME® with an elegant SCHOTT NEXTREMA® glass ceramics front. The design heaters are available with infrared short-wave, IR-A for instant heat at the push of a button, or can also be ordered in the 1200 Watt version as an infrared medium-wave heater (IR-B) with mild light and convection heat. Performance varies between 1200, 1500, 1800, 2200 and 3000 Watt per model. All RELAX GLASS models offer a selection of colours for the case (silver or black) and the glass ceramics covering (white or black). The infrared heaters are also available as built-in heaters in frames (except models with 2200/3000 Watt).

RELAX DARK IRC IP55 – dark heaters with infrared long-wave for indoor spaces and wind-protected outdoor areas

Powerful dark heaters with an elegant look – without any light at all. The long-wave heater RELAX DARK IRC IP55 uniformly supplies the surrounding air with heat (convection heat) and elegantly blends into every surrounding with its linear silver and black design. Plain elegance and high functionality offer a variety of possible applications. **Please note:** For efficacy in outdoor areas, only absolutely windless areas are suitable, because of the long-wave IR radiation.

APPLICATIONS

In all private, commercial, public, gastronomic or industrial outdoor areas.

RELAX GLASS IRA IP65

Extremely light reduced with tinted ceramic-glass SCHOTT NEXTREMA®

Waterproof

CASE COLORS: Silver, Black

GLASS SCREEN: White, Black

1.5 kW

1.8 kW

2.2 kW

1.2 kW

90 cm

58.5 cm

REMOTE/DIMMER OPTIONAL

Mounting bracket included



INFRARED HEATER

CODE	EAN	POWER (in watt)	COLOR (Case/Glass)	PROTECTION CLASS	DIMENSIONS (w x h x d in cm)	WEIGHT (in g)	CABLE	CONNECTION
With Dimmer/Remote								
BRELG1200R-3	4260409695467	1200	Silver/Black	IP65	58.5 x 17 x 8	3600	1.8 m 3-wire 1.5 mm ² , Schuko plug	L/N/PE, 230-240 V ~ 50 Hz
BRELG1200R-3W	4260409695801	1200	Silver/White	IP65	58.5 x 17 x 8	3600	1.8 m 3-wire 1.5 mm ² , Schuko plug	L/N/PE, 230-240 V ~ 50 Hz
BRELG1200R-1	4260409695733	1200	Black/Black	IP65	58.5 x 17 x 8	3600	1.8 m 3-wire 1.5 mm ² , Schuko plug	L/N/PE, 230-240 V ~ 50 Hz
BRELG1500RD-3	4260409695443	1500	Silver/Black	IP65	90 x 17 x 8	5200	1.8 m 3-wire 1.5 mm ² , Schuko plug	L/N/PE, 230-240 V ~ 50 Hz
BRELG1500RD-3W	4260409695818	1500	Silver/White	IP65	90 x 17 x 8	5200	1.8 m 3-wire 1.5 mm ² , Schuko plug	L/N/PE, 230-240 V ~ 50 Hz
BRELG1500RD-1	4260409695450	1500	Black/Black	IP65	90 x 17 x 8	5200	1.8 m 3-wire 1.5 mm ² , Schuko plug	L/N/PE, 230-240 V ~ 50 Hz
BRELG1800RD-3	4260409695429	1800	Silver/Black	IP65	90 x 17 x 8	5200	1.8 m 3-wire 1.5 mm ² , Schuko plug	L/N/PE, 230-240 V ~ 50 Hz
BRELG1800RD-3W	4260409695825	1800	Silver/White	IP65	90 x 17 x 8	5200	1.8 m 3-wire 1.5 mm ² , Schuko plug	L/N/PE, 230-240 V ~ 50 Hz
BRELG1800RD-1	4260409695436	1800	Black/Black	IP65	90 x 17 x 8	5200	1.8 m 3-wire 1.5 mm ² , Schuko plug	L/N/PE, 230-240 V ~ 50 Hz
BRELG2200RD-3	4260409695405	2200	Silver/Black	IP65	90 x 17 x 8	5200	1.8 m 3-wire 1.5 mm ² , Schuko plug	L/N/PE, 230-240 V ~ 50 Hz
BRELG2200RD-3W	4260409695832	2200	Silver/White	IP65	90 x 17 x 8	5200	1.8 m 3-wire 1.5 mm ² , Schuko plug	L/N/PE, 230-240 V ~ 50 Hz
BRELG2200RD-1	4260409695412	2200	Black/Black	IP65	90 x 17 x 8	5200	1.8 m 3-wire 1.5 mm ² , Schuko plug	L/N/PE, 230-240 V ~ 50 Hz
Without Dimmer/Remote								
BRELG1200-3	4260409695399	1200	Silver/Black	IP65	58.5 x 17 x 8	3500	1.8 m 3-wire 1.5 mm ² , Schuko plug	L/N/PE, 230-240 V ~ 50 Hz
BRELG1200-3W	4260409695849	1200	Silver/White	IP65	58.5 x 17 x 8	3500	1.8 m 3-wire 1.5 mm ² , Schuko plug	L/N/PE, 230-240 V ~ 50 Hz
BRELG1200-1	4260409695757	1200	Black/Black	IP65	58.5 x 17 x 8	3500	1.8 m 3-wire 1.5 mm ² , Schuko plug	L/N/PE, 230-240 V ~ 50 Hz
BRELG1500-3	4260409695382	1500	Silver/Black	IP65	90 x 17 x 8	5100	1.8 m 3-wire 1.5 mm ² , Schuko plug	L/N/PE, 230-240 V ~ 50 Hz
BRELG1500-3W	4260409695856	1500	Silver/White	IP65	90 x 17 x 8	5100	1.8 m 3-wire 1.5 mm ² , Schuko plug	L/N/PE, 230-240 V ~ 50 Hz
BRELG1500-1	4260409695764	1500	Black/Black	IP65	90 x 17 x 8	5100	1.8 m 3-wire 1.5 mm ² , Schuko plug	L/N/PE, 230-240 V ~ 50 Hz
BRELG1800-3	4260409695375	1800	Silver/Black	IP65	90 x 17 x 8	5100	1.8 m 3-wire 1.5 mm ² , Schuko plug	L/N/PE, 230-240 V ~ 50 Hz
BRELG1800-3W	4260409695863	1800	Silver/White	IP65	90 x 17 x 8	5100	1.8 m 3-wire 1.5 mm ² , Schuko plug	L/N/PE, 230-240 V ~ 50 Hz
BRELG1800-1	4260409695771	1800	Black/Black	IP65	90 x 17 x 8	5100	1.8 m 3-wire 1.5 mm ² , Schuko plug	L/N/PE, 230-240 V ~ 50 Hz
BRELG2200-3	4260409695368	2200	Silver/Black	IP65	90 x 17 x 8	5100	1.8 m 3-wire 1.5 mm ² , Schuko plug	L/N/PE, 230-240 V ~ 50 Hz
BRELG2200-3W	4260409695870	2200	Silver/White	IP65	90 x 17 x 8	5100	1.8 m 3-wire 1.5 mm ² , Schuko plug	L/N/PE, 230-240 V ~ 50 Hz
BRELG2200-1	4260409695788	2200	Black/Black	IP65	90 x 17 x 8	5100	1.8 m 3-wire 1.5 mm ² , Schuko plug	L/N/PE, 230-240 V ~ 50 Hz

RELAX GLASS MULTI IRA IP65 DOUBLE HEATER

Extremely light reduced with tinted ceramic-glass SCHOTT NEXTREMA®

Waterproof

CASE COLORS: Silver

GLASS SCREEN: White, Black

3 kW

128.6 cm

REMOTE/DIMMER OPTIONAL

Mounting bracket included

NEW

CODE	EAN	POWER (in watt)	COLOR (Case/Glass)	PROTECTION CLASS	DIMENSIONS (w x h x d in cm)	WEIGHT (in g)	CABLE	CONNECTION
With Dimmer/Remote								
BRELG3000RD-3W	4260051488226	3000	Silver/White	IP65	128.6 x 17 x 8	6800	1.8 m 3-wire, 1.5 mm ² , Schuko plug	L/N/PE, 230-240 V ~ 50 Hz
BRELG3000RD-3	4260409695252	3000	Silver/Black	IP65	128.6 x 17 x 8	6800	1.8 m 3-wire, 1.5 mm ² , Schuko plug	L/N/PE, 230-240 V ~ 50 Hz
Without Dimmer/Remote								
BRELG3000-3W	4260409696761	3000	Silver/White	IP65	128.6 x 17 x 8	6800	1.8 m 3-wire, 1.5 mm ² , Schuko plug	L/N/PE, 230-240 V ~ 50 Hz
BRELG3000-3	4260409696754	3000	Silver/Black	IP65	128.6 x 17 x 8	6800	1.8 m 3-wire, 1.5 mm ² , Schuko plug	L/N/PE, 230-240 V ~ 50 Hz

RELAX GLASS CARBON IRB IP65

1.2 kW

Extremely light reduced with tinted ceramic-glass SCHOTT NEXTREMA®

Carbon heater with infrared medium-wave (IR-B), 1200 Watt and SCHOTT NEXTREMA® glass ceramics covering with soft light for gentle heat on the skin and in the bathroom.



CODE	EAN	POWER (in watt)	COLOR (Case/Glass)	PROTECTION CLASS	DIMENSIONS (w x h x d in cm)	WEIGHT (in g)	CABLE	CONNECTION
Without Remote								
BRELG1200C-3W	4260409695030	1200	Silver/White	IP65	58.5 x 17 x 8	3600	1.8 m 3-wire, 1.5 mm², Schuko plug	L/N/PE, 230-240 V ~ 50 Hz
BRELG1200C-3	4260409696624	1200	Silver/Black	IP65	58.5 x 17 x 8	3600	1.8 m 3-wire, 1.5 mm², Schuko plug	L/N/PE, 230-240 V ~ 50 Hz
With Remote								
BRELG1200CR-3W	4260409695054	1200	Silver/White	IP65	58.5 x 17 x 8	3600	1.8 m 3-wire, 1.5 mm², Schuko plug	L/N/PE, 230-240 V ~ 50 Hz
BRELG1200CR-3	4260409696631	1200	Silver/Black	IP65	58.5 x 17 x 8	3600	1.8 m 3-wire, 1.5 mm², Schuko plug	L/N/PE, 230-240 V ~ 50 Hz

RELAX GLASS BUILT-IN MODELS

All* RELAX GLASS models are also suitable for flush-mounted ceiling installation. Just select the appropriate frame!

S: Frame for 1200 Watt models
L: Frame for 1500/1800 Watt models.

* except 2200 and 3000 Watt heaters

FRAME COLOUR SELECTION



CODE	EAN	DESCRIPTION	COLOR	MATERIAL	DIMENSIONS (w x h x d in cm)	WEIGHT (in g)
Frame						
BRELGFS-3	4260409695498	Frame for 1200 watt models	Silver	Stainless steel	60 x 21.4 x 12.3	2000
BRELGFS-1	4260409695795	Frame for 1200 watt models	Black	Cold-rolled steel	60 x 21.4 x 12.3	1700
BRELGFL-3	4260409695474	Frame for 1500/1800 watt models	Silver	Stainless steel	97.8 x 23.1 x 12.3	3500
BRELGFL-1	4260409695481	Frame for 1500/1800 watt models	Black	Cold-rolled steel	97.8 x 23.1 x 12.3	3200

RELAX GLASS ADD ON

The RELAX GLASS series can be extended to a multifunctional system with light (RELAX GLASS LIGHT), cooling (RELAX GLASS NOZZLES), loudspeakers (RELAX GLASS Sound) and PANELS. A 10 cm connecting element (MODULAR DISTANCE) with connecting screws (MODULAR CONNECTOR) is required to connect the modules on the switching page. The connection of smooth sides only requires the connecting element. All RELAX MODULES are also available as stand-alone products* for individual installation.

*except NOZZLES

RELAX GLASS LIGHT IP65

As a stand-alone product or modular extension

2 x 5 W

Light module with two LED spots and glass front.

CASE COLORS



GLASS SCREEN

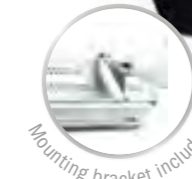

CODE	EAN	POWER (in watt)	COLOR (Case/Glass)	PROTECTION CLASS	DIMENSIONS (w x h x d in cm)	WEIGHT (in g)	CABLE	CONNECTION
BRELGL-1	4260409696211	2 X 5 W	Black/Black	IP65	90 x 17 x 8	4150	1.8 m 3-wire, 1.5 mm², Schuko plug	L/N/PE, 230-240V-50 Hz
BRELGL-3	4260409696228	2 X 5 W	Silver/Black	IP65	90 x 17 x 8	4150	1.8 m 3-wire, 1.5 mm², Schuko plug	L/N/PE, 230-240V-50 Hz

RELAX GLASS SOUND IP65

As a stand-alone product or modular extension

100 W

Bluetooth speaker

CASE COLORS



GLASS SCREEN

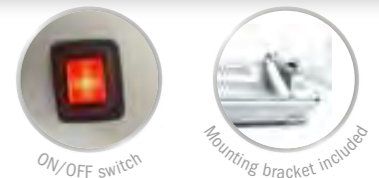

CODE	EAN	POWER (in Watt)	COLOR (Case/Glass)	PROTECTION CLASS	DIMENSIONS (w x h x d in cm)	WEIGHT (in g)	CABLE	CONNECTION
BRELGS-3	4260409695351	100	Silver/Black	IP65	90 x 17 x 8	5900	1.8 m 3-wire, 1.0 mm², Schuko plug	L/N/PE, 230-240 V ~ 50 Hz
BRELGS-1	4260051488233	100	Black/Black	IP65	90 x 17 x 8	5900	1.8 m 3-wire, 1.0 mm², Schuko plug	L/N/PE, 230-240 V ~ 50 Hz

RELAX GLASS MODULAR NOZZLE

Extension with connector

Nozzle for evaporative cooling in connection with pump* and water supply*.

* not included in the delivery.

CASE COLORS



GLASS SCREEN



CODE	EAN	COLOR (Case/Glass)	DIMENSIONS (w x h x d in cm)	WEIGHT (in g)
BRELGD-1	4260409696297	Black/Black	10 x 17 x 8	620
BRELGD-3	4260409696303	Silver/Black	10 x 17 x 8	620

RELAX GLASS BLENDE

The systems can be extended at will with the RELAX GLASS PANEL.

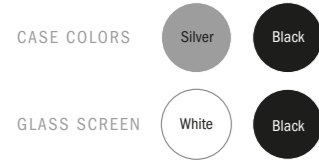

90 cm

CODE	EAN	COLOR (Case/Glass)	DIMENSIONS (w x h x d in cm)	WEIGHT (in g)
BRELGBL-1	4260409696266	Black/Black	90 x 17 x 8	4000
BRELGBL-3W	4260409696242	Silver/White	90 x 17 x 8	4000
BRELGBL-3	4260409696259	Silver/Black	90 x 17 x 8	4000

RELAX GLASS MODULAR DISTANCE 10 CM

Connecting element with BRELGCP connector for extending the RELAX GLASS heater with RELAX GLASS SOUND, RELAX GLASS LIGHT, RELAX GLASS BLENDE or RELAX GLASS NOZZLE - only required for connection sides with switch.

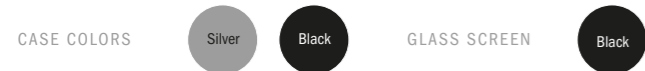

BRELGCP

CODE	EAN	COLOR (Case/Glass)	DIMENSIONS (w x h x d in cm)	WEIGHT (in g)
BRELGCP-1	4260409696327	Black/Black	10 x 17 x 8	600
BRELGCP-3	4260409696310	Silver/Black	10 x 17 x 8	600

RELAX GLASS MODULAR CONNECTOR				
CODE	EAN	COLOR	DIMENSIONS (w x h x d in cm)	WEIGHT (in g)
BRELGCP	4260409696334	Silver	10.5 x 10 x 2.5	113

SPARE PARTS

CODE	EAN	DESCRIPTION	COLOR	MATERIAL	DIMENSIONS (w x h x d in cm)	WEIGHT (in g)
Remote						
BRELGR	4260409695511	Remote for 1200 watt models, ON/OFF function, Timer 1 h.	Black	ABS: Acrylonitrile Butadiene Styrene	4.5 x 12.5	50
BRELGRD	4260409695504	Remote for 1500/1800/2200 watt models with Dimmer (33/66/100 %) and Timer (3 h.)	Black	ABS: Acrylonitrile Butadiene Styrene	4.5 x 12.5	50
Mounting bracket						
BRELGB-3	4260409695566	Mounting bracket	Silver	Stainless steel	16.6 x 11.6	450 g/set



INFRARED HEATER



158 cm

- 2.2 kW
- 2.4 kW
- 4.5 kW



RELAX DARK IRC IP55

NO LIGHT with intelligent long-wave technology



- ✓ Infrared-long-wave IRC with 2200/2400 and 3000 watt for comforting warmth
- ✓ NO light emission
- ✓ High quality, waterproof design IP55
- ✓ Colors Black and Silver (4500 watt black only)
- ✓ Power connection 230/380-400 Volt with 16A fuse
- ✓ 2-year guarantee

INDOOR: For indoor use of the models BRELD2200 and BRELD2400, the external control BPIRF (wireless), BHCINSTA+3R (wired) or BHC-FIT3R (wired) or equivalent must be used to comply with EU Regulation 2015/1188. Otherwise the device loses the CE mark.

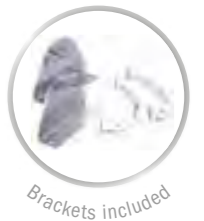

CODE	EAN	POWER (in watt)	COLOR	PROTECTION CLASS	DIMENSIONS (w x h x d in cm)	WEIGHT (in g)	CABLE	CONNECTION
BRELD2200-3	4260409695580	2200	Silver	IP55	158 x 20.1 x 5.8	8100	1.90 m 3-wire, 1.5 mm ² , Schuko plug	220-240 V ~ 50-60 Hz
BRELD2400-1	4260409695573	2400	Black	IP55	158 x 20.1 x 5.8	8100	1.90 m 3-wire, 1.5 mm ² , Schuko plug	220-240 V ~ 50-60 Hz
BRELD4500-1	4260409696549	4500	Black	IP55	212 x 25 x 7	16000	3 m, 5-wire, 1 mm ² , bared and stripped, without sleeve	3/N/PE 380-400 V ~ 50-60 Hz



TERM2000

OUTDOOR

The weatherproof TERM2000 easily supplies all outdoor areas with instant and cosy warmth – for up to 5000 hours. Depending on the application area and requirement, the TERM2000 is available in the protection category IP44 (splash water protection) or completely waterproof in the IP67 version. The powerful heaters are available both as single or double heaters as well as triple power heaters and offer a range of 1000 up to 8000 Watt – depending on the configuration. The TERM2000 series also fulfils every desire in terms of colour choice: ranging from popular standard colours in white, black or anthracite to your favourite colour, all RAL colours are available at extra charge.

For large outdoor areas, all the advantages of the TERM2000 series are also available to set up as TERM TOWER PALMS. Ideal for the hotel and food service industry the TERM TOWER PALMS offer optimal heating performance in all areas – especially in places where lacking mounting options have prevented the use of other systems so far.

APPLICATIONS

In all private, commercial, public, gastronomic or industrial outdoor areas.



TERM TOWER PALMS IP67



TERM2000 IP67

TERM2000 IP44



TERM2000 IP67



Waterproof

CODE	EAN	POWER (in watt)	COLOR	PROTECTION CLASS	DIMENSIONS (w x h x d in cm)	WEIGHT (in g)	CABLE	CONNECTION
RCA100	4260051480503	1000	Polished aluminum	IP67	45 x 9.5 x 12.5	2000	1.9 m 3-wire 1.5 mm ² , Schuko plug	1/N/PE – 230 V 50 Hz
RCA165	4260051480237	1650	Polished aluminum	IP67	61 x 9.5 x 12.5	2300	1.9 m 3-wire 1.5 mm ² , Schuko plug	1/N/PE – 230 V 50 Hz
RCA200V	4260051480275	2000	Polished aluminum	IP67	61 x 9.5 x 12.5	2300	1.9 m 3-wire 1.5 mm ² , Schuko plug	1/N/PE – 230 V 50 Hz
URCA100V	4260051485577	1000	Polished aluminum	IP67	45 x 9.5 x 12.5	2000	1.9 m 3-wire 1.5 mm ² , Schuko plug	1/N/PE – 230 V 50 Hz
URCA150V	4260051485386	1500	Polished aluminum	IP67	61 x 9.5 x 12.5	2300	1.9 m 3-wire 1.5 mm ² , Schuko plug	1/N/PE – 230 V 50 Hz
URCA165V	4260051483863	1650	Polished aluminum	IP67	61 x 9.5 x 12.5	2300	1.9 m 3-wire 1.5 mm ² , Schuko plug	1/N/PE – 230 V 50 Hz
URCA200V	4260051484150	2000	Polished aluminum	IP67	61 x 9.5 x 12.5	2300	1.9 m 3-wire 1.5 mm ² , Schuko plug	1/N/PE – 230 V 50 Hz
URCAC150V9010	4260051485607	1500	White	IP67	61 x 9.5 x 12.5	2000	1.9 m 3-wire 1.5 mm ² , Schuko plug	1/N/PE – 230 V 50 Hz
URCAC165V9010	4260051485614	1650	White	IP67	61 x 9.5 x 12.5	2000	1.9 m 3-wire 1.5 mm ² , Schuko plug	1/N/PE – 230 V 50 Hz
URCAC200V9010	4260051485621	2000	White	IP67	61 x 9.5 x 12.5	2000	1.9 m 3-wire 1.5 mm ² , Schuko plug	1/N/PE – 230 V 50 Hz
URCAC150V9005	4260051486222	1500	Black	IP67	61 x 9.5 x 12.5	2000	1.9 m 3-wire 1.5 mm ² , Schuko plug	1/N/PE – 230 V 50 Hz
URCAC165V9005	4260051486239	1650	Black	IP67	61 x 9.5 x 12.5	2000	1.9 m 3-wire 1.5 mm ² , Schuko plug	1/N/PE – 230 V 50 Hz
URCAC200V9005	4260051486246	2000	Black	IP67	61 x 9.5 x 12.5	2000	1.9 m 3-wire 1.5 mm ² , Schuko plug	1/N/PE – 230 V 50 Hz
URCAC150V7016	4260051488240	1500	Anthracite	IP67	61 x 9.5 x 12.5	2000	1.9 m 3-wire 1.5 mm ² , Schuko plug	1/N/PE – 230 V 50 Hz
URCAC165V7016	4260051488257	1650	Anthracite	IP67	61 x 9.5 x 12.5	2000	1.9 m 3-wire 1.5 mm ² , Schuko plug	1/N/PE – 230 V 50 Hz
URCAC200V7016	4260051486581	2000	Anthracite	IP67	61 x 9.5 x 12.5	2000	1.9 m 3-wire 1.5 mm ² , Schuko plug	1/N/PE – 230 V 50 Hz



Mounting bracket included (L-Bracket)



3.3 kW
4 kW
4.95 kW
6 kW

TERM2000 MULTI IP67



Waterproof

CODE	EAN	POWER (in watt)	COLOR	PROTECTION CLASS	DIMENSIONS (w x h x d in cm)	WEIGHT (in g)	CABLE	CONNECTION
RCJ330	4260051480435	2 x 1650	Polished aluminum	IP67	123.5 x 9.5 x 12.5	4900	0.65 m 5-wire 1.5 mm ² , Wire-end sleeves	2/N/PE – 230 (2N) V 50 Hz
RCJ400V	4260051480442	2 x 2000	Polished aluminum	IP67	123.5 x 9.5 x 12.5	4900	0.65 m 5-wire 1.5 mm ² , Wire-end sleeves	2/N/PE – 400 (2N) V 50 Hz
URCJ330V	4260051483870	2 x 1650	Polished aluminum	IP67	123.5 x 9.5 x 12.5	4900	0.65 m 5-wire 1.5 mm ² , Wire-end sleeves	2/N/PE – 230 (2N) V 50 Hz
URCJ400V	4260051483887	2 x 2000	Polished aluminum	IP67	123.5 x 9.5 x 12.5	4900	0.65 m 5-wire 1.5 mm ² , Wire-end sleeves	2/N/PE – 400 (2N) V 50 Hz
URCC495V	4260051483894	3 x 1650	Polished aluminum	IP67	60 x 29 x 12.5	6800	0.65 m 5-wire 2.5 mm ² , Wire-end sleeves	3/N/PE – 400 (3N) V 50 Hz
URCC600V	4260051483900	3 x 2000	Polished aluminum	IP67	60 x 29 x 12.5	6800	0.65 m 5-wire 2.5 mm ² , Wire-end sleeves	3/N/PE – 400 (3N) V 50 Hz

Available with table and ashtray

250-270 cm

3 kW
4 kW
6 kW
8 kW

TERM TOWER PALMS IP67

ULTRA LOW GLARE
Waterproof

CODE	EAN	POWER (in watt)	COLOR	PROTECTION CLASS	DIMENSIONS (w x h x d in cm)	WEIGHT (in kg)	CABLE	CONNECTION
URTT300V	4260051488561	2 x 1500	Polished aluminum	IP67	110 X 250-270	ca. 45	10 m 5-wire 2.5 mm ² , Wire-end sleeves	3/N/PE ~ 400 (3N) V 50 Hz
URTT400V	4260051483917	2 x 2000	Polished aluminum	IP67	110 x 250-270	ca. 49	10 m 5-wire 2.5 mm ² , Wire-end sleeves	3/N/PE ~ 400 (3N) V 50 Hz
URTT600V	4260051483924	3 x 2000	Polished aluminum	IP67	110 x 250-270	ca. 51	10 m 5-wire 2.5 mm ² , Wire-end sleeves	3/N/PE ~ 400 (3N) V 50 Hz
URTT800V	4260051483931	4 x 2000	Polished aluminum	IP67	110 x 250-270	ca. 53	10 m 5-wire 2.5 mm ² , Wire-end sleeves	3/N/PE ~ 400 (3N) V 50 Hz
UR TTC300V9005	4260051488578	2 x 1500	Black	IP67	110 x 250-270	ca. 49	10 m 5-wire 2.5 mm ² , Wire-end sleeves	3/N/PE ~ 400 (3N) V 50 Hz
UR TTC400V9005	4260051487779	2 x 2000	Black	IP67	110 x 250-270	ca. 49	10 m 5-wire 2.5 mm ² , Wire-end sleeves	3/N/PE ~ 400 (3N) V 50 Hz
UR TTC600V9005	4260051487786	3 x 2000	Black	IP67	110 x 250-270	ca. 51	10 m 5-wire 2.5 mm ² , Wire-end sleeves	3/N/PE ~ 400 (3N) V 50 Hz
UR TTC800V9005	4260051487793	4 x 2000	Black	IP67	110 x 250-270	ca. 53	10 m 5-wire 2.5 mm ² , Wire-end sleeves	3/N/PE ~ 400 (3N) V 50 Hz
UR TTC300V9010	4260051488585	2 x 1500	White	IP67	110 x 250-270	ca. 49	10 m 5-wire 2.5 mm ² , Wire-end sleeves	3/N/PE ~ 400 (3N) V 50 Hz
UR TTC400V9010	4260051488196	2 x 2000	White	IP67	110 x 250-270	ca. 49	10 m 5-wire 2.5 mm ² , Wire-end sleeves	3/N/PE ~ 400 (3N) V 50 Hz
UR TTC600V9010	4260051488202	3 x 2000	White	IP67	110 x 250-270	ca. 51	10 m 5-wire 2.5 mm ² , Wire-end sleeves	3/N/PE ~ 400 (3N) V 50 Hz
UR TTC800V9010	4260051488219	4 x 2000	White	IP67	110 x 250-270	ca. 53	10 m 5-wire 2.5 mm ² , Wire-end sleeves	3/N/PE ~ 400 (3N) V 50 Hz
RTTT	4260051480589	Table	Black Werzalit		59 x 2.3 x 59	4.16	-	-
RTTA	4260051480596	Ashtray	Polished aluminum		6 x 12.5 x 6	1	-	-

1 kW
1.5 kW

51 cm

TERM2000 IP44

ULTRA LOW GLARE

Mounting bracket included (L-Bracket)

INFRARED HEATER

CODE	EAN	POWER (in watt)	COLOR	PROTECTION CLASS	DIMENSIONS (w x h x d in cm)	WEIGHT (in g)	CABLE	CONNECTION
URCA01044V	4260051488653	1000	Polished aluminum	IP44	50.3 x 10 x 12.5	2300	1.9 m 3-wire 1.5 mm ² , Schuko plug	1/N/PE ~ 230 V 50 Hz
URCA01544V	4260051488509	1500	Polished aluminum	IP44	50.3 x 10 x 12.5	2300	1.9 m 3-wire 1.5 mm ² , Schuko plug	1/N/PE ~ 230 V 50 Hz

INDOOR: For indoor use of all models, the external control BPIRF (wireless), BHCINSTAT+3R (wired) or BHCFIT3R (wired) or equivalent must be used to comply with EU Regulation 2015/1188. Otherwise the device loses the CE mark.

0.65 kW
1.3 kW
1.95 kW

35.7 cm
60.7 cm
85.5 cm

TERM2000 NO GLARE IP20 CERAMIC

NO GLARE

Mounting bracket included (T-Bracket)

CODE	EAN	POWER (in watt)	COLOR	PROTECTION CLASS	DIMENSIONS (w x h x d in cm)	WEIGHT (in g)	CABLE	CONNECTION
NRCA065	4260051488523	650	White	IP20	35.7 x 12.5 x 8	2100	1.9 m 3-wire 1.5 mm ² , Schuko plug	1/N/PE ~ 230 V 50 Hz
NRCA065-1	4260051488530	650	Black	IP20	35.7 x 12.5 x 8	2100	1.9 m 3-wire 1.5 mm ² , Schuko plug	1/N/PE ~ 230 V 50 Hz
NRCJ130	4260051488554	2 x 650	White	IP20	60.7 x 12.5 x 8	3000	1.9 m 3-wire 1.5 mm ² , Schuko plug	1/N/PE ~ 230 V 50 Hz
NRCJ130-1	4260051488547	2 x 650	Black	IP20	60.7 x 12.5 x 8	3000	1.9 m 3-wire 1.5 mm ² , Schuko plug	1/N/PE ~ 230 V 50 Hz
NRCK195	4260051488677	3 x 650	White	IP20	85.5 x 12.5 x 8	3800	1.9 m 3-wire 1.5 mm ² , Schuko plug	1/N/PE ~ 230 V 50 Hz
NRCK195-1	4260051488684	3 x 650	Black	IP20	85.5 x 12.5 x 8	3800	1.9 m 3-wire 1.5 mm ² , Schuko plug	1/N/PE ~ 230 V 50 Hz

1 kW
1.5 kW

46.6 cm

TERM2000 COLOR SHORT IP44

ULTRA LOW GLARE

All colors available!

Mounting bracket included (T-Bracket)

CODE	EAN	POWER (in watt)	COLOR	PROTECTION CLASS	DIMENSIONS (w x h x d in cm)	WEIGHT (in g)	CABLE	CONNECTION
URCACS01044V9010	4260051488592	1000	White	IP44	46.4 x 9.5 x 12.5	2100	1.9 m 3-wire 1.5 mm ² , Schuko plug	1/N/PE ~ 230 V 50 Hz
URCACS01544V9010	4260051488370	1500	White	IP44	46.4 x 9.5 x 12.5	2100	1.9 m 3-wire 1.5 mm ² , Schuko plug	1/N/PE ~ 230 V 50 Hz
URCACS01044V9005	4260051488608	1000	Black	IP44	46.4 x 9.5 x 12.5	2100	1.9 m 3-wire 1.5 mm ² , Schuko plug	1/N/PE ~ 230 V 50 Hz
URCACS01544V9005	4260051488394	1500	Black	IP44	46.4 x 9.5 x 12.5	2100	1.9 m 3-wire 1.5 mm ² , Schuko plug	1/N/PE ~ 230 V 50 Hz
URCACS01044V7016	4260051488615	1000	Anthracite	IP44	46.4 x 9.5 x 12.5	2100	1.9 m 3-wire 1.5 mm ² , Schuko plug	1/N/PE ~ 230 V 50 Hz
URCACS01544V7016	4260051488424	1500	Anthracite	IP44	46.4 x 9.5 x 12.5	2100	1.9 m 3-wire 1.5 mm ² , Schuko plug	1/N/PE ~ 230 V 50 Hz

2 kW

42.5 cm

TERM2000 CVH IP20

Infrared lacquer or building dryer - Multifunctional, portable dryer for material heating and drying

CODE	EAN	POWER (in watt)	COLOR	PROTECTION CLASS	DIMENSIONS (w x h x d in cm)	WEIGHT (in g)	CABLE	CONNECTION
RCAC020VH-1	4260051482293	2000	Black	IP20	42.5 x 15 x 21	1500	1.9 m 3-wire 1.5 mm ² , Schuko plug	1/N/PE ~ 230 V 50 Hz
RCAC020VH-4	4260051482309	2000	Red	IP20	42.5 x 15 x 21	1500	1.9 m 3-wire 1.5 mm ² , Schuko plug	1/N/PE ~ 230 V 50 Hz



TERM2000 LIGHT & HEAT

OUTDOOR

Wherever the “right” brightness counts, our patented heating/lighting combination appliances are the first choice. In terms of technology and design, they are based on the established TERM2000 series combined with 2 or 4 LED spots (240V/3.5W). The appliances are waterproof in accordance with IP65. Heating tubes and light can be controlled and dimmed analogously or separately. Especially modulated dimmers are available as accessories.

APPLICATIONS

In all private, commercial, public, gastronomic or industrial outdoor areas.



TERM2000 L&H XL IP65 LED



Mounting bracket included
aluminum colored heater: **T-Bracket**
aluminum polished heater: **L-Bracket**

4.0 kW + 14 W (LEDs)
200 cm
ULTRA LOW GLARE | LIGHT | Waterproof

CODE	EAN	POWER (in watt)	COLOR	PROTECTION CLASS	DIMENSIONS (w x h x d in cm)	WEIGHT (in g)	CABLE	CONNECTION
URLH4265	4260051484075	2 x 2000 + 14	Polished aluminum	IP65	200 x 9.5 x 12.5	7100	1.9 m 5-wire 2.5 mm ² , Wire-end sleeves	3/N/PE ~ 400 V 50 Hz
URLHC42657016	4260409692602	2 x 2000 + 14	Anthracite	IP65	200 x 9.5 x 12.5	7100	1.9 m 5-wire 2.5 mm ² , Wire-end sleeves	3/N/PE ~ 400 V 50 Hz
URLHC42659010	4260409691575	2 x 2000 + 14	White	IP65	200 x 9.5 x 12.5	7100	1.9 m 5-wire 2.5 mm ² , Wire-end sleeves	3/N/PE ~ 400 V 50 Hz
URLHC42659005	4260409691582	2 x 2000 + 14	Black	IP65	200 x 9.5 x 12.5	7100	1.9 m 5-wire 2.5 mm ² , Wire-end sleeves	3/N/PE ~ 400 V 50 Hz



INFRARED HEATER

TERM2000 L&H FIX IP65 LED

1.65 kW + 7 W (LEDs)
2.0 kW + 7 W (LEDs)
Mounting bracket included (L-Bracket)
ULTRA LOW GLARE | LIGHT | Waterproof

CODE	EAN	POWER (in watt)	COLOR	PROTECTION CLASS	DIMENSIONS (w x h x d in cm)	WEIGHT (in g)	CABLE	CONNECTION
URLH1765F	4260051484044	1650 + 7	Polished aluminum	IP65	78 x 9.5 x 12.5	3350	1.9 m 5-wire 1.5 mm ² , Wire-end sleeves	2/N/PE ~ 230 V 50 Hz
URLH2165F	4260051484051	2000 + 7	Polished aluminum	IP65	78 x 9.5 x 12.5	3350	1.9 m 5-wire 1.5 mm ² , Wire-end sleeves	2/N/PE ~ 230 V 50 Hz



TERM2000 L&H IP65 LED

1.65 kW + 7 W (LEDs)
2.0 kW + 7 W (LEDs)
180°
82.5 cm
ULTRA LOW GLARE | LIGHT | Waterproof



CODE	EAN	POWER (in watt)	COLOR	PROTECTION CLASS	DIMENSIONS (w x h x d in cm)	WEIGHT (in g)	CABLE	CONNECTION
URLH1765	4260051484020	1650 + 7	Polished aluminum	IP65	82.5 x 9.5 x 12.5	3350	1.9 m 5-wire 1.5 mm ² , Wire-end sleeves	2/N/PE ~ 230 V 50 Hz
URLH2165	4260051484037	2000 + 7	Polished aluminum	IP65	82.5 x 9.5 x 12.5	3350	1.9 m 5-wire 1.5 mm ² , Wire-end sleeves	2/N/PE ~ 230 V 50 Hz



SMART

OUTDOOR

Compact infrared heater with splash water protection and dimmed LOW GLARE technology

The compact infrared heaters of the SMART series, which are equipped with large reflectors, cut a fine figure wherever quick heating is required. The smart heaters are protected against splash water and can be installed onto walls in outdoor areas, under ceilings, as built-in ceiling models or set up as a **SMART TOWER** standing heater. The SMART series is exclusively manufactured with **LOW GLARE** heating tubes, which significantly minimise the infrared light.

APPLICATIONS

In all private, commercial, public, gastronomic or industrial outdoor areas.



- 1.5 kW
- 2 kW
- 3 kW
- 4 kW
- 6 kW



SMART IP24 & SMART MULTI IP24



Optional with switch: SMART S IP24

CODE	EAN	POWER (in watt)	COLOR	PROTECTION CLASS	DIMENSIONS (w x h x d in cm)	WEIGHT (in g)	CABLE	CONNECTION
BHS1524	4260051489568	1500	White	IP24	48 x 14.5 x 9.5	2500	1.9 m 3-wire 1.5 mm ² , Schuko plug	1/N/PE ~ 230 V 50 Hz
BHS1524-3	4260051489551	1500	Silver	IP24	48 x 14.5 x 9.5	2500	1.9 m 3-wire 1.5 mm ² , Schuko plug	1/N/PE ~ 230 V 50 Hz
BHS2024	4260051489575	2000	White	IP24	48 x 14.5 x 9.5	2500	1.9 m 3-wire 1.5 mm ² , Schuko plug	1/N/PE ~ 230 V 50 Hz
BHS2024-3	4260051489582	2000	Silver	IP24	48 x 14.5 x 9.5	2500	1.9 m 3-wire 1.5 mm ² , Schuko plug	1/N/PE ~ 230 V 50 Hz
BHS2024-1	4260051480053	2000	Black	IP24	48 x 14.5 x 9.5	2500	1.9 m 3-wire 1.5 mm ² , Schuko plug	1/N/PE ~ 230 V 50 Hz
BHS3024	4260051487243	2 x 1500	White	IP24	89.5 x 14.5 x 9.5	4000	1.9 m 3-wire 1.5 mm ² , Schuko plug	1/N/PE ~ 230 V/50 Hz
BHS4024	4260051487267	2 x 2000	White	IP24	89.5 x 14.5 x 9.5	4000	0.65 m 5-adri 2.5 mm ² , Wire-end sleeves	2/N/PE ~ 230 V 50 Hz
BHS6024	4260051487281	3 x 2000	White	IP24	129 x 14.5 x 9.5	6000	0.65 m 5-wire 2.5 mm ² , Wire-end sleeves	3/N/PE ~ 400 (3N) V 50 Hz
BHSS1524	4260409694934	1500	White	IP24	48 x 14.5 x 9.5	2500	1.9 m 3-wire 1.5 mm ² , Schuko plug	1/N/PE ~ 230 V 50 Hz
BHSS1524-1	4260409694941	1500	Black	IP24	48 x 14.5 x 9.5	2500	1.9 m 3-wire 1.5 mm ² , Schuko plug	1/N/PE ~ 230 V 50 Hz
BHSS1524-3	4260409694958	1500	Silver	IP24	48 x 14.5 x 9.5	2500	1.9 m 3-wire 1.5 mm ² , Schuko plug	1/N/PE ~ 230 V 50 Hz
BHSS2024	4260409694965	2000	White	IP24	48 x 14.5 x 9.5	2500	1.9 m 3-wire 1.5 mm ² , Schuko plug	1/N/PE ~ 230 V 50 Hz
BHSS2024-1	4260409694972	2000	Black	IP24	48 x 14.5 x 9.5	2500	1.9 m 3-wire 1.5 mm ² , Schuko plug	1/N/PE ~ 230 V 50 Hz
BHSS2024-3	4260409694989	2000	Silver	IP24	48 x 14.5 x 9.5	2500	1.9 m 3-wire 1.5 mm ² , Schuko plug	1/N/PE ~ 230 V 50 Hz

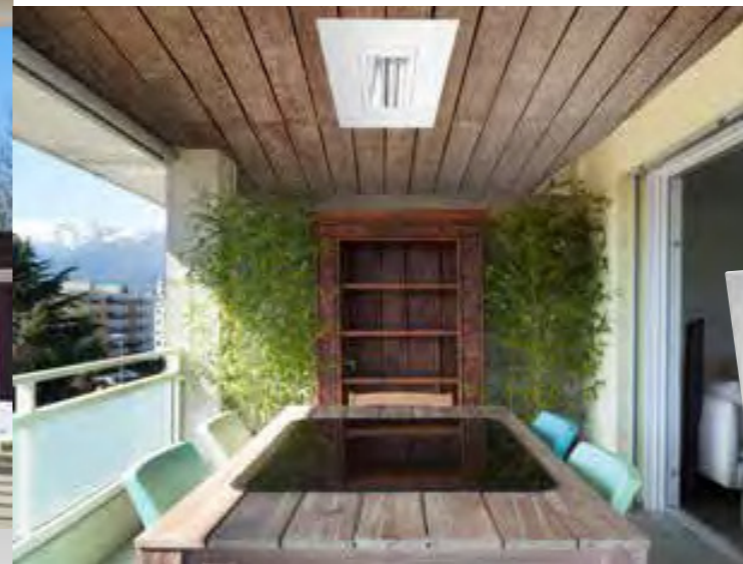

- 1.5 kW
- 2 kW



SMART FRAME IP24 BUILT-IN HEATERS



CODE	EAN	POWER (in watt)	COLOR	PROTECTION CLASS	DIMENSIONS (w x h x d in cm)	WEIGHT (in g)	CABLE	CONNECTION
BHSF1524-2	4260409694842	1500	White	IP24	60 x 32.5 x 10	3400	1.9 m 3-wire 1.5 mm ² , Schuko plug	1/N/PE ~ 230 V 50 Hz
BHSF1524-3	4260409694859	1500	Silver	IP24	60 x 32.5 x 10	3400	1.9 m 3-wire 1.5 mm ² , Schuko plug	1/N/PE ~ 230 V 50 Hz
BHSF2024-2	4260409694835	2000	White	IP24	60 x 32.5 x 10	3400	1.9 m 3-wire 1.5 mm ² , Schuko plug	1/N/PE ~ 230 V 50 Hz
BHSF2024-3	4260409694866	2000	Silver	IP24	60 x 32.5 x 10	3400	1.9 m 3-wire 1.5 mm ² , Schuko plug	1/N/PE ~ 230 V 50 Hz



- 3 kW

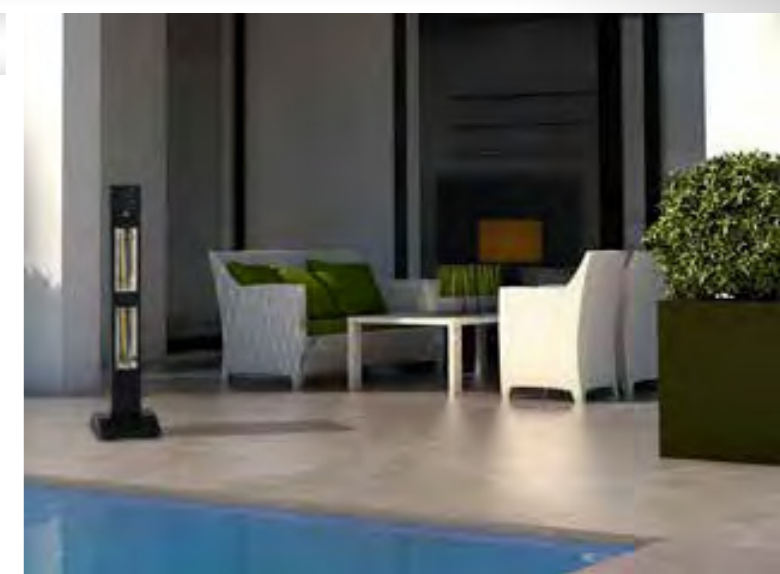

SMART TOWER IP24



CODE	EAN	POWER (in watt)	COLOR	PROTECTION CLASS	DIMENSIONS (w x h x d in cm)	WEIGHT (in g)	CABLE	CONNECTION
BHST3024-1	4260051484686	2 x 1500	Black	IP24	29 x 126 x 32	7300	1.9 m 3-wire 1.5 mm ² , Schuko plug	1/N/PE ~ 230 V 50 Hz
BHST3024	4260051484693	2 x 1500	White	IP24	29 x 126 x 32	7300	1.9 m 3-wire 1.5 mm ² , Schuko plug	1/N/PE ~ 230 V 50 Hz
BHST3024-3	4260051484709	2 x 1500	Silver	IP24	29 x 126 x 32	7300	1.9 m 3-wire 1.5 mm ² , Schuko plug	1/N/PE ~ 230 V 50 Hz
BHST3024-4	4260051484716	2 x 1500	Red	IP24	29 x 126 x 32	7300	1.9 m 3-wire 1.5 mm ² , Schuko plug	1/N/PE ~ 230 V 50 Hz



PATENTED



MODULARSYSTEM

OUTDOOR

YOU HAVE THE CHOICE – COMPLETELY INDIVIDUAL OR STANDARD SETS

We adjust and combine according to your needs, wishes and design – easy and completely individual! Our unique and patented modular concept with heating, LED lights and cooling systems, offer individual combinations for every project: Together with awnings, conservatories, patio roofs, i. e. also for stadiums, exhibition halls, or just stand-alone on your balcony. Combine single modules or standard sets to every desired color and length – 10, 20, 30, 50 or 100 m, no problem! Choose from our standard colors pure white (9010), Black (9005) and anthracite (7016) or with a supplementary charge for an individual color of your choice. Mounting brackets are included. Whether single modules or standard modular sets, order now!

- ✓ MODULAR ✓ INDIVIDUAL ✓ EVERY LENGTH
- ✓ EVERY COLOR ✓ WATERPROOF IP65/67 ✓ LEDS WITH 3.5 W

APPLICATIONS

In all private, gastronomic, commercial, public or industrial outdoor areas

Standard Colors:

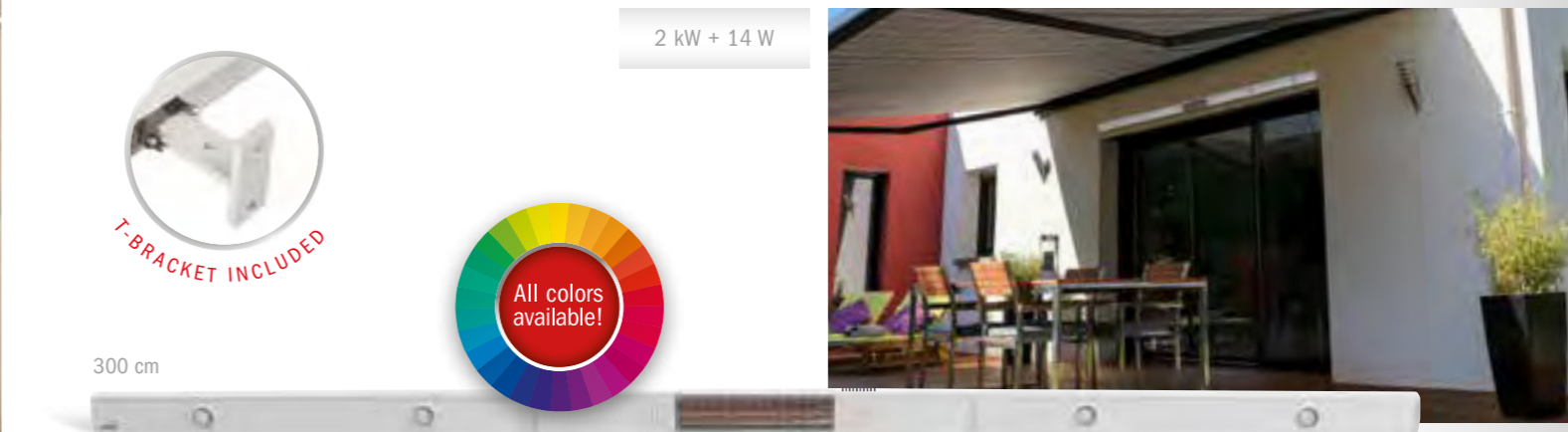

MSET 3.1 = M1 + M2 + M1

2 x LED + 1 x Heater



IP65

MODULAR

CODE	EAN	POWER (in watt)	COLOR	PROTECTION CLASS	DIMENSIONS (w x h x d in cm)	WEIGHT (in g)	CABLE	CONNECTION
MSET3.1 9010	4260409691636	2000 + 14	White	IP65	300 x 9.5 x 12.5	7100	1 m 5-wire 1.5 mm ² Wieland plug	3/N/PE – 400 (3N) V 50 Hz
MSET3.1 9005	4260409692831	2000 + 14	Black	IP65	300 x 9.5 x 12.5	7100	1 m 5-wire 1.5 mm ² Wieland plug	3/N/PE – 400 (3N) V 50 Hz
MSET3.1 7016	4260409691643	2000 + 14	Anthracite	IP65	300 x 9.5 x 12.5	7100	1 m 5-wire 1.5 mm ² Wieland plug	3/N/PE – 400 (3N) V 50 Hz

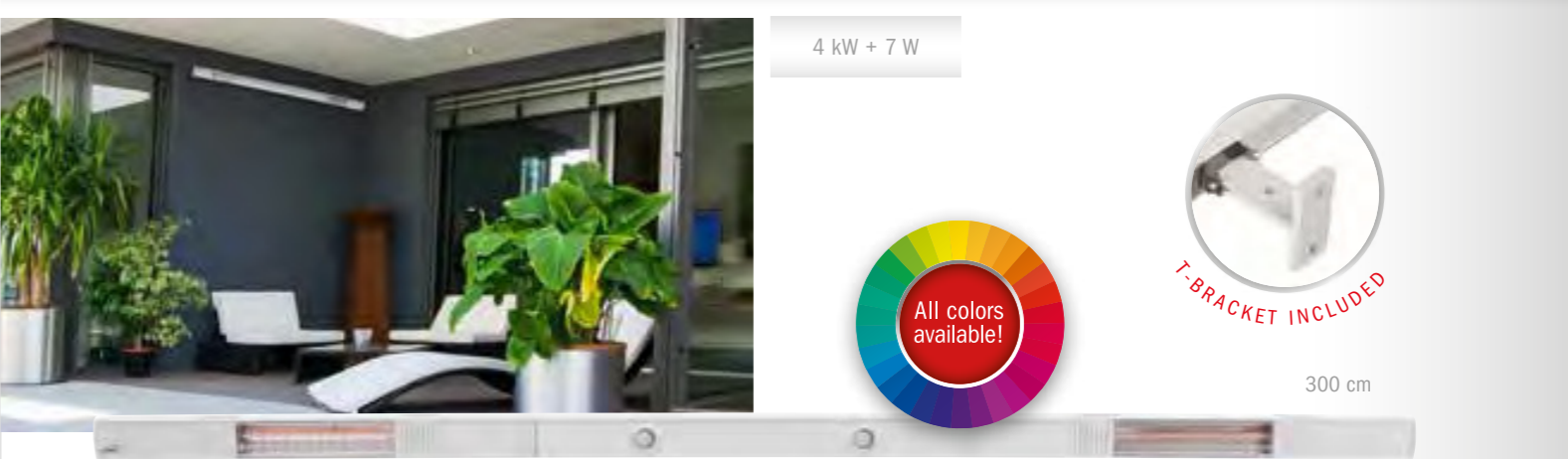

MSET 3.2 = M2 + M1 + M2

1 x LED + 2 x Heater



IP65

CODE	EAN	POWER (in watt)	COLOR	PROTECTION CLASS	DIMENSIONS (w x h x d in cm)	WEIGHT (in g)	CABLE	CONNECTION
MSET3.2 9010	4260409691858	4000 + 7	White	IP65	300 x 9.5 x 12.5	7000	1 m 5-wire 1.5 mm ² Wieland plug	3/N/PE – 400 (3N) V 50 Hz
MSET3.2 9005	4260409692848	4000 + 7	Black	IP65	300 x 9.5 x 12.5	7000	1 m 5-wire 1.5 mm ² Wieland plug	3/N/PE – 400 (3N) V 50 Hz
MSET3.2 7016	4260409691872	4000 + 7	Anthracite	IP65	300 x 9.5 x 12.5	7000	1 m 5-wire 1.5 mm ² Wieland plug	3/N/PE – 400 (3N) V 50 Hz

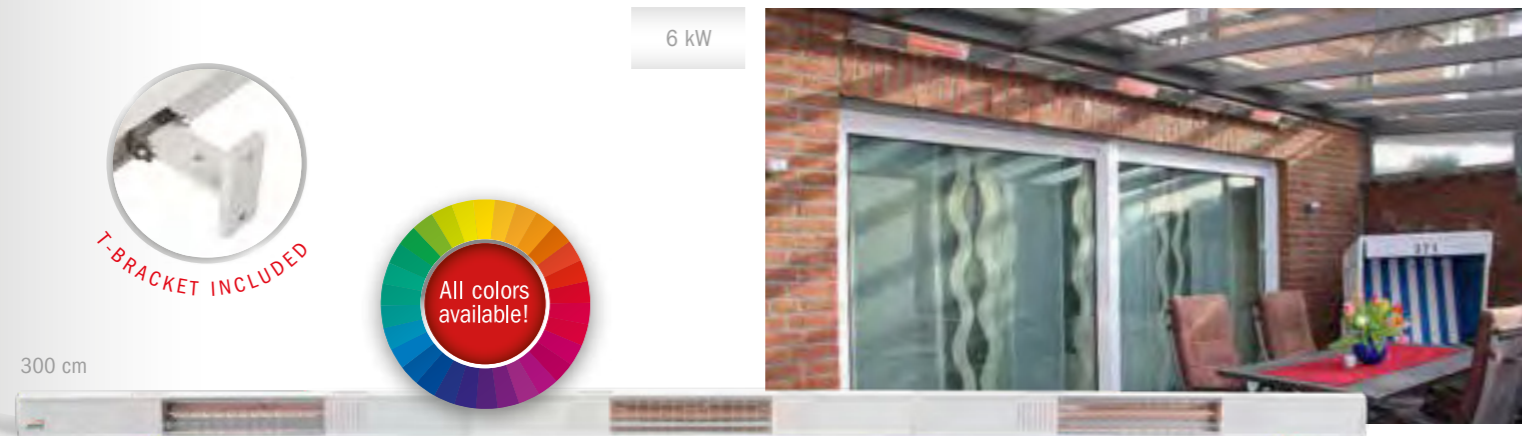

MSET 3.3 = M2 + M2 + M2
3 x Heater

ULTRA LOW GLARE | Waterproof

CODE	EAN	POWER (in watt)	COLOR	PROTECTION CLASS	DIMENSIONS (w x h x d in cm)	WEIGHT (in g)	CABLE	CONNECTION
MSET3.3 9010	4260409692657	6000	White	IP67	300 x 9.5 x 12.5	6900	1 m 5-wire 1.5 mm ² Wieland plug	3/N/PE - 400 (3N) V 50 Hz
MSET3.3 9005	4260409692664	6000	Black	IP67	300 x 9.5 x 12.5	6900	1 m 5-wire 1.5 mm ² Wieland plug	3/N/PE - 400 (3N) V 50 Hz
MSET3.3 7016	4260409692688	6000	Anthracite	IP67	300 x 9.5 x 12.5	6900	1 m 5-wire 1.5 mm ² Wieland plug	3/N/PE - 400 (3N) V 50 Hz

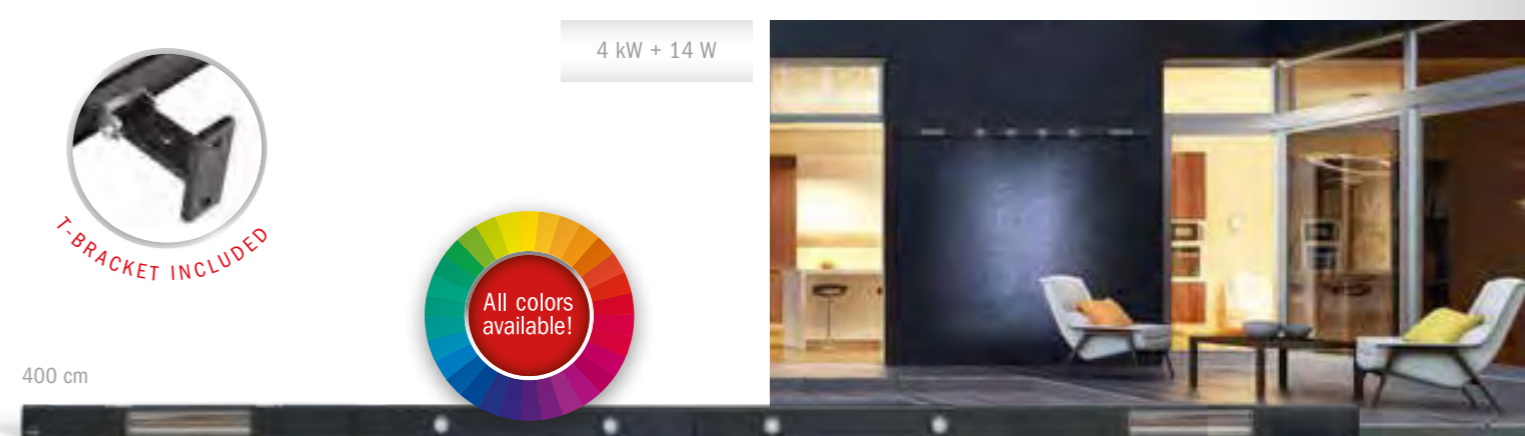

MSET 4.2 = M2 + M1 + M1 + M2
2 x LED + 2 x Heater

ULTRA LOW GLARE | LIGHT | Waterproof

CODE	EAN	POWER (in watt)	COLOR	PROTECTION CLASS	DIMENSIONS (w x h x d in cm)	WEIGHT (in g)	CABLE	CONNECTION
MSET4.2 9010	4260409692732	4000 + 14	White	IP65	400 x 9.5 x 12.5	9400	1 m 5-wire 1.5 mm ² Wieland plug	3/N/PE - 400 (3N) V 50 Hz
MSET4.2 9005	4260409692749	4000 + 14	Black	IP65	400 x 9.5 x 12.5	9400	1 m 5-wire 1.5 mm ² Wieland plug	3/N/PE - 400 (3N) V 50 Hz
MSET4.2 7016	4260409692763	4000 + 14	Anthracite	IP65	400 x 9.5 x 12.5	9400	1 m 5-wire 1.5 mm ² Wieland plug	3/N/PE - 400 (3N) V 50 Hz

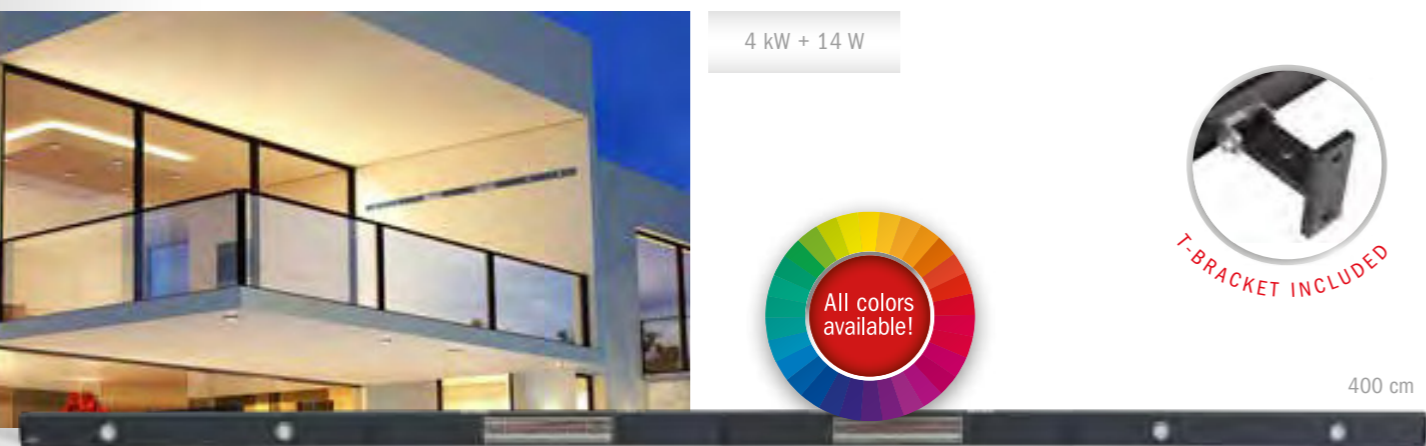

MSET 4.1 = M1 + M2 + M2 + M1
2 x LED + 2 x Heater

ULTRA LOW GLARE | LIGHT | Waterproof

CODE	EAN	POWER (in watt)	COLOR	PROTECTION CLASS	DIMENSIONS (w x h x d in cm)	WEIGHT (in g)	CABLE	CONNECTION
MSET4.1 9010	4260409692695	4000 + 14	White	IP65	400 x 9.5 x 12.5	9400	1 m 5-wire 1.5 mm ² Wieland plug	3/N/PE - 400 (3N) V 50 Hz
MSET4.1 9005	4260409692701	4000 + 14	Black	IP65	400 x 9.5 x 12.5	9400	1 m 5-wire 1.5 mm ² Wieland plug	3/N/PE - 400 (3N) V 50 Hz
MSET4.1 7016	4260409692725	4000 + 14	Anthracite	IP65	400 x 9.5 x 12.5	9400	1 m 5-wire 1.5 mm ² Wieland plug	3/N/PE - 400 (3N) V 50 Hz

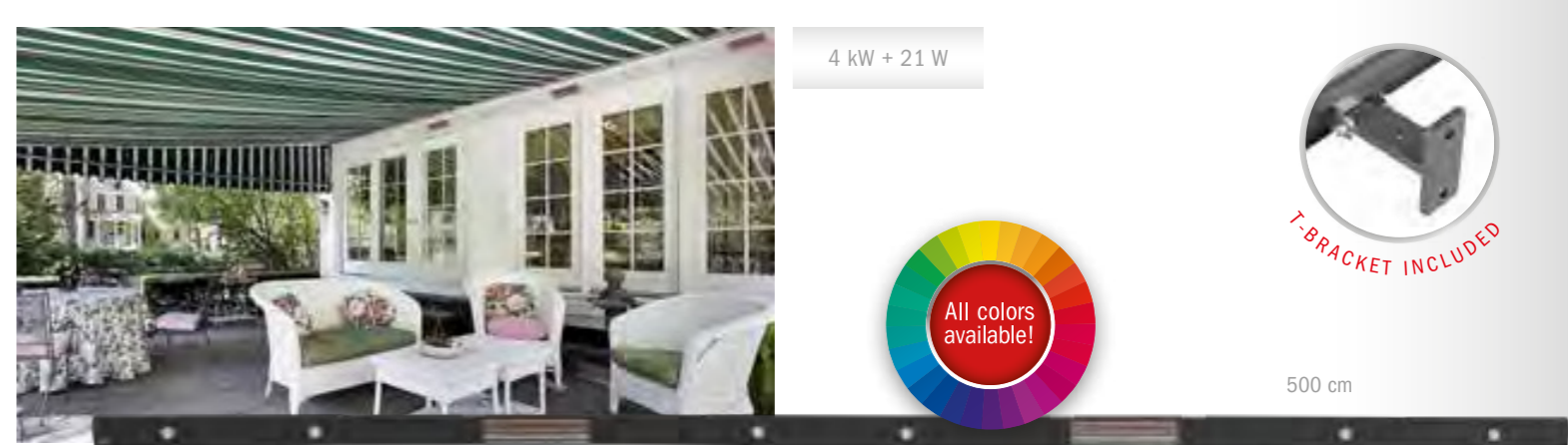

MSET 5.1 = M1 + M2 + M1 + M2 + M1
3 x LED + 2 x Heater

ULTRA LOW GLARE | LIGHT | Waterproof

CODE	EAN	POWER (in watt)	COLOR	PROTECTION CLASS	DIMENSIONS (w x h x d in cm)	WEIGHT (in g)	CABLE	CONNECTION
MSET5.1 9010	4260409692770	4000 + 21	White	IP65	500 x 9.5 x 12.5	11800	1 m 5-wire 1.5 mm ² Wieland plug	3/N/PE - 400 (3N) V 50 Hz
MSET5.1 9005	4260409692787	4000 + 21	Black	IP65	500 x 9.5 x 12.5	11800	1 m 5-wire 1.5 mm ² Wieland plug	3/N/PE - 400 (3N) V 50 Hz
MSET5.1 7016	4260409692800	4000 + 21	Anthracite	IP65	500 x 9.5 x 12.5	11800	1 m 5-wire 1.5 mm ² Wieland plug	3/N/PE - 400 (3N) V 50 Hz

INDIVIDUAL MODULES AND EQUIPMENT

M 1 LED MODUL

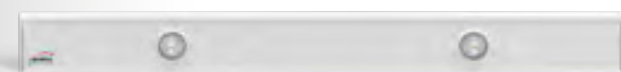

100 cm - 2 x 3.5 W LED

M 2 HEATER MODUL



100 cm - 1 x 2000 W Heater

M 3 HEATER & LED MODUL



100 cm - 2 x 3.5 W LED + 1 x 2000 W Heater

M 4 SOUND MODUL



100 cm - 2 x 15 W Bluetooth speaker



CODE	EAN	POWER (in watt)	COLOR	PROTECTION CLASS	DIMENSIONS (w x h x d in cm)	WEIGHT (in g)	CABLE	CONNECTION
M1 LED MODUL								
MRL2C9010	4260409691605	2 x 3.5	White	IP65	100 x 9.5 x 12.5	2000	1.9 m 3-wire 1.5 mm ² , Schuko plug	1/N/PE ~ 230 V 50 Hz
MRL2C9005	4260409693098	2 x 3.5	Black	IP65	100 x 9.5 x 12.5	2000	1.9 m 3-wire 1.5 mm ² , Schuko plug	1/N/PE ~ 230 V 50 Hz
MRL2C7016	4260409691629	2 x 3.5	Anthracite	IP65	100 x 9.5 x 12.5	2000	1.9 m 3-wire 1.5 mm ² , Schuko plug	1/N/PE ~ 230 V 50 Hz
M2 HEATER MODUL								
MURCAC200V9010	4260409691520	2000	White	IP67	100 x 9.5 x 12.5	2300	1.9 m 3-wire 1.5 mm ² , Schuko plug	1/N/PE ~ 230 V 50 Hz
MURCAC200V9005	4260409693104	2000	Black	IP67	100 x 9.5 x 12.5	2300	1.9 m 3-wire 1.5 mm ² , Schuko plug	1/N/PE ~ 230 V 50 Hz
MURCAC200V7016	4260409691513	2000	Anthracite	IP67	100 x 9.5 x 12.5	2300	1.9 m 3-wire 1.5 mm ² , Schuko plug	1/N/PE ~ 230 V 50 Hz
M3 HEATER & LED MODUL								
MURLHC21659010	4260409691551	2000 + 7	White	IP65	100 x 9.5 x 12.5	2400	1 m 5-wire 1.5 mm ² , Wire-end sleeves	1/N/PE ~ 230 V 50 Hz
MURLHC21659005	4260409691544	2000 + 7	Black	IP65	100 x 9.5 x 12.5	2400	1 m 5-wire 1.5 mm ² , Wire-end sleeves	1/N/PE ~ 230 V 50 Hz
MURLHC21657016	4260409691568	2000 + 7	Anthracite	IP65	100 x 9.5 x 12.5	2400	1 m 5-wire 1.5 mm ² , Wire-end sleeves	1/N/PE ~ 230 V 50 Hz
M4 SOUND MODUL								
MSOUND9010	4260409696518	2 x 15	White	IP65	100 x 9.5 x 12.5	4200	1.9 m 3-wire 1.5 mm ² , Schuko plug	1/N/PE ~ 230 V 50 Hz
MSOUND9005	4260409696525	2 x 15	Black	IP65	100 x 9.5 x 12.5	4200	1.9 m 3-wire 1.5 mm ² , Schuko plug	1/N/PE ~ 230 V 50 Hz
MSOUND7016	4260409696532	2 x 15	Anthracite	IP65	100 x 9.5 x 12.5	4200	1.9 m 3-wire 1.5 mm ² , Schuko plug	1/N/PE ~ 230 V 50 Hz

MODULAR PANEL

The MODULAR SYSTEM can be extended at will with the MODULAR PANEL, or space out your heating, cooling and lighting modules.

Standard Colors:



CODE	EAN	DESCRIPTION	COLOR	DIMENSIONS (w x h x d in cm)	WEIGHT (in g)
M50BL9010	4260409693203	BLENDE 50 cm	White	50 x 9.5 x 12.5	80
M50BL9005	4260409693210	BLENDE 50 cm	Black	50 x 9.5 x 12.5	80
M50BL7016	4260409693227	BLENDE 50 cm	Anthracite	50 x 9.5 x 12.5	80
M75BL9010	4260409693234	BLENDE 75 cm	White	75 x 9.5 x 12.5	120
M75BL9005	4260409693241	BLENDE 75 cm	Black	75 x 9.5 x 12.5	120
M75BL7016	4260409693258	BLENDE 75 cm	Anthracite	75 x 9.5 x 12.5	120
M100BL9010	4260409693265	BLENDE 100 cm	White	100 x 9.5 x 12.5	160
M100BL9005	4260409693272	BLENDE 100 cm	Black	100 x 9.5 x 12.5	160
M100BL7016	4260409693289	BLENDE 100 cm	Anthracite	100 x 9.5 x 12.5	160

MODULAR SIDEPART SET

With the modular sidepart sets you can easily connect every single Modules of Heat, Light, Nozzles, Panels or even TERM Color heaters within only seconds.

Standard Colors:



CODE	EAN	DESCRIPTION	COLOR	DIMENSIONS (w x h x d in cm)	WEIGHT (in g)
MSPS9010	4260409692213	SIDEPART-SET	White	9.5 x 8 x 1	140
MSPS9005	4260409692220	SIDEPART-SET	Black	9.5 x 8 x 1	140
MSPS7016	4260409692237	SIDEPART-SET	Anthracite	9.5 x 8 x 1	140

NOZZLES

Our special cooling nozzles can be integrated at any desired place in the system. The cooling takes places with the tried and tested PerfectClime® technology with high-pressure pump and water feed line.

Standard Colors:



CODE	EAN	DESCRIPTION	COLOR	DIMENSIONS (w x h x d in cm)	WEIGHT (in g)
MD19010	4260409692176	MD1 Nozzles	White	4.5 x 10 x 8	194
MD19005	4260409692534	MD1 Nozzles	Black	4.5 x 10 x 8	194
MD17016	4260409692619	MD1 Nozzles	Anthracite	4.5 x 10 x 8	194



The first Heating & Cooling Sensation!

PATENTED

PERFECTCLIME® OUTDOOR

The first heating & cooling concept combines infrared short-wave technology in one unit. Instant comfortable heat or refreshing cool air – resulting in a perfect temperature anytime and anywhere. Based on the successful TERM2000 IP67 and SMART IP24, instant heating is guaranteed and due to the integrated nozzle a fine haze leads to a comfortable atmosphere for nearly unlimited professional and private usage. PERFECTCLIME® only at Burda!

APPLICATIONS

In all private, gastronomic, commercial, public or industrial outdoor areas



Perfectclime® COOLING

Customized atomization and cooling system made of stainless steel in modular design or as ready BASIC COOLING SET for the perfect humidity and cool temperatures on hot days. See page 32.



1.65 kW
2 kW

70 cm

With two nozzles



Mounting bracket included
Aluminum-Color-Heater: T-Bracket
Aluminum-Heater: L-Bracket

PERFECTCLIME® TERM2000 IP67

PERFECTCLIME® | ULTRA LOW GLARE | Waterproof

CODE	EAN	POWER (in watt)	COLOR	PROTECTION CLASS	DIMENSIONS (w x h x d in cm)	WEIGHT (in g)	CABLE	CONNECTION
UPCRCA165V2	4260051484426	1650	Polished aluminum	IP67	70 x 9.5 x 12.5	2900	1.9 m 3-wire 1.5 mm², Schuko plug	1/N/PE ~ 230 V 50 Hz
UPCRCA200V2	4260051484488	2000	Polished aluminum	IP67	70 x 9.5 x 12.5	2900	1.9 m 3-wire 1.5 mm², Schuko plug	1/N/PE ~ 230 V 50 Hz
UPCRCAC165V29010	4260409691674	1650	White	IP67	70 x 9.5 x 12.5	2900	1.9 m 3-wire 1.5 mm², Schuko plug	1/N/PE ~ 230 V 50 Hz
UPCRCAC200V29010	4260409691681	2000	White	IP67	70 x 9.5 x 12.5	2900	1.9 m 3-wire 1.5 mm², Schuko plug	1/N/PE ~ 230 V 50 Hz
UPCRCAC165V29005	4260409691698	1650	Black	IP67	70 x 9.5 x 12.5	2900	1.9 m 3-wire 1.5 mm², Schuko plug	1/N/PE ~ 230 V 50 Hz
UPCRCAC200V29005	4260409691704	2000	Black	IP67	70 x 9.5 x 12.5	2900	1.9 m 3-wire 1.5 mm², Schuko plug	1/N/PE ~ 230 V 50 Hz
UPCRCAC165V27016	4260409691711	1650	Anthracite	IP67	70 x 9.5 x 12.5	2900	1.9 m 3-wire 1.5 mm², Schuko plug	1/N/PE ~ 230 V 50 Hz
UPCRCAC200V27016	4260409691728	2000	Anthracite	IP67	70 x 9.5 x 12.5	2900	1.9 m 3-wire 1.5 mm², Schuko plug	1/N/PE ~ 230 V 50 Hz

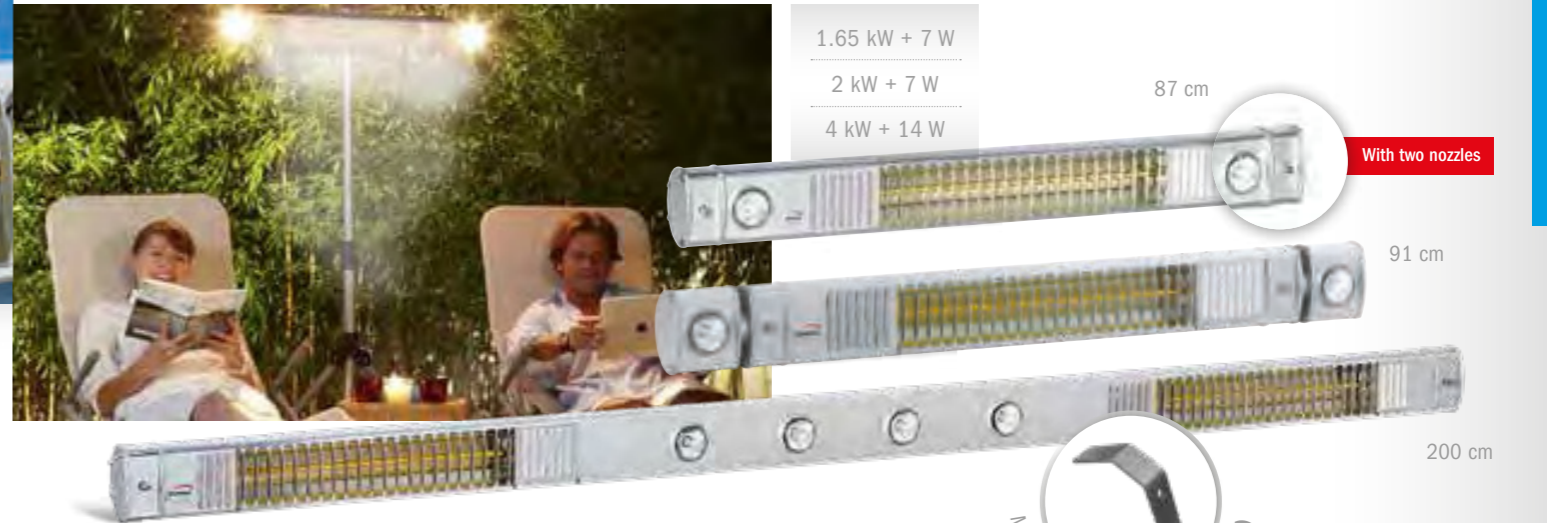

1.65 kW + 7 W
2 kW + 7 W
4 kW + 14 W

87 cm

With two nozzles

91 cm

200 cm



PERFECTCLIME® TERM2000 L&H IP65

PERFECTCLIME® | ULTRA LOW GLARE | LIGHT | Waterproof

CODE	EAN	POWER (in watt)	COLOR	PROTECTION CLASS	DIMENSIONS (w x h x d in cm)	WEIGHT (in g)	CABLE	CONNECTION
UPCRLH1765F2	4260051484563	1650 + 7	Polished aluminum	IP65	87 x 9.5 x 12.5	4050	2 m 5-wire 1.5 mm², Wire-end sleeves	2/N/PE ~ 230 V/50 Hz
UPCRLH2165F2	4260051484594	2000 + 7	Polished aluminum	IP65	87 x 9.5 x 12.5	4050	2 m 5-wire 1.5 mm², Wire-end sleeves	2/N/PE ~ 230 V/50 Hz
UPCRLH17652	4260051484556	1650 + 7	Polished aluminum	IP65	91 x 9.5 x 12.5	4050	2 m 5-wire 1.5 mm², Wire-end sleeves	2/N/PE ~ 230 V/50 Hz
UPCRLH21652	4260051484570	2000 + 7	Polished aluminum	IP65	91 x 9.5 x 12.5	4050	2 m 5-wire 1.5 mm², Wire-end sleeves	2/N/PE ~ 230 V/50 Hz
UPCRLH42652	4260051484624	2 x 2000 + 14	Polished aluminum	IP65	200 x 9.5 x 12.5	7700	2 m 5-wire 2.5 mm², Wire-end sleeves	3/N/PE ~ 400 V 50 Hz

PERFECTCLIME®

PERFECTCLIME®
TERM TOWER PALMS IP67

Available and combinable with:



CODE	EAN	POWER (in watt)	COLOR	PROTECTION CLASS	DIMENSIONS (w x h x d in cm)	WEIGHT (in kg)	CABLE	CONNECTION
UPCRTT400V	4260051484631	2 x 2000	Polished aluminum	IP67	110 x 250-270	ca. 49	10 m 5-wire 2.5 mm ² , Wire-end sleeves	3/N/PE ~ 400 (3N) V 50 Hz
UPCRTT600V	4260051484648	3 x 2000	Polished aluminum	IP67	110 x 250-270	ca. 51	10 m 5-wire 2.5 mm ² , Wire-end sleeves	3/N/PE ~ 400 (3N) V 50 Hz
UPCRTT800V	4260051484365	4 x 2000	Polished aluminum	IP67	110 x 250-270	ca. 53	10 m 5-wire 2.5 mm ² , Wire-end sleeves	3/N/PE ~ 400 (3N) V 50 Hz
UPCRTT400V9005	4260409691797	2 x 2000	Black	IP67	110 x 250-270	ca. 49	10 m 5-wire 2.5 mm ² , Wire-end sleeves	3/N/PE ~ 400 (3N) V 50 Hz
UPCRTT600V9005	4260409691803	3 x 2000	Black	IP67	110 x 250-270	ca. 51	10 m 5-wire 2.5 mm ² , Wire-end sleeves	3/N/PE ~ 400 (3N) V 50 Hz
UPCRTT800V9005	4260409691810	4 x 2000	Black	IP67	110 x 250-270	ca. 53	10 m 5-wire 2.5 mm ² , Wire-end sleeves	3/N/PE ~ 400 (3N) V 50 Hz
UPCRTT400V9010	4260409691827	2 x 2000	White	IP67	110 x 250-270	ca. 49	10 m 5-wire 2.5 mm ² , Wire-end sleeves	3/N/PE ~ 400 (3N) V 50 Hz
UPCRTT600V9010	4260409691834	3 x 2000	White	IP67	110 x 250-270	ca. 51	10 m 5-wire 2.5 mm ² , Wire-end sleeves	3/N/PE ~ 400 (3N) V 50 Hz
UPCRTT800V9010	4260409691841	4 x 2000	White	IP67	110 x 250-270	ca. 53	10 m 5-wire 2.5 mm ² , Wire-end sleeves	3/N/PE ~ 400 (3N) V 50 Hz

PERFECTCLIME® PUMP



CODE	EAN	DESCRIPTION	PROTECTION CLASS	PRESSURE	CONSUMPTION
PCE05	4260051482347	Pump 05	IP21	70 Bar	0.5 l/m
PCE1	4260051482354	Pump 1	IP21	70 Bar	0.9 l/m

PERFECTCLIME® COUPLINGS

PICTURE	CODE	EAN	DESCRIPTION
	PCKT	4260051483245	T-Coupling
	PCKL	4260051483252	L-Coupling
	PCKS	4260051483856	Straight Coupling
	PCKE	4260051483269	End Coupling
	PCKG	4260051483276	Angle Coupling
	PCIT.0330	4260409695948	Connection coupling, nickel-plated brass, 1/4" NPT M - ø6.35mm - 1/4"

PERFECTCLIME® POLYAMIDE PIPELINE

PICTURE	CODE	EAN	DESCRIPTION
	PCPS25	4260051483290	Polyamide hose 25 cm
	PCPG7	4260051483313	Polyamide hose 75 cm
	PCPC	4260051483320	Polyamide cutter
	PCPB	4260051483337	Polyamide hose mounting
	PCSS100	4260409695306	Stainless steel pipeline, 100 cm, ø6.35 mm
	PCSS75	4260409695313	Stainless steel pipeline, 75 cm, ø6.35 mm
	PCSS30	4260409695320	Stainless steel pipeline, 30 cm, ø6.35 mm

PERFECTCLIME® NOZZLES

CODE	EAN	DESCRIPTION	56 BAR VERSION	70 BAR VERSION	84 BAR VERSION
PCN15	4260051483207	Nozzle 0.15 mm	0.041 l/min 0.011 US Gpm	0.046 l/min 0.0095 US Gpm	0.051 l/min 0.012 US Gpm
PCN20	4260051483214	Nozzle 0.20 mm	0.080 l/min 0.021 US Gpm	0.089 l/min 0.024 US Gpm	0.098 l/min 0.026 US Gpm
PCN30	4260051483221	Nozzle 0.30 mm	0.130 l/min 0.034 US Gpm	0.145 l/min 0.038 US Gpm	0.159 l/min 0.042 US Gpm
PCN40	4260051483238	Nozzle 0.40 mm	0.159 l/min 0.047 US Gpm	0.178 l/min 0.047 US Gpm	0.195 l/min 0.052 US Gpm

PERFECTCLIME® FILTER



CODE	EAN	DESCRIPTION
PCFKUEU	4260051483344	Particle and scale filter set
PCFS	4260051483351	Particle filter
PCFSM	4260409695955	Particle filter Mini
PCFUV4	4260051482880	UV filter 480 l/h 6 bar
PCFUV5	4260051482897	UV filter 500l/h 7-10 bar

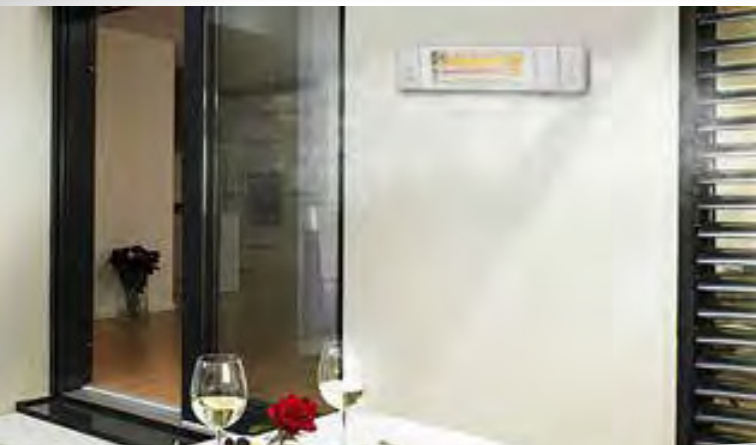

PERFECTCLIME® SMART IP24



CODE	EAN	POWER (in watt)	COLOR	PROTECTION CLASS	DIMENSIONS (w x h x d in cm)	WEIGHT (in g)	CABLE	CONNECTION
PCBHS15242	4260051486536	1500	White	IP24	63 x 14.5 x 9.5	2500	1.9 m 3-wire 1.5 mm ² , Schuko plug	1/N/PE ~ 230 V 50 Hz
PCBHS20242	4260051486543	2000	White	IP24	63 x 14.5 x 9.5	2500	1.9 m 3-wire 1.5 mm ² , Schuko plug	1/N/PE ~ 230 V 50 Hz
PCBHS30242	4260051485065	2 x 1500	White	IP24	111.5 x 14.5 x 9.5	4000	1.9 m 3-wire 1.5 mm ² , Schuko plug	1/N/PE ~ 230 V 50 Hz
PCBHS40242	4260051485089	2 x 2000	White	IP24	111.5 x 14.5 x 9.5	4000	0.65 m 5-wire 2.5 mm ² , Wire-end sleeves	2/N/PE ~ 230 V 50 Hz
PCBHS60242	4260051485102	3 x 2000	White	IP24	151.5 x 14.5 x 9.5	6000	0.65 m 5-wire 2.5 mm ² , Wire-end sleeves	3/N/PE ~ 400 (3N) V 50 Hz

NEW

PERFECTCLIME® COOLING KIT

Customized atomization and cooling system made of stainless steel in modular design for perfect humidity, cool temperatures in the desired cooling radius. **So simple and so effective!** The atomized water from the row of premium, stainless steel nozzles lowers the ambient temperature by up to 12°C and evaporates when it falls to the ground, without moistening objects or people in the process. The PERFECTCLIME® COOLING KIT contains premium accessories and is very easy and quick to install without the need for any special tools, making it a great option.



PICTURE	CODE	EAN	DESCRIPTION
	PCSS100	4260409695306	Stainless steel Pipeline, 100 cm, ø6.35 mm
	PCSS75	4260409695313	Stainless steel Pipeline, 75 cm, ø6.35 mm
	PCSS30	4260409695320	Stainless steel Pipeline, 30 cm, ø6.35 mm
	PCPS25	4260051483290	Polyamid Pipeline, 25 m, Black
	PCPS25-2	4260409695245	Polyamid Pipeline, 25 m, White
	PCN30	4260051483221	Nozzle 0.3 mm
	PCN20	4260051483214	Nozzle 0.2 mm
	PCN15	4260051483207	Nozzle 0.15 mm
	PCKDE	4260409695337	Nozzle Coupling, End
	PCKDM	4260409695344	Nozzle Coupling, Straight
	PCIT.0330	4260409695948	Connection coupling, nickel-plated brass, 1/4" NPT M - ø6.35 mm - 1/4"
	PCKS	4260051483856	Straight Coupling 6.35 mm
	PCKE	4260051483269	End Coupling 6.35 mm
	PCKT	4260051483245	T-Coupling 6.35 mm
	PCKL	4260051483252	L-Coupling 6.35 mm
	PCPB	4260051483337	Polyamid pipe mounting, ø6.35 mm
	PCPC	4260051483320	Polyamid cutter
ADD ON MISTING			
	PCE05	4260051482347	Pump 0.5
	PCE1	4260051482354	Pump 1 l
	PCFS	4260051483351	Particle filter
ADD ON MISTING OPTIONAL			
	PCFKUEU	4260051483344	Filter clause chalk
	PCFUV4	4260051482880	UV filter, 480 l/hr
	PCFUV5	4260051482897	UV filter, 500 l/hr

PERFECTCLIME® COOLING BASIC SET

PC COOLING set in three meters total length, straight, including four nozzles. Easy installation without special tools.

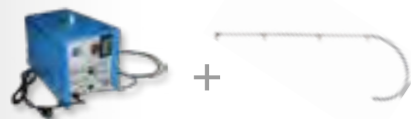

CODE	EAN	DESCRIPTION
PCBASIC300	4260409695733	PERFECTCLIME® COOLING BASIC SET

BASIC SET INCLUDES: ✓3 x PCSS100 Stainless steel pipe, ø6.35 mm ✓3 x PCKDM Nozzle Coupling, Straight ✓1 x PCKDE Nozzle Coupling, End ✓4 x PCN20 Nozzle ✓1 x PCKL L-Coupling 6.35 mm, Hose guide from pipeline to pump ✓1 x PCPS25 Polyamid pipe, black, ø6.35 mm ✓6 x PCPB Polyamid pipe mounting ø6.35 mm ✓1 x PCPC Polyamid cutter ✓1 x PCE05 Pump 0.5 l ✓1x PCFS Particle filter ✓1 x PCFSV ✓1 x PCIT.0330 Connection coupling, nickel-plated brass, 1/4" NPT M - ø6.35 mm - 1/4"

HEATER ADD ONS

Accessories and spare parts to control and install BURDA infrared heaters in order to upgrade, retrofit or expand existing systems.



CONTROL

Dimmers, timers and motion sensors do not only guarantee that our infrared heaters operate resource-efficiently but also contribute to decreased energy costs. Here you will find a large selection of control options for BURDA infrared heaters, from cable (fixed connection), to radio or Bluetooth. Enjoy the comfort of controlling your heater via a remote.

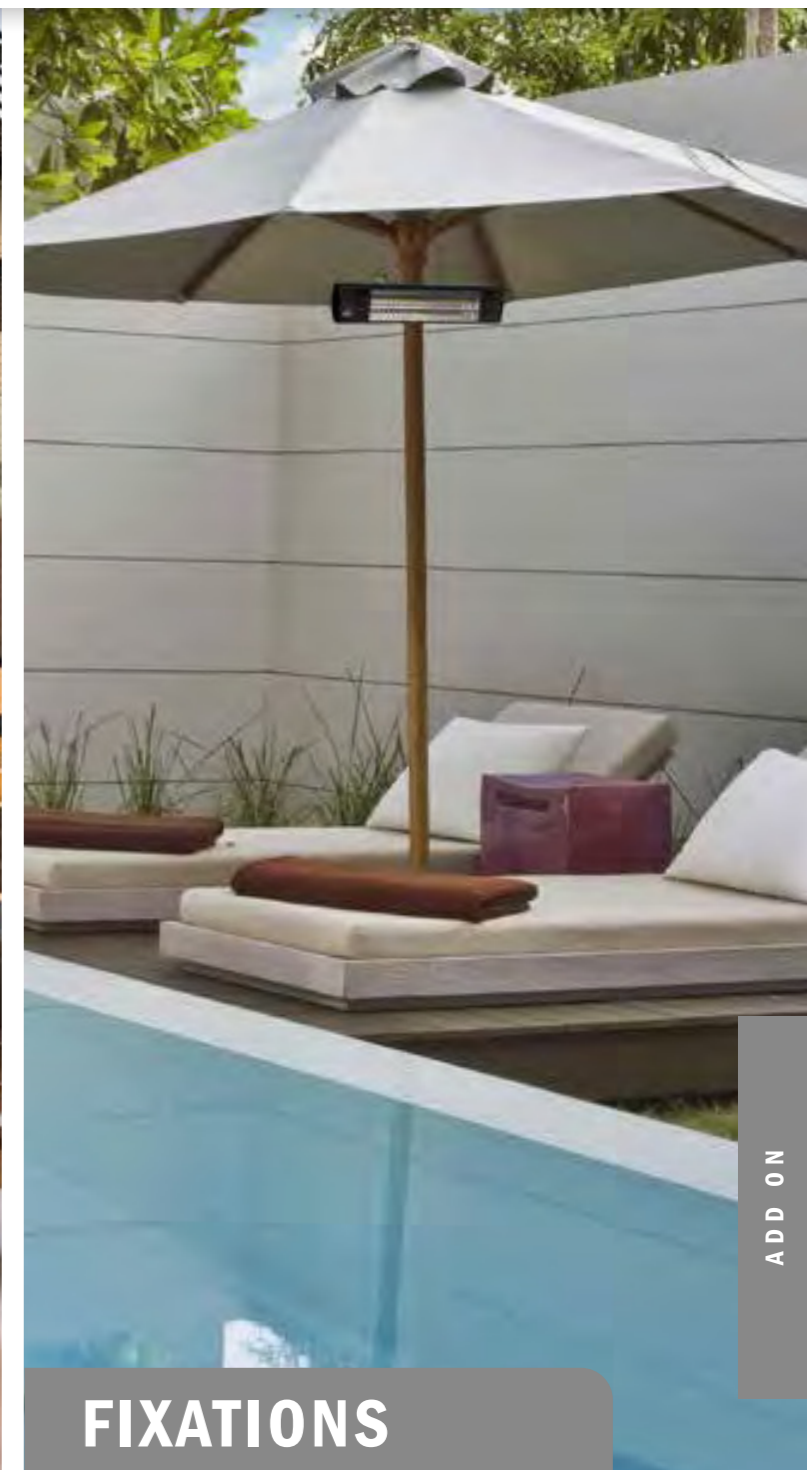

FIXATIONS

All BURDA infrared heaters are equipped with a wall attachment (T- or L- bracket) in their standard configuration. However, we offer numerous alternatives such as attachments for ceiling installation, below shutters, with Velcro for installation on rods or polls for example for sun screens, or free-standing on a tripod.

BLUETOOTH DIMMER IP65

Weather-proof BLUETOOTH DIMMER IP65 for App control of heaters with a total power of 3000 to 4000 Watt (depending on model).

Slow blow fuse 16 amp (C16) recommended



BTR



BTD3

3 kW
1 Channel



BTD4

4 kW
1 Channel



CODE	EAN	POWER (in watt)	COLOR	PROTECTION CLASS	DIMENSIONS (w x h x d in cm)	WEIGHT (in g)	CABLE	CONNECTION
BLUETOOTH DIMMER IP65								
BTD3	4260409691094	3000, 1 Zone	Aluminum	IP65	11.8 x 8.8 x 4.8	900	2 x 1.9 m 3-wire 1.5 mm ² , Schuko plug and socket	1/N/PE ~ 230 V 50 Hz
BTD4	4260409696495	4000, 1 Zone	Silver	IP65	16.5 x 11.8 x 6.7	550	Cablelos, fest verdrahtet, 1 x IN / 2 x OUT	L1/N/PE, 230-240 V ~ 50 Hz
BLUETOOTH REMOTE								
BTR	4260409692510	-	White	IP20	11.8 x 4 x 1.5	60	-	-

RADIO DIMMER + REMOTE



BRFE20

2 kW
1 Zone



SOLO Bi-Directional



MONO/VARIO Bi-Directional

CODE	EAN	DESCRIPTION	POWER (in watt)	PROTECTION CLASS	DIMENSIONS (w x h x d in cm)	WEIGHT (in g)	CABLE	CONNECTION
RADIO DIMMER								
BRFE20	4260051489261	Radio dimmer 50/66/100%	2000	IP54	14.5 x 4.8 x 2.9	360	Power feed 490 mm (STAS 3), Line to the heater 235 mm (STAK 3)	1/N/PE ~ 230 V 50 Hz
BRHS	4260051489094	Hirschmann Set STAS 3 + STAK 3 + Stasi	-	IP54	14.5 x 2.8 x 2.3	8	-	250 V/16 A

CODE	EAN	DESCRIPTION	COLOR	PROTECTION CLASS	DIMENSIONS (w x h x d in cm)	WEIGHT (in g)
REMOTE RADIO DIMMER						
BRD-S1	4260051489209	BiDirectional Solo 1 channel	Black	IP20	7.4 x 4.4 x 1.5	120
BRD-S2	4260051489216	BiDirectional Solo 1 channel	White	IP20	7.4 x 4.4 x 1.5	120
BRD-S3	4260051489223	BiDirectional Solo 1 channel	Silver	IP20	7.4 x 4.4 x 1.5	120
BRD-BM3	4260051483801	BiDirectional Mono 1 channel	Silver	IP20	5.1 x 12 x 2.6	120
BRD-BM2	4260051483818	BiDirectional Mono 1 channel	White	IP20	5.1 x 12 x 2.6	120
BRD-BM5	4260051484204	BiDirectional Mono 1 channel	Anthracite	IP20	5.1 x 12 x 2.6	120
BRD-BV2	4260051483825	BiDirectional Vario 5 channel	White	IP20	5.1 x 12 x 2.6	120
BRD-BV3	4260051483832	BiDirectional Vario 5 channel	Silver	IP20	5.1 x 12 x 2.6	120
BRD-BV5	4260051484211	BiDirectional Vario 5 channel	Anthracite	IP20	5.1 x 12 x 2.6	120

DIMMER FIXED CONNECTION (CABLE)



Waterproof
4 kW
6 kW
1 Channel

BHC 4001/BHC 6001



Waterproof
4 kW
6 kW
2 Channels
3 Channels

BHC 4002/BHC 6003
9 Channels bus system

CODE	EAN	DESCRIPTION	POWER (in watt)	PROTECTION CLASS	DIMENSIONS (w x h x d in cm)	WEIGHT (in g)	CONNECTION
BH CONTROLLER 1 ZONE IP65 FIXED CONNECTION							
BHC4001	4260051480169	Dimmer, 10-stage	4000, 1 Channel	IP65	28 x 17 x 8.7	2150	1/N/PE ~ 230 V 50 Hz
BHC6001	4260051481562	Dimmer, 10-stage	6000, 1 Channel	IP65	28 x 17 x 8.7	2150	1/N/PE ~ 230 V 50 Hz
BHCR1	4260051480176	Remote 1	Dimmer, 10-stage	IP20	4.5 x 26 x 2	80	-
BH CONTROLLER 9 ZONE IP65 FIXED CONNECTION							
BHC4002-ER	4260051482835	Dimmer, 10-stage	4000, 2 Channels	IP65	28 x 17 x 8.7	2150	1/N/PE ~ 230 V 50 Hz
BHC6003-ER	4260051482842	Dimmer, 10-stage	6000, 3 Channels	IP65	28 x 17 x 8.7	2150	3/N/PE ~ 400 V 50 Hz
BHC4002D	4260051483443	Dimmer, 10-stage	4000, 2 Channels	IP65	28 x 17 x 8.7	2150	1/N/PE ~ 230 V 50 Hz
BHC6003D	4260051483450	Dimmer, 10-stage	6000, 3 Channels	IP65	28 x 17 x 8.7	2150	3/N/PE ~ 400 V 50 Hz
BHCK	4260051483559	Keypad	-	IP65	12 x 9 x 4	220	-
BHCR9	4260051483306	Remote 9	-	IP20	4.5 x 26 x 2	80	-

TIMER



2 kW
1 Channel

Timer TS2



4 kW
1 Channel

Timer TS4



6 kW
1 Channel

Timer TS6

CODE	EAN	DESCRIPTION	POWER (in watt)	PROTECTION CLASS	DIMENSIONS (w x h x d in cm)	WEIGHT (in g)	CABLE	CONNECTION
TS2-C	4260051480107	Timer 5-60 Seconds	2000	IP20	9.5 x 13 x 5.5	475	1.5 m 3-wire 1.5 mm ² PVC; with Schuko plug 0.5 m 3-wire 1.5 mm ² PVC; with socket	1/N/PE ~ 230 V 50 Hz
TS4	4260051480077	Timer 1-40 Minutes	4000	IP65	10 x 12.5 x 7	475	Fixed connection	1/N/PE ~ 230 V 50 Hz
TS6	4260409691254	Timer 1-30 Minutes	6000	IP65	13 x 13 x 7	475	Fixed connection	1/N/PE ~ 230 V 50 Hz

MOTION DETECTORS/TEMPERATURE SENSORS



BPIR4

4 kW



BPIR6

6 kW

CODE	EAN	POWER (in watt)	COLOR	PROTECTION CLASS	DIMENSIONS (w x h x d in cm)	WEIGHT (in g)	CABLE	CONNECTION
BPIR4	4260051485959	4000	White	IP65	10 x 11.2 x 5.5	280	Fixed connection	1/N/PE ~ 230 V 50 Hz
BPIR6	4260051485966	6000	White	IP65	13 x 13 x 7.5	600	Fixed connection	1/N/PE ~ 230 V 50 Hz
BPIR4T	4260409696730	4000	White	IP65	10 x 11.2 x 5.5	280	Fixed connection	1/N/PE ~ 230-240 V 50 Hz

FIXATIONS



CODE	EAN	COLOR	DIMENSIONS (Length in cm)	WEIGHT (in g)
T-BRACKET (standard for all TERM2000 colour heaters)				
BCTF9010	4260409692961	White	8	50
BCTF9005	4260409692978	Black	8	50
BCTF7016	4260409692985	Anthracite	8	50
L-BRACKET (standard for all aluminium heaters)				
BCLF	4260409693494	Silver	13	50
CEILING ATTACHMENT				
BCDF20	4260409691452	Silver	20	50
BCDF209010	4260409691469	White	20	50
BCDF209005	4260409691476	Black	20	50
BCDF207016	4260409691483	Anthracite	20	50
AWNING BRACKETS				
MB40409010	4260409692176	White	4 x 4 (w x d)	50
MB40409005	4260409692534	Black	4 x 4 (w x d)	50
MB40407016	4260409692619	Anthracite	4 x 4 (w x d)	50
MB40402009010	4260409693432	White	4 x 4 x 20 (w x h x d)	55
MB40402009005	4260409693425	Black	4 x 4 x 20 (w x h x d)	55
MB40402007016	4260409693418	Anthracite	4 x 4 x 20 (w x h x d)	55
VELCRO ATTACHMENT				
KLS1KS	4260051489186	Silver	-	-

TRIPODS



Tripod BHSS for TERM2000 and SMART

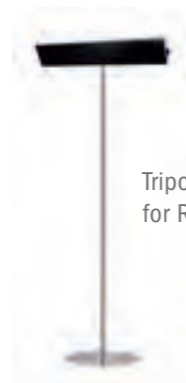

Tripod BRELGS, stainless steel, for RELAX GLASS heaters

CODE	EAN	DESCRIPTION	COLOR	DIMENSIONS (Length in cm)	WEIGHT (in g)
BHSS-2	4260051487144	Tripod	White	210	2600
BHSS-3	4260051487151	Tripod	Silver	210	2600
BHSS-1	4260051481357	Tripod	Black	210	2600
BRELGS-3	4260409696556	Stativ	Stainless steel, Silver	Base: Ø 500 mm, Pole: Ø 38 mm, Overall height: 210 cm	18000

Spare tubes for TERM2000-, RELAX- and SMART-infrared heaters

CODE	EAN	DESCRIPTION	POWER (in watt)	PROTECTION CLASS	DIMENSIONS (Length in cm)	WEIGHT (in g)	CABLE	CONNECTION
LAMPS TERM2000 IP20/IP24/IP44								
LG1000	4260051486017	Cable 357.5 mm	1000	IP20	35.75	50	295 mm double-sided, Wire-end sleeves	230 V 50 Hz
LG1000V	4260051486048	Cable 357.5 mm	1000	IP20	35.75	50	295 mm double-sided, Wire-end sleeves	230 V 50 Hz
LG1500	4260051486024	Cable 357.5 mm	1500	IP20	35.75	50	295 mm double-sided, Wire-end sleeves	230 V 50 Hz
LG1500V	4260051486000	Cable 357.5 mm	1500	IP20	35.75	50	295 mm double-sided, Wire-end sleeves	230 V 50 Hz
LG2000	4260051486031	Cable 357.5 mm	2000	IP20	35.75	50	295 mm double-sided, Wire-end sleeves	230 V 50 Hz
LG2000V	4260051486055	Cable 357.5 mm	2000	IP20	35.75	50	295 mm double-sided, Wire-end sleeves	230 V 50 Hz
LG1024	4260051486123	Cable 355 mm	1000	IP24	35.5	50	235 mm and 590 mm, Wire-end sleeves	230 V 50 Hz
LG1524	4260051486130	Cable 355 mm	1500	IP24	35.5	50	295 mm double-sided, Wire-end sleeves	230 V 50 Hz
LG2024	4260051486147	Cable 355 mm	2000	IP24	35.5	50	235 mm and 590 mm, Wire-end sleeves	230 V 50 Hz
ULGS1024V	4260051485454	Cable 355 mm	1000	IP24	35.5	50	235 mm and 590 mm, Wire-end sleeves	230 V 50 Hz
ULGS1524V	4260051484129	Cable 355 mm	1500	IP24	35.5	50	235 mm and 590 mm, Wire-end sleeves	230 V 50 Hz
ULGS2024V	4260051484136	Cable 355 mm	2000	IP24	35.5	50	235 mm and 590 mm, Wire-end sleeves	230 V 50 Hz
LAMPS TERM2000 IP65/IP67								
LG1001	4260051486185	Cable 380 mm	1000	IP65/67	38	50	300 mm and 920 mm, Wire-end sleeves	230 V 50 Hz
LGS1700V	4260051485973	Cable 380 mm	1700	IP65/67	38	50	300 mm and 920 mm, Wire-end sleeves	230 V 50 Hz
LG1650	4260051486093	Cable 529 mm	1650	IP65/67	52.9	50	300 mm and 920 mm, Wire-end sleeves	230 V 50 Hz
LG2001V	4260051486109	Cable 529 mm	2000	IP65/67	52.9	50	300 mm and 920 mm, Wire-end sleeves	230 V 50 Hz
ULG1001V	4260051485508	Cable 380 mm	1000	IP65/67	38	50	300 mm and 920 mm, Wire-end sleeves	230 V 50 Hz
ULG1500V	4260051485430	Cable 529 mm	1500	IP65/67	52.9	50	300 mm and 920 mm, Wire-end sleeves	230 V 50 Hz
ULG1650V	4260051484105	Cable 529 mm	1650	IP65/67	52.9	50	300 mm and 920 mm, Wire-end sleeves	230 V 50 Hz
ULG2001V	4260051484112	Cable 529 mm	2000	IP65/67	52.9	50	300 mm and 920 mm, Wire-end sleeves	230 V 50 Hz
LAMPS NO GLARE IP20								
NLG650	4260409691018	White	0.65	IP20	Ø6.3	0.8	110 mm, Wire-end sleeves	230 V 50 Hz
NLG650-1	4260409691391	Black	0.65	IP20	Ø6.3	0.8	110 mm, Wire-end sleeves	230 V 50 Hz
LAMPS BH SMART SK15 IP20/IP24								
LGHS1500V	4260051484877	Cable 350 mm	1500	IP20	-	50	300 mm double-sided, Wire-end sleeves	230 V 50 Hz
LGHS2000	4260051488103	Cable 350 mm	2000	IP20	-	50	300 mm double-sided, Wire-end sleeves	230 V 50 Hz
LGHS1524V	4260051480770	Cable 350 mm	1500	IP24	-	50	590 mm and 240 mm, Wire-end sleeves	230 V 50 Hz
LGHS2024	4260051489605	Cable 350 mm	2000	IP24	-	50	590 mm and 240 mm, Wire-end sleeves	230 V 50 Hz
LAMPS RELAX GLASS IRA/IRB IP65								
BRELGR1200	4260409695559	RELAX GLASS Tube	1200	IP65	42.5	50 g/pc	A: 21 cm x 1.5 mm B: 78 cm x 1.5 mm	230-240 V ~ 50 Hz
BRELGR1200C	4260409696747	RELAX GLASS Tube	1200	IP65	66.5	70 g/pc	A: 21 cm x 1.5 mm B: 78 cm x 1.5 mm	230-240 V ~ 50 Hz
BRELGR1500	4260409695542	RELAX GLASS Tube	1500	IP65	66.5	70 g/pc	18 cm x 1.5 mm double-sided	230-240 V ~ 50 Hz
BRELGR1800	4260409695535	RELAX GLASS Tube	1800	IP65	66.5	70 g/pc	18 cm x 1.5 mm double-sided	230-240 V ~ 50 Hz
BRELGR2200	4260409695528	RELAX GLASS Tube	2200	IP65	66.5	70 g/pc	18 cm x 1.5 mm double-sided	230-240 V ~ 50 Hz



Panel heaters from Burda – **COSY WARMTH** like from a tiled stove

HEATPANELS

INDOOR

BURDA heatpanels function like the sun: They emit infrared beams which create warmth and work as heat accumulators when they hit people and objects. The energy-consuming „detour“ of convection heating of air in conventional rooms is no longer required. This makes Burda heatpanels economical and your heating experience refreshingly relaxing. Enjoy Burda heatpanels like the sun's rays on a clear winter's day!

APPLICATIONS

Bathroom, waiting rooms, medical practice, hotels, office and home

EU Ecodesign 2015/1188

The installation and use of the heatpanels from 1.1.2018 is only permitted in connection with external thermostats which fulfill the following functions:

- Electronic room temperature control and weekday control
- Adaptive heating control

These requirements are met i. e. with our thermostats: BHC1868, BHCINSTAT+3R, BHCFIT3R
Failure to comply with these requirements will result in the loss of the CE mark



BASIC HEAT IP54

FRAMELESS WALL HEATER

The wall heater BASIC HEAT is our cost-effective universal solution. The 500 watt heating plate in white is certified with protection class IP54 (splash water proof) and thus also suitable for use in damp areas. A toggle switch on the device allows convenient on/off switching. Please note: the heating panel is not suitable for ceiling mounting!

- ✓ ON-/OFF switch
- ✓ Painted smooth white
- ✓ Frameless
- ✓ 1.5 cm deep
- ✓ Heat dissipation at almost 100 % on the front
- ✓ Comes with wall-mounting kit
- ✓ Includes 1.9 m cable and plug
- ✓ Protection Class IP54, waterproof
- ✓ 5-year guarantee

CODE	EAN	SURFACE	DIMENSIONS (w x h x d in cm)	POWER (in watt)	PROTECTION CLASS	WEIGHT (in kg)	CONNECTION
BHPBH50100500	4260409694712	White smooth	50 x 100 x 1.5	500	IP54	10	1/N/PE ~ 230 V 50 Hz

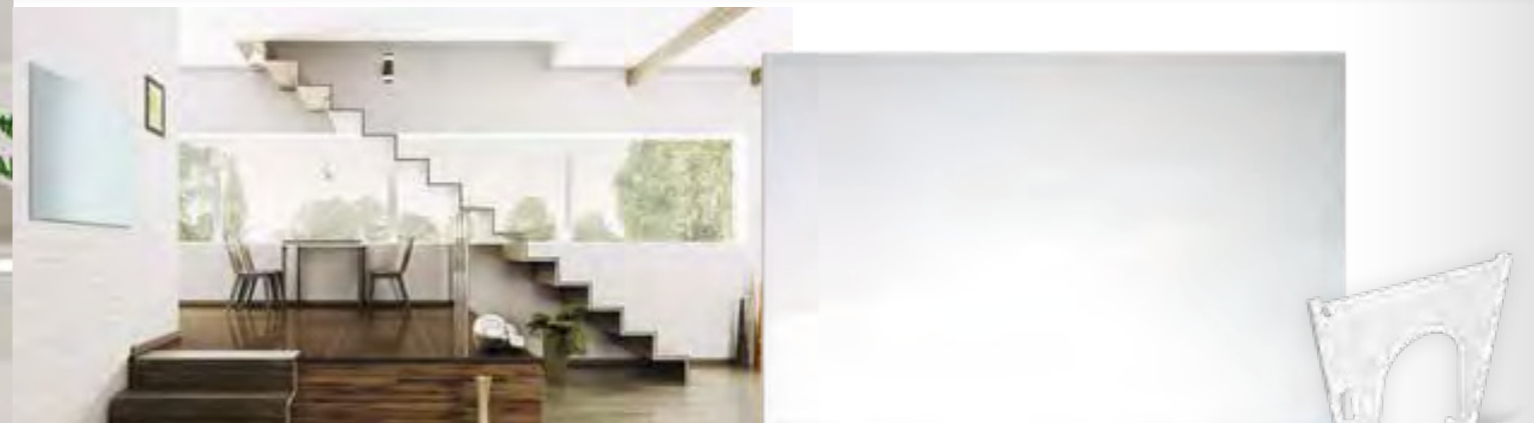

CLASSIC HEAT IP20

FRAMELESS WALL AND CEILING HEATER

Our standard model with optimal heating performance. Robust aluminum/steel housing 1.6 cm thick. The CLASSIC HEAT guarantees particularly high heat dissipation through its specially coated surface. The heat panel is scratch resistant and non-yellowing. Suitable for wall and ceiling mounting.

Base (BHPFC) for all CLASSIC HEAT models optional, except BHPCLH4060300.

- ✓ White RAL9016, smooth
- ✓ Frameless
- ✓ 1.6 cm deep
- ✓ Heat dissipation at almost 100 % on the front
- ✓ Safety shut-down in case of overheating
- ✓ Comes with wall- or ceiling mounting kit
- ✓ Includes 1.9 m cable and plug
- ✓ Protection Class IP20
- ✓ 5-year guarantee

BHPFC

CODE	EAN	SURFACE	DIMENSIONS (w x h x d in cm)	POWER (in watt)	PROTECTION CLASS	WEIGHT (in kg)	CONNECTION
BHPCLH4060300	4260409694514	White smooth	40 x 60 x 1.4	300	IP20	4	1/N/PE ~ 230 V 50 Hz
BHPCLH6262400	4260409694347	White smooth	62 x 62 x 1.6	400	IP20	4	1/N/PE ~ 230 V 50 Hz
BHPCLH6060400	4260409694354	White smooth	60 x 60 x 1.6	400	IP20	4	1/N/PE ~ 230 V 50 Hz
BHPCLH6090600	4260409694361	White smooth	60 x 90 x 1.6	600	IP20	8	1/N/PE ~ 230 V 50 Hz
BHPCLH60120900	4260409694378	White smooth	60 x 120 x 1.6	900	IP20	9	1/N/PE ~ 230 V 50 Hz
BHPCLSF	4260409695979	White smooth	28.15 x 28.8	-	-	0.565	-

RADIO



BHCI868*
Radio controlled thermostat INSTAT-868 - **230 V/16 A**

INSTAT-868, the radio-controlled thermostat by Eberle, serves as a temperature and time dependent switch of electrical devices such as fan heaters, circulation pumps, radiators, etc. in conjunction with an INSTAT switching unit. Operation is very simple. Among others, daily and weekly programmes can be set. Battery powered.

CODE	EAN
BHCI868	4260409690646



BHCI868a1A
Receiver/switching unit INSTAT868-a1A - **230V/16 A**

Single channel radio controlled receiver as an additional receiver for INSTAT radio controlled thermostats. This device is the ideal surface-mounted solution and switches up to 16 A.

CODE	EAN
BHCI868a1A	4260409690660



BHCI868UP
Receiver/switching unit INSTAT-868-UP - **230 V**

Additional receiver for INSTAT radio-controlled thermostats. This device is the ideal flush-mounted solution.

CODE	EAN
BHCI868UP	4260409690677



BHCI868r1F
RF window contact INSTAT 868-r1F

Detects open windows in connection with flush-mounted receiver and switches the heater off for max. 30 minutes. Protection class: IP54, Dimensions: 65 x 12 x 28 mm, Power supply: Battery 3 V (CR 2030)

CODE	EAN
BHCI868r1F	4260409694750

* External control of indoor longwave heaters to comply with EU Regulation 2015/1188.

WIRED



BHCRTTR-E 3311
Schuko socket thermostat - **230 V**

Room temperature regulator, surface-mounted, pure white unit. IP30, adjustable from 5 °C - 30 °C, 1.8 m cable and adapter, thermal feedback.

CODE	EAN
BHCRTTR-E 3311	4260409690684



BHCITCTI
Socket thermostat with thermo-timer - **230 V/16 A**

Temperature and time dependent switching of electrical devices such as fan heaters, circulation pumps, radiators, etc. You can set daily and weekly schedules. Battery powered. 2-year guarantee.

CODE	EAN
BHCITCTI	4260409691001



BHCINSTAT+3R*
Radio-controlled thermostat - **230 V**

INSTAT-868, the radio-controlled thermostat by Eberle, serves as a temperature and time dependent switch of electrical devices such as fan heaters, circulation pumps, radiators, etc. in conjunction with an INSTAT switching unit. Operation is very simple. Among others, daily and weekly programmes can be set. Battery powered.

CODE	EAN
BHCINSTAT+3R	4260409690998



BHCFIT3R*
Digital socket thermostat - **230 V/16 A**

Pure white colour, flush-mounted. Temperature settings between 5°C - 30°C in increments of 0.5°C. Large display with backlighting at the touch of a button, user-friendly operation, pre-set and adjustable lifestyle programmes, wide range of custom programme settings, automatic switchover to summer/winter settings, protection against unauthorised access, holiday settings by date, frost control, energy consumption indicator.

CODE	EAN
BHCFIT3R	4260409690981

More Sales Through Sales Promotion

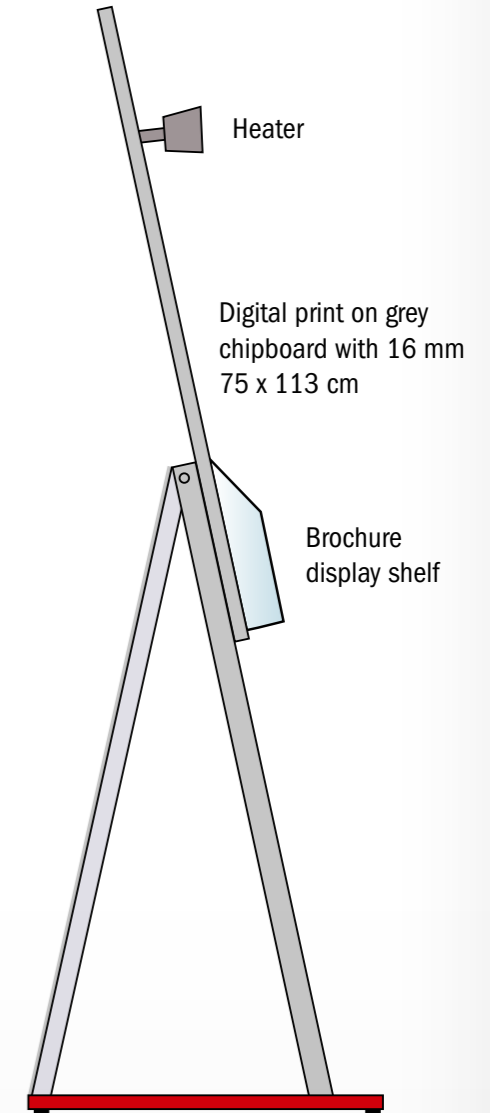

We will gladly advise you on start-up and language variants +49 6173/324 24 0

YOU WILL BE INSPIRED BY THE INNOVATIVE INFRARED HEATER FROM BURDA.

Convince your clients with intelligent comfortable heat at the push of a button. With this new professional display, guide the attention of your clients to our innovative heaters. The huge and instant heat output is most effective during this live demonstration.

A push-button timer and a display shelf for complimentary brochures is included.

Good to know

WHAT IS INFRARED?

Infrared radiation is a segment of the light spectrum created by the sun. This type of light is no longer visible to the human eye, but only acts as heat radiation. The following applies in general: the shorter the wavelength, the lighter the penetration of the air and the more intensive the heat effect in the body.

HOW DOES INFRARED RADIATION WORK?

Due to the various wavelengths and the resulting modes of action a distinction is made between three types of infrared radiation:

Infrared-A: short-wave IR-A

780 - 1.400 nm (0,8 - 1,4 μ) 3620 K - 2070 K

Short-wave infrared produces heat through heating up the body, which is hit by the radiation, without warming up the surrounding air in the process. In summary: instant heat without heat loss:

Series: TERM2000 IRA, SMART, RELAX GLASS IRA

Infrared-B: medium-wave IR-B

1.400 - 3.000 nm (1,4 - 3 μ) 2070 K - 965 K

Medium-wave infrared produces a heat radiation, which is also emitted to the surrounding air, to a small extent, and thus does not only increase the perceived temperature but also the room temperature. There is a short lead time.

Series: RELAX GLASS CARBON IRB

Infrared-C: long-wave

3.000 - 10.000 nm (3 - 10 μ) 965 K - 290 K

Long-wave infrared is the most similar to convection heat in principle. The radiation does not penetrate the body as deeply and leads to an increase in the surrounding temperature. Lead time maximum 20 minutes.

Series: TERM2000 NO GLARE, RELAX DARK, HEATPANELS

PROTECTION CATEGORY: IP

The protection category IP first of all offers information on the particle/dust protection and second of all on the water density of the heater. The water density is especially pivotal to the use of the heater in outdoor areas.

IP20 is not water resistant.

Not suitable for outdoor areas.

Series: TERM2000 NO GLARE, TERM2000 CVH

IP24 with splash water protection.

Suitable for protected outdoor areas.

Series: SMART

IP44 with splash water protection.

Suitable for protected outdoor areas.

Series: TERM2000 COLOR

IP55 Waterproof.

Suitable for all outdoor areas.

Series: RELAX DARK

IP65 Waterproof.

Suitable for all outdoor areas.

Series: TERM2000 L&H, RELAX GLASS

IP67 completely Waterproof - only by BURDA!

Also suited for unprotected outdoor areas.

Series: TERM2000 IP67

INFRARED HEATER RANGE IN OUTDOOR AREAS

The same rule of thumb applies for IRA and IRB heaters: under optimal dry conditions without wind on a terrace or other outdoor areas, the heater covers an area of 6-8 square metres per kilowatt.

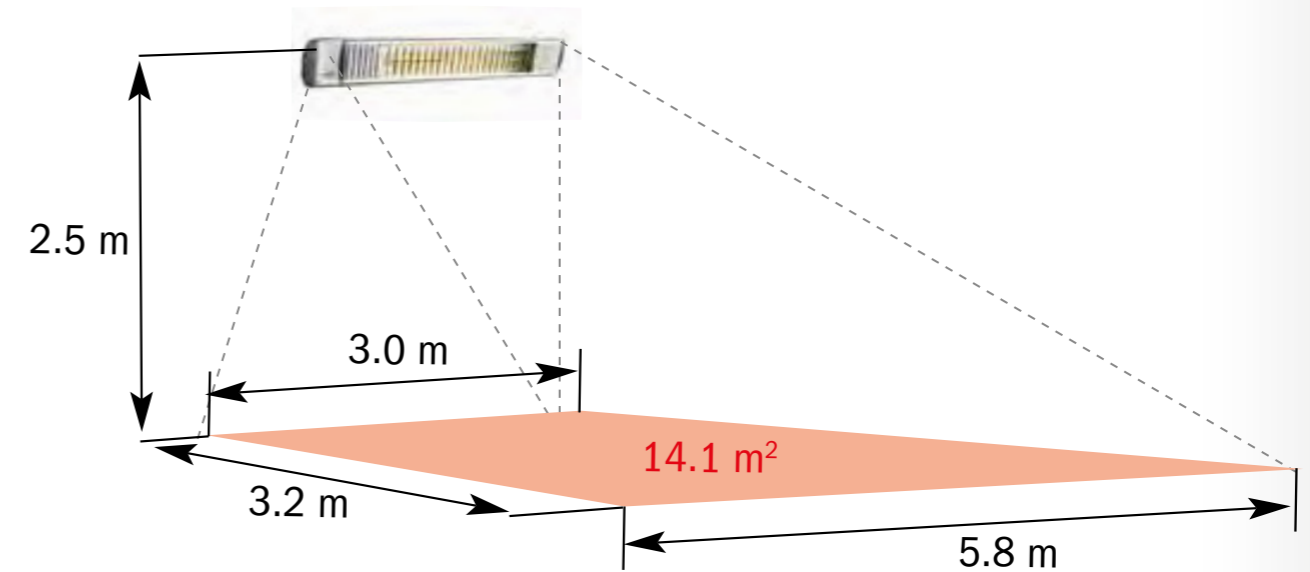

Long-wave infrared HEATPANELS have a heating radius of approximately 10 square metres per 500 Watt in indoor spaces.

INFRARED LIGHT INTENSITY

Burda PerfectClima was the first producer of heaters with reduced infrared light using specially coated heating tubes, which, depending on the series, significantly minimise or even reduce the infrared light intensity up to 80 percent:

- EXTREME LOW GLARE** - up to 95% light reduction in the surrounding space. Series: RELAX GLASS
- ULTRA LOW GLARE** - up to 80% less red light. Series: TERM2000
- LOW GLARE** - strongly reduced red light. Series: SMART
- NO GLARE** - completely dimmed dark heater. Series: TERM2000 No Glare, RELAX DARK

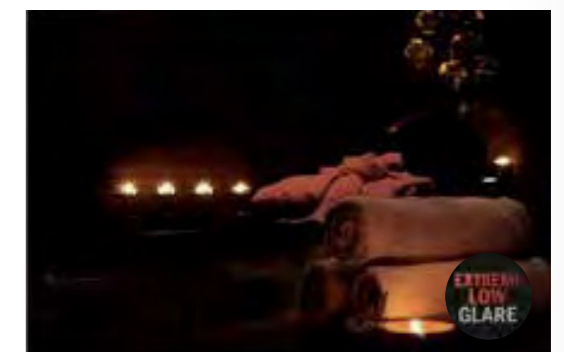

Your dealer

INTELLIGENT DECISIONS!

Our clients value the outstanding quality and the broad range of application of our products. Whether in the hotel or catering industry or in private areas the BURDA infrared short-wave technology heater and cooler product range convinces the world leading brands and industries. Choose the intelligent solutions to your needs.

SELECTION OF REFERENCES

International Cooperation

- AEG/Stiebel Eltron
- Bartscher
- Schwank

Worldwide first class hotels

- Adlon
- Holiday Inn
- Hilton
- Marriott
- Sheraton
- Steigenberger
- The Century
- Vier Jahreszeiten ...

International and national restaurants and cafes

- Blockhouse
- Burger King
- Cafetiero
- Häagen-Dazs
- Hard Rock Cafe
- Le Crobag
- McDonald's
- Nordsee
- Starbucks ...

Superior grandhotel at sea

- AIDA Cruises
- A-Rosa Cruises
- Celebrity Cruises

TV-Studio

- Big Brother
- Endemol

Museum and events

- Louvre Paris – France
- Berlinale Berlin – Germany

Trade and industry

- Areva
- Ford
- Mercedes
- Thyssen Krupp
- Volkswagen ...

Air Traffic

- Condor
- Lufthansa
- Royal Air Force
- US Army ...

BURDA WORLDWIDE TECHNOLOGIES GMBH

Rudolf-Diesel-Strasse 18 · 65760 Eschborn · Germany
tel +49 6173 /324 24 0 · fax +49 6173 /324 24 24
email info@burdawtg.de · www.burdawtg.com