



333 Bayview Avenue Amityville, New York 11701
 For Sales and Repairs, (800) 645-9445
 For Technical Service, (800) 645-9440 or visit us at
<http://tech.napcosecurity.com/>

(Note: Technical Service is for security professionals only)
 Publicly traded on NASDAQ Symbol: NSSC

© NAPCO 2018

StarLink™ Connect Series SLE-CDMA-C / SLE-CDMA-Z Multi-Function Alarm Communicators INSTALLATION INSTRUCTIONS



WI2246LF 8/18

OVERVIEW

The StarLink™ Connect models **SLE-CDMA-C** and **SLE-CDMA-Z** are multi-function Commercial / Residential Burglary and Residential Fire alarm radio communicators and supervised system interface modules. They provide several options to the user:

1. A monitoring path to a central station through a digital CDMA radio and optionally through a TCP/IP network to the Internet using a hardwired or optional Wi-Fi connection;
2. Notification alerts of alarm system changes to a mobile device. Notifications use *iBridge Messenger* SMS text messaging and/or emails to inform the user and/or dealer of system state changes. For this release, these notifications are enabled in the *iBridge Connected Home Services* website at <http://ibridge.napconoc2.com/>;
3. Allows homeowners to remotely view and control their alarm system and Z-Wave devices through a mobile device app;
4. Both radio models are compatible with most 12VDC alarm control panels, including Honeywell and DSC (always adhere to the documentation provided by the control panel manufacturer). Residing in the Windows *System Tray*, the *StarLink Connect* application allows you to use your customary control panel communication software for remote programming and communication:
 - **DSC DLS**
 - **Honeywell Compass®**

NAPCO control panels are programmed in the traditional way using PCD-Windows Quickloader software. *StarLink Connect* is available on the enclosed CD.
5. Optionally allows homeowners to control Z-WAVE devices in several ways:
 - a. Through the use of a mobile device app;
 - b. Through Z-Wave Schedules;
 - c. Through Z-Wave Scenes;

If required, mount the unit to a single-, dual-, or three-gang electrical box and route the wires through the back knock-out(s), or as specified by local codes. **See WI2140 for programming instructions** (all manuals are available for download at <http://tech.napcosecurity.com/>).

StarLink SLE Series radios use proprietary data-capture technology that captures the alarm report from the control panel and transmits the alarm signals to the SLE Control Center (the Napco "NOC"); the alarm signals are then forwarded to ANY central station via Contact ID or Sur-Gard System II or Sur-Gard System V central station receivers via TCP/IP using standard line security. The SLE Control Cen-

ter reports a trouble signal in the event that the network does not receive the expected supervision signal from the wireless communicator. In addition, both StarLink radio models can be powered directly from the control panel. The StarLink radio model names are as follows:

SLE-CDMA-C - Residential Burglary and Fire Network Compatible CDMA alarm capture radio communicator. White plastic enclosure.

SLE-CDMA-Z - Residential Burglary and Fire Network Compatible CDMA alarm capture radio communicator. Includes the **SLE-ZWAVE-MOD** Z-Wave module. White plastic enclosure.



ADDITIONAL COMPONENTS

In addition to the models listed above, the following sub-assemblies are available:

SLE-WIFI-MODULE - Allows your StarLink™ device to connect to the Internet by means of a wireless (Wi-Fi) link, eliminating a wired Ethernet cable connection.

SLE-ZWAVE-MOD - Included with the **SLE-CDMA-Z** radio, the Z-Wave module (PC board) allows your StarLink™ device to connect to your Z-Wave devices.

SLE-DLCBL - Download Cable, 6 feet.

SLE-ANTEXT30 - Extended antenna with 30 feet of cable.

SLE-ANTEXT50 - Extended antenna with 50 feet of cable.

SLE-ANTEXT75 - Extended antenna with 75 feet of cable.

(Any suitable external cellular antenna is permitted by UL). Always follow the manufacturer's installation instructions. **Note:** Antennas are not Listed by UL. For 3/4G radios where an External Antenna needs to be installed outside of the room in which the radio is installed (maximum 30 meters (98 feet) in Residential applications), please use RF Transmitter Board 9GPS5320EXAPSLD available from our Customer Service Department, if not provided. The 9GPS5320EXAPSLD is identified by "two red dots" located on the lower right corner of the board. See WI2222 included with the 9GPS5320EXAPSLD for the simple installation procedure.

SPECIFICATIONS

The following specifications apply to all StarLink radio models in these installation instructions unless otherwise stated:

Electrical Ratings for +12V (both models powered by the control panel)

- Input Voltage: 10-15VDC (power-limited output from con-

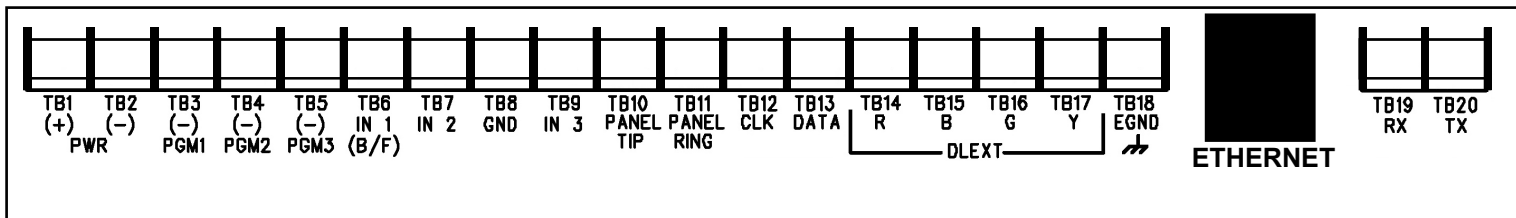

trol panel). Do NOT connect to full-wave rectified (FWR) power.

- Input Current:
 - SLE-CDMA-C** standby current: 100mA (110mA with telco EOLR)
 - SLE-CDMA-Z** standby current: 120mA (130mA with telco EOLR)
 - Transmission current (both models): 200mA max.

Electrical Ratings for the IN 1 Burg/Fire Input:

- Input Voltage: 9-15VDC.
- Maximum Input Current: Up to 2mA from control panel supply circuit

Electrical Ratings for IN 2 and IN 3:

- Maximum Loop Voltage: 15VDC max.
- Maximum Loop Current: 1.2mA
- End of Line Resistor (EOLR) Value: 10K

Electrical Ratings for 3 PGM Outputs:

- Open Collector Outputs: Maximum Voltage 3V when active; 15V maximum when not active
- Maximum PGM Sink Current: 50mA (up to 15VDC)

Physical (W x H x D)

- Plastic Housing: 8 x 5⁻²⁹/₆₄ x 1½" (20.3 x 13.9 x 3.8cm)
- Mounting: Plastic housing includes three keyhole slots for triple gang boxes (see scale template on page 15);

Environmental

- Operating Temperature: 0°C - 49°C (32°F - 120°F)
- Humidity: Maximum 93% Non-Condensing
- Indoor / dry location use only

TERMINAL DESCRIPTIONS

Configure all inputs and outputs using the Management Center (the Napco "NOC" located at <http://NapcoNoc2.com>). Located at the bottom of the StarLink radio PC board, the 20 terminals are described as follows:

- TB1: PWR (+)** +10 - 15VDC. Do NOT connect to FWR power.
- TB2: PWR (-)**
- TB3: PGM1 (-):** Open collector output. PGM1 is normally on (active low). When it is triggered (for example, a trouble is detected) it becomes open collector/high. To have a zone dedicated to an StarLink radio trouble, insert one side of the end of line resistor into this PGM1 terminal, and wire the other side of the resistor to the positive terminal of the zone.
- TB4: PGM2 (-):** Open collector output. This output is normally open collector / high. When a report fails to communicate anywhere in the communications path, the output is active low.
- TB5: PGM3 (-):** Open collector output. This output is normally open collector / high. Use the Napco "NOC" to configure options for PGM activation.

- TB6: IN 1:** Active high input for wiring to the control panel bell output. When this input detects a pulsing temporal 3 high, it sends a Fire alarm; a pulsing temporal 4 (CO Alarm), a CO alarm is sent. For this input to report to a central station, the StarLink radio must be configured with the central station telephone number and correct reporting formats and codes.
- TB7: IN 2:** See **TB9**, below.
- TB8: GND:** Common ground terminal.
- TB9: IN 3:** Both terminals **IN 2** and **IN 3** default to 'User Defined'; no end-of-line resistor supervision required. Wire the common ground terminal **GND** (terminal **TB8**) to the relay common. When used as arm/disarm status input, a low indicates "armed" and a high indicates "disarmed". For these inputs to report to a central station, the radio must be configured with the central station telephone number and correct reporting formats and codes.
- TB10: PANEL TIP:** See wiring diagram(s).
- TB11: PANEL RING:** See wiring diagram(s).
- TB12: CLK:** See wiring diagram(s).
- TB13: DATA:** See wiring diagram(s).
- TB14: R:** Red wire. See TB17.
- TB15: B:** Blue wire. See TB17.
- TB16: G:** Green wire. See TB17.
- TB17: Y:** Yellow wire. Do NOT connect if using the **SLE -DLCBL Download Cable**.
- TB18: EGND:** Earth ground (optional)
- TB19: RX:** See wiring diagram(s).
- TB20: TX:** See wiring diagram(s).

LED DESCRIPTIONS

The PC board contains several LEDs, as follows:

GREEN RF SIGNAL STRENGTH LED

Labeled "D3", this LED is located at the lower right corner of the PC board (see image). Every 30 seconds, the StarLink radio receiver section turns on and listens to the cell tower. Depending on the signal strength detected, it will blink the Signal Strength LED from 1 to 8 times, providing a signal strength indicator that is updated constantly and is always displayed. Refer to the Coverage Table:

GREEN RF SIGNAL STRENGTH LED RADIO RECEIVER COVERAGE TABLE								
LED Blinks	8	7	6	5	4	3	2	1
Power (dBm)	-55	-65	-75	-85	-91	-95	-99	-105
	Stronger ······ Weaker							

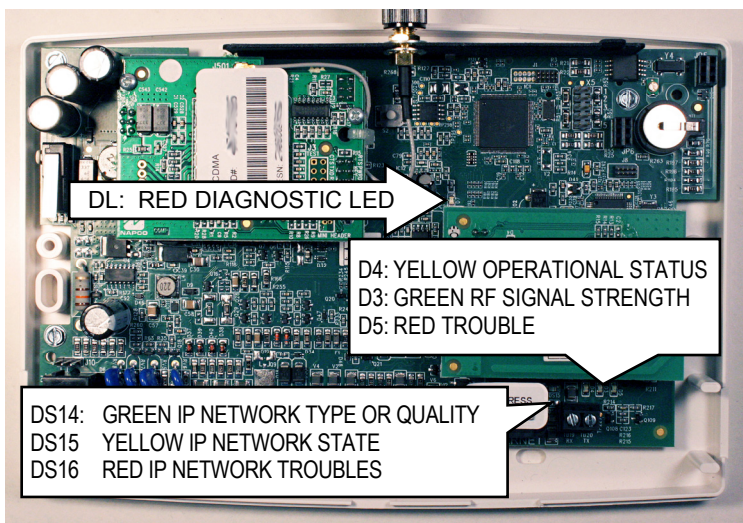

LED LOCATIONS

Green LED Operation

Signal strength (as received by the radio) is displayed by this LED blinking 1 to 8 times at a constant rate (with a short delay between blink cycles). Acceptable power level is greater than or equal to -91dBm (minimum 4 blinks at the mounting location).

YELLOW OPERATIONAL STATUS LED (Radio)

Labeled "D4", this yellow LED is located at the bottom right of the PC board. Operation is as follows:

Normal Standby Condition:

- **Blinks on momentarily every 10 seconds:** Unit is in standby waiting for an alarm to report.

Processing Alarm Conditions:

- When processing an alarm, this yellow LED will blink variably during each part of the process (dialing, handshaking, data transmission, etc.).
- This yellow LED will light when communicating with the phone app and when notifications are transmitted.

RED TROUBLE LED

Labeled "D5", this LED is located at the bottom right of the PC board. Operation is as follows:

- **1 Blink:** Low Aux Power input voltage
- **2 Blinks:** Battery trouble
- **3 Blinks:** Alarm report Failed to Communicate (will restore only when both paths are operational)
- **4 Blinks:** RF trouble (antenna connection or cellular registration)
- **5 Blinks:** Radio poll or check-in failure (radio only). The unit must only fail on one path to trigger the trouble, but for the trouble to clear, unit requires both IP and radio polling / checkins to be operational.
- **6 Blinks:** Unit disabled (reporting or control panel downloading not allowed)
- **7 Blinks:** Unit was shutdown and has no functionality; requires a restart (full power down and full power up sequence) to restore operation.

RED DIAGNOSTIC LED

Labeled "D7", this LED is located in the middle of the PC board. One blink indicates a weak or non-existent signal

from the network (green LED is off). If this red LED is blinking in any other manner, please contact technical support.

NETWORK CONNECTION LEDs

Labeled "DS14" (green), "DS15" (yellow) and "DS16" (red), these LEDs are located at the bottom right of the PC board.

The green LED labeled "DS14" describes the IP network connection type or the connection quality, as follows:

- When **DS14** is off = No network cable detected
- When **DS14** is flashing rapidly = No IP connection (occurs just after power on while trying to obtain an IP address; therefore has priority over any other green flashing LEDs)
- When **DS14** is flashing slowly = Normal operation:
 - **1 Slow Blink:** Static IP Address (as programmed by the NOC)
 - **2 Slow Blinks:** DHCP (default)
 - **3 Slow Blinks:** Auto IP (if unable to acquire DHCP address, after 5 minutes radio will convert to Auto IP).

The Yellow LED labeled "DS15" describes the status of the IP network.

- When **DS15** is off = No power
- When **DS15** is flashing rapidly = Push button on Wi-Fi module is being pressed
- When **DS15** is flashing steady with 1 quick blink off every 2 seconds = Reporting signal to NOC
- When **DS15** is flashing steady with 2 quick blinks off every 2 seconds = Downloading to control panel or the module
- When **DS15** is flashing slowly:
 - **1 Slow Blink:** Ethernet available (must detect that the CAT5 cable is connected and must be connected to the Internet via customer router, etc.)
 - **2 Slow Blinks:** Wi-Fi Station Mode
 - **3 Slow Blinks:** Wi-Fi APN Mode (Access Point)

The red LED labeled "DS16" describes the IP network troubles.

- When **DS16** is off = No network troubles detected
- When **DS16** is flashing rapidly = No IP connection (occurs just after power up while the radio tries to obtain a DHCP IP address)
- When **DS16** is flashing slowly:
 - **1 Slow Blink:** No network cable detected
 - **2 Slow Blinks:** No network cable access to the Internet (mutually exclusive with "1 Blink"). If the radio is configured for only an Ethernet connection (no Wi-Fi) and the Ethernet cable is connected but the router is non-functional, the radio will detect the loss of access to the Internet within a programmable amount of seconds. The default of 500 seconds (8-1/3 minutes) is intended to display a trouble to the installer sooner in case the account is set for 1-hour, 24-hour or 7-day Supervisory Failure
 - **3 Slow Blinks:** Ethernet failed to communicate
 - **4 Slow Blinks:** Ethernet poll / check-in failure
 - **5 Slow Blinks:** Wi-Fi enabled but the **SLE-WIFI-MODULE** is not detected

- **6 Slow Blinks:** = No Wi-Fi access to the Internet. May occur when the Wi-Fi and the network cable each access the Internet via separate means (for example two different routers). **Note:** This indication may be combined with the "**2 Blinks**" indication if both the Wi-Fi and network cable use the same ISP.
- **7 Slow Blinks:** Wi-Fi failed to communicate
- **8 Slow Blinks:** Wi-Fi poll / checkin fail
- **9 Slow Blinks:** Wi-Fi serial data error or no serial data response
- **10 Slow Blinks:** Wi-Fi Security / Authentication failed

OTHER LEDs

Labeled "**D607**" (green) and "**D606**" (red), these LEDs indicate the status when connected to a DSC or Honeywell control panel (when connected to a NAPCO control panel, both LEDs remain off). The LED labeled "**D44**" is not used.

When connected to a Honeywell control panel, **D607** (green) flashes once every 5 seconds, and:

- When **D606** (red) is off = No troubles
- When **D606** (red) is flashing rapidly = Bootloader mode
- When **D606** (red) is flashing 1 = Keypad bus fault
- When **D606** (red) is flashing 3 = Configuration memory error

When connected to a DSC control panel, **D607** (green) flashes twice every 5 seconds and:

- When **D606** (red) is off = No troubles
- When **D606** (red) is flashing rapidly = Bootloader mode
- When **D606** (red) is flashing 1 = Keypad bus fault (radio terminals 12 and 13)
- When **D606** (red) is flashing 2 = DSC download connection faulted (radio terminals 19 and 20)

SUPPLYING POWER TO THE RADIO

Control panels can provide power through their Auxiliary Power terminals if the available standby current is reduced by the SLE standby power. If the control panel Auxiliary Power is insufficient to power the communicator, a suitably rated power limited Residential Fire or Commercial / Residential Burglary power supply may be used (such as the model GEMC-12V2APS).

RADIO INSTALLATION STEPS

STEP 1: ACCOUNT REGISTRATION

Create a new account and register specific StarLink radio modules at www.NapcoComNet.com. Accounts and modules registered via the Internet are enabled for activation within 24 hours.

STEP 2: SELECT A MOUNTING LOCATION

The mounting location should be indoors within the protected area and selected based on RF performance. It is HIGHLY recommended that the installer carefully adhere to the following recommendations BEFORE any wires are installed.

- Generally, high locations are best. DO NOT mount radio in basements or below grade as unpredictable performance may result.
- DO NOT mount the radio in non-climate controlled environments (i.e. attics may become extremely hot in summer, garages may become extremely cold in winter).
- Avoid mounting locations within 3 feet of AC power lines, fluorescent light fixtures, or large metal objects (air conditioners, metal garage doors, etc.) as these locations have been shown to have a detrimental effect on signal strength.
- A fair amount of care may be required to mount the radio so as to achieve an optimal RF path. The installer should spend as much time as needed to obtain the highest signal level possible.

- Before applying power, be sure to connect the antenna.** Temporarily connect power to the radio from a fully charged 12V (4AH minimum) battery. DO NOT mount the StarLink radio at this time. Press **Tamper** switch to send a signal.
- Position the unit in the desired mounting location, with antenna oriented vertically. The signal strength is displayed by the Green "Signal Strength LED" labeled "D3" (located at the lower right corner of the PC board). The CDMA radio tower signal strength may fluctuate from day to day, therefore it is best to try to find a mounting location where the LED provides a **minimum of 4 blinks**.
- Once a location has been selected based on signal coverage, permanently secure the unit using #8 screws (not supplied) in the two mounting holes.

WARNING: To ensure user safety and to satisfy FCC RF exposure requirements, this unit must be installed so that a minimum separation distance of 60cm (24") is always maintained between the antenna of the transmitting device and nearby persons.

STEP 3: WIRING

22-gauge wire may be used if mounted up to 50 feet from the control panel, and 18-gauge wire should be used for up to 100 feet. Reference the wiring diagrams further in this manual. All wiring methods must be performed in accordance with NFPA70, Articles 725, and 800

STEP 4: APPLY POWER

- **Attach antenna before applying power !**
- Apply 12 VDC to terminals 1 and 2.

STEP 5: SIGNAL VERIFICATION

After triggering channels, use the StarLink radio Signal Verification to ensure that the StarLink radio Network has properly received the signals.

- **Verify Online:** To verify that the signals have been received by the StarLink radio Network online, go to <http://NapcoNoc2.com>, log in with your Username and Password, enter your **Company ID** number and the StarLink **Radio Number**, then click **Signal Log**.

IMPORTANT: Verify that the signals transmitted by the StarLink radio have been properly received by your central station before leaving the premises.

NOTE: This equipment has been tested and found to comply with the limits for a Class B Unintentional Radiator, pursuant to Part 15 of the FCC Rules. These limits are designed to provide reasonable protection against harmful interference in a residential installation. This equipment generates, uses, and can radiate radio frequency energy and, if not installed and used in accordance with the Instruction Manual, may cause harmful interference to radio communications. However, there is no guarantee that interference will not occur in a particular installation. If this equipment does cause harmful interference to radio or television reception, which can be determined by turning the equipment off and on, the user is encouraged to try to correct the interference by one of more of the following measures: 1. Reorient or relocate the receiving antenna; 2. Increase the separation between the equipment and receiver; 3. Connect the equipment into an outlet on a circuit different from that to which the receiver is connected; 4. Consult the dealer or an experienced radio/TV technician for help.

NAPCO CONTROL PANEL PROGRAMMING

To program the central station receiver reporting format, use PCD-Windows Quickloader download software. Open the **Digital Communications** screen, **Central Station Receivers** tab, as shown in the following image:

A "Point ID" (also called "Contact ID") receiver format programming example:

The screenshot shows a software interface with several tabs: 'Central Station Receivers', 'Subscriber ID Numbers', 'General Report Codes', 'Digital/Dialing Options', 'Pager Options', and 'NL-Mod Setup'. The 'Central Station Receivers' tab is active. It contains a 'Telephone No. 1' field, a 'Contact ID' dropdown menu, and a checkbox labeled 'Report to TCP/IP Receiver or AES'.

The radio can transmit to any central station capable of receiving Contact ID or the DSC Sur-Gard System II or Sur-Gard System V central station receivers via TCP/IP.

Note: A receiver reporting format must be entered for each telephone number used, but each telephone number may be assigned a different format.

CAUTION: The installer should always be certain an area code is programmed into the control panel.

Optional: If you wish the StarLink radio to report a code and zone number (Contact ID by default) to the central station in response to a triggered input event, see the table on page 5. **Note:** These event codes and zone numbers can be changed from the Management Center screen (located at <http://NapcoNoc2.com>).

Programming StarLink Radio Troubles

It is required that if a StarLink radio or control panel trouble is detected, that it is reported to the central station.

Telco Line to Alarm Panel Supervision

A 10K ohm resistor (5% tolerance) can be placed across the "house side" of the telephone line circuit (see wiring diagrams). Use this resistor instead of using a relay on the alarm control panel to trip an input on the radio to supervise the connection between the alarm control panel telco circuit and the radio.

REMEMBER: Enable the feature "Tip / Ring Wiring Fault Report" in the NOC (www.NapcoComNet.com) to supervise the telephone line connection to the control panel.

When the StarLink radio detects and sends a trouble to the control panel, the control panel must be programmed to announce this trouble. The radio can detect multiple troubles as indicated by the "Red Trouble LED" ("D5"). For these troubles to be announced at the control panel, there are several methods, some of them are configurable at the Management Center screen (<http://NapcoNoc2.com>):

Wire the radio PGM1 output to a dedicated control panel zone (input) to announce the trouble (activate a trouble sounder) when an open is detected. With Napco control panels, program a dedicated zone for Day Zone, Mini-sounder on Alarm and No bell on Alarm. Wire the zone as indicated in the wiring diagrams further in this manual.

For radio models powered by the control panel Aux Power terminals, wire the radio directly to the PGM1 output of the control panel (program the radio to report all troubles on PGM1).

You can also wire to the positive terminal of the dedicated zone on a GEMC-EZM8. Thus when a radio trouble is detected, the radio PGM activates the control panel zone, and the control panel generates a trouble.

StarLink Panel / Radio Supervision of Tip/Ring Wiring

The StarLink radio connection to the control panel shall be supervised with local trouble annunciation and report to the central station if the Tip/Ring wiring is cut or shorted.

For local annunciation of radio troubles, the control panel must be programmed for Telco line supervision that will produce a local trouble at the premises (refer to control panel programming).

To report the radio trouble to the central station:

1. Program the SLE-CDMA-C/Z (select "Y") for the "Tip/Ring Wiring Fault Report" feature located in the **Advanced Features** screen of the Napco "NOC" (at <http://NapcoNoc2.com>).
2. Install the supplied 10K EOLR across the control panel terminals normally intended to be wired to the home telephone if Telco service was used (shown in the wiring diagram examples).

Note: Some control panels may require a different duration than the default time of 3 minutes. See also the alternate supervision method described below, "Telco Line to Alarm Panel Supervision (For Primary Mode Only)".

Supervision Time Schedule Considerations

If a status change (alarm trouble, etc.) is transmitted, the radio supervision timer is restarted.

For example, if a status change is sent, the next regular supervision transmission will occur at the interval determined by your rate plan.

JUMPER DESCRIPTIONS

Jumper block labeled "X5"; from top to bottom, as detailed in the following table. **Note:** Contact ID is always available in response to a Contact ID handshake.

Jumper Block "X5" Options		
Jumper block labeled "X5" contains 5 jumper terminals; from top (labeled "1") to bottom (labeled "5") as follows:		
Jumper ON	Jumper Number	Jumper OFF
Not used; do NOT install jumper	1	Not used; do NOT install jumper
4/2 with Checksum Pulse Format	2	Contact ID or 4/2 format without sum check
Not used; do NOT install jumper	3	Not used; do NOT install jumper
10K EOLR Required	4	IN3 no EOLR (normally high, active low trigger)
10K EOLR Required	5	IN2 no EOLR (normally high, active low trigger)

The SLE series radios are compatible with 4/2 Pulse Dialing formats with 10pps, 20pps, and 40pps with and without checksum, either 1400Hz or 2300Hz handshake / kissoff. See page 14 for table of formats.

Refer to WI2140 for selecting the required handshake / kissoff frequency in the NOC (<http://NapcoNoc2.com>) setup screens (as required by the control panel).

COVER TAMPER SWITCH

The SLE series radios in the plastic housings are provided with a front tamper switch. **Note:** The tamper switch on the radio PC board is always functional and requires no programming.

STARLINK RADIO RELATED EVENT REPORT CODES (Contact ID by default)

EVENT	AREA	CONTACT ID		PULSE 4/2
		CODE	ZONE #	
IN 1 Fire	0	E110	990	1A
IN 2 Panic	0	E120	992	22
IN 3 Trouble	0	E300	993	F3
Low Battery/Voltage	0	E302	994	F4
Tamper Trouble	0	E341	995	F5
Reboot	0	E625	997	F7
IN 1 CO (Carbon Monoxide)	0	E162	998	18
Panic Alarm*		E123		
Holdup Alarm*		E122		
Medical Alarm*		E100		
24 hour Aux. Alarm*		E150		
24 hour Aux. Restore*		R150		
Burg Perimeter Alarm*		E131		
Burg Interior Alarm*		E132		
Keypad Holdup Alarm (ambush)*		E121		
Keypad Panic Alarm*		E123		
Keypad Emergency Alarm*		E140		
Opening*		E401		
Closing*		R401		
A.C. Trouble*		E301		
Tel 1 Fail*		E351		
Fire Polling Report		E780	999	F9
Supv Failure Report		E788	000	D1 or D2
Tip/Ring Wiring Fault Report		E789	000	F2
Path Test Report		E602	890	77

*Not generated by the StarLink radio.

SIGNALS ORIGINATED AT THE NOC

NOC Originated Alarms	Contact ID Event Data Sent	Pulse Format Event Code Sent	Initiated By	Comments
Supervisory Fail	E356 A00 Zn000	99	Automatically by NOC if fail to receive any signal from StarLink radio within Supervisory Timeout duration.	For Auto Enroll, uses captured telephone number, Sub ID and format. For Dealer Programmed, uses entered telephone number, Sub ID and format.
Press to Send Test Signal	E601 A00 Zn000	98	Manually by dealer from the Management Center Signal Log screen (located at http://NapcoNoc2.com). Sends test into CS receiver.	Same comment as above.
Press to Send Radio Test	Not Applicable Nothing sent to CS receiver	Not Applicable	Manually by dealer from the Management Center Checkins screen (located at http://NapcoNoc2.com). Sends a command to the StarLink radio to force a check-in to the NOC.	----

Wiring Diagram for PRIMARY Reporting Configuration GEM-P816 / GEM-P1632 / GEM-P1664 Control Panels

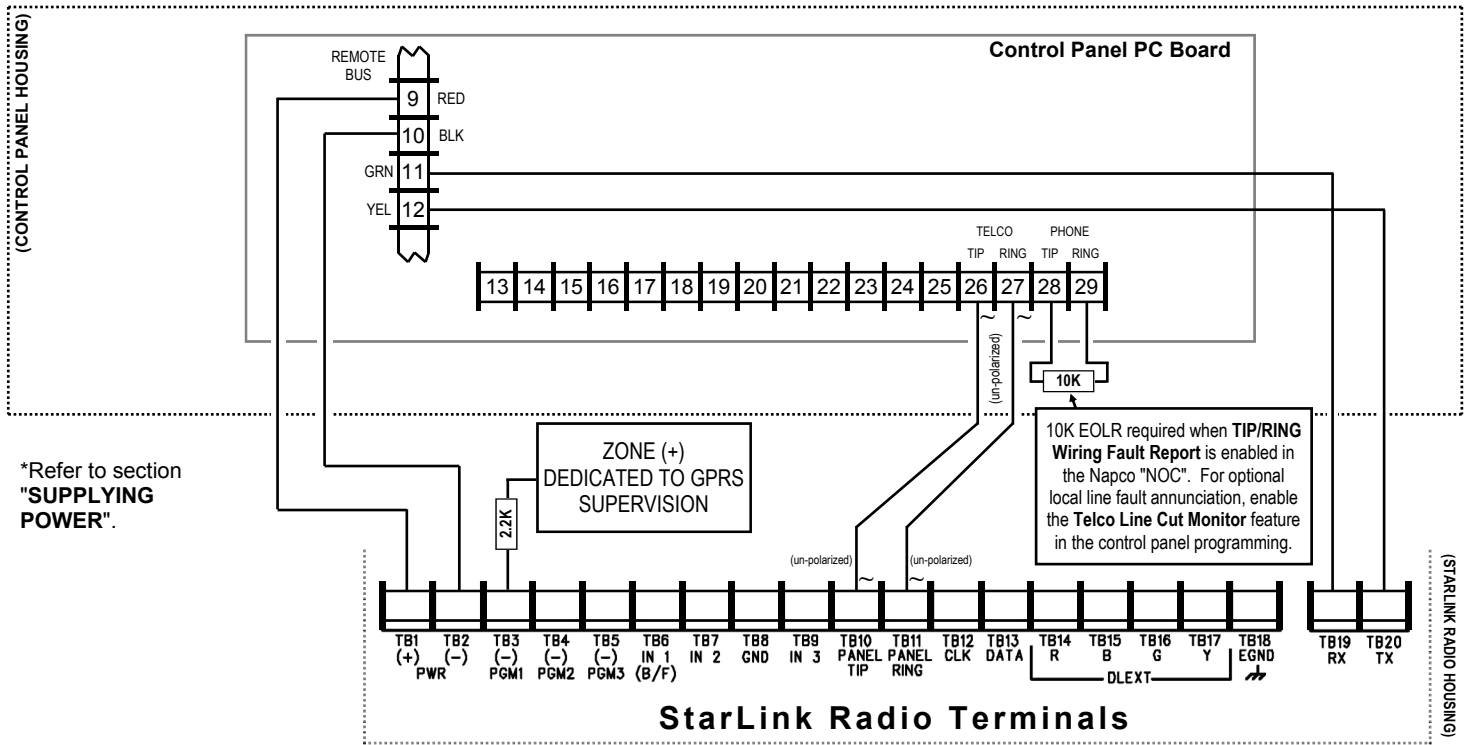

Wiring Diagram for PRIMARY Reporting Configuration GEM-X255 / GEM-P9600 / GEM-P3200 Control Panels

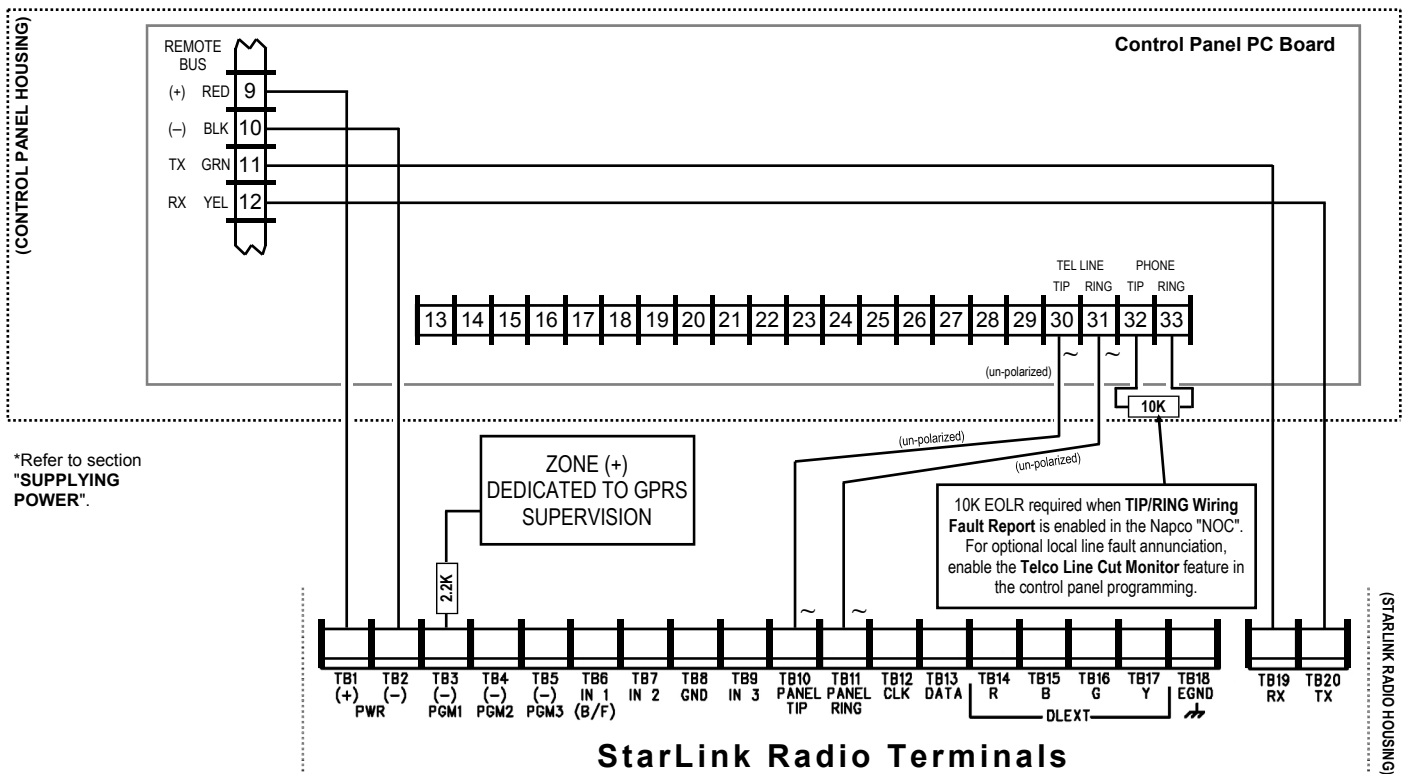

Control Panel Compatibility

Napco StarLink Connect Software

Installs in the Windows *System Tray*, the **Napco StarLink Connect** communication software allows remote management of alarm control panels connected to the StarLink radio. **Napco StarLink Connect** supports Honeywell Compass and DSC software, thus allowing you to use the original software supplied with your Honeywell or DSC control panel.

Installation and Setup

To install, proceed as follows:

1. **Napco StarLink Connect** is available for download at tech.napcosecurity.com in the Software Downloads area and is also on the supplied PCD-Windows 6.3.6 CD (located in the **StarLink Connect** root folder). Save the **StarlinkConnectSetup.exe** file to a folder on your PC.
2. Run **StarlinkConnectSetup.exe** and follow the installation prompts. After the installation process completes, right-click the desktop icon (shown at right) and select "**Run as administrator**" (you can optionally use the icon in the Windows **Start** menu).

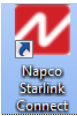

3. In the System Tray (usually located at the bottom right side of the Windows Taskbar) single or double-click to open the red **Napco StarLink Connect** icon (shown at right).
4. In the **Napco StarLink Connect** dialog that appears, click the **Settings** tab and click the **StarLink Authentication** button.

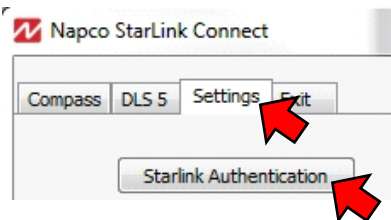

5. Type the **Dealer ID** and **Password** used to log in to the Napco NOC website (<http://NapcoNoc2.com>). Click **OK**.

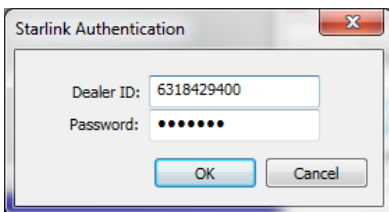

6. Close the **Napco StarLink Connect** dialog by clicking the **X** in the upper right corner. The **Exit** tab is only used if you want to **Suspend** or **Exit** the application; clicking the **X** in the upper right corner will keep the application running in the background.

IMPORTANT: If using a non-StarLink radio to connect to a DSC or Honeywell control panel (using your customary DSC *DLS* or Honeywell *Compass* software), ALWAYS click **Suspend** (shown below) to suspend the **Napco StarLink Connect** software.

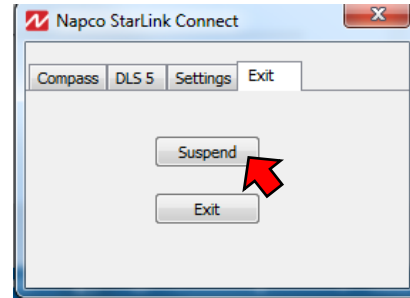

In the System Tray, the **Napco StarLink Connect** icon will turn red to indicate the software has paused.



IMPORTANT: If you decide to uninstall the **Napco StarLink Connect** software, always click **Exit** (shown above) before uninstalling.

Napco StarLink Connect Software Supported Control Panels

Panel	Revision
DSC PC1616.....	4.13+
DSC PC1832.....	4.13+
DSC PC1864.....	4.13+
Honeywell Vista-10P.....	2.6+
Honeywell Vista-10PSIA.....	3.0+
Honeywell Vista-15P.....	5+
Honeywell Vista-15PSIA.....	4.0+
Honeywell Vista-20P.....	5+
Honeywell Vista-20PSIA.....	4.0+
Honeywell Vista-21iP.....	4.23+
Honeywell Vista-21iPSIA.....	1.0+
Honeywell Vista-128BP.....	Any
Honeywell Vista-128BPEN.....	Any
Honeywell Vista-128BPT.....	Any
Honeywell Vista-128FBP.....	Any
Honeywell Vista-128FBPN.....	Any
Honeywell Vista-128FBPT.....	Any
Honeywell First Alert FA130.....	2.6+
Honeywell First Alert FA148.....	5+
Honeywell First Alert FA168.....	5+

Note: The **Napco StarLink Connect** communication software only works with control panels that support IP communications.

DSC Control Panel Connections

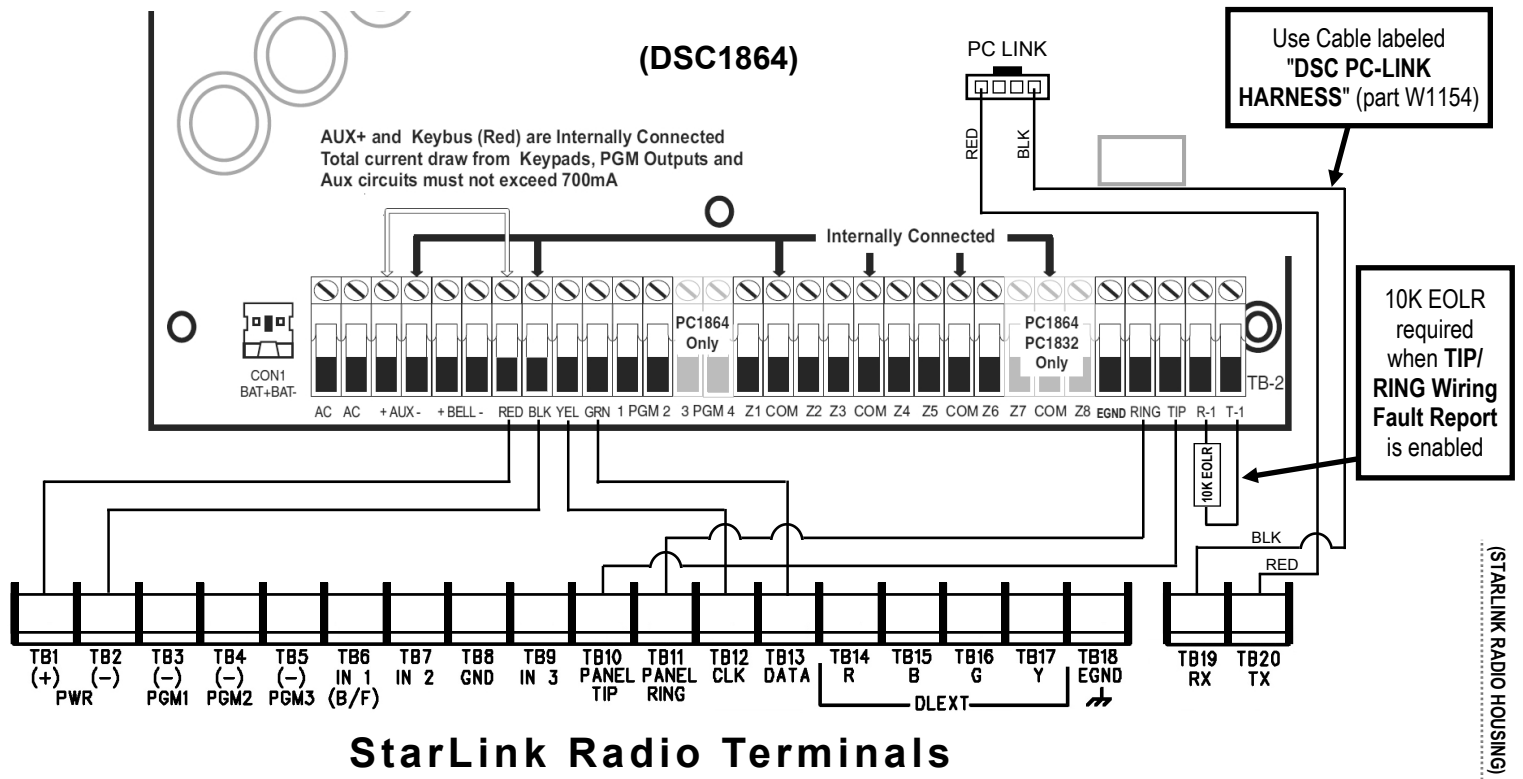

Using StarLink Connect Software with DSC Control Panels

The **Napco StarLink Connect** software is compatible with the DSC DLS Programming Software. See www.dsc.com for more information regarding DSC control panel compatibility with their DLS software. Before proceeding, the **StarLink Connect** SLE radio must be wired to the DSC control panel as described earlier in this manual.

- Before connecting each time to the DLS Programming Software, launch the **Napco StarLink Connect** software by pressing "Alt + S" on the keyboard. In the popup that appears, click the **DLS** tab and type the StarLink radio **Device ID** (printed on the radio PCB sticker) and click **OK**. **Note:** Always verify the radio is a "StarLink Connect" radio with the correct panel type before entering "ready to connect" mode (click **Info** to view radio data). In addition, the PC-Security Code prompt will appear if a Code was used (the app will remember the last Code used until you exit the app from the System Tray).
- When the **Napco StarLink Connect** icon in the System Tray turns green with a black "D" in the center (shown at right), the **Napco StarLink Connect** software is ready to connect with the DSC DLS Programming Software.
- Launch the DSC DLS Programming Software and log in

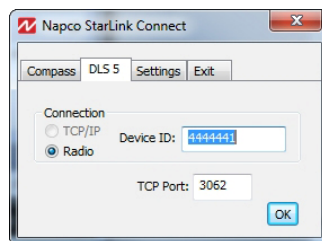

normally. When connected to the DSC DLS Programming Software, the **Napco StarLink Connect** icon in the System Tray turns yellow. Upload, download and/or program the DSC control panel as usual.

- To indicate real-time communication activity from the DSC DLS Programming Software, through the **Napco StarLink Connect** software to the DSC control panel, the "D" in the center of the yellow StarLink icon will toggle between "black on white" and "white on black".
- Upon disconnection, the yellow StarLink icon turns back to green and waits for another DSC DLS Programming Software connection. The last Radio ID used will be retained in memory (RAM) for convenient reconnection.



The **Napco StarLink Connect** software state changes are reflected in the appearance of its **System Tray** icons:



Red Icon: "Stopped" (initial state)



Green Icon: "Listening for DLS Programming Software outgoing connection"



Yellow Icons: "Connected with DLS Programming Software". During data transfer, yellow icon will toggle between "black on white" and "white on black" to indicate data transfer activity.



DSC Control Panel Programming

DSC Control Panel Programming

Program the DSC control panel to allow the operation of four (4) functional areas:

- Allow telco reporting to the central station
- Allow notification alerts (*iBridge Messenger* text messaging)
- Allow mobile device app communication for remote system control
- Allow **Napco StarLink Connect** software to support DSC DLS IV& DLS 5 software.

IMPORTANT: See page 8 for compatible DSC control panels.

Programming for Telco Reporting

To report to a central station, you **must** program the DSC control panel to use Tip and Ring to send signals, as follows:

Section	As Sole Communicator	Code Summarization
301	Enter a Receiver Number	
310	Enter Account Number	
350	Enter '03' to send Contact ID	Panel default is SIA (04).

Note: Ensure All Report Codes are in, and signals can be sent.

Communicator Programming

Required communicator options are as follows:

Section	Required Communicator Options	Code Summarization
015	Enable Option 7	Option 7 turns on telephone line supervision.
167	Set '060' Seconds	Sets T-Link acknowledgement delay to 60 seconds.
350	Set '03'	Format sent as Contact ID (03).
351	Enable Option 1	Options to turn on/off alarm/restore for telephone 1 (option 1), telephone 2 (option 2), and alternate communications (option 5).
359	Enable Option 1	Options to turn on/off tamper/restore for telephone 1 (option 1), telephone 2 (option 2), and alternate communications (option 5).
375	Enable Option 1	Options to turn on/off maintenance for telephone 1 (option 1), telephone 2 (option 2), and alternate communications (option 5)
376	Enable Option 1	Options to turn on/off testing for telephone 1 (option 1), telephone 2 (option 2), and alternate communications (option 5)
380	Enable Option 1	Option 1 turns on/off communications. Option 5 turns on/off 3rd telephone number.
381	Disable Option 3	Option 3 turns on/off code reporting.
382	Enable Option 5	Option 5 enables/disables communication link.
401	Enable Option 1	Option 1 enables/disables Double Call.
389	Set '003' Seconds	The time it will take to periodically check for faults.

Honeywell Control Panel Connections

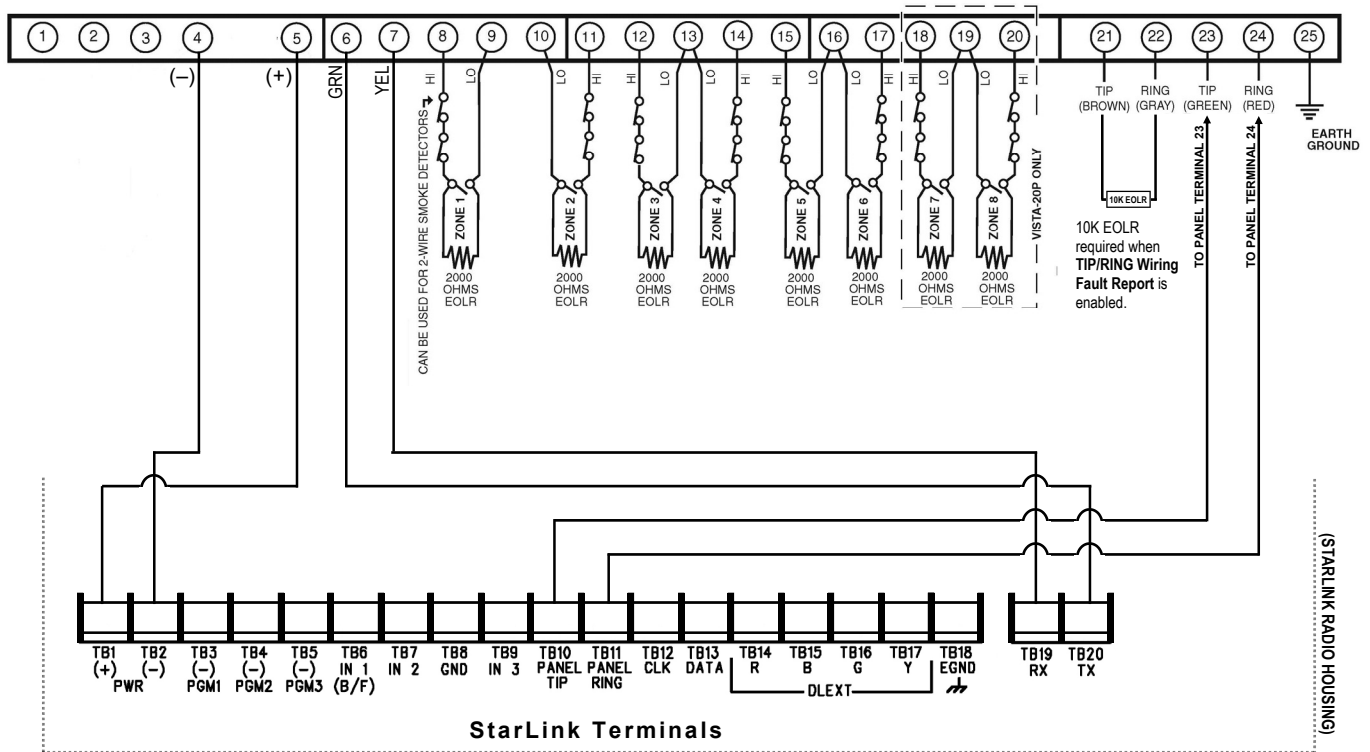

Using StarLink Connect Software with Honeywell Control Panels

The **Napco StarLink Connect** software is compatible with the Honeywell Compass® Downloader for Windows® Software. See www.security.honeywell.com for more information regarding Honeywell control panel compatibility with their Compass software. Before proceeding, the *StarLink Connect* SLE radio must be wired to the Honeywell control panel as described earlier in this manual.

1. Before connecting each time to the Compass Downloader for Windows software, launch the **Napco StarLink Connect** software by pressing "Alt + S" on the keyboard. In the popup that appears, click the **Compass** tab and type the StarLink radio **Device ID** (printed on the radio PCB sticker) and click **OK**. **Note:** Always verify the radio is a "StarLink Connect" radio with the correct panel type before entering "ready to connect" mode (click **Info** to view radio data). In addition, the PC-Security Code prompt will appear if a Code was used (the app will remember the last Code used until you exit the app from the System Tray).
2. When the **Napco StarLink Connect** icon in the System Tray turns green with a black "C" in the center (shown at right), the **Napco StarLink Connect** software is ready to connect with the Compass Downloader for Windows software.
3. Launch the Compass Downloader for Windows software and log in normally. When connected to the Compass

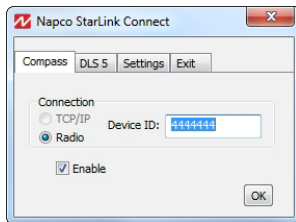





Downloader for Windows software, the **Napco StarLink Connect** icon in the System Tray turns yellow. Upload, download and/or program the Honeywell control panel as usual.

4. To indicate real-time communication activity from the Compass Downloader for Windows software, through the **Napco StarLink Connect** software to the Honeywell control panel, the "C" in the center of the yellow StarLink icon will toggle between "black on white" and "white on black".
5. Upon disconnection, the yellow StarLink icon turns back to green and waits for another Compass Downloader for Windows software connection. The last Radio ID used will be retained in memory (RAM) for convenient reconnection.



The **Napco StarLink Connect** software state changes are reflected in the appearance of its *System Tray* icons:

-  **Red Icon:** "Stopped" (initial state)
-  **Green Icon:** "Listening for Compass outgoing connection"
-  **Yellow Icons:** "Connected with Compass". During data transfer, yellow icon will toggle between "black on white" and "white on black" to indicate data transfer activity.
- 

Honeywell Control Panel Programming

(This Page for use with Vista-10, 15, 20 and 21 Panels Only)

Program the Honeywell control panel to allow the operation of four (4) functional areas:

- Allow telco reporting to the central station
- Allow notification alerts (*iBridge Messenger* text messaging)
- Allow mobile device app communication for remote system control
- Allow **Napco StarLink Connect** software to support Honeywell Compass software.

IMPORTANT: See page 8 for compatible control panel models and firmware versions.

Programming for Telco Reporting

To report to a central station, you **must** program the Honeywell control panel to use Tip and Ring to send signals, as follows:

Field	Radio as Sole Communicator	Description
*41	Enter telephone number.	(This is the central station telephone number).
*43	Enter Account number.	(This is the central station account number).
*49	Enter 0	For All Communications to Radio.
*54 & *55	Enter 0 for both	Phone Line Communicates First.
*65 & *66	Enter 1 for both	(Optional) Enable Opening/Closing Reports to the central Station.
*193	Enter 1, 0	Enable to turn on Address 20. "0" sets sound to beep.

Programming for Notifications, Mobile App and Napco StarLink Connect

To allow notification alerts (*iBridge Messenger* text messaging), mobile device app communication for remote system control and the **Napco StarLink Connect** software to support Honeywell Compass software. Program the Honeywell control panel as detailed in the table below. **IMPORTANT:** This table is used for Honeywell Vista-10, 15, 20 and 21 control panels only; see page 8 for compatible models and firmware versions. **Note:** If telco reporting and using Notifications, the Mobile App and/or Napco *StarLink Connect*, program the items in the above table and also the table below. For Honeywell Vista-128 control panels, go to page 13.

In addition, verify that your Vista control panel firmware revision allows for GSM emulation programming.

Field	Radio as Sole Communicator	Description
*29	Enter 1	This enables GSM (the radio emulates a GSM).
*43	Enter Account Number	This is the central station account number.
*193	Enter 1, 0	"1" turns on/off keypad address (enable address 20). "0" sets sound to beep.

VISTA-21iP Additional Programming

Programming a Honeywell **VISTA-21iP** control panel requires the following ADDITIONAL programming steps:

1. Power down the Vista control panel by removing all AC and battery power.
2. On the **VISTA-21iP** motherboard, move the **Internal IP/GSM** jumper to the "OFF" position.
3. Restore power to the Vista control panel.
4. In the control panel programming ***29 menu mode**, set the **Internal IP/GSM** to **DISABLED** (refer to the Vista-21iP programming manual if needed).

Honeywell Control Panel Programming

(This Page for use with Vista-128 Panels Only)

IMPORTANT: These tables are used with **Honeywell Vista-128** control panels only; see page 8 for compatible models and firmware versions. For Honeywell Vista-10, 15, 20 and 21 control panels, see page 12. *Always adhere to the documentation for the Honeywell control panel in use.*

Program the Honeywell Vista-128 control panel to allow the operation of four (4) functional areas:

- Allow telco reporting to the central station
- Allow notification alerts (*iBridge Messenger* text messaging)
- Allow mobile device app communication for remote system control
- Allow **Napco StarLink Connect** to support Honeywell Compass software.

In addition, verify that your Vista control panel firmware revision allows for GSM emulation programming.

Programming for Telco Reporting (Vista-128)

To report to a central station, you **must** program the Honeywell control panel to use Tip and Ring to send signals, as follows:

Field	Radio as Sole Communicator	Description
*32	Enter Account number.	(This is the central station account number).
*33	Enter telephone number.	(This is the central station telephone number).
*37	Enter 1	Enable Download Command.
*56	Enter 0	Dynamic Signal Delay.
*57	Enter 1	Dynamic Signal Priority; setting "1" gives signal priority to the radio.
#93	Enter 0	To enter "Menu Driven Mode". (Press #93 while still in programming mode to display the first choice of the "menu driven" programming functions). Go to the table below to continue.

Programming With #93 Menu Driven Mode

Press #93 while still in programming mode to display the first choice of the menu driven programming functions. Press 0 for "NO", or press 1 for "YES" in response to the displayed menu selection. Press [*] (keypad "star" key) to display the next selection in sequence. Program the following items in this #93 Menu:

Prompt	Enter	Description
ZONE PROG?	Enter 0	Answer "NO" to this question, then press [*] (keypad "star" key) repeatedly until the next selection (DEVICE PROG?) appears.
DEVICE PROG?	Enter 1	Enter "Device Programming" menu to identify the StarLink radio to the control panel as a "keypad".
DEVICE ADDRESS	Enter 20	Identifies the StarLink radio device address number to the control panel (the default address 20 is set in the radio at the factory, and therefore will be used in this documentation). Press [*] to accept entry.
20 DEVICE TYPE	Enter 01	01 = Alpha keypad. Press [*] to accept entry.
20 CONSOLE PART.	Enter 1	Enter the addressable device's primary default partition number (1 to maximum number of partitions programmed for the system). Press [*] to accept entry.
20 SOUND OPTION	Enter 0	0 = No suppression of keypad sounds.
20 KEYPAD GLOBAL?	Enter 1	1 = Enables keypad for global arming/disarming. Press [*] to accept entry.
20 AUI ?	Enter 0	0 = "NO" Keypad is a standard alpha physical (not virtual) keypad.
DEVICE ADDRESS	Enter 03	Begin programming of the LRR (Long Range Radio Communicator) section of the StarLink radio. This prompt identifies the LRR address number to the control panel (the default address 03 is set in the radio at the factory, and therefore will be used in this documentation). Press [*] to accept entry.
03 DEVICE TYPE	Enter 06	06 = LRR (Long Range Radio Communicator). Press [*] to accept entry.
03 RADIO PROG?	Enter 0	0 = Disable LRR (Long Range Radio). Press 00* to quit programming mode and follow the remaining prompts to exit normally.

4/2 Pulse Dialing Format Compatibility

Note: The SLE Series Radios are compatible with any Listed 4/2 Receiver such as the Ademco 685.

Name	Format Type	Handshake Frequency	Speed
Ademco Slow	4/2	1400 Hz or 2300Hz	10pps
Ademco Slow	4/2 checksum	1400 Hz or 2300Hz	10pps
Radionics Slow	4/2	2300Hz	10pps
Radionics Slow	4/2 checksum	2300Hz	10pps
Silent Knight Fast	4/2	1400 Hz or 2300Hz	20pps
Silent Knight Fast	4/2 checksum	1400 Hz or 2300Hz	20pps
Radionics Fast	4/2	2300Hz	40pps
Radionics Fast	4/2 checksum	2300Hz	40pps
Universal High Speed	4/2	1400 Hz or 2300Hz	40pps
Universal High Speed	4/2 checksum	1400 Hz or 2300Hz	40pps

IMPORTANT WIRING METHODS



For single-conductor terminal blocks (like the type shown at left), to terminate more than one conductor to a terminal, use the wiring methods shown at right:

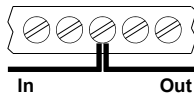

Incorrect

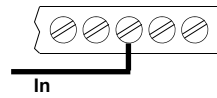

Correct -- Single incoming and/or pigtail with wire nut / crimp connectors

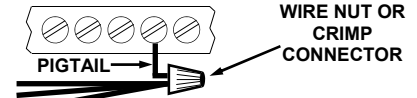

For "barrier" type terminal blocks (like the type shown at left), to terminate two conductors to a terminal, use the wiring methods shown at right:

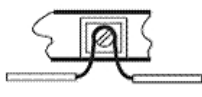

Incorrect

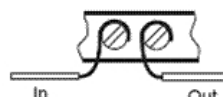

Correct -- Separate incoming and outgoing conductors



To terminate more than two conductors or conductors of different wire sizes to a terminal, use the "pigtail" type wiring method as shown at right. Use insulated wire for the pigtail, and firmly secure the conductors to the pigtail using an appropriate wire nut or crimp connector for the number and gauge of conductors used.

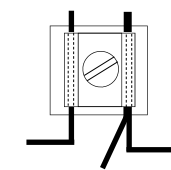

Incorrect

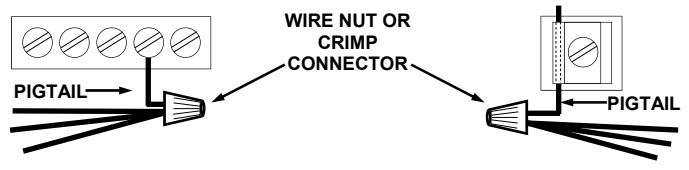

Correct -- Use pigtail and wire nut / crimp connector

Important: © NAPCO 2016. All rights reserved. All trademarks, service marks, and product or service names described in this manual are for identification purposes only and may be trademarks or registered trademarks of their respective owners. The absence of a name or logo in this document does not constitute a waiver of any and all intellectual property rights that NAPCO Security Technologies, Inc. has established in any of its product, feature, or service names or logos. **Note:** Multiple illustrations that appear within a single page may not be to scale.

Housing Template (1:1 Scale)

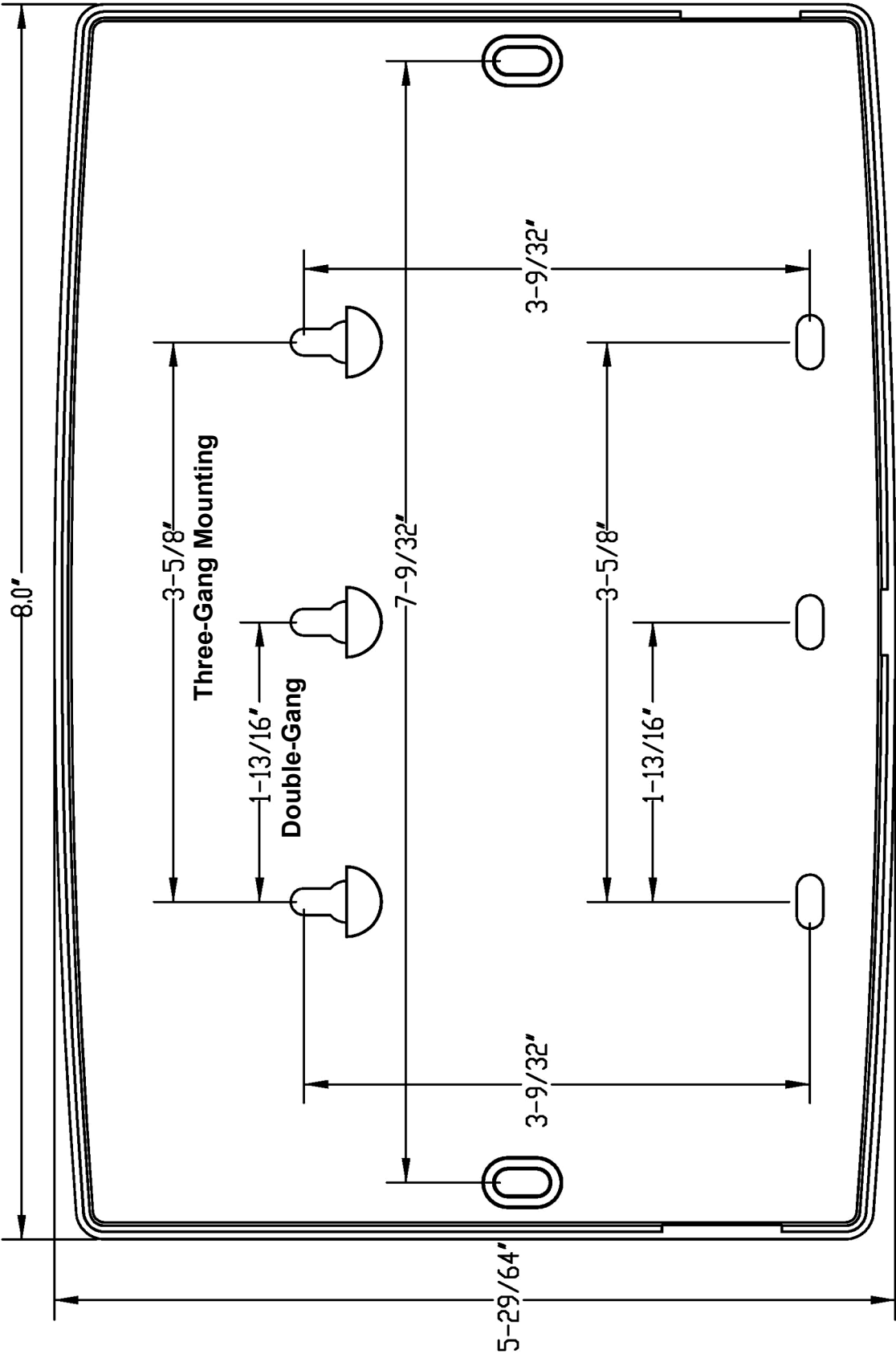

NAPCO LIMITED WARRANTY

NAPCO SECURITY SYSTEMS, INC. (NAPCO) warrants its products to be free from manufacturing defects in materials and workmanship for *thirty-six months* following the date of manufacture. NAPCO will, within said period, at its option, repair or replace any product failing to operate correctly without charge to the original purchaser or user.

This warranty shall not apply to any equipment, or any part thereof, which has been repaired by others, improperly installed, improperly used, abused, altered, damaged, subjected to acts of God, or on which any serial numbers have been altered, defaced or removed. Seller will not be responsible for any dismantling or reinstallation charges.

THERE ARE NO WARRANTIES, EXPRESS OR IMPLIED, WHICH EXTEND BEYOND THE DESCRIPTION ON THE FACE HEREOF. THERE IS NO EXPRESS OR IMPLIED WARRANTY OF MERCHANTABILITY OR A WARRANTY OF FITNESS FOR A PARTICULAR PURPOSE. ADDITIONALLY, THIS WARRANTY IS IN LIEU OF ALL OTHER OBLIGATIONS OR LIABILITIES ON THE PART OF NAPCO.

Any action for breach of warranty, including but not limited to any implied warranty of merchantability, must be brought within the six months following the end of the warranty period. IN NO CASE SHALL NAPCO BE LIABLE TO ANYONE FOR ANY CONSEQUENTIAL OR INCIDENTAL DAMAGES FOR BREACH OF THIS OR ANY OTHER WARRANTY, EXPRESS OR IMPLIED, EVEN IF THE LOSS OR DAMAGE IS CAUSED BY THE SELLER'S OWN NEGLIGENCE OR FAULT.

In case of defect, contact the security professional who installed and maintains your security system. In order to exercise the warranty, the product must be returned by the security professional, shipping costs prepaid and insured to NAPCO. After repair or replacement, NAPCO assumes the cost of returning products under warranty. NAPCO shall have no obligation under this warranty, or otherwise, if the product has been repaired by others, improperly installed, improperly used, abused, altered, damaged, subjected to accident, nuisance, flood, fire or acts of God, or on which any serial numbers have been altered, defaced or removed. NAPCO will not be responsible for any dismantling, reassembly or reinstallation charges.

This warranty contains the entire warranty. It is the sole warranty and any prior agreements or representations, whether oral or written, are either merged herein or are expressly cancelled. NAPCO neither assumes, nor authorizes any other person purporting to act on its behalf to modify, to change,

or to assume for it, any other warranty or liability concerning its products.

In no event shall NAPCO be liable for an amount in excess of NAPCO's original selling price of the product, for any loss or damage, whether direct, indirect, incidental, consequential, or otherwise arising out of any failure of the product. Seller's warranty, as hereinabove set forth, shall not be enlarged, diminished or affected by and no obligation or liability shall arise or grow out of Seller's rendering of technical advice or service in connection with Buyer's order of the goods furnished hereunder.

NAPCO RECOMMENDS THAT THE ENTIRE SYSTEM BE COMPLETELY TESTED WEEKLY.

Warning: Despite frequent testing, and due to, but not limited to, any or all of the following; criminal tampering, electrical or communications disruption, it is possible for the system to fail to perform as expected. NAPCO does not represent that the product/system may not be compromised or circumvented; or that the product or system will prevent any personal injury or property loss by burglary, robbery, fire or otherwise; nor that the product or system will in all cases provide adequate warning or protection. A properly installed and maintained alarm may only reduce risk of burglary, robbery, fire or otherwise but it is not insurance or a guarantee that these events will not occur. CONSEQUENTLY, SELLER SHALL HAVE NO LIABILITY FOR ANY PERSONAL INJURY, PROPERTY DAMAGE, OR OTHER LOSS BASED ON A CLAIM THE PRODUCT FAILED TO GIVE WARNING. Therefore, the installer should in turn advise the consumer to take any and all precautions for his or her safety including, but not limited to, fleeing the premises and calling police or fire department, in order to mitigate the possibilities of harm and/or damage.

NAPCO is not an insurer of either the property or safety of the user's family or employees, and limits its liability for any loss or damage including incidental or consequential damages to NAPCO's original selling price of the product regardless of the cause of such loss or damage.

Some states do not allow limitations on how long an implied warranty lasts or do not allow the exclusion or limitation of incidental or consequential damages, or differentiate in their treatment of limitations of liability for ordinary or gross negligence, so the above limitations or exclusions may not apply to you. This Warranty gives you specific legal rights and you may also have other rights which vary from state to state.