

Possible Ecological Interactions between Small-pelagic and Mesopelagic Fishes in the Kuroshio-Oyashio Transition Zone and Kuroshio Extension in Spring

Horizontal Distribution
Vertical Distribution
Stomach Contents

Akihiko Yatsu, Masatoshi Moku,
Hiroshi Nishida, Kaori Takagi,
Norio Yamashita and Hiroshi Itoh



Survey Area (Spring)

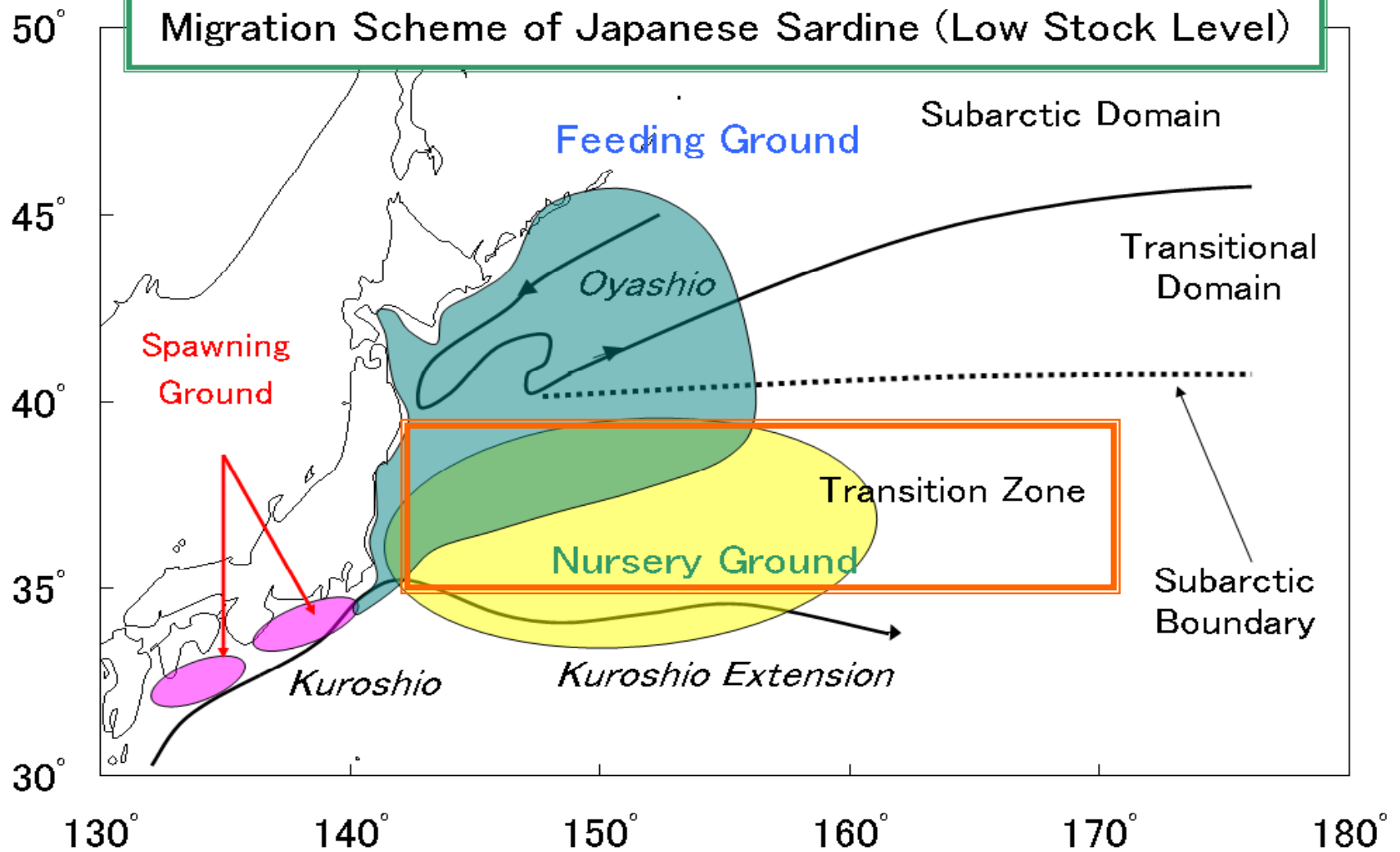

Lantern Fish Migration: *Myctophum asperum* (left) and *Symbolophorus californiensis* (right)

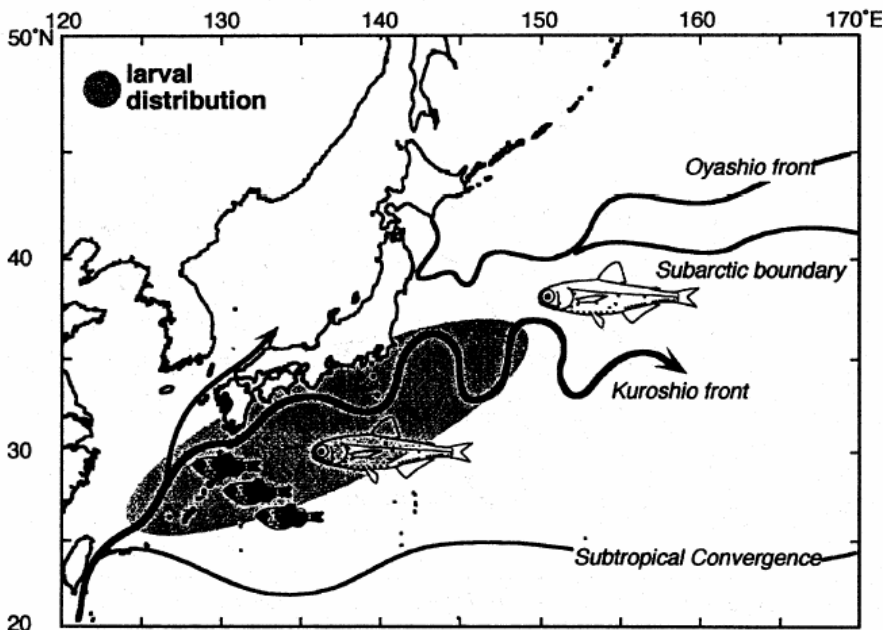

Kuroshio Water group—*Myctophum asperum* and *Diaphus garmani*

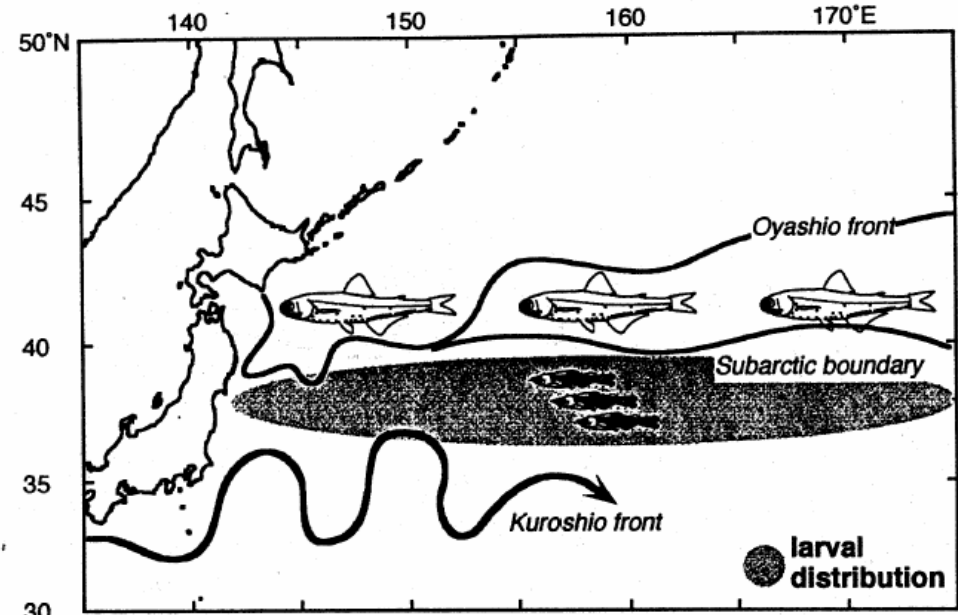

Southern Transitional Water group (2)—*Symbolophorus californiensis*



After Sassa (2001)

Backgrounds and Purpose

- Kuroshio-Oyashio Transition Zone (KOTZ) and Kuroshio Extension (KE) are the key areas for recruitment of sardine, anchovy, and mackerel
- Mortality of anchovy larvae in KOTZ-KE is mainly caused by predation by black snake mackerel (*Nealotus tripes*).
- Biological interactions between juvenile small pelagics and myctophids may be possible because 1) myctophids are abundant in KOTZ and 2) both are zooplankton feeder
- Seek for possible interaction between small pelagics and micronectonic mesopelagic fishes in KOTZ

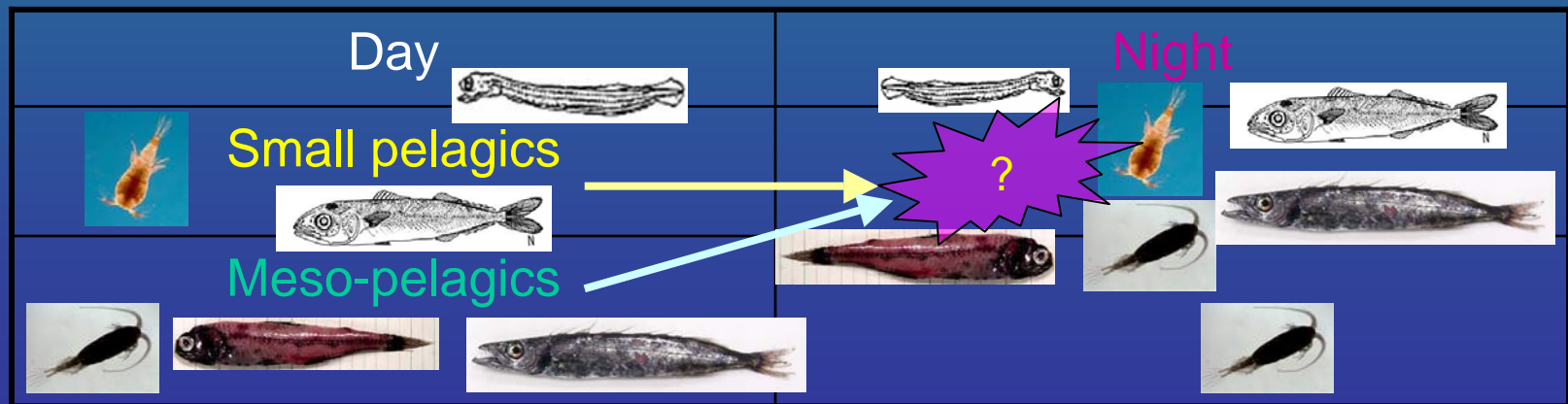

Surface Trawl Survey in Kuroshio/Oyashio Transition Zone in Spring since 1996

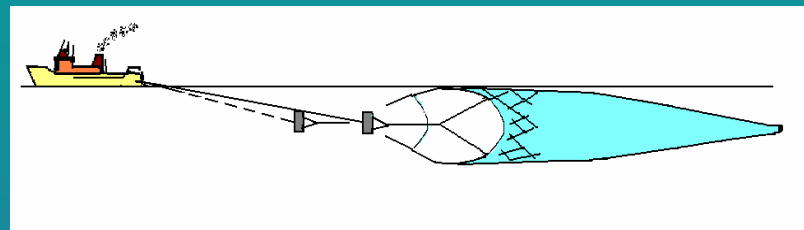

Net opening diam.: 27m

Towing at: 3.5 knots at night

Typical towing depth: 0-30m



Tansyu Maru (499GT, 1800HP): -1999



Hokuho Maru.(664 GT, 2200HP.2000-

CPUE (kg / 30 min tow) of Japanese Sardine and SST

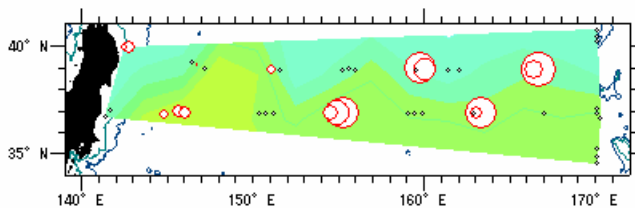

1996

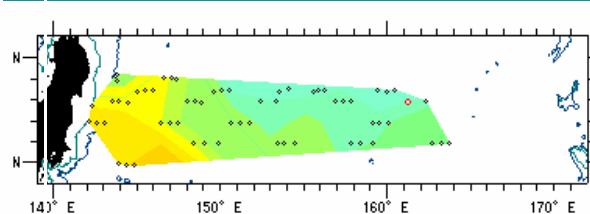
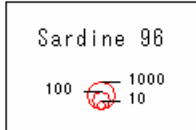

2001

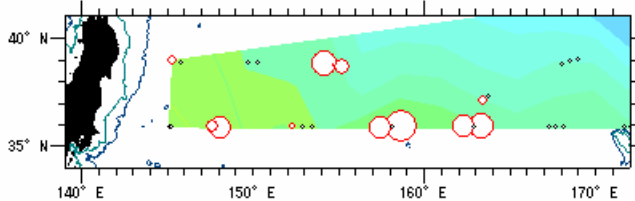
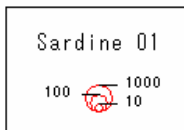

1997

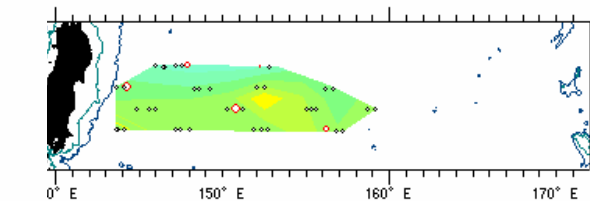
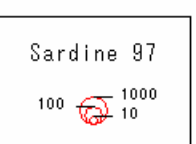

2002

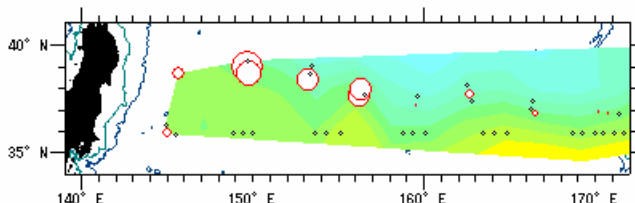
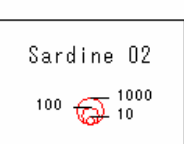

1998

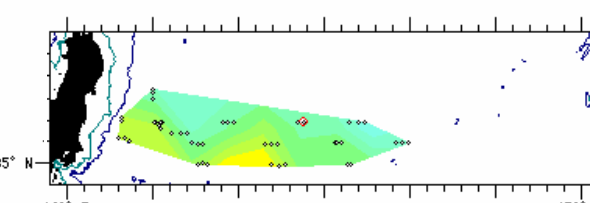
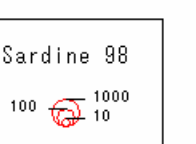

2003

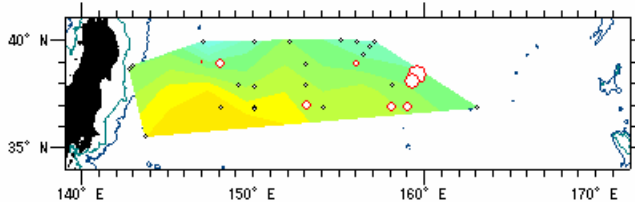
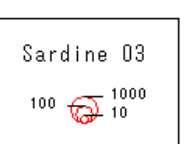

1999

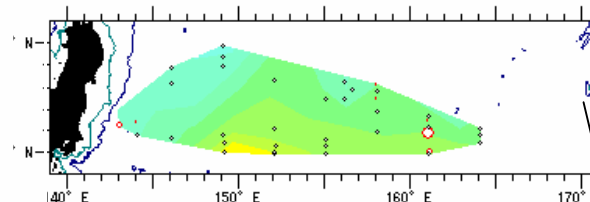
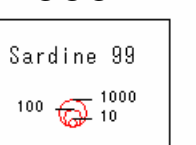

2004

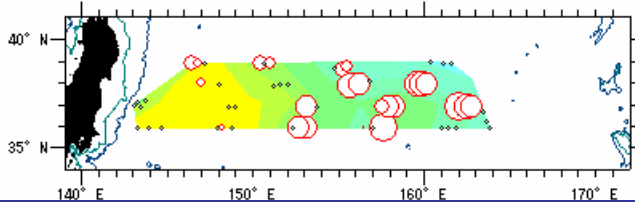
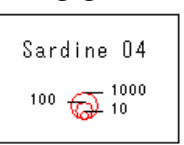

2000

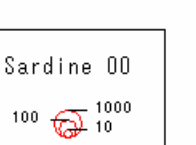

TO 2004

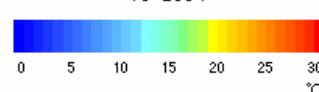

Emperor
Sea Mt.

1000m and 3000m isobath

Survey Index of and Estimated Recruit No.

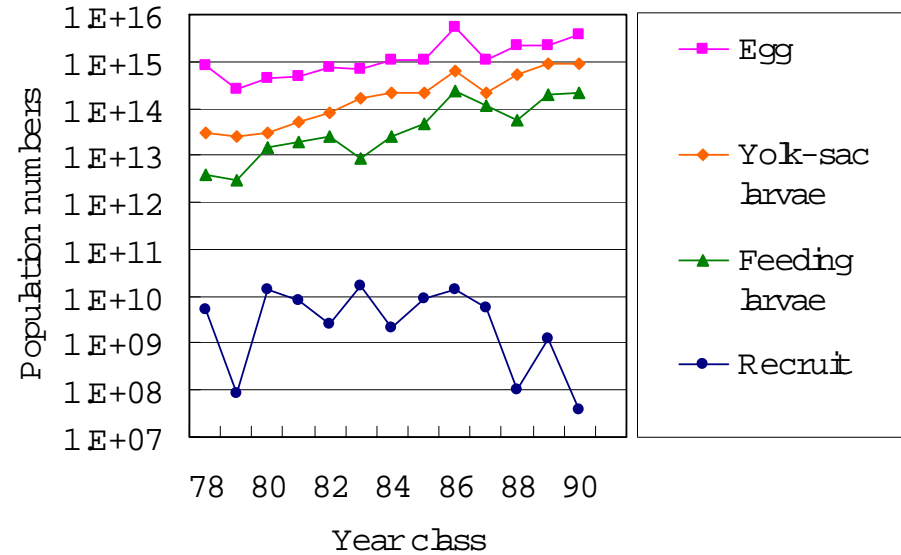
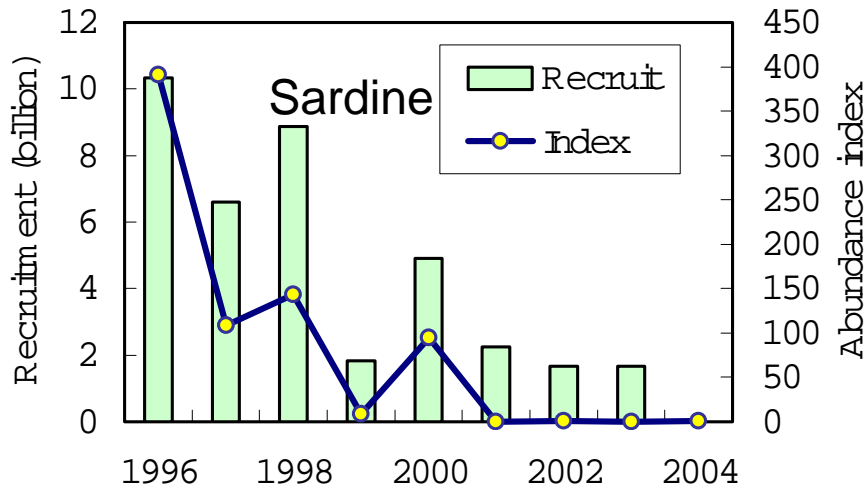

Sardine (Watanabe et al., 1995)

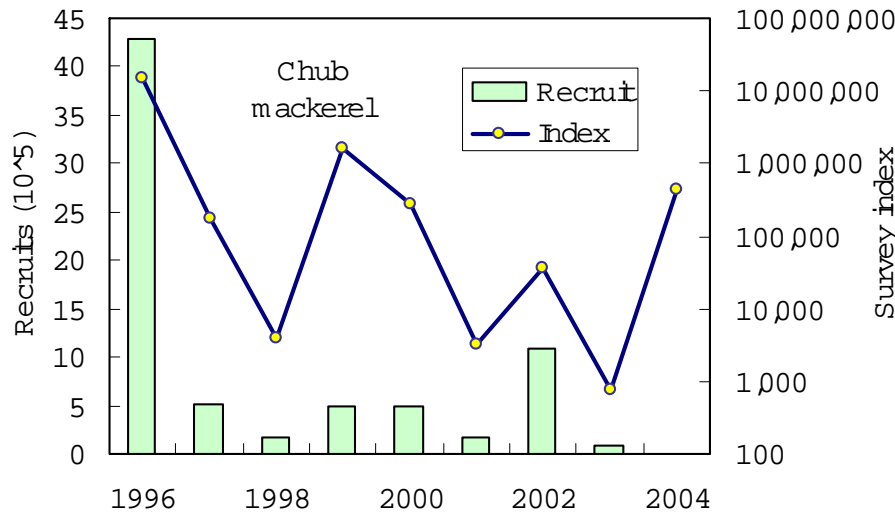

Fairly good relation indicate early survival is mainly determined after the feeding larvae distributing in Kuroshio and KOTZ

Catch Weight Composition in 2002 (0-30m depth)



56.37

Adult Myctophid Biomass Composition in 2002 and 2003 (0-30m depth)

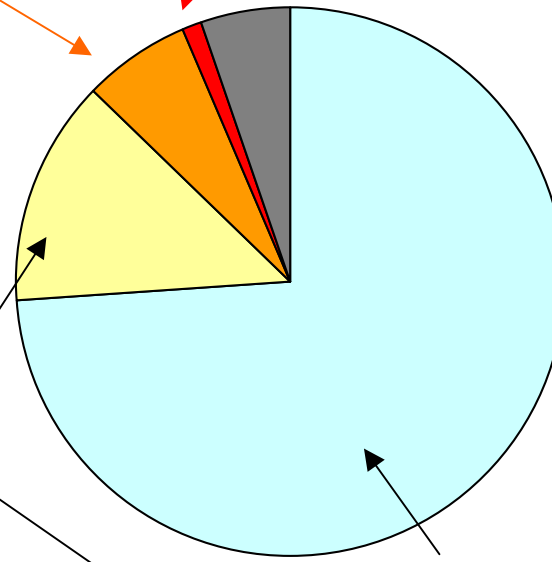
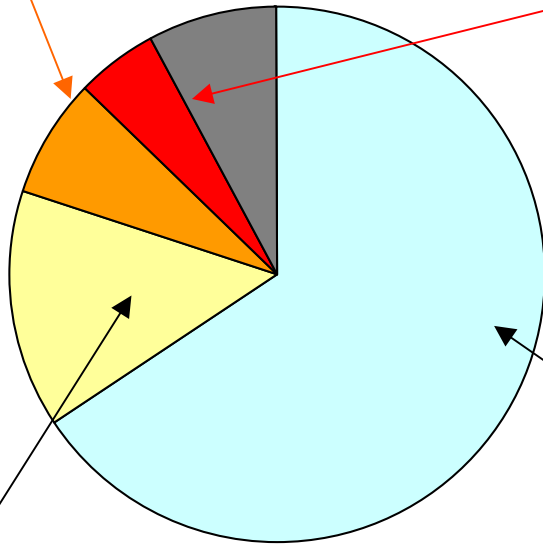
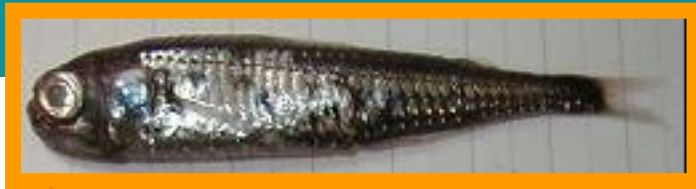

- Symbobphorus californiensis*
- Ceratoscopelus warnigii*
- Myctophum asperum*
- Diaphus perspicillatus*
- others



CPUE (kg / 30 min tow) of Small Pelagic Fishes and Myctophids (juv+ad) in 2000

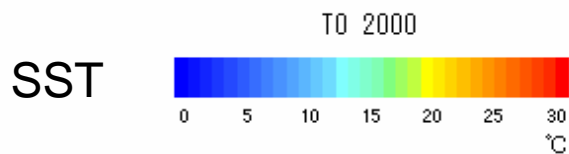
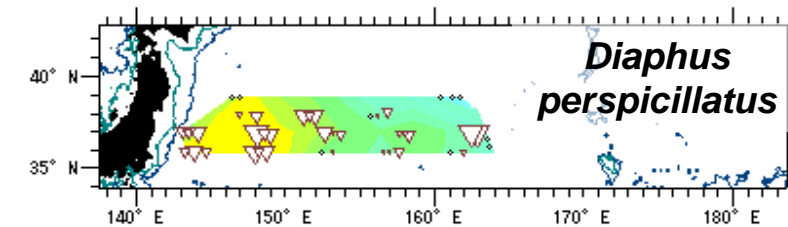
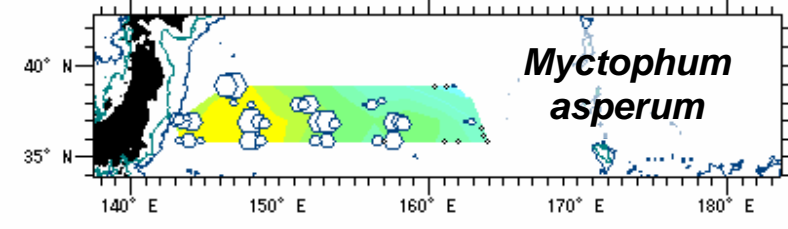
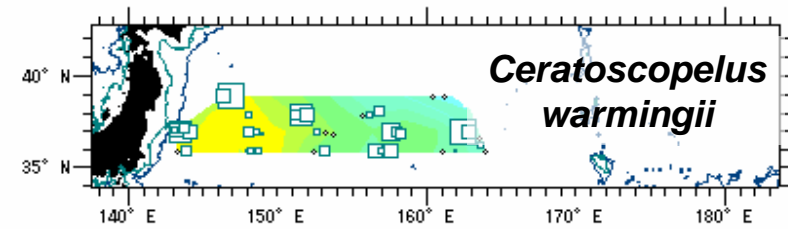
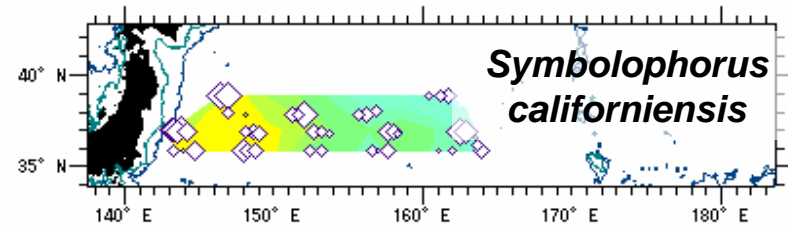
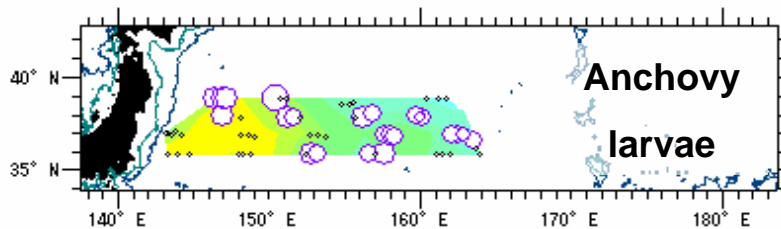
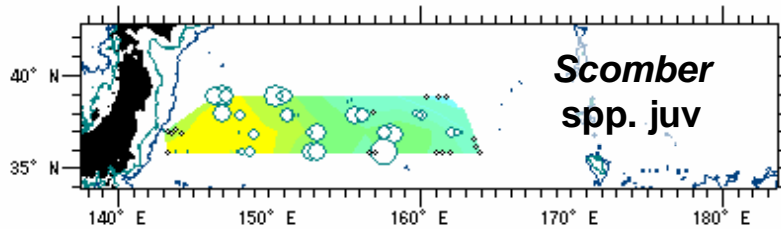
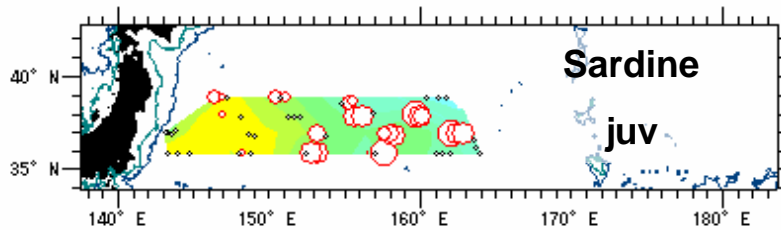

1000m and 3000m isobath

Size Composition of Small Pelagic Fishes and Myctophids in 2002

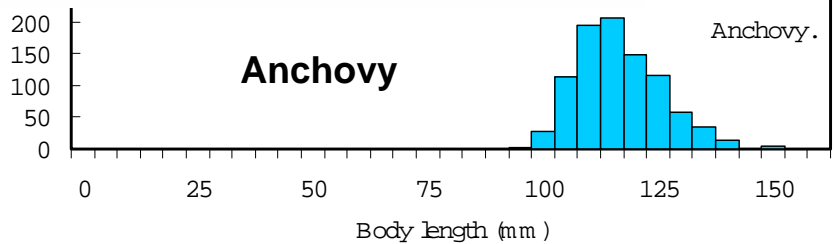
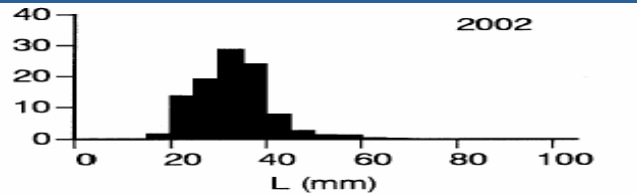
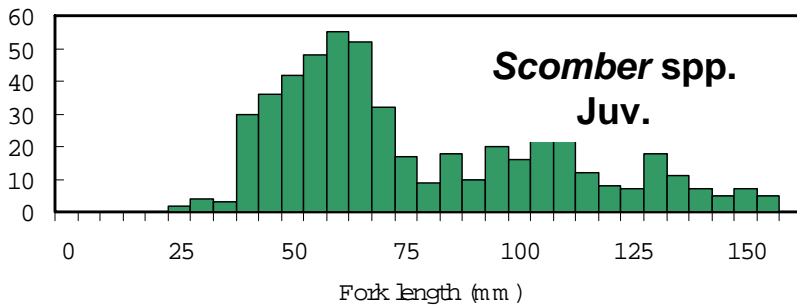

Larvae+Juv. (black) and adults (blue)

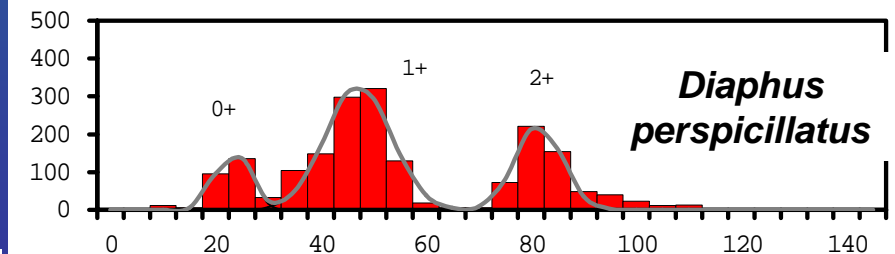
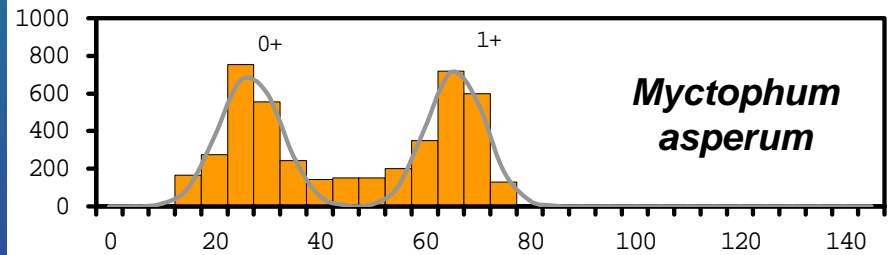
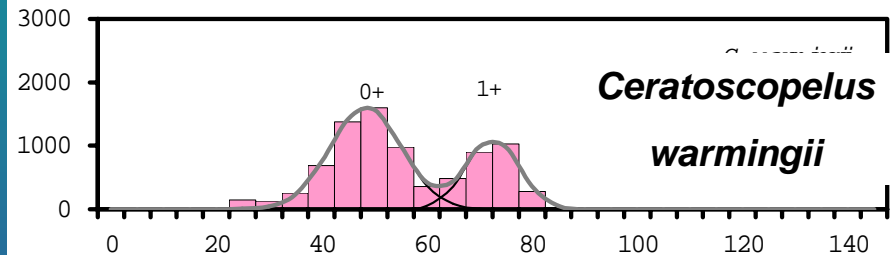
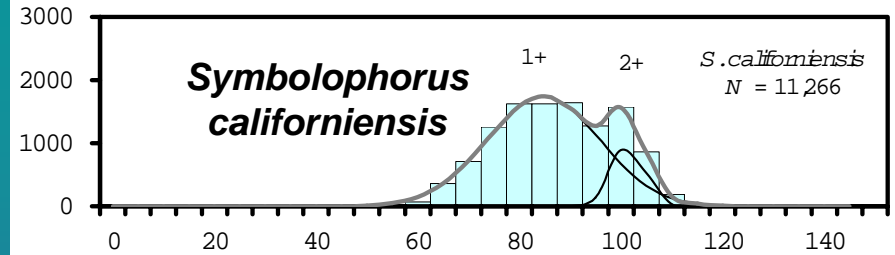

Standard length (mm)

Nighttime Vertical Distribution of Small Pelagics, Myctophids and Black Snake Mackerel in May 1995 at 37N 147E

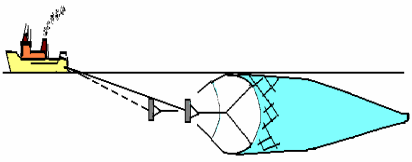
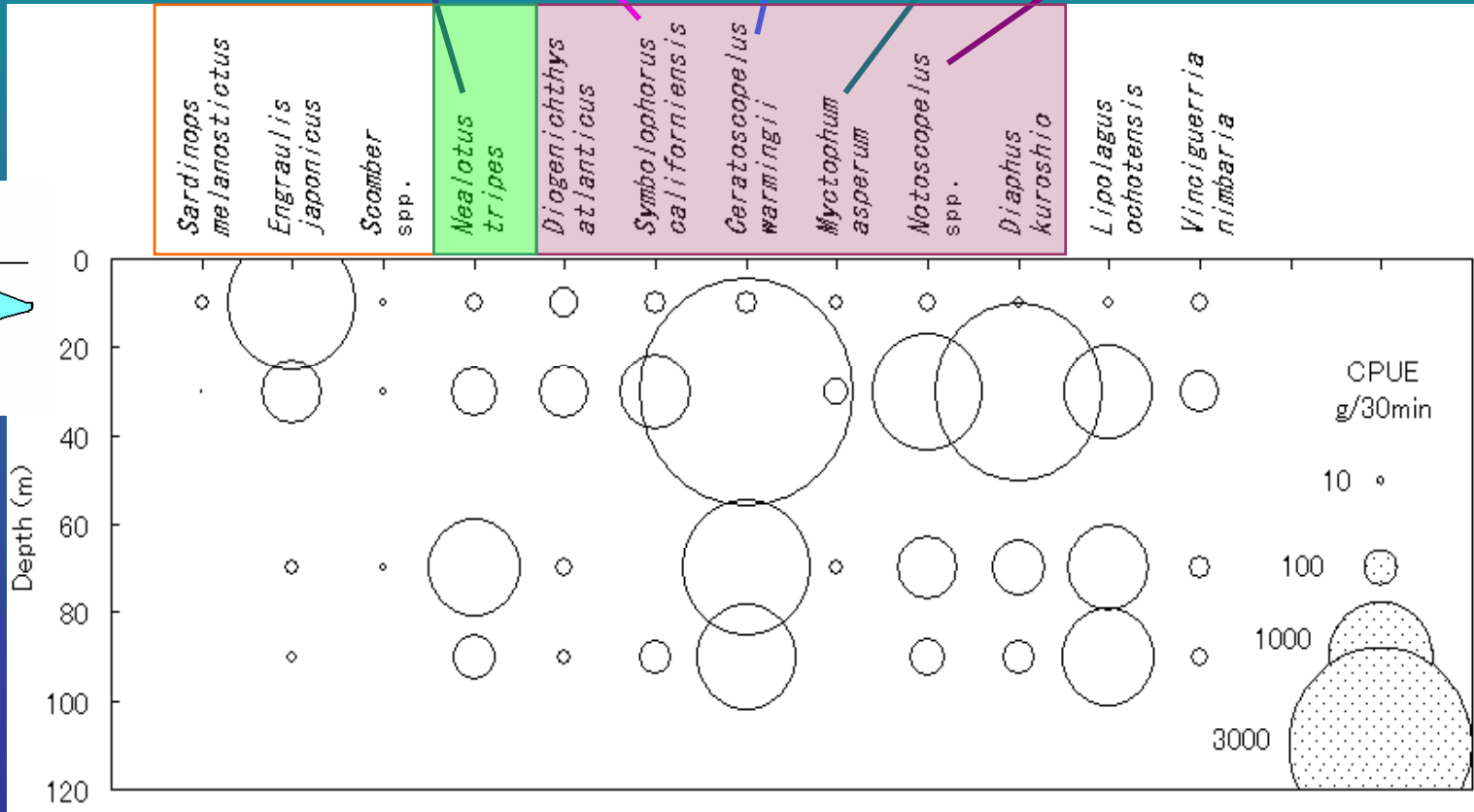

Black Snake Mackerel *Nealotus tripes* as a Predator

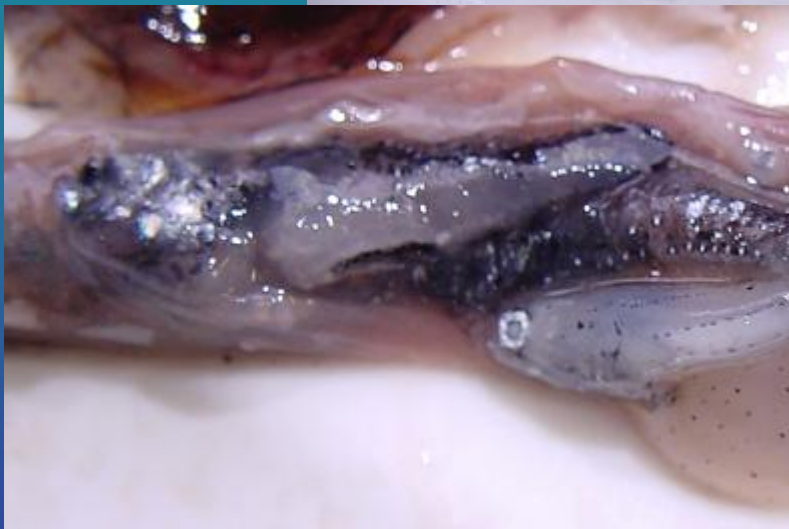

Index of Relative Importance of Diets of Black Snake Mackerel in May 2002

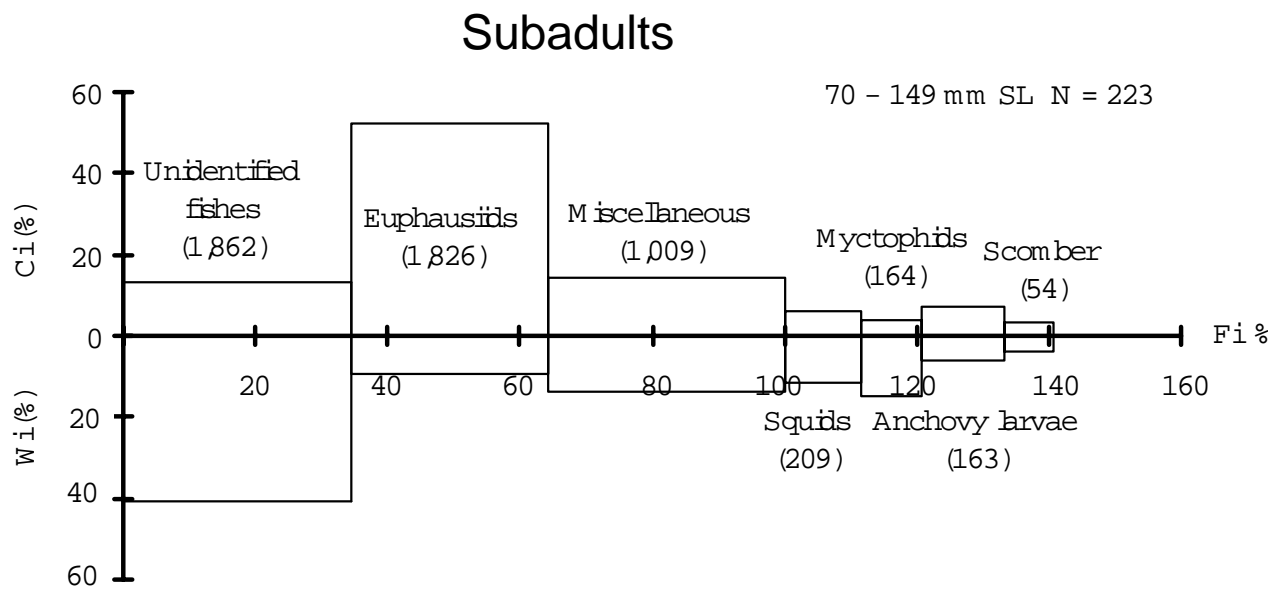
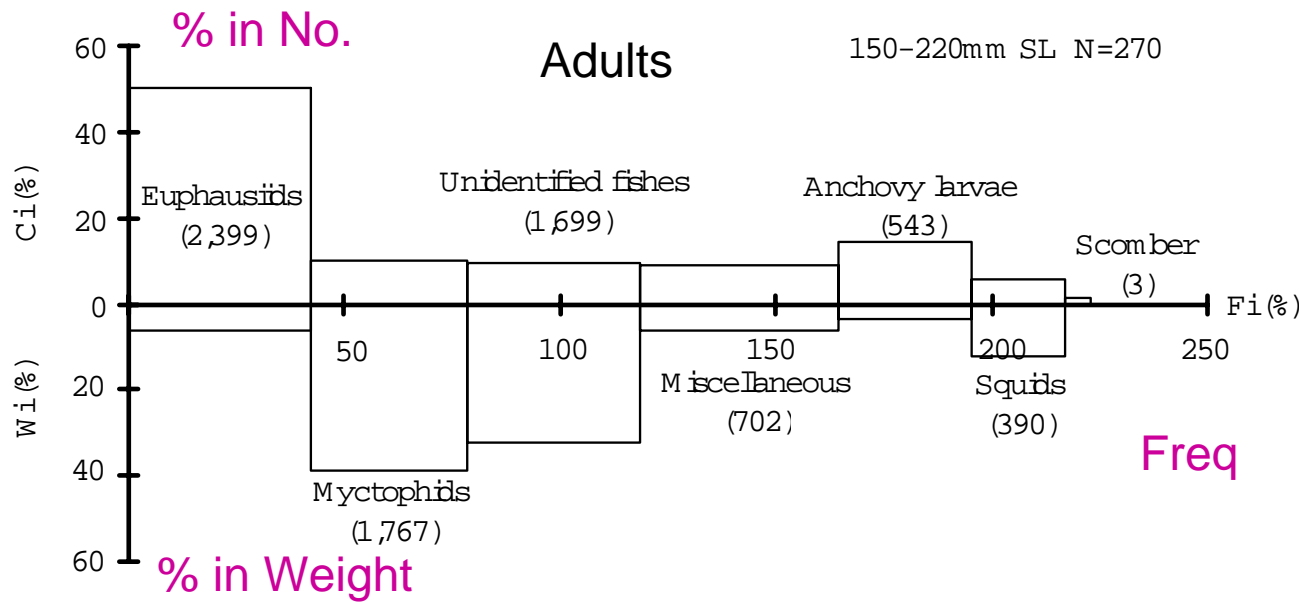

Larvae BSM selectively feeds on anchovy larvae (Kubota, 2003)

Prey Composition of Juvenile Small Pelagic Fishes and Myctophids (Adults & Juveniles) in May 2002

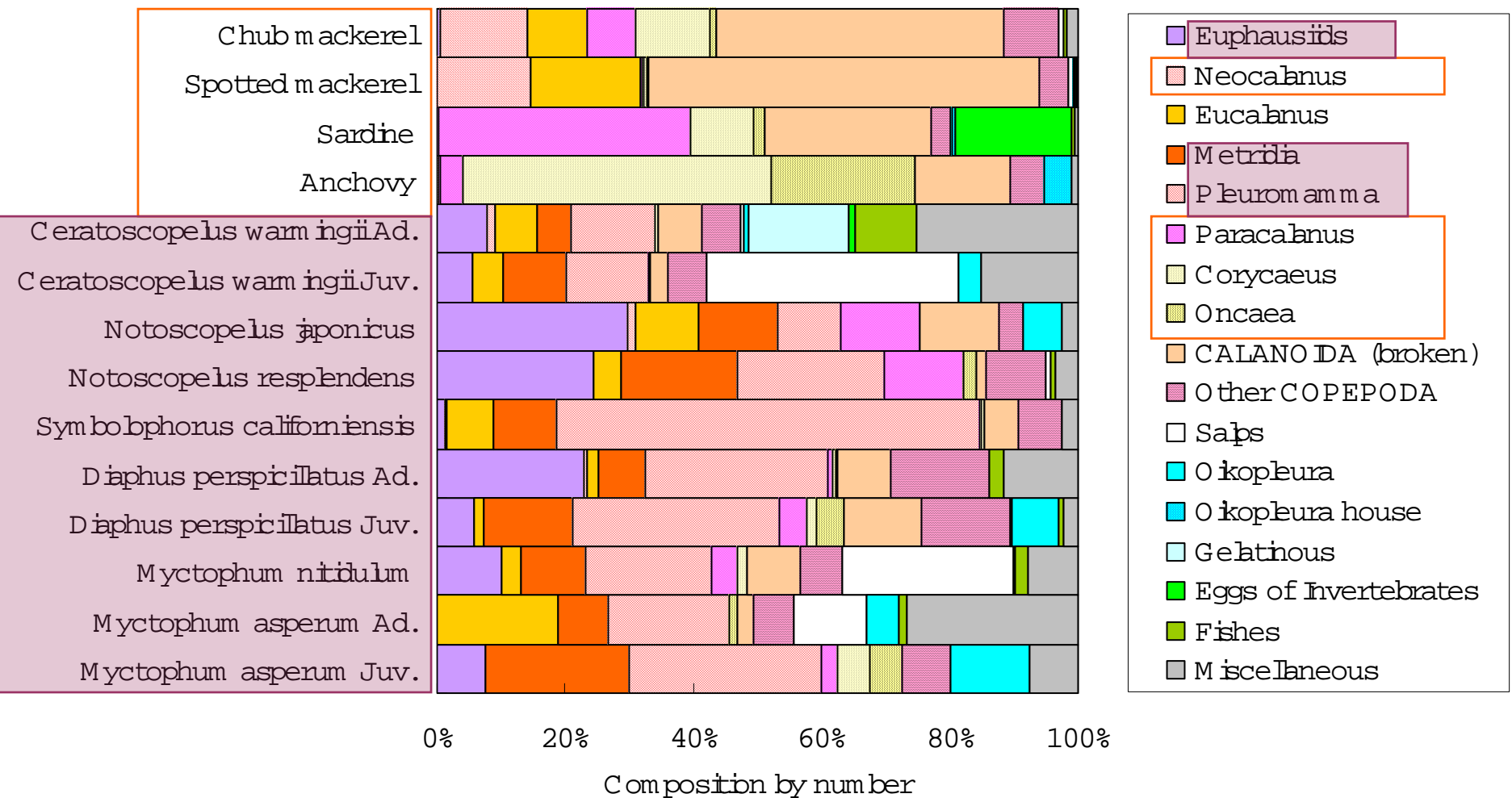

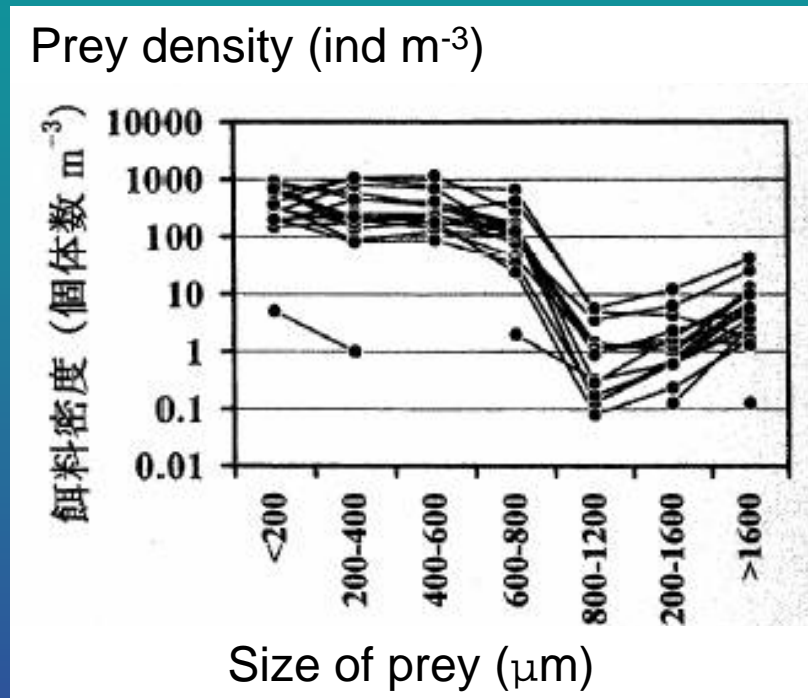

Stomach Contents of Sardine and Prey Availability in Kuroshio Extension during 1997-1998 (Saito et al., 2001)

- Small copepods (<0.8mm BL, *Paracalanus* etc.) are abundant
- Large copepods (*Calanus pacificus* etc.) was less abundant
- Optimum prey size for juvenile sardine (25-40mm BL) is 0.8-1.2mm
- Juvenile sardine (>33 mm BL) selectively fed on large copepods
- Larval sardine (26-31 mm BL) preyed upon small copepods
- Juveniles of both myctophids and small pelagics fed on 0.6-0.9 mm BL *Paracalanus* in KOTZ (our results)



Summary

- Juvenile small pelagics and myctophids (ad.+juv.) horizontally overlap in surface waters (0-30m) of KOTZ in spring
- Black snake mackerel shift their diet from anchovy larvae, to krill and myctophids with ontogenetic descent
- *Corycaeus* and *Oncea* (epipelagic) were preyed by juveniles of small pelagics and some juvenile myctophids 
- Krill, *Pleuromamma* and *Metridia* (diel vertical migrants with photophores) were exclusively consumed by myctophids 
- Possible competition for large copepods
- Further studies are needed for
 - 1) competition with juvenile myctophids for epipelagic ZP,
 - 2) indirect effects of black snake mackerel,
 - 3) quantitative evaluation

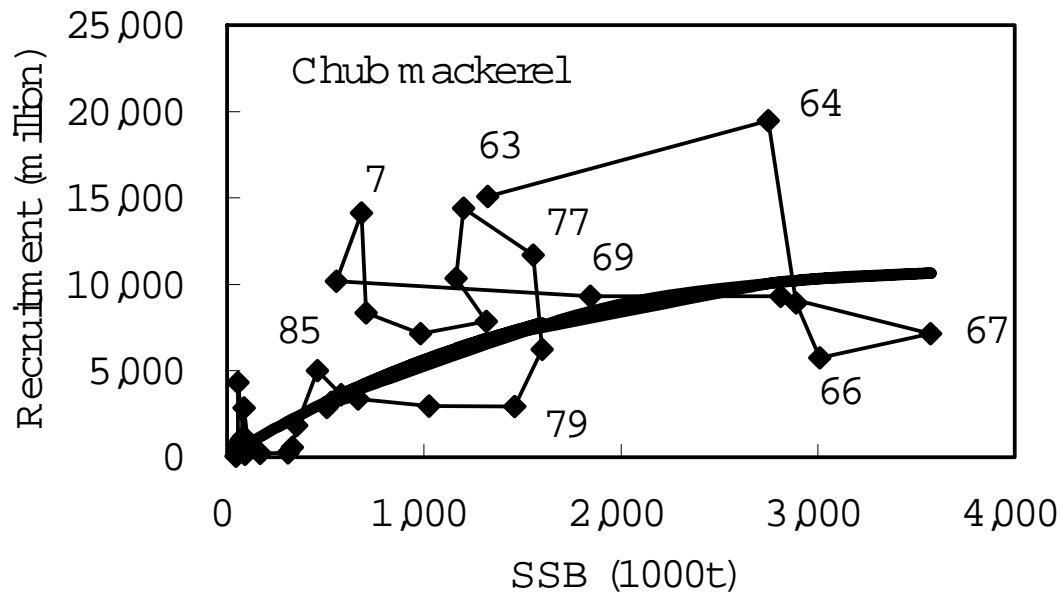
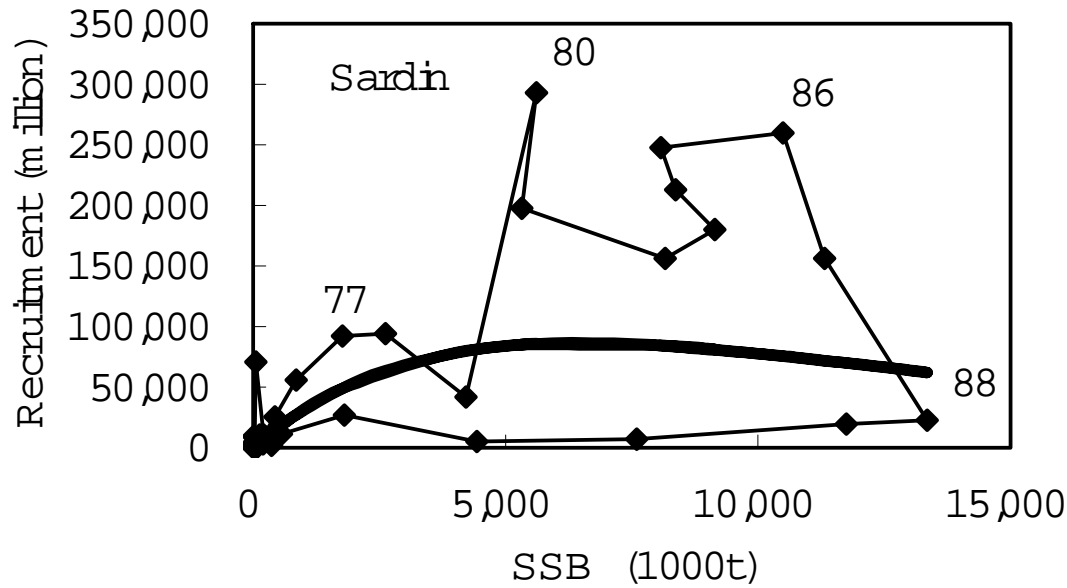

Spawning Stock Biomass and Recruitment of Sardine and Chub mackerel

$R \text{ per SSB} = f(\text{SSB}, \text{SST in key areas})$
but imperfect

Myctophids: Diel Vertical Migration and Feeding in Oyashio Area (Moku et al., 2000)

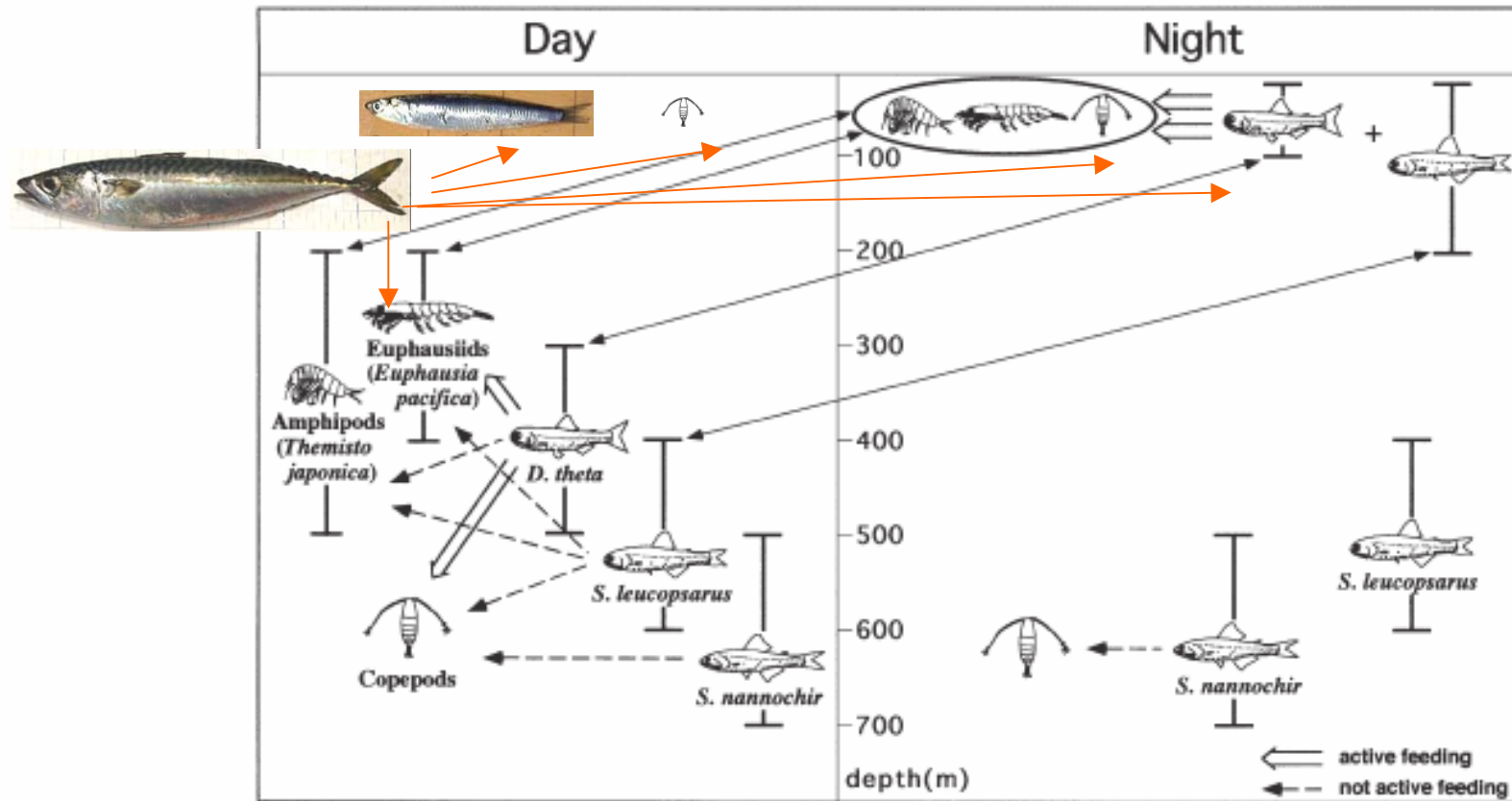
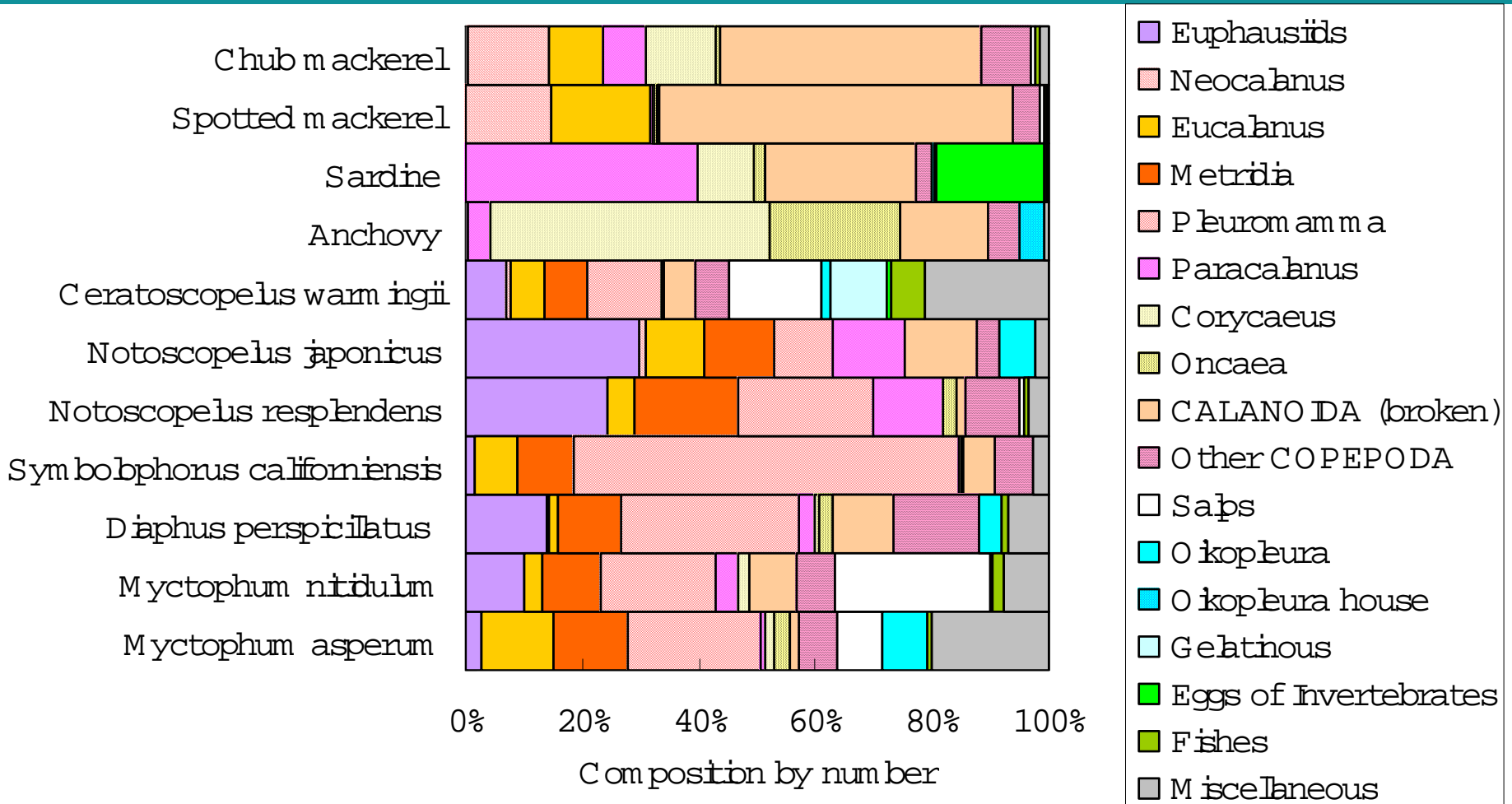
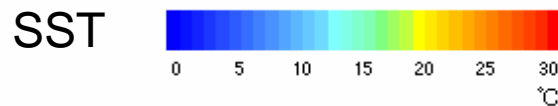
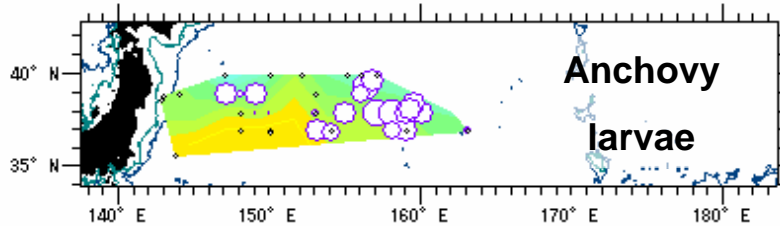
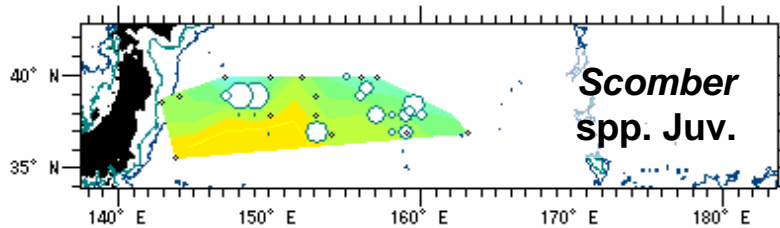
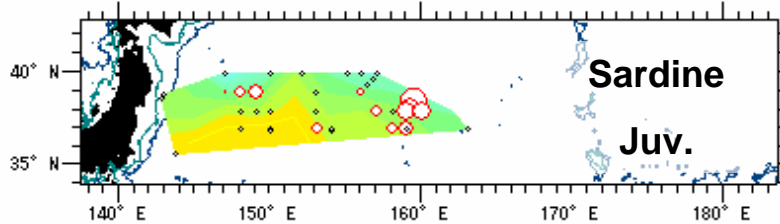

Fig. 9. *Diaphus theta*, *Stenobranchius leucopsarus*, and *S. nannochir*. Feeding habits and diel vertical migration patterns of the 3 myctophid fishes in the subarctic and transitional waters of the western North Pacific

Prey Composition of Juvenile Small Pelagic Fishes and Myctophids (ad.+juv.) in May 2002



CPUE (catch weight per a tow) of Small Pelagic Fishes and Myctophids (juv+ad) in 1999



1000m and 3000m isobath

