

17 cm Component Speaker Package

260 W MAX.

OPEN & SMOOTH™

Twaron®

The power of Aramid



Key Selling Point

- Twaron\*\* Aramid fiber cone reproduces deep and bold bass & bold vocal sound and also expresses even the most subtle nuances.
- Open & Smooth™ sound concept delivers open staging & smooth transition of driver response to provide the ultimate in-car sound.
- Included brackets\*\* provide for installation flexibility and wide coverage.

Speaker Technology

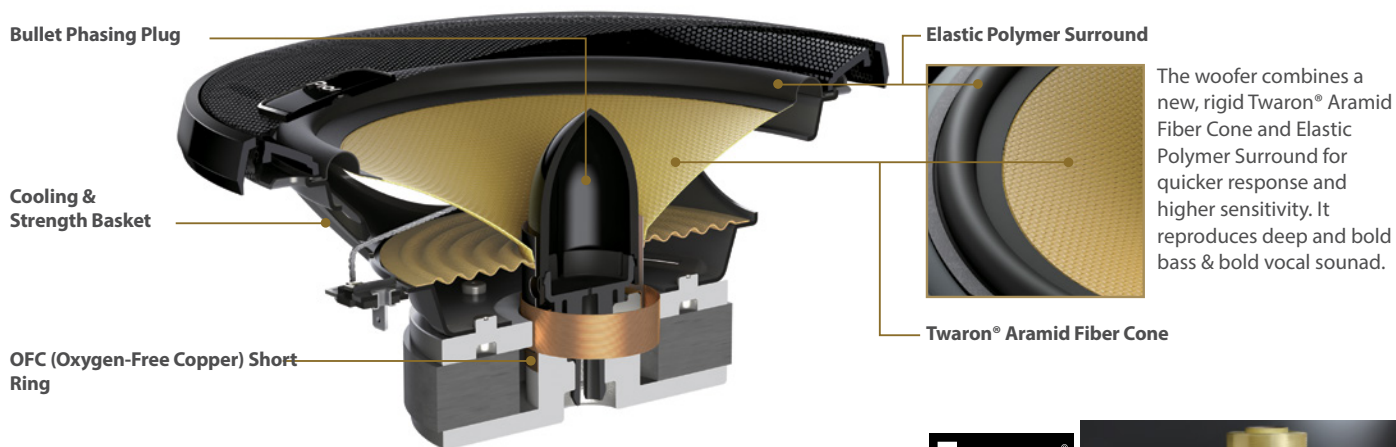

Twaron®  
The power of Aramid

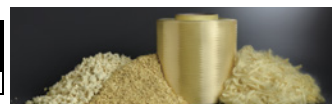

	<p>Open*</p>	<p>Open staging and sound characteristics enhance the widening effect that extends way beyond the space between speakers.</p>
	<p>Smooth*</p>	<p>With smooth transitions between mid-bass and tweeter frequency characteristics, sound from these speakers is not marred by crossover frequency dips.</p>

The new cone on the woofer of the Pioneer TS-D component offers a variety of improvements for optimal performance and phenomenal sound. The aramid fiber cone is constructed from Twaron® woven cloth that is hardened and shaped to produce a rigid and durable cone. The woofer offers stiffer dampening for quicker response. The woofer section of the TS-D component produces deep and bold bass & bold vocal sound.

\* Twaron® is a registered trade mark of Teijin Aramid BV.

With the "Open & Smooth" sound of Pioneer D-Series Speakers out on the open road, the journey to more dramatic in-car audio sensations moves every passenger in its natural, dynamic flow.

# A Superior Characteristic of D-Series: Smaller Dips for Wider Angles

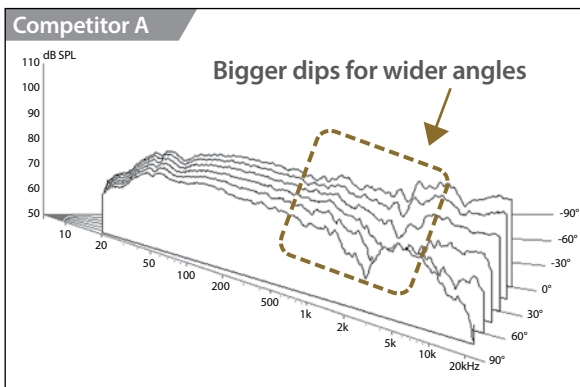
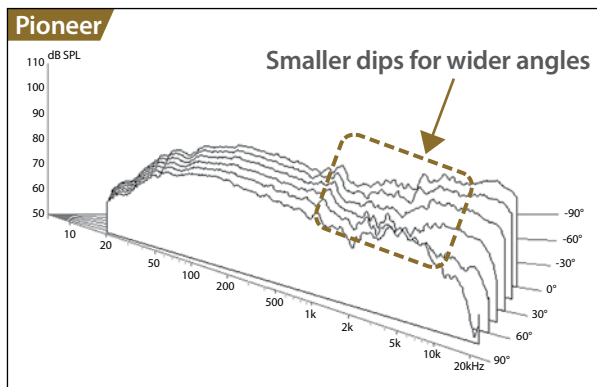

Unlike competitors' speakers, Pioneer D-Series speakers produce more natural sound without big gaps in the high-to-midrange frequency range for various angles.

## Tweeter

### Rear Chamber

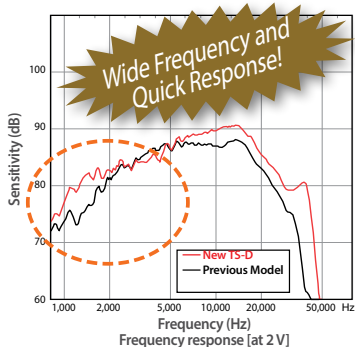

### Light Weight Soft Dome Diaphragm

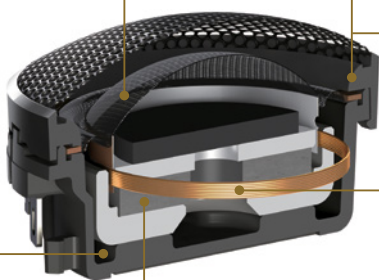

### Optimized Flange Shape

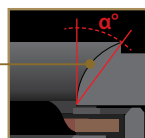

### CCA W (Copper-Clad Aluminum) Voice Coil

### Neodymium Magnet

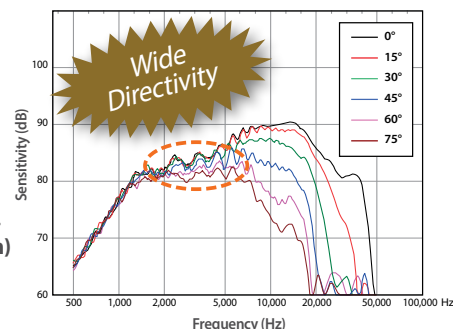

The flange is optimally shaped for wider directivity and reproduces steady sound.

The new D-Series components are capable of wider frequency sound and quicker response in playback than any models that preceded them.

## Brackets (for TS-D1730C)

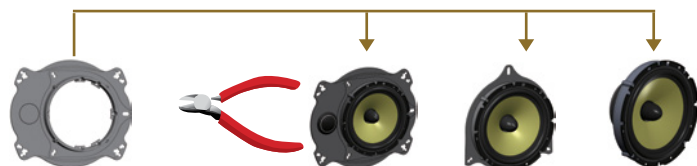

OEM-like multi-application

The included bracket can be cut as needed for flexible installation in various types of cars without having to cut vehicle doors.

### 23 Pole Tweeter

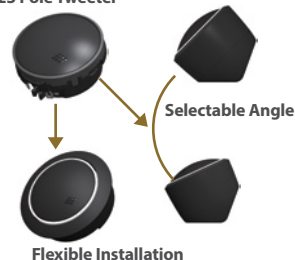

## Main Specifications

Max input	Nominal Input	Frequency Response	Sensitivity	Impedance	Size
260 W	60 W	27 Hz to 44 KHz	88dB	4Ω	17 cm

## Dimension

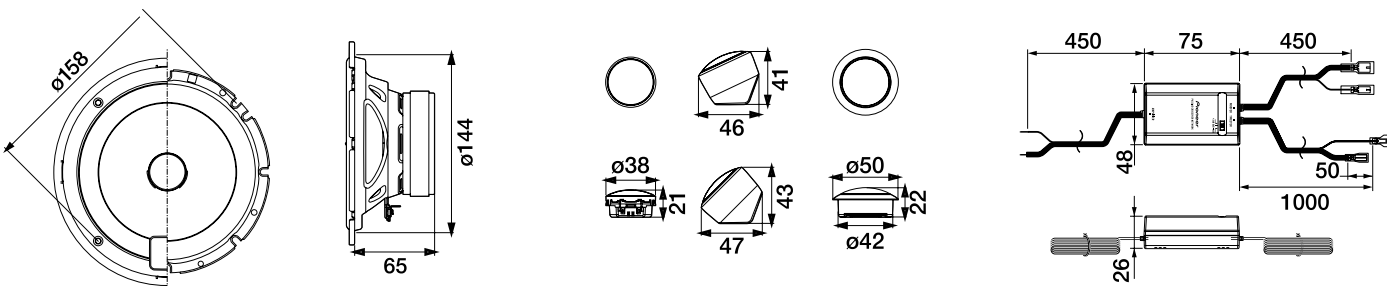

For more information please visit [www.pioneer-mea.com](http://www.pioneer-mea.com)

Year of Release: 2016

Pioneer, Gulf Free Zone Dubai, U.A.E.  
Tel: +971 4 8815756, Fax 8816414  
Email: support@pioneer-uae.com  
[www.pioneer-mea.com](http://www.pioneer-mea.com)

Corporate web : [www.pioneer.jp](http://www.pioneer.jp)

Copyright Info: ©2016 Pioneer MEA. All Rights Reserved. Reproduction in whole or in part without written permission is prohibited. Design, Features and Specifications are subject to change without notice.



DS - 2016/TS-D1730C