

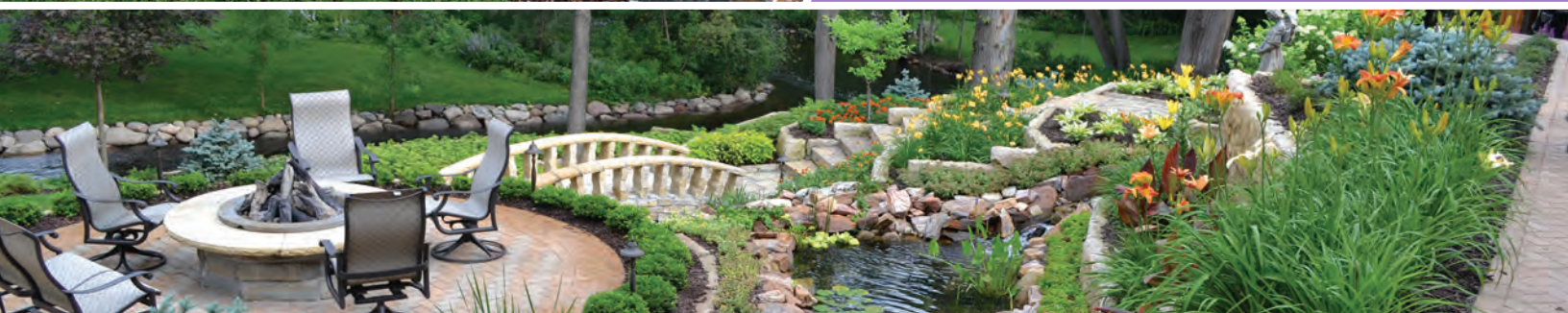

2019 Hardscapes Catalog



Bachman's™

WHOLESALE NURSERY & HARDSCAPES

BachmansWholesale.com

Hardscapes Cedar Acres | 23004 Cedar Ave. S., Farmington, MN 55024

(952) 469-9665 | Fax: (952) 469-9674

Bachman's™

WHOLESALE NURSERY & HARDSCAPES

To place your order, call

HARDSCAPES CEDAR ACRES
 23004 CEDAR AVE. S.
 FARMINGTON, MN 55024

952-469-9665 Fax 952-469-9674

cahardscapes@bachmans.com

FARMINGTON WHOLESALE NURSERY CENTER

651-463-3288 800-525-6641 Fax 651-463-4747

nurserysales@bachmans.com

Visit our website at
bachmanswholesale.com

HARDSCAPES HOURS OF OPERATION

March 11 - April 21

Monday - Friday 7:30 am - 4:00 pm

April 22 - June 29

Monday - Friday 7:30 am - 6:00 pm

Saturday 9:00 am - 3:00 pm

Sunday 10:00 am - 3:00 pm

- Open Memorial Day

June 30 - October 25

Monday - Friday 7:30 am - 5:00 pm

Saturday 8:00 am - 3:30 pm

- Open July 4th
- Closed Labor Day
- Hardscape center's Saturday store hours are subject to change after September
- Sufficient time must be allowed to complete loading by closing time.

WE'RE HERE TO HELP YOU

Kevin Becker	Manager - Hardscapes Center, ICPI/PICP kbecker@bachmans.com
Mark Calverley	Lead Sales mcalverley@bachmans.com
Kristi Fjerstad	Cedar Acres Supervisor kfjerstad@bachmans.com
Zack Fjerstad	Sales/Yard Operations, ICPI/NCMA zfjerstad@bachmans.com
Jesse Guillette	Yard Operations jguillette@bachmans.com
Loy Jeffrey	Nursery Coordinator - Customer Selections ljeffrey@bachmans.com
Aaron Mehus	Lead Sales, ICPI amehus@bachmans.com
Michael Phillion	Assistant Manager Hardscapes Cedar Acres, ICPI/PICP mphillion@bachmans.com
Tony Vogel	Assistant Manager Hardscapes Cedar Acres, PICP avogel@bachmans.com

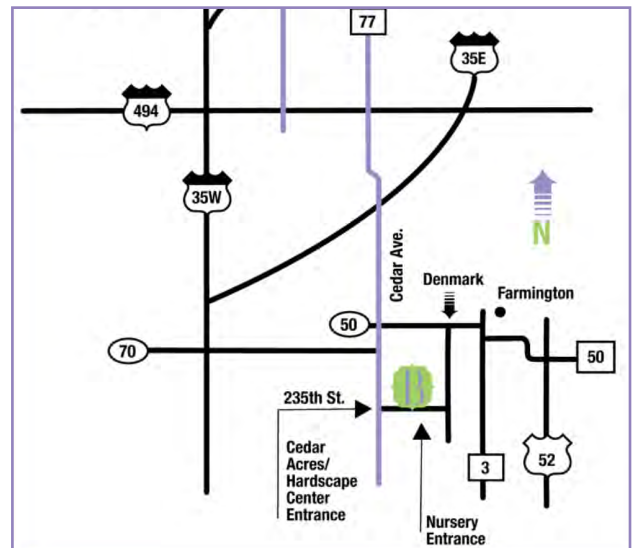

HARDSCAPES CEDAR ACRES
 23004 CEDAR AVE. S.
 FARMINGTON, MN 55024

Bachman's

WHOLESALE NURSERY & HARDSCAPES

Bachman's Hardscapes Cedar Acres would like to thank all of our customers for a successful but challenging 2018. In 2019 Bachman's Hardscapes Cedar Acres will again have increased in-stock material including being an "A" supplier for Belgard which guarantees select product to always be in stock.

On-time delivery, quality service, unsurpassed selection, and competitive pricing are just a few of the reasons why Bachman's Hardscapes Cedar Acres continues to be the first choice of contractors across the metro area. We thank you for making Bachman's your preferred hardscapes distributor. For larger or commercial projects remember to call your hardscapes salesperson for direct pricing. Again, we will be ready with the materials you need so you can deliver superior results to your customers.

This year we will again be presenting the Wholesale Hardscapes catalog in FULL COLOR. This feature will help you to identify items and make product selections more conveniently. New products will be highlighted by a *STAR BURST* icon throughout the catalog. Inside our catalog you will find the reliable and favored selection of products you have come to know and depend on. In addition, you will find many new items from trusted vendors including: Belgard, Rochester Concrete, Allan Block, County Materials, and Uni-Lock, and our EXCLUSIVE natural stone line from Banas Stones. Also new in our 2019 catalog are ads for industry supporting businesses. Be sure to support companies that support all of us. Our goal is to provide our customers with the largest inventory selection of concrete pavers, wall block, and natural stone in the metro area.

Bachman's Hardscapes Cedar Acres is your trusted supplier for all your hardscapes materials.

Thank you again for choosing Bachman's and we look forward to working with you in the 2019 season!

Sincerely,

Bachman's Hardscapes Staff

In the Catalog:

- ◆ New products will be highlighted by a *STAR BURST* icon through-out the catalog
- ◆ **FULL COLOR CATALOG**



Table of Contents

Description	Page
ADHESIVES	337
ALLAN BLOCK WALLS	11-24
ANCHOR (SEE BELGARD)	32-85
BASALT COLUMNS & FOUNTAINS	297, 389
BEACH PEBBLES	313
BANAS STONES NATURAL STONE PRODUCTS	264-279
BELGARD PAVERS / WALLS	33-85
BORGERT PAVERS / WALLS	88-129
BOULDERS	301-307
BULLNOSE COPING	53, 56, 58-59, 128, 133, 181, 183, 222, 265, 275
CHEMICALS and PESTICIDES	350-358
COUNTY MATERIALS PAVERS / WALLS	132-160
CREDIT APPLICATION	391-392
DIAMOND BLADES	370
DRAIN TILE and ACCESSORIES	344-346
EDGING-vinyl, paver, concrete, and stone & ACCESSORIES	85, 188, 288-289, 321-325, 338
EROSION CONTROL / SILT FENCE	370
FABRICS-geotextile, landscape, boulder, silt, and erosion control	326
FERTILIZERS	349-359
FIRE RINGS—concrete	226, 236-239
FIRE RINGS—natural stone	236
FIRE RINGS-metal	234-235, 239-240, 340-341
FIRE PLACE KITS	242-249
FLAGSTONE	289-294, 266-273
FOUNTAINS	261, 389
GATOR BASE	333
GEOGRID	333
GLOVES	372-374
GRASS SEED	349-350
KEYSTONE WALLS	25-29
LIGHTING	342-343
MULCH-bagged	315
MULCH-bulk	314
NATURAL WALLSTONE	283-287, 306
OUTCROPPINGS	301-307
OUTDOOR GREATROOM COMPANY	233
OUTDOOR KITCHEN/BAR	242-243, 250-261

Description	Page
PATTERNED FLAGSTONE	265-273, 293-294
PAVER RESTRAINT	322-323
PERGOLAS	233
PILLAR/PILLAR CAPS—natural stone & concrete	85, 128, 189- 223, 272, 298
POLY-6 mil black	327
POLYMERIC SAND	332
POND SUPPLIES	387-390
PORCELAIN PAVERS	53-58
RADIANT HEAT SNOW MELTING MATS	331
ROCK-bagged	313
ROCK-bulk	311-312
ROCHESTER CONCRETE PAVERS / WALLS	163-209
SAFETY GLASSES	371
SAND-bagged	312
SAND-bulk	312, 316
SEALERS and CLEANERS	334-336
SEAT WALL CAPS/BAR TOPS	81, 84, 190-200, 222, 239, 265, 275, 294
SILVER CREEK LANDSCAPE TILES	182-185
SOIL & SOIL AMENDMENTS-bagged	316, 350-358
SOIL & SOIL AMENDMENTS-bulk	316
SPECIALITY STONES and DEKORRA PRODUCTS	307-308
SPIKES	323
STAPLES	327
STEPPING STONES—concrete & exposed aggregate	339
STEPS-concrete	70, 84,129, 186-187, 206,233
STEPS-natural stone	277-278, 295-298
STEPPERS	185, 289-293
SPLASH PADS/PARKING KERBS	160
TARPS	375
TERMS, CONDITIONS, DELIVERY, and RETURNS POLICIES	4-7
TIMBERS	338
TOOLS	363-370, 375-384
TORPEDO BASE BLOCK	67
UNILOCK PAVERS & WALLS	213-230
V.I.P. INCENTIVE PROGRAM	3
WHEELBARROWS	375

2019 Hardscapes V.I.P. Program

Bachman's is your wholesale nursery and hardscapes leader. Bachman's Hardscapes Cedar Acres in Farmington is located on Cedar Ave adjacent to the Wholesale Nursery. Landscape contractors and alike have quickly discovered the convenience and efficiency of "one stop shopping" at Bachman's for both plants and hardscapes. We've got it all...so you can have it all and be back at your job site with everything the project requires. Of course if you need your materials delivered directly to your jobsite, we have the ability to deliver both your plants and hardscapes materials together— saving you time and money to keep your jobs efficient and smooth-sailing.

Our Hardscapes V.I.P. Program works just like our plant V.I.P. program, where you earn discounts based on your purchases the previous year. It gets even better: you not only earn discounts on your Hardscapes purchases, but your hardgoods purchases *also* count toward your plant V.I.P. purchase volume! It's a double-bonus program!

1. Earn your hardscapes V.I.P. discount for 2020 with all hardgoods products purchased in 2019*.
2. Earn credit towards your 2020 green goods V.I.P. discount with all hardscapes products purchased in 2019.

AMOUNT OF TOTAL HARDSCAPES PURCHASES	HARDSCAPES V.I.P. DISCOUNT
\$15,000 +	2%
\$30,000 +	3%
\$50,000 +	4%
\$100,000 +	5%
\$150,000 +	6%
\$200,000 +	7%
\$250,000 +	8%

* V.I.P. discount is not cumulative with sale items, specials, discontinued items, or factory direct pricing; Customer receives the V.I.P. discount *or* sale price *or* factory direct pricing, whichever discount is highest.

HARDSCAPES CENTER

- TERMS
- CONDITIONS OF SALE
- RETURN POLICIES
- DELIVERIES

TERMS

Scan here for
credit
application



NET 30 DAYS

Terms for established accounts are net 30 days. Bachman's Charge Account, Discover, MasterCard, and Visa are accepted. 1.5% per month will be charged on past due accounts. In the event additional terms would be needed, our credit department is available to assist you prior to shipment. When a balance goes beyond the third of the following month, additional credit extension will cease until other arrangements have been made with our credit department and all purchases will be on a C.O.D. basis until the overdue balance is paid in full.

CONDITIONS OF SALE

Scan here for
nursery
license
application



Wholesale Pricing Qualifications

This wholesale listing is offered to licensed nurseries, dealers, and landscape contractors. Hardscapes wholesale pricing is also available to hardscapes professionals who demonstrate proof of a hardscapes installation or sales business by providing Tax ID# or other proof of business in lieu of a nursery license. Wholesale hardscapes customers will be required to provide a nursery license to purchase plant materials at wholesale pricing. We do not quote wholesale prices or sell wholesale to retail customers.

Wholesale pricing is offered only at Cedar Acres and Nursery Wholesale (Farmington). Wholesale customers receive **20% off retail price on nursery stock only** at all other Bachman's locations; some exclusions apply.

F.O.B. Farmington, Minnesota

Prices quoted herein are F.O.B. our wholesale yard at Farmington, Minnesota.

Pricing

Prices are subject to change without notice. This catalog cancels all previous price lists. ***Bachman's Hardscapes is not responsible for catalog typographical errors***, manufacturer's misinformation, or any changes which occur after printing. Pricing and product information is represented to be as accurate and factual as possible at time of printing.

Scan here for
Minnesota
ST3



Sales Tax

Sales tax will be charged based on the local sales tax charged at the pick-up location, or the local sales tax of the delivery location for delivered product, unless a Minnesota ST3 Certificate of Exemption is on file with Bachman's.

Claims

Claims, for any cause, must be made within two business days of receipt of product. All shipments travel at purchaser's risk. Bachman's, Inc. warrants to the extent of the purchase price that products are true to name and as described within recognizable tolerances. Seller gives no other warranty, expressed or implied, and will, under no circumstances, be liable for more than the invoice value at the time of purchase.

Delivery and Pick-Up Information

- For prompt delivery service, orders must be placed a minimum of 24 hours prior to scheduled ship date. A \$50.00/hour charge will be billed for drivers having to wait to unload.
- Delivery Charges: Please call for current delivery rates to your location.
- Customer Pick-Up: To help us give you the best customer service possible, we encourage you to place your order online or via e-mail, fax, or phone.

Delivery Locations and Property Damage

- The customer is responsible to clearly identify the delivery location and to provide adequate, safe access to that location.
- Bachman's, Inc. will not be liable for any property damage resulting from normal truck, forklift, etc. activity.
- Any additional delivery charges incurred by Bachman's due to inadequate access or change of delivery location will be charged to the customer.

Guarantee of Color and Texture

Because of the inherent qualities of natural stone and concrete products, there is no implied guarantee of color, texture, etc. Concrete products may vary slightly in color from lot to lot. Natural stone products will vary in color, size, and texture.

Accuracy of Estimates

Estimating of product needs will be to the best of our ability with the information provided by the customer. Bachman's will not be responsible for the accuracy of these estimates.

RETURN POLICIES

Special Orders

- **All special orders must be prepaid.**
- Special orders must be picked up or delivered within two weeks of order ready date.
- There is no return or refund on special orders of natural stone or other non-stocked items.

Re-stock fee

- A re-stocking fee of 20% of the invoice amount will be charged for any returned product normally stocked in our yard.
- If the customer wants Bachman's to pick up the product to be returned, the customer is responsible for all delivery charges related to the return of said product.
- No returns will be accepted on non-stocked product, either full or partial pallets
- There are no refunds and no returns on bulk products or boulders
- Boulder delivery trucks may have a small amount of soil or sand in the bottom of the truck to protect the truck bed. This protective layer will be dumped with the boulders and will be the customer's responsibility.

Concrete Wall Products

- Clean, reusable, and resalable product (as determined by Bachman's) may be returned.
- A 20% restocking fee will be charged for returned product.
- There are no returns and no refunds for special order products.
- Products sold as "full pallets only" must be returned as such, i.e. full, unbroken factory pallets.

Pavers

- Clean, reusable, and resalable product (as determined by Bachman's) may be returned.
- A 20% restocking fee will be charged for returned product.
- Pavers must be purchased and/or returned in minimum increments of unbroken factory bands. (Note: Some tumbled pavers are not banded and do not have to be purchased or returned as such.)
- Paver circles may be returned only in complete factory packaged pallets.
- There are no returns and no refunds for special order products.

Natural Stone

- Clean, reusable, and resalable product (as determined by Bachman's) may be returned.
- A restocking fee will be charged for returned product as follows:

A 20% restocking fee will be charged for full, quarry-wrapped pallets.

A 50% restocking fee will be charged for partial natural stone pallets. Stone must be palletized separately by style, size, and color.

- There are no returns and no refunds for special order products.

NO RETURNS AFTER 45 DAYS FOR ANY ITEMS! NO EXCEPTIONS!

DELIVERY SERVICE

F.O.B Farmington, Minnesota:

Prices quoted herein are F.O.B. our wholesale yard at Farmington. Customers are encouraged to take advantage of our convenient, economical delivery service.

Delivery Rates:

Please call for delivery price quotes to your location. Prices may vary depending on location, type of product, type of delivery equipment required, and time required for unloading. **A fuel surcharge may be added to your invoice in 2019 depending on the cost of fuel.**

Lead Time:

Bachman's will make every effort to have product to your specified delivery location when you need it. Because of the many variables involved, Bachman's will not guarantee an exact delivery time. We will communicate to the best of our abilities to coordinate locations and times of deliveries. For prompt delivery service, order must be placed a minimum of 24 hours prior to the scheduled ship date.

Unloading Charges:

A \$50.00/hour charge may be billed for drivers having to wait to unload. When ordering palletized product, please let your Bachman's sales rep know if you have the capability to offload pallets or if you will require forklift service.

Delivery Locations and Property Damage:

The customer is responsible to clearly identify the delivery location and to provide adequate, safe access to that location. Bachman's, Inc. will not be liable for any property damage resulting from normal truck, forklift, etc. activity.

Manufacturer Direct:

For concrete paver and wall products you will receive manufacturer-direct pricing (F.O.B. manufacturer) when you pick up or have product delivered directly from the manufacturer. See catalog sections for minimum order requirements for F.O.B. pricing.

Amcon Block

Producers of Allan Block and Keystone Retaining Walls



allanblock.com

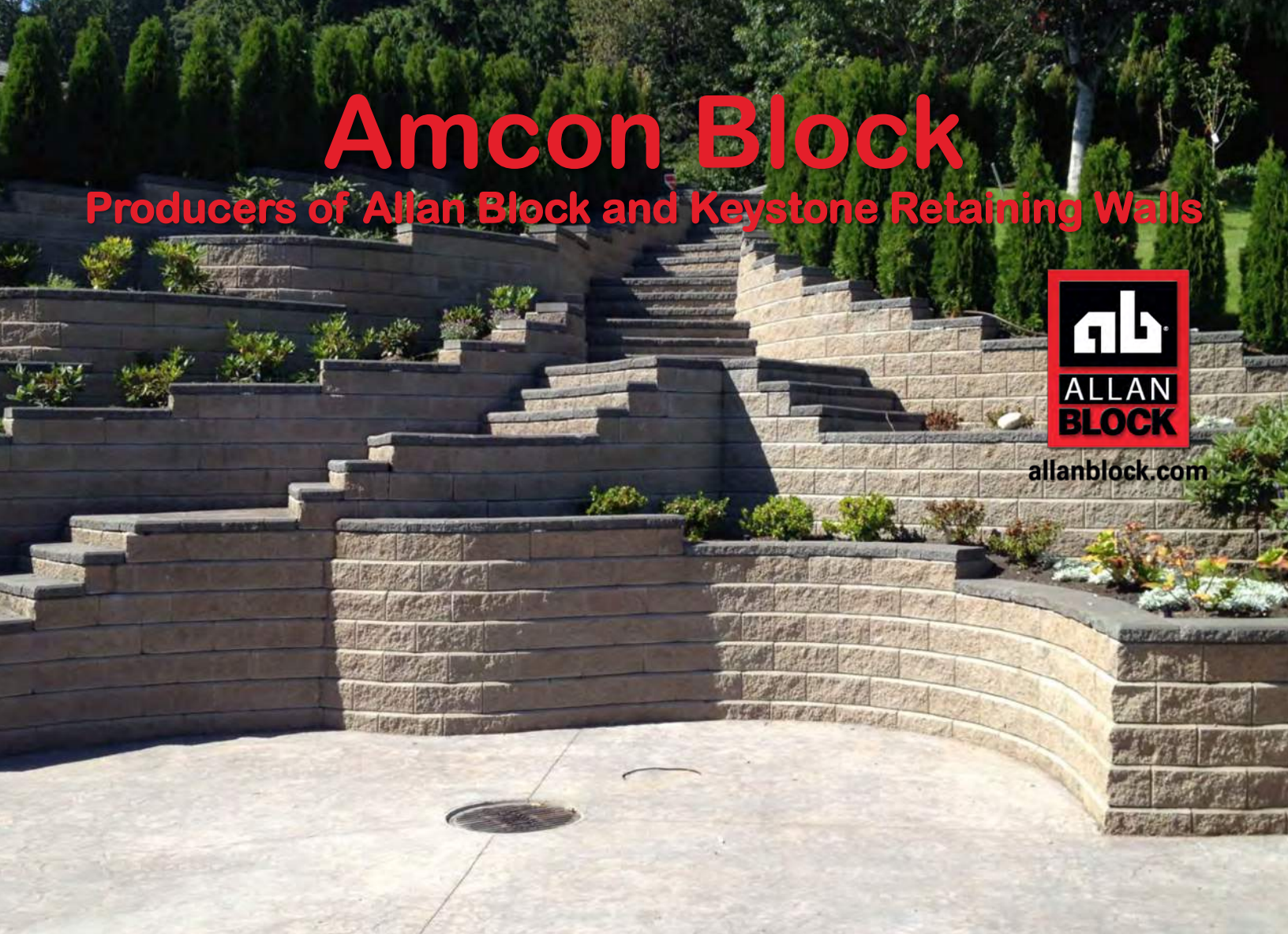

Section Contents

Description	Page
Allan Block Wall Blocks <ul style="list-style-type: none"> • AB Aztec Retaining Wall • AB Collection Retaining Wall • AB Courtyard Collection Seating Wall • AB Europa Collection Retaining Wall • AB Fence Collection • AB Fieldstone Collection Retaining Wall 	11-24 11-12 13-15 16-17 18-19 20-22 23-24
Keystone Retaining Walls <ul style="list-style-type: none"> • Keystone Compac • Intermediate II • Stonegate Contemporary • Regal Stone Pro 	25-29 25-26 27-28 29 29

Geotechnical Engineering Specializing in Retaining Walls for Residential & Commercial



- | | |
|--|--|
| <ul style="list-style-type: none"> • Block Wall Designs (Large & Small) • Reinforced Slope Design • Bridge/Abutment Design • Boulder Walls | <ul style="list-style-type: none"> • Soil Nail/Tie Back Retaining Walls • Soil Assessment • Material Estimates • Sound/Noise Walls |
|--|--|

Kyle Huerd, PE • 218.280.2465



allanblock.com



Design Book

AB Aztec™ Retaining Wall

Estimator App



Apple



Android



AB Aztec™ Classic—6° Setback

Yard Price:	\$9.95/Each	SKU	Color	Stock Location	Dimensions	7 $\frac{7}{8}$ "H x 17 $\frac{7}{8}$ "W x 11 $\frac{1}{8}$ "D
	\$9.95/SqFt	223276	Autumn Blend	Non-Stock	SF/Block	1
Factory Direct:	\$8.79/Each	223278	Shadow Blend	Non-Stock	SF/Pallet	32
	\$8.79/SqFt				Blocks/Pallet	32
					Weight/Block	80 Lbs
					Pallet Weight	2,446 Lbs

Create an Ashlar pattern by combining with the AB Junior Block, AB Lite Block, and AB Half Lite Block.

AB Aztec™ Junior—6° Setback

Yard Price:	\$6.35/Each	SKU	Color	Stock Location	Dimensions	7 $\frac{7}{8}$ "H x 8 $\frac{3}{4}$ "W x 9 $\frac{1}{2}$ "D
	\$12.70/SqFt	223288	Autumn Blend	Non-Stock	SF/Block	.5
Factory Direct:	\$5.81/Each	223290	Shadow Blend	Non-Stock	SF/Pallet	32
	\$11.62/SqFt				Blocks/Pallet	64
					Weight/Block	36 Lbs
					Pallet Weight	3,112 Lbs

- Factory Direct pricing on drop ship order or factory pick-up; FULL PALLETS only; minimum drop ship order is 10 pallets
- All products can be delivered anywhere in the metro area; all deliveries quoted individually for best rate; PLEASE CALL
- Please call for out-state and out-of-state delivery; special delivery quotes available
- Non-stocked product can be obtained quickly with advance notice, subject to factory availability
- 4136819: \$20 refundable pallet deposit on Allan Block pallets; **must have receipt when returning pallets for refund.**
- No broken pallet fees with Allan Block; **no returns on non-stock item orders**



allanblock.com



Design Book

AB Aztec™ Retaining Wall

Estimator App



Apple



Android

AB Aztec™ Retaining Wall

www.bachmanswholesale.com

AB Aztec™ Lite—6° Setback

Yard Price: \$6.55/Each \$13.10/SqFt	SKU	Color	Stock Location	Dimensions	3¼"H x 17⅝"W x 11⅞"D
	223280	Autumn Blend	Non-Stock	SF/Block	.5
	223282	Shadow Blend	Non-Stock	SF/Pallet	32
Factory Direct: \$5.81/Each \$11.61/SqFt				Blocks/Pallet	64
				Weight/Block	42 Lbs
				Pallet Weight	3,096 Lbs

AB Aztec™ Half Lite—6° Setback

Yard Price: \$3.75/Each \$15.00/SqFt	SKU	Color	Stock Location	Dimensions	3¾"H x 8¾"W x 9½"D
	223284	Autumn Blend	Non-Stock	SF/Block	.25
	223286	Shadow Blend	Non-Stock	SF/Pallet	32
Factory Direct: \$3.36/Each \$13.44/SqFt				Blocks/Pallet	128
				Weight/Block	23 Lbs
				Pallet Weight	3,112 Lbs

AB Aztec™ Corner

Yard Price: \$14.65/Each	SKU	Color	Stock Location	Dimensions	7⅝"H x 15⅝"W x 7⅝"D
	223292	Autumn Blend	Non-Stock	SF/Block	.83
	223294	Shadow Blend	Non-Stock	SF/Pallet	50
Factory Direct: \$13.28/Each				Blocks/Pallet	60 (30 Right, 30 Left)
				Weight/Block	53 Lbs
				Pallet Weight	3,112 Lbs

AB Aztec™ Cap

Yard Price: \$9.95/Each	SKU	Color	Stock Location	Dimensions	3¼"H x 17⅝"W x 11⅞"D
	223296	Autumn Blend	Non-Stock	LF/Cap	1.46
	223300	Shadow Blend	Non-Stock	LF/Pallet	46.72
Factory Direct: \$8.90/Each				Caps/Pallet	32
				Weight/Cap	59 Lbs
				Pallet Weight	1,928 Lbs



allanblock.com



Design Book

AB Collection Retaining Wall

Estimator App



Apple



Android

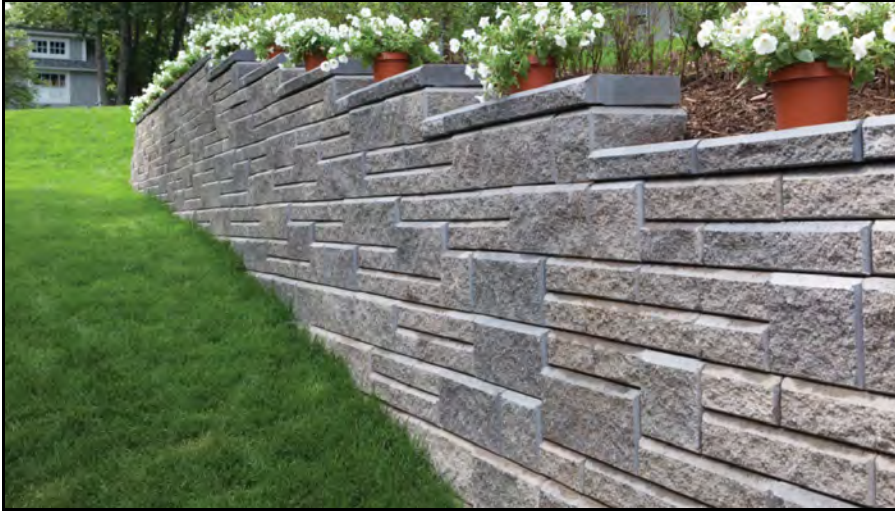

AB Classic Block—6° Setback

Yard Price: \$9.25/Each \$9.25/SqFt	SKU	Color	Stock Location	Dimensions	7 ⁵ / ₈ "H x 17 ⁷ / ₈ "W x 11 ¹ / ₈ "D
	Factory Direct: \$8.00/Each \$8.00/SqFt	2980483	Autumn	Non-Stock	SF/Block
3722044		Charcoal	Non-Stock	SF/Pallet	32
	3722037	Coffee	Non-Stock	Blocks/Pallet	32
	2768821	Gray	Non-Stock	Weight/Block	80 Lbs
	3722051	Harvest	Non-Stock	Pallet Weight	2,578 Lbs
	2768906	Oak	Non-Stock	Create an Ashlar pattern by combining with the AB Junior Block, AB Lite, and AB Junior Lite.	
	2980469	Riviera	Non-Stock		
	2768982	Salmon	Non-Stock		
	2980476	Shadow	Non-Stock		

AB Junior Block—6° Setback

Yard Price: \$5.85/Each \$11.70/SqFt	SKU	Color	Stock Location	Dimensions	7 ⁵ / ₈ "H x 8 ³ / ₄ "W x 9 ¹ / ₂ "D
	Factory Direct: \$5.14/Each \$10.28/SqFt	2980643	Autumn	Special Order	SF/Block
3722549		Charcoal	Special Order	SF/Pallet	40
	3722532	Coffee	Special Order	Blocks/Pallet	80
	2770442	Gray	Special Order	Weight/Block	35 Lbs
	3722594	Harvest	Special Order	Pallet Weight	2,824 Lbs
	2770473	Oak	Special Order		
	2770497	Riviera	Special Order		
	3723041	Salmon	Special Order		
	2980629	Shadow	Special Order		

- Factory Direct pricing on drop ship order or factory pick-up; FULL PALLETS only; minimum drop ship order is 10 pallets
- All products can be delivered anywhere in the metro area; all deliveries quoted individually for best rate; PLEASE CALL
- Please call for out-state and out-of-state delivery; special delivery quotes available
- Non-stocked product can be obtained quickly with advance notice, subject to factory availability
- 4136819: \$20 refundable pallet deposit on Allan Block pallets; **must have receipt when returning pallets for refund.**
- No broken pallet fees with Allan Block; **no returns on non-stock item orders**



allanblock.com



Design Book

AB Collection Retaining Wall

Estimator App



Apple



Android

AB Collection Retaining Wall

www.bachmanswholesale.com

AB Lite—6° Setback

Yard Price: \$5.95/Each \$11.90/SqFt		SKU	Color	Stock Location	Dimensions	3¾"H x 17½"W x 11⅞"D
		2980704	Autumn	Non-Stock	SF/Block	.5
		2770602	Gray	Non-Stock	SF/Pallet	32
		3722600	Harvest	Non-Stock	Blocks/Pallet	64
		2770633	Oak	Non-Stock	Weight/Block	42 Lbs
		2770664	Riviera	Non-Stock	Pallet Weight	2,728 Lbs
Factory Direct: \$5.28/Each \$10.56/SqFt		2980667	Shadow	Non-Stock		

AB Half Lite—6° Setback

Yard Price: \$5.80/Each \$23.20/SqFt		SKU	Color	Stock Location	Dimensions	3¾"H x 8¾"W x 9½"D
		2980766	Autumn	Special Order	SF/Block	.25
		2770763	Gray	Special Order	SF/Pallet	32
		3722730	Harvest	Special Order	Blocks/Pallet	128
		2770787	Oak	Special Order	Weight/Block	23 Lbs
		3722716	Riviera	Special Order	Pallet Weight	2,728 Lbs
Factory Direct: \$5.28/Each \$21.12/SqFt		2980728	Shadow	Special Order		

AB Corner Block

Yard Price: \$13.40/Each		SKU	Color	Stock Location	Dimensions	7¾"H x 15¾"W x 7¾"D
		2980193	Autumn	Non-Stock	SF/Block	.83
		3722280	Charcoal	Non-Stock	SF/Pallet	50
		3722259	Coffee	Non-Stock	Blocks/Pallet	60 (30 Right, 30 Left)
		2769200	Gray	Non-Stock	Weight/Block	54 Lbs
		3722426	Harvest	Non-Stock	Pallet Weight	3,244 Lbs
		2769224	Oak	Non-Stock		
		2770879	Riviera	Non-Stock		
		3722228	Salmon	Non-Stock		
Factory Direct: \$12.07/Each		2980094	Shadow	Non-Stock		

AB Capstone

Yard Price: \$9.25/Each		SKU	Color	Stock Location	Dimensions	3¾"H x 17½"W x 11⅞"D
		2980261	Autumn	Non-Stock	LF/Cap	1.46
		3722518	Charcoal	Non-Stock	LF/Pallet	46.72
		3722488	Coffee	Non-Stock	Caps/Pallet	32
		2769354	Gray	Non-Stock	Weight/Cap	59 Lbs
		3722525	Harvest	Non-Stock	Pallet Weight	1,928 Lbs
		2769378	Oak	Non-Stock		
		2771586	Riviera	Non-Stock		
		2769477	Salmon	Non-Stock		
Factory Direct: \$8.00/Each		2980247	Shadow	Non-Stock		



allanblock.com



Design Book

AB Collection Retaining Wall

Estimator App





Apple



Android

AB Stones—12° Setback						
Yard Price: \$9.25/Each \$9.25/SqFt		SKU	Color	Stock Location	Dimensions	7 $\frac{7}{8}$ "H x 17 $\frac{7}{8}$ "W x 11 $\frac{1}{8}$ "D
Factory Direct: \$8.00/Each \$8.00/SqFt		2768753	Gray	Special Order	SF/Block	1
		2768760	Oak	Special Order	SF/Pallet	32
 <p>Best choice for building AB Collection walls with a single block.</p>					Blocks/Pallet	32
					Weight/Block	79 Lbs
					Pallet Weight	2,581 Lbs

AB Vertical—3° Setback						
Yard Price: \$9.25/Each \$9.25/SqFt		SKU	Color	Stock Location	Dimensions	7 $\frac{7}{8}$ "H x 17 $\frac{7}{8}$ "W x 11 $\frac{1}{8}$ "D
Factory Direct: \$8.00/Each \$8.00/SqFt		3722150	Gray	Special Order	SF/Block	1
		3722167	Oak	Special Order	SF/Pallet	32
 <p>Best choice for building vertical AB Collection walls.</p>					Blocks/Pallet	32
					Weight/Block	79 Lbs
					Pallet Weight	2,559 Lbs

AB Rocks—6° Setback						
Yard Price: \$9.25/Each \$9.25/SqFt		SKU	Color	Stock Location	Dimensions	7 $\frac{7}{8}$ "H x 17 $\frac{7}{8}$ "W x 11 $\frac{1}{8}$ "D
Factory Direct: \$8.00/Each \$8.00/SqFt		2769071	Charcoal	Special Order	SF/Block	1
		3722075	Coffee	Special Order	SF/Pallet	32
		2769026	Gray	Special Order	Blocks/Pallet	32
		3686797	Oak	Special Order	Weight/Block	75 Lbs
		3722068	Salmon	Special Order	Pallet Weight	2,440 Lbs
 <p>Best choice for building AB Collection walls with a tri-face block.</p>						

- Factory Direct pricing on drop ship order or factory pick-up; FULL PALLETS only; minimum drop ship order is 10 pallets
- All products can be delivered anywhere in the metro area; all deliveries quoted individually for best rate; PLEASE CALL
- Please call for out-state and out-of-state delivery; special delivery quotes available
- Non-stocked product can be obtained quickly with advance notice, subject to factory availability
- 4136819: \$20 refundable pallet deposit on Allan Block pallets; *must have receipt when returning pallets for refund.*
- No broken pallet fees with Allan Block; *no returns on non-stock item orders*



allanblock.com



Design Book

AB Courtyard Collection Seating Wall

Estimator App



Apple





Android



AB Courtyard Collection

www.bachmanswholesale.com

AB Dublin Block						
	SKU	Color	Stock Location	Dimensions	6"H x 16½"W x 7"D	
Courtyard					SF/Block	.7
Yard Price: \$6.70/Each \$9.57/SqFt	2772040	Autumn	Non-Stock	SF/Pallet	33	
	2772033	Shadow	Non-Stock	Blocks/Pallet	48	
Factory Direct: \$5.85/Each \$8.36/SqFt				Weight/Block	43 Lbs	
				Pallet Weight	2,100 Lbs	
Old Country Courtyard—Tumbled Look						
Yard Price: \$8.80/Each \$12.57/SqFt	2772781	Autumn	Special Order			
	2772774	Shadow	Special Order			
Factory Direct: \$7.75/Each \$11.07/SqFt	Allow 1-2 week lead-time					

AB York Block						
	SKU	Color	Stock Location	Dimensions	Front: 6"H x 7½"W x 9"D Back: 6"H x 7"W x 9"D	
Courtyard					SF/Block	.3
Yard Price: \$3.50/Each \$11.67/SqFt	2771975	Autumn	Non-Stock	SF/Pallet	28.8	
	2771951	Shadow	Non-Stock	Blocks/Pallet	96	
Factory Direct: \$3.04/Each \$10.13/SqFt				Weight/Block	21 Lbs	
				Pallet Weight	2,066 Lbs	
Old Country Courtyard—Tumbled Look						
Yard Price: \$5.15/Each \$17.17/SqFt	2772743	Autumn	Special Order			
	2772736	Shadow	Special Order			
Factory Direct: \$4.60/Each \$15.33/SqFt	Allow 1-2 week lead-time					

- Factory Direct pricing on drop ship order or factory pick-up; FULL PALLETS only; minimum drop ship order is 10 pallets
- All products can be delivered anywhere in the metro area; all deliveries quoted individually for best rate; PLEASE CALL
- Please call for out-state and out-of-state delivery; special delivery quotes available
- Non-stocked product can be obtained quickly with advance notice, subject to factory availability
- 4136819: \$20 refundable pallet deposit on Allan Block pallets; **must have receipt when returning pallets for refund.**
- No broken pallet fees with Allan Block; **no returns on non-stock item orders**



allanblock.com



Design Book

AB Courtyard Collection Seating Wall

Estimator App



Apple



Android

AB Courtyard Corner Block

	SKU	Color	Stock Location	Dimensions	Front: 6"H x 15½"W x 7"D Back: 6"H x 14¼"W x 7"D
Courtyard					
Yard Price: \$8.50/Each	2772118	Autumn	Non-Stock	SF/Block	.65
	2772101	Shadow	Non-Stock	SF/Pallet	39
Factory Direct: \$7.58/Each				Blocks/Pallet	60 (30 Right, 30 Left)
				Weight/Block	43 Lbs
Old Country Courtyard—Tumbled Look					
Yard Price: \$12.85/Each	2772828	Autumn	Special Order	Pallet Weight	2,644 Lbs
	2772811	Shadow	Special Order		
Factory Direct: \$11.72/Each					

AB Courtyard/Old Country Wall Cap

	SKU	Color	Stock Location	Dimensions	Front: 3½"H x 9¼"W x 10"D Back: 3½"H x 7¼"W x 10"D
Yard Price: \$3.15/Each	2772569	Autumn	Non-Stock	LF/Cap	.688
Factory Direct: \$2.71/Each	2772552	Shadow	Non-Stock	LF/Pallet	55
				Caps/Pallet	80
				Weight/Cap	23 Lbs
				Pallet Weight	1,872 Lbs

AB Courtyard/Old Country Post Cap

	SKU	Color	Stock Location	Dimensions	Front: 3½"H x 24"W x 12"D
Yard Price: \$13.15/Each	2772606	Autumn	Non-Stock	Coverage	2 Caps/Column
Factory Direct: \$11.33/Each	2772590	Shadow	Non-Stock	Coverage/Pallet	12 Columns Capped
				Caps/Pallet	24
				Weight/Cap	78 Lbs
				Pallet Weight	1,903 Lbs

- Factory Direct pricing on drop ship order or factory pick-up; FULL PALLETS only; minimum drop ship order is 10 pallets
- All products can be delivered anywhere in the metro area; all deliveries quoted individually for best rate; PLEASE CALL
- Please call for out-state and out-of-state delivery; special delivery quotes available
- Non-stocked product can be obtained quickly with advance notice, subject to factory availability
- 4136819: \$20 refundable pallet deposit on Allan Block pallets; **must have receipt when returning pallets for refund.**
- No broken pallet fees with Allan Block; **no returns on non-stock item orders**



allanblock.com



Design Book

AB Europa Collection Retaining Wall

Estimator App



Apple



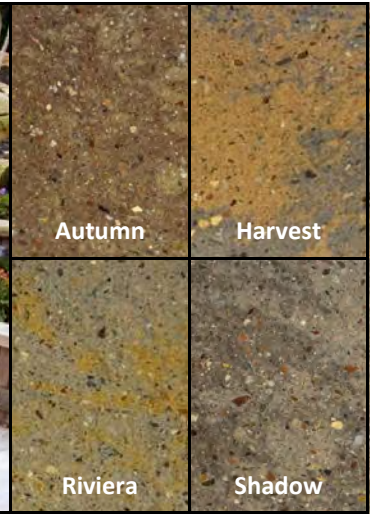

Android



AB Europa Collection

www.bachmanswholesale.com

AB Dover Block—6° Setback						
Yard Price: \$13.60/Each \$13.60/SqFt		SKU	Color	Stock Location	Dimensions	7 ⁵ / ₈ "H x 17 ³ / ₈ "W x 10 ¹ / ₂ "D
		2769729	Autumn	Special Order	SF/Block	1
		2769736	Harvest	Special Order	SF/Pallet	32
		3400027	Riviera	Special Order	Blocks/Pallet	32
		2769712	Shadow	Special Order	Weight/Block	84 Lbs
				Pallet Weight	2,719 Lbs	

AB Palermo Block—6° Setback						
Yard Price: \$7.25/Each \$14.50/SqFt		SKU	Color	Stock Location	Dimensions	7 ⁵ / ₈ "H x 8 ³ / ₄ "W x 10 ¹ / ₂ "D
		2769750	Autumn	Special Order	SF/Block	.5
		2769767	Harvest	Special Order	SF/Pallet	32
		3400041	Riviera	Special Order	Blocks/Pallet	64
		2769743	Shadow	Special Order	Weight/Block	40 Lbs
				Pallet Weight	2,549 Lbs	

- Factory Direct pricing on drop ship order or factory pick-up; FULL PALLETS only; minimum drop ship order is 10 pallets
- All products can be delivered anywhere in the metro area; all deliveries quoted individually for best rate; PLEASE CALL
- Please call for out-state and out-of-state delivery; special delivery quotes available
- Non-stocked product can be obtained quickly with advance notice, subject to factory availability
- 4136819: \$20 refundable pallet deposit on Allan Block pallets; **must have receipt when returning pallets for refund.**
- No broken pallet fees with Allan Block; **no returns on non-stock item orders**



allanblock.com



Design Book

AB Europa Collection Retaining Wall

Estimator App



Apple



Android

AB Barcelona Block—3° Setback

Yard Price: \$8.40/Each \$16.80/SqFt	SKU	Color	Stock Location	Dimensions	3¾"H x 17⅝"W x 10½"D
	2769798	Autumn	Special Order	SF/Block	.5
Factory Direct: \$7.57/Each \$15.14/SqFt	2769804	Harvest	Special Order	SF/Pallet	32
	3400065	Riviera	Special Order	Blocks/Pallet	64
	2769781	Shadow	Special Order	Weight/Block	42 Lbs
				Pallet Weight	2,728 Lbs

AB Bordeaux Block—3° Setback

Yard Price: \$3.55/Each \$14.20/SqFt	SKU	Color	Stock Location	Dimensions	3¾"H x 8¾"W x 10½"D
	2769972	Autumn	Special Order	SF/Block	.25
Factory Direct: \$3.15/Each \$12.60/SqFt	2769996	Harvest	Special Order	SF/Pallet	32
	3400102	Riviera	Special Order	Blocks/Pallet	128
	2769965	Shadow	Special Order	Weight/Block	21 Lbs
				Pallet Weight	2,728 Lbs

AB Europa Corner Block—6° Setback

Yard Price: \$17.20/Each	SKU	Color	Stock Location	Dimensions	7⅝"H x 15⅝"W x 7¾"D
	2770046	Autumn	Special Order	SF/Block	.83
Factory Direct: \$15.53/Each	2770060	Harvest	Special Order	SF/Pallet	50
	3400164	Riviera	Special Order	Blocks/Pallet	60 (30 Right, 30 Left)
	2770039	Shadow	Special Order	Weight/Block	54 Lbs
				Pallet Weight	3,244 Lbs

AB Europa Capstone—6° Setback

Yard Price: \$13.70/Each	SKU	Color	Stock Location	Dimensions	4"H x 18"W x 11"D
	2770107	Autumn	Special Order	LF/Cap	1.5
Factory Direct: \$12.21/Each	2770114	Harvest	Special Order	LF/Pallet	48
	3400218	Riviera	Special Order	Caps/Pallet	32
	2770091	Shadow	Special Order	Weight/Cap	61 Lbs
				Pallet Weight	1,992 Lbs

AB Europa Collection

www.bachmanswholesale.com



allanblock.com



Design Book

AB Fence Collection

Estimator App



Apple



Android



AB Fence Panel Block

Solids	SKU	Color	Stock Location	Dimensions	7 $\frac{7}{8}$ "H x 17 $\frac{7}{8}$ "W x 6"D
Yard Price: \$6.15/Each \$6.15/SqFt	2772927	Autumn (Blend)	Special Order	SF/Block	1
	3722808	Gray (Solid)	Special Order	SF/Pallet	64
Factory Direct: \$5.31/Each \$5.31/SqFt	3722815	Oak (Solid)	Special Order	Blocks/Pallet	64
	3722822	Shadow (Blend)	Special Order	Weight/Block	47.75 Lbs
				Pallet Weight	3,096 Lbs
Blends				CALL FOR LEAD-TIME	
Yard Price: \$8.45/Each \$8.45/SqFt					
Factory Direct: \$7.46/Each \$7.46/SqFt					

AB Fence Post Block

Solids	SKU	Color	Stock Location	Dimensions	7 $\frac{7}{8}$ "H x 18"W x 12"D
Yard Price: \$8.80/Each \$8.80/SqFt	2772880	Autumn (Blend)	Special Order	SF/Block	1
	3722761	Gray (Solid)	Special Order	SF/Pallet	32
Factory Direct: \$7.46/Each \$7.46/SqFt	3722778	Oak (Solid)	Special Order	Blocks/Pallet	32
	3722785	Shadow (Blend)	Special Order	Weight/Block	75.2 Lbs
				Pallet Weight	2,446 Lbs
Blends				CALL FOR LEAD-TIME	
Yard Price: \$11.55/Each \$11.55/SqFt					
Factory Direct: \$10.04/Each \$10.04/SqFt					

- Factory Direct pricing on drop ship order or factory pick-up; FULL PALLETS only; minimum drop ship order is 10 pallets
- All products can be delivered anywhere in the metro area; all deliveries quoted individually for best rate; PLEASE CALL
- Please call for out-state and out-of-state delivery; special delivery quotes available
- Non-stocked product can be obtained quickly with advance notice, subject to factory availability
- 4136819: \$20 refundable pallet deposit on Allan Block pallets; **must have receipt when returning pallets for refund.**
- No broken pallet fees with Allan Block; **no returns on non-stock item orders**



allanblock.com



Design Book

AB Fence Collection

Estimator App



Apple



Android

AB Fence Panel Half Block							
Solids	SKU	Color	Stock Location	Dimensions	7 ³ / ₈ " H x 8 ³ / ₄ " W x 6" D		
Yard Price: \$4.25/Each \$8.50/SqFt	2772965	Autumn (Blend)	Special Order	SF/Block	.5		
	3722839	Gray (Solid)	Special Order	SF/Pallet	64		
Factory Direct: \$3.74/Each \$7.48/SqFt	3722846	Oak (Solid)	Special Order	Blocks/Pallet	128		
	3722853	Shadow (Blend)	Special Order	Weight/Block	24 Lbs		
Blends				Pallet Weight	3,112 Lbs		
				CALL FOR LEAD-TIME			
						Yard Price: \$5.85/Each \$11.70/SqFt	
						Factory Direct: \$5.24/Each \$10.48/SqFt	

AB Fence Panel Lite Block							
Solids	SKU	Color	Stock Location	Dimensions	3 ³ / ₄ " H x 17 ⁷ / ₈ " W x 6" D		
Yard Price: \$5.50/Each \$11.00/SqFt	3549986	Autumn (Blend)	Special Order	SF/Block	.5		
	3549979	Gray (Solid)	Special Order	SF/Pallet	64		
Factory Direct: \$4.93/Each \$9.86/SqFt	3549962	Oak (Solid)	Special Order	Blocks/Pallet	128		
	3549993	Shadow (Blend)	Special Order	Weight/Block	24 Lbs		
Blends				Pallet Weight	3,112 Lbs		
				CALL FOR LEAD-TIME			
						Yard Price: \$7.60/Each \$15.20/SqFt	
						Factory Direct: \$6.89/Each \$13.78/SqFt	

AB Fence Panel Half Lite Block							
Solids	SKU	Color	Stock Location	Dimensions	3 ³ / ₄ " H x 8 ³ / ₄ " W x 6" D		
Yard Price: \$3.85/Each \$15.40/SqFt	3966172	Autumn (Blend)	Special Order	SF/Block	.25		
	3966158	Gray (Solid)	Special Order	SF/Pallet	64		
Factory Direct: \$3.51/Each \$14.04/SqFt	3966134	Oak (Solid)	Special Order	Blocks/Pallet	256		
	3966196	Shadow (Blend)	Special Order	Weight/Block	12 Lbs		
Blends				Pallet Weight	3,112 Lbs		
				CALL FOR LEAD-TIME			
						Yard Price: \$6.00/Each \$24.00/SqFt	
						Factory Direct: \$5.54/Each \$22.16/SqFt	

- Factory Direct pricing on drop ship order or factory pick-up; FULL PALLETS only; minimum drop ship order is 10 pallets
- All products can be delivered anywhere in the metro area; all deliveries quoted individually for best rate; PLEASE CALL
- Please call for out-state and out-of-state delivery; special delivery quotes available
- Non-stocked product can be obtained quickly with advance notice, subject to factory availability
- 4136819: \$20 refundable pallet deposit on Allan Block pallets; **must have receipt when returning pallets for refund.**
- No broken pallet fees with Allan Block; **no returns on non-stock item orders**



allanblock.com



Design Book

AB Fence Collection

Estimator App



Apple



Android

AB Fence Collection

AB Fence Corner Block

Solids	SKU	Color	Stock Location	Dimensions	7 7/8" H x 12" W x 12" D	
Yard Price: \$8.50/Each	3723034	Autumn (Blend)	Special Order	SF/Block	1.33	
	3722983	Gray (Solid)	Special Order	SF/Pallet	64	
Factory Direct: \$7.46/Each	3722990	Oak (Solid)	Special Order	Blocks/Pallet	48	
	3723027	Shadow (Blend)	Special Order	Weight/Block	53.25 Lbs	
Blends				Pallet Weight	2,596 Lbs	
Yard Price: \$11.25/Each				CALL FOR LEAD-TIME		
Factory Direct: \$10.04/Each						

AB Fence Cap

Solids	SKU	Color	Stock Location	Dimensions	5" H x 18" W x 12" D	
Yard Price: \$8.70/Each	2773023	Autumn (Blend)	Special Order	LF/Block	1.5	
	3722877	Gray (Solid)	Special Order	LF/Pallet	72	
Factory Direct: \$7.46/Each	3722891	Oak (Solid)	Special Order	Caps/Pallet	48	
	3722914	Shadow (Blend)	Special Order	Weight/Cap	66.5 Lbs	
Blends				Pallet Weight	3,232 Lbs	
Yard Price: \$11.40/Each				CALL FOR LEAD-TIME		
Factory Direct: \$10.04/Each						



Amcon Ledgerock® now available.
Please call 952-469-9665 for pricing and details.

- Factory Direct pricing on drop ship order or factory pick-up; FULL PALLETS only; minimum drop ship order is 10 pallets
- All products can be delivered anywhere in the metro area; all deliveries quoted individually for best rate; PLEASE CALL
- Please call for out-state and out-of-state delivery; special delivery quotes available
- Non-stocked product can be obtained quickly with advance notice, subject to factory availability
- 4136819: \$20 refundable pallet deposit on Allan Block pallets; **must have receipt when returning pallets for refund.**
- No broken pallet fees with Allan Block; **no returns on non-stock item orders**

www.bachmanswholesale.com



allanblock.com



Design Book

AB Fieldstone Sierra Collection Retaining Wall

Estimator App



Apple



Android



AB Fieldstone Sierra 812 Block—Pricing Includes Face Panel and Anchor					
812 Short	SKU	Color	Stock Location	Dimensions	8"H x 12"W x 12¼"D
Yard Price: \$10.50/Each	812 Short			SF/Block	.66
	4174040	Glacier Bay	Non-Stock	SF/Pallet	66
Factory Direct: \$9.07/Each	4174033	Sandstone	Non-Stock	Blocks/Pallet	100 Face Panels 96 Anchors
812 Long	812 Long			Weight/Block	Face Panel: 30 Lbs Anchor: 32 Lbs Total Unit: 62 Lbs
	147014	Glacier Bay	Non-Stock		
Yard Price: \$12.25/Each	147016	Sandstone	Non-Stock		
Factory Direct: \$10.69/Each	Dogbone Only: \$2.15 Each SKU: 128976			Pallet Weight	Face Panels: 3,040 Lbs Anchors: 3,112 Lbs

AB Fieldstone Sierra 824 Block—Pricing Includes Face Panel and Anchor					
824 Short	SKU	Color	Stock Location	Dimensions	8"H x 24"W x 12¼"D
Yard Price: \$20.35/Each	824 Short			SF/Block	1.33
	4174064	Glacier Bay	Non-Stock	SF/Pallet	66
Factory Direct: \$18.36/Each	4174057	Sandstone	Non-Stock	Blocks/Pallet	50 Face Panels 96 Anchors
824 Long	824 Long			Weight/Block	Face Panel: 62 Lbs Anchor: 32 Lbs Total Unit: 94 Lbs
	147020	Glacier Bay	Non-Stock		
Yard Price: \$23.85/Each	147018	Sandstone	Non-Stock		
Factory Direct: \$21.64/Each	Dogbone Only: \$2.15 Each SKU: 128976			Pallet Weight	Face Panels: 3,140 Lbs Anchors: 3,112 Lbs

AB Fieldstone Wall Cap					
Yard Price: \$7.55/Each	SKU	Color	Stock Location	Dimensions	F: 3¾"H x 16"W x 11¼"D B: 3¾"H x 11"W x 11¼"D
Factory Direct: \$6.57/Each	4174101	Glacier Bay	Non-Stock	LF/Cap	1.125
	4174071	Sandstone	Non-Stock	LF/Pallet	54
USE FOR HERITAGE OR SIERRA RETAINING WALLS				Caps/Pallet	48
				Weight/Cap	50 Lbs
				Pallet Weight	2,440 Lbs



allanblock.com



Design Book

AB Fieldstone Heritage Collection Retaining Wall

Estimator App



Apple



Android



AB Fieldstone Heritage 812 Block—Pricing Includes Face Panel and Anchor

812 Short	SKU	Color	Stock Location	Dimensions	8"H x 12"W x 12¼"D
Yard Price: \$14.75/Each	812 Short			SF/Block	.66
	183280	Gray	Non-Stock	SF/Pallet	66
Factory Direct: \$13.08/Each				Blocks/Pallet	100 Face Panels 96 Anchors
812 Long	812 Long			Weight/Block	Face Panel: 30 Lbs Anchor: 32 Lbs Total Unit: 62 Lbs
	Yard Price: \$16.50/Each	183282	Gray		
Factory Direct: \$14.72/Each	Dogbone Only: \$2.15 Each SKU: 128976			Pallet Weight	Face Panels: 3,040 Lbs Anchors: 3,112 Lbs

AB Fieldstone Heritage 824 Block—Pricing Includes Face Panel and Anchor

824 Short	SKU	Color	Stock Location	Dimensions	8"H x 24"W x 12¼"D
Yard Price: \$29.10/Each	824 Short			SF/Block	1.33
	183284	Gray	Non-Stock	SF/Pallet	66
Factory Direct: \$26.58/Each				Blocks/Pallet	50 Face Panels 96 Anchors
824 Long	824 Long			Weight/Block	Face Panel: 62 Lbs Anchor: 32 Lbs Total Unit: 94 Lbs
	Yard Price: \$32.55/Each	183286	Gray		
Factory Direct: \$29.86/Each	Dogbone Only: \$2.15 Each SKU: 128976			Pallet Weight	Face Panels: 3,140 Lbs Anchors: 3,112 Lbs

AB Fieldstone Parapet Cap

Yard Price: \$12.70/Each	SKU	Color	Stock Location	Dimensions	4"H x 18"W x 12"D
Factory Direct: \$11.46/Each	222702	Glacier Bay	Non-Stock	LF/Cap	1.5
	222704	Sandstone	Non-Stock	LF/Pallet	24
USE FOR HERITAGE OR SIERRA FREE-STANDING WALLS				Caps/Pallet	16
				Weight/Cap	100 Lbs
				Pallet Weight	1,600 Lbs

Compac Retaining Wall



Compac III Curved Retaining Wall

	SKU	Color	Stock Location	Dimensions	8" H x 18" W x 12" D	
	223332	Cocoa Brown	Non-Stock	SF/Block	1	
	223334	Glacier Gray	Non-Stock	SF/Pallet	32	
	223342	Golden Wheat	Non-Stock	Blocks/Pallet	32	
	Yard Price:			\$8.95/Each	Weight/Block	89 Lbs
	Factory Direct Price:			\$7.58/Each	Pallet Weight	2,848 Lbs
				\$8.95/SqFt	Pins sold separately	
			\$7.58/SqFt			

Compac III Straight Retaining Wall

	SKU	Color	Stock Location	Dimensions	8" H x 18" W x 12" D	
	223312	Cocoa Brown	Special Order	SF/Block	1	
	223318	Glacier Gray	Special Order	SF/Pallet	32	
	223322	Golden Wheat	Special Order	Blocks/Pallet	32	
	Yard Price:			\$8.95/Each	Weight/Block	92 Lbs
	Factory Direct Price:			\$7.58/Each	Pallet Weight	2,944 Lbs
				\$8.95/SqFt	Pins sold separately	
			\$7.58/SqFt			

Keystone Non-Shouldered Pins, SKU 4277055: \$25.00/Case of 100; Sold in Full Cases Only

- Factory Direct pricing on drop ship order or factory pick-up; FULL PALLETS only; minimum drop ship order is 10 pallets
- All products can be delivered anywhere in the metro area; all deliveries quoted individually for best rate; PLEASE CALL
- Please call for out-state and out-of-state delivery; special delivery quotes available
- Non-stocked product can be obtained quickly with advance notice, subject to factory availability
- 4136826: \$20 refundable pallet deposit on Keystone pallets; **must have receipt when returning pallets for refund.**
- 3625284: **\$25 broken pallet charge** on non-stock items if not ordered in full pallets; no split pallets out of Jordan yard; **no returns on non-stock item orders**

Compac Retaining Wall

8" Corner Block

	SKU	Color	Stock Location	Dimensions	8"H x 18"W x 9"D	
	3962419	Cocoa Brown	Non-Stock	SF/Block	1	
	3962396	Glacier Gray	Non-Stock	SF/Pallet	30	
	3962402	Golden Wheat	Non-Stock	Blocks/Pallet	30	
	Yard Price: \$13.90/Each				Weight/Block	103 Lbs
	Factory Direct Price: \$12.29/Each				Pallet Weight	3,090 Lbs

4" Universal Cap

- Sold in full pallets or mini pallets (mini pallets in Jordan only)

	SKU	Color	Stock Location	Dimensions	4"H x 18"W (F)/12"W (B) x 10½"D	
	3721658	Cocoa Brown	Non-Stock	LF/Cap	1.25	
	3721641	Glacier Gray	Non-Stock	LF/Pallet	56.25 (Full Pal), 33.75 (Mini Pal)	
	3721665	Golden Wheat	Non-Stock	Caps/Pallet	45 (Full Pal) or 27 (Mini Pal)	
	Yard Price: \$7.85/Each				Weight/Cap	54 Lbs
	Factory Direct Price: \$6.57/Each				Pallet Weight	2,340 Lbs (Full) or 1,404 Lbs (Mini)



- Factory Direct pricing on drop ship order or factory pick-up; FULL PALLETS only; minimum drop ship order is 10 pallets
- All products can be delivered anywhere in the metro area; all deliveries quoted individually for best rate; PLEASE CALL
- Please call for out-state and out-of-state delivery; special delivery quotes available
- Non-stocked product can be obtained quickly with advance notice, subject to factory availability
- 4136826: \$20 refundable pallet deposit on Keystone pallets; **must have receipt when returning pallets for refund.**
- 3625284: \$25 broken pallet charge on non-stock items if not ordered in full pallets; no split pallets out of Jordan yard; **no returns on non-stock item orders**

Intermediate II Retaining Wall



Intermediate II Retaining Wall

Intermediate II 3-Way Retaining Wall

	SKU	Color	Stock Location	Dimensions	6" H x 16" W x 10" D	
	3653355	Bedrock Blend	Non-Stock	SF/Block	.67	
	3653393	Cocoa Brown	Non-Stock	SF/Pallet	24.12	
	3653379	Glacier Gray	Non-Stock	Blocks/Pallet	36	
	3653416	Golden Wheat	Non-Stock	Weight/Block	61 Lbs	
	4350994	Split Rock Blend	Non-Stock	Pallet Weight	2,196 Lbs	
	Yard Price:			\$6.25 Each		
				\$9.33/SqFt		
Factory Direct Price:			\$5.07 Each			
			\$7.57/SqFt			

Intermediate II Straight Retaining Wall

	SKU	Color	Stock Location	Dimensions	6" H x 16" W x 10" D	
	3653430	Bedrock Blend	Non-Stock	SF/Block	.67	
	3653454	Cocoa Brown	Non-Stock	SF/Pallet	24.12	
	3653447	Glacier Gray	Non-Stock	Blocks/Pallet	36	
	3653461	Golden Wheat	Non-Stock	Weight/Block	66 Lbs	
	4351007	Split Rock Blend	Non-Stock	Pallet Weight	2,376 Lbs	
	Yard Price:			\$6.25 Each		
				\$9.33/SqFt		
Factory Direct Price:			\$5.07 Each			
			\$7.57/SqFt			

- Factory Direct pricing on drop ship order or factory pick-up; FULL PALLETS only; minimum drop ship order is 10 pallets
- All products can be delivered anywhere in the metro area; all deliveries quoted individually for best rate; PLEASE CALL
- Please call for out-state and out-of-state delivery; special delivery quotes available
- Non-stocked product can be obtained quickly with advance notice, subject to factory availability
- 4136826: \$20 refundable pallet deposit on Keystone pallets; **must have receipt when returning pallets for refund.**
- 3625284: **\$25 broken pallet charge** on non-stock items if not ordered in full pallets; no split pallets out of Jordan yard; **no returns on non-stock item orders**

www.bachmanswholesale.com

Intermediate II Retaining Wall

Intermediate II 3" Large Universal Cap

- Sold in full pallets or mini pallets (mini pallets in Jordan only)

	SKU	Color	Stock Location	Dimensions	3"H x 18"W (F)/12"W (B) x 10½"D	
	3653522	Bedrock Blend	Non-Stock	LF/Cap	1.25	
	3653560	Cocoa Brown	Non-Stock	LF/Pallet	70 (Full Pal) or 35 (Mini Pal)	
	3653546	Glacier Gray	Non-Stock	Caps/Pallet	54 (Full Pal) or 27 (Mini Pal)	
	3653584	Golden Wheat	Non-Stock	Weight/Cap	38 Lbs	
	4351014	Split Rock Blend	Non-Stock	Pallet Weight	2,052 Lbs (Full Pal) or 1,026 (Mini Pal)	
	Yard Price: \$6.25 Each					
	Factory Direct Price: \$5.07 Each					

6" Corner/Step Block

- Sold in full pallets or mini pallets (mini pallets in Jordan only)

	SKU	Color	Stock Location	Dimensions	6"H x 16"W x 16"D	
	3950508	Bedrock Blend	Non-Stock	SF/Block	.67 (Wall Face), 1.77 (Step Surface)	
	3950522	Cocoa Brown	Non-Stock	SF/Pallet	16.08 (Wall Face), 42.72 (Step Surface)	
	3950515	Glacier Gray	Non-Stock	Blocks/Pallet	24 (Full Pal) or 12 (Mini Pal)	
	3950539	Golden Wheat	Non-Stock	Weight/Block	120 Lbs	
	4351038	Split Rock Blend	Non-Stock	Pallet Weight	2,880 Lbs (Full) or 1,440 Lbs (Mini)	
	Yard Price: \$12.60 Each					
	Factory Direct Price: \$11.07 Each					

6" Corner Block

- Sold in full pallets or mini pallets (mini pallets in Jordan only)

	SKU	Color	Stock Location	Dimensions	6"H x 16"W x 8"D	
	3653607	Bedrock Blend	Non-Stock	SF/Block	.67 & .33	
	3653621	Cocoa Brown	Non-Stock	SF/Pallet	32.16 (Full Pal), 16.08 (Mini Pal)	
	3653614	Glacier Gray	Non-Stock	Blocks/Pallet	48 (Full Pal) or 24 (Mini Pal)	
	3653638	Golden Wheat	Non-Stock	Weight/Block	60 Lbs	
	4351021	Split Rock Blend	Non-Stock	Pallet Weight	2,880 Lbs (Full) or 1,440 Lbs (Mini)	
	Yard Price: \$12.60 Each					
	Factory Direct Price: \$11.07 Each					

Stonegate Contemporary & Regal Stone Pro Retaining Wall

Stonegate Contemporary Retaining Wall

	SKU	Color	Stock Location	Dimensions	Sm: 6"H x 6"W (F)/4"W (B) x 10"D Med: 6"H x 12"W (F)/10"W (B) x 10"D Lg: 6"H x 16"W (F)/14"W (B) x 10"D	
	223370	Bedrock Blend	Non-Stock		SF/Set	1.42
	223376	Splitrock Blend	Non-Stock		SF/Pallet	34.08
	Yard Price: \$16.33/set \$11.50/SqFt				Blocks/Pallet	24 Sets (24 Sm, 24 Med, & 24 Lg)
	Factory Direct Price: \$14.20/set \$10.00/SqFt				Weight/Block	65, 51, 24
	Pins sold separately. \$25.00 box				Pallet Weight	3,400 Lbs

Stonegate Contemporary Cap

	SKU	Color	Stock Location	Dimensions	3"H x 12"W (F)/10"W (B) x 11"D	
	223400	Bedrock Blend	Non-Stock	LF/Block	0.83	
	223402	Splitrock Blend	Non-Stock	LF/Pallet	83	
	Yard Price: \$6.30/Each				Blocks/Pallet	100
	Factory Direct Price: \$5.80/Each				Weight/Block	30
					Pallet Weight	3,040 Lbs

Regal Stone Pro Retaining Wall

Yard Price:	SKU	Color	Stock Location	Dimensions	8"H x 18"W x 12"D
\$9.35/Each \$9.35/SqFt	Straight Face			SF/Block	1
	223404	Bedrock Blend	Non-Stock	SF/Pallet	32
Factory Direct Price:	223406	Glacier Gray	Non-Stock	Blocks/Pallet	32
	223408	Golden Wheat	Non-Stock	Weight/Block	76 Lbs
\$8.00/Each \$8.00/SqFt	223410	Splitrock Blend	Non-Stock	Pallet Weight	2,472 Lbs (straight) 2,344 Lbs (curved)
	Curved Face				
223412	Bedrock Blend	Non-Stock			
223416	Glacier Gray	Non-Stock			
223420	Golden Wheat	Non-Stock			
	223422	Splitrock Blend	Non-Stock		

Keystone Non-Shouldered Pins, SKU 4277055: \$25.00/Case of 100; Sold in Full Cases Only

- Factory Direct pricing on drop ship order or factory pick-up; FULL PALLETS only; minimum drop ship order is 10 pallets
- All products can be delivered anywhere in the metro area; all deliveries quoted individually for best rate; PLEASE CALL
- Please call for out-state and out-of-state delivery; special delivery quotes available
- Non-stocked product can be obtained quickly with advance notice, subject to factory availability
- 4136826: \$20 refundable pallet deposit on Keystone pallets; **must have receipt when returning pallets for refund.**
- 3625284: **\$25 broken pallet charge** on non-stock items if not ordered in full pallets; no split pallets out of Jordan yard; **no returns on non-stock item orders**

NOTES

TITAN MACHINERY

Sales • Parts • Service • Rentals



*Subject to availability. Items may not be available at all locations.

Titan Machinery Shakopee - 952-445-5400

www.titanmachinery.com





BELGARD
PAVES THE WAY

Section Contents

Description	Page
Concrete Pavers	33-52
• Afton	33, 39
• Agilina	34
• Belgian Cobble	35
• Catalina Plus Grana	36-37
• Charleston Tumbled	38-39
• Eco-Dublin	39
• Mega Dublin	40
• Holland	41
• Holland Permeable	41
• Mega Kingston	42
• Lafitt	43
• Lafitt Rustic Slab	44
• Madria	45
• Mega-Arbel	45
• Melville (80mm)	46
• Melville (60mm)	47
• Old World	47
• Slaton Plus Tumbled	48-49
• Urbana Stone	50
• RINN Hydropor Laziano	51
• RINN Laziano	51
• RINN Medino	52
• RINN Padio 14	52
Porcelain Pavers	53-58
• Ardesie & UNICO Ardesie	53
• Noon & UNICO Noon	54
• Quarziti 2.0	55
• Turin	56
• Verona	56
• Quarziti Unico	57
• Sundeck	57
• UNICO Sundeck	58
• Silca System	58
Bullnose Coping	59

Description	Page
Pillar Caps	59, 85
Tru-Scapes Lighting Reference	60-61
Walls	62-83
• Belair 2.0 Retaining Walls	62-64
• Belair 2.0 Freestanding Walls	62-64
• Brisa Retaining Walls	65-67
• Brisa Freestanding Wall	65-67
• Diamond Beveled Retaining Wall	68-69
• Diamond Straight Retaining Wall	68-69
• Diamond Stone Cut Retaining Wall	70
• Diamond Pro Stone Cut Retaining Wall	71-72
• Diamond Pro Retaining Wall	73-74
• Highland Retaining Wall	75, 77
• Highland Freestanding Wall	76-77
• Sterling Wall	78
• Tandem Wall—Ashlar	79, 82
• Tandem Wall—Lamina	80, 82
• Tandem Wall—Melville	81-82
• Mega Tandem	82
• Tandem Wall Accessories	82
• Weston Wall	83
Torpedo Base Block	64, 67, 84
Landings	84
Seat Wall Caps	84
Pillar Caps	85
Edgers	85
• Edgestone	85



Afton Paving Stones

Formerly Charleston Non-Tumbled



Note: A vibratory roller is highly recommended for compaction of Afton pavers

Afton—4 Piece Combo—70mm

Yard Price: \$5.45/SF	SKU	Color	Stock Location	Dimensions 2¾" H x 8¼" W x 11" L 2¾" H x 5½" W x 11" L 2¾" H x 5½" W x 8¼" L 2¾" H x 5½" W x 5½" L
Factory Direct: \$4.70/SF	146550	Fieldstone	Cedar Acres	
	146552	Mahogany	Cedar Acres	
	146554	Northwoods	Cedar Acres	
				SF/Pattern Set 1.55 SF/Layer 9.29 SF/Pallet 74.36 Sets/Pallet 48 Pieces/Layer 6 of each size Layers/Pallet 8 Pallet Weight 2,580 Lbs

Afton Small Rectangle—5x8

Yard Price: \$5.45/SF	SKU	Color	Stock Location	Dimensions
Factory Direct: \$4.70/SF	177658	Barkwood	Cedar Acres	2¾" H x 5½" W x 8¼" L
	3704040	Cambray Tan	Cedar Acres	
	3609062	Charcoal	Cedar Acres	
				SF/Piece .315 SF/Band 15.2 SF/Pallet 76 Pavers/Pallet 240 Pavers/SF 3.17 Pavers/Band 48 Bands/Pallet 5 LF/Paver (Sailor) .69 LF/Paver (Soldier) .46 Pallet Weight 2,572 Lbs

*A \$10 split pallet fee will be charged on pavers sold by band or layer only. Excludes circle pavers and kits.

- Factory Direct pricing on drop ship order or factory pick-up; FULL PALLETS only; minimum drop ship order is 10 pallets
- All products can be delivered anywhere in the metro area; all deliveries quoted individually for best rate; PLEASE CALL
- Please call for out-state and out-of-state delivery; special delivery quotes available
- Non-stocked product can be obtained quickly with advance notice, subject to factory availability
- 4136789: \$20 pallet deposit on Belgard pallets; **\$18.00 will be credited upon return**
- 3625284: **\$10 broken pallet charge** on non-stock items if not ordered in full pallets; **no returns on non-stock item orders**



Agilina Pavers

Belgard Agilina Pavers



Agilina 5"—3 Piece Combo—80mm

Yard Price: \$5.70/SF		SKU	Color	Stock Location	Dimensions 3 3/8" H x 5" W x 11.7" L 3 3/8" H x 5" W x 15.6" L 3 3/8" H x 5" W x 19.6" L
Factory Direct: \$4.92/SF (Full Pallets Only)		181108	Newport Gray	Non-Stock	
		181110	Savannah Beige	Non-Stock	
				SF/Pattern Set	1.59
				SF/Layer	11.1
				SF/Pallet	77.7
				Sets/Pallet	49
				Pieces/Layer	7 of each size
				Layers/Pallet	7
				Pallet Weight	3,018 Lbs

Agilina 7.5"—3 Piece Combo—80mm

Yard Price: \$5.70/SF		SKU	Color	Stock Location	Dimensions 3 3/8" H x 7.5" W x 11.7" L 3 3/8" H x 7.5" W x 15.6" L 3 3/8" H x 7.5" W x 19.6" L
Factory Direct: \$4.92/SF (Full Pallets Only)		181112	Newport Gray	Non-Stock	
		181114	Savannah Beige	Non-Stock	
				SF/Pattern Set	2.4
				SF/Layer	9.6
				SF/Pallet	67.13
				Sets/Pallet	28
				Pieces/Layer	4 of each size
				Layers/Pallet	7
				Pallet Weight	2,608 Lbs

***A \$10 split pallet fee will be charged on pavers sold by band or layer only. Excludes circle pavers and kits.**

- Factory Direct pricing on drop ship order or factory pick-up; FULL PALLETS only; minimum drop ship order is 10 pallets
- All products can be delivered anywhere in the metro area; all deliveries quoted individually for best rate; PLEASE CALL
- Please call for out-state and out-of-state delivery; special delivery quotes available
- Non-stocked product can be obtained quickly with advance notice, subject to factory availability
- 4136789: \$20 pallet deposit on Belgard pallets; **\$18.00 will be credited upon return**
- 3625284: **\$10 broken pallet charge** on non-stock items if not ordered in full pallets; **no returns on non-stock item orders**

www.bachmanswholesale.com



Belgian Cobble Pavers



Belgian Cobble creates picturesque walkways, driveways, patios, and pool scapes with a multi-piece system that looks like natural stone pulled from the bed of a mountain creek. Belgian Cobble can be installed as either a standard or permeable paver system. Belgian Cobble also make a unique border or inlay.

Belgian Cobble

Yard Price: \$5.15/SF	SKU	Color	Stock Location	Dimensions	7 Pieces, Variable Shapes & Sizes 2 3/8" Thick
	181116	Barkwood	Cedar Acres		
Factory Direct: \$4.42/SF (Full Pallets Only)	181146	Midnight	Cedar Acres	Approx. Lbs/SF	25
	181148	Moonlight	Cedar Acres	Pallet Weight	1,692 Lbs
				<p>Priced by the square foot, but loaded by the pound. To calculate quantity of square feet, divide the weight loaded by 25.</p>	

Paver Math

<p>Weight Needed for Given Square Feet $SF \times 25 = Lbs \text{ needed for job}$</p> <p>Example: A 350 SF patio would require 8,750 Lbs (350 x 25) of Belgian Cobble.</p>	<p>Weight Needed for Given Length of Border or Inlay $(Width \text{ of inlay in inches} \div 12) \times length \text{ of inlay in feet} \times 25 = Lbs \text{ needed for job}$</p> <p>Example: A 120 border, 9 inches wide, would require 2,250 Lbs (120 x .75 x 25) of Belgian Cobble</p>
--	--

- Factory Direct pricing on drop ship order or factory pick-up; FULL PALLETS only; minimum drop ship order is 10 pallets
- All products can be delivered anywhere in the metro area; all deliveries quoted individually for best rate; PLEASE CALL
- Please call for out-state and out-of-state delivery; special delivery quotes available
- Non-stocked product can be obtained quickly with advance notice, subject to factory availability
- 4136789: \$20 pallet deposit on Belgard pallets; **\$18.00 will be credited upon return**
- 3625284: **\$10 broken pallet charge** on non-stock items if not ordered in full pallets; **no returns on non-stock item orders**



Catalina Plus Grana



Catalina Plus Grana—3 Piece Combo—Small—60mm

Yard Price: \$5.15/SF	SKU	Color	Stock Location	Dimensions 2 ³ / ₈ "H x 3"W x 6"L 2 ³ / ₈ "H x 6"W x 6"L 2 ³ / ₈ "H x 6"W x 9"L	
Factory Direct: \$4.43/SF (Full Pallets Only)	146538	Aspen	Cedar Acres		
	146540	Cotswold Mist	Cedar Acres		
	146542	Fossil	Cedar Acres		
				SF/Pattern Set	.75
				SF/Layer	10.3
				SF/Pallet	103
				Sets/Pallet	140
				Pieces/Layer	14 of each size
				Layers/Pallet	10
				Pallet Weight	3,121 Lbs

Catalina Plus Grana—3 Piece Combo—Large—60mm

Yard Price: \$5.15/SF	SKU	Color	Stock Location	Dimensions 2 ³ / ₈ "H x 6"W x 12"L 2 ³ / ₈ "H x 9"W x 12"L 2 ³ / ₈ "H x 12"W x 12"L	
Factory Direct: \$4.43/SF (Full Pallets Only)	146544	Aspen	Cedar Acres		
	146546	Cotswold Mist	Cedar Acres		
	146548	Fossil	Cedar Acres		
				SF/Pattern Set	2.25
				SF/Layer	11.8
				SF/Pallet	118.1
				Sets/Pallet	53
				Pieces/Layer	5
				Layers/Pallet	10
				Pallet Weight	3,377 Lbs

***A \$10 split pallet fee will be charged on pavers sold by band or layer only. Excludes circle pavers and kits.**

- Factory Direct pricing on drop ship order or factory pick-up; FULL PALLETS only; minimum drop ship order is 10 pallets
- All products can be delivered anywhere in the metro area; all deliveries quoted individually for best rate; PLEASE CALL
- Please call for out-state and out-of-state delivery; special delivery quotes available
- Non-stocked product can be obtained quickly with advance notice, subject to factory availability
- 4136789: \$20 pallet deposit on Belgard pallets; **\$18.00 will be credited upon return**
- 3625284: **\$10 broken pallet charge** on non-stock items if not ordered in full pallets; **no returns on non-stock item orders**



Catalina Plus Grana



Catalina Plus Grana—6x9—60mm

Yard Price: \$5.15/SF	SKU	Color	Stock Location	Dimensions	2 3/8" H x 6" W x 9" L
	181180	Barkwood	Cedar Acres	SF/Piece	.375
Factory Direct: \$4.43/SF (Full Pallets Only)	181182	Cambray Tan	Cedar Acres	SF/Layer	11.25
	181184	Midnight	Cedar Acres	SF/Pallet	112.5
				Pieces/Pallet	300
				Pieces/Layer	30
				Layers/Pallet	10
				LF/Paver (Sailor)	.75
				LF/Paver (Soldier)	.5
				Pallet Weight	3,325 Lbs

Belgard’s Catalina combines their face mix technology with a contemporary look. Pallets are offered in mixed sizing with two different formats:

Small piece: 3"x6", 6"x6", and 6"x9" for sailor coursing or patios

Large piece: 6"x12", 9"x12", and 12"x12" for driveways, pool decks, and patios

Mix both pallets for a 6 piece pattern!



The Texturgard™ manufacturing process fuses a combination of rich pigments into the matrix of the top wear course of the paving units. This process produces a rich color, wear-resistant surface, and a distinctive texture.

Pattern 1

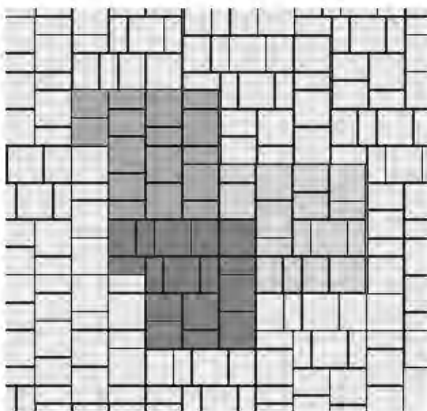

Pattern 2

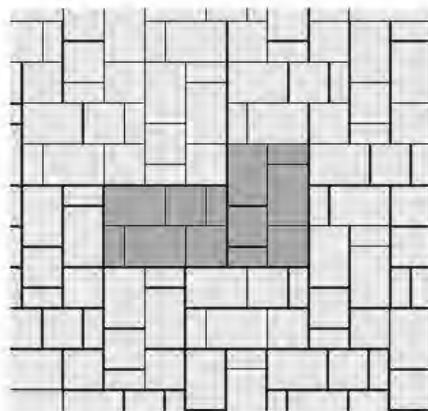

Pattern 3

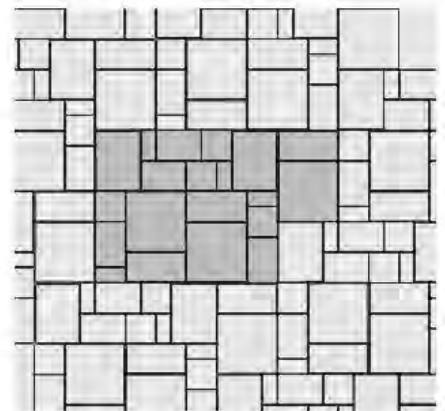

***A \$10 split pallet fee will be charged on pavers sold by band or layer only. Excludes circle pavers and kits.**

- Factory Direct pricing on drop ship order or factory pick-up; FULL PALLETS only; minimum drop ship order is 10 pallets
- All products can be delivered anywhere in the metro area; all deliveries quoted individually for best rate; PLEASE CALL
- Please call for out-state and out-of-state delivery; special delivery quotes available
- Non-stocked product can be obtained quickly with advance notice, subject to factory availability
- 4136789: \$20 pallet deposit on Belgard pallets; **\$18.00 will be credited upon return**
- 3625284: **\$10 broken pallet charge** on non-stock items if not ordered in full pallets; **no returns on non-stock item orders**





Charleston Tumbled Paving Stones

Belgard Charleston Tumbled Paving Stones



Note: A vibratory roller is highly recommended for compaction of Charleston pavers

Charleston Tumbled—4 Piece Combo—70mm

Yard Price: \$6.85/SF	SKU	Color	Stock Location	Dimensions 2¾" H x 8¼" W x 11" L 2¾" H x 5½" W x 11" L 2¾" H x 5½" W x 8¼" L 2¾" H x 5½" W x 5½" L
Factory Direct: \$5.93/SF	146556	Fieldstone	Cedar Acres	
	146558	Mahogany	Cedar Acres	
	146560	Northwoods	Cedar Acres	
				SF/Pattern Set 1.55 SF/Layer 9.29 SF/Pallet 74.36 Sets/Pallet 48 Pieces/Layer 6 of each size Layers/Pallet 8 Pallet Weight 2,580 Lbs
				

Charleston Tumbled Small Rectangle—5x8

Yard Price: \$6.85/SF	SKU	Color	Stock Location	Dimensions
Factory Direct: \$5.93/SF	181216	Barkwood	Cedar Acres	2¾" H x 5½" W x 8¼" L
	2757849	Cambray Tan	Cedar Acres	
	2757832	Charcoal	Cedar Acres	
				SF/Piece .315 SF/Layer 9.5 SF/Pallet 76 Pavers/Pallet 240 Pavers/SF 3.10 Pavers/Layer 30 Layers/Pallet 8 LF/Paver (Sailor) .69 LF/Paver (Soldier) .46 Pallet Weight 2,572 Lbs
				

*A \$10 split pallet fee will be charged on pavers sold by band or layer only. Excludes circle pavers and kits.

- Factory Direct pricing on drop ship order or factory pick-up; FULL PALLETS only; minimum drop ship order is 10 pallets
- All products can be delivered anywhere in the metro area; all deliveries quoted individually for best rate; PLEASE CALL
- Please call for out-state and out-of-state delivery; special delivery quotes available
- Non-stocked product can be obtained quickly with advance notice, subject to factory availability
- 4136789: \$20 pallet deposit on Belgard pallets; **\$18.00 will be credited upon return**
- 3625284: **\$10 broken pallet charge** on non-stock items if not ordered in full pallets; **no returns on non-stock item orders**

www.bachmanswholesale.com



Charleston Paving Stones & Eco-Dublin

Afton and Charleston Patterns

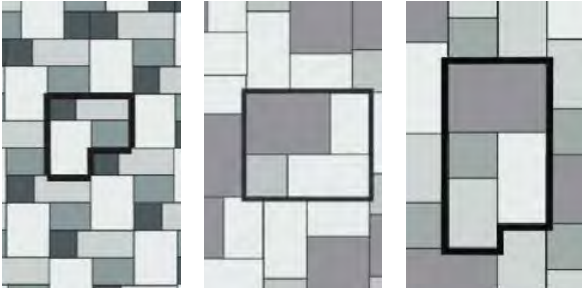

Afton & Charleston 4 Piece Combos are palletized for 1 : 1 : 1 : 1 patterns.

To calculate product needed:

- Subtract the square footage of the border from the total square footage of the project
- Add 5% for cuts and waste
- Divide result (total SF of field) by 1.55 (SF of 1 pattern set)
- Result is the number of sets needed for the project

Eco Dublin® Permeable Pavers



Eco Dublin®—3 Piece Combo—80mm

Yard Price: \$7.10/SF	SKU	Color	Stock Location	Dimensions $3\frac{3}{8}''\text{H} \times 6\frac{15}{16}''\text{W} \times 3\frac{7}{16}''\text{L}$ $3\frac{3}{8}''\text{H} \times 6\frac{15}{16}''\text{W} \times 6\frac{15}{16}''\text{L}$ $3\frac{3}{8}''\text{H} \times 6\frac{15}{16}''\text{W} \times 10\frac{5}{16}''\text{L}$	
Factory Direct: \$6.20/SF (Full Pallets Only)	114518	Ashbury Haze	Special Order		
	114524	Brookstone Slate	Special Order		
	114526	Cotswold Mist	Special Order		
	114528	Gascony Tan	Special Order		
				SF/Set	1.00
				SF/Layer	11.45
				SF/Pallet	91.6
				Sets/Pallet	96
				Sets/Layer	12
				Layers/Pallet	8
				Pallet Weight	3,195 Lbs



*A \$10 split pallet fee will be charged on pavers sold by band or layer only. Excludes circle pavers and kits.

- Factory Direct pricing on drop ship order or factory pick-up; FULL PALLETS only; minimum drop ship order is 10 pallets
- All products can be delivered anywhere in the metro area; all deliveries quoted individually for best rate; PLEASE CALL
- Please call for out-state and out-of-state delivery; special delivery quotes available
- Non-stocked product can be obtained quickly with advance notice, subject to factory availability
- 4136789: \$20 pallet deposit on Belgard pallets; **\$18.00 will be credited upon return**
- 3625284: **\$10 broken pallet charge** on non-stock items if not ordered in full pallets; **no returns on non-stock item orders**



Mega Dublin Paving Stones



Mega Dublin—3 Piece Combo—60mm

Yard Price: \$5.40/SF	SKU	Color	Stock Location	Dimensions	
	114562	Cotswold Mist	Cedar Acres		$2\frac{3}{8}''\text{H} \times 7\frac{1}{16}''\text{W} \times 3\frac{9}{16}''\text{L}$ $2\frac{3}{8}''\text{H} \times 7\frac{1}{16}''\text{W} \times 7\frac{1}{16}''\text{L}$ $2\frac{3}{8}''\text{H} \times 7\frac{1}{16}''\text{W} \times 10\frac{5}{8}''\text{L}$
Factory Direct: \$4.71/SF (Full Pallets Only)	114564	Fieldstone	Cedar Acres		
	114566	Northwoods	Cedar Acres		
	114568	Walnut	Cedar Acres		
				SF/Set	1.04
				SF/Layer	10.4
				SF/Pallet	104
				Sets/Pallet	100
				Sets/Layer	10
				Layers/Pallet	10
				Pallet Weight	2,870 Lbs



Mega Dublin—Rectangle—60mm

Yard Price: \$5.40/SF	SKU	Color	Stock Location	Dimensions	
	181316	Barkwood	Non-Stock	$2\frac{3}{8}''\text{H} \times 5\frac{7}{8}''\text{W} \times 8\frac{7}{8}''\text{L}$	
Factory Direct: \$4.71/SF	114570	Cambray Tan	Cedar Acres		
	114572	Charcoal	Cedar Acres	SF/Piece	.36
				SF/Layer	10.75
				SF/Pallet	87
				Pavers/Pallet	240
				Pavers/SF	2.78
				Pavers/Layer	30
				Layers/Pallet	8
				LF/Paver	.74 (Sailor) or .49 (Soldier)
				Pallet Weight	2,452 Lbs



A \$10 split pallet fee will be charged on pavers sold by band or layer only. Excludes circle pavers and kits.

- Factory Direct pricing on drop ship order or factory pick-up; FULL PALLETS only; minimum drop ship order is 10 pallets
- All products can be delivered anywhere in the metro area; all deliveries quoted individually for best rate; PLEASE CALL
- Please call for out-state and out-of-state delivery; special delivery quotes available
- Non-stocked product can be obtained quickly with advance notice, subject to factory availability
- 4136789: \$20 pallet deposit on Belgard pallets; **\$18.00 will be credited upon return**
- 3625284: **\$10 broken pallet charge** on non-stock items if not ordered in full pallets; **no returns on non-stock item orders**



Holland Paving Stones & Holland Permeable Pavers



Holland 60mm Paver



Yard Price: \$2.65/SF		SKU	Color	Stock Location	Dimensions	2 $\frac{5}{8}$ "H x 3 $\frac{3}{8}$ "W x 7 $\frac{7}{8}$ "L
		114530	Cambray Tan	Non-Stock	SF/Piece	.216
Factory Direct: \$2.59/SF		114532	Charcoal	Non-Stock	SF/Band	17.33
		2754725	Fieldstone	Non-Stock	SF/Pallet	105
					Pavers/Pallet	486
					Pavers/SF	4.6
					Pavers/Band	81
					Bands/Pallet	6
					LF/Paver (Sailor)	.656
					LF/Paver (Soldier)	.323
					Pallet Weight	3,012 Lbs

			
	Cambray Tan	Charcoal	Fieldstone



Holland Permeable Pavers—80mm (Full Pallets Only)

Yard Price: \$4.35/SF		SKU	Color	Stock Location	Dimensions	3 $\frac{1}{8}$ "H x 5"W x 10"L (Full) 3 $\frac{1}{8}$ "H x 5"W x 5"L (Half) 4 Full & 1 Half per Set
		3957538	Autumn Blend	Non-Stock	SF/Piece	.35 (Full) & .17 (Half)
Factory Direct: \$3.85/SF (Full Pallets Only)		3957521	Fieldstone	Non-Stock	SF/Layer	9.6
					SF/Pallet	77
					Pavers/Pallet	196 Full & 49 Half
					Pavers/SF	2.88 (Full) & 5.78 (Half)
					Layers/Pallet	8
					Pallet Weight	2,855 Lbs

		
	Autumn Blend	Fieldstone

A \$10 split pallet fee will be charged on pavers sold by band or layer only. Excludes circle pavers and kits.



Mega Kingston Pavers

Belgard Mega Kingston



Mega Kingston—3 Piece Combo—60mm

Yard Price: \$3.95/SF	SKU	Color	Stock Location	Dimensions $2\frac{3}{8}''\text{H} \times 7\frac{1}{16}''\text{W} \times 3\frac{9}{16}''\text{L}$ $2\frac{3}{8}''\text{H} \times 7\frac{1}{16}''\text{W} \times 7\frac{1}{16}''\text{L}$ $2\frac{3}{8}''\text{H} \times 7\frac{1}{16}''\text{W} \times 10\frac{1}{8}''\text{L}$	
Factory Direct: \$3.40/SF (Full Pallets Only)	114578	Barkwood*	Cedar Acres		
	114580	Cotswold Mist	Cedar Acres		
	114582	Fieldstone	Cedar Acres		
	114584	Northwoods	Cedar Acres		
				SF/Set	1.04
				SF/Layer	10.4
				SF/Pallet	104
				Sets/Pallet	100
				Sets/Layer	10
				Layers/Pallet	10
				Pallet Weight	3,050 Lbs



Mega Kingston Rectangle—60mm

Yard Price: \$3.95/SF	SKU	Color	Stock Location	Dimensions	
Factory Direct: \$3.40/SF (Full Pallets Only)	181312	Barkwood*	Cedar Acres	$2\frac{3}{8}''\text{H} \times 5\frac{1}{2}''\text{W} \times 8\frac{1}{4}''\text{L}$	
	3703586	Cambray Tan	Cedar Acres		
	2832218	Charcoal	Cedar Acres		
				SF/Piece	.315
				SF/Band	15.2
				SF/Pallet	76
				Pavers/Pallet	240
				Pavers/SF	3.17
				Pavers/Band	48
				Bands/Pallet	5
				LF/Paver (Sailor)	.69
				LF/Paver (Soldier)	.49
				Pallet Weight	2,212 Lbs



***Barkwood color is discontinued and will be available only while supplies last.**

A \$10 split pallet fee will be charged on pavers sold by band or layer only. Excludes circle pavers and kits.

- Factory Direct pricing on drop ship order or factory pick-up; FULL PALLETS only; minimum drop ship order is 10 pallets
- All products can be delivered anywhere in the metro area; all deliveries quoted individually for best rate; PLEASE CALL
- Please call for out-state and out-of-state delivery; special delivery quotes available
- Non-stocked product can be obtained quickly with advance notice, subject to factory availability
- 4136789: \$20 pallet deposit on Belgard pallets; **\$18.00 will be credited upon return**
- 3625284: **\$10 broken pallet charge** on non-stock items if not ordered in full pallets; **no returns on non-stock item orders**

www.bachmanswholesale.com



Lafitt—3 Piece Combo—60mm

Yard Price: \$4.50/SF Factory Direct: \$3.90/SF (Full Pallets Only)	SKU	Color	Stock Location	Dimensions $2\frac{3}{8}''\text{H} \times 7\frac{1}{16}''\text{W} \times 3\frac{9}{16}''\text{L}$ $2\frac{3}{8}''\text{H} \times 7\frac{1}{16}''\text{W} \times 7\frac{1}{16}''\text{L}$ $2\frac{3}{8}''\text{H} \times 7\frac{1}{16}''\text{W} \times 10\frac{5}{8}''\text{L}$ 1 : 1 : 1
	114546	Aspen	Cedar Acres	
	114542	Cotswold Mist	Cedar Acres	
	220144	Newport Gray	Cedar Acres	
	114550	Walnut	Cedar Acres	
	Aspen	Cotswold Mist	Newport Gray	Walnut
				SF/Pattern Set 1.046 SF/Layer 10.46 SF/Pallet 104.6 Sets/Pallet 100 Pattern Sets Sets/Layer 10 Pattern Sets Layers/Pallet 10 Pallet Weight 2,870 Lbs

Lafitt Patterns			Paver Math
			<p>For this example we will use a total field area of 400 SF including an 82 linear foot soldier course of Mega Kingston Rectangle.</p> <ul style="list-style-type: none"> Calculate square footage of border <p>Divide linear feet of border (82) by linear feet per paver (0.49) $82 \div 0.49 = 168 \text{ pieces}$</p> <p>168 pieces x .315 SF per piece = 53 SF</p> <ul style="list-style-type: none"> Subtract square footage of border (53) from total square footage of field (400) <p>400 - 53 = 357 SF</p> <p>Add 5% for cuts/loss = 357 x 1.05 = 375 SF</p> <ul style="list-style-type: none"> Divide square footage of field by the square feet of a "Pattern Set" to determine number of pattern sets needed <p>375 ÷ 1.046 = 359 pattern sets</p> <p>For Lafitt there are 10 pattern sets per layer and 10 layers on a pallet. The example patio will require 36 layers, which is 3 pallets and 6 layers of Lafitt, plus the 168 pieces (round up to 4 bands) of Mega Kingston Rectangle for the border.</p>
3 Piece Pattern	3 Piece Pattern	3 Piece Pattern	
Each "Pattern Set" is comprised of: 1 Large Rectangle 1 Small Rectangle 1 Square 1 Pattern Set = 1.046 SqFt			

***A \$10 split pallet fee will be charged on pavers sold by band or layer only. Excludes circle pavers and kits.**

- Factory Direct pricing on drop ship order or factory pick-up; FULL PALLETS only; minimum drop ship order is 10 pallets
- All products can be delivered anywhere in the metro area; all deliveries quoted individually for best rate; PLEASE CALL
- Please call for out-state and out-of-state delivery; special delivery quotes available
- Non-stocked product can be obtained quickly with advance notice, subject to factory availability
- 4136789: \$20 pallet deposit on Belgard pallets; **\$18.00 will be credited upon return**
- 3625284: **\$10 broken pallet charge** on non-stock items if not ordered in full pallets; **no returns on non-stock item orders**



Lafitt Rustic Slab

Belgard Lafitt Rustic Slab



Lafitt Rustic Slab—3 Piece Combo—60mm

Yard Price: \$5.05/SF	SKU	Color	Stock Location	Dimensions 2 3/8" H x 7 1/2" W x 15" L 2 3/8" H x 15" W x 15" L 2 3/8" H x 15" W x 22 1/2" L 3 : 3 : 2	
	114552	Aspen	Cedar Acres		
Factory Direct: \$4.42/SF (Full Pallets Only)	146572	Cotswold Mist	Cedar Acres		
		Newport Gray	Cedar Acres		
	114554	Walnut	Cedar Acres		
	Aspen	Cotswold Mist	Newport Gray	Walnut	
				SF/Pattern Set	11.65
				SF/Layer	11.65
				SF/Pallet	116.5
				Sets/Pallet	10 Pattern Sets
				Pieces/Layer	1 Pattern Set
				Layers/Pallet	10
				Pallet Weight	3,170 Lbs

Lafitt Rustic Slab Patterns			Paver Math
			For this example we will use a total field area of 550 SF including an 80 linear foot soldier course of Mega Kingston Rectangle. <ul style="list-style-type: none"> Calculate square footage of border <i>Divide linear feet of border (80) by linear feet per paver (0.49)</i> $80 \div 0.49 = 164 \text{ pieces}$ $164 \text{ pieces} \times .315 \text{ SF per piece} = 51 \text{ SF}$ Subtract square footage of border (51) from total square footage of field (550) $550 - 51 = 499 \text{ SF}$ $499 \text{ SF} \times 1.05 = 524 \text{ SF}$ Divide square footage of field by the square feet of a "Pattern Set" to determine number of pattern sets needed $524 \div 11.65 = 45 \text{ pattern sets}$ For Lafitt Rustic Slab 1 pattern set equals 1 layer. There are 10 layers on a pallet, so the example patio will require 45 layers, which if 4 1/2 pallets of Lafitt Rustic Slab, plus the 164 pieces (round up to 4 bands) of Mega Kingston Rectangle for the border.
3 Piece Pattern	3 Piece Pattern	3 Piece Pattern	
Each "Pattern Set" is comprised of: 1 Large Rectangle 1 Square 1 Small Rectangle 1 Pattern Set = 11.65 SqFt			

***A \$10 split pallet fee will be charged on pavers sold by band or layer only. Excludes circle pavers and kits.**

- Factory Direct pricing on drop ship order or factory pick-up; FULL PALLETS only; minimum drop ship order is 10 pallets
- All products can be delivered anywhere in the metro area; all deliveries quoted individually for best rate; PLEASE CALL
- Please call for out-state and out-of-state delivery; special delivery quotes available
- Non-stocked product can be obtained quickly with advance notice, subject to factory availability
- 4136789: \$20 pallet deposit on Belgard pallets; **\$18.00 will be credited upon return**
- 3625284: **\$10 broken pallet charge** on non-stock items if not ordered in full pallets; **no returns on non-stock item orders**



www.bachmanswholesale.com



Madria™ & Mega-Arbel Paving Stones





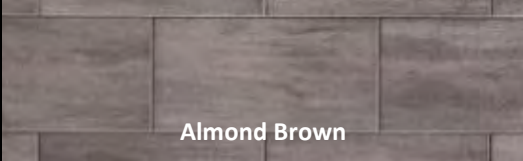

Madria™—Rectangle—60mm

Yard Price: \$10.60/SF	SKU	Color	Stock Location	Dimensions	2 ³ / ₈ " H x 15" W x 30" L
	220148	Almond Brown	Non-Stock	SF/Piece	3.125
Factory Direct: \$9.40/SF (Full Pallets Only)				SF/Layer	
				SF/Pallet	84
	 <p style="text-align: center;">Almond Brown</p>			Pavers/Pallet	27
				Pavers/SF	
				Pavers/Layer	
				Layers/Pallet	
				Pallet Weight	2,430 Lbs



Mega-Arbel Collection—80mm

Yard Price: \$7.55/SF	SKU	Color	Stock Location	Dimensions	3 ¹ / ₈ " H x 15 ³ / ₈ " W x 21" L
	114556	Ashbury Haze	Cedar Acres	SF/Piece	1.44
Factory Direct: \$6.60/SF	114558	Cotswold Mist	Cedar Acres	SF/Layer	8.62
	114560	Gascony Tan	Cedar Acres	SF/Pallet	77.6
	 <p style="text-align: center;">Ashbury Haze</p>  <p style="text-align: center;">Cotswold Mist</p>  <p style="text-align: center;">Gascony Tan</p>			Pavers/Pallet	54
				Pavers/SF	.69
				Pavers/Layer	6
				Layers/Pallet	9
				Pallet Weight	2,940 Lbs

***A \$10 split pallet fee will be charged on pavers sold by band or layer only. Excludes circle pavers and kits.**

- Factory Direct pricing on drop ship order or factory pick-up; FULL PALLETS only; minimum drop ship order is 10 pallets
- All products can be delivered anywhere in the metro area; all deliveries quoted individually for best rate; PLEASE CALL
- Please call for out-state and out-of-state delivery; special delivery quotes available
- Non-stocked product can be obtained quickly with advance notice, subject to factory availability
- 4136789: \$20 pallet deposit on Belgard pallets; **\$18.00 will be credited upon return**
- 3625284: **\$10 broken pallet charge** on non-stock items if not ordered in full pallets; **no returns on non-stock item orders**



Melville Paving Stones



Melville—3 Piece Combo—80mm

Yard Price: \$7.15/SF		SKU	Color	Stock Location	Dimensions 3 3/8" H x 7 1/2" W x 15" L 3 3/8" H x 15" W x 15" L 3 3/8" H x 15" W x 22 3/8" L 3 : 3 : 2	
Factory Direct: \$6.27/SF (Full Pallets Only)		220150	Cotswold Mist	Non-Stock		
		114610	Newport Gray	Non-Stock		
		114612	Savannah Beige	Non-Stock		
					SF/Pattern Set	11.99
					SF/Layer	11.99
					SF/Pallet	83.97
					Sets/Pallet	7 Pattern Sets (56 Pcs)
					Sets/Layer	1 Pattern Set (8 Pcs)
					Layers/Pallet	7
					Pallet Weight	3,080 Lbs

Melville—Rectangle—80mm

Yard Price: \$7.15/SF		SKU	Color	Stock Location	Dimensions	
Factory Direct: \$6.27/SF (Full Pallets Only)		146580	Midnight	Non-Stock	3 3/8" H x 7 1/2" W x 15" L	
						SF/Piece
					SF/Layer	11.38
					SF/Pallet	79.67
					Pavers/Pallet	105
					Pavers/SF	1.28
					Pavers/Layer	15
					Layers/Pallet	7
					LF/Paver (Sailor)	1.25
					LF/Paver (Soldier)	.625
					Pallet Weight	2,925 Lbs

***A \$10 split pallet fee will be charged on pavers sold by band or layer only. Excludes circle pavers and kits.**

- Factory Direct pricing on drop ship order or factory pick-up; FULL PALLETS only; minimum drop ship order is 10 pallets
- All products can be delivered anywhere in the metro area; all deliveries quoted individually for best rate; PLEASE CALL
- Please call for out-state and out-of-state delivery; special delivery quotes available
- Non-stocked product can be obtained quickly with advance notice, subject to factory availability
- 4136789: \$20 pallet deposit on Belgard pallets; **\$18.00 will be credited upon return**
- 3625284: **\$10 broken pallet charge** on non-stock items if not ordered in full pallets; **no returns on non-stock item orders**

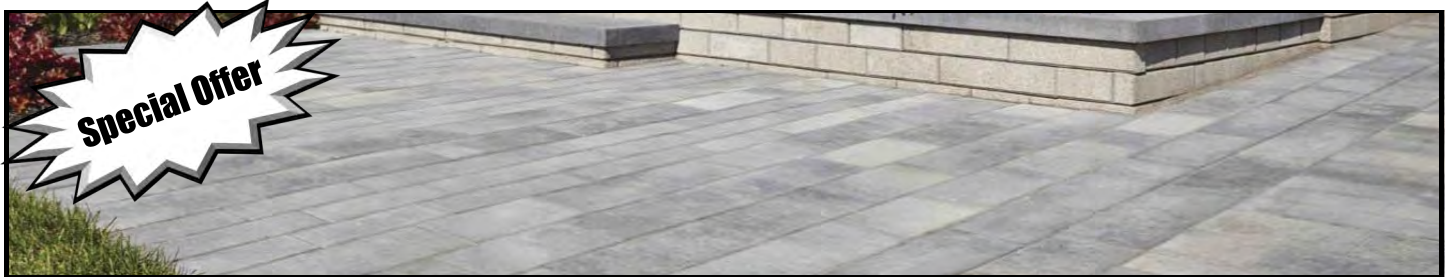

Melville—3 Piece Combo—60mm

Yard Price: \$4.32/SF Factory Direct: \$3.78/SF (Full Pallets Only)	SKU	Color	Stock Location	Dimensions $2\frac{3}{8}''\text{H} \times 7\frac{1}{2}''\text{W} \times 15''\text{L}$ $2\frac{3}{8}''\text{H} \times 15''\text{W} \times 15''\text{L}$ $2\frac{3}{8}''\text{H} \times 15''\text{W} \times 22\frac{7}{8}''\text{L}$ 3 : 3 : 2	
	220152	Aspen	Cedar Acres		
	220154	Cotswold Mist	Cedar Acres		
220156	Newport Gray	Cedar Acres			
				SF/Pattern Set	11.47
				SF/Layer	11.47
				SF/Pallet	114.7
				Sets/Pallet	10 Pattern Sets
				Sets/Layer	1 Pattern Set
				Layers/Pallet	10
				Pallet Weight	3,170 Lbs



Old World—3 Piece Combo—80mm

Yard Price: \$7.60/SF Factory Direct: \$6.69/SF (Full Pallets Only)	SKU	Color	Stock Location	Dimensions $3\frac{1}{8}''\text{H} \times 5\frac{1}{8}''\text{W} \times 7\frac{3}{4}''\text{L}$ $3\frac{1}{8}''\text{H} \times 5\frac{1}{8}''\text{W} \times 10\frac{5}{8}''\text{L}$ $3\frac{1}{8}''\text{H} \times 5\frac{1}{8}''\text{W} \times 12\frac{7}{8}''\text{L}$ 3 : 3 : 2	
	114618	Cotswold Mist	Non-Stock		
	114620	Gascony Tan	Non-Stock		
					SF/Pattern Set
				SF/Layer	11.28
				SF/Pallet	90.27
				Sets/Pallet	32 Pattern Sets (256 Pcs)
				Sets/Layer	4 Pattern Sets (32 Pcs)
				Layers/Pallet	8
				Pallet Weight	2,947 Lbs

***A \$10 split pallet fee will be charged on pavers sold by band or layer only. Excludes circle pavers and kits.**

- Factory Direct pricing on drop ship order or factory pick-up; FULL PALLETS only; minimum drop ship order is 10 pallets
- All products can be delivered anywhere in the metro area; all deliveries quoted individually for best rate; PLEASE CALL
- Please call for out-state and out-of-state delivery; special delivery quotes available
- Non-stocked product can be obtained quickly with advance notice, subject to factory availability
- 4136789: \$20 pallet deposit on Belgard pallets; **\$18.00 will be credited upon return**
- 3625284: **\$10 broken pallet charge** on non-stock items if not ordered in full pallets; **no returns on non-stock item orders**



Slaton Plus Tumbled Paving Stones



Slaton Plus Patterns

<p>Pattern 1 16% (2) Small Rectangle 50% (3) Large Rectangle 34% (1) Large Square 3.84 SF per Pattern Set</p>	<p>Pattern 2 32% (1) Large Rectangle 68% (1) Large Square 1.94 SF per Pattern Set</p>	<p>Pattern 3 19% (1) Small Rectangle 81% (1) Large Square 1.63 SF per Pattern Set</p>	<p>Pattern 4 67% (1) Large Rectangle 33% (1) Small Rectangle .95 SF per Pattern Set</p>	<p>Pattern 5 20% (3) Small Rectangle 53% (4) Large Rectangle 27% (1) Large Square 4.79 SF per Pattern Set</p>

Paver Math

(For the examples below we will use a 400 SqFt patio of Pattern 1 with a 80 LF soldier course of Slaton Plus Large Rectangles.)

- Subtract square footage of border from total square feet to determine square footage of the field
 $\# \text{ of Border Pieces} = 80 \div .69 \text{ (LF of Large Rectangle)} = 116$
 $\text{SF of Border} = 116 \times .63 \text{ (SF of Large Rectangle Piece)} = 73$
 $\text{SF of Field} = 400 - 73 = 327 \text{ SF}$
 $\text{Add 5\% for cuts/loss} = 327 \times 1.05 = 343 \text{ SF}$
- Multiply total square feet of the field by each of the percentages shown to determine total square feet needed of each piece size
 $343 \text{ SF} \times .16 = 55 \text{ SF of Small Rectangle}$
 $343 \text{ SF} \times .5 = 171 \text{ SF of Large Rectangle}$
 $343 \text{ SF} \times .34 = 117 \text{ SF of Large Square}$
- Divide results by square feet of individual piece for each size to determine number of pieces of each size needed
 $55 \text{ SF} \div .32 = 172 \text{ Pieces of Small Rectangle}$
 $171 \text{ SF} \div .63 = 272 \text{ Pieces of Large Rectangle}$
 $117 \text{ SF} \div 1.31 = 90 \text{ Pieces of Large Square}$

This method will provide a result as close as possible to the exact number of square feet needed.

OR

- Subtract square footage of border from total square feet to determine square footage of field
 $\# \text{ of Border Pieces} = 80 \div .69 \text{ (LF of Large Rectangle)} = 116$
 $\text{SF of Border} = 116 \times .63 \text{ (SF of Large Rectangle Piece)} = 73$
 $\text{SF of Field} = 400 - 73 = 327 \text{ SF}$
 $\text{Add 5\% for cuts/loss} = 327 \times 1.05 = 343 \text{ SF}$
- Divide square footage of field by the square feet of a "Pattern Set" to determine number of pattern sets needed
 $343 \text{ SF} \div 3.84 \text{ (SF of Pattern 1 Pattern Set)} = 90 \text{ Pattern Sets}$
- Multiply number of pattern sets by number of pieces of each size used for the pattern to calculate total number of pieces of each size needed
 $90 \times 2 = 180 \text{ Pieces of Small Rectangle}$
 $90 \times 3 = 270 \text{ Pieces of Large Rectangle}$
 $90 \times 1 = 90 \text{ Pieces of Large Square}$

This method will retain the correct ratio of the pieces to give a result in "complete set" quantities.



Slaton Plus Tumbled Paving Stones



Slaton Plus Tumbled Large Square—13x13—70mm

Yard Price: \$7.50/SF	SKU	Color	Stock Location	Dimensions	2 3/4" H x 13 3/4" W x 13 3/4" L
	3705306	Blu Iron	Non-Stock	SF/Piece	1.31
Factory Direct: \$6.52/SF	4344122	Northwoods	Non-Stock	SF/Layer	11.86
				SF/Pallet	83
				Pavers/Pallet	63
				Pavers/SF	.76
				Pavers/Layer	9
				Layers/Pallet	7
				LF/Paver (Sailor)	1.15
				LF/Paver (Soldier)	1.15
				Pallet Weight	2,860 Lbs

Slaton Plus Tumbled Large Rectangle—8x11—70mm

Yard Price: \$7.50/SF	SKU	Color	Stock Location	Dimensions	2 3/4" H x 8 3/4" W x 11" L
	3705290	Blu Iron	Non-Stock	SF/Piece	.63
Factory Direct: \$6.52/SF	4344115	Northwoods	Non-Stock	SF/Band	10.12
				SF/Pallet	81
				Pavers/Pallet	128
				Pavers/SF	1.58
				Pavers/Band	16
				Bands/Pallet	8
				LF/Paver (Sailor)	.92
				LF/Paver (Soldier)	.69
				Pallet Weight	2,750 Lbs

Slaton Plus Tumbled Small Rectangle—5x8—70mm

Yard Price: \$7.50/SF	SKU	Color	Stock Location	Dimensions	2 3/4" H x 5 1/2" W x 8 3/4" L
	3705283	Blu Iron	Non-Stock	SF/Piece	.32
Factory Direct: \$6.52/SF	4344108	Northwoods	Non-Stock	SF/Band	9.5
				SF/Pallet	76
				Pavers/Pallet	240
				Pavers/SF	3.17
				Pavers/Band	30
				Bands/Pallet	8
				LF/Paver (Sailor)	.69
				LF/Paver (Soldier)	.46
				Pallet Weight	2,572 Lbs

*A \$10 split pallet fee will be charged on pavers sold by band or layer only. Excludes circle pavers and kits.

- Factory Direct pricing on drop ship order or factory pick-up; FULL PALLETS only; minimum drop ship order is 10 pallets
- All products can be delivered anywhere in the metro area; all deliveries quoted individually for best rate; PLEASE CALL
- Please call for out-state and out-of-state delivery; special delivery quotes available
- Non-stocked product can be obtained quickly with advance notice, subject to factory availability
- 4136789: \$20 pallet deposit on Belgard pallets; **\$18.00 will be credited upon return**
- 3625284: **\$10 broken pallet charge** on non-stock items if not ordered in full pallets; **no returns on non-stock item orders**



Urbana Stone Pavers

Belgard Urbana Stone Pavers



Urbana Stone—3 Piece Combo—80mm

Yard Price: \$6.40/SF	SKU	Color	Stock Location	Dimensions	3 1/8" H x 4" W x 8" L 3 1/8" H x 8" W x 8" L 3 1/8" H x 8" W x 12" L
	146624	Brookstone Slate	Non-Stock		
Factory Direct: \$5.56/SF (Full Pallets Only)	114642	Cotswold Mist	Non-Stock		
	114644	Gascony Tan	Non-Stock		
				SF/Set	1.33
				SF/Layer	11.625
				SF/Pallet	93
				Pieces/Pallet	216
				Pieces/Layer	9 of Each Size
				Layers/Pallet	8
				Pallet Weight	3,420 Lbs



***A \$10 split pallet fee will be charged on pavers sold by band or layer only. Excludes circle pavers and kits.**

- Factory Direct pricing on drop ship order or factory pick-up; FULL PALLETS only; minimum drop ship order is 10 pallets
- All products can be delivered anywhere in the metro area; all deliveries quoted individually for best rate; PLEASE CALL
- Please call for out-state and out-of-state delivery; special delivery quotes available
- Non-stocked product can be obtained quickly with advance notice, subject to factory availability
- 4136789: \$20 pallet deposit on Belgard pallets; **\$18.00 will be credited upon return**
- 3625284: **\$10 broken pallet charge** on non-stock items if not ordered in full pallets; **no returns on non-stock item orders**

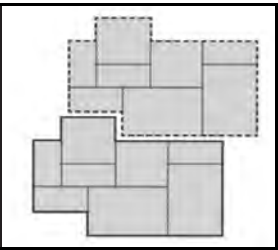
www.bachmanswholesale.com



RINN Lazio—3 Piece System—60mm

Yard Price: \$8.20/SF	SKU	Color	Stock Location	Dimensions	2 3/8" H x 4 1/8" W x 8 1/4" L 2 3/8" H x 8 1/4" W x 8 1/4" L 2 3/8" H x 8 1/4" W x 12 3/8" L 4 : 2 : 2	
	4180898	Beluga Gray	Non-Stock			
Factory Direct: \$7.18/SF (Full Pallets Only)	4180942	Sahara Beige	Non-Stock	SF/Pattern Set	3.31	
				SF/Layer	8.08	
					SF/Pallet	97
					Pieces/Pallet	240 (120, 60, & 60)
					Pieces/Layer	20 (10, 5, & 5)
					Layers/Pallet	12
					Pallet Weight	2.836 Lbs

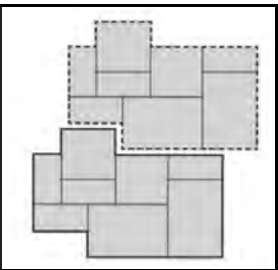

RINN Hydropor Lazio—3 Piece System—80mm

Yard Price: \$8.65/SF	SKU	Color	Stock Location	Dimensions	3 1/8" H x 4 1/8" W x 8 1/4" L 3 1/8" H x 8 1/4" W x 8 1/4" L 3 1/8" H x 8 1/4" W x 12 3/8" L 4 : 2 : 2	
	4344153	Latte Macchiato	Special Order			
Factory Direct: \$7.60/SF (Full Pallets Only)	4344160	Sahara Beige	Special Order	SF/Pattern Set	3.31	
				SF/Layer	8.22	
					SF/Pallet	74
					Pieces/Pallet	180 (90, 45, & 45)
					Pieces/Layer	20 (10, 5, & 5)
					Layers/Pallet	9
					Pallet Weight	2.705 Lbs

*A \$10 split pallet fee will be charged on pavers sold by band or layer only. Excludes circle pavers and kits.

- Factory Direct pricing on drop ship order or factory pick-up; FULL PALLETS only; minimum drop ship order is 10 pallets
- All products can be delivered anywhere in the metro area; all deliveries quoted individually for best rate; PLEASE CALL
- Please call for out-state and out-of-state delivery; special delivery quotes available
- Non-stocked product can be obtained quickly with advance notice, subject to factory availability
- 4136789: \$20 pallet deposit on Belgard pallets; **\$18.00 will be credited upon return**
- 3625284: **\$10 broken pallet charge** on non-stock items if not ordered in full pallets; **no returns on non-stock item orders**

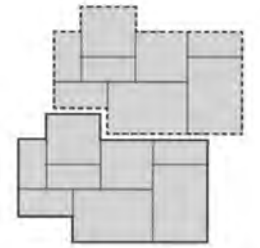

RINN Medino—3 Piece System—70mm

Yard Price: \$8.65/SF	SKU	Color	Stock Location	Dimensions	2¼" H x 6⅞" W x 13¾" L 2¾" H x 13¾" W x 13¾" L 2¾" H x 8¼" W x 20⅝" L 4 : 2 : 2
	4180973	Beluga Gray	Non-Stock		
Factory Direct: \$7.60/SF (Full Pallets Only)	SKU	Color	Stock Location	SF/Pattern Set	7.61
	4181000	Sahara Beige	Non-Stock	SF/Layer	9.09
				SF/Pallet	100
				Pieces/Pallet	88 (44, 22, & 22)
				Pieces/Layer	8 (4, 2, & 2)
				Layers/Pallet	11
				Pallet Weight	3,396 Lbs

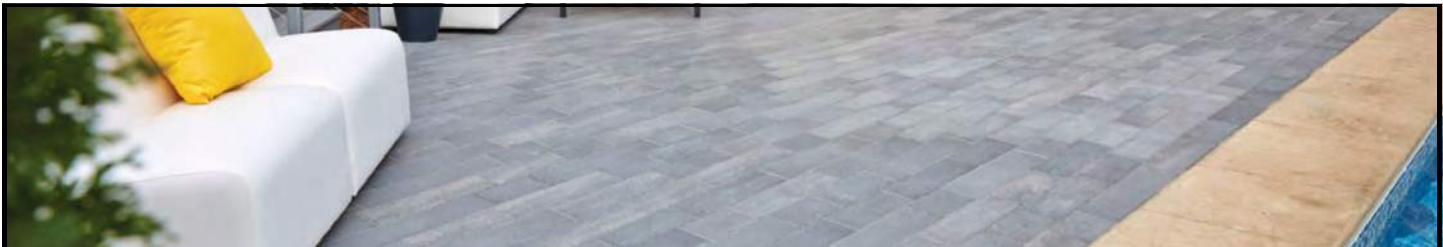

RINN Padio 14—4 Piece System—80mm

Yard Price: \$8.65/SF	SKU	Color	Stock Location	Dimensions	3⅞" H x 5⅝" W x 9" L 3⅞" H x 5⅝" W x 12.88" L 3⅞" H x 5⅝" W x 18.44" L 3⅞" H x 5⅝" W x 22.36" L
	4545581	Graphite	Non-Stock		
Factory Direct: \$7.60/SF (Full Pallets Only)				SF/Pattern Set	2.45
				SF/Layer	9.75
				SF/Pallet	78
				Pieces/Pallet	128 (32 of each)
				Pieces/Layer	16 (4 of each)
				Layers/Pallet	8
				Pallet Weight	3,008 Lbs

***A \$10 split pallet fee will be charged on pavers sold by band or layer only. Excludes circle pavers and kits.**

- Factory Direct pricing on drop ship order or factory pick-up; FULL PALLETS only; minimum drop ship order is 10 pallets
- All products can be delivered anywhere in the metro area; all deliveries quoted individually for best rate; PLEASE CALL
- Please call for out-state and out-of-state delivery; special delivery quotes available
- Non-stocked product can be obtained quickly with advance notice, subject to factory availability
- 4136789: \$20 pallet deposit on Belgard pallets; **\$18.00 will be credited upon return**
- 3625284: **\$10 broken pallet charge** on non-stock items if not ordered in full pallets; **no returns on non-stock item orders**



Porcelain Pavers—Ardesie



Ardesie Porcelain Pavers—.75 Inch

<i>African Stone & Vulcan</i>				Dimensions	¾" H x 23.54" W x 23.54" L
Yard Price: \$12.05/SF	SKU	Color	Stock Location	SF/Piece	3.85
	114506	African Stone	Special Order	SF/Pallet	232.5
Factory Direct: \$10.74/SF	114508	Island	Special Order	Pieces/Pallet	60 (30 boxes)
	146742	Shore	Special Order	Pallet Weight	2,280 Lbs
146740	Vulcan	Special Order	Spacers are recommended for all porcelain paver installations.		
<i>Island & Shore</i>					
Yard Price: \$11.55/SF					
Factory Direct: \$10.30/SF					
		African Stone	Island	Shore	Vulcan

UNICO Ardesie—.75 Inch with Bullnose

<i>UNICO Ardesie—.75 Inch with Bullnose</i>			
Yard Price: \$65.45/Each	SKU	Color	Stock Location
	114638	Island	Special Order
Factory Direct: \$59.09/Each	146762	Shore	Special Order
	Dimensions	¾" H x 23.54" W x 12.99" D	
	SF/Piece	2.12	
	LF/Piece	1.08	
	Pieces/Pallet	120	
	Pallet Weight	2,360 Lbs	

***A \$100 split pallet/box fee will be charged on all porcelain products.**

- Factory Direct pricing on drop ship order or factory pick-up; FULL PALLETS only; minimum drop ship order is 10 pallets
- All products can be delivered anywhere in the metro area; all deliveries quoted individually for best rate; PLEASE CALL
- Please call for out-state and out-of-state delivery; special delivery quotes available
- Non-stocked product can be obtained quickly with advance notice, subject to factory availability
- 4136789: \$20 pallet deposit on Belgard pallets; **\$18.00 will be credited upon return**
- **\$100 broken pallet charge** on non-stock items if not ordered in full pallets; **no returns on non-stock item orders**



Porcelain Pavers—Noon

Porcelain—Noon & UNICO Noon



Noon Wood Finish Porcelain Pavers—.75 Inch

Yard Price: \$15.30/SF	SKU	Color	Stock Location	Dimensions	¾" H x 7.80" W x 47.14" L	
Factory Direct: \$13.69/SF	146682	Charcoal	Special Order	SF/Piece	2.55	
	146688	Daylight	Special Order	SF/Pallet	151	
	146692	Ember	Special Order	Pieces/Pallet	80 (40 boxes)	
	146696	Honey	Special Order	Pallet Weight	1,425 Lbs	
				Spacers are recommended for all porcelain paver installations.		
	Charcoal		Daylight		Ember	

UNICO Noon—.75 Inch with Bullnose

Yard Price: \$65.45/Each	SKU	Color	Stock Location	<p>SIZE* 12.99 x 23.54 x ¾" Double sided special trim</p> <p>ROUNDED EDGE STRAIGHT EDGE</p>
Factory Direct: \$59.09/Each	181346	Charcoal	Special Order	
	181344	Daylight	Special Order	
	191340	Ember	Special Order	
	181348	Honey	Special Order	
	Dimensions		¾" H x 23.54" W x 12.99" D	
	SF/Piece		2.12	
	LF/Piece		1.08	
	Pieces/Pallet		120	
	Pallet Weight		2,360 Lbs	

***A \$100 split pallet/box fee will be charged on all direct ship porcelain products.**

- Factory Direct pricing on drop ship order or factory pick-up; FULL PALLETS only; minimum drop ship order is 10 pallets
- All products can be delivered anywhere in the metro area; all deliveries quoted individually for best rate; PLEASE CALL
- Please call for out-state and out-of-state delivery; special delivery quotes available
- Non-stocked product can be obtained quickly with advance notice, subject to factory availability
- 4136789: \$20 pallet deposit on Belgard pallets; **\$18.00 will be credited upon return**
- **\$100 broken pallet charge** on non-stock items if not ordered in full pallets; **no returns on non-stock item orders**

www.bachmanswholesale.com



Porcelain Pavers—Quarziti 2.0



Quarziti 24" x 24" Porcelain Pavers—.75 Inch

<i>Glacier, Mantle, & Mountains</i>	SKU	Color	Stock Location	Dimensions	¾" H x 23.54" W x 23.54" L
	146656	Glacier	Special Order	SF/Piece	3.85
Yard Price: \$11.65/SF	146662	Mantle	Special Order	SF/Pallet	232.5
	114622	Mountains	Special Order	Pallet Weight	2,280 Lbs
Factory Direct: \$10.37/SF	114624	River	Special Order	Spacers are recommended for all porcelain paver installations.	
	114626	Waterfall	Special Order		
<i>River & Waterfall</i>					
Yard Price: \$11.40/SF					
Factory Direct: \$10.16/SF					
	Glacier	Mantle	Mountain	River	Waterfall

Quarziti 24" x 48" Porcelain Pavers—.75 Inch

Yard Price: \$13.50/SF	SKU	Color	Stock Location	Dimensions	¾" H x 23.54" W x 48" L
	181332	Glacier	Special Order	SF/Piece	7.85
Factory Direct: \$12.05/SF	146660	Waterfall	Special Order	SF/Pallet	155
	Spacers are recommended for all porcelain paver installations.			Pallet Weight	1,475 Lbs

Quarziti 12" x 24" & 24" x 36" Porcelain Pavers—.75 Inch

Yard Price: \$17.75/SF	SKU	Color	Stock Location	Dimensions	¾" H x 11.73" W x 23.54" L ¾" H x 23.54" W x 35.35" L
	146756	Mountains	Special Order	SF/Piece	1.92 & 5.78 (7.7 per set)
Factory Direct: \$17.72/SF	146758	Waterfall	Special Order	SF/Pallet	155
	Spacers are recommended for all porcelain paver installations.			Pallet Weight	1,560 Lbs

***A \$100 split pallet/box fee will be charged on all direct ship porcelain products.**

- Factory Direct pricing on drop ship order or factory pick-up; FULL PALLETS only; minimum drop ship order is 10 pallets
- All products can be delivered anywhere in the metro area; all deliveries quoted individually for best rate; PLEASE CALL
- Please call for out-state and out-of-state delivery; special delivery quotes available
- Non-stocked product can be obtained quickly with advance notice, subject to factory availability
- 4136789: \$20 pallet deposit on Belgard pallets; **\$18.00 will be credited upon return**
- **\$100 broken pallet charge** on non-stock items if not ordered in full pallets; **no returns on non-stock item orders**



Porcelain Pavers—Turin & Verona

Porcelain—Turin & Verona



Turin 24" x 24" Porcelain Pavers—.75 Inch

Yard Price: \$8.05/SF	SKU	Color	Stock Location	Dimensions	
					¾" H x 23.54" W x 23.54" L
Factory Direct: \$7.10/SF	221490	Canyon	Non-Stock	SF/Piece	3.85
	221488	Frost	Non-Stock	SF/Pallet	232.5
	221492	Rapids	Non-Stock	Pieces/Pallet	60 (30 boxes)
Spacers are recommended for all porcelain paver installations.	221494	Stream	Non-Stock	Pallet Weight	2,280 Lbs
	Canyon		Frost		Rapids
					Stream



Verona 24" x 24" Porcelain Pavers—.75 Inch

Yard Price: \$8.05/SF	SKU	Color	Stock Location	Dimensions	
					¾" H x 23.54" W x 23.54" L
Factory Direct: \$7.10/SF	221480	Blue Stone	Non-Stock	SF/Piece	3.85
	221484	Platinum	Non-Stock	SF/Pallet	232.5
	221486	Taos	Special Order	Pieces/Pallet	60 (30 boxes)
Spacers are recommended for all porcelain paver installations.	221482	Yukon	Non-Stock	Pallet Weight	2,280 Lbs
	Blue Stone		Platinum		Taos
					Yukon

***A \$100 split pallet/box fee will be charged on all direct ship porcelain products.**

- Factory Direct pricing on drop ship order or factory pick-up; FULL PALLETS only; minimum drop ship order is 10 pallets
- All products can be delivered anywhere in the metro area; all deliveries quoted individually for best rate; PLEASE CALL
- Please call for out-state and out-of-state delivery; special delivery quotes available
- Non-stocked product can be obtained quickly with advance notice, subject to factory availability
- 4136789: \$20 pallet deposit on Belgard pallets; **\$18.00 will be credited upon return**
- **\$100 broken pallet charge** on non-stock items if not ordered in full pallets; **no returns on non-stock item orders**

www.bachmanswholesale.com



Porcelain Pavers—UNICO Quarziti

UNICO Quarziti—.75 Inch with Bullnose			
Yard Price: \$65.45/Each	SKU	Color	Stock Location
	146760	Glacier	Special Order
Factory Direct: \$59.09/Each	181336	Mantle	Special Order
	114632	Mountains	Special Order
	114634	River	Special Order
	114636	Waterfall	Special Order
	Dimensions	¾" H x 23.54" W x 12.99" D	
	SF/Piece	2.12	
	LF/Piece	1.08	
	Pieces/Pallet	120	
	Pallet Weight	2,360 Lbs	

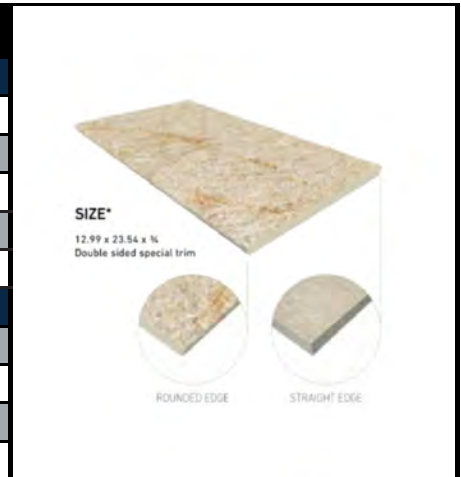

Porcelain Pavers—Sundeck

Sundeck 12" x 48" Porcelain Pavers—.75 Inch			
"Classic" Color	SKU	Color	Stock Location
	146672	Classic	Special Order
Yard Price: \$16.10/SF	146678	Spirit	Special Order
Factory Direct: \$14.42/SF			
"Spirit" Color	Dimensions	¾" H x 11.73" W x 47.17" L	
	SF/Piece	3.84	3.84
Yard Price: \$15.50/Each	SF/Pallet	155	155
Factory Direct: \$13.87/Each	Pallet Weight	1,460 Lbs	1,460 Lbs
Sundeck 24" x 24" Porcelain Pavers—.75 Inch			
"Classic" Color	SKU	Color	Stock Location
	146670	Classic	Special Order
Yard Price: \$12.60/SF	146676	Spirit	Special Order
Factory Direct: \$11.24/SF			
"Spirit" Color	Dimensions	¾" H x 23.54" W x 23.54" D	
	SF/Piece	3.85	
Yard Price: \$12.20/SF	SF/Pallet	232.5	
Factory Direct: \$10.89/SF	Pallet Weight	2,280 Lbs	

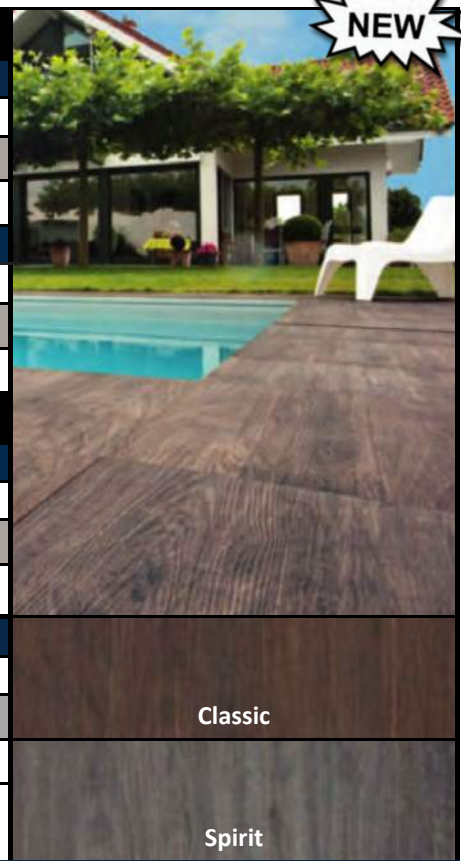

*A \$100 split pallet/box fee will be charged on all direct ship porcelain products.

- Factory Direct pricing on drop ship order or factory pick-up; FULL PALLETS only; minimum drop ship order is 10 pallets
- All products can be delivered anywhere in the metro area; all deliveries quoted individually for best rate; PLEASE CALL
- Please call for out-state and out-of-state delivery; special delivery quotes available
- Non-stocked product can be obtained quickly with advance notice, subject to factory availability
- 4136789: \$20 pallet deposit on Belgard pallets; **\$18.00 will be credited upon return**
- **\$100 broken pallet charge** on non-stock items if not ordered in full pallets; **no returns on non-stock item orders**



Porcelain Pavers—UNICO Sundeck

UNICO Sundeck—.75 Inch with Bullnose			
Yard Price: \$65.45/Each	SKU	Color	Stock Location
	146772	Classic	Special Order
Factory Direct: \$59.09/Each	146774	Spirit	Special Order
Dimensions		¾"H x 23.54"W x 12.99"D	
SF/Piece	2.12		
LF/Piece	1.08		
Pieces/Pallet	120		
Pallet Weight	2,360 Lbs		



Silca System®

Silca System® is a structural underlayment for elevated decks that is connected to wood floor joists, providing a substructure for a wide variety of decking materials such as stone and porcelain pavers.

Silca System® is engineered for strength and easy installation to create an attractive, long-lasting, and low maintenance deck.



A variety of paver products can be set onto the SilcaSystem panels including Mirage® porcelain pavers (as show here) or Belgard® pavers and slabs (as shown below). Recommended product heights of ¾" - 3".

SKU	Description	Price
181320 Non-Stock	Silca Grate 16" x 18¼" x 1½" 2.03 SF/Grate	\$13.25 Each

SKU	Description	Price
181322 Non-Stock	Silca Mat (1/16") 1mm x 4' x 75'	\$198.55 Roll
181324 Special Order	Silca Mat (1/8") 2mm x 4' x 75'	\$340.30 Roll
◆ Permeable rubber underlayment		
◆ Reduces sound and horizontal movement		

SKU	Description	Price
181326 Non-Stock	Silca Spacers 3" x 3⅞" x ⅜" Flexible (100/Box)	\$94.20/Box

***A \$100 split pallet/box fee will be charged on all direct ship porcelain products.**

- Factory Direct pricing on drop ship order or factory pick-up; FULL PALLETS only; minimum drop ship order is 10 pallets
- All products can be delivered anywhere in the metro area; all deliveries quoted individually for best rate; PLEASE CALL
- Please call for out-state and out-of-state delivery; special delivery quotes available
- Non-stocked product can be obtained quickly with advance notice, subject to factory availability
- 4136789: \$20 pallet deposit on Belgard pallets; **\$18.00 will be credited upon return**
- **\$100 broken pallet charge** on non-stock items if not ordered in full pallets; **no returns on non-stock item orders**



Marina Coping & Pillar Caps



Marina Coping—60mm

Yard Price: \$2.10 Each		SKU	Color	Stock Location	Dimensions	2 3/8" H x 6" W x 12" L
		220180	Cambray Tan	Cedar Acres	SF/Piece	.5
Factory Direct: \$1.82 Each		220182	Cotswold Mist	Cedar Acres	SF/Layer	
		220184	Midnight	Cedar Acres	Linear Feet/Pallet	60
					SF/Pallet	60
					Pavers/Pallet	120
					Pavers/Linear Foot	2
					Pavers/Layer	
					Layers/Pallet	
					LF/Paver (Sailor)	
					Pallet Weight	2,270 Lbs

Pillar Caps

24" x 24"		SKU	Color	Stock Location	Dimensions	2 1/2" H x 24" L x 24" D
		181646	Anthracite	Non-Stock	Coverage	1 Cap/Pillar
		181648	Leather	Non-Stock	Caps/Pallet	6
		Yard Price: \$175.00 Each			Weight/Cap	188 Lbs.
		Factory Direct Price: \$157.70 Each			Pallet Weight	1,132 Lbs.
30" x 30"		SKU	Color	Stock Location	Dimensions	2 1/2" H x 30" L x 30" D
		114464	Anthracite	Non-Stock	Coverage	1 Cap/Pillar
		146882	Leather	Non-Stock	Caps/Pallet	6
		Yard Price: \$205.00 Each			Weight/Cap	252 Lbs.
		Factory Direct Price: \$182.39 Each			Pallet Weight	1,512 Lbs.

*A \$10 split pallet fee will be charged on pavers sold by band or layer only. Excludes circle pavers and kits.

- Factory Direct pricing on drop ship order or factory pick-up; FULL PALLETS only; minimum drop ship order is 10 pallets
- All products can be delivered anywhere in the metro area; all deliveries quoted individually for best rate; PLEASE CALL
- Please call for out-state and out-of-state delivery; special delivery quotes available
- Non-stocked product can be obtained quickly with advance notice, subject to factory availability
- 4136789: \$20 pallet deposit on Belgard pallets; **\$18.00 will be credited upon return**
- 3625284: **\$10 broken pallet charge** on non-stock items if not ordered in full pallets; **no returns on non-stock item orders**

ACCENT/SPOT LIGHTS FOR TREES, PLANTS, HOUSES & LANDSCAPE FEATURES



TS-B102
Standard Accent Light

Accent for key landscape features

- 40° Beam Spread LED Lamp
- 4 Watt
- 250 Lumens
- MR16 LED Drop-in Lamp
- 2700 Kelvin Light Temperature
- Constructed of Solid Brass



TS-B103
Accent/Spot Light

Emits a tighter beam due to cowl design

- 40° Beam Spread LED Lamp
- 4 Watt
- 250 Lumens
- MR16 LED Drop-in Lamp
- 2700 Kelvin Light Temperature
- Constructed of Solid Brass



TS-B105
Wall Wash Light

Wide beam output – great for walls and landscape features

- 60° Beam Spread LED Lamp
- 5.5 Watt
- 450 Lumens
- MR16 LED Drop-in Lamp
- 2700 Kelvin Light Temperature
- Constructed of Solid Brass
- Includes a frosted lens to reduce glare



TS-B106
High Power Accent Light

Great for larger mature trees & flagpoles

- 120° Beam Spread LED Lamp
- 8 Watt
- 900 Lumens
- PAR36 LED Lamp
- 2700 Kelvin Light Temperature
- Constructed of Solid Brass

IN-GROUND WELL LIGHTS FOR PLANTS, TREES, HOUSES & LANDSCAPE FEATURES



TS-B201
High Power In-ground Well Light

Highlight houses, larger mature trees & flagpoles

- 120° Beam Spread LED Lamp
- 8 Watt
- 900 Lumens
- PAR16 LED Bulb
- 2700 Kelvin Light Temperature
- Constructed of a plastic housing with brass cowl and glass lens



TS-B203
Sealed In-ground Well Light

Highlight focal point plants/trees or a wall, statue or fountain

- 60° Beam Spread LED Lamp
- 4 Watt
- 250 Lumens
- MR16 LED Bulb
- 2700 Kelvin Light Temperature
- Constructed of a plastic housing with brass cowl and glass lens



PATH LIGHTS FOR PATHWAYS, PATIO EDGES & FLOWER BEDS



TS-B301
Low Voltage Path Light

Typical placement every 8-10 feet along walkways and patios

- 360° Beam Spread LED Lamp
- 3 Watt
- 300 Lumens
- G4 Bi-Pin LED Bulb
- 2700 Kelvin Light Temperature
- Constructed of Solid Brass



TS-B302
Low Voltage Path Light

Typical placement every 8-10 feet along walkways and patios

- 360° Beam Spread LED Lamp
- 3 Watt
- 300 Lumens
- G4 Bi-Pin LED Bulb
- 2700 Kelvin Light Temperature
- Constructed of Solid Brass



TS-B304
Low Voltage Path Light

Typical placement every 8-10 feet along walkways and patios

- 360° Beam Spread LED Lamp
- 3 Watt
- 300 Lumens
- G4 Bi-Pin LED Bulb
- 2700 Kelvin Light Temperature
- Constructed of Solid Brass



TS-B306
Low Voltage Path Light

Typical placement every 8-10 feet along walkways and patios

- 360° Beam Spread LED Lamp
- 3 Watt
- 300 Lumens
- G4 Bi-Pin LED Bulb
- 2700 Kelvin Light Temperature
- Constructed of Solid Brass

HARDSCAPE LIGHTS FOR WALLS, STEPS & OUTDOOR KITCHENS

TS-A500 Single LED Step & Wall Light

For narrow steps and radius walls

- 0.2 Watt
- Surface Mount LED (SMLED) Lamp
- 2700 Kelvin Light Temperature
- Constructed of Powder Coated Aluminum with Bronze Finish
- Stainless Steel Mounting Plate



TS-A1000 Four LED Step & Wall Light

Typical placement every 4-6' on a seating wall, industry standard under-cap light

- 1.4 Watt
- Surface Mount LED (SMLED) Lamp
- 2700 Kelvin Light Temperature
- Constructed of Powder Coated Aluminum with Bronze Finish
- Stainless Steel Mounting Plate



TS-A2000 Eight LED Step & Wall Light

For wider steps and taller wall applications where more output is desired

- 2.5 Watt
- Surface Mount LED (SMLED) Lamp
- 2700 Kelvin Light Temperature
- Constructed of Powder Coated Aluminum with Bronze Finish
- Stainless Steel Mounting Plate



PILLAR LIGHTS

PL-100 Traditional Pillar Light

Includes all components required for installation

(Mounting Base, Drill Template, Anchor Kit, Masonry Drill Bit, LED lamp and wire nuts)

- 360° Beam Spread LED Lamp
- 3 Watt
- 300 Lumens
- G4 Bi-Pin LED Bulb
- 2700 Kelvin Light Temperature
- Constructed of Powder Coated Aluminum with Bronze Finish



PL-101 Modern Pillar Light

Includes all components required for installation

(Mounting Base, Drill Template, Anchor Kit, Masonry Drill Bit, LED lamp and wire nuts)

- 360° Beam Spread LED Lamp
- 3 Watt
- 300 Lumens
- G4 Bi-Pin LED Bulb
- 2700 Kelvin Light Temperature
- Constructed of Powder Coated Aluminum with Bronze Finish



PAVER LIGHTS



NEW AVAILABLE SUMMER 2019

Available in 6", 8" and 9" Length to match popular Soldier or Sailor course edge pavers

- 60 mm Height
- Base feet to prevent lift from freeze/thaw
- Protective tear off strip for protection during installation
- Integrated Sealed Construction
- 2700 Kelvin Light Temperature LED Lamp

BLUETOOTH TRANSFORMER

TAAB-150 150 Watt Transformer

App based transformer allows for easy set-up and programming

Does not require timer or photocell – unit is all inclusive



TAAB-300 300 Watt Transformer

App based transformer allows for easy set-up and programming

Does not require timer or photocell – unit is all inclusive



KEY FEATURES FOR ALL FIXTURES

- Everything is included in the box – Fixture, LED Lamp, Gel filled wire nuts and heavy duty ground stake
- Tool-less design, simple hand assembly on site
- Directional Fixtures include a lock nut – essential for proper installation of the stake and fixture
- Lifetime Warranty on the Socket and Housing; Five Year Warranty on the Finish and Lamp
- UL and ETL Listed; FCC Compliant



Belair 2.0 Wall—Retaining & Freestanding

Formerly known as Artisana

Belgard Belair 2.0 Wall



Belair 2.0 Retaining Wall—6" Small, Medium, & Large Mixed Pallets

SKU	Color	Stock Location	Dimensions
4170226	Gold Creek	Cedar Acres	Large (2/Set): 6"H x 16"W x 8"D Medium (1/Set): 6"H x 10"W x 8"D Small (1/Set): 6"H x 6"W x 8"D
220196	Newport Gray	Non-Stock	
Yard Price: \$36.95/Set \$18.48/SqFt			
Factory Direct Price: \$32.32/Set (Full Pallets Only) \$16.16/SqFt			SF/Set 2
			SF/Pallet 30
Gold Creek			Blocks/Pallet 30 Lg, 15 Med, 15 Sm
Newport Gray			Sets/Pallet 15
			Weight/Block 52 Lbs (Lg), 31 Lbs (Med), 20 Lbs (Sm)
			Pallet Weight 2,377 Lbs

Belair 2.0 Retaining and Freestanding Wall are sold only in full sets.

Belair 2.0 Freestanding Wall—6" Small, Medium, & Large Mixed Pallets

SKU	Color	Stock Location	Dimensions
4170127	Gold Creek	Cedar Acres	Large (4/Set): 6"H x 16"W x 5"D Medium (2/Set): 6"H x 10"W x 5"D Small (2/Set): 6"H x 6"W x 5"D
220198	Newport Gray	Non-Stock	
Yard Price: \$44.45/Set \$22.23/SqFt			
Factory Direct Price: \$39.11/Set (Full Pallets Only) \$19.56/SqFt			SF/Set 2 SF of Front & 2 SF of Back
			SF/Pallet 30 SF of Front & 30 SF of Back
Gold Creek			Blocks/Pallet 60 Lg, 30 Med, 30 Sm
Newport Gray			Sets/Pallet 15
			Weight/Block 28 Lbs (Lg), 19 Lbs (Med), 11 Lbs (Sm)
			Pallet Weight 2,632 Lbs

- Factory Direct pricing on drop ship order or factory pick-up; FULL PALLETS only; minimum drop ship order is 10 pallets
- All products can be delivered anywhere in the metro area; all deliveries quoted individually for best rate; PLEASE CALL
- Please call for out-state and out-of-state delivery; special delivery quotes available
- Non-stocked product can be obtained quickly with advance notice, subject to factory availability
- 4136789: \$20 pallet deposit on Belgard pallets; **\$18.00 will be credited upon return**
- 3625284: **\$10 broken pallet charge** on non-stock items if not ordered in full pallets; **no returns on non-stock item orders**



www.bachmanswholesale.com



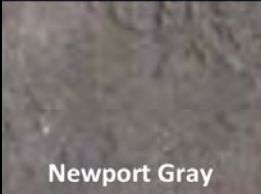

Belair 2.0 Wall Accessories

Belair 2.0 formerly known as Artisana

Belair 2.0 6" Column/Corner Block—For Retaining and Freestanding Wall

 <p>Gold Creek</p>	SKU	Color	Stock Location	Dimensions 6"H x 16¾"W x 8"D
	3335398	Gold Creek	Cedar Acres	
 <p>Newport Gray</p>	220202	Newport Gray	Non-Stock	Coverage 1.03 SqFt/Block (Two Sides Combined)
	Yard Price: \$16.70 Each			SF/Pallet 29 (Two Sides Combined)
Factory Direct Price: \$14.85 Each				Blocks/Pallet 28
				Weight/Cap 57 Lbs
				Pallet Weight 1,648 Lbs

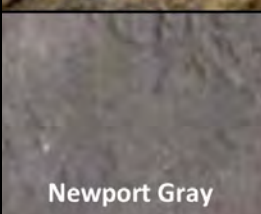
Belair 2.0 Sculpted Wall End—For Freestanding Wall

 <p>Gold Creek</p>	SKU	Color	Stock Location	Dimensions 6"H x 11"W x 8"D
	4545857	Gold Creek	Cedar Acres	
 <p>Newport Gray</p>	220200	Newport Gray	Non-Stock	Coverage .46 SqFt/Block for end of wall
	Yard Price: \$30.50 Each			SF/Pallet 29 (Face)
Factory Direct Price: \$27.22 Each				Blocks/Pallet 63
				Weight/Block 38 Lbs
				Pallet Weight 2,325 Lbs

Formulas for Calculating Belair 2.0 Retaining Walls

$$\text{SqFt of Wall Above Grade} \div 2 = \text{Number of Belair 2.0 Wall SETS Required}$$

For Retaining Wall:

Number of Sets x 2 = Number of Large Block
 Number of Sets x 1 = Number of Medium Block
 Number of Sets x 1 = Number of Small Block

For Freestanding Wall:

Number of Sets x 4 = Number of Large Block
 Number of Sets x 2 = Number of Medium Block
 Number of Sets x 2 = Number of Small Block

Base Course Using Belair 2.0 6" Wall

For Retaining Wall:

Wall Length in Feet \div 4 = Number of Additional Sets

For Freestanding Wall:

Wall Length in Feet \div 8 = Number of Additional Sets

Base Course Using Torpedo Base

Wall Length in Feet \div 1.32 = Number of Torpedo Base Block Needed

Wall Cap Formula

Length of Wall in Feet \div .625 = Number of Caps Required

- Factory Direct pricing on drop ship order or factory pick-up; FULL PALLETS only; minimum drop ship order is 10 pallets
- All products can be delivered anywhere in the metro area; all deliveries quoted individually for best rate; PLEASE CALL
- Please call for out-state and out-of-state delivery; special delivery quotes available
- Non-stocked product can be obtained quickly with advance notice, subject to factory availability
- 4136789: \$20 pallet deposit on Belgard pallets; **\$18.00 will be credited upon return**
- 3625284: **\$10 broken pallet charge** on non-stock items if not ordered in full pallets; **no returns on non-stock item orders**





Belair 2.0 Wall Accessories

Belair 2.0 formerly known as Artisana

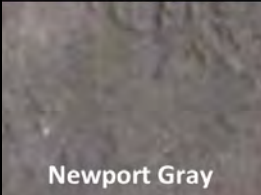
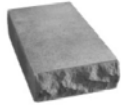
Belair 2.0 3" Cap Block—For Retaining and Freestanding Wall

 Gold Creek	SKU	Color	Stock Location	Dimensions Long Side: 3"H x 8"W x 13½"D Short Side: 3"H x 7"W x 13½"D
	3335411	Gold Creek	Cedar Acres	
 Newport Gray	220206	Newport Gray	Non-Stock	Coverage .625 Linear Feet/Cap
	Yard Price: \$7.70 Each			LF/Pallet 79
Factory Direct Price: \$6.69 Each			Caps/Pallet 126	
			Weight/Cap 22 Lbs	
			Pallet Weight 2,937 Lbs	

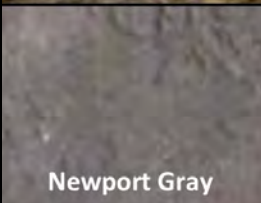
Belair 2.0 3" Sculpted Cap End Block—For Retaining and Freestanding Wall

 Gold Creek	SKU	Color	Stock Location	Dimensions 3"H x 8"W x 13½"D
	4545871	Gold Creek	Cedar Acres	
 Newport Gray	220204	Newport Gray	Non-Stock	Coverage .67 Linear Feet/Cap for end of wall
	Yard Price: \$12.25 Each			LF/Pallet 40.5
Factory Direct Price: \$10.85 Each			Caps/Pallet 36	
			Weight/Cap 23.75 Lbs	
			Pallet Weight 855 Lbs	

4" Torpedo Base Block

	SKU	Color	Stock Location	Dimensions 4"H x 11"W x 15¼"L
	3957774	Gray	Cedar Acres	LF/Piece 1.32
Yard Price: \$8.05 Each			LF/Pallet 64	
Factory Direct Price: \$6.95 Each (Full Pallets Only)			Blocks/Pallet 48	
			Weight/Block 47 Lbs.	
			Pallet Weight 2,308 Lbs.	

- Factory Direct pricing on drop ship order or factory pick-up; FULL PALLETS only; minimum drop ship order is 10 pallets
- All products can be delivered anywhere in the metro area; all deliveries quoted individually for best rate; PLEASE CALL
- Please call for out-state and out-of-state delivery; special delivery quotes available
- Non-stocked product can be obtained quickly with advance notice, subject to factory availability
- 4136789: \$20 pallet deposit on Belgard pallets; **\$18.00 will be credited upon return**
- 3625284: **\$10 broken pallet charge** on non-stock items if not ordered in full pallets; **no returns on non-stock item orders**



Brisa Wall—Retaining & Freestanding



Belgard Brisa Wall

Brisa Retaining Wall—6" Small, Medium, & Large Mixed Pallets

	SKU	Color	Stock Location		
Arctic Gold	3957569	Arctic Gold	Cedar Acres	Dimensions Large (2/Set): 6"H x 16"W x 8"D Medium (1/Set): 6"H x 10"W x 8"D Small (1/Set): 6"H x 6"W x 8"D	
	3957576	Heritage	Cedar Acres		
	146782	Moonlight	Cedar Acres		
	Yard Price: \$36.95/Set \$18.48/SqFt			SF/Set	2
Heritage	Factory Direct Price: \$32.32/Set \$16.16/SqFt			SF/Pallet	30
				Blocks/Pallet	30 Lg, 15 Med, 15 Sm
Moonlight				Sets/Pallet	15
				Weight/Block	52 Lbs (Lg), 31 Lbs (Med), 20 Lbs (Sm)
				Pallet Weight	2,377 Lbs

Brisa Retaining and Freestanding Wall are sold only in full sets.

Brisa Freestanding Wall—6" Small, Medium, & Large Mixed Pallets

	SKU	Color	Stock Location		
Arctic Gold	3957736	Arctic Gold	Cedar Acres	Dimensions Large (4/Set): 6"H x 16"W x 5"D Medium (2/Set): 6"H x 10"W x 5"D Small (2/Set): 6"H x 6"W x 5"D	
	3957743	Heritage	Cedar Acres		
	146784	Moonlight	Cedar Acres		
	Yard Price: \$43.95/Set \$21.98/SqFt			SF/Set	2 SF of Front & 2 SF of Back
Heritage	Factory Direct Price: \$39.11/Set \$19.56/SqFt			SF/Pallet	30 SF of Front & 30 SF of Back
				Blocks/Pallet	60 Lg, 30 Med, 30 Sm
Moonlight				Sets/Pallet	15
				Weight/Block	28 Lbs (Lg), 19 Lbs (Med), 11 Lbs (Sm)
				Pallet Weight	2,632 Lbs

- Factory Direct pricing on drop ship order or factory pick-up; FULL PALLETS only; minimum drop ship order is 10 pallets
- All products can be delivered anywhere in the metro area; all deliveries quoted individually for best rate; PLEASE CALL
- Please call for out-state and out-of-state delivery; special delivery quotes available
- Non-stocked product can be obtained quickly with advance notice, subject to factory availability
- 4136789: \$20 pallet deposit on Belgard pallets; **\$18.00 will be credited upon return**
- 3625284: **\$10 broken pallet charge** on non-stock items if not ordered in full pallets; **no returns on non-stock item orders**

www.bachmanswholesale.com



Brisa Wall Accessories

Belgard Brisa Wall Accessories

Brisa 6" Column/Corner Block—For Retaining and Freestanding Wall

SKU	Color	Stock Location	Dimensions	6"H x 16¾"W x 8"D
3957712	Arctic Gold	Cedar Acres		
3957729	Heritage	Cedar Acres		
146806	Moonlight	Cedar Acres	SF/Pallet	29 (Two Sides Combined)
Yard Price: \$16.70 Each			Blocks/Pallet	28
Factory Direct Price: \$14.85 Each			Weight/Cap	57 Lbs
			Pallet Weight	1,648 Lbs

Brisa Sculpted Wall End—For Freestanding Wall

SKU	Color	Stock Location	Dimensions	6"H x 11"W x 8"D
4545895	Arctic Gold	Cedar Acres		
4545901	Heritage	Cedar Acres		
146794	Moonlight	Cedar Acres	SF/Pallet	29 (Face)
Yard Price: \$30.40 Each			Blocks/Pallet	63
Factory Direct Price: \$27.22 Each			Weight/Block	38 Lbs
			Pallet Weight	2,325 Lbs

Formulas for Calculating Brisa Walls

SqFt of Wall Above Grade ÷ 2 = Number of Wall SETS Required

For Retaining Wall:

Number of Sets x 2 = Number of Large Block
 Number of Sets x 1 = Number of Medium Block
 Number of Sets x 1 = Number of Small Block

For Freestanding Wall:

Number of Sets x 4 = Number of Large Block
 Number of Sets x 2 = Number of Medium Block
 Number of Sets x 2 = Number of Small Block

Base Course Using Brisa 6" Wall

For Retaining Wall:

Wall Length in Feet ÷ 4 = Number of Additional Sets

For Freestanding Wall:

Wall Length in Feet ÷ 8 = Number of Additional Sets

Base Course Using Torpedo Base

Wall Length in Feet ÷ 1.32 = Number of Torpedo Base Block Needed

Wall Cap Formula

Length of Wall in Feet ÷ .625 = Number of Caps Required

- Factory Direct pricing on drop ship order or factory pick-up; FULL PALLETS only; minimum drop ship order is 10 pallets
- All products can be delivered anywhere in the metro area; all deliveries quoted individually for best rate; PLEASE CALL
- Please call for out-state and out-of-state delivery; special delivery quotes available
- Non-stocked product can be obtained quickly with advance notice, subject to factory availability
- 4136789: \$20 pallet deposit on Belgard pallets; **\$18.00 will be credited upon return**
- 3625284: **\$10 broken pallet charge** on non-stock items if not ordered in full pallets; **no returns on non-stock item orders**

www.bachmanswholesale.com



Brisa Wall Accessories

Brisa 3" Cap Block—For Retaining and Freestanding Wall

	SKU	Color	Stock Location			
Arctic Gold	3957637	Arctic Gold	Cedar Acres		Dimensions Long Side: 3"H x 8"W x 13½"D Short Side: 3"H x 7"W x 13½"D	
	3957651	Heritage	Cedar Acres			
	146800	Moonlight	Cedar Acres			
Yard Price: \$7.70 Each						
Factory Direct Price: \$6.69 Each						
Heritage					Coverage	.625 Linear Feet/Cap
				LF/Pallet	79	
				Caps/Pallet	126	
				Weight/Cap	22 Lbs	
				Pallet Weight	2,935 Lbs	
Moonlight						

Brisa 3" Sculpted Cap End Block—For Retaining and Freestanding Wall

	SKU	Color	Stock Location			
Arctic Gold	4545918	Arctic Gold	Cedar Acres		Dimensions 3"H x 8"W x 13½"D	
	4545925	Heritage	Cedar Acres			
	146798	Moonlight	Cedar Acres			
Yard Price: \$12.25 Each						
Factory Direct Price: \$10.85 Each						
Heritage					Coverage	.67 Linear Feet/Cap for end of wall
				LF/Pallet	40.5	
				Caps/Pallet	36	
				Weight/Cap	23.75 Lbs	
				Pallet Weight	855 Lbs	
Moonlight						

4" Torpedo Base Block

	SKU	Color	Stock Location			
	3957774	Gray	F	Dimensions 4"H x 11"W x 15¼"L		
	Yard Price: \$8.05 Each				LF/Piece	1.32
	Factory Direct Price: \$6.95 Each (Full Pallets Only)				LF/Pallet	64
					Blocks/Pallet	48
			Weight/Block	47 Lbs.		
			Pallet Weight	2,308 Lbs.		



- Factory Direct pricing on drop ship order or factory pick-up; FULL PALLETS only; minimum drop ship order is 10 pallets
- All products can be delivered anywhere in the metro area; all deliveries quoted individually for best rate; PLEASE CALL
- Please call for out-state and out-of-state delivery; special delivery quotes available
- Non-stocked product can be obtained quickly with advance notice, subject to factory availability
- 4136789: \$20 pallet deposit on Belgard pallets; **\$18.00 will be credited upon return**
- 3625284: **\$10 broken pallet charge** on non-stock items if not ordered in full pallets; **no returns on non-stock item orders**



Diamond Retaining Wall





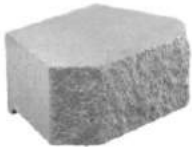

Diamond Retaining Wall—Beveled (3-Way)

	SKU	Color	Stock Location	Dimensions	6" H x 15 7/8" W x 12" D
 Desert Tan	2744108	Desert Tan	Cedar Acres	SF/Block	.67
	2747802	Gray	Cedar Acres	SF/Pallet	30.15
	2747826	Umber	Cedar Acres	Blocks/Pallet	45
 Gray	Yard Price: \$6.25 Each \$9.33/SqFt			Weight/Block	65 Lbs
				Factory Direct Price: \$5.16 Each (Full Pallets Only) \$7.70/SqFt	
 Umber	<i>Call for pricing on larger orders</i>				

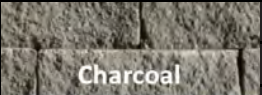

Diamond Retaining Wall—Straight

	SKU	Color	Stock Location	Dimensions	6" H x 17 1/2" W x 12" D
 Charcoal	146808	Charcoal	Cedar Acres	SF/Block	.73
 Desert Tan	2747864	Desert Tan	Cedar Acres	SF/Pallet	32.85
	2747888	Gray	Cedar Acres	Blocks/Pallet	45
	2747901	Umber	Cedar Acres	Weight/Block	68 Lbs
 Gray	Yard Price: \$6.25/Each \$8.56/SqFt			Pallet Weight	3,112 Lbs
				Factory Direct Price: \$5.16 Each (Full Pallets Only) \$7.07/SqFt	
 Umber	<i>Call for pricing on larger orders</i>				

- Factory Direct pricing on drop ship order or factory pick-up; FULL PALLETS only; minimum drop ship order is 10 pallets
- All products can be delivered anywhere in the metro area; all deliveries quoted individually for best rate; PLEASE CALL
- Please call for out-state and out-of-state delivery; special delivery quotes available
- Non-stocked product can be obtained quickly with advance notice, subject to factory availability
- 4136789: \$20 pallet deposit on Belgard pallets; **\$18.00 will be credited upon return**
- 3625284: **\$10 broken pallet charge** on non-stock items if not ordered in full pallets; **no returns on non-stock item orders**



Diamond Retaining Wall Accessories

Diamond XL Cap Unit

- Colors listed are in Diamond colors—additional colors listed with Diamond Stone Cut Block & Highland Wall Block

	SKU	Color	Stock Location	Dimensions	3"H x 18"W (F) / 12"W (B) x 13"D
Charcoal	146812	Charcoal	Cedar Acres	Coverage	1.25 Linear Feet/Cap (Average)
	2748014	Desert Tan	Cedar Acres	LF/Pallet	90 (Average)
Desert Tan	2748021	Gray	Cedar Acres	Caps/Pallet	72
	2748038	Umber	Cedar Acres	Weight/Cap	44 Lbs
Yard Price: \$10.25 Each				Pallet Weight	3,335 Lbs
Factory Direct Price: \$8.92 Each					

Diamond Large Step Block

- Colors listed are in Diamond colors—additional colors listed with Diamond Stone Cut Block & Highland Wall Block

	SKU	Color	Stock Location	Dimensions	6"H x 16"W x 16"D
Charcoal	146814	Charcoal	Cedar Acres	SF/Block	.67 (Face) & 1.77 (Surface)
	2748229	Desert Tan	Cedar Acres	SF/Pallet	16 (Face) & 42.48 (Surface)
Desert Tan	2748236	Gray	Cedar Acres	Blocks/Pallet	24
	2748243	Umber	Cedar Acres	Weight/Block	112 Lbs
Yard Price: \$15.95 Each				Pallet Weight	2,835 Lbs
Factory Direct Price: \$13.54 Each					

- Factory Direct pricing on drop ship order or factory pick-up; FULL PALLETS only; minimum drop ship order is 10 pallets
- All products can be delivered anywhere in the metro area; all deliveries quoted individually for best rate; PLEASE CALL
- Please call for out-state and out-of-state delivery; special delivery quotes available
- Non-stocked product can be obtained quickly with advance notice, subject to factory availability
- 4136789: \$20 pallet deposit on Belgard pallets; **\$18.00 will be credited upon return**
- 3625284: **\$10 broken pallet charge** on non-stock items if not ordered in full pallets; **no returns on non-stock item orders**



Diamond Stone Cut Retaining Wall

Belgard Diamond Stone Cut Retaining Wall

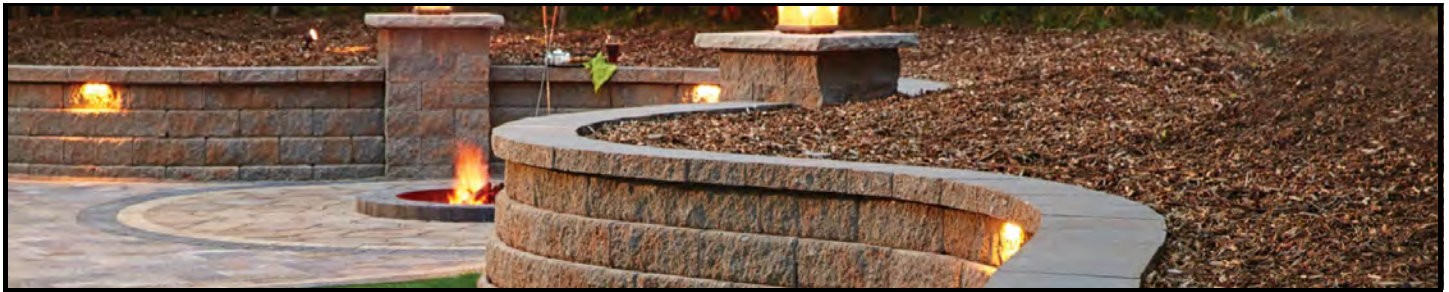

Diamond Stone Cut Formal Retaining Wall

	SKU	Color	Stock Location	Dimensions	6"H x 17 1/4"W x 12"D
Charcoal Brown	3368983	Charcoal Brown	Cedar Acres	SF/Block	.72
	3368976	Chestnut Tan	Cedar Acres	SF/Pallet	26
Chestnut Tan	3705320	Quail	Cedar Acres	Blocks/Pallet	36
	Yard Price: \$7.90 Each \$10.97/SqFt			Weight/Block	71 Lbs
Quail	Factory Direct Price: \$6.61 Each (Full Pallets Only) \$9.18/SqFt			Pallet Weight	2,716 Lbs
					

Diamond Stone Cut XL Cap Unit

- Colors listed are in Diamond Stone Cut color blends—additional colors listed with Diamond Block & Highland Wall Block

	SKU	Color	Stock Location	Dimensions	3"H x 18"W (F) / 12"W (B) x 13"D
Charcoal Brown	3369645	Charcoal Brown	Cedar Acres	Coverage	1.25 Linear Feet/Cap (Average)
	3369638	Chestnut Tan	Cedar Acres	LF/Pallet	90 (Average)
Chestnut Tan	3705337	Quail	Cedar Acres	Caps/Pallet	72
	Yard Price: \$10.25 Each			Weight/Cap	44 Lbs
Quail	Factory Direct Price: \$8.92 Each			Pallet Weight	3,335 Lbs
					

Diamond Large Step Block

- Colors listed are in Diamond Stone Cut color blends—additional colors listed with Diamond Block & Highland Wall Block

	SKU	Color	Stock Location	Dimensions	6"H x 16"W x 16"D
Charcoal Brown	4545758	Charcoal Brown	Cedar Acres	SF/Block	.67 (Face) & 1.77 (Surface)
	3545360	Chestnut Tan	Cedar Acres	SF/Pallet	16 (Face) & 42.48 (Surface)
Chestnut Tan	4545772	Quail	Cedar Acres	Blocks/Pallet	24
	Yard Price: \$15.95 Each			Weight/Block	126 Lbs
Quail	Factory Direct Price: \$13.54 Each			Pallet Weight	2,835 Lbs
					

www.bachmanswholesale.com



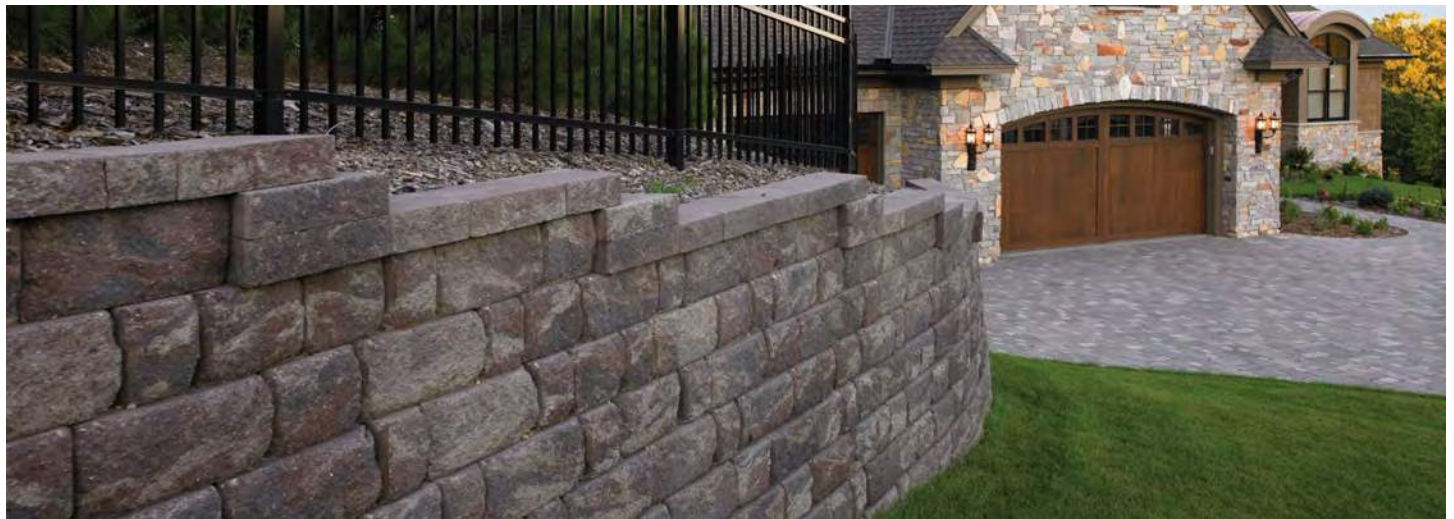

Diamond Pro Stone Cut Retaining Wall





Diamond Pro Stone Cut Retaining Wall

Diamond Pro Stone Cut Formal Retaining Wall—Large Unit

 Ironstone	SKU	Color	Stock Location	Dimensions	8" H x 18" W x 12" D
		114660	Ironstone	Special Order	SF/Block
 Sand	114654	Sand	Non-Stock	SF/Pallet	36
	Yard Price: \$11.95 Each \$11.95/SqFt			Blocks/Pallet	36
Factory Direct Price: \$9.99 Each (Full Pallets Only) \$9.99/SqFt			Weight/Block	77 Lbs	
			Pallet Weight	2,832 Lbs	
					

*****Special Order Only—No Returns on Full or Partial Pallets*****

Diamond Pro Stone Cut Formal Retaining Wall—Virtual Joint Unit

 Ironstone	SKU	Color	Stock Location	Dimensions	8" H x 18" W x 12" D
		114662	Ironstone	Special Order	SF/Block
 Sand	114656	Sand	Non-Stock	SF/Pallet	36
	Yard Price: \$11.95 Each \$11.95/SqFt			Blocks/Pallet	36
Factory Direct Price: \$9.99 Each (Full Pallets Only) \$9.99/SqFt			Weight/Block	77 Lbs	
			Pallet Weight	2,832 Lbs	
					

- Factory Direct pricing on drop ship order or factory pick-up; FULL PALLETS only; minimum drop ship order is 10 pallets
- All products can be delivered anywhere in the metro area; all deliveries quoted individually for best rate; PLEASE CALL
- Please call for out-state and out-of-state delivery; special delivery quotes available
- Non-stocked product can be obtained quickly with advance notice, subject to factory availability
- 4136789: \$20 pallet deposit on Belgard pallets; **\$18.00 will be credited upon return**
- 3625284: **\$10 broken pallet charge** on non-stock items if not ordered in full pallets; **no returns on non-stock item orders**



www.bachmanswholesale.com



Diamond Pro Stone Cut Retaining Wall Accessories



Belgard Diamond Pro Stone Cut Accessories

Diamond Pro Stone Cut 4" Cap Unit

Diamond Pro Stone Cut 4" Cap Unit				Dimensions	4" H x 17 1/4" W x 10" D
	SKU	Color	Stock Location	Coverage	1.137 Linear Feet/Cap
	114648	Ironstone	Special Order	LF/Pallet	91 (Average)
	114650	Sand	Non-Stock	Blocks/Pallet	80
	Yard Price: \$9.35 Each				Weight/Block
Factory Direct Price: \$7.58 Each				Pallet Weight	3,812 Lbs
					

*****Special Order Only—No Returns on Full or Partial Pallets*****

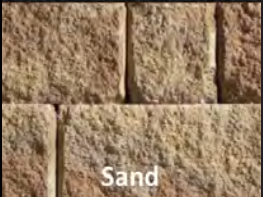
Diamond Pro Stone Cut Corner

Diamond Pro Stone Cut Corner				Dimensions	8" H x 18" W x 9" D
	SKU	Color	Stock Location	SF/Block	1.5 (Combined Sides)
	114658	Ironstone	Special Order	SF/Pallet	30 (Combined Sides)
	114652	Sand	Non-Stock	Blocks/Pallet	20
	Yard Price: \$15.70 Each				Weight/Block
Factory Direct Price: \$13.32 Each				Pallet Weight	2,112 Lbs
					

- Factory Direct pricing on drop ship order or factory pick-up; FULL PALLETS only; minimum drop ship order is 10 pallets
- All products can be delivered anywhere in the metro area; all deliveries quoted individually for best rate; PLEASE CALL
- Please call for out-state and out-of-state delivery; special delivery quotes available
- Non-stocked product can be obtained quickly with advance notice, subject to factory availability
- 4136789: \$20 pallet deposit on Belgard pallets; **\$18.00 will be credited upon return**
- 3625284: **\$10 broken pallet charge** on non-stock items if not ordered in full pallets; **no returns on non-stock item orders**





www.bachmanswholesale.com



Diamond Pro Retaining Wall







Diamond Pro Retaining Wall—Beveled (3-Way)

	SKU	Color	Stock Location	Dimensions	8" H x 18" W x 13" D
 Desert Tan	2750871	Desert Tan	Non-Stock	SF/Block	1
	2750888	Gray	Non-Stock	SF/Pallet	36
	2750895	Umber	Non-Stock	Blocks/Pallet	36
Yard Price: \$11.25 Each \$11.25/SqFt				Weight/Block	85 Lbs
Factory Direct Price: \$9.20 Each (Full Pallets Only) \$9.20/SqFt				Pallet Weight	2,752 Lbs
<i>Call for pricing on larger orders</i>					
 Gray					
 Umber					

*****Special Order Only—No Returns on Full or Partial Pallets*****



Diamond Pro Retaining Wall—Straight

	SKU	Color	Stock Location	Dimensions	8" H x 18" W x 13" D
 Desert Tan	3705962	Desert Tan	Non-Stock	SF/Block	1
	2750956	Gray	Non-Stock	SF/Pallet	36
	3705986	Umber	Non-Stock	Blocks/Pallet	36
Yard Price: \$11.25 Each \$11.25/SqFt				Weight/Block	86 Lbs
Factory Direct Price: \$9.20 Each (Full Pallets Only) \$9.20/SqFt				Pallet Weight	2,824 Lbs
<i>Call for pricing on larger orders</i>					
 Gray					
 Umber					

- Factory Direct pricing on drop ship order or factory pick-up; FULL PALLETS only; minimum drop ship order is 10 pallets
- All products can be delivered anywhere in the metro area; all deliveries quoted individually for best rate; PLEASE CALL
- Please call for out-state and out-of-state delivery; special delivery quotes available
- Non-stocked product can be obtained quickly with advance notice, subject to factory availability
- 4136789: \$20 pallet deposit on Belgard pallets; **\$18.00 will be credited upon return**
- 3625284: **\$10 broken pallet charge** on non-stock items if not ordered in full pallets; **no returns on non-stock item orders**



Diamond Pro Retaining Wall Accessories

Diamond Pro Retaining Wall Accessories

Diamond Pro 4" Cap Unit

SKU	Color	Stock Location	Dimensions	4" H x 17 1/4" W x 10" D
2751014	Desert Tan	Non-Stock	Coverage	1.137 Linear Feet/Cap
2751021	Gray	Non-Stock	LF/Pallet	91 (Average)
2751038	Umber	Non-Stock	Blocks/Pallet	80
Yard Price: \$9.35 Each			Weight/Block	50 Lbs
Factory Direct Price: \$7.58 Each			Pallet Weight	3,812 Lbs



*****Special Order Only—No Returns on Full or Partial Pallets*****

Diamond Pro Corner

SKU	Color	Stock Location	Dimensions	8" H x 18" W x 9" D
2751083	Desert Tan	Non-Stock	SF/Block	1.5 (Combined Sides)
2751090	Gray	Non-Stock	SF/Pallet	30 (Combined Sides)
3706020	Umber	Non-Stock	Blocks/Pallet	20
Yard Price: \$15.70 Each			Weight/Block	103 Lbs
Factory Direct Price: \$13.32 Each			Pallet Weight	2,112 Lbs



For Fresco Wall please see Weston Wall.

- Factory Direct pricing on drop ship order or factory pick-up; FULL PALLETS only; minimum drop ship order is 10 pallets
- All products can be delivered anywhere in the metro area; all deliveries quoted individually for best rate; PLEASE CALL
- Please call for out-state and out-of-state delivery; special delivery quotes available
- Non-stocked product can be obtained quickly with advance notice, subject to factory availability
- 4136789: \$20 pallet deposit on Belgard pallets; **\$18.00 will be credited upon return**
- 3625284: **\$10 broken pallet charge** on non-stock items if not ordered in full pallets; **no returns on non-stock item orders**





www.bachmanswholesale.com







Highland Retaining Wall



Belgard Highland Retaining Wall

Highland Retaining Wall—6" Large			
 Ironstone	SKU	Color	Stock Location
	2748328	Ironstone	Cedar Acres
	3242184	Majestic Gray	Cedar Acres
 Majestic Gray	2748298	Sand	Cedar Acres
	Yard Price: \$11.75 Each \$15.66/SqFt		
	Factory Direct Price: \$10.03 Each (Full Pallets Only) \$13.37/SqFt		
 Sand			
		Dimensions	6" H x 18" W x 12" D
		SF/Block	.75
		SF/Pallet	27
		Blocks/Pallet	36
		Weight/Block	73 Lbs
		Pallet Weight	2,939 Lbs
			

Highland Retaining Wall—6" Medium/Small Sets			
 Ironstone	SKU	Color	Stock Location
	2748380	Ironstone	Cedar Acres
	3242191	Majestic Gray	Cedar Acres
 Majestic Gray	2748373	Sand	Cedar Acres
	Yard Price: \$11.70/Set \$15.60/SqFt		
	Factory Direct Price: \$9.88/Set (Full Pallets Only) \$13.17/SqFt		
 Sand			
		Dimensions	Medium: 6" H x 12" W x 12" D Small: 6" H x 6" W x 12" D
		SF/Set	.75
		SF/Pallet	20.25
		Blocks/Pallet	27 Medium & 27 Small
		Weight/Block	59 Lbs (Medium) and 30 Lbs (Small)
		Pallet Weight	2,455 Lbs
			

Highland Small/Medium Block are sold only in full sets.

Formulas for Calculating Highland Stone Retaining Walls

SqFt of Wall Above Grade ÷ 1.5 = Number of Highland Wall *3-PIECE SETS* Required

Base Course: Length of Wall in Feet ÷ 1.4 = Number of *Additional* Large Block Required

Wall Cap: Length of Wall in Feet ÷ 1.25 = Number of XL Caps Required

www.bachmanswholesale.com



Highland Freestanding Wall

Belgard Highland Freestanding Wall



Highland Freestanding Wall—6" Large

SKU	Color	Stock Location	Dimensions	6"H x 18"W (F) / 16"W (B) x 12"D
2750635	Ironstone	Cedar Acres	SF/Block	.75 (Front) & .67 (Back)
3242306	Majestic Gray	Cedar Acres	SF/Pallet	29 (Average)
2750642	Sand	Cedar Acres	Blocks/Pallet	40
Yard Price: \$13.60 Each \$18.75/SqFt			Weight/Block	70 Lbs
			Pallet Weight	3,450 Lbs
Factory Direct Price: \$11.81 Each (Full Pallets Only) \$16.29/SqFt				

Highland Freestanding Wall—6" Medium/Small Sets

SKU	Color	Stock Location	Dimensions	Med: 6"H x 12"W (F) / 10"W (B) x 12"D Sm: 6"H x 6"W (F) / 4"W (B) x 12"D
2750703	Ironstone	Cedar Acres	SF/Set	.67 (Average)
3242313	Majestic Gray	Cedar Acres	SF/Pallet	20 (Average)
2750697	Sand	Cedar Acres	Blocks/Pallet	30 Medium & 30 Small
Yard Price: \$12.90/Set \$19.25/SqFt			Weight/Block	45 Lbs (Medium) and 20 Lbs (Small)
			Pallet Weight	2,495 Lbs
Factory Direct Price: \$11.12/Set (Full Pallets Only) \$16.60/SqFt				

Highland Small/Medium Block are sold only in full sets.

Formulas for Calculating Highland Stone Free-Standing Walls

SqFt of Wall Above Grade ÷ 1.38 = Number of Highland Wall 3-PIECE SETS Required

Base Course: Length of Wall in Feet ÷ 1.4 = Number of *Additional* Large Block Required

Wall Cap: Length of Wall in Feet ÷ 1.25 = Number of XL Caps Required





www.bachmanswholesale.com







Highland Wall Accessories

Highland XL Cap

• Colors listed are in Highland color blends—additional colors listed with Diamond Block and Diamond Stone Cut Block





 Ironstone	SKU	Color	Stock Location	Dimensions	3"H x 18"W (F) / 12"W (B) x 13"D
	2750604	Ironstone	Cedar Acres	Coverage	1.25 Linear Feet/Cap (Average)
	3242269	Majestic Gray	Cedar Acres	LF/Pallet	90 (Average)
	2750611	Sand	Cedar Acres	Caps/Pallet	72
Yard Price: \$10.25 Each				Weight/Cap	44 Lbs
Factory Direct Price: \$8.92 Each				Pallet Weight	3,335 Lbs
 Majestic Gray					
 Sand					

Highland Column/Corner Unit—6"

 Ironstone	SKU	Color	Stock Location	Dimensions	6"H x 18"W x 9"D
	2750727	Ironstone	Cedar Acres	SF/Block	1.125 (Combined Sides)
	3242320	Majestic Gray	Cedar Acres	Height/Pallet	Builds a 2.5' Pillar (5 Courses)
	2750734	Sand	Cedar Acres	Blocks/Pallet	20
Yard Price: \$15.40 Each				Weight/Block	75 Lbs
Factory Direct Price: \$13.09 Each				Pallet Weight	1,752 Lbs
 Majestic Gray					
 Sand					

Highland Large Step Block

• Colors listed are in Highland color blends—additional colors listed with Diamond Block and Diamond Stone Cut Block

 Ironstone	SKU	Color	Stock Location	Dimensions	6"H x 16"W x 16"D
	2748526	Ironstone	Cedar Acres	SF/Block	.67 (Face) & 1.77 (Surface)
	3242238	Majestic Gray	Cedar Acres	SF/Pallet	16 (Face) & 42.48 (Surface)
	2748533	Sand	Cedar Acres	Blocks/Pallet	24
Yard Price: \$15.95 Each				Weight/Block	112 Lbs
Factory Direct Price: \$13.54 Each				Pallet Weight	2,835 Lbs
 Majestic Gray					
 Sand					

- Factory Direct pricing on drop ship order or factory pick-up; FULL PALLETS only; minimum drop ship order is 10 pallets
- All products can be delivered anywhere in the metro area; all deliveries quoted individually for best rate; PLEASE CALL
- Please call for out-state and out-of-state delivery; special delivery quotes available
- Non-stocked product can be obtained quickly with advance notice, subject to factory availability
- 4136789: \$20 pallet deposit on Belgard pallets; **\$18.00 will be credited upon return**
- 3625284: **\$10 broken pallet charge** on non-stock items if not ordered in full pallets; **no returns on non-stock item orders**



Sterling Wall System

Belgard Sterling Wall



Sterling Wall—6"

SKU	Color	Stock Location	Dimensions	6"H x 17 $\frac{3}{4}$ "W x 12"D *See Notes
181628	Desert Tan	Non-Stock	SF/Block	.75 (Front) & .65 (Split Back)
181632	Graphite	Non-Stock	SF/Pallet	33.75
181630	Quail	Non-Stock	Blocks/Pallet	45
Yard Price: \$7.95 Each \$10.60/SqFt			Weight/Block	75 Lbs
			Pallet Weight	3,405 Lbs
Factory Direct Price: \$6.99 Each (Full Pallets Only) \$9.32/SqFt				
*Block depth when split is 10" *Back width when split is 13"				
Pins Included in Price!!!				

Diamond XL Cap Unit

• Colors listed are in Sterling colors—additional colors listed with Diamond, Diamond Stone Cut, Block & Highland Wall Block

SKU	Color	Stock Location	Dimensions	3"H x 18"W (F) / 12"W (B) x 13"D
2748014	Desert Tan	Non-Stock	Coverage	1.25 Linear Feet/Cap (Average)
181634	Graphite	Non-Stock	LF/Pallet	90 (Average)
3705337	Quail	Non-Stock	Caps/Pallet	72
Yard Price: \$10.25 Each			Weight/Cap	44 Lbs
			Pallet Weight	3,335 Lbs
Factory Direct Price: \$8.92 Each				

Sterling Wall Advantages

- ◆ Can be used for SRW, free-standing walls, pillars, stairs, and corners
- ◆ .75 square foot unit for faster installation
- ◆ Pin holes are located on outside for easy alignment in view instead of guessing
- ◆ Built-in hand holds—easier than smooth sides
- ◆ No middle "V" groove when using half blocks
- ◆ Front and back handle areas also make trimming faster for free-standing walls—just cut instead of cut, flip, cut
- ◆ Can lift with existing lifting tools
- ◆ Clean channels and pin holes
- ◆ Pins included in price and on pallet
- ◆ Cap with Belgard's 13" XL Cap (same as Diamond Wall)



www.bachmanswholesale.com





Ashlar Tandem™ Wall



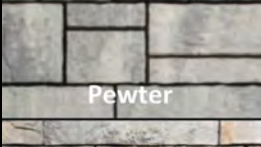

WALLS

The Tandem Wall system designed by Belgard® is an innovative, versatile system that can be used to create attractive curved or straight retaining and freestanding landscape walls. Great for use in a wide range of residential and light commercial hardscape projects.

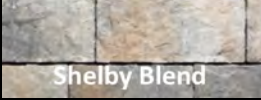
Ashlar Tandem Wall™—3 Piece Set

	SKU	Color	Stock Location	Dimensions	
 Danville Beige	146854	Danville Beige	Non-Stock	7" H x 13 1/8" W x 2 5/8" D	
	181458	Pewter	Cedar Acres	7" H x 15 3/4" W x 2 5/8" D	
	146856	Shelby Blend	Cedar Acres	7" H x 18 3/8" W x 2 5/8" D	
 Pewter	 Yard Price: \$15.52/Set \$6.75/SqFt Factory Direct \$13.38/Set Price: \$5.82/SqFt (Full Pallets Only)			SF/Set	2.3/Set (Sold in sets only)
				SF/Pallet	70.1
 Shelby Blend				Blocks/Pallet	30 Sets (30 of Each Size)
				Weight/Block	Approx 55 Lbs/Set
				Pallet Weight	2,131 Lbs

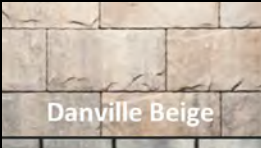
Ashlar Tandem Wall™ Column Veneer

	SKU	Color	Stock Location	Dimensions	
 Danville Beige	146870	Danville Beige	Non-Stock	7" H x 18 1/2" W x 2 5/8" D	
	181460	Pewter	Cedar Acres		
	146868	Shelby Blend	Cedar Acres		
 Pewter	Yard Price: \$7.50 Each \$6.75/SqFt Factory Direct \$6.46 Each Price: \$5.82/SqFt (Full Pallets Only)			SF/Piece	.9
				SF/Pallet	45.43
 Shelby Blend				Blocks/Pallet	50
				Weight/Block	25 Lbs
				Pallet Weight	1,388 Lbs
1 pallet makes 2 columns at 42" tall and 20.5" wide					

MODULAR GRID

Tandem® Modular Grid is a revolutionary system that makes it easy to construct outdoor living elements. Use steel grids and heavy-duty connectors to construct virtually any structure up to 7 feet tall including privacy walls, outdoor benches, kitchens, and much more.





Lamina Tandem™ Wall

Belgard Lamina Tandem™ Wall



WALLS

The Tandem Wall system designed by Belgard® is an innovative, versatile system that can be used to create attractive curved or straight retaining and freestanding landscape walls. Great for use in a wide range of residential and light commercial hardscape projects.

Lamina Tandem Wall™—3 Piece Set			
	SKU	Color	Stock Location
	181466	Sienna	Non-Stock
	SKU	Color	Stock Location
	220192	Pewter	Non-Stock
		Yard Price: \$15.52/Set \$6.75/SqFt	
		Factory Direct \$13.38/Set Price: \$5.82/SqFt (Full Pallets Only)	
		Dimensions	7"H x 13 ³ / ₈ "W x 3"D 7"H x 15 ³ / ₈ "W x 3"D 7"H x 18"W x 3"D
		SF/Set	2.3
		SF/Pallet	56
		Blocks/Pallet	24 Sets (24 of Each Size)
		Weight/Block	Approx. 50 Lbs/Set
		Pallet Weight	1,593 Lbs

Lamina Tandem Wall™ Column Veneer			
	SKU	Color	Stock Location
	183586	Sienna	Non-Stock
	SKU	Color	Stock Location
	220194	Pewter	Non-Stock
		Yard Price: \$7.50 Each \$6.75/SqFt	
		Factory Direct \$6.46 Each Price: \$5.82/SqFt (Full Pallets Only)	
		Dimensions	7"H x 18 ¹ / ₂ "W x 2 ⁵ / ₈ "D
		SF/Piece	.9
		SF/Pallet	45.43
		Blocks/Pallet	50
		Weight/Block	25 Lbs
		Pallet Weight	1,388 Lbs
1 pallet makes 2 columns at 42" tall and 20.5" wide			

www.bachmanswholesale.com

MODULAR GRID
 Tandem® Modular Grid is a revolutionary system that makes it easy to construct outdoor living elements. Use steel grids and heavy-duty connectors to construct virtually any structure up to 7 feet tall including privacy walls, outdoor benches, kitchens, and much more.







Melville Tandem™ & Mega-Tandem™ Wall



TANDEM™ WALLS

The Tandem Wall system designed by Belgard® is an innovative, versatile system that can be used to create attractive curved or straight retaining and freestanding landscape walls. Great for use in a wide range of residential and light commercial hardscape projects.

Melville Tandem Wall™—3 Piece Set

 <p>Pewter</p>	SKU	Color	Stock Location		Dimensions	
	181462	Pewter	Cedar Acres		7"H x 13 ¹ / ₈ "W x 2 ⁵ / ₈ "D 7"H x 15 ³ / ₄ "W x 2 ⁵ / ₈ "D 7"H x 18 ³ / ₈ "W x 2 ⁵ / ₈ "D	
	Yard Price: \$13.68/Set \$5.95/SqFt				SF/Set	2.3/Set (Sold in sets only)
	Factory Direct Price: \$11.75/Set \$5.11/SqFt				SF/Pallet	70.1
	For contemporary look or can be used as back of retaining walls				Blocks/Pallet	30 Sets (30 of Each Size)
					Weight/Block	Approx 70 Lbs/Set
					Pallet Weight	2,131 Lbs



Melville Tandem Wall™ Column Veneer

 <p>Pewter</p>	SKU	Color	Stock Location	Dimensions	
	181464	Pewter	Cedar Acres	7"H x 18 ¹ / ₂ "W x 2 ⁵ / ₈ "D	
	Yard Price: \$7.50 Each \$6.75/SqFt			SF/Piece	.9
	Factory Direct Price: \$6.46 Each \$5.82/SqFt			SF/Pallet	45.43
				Blocks/Pallet	50
				Weight/Block	25 Lbs
				Pallet Weight	1,388 Lbs
1 pallet makes 2 columns at 42" tall and 20.5" wide					

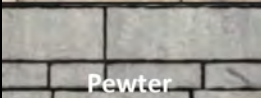
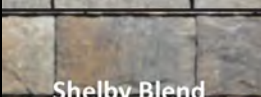

Tandem Wall Accessories

Tandem Wall Cap

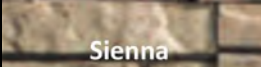
 <p>Danville Beige</p>	SKU	Color	Stock Location	Dimensions	
	146878	Danville Beige	Non-Stock	3 ³ / ₄ "H x 24"W x 15"D	
 <p>Pewter</p>	181612	Pewter	Cedar Acres	LF/Cap	2
	146876	Shelby Blend	Cedar Acres	LF/Pallet	64
 <p>Shelby Blend</p>	181614	Sienna	Non-Stock	Caps/Pallet	32
		Yard Price: \$21.75 Each			Weight/Cap
Factory Direct Price: \$19.08 Each			Pallet Weight	3,042 Lbs	
 <p>Sienna</p>					



Tandem Wall Accessories

CA



Tandem Wall 8" Connector

146860

\$1.72 Each

- 2.6/SF
- 3 bags needed per pallet
- 30 connectors per bag
- For retaining walls

CA



Tandem Wall Column and Modular Grid Connector

146862

\$66.85/Bag

- 1 bag of clips for 1 column

CA



Tandem Wall Column Frame

146864

\$124.20 Each

- 42" tall
- 1 frame per column

CA

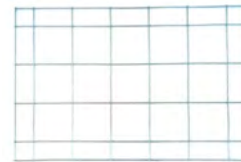

Tandem Modular Grid Kit

146866

\$66.45/Kit

- 28 3/8" x 42 1/2"



Mega-Tandem™ Wall



MEGA-TANDEM™ WALLS

With the natural appearance of hand-chiseled stone, the Mega-Tandem™ MSRW system is an innovative and versatile system capable of building large straight or curved walls.

Mega-Tandem™

	SKU	Color	Stock Location	Dimensions	12"H x 24"W x 3"D
Cotswold Mist	171922	Cotswold Mist	Special Order	SF/Piece	2
	181622	Margaux Beige	Special Order	SF/Pallet	96
	181624	Smooth Grey	Special Order	Blocks/Pallet	48
Margeaux Beige		Yard Price: \$22.10 Each \$11.05/SqFt		Weight/Block	64 Lbs
		Factory Direct Price: \$19.46 Each \$9.73/SqFt		Pallet Weight	3,080 Lbs
Full Pallet Quantities Only					

Mega Tandem Accessories

SO



Tandem Wall 22" L Connector

171924

\$9.75 Each

SO



Tandem Wall 43" L Connector

181626

\$11.05 Each



Weston Wall



Weston Stone 3 Piece Set

	SKU	Color	Stock Location	Dimensions
Cotswold Mist	146830	Cotswold Mist	Cedar Acres	Sm: 4" H x 8" W (F)/5" W (B) x 8" D Med: 4" H x 12" W (F)/9" W (B) x 8" D Lg: 4" H x 16" W (F)/13" W (B) x 8" D
	146832	Gascony Tan	Non Stock	
Gascony Tan	181442	Northwoods	Cedar Acres	
	Yard Price: \$8.35/Set \$8.35/SqFt			
Northwoods	Factory Direct Price: \$7.34/Set (Full Pallets Only) \$7.34/SqFt			
				SF/Set 1/Set (Fronts) (Sold in sets only)
				SF/Pallet 35
				Blocks/Pallet 35 Sets (35 Sm, 35 Med, & 35 Lg)
				Weight/Block Approx 80 Lbs/Set
				Pallet Weight 2,930 Lbs

Weston Stone Universal

	SKU	Color	Stock Location	Dimensions
Cotswold Mist	146842	Cotswold Mist	Cedar Acres	4" H x 12" W x 8" D
	146844	Gascony Tan	Non Stock	
Gascony Tan	177690	Northwoods	Cedar Acres	
	Yard Price: \$5.45 Each \$16.51/SqFt			
Northwoods	Factory Direct Price: \$4.69 Each (Full Pallets Only) \$14.21/SqFt			
				SF/Block .33
				SF/Pallet 33
				Blocks/Pallet 100
				Weight/Block 31 Lbs
				Pallet Weight 3,150 Lbs

- Factory Direct pricing on drop ship order or factory pick-up; FULL PALLETS only; minimum drop ship order is 10 pallets
- All products can be delivered anywhere in the metro area; all deliveries quoted individually for best rate; PLEASE CALL
- Please call for out-state and out-of-state delivery; special delivery quotes available
- Non-stocked product can be obtained quickly with advance notice, subject to factory availability
- 4136789: \$20 pallet deposit on Belgard pallets; **\$18.00 will be credited upon return**
- 3625284: **\$10 broken pallet charge** on non-stock items if not ordered in full pallets; **no returns on non-stock item orders**







Belgard Accessories & Accents

Belgard Accessories & Accents

www.bachmanswholesale.com

4" Torpedo Base Block							
	SKU	Color	Stock Location	Dimensions	4"H x 11"W x 15 3/4"L		
	3957774	Gray	Cedar Acres	LF/Piece	1.32		
	Yard Price: \$8.05 Each				LF/Pallet	64	
	Factory Direct Price: \$6.95 Each (Full Pallets Only)				Blocks/Pallet	48	
					Weight/Block	47 Lbs.	
				Pallet Weight	2,308 Lbs.		

Landings						
	SKU	Color	Stock Location	Dimensions	6"H x 48"L x 18"D	
	76148	Blu Stone	Cedar Acres	Steps/Pallet	4	
	76150	Brown	Cedar Acres	Weight/Step	460 Lbs.	
	76152	Desert Tan	Cedar Acres	Pallet Weight	2,812 Lbs.	
	76154	Moonlight	Cedar Acres			
Yard Price: \$134.00 Each						
Factory Direct Price: \$117.39 Each (Full Pallets Only)						
						
Blu Stone		Brown		Desert Tan		Moonlight





Seat Wall Cap							
	SKU	Color	Stock Location	Dimensions	2 1/2"H x 30"L x 14"D		
	114646	Anthracite	Non-Stock	LF/Piece	2.5		
	146880	Leather	Non-Stock	LF/Pallet	45		
	Yard Price: \$101.00 Each				Caps/Pallet	18	
	Factory Direct Price: \$91.20 Each				Weight/Caps	60 Lbs.	
				Pallet Weight	1,565 Lbs.		
							
Anthracite					Leather		

- Factory Direct pricing on drop ship order or factory pick-up; FULL PALLETS only; minimum drop ship order is 10 pallets
- All products can be delivered anywhere in the metro area; all deliveries quoted individually for best rate; PLEASE CALL
- Please call for out-state and out-of-state delivery; special delivery quotes available
- Non-stocked product can be obtained quickly with advance notice, subject to factory availability
- 4136789: \$20 pallet deposit on Belgard pallets; \$18.00 will be credited upon return
- 3625284: \$10 broken pallet charge on non-stock items if not ordered in full pallets; no returns on non-stock item orders



Belgard Pillar Caps, and Edgers

Pillar Caps

		24" x 24"			Dimensions	2½"H x 24"L x 24"D
		SKU	Color	Stock Location	Coverage	1 Cap/Pillar
 Anthracite		181646	Anthracite	Non-Stock	Caps/Pallet	6
		181648	Leather	Non-Stock	Weight/Cap	188 Lbs.
		Yard Price: \$175.00 Each			Pallet Weight	1,132 Lbs.
		Factory Direct Price: \$157.70 Each				
 Leather		30" x 30"			Dimensions	2½"H x 30"L x 30"D
		SKU	Color	Stock Location	Coverage	1 Cap/Pillar
 Anthracite		114464	Anthracite	Non-Stock	Caps/Pallet	6
		146882	Leather	Non-Stock	Weight/Cap	252 Lbs.
		Yard Price: \$205.00 Each			Pallet Weight	1,512 Lbs.
		Factory Direct Price: \$182.39 Each				

Edgestone

Yard Price: \$1.45 Each	SKU	Color	Stock Location	Dimensions	3" x 4" x 12¼"
	Factory Direct: \$1.23 Each	2759102	Brown	Cedar Acres	LF/Piece
3705108		Cambay Tan	Cedar Acres	LF/Pallet	288
	2759225	Charcoal	Cedar Acres	Edgers/Pallet	288
	4344184	Charcoal/Tan	Cedar Acres	Min. OD Circle	6'
	2759270	Copper	Cedar Acres	Minimum Radius	36"
	4344177	Red	Cedar Acres	Weight/Edger	11 Lbs.
	2759119	Red/Charcoal	Cedar Acres	Pallet Weight	3,050 Lbs.
	4344191	Tan/Brown	Cedar Acres		

- Factory Direct pricing on drop ship order or factory pick-up; FULL PALLETS only; minimum drop ship order is 10 pallets
- All products can be delivered anywhere in the metro area; all deliveries quoted individually for best rate; PLEASE CALL
- Please call for out-state and out-of-state delivery; special delivery quotes available
- Non-stocked product can be obtained quickly with advance notice, subject to factory availability
- 4136789: \$20 pallet deposit on Belgard pallets; **\$18.00 will be credited upon return**
- 3625284: **\$10 broken pallet charge** on non-stock items if not ordered in full pallets; **no returns on non-stock item orders**

NOTES

Geotechnical Engineering Specializing in Retaining Walls for Residential & Commercial



- **Block Wall Designs (Large & Small)**
- **Reinforced Slope Design**
- **Bridge/Abutment Design**
- **Boulder Walls**
- **Soil Nail/Tie Back Retaining Walls**
- **Soil Assessment**
- **Material Estimates**
- **Sound/Noise Walls**

Kyle Huerd, PE • 218.280.2465

Notes

www.bachmanswholesale.com



B **BORGERT**
PAVERS | SLABS | WALLS | EST. 1923

OUTDOOR LIVING, REDEFINED.

TWENTY NINETEEN COLLECTION

Section Contents

Description	Page	Description	Page
Concrete Pavers	89-115	Walls	116-127
• Brükstone	89	• Madera Wall	116-119
• Old Munich	89	• Morteza Wall	120-123
• Bulovar	90	• Panomur Wall	124-125
• Bulovar Max	90	• Strassen Wall	125-127
• Cobble Series	91-95	• Strassen Wall II	125, 127
• Cracovia Series	96-99	Fire Rings	126
• DrenaPave & DrenaMontage	100-101	Precast Wall Caps	128
• Holland Stone	102-103	Bullnose	128
• Kastle Flats	104-105	Pillar Caps	128
• Strassen Classic Series	106-107	Step Units	129
• Strassen Bavaria Tumbled	108-110		
• Bavaria II Non-Tumbled	110-112		
• Vavel Stone Tumbled	113-114		
• Vavel Stone II Non-Tumbled	114-115		

TITAN **MACHINERY**

OEM Parts / Service Support



Aggregate
McCloskey



Street Sweepers
Schwarze

Snow Products
Arctic Snow and Ice
Falls
Henke
Teamco



Utility Products
Atlas Copco
Leica
Magnum



Attachments
ACS
Erskine
Paladin/JRB
Virnig
Werk Brau



Underground
Rapidview / IBAK
Vacall



Land Clearing
FAE



Trailers
Felling
Sidumpr'
Thunder Creek
Towmaster



Compaction
Atlas Copco
Case CE

Titan Machinery Shakopee - 952-445-5400

*Subject to availability. Items may not be available at all locations.

www.titanmachinery.com



Brükstone & Old Munich

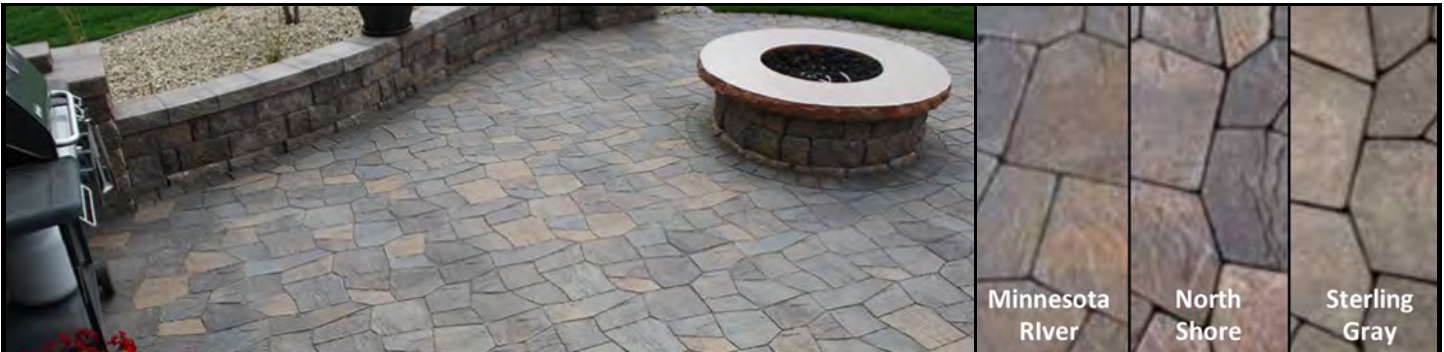

Minnesota River North Shore Sterling Grey

Brükstone—80mm

Yard Price: \$4.60/SF	SKU	Color	Stock Location	Dimensions	3 1/8" x Various
Factory Direct: \$3.88/SF	3712748	Minnesota River	Special Order	SF/Layer	12.68
	3712762	North Shore	Special Order	Pavers/Layer	14 Various
	178676	Sterling Grey	Special Order	Layers/Pallet	6
Sold by full pallets only No returns on partial pallets	Suggested Soldier Course products are Vavel II and Bavaria II			Pavers/Pallet	84
				SF/Pallet	76.08
				Pallet Weight	2,690 Lbs



Boulder Blend Flagstaff Iron Range Minnesota River

Old Munich—70mm

Yard Price: \$4.45/SF	SKU	Color	Stock Location	Dimensions	2 3/4" x Various
Factory Direct: \$3.74/SF	178678	Boulder Blend	Special Order	SF/Layer	11.10
	178680	Iron Range	Special Order	Layers/Pallet	7
	100494	Minnesota River	Special Order	SF/Pallet	77.7
Sold by full pallets only No returns on partial pallets	178682	Sterling Grey	Special Order	Pallet Weight	2,525 Lbs

- Factory Direct Pricing on drop ship orders or factory pickup; FULL PALLETS ONLY; 10 pallet minimum drop ship order
- All product can be delivered anywhere in the metro area; all deliveries quoted individually for best rate; please call
- Please call for out-state and out-of-state delivery; special delivery quotes available
- Non-stocked product can be obtained quickly with advance notice, subject to factory availability
- 4136796: \$20 refundable pallet deposit on Borgert pallets; **must have receipt when returning pallets for refund**
- 3625284: **\$25 broken pallet charge on non-stock items** if not ordered in full pallets; **NO RETURNS on non-stock item orders**

Bulovar® Linear Slab Series



Bulovar®—100mm

Yard Price: \$6.85/SF	SKU	Color	Stock Location	Dimensions	3"W x 15¼"L x 4"H
	225052	Graphite	Special Order	SF/Piece	.322
Factory Direct: \$5.88/SF	225054	Pewter	Special Order	SF/Pallet	67.7
	225056	Slate	Special Order	Pavers/Pallet	210
Sold by full pallets only No returns on partial pallets				LF/Paver (Sailor)	1.31
				Pallet Weight	2,975 Lbs



Bulovar® Max—100mm

Yard Price: \$7.20/SF	SKU	Color	Stock Location	Dimensions	6"W x 15¼"L x 4"H
	225062	Graphite	Special Order	SF/Piece	.645
Factory Direct: \$6.22/SF	225066	Pewter	Special Order	SF/Pallet	62
	225070	Slate	Special Order	Pavers/Pallet	96
Sold by full pallets only No returns on partial pallets				LF/Paver (Sailor)	1.31
				Pallet Weight	2,728 Lbs

- Factory Direct Pricing on drop ship orders or factory pickup; FULL PALLETS ONLY; 10 pallet minimum drop ship order
- All product can be delivered anywhere in the metro area; all deliveries quoted individually for best rate; please call
- Please call for out-state and out-of-state delivery; special delivery quotes available
- Non-stocked product can be obtained quickly with advance notice, subject to factory availability
- 4136796: \$20 refundable pallet deposit on Borgert pallets; **must have receipt when returning pallets for refund**
- 3625284: **\$25 broken pallet charge on non-stock items** if not ordered in full pallets; **NO RETURNS on non-stock item orders**



Bronze Granite

COBBLE SERIES™



Chamois



Charcoal



Autumn Blend



Golden Brown



Minnesota River



Iron Range



North Shore



Sterling Gray



Bronze Granite

Cobble
 4x6, 6x6
 & 6x9 also
 available in
 Chamois &
 Charcoal.

Cobble Series

Borgert Cobble

Cobble Half Square—3x6

Yard Price: \$3.65/SF	SKU	Color	Stock Location	Dimensions	2 ³ / ₈ " x 3 ³ / ₈ " x 6 ¹ / ₄ "
	Factory Direct: \$3.01/SF	3016532	Autumn Blend	Cedar Acres	SF/Piece
3016563		Bronze Granite	Cedar Acres	SF/Band	8.1
	3016525	Golden Brown	Cedar Acres	SF/Pallet	56.8
	118512	Iron Range	Cedar Acres	Pavers/Pallet	420
	3016556	Minnesota River	Cedar Acres	Pavers/SF	7.4
	3409129	North Shore	Cedar Acres	Pavers/Band	60
	178684	Sterling Grey	Cedar Acres	Bands/Pallet	7
				LF/Paver (Sailor)	.521
				LF/Paver (Soldier)	.260
			Pallet Weight	1,590 Lbs	

Cobble Square—6x6

Yard Price: \$3.65/SF	SKU	Color	Stock Location	Dimensions	2 ³ / ₈ " x 6 ¹ / ₄ " x 6 ¹ / ₄ "
	Factory Direct: \$3.01/SF	3016631	Autumn Blend	Cedar Acres	SF/Piece
3016679		Bronze Granite	Cedar Acres	SF/Band	12.2
	3353361	Chamois	Cedar Acres	SF/Pallet	85.4
	3409150	Charcoal	Cedar Acres	Pavers/Pallet	315
	3016624	Golden Brown	Cedar Acres	Pavers/SF	3.69
	118516	Iron Range	Cedar Acres	Pavers/Band	45
	3016662	Minnesota River	Cedar Acres	Bands/Pallet	7
	3409136	North Shore	Cedar Acres	LF/Paver (Sailor)	.521
	178686	Sterling Grey	Cedar Acres	LF/Paver (Soldier)	.521
			Pallet Weight	2,395 Lbs	

Cobble Rectangle—6x9

Yard Price: \$3.65/SF	SKU	Color	Stock Location	Dimensions	2 ³ / ₈ " x 6 ¹ / ₄ " x 9 ³ / ₈ "
	Factory Direct: \$3.01/SF	3016785	Autumn Blend	Cedar Acres	SF/Piece
3016815		Bronze Granite	Cedar Acres	SF/Band	18.28
	3016839	Chamois	Cedar Acres	SF/Pallet	91.4
	3016853	Charcoal	Cedar Acres	Pavers/Pallet	225
	3016778	Golden Brown	Cedar Acres	Pavers/SF	2.46
	118518	Iron Range	Cedar Acres	Pavers/Band	45
	3016808	Minnesota River	Cedar Acres	Bands/Pallet	5
	3409167	North Shore	Cedar Acres	LF/Paver (Sailor)	.781
	178692	Sterling Grey	Cedar Acres	LF/Paver (Soldier)	.521
			Pallet Weight	2,560 Lbs	

- Factory Direct Pricing on drop ship orders or factory pickup; FULL PALLETS ONLY; 10 pallet minimum drop ship order
- All product can be delivered anywhere in the metro area; all deliveries quoted individually for best rate; please call
- Please call for out-state and out-of-state delivery; special delivery quotes available
- Non-stocked product can be obtained quickly with advance notice, subject to factory availability
- 4136796: \$20 refundable pallet deposit on Borgert pallets; **must have receipt when returning pallets for refund**
- 3625284: **\$25 broken pallet charge on non-stock items** if not ordered in full pallets; **NO RETURNS on non-stock item orders**

www.bachmanswholesale.com

Cobble Series

Cobble Large Square—9x9

Yard Price: \$3.65/SF	SKU	Color	Stock Location	Dimensions	2 ³ / ₈ " x 9 ³ / ₈ " x 9 ³ / ₈ "
Factory Direct: \$3.01/SF	3016716	Autumn Blend	Non-Stock	SF/Piece	.610
	3016747	Bronze Granite	Non-Stock	SF/Band	16.5
	3710126	Golden Brown	Non-Stock	SF/Pallet	82.5
	118520	Iron Range	Non-Stock	Pavers/Pallet	135
	3016730	Minnesota River	Non-Stock	Pavers/SF	1.64
	3409174	North Shore	Non-Stock	Pavers/Band	27
	178698	Sterling Grey	Non-Stock	Bands/Pallet	5
				LF/Paver (Sailor)	.781
				LF/Paver (Soldier)	.781
				Pallet Weight	2,310 Lbs

Cobble Large Rectangle—9x12

Yard Price: \$3.65/SF	SKU	Color	Stock Location	Dimensions	2 ³ / ₈ " x 9 ³ / ₈ " x 11 ³ / ₈ "
Factory Direct: \$3.01/SF	3972869	Autumn Blend	Non-Stock	SF/Piece	.741
	3972883	Bronze Granite	Non-Stock	SF/Band	29.5
	3972852	Golden Brown	Non-Stock	SF/Pallet	88.5
	118522	Iron Range	Non-Stock	Pavers/Pallet	108
	3972876	Minnesota River	Non-Stock	Pavers/SF	1.22
	3972890	North Shore	Non-Stock	Pavers/Band	36
	178700	Sterling Grey	Non-Stock	Bands/Pallet	3
				LF/Paver (Sailor)	.948
				LF/Paver (Soldier)	.781
			Pallet Weight	2,506 Lbs	

Cobble 3/4 Stone—4x6

Yard Price: \$3.65/SF	SKU	Color	Stock Location	Dimensions	2 ³ / ₈ " x 4 ³ / ₄ " x 6 ¹ / ₄ "
Factory Direct: \$3.01/SF	3016907	Autumn Blend	Cedar Acres	SF/Piece	.206
	3016945	Bronze Granite	Cedar Acres	SF/Band	11.57
	3601738	Chamois	Cedar Acres	SF/Pallet	81
	3016983	Charcoal	Cedar Acres	Pavers/Pallet	392
	3016877	Golden Brown	Cedar Acres	Pavers/SF	4.84
	118524	Iron Range	Cedar Acres	Pavers/Band	56
	3016938	Minnesota River	Cedar Acres	Bands/Pallet	7
	3409181	North Shore	Cedar Acres	LF/Paver (Sailor)	.521
	178702	Sterling Grey	Cedar Acres	LF/Paver (Soldier)	.396
				Pallet Weight	2,268 Lbs

- Factory Direct Pricing on drop ship orders or factory pickup; FULL PALLETS ONLY; 10 pallet minimum drop ship order
- All product can be delivered anywhere in the metro area; all deliveries quoted individually for best rate; please call
- Please call for out-state and out-of-state delivery; special delivery quotes available
- Non-stocked product can be obtained quickly with advance notice, subject to factory availability
- 4136796: \$20 refundable pallet deposit on Borgert pallets; **must have receipt when returning pallets for refund**
- 3625284: \$25 broken pallet charge on non-stock items if not ordered in full pallets; **NO RETURNS on non-stock item orders**

Cobble Series—Circle

Borgert Cobble

Cobble Circle Center Pack—Creates Rings 1 & 2

Yard Price: \$37.24/Pack	SKU	Color	Stock Location	Circle Pack Configuration 1 Center Circle Stone (1 Needed) 19 Small Circle Stones (16 Needed) 9 Three Quarter Stones (8 Needed) 3 Half Squares (For Rings 6 & 8; 3 Needed)
	3017010	Autumn Blend	Cedar Acres	
Factory Direct: \$32.03/Pack	3017058	Bronze Granite	Cedar Acres	
	3017003	Golden Brown	Cedar Acres	
	118530	Iron Range	Cedar Acres	
	3017034	Minnesota River	Cedar Acres	
	3409198	North Shore	Cedar Acres	
	178704	Sterling Grey	Cedar Acres	

Cobble Large Circle Stone—For Rings 3 - 10

Yard Price: \$3.65/SF	SKU	Color	Stock Location	Dimensions	Trapezoid Shape
	3017249	Autumn Blend	Cedar Acres	SF/Piece	.203
Factory Direct: \$3.01/SF	3017300	Bronze Granite	Cedar Acres	SF/Band	6
	4363659	Chamois	Cedar Acres	SF/Pallet	54
	4363635	Charcoal	Cedar Acres	Pavers/Pallet	270
	3017225	Golden Brown	Cedar Acres	Pavers/SF	4.92
	118528	Iron Range	Cedar Acres	Pavers/Band	30
	3017287	Minnesota River	Cedar Acres	Bands/Pallet	9
	3409204	North Shore	Cedar Acres	LF/Paver (Soldier)	.375
	178706	Sterling Grey	Cedar Acres	Pallet Weight	1,512 Lbs

Strassen Wall Fire Ring Kit

Yard Price: \$409.00/Kit	SKU	Color	Stock Location	Dimensions: 52"OD x 36"ID x 12"H Kit Includes: <ul style="list-style-type: none"> • 63 Strassen Trapezoid Block • 36" Diameter x 12" High Metal Ring • 3 Tubes SRW adhesive Cap Kit Dimensions: 55"OD x 18"ID x 2½"H <ul style="list-style-type: none"> • 4 Pieces per Complete Set
	4362980	Boulder Blend	Non-Stock	
Factory Direct: \$347.01/Kit	84150	Iron Range	Non-Stock	
	4193362	Minnesota River	Non-Stock	
Caps sold separately.	4362973	North Shore	Non-Stock	

Precast Strassen Fire Ring Caps

Yard Price: \$75.00/Piece	SKU	Color	Stock Location
	178708	Brown	Non-Stock
Factory Direct: \$66.22/Piece	88448	Charcoal	Non-Stock
	88450	Limestone	Non-Stock
Pieces sold individually. 4 pieces per complete set.			



www.bachmanswholesale.com

Calculation Table for Cobble and Cracovia Circles

Ring	Circle Diameter (in Feet)	Center Circle Pack	Large Circle Stone	Three Quarter Stone	Cumulative Total Needed
0-2	2.65	1 Pack	0	0	1 Pack = 5.6 SF
3	3.72	1 Pack	1 Band	0	1 Pack = 5.6 SF 1 Band LC = 6 SF
4	4.78	1 Pack	2 Bands	0	1 Pack = 5.6 SF 2 Bands LC = 12 SF
5	5.84	1 Pack	3 Bands	1 Band	1 Pack = 5.6 SF 3 Bands LC = 18 SF 1 Band ¾ Stone = 11.5 SF
6	6.91	1 Pack	4 Bands	1 Band	1 Pack = 5.6 SF 4 Bands LC = 24 SF 1 Band ¾ Stone = 11.5 SF
7	8.05	1 Pack	5 Bands	2 Bands	1 Pack = 5.6 SF 5 Bands LC = 30 SF 2 Bands ¾ Stone = 23 SF
8	9.03	1 Pack	6 Bands	2 Bands	1 Pack = 5.6 SF 6 Bands LC = 36 SF 2 Bands ¾ Stone = 23 SF
9	10.06	1 Pack	7 Bands	3 Bands	1 Pack = 5.6 SF 7 Bands LC = 42 SF 3 Bands ¾ Stone = 34.5 SF
10	11.13	1 Pack	8 Bands	4 Bands	1 Pack = 5.6 SF 8 Bands LC = 48 SF 4 Bands ¾ Stone = 46 SF
11	12.18	1 Pack	1 Pallet	5 Bands	1 Pack = 5.6 SF 1 Pallet LC = 54 SF 5 Bands ¾ Stone = 57.5 SF
12	13.25	1 Pack	1 Pallet	1 Pallet	1 Pack = 5.6 SF 1 Pallet LC = 54 SF 1 Pallet ¾ Stone = 81 SF
13	14.31	1 Pack	1 Pallet	1 Pallet + 2 Bands	1 Pack = 5.6 SF 1 Pallet LC = 54 SF 1 P + 2 B ¾ Stone = 104 SF
14	15.37	1 Pack	1 Pallet	1 Pallet + 4 Bands	1 Pack = 5.6 SF 1 Pallet LC = 54 SF 1 P + 4 B ¾ Stone = 127 SF
15	16.43	1 Pack	1 Pallet	2 Pallets	1 Pack = 5.6 SF 1 Pallet LC = 54 SF 2 Pallets ¾ Stone = 162 SF
16	17.49	1 Pack	1 Pallet	2 Pallets + 2 Bands	1 Pack = 5.6 SF 1 Pallet LC = 54 SF 2 P + 2 B ¾ Stone = 185 SF
17	18.55	1 Pack	1 Pallet	2 Pallets + 5 Bands	1 Pack = 5.6 SF 1 Pallet LC = 54 SF 2 P + 5 B ¾ Stone = 220 SF
18	19.61	1 Pack	1 Pallet	3 Pallets	1 Pack = 5.6 SF 1 Pallet LC = 54 SF 3 Pallets ¾ Stone = 243 SF

- Factory Direct Pricing on drop ship orders or factory pickup; FULL PALLETS ONLY; 10 pallet minimum drop ship order
- All product can be delivered anywhere in the metro area; all deliveries quoted individually for best rate; please call
- Please call for out-state and out-of-state delivery; special delivery quotes available
- Non-stocked product can be obtained quickly with advance notice, subject to factory availability
- 4136796: \$20 refundable pallet deposit on Borgert pallets; **must have receipt when returning pallets for refund**
- 3625284: **\$25 broken pallet charge on non-stock items** if not ordered in full pallets; **NO RETURNS on non-stock item orders**



Minnesota River

STRASSEN® SERIES
CRACOVIA



Minnesota River



Grand Canyon



Iron Range



North Shore



Mesa



Sterling Gray

Cracovia 4x6 & large circle
 also available in
 Chamois & Charcoal.

Cracovia Series

Cracovia Half Square—3x6

Yard Price: \$4.35/SF	SKU	Color	Stock Location	Dimensions	2 ³ / ₈ " x 3 ³ / ₈ " x 6 ¹ / ₄ "
Factory Direct: \$3.65/SF	3736249	Grand Canyon	Non-Stock	SF/Piece	.135
	118542	Iron Range	Non-Stock	SF/Band	8.1
	3736232	Mesa	Non-Stock	SF/Pallet	56.8
	3735440	Minnesota River	Cedar Acres	Pavers/Pallet	420
	4313203	North Shore	Non-Stock	Pavers/SF	7.4
	178710	Sterling Grey	Non-Stock	Pavers/Band	60
				Bands/Pallet	7
				LF/Paver (Sailor)	.521
			LF/Paver (Soldier)	.260	
			Pallet Weight	1,590 Lbs	

Cracovia Square—6x6

Yard Price: \$4.35/SF	SKU	Color	Stock Location	Dimensions	2 ³ / ₈ " x 6 ¹ / ₄ " x 6 ¹ / ₄ "
Factory Direct: \$3.65/SF	3736263	Grand Canyon	Non-Stock	SF/Piece	.271
	118544	Iron Range	Non-Stock	SF/Band	12.2
	3736256	Mesa	Non-Stock	SF/Pallet	85.4
	3735464	Minnesota River	Cedar Acres	Pavers/Pallet	315
	4313210	North Shore	Non-Stock	Pavers/SF	3.69
	178712	Sterling Grey	Non-Stock	Pavers/Band	45
				Bands/Pallet	7
				LF/Paver (Sailor)	.521
			LF/Paver (Soldier)	.521	
			Pallet Weight	2,395 Lbs	

Cracovia Rectangle—6x9

Yard Price: \$4.35/SF	SKU	Color	Stock Location	Dimensions	2 ³ / ₈ " x 6 ¹ / ₄ " x 9 ³ / ₈ "
Factory Direct: \$3.65/SF	3736348	Grand Canyon	Non-Stock	SF/Piece	.407
	118546	Iron Range	Non-Stock	SF/Band	18.28
	3736287	Mesa	Non-Stock	SF/Pallet	91.4
	3735488	Minnesota River	Cedar Acres	Pavers/Pallet	225
	4313227	North Shore	Non-Stock	Pavers/SF	2.46
	178714	Sterling Grey	Non-Stock	Pavers/Band	45
				Bands/Pallet	5
				LF/Paver (Sailor)	.781
			LF/Paver (Soldier)	.521	
			Pallet Weight	2,395 Lbs	

- Factory Direct Pricing on drop ship orders or factory pickup; FULL PALLETS ONLY; 10 pallet minimum drop ship order
- All product can be delivered anywhere in the metro area; all deliveries quoted individually for best rate; please call
- Please call for out-state and out-of-state delivery; special delivery quotes available
- Non-stocked product can be obtained quickly with advance notice, subject to factory availability
- 4136796: \$20 refundable pallet deposit on Borgert pallets; **must have receipt when returning pallets for refund**
- 3625284: **\$25 broken pallet charge on non-stock items** if not ordered in full pallets; **NO RETURNS on non-stock item orders**

Cracovia Series—Circle

Cracovia Circle Center Pack—Creates Rings 1 & 2

Yard Price: \$41.16/Pack	SKU	Color	Stock Location	Circle Pack Configuration 1 Center Circle Stone (1 Needed) 19 Small Circle Stones (16 Needed) 9 Three Quarter Stones (8 Needed) 3 Half Squares (For Rings 6 & 8; 3 Needed)	
	3968831	Grand Canyon	Non-Stock		
Factory Direct: \$35.56/Pack	118536	Iron Range	Non-Stock		
	3968824	Mesa	Non-Stock		
	3968800	Minnesota River	Cedar Acres		
	4362911	North Shore	Non-Stock		
	178716	Sterling Grey	Non-Stock		
				SF/Pack	5.6
				Pavers/Pack	32 (28 Needed)
				Packs/Pallet	10
				Pallet Weight	160 Lbs

Cracovia Large Circle Stone—For Rings 3 - 10

Yard Price: \$4.35/SF	SKU	Color	Stock Location	Dimensions	Trapezoid Shape
	184482	Chamois	Non-Stock		SF/Piece
Factory Direct: \$3.65/SF	4362935	Charcoal	Non-Stock	SF/Band	6
	3968879	Grand Canyon	Non-Stock	SF/Pallet	54
	118538	Iron Range	Non-Stock	Pavers/Pallet	270
	3968862	Mesa	Non-Stock	Pavers/SF	4.92
	3968848	Minnesota River	Cedar Acres	Pavers/Band	30
	4362928	North Shore	Non-Stock	Bands/Pallet	9
	178718	Sterling Grey	Non-Stock	LF/Paver (Soldier)	.375
				Pallet Weight	1,512 Lbs

Cracovia 3/4 Stone—4x6

Yard Price: \$4.35/SF	SKU	Color	Stock Location	Dimensions	2 3/8" x 4 3/4" x 6 1/4"
	184480	Chamois	Non-Stock		SF/Piece
Factory Direct: \$3.65/SF	4362959	Charcoal	Non-Stock	SF/Band	11.57
	3968916	Grand Canyon	Non-Stock	SF/Pallet	81
	118540	Iron Range	Non-Stock	Pavers/Pallet	392
	3968909	Mesa	Non-Stock	Pavers/SF	4.84
	3968886	Minnesota River	Cedar Acres	Pavers/Band	56
	4362942	North Shore	Non-Stock	Bands/Pallet	7
	178720	Sterling Grey	Non-Stock	LF/Paver (Sailor)	.521
				LF/Paver (Soldier)	.396
			Pallet Weight	2,268 Lbs	

- Factory Direct Pricing on drop ship orders or factory pickup; FULL PALLETS ONLY; 10 pallet minimum drop ship order
- All product can be delivered anywhere in the metro area; all deliveries quoted individually for best rate; please call
- Please call for out-state and out-of-state delivery; special delivery quotes available
- Non-stocked product can be obtained quickly with advance notice, subject to factory availability
- 4136796: \$20 refundable pallet deposit on Borgert pallets; **must have receipt when returning pallets for refund**
- 3625284: **\$25 broken pallet charge on non-stock items** if not ordered in full pallets; **NO RETURNS on non-stock item orders**

Cracovia Series—Circle

Calculation Table for Cobble and Cracovia Circles

Ring	Circle Diameter (in Feet)	Center Circle Pack	Large Circle Stone	Three Quarter Stone	Cumulative Total Needed
0-2	2.65	1 Pack	0	0	1 Pack = 5.6 SF
3	3.72	1 Pack	1 Band	0	1 Pack = 5.6 SF 1 Band LC = 6 SF
4	4.78	1 Pack	2 Bands	0	1 Pack = 5.6 SF 2 Bands LC = 12 SF
5	5.84	1 Pack	3 Bands	1 Band	1 Pack = 5.6 SF 3 Bands LC = 18 SF 1 Band ¾ Stone = 11.5 SF
6	6.91	1 Pack	4 Bands	1 Band	1 Pack = 5.6 SF 4 Bands LC = 24 SF 1 Band ¾ Stone = 11.5 SF
7	8.05	1 Pack	5 Bands	2 Bands	1 Pack = 5.6 SF 5 Bands LC = 30 SF 2 Bands ¾ Stone = 23 SF
8	9.03	1 Pack	6 Bands	2 Bands	1 Pack = 5.6 SF 6 Bands LC = 36 SF 2 Bands ¾ Stone = 23 SF
9	10.06	1 Pack	7 Bands	3 Bands	1 Pack = 5.6 SF 7 Bands LC = 42 SF 3 Bands ¾ Stone = 34.5 SF
10	11.13	1 Pack	8 Bands	4 Bands	1 Pack = 5.6 SF 8 Bands LC = 48 SF 4 Bands ¾ Stone = 46 SF
11	12.18	1 Pack	1 Pallet	5 Bands	1 Pack = 5.6 SF 1 Pallet LC = 54 SF 5 Bands ¾ Stone = 57.5 SF
12	13.25	1 Pack	1 Pallet	1 Pallet	1 Pack = 5.6 SF 1 Pallet LC = 54 SF 1 Pallet ¾ Stone = 81 SF
13	14.31	1 Pack	1 Pallet	1 Pallet + 2 Bands	1 Pack = 5.6 SF 1 Pallet LC = 54 SF 1 P + 2 B ¾ Stone = 104 SF
14	15.37	1 Pack	1 Pallet	1 Pallet + 4 Bands	1 Pack = 5.6 SF 1 Pallet LC = 54 SF 1 P + 4 B ¾ Stone = 127 SF
15	16.43	1 Pack	1 Pallet	2 Pallets	1 Pack = 5.6 SF 1 Pallet LC = 54 SF 2 Pallets ¾ Stone = 162 SF
16	17.49	1 Pack	1 Pallet	2 Pallets + 2 Bands	1 Pack = 5.6 SF 1 Pallet LC = 54 SF 2 P + 2 B ¾ Stone = 185 SF
17	18.55	1 Pack	1 Pallet	2 Pallets + 5 Bands	1 Pack = 5.6 SF 1 Pallet LC = 54 SF 2 P + 5 B ¾ Stone = 220 SF
18	19.61	1 Pack	1 Pallet	3 Pallets	1 Pack = 5.6 SF 1 Pallet LC = 54 SF 3 Pallets ¾ Stone = 243 SF

- Factory Direct Pricing on drop ship orders or factory pickup; FULL PALLETS ONLY; 10 pallet minimum drop ship order
- All product can be delivered anywhere in the metro area; all deliveries quoted individually for best rate; please call
- Please call for out-state and out-of-state delivery; special delivery quotes available
- Non-stocked product can be obtained quickly with advance notice, subject to factory availability
- 4136796: \$20 refundable pallet deposit on Borgert pallets; **must have receipt when returning pallets for refund**
- 3625284: **\$25 broken pallet charge on non-stock items** if not ordered in full pallets; **NO RETURNS on non-stock item orders**



Minnesota River

DRENA™ SERIES
DRENA PAVE & DRENA MONTAGE



Minnesota River



Sterling Gray

DrenaPave™—80mm—Sold in Full Pallets Only

Yard Price: \$4.40/SF	SKU	Color	Stock Location	Dimensions	3⅜" H x 5" W x 10" L
	147748	Minnesota River	Non-Stock	SF/Piece	.347
Factory Direct: \$3.69/SF	178750	Sterling Grey	Non-Stock	SF/Pallet	81
Lead Time Required	Use to reduce storm water runoff and where impervious surface is regulated.			Pavers/Pallet	240
				Pallet Weight	2,875 Lbs

DrenaMontage™

DrenaMontage™—60mm—Sold in Full Pallets Only

Yard Price: \$4.10/SF	SKU	Color	Stock Location	Dimensions	2⅜" H x 6" W x 6" L 2⅜" H x 6" W x 12" L 2⅜" H x 12" W x 12" L
	147752	Minnesota River	Non-Stock	SF/Layer	15.34
Factory Direct: \$3.41/SF	178752	Sterling Grey	Non-Stock	SF/Pallet	92.04
Lead Time Required	Use to reduce storm water runoff and where impervious surface is regulated.			Layers/Pallet	6
				Pallet Weight	2,557 Lbs



- Factory Direct Pricing on drop ship orders or factory pickup; FULL PALLETS ONLY; 10 pallet minimum drop ship order
- All product can be delivered anywhere in the metro area; all deliveries quoted individually for best rate; please call
- Please call for out-state and out-of-state delivery; special delivery quotes available
- Non-stocked product can be obtained quickly with advance notice, subject to factory availability
- 4136796: \$20 refundable pallet deposit on Borgert pallets; **must have receipt when returning pallets for refund**
- 3625284: **\$25 broken pallet charge on non-stock items** if not ordered in full pallets; **NO RETURNS on non-stock item orders**



HOLLAND STONE™



Chamois



Charcoal



Autumn Blend



Sterling Gray



Bronze Granite



North Shore



Iron Range



Minnesota River



Holland Stone™—60mm

Yard Price: \$2.90/SF	SKU	Color	Stock Location	Dimensions	2 ³ / ₈ " x 3 ³ / ₈ " x 7 ⁷ / ₈ "
Factory Direct: \$2.32/SF	3015856	Autumn Blend	Cedar Acres	SF/Piece	.222
	3015894	Bronze Granite	Cedar Acres	SF/Band	15.7
	3015818	Chamois	Non-Stock	SF/Pallet	94
	3015801	Charcoal	Cedar Acres	Pavers/Pallet	432
	118532	Iron Range	Non-Stock	Pavers/SF	4.5
	3015887	Minnesota River	Cedar Acres	Pavers/Band	72
	3409099	North Shore	Non-Stock	Bands/Pallet	6
	224462	Sterling Gray	Non-Stock	LF/Paver (Sailor)	.656
				LF/Paver (Soldier)	.323
				Pallet Weight	2,640 Lbs

Holland Stone™—80mm

Yard Price: \$4.40/SF	SKU	Color	Stock Location	Dimensions	3 ¹ / ₈ " x 3 ³ / ₈ " x 7 ⁷ / ₈ "
Factory Direct: \$3.69/SF	130062	Charcoal	Non-Stock	SF/Piece	.222
				SF/Band	Not Banded
				SF/Pallet	64
				Pavers/Pallet	288
				Pavers/SF	4.5
				Pavers/Band	Not Banded
				LF/Paver (Sailor)	.656
				LF/Paver (Soldier)	.323
				Pallet Weight	2,272

- Factory Direct Pricing on drop ship orders or factory pickup; FULL PALLETS ONLY; 10 pallet minimum drop ship order
- All product can be delivered anywhere in the metro area; all deliveries quoted individually for best rate; please call
- Please call for out-state and out-of-state delivery; special delivery quotes available
- Non-stocked product can be obtained quickly with advance notice, subject to factory availability
- 4136796: \$20 refundable pallet deposit on Borgert pallets; **must have receipt when returning pallets for refund**
- 3625284: **\$25 broken pallet charge on non-stock items** if not ordered in full pallets; **NO RETURNS on non-stock item orders**



Classic Bronze

KASTLE FLATS



Sterling Gray





Classic Bronze

Available in custom colors, call for quote.

Kastle Flats



Kastle Flats—60mm—8 x 16—Sold in Full Pallets Only

Yard Price: \$5.10/SF	SKU	Color	Stock Location	Dimensions	2 ³ / ₈ " x 7 ⁷ / ₈ " x 15 ³ / ₄ "
		147758	Classic Bronze	Non-Stock	SF/Piece
Factory Direct: \$4.31/SF	178762	Sterling Grey	Non-Stock	SF/Pallet	92.94
				Pavers/Pallet	108
				Pavers/SF	1.16
				LF/Paver (Sailor)	1.31
				LF/Paver (Soldier)	.66
				Pallet Weight	2,602 Lbs
			Sold in Full Pallets Only		

Kastle Flats—60mm—16 x 16—Sold in Full Pallets Only

Yard Price: \$5.10/SF	SKU	Color	Stock Location	Dimensions	2 ³ / ₈ " x 15 ³ / ₄ " x 15 ³ / ₄ "
		147762	Classic Bronze	Non-Stock	SF/Piece
Factory Direct: \$4.31/SF	178766	Sterling Grey	Non-Stock	SF/Pallet	81.84
				Pavers/Pallet	48
				Pavers/SF	.58
				LF/Paver (Sailor)	1.31
				LF/Paver (Soldier)	1.31
				Pallet Weight	2,292 Lbs
			Sold in Full Pallets Only		

Kastle Flats—60mm—16 x 24—Sold in Full Pallets Only

Yard Price: \$5.10/SF	SKU	Color	Stock Location	Dimensions	2 ³ / ₈ " x 15 ³ / ₄ " x 23 ³ / ₄ "
		147766	Classic Bronze	Non-Stock	SF/Piece
Factory Direct: \$4.31/SF	178768	Sterling Grey	Non-Stock	SF/Pallet	81.84
				Pavers/Pallet	32
				Pavers/SF	.38
				LF/Paver (Sailor)	1.98
				LF/Paver (Soldier)	1.31
				Pallet Weight	2,292 Lbs
			Sold in Full Pallets Only		



Boulder Blend

STRASSEN® SERIES
CLASSIC



Boulder Blend



Minnesota River



Sterling Gray

Strassen Classic Series

Strassen Classic Half Rectangle—4x6

Yard Price: \$5.75/SF	SKU	Color	Stock Location	Dimensions	2¾" x 4¼" x 6¾"
		3175536	Boulder Blend	Non-Stock	SF/Piece
Factory Direct: \$4.93/SF	3017324	Minnesota River	Non-Stock	SF/Band	4.75
	178772	Sterling Grey	Non-Stock	SF/Pallet	52.2
	 Boulder Blend	 Minnesota River	 Sterling Gray (Shown in Bavaria)	Pavers/Pallet	264
				Pavers/SF	5.06
				Pavers/Band	24
	Bands/Pallet	11			
	LF/Paver (Sailor)	.563			
	LF/Paver (Soldier)	.354			
	Pallet Weight	1,696 Lbs			

Strassen Rectangle—6x8

Yard Price: \$5.75/SF	SKU	Color	Stock Location	Dimensions	2¾" x 6¾" x 8¼"
		3175505	Boulder Blend	Non-Stock	SF/Piece
Factory Direct: \$4.93/SF	3017478	Minnesota River	Non-Stock	SF/Band	9.49
	178776	Sterling Grey	Non-Stock	SF/Pallet	66.4
	 Boulder Blend	 Minnesota River	 Sterling Gray (Shown in Bavaria)	Pavers/Pallet	168
				Pavers/SF	2.53
				Pavers/Band	24
	Bands/Pallet	7			
	LF/Paver (Sailor)	.688			
	LF/Paver (Soldier)	.563			
	Pallet Weight	2,160 Lbs			

Strassen Large Rectangle—8x13

Yard Price: \$5.75/SF	SKU	Color	Stock Location	Dimensions	2¾" x 8¼" x 13⅝"
		3175680	Boulder Blend	Non-Stock	SF/Piece
Factory Direct: \$4.93/SF	3017515	Minnesota River	Non-Stock	SF/Band	9.38
	178778	Sterling Grey	Non-Stock	SF/Pallet	56.3
	 Boulder Blend	 Minnesota River	 Sterling Gray (Shown in Bavaria)	Pavers/Pallet	72
				Pavers/SF	1.28
				Pavers/Band	12
	Bands/Pallet	6			
	LF/Paver (Sailor)	1.135			
	LF/Paver (Soldier)	.688			
	Pallet Weight	1,830 Lbs			

Strassen Bavaria Tumbled

Strassen Bavaria Small Square—5½ x 5½

Yard Price: \$6.20/SF	SKU	Color	Stock Location	Dimensions	2¾" x 5½" x 5½"
Factory Direct: \$5.32/SF	3973033	Chamois	Non-Stock	SF/Piece	.210
	3973026	Charcoal	Non-Stock	SF/Band	6.25
	4565688	Iron Range	Non-Stock	SF/Pallet	50
	3170012	Minnesota River	Cedar Acres	Pavers/Pallet	240
	3169955	North Shore	Cedar Acres	Pavers/SF	4.8
	179104	Sterling Grey	Non-Stock	Pavers/Band	30
				Bands/Pallet	8
				LF/Paver (Sailor)	.458
				LF/Paver (Soldier)	.458
			Pallet Weight	1,625 Lbs.	

Strassen Bavaria Small Rectangle—5½ x 11



Yard Price: \$6.20/SF	SKU	Color	Stock Location	Dimensions	2¾" x 5½" x 11"
Factory Direct: \$5.32/SF	3973071	Chamois	Non-Stock	SF/Piece	.420
	3973064	Charcoal	Non-Stock	SF/Band	7.56
	4565695	Iron Range	Non-Stock	SF/Pallet	60.48
	3170210	Minnesota River	Cedar Acres	Pavers/Pallet	144
	3170159	North Shore	Cedar Acres	Pavers/SF	2.4
	179106	Sterling Grey	Non-Stock	Pavers/Band	18
				Bands/Pallet	8
			LF/Paver (Sailor)	.917	
			LF/Paver (Soldier)	.458	
			Pallet Weight	1,925 Lbs.	

Strassen Bavaria Large Square—11 x 11

Yard Price: \$6.20/SF	SKU	Color	Stock Location	Dimensions	2¾" x 11" x 11"
Factory Direct: \$5.32/SF	3973057	Chamois	Non-Stock	SF/Piece	.841
	3973040	Charcoal	Non-Stock	SF/Band	15.12
	4565701	Iron Range	Non-Stock	SF/Pallet	60.48
	3170111	Minnesota River	Cedar Acres	Pavers/Pallet	72
	3170067	North Shore	Cedar Acres	Pavers/SF	1.2
	179108	Sterling Grey	Non-Stock	Pavers/Band	18
				Bands/Pallet	4
			LF/Paver (Sailor)	.917	
			LF/Paver (Soldier)	.917	
			Pallet Weight	1,965 Lbs.	

Strassen Bavaria Tumbled

Strassen Bavaria Large Rectangle—11 x 16

Yard Price: \$6.20/SF	SKU	Color	Stock Location	Dimensions	2¾" x 11" x 16"	
Factory Direct: \$5.32/SF	3973095	Chamois	Non-Stock	SF/Piece	1.261	
	3973088	Charcoal	Non-Stock	SF/Band	22.5	
	4565718	Iron Range	Non-Stock	SF/Pallet	67.5	
	3170296	Minnesota River	Non-Stock	Pavers/Pallet	54	
	3170241	North Shore	Non-Stock	Pavers/SF	.8	
	179110	Sterling Grey	Non-Stock	Pavers/Band	18	
					Bands/Pallet	3
					LF/Paver (Sailor)	1.375
				LF/Paver (Soldier)	.917	
				Pallet Weight	2,195 Lbs.	

Strassen Bavaria ¾ Stone—6½ x 9

Yard Price: \$6.20/SF	SKU	Color	Stock Location	Dimensions	2¾" x 6½" x 9"	
Factory Direct: \$5.32/SF	3973156	Chamois	Non-Stock	SF/Piece	.407	
	3973149	Charcoal	Non-Stock	SF/Band	7.5	
	4565749	Iron Range	Non-Stock	SF/Pallet	52.5	
	3409518	Minnesota River	Non-Stock	Pavers/Pallet	126	
	3409501	North Shore	Non-Stock	Pavers/SF	2.4	
	179112	Sterling Grey	Non-Stock	Pavers/Band	18	
					Bands/Pallet	7
					LF/Paver (Sailor)	.750
				LF/Paver (Soldier)	.542	
				Pallet Weight	1,706 Lbs.	

- Factory Direct Pricing on drop ship orders or factory pickup; FULL PALLETS ONLY; 10 pallet minimum drop ship order
- All product can be delivered anywhere in the metro area; all deliveries quoted individually for best rate; please call
- Please call for out-state and out-of-state delivery; special delivery quotes available
- Non-stocked product can be obtained quickly with advance notice, subject to factory availability
- 4136796: \$20 refundable pallet deposit on Borgert pallets; **must have receipt when returning pallets for refund**
- 3625284: \$25 broken pallet charge on non-stock items if not ordered in full pallets; **NO RETURNS on non-stock item orders**



Minnesota River

STRASSEN® SERIES
BAVARIA



Minnesota River

North Shore

Sterling Gray

Iron Range

Bavaria 5x5 & 6x9 also available in Charcoal & Chamois.
 5x11 available in Charcoal only



Iron Range

BAVARIA II



Minnesota River

North Shore

Sterling Gray

Iron Range

Bavaria II 5x5, 6x9 & Large Circle also available in Charcoal & Chamois.

Bavaria II Non-Tumbled

Bavaria II Non-Tumbled Small Square—5½ x 5½

Yard Price: \$5.15/SF	SKU	Color	Stock Location	Dimensions	2¾" x 5½" x 5½"
Factory Direct: \$4.38/SF	3973170	Chamois	Non-Stock	SF/Piece	.210
	3973163	Charcoal	Non-Stock	SF/Band	9.98
	4565756	Iron Range	Non-Stock	SF/Pallet	79.8
	3554072	Minnesota River	Non-Stock	Pavers/Pallet	384
	3554065	North Shore	Non-Stock	Pavers/SF	4.8
	179462	Sterling Grey	Non-Stock	Pavers/Band	48
				Bands/Pallet	8
				LF/Paver (Sailor)	.458
			LF/Paver (Soldier)	.458	
			Pallet Weight	2,595 Lbs.	

Bavaria II Non-Tumbled Small Rectangle—5½ x 11

Yard Price: \$5.15/SF	SKU	Color	Stock Location	Dimensions	2¾" x 5½" x 11"
Factory Direct: \$4.38/SF	224470	Charcoal	Non-Stock	SF/Piece	.420
	4565763	Iron Range	Non-Stock	SF/Band	20.25
	3554102	Minnesota River	Non-Stock	SF/Pallet	81
	3554096	North Shore	Non-Stock	Pavers/Pallet	192
	179472	Sterling Grey	Non-Stock	Pavers/SF	2.4
				Pavers/Band	48
			Bands/Pallet	4	
			LF/Paver (Sailor)	.917	
			LF/Paver (Soldier)	.458	
			Pallet Weight	2,635 Lbs.	

Bavaria II Non-Tumbled Large Square—11 x 11

Yard Price: \$5.15/SF	SKU	Color	Stock Location	Dimensions	2¾" x 11" x 11"
Factory Direct: \$4.38/SF	4565770	Iron Range	Non-Stock	SF/Piece	.841
	3554133	Minnesota River	Non-Stock	SF/Band	20.25
	3554126	North Shore	Non-Stock	SF/Pallet	81
	179474	Sterling Grey	Non-Stock	Pavers/Pallet	96
				Pavers/SF	1.2
				Pavers/Band	24
				Bands/Pallet	4
				LF/Paver (Sailor)	.917
			LF/Paver (Soldier)	.917	
			Pallet Weight	2,635 Lbs.	

Bavaria II Non-Tumbled

Bavaria II Non-Tumbled—Large Rectangle—11 x 16

Yard Price: \$5.15/SF	SKU	Color	Stock Location	Dimensions	2¾" x 11" x 16"
Factory Direct: \$4.38/SF	4565787	Iron Range	Non-Stock	SF/Piece	1.261
	3554164	Minnesota River	Non-Stock	SF/Band	30
 	3554157	North Shore	Non-Stock	SF/Pallet	90
	179540	Sterling Grey	Non-Stock	Pavers/Pallet	72
				Pavers/SF	.8
				Pavers/Band	24
				Bands/Pallet	3
			LF/Paver (Sailor)	1.375	
			LF/Paver (Soldier)	.917	
			Pallet Weight	2,925 Lbs.	

Bavaria II Non-Tumbled ¾ Stone—6½ x 9

Yard Price: \$5.15/SF	SKU	Color	Stock Location	Dimensions	2¾" x 6½" x 9"
Factory Direct: \$4.38/SF	4178758	Chamois	Non-Stock	SF/Piece	.407
	4178741	Charcoal	Non-Stock	SF/Band	15
Rectangle piece For borders	4565817	Iron Range	Non-Stock	SF/Pallet	75
	4178710	Minnesota River	Non-Stock	Pavers/Pallet	180
	4178703	North Shore	Non-Stock	Pavers/SF	2.4
	179548	Sterling Grey	Non-Stock	Pavers/Band	36
				Bands/Pallet	5
			LF/Paver (Sailor)	.750	
			LF/Paver (Soldier)	.542	
			Pallet Weight	2,440 Lbs.	

- Factory Direct Pricing on drop ship orders or factory pickup; FULL PALLETS ONLY; 10 pallet minimum drop ship order
- All product can be delivered anywhere in the metro area; all deliveries quoted individually for best rate; please call
- Please call for out-state and out-of-state delivery; special delivery quotes available
- Non-stocked product can be obtained quickly with advance notice, subject to factory availability
- 4136796: \$20 refundable pallet deposit on Borgert pallets; **must have receipt when returning pallets for refund**
- 3625284: \$25 broken pallet charge on non-stock items if not ordered in full pallets; **NO RETURNS on non-stock item orders**

Vavel Stone *Tumbled*

Vavel *Tumbled* Small Square—7 x 7

Yard Price: \$6.05/SF		SKU	Color	Stock Location	Dimensions	2¾" x 7" x 7"
Factory Direct: \$5.45/SF		4178925	Iron Range	Non-Stock	SF/Piece	.340
		4178918	Minnesota River	Non-Stock	SF/Band	8.16
		4178901	North Shore	Non-Stock	SF/Pallet	48.96
		179572	Sterling Grey	Non-Stock	Pavers/Pallet	144
					Pavers/SF	2.94
					Pavers/Band	24
					Bands/Pallet	6
					LF/Paver (Sailor)	.583
					LF/Paver (Soldier)	.583
					Pallet Weight	1,591 Lbs.

Iron Range

Minnesota River

North Shore

Sterling Grey
(Shown in Bavaria)

Vavel *Tumbled* Rectangle—7 x 14

Yard Price: \$6.05/SF		SKU	Color	Stock Location	Dimensions	2¾" x 7" x 14"
Factory Direct: \$5.45/SF		4178963	Iron Range	Non-Stock	SF/Piece	.68
		4178956	Minnesota River	Non-Stock	SF/Band	21.76
		4178949	North Shore	Non-Stock	SF/Pallet	65.28
		179576	Sterling Grey	Non-Stock	Pavers/Pallet	96
					Pavers/SF	1.47
					Pavers/Band	32
					Bands/Pallet	3
					LF/Paver (Sailor)	1.167
					LF/Paver (Soldier)	.583
					Pallet Weight	2,122 Lbs.

Iron Range

Minnesota River

North Shore

Sterling Grey
(Shown in Bavaria)

Vavel *Tumbled* Large Square—14 x 14

Yard Price: \$6.05/SF		SKU	Color	Stock Location	Dimensions	2¾" x 14" x 14"
Factory Direct: \$5.45/SF		4179021	Iron Range	Non-Stock	SF/Piece	1.36
		4179014	Minnesota River	Non-Stock	SF/Band	21.76
		4178994	North Shore	Non-Stock	SF/Pallet	65.28
		179578	Sterling Grey	Non-Stock	Pavers/Pallet	48
					Pavers/SF	.74
					Pavers/Band	16
					Bands/Pallet	3
					LF/Paver (Sailor)	1.167
					LF/Paver (Soldier)	1.167
					Pallet Weight	2,122 Lbs.

Iron Range

Minnesota River

North Shore

Sterling Grey
(Shown in Bavaria)

- Factory Direct Pricing on drop ship orders or factory pickup; FULL PALLETS ONLY; 10 pallet minimum drop ship order
- All product can be delivered anywhere in the metro area; all deliveries quoted individually for best rate; please call
- Please call for out-state and out-of-state delivery; special delivery quotes available
- Non-stocked product can be obtained quickly with advance notice, subject to factory availability
- 4136796: \$20 refundable pallet deposit on Borgert pallets; **must have receipt when returning pallets for refund**
- 3625284: **\$25 broken pallet charge on non-stock items** if not ordered in full pallets; **NO RETURNS on non-stock item orders**



STRASSEN® SERIES
VAVEL™



Iron Range

Minnesota River

North Shore

Sterling Gray

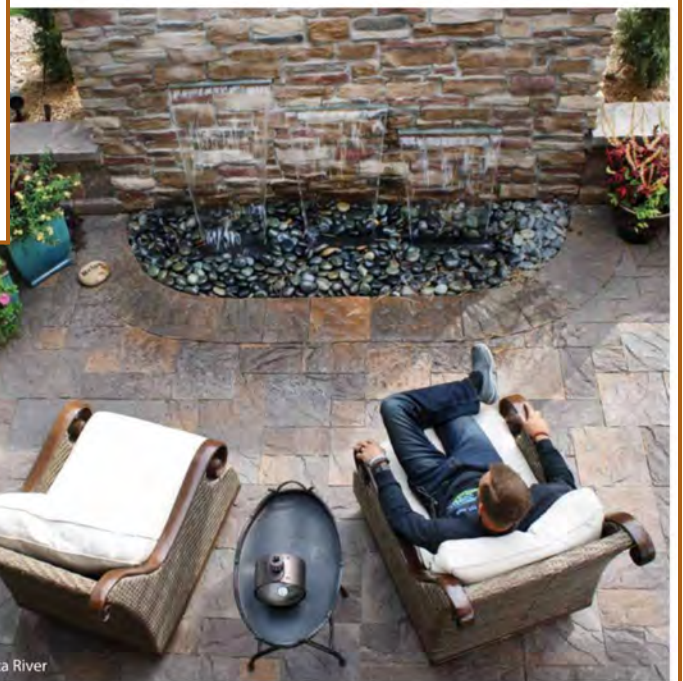

VAVEL II™



Iron Range

Minnesota River

North Shore

Sterling Gray

Vavel Stone II Non-Tumbled

Vavel II Small Square—7 x 7

Yard Price: \$5.30/SF		SKU	Color	Stock Location	Dimensions	2¾" x 7" x 7"
Factory Direct: \$4.51/SF		4178802	Iron Range	Non-Stock	SF/Piece	.340
		4178796	Minnesota River	Non-Stock	SF/Band	12.24
		4178789	North Shore	Non-Stock	SF/Pallet	85.68
		179586	Sterling Grey	Non-Stock	Pavers/Pallet	252
	Iron Range	Minnesota River	North Shore	Sterling Grey (Shown in Bavaria II)	Pavers/SF	2.94
					Pavers/Band	36
					Bands/Pallet	7
					LF/Paver (Sailor)	.583
					LF/Paver (Soldier)	.583
					Pallet Weight	2,785 Lbs.

Vavel II Rectangle—7 x 14

Yard Price: \$5.30/SF		SKU	Color	Stock Location	Dimensions	2¾" x 7" x 14"
Factory Direct: \$4.51/SF		4178840	Iron Range	Non-Stock	SF/Piece	.68
		4178833	Minnesota River	Non-Stock	SF/Band	24.48
		4178826	North Shore	Non-Stock	SF/Pallet	73.44
		179590	Sterling Grey	Non-Stock	Pavers/Pallet	108
	Iron Range	Minnesota River	North Shore	Sterling Grey (Shown in Bavaria II)	Pavers/SF	1.47
					Pavers/Band	36
					Bands/Pallet	3
					LF/Paver (Sailor)	1.167
					LF/Paver (Soldier)	.583
					Pallet Weight	2,387 Lbs.

Vavel II Large Square—14 x 14

Yard Price: \$5.30/SF		SKU	Color	Stock Location	Dimensions	2¾" x 14" x 14"
Factory Direct: \$4.51/SF		4178888	Iron Range	Non-Stock	SF/Piece	1.36
		4178871	Minnesota River	Non-Stock	SF/Band	21.76
		4178864	North Shore	Non-Stock	SF/Pallet	65.28
		179594	Sterling Grey	Non-Stock	Pavers/Pallet	48
	Iron Range	Minnesota River	North Shore	Sterling Grey (Shown in Bavaria II)	Pavers/SF	.74
					Pavers/Band	16
					Bands/Pallet	3
					LF/Paver (Sailor)	1.167
					LF/Paver (Soldier)	1.167
					Pallet Weight	2,122 Lbs.



Minnesota River

MADERA WALL



Iron Range



Minnesota River



North Shore



Sterling Gray



Use for both freestanding and gravity walls. 11 different sizes combining 3 heights & 18 different faces.

6" Madera Tumbled Wall System—Pallet A

	SKU	Color	Stock Location			
Iron Range	4565824	Iron Range	Non-Stock		Dimensions Block 1: 6"H x 8"W x 12"D Block 2: 6"H x 12"W x 12"D Block 3: 6"H x 16"W x 12"D	
	3171590	Minnesota River	Non-Stock			
Minnesota River	3171538	North Shore	Non-Stock		Coverage/Block Block 1: .33 SqFt Max Block 2: .50 SqFt Max Block 3: .66 SqFt Max	
	179600	Sterling Grey	Non-Stock			
Yard Price: \$14.70/SqFt					Blocks/Pallet	36 Total (12 of Each Size)
Factory Direct Price: \$13.03/SqFt					Weight/Block	Block 1: 32 Lbs. Block 2: 55 Lbs. Block 3: 78 Lbs.
North Shore				SF/Pallet	15 SF (30 Lin. Ft.)	
Sterling Grey (Shown in Panomur)				Pallet Weight	2,100 Lbs.	

6" Madera Tumbled Wall System—Pallet B

	SKU	Color	Stock Location			
Iron Range	4565831	Iron Range	Non-Stock		Dimensions Block 5: 6"H x 24"W x 12"D Block 6: 6"H x 28"W x 12"D	
	3712878	Minnesota River	Non-Stock			
Minnesota River	3712847	North Shore	Non-Stock		Coverage/Block Block 5: 1.0 SqFt Max Block 6: 1.17 SqFt Max	
	179606	Sterling Grey	Non-Stock			
Yard Price: \$14.70/SqFt					Blocks/Pallet	18 Total (9 of Each Size)
Factory Direct Price: \$13.03/SqFt					Weight/Block	Block 5: 124 Lbs. Block 6: 147 Lbs.
North Shore				SF/Pallet	18 SF (36 Lin. Ft.)	
Sterling Grey (Shown in Panomur)				Pallet Weight	2,440 Lbs.	

- Factory Direct Pricing on drop ship orders or factory pickup; FULL PALLETS ONLY; 10 pallet minimum drop ship order
- All product can be delivered anywhere in the metro area; all deliveries quoted individually for best rate; please call
- Please call for out-state and out-of-state delivery; special delivery quotes available
- Non-stocked product can be obtained quickly with advance notice, subject to factory availability
- 4136796: \$20 refundable pallet deposit on Borgert pallets; **must have receipt when returning pallets for refund**
- 3625284: **\$25 broken pallet charge on non-stock items** if not ordered in full pallets; **NO RETURNS on non-stock item orders**

Use for both freestanding and gravity walls. 11 different sizes combining 3 heights & 18 different faces.

6" Madera Tumbled Wall System—Pallet C

SKU	Color	Stock Location	Dimensions
4565848	Iron Range	Non-Stock	Block 4: 6" H x 20" W x 12" D Block 7: 6" H x 32" W x 12" D
3712915	Minnesota River	Non-Stock	
3712892	North Shore	Non-Stock	Block 4: .83 SqFt Max Block 7: 1.33 SqFt Max
179610	Sterling Grey	Non-Stock	
Yard Price: \$14.70/SqFt			Blocks/Pallet: 18 Total (9 of Each Size)
Factory Direct Price: \$13.03/SqFt			Weight/Block: Block 4: 101 Lbs. Block 7: 170 Lbs.
			SF/Pallet: 18 SF (36 Lin. Ft.)
			Pallet Weight: 2,440 Lbs.

3" Madera Tumbled Wall System—Pallet D

SKU	Color	Stock Location	Dimensions
4565855	Iron Range	Non-Stock	Block 1: 3" H x 8" W x 12" D Block 2: 3" H x 12" W x 12" D Block 3: 3" H x 16" W x 12" D
3712953	Minnesota River	Non-Stock	
3712939	North Shore	Non-Stock	
179612	Sterling Grey	Non-Stock	Block 1: .16 SqFt Max Block 2: .25 SqFt Max Block 3: .33 SqFt Max
Yard Price: \$14.70/SqFt			
Factory Direct Price: \$13.03/SqFt			Blocks/Pallet: 72 Total (24 of Each Size)
			Weight/Block: Block 1: 16 Lbs. Block 2: 28 Lbs. Block 3: 39 Lbs.
			SF/Pallet: 15 SF (60 Lin. Ft.)
			Pallet Weight: 2,160 Lbs.

- Factory Direct Pricing on drop ship orders or factory pickup; FULL PALLETS ONLY; 10 pallet minimum drop ship order
- All product can be delivered anywhere in the metro area; all deliveries quoted individually for best rate; please call
- Please call for out-state and out-of-state delivery; special delivery quotes available
- Non-stocked product can be obtained quickly with advance notice, subject to factory availability
- 4136796: \$20 refundable pallet deposit on Borgert pallets; **must have receipt when returning pallets for refund**
- 3625284: \$25 broken pallet charge on non-stock items if not ordered in full pallets; **NO RETURNS on non-stock item orders**

Madera Wall

Use for both freestanding and gravity walls. 11 different sizes combining 3 heights & 18 different faces.

6" Madera Column Block

	SKU	Color	Stock Location	Dimensions	6" H x 8" W x 12" D
Iron Range	4565879	Iron Range	Non-Stock	Coverage/Block	.83 SqFt
Minnesota River	3409662	Minnesota River	Non-Stock	Blocks/Pallet	54
	3409648	North Shore	Non-Stock	Weight/Block	47 Lbs.
	179616	Sterling Grey	Non-Stock	SF/Pallet	44.82
North Shore	Yard Price: \$8.50/Each			Pallet Weight	2,538 Lbs.
Sterling Grey (Shown in Panomur)	Factory Direct Price: \$7.42/Each				

Madera Dual Split Cap

	SKU	Color	Stock Location	Dimensions	2 3/4" H x 14" W x 15" D
Iron Range	4565886	Iron Range	Non-Stock	Coverage/Block	0.86 Lin. Ft./Cap
Minnesota River	3409754	Minnesota River	Non-Stock	Blocks/Pallet	36
	3409693	North Shore	Non-Stock	Weight/Block	50 Lbs.
	179618	Sterling Grey	Non-Stock	LF/Pallet	42
North Shore	Yard Price: \$9.25/Each			Pallet Weight	1,800 Lbs.
Sterling Grey (Shown in Panomur)	Factory Direct Price: \$8.07/Each				

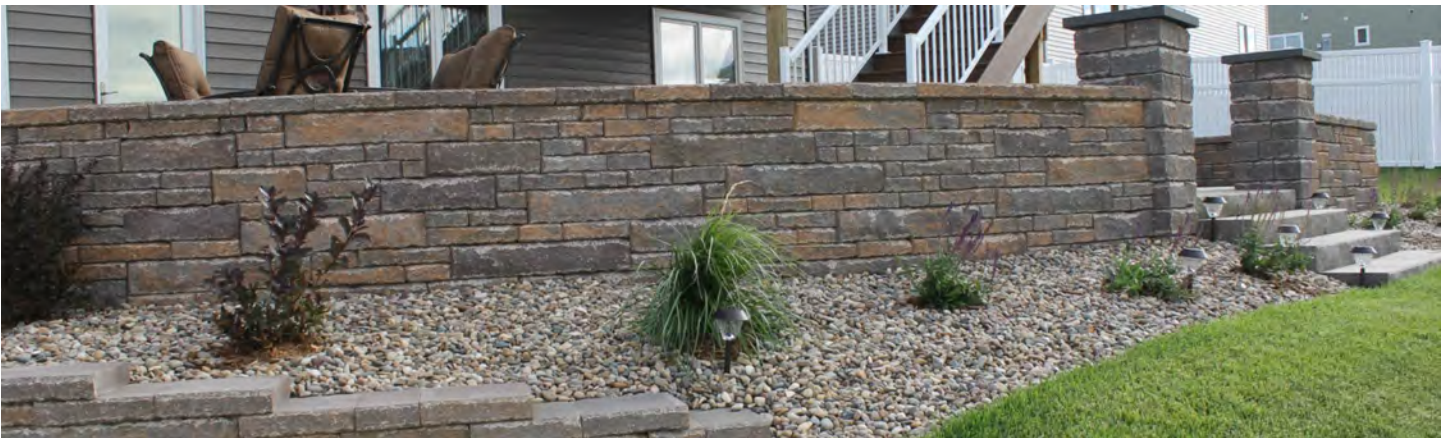

- Factory Direct Pricing on drop ship orders or factory pickup; FULL PALLETS ONLY; 10 pallet minimum drop ship order
- All product can be delivered anywhere in the metro area; all deliveries quoted individually for best rate; please call
- Please call for out-state and out-of-state delivery; special delivery quotes available
- Non-stocked product can be obtained quickly with advance notice, subject to factory availability
- 4136796: \$20 refundable pallet deposit on Borgert pallets; **must have receipt when returning pallets for refund**
- 3625284: **\$25 broken pallet charge on non-stock items** if not ordered in full pallets; **NO RETURNS on non-stock item orders**



MORTEZA WALL



Iron Range



Minnesota River



North Shore



Sterling Gray

Morteza Wall



Use for both freestanding and gravity walls. 11 different sizes combining 3 heights & 18 different faces.

6" Morteza Non-Tumbled Wall System—Pallet A

	SKU	Color	Stock Location		
Iron Range	4565893	Iron Range	Non-Stock	Dimensions	Block 1: 6"H x 8"W x 12"D Block 2: 6"H x 12"W x 12"D Block 3: 6"H x 16"W x 12"D
	3969142	Minnesota River	Non-Stock		
Minnesota River	3969128	North Shore	Non-Stock	Coverage/Block	Block 1: .33 SqFt Max Block 2: .50 SqFt Max Block 3: .66 SqFt Max
	179620	Sterling Grey	Non-Stock		
Yard Price: \$13.65/SqFt				Blocks/Pallet	36 Total (12 of Each Size)
Factory Direct Price: \$12.08/SqFt				Weight/Block	Block 1: 32 Lbs. Block 2: 55 Lbs. Block 3: 78 Lbs.
North Shore				SF/Pallet	15 SF (30 Lin. Ft.)
Sterling Grey (Shown in Panomur)				Pallet Weight	2,100 Lbs.

6" Morteza Non-Tumbled Wall System—Pallet B

	SKU	Color	Stock Location		
Iron Range	4565909	Iron Range	Non-Stock	Dimensions	Block 5: 6"H x 24"W x 12"D Block 6: 6"H x 28"W x 12"D
	3969197	Minnesota River	Non-Stock		
Minnesota River	3969166	North Shore	Non-Stock	Coverage/Block	Block 5: 1.0 SqFt Max Block 6: 1.17 SqFt Max
	179622	Sterling Grey	Non-Stock		
Yard Price: \$13.65/SqFt				Blocks/Pallet	18 Total (9 of Each Size)
Factory Direct Price: \$12.08/SqFt				Weight/Block	Block 5: 124 Lbs. Block 6: 147 Lbs.
North Shore				SF/Pallet	18 SF (36 Lin. Ft.)
Sterling Grey (Shown in Panomur)				Pallet Weight	2,520 Lbs.

- Factory Direct Pricing on drop ship orders or factory pickup; FULL PALLETS ONLY; 10 pallet minimum drop ship order
- All product can be delivered anywhere in the metro area; all deliveries quoted individually for best rate; please call
- Please call for out-state and out-of-state delivery; special delivery quotes available
- Non-stocked product can be obtained quickly with advance notice, subject to factory availability
- 4136796: \$20 refundable pallet deposit on Borgert pallets; **must have receipt when returning pallets for refund**
- 3625284: **\$25 broken pallet charge on non-stock items** if not ordered in full pallets; **NO RETURNS on non-stock item orders**

Morteza Wall

Use for both freestanding and gravity walls. 11 different sizes combining 3 heights & 18 different faces.

6" Morteza Non-Tumbled Wall System—Pallet C

Color	SKU	Color	Stock Location	Dimensions
Iron Range	4565916	Iron Range	Non-Stock	Block 4: 6"H x 20"W x 12"D Block 7: 6"H x 32"W x 12"D
	3969234	Minnesota River	Non-Stock	
Minnesota River	3969203	North Shore	Non-Stock	Coverage/Block Block 4: .83 SqFt Max Block 7: 1.33 SqFt Max
	179624	Sterling Grey	Non-Stock	
Yard Price: \$13.65/SqFt				Blocks/Pallet
Factory Direct Price: \$12.08/SqFt				Weight/Block
				SF/Pallet
				Pallet Weight
North Shore Sterling Grey (Shown in Panomur)				Block 4: 101 Lbs. Block 7: 170 Lbs.
				18 SF (36 Lin. Ft.)
				2,520 Lbs.

3" Morteza Non-Tumbled Wall System—Pallet D

Color	SKU	Color	Stock Location	Dimensions
Iron Range	4565923	Iron Range	Non-Stock	Block 1: 3"H x 8"W x 12"D Block 2: 3"H x 12"W x 12"D Block 3: 3"H x 16"W x 12"D
	3969289	Minnesota River	Non-Stock	
Minnesota River	3969265	North Shore	Non-Stock	
	179626	Sterling Grey	Non-Stock	
Yard Price: \$13.65/SqFt				Coverage/Block
Factory Direct Price: \$12.08/SqFt				Blocks/Pallet
				Weight/Block
				SF/Pallet
North Shore Sterling Grey (Shown in Panomur)				Block 1: 16 Lbs. Block 2: 28 Lbs. Block 3: 39 Lbs.
				15 SF (60 Lin. Ft.)
				2,160 Lbs.

- Factory Direct Pricing on drop ship orders or factory pickup; FULL PALLETS ONLY; 10 pallet minimum drop ship order
- All product can be delivered anywhere in the metro area; all deliveries quoted individually for best rate; please call
- Please call for out-state and out-of-state delivery; special delivery quotes available
- Non-stocked product can be obtained quickly with advance notice, subject to factory availability
- 4136796: \$20 refundable pallet deposit on Borgert pallets; **must have receipt when returning pallets for refund**
- 3625284: \$25 broken pallet charge on non-stock items if not ordered in full pallets; **NO RETURNS on non-stock item orders**

Morteza Wall

Use for both freestanding and gravity walls. 11 different sizes combining 3 heights & 18 different faces.

6" Morteza Column Block

	SKU	Color	Stock Location	Dimensions	6" H x 8" W x 12" D
Iron Range	4565947	Iron Range	Non-Stock	Coverage/Block	.83 SqFt
	3969395	Minnesota River	Non-Stock	Blocks/Pallet	54
Minnesota River	3969364	North Shore	Non-Stock	Weight/Block	47 Lbs.
	179628	Sterling Grey	Non-Stock	SF/Pallet	44.82
North Shore	Yard Price: \$7.50/Each			Pallet Weight	2,538 Lbs.
Sterling Grey (Shown in Panomur)	Factory Direct Price: \$6.47/Each				





Morteza Dual Split Cap

	SKU	Color	Stock Location	Dimensions	2 3/4" H x 14" W x 15" D
Iron Range	4565954	Iron Range	Non-Stock	Coverage/Block	0.86 Lin. Ft./Cap
	3969456	Minnesota River	Non-Stock	Blocks/Pallet	36
Minnesota River	3969432	North Shore	Non-Stock	Weight/Block	50 Lbs.
	179630	Sterling Grey	Non-Stock	LF/Pallet	42
North Shore	Yard Price: \$8.10/Each			Pallet Weight	1,800 Lbs.
Sterling Grey (Shown in Panomur)	Factory Direct Price: \$7.04/Each				



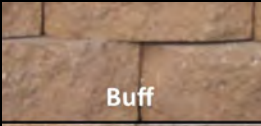

- Factory Direct Pricing on drop ship orders or factory pickup; FULL PALLETS ONLY; 10 pallet minimum drop ship order
- All product can be delivered anywhere in the metro area; all deliveries quoted individually for best rate; please call
- Please call for out-state and out-of-state delivery; special delivery quotes available
- Non-stocked product can be obtained quickly with advance notice, subject to factory availability
- 4136796: \$20 refundable pallet deposit on Borgert pallets; **must have receipt when returning pallets for refund**
- 3625284: **\$25 broken pallet charge on non-stock items** if not ordered in full pallets; **NO RETURNS on non-stock item orders**

Panomur Wall System



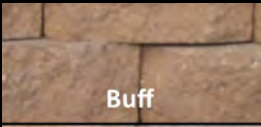

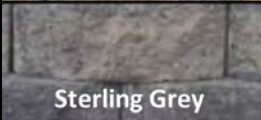
Panomur Wall Block—6"

	SKU	Color	Stock Location	Dimensions	6" H x 16" W x 12" D
 Buff	179632	Buff	Non-Stock	Coverage/Block	.66 SqFt
	3712984	Minnesota River	Non-Stock	Blocks/Pallet	45
	179634	Sterling Grey	Non-Stock	Weight/Block	49 Lbs.
 Minnesota River	Yard Price: \$6.65/Each			SF/Pallet	30
	Factory Direct Price: \$5.74/Each			Pallet Weight	2,205 Lbs.
 Sterling Grey					

Panomur Corner Block—6"

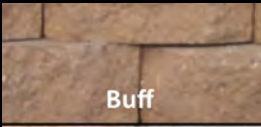
	SKU	Color	Stock Location	Dimensions	6" H x 16" W x 8" D
 Buff	179636	Buff	Non-Stock	Coverage/Block	1 SqFt (total for both sides)
	3713035	Minnesota River	Non-Stock	Blocks/Pallet	36
	179638	Sterling Grey	Non-Stock	Weight/Block	60 Lbs.
 Minnesota River	Yard Price: \$9.30/Each			SF/Pallet	36 (total for both sides)
	Factory Direct Price: \$8.14/Each			Pallet Weight	2,160 Lbs.
 Sterling Grey					

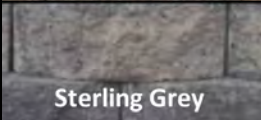
Panomur Split Cap Block—3½"

	SKU	Color	Stock Location	Dimensions	3½" H x 16" W x 12½" D
 Buff	179640	Buff	Non-Stock	Coverage/Cap	1.25 Linear Feet
	3410545	Minnesota River	Non-Stock	Caps/Pallet	60
	179642	Sterling Grey	Non-Stock	Weight/Block	47 Lbs.
 Minnesota River	Yard Price: \$6.65/Each			LF/Pallet	75
	Factory Direct Price: \$5.74/Each			Pallet Weight	2,850 Lbs.
 Sterling Grey					

Special Order—Sold in full pallets or partial pallets. Partial pallet charge applies. No returns on Panomur.

- Factory Direct Pricing on drop ship orders or factory pickup; FULL PALLETS ONLY; 10 pallet minimum drop ship order
- All product can be delivered anywhere in the metro area; all deliveries quoted individually for best rate; please call
- Please call for out-state and out-of-state delivery; special delivery quotes available
- Non-stocked product can be obtained quickly with advance notice, subject to factory availability
- 4136796: \$20 refundable pallet deposit on Borgert pallets; **must have receipt when returning pallets for refund**
- 3625284: **\$25 broken pallet charge on non-stock items** if not ordered in full pallets; **NO RETURNS on non-stock item orders**



Minnesota River

CURVED & STRAIGHT FACE
PANOMUR® WALL



Sterling Gray

Minnesota River

Buff



Minnesota River | North Shore

**STRASSEN® WALL &
 STRASSEN® WALL II (UNTUMBLD)**



Minnesota River

Iron Range

North Shore

Minnesota River - 8x12 & trapezoid only

Sterling Gray - 8x12 & trapezoid only

Sterling Gray

Boulder Blend

Charcoal - 8x12 & trapezoid only

Charcoal - 8x12 & trapezoid only

Strassen Fire Pit & Wall

Borgert Strassen Fire Pit & Wall

Strassen Wall Fire Ring Kit

Yard Price: \$409.00/Kit	SKU	Color	Stock Location
	4362980	Boulder Blend	Non-Stock
Factory Direct: \$347.01/Kit	84150	Iron Range	Non-Stock
	4193362	Minnesota River	Non-Stock
Caps sold separately.	4362973	North Shore	Non-Stock
	225074	Sterling Grey	Non-Stock

Dimensions: 52"OD x 36"ID x 12"H
Kit Includes:

- 63 Strassen Trapezoid Block
- 36" Diameter x 12" High Metal Ring
- 3 Tubes SRW adhesive

Cap Kit Dimensions: 55"OD x 18"ID x 2½"H

- 4 Pieces per Complete Set

Precast Strassen Fire Ring Caps

Yard Price: \$75.00/Piece	SKU	Color	Stock Location
	178708	Brown	Non-Stock
Factory Direct: \$66.22/Piece	88448	Charcoal	Non-Stock
	88450	Limestone	Non-Stock

Pieces sold individually. 4 pieces per complete set.



Strassen Trapezoid Wall Block

Yard Price: \$4.34/Block	SKU	Color	Stock Location
	4179182	Boulder Blend	Non-Stock
Factory Direct: \$3.65/Block	184566	Charcoal	Non-Stock
	4363321	Iron Range	Non-Stock
	4179151	Minnesota River	Cedar Acres
	4179199	North Shore	Non-Stock
	184570	Sterling Grey	Non-Stock

Dimensions	4" x (5½" / 7¾") x 7⅞"
SF/Block (Narrow)	.153
SF/Block (Wide)	.215
SF/Pallet (Avg)	19.32
Weight/Block	15 Lbs
Weight/Pallet	1,575 Lbs
Blocks/Pallet	105

Strassen Wall Block—Large—4x8x12 (A)

Yard Price: \$4.80/Each	SKU	Color	Stock Location
	3175703	Boulder Blend	Non-Stock
Factory Direct: \$3.99/Each	184562	Charcoal	Non-Stock
	4363000	Iron Range	Non-Stock
	3017553	Minnesota River	Cedar Acres
	3553976	North Shore	Non-Stock
	179646	Sterling Grey	Non-Stock

Dimensions	4" x 7⅞" x 11¾"
SF/Block (Face)	.33
SF/Block (Surface)	.66
SF/Pallet (Face)	31.68
Weight/Block	28 Lbs
Weight/Pallet	2,825 Lbs
Blocks/Pallet	96

- Factory Direct Pricing on drop ship orders or factory pickup; FULL PALLETS ONLY; 10 pallet minimum drop ship order
- All product can be delivered anywhere in the metro area; all deliveries quoted individually for best rate; please call
- Please call for out-state and out-of-state delivery; special delivery quotes available
- Non-stocked product can be obtained quickly with advance notice, subject to factory availability
- 4136796: \$20 refundable pallet deposit on Borgert pallets; **must have receipt when returning pallets for refund**
- 3625284: **\$25 broken pallet charge on non-stock items** if not ordered in full pallets; **NO RETURNS on non-stock item orders**

www.bachmanswholesale.com

Strassen Wall

Strassen Wall Block—Medium—4x8x8 (B)

Yard Price: \$3.30/Each	SKU	Color	Stock Location	Dimensions 4" x 7 ⁷ / ₈ " x 7 ⁷ / ₈ "	
		4363086	Boulder Blend	Non-Stock	SF/Block (Face)
Factory Direct: \$2.70/Each	4363130	Iron Range	Non-Stock	SF/Block (Surface)	.44
	4363017	Minnesota River	Cedar Acres	SF/Pallet (Face)	21.12
	4363109	North Shore	Non-Stock	Weight/Block	18.6 Lbs
	180328	Sterling Grey	Non-Stock	Weight/Pallet	1,650 Lbs
				Blocks/Pallet	96

Strassen Wall Block—Small—4x8x4 (C)

Yard Price: \$1.80/Each	SKU	Color	Stock Location	Dimensions 4" x 7 ⁷ / ₈ " x 4"	
		4363253	Boulder Blend	Non-Stock	SF/Block (Face)
Factory Direct: \$1.35/Each	4363291	Iron Range	Non-Stock	SF/Block (Surface)	.22
	4363208	Minnesota River	Cedar Acres	SF/Pallet (Face)	15.84
	4363260	North Shore	Non-Stock	Weight/Block	9.3 Lbs
	180358	Sterling Grey	Non-Stock	Weight/Pallet	1,175 Lbs
				Blocks/Pallet	144

Strassen II Wall (Non-Tumbled)

Strassen II Trapezoid Wall Block

Yard Price: \$3.75/Block	SKU	Color	Stock Location	Dimensions 4" x (5 ¹ / ₂ " / 7 ³ / ₄ ") x 7 ⁷ / ₈ "	
		225078	Charcoal	Special Order	SF/Block (Narrow)
Factory Direct: \$3.12/Block	179658	Minnesota River	Special Order	SF/Block (Wide)	.215
	180384	Sterling Grey	Special Order	SF/Pallet (Avg)	19.32
				Weight/Block	15 Lbs
				Weight/Pallet	1,575 Lbs
				Blocks/Pallet	105

Strassen II Wall Block—Large—4x8x12 (A)

Yard Price: \$4.20/Each	SKU	Color	Stock Location	Dimensions 4" x 7 ⁷ / ₈ " x 11 ¹ / ₄ "	
		225080	Charcoal	Special Order	SF/Block (Face)
Factory Direct: \$3.47/Each	179670	Minnesota River	Special Order	SF/Block (Surface)	.66
	179674	Sterling Grey	Special Order	SF/Pallet (Face)	31.68
				Weight/Block	28 Lbs
				Weight/Pallet	2,825 Lbs
				Blocks/Pallet	96

Strassen Precast Wall Cap

Yard Price: \$75.00/Each	SKU	Color	Stock Location	Dimensions	2" x 11" x 30"
	118550	Brown	Non-Stock	Coverage (LF/Cap)	2.5'
Factory Direct: \$70.10/Each	118552	Charcoal	Non-Stock	Weight/Block	71 Lbs
	118554	Limestone	Non-Stock	Weight/Pallet	1,503 Lbs
				Blocks/Pallet	21

Bullnose Pavers—60mm

Yard Price: \$1.30/Each	SKU	Color	Stock Location	Dimensions	2 ³ / ₈ " x 3" x 12"
	3553891	Chamois	Non-Stock	SF/Piece	.25
Factory Direct: \$1.11/Each	3553860	Charcoal	Non-Stock	SF/Band	18.75
	3553792	Minnesota River	Non-Stock	SF/Pallet	75
				Pavers/Pallet	300
				Pavers/SF	4
				Pavers/Band	75
				Bands/Pallet	4
				LF/Paver (Soldier)	.323
				Pallet Weight	2,125

Strassen Pillar Cap

Yard Price: \$117.50 Each	SKU	Color	Stock Location	Dimensions	2 ¹ / ₄ " x 24" x 24"
Factory Direct: \$103.38 Each	Sloped Top-Smooth Edges			Weight/Cap	145 Lbs
	3017591	Charcoal	Non-Stock	Blocks/Pallet	6
	3710225	Limestone	Non-Stock	Weight/Pallet	900 Lbs
 Sloped Top Smooth Face Pillar Cap	Sloped Top-Rock Faced Edges				
	3553983	Brown	Non-Stock		
	3553990	Charcoal	Non-Stock		
	3554010	Limestone	Non-Stock		
	3554003	Brown	Non-Stock		
	Smooth Top-Smooth Edges				
 Smooth Top Rock Face Pillar Cap	Smooth Top-Smooth Edges				
	118162	Charcoal	Non-Stock		
	118166	Limestone	Non-Stock		
	118160	Brown	Non-Stock		
	Smooth Top-Rock Faced Edges				
	118172	Charcoal	Non-Stock		
118174	Limestone	Non-Stock			
118168	Brown	Non-Stock			



North Shore

STEP UNITS

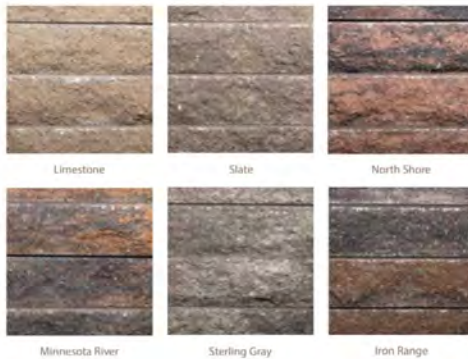

Limestone

Slate

North Shore

Minnesota River

Sterling Gray

Iron Range

Step Unit

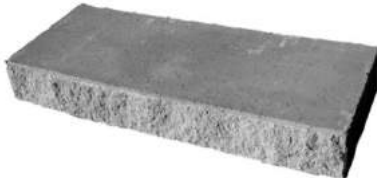
Yard Price: \$121.50/Each	SKU	Color	Stock Location	Dimensions	6" x 18" x 48"
		125748	Iron Range	Non-Stock	Steps/Pallet
Factory Direct: \$106.15/Each	3018673	Limestone	Non-Stock	Weight/Step	425 Lbs
	3409822	Minnesota River	Cedar Acres	Pallet Weight	2,550 Lbs
	4229313	North Shore	Cedar Acres		
	3018666	Slate	Cedar Acres		
	179676	Sterling Grey	Cedar Acres		

- Factory Direct Pricing on drop ship orders or factory pickup; FULL PALLETS ONLY; 10 pallet minimum drop ship order
- All product can be delivered anywhere in the metro area; all deliveries quoted individually for best rate; please call
- Please call for out-state and out-of-state delivery; special delivery quotes available
- Non-stocked product can be obtained quickly with advance notice, subject to factory availability
- 4136796: \$20 refundable pallet deposit on Borgert pallets; **must have receipt when returning pallets for refund**
- 3625284: **\$25 broken pallet charge on non-stock items** if not ordered in full pallets; **NO RETURNS on non-stock item orders**



Pavers and Slabs
Retaining Walls
Outdoor Living Products



COUNTY
MATERIALS CORPORATION

Proud to be American based & American made
Request our most current *Inspirations Catalog* today.
www.countymaterials.com

Section Contents

Description	Page	Description	Page
Bullnose	133	Wall	150-159
• Crest Bullnose Fine Finish	133	• Summit Wall	150
• Crest Bullnose Tumbled	133	• Tribute Standard Split Face Single Sided Wall	151
Concrete Pavers	134-149	• Tribute Standard Split Face Two Side Wall	151
• Destination Pavers	134	• Tribute Split Face Corner Block	152
• Elements Fine Finish Paving Stones	135-137	• Tribute Rustic Single Sided Wall	153
• Elements Tumbled Paving Stones	138-139	• Tribute Rustic Two Sided Wall	153
• Elements Shot Blast Paving Stones	140-142	• Tribute Rustic Straight Wall Cap	154
• Elements Rough Estate Paving Stones	143	• Tribute Rustic Tapered Wall Cap	154
• Essence Wood Grain Plank Pavers	144	• Tribute Rustic Corner Block	154
• H ₂ O Pro Pavers	145	• Wall Caps (for Tribute and Winston)	155
• H ₂ O Pro Tumbled Pavers	146	• Winston Tri-Split Face Block	156
• Lifestyle Pavers	147	• Winston Tri-Split Corner	156
• Grand Lifestyle Pavers	147	• Winston Straight Face Block	157
• Grand Milestone Pavers	148	• Winston Straight Corner	157
• Tranquility Pavers	149	• Landscape Step Unit	157
		• Oversize Rib Rock Wall System	158-159
		Landscape Accessories	160
		• Splash Blocks	160
		• Parking Kerbs	160
		• Bin Blocks	160

Geotechnical Engineering Specializing in Retaining Walls for Residential & Commercial



- | | |
|--|--|
| <ul style="list-style-type: none"> • Block Wall Designs (Large & Small) • Reinforced Slope Design • Bridge/Abutment Design • Boulder Walls | <ul style="list-style-type: none"> • Soil Nail/Tie Back Retaining Walls • Soil Assessment • Material Estimates • Sound/Noise Walls |
|--|--|

Kyle Huerd, PE • 218.280.2465

Crest Bullnose

Yard Price: \$2.70/Each	Crest Bullnose Pavers—Fine Finish		
	2¾" x 6" x 12"	Pieces/SqFt: 2	
Factory Direct: \$2.21/Each	SqFt: .5/Piece, 140/Pallet	Lbs./Piece: 13.86	
	Pieces/Pallet: 280	Pallet Weight: 3,235 Lbs.	
	SKU	Color	Stock Location
	76770	Haven	Non-Stock
	76772	Oasis	Non-Stock
	76778	Reflection	Cedar Acres
	76774	Serenity	Non-Stock
	76776	Timeless	Cedar Acres
	76780	Vision	Non-Stock

Yard Price: \$3.05/Each	Crest Bullnose Pavers—Tumbled		
	2¾" x 6" x 12"	Pieces/SqFt: 2	
Factory Direct: \$2.56/Each	SqFt: .5/Piece, 140/Pallet	Lbs./Piece: 13.86	
	Pieces/Pallet: 280	Pallet Weight: 3,235 Lbs.	
	SKU	Color	Stock Location
	76784	Haven	Non-Stock
	76786	Oasis	Non-Stock
	76792	Reflection	Non-Stock
	76788	Serenity	Non-Stock
	76790	Timeless	Non-Stock
	76794	Vision	Non-Stock

Bullnose Colors					
Haven	Oasis	Reflection	Serenity	Timeless	Vision
Haven Tumbled	Oasis Tumbled	Reflection Tumbled	Serenity Tumbled	Timeless Tumbled	Vision Tumbled

- Freight rate for 7 county metro area: \$175.00, flatbed with moffett or boom truck
- No split fees on County Materials products; Pavers are sold by layer, block by each
- 4563714: \$20 refundable pallet deposit on County Materials pallets; **must have receipt when returning pallets for refund.**
- Free jobsite clean up policies for County Materials products only when product is delivered:
 - Cleanups are made when County trucks are "in the area" of jobsite. As such, please allow up to 5 business days to have cleanup completed.
 - **Paver returns:** County Materials will pick up from your jobsite any empty pallets & full unopened pallets of product. All partial pallets of product will be left on jobsite.
 - **Retaining wall returns:** County Materials will pick up any full, partial, or empty pallets on jobsite.

Destination Pavers

Yard Price: \$5.25/SF	Destination Pavers—9 Sizes Mixed on 1 Pallet				
	SqFt/Layer: 11.11		Layers/Pallet: 8		
Factory Direct: \$4.51/SF	SqFt/Pallet: 88.88		Pallet Weight: 3,000 Lbs.		
	Piece	Dimensions (H x W x L)	Pieces/Pallet	Pieces/Layer	
SOLD IN FULL LAYERS ONLY	A	3 $\frac{3}{8}$ " x Various Irregular	8	1	
	B	3 $\frac{3}{8}$ " x Various Irregular	8	1	
	C	3 $\frac{3}{8}$ " x Various Irregular	8	1	
	D	3 $\frac{3}{8}$ " x Various Irregular	8	1	
	E	3 $\frac{3}{8}$ " x Various Irregular	8	1	
	F	3 $\frac{3}{8}$ " x Various Irregular	8	1	
	G	3 $\frac{3}{8}$ " x Various Irregular	8	1	
	H	3 $\frac{3}{8}$ " x Various Irregular	8	1	
	I	3 $\frac{3}{8}$ " x Various Irregular	8	1	
	SKU		Color	Stock Location	
	4561031		Haven	Non-Stock	
4561048		Oasis	Non-Stock		
4561055		Serenity	Non-Stock		
4561062		Timeless	Non-Stock		

Destination Paver Colors	
 <p>Haven</p>	 <p>Oasis</p>
 <p>Serenity</p>	 <p>Timeless</p>

INSTALLATION NOTE: Textured paver and patio stone surfaces require a buffer between the plate compactor and the paver surface to prevent scuffing. Please call Bachman's Hardscapes center for more information.

Elements Fine Finish Paving Stones

Yard Price: \$3.60/SF	Elements 'A'—Fine Finish			
	2¾" x 4" x 8"	Pieces/SqFt: 4.5		
Factory Direct: \$3.03/SF	SqFt/Piece: .222	Pieces/Pallet: 400		
	SqFt/Layer: 11	Layers/Pallet: 8		
SOLD IN FULL LAYERS ONLY	SqFt/Pallet: 88	Pallet Weight: 2,820 Lbs.		
	SKU	Color	Stock Location	
	147618	Calm	Non-Stock	
	76730	Dream	Cedar Acres	
	76720	Haven	Cedar Acres	
	76736	Homecoming	Non-Stock	
	220004	Majestic	Cedar Acres	
	76722	Oasis	Cedar Acres	
	76728	Reflection	Cedar Acres	
	76738	Reunion	Non-Stock	
	76724	Serenity	Cedar Acres	
	76726	Timeless	Cedar Acres	
	76732	Traditions	Non-Stock	
	76734	Vision	Cedar Acres	
	Yard Price: \$3.85/SF	Elements 'B'—Fine Finish		
		2¾" x 8" x 8"	Pieces/Layer: 30	
Factory Direct: \$3.25/SF	SqFt/Piece: .444	Layers/Pallet: 8		
	SqFt/Layer: 13.33	Pieces/Pallet: 240		
SOLD IN FULL LAYERS ONLY	SqFt/Pallet: 106.64	Pallet Weight: 3,380 Lbs.		
	SKU	Color	Stock Location	
	147624	Calm	Non-Stock	
	116766	Dream	Non-Stock	
	4560843	Haven	Cedar Acres	
	116768	Homecoming	Non-Stock	
	220010	Majestic	Cedar Acres	
	4560850	Oasis	Cedar Acres	
	116770	Reflection	Cedar Acres	
	116772	Reunion	Non-Stock	
	4560157	Serenity	Cedar Acres	
	4560867	Timeless	Cedar Acres	
	116774	Traditions	Non-Stock	
	116776	Vision	Cedar Acres	

Yard Price: \$3.85/SF	Elements 'C'—Fine Finish		
	2¾" x 8" x 16"	Pieces/Layer: 15	
Factory Direct: \$3.25/SF	SqFt/Piece: .888	Layers/Pallet: 8	
	SqFt/Layer: 13.33	Pieces/Pallet: 120	
SOLD IN FULL LAYERS ONLY	SqFt/Pallet: 106.64	Pallet Weight: 3,637 Lbs.	
		SKU	Color
147626		Calm	Non-Stock
116778		Dream	Non-Stock
4560874		Haven	Cedar Acres
116780		Homecoming	Non-Stock
220014		Majestic	Cedar Acres
4560881		Oasis	Cedar Acres
116784		Reflection	Non-Stock
116786		Reunion	Non-Stock
4560195		Serenity	Cedar Acres
4560898		Timeless	Cedar Acres
116788		Traditions	Non-Stock
116790		Vision	Non-Stock

Elements Colors					
Calm	Dream	Haven	Homecoming	Majestic	Oasis
Reflection	Reunion	Serenity	Timeless	Traditions	Vision

Elements Finishes			
Timeless Standard	Timeless Tumbled	Timeless Rough Estate	Majestic Shot Blast

- Freight rate for 7 county metro area: \$175.00, flatbed with moffett or boom truck
- No split fees on County Materials products; Pavers are sold by layer, block by each
- 4563714: \$20 refundable pallet deposit on County Materials pallets; **must have receipt when returning pallets for refund.**
- Free jobsite clean up policies for County Materials products only when product is delivered:
 - Cleanups are made when County trucks are "in the area" of jobsite. As such, please allow up to 5 business days to have cleanup completed.
 - **Paver returns:** County Materials will pick up from your jobsite any empty pallets & full unopened pallets of product. All partial pallets of product will be left on jobsite.
 - **Retaining wall returns:** County Materials will pick up any full, partial, or empty pallets on jobsite.



INSTALLATION NOTE: Textured paver and patio stone surfaces require a buffer between the plate compactor and the paver surface to prevent scuffing. Please call Bachman's Hardscapes center for more information.

Elements Fine Finish Paving Stones

<p>Yard Price: \$5.25/SF</p> <p>Factory Direct: \$4.51/SF</p> <p>SOLD IN FULL LAYERS ONLY</p> 	Elements 'D'—Fine Finish		
	2¾" x 16" x 16"		Pieces/Layer: 9
	SqFt/Piece: 1.778		Layers/Pallet: 6
	SqFt/Layer: 16.02		Pieces/Pallet: 54
SqFt/Pallet: 96.12		Pallet Weight: 3,080 Lbs.	
SKU	Color	Stock Location	
147628	Calm	Non-Stock	
4560904	Haven	Cedar Acres	
220018	Majestic	Cedar Acres	
4560911	Oasis	Cedar Acres	
4560928	Serenity	Cedar Acres	
4560935	Timeless	Cedar Acres	
Elements 'E'—Fine Finish			
2¾" x 12" x 24"		Pieces/Layer: 6	
SqFt/Piece: 2		Layers/Pallet: 8	
SqFt/Layer: 12		Pieces/Pallet: 48	
SqFt/Pallet: 96		Pallet Weight: 3,130 Lbs.	
SKU	Color	Stock Location	
147630	Calm	Non-Stock	
4560942	Haven	Cedar Acres	
220024	Majestic	Cedar Acres	
4560959	Oasis	Cedar Acres	
4560966	Serenity	Cedar Acres	
4560973	Timeless	Cedar Acres	
Elements 'F'—Fine Finish			
2¾" x 24" x 24"		Pieces/Layer: 2	
SqFt/Piece: 4		Layers/Pallet: 8	
SqFt/Layer: 8		Pieces/Pallet: 16	
SqFt/Pallet: 64		Pallet Weight: 2,095 Lbs.	
SKU	Color	Stock Location	
147632	Calm	Non-Stock	
4560980	Haven	Cedar Acres	
220028	Majestic	Cedar Acres	
4560997	Oasis	Cedar Acres	
4561000	Serenity	Cedar Acres	
4561017	Timeless	Cedar Acres	

Elements Tumbled Paving Stones

2 to 3 Week Lead Time

Yard Price: \$4.65/SF	Elements 'A'—Tumbled		
	2¾" x 4" x 8"	Pieces/SqFt: 4.5	
Factory Direct: \$4.00/SF	SqFt/Piece: .222	Pieces/Pallet: 400	
	SqFt/Layer: 11	Layers/Pallet: 8	
SOLD IN FULL LAYERS ONLY	SqFt/Pallet: 88	Pallet Weight: 2,820 Lbs.	
	SKU	Color	Stock Location
	147634	Calm	Special Order
	76750	Dream	Special Order
	76740	Haven	Special Order
	76756	Homecoming	Special Order
	222986	Majestic	Special Order
	76742	Oasis	Special Order
	76748	Reflection	Special Order
	76758	Reunion	Special Order
	76744	Serenity	Special Order
	76746	Timeless	Special Order
	76752	Traditions	Special Order
	76754	Vision	Special Order
	Yard Price: \$4.95/SF	Elements 'B'—Tumbled	
	2¾" x 8" x 8"	Pieces/Layer: 30	
Factory Direct: \$4.22/SF	SqFt/Piece: .444	Layers/Pallet: 8	
	SqFt/Layer: 13.33	Pieces/Pallet: 240	
SOLD IN FULL LAYERS ONLY	SqFt/Pallet: 106.64	Pallet Weight: 3,380 Lbs.	
	SKU	Color	Stock Location
	147636	Calm	Special Order
	116792	Dream	Special Order
	116794	Haven	Special Order
	116796	Homecoming	Special Order
	222988	Majestic	Special Order
	116798	Oasis	Special Order
	116800	Reflection	Special Order
	116804	Reunion	Special Order
	116806	Serenity	Special Order
	116810	Timeless	Special Order
	116812	Traditions	Special Order
	116814	Vision	Special Order

Elements Tumbled Paving Stones

2 to 3 Week Lead Time

Yard Price: \$4.95/SF	Elements 'C'—Tumbled		
	2¾" x 8" x 16"	Pieces/Layer: 15	
Factory Direct: \$4.22/SF	SqFt/Piece: .888	Layers/Pallet: 8	
	SqFt/Layer: 13.33	Pieces/Pallet: 120	
SOLD IN FULL LAYERS ONLY	SqFt/Pallet: 106.64	Pallet Weight: 3,305 Lbs.	
	SKU	Color	Stock Location
	147640	Calm	Special Order
	116816	Dream	Special Order
	116818	Haven	Special Order
	116820	Homecoming	Special Order
	222990	Majestic	Special Order
	116822	Oasis	Special Order
	116824	Reflection	Special Order
	116826	Reunion	Special Order
	116828	Serenity	Special Order
	116830	Timeless	Special Order
	116832	Traditions	Special Order
	116834	Vision	Special Order



- Freight rate for 7 county metro area: \$175.00, flatbed with moffett or boom truck
- No split fees on County Materials products; Pavers are sold by layer, block by each
- 4563714: \$20 refundable pallet deposit on County Materials pallets; **must have receipt when returning pallets for refund.**
- Free jobsite clean up policies for County Materials products only when product is delivered:
 - Cleanups are made when County trucks are "in the area" of jobsite. As such, please allow up to 5 business days to have cleanup completed.
 - **Paver returns:** County Materials will pick up from your jobsite any empty pallets & full unopened pallets of product. All partial pallets of product will be left on jobsite.
 - **Retaining wall returns:** County Materials will pick up any full, partial, or empty pallets on jobsite.

INSTALLATION NOTE: Textured paver and patio stone surfaces require a buffer between the plate compactor and the paver surface to prevent scuffing. Please call Bachman's Hardscapes center for more information.



Elements Shot Blast Paving Stones

2 to 3 Week Lead Time

County Elements Shot Blast Paving Stones

Elements 'A'—Shot Blast Finish			
Yard Price: \$4.20/SF			
2¾" x 4" x 8"		Pieces/SqFt: 4.5	
Factory Direct: \$3.58/SF			
SqFt/Piece: .222		Pieces/Pallet: 400	
SqFt/Layer: 11		Layers/Pallet: 8	
SOLD IN FULL LAYERS ONLY			
SqFt/Pallet: 88		Pallet Weight: 2,820 Lbs.	
	SKU	Color	Stock Location
	147642	Calm	Special Order
	76762	Dream	Special Order
	147644	Haven	Special Order
	76766	Homecoming	Special Order
	224580	Majestic	Special Order
	147646	Oasis	Special Order
	76760	Reflection	Special Order
	76768	Reunion	Special Order
	147648	Serenity	Special Order
	147650	Timeless	Special Order
	147652	Traditions	Special Order
	76764	Vision	Special Order
	Elements 'B'—Shot Blast Finish		
Yard Price: \$4.45/SF			
2¾" x 8" x 8"		Pieces/Layer: 30	
Factory Direct: \$3.81/SF			
SqFt/Piece: .444		Layers/Pallet: 8	
SqFt/Layer: 13.33		Pieces/Pallet: 240	
SOLD IN FULL LAYERS ONLY			
SqFt/Pallet: 106.64		Pallet Weight: 3,380 Lbs.	
	SKU	Color	Stock Location
	147654	Calm	Special Order
	116838	Dream	Special Order
	147658	Haven	Special Order
	116840	Homecoming	Special Order
	224582	Majestic	Special Order
	147660	Oasis	Special Order
	116842	Reflection	Special Order
	116844	Reunion	Special Order
	147662	Serenity	Special Order
	147644	Timeless	Special Order
	147666	Traditions	Special Order
	116846	Vision	Special Order

www.bachmanswholesale.com



Elements Shot Blast Paving Stones

2 to 3 Week Lead Time

Yard Price: \$4.45/SF	Elements 'C'—Shot Blast Finish		
		2¾" x 8" x 16"	Pieces/Layer: 15
Factory Direct: \$3.81/SF	SqFt/Piece: .888	Layers/Pallet: 8	
	SqFt/Layer: 13.33	Pieces/Pallet: 120	
SOLD IN FULL LAYERS ONLY	SqFt/Pallet: 106.64	Pallet Weight: 3,637 Lbs.	
	SKU	Color	Stock Location
	147668	Calm	Special Order
	116848	Dream	Special Order
	147672	Haven	Special Order
	116850	Homecoming	Special Order
	224584	Majestic	Special Order
	147676	Oasis	Special Order
	116852	Reflection	Special Order
	116854	Reunion	Special Order
	147678	Serenity	Special Order
	147682	Timeless	Special Order
	147684	Traditions	Special Order
	116856	Vision	Special Order

- Freight rate for 7 county metro area: \$175.00, flatbed with moffett or boom truck
- No split fees on County Materials products; Pavers are sold by layer, block by each
- 4563714: \$20 refundable pallet deposit on County Materials pallets; **must have receipt when returning pallets for refund.**
- Free jobsite clean up policies for County Materials products only when product is delivered:
 - Cleanups are made when County trucks are "in the area" of jobsite. As such, please allow up to 5 business days to have cleanup completed.
 - **Paver returns:** County Materials will pick up from your jobsite any empty pallets & full unopened pallets of product. All partial pallets of product will be left on jobsite.
 - **Retaining wall returns:** County Materials will pick up any full, partial, or empty pallets on jobsite.

INSTALLATION NOTE: Textured paver and patio stone surfaces require a buffer between the plate compactor and the paver surface to prevent scuffing. Please call Bachman's Hardscapes center for more information.



Elements Shot Blast Paving Stones

2 to 3 Week Lead Time

County Elements Shot Blast Paving Stones

www.bachmanswholesale.com

Yard Price: \$4.45/SF Factory Direct: \$3.81/SF SOLD IN FULL LAYERS ONLY	Elements 'D'—Shot Blast Finish		
	2¾" x 16" x 16"		Pieces/Layer: 9
	SqFt/Piece: 1.778		Layers/Pallet: 6
	SqFt/Layer: 16.02		Pieces/Pallet: 54
	SqFt/Pallet: 96.12		Pallet Weight: 3,080 Lbs.
	SKU	Color	Stock Location
	147688	Calm	Special Order
	147690	Haven	Special Order
	224586	Majestic	Special Order
	147692	Oasis	Special Order
147694	Serenity	Special Order	
147696	Timeless	Special Order	
Elements 'E'—Shot Blast Finish			
2¾" x 12" x 24"		Pieces/Layer: 6	
SqFt/Piece: 2		Layers/Pallet: 8	
SqFt/Layer: 12		Pieces/Pallet: 48	
SqFt/Pallet: 96		Pallet Weight: 3,130 Lbs.	
SKU	Color	Stock Location	
147698	Calm	Special Order	
147700	Haven	Special Order	
224588	Majestic	Special Order	
147702	Oasis	Special Order	
147704	Serenity	Special Order	
147706	Timeless	Special Order	
Elements 'F'—Shot Blast Finish			
2¾" x 24" x 24"		Pieces/Layer: 2	
SqFt/Piece: 4		Layers/Pallet: 8	
SqFt/Layer: 8		Pieces/Pallet: 16	
SqFt/Pallet: 64		Pallet Weight: 2,095 Lbs.	
SKU	Color	Stock Location	
147708	Calm	Special Order	
147710	Haven	Special Order	
224590	Majestic	Special Order	
147712	Oasis	Special Order	
147714	Serenity	Special Order	
147716	Timeless	Special Order	

Elements Rough Estate Paving Stones

4 to 6 Week Lead Time

Elements 'A'—Rough Estate Finish			
Yard Price: \$3.80/SF	2¾" x 4" x 8"		Pieces/SqFt: 4.5
	SqFt/Piece: .222		Pieces/Pallet: 400
Factory Direct: \$3.30/SF	SqFt/Layer: 11		Layers/Pallet: 8
	SqFt/Pallet: 88		Pallet Weight: 2,820 Lbs.
SOLD IN FULL LAYERS ONLY			
SKU		Color	Stock Location
117022		Reflection	F
117032		Vision	F
Elements 'B'—Rough Estate Finish			
Yard Price: \$3.80/SF	2¾" x 8" x 8"		Pieces/Layer: 30
	SqFt/Piece: .444		Layers/Pallet: 8
Factory Direct: \$3.30/SF	SqFt/Layer: 13.33		Pieces/Pallet: 240
	SqFt/Pallet: 106.64		Pallet Weight: 3,380 Lbs.
SOLD IN FULL LAYERS ONLY			
SKU		Color	Stock Location
116938		Reflection	F
116948		Vision	F
Elements 'C'—Rough Estate Finish			
Yard Price: \$4.10/SF	2¾" x 8" x 16"		Pieces/Layer: 15
	SqFt/Piece: .888		Layers/Pallet: 8
Factory Direct: \$3.49/SF	SqFt/Layer: 13.33		Pieces/Pallet: 120
	SqFt/Pallet: 106.64		Pallet Weight: 3,305 Lbs.
SOLD IN FULL LAYERS ONLY			
SKU		Color	Stock Location
116958		Reflection	Special Order
116968		Vision	Special Order



- Freight rate for 7 county metro area: \$175.00, flatbed with moffett or boom truck
- No split fees on County Materials products; Pavers are sold by layer, block by each
- 4563714: \$20 refundable pallet deposit on County Materials pallets; **must have receipt when returning pallets for refund.**
- Free jobsite clean up policies for County Materials products only when product is delivered:
 - Cleanups are made when County trucks are "in the area" of jobsite. As such, please allow up to 5 business days to have cleanup completed.
 - **Paver returns:** County Materials will pick up from your jobsite any empty pallets & full unopened pallets of product. All partial pallets of product will be left on jobsite.
 - **Retaining wall returns:** County Materials will pick up any full, partial, or empty pallets on jobsite.

Essence Wood Grain Plank Pavers

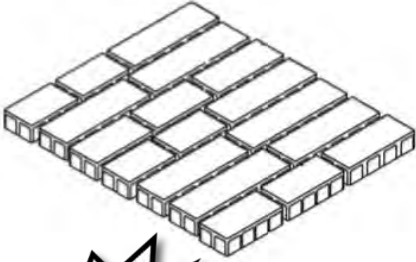
Essence Wood Grain Plank Pavers—5 Sizes Mixed on 1 Pallet					
Yard Price: \$5.25/SF	SqFt/Layer: 10.74		Layers/Pallet: 8		
	SqFt/Pallet: 85.92		Pallet Weight: 3,210 Lbs.		
Factory Direct: \$4.51/SF	Piece	Dimensions (H x W x L)	Pieces/Pallet	Pieces/Layer	
	SOLD IN FULL LAYERS ONLY				
	A	3 1/8" x 5 3/4" x 9 11/16"	32	4	
	B	3 1/8" x 5 3/4" x 11 5/8"	32	4	
	C	3 1/8" x 5 3/4" x 13 5/8"	16	2	
	D	3 1/8" x 5 3/4" x 17 1/2"	40	5	
	E	3 1/8" x 5 3/4" x 19 1/2"	24	3	
	SKU		Color	Stock Location	
	183740		Aware	Non-Stock	
	183744		Bliss	Non-Stock	
	183746		Pride	Non-Stock	
	183750		Timeless	Non-Stock	

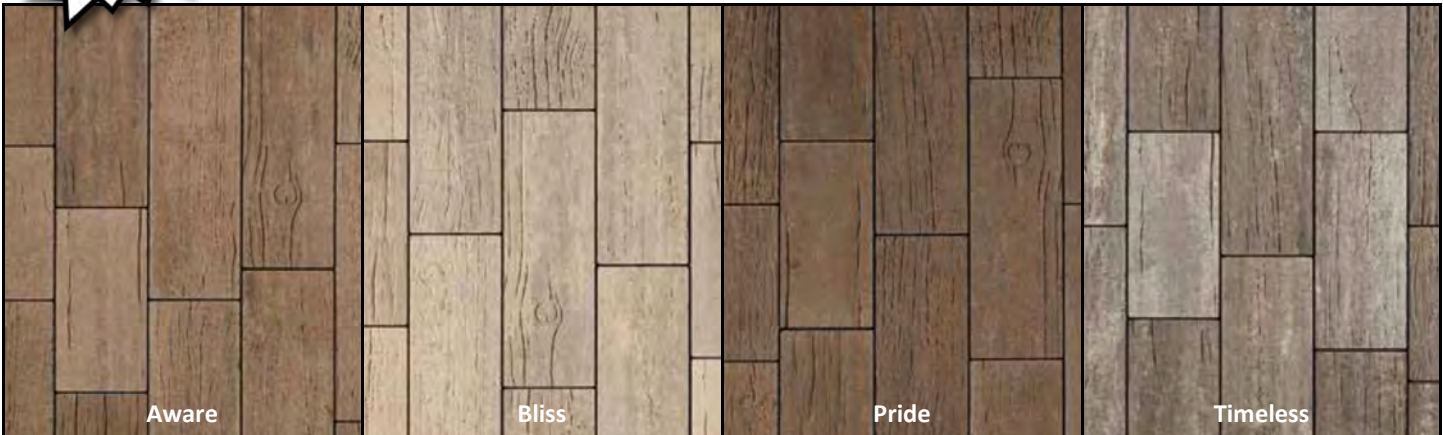

- Freight rate for 7 county metro area: \$175.00, flatbed with moffett or boom truck
- No split fees on County Materials products; Pavers are sold by layer, block by each
- 4563714: \$20 refundable pallet deposit on County Materials pallets; **must have receipt when returning pallets for refund.**
- Free jobsite clean up policies for County Materials products only when product is delivered:
 - Cleanups are made when County trucks are "in the area" of jobsite. As such, please allow up to 5 business days to have cleanup completed.
 - **Paver returns:** County Materials will pick up from your jobsite any empty pallets & full unopened pallets of product. All partial pallets of product will be left on jobsite.
 - **Retaining wall returns:** County Materials will pick up any full, partial, or empty pallets on jobsite.

H₂O Pro Pavers

<p>Yard Price: \$3.80/SF</p> <p>Factory Direct: \$3.22/SF</p> <p>SOLD IN FULL LAYERS ONLY</p> 	H₂O Pro 'A' Pavers		
	3 7/8" x 4" x 8"		Pieces/Layer: 50
	SqFt/Piece: .222		Layers/Pallet: 8
	SqFt/Layer: 11		Pieces/Pallet: 400
SqFt/Pallet: 88		Pallet Weight: 3,085 Lbs.	
SKU	Color	Stock Location	
4561079	Haven	Non-Stock	
221690	Majestic	Non-Stock	
4561086	Oasis	Non-Stock	
147424	Reflection	Non-Stock	
4561093	Serenity	Non-Stock	
4561109	Timeless	Non-Stock	
137460	Vision	Non-Stock	
H₂O Pro 'B' Pavers			
3 7/8" x 8" x 8"		Pieces/Layer: 30	
SqFt/Piece: .444		Layers/Pallet: 8	
SqFt/Layer: 13.2		Pieces/Pallet: 240	
SqFt/Pallet: 105.6		Pallet Weight: 3,695 Lbs.	
SKU	Color	Stock Location	
4561116	Haven	Non-Stock	
221692	Majestic	Non-Stock	
4561123	Oasis	Non-Stock	
147428	Reflection	Non-Stock	
4561130	Serenity	Non-Stock	
4561147	Timeless	Non-Stock	
147850	Vision	Non-Stock	
H₂O Pro 'C' Pavers			
3 7/8" x 8" x 16"		Pieces/Layer: 15	
SqFt/Piece: .889		Layers/Pallet: 8	
SqFt/Layer: 13.2		Pieces/Pallet: 120	
SqFt/Pallet: 105.6		Pallet Weight: 3,820 Lbs.	
SKU	Color	Stock Location	
4561154	Haven	Non-Stock	
221696	Majestic	Non-Stock	
4561161	Oasis	Non-Stock	
107856	Reflection	Non-Stock	
4561178	Serenity	Non-Stock	
4561185	Timeless	Non-Stock	
147430	Vision	Non-Stock	



H₂O Pro Tumbled Pavers

County H₂O Pro Tumbled Pavers

<p>Yard Price: \$5.30/SF</p> <p>Factory Direct: \$4.57/SF</p> <p>SOLD IN FULL LAYERS ONLY</p> 	H ₂ O Pro Tumbled 'A' Pavers		
	3 1/8" x 4" x 8"		Pieces/Layer: 50
	SqFt/Piece: .222		Layers/Pallet: 8
	SqFt/Layer: 11		Pieces/Pallet: 400
SqFt/Pallet: 88		Pallet Weight: 3,085 Lbs.	
SKU	Color	Stock Location	
147580	Haven	Non-Stock	
224592	Majestic	Non-Stock	
147582	Oasis	Non-Stock	
147588	Reflection	Non-Stock	
147584	Serenity	Non-Stock	
147586	Timeless	Non-Stock	
147590	Vision	Non-Stock	
H ₂ O Pro Tumbled 'B' Pavers			
3 1/8" x 8" x 8"		Pieces/Layer: 30	
SqFt/Piece: .444		Layers/Pallet: 8	
SqFt/Layer: 13.2		Pieces/Pallet: 240	
SqFt/Pallet: 105.6		Pallet Weight: 3,695 Lbs.	
SKU	Color	Stock Location	
147592	Haven	Non-Stock	
224594	Majestic	Non-Stock	
147594	Oasis	Non-Stock	
147600	Reflection	Non-Stock	
147596	Serenity	Non-Stock	
147598	Timeless	Non-Stock	
147602	Vision	Non-Stock	
H ₂ O Pro Tumbled 'C' Pavers			
3 1/8" x 8" x 16"		Pieces/Layer: 15	
SqFt/Piece: .889		Layers/Pallet: 8	
SqFt/Layer: 13.2		Pieces/Pallet: 120	
SqFt/Pallet: 105.6		Pallet Weight: 3,820 Lbs.	
SKU	Color	Stock Location	
147604	Haven	Non-Stock	
224596	Majestic	Non-Stock	
147608	Oasis	Non-Stock	
147614	Reflection	Non-Stock	
147610	Serenity	Non-Stock	
147612	Timeless	Non-Stock	
147616	Vision	Non-Stock	

www.bachmanswholesale.com

Lifestyle & Grand Lifestyle

Yard Price: \$5.25/SF	Lifestyle Pavers—5 Sizes Mixed on 1 Pallet				
	SqFt/Layer: 11		Layers/Pallet: 8		
Factory Direct: \$4.51/SF	SqFt/Pallet: 88		Pallet Weight: 2,760 Lbs.		
	Piece	Dimensions (H x W x L)	Pieces/Pallet	Pieces/Layer	
SOLD IN FULL LAYERS ONLY	A	2¾" x 5 ¹⁵ / ₁₆ " x 2 ¹⁵ / ₁₆ "	32	4	
	B	2¾" x 5 ¹⁵ / ₁₆ " x 8 ⁷ / ₈ "	32	4	
	C	2¾" x 8 ⁷ / ₈ " x 8 ⁷ / ₈ "	32	4	
	D	2¾" x 8 ⁷ / ₈ " x 11 ¹⁵ / ₁₆ "	32	4	
	E	2¾" x 11 ¹⁵ / ₁₆ " x 11 ¹⁵ / ₁₆ "	32	4	
	SKU		Color	Stock Location	
	4560751		Haven	Non-Stock	
	219986		Majestic	Non-Stock	
	4560768		Oasis	Non-Stock	
	4560096		Serenity	Non-Stock	
	4560775		Timeless	Non-Stock	
Grand Lifestyle Pavers—5 Sizes Mixed on 1 Pallet					
SqFt/Layer: 12.33		Layers/Pallet: 8			
SqFt/Pallet: 98.64		Pallet Weight: 3,145 Lbs.			
Piece	Dimensions (H x W x L)	Pieces/Pallet	Pieces/Layer		
	F	2¾" x 5 ¹⁵ / ₁₆ " x 11 ¹⁵ / ₁₆ "	16	2	
	G	2¾" x 5 ¹⁵ / ₁₆ " x 17 ¹⁵ / ₁₆ "	16	2	
	H	2¾" x 11 ¹⁵ / ₁₆ " x 11 ¹⁵ / ₁₆ "	16	2	
	I	2¾" x 11 ¹⁵ / ₁₆ " x 17 ¹⁵ / ₁₆ "	16	2	
	J	2¾" x 17 ¹⁵ / ₁₆ " x 17 ¹⁵ / ₁₆ "	16	2	
	SKU		Color	Stock Location	
4560782		Haven	Non-Stock		
219990		Majestic	Non-Stock		
4560799		Oasis	Non-Stock		
4560102		Serenity	Non-Stock		
4560805		Timeless	Non-Stock		

- Freight rate for 7 county metro area: \$175.00, flatbed with moffett or boom truck
- No split fees on County Materials products; Pavers are sold by layer, block by each
- 4563714: \$20 refundable pallet deposit on County Materials pallets; **must have receipt when returning pallets for refund.**
- Free jobsite clean up policies for County Materials products only when product is delivered:
 - Cleanups are made when County trucks are "in the area" of jobsite. As such, please allow up to 5 business days to have cleanup completed.
 - **Paver returns:** County Materials will pick up from your jobsite any empty pallets & full unopened pallets of product. All partial pallets of product will be left on jobsite.
 - **Retaining wall returns:** County Materials will pick up any full, partial, or empty pallets on jobsite.

INSTALLATION NOTE: Textured paver and patio stone surfaces require a buffer between the plate compactor and the paver surface to prevent scuffing. Please call Bachman's Hardscapes center for more information.

Grand Milestone

4 to 6 Week Lead Time

County Grand Milestone

Yard Price: \$5.25/SF	Grand Milestone Pavers—3 Sizes Mixed on 1 Pallet			
		SqFt/Layer: 11.36		Layers/Pallet: 8
Factory Direct: \$4.51/SF	SqFt/Pallet: 90.88		Pallet Weight: 2,970 Lbs.	
	Piece	Dimensions (H x W x L)	Pieces/Pallet	Pieces/Layer
	K	2¾" x 11⅝" x 11⅝"	24	3
	L	2¾" x 11⅝" x 17½"	16	2
	M	2¾" x 11⅝" x 23½"	24	3
	SKU		Color	Stock Location
	4560720		Haven	Special Order
	219978		Majestic	Special Order
	4560737		Oasis	Special Order
	4485412		Serenity	Special Order
4560744		Timeless	Special Order	



www.bachmanswholesale.com

- Freight rate for 7 county metro area: \$175.00, flatbed with moffett or boom truck
- No split fees on County Materials products; Pavers are sold by layer, block by each
- 4563714: \$20 refundable pallet deposit on County Materials pallets; **must have receipt when returning pallets for refund.**
- Free jobsite clean up policies for County Materials products only when product is delivered:
 - Cleanups are made when County trucks are "in the area" of jobsite. As such, please allow up to 5 business days to have cleanup completed.
 - **Paver returns:** County Materials will pick up from your jobsite any empty pallets & full unopened pallets of product. All partial pallets of product will be left on jobsite.
 - **Retaining wall returns:** County Materials will pick up any full, partial, or empty pallets on jobsite.



Tranquility Pavers



Yard Price: \$5.25/SF	Tranquility—5 Sizes Mixed on 1 Pallet				
	SqFt/Layer: 10.77		Layers/Pallet: 8		
Factory Direct: \$4.51/SF	SqFt/Pallet: 86.16		Pallet Weight: 2,750 Lbs.		
	Piece	Dimensions (H x W x L)	Pieces/Pallet	Pieces/Layer	
	A	2¾" x 4⅝" x 9¼"	32	4	
	B	2¾" x 9¼" x 9¼"	32	4	
	C	2¾" x 9¼" x 14"	16	2	
	D	2¾" x 14" x 14"	16	2	
	E	2¾" x 9¾" x 18¼"	16	2	
	SKU		Color	Stock Location	
	130136		Calm	Non-Stock	
	4560812		Haven	Non-Stock	
	219992		Majestic	Non-Stock	
	4560829		Oasis	Non-Stock	
4560119		Serenity	Non-Stock		
4560836		Timeless	Non-Stock		



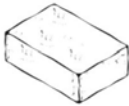

- Freight rate for 7 county metro area: \$175.00, flatbed with moffett or boom truck
- No split fees on County Materials products; Pavers are sold by layer, block by each
- 4563714: \$20 refundable pallet deposit on County Materials pallets; **must have receipt when returning pallets for refund.**
- Free jobsite clean up policies for County Materials products only when product is delivered:
 - Cleanups are made when County trucks are "in the area" of jobsite. As such, please allow up to 5 business days to have cleanup completed.
 - **Paver returns:** County Materials will pick up from your jobsite any empty pallets & full unopened pallets of product. All partial pallets of product will be left on jobsite.
 - **Retaining wall returns:** County Materials will pick up any full, partial, or empty pallets on jobsite.

Summit Wall—Non-Tumbled & Tumbled

Summit Wall—"A"		3 $\frac{5}{8}$ "H x 7 $\frac{1}{4}$ "L x 7 $\frac{1}{4}$ "D	Weight/Block: 14 Lbs.	
Yard Price: \$2.90/Block		SqFt/Block: .18	Blocks/Pallet: 240	
Factory Direct: \$2.11/Block		SqFt/Pallet: 43.2	Pallet Weight: 3,450 Lbs.	
 		SKU	Color	Stock Location
		Non-Tumbled		
		224598	Reflection	Non-Stock
		224600	Vision	Non-Stock
		Tumbled		
		224610	Haven	Non-Stock
		224612	Hush	Non-Stock
		224614	Solace	Non-Stock
		224616	Timeless	Non-Stock

Summit Wall—"B"		3 $\frac{5}{8}$ "H x 10 $\frac{3}{8}$ "L x 7 $\frac{1}{4}$ "D	Weight/Block: 21 Lbs.	
Yard Price: \$4.05/Block		SqFt/Block: .27	Blocks/Pallet: 160	
Factory Direct: \$3.17/Block		SqFt/Pallet: 43.2	Pallet Weight: 3,290 Lbs.	
 		SKU	Color	Stock Location
		Non-Tumbled		
		224602	Reflection	Non-Stock
		224604	Vision	Non-Stock
		Tumbled		
		224618	Haven	Non-Stock
		224620	Hush	Non-Stock
		224622	Solace	Non-Stock
		224624	Timeless	Non-Stock

Summit Wall—"C"		3 $\frac{5}{8}$ "H x 14 $\frac{1}{2}$ "L x 7 $\frac{1}{4}$ "D	Weight/Block: 28 Lbs.	
Yard Price: \$5.35/Block		SqFt/Block: .37	Blocks/Pallet: 120	
Factory Direct: \$4.33/Block		SqFt/Pallet: 44.4	Pallet Weight: 3,375 Lbs.	
 		SKU	Color	Stock Location
		Non-Tumbled		
		224606	Reflection	Non-Stock
		224608	Vision	Non-Stock
		Tumbled		
		224626	Haven	Non-Stock
		224628	Hush	Non-Stock
		224630	Solace	Non-Stock
		224632	Timeless	Non-Stock

Tribute Wall

Yard Price: \$4.45/Block	Tribute Standard Split Face Unit—Single Sided		
	6”H x 16”L x 12”D	Weight/Block: 75 Lbs.	
Factory Direct: \$3.67/Block	SqFt/Block: .67	Blocks/Pallet: 36	
	SqFt/Pallet: 24.12	Pallet Weight: 2,745 Lbs.	
	SKU	Color	Stock Location
	4561260	Brown	Non-Stock
	4561253	Buff	Cedar Acres
	4561277	Canyon Brown	Cedar Acres
	221698	Graphite	Cedar Acres
	4561284	Gray	Non-Stock
	4561291	Hickory Blend	Non-Stock
	4561314	October Oak	Cedar Acres
	4561338	Silvertone	Cedar Acres
	4561345	Swiss Mocha	Non-Stock

2 County pins are needed with each block unit

Item# 4561246

\$.35 Each

500 Pins/Box

Yard Price: \$5.25/Block	Tribute Standard Split Face Unit—Two Sided		
	6”H x 16”L x 10”D	Weight/Block: 63 Lbs.	
Factory Direct: \$4.41/Block	SqFt/Block: .67	Blocks/Pallet: 36	
	SqFt/Pallet: 24.12	Pallet Weight: 2,313 Lbs.	
	SKU	Color	Stock Location
	4561369	Brown	Non-Stock
	4561352	Buff	Cedar Acres
	4561376	Canyon Brown	Cedar Acres
	221700	Graphite	Cedar Acres
	4561383	Gray	Non-Stock
	4561390	Hickory Blend	Non-Stock
	4561413	October Oak	Cedar Acres
	4561437	Silvertone	Cedar Acres
	4561444	Swiss Mocha	Non-Stock

- Freight rate for 7 county metro area: \$175.00, flatbed with moffett or boom truck
- No split fees on County Materials products; Pavers are sold by layer, block by each
- 4563714: \$20 refundable pallet deposit on County Materials pallets; **must have receipt when returning pallets for refund.**
- Free jobsite clean up policies for County Materials products only when product is delivered:
 - Cleanups are made when County trucks are “in the area” of jobsite. As such, please allow up to 5 business days to have cleanup completed.
 - **Paver returns:** County Materials will pick up from your jobsite any empty pallets & full unopened pallets of product. All partial pallets of product will be left on jobsite.
 - **Retaining wall returns:** County Materials will pick up any full, partial, or empty pallets on jobsite.

Yard Price: \$3.35/Block	Tribute Split Face Corner Block		
	6H x 8"L x 12"D	Weight/Block: 38 Lbs.	
Factory Direct: \$2.75/Block	SqFt/Block: .33 (Short Side), .5 (Long Side)	Blocks/Pallet: 72	
	SqFt/Pallet: 23.76	Pallet Weight: 1,869 Lbs.	
	SKU	Color	Stock Location
	4561710	Brown	Non-Stock
	4561734	Canyon Brown	Cedar Acres
	221702	Graphite	Cedar Acres
	4561741	Gray	Non-Stock
	4561758	Hickory Blend	Non-Stock
	4561789	October Oak	Cedar Acres
	4561819	Silvertone	Cedar Acres
	4561826	Swiss Mocha	Non-Stock

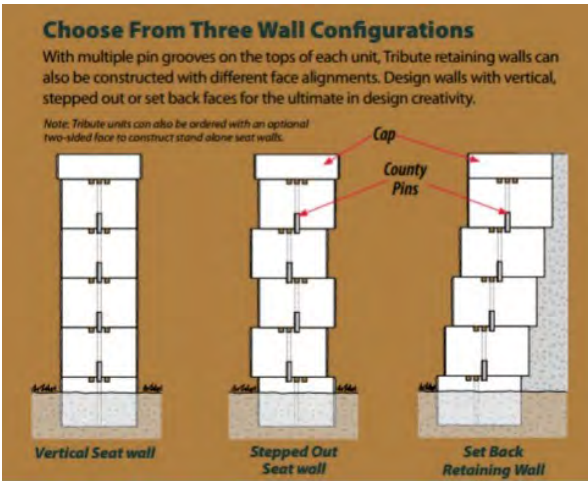

- Freight rate for 7 county metro area: \$175.00, flatbed with moffett or boom truck
- No split fees on County Materials products; Pavers are sold by layer, block by each
- 4563714: \$20 refundable pallet deposit on County Materials pallets; **must have receipt when returning pallets for refund.**
- Free jobsite clean up policies for County Materials products only when product is delivered:
 - Cleanups are made when County trucks are "in the area" of jobsite. As such, please allow up to 5 business days to have cleanup completed.
 - **Paver returns:** County Materials will pick up from your jobsite any empty pallets & full unopened pallets of product. All partial pallets of product will be left on jobsite.
 - **Retaining wall returns:** County Materials will pick up any full, partial, or empty pallets on jobsite.

Tribute Rustic Wall

2 to 3 Week Lead Time

Yard Price: \$4.45/Block	Tribute Rustic Unit—Single Sided		
	6”H x 16”L x 12”D	Weight/Block: 75 Lbs.	
Factory Direct: \$3.49/Block	SqFt/Block: .67	Blocks/Pallet: 36	
	SqFt/Pallet: 24.12	Pallet Weight: 2,745 Lbs.	
	SKU	Color	Stock Location
	4562120	Canyon Brown	Special Order
	222992	Graphite	Special Order
	147736	Hickory Blend	Special Order
	4562090	October Oak	Special Order
	4562144	Silvertone	Special Order

2 County pins are needed with each block unit
 Item# 4561246 | \$.35 Each | 500 Pins/Box

Yard Price: \$5.25/Block	Tribute Rustic Unit—Two Sided		
	6”H x 16”L x 10”D	Weight/Block: 63 Lbs.	
Factory Direct: \$4.24/Block	SqFt/Block: .67	Blocks/Pallet: 36	
	SqFt/Pallet: 24.12	Pallet Weight: 2,313 Lbs.	
	SKU	Color	Stock Location
	4562175	Canyon Brown	Special Order
	222994	Graphite	Special Order
	147738	Hickory Blend	Special Order
	4562151	October Oak	Special Order
	4562205	Silvertone	Special Order



- Freight rate for 7 county metro area: \$175.00, flatbed with moffett or boom truck
- No split fees on County Materials products; Pavers are sold by layer, block by each
- 4563714: \$20 refundable pallet deposit on County Materials pallets; **must have receipt when returning pallets for refund.**
- Free jobsite clean up policies for County Materials products only when product is delivered:
 - Cleanups are made when County trucks are “in the area” of jobsite. As such, please allow up to 5 business days to have cleanup completed.
 - **Paver returns:** County Materials will pick up from your jobsite any empty pallets & full unopened pallets of product. All partial pallets of product will be left on jobsite.
 - **Retaining wall returns:** County Materials will pick up any full, partial, or empty pallets on jobsite.

Tribute Rustic Wall

2 to 3 Week Lead Time

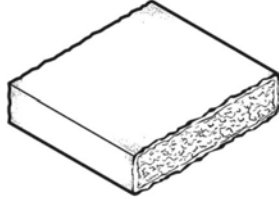
Yard Price: \$5.35/Block	Tribute Rustic Straight Wall Cap		
	3 $\frac{3}{8}$ "H x 15 $\frac{1}{2}$ "L x 12"D	Weight/Block: 55 Lbs.	
Factory Direct: \$4.50/Block	LF/Cap: 1.29	Blocks/Pallet: 70	
	LF/Pallet: 90.3	Pallet Weight: 3,895 Lbs.	
	SKU	Color	Stock Location
	147742	Brown	Special Order
	4562243	Canyon Brown	Special Order
	224634	Graphite	Special Order
	4562229	October Oak	Special Order
	4562267	Silvertone	Special Order

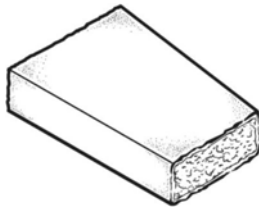
Yard Price: \$5.15/Block	Tribute Rustic Tapered Wall Cap		
	3 $\frac{3}{8}$ "H x 9 $\frac{3}{8}$ "L (Front) x 7 $\frac{3}{8}$ "L (Back) x 12 $\frac{1}{2}$ "D	Weight/Block: 31 Lbs.	
Factory Direct: \$4.44/Block	LF/Cap: .719	Blocks/Pallet: 90	
	LF/Pallet: 64.73	Pallet Weight: 2,835 Lbs.	
	SKU	Color	Stock Location
	147744	Brown	Special Order
	4562298	Canyon Brown	Special Order
	224636	Graphite	Special Order
	4562274	October Oak	Special Order
	4562311	Silvertone	Special Order

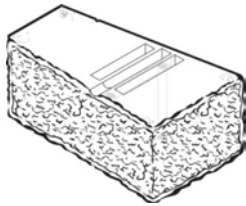
Yard Price: \$3.95/Block	Tribute Rustic Corner Block		
	6H x 8"L x 12"D	Weight/Block: 38 Lbs.	
Factory Direct: \$3.32/Block	SqFt/Block: .33 (Short Side), .5 (Long Side)	Blocks/Pallet: 72	
	SqFt/Pallet: 23.76	Pallet Weight: 1,869 Lbs.	
	SKU	Color	Stock Location
	4562342	Canyon Brown	Special Order
	222996	Graphite	Special Order
	147740	Hickory Blend	Special Order
	4562328	October Oak	Special Order
	4562366	Silvertone	Special Order

- Freight rate for 7 county metro area: \$175.00, flatbed with moffett or boom truck
- No split fees on County Materials products; Pavers are sold by layer, block by each
- 4563714: \$20 refundable pallet deposit on County Materials pallets; **must have receipt when returning pallets for refund.**
- Free jobsite clean up policies for County Materials products only when product is delivered:
 - Cleanups are made when County trucks are "in the area" of jobsite. As such, please allow up to 5 business days to have cleanup completed.
 - **Paver returns:** County Materials will pick up from your jobsite any empty pallets & full unopened pallets of product. All partial pallets of product will be left on jobsite.
 - **Retaining wall returns:** County Materials will pick up any full, partial, or empty pallets on jobsite.

Wall Caps

Yard Price: \$3.80/Block	Straight Wall Cap		
	Factory Direct: \$3.13/Block	3 $\frac{3}{8}$ "H x 15 $\frac{1}{2}$ "L x 12"D	Weight/Block: 55 Lbs.
LF/Cap: 1.29		Blocks/Pallet: 70	
	LF/Pallet: 90.3	Pallet Weight: 3,895 Lbs.	
	SKU	Color	Stock Location
	4561468	Brown	Non-Stock
	4561567	Buff	Cedar Acres
	4561475	Canyon Brown	Cedar Acres
	221720	Graphite	Cedar Acres
	4561482	Gray	Non-Stock
	4561499	Hickory Blend	Non-Stock
	4561512	October Oak	Cedar Acres
	4561536	Silvertone	Cedar Acres
	4561543	Swiss Mocha	Non-Stock

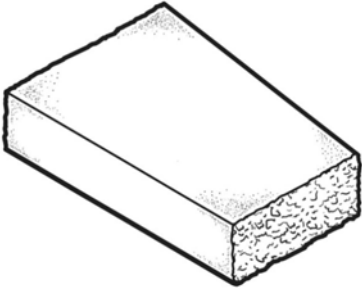
Yard Price: \$2.30/Block	Tapered Wall Cap		
	Factory Direct: \$1.88/Block	3 $\frac{3}{8}$ "H x 9 $\frac{3}{8}$ "L (Front) x 7 $\frac{3}{8}$ "L (Back) x 12 $\frac{1}{2}$ "D	Weight/Block: 31 Lbs.
LF/Cap: .59		Blocks/Pallet: 90	
	LF/Pallet: 53.44	Pallet Weight: 2,835 Lbs.	
	SKU	Color	Stock Location
	4561581	Brown	Non-Stock
	4561598	Canyon Brown	Non-Stock
	221722	Graphite	Non-Stock
	4561611	Gray	Non-Stock
	4561635	Hickory Blend	Non-Stock
	4561666	October Oak	Non-Stock
	4561680	Silvertone	Non-Stock
	4561697	Swiss Mocha	Non-Stock

- Freight rate for 7 county metro area: \$175.00, flatbed with moffett or boom truck
- No split fees on County Materials products; Pavers are sold by layer, block by each
- 4563714: \$20 refundable pallet deposit on County Materials pallets; **must have receipt when returning pallets for refund.**
- Free jobsite clean up policies for County Materials products only when product is delivered:
 - Cleanups are made when County trucks are "in the area" of jobsite. As such, please allow up to 5 business days to have cleanup completed.
 - **Paver returns:** County Materials will pick up from your jobsite any empty pallets & full unopened pallets of product. All partial pallets of product will be left on jobsite.
 - **Retaining wall returns:** County Materials will pick up any full, partial, or empty pallets on jobsite.

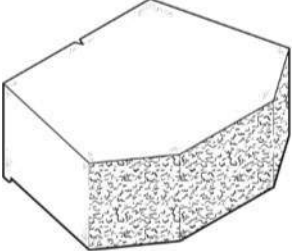

Yard Price: \$4.30/Block	Winston Tri-Split Block— Solid Core		
	6”H x 16”L x 12”D	Weight/Block: 60 Lbs.	
Factory Direct: \$3.47/Block	SqFt/Block: .67	Blocks/Pallet: 45	
	SqFt/Pallet: 30.15	Pallet Weight: 2,740 Lbs.	
	SKU	Color	Stock Location
	77934	Brown	Non-Stock
	77940	Canyon Brown	Cedar Acres
	221704	Graphite	Special Order
	77942	Gray	Non-Stock
	83226	October Oak	Cedar Acres
	77944	Silvertone	Cedar Acres

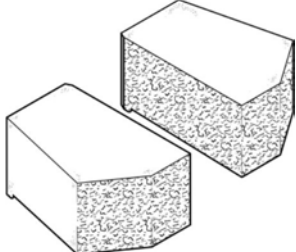
Yard Price: \$4.05/Block	Winston Tri-Split Corner—Left or Right		
	6”H x 8”L x 12”D	Weight/Block: 32 Lbs.	
Factory Direct: \$3.47/Block	SqFt/Block: .67	Blocks/Pallet: 108	
	SqFt/Pallet: 35.64	Pallet Weight: 3,501 Lbs.	
	SKU	Color	Stock Location
	77946	Brown	Non-Stock
	77948	Canyon Brown	Non-Stock
	221706	Graphite	Special Order
	77950	Gray	Non-Stock
	83228	October Oak	Non-Stock
	77952	Silvertone	Non-Stock

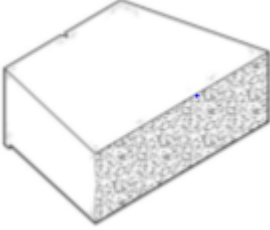

- Freight rate for 7 county metro area: \$175.00, flatbed with moffett or boom truck
- No split fees on County Materials products; Pavers are sold by layer, block by each
- 4563714: \$20 refundable pallet deposit on County Materials pallets; **must have receipt when returning pallets for refund.**
- Free jobsite clean up policies for County Materials products only when product is delivered:
 - Cleanups are made when County trucks are “in the area” of jobsite. As such, please allow up to 5 business days to have cleanup completed.
 - **Paver returns:** County Materials will pick up from your jobsite any empty pallets & full unopened pallets of product. All partial pallets of product will be left on jobsite.
 - **Retaining wall returns:** County Materials will pick up any full, partial, or empty pallets on jobsite.

Winston Retaining Wall

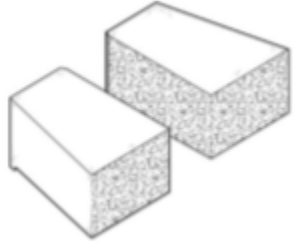
Yard Price: \$4.30/Block	Winston Straight Face Block— Solid Core		
	6"H x 17½"L x 12"D	Weight/Block: 70 Lbs.	
Factory Direct: \$3.47/Block	SqFt/Block: .73	Blocks/Pallet: 45	
	SqFt/Pallet: 39.42	Pallet Weight: 3,190 Lbs.	
	SKU	Color	Stock Location
	77954	Brown	Non-Stock
	77956	Canyon Brown	Cedar Acres
	221708	Majestic	Special Order
	77958	Gray	Non-Stock
	83230	October Oak	Cedar Acres
	77960	Silvertone	Non-Stock

Yard Price: \$4.05/Block	Winston Straight Corner—Left or Right		
	6"H x 9"L x 12"D	Weight/Block: 33 Lbs.	
Factory Direct: \$3.47/Block	SqFt/Block: .38	Blocks/Pallet: 108	
	SqFt/Pallet: 41.04	Pallet Weight: 3,609 Lbs.	
	SKU	Color	Stock Location
	77962	Brown	Non-Stock
	77964	Canyon Brown	Non-Stock
	221710	Graphite	Non-Stock
	77966	Gray	Non-Stock
	83232	October Oak	Non-Stock
	77968	Silvertone	Non-Stock

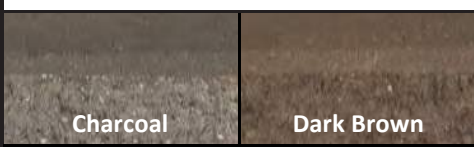
Landscape Step Units

Yard Price: \$10.75/Step	Landscape Step Units		
	6"H x 24"W x 14"D	Weight/Block: 164 Lbs.	
Factory Direct: \$9.73/Step	Blocks/Pallet: 10	Pallet Weight: 1,680 Lbs.	
	SKU	Color	Stock Location
	185534	Charcoal	Non-Stock
	185536	Dark Brown	Non-Stock
	185538	Gray	Non-Stock
	185540	Sandstone	Non-Stock





Factory Direct: \$155.21/Block 	Rib Rock Tapered Flat—A		
	24"H x 48"L x 24"D	Weight/Block: 2,000 Lbs.	
	SqFt/Block: 8	Blocks/Pallet: 2	
	SqFt/Pallet: 16	Pallet Weight: 4,045 Lbs.	
	SKU	Face/Color	Stock Location
	224638	Dry Stack Gray	Factory Direct Only
	4562373	Rough Gray	Factory Direct Only

Factory Direct: \$166.47/Block 	Rib Rock Corner		
	24"H x 51½"L x 27½"D	Weight/Block: 2,730 Lbs.	
	SqFt/Block: 8.58	Blocks/Pallet: 2	
	SqFt/Pallet: 17.16	Pallet Weight: 5,505 Lbs.	
	SKU	Color	Stock Location
	LH Corner		
	224640	Dry Stack Gray	Factory Direct Only
	4562380	Rough Gray	Factory Direct Only
	RH Corner		
	224642	Dry Stack Gray	Factory Direct Only
	214448	Rough Gray	Factory Direct Only

Oversize Rib Rock Wall System

<p>Factory Direct: \$116.44/Block</p> 	Rib Rock Half Block—D		
	24"H x 24"L x 24"D		Weight/Block: 960 Lbs.
	SqFt/Block: 4		Blocks/Pallet: 2
	SqFt/Pallet: 8		Pallet Weight: 1,965 Lbs.
	SKU	Face/Color	Stock Location
	224644	Dry Stack Gray	Factory Direct Only
4562397	Rough Gray	Factory Direct Only	

<p>Factory Direct: \$101.59/Block</p> 	Rib Rock Cap—G		
	7"H x 48"L x 25"D		Weight/Block: 760 Lbs.
	SqFt/Block: 2.33		Blocks/Pallet: 4
	SqFt/Pallet: 9.33		Pallet Weight: 3,085 Lbs.
	SKU	Face/Color	Stock Location
	224646	Dry Stack Gray	Factory Direct Only
4562403	Rough Gray	Factory Direct Only	

<p>Factory Direct: \$132.63/Block</p> 	Rib Rock Corner Cap—Right		
	7"H x 48"L x 25"D		Weight/Block: 760 Lbs.
	SqFt/Block: 2.33 + 1.22		Blocks/Pallet: 4
	SqFt/Pallet: 14.19		Pallet Weight: 3,085 Lbs.
	SKU	Face/Color	Stock Location
	224648	Dry Stack Gray	Factory Direct Only
4562410	Rough Gray	Factory Direct Only	

<p>Factory Direct: \$132.63/Block</p> 	Rib Rock Corner Cap—Left		
	7"H x 48"L x 25"D		Weight/Block: 760 Lbs.
	SqFt/Block: 2.33 + 1.22		Blocks/Pallet: 4
	SqFt/Pallet: 14.19		Pallet Weight: 3,085 Lbs.
	SKU	Face/Color	Stock Location
	224650	Dry Stack Gray	Factory Direct Only
4562427	Rough Gray	Factory Direct Only	

- Freight rate for 7 county metro area: \$175.00, flatbed with moffett or boom truck
- No split fees on County Materials products; Pavers are sold by layer, block by each
- 4563714: \$20 refundable pallet deposit on County Materials pallets; **must have receipt when returning pallets for refund.**
- Free jobsite clean up policies for County Materials products only when product is delivered:
 - Cleanups are made when County trucks are "in the area" of jobsite. As such, please allow up to 5 business days to have cleanup completed.
 - **Paver returns:** County Materials will pick up from your jobsite any empty pallets & full unopened pallets of product. All partial pallets of product will be left on jobsite.
 - **Retaining wall returns:** County Materials will pick up any full, partial, or empty pallets on jobsite.



Splash Blocks

224652	24"	\$8.90 Each
224654	30"	\$9.70 Each



Parking Kerbs

224656	6' Notched	\$37.00 Each
224658	7' Notched	\$43.00 Each

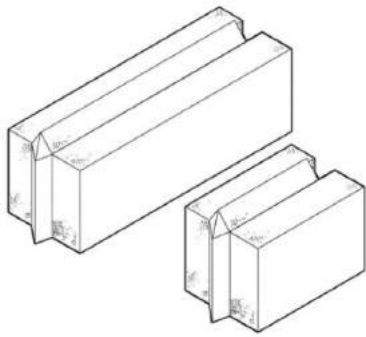

Bin Blocks

139636	Full—2' x 2' x 6'	\$135.00 Each
143330	Half—2' x 2' x 3'	\$95.00 Each

TITAN MACHINERY

Sales • Parts • Service • Rentals



TEAMCO
INC
SNOWBLAST

VACALL™

CASE
CONSTRUCTION



Titan Machinery Shakopee - 952-445-5400

*Subject to availability items may not be available at all locations.

www.titanmachinery.com



2019

welcome to the backyard...



hardscapes **collection**

Section Contents

Description	Page
Concrete Pavers & Slabs	163-180
• American Brick	163
• Barrington	163
• Broadmour (6cm)	164-165
• Broadmour Plank	165
• Broadmour XXL (10cm)	166-167
• Cobble Stone Pavers	167
• Colonial Pavers	168-171
• Flagstone Pavers	172
• Granite Pavers	172
• Holland Eco Pavers	173
• Holland Pavers	174
• Lamont Pavers	175-177
• Mezzano Pavers	178
• Minnetonka Pavers	179
• Serano Pavers	180
Bullnose Pavers	181,183, 185
Silver Creek Landscape Tiles	182-185
• Barn Plank Landscape Tiles	182
• Antique Travertine Landscape Tiles	183
• Slate Landscape Tiles	184-185
Silver Creek Stepping Stones	185
Steps	186-187
• Silver Creek Chiseled Steps	186
• Antique Travertine Steps	186
• Barn Plank Steps	186
• Grand Step	187
• Stair Stacker Step Unit	187
Edgers	188
• Interlock Bullet Edgers	188
• Rockwood Tumbled Granite Edgers	188
Silver Creek Pillar Caps	189

Description	Page
Silver Creek Seat Wall Caps	190
Walls	191-209
• Barn Plank Wall	191
• Travertine Wall	191
• 6" Classic Beveled Retaining Wall	192-193
• 6" Classic Straight Retaining Wall	192-193
• 6" Classic Corner Block	194
• 6" Classic Big Step	194
• Classic Universal Cap	194
• 8" Classic Chiseled Wall	195
• 8" Classic Chiseled Corner Block	195
• 6" Classic Colonial Wall	196-197
• 6" Classic Colonial Corner Block	197
• 4" Universal Tapered Cap	197
• Lakeland Freestanding Wall	198
• Lakeland Smooth Freestanding Wall	198
• Riverland Freestanding Wall	200
• Riverland Smooth Cap	200
• Granite Wall Accent	200
• Premier 8	201
• Sapphire Wall	202
• 3" Split Cap	202
• 6" Vintage Wall	203
• 6" Vintage Corner/Pillar Block	203
• 6" Vintage Wall End	204
• Vintage Seat Wall Cap	204
• 3" Split Cap	204
• Rosetta Outcropping Wall	205-206
• Rosetta Outcropping Corner	206
• Rosetta Irregular Steps	206
• Rosetta Belvedere Wall Stone	207
• Rosetta Belvedere Corner/Pillar Stone	207
• Rosetta Belvedere Cap Stone	207
• Rosetta Kodah Wall Stone	208
• Recon	209



KolorLast is applied in the manufacturing process, creating a molecular bond with concrete to unlock the natural beauty of pavers while improving colorfastness and resistance to acid rain and staining.

American Brick—6cm					
Yard Price: \$6.30/SF	SKU	Color	Stock Location	Dimensions	2 ³ / ₈ " H x 2 ³ / ₈ " W x 8" L
	184718	Brown	Non-Stock	SF/Piece	.146
Factory Direct: \$5.42/SF	184720	Buff	Non-Stock	SF/Layer	8.4
	184722	Heritage Blend	Non-Stock	SF/Pallet	84
All American Brick pavers are KolorLast protected.	184724	Onyx	Non-Stock	Pavers/Pallet	600
	184726	Tuscan Red	Non-Stock	Pavers/Layer	60
				Layers/Pallet	10
				LF/Paver (Sailor)	.667
				LF/Paver (Soldier)	.219
				Pallet Weight	1,800 Lbs



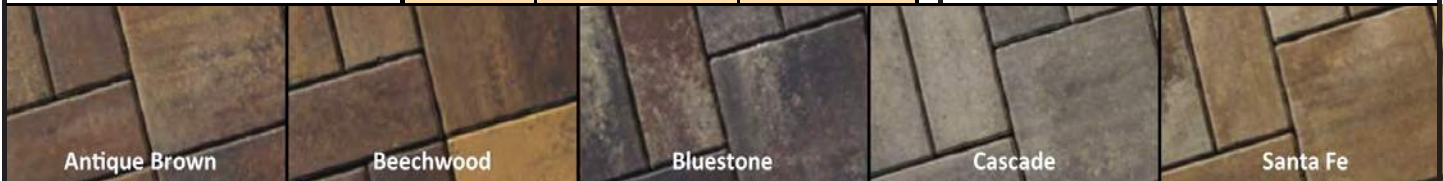

Barrington—3 Piece System—6cm *See Serano for 6 x 12 Accent Pavers



Standard Barrington				Dimensions	2 ³ / ₈ " H x 8" W x 16" L 2 ³ / ₈ " H x 16" W x 16" L 2 ³ / ₈ " H x 16" W x 24" L 1 : 1 : 1
Yard Price: \$5.15/SF	SKU	Color	Stock Location		SF/Pattern Set
	223810	Antique Brown	Non-Stock	SF/Layer	10.2
Factory Direct: \$4.33/SF	116400	Beechwood	Cedar Acres	SF/Pallet	102
	223812	Bluestone	Non-Stock	Pieces/Pallet	60 (20 of each size)
	116402	Cascade	Non-Stock	Pieces/Layer	6 (2 of each size)
	116404	Santa Fe	Cedar Acres	Layers/Pallet	10
Kolorlast Barrington				Pallet Weight	3,000 Lbs
Yard Price: \$6.30/SF	SKU	Color	Stock Location		
	147916	Beechwood	Non-Stock		
Factory Direct: \$5.42/SF	223794	Bluestone	Non-Stock		
	147920	Santa Fe	Non-Stock		



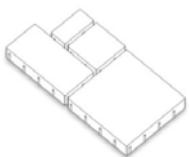

- Factory Direct Pricing on drop ship orders or factory pickup; FULL PALLETS only; minimum drop ship order is 10 pallets
- All product can be delivered anywhere in the metro area; all deliveries quoted individually for best rate; please call
- Please call for out-state and out-of-state delivery; special delivery quotes available
- Non-stocked product can be obtained quickly with advance notice, subject to factory availability
- 4136833: \$20 refundable pallet deposit on Rochester Concrete pallets; **must have receipt when returning pallets for refund.**
- A \$10.00 split pallet fee will be charged on all less-than-pallet quantities of Rochester Concrete Products.



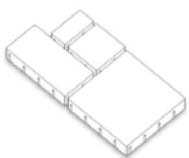

Broadmour Paver Small Rectangle—6cm					
Yard Price: \$6.30/SF	SKU	Color	Stock Location	Dimensions	2 $\frac{3}{8}$ "H x 6"W x 12"L
		224140	Beechwood 	Non-Stock	SF/Piece
Factory Direct: \$5.42/SF	184846	Cascade	Non-Stock	SF/Layer	12
	184848	Natural	Non-Stock	SF/Pallet	72
	184850	Onyx 	Non-Stock	Pavers/Pallet	144
				Pavers/SF	2
				Pavers/Layer	24
				Layers/Pallet	6
				Pallet Weight	2,305 Lbs

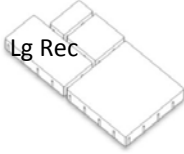
Broadmour Paver Square—6cm					
Yard Price: \$6.30/SF	SKU	Color	Stock Location	Dimensions	2 $\frac{3}{8}$ "H x 12"W x 12"L
		224142	Beechwood 	Non-Stock	SF/Piece
Factory Direct: \$5.42/SF	184854	Cascade	Non-Stock	SF/Layer	9
	184856	Natural	Non-Stock	SF/Pallet	90
	184858	Onyx 	Non-Stock	Pavers/Pallet	90
				Pavers/SF	1
				Pavers/Layer	9
				Layers/Pallet	10
				Pallet Weight	2,790 Lbs

- Factory Direct Pricing on drop ship orders or factory pickup; FULL PALLETS only; minimum drop ship order is 10 pallets
- All product can be delivered anywhere in the metro area; all deliveries quoted individually for best rate; please call
- Please call for out-state and out-of-state delivery; special delivery quotes available
- Non-stocked product can be obtained quickly with advance notice, subject to factory availability
- 4136833: \$20 refundable pallet deposit on Rochester Concrete pallets; **must have receipt when returning pallets for refund.**
- A \$10.00 split pallet fee will be charged on all less-than-pallet quantities of Rochester Concrete Products.

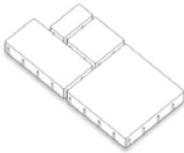
Broadmour Paver Large Rectangle—6cm						
Yard Price: \$6.30/SF	SKU	Color	Stock Location	Dimensions	2 ³ / ₈ "H x 12"W x 24"L	
	224144	Beechwood 	Non-Stock	SF/Piece	2	
Factory Direct: \$5.42/SF	184862	Cascade	Non-Stock	SF/Layer	12	
	184864	Natural	Non-Stock	SF/Pallet	96	
	184866	Onyx 	Non-Stock	Pavers/Pallet	48	
				Pavers/SF	.5	
				Pavers/Layer	6	
				Layers/Pallet	8	
				Pallet Weight	2,880 Lbs	

Broadmour Paver Large Square—6cm						
Yard Price: \$6.30/SF	SKU	Color	Stock Location	Dimensions	2 ³ / ₈ "H x 24"W x 24"L	
	224146	Beechwood 	Non-Stock	SF/Piece	4	
Factory Direct: \$5.42/SF	184870	Cascade	Non-Stock	SF/Layer	8	
	184872	Natural	Non-Stock	SF/Pallet	80	
	184874	Onyx 	Non-Stock	Pavers/Pallet	20	
				Pavers/SF	.25	
				Pavers/Layer	2	
				Layers/Pallet	10	
				Pallet Weight	2,320 Lbs	



Broadmour Plank Paver XXL—10cm						
Yard Price: \$8.15/SF	SKU	Color	Stock Location	Dimensions	4"H x 3"W x 18"L	
	4357597	Beechwood	Non-Stock	SF/Piece	.36	
Factory Direct: \$7.06/SF	4357684	Cascade	Non-Stock	SF/Layer	7.92	
	223804	Natural	Non-Stock	SF/Pallet	47.5	
KolorLast Broadmour Plank Pavers	185040	Onyx (KolorLast)	Non-Stock	Pavers/Pallet	132	
Yard Price: \$8.95/SF 				Pavers/SF	2.78	
	Factory Direct: \$7.99/SF 				Pavers/Layer	22
				LF/Paver (Sailor)	1.5	
				LF/Paver (Soldier)	.25	
				Pallet Weight	2,130 Lbs	

Sold by full pallets only, special order, no returns.

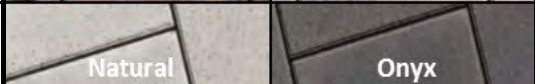

Broadmour XXL Paver Small Rectangle—10cm					
Price	SKU	Color	Stock Location	Dimensions	4" H x 6" W x 12" L
Yard Price: \$9.15/SF	224170	Beechwood	Special Order	SF/Piece	.5
	184884	Cascade	Special Order	SF/Layer	7.17
Factory Direct: \$8.00/SF	184886	Natural	Special Order	SF/Pallet	43
	184878	Onyx (KolorLast)	Special Order	Pavers/Pallet	90
KolorLast Broadmour XXL Pavers				Pavers/SF	2
Yard Price \$10.90 /SF 				Pavers/Layer	15
				Layers/Pallet	6
Factory Direct \$9.60 /SF 				Pallet Weight	2,050 Lbs



Broadmour XXL Paver Square—10cm					
Price	SKU	Color	Stock Location	Dimensions	4" H x 12" W x 12" L
Yard Price: \$9.15/SF	224174	Beechwood	Special Order	SF/Piece	1
	184888	Cascade	Special Order	SF/Layer	8.67
Factory Direct: \$8.00/SF	184890	Natural	Special Order	SF/Pallet	52
	184880	Onyx (KolorLast)	Special Order	Pavers/Pallet	54
KolorLast Broadmour XXL Pavers				Pavers/SF	1
Yard Price \$10.90 /SF 				Pavers/Layer	9
				Layers/Pallet	6
Factory Direct \$9.60 /SF 				Pallet Weight	2,500 Lbs

Sold by full pallets only, special order, no returns.

- Factory Direct Pricing on drop ship orders or factory pickup; FULL PALLETS only; minimum drop ship order is 10 pallets
- All product can be delivered anywhere in the metro area; all deliveries quoted individually for best rate; please call
- Please call for out-state and out-of-state delivery; special delivery quotes available
- Non-stocked product can be obtained quickly with advance notice, subject to factory availability
- 4136833: \$20 refundable pallet deposit on Rochester Concrete pallets; **must have receipt when returning pallets for refund.**
- A \$10.00 split pallet fee will be charged on all less-than-pallet quantities of Rochester Concrete Products.

Broadmour XXL Paver Large Rectangle—10cm							
Yard Price: \$9.15/SF	SKU	Color	Stock Location	Dimensions	4" H x 12" W x 24" L		
	224176	Beechwood	Special Order		SF/Piece	2	
Factory Direct: \$8.00/SF	184892	Cascade	Special Order	SF/Layer	7.67		
	184894	Natural	Special Order	SF/Pallet	46		
KolorLast Broadmour XXL Pavers			184882	Onyx (KolorLast)	Special Order	Pavers/Pallet	24
Yard Price: \$10.90 /SF 	Beechwood		Cascade		Pavers/SF	.5	
	Natural		Onyx		Pavers/Layer	4	
Factory Direct: \$9.60 /SF 	Natural		Onyx		Layers/Pallet	6	
					Pallet Weight	2,270 Lbs	





Cobble Stone Pavers—4 Piece System—8cm								
Yard Price: \$6.85/SF	SKU	Color	Stock Location	Dimensions	3.15" H x 5 $\frac{7}{8}$ " W x 7 $\frac{1}{8}$ " L			
	83162	Beechwood	Non-Stock		3.15" H x 5 $\frac{7}{8}$ " W x 8 $\frac{5}{8}$ " L			
Factory Direct: \$5.90/SF	224178	Moonlight Gray	Non-Stock	3.15" H x 5 $\frac{7}{8}$ " W x 10 $\frac{3}{8}$ " L				
	KolorLast			3.15" H x 5 $\frac{7}{8}$ " W x 11 $\frac{1}{8}$ " L	1 : 1 : 1 : 1			
KolorLast Cobble Stone Pavers			83164	Onyx (KolorLast)	Non-Stock	SF/Pattern Set	1.55	
Yard Price: \$8.60/SF 	Beechwood		Moonlight Gray		Onyx		SF/Layer	12.33
	Moonlight Gray		Onyx				SF/Pallet	74
Factory Direct: \$7.50/SF 	Beechwood		Moonlight Gray		Onyx		Pieces/Pallet	192 (48 of each size)
	Moonlight Gray		Onyx				Pieces/Layer	32 (8 of each size)
						Layers/Pallet	6	
						Pallet Weight	2,575 Lbs	

- Factory Direct Pricing on drop ship orders or factory pickup; FULL PALLETS only; minimum drop ship order is 10 pallets
- All product can be delivered anywhere in the metro area; all deliveries quoted individually for best rate; please call
- Please call for out-state and out-of-state delivery; special delivery quotes available
- Non-stocked product can be obtained quickly with advance notice, subject to factory availability
- 4136833: \$20 refundable pallet deposit on Rochester Concrete pallets; **must have receipt when returning pallets for refund.**
- A \$10.00 split pallet fee will be charged on all less-than-pallet quantities of Rochester Concrete Products.



Colonial Rectangle Paver—6cm

Yard Price: \$3.95/SF	SKU	Color	Stock Location	Dimensions	2 $\frac{3}{8}$ "H x 6.3"W x 9.45"L
	3543243	Antique Copper	Cedar Acres	SF/Piece	.413
Factory Direct: \$3.25/SF	3493418	Beechwood	Cedar Acres	SF/Band	18.45
	4288419	Brown	Non-Stock	SF/Pallet	92
	3959112	Carmel	Cedar Acres	Pavers/Pallet	225
	185044	Desert Buff	Non-Stock	Pavers/SF	2.43
	3543250	Moonlight Gray	Cedar Acres	Pavers/Band	45
KolorLast Colonial Paver	4357474	Onyx	Cedar Acres	Bands/Pallet	5
Yard Price: \$5.95/SF 	185042	Onyx (KolorLast)	Non-Stock	LF/Paver (Sailor)	.788
				LF/Paver (Soldier)	.525
Factory Direct: \$5.07/SF 				Pallet Weight	2,650 Lbs

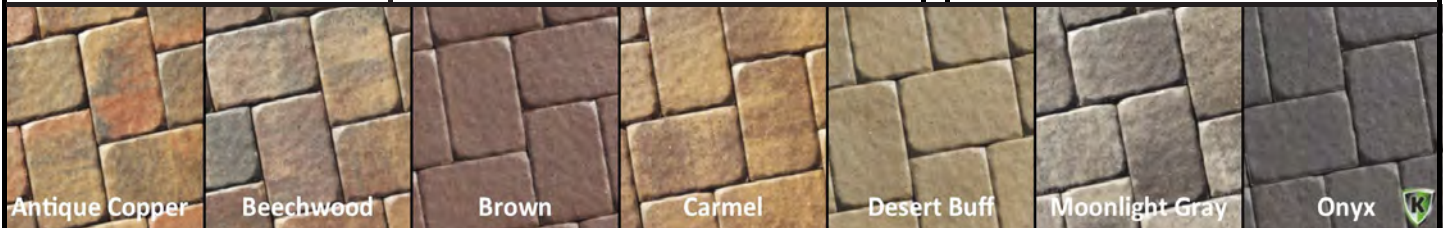

- Factory Direct Pricing on drop ship orders or factory pickup; FULL PALLETS only; minimum drop ship order is 10 pallets
- All product can be delivered anywhere in the metro area; all deliveries quoted individually for best rate; please call
- Please call for out-state and out-of-state delivery; special delivery quotes available
- Non-stocked product can be obtained quickly with advance notice, subject to factory availability
- 4136833: \$20 refundable pallet deposit on Rochester Concrete pallets; **must have receipt when returning pallets for refund.**
- A \$10.00 split pallet fee will be charged on all less-than-pallet quantities of Rochester Concrete Products.

Colonial Square Paver—6cm

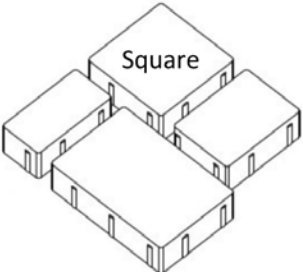
Yard Price: \$3.95/SF	SKU	Color	Stock Location	Dimensions	2 3/8" H x 6.3" W x 6.3" L
		3543335	Antique Copper	Cedar Acres	SF/Piece
Factory Direct: \$3.25/SF	3493425	Beechwood	Cedar Acres	SF/Band	14
	3959136	Carmel	Cedar Acres	SF/Pallet	98
	3543342	Moonlight Gray	Cedar Acres	Pavers/Pallet	350
				Pavers/SF	3.63
				Pavers/Band	50
				Bands/Pallet	7
				LF/Paver (Sailor)	.525
				LF/Paver (Soldier)	.525
				Pallet Weight	2,690 Lbs

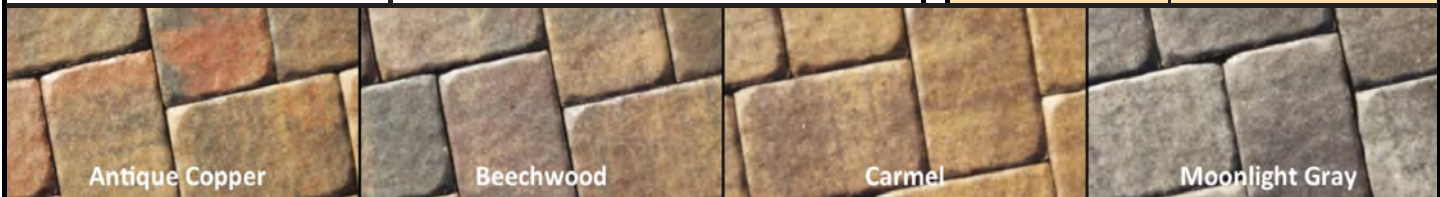

Colonial Half Square Paver—6cm

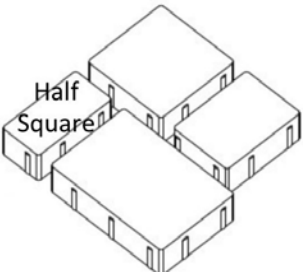
Yard Price: \$3.95/SF	SKU	Color	Stock Location	Dimensions	2 3/8" H x 3.15" W x 6.3" L
		3543427	Antique Copper	Cedar Acres	SF/Piece
Factory Direct: \$3.25/SF	3493432	Beechwood	Cedar Acres	SF/Band	6.86
	3959150	Carmel	Cedar Acres	SF/Pallet	48
	3543434	Moonlight Gray	Cedar Acres	Pavers/Pallet	350
				Pavers/SF	7.14
				Pavers/Band	50
				Bands/Pallet	7
				LF/Paver (Sailor)	.525
				LF/Paver (Soldier)	.263
				Pallet Weight	1,300 Lbs

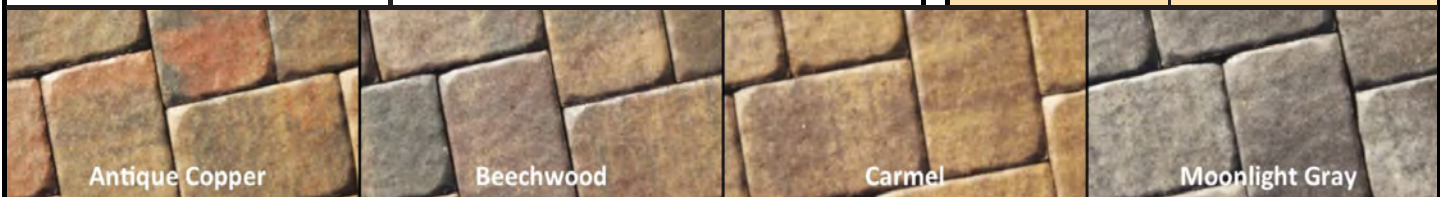



1 : 1 : 1 Pattern Calculations:

Divide total square footage of field by .824 (SF of pattern set) for number of pieces of each size needed.

- Factory Direct Pricing on drop ship orders or factory pickup; FULL PALLETS only; minimum drop ship order is 10 pallets
- All product can be delivered anywhere in the metro area; all deliveries quoted individually for best rate; please call
- Please call for out-state and out-of-state delivery; special delivery quotes available
- Non-stocked product can be obtained quickly with advance notice, subject to factory availability
- 4136833: \$20 refundable pallet deposit on Rochester Concrete pallets; **must have receipt when returning pallets for refund.**
- A \$10.00 split pallet fee will be charged on all less-than-pallet quantities of Rochester Concrete Products.

Colonial ¾ Square Paver—6cm

Yard Price: \$3.95/SF	SKU	Color	Stock Location	Dimensions	2⅝" H x 4.65" W x 6.3" L
	3543632	Antique Copper	Cedar Acres	SF/Piece	.203
Factory Direct: \$3.25/SF	3493463	Beechwood	Cedar Acres	SF/Band	11.4
	120444	Brown	Cedar Acres	SF/Pallet	80
	3959198	Carmel	Cedar Acres	Pavers/Pallet	392
	185048	Desert Buff	Cedar Acres	Pavers/SF	4.35
	3543656	Moonlight Gray	Cedar Acres	Pavers/Band	56
KolorLast Colonial Paver	120442	Onyx	Cedar Acres	Bands/Pallet	7
Yard Price: \$5.95/SF 	185046	Onyx (KolorLast)	Non-Stock	LF/Paver (Sailor)	.525
				LF/Paver (Soldier)	.388
Factory Direct: \$5.07/SF 				Pallet Weight	2,180 Lbs

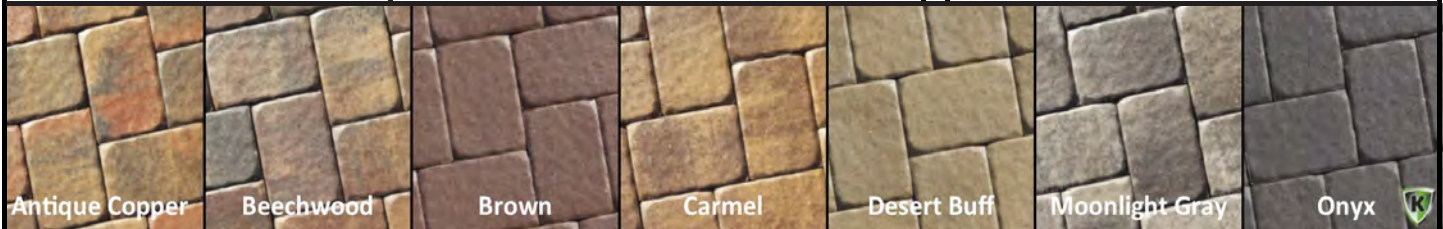

Colonial Large Circle Paver—6cm

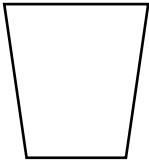
Yard Price: \$6.40/SF	SKU	Color	Stock Location	Dimensions	2⅝" H x 5.2" W x 6.3" L
	3543571	Antique Copper	Cedar Acres	SF/Piece	.227
Factory Direct: \$5.49/SF	3493456	Beechwood	Cedar Acres	SF/Band	8
	3543595	Moonlight Gray	Cedar Acres	SF/Pallet	56
				Pavers/Pallet	280
				Pavers/SF	5
				Pavers/Band	40
				Bands/Pallet	7
				LF/Paver (Soldier)	.433
				Pallet Weight	1,550 Lbs

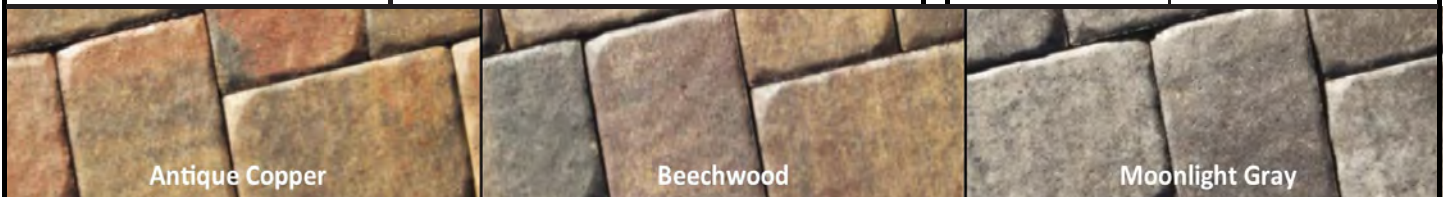

- Factory Direct Pricing on drop ship orders or factory pickup; FULL PALLETS only; minimum drop ship order is 10 pallets
- All product can be delivered anywhere in the metro area; all deliveries quoted individually for best rate; please call
- Please call for out-state and out-of-state delivery; special delivery quotes available
- Non-stocked product can be obtained quickly with advance notice, subject to factory availability
- 4136833: \$20 refundable pallet deposit on Rochester Concrete pallets; **must have receipt when returning pallets for refund.**
- A \$10.00 split pallet fee will be charged on all less-than-pallet quantities of Rochester Concrete Products.

Colonial Starter Circle Kit—6cm

Yard Price: \$38.40/ Pack	SKU	Color	Stock Location	Kit Configuration 30 Pieces Total 1 Center Piece 16 Small Circle Stones 8 Three Quarter Stones 3 Half Squares (used in rings 6 & 8)		
	3543519	Antique Copper	Cedar Acres			
Factory Direct: \$32.94/ Pack	3493449	Beechwood	Cedar Acres			
	3543533	Moonlight Gray	Cedar Acres			
 <p style="text-align: center;">1 Kit = 2.65' Diameter Circle</p>					SF/Kit	6
					SF/Pallet	36
				Pavers/Kit	30	
				Kits/Pallet	6	
				Pallet Weight	1,060 Lbs	



Course#	Diameter (Inches)	Diameter (Feet)	Area (SqFt)	Circle Starter Kit	Large Circle (Wedges)			¾ Square		
					Pallet	Units Per Course	Layers	Units Per Course	Pallets	Bands
Center	6.3	.53	.22	1 Kit						
1	19	1.58	1.97	1 Kit						
2	31.7	2.64	5.48	1 Kit						
3	44.4	3.70	10.75	1 Kit		26	1			
4	57.1	4.76	17.78	1 Kit		34	2			
5	69.8	5.82	26.57	1 Kit		21	2	21		1
6	82.5	6.88	37.12	1 Kit		26	3	24		1
7	95.2	7.93	49.43	1 Kit		30	4	30		2
8	107.9	8.99	63.50	1 Kit		34	5	33		2
9	120.6	10.05	79.33	1 Kit		38	6	38		3
10	133.3	11.11	96.91	1 Kit	1	42		42		4
11	146	12.17	116.26	1 Kit	1			90		5
12	158.7	13.23	137.37	1 Kit	1			99	1	
13	171.4	14.28	160.23	1 Kit	1			107	1	2
14	184.1	15.34	184.86	1 Kit	1			116	1	4
15	196.8	16.40	211.24	1 Kit	1			124	1	6
16	209.5	17.46	239.38	1 Kit	1			133	2	2
17	222.2	18.52	269.29	1 Kit	1			142	2	4
18	234.9	19.58	300.95	1 Kit	1			150	3	

- Factory Direct Pricing on drop ship orders or factory pickup; FULL PALLETS only; minimum drop ship order is 10 pallets
- All product can be delivered anywhere in the metro area; all deliveries quoted individually for best rate; please call
- Please call for out-state and out-of-state delivery; special delivery quotes available
- Non-stocked product can be obtained quickly with advance notice, subject to factory availability
- 4136833: \$20 refundable pallet deposit on Rochester Concrete pallets; **must have receipt when returning pallets for refund.**
- A \$10.00 split pallet fee will be charged on all less-than-pallet quantities of Rochester Concrete Products.

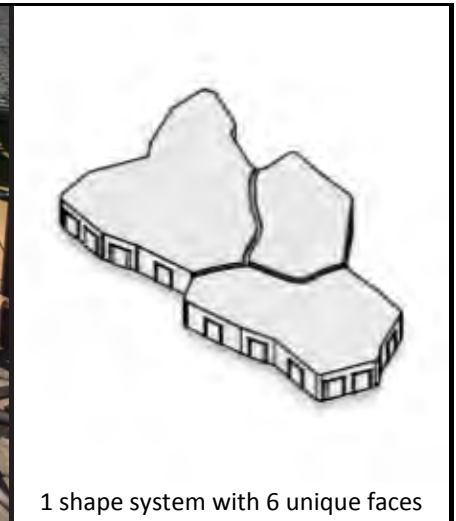

Flagstone Pavers—6cm

Yard Price: \$6.05/SF	SKU	Color	Stock Location	Dimensions	Irregular
Factory Direct: \$5.13/SF	116406	Antique Brown	Non-Stock	SF/Piece	1.58
	116410	Santa Fe	Non-Stock	SF/Layer	9.5
	116408	Sierra Gray	Non-Stock	SF/Pallet	95
Sold by full pallet only				Pavers/Pallet	60
				Pavers/SF	.633
				Pavers/Layer	6
				Layers/Pallet	10
				Pallet Weight	2,800 Lbs

Granite Pavers—6cm—Accent Border

Yard Price: \$3.15/SF	SKU	Color	Stock Location	Dimensions	2 3/8" H x 4" W x 8" L
Factory Direct: \$2.64/SF	116412	Brown	Non-Stock	SF/Piece	.22
	116414	Buff	Non-Stock	SF/Layer	17.6
	116416	Onyx	Non-Stock	SF/Pallet	70.4
				Pavers/Pallet	320
				Pavers/SF	4.54
				Pavers/Layer	80
				Layers/Pallet	4
				Pallet Weight	2,130 Lbs

- Factory Direct Pricing on drop ship orders or factory pickup; FULL PALLETS only; minimum drop ship order is 10 pallets
- All product can be delivered anywhere in the metro area; all deliveries quoted individually for best rate; please call
- Please call for out-state and out-of-state delivery; special delivery quotes available
- Non-stocked product can be obtained quickly with advance notice, subject to factory availability
- 4136833: \$20 refundable pallet deposit on Rochester Concrete pallets; **must have receipt when returning pallets for refund.**
- A \$10.00 split pallet fee will be charged on all less-than-pallet quantities of Rochester Concrete Products.



Holland Eco Pavers—8cm					
Yard Price: \$4.10/SF	SKU	Color	Stock Location		
	3735037	Beechwood	Non-Stock		
Factory Direct: \$3.75/SF	3735044	Carmel	Non-Stock		
 <div style="display: flex; justify-content: space-around; width: 100%;"> Beechwood Carmel </div>				Dimensions	Rec: 3 $\frac{1}{8}$ "H x 4 $\frac{7}{8}$ "W x 9 $\frac{3}{4}$ "L Sq: 3 $\frac{1}{8}$ "H x 4 $\frac{7}{8}$ "W x 4 $\frac{7}{8}$ "L
				SF/Piece	.34 (Rec) & .17 (Sq)
				SF/Layer	10.375
				SF/Pallet	84.7
				Pavers/Pallet	224 (Rec) & 56 (Sq)
				Pavers/SF	2.94 (Rec) & 5.88 (Sq)
				Pavers/Layer	28 Rectangle & 7 Square
				Layers/Pallet	8
				Pallet Weight	3,050 Lbs

- Factory Direct Pricing on drop ship orders or factory pickup; FULL PALLETS only; minimum drop ship order is 10 pallets
- All product can be delivered anywhere in the metro area; all deliveries quoted individually for best rate; please call
- Please call for out-state and out-of-state delivery; special delivery quotes available
- Non-stocked product can be obtained quickly with advance notice, subject to factory availability
- 4136833: \$20 refundable pallet deposit on Rochester Concrete pallets; **must have receipt when returning pallets for refund.**
- A \$10.00 split pallet fee will be charged on all less-than-pallet quantities of Rochester Concrete Products.







Holland Pavers—6cm





Yard Price: \$3.15/SF	SKU	Color	Stock Location	Dimensions	2 3/8" H x 4 1/4" W x 8 1/2" L
	3542734	Antique Copper	Non-Stock	SF/Piece	.25
Factory Direct: \$2.57/SF	3542741	Beechwood	Non-Stock	SF/Band	19.6
	3542802	Brown	Non-Stock	SF/Pallet	98
	3542819	Buff	Non-Stock	Pavers/Pallet	400
	3542758	Carmel	Non-Stock	Pavers/SF	4
KolorLast Holland Pavers	3542765	Moonlight Gray	Non-Stock	Pavers/Band	80
Yard Price: \$5.90/SF	3542727	Rosewood	Non-Stock	Bands/Pallet	5
	KolorLast			LF/Paver (Sailor)	.708
Factory Direct: \$5.07/SF	185050	Onyx (KolorLast)	Non-Stock	LF/Paver (Soldier)	.354
				Pallet Weight	2,785 Lbs

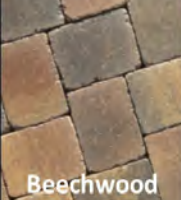

- Factory Direct Pricing on drop ship orders or factory pickup; FULL PALLETS only; minimum drop ship order is 10 pallets
- All product can be delivered anywhere in the metro area; all deliveries quoted individually for best rate; please call
- Please call for out-state and out-of-state delivery; special delivery quotes available
- Non-stocked product can be obtained quickly with advance notice, subject to factory availability
- 4136833: \$20 refundable pallet deposit on Rochester Concrete pallets; **must have receipt when returning pallets for refund.**
- A \$10.00 split pallet fee will be charged on all less-than-pallet quantities of Rochester Concrete Products.

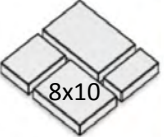

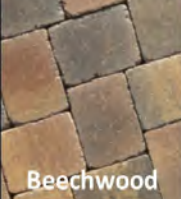



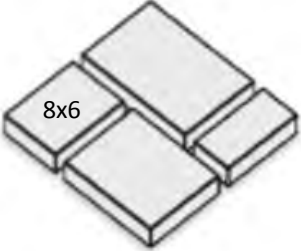

Lamont 8x12 Rectangle Paver—6cm						
Yard Price: \$5.45/SF	SKU	Color	Stock Location	Dimensions	2 $\frac{3}{8}$ "H x 8 $\frac{1}{4}$ "W x 12 $\frac{3}{8}$ "L	
	3457588	Antique Brown	Cedar Acres	SF/Piece	.71	
Factory Direct: \$4.78/SF	3959051	Beechwood	Cedar Acres	SF/Band	28.5	
	4357429	Santa Fe	Cedar Acres	SF/Pallet	114	
	3457595	Sierra Gray	Cedar Acres	Pavers/Pallet	160	
				Pavers/SF	1.4	
	 Antique Brown			 Beechwood		
	 Santa Fe			 Sierra Gray		
	Pavers/Band				40	
	Bands/Pallet				4	
	LF/Paver (Sailor)				1.03	
	LF/Paver (Soldier)				.69	
				Pallet Weight	3,170 Lbs	

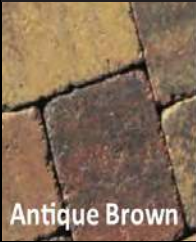



Lamont 8x10 Rectangle Paver—6cm						
Yard Price: \$5.45/SF	SKU	Color	Stock Location	Dimensions	2 $\frac{3}{8}$ "H x 8 $\frac{1}{4}$ "W x 10 $\frac{1}{4}$ "L	
	3457618	Antique Brown	Cedar Acres	SF/Piece	.59	
Factory Direct: \$4.78/SF	3959075	Beechwood	Cedar Acres	SF/Band	23.75	
	4357436	Santa Fe	Cedar Acres	SF/Pallet	95	
	3457625	Sierra Gray	Cedar Acres	Pavers/Pallet	160	
				Pavers/SF	1.7	
	 Antique Brown			 Beechwood		
	 Santa Fe			 Sierra Gray		
	Pavers/Band				40	
	Bands/Pallet				4	
	LF/Paver (Sailor)				.85	
	LF/Paver (Soldier)				.69	
				Pallet Weight	2,710 Lbs	

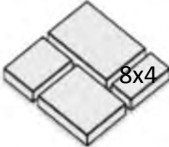

- Factory Direct Pricing on drop ship orders or factory pickup; FULL PALLETS only; minimum drop ship order is 10 pallets
- All product can be delivered anywhere in the metro area; all deliveries quoted individually for best rate; please call
- Please call for out-state and out-of-state delivery; special delivery quotes available
- Non-stocked product can be obtained quickly with advance notice, subject to factory availability
- 4136833: \$20 refundable pallet deposit on Rochester Concrete pallets; **must have receipt when returning pallets for refund.**
- A \$10.00 split pallet fee will be charged on all less-than-pallet quantities of Rochester Concrete Products.

Lamont 8x6 Rectangle Paver—6cm						
Yard Price: \$5.45/SF	SKU	Color	Stock Location	Dimensions	2 ³ / ₈ "H x 6 ¹ / ₄ "W x 8 ¹ / ₄ "L	
Factory Direct: \$4.78/SF	3457649	Antique Brown	Cedar Acres	SF/Piece	.36	
	3959082	Beechwood	Cedar Acres	SF/Band	17.8	
	4553807	Brown	Non-Stock	SF/Pallet	89	
	3457663	Desert Buff	Non-Stock	Pavers/Pallet	250	
	147986	Onyx	Cedar Acres	Pavers/SF	2.8	
	4357443	Santa Fe	Cedar Acres	Pavers/Band	50	
	3457656	Sierra Gray	Cedar Acres	Bands/Pallet	5	
					LF/Paver (Sailor)	.69
				LF/Paver (Soldier)	.52	
				Pallet Weight	2,450 Lbs	

Lamont 8x4 Rectangle Paver—6cm						
Yard Price: \$5.45/SF	SKU	Color	Stock Location	Dimensions	2 ³ / ₈ "H x 8 ¹ / ₄ "W x 4 ¹ / ₈ "L	
Factory Direct: \$4.78/SF	3457670	Antique Brown	Cedar Acres	SF/Piece	.24	
	3959099	Beechwood	Cedar Acres	SF/Band	19.2	
	224150	Brown	Non-Stock	SF/Pallet	96	
	3457694	Desert Buff	Cedar Acres	Pavers/Pallet	400	
	147988	Onyx	Non-Stock	Pavers/SF	4.2	
	4357450	Santa Fe	Cedar Acres	Pavers/Band	80	
	3457687	Sierra Gray	Cedar Acres	Bands/Pallet	5	
					LF/Paver (Sailor)	.69
				LF/Paver (Soldier)	.34	
				Pallet Weight	2,625 Lbs	

1 : 1 : 1 : 1 Pattern Calculations:

**Multiply total SF by 38% 8x12 : 31% 8x10 : 19% 8x6 : 12% 8x4 to calculate SF of each size needed.
 Divide total square footage of field by 1.9 (SF of pattern set) for number of pieces of each size needed.**

- Factory Direct Pricing on drop ship orders or factory pickup; FULL PALLETS only; minimum drop ship order is 10 pallets
- All product can be delivered anywhere in the metro area; all deliveries quoted individually for best rate; please call
- Please call for out-state and out-of-state delivery; special delivery quotes available
- Non-stocked product can be obtained quickly with advance notice, subject to factory availability
- 4136833: \$20 refundable pallet deposit on Rochester Concrete pallets; **must have receipt when returning pallets for refund.**
- A \$10.00 split pallet fee will be charged on all less-than-pallet quantities of Rochester Concrete Products.

Lamont Circle Pallet—6cm

Yard Price: \$8.05/SF	SKU	Color	Stock Location	Dimensions	One 10.33' Dia. Circle		
Factory Direct: \$7.15/SF	3457700	Antique Brown	Non-Stock	Configuration	9 Center Pieces 9 Small Circle Stones 18 Middle Circle Stones 135 Large Circle Stones 81 Rectangles (6 x 8)		
	3959105	Beechwood	Non-Stock				
\$627.45/Pallet (Yard Price) Sold in full pallets only	4357467	Santa Fe	Non-Stock			SF/Pallet	89
	3457717	Sierra Gray	Non-Stock			Pavers/Pallet	252
Extra pieces of each size are included on the pallet.				Pallet Weight	2,520 Lbs		



Calculation Table for Lamont Circle

Course#	Diameter (Feet)	Circle Pallet	Lamont 6x8 Rectangles	Cumulative Total Needed
0-7	10.33	1 Center Stone 8 Small Circle Stones 16 Middle Circle Stones 128 Large Circle Stones 73 Rectangles (6x8)		1 Pallet = 89 SqFt
8	11.66	1	65	1 Circle Pallet = 89 SqFt 2 Bands 6x8 = 36 SqFt
9	13.00	1	74 (139 Total)	1 Circle Pallet = 89 SqFt 3 Bands 6x8 = 54 SqFt
10	14.33	1	81 (220 Total)	1 Circle Pallet = 89 SqFt 1 Pallet 6x8 = 89 SqFt
11	15.66	1	89 (309 Total)	1 Circle Pallet = 89 SqFt 1 Pallet + 2 Bands 6x8 = 125 SqFt
12	17.00	1	97 (406 Total)	1 Circle Pallet = 89 SqFt 1 Pallet + 4 Bands 6x8 = 160 SqFt
13	18.33	1	104 (510 Total)	1 Circle Pallet = 89 SqFt 2 Pallets + 1 Band 6x8 = 196 SqFt
14	19.66	1	113 (623 Total)	1 Circle Pallet = 89 SqFt 2 Pallets + 3 Bands 6x8 = 232 SqFt
15	21.00	1	121 (744 Total)	1 Circle Pallet = 89 SqFt 3 Pallets 6x8 = 267 SqFt

- Factory Direct Pricing on drop ship orders or factory pickup; FULL PALLETS only; minimum drop ship order is 10 pallets
- All product can be delivered anywhere in the metro area; all deliveries quoted individually for best rate; please call
- Please call for out-state and out-of-state delivery; special delivery quotes available
- Non-stocked product can be obtained quickly with advance notice, subject to factory availability
- 4136833: \$20 refundable pallet deposit on Rochester Concrete pallets; **must have receipt when returning pallets for refund.**
- A \$10.00 split pallet fee will be charged on all less-than-pallet quantities of Rochester Concrete Products.



Mezzano Pavers—3 Piece System—6cm

Standard Mezzano Pavers				Dimensions	2 3/8" H x 5 3/4" W x 5 3/4" L 2 3/8" H x 5 3/4" W x 11 1/2" L 2 3/8" H x 11 1/2" W x 11 1/2" L 1 : 1 : 1		
Yard Price: \$5.05/SF	SKU	Color	Stock Location				
Factory Direct: \$4.38/SF	64446	Antique Brown	Cedar Acres	SF/Pattern Set	1.66		
	83156	Beechwood	Cedar Acres				
	147922	Bluestone	Cedar Acres			SF/Layer	9.7
	147924	Cascade	Cedar Acres			SF/Pallet	97
	83158	Santa Fe	Cedar Acres			Pieces/Pallet	180 (60 of each size)
Kolorlast Mezzano Pavers						Pieces/Layer	18 (6 of each size)
Yard Price: \$6.35/SF	SKU	Color	Stock Location			Layers/Pallet	10
Factory Direct: \$5.47/SF	147926	Beechwood	Non-Stock			Pallet Weight	2,685 Lbs
	223796	Bluestone	Non-Stock				
	147930	Santa Fe	Non-Stock				



Mezzano Accent Pavers—6 x 12 Rectangle—6cm

Standard Mezzano Pavers				Dimensions	2 3/8" H x 5 3/4" W x 11 1/2" L	
Yard Price: \$5.05/SF	SKU	Color	Stock Location			
Factory Direct: \$4.38/SF	185052	Brown	Cedar Acres	SF/Paver	.46	
	185054	Buff	Cedar Acres	SF/Layer	9.66	
				SF/Pallet	96.6	
	Kolorlast Mezzano Pavers				Pavers/Pallet	210
	Yard Price: \$6.35/SF	SKU	Color	Stock Location	Pavers/Layer	21
Factory Direct: \$5.47/SF	147962	Onyx	Cedar Acres	Layers/Pallet	10	
				LF/Paver (Sailor)	.96	
				LF/Paver (Soldier)	.48	
				Pallet Weight	2,780 Lbs	

- Factory Direct Pricing on drop ship orders or factory pickup; FULL PALLETS only; minimum drop ship order is 10 pallets
- All product can be delivered anywhere in the metro area; all deliveries quoted individually for best rate; please call
- Please call for out-state and out-of-state delivery; special delivery quotes available
- Non-stocked product can be obtained quickly with advance notice, subject to factory availability
- 4136833: \$20 refundable pallet deposit on Rochester Concrete pallets; **must have receipt when returning pallets for refund.**
- A \$10.00 split pallet fee will be charged on all less-than-pallet quantities of Rochester Concrete Products.



Minnetonka Pavers—3 Piece System—6cm

*See Mezzano for 6 x 12 Accent Pavers

Standard Minnetonka Pavers

Yard Price: \$5.00/SF	SKU	Color	Stock Location
	223806	Antique Brown	Non-Stock
Factory Direct: \$4.19/SF	116392	Beechwood	Cedar Acres
	223808	Bluestone	Non-Stock
	116394	Cascade	Non-Stock
	116398	Santa Fe	Cedar Acres

Dimensions	2 $\frac{3}{8}$ "H x 8"W x 16"L 2 $\frac{3}{8}$ "H x 16"W x 16"L 2 $\frac{3}{8}$ "H x 16"W x 24"L 1 : 1 : 1
SF/Pattern Set	5.34
SF/Layer	10.2
SF/Pallet	102
Pieces/Pallet	60 (20 of each size)
Pieces/Layer	6 (2 of each size)
Layers/Pallet	10
Pallet Weight	3,000 Lbs

Kolorlast Minnetonka Pavers

Yard Price: \$6.15/SF	SKU	Color	Stock Location
	147908	Beechwood	Non-Stock
Factory Direct: \$5.24/SF	223800	Bluestone	Non-Stock
	147912	Santa Fe	Non-Stock



KolorLast is applied in the manufacturing process, creating a molecular bond with concrete to unlock the natural beauty of pavers while improving colorfastness and resistance to acid rain and staining

- Factory Direct Pricing on drop ship orders or factory pickup; FULL PALLETS only; minimum drop ship order is 10 pallets
- All product can be delivered anywhere in the metro area; all deliveries quoted individually for best rate; please call
- Please call for out-state and out-of-state delivery; special delivery quotes available
- Non-stocked product can be obtained quickly with advance notice, subject to factory availability
- 4136833: \$20 refundable pallet deposit on Rochester Concrete pallets; **must have receipt when returning pallets for refund.**
- A \$10.00 split pallet fee will be charged on all less-than-pallet quantities of Rochester Concrete Products.

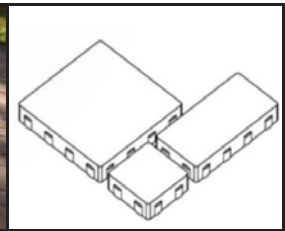

Serano Pavers—3 Piece System—6cm

Standard Serano Pavers				Dimensions	2 3/8" H x 5 3/4" W x 5 3/4" L 2 3/8" H x 5 3/4" W x 11 1/2" L 2 3/8" H x 11 1/2" W x 11 1/2" L 1 : 1 : 1
Yard Price: \$4.30/SF	SKU	Color	Stock Location		
	4322021	Antique Brown	Cedar Acres	SF/Pattern Set	1.66
	4357320	Beechwood	Cedar Acres		
Factory Direct: \$3.73/SF	4322045	Bluestone	Cedar Acres	SF/Layer	9.7
	147990	Cascade	Cedar Acres	SF/Pallet	97
	4322038	Santa Fe	Cedar Acres	Pieces/Pallet	180 (60 of each size)
Kolorlast Serano Pavers				Pieces/Layer	18 (6 of each size)
Yard Price: \$5.45/SF	SKU	Color	Stock Location	Layers/Pallet	10
	147992	Beechwood	Non-Stock	Pallet Weight	2,685 Lbs
Factory Direct: \$4.76/SF	223802	Bluestone	Non-Stock		
	147996	Santa Fe	Non-Stock		



Serano Accent Pavers—6 x 12 Rectangle—6cm

Standard Serano Pavers				Dimensions	2 3/8" H x 5 3/4" W x 11 1/2" L
Yard Price: \$4.15/SF	SKU	Color	Stock Location		
	185058	Brown	Cedar Acres	SF/Paver	.46
Factory Direct: \$3.73/SF	185060	Buff	Cedar Acres	SF/Layer	9.7
				SF/Pallet	97
Kolorlast Serano Pavers				Pavers/Pallet	210
Yard Price: \$5.45/SF	SKU	Color	Stock Location	Pavers/Layer	21
	147982	Onyx	Cedar Acres	Layers/Pallet	10
Factory Direct: \$4.76/SF				LF/Paver (Sailor)	.96
				LF/Paver (Soldier)	.48
				Pallet Weight	2,780 Lbs

- Factory Direct Pricing on drop ship orders or factory pickup; FULL PALLETS only; minimum drop ship order is 10 pallets
- All product can be delivered anywhere in the metro area; all deliveries quoted individually for best rate; please call
- Please call for out-state and out-of-state delivery; special delivery quotes available
- Non-stocked product can be obtained quickly with advance notice, subject to factory availability
- 4136833: \$20 refundable pallet deposit on Rochester Concrete pallets; **must have receipt when returning pallets for refund.**
- A \$10.00 split pallet fee will be charged on all less-than-pallet quantities of Rochester Concrete Products.



Bullnose Paver—6cm

Yard Price: \$3.70 Each	SKU	Color	Stock Location	Dimensions	2 3/8" H x 6" W x 12" L
Factory Direct: \$3.18 Each	4173128	Antique Brown	Non-Stock	SF/Piece	.5
	4173180	Beechwood	Non-Stock	SF/Layer	24
	4357719	Brown	Non-Stock	SF/Pallet	72
	4173135	Desert Buff	Non-Stock	Pavers/Pallet	144
	147936	Onyx	Cedar Acres	Pavers/SF	2
	4357702	Santa Fe	Non-Stock	Pavers/Layer	48
	4173166	Sierra Gray	Non-Stock	Layers/Pallet	3
				LF/Paver	.5
				Pallet Weight	1,930 Lbs



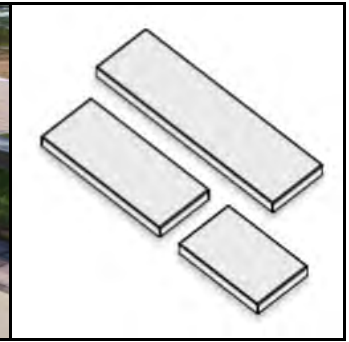

- Factory Direct Pricing on drop ship orders or factory pickup; FULL PALLETS only; minimum drop ship order is 10 pallets
- All product can be delivered anywhere in the metro area; all deliveries quoted individually for best rate; please call
- Please call for out-state and out-of-state delivery; special delivery quotes available
- Non-stocked product can be obtained quickly with advance notice, subject to factory availability
- 4136833: \$20 refundable pallet deposit on Rochester Concrete pallets; **must have receipt when returning pallets for refund.**
- A \$10.00 split pallet fee will be charged on all less-than-pallet quantities of Rochester Concrete Products.



3 different surface designs per size. Pull from multiple pallets for best results.

Barn Plank—Small

Yard Price: \$9.68/SF	SKU	Color	Stock Location	Dimensions	2" H x 9¾" W x 15½" L
	185064	Mahogany	Non-Stock	SF/Piece	1.05
Factory Direct: \$8.74/SF	185066	Weathered Gray	Non-Stock	Pieces/Pallet	40
 All Barn Plank tiles are KolorLast protected				SF/Pallet	42
				Weight/Piece	24 Lbs
				Pallet Weight	1,000 Lbs

Barn Plank—Medium

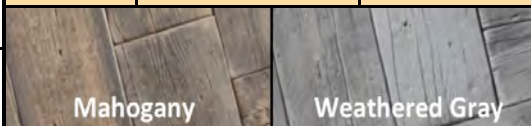
Yard Price: \$9.68/SF	SKU	Color	Stock Location	Dimensions	2" H x 9¾" W x 23¾" L
	185068	Mahogany	Non-Stock	SF/Piece	1.59
Factory Direct: \$8.74/SF	185070	Weathered Gray	Non-Stock	Pieces/Pallet	20
 All Barn Plank tiles are KolorLast protected				SF/Pallet	31.8
				Weight/Piece	33 Lbs
				Pallet Weight	700 Lbs

Barn Plank—Large

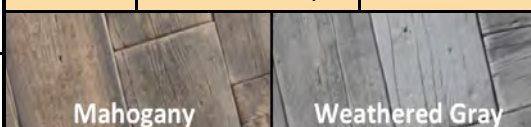
Yard Price: \$9.68/SF	SKU	Color	Stock Location	Dimensions	2" H x 9¾" W x 35" L
	185072	Mahogany	Non-Stock	SF/Piece	2.37
Factory Direct: \$8.74/SF	185074	Weathered Gray	Non-Stock	Pieces/Pallet	20
 All Barn Plank tiles are KolorLast protected				SF/Pallet	47.4
				Weight/Piece	52 Lbs
				Pallet Weight	1,080 Lbs

- Factory Direct Pricing on drop ship orders or factory pickup; FULL PALLETS only; minimum drop ship order is 10 pallets
- All product can be delivered anywhere in the metro area; all deliveries quoted individually for best rate; please call
- Please call for out-state and out-of-state delivery; special delivery quotes available
- Non-stocked product can be obtained quickly with advance notice, subject to factory availability
- 4136833: \$20 refundable pallet deposit on Rochester Concrete pallets; **must have receipt when returning pallets for refund.**
- A \$10.00 split pallet fee will be charged on all less-than-pallet quantities of Rochester Concrete Products.

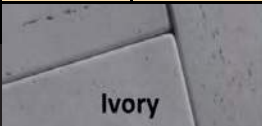
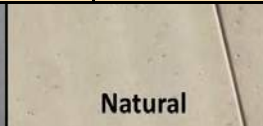

Antique Travertine—24" x 24" Large Square					
Natural Color Yard Price: \$9.60/SF Factory Direct: \$8.40/SF	SKU	Color	Stock Location	Dimensions	2"H x 24"W x 24"L
	79182	Ivory	Non-Stock	SF/Piece	4
Ivory Color Yard Price: \$11.70/SF Factory Direct: \$10.36/SF	185076	Natural	Non-Stock	Pieces/Pallet	20
	 			SF/Pallet	80
				Weight/Piece	88 Lbs
				Pallet Weight	1,640 Lbs

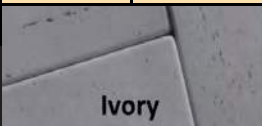
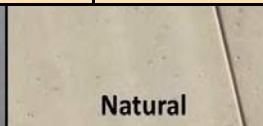
Antique Travertine—18" x 24" Large Rectangle					
Natural Color Yard Price: \$9.60/SF Factory Direct: \$8.40/SF	SKU	Color	Stock Location	Dimensions	2"H x 18"W x 24"L
	79180	Ivory	Non-Stock	SF/Piece	3
Ivory Color Yard Price: \$11.70/SF Factory Direct: \$10.36/SF	185078	Natural	Non-Stock	Pieces/Pallet	20
	 			SF/Pallet	60
				Weight/Piece	70 Lbs
				Pallet Weight	1,300 Lbs

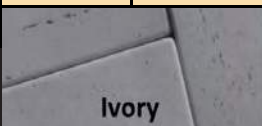
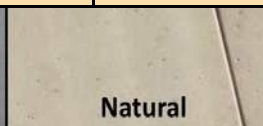
Antique Travertine—12" x 24" Small Rectangle					
Natural Color Yard Price: \$9.60/SF Factory Direct: \$8.40/SF	SKU	Color	Stock Location	Dimensions	2"H x 12"W x 18"L
	79176	Ivory	Non-Stock	SF/Piece	2
Ivory Color Yard Price: \$11.70/SF Factory Direct: \$10.36/SF	185080	Natural	Non-Stock	Pieces/Pallet	20
	 			SF/Pallet	40
				Weight/Piece	46 Lbs
				Pallet Weight	960 Lbs

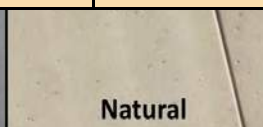
Antique Travertine—12" x 24" Bullnose					
Natural Color Yard Price: \$13.86/SF Factory Direct: \$12.35/SF	SKU	Color	Stock Location	Dimensions	2"H x 12"W x 24"L
	79186	Ivory	Non-Stock	SF/Piece	2
Ivory Color Yard Price: \$15.55/SF Factory Direct: \$13.89/SF	185082	Natural	Non-Stock	Pieces/Pallet	20
	 			SF/Pallet	40
				Weight/Piece	43 Lbs
				Pallet Weight	900 Lbs

- Factory Direct Pricing on drop ship orders or factory pickup; FULL PALLETS only; minimum drop ship order is 10 pallets
- All product can be delivered anywhere in the metro area; all deliveries quoted individually for best rate; please call
- Please call for out-state and out-of-state delivery; special delivery quotes available
- Non-stocked product can be obtained quickly with advance notice, subject to factory availability
- 4136833: \$20 refundable pallet deposit on Rochester Concrete pallets; **must have receipt when returning pallets for refund.**
- A \$10.00 split pallet fee will be charged on all less-than-pallet quantities of Rochester Concrete Products.



Slate 24" x 36" Large Rectangle					
Yard Price: \$7.95/SF	SKU	Color	Stock Location	Dimensions	1½" H x 24" W x 36" L
Factory Direct: \$6.93/SF	4553708	Bluestone	Non-Stock	SF/Piece	6
Cream Color	4553753	Cream	Non-Stock	Pieces/Pallet	16
	4553746	Fond du Lac	Non-Stock	SF/Pallet	96
Yard Price: \$9.91/SF	4553722	Western Buff	Non-Stock	Weight/Piece	106 Lbs
Factory Direct: \$8.72/SF				Pallet Weight	1,750 Lbs

Slate 24" x 24" Large Square					
Yard Price: \$7.95/SF	SKU	Color	Stock Location	Dimensions	1½" H x 24" W x 24" L
Factory Direct: \$6.93/SF	3538065	Bluestone	Non-Stock	SF/Piece	4
Cream Color	3716739	Cream	Non-Stock	Pieces/Pallet	24
	3716722	Fond du Lac	Non-Stock	SF/Pallet	96
Yard Price: \$9.91/SF	3538089	Western Buff	Non-Stock	Weight/Piece	77 Lbs
Factory Direct: \$8.72/SF				Pallet Weight	1,890 Lbs

Slate 12" x 24" Rectangle					
Yard Price: \$7.95/SF	SKU	Color	Stock Location	Dimensions	1½" H x 12" W x 24" L
Factory Direct: \$6.93/SF	3538027	Bluestone	Non-Stock	SF/Piece	2
Cream Color	3716715	Cream	Non-Stock	Pieces/Pallet	24
	3716708	Fond du Lac	Non-Stock	SF/Pallet	48
Yard Price: \$9.91/SF	3538041	Western Buff	Non-Stock	Weight/Piece	38 Lbs
Factory Direct: \$8.72/SF				Pallet Weight	960 Lbs

- Factory Direct Pricing on drop ship orders or factory pickup; FULL PALLETS only; minimum drop ship order is 10 pallets
- All product can be delivered anywhere in the metro area; all deliveries quoted individually for best rate; please call
- Please call for out-state and out-of-state delivery; special delivery quotes available
- Non-stocked product can be obtained quickly with advance notice, subject to factory availability
- 4136833: \$20 refundable pallet deposit on Rochester Concrete pallets; **must have receipt when returning pallets for refund.**
- A \$10.00 split pallet fee will be charged on all less-than-pallet quantities of Rochester Concrete Products.

Slate 12" x 12" Small Square

Yard Price: \$7.95/SF Factory Direct: \$6.93/SF	SKU	Color	Stock Location	Dimensions	1½"H x 12"W x 12"L
Cream Color Yard Price: \$9.91/SF Factory Direct: \$8.72/SF	3537839	Bluestone	Non-Stock	SF/Piece	1
	3716692	Cream	Non-Stock	Pieces/Pallet	48
	3716685	Fond du Lac	Non-Stock	SF/Pallet	48
	3537853	Western Buff	Non-Stock	Weight/Piece	19 Lbs
				Pallet Weight	940 Lbs

Slate 14" x 14" Bullnose

Yard Price: \$13.86/SF Factory Direct: \$12.35/SF	SKU	Color	Stock Location	Dimensions	1½"H x 14"W x 14"L
Cream Color Yard Price: \$15.55/SF Factory Direct: \$13.89/SF	3538140	Bluestone	Non-Stock	SF/Piece	1.36
	3716777	Cream	Non-Stock	Pieces/Pallet	24
	3716760	Fond du Lac	Non-Stock	SF/Pallet	32.66
	3538164	Western Buff	Non-Stock	Weight/Piece	25 Lbs
				Pallet Weight	650 Lbs

Silver Creek Stepping Stones







Slate Stepping Stones

Yard Price: \$19.55/Each Factory Direct: \$17.68/Each	SKU	Color	Stock Location	Dimensions	4 Random Shapes
	3736959	Bluestone	Cedar Acres	SF/Piece	Approximately 3.75
	223790	Buff	Cedar Acres	Pieces/Pallet	20 (5 of Each Shape)
	223792	Indiana Limestone	Cedar Acres	SF/Pallet	75
					Pallet Weight

- Factory Direct Pricing on drop ship orders or factory pickup; FULL PALLETS only; minimum drop ship order is 10 pallets
- All product can be delivered anywhere in the metro area; all deliveries quoted individually for best rate; please call
- Please call for out-state and out-of-state delivery; special delivery quotes available
- Non-stocked product can be obtained quickly with advance notice, subject to factory availability
- 4136833: \$20 refundable pallet deposit on Rochester Concrete pallets; **must have receipt when returning pallets for refund.**
- A \$10.00 split pallet fee will be charged on all less-than-pallet quantities of Rochester Concrete Products.

Silver Creek Chiseled Steps

Yard Price: \$162.95 Each Factory Direct: \$145.01 Each	SKU	Color	Stock Location	Dimensions	5.75" x 18" x 48"
Rock Faced 3 Sides—Textured Top				Steps/Pallet	4
 Bluestone	3538621	Bluestone	Non-Stock	Weight/Step	450 Lbs
	224042	Buff	Non-Stock	Pallet Weight	1,850 Lbs
	224044	Indiana Limestone	Non-Stock		
Rock Faced Front Only—Smooth Top					
 Buff	3957040	Bluestone	Non-Stock		
	224038	Buff	Non-Stock		
	224040	Indiana Limestone	Non-Stock		
 Indiana Limestone					

Antique Travertine Steps



Ivory Price Yard Price: \$256.95 Each Factory Direct: \$230.76 Each	SKU	Color	Stock Location	Dimensions	5.75" x 18" x 48"
Natural Price Yard Price: \$199.95 Each Factory Direct: \$178.84 Each	185112	Ivory	Non-Stock	Steps/Pallet	4
	185114	Natural	Non-Stock	Weight/Step	450 Lbs
				Pallet Weight	1,850 Lbs
 Ivory		 Natural			

Barn Plank Steps

Yard Price: \$175.00 Each Factory Direct: \$158.93 Each	SKU	Color	Stock Location	Dimensions	5.75" x 18" x 48"
	185106	Mahogany	Non-Stock	Steps/Pallet	4
	185108	Weathered Gray	Non-Stock	Weight/Step	450 Lbs
				Pallet Weight	1,850 Lbs
 Mahogany	 Weathered Gray				

- Factory Direct Pricing on drop ship orders or factory pickup; FULL PALLETS only; minimum drop ship order is 10 pallets
- All product can be delivered anywhere in the metro area; all deliveries quoted individually for best rate; please call
- Please call for out-state and out-of-state delivery; special delivery quotes available
- Non-stocked product can be obtained quickly with advance notice, subject to factory availability
- 4136833: \$20 refundable pallet deposit on Rochester Concrete pallets; **must have receipt when returning pallets for refund.**
- A \$10.00 split pallet fee will be charged on all less-than-pallet quantities of Rochester Concrete Products.



Grand Step							
 <p>grand step</p>	Yard Price: \$94.45 Each Factory Direct: \$82.24 Each	SKU	Color	Stock Location	Outside Dims	6"H x 18"D x 48"W	
	185116	Beechwood	Cedar Acres	Steps/Pallet	6		
	185120	Buff	Cedar Acres	Weight/Step	410 Lbs		
	224036	Charcoal	Cedar Acres	Pallet Weight	2,500 Lbs		
	185122	Natural	Cedar Acres				
	185124	Santa Fe	Cedar Acres				
Beechwood				Buff			
Charcoal							
Natural				Santa Fe			
				Smooth surfaces on top and three sides. Faces are smooth with beveled face on one side, straight split on the other.			

Stair Stacker Step Unit						
<ul style="list-style-type: none"> Requires 10 Holland Pavers and 1 Half-Holland Paver 						
	Yard Price: \$42.95/Each Factory Direct: \$37.85/Each	SKU	Color	Stock Location	Outside Dims	6½"H x 18"D x 36"W
	3544660	Brown	Non-Stock	Inside Dims	12¾" x 29½"	
	3544684	Buff	Non-Stock	SF/Stacker	4.5	
	3544677	Charcoal	Non-Stock	Stackers/Pallet	8	
	3544691	Natural	Non-Stock	Weight/Stacker	148 Lbs	
					Pallet Weight	1,224 Lbs

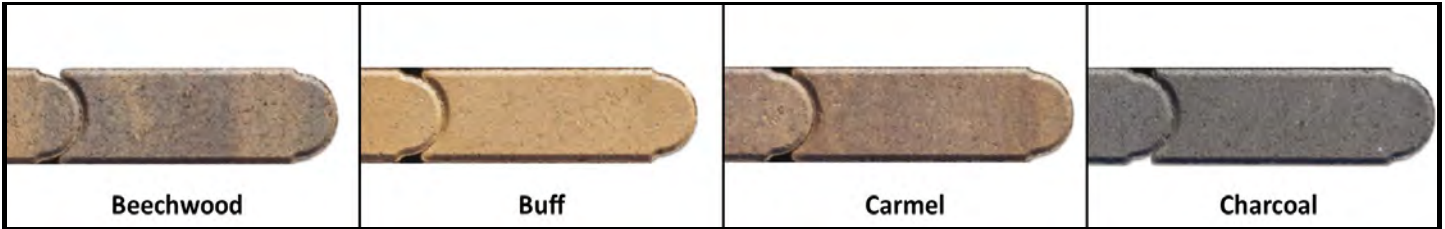

Interlock Bullet Edgers					
Yard Price: \$1.75/Each Factory Direct: \$1.44/Each	SKU	Color	Stock Location	Dimensions	4" x 4" x 12 1/4"
		3735136	Beechwood	Cedar Acres	LF/Piece
3544837		Buff	Cedar Acres	LF/Pallet	168.75
3544813		Carmel	Cedar Acres	Edgers/Pallet	180
3544851		Charcoal	Cedar Acres	Weight/Edger	14 Lbs.
				Pallet Weight	2,560 Lbs.
				14 edgers make a 46" diameter circle	

Rockwood Tumbled Granite Edgers						
Yard Price: \$3.05/Each Factory Direct: \$2.68/Each	SKU	Color	Stock Location	Dimensions	4" x 4" x 12"	
		3735167	Bluestone	Cedar Acres	LF/Piece	1
3735143		Santa Fe	Cedar Acres	LF/Pallet	160	
				Edgers/Pallet	160	
				Weight/Edger	16 Lbs.	
				Pallet Weight	2,600 Lbs.	

- Factory Direct Pricing on drop ship orders or factory pickup; FULL PALLETS only; minimum drop ship order is 10 pallets
- All product can be delivered anywhere in the metro area; all deliveries quoted individually for best rate; please call
- Please call for out-state and out-of-state delivery; special delivery quotes available
- Non-stocked product can be obtained quickly with advance notice, subject to factory availability
- 4136833: \$20 refundable pallet deposit on Rochester Concrete pallets; **must have receipt when returning pallets for refund.**
- A \$10.00 split pallet fee will be charged on all less-than-pallet quantities of Rochester Concrete Products.



2¼" Silver Creek Pillar Caps—Chiseled Edges					
2¼" x 25" x 25" Yard Price: \$11.95 Each Factory Direct: \$99.46 Each	SKU	Color	Stock Location	Dimensions	2¼" H x 25" W x 25" L
	2¼" x 25" x 25"			Caps/Pallet	6
	3716920	Bluestone	Non-Stock	Weight/Cap	110 Lbs
	185172	Buff	Non-Stock	Pallet Weight	700 Lbs
	3538713	Indiana Limestone	Non-Stock		
2¼" x 30" x 30" Yard Price: \$146.95 Each Factory Direct: \$131.44 Each	SKU	Color	Stock Location	Dimensions	2¼" H x 30" W x 30" L
	2¼" x 30" x 30"			Caps/Pallet	6
	3716937	Bluestone	Non-Stock	Weight/Cap	125 Lbs
	185174	Buff	Non-Stock	Pallet Weight	800 Lbs
	3538744	Indiana Limestone	Non-Stock		

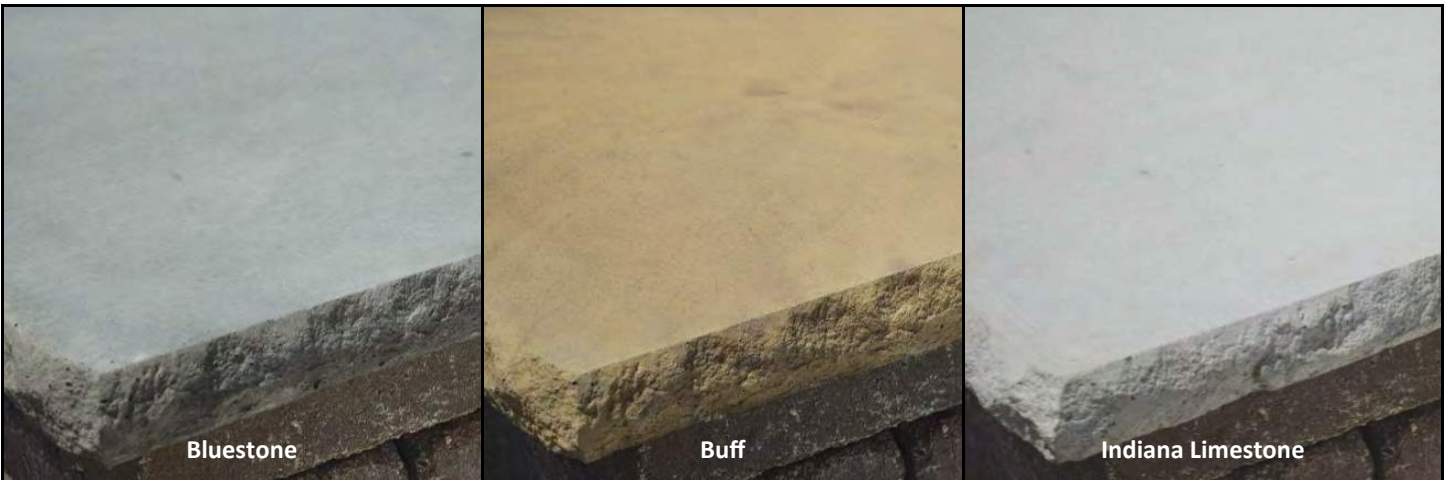

- Factory Direct Pricing on drop ship orders or factory pickup; FULL PALLETS only; minimum drop ship order is 10 pallets
- All product can be delivered anywhere in the metro area; all deliveries quoted individually for best rate; please call
- Please call for out-state and out-of-state delivery; special delivery quotes available
- Non-stocked product can be obtained quickly with advance notice, subject to factory availability
- 4136833: \$20 refundable pallet deposit on Rochester Concrete pallets; **must have receipt when returning pallets for refund.**
- A \$10.00 split pallet fee will be charged on all less-than-pallet quantities of Rochester Concrete Products.



2¼" Silver Creek Seat Wall Caps—Chiseled Edges

2 Sided 12"		SKU	Color	Stock Location	Dimensions	2¼"H x 12"D x 24"L
Yard Price: \$24.10/Each Factory Direct: \$20.94/Each	2 Sided 12"				Caps/Pallet	15
	163262	Bluestone	Non-Stock	Weight/Cap	53 Lbs	
	185228	Buff	Non-Stock	Pallet Weight	835 Lbs	
	116440	Indiana Limestone	Non-Stock			
3 Sided 12"		SKU	Color	Stock Location	Dimensions	2¼"H x 12"D x 24"L
Yard Price: \$27.90/Each Factory Direct: \$24.40/Each	3 Sided 12"				Caps/Pallet	15
	185230	Bluestone	Non-Stock	Weight/Cap	53 Lbs	
	185234	Buff	Non-Stock	Pallet Weight	835 Lbs	
	116442	Indiana Limestone	Non-Stock			
8' Radius 12"		SKU	Color	Stock Location	Dimensions	2¼"H x 12"D x 18¾"L
Yard Price: \$24.10/Each Factory Direct: \$20.94/Each	Radius 12"				Caps/Pallet	15
	185236	Bluestone	Non-Stock	Weight/Cap	39 Lbs	
	185238	Buff	Non-Stock	Pallet Weight	625 Lbs	
	116444	Indiana Limestone	Non-Stock			

- Factory Direct Pricing on drop ship orders or factory pickup; FULL PALLETS only; minimum drop ship order is 10 pallets
- All product can be delivered anywhere in the metro area; all deliveries quoted individually for best rate; please call
- Please call for out-state and out-of-state delivery; special delivery quotes available
- Non-stocked product can be obtained quickly with advance notice, subject to factory availability
- 4136833: \$20 refundable pallet deposit on Rochester Concrete pallets; **must have receipt when returning pallets for refund.**
- A \$10.00 split pallet fee will be charged on all less-than-pallet quantities of Rochester Concrete Products.



Mahogany

Weathered Gray

Barn Plank Wall

	SKU	Color	Stock Location	Dimensions	6"H x 8"D x 40"L	
	185250	Mahogany	Non-Stock	SF/Block	1.66	
	185254	Weathered Gray	Non-Stock	SF/Pallet	26.56	
	Yard Price:			\$49.25 Each	Blocks/Pallet	16
				\$29.67/SqFt	Weight/Block	162 Lbs
	Factory Direct Price:			\$44.42 Each	Pallet Weight	2,650 Lbs
				\$26.76/SqFt	Soft radius 90° corners on all sides	



Ivory

Travertine Wall

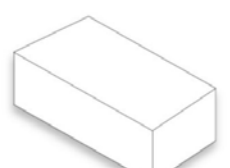

	SKU	Color	Stock Location	Dimensions	6"H x 9"D x 18"L (Front) 6"H x 9"D x 16½"L (Back)	
	185246	Ivory	Non-Stock	SF/Block	.75	
	Yard Price:			\$22.65 Each	SF/Pallet	15
				\$30.20/SqFt	Blocks/Pallet	20
	Factory Direct Price:			\$20.01 Each	Weight/Block	80 Lbs
				\$26.68/SqFt	Pallet Weight	1,650 Lbs
	Soft radius on all sides			Builds an 8' radius wall without cutting		

- Factory Direct Pricing on drop ship orders or factory pickup; FULL PALLETS only; minimum drop ship order is 10 pallets
- All product can be delivered anywhere in the metro area; all deliveries quoted individually for best rate; please call
- Please call for out-state and out-of-state delivery; special delivery quotes available
- Non-stocked product can be obtained quickly with advance notice, subject to factory availability
- 4136833: \$20 refundable pallet deposit on Rochester Concrete pallets; **must have receipt when returning pallets for refund.**
- A \$10.00 split pallet fee will be charged on all less-than-pallet quantities of Rochester Concrete Products.





6" Classic Split Retaining Wall					
 Bluestone	SKU	Color	Stock Location	Dimensions	6" H x 18" W x 12" D
	Beveled			SF/Block	.75
	3547326	Bluestone	Non-Stock	SF/Pallet	27
	3547333	Charcoal	Non-Stock	Blocks/Pallet	36
 Charcoal	3547364	Gray	Non-Stock	Weight/Block	60 Lbs
	3547340	Sandstone	Non-Stock	Pallet Weight	2,210 Lbs
	3547302	Sandstone/Brown	Non-Stock		
	3547296	Santa Fe	Non-Stock		
 Gray	SKU	Color	Stock Location	Dimensions	6" H x 18" W x 12" D
	Straight			SF/Block	.75
 Sandstone	3547401	Bluestone	Non-Stock	SF/Pallet	27
	3547418	Charcoal	Non-Stock	Blocks/Pallet	36
	3547449	Gray	Non-Stock	Weight/Block	64 Lbs
	3547425	Sandstone	Non-Stock	Pallet Weight	2,350 Lbs
 Sandstone/Brown	3547388	Sandstone/Brown	Non-Stock		
	3547371	Santa Fe	Non-Stock		
 Santa Fe	Yard Price: \$7.95 Each \$10.60/SqFt				
	Factory Direct Price: \$6.79 Each \$9.05/SqFt				

- Factory Direct Pricing on drop ship orders or factory pickup; FULL PALLETS only; minimum drop ship order is 10 pallets
- All product can be delivered anywhere in the metro area; all deliveries quoted individually for best rate; please call
- Please call for out-state and out-of-state delivery; special delivery quotes available
- Non-stocked product can be obtained quickly with advance notice, subject to factory availability
- 4136833: \$20 refundable pallet deposit on Rochester Concrete pallets; **must have receipt when returning pallets for refund.**
- A \$10.00 split pallet fee will be charged on all less-than-pallet quantities of Rochester Concrete Products.

6" Classic Split Half Block					
Bluestone	SKU	Color	Stock Location	Dimensions	6"H x 9"W x 12"D
	Beveled			SF/Block	.375
	3547487	Bluestone	Non-Stock	SF/Pallet	4.5
Charcoal	3547494	Charcoal	Non-Stock	Blocks/Pallet	12
	3547524	Gray	Non-Stock	Weight/Block	30 Lbs
	3547500	Sandstone	Non-Stock	Pallet Weight	400 Lbs
Gray	3547463	Sandstone/Brown	Non-Stock		
	3547456	Santa Fe	Non-Stock		
	SKU	Color	Stock Location	Dimensions	6"H x 9"W x 12"D
Straight			SF/Block	.375	
Sandstone	3547562	Bluestone	Non-Stock	SF/Pallet	4.5
	3547579	Charcoal	Non-Stock	Blocks/Pallet	12
	3547609	Gray	Non-Stock	Weight/Block	30 Lbs
Sandstone/Brown	3547586	Sandstone	Non-Stock	Pallet Weight	400 Lbs
	3547548	Sandstone/Brown	Non-Stock		
	3547531	Santa Fe	Non-Stock		
Santa Fe	Yard Price: \$12.20 Each \$32.53/SqFt				
	Factory Direct Price: \$10.68 Each \$28.48 /SqFt				

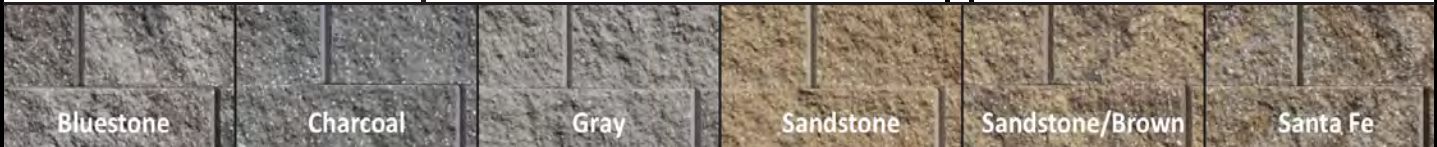
- Factory Direct Pricing on drop ship orders or factory pickup; FULL PALLETS only; minimum drop ship order is 10 pallets
- All product can be delivered anywhere in the metro area; all deliveries quoted individually for best rate; please call
- Please call for out-state and out-of-state delivery; special delivery quotes available
- Non-stocked product can be obtained quickly with advance notice, subject to factory availability
- 4136833: \$20 refundable pallet deposit on Rochester Concrete pallets; **must have receipt when returning pallets for refund.**
- A \$10.00 split pallet fee will be charged on all less-than-pallet quantities of Rochester Concrete Products.

6" Classic Corner Block					
Yard Price: \$13.85 Each	SKU	Color	Stock Location	Dimensions	6"H x 13"W x 5½"D
	3547647	Bluestone	Non-Stock	SF/Block	.77 (Combined Faces)
Factory Direct Price: \$12.22 Each	3547654	Charcoal	Non-Stock	SF/Pallet	9.24 (Combined Faces)
	3547685	Gray	Non-Stock	Blocks/Pallet	12
	3547661	Sandstone	Non-Stock	Weight/Block	32 Lbs
	3547623	Sandstone/Brown	Non-Stock	Pallet Weight	430 Lbs
	3547616	Santa Fe	Non-Stock		
					

6" Classic Big Step					
Yard Price: \$18.85 Each	SKU	Color	Stock Location	Dimensions	6"H x 16"W x 16"D
	3547722	Bluestone	Non-Stock	SF/Block	.67
Factory Direct Price: \$15.82 Each	3547739	Charcoal	Non-Stock	SF/Pallet	16
	3547760	Gray	Non-Stock	Blocks/Pallet	24
	3547746	Sandstone	Non-Stock	Weight/Block	123 Lbs
	3547708	Sandstone/Brown	Non-Stock	Pallet Weight	2,952 Lbs
	3547692	Santa Fe	Non-Stock		
					

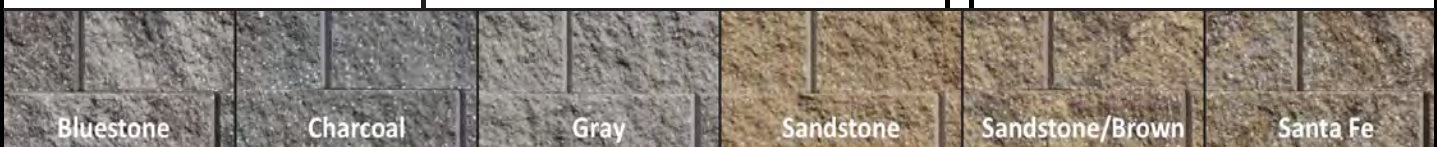
Classic Universal Cap					
Yard Price: \$8.90 Each	SKU	Color	Stock Location	Dimensions	F: 4"H x 18"W x 10½"D B: 4"H x 14"W x 10½"D
	3546978	Bluestone	Non-Stock	LF/Block	1.33 (Average)
Factory Direct Price: \$7.64 Each	3546985	Charcoal	Non-Stock	LF/Pallet	48 (Average)
	3547029	Gray	Non-Stock	Blocks/Pallet	36
	3546992	Sandstone	Non-Stock	Weight/Block	54 Lbs
	3547012	Sandstone/Brown	Non-Stock	Pallet Weight	1,984 Lbs
	3546954	Santa Fe	Non-Stock		
					



8" Classic Chiseled Wall					
Bluestone	SKU	Color	Stock Location	Dimensions	8" H x 18" W x 12" D
	120636	Bluestone	Non-Stock	SF/Block	1
	224180	Gray	Non-Stock	SF/Pallet	24
Gray	4359232	Santa Fe	Non-Stock	Blocks/Pallet	24
	Yard Price: \$13.30 Each \$13.30/SqFt			Weight/Block	80 Lbs
	Factory Direct Price: \$11.46 Each \$11.46/SqFt			Pallet Weight	1,960 Lbs
Santa Fe					





8" Classic Chiseled Corner Block					
Bluestone	SKU	Color	Stock Location	Dimensions	8" H x 13" W x 5½" D
	120640	Bluestone	Non-Stock	SF/Block	.77 (Combined Faces)
	224182	Gray	Non-Stock	SF/Pallet	9.24 (Combined Faces)
Gray	4359249	Santa Fe	Non-Stock	Blocks/Pallet	12
	Yard Price: \$22.70 Each			Weight/Block	40 Lbs
	Factory Direct Price: \$20.06 Each			Pallet Weight	520 Lbs
Santa Fe					

- Factory Direct Pricing on drop ship orders or factory pickup; FULL PALLETS only; minimum drop ship order is 10 pallets
- All product can be delivered anywhere in the metro area; all deliveries quoted individually for best rate; please call
- Please call for out-state and out-of-state delivery; special delivery quotes available
- Non-stocked product can be obtained quickly with advance notice, subject to factory availability
- 4136833: \$20 refundable pallet deposit on Rochester Concrete pallets; **must have receipt when returning pallets for refund.**
- A \$10.00 split pallet fee will be charged on all less-than-pallet quantities of Rochester Concrete Products.



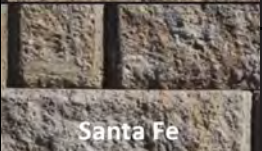

6" Classic Colonial Retaining Wall





6" Classic Colonial Retaining Wall—Standard Block



				Dimensions	6" H x 18" W x 12" D
 Bluestone	SKU	Color	Stock Location	SF/Block	.75
	3547951	Bluestone	Non-Stock	SF/Pallet	27
	3547937	Sandstone/Brown	Non-Stock	Blocks/Pallet	36
 Sandstone/Brown	3547920	Santa Fe	Non-Stock	Weight/Block	60 Lbs
	Yard Price: \$10.65 Each \$14.20/SqFt			Pallet Weight	2,200 Lbs
 Santa Fe	Factory Direct Price: \$9.24 Each \$12.32/SqFt				





6" Classic Colonial Retaining Wall—6 / 12 Block

				Dimensions	6" H x 18" W x 12" D
 Bluestone	SKU	Color	Stock Location	SF/Block	.75
	3547999	Bluestone	Non-Stock	SF/Pallet	27
	3547975	Sandstone/Brown	Non-Stock	Blocks/Pallet	36
 Sandstone/Brown	3547968	Santa Fe	Non-Stock	Weight/Block	60 Lbs
	Yard Price: \$10.65 Each \$14.20/SqFt			Pallet Weight	2,200 Lbs
 Santa Fe	Factory Direct Price: \$9.24 Each \$12.32/SqFt				

- Factory Direct Pricing on drop ship orders or factory pickup; FULL PALLETS only; minimum drop ship order is 10 pallets
- All product can be delivered anywhere in the metro area; all deliveries quoted individually for best rate; please call
- Please call for out-state and out-of-state delivery; special delivery quotes available
- Non-stocked product can be obtained quickly with advance notice, subject to factory availability
- 4136833: \$20 refundable pallet deposit on Rochester Concrete pallets; **must have receipt when returning pallets for refund.**
- A \$10.00 split pallet fee will be charged on all less-than-pallet quantities of Rochester Concrete Products.

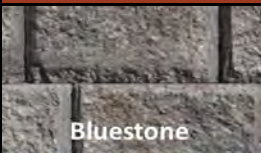
6" Classic Colonial Retaining Wall—Half Block					
	SKU	Color	Stock Location	Dimensions	6"H x 9"W x 12"D
	3548033	Bluestone	Non-Stock	SF/Block	.375
	3548019	Sandstone/Brown	Non-Stock	SF/Pallet	4.5
	3548002	Santa Fe	Non-Stock	Blocks/Pallet	12
	Yard Price: \$14.55 Each \$38.80/SqFt			Weight/Block	30 Lbs
	Factory Direct Price: \$12.85 Each \$34.27/SqFt			Pallet Weight	400 Lbs

6" Classic Colonial Retaining Wall—Corner Block					
	SKU	Color	Stock Location	Dimensions	6"H x 13"W x 5½"D
	3548071	Bluestone	Non-Stock	SF/Block	.77 (Combined Faces)
	3548057	Sandstone/Brown	Non-Stock	SF/Pallet	9.24 (Combined Faces)
	3548040	Santa Fe	Non-Stock	Blocks/Pallet	12
	Yard Price: \$16.70 Each			Weight/Block	32 Lbs
	Factory Direct Price: \$14.72 Each			Pallet Weight	430 Lbs

4" Universal Tapered Cap					
	SKU	Color	Stock Location	Dimensions	F: 4"H x 18"W x 10½"D B: 4"H x 14"W x 10½"D
	3546978	Bluestone	Non-Stock	LF/Block	1.33 (Average)
	3547012	Sandstone/Brown	Non-Stock	LF/Pallet	48 (Average)
	3546954	Santa Fe	Non-Stock	Blocks/Pallet	36
	Yard Price: \$8.90 Each			Weight/Block	54 Lbs
	Factory Direct Price: \$7.64 Each			Pallet Weight	1,984 Lbs
					

- Factory Direct Pricing on drop ship orders or factory pickup; FULL PALLETS only; minimum drop ship order is 10 pallets
- All product can be delivered anywhere in the metro area; all deliveries quoted individually for best rate; please call
- Please call for out-state and out-of-state delivery; special delivery quotes available
- Non-stocked product can be obtained quickly with advance notice, subject to factory availability
- 4136833: \$20 refundable pallet deposit on Rochester Concrete pallets; **must have receipt when returning pallets for refund.**
- A \$10.00 split pallet fee will be charged on all less-than-pallet quantities of Rochester Concrete Products.



Lakeland Freestanding Wall—4" Large Block					
Beechwood	SKU	Color	Stock Location	Dimensions	4"H x 12"W x 8"D
	54642	Beechwood	Cedar Acres	SF/Block	.33 (Main Face)
Bluestone	3547081	Bluestone	Cedar Acres	SF/Pallet	26
	3547067	Desert	Cedar Acres	Blocks/Pallet	80
Desert	185282	Onyx	Cedar Acres	Weight/Block	31 Lbs
	3547050	Santa Fe	Cedar Acres	Pallet Weight	2,530 Lbs
Onyx	Yard Price: \$4.20 Each				
Santa Fe	Factory Direct Price: \$3.63 Each				

Lakeland Freestanding Wall—4" Small/Medium Set					
Beechwood	SKU	Color	Stock Location	Dimensions	Small: 4"H x 4"W x 8"D Medium: 4"H x 8"W x 8"D
	54644	Beechwood	Cedar Acres	SF/Set	.33 (Main Faces Combined)
Bluestone	3547135	Bluestone	Cedar Acres	SF/Pallet	26
	3547111	Desert	Cedar Acres	Blocks/Pallet	160 (80 Small & 80 Medium)
Desert	3547104	Santa Fe	Cedar Acres	Weight/Block	10 Lbs (Small) & 21 Lbs (Medium)
	Yard Price: \$5.05/Set			Pallet Weight	2,530 Lbs
Onyx	Factory Direct Price: \$4.39/Set				
Santa Fe					

- Factory Direct Pricing on drop ship orders or factory pickup; FULL PALLETS only; minimum drop ship order is 10 pallets
- All product can be delivered anywhere in the metro area; all deliveries quoted individually for best rate; please call
- Please call for out-state and out-of-state delivery; special delivery quotes available
- Non-stocked product can be obtained quickly with advance notice, subject to factory availability
- 4136833: \$20 refundable pallet deposit on Rochester Concrete pallets; **must have receipt when returning pallets for refund.**
- A \$10.00 split pallet fee will be charged on all less-than-pallet quantities of Rochester Concrete Products.



Lakeland Smooth Freestanding Wall—4" Large Block

	SKU	Color	Stock Location	Dimensions	4"H x 12"W x 8"D
Beechwood	185284	Beechwood	Non-Stock	SF/Block	.33 (Main Face)
	185286	Bluestone	Non-Stock	SF/Pallet	26
Bluestone	185288	Desert	Non-Stock	Blocks/Pallet	80
	120778	Onyx	Cedar Acres	Weight/Block	31 Lbs
Desert	185290	Santa Fe	Non-Stock	Pallet Weight	2,530 Lbs
	Yard Price: \$3.95 Each				
Onyx	Factory Direct Price: \$2.90 Each				
Santa Fe					

- Factory Direct Pricing on drop ship orders or factory pickup; FULL PALLETS only; minimum drop ship order is 10 pallets
- All product can be delivered anywhere in the metro area; all deliveries quoted individually for best rate; please call
- Please call for out-state and out-of-state delivery; special delivery quotes available
- Non-stocked product can be obtained quickly with advance notice, subject to factory availability
- 4136833: \$20 refundable pallet deposit on Rochester Concrete pallets; **must have receipt when returning pallets for refund.**
- A \$10.00 split pallet fee will be charged on all less-than-pallet quantities of Rochester Concrete Products.



Riverland Freestanding Wall & Granite Wall Accent

Riverland Freestanding Wall—4" 3-Piece Set—Tapered for Curves					
Color	SKU	Color	Stock Location	Dimensions	Small: 4"H x 4"W x 8"D Medium: 4"H x 8"W x 8"D Large: 4"H x 16"W x 8"D
Beechwood	120314	Beechwood	Cedar Acres	SF/Set 1 SF/Pallet 30 Sets/Pallet 30 Weight/Set 90 Lbs Pallet Weight 2,750 Lbs	
Bluestone	3547234	Bluestone	Cedar Acres		
Bluestone	3547210	Desert	Cedar Acres		
Desert	210836	Onyx	Non-Stock		
Desert	3547203	Santa Fe	Cedar Acres		
Onyx	Yard Price: \$14.85/Set \$14.85/SF				
Santa Fe	Factory Direct Price: \$12.96/Set \$12.96/SF				

Riverland Smooth Freestanding Wall—4" 3-Piece Set—Tapered for Curves					
Color	SKU	Color	Stock Location	Dimensions	Small: 4"H x 4"W x 8"D Medium: 4"H x 8"W x 8"D Large: 4"H x 16"W x 8"D
Beechwood	185294	Beechwood	Non-Stock	SF/Set 1 SF/Pallet 20 Sets/Pallet 20 Weight/Set 90 Lbs Pallet Weight 1,825 Lbs	
Bluestone	185296	Bluestone	Non-Stock		
Bluestone	185298	Desert	Non-Stock		
Desert	185300	Santa Fe	Non-Stock		
Desert	Yard Price: \$12.50/Set \$12.50/SF				
Onyx	Factory Direct Price: \$10.72/Set \$10.72/SF				
Santa Fe					

3" Riverland Smooth Cap					
Color	SKU	Color	Stock Location	Dimensions	3"H x 15"W x 11"D
Beechwood	148692	Beechwood	Non-Stock	LF/Cap 1.25 LF/Pallet 56.25 Blocks/Pallet 45 Weight/Block 36 Lbs Pallet Weight 1,670 Lbs	
	148694	Santa Fe	Non-Stock		
Yard Price: \$6.35 Each					
Factory Direct Price: \$6.64 Each					
Santa Fe					

Granite Wall Accent					
Color	SKU	Color	Stock Location	Dimensions	4"H x 8"W x 4"D
	147940	Brown	Non-Stock	SF/Block .22 (Main Face) SF/Pallet 70.4 Blocks/Pallet 320 Weight/Block 6.75 Lbs Pallet Weight 2,130 Lbs	
	147942	Buff	Non-Stock		
	116418	Onyx	Non-Stock		
	Yard Price: \$3.55 Each				
Factory Direct Price: \$3.01 Each					



Say hello to Premier 8.™

Premier 8™ has one of the strongest block-to-grid connections in the SRW industry. Its gravel filled cores create vertical “stone columns” to create a multi-point interlock for a more uniform block-to-grid connection. This unique and patented block design is changing the SRW industry – its 54 lb. unit weight beats all other block systems for strength, performance, freight efficiencies and ease of construction.

- 18" W x 12" D x 8" H
- 54 lbs. (approx. 860 sq. ft./load)
- Superior grid pull testing
- Lightweight, easy-to-handle and build
- Straight split-face



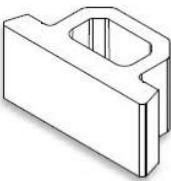

Without cumbersome pins and clips, Premier 8 builds incredibly fast. Each unit's bottom anchor bar creates an automatic 1" setback.



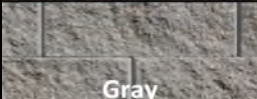

Premier 8					
	SKU	Color	Stock Location	Dimensions	
	148012	Special Order	Made to Order	8"H x 18"W x 12"D	
	Factory Direct Price: Call for Quote			SF/Block	1
	Set up fees and minimum quantities apply			SF/Pallet	36
				Blocks/Pallet	36
			Weight/Block	54 Lbs	
			Pallet Weight	1,994 Lbs	

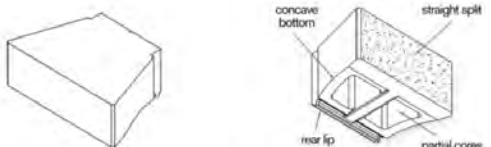
- Factory Direct Pricing on drop ship orders or factory pickup; FULL PALLETS only; minimum drop ship order is 10 pallets
- All product can be delivered anywhere in the metro area; all deliveries quoted individually for best rate; please call
- Please call for out-state and out-of-state delivery; special delivery quotes available
- Non-stocked product can be obtained quickly with advance notice, subject to factory availability
- 4136833: \$20 refundable pallet deposit on Rochester Concrete pallets; **must have receipt when returning pallets for refund.**
- A \$10.00 split pallet fee will be charged on all less-than-pallet quantities of Rochester Concrete Products.



6" Sapphire Wall					
	SKU	Color	Stock Location	Dimensions	6"H x 17 1/4"W x 12"D
	148012	Beechwood	Non-Stock	SF/Block	.75
	152214	Gray	Non-Stock	SF/Pallet	33.75
	148014	Sandstone	Non-Stock	Blocks/Pallet	45
	148016	Santa Fe	Non-Stock	Weight/Block	68 Lbs
	Yard Price: \$4.90 Each			Pallet Weight	3,100 Lbs
	Factory Direct Price: \$6.53/SqFt				
	Factory Direct Price: \$4.01 Each				
	Factory Direct Price: \$5.35 /SqFt				

3" Split Cap					
	SKU	Color	Stock Location	Dimensions	3"H x 12"W x 12"D
	148684	Beechwood	Non-Stock	LF/Cap	1
	148686	Bluestone	Non-Stock	LF/Pallet	48
	148688	Desert Buff	Non-Stock	Caps/Layer	12
	152246	Gray	Non-Stock	Layers/Pallet	4
	167846	Sandstone	Non-Stock	Caps/Pallet	48
	148690	Santa Fe	Non-Stock	Weight/Cap	26 Lbs
	Yard Price: \$5.35 Each			Pallet Weight	1,298 Lbs
		Factory Direct Price: \$4.67 Each			
					

- Factory Direct Pricing on drop ship orders or factory pickup; FULL PALLETS only; minimum drop ship order is 10 pallets
- All product can be delivered anywhere in the metro area; all deliveries quoted individually for best rate; please call
- Please call for out-state and out-of-state delivery; special delivery quotes available
- Non-stocked product can be obtained quickly with advance notice, subject to factory availability
- 4136833: \$20 refundable pallet deposit on Rochester Concrete pallets; **must have receipt when returning pallets for refund.**
- A \$10.00 split pallet fee will be charged on all less-than-pallet quantities of Rochester Concrete Products.



6" Vintage Wall—3 Piece Set

	SKU	Color	Stock Location	Dimensions	S: 6"H x 6"W (F) / 6"W (B) x 10"D M: 6"H x 12"W (F) / 10"W (B) x 10"D L: 6"H x 18"W (F) / 16"W (B) x 10"D
Beechwood	116420	Beechwood	Cedar Acres	SF/Set 1.5 (Front) & 1.33 (Back) SF/Pallet 30 Blocks/Pallet 60 (20 Sets) Weight/Set 140 Pallet Weight 2,800 Lbs	
	148000	Bluestone	Non-Stock		
Bluestone	148002	Desert Buff	Non-Stock		
	116422	Santa Fe	Cedar Acres		
Desert Buff	Yard Price: \$20.85/Set \$13.90/SqFt				
	Factory Direct Price: \$18.15/Set \$12.10/SqFt				
Santa Fe					

6" Vintage Wall—Corner/Pillar Block

	SKU	Color	Stock Location	Dimensions	6"H x 12"W x 9"D
Beechwood	116424	Beechwood	Cedar Acres	SF/Block .875 (Combined Sides) SF/Pallet 15 (Combined Sides) Blocks/Pallet 30 Weight/Block 48 Lbs Pallet Weight 1,500 Lbs	
	148004	Bluestone	Non-Stock		
Bluestone	148006	Desert Buff	Non-Stock		
	116426	Santa Fe	Cedar Acres		
Desert Buff	Yard Price: \$16.95 Each				
	Factory Direct Price: \$14.88 Each				
Santa Fe					

- Factory Direct Pricing on drop ship orders or factory pickup; FULL PALLETS only; minimum drop ship order is 10 pallets
- All product can be delivered anywhere in the metro area; all deliveries quoted individually for best rate; please call
- Please call for out-state and out-of-state delivery; special delivery quotes available
- Non-stocked product can be obtained quickly with advance notice, subject to factory availability
- 4136833: \$20 refundable pallet deposit on Rochester Concrete pallets; **must have receipt when returning pallets for refund.**
- A \$10.00 split pallet fee will be charged on all less-than-pallet quantities of Rochester Concrete Products.

6" Vintage Wall End—2 Piece Set					
Beechwood	SKU	Color	Stock Location	Dimensions	S: 6"H x 6"W x 10"D M: 6"H x 12"W x 10"D
	116428	Beechwood	Cedar Acres		SF/Set
Bluestone	148008	Bluestone	Non-Stock	SF/Pallet	6 (Front Faces Combined)
	148010	Desert Buff	Non-Stock	Blocks/Pallet	16 (8 Small & 8 Medium)
	116430	Santa Fe	Cedar Acres	Weight/Block	27 Lbs (Small) & 54 Lbs (Medium)
Desert Buff	Yard Price:		\$18.65 Set	Pallet Weight	700 Lbs
	Factory Direct Price:		\$16.44/Set		
Santa Fe					

Vintage Seat Wall Cap					
Bluestone	SKU	Color	Stock Location	Dimensions	4"H x 13"W x 11½"D
	3716661	Bluestone	Non-Stock	LF/Cap	1.08
	3585861	Desert	Cedar Acres	LF/Pallet	52
Desert	3585854	Santa Fe	Cedar Acres	Caps/Pallet	48
	Yard Price:		\$14.05 Each	Weight/Cap	47 Lbs
Santa Fe	Factory Direct Price:		\$12.53 Each	Pallet Weight	2,300 Lbs
					

3" Split Cap					
Beechwood	SKU	Color	Stock Location	Dimensions	3"H x 12"W x 12"D
	148684	Beechwood		LF/Cap	1
Bluestone	148686	Bluestone		LF/Pallet	48
	148688	Desert Buff		Caps/Layer	12
Desert Buff	152246	Gray	Non-Stock	Layers/Pallet	4
	167846	Sandstone	Non-Stock	Caps/Pallet	48
Gray	148690	Santa Fe	Non-Stock	Weight/Cap	26 Lbs
	Yard Price:		\$5.35 Each	Pallet Weight	1,300 Lbs
Sandstone					
Santa Fe	Factory Direct Price:		\$4.67 Each		

- Factory Direct Pricing on drop ship orders or factory pickup; FULL PALLETS only; minimum drop ship order is 10 pallets
- All product can be delivered anywhere in the metro area; all deliveries quoted individually for best rate; please call
- Please call for out-state and out-of-state delivery; special delivery quotes available
- Non-stocked product can be obtained quickly with advance notice, subject to factory availability
- 4136833: \$20 refundable pallet deposit on Rochester Concrete pallets; **must have receipt when returning pallets for refund.**
- A \$10.00 split pallet fee will be charged on all less-than-pallet quantities of Rochester Concrete Products.

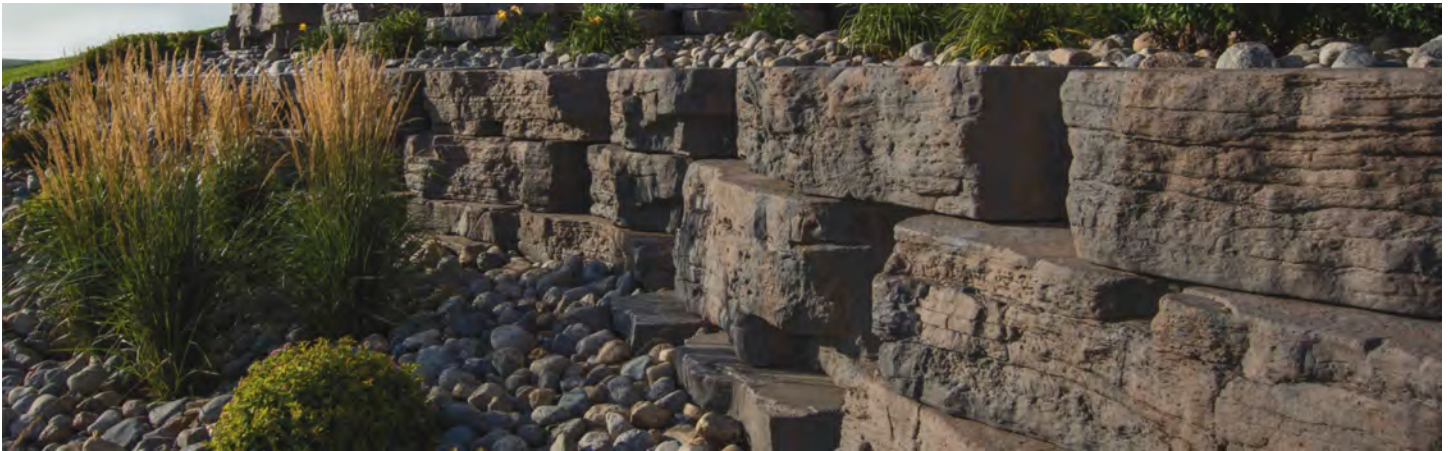

Rosetta Outcropping Wall Pallet A—Sold in Full Pallets Only

	SKU	Color	Stock Location		
Copper Canyon	4173531	Copper Canyon	Non-Stock	Dimensions Stone 1: 1'H x 3½'W Stone 2: 1'H x 4'W Stone 3: 1'H x 5'W Stone 4: 1'H x 5½'W	Stones/Pallet 4 (1 of Each)
	4173548	Fond du Lac	Non-Stock		
	4173562	Pacific Gray	Non-Stock		
Yard Price: \$39.35/SqFt \$708.30/Pal			SF/Pallet 18		
Fond du Lac	Factory Direct Price: \$36.06/SqFt \$649.08/Pal			Pallet Weight 4,000 Lbs.	
Pacific Gray					

Rosetta Outcropping Wall Pallet B—Sold in Full Pallets Only

	SKU	Color	Stock Location		
Copper Canyon	4173579	Copper Canyon	Non-Stock	Dimensions Stone 1: ½'H x 2'W Stone 2: ½'H x 3'W Stone 3: ½'H x 4'W Stone 4: 1'H x 3'W Stone 5: 1'H x 4½'W Stone 6: 1'H x 6'W	Stones/Pallet 6 (1 of Each)
	4173593	Fond du Lac	Non-Stock		
	4173609	Pacific Gray	Non-Stock		
Yard Price: \$39.35/SqFt \$708.30/Pal			SF/Pallet 18		
Fond du Lac	Factory Direct Price: \$36.06/SqFt \$649.08/Pal			Pallet Weight 4,000 Lbs.	
Pacific Gray					

- Factory Direct Pricing on drop ship orders or factory pickup; FULL PALLETS only; minimum drop ship order is 10 pallets
- All product can be delivered anywhere in the metro area; all deliveries quoted individually for best rate; please call
- Please call for out-state and out-of-state delivery; special delivery quotes available
- Non-stocked product can be obtained quickly with advance notice, subject to factory availability
- 4136833: \$20 refundable pallet deposit on Rochester Concrete pallets; **must have receipt when returning pallets for refund.**
- A \$10.00 split pallet fee will be charged on all less-than-pallet quantities of Rochester Concrete Products.

Rosetta Outcropping Wall Pallet C—Sold in Full Pallets Only

SKU	Color	Stock Location	Dimensions	Stone 1: ½'H x 2'W Stone 2: ½'H x 3'W Stone 3: 2'H x 4'W Stone 4: 1½'H x 5'W
4173616	Copper Canyon	Non-Stock		
4173630	Fond du Lac	Non-Stock		
4173647	Pacific Gray	Non-Stock		
Yard Price: \$39.35/SqFt \$708.30/Pal			Stones/Pallet	4 (1 of Each)
Factory Direct Price: \$36.06/SqFt \$649.08/Pal			SF/Pallet	18
			Pallet Weight	4,000 Lbs.
				



Rosetta Outcropping Corner Block Pallet—Sold in Full Pallets Only

SKU	Color	Stock Location	Dimensions	4 Sided Corner Approximately 1'H x 4'W
4173487	Copper Canyon	Non-Stock		
4173500	Fond du Lac	Non-Stock		
4173524	Pacific Gray	Non-Stock		
Yard Price: \$39.35/SqFt \$767.33/Pal			Stones/Pallet	3
Factory Direct Price: \$36.06/SqFt \$703.17/Pal			SF/Pallet	19.5
			Pallet Weight	3,650 Lbs.
				

Rosetta Irregular Steps—Sold in Full Pallets Only

SKU	Color	Stock Location	Dimensions	Step A: 7"H x 4½' x 1'10" Step B: 7"H x 5' x 2' Step C: 7"H x 3½' x 1'5" Step D: 7"H x 4' x 2'4" Step E: 7"H x 3½' x 2'4" Step F: 7"H x 4' x 2'
4173432	Copper Canyon	Non-Stock		
4173456	Fond du Lac	Non-Stock		
4173463	Pacific Gray	Non-Stock		
Yard Price: \$899.70/Pal			Stones/Pallet	6 (1 of Each)
Factory Direct Price: \$824.82/Pal			Weight/Unit	495
			Pallet Weight	3,000 Lbs.
				

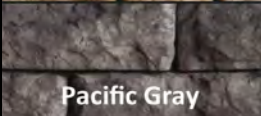

Rosetta Belvedere Wall Stone—Sold in Full Pallets Only					
 <p>Copper Canyon</p>	SKU	Color	Stock Location	<p>Dimensions</p> <p>Block 1: 3”H x 6”/4”W x 9”D Block 2: 3”H x 12”/10”W x 9”D Block 3: 3”H x 18”/16”W x 9”D Block 4: 6”H x 6”/4”W x 9”D Block 5: 6”H x 12”/10”W x 9”D Block 6: 6”H x 18”/16”W x 9”D</p>	<p>Block 1: 3”H x 6”/4”W x 9”D Block 2: 3”H x 12”/10”W x 9”D Block 3: 3”H x 18”/16”W x 9”D Block 4: 6”H x 6”/4”W x 9”D Block 5: 6”H x 12”/10”W x 9”D Block 6: 6”H x 18”/16”W x 9”D</p>
	3959310	Copper Canyon	Non-Stock		
	3959297	Fond du Lac	Non-Stock		
4173678	Pacific Gray	Non-Stock			
 <p>Fond du Lac</p>	Yard Price:		\$21.80/SqFt		
	Factory Direct Price:		\$588.60/Pal		
 <p>Pacific Gray</p>	Yard Price:		\$19.97/SqFt		
	Factory Direct Price:		\$539.19/Pal		
				Blocks/Pallet	72 (12 of Each Size)
				SF/Set	2.25
				SF/Pallet	27
				Pallet Weight	2,475 Lbs.

Rosetta Belvedere Corner/Pillar Stone—Sold in Full Pallets Only					
	SKU	Color	Stock Location	<p>Dimensions</p> <p>Block 1: 3”H x 15”/14”W x 9”D Block 2: 6”H x 15”/14”W x 9”D 1 of Each Size per Set</p>	<p>Block 1: 3”H x 15”/14”W x 9”D Block 2: 6”H x 15”/14”W x 9”D 1 of Each Size per Set</p>
	3959358	Copper Canyon	Non-Stock		
	3959334	Fond du Lac	Non-Stock		
	4173685	Pacific Gray	Non-Stock		
Yard Price:		\$21.80/SqFt			
Factory Direct Price:		\$523.20/Pal			
				Blocks/Pallet	32 (16 of Each Size)
				SF/Set	1.5
				SF/Pallet	24
				Pallet Weight	1,520 Lbs.
27” x 27” Pillar Caps					
3644155	FDL Pillar Cap	Non-Stock			

Rosetta Belvedere Cap Stone—Sold in Full Pallets Only					
	SKU	Color	Stock Location	<p>Dimensions</p> <p>Cap 1: 2¼”H x 6”/4”W x 10¼”D Cap 2: 2¼”H x 12”/10”W x 10¼”D Cap 3: 2¼”H x 18”/16”W x 10¼”D Cap 4: 2¼”H x 18”/17”W x 10¼”D Cap 5: 2¼”H x 18”/17”W x 10¼”D</p>	<p>Cap 1: 2¼”H x 6”/4”W x 10¼”D Cap 2: 2¼”H x 12”/10”W x 10¼”D Cap 3: 2¼”H x 18”/16”W x 10¼”D Cap 4: 2¼”H x 18”/17”W x 10¼”D Cap 5: 2¼”H x 18”/17”W x 10¼”D</p>
	3959396	Copper Canyon	Non-Stock		
	3959372	Fond du Lac	Non-Stock		
	4173692	Pacific Gray	Non-Stock		
	Yard Price:		\$11.25/LF		
Factory Direct Price:		\$371.25/Pal			
				Caps/Pallet	72 (24 : 24 : 12 : 6 : 6)
				LF/Pallet	33
				Pallet Weight	1,550 Lbs.



RCP Rosetta Kodah Wall Stone

Rosetta Kodah Wall—Sold in Full Pallets Only

	SKU	Color	Stock Location		Dimensions	
Copper Canyon	185320	Copper Canyon	Non-Stock	Yard Price: \$26.55/SqFt \$557.55/Pal	Block 1: 6”H x 42”W x 10½”D Block 2: 6”H x 30”W x 10½”D Block 3: 6”H x 21”W x 10½”D Block 4: 6”H x 12”W x 10½”D	
	185326	Fond du Lac	Non-Stock			
	185336	Pacific Gray	Non-Stock			
Fond du Lac	Factory Direct Price: \$24.35/SqFt \$511.35/Pal					SF/Pallet
					Blocks/Pallet	18
					Weight/Set	490
Pacific Gray					Pallet Weight	2,400 Lbs.

Rosetta Kodah Corner Wall—Sold in Full Pallets Only

	SKU	Color	Stock Location	Dimensions	
Copper Canyon	185346	Copper Canyon	Non-Stock	6”H x 21”W x 10½”D	
	185352	Fond du Lac	Non-Stock	SF/Pallet	21
	185356	Pacific Gray	Non-Stock	SF/Block	.88
Fond du Lac	Yard Price: \$26.55/SqFt \$557.55/Pal			Blocks/Pallet	24
	Factory Direct Price: \$24.35/SqFt \$511.35/Pal			Weight/Block	100 Lbs
Pacific Gray				Pallet Weight	2,400 Lbs

- Factory Direct Pricing on drop ship orders or factory pickup; FULL PALLETS only; minimum drop ship order is 10 pallets
- All product can be delivered anywhere in the metro area; all deliveries quoted individually for best rate; please call
- Please call for out-state and out-of-state delivery; special delivery quotes available
- Non-stocked product can be obtained quickly with advance notice, subject to factory availability
- 4136833: \$20 refundable pallet deposit on Rochester Concrete pallets; **must have receipt when returning pallets for refund.**
- A \$10.00 split pallet fee will be charged on all less-than-pallet quantities of Rochester Concrete Products.

www.bachmanswholesale.com

Recon Wall

Features

- Blocks are 48" W x 16" H, depths range from 24" to 84"
- Stocked in Le Sueur County Limestone and Weathered Edge faces
- Northshore Granite and Rustic faces are special order
- Color: Gray (color/stain is applied after construction)

Installation details at:
www.reconwalls.com

Name	Size W x D x H	Face Area	Weight
Full Base Block - 24"	48 x 24 x 16" H	5.33 sq. ft.	1,457 lbs.
Full Base Block - 39"	48 x 39 x 16" H	5.33 sq. ft.	2,201 lbs.
Full Base Block - 45"	48 x 45 x 16" H	5.33 sq. ft.	2,491 lbs.
Full Base Block - 60"	48 x 60 x 16" H	5.33 sq. ft.	3,115 lbs.
Full Base Block - 66"	48 x 66 x 16" H	5.33 sq. ft.	3,416 lbs.
Full Base Block - 72"	48 x 72 x 16" H	5.33 sq. ft.	3,660 lbs.
Full Base Block - 78"	48 x 78 x 16" H	5.33 sq. ft.	3,902 lbs.
Full Base Block - 84"	48 x 84 x 16" H	5.33 sq. ft.	4,088 lbs.
Full Top Block - 24"	48 x 24 x 16" H	5.33 sq. ft.	971 lbs.
Regular Corner	48 x 24 x 16" H	5.33 sq. ft.	1,401 lbs.
Corner Top	48 x 24 x 16" H	5.33 sq. ft.	1,103 lbs.
Half Block 24"	48 x 24 x 16" H	5.33 sq. ft.	667 lbs.
Half Block 39"	48 x 36 x 16" H	5.33 sq. ft.	973 lbs.
Capstone	48 x 26 x 6.5" H	2.16 sq. ft.	551 lbs.
Fence Middle Block	16 x 48 x 24" H	2.66 sq. ft.	1,449 lbs.
Fence Middle End Block	16 x 48 x 24" H	2.66 sq. ft.	1,476 lbs.
Half Fence Middle End Block	16 x 24 x 24" H	2.66 sq. ft.	709 lbs.
Guardrail Middle Block	16 x 48 x 24" H	2.66 sq. ft.	1,373 lbs.

Call your Bachman's sales representative for pricing.



Le Sueur County Limestone



Weathered Edge

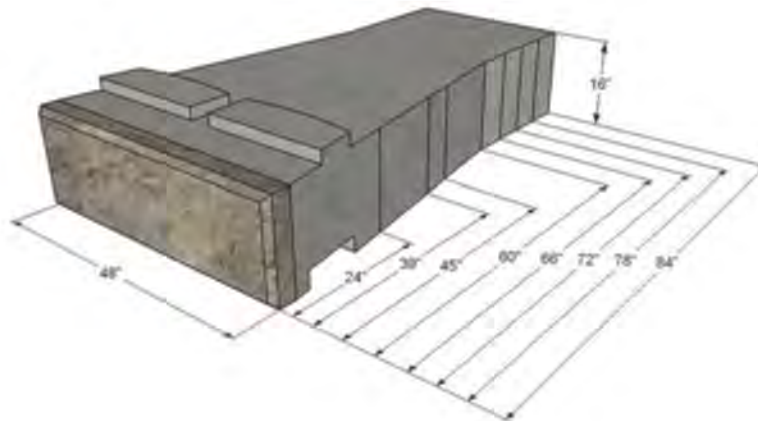



PUT A **LOCK** ON THAT NEXT JOB

Give yourself an edge the next time you quote a landscaping project. Give yourself the Unilock® advantage. As the leader in the industry, Unilock's distinctive products will grab your client's attention and never let go, with leading edge designs that will help you blow the competition away.

UNILOCK®
DESIGNED TO CONNECT.

UNILOCK.COM | 1-800-UNILOCK

Section Contents

Description	Page
Pavers	213-221
• Artline™ Antiqued	213
• Artline™ Smooth	213
• Copthorne®	214
• Courtstone®	214
• Eco-Priora™	215
• Richcliff®	216
• Series 3000®	217-218
• Town Hall™	219
• Umbriano	219-221

Description	Page
Coping	222
• Ledgestone™	222
• Ledgestone™ Fullnose	222
Ledgestone™ Pillar Caps	223
Ledgestone™ Steps	223
Wall	224-230
• Lineo Dimensional Stone	224
• Rivercrest™ Wall	225-226
• Rivercrest™ Pillar	226
• Rivercrest™ Fire Pit Kit	226
• Ucara™	227-230
• Ucara™ Accessories	230

Items Not Listed

The following Unilock products are available for special order, but not listed in the Bachman's Hardscapes catalog. Please see the Unilock catalog for more information and call your Bachman's Hardscapes sales representative for pricing.

Description
Pavers
• Arcana Paving Slabs
• Avante Ashlar™
• Beacon Hill Flagstone™
• Bristol Valley®
• Brussels Block®
• Brussels Premier™
• Eco-Priora™ Permeable Paver
• Il Campo
• Mattoni
• Rivenstone™
• Soreno
• Thornbury™
• Tribeca
• Yorkstone

Description
Coping
Brussels Fullnose



Artline™ Antiqued—7cm

Yard Price: \$8.05/SF			Unit	Dimensions	Quantity	SF/Layer	11.66
Factory Direct: \$6.99/SF			A	2¾" H x 4⅞" W x 6¾" L	32	Layers/Pallet	8
			B	2¾" H x 4⅞" W x 10⅝" L	32	SF/Pallet	93.25
SKU	Color	Stock Location	C	2¾" H x 4⅞" W x 13⅜" L	32	Pallet Weight	2,963 Lbs
72390	Bavarian Blend	Special Order	D	2¾" H x 4⅞" W x 17¼" L	32		
81232	Copper Ridge	Special Order	E	2¾" H x 7½" W x 8⅞" L	32		
81234	Steel Mountain	Special Order	F	2¾" H x 7½" W x 13⅜" L	16		
			G	2¾" H x 7½" W x 17¼" L	16		

Artline™ is manufactured with an integral surface protection, EasyClean Stain Resistance, that allows for easier cleanup of spills when they happen, and before a stain can develop.

Unilock® provides a transferable *LIFETIME GUARANTEE* on the structural integrity of its paving stones, slabs, retaining wall units and natural stone for residential use.



Artline™ Smooth—7cm

Yard Price: \$8.05/SF			Unit	Dimensions	Quantity	SF/Layer	11.66
Factory Direct: \$6.99/SF			A	2¾" H x 4⅞" W x 6¾" L	32	Layers/Pallet	8
			B	2¾" H x 4⅞" W x 10⅝" L	32	SF/Pallet	93.25
SKU	Color	Stock Location	C	2¾" H x 4⅞" W x 13⅜" L	32	Pallet Weight	2,963 Lbs
103300	Bavarian Blend	Special Order	D	2¾" H x 4⅞" W x 17¼" L	32		
103304	Copper Ridge	Special Order	E	2¾" H x 7½" W x 8⅞" L	32		
103302	Steel Mountain	Special Order	F	2¾" H x 7½" W x 13⅜" L	16		
			G	2¾" H x 7½" W x 17¼" L	16		

- Artline Pallet Deposit #49534: \$20.00/Pallet
- \$25.00 Split Pallet Charge
- Important: Textured surfaces require a buffer between the plate compactor and the paver surface to prevent scuffing.
- All measurements are nominal.



Copthorne®—6cm

		SKU	Color	Stock Location	Dimensions	2 3/8" H x 2 1/2" W x 7 7/8" L
 Basalt	 Burgundy Red	120654	Basalt	Special Order	SF/Piece	.14
		4554606	Burgundy Red	Special Order	SF/Band	Not Banded
		4554613	Burnt Clay	Special Order	SF/Pallet	89.2
		4554620	Old Oak	Special Order	Pavers/Pallet	600
 Burnt Clay	 Old Oak	Yard Price: \$10.30/SF			Pavers/SF	6.73
		Factory Direct: \$9.04/SF			Pavers/Band	Not Banded
					LF/Paver (Sailor)	.66
					LF/Paver (Soldier)	.21
				Pallet Weight	2,349 Lbs	

- Copthorne: No pallet deposit.
- Important: Textured surfaces require a buffer between the plate compactor and the paver surface to prevent scuffing.
- All measurements are nominal.



Courtstone™—6cm—5 Sizes Mixed on 1 Pallet

Yard Price: \$10.30/SF			Unit	Dimensions	Quantity	SF/Layer	12.288															
Factory Direct: \$9.04/SF			XL Rec	2 3/8" H x 5 1/8" W x 8 3/8" L	128	Layers/Pallet	8															
			Lg Rec	2 3/8" H x 5 1/8" W x 7 1/4" L	64	SF/Pallet	98.3															
<table border="1"> <thead> <tr> <th>SKU</th> <th>Color</th> <th>Stock Location</th> </tr> </thead> <tbody> <tr> <td>4554637</td> <td>Basalt</td> <td>Special Order</td> </tr> <tr> <td>4554644</td> <td>Belgian Blue</td> <td>Special Order</td> </tr> <tr> <td>4554651</td> <td>Dawn Mist</td> <td>Special Order</td> </tr> <tr> <td>4554668</td> <td>Pebble Taupe</td> <td>Special Order</td> </tr> </tbody> </table>			SKU	Color	Stock Location	4554637	Basalt	Special Order	4554644	Belgian Blue	Special Order	4554651	Dawn Mist	Special Order	4554668	Pebble Taupe	Special Order	Rec	2 3/8" H x 5 1/8" W x 6 1/2" L	64	Pallet Weight	2,326 Lbs
			SKU	Color	Stock Location																	
			4554637	Basalt	Special Order																	
4554644	Belgian Blue	Special Order																				
4554651	Dawn Mist	Special Order																				
4554668	Pebble Taupe	Special Order																				
Sm Rec	2 3/8" H x 5 1/8" W x 5 3/4" L	64																				
Square	2 3/8" H x 5 1/8" W x 5 1/8" L	64																				

- Courtstone: No pallet deposit
- Important: Textured surfaces require a buffer between the plate compactor and the paver surface to prevent scuffing.
- All measurements are nominal.



Eco-Priora™ 10 x 10 Standard Finish—8cm			
	SKU	Color	Stock Location
	4554675	River	Special Order
	4551605	Sierra	Special Order
	Yard Price: \$6.60/SF		
	Factory Direct: \$5.50/SF		
Dimensions		3 1/8" H x 10" W x 10" L	
SF/Piece		.619	
SF/Pallet		86.6	
Pavers/Pallet		140	
Pavers/SF		1.62	
LF/Paver (Sailor)		.83	
LF/Paver (Soldier)		.83	
Pallet Weight		3,099 Lbs	

Eco-Priora™ 5 x 10 Standard Finish—8cm			
	SKU	Color	Stock Location
	4554682	River	Special Order
	4551612	Sierra	Special Order
	Yard Price: \$6.60/SF		
	Factory Direct: \$5.50/SF		
Dimensions		3 1/8" H x 5" W x 10" L	
SF/Piece		.304	
SF/Pallet		74.6	
Pavers/Pallet		245	
Pavers/SF		3.29	
LF/Paver (Sailor)		.83	
LF/Paver (Soldier)		.42	
Pallet Weight		2,669 Lbs	

Eco-Priora™ 5 x 10 ANTIQUED Finish—8cm			
	SKU	Color	Stock Location
	4554669	River	Special Order
	4551636	Sierra	Special Order
	Yard Price: \$6.60/SF		
	Factory Direct: \$5.50/SF		
Dimensions		3 1/8" H x 5" W x 10" L	
SF/Piece		.304	
SF/Pallet		74.6	
Pavers/Pallet		245	
Pavers/SF		3.29	
LF/Paver (Sailor)		.83	
LF/Paver (Soldier)		.42	
Pallet Weight		2,669 Lbs	

- Eco-Priora pallet deposit #49534: \$20.00/Pallet
- Important: Textured surfaces require a buffer between the plate compactor and the paver surface to prevent scuffing.
- All measurements are nominal.



Richcliff® 3pc—6cm

Yard Price: \$10.20/SF			Unit		Dimensions		Quantity		SF/Layer		11.29	
Factory Direct: \$9.04/SF (Full Pallets Only)			Lg Rec	2 3/8" H x 12" W x 9" L		64		Layers/Pallet		8		
			Square	2 3/8" H x 9" W x 9" L		32		SF/Pallet		90.3		
			Sm Rec	2 3/8" H x 6" W x 9" L		64		Pallet Weight		2,472 Lbs		
SKU	Color	Stock Location										
4554828	Dawn Mist	Special Order										
4554835	Pebble Taupe	Special Order										
224184	Smoke Shale	Special Order										

Richcliff® Lg Rec—6cm

Yard Price: \$10.20/SF			Unit		Dimensions		Quantity		SF/Piece		1.72			
Factory Direct: \$9.04/SF (Full Pallets Only)			Lg Rec	2 3/8" H x 21" W x 12" L		48		Pieces/Pallet		48				
												SF/Pallet		82.39
												Pallet Weight		2,410 Lbs
SKU	Color	Stock Location												
224186	Dawn Mist	Special Order												
224188	Pebble Taupe	Special Order												
224190	Smoke Shale	Special Order												



WHY CHOOSE

ENDURACOLOR™
PLUS ARCHITECTURAL FINISHES

Unilock products deliver on style because our technologies allow us to make the most unique products on the market. EnduraColor Plus is the defining difference when it comes to superior wear resistance and color longevity. EnduraColor Plus is not a coating or secondary treatment, but rather a proprietary blended layer of nature’s highest performing minerals (which never fade) that have been embedded right into the surface of each stone during the manufacturing process. This ensures that the surface will not fade, crack, peel or delaminate, and the beauty of your project will last a lifetime.

Series 3000®: 4 x 8—7cm							
		SKU	Color	Stock Location	Dimensions	2¾" H x 4" W x 8" L	
Golden Tan		4555221	Golden Tan	Special Order	SF/Piece	.218	
		4555238	Mineral Ice Grey	Special Order	SF/Band	17.69	
		4555245	Mocha Brown	Special Order	SF/Pallet	106.11	
				Yard Price: \$10.85/SF			
Mineral Ice Grey						Pavers/Pallet	486
						Pavers/SF	4.58
Mocha Brown						Pavers/Band	81
						Bands/Pallet	6
						LF/Paver (Sailor)	.67
					LF/Paver (Soldier)	.33	
					Pallet Weight	3,581 Lbs	

Series 3000®: 6 x 12—7cm								
			SKU	Color	Stock Location	Dimensions	2¾"H x 6"W x 12"L	
Golden Tan			4555160	Golden Tan	Special Order	SF/Piece	.5	
			4555177	Mineral Ice Grey	Special Order	SF/Band	23.26	
			4555184	Mocha Brown	Special Order	SF/Pallet	93.04	
			Yard Price: \$10.85/SF				Pavers/Pallet	192
Mineral Ice Grey			Factory Direct: \$9.46/SF				Pavers/SF	2.06
							Pavers/Band	48
Mocha Brown							Bands/Pallet	4
						LF/Paver (Sailor)	.985	
							LF/Paver (Soldier)	.492
							Pallet Weight	3,140 Lbs

Series 3000: 12 x 12—7cm								
			SKU	Color	Stock Location	Dimensions	2¾"H x 12"W x 12"L	
Golden Tan			4555139	Golden Tan	Special Order	SF/Piece	1	
			4555146	Mineral Ice Grey	Special Order	SF/Band	23.26	
			4555153	Mocha Brown	Special Order	SF/Pallet	93.04	
			Yard Price: \$10.85/SF				Pavers/Pallet	96
Mineral Ice Grey			Factory Direct: \$9.46/SF				Pavers/SF	1.03
							Pavers/Band	24
Mocha Brown							Bands/Pallet	4
						LF/Paver (Sailor)	1	
							LF/Paver (Soldier)	1
							Pallet Weight	2,979 Lbs

- No pallet deposit on Unilock's Series 3000 or Town Hall
- Important: Textured surfaces require a buffer between the plate compactor and the paver surface to prevent scuffing.
- All measurements are nominal.



Town Hall—7cm—Permeable

		SKU	Color	Stock Location	Dimensions	2 3/4" H x 4" W x 9 3/4" L
Basalt	Burgundy Red	62210	Basalt	Special Order	SF/Piece	.276
		4555344	Burgundy Red	Special Order	SF/Layer	11.05
Burnt Clay	Heritage Clay	4555351	Burnt Clay	Special Order	SF/Pallet	88.41
		62212	Heritage Clay	Special Order	Pavers/Pallet	320
	62214	Heritage Red	Special Order	Pavers/SF	3.62	
	4555368	Old Oak	Special Order	Pavers/Layer	40	
Heritage Red	Old Oak	Yard Price: \$11.95/SF			LF/Paver (Sailor)	.81
					LF/Paver (Soldier)	.33
					Pallet Weight	2,788 Lbs
					Factory Direct: \$10.51/SF	



French Gray
Midnight Sky
Summer Wheat
Winter Marvel

Umbriano® Random—6cm

Yard Price: \$10.50 /SF			Unit	Dimensions	Quantity	SF/Layer	10.47
Factory Direct: \$9.17 /SF (Full Pallets Only)			Lg Rec	2 3/8" H x 21" W x 14" L	64	Layers/Pallet	9
			Square	2 3/8" H x 14" W x 14" L	32	SF/Pallet	94.20
			Sm Rec	2 3/8" H x 14" W x 7" L	64	Pallet Weight	2,584 Lbs
SKU	Color	Stock Location					
224192	French Grey	Special Order					
224194	Midnight Sky	Special Order					
224196	Summer Wheat	Special Order					
189048	Winter Marvel	Special Order					



Umbriano 24 x 24 Square—7cm

		SKU	Color	Stock Location	Dimensions	2 3/4" H x 24" W x 24" L
 Autumn Sunset	 Midnight Sky	4555436	Autumn Sunset	Special Order	SF/Piece	3.85
		4555450	Midnight Sky	Special Order	SF/Layer	7.75
 Summer Wheat	 Winter Marvel	4555467	Summer Wheat	Special Order	SF/Pallet	62
		4555474	Winter Marvel	Special Order	Pavers/Pallet	16
Yard Price: \$10.85/SF					Pavers/SF	.259
Factory Direct: \$9.46/SF					Pavers/Layer	2
					Layers/Pallet	8
					LF/Paver (Sailor)	1.969
					LF/Paver (Soldier)	1.969
					Pallet Weight	2,062 Lbs

Umbriano 12 x 24 Rectangle—7cm

		SKU	Color	Stock Location	Dimensions	2 3/4" H x 12" W x 24" L
 Autumn Sunset	 Midnight Sky	4555481	Autumn Sunset	Special Order	SF/Piece	1.938
		4555498	Midnight Sky	Special Order	SF/Layer	11.625
 Summer Wheat	 Winter Marvel	4555504	Summer Wheat	Special Order	SF/Pallet	93
		4555511	Winter Marvel	Special Order	Pavers/Pallet	48
Yard Price: \$10.85/SF					Pavers/SF	.516
Factory Direct: \$9.46/SF					Pavers/Layer	6
					Layers/Pallet	8
					LF/Paver (Sailor)	1.969
					LF/Paver (Soldier)	.969
					Pallet Weight	3,142 Lbs

- Important: Textured surfaces require a buffer between the plate compactor and the paver surface to prevent scuffing.
- All measurements are nominal.
- Umbriano 24" pavers are not suitable for vehicular applications

Umbriano 16 x 16 Square—7cm

		SKU	Color	Stock Location	Dimensions	2¾" H x 16" W x 16" L	
Autumn Sunset	Midnight Sky	4555535	Autumn Sunset	Special Order	SF/Piece	1.722	
		4555542	Midnight Sky	Special Order	SF/Layer	10.33	
Summer Wheat	Winter Marvel	4555559	Summer Wheat	Special Order	SF/Pallet	82.67	
		4555566	Winter Marvel	Special Order	Pavers/Pallet	48	
				Yard Price: \$10.85/SF		Pavers/SF	.584
				Factory Direct: \$9.46/SF		Pavers/Layer	6
					Layers/Pallet	8	
					LF/Paver (Sailor)	1.312	
					LF/Paver (Soldier)	1.312	
					Pallet Weight	2,647 Lbs	

Umbriano 8 x 16 Rectangle—7cm

		SKU	Color	Stock Location	Dimensions	2¾" H x 8" W x 16" L	
Autumn Sunset	Midnight Sky	4555573	Autumn Sunset	Special Order	SF/Piece	.861	
		4555597	Midnight Sky	Special Order	SF/Layer	10.33	
Summer Wheat	Winter Marvel	4555603	Summer Wheat	Special Order	SF/Pallet	82.67	
		4555627	Winter Marvel	Special Order	Pavers/Pallet	96	
				Yard Price: \$10.85/SF		Pavers/SF	1.16
				Factory Direct: \$9.46/SF		Pavers/Layer	12
					Layers/Pallet	8	
					LF/Paver (Sailor)	1.312	
					LF/Paver (Soldier)	.656	
					Pallet Weight	2,647 Lbs	

Umbriano 8 x 8 Square—7cm

		SKU	Color	Stock Location	Dimensions	2¾" H x 8" W x 8" L	
Autumn Sunset	Midnight Sky	4555634	Autumn Sunset	Special Order	SF/Piece	.431	
		4555658	Midnight Sky	Special Order	SF/Layer	10.33	
Summer Wheat	Winter Marvel	4555665	Summer Wheat	Special Order	SF/Pallet	82.67	
		4555689	Winter Marvel	Special Order	Pavers/Pallet	192	
				Yard Price: \$10.85/SF		Pavers/SF	2.32
				Factory Direct: \$9.46/SF		Pavers/Layer	24
					Layers/Pallet	8	
					LF/Paver (Sailor)	.656	
					LF/Paver (Soldier)	.656	
					Pallet Weight	2,647 Lbs	

- No pallet deposit on Unilock Umbriano
- Important: Textured surfaces require a buffer between the plate compactor and the paver surface to prevent scuffing.
- All measurements are nominal.



Ledgestone™ Coping

	SKU	Color	Stock Location	Dimensions	2¾" H x 13.5" W x 30" L	
Standard	Rock Face Front & Back			Units/Pallet	12	
Yard Price: \$27.55 Each	4551698	Buff	Special Order	LF/Pallet	24	
Factory Direct: \$22.11 Each	4551711	Grey	Special Order	Pallet Weight	772 Lbs	
	SKU	Color	Stock Location	Dimensions	2¾" H x 13.5" W x 30" L	
Closed-End	Closed-End—Rock Face on 3 Sides			Units/Pallet	12	
Yard Price: \$28.30 Each	4551728	Buff	Special Order	LF/Pallet	24	
Factory Direct: \$22.61 Each	4551742	Grey	Special Order	Pallet Weight	796 Lbs	



Ledgestone™ Fullnose Coping

	SKU	Color	Stock Location	Dimensions	2¾" H x 12" W x 24" L	
Buff	4551759	Buff	Special Order	SF/Piece	2	
	4551773	Grey	Special Order	Units/Pallet	16	
	Yard Price: \$26.50 Each			Units/SF	.5	
	Factory Direct: \$22.11 Each			LF/Paver (Soldier)	2	
				LF/Pallet (Soldier)	32	
				Pallet Weight	667 Lbs	

- Ledgestone pallet deposit #50540: \$20.00/pallet
- Important: Textured surfaces require a buffer between the plate compactor and the paver surface to prevent scuffing.
- All measurements are nominal.



Ledgestone™ Pillar Caps—4"			
	SKU	Color	Stock Location
Yard Price: \$148.35 Each	4551667	Buff	Special Order
	4551681	Grey	Special Order
Factory Direct: \$130.73 Each			

Dimensions	4"H x 24"W x 24"D
Units/Pallet	5
Weight/Unit	159
Pallet Weight	795 Lbs



Ledgestone™ Steps			
	SKU	Color	Stock Location
36" Step	Rock Face on 3 Sides		
Yard Price: \$129.00 Each Factory Direct: \$113.71 Each	4551780	Buff	Special Order
	4551797	Grey	Special Order
	SKU	Color	Stock Location
48" Step	Rock Face on 3 Sides		
Yard Price: \$180.00 Each Factory Direct: \$157.84 Each	4551803	Buff	Special Order
	4551810	Grey	Special Order

Dimensions	6"H x 36"W x 18"D
Units/Pallet	3
Weight/Step	327 Lbs
Pallet Weight	982 Lbs

Dimensions	6"H x 48"W x 24"D
Units/Pallet	3
Weight/Step	574 Lbs
Pallet Weight	1,721 Lbs

• All measurements are nominal.



Lineo Dimensional Stone—4"—4 Piece Set

	SKU	Color	Stock Location	Dimensions Small Rec: 3.94"H x 11.81"W x 7.87"D Rectangle: 3.94"H x 15.75"W x 7.87"D Large Rec: 3.94"H x 19.61"W x 7.87"D XL Rec: 3.94"H x 23.62"W x 7.87"D	
	120664	Granite	Special Order		
	120666	Sandalwood	Special Order		
	120668	Sierra	Special Order		
	Yard Price: \$14.30/SF				
	Factory Direct Price: \$12.35/SF				
				SF/Piece	Small Rec: .333 Rectangle: .444 Large Rec: .554 XL Rec: .664
				Blocks/Pallet	15 Sm Rec, 15 Rec, 15 Lg Rec, 18 XL Rec
				SF/Pallet	31.91
				Pallet Weight	2,845

Lineo Dimensional Stone—4"—Corner

	SKU	Color	Stock Location	Dimensions	3.94"H x 15.75"W x 7.87"D
	120670	Granite	Special Order	SF/Piece	.43 (Main Face) & .22 (End Face)
	120672	Sandalwood	Special Order	Blocks/Pallet	72
	120674	Sierra	Special Order	SF/Pallet	31 (Main Face)
	Yard Price: \$14.30/SF			Pallet Weight	2,837
	Factory Direct Price: \$12.35/SF				

- Spacing strips are shipped with random wall bundles to create even spacing between units.



Rivercrest™ Random Wall Bundle—Standard Units

	SKU	Color	Stock Location	Dimensions Unit 1: 2¼”H x 8”W x 9-10”D Unit 2: 2¼”H x 12”W x 9-10”D Unit 3: 2¼”H x 12”W x 9-10”D Unit 4: 2¼”H x 17”W x 9-10”D	
	4551827	Buff	Special Order		
	455108	Coastal Slate	Special Order		
	Yard Price: \$26.55/SF				
	Factory Direct Price: \$22.81/SF				
				SF/Piece	Unit 1: .12 Unit 2: .19 Unit 3: .19 Unit 4: .25
				Blocks/Pallet	128 (32 of Each Size)
				SF/Pallet	24.3
				Pallet Weight	1,990

Rivercrest™ Jumper Wall Bundle

	SKU	Color	Stock Location	Dimensions Jumper Unit 1: 4½”H x 8”W x 9-10”D Jumper Unit 2: 4½”H x 12”W x 9-10”D Jumper Unit 3: 4½”H x 12”W x 9-10”D Jumper Unit 4: 4½”H x 17”W x 9-10”D	
	4551834	Buff	Special Order		
	4551841	Coastal Slate	Special Order		
	Yard Price: \$31.25/SF				
	Factory Direct Price: \$25.65/SF				
				SF/Piece	Jumper Unit 1: .24 Jumper Unit 2: .38 Jumper Unit 3: .38 Jumper Unit 4: .5
				Blocks/Pallet	64 (16 of Each Size)
				SF/Pallet	24.3
				Pallet Weight	2,720

Rivercrest™ Corner Units				
	SKU	Color	Stock Location	Dimensions
	4551865	Buff	Special Order	Long Corner Unit: 2¼”H x 12”W x 9-10”D Short Corner Unit: 2¼”H x 10”W x 9-10”D
	4555115	Coastal Slate	Special Order	
Yard Price: \$26.55/SF				SF/Piece
Factory Direct Price: \$22.81/SF				Blocks/Pallet
				SF/Pallet
				Pallet Weight



Rivercrest™ Jumper Corner Unit				
	SKU	Color	Stock Location	Dimensions
	4551872	Buff	Special Order	Jumper Corner: 4½”H x 12”W x 9-10”D
	4555115	Coastal Slate	Special Order	
Yard Price: \$31.25/SF				SF/Piece
Factory Direct Price: \$25.65/SF				Blocks/Pallet
				SF/Pallet
				Pallet Weight

Rivercrest™ Pillar Unit				
	SKU	Color	Stock Location	Dimensions
	65164	Buff	Special Order	4½”H x 20”W x 20”L
	83234	Coastal Slate	Special Order	
Pillar cap sold separately				Units/Pallet
Yard Price: \$82.95 Each (1 Layer)				Weight/Piece
Factory Direct Price: \$72.47 Each (1 Layer)				Pallet Weight



Rivercrest™ Fire Pit Kit				
	SKU	Color	Stock Location	Dimensions
	122384	Buff	Special Order	54” OD, 35” ID
	148086	Coastal Slate	Special Order	
Yard Price: \$1,405.00				Pallet Weight
Factory Direct Price: \$1,193.75				
				Includes coping



U-Cara Standard Fascia Panel—Pitched Face



	SKU	Color	Stock Location	Dimensions	5 7/8" H x 18 3/4" L x 2 3/8" D
 Bavarian	224224	Bavarian	Special Order	Face Feet/Piece	.732
	196410	Granite Fusion	Special Order	Pieces/Layer	14
	224226	Opal	Special Order	Layers/Pallet	6
Yard Price: \$6.25/SF				Pieces/Pallet	84
 Granite Fusion	Factory Direct: \$5.86/SF			Face Feet/Layer	10.25
				 Opal	Price is for fascia panel only. Construction of wall requires backer block.
Weight/Piece	21 Lbs				
Pallet Weight	1,924 Lbs				

U-Cara Corner Bundle—Closed End & Half Fascia—Pitched Face



	SKU	Color	Stock Location	Dimensions	5 7/8" H x 20 3/4" L x 2 3/8" D 5 7/8" H x 9 3/8" L x 2 3/8" D
 Bavarian	224228	Bavarian	Special Order	Face Feet/Piece	.833 (Closed End) .363 (Half)
	196434	Granite Fusion	Special Order	Pieces/Layer	7 of Each
	224230	Opal	Special Order	Layers/Pallet	6
Yard Price: \$7.45/SF				Pieces/Pallet	42 of Each
 Granite Fusion	Factory Direct: \$7.03/SF			Face Feet/Layer	8.37
				 Opal	Price is for fascia panel only. Construction of wall requires backer block.
Weight/Piece	24 Lbs / 10 Lbs				
Pallet Weight	1,416 Lbs				

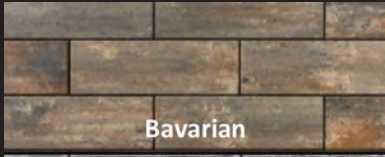

U-Cara Standard Fascia Panel—Smooth Face

	SKU	Color	Stock Location	Dimensions	5 7/8" H x 18 3/4" L x 2 3/8" D
 Bavarian	224232	Bavarian	Special Order	Face Feet/Piece	.732
	196424	Granite Fusion	Special Order	Pieces/Layer	14
	224234	Opal	Special Order	Layers/Pallet	6
 Granite Fusion	Yard Price: \$6.25/SF			Pieces/Pallet	84
	Factory Direct: \$5.86/SF			Face Feet/Layer	10.25
	Price is for fascia panel only. Construction of wall requires backer block.			Face Feet/Pallet	61.52
 Opal				Weight/Piece	18 Lbs
				Pallet Weight	1,648 Lbs

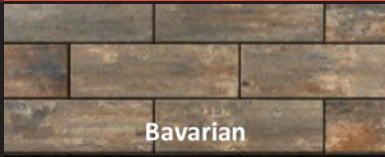
U-Cara Corner Bundle—Closed End & Half Fascia—Smooth Face

	SKU	Color	Stock Location	Dimensions	5 7/8" H x 20 3/4" L x 2 3/8" D 5 7/8" H x 9 3/4" L x 2 3/8" D
 Bavarian	224236	Bavarian	Special Order	Face Feet/Piece	.833 (Closed End) .363 (Half)
	196430	Granite Fusion	Special Order	Pieces/Layer	7 of Each
	224238	Opal	Special Order	Layers/Pallet	6
 Granite Fusion	Yard Price: \$7.45/SF			Pieces/Pallet	42 of Each
	Factory Direct: \$7.03/SF			Face Feet/Layer	8.37
	Price is for fascia panel only. Construction of wall requires backer block.			Face Feet/Pallet	50.23
 Opal				Weight/Piece	21 Lbs / 9 Lbs
				Pallet Weight	1,241 Lbs



U-Cara Standard Fascia Panel—Umbriano Finish				
SKU	Color	Stock Location	Dimensions	
224240	French Grey	Special Order	5 7/8" H x 18 3/4" L x 2 3/8" D	
224242	Summer Wheat	Special Order		
			Face Feet/Piece	.732
			Pieces/Layer	14
Yard Price: \$9.75/SF Factory Direct: \$9.17/SF			Layers/Pallet	6
			Pieces/Pallet	84
Price is for fascia panel only. Construction of wall requires backer block.			Face Feet/Layer	10.25
			Face Feet/Pallet	61.52
			Weight/Piece	25 Lbs
			Pallet Weight	2,067 Lbs

U-Cara Corner Bundle—Closed End & Half Fascia—Umbriano Finish				
SKU	Color	Stock Location	Dimensions	
224244	French Grey	Special Order	5 7/8" H x 20 3/4" L x 2 3/8" D	
224246	Summer Wheat	Special Order	5 7/8" H x 9 3/8" L x 2 3/8" D	
			Face Feet/Piece	.833 (Closed End) .363 (Half)
			Pieces/Layer	7 of Each
Yard Price: \$11.65/SF Factory Direct: \$11.00/SF			Layers/Pallet	6
			Pieces/Pallet	42 of Each
Price is for fascia panel only. Construction of wall requires backer block.			Face Feet/Layer	8.37
			Face Feet/Pallet	50.23
			Weight/Piece	28 Lbs / 12 Lbs
			Pallet Weight	1,680 Lbs

U-Cara 3 Inch Fascia Panel—Smooth Face

Image	SKU	Color	Stock Location	Dimensions	3" H x 9 1/4" L x 2 3/8" D
	<p>Bavarian</p>	225234	Bavarian	Special Order	Face Feet/Piece
225240		Granite Fusion	Special Order	Pieces/Layer	56
225242		Opal	Special Order	Layers/Pallet	6
<p>Granite Fusion</p>	Yard Price: \$6.25 /SF			Pieces/Pallet	336
	Factory Direct: \$5.86 /SF			Face Feet/Layer	10.53
	<p>Opal</p>				Face Feet/Pallet
			Weight/Piece	4.47	
			Pallet Weight	1,501 Lbs	

U-Cara 3 Inch Fascia Panel—Series Finish

Image	SKU	Color	Stock Location	Dimensions	3" H x 9 1/4" L x 2 3/8" D
		225244	Onyx Black	Special Order	Face Feet/Piece
Yard Price: \$6.25 /SF			Pieces/Layer	56	
Factory Direct: \$5.86 /SF			Layers/Pallet	6	
			Pieces/Pallet	336	
				Face Feet/Layer	10.53
				Face Feet/Pallet	63.2
				Weight/Piece	4.47
				Pallet Weight	1,501 Lbs

U-Cara Accessories



	Standard Backer	Large/Corner Backer	Corner Insert	Universal Coping
SKU:	224222	196358	225248	196446
Yard Price:	\$3.25 Each	\$4.00 Each	\$25.00/Bag	\$16.85 Each
Factory Direct: (Full Pallets Only)	\$2.35 Each	\$3.78 Each	\$25.00/Bag	\$15.92 Each
Dimensions:	5 7/8" H x 7 1/2" L x 5 1/2" D	5 7/8" H x 6 1/2" L x 11 3/4" D		2 3/4" H x 19" L x 14" D
LF/Piece:	.656	.573		1.58
LF/Pallet:	69	32		76
Blocks/Pallet:	105	56	40 Corner Inserts/Bag	48
Weight/Block:	23 Lbs	36 Lbs		60 Lbs
Pallet Weight:	2,458 Lbs	2,163 Lbs		2,864 Lbs

Fire & Outdoor Living



Section Contents

Description	Page
The Outdoor GreatRoom Company	233
Zentro Smoke Less Fire Ring Liner	234-235
Natural Stone Fire Rings	236
Unilock Rivercrest Fire Ring	236
Necessaries Fire Ring Kits	237-239
• Grand Gas Fire Ring	237
• Grand Fire Ring	237
• Victorian Fire Pit Kits	238
• Travertine Fire Pit Kit	238
• Barn Plank Fire Pit Kit	238
• Fire Ring Cap Block Kit	239
• Steel Insert	239
• Accessories	239
Belgard Fire Pit Kits	240
• Weston Round Fire Pit Kit	240
• Fire Ring Cap Kit	240
• Fire Ring Liner and Cover	240
Borgert Strassen Fire Pit Kits	241
• Borgert Round Fire Pit Kit	241
• Borgert Square Fire Pit Kit	241
• Borgert Precast Fire Ring Cap Kit	241
Belgard Elements Fireplaces	242-243
• Bordeaux® Series Fireplace	242
• Bordeaux® Series Brick Oven	242
• Bordeaux® Series Wood Boxes	242
• Bristol® Series Fireplace	243
• Bristol® Series Brick Oven	243
• Bristol® Series Arched Hearth	243
• Bristol® Series Wood Boxes	243
• Brighton® Series Fireplace	243
• Brighton® Series Wood Boxes	243
Belgard Elements Grill Island	242-243
• Bordeaux® Series Grill Island	242
• Bristol Series Grill Island	243
King of Hearths Fireplace Kits	244
• King Arthur Fireplace	244
• Guinevere Fireplace	244
• Camlann Fireplace	244
• Lancelot Outdoor Oven	244
Necessaries Fireplace Kits	245-249
• Colonial Outdoor Fireplace	245
• Colonial Wood Box	245
• Colonial Hearth	245

Description	Page
Necessaries Fireplace Kits	245-249
• Compact Outdoor Fireplace	246
• Compact Wood Box	246
• Compact Hearth	246
• Contemporary Outdoor Fireplace	247
• Contemporary Hearth	247
• Grand Outdoor Fireplace	248
• Grand Wood Box	248
• Grand Hearth	248
• Victorian Outdoor Fireplace	249
• Victorian Wood Box	249
• Victorian Hearth	249
The Kitchen by Necessaries	250-256
• Grill Cabinets	250
• Rotisserie Kit	250
• The Refrigerator Cabinet	251
• Outdoor Refrigerator	251
• The Trash Cabinet	251
• The Prep Center Cabinet	252
• The Prep Center Cabinet with Sink	252
• The Outdoor Oven Cabinet	253
• Outdoor Oven	253
• The Side Burner Cabinet	253
• The Smoker Cabinet	254
• Smoker	254
• The Storage Cabinet	254
• The Island Cabinet	255
• The Island with Sink Cabinet	255
• Corner/End Cap Cabinet	256
Necessaries Bars and Islands	257-259
• Grand Island Bar	257-258
• Grill Surround	258
• Corner Return	258
• 4' Bar Section	258
• Compact Bar	259
Necessaries Tables & Bar Tops	260
• Pub Table	260
• Bistro Table	260
• Dining Table	260
• 4' Bar Tops	260
Necessaries Pillars	261
Necessaries Waterfall Kits	261
• Compact Waterfall Kit	261
• Grand Waterfall Kit	261



**THE OUTDOOR
GREATROOM
COMPANY**

Pergolas and Fire Pits



Pergola Colors

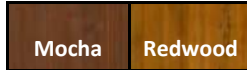

Pergolas

SKU	Color	Price
Sonoma 16 Pergola Structure		
108170	Mocha Stain Finish	\$3,810.00
108176	Redwood Stain Finish	\$3,810.00
<ul style="list-style-type: none"> 16 x 16 Sonoma Wood Pergola made of Douglas Fir with hardware 		
Lattice Roof Panels		
108172	Mocha Stain Finish	\$510.00/Box of 4
108178	Redwood Stain Finish	\$510.00/Box of 4
<ul style="list-style-type: none"> Order 4 boxes for a complete roof 		
Wall with Window Shutters		
108174	Mocha Stain Finish	\$1,199.00
108180	Redwood Stain Finish	\$1,199.00
<ul style="list-style-type: none"> Wall structure for one side of pergola 		

Cove 30 Gas Fire Pit Bowl

SKU	Price
107908	\$1,600.00
<ul style="list-style-type: none"> Natural gray contemporary concrete finish Includes 30" round stainless steel gas burner and burner cover 	

A large variety of pergolas, gas fire pits, gas fire tables, gas fireplaces, and outdoor kitchen islands are available from The Outdoor GreatRoom Company™ through Bachman's Hardscapes. Visit The Outdoor GreatRoom Company's showroom conveniently located in Burnsville, MN for product selection. Call Bachman's Hardscapes for details.



Smoke Less Fire Ring Liner



Hot oxygen enters the top of the pit through small holes, mixing with the smoke and causing it to reburn

Patent Pending Technology

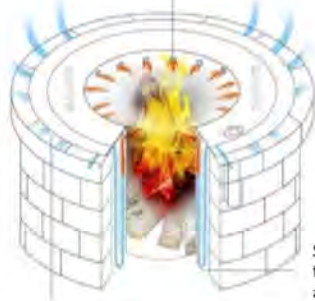

Main air supply enters between the stone and metal ring

Secondary air supply rises through double outer walls and exits holes at top of pit



Scan here with your QR code reader or visit <http://brecoillc.com/how-it-works/> to see the Zentro Smoke Less Fire Ring Liner in action.

- **Old-fashioned, real wood fire, without the smoke**
- **Smoke re-burning technology nearly eliminates annoying smoke**
- **Secondary afterburner drastically reduces smoke by igniting it before it has a chance to escape**
- **Double-walled constructions makes the outer surface and top rail stay cooler, for safer campfires**



Zentro Round Smoke Less Pit with Lid

SKU		Price Each
24" ID Liner—For use in 30" to 33" ID fire ring.		
142776	Steel—Black Painted	\$562.00
225134	Stainless Steel	\$1075.00
28" ID Liner—For use in 34" to 37" ID fire ring.		
182816	Steel—Black Painted	\$671.00
225140	Stainless Steel	\$1358.00
32" ID Liner—For use in 38" to 41" ID fire ring.		
182824	32" ID Liner	\$792.00
225142	Stainless Steel	\$1745.00



Zentro Square Smoke Less Pit with Lid

SKU		Price Each
24" ID Liner—For use in 30" to 33" ID fire ring.		
183222	Steel—Black Painted	\$562.00
225144	Stainless Steel	\$1075.00
28" ID Liner—For use in 34" to 37" ID fire ring.		
183224	Steel—Black Painted	\$671.00
225146	Stainless Steel	\$1358.00
32" ID Liner—For use in 38" to 41" ID fire ring.		
183226	32" ID Liner	\$792.00
225148	Stainless Steel	\$1745.00

Zentro Accessories and Ablaze Fire Pit



Zentro Accessory Post with Collar
175208 \$45.00

- For use with Zentro fire ring liners. The Ablaze Fire Pit uses a different post—see below.



Zentro/Ablaze 24" Swing Away Grill
153524 \$225.00



Zentro/Ablaze 24" Chicken Rotisserie Grill
167144 \$422.00



Zentro/Ablaze 18" Griddle
175222 \$315.00



Zentro/Ablaze Kettle Winch
167134 \$263.00

ablaze
fire it up.



Ablaze 24" Smoke Less Fire Pit w/Lid
153520 \$580.00

- 24" inside diameter
- 102 lbs.



Ablaze Accessory Post with Collar
153522 \$67.00

- *Ablaze is the original smokeless fire pit*
- *Smoke re-burning technology nearly eliminates annoying smoke*
- *Ablaze won Best-In-Category and BEST-IN-SHOW at the 2014 VESTA Awards (Hearth and Home Magazine). This is one of the most prestigious industry awards available for fire pits and outdoor hearth products.*

Natural Stone Fire Ring Kits

*** Special Order *** Allow lead time *** No returns on fire ring kits



Shown with 3 layers and cap kit

36" Banas Stones Fire Ring

NS

Yard Price

Natural Stone Fire Ring Kit—Single 4" Layer

148616 Silver Grey \$350.00/Layer

Natural Stone Fire Ring Cap Set

148620 Silver Grey \$350.00/Set

- 36" inside diameter
- 10 pieces per layer
- Buildable in multiple configurations as layers are stacked
- Recommended Liner—Zentro 30" Smoke Less Fire Pit



Kasota Stone Fire Ring

F

Yard Price

Factory Direct

Limestone

148624 Amber \$465.00 \$400.00

148626 Cream \$480.00 \$415.00

148628 Gray \$500.00 \$435.00

Granite

148630 Echo \$500.00 \$435.00

148632 Mahogany \$500.00 \$435.00

148634 Superior Northern \$540.00 \$470.00

- 8 piece octagon
- 32" inside diameter and 49" outside diameter
- Recommended Liner—Zentro 24" Smoke Less Fire Pit with 41" Fire Pit Retro Ring



Lannon Stone Fire Ring

NS

Yard Price

Factory Direct

148622 \$2,230.00 \$1,935.00

- 8 total pieces—4 per layer
- Natural top surface—no coping necessary
- Rockface edges
- 36" inside diameter, 56" outside diameter
- 12" height (2 six inch layers)
- Recommended Liner—Zentro 30" Smoke Less Fire Pit

Unilock Rivercrest Fire Ring



Rivercrest Firepit Kit

NS

Yard Price

Factory Direct

122384 Buff \$1,405.00 \$1,193.75

148086 Coastal Slate (All Colors) (All Colors)

- 4 pieces per layer
- Pre-stacked on pallet for easy installation
- 35" inside diameter, 54" outside diameter
- Recommended Liner—Zentro 24" Smoke Less Fire Pit with 41" Fire Pit Retro Ring

Necessaries Fire Ring Kits

*** Special Order *** Allow lead time *** No returns on fire ring kits

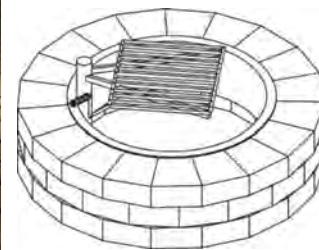
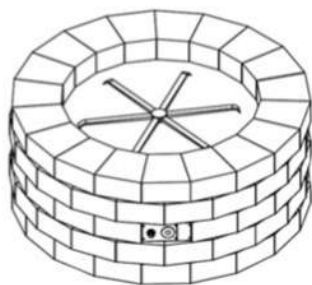

Grand Gas Fire Ring

		Yard Price	Factory Direct
116446	Beechwood	\$1,596.00	\$1,470.30
116448	Bluestone	(All Colors)	(All Colors)
116450	Desert		
116452	Santa Fe		
	LP Conversion Kit	Call	Call

Dimensions: 48"OD x 31"ID x 20"H—1,700 Lbs on 1 Pallet

Kit Includes:

- Quality stainless steel/brass hardware
- Push button ignition
- Adhesive
- Lakeland blocks
- 50 Lbs black lava rock
- Vent kit

Grand Fire Ring with Steel Insert & Grate

		Yard Price	Factory Direct
4557584	Beechwood	\$510.00	\$458.86
3717088	Bluestone	(All Colors)	(All Colors)
3717101	Desert		
3717095	Santa Fe		

Dimensions: 48"OD x 31"ID x 12"H—1,075 Lbs on 1 Pallet

Kit Includes:

- 7" x 30" steel insert
- Swing style cooking grate
- Adhesive
- Lakeland blocks

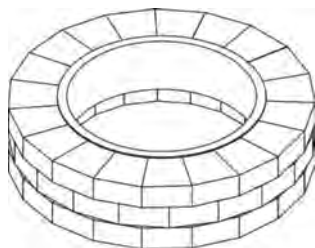

Grand Fire Ring with Steel Insert

		Yard Price	Factory Direct
4557591	Beechwood	\$398.00	\$354.34
3717118	Bluestone	(All Colors)	(All Colors)
3717132	Desert		
3717125	Santa Fe		

Dimensions: 48"OD x 31"ID x 12"H—1,047 Lbs on 1 Pallet

Kit Includes:

- 7" x 30" steel insert
- Adhesive
- Lakeland blocks

Grand Fire Ring—Block Only

		Yard Price	Factory Direct
4557607	Beechwood	\$359.00	\$318.18
3717149	Bluestone	(All Colors)	(All Colors)
3717163	Desert		
3717156	Santa Fe		

Dimensions: 48"OD x 31"ID x 12"H—1,009 Lbs on 1 Pallet

Kit Includes:

- Adhesive
- Lakeland blocks

4136833: \$20.00 RCP Pallet Charge
 All product can be delivered anywhere in the metro area
 All deliveries quoted individually for best rate—please call
 Please call for out-state and out-of-state delivery



Necessaries Victorian Fire Pit Kits

*** Special Order *** Allow lead time *** No returns on fire ring kits

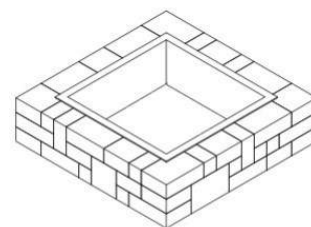
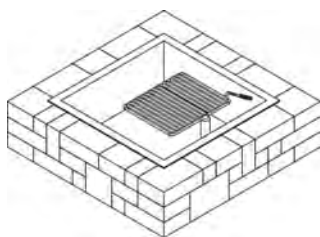

Victorian Fire Pit Kit with Steel Insert & Grate

		Yard Price	Factory Direct
4557669	Beechwood	\$566.00	\$510.38
4557638	Bluestone	(All Colors)	(All Colors)
4557652	Desert		
4557645	Santa Fe		

Dimensions: 48"W x 48"L x 12"H—1,300 Lbs on 1 Pallet

Kit Includes:

- 7" x 31" Steel Insert
- Swing style cooking grate
- Adhesive
- Lakeland blocks

Victorian Fire Pit Kit with Steel Insert

		Yard Price	Factory Direct
4557706	Beechwood	\$501.00	\$449.84
4557676	Bluestone	(All Colors)	(All Colors)
4557690	Desert		
4557683	Santa Fe		

Dimensions: 48"W x 48"L x 12"H—1,275 Lbs on 1 Pallet

Kit Includes:

- 7" x 31" Steel Insert
- Adhesive
- Lakeland blocks

Necessaries Travertine Fire Pit Kits

*** Special Order *** Allow lead time
*** No returns on fire ring kits



Travertine Fire Pit Kit with Steel Insert

		Yard Price	Factory Direct
185480	Ivory	\$867.00	\$791.11

Dimensions: 48"W x 48"L x 12"H

Kit Includes:

- 7" x 31" Steel Insert
- Adhesive

Travertine Fire Pit Kit with Steel Insert

		Yard Price	Factory Direct
185482	Ivory	\$991.00	\$906.16

- Same as above but includes swing style cooking grate

Necessaries Barn Plank Fire Pit Kits

*** Special Order *** Allow lead time
*** No returns on fire ring kits



Barn Plank Fire Pit Kit—No Grate

		Yard Price	Factory Direct
185470	Mahogany	\$638.00	\$577.41
185472	Weathered Gray	\$638.00	\$577.41

Dimensions: 48"W x 48"L x 12"H

Kit Includes:

- 7" x 31" Steel Insert
- Adhesive

Barn Plank Fire Pit Kit with Grate

		Yard Price	Factory Direct
185474	Mahogany	\$744.00	\$676.03
185476	Weathered Gray	\$744.00	\$676.03

- Same as above but includes swing style cooking grate

Necessaries Fire Ring Kits

*** Special Order *** Allow lead time *** No returns on fire ring kits



Round Fire Ring Cap Block Kit

		Yard Price	Factory Direct
8 Piece Silver Creek Edge Cap			
129578	Bluestone	\$301.00	\$258.61
202016	Buff	(All Colors)	(All Colors)
4171568	Indiana Limestone		

Accessories

		Price
4222130	Round Steel Insert	\$236.00
122360	Square Steel Insert	\$276.00
4222123	Grate Only	\$123.00
53732	Cover w/slot	\$229.00
4222147	Spark Screen	\$323.00



Extend the enjoyment of your fire pit patio into winter with a radiant heat snow melting system.

See page 331 for more information.

Belgard Fire Pit Kits

*** Special Order *** Allow lead time *** No returns on fire ring kits



Weston Round Fire Pit Kit

		Yard Price	Factory Direct
181450	Cotswold Mist	\$394.00	\$357.04
181452	Gascony Tan	(All Colors)	(All Colors)
181454	Northwoods		

Dimensions: 53"OD x 37"ID x 12"H—1,218 Lbs on 1 Pallet

Kit Includes:

- Weston blocks
- Steel liner

Belgard Fire Ring Caps for Round Fire Pit

		Yard Price	Factory Direct
220176	Anthracite	\$95.00/Piece	\$84.46/Piece
220178	Leather		

- Pieces sold separately. **4 pieces per complete set.**
- Smooth inside edge and rock face outside edge
- 2½" thick

4136789: \$20.00 Belgard Pallet Charge
 All product can be delivered anywhere in the metro area
 All deliveries quoted individually for best rate—please call
 Please call for out-state and out-of-state delivery



Fire Ring Liner

224452	30" Diameter x 12" High	\$137.00
224454	36" Diameter x 12" High	\$154.00
224456	39" Diameter x 12" High	\$162.00
224458	48" Diameter x 12" High	\$186.00



Fire Ring Cover

30" Diameter	\$137.00
36" Diameter	\$154.00
39" Diameter	\$162.00
48" Diameter	\$186.00



CONTRACTOR TAXES AND GUIDANCE BY
 A FELLOW CONTRACTOR JUST LIKE YOU.

JACK EVANS

JACK@JAX-TAX.COM
 (PREFERRED CONTACT)

952-270-3385

WWW.JAX-TAX.COM

Borgert Strassen Fire Pit Kits

*** Special Order *** Allow lead time *** No returns on fire ring kits



Borgert Round Fire Pit Kit

		Yard Price	Factory Direct
4362980	Boulder Blend	\$395.00	\$350.00
225076	Charcoal	(All Colors)	(All Colors)
84150	Iron Range		
4193362	Minnesota River		
4362973	North Shore		
225074	Sterling Gray		

Dimensions: 52"OD x 36"ID x 12"H

Kit Includes:

- 63 Strassen Trapezoid blocks
- 36" Diameter x 12"H metal ring
- Adhesive
- Caps sold separately

Borgert Square Fire Pit Kit

		Yard Price	Factory Direct
120492	Boulder Blend	\$395.00	\$350.00
120496	Iron Range	(All Colors)	(All Colors)
120498	Limestone		
120500	Minnesota River		
120502	North Shore		

Dimensions: 52"OD x 36"ID x 12"H

Kit Includes:

- 42 blocks (Pallet A) and 6 blocks (Pallet C)
- Square metal liner
- Adhesive



Borgert Precast Fire Ring Caps for Round Fire Pit

		Yard Price	Factory Direct
178708	Brown	\$75.00/Piece	\$66.22/Piece
88448	Charcoal		
88450	Limestone	(All Colors)	(All Colors)

- Pieces sold separately. **4 pieces per complete set.**
- Creates a 36" inside diameter and a 55" outside diameter
- Smooth inside edge and rock face outside edge
- 2½" thick



4136796: \$20.00 Borgert Pallet Charge

All product can be delivered anywhere in the metro area

All deliveries quoted individually for best rate—please call

Please call for out-state and out-of-state delivery

Belgard Elements Fireplace Kits, Brick Ovens & Grill Islands

*** Special Order *** No returns on fireplace kits



Bordeaux® Series Fireplace

220158	Pewter/Midnight	\$5,215.00
181650	Shelby/Midnight	\$5,215.00
114472	Sienna/Buff	\$5,215.00
120542	Sienna/Midnight	\$5,215.00

* See page 80 for matching wall option



Bordeaux® Series Brick Oven

220162	Pewter/Midnight	\$6,825.00
181654	Shelby/Midnight	\$6,825.00
114470	Sienna/Buff	\$6,825.00
120540	Sienna/Midnight	\$6,825.00

* See page 80 for matching wall option

Delivery of Belgard Elements Fireplace Kits and Grill Islands includes offloading at site, but not placement/installation. Please call for details.



Bordeaux® Series Wood Boxes

220160	Pewter/Midnight	\$1,662.00
181652	Shelby/Midnight	\$1,662.00
114476	Sienna/Buff	\$1,662.00
120538	Sienna/Midnight	\$1,662.00

• Wood boxes are sold as a pair



Bordeaux® Series Grill Island

181658	Shelby/Midnight LP	\$6,547.00
181656	Shelby/Midnight NG	\$6,547.00
114474	Sienna/Buff	\$6,547.00
146886	Sienna/Midnight	\$6,547.00
220164	Pewter/Midnight	\$6,547.00

• Includes Grill and Double Doors

Belgard Elements Fireplace Kits & Brick Ovens

*** Special Order *** No returns on fireplace kits



Brighton® Series Fireplace

120560	Cotswold Mist/Brookstone Slate	\$6,854.00
120562	Gascony Tan/Ashbury Haze	\$6,854.00



Brighton® Series Wood Boxes

120564	Cotswold Mist/Brookstone Slate	\$2,569.00
120566	Gascony Tan/Ashbury Haze	\$2,569.00

- Wood boxes are sold as a pair

Delivery of Belgard Elements Fireplace Kits and Grill Islands includes offloading at site, but not placement/installation. Please call for details.



Bristol® Series Fireplace

120544	Cotswold Mist/ Brookstone Slate	\$7,499.00
120546	Gascony Tan/ Ashbury Haze	\$7,499.00



Bristol® Series Brick Oven

120548	Cotswold Mist/ Brookstone Slate	\$11,255.00
120550	Gascony Tan/ Ashbury Haze	\$11,255.00



Bristol® Series Arched Hearth

120552	Cotswold Mist/ Brookstone Slate	\$1,207.00
120554	Gascony Tan/ Ashbury Haze	\$1,207.00



Bristol® Series Wood Boxes

120556	Cotswold Mist/Brookstone Slate	\$3,238.00
120558	Gascony Tan/Ashbury Haze	\$3,238.00

- Wood boxes are sold as a pair



Bristol® Series Grill Island

146884	Cotswold Mist/Brookstone Slate	\$10,455.00
114488	Gascony Tan/Ashbury Haze	\$10,455.00

- Includes 36" AOG Grill and Double Doors



King of Hearths Fireplace Kits

*** Special Order *** Allow lead time *** No returns on fireplace kits

All fireplace models feature:

- Forklift pockets built into precast concrete form
 - Protective fire brick pre-installed
- Spark arrester mount set in precast chimney
- Finish with your choice of stone, brick, or stucco

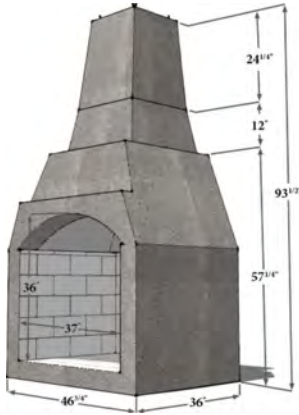

King Arthur 46" Fireplace

- | | | | |
|---------|------------|-------------------|-----------------------|
| 3554201 | Unfinished | Yard Price | Factory Direct |
| | | \$2,280.00 | \$2,065.50 |
- 7' 10"H x 3' 10"W x 3'D (Unfinished)
 - 2,500 Lbs (Unfinished)
 - Simple 3-piece mortarless design makes set up quick & easy
 - Extra large fire box opening

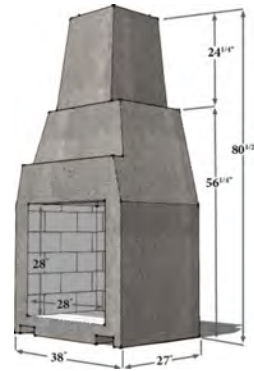

Guinevere 38" Fireplace

- | | | | |
|---------|------------|-------------------|-----------------------|
| 3554218 | Unfinished | Yard Price | Factory Direct |
| | | \$1,875.00 | \$1,697.58 |
- 6' 7"H x 3' 2"W x 2' 4"D (Unfinished)
 - 1,650 Lbs (Unfinished)
 - Simple 2-piece mortarless design makes set up quick & easy

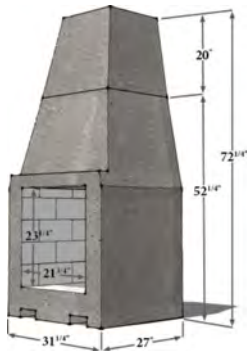

Camlann 31" Fireplace

- | | | | |
|---------|------------|-------------------|-----------------------|
| 4362881 | Unfinished | Yard Price | Factory Direct |
| | | \$1,635.00 | \$1,478.09 |
- 5' 9"H x 2' 7"W x 2' 2 1/2"D (Unfinished)
 - 1,220 Lbs (Unfinished)
 - Simple 2-piece mortarless design makes set up quick & easy

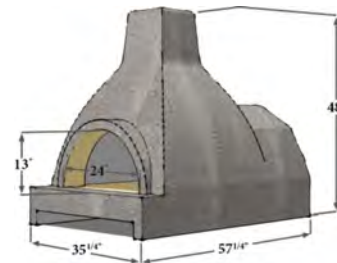

Lancelot Outdoor Oven

- | | | | |
|---------|------------|-------------------|-----------------------|
| 4362898 | Unfinished | Yard Price | Factory Direct |
| | | \$2,485.00 | \$2,249.05 |
- 44"H x 35"W x 57"D (Unfinished)
 - 1,500 Lbs (Unfinished)
 - Great for stone fired pizzas and more
 - Custom fit to new or existing outdoor kitchen

Necessaries Colonial Outdoor Fireplace

*** Special Order *** Allow lead time *** No returns on fireplace kits

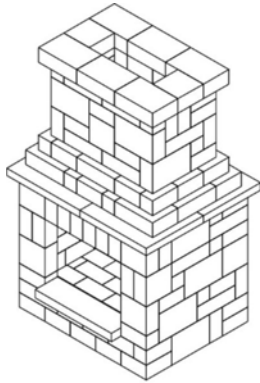

Colonial Outdoor Fireplace

		Yard Price	Factory Direct
4557140	Beechwood	\$2,568.00	\$2,305.67
4171315	Bluestone	(All Colors)	(All Colors)
4171339	Desert		
4171322	Santa Fe		

Dimensions: 40"W x 32"D x 70"H—4,350 Lbs on 2 Pallets

Kit Includes:

- Fireplace
- Firebrick for lining interior
- Adhesive
- Lakeland blocks
- Silver Creek Stone
- Gray Indiana Limestone tops

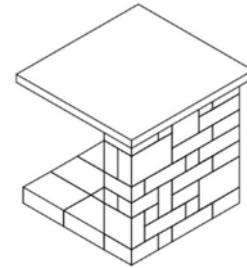

Colonial Wood Box

		Yard Price	Factory Direct
4557072	Beechwood	\$1013.00	\$901.53
3956685	Bluestone	(All Colors)	(All Colors)
3956708	Desert		
3956692	Santa Fe		

Dimensions: 32"W x 32"D x 34"H—1,655 Lbs on 1 Pallet

Kit Includes:

- Adhesive
- Lakeland block
- Gray Indiana Limestone top

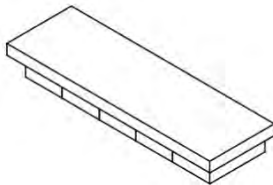

Colonial Hearth

		Yard Price	Factory Direct
4557102	Beechwood	\$382.00	\$329.43
3956715	Bluestone	(All Colors)	(All Colors)
3956739	Desert		
3956722	Santa Fe		

Dimensions: 40"W x 12"D x 6"H—285 Lbs on 1 Pallet

Kit Includes:

- Adhesive
- Lakeland Block
- Gray Indiana Limestone top

4136833: \$20.00 RCP Pallet Charge

All product can be delivered anywhere in the metro area
All deliveries quoted individually for best rate—please call
Please call for out-state and out-of-state delivery



Necessaries Compact Outdoor Fireplace

*** Special Order *** Allow lead time *** No returns on fireplace kits

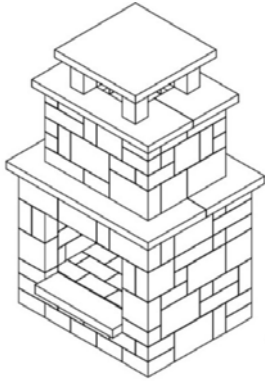

Compact Outdoor Fireplace

		Yard Price	Factory Direct
4557058	Beechwood	\$2,568.00	\$2,305.67
3733958	Bluestone	(All Colors)	(All Colors)
3733972	Desert		
3733965	Santa Fe		

Dimensions: 40"W x 32"D x 70"H—3,725 Lbs on 2 Pallets

Kit Includes:

- Fireplace
- Firebrick for lining interior
- Adhesive
- Lakeland blocks
- Silver Creek Stone
- Gray Indiana Limestone tops

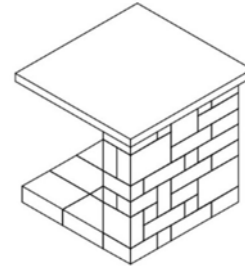

Compact Wood Box

		Yard Price	Factory Direct
4557072	Beechwood	\$1,013.00	\$900.53
3956685	Bluestone	(All Colors)	(All Colors)
3956708	Desert		
3956692	Santa Fe		

Dimensions: 32"W x 32"D x 34"H—1,655 Lbs on 1 Pallet

Kit Includes:

- Adhesive
- Lakeland block
- Gray Indiana Limestone top

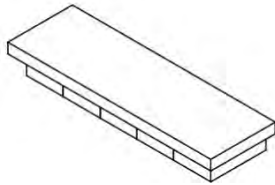

Compact Hearth

		Yard Price	Factory Direct
4557102	Beechwood	\$382.00	\$329.43
3956715	Bluestone	(All Colors)	(All Colors)
3956739	Desert		
3956722	Santa Fe		

Dimensions: 40"W x 12"D x 6"H—285 Lbs on 1 Pallet

Kit Includes:

- Adhesive
- Lakeland Block
- Gray Indiana Limestone top

4136833: \$20.00 RCP Pallet Charge

All product can be delivered anywhere in the metro area
 All deliveries quoted individually for best rate—please call
 Please call for out-state and out-of-state delivery

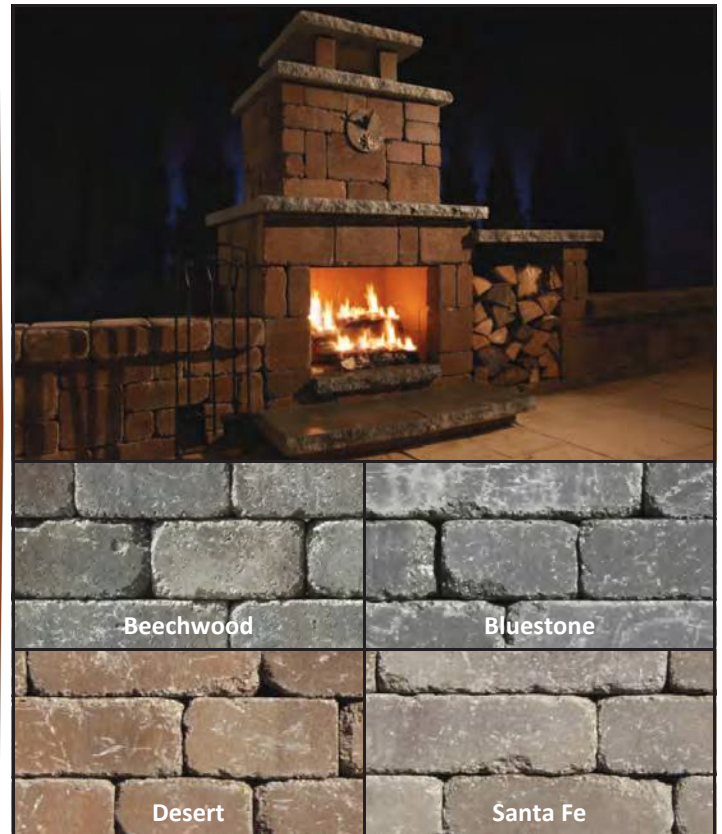

Necessaries Contemporary Outdoor Fireplace

*** Special Order *** Allow lead time *** No returns on fireplace kits

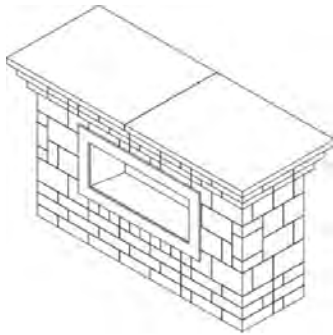

Contemporary Outdoor Fireplace

		Yard Price	Factory Direct
4557379	Beechwood	\$8,571.00	\$7,822.25
4171346	Bluestone	(All Colors)	(All Colors)
4171360	Desert		
4171353	Santa Fe		

Dimensions: 96"W x 36"D x 54"H—4,700 Lbs on 5 Pallets

Kit Includes:

- Fireplace
- Firebrick for lining interior
- Glass wind screen
- 43,000+ BTU
- Natural gas or LP
- Electronic Ignition
- Adhesive
- Lakeland blocks
- Silver Creek Stone
- Gray Indiana Limestone tops

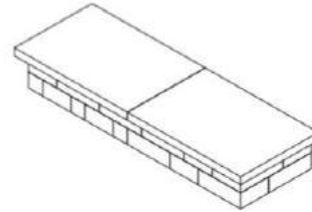

Contemporary Fireplace Hearth

		Yard Price	Factory Direct
4557386	Beechwood	\$877.00	\$783.29
4171377	Bluestone	(All Colors)	(All Colors)
4171391	Desert		
4171384	Santa Fe		

Dimensions: 60"W x 20"D x 10"H—700 Lbs on 1 Pallet

Kit Includes:

- Adhesive
- Lakeland block
- Gray Indiana Limestone top



4136833: \$20.00 RCP Pallet Charge

All product can be delivered anywhere in the metro area
All deliveries quoted individually for best rate—please call
Please call for out-state and out-of-state delivery

Necessaries Grand Outdoor Fireplace

*** Special Order *** Allow lead time *** No returns on fireplace kits

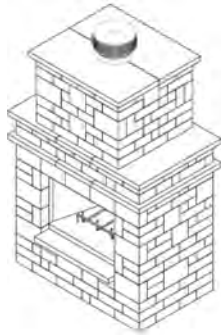

Grand Outdoor Fireplace

		Yard Price	Factory Direct
4557348	Beechwood	\$8,020.00	\$7,289.53
3548309	Bluestone	(All Colors)	(All Colors)
3717057	Desert		
3548316	Santa Fe		

Dimensions: 60"W x 36"D x 102"H—9,667 Lbs on 5 Pallets

Kit Includes:

- Fireplace
- Stainless steel fireplace insert
- 4' Chimney
- Spark suppressor cap
- Adhesive
- Lakeland blocks
- Silver Creek Stone
- Gray Indiana Limestone tops

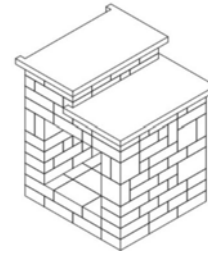

Grand Wood Box

		Yard Price	Factory Direct
4557355	Beechwood	\$1,599.00	\$1,431.15
3956623	Bluestone	(All Colors)	(All Colors)
3956647	Desert		
3956630	Santa Fe		

Dimensions: 40"W x 36"D x 50"H—4,060 Lbs on 2 Pallets

Kit Includes:

- Adhesive
- Lakeland block
- Gray Indiana Limestone top

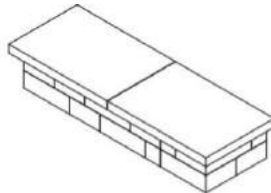

Grand Hearth

		Yard Price	Factory Direct
4557362	Beechwood	\$922.00	\$824.53
3956654	Bluestone	(All Colors)	(All Colors)
3956678	Desert		
3956661	Santa Fe		

Dimensions: 60"W x 20"D x 10"H—700 Lbs on 1 Pallet

Kit Includes:

- Adhesive
- Lakeland Block
- Gray Indiana Limestone top

4136833: \$20.00 RCP Pallet Charge

All product can be delivered anywhere in the metro area
 All deliveries quoted individually for best rate—please call
 Please call for out-state and out-of-state delivery



Necessaries Victorian Outdoor Fireplace

*** Special Order *** Allow lead time *** No returns on fireplace kits

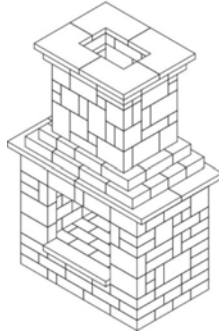

Victorian Outdoor Fireplace

		Yard Price	Factory Direct
4557164	Beechwood	\$4,913.00	\$4,455.78
4359348	Bluestone	(All Colors)	(All Colors)
4359362	Desert		
4359355	Santa Fe		

Dimensions: 52"W x 32"D x 89"H—6,600 Lbs on 5 Pallets

Kit Includes:

- Fireplace
- Firebrick for lining interior
- Adhesive
- Lakeland blocks
- Silver Creek Stone
- Gray Indiana Limestone tops

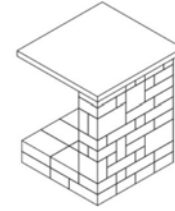

Victorian Wood Box

		Yard Price	Factory Direct
4557188	Beechwood	\$1,285.00	\$1,157.64
4359379	Bluestone	(All Colors)	(All Colors)
4359393	Desert		
4359386	Santa Fe		

Dimensions: 32"W x 32"D x 42"H—2,190 Lbs on 2 Pallets

Kit Includes:

- Adhesive
- Lakeland block
- Gray Indiana Limestone top

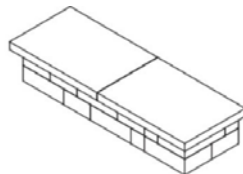

Victorian Hearth

		Yard Price	Factory Direct
4557201	Beechwood	\$566.00	\$491.39
4359409	Bluestone	(All Colors)	(All Colors)
4359423	Desert		
4359416	Santa Fe		

Dimensions: 52"W x 18"D x 6"H—570 Lbs on 1 Pallet

Kit Includes:

- Adhesive
- Lakeland Block
- Gray Indiana Limestone top

4136833: \$20.00 RCP Pallet Charge

All product can be delivered anywhere in the metro area
All deliveries quoted individually for best rate—please call
Please call for out-state and out-of-state delivery



The Kitchen by Necessaries

*** Special Order *** Allow lead time *** No returns on bars and islands

The Kitchen by Necessaries



4136833: \$20.00 RCP Pallet Charge
 All product can be delivered anywhere in the metro area
 All deliveries quoted individually for best rate—please call
 Please call for out-state and out-of-state delivery

32" Grill Cabinet

Dimensions: 48"W x 28"D x 37"H

Kit Includes:

- Summerset Sizzler 32" grill
- 30" double doors
- Grill cover
- Adhesive
- Lakeland blocks
- Granite tops

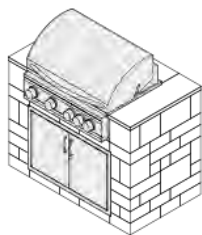

		Yard Price	Factory Direct
Black Pearl Top			
116460	Beechwood	\$4,698.00	\$4,306.75
116462	Bluestone	(All Colors)	(All Colors)
116464	Desert		
116466	Santa Fe		
Viscon White Top			
116468	Beechwood	\$4,698.00	\$4,306.75
116470	Bluestone	(All Colors)	(All Colors)
116472	Desert		
116474	Santa Fe		
Deluxe Rotisserie Kit			
116704		\$145.00	

40" Grill Cabinet

Dimensions: 56"W x 28"D x 37"H

Kit Includes:

- Summerset Sizzler 40" grill
- 30" double doors
- Grill cover
- Adhesive
- Lakeland blocks
- Granite tops

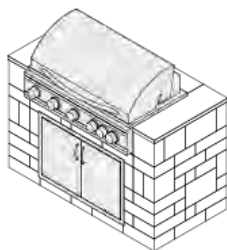

		Yard Price	Factory Direct
Black Pearl Top			
116478	Beechwood	\$5,273.00	\$4,834.38
116480	Bluestone	(All Colors)	(All Colors)
116482	Desert		
116484	Santa Fe		
Viscon White Top			
116486	Beechwood	\$5,273.00	\$4,834.38
116488	Bluestone	(All Colors)	(All Colors)
116490	Desert		
116492	Santa Fe		
Deluxe Rotisserie Kit			
116706		\$151.00	

www.bachmanswholesale.com

The Kitchen by Necessaries

*** Special Order *** Allow lead time *** No returns on bars and islands



4136833: \$20.00 RCP Pallet Charge
 All product can be delivered anywhere in the metro area
 All deliveries quoted individually for best rate—please call
 Please call for out-state and out-of-state delivery

The Refrigerator Cabinet (Refrigerator Sold Separately)

Dimensions: 32"W x 28"D x 37"H

Kit Includes:

- 24"W x 24"D x 36"H refrigerator opening
- Adhesive
- Lakeland blocks
- Granite tops

Optional Refrigerator (Sold Separately)

- UL certified for outdoor use
- 5.5 CF capacity
- Reversible door with lock and key
- Digital temperature display
- #304 stainless steel construction

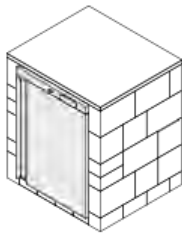

		Yard Price	Factory Direct
Black Pearl Top			
116542	Beechwood	\$910.00	\$834.75
116544	Bluestone	(All Colors)	(All Colors)
116546	Desert		
116548	Santa Fe		
Viscon White Top			
116550	Beechwood	\$910.00	\$834.75
116552	Bluestone	(All Colors)	(All Colors)
116554	Desert		
116556	Santa Fe		
Optional Refrigerator-Outdoor Rated			
116698		\$1,281.00	

The Trash Cabinet

Dimensions: 28"W x 28"D x 37"H

Kit Includes:

- Easy glide pullout drawer
- Accommodates a 12 gallon trash can
- #304 stainless steel construction
- Adhesive
- Lakeland blocks
- Granite tops

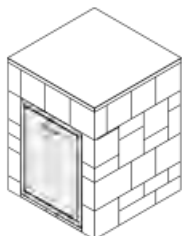

		Yard Price	Factory Direct
Black Pearl Top			
116526	Beechwood	\$1,630.00	\$1,494.50
116528	Bluestone	(All Colors)	(All Colors)
116530	Desert		
116532	Santa Fe		
Viscon White Top			
116534	Beechwood	\$1,630.00	\$1,494.50
116536	Bluestone	(All Colors)	(All Colors)
116538	Desert		
116540	Santa Fe		

The Kitchen by Necessaries

*** Special Order *** Allow lead time *** No returns on bars and islands

The Kitchen by Necessaries



4136833: \$20.00 RCP Pallet Charge
 All product can be delivered anywhere in the metro area
 All deliveries quoted individually for best rate—please call
 Please call for out-state and out-of-state delivery

The Prep Center Cabinet

Dimensions: 48"W x 28"D x 37"H

Kit Includes:

- Two easy glide stainless steel doors with magnetic close door
- Adhesive
- Lakeland blocks
- Granite tops

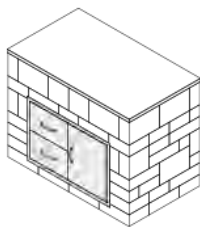

		Yard Price	Factory Direct
Black Pearl Top			
116558	Beechwood	\$2,877.00	\$2,637.25
116560	Bluestone	(All Colors)	(All Colors)
116562	Desert		
116564	Santa Fe		
Viscon White Top			
116566	Beechwood	\$2,877.00	\$2,637.25
116568	Bluestone	(All Colors)	(All Colors)
116572	Desert		
116574	Santa Fe		

The Prep Center Cabinet with Sink

Dimensions: 48"W x 28"D x 37"H

Kit Includes:

- Two easy glide stainless steel doors with magnetic close door
- Adhesive
- Lakeland blocks
- Granite tops

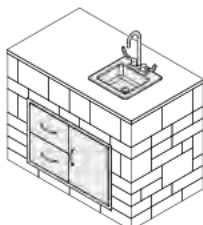

		Yard Price	Factory Direct
Black Pearl Top			
116576	Beechwood	\$3,163.00	\$2,899.75
116578	Bluestone	(All Colors)	(All Colors)
116580	Desert		
116582	Santa Fe		
Viscon White Top			
116584	Beechwood	\$3,163.00	\$2,899.75
116586	Bluestone	(All Colors)	(All Colors)
116588	Desert		
116590	Santa Fe		

www.bachmanswholesale.com

The Kitchen by Necessaries

*** Special Order *** Allow lead time *** No returns on bars and islands



4136833: \$20.00 RCP Pallet Charge
 All product can be delivered anywhere in the metro area
 All deliveries quoted individually for best rate—please call
 Please call for out-state and out-of-state delivery

The Outdoor Oven Cabinet

Woodbox/Stand Kit Dimensions: 32"W x 28"D x 37"H

Woodbox/Stand Kit Includes:

- 4.75 CF, 16"W x 16"D x 32" storage opening
- Adhesive
- Lakeland blocks
- Granite tops

Outdoor oven—***sold separately***

- 30"W x 32"D x 40"H
- 24" x 24" cooking surface
- Reinforced, polished stainless steel chimney pipe
- Stainless steel wood caddy
- Stainless steel door with beech wood handle
- Thermometer

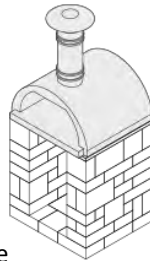

		Yard Price	Factory Direct
Woodbox/Stand with Black Pearl Top			
116626	Beechwood	\$910.00	\$834.75
116628	Bluestone	(All Colors)	(All Colors)
116630	Desert		
116632	Santa Fe		
Woodbox/Stand with Viscon White Top			
116634	Beechwood	\$910.00	\$834.75
116636	Bluestone	(All Colors)	(All Colors)
116638	Desert		
116640	Santa Fe		
Outdoor Oven Nonno Peppe			
116710		\$1,356.00	

The Side Burner Cabinet

Dimensions: 32"W x 28"D x 37"H

Kit Includes:

- Sizzler double side burner
- Double drawer
- Adhesive
- Lakeland blocks
- Granite tops



		Yard Price	Factory Direct
Black Pearl Top			
116494	Beechwood	\$3,020.00	\$2,768.50
116496	Bluestone	(All Colors)	(All Colors)
116498	Desert		
116500	Santa Fe		
Viscon White Top			
116502	Beechwood	\$3,020.00	\$2,768.50
116504	Bluestone	(All Colors)	(All Colors)
116506	Desert		
116508	Santa Fe		

The Kitchen by Necessaries

*** Special Order *** Allow lead time *** No returns on bars and islands

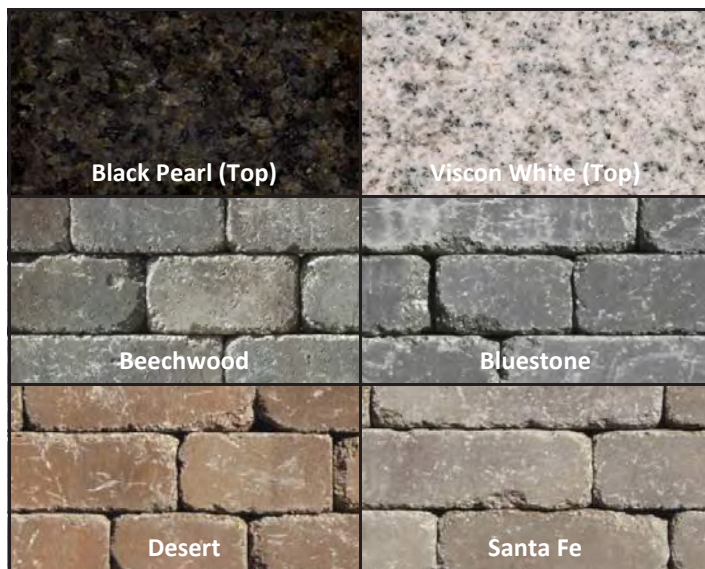

4136833: \$20.00 RCP Pallet Charge
 All product can be delivered anywhere in the metro area
 All deliveries quoted individually for best rate—please call
 Please call for out-state and out-of-state delivery

The Smoker Cabinet

Smoker Kit Dimensions: 40"W x 28"D x 37"H

Kit Includes:

- Adhesive
- Lakeland blocks
- Granite tops

Primo Kamado Smoker—*sold separately*

- 18.5" round



		Yard Price	Factory Direct
Smoker Cabinet with Black Pearl Top			
116610	Beechwood	\$1,149.00	\$1,053.50
116612	Bluestone	(All Colors)	(All Colors)
116614	Desert		
116616	Santa Fe		
Smoker Cabinet with Viscon White Top			
116618	Beechwood	\$1,149.00	\$1,053.50
116620	Bluestone	(All Colors)	(All Colors)
116622	Desert		
116624	Santa Fe		
Primo Smoker All in One Grill			
85404		\$953.00	

The Storage Cabinet

Dimensions: 32"W x 28"D x 37"H

Kit Includes:

- Double drawer
- Adhesive
- Lakeland blocks
- Granite tops

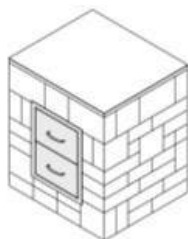

		Yard Price	Factory Direct
Black Pearl Top			
116510	Beechwood	\$1,820.00	\$1,668.63
116512	Bluestone	(All Colors)	(All Colors)
116514	Desert		
116516	Santa Fe		
Viscon White Top			
116518	Beechwood	\$1,820.00	\$1,668.63
116520	Bluestone	(All Colors)	(All Colors)
116522	Desert		
116524	Santa Fe		

The Kitchen by Necessaries

*** Special Order *** Allow lead time *** No returns on bars and islands



4136833: \$20.00 RCP Pallet Charge
 All product can be delivered anywhere in the metro area
 All deliveries quoted individually for best rate—please call
 Please call for out-state and out-of-state delivery

The Island Cabinet

Island Kit Dimensions: 90"W x 45½"D x 37"H

Kit Includes:

- Double door—30"x30"
- Adhesive
- Lakeland blocks
- Granite tops

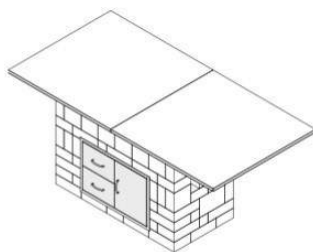

		Yard Price	Factory Direct
Black Pearl Top			
116642	Beechwood	\$4,890.00	\$4,482.63
116644	Bluestone	(All Colors)	(All Colors)
116646	Desert		
116650	Santa Fe		
Viscon White Top			
116652	Beechwood	\$4,890.00	\$4,482.63
116654	Bluestone	(All Colors)	(All Colors)
116656	Desert		
116658	Santa Fe		

The Island with Sink Cabinet

Island Kit Dimensions: 90"W x 45½"D x 37"H

Kit Includes:

- Sink
- Double door and drawer combo
- Adhesive
- Lakeland blocks
- Granite tops

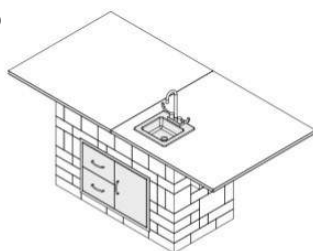

		Yard Price	Factory Direct
Black Pearl Top			
116660	Beechwood	\$5,177.00	\$4,746.00
116662	Bluestone	(All Colors)	(All Colors)
116664	Desert		
116666	Santa Fe		
Viscon White Top			
116668	Beechwood	\$5,177.00	\$4,746.00
116670	Bluestone	(All Colors)	(All Colors)
116672	Desert		
116674	Santa Fe		

The Kitchen by Necessaries

*** Special Order *** Allow lead time *** No returns on bars and islands

Corner/End Cap Cabinet

Corner/End Cap Kit Dimensions: 28"W x 28"D x 37"H

Kit Includes:

- Adhesive
- Lakeland blocks
- Granite tops

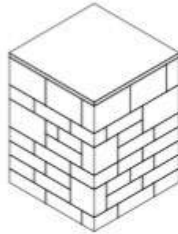

Black Pearl Top

- 116592 Beechwood
- 116596 Bluestone
- 116598 Desert
- 116600 Santa Fe

Yard Price Factory Direct

\$910.00 \$834.75
(All Colors) (All Colors)

Viscon White Top

- 116602 Beechwood
- 116604 Bluestone
- 116606 Desert
- 116608 Santa Fe

\$910.00 \$834.75
(All Colors) (All Colors)



4136833: \$20.00 RCP Pallet Charge

All product can be delivered anywhere in the metro area
All deliveries quoted individually for best rate—please call
Please call for out-state and out-of-state delivery

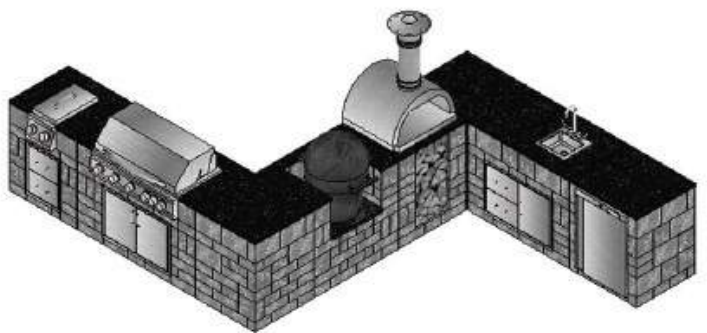
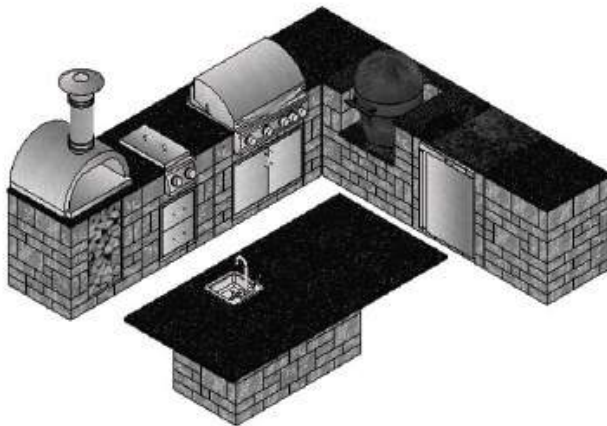

Necessaries Grand Island Bar/Grill

*** Special Order *** Allow lead time *** No returns on bars and islands

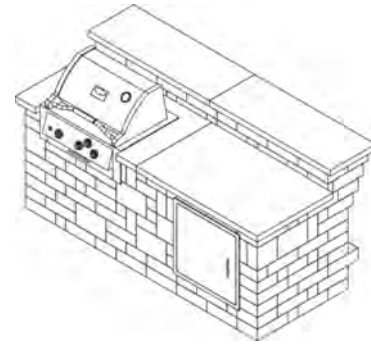
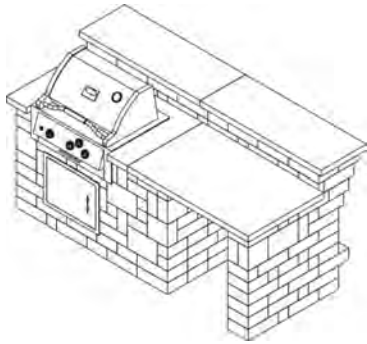

Grand Island Bar/Grill with Refrigerator Opening

		Yard Price	Factory Direct
4557393	Beechwood	\$5,920.00	\$5,364.21
3550517	Bluestone (All Colors)	(All Colors)	(All Colors)
3717064	Desert		
3550524	Santa Fe		

Dimensions: 96"W x 48"D x 46"H—7,331 Lbs on 4 Pallets

Kit Includes:

- Bar, bar top, countertop, grill, & door
- Stainless steel gas grill (LP or NG)
- Stainless steel 30" x 30" refrigerator door
- Adhesive
- Lakeland blocks
- Silver Creek countertops

Grand Island Bar/Grill with Storage Kit

		Yard Price	Factory Direct
4557409	Beechwood	\$5,920.00	\$5,364.21
3956746	Bluestone (All Colors)	(All Colors)	(All Colors)
3956760	Desert		
3956753	Santa Fe		

Dimensions: 96"W x 48"D x 46"H—7,331 Lbs on 4 Pallets

Kit Includes:

- Bar, bar top, countertop, grill, & door
- Stainless steel gas grill (LP or NG)
- Stainless steel 30" x 30" storage door
- Adhesive
- Lakeland block
- Silver Creek countertops



4136833: \$20.00 RCP Pallet Charge
 All product can be delivered anywhere in the metro area
 All deliveries quoted individually for best rate—please call
 Please call for out-state and out-of-state delivery

Necessories Grand Island Bar

*** Special Order *** Allow lead time *** No returns on bars and islands

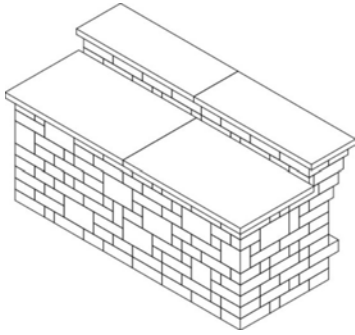

Grand Island 8' Bar

		Yard Price	Factory Direct
4557416	Beechwood	\$3,575.00	\$3,214.94
3956777	Bluestone	(All Colors)	(All Colors)
3956791	Desert		
3956784	Santa Fe		

Dimensions: 96"W x 48"D x 46"H—7,261 Lbs on 3 Pallets

Kit Includes:

- Adhesive
- Lakeland blocks
- Silver Creek Stone

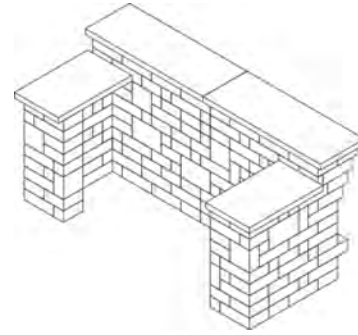

Grill Surround

		Yard Price	Factory Direct
4557430	Beechwood	\$2,598.00	\$2,319.40
3956838	Bluestone	(All Colors)	(All Colors)
3956852	Desert		
3956845	Santa Fe		

Dimensions: 96"W x 48"D x 46"H—4,905 Lbs on 2 Pallets

Kit Includes:

- Adhesive
- Lakeland block
- Gray Indiana Limestone top

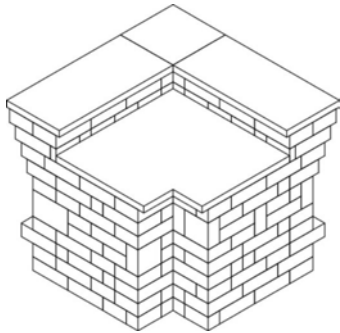

Corner Return

		Yard Price	Factory Direct
4557447	Beechwood	\$3,487.00	\$3,134.33
3956876	Bluestone	(All Colors)	(All Colors)
3956883	Desert		
3956876	Santa Fe		

Dimensions: 48"W x 48"D x 46"H—5,140 Lbs on 2 Pallets

Kit Includes:

- Adhesive
- Lakeland Block
- Gray Indiana Limestone top

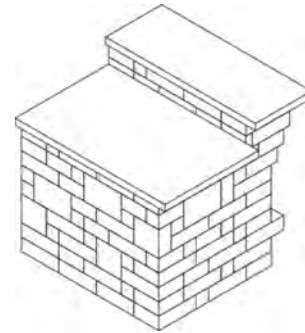

4' Bar Section

		Yard Price	Factory Direct
4557423	Beechwood	\$2,012.00	\$1,782.08
3956807	Bluestone	(All Colors)	(All Colors)
3956821	Desert		
3956814	Santa Fe		

Dimensions: 48"W x 48"D x 46"H—3,770 Lbs on 1 Pallet

Kit Includes:

- Adhesive
- Lakeland Block
- Gray Indiana Limestone top

4136833: \$20.00 RCP Pallet Charge
 All product can be delivered anywhere in the metro area
 All deliveries quoted individually for best rate—please call
 Please call for out-state and out-of-state delivery

Necessaries Compact Bar

*** Special Order *** Allow lead time *** No returns on bar kits

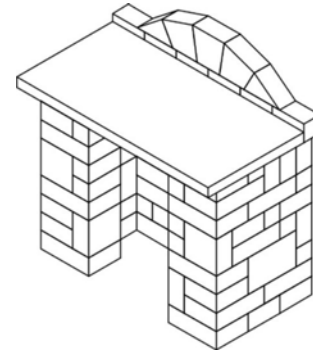
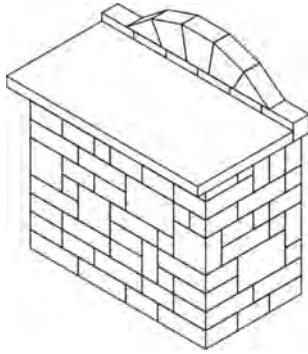

Compact Bar

		Yard Price	Factory Direct
4557454	Beechwood	\$1,484.00	\$1,338.67
3956890	Bluestone	(All Colors)	(All Colors)
3956913	Desert		
3956906	Santa Fe		

Dimensions: 48"W x 24"D x 38"H—2,820 Lbs on 1 Pallet

Kit Includes:

- Adhesive
- Lakeland blocks
- Silver Creek Stone countertop

Compact Bar with Opening

		Yard Price	Factory Direct
4557461	Beechwood	\$1,484.00	\$1,338.67
3956920	Bluestone	(All Colors)	(All Colors)
3956944	Desert		
3956937	Santa Fe		

Dimensions: 48"W x 24"D x 38"H—2,820 Lbs on 1 Pallet

Kit Includes:

- Adhesive
- Lakeland block
- Silver Creek Stone countertop



4136833: \$20.00 RCP Pallet Charge
 All product can be delivered anywhere in the metro area
 All deliveries quoted individually for best rate—please call
 Please call for out-state and out-of-state delivery

Necessaries Tables & Bar Tops

*** Special Order *** Allow lead time *** No returns on table kits

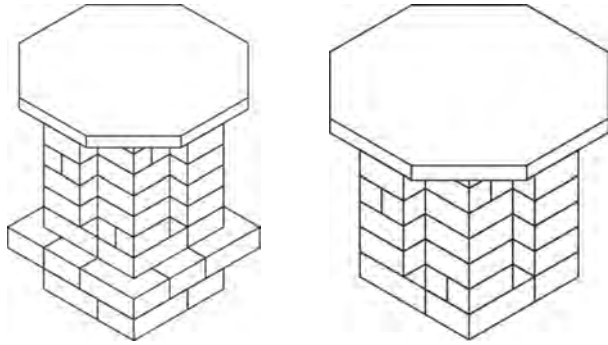

Pub Table/Bistro Table

		Yard Price	Factory Direct
4557485	Beechwood	\$947.00	\$840.89
3956982	Bluestone	(All Colors)	(All Colors)
3957002	Desert		
3956999	Santa Fe		

Dimensions: 36"W x 36"L x 42"H—1,505 Lbs on 1 Pallet

Kit Includes:

- Adhesive
- Lakeland blocks
- Silver Creek Stone top



4' Bar Tops

		Yard Price	Factory Direct
Rock Faced 2 Sides—Front & Back			
3717002	Bluestone	\$436.95	\$496.99
3716999	Indiana Limestone	(All Colors)	(All Colors)
4359522	Western Buff		
Rock Faced 3 Sides			
3717033	Bluestone	\$436.95	\$496.99
3717026	Indiana Limestone	(All Colors)	(All Colors)
3627660	Western Buff		

Dimensions: 36"W x 48"L x 2¼"H—367 Lbs each, 1/Pallet

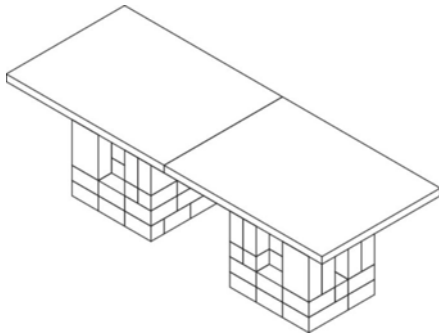

Dining Table

		Yard Price	Factory Direct
4557508	Beechwood	\$1,824.00	\$1,637.54
3956951	Bluestone	(All Colors)	(All Colors)
3956975	Desert		
3956968	Santa Fe		

Dimensions: 36"W x 96"L x 30"H—2,860 Lbs on 1 Pallet

Kit Includes:

- Adhesive
- Lakeland block
- Silver Creek Stone top



4136833: \$20.00 RCP Pallet Charge

All product can be delivered anywhere in the metro area
All deliveries quoted individually for best rate—please call
Please call for out-state and out-of-state delivery

Necessaries Pillar & Waterfall Kits

*** Special Order *** Allow lead time *** No returns on waterfall kits

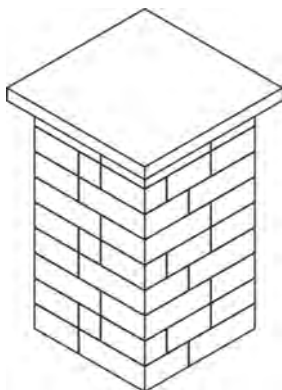

20" Pillar

		Yard Price	Factory Direct
4557546	Beechwood	\$453.00	\$416.01
3956449	Bluestone	(All Colors)	(All Colors)
3956463	Desert		
3956456	Santa Fe		

Dimensions: 20"W x 20"L x 38"H—1,250 Lbs on 1 Pallet

Kit Includes:

- 25" x 25" Gray Indiana Limestone Pillar Cap

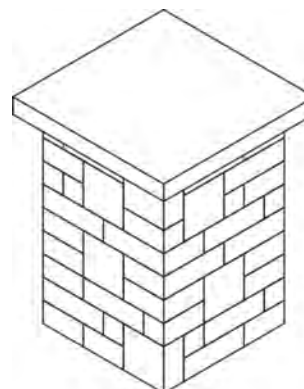

24" Pillar

		Yard Price	Factory Direct
4557553	Beechwood	\$646.00	\$593.06
3956500	Bluestone	(All Colors)	(All Colors)
3956524	Desert		
3956517	Santa Fe		

Dimensions: 24"W x 24"L x 39"H—1,655 Lbs on 1 Pallet

Kit Includes:

- 30" x 30" Gray Indiana Limestone Pillar Cap

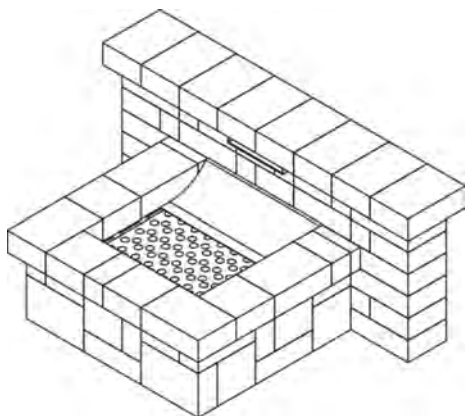

Compact Waterfall Kit

		Yard Price	Factory Direct
4557560	Beechwood	\$1,656.00	\$1,490.72
4171438	Bluestone	(All Colors)	(All Colors)
4171452	Desert		
4171445	Santa Fe		

Dimensions: 64"W x 40"D x 28"H—1,650 Lbs on 1 Pallet

Kit Includes:

- 26" square basin
- Instructions for easy assembly
- Adhesive
- Lakeland block and caps
- 850 GPH mag drive pump
- All plumbing connections

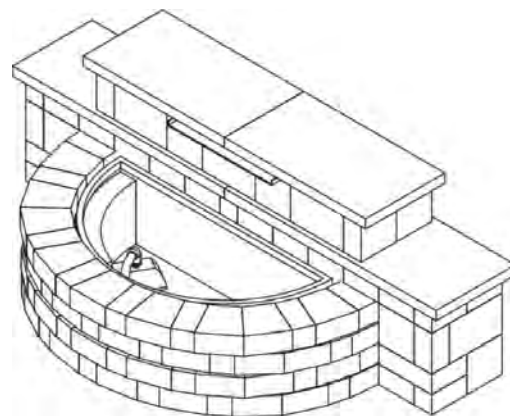

Grand Waterfall Kit

		Yard Price	Factory Direct
4557577	Beechwood	\$3,473.00	\$3,156.31
4171469	Bluestone	(All Colors)	(All Colors)
4171483	Desert		
4171476	Santa Fe		

Dimensions: 98"W x 48"D x 32"H—3,465 Lbs on 3 Pallets

Kit Includes:

- 48" square basin
- Instructions for easy assembly
- Adhesive
- Lakeland block and caps
- 1,350 GPH mag drive pump
- All plumbing connections



Banass Stones®

Premium Natural Stone



Natural Stone Pavers



Pool Coping - Treads



Hand Dressed Steps - Risers

Banass Stones® is proud to offer a complete collection of premium quality natural stone pavers and accessories to add a sense of class to patios, walkways, pools, and other interior and exterior applications

Leaders in Natural Stone

Section Contents

Description	Page
Cut & Patterned Flagstone	265-273
• NEW Venetian Collection	265
• Algonquin Brown Limestone	266
• Antique Black Limestone	266
• Banas Beige Sandstone	266
• Banas Bronte Sandstone	267
• Banas Brown Sandstone	267
• Banas Dove Grey	267
• Banas Flint Sandstone	268
• Banas Fossil Sandstone	268
• Banas Imperial Black Sandstone	268
• Banas Lavender Sandstone	269
• Banas Slate Grey Sandstone	269
• Brown Wave Sandstone	269
• Kota Black Limestone	270
• Kota Blue Limestone	270
• Kota Brown Limestone	270
• Silver Grey Limestone	271
• Banas Amber Granite	271
• Fine Gray Granite	272
• Mahogany Granite	272
• Paradiso Granite	272
• Salt & Pepper Granite	273
Pillar Caps	273
Coping	274-275
• Rockface	274
• Bullnose	275
• Rebated Rockface	275
• Rebated Bullnose	275
Kerbs	276
Steps	276-278
• 4'	276
• 5'	277
• 6'	277
• 7'	278
• 8'	278

AVAILABILITY: Product availability and lead times will vary. Bachman's Cedar Acres Hardscapes keeps a large supply of on-hand Banas Stones inventory and receives regular shipments from Banas Stones, however not all products are available at all times. Please call for details and inventory updates.



Banas Stones®

NEW FROM BANAS STONES

- Venetian Collection shot-blasted sandstone -



Venetian Crema—1"

SKU	Size	Pcs/Crate	Coverage	Price	
				/SF	/Each
185872	11.8" x 23.6" ~ 2 SF	~66	~132 SF/Crate	\$7.35	\$14.71
185874	17.7" x 23.6" ~ 3 SF	~44	~132 SF/Crate		\$22.06
185876	23.6" x 23.6" ~ 4 SF	~33	~132 SF/Crate		\$29.42
185890	23.6" x 35.4" ~ 6 SF	~22	~132 SF/Crate		\$44.13

- Shot-blasted surface offers consistency in thickness with a slip-reducing texture

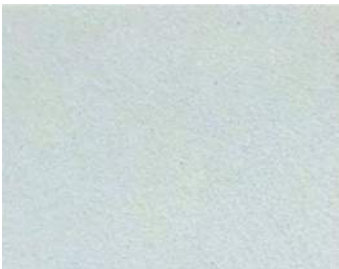

Venetian Grey—1"

SKU	Size	Pcs/Crate	Coverage	Price	
				/SF	/Each
185892	11.8" x 23.6" ~ 2 SF	~66	~132 SF/Crate	\$7.35	\$14.71
185894	17.7" x 23.6" ~ 3 SF	~44	~132 SF/Crate		\$22.06
185896	23.6" x 23.6" ~ 4 SF	~33	~132 SF/Crate		\$29.42
185898	23.6" x 35.4" ~ 6 SF	~22	~132 SF/Crate		\$44.13

- Shot-blasted surface offers consistency in thickness with a slip-reducing texture

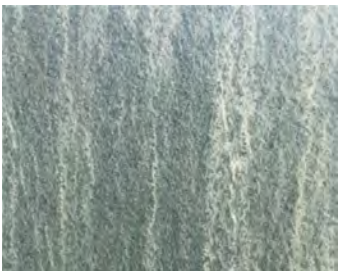

Venetian Mist—1"

SKU	Size	Pcs/Crate	Coverage	Price	
				/SF	/Each
185900	11.8" x 23.6" ~ 2 SF	~66	~132 SF/Crate	\$8.97	\$17.93
185904	17.7" x 23.6" ~ 3 SF	~44	~132 SF/Crate		\$26.87
185908	23.6" x 23.6" ~ 4 SF	~33	~132 SF/Crate		\$35.86
185910	23.6" x 35.4" ~ 6 SF	~22	~132 SF/Crate		\$53.78

- Shot-blasted surface offers consistency in thickness with a slip-reducing texture



Venetian Coping—Special Order

2" Thick Natural Stone Coping

- All are natural top and calibrated bottom

12" Deep x 48" Long—Bullnose

185936	Venetian Crema	\$80.43
185940	Venetian Grey	\$80.43
185942	Venetian Mist	\$93.40

12" Deep x 48" Long—Square Edge

185930	Venetian Crema	\$66.38
185932	Venetian Grey	\$66.38
185934	Venetian Mist	\$79.25

* Additional sizes available upon request—please call

Venetian Steps—Special Order

6" Thick x 16" Deep Natural Stone Steps

- All are shot-blasted top, calibrated bottom, and hand-dressed three sides unless otherwise noted
- Approximately 867 Lbs each

4'

185912	Venetian Crema	\$237.92/Step
185914	Venetian Grey	\$237.92/Step
185916	Venetian Mist	\$297.14/Step

5'

185918	Venetian Crema	\$293.07/Step
185920	Venetian Grey	\$293.07/Step
185922	Venetian Mist	\$372.11/Step

6'

185924	Venetian Crema	\$358.20/Step
185926	Venetian Grey	\$358.20/Step
185928	Venetian Mist	\$447.04/Step

* 7' and 8' sizes available upon request—please call



Banas Stones® Cut & Patterned Flagstone - Exclusively from Bachman's -

Banas Stones®

Natural Stone Cut & Patterned Flagstone



Antique Black

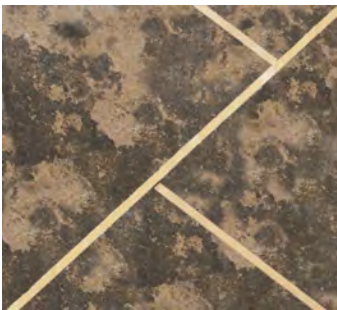

Algonquin Brown—1¼"

SKU	Size	Pcs/Crate	Coverage	Price /SF	Price /Each CA
148018	11.8" x 23.6" ~ 2 SF	~66	~132 SF/Crate	\$11.056	\$22.11
148020	17.7" x 23.6" ~ 3 SF	~44	~132 SF/Crate		\$33.17
148022	23.6" x 23.6" ~ 4 SF	~33	~132 SF/Crate		\$44.23
148024	23.6" x 35.4" ~ 6 SF	~22	~132 SF/Crate		\$66.34

- Brown limestone with non-skid acid wash top, sawn bottom, and sawn edges

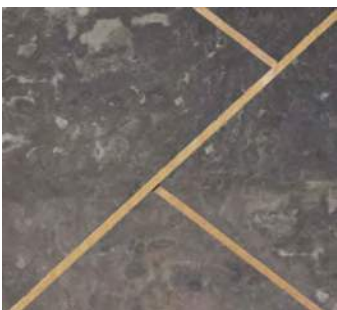

Antique Black—1¼"

SKU	Size	Pcs/Crate	Coverage	Price /SF	Price /Each CA
132690	11.8" x 23.6" ~ 2 SF	~66	~132 SF/Crate	\$9.688	\$19.38
132692	17.7" x 23.6" ~ 3 SF	~44	~132 SF/Crate		\$29.06
132694	23.6" x 23.6" ~ 4 SF	~33	~132 SF/Crate		\$38.75
132696	23.6" x 35.4" ~ 6 SF	~22	~132 SF/Crate		\$58.13

- Ebony limestone with non-skid acid wash top, sawn bottom, and sawn edges
- May have longer lead times in 2018. Please call.

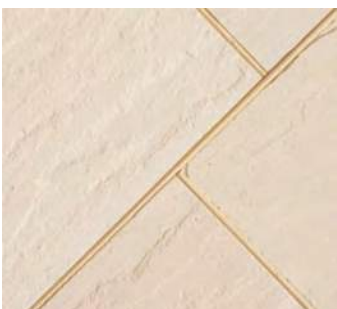

Banas Beige®—1"

SKU	Size	Pcs/Crate	Coverage	Price /SF	Price /Each CA
132612	11.8" x 11.8" ~ 1 SF	~160	~160 SF/Crate	\$6.711	\$6.71
132614	11.8" x 23.6" ~ 2 SF	~80	~160 SF/Crate		\$13.42
132616	17.7" x 23.6" ~ 3 SF	~80	~240 SF/Crate		\$20.13
132618	23.6" x 23.6" ~ 4 SF	~40	~160 SF/Crate		\$26.84
132620	23.6" x 35.4" ~ 6 SF	~40	~240 SF/Crate		\$40.27

- Beige sandstone with natural top, calibrated bottom, and sawn edges

www.bachmanswholesale.com



Banas Stones®

Banas Stones® Cut & Patterned Flagstone - Exclusively from Bachman's -



Banas Flint



Banas Bronte®—1"

SKU	Size	Pcs/Crate	Coverage	Price	
				/SF	/Each
132698	11.8" x 23.6" ~ 2 SF	~80	~160 SF/Crate	\$6.55	\$13.10
132700	17.7" x 23.6" ~ 3 SF	~80	~240 SF/Crate		\$19.65
132702	23.6" x 23.6" ~ 4 SF	~40	~160 SF/Crate		\$26.20
132704	23.6" x 35.4" ~ 6 SF	~40	~240 SF/Crate		\$39.30

- Variegated copper, green, and brown swirled sandstone with natural top, calibrated bottom, and sawn edges



Banas Brown®—1"

SKU	Size	Pcs/Crate	Coverage	Price	
				/SF	/Each
132706	11.8" x 23.6" ~ 2 SF	~80	~160 SF/Crate	\$6.55	\$13.10
132708	17.7" x 23.6" ~ 3 SF	~80	~240 SF/Crate		\$19.65
132710	23.6" x 23.6" ~ 4 SF	~40	~160 SF/Crate		\$26.20
132712	23.6" x 35.4" ~ 6 SF	~40	~240 SF/Crate		\$39.30

- Brown quartzitic sandstone with natural top, calibrated bottom, and sawn edges



Banas Dove Grey®—1"

SKU	Size	Pcs/Crate	Coverage	Price	
				/SF	/Each
132632	11.8" x 11.8" ~ 1 SF	~160	~160 SF/Crate	\$6.55	\$6.55
132634	11.8" x 23.6" ~ 2 SF	~80	~160 SF/Crate		\$13.10
132636	17.7" x 23.6" ~ 3 SF	~80	~240 SF/Crate		\$19.65
132638	23.6" x 23.6" ~ 4 SF	~40	~160 SF/Crate		\$26.20
132640	23.6" x 35.4" ~ 6 SF	~40	~240 SF/Crate		\$39.30

- Grey sandstone with natural top, calibrated bottom, and sawn edges



Banas Stones® Cut & Patterned Flagstone - Exclusively from Bachman's -

Banas Stones®

Natural Stone Cut & Patterned Flagstone



Banas Fossil



Banas Flint®—1"

SKU	Size	Pcs/Crate	Coverage	Price	
				/SF	/Each
132714	11.8" x 23.6" ~ 2 SF	~80	~160 SF/Crate	\$6.55	\$13.10
132716	17.7" x 23.6" ~ 3 SF	~80	~240 SF/Crate		\$19.65
132718	23.6" x 23.6" ~ 4 SF	~40	~160 SF/Crate		\$26.20
132720	23.6" x 35.4" ~ 6 SF	~40	~240 SF/Crate		\$39.30

- Consistent gray, brown, and beige sandstone with natural top, calibrated bottom, and sawn edges



Banas Fossil®—1"

SKU	Size	Pcs/Crate	Coverage	Price	
				/SF	/Each
132622	11.8" x 11.8" ~ 1 SF	~156	~156 SF/Crate	\$6.711	\$6.71
132624	11.8" x 23.6" ~ 2 SF	~80	~160 SF/Crate		\$13.42
132626	17.7" x 23.6" ~ 3 SF	~80	~240 SF/Crate		\$20.13
132628	23.6" x 23.6" ~ 4 SF	~40	~160 SF/Crate		\$26.84
132630	23.6" x 35.4" ~ 6 SF	~40	~240 SF/Crate		\$40.27

- Light cream to copper and dark brown sandstone with natural top, calibrated bottom, and sawn edges. Marked with fern-like fossil shapes.

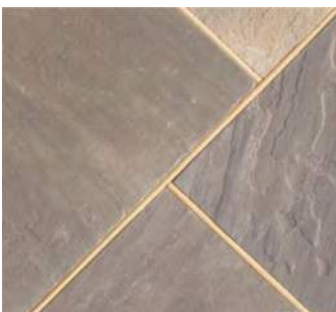

Banas Imperial Black®—1"

SKU	Size	Pcs/Crate	Coverage	Price	
				/SF	/Each
132642	11.8" x 11.8" ~ 1 SF	~140	~140 SF/Crate	\$7.516	\$7.52
132644	11.8" x 23.6" ~ 2 SF	~70	~140 SF/Crate		\$15.03
132646	17.7" x 23.6" ~ 3 SF	~70	~210 SF/Crate		\$22.55
132648	23.6" x 23.6" ~ 4 SF	~35	~140 SF/Crate		\$30.06
132650	23.6" x 35.4" ~ 6 SF	~35	~210 SF/Crate		\$45.09

- Unusual dark brown to black sandstone with strongly riven texture; Natural top, calibrated bottom, and sawn edges

www.bachmanswholesale.com



Banas Stones®

Banas Stones® Cut & Patterned Flagstone - Exclusively from Bachman's -



Banas Slate Grey



Banas Lavender®—1"

SKU	Size	Pcs/Crate	Coverage	Price /SF	Price /Each
132652	11.8" x 11.8" ~ 1 SF	~160	~160 SF/Crate	\$6.55	\$6.55
132654	11.8" x 23.6" ~ 2 SF	~80	~160 SF/Crate		\$13.10
132656	17.7" x 23.6" ~ 3 SF	~80	~240 SF/Crate		\$19.65
132658	23.6" x 23.6" ~ 4 SF	~40	~160 SF/Crate		\$26.20
132660	23.6" x 35.4" ~ 6 SF	~40	~240 SF/Crate		\$39.30

Price **CA**

- Unique sandstone with range of color and tonal variation; Natural top, calibrated bottom, and sawn edges

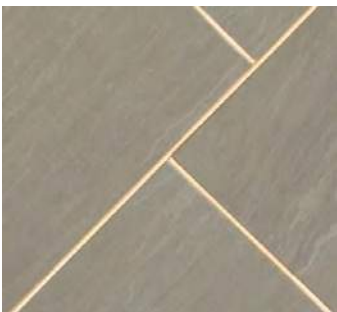

Banas Slate Grey®—1"

SKU	Size	Pcs/Crate	Coverage	Price /SF	Price /Each
132662	11.8" x 11.8" ~ 1 SF	~160	~160 SF/Crate	\$6.711	\$6.71
132664	11.8" x 23.6" ~ 2 SF	~80	~160 SF/Crate		\$13.42
132666	17.7" x 23.6" ~ 3 SF	~80	~240 SF/Crate		\$20.13
132668	23.6" x 23.6" ~ 4 SF	~40	~160 SF/Crate		\$26.84
132670	23.6" x 35.4" ~ 6 SF	~40	~240 SF/Crate		\$40.27

Price **CA**

- Dark grey to charcoal sandstone with natural top, calibrated bottom, and sawn edges



Brown Wave®—1¼"

SKU	Size	Pcs/Crate	Coverage	Price /SF	Price /Each
132722	11.8" x 23.6" ~ 2 SF	~66	~132 SF/Crate	\$8.642	\$17.28
132724	17.7" x 23.6" ~ 3 SF	~44	~132 SF/Crate		\$25.93
132726	23.6" x 23.6" ~ 4 SF	~33	~132 SF/Crate		\$34.57
132728	23.6" x 35.4" ~ 6 SF	~22	~132 SF/Crate		\$51.85

Price **SO**

- Medium brown sandstone with darker brown patches in some pieces; Flamed top, sawn bottom, and sawn edges



Banas Stones® Cut & Patterned Flagstone - Exclusively from Bachman's -

Banas Stones®

Natural Stone Cut & Patterned Flagstone



Kota Brown



Kota Black®—1"

SKU	CA	Size	Pcs/Crate	Coverage	Price	
					/SF	/Each
132730	CA	12" x 24" = 2 SF	~74	~148 SF/Crate	\$6.309	\$12.62
132732	SO	18" x 24" = 3 SF	~74	~222 SF/Crate		\$18.93
132734	SO	24" x 24" = 4 SF	~37	~148 SF/Crate		\$25.23
132736	SO	24" x 36" = 6 SF	~37	~222 SF/Crate		\$37.85

- Consistent dark grey to black dolomitic limestone with natural top, calibrated bottom, and sawn edges



Kota Blue®—1"

SKU	CA	Size	Pcs/Crate	Coverage	Price	
					/SF	/Each
132738	CA	12" x 24" = 2 SF	~74	~148 SF/Crate	\$6.309	\$12.62
132740		18" x 24" = 3 SF	~74	~222 SF/Crate		\$18.93
132742		24" x 24" = 4 SF	~37	~148 SF/Crate		\$25.23
132744		24" x 36" = 6 SF	~37	~222 SF/Crate		\$37.85

- Gently rippled blue and grey limestone with natural top, calibrated bottom, and sawn edges



Kota Brown®—1"

SKU	CA	Size	Pcs/Crate	Coverage	Price	
					/SF	/Each
132746	CA	12" x 24" = 2 SF	~74	~148 SF/Crate	\$6.309	\$12.62
132748		18" x 24" = 3 SF	~74	~222 SF/Crate		\$18.93
132750		24" x 24" = 4 SF	~37	~148 SF/Crate		\$25.23
132752		24" x 36" = 6 SF	~37	~222 SF/Crate		\$37.85

- Varied buff colors of limestone with natural top, calibrated bottom, and sawn edges

www.bachmanswholesale.com



Banas Stones®

Banas Stones® Cut & Patterned Flagstone - Exclusively from Bachman's -



Silver Grey

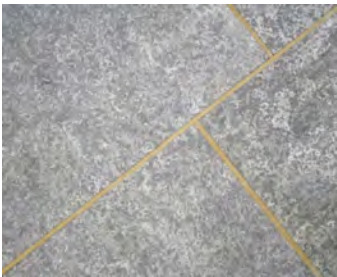

Silver Grey®—1"

SKU	Size	Pcs/Crate	Coverage	Price	
				/SF	/Each
132754	11.8" x 23.6" ~ 2 SF	~66	~132 SF/Crate	\$8.642	\$17.28
132756	17.7" x 23.6" ~ 3 SF	~44	~132 SF/Crate		\$25.93
132758	23.6" x 23.6" ~ 4 SF	~33	~132 SF/Crate		\$34.57
132760	23.6" x 35.4" ~ 6 SF	~22	~132 SF/Crate		\$51.85

- Grey limestone with white undertones; Slip resistant flamed top, sawn bottom, & sawn edges
- May have longer lead times in 2018. Please call.



Banas Amber®—1¼"

SKU	Size	Pcs/Crate	Coverage	Price	
				/SF	/Each
132762	11.8" x 23.6" ~ 2 SF	~66	~132 SF/Crate	\$11.056	\$22.11
132764	17.7" x 23.6" ~ 3 SF	~44	~132 SF/Crate		\$33.17
132766	23.6" x 23.6" ~ 4 SF	~33	~132 SF/Crate		\$44.23
132768	23.6" x 35.4" ~ 6 SF	~22	~132 SF/Crate		\$66.34

- Light golden cream flecked granite; Bush-hammered top, sawn bottom, & sawn edges

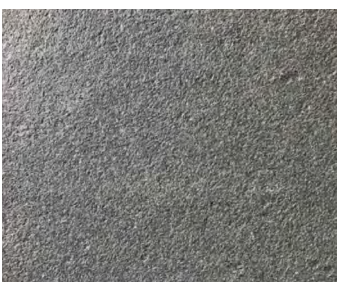

Banas Sombre®—1¼"

SKU	Size	Pcs/Crate	Coverage	Price	
				/SF	/Each
225104	11.8" x 23.6" ~ 2 SF	~66	~132 SF/Crate	\$9.85	\$19.70
225106	17.7" x 23.6" ~ 3 SF	~44	~132 SF/Crate		\$29.55
225108	23.6" x 23.6" ~ 4 SF	~33	~132 SF/Crate		\$39.40
225110	23.6" x 35.4" ~ 6 SF	~22	~132 SF/Crate		\$59.10

- Dark ebony granite; Flamed top, sawn bottom, and sawn edges



Banas Stones® Cut & Patterned Flagstone - Exclusively from Bachman's -

Banas Stones®

Natural Stone Cut & Patterned Flagstone



Fine Grey

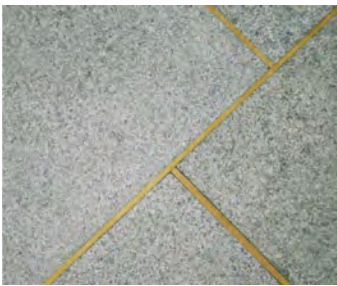

Fine Grey—1¼"

SKU	Size	Pcs/Crate	Coverage	Price	
				/SF	/Each
132770	11.8" x 23.6" ~ 2 SF	~66	~132 SF/Crate	\$10.734	\$21.47
132772	17.7" x 23.6" ~ 3 SF	~44	~132 SF/Crate		\$32.20
132776	23.6" x 23.6" ~ 4 SF	~33	~132 SF/Crate		\$42.94
132778	23.6" x 35.4" ~ 6 SF	~22	~132 SF/Crate		\$64.41

- Medium gray flecked granite; Flamed top, sawn bottom, & sawn edges



Mahogany—1¼"

SKU	Size	Pcs/Crate	Coverage	Price	
				/SF	/Each
132780	11.8" x 23.6" ~ 2 SF	~66	~132 SF/Crate	\$11.056	\$22.11
132784	17.7" x 23.6" ~ 3 SF	~44	~132 SF/Crate		\$33.17
132788	23.6" x 23.6" ~ 4 SF	~33	~132 SF/Crate		\$44.23
132790	23.6" x 35.4" ~ 6 SF	~22	~132 SF/Crate		\$66.34

- Grey granite with flecks of rusty brown; Flamed top, sawn bottom, and sawn edges

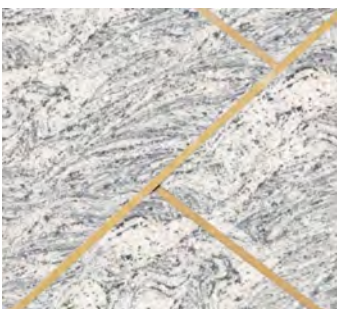

Paradiso—1¼"

SKU	Size	Pcs/Crate	Coverage	Price	
				/SF	/Each
132682	11.8" x 23.6" ~ 2 SF	~66	~132 SF/Crate	\$12.827	\$25.65
132684	17.7" x 23.6" ~ 3 SF	~44	~132 SF/Crate		\$38.48
132686	23.6" x 23.6" ~ 4 SF	~33	~132 SF/Crate		\$51.31
132688	23.6" x 35.4" ~ 6 SF	~22	~132 SF/Crate		\$76.96

- Pink-white granite with grey streaks; Flamed top, sawn bottom, and sawn edges

www.bachmanswholesale.com



Banas Stones®

Banas Stones® Cut & Patterned Flagstone - Exclusively from Bachman's -



Salt & Pepper—1¼"

SKU	Size	Pcs/Crate	Coverage	Price /SF	Price /Each
132806	11.8" x 23.6" ~ 2 SF	~66	~132 SF/Crate	\$11.941	\$23.88
132814	17.7" x 23.6" ~ 3 SF	~44	~132 SF/Crate		\$35.82
132816	23.6" x 23.6" ~ 4 SF	~33	~132 SF/Crate		\$44.77
132820	23.6" x 35.4" ~ 6 SF	~22	~132 SF/Crate		\$71.65

- White granite with black flecks; Flamed top, sawn bottom, and sawn edges

Banas Stones® Pillar Caps



3" Thick Natural Stone Pillar Caps

- All are natural top, calibrated bottom, and hand-dressed all sides unless otherwise noted

24" x 24" Pillar Caps—Approximately 220 Lbs Each

132922	Antique Black*	\$123.62/Cap
132924	Banas Beige	\$112.68/Cap
132926	Banas Bronte	\$112.68/Cap
132920	Banas Brown	\$112.68/Cap
132930	Banas Dove Grey	\$112.68/Cap
132928	Banas Flint	\$112.68/Cap
132918	Banas Fossil	\$112.68/Cap
132932	Banas Imperial Black	\$128.77/Cap
132934	Banas Lavender	\$112.68/Cap
132936	Banas Slate Grey	\$112.68/Cap
	Banas Sombre†	Call
132916	Kota Black	\$112.68/Cap
132938	Silver Grey†	\$123.62/Cap
	Venetian Crema	Call
	Venetian Grey	Call
	Venetian Mist	Call

* Acid wash top, sawn bottom, hand-dressed all sides

† Flamed top, sawn bottom, hand-dressed all sides

3" Thick Natural Stone Pillar Caps

- All are natural top, calibrated bottom, and hand-dressed all sides unless otherwise noted

30" x 30" Pillar Caps—Approximately 330 Lbs Each

137916	Antique Black*	\$192.13/Cap
137918	Banas Beige	\$192.13/Cap
137920	Banas Bronte	\$192.13/Cap
137922	Banas Brown	\$192.13/Cap
137928	Banas Dove Grey	\$175.03/Cap
137924	Banas Flint	\$192.13/Cap
137926	Banas Fossil	\$192.13/Cap
137930	Banas Imperial Black	\$200.18/Cap
137934	Banas Lavender	\$175.03/Cap
137936	Banas Slate Grey	\$175.03/Cap
	Banas Sombre†	Call
137940	Kota Black	\$175.03/Cap
137942	Silver Grey†	\$192.13/Cap
	Venetian Crema	Call
	Venetian Grey	Call
	Venetian Mist	Call

* Acid wash top, sawn bottom, hand-dressed all sides

† Flamed top, sawn bottom, hand-dressed all sides



Banas Stones®

Banas Stones® Coping

- Exclusively from Bachman's -

Natural Stone Coping



2" Thick Natural Stone Rock Face Coping

- All are natural top, calibrated bottom unless otherwise noted

12" Deep x 48" Long

1-Sided	2-Sided		
138020	225152	Algonquin Brown*	\$74.42
138022	225154	Antique Black*	\$66.05
138024	225156	Banas Beige	\$59.94
138026	225158	Banas Bronte	\$59.94
138028	225160	Banas Brown	\$59.94
138034	225162	Banas Dove Grey	\$59.94
138030	225164	Banas Flint	\$59.94
138032	225166	Banas Fossil	\$64.77
138036	225168	Banas Imperial Black	\$72.81
138040	225170	Banas Lavender	\$59.94
138042	225172	Banas Slate Grey	\$59.94
225112	225182	Banas Sombre†	\$77.64
138044	225174	Brown Wave	\$59.62
138046	225176	Fine Grey†	\$75.71
137306	225178	Kota Black	\$59.94
138050	225180	Paradiso†	\$85.37
138052	225184	Silver Grey†	\$64.74

* Acid wash top, sawn bottom, 1 long side hand-dressed
 † Flamed top, sawn bottom, 1 long side hand-dressed

2" Thick Natural Stone Rock Face Coping

- All are natural top, calibrated bottom unless otherwise noted

14" Deep x 48" Long

1-Sided	2-Sided		
138082	225362	Algonquin Brown*	\$86.97
138084	225366	Antique Black*	\$77.20
138086	225368	Banas Beige	\$70.06
138088	225370	Banas Bronte	\$70.06
138090	225372	Banas Brown	\$70.06
138096	225378	Banas Dove Grey	\$70.06
138092	225374	Banas Flint	\$70.06
138094	225376	Banas Fossil	\$75.70
138098	225380	Banas Imperial Black	\$85.10
138102	225388	Banas Lavender	\$70.06
138104	225390	Banas Slate Grey	\$71.94
138106	225392	Brown Wave	\$69.69
138108	225394	Fine Grey†	\$88.48
138114	225396	Kota Black	\$70.06
138116	225398	Paradiso†	\$99.75
138118	225400	Silver Grey†	\$75.32

16" Deep x 48" Long

158518	225402	Algonquin Brown*	\$99.33
158520	225404	Antique Black*	\$88.18
158522	225406	Banas Beige	\$80.02
158526	225408	Banas Bronte	\$80.02
158528	225410	Banas Brown	\$80.02
158534	225116	Banas Dove Grey	\$80.02
158530	225412	Banas Flint	\$80.02
158532	225414	Banas Fossil	\$86.46
158536	225418	Banas Imperial Black	\$97.19
158538	225422	Banas Lavender	\$80.02
158540	225424	Banas Slate Grey	\$82.17
225114	225436	Banas Sombre†	\$103.62
158542	225426	Brown Wave	\$79.59
158544	225428	Fine Grey†	\$101.05
158548	225430	Kota Black	\$80.02
158550	225432	Paradiso†	\$113.92
158552	225438	Silver Grey†	\$86.03

* Acid wash top, sawn bottom, 1 long side hand-dressed
 † Flamed top, sawn bottom, 1 long side hand-dressed

AVAILABILITY: Product availability and lead times will vary. Bachman's Hardscapes Cedar Acres keeps a large supply of on-hand Banas Stones inventory and receives regular shipments from Banas Stones, however not all products are available at all times. Please call for details and inventory updates.

www.bachmanswholesale.com



Banas Stones®

Banas Stones® Rebated Coping

- Exclusively from Bachman's -



3 to 6 week lead time

SO

2" Thick Natural Stone Bullnose Coping

- All are natural top, calibrated bottom, and 1 bullnose long side unless otherwise noted

12" Deep x 48" Long

137992	Antique Black*	\$80.86
137994	Banas Beige	\$72.49
137996	Banas Bronte	\$72.49
137998	Banas Brown	\$72.49
138000	Banas Flint	\$72.49
138002	Banas Fossil	\$72.49
138004	Banas Dove Grey	\$72.49
138006	Banas Imperial Black	\$85.37
138010	Banas Lavender	\$72.49
138012	Banas Slate Grey	\$72.49
225116	Banas Sombre†	\$93.73
138016	Kota Black	\$72.49
138018	Silver Grey†	\$80.86

14" Deep x 48" Long

138054	Antique Black*	\$94.49
138056	Banas Beige	\$84.72
138058	Banas Bronte	\$84.72
138060	Banas Brown	\$84.72
138062	Banas Flint	\$84.72
138064	Banas Fossil	\$84.72
138066	Banas Dove Grey	\$84.72
138068	Banas Imperial Black	\$99.75
138072	Banas Lavender	\$84.72
138074	Banas Slate Grey	\$84.72
138078	Kota Black	\$84.72
138080	Silver Grey†	\$94.49

- * Acid wash top, sawn bottom, 1 long side bullnosed
- † Flamed top, sawn bottom, 1 long side bullnosed

AVAILABILITY: Product availability and lead times will vary. Bachman's Hardscapes Cedar Acres keeps a large supply of on-hand Banas Stones inventory and receives regular shipments from Banas Stones, however not all products are available at all times. Please call for details and inventory updates.

2"/1" Thick Natural Stone Rock Face *Rebated* Coping

- All are natural top, calibrated bottom reducing from 2" to 1", and hand-dressed on one long side

12" Deep x 48" Long

137950	Antique Black*	\$69.66
137952	Banas Bronte	\$63.55
137954	Banas Flint	\$63.55
137956	Banas Dove Grey	\$63.55
137958	Banas Lavender	\$63.55
137960	Banas Slate Grey	\$63.55
137964	Silver Grey†	\$69.66

16" Deep x 48" Long

137972	Antique Black*	\$96.76
137974	Banas Bronte	\$88.60
137976	Banas Flint	\$88.60
137978	Banas Dove Grey	\$88.60
137980	Banas Lavender	\$88.60
137982	Banas Slate Grey	\$88.60
137990	Silver Grey†	\$96.76

- * Acid wash top, sawn bottom, 1 long side hand-dressed
- † Flamed top, sawn bottom, 1 long side hand-dressed

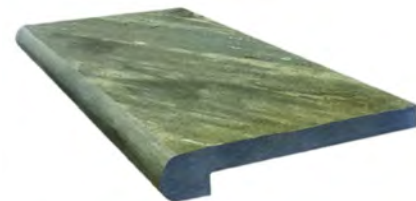

SO

2"/1" Thick Natural Stone Bullnose *Rebated* Coping

- All are natural top, calibrated bottom reducing from 2" to 1", and bullnosed on one long side

12" Deep x 48" Long

137944	Banas Flint	\$76.10
137946	Banas Dove Grey	\$76.10
137948	Banas Lavender	\$76.10

16" Deep x 48" Long

137966	Banas Flint	\$105.34
137968	Banas Dove Grey	\$105.34
137970	Banas Lavender	\$105.34

Natural Stone Rebated Coping

www.bachmanswholesale.com



Banas Stones®

Banas Stones® Kerbs & 4' Steps

- Exclusively from Bachman's -

Natural Stone Kerbs & Steps



6" Thick Natural Stone Kerbs

- Natural top, calibrated bottom, and 1 long side hand-dressed unless otherwise noted.
- 15/Crate except Antique Black and Silver Grey, which are 16/Crate.
- Approximately 160 Lbs each

6" Deep x 46" Long

138294	Antique Black†	\$112.26
134778	Banas Beige	\$84.90
138300	Banas Bronte	\$84.90
138302	Banas Brown	\$84.90
138306	Banas Dove Grey	\$84.90
138304	Banas Flint	\$84.90
138308	Banas Imperial Black	\$97.78
138310	Banas Lavender	\$84.90
138278	Banas Slate Grey	\$84.90
225118	Banas Sombre†	\$103.20
138318	Kota Black	\$84.9
138322	Silver Grey†	\$112.26
	Venetian Crema	Call
	Venetian Grey	Call
	Venetian Mist	Call

† Flamed top, sawn bottom, 2 long sides hand-dressed

6" Thick x 16" Deep Natural Stone Steps

- All are natural top, calibrated bottom, and hand-dressed three sides unless otherwise noted
- Approximately 433 Lbs each

4' Steps

138120	Algonquin Brown†	\$243.93/Step
138122	Antique Black*	\$260.23/Step
138124	Banas Beige	\$212.17/Step
138126	Banas Bronte	\$212.17/Step
138128	Banas Brown	\$212.17/Step
138134	Banas Dove Grey	\$212.17/Step
138130	Banas Flint	\$212.17/Step
138132	Banas Fossil	\$220.75/Step
138136	Banas Imperial Black	\$271.39/Step
138140	Banas Lavender	\$212.17/Step
138142	Banas Slate Grey	\$220.75/Step
225122	Banas Sombre†	\$307.04/Step
138144	Brown Wave	\$229.33/Step
134644	Kota Black	\$207.88/Step
138148	Paradisot	\$319.45/Step
134646	Silver Grey†	\$251.65/Step
185912	Venetian Crema‡	\$237.92/Step
185914	Venetian Grey‡	\$237.92/Step
185916	Venetian Mist‡	\$297.14/Step

* Acid wash top, sawn bottom, hand-dressed all sides

† Flamed top, sawn bottom, hand-dressed all sides

‡ Shot-blasted top, hand-dressed three sides

AVAILABILITY: Product availability and lead times will vary. Bachman's Hardscapes Cedar Acres keeps a large supply of on-hand Banas Stones inventory and receives regular shipments from Banas Stones, however not all products are available at all times. Please call for details and inventory updates.

www.bachmanswholesale.com



Banas Stones®

Banas Stones® 5' & 6' Steps - Exclusively from Bachman's -



Banas Bronte



Banas Brown

6" Thick x 16" Deep Natural Stone Steps

- All are natural top, calibrated bottom, and hand-dressed three sides unless otherwise noted
- Approximately 550 Lbs each

5' Steps

138150	Algonquin Brown*	\$305.58/Step
138152	Antique Black*	\$325.97/Step
138154	Banas Beige	\$265.88/Step
138156	Banas Bronte	\$265.88/Step
138158	Banas Brown	\$265.88/Step
138164	Banas Dove Grey	\$265.88/Step
138160	Banas Flint	\$265.88/Step
138162	Banas Fossil	\$276.61/Step
138166	Banas Imperial Black	\$339.92/Step
138170	Banas Lavender	\$265.88/Step
138172	Banas Slate Grey	\$276.61/Step
225124	Banas Sombre†	\$384.44/Step
138174	Brown Wave	\$287.34/Step
138178	Kota Black	\$260.52/Step
138180	Paradiso†	\$400.00/Step
138182	Silver Grey†	\$315.24/Step
185918	Venetian Crema‡	\$298.07/Step
185920	Venetian Grey‡	\$297.07/Step
185922	Venetian Mist‡	\$372.11/Step

* Acid wash top, sawn bottom, hand-dressed all sides

† Flamed top, sawn bottom, hand-dressed all sides

‡ Shot-blasted top, hand-dressed three sides

6" Thick x 16" Deep Natural Stone Steps

- All are natural top, calibrated bottom, and hand-dressed three sides unless otherwise noted
- Approximately 667 Lbs each

6' Steps—Call for Availability

138184	Algonquin Brown*	\$367.21/Step
138186	Antique Black*	\$391.68/Step
138188	Banas Beige	\$319.58/Step
138190	Banas Bronte	\$319.58/Step
138192	Banas Brown	\$319.58/Step
138198	Banas Dove Grey	\$319.58/Step
138194	Banas Flint	\$319.58/Step
138196	Banas Fossil	\$332.45/Step
138200	Banas Imperial Black	\$408.41/Step
138204	Banas Lavender	\$319.58/Step
138206	Banas Slate Grey	\$332.45/Step
225128	Banas Sombre†	\$461.44/Step
138208	Brown Wave	\$345.33/Step
138212	Kota Black	\$313.14/Step
138214	Paradiso†	\$480.51/Step
138216	Silver Grey†	\$378.80/Step
185924	Venetian Crema‡	\$358.20/Step
185926	Venetian Grey‡	\$358.20/Step
185928	Venetian Mist‡	\$447.04/Step

* Acid wash top, sawn bottom, hand-dressed all sides

† Flamed top, sawn bottom, hand-dressed all sides

‡ Shot-blasted top, hand-dressed three sides

AVAILABILITY: Product availability and lead times will vary. Bachman's Hardscapes Cedar Acres keeps a large supply of on-hand Banas Stones inventory and receives regular shipments from Banas Stones, however not all products are available at all times. Please call for details and inventory updates.



Banas Stones®

Banas Stones® 7' & 8' Steps - Exclusively from Bachman's -

Natural Stone Steps

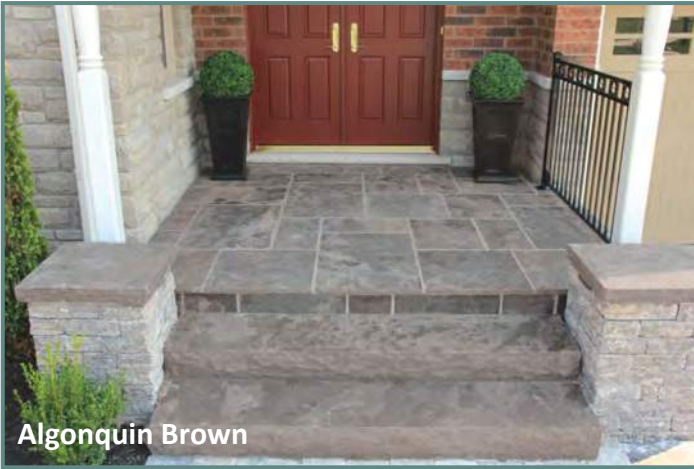

Algonquin Brown



Banas Silver Grey

6" Thick x 16" Deep Natural Stone Steps

- All are natural top, calibrated bottom, and hand-dressed three sides unless otherwise noted
- Approximately 700 Lbs each

7' Steps—Call for Availability

138218	Algonquin Brown*	\$422.51/Step
138220	Antique Black*	\$451.10/Step
138222	Banas Beige	\$366.99/Step
138224	Banas Bronte	\$366.99/Step
138226	Banas Brown	\$366.99/Step
138232	Banas Dove Grey	\$366.99/Step
138228	Banas Flint	\$366.99/Step
138230	Banas Fossil	\$382.01/Step
138234	Banas Imperial Black	\$470.63/Step
138238	Banas Lavender	\$366.99/Step
138240	Banas Slate Grey	\$382.01/Step
225130	Banas Sombre†	\$532.96/Step
138242	Brown Wave	\$397.03/Step
138246	Kota Black	\$359.48/Step
138248	Paradisot	\$554.71/Step
138250	Silver Grey†	\$436.08/Step

* Acid wash top, sawn bottom, hand-dressed all sides

† Flamed top, sawn bottom, hand-dressed all sides

6" Thick x 16" Deep Natural Stone Steps

- All are natural top, calibrated bottom, and hand-dressed three sides unless otherwise noted
- Approximately 867 Lbs each

8' Steps—Call for Availability

138254	Algonquin Brown*	\$487.97/Step
138256	Antique Black*	\$520.59/Step
138258	Banas Beige	\$424.45/Step
138260	Banas Bronte	\$424.45/Step
138262	Banas Brown	\$424.45/Step
138268	Banas Dove Grey	\$424.45/Step
138264	Banas Flint	\$424.45/Step
138266	Banas Fossil	\$441.62/Step
138270	Banas Imperial Black	\$542.90/Step
138274	Banas Lavender	\$424.45/Step
138172	Banas Slate Grey	\$441.62/Step
225132	Banas Sombre†	\$614.15/Step
138280	Brown Wave	\$458.78/Step
138284	Kota Black	\$415.87/Step
138288	Paradisot	\$639.04/Step
138290	Silver Grey†	\$503.42/Step

* Acid wash top, sawn bottom, hand-dressed all sides

† Flamed top, sawn bottom, hand-dressed all sides

AVAILABILITY: Product availability and lead times will vary. Bachman's Hardscapes Cedar Acres keeps a large supply of on-hand Banas Stones inventory and receives regular shipments from Banas Stones, however not all products are available at all times. Please call for details and inventory updates.

www.bachmanswholesale.com



Banas Stones®

Banas Stones® Jumbo Slabs - Exclusively from Bachman's -



AVAILABLE BY SPECIAL ORDER ONLY

Banas Stones® offers Jumbo Slabs in several sizes. Custom cutting is available upon request.

Additional colors are available. Contact Bachman's Cedar Acres for more details.



Jumbo Slabs



Natural Top—2" thick

	24"	36"	48"	Price SO /SF
Dove Grey	48", 60", 72"	72", 96"	72", 96"	Call for Pricing
Slate Grey	48", 60", 72"	72", 96"	72", 96"	
Kota Black	48", 60", 72"	72"		
Imperial Black	48", 60", 72"			
Venetian Crema†	48", 60", 72"	72"	72"	

Natural top, sawn bottom, and rock-faced on all 4 sides/ † Shot-blasted top



Polished Top—2" thick

	24"	36"	48"	Price SO /SF
Nero Black		72", 96"	72", 96"	Call for Pricing
Silver Grey		72"	72", 96"	Call for Pricing

- Polished top, sawn bottom, and rock-faced on all 4 sides



Acid Wash Top—2" thick

	24"	36"	48"	Price SO /SF
Antique Black	48", 60", 72"	72", 96"	72", 96"	Call for Pricing

- Non-skid acid wash top, sawn bottom, and rockfaced on all 4 sides

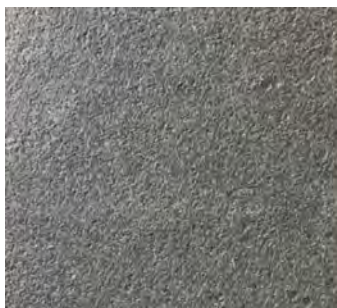

Flamed Top—2" thick

	24"	36"	48"	Price SO /SF
Banas Sombre	48", 72"	72", 96"	72", 96"	Call for Pricing
Silver Grey	48", 60", 72"	72", 96"	72", 96"	Call for Pricing

- Flamed top, sawn bottom, and rockfaced on all 4 sides

www.bachmanswholesale.com

Natural Stone



Cut and Patterned Thermalled Bluestone

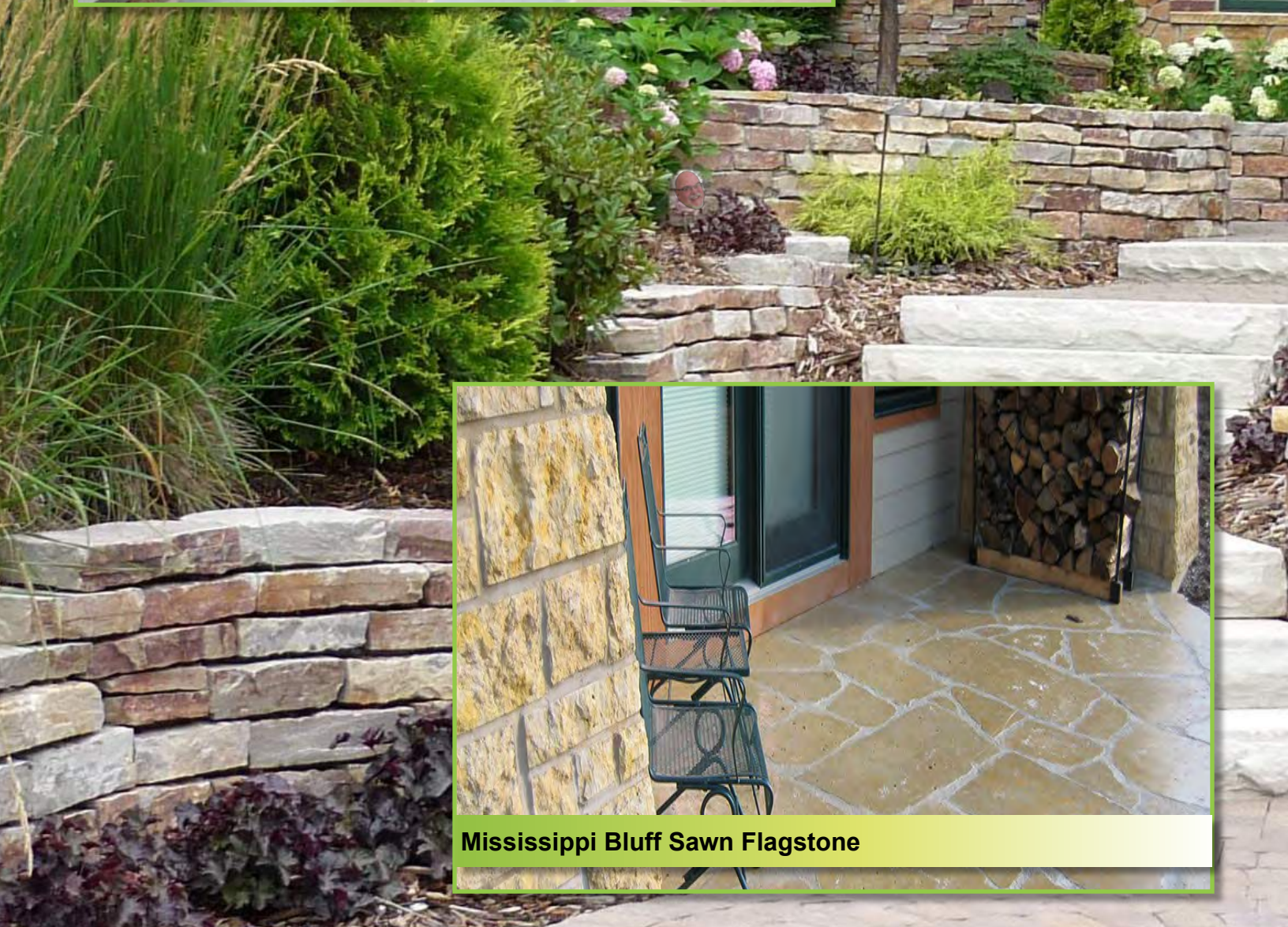

Mississippi Bluff Sawn Flagstone

Section Contents

Description	Page	Description	Page	
Natural Wall Stone <ul style="list-style-type: none"> • Aqua Grantique • Arizona Buckskin • Chilton • Chilton Weathered Edge • Colorado Red • Copper Mountain • Fond du Lac • Fond du Lac Weathered Edge • Graphite • Highland Brown • Kasota Stone • Kettle River (Tacoma Quartz) • Lannon • Lannon Weathered Edge • Mahogany • McGregor Lake Oversized Ledge Rock • Mississippi Bluff • New York Blue • Ozark Cherry • Sandy Creek • Smokey Mountain Blue (Cheyenne) • Sunset Bronze • Winnebago 	 Scan for Images	283-287 283 283 283 283 283 284 284 284 284 284 285 285 285 285 285 285 286 286 287 287 287 287 287	Flagstone & Steppers (Continued) <ul style="list-style-type: none"> • Fond du Lac • Kasota Gold • Longhorn • Mahogany • McGregor Lake • Mississippi Bluff • New York Bluestone • Ozark Cherry • Sandy Creek • Sawtooth Moss • Smokey Mountain Blue (Cheyenne) • Sunset Bronze • Tres Rios • Vermillion Slate • White Diamond • Yukon Gold • Cut & Patterned New York Blue 	289-294 290 290 290 291 291 291 291-292 292 292 292 292 292 293 293 293 293 293 293 293 293-294
		Kasota Granite Slabs/Counter Tops	294	
		Natural Stone Step Treads and Wall Caps	294	
Natural Stone Edgers <ul style="list-style-type: none"> • Aqua Grantique • Carmel Cream • Chilton • Fond du Lac • Kasota Stone Amber • Kasota Stone Cream • Lannon Stone • Mahogany • New York Bluestone • Ozark Cherry • Sandy Creek • Smokey Mountain Blue • Wild Horse 	 Scan for Images	288-289 288 288 288 288 288 288 288 288 288 289 289 289 289	Natural Stone Steps <ul style="list-style-type: none"> • Aqua Grantique • Chilton • Chilton Weathered Edge • Echo Granite • Fond du Lac • Highland Brown • Kasota Stone Blend • Longhorn • Mahogany Granite • Mississippi Bluff Limestone • New York Bluestone • Sandy Creek • Sawn Granite Boulder • Sunset Bronze • Superior Northern Granite 	 Scan for Images 295-298 295 295 295 295 295 295 296 296 296 296 296 296-297 297 297 297 297 298
		Natural Stone Pillar Caps	298	
		<ul style="list-style-type: none"> • Indiana Limestone Pillar Cap • Buff Pillar Cap 	298 298	
		Basalt	298	
Flagstone & Steppers <ul style="list-style-type: none"> • Acadia Rose • Arizona Buckskin • Cabinet Ridge • Chilton • Colorado Red • Emerald River 	 Scan for Images	289-294 289 289 289 289 290 290		

Natural Wall Stone

All listed wall stone is 8" deep, unless noted otherwise.
12" deep wall stone is available by special order on most product



Aqua Grantique

SKU	Size	Coverage	/SF	Price /Lb	Price /Ton	SO
2760726	3½" Sawn Top & Bottom	~18 SF/Ton	~\$25.67†	\$.231	\$462.00	
2760733	7½" Sawn Top & Bottom	~18 SF/Ton	~\$22.67†	\$.204	\$408.00	



Chilton

SKU	Size	Coverage	/SF	Price /Lb	Price /Ton	CA
2760566	2"-3"	~20 SF/Ton	~\$13.90†	\$.139	\$278.00	
2760573	3"-4"	~20 SF/Ton	~\$13.90†	\$.139	\$278.00	
2760580	4"-5"	~20 SF/Ton	~\$13.90†	\$.139	\$278.00	
4131210	5"-7"	~20 SF/Ton	~\$13.90†	\$.139	\$278.00	



Chilton Weathered Edge

SKU	Size	Coverage	/SF	Price /Lb	Price /Ton	CA
3708444	2"-5"	~20 SF/Ton	~\$17.40†	\$.174	\$348.00	
3708451	5"-8"	~20 SF/Ton	~\$17.40†	\$.174	\$348.00	



Colorado Red

SKU	Size	Coverage	/SF	Price /Lb	Price /Ton	SO
2977698	2"-4"	~20 SF/Ton	~\$15.54†	\$.155	\$310.00	
2977759	4"-6"	~20 SF/Ton	~\$15.54†	\$.155	\$310.00	



Aqua Grantique Wall Stone



Chilton Weathered Edge Wall Stone

† Approximate price per square foot is for cost comparison purposes; Stone is sold by weight, not by the square foot.

Natural Wall Stone

All listed wall stone is 8" deep, unless noted otherwise.
12" deep wall stone is available by special order on most product



Fond du Lac

SKU	Size	Coverage	/SF	Price /Lb	Price /Ton
2760634	2"-3"	~20 SF/Ton	~\$14.80†	\$.148	\$296.00
2760641	3"-4"	~20 SF/Ton	~\$14.00†	\$.140	\$280.00
2760658	4"-5"	~20 SF/Ton	~\$13.75†	\$.138	\$275.00

CA



Fond du Lac Weathered Edge

SKU	Size	Coverage	/SF	Price /Lb	Price /Ton
52102	2"-5"	~20 SF/Ton	~\$18.00†	\$.180	\$360.00

CA



Graphite

SKU	Size	Coverage	/SF	Price /Lb	Price /Ton
148276	3"-4"	~20 SF/Ton	~\$13.35†	\$.134	\$267.00

SO



Highland Brown

SKU	Size	Coverage	/SF	Price /Lb	Price /Ton
4564094	2"-3"	~24 SF/Ton	~\$20.80†	\$.208	\$416.00
4564100	3"-4"	~24 SF/Ton	~\$21.50†	\$.215	\$430.00
4564117	4"-5"	~24 SF/Ton	~\$21.20†	\$.212	\$424.00
4564124	5"-6"	~24 SF/Ton	~\$20.80†	\$.208	\$416.00
4564131	6"-8"	~24 SF/Ton	~\$20.80†	\$.208	\$416.00

CA

• Rusty brown sandstone *Call for 5+ pallet pricing while supplies last

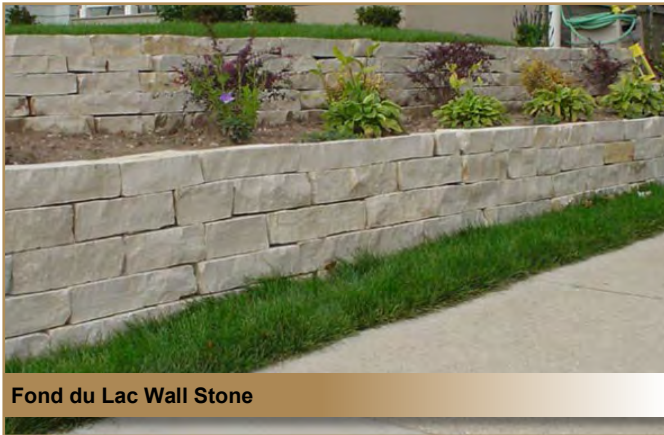

Fond du Lac Wall Stone



Highland Brown Wall Stone

† Approximate price per square foot is for cost comparison purposes; Stone is sold by weight, not by the square foot.

Natural Wall Stone

All listed wall stone is 8" deep, unless noted otherwise.
12" deep wall stone is available by special order on most product



Kasota Stone—Amber

SKU	Size	Coverage	/SF	Price /Lb	Price /Ton	CA
3407811	3" Sawn Top & Bottom	~20 SF/Ton	~\$18.00†	\$.18	\$360.00	
	6" Sawn Top & Bottom	~20 SF/Ton	~\$17.00†	\$.17	\$340.00	

- \$20.00 pallet charge, SKU 122684



Kasota Stone—Gray

SKU	Size	Coverage	/SF	Price /Lb	Price /Ton	CA
	3" Sawn Top & Bottom	~20 SF/Ton	~\$18.00†	\$.18	\$360.00	
	6" Sawn Top & Bottom	~20 SF/Ton	~\$17.00†	\$.17	\$340.00	

- \$20.00 pallet charge, SKU 122684



Lannon

SKU	Size	Coverage	/SF	Price /Lb	Price /Ton	SO
120364	3"-4", 8" Depth	~20 SF/Ton	~\$13.00†	\$.13	\$260.00	
120366	4"-6", 12" Depth	~13 SF/Ton	~\$13.00†	\$.13	\$260.00	

- Gray limestone



Lannon Weathered Edge

SKU	Size	Coverage	/SF	Price /Lb	Price /Ton	SO
120368	3"-4", 8" Depth	~20 SF/Ton	~\$16.45†	\$.165	\$329.00	

- Gray limestone with gold to rustic shades of brown



Mahogany

SKU	Size	Coverage	/SF	Price /Lb	Price /Ton	CA
3551736	3½"-5"	~20 SF/Ton	~\$16.45†	\$.165	\$329.00	



McGregor Lake Ledge Rock

SKU	Size	Coverage	/SF	Price /Lb	Price /Ton	CA
4258443	6"-8"	~17 SF/Ton	~\$22.50†	\$.225	\$450.00	

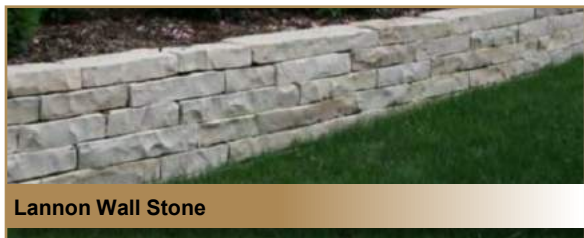

Lannon Wall Stone

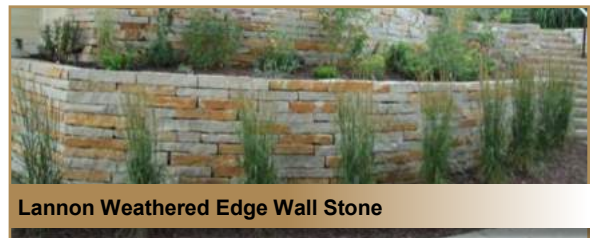

Lannon Weathered Edge Wall Stone

† Approximate price per square foot is for cost comparison purposes; Stone is sold by weight, not by the square foot.

Natural Wall Stone

All listed wall stone is 8" deep, unless noted otherwise.
12" deep wall stone is available by special order on most product



Mississippi Bluff

is a buff colored limestone to match the color of much of the naturally occurring rock in

the Twin Cities region, but with a higher density and lower water absorption than our local stone.



Mississippi Bluff wall stone is available in split top and bottom for a rugged look or sawn top and bottom for a formal look. The natural top, sawn bottom wall is used for capping the sawn top and bottom wall, but also makes a nice stacked wall all its own, having the height consistency of the sawn top and bottom wall, but with a somewhat more rugged look.

Matching sawn top and bottom flagstone to the left.



Mississippi Bluff Limestone—Split

SKU	Size	Coverage	/SF	Price	
				/Lb	/Ton
81282	6"-7"H x 8"-10"D	~18 SF/Ton	~\$20.83†	\$.188	\$375.00
81284	10"-11"H x 12"-14"D	~12 SF/Ton	~\$26.58†	\$.16	\$319.00

- Dense buff limestone with rustic split face, top, and bottom—**Contains fossils**
- Low water absorption of approximately 1.6% and 11,000 PSI compressive strength



Mississippi Bluff Limestone—Sawn Top & Bottom

SKU	Size	Coverage	/SF	Price	
				/Lb	/Ton
98202	3"H x 10"D (Cap)	~60 LF/Ton	\$7.25/LF	\$.218	\$435.00
81286	6"-7"H x 8"-10"D	~18 SF/Ton	~\$19.83†	\$.18	\$357.00
81288	10"-11"H x 12"-14"D	~12 SF/Ton	~\$25.83†	\$.155	\$310.00

- Dense buff limestone with split face, sawn top and bottom—**Contains fossils**
- Low water absorption of approximately 1.6% and 11,000 PSI compressive strength



Mississippi Bluff Limestone—Natural Top, Sawn Bottom

SKU	Size	Coverage	/SF	Price	
				/Lb	/Ton
81290	6"-7"H x 8"-10"D	~18 SF/Ton	~\$20.83†	\$.188	\$375.00
81292	10"-11"H x 12"-14"D	~12 SF/Ton	~\$26.58†	\$.160	\$319.00

- Use to cap sawn walls with a textured, split top—**Contains fossils**
- Dense buff limestone with split face and top, and a sawn bottom
- Low water absorption of approximately 1.6% and 11,000 PSI compressive strength



New York Blue—Sawn Top & Bottom

SKU	Size	Coverage	/SF	Price	
				/Lb	/Ton
182010	2"-6"H x 8"D x Random	~20 SF/Ton	~\$27.80†	\$.278	\$556.00

- Varied bluestone with blue/gray and bronze tones
- Snapped front and back

† Approximate price per square foot is for cost comparison purposes; Stone is sold by weight, not by the square foot.

Natural Wall Stone

All listed wall stone is 8" deep, unless noted otherwise.
12" deep wall stone is available by special order on most product



Ozark Cherry

SKU	Size	Coverage	/SF	Price /Lb	Price /Ton
3392711	2"-7"	~22 SF/Ton	~\$16.95†	\$.17	\$339.00

- Creams, golden browns, and cinnamon browns with rosy and peachy hue

CA



Sandy Creek

SKU	Size	Coverage	/SF	Price /Lb	Price /Ton
4564155	2"-3"	~24 SF/Ton	~\$16.50†	\$.165	\$330.00
4564162	3"-4"	~24 SF/Ton	~\$15.00†	\$.15	\$300.00
4564179	4"-5"	~24 SF/Ton	~\$15.00†	\$.15	\$300.00
4564186	5"-6"	~24 SF/Ton	~\$15.00†	\$.15	\$300.00
4564193	6"-8"	~24 SF/Ton	~\$15.00†	\$.15	\$300.00

*Call for 5+ pallet pricing while supplies last

CA



Smokey Mountain Blue

SKU	Size	Coverage	/SF	Price /Lb	Price /Ton
3392728	2"-7"	~22 SF/Ton	~\$18.00†	\$.18	\$360.00

- Smokey grays, bluestone, pewters, and dappled bronze

CA



Sunset Bronze

SKU	Size	Coverage	/SF	Price /Lb	Price /Ton
3151851	6"-16"	~20 SF/Ton	~\$25.00†	\$.248	\$495.00

- Shades of brown, gold, and rust
- Random thicknesses and lengths

CA

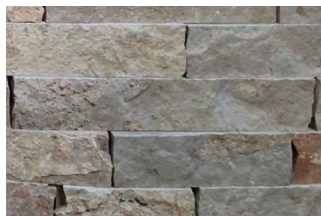

Winnebago

SKU	Size	Coverage	/SF	Price /Lb	Price /Ton
148278	4" Sawn Top and Bottom NS	~20 SF/Ton	\$19.50	\$.195	\$390.00
148280	6" Sawn Top and Bottom CA	~20 SF/Ton	\$19.50	\$.195	\$390.00

- Gray and buff with hints of purple and red
- Easy to install, reducing cost of labor

NS

CA

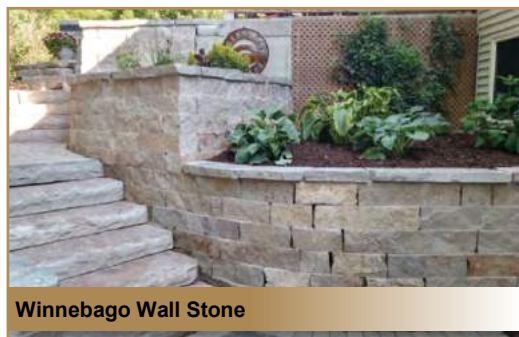

Winnebago Wall Stone

† Approximate price per square foot is for cost comparison purposes; Stone is sold by weight, not by the square foot.

Natural Stone Edgers

Priced by weight unless otherwise noted



Aqua Grantique

SKU	Size	Coverage	/LF	Price /Lb	Price /Ton
2760740	Sawn 4" x 4" x Random	80-90 LF/Ton	~\$5.88†	\$.25	\$500.00

CA



Carmel Cream

SKU	Size	Coverage	/LF	Price /Lb	Price /Ton
148308	Sawn 3½" x 4" x Random	100-110 LF/Ton	~\$7.14†	\$.375	\$750.00

CA



Chilton

SKU	Size	Coverage	/LF	Price /Lb	Price /Ton
2760627	Snapped 4" x 4" x Random	90-100 LF/Ton	~\$3.89†	\$.185	\$370.00

CA



Fond du Lac

SKU	Size	Coverage	/LF	Price /Lb	Price /Ton
2760702	Snapped 4" x 4" x Random	90-100 LF/Ton	~\$4.10†	\$.195	\$390.00

CA



Kasota Stone—Amber

SKU	Size	Coverage	/LF	Price /Lb	Price /Ton
3530847	Sawn 4" x 4" x Random	90-100 LF/Ton	~\$4.84†	\$.213	\$426.00

SO

- \$20.00 pallet charge, SKU 122684



Kasota Stone—Gray

SKU	Size	Coverage	/LF	Price /Lb	Price /Ton
3530830	Sawn 4" x 4" x Random	90-100 LF/Ton	~\$4.84†	\$.213	\$426.00

SO

- \$20.00 pallet charge, SKU 122684



Lannon Stone

SKU	Size	Coverage	/LF	Price /Lb	Price /Ton
148282	Snapped 4" x 4" x Random	90-100 LF/Ton	~\$3.47†	\$.165	\$330.00

SO



Mahogany

SKU	Size	Coverage	/LF	Price /Lb	Price /Ton
119216	Snapped 4" x 4" x Random	90-100 LF/Ton	~\$3.26†	\$.155	\$310.00

CA



New York Bluestone





SKU	Size	Coverage	/LF	Price /Lb	Price /Ton
3391950	Snapped 3-4" x 4" x Random	90-100 LF/Ton	~\$8.82†	N/A	N/A

CA

† Approximate price per square foot/linear foot is for cost comparison purposes; Stone is sold by weight, not by the square foot.

Natural Stone Edgers

Priced by weight unless otherwise noted



	Ozark Cherry SKU 4155384 Size Snapped 4" x 4" x Random Coverage 90-100 LF/Ton /LF ~\$3.79† Price /Lb \$.18 /Ton \$360.00	CA
	Sandy Creek SKU 160862 Size Snapped 4" x 4" x Random Coverage 90-100 LF/Ton /LF ~\$3.58† Price /Lb \$.170 /Ton \$340.00	CA
	Smokey Mountain Blue SKU 4155391 Size Snapped 4" x 4" x Random Coverage 90-100 LF/Ton /LF ~\$3.79† Price /Lb \$.18 /Ton \$360.00	CA
	Wild Horse SKU 3264001 Size Snapped 4" x 4" x Random Coverage 90-100 LF/Ton /LF ~\$5.20† Price /Lb \$.248 /Ton \$495.00	CA

Flagstone & Steppers

Steppers are ~1-2 SqFt/piece (typically non-stock)

Premium steppers are ~2-4 SqFt/piece

Flagstones are 4+ SqFt/piece

	Acadia Rose SKU 96040 Size 1½"-2" Premium Stepper Coverage ~80-90 SF/Ton /SF ~\$6.24† Price /Lb \$.265 /Ton \$530.00 <ul style="list-style-type: none"> Blend of red and gray with a small amount of buff and green Similar to Chilton, but most red/purple tones and darker gray tones 	CA
	Cabinet Ridge SKU 4150754 Size 1½"-2½" Flagstone Coverage ~75-80 SF/Ton /SF† ~\$7.74† Price /Lb \$.30 /Ton \$600.00 <ul style="list-style-type: none"> Slate texture with swirls of greenish grays, golds, and browns 	CA
	Chilton SKU 3851782 Size 1½"-2½" Premium Steppers Coverage ~80-90 SF/Ton /SF ~\$5.68† 2760597 1½"-2½" Flagstone ~80-90 SF/Ton ~\$7.73† Price /Lb \$.24 /Ton \$483.00 \$.310 /Ton \$619.00 <ul style="list-style-type: none"> Gray base color with purple, rust, green, and buff accents 	CA

† Approximate price per square foot is for cost comparison purposes; Stone is sold by weight, not by the square foot.

Flagstone & Steppers

Steppers are ~1-2 SqFt/piece (typically non-stock), Premium steppers are ~2-4 SqFt/piece
Flagstones are 4+ SqFt/piece



Colorado Red

SKU	Size	Coverage	/SF	Price /Lb	Price /Ton
2977681	1½"-2½" Flagstone	~85-95 SF/Ton	~\$4.00†	\$.18	\$360.00

SO



Emerald River

SKU	Size	Coverage	/SF	Price /Lb	Price /Ton
3092734	1½"-2½" Flagstone	~85-90 SF/Ton	~\$5.26†	\$.23	\$460.00

CA

- A jade flagstone with flecks of emerald and a subtle sparkle



Fond du Lac—Silver

SKU	Size	Coverage	/SF	Price /Lb	Price /Ton
4482176	1½"-2½" Premium Steppers	~80-90 SF/Ton	~\$5.58†	\$.24	\$475.00
2760665	1½"-2½" Flagstone	~80-90 SF/Ton	~\$7.41†	\$.315	\$630.00

CA

- Silver-gray Fond du Lac color ranges



Georgia Peach

SKU	Size	Coverage	/SF	Price /Lb	Price /Ton
185814	1½"-2" Premium Steppers	~80-90 SF/Ton	~\$3.65†	\$.155	\$310.00

CA

- Buff sandstone with peach accents. Similar to Ozark Cherry but with little to no black



Kasota Gold

SKU	Size	Coverage	/SF	Price /Lb	Price /Ton
3411504	2-1/6" Flagstone	~80-90 SF/Ton	~\$5.41†	\$.23	\$460.00

CA

- \$20.00 pallet charge, SKU 122684

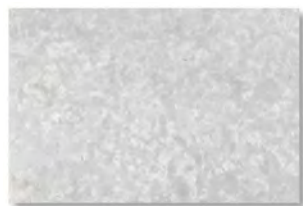

Kasota Gray

SKU	Size	Coverage	/SF	Price /Lb	Price /Ton
	2-1/6" Flagstone	~80-90 SF/Ton	~\$5.41†	\$.23	\$460.00

CA

- \$20.00 pallet charge, SKU 122684



Longhorn

SKU	Size	Coverage	/SF	Price /Lb	Price /Ton
185826	1½"-2" Premium Steppers	~80-90 SF/Ton	~\$3.88†	\$.165	\$330.00
165774	1½"-2½" Flagstone	~80-90 SF/Ton	~\$5.22†	\$.22	\$444.00

CA

† Approximate price per square foot is for cost comparison purposes; Stone is sold by weight, not by the square foot.

Flagstone & Steppers

Steppers are ~1-2 SqFt/piece (typically non-stock), Premium steppers are ~2-4 SqFt/piece
Flagstones are 4+ SqFt/piece



Mahogany

SKU	Size	Coverage	/SF	Price /Lb	Price /Ton
154460	1½"-2" Premium Steppers	~80-90 SF/Ton	~\$3.53†	\$.15	\$300.00
3551743	1½"-2½" Flagstone	~80-90 SF/Ton	~\$5.43†	\$.221	\$462.00

- Buckskin/chocolate brown, consistent thickness

CA

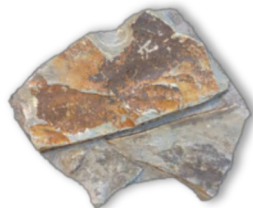

McGregor Lake

SKU	Size	Coverage	/SF	Price /Lb	Price /Ton
4151003	1½"-2½" Premium Steppers	~80-90 SF/Ton	~\$6.41†	\$.27	\$545.00

- Gray base color with beautiful brown and rust accents

CA



Mississippi Bluff Limestone—Sawn Top

SKU	Size	Coverage	/SF	Price /Lb	Price /Ton
81296	2½" Thick Irregular	~65 SF/Ton	~\$7.84†	\$.25	\$510.00
131282	12" x 24" Cut & Patterned		\$10.75		
131286	18" x 24" Cut & Patterned		\$10.75		
131288	24" x 24" Cut & Patterned		\$10.75		

- Golden buff with sawn, smooth surface
- Low water absorption of approximately 1.6% and 11,000 PSI compressive strength

CA

SO
SO
SO



New York Blue—Blue Select

SKU	Size	Coverage	/SF	Price /Lb	Price /Ton
2810988	1½"-2½" Flagstone	~80-90 SF/Ton	~\$8.22†	\$.35	\$699.00

- Selected for blue color throughout stone

CA



New York Blue—Full Color

SKU	Size	Coverage	/SF	Price /Lb	Price /Ton
2977513	1½"-2½" Flagstone	~80-90 SF/Ton	~\$4.80†	\$.20	\$408.00

- Variegated Blue Stone with green and rust colors

CA

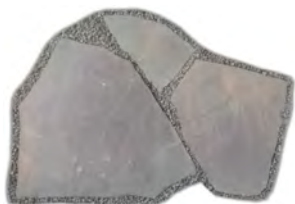

New York Blue—Lilac

SKU	Size	Coverage	/SF	Price /Lb	Price /Ton
2977506	1½"-2½" Flagstone	~80-90 SF/Ton	~\$5.80†	\$.247	\$493.00

- Selected for lilac purple color throughout stone

CA

† Approximate price per square foot is for cost comparison purposes; Stone is sold by weight, not by the square foot.

Flagstone & Steppers

Steppers are ~1-2 SqFt/piece (typically non-stock), Premium steppers are ~2-4 SqFt/piece
Flagstones are 4+ SqFt/piece



New York Blue Sawn and Thermalled Irregular Flag

is an irregular flagstone calibrated to 1½" thickness for easier installation on the jobsite.

- Stone surface is heat treated which gives a consistent, uniform texture
- Installs faster than standard irregular flagstone to save money
- Reduced waste material
- Variations of blue, gray, and bronze color tones
- Individual pieces can range in size from 3 to 15 square feet



Flagstone



New York Blue—Sawn and Thermalled Irregular

SKU	Size	Coverage	/SF	Price /Lb	Price /Ton
157700	1½" Flagstone	~80-90 SF/Ton	~\$6.68†	\$.284	\$568.00

- Irregular pieces sawn to consistent thickness for faster, easier installation
- Thermalled for very even surface with good slip resistance
- Mix of blue, gray, and bronze colors of New York Bluestone

CA



Ozark Cherry

SKU	Size	Coverage	/SF	Price /Lb	Price /Ton
3156405	1½"-2½" Premium Steppers	~80-85 SF/Ton	~\$4.09†	\$.21	\$340.00
99020	1½"-2½" Flagstone	~80-85 SF/Ton	~\$5.27†	\$.214	\$438.00

- Creams, golden browns, and cinnamon browns with peach and black hues

CA



Sawtooth Moss

SKU	Size	Coverage	/SF	Price /Lb	Price /Ton
2977605	1½"-2½" Flagstone	~90-100 SF/Ton	~\$4.54†	\$.216	\$432.00

- Premium flagstone with blacks, creams, and mossy greens
- Silver glint

CA



Smokey Mountain Blue Stone (AKA Cheyenne)

SKU	Size	Coverage	/SF	Price /Lb	Price /Ton
3551767	1½"-2½" Premium Steppers	~80-85 SF/Ton	~\$5.30†	\$.227	\$453.00
120420	1½"-2½" Flagstone	~80-85 SF/Ton	~\$5.20†	\$.214	\$428.00

- Buckskin and blue tones
- Consistent thickness

CA



Sunset Bronze

SKU	Size	Coverage	/SF	Price /Lb	Price /Ton
95520	1"-2" Stepper	~75-80 SF/Ton	~\$8.00†	\$.31	\$620.00
3151905	1"-2" Flagstone	~75-80 SF/Ton	~\$9.00†	\$.345	\$690.00
90966	2"-3" Flagstone	~45-50 SF/Ton	~\$14.50†	\$.345	\$690.00

- Pewter base color with mottled shades of rust, gold, and green

CA

† Approximate price per square foot is for cost comparison purposes; Stone is sold by weight, not by the square foot.

www.bachmanswholesale.com

Flagstone & Steppers

Steppers are ~1-2 SqFt/piece (typically non-stock), Premium steppers are ~2-4 SqFt/piece
Flagstones are 4+ SqFt/piece



Tres Rios

SKU	Size	Coverage	/SF	Price /Lb	Price /Ton
3391943	1½"-2½" Flagstone	~65-75 SF/Ton	~\$9.20†	\$.31	\$620.00

- Very unique! Deep brown/plum tones with cream swirls
- Dappled
- **WHILE SUPPLIES LAST**

CA



Vermillion Slate

SKU	Size	Coverage	/SF	Price /Lb	Price /Ton
2977575	1½"-2" Premium Steppers	60-70~	~\$7.15†	\$.233	\$465.00

- Slate gray with scattered rust and bronze accents

CA



White Diamond

SKU	Size	Coverage	/SF	Price /Lb	Price /Ton
3092741	1½"-2½" Flagstone	~90-100 SF/Ton	~\$4.78†	\$.228	\$455.00

- Creamy white quartz flagstone with a subtle sparkle

CA



Yukon Gold

SKU	Size	Coverage	/SF	Price /Lb	Price /Ton
2977612	1½"-2½" Flagstone	~90-100 SF/Ton	~\$4.78†	\$.228	\$455.00

- Rich blend of golds, caramels, and umbers fleck with silver

CA



New York Blue Select—1½"

SKU	Size	Coverage	Price /SF
2977551	Random	~165 SF/Pallet	\$8.20

- Selected for only premium blue color
- **LIMITED AVAILABILITY**

CA



New York Blue Full Color—1½"

SKU	Size	Coverage	Price /SF
4564209	12" x 12" = 1 SF	~165 SF/Pallet	\$7.75
4564216	12" x 18" = 1.5 SF	~165 SF/Pallet	\$7.75
4564223	12" x 24" = 2 SF	~165 SF/Pallet	\$7.75
4564230	18" x 18" = 2.25 SF	~165 SF/Pallet	\$7.75
4564247	18" x 24" = 3 SF	~165 SF/Pallet	\$7.75
4564254	24" x 24" = 4 SF	~165 SF/Pallet	\$7.75

- Pewter base color with mottled shades of rust, gold, and green

CA

† Approximate price per square foot is for cost comparison purposes; Stone is sold by weight, not by the square foot.

Cut & Patterned Flagstone



New York Blue Lilac—1½"

SKU	Size	Coverage	Price /SF
3151936	Random	~165 SF/Pallet	\$6.95

- Selected for lilac purple color

SO



New York Sawn & Thermalled Full Color

SKU	Size	Coverage	Price /SF
185676	Random	~165 SF/Pallet	\$10.35

- ADD \$1.50/SF FOR BLUE SELECT

CA

Kasota Granite Slabs/Counter Tops



Custom Cut Granite Slabs

SKU	Color	Price
58236	Mahogany	Custom order—Call for price
58236	Superior Northern	Custom order—Call for price

- Special order only. Please contact your Bachman's Hardscapes representative for lead times.
- Custom made to your design.
- A variety of finishes are available. Please call to request samples.

SO

Natural Stone Step Treads & Wall Caps



New York Bluestone



Indiana Limestone

Bluestone			SO
3944590	1½" x 14" x 36"	Rockface on 1 long edge	\$71.00 Each
3944606	1½" x 14" x 36"	Rockface on 2 long edges	\$81.00 Each
3944620	1½" x 14" x 48"	Thermal on all 6 edges	\$91.00 Each
Limestone			
3944583	2" x 14" x 36"	Rock face on 1 long edge	\$47.00 Each

Additional natural stone wall cap options available from Banas Stones on pages 274 & 275

Natural Stone Steps

Natural stone steps are approximately 5½"-6" thick unless otherwise noted



Aqua Grantique

2780137
2780144

18" x 36"
18" x 48"

SO

\$274.00
\$350.00



Chilton

3459674
2760252
2760269

18" x 24"
18" x 36"
18" x 48"

CA

\$120.00
\$150.00
\$199.00



Chilton Weathered Edge

3708468
3708475

18" x 36"
18" x 48"

CA

\$192.00
\$251.00



Fond du Lac

2760375
2760382

18" x 24"
18" x 36"
18" x 48"

CA

\$145.00
\$199.00



Echo Granite

148284
148286

18" x 36"
18" x 48"

NS

\$125.00
\$150.00

- Sawn top & bottom
- Sapphire finish top
- Snap face



Highland Brown

2760474
2760481

18" x 36"
18" x 48"

CA

\$185.00
\$325.00

Natural Stone Steps

Natural stone steps are approximately 5½"-6" thick unless otherwise noted



Kasota Stone Amber

CA

3530854	18" x 36"	\$150.00
3530861	18" x 48"	\$165.00



Kasota Stone Gray

NS

3530854	18" x 36"	\$150.00
3530861	18" x 48"	\$165.00



Longhorn

CA

165776	18" x 36"	\$95.00
165778	18" x 48"	\$130.00

- Snap face



Mahogany Granite

CA

4564315	18" x 36"	\$155.00
4564322	18" x 48"	\$170.00

- Sawn top & bottom
- Sapphire finish top
- Snap face



Mississippi Bluff Limestone

CA

81300	18" x 36" x 6" High	\$105.00
81302	18" x 36" x 7¾" High	\$126.00
81306	18" x 48" x 6" High	\$115.00
81308	18" x 48" x 7¾" High	\$135.00

- High quality buff colored limestone
- High density and low water absorption

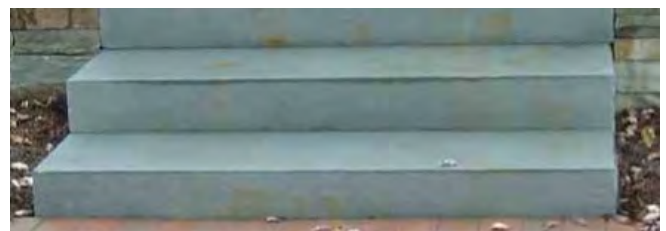

New York Blue—Select Thermalled

CA

	~ 14" x 36"	
208190	~ 14" x 48"	\$285.00

- Selected for blue color
- Thermalled finish

Natural Stone Steps

Natural stone steps are approximately 5½"-6" thick unless otherwise noted



New York Blue—Full Color Thermalled

CA

3391967	16" x 36"	\$220.00
3391974	16" x 48"	\$250.00

- Thermal finish on three sides



New York Blue—Full Color Natural Snapped

CA

3698301	~ 18" x 36"	\$180.00
3698318	~ 18" x 48"	\$230.00

- Natural random sizing; 5"-8" thick; 15"-18" deep



New York Blue Outcropping Steps

CA

Irregular \$

- Natural irregular pieces approximately 5" to 8" thick.



Sandy Creek

CA

2760535	18" x 36"	\$160.00
2760542	18" x 48"	\$275.00



Sawn Granite Boulder Steps

CA

3583805	2'-5' Oval	\$540.00/Ton
		Over 2 Tons: \$472.00/Ton

- Natural random sizing
- Approximately 6" thick
- Thermal surface
- \$20.00 pallet deposit



Sunset Bronze

CA

95518	Random	\$410.00/Ton
		\$.205/Pound

Natural Stone Steps

Natural stone steps are approximately 5½"-6" thick unless otherwise noted



Superior Northern Granite

4564339	18" x 36"	CA	\$155.00
4564346	18" x 48"		\$170.00

- Sawn top & bottom
- Sapphire finished top
- Snap face



Additional natural stone step options in a wide variety of colors and sizes available from Banas Stones on pages 276-278.

Natural Stone Pillar Caps



Indiana Limestone Column Cap—Grey

81468	2¼" x 24" x 24"	CA	\$88.00
3944538	2¼" x 30" x 30"		\$165.00
3495924	3" x 30" x 30"		\$179.00



Buff Column Cap

49314	3" x 27" x 27"	CA	\$170.00
49318	3" x 30" x 30"		\$215.00



Basalt Pieces

3383849	Small—Under 200 Lbs	F	\$1.00/Lb
3383931	Medium—200 to 400 Lbs		\$1.35/Lb
3383948	Large—400 to 1000 Lbs		\$1.30/Lb

* WHILE SUPPLIES LAST

Boulders & Outcroppings



Split Rock Blue Boulders

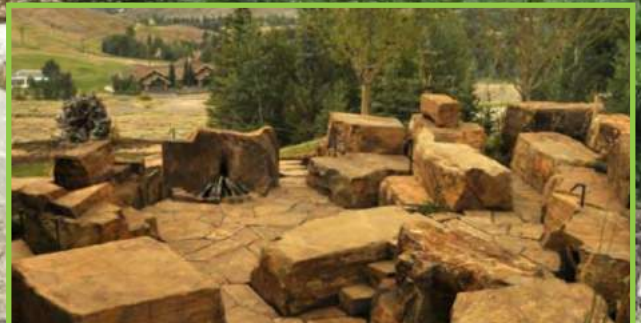

Sunset Bronze Outcropping



Mississippi Bluff Outcropping

Section Contents

Description	Page	Description	Page
Boulders	301-302	Basketed Cobbler, Flats, & Boulders	307
• Black Obsidian	301	• Canyon Cobbles	307
• Buff Limestone	301	• Piney Creek	307
• Dresser Gray Trap	301	• Rio Bravo	307
• Fieldstone	301	• Thunder Bay Amethyst	307
• Grand Marais Red	301		
• Gunflint Trail Green	301	Basalt	307
• Iron Range Rainbow	301		
• Kodiak Brown	301	Dekorrra Replicated Rocks	308
• Meridian Red	302		
• North Shore Brown	302		
• Painted Mesa	302		
• Split Rock Blue Superior Trap	302		
Outcroppings	303-306		
• Alverson Limestone	303		
• Chilton	303		
• Chilton Weatheredge	303		
• Copper Mountain	303		
• Fond du Lac Chunks	303		
• Fond du Lac	303		
• Fond du Lac Weatheredge	304		
• Goldenrod	304		
• Highland Brown	304		
• Kodiak Brown	304		
• Lannon	304		
• Lannon Weathered Edge	304		
• Limestone Cubes	305		
• Limestone—Weathered	305		
• McGregor Lake	305		
• Meridian Red	305		
• Mississippi Bluff	306		
• Stonebridge Beam Rock	306		
• Sunrise Brown	306		
• Sunset Bronze	306		



Scan here for images

Boulders

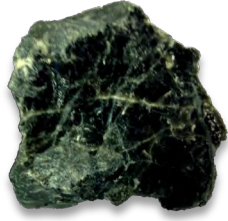

Black Obsidian (Limited Quantity)

		Price	
	Size	/Lb	/Ton
2760955	18-36"	\$.08	\$160.00

CA



Buff Limestone

		Price	
	Size	/Lb	/Ton
3610488	4-8" Rip Rap	\$.032	\$64.00
3395385	18-36"	\$.04	\$80.00

CA

CA



Dresser Gray Trap

		Price	
	Size	/Lb	/Ton
3697991	18-36"	\$.06	\$139.00

CA



Fieldstone

		Price	
	Size	/Lb	/Ton
2760832	6-12"	\$.037	\$74.00
3556465	12-36"+	\$.037	\$74.00

CA

CA

- Specify sizes when ordering
- Call for pricing on direct shipment and clam truck deliveries



Grand Marais Red

		Price	
	Size	/Lb	/Ton
2983828	18-30"	\$.06	\$125.00

CA

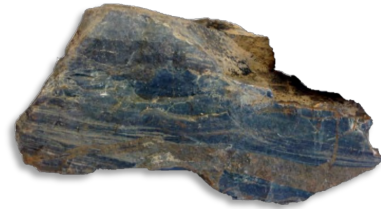

Gunflint Trail Green

		Price	
	Size	/Lb	/Ton
2983835	18-30"	\$.06	\$120.00

CA



Iron Range Rainbow

		Price	
	Size	/Lb	/Ton
2983842	18-30"	\$.06	\$128.00

CA



Kodiak Brown

		Price	
	Size	/Lb	/Ton
81380	16-36"	\$.06	\$128.00
148288	Cubes	\$.07	\$138.00

CA

CA

Custom Sorting, Item# 2932866: Add \$30/Ton

Core Charge, Item# 3588817

Full loads are 23-25 tons of boulders drop-shipped directly to you site. Please call for quotes.

Clam truck deliveries are available upon request. Please call for details and quotes.

Boulders



CA

Meridean Red

	Size	/Lb	/Ton
4348014	18-24"	\$.114	\$228.00



CA

North Shore Brown

	Size	/Lb	/Ton
3081035	18-30"	\$.06	\$128.00



CA

Painted Mesa

	Size	/Lb	/Ton
2977940	18-24"	\$.13	\$290.00



CA

Split Rock Blue Superior Trap

	Size	/Lb	/Ton
2760894	18-30"	\$.06	\$128.00

Custom Sorting, Item# 2932866: Add \$30/Ton

Core Drilling Charge, Item# 3588817: \$60.00/Linear Foot

Full loads are 23-25 tons of boulders drop-shipped directly to you site. Please call for quotes

Clam truck deliveries are available upon request. Please call for details and quotes.

Weight and Coverage Estimations

Estimated Weights per Boulder (2000 Lbs = 1 Ton)			
Size	Weight	Size	Weight
6"	10-15 Lbs.	18"	150-250 Lbs.
8"	20-30 Lbs.	20"	300-450 Lbs.
10"	40-50 Lbs.	24"	500-750 Lbs.
12"	60-90 Lbs.	30"	800-1000 Lbs.
15"	100-125 Lbs.	36"	1200-2000+ Lbs.

Estimated Coverage of Boulders	
Size	Coverage
6"-12"	15-20 SqFt of Wall/Ton
12"-18"	10-15 SqFt of Wall/Ton
18"-24"	6-10 SqFt of Wall/Ton
24"-30"	5-8 SqFt of Wall/Ton
30"-36"	3-6 SqFt of Wall/Ton
Rip Rap	Approximately 40 SqFt/Ton @ 3" Deep
6"-12" Edging	35-40 Linear Feet/Ton

Outcroppings

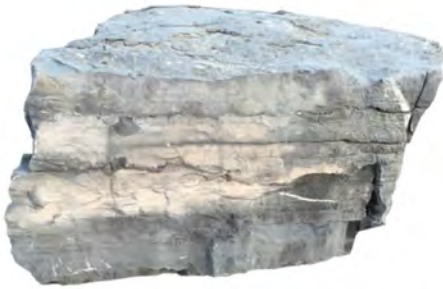

CA

Alverson Armor Rock Outcroppings

	Size	Price	
		/Lb	/Ton
3698011	14"-16"	\$.11	\$150.00

- Weathered blue-gray & tan
- Blocky—Easy stack
- Great for large walls
- 2'-5' random lengths
- While supplies last



CA

Chilton Outcroppings

	Size	Price	
		/Lb	/Ton
120676	5"-12"	\$.143	\$285.00

- Perfect for large, irregular walls, water features, and more



CA

Chilton Weatheredge Outcroppings

	Size	Price	
		/Lb	/Ton
3392247	8"-15"	\$.150	\$299.00

- Outcroppings with weathered edge
- Perfect for large, irregular walls, water features, and more



CA

Copper Mountain Outcropping

	Size	Price	
		/Lb	/Ton
160864	8"-12"	\$.11	\$220.00
160866	12"-24"	\$.09	\$180.00

- Rusty brown tones



CA

Fond du Lac Chunks

	Size	Price	
		/Lb	/Ton
153216	18"-22"	\$.098	\$196.00

- Thick, split, stackable quarry run Fond du Lac pieces



CA

Fond du Lac Outcropping

	Size	Price	
		/Lb	/Ton
61900	1-2 Man	\$.098	\$196.00
61902	2-3 Man	\$.098	\$196.00
4353094	5"-12"	\$.098	\$196.00

- Irregular, random, quarry run Fond du Lac pieces

Custom Sorting, Item# 2932866: Add \$30/Ton

Core Charge, Item# 3588817

Full loads are 23-25 tons of boulders drop-shipped directly to you site. Please call for quotes.

Clam truck deliveries are available upon request. Please call for details and quotes.

Outcroppings



CA

Fond du Lac Weathered Edge Outcropping

	Size	Price	
		/Lb	/Ton
79794	5"-12"	\$.11	\$228.00

- Irregular, random, quarry run Fond du Lac pieces



CA

Goldenrod Outcropping

	Size	Price	
		/Lb	/Ton
129470	24"-30"	\$.12	\$240.00

- Heavily weathered golden brown and tan shades
- Large, cube-shaped pieces for easy stacking



CA

Highland Brown Outcropping

	Size	Price	
		/Lb	/Ton
3152186	10"-16"	\$.082	\$170.00

- Rusty brown irregular sandstone pieces



CA

Kodiak Brown Outcropping

	Size	Price	
		\$/Lb	/Ton
148288	24"-48"	\$.06	\$128.00

- Dark gray with medium brown accents



NS

Lannon Outcropping

	Size	Price	
		/Lb	/Ton
120678	5"-12"	\$.098	\$195.00
120680	13"-42"	\$.090	\$179.00

- Gray, irregular limestone



NS

Lannon Weathered Edge Outcropping

	Size	Price	
		/Lb	/Ton
120682	5"-12"	\$.113	\$225.00
120684	13"-42"	\$.103	\$205.00

- Gold to rustic shades of brown, irregular limestone

Custom Sorting, Item# 2932866: Add \$30/Ton

Core Charge, Item# 3588817

Full loads are 23-25 tons of boulders drop-shipped directly to you site. Please call for quotes.

Clam truck deliveries are available upon request. Please call for details and quotes.

Outcroppings



CA

Limestone Outcropping Cubes

	Size	/Lb	Price /Ton
4160920	18"-30"	\$.06	\$135.00

- Irregular limestone outcroppings
- Good size
- Stackable
- CALL FOR DIRECT SHIP PRICING—CLAM DELIVERED



CA

Limestone Boulders/Outcropping Weathered

	Size	/Lb	Price /Ton
3163748	18"-36"+	\$.148	\$295.00

- Craggy "holey" boulders
- Fantastic water feature
- Has moss & lichen

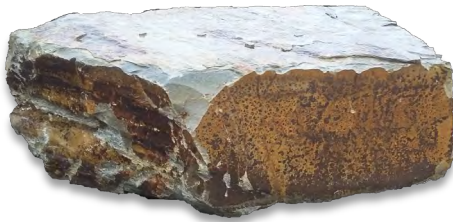

CA

McGregor Lake Montana Outcroppings

	Size	/Lb	Price /Ton
4258467	18"-24"	\$.15	\$300.00
4258481	24"-36"	\$.13	\$260.00



CA

McGregor Lake Montana Ledge Rock

	Size	/Lb	Price /Ton
4258443	6"-8"	\$.22	\$440.00



CA

McGregor Lake Montana Lintel Beam Rock

	Size	/Lb	Price /Ton
4263454	Random	\$.34	\$680.00



CA

Meridian Red Outcropping

	Size	/Lb	Price /Ton
4348038	10"-16"	\$.10	\$200.00

- Deep red outcroppings
- Stackable

Custom Sorting, Item# 2932866: Add \$30/Ton
 Core Charge, Item# 3588817
 Full loads are 23-25 tons of boulders drop-shipped directly to you site. Please call for quotes.
 Clam truck deliveries are available upon request. Please call for details and quotes.

Outcroppings



CA

Mississippi Bluff Limestone

	Size	Price	
		/Lb	/Ton
81310	See Notes	\$.09	\$187.00

- Premium quality buff colored limestone
- Uniform tops and bottoms for flat stacking
- Sorted in 5"-9", 10"-14", 15"-22", and 23"-27" thicknesses



CA

Stonebridge Beam Rock Outcropping

	Size	Price	
		/Lb	/Ton
3392254	14"-16"	\$.18	\$365.00

- Stone "beams"
- Deep caramel colors
- Very blocky and flat
- 14"-16" x 14"-16" x 3'-6' random lengths
- Approximately 6-9 SqFt/Ton coverage for walls



CA

Sunrise Brownstone Outcropping

	Size	Price	
		/Lb	/Ton
3152179	18"-36"+	\$.12	\$240.00

- Tan and dark brown cubes



CA

Sunset Bronze Outcropping

	Size	Price	
		/Lb	/Ton
3961481	5"-10"	\$.198	\$395.00

- Great for outcrop steps
- Bronzes and buffs



COMING
IN 2019

Sawn Granite Boulder Wall

- Sawn to 6" heights for easy installation
- Available in 8" or 12" depths
- Approximate coverage of 18-20 square feet per ton at 8" depth, and 12-13 square feet per ton for 12" depth
- Call your Bachman's Hardscapes salesperson for pricing

Custom Sorting, Item# 2932866: Add \$30/Ton

Core Charge, Item# 3588817

Full loads are 23-25 tons of boulders drop-shipped directly to you site. Please call for quotes.

Clam truck deliveries are available upon request. Please call for details and quotes.

Specialty Stone—Basketed Cobblers, Flats, and Boulders

Palletized in wire baskets for convenience

Pallets weigh 2,500—3,000 Lbs.



CA

Mini Canyon Cobbles

	Size	Price	
		/Lb	/Ton
81466	3"-7"—Mini	\$.29	\$585.00

- Flat & smooth stones that are red, charcoal, tan, brown, and bone colors
- Great for fountains and creek beds



CA

Canyon Cobbles

	Size	Price	
		/Lb	/Ton
81464	4"-12"	\$.29	\$585.00

- Flat & smooth stones that are red, charcoal, tan, brown, and bone colors
- Great for fountains and creek beds



CA

Piney Creek Flats

	Size	Price	
		/Lb	/Ton
4347994	6"-10"	\$.16	\$320.00

- Creek flats in earthtone colors
- Very smooth texture
- Approximately 60 SqFt/ton



CA

Rio Bravo Boulders

	Size	Price	
		/Lb	/Ton
3211241	18"-24"	\$.26	\$520.00

- Perfect for dry stream beds, water features, decorative, etc.
- Very intense colors of purple, pink, green, and blue/gray, especially in water



CA

Thunder Bay Amethyst Boulders

	Size	Price	
		/Lb	/Ton
4215897	12"-24"	\$1.95	\$3,900.00

- **Limited Quantities**
- Incredible boulders from Canada, veined with amethyst jewels



CA

Basalt Pieces

	Size	Price	
		/Lb	/Ton
3383849	Small—Under 200 Lbs	\$1.00	\$2,000.00
3383931	Med—200 to 400 Lbs	\$1.35	\$2,700.00
3383948	Lg—400 to 1000 Lbs	\$1.30	\$2,600.00

Custom Sorting, Item# 2932866: Add \$30/Ton

Core Charge, Item# 3588817

Full loads are 23-25 tons of boulders drop-shipped directly to you site. Please call for quotes.

Clam truck deliveries are available upon request. Please call for details and quotes.



CA

Replicated Rock Model 101

3379958	Fieldstone/Gray	\$105.00
3379965	Riverbed/Brown	\$105.00
31"L x 26"W x 21"H		



CA

Replicated Rock Model 102

79956	Fieldstone/Gray	\$105.00
79958	Riverbed/Brown	\$105.00
27"L x 21"W x 25"H		



CA

Replicated Rock Model 105

3379972	Fieldstone/Gray	\$65.00
3379989	Riverbed/Brown	\$65.00
24"L x 12"W x 12½"H		



CA

Replicated Rock Model 106

79954	Fieldstone/Gray	\$84.00
53222	Riverbed/Brown	\$84.00
19"L x 14"W x 12"H		



CA

Replicated Rock Model 107

53226	Fieldstone/Gray	\$105.00
53224	Riverbed/Brown	\$105.00
15"L x 14"W x 23"H		



CA

Replicated Rock Model 109

3379996	Fieldstone/Gray	\$95.00
3380008	Riverbed/Brown	\$95.00
30"L x 23"W x 18"H		



CA

Replicated Rock Model 111

3380015	Fieldstone/Gray	\$130.00
3380022	Riverbed/Brown	\$130.00
34"L x 32"W x 15"H		



CA

Replicated Rock Model 112

3380039	Fieldstone/Gray	\$130.00
3380046	Riverbed/Brown	\$130.00
36"L x 36"W x 9"H		

Bulk & Bagged Products



Cocoa Brown Rock



Polished Black Mexican Beach Pebbles



Western Red Cedar



1/2" Minus Unwashed Granite



Washed Sand

Section Contents

Description	Page
Bulk Decorative Landscape Rock	311
<ul style="list-style-type: none"> • Bryan Red Rock 311 • Buff Limestone 311 • Cocoa Brown Rock 311 • Desert Sunset 311 • Dresser Gray Trap Rock 311 • Fort Dodge White 311 • Minnesota Mahogany Red Granite 311 • Pink Sioux Quartz 311 • Purple Quartz 311 • Red Volcanic Rock 311 • River Rock 311 • River Rock Rip-Rap 311 • St. Cloud Grey Granite 311 	
Bulk Sand, Base, Joint, & Pathway Materials	312
<ul style="list-style-type: none"> • Dresser Gray 312 • Limestone 312 • Recycled Concrete 312 • River Rock Pea Gravel 312 • Screened Sand 312 • St. Cloud Granite 312 	
Bagged Sand, Base, Joint, & Pathway Materials	312
<ul style="list-style-type: none"> • Class 5 Paver Base 312 • Granite Sand 312 • Grey Slate 312 • Pea Gravel 312 • Sand 312 	
Bagged Decorative Landscape Rock	313
<ul style="list-style-type: none"> • River Rock 313 • Mexican Beach Pebbles 313 • Polished Beach Pebbles 313 • Rolled White Marble 313 • Seaside Pebbles 313 	



Scan here for more images of landscape rock and mulch

Description	Page
Bulk Wood & Bark Landscape Mulch	314
<ul style="list-style-type: none"> • Dyed Shredded Hardwood 314 • Natural Shredded Hardwood 314 • Shredded Cedar 314 • Shredded Cypress 314 • Hardwood Chips 314 • Pine Bark Mulch 314 • Playground Mulch 314 	
Bagged Landscape Mulch	315
<ul style="list-style-type: none"> • Bark Nuggets 315 • Cedar Chips 315 • Cocoa Bean Mulch 315 • Cypress Mulch 315 • Pine Bark Mulch 315 • Pine Straw 315 • Cedar Mulch 315 • Dyed Shredded Hardwood 315 • Natural Shredded Hardwood 315 	
Mulch Stabilizer	316
Bulk Soils & Amendments	316
<ul style="list-style-type: none"> • Screened Garden Mix 316 • Pulverized & Screened Black Soil 316 • Pure Organic Compost 316 • Composted Pine Bark (Pine Fines) 316 • Screened "Concrete" Sand 316 	
Bagged Soils & Amendments	317-318
<ul style="list-style-type: none"> • Gypsum 317 • Limestone Pellets 317 • Garden Soil 317 • Potting Soil 317 • Top Soil 317 • Manure 317 • Miracle Gro Moisture Control 317 • Mushroom Compost 317 • Peat Moss 318 • Soil Pep Bark Fines 318 • Total Garden Blend 318 	

Bulk Decorative Landscape Rock—Stock Varieties



Bryan Red Rock Price/Yard
 2744443 ¾" \$53.00
 2761198 1½" \$53.00



Buff Limestone Price/Yard
 2761297 ¾" \$49.00
 2761310 1½" \$49.00
 164468 3" \$45.70



Cocoa Brown Rock Price/Yard
 4016197 1½" \$99.00



Dresser Gray Trap Rock Price/Yard
 2761211 ¾" \$102.00
 2761235 1½" \$102.00
 163524 3"-6" \$102.00



River Rock Price/Yard
 2758402 ¾" \$40.50
 2758433 ¾" \$37.75
 2758488 1½" \$37.00
 4293024 2"-3" \$40.00



River Rock Rip-Rap Price/Yard
 3200092 2"-6" \$45.00



St. Cloud Grey Granite Price/Yard
 3400713 ¾" \$84.00
 4264048 ¾" \$62.75
 2761273 1½" \$62.75

ESTIMATING GUIDE—TO DETERMINE CUBIC YARDS NEEDED (1 CY = 27 CF)								
Material Depth	1"	2"	3"	4"	6"	9"	10"	12"
Divide Area SqFt by:	324	162	108	81	54	36	33	27

FORMULAS		
Area—Rectangle	L x W	L = Length, W = Width π=3.1416, r=Radius, D=Diameter
Area—Circle	πr ²	
Circumference—Circle	πD	
Volume	L x W x Depth	

Bulk Decorative Landscape Rock—Special Order—Call for Quote



Desert Sunset Price/Yard
 100286 1½" \$124.00



Fort Dodge White Price/Yard
 3410491 ¾" \$92.00



Minnesota Mahogany Red Granite Price/Yard
 3303472 1½" \$110.00



Pink Sioux Quartz Price/Yard
 2979104 1½" \$96.00



Purple Quartz Price/Yard
 2792185 1½"-2" \$71.00



Red Volcanic Price/Yard
 100284 1½" \$234.50

Bulk Sand, Base, Joint, & Pathway Materials

Description	Size	Stock Location	Item Number	Price/Yard	
Dresser Gray	¾" Chips	CA	65090	\$81.00	
	½" Minus	CA	4226985	\$65.00	
Limestone	Sewer Rock	SO		\$	
	Class 2	CA	2761792	\$32.25	
Recycled Concrete	Base	CA	4563783	\$22.00	
River Rock Pea Gravel	¾"	CA	2758402	\$40.50	
Screened Sand		CA	2761730	\$17.50	
St. Cloud Granite	Sand	CA	3663972	\$62.00	
	¾" Chips	Great for under pavers in lieu of sand	CA	3400713	\$84.00
	½" Minus		CA	4563790	\$55.00

Calculations		
Paver Base	$A \div 200 \times D \times 1.25 = \text{Tons of Base}$	A = Area (in Square Feet) D = Depth (in Inches)
Paver Bedding Sand	$A \div 200 \times 1.25 = \text{Tons of Sand (1 inch thick)}$	A = Area (in Square Feet)
Wall Leveling Pad Aggregate	$L \div 27 \times 1.1 = \text{Cubic Yards of Base Aggregate}$	L = Length of Wall (in Feet)
Retaining Wall Drainage Aggregate	$(L \times H) \div 27 \times 1.1 = \text{Cubic Yards of Aggregate}$	L = Length of Wall (in Feet) H = Height of Wall (in Feet)

Bagged Sand, Base, Joint, & Pathway Materials

Description	Bags/Pallet	Bag Size	Stock Location	Item Number	Price/Bag
Class 5—Paver Base	56	½ CF	NS	3387496	\$3.50
Granite Sand	60	50 Lbs	NS	88208	\$8.25
Pea Gravel	56	½ CF	NS	1752265	\$3.95
Sand—Clean Washed	56	½ CF	NS	1221976	\$3.75
Bucket-O-Rock • Bring your own 5 gallon pail and fill with your choice of bulk landscape rock, mulch, or soil (does not included Polished, Seaside, or Mexican Beach Pebbles)			CA	3260140	\$5.00
Empty 5 Gallon Bucket			CA		
Bulk Bag			CA	2872856	\$50.00

Bagged (5 Gallon Bucket) Decorative Landscape Rock



River Rock
1221983 1½" **CA** Price/Bag \$4.05
.5 Cubic Foot Bag; 56 Bags/Pallet



- Bulk - Mexican Beach Pebbles Black
118556 1"-2" **CA** Price/Lb (Bulk) \$.34
118558 2"-3" **CA** \$.34
118560 3"-5" **CA** \$.34
≈2000 Lb Bag; 1 Bag/Pallet



Polished Pebbles Black
3381616 ½"-1½" **CA** Price/Bag \$33.00
3381623 1½"-2½" **CA** \$33.00
≈50 Lbs (.5 CF) Bag; 49 Bags/Pallet



Polished Pebbles White
3381685 ½"-1½" **CA** Price/Bag \$34.00
3381692 1½"-2½" **CA** \$34.00
≈50 Lbs (.5 CF) Bag; 49 Bags/Pallet



Seaside Pebbles Ivory
3381746 1"-2" **CA** Price/Bag \$34.00
≈50 Lbs (.5 CF) Bag; 49 Bags/Pallet



Mexican Beach Pebbles Baja Sunburst
4127022 2"-3" **CA** Price/Bag \$29.00
4127039 3"-5" **CA** \$29.00
≈75 Lbs (.7 CF) Bag; 40 Bags/Pallet



Mexican Beach Pebbles Bone White
3381845 1"-2" **CA** Price/Bag \$29.00
3381852 2"-3" **CA** \$29.00
3381869 3"-5" **CA** \$29.00
≈75 Lbs (.7 CF) Bag; 40 Bags/Pallet



Polished Pebbles Red
3381654 ½"-1½" **CA** Price/Bag \$33.00
3381661 1½"-2½" **CA** \$33.00
≈50 Lbs (.5 CF) Bag; 49 Bags/Pallet



Rolled Marble White
4043469 ½"-1½" **CA** Price/Bag \$34.00
4043476 1½"-2½" **CA** \$34.00
≈50 Lbs (.5 CF) Bag; 49 Bags/Pallet



Seaside Pebbles Salmon
3381791 1"-2" **CA** Price/Bag \$34.00
≈50 Lbs (.5 CF) Bag; 49 Bags/Pallet



Mexican Beach Pebbles Black
3381814 1"-2" **CA** Price/Bag \$33.25
3381821 2"-3" **CA** \$33.25
3381838 3"-5" **CA** \$33.25
≈75 Lbs (.7 CF) Bag; 40 Bags/Pallet



Mexican Beach Pebbles Mixed Color
3381876 1"-2" **CA** Price/Bag \$29.00
3381883 2"-3" **CA** \$29.00
3381890 3"-5" **CA** \$29.00
≈75 Lbs (.7 CF) Bag; 40 Bags/Pallet



Polished Pebbles Striped
3381630 ½"-1½" **CA** Price/Bag \$33.00
3381647 1½"-2½" **CA** \$33.00
≈50 Lbs (.5 CF) Bag; 49 Bags/Pallet



Seaside Pebbles Green (Limited Supply)
3381715 2"-3" **CA** Price/Bag \$34.00
≈50 Lbs (.5 CF) Bag; 49 Bags/Pallet

Bag Size	Bags/Cubic Yard
.25 CF	108
.5 CF	54
.7 CF	40
Bag Size	Approx Coverage
50 Lb.	2 SF at 3" Deep
75 Lb.	3 SF at 3" Deep

Bulk Wood and Bark Landscape Mulches



CA

Autumn Blaze Colored Shredded Hardwood Mulch

3410477 <10 Yards \$37.00/Yd
 10+ Yards \$33.50/Yd
 Full Load* \$27.50/Yd
 ≈90 Yards/Semi Load



CA

Cedar—Western Red

2761587 <10 Yards \$43.00/Yd
 10+ Yards \$38.50/Yd
 Full Load* \$34.95/Yd
 ≈120 Yards/Semi Load



CA

Cypress—100% Pure

2761525 <10 Yards \$62.00/Yd
 10+ Yards \$56.00/Yd
 Full Load* \$51.00/Yd
 ≈100 Yards/Semi Load



CA

Double Shredded Hardwood Mulch—Natural

2761464 <10 Yards \$25.00/Yd
 10+ Yards \$22.00/Yd
 Full Load* \$19.95/Yd
 ≈100 Yards/Semi Load



CA

Hardwood Chips—Northern Premium

3194230 <10 Yards \$33.00/Yd
 10+ Yards \$30.00/Yd
 Full Load* \$28.00/Yd
 ≈100 Yards/Semi Load



CA

Pine Bark Mulch—Shredded

2761488 <10 Yards \$40.00/Yd
 10+ Yards \$36.00/Yd
 Full Load* \$34.00/Yd
 ≈100 Yards/Semi Load



SO

Playground Mulch—Certified

3743780 10+ Yards \$26.00/Yd
 Full Load* Call
 ≈100 Yards/Semi Load
 †10 Yd Minimum



CA

Premium Colored Shredded Hardwood Mulch—Black

3778416 <10 Yards \$38.00/Yd
 10+ Yards \$34.50/Yd
 Full Load* \$28.50/Yd
 ≈90 Yards/Semi Load



CA

Premium Colored Shredded Hardwood Mulch—Cedartone

2761648 <10 Yards \$38.00/Yd
 10+ Yards \$34.50/Yd
 Full Load* \$28.50/Yd
 ≈90 Yards/Semi Load



CA

Premium Colored Shredded Hardwood Mulch—Cocoa Brown

3059065 <10 Yards \$38.00/Yd
 10+ Yards \$35.00/Yd
 Full Load* \$27.50/Yd
 ≈100 Yards/Semi Load



CA

Premium Colored Shredded Hardwood Mulch—Gold

3410453 <10 Yards \$38.00/Yd
 10+ Yards \$35.00/Yd
 Full Load* \$27.50/Yd
 ≈90 Yards/Semi Load



CA

Premium Colored Shredded Hardwood Mulch—Red

2761617 <10 Yards \$38.00/Yd
 10+ Yards \$35.00/Yd
 Full Load* \$27.50/Yd
 ≈90 Yards/Semi Load

ESTIMATING GUIDE—TO DETERMINE CUBIC YARDS NEEDED (1 CY = 27 CF)

Material Depth	1"	2"	3"	4"	6"	9"	10"	12"
Divide Area SqFt by:	324	162	108	81	54	36	33	27

* Includes metro area delivery, drop shipped to your site. Full semi loads amounts are approximate and will vary based on weight of material at time of loading.

† Non-stock mulch; Set up delivery or pick up at mill; Delivery charges apply; Call for 100 yard quote.

Bagged Mulch



CA

Bark Nuggets—Small

4372811 2 CF \$5.45/Bag

- 65 Bags/Pallet



CA

Bark Nuggets—Medium

4372828 2 CF \$5.45/Bag

- 65 Bags/Pallet



CA

Bark Nuggets—Large

4372835 2 CF \$5.45/Bag

- 65 Bags/Pallet



CA

Cedar Chips

409351 3 CF \$5.25/Bag

- 42 Bags/Pallet



CA

Cocoa Bean Mulch

331263 2 CF \$5.75/Bag

- 65 Bags/Pallet



CA

Cypress Mulch

2527251 3 CF \$5.75/Bag

- 56 Bags/Pallet



CA

Pine Bark Mulch—Shredded

3585526 3 CF \$7.25/Bag

- 45 Bags/Pallet



CA

Pine Straw Mulch

95446 2 CF Bale \$10.80/Bale

- 48 Bales/Pallet
- Good deterrent for slugs in Hosta gardens



CA

Shredded Hardwood—Dyed Brown

4247041 2 CF \$4.25/Bag

- 70 Bags/Pallet



CA

Shredded Hardwood—Dyed Red

4247034 2 CF \$4.25/Bag

- 70 Bags/Pallet



CA

Shredded Hardwood—Natural

86238 3 CF \$5.25/Bag

- 44 Bags/Pallet



CA

Western Red Cedar Mulch

1249185 3 CF \$6.45/Bag

- 52 Bags/Pallet

Calculating Coverage of Bagged Mulch (1 CY = 27 CF)

Depth	½ CF Bag (54 Bags/1 CY)	2 CF Bag (13½ Bags/1 CY)	3 CF Bag (9 Bags/1 CY)
1"	6 SqFt / Bag	24 SqFt / Bag	36 SqFt / Bag
2"	3 SqFt / Bag	12 SqFt / Bag	18 SqFt / Bag
3"	-	8 SqFt / Bag	12 SqFt / Bag
4"	-	6 SqFt / Bag	9 SqFt / Bag

Messy mulch?

SOLVED.



SRW Mulch Stabilizer

Description	Item#	Stock Location	Price Each
1 Gallon Bottle	115420	CA	\$23.50
5 Gallon Bottle	115422	CA	\$102.95

- Up to 100 SqFt/Gallon. Coverage may vary depending on surface and application

Bulk Soils & Amendments



CA
Black Soil—Screened & Pulverized
 4155223 \$26.00/CY



CA
Compost—Pure Organic
 3550487 \$25.00/CY
 • Organic leaf compost



CA
Composed Pine Bark (“Pine Fines”)
 2832232 \$41.50/CY



CA
Fill Dirt
 120890 \$5.00/CY
 • Our native soil from the wholesale nursery in Farmington mixed with heel material (when available)



CA
Garden Soil Mix—Screened 1:1:1
 2761693 \$29.00/CY
 • Pulverized black soil, sand, and peat



CA
Screened “Concrete” Sand
 2761730 \$18.00/CY



SALES • SERVICE • RENTALS • PARTS

1200 HIGHWAY 13 EAST, BURNSVILLE, MN
 952-894-0894

Bagged Soils & Amendments

CA



Gypsum

56890 40 Lbs 63 Bags/Pallet \$8.45/Bag

CA



Pelletized Limestone

474175 40 Lbs 63 Bags/Pallet \$8.95/Bag

CA



Mighty Earth Garden Soil

1931370 16 Qt 98 Bags/Pallet \$2.95/Bag

- 60% peat moss for better moisture retention
- For outdoor use in the garden or for landscaping

CA



Mighty Earth Potting Soil

1931400 8 Qt 200 Bags/Pallet \$2.50/Bag

1931387 16 Qt 98 Bags/Pallet \$4.75/Bag

3750955 32 Qt 60 Bags/Pallet \$8.25/Bag

- For indoor and outdoor potted plants

CA



Mighty Earth Manure

450872 40 Lbs 60 Bags/Pallet \$3.50/Bag

CA



Might Earth Topsoil

720661 40 Lbs 60 Bags/Pallet \$2.25/Bag

CA



Miracle Gro Moisture Control

3144105 16 Qt 84 Bags/Pallet \$8.25/Bag

3059683 1 CF 60 Bags/Pallet \$9.95/Bag

3059690 2 CF 39 Bags/Pallet \$14.95/Bag

- Protects against over and under watering
- Feeds up to 6 months

CA



Mushroom Compost

1472064 40 Lbs 60 Bags/Pallet \$7.25/Bag

Bagged Soils & Amendments



CA

Peat Moss			
2110309	1 CF	100 Bags/Pallet	\$7.95/Bag
2110262	2.2 CF	50 Bags/Pallet	\$9.95/Bag
2110248	3.8 CF	30 Bags/Pallet	\$13.95/Bag



CA

Soil Pep Bark Fines			
2201076	1.5 CF	65 Bags/Pallet	\$4.95/Bag



CA

Total Garden Blend			
122314	1.5 CF	60 Bags/Pallet	\$9.00/Bag

TITAN MACHINERY

OEM Parts / Service Support



Aggregate
McCloskey



Street Sweepers
Schwarze

Snow Products
Arctic Snow and Ice
Falls
Henke
Teamco

Utility Products
Atlas Copco
Leica
Magnum



Attachments
ACS
Erskine
Paladin/JRB
Virnig
Werk Brau



Underground
Rapidview / IBAK
Vacall



Trailers
Felling
Sidump
Thunder Creek
Towmaster



Compaction
Atlas Copco
Case CE



Land Clearing
FAE





*Subject to availability. Items may not be available at all locations.

Titan Machinery Shakopee - 952-445-5400

www.titanmachinery.com

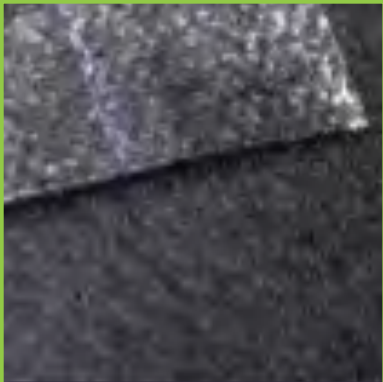

Edging & Fabric





Section Contents

Description	Page
Poly Edging	321
• Ace of Diamonds	321
• Black Diamond	321
• Diamondback Royal	321
• Steel Edging Stakes	321
• Edging Connectors	321
Metal Edging	322
• Sure-Loc Steel Edging	322
• Curv-Rite Aluminum Edging	322
Paver Restraint	323
• Snap Edge	323
• Pave Tech	323
• Curv-Rite Aluminum Paver Restraint	323
• Timber Spikes	323
Concrete Edgers	323-324
• Belgard Bullet Edgers	323
• Interlock Bullet Edger	324
• RCP Tumbled Granite Edger	324

Description	Page
Natural Stone Edgers	324-325
• Aqua Grantique	324
• Carmel Cream	324
• Chilton	324
• Fond du Lac	324
• Kasota Stone Amber	325
• Kasota Stone Cream	325
• Lannon	325
• Mahogany	325
• New York Bluestone	325
• Ozark Cherry	325
• Sandy Creek	325
• Smokey Mountain Blue	325
• Wild Horse	325
Landscape Fabric	326
• Spunbond Fabric	326
• Non-Woven Boulder & Rip Rap Fabric	326
• Woven Needle-Punched Fabric	326
• Soil Stabilization Fabric	326
Geogrid	326
Landscape Poly	327
Sod Staples	327
Excelsior Blanket	327
Straw Blanket	327
Silt Fence	327
AgGrow Wattle	327









Vinyl Edging

SKU	Description	1-24 Piece Price/Strip	25-99 Piece Price/Strip	100+ Piece Price/Strip
 CA 4562533	Ace of Diamonds <ul style="list-style-type: none"> • 20' L x 5¼" H, 6 Lbs/Strip • Medium density polyethylene • An industry standard for contractors • Includes 4 stakes & 1 connector 	\$12.50	\$11.50	11.00
 CA 433813	Black Diamond <ul style="list-style-type: none"> • 20' L x 5½" H, 7 Lbs/Strip • The industry leader • Heavy-duty • The original patented lawn edging • Includes 4 stakes & 1 connector 	\$14.75	\$13.25	\$12.75
 CA 3391875	Diamondback Royal <ul style="list-style-type: none"> • 20' L x 5¼" H • Strong resin construction • Corrugated side wall • Stakeless t-shaped anchoring • Includes connector 	\$13.95	\$12.55	\$11.95

All options are 5 Strips per Bundle

Poly Edging Accessories

 CA Stake Kit 51161	\$4.50/Kit	 CA Metal Stakes 670157	\$1.25/Stake	 CA 8 Inch Ribbed Connector 3160617 "C" 670195 Straight	\$1.10 Each \$1.10 Each
 CA 90° Corner Connector 51178	\$4.05 Each	 CA 60° Connector 51222	\$4.05 Each	 CA 120° Connector 51246	\$4.05 Each
 CA Tee Connector 51239	\$4.05 Each				





Steel Edging

Metal Edging

SKU	Description	Price/Strip	
	Black: 2148500 Green: 85020	1/8" x 4" x 16' Black Steel <ul style="list-style-type: none"> .120 - .125 average thickness Primarily used in residential applications 	CA \$38.00
	2148531	3/16" x 4" x 16' Black Steel <ul style="list-style-type: none"> .182 - .188 average thickness Primarily used in commercial applications 36" minimum radius 6 stakes (3/16") per section 	CA \$58.00

All options are 5 Strips per Bundle

Steel Edging Accessories

	
CA Universal Corner—10/Box 122212 Black \$28.00 Each 122214 Green \$28.00 Each	CA Steel Edging Stakes (Extra) 2148685 \$3.00/Stake



Aluminum Edging

	
16' Series 3000 Aluminum Edging—14 Strips/Box CA	
72802 Black \$35.95 72806 Bronze \$35.95 72804 Green \$35.95 72800 Mill (Natural Aluminum) \$29.80	

- 5 - 12" stakes per strip
- Secure telescoping connection—no coupler
- Great flexibility and easy install

8' Series 3000 Aluminum Edging—14 Strips/Box CA	
72810 Black \$18.90 72814 Bronze \$18.90 72812 Green \$18.90 72808 Mill (Natural Aluminum) \$15.65	

- 3 - 12" stakes per strip
- Secure telescoping connection—no coupler
- Great flexibility and easy install

	Corner Set—Sold in Left & Right Pair Sets Only CA
72818 Black \$3.45 72822 Bronze \$3.45 72820 Green \$3.45 72816 Mill (Natural Aluminum) \$3.00	

	Tapered End CA
72826 Black \$3.75 72830 Bronze \$3.75 72828 Green \$3.75 72824 Mill (Natural Aluminum) \$3.25	

	12" Aluminum Edging Stake—Replacement CA
90174 Black \$2.00 90168 Bronze \$2.00 90172 Green \$2.00 90170 Mill (Natural Aluminum) \$2.00	

www.bachmanswholesale.com

Paver Restraint



Snap Edge

2779124

143296

- 8' Lengths
- 24/Bundle

Standard Height
Low Profile

CA

\$8.50 Each
\$8.50 Each



Pave Tech Paver Edging

3538799

3538805

- 7' Lengths
- 12/Bundle

Rigid
Flex

CA

\$12.50/Strip
\$13.80/Strip

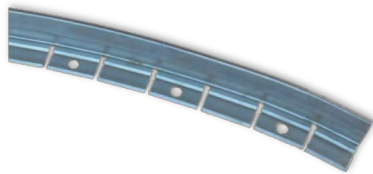

Curv-Rite Stable Edge Aluminum Paver Restraint

151596

175674

- ½" x 1½" x 8'
- Can be installed with flange outside of pavers or under pavers, making it a great choice for thin materials like porcelain and cut & patterned natural stone.

Natural Finish Flex
Natural Finish Rigid

CA

\$11.70/Strip
\$11.70/Strip



Timber Spikes

88877 (Case of ≈150)

419992 (Each)

88884 (Case of ≈125)

420004 (Each)

10"
10"
12"
12"

CA

\$48.95/Case
\$.50/Spike
\$48.95/Case
\$.50/Spike

Belgard Concrete Edgers

Edgestone

Yard Price: \$1.45 Each	SKU	Color	Stock Location	Dimensions	3" x 4" x 12 1/4"
	2759102	Brown	CA	LF/Piece	1
Factory Direct: \$1.23 Each	3705108	Cambay Tan	CA	LF/Pallet	288
	2759225	Charcoal	CA	Edgers/Pallet	288
	4344184	Charcoal/Tan	CA	Min. OD Circle	6'
	2759270	Copper	CA	Minimum Radius	36"
	4344177	Red	CA	Weight/Edger	11 Lbs.
	2759119	Red/Charcoal	CA	Pallet Weight	3,050 Lbs.
	4344191	Tan/Brown	CA		

Concrete Edgers





Concrete Edging

Interlock Bullet Edger		
Yard Price: \$1.75 Each		
Factory Direct: \$1.44 Each		
	Dimensions	4" x 4" x 12 1/4"
	LF/Piece	.9375
	LF/Pallet	168.75
	Edgers/Pallet	180
	Weight/Edger	14 Lbs.
	Pallet Weight	2,560 Lbs.
SKU	Color	Stock Location
3735136	Beechwood	CA
3544837	Buff	CA
3544813	Carmel	CA
3544851	Charcoal	CA
14 edgers make a 46" diameter circle		

Tumbled Granite Edger		
Yard Price: \$3.05 Each		
Factory Direct: \$2.68 Each		
	Dimensions	4" x 4" x 12"
	LF/Piece	1
	LF/Pallet	160
	Edgers/Pallet	160
	Weight/Edger	16 Lbs.
	Pallet Weight	2,600 Lbs.
SKU	Color	Stock Location
3735167	Bluestone	CA
3735143	Santa Fe	CA
		

Natural Stone Edgers









Snapped edges and random lengths, unless otherwise noted

	Aqua Grantique SKU: 2760740 Size: Sawn 4" x 4" x Random Coverage: 80-90 LF/Ton Price: ~\$5.88+ /LF, \$.25 /Lb /Ton: \$500.00	CA
	Carmel Cream SKU: 148308 Size: Sawn 3 1/2" x 4" x Random Coverage: 100-110 LF/Ton Price: ~\$7.14+ /LF, \$.375 /Lb /Ton: \$750.00	CA
	Chilton SKU: 2760627 Size: Snapped 4" x 4" x Random Coverage: 90-100 LF/Ton Price: ~\$3.89+ /LF, \$.185 /Lb /Ton: \$370.00	CA
	Fond du Lac SKU: 2760702 Size: Snapped 4" x 4" x Random Coverage: 90-100 LF/Ton Price: ~\$4.10+ /LF, \$.195 /Lb /Ton: \$390.00	CA

www.bachmanswholesale.com

Natural Stone Edgers

Snapped edges and random lengths, unless otherwise noted

	Kasota Stone—Amber SKU 3530847 Size Sawn 4" x 4" x Random • \$20.00 pallet charge, SKU 122684	Coverage 90-100 LF/Ton /LF ~\$4.84†	Price /Lb \$.21 /Ton \$426.00	SO
	Kasota Stone—Grey SKU 3530830 Size Sawn 4" x 4" x Random • \$20.00 pallet charge, SKU 122684	Coverage 90-100 LF/Ton /LF ~\$4.84†	Price /Lb \$.21 /Ton \$426.00	SO
	Lannon Stone SKU 148282 Size Snapped 4" x 4" x Random	Coverage 90-100 LF/Ton /LF ~\$3.47†	Price /Lb \$.165 /Ton \$330.00	SO
	Mahogany SKU 119216 Size Snapped 4" x 4" x Random	Coverage 90-100 LF/Ton /LF ~\$3.26†	Price /Lb \$.155 /Ton \$310.00	CA
	New York Bluestone SKU 3391950 Size Snapped 3-4" x 4" x Random	Coverage 90-100 LF/Ton /LF ~\$8.82†	Price /Lb N/A /Ton N/A	CA
	Ozark Cherry SKU 4155384 Size Snapped 4" x 4" x Random	Coverage 90-100 LF/Ton /LF ~\$3.79†	Price /Lb \$.18 /Ton \$360.00	CA
	Sandy Creek SKU 160862 Size Snapped 4" x 4" x Random	Coverage 90-100 LF/Ton /LF ~\$3.58†	Price /Lb \$.170 /Ton \$340.00	CA
	Smokey Mountain Blue SKU 4155391 Size Snapped 4" x 4" x Random	Coverage 90-100 LF/Ton /LF ~\$3.79†	Price /Lb \$.18 /Ton \$360.00	CA
	Wild Horse SKU 3264001 Size Snapped 4" x 4" x Random	Coverage 90-100 LF/Ton /LF ~\$5.20†	Price /Lb \$.248 /Ton \$495.00	CA

Landscape Fabric



SB3 3oz. Spunbond Fabric

CA

2792154	3' x 100'	\$26.00/Roll
72336	3' x 300'	\$68.00/Roll
3380220	4' x 100'	\$34.00/Roll
2938699	4' x 300'	\$88.00/Roll
3533152	6' x 100'	\$47.00/Roll
2792161	6' x 300'	\$130.00/Roll
86954	8' x 300' (Non-Stock)	\$165.00/Roll
4306045	12' x 300' (Non-Stock)	\$269.00/Roll

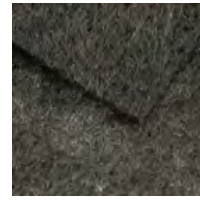

Non-Woven Boulder, Rip-Rap & Filtration Fabric

CA

76988	3oz. LS3, 3' x 300'	\$85.00/Roll
76990	3oz. LS3, 4' x 300'	\$113.00/Roll
58212	3oz. LS3, 6' x 300'	\$169.00/Roll
60402	4.5oz. NW4.5, 4' x 50'	\$25.95/Roll
60404	4.5oz. NW4.5, 4' x 100'	\$50.95/Roll
60406	4.5oz. NW4.5, 6' x 100'	\$78.95/Roll
60408	4.5oz. NW4.5, 6' x 300'	\$237.00/Roll
3380268	8oz. EC8, 6' x 100' Boulder	\$110.00/Roll
3380275	8oz. EC8, 6' x 300' Boulder	\$329.00/Roll



SRW Pro Plus V Premium Woven Needle-Punched Fabric

CA

3380244	5oz. 4' x 250'	\$126.00/Roll
3380251	5oz. 6' x 250'	\$179.00/Roll



SRW Geogrid

CA

2792123	Universal 4' x 50' (200 SF)	\$56.95/Roll
3533169	Universal 6' x 50' (300 SF)	\$84.95/Roll
2792130	SRW3 6' x 150' (900 SF)	\$225.00/Roll
2792147	SRW3 12' x 150' (1,800 SF)	\$430.00/Roll

- Above options are bi-directional
- Call for availability

224768	SRW5 6' x 50' (300 SF)	\$125.00/Roll
224770	SRW5 6' x 150' (900 SF)	\$279.00/Roll
224772	SRW5 12' x 150' (1,800 SF)	\$548.00/Roll

- 5 Series geogrid is uni-directional
- Call for availability



SRW SS5 5oz. Soil Stabilization Geotextiles

CA

3918287	4' x 100' - Perfect for Sidewalks	\$51.95/Roll
3696680	6' x 100' Unfolded Roll	\$74.95/Roll
2792086	12.5' x 27' Folded Roll	\$44.75/Roll
2792093	12.5' x 54' Folded Roll	\$83.75/Roll
3696673	12.5' x 108' Folded Roll	\$167.00/Roll
2792109	12.5' x 432' Unfolded Roll (NS)	\$345.00/Roll
2792116	15' x 360' Unfolded Roll (NS)	\$345.00/Roll
126824	17.5' x 103' Folded Roll (NS)	\$230.00/Roll



Staples & Poly



6 Mil Landscape Poly

56975	6' x 100'	\$28.00/Roll	CA
56982	10' x 100'	\$44.00/Roll	



6" x 1" Steel Sod Staples

2985518	Case of 1000	\$37.00	CA
2985495	Each	\$.05	



Erosion Control Fabric

Wood Fiber—Regular Degrade (8-10 month breakdown)			
2985457	4' x 112.5'	\$36.00	CA
2985464	8' x 112.5'	\$72.00	
Straw			
183706	8' x 112.5' Single Net	\$36.95	
183708	8' x 112.5' Double Net	\$42.95	



Silt Fence—3' x 100' with 11 Stakes

3162246		\$25.95	CA
---------	--	---------	----

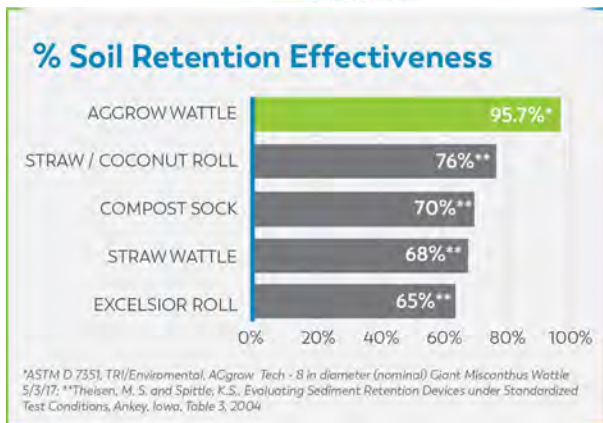

East to Install

- Lighter at installation than compost filter sock alternatives
- Minimal trenching required for installation
- Lower labor cost than alternatives
- Works well on difficult ground conditions
- Easily moved or removed

Good for the Environment

- (pertains to Giant Miscanthus filter media)
- Carbon negative
 - Neutral pH is good for vegetative growth
 - Certified weed seed free
 - Certified sustainably grown

AGgrow Wattle

121034	9" x 20' Black	\$35.95/Roll	CA
121036	9" x 20' Green	\$35.95/Roll	

- Filled with Freedom™ Giant Miscanthus Biomass for superior soil and water retention.
- Filter media absorbs over 2 times its weight in water
- 8/Bundle

Hardscape Accessories & Patio Stones

EVOLUTION
Polymeric Sand & Stone Dust

The Evolution Revolution
The original all-in-one Pro formula
The only sand you'll ever need

Urban White Beige Granite Grey Granite Black

For paver & natural stone joints up to **6 inches**
Sets above **32°F / 1hr**

EVOLUTION
POLYMERIC SAND

Sable MARCO

1-866-999-4509 / www.sablemarco.com

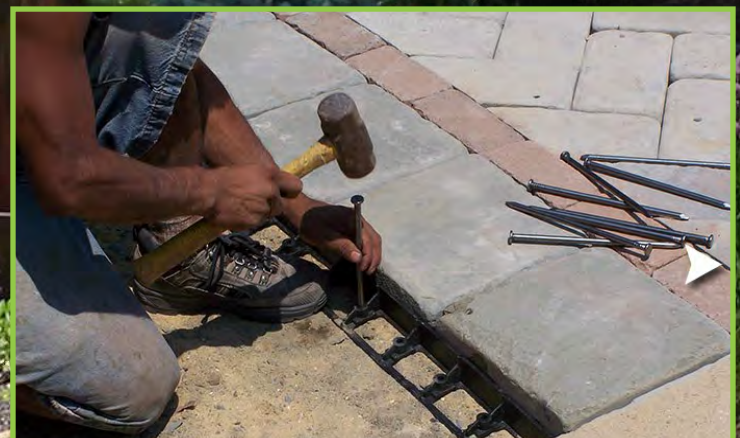

Section Contents

Description	Page
<i>NEW</i> Radiant Heat Snow Melting Mats	331
Polymeric Sand	332
• Evolution Sand	332
• NextGel	332
• Gator Maxx G2	332
• Gator Supersand G2	332
Mortar Mix	332
Gator Base	333
Soil Stabilization Fabric	333
Geogrid	333
Vibratory Roller	333
Concrete & Stone Cleaners	334
• Efflorescence Cleaner	334
• Cleaner & Degreaser	334
• Paver Clean	334
• Rust Eliminator	334
• Mold, Moss, & Mildew Cleaner	334
• Organic Stain Cleaner	334
• Tar & Rubber Cleaner	334
• Stone Cleaner	334
• Wetcast Cleaner	334
• <i>NEW</i> Masonry Detergent	334
Concrete & Stone Sealers	335-336
• Paver Sealers & Joint Stabilizers	335
• Wetcast Sealers	336
• Stone Sealers	336
• Retaining Wall Sealers	336
Cleaner & Sealer Accessories	336
• Sprayers	336
• Rollers	336
• Seal Stripper	336
• Xylene	336
Landscape Adhesives	337
• SRW Adhesives	337
• Caulk Guns	337
• Structure Bond	337
• Structure Bond Applicator Gun	337
• Structure Bond Gun Cleaner	337

Description	Page
Paver Restraint	338
• Snap Edge	338
• Pave Tech	338
• Curv-Rite Aluminum Paver Restraint	338
Timber Spikes	338
Landscape Timbers	338
Exposed Aggregate Stepping Stones	339
Silver Creek Stepping Stones	339
Fire Ring Liners & Accessories	340-341
• Zentro Smoke Less Fire Ring Liner	340
• Zentro Accessories	340
• Ablaze Smoke Less Fire Ring	341
• Fire Ring Liners	341
• Fire Ring Grate	341
• Fire Ring Cover	341
TruScapes Landscape Lighting	342-343
Drainage Products	344-346
• Wall Drain Pro	344
• Drain Tile/Accessories	344
• Drain Boxes	345
• Drain Grates	345-346
• Drain Box Accessories	345
• Pop-Up Valve	346
• Mitered Drain	346
Erosion Control	346
• Excelsior Blanket	346
• Straw Blanket	346
• Sod Staples	346
• AgGrow Wattles	346
• Silt Fence	346

Radiant Heat Snow Melting Mats



Radiant snow melting mats can be used to provide snowmelt for clay brick, concrete pavers, natural stone, poured concrete, and even asphalt installations. Mats are pre-spaced and sold in "rolls" for easy "roll-out" installation.



Snow melting mats are ideal for sidewalks, driveways, and even patios. The cable is laid out in the bedding material and then a bed of sand or chips is applied over the cable. Pavers or stone are then placed on top of the heat cable.

Provide your Bachman's Hardscapes representative with your sidewalk, driveway, or patio design to get your custom snow melting system quote.

- ◆ Available in 3- and 4- inch spacing (and custom spacing). The heat cable provides convenient, versatile design that ensures proper cable spacing and facilitates quick, easy installation.
- ◆ The electric snowmelt system utilizes an advanced snow sensor (either an aerial mount or in-ground mount) to activate the system when needed—fully automated and energy-efficient.
- ◆ Activation device also features manual override capability to deal with snow drifts or areas in shade where water has frozen.
- ◆ The electric snowmelt cable is extremely durable and versatile, features a copper metal sheath, fluoropolymer conductor insulation with a polyolefin outer sheath, and carries a 10-year warranty. Radiant heating cable on the spool allows greater installation flexibility with custom layouts, and is often used for large snow melting jobs in inconveniently-shaped areas where only free-standing cable can reach.

Polymeric Sand

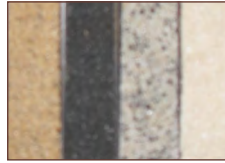

Beige Black Gray White

CA

Evolution Sand

103192	Beige	\$24.00/Bag
103196	Black	\$25.00/Bag
103194	Gray	\$25.95/Bag
103198	White	\$29.00/Bag

- 50 Lbs/bag
- 63 bags/pallet
- Typical coverage for pavers is about 65 SqFt/Bag—coverage will vary based on dimensions and joint size of pavers
- For paver or natural stone joints **up to 4"**
- Stable and flexible in the most extreme weather conditions
- For residential and high traffic commercial applications
- **Non-hazing**—no Portland cement—will not stain pavers
- Safe to use by the pool
- Natural sand colors—no pigments or dyes



BEIGE SLATE GREY



CA

Alliance Gator Maxx G2—Up to 4" Joints

175000	Beige	\$31.95/Bag
175006	Slate Grey	\$34.95/Bag

Alliance Gator Supersand G2—Up to 2" Joints

170948	Beige	\$29.95/Bag
172232	Slate Grey	\$31.95/Bag

- 50 Lbs/bag, 56 bags/pallet
- Typical coverage for pavers is about 65 SqFt/Bag—coverage will vary based on dimensions and joint size of pavers
- For overlay, non-overlay, residential and commercial applications
- Helps prevent weeds and damage caused by insect
- Helps prevent erosion from wind, rain, and freeze/thaw
- Sets within 1 hour after water activation at or above 32° (No rain within 1 hour after activation)
- No dust or haze, no blower, and one watering



CA

NextGel

214180	Prairie Tan	\$22.95/Bag
214182	Prairie Gray	\$22.95/Bag

- 50 Lbs/bag
- 56 bags/pallet
- Typical coverage for pavers is about 65 SqFt/Bag—coverage will vary based on dimensions and joint size of pavers
- Ideal for tight joints
- No dust
- "No haze" technology
- No waste
- 50% faster wetting than original polymeric sands
- Fast and clean installation
- Use for false and wide joints, heavy-sloped and high-traffic areas, high-humidity areas and pool decks, and natural stone installations.



CA

Mortar Mix

152564	Concrete Patch PD	\$8.00/Bag
152568	Mighty Bond Additive	\$29.00/Gallon

- 50 lbs/bag (Concrete Patch PD)
- 56 bags/pallet (Concrete Patch PD)
- Concrete Patch PD is ideal for placing overlays less than 2" deep
- Use for adhering pavers to concrete steps and walks
- ProSpec® Mighty Bond™ is a high-solids, acrylic, liquid bonding agent that substantially improves adhesion, impact, and shear bond, tensile, and flexural and compressive strength of unmodified concrete, mortars, patches and grouts
- Mighty Bond adds excellent freeze/thaw and salt resistance and creates more durable cement-based materials.

Gator Base, and Underlayment



CA

Gator Base

83950 5.79 SqFt Sheet \$15.00/Sheet

- 23½" x 35½" x ¾"
- 10 sheets/pack
- 120 sheets/pallet
- Replaces 6 inches of compacted crushed stone
- Evacuates water through the channel
- Extremely durable—will not degrade in the ground
- Designed with a tongue and groove system
- Has an R value of 3.6 per inch of thickness
- Will significantly reduce the number of freeze-thaw cycles



CA

SRW SS5 5oz. Soil Stabilization Geotextiles

3918287	4' x 100' - Perfect for Sidewalks	\$51.95/Roll
3696680	6' x 100' Unfolded Roll	\$74.95/Roll
2792086	12.5' x 27' Folded Roll	\$44.75/Roll
2792093	12.5' x 54' Folded Roll	\$83.75/Roll
3696673	12.5' x 108' Folded Roll	\$167.00/Roll
2792109	12.5' x 432' Unfolded Roll (NS)	\$345.00/Roll
2792116	15' x 360' Unfolded Roll (NS)	\$345.00/Roll



CA

SRW Geogrid

2792123	Universal 4' x 50' (200 SF)	\$56.95/Roll
3533169	Universal 6' x 50' (300 SF)	\$84.95/Roll
2792130	SRW3 6' x 150' (900 SF)	\$225.00/Roll
2792147	SRW3 12' x 150' (1,800 SF)	\$430.00/Roll

- Above options are bi-directional
- Call for availability

224768	SRW5 6' x 50' (300 SF)	\$125.00/Roll
224770	SRW5 6' x 150' (900 SF)	\$279.00/Roll
224772	SRW5 12' x 150' (1,800 SF)	\$548.00/Roll

- 5 Series geogrid is uni-directional
- Call for availability



CA

ESI Slab and Paver Vibratory Roller Compactor

136936		\$3,150.00
136938	Rental Only	\$100.00/Day

- 24" x 26" plate area with rubber-coated rollers to protect slabs and pavers from damage
- 2,315 lbs of centrifugal force
- Honda GX-160 engine

SRW Cleaners—Water Based

Cleaners



Efflorescence Cleaner CA
 3382293 1 Gallon \$21.80
 5 Gallon
 • 150-200 SqFt/gallon
 • Dissolves mineral deposit & grease stains



Cleaner and Degreaser CA
 3382309 1 Quart \$17.50
 • 200-250 SqFt/quart
 • Works on pavers, concrete, brick, & masonry



PW Paver Clean CA
 50084 1 Gallon \$21.80
 50086 5 Gallon \$105.00
 • 200 SqFt/gallon
 • Prepares pavers for sealer
 • Cleans dust, dirt, & haze



RE Rust Eliminator CA
 52434 1 Quart \$19.25
 • Spot treatment
 • Fast-acting, concentrated rust remover



M³C Mold, Moss, Mildew Cleaner CA
 72648 1 Quart \$13.00
 72650 1 Gallon \$21.10
 • Spot treatment
 • Fast-acting formula works without pressure-washing



Organic Stain Cleaner CA
 115416 2 Pound \$22.95
 • Breaks down organic stains from leaves, pine needles, acorns, fruit, wine, etc.
 • Rinses clean with water
 • For pavers, concrete, wetcast, natural stone, and clay/brick



SW Premium Stone Clean CA
 115408 1 Gallon \$19.35
 115410 5 Gallon \$85.95
 • 200 SqFt/gallon
 • Non-acidic formula for granite, limestone, marble, travertine, and sandstone



WW Premium Wetcast Clean CA
 115412 1 Gallon \$19.35
 115414 5 Gallon \$85.95
 • 200 SqFt/gallon
 • Non-acidic formula removes release agents from wetcast process for best bond between surface and sealer
 • For wetcast and cultured stone



NEW Masonry Detergent CA
 211340 1 Gallon \$16.95
 • Use on brick, stone, synthetic stone, precast concrete, and colored block
 • Works great to remove polymeric haze
 • Extremely effective cleaning and efflorescence removal without brushing or scrubbing

www.bachmanswholesale.com

SRW Sealers



LG Paver Seal & Joint Stabilizer

3382231 1 Gallon \$32.90
3382248 5 Gallon \$135.00

- 100-150 SqFt/gallon
- Low gloss natural finish
- Hardens joint sand
- Compare to cost of polymeric sand



HG Paver Seal & Joint Stabilizer

3382279 1 Gallon \$37.50
3382286 5 Gallon \$164.00

- 100-200 SqFt/gallon
- High gloss "wet look" finish
- Hardens joint sand



HGX High Gloss Xtreme Paver Seal

92556 1 Gallon \$46.05
92558 5 Gallon \$214.00

- 250 SqFt/gallon
- High gloss "wet look" finish
- For commercial or high-traffic areas



PS Paver Seal

3382255 1 Gallon \$25.90
3382262 5 Gallon \$121.00

- 100-125 SqFt/gallon
- Penetrating clear finish



PSX Penetrating X-Treme Sealer

119244 1 Gallon \$38.20
53220 5 Gallon \$177.00

- Up to 200 SqFt/gallon
- Extreme sealer for commercial, high-traffic areas



W-PSX Penetrating X-Treme Wetcast Seal

115436 1 Gallon \$51.60
115438 5 Gallon \$229.00

- 200 SqFt/gallon
- Invisible natural look finish
- Excellent for high traffic areas



W-HGX High Gloss X-Treme Wetcast Seal

115440 1 Gallon \$53.05
115442 5 Gallon \$235.00

- 250 SqFt/gallon
- High gloss, wet-look finish
- Ideal for high traffic areas



S-PS Penetrating Premium Stone Seal

115424 1 Gallon \$48.50
115426 5 Gallon \$213.50

- 200 SqFt/gallon
- Invisible, natural-look finish
- Use on granite, quartz, marble, travertine, limestone, & sandstone



S-PSX Penetrating X-Treme Premium Stone Seal

115428 1 Gallon \$158.00
115430 5 Gallon \$753.00

- 200 SqFt/gallon
- Invisible, natural-look finish
- For high-traffic, commercial areas
- Use on granite, quartz, marble, travertine, limestone, & sandstone



S-HGX High Gloss X-Treme Premium Stone Seal

S CA

115432	1 Gallon	\$53.80
115434	5 Gallon	\$239.00

- 250 SqFt/gallon
- High gloss “wet look” finish
- For high-traffic, commercial areas
- Use on granite, marble, travertine, limestone, & cultured stone



DG Dual Guard

CA

119246	1 Gallon	\$54.20
119248	5 Gallon	\$243.00

- 250 SqFt/gallon
- For high traffic or commercial areas
- High gloss, wet look finish
- 2 levels of protection in 1 application
- For concrete pavers, wetcast, and natural stone



RWX Retaining Wall Xtreme Penetrating Seal (Salt Guard)

CA

119252	1 Gallon	\$54.40
119254	5 Gallon	\$182.00

- 75 SqFt/gallon
- Invisible natural look
- Breathable, long-lasting protection
- Minimizes damage from salt stains and freeze/thaw



Gator Signature Series Natural Stone + Color Enhancer

W CA

154286	1 Gallon	\$46.00
--------	----------	---------

- Water based, zero gloss
- Non film-forming
- Rain safe after 24 hours



2½ Gallon Hand-Held Poly Sprayer

CA

3533237		\$145.00
---------	--	----------

- Perfect for SRW brand and other sealers
- Built to handle aggressive chemicals

131794	Blue Nozzle	\$3.50
--------	-------------	--------



Slit-Foam Rollers

CA

3533244	Yellow (Water)	\$8.45
119262	Black (Solvent)	\$10.95

- Use with any paint roller handle
- Foam roller stays spongy during sealer applications
- Perfect for sealing smooth or textured surfaces



3.2oz Paver Grip

CA

128922		\$7.41
--------	--	--------

- Polypropylene particle mixture used to create a textured surface
- Improve slip resistance
- Not visible when dry
- Great around pools



Seal Stripper

CA

119256	1 Gallon	\$72.95
--------	----------	---------

- Industrial strength
- Biodegradable



XY Xylene Solvent

CA

174986	1 Quart	\$16.50
166188	1 Gallon	\$29.00
174988	5 Gallon	\$139.00

- Up to 200 SqFt/gallon
- Thins and dissolves acrylic sealers to aid in tool clean-up and overspray.



SRW Retaining Wall & Paver Adhesive

CA

2792062 10oz. \$4.05/Tube
2792079 28oz. \$7.85/Tube

- 12 tubes per case
- Solvent-based for superior strength
- Ideal for wet or frozen materials—works down to 10°F



SRW Rapid-Set Polyurethane Wall & Paver Adhesive

CA

119264 10oz. \$4.85/Tube
119266 28oz. \$9.00/Tube

- Fastest set-up time on the market
- High temperature adhesive suitable for firepits and outdoor kitchens
- Suitable for damp or dry surfaces
- VOC compliant



Techniseal Structure Bond Foam Adhesive

CA

175996 24oz. Can \$34.95

- Approximately 500 linear feet of coverage per can
- Super-strength hardscape foam adhesive
- Precise delivery—No mess, no waste
- Adjustable bead size
- Materials are bonded in just 8 minutes and adhesive is fully cured within 24 hours



SRW Vertical Instant Lock Adhesive

CA

115528 9.5oz. \$9.05/Tube

- Holds tight instantly
- Strong, permanent bond
- Quick curing and non-corrosive
- Weather resistant when cured



Caulking Gun

CA

2811015 For 10oz. \$5.00
2811022 For 28oz. \$10.00



Techniseal Structure Bond Foam Gun

CA

175998 \$36.95

- Non drip, instant on/off valve tip

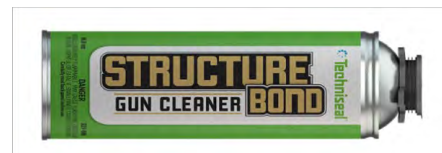

Techniseal Structure Bond Foam Gun Cleaner

CA

176000 16.5oz Can \$11.95

- Cleans residual adhesive from inside of applicator gun

Paver Restraint



Snap Edge

2779124

143296

- 24/Bundle
- 8' Lengths

Standard Height
Low Profile

CA

\$8.50 Each
\$8.50 Each



Pave Tech Paver Edging

3538799

3538805

- 12/Bundle
- 7½' Lengths

Rigid
Flex

CA

\$12.50/Strip
\$13.80/Strip

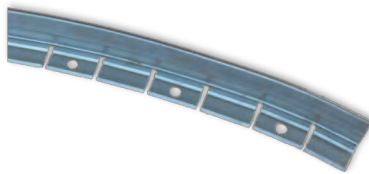

Curv-Rite Stable Edge Aluminum Paver Restraint

151596

175674

- ½" x 1½" x 8'
- Can be installed with flange outside of pavers or under pavers, making it a great choice for thin materials like porcelain and cut & patterned natural stone.

Natural Finish Flex
Natural Finish Rigid

CA

\$11.70/Strip
\$11.70/Strip



Timber Spikes

88877

419992

88884

420004

10" (Case of ≈150)
10" (Each)
12" (Case of ≈125)
12" (Each)

CA

\$48.95/Case
\$.50/Spike
\$48.95/Case
\$.50/Spike

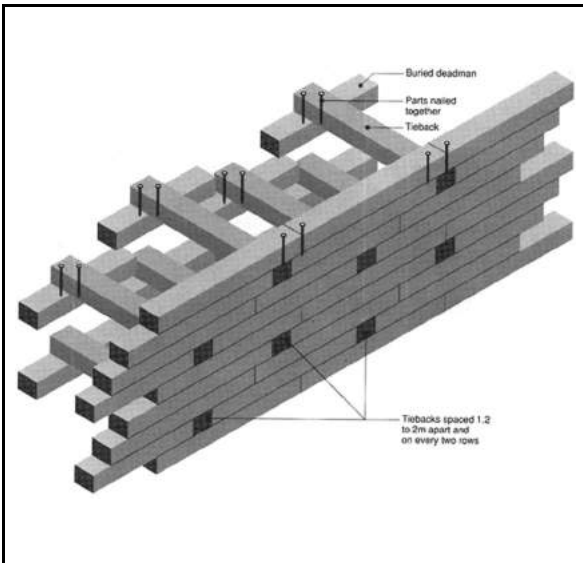

Treated Pine Timbers

Description	Item#	Stock Location	Price Each	Price/Bundle (25/Bundle)
5" x 6" x 8' Brown Color	2775188	CEDAR ACRES	\$20.30	\$456.75 (\$18.27 Each)
5" x 6" x 8' Cedartone Color	45559	CEDAR ACRES	\$20.30	\$456.75 (\$18.27 Each)
5" x 6" x 8' Green Color	131824	CEDAR ACRES	\$18.80	\$423.00 (\$16.92 Each)
6" x 6" x 8' Cedartone Color	127626	CEDAR ACRES	\$24.35	\$438.40 (20) (\$21.92 Each)

All treated timbers are rated for ground contact.

Patio Stones



Round Exposed Aggregate Stepping Stones				CA
2767985	12"	108/Pallet		\$4.65
2768180	16"	60/Pallet		\$7.65
2768265	24"	24/Pallet		\$17.00



Square Exposed Aggregate Stepping Stones				CA
2767992	12"	108/Pallet		\$4.00
2768159	16"	60/Pallet		\$7.65
2768289	24"	24/Pallet		\$17.00



Moon Exposed Aggregate Stepping Stones				CA
2768227	18"	72/Pallet		\$8.60
2768319	24"	24/Pallet		\$14.50

Silver Creek Stepping Stones

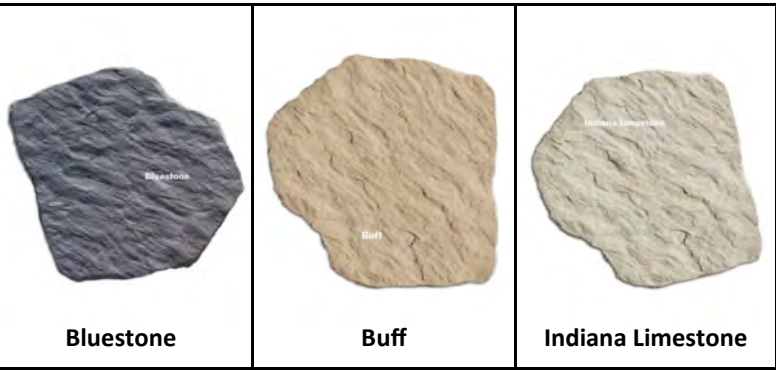

Slate Stepping Stones

Yard Price: \$19.55/Each Factory Direct: \$17.68/Each	SKU	Color	Stock Location	Dimensions	
				SF/Piece	4 Random Shapes
	3736959	Bluestone	Cedar Acres		Approximately 3.75
	223790	Buff	Cedar Acres		20 (5 of Each Shape)
	223792	Indiana Limestone	Cedar Acres		75
					Pallet Weight

Smoke Less Fire Ring Liner



Zentro Round Smoke Less Pit with Lid

SKU		F Price Each
142776	24" ID Round Liner	\$562.00
•	For use in 30" to 33" ID fire ring.	
182816	28" ID Round Liner	\$671.00
•	For use in 34" to 37" ID fire ring.	
182824	32" ID Round Liner	\$792.00
•	For use in 38" to 41" ID fire ring.	

Zentro Square Smoke Less Pit with Lid

SKU		F Price Each
183222	24" ID Square Liner	\$562.00
•	For use in 30" to 33" ID fire ring.	
183224	28" ID Square Liner	\$671.00
•	For use in 34" to 37" ID fire ring.	
183226	32" ID Square Liner	\$792.00
•	For use in 38" to 41" ID fire ring.	



Zentro Accessory Post with Collar
175208 \$45.00

- For use with Zentro fire ring liners. The Ablaze Fire Pit uses a different post—see below.



Zentro/Ablaze 24" Swing Away Grill
153524 \$225.00



Zentro/Ablaze 24" Chicken Rotisserie Grill
167144 \$422.00



Zentro/Ablaze 18" Griddle
175222 \$315.00



Zentro/Ablaze Kettle Winch
167134 \$263.00

Smoke Less Fire Ring



Ablaze 24" Smoke Less Fire Pit w/Lid
153520 \$582.00

- 24" inside diameter
- 102 lbs.



- *Ablaze is the original smokeless fire pit*
- *Smoke re-burning technology nearly eliminates annoying smoke*
- *Ablaze won Best-In-Category and BEST-IN-SHOW at the 2014 VESTA Awards (Hearth and Home Magazine). This is one of the most prestigious industry awards available for fire pits and outdoor hearth products.*

- *Old-fashioned, real wood fire, without the smoke*
- *Smoke re-burning technology nearly eliminates annoying smoke*
- *Secondary afterburner drastically reduces smoke by igniting it before it has a chance to escape*
- *Double-walled constructions makes the outer surface and top rail stay cooler, for safer campfires*

Fire Ring Liners



Rockwood Fire Ring Liner

4222130
122360

Round
Square

CA

\$236.00
\$276.00



Rockwood Fire Ring Grate

4222123

CA

\$123.00



Fire Ring Liner

224452
224454
224456
224458

30" Diameter x 12" High
36" Diameter x 12" High
39" Diameter x 12" High
48" Diameter x 12" High

CA

\$137.00
\$154.00
\$162.00
\$186.00



Fire Ring Cover

30" Diameter
36" Diameter
39" Diameter
48" Diameter

CA

\$137.00
\$154.00
\$162.00
\$186.00



Tru-Scapes offers a high quality line of LED Landscape Lighting at an affordable cost. The product is simple and focused on the most common light styles.

- LED bulb included with fixtures
- Solid brass tool-less fixtures—bronze finish
- Gel filled wire connectors included with fixtures

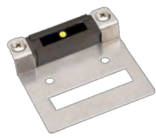

A500



A1000

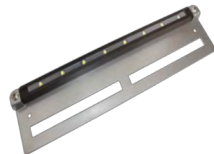

A2000

Hardscape Lights

CA

173832	A500 3.5", 1 LED, 2.5W	\$42.95
173828	A1000 6.75", 4 LED, 1.2W	\$41.55
173830	A2000 13", 8 LED, 2.5W	\$59.50

- 12V, bronze finish
- 2700k
- Silicone wire nuts included



TS-B102



TS-B103



TS-B105



TS-B106

Accent Lights

CA

173834	TS-B102 4W MR-16 LED, 40° Beam	\$90.50
173836	TS-B103 4W MR-16 LED, 40° Beam	\$82.50
173838	TS-B105 5.5W MR-16 LED, 60° Beam	\$96.25
	TS-B106 8W PAR36 LED, 120° Beam	

- 12V, bronze finish
- 2700k
- Silicone wire nuts included



B201



B203

Well Lights

CA

173840	B201 8W PAR36 LED, 120° Beam	\$113.50
173842	B203 4W MR16 LED, 40° Beam	\$89.40

- 12V, bronze finish
- 2700k
- Silicone wire nuts included



B301



B302



B304



B306

Path Lights

CA

173854	B301 2W G4 LED, 360° Beam	\$85.90
173886	B302 2W G4 LED, 360° Beam	\$93.95
173888	B304 2W G4 LED, 360° Beam	\$90.50
173892	B306 2W G4 LED, 360° Beam	\$79.00

- 12V, bronze finish
- 2700k
- Silicone wire nuts included



PL100



PL101

Pier Light

CA

173894	PL100 2W G4 LED, 360° Beam	\$213.80
	PL101 2W G4 LED, 360° Beam	

- 12V, bronze finish
- 2700k
- Mounting base, drill template, anchor kit, masonry drill bit, and silicone wire nuts included



Paver Lights—Available Summer 2019

- 6"
- 8"
- 9"
- 60mm height
- 2700k
- Integrated sealed construction & base feet to prevent lifting

Tru-Scapes Landscape Lighting



TS-MR1640



TS-MR1660



PAR36



TS-G4

Replacement Bulbs

173964	TS-MR1640 LED MR16 Bulb, 4W 40°	\$27.80	NS
173966	TS-MR1660 LED MR16 Bulb, 5.5W 60°	\$27.80	
173960	PAR36 LED Bulb, 8W 120°	\$65.70	
173962	TS-G4 LED G4 Bulb, 3W 360°	\$11.55	

• 2700k



Plug-In Controls

173900	Digital Timer	\$28.45	CA
173924	Photocell w/9' Lead	\$41.70	
173922	Photocell w/15' Lead	\$59.55	



Lighting Accessories

173930	12" Extension Stem	\$15.20	NS
173932	Base Mount	\$13.70	
173958	Wire Nuts—Silicone Filled	\$83.40	



75W



150W



300W

Transformer—Stainless Steel Case

173902	75W w/Built-in Timer	\$176.20	CA
173920	100W w/Plug for Timer	\$88.45	
173904	150W w/Plug for Timer	\$225.95	
173918	300W w/Plug for Timer	\$275.60	



Bluetooth Transformer—Stainless Steel Case

189814	150W w/Plug for Timer	\$411.90	CA
189816	300W w/Plug for Timer	\$445.15	



Low Voltage Wire

173926	12/2, 250'	\$182.60	CA
--------	------------	----------	----

Tru-Scapes Landscape Lighting warrants that its products will be free from defects in workmanship and materials for (1) year. The exceptions are:

- Light fixtures of brass, copper, or stainless steel, including finished are warranted for five (5) years
- LED bulbs are warranted for five (5) years or 30,000 hours, whichever comes first
- Stainless steel, painted, and weatherproof (plastic housing) transformers, excluding timers and photo cells, are warranted for five (5) years for the original purchaser
- Light sockets and fixture housing on all fixtures are warranted for life to the original purchaser
- Exterior black powder coat finishes are warranted for 5 years for chipping and flaking to the original purchaser
- Natural patina on brass is natural and normally occurring and covered under any warranty
- Tru-Scapes warranties do not cover plants that die or burn because of continuous light shined on them. This is not a defect, but the inherent nature of such plants. Certain acid-loving plants such as arborvitae, pine trees, and others must not be exposed to light of any kind for more than 18 hours per day as these plant need to sleep and allow photosynthesis to naturally occur

Water Management



Wall Drain Pro

CA

122382	Black Outlet	\$11.50
175192	Gray Outlet	\$11.50
175182	Tan Outlet	\$11.50

- Easy installation
- 1 3/8" wide, customizable height
- Aesthetically pleasing



Wall Drain Pro®
The new and improved way to daylight your retaining walls!

Stop doing it the old way!



Available in 3 colors, Black, Tan & Gray



Adaptor snaps into 4" drain tile
Designed for block 8" or shorter

Aesthetically pleasing
Reduced labor costs

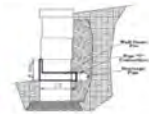

Drain Tile



4" Drain Tile

CA

Non-Perforated

2811077	4" x 10'	\$5.85
2811053	4" x 100'	\$58.50

Perforated

2811060	4" x 10'	\$5.85
2811039	4" x 100'	\$58.50

Perforated with Sock

2811046	4" x 100'	\$78.00
---------	-----------	---------



4" 90° Elbow

2811114

CA

\$4.85



4" Wye Connector

2811121

CA

\$5.25



4" Internal End Cap

2811107

CA

\$1.95



Downspout Adaptor

2811138

CA

\$2.50



4" Internal Coupler

2811084

CA

\$1.95



3" - 4" Tee Connector

2811091

CA

\$4.50



4" Perforated End Plug

3283347

CA

\$1.95

Drainage Products



Catch Basin Kit

		CA
147862	12" Kit w/Black Grate	\$53.00
147864	12" Kit w/Green Grate	\$53.00
147858	9" Kit w/Black Grate	\$37.40
147860	9" Kit w/Green Grate	\$37.40

- Kit includes catch basin, black grate, 3"/4" universal outlet, and plug

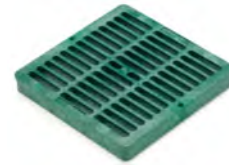

Square Catch Basin Grate

		CA
147878	12" x 12" Black	\$24.00
147880	12" x 12" Green	\$24.00
147874	9" x 9" Black	\$18.00
147876	9" x 9" Green	\$18.00



Square Catch Basins—Double Outlet

		CA
2983873	12" x 12"	\$32.15
3928903	9" x 9"	\$18.80



Extension

		CA
147872	12" x 12", 6" Height	\$12.90
147870	9" x 9", 6" Height	\$13.35



Basin Plug

147896		CA
		\$2.65



3"/4" Adapters

		CA
147894	Basin Adapter	\$3.10
147892	Fitting Adapter	\$3.10



6" Basin, No Grate

		CA
147868	Double Outlet	\$8.67
147866	Single Outlet	\$8.67



Grates for 6" Catch Basin

		CA
3380367	7" Square—Black	\$9.00
3380374	7" Square—Green	\$9.00
3380381	6" Round—Black	\$6.00
147884	6" Round—Green	\$5.30
147888	6" Atrium—Green	\$9.00

Drainage Products



3 3/4" Pop-Up Valve

147890

CA

\$15.75

- Includes elbow and universal adapter for 4" drain tile

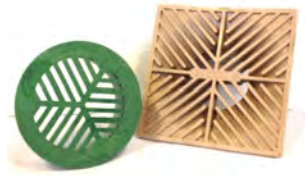

Grates for 4" Drain Tile

3380411
3380428
3928538
3380435
3380442
3928606
4489755
147886

4" Round—Black
4" Round—Green
4" Round—Sand
6" Square—Black
6" Square—Green
6" Square—Sand
6" Square—Gray
4" Atrium—Green

CA

\$3.00
\$3.00
\$3.00
\$6.75
\$6.75
\$6.75
\$6.75
\$6.75

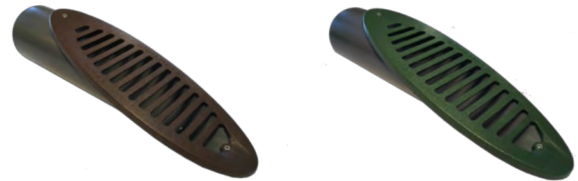

Mitered Drain

148292
148294

Brown
Green

CA

\$39.00
\$39.00

- 3 : 1 Slope
- For use with 4" Schedule 40 Pipe

Erosion Control Products



Erosion Control Fabric

Wood Fiber—Regular Degrade (8-10 month breakdown)

2985457 4' x 112.5' \$36.00
2985464 8' x 112.5' \$72.00

Straw

183706 8' x 112.5' Single Net \$36.95
183708 8' x 112.5' Double Net \$42.95

CA



AGgrow Wattle

121034
121036

9" x 20' Black
9" x 20' Green

CA

\$35.95/Roll
\$35.95/Roll

- Filled with Freedom™ Giant Miscanthus Biomass for superior soil and water retention.
- 8/Bundle



6" x 1" Steel Sod Staples

2985518 Case of 1000
2985495 Each

CA

\$37.00
\$.05

Silt Fence—3' x 100' with 11 Stakes

3162246

CA

\$25.95

Garden Chemicals, Fertilizers, Grass Seed, and Tree Care



Section Contents

Description	Page	Description	Page
Grass Seed	349-350	Garden Chemicals	352-358
Soil Amendments	350	• Repellents	352
• Gypsum	350	• Wilt Pruf	352
• Pelletized Limestone	350	• Insect & Disease Control Combos	352
Sod Cutter	350	• Disease Control	352
Lawn Spreader	350	• Insect Control	353
Lawn Fertilizers	351	• Preen	354
• Bachman's Brand	351	• Stump & Vine Killer	354
• Milorganite	351	• Round-Up	354
• Ringer's Lawn Restore	351	• Weed Free Zone	354
		• Ortho Weed-B-Gon	355
		• Bachman's Brand Garden Fertilizers	355
		• Miracle Gro Fertilizers	356
		• Osmocote	356
		• Hi-Yield Fertilizers	357
		• Espoma Organic Fertilizer	357
		• Sustane Fertilizer	357
		• Jobes Fertilizers	358
		• Harrell's Top Dress Fertilizer	358
		• Agriform Tablets	358
		• Woodace Briquettes	358
		Tree Care Products	359
		• Dew Right Tree Watering Bag	359
		• Dramm Watering Wand	359
		• Tree Staking Kit	359
		• Tree Pruning Paint	359
		• Tree Wrap	359

Grass Seed

Our Mighty Turf grass seed mixes are selected for:

- Wear tolerance
- Fine texture
- Dark green color
- Disease resistance
- Fast establishment
- Successful growth in northern climates



Mighty Turf Premium Sunny Mix

175744	3 Lb	\$10.00/Bag	CA
175746	10 Lb	\$30.70/Bag	

- 15% Fielder Arcadia Kentucky Blue
- 15% Cascade Chewings Fescue
- 10% Turf-Type Annual Ryegrass
- 30% NAMED Perennial Ryegrass
- 30% Kentucky Bluegrass 85/80
- Thrives in full sun (8-12 hours per day)
- Great for establishing new lawns
- Produces tough, long-lasting turf



Mighty Turf All Purpose Landscaper's Mix

175766	3 Lb	\$10.15/Bag	CA
175770	10 Lb	\$29.25/Bag	

- 10% Boreal Creeping Red Fescue
- 20% Cascade Chewings Fescue
- 25% NAMED Perennial Ryegrass
- 45% Kentucky Bluegrass 85/80
- Use in areas with both sun and shade
- A great choice for both over-seeding and establishing new lawns
- Highly adaptable to various soil conditions



Mighty Turf Deep Shade

175756	3 Lb	\$10.00/Bag	CA
175760	10 Lb	\$30.70/Bag	

- 10% NAMED Ryegrass Perennial
- 10% Hard Fescue
- 20% Kentucky Bluegrass 98/85
- 30% Boreal Creeping Red Fescue
- 30% Maxima 1 Creeping Red Fescue
- Grows thick in filtered sunlight (5-7 hours per day)
- Very adaptable and easy to grow
- Tolerates poor soil and blends well with existing lawns



Mighty Turf Sun & Shade

175750	3 Lb	\$8.60/Bag	CA
175752	10 Lb	\$24.15/Bag	

- 20% Fielder Kentucky Bluegrass
- 20% Mercury Kentucky Bluegrass
- 15% Merit Kentucky Bluegrass
- 15% Esquire Perennial Ryegrass
- 15% Ponderosa Perennial Ryegrass
- 15% Creeping Red Fescue
- Use in sun or part shade
- Quick germinating and great for high traffic

Grass Seed



Mighty Turf Bluegrass

175736 3 Lb \$12.30/Bag
 175738 10 Lb \$41.40/Bag

CA

33% Arcadia Kentucky Bluegrass
 33% Argyle Kentucky Bluegrass
 34% Geronimo Kentucky Bluegrass

- Use for thick lawns in full sun (8-12 hours per day)
- Premium blend of improved Kentucky Bluegrass varieties
- Durable, long-lasting, and disease resistant



Soil Conditioners

56890 40 Lb Gypsum \$8.45
 474175 40 Lb Pelletized Limestone \$6.95

CA

Approximate Seed Coverages

Type	New Lawns	Overseeding
Bluegrass Mixes	500 to 600 SqFt/Lb	1,000 to 1,200 SqFt/Lb
Other Mixes	300 to 350 SqFt/Lb	600 to 700 SqFt/Lb

Sod Cutter & Spreader



Sod Cutter

501901 12 Blade Sod Cutter \$325.00
 551166 12" Replacement Blade \$69.00
 551180 Replacement Handles \$65.00 Each

CA

* Handles are sold individually—not in pairs.



Scott's Deluxe Broadcast Spreader

2930358 \$64.00

CA

Lawn Fertilizers

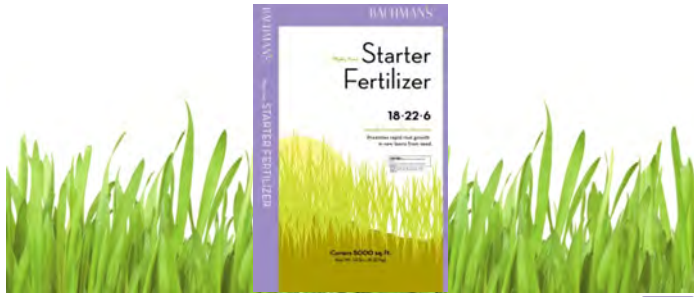

Bachman's Starter Fertilizer 18-22-6 CA
 2724148 18 Lb, 5,000 SqFt \$15.95



Bachman's Crabgrass Preventer Fertilizer 18-0-12 CA
 2724117 25 Lb, 5,000 SqFt \$21.95



Bachman's Weed & Feed 23-0-6 CA
 2724124 25 Lb, 5,000 SqFt \$15.95



Bachman's Turf Food 26-0-4 CA
 2724131 25 Lb, 5,000 SqFt \$15.95



Milorganite CA
 4373429 36 Lb \$9.95



Ringer Lawn Restore CA
 462653 25 Lb, 5000 SqFt \$31.95

Garden Chemicals—Repellents



Liquid Fence RTU CA
 2314615 1 gallon \$22.95
 2314622 32 oz. \$11.95



Bonide Repels All CA
 3033720 1 gallon RTU \$27.95
 2902867 1 quart RTU \$11.95
 3145041 1 quart concentrate \$16.95



Repellex Systemic Tablets CA
 4000677 150 Count \$36.00
 4000660 50 Count \$15.00



Wilt Pruf CA
 517889 1 Gallon \$89.00
 882345 32 oz. RTU \$15.95

Insect & Disease Control



Bonide All Seasons Spray Oil CA
 1946015 32 oz RTS \$9.95
 906515 Pint Concentrate \$7.95



Bonide Rose Rx 3-in-1 CA
 2313069 32 oz. RTU \$8.95



Bonide Fruit Tree Spray CA
 432694 1 Pint \$13.95



Bonide Fung-onil CA
 433134 16 oz. Concentrate \$15.95
 433127 8 oz. Concentrate \$11.95
 1173039 32 oz. RTU \$7.95

Disease Control

Garden Chemicals—Insect Control



Bayer 24 Hour Grub Control

2710134

CA

\$22.95

- Control grubs to reduce mole problems in lawns and summer Japanese Beetle problems



Bonide Eight Yard & Garden

1834633

32 oz. RTS

CA

\$12.95



Bonide Hot Pepper Wax

903828

32 oz. RTU

CA

\$10.95



Bonide Insecticidal Soap

3713486

12 oz. Houseplant

CA

\$4.95

2703754

32 oz. RTU

\$7.95



Bonide Malathion

903682

8 oz.

CA

\$7.95



Bonide Systemic Insect Control

2703792

Pint

CA

\$14.95



Buggslayer Insecticide Concentrate

3139682

Pint

CA

\$26.95



Sluggo

1742174

2.5 Lb

CA

\$16.95

Garden Chemicals—Herbicides



Preen Weed Preventer

906379	2560 SF, 16 Lb.	CA	\$25.95
2836162	900 SF, 5.625 Lb.		\$12.95



Preen-N-Green Weed Preventer with Fertilizer

2836193	2560 SF, 16 Lb.	CA	\$25.95
2836179	900 SF, 5.625 Lb.		\$14.95



Preen Vegetable Garden Organic Weed Preventer

3135028	5 Lb.	CA	\$14.95
---------	-------	----	---------



Bonide Stump & Vine Killer

3524693	8 oz,	CA	\$8.95
---------	-------	----	--------



Roundup

423531	64 oz. RTU	CA	\$12.95
2333661	30 oz. RTU		\$6.50
423548	36.8 oz. Concentrate		\$33.95



Roundup Extended Control

2930419	1.33 Gallon RTU	CA	\$31.95
---------	-----------------	----	---------



Roundup Poison Ivy Control

2314431	24 oz. RTU	CA	\$5.95
---------	------------	----	--------



Weed Free Zone

2816294	24 oz. RTU	CA	\$5.95
2984894	Quart Concentrate		\$31.95
2816287	Pint Concentrate		\$17.95

Garden Chemicals—Herbicides



Ortho Weed-B-Gone

2702283 32 oz. Concentrate
2702276 32 oz. RTS

CA

\$11.95
\$11.95



Ortho Weed-B-Gone Crabgrass

3369379 32 oz. RTS

CA

\$14.95



Ortho Weed-B-Gone Max

2702252 24 oz. RTU

CA

\$6.25

Garden Fertilizers



Bachman's Garden Fertilizer 10-20-10

699516 18 Lbs

CA

\$11.95



Bachman's Mighty Bloom 10-54-10

3947867 4 Lbs

CA

\$13.95



Bachman's All Purpose 20-20-20

3947904 4 Lbs

CA

\$10.95



Bachman's Acid Loving 21-7-7

3947881 4 Lbs

CA

\$10.95

Garden Fertilizers



Miracle Gro All Purpose 20-20-20
3905751 4 Lbs

CA
\$13.95



Miracle Gro Miracid
3905713 4 Lbs

CA
\$13.95



Miracle Gro Shake 'N Feed All Purpose 21-7-7
2531104 4 Lbs

CA
\$14.95



Miracle Gro Bloom Booster Flower Food
3905737 4 Lbs

CA
\$13.95



Miracle Gro Garden Feeder
3524150 Includes Fertilizer

CA
\$14.95



Bonide Start-Up Plant Starter
433356 Quart

CA
\$6.95



Osmocote Outdoor & Indoor 15-9-12
50950 8 Lbs

CA
\$25.00



Osmocote Flower & Vegetable 14-14-14
3144556 4.5 Lbs

CA
\$19.95

Garden Fertilizers

Hi-Yield

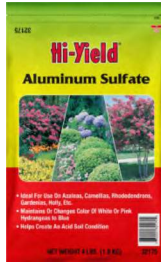

Hi-Yield Aluminum Sulfate
908052 4 Lbs

CA
\$4.95

Hi-Yield



Hi-Yield Bone Meal
3351527 4 Lbs

CA
\$4.95

Hi-Yield

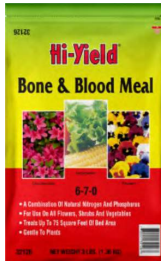

Hi-Yield Bone & Blood Meal
51260 3 Lbs

CA
\$7.95

Hi-Yield



Hi-Yield Soil Sulfur
2459385 4 Lbs
53480 50 Lbs

CA
\$6.95
\$45.00

Hi-Yield

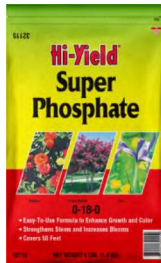

Hi-Yield Super Phosphate
908069 4 Lbs

CA
\$4.95



A natural in the garden since 1929.



Espoma Bulb-tone Organic Fertilizer
3652501 4 Lbs

CA
\$6.95



Sustane Organic Fertilizer
1471371 5 Lbs

CA
\$6.95



Sustane Bolster with Mycorrhizae 4-4-4
4347949 50 Lbs

CA
\$37.00

Fertilizer Spikes & Tablets



Jobes Tree & Shrub Fertilizer Spikes

378671 15 Pack
378695 5 Pack

CA

\$9.95
\$4.95



Jobes Evergreen Fertilizer Spikes

378664 15 Pack

CA

\$9.95



Ross®

Ross Root Feeder

378619

CA

\$34.95



Ross®

Ross Tree & Shrub Root Feeder Refills

378534 54-Pack

CA

\$14.95



Ross®

Ross Evergreen Foot Feeder Refill

378558 54-Pack

CA

\$14.95



Harrell's Top Dress 22-3-8

3814213 50 Lbs

CA

\$45.00



Scott's Agriform Tablets 20-10-5

1938980 500 Tablets

CA

\$65.00

Woodace Briquettes 14-4-6

1674918 600 Tablets

CA

\$79.00

Tree Care Products



Dew Right Tree Watering Bag

4458881

CA

\$17.00

- Continuously water for up to 8 hours
- Concentrates water on the root zone and slowly releases its contents for a deep, penetrating watering



Dramm Watering Wand with Brass Shut-Off

1173367

30"

CA

\$28.00



Stake-It Standard Tree Staking Kit

2165323

CA

\$6.95

- Supports trees between 8 and 12 feet tall



Tanglefoot Tree Pruning Paint

675992

8 oz.

CA

\$4.95

- Seals pruning cuts and tree wounds
- For use on shade and ornamental trees



Clark's Tree Wrap

713571

4" x 150' Roll

CA

\$17.50

Tools



AIRLIFT



Section Contents

Description	Page
Leveling	363-364
• Sola Screed Levels	363
• ZipLevel and U-Level	363
• Beam, Torpedo, and Line Levels	364
• Stringalong Collar	364
Measuring	364
• Tapes	364
• Wheels	364
Marking	365
• Chalk Line	365
• Lumber Crayon	365
• Upside-down Paint	365
• Flags	365
Palletizing	365
• Band Snips	365
• Stretch Wrap	365
Knives	366
Chisels	366
Masonry Tools	366
• Trowels	366
• Concrete Spreader	366
• Knee Board	366
• Acid Brush	366
Hammers	367
Tampers	367
Vibratory Roller	368
AIRLIFT VACUUM Paver Placer	368
PAVETECH Hardscape Tools	369
The Kracker Splitter	369

Description	Page
Diamond Blades & Grinding Wheels	370
Personal Protection	370-374
• Dust Masks	370
• Safety Glasses	371
• Gloves	372-374
Truck Supplies	375
• Tarps & Straps	375
• Stretch Wrap	375
Wheelbarrows	375
Ball Carts	375
Pruning Tools	376-379
• Felco	376-377
• Valley Tools	378
• ARS	379
• Wolverine	379
Shovels, Forks, and Brooms	380-383
• Wolverine Spades	380
• Wolverine Scoops	381
• Wolverine Mulch Fork	381
• Wolverine Bristle Broom	381
• Crew by Wolverine Spades & Rakes	382
• Valley Tools Spades	383
• Valley Tools Trenching Spades	383
• Valley Tools Forks	383
Rakes—Garden, Leaf, & Landscape	382-383
• Wolverine Rakes	382
• Valley Tools Rakes	383
Garden Hand Tools	384



≤ .043°
≤ 0.75 MM/M

Accuracy in standard position
Highest accuracy for perfect measuring results



GUARANTEE

Lifetime guarantee against leakage and fading of vial

In proper use of the level, vials will neither leak nor fade in the sun



870 G/M

Weight of profile
Profile-weight allows level to withstand rugged use



ACRYLICBLOCK

Shockproof acrylic block-vials
Vials will neither crack nor break when used at the jobsite

SOLA SCREED LEVELS

		Description	Size	Item#	Stock Location	Price Each
		SCREED LEVEL	39" - Perfect for sidewalks	3959709	CA	\$60.75
			39"/78" Combo	102506	CA	\$125.00
			60"	3697939	CA	\$82.00
			78"	3697946	CA	\$104.00
			98"	3697953	CA	\$115.00
			118"	3697960	CA	\$117.00

SOLA BLOCK & PAVER PENCILS

		Description	Item#	Stock Location	Price Each
		STB 9.5" MASON'S PENCIL	3697977	CA	\$1.00
		KB 9.5" WET / DRY PENCIL	3697984	CA	\$1.50

Zip Level



- True one-person operation
- Sets up in seconds
- No line-of-site issues
- Built job-site rugged and never needs factory calibration
- Displays elevations directly to 0.1", 1/8", 0.01', or 2mm
- 0.01", 0.001', or 0.2mm in high precision (HP) range
- 40' vertical range (4' in HP) by 200' horizontal circle
- No more tripods or sensors
- 2 year warranty

DESCRIPTION	ITEM#	STOCK LOCATION	\$ EACH
ZipLevel Pro-2000	61514	Cedar Acres	950.00

U-Level™



- U-Level™ app connects by Bluetooth to any smart device
- Set any point as your "0" reference point
- Typical accuracy +/- .1 (1/10) inch
- No clear line of sight needed. Works around obstructions.
- Comes with water-resistant carrying case and magnetic monopod.
- No "back to the factory" for calibrations. The tubing is easily repaired on site if damaged.

DESCRIPTION	ITEM#	STOCK LOCATION	\$ EACH
U-Level	224764	Cedar Acres	750.00

PRODUCTS DENOTED WITH A "CA" ARE AVAILABLE AT CEDAR ACRES. ALL ITEMS DENOTED WITH "NS" ARE NON-STOCK, SPECIAL ORDER

Leveling Products

CA



9" Aluminum Torpedo Level
117120 \$15.00
• 3 Vials

CA



3" Aluminum Line Level
117122 \$4.00

CA



Professional Extruded Aluminum Level
117116 24" \$32.00
117118 48" \$42.00
• 6 Vials
• Heavy-duty aluminum I-beam frame
• Shock absorbent end caps
• Replaceable protective plastic lenses and vials

CA



Contractor Twisted Mason's Nylon Line
117100 \$5.50
• Fluorescent Pink
• 350'

CA



Stringalong Collar
4200565 Collar \$3.50
85398 Stake \$3.90
72338 Stake 10 Pack \$35.95
• Forming stake is 3/4" x 24"

Measuring Products

CA



Keson Diameter Tape
417806 \$10.95

CA



Measuring Tapes
231891 25' Keson \$12.95
148328 3/4" x 16' Valley \$2.95
148330 1" x 25' Valley \$4.65

CA



Keson 100' Steel Case Measuring Tape
206431 \$19.95

CA



Reel Measuring Tapes
206479 100' Keson \$24.95
206486 300' Keson \$69.00
148326 100' Valley \$5.65

CA



Measuring Wheels
206509 Keson \$73.00
148332 Valley 5 1/2" \$12.40

CA



Tree Caliper
584713 \$8.00

Marking Products



CA
100' Metal Case Chalk Line
 2778233 \$6.00



CA
12oz Chalk for Chalk Line Case
 2778240 Blue \$2.00
 2778257 Red \$2.00



CA
Soft Lumber Crayon—Red
 2778974 \$.75



CA
Stripe® Marking Paint—20oz.
 115402 Glo-Pink \$3.70
 115404 White \$3.70
 *Full case quantities just \$3.40/Can!
 • 12 cans/case



CA
Keson Paint Handi-Marker
 1354834 \$13.00



CA
Keson Paint Rolla-Marker
 1663066 \$19.00

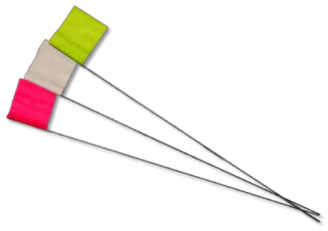

CA
Keson Marking Flags
 1515037 \$8.95
 • White, Glo-Lime, or Glo-Pink
 • Bundle of 100

Band Cutting and Pallet Wrapping



CA
10" Aviation Tin Snip—Straight
 148352 \$4.20



CA
Stretch Wrap
 114888 Clear \$22.00/Roll
 • 80 Gauge
 • 18" x 1500'
 • 4 Rolls/Case

Knives



CA

Finger Grip Utility Knife

135266

\$1.85



CA

10-Pack Utility Knife Blades

135278

\$1.25



CA

6" Snap-Off Utility Knife

135276

\$1.85

CA



Vintool Knife

1577479

\$29.00

1585894

Blades

\$5.95

CA



Rubber Grip English Bolster Chisel

117108

\$29.00

- Forged and heat treated for longer life
- Rubber grip makes it easier to hold while using
- 4" Wide cutting blade

Chisels

CA



Tooth Stone Mason's Chisel

117112

\$14.00

- Forged from the finest tool steel, well tempered
- Properly balanced for a comfortable hold
- 2 1/4" Wide cutting blade

Masonry Tools

CA



Hi-Craft™ Economy Concrete Trowel

117092

\$3.00

- 9" x 4" Steel with contoured plastic handle

CA



Hi-Craft™ Concrete Trowel with Wood Handle

117088

\$11.00

- 11" x 4 1/2" Carbon steel with aluminum mounting
- Comfortable camelback wood handle for cement finishing

CA



Hi-Craft™ Pointed Sword Trowel

117096

\$11.50

- 14" x 4" High carbon steel blade with soft handle
- Used in tight corners and spaces

CA



Lightweight Aluminum Concrete Spreader

117084

\$19.50

- 3 Lbs.
- 54" Handle
- Two heavy-duty aluminum braces for added strength

CA



EZ-Kneeler Knee Board

117080

\$20.00

- 1 1/2" Thick foam on 14" x 24" tray
- Washable and chemical resistant
- Large handle grips for support and carrying

CA



Long Arm Acid Brush

117104

\$9.50

- Keeps your hands out of acid
- Stiff palmyra bristles on smooth, tumbled block wood handle

Hammers



CA

Wide Bit Brick Hammer

117114 \$39.50

- 1" Square flat face
- 1 7/8" Bit for breaking brick and stone
- Head forged from high quality tool steel
- Fiberglass handle with non-slip grip



CA

20oz Stanley Claw Hammer

2777786 \$24.95



CA

Wolverine Dead Blow Hammer

3154418 4 Lb. \$49.00
3154425 7 Lb. \$69.00



CA

24oz Wide Bit Brick Hammer

148368 \$12.40

- Fiberglass Handle



CA

3 Lb Sledge Hammer

190472 \$20.95

- Uni-forged Steel Handle



CA

Dead Blow Hammers

148374 4 Lb \$10.55

Tampers



CA

Wolverine Tampers—Wood Handle

2778936 8" Plate \$29.00
2778943 10" Plate \$35.00



CA

Wolverine Tampers—Steel Handle

2778950 8" Plate \$66.00



CA

Plate Compactor Pads

85534 \$140.00



ESI Slab and Paver Vibratory Roller Compactor

CA

136936 Model EVPC120H \$3,150.00
 136938 Rental Only \$100.00/Day

- 24" x 26" plate area with rubber-coated rollers to protect slabs and pavers from damage
- 2,315 lbs of centrifugal force
- Honda GX-160 engine



AIRLIFT Vacuum Setting Tool



Powerful portable setting suction









AIRLIFT

THE HOTTEST NEW TOOL IN THE INDUSTRY



The new standard in vacuum setting equipment.

AIRLIFT is designed to make lifting and moving slabs, pavers, and even porcelain tiles easy, safe, and more ergonomic. AIRLIFT is electric, so it does not require an air compressor like most similar tools. A wide variety of suction plates are available besides the 5x5 plate in the base kit, and a one-hand lift handle is available as well. The backpack vacuum is also very light weight and easy to maintain.

	DESCRIPTION	ITEM#	STOCK LOCATION	\$ EACH
	AIRLIFT Base Kit Includes: <ul style="list-style-type: none"> • Back Vac (110V) • One-man T-Handle • Adjustable Height Center Post • 5" x 5" Suction Plate 	191914	Cedar Acres	\$1,060.00
	3" x 11" AIRLIFT Suction Plate	191916	Cedar Acres	\$197.00
	4" x 15" AIRLIFT Suction Plate	224748	Special Order	\$237.00
	10" x 10" AIRLIFT Suction Plate	191920	Cedar Acres	\$316.00
	6" Round AIRLIFT Suction Plate	224750	Special Order	\$197.00
	6½" x 6½" AIRLIFT Suction Plate	224752	Cedar Acres	\$197.00
	6" x 12½" AIRLIFT Suction Plate	224756	Special Order	\$276.00
	AIRLIFT One-hand Lift Handle	191926	Cedar Acres	\$197.00
	AIRLIFT 10" Extension	224758	Special Order	\$128.00



Hardscape Tools



CA

PaverSAVER

65048

\$285.00

- Universal design for use on most compactors
- 22" x 30" honeycomb urethane rubber



CA

PaverPERSUADER

191864

\$97.95



CA

PaverADJUSTER

191866

\$165.00



CA

PaverPULLER

191870

\$216.00



CA

PaverEXTRACTOR

191876

\$180.00



CA

WallSPLITTER

163558

\$1,300.00

THE KRACKER SPLITTER



- Easily pumped hydraulic foot action.
- Hardened steel blades—simply grind—no need for expensive replacements
- Wide, 24" wheel base—easily move around rough job sites
- 2 Year warranty
- 2"-8¾" material height
- 40,000 psi force

DESCRIPTION

ITEM#

STOCK
LOCATION

PRICE
EACH

THE KRACKER SPLITTER

3961474

Cedar Acres

\$1,285.00



Diamond Professionals Diamond Blades



CA
Tornado Series Extreme TST14 Laser Seg-Turbo Blade
 148844 12" \$141.00
 120114 14" \$151.00

- Good for cutting soft to hard material



CA
Hurricane Elite Series
 148846 14" \$105.00



CA
"Bronze" Series BCC04 Dry Grinding Cup Wheel
 120116 4.0" \$22.99



CA
"Bronze" Series BCC07 Dry Grinding Cup Wheel
 120118 7.0" \$42.99



SRW Diamond Blades



CA
BGPC General Purpose Premium Blade
 3382323 10" \$59.00
 3382330 12" \$77.00
 3382347 14" \$96.00

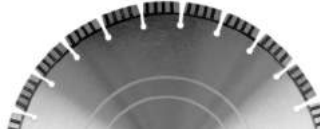

CA
BPPC Stone & Paver Blade
 4547431 12" \$79.00
 4547448 14" \$99.00



CA
BGPP Stone & Paver Premium Blade
 3382354 14" \$127.00

Dust Masks



RZ Filter Mask M1
 4387037 Camo \$24.95
 4387044 Replacement Filters—3 Pack \$5.00

- Neoprene mask with replaceable filter inserts
- Dual one-way valves reduce moisture inside mask
- Comfortable 360 degree fit
- Includes two 99.9% replaceable active carbon filters



RZ Filter Mask M2
 190478 Black—Large \$29.95
 190482 Gray—Large (All Colors)
 190484 Safety Green—Large
 190486 Safety Orange—Large
 190488 Navy—Large
 4387044 Replacement Filters—3 Pack \$5.00

- Lightweight, breathable mesh mask with replaceable filter inserts
- Dual one-way valves reduce moisture inside mask
- Comfortable 360 degree fit
- Includes two 99.9% replaceable active carbon filters and 1 storage bag



Safety Glasses

All Bullhead Safety Eyewear:

- Meet ANSI Z87.1—2010 Standards
- Filter 99.9% of UVA/UVB/UVC light rays
- Feature Hard Coat treated lens
- Feature tapered lens



CA
BH10116AF Swordfish Glasses
 116236 \$8.25

- Green mirror anti-fog lens
- Ballistic rated



CA
Swordfish Glasses
 129294 Black \$7.00
 116238 Brown \$6.50

- Flash mirror lens
- Ballistic rated



CA
BH11108 Mojarra Camo Glasses
 116240 \$8.25

- Brown lens with camouflage frame
- Ballistic rated



CA
BH9187 Dorado Glasses
 116242 \$7.70

- Silver mirror lens with white frame
- Ballistic rated



CA
BH14183AF Maki Glasses
 116244 \$7.45

- Smoke color anti-fog lens
- Ballistic rated
- Accepts optional foam gasket



CA
BH1419AF Maki Glasses
 116246 \$8.25

- Blue mirror anti-fog lens, clear frame
- Ballistic rated
- Accepts optional foam gasket



CA
BH633AF Stinger Glasses
 116248 \$3.70

- Smoke color anti-fog lens
- Crystal black frame
- Ballistic rated



CA
BH691AF Stinger Glasses
 116250 \$3.85

- Clear anti-fog lens with gray frame
- Ballistic rated



CA
Stinger Camo Glasses
 116252 Smoke \$6.70
 122210 Yellow \$6.70

- Anti-fog lens
- Camouflage frame
- Ballistic rated



CA
BH7615AF Snipefish Glasses
 116254 \$3.00

- Orange anti-fog frameless lens
- Ballistic rated



CA
BH511AF Pavon Glasses
 116256 \$1.90

- Clear anti-fog lens
- Crystal clear temples



CA
Torrent Glasses
 116258 Clear \$1.50
 152394 Smoke \$1.55

- Clear anti-fog lens
- Crystal clear temples



CA
BH233 Over Glass
 127566 \$6.00

- Smoke Lens
- Accommodates prescription glasses with a 5 base curve



CA
BHR3 Stainless Steel Retainer Cord
 127568 \$2.80

Gloves



CA

Max Performance

4565091	X-Large	\$8.95
4565107	Large	
140316	Medium	



CA

Men's Smooth Cowhide

140328	X-Large	\$10.95
140326	Large	
140324	Medium	



CA

Men's Fleece Lined Split Cowhide

140338	X-Large	\$9.95
140336	Large	
140334	Medium	



CA

Brown Jersey Knit with Cuff

140346	Large	\$1.95
--------	-------	--------



CA

PVC Coated with Cotton Lining

140356	Large	\$3.95
--------	-------	--------

Sold in Black



CA

Max Force

140322	X-Large	\$12.95
140320	Large	
140318	Medium	



CA

Men's Split Cowhide

109666	X-Large	\$8.95
109664	Large	
140330	Medium	



CA

Men's Pigskin with Cotton Back

140344	X-Large	\$9.95
140342	Large	
140340	Medium	



CA

Knit Glove with Rubber Coated Palm

140354	X-Large	\$2.95
140350	Large	
140348	Medium	

Sold in Black

Gloves



CA

PUG17 Polyurethane Grip Glove

116260	XXL	\$1.15
116262	X-Large	All Sizes
116264	Large	
116266	Medium	
116268	Small	

- Excellent tactile dexterity with ultra thin bare-hand sensitivity



CA

500MF Tsunami Grip Double Mach Finish Nitrile

116270	XXL	\$3.10
116272	X-Large	All Sizes
116274	Large	
116276	Medium	
116278	Small	

- Great dexterity, fit, and feel with high abrasion resistance
- Outstanding wet oil grip



CA

500G Tsunami Grip Light

116280	XXL	\$2.30
116282	X-Large	All Sizes
116284	Large	
116286	Medium	
116288	Small	

- Great dexterity, fit, and feel
- Outstanding wet oil grip



CA

360HV Gripster Foam Rubber Hi-Viz

116290	XXL	\$2.50
116292	X-Large	All Sizes
116294	Large	
116296	Medium	
116298	Small	

- Great dexterity, fit, and feel
- High visibility neon shell



CA

300NBE Gripster

116300	X-Large	\$1.75
116302	Large	All Sizes
116304	Medium	
116306	Small	

- Great fitting glove with excellent grip
- Neon color for high visibility



CA

300P Gripster Plus

116310	X-Large	\$2.50
116312	Large	All Sizes
116314	Medium	
116316	Small	

- Seamless poly/cotton liner
- Ergonomically correct hand shape for extra comfort and wear ability
- Premium etched rubber grip palm for extra grip



CA

CR998MF Samurai Cut Resistant Glove

116318	X-Large	\$9.70
116320	Large	All Sizes
116322	Medium	

- Great comfort and dexterity
- Mach Finish Nitrile for excellent wet/oily grip
- ANSI level 4 cut and puncture resistance



CA

PUG-313 Samurai Cut Resistant Glove

116324	X-Large	\$8.20
116326	Large	All Sizes
116328	Medium	

- Lightweight for excellent grip, comfort, and dexterity
- ANSI level 2 cut resistance



CA

300INT Ice Gripster Thermal Glove

116330	X-Large	\$4.40
116332	Large	All Sizes
116334	Medium	

- Black etched rubber grip on water repellent terrycloth shell
- Snug stretch fit
- Water repellent and extra warm for cold weather



CA

378INT Ice Gripster Thermal Glove

116336	X-Large	\$4.30
116338	Large	All Sizes
116340	Medium	

- Black Foam Latex provides great grip and flexibility, even in cold weather
- Water repellent and extra warm for cold weather
- ANSI level 2 cut resistance



CA

388INT Ice Gripster Thermal Glove

116342	X-Large	\$7.35
116344	Large	All Sizes
116346	Medium	

- Black etched rubber for great grip and knuckle protection
- Snug stretch fit
- Water repellent and extra warm for cold weather



CA

800F Panther Guard Glove

116348	X-Large	\$20.30/Case of 50
116350	Large	All Sizes
116352	Medium	

- Disposable flock-line 100% Nitrile polymer
- Ideal for washing and sealing concrete



CA

SG9003 Gripster Sport Glove

116354	X-Large	\$14.75
116356	Large	All Sizes
116358	Medium	

- Durable and flexible AireFlex synthetic leather palm
- Silicone pattern on palm for great dexterity and grip



CA

HR5008 Hot Rod Mechanics Glove

116360	X-Large	\$18.75
116362	Large	All Sizes
116364	Medium	

- Flex spandex back with silicone dotted palm
- Palm, knuckle, and side of hand padding

Tarps, Straps, and Stretch Wrap

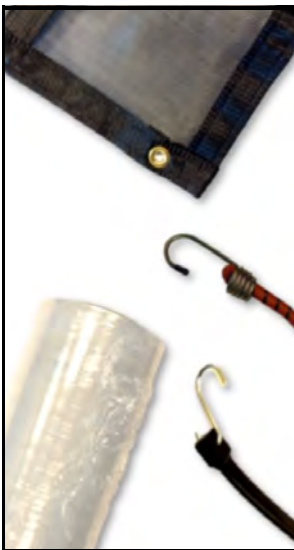

Description	Item#	Stock Location	Price Each
5' x 8' Adjustable Truck Bed Tarp	3236442	Cedar Acres	\$33.00
8' x 10' Breathable Truck Tarp	45535	Cedar Acres	\$45.00
12' x 20' Breathable Truck Tarp	45542	Cedar Acres	\$79.00
12mm x 24" Bungee Cord	150494	Cedar Acres	\$1.00
12mm x 36" Bungee Cord	150496	Cedar Acres	\$1.25
10" EPDM Rubber Tie-Down	1029664	Cedar Acres	\$1.00
15" EPDM Rubber Tie-Down	356341	Cedar Acres	\$1.15
21" EPDM Rubber Tie-Down	356334	Cedar Acres	\$1.25
31" EPDM Rubber Tie-Down	356327	Cedar Acres	\$1.50
Quickload Ratchet Strap 1" x 12'	97894	Cedar Acres	\$35.95
80 Gauge 18" x 1500' Clear Stretch Wrap	114888	Cedar Acres	\$16.75

Wheelbarrows



CA

Brentwood Single Wheel Wheelbarrow

85742	6 CF Heavy Duty Poly Tub	\$240.00
206144	8 CF Heavy Duty Poly Tub	\$275.00



CA

Brentwood Dual Wheel No-Flat Wheelbarrow

85744	8 CF Heavy Duty Poly Tub	\$340.00
85746	10 CF Heavy Duty Poly Tub	\$350.00

Brentwood wheelbarrows feature:

- Heavy-duty pans and hardware with smooth, recessed bolts.
- Robust structural steel frame for the heaviest of loads.
- Rugged wheel assembly with sealed precision bearings and 6" wide turf tire.
- Heavy gauge front braces with v-shaped cross-section for superior bend resistance.



CA

Wolverine 6 CF Single Wheel Wheelbarrow

3365937	Heavy Duty Poly Tub	\$155.00
---------	---------------------	----------



CA

Wolverine 6 CF Single Wheel Wheelbarrow

3365920	Heavy Duty Steel Tub	\$160.00
---------	----------------------	----------



CA

Wolverine 10 CF Dual Wheel Wheelbarrow

3365944	Heavy Duty Poly Tub	\$199.00
---------	---------------------	----------

Ball Carts



CA

Wolverine 1000 Lb. Ball Cart

3365975		\$379.00
---------	--	----------



CA

Wolverine 1600 Lb. Ball Cart

3365999		\$379.00
---------	--	----------

Felco Pruning Tools



Felco 20 Lopper
418629
• 17"

CA
\$110.00



Felco 21 Lopper
418612
• 25"

CA
\$139.00



Felco 22 Lopper
1221358
• 33"

CA
\$179.00



Felco 2 Pruner
53806

CA
\$55.00



Felco 6 Pruner
580968

CA
\$56.00



Felco 7 Pruner
418667
• Swivel handle

CA
\$71.00



Felco 9 Pruner
679174
• Left-handed

CA
\$57.00



Felco 10 Pruner
418650
• Swivel handle
• Left-handed

CA
\$71.00



Felco 13 Pruner
1415689

CA
\$71.00



Felco All-Purpose Cutter
1598351

CA
\$47.00



Felco Holster
879451 Belt
555867 Clip
1415702 Belt & Clip

Belt
Clip
Belt & Clip

CA
\$10.95
\$10.95
\$11.95



Felco Lopper Holster
798271

CA
\$23.95



Felco 600 6" Folding Saw
418605
418599 Blade

CA
\$26.00
\$23.00



Felco 611 20" Pruning Saw
721835
811642 Blade

CA
\$49.00
\$38.00



Felco 621 16" Turbocut Saw
888514
888521 Blade

CA
\$46.00
\$35.00



Silky 16' Pole Saw

679198

1295465

Blade

CA

\$245.00

\$85.00



www.felco.com

Professional tools



Felco Pruning Tools



Replacement Blades

DESCRIPTION	ITEM#	STOCK LOCATION	PRICE EACH
Felco 2 Blade	53813	CA	\$14.95
Felco 6 Blade	679129	CA	\$14.95
Felco 7 Blade	418643	CA	\$14.95
Felco 9 & 10 Blade	418636	CA	\$14.95
Felco 13 Blade	1415696	CA	\$16.95
Felco 200 A-40 & A-60 Lopper Blade	418582	CA	\$29.00
Felco 22 Lopper Blade	1314500	CA	\$39.00
Felco 200-4 Lopper Anvil Blade	4012366	CA	\$35.00
Felco 22-4 Lopper Anvil Blade	3488278	CA	\$45.00
Felco 600 Saw Blade	418599	CA	\$23.00
Felco 611 Saw Blade	811642	CA	\$38.00
Felco 621 Saw Blade	888521	CA	\$35.00
Felco Silky Pole Saw Blade	1295465	CA	\$85.00

Replacement Parts

DESCRIPTION	ITEM#	STOCK LOCATION	PRICE EACH
Felco Nut & Bolt Set	1004548	CA	\$10.95
Felco Catch Plate	1004265	CA	\$2.95
Felco Repair Kit	1004470	CA	\$5.95
Felco 2 & 7 Spring	53820	CA	\$4.95
Felco 6 Spring	1004333	CA	\$4.95
Felco Thumb Catch	4206000	CA	\$2.95

Sharpeners & Lubricant

DESCRIPTION	ITEM#	STOCK LOCATION	PRICE EACH
Felco Standard Sharpener	2688471	CA	\$21.00
Felco Professional Sharpener	2688495	CA	\$37.00
Felco Lubricant Spray	4249922	CA	\$14.00



8" Bypass Forged Pruning Shears w/Matte Grips
135284

CA
\$5.50



8" Aluminum Handle Pruning Shears
148338

CA
\$3.50



24"-38" Telescoping Compound Action Lopping Shears
148340

CA
\$17.30



28" Tubular Handle Lopping Shears, Forged Blade
148342

CA
\$18.55



21" Pro Forged Hedge Shear w/Wood Handles
148344

- Rubber bumpers

CA
\$21.65



22" Pro Forged Hedge Shear w/Oval Metal Handles
148346

- Special wave-patterned blades for quick cutting
- Rubber bumpers

CA
\$9.95



7" Pro-Series Folding Saw with Soft-Touch™ Handle
148348

CA
\$7.40



9" Pro-Series Folding Gator™ Saw
148350

CA
\$9.30

ARS Pruning Tools



Hand Pruner

682556

4356507 Blade

\$19.00

\$7.00

CA



Long Arm Pruner with Telescoping Handle

427843

4375669 Blade

\$127.00

\$59.00

CA



Hedge Shear with Telescoping Handles

1586396

\$69.00

CA



Superlight Hedge Shears

427829

4375652 Blade Set

\$99.00

\$42.00

CA



SS-FL18

FL18 Floral Scissors

427836

\$29.00

CA



Telescoping Pole Saw

3762040

4216009

4433819 Blade

4'-6'

6'-9'

\$80.00

\$99.00

\$30.00

CA



Pruning Tools



Deluxe Bypass Pruner

72698

72700

Blade

\$21.00

\$8.00

CA



24" Lopper—Aluminum Handle

72704

\$49.00

CA



Hedge Shear—Aluminum Handle

72706

\$39.00

CA



7" Folding Saw

72702

\$19.00

CA



Shovels & Forks



Long-Handle Round Point Shovel with Wood Handle

2520009 Open Back
1935941 Closed Back

CA

\$26.00
\$30.00



Long-Handle Round Point Shovel with Fiberglass Handle

4514310 Open Back
1935958 Closed Back

CA

\$30.00
\$33.00



Long-Handle Square Point Shovel with Fiberglass Handle

4514341

CA

\$30.00



Long-Handle Edging Spade with Fiberglass Handle

4514334

CA

\$30.00



Long-Handle Drain Spade with Fiberglass Handle

2519997

CA

\$28.00



D-Handle Drain Spade With Fiberglass Handle

95020

CA

\$27.00



Long-Handle All Steel Edging Spade

1692578

2649991

Foot Pad

CA

\$85.00

\$10.00



D-Handle All Steel Edging Spade

1692554

2649991

Foot Pad

CA

\$67.00

\$10.00

Shovels & Forks



**D-Handle Round Point Shovel
with Wood Handle**

2519973

CA

\$29.00



**D-Handle Round Point Shovel
With Fiberglass Handle**

4514327

CA

\$27.00



**Aluminum Grain Scoop with
Wood Handle**

2395164

CA

\$46.00



**Steel Scoop Shovel with
48" Wood Handle**

4514297

CA

\$24.00



**10-Tine Mulching Fork with
D-Grip Wood Handle**

2395171

CA

\$69.00



**Wolverine 24" Poly Bristle Broom with
Wood Handle**

1692462

CA

\$38.00



Rakes



16-Tine Bow Rake with Wood Handle
2519904

CA
\$32.00



16-Tine Bow Rake with Fiberglass Handle
2519911

CA
\$34.00



16-Tine Level Head Rake with Wood Handle
4514303

CA
\$24.00



30-Tine Poly Leaf Rake with Wood Handle
3435791

CA
\$15.00



24" Wide Steel Spring Rake with Wood Handle
2519928

CA
\$15.00



Aluminum Landscape Rake

2082750	36" Head	\$53.00
4514280	42" Head	\$56.00

CA
\$53.00
\$56.00



Crew by Wolverine Tools



Long-Handle Round Point Shovel with Fiberglass Handle
4508456

CA
\$21.00



Long-Handle Square Point Shovel with Fiberglass Handle
4508463

CA
\$21.00



Long-Handle Edging Spade with Fiberglass Handle
4508487

CA
\$21.00



D-Handle Edging Spade with Fiberglass Handle
4508500

CA
\$21.00



16-Tine Bow Rake with Fiberglass Handle
4508531

CA
\$21.00



Long Handle Shovel with Hardwood Handle

CA

148480	Round Point	\$11.35
148482	Square Point	\$11.35



XL Series Long Handle Round Point Contractor Grade Shovel

CA

148484	Ash Handle	\$21.60
148486	Fiberglass Handle	\$21.60

- Extra long protective socket to protect handle



Long Handle Closed Back Shovel with Fibercore™ Handle

CA

148488	Round Point	\$24.45
148490	Square Point	\$24.45



Trenching & Trench/Clean Out Shovels with 48” Fiberglass Handle

CA

148492	5” Trench/Clean Out	\$19.85
148494	4” Trenching	\$19.35



Steel Scoops

CA

148498	D-Handle	\$29.95
151866	Long Handle	\$21.95



10 Tine D-Handled Mulch Fork

CA

150482	Hardwood Handle	\$30.70
--------	-----------------	---------

Pro-Series Spading Fork with Hardwood Handle

148468		\$20.45
--------	--	---------



Fiberglass Handled Pitch Forks/Bedding Forks

CA

148466	5-Tine	\$15.95
148472	10-Tine	\$24.95



Rakes

CA

148476	Pro-Series Bow Rake	\$14.75
148478	Poly Leaf Rake	\$10.85

Garden Hand Tools



Bond Long handled Bulb Planter
1125304 CA \$12.50



Bond Short Handle Bulb Planter
1125335 CA \$7.00



24" Bulb Auger
314693 CA \$21.00



Bond Stainless Steel Hand Cultivator
2544456 CA \$6.95



Stainless Steel Hand Trowel
2544470 CA \$6.95

TITAN MACHINERY

Sales • Parts • Service • Rentals



TEAMCO INC
SNOWBLAST

VACALL™

CASE CONSTRUCTION



*Subject to availability. Items may not be available at all locations.

Titan Machinery Shakopee - 952-445-5400

www.titanmachinery.com



Water Gardening



Section Contents

Description	Page
EasyPro Pond Kits & Pumps <ul style="list-style-type: none"> • Mag Drive Pumps • Vertical Pumps • High Volume Pump • Matala Horizontal/Vertical Pumps 	387 387 387 387 387
EasyPro Just-A-Falls <ul style="list-style-type: none"> • Eco-Series Waterfall Diffuser • Pump Vault • Reservoir Cubes 	388 388 388 388
Flex PVC & Accessories	388
Pond Liner & Accessories <ul style="list-style-type: none"> • Liner Joint Cover Tape • Liner Joint Seam Tape • Liner Adhesive • Liner Patch 	388 388 388 388 388

Description	Page
Tranquil Décor Basalt Fountains <ul style="list-style-type: none"> • Polished Top Basalt • Sloped Top Basalt • Domed Top Basalt • Polished 3-Side Basalt • Split Face Double Basalt 	389 389 389 389 389 389
Water Feature Accessories <ul style="list-style-type: none"> • Fill Valve • Basalt Plumbing Kit • Water Feature Lights • Waterfall Foam • Silicone Sealant • Filter Media • Pond Deicer 	390 390 390 390 390 390 390
Water Feature Treatments	390

EasyPro Pond Kits & Pumps



EasyPro All Pro Series Medium Pond Kit

68192 EM1621FB \$2,195.00

Includes:

- 45 mil EPDM rubber liner—20' x 25'
- Liner underlayment
- Medium AquaFalls filter/waterfall base and PS1FB Skimmer
- EasyPro TH pump with two year warranty
- Beneficial bacteria
- 2" flexible PVC—2" x 50'
- Check valve assembly
- Three mini LED lights with 45 watt transformer
- Installation kit with PVC primer, glue, liner patch, silicone, and black foam



EasyPro Mag Drive Pumps

4563875	EP600, 600 GPH	\$100.00
4563882	EP850, 850 GPH	\$109.00
4563899	EP1050, 1050 GPH	\$135.00
4563905	EP1350, 1350 GPH	\$175.00
50586	EP1750, 1750 GPH	\$215.00
4563912	EP2200, 2200 GPH	\$235.00
4563929	EP3200N, 3200 GPH	\$260.00

- Quiet and very energy efficient
- Epoxy filled—no oil
- 3 year limited warranty
- Female threaded discharge ports for easy fitting connection



EasyPro Stainless Steel Vertical Pump

4469085	TH150, 3100 GPH	\$327.00
4468989	TH250, 4100 GPH	\$389.00
4563936	TH400, 5100 GPH	\$472.00
4563943	TH750, 6000 GPH	\$581.00

- Designed for long life, continuous duty operation
- Motor housing is corrosion resistant stainless steel
- Vortex design prevents clogging
- Built-in overload and overheat motor protection
- 2" female threaded outlet
- 2 year limited warranty



EasyPro High Volume Pump

65286	TB8000, 8000 GPH	\$675.00
-------	------------------	----------

- Best choice for water features above 20'
- 3" outlet
- Top quality double mechanical seals—over 100,000 hour life expectancy
- Thermal overload protection
- 2 year limited warranty



Matala Horizontal/Vertical Pump

4469139	MHP32, 3200 GPH	\$322.00
4469153	MHP39, 3900 GPH	\$337.00

- For shallow water applications without overheating
- Operates in horizontal or vertical position
- Vortex style intake reduced plugging
- Removable inlet screen prevents large objects from plugging pump
- Continuous duty rated
- Energy efficient design reduces operating costs
- 2 year limited warranty

EasyPro Just-A-Falls



Just-A-Falls

4563950	JAF8W, 8' Stream, EP2000 Pump	\$910.00
4469283	JAF16W, 16' Stream, TH250 Pump	\$1,255.00

Kit Includes:

- 45 mil EPDM rubber liner
- Pump discharge assembly
- Underlayment
- UWD23 waterfall spillway
- EasyPro pump vault
- Flexible tubing
- Submersible pump
- Reservoir cubes
- Installation kit with glue, foam, and fittings



Eco-Series 23" Waterfall Diffuser

4469009	UWD23	\$109.00
---------	-------	----------



Small Pump Vault

4468972	JAFM—16" x 16" x 22"	\$200.00
---------	----------------------	----------



Reservoir Cubes

4563967	HSC22 9½" x 16" x 27" Half Cube	\$36.00 Each
4468996	HSC44 17½" x 16" x 27" Full Cube	\$46.00 Each



Eco-Series Fountain Basin with Bench Grating

4563974	FBL40—40" Fountain Basin	\$210.00
4563981	FBL48—48" Fountain Basin	\$242.00
62400	Fine Screen for FBL40/FBL48	\$10.00/Foot

- 100 Lb load rating with grating only; 500 Lb load rating when used with concrete blocks

Flex PVC & Accessories

4469771	FP20 Ultimate Flex PVC 2" x 25'	\$75.00
4469788	FP200 Ultimate Flex PVC 2" x 50'	\$149.00
4469016	Cut-to-Length Flex PVC—2"	\$4.27/Foot
62244	Cut-to-Length Vinyl Tubing—¾"	\$.77/Foot
4564018	2" Rubber Coupling	\$8.10
4564025	PVC Glue—4oz.	\$5.40
4564032	PVC Primer—4oz.	\$5.15
4469108	PVC Gate Valve	\$22.25
4564896	Hose Clamp—¼" - ⅝"	\$1.15
4564902	Hose Clamp—⅝/16" - ⅞"	\$1.15
4564919	Hose Clamp—7/16" - 1"	\$1.40

Pond Liner & Accessories

4469160	10' x 100' 45 mil EPDM Liner Roll	\$850.00
4563998	15' x 100' 45 mil EPDM Liner Roll	\$1,267.00
4564001	20' x 100' 45 mil EPDM Liner Roll	\$1,290.00
579474	Cut-to-Length 10' Wide Liner*	\$8.60
3236213	Cut-to-Length 15' Wide Liner*	\$13.10
579498	Cut-to-Length 20' Wide Liner*	\$17.20
4469726	Liner Joint Cover Tape—6" x 100'	\$285.00
4469733	Liner Joint Cover Tap—6" x 25'	\$82.00
4469740	Liner Joint Seam Tape—3" x 50'	\$67.00
4469757	Liner Joint Seam Tape—3" x 25'	\$36.00
4469764	QuickPrime Liner Adhesive 1 Qt	\$53.50
4469801	LPK—Liner Patch Repair Kit	\$7.15
4469795	FJC—6" Circular Liner Patch	\$31.95

* Minimum 5 linear feet on cut-to-length liners

Tranquil Décor Real Basalt Fountain Kits



Polished Top Basalt Fountain Kits

66426	HBR3ASL Short—10", 14", 20"	\$795.00
66428	HBR3BSL Medium—12", 20", 27"	\$920.00
66430	HBR3CSL Large—20", 27", 35"	\$1065.00

Kit Includes:

- 3-pack real basalt columns
- 40" octagon basin
- MP1000 GPH pump with splitter & plumbing kit
- 3 LED statuary lights with transformer



Sloped Top Basalt Fountain Kit

77118	HBS35KL 35" Sloped Top Basalt	\$420.00
-------	-------------------------------	----------

Kit Includes:

- Sloped real basalt column
- 21" x 28" rectangle basin
- MP230 GPH pump with plumbing kit
- 1 LED statuary light with transformer



Domed Top Basalt Fountain Kit

76982	HRD24K 24" Domed Top Basalt	\$475.00
-------	-----------------------------	----------

Kit Includes:

- Domed real basalt column
- 21" x 28" rectangle basin
- MP230 GPH pump with plumbing kit
- 1 LED statuary light with transformer



Polished 3-Side Basalt Fountain Kit

76984	HPS39K 39" Flat Sided Basalt	\$848.00
-------	------------------------------	----------

Kit Includes:

- Flat top, polished 3-side real basalt column
- 40" octagon basin
- MP425 GPH pump with plumbing kit
- 1 LED statuary light with transformer



Split Face Double Basalt Fountain Kit

76986	HST24K 24" Flat Split Face Double	\$1,098.00
-------	-----------------------------------	------------

Kit Includes:

- 2 real basalt columns
- 40" octagon basin
- MP575 GPH pump with plumbing kit
- 1 LED statuary light with transformer

Water Feature Accessories & Treatments

Water Feature Accessories

4469078	WIK—Water Feature Installation Kit	\$49.50
4469092	BFS—Box Style Fill Valve	\$37.00
4469030	PDA20TH—2" Pump Assembly (TH Style Pumps)	\$31.95
65362	PK1L—Basalt Single Plumbing Kit 3/4" Barb	\$7.15
65364	PK3L—Basalt Triple Plumbing Kit 3/4" Barb	\$28.80
4469047	LED6WP—6W LED Warm White Light	\$100.95
62242	LED8B—LED Light & Transformer	\$36.00
4469061	LED6WPK—2-Pack 6W LED Warm White w/EPT45 Transformer	\$247.00
4469115	BWFN—EasyPro Black Waterfall Foam w/Straw (20 oz.)	\$19.75
4469122	BGF—EasyPro Black Waterfall Foam for Foam Gun (29 oz.)	\$43.25
4564056	GFC—Professional Foam Gun Cleaner	\$19.05
4564063	FSG—Professional Foam Gun	\$142.00
4564049	SCT1—Silicone Sealant Tube—2.8 oz.	\$8.60
62398	PK3LG—Foam Grommet for Basalt	\$3.10
4564070	PFM5B—Coarse Density Filter Media—2" x 28"	\$7.80/LF
66612	TP-100—Thermo-Pond 100 Watt Deicer	\$62.30



GreenClean Algaecide

4564384 2.5 Lbs. \$21.90



All Season Liquid Bacteria

4564438 16 oz. \$9.85
 4564445 32 oz. \$13.90
 4564452 128 oz. \$46.70



Sludge Remover Bacteria

4564469 12 Dry Packets \$21.90
 4564476 24 Dry Packets \$20.65



Liquid Barley Extract

4564483 16 oz. \$11.60
 4564490 32 oz. \$20.25
 4564506 128 oz. \$42.05



Rock & Waterfall Cleaner

4564582 2 Lbs. \$13.15
 4564599 4 Lbs. \$39.40



Water Conditioner

4564612 16 oz. \$11.85
 4564667 32 oz. \$22.10
 4564674 128 oz. \$54.05



Water Clarifier

4564735 16 oz. \$11.45
 4564759 32 oz. \$22.50
 4564803 128 oz. \$54.65



Blue Pond Dye

4564889 16 oz. \$16.75



pH Adjusters

4564810 pH Up 16 oz. \$9.85
 4564858 pH Down 16 oz. \$13.90

Bachman's

6010 Lyndale Avenue South
Minneapolis, MN 55419-2289
Credit Office: 612-861-7670 Fax: 612-861-7767

CUSTOMER APPLICATION

TODAY'S DATE _____
COMPANY NAME _____ DATE ESTABLISHED _____
ADDRESS _____
CITY _____ STATE _____ ZIP _____
OFFICE PHONE # _____ FAX # _____
MAIN CONTACT _____ CONTACT'S EMAIL _____
WEBSITE _____ ****PLEASE ATTACH COPY OF BUSINESS CARD****

SERVICES REQUESTED:

WHOLESALE _____ GENERAL BUSINESS _____ LANDSCAPE SERVICES _____
PLANT LEASING _____ GARDEN SERVICES _____ OTHER _____

D & B NUMBER: _____ FED ID #: _____
(ST3) SALES TAX EXEMPTION NUMBER _____

****SALES TAX EXEMPTION STATUS REQUIRES WE HAVE A COMPLETED ST3 FORM ON FILE-PLEASE ATTACH****

BILLING INFORMATION

Would you like to have a PO # or job name on all orders/invoices? YES ___ NO ___
Would you like to have Invoices/Credits sent to you by email? YES ___ NO ___
Would you like to have Statements sent to you by email? YES ___ NO ___

NAMES OF OFFICERS & OTHER AUTHORIZED BUYERS:

WOULD YOU LIKE TO RECEIVE
EMAILED INVOICES / STATEMENTS?

Name _____	Title _____	YES ___ NO ___
Email _____	Cell # _____	
Name _____	Title _____	YES ___ NO ___
Email _____	Cell # _____	
Name _____	Title _____	YES ___ NO ___
Email _____	Cell # _____	
Name _____	Title _____	YES ___ NO ___
Email _____	Cell # _____	

IF APPLICABLE:

CONTRACTOR LICENSE #: _____ MN NURSERY LICENSE #: _____

For further information go to <https://www.mda.state.mn.us/licensing/licensetypes/nurseryprogram.aspx>

MNLA FOUNDATION: Improving the Environment by Investing in Research and Education. You are encouraged to participate in this voluntary donation ¼ of 1% on all purchases. All monies are forwarded by Bachman's to the MNLA Foundation to grow a brighter future for the industry. YES ___ NOT AT THIS TIME ___

TRADE REFERENCE SECTION: (complete this section only to be considered for open credit terms)**BANKING INFORMATION:**

BANK NAME _____ PHONE # _____ EMAIL _____
 ACCT. NUMBER _____ TYPE: CHECKING LOAN SAVINGS

COMMERCIAL REFERENCES: (complete this section only to be considered for open credit terms)

NAME: _____ PHONE: _____ FAX: _____
 ADDRESS: _____
 CONTACT: _____ ACCT. NUMBER: _____

NAME: _____ PHONE: _____ FAX: _____
 ADDRESS: _____
 CONTACT: _____ ACCT. NUMBER: _____

I/we certify that the information provided above is true and correct. If credit is granted, we agree to pay all lawful charges, including reasonable attorney fees, court costs, filing fees and other collection costs incurred by Bachman's, Inc. in connection with the collection of this account.

Signature: _____ Date: _____

Printed Name: _____ Title: _____

Bachman's will bill on the 21st day of each month, with payments due by the 20th day of the following month. If there are any questions on billing method please call 612-861-7796 for assistance.

No discounts are given unless they are specifically identified in a contract. All billed amounts are due and payable by the due date. A finance charge of 1.5% per month (or maximum allowed by law) will accrue on balances not paid by the due date shown on the statement. In the event Bachman's commences collection action, the customer, agrees to pay all costs of collection, including but not limited to reasonable attorney fees and collection proceeding costs including arbitration, mediation or civil action as deemed necessary to collect the outstanding obligation due to Bachman's. A 1.5% convenience fee will be charged if you pay your open charge account balance with a credit card after your net standard payment terms, unless credit card payment is received at point of sale.

Personal Guarantee of Payment Of Charges:

The undersigned, in consideration of the sales on credit to the above customer, jointly and severally, do unconditionally and irrevocably personally guarantee the payment of this account when due according to its terms. IF THERE IS REFERENCE TO AN OFFICE HOLDER BELOW, IT IS FOR IDENTIFICATION PURPOSES ONLY AND DOES NOT LIMIT PERSONAL LIABILITY OR RELIEVE THE UNDERSIGNED FROM JOINT AND SEVERAL PERSONAL LIABILITY. Revocation of the guaranty of payment can be made only in writing, sent by certified mail, return receipt requested. Revocation of the guaranty of payment will be effective only when accepted in writing by Bachman's and only applies to materials sold after the date of the acceptance of this guaranty and consent to all changes of the terms: extensions of credit and releases of security. Any extensions or forbearance by Bachman's shall have no effect on the enforceability of the guaranty. In the event of non-payment under the guaranty, the undersigned agrees to pay all costs of collection, including but not limited to reasonable attorney fees and collection proceeding including arbitration, mediation or civil action as deemed necessary to collect the outstanding obligation due to Bachman's.

Signature: _____ Date: _____

Printed Name: _____ Title: _____

Please check if you do not wish to receive promotional emails/texts from Bachman's _____

****Payment Remittance: Bachman's Inc. 6010 Lyndale Avenue South, Minneapolis MN 55416-2289**

Helpful Formulas

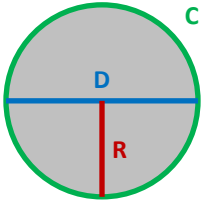

Circumference of a Circle = $2 \times \text{Radius} \times 3.1416 = \text{Diameter} \times 3.1416$

Area of a Circle = $3.1416 \times \text{Radius} \times \text{Radius}$

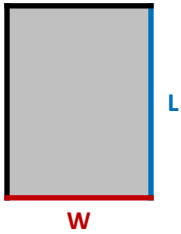

Area of a Rectangle or Square = $\text{Width} \times \text{Length}$

Natural Stone Flagstone Coverage (Based on 165 Lbs/SF Stone Density—Stone Densities Will Vary)	
Stone Thickness	Approximate Pounds Needed per SF
1"-1½"	~17
1½"-2"	~24
2"-2½"	~31

Natural Stone Wall Stone Coverage (Based on 165 Lbs/SF Stone Density—Stone Densities Will Vary)	
Stone Depth	Approximate Pounds Needed per SF
8"	~110
10"	~138
12"	~165

Base and Fill Material Calculations		
Paver Base	$A \div 200 \times D \times 1.25 = \text{Tons of Base}$	A = Area (in Square Feet) D = Depth (in Inches)
Paver Bedding Sand	$A \div 200 \times 1.25 = \text{Tons of Sand (1 inch thick)}$	A = Area (in Square Feet)
Wall Leveling Pad Aggregate	$L \div 27 \times 1.1 = \text{Cubic Yards of Base Aggregate}$	L = Length of Wall (in Feet)
Retaining Wall Drainage Aggregate	$(L \times H) \div 27 \times 1.1 = \text{Cubic Yards of Aggregate}$	L = Length of Wall (in Feet) H = Height of Wall (in Feet)

Estimating Guide to Determine Cubic Yards of Mulch or Rock Needed (1 CY = 27 CF)								
Material Depth	1"	2"	3"	4"	6"	9"	10"	12"
Divide Area SqFt by:	324	162	108	81	54	36	33	27

Estimated Coverage of Boulders							
Boulder Size	6"-12"	12"-18"	18"-24"	24"-30"	30"-36"	Rip Rap	6"-12" Edging
Approx Coverage	15-20 SF	10-15 SF	6-10 SF	5-8 SF	3-6 SF	~40 SF/Ton @ 3" Deep	35-40 LF/Ton



Lano Equipment: The world's oldest Bobcat Dealer.

Offering the full line of new and used Bobcat skid-steer loaders, compact track loaders, excavators, utility vehicles and more. Choose the location nearest you: Anoka, Shakopee, Loretto. Visit www.lanoequip.com for details.

