

Midwest Small Fruit Pest Management Handbook



T · H · E
OHIO
STATE
UNIVERSITY

EXTENSION

Bulletin 861

Copyright © 2004, Ohio State University Extension

OSU Extension embraces human diversity and is committed to ensuring that all educational programs conducted by Ohio State University Extension are available to clientele on a nondiscriminatory basis without regard to race, color, age, gender identity or expression, disability, religion, sexual orientation, national origin, or veteran status.

Keith L. Smith, Associate Vice President for Agricultural Administration and Director, OSU Extension.

TDD No. 800-589-8292 (Ohio only) or 614-292-1868

Reprinted 1/11 — 2.5M —XXXXX



Midwest Small Fruit Pest Management Handbook

Edited By

Michael A. Ellis

Professor and Extension Specialist
Department of Plant Pathology
Ohio Agricultural Research and Development Center
The Ohio State University

Celeste Welty

Associate Professor and Extension Specialist
Department of Entomology
Ohio Agricultural Research and Development Center
The Ohio State University

Richard C. Funt

Professor and Extension Specialist
Department of Horticulture and Crop Science
Ohio Agricultural Research and Development Center
The Ohio State University

Douglas Doohan

Associate Professor and Extension Weed Ecologist
Department of Horticulture and Crop Science
Ohio Agricultural Research and Development Center
The Ohio State University

Roger N. Williams

Professor
Department of Entomology
Ohio Agricultural Research and Development Center
The Ohio State University

Maurus Brown

Assistant Professor and Extension Educator
Department of Extension
The Ohio State University

Bruce Bordelon

Associate Professor and Viticulture Specialist
Department of Horticulture and Landscape
Architecture
Purdue University

Acknowledgments

We extend grateful appreciation to the following persons who have contributed their talent to this publication:

David E. Scardena, Joy Ann Fischer, Editing
Tim Bowman, Graphic Design
Communications and Technology
The Ohio State University

Michele Hobbs, Office Associate
Department of Horticulture and Crop Science
The Ohio State University

Shirley M. Funt, Continuing Education Assistant
The Ohio State University

Additional Copies

Additional copies of this handbook can be purchased from your land-grant university listed on page ii. If you live outside the Midwest, you may write or call: Ohio State University Extension, Media Distribution, 385 Kottman Hall, 2021 Coffey Road, Columbus, OH 43210-1044. Phone: 614-292-1607.

Trade Names

Trade names, suppliers, or other private labels are used for identification. No product endorsement is implied nor is discrimination intended toward similar products or materials not mentioned or listed. Ohio State University Extension and the participating universities make no warranty or guidance of any kind, expressed or implied, concerning the use of these products.

A portion of the funding for this publication was provided by the North Central Integrated Pest Management Center and the Ohio Integrated Pest Management Program.

Prepared By

University of Arkansas, Fayetteville, AR 72701

Horticulture ~ J. R. Clark

Entomology ~ D. T. Johnson

Plant Pathology ~ P. Fenn, S. R. Vann

Iowa State University, Ames IA 50011

Horticulture ~ Paul Domoto, Gail Nonnecke

Entomology ~ Donald Lewis

Plant Pathology ~ Mark Gleason

Kansas State University, Manhattan KS 66506

Horticulture ~ Sorkel Kadir

Entomology ~ Robert Bauernfeind

Plant Pathology ~ N. A. Tisserat

The Ohio State University, Columbus OH 43210

Horticulture ~ Richard C. Funt, Doug Doohan, Maurus Brown, Imed Dami

Entomology ~ Celeste Welty, Roger Williams

Plant Pathology ~ Mike Ellis

Purdue University, West Lafayette IN 47907

Horticulture ~ Bruce P. Bordelon, Steve C. Weller

Entomology ~ Rick E. Foster

Plant Pathology ~ Paul C. Pecknold

University of Illinois, Urbana IL 61808

Horticulture ~ Mosbah Kushad, Bob Skirvin

Entomology ~ Rick Weinzierl

Plant Pathology ~ Mohammad Babadoost

University of Kentucky, Lexington KY 40546

Horticulture ~ J. G. Strang, R. T. Jones, J. G. Masabni

Entomology ~ R. T. Bessin

Plant Pathology ~ J. R. Hartman

University of Missouri, Columbia MO 65211

Southwest Missouri State University, Mountain Grove 65711

Horticulture ~ Patrick Byers (SMSU), Michele Warmund (UMC)

Entomology ~ Bruce Barrett (UMC), Martin Kaps (SMSU), Daniel Waldstein (SMSU)

Plant Pathology ~ James Moore (SMSU)

University of Nebraska, Lincoln NE 68588

Horticulture ~ P. Real

Entomology ~ F. Baxendale

Plant Pathology ~ J. Watkins

Weed Science ~ A. Martin

University of Wisconsin, Madison WI 53706

Horticulture ~ Teryl R. Roper

Entomology ~ Daniel L. Mahr

Plant Pathology ~ Patricia S. McManus

Contents

PREFACE 1

CHAPTER 1 – General Concepts of Integrated Pest Management 2

Pest Management 2
 Integrated Pest Management (IPM) 2
 Strategies of Pest Management 3
 Biological Control 3
 Monitoring Pests and Making Control Decisions 6



CHAPTER 2 – Strawberries 12

General 12
 Integrated Management of Strawberry Diseases 13
 Identifying and Understanding the Major Strawberry Diseases 13
 Foliar Diseases 13
 Strawberry Root Diseases 18
 Strawberry Fruit Rots 22
 Use of Disease-Resistant Cultivars 26
 Cultural Practices for Disease Control in Strawberry 26
 Fungicides for Strawberry Disease Control 33
 Leaf Diseases 35
 Strawberry Pests and Their Management . 37
 Fruit- or Flower-Feeding Pests 37
 Foliage- or Stem-Feeding Pests 42
 Root- or Crown-Feeding Pests 46
 Summary of Strawberry Insect Pest Management Procedures 50
 Weed Management in Strawberries 51
 Weed Control with Herbicides 51



CHAPTER 3 – Brambles (Raspberries and Blackberries) 55

General 55
 Integrated Management of Bramble Diseases 56
 Identifying and Understanding the Major Bramble Diseases 57
 Cane and Leaf Diseases 57
 Root Diseases 70
 Virus Diseases of Raspberries 73
 Control of Virus Diseases 75
 Use of Disease-Resistant Cultivars 76
 Cultural Practices for Disease Control in Brambles 76
 Fungicides for Bramble Disease Control 81
 Bramble Pests and Their Management . . 84
 Fruit- or Flower-Feeding Pests 84
 Cane- or Crown-Feeding Pests 89
 Foliage-Feeding Pests 95
 Summary of Bramble Insect Pest Management Procedures 99
 Weed Management in Brambles 100



CHAPTER 4 – Highbush Blueberries 102

General 102
 Integrated Management of Blueberry Diseases 104
 Identifying and Understanding the Major Blueberry Diseases 104
 Fruit Diseases 104

Stem and Foliage Diseases	106
Root Diseases	107
Viruses and Phytoplasmas	108
Use of Disease-Resistant Cultivars	108
Cultural Practices for Disease Control in Blueberry	110
Blueberry Pests and Their Management	111
Insect Pests	111
Vertebrate Pests	118
Summary of Blueberry Insect Pest Management Procedures	119
Weed Management in Highbush Blueberries	120

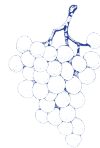

CHAPTER 5 – Grapes	122
General	122
Integrated Management of Grape Diseases	122
Identifying and Understanding the Major Grape Diseases	122
Black Rot	123
Powdery Mildew	125
Phomopsis Cane and Leaf Spot	129
Downy Mildew	131
Botrytis Bunch Rot	133
Eutypa Dieback	134
Anthracnose	136
Crown Gall	138
Use of Resistant Cultivars for Grape Disease Management	139
Cultural Practices for Disease Control in Grapes	139
Using Fungicides for Controlling Grape Diseases	141
Fungicides for Controlling Specific Grape Diseases	143
Fungicides for Controlling Black Rot	143
Fungicides for Powdery Mildew	145

Fungicides for Phomopsis Cane and Leaf Spot	146
Fungicides for Downy Mildew	146
Grape Insects and Their Management	149
Introduction	149
Insect Monitoring Devices	149
Cultural Practices	150
Resistant Cultivars	150
Behavior and Biology	150
Identifying and Understanding the Major Insects and Mites on Grapes	150
Insects That Attack Buds	150
Insects That Attack Flower Clusters and Berries	152
Insects That Attack Grape Foliage	158
Insects That Attack the Roots and Crown	164
Mites That Attack Grapes	167
Weed Management in Grapes	167



CHAPTER 6 – Weed Management	172
General Information and Guidelines	172
Weed Identification and Scouting	172
Cultural Controls	174
Mechanical Controls and Hand Weeding	177
Chemical Controls	177
Herbicide Application	178
Controlling Weeds Before Planting	178
Herbicide Types	181
Herbicide Injury	183
Methods of Application	183
Soil Fumigation	183
Preplant Cover Crops	184
Selecting a Preplant Cover Crop	185
Weed Identification	188
Broadleaf Weeds	188
Creeping or Prostrate Broadleaf Weeds	190



CHAPTER 7 – Reducing Bird and Other Wildlife Damage in Berries and Grapes 192

Birds 192
Wild Turkey 193
Deer 193



CHAPTER 8 – Using Pesticides in Small Fruit Production 195

Pesticide Application 195
 Pesticide Labels 195
 Pesticide Formulations 195
 Conversion of Label Formulation Rates to Actual Toxicant Rates 196
 Calibrating Single Nozzle and Boom Sprayers 200
 Spray Pattern Alignment 200
 Calibration of Air-Blast Sprayers 200
 Determining the Amount of Spray to Apply Per Acre 202
 How Much Pesticide Is Needed per Tank? 203
 Cleaning Spray Equipment 203
Pesticide Safety 204
 Toxicity of Pesticides 204
 Pesticide Applicator Certification 204
 Record Keeping, Worker Protection, and Reentry Times 208
 Pesticide Safety and Use 208
 Protecting the Birds and the Bees 208
 Ground Water and Surface Water Protection 209
 Safe Storage of Pesticides 213
 Fungicides and Insecticides for Small Fruits 214

CHAPTER 9 – Plant Tissue Analysis for Small Fruit and Fertilizer Recommendations 222

Sampling 223
 Sample Dates (Table 9-2) 223
 Sample Time 223
 Number of Leaves Sampled 223
 Location of Plants in the Field 223
 Process Samples 223
 Interpretation of Results 223
Recommendations for Strawberries 224
Recommendations for Brambles 226
Recommendations for Blueberries 227
Recommendations for Grapes 229

REFERENCES 233

Midwest Small Fruit Pest Management Handbook

PREFACE

This small fruit pest management handbook is presented in an ongoing attempt to better serve Midwestern fruit growers. Financial constraints make the production of such publications by each of the states in the North Central region increasingly difficult. As a result of pooling the resources and expertise of the various states, this regional publication presents detailed information that is adaptable over a wide range of climates, soils, and small fruit production schemes.

This handbook contains information on pests, production methods, and pest management practices that should not change on an annual basis. It is intended to remain useful for several years between revisions. Your state's fruit spray guide, which is a publication that lists pesticides for specific crops and specific problems, is published separately and is updated each year.

To make the best possible decisions about small fruit pest management, this handbook should be used in conjunction with an up-to-date state spray guide and with the newsletters issued by several of the state's Extension services. Contact your state's Extension fruit specialist for information on newsletters.

This publication does not replace the many publications on fruit cultivars and management practices that are available from your Extension service.

The authors solicit your suggestions regarding the usefulness of this publication and the ways that it might be improved. Its purpose is to assist you in producing top-quality fruit while protecting yourself, the consumer, and the environment.

CHAPTER 1

General Concepts of Integrated Pest Management

Pest Management

Effective fruit crop production depends on the grower developing a system of crop management that is appropriate for each farm. Decisions need to be made for how to manage all of the normal cultural practices such as planting, fertility, harvesting, and pruning as well as managing the insect, disease, and weed problems that occur either regularly or sporadically. The information in this handbook will address management issues related to both common, expected pest problems as well as the occasional appearance of minor pest problems.

Effective management of a pest problem depends on:

- Correct diagnosis of the problem and correct identification of the pest causing it.
- Use of techniques to prevent or delay infestations or infections as well as techniques to control them.
- Early detection of pests by frequent inspection of plants.
- Tolerance of pests at population densities that do not cause economic damage.

Integrated Pest Management (IPM)

Integrated pest management (IPM) is a unified program of multiple strategies used to avoid economic damage to crops and to minimize environmental disturbance. IPM includes *cultural and mechanical practices* to prevent pest outbreaks from developing; *biological control* to encourage the pest's natural enemies to survive and attack the pests; and *chemical control*, which is usually used when cultural and biological controls are inadequate and a crop needs to be rescued from a damaging pest population. During the years from the mid-1940s to the mid-1970s, chemical control of pests was widely used on most commercial crops in the United States, often to the exclusion of other methods. Due to increasing incidence of some pests

developing resistance to pesticides and to concerns about pesticides contributing to environmental contamination, there has been a trend since the mid-1970s towards using pesticides more judiciously and taking a more multi-tactic or integrated approach to pest management. Although the term *pest* means *insects* to many people, in IPM the term *pest* is usually used in a broader sense that *includes disease-causing microorganisms and weeds as well as certain insects, mites, birds, and mammals*.

For some commercial crops in some regions of the world, a comprehensive IPM program has been worked out, and simple instructions are available to growers who want to follow an IPM program. In these cases, the only knowledge required of the grower is how to identify the important pests and natural enemies in the system, and how to follow the recommended procedures for preventive cultural practices, monitoring, and control decisions.

For other commercial crops or in other regions of the world, no guidelines are yet available for a comprehensive IPM program. This does not mean that a grower cannot attempt to manage a crop with an IPM approach, but it means that the grower may have to learn more about the habits and life cycles of all pests and natural enemies found in a crop and be willing to experiment with various thresholds and control measures in order to develop an appropriate management strategy.

In the case of small fruit, some good information has been generated in the Midwest on certain components of the IPM system, but not all components for all crops have been developed. Some information generated elsewhere (for example, California) might be relevant to the same crop in other regions (for example, the Midwest), but often this is not the case because the key pests of a crop in warmer or drier climates are often not the same key pests of the same crop in a cooler or wetter climate. The information presented in this bulletin is the most comprehensive and regionally relevant information currently available.

Strategies of Pest Management

Some of the strategies that are used in Integrated Pest Management programs are summarized here. For specific examples of how these apply to management of weeds, specific diseases, and insect pests, see the summary at the end of the weed section, the disease section, and the insect section within each crop chapter.

Cultural Controls

Growers can minimize infestations and infections by choosing appropriate cultural practices.

When establishing a new planting:

- Site selection
- Crop rotation
- Soil preparation
- Cultivar selection
- Disease-free planting stock
- Row spacing and plant density.

When maintaining a planting:

- Mulch: Apply at times and in amounts that prevent weeds, diseases, and slugs.
- Pruning: Cut and remove branches to mechanically kill some cane pests.
- Fertilization: Provide plants with optimum nutrient levels.
- Cultivation (plowing, harrowing, hoeing): Turn under the soil to mechanically kill some soil pests.
- Irrigation: Provide water at times and by methods that minimize disease development and restrict water availability to weeds.
- Sanitation: Use weed-free straw and mulch; control weeds around field edges; and clean up crop debris, especially after harvest.
- Renovation: Mow or plow under plants after harvest to mechanically kill some foliar pests and disease inoculum.
- Habitat modification: Remove alternate hosts of pests; rotate short-term berry crops (strawberries) with annual crops to break the life cycle of problem weeds and other pests.

Mechanical Controls

- Prevent pests from reaching the crop: Use traps, row covers, or netting.

- Remove pests: Hosing, vacuums, or hand removal.
- Roguing of diseased plants.
- Cultivation and hand-weeding: Hoe, hand-weed, cultivate, and plow to kill or to bury weeds.

Biological Controls

- Natural enemies: Encourage predators, parasitoids, and antagonists that attack pests.
- Microbial pesticides: Treat crops with beneficial pathogens that kill pests.
- Behavior modification: Use mating disruption pheromones or poisoned feeding stimulants to modify the behavior of pests to prevent infestation.

Chemical Control

Kill pests by treating crops with pesticides.

- Conventional synthetic pesticides
- Inorganic pesticides
- Botanical pesticides
- Soaps, oils
- Insect growth regulators.

Biological Control

Natural enemies of disease-causing pathogens.

Biological control of insect pests has a longer and better-known history than biological control of disease-causing microorganisms, but research in both disciplines has been increasing recently. Beneficial microorganisms that have potential for incorporation into IPM programs include some fungi that attack pathogenic nematodes and mycoparasitic fungi, such as *Trichoderma*, that are antagonistic to crop pathogens. Although biological control has great potential in the future, it plays a relatively small role in current management programs for small fruit crops.

Types of natural enemies attacking arthropods.

All insects and mites have natural enemies that attack them. Many of these natural enemies are small, drab, and easily overlooked, but they can contribute greatly to pest management. In unmanaged fruit plantings, it can be difficult to find some pests because they are kept under control by natural enemies. In managed plantings, natural enemies are often absent because they are easily killed by pesticides. Natural enemies can be categorized as predators, parasitoids, and pathogens. For detailed information about natural

enemies and their use in pest management, see the publications by Mahr and Ridgway (1993) and Henn and Weinzierl (1990) that are listed in the References in the back of this publication.

Predators are usually larger than their prey. Vertebrate predators of insect pests include birds and some mammals. Among insects, predators include lady beetle adults (also called ladybird beetles or ladybugs), lady beetle larvae, lacewing larvae, minute pirate bugs, hover fly larvae (also called flower fly or syrphid fly larvae), damsel bugs, assassin bugs, some stink bugs, ground beetles, and yellowjackets (Figure 1). Certain kinds of mites are also predators. Predators commonly attack pests that are slow movers, such as aphids and spider mites, or pests that are immobile, such as scales and the egg stage of caterpillars and other pests.

Parasitoids (also called parasites) are usually smaller than their hosts and include a variety of wasps and flies. Adult female parasitoids (Figure 2) usually lay eggs inside the body of the host pest, and the egg hatches into a larva that slowly consumes the body of the host. The host pest does not die until the parasitoid completes its development. Parasitoids commonly attack soft-bodied insects such as caterpillars, or eggs, or pupae.

Beneficial pathogens are bacteria, fungi, viruses, and nematodes that cause pest insects to become sick and die. These occur naturally, particularly when weather conditions are wet and warm. They are not the same pathogens that cause disease in plants. Some are commercially available, such as the bacterium *Bacillus thuringiensis* (*Bt*), which is sold as DiPel, Javelin, CryMax, Agree, and XenTari. The insect-attacking fungal pathogen *Beauveria bassiana* is commercially available for food crops as a product called Mycotrol ES.

Biological Control Methods. Biological control involves conserving and encouraging naturally occurring enemies, or releasing enemies that have been purchased from a commercial supplier. The best way to encourage the survival of natural enemies is to avoid exposing them to pesticides that are highly toxic to them. This can be done by refraining from applying broad-spectrum pesticides and instead choosing pesticides that are toxic to target pests but relatively nontoxic to predators. For example, *Bt* insecticides are toxic only to caterpillars and not to

any other types of insects. Some insecticides such as Guthion, Asana, Sevin, and Thiodan are toxic to a broad range of chewing and sucking pests. Other insecticides have a narrower range of activity, such as dimethoate and Metasystox-R, which are toxic primarily to sucking pests such as aphids. To attract and preserve a population of local beneficial insects, flowering plants such as dill and angelica can be grown and some weeds such as dandelions and wild carrot can be allowed to survive in the area. These flowering plants serve as nectar and pollen sources for natural enemies such as parasitoid wasps, lady beetles, hover flies, and minute pirate bugs.

If beneficial insects are not present, they can be purchased commercially from insectaries that mass-rear them (Table 1-1). The success of this approach depends on which type of predator is purchased. Lacewings sold as eggs or pre-fed larvae can be effective for controlling aphids and other soft-bodied pests. Lady beetles collected and shipped from distant states seem to be of lesser value for pest control than local populations, making their purchase uneconomical. Predatory mites can be used to control spider mites on strawberries. Few specific guidelines are available on release rates and timing.

Biological Control of Weeds. Weeds and weed seeds are attacked by many organisms in the agroecosystem. Juvenile and adult plants may be attacked by insects and mites and may become infected by disease organisms. Weed seeds are consumed by various insects and mammals, sometimes in large quantity. In rare instances, successful controls have been developed and marketed, or otherwise made available. However, biological controls will not maintain weed populations below densities that cause economic loss. This fact is a primary reason why berry growers rely extensively upon herbicides for weed control.

Chemical Control. If a pest population reaches a threshold level despite preventive measures and other types of controls, chemicals may be the last resort as a rescue treatment. Even chemicals are not a foolproof way of controlling pests. If the pest is too far along in its growth cycle or has built up a resistance to a pesticide, use of a chemical may do more harm than good. A full range of topics related to safe and effective use of pesticides is covered in Chapter 8 of this handbook.



Lady beetle adults



Minute pirate bug



Lady beetle larva



Hover fly larva



Lady beetle larva



Predatory ground beetle



Green lacewing larva



Predatory mite

Figure 1. Predatory insects common in Midwestern fruit crops.



A braconid wasp that parasitizes strawberry sap beetle.



A proctotrupid wasp that parasitizes strawberry sap beetle.



A cecidomyiid fly whose larvae are predators of the foliar form of grape phylloxera.



A chamaemyiid fly whose larvae are predators of the foliar form of grape phylloxera.

Figure 2. Parasitic insects.

Monitoring Pests and Making Control Decisions

Action Thresholds

Many crops can tolerate a certain amount of pest damage. Some pests cause economic damage only when they occur in large numbers (for example, spider mites and aphids), while others are considered serious even at very low levels (for example, strawberry clipper and plum curculio). A rescue treatment is not needed until the pest population reaches a critical density usually referred to as a threshold or an action threshold. A threshold is the density of pests that signals the need for control if economic damage is to be avoided. Thresholds for different pests may vary greatly and may be expressed as a number of pests per leaf or per plant, or as a percentage of leaves infested.

One goal in the development of IPM programs is to have an appropriate action threshold for each pest. For example, spider mite control on strawberries is suggested if the percentage of mite-infested leaflets is 25% or greater in a random sample of 60 leaflets. Grape berry moth control is suggested on grapes if the average percentage of infested clusters is 5% or greater in a sample of 100 clusters from the interior of a vineyard and a sample of 100 clusters from the edge of a vineyard. Tarnished plant bug control in brambles is suggested if there is at least 0.5 plant bug per cluster in a sample of 50 clusters. Precise thresholds have not yet been determined for many pests of small fruit crops in the Midwest.

Monitoring Overview

One basic principle of pest management is that you do not take action against a pest unless you are certain the pest is present and is a threat to your crop. Growers who practice IPM as part of their fruit production operation need to know how to monitor pests, because pest control decisions are based on knowledge of which pests are present in their plantings, how many of each are present, and when they are present, as well as how many are economically tolerable.

Two common types of pest monitoring methods are scouting and trapping. Scouting and trapping each have their merits. Scouting may be somewhat time

Table 1-1. Sources of Living Natural Enemies.

Beneficial Insectary

9664 Tanqueray Ct., Redding, CA 96003
1-530-226-6300 or 1-800-477-3715
Fax: 1-530-226-6310 or 1-888-472-0708
www.insectary.com
bi@insectary.com

IPM Laboratories, Inc.

Main Street, Locke, NY 13092-0300
1-315-497-2063
Fax: 1-315-497-3129
www.ipmlabs.com
ipmlabs@ipmlabs.com

Koppert Biological Systems, Inc.

28465 Beverly Road, Romulus, MI 48174
1-734-641-3763
Fax: 1-734-641-3793
www.koppert.com
info@koppert.nl

Rincon-Vitova Insectaries, Inc.

P. O. Box 1555, Ventura, CA 93002
1-800-248-2847
Fax: 1-805-643-6267
www.rinconvitova.com
bugnet2@rinconvitova.com

A directory, *Suppliers of Beneficial Organisms in North America* by Charles D. Hunter, is available on-line at:

<http://www.cdpr.ca.gov/docs/dprdocs/goodbug/benefic.htm> or from:

California Environmental Protection Agency
Department of Pesticide Regulation
Environmental Monitoring and Pest Management
Branch
1020 N Street, Room 161
Sacramento, CA 95814-5604
1-916-324-4100

consuming but can provide accurate information on the presence of the pest in its damaging life stage. Trapping is easily done, but because it is often done to monitor the adult stage of pests that cause damage in the larval stage, the results may not be directly applicable to making a control decision for the larval form. Both methods should be used, where appropriate, to provide information on which pest control decisions can be based. Another monitoring

method that is more predictive of when pests are likely to appear is based on weather monitoring. Development of several fungal diseases can be predicted by monitoring temperature, leaf wetness, and rainfall. Activity of some insects can be predicted by monitoring temperatures and calculating degree-days.

Scouting

Scouting means walking through the planting and looking for pests or symptoms of their presence. The purpose of scouting is to evaluate the effectiveness of preventive measures and the possible need for a rescue treatment. Scouting is done by examining a representative sample of each crop to determine the average infestation or infection level. Infestation may be expressed as presence or absence of pests on each sample, or as the number of pests on each sample, or as the percentage of plant parts damaged. The number of plants or plant parts to examine can vary according to the crop, size of the planting, and time of the year.

For some crops and pests, very specific scouting procedures have been developed so that a minimum number of leaves or fruit need to be examined in order to confidently make a decision about the need for applying a control measure. For other crops or pests, specific scouting procedures have not yet been worked out, but a general scouting plan can be followed, such as examining 25 whole plants per field. Under a general scouting plan, fruit plantings should be scouted on a regular basis, generally once per week. When examining plants, it is important to look at them closely in order to see small egg masses or small larvae that may be present before damage is evident. In a general scouting plan, all parts of the plant should be examined, even if they are not parts that will be harvested. Pests may be found on the underside of leaves, on top of leaves, on stems, in stems, in buds, on or in developing fruit, or in the crown. A prerequisite to scouting is knowing how to recognize the pests that can attack the crop.

Insect Trapping

Traps that have the ability to catch insects are useful in some cases as a mechanical control method and in other cases as monitoring tools. Insect traps are a good method of determining if an insect species

is present, and they can also give an estimate of the insect's concentration and distribution. Insects can be attracted to traps by visual appearance or by odor. Visual traps use light, color, and/or shape to attract certain insects. Odor traps attract certain insects by using scents associated with food or mates. Another form of trap more often used in gardens than on commercial farms is a shelter trap, such as shingles or boards placed on the ground to attract pests such as slugs, which can then be collected and killed mechanically. Some commercial suppliers of traps are shown in Table 1-2.

Table 1-2. Sources of Traps and Pest Management Supplies.

Great Lakes IPM

(for traps, lures, and other monitoring supplies)
10220 Church Street NE, Vestaburg, MI 48891
1-989-268-5693 or 268-5911
Fax: 1-989-268-5311
www.greatlakesipm.com
glipm@nethawk.com

Gempler's, Inc.

(for traps, lures, and other monitoring supplies)
P.O. Box 270, Belleville, WI 53508
1-800-332-6744 or 1-800-382-8473
Fax: 1-800-551-1128
www.gemplers.com

Forestry Suppliers, Inc.

(for magnifiers, Optivisors, tally counters, sweep nets, aspirators, waterproof notebooks, stake flags, etc.)
P. O. Box 8397, Jackson, MI 39284-8397
1-800-647-5368
Fax: 1-800-543-4203
www.forestry-suppliers.com

BioQuip Products, Inc.

(for beating sheets, vials, sweep nets, magnifiers, etc.)
2321 Gladwick St., Rancho Dominguez, CA 90220
1-310-324-0620
Fax: 1-310-324-7931
www.bioquip.com
bioquip@aol.com

Food Attractant Traps

Traps based on the scent of a food source are now commercially available for rose chafer and Japanese beetle. Although these are most often used as mechanical control devices, they can also be used for monitoring purposes. A well-known bag trap for Japanese beetles uses a food attractant scent to lure both male and female beetles into the trap. This trap is so effective at attracting beetles that it can actually increase the number of beetles in the vicinity of the trap. Despite the sometimes bad reputation the Japanese beetle trap has earned because of its super-attractiveness, the trap still can be effectively used if it is placed at some distance away from the fruit planting to be protected.

Colored Sticky Traps

The adult form of blueberry maggot is a true fruit fly that is attracted to yellow and to the scent of ammonium. Traps commercially available for monitoring blueberry maggot flies are yellow cardboard or plastic cards coated with a sticky material, which come with an ammonium bait included in the sticky material. The bait is effective for about one week. Small capsules of ammonium bait can also be purchased separately to prolong the attractive life of a trap. Another example is white sticky traps that are sold for monitoring the tarnished plant bug. An alternative to sticky traps is colored bowls filled with soapy water.

Pheromone Traps

The most common type of trap used for monitoring certain pests in recent years is the pheromone trap. Pheromones are natural scents produced by insects for purposes such as attracting mates. The main advantage of pheromones is that they are specific to individual pest species; for example, the pheromone for grape berry moth attracts only grape berry moth and not the redbanded leafroller or other related moths. Man-made imitations of pheromones are commercially available as lures that can be placed in traps. Most commercial pheromones are imitations of secretions from unfertilized adult female insects, which are used to attract male insects of the same species. Most commercial pheromones are used to monitor various species of moths. Some of the fruit pests that can be monitored with pheromone traps are the grape berry moth, red-banded leafroller, grape

root borer, cherry fruitworm, cranberry fruitworm, Sparganothis fruitworm, variegated cutworm, and black cutworm.

Traps used with pheromone lures come in a variety of styles and materials; one of the most common types is called a wing trap (Figure 3). A wing trap is made of a plastic or cardboard top and a sticky cardboard bottom held together by a wire hanger; the pheromone lure can be placed in the middle of the sticky bottom or glued to the trap top. Another style is a bucket trap such as a Unitrap or Multi-Pher trap. Bucket traps have a funnel entry system for keeping the pest from escaping and do not require a sticky coating; the lure is placed near the top of the funnel. The traps can be hung from a vine or be mounted on fence posts. In either sticky wing traps or bucket traps, the pheromone lures need to be replaced periodically, usually every four weeks or as recommended by the manufacturer. Although it is convenient to buy traps ready-made, homemade traps can also be used, with materials such as cardboard milk cartons as a base and Tanglefoot as an adhesive; Tanglefoot is a sticky material available at many garden supply shops.

While it is the larval stage that often causes the damage, traps catch many pests when they are in

the moth (adult) stage of their life cycle because only adult males are attracted by the odor of the pheromone. The moths lay eggs that develop into larvae that feed on crops. To complete their life cycle, the larvae pupate, then change to moths that in turn lay more eggs, thus producing more larvae. By knowing when the moth stage of a pest is present by using traps, the grower can be on the lookout for damaging larvae that are likely to follow. The appearance of the first moth can also be used as a starting point for calculating the number of degree days before the emergence of the larvae, if such information is available for a specific pest. This information can help the grower determine the best time to spray for insect control. Some of the insects that follow this pattern of development in apples are the codling moth and San Jose scale; initial catches of either of these in their respective traps determine the timing and/or need for insecticide treatments against these pests. Similar management guidelines may be developed in the future for pests of small fruit crops.

Insect Pheromone Trapping Guidelines

- Use a minimum of two traps for each pest species in representative locations.
- Examine traps at least twice per week.

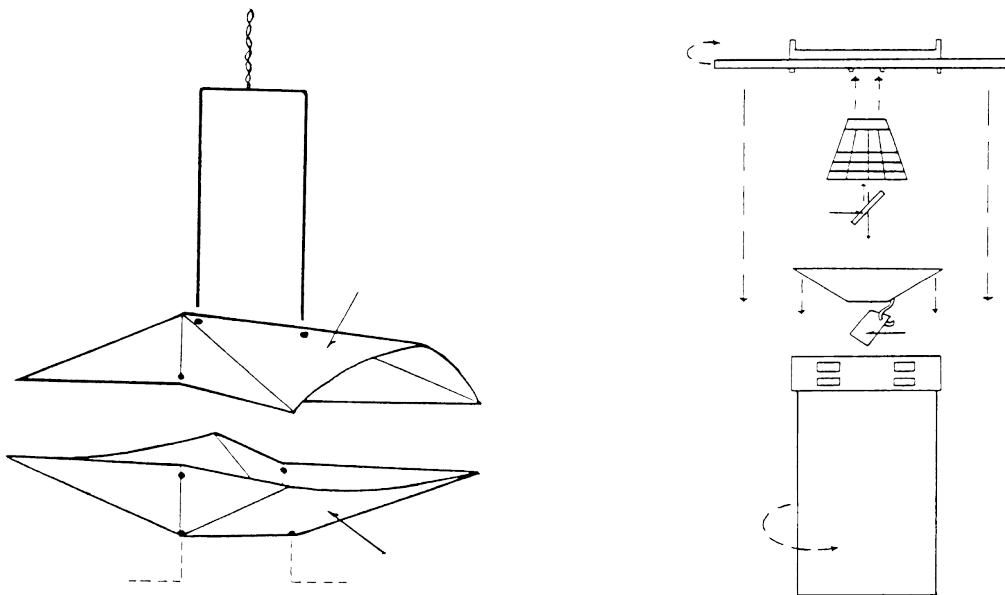

Figure 3. Two Common Types of Insect Traps Using Pheromone Lures — the Wing Style Trap (left) and the Bucket Style Trap.

- Count and record the number of captured insects in each trap. Remove the captured insects during each visit with a wire or a twig, wipe them on a rag or paper towel, and dispose of them away from the field.
- Record trap catches on each date in an IPM scouting log. It can help to keep a running graph of the information.
- Change sticky panels (the bottom half of wing traps) regularly to maintain trap effectiveness; replace the panel each month or when covered with debris. Replace the complete trap if it is drooping or broken.
- Change pheromone lures (baits) every four weeks or according to the manufacturer's directions. DO NOT dispose of used pheromone lures in the fruit planting; these would compete with traps and cause lower trap catch numbers. It is useful to establish a pattern when changing lures, such as the first week of every month.
- Store replacement lures in a freezer or refrigerator. It is best to purchase only a one-year supply at a time, but lures can be stored from one season to the next in the freezer. On each package, write the date the lures were purchased and placed in the freezer so that you can use the oldest ones first.

If you are trapping for more than one species:

- Change gloves or wash your hands when handling pheromones for different species of insects to prevent cross contamination. Minute traces of one pheromone on another can render the second repellent completely ineffective to its target pest.
- Be sure to label each trap with the target pest name and be sure to place the correct pheromone lure into the correct trap.

Weather Monitoring

The optimum weather conditions for development of some diseases can be monitored to determine the optimal time to control the insect, disease, or weed with pesticides. Temperature, leaf wetness, rainfall, and other weather factors can be measured either manually or by a computer. Weather data obtained then can be plugged into equations or computer programs for disease development to determine management actions. An example is management of powdery mildew on grapes, for which a computer forecasting program is available.

Insect Development and Degree Days

While scouting and trapping can give information about which pests are present at a given time, another monitoring tool of a more predictive nature is temperature-based development models. Temperature plays a major role in determining the rate at which insects develop. Each insect has a temperature range at which it is the most comfortable. Below that temperature range the insect will not develop, and above that temperature range development will slow drastically or stop. Each insect also has an optimum temperature at which it will develop at its fastest rate. By using this relationship, you can make predictions on the rate of development of insects. By being able to predict when an insect will appear, you can estimate when your crop is most likely to be damaged and when to intervene to prevent damage from occurring.

A method of estimating development time is called the degree-day method. The degree-day method can be used to predict when insects and weeds will reach a particular stage of their life cycle if you know three things — the threshold temperature, the average daily temperature, and a thermal constant. Each insect species has a threshold temperature. Below this temperature no development of the insect occurs. The threshold temperature is 50°F for many insect species and 43°F for other species. A degree day is the number of degrees above the threshold temperature over a one-day (24-hour) period. For example, if the threshold temperature of an insect is 50°F and the average temperature for the day is 70°F, then 20 degree days would have accumulated on this day ($70 - 50 = 20$).

The accumulation of degree days can be used to predict when insects will hatch, pupate, and emerge as adults. By using accumulated degree days, a farmer can estimate when a pest should appear in his crop, then scout for the pest and determine if treatment is needed. However, for degree days to be used to make these predictions, researchers must have determined the number of degree days necessary for the event to occur. That is called the thermal constant. The thermal constant, just like the threshold temperature, will be different for different insects and for different events in the life cycle.

The easiest way to calculate degree days for a date is to subtract the threshold temperature from the average daily temperature. The average daily temperature can be determined by simply averaging the high temperature and low temperature for the date: $(\text{maximum temp} + \text{minimum temp}) \div 2$. For example, if the high temperature for the day was 90°F and the low was 60°F, then the average temperature for the day would be $(90 + 60) \div 2 = 150 \div 2 = 75$. If the threshold temperature for an insect were 50°F, the degree days accumulated on this day would be 25 because $75 - 50 = 25$.

Temperature extremes add variables to this simple method of calculating degree days. To overcome these and to more accurately predict when insects will be present, follow these rules:

1. If the maximum temperature for a 24-hour period is not greater than the threshold temperature, no degree days are accumulated. For example:
 maximum daytime temperature = 45°F
 threshold temperature = 50°F
2. If the high temperature for the day is greater than the threshold temperature but the low temperature for the day is less than the threshold temperature, then when calculating the average temperature for the day, the threshold temperature is used as the low temperature for that day. For example:
 maximum daytime temperature = 65°F
 low daytime temperature = 45°F
 threshold temperature = 50°F
 The threshold temperature of 50°F would be used as the low daytime temperature

when calculating the average daily temperature.

3. If the high temperature for the day is greater than the optimum temperature, the temperature at which the insect will develop at the fastest rate, then you use the optimum temperature as the high temperature for the day when calculating the average temperature for the day. For example:
 maximum daytime temperature = 98°F
 optimum temperature = 95°F
 The optimum temperature of 95°F would be used as the high temperature for the day when calculating the average temperature for that day.

Weed Development and Degree Days

For those interested in applying degree-day forecasting to weed management, an easy-to-use computer program is available free on the Internet at <http://www.mrsars.usda.gov/morris/products/weedcast/weed2.htm>. By entering the local air temperatures and rainfall data, growers can use this software to predict current percentage germination of 20 different species that are common to farm fields in the Midwest. In berry crops, maximum effectiveness of most pre-emergence herbicides will be achieved by application close to the time of initial emergence or during the very early seedling stage (cotyledon stage). Generally, berry growers should target herbicide applications to this stage (pre-emergence to early seedling) for the most difficult-to-control species in their field. Other more sensitive weeds will also be well controlled with this timing.

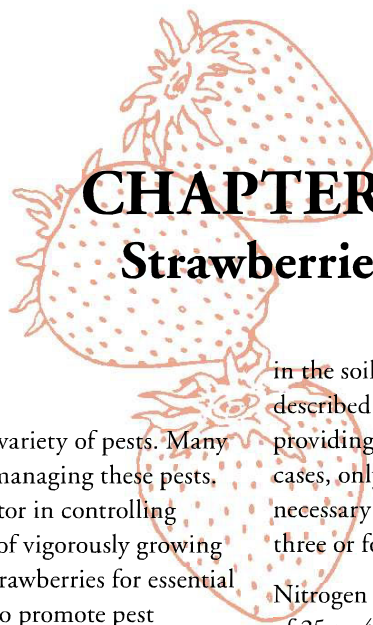

CHAPTER 2

Strawberries

General

Strawberries are attacked by a variety of pests. Many cultural practices can help in managing these pests. The single most important factor in controlling pathogens is the maintenance of vigorously growing plants. Weeds compete with strawberries for essential water and nutrients. Weeds also promote pest injury by acting as alternate homes for pathogens and insects, by inhibiting spray penetration, and by maintaining a high humidity in the canopy.

Good soil and air drainage are essential. Roots quickly rot in waterlogged soils, and fruit rots are more prevalent when the soil surface does not dry quickly. Well-drained loams are the most suitable soil types for good root penetration. Sites where cold air can drain away to lower levels will decrease the possibility of frost damage to the plants and fruits. A southern, sloping site is the ideal location, providing quick-drying soil and earlier maturing berries.

For good root penetration, aeration, and drainage, organic materials should be added to the soil. Disk farm manures and/or green manure crops (cover crops) thoroughly into the soil before planting. (Poultry manure is least desirable, as it tends to promote too much vegetative growth and soft berries; both conditions encourage disease.) Have the soil pH determined at your Extension office and apply the necessary lime to adjust the pH in the range of 5.8 to 6.5 (see Table 9-1 on page 222). The calcium level should be above 1,000 pounds per acre. Some soils that are low in magnesium may benefit from the use of dolomitic (Hi-Mag) lime or magnesium sulfate (Epsom salts).

In new plantings, a soil test should be taken to determine the rate and type of fertilizer that should be applied. Fertilizer, such as phosphorus and potassium, should be applied in a broad band and incorporated before planting.

Minor elements, boron and zinc, can be blended or mixed with phosphorus and/or potassium and incorporated into the soil. Correcting the elements

in the soil by applying the recommended amounts as described by a soil test is the most efficient means of providing optimal nutrition to the planting. In most cases, only annual applications of nitrogen may be necessary for strawberries, which are managed for three or four harvest seasons.

Nitrogen should be applied at the broadcast rate of 25 to 40 pounds of actual nitrogen (N) within seven days after transplanting. Apply lower rates to silt loam soils with organic matter of 2% to 4% and higher amounts to sandy loam soils with low organic matter. In mid-August to early September, broadcast 25 to 40 pounds of actual nitrogen to aid flower bud formation in the transplanting year. Use similar amounts at renovation and in mid-August during the bearing years. Reduce the nitrogen to one half or less when leaf test results are excessive or when applying nitrogen as a side dress or applying nitrogen in sprinkler or microirrigation systems.

Heavy nitrogen fertilizer applications should be avoided in the spring on established beds; too much nitrogen will promote abundant vegetative growth that encourages disease by inhibiting good air circulation needed to dry plant surfaces. The longer moisture films remain on fruit and leaves from irrigation, rain, dew, or high humidity, the greater the chance of fungal spores germinating and disease outbreaks occurring. Berries also may become soft as a result of too much nitrogen which can reduce yields and storage life. Light applications of fertilizer may be made in the spring (8 to 12 lbs of actual N per acre) to promote early plant growth and fruit development on sandy soils. One or two foliar sprays of nitrogen may be more beneficial than soil-applied fertilizer.

Leaf-tissue analysis is a good way to determine nutrient levels actually in the plant. Sometimes the nutrients in the soil are not available to the plant due to pH, organic matter content, or some other reason. Leaf-tissue analysis tells you what elements the plant is getting and what the plant is lacking. The samples are taken after renovation from the



first fully expanded new leaves. At least 50 complete leaves per planting should be collected, rinsed, and allowed to dry completely before processing. Contact your regional or state fruit specialists for the exact procedure, processing instructions, and fees. Standards are available for comparison to determine if your results indicate the need for corrective measures.

Strawberries are a cool weather crop, producing most of their growth in the spring and fall. Growth is greatly slowed during the hot, dry summer months, resulting in a shallow root system. During the growing season (April, May, August, September, and October), applying 1-1/2 in. of water every seven to 10 days will aid in growth and fruit bud development. During fruiting, adequate moisture (1/2 to 3/4 in. of water every two to three days) will maintain fruit size and production.

Irrigation also can eliminate losses due to freezing temperatures during the early bloom periods. If sprinklers are turned on before the temperature at ground level drops to 32°F and continued until air temperature is above freezing and all ice has melted off the plants, the blossoms will be protected. Remember, the first blossoms to open will bear the largest berries. The sensitive, actively growing tissue in the crown needs to be protected from freezing injury that would make it more susceptible to pathogen attack. When temperatures drop too low or wind speed increases, the irrigation system may not be able to give maximum protection.

Integrated Management of Strawberry Diseases

The objective of an integrated disease-management program is to provide a commercially acceptable level of disease control on a consistent (year-to-year) basis. This is accomplished by developing a program that integrates all available control methods into one program. An effective disease-management program for strawberries must emphasize the integrated use of specific cultural practices, knowledge of the pathogen and disease biology, disease-resistant cultivars, and timely applications of approved fungicides or biological control agents, when needed. In order to reduce the use of fungicides to an absolute minimum, the use of disease-resistant cultivars and various

cultural practices must be strongly emphasized. Many strawberry cultivars adapted to the Midwest have good resistance to a number of important diseases. (See Table 2-1 on page 27.) This is generally not the case with other small fruit crops.

Identifying and Understanding the Major Strawberry Diseases

It is important for growers to be able to recognize the major strawberry diseases. Proper disease identification is critical to making the correct disease management decisions. In addition, growers should develop a basic understanding of pathogen biology and disease cycles for the major strawberry diseases. The more you know about the disease, the better equipped you will be to make sound and effective management decisions. Color photographs of disease symptoms on strawberries, as well as information on pathogen biology and disease development, can be found in the following literature:

Strawberry Production Guide — This is a very comprehensive book covering most phases of strawberry production. It can be purchased from the Northeast Regional Agricultural Engineering Service, 152 Riley-Robb Hall, Cooperative Extension, Ithaca, NY 14853. Phone: 607-255-7654.

Compendium of Strawberry Diseases — Published by the American Phytopathological Society, 3340 Pilot Knob Rd., St. Paul, Minnesota 55121. Phone: 612-454-7250, 1-800-328-7560. This is the most comprehensive book on strawberry diseases available. All commercial growers should have a copy.

A description of symptoms, causal organisms, and control of the most common strawberry diseases in the Midwest is presented here.

Foliar Diseases

There are three major leaf diseases of strawberries in the Midwest. They are leaf spot, leaf scorch, and leaf blight (Figure 4). All three diseases can occur singly or together on the same plant or even on the same leaf. All three are caused by fungi. Under favorable environmental conditions, these three diseases can cause serious reductions in strawberry yields. They damage the strawberry plant by causing premature leaf death, reduction in fruit quality, a general



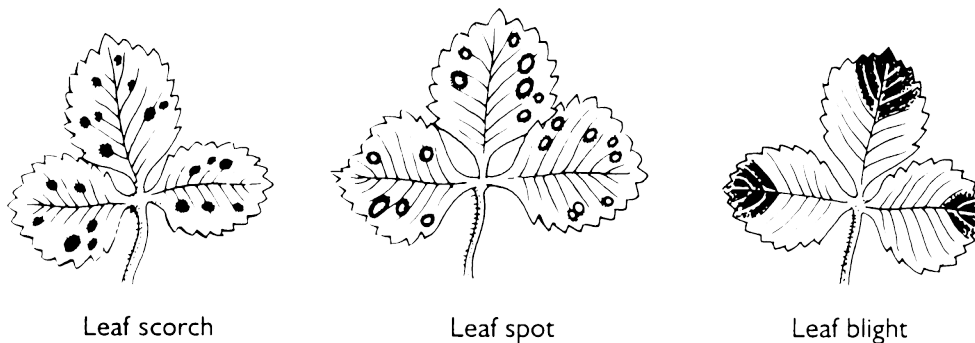

Figure 4. Typical symptoms of leaf scorch, leaf spot, and leaf blight on strawberry leaves.

weakening of the plant, and (in some situations) plant death. In order to maximize strawberry production, these leaf diseases must be recognized and controlled. Fortunately, several cultivars have good resistance to leaf spot and leaf scorch.

Leaf spot and leaf scorch usually appear first in early to mid-spring. Leaf blight is more common during the summer and early fall.

Leaf Spot

Symptoms

Leaf spot is caused by the fungus *Mycosphaerella fragariae*. The leaf spot fungus can infect leaves, fruit, petioles, runners, fruit stalks, and berry caps or calyxes. The most obvious symptoms of the disease are small round spots. These spots develop on the upper surface of the leaf and at first are dark purple to reddish-purple (Figure 5). They range in size from 1/8 to 1/4 inch in diameter. With time, the centers of the spots become tan or gray and eventually almost white, while their margins remain dark purple. Later in the season, tan or bluish areas form on the underleaf surface. Symptoms on other plant parts, except fruit, are almost identical to those on the upper leaf surface. On fruits, superficial black spots may form during moist weather (Figure 6). The spots form on ripe berries and around groups of seeds. They are about 1/4 inch in diameter, and usually there are only one or two spots per fruit. However, some fruits may be more severely infected.

Disease Development

This fungus can produce two types of spores that infect newly-emerging leaves in spring. First, older infected leaves that remain alive during winter may

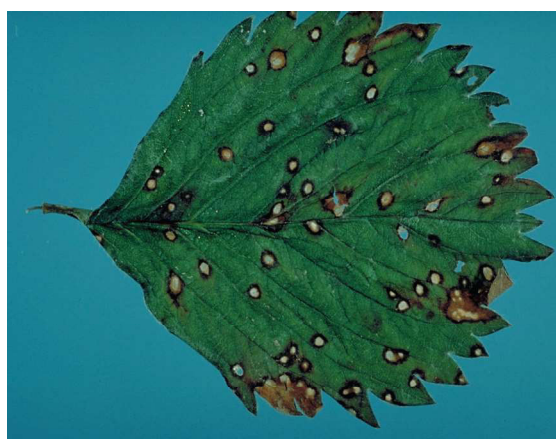

Figure 5. Strawberry leaf spot symptoms on leaflet.



Figure 6. Black seed disease on strawberry fruit. This disease is caused by the same fungus that causes strawberry leaf spot.

give rise to conidia (spores) that are spread to new foliage by splashing water or by handling infected plants. Another type of spore (ascospore) is produced in speck-sized black perithecia, which form at the edges of the leaf spots during autumn. In the spring,



these ascospores are forcibly ejected from perithecia and are carried by wind or water to new leaf tissue.

Infection by both types of spores occurs through the underleaf surface. Temperatures between 65°F and 75°F are optimum for infection and disease development. Infections may occur throughout the growing season, except during hot, dry weather. Young expanding leaves are the most susceptible to infection.

Leaf Scorch

Symptoms

Leaf scorch is caused by the fungus *Diplocarpon earliana*. The leaf scorch fungus can infect leaves, petioles, runners, fruit stalks, and caps of strawberry plants. Leaf scorch symptoms are very similar to the early stages of leaf spot. Round to angular or irregular dark-purple spots up to 1/4 inch in diameter are scattered over the upper leaf surface (Figure 7). As spots enlarge, they resemble small drops of tar. This tar-like appearance is caused by the formation of large numbers of minute, black, fungal fruiting bodies (acervuli). The centers of the spots remain dark purple. This distinguishes the disease from leaf spot where the center turns white. If many infections occur on the same leaf, the entire leaf becomes reddish or light purple. Severely infected leaves dry up and appear scorched. Similar, but elongated, spots may appear on other affected plant parts. Lesions may girdle fruit stalks, causing flowers and young fruit to die. Infections on green berries are rare, appearing as red-to-brown discolorations or a flecking on the fruit surface. The leaf scorch fungus can infect strawberry leaves at all stages of development.

Disease Development

The fungus overwinters on infected leaves that survive the winter. In the spring, conidia are produced on both leaf surfaces in speck-sized, black acervuli. The fungus also produces ascospores in the early spring within disk-shaped apothecia (fungal fruiting structures) that appear as black dots in old lesions on the lower surface of diseased leaves that died during winter. In the presence of moisture, ascospores germinate within 24 hours and infect the plant through the lower leaf surface. After symptom development, conidia are produced on the leaf spots

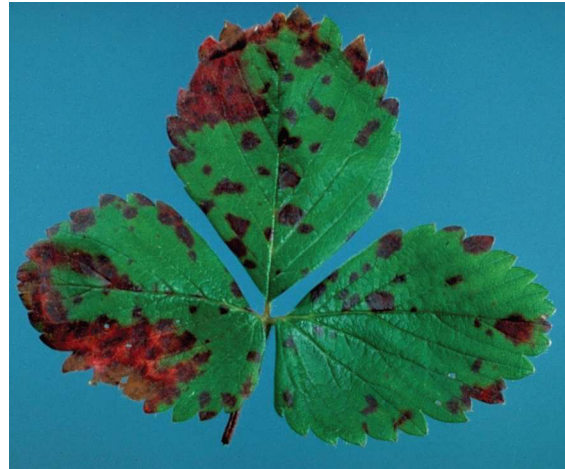

Figure 7. Leaf scorch on strawberry. First symptoms are individual red spots.

in large numbers throughout the growing season. Therefore, repeated infections occur whenever weather conditions are favorable. Conidia are spread mainly by splashing water.

Leaf Blight (Phomopsis Leaf Blight)

Symptoms

Leaf blight is caused by the fungus *Phomopsis obscurans*. Leaf blight is found most commonly on plants after harvest. The disease is distinctively different from both leaf spot and leaf scorch. The enlarging leaf spots of this disease are round to elliptical or angular and a quarter of an inch to an inch in diameter (Figure 8). Spots are initially reddish-purple. Later, they develop a darker brown

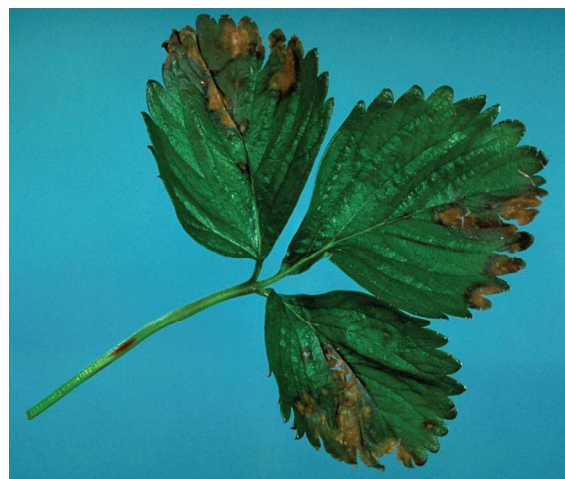

Figure 8. *Phomopsis* leaf blight on strawberry.



or reddish-brown center surrounded by a light-brown area with a purple border. Similar spots may sometimes develop on the fruit caps. Usually, only one to six lesions develop on a leaflet. Often the infected area becomes V-shaped with the widest part of the V at the leaf margin. New lesions appear throughout the summer and fall if weather conditions are favorable. Older leaves become blighted and may die in large numbers. This disease is usually more destructive on slow growing or weak plants. The same fungus can cause an enlarging, soft, pale-pink rot at the stem end of the fruit. Information on resistance to leaf blight in currently used cultivars is limited. If growers encounter a high level of disease on certain cultivars, these cultivars should be avoided.

Disease Development

This fungus produces spores (conidia) in speck-sized black pycnidia (fungal fruiting bodies) embedded in the centers of older leaf lesions. Conidia ooze out of pycnidia during damp weather when temperatures are high. Conidia are splashed to new leaf tissue where they germinate in the presence of free water to initiate new infections on leaves and fruit. The fungus overwinters on either infected leaves that survive the winter or in dead tissue on old infected leaves.

Powdery Mildew

Powdery mildew is caused by the fungus *Sphaerotheca macularis*. Generally, the disease is not a serious problem in the Midwest; however, under the proper environmental conditions and on highly susceptible cultivars, the disease can become serious. Disease resistance is available in several cultivars. Growers who wish to reduce fungicide use are encouraged to avoid highly susceptible cultivars.

Symptoms

Foliage symptoms usually are the most obvious. An upward curling of leaf edges usually is the first symptom seen. Dry, purplish or brownish patches develop on the lower surface of infected leaves, and reddish discoloration may develop on the upper surface (Figure 9). Patches of white, powdery fungus mycelium may appear on the undersides of leaves as the disease progresses (Figure 10).



Figure 9. Reddish-purple discoloration of leaf often associated with powdery mildew infection.



Figure 10. Patches of white fungus growth on strawberry infected with powdery mildew.

Disease Development

The fungus that causes strawberry powdery mildew infects only wild and cultivated strawberries. This pathogen cannot survive in the absence of living host tissue. It apparently overwinters in infected leaves. Spores are carried by wind to infect new growth in the spring. Development and spread of powdery mildew is favored by moderate to high humidity and temperatures of about 60°F to 80°F (15°C to 27°C). Unlike most other fungi that cause plant disease, powdery mildew does not require free water for spores to germinate and infect. In dry years, when most other diseases are not a problem, powdery mildew can be very serious.

Angular Leaf Spot (Bacterial Blight)

Angular leaf spot or bacterial blight of strawberries is caused by the bacterium *Xanthomonas fragariae*. In the Midwest, it is the only reported strawberry disease that is caused by a bacterium. The disease was first reported in Minnesota in 1960 and has



since been found in other regions of the United States. It appears to be spreading rapidly to many strawberry-growing areas of the world with the importation of planting material. Although the disease has not been a major problem in the Midwest, it can become serious and does represent a potential threat to production. Copper fungicides have been recommended for control of bacterial blight with varying degrees of success when applied in a protectant program. Once the disease is established in the planting, there is little or nothing that can be done to control it. Hot, dry weather is the best cure for the disease. Cultivars differ in their susceptibility to the disease. None are completely resistant, but Cavendish, Annapolis, Allstar, Honeoye, and Kent are all highly susceptible.

Symptoms

Typical symptoms of angular leaf spot appear initially as minute water-soaked lesions on the lower leaf surface (Figure 11). These lesions enlarge to become angular spots, usually delineated by small veins. An important distinguishing characteristic of this disease is that lesions are translucent when viewed with transmitted light, but dark green when viewed with reflected light (Figure 12).

Under moist conditions, lesions often have a viscous bacterial exudate on the lower leaf surface. When it dries, the exudate forms a whitish, scaly film. This exudate or film is an additional characteristic that is useful in the identification of angular leaf spot.

Lesions may coalesce to cover large portions of the leaf. Eventually, lesions become visible on the upper leaf surface as irregular, reddish-brown spots, which are necrotic and opaque to transmitted light. A chlorotic halo may surround the lesion. At this stage, symptoms may be difficult to distinguish from those of common leaf spot and leaf scorch.

Heavily infected leaves may die, especially if major veins are infected. Occasionally, under natural conditions, infection follows the major veins, resulting in veinal water-soaking that may or may not spread to the interveinal regions.

Infection by *X. fragariae* may become systemic. The pathogen can infect all plant parts except fruits and roots and, in some cases, even the fruits have been infected, apparently only in the tissue adjacent to



Figure 11. Angular leaf spot (bacterial blight) symptoms on lower leaf surface. Note the water-soaked spots.



Figure 12. Angular leaf spot (bacterial blight) symptoms on upper leaf surface. Note the translucent yellow spots.

an infected calyx (fruit cap). Calyx infection can be serious. Infected tissues turn black resulting in unattractive fruit (Figure 13).

Disease Development

Inoculum for the primary infection of new growth in the spring comes from infected dead leaves where the pathogen overwintered. *X. fragariae* may survive for extended periods in dry leaves or in infected leaves buried in the soil. Spread is primarily from infected leaf debris or infected crowns.

Bacteria that exude from lesions under high-moisture conditions may provide secondary inoculum. Bacteria may be disseminated to uninfected plants or leaves by splashing water, such as rain or overhead irrigation. *X. fragariae* gains entrance into host tissue either





Figure 13. Angular leaf spot (bacterial blight) symptoms on strawberry calyx. Note the brown discoloration and drying.

passively through wounds or actively as motile cells that swim into natural plant openings by means of drops of dew, gutation fluid, rain, or irrigation water.

Very little is known about the epidemiology of angular leaf spot. Development of the disease is favored by moderate to cool daytime temperatures around 68°F (20°C), low nighttime temperature (near or just below freezing), and high relative humidity. Long periods of precipitation, sprinkler irrigation to protect plants from freezing, or heavy dews in the spring also favor the disease. Young leaf tissue or leaves on healthy, vigorous plants are more likely to become infected than those on diseased or environmentally stressed plants.

Strawberry Root Diseases

Red Stele

Red stele is caused by the soil-borne fungus *Phytophthora fragariae*. Many commercial strawberry cultivars are susceptible to the red stele fungus; however, many cultivars have good resistance to several races of the red stele fungus (see Table 2-1 on page 27). The use of disease-resistant cultivars and selection of sites with good soil drainage are the key methods of control. This root-rot disease has become a serious problem facing strawberry production in the northern two-thirds of the United States. The disease is most destructive in heavy clay soils that are saturated with water during cool weather. Once it becomes established in the field, the red stele fungus can survive in soil up to 13 years. Normally, the disease is prevalent only in the lower or poorly drained areas of the planting; however, it

may become fairly well distributed over the entire field, especially during a cool, wet spring. The red stele fungus may become active at a soil temperature of 40°F. However, the optimum soil temperature for growth and disease development is between 55°F and 60°F. Under favorable conditions of high soil moisture and cool temperatures, plants will show typical disease symptoms within 10 days after infection.

Symptoms

When plants start wilting and dying in the more poorly drained portions of the strawberry field, the cause is very likely red stele disease (Figure 14). Infected plants are stunted, lose their shiny green luster, and produce few runners. Younger leaves often have a metallic bluish-green cast. Older leaves turn prematurely yellow or red. With the first hot, dry weather of early summer, diseased plants wilt rapidly and die. Diseased plants have very few new roots compared to healthy plants that have thick, bushy white roots with many secondary feeder roots (Figure 15). Infected strawberry roots usually appear gray, while the new roots of a healthy plant are yellowish-white.

The best way to identify the disease is to carefully dig up a wilted plant and peel off the outside portion of several roots. The inside or central portion of the root is known as the stele. If the stele is pink to brick red or brownish red, the plant has the red stele disease (Figure 16). The stele of normal plants is yellowish-white. The red color may show only near the dead tip of the root or it may extend the length of the root. The red stele is best seen in the spring up to the time of fruiting. No other disease of strawberry produces this symptom.



Figure 14. Plants dying from red stele root rot.





Figure 15. Root system from a red-stele-infected strawberry plant.



Figure 16. Longitudinal section of a healthy (left) and red-stele-infected (right) strawberry root.

Disease Development

The red stele fungus is introduced into new planting sites mainly through the distribution of infected plants. The fungus can be spread within a field or area by anything that carries or moves infested soil (implements, shoes, water, etc.). Once in the field, spores (oospores) of the fungus produce large numbers of smaller spores (zoospores). Zoospores are motile and swim about when soil moisture is high. Zoospores invade the tips of young fleshy roots. Once in the roots, the fungus grows and destroys the water- and food-conducting tissues, resulting in wilting and

plant death (Figure 17). As soil temperatures rise, the fungus forms large numbers of oospores in the stele of infected plants. These oospores survive periods of hot, dry, and freezing weather for several years in the soil.

Verticillium Wilt

Verticillium wilt, caused by the soil-borne fungus *Verticillium albo-atrum*, can be a major factor limiting production. When a plant is severely infected, the probability of it surviving to produce a crop is greatly reduced. The *Verticillium* fungus can infect nearly 300 different host plants, including many fruits, vegetables, trees, shrubs, and flowers as well as numerous weeds and some field crops. Once it becomes established in the field or garden, it may remain alive for 25 years or longer. Several cultivars have resistance to Verticillium wilt. The use of resistant cultivars and proper site selection and crop rotation to avoid infested soil are the key methods of control.

Cool, overcast weather interspersed with warm, bright days is most favorable for development of Verticillium wilt. Optimal conditions for infection and disease development occur when soil temperatures are 70°F to 75°F.

Many soils in the Midwest contain the Verticillium wilt fungus. The fungus can be introduced into uninfested soil on seeds, tools, farm machinery, and from the soil and roots of transplants.

Symptoms

The first symptoms of Verticillium wilt in new strawberry plantings often appear about the time runners begin to form. In older plantings, symptoms usually appear just before picking time. Symptoms on above-ground plant parts may differ with the susceptibility of the cultivar affected. In addition, above-ground symptoms are difficult to differentiate from those caused by other root-infecting fungi. Isolation from diseased tissue and culturing the fungus in the laboratory are necessary for positive disease identification.

On infected strawberry plants, the outer and older leaves drop, wilt, turn dry, and become reddish-yellow or dark brown at the margins and between veins (Figure 18). Few new leaves develop and those that do tend to be stunted and may wilt and curl



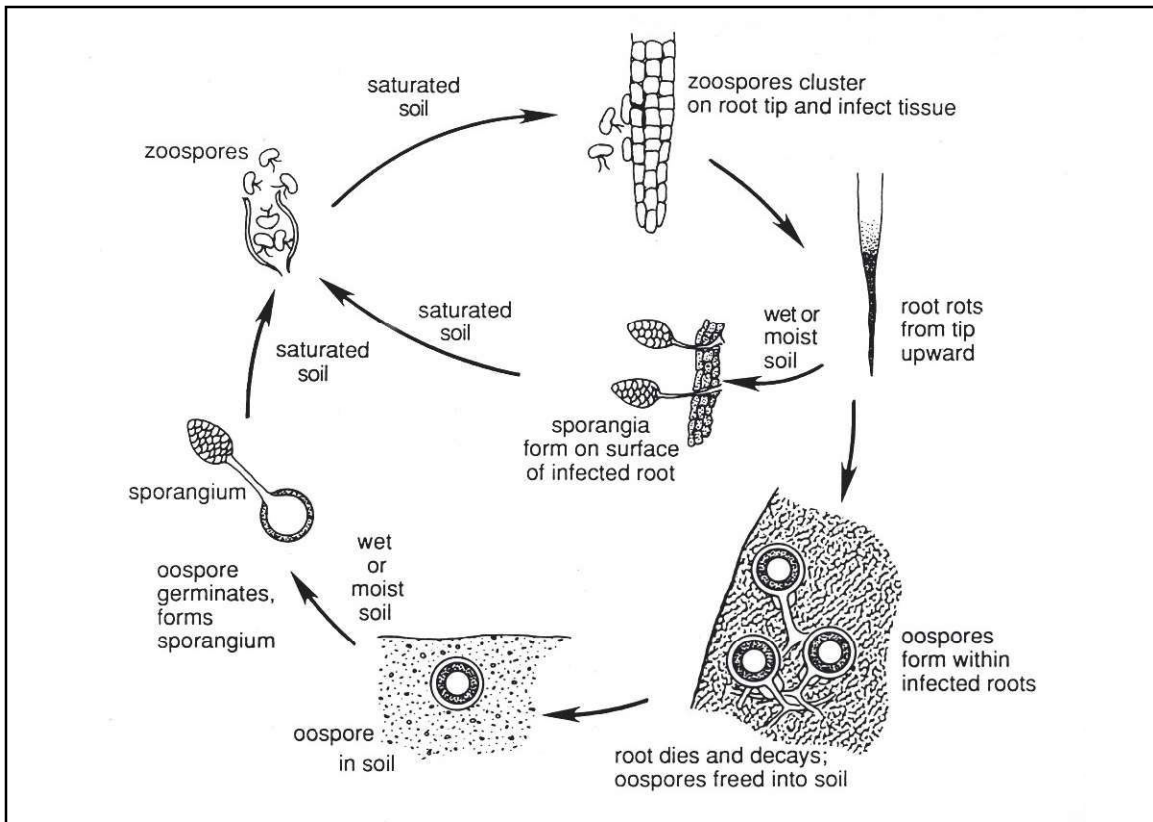

Figure 17. Disease cycle of Red Stele Root Rot on strawberry. We wish to thank the New York State Agricultural Experiment Station for use of this figure. Figure taken from the Small Fruit IPM Disease Identification Sheet No. 2.



Figure 18. Strawberry plant dying from *Verticillium* wilt. Note the outer leaves die first.

up along the midvein. Severely infected plants may appear stunted and flattened with small yellowish leaves. Brownish-to-bluish black streaks or blotches may appear on the runners or petioles. New roots that grow from the crown are often dwarfed with blackened tips. Brownish streaks may occur within the decaying crown and roots. If the disease is

serious, large numbers of plants may wilt and die rapidly (Figure 19). When the disease is not so serious, an occasional plant or several plants scattered over the entire planting may wilt and die.

Disease Development

The fungus overwinters in soil or plant debris as dormant mycelium or black speck-sized bodies (microsclerotia). These microsclerotia can remain viable in the soil for many years. Under favorable environmental conditions, they germinate and produce thread-like fungal structures (hyphae). Hyphae can penetrate root hairs directly or through breaks or wounds in the rootlets. Once inside the root, the fungus invades and destroys the water-conducting tissue. Destruction of water-conducting tissue results in reduced water uptake by the plant; thus, plants wilt and wither. As fungal colonies get older, they produce microsclerotia in infected host tissue, and the disease cycle is completed.





Figure 19. Strawberry field showing symptoms of *Verticillium wilt*.

Black Root Rot

Black root rot is the general name for several root disorders that produce similar symptoms. The disorders are not clearly understood and are generally referred to as a root-rot complex. Although the exact cause of the black root rot is not known, one or more of the following is thought to be responsible — soil fungi (such as *Rhizoctonia* and *Fusarium*); nematodes; winter injury; fertilizer burn; soil compaction; herbicide damage; drought; excess salt or water; or improper soil pH. Black root rot has been found in every strawberry-growing area of the United States. Injured plants may be scattered throughout the planting or localized in one or more areas (Figure 20). A considerable incidence of black root rot has been observed in recent years throughout the Midwest. Once the disease is established (shows up) in the planting, little or nothing can be done to control it.

To recognize black root rot symptoms, it is necessary to know what a normal root looks like. Newly developed main roots of a normal strawberry plant are pliable and almost white. After several months of growth, they generally become woody and are dark brown to black on the surface. When this dark surface is scraped away, a yellowish-white living core can be seen. Small feeder roots that branch out from the main roots should be white as long as they are active.

Roots affected by black root rot have one or more of the following symptoms: (1) the root system is much smaller than normal; (2) the main roots are spotted with dark patches or zones (Figure 21); (3) the feeder roots are lacking or are spotted with dark patches or zones; (4) all or part of the main root is dead



Figure 20. Strawberry field showing black root rot symptoms.



Figure 21. Strawberry root with black root rot symptoms. Note black discoloration (lesions) on the root.

(Figure 22). A cross-section of the dead root shows it blackened throughout. Plants with black root rot are less vigorous than normal plants and produce fewer runner plants. Severely affected plants usually die.





Figure 22. Strawberry root system with advanced stages of black root rot. Note the dead, black rat-tail roots.



Figure 23. Immature strawberry fruit with symptoms of *Botrytis* fruit rot (gray mold). Note the symptoms usually develop first on the calyx end of the fruit.

Strawberry Fruit Rots

Botrytis Fruit Rot (Gray Mold)

One of the most serious and common fruit rot diseases of strawberry is gray mold. Gray mold is caused by the fungus *Botrytis cinerea*. Under favorable environmental conditions for disease development, serious losses can occur. The gray mold fungus can infect petals, flower stalks (pedicels), fruit caps, and fruit. During wet springs, no other disease causes a greater threat to flowers and fruit. The disease is most severe during prolonged rainy and cloudy periods during bloom and harvest. Abundant gray-brown, fluffy, fungal growth on infected tissue is responsible for the disease's name of gray mold. Resistance is not available in most cultivars; therefore, fungicide application during bloom and the use of various cultural practices are key control methods.

Symptoms

Young blossoms are very susceptible to infection. One to several blossoms in a cluster may show blasting (browning and drying) that may spread down the pedicel. Fruit infections usually appear as soft, light brown, rapidly enlarging areas on the fruit (Figure 23). If it remains on the plant, the berry usually dries up, mummifies, and becomes covered with a gray, dusty powder (Figure 24). Fruit infection is most severe in well-protected, shaded areas of the plant where the humidity is higher and air movement is reduced. Berries resting on soil or touching another decayed berry or a dead leaf in dense foliage are most commonly affected. The disease may develop on young (green) fruits, but symptoms are more common as the fruits mature.



Figure 24. *Botrytis* fruit rot (gray mold) on a mature strawberry fruit.

Often, the disease is not detected until berry picking time. During harvest, the handling of infected fruit will spread the fungus to healthy berries. After picking, mature fruits are extremely susceptible to gray mold, especially if bruised or wounded. Under favorable conditions for disease development, healthy berries may become a rotted mass within 48 hours after picking.

Disease Development

The fungus is capable of infecting a great number of different plants. It overwinters as minute, black,



fungal bodies (sclerotia) and/or mycelium in plant debris, such as dead strawberry leaves in the row. In early spring, these fungal bodies produce large numbers of microscopic spores (conidia), which are spread by wind throughout the planting. They are deposited on blossoms and other plant parts where they germinate in a film of moisture. Infection occurs within a few hours (Figure 25).

Disease development is favored by wet conditions accompanied by temperatures between 41 and 86°F. Conditions that keep flowers and fruit wet, such as rain, dew, or sprinkler irrigation encourage Botrytis rot.

Strawberries are susceptible to Botrytis during bloom and again as fruits ripen. During the blossom blight phase of the disease, the fungus colonizes senescing flower parts, turning the blossoms brown. The fungus usually enters the fruit through flower parts, where it remains inactive (latent) within the tissues of infected green fruits. As the fruit matures, the fungus becomes active and rots the fruit. Thus, while infection actually occurs during bloom, symptoms

are usually not observed until harvest. This is important to remember when one considers the use of fungicides for control. Temperatures between 70°F and 80°F and moisture on the foliage from rain, dew, fog, or irrigation are ideal conditions for disease development.

Leather Rot

Leather rot is caused by the soil-borne fungus *Phytophthora cactorum*. Leather rot has been reported in many regions throughout the United States. In many areas, it is considered a minor disease of little economic importance. However, excessive rainfall during May, June, and July can lead to severe fruit losses and quality reduction. In 1981, many commercial growers in the Midwest lost up to 50% of their crop to leather rot. The leather rot fungus primarily attacks the fruit but may also infect blossoms. The key control methods are maintaining a good layer of straw mulch between fruit and the soil, and site selection or improvement for good water drainage (avoid saturated soil).

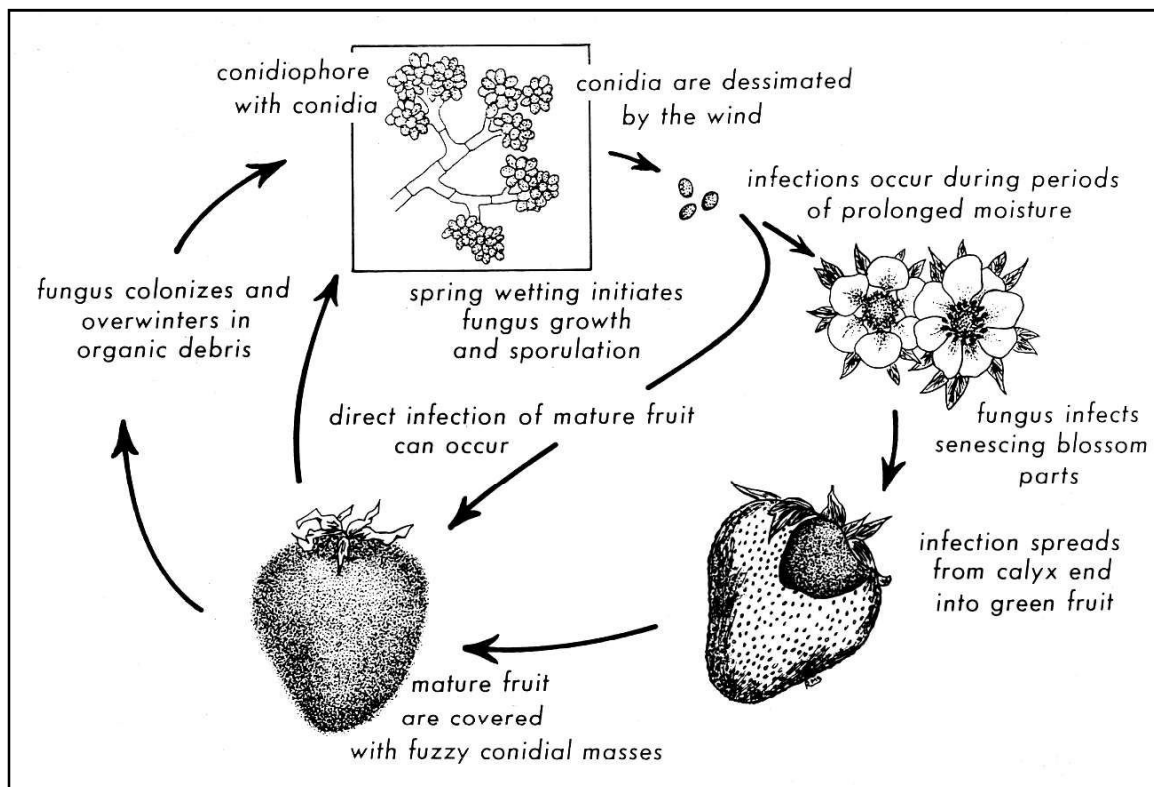

Figure 25. Disease cycle of gray mold on strawberry. We wish to thank the New York State Agricultural Experiment Station for use of this figure. Figure taken from the Small Fruit IPM Disease Identification Sheet No. 1.



Symptoms

The leather rot pathogen can infect berries at any stage of development. When the disease is serious, infection of green fruit is common. On green berries, diseased areas may be dark brown or natural green outlined by a brown margin (Figure 26). As the rot spreads, the entire berry becomes brown, maintains a rough texture, and is leathery in appearance. The disease is more difficult to detect on ripe fruit. On fully mature berries, symptoms may range from little color change to discoloration that is brown to dark purple (Figure 27). Generally, infected mature fruit are dull in color and are not shiny or glossy. Infected ripe fruit are usually softer to the touch than healthy fruit. When diseased berries are cut across, a marked darkening of the water-conducting system to each seed can be observed. In later stages of decay, mature fruits also become tough and leathery. Occasionally, a white moldy growth can be observed on the surface of infected fruit. In time, infected fruit dry up to form stiff, shriveled mummies.

Berries that are affected by leather rot have a distinctive and very unpleasant odor and taste. Even healthy tissue on a slightly rotted berry is bitter. This presents a special problem to growers in pick-your-own operations. An infected mature berry with little color change may appear normal and be picked and processed with healthy berries. Consumers have complained of bitter tasting jam or jelly made with berries from fields where leather rot was a problem. Leather rot is most commonly observed in poorly drained areas where there is or has been free-standing water or on berries in direct contact with the soil.

Disease Development

The fungus survives the winter as thick-walled resting spores, called oospores, that form within infected fruit as they mummify (Figure 28). These oospores can remain viable in soil for long periods of time. In the spring, oospores germinate in the presence of free water and produce a second type of spore called a sporangium. A third type of spore called a zoospore is produced inside the sporangium. Up to 50 zoospores may be produced inside one sporangium. The zoospores have tails and can swim in a film of water. In the presence of free water on the fruit surface, the zoospores germinate and infect the fruit. In later stages of disease development, sporangia are produced on the surface of infected fruit under moist conditions.



Figure 26. Leather rot symptoms on an immature strawberry fruit.



Figure 27. Leather rot symptoms on a mature strawberry fruit. Note the purplish discoloration.

The disease is spread by splashing or wind-blown water from rain or overhead irrigation. Sporangia and/or zoospores are carried in water from the surface of the infected fruit to healthy fruit where new infections occur. Under the proper environmental conditions, the disease can spread very quickly. A wet period (free water on fruit surface) of two hours is sufficient for infection. The optimum temperatures for infection are between 62 and 77°F. As the length of the wet period increases, the temperature range at which infection can occur becomes much broader. As infected fruit dry up and mummify, they fall to the ground and lie at or slightly below the soil surface. Oospores formed within the mummified fruit enable the fungus to survive the winter and cause new infections the following year, thus, completing the disease cycle.

Strawberry Anthracnose

Anthracnose is a disease that can affect foliage, runners, crowns, and fruit. Various forms of anthracnose can be caused by several fungi. In the



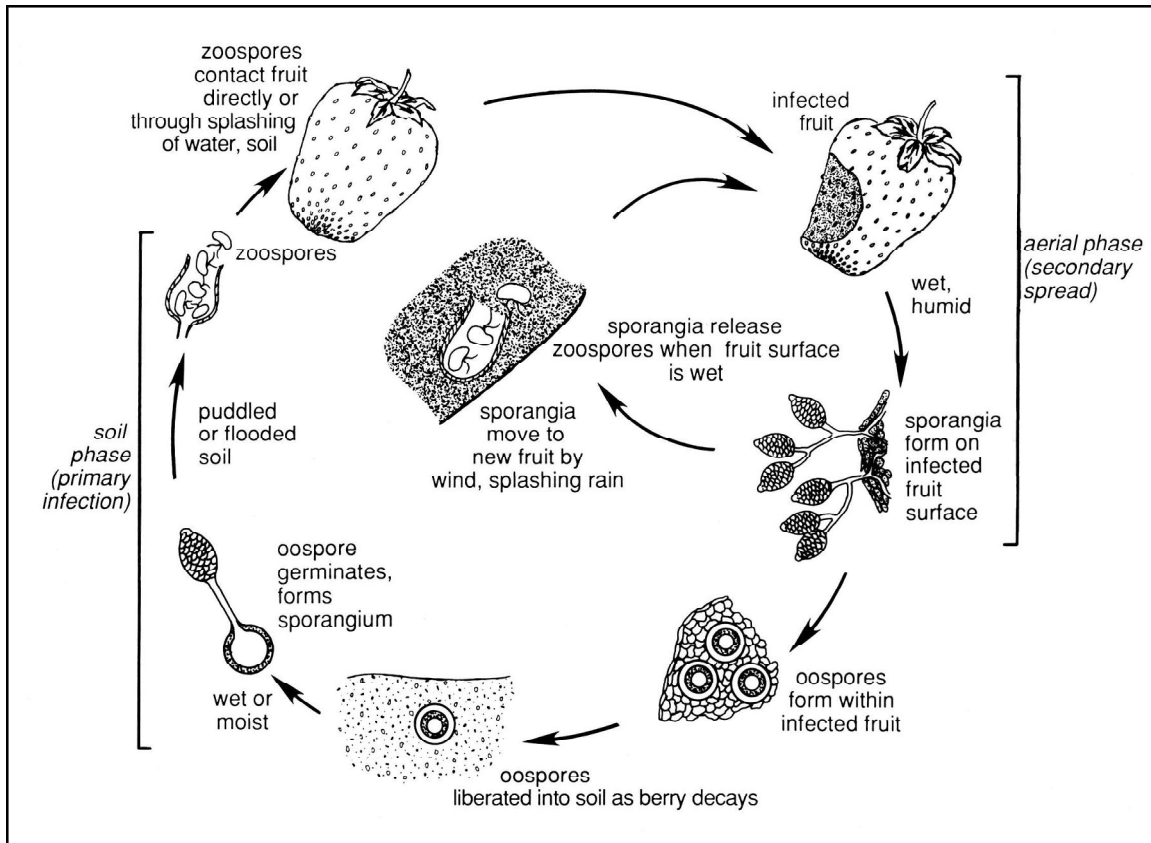

Figure 28. Disease cycle of strawberry leather rot. We wish to thank the New York State Agricultural Experiment Station for use of this figure. Figure taken from the Small Fruit Crop IPM Disease Identification Sheet No. 4.

Midwest, the most common form of the disease is fruit rot, caused by the fungus *Colletotrichum acutatum*. Although the disease is not very common, if it becomes established in the planting, serious losses can occur. Very few Midwest cultivars with resistance are available. Several new fungicides are effective for controlling anthracnose; however, once the disease develops on fruit in the planting, there is little that can be done to control it. Managing the movement of pickers into and out of infested areas and adjusting irrigation practices can be beneficial in preventing disease spread.

Symptoms

Affected stems are sometimes girdled by lesions, causing individual leaves or entire daughter plants to wilt. Under warm, humid conditions, salmon-colored masses of spores may form on anthracnose lesions.

When crown tissue is infected and becomes decayed, the entire plant may wilt and die. When infected crowns are sliced open, internal tissue is firm and

reddish brown. Crown tissue may be uniformly discolored or streaked with brown.

On fruit, symptoms first appear as whitish, water-soaked lesions up to 1/8 inch in diameter which turn brown and enlarge within two to three days to involve most of the fruit (Figure 29). Lesions are covered with salmon-colored spore masses. Infected fruit eventually dry down to form hard, black, shriveled mummies. Fruit can be infected at any stage of development.

Disease Development

The disease is probably introduced into new plantings on infected plants. Spore production, spore germination, and infection of strawberry fruits are favored by warm, humid weather and by rain. Spores require free water on the plant surface in order to germinate and infect. Anthracnose fruit rot is considered to be a warm-weather disease with an optimum temperature for disease development near 80°F. Thus, the disease is generally a problem in the





Figure 29. Anthracnose lesion on strawberry fruit.

Midwest when abnormally high temperatures and rainfall occur during fruit set and harvest. Spores are dispersed primarily by water splash. Once the disease is established in the field, the fungus can overwinter on infected plant debris, primarily old-infected, mummified fruit.

Plant Parasitic Nematodes

Plant parasitic nematodes are microscopic round worms and are common in soils throughout the Midwest. Lesion and root-knot nematodes are probably the most destructive kinds in Midwestern plantings. These organisms restrict root growth by feeding directly on roots. This makes plants less efficient at taking up water and minerals from the soil. Nematodes can also cause strawberry roots to be more susceptible to root-rotting fungi. Strawberry plantings in nematode infested soils are not long-lived. Production will decline rapidly after one or two seasons. Nematode damage is most common and most severe in replant situations, because preceding crops increase nematode numbers, and high populations of these parasites may be present when the young plants are set. Under these conditions, strawberries never develop strong root systems.

Symptoms

Strawberry plants infested with nematodes are stunted and show symptoms of mineral deficiencies and water stress, particularly as the berries form. Because nematodes are unevenly distributed in the field, damaged plants tend to occur in patches. Heavily infested plantings decline rapidly.

Root-knot nematodes cause the formation of knots or galls on fine roots. Heavy galling may cause abundant adventitious root formation and lead to a “whiskery root” condition. Other types do not form such distinct root symptoms. Infested roots are not well developed. Lateral roots may be few. Roots attacked by lesion nematodes are dark in color.

Causal Organisms

The lesion nematode (*Pratylenchus penetrans*) and the northern root-knot nematode (*Meloidogyne hapla*) are common in the Midwest. The dagger nematode (*Xiphinema americanum*) is frequently found. The dagger nematode is the vector of tomato ring-spot virus, which it can acquire from common weed hosts, such as dandelion. Ring nematodes (*Criconebella* spp.) and lance nematodes (*Hoplolaimus* spp.) are also found in soils in the Midwest. Their effect on strawberries is not known.

Use of Disease-Resistant Cultivars

In the integrated disease management program, the use of cultivars with disease resistance must be emphasized. Many commercial cultivars have resistance and/or tolerance to leaf spot, leaf scorch, red stele, verticillium wilt, and powdery mildew. The more disease resistance within the program, the better. Table 2-1 (on page 27) lists ratings for disease resistance in several of the more commonly grown cultivars. This type of information is available from a number of sources. Most nurseries should be able to provide information on disease resistance for the cultivars they sell.

Cultural Practices for Disease Control in Strawberry

The use of any practice that provides an environment within the planting that is less conducive to disease development and spread should be used. The practices described here should be carefully considered and implemented in the disease-management program.

Continued on page 31.



Table 2-1. Disease Resistance of Several Strawberry Cultivars Commonly Grown in the Midwest.

Cultivar	Season	Disease Resistance ^a				Comments
		Verticillium Wilt	Red Stele	Leaf Diseases ^b	Powdery Mildew	
June Bearing						
Earliglow	Early	R	R	R	PR	Standard for early cultivars; berry size medium. Excellent flavor, but only moderately productive.
Veestar	Early	T	S	T	PR	Early, productive. Has performed well in southeastern Pa., with medium bright berries. Fruit shows some <i>Botrytis</i> resistance.
Annapolis	Early	I	R	S	S	Fruit medium-large, firm, and glossy with good flavor. Plants runner freely. Fairly susceptible to <i>Botrytis</i> .
Noreaster	Early	R	R	I	S	Very large, early, and firm fruit with aromatic flavor and aroma. King berries slightly rough. Well adapted to heavy soils.
Mohawk	Early	R	R	PR	T	Medium-sized fruit, comparable to Earliglow. Good flavor. Tolerant of <i>Botrytis</i> . Has been very variable, as two lines of plant material exist. Plant only small quantities.
Avalon	Early	R	R	T	R	Large berry with good color and flavor; average productivity and vigor. Has performed well in southeastern Pa. For trial only.
Sable	Early	U	R	PR	S	Veestar x Cavendish cross. Productive, well suited to U-pick operations. Available in small quantities. For trial only. Produces dense beds; <i>Botrytis</i> control may require more effort than usual.
Evangeline	Early	U	S	U	R	Medium yields of conical, firm berries. Flavor good if fully ripe. Berries produced on stiff, upright stalks. May not runner well. For trial only. Limited quantities available.
Honeoye	Early-mid	S	S	PR	T	Large fruit, productive; has performed well in Pa., but lack of red stele resistance is a concern. Tends to become soft in hot weather. Flavor distinctive, “perfumy.”
Cavendish	Early-mid	I	R	PR	S	Very large firm fruit with good flavor. Very productive (yields 85% of Kent) and moderately vigorous. Tends to ripen unevenly in certain years.

^a I = intermediate, PR = partially resistant, R = resistant, S = susceptible, T = tolerant, U = unknown.

^b Includes leafscorch and leaf spot.



Table 2-1 (continued). Disease Resistance of Several Strawberry Cultivars Commonly Grown in the Midwest.

Cultivar	Season	Disease Resistance ^a				Comments
		Verticillium Wilt	Red Stele	Leaf Diseases ^b	Powdery Mildew	
June Bearing (continued)						
Brunswick	Early-mid	U	R	U	U	Good size and flavor. May perform better in cooler locations. Susceptible to Phytophthora crown rot. For trial.
Raritan	Mid	S	S	S	S	Widely planted cultivar in spite of disease susceptibility; first fruits are large, but size decreases more rapidly than most cultivars. Very flavorful.
Guardian	Mid	R	R	R	S	Very productive, firm, large fruit, sometimes rough (uneven) looking. <i>Botrytis</i> is generally more prevalent. Tends to get a “long neck,” which breaks down and allows easy entry for slugs and sap beetles. Susceptible to Sinbar injury.
Redchief	Mid	PR	R	R	R	Productive, with good color and size. Flavor average. Excellent disease resistance.
Lester	Mid	S	R	R	U	Productive, good-sized berry. Flavor is good, though size tends to “run down” quickly. Fruit is fairly susceptible to <i>Botrytis</i> .
Kent	Mid	S	S	S	T	Extremely productive berry with large firm fruit. Tends to yield fruit in middle of rows, resulting in high rot, so keep rows narrow. Flavor average. Susceptible to Sinbar injury.
Settler	Mid	T	U	T	S	Large, attractive, moderately firm fruit. Very susceptible to Sinbar injury. In Pa., for trial only.
DelMarvel	Mid	R	R	R	U	Very vigorous plants, with high production; large, firm, aromatic fruit. In Pa., for trial only.
Primetime	Mid	R	R	R	U	Medium-firm berry with mild, lightly aromatic flavor. Good <i>Botrytis</i> resistance. In Pa., for trial only.
Mira	Mid	U	R	S	R	Glossy, medium-red, tart berries. High yielding in areas north of Pa. Good winter hardiness. Vigorous plants. In Pa., for trial only.
Eros	Mid	S	R	U	U	‘Allstar’ hybrid from England, with darker fruit color than ‘Allstar.’ Large fruit, well-balanced flavor. Available in small quantities. For trial only.



Table 2-1 (continued). Disease Resistance of Several Strawberry Cultivars Commonly Grown in the Midwest.						
Cultivar	Season	Disease Resistance ^a				Comments
		Verticillium Wilt	Red Stele	Leaf Diseases ^b	Powdery Mildew	
June Bearing (continued)						
Darselect	Mid	U	U	T	U	Attractive fruit with good color and quality. Vigorous. Available in small quantities for trial.
Jewel	Mid-late	S	S	PR	R	Large soft fruit; can be very dark. Tends to soften in hot weather. Very productive, though dense foliage can encourage <i>Botrytis</i> .
Allstar	Mid-late	R-T	R	T	T	Productive, elongated, flavorful berries. Lighter color than most berries. Good fruit size. Has become the standard mid-season berry in Pa., in spite of light color. Has potential for the annual system on plastic mulch. Susceptible to angular leaf spot.
Seneca	Mid-late	S	S	U	U	Round, large, medium-red, exceptionally firm fruit with firm skin. Plant is vigorous. Flavor mediocre, but firmness of fruit may be useful for shipping market. Has potential for the annual system on plastic mulch.
Lateglow	Mid-late	R	R	T	T	Productive; good size and flavor. First berries extremely large, though size “runs down” over season. Extremely vigorous plant and needs to be controlled.
Latestar	Mid-late	R	R	R	U	Mild flavor, but variable yields and small fruit size. Vigorous plants. Flowers and ripens a few days later than ‘Allstar.’ In Pa., for trial only. Susceptible to gray mold.
Winona	Mid-late	T	R	R	U	Large, firm conical fruit with bright red-orange color and good flavor. Released from Minnesota. May be marginal quality when warm. In Pa., for trial only.
Mesabi	Mid-late	R	R	R	R	Large, dark-red fruit with good flavor. Winter hardy. Skin tends to become weak in warm weather.
Cabot	Mid-late	U	R	T	U	Huge berries, averaging 20 to 30 g over season. Berries rough-looking with firm flesh and tender skin. Available in small quantities. Greatest value may be as a novelty berry. Doesn't runner well. For trial only.



Table 2-1 (continued). Disease Resistance of Several Strawberry Cultivars Commonly Grown in the Midwest.

Cultivar	Season	Disease Resistance ^a				Comments
		Verticillium Wilt	Red Stele	Leaf Diseases ^b	Powdery Mildew	
June Bearing (continued)						
Delite	Late	R	R	R	U	Large berries, very resistant to disease, average flavor.
Sparkle	Late	S	R	S	S	Flavorful, high-quality, attractive but soft fruit. Tends to grow very thickly. Size decreases rapidly during harvest season.
Day Neutral						
Tribute		PR	R	T	R	Slightly later than 'Tristar,' with larger fruit. Flavor not as strong, and plants are more vigorous.
Tristar		R	R	T	R	Bears an early crop; smaller than 'Tribute;' flavor is excellent. Flesh and skin firm. Moderate vigor. Size reduced when weather is too hot.
Everest		U	U	U	U	An alternative for growers who wish to try a day-neutral other than 'Tribute' or 'Tristar.' Recommended for small quantity trials only.
Plasticulture System						
Sweet Charlie	Early	U	U	U	U	Good flavor and size. Yields lower than for 'Chandler' but produces crop for early market. Tends to break dormancy and flower during warm spells in late winter and early spring.
Chandler	Mid	U	S	S	S	Standard berry for this production system. Large, firm berries. Flavor is sweet if allowed to ripen fully and not over-fertilized with nitrogen.
Camarosa	Mid	U	U	S	S	Large, firm berries. Productive and vigorous in warmer climates. Flavor fair. Cool fall temperatures may negatively affect flower bud initiation.
Marmolada	Mid	R	U	U	U	Requires high nitrogen rates for high yields. Large, glossy, bright red fruit with red flesh. Flavor fair. In Pa., for trial only.
^a I = intermediate, PR = partially resistant, R = resistant, S = susceptible, T = tolerant, U = unknown.						
^b Includes leafscorch and leaf spot.						
Used with permission from the <i>Commercial Berry Production and Pest Management Guide, 2002-2004</i> , The Pennsylvania State University.						



Use Disease-Free Planting Stock

Always start the planting with healthy, virus-indexed plants obtained from a reputable nursery. Remember that disease-free plants are not necessarily disease resistant — cultivar selection determines disease resistance.

Select the Site Carefully

Soil Drainage (*Extremely Important*)

Select a planting site with good water drainage. Avoid low, poorly-drained wet areas. Good water drainage (both surface and internal drainage) is especially important for control of leather rot and red stele. Both of these diseases require free water (saturated soil) in order to develop. If there are low areas in the field that have a tendency to remain wet, this is the first place that red stele will develop. Under Midwestern growing conditions, any time there is standing water in the field, plants are subject to leather rot infection. Any site in which water tends to remain standing is, at best, only marginally suited for strawberry production and should be avoided.

Any practice, such as tiling, ditching, or planting on ridges or raised beds, that aids in removing excessive water from the root zone will be beneficial to the disease-management program.

Previous Cropping History

Select a site that does not have a history of Verticillium wilt in any crop. Select a site that does not have a history of red stele or black root rot. To minimize the risk of black root rot, do not replant strawberries immediately after removing an old strawberry planting. In general, it is also not a good practice (due primarily to *Verticillium*) to plant strawberries immediately after solanaceous or other *Verticillium*-susceptible crops. These include tomatoes, potatoes, peppers, eggplant, melons, okra, mint, brambles, chrysanthemums, roses, or related crops. If possible, select sites that have not been planted to any of these crops for at least three to five years. There should be no herbicide residual in the soil from previous crops.

Site Exposure

A site with good air circulation that is fully exposed to direct sunlight should be selected. Avoid shaded areas. Good air movement and sunlight exposure are

important to aid in drying fruit and foliage after a rain or irrigation. Any practice that promotes faster drying of fruit or foliage will aid in the control of many different diseases.

Crop Rotation

First Planting of Strawberry — If the land has no recent (five years or less) history of strawberry production or Verticillium diseases in other crops, soil-borne diseases such as red stele or Verticillium wilt should not be a problem.

Replanting Strawberries, Crop Rotation, and Soil Fumigation — If strawberries are to be replanted in the same field, crop rotation must be used or the field should be fumigated. Fumigation is currently not an option in organic production systems. With rotation, the site should be plowed, worked down, and planted to a crop that is not susceptible to Verticillium wilt for a minimum of two years. Many soil-borne pathogens form specialized survival structures and are capable of surviving for several years in soil, even when strawberries are not present. The longer the site can be rotated away from strawberries prior to replanting, the better.

The combination of crop rotation plus soil fumigation is a sound approach that is used by many conventional growers. However, for organic growers (who cannot use soil fumigation), crop rotation alone often provides acceptable control for most soil-borne diseases, if the rotation is sufficiently long.

Neither crop rotation nor soil fumigation will reliably provide adequate control of red stele. With red stele, disease-resistant cultivars and improved soil drainage must be emphasized. Cultivars with resistance to red stele and Verticillium wilt should always be used.

Fertility

Fertility should be based on soil and foliar analysis. Soil should be analyzed and nutrient levels adjusted before planting. The use of excess fertilizer, especially nitrogen, should be avoided. Sufficient fertility is essential to produce a crop, but excess nitrogen results in dense foliage that increases drying time in the planting (stays wet longer) and also results in softer berries that are more susceptible to fruit rots. Avoid the application of nitrogen in the spring prior to harvest on medium to heavy soils. Excessive use of nitrogen has been shown to increase the level of Botrytis fruit rot (gray mold).



Weed Control

Good weed control is essential to successful strawberry production. From the disease control standpoint, weeds in the planting prevent air circulation and result in fruit and foliage staying wet for longer periods. Gray mold, in particular, is a much more serious problem in plantings with poor weed control compared to plantings with good weed control.

In addition, weeds will reduce production through direct competition for light, nutrients, and moisture with strawberry plants and will make the planting less attractive to pick-your-own customers, especially if you have thistles!

Mulch

Research and grower experience has shown that a good layer of straw mulch is very beneficial for controlling fruit rots, especially leather rot. Bare soil between the rows should be avoided and a good layer of straw mulch is highly recommended. The mulch keeps berries from contacting the soil where the leather rot fungus overwinters. In addition, it also aids in preventing infested soil from splashing onto the berries. Recent research has shown that plastic mulch (a layer of plastic) under the plants and/or between the rows increases splash dispersal of the pathogens that cause anthracnose and leather rot.

Sanitation

Any practice that removes old leaves and other plant debris from the planting is beneficial in reducing the amount of *Botrytis inoculum*. Leaf removal at renovation is highly recommended.

Irrigation Practices

The application of supplemental water should be timed so that the foliage and fruit will dry as rapidly as possible. For example, irrigating early in the day is better than in the evening. If diseases, such as gray mold, leather rot, anthracnose, or bacterial blight, become established in the planting, overhead irrigation should be minimized or avoided.

Control Movement of People and Machinery

Movement of people (pickers) and machinery from a field or area that is infested to a clean or uninfested

field should be avoided. Diseases of primary concern are anthracnose, leather rot, and angular leaf spot (bacterial blight). Diseases such as these are usually spread over relatively short distances by splash dispersal (rain or irrigation). Movement from one field to another field through the air (wind-blown spores) is generally not a problem with these diseases. However, pickers moving from a field where the disease is present to a non-infested field can transport fungal spores or bacteria very efficiently on shoes, hands, and clothing. If people or machinery are used in fields where these diseases are a problem, they should complete work in non-infested fields before moving to infested fields.

In addition, any machinery that moves soil from one field to another can introduce soil-borne diseases, such as red stele, *Verticillium* wilt, leather rot, and nematodes, from infested into non-infested fields.

Harvesting Procedures

- Pick fruit frequently and early in the day before the heat of the afternoon (preferably as soon as plants are dry). Picking berries as soon as they are ripe is critical. Overripe berries will cause nothing but problems during and after harvest.
- Handle berries with care during harvest to avoid bruising. Bruised and damaged berries are extremely susceptible to rot.
- Train pickers to recognize and avoid berries that have disease symptoms of gray mold and leather rot. If at all possible, have pickers put these berries in a separate container and remove them from the field.

Post-Harvest Handling

- Always handle fruit with care during movement from the field to market to avoid any form of damage.
- Get the berries out of the sun as soon as possible.
- Refrigerate berries immediately to 35 to 40°F in order to slow the development of gray mold (*Botrytis*) and other fruit rots.
- Market the berries as fast as possible. Encourage your customers to handle, refrigerate, and consume or process the fruit immediately. Remember that even under the best conditions, strawberries are very perishable.



Fungicides for Strawberry Disease Control

Most fungicides used on strawberries are directed at the control of fruit rots and foliar diseases (Table 2-2). By using resistant cultivars to control foliar diseases, the use of fungicides can be directed primarily toward controlling fruit rots. The fruit rots that are most prevalent in the Midwest are leather rot, *Botrytis* fruit rot (gray mold), and anthracnose fruit rot.

Leather Rot

Most fungicides currently available for use on strawberries are generally ineffective for controlling leather rot. Although Captan and Thiram are beneficial in suppressing leather rot, they will not provide adequate control if an epidemic develops. Furthermore, the use of these fungicides is severely restricted or prohibited during harvest due to re-entry restrictions or preharvest intervals.

Ridomil is registered for use on strawberries for control of red stele and leather rot. Ridomil is very effective for control of leather rot and may be applied in the spring after the ground thaws and before first growth. This early application is recommended primarily for control of red stele but may be beneficial in providing some control of leather rot. A second application is recommended specifically for leather rot and can be made during the growing season at fruit set.

Aliette 80% WDG is also registered for use on strawberries and should provide good control of both red stele and leather rot. It can be applied from the initiation of bloom through harvest on a seven- to 14-day schedule and has no preharvest restriction.

Abound (azoxystrobin), Cabrio (pyraclostrobin), and Pristine (pyraclostrobin plus boscalid) are strobilurin fungicides registered for use on strawberry for control of powdery mildew and anthracnose fruit rot.

Although leather rot is not listed on the label, Abound and Carbrio are very effective for controlling diseases caused by *Phytophthora* on several other crops; thus, Abound and Carbrio will provide some level of leather rot control.

Although these fungicides are very effective against leather rot, the emphasis for controlling leather rot

should be placed on the use of cultural practices, such as using a good layer of mulch and preventing standing water in the planting (good drainage). In many plantings throughout the Midwest and in drier growing seasons, leather rot is generally not a problem.

Phosphorous Acid (Agri-Fos, ProPhyt, Phostrol)

Several products containing phosphorous acid (PA, also called phosphite or phosphonate) are sold as nutritional supplements and plant conditioners, but only Agri-Fos, ProPhyt, and Phostrol are currently registered for control of plant diseases. These products are registered on strawberry for control of leather rot. They are essentially the same active ingredient that occurs in the fungicide Aliette (fosetyl-AL) and most have labels that are very similar to the label of Aliette.

Botrytis Fruit Rot (Gray Mold)

Several fungicides have excellent activity against *Botrytis*. Topsin-M has been registered for many years and is highly effective in areas where *Botrytis* has not developed resistance to it.

Rovral is registered for control of *Botrytis* on strawberry and was highly effective for gray mold control prior to some changes in the label use recommendations in 1999. At present, the label states that not more than one application can be made per year, and it cannot be applied after first fruiting flower. These label restrictions make Rovral of little value for gray mold control on strawberry.

Elevate, Switch, and Pristine are relatively new fungicides that have excellent activity against *Botrytis*. There are two major problems involved with using these fungicides (Topsin-M, Elevate, Switch, or Pristine) for fruit rot control — none of them have any activity against leather rot, and all of them are at risk with respect to the development of resistant strains of *Botrytis*. Because of differences in fungicide chemistry and previous frequency of use, the threat of resistance developing may be somewhat greater for Topsin-M than it is for Elevate, Switch, or Pristine. For these to aid in fungicide-resistance management, the use of minimal numbers of fungicide applications, alternation of fungicides, and fungicide combinations should be encouraged



Table 2-2. Efficacy of Fungicides for Strawberry Disease Management.						
Fungicide ^a	Gray Mold	Leather Rot	Leaf Spot	Powdery Mildew	Anthraco-nose	Preharvest Interval Days
Alone						
Abound ^b	++	+++	++	+++	+++	0
Aliette	0	+++	0	0	0	0
Cabrio ^b	++	+++	++	+++	+++	0
Captan ^c	++	+	++	0	++	0
Elevate	+++	0	0	0	0	0
Nova	0	0	+++	+++	0	1
Ridomil	0	+++	0	0	0	0 ^a
Sulfur	0	0	0	+++	0	0
Switch	+++	0	0	0	++	0
Thiram ^d	++	+	++	0	+	0 ^c
Topsin ^c	+++	0	+++	+++	++	1
Phosphorous Acid	0	+++	0	0	0	0
Pristine ^b	++	+++	++	+++	+++	0
In Combination						
Abound + Captan	++	+++	++	+++	+++	0 ^c
Cabrio ^b + Captan ^b	++	+++	++	+++	+++	0 ^c
Elevate + Captan	+++	+	++	0	++	--
Elevate + Thiram	+++	+	++	0	+	--
Switch + Captan	+++	+	++	0	++	--
Switch + Thiram	+++	+	++	0	+	--
Topsin + Captan	+++	+	+++	+++	++	--
Topsin + Thiram	+++	+	+++	+++	++	--
Efficacy rating system: +++ = highly effective; ++ = moderately effective; + = slightly effective; 0 = not effective, ? = activity unknown.						
^a See label for harvest restrictions. ^b Abound, Cabrio, and Pristine should have good activity against leather rot. ^c Although the preharvest interval for Captan is 0 days, protective clothing must be worn for 24 hours after application when entering the planting or harvesting fruit. ^d If Thiram is applied within three days of harvest, residues must be removed by washing the fruit. ^e Always apply Topsin, Elevate, or Switch in combination with an unrelated fungicide such as Captan or Thiram, or in an alternating program with a fungicide of different chemistry.						



in the disease-management program. The benefits of these fungicide-use strategies (at least in theory) are to provide a wider spectrum of disease control and to reduce or delay the development of fungicide-resistant strains of the fungus. The strobilurin fungicides Abound and Cabrio will provide some suppression of Botrytis fruit rot.

Fungicide application timing is important for gray mold management. Sprays applied during bloom are much more effective than sprays applied after fruit set and during harvest. Bloom sprays also leave less residue on harvested berries.

Anthracnose Fruit Rot

Anthracnose fruit rot is not a common problem in many areas, but its occurrence is increasing across the Midwest. The disease is very important in plasticulture systems. Once anthracnose fruit rot is established in a planting, it is difficult to control and can be very severe, resulting in complete loss of the crop.

Captan and Thiram are protectant fungicides that have some activity against anthracnose. If used in a protectant program, they will provide some level of control. Abound, Cabrio, and Pristine are strobilurin fungicides and are labeled for control of anthracnose on strawberry. They have the best activity against anthracnose on strawberry of all currently registered fungicides. For purposes of fungicide-resistance management and increased efficacy, Abound, Cabrio, and Pristine should be used in alternation with or in combination with Captan or Thiram. Abound, Cabrio, and Pristine are the same class of chemistry so they should not be alternated with each other as a fungicide-resistance strategy. Switch has also been reported to have moderate to good activity against anthracnose fruit rot.

Leaf Diseases

Leaf Spot, Leaf Scorch, Leaf Blight

The emphasis for controlling leaf diseases should be placed on the use of resistant cultivars whenever possible (Table 2-1). If resistance is not available, highly susceptible cultivars should be avoided. Several fungicides are registered for control of strawberry leaf diseases (Table 2-2). Topsin-M, Captan, Thiram,

Nova, and Syllit (previously marketed as Cyprex) are registered for use on strawberries. The label states that Topsin-M cannot be applied before early bloom; thus, applications made very early in the season (as new growth starts) should use Syllit, Captan, Nova, or Thiram. The strobilurin fungicides (Cabrio, Abound, and Pristine) also have some activity against leaf diseases. If leaf diseases are a serious problem, post-harvest or post-renovation applications of these fungicides may be required.

Powdery Mildew

Topsin-M is labeled for use on strawberries and was very effective against mildew when it was first introduced; however, due to the development of fungicide resistance, Topsin-M generally does not provide adequate control in many production areas across the country. In areas where Topsin-M has not been used to control powdery mildew, it still might provide effective control.

Nova, Procure, Abound, Cabrio, and Pristine are all registered for control of powdery mildew on strawberry and should provide excellent control. Sulfur is also effective for powdery mildew control if used in a seven- to 10-day-interval protectant program. Sulfur has little or no activity against the other strawberry diseases.

The use of cultivars with resistance to powdery mildew should be emphasized, and the use of highly susceptible cultivars must be avoided.

Red Stele in Established Plantings

The emphasis for control of red stele should be placed on the use of resistant cultivars and good soil drainage. However, if red stele develops in an established planting, the use of Ridomil Gold may help reduce losses. Ridomil Gold should be applied in sufficient water to move the fungicide into the root zone of the plants. The label states: "Make one application at time of transplanting or in the spring after the ground thaws before first growth. Make another application in the fall after harvest."

Aliette WDG is also registered for red stele control. It is registered as a pre-plant dip and a foliar spray. The *pre-plant dip* label reads as follows: Use 2.5 lbs per 100 gallon and "Apply as a pre-plant dip to strawberry roots and crowns for 15 to 30 minutes.



Disease Control Considerations	Verticillium Wilt	Red Stele	Black Root Rot	Nematodes	Viruses	Fruit Rot	Leaf Spots	Powdery Mildew
1. Good drainage	-	++	++	-	-	++	+	-
2. No shade	-	+	-	-	-	++	++	-
3. No infested runoff	+	++	+	+	-	U	-	U
4. Rotation	++ ^a	++ ^a	++ ^a	++ ^a	-	-	+	-
5. Resistant cultivars	++ ^b	++ ^c	-	-	-	-	++ ^d	++
6. Disease-free plants	++	++	+	+	++	-	+	+
7. Adequate plant and row spacing	-	-	-	-	-	++	++	+
8. Mulch for winter injury/fruit rot	-	-	++	-	U	++	-	-
9. Fruit storage conditions	-	-	-	U	-	++	-	-
10. Renovation	+	-	-	+	-	-	++	+
11. Weed control	+	-	-	+	U	++	+	+

All possible control strategies must be employed if strawberry diseases are to be controlled.
Key: ++ = most important controls; + = helpful controls; - = no controls; and U = unknown.

^a Rotations: Verticillium wilt, black root rot, nematodes are three to five years; red stele is much longer, perhaps more than 20 years.

^b Resistant to Verticillium wilt: Earliglow, Sunrise, Catskill, Guardian, Midway, Redchief, Surecrop, Delite, Sparkle.

^c Resistant to some strains of red stele: Earliglow, Redglow, Sunrise, Guardian, Midway, Redchief, Surecrop, Delite, Sparkle.

^d Resistant to leaf spot: Guardian, Midland, Redchief, Surecrop. Resistant to leaf scorch: Catskill, Guardian, Midland, Redchief, Sunrise, Surecrop.

Plant within 24 hours after dipping.” The *foliar application* label reads as follows: “In the spring begin foliar applications when the plants start active growth. If disease conditions persist or re-occur, make additional applications on a 30- to 60-day interval.” The use rate is 2.5 to 5 lbs per acre.

Phosphorous Acid (Agri-Fos, ProPhyt, Phostrol)

Several products containing phosphorous acid (PA, also called phosphite or phosphonate) are sold as nutritional supplements and plant conditioners, but only Agri-Fos, ProPhyt, and Phostrol are currently registered for control of plant diseases. These products are registered on strawberry for control of Phytophthora root rot (red stele). They are essentially the same active ingredient that occurs in the fungicide Aliette (fosetyl-AL), and most have labels that are very similar to the label of Aliette.



Strawberry Pests and Their Management

Fruit- or Flower-Feeding Pests

Tarnished Plant Bug

(*Lygus lineolaris*; order Heteroptera, family Miridae)

Damage: Slightly to severely uneven berry growth and deformed berries with hollow seeds can result from tarnished plant bug feeding on flower buds and developing fruit. Ripening berries that remain small, with a concentration of seeds at the tip, may be called button berries, cat-faced berries, or nubbins. Injured berries can be woody and unmarketable. Later-maturing cultivars are more seriously affected by this pest than early cultivars.

Appearance: Adult tarnished plant bugs are about 1/4-inch long, coppery brown with yellow and dark brown markings, and somewhat shiny in appearance (Figure 30). A yellow-tipped triangular plate is present in the middle of their backs. The immature stages, or nymphs, are smaller and green (Figure 31). Nymphs are plain green when young but marked with black spots when older. Both nymphs and adults have a beak used for sucking plant juices.

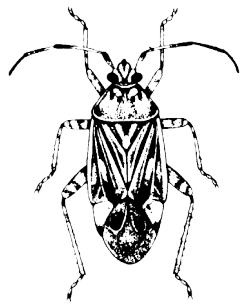

Figure 30. Tarnished plant bug adult.

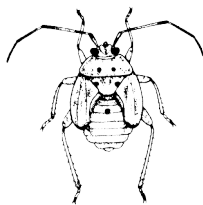

Figure 31. Tarnished plant bug nymph.

Life Cycle and Habits: Adults overwinter in vegetation or stubble that provides protection from extreme cold. In the spring, they are attracted to flower buds (Figure 32) and shoot tips of many plants, including strawberry, peach, and apple. They lay eggs in plant tissues of crops and weeds. Eggs hatch in about one week, and the nymph stages last about three weeks.



Figure 32. Tarnished plant bug on flower.

Tarnished plant bugs suck sap from developing seeds during and after bloom, or from the receptacle of developing fruit. Their feeding kills surrounding cells and leads to distorted seedy berries. Several generations of this insect develop each year, and adults and nymphs are present on many different plants from April or May until a heavy frost in the fall.

Cultural Control: Strawberry cultivars that are least susceptible to plant bug injury are Honeoye, Sparkle, Canoga, Catskill, and Veestar, according to work in New England. Controlling weeds in and around strawberry fields reduces in-field overwintering and removes sources of early-season flowers that attract adult tarnished plant bugs to fields. However, *weeds in and near strawberry fields should not be mowed when strawberry buds are swelling and flowers are beginning to open*, because tarnished plant bugs will move from weed hosts to strawberries at a time when the crop is especially vulnerable to damage. If mowing must be done during this period, it is better to mow after applying insecticide than to mow before applying insecticide.

Mechanical Control: Row covers put on in the fall to exclude plant bugs in the spring have been shown in New England to reduce, but not eliminate, plant bug injury.

Monitoring and Thresholds: Guidelines for monitoring tarnished plant bug infestations and



determining whether or not to use an insecticide vary depending on whether adults or nymphs commonly cause damage in a particular region.

Where adults that migrate into fields appear to cause more damage than subsequent nymphs, as happens during most seasons in Illinois, producers are advised to monitor the bug population by sweep net sampling as buds begin to form. Control is suggested if the population is found to be above the threshold of two tarnished plant bug adults per 10 sweeps.

Where damage tends to be caused by nymphs that are present when buds are forming, particularly for later cultivars or day-neutral cultivars, then shake sampling is more useful than sweep net sampling. At each of five sites per field, shake 10 flower clusters over a white pan or paper to dislodge the nymphs, and then count them. Calculate the average number per flower cluster. If counts exceed 0.25 nymph per flower cluster, or more than 10% of the flower clusters are infested (regardless of count), then application of an insecticide is warranted.

White sticky traps are commercially available for monitoring tarnished plant bug adults, but recent evaluations of these traps in Iowa has shown them to be unreliable for detecting plant bug infestations in strawberries.

Control by Insecticides: Control of tarnished plant bugs may be justified if the field has suffered substantial damage from tarnished plant bugs in previous years or where the threshold (as described earlier) is exceeded. Insecticide should be applied soon after blossom buds first become visible and again if reinfestation occurs just before bloom. To protect bees and other insect pollinators, do not spray insecticide during bloom.

Strawberry Bud Weevil or Strawberry Clipper

*(Anthonomus signatus; order
Coleoptera, family Curculionidae)*

Damage: Nearly mature blossom buds are injured by adult clippers that puncture buds with their snouts, deposit eggs inside buds, then clip the stem below the buds (Figure 33). Clipped buds hang down or fall to the ground. Injured buds that survive to flowering may have small holes in the petals.

Appearance: The strawberry clipper adult is a dark, reddish-brown weevil about 1/10-inch long; its head is prolonged to form a slender, curved snout about one-third as long as the body (Figure 34). The larva is white and 1/16-inch long.



Figure 33. Strawberry clipper damage.



Figure 34. Strawberry clipper adult.

Life Cycle and Habits: Adult clippers overwinter in fence rows and woodlots near strawberry plantings. Once temperatures reach 60°F, the adults move to plants with developing fruit buds. A small portion of a population may remain in the strawberry field over the winter. Strawberry flowering coincides with the time that clippers move out of their overwintering sites, so strawberries are ideal host plants for this insect. Redbud trees are another early host. Adult clippers first feed on immature pollen by puncturing nearly mature blossom buds with their snouts. Each female then deposits a single egg inside the bud and girdles the bud, which prevents it from opening and exposing the developing larva. The female then clips the stem. Eggs hatch in about one week. Larvae feed within the damaged bud for three to four weeks; a new generation of adults emerges in late June and July. These weevils feed on the pollen of various flowers for a short time, but seek shelter in midsummer in preparation for overwintering. There is one generation per year.



Cultural Control: Because the strawberry clipper does not disperse over long distances, locating strawberry plantings away from woodlots and hedgerows that harbor this insect through the winter can reduce the number of adults that move into strawberries in the spring. Because early cultivars are usually damaged more than later ones, planting two or three rows of an early cultivar as a trap crop around the perimeter of each field has been suggested as a way to reduce overall damage or to concentrate the adults for control by use of an insecticide only in the trap crop.

Monitoring: Early detection of clipper activity is important. Watch for clipper adults and damage when flower buds start coming out of the crown and when temperatures approach 65°F. Check one meter (3 feet) of row at each of five sites per field. Sampling should be most intensive along field edges near woods or hedgerows or where weeds are heavy. Get down on hands and knees and look closely for clipped buds of unopened flowers and look for adult weevils in unexpanded flower clusters.

Thresholds: Treat with insecticide if there are three or more clipped primary buds per meter of row, or 30 or more clipped secondary or tertiary buds per meter of row.

Control by Insecticides: If control is necessary, insecticide should be applied as soon as the threshold is exceeded; this can occur before most flowers have begun to open. When damage is observed only in rows along a field border, then insecticide application can be limited to border rows.

Strawberry Sap Beetle

(*Stelidota geminata*; order Coleoptera, family Nitidulidae)

Damage: Deep cavities in ripe berries are chewed by strawberry sap beetle adults (Figure 35). This injury also can lead to infection of berries by rot organisms. Because over-ripe fruit is especially attractive to sap beetles, damage is often greatest in pick-your-own operations where pickers leave large numbers of ripe and over-ripe berries in the field.

Appearance: Adult strawberry sap beetles are about 1/8-inch long, oval shaped, flat, and mottled brown in color (Figure 36). Larvae are white with a brown head and up to 1/10-inch long.



Figure 35. Strawberry sap beetle damage.



Figure 36. Strawberry sap beetle adult.

Life Cycle and Habits: Strawberry sap beetle adults fly into strawberry plantings from wooded areas at about the time berries begin to ripen. They chew on berries, often in groups of several beetles per berry. They may be hard to see because they drop to the ground when disturbed.

Females deposit eggs on the injured fruit. Eggs hatch in two to three days. Although larvae feed in berries for about one week, they usually are unnoticed because the fruit has already begun to decompose as a result of damage caused by adults.

A parasitic wasp contributes to suppression of this pest by laying eggs in the adult beetles; parasitized beetles lay fewer eggs than healthy beetles.

Cultural Control: Strawberry sap beetles are best controlled by timely and complete picking of harvestable berries and the removal of over-ripe and damaged berries.

Mechanical Control: Trap buckets of over-ripe fruit can be placed outside field borders as the crop begins to ripen, to intercept immigrating beetles and reduce pest numbers in the crop.



Control by Insecticides: Because sap beetle populations usually do not build up until the picking cycle is underway, the use of insecticides is limited by frequent harvests.

The required preharvest interval specified on the insecticide label must be obeyed.

Slugs

Deroceras (Agriolimax) species (family Limacidae) and Arion species (family Arionidae; Phylum Mollusca, Class Gastropoda)

Damage: Slugs damage fruit by eating deep ragged holes into the surface of berries, especially under the cap (Figure 37). Slugs leave slime trails on the fruit or leaf surfaces as they move around.



Figure 37. Slug and its damage on strawberry .

Appearance: Soft-bodied and slimy, slugs are worm-like molluscs that range in size from 1.5- to 7-inches long. They may be dark gray, black, yellow-gray, or brown, and may be covered with spots.

Life Cycle and Habits: Slugs that damage strawberries in the spring and early summer hatched from eggs deposited in the soil in strawberry plantings the previous fall. Conditions that favor egg-laying in the fall include the continuous presence of straw mulches. Slugs survive best and damage fruit the most in fields with rows close together and thick mulch, and when overcast and rainy weather creates continuously moist conditions in strawberry beds. Slugs feed mainly at night.

Cultural Control: Planting at lower densities, removal of straw mulch after harvest, summer

renovation, and delaying fall mulching as long as is practical are effective steps in reducing slug populations. Removal of trash and debris around the field helps to eliminate slug breeding grounds.

Mechanical Control: Traps made of wet boards or burlap bags may be set out in the evening. Remove and destroy trapped slugs the following morning. Shallow dishes of beer can be used as a bait under the traps. Although trapping can remove many slugs, it usually does not remove enough to result in significantly less injury to fruit.

Control by Insecticides: Slug baits that contain metaldehyde or iron phosphate may be used in strawberries only if the baits are applied to the soil or mulch surface and do not contact plants. Baits are most likely to work when used at the full labeled rate and when they are applied before ripe berries are present. Some growers have tried diatomaceous earth for slug control, but research results are not available to verify the effectiveness of this material.

Flower Thrips or Eastern Flower Thrips (*Frankliniella tritici*; order Thysanoptera, family Thripidae)

Damage: Strawberry fruits can be dull or bronzed, small, and seedy as a result of the flower thrips feeding during bloom and fruit set (Figure 38). Thrips may also cause blemished seeds on achenes and uneven maturity of fruit. Berries may be marketable if thrips damage is light but unmarketable when damage is severe. In California, a related species called the western flower thrips causes golden brown discoloration of fruit that renders berries unmarketable when populations of thrips are large.

Thrips damage to strawberries was rare until 1994, when problems were reported throughout the Midwestern and eastern United States. The strawberry crop failed to develop normally in 1994; berries failed to enlarge or ripen and remained golden brown and leathery. Some plantings had yield reductions of up to 90%. Scattered infestations have been observed in most years since 1994.

In Illinois, this problem was greatest in the central portion of the state and less severe in the far south



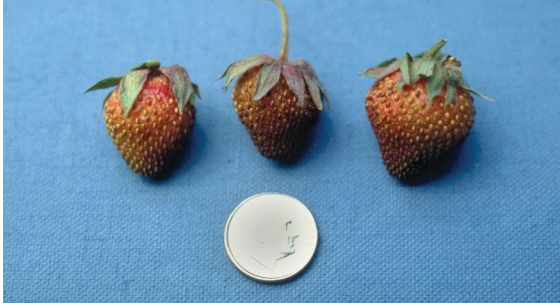

Figure 38. *Thrips damage on strawberries.*

and the north. Whether or not the flower thrips caused these dramatic strawberry losses cannot be proved, but many observations now suggest that thrips were to blame. The thrips injury in 1994 probably resulted from an earlier-than-normal immigration of thrips that coincided with strawberry bloom and fruit set in a large portion of the Midwest.

Appearance: The flower thrips, which is sometimes called the eastern flower thrips, is a tiny, slender, cigar-shaped insect (Figure 39). Nymphs and adults have the same general shape. Nymphs are wingless, whitish yellow when small, and yellow when fully grown. Adults are yellowish brown, 1/16-inch long, and have narrow wings that are fringed with hairs. While resting, the wings are folded lengthwise over the back.



Figure 39. *Flower thrips.*

Life Cycle and Habits: The flower thrips is not known to overwinter outdoors in the upper Midwest, but overwintering in greenhouses probably occurs. Populations of flower thrips develop each year as a result of long-distance migrations from southern states on high-level winds associated with weather fronts. Migration of thrips probably

occurs simultaneously with migration of the potato leafhopper.

Adult flower thrips are attracted to flowers of many different plants. Adults and nymphs feed using rasping-sucking mouthparts to obtain sap. On strawberry fruit, they begin feeding on seeds soon after the buds open. They feed on the tissue between the seeds as the fruit expands. Bronzing results from surface cells being killed.

Thrips are often overlooked because they prefer to feed from protected sites, such as under the calyx (cap) and in grooves around seeds, rather than exposed sites. When the population is large, they run out of space in protected sites and thus may be found anywhere on the fruit. They actively run when disturbed. The adults lay eggs in plant tissue. There are two active nymph stages and two inactive pupal-like nymph stages. The life cycle can be completed in several weeks; there can be many generations per year.

Monitoring and Thresholds: To determine whether or not thrips control is warranted, strawberry growers should begin sampling for thrips by examining early flower clusters on early cultivars and continue sampling all cultivars as they begin to bloom. Tap flowers onto a white or very dark plate or saucer and look for the slender yellow thrips. As an alternative, flower blossoms can be placed into a zipper-type reclosable plastic bag and shaken to dislodge thrips and allow counting. Although the relationship between eastern flower thrips density and strawberry damage is not well understood, control is probably warranted if populations exceed two to 10 thrips per blossom. Once berries are 1/4 inch in diameter, 50 randomly selected fruit should be picked and examined; control is suggested if an average of 0.5 or more thrips per fruit are detected.

Control by Insecticides: If insecticides are to be used for thrips control, applications must be timed to avoid killing pollinators. Insecticide should be applied prebloom or before 10% of the plants have open blossoms.



Foliage- or Stem-Feeding Pests

Meadow Spittlebug

(*Philaenus spumarius*; order Homoptera, family Cercopidae)

Damage: Spittlebugs pierce the plant and suck on sap, which can result in reduced plant vigor, stunting, and decreased yield. Early-season feeding can result in stunted, off-color plants; this damage can appear much like that caused by cyclamen mite. Spittlebugs are not liked by pickers at pick-your-own operations because of the unsightly foam on plants when picking.

Appearance: Hidden beneath masses of frothy spittle on stems or leaves (Figure 40) are the immature spittlebugs, which are soft-bodied, elongated bugs. Young nymphs (Figure 41) are 1/8-inch long and yellow; older nymphs are 1/4-inch long and green. The adults, which are called froghoppers, are brown or gray and 1/4-inch long.



Figure 40. Meadow spittlebug.

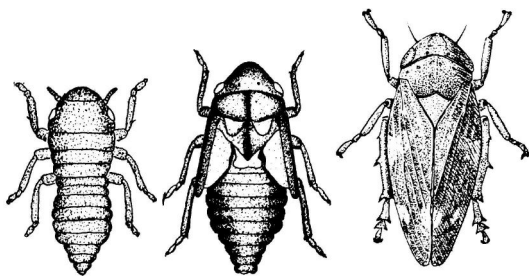

Figure 41. Meadow spittlebug – young nymph, older nymph, and adult (left to right).

Life Cycle and Habits: The meadow spittlebug overwinters as egg masses in the stubble of strawberries and other hosts such as small grains or alfalfa. Eggs hatch at about the time that the earliest strawberry flowers appear. Once nymphs begin feeding, they begin to produce spittle. Spittlebugs feed first at the base of plants, then move up on stems and blossom clusters before and during bloom. They pierce the plant and suck on plant sap. The nymph stages last for five to eight weeks. Once they reach adulthood, they leave the spittle mass. Female adults lay eggs in September. There is only one generation per year.

Threshold: Complaints most often occur when there is one or more spittle mass per square foot of canopy.

Cultural Control: Spittlebugs are most abundant in weedy fields, so weed control can contribute to spittlebug management. Often heavy rains or irrigation can wash froth from plants.

Control by Insecticides: Insecticide applications early in the season, such as those targeting the tarnished plant bug, are usually adequate for keeping spittlebugs in check.

Strawberry Rootworm

(*Paria fragariae*; order Coleoptera, family Chrysomelidae)

Damage: Strawberry leaves attacked by strawberry rootworm beetles are riddled with small holes (Figure 42). Some leaf damage occurs in May, but most occurs in August. Heavy infestations can reduce plant growth or kill plants. Although *larvae* of the strawberry rootworm feed on the *roots* of strawberry, *leaf-feeding* by *adult* beetles is more damaging to strawberry production.



Figure 42. Strawberry rootworm damage.



Appearance: Adult strawberry rootworms are brown to black, shiny, oval-shaped beetles with four blotches on the shell-like wing covers (Figure 43). They are 1/8-inch long. The immatures (Figure 44) are grubs that are 1/8-inch long, creamy white, with three pairs of legs.



Figure 43. Strawberry rootworm adult.



Figure 44. Strawberry rootworm larva.

Life Cycle and Habits: Adult strawberry rootworms overwinter in mulch and soil crevices and become active in May and June. Adults feed primarily at night and hide in soil or mulch during the day. They chew small holes in leaves, and females lay eggs on older leaves near the soil surface. Larvae burrow into the ground to feed on strawberry roots from late spring to early summer. New adults begin emerging in mid-summer, and these beetles feed on strawberry foliage through early fall.

Monitoring: Scouting for the presence of adult beetles is best done after dark using a flashlight to examine plants. No threshold has been established for this insect, but a population of 10 to 20 beetles per square foot is considered high.

Control by Insecticides: As with all the root-feeding insects, control of the root-feeding stage is very difficult. Therefore, control measures for strawberry rootworm should be directed toward the

adult stage. If feeding injury is observed in May or June, an insecticide spray at this time will reduce the number of egg-laying females and, therefore, the number of grubs feeding during the summer. When the next generation of adults emerges in July or August, control measures may be needed again. Post-harvest foliar sprays of registered insecticides applied according to label directions provide control of adult strawberry rootworms.

Two-Spotted Spider Mite (*Tetranychus urticae*; order Acari, family Tetranychidae)

Damage: Spider mites feed on plant sap by rasping and sucking on leaf surfaces. This destroys leaf chlorophyll and causes mottling, speckling, or bronzing of foliage (Figure 45). Severely damaged leaves die and drop, which can lead to reduced plant vigor and yield reduction. The undersides of infested leaves can be covered with a fine webbing. Two-spotted spider mites are common pests in Midwestern crops, but infestations in most strawberry fields do not reach densities high enough to require control by pesticides.



Figure 45. Spotted spider mite damage.

Appearance: Adult two-spotted spider mites are 1/50-inch long and barely visible to the naked eye. They are yellowish-white with two large dark spots (Figure 46). They have eight legs. Immature forms are usually dark in color.





Figure 46. Spider mite adults.

Life Cycle and Habits: Mated adult females overwinter in the cover of vegetation in fields and along roadsides and hedgerows. They begin feeding and laying eggs when temperatures rise in the spring, and many generations develop each season. Adults and immatures feed on the underside of leaves. Although wingless, the adults are highly mobile, as they disperse by ballooning in the wind on fine silken threads that they secrete while feeding. Warm, dry weather favors spider mite outbreaks, and problems occur most often in new fields where spider mites are carried in by winds before predatory mites have reached the field or in older plantings where insecticides have eliminated predators.

Cultural Control: Annual renovation of strawberry beds reduces the potential for mite outbreaks in the following season, because the destruction of leaf tissue by renovation removes the mites' food and habitat.

Biological Control: There is a natural predator called *Neoseiulus (Amblyseius) fallacis* that feeds on the two-spotted spider mite. This predator is also a mite that is equally as small as two-spotted mites but is flatter and lacks the two spots on its back; it is teardrop shaped, shiny, and yellowish white.

The predatory mites move around on the leaf much more rapidly than the two-spotted mite. It is important to encourage natural enemies of spider mites by reducing the use of pesticides that harm them.

Several companies commercially produce predatory mites, including *N. fallacis*. These predators can be released in strawberry plantings and may provide some control of spider mites, but more research is

needed to determine appropriate release rates and timing. See Table 1-1 in Chapter 1 for predatory mite suppliers.

Monitoring and Thresholds: Mite colonies are usually localized in hot-spots in the field rather than being evenly distributed throughout the field. Look over the whole field and choose the first samples in any spots where bronzing is seen on leaves. Collect and examine 60 strawberry leaflets per field. Examine the underside of the leaves for the presence or absence of mites. A magnifier can help. Record the information on a field map so that hot spots can be identified and treated.

The use of a miticide for control of spider mites is justified if 25% of the leaflets (15 out of 60) are infested by one or more mites. This threshold corresponds to an average infestation of five mites per leaflet during random sampling.

When sampling a field, presence of predatory mites, as well as two-spotted spider mite, should be noted. Where predatory mites such as *N. fallacis* are present, miticide applications usually are unnecessary. A ratio of one predatory mite per 10 two-spotted mites is an approximate target for adequate biological control.

Control by Insecticides: Several miticides and combination miticide/insecticides are currently registered for use on strawberries. Most miticides do not kill eggs, so if eggs and motile mites are both present at the time of application, then a second application may be needed five to seven days later to kill motile mites that emerge from eggs.

Cyclamen Mite

(Phytonemus pallidus; order Acari, family Tarsonemidae)

Distorted purplish leaves and distorted blossoms and fruits can result from the cyclamen mite feeding on young, unfolding leaves in the crowns of plants and on blossoms. This mite is most common as a pest of greenhouse plants, but it can cause serious losses where infested strawberry plants are transplanted in new fields. It is important to buy nursery stock from a reputable source to avoid bringing in mite-infested plants. The cyclamen mite is tiny (Figure 47); it is only 1/100-inch long and is not visible without the aid of a magnifying glass. Cyclamen mite varies in color from orange-pink to white or green.



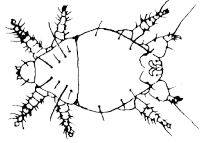

Figure 47. Cyclamen mite – adult male.

Control of cyclamen mites is best accomplished by planting only transplants that are mite-free, as determined by careful examination as soon as plants arrive from the nursery. This pest is difficult to control by pesticides once it becomes established. If a field infestation is discovered, use a registered pesticide one to two days before bloom and again 10 to 14 days later. Pesticides are not effective at controlling cyclamen mite if application is delayed until mid-summer.

Strawberry Leafroller (*Ancylis comptana fragariae*; order Lepidoptera, family Tortricidae)

Damage: Strawberry leaflets infested by leafroller are folded and tied together with silken threads. Only the epidermis of each leaf is fed upon, but entire leaflets usually turn brown. Damage by first-generation larvae occurs in late May and June. Damage by second-generation larvae occurs in late July and August.

Other leafroller species that can cause similar damage in strawberries are the variegated leafroller (*Platynota flavedana*), the oblique-banded leafroller (*Choristoneura rosaceana*), and the blueberry leafroller (*Sparganothis sulfureana*).

Appearance: Strawberry leafroller larvae change from pale green when young to grayish brown when fully grown (Figure 48). Larvae are approximately 1/2-inch long when fully grown. The adult stage of strawberry leafroller is a reddish brown moth, with distinctive yellow markings on the forewings (Figure 49). The wingspan is approximately 1/2-inch.

Life Cycle and Habits: Strawberry leafrollers overwinter as fully grown larvae or pupae in folded leaves or leaf litter. Adult moths emerge in April and



Figure 48. Strawberry leafroller larva.

May and deposit translucent eggs, usually on the lower surface of strawberry leaves. Eggs hatch in one to two weeks. As larvae feed on leaves, they secrete silken threads to fold and tie leaves around them. They pupate for about one week inside the folded leaves. The strawberry leafroller undergoes two or three generations each year. Moths of the summer generations are often present from July through September. Infestations may develop in spring and early summer, but they may also build up after harvest. Natural enemies of strawberry leafroller include two parasitoid wasp species that often kill a high percentage of larvae, especially during summer generations.

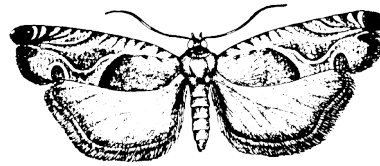

Figure 49. Strawberry leafroller moth.

Threshold: Low levels of leafroller infestation do not warrant control because they do not cause reductions in plant vigor or yield during the current or subsequent season. The definition of low-level infestation has not been defined, but 10% to 20% of strawberry leaflets, especially after harvest, is a reasonable estimate.

Mechanical Control: If an infestation is detected at an early stage, rolled leaves can be removed and destroyed.

Control with Insecticides: Where control is necessary, several registered insecticides are effective. Products that contain *Bacillus thuringiensis* (*Bt*) can provide effective control if spray coverage is good and applications are made when many larvae are young and have not yet webbed leaves together fully. For *Bt* products to work, sprays must reach the leaf surfaces where larvae are feeding.

Strawberry Aphid (*Chaetosiphon fragaefolii*; order Homoptera, family Aphididae)

Aphids cause damage primarily by transmitting viruses from infected to non-infected plants. When present in great numbers, aphid feeding can result



in stunted, malformed plants. Aphids occur on new shoots, undersides of leaves, and on buds while they are still in crowns. There are several species of aphids that infest strawberries; all are small (1/16-inch long), soft-bodied insects. Both wingless and winged forms of aphids can be found. Viruses are best managed by using virus-tolerant cultivars, planting certified virus-free plants, and eliminating wild strawberries from the area.

Strawberry Whitefly
(Trialeurodes packardii; order Homoptera, family Aleyrodidae)

Strawberry plants infested with whiteflies may show a large number of tiny white adults (Figure 50) that move actively when plants are shaken, or they may show a large number of immobile scale-like immatures on the underside of leaves. Both immatures and adults suck on plant sap. They produce honeydew, a sticky substance that drips onto plants and serves as a substrate for growth of black sooty mold. They overwinter as eggs on the underside of leaves.



Figure 50. Whiteflies.

Potato Leafhopper
(Empoasca fabae; order Homoptera, family Cicadellidae)

Leafhoppers feed primarily on the underside of strawberry leaves, causing them to yellow between the veins and become curled and distorted (Figure 51). Feeding activity is most serious during the late spring and early summer. Potato leafhoppers (Figure

52) are 1/8-inch long, green, bullet-shaped insects that take flight quickly if disturbed.



Figure 51. Potato leafhopper damage.

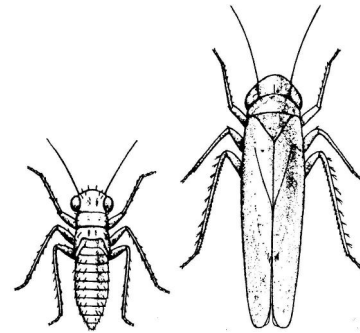

Figure 52. Potato leafhopper nymph (left) and adult (right).

The nymphs are light green and do not fly. Nymphs are easily identified by their habit of moving sideways when disturbed. Insecticides should be applied only when large populations of nymphs are noted on the leaves or symptoms become apparent.

Root- or Crown-Feeding Pests

White Grubs
(Phyllophaga species; order Coleoptera, family Scarabaeidae)

Damage: White grub larvae feed on crop roots. Root injury weakens the plant and also provides an entry site for root diseases like black root rot. Risk of white grub infestation is highest in new plantings



established on newly plowed sod or other grasses. As adults, the beetles feed on leaves in late summer, which results in skeletonized leaves.

Appearance: Adults are called May beetles or June beetles (Figure 53). They range in length from 1/2 to 1 inch and vary in color from tan to dark brown, and are shiny. C-shaped larvae are whitish gray with brown heads and three pairs of legs; they are 1/2- to 1-1/2-inches long (Figure 54). White grub species in the genus *Phyllophaga* are known as perennial white grubs or true white grubs. Other beetle species that have similar grubs are Japanese beetle (*Popilla japonica*), rose chafer (*Macrodactylus subspinous*), and green June beetle (*Cotinis nitida*); these are described in the chapter on brambles.

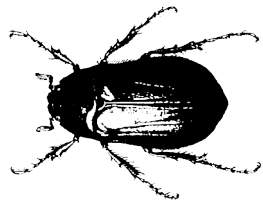

Figure 53. White grub adult.

Life Cycle and Habits: Females deposit eggs in soil during late spring or early summer; they especially prefer grass sod near wooded areas for egg-laying. Eggs hatch in two to three weeks. Newly hatched larvae feed on crop roots throughout the summer, then burrow deep in the soil to overwinter. The following year they again migrate to the root zone to feed. These larger larvae cause much greater damage than they did the year before. After overwintering again well below the soil surface, white grubs pupate early in the following summer, and adults emerge from pupal cells the next spring, three years after the cycle began. Adult beetles hide in soil during the day and fly to trees to feed at night.



Figure 54. White grub larva.

Cultural Control: Do not put new strawberry plantings on newly turned ground that was used for sod, pasture, or grass set-aside the previous year. On such sites, plow the field and let it lie fallow or in a rotational cover crop such as sudan grass or buckwheat, or a salable crop such as pumpkins or squash, for at least one season prior to planting with strawberries. Avoid setting a strawberry field next to large grassy fields that could be a source of these beetles and their larvae.

Control by Microbial Insecticides: This method currently is not effective in northern soils and thus is not recommended for Midwestern fruit growers but is included here because growers sometimes ask about it. Milky spore is a bacterial disease that kills white grubs; it is commercially available as a product that is incorporated into the ground. Several formulations are on the market. Once this kind of bacteria is established in the soil, grub control is perennial and effective. There has been difficulty in getting the bacteria established in northern soils; milky spore cannot be considered a reliable control measure in the Midwest until this problem is overcome.

Control by Conventional Insecticides: An insecticide labelled for grub control can be banded over the row to reduce the amount and cost of insecticide treatment.

Strawberry Root Weevil (*Otiorhynchus ovatus*; order Coleoptera, family Curculionidae)

Damage: The larvae of root weevils feed on strawberry roots and crowns, which can weaken, stunt, or kill plants. Root systems weakened by weevils are then more susceptible to winter injury and diseases. Infested plants can have leaves that turn red and berries that are undersized. Infestations are generally in patches in the field. Damage is worse when plants are under stress such as during droughty periods (Figure 55). Although the adult weevils chew notches from the edges of leaves, their feeding usually causes no economic losses.

Appearance: Adult strawberry root weevils are black or dark brown beetles that are about 1/5-inch long (Figure 56). They have a prominent blunt snout and elbowed antennae on the snout. Their backs are marked by many rows of small pits. Larvae are thick-





Figure 55. Root weevil damage.



Figure 56. Root weevil life stages: egg, larva, pupa, adult.

bodied, white, legless grubs with brown heads; they are usually found in a curved position (Figure 56). Larvae reach about 1/4-inch in length.

Two other species of weevils similar to the strawberry root weevil are the black vine weevil (*Otiorhynchus sulcatus*) and the rough strawberry weevil (*Otiorhynchus rugosostriatus*). These two species are similar in appearance to the strawberry root weevil except that they are larger — 1/4 inch for rough strawberry weevil and 1/3 inch for black vine weevil. They are also similar to the strawberry root weevil in damage and life cycle.

Life Cycle and Habits: The strawberry root weevil overwinters as a full-grown larva, pupa, or adult in soil, or as an adult in plant debris or other protective habitat. Larvae and pupae complete development in the spring and emerge as adults in May or June; overwintered adults become active in strawberries in May. The adult strawberry root weevil cannot fly. Adults feed on leaves at night. Root weevil adults lay eggs in strawberry fields throughout the summer, with each female depositing 150 to 200 eggs in the

soil. Eggs hatch in about 10 days. Larvae burrow through the soil to feed on roots until they mature or until cold temperatures suspend their activity.

Cultural Control: New plantings should be isolated from existing fields and wooded overwintering sites, because flightless adults do not travel far. Infested old plantings should be plowed under to destroy grubs before new beds are planted.

Monitoring: Plants should be examined in the spring if patches of poor vigor are noticed. Lift up a section of row with a spade and examine the roots within a 6-inch layer of soil. If grubs are found, control measures should be taken after harvest, when the adults emerge. In mid- and late summer, look every one to two weeks for notch-like feeding damage on leaves.

Control by Insecticides: Sprays directed to adults are not usually very effective. In some states, a systemic insecticide (carbofuran) is permitted after harvest for control of root weevil larvae under a Special Local Needs (SLN) label, also called a 24(c) label. Check in the annual Small Fruit Spray Guide or check with your state's Department of Agriculture to find out if your state has such a SLN label.

Strawberry Crown Borer (*Tyloderma fragariae*; order Coleoptera, family Curculionidae)

Damage: Strawberry plants are weakened, stunted, or killed as one or more larvae bore downward in the crown. Field borders or the portions of fields nearest older, infested plantings are often most heavily damaged. Infestations spread slowly. Leaves of infested plants might turn red. The adult beetles chew many small round holes in leaves in the fall, but this defoliation rarely is economically damaging.

Appearance: Adult crown borers are reddish-brown weevils about 1/6-inch long. They have a short thick snout. Their backs are marked with three pairs of dark spots. The larva is a yellowish, legless grub, about 1/5-inch long when fully grown (Figure 57).

Life Cycle and Habits: Adults overwinter in plant debris in strawberry fields or in surrounding areas.

They become active in the spring at about the same time that strawberries begin to bloom. They feed in crowns, opening holes into which they lay eggs



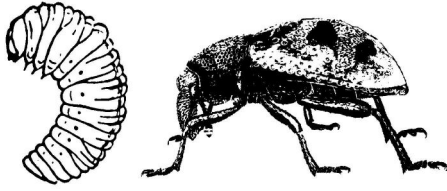

Figure 57. Strawberry crown borer larva (left) and adult (right).

that hatch in about one week. Egg-laying continues through mid-June. Eggs hatch into grubs that feed for several weeks in strawberry crowns before pupating in late summer and emerging as adults in the fall. Adults are unable to fly; they feed on strawberry foliage and then seek shelter in plant debris to pass the winter.

Cultural Control: Isolating new fields from existing infestations greatly reduces the likelihood that this insect will cause significant losses, because adult strawberry crown borers cannot fly. Commercial growers should purchase plants that are free of crown

borer and establish new fields at least 300 yards from existing fields. To prevent crown borer survival and migration, infested fields should be destroyed and tilled soon after the final picking.

Control by Insecticides: Although chemical control is rarely advised, some insecticides applied to control other insects may kill crown borers as well. Prebloom sprays intended to limit damage by tarnished plant bug can kill some crown borer adults, but peak adult activity occurs slightly later. Egg-laying adults are especially active during bloom, a time period when insecticides should not be applied.

Insecticide applied between bloom and harvest for the control of leafroller or sap beetle may also kill crown borer adults if they are still active on foliage, but killing adults at this time is unlikely to significantly reduce crown damage. Post-harvest sprays may be used to reduce the population of newly emerged adults in late summer before they overwinter, but this practice is seldom warranted.



Summary of Strawberry Insect Pest Management Procedures

I. Cultural controls when establishing a new planting.

- A. Site selection:
 - 1. Do not plant after sod or grasses to avoid problems with white grubs.
 - 2. Avoid planting near woods or fence rows to avoid problems with clipper weevils.
 - 3. Do not plant near old plantings if root weevils or crown borers were present.
- B. Cultivar selection: Avoid cultivars highly susceptible to tarnished plant bug injury.
- C. Source of nursery stock: Get plants that are free of cyclamen mite.
- D. Plant density and row spacing: Wide plant spacing will contribute to slug management.

II. Cultural controls while maintaining a planting.

- A. Weed control: Contributes to tarnished plant bug and spittlebug management.
- B. Harvest: Prompt removal of all ripe and cull berries helps sap beetle management.
- C. Mulch: Remove mulch after harvest and delay mulching in fall to discourage slugs.
- D. Renovation: Helps with slug and mite management.
- E. Sanitation: Remove debris that may shelter pests, in and around fields.

III. Mechanical control options.

- A. Bait buckets during harvest for sap beetles.
- B. Traps for slugs.
- C. Row covers to exclude tarnished plant bug.

IV. Scouting for pests.

- A. Pre-bloom (once per week)
 - 1. Strawberry clipper: Examine plants for clipped buds.
 - 2. Two-spotted spider mite and predatory mites: Examine leaflets.
 - 3. Tarnished plant bug, adults: Sweep-net sampling.
- B. During bloom (once per week)
 - 1. Flower thrips: Shake flowers in plastic bag.
 - 2. Tarnished plant bug, nymphs: Shake flowers over dish.
 - 3. Spittlebug: Examine plant stems.
- C. Post-harvest (once every two weeks)
 - 1. Two-spotted spider mite and predatory mites: Examine leaflets.
 - 2. Strawberry rootworm beetles: Examine leaflets.
 - 3. Miscellaneous pests: Leafrollers, leafhoppers, whiteflies, aphids, root weevils.



Weed Management in Strawberries

The strawberry plant is shallow rooted and is a poor competitor against weeds for sunlight (for growth and flower buds), nutrients, and moisture. Weeds can reduce yields up to 40% or more. Harvesting fruit by hand presents a challenge when weeds are present. Where customers pick their own berries, weed-free fields are important for repeated sales and customer satisfaction. A weed control program (see *Weed Management: General Information and Guidelines*, page 172) integrates knowledge of how weeds enter the field (prevention of infestation), cultural control practices, and chemical control (Table 2-4).

Weed Control with Herbicides

Fumigation is recommended when a site is being replanted to strawberries or when there is evidence of nematodes or soil pathogens. Correctly applied, certain fumigants may control most weeds during the establishment year, but cultivation and hand weeding will be required to remove “misses,” and herbicides will be necessary by fall, even if fumigation is used.

Good weed control starts the year before the field is planted to strawberries by eradicating perennial weeds (see the section on *Controlling Weeds Before Planting*, page 178). Identify all weeds in order to select an effective herbicide. (See Table 6-1, *Weed*

Table 2-4. Recommended Herbicides for Strawberries: THE TRANSPLANTING YEAR.		
Weeds	Timing of Treatment^a	Herbicide/Acre
Preemergence		
Annual grasses, some broadleaves	Anytime before or after transplanting.	• Dacthal W-75, 8-12 lb.
Annual grasses, some broadleaves	After adequate number of runners have rooted, or in late fall.	• Devrinol 50WP, 4-8 lb; irrigate within 2-3 days.
Broadleaf weeds, some grasses	After transplanting, but before rooting of runners.	• Sinbar 2-3 oz, followed immediately by rainfall or irrigation equal to 1/2 - 1”.
Winter annual weeds	Late summer/ early fall.	• Sinbar 2-6 oz, followed immediately by rainfall or irrigation equal to 1/2 - 1”.
Postemergence		
Grasses	When grasses are 2-8” tall (before seed head formation).	• Fusilade DX, 16-24 oz + 2 pt crop oil concentrate/25 gal. or 1/2 pt nonionic surfactant/25 gal. • Poast 2 pt + 2 pt crop oil concentrate; • Select, 8 oz + 1 quart crop oil concentrate/A; apply no more than 32 oz/season.
Nonselective (kills all)	Before weed growth is 6”. <i>Directed spray only</i> (do not spray strawberry plants).	Gramoxone Extra, 1.5 pt. in 20-60 gal water + non-ionic surfactant. <i>Directed spray only.</i>
Nonselective (kills all)	Late summer-fall (August—mid-September).	Roundup Ultra, 1-3 qt <i>Directed spray or wiper only.</i>
^a Before using, read comments on herbicides in Table 6-2, Small Fruit Herbicides, page 175.		



Susceptibility Table for Small Fruit Herbicides, page 173.) Observe precautions on the label regarding herbicide rates and soil texture and organic matter. Apply herbicides at the appropriate timing or weed stage of growth.

Some mechanical cultivation and hand-hoeing will be required to supplement herbicides used at planting

and will become more important as these herbicides lose their effectiveness, usually about one to two months after planting. Strawberry cultivars differ in their sensitivity to herbicides, especially Sinbar. Always evaluate tolerance of a new cultivar on a small scale, i.e., a few plants or rows, before treating the entire area.

Table 2-5. Recommended Herbicides for: ESTABLISHED STRAWBERRY BEDS.		
Weeds	Timing of Treatment^a	Herbicide/Acre
Preemergence		
Annual grasses, some broadleaves	Late fall or early spring.	• Dacthal W-75, 8-12 lb.
Annual grasses, some broadleaves	Fall or early spring.	• Devrinol 50WP, 4-8 lb; irrigate within 2 to 3 days.
Broadleaf weeds, some grasses	Renovation, before new growth begins.	• Sinbar 4- 8 oz.
	Late fall, just before mulching.	• Sinbar 4-8 oz .
Postemergence		
Dandelions, other broadleaves	Renovation (before mowing).	• 2,4-D (Formula 40) 1-3 pt.
Annual and perennial grasses	When grasses are 2-8" tall, before seed head formation.	• Poast 2 pt + 2 pt crop oil concentrate; • Select, 8 oz + 1 qt crop oil concentrate/A; apply no more than 32 oz/season.
Nonselective (kills all).	When weeds are 6" or less.	• Gramoxone Extra, 1.5 pt in 20 to 60 gal water + non-ionic surfactant.
^a Before using, read comments on herbicides in Table 6-2, Small Fruit Herbicides, on page 175.		



Table 2-6. Herbicide Efficacy Against Common Weeds in Strawberries.						
Herbicides						
Common Weeds	Postemergence			Preemergence		
	Select	2,4-D	Poast	Devrinol	Dacthal	Sinbar
Perennial Grass						
Quackgrass	E	N	G	N	N	P
Bluegrass	G	N	P	N	N	P
Yellow Nutsedge	P	F	N	P	N	F
Perennial Broadleaf Weeds						
Dandelion	P	E	N	N	N	F
Clovers	P	E	N	N	N	F
Thistle	P	G	N	N	N	N
Curley Dock	P	G	N	N	N	N
Annual Grasses						
Crabgrass/Foxtails/ Barnyard Grass	E	N	E	E	E	G
Oats or Rye (from mulch)	E	N	E	E	E	G
Annual Broadleaf Weeds						
Lambsquarters	P	E	N	F	G	E
Redroot Pigweed	P	E	N	F	G	G
Galinsoga	P	G	N	G	P	G
Yellow Wood Sorrel	P	P	N	P	G	F
Chickweeds	P	F	N	E	G	E
Purslane	P	G	N	G	G	G
Shepherd's Purse	P	G	N	P	P	E
Carpetweed	P	G	N	G	G	G
Horseweed	P	G	N	N	N	G
Common Groundsel	P	F	N	F	P	F
Field Violet	N	P	N	P	G-E	G
E = Excellent; G = Good; F = Fair; P = Poor; N = No Control						



Table 2-7. Observations on Strawberry Cultivar Sensitivity to Sinbar Herbicide.

<p style="text-align: center;">Very Sensitive to Sinbar</p> <p style="text-align: center;">Kent Micmac Bounty Blomidon</p>
<p style="text-align: center;">Sensitive to Sinbar</p> <p style="text-align: center;">Cavendish Glooscap Redchief</p>
<p style="text-align: center;">Moderately Sensitive to Sinbar</p> <p style="text-align: center;">Governor Simcoe Settler Honeoye</p>
<p style="text-align: center;">Slightly Sensitive to Sinbar</p> <p style="text-align: center;">Veestar</p>
<p style="text-align: center;">Not Very Sensitive to Sinbar</p> <p style="text-align: center;">Redcoat Allstar</p>
<p>Source: <i>Ontario Small Fruit Newsletter</i>. Used with permission.</p>



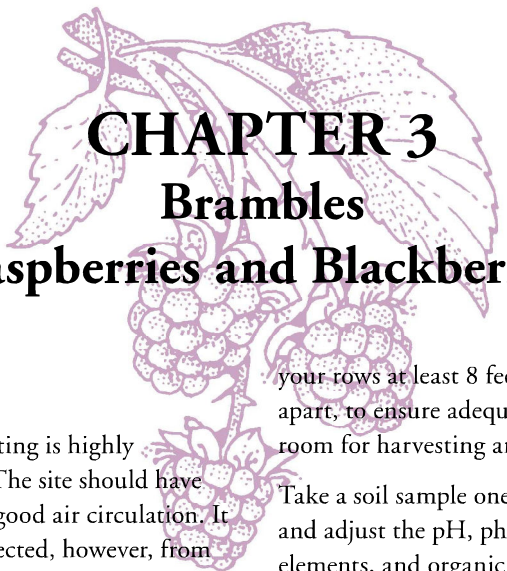

CHAPTER 3

Brambles

(Raspberries and Blackberries)

General

The success of a bramble planting is highly dependent upon its location. The site should have full exposure to sunlight and good air circulation. It should also be somewhat protected, however, from cold winter wind, since brambles are quite susceptible to winter injury. Temperatures below -20°F will injure most fruit buds above the snow line. Colder temperatures, especially if no snow cover is present, can kill canes to the ground or damage roots, causing plants to die in the early summer when not enough water can be taken in to support them.

The soil should be well drained; brambles simply will not tolerate “wet feet.” Wet soils encourage the spread of *Phytophthora* root rot, which will destroy brambles. Brambles should be planted on raised beds that are approximately 8 inches high and 4 feet wide. The soil should have 2% to 4% organic matter. Incorporate animal manure or green manures into the soil one to two years before planting. If additional organic matter is necessary, apply composted animal manure or composted yard waste to the raised bed and incorporate the material into the upper 2 to 3 inches of soil several months before planting. If there are areas of standing water after a heavy rain or poor internal drainage (percolation), then drain tile is necessary. Place lateral lines 20 to 25 feet apart according to soil conservation district recommendations.

Do not plant brambles where potatoes, tomatoes, or eggplant have recently been grown as these crops carry *Vorticillium*, another root rot fungus, which can infect brambles. Avoid planting brambles near any wild brambles. Wild raspberries and blackberries harbor insects and virus diseases, which will spread to cultivated plants. If possible, destroy all wild brambles within 600 feet of your planting.

Always obtain raspberry plants from a reputable nursery that certifies its plants to be virus-free. Raspberries are best planted in early spring. Plant

your rows at least 8 feet apart, preferably 10 to 12 feet apart, to ensure adequate air circulation as well as room for harvesting and pruning operations.

Take a soil sample one to two years before planting and adjust the pH, phosphorus, potassium, minor elements, and organic matter as recommended. A pH of 6.0 to 6.5, 25 to 40 pounds available phosphorus, 280 to 320 pounds of potassium (K), and 2% to 4% organic matter are good to excellent levels of elements.

Nitrogen (N) should be the only element required for the first three years if the soil contains adequate nutrients as described. Broadcast 20 to 30 pounds of actual nitrogen per acre one to two weeks after planting using a low nitrogen fertilizer such as calcium nitrate or ammonium sulfate to reduce plant injury. If necessary, 10-10-10 can also be used successfully. Use low rates on silt loam or heavy soils and higher rates on light soils. Split applications of one half of the above on light soils four to six weeks apart can be helpful. Do not apply high rates of granular fertilizer after late June or winter injury can be increased.

If vigorous nursery-matured tissue-cultured plants are being grown and compost is incorporated, a low rate of nitrogen should be used. When using injected fertilizers in microirrigation systems, use one half the rates suggested. Stop fertilizer injection in late July but continue to irrigate (water only) until mid-September if dry weather continues. Where rainfall equals or exceeds daily evaporation in August and September, irrigation should end in mid-August. Broadcast 40 to 70 pounds of actual N in the second year and later years based on vigor of the current year's fruiting canes — height and diameter. Red raspberries can be 7 feet high for optimal production.

Thornless blackberries may require less fertilizer. At planting broadcast 20 lbs/acre of actual nitrogen, seven to 10 days after planting. Use a low analysis nitrogen fertilizer or 10-10-10 to avoid plant damage.



For bearing thornless blackberry plants, broadcast 25 to 40 lbs/acre of actual nitrogen in late April. Use low rates on vigorous plants growing on silt loam soils with high organic matter. Split applications are suggested with 50% in late April and the remainder in mid-May to early June but before bloom.

New recommendations for raspberries, blueberries, and blackberries have suggested rates per 100 linear feet of row (Table 3-1). As the drive row distance decreases, the amount of linear feet per acre increases. Thus, higher amounts of nitrogen may be required for narrow rows. In most raspberry, blueberry, or blackberry plantings, distance between rows can be 14, 12, or 10 feet. If an acre is 215 ft (long) by 200 ft (width), then the broadcast rates per 100 ft of row apply as shown in Table 3-1. If you are banding fertilizer or using microirrigation (fertigation), use one-half of these rates.

There are 2,940, 3,360, and 4,200 linear feet of rows, respectively, if rows are spaced 14, 12, or 10 feet apart. There are 13% and 30% more linear feet in a 12-ft or 10-ft-row width, respectively, than a 14-ft width. You may wish to adjust the amount of actual nitrogen by these amounts. All brambles will require less fertilizer with high soil fertility, high organic matter, and microirrigation. Injected nutrients from May to mid-June can use one fourth or less actual N and K as KNO₃ (potassium nitrate) when a one-half rate granular fertilizer is applied in late March. Take leaf and soil samples during July and late August during the production years to monitor your fertilizer programs. When berries are soft or do not ship well

or have fungus problems, high nitrogen may be the cause. Review spray programs and fertilizer rates and adjust both to your conditions.

Proper pruning is a crucial part of pest management for raspberries. Remove old, second-year canes in the fall and also thin out weak, spindly, first-year canes. In the early spring, thin out the remaining canes, leaving only those with good height, large cane diameters, and no symptoms of winter injury, insect or disease damage. Everbearing cultivars (*e.g.*, Heritage) may be completely mowed down each year in March as a pruning practice.

Plant rows for red or yellow raspberries should be narrowed to a width of 2 feet or less. When finished, there should be no more than three or four canes per square foot of row remaining. Canes that have been cut should be removed from the planting and destroyed. Pruning in this manner will greatly reduce the incidence of most raspberry cane diseases by increasing air circulation and reducing disease inoculum. Check with your Extension office for local bramble cultivar and cultural recommendations.

Integrated Management of Bramble Diseases

An integrated disease-management program for controlling raspberry and blackberry diseases integrates the use of all available control methods into one program. The use of fungicides for control of several important diseases can be a major part of

Actual Nitrogen/Acre	Width Between Rows		
	14 ft	12 ft	10 ft
10	0.34	0.30	0.24
20	0.68	0.59	0.48
30	1.0	0.90	0.71
40	1.4	1.2	0.95
50	1.7	1.5	1.20
60	2.0	1.8	1.4
70	2.4	2.1	1.7
80	2.7	2.4	1.9

¹ When using 33% nitrogen, multiply amount by 3 to give total amount per year. When using 20% nitrogen, multiply amount by 5 to give total amount per year.



the overall disease management program, but the use of various cultural practices is perhaps even more important in obtaining effective disease control. Furthermore, many important bramble diseases cannot be controlled by fungicides. Thus, their control is almost completely dependent upon the use of cultural practices (see Table 3-2). An effective disease management program for brambles must emphasize the integrated use of specific cultural practices, knowledge of the pathogen and disease biology, disease resistant cultivars, and timely applications of fungicides or biological control agents when needed.

Fungicides can play an important role in the disease-management program; however, increasing emphasis is being placed on minimizing the overall use of fungicides while maximizing their benefits. Thus, the objective of the disease-management program is to provide a commercially acceptable level of disease control on a consistent (year-to-year) basis, with minimal fungicide use.

Identifying and Understanding the Major Bramble Diseases

It is important for growers to be able to recognize the major bramble diseases. Proper disease identification is critical to making the correct disease-management decisions. In addition, growers should develop a basic understanding of pathogen biology and disease cycles for the major bramble diseases. The more you know about the disease, the better equipped you will be to make sound and effective management decisions.

The literature listed here contains color photographs of disease symptoms on brambles as well as in-depth information on pathogen biology and disease development. These publications also contain excellent color photographs and information about insect pests as well.

Compendium of Raspberry and Blackberry Diseases and Insects — Published by the American Phytopathological Society, 3340 Pilot Knob Rd., St. Paul, MN 55121. Phone: 612-454-7250, 1-800-328-7560. This is the most comprehensive book on bramble diseases and insects available. All commercial growers should have a copy.

Bramble Production Guide — This is a comprehensive book covering most phases of bramble production. It can be purchased from the Northeast Regional Agricultural Engineering Service, 152 Riley-Robb Hall, Cooperative Extension, Ithaca, NY 14853. Phone: 607-255-7654.

Brambles: Production, Management, and Marketing — Bulletin 782, Ohio State University Extension. Can be obtained from Ohio State University Extension, Publications Distribution, 385 Kottman Hall, 2021 Coffey Road, Columbus, OH 43210-1044. Phone 614-292-1607.

The information presented on the following pages gives a description of symptoms and causal organisms for the most common raspberry and blackberry diseases in the Midwest.

Cane and Leaf Diseases

Anthracnose

Anthracnose is caused by the fungus *Elsinoe veneta*. One of the most common and widespread diseases of brambles in the United States, anthracnose can infect red, black, and purple raspberries, blackberries, dewberries, and loganberries. The disease is very destructive on black and purple raspberries. On red raspberries, it can be common but is usually not a serious problem. Disease losses can occur from defoliation, general stunting and a decrease in cane vigor, reduction in fruit yield and quality, and cane death. Resistance to anthracnose is not available in most cultivars. The use of fungicide (lime sulfur) and cultural practices such as sanitation (removal of old and infected canes) are key control methods.

Symptoms

Anthracnose can cause symptoms on canes, leaves, fruit, and stems of berry clusters. The most striking symptoms are on canes. A few days after the fungus invades the succulent tissue of young canes, minute purplish spots appear. These spots enlarge in diameter and become oval or lens-shaped. The centers become somewhat sunken and are pale-buff to an ash-gray color (Figure 58). Margins are somewhat raised and purple to purple-brown. If numerous, the lesions may merge and cover large portions of the cane. Diseased tissue extends down



Disease Control	Viruses^a	Verticillium Wilt	Orange Rust	Cane Blights^b	Powdery Mildew	Fruit Rot
Good air/water drainage	-	-	-	++	+	++
500+ ft from wild brambles	++	-	-	-	-	-
Rotation	+ ^c	++ ^d	-	-	-	-
Cultivar tolerance/resistance	++ ^e	++ ^f	++ ^g	-	+	-
Avoid adjacent plantings	++ ^j	-	++	-	+	-
Eliminate wild brambles	++	-	++	-	+	-
Disease-free stock	++	++	++	++	+	-
Aphid control (vectors)	++	-	-	-	-	-
Rogue infected plants	++	-	++	-	-	-
Speed drying (weeds, pruning)	-	-	++	++	-	++
Prune 3 days before rain	-	-	-	++	-	-
Dispose of diseased pruned canes	-	+	+	++	-	-
Maintain plant vigor	-	-	-	++	-	-
Fungicide sprays	-	-	++	++ ^h	++ ⁱ	-
Harvest before overripe	-	-	-	-	-	++
Fruit storage conditions	-	-	-	-	-	++

Key: ++ = most important controls; + = helpful controls; - = no effect.

^a Viruses: Mosaic (rasp.), Leaf Curl (raspberry, with blackberry symptomless), Ringspot (red raspberry), and Streak (purple and black raspberry).

^b Cane blights: Anthracnose, cane blight, spur blight, and Botrytis blight.

^c Rotation effective for ringspot virus only; two years of grass crop (*e.g.*, corn) with excellent weed control before planting red raspberry should eliminate need to fumigate for *Xiphinema*, a nematode vector.

^d Rotation for Verticillium wilt: Avoid fields planted to susceptible crops (tomatoes, potatoes, eggplant, peppers, strawberries, raspberries, stone fruit) within the past five years. Avoid fields with history of Verticillium wilt unless soil is fumigated.

^e Virus resistance, tolerance, and immunity: Mosaic — Blackberries are not affected; black and purple raspberries are more severely affected than red raspberries. Of purple and black raspberries, New Logan, Bristol, and Black Hawk are tolerant; Cumberland is susceptible. Of red raspberries, Milton, September, Canby, and Indian Summer are “resistant” because aphid vectors avoid them. Leaf Curl — Blackberries are symptomless; all raspberries are affected. Tomato Ringspot — Red raspberries are affected. Streak — Black and purple raspberries are affected.

^f Verticillium tolerance: Most blackberries are resistant; red raspberries are more tolerant than black raspberries. Cuthbert and Syracuse red raspberries appear to be resistant under field conditions.

^g Orange rust resistance: Red raspberries are immune. Other brambles are affected. Of blackberries, Eldorado, Raven, Snyder, Ebony King, Choctaw, Commanche, Cherokee, and Cheyenne are reported resistant.

^h Fungicide program for cane blights: The lime-sulfur spray (delayed dormant) is most important for anthracnose and cane blight.

ⁱ Fungicide program for powdery mildew: Sulfur will provide good control of powdery mildew.

^j Keep blacks and purples away from reds because mosaic virus can spread from reds and is more severe on blacks and purples. Keep all reds away from blackberries because blackberries can be a symptomless carrier of leaf curl virus.





Figure 58. Anthracnose lesions on black raspberry canes.

into the bark, partly girdling the cane. As the canes dry in late summer and early fall, diseased tissue often cracks. In the following year, fruit produced on severely diseased canes may fail to develop to normal size and may shrivel and dry, especially in a dry growing season.

On leaves, anthracnose appears on the upper surface in early to mid-summer as irregular, yellowish-white spots about 1/16 inch in diameter (Figure 59). The spots gradually enlarge and develop a reddish-purple margin around a light-gray center. The centers of these spots may drop out, producing a “shot hole” effect. This shot hole symptom is more common on trailing blackberries and raspberries.

On blackberries, leaf spots may merge together, producing large grayish dead areas between the veins. Anthracnose does not usually cause much damage to leaves of erect blackberries.



Figure 59. Anthracnose leaf symptoms on black raspberry.

Disease Development

The anthracnose fungus overwinters in the bark or within lesions on infected canes (Figure 60). In early spring the fungus produces two types of microscopic spores called conidia and ascospores. Conidia, which are produced in small fungal fruiting structures called acervuli, are the most common form of inoculum. Ascospores are comparatively rare. Production of these spores coincides with the leafing out of brambles in early spring. Spores are rain-splashed, blown, or carried by insects to young, succulent, rapidly growing plant parts that are susceptible to infection. The spores germinate in a film of water and penetrate into the plant tissue. Symptoms appear about a week later. Small pimple-like reproductive bodies are produced within lesions on infected canes and the fungus overwinters there. These bodies produce conidia for new infections the next spring, completing the disease cycle. As canes age and harden, they become much less susceptible.

Cane Blight

Cane blight is caused by the fungus *Leptosphaeria coniothyrium*. Cane blight is one of the more damaging diseases of raspberries. The disease is most common on black raspberries, but also occurs on red and purple cultivars. Cane blight occasionally occurs on blackberries and dewberries. Cane blight can result in wilt and death of lateral shoots, a general weakening of the cane, and reduced yield. It is usually most severe during wet seasons. The fungus often invades the cane through wounds. Any practice that reduces wounding on canes is beneficial for control. Key control methods are the same as for anthracnose.



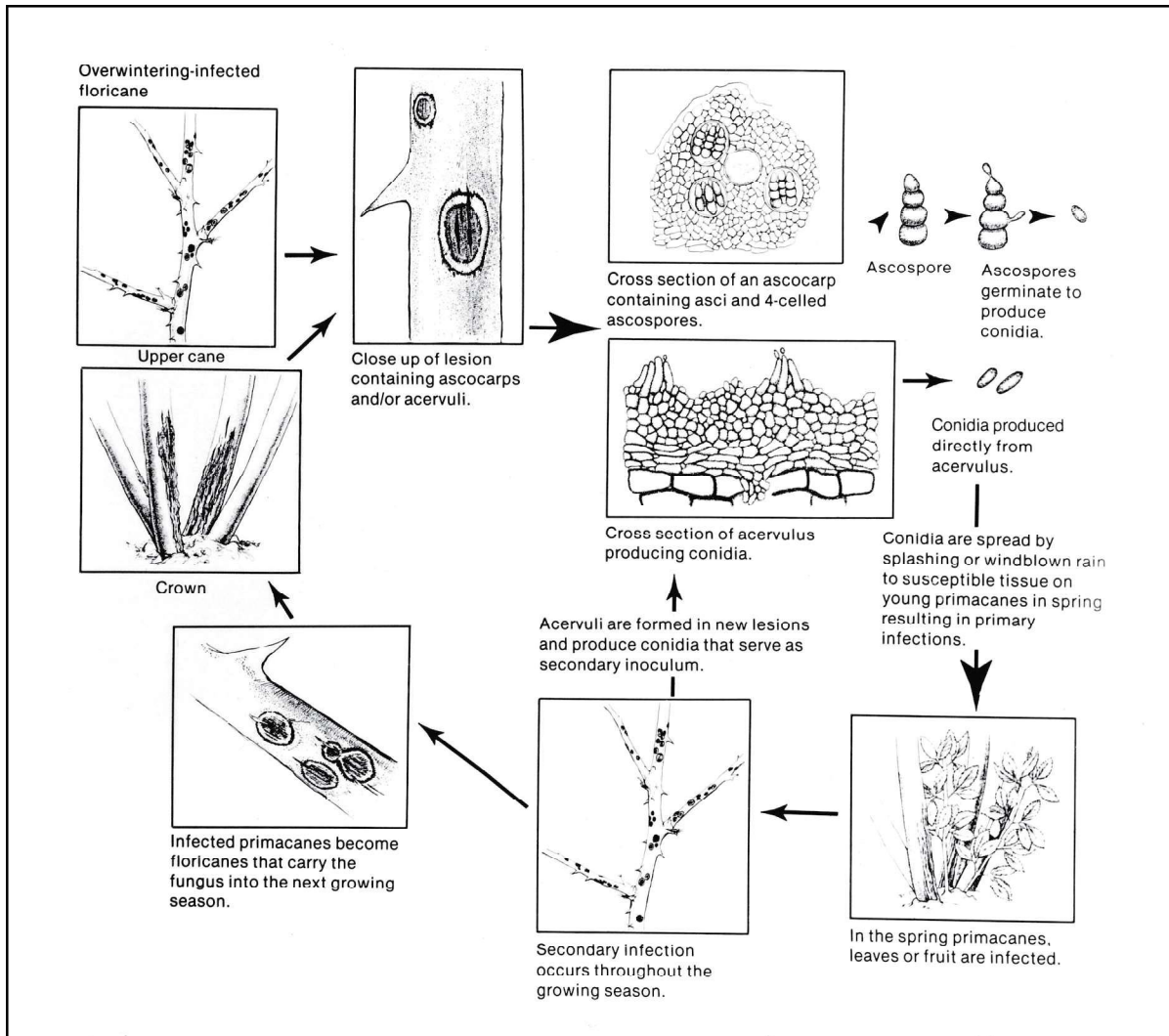

Figure 60. Disease cycle of raspberry anthracnose. Taken from the *Compendium of Raspberry and Blackberry Diseases and Insects of the American Phytopathological Society*. Used with permission.

Symptoms

Dark brown to purplish cankers form on new canes near the end of the season, where pruning, insect, and other wounds are present. The cankers enlarge and extend down the cane or encircle it, causing lateral shoots to wilt and eventually die (Figure 61). On second-year canes, the side branches may suddenly wilt and die, usually between blossoming and fruit ripening. On close examination, dark brown or purplish cankers can be observed on the main cane or branches below the wilted area. Infected canes commonly become cracked and brittle and break easily. Tiny black specks (pycnidia), which are reproductive bodies of the cane blight fungus, develop in the brown cankered bark. In wet weather,

large numbers of microscopic spores (conidia) ooze out of the pycnidia. This ooze gives the bark a dark-gray, smudgy appearance.

Disease Development

The pathogen survives over winter on infected or dead canes (Figure 62). The following spring, conidia, formed in the pycnidia, ooze from them during wet periods, and are blown, splashed by rain, and carried by insects to nearby canes. Under moist conditions, the spores germinate and penetrate into the plant through pruning wounds, insect punctures, fruit stem breaks, and other wounds. After entry, the fungus rapidly invades and kills bark and other cane tissues. Pycnidia are formed in older cankers and





Figure 61. Cane blight lesion on thornless blackberry.

complete the disease cycle. Dead canes can continue to produce conidia and remain a source of infection for several years.

Spur Blight of Red Raspberries

Spur blight is caused by the fungus *Didymella applanata*. Spur blight occurs only on red and purple raspberries. Spur blight has been considered to be a serious disease of red raspberry; however, recent studies in Scotland suggest that spur blight actually does little damage to the cane. The extent of damage caused by spur blight in the United States is not clearly understood. Key control methods are the same as for anthracnose and cane blight.

Symptoms

Symptoms first appear on young canes in late spring or early summer. Purple to brown areas (cankers) appear just below the leaf or bud, usually on the lower portion of the stem (Figure 63). These cankers expand, sometimes covering all of the area between two leaves. In late summer or early fall, bark in the cankered cane area splits lengthwise, and fungal fruiting bodies, appearing as small black specks, develop in the cankers. They are followed shortly by the formation of many slightly larger, black, erupting

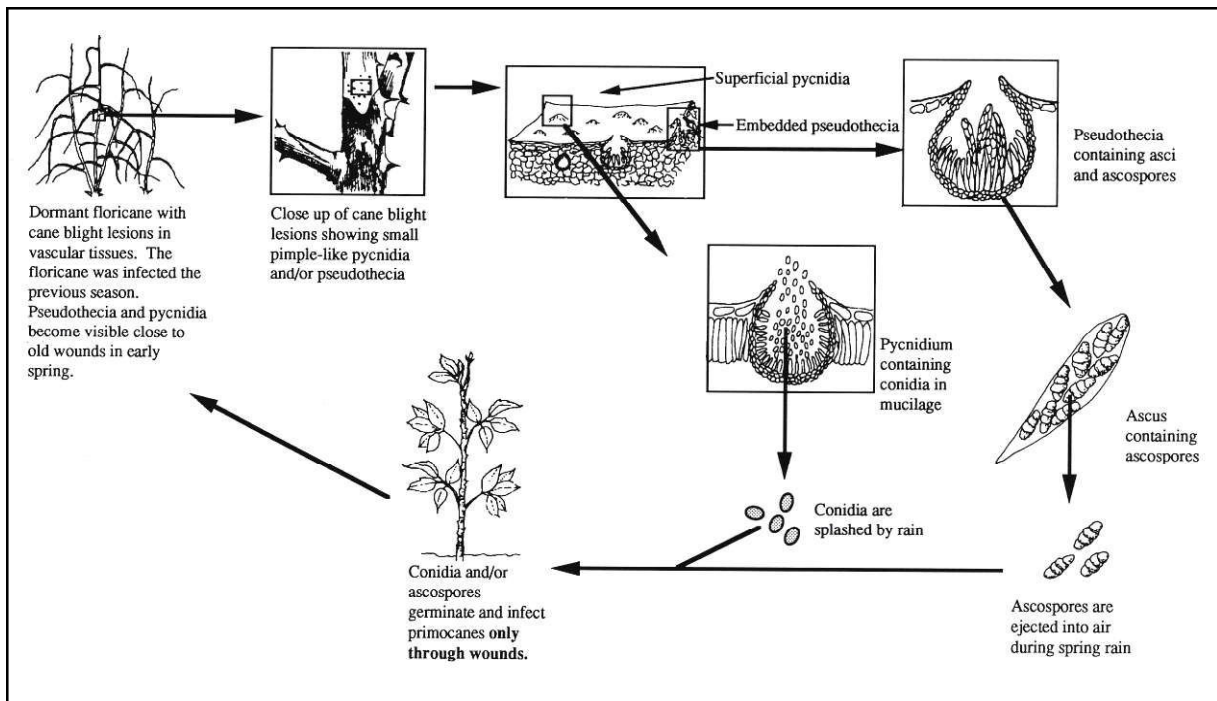

Figure 62. Disease cycle of raspberry cane blight. Taken from the *Compendium of Raspberry and Blackberry Diseases and Insects of the American Phytopathological Society*. Used with permission.





Figure 63. Typical symptoms of spur blight on red raspberry canes.



Figure 64. Symptoms of spur blight on red raspberry leaves. The V-shaped lesions are characteristic.

spots, another form of fungal fruiting body. Leaflets sometimes become infected and show brown, wedge-shaped diseased areas, with the widest portion of the wedge at the top of the leaf. Infected leaves may fall off, leaving only petioles without leaf blades attached to the cane (Figure 64).

As diseased primocanes become fruiting canes (floricanes) during the next season, the side branches growing from diseased buds are often weak and withered and produce less fruit.

Disease Development

The fungus survives the winter in diseased canes (Figure 65). The following spring and summer, during wet and rainy periods, spores are released and carried by splashing rain and wind to nearby new growth. There they germinate and produce new infections, where the fungus will again overwinter.

Septoria Leaf and Cane Spot

Septoria leaf and cane spot is caused by the fungus *Septoria rubi*. The disease is common and can be

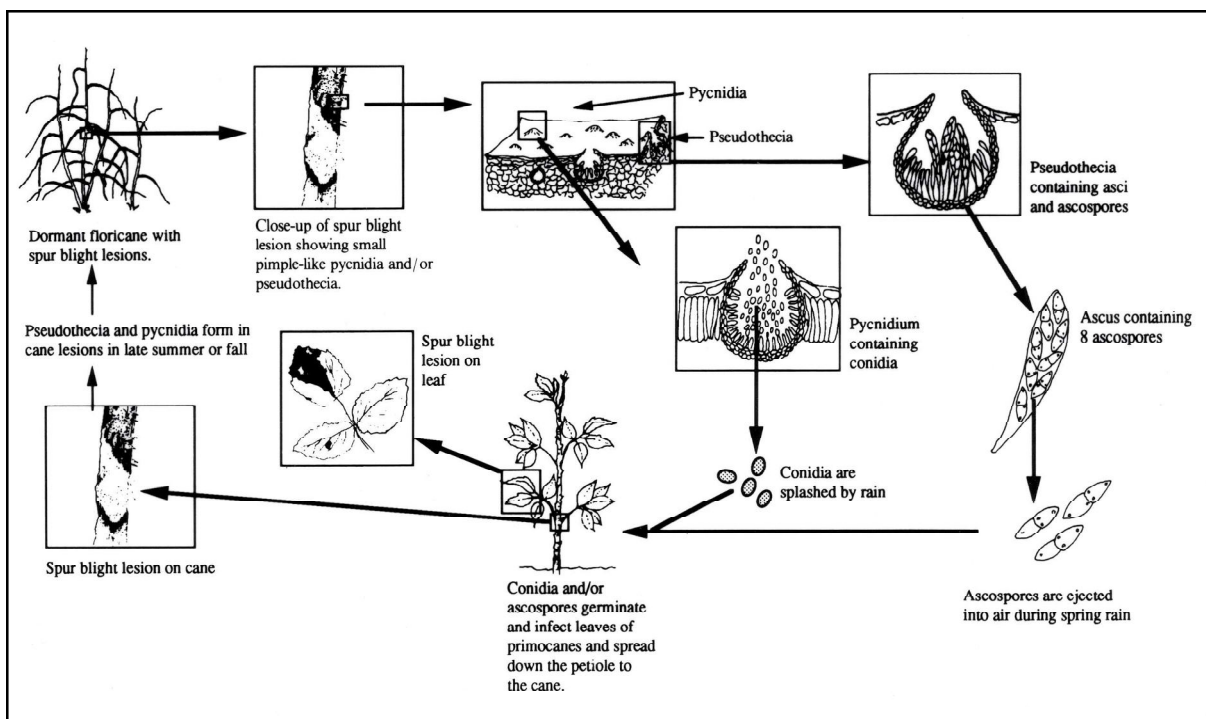

Figure 65. Disease cycle of raspberry spur blight. Taken from the *Compendium of Raspberry and Blackberry Diseases and Insects of the American Phytopathological Society*. Used with permission.



quite severe on erect and trailing blackberries and black raspberries growing in the southern portions of the Midwest. Leaves and canes of severely infected plants become badly spotted. The disease can cause premature defoliation, which will produce weak plants that are more susceptible to winter injury.

Symptoms

On leaves, Septoria leaf spot lesions have a whitish to gray center surrounded by a brown to purple border (Figure 66). The spots are circular and are about 1/8 inch in diameter. Tiny black pycnidia (fungal fruiting bodies) form in the center of the spots. The pycnidia are small; therefore, it may be necessary to use a magnifying glass (10X hand lens) to see them. Leaf spots caused by Septoria are similar to those of anthracnose. Spots on canes and petioles are similar to those on leaves but are generally more elongated.

Disease Development

The fungus overwinters as mycelium and pycnidia (fungal fruiting bodies) in dead plant debris (leaves and stems) and on infected canes. Pycnidia on infected canes from a nursery can be an effective means for moving the fungus into new fields. In the spring, spores (conidia) are produced inside the pycnidia. They are released in high numbers and carried to young susceptible leaves and canes by splashing or wind-driven rain. The fungus spores germinate in a film of moisture and penetrate the leaf or cane tissue. As leaf and cane spots form and age, new pycnidia form in the centers. These also produce and release spores that can cause secondary infections throughout the growing season. Although the environmental conditions required for infection are not clearly understood, periods of rainfall are

highly conducive to disease development. After overwintering in infected canes or debris, the fungus produces spores for new infections the following spring, completing the disease cycle.

Rosette

Rosette, or double blossom, is caused by the fungus *Cercospora rubi*. Rosette is a serious disease of many cultivars of erect and trailing blackberries, particularly in the humid southern United States and the southern regions of the Midwest. The disease is not present in the more northern regions of the Midwest. Rosette also occurs on red and black raspberry but is seldom serious. Rosette infected blossoms do not form berries and non-infected parts of the same cane may produce poor quality fruit. The disease seriously reduces fruit quality and yield.

Symptoms

Symptoms of rosette disease are striking and may completely change the plant's appearance due to a proliferation of shoots. This proliferation of shoots is referred to as a witches' broom. Buds on new canes of erect and trailing blackberries are infected in early summer. Generally, no symptoms will develop until the following spring, although a few witches' brooms may develop during warm spells in late fall. In the spring, numerous leafy sprouts develop from infected buds (Figure 67). These shoots are generally smaller than normal and have pale green foliage that later turns a bronze color. Several of these witches' brooms may be formed on one cane.

Unopened infected flower buds are abnormally large and coarse and frequently somewhat redder. Sepals enlarge and occasionally change into leaves.



Figure 66. Septoria leaf spot on blackberry leaflet.



Figure 67. Symptoms of rosette disease on blackberry.



Flower petals may become green and leaf-like. As flower buds open, petals are usually pinkish in color, wrinkled, and twisted. Pistils are usually larger and longer than normal and occasionally become abnormally shaped. The fungus produces a whitish spore mass that can cover the surface of the infected pistils and stamens. Berries do not develop from infected blossoms. Non-infected parts of the same cane often produce small, poor quality fruit. In some cultivars the witches' brooms symptoms may not be apparent; however, the fruit set in infected blossoms is always impaired.

Disease Development

Young buds on vegetative canes are infected in early spring (Figure 68). The double blossom fungus grows between the bud scales and surrounds the embryonic tissues within the bud. As secondary buds develop beside an infected bud, they are also invaded. After the bud is colonized by the fungus, very little happens. Infected buds usually remain symptomless until the next spring. A few infected buds are sometimes forced out in an unusually warm late fall. The fungus overwinters in infected buds. During the

winter the fungus continues to grow within the bud. Bud proliferation is induced.

When infected buds break dormancy in spring, they develop a large number of short, abnormal, and off-colored shoots (the witches' broom effect). Infected flower buds usually produce abnormal blossoms upon which the fungus produces its spores. These spores are carried by wind or insects to the newly formed vegetative buds, which are only susceptible to infection in early spring. The fungus infects these buds and overwinters in them to cause new symptoms the next spring, thus completing the disease cycle.

Powdery Mildew

Powdery mildew is caused by the fungus *Sphaerotheca macularis*. Powdery mildew affects susceptible cultivars of red, black, and purple raspberries. Blackberries and their hybrids are usually not affected. The disease can be severe (varying from year to year) on highly susceptible cultivars, and these plants may be stunted and less productive. The infection of flower buds reduces fruit

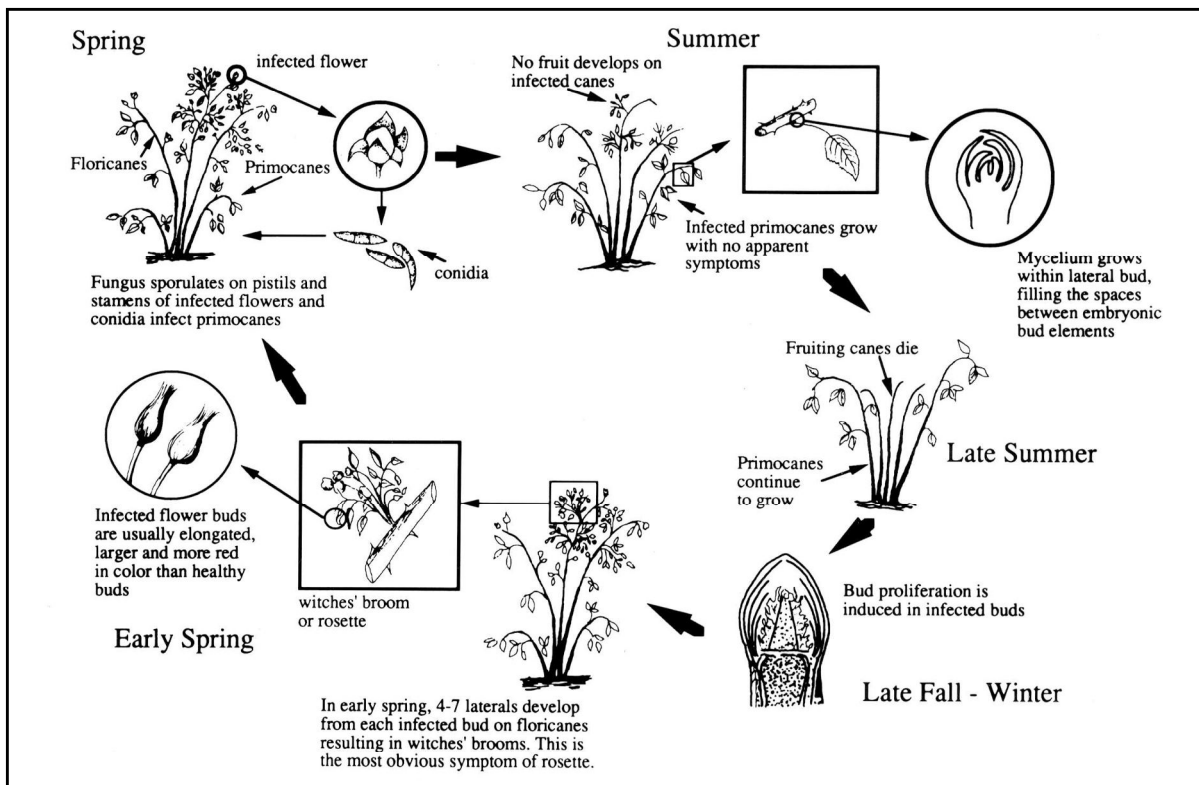

Figure 68. Disease cycle of rosette or double blossom. Taken from the Compendium of Raspberry and Blackberry Diseases and Insects of the American Phytopathological Society. Used with permission.



quantity. Infected fruit may be lower in quality or unmarketable as a result of the unsightly covering of mycelial growth. The key control method is to avoid susceptible cultivars. Sulfur or Nova fungicides will provide good control on susceptible cultivars.

Symptoms

Infected leaves develop light green blotches on the upper surface. Generally, the lower surface of the leaf directly beneath these spots becomes covered by white, mycelial growth of the powdery mildew fungus. The leaf spots may appear water-soaked. Infected leaves are often mottled, and if surface growth of the fungus is sparse, they often appear to be infected by a mosaic virus. Infected shoot tips may also become covered with mycelial growth (Figure 69). When severely infected, the shoots become long and spindly (rat-tailed), with dwarfed leaves that are often curled upward at the margins (Figure 70). Infected fruit may also become covered with a white mycelial mat. When the disease is severe, the entire plant may be stunted.

Disease Development

The fungus has been reported to overwinter as mycelium in buds on shoot tips in Minnesota, but in California it has been reported to overwinter only as cleistothecia (fungal fruiting structures), producing ascospores as primary inoculum in the spring. Conidia are generally abundantly produced on the surface of infected tissue, and these serve as secondary inoculum for repeated cycles of infection throughout the growing season. They are airborne and probably remain viable for no more than 21 days. The development of this disease, like most other powdery mildew diseases, is favored by warm, dry weather.



Figure 69. Powdery mildew on blackberry leaves. Note the leaves are covered with the white growth of the fungus.



Figure 70. Powdery mildew on blackberry. Note the distortion of leaves.

Orange Rust

Orange rust is the most important of several rust diseases that attack brambles. All cultivars of black and purple raspberries and most cultivars of erect blackberries and trailing blackberries are very susceptible. Orange rust does not affect red raspberries. Orange rust is caused by two fungi that are almost identical, except for a few differences in their life cycles. *Arthuriomyces peckianus* occurs primarily in the northeastern quarter of the United States and is the causal agent for the disease in the Midwest. *Gymnoconia nitens* is a microcyclic (lacks certain spores) stage of *A. peckianus*. *G. nitens* is the more common rust pathogen on erect and trailing blackberries in the Southeast.

Unlike all other fungi that infect brambles, the orange rust fungus grows systemically throughout the roots, crown, and shoots of an infected plant and is perennial inside the below-ground plant parts. Once a plant is infected by orange rust, it is infected for life. Orange rust does not normally kill plants



but causes them to be so stunted and weakened that they produce little or no fruit. Key control methods are cultural practices such as removing infected plants early in the spring and eradication of wild hosts (brambles) near the planting. Nova fungicide is registered for control of orange rust. In severely infested areas, black raspberries or blackberries should probably not be planted. Red raspberries are not susceptible.

Symptoms

Orange-rust-infected plants can be easily identified shortly after new growth appears in the spring. Newly formed shoots are weak and spindly (Figure 71). The new leaves on such canes are stunted or misshapen and pale green to yellowish (Figure 72). This is important to remember when one considers control, because infected plants can be easily



Figure 71. Black raspberry plants showing early season symptoms of orange rust. Note the spindly elongated shoots. Orange pustules will develop on the underside of infected leaves.



Figure 72. Leaves on infected plants are usually yellow (chlorotic) and smaller than leaves on healthy plants.

identified and removed at this time. Within a few weeks, the lower surface of infected leaves are covered with blister-like pustules that are waxy at first but soon turn powdery and bright orange (Figures 73 and 74). This bright orange, rusty appearance is what gives the disease its name. Rusted leaves wither and drop in late spring or early summer. Later in the season, the tips of infected young canes appear to have outgrown the fungus and may appear normal. At this point, infected plants are often difficult to identify. In reality, the plants are systemically infected, and in the following years, infected canes will be bushy and spindly and will bear little or no fruit.

Disease Development

In late May to early June, wind and perhaps rain-splash spreads the bright orange aeciospores from the pustules on infected leaves to healthy susceptible leaves where they infect only localized areas of individual mature leaves (Figure 75). When environmental conditions favorable for infection





Figure 73. Orange rust symptoms on the underside of a black raspberry leaf.



Figure 74. Close-up of blister-like pustules on the underside of an infected black raspberry leaf. Pustules contain bright orange masses of fungus spores.

occur, the spores germinate and penetrate the leaf. About 21 to 40 days after infection, small, brownish-black telia develop on the underside of infected leaflets. The teliospores borne in these telia germinate to produce a basidium, which in turn produces basidiospores. In blackberries

these spores then infect buds on cane tips as they root. They also may infect buds or new shoots being formed at the crowns of healthy plants in the summer. The fungus becomes systemic in these young plants, growing into the crown at the base of the infected shoot, and into newly formed roots. As a

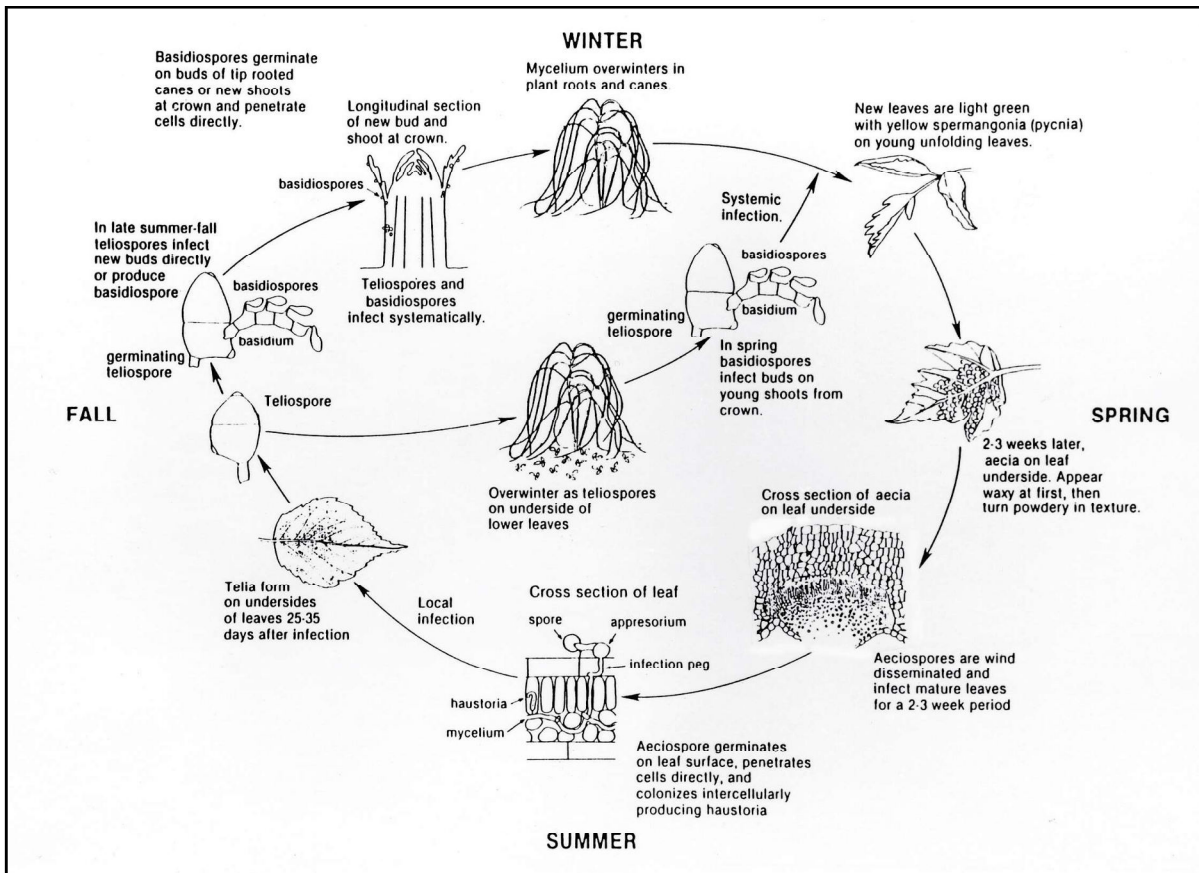

Figure 75. Disease cycle of orange rust on black raspberry. Taken from the *Compendium of Raspberry and Blackberry Diseases and Insects of the American Phytopathological Society*. Used with permission.



result, a few canes from the crown will show rust the following year. The fungus overwinters as systemic, perennial mycelium within the host.

Orange rust is favored by low temperatures and high humidity. Temperatures ranging from 43 to 72°F favor penetration and development of the fungus, but higher temperatures decrease the percentage of spore germination. At 77°F, aeciospores germinate very slowly, and disease development is greatly retarded. Spore germination and plant penetration have not been observed at 86°F. Aeciospores require long periods of leaf wetness before they germinate, penetrate, and infect plants.

Late Leaf Rust

Late leaf rust, caused by the fungus *Pucciniastrum americanum*, can cause serious damage to susceptible red raspberry cultivars. Economic losses occur from fruit infection and premature defoliation. Because it usually appears late in the season and only occasionally in a severe form, some consider it to be a minor disease. The wild red raspberry, *Rubus strigosus*, in the eastern United States is very susceptible to this rust. A number of cultivars originating from this species also are highly susceptible. While late leaf rust occurs throughout the northern half of the United States and southern Canada, it is more common east of the Mississippi River. In recent years, its occurrence has increased in the northern areas of the Midwest, and it has caused significant losses. The rust does not occur on black raspberries or blackberries. Nova fungicide should provide good control of late leaf rust.

Symptoms

On mature leaves, late leaf rust causes small chlorotic or yellow spots to form on the upper leaf surface (Figure 76). These spots may turn brown before leaves die in the fall. Unless the disease is severe, foliar infections can be rather inconspicuous. Small pustules filled with powdery spores (not waxy like orange rust spores) are formed on the undersides of infected leaves (Figure 77). These spore masses may also occur on leaf petioles, canes, and even on the fruit. Infected fruit are worthless; thus, yield of marketable fruit is reduced (Figure 78). Badly infected leaves may drop prematurely, and in years when the disease is severe, canes may be defoliated by September.



Figure 76. Symptoms of late leaf rust on the upper surface of red raspberry leaves. Note the chlorotic spots.



Figure 77. Symptoms of late leaf rust on the lower surface of red raspberry leaves. Note the masses of powdery yellow spores.



Figure 78. Late leaf rust symptoms on red raspberry fruit. Note the pustules on individual drupelets.



Disease Development

Unlike the orange rust fungus, the late leaf rust fungus is not systemic. The rust fungus produces two types of spores (urediniospores and teliospores) only on raspberries (Figure 79). The alternate host for the rust is white spruce (*Picea canadensis*), on which another type of spore (aeciospore) is produced. The rust apparently does not need the aeciospores stage to survive on raspberries, because the disease is found year after year in regions remote from any spruce trees. The fungus probably overwinters on raspberry canes and, in the following season, produces urediniospores that serve as the source of primary inoculum for new infections.

The small, numerous, light-yellow spots seen on the undersurfaces of the leaves are the uredinial pustules that contain the urediniospores of the fungus. These spores are capable of causing new infections throughout the growing season. Black, one-celled teliospores may be found later in the season intermingled with the uredinial pustules. They are capable of infecting the alternate host (spruce)

through the production of yet another type of spore (basidiospore), but probably play little part in the life cycle of the rust on *Rubus*.

Botrytis Fruit Rot (Gray Mold)

Many fungi are capable of rotting mature or near-mature fruits of raspberries and blackberries under favorable environmental conditions. The most serious and common fruit rot disease worldwide is gray mold. Gray mold is caused by the fungus *Botrytis cinerea*. In wet seasons with moderate temperatures, probably no other disease causes a greater loss of flowers and fruit. The disease is most severe during prolonged rainy and cloudy periods just before or during harvest.

Symptoms

Young blossoms are very susceptible to infection. One to several blossoms in a cluster may show blasting (browning and drying) that may extend down the pedicel. Fruit infections usually appear as soft, light brown, rapidly enlarging areas on the fruit. Infected

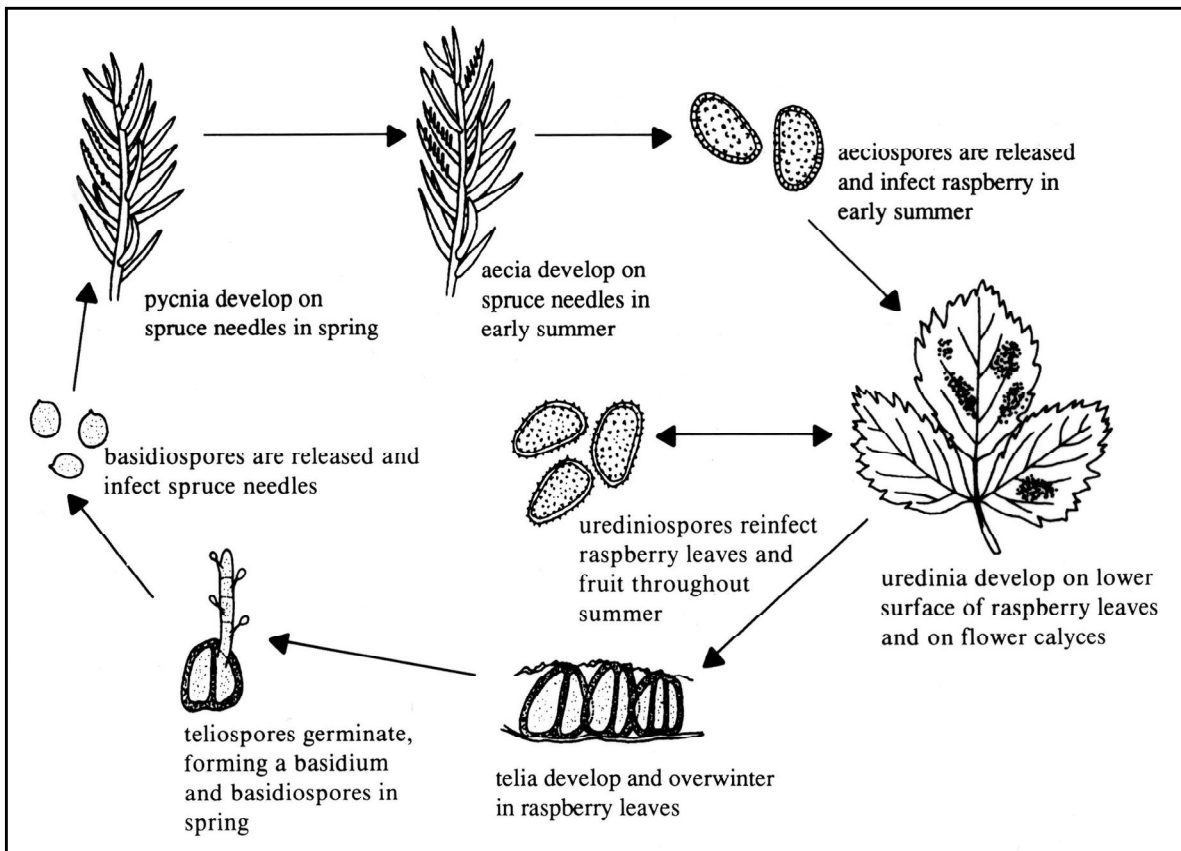

Figure 79. Disease cycle of late leaf rust on red raspberry. Taken from the *Compendium of Raspberry and Blackberry Diseases and Insects of the American Phytopathological Society*. Used with permission.



berries usually become covered with a gray, dusty, or powdery growth of the fungus (Figure 80). This is why the disease is called Gray Mold.

Fruit infections are most severe in the interior areas of the plant canopy, where the humidity is high and air movement is poor. Berries touching another infected berry or a dead leaf in dense foliage are commonly affected. Symptoms may develop on green fruits, but fruits become more susceptible as they mature. Symptoms are generally not detected until harvest.

After picking, mature fruits are extremely susceptible to infection, especially if bruised. During picking, the handling of infected fruit will spread the fungus to healthy ones. Under favorable conditions for disease development, healthy berries may become a rotted mass within 48 hours of picking.

Disease Development

The gray mold fungus is capable of infecting a great number of different plants. It overwinters as minute, black fungus bodies (sclerotia) on infected plant debris including dead raspberry leaves and canes. In early spring, these fungal bodies produce large numbers of microscopic spores (conidia). The spores are spread by wind where they are deposited on

blossoms and fruits. They germinate when moisture is present and infection occurs within a few hours. The fungus usually enters the fruit through flower parts, where it remains inactive (latent) within the tissues of infected green fruits. As the fruit matures, the fungus becomes active and rots the fruit. Thus, while infection actually occurs during bloom, symptoms are usually not observed until harvest. This is important to remember when one considers control. Temperatures between 70 and 80°F and moisture on the foliage from rain, dew, fog, or irrigation create ideal conditions for disease development. The disease can develop at lower temperatures if foliage remains wet for long periods.

Vast numbers of conidia are produced on the surface of infected plant parts, especially fruit. One infected fruit may be covered by millions of spores, which are carried by wind to cause additional infections on flowers and ripe fruit.

Root Diseases

Phytophthora Root Rot

Phytophthora root rot is caused by several related species of soilborne fungi belonging to the genus *Phytophthora*. To date, *P. megasperma*, *P. cryptogea*, *P. citriicola*, *P. cactorum*, and at least two additional unidentified *Phytophthora* species have been implicated in this disease. The disease occurs on red, black, and purple raspberries, although in the northeastern United States, it has been documented most commonly on red raspberries. The disease has been reported to occur in blackberries in Kentucky. *Phytophthora* root rot can be an extremely destructive disease on susceptible cultivars where conditions favor its development. Infected plants become weak and stunted and are particularly susceptible to winter injury; seriously infected plants commonly collapse and die. Key methods of control include site selection or improvement to avoid saturated soils and the selection of more resistant red raspberry cultivars.

Symptoms

The disease is most commonly associated with heavy soils or portions of the planting that are the slowest to drain (lower ends of rows, dips in the field, etc.). In fact, declining plants that are considered



Figure 80. *Botrytis* fruit rot (gray mold) on raspberry fruit.



suffering from “wet feet” are probably suffering from *Phytophthora* root rot. Symptoms include a general lack of vigor and a sparse plant stand. Apparently healthy canes may suddenly decline and collapse during the late spring or summer (Figure 81). In such cases, leaves may initially take on a yellow, red, or orange color or appear scorched along the edges. As the disease progresses, affected canes wilt and die. Infected plants frequently occur in patches, which may spread along the row if conditions remain favorable for disease development.

Because wilting and collapsing may be caused by other factors (winter injury, cane borers, etc.), it is necessary to examine the root system of infected plants to diagnose the disease. Suspect plants should be dug up and the epidermis (outer surface) scraped off the main roots and crown. On healthy plants, the tissue just beneath the epidermis should be white; on plants with *Phytophthora* root rot, this tissue will be a characteristic brick red (eventually turning dark brown as the tissue decays) (Figure 82). Sometimes a distinct line can be seen between infected and



Figure 81. Above-ground symptoms of *Phytophthora* root rot on primocanes of Heritage red raspberry.

healthy tissue, especially on the below-ground portion of the crown.

Disease Development

The fungi persist primarily as mycelium in infected roots or as dormant resting spores in the soil. When the soil is moist, reproductive structures (sporangia) are formed upon the infected tissue or by germinating resting spores (oospores) in the soil. Within each of these structures, a number of individual spores called zoospores are formed. These zoospores are expelled into the soil during periods when the soil is saturated with water. The zoospores have tails (flagella), which allow them to swim through the water-filled soil pores to reach new plant parts. Upon reaching a plant root or crown, the zoospores become attached and infect.

As water remains standing and oxygen is depleted from the root zone, the plant is progressively less capable of resisting the fungus, and infection



Figure 82. Below-ground symptoms of *Phytophthora* root and crown rot on red raspberry. Note the sharp line of demarcation between healthy white tissue and infected reddish-brown tissue. This reddish-brown or brick-red discoloration on roots is typical of *Phytophthora* root rot.



becomes more likely and severe. Each new infection site is a potential source of additional resting spores and zoospores, allowing for epidemic disease development in sites that are subjected to repeated periods of standing water. Although the optimum season for infection is not known for certain, it is likely that spring and fall are particularly favorable periods. However, it is assumed that infection can occur throughout the growing season if soil moisture conditions are favorable.

Verticillium Wilt

Verticillium wilt is caused by the soil-borne fungus *Verticillium dahliae* and is one of the most serious diseases of raspberries. This disease reduces raspberry yields by wilting, stunting, and eventually killing the fruiting cane or the entire plant. The disease is usually more severe in black and purple than in red raspberries. Blackberries are also susceptible to the disease, but seldom suffer severe losses.

Verticillium wilt is usually a cool-weather disease and is most severe in poorly drained soils and following cold, wet springs. The appearance of symptoms on new canes frequently coincides with drought stress during hot, dry, midsummer weather. Key methods for control are site selection and proper crop rotation to avoid planting in infested soils.

Symptoms

Symptoms usually appear on black raspberries in June to early July and on red raspberries about a month later. The lower leaves of diseased plants may at first appear to have a dull green cast as compared to the bright green of normal leaves. Starting at the base of the cane and progressing upward, leaves wilt, turn yellow, and drop. Eventually, the cane may be completely defoliated except for a few leaves at the top (Figure 83). Black raspberry and blackberry canes may exhibit a blue or purple streak from the soil line extending up the cane to varying heights (Figure 84). This streak is often not present or is difficult to detect on red raspberries. In the spring following infection, many of the diseased canes are dead. Others are poorly developed and have shriveled buds. The new leaves are usually yellow and stunted. Infected canes may die before fruit matures, resulting in withered, small, and tasteless berries.



Figure 83. *Verticillium* wilt symptoms on black raspberry plant.



Figure 84. Bluish streaks can often be observed on black raspberry canes affected by *Verticillium* wilt.



Disease Development

Verticillium is a common soil-borne fungus. It causes disease on more than 160 different kinds of plants, including strawberries, eggplant, tomatoes, potatoes, stone fruits, and peppers. The fungus overwinters in the soil and plant debris as dormant mycelium or tiny black specks called microsclerotia. The fungus can survive in the soil for many years. When conditions are favorable, microsclerotia germinate and produce threadlike fungal filaments (hyphae). These hyphae can penetrate the root directly, but invasion is aided by breaks or wounds in the roots. Once inside the root, the fungus grows into the water-conducting tissue (xylem). The destruction of water-conducting tissue prevents the movement of water from the roots to the rest of the plant. Thus, the plant eventually wilts and dies.

Bacterial Crown Gall and Cane Gall

Crown gall is caused by the bacterium *Agrobacterium tumefaciens*. Cane gall is caused by a very similar bacterium, *Agrobacterium rubi*. Crown gall is a widespread disease of all brambles. Cane gall affects black and purple raspberries more frequently than red raspberries or blackberries. These diseases are particularly serious in nursery fields where freedom from the disease is essential. The bacteria induce galls or tumors on the roots, crowns, or canes of infected plants. Galls interfere with water and nutrient flow in the plants. Seriously infected plants may become weakened, stunted, and unproductive. Key methods of control include starting the planting with disease-free plants and using crop rotation. A biocontrol agent (Galltrol) is currently available as a preplant treatment.

Symptoms

Young galls (tumor-like swellings) are rough, spongy, and wart-like (Figure 85). Galls can be formed each season and vary in size from a pinhead to several inches in diameter. They develop near the soil line or underground in the spring. Cane galls occur almost exclusively on fruiting canes and usually appear in late spring or early summer. Both crown and cane galls become hard, brown to black, woody knots as they age. Some disintegrate with time, and others may remain for the life of the plant. The tops of infected plants may show no symptoms, but plants



Figure 85. Gall on the root of a crown-gall-infected red raspberry plant.

with numerous galls may be stunted; produce dry, poorly-developed berries; break easily and fall over; or show various deficiency symptoms due to impaired uptake and transport of nutrients and water.

Disease Development

Crown gall bacteria enter the plant only through natural openings or wounds in the epidermis or bark of the plant. The bacteria survive in infested soil for years and can invade the roots and crowns of susceptible plants through natural growth cracks, tissue damaged by winter injury, or damage caused by soil insects. Man-made wounds that occur during pruning and cultivation are important points of entry. After the bacteria enter plant tissues, an incubation period of 11 to 28 days, or more if the host is dormant, may be required before the bacteria induce cell proliferation, enlargement, and disorganized growth, resulting in the production of galls. Bacteria, abundant in the outer portions of galls, are continually sloughed off into the soil. The bacteria overwinter in soil and in diseased galls. The following spring, these bacteria are spread by splashing rain, water, cultivation (any practice that moves soil), pruning tools, and insect feeding. When they contact wounded tissue of a susceptible host, they enter and induce gall formation, completing the disease cycle.

Virus Diseases of Raspberries

Red and black raspberries are susceptible to numerous viruses. Raspberries probably suffer greater infection and more serious damage from viruses



than any other fruit crop in the United States. Virus infection in raspberries can reduce fruit yields 70% or more. There are four main virus-induced diseases of raspberries — mosaic, leaf curl, streak, and tomato ringspot. Key control methods include starting the planting with disease-free (virus-indexed) plants and eradication of wild hosts as well as infected plants within the planting.

Other disorders of raspberries can cause symptoms similar to viruses. Late-spring frosts, mineral deficiencies (such as iron and nitrogen), powdery mildew, pesticide injury, and feeding by leafhoppers, aphids, and mites can all cause symptoms similar to those caused by various viruses. Positive identification of a bramble virus or virus complex cannot be based on foliar symptoms alone. Greenhouse and laboratory tests using specific scientific techniques are required for positive identification of viruses.

Mosaic

This disease is caused by a virus complex (more than one virus involved). Viruses of the mosaic complex (Rubus yellow net, black raspberry necrosis, raspberry leaf mottle, and raspberry leaf spot virus) cause the greatest reduction in growth, vigor, fruit yield, and quality of any of the bramble viruses. No raspberry plants are immune, but black and purple cultivars are damaged more severely than red cultivars.

The symptoms of mosaic vary considerably, depending upon the cultivar grown, which virus or viruses of the complex are involved, and time of year. Symptoms are most evident on new canes during cooler weather of spring and fall. Symptoms may disappear in the summer when temperatures are high. This is an important point to remember when considering control of virus diseases. Even though symptoms may disappear temporarily, plants remain infected for life.

Infected canes are usually short and less vigorous than healthy canes. Leaves are mottled with yellowish or light green spots on a darker green background (Figure 86). On more susceptible cultivars, leaves become puckered with large, dark-green blisters surrounded by yellowish or yellowish-green tissue. Leaves that develop in hot weather may be symptomless or show only faint mosaic pattern with yellow flecks in the normal green color. Leaves



Figure 86. Mosaic virus symptoms on raspberry leaves. Note the mottled areas of dark green and light green or yellow.

formed in late summer show a fine, yellowish, speckled mottling.

Mosaic-infected plants are often progressively more stunted each year. In addition to leaf symptoms, the fruit yield is reduced and may be dry, seedy (often crumbly), and lack flavor. On black and purple raspberries, the tops of newly-infected canes often curl downward, turn black, and die.

The raspberry mosaic virus complex is spread almost exclusively by one species of insect, the large raspberry aphid (*Amophorophora agathonica*). The aphid is widespread and feeds on the undersides of leaves near the tip of the canes. The aphids become contaminated with the viruses and can spread the viruses to healthy plants up to a quarter of a mile or more away. The mosaic virus can also be spread by commercial propagation from infected plants and movement of the diseased nursery plants.

Leaf Curl

Leaf curl is less common than the mosaic complex, but it is considerably more destructive. Infected plants are worthless and should be destroyed immediately. The yield of infected raspberries can be reduced up to 70 percent. Infected black raspberry plants may degenerate and die after two or three years.

Leaf curl symptoms are easily recognized. Leaves on infected plants are uniformly small, dark green, crinkled, and tightly curled downward and inward. When diseased shoots first appear, they are pale yellowish-green, but they soon turn dark green, become stiff and brittle, and usually do not



branch. Each year the plant loses more vigor and is progressively more dwarfed. Fruiting laterals are shorter and more upright than normal ones. Berries on infected plants may ripen prematurely and are small, dry, seedy, and crumbly.

The raspberry leaf curl virus, the causal agent of raspberry leaf curl disease, is spread exclusively by the small raspberry aphid (*Aphis rubicola*). Heavy populations of this aphid can cause severe inrolling of leaves even in the absence of the leaf curl virus. Winged forms of the aphid can transmit the virus to healthy raspberries from nearby infected brambles. Windborne aphids may spread the disease several miles.

Raspberry Streak

Raspberry streak, caused by tobacco streak virus, is generally a minor but widespread disease. It is presently limited to northern Ohio, western Pennsylvania, and western New York. Streak affects only black raspberries.

The most obvious symptom of the disease is numerous purplish streaks that appear on the lower parts of infected canes. Usually, the streaks are less than an inch long. Terminal leaves on infected canes are often hooked or recurved, twisted or rolled, and darker green than normal. Leaves on the lower positions of the cane may show yellowing along veins and mottling. Fruits on infected canes are smaller than normal, dull, seedy, and crumbly and lack flavor. The individual drupelets often ripen unevenly, giving the fruit a blotched appearance.

Tomato Ringspot Virus

This virus disease occurs only in red raspberries and is widespread in the major red raspberry-producing areas of the Pacific Coast and northeastern United States. Infected plants may appear normal, but they are usually somewhat less vigorous than healthy plants. The most obvious symptom of the disease is the production of small, crumbly berries that fall apart when touched. The crumbly berry is caused by the failure of some of the tiny fruitlets (drupelets), which make up the fruit, to develop.

The tomato ringspot virus can affect many other species of woody and herbaceous plants. This virus is transmitted through the soil by the dagger nematode (*Xiphinema americanum*).

Control of Virus Diseases

Always start new plantings with the highest-quality plants available. Use only certified, disease-free, virus-indexed stock. Avoid obtaining uninspected plants from friends or neighbors. Select a planting site that is sunny and fertile and has good air and water drainage. Destroy all wild and neglected raspberries and other brambles located within 500 to 1,000 feet of your planting site.

Do not plant black or purple raspberries near red raspberries, even though the red raspberries appear to be healthy. Red raspberries may have latent infections. This means that they can be infected but do not show symptoms. Even though infected plants are symptomless, the virus can still be transmitted from them to healthy plants.

If black and red raspberries are planted together, separate them as far apart as possible. If possible, plant black raspberries upwind from reds. The reason for this is the aphids that transmit viruses are generally blown or carried by wind rather than by active flight. Therefore, you do not want aphids to be blown from your red raspberries to your more susceptible black raspberries.

Go through the raspberry planting at least twice a year and remove all plants showing any virus symptoms. This should be done once about mid-June and again in August or September. Before removing infected plants, kill all aphids on them by spraying infected plants with an insecticide a day or two before removal. Dig out the diseased plants, including roots, and dispose of them away from the planting site.

In established plantings, where more than 5% to 10% of the plants show visible virus symptoms, removal of infected plants probably will not pay. In this case, maintain the planting until fruit yield becomes unprofitable, then destroy it. It is unwise to establish new plantings next to old, infected ones. Maintain strict aphid control at all times, especially in late spring and early summer when aphid populations are highest.

If the virus is transmitted by nematodes, the nematodes must be controlled in order to control the disease. Have the soil tested for plant parasitic nematodes before planting. Samples should be taken in July of the year preceding planting. Spring



samples, taken when soils are cold, are not accurate and do not give the grower sufficient time to apply a preplant nematicide. Information on collecting soil samples and submitting them for analysis is available from your Extension service.

Use of Disease-Resistant Cultivars

In an organic disease-management program where emphasis is placed on reducing overall fungicide use, it is essential to identify any available disease resistance and use it. Unfortunately, a high level of resistance to most of the major diseases is not available in most commercially grown raspberry and blackberry cultivars in the Midwest. Thus, the disease-management program must rely mainly on the use of cultural practices and efficient fungicide use. Whereas resistant cultivars are not generally available for most diseases, cultivars do vary greatly in their level of susceptibility to certain diseases. If resistance is not available, those cultivars that are highly susceptible to important diseases at least should be avoided.

Notes on Disease Resistance

Phytophthora Root Rot

Phytophthora root rot is most serious on red raspberries and some of the hybrids. The black raspberry cultivars Cumberland and Munger are reported to be susceptible. The cultivars Bristol, Dundee, and Jewel appear to be moderately to highly resistant. Among red raspberry cultivars, none are immune to the disease, but cultivars do differ greatly in their level of susceptibility. Among cultivars grown in the Midwest and Northeast, Titan and Hilton are extremely susceptible, with Festival, Heritage, Reveille, and Taylor moderately to highly susceptible. Newburgh is somewhat resistant, and Latham, Boyne, Killarney, and Nordic are considered to be fairly resistant.

Verticillium Wilt

Red raspberries are more tolerant than black raspberries. Cuthbert and Syracuse appear to be resistant under field conditions. Black raspberries are highly susceptible. Blackberries are susceptible, but the disease is seldom a serious problem.

Orange Rust

Red raspberries are immune. Other brambles are susceptible. Of blackberries, Eldorado, Raven, Snyder, and Ebony King are reported to be resistant. The Arkansas erect types (Arkansas Indian series) are reported to be resistant to orange rust.

Virus Diseases

Mosaic Virus

Blackberries are resistant. Black and purple raspberries are more severely affected than red raspberries. Of the purple or black raspberries, New Logan, Bristol, and Black Hawk are tolerant, and Cumberland is susceptible. The red raspberries Milton, September, Canby, and Indian Summer are resistant because the aphid vectors of the virus avoid them.

Leaf Curl Virus

Blackberries are symptomless. All raspberries are susceptible.

Tomato Ringspot Virus

Red raspberries and blackberries are susceptible.

Raspberry Streak

Black and purple raspberries are susceptible.

Cultural Practices for Disease Control in Brambles

The use of any practice that reduces or eliminates pathogen populations or creates an environment within the planting that is less conducive to disease development must be used. It is important to remember that many diseases, such as viruses, cannot be controlled with fungicides. Thus, cultural practices are the major means for their control. When fungicides are used, certain cultural practices, such as maintaining narrow row width or cane thinning to open the plant canopy, will greatly increase the efficacy of the fungicide program by allowing better spray penetration and promoting faster drying of susceptible plant parts. The practices described in the next section should be carefully considered and implemented whenever possible in the disease-management program.



Use Virus-Indexed Planting Stock

Always start the planting with healthy virus-indexed nursery stock from a reputable nursery. The importance of establishing plantings with virus-indexed nursery stock cannot be overemphasized, since the selection of planting stock and planting site are the only actions a grower can take to prevent or delay the introduction of most virus diseases. Plants obtained from an unknown source or a neighbor may be contaminated with a number of pathogens that experienced nurserymen work hard to control.

Select the Site Carefully

Proper site selection is critical to developing a successful disease-management program. Establishing a planting on a site that is conducive to disease development is a critical error. Such plantings may be doomed to failure, regardless of the amount of pesticide a grower uses. The considerations discussed here should play a major role in the disease-management program.

Soil Drainage

Soil drainage (both surface and internal drainage) is an **extremely important** consideration when selecting a planting site. Planting brambles on poorly or even marginally drained sites is a poor management decision. For example, poorly drained soils that are frequently saturated with water are highly conducive to the development of Phytophthora root rot, **especially in red raspberries**. Even in the absence of plant disease, wet soils are not conducive to good plant growth and productivity.

Any practice such as tiling, ditching, or planting on ridges that aids in removing excessive water from the root zone will increase the efficacy of the disease-management program. Once the planting is established, it is difficult, if not impossible to improve soil drainage.

Site Exposure (Air Circulation and Sunlight Exposure)

Avoid sites that do not have full exposure to sunlight, such as shaded areas near woods or buildings. In addition, sites with poor air circulation that tend to accumulate still, damp air should be avoided. Planting rows in the direction of the prevailing winds will help promote air circulation and rapid plant drying.

The primary reason for these previously mentioned considerations is to **promote faster drying of canes, foliage, and fruit**. Most plant pathogenic fungi and bacteria require water on plant surfaces in order to penetrate and infect the plant. Any practice that reduces wetness duration (speeds drying time) of susceptible plant parts is beneficial to the disease-management program.

Previous Cropping History

Avoid establishing plantings on sites that have a previous history of problems with Verticillium wilt, either in previous plantings of brambles or other susceptible crops. In general, it is not a good practice to plant brambles immediately after solanaceous or other Verticillium-susceptible crops, such as tomatoes, potatoes, peppers, eggplant, melons, strawberries, and other related crops. Certain common weeds, such as black nightshade, redroot pigweed, lamb's-quarters, and horse nettle will also support growth of the *Verticillium* fungus, and fields with a high population of these weeds should also be avoided. This is particularly important if Verticillium wilt is known to have been a problem on the site in the past. The fungus that causes Verticillium wilt can survive in soil for very long periods of time (at least 14 years in California). If a site is known to have had a problem with Verticillium wilt within the last five to 10 years, it should probably not be used for establishing plantings of Verticillium-susceptible bramble cultivars unless the soil is fumigated before planting.

Most brambles are susceptible to Verticillium wilt, and when the disease becomes established within the planting, it can be devastating. Resistance to Verticillium wilt in the cultivars currently grown in the Midwest is not available. In general, black raspberries are significantly more susceptible than red raspberries, and (in general) blackberries are the least susceptible.

If the site has a previous history of Phytophthora root rot, either in previous bramble plantings or other perennial fruit crops, it should probably be avoided. *Phytophthora* spp. (like *Verticillium*) can also survive in soil for extended periods of time. It is important to remember that Phytophthora root rot is usually associated with poorly drained (wet) sites, and improving soil drainage is one of the principal means of control.



If nematodes have been a problem in previous crops or if they are suspected to be a problem on the site, a soil analysis to determine the presence of harmful nematodes should be conducted. Nematodes are most likely to be a problem on the lighter (sandy) soils. Nematode sampling kits and instructions on taking samples can be obtained through your Extension office. Infested sites may be treated with an approved nematicide before planting if sampling indicates a need to do so.

Proximity (Closeness) to Established Bramble Plantings and Wild Bramble Plants

Ideally, a new planting should be isolated as far as possible from old established plantings or wild bramble plants that serve as reservoirs for diseases and other pests. The benefits of using virus-indexed plants to establish a new field are greatly reduced if the fence row around the planting or a woods directly adjacent to the planting contains wild virus-infected or orange-rust-infected plants. The same is true if a new planting is established next to an old planting that has disease problems.

Currently, no information is available on exactly how far away from an established planting or weeded area is “far enough.” The distance of 600 to 1,000 feet is used commonly in Extension literature; similarly, the New York State virus certification program requires that nurseries in the program use a minimum distance of 1,000 ft. It is probably safe to say “the farther the better.”

Consider Crop Rotation (Replanting Brambles)

When replanting brambles on the same site, the practice of crop rotation must be considered. Due to the build up and persistence of soil-borne plant pathogens, replanting brambles on the same site is not recommended without the use of crop rotation. Soil fumigation is not an option in organic production systems.

At present, data describing how long a rotation is required before replanting brambles on the same site is not available. In fact, this requirement is probably different for every different planting site. Once again, the safest recommendation is probably “the longer, the better,” particularly if the site has a history of soil-borne diseases.

All soil-borne diseases, however, are not the same. For instance, *Verticillium* wilt generally becomes a problem only after populations of the *Verticillium* fungus slowly build up to high levels. Thus, if no brambles or other susceptible crops are grown for a suitable period (probably at least five years), the fungus population declines, and brambles can be reintroduced and grown for a number of years before the population builds back up to damaging levels. This same principle is true for many harmful nematodes, but it is not true for *Phytophthora* root rot. The *Phytophthora* fungi reproduce very rapidly under proper environmental conditions, so even a low population can rebuild to damaging levels within one or two seasons.

Crop rotation will not eliminate all problems associated with soil-borne diseases. It should always be integrated with other control measures, such as the choice of resistant or partially resistant cultivars, improvements in drainage, etc. Where other control measures cannot be used (for instance, the site cannot be adequately drained), it is not advisable to replant brambles.

Avoid Excessive Fertilization

Fertility should be based on soil and foliar analysis. The use of excessive fertilizer, especially nitrogen, should be avoided. Sufficient fertility is essential for producing a crop, but excessive nitrogen can result in dense foliage that increases drying time in the plant canopy, i.e., it stays wet longer. Research has shown that excessive use of nitrogen can result in increased levels of *Botrytis* fruit rot (gray mold).

Control Weeds In and Around the Planting

Good weed control within and between the rows is essential. From a disease-control standpoint, weeds in the planting prevent air circulation and result in fruit and foliage staying wet for longer periods. For this reason, most diseases caused by fungi are generally more serious in plantings with poor weed control than in those with good weed control. Furthermore, some disease-causing organisms (*Verticillium* wilt fungus, crumbly berry virus) can build up on certain broadleaf weeds in the planting. Any practice that opens up the canopy in order to increase air circulation and reduce drying time of fruit, foliage,



and young canes is generally beneficial to disease control. Controlling wild brambles (which are weeds) near the planting is also important because they can serve as a reservoir for several important diseases and insect pests.

Sanitation (Removal of Overwintering Inoculum)

The fungi that cause anthracnose, cane blight, spur blight, Botrytis fruit rot, cane and leaf rust, and several other important diseases overwinter within the planting on canes infected during the previous year. Pruning out all **old fruited** canes and any diseased new canes (primocanes) immediately after harvest and removing them from the planting breaks the disease cycle and greatly reduces the inoculum. All infected pruning waste should be removed from the field and destroyed. If you are attempting to minimize fungicide use, good sanitation (removing old fruited canes) is critical. If old fruited canes cannot be removed before winter, they should **definitely** be removed before new growth starts in the spring.

For fall-bearing raspberries, such as Heritage, all canes are cut off each year. Removing all cut canes from the planting will aid the disease-management program. If it is impossible to remove pruned canes from the field, they should be chopped in place as quickly as possible with a flail mower to speed decomposition before new canes emerge.

Manage the Plant Population and Canopy

Any practice that alters the density of the plant canopy and increases air circulation and exposure to sunlight is generally beneficial to disease control. Optimizing between-row and within-row spacings and maintaining interplant spacings through judicious cane thinning throughout the life of the planting is desirable. Ideally, rows for red raspberries should not be more than 2-feet wide and should contain about three or four canes per square foot. Control of plant vigor, particularly through avoidance of high levels of nitrogen and careful use of cane vigor-control techniques, can greatly aid in improving the canopy density. Specialized trellis designs for various *Rubus* spp. can further improve air circulation and increase exposure to sunlight, as

well as increase harvest efficiency. Trickle irrigation, as opposed to overhead sprinkler irrigation, greatly reduces the wetting of foliage and fruit and the risk of splash dispersal of several important fungal pathogens.

Removing young fruiting shoots (before they exceed 4 inches in length) from the lower portions of canes (approximately the lower 20 inches) will remove fruit that might become soiled. This practice also removes shoots that disproportionately contribute to shading and poor air circulation in the canopy.

For information on methods for cane vigor control, trellis designs, and optimum spacing requirements, this book is very useful: *Bramble Production Guide*, edited by Marvin Pritts and David Handley. It can be purchased from the Northeast Regional Agricultural Engineering Service, 152 Riley-Robb Hall, Cooperative Extension, Ithaca, NY 14853. Phone: 607-255-7654.

Inspect the Planting Frequently and Rogue Out (Remove) Diseased Plants

Plants showing symptoms of virus diseases, rosette, or orange rust must be removed and destroyed immediately, including the roots, whenever they are found. These plants may bear fruit, but it will be of poor quality. The longer these plants remain, the greater the chances that other plants will become infected. Viruses and the orange-rust fungus are systemic and can move to adjacent plants by means of root grafts. Because of this possibility, use a flag to mark the locations where diseased plants are removed so the adjacent plants can be checked frequently for new symptoms.

For **orange rust**, it is particularly important to inspect the planting early in the growing season. The planting should also be inspected on a routine basis (at least once a week) from the time growth starts in the spring through harvest. New leaves of early spring growth on orange-rust-infected plants are chlorotic (yellowish), and shoots are bunched and spindly. They are easy to identify in the spring. It is important that infected plants be identified and removed prior to the development of the orange-rust pustules on the leaves. If these pustules are allowed to develop, they will produce large numbers of aecio-



spores which will spread the disease. If infected plants are not removed early in the spring, they become more difficult to identify later in the growing season.

Early spring is also a good time to inspect for virus diseases. Symptom expression of many viruses is more obvious during cool growing conditions. The higher temperatures of mid- to late-summer often reduce virus symptoms, making infected plants difficult, if not impossible, to detect.

Adjust Production Practices to Prevent Plant Injury and Infection

Many plant pathogens take advantage of wounds in order to penetrate and infect the plant. Therefore, any practice that minimizes unnecessary physical damage to the plant is beneficial to the disease-management program. Cane blight and bacterial crown gall are two important pathogens of brambles that enter the plant almost exclusively through wounds. The use of sharp pruning tools will help minimize damage to canes during pruning operations. Prune only when necessary (avoid cosmetic pruning of primocanes) and avoid pruning during periods when plants are wet or immediately before wet weather is forecast. Most plant pathogens require water on the surface of plant tissues before they can penetrate the plant. Providing proper cane support through trellising or otherwise tying the canes will aid greatly in avoiding abrasions from sharp spines and wind whipping of plants during windy conditions. Proper spacing between rows and the use of the proper size equipment will also prevent plant damage.

Proper Harvest, Handling, and Storage of Fruit

Proper harvesting and storage methods are critical components of the disease-management program. It is of little value to produce high-quality fruit in the field if it is bruised or crushed during harvest or permitted to rot during storage. Raspberry and blackberry fruit are **very perishable**. Even under the best conditions these tender fruits are extremely susceptible to physical damage and post harvest rots. The practices described in this section need to be

considered well in advance of initiating the harvest. The proper implementation of these practices will aid greatly in providing your customers with the best quality fruit possible.

- Handle all fruit carefully throughout all phases of harvest, transport, and sale. Bruised or crushed (leaky) fruit are much more susceptible to fungal infection and rot than firm, intact fruit.
- Harvest all fruits as soon as they are ripe. During periods of warm weather, harvest may require picking intervals as short as 36 to 48 hours. Pick early in the day before the heat of the afternoon. Overripe fruit in the planting will attract a number of insect pests and provide a source for inoculum buildup of fruit-rotting fungi.
- It is highly desirable to combine harvesting and packing into one operation. This prevents unnecessary handling and additional physical injuries.
- If possible, train pickers to remove damaged or diseased berries from the field. Some growers have programs where they pay the picker as much, or more, for damaged berries picked into separate containers, than for healthy berries. This is a good sanitation practice that reduces inoculum levels of fruit-rotting fungi in the field. Providing hand-washing facilities in the field so pickers can periodically clean their hands should be helpful in reducing the movement of fungus spores that are encountered by touching rotten (diseased) berries.
- Pick into shallow containers. Ideally, fruit should be no more than three to four berries deep; this greatly reduces bruising and crushing the fruit, which results in juice leakage that encourages the development of fungal fruit rots.
- Refrigerate fruit immediately after harvest. Fruit should be cooled as close to 32°F as possible within a few hours after harvest. This temperature should be maintained throughout storage and, if possible, throughout shipment and sale. If you do not have refrigeration, fruit should be placed in the coolest place possible. Never allow the fruit to sit in the sun.
- Avoid condensation of water on fruit after it is removed from cold storage. This is best accomplished by enclosing it in a waterproof over-wrap before it leaves the refrigerated area. The over-wrap should be kept in place until the fruit temperature has risen past the dew point.



- Sell the fruit immediately (move it or lose it). Many berries produced in the Midwest are sold to pick-your-own customers or directly at farm markets and are not refrigerated prior to sale. Customers should be encouraged (educated) to handle, refrigerate, and consume or process the fruit immediately in order to assure the highest quality possible. We must remember that even under the best conditions, raspberry and blackberry fruits are very perishable.

Fungicides for Bramble Disease Control

Fungicides can play an important role in the bramble disease-management program. However, in order to obtain maximum benefits with minimal use, fungicides must be integrated with the use of the previously described cultural practices and resistant or less susceptible cultivars. Several important bramble diseases cannot be controlled with fungicides. These include Verticillium wilt and all of the virus diseases. On the other hand, fungicides can be a very effective component in control programs for Botrytis fruit rot (gray mold), powdery mildew, Septoria leaf spot, raspberry leaf spot, anthracnose, cane blight, Phytophthora root rot, and rust diseases.

Although fungicides are an important disease management tool, **relatively few** fungicides are currently labeled for use on brambles in the United States. The lack of currently registered fungicides combined with the fact that several important diseases cannot be controlled with fungicides makes the diligent use of cultural practices within the disease-management program **extremely important**. The content presented here is intended to provide some general information about the currently registered fungicides. It is always the growers' responsibility to read and follow all label instructions. Regulations and recommendations can **change rapidly**; therefore, the information contained here could change before you read it.

Cabrio 20EG

Cabrio is registered for control of anthracnose, spur blight, leaf spot, powdery mildew, and rust on brambles. Cabrio provides good to excellent control of all these diseases and provides some suppression of

Botrytis fruit rot (gray mold). It is used at the rate of 14 oz per acre and can be applied up to and including the day of harvest; however, the re-entry interval for Cabrio on brambles is 24 hrs. No more than four applications can be made per season, and no more than two sequential sprays can be made without alternating to a fungicide with a different chemistry in order to prevent the development of fungicide resistance.

Pristine 38WG

Pristine 38WG fungicide is registered for use on all brambles (blackberry and raspberry) for control of anthracnose, Botrytis gray mold, leaf spots, powdery mildew, rust diseases, and spur blight. Pristine is a combination of two active ingredients (pyraclostrobin and boscalid). It cannot be applied more than four times per season and has a 0-day preharvest interval. Pyraclostrobin is the same material as in Cabrio (strobilurin fungicide); thus, Cabrio and Pristine cannot be alternated with each other in a fungicide resistance management program. For control of rust diseases, Cabrio and Pristine should be alternated with Nova to prevent fungicide resistance development.

Captan 50WP, 80WP, and Captec 4L

In 1995, Ohio received a special local need (24-C) label for the use of Captan 50WP and 80WP on brambles. This registration is good for Ohio only. For information about the use of Captan on brambles in Ohio, contact Mike Ellis at 330-263-3849. Contact your local Extension office for up-to-date information on the status of Captan.

Captan 80WDG

Several changes and additions have occurred on the Captan 80WDG label. These changes have not been made on any other formulations of Captan to date (Captan 80W, Captan 50W, and Captec 4L). However, these changes are in the registration process and should be made soon on other formulations.

Blackberries, raspberries, and dewberries have been added to the label. Ohio has a 24-C registration for the use of Captan 50W and Captan 80W. The 24-C registration is not needed for use of the Captan



80WDG formulation. The information presented here is from the Captan 80WDG label:

BLACKBERRIES, RASPBERRIES, DEWBERRIES: Anthracnose, Botrytis, Spur Blight: Apply 2-1/2 pounds CAPTAN 80WDG per acre when blossoms are in bud (young canes are 8- to 10-inches long). Make a second application two weeks later. Apply a fall spray after old canes are removed.
Fruit rot: Apply 2-1/2 pounds of CAPTAN 80WDG per acre at early bloom (5% to 10% bloom) and again at full bloom. Additional applications can be made at 10- to 14-day intervals as needed. Do not apply within three days of harvest. The REI is 72 hours.

In bloom and preharvest sprays for control of Botrytis fruit rot (gray mold), Captan is an excellent material to use in combination (tank mix) with Switch, Elevate, or Rovral. At the 2-1/2 pound rate, Captan may result in visible residues on fruit. If this is a problem, use Elevate, Switch, or Rovral alone in preharvest sprays.

Liquid Lime Sulfur

Lime sulfur is recommended for use on brambles as a delayed-dormant application in early spring (when buds show 1/4-inch green). It is used at the rate of 5 to 10 gallons per 100 gallons of water or 10 to 20 gallons per acre. If applied at this rate later in the season, it can cause severe damage to leaves and young canes. Lime sulfur is recommended for control of the cane-infecting fungi (anthracnose, cane blight, and spur blight). The delayed dormant application in spring is intended to eliminate or reduce the overwintering inoculum for these diseases on canes. Where cane diseases are a problem, this spray is very important. When good sanitation is used (old fruited and infected canes are removed from the field) and cane diseases are not a problem, this spray may not be necessary.

Lime sulfur has a bad smell (like rotten eggs) so there can be a problem spraying it around your neighbors. Some growers have received complaints from neighbors after applying lime sulfur. In addition, lime sulfur is very caustic. It is harmful to machine parts, paint (especially on cars), and sprayers. Special care should be taken to avoid drift to non-target

objects, and proper protective clothing should be worn by the applicator.

If a delayed-dormant application of fungicide is required and lime sulfur cannot be used, Bordeaux mixture or a fixed copper fungicide can be used in its place. Although lime sulfur is the proven material, delayed-dormant sprays of copper should provide some level of control. The use of copper in the growing season (after leaves are present) could result in significant plant damage.

Nova 40W

Nova was recently registered on blackberry for control of cane and leaf rust, orange rust, powdery mildew, and yellow rust. On raspberry it is registered for control of cane and leaf rust, leaf spot, orange rust, powdery mildew, and yellow rust. Although late leaf rust is not mentioned on the label, Nova should be highly effective for its control. Nova has excellent activity against most rust diseases and powdery mildew. It is used at the rate of 1.25 to 2.5 ounces per acre. No more than 10 ounces may be used per acre per growing season. It can be applied up to the day before harvest.

Phosphorous Acid (Agri-Fos, ProPhyt, Phostrol)

Several products containing phosphorous acid (PA, also called phosphite or phosphonate) are sold as nutritional supplements and plant conditioners, but only Agri-Fos, ProPhyt, and Phostrol are currently registered for control of plant diseases. These products are registered on brambles for control of Phytophthora root rot. They are essentially the same active ingredient that occurs in the fungicide Aliette (fosetyl-AL), and most have labels that are very similar to the label of Aliette. The materials are applied to the foliage where they are absorbed and translocated down to the roots to provide disease control.

Sulfur

Sulfur is registered for control of powdery mildew. It is available as a wettable powder or in flowable formulations. Sulfur has little or no activity against the other bramble diseases caused by fungi. Because powdery mildew is generally not a serious problem in



the Midwest, sulfur is generally of little importance within the bramble disease-management program.

Rovral 50WP and 4F

Rovral has excellent activity against *Botrytis* fruit rot (gray mold) but has little or no activity against the other fungal pathogens on brambles. Rovral is at risk for resistance development by the fungus that causes gray mold fruit rot. Therefore, Rovral should not be used more often than necessary; the less it is used, the longer it will last. Its use should be limited to no more than two applications before switching to a fungicide with a different mode of action. These fungicides include Elevate, Switch, and Captan.

Rovral can be applied up to and including the day of harvest (0-day preharvest interval or PHI). In addition, the label states it can be used on “caneberries;” therefore, it can be used on all brambles. Rovral may be applied to caneberries at the rate of 1 to 2 pounds per acre. Apply Rovral first at early bloom (5% to 10% bloom) and make a repeat application again at full bloom. Up to three subsequent applications can be applied at 14-day intervals or as required. The final application can be made up to and including the day of harvest.

It is our intention to provide a program that will allow growers to use a **minimum** number of fungicide applications. In general, use of Rovral can be minimized by cultural practices that improve air circulation in the planting (very important for *Botrytis* control); prompt harvest of ripe fruit and removal of overripe or rotten fruit from the planting (also very important for *Botrytis* control); and focusing sprays during bloom (and immediately before harvest, if necessary), just before long rainy or foggy periods.

Elevate 50WDG

Elevate is registered for control of *Botrytis* fruit rot on brambles and provides excellent control. Use recommendations for Elevate are identical to those of Rovral for control of *Botrytis* fruit rot. Elevate, Switch, and Rovral have different chemistry or modes of action. Because all of them are at high risk for fungicide resistance development in *Botrytis*, alternating their use in one to two spray blocks is recommended. Elevate may be applied up to

and including the day of harvest. The following information is taken from the label:

For control of *Botrytis cinerea* (gray mold), apply 1.5 pounds ELEVATE 50 WDG Fungicide per acre (0.75 lb AI/acre). Begin application at 10% bloom and continue through harvest. Applications should be made every seven days or when conditions favor disease development.

Avoid making more than two consecutive applications with ELEVATE 50 WDG Fungicide. After the second application, use an alternative fungicide effective in controlling *Botrytis cinerea* for two consecutive applications before reapplying the active ingredient in this product. Alternative fungicides include Rovral, Switch, and Captan. Consult your local crop advisory for appropriate alternative products. The final application may be made up to and including the day of harvest (PHI = 0). DO NOT apply more than 6.0 pounds of product per acre per season (3.0 lb AI/acre/season).

Ridomil Gold EC

Ridomil Gold is labeled for control of *Phytophthora* root and crown rot on raspberries. It has no activity against the other bramble diseases caused by fungi in the Midwest. It is available in a liquid or granular formulation. Although Ridomil is very effective for control of *Phytophthora* root rot, it needs to be emphasized that cultural practices (primarily good soil drainage) are the primary means for controlling this disease. In other words, Ridomil is most effective when used in combination with these cultural practices and/or the avoidance of highly susceptible cultivars (Titan, Ruby, Hilton). It is often ineffective if used in very wet sites, particularly on the above cultivars.

Switch 62.5%WDG

Switch is registered on blackberries and raspberries for control of *Botrytis* fruit rot (gray mold). Switch is an excellent material for control of *Botrytis*. It is used at the rate of 11 to 14 ounces per acre and has a 0-day preharvest interval. No more than 56 ounces of product can be applied per acre per year.



The label states:

Make the first application during early bloom. A second application should be made seven to 10 days later. Additional applications can be made at seven- to 10-day intervals if conditions remain favorable for disease development.

Make no more than two (2) sequential applications before using another registered fungicide. Switch 62.5WG may be applied in an alternating or blocking program.

Rotational Crop Restrictions: Do not plant any other crop for a period of 12 months unless Switch 62.5WG is registered for that use.

For purposes of fungicide resistance management, no more than two sequential applications can be made before using another registered fungicide with different chemistry. For Botrytis control on brambles, Switch can be used in alternating programs with Elevate, Rovral, or Captan. No more than four applications of Switch can be made per growing season.

Bramble Pests and Their Management

Fruit- or Flower-Feeding Pests

Raspberry Fruitworm

(Byturus unicolor; order Coleoptera, family Byturidae)

Damage: The grubs feed in the fruit receptacle or carpels and may end up as contaminants in the harvested berries (Figure 87). The adults chew holes in unfolding leaves and in flower buds. Damaged leaves look skeletonized or tattered, while damaged flower buds result in distorted berries, reduced fruit set, or premature fruit drop. Many flowers and fruit can be destroyed by this insect. Early fruit is more at risk of attack than late fruit.

Appearance: Raspberry fruitworm adults are beetles that are small, yellowish brown, about 1/8-inch long, with clubbed antennae (Figure 88). When viewed



Figure 87. Raspberry fruitworm damage.



Figure 88. Raspberry fruitworm adult.

through a magnifier, dense hairs can be seen on their backs. The immature or larval forms, called grubs, are yellowish white with a light brown section on top of each segment and a light brown head. Grubs are about 1/4-inch long when fully grown.

Life Cycle and Habits: Raspberry fruitworms overwinter as pupae in soil around brambles. The adults emerge at about the time raspberry leaves are unfolding, in late April to early May. The adults first feed along the midrib of folded leaves, then move to developing flower buds, then to flowers where they feed on pistils and stamens. Females usually deposit eggs on swollen but unopened flower buds; they sometimes lay eggs on developing fruit. Eggs hatch in a few days. Larvae tunnel into the flower receptacle to feed, then into the center of developing fruits. Larvae feed for about 30 days. When infested fruit is picked, larvae often remain attached to the inner surface of the drupelets. Those that remain on receptacles after harvest will drop to the ground to pupate and overwinter.



Cultural Control: Cultivation of plant rows in late summer or early fall kills some larvae and pupae in the soil. There is some evidence that this insect is more of a problem in weedy plantings; good weed control thus may prevent fruitworm infestation. Because fruitworm larvae drop to the ground in early July, fall-fruiting brambles escape injury. Long ago, effective control resulted when poultry were allowed in the planting after harvest to feed on fruitworm larvae or pupae in the soil.

Monitoring: Raspberry fruitworm infestations can be detected by examining foliage for long holes that give leaves a tattered appearance; this symptom indicates the potential for infestation of fruit by larvae. Flower buds can be examined for small holes. The adults tend to be most active and noticeable on plants in the early evening hours.

Control by Insecticides: Raspberry fruitworm can be controlled by insecticide applied in the early pre-bloom stage (as blossom buds first appear) and again at the late prebloom stage (just before flowers begin to open).

Tarnished Plant Bug

(Lygus lineolaris; order Heteroptera, family Miridae)

Damage: Malformed berries or failed drupelets result from tarnished plant bugs sucking juices from developing fruits. Whitening of the damaged drupelet results from plant bug feeding on mature fruit. Injured fruit tend to crumble easily and are generally unmarketable. Other plant bug species and stink bugs can cause similar damage.

Appearance: Adults of tarnished plant bug are about 1/4-inch long, somewhat flattened, and generally brassy in appearance (Figure 89). They are coppery brown with a yellow-tipped triangular area on their backs. The immature stages, or nymphs, are smaller and bright green (Figure 90). Nymphs resemble aphids but are much more active than aphids.

Life Cycle and Habits: The tarnished plant bug overwinters as adults in vegetation that provides protection from extreme cold. In the spring, they are attracted to flower buds and shoot tips of many plants, including apple, peach, and strawberry (Figure 89). Several generations of this insect develop each year, and adults and nymphs are present



Figure 89. Tarnished plant bug adult.

on many different plants from April or May until a heavy frost in the fall. Adults of early and midsummer generations move onto blossoms and fruits of brambles as fruit begins to form. Both adults and nymphs use piercing/sucking mouthparts to feed on the developing flowers and fruit.

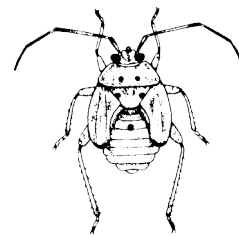

Figure 90. Tarnished plant bug nymph.

Cultural Control: Controlling weeds in and around brambles helps to reduce populations of the tarnished plant bug. However, weeds and nearby forage crops such as alfalfa should not be mowed when brambles are flowering and setting fruit, because mowing encourages the movement of tarnished plant bugs from these plants to blackberries and raspberries.

Monitoring and Thresholds: To monitor the tarnished plant bug population in brambles, sample 50 plants in mid-morning by tapping one flower or fruit cluster per plant over a small saucer or tray to dislodge tarnished plant bugs. Control is suggested if counts exceed a threshold of 0.5 plant bugs per cluster, especially in blackberries.

Control by Insecticides: If needed, sprays are most effective in reducing damage if applied just before flowers begin to open, and again when fruits begin to color.



Picnic Beetles

(*Glischrochilus* species; order Coleoptera, family Nitidulidae)

Damage: Picnic beetles bore into ripe, overripe, and damaged fruit to feed and lay eggs. Their feeding makes fruit unmarketable, and the beetles themselves become contaminants in harvested fruits. They also introduce fruit-rotting fungi to berries. Late-maturing raspberries are more vulnerable to picnic beetle damage than early berries because beetle populations are greatest in late summer and early fall.

Appearance: The picnic beetle is about 1/5-inch long, black, with four yellow-orange spots on its back (Figure 91). It has knobbed antennae. Other related sap beetles are smaller and brown. The immature form of the picnic beetle is a larva that is white with a brown head; it reaches 1/4- to 3/8-inches long.

Life Cycle and Habits: Picnic beetles overwinter as adults in many types of plant cover near the soil surface. Once temperatures reach 60°F to 65°F in the spring, they become active and feed on fungi, pollen, or sap from many kinds of plants. They lay eggs in old corn ears or other decaying matter. Larvae develop in decomposing plant material, then pupate in the soil. New adults emerge in midsummer. There is one generation per year.

Cultural Control: Sanitation is the key to preventing sap beetle infestation. Keep berries off the ground and practice frequent, complete picking. Remove overripe and damaged berries, and bury cullled berries.

Mechanical Control: Use bait buckets filled with overripe fruit; place the buckets outside the fruit planting to trap picnic beetles.



Figure 91. Picnic beetle adult.

Control by Insecticides: Because picnic beetles are attracted to overripe fruit, infestations usually build up after harvests are underway, and the use of insecticides is precluded by a combination of frequent picking and required preharvest intervals.

Scarab Beetles

(order Coleoptera, family Scarabaeidae):

Japanese Beetle

(*Popillia japonica*)

Rose Chafer

(*Macrodactylus subspinosus*)

Green June Beetle

(*Cotinis nitida*)

Damage: Leaves are skeletonized during mid- to late-summer by Japanese beetles; leaves may also be fed upon in early summer by rose chafers. Ripe berries are destroyed by Japanese beetles and green June beetles. Flower buds are destroyed by rose chafers. Japanese beetle is most troublesome in the first two to three years after a planting is established. Rose chafer is most common in areas with light sandy soil. Green June beetles are most numerous in plantings near sites where manure or compost has been spread.

Appearance: The Japanese beetle is about 1/2-inch long and copper-colored, with metallic green markings and tufts of white hairs on the abdomen (Figures 92, 97, and 150). The rose chafer is light brown, 1/2-inch long, and long legged (Figure 93). The green June beetle is one-inch long, metallic green on top and brown on the sides (Figure 94). Larvae of all are soft white grubs with six legs and a brown head, usually found in a curled position (Figure 95).

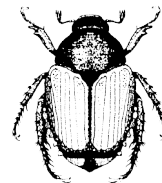

Figure 92. Japanese beetle.



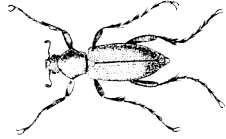

Figure 93. Rose chafer.

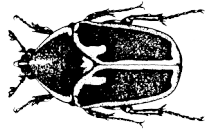

Figure 94. Green June beetle.

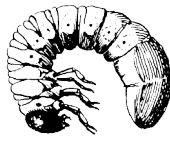

Figure 95. White grub larva.

Life Cycle and Habits: There is one generation per year of all three of these beetle species. Larvae, or grubs, of these scarab beetles develop in pastures, lawns, and other types of turf, where they live in the soil and feed on organic matter and roots of grasses. The adults move to raspberries and blackberries to feed on flowers, leaves, and fruit. Rose chafers emerge in May and June; they feed most commonly on the white flowers and foliage of brambles, sometimes destroying flower buds and greatly reducing fruit production (Figure 96). Japanese beetles begin emerging in June and July; they feed on foliage but prefer ripe berries, especially those that are exposed to full sunlight (Figure 97). Green June beetles also emerge in July, and they also feed on ripe fruit (Figure 98). Green June beetles are common where manure or compost has been spread, because such



Figure 96. Rose chafer damage.



Figure 97. Japanese beetles.



Figure 98. Green June beetles feeding on blackberries.

soils attract egg-laying females and serve as ideal sites for larval development.

Cultural Control: Clean harvesting, which prevents an accumulation of overripe fruit, helps to prevent beetles from being attracted to plantings. Plowing or cultivation can destroy pupae in the soil, but the beetles can be attracted from a long distance to these plantings.

Mechanical Control: For Japanese beetle and rose chafers, traps are available that use a sex attractant and/or feeding attractant to capture the beetles in a can or plastic bag, but such traps may not provide adequate control. Place traps near the planting, but not in the planting, because plants close to a trap may suffer increased localized damage from beetles that are attracted to the trap but not caught by it.

Control by Insecticides: Where immigrations of these beetles occur, insecticide application currently offers the only effective means of control. Preharvest restrictions must be obeyed.



Yellowjackets

(*Paravespula* species, *Vespa* species, and *Vespula* species; order Hymenoptera, family Vespidae)

Damage: Yellowjackets feed on ripe and injured fruit. Their ability to sting and their aggressive behavior make them an annoyance and a danger to pickers.

Appearance: There are several species of this group of wasps found in the north-central United States. Yellowjackets are yellow-and-black wasps that are about 1/2- to one-inch long (Figure 99). Whitejackets and bald-faced hornets are close relatives that are black and white. Both are aggressive and nasty stingers.



Figure 99. Yellowjacket.

Life Cycle and Habits: Depending on the species, the yellowjacket builds its nest underground or in old logs, or builds a large paper nest in trees or houses. The workers scavenge food such as caterpillars or other insects, pieces of flesh from dead animals, or ripe or injured fruit. Food is taken back to the nest to feed the larvae. Yellowjackets are attracted to ripe and injured fruit to feed on fluids and sugars, especially in late summer and during dry weather. Populations of yellowjackets peak in late summer.

Cultural Control: Yellowjackets can be discouraged by sanitation, which is regular and thorough picking of all berries as soon as they begin to ripen, and frequent removal of overripe fruit and fruit debris. Do not allow pickers to bring sweet drinks, lunches, or other attractants into the planting.

Mechanical Control: Where yellowjackets are attracted to brambles despite good harvest practices, traps offer the only practical method for reducing problems. The key to trapping success is to get traps out early. Traps should be put up around the perimeter of the planting before the berries begin to ripen. Although commercial traps are marketed for some yellowjackets, these traps do not work for all species. For example, traps that contain heptyl butyrate to attract *Vespula pensylvanica*, the western yellowjacket, do not attract the German yellowjacket, *Paravespula germanica*, or several other common species in eastern North America. There are many yellowjacket traps on the market, and various baits such as fish, meat, jam, honey, beer, and yeast have been used with some success. Different baits and traps may have to be tried to determine which combination will work in a particular raspberry planting. Fish traps, made with a fish suspended over a tub of soapy water, can be effective against all species.

Control by Insecticides: Insecticides cannot be used effectively in bramble plantings for yellowjacket control.

Strawberry Bud Weevil or Strawberry Clipper

(*Anthonomus signatus*; order Coleoptera, family Curculionidae)

Damage: Stems of infested flower buds are girdled; buds then dry and dangle from the stem, eventually falling to the ground. The strawberry clipper is an important pest of strawberries (see page 38), but will also attack raspberries (Figure 100). This pest is not always present and may cause only minimal damage in raspberries.



Figure 100. Strawberry clipper damage on raspberries.



Appearance: This insect is a tiny beetle, 1/8-inch long, with a copper-colored body and a black head with a long snout (Figure 101).



Figure 101. Strawberry clipper.

Life Cycle and Habits: The female weevil chews a small hole in unopened flower buds, then feeds on pollen and lays an egg in the hole. She then girdles the stem just below the bud. The immature weevils, or grubs, develop in the girdled buds, emerging as adults in the early summer, and then migrating to wooded areas.

Management: Examine the plants before bloom and look for dead or clipped-off buds. Insecticide applied prebloom for control of raspberry fruitworm should also control the bud weevil.

Cane- or Crown-Feeding Pests

Raspberry Crown Borer (*Pennisetia marginata*; order Lepidoptera, family Sesiidae)

Damage: Canes damaged by crown borer will wilt and become weak and spindly. Foliage may turn prematurely red then die, even on fruit-bearing canes. Crowns infested by crown borer larvae often swell, and all canes from those crowns can die. The entire crown might eventually die. Infested canes will break easily when given a sharp tug, and a larva may be found at the break point. When injured plants are dug up, roots and crowns may be girdled and marked with swellings, galls, cracks, or cavities. Piles of sawdust-like frass may be present.

Appearance: The adult of the raspberry crown borer is a clearwing moth with a wingspan of 1-1/4 inches. Yellow bands across its black abdomen allow this moth to resemble a yellowjacket wasp (Figure 102). Larvae are dull white with a brown head (Figure 103). Larvae are 1/2- to 3/4-inch long by the end of their first full summer, and they



Figure 102. Raspberry crown borer adult.



Figure 103. Raspberry crown borer larva.

reach a length of 1-1/4 inches when fully grown during their second summer. Larvae have three pairs of true legs and four pairs of hooked prolegs.

Life Cycle and Habits: This pest takes two years to complete its life cycle. Moths are active during daylight hours beginning in late July or August and live for about one week. Starting the day after emergence, females lay eggs singly on the lower surface of leaves (Figure 104). Eggs take 30 to 60 days to hatch. In September and October, newly hatched larvae crawl down the cane and form a



Figure 104. Raspberry crown borer egg.



blister-like hibernation cavity at the base of a cane, below the soil line. The following spring, they tunnel into and girdle new canes and the crown. They pass the second winter in bramble roots. They pupate inside the plant base in mid- to late-summer of the second year, and new adults emerge from late July to September.

Cultural and Mechanical Control: To control raspberry crown borer, infested canes and crowns should be removed and destroyed. Eliminating nearby wild brambles also reduces infestations.

Control by Insecticides: In the past, insecticide could be used to control this pest, but there are no insecticides currently registered for its control. If an insecticide becomes available for this use, it could be used as a drench around the base of plants in early spring to provide some control of larvae, or applied to lower canes after harvest in the fall to reduce egg-laying by adults. Control might not be achieved until after two or three years of treatment.

Raspberry Cane Borer

(Oberea bimaculata; order Coleoptera, family Cerambycidae)

Damage: Canes infested by raspberry cane borer show tip dieback (Figure 105). Wilted tips are usually observed in June. Cane tips wilt, blacken, and may fall off after they are girdled by the female beetles. The beetles girdle the tips of young raspberry canes by chewing two rings of punctures, about 1/2 inch apart, around the stems about 3 to 8 inches below the tip or a lateral shoot (Figures 106, 107, and 108).

Appearance: Adult beetles are about 1/2-inch long and black with a bright yellow/orange thorax (neck) that is marked with two or three black spots. This beetle's black antennae are nearly as long as its body (Figure 109). The larvae are white, legless, 3/4 inch when fully grown, and round-headed (Figure 110).

Life Cycle and Habits: The raspberry cane borer has a two-year life cycle. Adult beetles feed on the epidermis of cane tips from June through August. Females use their mouthparts to chew two rings of punctures around canes. They then deposit an egg between the rings of punctures. Eggs hatch into larvae, or grubs, that feed inside the cane. Larvae bore down to the base of the cane by fall and into the crown by the next summer. Larvae feed at the crown



Figure 105. Raspberry cane borer damage.



Figure 106. Raspberry cane borer damage.



Figure 107. Raspberry cane borer damage.

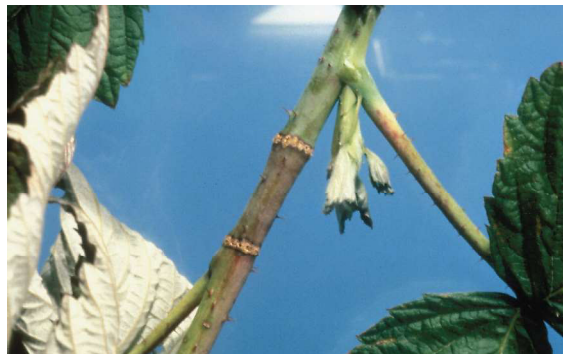

Figure 108. Raspberry cane borer damage.



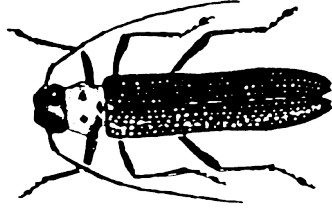

Figure 109. Raspberry cane borer adult.



Figure 110. Raspberry cane borer larva.

level for the next full season, then pupate the following spring; adult beetles emerge in June through August.

Cultural and Mechanical Control: This pest is controlled most effectively by pruning and destroying canes that exhibit wilted tips in July and August. As soon as the wilted tips are noticed, they should be cut off, several inches below the lowest girdle mark. Remove the infested tips from the field and destroy them. Also prune and destroy damaged canes and roots during the fall and winter. Eliminating nearby wild brambles also reduces populations.

Control by Insecticides: Foliar sprays of insecticide provide some control if applied when beetles are present on lower foliage, usually just before blossoms begin to open.

Red-Necked Cane Borer (*Agrilus ruficollis*)

Bronze Cane Borer (*Agrilus rubicola*; order Coleoptera, family Buprestidae)

Two flat-headed cane borers attack brambles — the red-necked cane borer and the bronze cane borer. The red-necked cane borer is the more common.

Damage: Infested canes develop galls at the site where larvae are tunnelling. These galls are symmetrical swellings, usually 1 to 3 inches in length, usually within one foot (but up to 4 feet) above the soil surface (Figure 111). Canes often break near these swellings, and unbroken canes wither

and die. Swollen canes are usually observed in July or August. Spiral tunnels just below the bark are another symptom of attack.



Figure 111. Red-necked cane borer damage.

Appearance: The adult is a slender, metallic black beetle, about 1/4-inch long, with a reddish or coppery thorax (neck) and short antennae (Figure 112). The larvae are white, legless, 3/4 inch when fully grown, and flat-headed (Figure 113).



Figure 112. Red-necked cane borer adult.

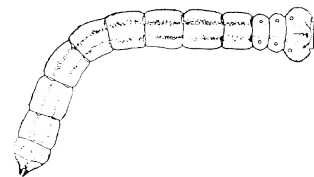

Figure 113. Red-necked cane borer larva.

Life Cycle and Habits: Adults feed along leaf margins from May through early August. During May and June, females deposit eggs on the bark of new growth, usually within 10 inches of the base



of the cane. Eggs hatch into larvae, or grubs, that tunnel upward or downward in a spiral pattern through canes, feeding in sapwood, hardwood, then in the pith. Larvae reach full size by fall. They overwinter in canes and pupate in the spring.

Monitoring and Thresholds: Before the delayed dormant stage, scout for galls made by the red-necked cane borer. If less than 5% of canes have galls, then prune out galled canes and burn, bury, or otherwise destroy infested canes to kill overwintering larvae. In the past, insecticide was recommended between first bloom and petalfall if more than 5% of canes have galls.

Cultural and Mechanical Control: Pruning and destroying infested canes in late fall or early spring helps to reduce infestations during the new year. Eliminate any nearby wild brambles that act as hosts for these pests.

Control by Insecticides: Insecticide can provide some control by targeting emerging new adult beetles; however, no insecticides are currently registered for control of this pest. If an insecticide becomes available for this use, it should be applied when red-necked cane borer beetles first appear on foliage of primocanes, which is generally at the time that bloom begins. Adult beetles emerge for two to three weeks. Sprays can be repeated at weekly intervals until no more adults are found, which is usually by petalfall.

Raspberry Cane Maggot

(Pegomya rubivora; order Diptera, family Anthomyiidae)

Damage: A wilted cane tip, or a cleanly cut tip, results from a cane maggot tunneling around inside the stem and girdling it. A gall-like swelling forms where the cane was girdled. Damage is apparent in May. Tips of infested canes wilt rapidly and darken in color, producing a symptom sometimes called limberneck. Although the raspberry cane maggot is a common pest of brambles throughout North America, it rarely causes economically significant damage.

Appearance: The adult is a small, dark gray fly, about 1/4-inch long; it is similar to a house fly but about half as large. The larvae are legless maggots;

they are white, tapered in shape, and 1/3 inch when fully grown.

Life Cycle and Habits: This pest overwinters as pupae in the soil. Adult flies emerge from pupae in early spring and deposit eggs on terminal leaves of rapidly growing primocanes. Larvae tunnel into the pith and downward, destroying water-conducting tissues and eventually girdling the stem.

Cultural and Mechanical Control: Cut off the infested part of canes a few inches below the girdle and burn the prunings. This should be done as soon as wilted tips are detected in early summer. Lower pruning and burning during the winter reduces fly populations the next spring.

Control by Insecticides: Not recommended for this pest.

Tree Crickets

(Oecanthus species; order Orthoptera, family Gryllidae)

Damage: Canes are injured in late summer by female tree crickets that chew small holes in the cane then insert eggs into the punctures (Figure 114). Punctures are usually in single rows, one- to three-inches long, lengthwise on the cane, and located in the top two feet of the cane. Each row of punctures contains about 30 eggs, but up to 80 eggs is possible. Egg-laying punctures weaken the plant. Canes damaged by tree crickets usually split or break, and punctures allow the entry of pathogens that can further damage the plant.

Appearance: Nymphs and adults are slender, somewhat flattened insects that are pale whitish



Figure 114. Tree cricket damage.



green. They have long hindlegs, antennae longer than the body, and a small head (Figure 115). Adults are about 1-inch long and have soft transparent wings that fold over their backs. Eggs are pale yellow and 1/8-inch long.

Life Cycle and Habits: This pest overwinters in the egg stage. Eggs hatch in early summer, and nymphs feed primarily as predators, eating aphids and a variety of other insects. There are five nymphal instars. Tree cricket nymphs and adults become noticeable on bramble canes in midsummer, where they may feed occasionally on foliage and ripening fruit, rarely causing much damage (Figure 116). In late summer, female tree crickets lay eggs in canes.

Cultural and Mechanical Control: Prune out and destroy damaged canes, especially old fruiting canes after harvest, to reduce the overwintering population and help reduce damage the next season.

Control by Insecticides: If infestation is severe, an insecticide may be applied when adults are present in August or September but before they lay eggs, or when young nymphs appear in the spring.



Figure 115. Tree cricket adults: male (left) and female (right).



Figure 116. Tree cricket damage on raspberry.

Periodical Cicada (*Magicicada septendecim*; order Homoptera, family Cicadidae)

Damage: The adult female cicadas make rows of pocket-like slits in canes in which to deposit their eggs (Figure 117). Each female makes five to 20 of these pockets, laying from 24 to 28 eggs in two rows in each pocket. For laying eggs, the females prefer oak, hickory, apple, peach, and pear trees and grapevines. Injured twigs turn brown and die, sometimes breaking off. The damage may be severe in newly planted orchards or on new plantings of shade trees or shrubs. Heavy populations of nymphs in the soil may also affect the growth and vigor of certain trees. In contrast to periodical cicadas, annual cicadas ordinarily do not cause much damage.

Appearance: Periodical cicadas are orange to black, about 1-1/2-inches long with black transparent wings (Figure 118). Annual or dog-day cicadas are larger, green to black.

Life Cycle and Habits: Annual or dog-day cicadas appear each year from July to September, while periodical cicadas appear from May to July only in certain years. The total life cycle of the periodical cicada takes either 13 or 17 years. There are 17



Figure 117. Female cicada damage.



Figure 118. Cicada.



broods of the 17-year race (I-XVII) and 13 broods (XVIII-XXX) of the 13-year race. Each year, somewhere in the United States at least one of these broods emerges; any one brood will emerge only once every 13 or 17 years.

The adult females lay eggs in small branches. The eggs hatch in six or seven weeks; the newly hatched nymphs fall to the ground and burrow until they find suitable roots, usually 1-1/2 to 2 feet beneath the soil. With their sucking mouthparts, they immediately begin to suck juices from the root. During the spring of the 13th or 17th year, depending on which brood is involved, the cicadas burrow upward until they are about 1 inch below the soil surface. When the proper night comes, they leave the ground in large numbers and head for the nearest upright object, preferably a tree. The nymph attaches itself firmly to this object. By splitting its skin down the middle of the back, it emerges as a winged adult. At first, the adults are soft and white, but they become harder and darker as the tissues dry.

Cicada males announce their presence to the voiceless females by making a continuous, high-pitched shrill sound. The sound is produced by vibrating membranes on the underside of the first abdominal segment. Mating takes place within a few weeks, and eggs are laid for the next brood.

Mechanical Control: Egg-laying damage by cicadas on young fruit trees or shrubs can be prevented by covering the plant with a protective netting such as cheesecloth. Cover the plant and tie the netting to the trunk below the lower branches. Remove the covering when egg-laying is over.

Control by Insecticides: Apply an insecticide when egg-laying begins and repeat seven to 10 days later.

Rose Scale

(Aulacaspis rosae; order Homoptera, family Diaspididae)

The rose scale is an armored scale that attacks stems of brambles growing in damp, shady places. Scales may overlap and encrust the bark. The scale is white, circular, and 1/10 inch in diameter (Figure 119). The scale covers the insect, which is orange-pink. Scale insects suck sap from the plant, and infestation reduces plant vigor and can cause poor fruit sizing.



Figure 119. Rose scale.

There are at least two generations per year. Rose scale is managed by pruning out and burning all heavily infested canes that can be spared and eliminating wild brambles in the vicinity.

Blackberry Gallmaker

(Diastrophus nebulosis; order Hymenoptera, family Cynipidae)

The blackberry gallmaker causes the formation of large knot galls on the stems of brambles (Figure 120). The galls are first green and later red or brown. The causal agent is a tiny wasp. If this pest becomes noticeable, remove the galls by pruning and destroy them.

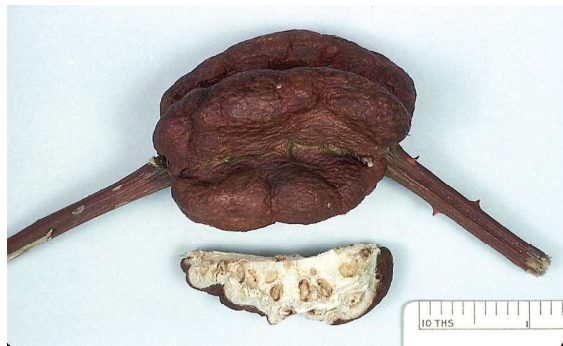

Figure 120. Blackberry gallmaker damage.

Stalk Borer

(Papaipema nebris; order Lepidoptera, family Noctuidae)

The primary symptoms of the stalk borer in a raspberry field are wilted tips and a large hole in the side of the cane about 6 to 8 inches back from the tip. Damage is done primarily by boring and tunneling in the stems. Bramble plantings adjacent to weedy



areas of the favored host such as giant ragweed are most often attacked. The stalk borer is a general feeder that attacks stems of any plant large enough to shelter it and soft enough to bore into (Figure 121).



Figure 121. Stalk borer larva in raspberry.

Foliage-Feeding Pests

Two-Spotted Spider Mite

(*Tetranychus urticae*; order Acari, family Tetranychidae)

Damage: Leaves are marked by white stippling or bronzing after spider mites have fed (Figure 122). Under heavy infestations, leaves turn brown and are covered by a fine webbing. Severe damage can reduce yield and fruit quality. Adult mites may also move onto the fruit, reducing consumer appeal by their presence. Infestations usually begin in the lower canopy. Outbreaks are favored by hot dry weather and dusty areas.



Figure 122. Spider mite damage to raspberry (left) compared to a clean leaf (right).

Appearance: Spider mites are tiny arthropods with eight legs (Figure 123). They are only 1/50-inch long. Adult females are oval shaped and white, marked with two large spots, one on each side. Immature mites are similar, but the two dark spots are more prominent than the white areas between them.

Life Cycle and Habits: Spider mites produce many generations per year and overwinter as adults in protected ground cover. Spider mites feed on juices from raspberry foliage by rasping and sucking.

Cultural and Mechanical Control: Soaking sprays of water applied at relatively high pressure can temporarily suppress mite populations.

Biological Control: It is important to conserve and encourage natural enemies of spider mites by reducing the use of pesticides that harm them. Natural enemies include predatory mites, lady beetles, and lacewings. Several companies now commercially produce predatory mites that feed on spider mites. These predators can be released in raspberry plantings and may provide some control of spider mites, but research is needed to determine appropriate release rates and timing. See the source list on page 7 for producers of predatory mites.

Monitoring and Thresholds: Use a 10X magnifier to examine leaves for mites. If leaves average more than 10 to 15 mites per leaf, chemical control may be justified.

Control by Insecticides: There is currently little available for chemical control of spider mites on brambles. Foliar sprays of an organophosphate insecticide may suppress populations of spider mites but may also reduce populations of natural predators that feed on the spider mites.



Figure 123. Two-spotted spider mite.



Aphids

Larger Raspberry Aphid

(*Amphorophora agathonica* and *A. sensoriata*)

Smaller Raspberry Aphid

(*Aphis rubicola*; order Homoptera, family Aphididae)

Damage: Aphid feeding causes the leaves to curl downward and become deformed. The most damaging aspect of aphid feeding is the spread of viruses. Aphids can pick up a virus by feeding on an infected plant for 15 to 30 minutes and later inject it into healthy plants. The virus then spreads throughout the plant, resulting in symptoms such as mosaic, leaf curl, or stunting. The larger raspberry aphid transmits the raspberry mosaic virus complex, while the smaller raspberry aphid transmits the raspberry leaf curl virus. Mosaic virus can cause yield loss of more than 50%.

Appearance: Aphids are small, pear-shaped, soft-bodied insects that feed on plant sap with straw-like sucking mouthparts (Figure 124). They have a characteristic pair of cornicles that look like tailpipes extending out near the end of the body. The larger raspberry aphids are 1/8-inch long and either yellow-green (*A. agathonica*) or pale bluish green (*A. sensoriata*). The smaller raspberry aphid is 1/16-inch long and pale yellowish green.

Life Cycle and Habits: Raspberry aphids overwinter as eggs on brambles. In the spring, eggs hatch into nymphs that go through several instars before molting to the adult stage. During the summer, adults are all females that give birth to live young. Most of the adult females are wingless, but winged forms can develop that fly to colonize different plants. Development is rapid during the summer; many generations can develop. Only in the fall do males develop, mating takes place, and eggs are laid. Aphids are slow moving and tend to congregate on the underside of leaves. They feed on succulent tissue near the cane tips. Aphids are attacked by a variety of natural predatory and parasitic insects.

Cultural and Mechanical Control: The cultivars Canby, Titan, Lloyd George, and Royalty are resistant to aphid feeding. To reduce the incidence



Figure 124. Raspberry aphids.

of aphids and viruses, start with certified virus-free plants; eliminate all wild brambles from within 600 feet of the planting; and rogue out all plants that show virus symptoms. Aphid populations are often wiped out by heavy rains.

Monitoring and Thresholds: Scout plants for aphids in late spring and early summer, paying particular attention to leaves at the tips of canes. Apply insecticide if more than two aphids per cane tip are detected, to reduce infield spread of viruses.

Control by Insecticides: A foliar spray of a systemic or contact aphicide can be used to control aphids if the population exceeds the threshold.

Blackberry Psyllid

(*Trioza tripunctata*; order Homoptera, family Psyllidae)

Damage: The blackberry psyllid curls and stunts the growth of new rapidly growing shoots and leaves of cultivated and wild brambles (Figure 125). Early in the season the injured tissue, particularly the leaves, are much darker green than normal tissue. The early



Figure 125. Blackberry psyllid damage.



stunting and malformation of the shoots and leaves is due entirely to adult females. Distorted growth shows up about one week after adults begin feeding. By the time the malformations are noticed, there often are no insects easily visible on the leaves, so damage is often mistaken for other maladies such as virus. In Ohio, more damage is seen in the southern portion of the state than in other areas. However, this insect has not been seen causing much injury anywhere in the state.

Appearance: The adult psyllid looks like a miniature cicada; it is 1/16-inch long, yellowish brown, with brown shadowing along veins in its wings. Nymphs are aphid-like but do not have cornicles (tailpipes); they are whitish green with red eye spots (Figure 126). They cover themselves with waxy secretions.

Life Cycle: There is one generation per year. They overwinter as adults on pines, spruces, cedars, and hemlocks. Females move into blackberries over a two-week period in late spring, prior to bloom. Females feed for a week, then lay eggs on leaves or petioles. Eggs hatch in 10 to 14 days into nymphs that spend the summer feeding on the undersides of leaves. In the fall, they reach the adult stage, then migrate to conifers for the winter.

Cultural Control: Do not plant blackberries within at least 1/8 mile of conifer trees; a separation of one mile is better.

Control by Insecticides: Insecticides are effective only if timed to kill adults in the spring after migration but before egg-laying.



Figure 126. Blackberry psyllid nymphs feeding on the undersides of leaves.

Potato Leafhopper

(*Empoasca fabae*; order Homoptera, family Cicadellidae)

Yellowish areas along edges of tender terminal leaves, sometimes with wrinkling or cupping, is the symptom of potato leafhopper feeding on brambles. Feeding causes stunted shoot growth; canes look bushy because internodes are shortened at the growing tips. Leafhoppers feed on plant sap with piercing/sucking mouthparts. They lay eggs on leaves; eggs hatch in 10 days; and nymphs develop into adults after about two to three weeks of feeding.

This pest migrates into the central and northern United States every spring and usually infests alfalfa first, but it is also a pest of potatoes, beans, and other crops. The adult leafhopper is wedge-shaped, pale green, about 1/8-inch long (Figure 127). Cane tips should be examined weekly in early summer. If two or more leafhopper nymphs are found per cane tip, then insecticide treatment is justified.

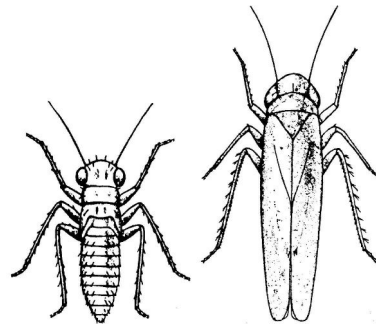

Figure 127. Potato leafhoppers: nymph (left) and adult (right).

Blackberry Leafminer

(*Metallus rubi*; order Hymenoptera, family Tenthredinidae)

The larva mines the leaves of blackberries by tunnelling between the upper and lower leaf surfaces (Figure 128). The loss of healthy leaf surface weakens plants, and at times injury can be serious. The white larva has a brown head and is 1/2-inch long when fully grown (Figure 129). Larvae hibernate in the soil, transform to pupae in the spring, and begin emerging as adults in early June. The adult form of the blackberry leafminer is a very small sawfly that is 1/5-inch long; its body is black with white knees





Figure 128. Blackberry leafminer damage.

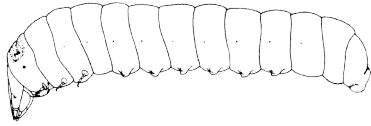

Figure 129. Blackberry leafminer larva.

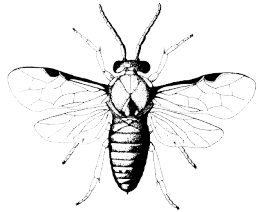

Figure 130. Blackberry leafminer adult.

and feet (Figure 130). Two generations are produced annually, with the second occurring in August and September.

Raspberry Sawfly (*Monophadnoides geniculatus*; order Hymenoptera, family Tenthredinidae)

Leaf tissue is consumed by larvae of the raspberry sawfly; a heavy infestation may result in loss of the crop. Larvae are light green and marked by conspicuous bristles, which arise from rows of small swellings on the body (Figure 131). These larvae reach 1/2 to 3/4 inch in length. Young larvae chew on the edges of leaves; older larvae feed anywhere on leaves except larger veins.



Figure 131. Raspberry sawfly larva.

They complete their feeding in less than two weeks, then construct cocoons in the ground. Larvae remain in these cocoons through the winter and pupate in early spring. The adult is a small, thick-bodied black sawfly, 1/4-inch in length, black with a yellow band on the abdomen (Figure 132). Adults lay eggs in the leaf tissue of the host in May and June. This is not a common pest in the Midwest, but it does occur at times, usually in low numbers.

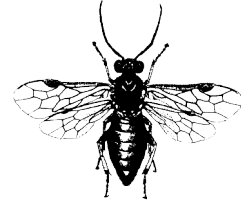

Figure 132. Raspberry sawfly adult.

Raspberry Leafroller (*Olethreutes permundana*; order Lepidoptera, family Tortricidae)

Terminal leaves of raspberries are sometimes webbed together in May and early June into a twisted mass by a small dark green larva with a black head and thorax (Figures 133 and 134). When fully grown, the larva usually folds over a part of a leaf, forming a cavity to pupate in. Moths appear about two weeks later. Wing expanse is about 1/2 inch, and the moth's forewings are dull yellowish or greenish-brown with irregular lighter markings crossing the wing obliquely. Hind wings are ash brown.



Figure 133. Raspberry leafroller.



Figure 134. Raspberry leafroller.



Summary of Bramble Insect Pest Management Procedures

I. Cultural controls when establishing a new planting.

- A. Site Selection:
 - 1. Do not plant within 250 yards of conifers to avoid blackberry psyllid.
 - 2. Do not plant near woods or fence rows to avoid problems with clipper weevils.
 - 3. Do not plant near wild brambles (or remove wild brambles in the vicinity).
- B. Cultivar Selection: Use cultivars resistant to aphid feeding.

II. Cultural controls while maintaining a planting.

- A. Pruning: Prune canes damaged by raspberry cane borer, red-necked cane borer, raspberry cane maggot, tree crickets, rose scale, blackberry gallmaker.
- B. Roguing: Remove plants with virus symptoms; remove crowns infested by raspberry crown borer.
- C. Harvest: Remove all ripe and cull berries promptly to help manage yellowjackets, picnic beetles, green June beetles, Japanese beetles.
- D. Weed Control: Contributes to tarnished plant bug management.
- E. Cultivation: In early fall, kill fruitworm larvae and pupae, Japanese beetle pupae.
- F. Avoid using manure or other organic matter if green June beetles are in the area.

III. Mechanical control options.

- A. Bait buckets during harvest for picnic beetles.
- B. Traps for Japanese beetles, rose chafers, yellowjackets.
- C. Netting to exclude periodical cicadas.

IV. Scouting for pests.

- A. Pre-bloom
 - 1. Raspberry fruitworm: Look for long holes in leaves; small holes in flower buds.
 - 2. Strawberry clipper: Examine plants for clipped buds.
- B. During bloom
 - 1. Tarnished plant bug, nymphs: Shake flowers over dish.
- C. Pre-harvest and post-harvest
 - 1. Two-spotted spider mite and predatory mites: Examine leaves.
 - 2. Miscellaneous pests: Sawflies, leafminers, leafhoppers, leafrollers, aphids, psyllids.



Weed Management in Brambles

Plan to start controlling weeds one to two years before planting brambles. Persistent and perennial weeds such as quackgrass, nutsedge, and thistle should be eliminated before planting brambles (see *Controlling Weeds Before Planting* section on page 178). For a complete discussion of methods used in a weed-control program, see page 172).

Herbicides for use at planting are listed in Table 3-3. Hand hoe or cultivate as needed to control weeds within the row. Plant sod between the rows in the fall before planting or in early spring after planting. The sod will aid in the control of weeds between rows. In the second and successive years, herbicides with a broad spectrum of control and longer residual

activity in the soil can be used (Table 3-4). Apply residual herbicides in early fall (September) and/or early spring (March) when weeds are germinating.

Use fall-applied herbicides to control winter annuals. Follow up with another herbicide application in the spring to control weeds in the summer. Do not apply Princep, Sinbar, Solicam, Roundup, or Gramoxone to young growing shoots in the spring. Shoots may die back and recover but will reduce yields, particularly of primocane cultivars such as Heritage.

Where soils have 2% or more organic matter, Sinbar alone or Sinbar + Karmex may be used. If the soil has less than 2% organic matter, use Surflan + Karmex. Princep has a similar mode of action as Sinbar, but generally is less likely to injure the crop. Avoid high rates of Princep or Sinbar on light soils or soils with less than 2% organic matter.

Table 3-3. Recommended Herbicides for Brambles: THE TRANSPLANTING YEAR.		
Weeds	Timing of Treatment^a	Herbicide/Acre
Spring/Fall		
Annual weeds, some broadleaf weeds	Within 2 to 3 days after planting.	• Devrinol ^b 50WP, 4-6 lb, in 20 to 100 gal. water, irrigation or rainfall to wet soil 2-4 inches within 24 hrs is required.
Grasses, some broadleaf weeds	Within 14 days after transplanting. Do not apply if soil is cracked.	• Surflan 4 A.S., 2 to 6 qt. in 20-40 gal. water.
Postemergence		
Grasses	When grasses are 2 to 8" tall before seed head formation.	• Fusilade DX, 16-24 oz + 2 pt crop oil concentrate/25 gal or 1/2 pt nonionic surfactant/25 gal. • Poast 2 pt + 2 pt crop oil concentrate.
Grasses, broadleaf weeds	Anytime.	• Gramoxone Extra, 2 to 3 pt. <i>Directed spray only.</i>
Fall		
Grasses, broadleaf weeds	Fall (mid-September).	• Roundup, 1 to 3 qt. <i>Directed spray only.</i>
Some grasses, some broadleaf weeds, some perennials	Apply Casoron in late fall (after Nov. 15) or winter of planting year.	• Casoron 4G, 100 lb.
^a Before using, read comments on herbicides in Table 6-2, Small Fruit Herbicides, page 175. ^b If growing tissue-culture propagated plants, use only 4 lbs of Devrinol until mid-July of the planting year.		



Table 3-4. Recommended Herbicides for Established Bramble Plantings.		
Weeds	Timing of Treatment^a	Herbicide/Acre
Preemergence		
Annual broadleaf weeds, grassy weeds	Fall or early spring.	• Karmex 80W, 2 to 3 lb in 25 to 40 gal. of water.
Annual broadleaf weeds, grassy weeds	Fall or early spring.	• Princep 80W, 2.5 to 5 lb.
Annual grasses, some broadleaf weeds	Late fall or early spring.	• Devrinol 50WP, 4 to 6 lb.
Some annual grasses, some annual broadleaf weeds, some perennials.	Late fall when soil temperature is <45°F.	• Casoron 4G, (or Norosac 4G), 100 to 150 lb.
Grasses, some broadleaf weeds	Early spring; over weed-free surface.	• Surflan A.S., 2 to 6 qt in 20 to 40 gal. water.
Broadleaf weeds, some 80 WP, 1 to 2 lb in primocane bearers.	Fall or early spring. Fall only for grasses.	• Sinbar at least 20 gal. <i>Directed spray only.</i>
Grasses	Fall or early spring.	• Solicam 80 DF, 2.5 to 5 lb. <i>Directed spray only.</i>
Postemergence		
Emerged weeds	When new weeds are present.	• Gramoxone Extra, 2 to 3 pt in 50 gal. water + non-ionic surfactant. <i>Directed spray only.</i>
Perennials, broadleaf weeds	Fall ^{a,b}	• Roundup, 1 to 3 qt. <i>Directed spray only.</i>
Grasses	When grasses are 2 to 8" tall before seed head formation. Do not apply within 45 days of harvest.	• Poast 2 pt + 2 pt crop oil concentrate.
^a Before using, read comments on herbicides in Table 6-2, Small Fruit Herbicides, page 175.		

An alternative approach that has been used by many growers is to apply sequential micro-rates of soil-active herbicides. Micro-rates are below-label rates of either Sinbar or Princep. For instance, Sinbar is labeled at 2 lb/acre, yet provides excellent control of annual broadleaf weeds at 1/2 lb/acre. Two or three sequential applications may be needed to control weeds all summer at these reduced rates, provided the cumulative amount of herbicide applied does not exceed the label rate and pre-harvest intervals are adhered to.

Avoid applying any products containing 2,4-D or Banvel or dicamba or the product Crossbow near brambles. Even slight drift or vapor movement from these herbicides into your planting may cause severe crop injury. Do not apply Liberty, Gramoxone, or Roundup to bramble leaves or severe damage will occur.





CHAPTER 4

Highbush Blueberries

General

Several species of blueberries are indigenous to the United States. These include the lowbush blueberry (*Vaccinium angustifolium*) which is of commercial importance in Maine and Canada; the rabbiteye blueberry (*V. ashei*), which is grown commercially in the southern United States; and the highbush blueberry (*V. corymbosum*), which is the commercial blueberry of importance in the Midwest. The information presented here pertains solely to highbush blueberry production.

The Blueberry Plant

The blueberry plant is a perennial, consisting of a shallow root system and woody canes that originate from the crown of the plant. The root system is very fibrous but is devoid of root hairs. Root hairs function in most plants by increasing the surface area of the root for water and nutrient uptake. This characteristic makes the blueberry plant very sensitive to changing soil water conditions.

A mature cultivated blueberry (at five to seven years) usually has 15 to 18 canes. Growth habit varies among cultivars, with some bushes growing very upright, while others have a more spreading growth habit. Fruit is borne on buds that are formed the previous growing season. The blueberry plant requires an acid soil pH (4.5 to 5.2).

Blueberries will generally tolerate temperatures to -20°F, although there is some cultivar variation. Most require 750 hours of chilling below 45°F. This requirement is usually met by no later than mid-January to early February. After the chilling requirement is met, the plant loses its dormancy, and thus its cold hardiness, with each warm period, making it increasingly more susceptible to cold injury as the season progresses.

Site Selection and Preparation

Select the site where winter temperatures do not go below -20°F. Depending on cultivar, snow cover, and acclimation prior to winter, blueberries have sustained -25°F with minimal plant damage, but flower buds can be damaged. Also the site should be on a high point (elevated) to avoid low spring temperatures. Blueberry flowers bloom later than peach or apple, and some cultivars can tolerate temperatures of 25°F to 28°F for a short duration without damage.

Soils

The best soils for blueberries are well-drained sandy silt loam or silt loam, with a pH of 4.5 to 5.2, organic matter of 4% to 7%, and adequate phosphorus and potassium. In major commercial blueberry areas, blueberries are produced on sandy soils with high water tables. Most Midwest (except some Michigan soils) soils require amendments and irrigation for maximum growth and yield. Tile drainage may be required, but in most Midwestern soils containing 10% or more clay, raised beds are preferred for optimal growth. A raised bed 8- to 10-inches high (original height) and 4-feet wide is required. Over time, the bed will compact to 6 inches, but the addition of hardwood or other suitable mulches maintains a height of 6 to 8 inches.

Most soils will need to be adjusted in pH. Too low a pH can result in manganese or aluminum toxicity, while a high pH results in the unavailability of certain nutrients such as iron. Do not plant blueberries without amending the pH at least one to two years before planting. Test the soil. Soil test kits are available from your local county Extension office. Where top and subsurface soils have a naturally high pH (6.0 to 8.0) and there is a high buffering capacity, soil amendments will be unable to adjust the pH, and blueberries should not be planted. Where soil pH is too low, apply lime to increase the pH. Sulfur can be



used to decrease the pH to the proper level if the pH is not too high (Table 4-1).

Incorporate sulfur, phosphorus, and organic matter into the raised bed (upper 6 to 12 inches) three to six months prior to planting. This allows time for the chemical reaction to occur and reduces potential root damage. Retest the soil three to six months after application to make further adjustments. Apply all nutrients according to the soil test. Phosphorus will not move through the soil and is ineffective after plant establishment. Applying sulfur to only the raised bed may require 500 to 800 pounds per acre of bed to decrease the pH by 0.5. Incorporate sulfur at least three weeks before planting.

Irrigation and Mulch

Because the blueberry plant is very sensitive to fluctuating soil moisture, mulch and irrigation are essential for a healthy planting and consistent yields. Peatmoss at 1/2 cubic foot per plant should be incorporated into the upper 6 inches of soil as the plants are planted. Blueberry plants require at least 1 to 2 inches of water per week. Hardwood bark mulch (oak or pine), rotted sawdust, and chopped corncobs are good mulches. They should be applied to a depth of 2 to 4 inches and replenished whenever necessary. Avoid mulch with a high pH, such as mushroom compost or noncomposted leaves, which may be high in natural toxins.

Though either overhead or trickle irrigation can be used in blueberries, trickle both conserves moisture and supplies the plant with adequate water. The trickle line can be placed under the mulch, so that it is out of the way and, in some cases, semipermanent. Because the small emitter holes in trickle irrigation components clog easily, the water source must be very clean (municipal, well water, or clean spring), or water should be filtered through a sand filter. Overhead irrigation has the advantage of cooling the plants and the berries during times of extremely high temperatures.

Annual applications of nitrogen are necessary. Where potassium is needed, applications of potassium nitrate or other potassium fertilizers can be used. Ammonium sulfate is recommended in upland soils where the pH is above 5.0. Urea is suggested for soils below 5.0. Apply urea during cool, rainy weather or irrigate after application. Ammonium sulfate, urea, or potassium nitrate can be injected through trickle (microirrigation) systems. Use one half the ground application rates when applying nitrogen with irrigation or in banded application.

For newly planted blueberries, broadcast two applications each of 10 pounds of actual nitrogen per acre at bloom and then three weeks later. (See Table 3-1 page 56.) Ten pounds of actual nitrogen per acre at each broadcast application in mid-April, mid-May, and mid-June should be applied in the second to

Present pH of Soil	Desired pH Value for Blueberries					
	4.5			5.0		
	Sand	Loam	Clay	Sand	Loam	Clay
4.5	0.0	0.0	0.0	0.0	0.0	0.0
5.0	0.4	1.2	1.4	0.0	0.0	0.0
5.5	0.8	2.4	2.6	0.4	1.2	1.4
6.0	1.2	3.5	3.7	0.8	2.4	2.6
6.5	1.5	4.6	4.8	1.2	3.5	3.7
7.0	1.9	5.8	6.0	1.5	4.6	4.8
7.5	2.3	6.9	7.1	1.9	5.8	6.0

^a To convert to lb/acre, multiply by 435.

Source: Pennsylvania State University, *Small Fruit Production and Pest Management Guide*. Used with permission.



fourth year. In mature plantings, 50 to 70 pounds of actual nitrogen can be used but maintain leaf nitrogen levels between 1.7% to 2.1% and potassium between 0.35% to 0.40%. Nitrogen applied to cool soils will require a longer time to convert ammonium. However, nitrogen applied at least three weeks before bloom will increase yields.

When injecting nitrogen fertilizer with irrigation, broadcast the mid-April application and apply one half the remaining broadcast amount from mid-May to mid-June with irrigation. (Example: 60 pounds annually = 30 pounds mid-April, broadcast; 30 pounds irrigated mid-May to mid-June). Continue to irrigate with water only after mid-June as needed. In most Midwest areas, a soil may lose 0.25 to 0.30 inches of water per day. Use tensiometers and maintain 20 to 25 centibars in the upper 12 inches of soil.

Integrated Management of Blueberry Diseases

The development and use of an integrated disease-management program is essential to the successful production of blueberries. The objective of an integrated disease-management program is to provide a commercially acceptable level of disease control on a consistent (year-to-year) basis. This is accomplished by developing a program that *integrates* all available control methods into one program. An effective disease-management program for blueberries must emphasize the integrated use of specific cultural practices, knowledge of the pathogen and disease biology, disease-resistant cultivars, and timely applications of approved fungicides or biological control agents, when needed. In order to reduce the use of fungicides to an absolute minimum, the use of disease-resistant cultivars and various cultural practices must be strongly emphasized.

Identifying and Understanding the Major Blueberry Diseases

It is important for growers to be able to recognize the major blueberry diseases. Proper disease identification is critical to making the correct disease-management

decisions. In addition, growers should develop a basic understanding of pathogen biology and disease cycles for the major blueberry diseases. The more you know about the disease, the better equipped you will be to make sound and effective management decisions.

The literature listed here contains color photographs of disease symptoms on blueberries, as well as information on pathogen biology and disease development:

Compendium of Blueberry and Cranberry Diseases — Published by the American Phytopathological Society, 3340 Pilot Knob Rd., St. Paul, Minnesota 55121. Phone: 612-454-7250, 1-800-328-7560. This is the most comprehensive book on blueberry diseases available. All commercial growers should have a copy.

Highbush Blueberry Production Guide — This is a very comprehensive book covering most phases of blueberry production. It can be purchased from the Northeast Regional Agricultural Engineering Service, 152 Riley-Robb Hall, Cooperative Extension, Ithaca, NY 14853. Phone: 607-255-7654.

For a description of symptoms, causal organisms, and control of the most common blueberry diseases in the Midwest, consult the following.

Fruit Diseases

Mummy Berry

(Monolinia vaccinii-corymbosi)

Mummy berry is becoming increasingly important in some parts of the Midwest; its severity varies from year to year. It is caused by a fungus that attacks new growth, foliage, and fruit and can cause extensive loss.

The fungus overwinters in mummified fruit on the ground (Figure 135). The mummies form cup- or globe-shaped structures called apothecia. Apothecia produce spores that infect young tissue and cause rapid wilting. This is called leaf and twig blight, or bud and twig blight. These symptoms are difficult to distinguish from frost injury. These first infections form more spores, which are spread by rain, wind, and bees to blossoms and other young tissue. The fungus infects and invades the developing fruit. The fruit becomes malformed, looking like a pumpkin,



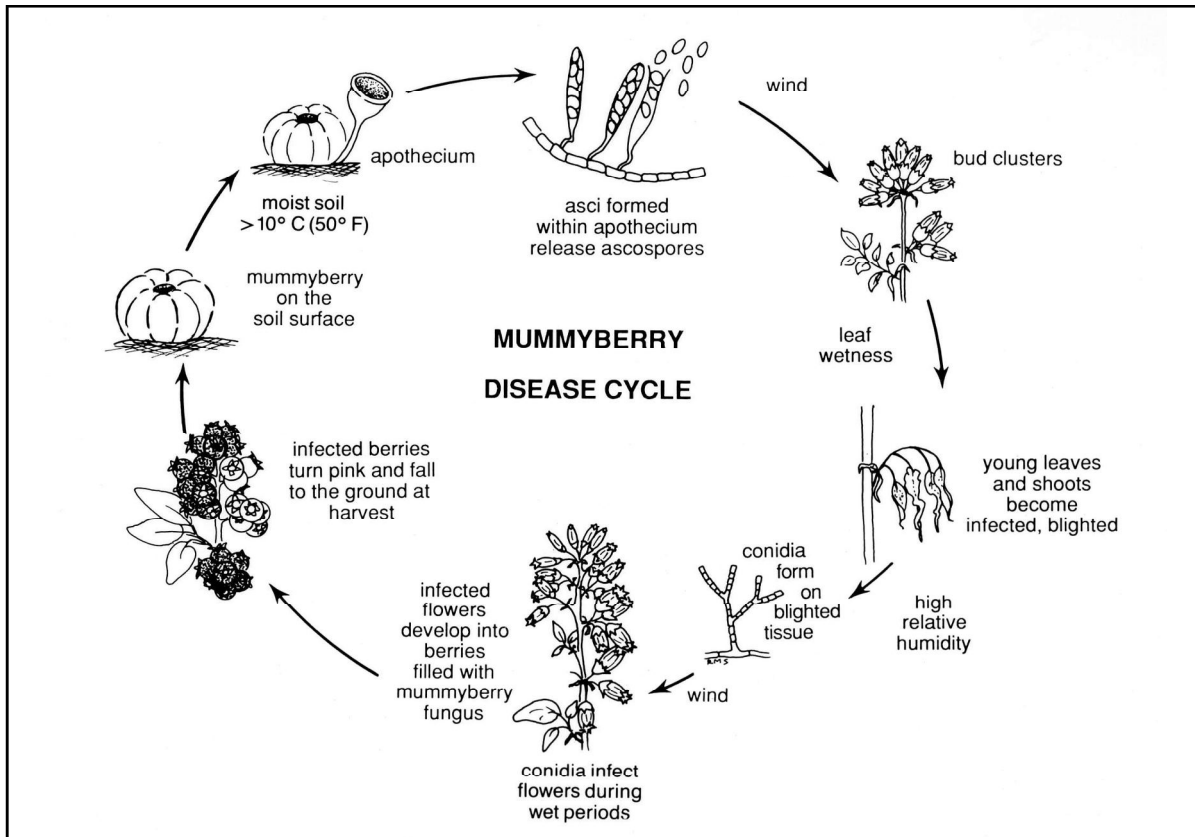

Figure 135. Disease cycle of mummy berry. We wish to thank the New York State Agricultural Experiment Station for use of this figure. Figure taken from the Small Fruit Crop IPM Disease Identification Sheet No. 3.

and turns salmon or gray by midsummer (Figure 136). By fall, these fruit drop to the ground where they turn into mummies, ready to produce apothecia the next spring.

Management

Cultural controls are extremely important in organic production and can be used to reduce inoculum levels in the spring. In very small plantings, mummies can be raked up and burned. In larger plantings, mummies can be buried by cultivating or disking between rows or by covering them with a new layer of mulch at least 2 inches in thickness. Combining cultivation and an application of nitrogen in the spring speeds destruction of the mummies. The cultivation should be done just as apothecia start to emerge in the spring, which usually coincides with budbreak on the blueberry bushes.

Organic fungicides (sulfur and copper) are not effective for control of mummy berry.



Figure 136. Mummy berry on blueberry.

Botrytis Blight/Gray Mold
(*Botrytis cinerea*)

As with other small fruits, *Botrytis* primarily affects ripening fruit, although under certain circumstances the fungus can cause stem blight as well. Infection occurs primarily during bloom on flowers. The fungus survives the winter on dead twigs and in soil organic matter. It is present every year, but



only causes severe damage during cool, wet periods of several days duration. The most critical period for infection is during bloom. The disease is more severe when excessive nitrogen has been used, where air circulation is poor, or when frost has injured blossoms. Rotted berries typically have a gray cast due to mycelium and spore-bearing structures present, which gives the disease its name. Stem symptoms are difficult to distinguish from those caused by *Phomopsis*. For positive diagnosis, the fungus usually must be isolated from infected tissue in a diagnostic laboratory. Cultivars possessing tight fruit clusters (Weymouth, Blueray, and Rancocas) are particularly susceptible to this disease.

Management

Any cultural practice that promotes faster drying of foliage and fruit in the planting should be beneficial for gray mold control. The use of excessive nitrogen should be avoided. Fertilization should be based on results for soil and foliar analysis. When weather or history indicates that *Botrytis* will be a problem, fungicides should be applied, starting at mid-bloom, with additional sprays at seven- to 10-day intervals through petal fall. Refer to your state's spray guide for recommended fungicides, rates, and timing.

Anthracnose

(Colletotrichum gloeosporioides)

This fungus damages primarily fruit but also infects twigs and spurs. It causes a salmon- or rust-colored berry rot. Infected fruit often exhibit a soft, sunken area near the calyx-end of the fruit. Spores spread to "good" fruit during and after harvest, causing significant post-harvest losses. Spores are spread mainly by rainwater. The disease is especially prevalent during hot, muggy weather and frequently occurs post-harvest.

The anthracnose fungus overwinters in dead or diseased twigs, fruit spurs, and cankers. Spores are released in the spring and are spread by rain and wind. Blossoms, mature fruit, and succulent tissue are infected; spores spread from these infections. Blossom clusters turn brown or black. Infected fruit shows bright pink spore masses at the blossom end. Stem cankers are rare, but when present are about 1/8-inch in diameter, with raised purple margins. Young girdled stems die back, resulting in a brown

withering of the leaves. Cultivars in which the ripe fruit hangs for a long time on the bush prior to picking are especially susceptible. These include Berkeley, Coville, Bluecrop, Blueray, and Jersey. No cultivars are entirely resistant when the weather conditions are favorable for the disease development (warm and wet).

Management

Organic fungicides are of little value for controlling anthracnose. Pruning out small twigs and frequent harvesting are beneficial to control. Removing and destroying infected fruit should be beneficial. Old canes and small twigs should be removed in order to increase air circulation around the fruit clusters.

Stem and Foliage Diseases

Fusicoccum Canker

(Godronia Canker)

Fusicoccum is a fungus that infects blueberry stems, causing dieback and plant decline. Losses from this disease can be serious. The fungus overwinters as mycelium in cankers on living plants. Spores are released from March to July. Infection probably occurs during this period. Spores are largely disseminated by rainwater. New infections occur following rains throughout the time tender new tissue is present and temperatures are between 50 and 72°F. New infections can occur throughout the growing season. Cold stress or winter injury may play a part in increasing disease damage. Leaves turn a reddish-chocolate color when dry and often hang on late into the fall.

Symptoms of *Fusicoccum* canker are similar to *Phomopsis* canker on blueberry. The most unique symptom is a red-maroon-brown lesion centered around a leaf scar, with a bull's-eye pattern obvious on the lesion. As the lesion enlarges, the margin remains red, and the center becomes gray and dies. On young (one- to two-year-old) stems, extensive stem infections quickly lead to flagging and dieback of the entire stem. On warm, dry days, shoots will suddenly wilt and die due to stem girdling.

Management

Sanitation is essential. Removal of infected canes from the planting is critical for control. A dormant



application of liquid lime sulfur (5 gallons in 100 gallons of water) may be beneficial for control. Cultivars differ in their resistance to the disease.

Phomopsis Twig Blight

(Phomopsis vaccinii)

This disease may be the most prevalent of the canker diseases. The fungus *Phomopsis* causes stem damage similar to that caused by *Fusicoccum*.

Spores from old cankers are released in the spring and, to a limited extent, in summer. Most spores are released from bud swell to petal fall. None are released after September 1. Rain is necessary for spore release; temperatures ranging from 70 to 80°F encourage infections. The disease is most severe after winters in which mild spells are interspersed with cold periods. Periods of hot, dry weather during the growing season probably predispose the plants to infection. The fungus overwinters in infected plant parts.

Symptoms first appear on smaller twigs. The disease then spreads into larger branches and may affect the crown. It is possible for *Phomopsis* to spread downward in injured canes to the crown and then progress upward on new canes. This is rare and usually only occurs where the crown itself has been injured, after a particularly severe winter, or in highly susceptible cultivars. Young tissue initially shows no symptoms then exhibits rapid wilting and dieback. Lesions, somewhat similar to those caused by *Fusicoccum* but generally lacking the bull's-eye pattern, may appear on the stems. Leaf spots also have been observed where the disease is particularly severe. The disease will cause premature ripening of the berries. Earliblue, Coville, Bluecrop, Blueray, Jersey, and Berkeley are susceptible to the disease. Weymouth may be the most susceptible cultivar.

Management

Since mechanical damage and cold stress seem to be necessary for *Phomopsis* infection, avoid careless pruning and cultivating and do not fertilize late in the summer. Pruning the weakest canes to the ground is best for long-term production of the bush. Keep the plants well-watered through prolonged periods of dry weather in the summer. Avoiding stress will help prevent this disease. Dormant sprays of lime

sulfur (5 gallons in 100 gallons water) also help to reduce inoculum of the pathogen. A fall application can be made when most of the leaves have dropped. Spring applications should be applied early, before warm weather occurs, or injury may result.

Root Diseases

Phytophthora Root Rot

(Phytophthora cinnamomi)

This disease is usually associated with poorly drained areas of a field. The fungus thrives in wet (saturated) soils and survives for long periods of time in soil. Symptoms are observed on the roots and on the above-ground portions of the plant. The very fine absorbing roots turn brown to black; larger diameter roots may also be discolored. In severely infected bushes, the entire root system is reduced and totally black. Above-ground symptoms include chlorosis and reddening of the leaves, small leaves, defoliation, branch dieback, death of entire canes, stunting, and death of the entire bush. The disease may be present in a few infected plants scattered throughout the planting or localized in a group of plants in a low-lying area of the field. The disease is most severe where plants are growing in heavy clay soils.

Phytophthora cinnamomi, in addition to attacking blueberry, attacks a number of additional susceptible Ericaceous hosts, including rhododendron, azalea, and cranberry. Lowbush blueberry appears to be immune. This species of *Phytophthora* is not an important pathogen on any other small fruit covered in this guide.

Management

The disease is avoided through careful site selection before planting. Heavy soil which becomes waterlogged or has a high water table should be avoided. Internal and surface water drainage should be improved before planting. Plants can be grown on raised beds if desired. Manage irrigation to avoid prolonged periods of saturated soil. Most cultivars are susceptible to the disease, although some cultivars may tolerate some degree of infection better than others. Bluecrop and Weymouth are two cultivars that have shown promise.

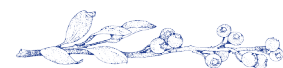

Bacterial Crown Gall *(Agrobacterium tumefaciens)*

This disease is caused by the bacterium *Agrobacterium tumefaciens*. Since blueberries are grown on acid soils and the crown gall bacterium does not grow well in an acid environment, the disease is uncommon. Globose, pea-size to large galls occur on low branches, twigs, and at the base of canes near the ground. Injured tissue is more likely to contain galls.

Management

Sanitation, purchasing healthy nursery plants, and maintaining proper soil conditions (pH 4.5 to 5.2) are the most reliable controls. A closely related bacterium, *Agrobacterium radiobacter*, produces an antibiotic called Agrocin and is available as a biological control agent for use either as a soil treatment or for dipping the root system of bushes prior to planting. This control measure is not recommended unless the planting has a history of crown gall problems.

Viruses and Phytoplasmas

Blueberry Shoestring Disease

This viral disease was originally described in New Jersey. In Michigan, the disease has been found in 0.5% of the bushes; however, an assessment has not been done for potential losses due to the virus.

The most common symptom is an elongated reddish streak along the new stems. The leaves may also show red banding or a red-purple oak-leaf pattern. Diseased leaves are narrow, wavy, and somewhat sickle-shaped. Flowers may be red-streaked, and berries turn purple prematurely. Within a few years, berry production drops dramatically.

Management

Other than buying disease-free plants, destroying wild plants near the planting, and removing diseased plants, controls do not exist. As with most virus diseases, the best controls are preventing disease introduction and detecting the disease when it is still localized in a small portion of the field. The virus has been observed most often in the cultivars Burlington,

Jersey, June, Cabot, and Rancocas. Other cultivars may possess field resistance to the disease.

Blueberry Stunt

This disease was originally thought to be caused by a virus but is now known to be caused by a phytoplasma. The only known carrier is the sharp-nosed leafhopper, though other vectors probably exist.

Symptoms vary with the stage of growth, time of year, age of infection, and the cultivar. Symptoms are most noticeable during mid-June and late-September. Affected plants are dwarfed with shortened internodes, excessively branched, and low in vigor. Small downward cupped leaves turn yellow along the margins and between the lateral veins, giving a green and yellow mottled appearance. These mottled areas turn brilliant red prematurely in late summer, although the midrib remains dark bluish-green. Fruits on affected bushes are small, hard, lack flavor, ripen late if at all, and remain attached to the plant much longer than on healthy plants.

Management

Planting virus-indexed plants is helpful. Diseased bushes cannot be cured. They must be removed from the field as soon as they are diagnosed. The removal process may facilitate the further spread of the disease in the field. Agitation of the bush during removal will dislodge the leafhoppers, causing them to move to a neighboring healthy bush. Therefore, infected bushes should be sprayed with malathion or another appropriate insecticide prior to removal. The cultivars Bluetta, Jersey, and Weymouth are particularly susceptible, whereas Rancocas is resistant.

Use of Disease-Resistant Cultivars

In the integrated disease-management program, the use of cultivars with disease resistance must be emphasized. Blueberry cultivars with high levels of resistance to most of the major diseases are not currently available; however, several cultivars are known to be resistant to some diseases. Table 4-2 provides information on disease resistance in several of the more common blueberry cultivars grown in the Midwest.



Cultivar	Mummy Berry	Phomopsis Twig Blight & Canker	Fusicoccum Canker	Powdery Mildew	Anthraxnose Fruit Rot	Red Ringspot Virus	Shoestring Virus
Berkeley	S	VS	-	R	-	-	-
Bonus	-	-	-	-	-	-	-
Bluecrop	MR	-	-	MR	S	MR	VR
Bluegold	S	-	-	-	-	-	-
Bluehaven	S	S	-	-	-	-	-
Bluejay	R	-	-	-	-	-	R
Blueray	S	-	-	-	S	-	-
Bluetta	S	R	-	-	-	-	-
Burlington	R	-	-	-	-	-	S
Chippewa	-	-	-	-	-	-	-
Collins	S	-	-	-	-	-	-
Coville	MR	-	MR	MR	-	-	-
Darrow	R	-	-	-	-	-	R
Duke	R	-	-	-	-	-	-
Earliblue	S	S	-	R	-	-	S
Elliott	R	R	-	-	R	-	S
Jersey	MR	VS	-	S	VS	MR	S
Lateblue	R	-	-	-	-	-	-
Little Giant	-	-	-	-	R	-	-
Nelson	-	-	-	-	-	-	-
Northblue	R	-	-	-	-	-	-
Northcountry	-	-	-	-	-	-	-
Northland	S	-	-	-	-	-	R
Northsky	R	-	-	-	-	-	-
Patriot	-	-	-	-	-	-	-
Polaris	-	-	-	-	-	-	-
Rancocas	MS	-	R	R	-	-	MS
Rubel	S	MR	MR	-	MS	-	S
Sierra	S	-	-	-	-	-	-
St. Cloud	-	-	-	-	-	-	-
Spartan	MR	-	-	-	-	-	S
Sunrise	-	-	-	-	-	-	-
Toro	-	-	-	-	-	-	-
Weymouth	S	-	-	-	-	-	S

VR = very resistant, R = resistant, MR = moderately resistant, MS = moderately susceptible, S = susceptible, VS = very susceptible; - = resistance is not known.

Table prepared by J. Hancock, E. Hanson, D. Trinka, and A. M. C. Schilder, Michigan State University.



Cultural Practices for Disease Control in Blueberry

The use of any practice that provides an environment within the planting that is less conducive to disease development and spread should be used. The practices listed here should be carefully considered and implemented in the disease-management program.

Use Disease-Free Planting Stock

Always start the planting with healthy, virus-indexed plants obtained from a reputable nursery. Remember that disease-free plants are not necessarily disease resistant — cultivar selection determines disease resistance.

Select Sites Carefully

Soil Drainage — *Extremely Important*

Select a planting site with good water drainage. Avoid low, poorly-drained wet areas. Good water drainage (both surface and internal drainage) is especially important for control of *Phytophthora* root rot.

This disease requires free water (saturated soil) in order to develop. If there are low areas in the field that have a tendency to remain wet, this is the first place that *Phytophthora* root rot will develop. Any time there is standing water in the field, plants are subject to infection. Any site in which water tends to remain standing is, at best, only marginally suited for blueberry production and should be avoided.

Any practice, such as tiling, ditching, or planting on ridges or raised beds, that aids in removing excessive water from the root zone will be beneficial to the disease-management program.

Site Exposure

A site with good air circulation that is fully exposed to direct sunlight should be selected. Avoid shaded areas. Good air movement and sunlight exposure are important to aid in drying fruit and foliage after rain or irrigation. Any practice that promotes faster drying of fruit or foliage will aid in the control of many different diseases.

Control Weeds

Good weed control is essential to successful blueberry production. From the disease-control standpoint, weeds in the planting prevent air circulation and result in fruit and foliage staying wet for longer periods. Several diseases can be more serious in plantings with poor weed control compared to plantings with good weed control.

In addition, weeds will reduce production through direct competition with blueberry plants for light, nutrients, and moisture and will make the planting less attractive to pick-your-own customers, especially if you have thistles!

Practice Good Sanitation

Any practice that removes infected twigs or branches and other plant debris from the planting is beneficial in reducing the amount of fungal inoculum. Removal of fruit mummies is critical for mummy-berry control. Removal of infected twigs and branches is also critical for control of *Phomopsis* twig blight and *Fusicoccum* canker. Infected plant material should be removed from the planting and destroyed.

Avoid Excessive Fertilization

Fertility should be based on soil and foliar analysis. The use of excessive fertilizer, especially nitrogen, should be avoided. Sufficient fertility is essential for producing a crop, but excessive nitrogen can result in dense foliage that increases drying time in the plant canopy, *i.e.*, it stays wet longer.

Maintain Proper Soil Conditions

One of the most common problems in Midwestern blueberry plantings is iron chlorosis. Affected plants are chlorotic (yellow) and stunted. The major cause of chlorosis is planting on a site with improper pH. The best soils for blueberries are well-drained sandy silt loam or silt loam, with a pH of 4.5 to 5.2, organic matter of 4% to 7%, and adequate phosphorus and potassium. At pH above 5.2, chlorosis will probably be a problem.

Most soils will need to be adjusted in pH. Too low a pH can result in manganese or aluminum toxicity, while a high pH results in the unavailability of certain nutrients such as iron. Do not plant



blueberries without amending the pH at least one to two years before planting. Soil test kits are available from your local county Extension office. Where top and subsurface soils have a naturally high pH (6.0 to 8.0) and there is a high buffering capacity, soil amendments will not adjust the pH and blueberries should not be planted. Where soil pH is too low, apply lime to increase the pH. Sulfur can be used to decrease the pH to the proper level if the pH is not too high.

Incorporate sulfur and organic matter into the raised bed (upper 6 to 12 inches) three to six months prior to planting. This allows time for the chemical reaction to occur and reduces potential root damage. Retest the soil three to six months after application to determine whether further adjustments are needed. Apply all nutrients according to soil test. Phosphorus will not move through the soil and is ineffective after plant establishment. Applying sulfur to only the raised bed may require 500 to 800 pounds per acre of bed to decrease the pH by 0.5. Incorporate sulfur at least three weeks before planting.

In major commercial blueberry areas, blueberries are produced on sandy soils with high water tables. Most Midwestern soils (except some Michigan and Wisconsin soils) require soil amendments and irrigation for maximum growth and yield. Tile drainage may be required, but in most Midwestern soils containing 10% or more clay, raised beds are preferred for optimal growth. A raised bed 8- to 10-inches high (original height) and 4-feet wide is required. Over time, the bed will compact to 6 inches, but the addition of hardwood or other suitable mulches maintains a height of 6 to 8 inches.

Protect from Winter Injury

Winter injury predisposes blueberry plants to many diseases. In colder regions of the Midwest, pile snow around bushes to insulate from fluctuating temperatures. Protect crowns (base of plant at soil line) with wood-chip or straw mulch.

Harvesting Procedures

- Pick fruit **frequently** and early in the day before the heat of the afternoon (preferably as soon as plants are dry). Picking berries as soon as they are ripe is critical. Overripe berries will cause nothing but problems during and after harvest.

- Handle berries with care during harvest to avoid bruising. Bruised and damaged berries are extremely susceptible to rot.
- Train pickers to recognize and avoid berries that have disease symptoms of mummy berry or anthracnose. If at all possible, have pickers put these berries in a separate container and remove them from the field.

Post Harvest Handling

- Always handle fruit with care during movement from the field to market to avoid any form of damage.
- Get the berries out of the sun as soon as possible.
- Refrigerate berries immediately to 32°F to 35°F in order to slow the development of fruit rots.
- Market the berries as fast as possible. Encourage your customers to handle, refrigerate, and consume or process the fruit immediately. Remember that even under the best conditions, blueberries are quite perishable.

Blueberry Pests and Their Management

Insect Pests

Cherry Fruitworm

(*Grapholita packardii*; order Lepidoptera, family Tortricidae)

Damage: Developing and ripening berries are infested by fruitworm larvae. Pairs of infested berries are usually joined by silk. Sawdust-like frass is in the berries but is not visible due to silk. Their feeding within berries reduces the crop and spoils marketability of the berries.

Appearance: The larva is an orangish-pink caterpillar with a brown head (Figure 137). When fully grown, it is about 1/3-inch long. The adult is a mottled gray/black moth with forewings about 3/16-inches long and a wingspan of about 3/8 inch.

Life Cycle and Habits: The cherry fruitworm overwinters as mature larvae under loose bark. They pupate and emerge as moths in late spring. Moths lay eggs on or near the developing fruit at the time that





Figure 137. Cherry fruitworm.

blossoms drop. Hatching larvae bore into the calyx cup (blossom end) of the berry, feed until about half-grown, and then move to a second fruit. There is one generation per year on blueberries.

Monitoring: Cherry fruitworm moths can be monitored by pheromone traps. Lures are available from Great Lakes IPM (see Table 1-2 on page 8). The date that sustained moth flight occurs should be considered the biofix date for that location. Degree-days (base 50°F) should be determined daily starting at biofix.

Control by Insecticides: When damage is severe, treat in the following year with insecticide. For conventional insecticides such as Imidan or Sevin, applications should be made when blossoms drop and again 10 days later. For insect growth regulators such as Confirm, application should be earlier; apply the first spray at initiation of egg-hatch, which occurs approximately when 400 degree-days have accumulated. The second application should be made at 100% petal-fall.

Cranberry Fruitworm (*Acrobasis vaccinii*; order Lepidoptera, family Pyralidae)

Damage: The inner flesh of developing and ripening berries is consumed entirely by fruitworm larvae (Figure 138). Fed-upon berries are covered with brown sawdust-like frass. Each larva consumes three to six berries. Damaged berries are usually webbed together with silk.

Appearance: In the larval stage, the cranberry fruitworm is a smooth caterpillar that is mostly green with some brownish-red coloration on its top surface.



Figure 138. Cranberry fruitworm.

It has three pairs of true legs on the thorax and five pairs of fleshy prolegs on the abdomen. Larvae are about 1/2-inch long when fully grown. The adults are brownish-gray moths with a wingspan of about 5/8 inch.

Life Cycle and Habits: Eggs are laid in the calyx cup (blossom end) of unripe fruit. Eggs hatch in about five days. Young larvae move to the stem end of the fruit, enter, and feed on the flesh. Once larvae are fully grown, they drop to the ground and spin a hibernation chamber where they overwinter. There is one generation per year.

Cultural Control: Elimination of weeds and trash around plants helps by cutting down on overwintering protection for fruitworm cocoons.

Mechanical Control: Cranberry fruitworm was effectively controlled in the past by picking off infested berries, which are easily detected because of the webbing and their early ripening. This method is still practical in small plantings with light infestations.

Monitoring: Cranberry fruitworm moths can be monitored by pheromone traps. Lures are available from Great Lakes IPM (see Table 1-2 on page 8). The date that sustained moth flight occurs should be considered the biofix date for that location. Degree-days (base 50°F) should be determined daily starting at biofix.

Control by Insecticides: When damage is severe, treat in the following year with insecticide. For conventional insecticides such as Imidan or Sevin, applications 10 and 20 days after blossom drop are important for cranberry fruitworm control. For insect growth regulators such as Confirm, application



should be earlier; apply the first spray at initiation of egg-hatch, which occurs approximately when 400 degree-days have accumulated.

Blueberry Maggot (*Rhagoletis mendax*; order Diptera, family Tephritidae)

Damage: Berries become soft, mushy, and unmarketable from maggots feeding within the berries. If undetected, infested berries will contaminate the packout. In much of the Midwestern United States, this pest is sporadic and does not require control measures every year.

Appearance: The adult is a black fly with three or four white bands across the abdomen and a W-shaped pattern of dark bands on its wings. It is 1/5-inch long, a bit smaller than a housefly. The immature forms are maggots that are white, legless, and about 1/4-inch long when fully grown (Figure 139).

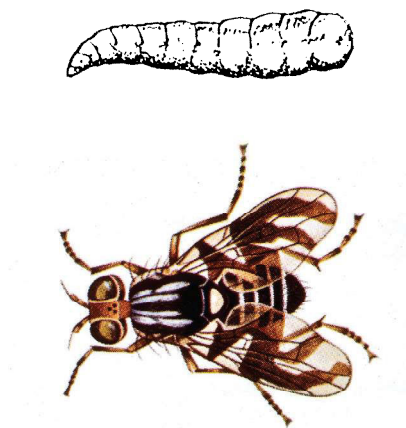

Figure 139. Blueberry maggot and adult fly.

Life Cycle and Habits: This pest overwinters in the pupa stage in the soil. Adults emerge over a prolonged period from late June to early August. The female flies do not begin laying eggs until about 10 days after emergence. Flies alight on fruit to lay one egg per berry under the fruit skin just as the fruit begins to turn blue. The egg hatches in about one week. Maggots feed for about three weeks inside ripening and harvested fruit. There is one generation per year.

Monitoring and Thresholds: Yellow sticky traps baited with ammonium acetate crystals (available from suppliers listed on page 8) can be used to monitor the local population of blueberry maggot in its adult stage. Traps most commonly used are yellow cardboard, 9 by 11 inches (Figure 140). These can be bent in half, sticky side down, to form a V pointing downward; traps can be suspended from angled stakes so that the bottom of the trap is 6 to 10 inches above the canopy. Place traps along field borders. Use at least three traps per field or one trap per acre. Set traps up in early June. Check traps twice per week and replace sticky panels every two to three weeks. Sustained catch of the blueberry maggot fly in traps indicates that it is an optimal time to make an insecticide treatment; sustained catch means not just the first one or two flies, but consistent catch of several flies per week.

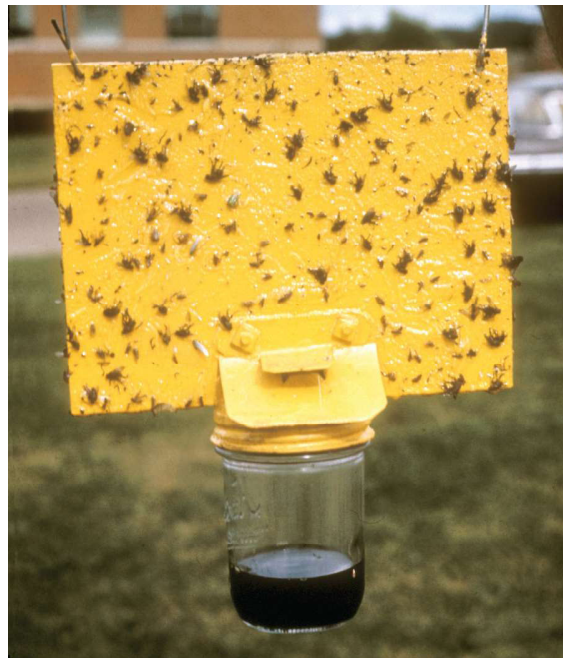

Figure 140. Blueberry maggot trap.

Mechanical Control: In small plantings, it may be possible to trap-out this insect if trap density is sufficient; one sticky trap per bush is suggested.

Control by Insecticides: Insecticide is effective if directed at adult flies before they lay eggs. This is usually close to harvest, so care must be taken to obey the required preharvest interval specified on each insecticide label.



Plum Curculio

(Conotrachelus nenuphar; order Coleoptera, family Curculionidae)

Damage: Berries are bored into and eaten by plum curculio larvae. Damaged fruit ripens prematurely and drops off the bush, thus reducing yield.

Appearance: This snout beetle (or weevil) is mottled brown and gray, has a long curved snout, and four humps and numerous pits on its back; it is about 1/5-inch long (Figure 141). Larvae are white legless grubs with a brown head; they are 1/3 inch when fully grown (Figure 142).

Life Cycle and Habits: The plum curculio overwinters in the adult stage in wooded areas near fields. Adults become active in the spring about the time that the earliest cultivars begin to bloom. They are found on developing flower buds and later on developing berries. The female beetle lays each egg in a crescent-shaped slit she cuts in a developing berry (Figure 143). The larva bores into the fruit and eats its contents over a two-week period. Larvae drop to the ground and pupate in the soil for about four weeks.

Cultural Control: Plum curculio is more abundant where blueberries are located near apples, peaches, and plums. If possible, plant blueberries away from tree fruit.

Control by Insecticides: Apply insecticide for plum curculio control at blossom drop and 10 days later.



Figure 141. Plum curculio adult on cherry.



Figure 142. Plum curculio larva on blueberry.



Figure 143. Plum curculio scars on blueberries.

Cranberry Weevil or Blueberry Blossom Weevil

(Anthonomus musculus; order Coleoptera, family Curculionidae)

Damage: Weevil-punctured flowers do not open. Damaged leaf buds produce an abnormal cluster of dwarfed leaves.

Appearance and Life Cycle: The adult is a dark reddish brown snout beetle, 1/8-inch long, with curved snout. It emerges in the spring when blossom buds are beginning to swell and feeds and lays eggs in expanding flower buds and leaf buds. The weevils hide between the clustered buds, and in small infestations they may be difficult to find. Adults of the second generation sometimes feed on blueberry leaves.



Cultural Control: Eradication of wild blueberries or other ericaceous plants in the vicinity of the blueberry planting is advised.

Control by Insecticides: Spraying is usually effective if done immediately after punctures are first observed. Do not apply insecticides while blueberries are in bloom.

Blueberry Tip Borer (*Hendecaneura shawiana*; order Lepidoptera, family Tortricidae)

Damage: Shoot dieback results from tip borers feeding as they tunnel through shoots (Figure 144). Early symptoms seen before new growth has begun to harden are wilting shoots and discoloration; the leaves turn yellowish with red veins and the stems turn purplish. This injury may be mistaken for primary mummy-berry infection. Injury causes increased secondary growth, which contributes shade and delays fruit ripening. Injury also results in the destruction of the stem's fruit-production potential in the following year.

Appearance: Larvae are tiny and pink when newly hatched, and 3/8 inch and white when fully grown (Figure 145). Adults are small moths. Their wings are brown with orange markings and a gray spot; the wingspan is about 1/2 inch (Figure 146).

Life Cycle and Habits: The blueberry tip borer overwinters as mature larvae inside stems. Adults emerge in early June and lay eggs on the underside of



Figure 144. Blueberry tip borer damage.



Figure 145. Blueberry tip borer larva.

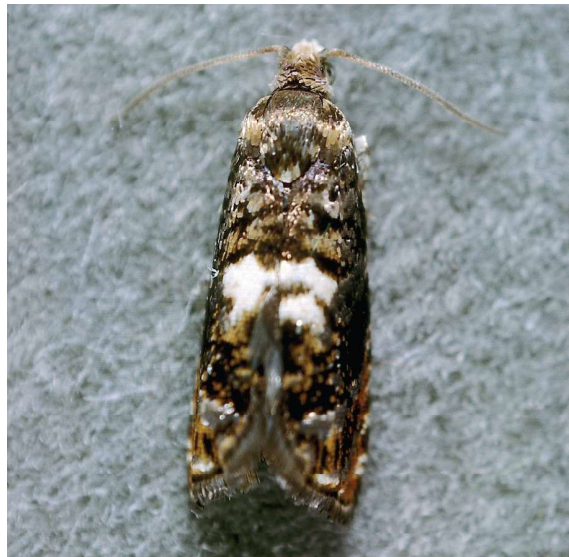

Figure 146. Blueberry tip borer.

leaves near the end of the shoot. Young larvae enter the soft stem and bore channels that may extend for 8 or 10 inches by autumn. There is one generation per year.

Cultural Control: Prune out damaged tips as they are observed and burn the prunings.

Control by Insecticides: An insecticide spray should be applied when eggs are hatching, before larvae bore into shoots.



Scale Insects

Terrapin Scale

(*Mesolecanium nigrofasciatum*; family Coccidae)

European Fruit Lecanium

(*Parthenolecanium corni*; family Coccidae)

Putnam Scale

(*Diaspidiotus ancylus*; order Homoptera, family Diaspididae)

Damage: Reduced vigor of bushes and reduced berry yield can result from scale insects feeding on plant sap. Scales are found on rough, loose bark of older stems and sometimes on fruit. Some scales secrete a sticky waste product called honeydew, which can serve as a substrate on which sooty mold can grow. Berries covered with honeydew or sooty mold are unmarketable.

Appearance and Life Stages: Scales are mound-shaped and usually about 1/8-inch long. Terrapin and lecanium scales have a tough shield-like body. Putnam scales are small soft-bodied insects that live beneath a waxy shell-like structure that is not attached to them (Figure 147). Adult females and immatures are wingless. Adult males are winged or wingless, depending on species. The first-stage nymphs are mobile and called crawlers. Crawlers are yellow or white, six-legged, and 1/50-inch long.



Figure 147. Putnam scale.

The adult female of the terrapin scale is red-orange marked with black lines (Figure 148). The European fruit lecanium female is yellow brown when young, and dark brown covered with grey/white waxy powder when older. The Putnam scale is dark gray with a dark red center.

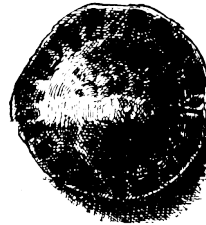
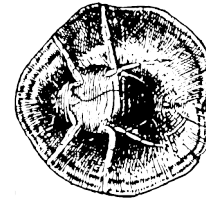

Figure 148. Terrapin scale.

Monitoring: Crawlers can be detected by wrapping sticky tape, sticky-side out, around twigs. Light-colored crawlers show up well if dark tape, such as black electrical tape, is used.

Cultural Control: Pruning out canes weakened by scales is the first step in control of scales on blueberries.

Control by Insecticides: During the dormant or delayed dormant period, scales can be controlled by applying superior-type oil of 60- or 70-second viscosity; mix 3 gallons oil per 100 gallons of water. Thorough coverage is needed for oil to be effective. To avoid phytotoxic injury, apply oil when there is no danger of freezing temperatures for at least 24 hours after treatment. An insecticide can be used to kill crawlers once they are detected.

Japanese Beetle

(*Popillia japonica*; order Coleoptera, family Scarabaeidae)

Damage: Leaves are skeletonized during mid- to late-summer by adult beetles (Figure 149). During harvest, adult beetles can end up as contaminants if they are shaken out along with the berries.

Appearance: The adult beetle is about 1/2-inch long and copper-colored, with metallic green markings and tufts of white hairs on the abdomen (Figure 150). Larvae are soft white grubs with six legs and a brown head, usually found in a curled position.



Life Cycle and Habits: There is one generation per year. Larvae, or grubs, develop in pastures, lawns, and other types of turf, where they live in the soil and



Figure 149. Japanese beetle damage on blueberry.



Figure 150. Japanese beetle adult.

feed on roots of grasses. Adults begin emerging in late June; they feed on the upper surface of blueberry foliage. Adults also feed on sassafras, raspberries, grapes, and peaches.

Cultural Control: Clean harvesting, which prevents an accumulation of overripe fruit, helps to prevent beetles from being attracted to plantings. Plowing or cultivation can destroy pupae in the soil.

Mechanical Control: Traps are available that use a sex attractant and/or feeding attractant to capture the beetles in a can or plastic bag, but such traps may not provide adequate control. Place traps near the planting, but not in the planting, because plants close to a trap may suffer increased localized damage from beetles that are attracted to the trap but not caught by it.

Control by Insecticides: Where immigrations of these beetles occur, insecticide application currently

offers the only effective means of control. Preharvest restrictions must be obeyed.

Gypsy Moth

(Lymantria dispar; order Lepidoptera, family Lymantriidae)

Damage: Partial to complete defoliation and bud loss result from caterpillars feeding on blueberries. Bud loss leads to fruit loss.

Appearance: Gypsy moth larvae are hairy, dark brown to black caterpillars that are marked with red and blue spots. They are large, from 1/4 to 2 inches in length, depending on their age. Egg masses are light brown and fuzzy and found on tree trunks from August to April. Adults are moths (Figure 151).

Life Cycle and Habits: Gypsy moth overwinters in the egg stage and has one generation per year. Eggs hatch in April or May. Larvae feed on leaves, buds, and stems of bushes until early July. Other favorite host plants are oaks, apple, hawthorn, birches, boxelder, willow, and sumac.

Mechanical Control: Scrape egg masses off tree trunks to destroy the eggs during the winter. Remove larvae by hand during May and June.

Control by Insecticides: If your plantings are surrounded by wooded areas known to be infested by gypsy moth, then apply protectant sprays, especially if larvae begin to migrate from the woods into your blueberry planting. Sprays applied to control other insects may be sufficient to control gypsy moth larvae. Microbial insecticides made from *Bacillus thuringiensis* (*Bt*) are effective only if treated foliage is eaten by the caterpillars; they work best on young larvae.

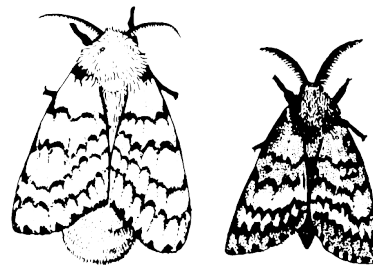

Figure 151. Gypsy moth female (left) and gypsy moth male (right).



Vertebrate Pests

Birds

Birds are a major pest problem in highbush blueberries. Left unchecked, they can destroy enough of the crop to ruin the profitability of a planting. The loss of chemical deterrents has made bird control a more difficult task in recent times, but effective means are still available. Some new chemical repellents might come on the market in the near future.

Netting is the most effective way to keep birds out of the planting. Although initial costs can be high, most netting will last for many years if cared for properly. Netting should be hung over some sort of support structure built around the planting. Usually posts are set nine feet above the ground around the perimeter of the planting. Wire is run from pole-to-pole to form a grid over the planting. The netting is hung over this grid when the fruit begins to turn color. Some temporary nine-foot poles may be placed within the planting at intersections of the grid to keep the netting from drooping. The edges of the netting are buried or anchored to the ground to keep birds from crawling underneath. The netting is removed when harvest is complete and stored in a cool, dry place.

Visual scare devices have variable effectiveness on birds. Scarecrows, balloons, kites, or stuffed owls may work on certain bird species in certain areas, but none seem to have widespread dependability. When using scarecrows, scare-eye balloons, stuffed owls, or snakes, put them in the planting only when the fruit begins to ripen and move them regularly, at least once per day. Six scare-eye balloons per acre are recommended. Take them out of the field as soon as harvest is over. This will reduce the chance of birds becoming accustomed to the devices and increase longevity of their effectiveness. Kites and helium-filled balloons positioned high above the planting with a silhouette of a hawk hanging from them have provided good results in some areas.

Noise deterrents, such as propane cannons, alarms, and recorded distress calls, seem to have the least effect on birds in blueberries but may greatly annoy neighbors. A combination of noise and visuals may be effective, however. Several operations have hired

people to regularly drive motorcycles and/or all-terrain vehicles through the planting when the fruit is ripe. This seems to keep birds away quite well. Be sure to make drivers aware of where pickers are, however, to avoid possible accidents.

Voles

Voles can be a serious problem in blueberry plantings. They feed on the bark of stems or on the roots, depending on which species of vole is present. In the Midwest, two species are found — the meadow vole (*Microtus pennsylvanicus*) and the pine vole (*Microtus pinetorum*). They may both be present in a blueberry planting. It is important to determine which species is present in order to make management decisions.

Size and appearance of the two species differ, although it is somewhat rare to actually see them. The meadow vole has a long body (6 to 8 inches = 150 to 195 cm) and long tail, prominent eyes and ears, coarse fur, and is dull gray to chestnut in color with a gray belly. The pine vole has a short body (4 to 5 inches = 110 to 135 cm) and short tail, sunken eyes and ears, fine velvety fur, and is bright chestnut in color with a slate gray belly.

Evidence of their activity is more diagnostic. *Meadow voles* are active on the *surface* of the ground, feeding on the bark of the bushes and making shallow trails in the grass or mulch around the plants. Food caches and droppings can be found in these surface trails. *Pine voles* are active *below* ground, feeding on roots. Subsurface trails can be found by digging around the bushes. These trails come to the surface where mounds of dirt can be seen. Holes leading into these trails are about 1 inch in diameter.

Simply finding evidence of voles does not indicate a serious problem. To determine whether the voles are causing serious injury to the bushes, it is necessary to estimate the population of voles present. This requires some specialized sampling. It is best to contact a wildlife specialist for help with this sampling procedure.

Management: In some cases, the removal of mulch material around the bushes can help in reducing



the meadow vole population. However, this is risky for bushes susceptible to drought stress. In those cases, choose a mulch material that does not support tunnelling, that is, a mulch that caves in easily. In some states, any application of toxicants

or poisons for the purpose of killing any mammal or bird is prohibited. However, some toxicants may be allowed under certain situations with proper permits. Check with your state pesticide specialists for recommendations.

Summary of Blueberry Pest Management Procedures

I. Cultural controls

- A. Selecting a site for a new planting:
 - 1. Do not plant near fruit trees to avoid problems with plum curculio.
 - 2. Do not plant near woods or fence rows to avoid cranberry weevil.
 - 3. Do not plant near wild blueberries or related plants (or remove them).
- B. Pruning: Prune branches damaged by blueberry tip borer or scale insects.
- C. Harvest: Promptly remove all ripe and cull berries to help manage Japanese beetles.
- D. Sanitation and weed control: Eliminates overwintering sites for fruitworms.
- E. Mulching: Consider potential vole problems when selecting type of mulch.

III. Mechanical control options

- A. Traps for blueberry maggots, Japanese beetles.
- B. Handpicking of berries infested with fruitworms.
- C. Handpicking of gypsy moth: Scrape off egg masses, collect larvae.
- D. Netting to exclude birds.
- E. Visual scare devices and/or noise deterrents for birds.

IV. Monitoring for pests

- A. Traps to detect blueberry maggot flies.
- B. Sticky tape around branches to detect scale crawlers.
- C. Scouting
 - 1. Prebloom: Look for buds damaged by cranberry weevil.
 - 2. After bloom: Look for fruitworms, plum curculio, tip borer, leafrollers.



Weed Management in Highbush Blueberries

Blueberry root systems are shallow and lack root hairs; this puts them at a disadvantage when competing for water and nutrients. Thus, good weed control is essential if optimum growth and yields are to be realized.

Eradicate perennials and reduce the annual weed seed bank one to two years before planting by following the instructions in the section on *Controlling Weeds Before Planting* (page 178). Use herbicides and cultivation in rotational grain crops to reduce the number of weed seeds. In late summer, establish the raised bed, incorporate amendments, and plant a ground cover (such as K-31 fescue) over the entire field. In early spring, kill the sod on the raised bed with Roundup and plant 8 to 10 days later. For a complete discussion of methods used in a weed-control program, see *Weed Management: General Information and Guidelines*, (page 172).

A permanent sod between the rows is effective in controlling weeds in establishing plantings. Within-row weeds can then be controlled with appropriate herbicides. Recommendations for controlling the wide range of weeds that are found in blueberries are presented here.

Herbicides can injure newly transplanted blueberries. Use recommended herbicides carefully and follow the label (see Table 4-3). Preemergence herbicides such as Devrinol and Surflan can be used in the row within five to seven days after planting and can be applied over the plant without damage to the plant if the soil has settled around the roots. Postemergence herbicide sprays can be directed to low-growing weeds without contacting leaves or stems of the crop. Fall-applied preemergence herbicides can be applied to control grasses and winter annuals.

For established plantings, preemergence herbicides are applied in either fall or early spring to weed-free soil (see Table 4-4). Combinations of two herbicides improve the spectrum of weeds controlled. For

Table 4-3. Recommended Herbicides for Blueberries: THE TRANSPLANTING YEAR.		
Weeds	Timing of Treatment^a	Herbicide/Acre
Preemergence		
Grasses and broadleaf weeds	At transplanting.	• Solicam DF, 2.5 lb.
Grasses	At transplanting.	• Devrinol 50WP, 4 lb.
Annual broadleaf weeds	Early spring or fall.	• Princep 80WP, 2.5 lb.
Some perennials, grasses, broadleaf weeds	Fall after transplanting.	• Casoron 4G, 100-150 lb.
Postemergent		
Grasses	When grasses are 2 to 8" tall prior to seed head.	• Poast 2 pt + 2 pt crop oil concentrate; • Fusilade DX, 16-24 oz + 2 pt crop oil concentrate/25 gal or 1/2 pt nonionic surfactant/25 gal.
Emerged Weeds	Fall (mid-September).	• Roundup, 1-3 qt. <i>Directed spray only.</i>
Emerged Weeds	When new weeds are present.	• Gramoxone Extra, 2-3 pt. <i>Directed spray only.</i>



Table 4-4. Recommended Herbicides: FOR ESTABLISHED BLUEBERRY PLANTINGS.		
Weeds	Timing of Treatment^a	Herbicide
Preemergence		
Annual broadleaf weeds, grasses	Fall to early spring.	• Princep 80W, 2.5-5 lb. in 40 gal. water.
Annual grasses, some broadleaf weeds	Late fall to early spring; before weed seeds germinate.	• Devrinol 50WP, 4 to 6 lb in 20 to 50 gal. water.
Some perennials, annual grasses, some broadleaf weeds	Late fall or early spring, soil temperature must be below 50°F.	• Casoron 4G, 100-150 lb.
Annual grasses, broadleaf weeds	Fall to early spring.	• Karmex 80W, 2-3 lb. in 25-40 gal. water.
Broadleaf weeds, some perennials	Early spring or in fall after harvest; preemergence or early stages of growth.	• Sinbar, 2-3 lb in minimum 40 gal water. <i>Directed spray only.</i>
Grasses, some broadleaf weeds	Early spring; over weed-free surface.	• Surflan AS, 2-6 qt. in 20-40 gal water.
Grasses and broadleaf weeds	Fall-early spring.	• Solicam DF, 2.5-5 lb.
Grasses, chickweed	Fall-early winter.	• Kerb 50W, 2-4 lb.
Postemergent		
Grasses	When grasses are 2 to 8" tall prior to seed head.	• Poast 2 pt + 2 pt crop oil concentrate.
Emerged weeds	When new weeds are present.	• Gramoxone Extra, 2-3 pts. <i>Directed spray only.</i>
Emerged weeds	Fall	• Roundup, 1-3 qt. <i>Directed spray only.</i>
^a Before using, read comments on herbicides in Table 6-2, Small Fruit Herbicides, page 175.		

instance, on soils with less than 2% organic matter, Surflan plus Karmex is recommended. With 2% or more organic matter, Sinbar plus Karmex or Princep plus Karmex can be used. Where annual grasses are actively growing, consider applying a systemic grass herbicide prior to or tank-mixed with Surflan to provide immediate and residual control. Check for compatibility before tank mixing. Kerb can be used when soil temperatures are below 50°F. Split applications of Princep in the fall and early spring have shown good results.

Most spring-applied preemergence herbicides lose effectiveness by August, especially where irrigation is heavily used. Directed contact herbicides may be used

to control these late-summer weeds. Weed growth in September may remove excess nitrogen and water and aid in acclimation. An alternative approach that has been used by many growers is to apply sequential micro-rates of soil-active herbicides. Micro-rates are below-label rates of either Sinbar or Princep. For instance, Sinbar is labeled at 2 to 3 lb/acre, yet provides excellent control of annual broadleaf weeds at 1/2 lb/acre. Two or three sequential applications may be needed to control weeds all summer at these rates, provided the cumulative amount of herbicide applied does not exceed the label rate. Do not apply within the pre-harvest interval. Because only the area under the blueberry row is treated, always remember to calculate the amount of row area per acre and apply herbicides at a per-treated-acre rate.



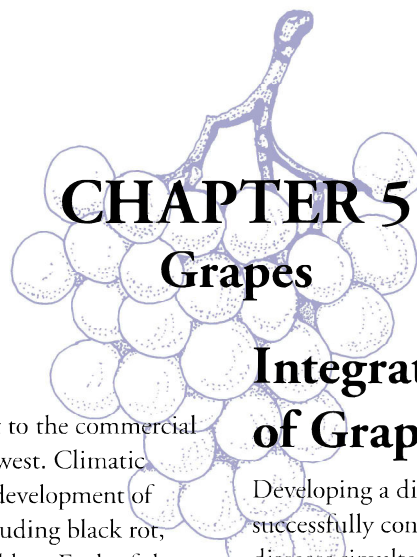

CHAPTER 5 Grapes

General

Diseases represent a major threat to the commercial production of grapes in the Midwest. Climatic conditions are conducive to the development of several major grape diseases, including black rot, downy mildew, and powdery mildew. Each of these diseases has the potential to destroy the entire crop under the proper environmental conditions. In addition, there are several other diseases (Phomopsis cane and leaf spot, Botrytis gray mold, Eutypa dieback and crown gall) that can also result in economic loss. It is important to note that most of these diseases can occur simultaneously within the same vineyard during the growing season.

The development and implementation of Integrated Pest Management (IPM) programs for grapes has great potential for improving our current pest control strategies and reducing our use of pesticides in general. Much of the potential for reducing pesticide use will be in the area of insect control. Many of the IPM methods for monitoring and controlling insects give the grower more flexibility in the decision-making process as to whether insecticides are needed, which insecticides to apply, and when to apply them.

Our currently available disease-management programs and recommendations have much less flexibility, and the level to which we will be able to reduce fungicide use is largely limited by the degree of susceptibility of the cultivars being grown and environmental conditions during the growing season (the most important of which is wet rainy weather). The introduction of new fungicide chemistry, such as the sterol inhibitors or SIs (Bayleton, Rubigon, and Nova), and the strobilurin fungicides (Abound, Savron, and Pristine), as well as new information related to the disease cycles of the various pathogens are providing opportunities for new disease control strategies that can be implemented in IPM programs.

Integrated Management of Grape Diseases

Developing a disease-management program that successfully controls all of the important grape diseases simultaneously presents a unique challenge. In order to accomplish this, all available control methods must be **integrated** into one overall disease-management program. The disease management program should emphasize the integrated use of disease resistance, various cultural practices, knowledge of disease biology, and the use of approved fungicides or biological control agents or products when necessary.

Identifying and Understanding the Major Grape Diseases

It is important for growers to be able to recognize the major grape diseases. Proper disease identification is critical to making the correct disease-management decisions. In addition, growers should develop a basic understanding of pathogen biology and disease cycles for the major grape diseases. The more one knows about the disease, the better equipped one is to make sound and effective management decisions. Color photographs of disease symptoms on grapes, as well as in-depth information on pathogen biology and disease development, can be found in these publications:

Compendium of Grape Diseases — Published by the American Phytopathological Society, 3340 Pilot Knob Rd., St. Paul, MN 55121. Phone: 612-454-7250, 1-800-328-7560. This is the most comprehensive book on grape diseases available. All commercial growers should have a copy.

Midwest Grape Production Guide — Bulletin 815, Ohio State University Extension. Can be obtained from Ohio State University Extension, Media Distribution, 385 Kottman Hall, 2021 Coffey Road, Columbus, OH 43210-1044. Phone 614-292-1607.

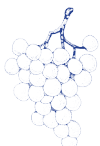

A description of symptoms and disease cycles for the most common grape diseases in the Midwest is presented here.

Black Rot

Symptoms and Disease Cycle (Figure 152)

Black rot is caused by the fungus *Guignardia bidwellii*. The fungus overwinters in mummified fruit on the vine or on the ground. Spring rains trigger the release of airborne ascospores and/or rain splashed conidia from the mummies. Primary infections occur on green tissues if temperatures and duration of leaf wetness are conducive (Table 5-1). Recent research indicates that the majority of ascospores from mummies on the ground are discharged within a time period from 1-inch shoot growth to two to three weeks after bloom. If mummies are allowed to hang on the vines, they can discharge ascospores and conidia throughout the growing season.

In conventional production systems, black rot is controlled primarily through the use of effective fungicides combined with various cultural practices. Black rot may be particularly important in organic production systems because the organically approved fungicides (copper and sulfur) are not very effective for black rot control. Growers should develop a thorough understanding of the black rot disease cycle and the cultural practices used to control it.

Lesions on canes from the previous season can also produce conidia for a period of at least one month starting at budbreak. Cane lesions are probably most important in mechanically pruned or hedged vineyards that have an abundance of canes in the canopy. All green tissues of the vine are susceptible to infection. Leaves are susceptible for about one week after they reach full size.

Brown circular lesions develop on infected leaves about nine to 11 days after infection (Figure 153). Within a few days, black spherical fruiting bodies

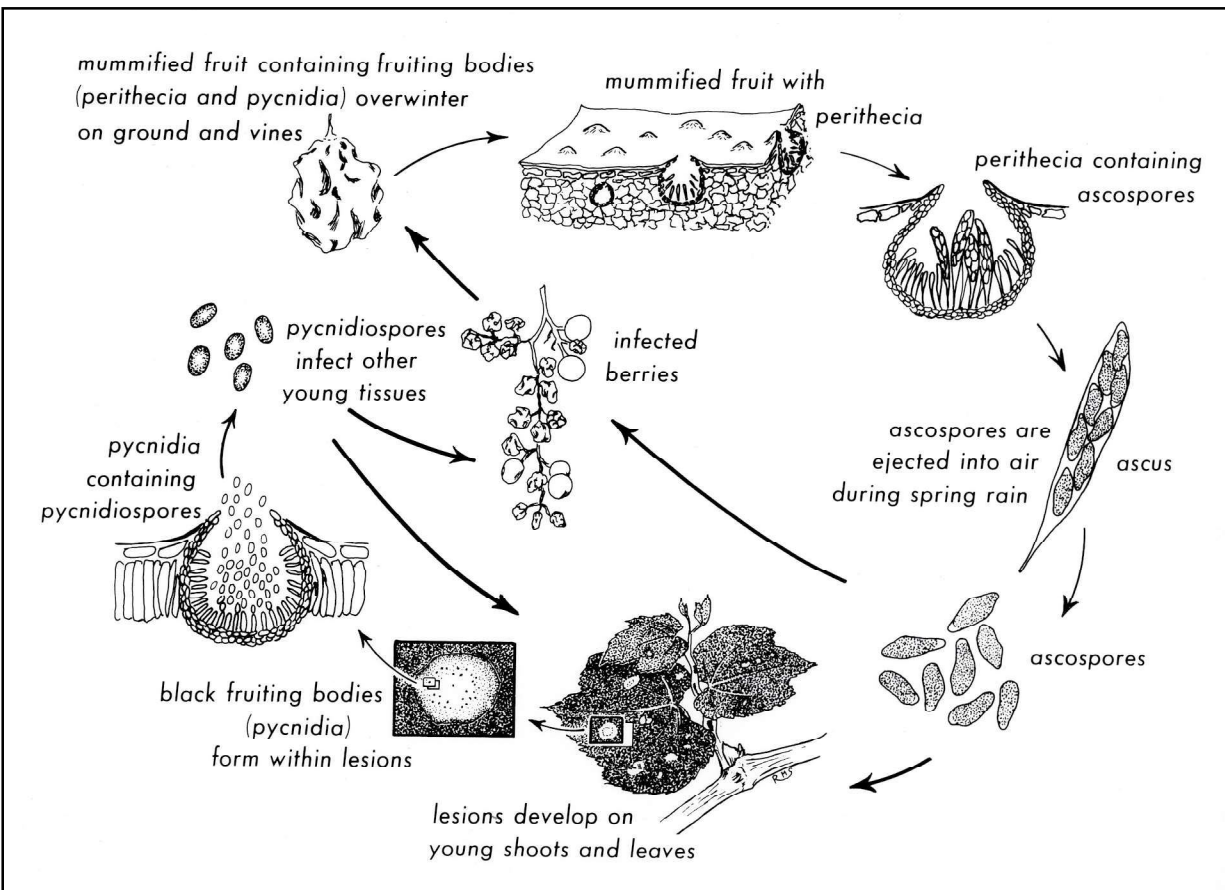

Figure 152. Disease cycle of grape black rot. We wish to thank the New York State Agricultural Experiment Station for use of this figure. Figure taken from the Grape IPM Disease Identification Sheet No. 4.

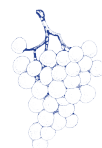

Table 5-1. Grape Black Rot. Leaf Wetness Duration-Temperature Combinations Necessary for Grape Foliar Infection by Black Rot.

Temperature °F	Minimum Leaf Wetness Duration (Hr) for Light Infection
50	24
55	12
60	9
65	8
70	7
75	7
80	6
85	9
90	12

* Data represent a compilation from several experiments with the cultivars Concord, Catawba, Aurora, and Baco noir.

(pycnidia) form within the lesions (Figure 154). The pycnidia are often arranged in a ring pattern just inside the margin of the lesion. Each one of these pycnidia can produce a second type of spore (conidium). These conidia are spread by rain splash and can cause secondary infections of leaves and fruit throughout the growing season and on fruit through about two to four weeks after bloom.

It is important to emphasize that a single ascospore can cause a primary infection (leaf lesion). Within each leaf lesion (primary infection), many pycnidia form. Each pycnidium can produce hundreds of thousands of conidia, each of which can cause another infection (secondary infection) later in the

season. Therefore, it is extremely important to control the early season primary infections caused by ascospores. Infection by one ascospore can result in the development of millions of secondary conidia in the vineyard.

Lesions may also develop on young shoots, cluster stems (rachis), and tendrils. These lesions are usually purple to black, oval-shaped, and sunken. Pycnidia also form on these lesions.

The fruit infection phase of the disease can result in serious economic loss (Figure 155). Berries are susceptible to the infection from bloom until shortly after bloom. Older literature reports that berries become resistant when they reach 5% to 8% sugar. Research in New York indicates that berries become resistant to black rot much earlier (three to four weeks after bloom). Therefore, the most critical time

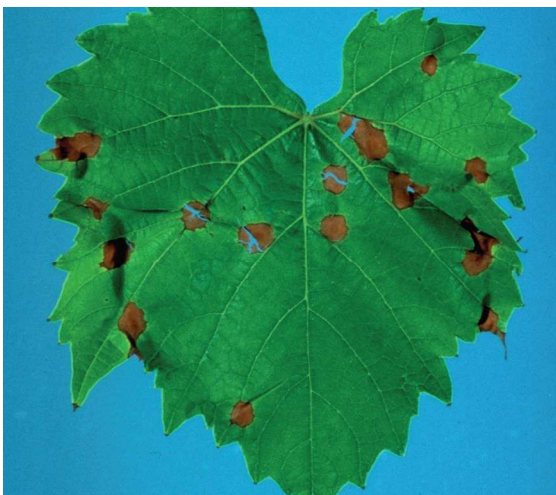

Figure 153. Black rot lesions on grape leaf.

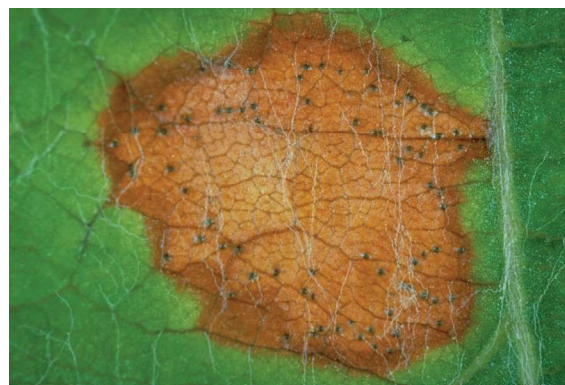
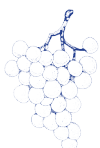

Figure 154. Close-up of black rot leaf lesion showing fungal fruit bodies (pycnidia).



to control black rot fruit infections with fungicide is from immediately prior to bloom through three to four weeks after bloom. An infected berry first appears light brown in color. Soon the entire berry turns dark brown, and then black pycnidia develop on its surface. Infected berries eventually turn into shriveled, hard, black mummies (Figure 156). These mummies also serve as a source of secondary inoculum later in the growing season and are the primary means by which the fungus overwinters.



Figure 155. Black rot on berries.



Figure 156. Close-up of black rot mummy.

The Bottom Line for Black Rot Control

Sanitation is critical to successful black rot control. Mummies are the most important overwintering source of the black rot fungus. If all mummies and infected canes are removed from the vineyard, there is no source of primary inoculum in the spring and, thus, the disease is controlled. Any practice that removes mummies and other infected material from the vineyard will be beneficial to the disease-management program. If all mummies cannot be removed from the vineyard, it is ***extremely important*** that they are not left hanging in the trellis. As mentioned previously, mummies on the ground appear to discharge their ascospores early in the season, while those hanging in the trellis may discharge ascospores and conidia throughout the

growing season. The most critical period to control black rot with fungicide is from immediate prebloom through three to four weeks after bloom.

Powdery Mildew

Powdery mildew is caused by the fungus *Uncinula necator*. If not controlled on susceptible cultivars, the disease can reduce vine growth, yield, quality, and winter hardiness. Cultivars of *Vitis vinifera* and its hybrids (French hybrids) are generally much more susceptible to powdery mildew than are native American cultivars such as Concord (see Table 5-2). On susceptible cultivars, the use of fungicides to control powdery mildew is an important part of the disease-management program. Failure to provide adequate control of powdery mildew early in the growing season can result in increased levels of other fruit rots such as Botrytis bunch rot and sour rot.

Symptoms and Disease Cycle (Figure 157)

The fungus can infect all green tissues of the grapevine. Disease losses due to fruit infection can be severe and can result in complete loss of the crop (Figure 158). It was previously thought that the fungus overwintered inside dormant buds of the grapevine. Research in New York has shown that almost all overwintering inoculum comes from cleistothecia, which are fungal fruiting bodies that overwinter primarily in bark crevices on the grapevine. In the spring, airborne spores (ascospores) released from the cleistothecia are the primary inoculum for powdery mildew infections.

NOTE: Ascospore discharge from cleistothecia is initiated if 0.10 inch of rain occurs at an average temperature of 50°F. Most mature ascospores are discharged within four to eight hours. These conditions can occur very early in the growing season. Thus, on highly susceptible cultivars, control needs to be initiated early in the growing season.

Ascospores are carried by wind. They germinate on any green surface on the developing vine, resulting in primary infections (Figure 159). The fungus grows and another type of spore (conidium) is formed over the infected area after six to eight days. The conidia and fungal mycelia give a powdery or dusty appearance to infected plant parts (Figure 160). Severely affected leaves may curl upward during hot dry weather. Young expanding leaves

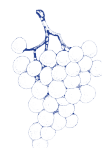

Table 5-2. Relative Disease Susceptibility and Sulfur and Copper Sensitivity Among Grape Cultivars.

Cultivar	BR	DM	PM	Bot	Phom	Eu	CG	ALS	Susceptible or Sensitive to	
									S ¹	C ²
Aurore	+++	++	++	+++	+	+++	++	+++	No	++
Baco Noir	+++	+	++	++	+	++	+++	++	No	?
Cabernet Franc	+++	+++	+++	+	?	?	+++	?	No	?
Cabernet Sauvignon	+++	+++	+++	+	+++	+++	+++	?	No	+
Candice	+++	++	+	++	?	?	++	++	?	?
Cascade	+	+	++	+	++	++	+	?	No	?
Catawba	+++	+++	++	+	+++	+	+	+	No	++
Cayuga White	+	++	+	+	+	+	++	++	No	+
Chambourcin	+++	++	+	++	?	?	++	?	Yes	?
Chancellor	+	+++	+++	+	+++	+	+++	+++	Yes	+++
Chardonel	++	++	++	++	?	?	++	++	No	?
Chardonnay	++	+++	+++	+++	+++	++	+++	++	No	+
Chelois	+	+	+++	+++	+++	+++	++	+++	No	+
Concord	+++	+	++	+	+++	+++	+	+	Yes	+
Cynthiana/Norton	+	++	+	+	+	?	+	?	Yes	?
DeChaunac	+	++	++	+	+++	+++	++	+++	Yes	+
Delaware	++	+++ ³	++	+	+++	+	+	+	No	+
Dutchess	+++	++	++	+	++	+	++	+	No	?
Elvira	+	++	++	+++	+	+	++	++	No	++
Einset Seedless	+++	++	+++	+	?	?	+	?	?	?
Foch	++	+	++	+	?	+++	+	+	Yes	?
Fredonia	++	+++	++	+	++	?	+	+	No	?
Frontenac	++	+	++	++	+	?	?	?	No	?
Gewurztraminer	+++	+++	+++	+++	?	?	+++	+	No	+
Himrod	++	+	++	+	?	?	?	+	No	?
Ives	+	+++	+	+	?	++	+	+	Yes	?
Jupiter	++	+	+++	+	+	?	?	?	?	?
LaCrosse	+++	++	++	+++	++	?	?	?	?	?
Leon Millot	+	++	+++	+	+	+	?	?	Yes	?
Limberger	+++	+++	+++	+	?	+++	+++	?	No	?
Maréchal Foch	++	+	++	+	?	+++	?	+	Yes	?
Marquis	+	+++	+	+	+++	?	?	?	?	?
Mars	+	+	+	+	+	?	+	?	?	?
Melody	+++	++	+	+	?	?	?	?	No	?
Merlot	++	+++	+++	++	+	+++	+++	?	No	++
Moore's Diamond	+++	+	+++	++	?	++	?	?	No	?
Muscat Ottonel	+++	+++	+++	++	?	+++	+++	?	No	?
Niagra	+++	+++	++	+	+++	+	++	+	No	+
Pinot gris	+++	+++	+++	++	?	+++	+++	?	No	?

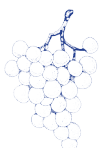

Table 5-2 (Continued). Relative Disease Susceptibility and Sulfur and Copper Sensitivity Among Grape Cultivars.

									Susceptible or Sensitive to	
Pinot Meunier	+++	+++	+++	+++	?	+++	+++	?	No	?
Pinot blanc	+++	+++	+++	++	?	?	+++	?	No	+
Pinot noir	+++	+++	+++	+++	?	?	+++	+	No	+
Reliance	+++	+++	++	+	++	?	?	?	No	?
Riesling	+++	+++	+++	+++	++	++	+++	+	No	+
Rosette	++	++	+++	+	++	++	++	++	No	+++
Rougeon	++	+++	+++	++	+++	+	++	+++	Yes	+++
Saint Croix	?	++	++	++	?	?	?	?	?	?
Sauvignon Blanc	+++	+++	+++	+++	?	?	+++	?	No	+
Seyval	++	++	+++	+++	++	+	++	++	No	+
Steuben	++	+	+	+	?	?	+	++	No	?
Traminette	+	++	+	+	?	?	++	?	?	?
Vanessa	+++	++	++	+	+	?	+	?	?	?
Ventura	++	++	++	+	+	?	+	+++	No	?
Vidal blanc	+	++	+++	+	+	+	++	+	No	?
Vignoles	+	++	+++	+++	++	++	++	++	No	?
Villard noir	?	+	+++	+	?	?	?	?	?	?

Key to susceptibility or sensitivity: BR = black rot; DM = downy mildew; PM = powdery mildew; Bot = Botrytis; Phom = Phomopsis; Eu = Eutypa; CG = crown gall; ALS = angular leaf scorch; S = sulfur; C = copper.

Key to ratings: + = slightly susceptible or sensitive; ++ = moderately susceptible or sensitive; +++ = highly susceptible or sensitive; No = not sensitive; Yes = sensitive; ? = relative susceptibility or sensitivity not established.

¹ Slight to moderate sulfur injury may occur even on tolerant cultivars when temperatures are 85°F or higher during or immediately following the application.

² Copper applied under cool, slow-drying conditions is likely to cause injury.

³ Berries not susceptible.

that are infected may become distorted and stunted. The conidia serve as secondary inoculum for new infections throughout the remainder of the growing season.

It is important to note that a primary infection caused by one ascospore will result in the production of hundreds of thousands of conidia, each of which is capable of causing secondary infections. Therefore, early season control of primary infections caused by ascospores is necessary. If primary infections are controlled until all the ascospores have been discharged, the amount of inoculum available for causing late-season (secondary) infections is greatly reduced. On young shoots, infections are more likely to be limited, and they appear as dark-brown to black patches that remain as dark patches on the surface of dormant canes.

Most economic losses from powdery mildew result from fruit infection. Infected berries often are misshapen or have rusty spots on the surface. Severely affected fruit often split open. When berries of purple or red cultivars are infected as they begin to ripen, they fail to color properly and have a blotchy appearance at harvest. Research in New York has shown that berries are susceptible to infection from bloom through a few weeks after bloom. Berries of Concord grapes are quite resistant within two to three weeks after bloom. Therefore, the most critical time to control fruit infection with fungicide is from immediately prior to bloom through two to four weeks after bloom. Even though the berries become resistant with age, cluster stems (rachis) and leaves remain susceptible throughout the season. Therefore, a full-season fungicide program is generally required for powdery mildew control on susceptible cultivars.

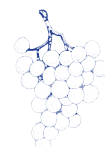

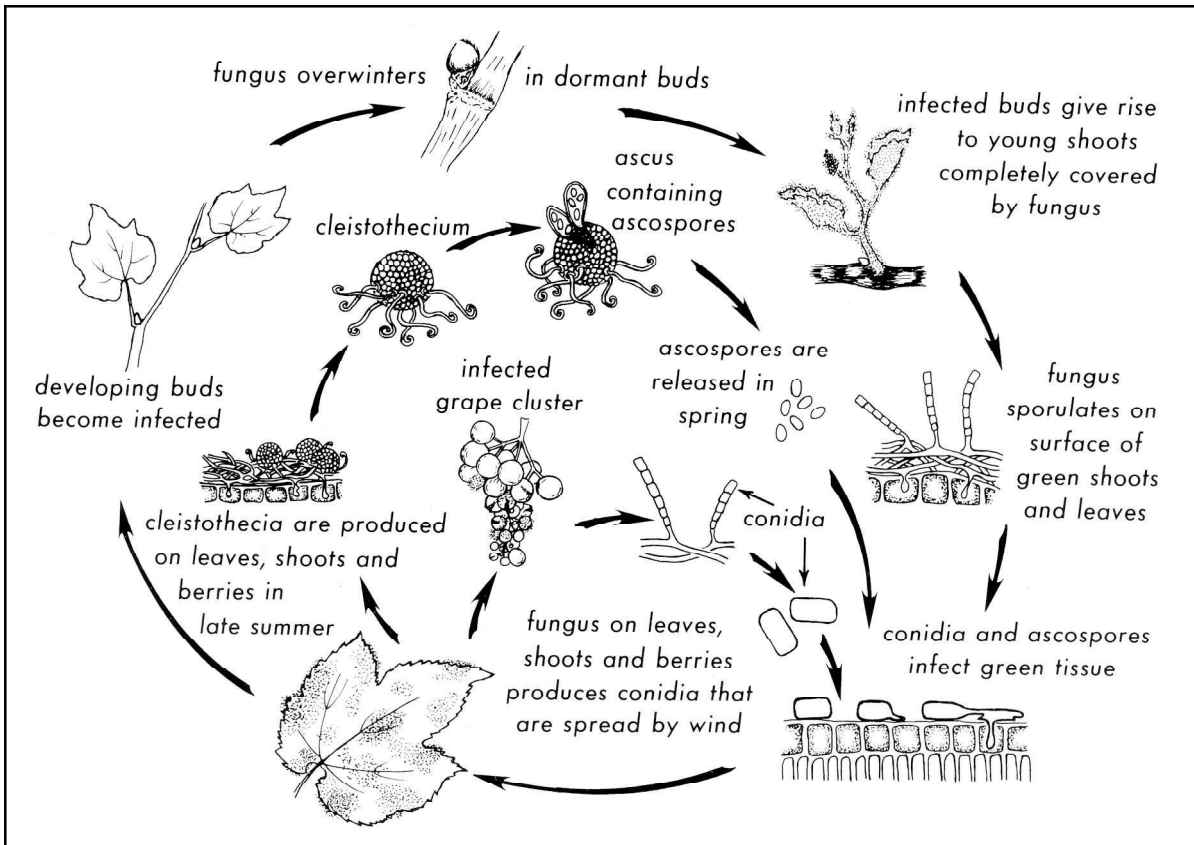

Figure 157. Disease cycle of Grape Powdery Mildew. We wish to thank the New York State Agricultural Experiment Station for use of this figure. Figure taken from the Grape IPM Disease Identification Sheet No. 2.



Figure 158. Powdery mildew on grape berries.



Figure 159. Powdery mildew primary infections on grape leaf.

Conditions That Favor Disease Development

Although infection can occur at temperatures from 59° to 90°F, temperatures of 68° to 77°F are optimal for infection and disease development. Temperatures above 95°F inhibit germination of conidia and above 104°F they are killed. High relative humidity is conducive to production of conidia. Atmospheric

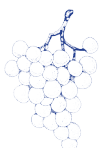



Figure 160. Powdery mildew covering grape leaf surface.

moisture in the 40% to 100% relative humidity range is sufficient for germination of conidia and infection. Free moisture, especially rainfall, is detrimental to the survival of conidia. This is in contrast to most other grape diseases, such as black rot and downy mildew, that require free water on the plant surface before the fungal spores can germinate and infect. Low, diffuse light seems to favor powdery mildew development. Under optimal conditions, the time from infection to production of conidia is only about seven days.

It is important to remember that powdery mildew can be a serious problem during growing seasons when it is too dry for most other diseases, such as black rot or downy mildew, to develop. Thick canopies that retain high levels of relative humidity are highly conducive to infections in the center of the row canopy.

Cleistothecia are formed on the surface of infected plant parts in late fall. Many of them are washed into bark crevices on the vine trunk where they overwinter to initiate primary infections during the next growing season.

Phomopsis Cane and Leaf Spot

For many years, the Eastern grape industry recognized a disease called dead-arm, which was thought to be caused by the fungus *Phomopsis viticola*. In 1976, researchers demonstrated that the dead-arm disease was actually two different diseases that often occur simultaneously. Phomopsis cane and leaf spot is the name for the cane-and-leaf-spotting phase of what was once known as dead-arm. Eutypa dieback is the name for the canker-and-shoot-dieback phase of what was also once known as dead-arm. The

name dead-arm has been dropped. Growers should remember that Phomopsis cane and leaf spot and Eutypa dieback are distinctly different diseases and their control recommendations vary greatly.

Disease incidence of Phomopsis cane and leaf spot appears to be increasing in many vineyards throughout the Midwest. Crop losses up to 30% have been reported in some Ohio vineyards in growing seasons with weather conducive to disease development. The most commonly observed symptoms are on shoots where infections give rise to black spots or elliptical lesions that are most numerous on the first three to four basal internodes. Although this phase of the disease can appear quite severe, crop loss due to shoot infections has not been demonstrated. Heavily infected shoots are more prone to wind damage.

Although shoot infections may not result in direct crop loss, lesions on shoots serve as an extremely important source of inoculum for cluster stem (rachis) and fruit infections in the spring. Rachis and fruit infection is the phase of the disease that causes most economic loss.

Symptoms and Disease Cycle (Figure 161)

Phomopsis cane and leaf spot is caused by the fungus *Phomopsis viticola*. The fungus overwinters in lesions or spots on one- to three-year-old wood infected during previous seasons. It requires cool weather and rainfall for spore (conidia) release and infection. Conidia are released from pycnidia (fungal fruiting bodies) in early spring and are spread by rain to developing shoots and leaves. Shoot and leaf infection (Figures 162 and 163) is most likely during the period from bud break until shoots are 6 to 8 inches in length. Lesions appear three to four weeks after infection.

The critical period for fruit and rachis infection (Figure 164) is also early in the season. The rachis and young fruits are susceptible to infection throughout the growing season; however, most infections appear to occur early in the growing season. The fungus does not appear to be active during warm summer months, and most or all of its primary inoculum is probably released and expended early in the growing season. Thus, the critical period to provide fungicide protection for fruit and rachis infection is probably from when the clusters are first exposed until two to four weeks after bloom.

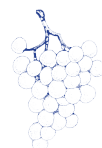

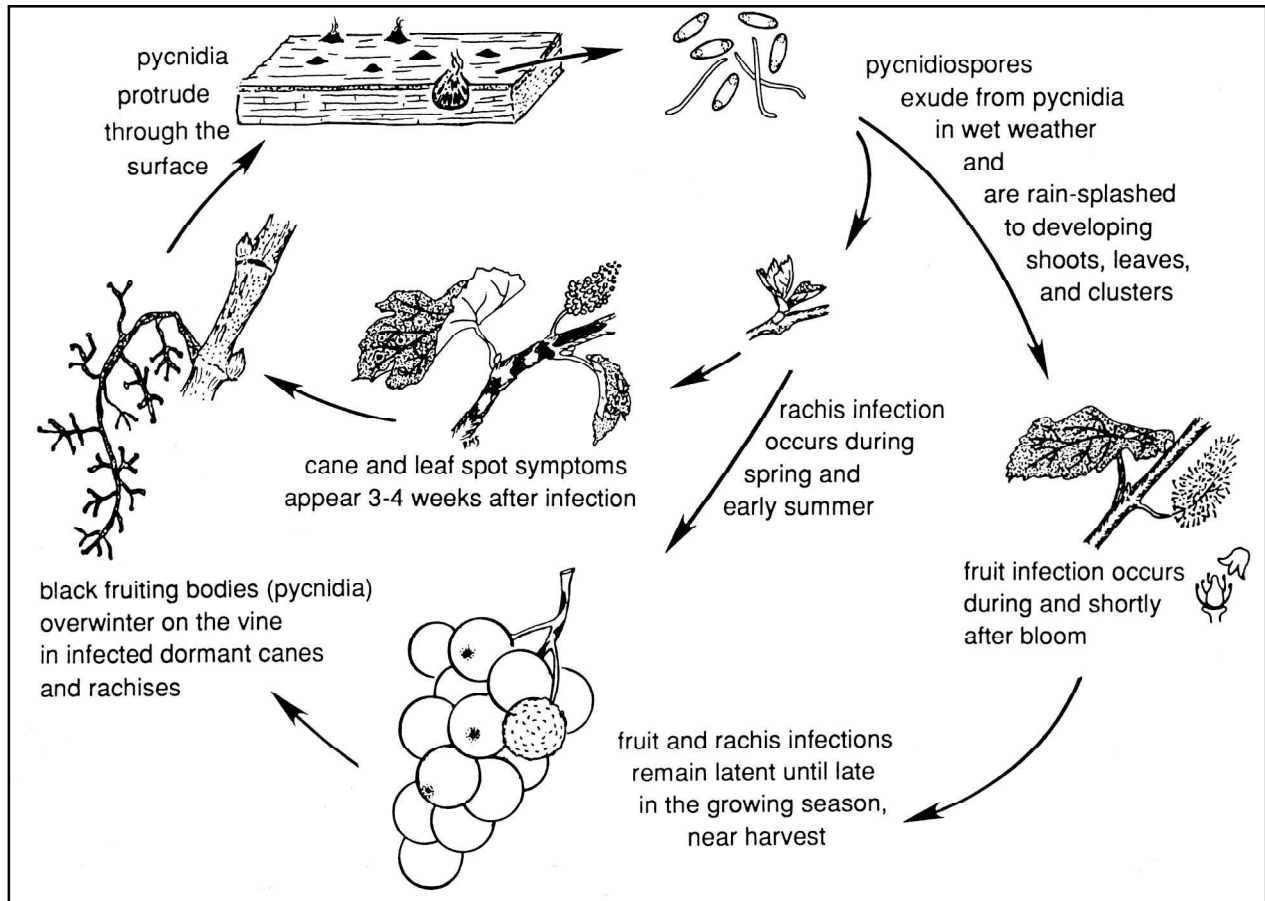

Figure 161. Disease cycle of *Phomopsis Cane and Leaf Spot*. We wish to think the New York State Agricultural Experiment Station for use of this figure. Figure taken from the *Grape IPM Disease Identification Sheet No. 6*.

The tiny green fruits that are infected during this critical period may appear to remain normal. The fungus remains inactive in these fruits as a latent infection. Not until the fruit starts to ripen near harvest does the fungus become active and cause the fruit to rot. Therefore, fruit rot that appears at harvest is probably due to infections that occurred during or shortly after bloom.

Fruit rot first appears close to harvest as a light-brown color. Black, spore-producing structures of the fungus (pycnidia) then break through the berry skin, and the berry soon shrivels.

At this advanced stage, *Phomopsis* fruit rot can be easily mistaken for black rot. Growers should remember that the black rot fungus does not infect berries late in the growing season, and black rot symptoms develop long before harvest. Berries become resistant to black rot infection by three to four weeks after bloom. Fruit rot symptoms caused by *Phomopsis* generally do not appear until harvest. Although the fungus does not appear to be active during the warm summer months, it can become active during cool, wet weather later in the growing season.

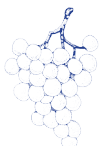



Figure 162. *Phomopsis* cane and leaf spot on internodes and rachis.



Figure 163. Symptoms of *Phomopsis* infection on grape leaf.



Figure 164. *Phomopsis* fruit rot on grape.

Downy Mildew

Downy mildew is a major disease of grapes throughout the eastern United States. The fungus causes direct yield losses by rotting inflorescences, clusters (Figure 165), and shoots. Indirect losses can result from premature defoliation. Premature defoliation is a serious problem, because it predisposes the vine to winter injury. It may take a vineyard several years to fully recover after severe winter injury. In general, vinifera (*Vitis vinifera*) cultivars are much more susceptible than American types; the French hybrids are somewhat intermediate in susceptibility (see Table 5-2 on page 126).

Symptoms and Disease Cycle (Figure 166)

Downy mildew is caused by the fungus *Plasmopora viticola*. The causal fungus overwinters as tiny oospores in leaf debris on the vineyard floor. In the spring, the oospores serve as primary inoculum and germinate in water to form sporangia. The sporangia liberate small swimming spores, called zoospores, when free water is present. The zoospores are disseminated by rain splash to grape tissues where they swim to the vicinity of stomata and encyst. Stomata are tiny pores through which the plants exchange air, and transpiration occurs. Stomata are concentrated on the underside of the leaves. Encysted zoospores infect grape tissues by forming germ tubes that enter stomata and from there invade inner tissues of the plant. The fungus can infect all green, actively growing parts of the vine that have mature, functional stomata.

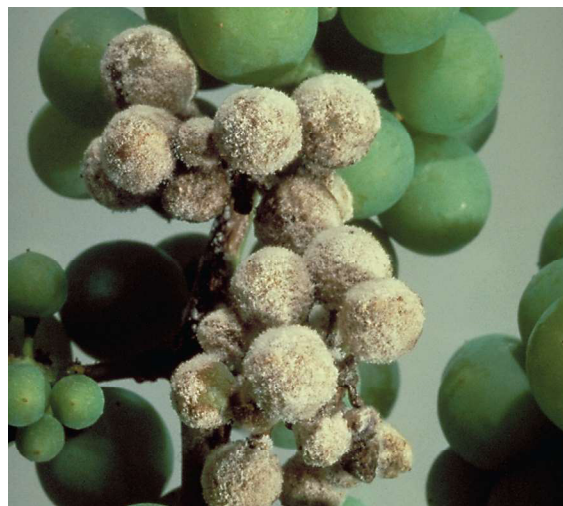
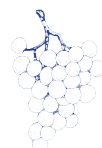

Figure 165. Downy mildew fruit infection.



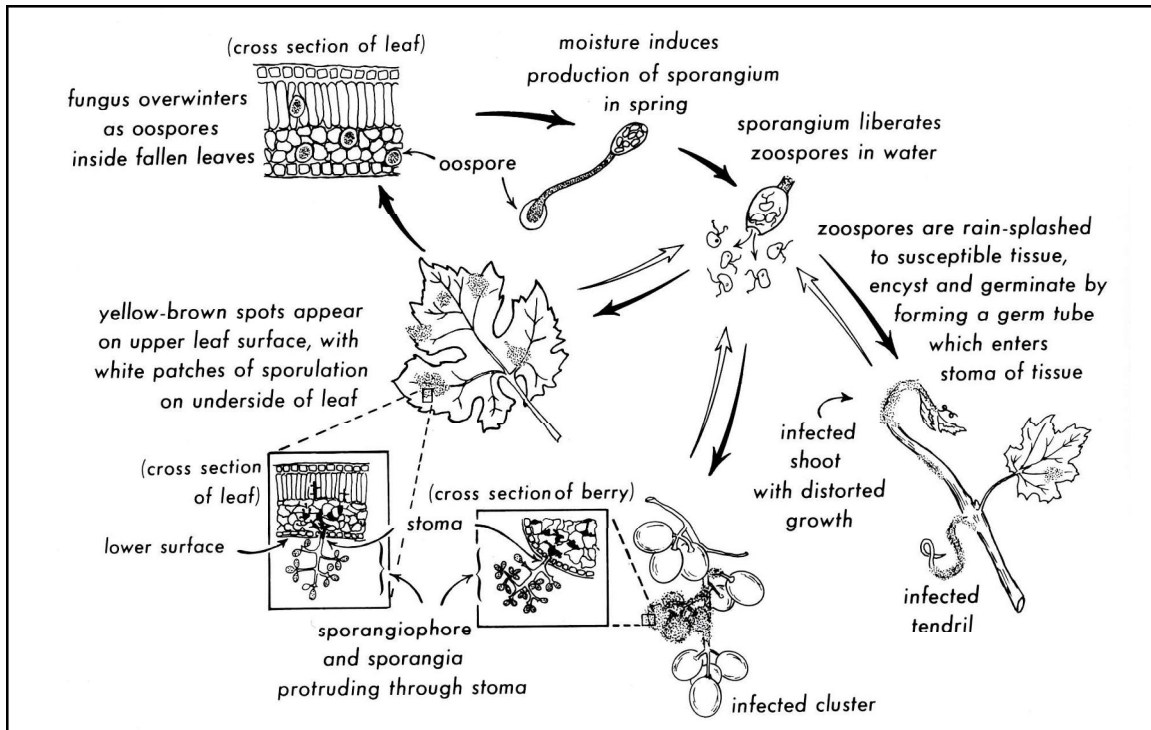

Figure 166. Disease cycle of downy mildew on grape. We wish to thank the New York State Agricultural Experiment Station for use of this figure. Figure taken from the Grape IPM Disease Identification Sheet No. 5.

Infected leaves develop yellowish-green lesions on their upper surfaces (Figure 167) seven to 12 days after infection. As lesions expand, the affected areas turn brown, necrotic, or mottled. At night, during periods of high humidity and temperatures above 55°F, the fungus sporulates by forming sporangia on numerous branched structures, called sporangiophores, that protrude out through stomata on the undersides of the leaf. Sporulation only occurs on plant surfaces that contain stomata, such as the underside of leaves, and it gives the surface of the lesion its white, downy appearance, which is characteristic of the disease (Figure 168). The sporulation (downy growth) generally occurs directly below the yellowish-green spots that develop on the upper surface of the leaf.

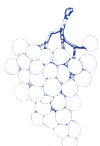

Figure 167. Downy mildew on upper leaf surface.

Sporangia are disseminated by wind or rain splash. On susceptible tissue they liberate zoospores into water films formed by rain or dew. These zoospores initiate secondary infections, which can occur in as little as two hours of wetting at 77°F or up to nine hours at 43°F. Infections are usually visible as lesions in about seven to 12 days, depending on temperature and humidity. The number of secondary infection cycles depends on the frequency of suitable wetting periods that occur during the growing season and



Figure 168. Downy mildew on lower leaf surface.



the presence of susceptible grape tissue. In general, Catawba, Chancellor, Chardonnay, Delaware, Fredonia, Ives, Niagara, White Riesling, and Rougeon are highly susceptible cultivars (see Table 5-2 on page 126).

Severely infected leaves may curl and drop from the vine. The disease attacks older leaves in late summer and autumn, producing a mosaic of small, angular, yellow to red-brown spots on the upper leaf surface. Lesions commonly form along leaf veins, and the fungus sporulates in these areas on the lower leaf surface. When young shoots, petioles, tendrils, or cluster stems are infected, they frequently become distorted, thickened, or curled. White, downy sporulation can be abundant on the surface of infected areas. Eventually, severely infected portions of the vine wither and die.

Infected green fruit turn light brown to purple, shrivel, and detach easily. White, cottony sporulation is abundant on these berries during humid weather. The fruits remain susceptible as long as stomata on their surfaces are functional. After that, new infections and sporulation do not develop. Recent research indicates that fruit become resistant to infection by downy mildew about three to four weeks after bloom. Although fruit become resistant shortly after bloom, cluster stems (rachis) and leaves remain susceptible throughout the growing season. Later in the season, some berries that were infected earlier in the growing season may turn dull green to reddish purple, remain firm, and are easily distinguished from non-infected ripening berries in a cluster. Infected berries are easily detached from their pedicels leaving a dry stem scar.

Throughout most of the Midwest, downy mildew symptoms often do not appear until after bloom. This is why we often refer to it as a late-season disease. The role of oospores in causing early season primary infections is not clearly defined. Although we emphasize the use of fungicides for downy mildew control after bloom, early season fungicide applications are very important. Especially on highly susceptible cultivars, the early season fungicide program should contain a fungicide effective against downy mildew. As with black rot and powdery mildew, the period from immediate prebloom through three to four weeks after bloom is critical for controlling fruit or cluster infections by downy mildew.

Botrytis Bunch Rot

Botrytis bunch rot (gray mold) is caused by the fungus *Botrytis cinerea*. The fungus causes blight of leaves, shoots, and blossom clusters and occurs throughout the viticultural world. The fungus causing the disease grows and reproduces on senescent or dead plant tissue. Botrytis bunch rot is especially severe in grape cultivars with tight, closely packed clusters of fruit. Botrytis is also responsible for storage losses of grapes picked for fresh market.

Symptoms

Botrytis infection of leaves begins as a dull, green spot, commonly surrounding a vein, which rapidly becomes a brown necrotic lesion. The fungus may also cause a blossom blight or a shoot blight, which can result in significant crop losses. However, the most common phase of this disease is the infection and rot of ripening berries (Figure 169). Fruit rot can spread rapidly throughout the cluster. Infected berries of white cultivars often become brown and shriveled, and those of purple cultivars develop a reddish color. Under proper weather conditions, the fungus produces a fluffy, gray-brown growth containing spores (Figure 170).



Figure 169. *Botrytis* bunch rot of grape.



Figure 170. Close up showing *Botrytis* sporulating on infected berries.

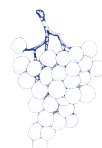

**Botrytis Bunch Rot Disease Cycle
(Figure 171)**

The fungus overwinters on debris in the vineyard floor and on the vine. The fungus produces small, dark, hard, resting structures called sclerotia. Sclerotia are resistant to adverse weather conditions and usually germinate in spring. Germinated sclerotia produce conidia, which spread the disease. Sporulation may also occur on debris left on the vine during the previous growing season, such as cluster stems remaining after mechanical harvest or mummified fruit. The fungus usually gains a foothold by colonizing dead tissue prior to infection of healthy tissue. Tissue injured by hail, wind, birds, other diseases or insects is readily colonized by *Botrytis*. Ripe berries that split because of internal pressure or because of early season infection by powdery mildew, are especially susceptible to infection by *Botrytis*. *Botrytis* conidia are usually present in the vineyard throughout the growing season. Moisture in the form of fog or dew and temperatures of 59°F to 77°F are ideal for conidia

production and infection. Rainfall is not required for disease development, although periods of rainfall are highly conducive to disease development.

Eutypa Dieback

Eutypa dieback is caused by the fungus *Eutypa lata*. Eutypa dieback is the new name for the canker-and-shoot-dieback phase of what was once known as dead-arm. The name dead-arm should be dropped.

Symptoms

The earliest symptom to develop is a canker that generally forms around pruning wounds in older wood of the main trunk (Figure 172). These cankers usually are difficult to see because they are covered with bark. One indication of a canker is a flattened area on the trunk. Removal of bark over the canker reveals a sharply defined region of darkened or discolored wood bordered by white, healthy wood. Cankers may be up to 3-feet long and extend below the soil line. When the trunk is cut in cross-section,

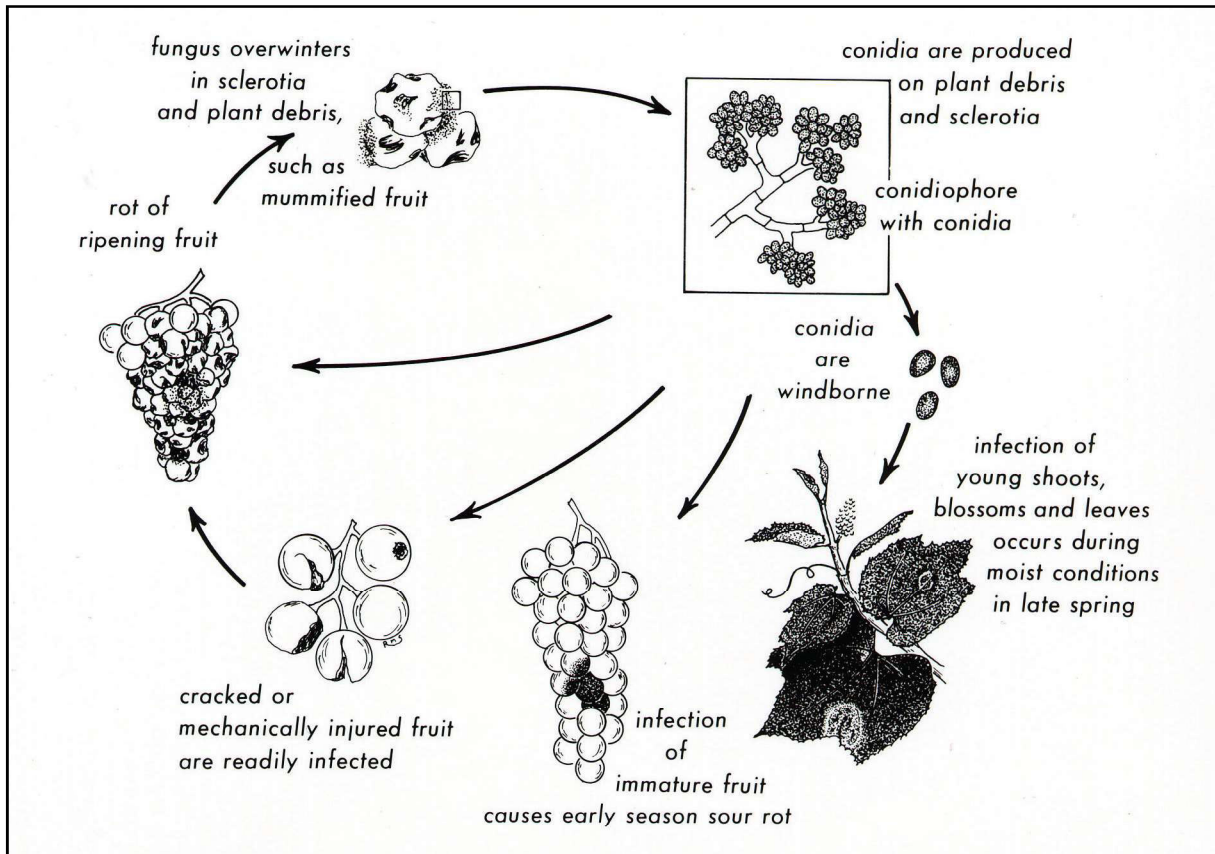

Figure 171. Disease cycle of *Botrytis* bunch rot. We wish to thank the New York State Agricultural Experiment Station for use of this figure. Figure taken from the Grape IPM Disease Identification Sheet No. 3.

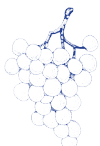



Figure 172. *Eutypa* canker on grape trunk.

the canker appears as darkened or discolored wood extending in a wedge shape to the center of the trunk.

The most striking and obvious symptoms of *Eutypa* dieback are the leaf-and-shoot symptoms (Figure 173), which may not develop for two to four years after the vine was first infected. These symptoms are most obvious in spring, when healthy shoots are 12- to 24-inches long. Spring shoot growth on diseased canes is weak and stunted above the cankered area. Leaves are at first smaller than normal, cupped,



Figure 173. *Eutypa* symptoms on grape leaves.

distorted, and yellow. These leaf and shoot symptoms may not be as obvious later in the season (mid July). Leaf and shoot symptoms are more pronounced each year until the affected portion of the vine finally dies.

Eutypa Dieback Disease Cycle (Figure 174)

The fungus survives in infected trunks for long periods, whether as part of the in-place vine or as old, dead grape wood in the vineyard. The fungus is generally present in older wood, such as vine trunks, but generally not in younger wood, such as one-

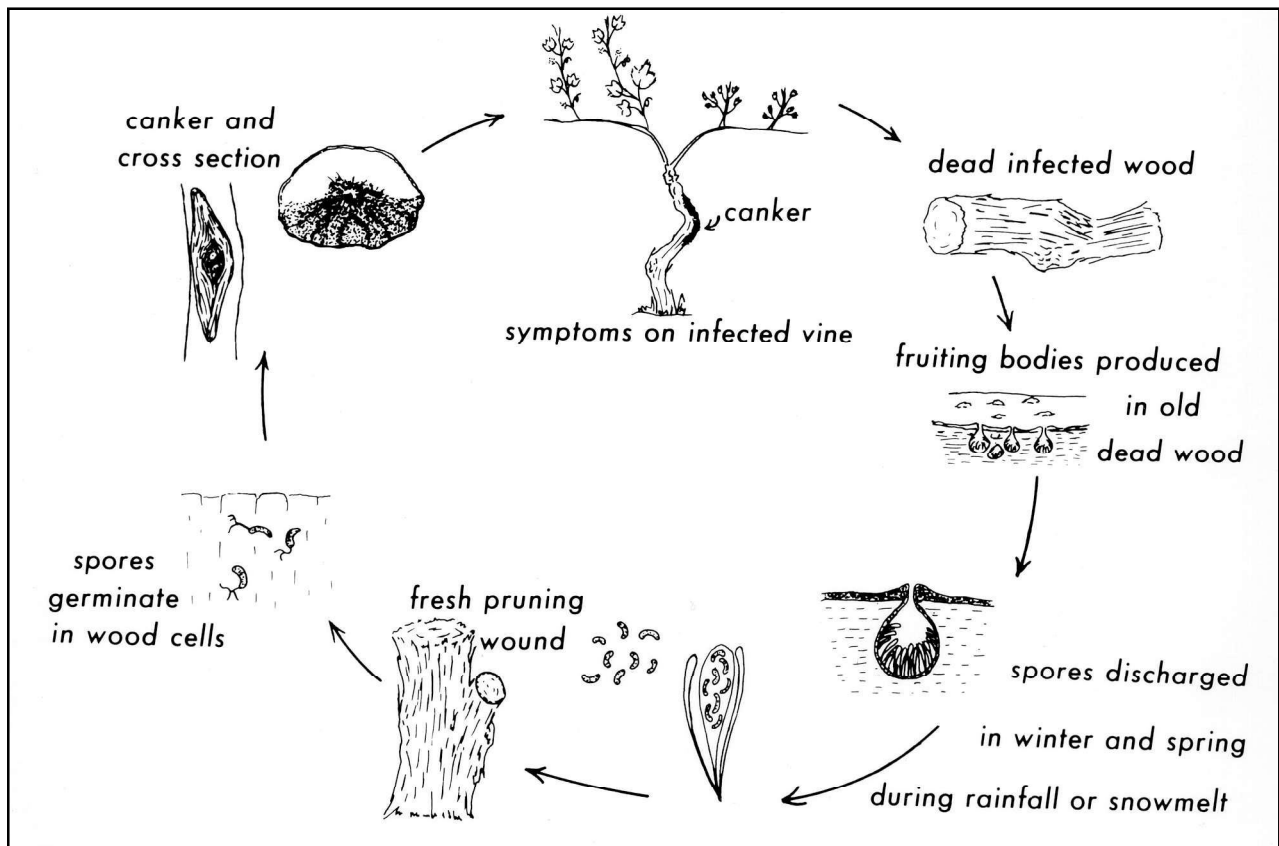
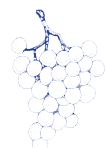

Figure 174. Disease cycle of *Eutypa* Dieback. We wish to thank the New York State Agricultural Experiment Station for use of this figure. Figure taken from the Grape IPM Disease Identification Sheet No. 1.



or two-year-old prunings. The fungus eventually produces reproductive structures (perithecia) on the surface of infected wood. Spores (ascospores) are produced in these structures and discharged into the air. Ascospore discharge is initiated by the presence of free water (rainfall or snow melt). Most spores appear to be released during winter or early spring; few are released during the summer. Unfortunately, most spores are released at about the same time pruning is being conducted. Air currents can carry the ascospores long distances to fresh wounds on the trunk. Pruning wounds are by far the most important points of infection. The ascospores germinate when they contact the newly cut wood, and a new infection is initiated. Stunted shoots and small, cupped leaves appear two to four years after infection. After approximately five years, the fungus produces perithecia and ascospores in the dead wood on cankers.

Control of Eutypa Dieback

The primary control method is removal of infected trunks from the vineyard. The vine must be cut off below the cankered or discolored wood. If the canker extends below the soil line, the entire vine must be removed. If the canker does not go below the soil line, the stump can be left and a new trunk formed. The best time to identify and remove infected vines is in early spring (May and June) when leaf and shoot symptoms are most obvious. In addition, large wounds are less susceptible to infection at this time of year, and fewer ascospores are present to cause reinfection. If trunks cannot be removed in the spring, they should be marked for easy identification and removal later in the growing season.

Sanitation is critical. All wood (especially trunks and stumps) from infected plants must be removed from the vineyard and destroyed (either buried or burned) as soon as possible. An old infected stump or trunk lying on the ground may continue to produce spores for several years.

The double trunk system of training, where each trunk is pruned to carry half the number of buds, may help reduce crop loss caused by *Eutypa dieback*. If a diseased trunk must be removed, the remaining trunk can be pruned to leave the full number of buds until a new second trunk can be established. Fungicide recommendations currently are not available for control of this disease.

Anthracnose

Anthracnose of grape was first detected in the United States in the mid 1800s. The disease was probably introduced into this country by grape plant material imported from Europe. It quickly established in American vineyards and became a significant disease of grape in rainy, humid, and warm regions of the United States. Anthracnose reduces the quality and quantity of fruit and weakens the vine. Once the disease is established in a vineyard, it can be very destructive.

Symptoms

All succulent parts of the plant, including fruit stems, leaves, petioles, tendrils, young shoots, and berries, can be attacked, but lesions on shoots and berries are most common and distinctive. Symptoms on young, succulent shoots first appear as numerous small, circular, and reddish spots. Spots then enlarge, become sunken, and produce lesions with gray centers and round or angular edges (Figure 175). Dark reddish-brown to violet-black margins eventually surround the lesions. Lesions may coalesce, causing a blighting or killing of the shoot. A slightly raised area may form around the edge of the lesion. Infected areas may crack, causing shoots to become brittle. Anthracnose lesions on shoots may be confused with hail injury; however, unlike hail damage, the edges of the wounds caused by the anthracnose fungus are raised and black. In addition, hail damage generally appears on only one side of the shoot, whereas anthracnose is more generally distributed. Anthracnose on petioles appears similar to that on the shoots.



Figure 175. Anthracnose symptoms on grape cane.

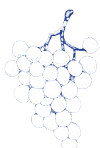

Leaf spots are often numerous and develop in a similar manner to those on shoots. Eventually, they become circular with gray centers and brown to black margins with round or angular edges. The necrotic center of the lesion often drops out, creating a shot-hole appearance (Figure 176). Young leaves are more susceptible to infection than older leaves. When veins are affected, especially on young leaves, the lesions prevent normal development, resulting in malformation or complete drying or burning of the leaf. Lesions may cover the entire leaf blade or appear mainly along the veins.

On berries, small, reddish circular spots initially develop. The spots then enlarge to an average diameter of 1/4 inch and may become slightly sunken. The centers of the spots turn whitish gray and are surrounded by narrow reddish-brown to black margins (Figure 177). This typical symptom on fruit often resembles a bird's eye, and the disease has been called bird's eye rot. Acervuli (fungal fruiting structures) eventually develop in the lesions. A pinkish mass of fungal spores (conidia) exudes from these structures during prolonged wet weather.

Causal Organism

Anthracoze of grape is caused by the fungus *Elsinoe ampelina*. The fungus overwinters in the vineyards as sclerotia (fungal survival structures) on infected



Figure 176. Anthracnose symptoms on grape leaf.



Figure 177. Anthracnose symptoms on grape berry. Note that the lesion resembles a bird's eye.

shoots. In the spring, sclerotia on infected shoots germinate to produce abundant spores (conidia) when they are wet for 24 hours or more and the temperature is above 36°F. Conidia are spread by splashing rain to new growing tissues and are not carried by wind alone.

Another type of spore, called an ascospore, is produced within sexual fruiting bodies and may also form on infected canes and berries left on the ground or in the trellis from the previous year. The importance of ascospores in disease development is not clearly understood.

Conidia are by far the most important source of primary inoculum in the spring. In early spring, when free moisture from rain or dew is present, conidia germinate and infect succulent tissue. Conidia germinate and infect at temperatures ranging from 36°F to 90°F. The higher the temperature, the faster disease develops. Disease symptoms start to develop approximately 13 days after infection occurs at 36°F and at four days after infection occurs at 90°F. Heavy rainfall and warm temperatures are ideal for disease development and spread.

Lesions may extend into the pulp and cause the fruit to crack. Lesions on the rachis and pedicels appear similar to those on shoots. Clusters are susceptible to infection before flowering and until veraison.

Once the disease is established, asexual fruiting bodies called acervuli form on diseased areas. These acervuli produce conidia during periods of wet weather. These conidia are the secondary source of inoculum and are responsible for continued spread of the fungus and the disease throughout the growing season.

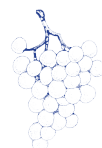

Disease Management

1. Sanitation is very important. Prune out and destroy (remove from the vineyard) diseased plant parts during the dormant season. This includes infected shoots, cluster stems, and berries. This should reduce the amount of primary inoculum for the disease in the vineyard.
2. Eliminate wild grapes near the vineyard. The disease can infect wild grapes, and infected wild grapes have been observed near diseased vineyards in Ohio. Wild grapes provide an excellent place for the disease to develop and serve as a reservoir for the disease. It is probably impossible to eradicate wild grapes from the woods, but serious efforts should be made to at least remove them from the fence rows and as far away from the vineyard as possible. Remember, the spores are spread over relatively short distances by splashing rain and should not be able to move over long distances by wind into the vineyard.
3. Cultivars differ in their susceptibility. In Ohio the disease has been observed on Vidal and Reliance. Vinifera and French Hybrid cultivars may be more susceptible than American grapes, such as Concord and Niagara.
4. Canopy management can aid in disease control. Any practice that opens the canopy to improve air circulation and reduce drying time of susceptible tissue is beneficial for disease control. These practices include selection of the proper training system, shoot positioning, and leaf removal.
5. Fungicide use. Where the disease is established, especially in a commercial vineyard, the use of fungicides is recommended. Fungicide recommendations for anthracnose control consist of a dormant application of Liquid Lime Sulfur in early spring, followed by applications of foliar fungicides during the growing season.

Crown Gall

Crown gall is caused by the bacterium *Agrobacterium tumefaciens*. The disease infects more than 2,000 species of plants. Crown gall of grape is a major problem in cold climate regions. Wounds are necessary for infection to occur. Observations suggest that freeze injury wounds are highly conducive to infection. The disease is particularly severe following winters that result in freeze injury on cold-sensitive cultivars, such as those of *Vitis vinifera*.

Crown gall is characterized by galls or overgrowths that usually form at the base of the trunk. Galls form as high as 3-feet or more up the trunk (aerial galls). Galls generally do not form on roots. The disease affects all grape cultivars. Vines with galls at their crowns or on their major roots grow poorly and have reduced yields. Severe economic losses result in vineyards where a high percentage of vines become galled within a few years of planting.

Symptoms

The disease first appears as small overgrowth or galls on the trunk, particularly near the soil line. Early in their development, the galls are more or less spherical, white or flesh-colored, and soft. Because they originate in a wound, the galls at first cannot be distinguished from callus. However, they usually develop more rapidly than callus tissue. As galls age, they become dark brown, knotty, and rough (Figure 178).

When galls are numerous on the lower trunks or major roots, they disrupt the translocation of water and nutrients, which leads to poor growth, gradual dieback, and sometimes death of the vine. In some cases, infected vines appear stunted and as if they are suffering from nutrient deficiency.



Figure 178. Crown gall symptoms on grape trunk.

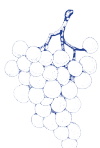

Life Cycle

The causal organism, a bacterium, is soil borne and persists for long periods in plant debris in the soil. Fresh wounds are required to infect and initiate gall formation. Wounds that commonly serve as infection sites are those made during pruning, machinery operations, freezing injury, or any other practice that injures the vine. In addition to the primary galls, secondary galls may also form around other wounds and on other portions of the plant, even in the absence of the bacterium. Crown gall bacteria also survive systemically within grapevines and probably are most commonly introduced into the vineyard on or in planting material.

Control of Crown Gall

Examine new plants before planting and discard any that have galls. Wounding by freeze injury appears to be important in the development of crown gall. If winter injury is controlled, crown gall may not be an important problem. Prevent winter injury to vines. Practices, such as hilling or burying vines of cold-sensitive cultivars, is beneficial. Proper pruning practices and proper crop loads for maximum vine vigor will result in stronger plants that are less susceptible to winter injury. Controlling other diseases, such as downy and powdery mildew, is also important in preventing winter injury and crown gall.

The double-trunk system of training, in which each trunk is pruned to carry half the number of buds, may help reduce crop loss caused by crown gall. If a diseased trunk must be removed, the remaining trunk can be pruned, leaving the full number of buds until a second trunk is established. Galls on arms or the upper parts of the trunk can be removed by pruning.

There are no current chemical or biological control recommendations for crown gall on grapes.

Use of Resistant Cultivars for Grape Disease Management

In an integrated disease-management program where emphasis is placed on reducing overall fungicide use, it is essential that any available disease resistance be

identified and used. If resistance is not available, we should at least identify and **avoid** those cultivars that are highly susceptible to important diseases.

A few grape cultivars have high levels of resistance to most diseases. Norton (Cynthiana) is a cultivar that has great potential for organic production in the southern portion of the Midwest. It has good resistance to most diseases, and in several commercial plantings, growers rarely apply fungicides. It is hoped that new cultivars with improved levels of disease resistance will be introduced in the near future.

Unfortunately, resistance to most of the major diseases is not available in most commercially grown grape cultivars in the Midwest. Thus, the disease-management program must rely heavily on the use of cultural practices and efficient use of approved fungicides or biocontrol agents or products. Whereas resistance is generally not available for most diseases, some grape cultivars are known to be much more susceptible to certain diseases than others (Table 5-2 on page 126). For example, the cultivar Chancellor is highly susceptible to downy mildew, whereas downy mildew is seldom a serious problem on Concord and several other cultivars.

Growers should consider disease susceptibility before establishing the vineyard. Segregating highly susceptible cultivars into blocks that can be easily treated separately allows growers to apply more fungicide or other control agents when needed for highly susceptible cultivars while reducing their use on less susceptible cultivars. In addition, cultivars differ greatly in their sensitivity to copper and sulfur fungicides. When planting the vineyard, it is important to isolate blocks of sensitive cultivars from those that will be sprayed with these materials.

Cultural Practices for Disease Control in Grapes

The use of any practice that reduces or eliminates pathogen populations or creates an environment within the planting that is less conducive to disease development should be used. Certain diseases, such as viruses, Eutypa dieback, and crown gall, cannot be directly controlled with pesticides at the present time. Therefore, cultural practices are the

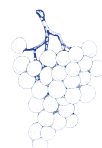

major means for their control. When fungicides or other control agents are required, any practice that opens the plant canopy, such as shoot thinning, leaf removal, berry and cluster thinning, and pruning and shoot positioning, can greatly increase the efficacy of the fungicide program by allowing better spray penetration and coverage. These practices also have a direct effect on vine microclimate.

Vine Microclimate

Vine microclimate refers to the climate within the leaf canopy of the vineyard. In relation to disease management, the most important elements of the vine microclimate are relative humidity, ventilation, the temperature of the air and of vine tissues, and the intensity and quality of light. In general, factors that increase relative humidity also increase fungal diseases. Factors that increase ventilation (air movement) of the vine canopy generally reduce disease incidence and severity by lowering the humidity, shortening periods of leaf and fruit wetness, and aiding spray penetration and coverage. Cultural practices should be carefully considered and implemented into the disease management program, whenever possible. Here are some cultural practices to consider.

Use Virus-Indexed Planting Stock

Always start the planting with healthy virus-indexed nursery stock from a reputable nursery. The importance of establishing plantings with virus-indexed nursery stock cannot be overemphasized, since the selection of planting stock and planting site are the only actions a grower can take to prevent or delay the introduction of most virus diseases. Plants obtained from an unknown source or a neighbor may be contaminated with a number of major diseases that reputable nurseries work hard to avoid.

Select the Site Carefully

Site selection can have a direct effect on vine microclimate. A site that provides for maximum air drainage, which promotes faster drying of foliage, can substantially reduce the risk of black rot and downy mildew. In the northern hemisphere, north-facing slopes receive less light than south-facing slopes. Therefore, vineyards on north-facing slopes may dry more slowly and be at a higher risk for disease development. Avoid planting the vineyard

adjacent to woods that will prevent sunlight from reaching the vines during any part of the day. Woods act as a windbreak that may be beneficial in preventing shoot breakage in high winds, but woods may also reduce air movement (ventilation) in the vineyard which results in prolonged wetting periods. Close proximity to woods can also increase the risk of introducing certain diseases and insect pests into the vineyard.

Planting rows in a north-south row orientation should be the grower's first choice for maximum light penetration. However, rows planted in the direction of prevailing winds will promote better air movement, which results in faster drying of foliage and fruit. Rows should never be planted parallel to a steep slope where erosion could be more of a problem than pests.

Good soil drainage is also extremely important. Avoid sites that are consistently wet during the growing season. These soils may have an impervious subsoil or other drainage problems. Such sites will usually result in unsatisfactory vine growth and yields, in addition to providing a humid microclimate that is conducive to disease development. In some situations poor drainage can be corrected by tiling prior to planting.

If nematodes have been a problem in previous crops or nematodes are suspected to be a problem on the site, a soil analysis to determine the presence of harmful nematodes should be conducted. Nematodes are most likely to be a problem on lighter (sandy) soils. Nematode sampling kits and instructions for taking samples can be obtained through your county Extension office.

Avoid Excessive Fertilization

Fertility should be based on soil and foliar analysis. The use of excessive fertilizer, especially nitrogen, should be avoided. Sufficient fertility is essential to produce a crop, but excessive nitrogen can result in dense foliage that increases drying time in the plant canopy.

Control Weeds

In and Around the Planting

Good weed control within and between the rows is essential. From a disease control standpoint, weeds in the planting prevent air circulation and result in

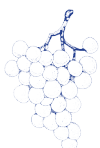

the fruit and foliage staying wet for longer periods. For this reason, most diseases caused by fungi are generally more serious in plantings with poor weed control than in those with good weed control.

Manage the Canopy

Any cultural practice that alters vegetative growth and canopy density has an effect on vine microclimate. Most cultural practices are chosen primarily to enhance yield or fruit quality rather than to influence the microclimate. However, practices, such as shoot thinning, pruning, and positioning, have a direct impact on vine microclimate. Increasing cluster thinning and decreasing pruning stimulates vegetative growth and hence reduces light exposure and ventilation within the canopy.

Shoot thinning, leaf removal, and summer pruning are frequently done specifically to reduce canopy density, so as to increase fruit exposure to light, improve ventilation, and aid spray coverage. Leaf removal in the fruiting zone of the canopy is important for optimal control of Botrytis bunch rot. This is a common practice in California vineyards and has been shown to be effective in Midwestern vineyards as well. Shoot positioning is usually done to ensure canopy separation of divided canopies or to enhance light exposure of the renewal zone of the vine; it also decreases vegetative growth and canopy density and increases light exposure of fruit.

Avoid Winter Injury

Wounding by freeze injury is important in the development of crown gall. If winter injury is reduced, crown gall may not become an important problem. Practices such as hilling or burying vines of cold-sensitive cultivars are beneficial. Proper pruning practices and proper crop loads for maximum vine vigor will result in stronger plants that are less susceptible to winter injury. Controlling other diseases, such as downy and powdery mildew, is also important in preventing winter injury and crown gall.

Practice Sanitation (Removal of Overwintering Inoculum)

Vineyard sanitation is an extremely important part of the disease-management program. Most pathogens overwinter (survive from one season to the next) in old diseased plant material, such as mummified fruit, leaves, and infected canes or trunks, within the

vineyard. Removal of old, infected wood, tendrils, and clusters with mummified berries from the vines and wires greatly reduces overwintering inoculum of several diseases.

Wild grapes in nearby woods and fence rows also are sources of disease inoculum and insects. Removal of these wild hosts is beneficial to the disease-management program. This especially applies to abandoned vineyards adjacent to managed sites with respect to contamination from powdery and downy mildews.

Using Fungicides for Controlling Grape Diseases

Fungicides are an important part of the grape disease-management program. Due to the lack of disease resistance in most of our currently grown cultivars combined with our environmental conditions (abundant moisture) that are highly conducive to disease development, successful commercial grape production in the Midwest is highly unlikely without the use of at least some fungicide. Whereas fungicides are important, growers need to recognize that they are only one part of the overall integrated disease-management program. The effectiveness of the fungicide program is greatly influenced by use of the various cultural practices described previously and the level of disease susceptibility of the cultivars being grown. For example, given a poorly pruned (dense canopy) vineyard of Chancellor grapes (highly susceptible to downy mildew) planted on a poor site (little air circulation) and with poor weed control, the chance of any reasonable fungicide program providing an acceptable level of downy mildew control is highly unlikely.

To use any fungicide effectively, consider these points:

Identify the Disease Correctly

If you do not know what disease or diseases are present in the vineyard, you cannot choose the most effective fungicide or fungicides for their control. Correct disease identification is essential for selecting the proper fungicide or fungicide combinations to use in the vineyard.

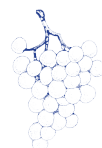

Select the Proper Fungicide

Fungicides differ greatly in their spectrum of activity (which fungi they can control). Selection of the wrong fungicide for use on a specific disease can result in financial loss and no control. For example, if a grower misidentified downy mildew for powdery mildew and sprayed Nova or Bayleton to control it, neither of these fungicides would have any effect on the downy mildew, although they would provide excellent control of powdery mildew.

Time the Application Properly

For most diseases it takes at least a week from the time the fungus enters the plant until the symptoms appear. In the case of Phomopsis fruit rot, the fungus enters the fruit during bloom, and symptoms do not appear until the fruit begins to ripen (harvest). Depending upon the weather, it may take two weeks for black rot symptoms to appear. Once symptoms appear, it is too late to control the disease; therefore, proper timing of the application is critical. The fungus must be controlled before or shortly after it enters the plant.

Cover All Susceptible Plant Parts Thoroughly

If the fungicide is not on or in susceptible plant parts, it cannot control the fungus. Cultural practices that open the plant canopy greatly improve fungicide coverage. Proper calibration and use of the sprayer is also critical to good coverage.

Fungicide Use Strategies for Grapes

Unfortunately, there are not many options to choose from when one considers our current fungicide-use strategies. The current options are:

Do Not Use Fungicides

This is always an option, but it is not recommended for commercial plantings. This option should not be confused with organic production. Grape growers in organic production systems will most probably use sulfur or copper to some extent for disease control. Sulfur, lime-sulfur, and copper are fungicides. Growers who choose not to use fungicides must rely completely on cultural practices and disease resistance for disease control.

Use a Protectant Fungicide

In a protectant program, fungicides are used to form a protective barrier on the plant surface. This chemical barrier prevents the fungus from entering the plant. It works much like paint on a piece of wood to keep out water. Protectant fungicides are not systemic and cannot move into plant tissues. Once the fungus penetrates into the plant, protectant fungicides will not control it. As the protective barrier breaks down or new foliage is produced, additional applications are required to maintain the protective barrier.

Protectant fungicide programs have been and still are very effective; however, they generally result in a fairly intensive use of fungicides. Protectant fungicides are usually applied on a seven- to 10-day schedule early in the growing season and on a 10- to 14-day schedule later in the season. Obviously, maintaining a protective barrier on the plant surface throughout the growing season requires many applications.

Use a Post-Infection or Curative Fungicide

The development and introduction of new systemic fungicides allows the use of a post-infection or curative fungicide-use strategy. In a post-infection program, fungicides are applied only after infection periods occur. The systemic properties of the fungicide allow it to move into plant tissues where it stops further development of the fungus after it has penetrated the plant. In the post-infection program, the fungicide is applied after the initiation of an infection period, but before symptoms develop. Thus, the fungicide must be applied within three to four days (72 to 96 hours) after the initiation of an infection period in order to be effective.

The sterol-inhibiting (SI) fungicides (Bayleton and Nova) have excellent post-infection activity against black rot and powdery mildew. Ridomil and Aliette have excellent post-infection activity against downy mildew. In dry growing seasons, with few or no infection periods, a post-infection program should result in reduced fungicide use.

There are several important points to remember about the post-infection program. In order to use a post-infection program, you must:

- Monitor the environment to determine when

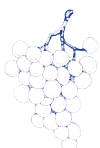

infection periods occur. If growers do not have the capability to accurately monitor the environment, they should not use a post-infection program.

- Know what an infection period is for a specific disease. This requires a great deal of knowledge about the biology of the pathogen. At present, we have this information for black rot (Table 5-1 on page 124). There are also predictive capabilities for powdery mildew and downy mildew, and Botrytis bunch rot. Predictive programs are currently being developed and evaluated for these diseases.
- Timing is critical. Post-infection applications must be made as soon as possible, but no later than three to four days (72 to 96 hours) after the initiation of an infection period and before symptom development. In most situations, once symptoms develop, the damage is done.

Fungicides for Controlling Specific Grape Diseases

Specific fungicide recommendations cannot be made in this publication because of constantly changing regulations and recommendations regarding their agricultural use. For specific fungicide recommendations, consult your local Extension service. Most Midwestern states have a small fruit and grape spray guide that is revised annually. General information about fungicides that were available at the time this bulletin was published is presented here.

Fungicides for Controlling Black Rot

Protectants

Mancozeb, **Ferbam**, and **Ziram** are all highly effective against black rot (see Table 5-3 on page 144). Because these fungicides are strictly protectants, they must be applied before the fungus infects or enters the plant. They protect fruit and foliage by preventing spore germination. They will not arrest lesion development after infection has occurred.

Mancozeb provides an excellent foundation for a protectant spray program for grapes in the Midwest.

It is a good protectant fungicide that will provide good to excellent control of downy mildew and Phomopsis cane and leaf spot in addition to black rot. The major problem with Mancozeb is a 66-day preharvest interval (PHI) on grapes. It cannot be applied within 66 days of harvest. Mancozeb is available under many trade names and formulations. Some common trade names are Manzate 200, Penncozeb, Dithane M45, Dithane F45, and Dithane Rainshield DF.

Some food processors may not accept Mancozeb-treated fruit or may have special restrictions on its use. This also applies to Captan. Growers need to know where they will sell their fruit and if the buyer has any restrictions on pesticide use prior to initiating a control program in the spring.

Ziram is similar in efficacy to Ferbam. It is highly effective against black rot and provides moderate control of downy mildew and Phomopsis cane and leaf spot.

Growers of processing grapes who cannot apply Mancozeb past the initiation of bloom could use Ziram during this period. Ziram can be applied up to 21 days before harvest.

Ferbam will provide excellent control of black rot but is not highly effective against the other grape diseases. In addition, there are restrictions on the number of applications that can be used. Always read and understand the label before using or purchasing a pesticide.

Captan and **copper fungicides** (fixed copper or Bordeaux mixture) are only slightly to moderately effective against black rot and will probably not provide adequate control under heavy disease pressure.

Sterol Inhibiting (SI) Fungicides

The locally systemic fungicides, Bayleton, Nova, Elite, and Procure, are also highly effective against black rot and will provide some post-infection (curative) activity of the disease if applied at the higher labeled rates within 72 to 96 hours after the initiation of an infection period. Post-infection or curative control must be achieved prior to symptom development on leaves or fruit. Once the symptoms are present, these fungicides will not eradicate or burn out the fungus. Bayleton, Nova,

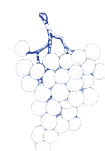

Fungicide	Phomopsis Cane and Leaf Spot	Black Rot	Downy Mildew	Powdery Mildew	Botrytis Rot
Abound	+	+++	+++	+++	++
Bayleton	0	+++	0	+++	0
Captan	+++	+	+++	0	+
Elevate	0	0	0	0	+++
Elite	0	+++	0	+++	0
Endura	0	0	0	+++	++
Ferbam	+	+++	+	0	0
Fixed Copper and Lime	+	+	+++	++	+
Flint	+	+++	+	+++	++
JMS Stylet Oil	0	0	0	+++	?
Mancozeb	+++	+++	+++	0	0
Nova	0	+++	0	+++	0
Phosphorous acid	0	0	+++	0	0
Potassium salts	0	0	0	++	0
Pristine	++	+++	+++	+++	++
Procure	0	+++	0	+++	0
Quintec	0	0	0	+++	0
Ridomil Gold MZ	+	++	+++	0	0
Ridomil Gold Copper	+	+	+++	0	0
Rovral	0	0	0	0	+++
Rubigan	0	++	0	+++	0
Sovran	+	+++	++	+++	++
Sulfur	+	0	0	+++	0
Vanguard	0	0	0	0	+++
Ziram	++	+++	++	0	0

+++ = highly effective, ++ = moderately effective, + = slightly effective, 0 = not effective, ? = activity unknown.

Note: These ratings are intended to provide the reader with an idea of relative effectiveness. They are based on published data and/or field observations from various locations. Ratings could change based on varietal susceptibility and environmental conditions for disease development, or changes in fungal sensitivity to specific fungicides.

Elite, and Procure also appear to provide good protectant activity against black rot if applied at the lower labeled rates in a protectant program. These fungicides also have excellent activity against powdery mildew as well.

Rubigan is another SI fungicide that is registered for use on grapes and will provide moderate control of black rot if applied in a protectant program. This fungicide is in the same general class of fungicides

as Bayleton, Nova, Elite, and Procure; however, it does not provide adequate curative or post-infection control of black rot. Nova, Elite, Procure, or Bayleton are the preferred SI fungicides for black rot control.

Strobilurin Fungicides

Abound, Sovran, Flint, and Pristine are locally systemic fungicides that are all highly effective for control of black rot. They do differ in their efficacy against some of the other important grape diseases.

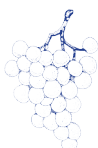

Note: Flint or Pristine cannot be applied on Concord grapes or phytotoxicity (damage) could occur. Always read the fungicide label carefully.

Fungicides for Powdery Mildew

Protectants

Sulfur is highly effective against powdery mildew if used in a protectant program with a minimum of seven to 14 days between applications (see Table 5-3). There are many formulations of sulfur (wettable powders, dusts, dry flowables, and flowables). The flowable formulations appear to be most effective and result in much less applicator exposure when preparing sprays.

Note: On sulfur-tolerant cultivars that are susceptible to powdery mildew (Table 5-2), sulfur will probably be a major component of the fungicide program. On highly susceptible cultivars, spray intervals shorter than 14 days (7 to 10 days) will probably be required with sulfur. Although sulfur is highly effective for powdery mildew control, it has little or no effect on the other grape diseases (Table 5-3). It is important to remember that sulfur will cause severe injury on some grape cultivars. Sulfur should only be used on cultivars known to be sulfur tolerant (Table 5-2).

Note: Chancellor, Concord, DeChaunac, Foch, and Rougeon grapes are highly sensitive to sulfur. Sulfur injury may occur even on sulfur-tolerant cultivars when temperatures of 80 to 85°F or higher are experienced during or immediately after application.

Copper fungicides (fixed coppers or Bordeaux mixture) have been rated moderately effective against powdery mildew; however, care must be taken when using copper due to the danger of foliage injury (phytotoxicity). Grape cultivars differ in their sensitivity to copper fungicides (Table 5-2). Under heavy disease pressure, copper fungicides may not provide adequate control. Copper is not the preferred fungicide for powdery mildew control. However, if copper is applied for downy mildew control, it will provide some protection against powdery mildew. On less susceptible cultivars, such as Concord, copper fungicides may provide satisfactory control.

Sterol Inhibiting (SI) Fungicides

Nova, Elite, Procure, and Rubigan are locally systemic and highly effective for control of powdery mildew. They will also provide good to excellent control of black rot, but they will not control downy mildew. Bayleton was highly effective against powdery mildew when it was first introduced; however, due to development of fungicide-resistant strains of the powdery mildew fungus, Bayleton is no longer recommended for powdery mildew control.

Strobilurin Fungicides

Abound, Sovran, Flint, and Pristine are locally systemic and all were good to excellent for control of powdery mildew when they were first introduced. Fungicide resistance development in powdery mildew has been observed in the strobilurin fungicides.

Note: Flint or Pristine cannot be applied on Concord grapes or phytotoxicity (damage) can occur. Always read the fungicide label carefully.

Endura 70WG Fungicide is new fungicide chemistry and is highly effective for control of powdery mildew and provides good control of Botrytis bunch rot. It is different chemistry from the sterol-inhibiting and strobilurin fungicides; therefore, it is an excellent material to use in rotation with these materials in a fungicide resistance management program.

JMS Stylet-Oil is a highly refined petroleum distillate that is registered for use on grapes in the United States. It has provided excellent powdery mildew control in fungicide tests in Ohio and New York and is currently being used rather extensively by California grape growers for powdery mildew control. It is registered for use at the rate of 1 to 2 gallons oil per 100 gallons water (1% to 2% concentration). The label states on grapes: "Make first application pre-bloom and continue sprays every two to three weeks depending on level of disease pressure. Use higher rates and shorter spray interval when disease conditions are severe."

Although this fungicide has not been used on grapes extensively in the Midwest or northeastern United States, it appears to have good potential as an alternative fungicide for powdery mildew control on grape.

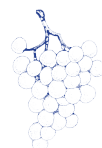

Note: One potential problem with stilet oil is that it removes the “bloom” or waxy coating from the grape berry. This apparently has no effect on quality of wine or juice grapes, but it does affect the appearance of the berry and probably should not be used for fresh-market table grapes.

Note: DO NOT use CAPTAN or SULFUR within two weeks after applying JMS STYLET- OIL. Mixing Captan or Sulfur with oil could result in severe damage to the vine. In addition, repeated use of oil during the growing season has been shown to be phytotoxic to vines.

Potassium Salts

Armicard 100 (potassium bicarbonate) and Nutrol (manopotassium phosphate) have been reported to provide fair control of powdery mildew on grape but provide no control of the other grape diseases. It is assumed that they provide control through limited eradication and antispore activity. They do not provide protectant activity.

Quintec

Quintec 2.08SC is new fungicide chemistry that is very effective for control of powdery mildew but has no activity against the other grape diseases. It is a protectant fungicide so it must be applied before infection occurs. It does not have curative activity. It is registered for use at the rate of 3 to 4 fluid ounces per acre on a seven- to 14-day schedule. Because it is new chemistry (not related to other fungicides), it will control strains of the powdery mildew fungus that are resistant to the strobilurin fungicides (Abound, Sovran, Flint, and Cabrio) and the sterol-inhibiting fungicides (Nova, Elite, Procure, and Rubigan). Quintec has a 12-hour re-entry interval and a 14-day preharvest interval.

Fungicides for Phomopsis Cane and Leaf Spot

At present, **Mancozeb**, **Captan**, or **Ziram** are the fungicides recommended for control of this disease (Table 5-3). They are ranked as moderately to highly effective.

Fungicide test results indicate that the sterol inhibitors are not effective and the strobilurins only provide moderate control. Copper and sulfur fungicides appear to be ineffective.

Note: Especially where Phomopsis is a problem or a concern, Mancozeb, Captan, or Ziram should be included in the early-season fungicide program.

Fungicides for Downy Mildew

Protectant Fungicides

Mancozeb, Captan, and Copper fungicides

(fixed coppers and Bordeaux mixture) are highly effective for control of downy mildew (Table 5-3). Ziram is moderately effective. All of these fungicides are effective only when used in a protectant spray program. They will not provide post-infection or curative activity and will not eradicate or burn out the fungus after symptoms appear.

Of the protectant fungicides currently available, **Mancozeb** is an excellent choice. Mancozeb is highly effective against downy mildew, black rot, and Phomopsis cane and leaf spot. One problem with Mancozeb is that it cannot be applied within 66 days of harvest. Even with this restriction, Mancozeb is an excellent protectant fungicide for early-season disease control and can also be used on later-maturing cultivars for post-bloom disease control (prior to 66 days of harvest).

Captan is also excellent for downy mildew and Phomopsis cane and leaf spot but is weak for controlling black rot. A good approach to using Mancozeb and Captan for downy mildew control is to use Mancozeb early in the season then switch to Captan within the 66-day preharvest interval for Mancozeb. Currently Captan does not have a preharvest interval for grapes.

Note: Although Captan has no preharvest interval on grapes, it does have a four-day reentry restriction. The following information is taken from the Captan label: “Do not allow persons to enter treated areas within four days following application unless a long-sleeved shirt and long pants or a coverall that covers all parts of the body except the head, hands, and feet, and chemically resistant gloves are worn. Conspicuously post reentry information at site of application.” Remember, always read the label.

Ziram is similar in efficacy to Ferbam. It provides only moderate control of downy mildew, and excellent control of black rot and Phomopsis cane

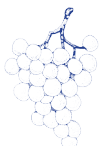

and leaf spot. Under heavy disease pressure, Ziram may not provide adequate control of downy mildew.

Locally Systemic Fungicides with Curative Properties

Ridomil Gold MZ and Ridomil Gold/Copper are by far the most efficacious fungicides available for control of downy mildew. Ridomil is locally systemic and has good post-infection or curative activity. If used in post-infection control programs, it should be applied as soon as possible, *but within* two to three days after the initiation of an infection period. Ridomil **should not be** applied after symptom development (sporulating lesions). Use of Ridomil in this manner (as an eradicant) will probably lead to a rapid buildup of Ridomil-resistant strains of the downy mildew fungus in your vineyard. If resistance develops in the vineyard, the use of Ridomil as a tool for downy mildew control is lost.

Ridomil also has excellent protectant activity against downy mildew. It should provide at least two weeks of protection, and in some tests in Ohio, it has provided up to three weeks of protection.

As mentioned previously, Ridomil Gold has a strong potential for fungicide resistance development by the downy mildew fungus. For this reason, the manufacturer (Syngenta) has registered its use only as a **Package Mix** with a protectant fungicide. The two formulations available for use on grapes are Ridomil Gold MZ (4% Ridomil and 64% Mancozeb) and Ridomil Gold/Copper (5% Ridomil and 60% Copper hydroxide). The purpose of the package mix (at least in theory) is to delay the development of strains of the downy mildew fungus with resistance to Ridomil. Both formulations are equally effective for controlling downy mildew. The Ridomil Gold MZ formulation should be used on copper sensitive cultivars.

Although Ridomil is very effective, the current label use recommendations restrict the timing of its use on grapes. These materials cannot be applied within 66 days of harvest. Based on the 66-day preharvest interval, Ridomil will be of limited use for late season downy mildew control in the Midwest. In seasons when downy mildew is a problem and on highly susceptible cultivars, pre-bloom and post-bloom applications of Ridomil will aid greatly in disease control. However, additional fungicide protection may be required within the

66-day preharvest interval on late-harvested, highly susceptible cultivars. The alternative fungicides for use during this period are Captan, copper fungicides, phosphorus acid fungicides, or the strobilurin fungicides Abound or Pristine.

Strobilurin fungicides are also locally systemic, and some have good to excellent activity against downy mildew. Whereas the strobilurins (Abound, Sovran, and Flint) all have good to excellent activity against black rot and powdery mildew, they vary greatly in their efficacy against downy mildew. Abound and Pristine have excellent activity and are the most effective for downy mildew control. Sovran is moderately effective if used at the highest labeled rate, and Flint is registered for “suppression” of downy mildew, not control.

Phosphorous Acid (Agri-Fos, ProPhyt, Phostrol)

Several products containing phosphorous acid (PA, also called phosphite or phosphonate) are sold as nutritional supplements and plant conditioners. Recently several of these materials have been registered in the United States as fungicides for control of downy mildew on grape. In multiple New York trials, PA has provided excellent control of downy mildew but has not controlled any other grape disease. Australian experience suggests that PA provides most control on *foliage* when it is applied within a few days after the start of an infection period, providing only a few days of additional residual (protective) activity. Experience in New York suggests that spray timing is less critical for control of downy mildew on *fruit*, perhaps because this highly mobile chemical (which is exempt from residue tolerances) accumulates in these organs. When applied on a seven to 10-day protectant program, they appear to provide good to excellent control of downy mildew.

Copper fungicides are highly effective against downy mildew and are moderately effective against powdery mildew. Copper fungicides are weak for controlling black rot. A major concern with the use of copper fungicides is the potential they have for phytotoxicity or vine damage. Grape cultivars differ in their sensitivity to copper fungicides (Table 5-2).

Note: Certain food processors, such as the National Grape Cooperative, will not accept grapes treated with Mancozeb past the initiation of bloom, and

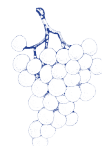

the use of Captan is not permitted at any time. If growers cannot use Mancozeb or Captan, Ridomil Gold/Copper, copper fungicides, a phosphorus acid fungicide, or a strobilurin fungicide are the other alternatives for downy mildew control. Thus, copper may be an important fungicide for producers of processing grapes that have these fungicide use restrictions.

Botrytis Bunch Rot

Vanguard, Elevate, Endura, and Rovral all have excellent activity against Botrytis bunch rot on grapes and are the fungicides of choice for control of Botrytis bunch rot. The strobilurins are moderately effective against Botrytis. Botrytis bunch rot is most commonly a problem on tight-clustered French hybrids and *Vitis vinifera* cultivars.

Proper timing and thorough spray coverage are essential for good control. Make at least two applications:

- When the disease is first observed or when the first berries reach 5°Brix (5% soluble solids/sugars), whichever comes first.
- Fourteen days after the first application. A third spray may be necessary on late cultivars, e.g., White Riesling, if the interval between the second spray and harvest is greater than four weeks.

Field experience suggests that effectiveness of the fungicide is reduced following a heavy prolonged rainfall. If such conditions occur after the last intended spray has been made, an additional application may be necessary. If only one application can be made, wait until the crop average is 5°Brix. Direct the spray toward the fruit; use a minimum of 100 gallons of water/acre.

The importance of bloom sprays for control of Botrytis bunch rot is not clear; however, during seasons with wet conditions during bloom, fungicide application during bloom is probably beneficial. Research in New York has shown that the strobilurin fungicides have moderate to good efficacy for Botrytis control. The use of a strobilurin fungicide during the bloom period may be beneficial for Botrytis control, especially on highly susceptible cultivars. In addition, a strobilurin fungicide such as Abound or Pristine during bloom will provide excellent control of black rot, powdery mildew, and downy mildew as well.

Note: Growers in Europe and Canada have experienced loss of disease control due to the development of fungicide resistance when more than three sprays per year of Rovral were applied over a period of three to five years. It is, therefore, strongly recommended that the use of Rovral, Endura, Vanguard, or Elevate be limited to a maximum of two to three applications per year to reduce the probability of developing strains of *Botrytis* that are resistant to this material. In addition, alternating these fungicides during the growing season or from season to season should be helpful in fungicide-resistance management.

Note: Removal of leaves around clusters on mid- or low-wire cordon-trained vines before bunch closing has been shown to reduce losses caused by Botrytis due to improved air circulation and improved spray penetration and coverage.

Post-Harvest Applications

On cultivars highly susceptible to downy mildew and powdery mildew, some post-harvest application may be required to protect foliage and prevent premature defoliation. This is especially true on early harvested cultivars in southern regions of the Midwest.

Fungicide Resistance Management

The development of strains of the powdery mildew fungus with resistance to the sterol-inhibiting (SI) fungicides (Bayleton, Nova, Procure, and Rubigan) or the strobilurin fungicides (Abound, Sovran, and Flint) is a serious threat to their continued use for powdery mildew control on grapes. There is good evidence that strains of the fungus with resistance to Bayleton and reduced sensitivity to other SI fungicides have developed in several areas.

Other grape diseases (fungi) and fungicides that are at high risk for fungicide resistance development include Botrytis bunch rot (Vanguard, Endura, Elevate, Rovral, and Topsin) and downy mildew (Ridomil Gold, Abound, Sovran, and Pristine). In order to prevent or delay the development of fungicide resistance, these fungicides should not be used alone for season-long control and should be used as little as possible. This means another fungicide with good activity against the disease should be incorporated into the spray program at some point during the growing season.

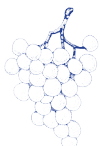

A good strategy for resistance management is to use one or two spray blocks of different fungicides. For example, a grower could start the season with two applications of a sterol-inhibiting fungicide, then switch to a strobilurin fungicide for two sprays. Other materials, such as a protectant fungicide, can be used in an alternating program such as this. The important thing is not to use one material season-long. Check with your local Extension service for the most current fungicide recommendations.

Grape Insects and Their Management

Introduction

The objective of the Integrated Pest Management (IPM) program is to provide a commercially acceptable level of insect and mite control with minimal use of pesticides, applied at the appropriate times. This is accomplished by following an integrated insect management program that integrates the use of insect monitoring devices,

cultural practices, resistant cultivars, a knowledge of insect behavior and biology, and pesticides.

Several species of insects and mites infest or feed on grapes in the Midwest. Damage is direct to the berry clusters or indirect to vines, shoots, roots, or leaves. Many of the pests are found only in certain regions; others only occasionally reach damaging population levels. Periodic vineyard inspections for these grape pests are an important part of the Integrated Pest Management program for grapes (Figure 179). Much of the potential for reducing pesticides used on grapes will be in the area of insect control. IPM methods have been developed for monitoring and controlling insects. These allow the grower more flexibility in making decisions on whether insecticides are needed, what alternative control methods might be applied, which control measures to apply, and when to apply them.

Insect Monitoring Devices

These devices are an important part of any IPM program. They have been developed for the most part to monitor adult activity. The devices themselves

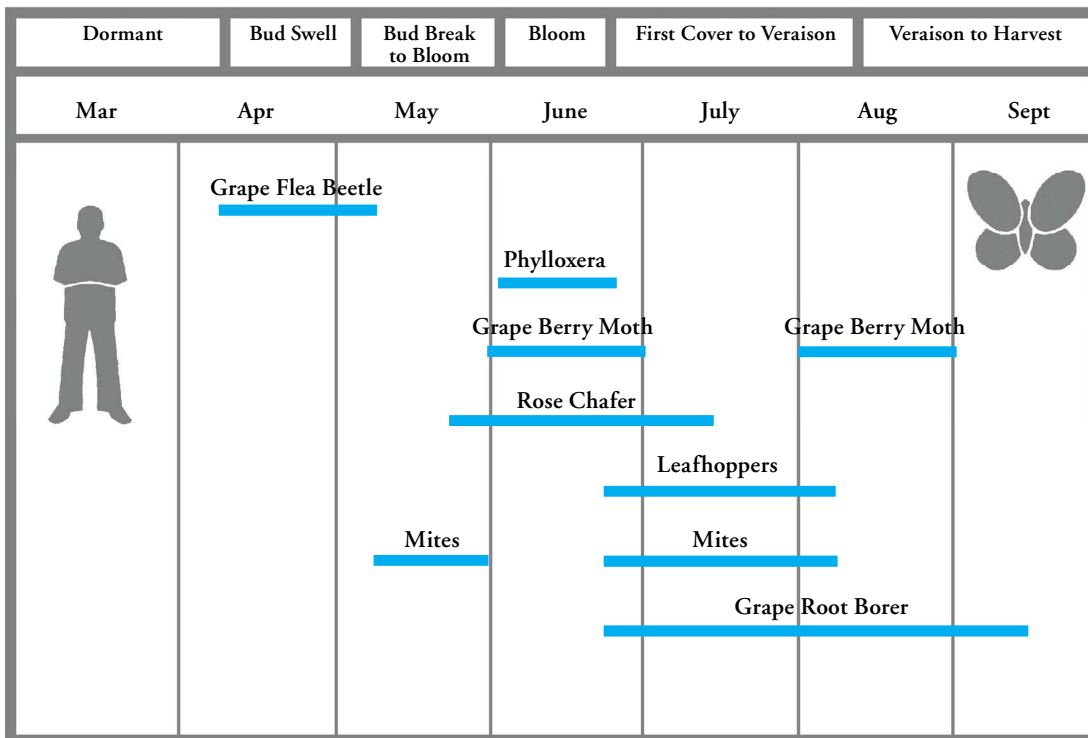
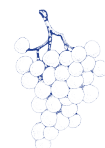

Figure 179. Suggested time to scout a vineyard for damage or presence of specific pests.



usually consist of some type of insect trap and a lure developed for a particular pest. Lures may consist of a feeding attractant, sex pheromone, or in some cases the shape or color of the trap alone is alluring. These devices provide a good indicator of adult activity and will help in the timing of cover sprays, thus increasing insecticide effectiveness and eliminating the need for additional sprays. In some cases, monitoring devices have been developed to the extent that they alone provide adequate control of the targeted pest, thus eliminating the need for pesticides completely. Most IPM programs use devices for monitoring and in some cases controlling insect outbreaks. See Table 1-2 on page 8 for information on where to obtain traps and various types of IPM supplies.

Cultural Practices

It is important to understand that insect pests may occupy different habitats during their life cycle. These include the grape canopy, weeds, sod, or soil within the vineyard, and adjacent fields, fence rows, and woodlots. These habitats may provide refuge for vineyard pests and should be considered in any vineyard IPM program. Proper management of these habitats may be an important part of controlling a given vineyard pest.

Resistant Cultivars

Cultivars that are known to be partially to fully resistant to certain insect pests should be considered when renovating an existing vineyard or planting a new one. Some cultivars have demonstrated resistance or tolerance to certain root dwelling insects. It should be noted, however, that in many situations growers do not have the flexibility of avoiding susceptible cultivars. The demand for a specific juice or wine often dictates which cultivars are planted.

Behavior and Biology

Understanding an insect's behavior and its biology helps determine the best method for controlling an individual pest. Knowing an insect's overwintering, reproductive, and feeding habits allows one to determine the best control method available as well as the best time to initiate it.

Identifying and Understanding the Major Insects and Mites on Grapes

Growers must be able to identify major grape pests so that correct management decisions can be made. It is also important that growers understand the life history and biology of the vineyard pest complex. Threshold levels and scouting techniques must be understood for each vineyard pest so that appropriate action may be taken. Management decisions should be made with a thorough understanding of the impact that pesticides might have on nontarget species, crop residues, water contamination, and the applicator's safety.

Insects That Attack Buds

Grape Flea Beetle

(Altica chalybea; order Coleoptera, family Chrysomelidae)

Damage

The grape flea beetle occasionally is a serious pest of grapes in the Midwest. Flea beetles cause two types of damage. Larvae and adults feed on the upper and lower leaf surfaces, although this injury usually is not serious. The most serious damage occurs in the spring as the adults emerge from overwintering sites and feed on newly swollen grape buds. The adult beetles chew holes in the sides and ends of the buds (Figure 180). Their feeding damages primary and occasionally secondary and tertiary buds. If all three buds are destroyed, no berries will be produced. If secondary or tertiary buds are not destroyed, a partial crop may develop but could be lost to an early frost. These beetles do not cause major damage once the buds have grown to 1/2 inch or more. Flea beetle attacks usually are confined to limited areas.

Appearance

The adult of the grape flea beetle is a dark shiny metallic greenish-blue or steel-blue beetle about 3/16-inch long (Figure 181). Newly hatched larvae of the grape flea beetle are dark brown and approximately

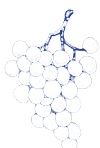

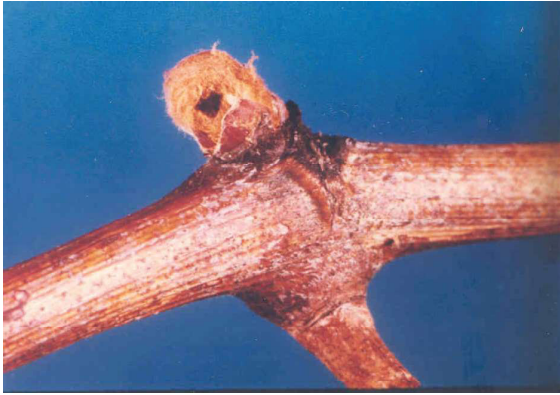

Figure 180. Flea beetle damage.

1/16-inch long. As the larvae grow, their color lightens and they reach a length of almost 1/3 inch (Figure 182). The larva's head is black, and there are six or eight shining black dots on each of the other segments of the body, each dot emitting a single brownish hair. The under surface is paler than the back. Larvae have six legs, which are black, and there is a fleshy, orange-colored proleg on the terminal segment.

Life Cycle

The flea beetles overwinter as adults and emerge at bud swell, which is usually in April. Upon emergence, adult beetles begin to feed upon newly swollen grape buds. Female beetles lay eggs under loose bark of the grapevine. Larvae hatch and crawl to the developing grape leaves, where they feed on the upper surfaces. Adult beetles and larvae also feed on leaves, but the injury they cause usually is negligible. When they are fully developed, the larvae drop to the soil, burrow 1 inch or less, and pupate. They emerge later as adults. There may be a partial or full second generation each year.

Monitoring by Scouting

Grape bud damage caused by the grape flea beetle is most often concentrated in vineyard borders near wooded areas. Early-season vineyard monitoring and past evidence of beetles in the vineyard will help determine the need for an early-season application of insecticide. Scouting of the vineyard for grape flea beetle should begin at bud swell (late April in northern Ohio) and continue until bud development is past the critical stage. These shiny metallic beetles are easily spotted on grape canes and buds on warm, sunny days in the spring. Surveys for



Figure 181. Grape flea beetle adult.



Figure 182. Grape flea beetle larva.

adult beetles should be conducted along the vineyard perimeter, on all sides, and near the center of the vineyard. At least 25 vines should be surveyed at each of the five locations.

Threshold

If scouting finds that 4% or more of buds are damaged, then insecticide is needed to prevent economic damage.

Cultural Control

Woodlots and wasteland areas near cultivated vineyards can be a continual source of flea beetles, and these areas should be cleaned up, if possible, to help reduce overwintering sites for the beetles. Cultivation of open areas between rows and around the vineyard can reduce the number of newly emerging adults by exposing the delicate pupae to desiccation and death. Cultivating does not eliminate emerging beetles from under the trellis and adjoining woodlots. Cultivating alone cannot be relied upon to control flea beetles.

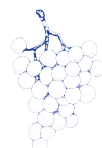

Chemical Control

If beetles are present above threshold at bud swell, a broad-spectrum insecticide should be applied to prevent bud damage. Timing is critical. Insecticide should be effective against adults migrating to vines from their hibernation sites. A second application of insecticide in June, when larvae are feeding on the grape foliage, can help to control an outbreak the following year.

Insects That Attack Flower Clusters and Berries

Grape Berry Moth

(Endopiza viteana; order Lepidoptera, family Tortricidae)

Grape berry moth is the major insect pest of grape berries in the eastern United States and Canada. When vineyards are left unmanaged, up to 90% of the fruit often is destroyed by the grape berry moth's larvae or by the rot diseases that often follow insect damage. Infestations vary greatly from vineyard to vineyard, from year to year, and within a vineyard. However, vineyards bordering wooded areas are most vulnerable.

Damage

First-generation larvae web small flower buds or berries together in early June and feed externally on them or on tender stems. Larvae that attack grape bunches during this time are difficult to see.

Second generation larvae tunnel directly into the green berries and feed internally. Conspicuous reddish spots develop on the berries at the point of larval entry. Berries affected in this manner are known as stung berries (Figure 183). The second generation is potentially more damaging than the first. A single larva may destroy two to six berries in a cluster, depending on berry size, and several larvae frequently inhabit a single cluster (Figure 184).

At harvest, severely infected bunches may contain several larvae, and many of the berries may be completely hollowed. In many cases, bunches are covered with bunch rot fungi and infested with *Drosophila* spp. fruit flies, and often have an unhealthy appearance (Figure 185).



Figure 183. Grape berry moth damage, resulting in stung berries.



Figure 184. Grape berry moth damage in a fruit cluster.



Figure 185. Grape berry moth damage.

Appearance

The adult is a small moth that is mottled-brown with some bluish-gray on the inner halves of the front wings (Figure 186). The larvae are active, greenish to purplish caterpillars about 3/8-inch long when fully grown.

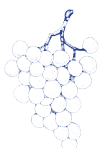



Figure 186. Grape berry moth adult.

Life Cycle

Grape berry moths overwinter in cocoons within folded leaves in debris on the vineyard floor and within adjacent woodlots. After emerging in the spring, the adults mate, and females lay eggs on or near flowers or berry clusters. Newly hatched larvae feed upon the flowers and young fruit clusters. Larvae that hatch in June make up the first generation of grape berry moth and will mature from mid- to late-July or August. After mating, female moths lay eggs on developing berries, and this second generation matures in August or September. Larvae of the second generation, after completing their development, form cocoons in which they overwinter. A third generation occurs commonly in the southern range of the pest and occasionally in the northern tier of states.

Cultural Control

To kill the overwintering pupae in leaves, leaves can be gathered and destroyed in the fall. As an alternative, leaves can be buried within the soil in the spring, two weeks before bloom, by rototilling or cultivating.

Monitoring by Trapping

Pheromone traps are available to monitor the emergence of male grape berry moths during the season. Pheromone traps should be used in vineyards with a history of grape berry moth problems. Trapping of adult male moths indicates the beginning of flight activity. This information can be useful for optimal spray timing; sprays should target the young larvae that emerge from hatching eggs. Eggs can be present over a two- to three-week period after the first moths are trapped.

It should be noted that the second flight activity period occurring in late July and August is the most important. These adult moths in late summer produce the eggs that hatch into larvae capable of causing major damage to the maturing fruit. The grower should not depend solely upon a pheromone trap for detecting this late season threat, but should use scouting as well.

A minimum of three traps is recommended for monitoring a single block of approximately 10 to 15 acres. Traps hung from the top wire of the trellis should be placed around the perimeter of the vineyard before bloom and should be at least 100 feet apart. Sticky trap bottoms should be checked weekly for moths, and pheromone caps (lures) should be changed monthly to obtain accurate flight information. Every vineyard location is unique, and growers should not rely on pheromone trap data from other vineyards for timing insecticide sprays.

Monitoring by Scouting

Scouting should be implemented on a weekly basis after bloom. The scout should inspect 100 randomly selected clusters along the perimeter of the vineyard and 100 clusters toward the center of the vineyard. These counts should be used to determine the percentage of clusters damaged by larvae. By keeping track of where damage is found, the grower can decide if treatment of the entire vineyard is necessary or if treatment of perimeter rows might be all that is necessary to control this pest.

Thresholds

The need for spray applications depends on the amount of infested berries the grower is willing to accept. Corrective measures are usually suggested if more than 5% of the clusters are injured. Table grapes require more attention than grapes grown for juice. If berry cluster damage reaches 6% in grapes used for processing or 3% in those grown for fresh market, then a protective cover spray should be applied.

Chemical Control

A protective cover spray to prevent damage can be required in areas infested by grape berry moth. Early season control of this pest can prevent it from becoming well established within the vineyard and may eliminate the need for control later in the season.

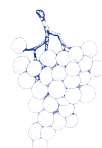

Control of maturing larvae in mid- to late-July is particularly important. In vineyards where this pest is a problem every year, one spray is usually used for each of the two generations. In vineyards where this pest is not always a problem, one spray targeting the first generation is all that is needed.

Behavioral Control with Mating Disruption

An alternative to chemical control is behavioral control using pheromone to disrupt the male mating behavior of the grape berry moth. The product used for this method was approved by the EPA in 1990. This method prevents mating, thus reducing the number of fertile grape berry moth females in a treated vineyard. Mating disruption is most effective in vineyards at least five acres in size. The original method of mating disruption uses pheromone imbedded in thin flexible tubes that look like twist-ties; these are manually dispensed at a rate of 400 ties per acre. A newer method available starting in 2002 is a sprayable formulation that is applied by conventional sprayers.

Studies indicate that vineyards in close proximity to external berry moth sources, such as woodlots, might require an application of insecticide in addition to mating disruption to keep the pest suppressed to acceptable levels. Vineyards using mating disruption should continue to be scouted in the same manner as previously mentioned. If the threshold is reached, the decision to apply an insecticide to part or all of a vineyard should be considered.

Rose Chafer

(Macrodactylus subspinosus; order Coleoptera, family Scarabaeidae)

Damage

Rose chafer adults attack grapes at bloom as the beetles emerge from the soil. Blossom buds are often completely destroyed, resulting in little or no grape production (Figure 187). Not only do they destroy the fruit at blossom but they frequently skeletonize the leaves so that only the large veins remain intact. Feeding activity on various plants can continue for four to six weeks. Damage can be especially heavy in sandy areas, which are the preferred habitat for egg-laying. Despite its common name, the rose chafer attacks the flowers, buds, foliage, and fruit of



Figure 187. Cluster damaged by rose chafer.

numerous plants including grape, rose, strawberry, peach, cherry, apple, raspberry, blackberry, clover, hollyhock, corn, bean, beet, pepper, cabbage, peony, and many more plants, trees, and shrubs. A toxin present in the beetles may kill poultry.

Appearance

The ungainly beetles have a straw-colored body, reddish-brown head and thorax with a black undersurface (Figure 188). The adult rose chafer is about 1/2 inch in length with long, spiny, reddish-brown legs that gradually become darker near the tip. As they age, hairs are worn off the head and thorax with normal activity, revealing the black color below. Thus, they become mottled in color as they mate and move around in the flower clusters, making it possible to distinguish newly emerged adults from older specimens. Females frequently lose more hairs, particularly on the thorax, in the mating process.



Figure 188. Rose chafer adult.

Eggs of the rose chafer are oval, white, shiny in appearance, and about 1/20-inch long and 1/30 inch in width. Larvae are C-shaped white grubs about 1/12-inch long and 1/8-inch wide when fully grown.

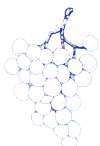

Mature larvae have three distinct pairs of legs, a brown head capsule, and a dark rectal sac visible through the exoskeleton. Larvae are found in sandy soil feeding on grass roots and can be identified by a distinctive raster pattern (Figure 189). The raster pattern is the arrangement of bristles and hairs on the underside of the tip of the larva's abdomen. The pupae are light yellowish-brown in color and have prominent legs. They measure about 1/2 inch in length.

Life Cycle

Adult rose chafers become active at the time of grape bloom, which in northeastern North America is from late May to early June. The adults appear suddenly. It seems as though the entire population reaches maturity practically at the same time, and multitudes of beetles suddenly make their appearance. Beetles feed and mate soon after emerging from the soil. It is common to see mating pairs in the newly formed grape clusters. Females deposit eggs singly a few centimeters below the soil surface. Mating and egg laying occur continuously for about two weeks, with each female depositing 24 to 36 eggs. The average life-span of the adult is about three weeks. Approximately two weeks after being deposited, eggs hatch into tiny, white, C-shaped grubs. The larvae feed on the roots of grasses, weeds, grains, and other plants throughout the summer, becoming fully developed by autumn. However, it is not easy to collect the larvae of rose chafer. They have been found occasionally on the roots of orchardgrass but never in proportion to the numbers found in adjacent grapes. Larvae move downward in the soil as soil temperatures decline and form earthen cells in which they overwinter. In the spring, larvae return to the soil surface, feed for a short time, and pupate in May. After two weeks in the pupal stage, the adults emerge

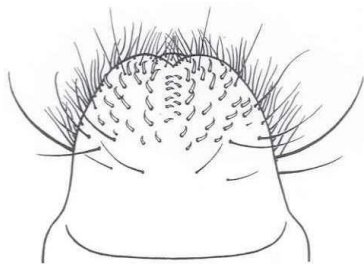

Figure 189. Raster pattern on rose chafer larva.

and crawl to the soil surface to begin their cycle again. There is but one generation per year.

Cultural and Mechanical Control

If only a few beetles are present, they can be handpicked from the vine and destroyed. The pupal stage is extremely sensitive to disturbance; therefore, cultivating between rows can be effective in destroying a good number of chafers. However, it is our experience that growers with numbers of beetles sufficient to inflict economic damage will not be able to control this pest by this method of cultural control.

Control by Mass Trapping

Where populations of rose chafer are large and pose a threat to the grape crop, massive trapping can be a safe alternative to applying insecticide. The desired effect of mass trapping is to bring the beetle population within a heavily infested vineyard to below threshold level; this is usually achieved after two to four years of intensive trapping.

Mass trapping of rose chafer has been developed in the entomology department at Ohio State University, using a very powerful feeding attractant and Japanese beetle traps. The number of traps needed per acre is 35. An application of insecticide might be required in combination with the trapping effort if the population is extremely high. Results of using this new powerful attractant have been very positive.

Monitoring by Scouting

Scouting for this pest within a vineyard should begin at bloom (late May) and continue for about one month (through late June). Newly emerged adults can be found feeding upon young grape buds and foliage.

To determine the number of beetles per vine, the scout should randomly survey 25 vines at all four corners of the vineyard and 25 in the center of the vineyard. This will give the total number of beetles present on 125 vines surveyed. Divide the number of beetles present by the number of vines (125) to obtain the average number of beetles per vine. It should be noted that with this survey method, the grower can determine if the rose chafer infestation is present throughout the vineyard or just located in a specific area. If the area is localized, then spot

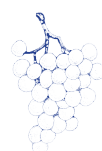

treatment of the infestation might be all that is required.

Monitoring by Trapping

Monitoring can also be conducted by using the attractant developed for rose chafer. Traps should be placed around the perimeter and dissecting the vineyard. For monitoring purposes, these traps can be spaced every 100 feet and should be checked daily for newly emerged chafers. If beetles are encountered in traps, then the vineyard should be scouted and control methods considered if beetles average two or more per vine.

Thresholds

An insecticide spray application is recommended if the average pest density is more than two beetles per vine.

Chemical Control

Treatment with an insecticide should be after bloom when the first newly emerged beetles are detected in adequate numbers to pose concern. A second application might be required if pressure is severe and rainfall is frequent. Protection of the young grape cluster is critical and should be maintained throughout June.

Multicolored Asian Lady Beetle (*Harmonia axyridis*; order Coleoptera; family Coccinellidae)

Damage

Lady beetles are normally considered as beneficial insects. However, at grape harvest, the multicolored Asian lady beetles are now considered a foe. During the 2001 harvest, there was a huge increase in the presence of these lady beetles in many vineyards in the Midwest. Entomologists in the region attribute this population explosion to the sudden arrival of the soybean aphid from China. Soybeans were highly infested over the entire region. As the soybeans matured and dried, the lady beetles dispersed. Some found mature ripe grapes with broken peels. They remained on the grapes and fed for several weeks, especially where ripe fruit was left in the field late in the season. The lady beetles fed on the damaged fruit, and in many instances 10 or more beetles were found per cluster (Figure 190). They were not



Figure 190. Cluster of multicolored Asian lady beetles on grapes.

causing primary damage, being unable to break the skin of the grapes with their mandibles. However, they did follow and take advantage of breaks in the skins caused by yellowjackets, hornets, birds, raccoons, or other pests.

The amount of physical damage lady beetles cause in grapes is minimal. However, the lady beetles are a menace to grapes due to a substance they produce when touched or squeezed that causes them to produce reflex bleeding. When infested grapes are harvested, the beetles inadvertently end up in the crusher and thus contaminate the juice with their special aroma. The hemolymph or blood of the insect is a protective mechanism to keep birds and other predators away. They exude the musty, basement-like odor from the joints of their legs. The detrimental effect is that this hemolymph taints the juice and is able to persist all the way through the process of fermentation into the wine. We are looking at methods to repel the lady beetles with several different compounds that pose minimal risk to humans in the event that this problem is persistent in future years.

Appearance

Adults are oval, about 5/16 inches long, and 1/4 inch wide (Figure 191). There are many different color forms ranging from pale yellow-orange to bright red-orange, with or without black spots on the wing covers. The head, antennae, and mouthparts are generally straw colored but are sometimes tinged with black. The pronotum (neck) is similarly straw-

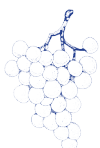



Figure 191. Multicolored Asian lady beetle adult.

yellow with up to five black spots or with lateral spots usually joined to form two curved lines, a W- or M-shaped mark, or a solid trapezoid. The wing covers are generally yellow-orange in unspotted beetles. In fully spotted beetles, each of two wing covers has 10 black spots.

Eggs are bright yellow, laid in clusters of about 20 on the undersides of leaves (Figure 192). Larvae are elongate, somewhat flattened, and adorned with strong tubercles and spines (Figure 193). The mature fourth instar larva is strikingly colored — the overall color is mostly black to dark bluish-gray, with a prominent bright yellow-orange patch on the sides of abdominal segments 1 to 5.

Life Cycle

The life cycle from egg to adult requires about a month or so, depending on the weather. Eggs hatch in three to five days. The larval stage lasts up to 14 days, during which time they consume large numbers of aphids, scale insects, and other soft-bodied insects. Pupation lasts five to six days followed by adult emergence (Figure 194). The adults are rather long lived with some lady beetles living up to three years. At least two generations with a partial to complete third generation occur each growing season. In the fall when the host plants such as soybeans begin to dry and cooler weather approaches, adult lady beetles begin to seek overwintering sites. They are attracted to vertical walls or cliffs where they seek shelter in cracks and crevices. Once one lady beetle lands, many others may follow in an aggregating behavior.



Figure 192. Multicolored Asian lady beetle egg mass.



Figure 193. Multicolored Asian lady beetle larva.



Figure 194. Multicolored Asian lady beetle pupa.

Management

Since the multicolored Asian lady beetle is not a native species, few diseases or parasites have been associated with this beetle. However, adult beetles have been found to vector fungal diseases, and therefore their aggregating nature may be favorable to the dissemination of bunch rot and other diseases from one grapevine to another.

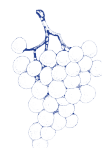

Due to the adverse habits of this predatory beetle, we have begun to evaluate some forms of chemical control. However, controlling these beetles in grapes at harvest poses a problem. Harvest restriction intervals must be considered. Pyrethroids are particularly good at knock down, but the only one currently labeled for grapes is Danitol (fenpropathrin) which has a 21-day pre-harvest interval (PHI). While Sevin (carbaryl) and Malathion (malathion) have shorter PHI's, seven and three days, respectively, they are still less than ideal.

Currently the only pesticide labeled for grapes with a zero-day harvest interval is Provado (imidacloprid). Preliminary efficacy tests with this product have yielded some interesting results. Imidacloprid is not considered a contact pesticide, but for some reason, the multicolored Asian lady beetle has shown sensitivity to this compound. Extremely low rates of this compound have demonstrated the ability to knock these beetles down but not kill them. After removal from contact exposure, the beetles fully recovered in just a few hours. This attribute may provide a means of knocking the beetles out of the grape canopy prior to harvest, but still allowing them to recover and continue to function as a predator in biocontrol programs.

Insects That Attack Grape Foliage

Japanese Beetle

(Popillia japonica; order Coleoptera, family Scarabaeidae)

Damage

The adult beetles feed on the foliage and fruits of more than 250 kinds of plants, but grape is one of the preferred hosts. The adults feed on the leaves of both wild and cultivated grapevines. Beetles prefer foliage exposed to direct sunlight and often are seen clustered together feeding on tender vegetative parts (Figure 195). Vines with thin, smooth leaves, such as French hybrids, are preferred over those with thick, pubescent leaves, such as Concord. Concord vineyards rarely need special control sprays for Japanese beetles. On the other hand, French hybrids and other thin-leaved cultivars require frequent



Figure 195. Japanese beetle damage in grapes.

inspection to prevent damage. Damaged leaves have a laced appearance, and severely affected leaves will drop prematurely.

Appearance

The larvae are C-shaped grubs found in the soil and are serious pests of grass roots. The distinguishing character of the grubs of scarab beetles is the raster pattern (Figure 196). The raster pattern is the arrangement of bristles and hairs on the underside of the tip of the grub's abdomen. The adult beetle has a shiny, metallic-green head and thorax, and coppery-brown wing covers (Figure 197). Tufts of white hairs are located along the sides of the body. Adult beetles are about 1/2-inch long.

Life Cycle

This insect overwinters as a larva below the soil surface (Figure 198). Larvae feed principally on grass roots. In the spring when the soil begins to warm, grubs move toward the surface where additional feeding can occur before they pupate in late spring. New adult beetles emerge from the ground in June and July and begin feeding upon foliage. Mating occurs at this time and eggs are laid in the thatch layer of soil. Eggs take 10 days to hatch. In August, young grubs begin feeding on plant roots. Grubs continue to feed and grow until cold weather, at which time they tunnel 3 to 12 inches down and make overwintering cells. There is one generation per year.

Monitoring

A Japanese beetle lure and trap is available for monitoring this pest; however, these beetles are easily detected while walking through the vineyard.

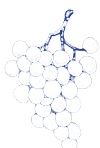

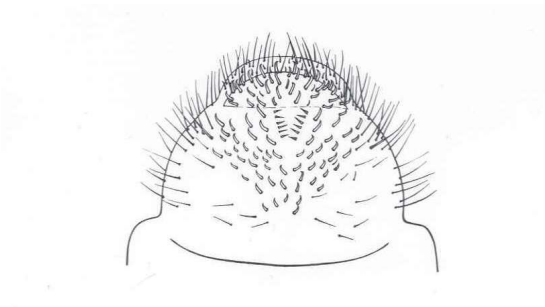

Figure 196. Raster pattern on Japanese beetle larva.



Figure 197. Japanese beetle adult.

Threshold

There is no proven economic threshold on the number of Japanese beetles or amount of damage that requires treatment. The usual threshold for making a spray application is about 15% of the leaves damaged.

Chemical Control

If skeletonizing of leaves becomes evident, thin-leaved cultivars may need to be protected with an application of insecticide. If a susceptible cultivar is being grown and growers previously have experienced high populations of Japanese beetles, then an insecticide can be applied when beetles emerge, feeding is apparent on most vines, and skeletonized leaves are found. Spot treatment is adequate in some cases. An insecticide with long residual activity is needed when beetle populations are high. Repeated applications can be needed to control new beetles flying in from surrounding areas.

A microbial insecticide is available to control Japanese beetle grubs in turf, although it is slower acting and more expensive than conventional insecticides. This substance is bacterial in nature and causes milky spore disease within the grub stage of development. This microbial insecticide cannot be relied upon to protect grapes from Japanese beetle.

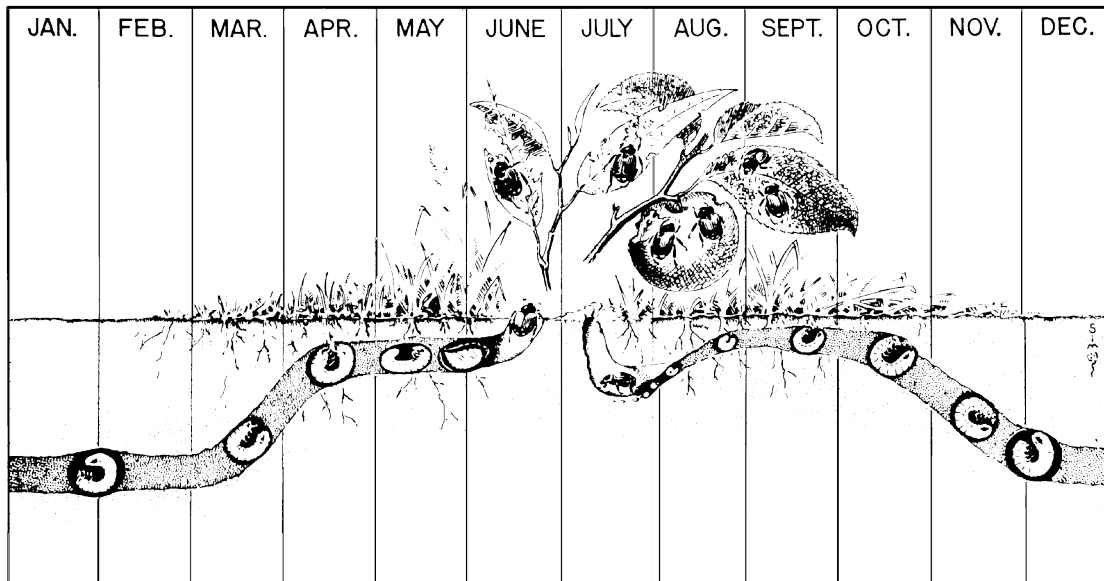
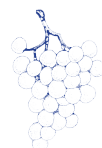

Figure 198. The Japanese beetle's seasonal life history.



Grape Phylloxera

(Daktulosphaira vitifoliae; order Homoptera, family Phylloxeridae)

Damage

Phylloxera is one of the most destructive grape pests worldwide. The insect forms galls on the leaves and roots of grapevines. The vine will die if its roots become heavily infested with phylloxera. If leaves become heavily infested, premature defoliation and retarded shoot growth may result.

Appearance and Life Cycle

This small aphid-like insect has a complex life cycle that involves survival on the roots throughout the year, and on the leaves during the growing season (Figure 199). The sequence of events in the life cycle is different for the foliar and root forms of this insect.

The foliar form survives the winter as an egg under the bark of the grapevine. Asexual, wingless forms

hatch in the spring and crawl onto the new leaves, where they develop galls. Young crawlers settle on the upper surface of immature leaves, causing galls to form on the under surface of the leaves (Figures 200 and 201). The only opening in a gall is to the upper leaf surface. Once mature, the female begins to lay eggs within a gall (Figure 202). Nymphs hatching from these eggs crawl to new leaves at shoot tips, settle on the leaves, and form new galls.

In the case of the root form of grape phylloxera, the insects overwinter as immature forms on the roots. These forms mature in the spring and produce eggs that hatch into nymphs (Figure 203). The nymphs then start new galls on the roots. Winged forms develop in the spring, summer, or fall and emerge from the soil to lay eggs on stems. These eggs hatch and produce the true sexual forms that produce the overwintering eggs laid under the bark. Several generations of each form of phylloxera can occur each season. Although the two forms behave differently, both belong to the same species of phylloxera that occurs on the leaves and roots of grapes.

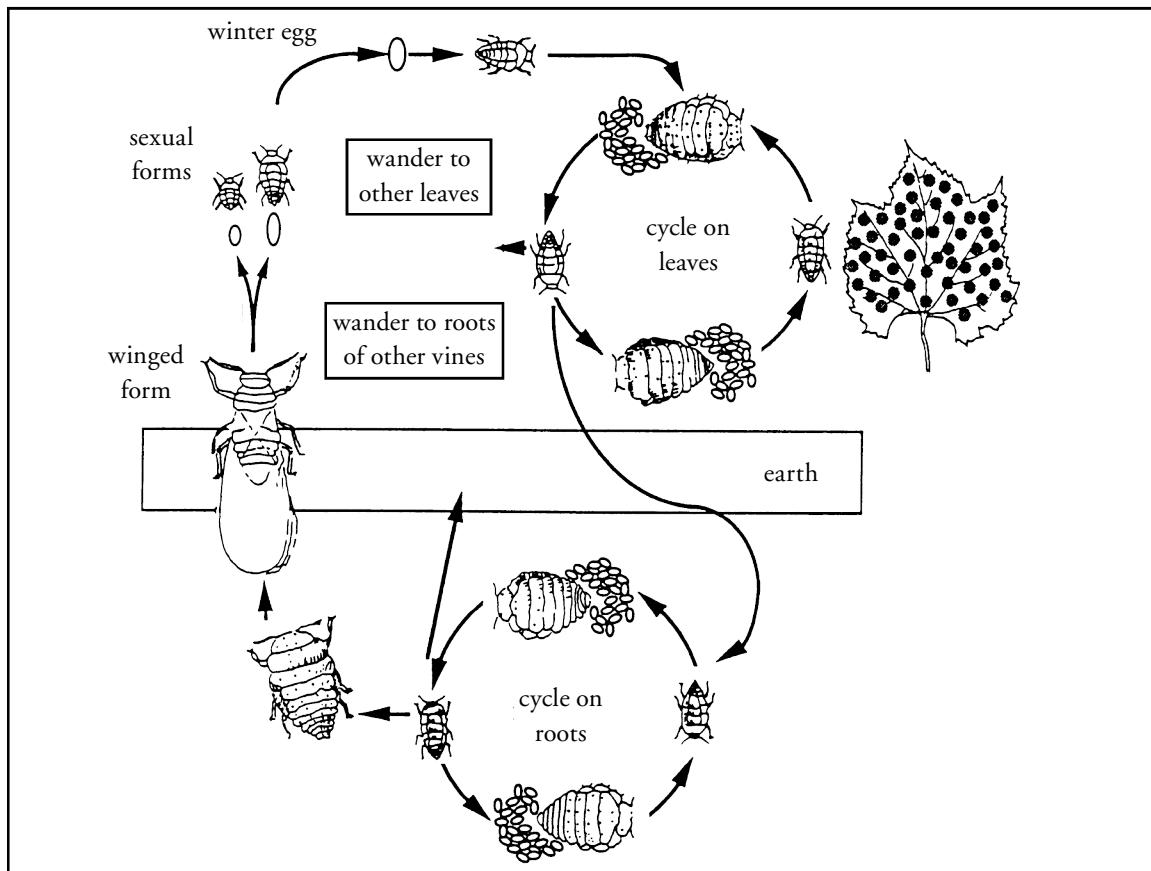

Figure 199. Life cycle of the grape phylloxera.

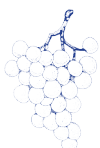



Figure 200. *Phylloxera* galls on leaf.



Figure 201. *Phylloxera* leaf galls on shoot.



Figure 202. *Phylloxera* opened leaf gall.



Figure 203. *Phylloxera* on roots.

Cultural and Natural Controls

Native American grapes tend to have resistance to grape phylloxera and are not a problem; however, French hybrid and vinifera grapes are usually very susceptible. Eastern growers usually do not have a problem with the root form of the phylloxera. In many areas of the world, susceptible cultivars are grafted onto resistant rootstocks to prevent damage by the root form. However, the foliar form still can occur in such cases. There are some natural predators that feed upon the foliar form of grape phylloxera, but none of these provide adequate control of the pest.

Monitoring

Phylloxera is usually spotty in Ohio vineyards, so identifying these areas within individual vineyards is important. Spot treatment can be all that is required to control this pest. To identify the location and extent of phylloxera within a vineyard, one should begin scouting for infested leaves after shoot length has reached 5 inches. Young galls will be forming on the underside of the terminal leaves; the galls are not easily noticed early in the season without taking the time to inspect the leaves closely.

These phylloxera galls should not be confused with grape tumid galls, commonly called the grape tomato gall. Tumid galls have a smooth outer surface and take on a reddish tomato-like appearance, whereas the grape phylloxera gall is green in appearance except early in the season when young grape leaves tend to have more of a reddish cast to them. The gall itself has a rough-looking surface rather than the smooth surface of the tumid gall. Tumid gall is present but not a problem in Midwestern vineyards.

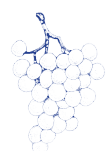

Chemical Control

Control of phylloxera is often needed on French hybrids and vinifera grapes. Growers cannot usually completely eradicate phylloxera from a vineyard that is already infested but can take measures to keep the infestation at a tolerable level. Control of the foliar form of phylloxera can be achieved by applying insecticide at bloom and again 10 to 14 days later. Late-season treatment of grape phylloxera is not effective and is a waste of time and money. Early season control of this pest is critical. There is no known completely successful chemical control for the root form of grape phylloxera.

Leafhoppers

Potato Leafhopper

(*Empoasca fabae*; order Homoptera, family Cicadellidae)

Damage

The potato leafhopper is a sucking insect that feeds sporadically on grape foliage. The potato leafhopper feeds on more than 200 plant species. Injury to grapes occurs when the adults fly into vineyards and feed on the leaves. Toxins injected while feeding cause leaves to cup and be misshapen (Figure 204). These leaves are often in the top of the vine and are quite obvious, especially at the end of the growing season.

Appearance

The adult leafhopper is pale to bright green, wedge-shaped, and about 1/8-inch long (Figure 205). The



Figure 205. Potato leafhopper adult.

adults are very active, jumping, flying, or running when disturbed. The immature forms, or nymphs, are pale green and wingless. They run forward, backward, or sideways rapidly when threatened.

Life Cycle

The potato leafhopper does not overwinter in areas north of the Gulf States. Each year large numbers of potato leafhoppers are carried to northern areas by warm spring air currents.

Eastern Grape Leafhopper

(*Erythroneura comes*; order Homoptera, family Cicadellidae)

Three-Banded Leafhopper

(*Erythroneura tricincta*; order Homoptera, family Cicadellidae)

Virginia Creeper Leafhopper

(*Erythroneura ziczac*; order Homoptera, family Cicadellidae)

Damage

Adults and nymphs feed on leaves by puncturing the leaf cell and sucking out the contents. Each puncture causes a white blotch to appear on the leaf (Figure 206). In heavy infestations, the leaves turn yellow or brown, and many will fall off. Feeding by these leafhoppers can reduce the photosynthetic capacity of the plant, and the quality and quantity of the fruit can be affected.

Grapevines can tolerate populations of up to 15 leafhoppers per leaf with little or no economic damage. However, heavy leafhopper feeding may



Figure 204. Potato leafhopper damage to grape leaf.

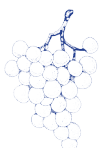



Figure 206. Leafhopper damage to grape.

result in premature leaf drop, lowered sugar content, increased acid, and poor coloration of the fruit.

The sticky excrement (honeydew) of the leafhoppers affects the appearance and supports the growth of sooty molds. Severely infested vines may be unable to produce sufficient wood the following year. Damage to the vine can be serious if infestations are allowed to persist unchecked for two or more years.

Appearance

The three species listed are three of the most common leafhoppers found on grapes in the Midwest, and they belong to the same genus, *Erythroneura*. These three species vary in their coloration and markings. The adults of these leafhoppers are about 1/8-inch long. *E. comes* is pale yellow or white with yellow, red, and blue markings (Figure 207). Overwintering adults are often nearly all red. *E. tricincta* is brown and black with touches of orange on the wings (Figure 208). *E. ziczac* is pale yellowish or white with a zigzag stripe down each wing and cross veins distinctly red.

Life Cycle

The biology of these three species is similar. They overwinter as adults in sheltered places such as the remains of old plants. During the first warm spring days, the leafhoppers become active, and they feed on the foliage of many different plants until grape leaves appear. Eggs are deposited under the leaf epidermis; they hatch in about two weeks. The immature leafhoppers, or nymphs, are wingless; they remain and feed on the leaves where they hatched (Figure 209). Nymphs molt five times, then transform into adults. There are two or three generations of leafhoppers each season.



Figure 207. Eastern grape leafhopper adult.



Figure 208. Three-banded leafhopper adult.



Figure 209. Leafhopper nymphs on grape.

Cultural Controls

Weeds and trash in and around a vineyard are a source of leafhoppers. If this material is cultivated before spring, the adults lose their protection and feeding sites, although in areas with extensive agriculture, this practice has less value as the adults will just move to an adjacent crop or weedy area.

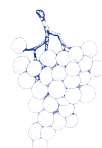

Certain cultivars are likely to suffer higher leafhopper populations than others. Wine and table grape cultivars fit this criteria. Moreover, late-producing cultivars are more likely to favor leafhoppers than early maturing cultivars.

Monitoring and Thresholds

Vigorous vines are preferred by leafhoppers. The heaviest populations are normally found on end vines and on outside rows. This is partly because these vines are usually the most vigorous and therefore the most attractive. It also is partly because of the border or boundary effect. Vigorous vines fortunately can tolerate the highest populations.

Sampling for leafhoppers should be done at 10 days post-bloom (about June 20 to 25 in northern Ohio), about one month later (about the third week in July), and again about one month later (the third to fourth week of August). This is approximately the same time one should be assessing grape berry moth risk, and both surveys can be conducted at the same time.

First Sampling, 10 Days Post-Bloom: Only adult leafhoppers are present at this time of the year, and it is not necessary to count them. If leafhoppers are present, you should see stippling damage on the lower sucker leaves and interior leaves of the grape canopy. By shaking the vines, adult leafhoppers, if present, will fly around the vine. If stippling damage is present throughout the vineyard, then an application of insecticide is recommended to prevent later damage from occurring. Early-season damage can indicate that populations might potentially build up to damaging levels later in the season. In vineyards that are at high risk for grape berry moth, insecticide is usually applied at this time, so scouting for leafhoppers at this time is not necessary.

Second Sampling, Late July: By mid- to late-July, first-generation nymphs are present and feeding on the undersides of grape leaves. At this time, the need to apply an insecticide for leafhopper control should be determined on a block-by-block basis. Sampling for grape berry moth and leafhoppers can be done with a single pass through the vineyard.

The first step in evaluating leafhopper damage is to look for stippling on leaves while you are doing counts of grape berry moth damage. Most damage will be found on the first seven leaves from the base of the shoot. If no stippling or minimal stippling

is visible on the leaves, then there is no point in counting how many leafhoppers are present. If moderate to heavy stippling is visible, then it is necessary to do counts of leafhopper nymphs to determine if damage levels warrant treatment. The sampling procedure for leafhoppers requires counting all leafhoppers on the undersides of the third through seventh leaves of one shoot on each of five vines. Sampling for leafhoppers should take only a few minutes per vineyard.

Third Sampling, Late August: In years when leafhoppers do build up to damaging levels in vineyards, it is most common for them to do so in late August. Vineyards with greater than 10 leafhoppers per leaf should be treated at this time. If there is very little visible stippling, sampling will not be necessary. Vineyards that had insecticides applied to them earlier in the season will probably not need treatment at this time. In Ohio, leafhoppers cause the most problems on the islands in Lake Erie and in vineyards near Lake Erie.

Cultural Control

Leafhoppers have few natural enemies. Cold and wet weather conditions in spring and fall are damaging to leafhopper populations, as are wet winters. Cultivation and cleanup of adjacent weedy land in the fall will eliminate favorable overwintering sites in and near a vineyard.

Chemical Control

When high populations of leafhoppers are encountered, an application of a contact insecticide can be required. In order to obtain good control of leafhoppers, complete coverage of the undersides of the leaves is important. Coverage of the fruit is of secondary importance.

Insects That Attack the Roots and Crown

Grape Root Borer

(Vitacea polistiformis; order Lepidoptera, family Sesiiidae)

Damage

Larvae of the grape root borer attack the larger roots and crown of grapevines. They tunnel into the roots

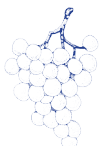

or crown and feed internally. The feeding and boring of the larvae will weaken and can eventually kill the vine. Larvae also provide entry points for disease organisms. Vines that are severely infested may wilt under stress; sometimes only part of the vine will show stress. This pest is severe only in the southern half of the Midwest but is slowly moving northward. It is an established problem in southern Ohio, but some moths have been detected in northern Ohio.

Appearance

The adult is a clearwing moth, with the forewings brown and the hindwings clear with brown borders. The body mimics that of a wasp and is brown with yellow markings. Male moths measure about 5/8 inch in length (Figure 210), while the female is larger, about 3/4-inch long (Figure 211). A fully developed larva is about 1-1/2-inches long and white with a brown head capsule (Figure 212).

Life Cycle

The moths emerge from the soil during July and August (Figure 213). Eggs are deposited individually on grape leaves or weeds, or dropped on the ground



Figure 210. Male grape root borer moth.



Figure 211. Female grape root borer moth.



Figure 212. Grape root borer larva and damage.

close to the trunk. The larvae hatch and burrow into the soil until they find their way to the roots and crown, where they feed. Larvae continue to feed within the vine's root system for about 22 months. Mature larvae move to places just under the surface of the soil and pupate in earthen cells. In southern Ohio, adults start emerging in late June or early July and continue to emerge through August.

Cultural Controls

Weed control is important in managing this insect pest. Weed control decreases the number of oviposition sites and provides an area under the trellis suitable for applying an insecticide. Researchers in North Carolina also have achieved good control of root borers with polyethylene mulch; this technique can be easily accomplished at planting. It works well for a while but the mulch must be maintained over the years in order to be successful.

External woodlots containing wild grapes are a good source of grape root borers. Such areas adjacent to vineyards should be considered when trying to manage this pest. Extermination of wild grapes from within these areas may help to reduce root borer pressure.

Behavioral Control by Mating Disruption

An alternative method of control using pheromone rope ties to disrupt the males of the grape root borer is being tested by researchers at Ohio State University. This method prevents the male root borers from locating the female borers and mating, thus reducing the number of fertile root borer females in a treated vineyard. Pheromone ties are dispensed manually at a rate of 100 ties per acre. They should be placed on the top trellis wire every six or seven vines. Results from these trials look promising, but

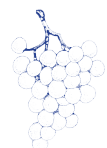

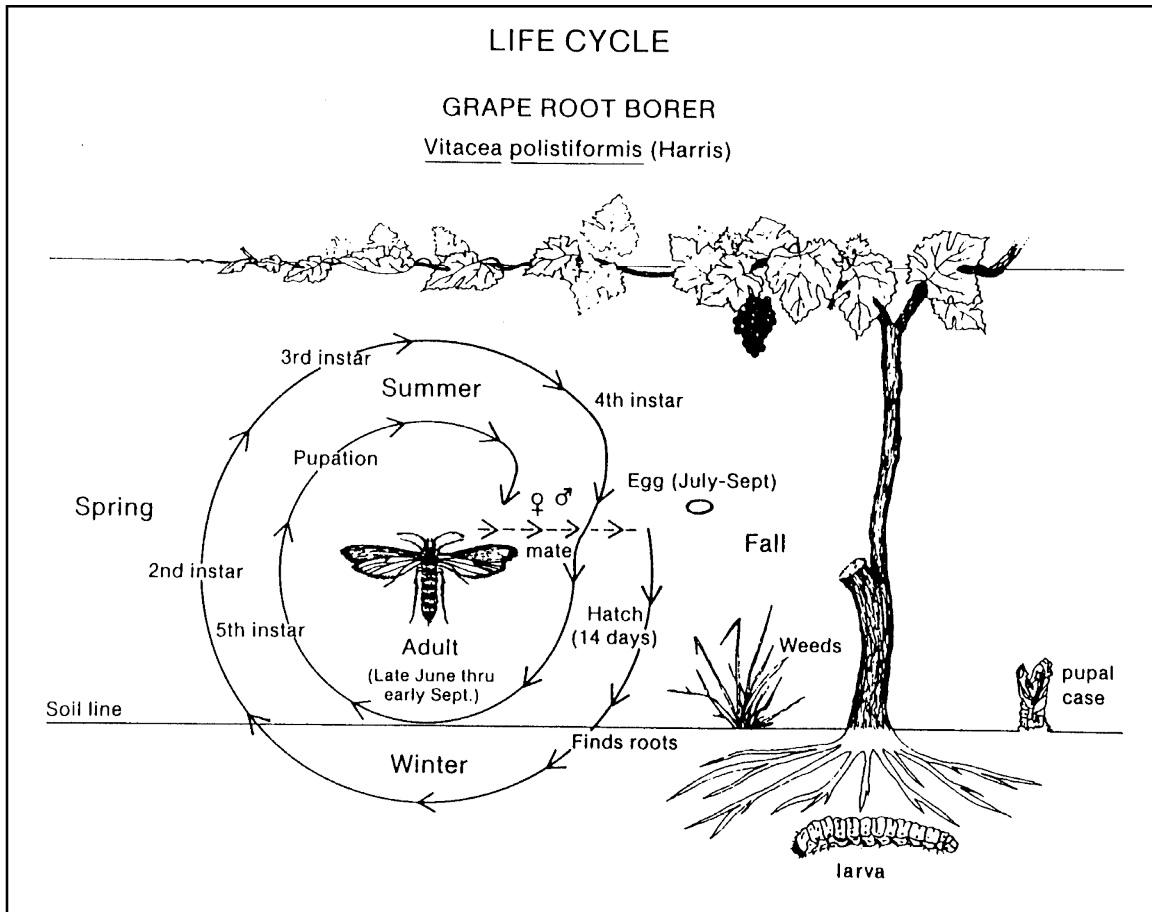

Figure 213. Life cycle of the grape root borer.

bringing the borer population down to acceptable levels requires several years.

Behavioral Control by Trapping-Out

Another method of using the grape root borer pheromone for control is being studied at two southern Ohio vineyards. Trapping-out uses the sex pheromone placed within IC Pherocon sticky traps. Traps are placed around the vineyard perimeter in late June at 35- to 50-foot intervals in an attempt to reduce the number of males available for mating. These traps should be checked on a weekly basis. Where infestations are high, many borers will be trapped, resulting in the need for removal of some of the trapped adults or replacement of the trap bottoms. Three years of study have shown the male population is continuing to decline by an average of about 30% per year. This method requires a continued effort year after year to reduce pressure in subsequent years. This method is still experimental at this time but certainly appears to be working.

Monitoring

Pheromone traps are the only means to easily monitor this pest. Response by male root borer moths to this sex pheromone is strong. A minimum of three pheromone traps should be placed transecting the vineyard in a diagonal manner. Traps should be in place by late June and checked on a weekly basis thereafter. A single pheromone cap (lure) within a trap will last the entire season.

Chemical Control

Chemical control of this pest is difficult due to its cryptic nature. Chemical control of emerging adults or newly hatched larvae will give some assistance if repeated over a wide area. Insecticide should be diluted according to label directions and applied to the soil surface on a 15-square-foot area around the base of each vine when the first adult males are captured in the pheromone traps; in southern Ohio, this usually occurs in the last week of June or very early in July. This application provides a toxic barrier,

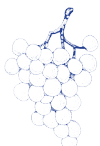

which newly hatched larvae must penetrate to gain access to the grape vine's root system.

Mites That Attack Grapes

European Red Mite

(*Panonychus ulmi*; order Acari, family Tetranychidae)

Damage

The European red mite causes considerable damage to apples in some orchards; it also becomes a problem in vineyards from time to time. The adults and nymphs of this species feed on the undersurfaces of leaves, and in heavy infestations, the leaves turn a bronze color. If bronzing occurs early enough in the season, a negative effect on fruit ripening can occur as feeding can interfere with the normal photosynthetic process of the leaves.

Appearance

The adult female of the European red mite is dark red to reddish-brown, has eight legs, and is about 1/50-inch long (Figure 214). Adult male mites are smaller than females and have a pointed abdomen; they are usually dull green to brown. Eggs are onion-shaped and red (Figure 215). The eggs are tiny and require a magnifying glass to be seen.

Life Cycle

Eggs are laid on the undersides of leaves in the summer. During late summer and early fall, eggs are laid around cane nodes, where they overwinter. Several generations occur each season.

Biological Control

In some vineyards this pest is kept at low levels by naturally occurring predatory mites and predaceous insects.

Monitoring

Monitoring for European red mite can be accomplished by looking at the underside of the leaves for their presence at the same time you are scouting your vineyard for leafhoppers and grape berry moth. You may also keep a close eye out for bronzing while traveling through the vineyard on your tractor. This can be done at the same time you are applying fungicide sprays to the vineyard.



Figure 214. European red mite.



Figure 215. European red mite eggs.

Control

Growers should apply miticide sprays before bronzing occurs. Fortunately, predatory mites on grapes show considerable resistance to a number of pesticides, in particular the organophosphates. Some chemicals reduce leafhopper and/or spider mite populations while allowing predatory mites to maintain control of the latter. Ideally, treatments should be applied so that mites are reduced below economic levels without killing predatory mites or reducing their food source to the extent that they starve.

Weed Management in Grapes

Weeds can be a major problem in vineyards. Weeds compete for water, nutrients, and sunlight. One or two years before planting grapes, begin to reduce perennial weeds such as dock, quackgrass, multiflora rose, poison ivy, Canada thistle, Johnsongrass, and brambles (see the section on *Controlling Weeds Before Planting*, page 178). Many different methods can be used to control weeds in established vineyards, but knowledge of the soil type, timing of herbicide application, use of irrigation, and equipment

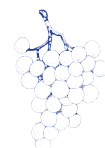

are several factors for successful weed control. Cultivation by hand hoeing can be done in a small vineyard. Certain types of rotary or cultivating machines, such as the grape hoe, are available but the risk of trunk and root injury is high.

Maintain a 3- to 4-foot weed-free zone under the vines for good growth. Establish a permanent sod cover between the rows either prior to planting or immediately after planting to prevent erosion. Companion grass is recommended for this purpose. Mulching with organic materials such as corncob, sawdust, composted grape pomace, or fine wood chips can reduce weeds, increase moisture, and reduce erosion. Plastic mulches are also beneficial, especially when applied at planting, and can provide nearly complete weed control. Mulching is good on sandy or coarse soils but avoid heavy mulching on poorly drained soils.

After planting, apply a preemergence herbicide to control annual weeds if plastic is not used (Table 5-4). Spot treat or remove weeds around plants by hand. Do not allow systemic herbicides or pre- or post-emergence herbicides to touch young grape leaves. In the second year, apply approved herbicides if the plants have grown and only the trunk (not the leaves) is in contact with herbicides. If vines are not touching the first wire in the second year, treat them as newly-planted vines and use only herbicides approved for newly transplanted grapes. As vines become established and the trunk becomes mature, certain herbicides can be used for persistent weeds.

In coarse or sandy soils with less than 2% organic matter, certain herbicides should not be used.

Sinbar, Princep, and Karmex may damage young or mature vines. Reduce the rate or use other less toxic herbicides. Follow local recommendations and those listed on the label.

Injury from herbicides can be confused with disease or insect injury. Herbicides used on grain crops and around non-crop land such as forests, ditches, power lines, railways, or roads may also contain harmful ingredients that injure grapes. Drift from some of these compounds can cause injury from 1/4 to 1/2 mile or more. If injury is not severe, normal growth will resume the following year. Severely injured vines may die or not recover for two years or more. Fruit ripening can be delayed, and injury may persist for several years. Concord is most susceptible to 2,4-D injury. Prevent drift on your farm and ask others to spray when winds are calm. Be sure chemicals are labeled for vineyards. Improper use of labeled chemicals can result in severe crop damage or lack of weed control.

Fall-applied applications may be required to control emerging winter annuals, which develop from September through November. Glyphosate (Roundup) may be used to control low growing perennials if applied after leaf-fall (Table 5-5). Full rates in the fall can control annual weeds until early spring. If the fall has high rainfall or the soil is coarse and sandy, a half rate in the fall and a half rate in the spring may provide weed control through to mid- or late-summer. For a complete discussion of methods used in a weed control program, see *Weed Management: General Information and Guidelines*, page 172.

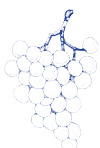

Table 5-4. Weed Management in Grapes, Transplant Year.		
Weed Problem	Herbicide and Rate/Acre	Comments and Limitations^a
Preemergence Weed Control		
Annual grasses and small seeded broadleaf weeds	Devrinol 50DF 4 to 6 lb.	Apply after transplanting to weed-free soil. Devrinol must be activated within 24 hours by cultivation or enough water by irrigation or rainfall to wet the soil to a depth of 2 to 4 inches. The full rate may not be necessary at transplanting.
	Surflan 4AS 2 to 4 qt.	Do not apply until soil has settled around the plants and no cracks are present. Irrigation or 1 inch of rain is needed within 14 days of application. Shallow cultivation will improve control. Do not make more than one application per season.
	Prowl 4EC 2 to 4 qt.	Apply to weed-free soil directly beneath vines. Do not apply if buds have started to swell. For non-bearing vines only.
Broadleaf weeds, some grasses, and some perennial weeds	Casoron 4G 150 lb.	Apply in late fall/winter for best results. Incorporate lightly for best results during warm weather. The soil must be settled and the plants recovered from transplant shock before application.
Postemergence Weed Control		
Emerged annual and perennial grasses	Fusilade DX 16 to 24 oz.	Will not control broadleaf weeds or sedges. Do not apply to crops that will be harvested within one year of application. Do not apply if rainfall is expected within one hour or if grasses are under drought stress. Must be used with a crop oil concentrate or non-ionic surfactant.
	Poast 1.5 to 2.5 pt.	Will not control broadleaf weeds or sedges. Do not apply to grasses under stress (<i>e.g.</i> , drought). Crop oil concentrate must be added to the spray tank. Do not cultivate within five days before or seven days after application. Do not apply more than 5 pints per acre per year.
Emerged annual grasses and broadleaf weeds. Suppression of emerged perennial weeds.	Gramoxone Extra 2-3 pt. <i>Directed spray only.</i>	Contact herbicide. Use with a non-ionic surfactant. Apply as a coarse directed spray on a warm calm day to wet the seeds. Avoid application to foliage or green shoots. Use of a shield is highly recommended.
^a Before using, read comments on herbicides in Table 6-2, Small Fruit Herbicides, on page 175.		

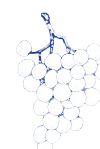

Table 5-5. Grape Herbicides in Established Plantings.		
Weed Problem	Herbicide and Rate/Acre	Comments and Limitations^a
Preemergence Weed Control		
Annual grasses and small seeded broadleaf weeds.	Devrinol 50DF 4 to 6 lb.	Apply to soil in the early spring before seedling weeds emerge. Devrinol must be activated within 24 hours by shallow cultivation or with enough rainfall or irrigation to wet the soil to a depth of 2 to 4 inches.
	Surflan 4AS 2 to 6 qt.	Apply to weed-free soil in the spring. Irrigation or 1 inch of rainfall is needed within 14 days of application. Do not make more than one application per year.
	Solicam 80DF 2.5 to 5 lb.	Apply in early spring, when the crop is dormant, to clean, weed-free soil. Do not apply after bud-break. Do not apply to coarse soils. Do not use on nursery stock. VINES MUST BE TWO YEARS OLD BEFORE APPLICATION.
	Kerb 50WP 2 to 8 lb.	Apply in early spring for preemergence control of weeds or as a directed fall application after harvest, but prior to leaf drop and soil freeze-up. Do not apply to vines less than one year old.
Broadleaf weeds, some grasses, and perennial weeds.	Princep 80WP 2.5 to 5 Caliber 90 2.2 to 4.5 Princep 4L 2 to 4 qt.	VINEYARD MUST BE ESTABLISHED AT LEAST 3 YEARS. Do not replant to other crops for 2 years. Apply in early spring. Do not apply on gravelly, sandy, or loamy sand soils or injury may result.
	Karmex 80WP 2.0 to 4.0 lb.	VINEYARD MUST BE ESTABLISHED AT LEAST 3 YEARS. Apply after harvest in the fall or in early spring.
	Casoron 4G 150 lb.	Use at temperatures below 40°F. May cause injury if plants are not well established. Apply in late fall or winter for best results.
	Goal 1.6E 2.5 to 10 pt	VINEYARD MUST BE ESTABLISHED AT LEAST 3 YEARS. Use a minimum of 40 gallons of water per acre, directed to the soil at the base of vines. Soil surface should be smooth and free of trash. Apply only to dormant vines. Do not apply to vines that are not staked or trellised.
Postemergence Weed Control		
Emerged annual grasses and broadleaf weeds. Suppression of emerged perennials.	Gramoxone Extra 2-3 qt. <i>Directed spray only.</i>	Contact herbicide. Use with a non-ionic surfactant. Apply as a coarse directed weed spray on a warm calm day to wet the weeds. Avoid application to foliage or green shoots. Use of a shield is highly recommended.

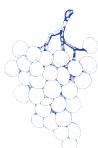
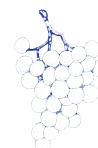

Table 5-5 (Continued). Grape Herbicides in Established Plantings.		
Weed Problem	Herbicide and Rate/Acre	Comments and Limitations
Postemergence Weed Control		
Emerged annual and perennial broadleaf weeds and grasses.	Roundup 1-4 qt. <i>Directed spray only.</i>	Do not allow spray, drift, or mist to contact green bark, suckers, or foliage. Suckers within the spray zone should be removed before application to reduce risk of crop damage. Use of a shield is highly recommended. Applications must be made prior to the end of bloom stage. Do not apply within 14 days before harvest. Do not apply in fall.
Emerged annual and perennial grasses.	Poast 1.5 to 2.5 pt.	Effective on actively growing grasses. Do not apply to grasses under stress (<i>e.g.</i> , drought). Crop oil concentrate must be added to the tank. Do not cultivate within five days before or seven days after application. Do not apply within 50 days before harvest or exceed 5 pints per acre per year.
NOTE: For broad spectrum weed control, consider applying one of the four grass herbicides (Devrinol, Surflan, Solicam, or Kerb) in addition to one of the following broadleaf herbicides (Princep, Karmex, Goal, or Casoron).		
CHECK VINEYARD AGE RESTRICTION BEFORE USING ANY HERBICIDE.		
^a Before using, read comments on herbicides in Table 6-2, Small Fruit Herbicides, on page 175.		





CHAPTER 6

Weed Management

General Information and Guidelines

The primary goal of weed management is to optimize yield by minimizing weed competition. Weeds reduce yields by competing with the crop for water, light, and nutrients. Weeds intercept crop protectant sprays, preventing penetration to crop foliage. Weeds may promote development of disease by maintaining high humidity in the crop canopy, and some species are alternate hosts for pathogens and insect pests. Timely cultivations, wise use of herbicides and mulches, and prevention (never letting weeds go to seed) are integral parts of a good weed management system.

Among the factors that can influence weed control are the species present, their stage of growth when controls are applied, crop competition, soil characteristics, and rainfall or irrigation. Understanding how each of these aspects may affect weed control will enable the grower to develop an effective weed-management program. In addition, the weed-management program must be thought of as a continuous management effort and not as a seasonal duty. Make it a practice to record any changes in predominant weed species and to modify the control program in response.

Often, repeated use of one successful control technique can lead to shifts in composition of the weed community. This happens when weeds that are not controlled by the technique in use (these species are referred to as *escapes*) become the most prevalent species in time. When weed shifts occur, or preferably before they become serious, change the control tactic to one that will control *escapes* (Table 6-1). Obviously, the ability to correctly identify weeds is essential to selection and proper use of controls. Images of many of the most common weed problems in berry crops are found on page 188.

Weed Identification and Scouting

Identifying weeds is essential so that the right control tactic can be used. Several excellent guides to weed identification are available. One we have found particularly useful is *Weeds of the Northeast*, published by Comstock Press. On-line weed identification guides can be found on most university Internet sites. Patches of perennial weeds must be located and identified so that rhizomes, stolons, and rootstocks can be destroyed by herbicide spraying and cultivation well in advance of planting. Problem annuals may also be identified during the pre-planting year, and controls, such as summer fallow, can be used to reduce weed seed in the soil before planting. Scout for weeds every year.

In the establishment year, scouting should begin in spring even before planting so that prevalent annual weeds can be identified and controls planned. After planting, and in fruiting years, scout for weeds whenever fields are scouted for insects and diseases or at least weekly during May to early July and again in late August to late October. Pay careful attention to problem weeds in the field at harvest time as many controls can be implemented during renovation. Scout renovated fields carefully in late summer and early fall when many winter annuals germinate. Scouts should watch for occurrence of new and invasive weeds and perennials such as quackgrass and Canada thistle at all scouting opportunities. Record the distribution of each species as:

- GENERAL = found throughout the field
- LOCAL = found in a small portion of the field
- SPOTTY = found in just a few places.

Also record the density of each species as either:

- 1 = Scattered, just a few weeds
- 2 = Slight, 1 weed per 6 feet of row
- 3 = Moderate, 1 weed per 3 feet of row
- Severe = More than 1 weed per 3 feet of row.



Table 6-1. Weed Susceptibility Table for Small Fruit Herbicides.

Weeds	Cul-ti-va-tion	Caso-ron	Kar-mex	Fusi-lade	Round-up	Dev-rinol	Soli-cam	Sur-flan	Gram-ox-one	Kerb	Poast	Prin-cep	Sin-bar
Broadleaf Weeds													
Bed-straw	G	G	P	P	--	--	--	F	P	P	P	--	
Bittercress	G	G	G	P	G	G	--	P	G	P	P	F	G
Buckwheat, wild	G	G	G	P	G	--	--	--	G	--	P	GG	--
Chickweed	G	G	G	P	G	G	G	G	G	G	P	GG	--
Clovers	F	--	P	P	P	--	--	P	P	P	P	P	--
Corn Spurry	G	G	G	P	G	G	--	G	G	--	P	GG	--
Dandelion, common	F	G	P	P	G	G*	G*	P	P	P	PG*	F	--
Dandelion, False	P	G	P	P	G	P	G*	P	P	P	P	G*	P
Field Bindweed	P	F-	P	P	P	F	P	--	P	P	P	P	P
Field Horsetail	P	G	P	P	P	P	P	P	P	P	P	P	P
Field Violet/Pansy	G	-	-	P	G	P	-	-	G	-	P	F	F
Filaree, redstem	G	G	F	P	G	G	G	P	F	P	P	PG	--
Geranium	G	G	G	P	G	G	--	--	G	P	P	--	--
Groundsel, common	G	G	F	P	G	G	F	P	G	P	P	F	F
Henbit	G	G	G	P	G	P	G	F	G	F	P	G	F
Knotweed	F	G	F	P	G	F	G	G	P	F	P	GG	--
Ladysthumb	G	G	G	P	G	G	G	G	F	F	P	F	G
Lambsquarter	G	G	G	P	G	G	G	G	F	F	P	F	G
Mustard, wild	G	G	G	P	G	G	G	G	G	F	P	GG	--
Nightshade, black	G	G	G	P	G	P	G	P	G	F	P	GG	--
Pigweed, redroot	G	G	G	P	G	G	F	G	G	P	P	F	F
Pineappleweed	G	--	G	P	G	G	G	PG*	P	P	--	G	--
Plantain	G	G	P	P	G	--	P	G	P	P	G	G	--
Prickly lettuce	G	--	G	P	G	G	--	P	G	P	P	GG	--
Purslane	G	G	G	P	G	G	F	G	G	F	P	G	G
Shepherd's Purse	G	--	P	G	G	F	P	G	P	P	F	G	--
Sowthistle, annual	G	--	F	P	G	G	F	P	G	P	P	F	G
Tansy Ragwort	F	G	P	P	G	P	--	P	G*	P	P	--	P
Thistle, bull	G	G	P	G	--	--	F*	P	P	PG*	F	--	--
Thistle, Canada	P	G	P	P	G	P	--	P	P	P	P	--	P
Grasses													
Barnyardgrass	G	G	G	G	G	F	G	G	G	P	G	F	F
Bluegrass, annual	G	G	G	P	G	G	G	G	G	G	P	GG	--
Crabgrass	G	G	F	G	G	G	G	G	G	F			G*
Foxtail	G	G	G	G	G	G	G	G	G	F	G		G*
Johnsongrass	G*	-		F	G	G*			G*		G		G*
Quackgrass	P	G	P	F	G	P	P	P	F	G	P	P	F
Ryegrass, annual	G	--	G	F	GG*	G	G	G	G	G*	G	--	--

G = Good (85%-100%), F = Fair (70%-84%), P = Poor (0%-69%), -- = Response not known, * = Seedling stage only.



Pay special attention to low spots, wet areas, and field margins where new weed problems develop first. Many species will fall into the GENERAL category and will be the primary targets of the weed-control program.

LOCAL distribution may indicate that the species has been recently introduced to the field, and eradication by preventing seed production may be possible.

SPOTTY distribution of common weeds, such as lambsquarters, may indicate that herbicide resistant bio-types have developed, in which case herbicides with alternate modes of action should be adopted.

Take samples of weeds that cannot be identified in the field. Small weeds (less than 1-inch high) can usually be dug up with a small amount of soil attached to, and protecting, the roots. Samples should be placed in an inflated zip-lock bag and placed in a cooler for later identification. In some instances it may be necessary to plant unknown seedlings in the greenhouse and allow them to size up before identification can be made.

Action thresholds for weeds have not been established for berry crops. Berry crops do not compete well with most weeds, and maintenance of nearly weed-free conditions is important for optimum production. Therefore, it is best to prevent weed seed production within the berry field, thereby reducing future weed problems.

Combining cultivation, hand weeding, and herbicide use is essential to maintain good weed control. Cultivation, hoeing, and hand weeding are most effective when weeds are small (less than 1/2 inch in height). Herbicides should be selected and applied at the appropriate timing to control the most dominant species (see Table 6-2).

But, remember that species occurring in small numbers that are not controlled may quickly become the dominant species! Therefore, carefully remove weeds that tolerate herbicides before they go to seed, thereby, preventing buildup of resistant species.

Cultural Controls

Cultural controls are those good agricultural practices that minimize the growth of weeds, while optimizing crop growth. Many decisions

and practices influence the effectiveness of cultural controls. These include:

- **Site selection** — Well-drained, coarse-textured soils, that are free of perennial weeds. Repeated tillage and cultivation one or two years before planting reduces perennial and annual weeds (see the section on *Controlling Weeds Before Planting* on page 178). If a field has been in sod or pasture for several years, cultivation reduces grubs that feed on strawberry roots which can reduce plant vigor and cause the loss of plants. After cultivation, plant a crop that does not increase verticillium wilt disease, nematodes, or insects (see *Preplant Cover Crops* beginning on page 184). For strawberries, consider a grain crop such as wheat, which can be used for straw mulch for winter protection and disease control in the berry crop.
- **Crop rotation** — The seeds of annual weeds in the soil (the weed seed bank) can be reduced by planting a series of annual crops prior to planting berries. Field or sweet corn is an excellent rotational crop because cultivation and chemical weed control can reduce weeds. With sweet corn, the crop is harvested by early August, making the field available for winter cover crops or additional chemical weed control, cultivation, or fumigation in the fall before spring planting. Successive grain crops or rotating from legumes to grain and to strawberries are rotations that have been used successfully.
Be sure to use herbicides in the preceding crop that will not leave a high residual in the soil when berry crops are planted six to 12 months later. Inserting a period of summer fallow the year before planting berries can be very effective in reducing the number of annual weed seeds in the soil. Summer fallow consists of tillage and cultivation to prepare a good seed bed for germination of weed seed followed by harrowing or light disking whenever a flush of weeds occurs. To be effective, harrow when weed seedlings are in the cotyledon stage. Non-crop land can be mowed several times during the year to prevent annual weeds.
- **Soil fertility and water use** — Provide the optimum fertilization for the berry crop, based upon testing the soil before planting. Consider trickle irrigation that will place irrigation water



Table 6-2. Small Fruit Herbicides.			
Common Name (Trade Name)	Formulations	For Use On	Comments
PREEMERGENCE GRASSES			
Dacthal (DCPA)	W-75	Strawberries	Good on annual grasses, chickweed, and lambsquarter. Poor on perennial grasses and broadleaves.
Casoron, Norosac (Dichlobenil)	4 G	Blueberries Brambles	Good on annual and perennial grasses.
Devrinol (Napropamide)	50 DF	Blueberries Brambles Strawberries Grapes	Good on annual grasses, chickweed, knotweed, thistle, and sorrel. Requires water or cultivation to activate. May inhibit rooting of strawberry daughter plants.
Surflan (Oryzalin)	4 AS	Blueberries Brambles Grapes	Good on annual grasses, lambsquarters, pigweed, and purslane.
Sinbar (Terbacil)	80 WP	Blueberries Brambles Strawberries	Good on annual grasses and broadleaf weeds such as chickweed, crabgrass, foxtail, henbit, mustards, nightshade, ragweed, prickly lettuce and smartweed. Partial control of quackgrass, nutsedge, and sorrel. DO NOT MIX OR USE IN CLOSE SEQUENCE WITH GRASS HERBICIDES SUCH AS FUSILADE, POAST, OR SELECT. SEVERE CROP INJURY MAY RESULT.
Solicam (Norflurazon)	80 DF	Blueberries Brambles Grapes	Good on annual grasses and broadleaf weeds. Will suppress nutsedge and perennial grasses.
Kerb (Pronamide)	50 WP	Blueberries Grapes	Good on annual grasses and some broadleaf weeds.
PREEMERGENCE BROADLEAF WEEDS			
Casoron, Norosac (Dichlobenil)	4 G	Blueberries Brambles Grapes	Good on annual and perennial grasses.
Princep, Caliper 90 (Simazine)	90 WDG 4 L	Blueberries Brambles Grapes	Fair control on grasses but good control of broadleaves.
Sinbar (Terbacil)	80 WP	Blueberries Brambles Strawberries	Good on annual grasses and broadleaf weeds such as chickweed, crabgrass, foxtail, henbit, mustards, nightshade, ragweed, prickly lettuce, and smartweed. Partial control of quackgrass, nutsedge, and sorrel. DO NOT MIX WITH GRASS HERBICIDES SUCH AS FUSILADE, POAST, OR SELECT. SEVERE CROP INJURY MAY RESULT.
Karmex (Diuron)	80 WP 80 DF	Blueberries Brambles Grapes	Good on annual grasses and broadleaf weeds. Good on lambsquarter, mustard, nightshade, pigweed, and purslane.



Table 6-2 (Continued). Small Fruit Herbicides.			
Common Name (Trade Name)	Formulations	For Use On	Comments
POSTEMERGENCE GRASSES			
Fusilade DX (Fluazifop)	2 E	Blueberries Brambles Grapes Strawberries	Good systemic/selective grass herbicide and poor on broadleaf weeds. Labeled only for non-bearing crops. Do not apply one year before harvest. Must be used with non-ionic surfactant or crop oil concentrate. DO NOT MIX WITH SINBAR, KARMEX, OR PRINCEP.
Poast (Sethoxydim)	1.5 EC	Blueberries Brambles Grapes	Action similar to Fusilade. Do not tank mix with 2,4-D. Preharvest interval varies on each crop. Must be used with crop oil concentrate. DO NOT MIX WITH SINBAR, KARMEX, OR PRINCEP.
Select (Clethodim)	2 EC	Strawberries	Action similar to Poast and Fusilade but generally more effective. Controls annual/perennial bluegrass and is also very effective on quackgrass. Must be used with crop oil concentrate. DO NOT MIX WITH SINBAR, KARMEX, OR PRINCEP.
Gramoxone Extra (Paraquat)	2.5 E	Blueberries Brambles Grapes Strawberries	Good on annual weeds but poor on perennials. Directed spray only kills vegetation.
Roundup (Glyphosate)	Various	Blueberries Brambles Grapes Strawberries	Good on perennial grasses and broadleaf weeds. Directed spray only, or wiper only. Contact with foliage or green bark of crop plants may result in severe injury or death. For wick or wiper applications, mix 1 gallon of Roundup in 4 gallons of water to prepare a 20% solution.
POSTEMERGENCE BROADLEAF WEEDS			
Formula 40 (2,4-D amine)	4 E	Strawberries	Excellent control of morning glory, cocklebur, lambsquarter, pigweed, ragweed, smartweed. Good control on dandelion. Poor on grasses. Used at renovation. Allow 5 days before mowing.
Gramoxone Extra (Paraquat)	2.5 E	Blueberries Brambles Grapes Strawberries	Good on annual weeds but poor on perennials. Directed spray only kills vegetation.



and nutrients in the zone of crop roots while minimizing availability to weeds growing between the rows.

- **Cultivar selection** — Only plant adapted, vigorous transplants that will compete with weeds. Consider that some crop cultivars vary in sensitivity to certain herbicides.
- **Planting density** — Dense plantings compete best with weeds.
- **Mulches** — Black or opaque plastic can be used to prevent weed growth for one or more years. Straw and various other mulches can prevent or reduce weed growth, depending on the amount used.
- **Sanitation and prevention** — The old adage that says *One year's seeding, seven year's weeding* should be heeded by every berry grower. Preventing new weeds from invading the farm and minimizing or eliminating seed production in the field will prevent future weed problems. Prevention of weeds is best practiced by careful attention to cultural practices, such as cleaning equipment before moving it into the field, using clean straw mulch, and preventing annual weeds from producing seeds. Pay careful attention to any weed that is new on the farm; it may soon be your worst weed problem if it goes to seed. Ensure that straw used to mulch strawberries is weed free; for instance, grow your own straw and practice excellent weed control throughout its production.

Mechanical Controls and Hand Weeding

Hand hoeing and mechanical cultivation are important components of weed management in berry crops, particularly during the establishment year. Cultivate and hoe carefully to prevent damage to the root systems and above-ground portions of the berry plants. Blueberries in particular have shallow root systems that are easily damaged during cultivation. Remove all established weeds between the rows and within rows during establishment in order to obtain maximum sunlight for growth. Maintaining full sunlight throughout the establishment year is essential to obtain maximum flower bud formation in berry crops. In strawberries, mechanical cultivation between rows is necessary to train runners during the establishment year and to maintain a row width of

12 to 18 inches at renovation, with no more than 20 to 24 inches in early September. Cultivation is also important to incorporate fertilizer and herbicides.

Chemical Controls

Herbicides can be used to control weeds in most berry crops. Because they are selective, there will always be some escapes, and these, if not controlled, will in time become the dominant weeds in the field. To prevent this, do not depend exclusively on herbicides. Cultivate, hoe, and pull escapes. Rotate crops and be sure to use herbicides with differing modes of action in rotational crops.

Herbicides recommended in this guide are referred to by their brand name, and application rates are provided in the actual amount of product per acre. The guide provides enough information to assist you in selecting a herbicide for a particular crop and weed situation. For complete information, it will be necessary to consult the label. Too often growers neglect the label until something goes wrong. Wouldn't it be better to spend 20 minutes reading the label in advance and thereby preventing problems from ever developing? Labels contain explicit directions on using herbicides correctly and indicate all weeds that are controlled. Full text labels and Material Safety Data Sheets (MSDS) should be provided by your dealer. They can also be obtained for most herbicides over the Internet from company web sites or from compilers such as C & P Press, Inc., *GREENBOOK* at <http://www.greenbook.net> or from CDMS, Inc., at <http://www.cdms.net/manuf/manuf.asp>.

Herbicides used to control weeds in berry crop plantings are applied:

- **PREPLANT** — Preplant treatments applied before the crop is planted.
- **PRE** — Preemergence treatments, applied at the time of planting or some time before weed seedlings emerge.
- **POST** — Postemergence treatments, applied after planting and after weed seedlings have emerged.

Mixing two or more herbicides may improve control and the spectrum of weeds controlled, while minimizing required rates. However, do not mix herbicides unless the mixture is approved on at least one label of the products intended for use.



Berry crops can be injured by residues of herbicides used in preceding rotational crops, residues that still remain in the soil. Herbicides used to control weeds in corn and soybeans are most likely to carry-over and damage berry crops. A few herbicides will damage berry crops two or more years after they were last used. If you purchase or rent new land, be sure to ask the owner or manager about herbicides used in previous years — the farther back, the better! Labels contain information on permissible rotational crops and the required time interval between use and rotational crops.

A bioassay is the simplest and most cost-effective method to check for herbicide carry-over. To do this, collect, at random, soil from all areas of the field in question. Sample the root zone, typically 6 inches deep. Each test requires about 1 gallon of soil. Ends of fields, knolls, and low areas often have higher residues and may need to be tested separately. Collect a second sample from a nearby area of the same soil that was not treated with herbicide and use this for a control (for comparison) soil. If untreated soil is not available, add 1 teaspoon of activated charcoal per quart of dry soil and mix thoroughly. Activated charcoal can be purchased at most drug stores. Three or four pots of the test and control soils should be made and seeded out to oats, radish, and lentils. Place the pots in a warm, sunny location and monitor seedling growth for the symptoms described in the table. If any injury is noted, then contact your pesticide dealer or local Extension specialist for advice on the probable sensitivity of berry crops.

Herbicide Application

Berry crops can be easily injured if too much herbicide is applied. To prevent this, calibrate the sprayer frequently and adjust nozzle tips to the proper height above soil level. Herbicides should be applied with a boom sprayer. Backpack and airblast sprayers should not be used because they will not give uniform application. Calibration of boom sprayers and mixing of pesticides are described in Chapter 8 of this publication. An excellent fact sheet from Ohio State University Extension that provides detailed information on this subject is *AEX-520, Boom Sprayer Calibration*. This fact sheet can be downloaded from the Internet at <http://www.ohioline.osu.edu/aex-fact/0520.html> and Ohio residents can also obtain it from most county offices of OSU Extension.

Controlling Weeds Before Planting

Many of the worst weeds found in berry crops are perennials such as quackgrass, johnsongrass, yellow nutsedge, Canada thistle, and field bindweed. Perennials spread and reproduce mainly by underground root stocks or rhizomes and are very difficult to control once berry crops are planted. Therefore, eliminate all perennial weeds before establishing a new planting by using a planned program of tillage, rotational crops, and herbicides. Time and money spent before planting will eliminate the need for more costly and on-going weed control methods during the establishment and production years. In addition, without the presence of competing perennial weeds, there will be a greater potential for vigorous, healthy establishment of the small fruit crop.

Glyphosate, hereafter referred to as Roundup or Touchdown (many formulations and brands are available though most simply refer to this herbicide as Roundup), applied directly to the foliage of perennial weeds before plowing is the most effective means of control. Roundup application must be timed correctly and the right rate used for the perennial weeds you are trying to control. Most perennials are best controlled with fall-applied Roundup. Grasses should be at least 8 inches tall when treated. An extended period of drought just before spraying may adversely affect control. Spring applications are effective on grasses but do not provide as good control of broadleaf perennials as fall applications.

Descriptions of the perennial weeds presented here were extracted from the *Ohio Perennial and Biennial Weed Guide*, which is available on the Internet at www.oardc.ohio-state.edu/weedguide/. In the recommendations for controlling these weeds, application rates are provided for two of the most common formulations of glyphosate. The use of these brand names does not imply an endorsement of these over other glyphosate products, nor a criticism of those products that are not named.

Canada Thistle

Canada thistle can be treated in the flower bud to flowering stage in early summer or in late summer and fall during the rosette to flower bud stage. In fallow fields, stop tillage in late July and allow thistles



to regrow for at least five weeks. Apply Roundup Ultra or Touchdown before a killing frost and when Canada thistle regrowth reaches the flower bud stage or is at least 10 to 12 inches high. Apply Roundup Ultra at 2 to 3 quarts per acre in 5 to 10 gallons of water or Touchdown at 2 quarts per acre. Spot sprays of a 2% solution (0.5 pints in 6 gallons of water) of either herbicide will also be effective.

Field Bindweed

Field bindweed is a twining perennial vine. Characteristics distinguishing it from other vines include arrowhead-shaped leaves, thin stems, pinkish petals fused into funnel-shaped flowers, the presence of small bracts attached to flower stalks about an inch below the base of the flower, a perennial taproot, and invasive rhizomes (horizontal underground stems). The plant reproduces by seeds and regenerates new plants from adventitious buds on roots and rhizomes. Field bindweed must be treated when it is actively growing and at or beyond bloom. Fall treatment is best, but apply herbicides before a killing frost. Apply Roundup Ultra at 3 to 4 quarts or Touchdown at 5.33 pints per acre. Spot spray with a 2% solution of either product.

Horsenettle

Horsenettle is a perennial that spreads through creeping rootstocks, in addition to reproduction by seed. A main distinguishing feature of horsenettle is the bristly stem, which is covered with hairs and spines. Leaves are alternate, oblong, and lobed, with yellow prickles on the petioles, midrib, and veins. The plant produces juicy, yellow berries that are about 1/2-inch in diameter and contain the seeds. Horsenettle is found mainly in no-till fields and is difficult to control. It typically emerges after crop planting, and postemergence herbicides are only marginally effective. Apply Roundup Ultra at 2.5 to 4 quarts per acre or use a 2% solution for spot treatment, when most of the plants have reached the bud to flowering stage. Banvel at 2 quarts per acre or 2,4-D ester at 2 quarts per acre when horsenettle is in the late bud to flowering stage can also be effective. Control ranges from fair to good with these treatments.

Hemp Dogbane

Hemp dogbane is a tall-growing perennial broadleaf weed often mistaken for common milkweed. It spreads by seed and over-wintering rootstocks. In Ohio, hemp dogbane tends to appear in areas that have not been tilled for a number of years. Apply Roundup Ultra at 3.25 quarts per acre or a 2% solution for spot treatment when dogbane is in the late bud to flower stage of growth. Roundup and 2,4-D can also be used effectively at 1 quart plus 1 pint per acre, respectively. Treatments following crop harvest or mowing should be delayed until weeds regrow to a mature stage.

Poison Ivy

Poison ivy is a deciduous woody perennial distinguished by its leaves that have three leaflets. The stalk attached to the middle leaflet is considerably longer than that attached to either of the two outer leaflets. Poison ivy grows in a variety of forms, including trailing, shrubby, or a vine. Reproduction is primarily by seeds that are dispersed by birds and animals. Also, it may spread by rhizomes (horizontal underground stems). Stems are capable of forming roots and sending out new shoots when in contact with soil. Apply Roundup Ultra at 2.5 to 5 quarts per acre to thoroughly wet the foliage but do not spray to run-off. Banvel at 1 quart per acre plus Roundup at 2 quarts per acre may also be effective.

Quackgrass

Quackgrass is a creeping, sod-forming perennial grass, characterized by its straw-colored, sharp-tipped rhizomes (horizontal underground stems) and the pair of whitish-green to reddish, claw-like structures (auricles) that clasp the stem at the top of the sheath. It reproduces through seed and creeping rhizomes. This species can form large patches. When killing sod, use Roundup Ultra at 2 quarts per acre or Touchdown at 3.33 pints per acre. Use the 1 quart per acre rate of Roundup Ultra in 5 to 10 gallons of water per acre on land that has been in row crops. Spray when the grass is about 8 inches high and wait at least three full days (72 hours) but generally not more than seven days before plowing. Fall frosts before spraying will not affect control provided at least 60% of the foliage is still green when you spray. If planning a spring application, do not fall plow; simply wait until quackgrass reaches the right growth stage (four to five new leaves) and spray.



Swamp Smartweed

A native of North America, swamp smartweed is a highly variable perennial. It exhibits two forms, terrestrial and aquatic. For this reason, the plant will invade shores, wet prairies, swamps, ponds, ditches, and quiet streams. However, it is quite common for plants to grow in drier soil. Swamp smartweed reproduces using rhizomes (rootstocks) and seeds. Plants normally grow from two-feet to three-feet tall. The stems are usually unbranched and thicken to form nodes at the leaf joints. Swamp smartweed blooms from July to September. The spreading root system allows for competition with other plants while making it difficult to kill the plants. Apply Roundup plus Banvel at 1 quart and 1/2 pint per acre, respectively.

Yellow Nutsedge

Yellow nutsedge is an erect, grass-like perennial, characterized by its shiny yellowish-green leaves, triangular stem, golden-brown flower head, and shallow rhizomes (horizontal underground stems) that produce many nut-like tubers. Young seedlings are often confused with grasses. This species reproduces primarily by tubers and less often by seeds. Rhizomes help to enlarge patches. Nutsedge persists by producing nutlets which grow at the end of rhizomes. Nutsedge emergence continues summer-long as more nutlets break dormancy and shoots emerge from expanding rhizomes. New nutlets begin to form on the end of rhizomes soon after shoot emergence in the spring. Nutsedge control with herbicides is rarely or never complete because insufficient herbicide translocates into the nutlets.

Attack nutsedge one or two years before planting berries using an integrated approach. Apply preplant glyphosate on small nutsedge plants (control with Round Ultra is best when nutsedge is 6 to 12 inches high; earlier applications will provide some suppression — *Monsanto Research*) and/or tillage before planting. For one or two years before planting berries, plant competitive crops and use close spacings. Plant and harvest early season crops before nutsedge emerges, then plant crops with selective herbicides later, around the anticipated time of nutsedge emergency. Selective herbicides can be used for seasonal control in corn, soybeans, dry and snap beans, potatoes, and green peas. Finally make use of post-harvest tillage and summer fallow.

Yellow nutsedge is sensitive to dense shade, thus close spacing of crops such as pumpkins will minimize growth and nutlet formation.

If you do not already have nutsedge in a field, prevent its introduction. Wash all soil from recently purchased equipment before allowing it on your farm. If you have some infested fields and others that are not, or if your equipment is used on fields of other farmers, be sure to wash all soil off the equipment before using it on land that is nutsedge-free. Nutsedge has also been introduced in transplants, nursery stock, and seed potatoes. Make sure all transplant materials were produced under nutsedge-free conditions.

Wild Brambles

Brambles are a diverse group of perennial herbs, shrubs, or trailing vines that are noted for their prickly stems and berry-like, usually edible, fruits. They can reproduce by many different methods including seeds, root sprouts, underground stems (rhizomes), and branches that root at the tips (stolons). In some species, individual stems live only two years, but new stems are continually produced. In all species, roots are perennial; apply Roundup Ultra plus Banvel at 2 quarts plus 1 quart per acre, respectively. Spray foliage till wet but not to runoff.

Water Volumes and Adjuvants with Roundup/Touchdown (Glyphosate)

Low water volumes of 5 to 10 gallons per acre provide best weed control. If higher water volumes must be used, use the maximum rate of glyphosate for the weed to be controlled. At high water volumes, adding a non-ionic surfactant at 0.5% (one pint in 25 gallons) or ammonium sulfate (2 to 4 pounds per acre) to the spray mix will improve control. Always add ammonium sulfate to the water before adding glyphosate. Hard water with more than 500 parts per million of calcium or magnesium will usually reduce glyphosate activity. If hard water must be used, keep the volume low (five gallons per acre) or increase the rate of herbicide. Use clean water. Silt, clay, and organic debris in water will also reduce glyphosate activity.

Table 6-3 provides information on use of herbicides to control perennial weeds during the year before planting and for spot treatment.



Prevalent Weeds	Timing of Treatment^a	Herbicide/Acre^b
Canada thistle	Bud to early bloom stage; regrowth in autumn following tillage.	• Roundup 2 to 3 qt. or 2% spot spray
Field bindweeds	When plants are at or past full bloom and before killing frost.	• Roundup 3-4 qt. or 2% spot spray; • 2,4-D 1 pt. or Banvel 8 oz. + Roundup 1 qt. ^c
Horsenettle	Late bud to flowering	• 2.5-4 qt. Roundup; • Banvel or 2,4-D ester at 2 qt.
Dogbane	Late bud to flowering stage	• Roundup at 3.25 qt.; • Roundup 1 qt. + 1 pt. 2,4-D; • Roundup 1 qt. + Banvel 1/2 pt.
Poison Ivy	7/1 to 9/15	• Roundup 2.5 to 5 qt.; • Banvel 1 qt. + Roundup 2 qt.; • Crossbow 2 qt.
Quackgrass	Spring — 8" tall to heading or Fall — 8" tall regrowth	• Roundup 1 to 2 qt.
Wild brambles	Bud to bloom stage	• Banvel 1 qt. + Roundup 1 qt. • Crossbow 6 qt. (1 to 1.5% solution)
Swamp Smartweed	7/1 to 9/15	• Banvel 8 oz. + Roundup 1 qt.
^a With the exception of quackgrass, apply before frost.		
^b Adding a surfactant to these herbicides will improve their effectiveness; Roundup already contains a surfactant. Rates are given in amounts of commercial product per acre.		
^c Apply Roundup with Banvel or 2,4-D where several weeds are present. Roundup alone is best applied on tall weeds, applied in 5 to 10 G of water per acre with surfactant and ammonium sulfate.		
Follow label recommendations. Do not apply Banvel, 2,4-D, or Crossbow near brambles or grapes.		
Avoid drift. Apply spot treatments using low pressure or a wick applicator.		

Herbicide Types

There are several types of herbicides. Regardless of the type of herbicide, improper concentration, improper calibration, or overlapping the spray can cause reduced yields and death of plants.

Terms Used to Describe Herbicides

- Selective — A selective herbicide (e.g., 2,4-D) will only control certain species or only one type of weed.
- Non-selective — A herbicide that kills all plants, both crops and weeds (e.g., Roundup).
- Contact — A herbicide that kills only the parts of the plant on which it is sprayed (e.g., Gramoxone and Liberty).
- Systemic — A herbicide that is applied to an actively growing weed; it is absorbed through the

leaves or the roots and moves to other areas of the plant.

- Residual — A herbicide that is applied to the soil and remains in the soil for one to several months, or more than a year, continuing to control weeds and potentially damage crops.
- Preplant (PREPLANT) — A herbicide applied to weed foliage before crops are planted, as in site preparation.
- Preemergence (PRE) — A herbicide applied to the soil before weed (and/or crop) emergence.
- Postemergence (POST) — A herbicide applied to the foliage of weeds.

Herbicides are usually formulated as wettable powders (e.g., 50 WP), emulsifiable concentrates (e.g., 2 EC), aqueous suspensions (e.g., AS), or granulars (e.g., 10G). The formulation of a herbicide improves mixing with water, allowing the herbicide



to remain in suspension (does not precipitate into the bottom of the tank), and helps it to adhere to the plant or soil surface. Granular formulations improve the ease of application and minimize contact of herbicides with crop foliage.

Preemergence herbicides are applied before weeds emerge above the soil surface. Postemergence herbicides are applied after weeds have emerged. Residual herbicides are usually applied preemergence to weed-free soil in the spring. Residual herbicides may control weeds for one month, for three to six months, or longer. Some herbicides, including those used on berries, may persist long enough to damage crops planted one or more years after their last use. The best control is achieved when the application is not impeded by trash or actively growing ground cover. Preemergence herbicides may be selective or non-selective, depending upon the rate applied. A post-emergence recommendation indicates that application typically consists of a systemic herbicide and should be applied to actively growing weeds in order for the herbicide to be absorbed by the weed leaves. However, a non-systemic herbicide such as Gramoxone is also applied postemergence to weed foliage. Good coverage is essential because the herbicide does not move. Gramoxone, Liberty, and Roundup Ultra are non-selective and must be directed away from the crop or applied before planting. Selective herbicides only control certain species of weeds; for instance, Poast, Fusilade, and Select only control grasses and can be safely applied to the foliage of berry crops.

Systemic herbicides generally need to be applied when plants are actively growing. This means that the weeds are young, not bearing seeds, and are growing under good soil moisture and moderate temperature conditions. Plants under these conditions are not under stress, have their stomates open, and are respiring normally. For the best control, applications should be made with day-time temperatures of 55°F to 75°F and with six to eight hours drying time (without irrigation or rainfall) for maximum absorption by the weed.

Consult the label or technical bulletin for the range of weeds controlled. Also check the broadcast rate for different types of weeds. Read all precautions for each crop.

What Rate Should Be Used When a Range Is Provided?

Generally, heavier soils require more herbicide than lighter soils, because in heavier soils the chemicals are adsorbed by clay particles and organic matter. The presence of trash on the soil surface can lower the effectiveness of applied herbicides. Therefore, control may be reduced if the herbicide is applied over mulching materials. In the effective use of herbicides, there is no substitute for thorough knowledge of soil and herbicide characteristics.

Selective herbicides will control certain weed species while being ineffective on others. Weeds not controlled are called *misses*, and if the herbicide program is not changed, in time the *misses* will become the prevalent weeds in the field. For this reason, it is essential to accurately identify the weeds in your field and select herbicides that will control those weeds according to the information on the product label. (See *Monitoring Pests and Making Control Decisions*, page 6). Be sure to read and understand the label before using any herbicide. Failure to follow label directions is illegal and may result in crop damage or poor weed control. Preventing injury to the crop plant depends on applying the right herbicide at the correct time and rate of application. Weak, unhealthy, or injured plants can be damaged by herbicides. Environmental conditions, which stress the crop, may also predispose the crop to herbicide injury.

If you choose to try a new herbicide or alter your existing weed-control program, try the proposed program on a limited area first. This will help you decide whether the new program is compatible with the ongoing production system. In addition, it will allow for changes and refinement before full-scale use.

Herbicide rates listed on the product label and in this bulletin are for broadcast applications. Reduce rates proportionally for banded or strip applications. For best results with herbicides, follow the manufacturer's application directions regarding rates, additives, soil type, soil moisture conditions, stage of weed growth, environmental conditions, and product limitations.

Certain herbicides listed in this publication may be discontinued by the manufacturer and thus are no



longer available. Using remaining stocks on dealers' shelves or stored on the farm is encouraged and legal.

Trade names are used for identification. No product endorsement is implied, nor is discrimination intended against similar materials not mentioned. Extension and the participating universities make no warranty or guidance of any kind, expressed or implied, concerning the use of these products.

Herbicide Injury

Crop injury resulting from the use of herbicides is common, particularly on light soils. Most herbicide injury can be traced to using too high a rate on light soils, incorrect timing of sprays, incorrectly calibrated sprayers, sensitive cultivars, and weak plants growing under unfavorable conditions. The grower usually has some control over these factors. Any factor that injures the crop (other pests, winter injury, exposure of crowns and root systems as a result of erosion, improper mineral nutrition, wet spots in the field, etc.) will make the crop more susceptible to injury.

Newly planted berry crops are especially sensitive to herbicides. Crop tolerance increases in late summer and fall. This corresponds to the time when preemergence herbicides can be used to control many winter annual and perennial weeds.

Remember that light, sandy soils require less herbicide than heavier soils for comparable levels of weed control. Berry crops growing on soils low in organic matter are especially prone to herbicide injury. Accordingly, lower rates of herbicide should be used on fields low in organic matter (less than 2%).

To minimize the risk of crop injury, growers must be careful not to exceed maximum recommended annual application rates. They should fully understand and follow the instructions on the product labels. Do not expect herbicides to control all weed problems. Understand that hand weeding and cultivation will be required to obtain complete weed control. Weakened plants are more susceptible to herbicide injury. Conversely healthy berry plants are most capable of tolerating recommended treatment rates.

Be cautious with tank-mixes. Severe Sinbar-type injury has occurred when certain postemergence grass herbicides and Sinbar were tank-mixed or even applied in close sequence.

Methods of Application

Uniform application is absolutely necessary if herbicides are to provide the desired results.

Variations in the spray pattern, speed of the rig, worn nozzle tips, etc., may change the application rate sufficiently to damage the crop or reduce weed control. Devrinol, Dacthal, Karmex, Kerb, Sinbar, and some formulations of Simazine are wettable powders that do not dissolve in water. These herbicides form a suspension in water that can only be maintained by constant agitation in the spray tank. Consequently, you must take several precautions to maintain a uniform application.

Precautions

1. Screens in the line should be no more than 50 mesh to avoid clogging.
2. The material will settle to the bottom of the tank if not constantly agitated. Either continuous mechanical agitation by paddles in the tank or hydraulic agitation by return flow jets (pressure regulator by-pass) is necessary.
3. Wettable powders are abrasive; therefore, do not use these herbicides in gear, roller, or impeller pumps. The clearances in these positive displacement pumps are close; they wear quickly when abrasives are pumped.
4. Wettable powders wear nozzles readily, too. Brass nozzles wear sooner than polymer and stainless steel nozzles. Because of wear, the amount of spray being pushed through the nozzle will gradually increase. The spray rig must be properly designed and calibrated often (approximately every 20 hours of use with brass nozzles) if you are to be sure of the amount of material being applied per acre.

Soil Fumigation

Soil fumigation kills most weed seeds, plant pathogens, nematodes, and insects in the soil. Fumigants may be applied as granular or liquid formulations. After application, true fumigants volatilize to form gases; other pesticides used in a similar manner may remain mixed with soil water. When using soil fumigation, consider the following points:

- **Target pests.** Rates vary for different target pests. In general, nematodes and soil insects are



killed at lower rates than weed seeds and fungal or bacterial pathogens.

- **Soil texture.** As the microscopic spaces between soil particles get smaller and less abundant (as in heavy or compacted soils), fumigant rates must be increased to overcome reduced or slower diffusion and penetration. On heavy soils, rototilling (when dry) can increase the pore space of the soil, improving the effectiveness of subsequent fumigation.
- **Soil temperature.** For effective fumigation, soil temperature at a depth of 6 inches must be at least 50°F. Higher soil temperatures favor greater volatilization of fumigants and greater movement through soil spaces.
- **Soil organic matter.** Decomposed organic matter improves soil structure and generally helps fumigant dispersion in the soil. However, very high amounts of organic matter may adsorb or tie up a fumigant, reducing its effectiveness. Fresh (undecomposed) crop debris may hinder fumigant dispersion in the soil and may also harbor insects and pathogens that escape the fumigant. Organic matter is most beneficial when it is thoroughly decomposed.
- **Soil moisture.** Fumigants move in soil water and must enter the soil solution to contact and kill pests. Moderate levels of soil moisture therefore aid in obtaining effective fumigation.

During or immediately after application of soil fumigants, the soil surface should be sealed to prevent the fumigant chemical from escaping into the air too rapidly. This can be done by rolling, irrigating, or covering with a tarp or plastic. At least two to three days of fumigant activity and at least four to 14 days of venting (for fumigant dissipation) should elapse between application of fumigants and planting. A three- to four-week interval is better. For this reason, fall is usually the best time to fumigate. Spring fumigation can be very effective, however, if soils are warm enough and the proper preplant interval is observed. Avoid plowing too deeply after fumigation so that untreated soil is not mixed with treated soil near the surface. Shallow plowing or tilling with clean equipment is recommended. See Table 8-8 (on page 207) for a summary of the characteristics of common soil fumigants.

Preplant Cover Crops

Seeding a preplant or green-manure cover crop on a site the year before planting is an excellent way to improve soil organic matter content. After a season of growth, the green manure is plowed or otherwise incorporated into the soil where it decomposes and adds organic matter to the soil. Benefits of preplant cover crops are greatest when:

- The soil is sandy and organic matter content is low.
- No animal manure is available to add to soil.
- The cover crop is a legume, which offers a good source of nitrogen.

Most cover crops perform best under the same general range of soil nutrients and conditions required by brambles. Small grains or vigorous sod grasses take considerable amounts of nitrogen from the soil but release it back slowly as they decompose. In accordance with soil test results before planting the cover crop, add 40 to 50 lbs. of nitrogen per acre and adjust soil pH, potassium, and phosphorus. These practices will help establish the preplant cover crop and promote more rapid decomposition when it is incorporated, preventing nitrogen drag (a lack of available nitrogen) when brambles are planted the following spring.

Since preplant cover crops are not intended to become permanently established, minimum seeding rates are usually recommended by suppliers to produce an acceptable turf stand. Where a dense, vigorous cover is needed to suppress weeds, higher seeding rates of cover crops such as buckwheat, rye, annual ryegrass, or sudan grass will maximize weed suppression and contribute much organic matter to the soil.

Preplant cover crops are usually plowed under in the late fall or early spring prior to planting. Those with low nitrogen content (most grains and dry grasses) should be plowed under in the fall to allow adequate time for decomposition and to prevent a lack of soil nitrogen needed by newly planted brambles. Leguminous cover crops contain more nitrogen and can be turned down in early spring, a month or so before planting brambles.

Usually, preplant cover crops are incorporated into the soil by plowing, disking, or rototilling before



planting the brambles. Weed-free alleys between rows are then maintained by preemergence herbicides, mulching, or periodic tilling.

An innovative preplant preparation method worth considering is known as killed sod. For the killed sod method, a vigorous sod grass, such as annual ryegrass or tall fescue, is established and then killed with systemic herbicides the following spring. Brambles are planted either directly into the killed sod or into a narrow, tilled strip. Studies of killed sod use in orchards suggest that this method provides some of the benefits of mulches. Killed sod may reduce residual weed seed germination by minimizing soil disturbance and may provide other benefits associated with no-till practices in field crops.

Selecting a Preplant Cover Crop

The selection of a preplant cover crop should depend upon several conditions:

- Time of year
- Crop to follow
- Soil pH and fertility
- Available tillage equipment
- The length of time the cover crop will be allowed to grow.

Descriptions of many species used for preplant cover crops are provided in this section. The descriptions include details about soil requirements, seeding rates, and planting dates for establishment, and other information related to growth and incorporation. Remember that seeding rates for preplant cover crops are much lower than for permanent cover crops because full establishment is not necessary.

Alfalfa is a perennial legume that requires a well-drained soil with a high pH (6.0 to 7.0). The most desirable periods for planting are early April to late May or late July to mid-August. The recommended seeding rate is 145 pounds per acre. Alfalfa grows tall enough to become difficult to incorporate if allowed to overwinter from a spring seeding. The cost of alfalfa seed is much greater than the cost of clover seed. It is recommended that alfalfa seed be inoculated when seeded on an area for the first time.

Buckwheat can be seeded successfully on sites with low soil pH. While there is fast growth of the top

portion of this grain, there is little organic matter contribution from the roots. The plants should not be allowed to mature, since reseeding will readily occur. Early seedings in late May or early June are better than summer seedings in late July. Buckwheat may be seeded at 60 lbs. per acre.

Alsike, ladino, and white clovers have low to moderately upright growth and tend to establish a good legume stand in about 10 weeks. Alsike clover, a very short-lived perennial, can be established on low pH soils. Ladino and other common white clovers respond to high soil fertility (notably phosphorus) and high soil pH. All of these clovers are fair to moderately good nitrogen-producing crops. They establish best when seeded in early April to late May or from late July to mid-August. Early seedings in either season are more successful. A late fall or late winter broadcast application to open ground may be another effective method of seeding these crops, depending on the soil-seed contact that follows.

The cost of seed varies with the type of clover, common white clover and alsike clover being cheaper than ladino. The cost of seed per acre is low for clover preplant cover crops, since the recommended seeding rate is only 4 lbs. per acre of alsike and common white clover and 2 lbs. per acre for ladino. Volunteer clovers grow naturally in most fields, so it may not be necessary to inoculate clover seed; however, several pounds of seed can be treated with inoculant for only a few dollars.

Red clover produces a top growth of 12 to 18 inches and establishes relatively quickly, depending on soil moisture and seed-bed conditions. Red clover grows best in soils with a pH of 5.6 or higher. Like other clovers, red clover should be seeded early in April or late May or from late July to mid-August. Early seedings in either season are more successful. As with white clovers, a late fall or late winter broadcast application on open, unfrozen soil may produce a successful seeding. Red clover is a good nitrogen-producing crop and is adapted to a broader range of soil conditions than alfalfa. The seeding rate for red clover is 8 lbs. per acre.

Sweet clover is a slow- to moderately fast-establishing biennial legume that responds better to higher soil pH than other clovers. It also responds well to soils with good phosphorus levels and is most easily established when seeded from early April to



mid-May or during the first half of August. Large, deeply penetrating roots and heavy top growth make large contributions of nitrogen and organic matter to the soil when incorporated. Second-year top growth may exceed 50 inches. However, this growth must be cut at a lower height and incorporated after cutting. The seeding rate is 12 lbs. per acre.

Hairy vetch is adapted to a range of soil conditions and is a moderately fast-growing winter annual when seeded in August or very early September. In the Northeast, the best practice to ensure good growth is early establishment. This vetch can supply much nitrogen to the soil when grown under ideal conditions. In the mid-Atlantic states, hairy vetch can provide up to 125 pounds of nitrogen for the next crop. Hairy vetch is a true vetch with purple flowers and viney growth, and it should not be confused with another legume known as crown vetch, which is commonly seeded along highways for bank stabilization. Hairy vetch is seeded at a rate of 40 lbs. per acre.

Annual field brome is a fast-establishing winter annual grass and has a much more extensive and fibrous root system than most other green manure crops. Seedlings made during July and August tend to be much more successful than seedlings made in late spring. The following year's spring growth is rapid and, after the seeds ripen in July, the crop can be easily reestablished with no further seeding. Since this is not desirable with a preplant cover crop, thoroughly disk or plow down the heavy root system early in the spring. This seed is not readily available, so plans for obtaining it should be made well in advance of the seeding date. Annual field brome is usually seeded at a rate of 20 lbs. per acre.

Japanese millet is a fast-growing summer annual that competes well with weeds and establishes faster on cooler soils than sudan grass. If planted between late May and mid-July, millet will grow 4 feet high in seven to eight weeks. Unlike small-seeded legumes and grasses, the large millet seed should be covered from 3/10- to 1-inch deep in a firm seedbed. The planting may be cut back and allowed to regrow at any time after reaching 20 inches of growth. Millet should not be allowed to mature and drop seed. Millet seed is relatively inexpensive; seed at a rate of 20 lbs. per acre.

Spring oats, when used as a very early spring green manure crop, should be planted in early to mid-April. Because of the fast spring growth, plan to incorporate the planting in early to mid-June. Oats will grow on soils of relatively low soil pH (5.5) and with moderately good fertility; however, this crop requires good soil drainage. A mid-August seeding will provide good growth and ground cover for protection against soil erosion during the fall and winter months. Oats will be gradually killed back by successive frosts and will not grow again in the spring. The dead plant residue is easily incorporated with very light tillage equipment. Three bushels of oats (approximately 100 lbs.) are usually seeded per acre.

Annual ryegrass seedlings establish very rapidly in spring or late summer. Ideal dates for spring seedings range from early April to early June; late summer seedings are more successful when made from early August to early September. Heavy root growth and rapid seedling development make annual ryegrass a very desirable green manure cover crop in areas where good soil-water relations can be maintained. Ryegrass will die out early in the second year, leaving a heavy root system and a moderate top growth residue to incorporate into the soil. A seeding rate of 10 lbs. per acre is suggested.

Perennial ryegrass seedlings become established more quickly than seedlings of other common perennial grasses such as timothy, brome grass, and orchard grass. The fibrous root system is extensive and, with the vigorous top growth, provides substantial material for incorporation into the soil in early spring. The dry-matter root growth of perennial ryegrass is approximately equal to the top growth. For many other crops, the top growth represents 60% to 70% of the material turned under at plowing. A seeding rate of 25 lbs. per acre is recommended.

Winter rye, a cereal grain, establishes quickly from late summer and early fall seedings. However, fall seedings made after October 1 are likely to provide only winter cover and are slower to produce heavy spring growth. Excessive early spring top growth can create tillage problems if the crop is not incorporated by early to mid-May. This date will vary with the location and season. The seed is readily available and is usually sold in bushel quantities of 56 lbs. Use a seeding rate of 2 bushels per acre to establish.



Sudan grass is a summer annual that requires much heat for good growth. Seedlings made in late May or early June will guarantee a more vigorous growth than seedlings made in late June or early July. Hybrid sudan grasses may have larger seeds and should be planted at heavy rates. Like millet and sorghum-sudan hybrids, which also have large seeds, sudan grass should be seeded to a depth of 1/2 to 1 inch into a firm seedbed. Similarly, this summer annual will recover after being cut. Due to its tall growth habit, sudan grass should be cut back when growth exceeds 20 to 25 inches or plowed down if a second growth is not desired. Use a seeding rate of 80 lbs. per acre.

Sorghum-sudan grass hybrids require more heat for growth than sudan grass. These hybrids are more expensive to establish and fail to adapt to most soils as readily as Japanese millet. This crop will grow to a greater height than sudan grass under ideal conditions of heat, moisture, and fertility, but the 4- to 6-foot growth is very difficult to incorporate with small or moderately sized tillage equipment. Like sudan grass, this crop will make a second growth if climatic conditions permit. Growth will cease by mid-September if night temperatures drop to near freezing. The seeding rate will vary from 35 to 50 lbs. per acre, depending on seed size.

(Courtesy W. Lord, I. Merwin, and J. Mitchell, *Bramble Production Guide*, NRAES Publication No. 35.)



Weed Identification

Weeds

On the next few pages are images of common weeds that you should be able to identify.

Key to Symbols

Life Cycle:

A	=	Annual
SA	=	Summer Annual
WA	=	Winter Annual
B	=	Biennial
P	=	Perennial

Control by Herbicides:

E	=	Easy to control. Weed is consistently killed by one application.
D	=	Difficult to control. Weed may be killed by one application, but a second treatment is often necessary.
U	=	Uncontrollable selectively.

Source: *Ohio Pesticide Applicator Training*, Bulletins 841 - 848, Ohio State University Extension.

Broadleaf Weeds

Rosette/Upright Broadleaf Weeds



Dandelion (*Taraxacum officinale*) has sharply lobed leaves and a strong taproot. The bright-yellow flowers turn into fluffy, white seedheads. P, E





Dock, curly (*Rumex crispus*) reproduces by seed. It has a fleshy taproot and large, smooth leaves that are crinkled on the edges. P, E



Plantain, buckhorn (*Plantago lanceolata*) has narrow, lance-like leaves with prominent parallel veins. Seed heads are bullet-shaped and are borne on long, slender stems. P, E



Plantain, broadleaf (*Plantago major* and *Plantago rugelii*) has finger-like stalks that protrude upward. Leaves are oval with prominent parallel veins. P, E

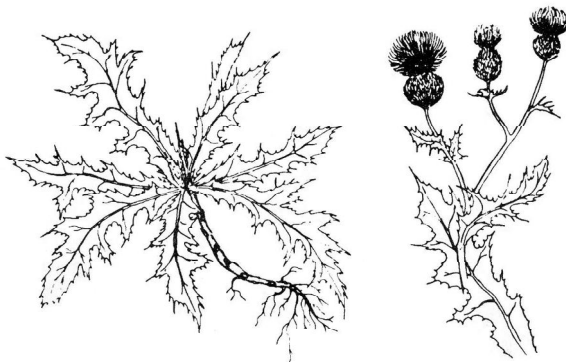

Thistles (*Cirsium species*) have spiny, notched leaves. A rosette-type growth typically occurs when the turf is mowed. Canada thistle spreads by deep rhizomes. B or P, E



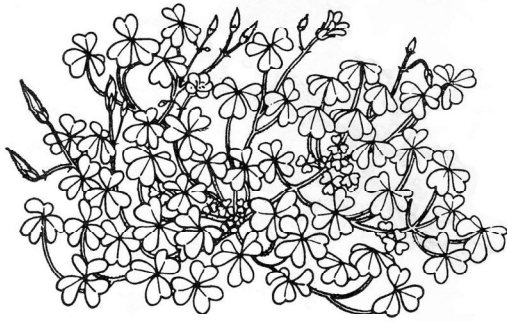

Oxalis or **yellow woodsorrel** (*Oxalis stricta* and *corniculata*) appears similar to clover and reproduces by seed. The pale-green leaves have three heart-shaped leaflets, slightly folded. Flowers are bright yellow.

Creeping oxalis (*O. corniculata*) has purplish leaves and creeping stems that root at nodes. A or P, D

Creeping or Prostrate Broadleaf Weeds

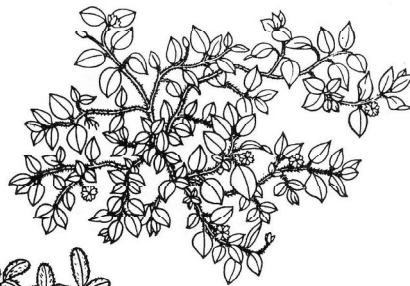

Common chickweed (*Stellaria media*) has small, pale-green leaves. Its hairy stems branch and take root, enabling the plant to spread over large areas and completely crowd out turfgrasses. The white, star-like flowers appear during cool seasons.



Mouse-ear chickweed has dark, fuzzy leaves and is perennial. WA, E

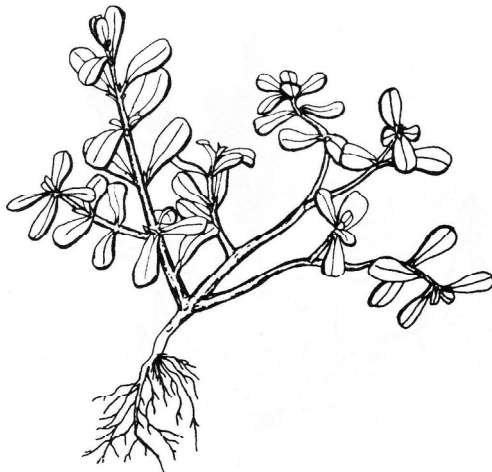

Purslane (*Portulaca oleracea*) has thick fleshy leaves with smooth, reddish stems that root where they contact soil. It may be particularly troublesome in new turf seedings. A, E





Knotweed (*Polygonum aviculare*) germinates in early spring. Young plants have long, slender, dark-green leaves and are often mistaken for grass. Mature plants have smaller, dull-green leaves and inconspicuous white flowers. Knotweed grows well on heavily trafficked, compacted soils. SA, D

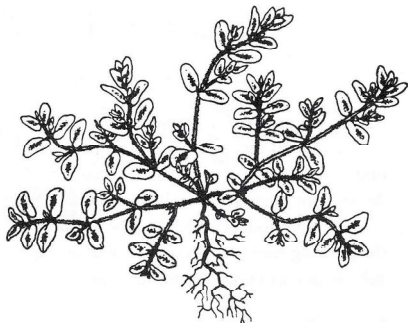

Prostrate spurge (*Euphorbia supina*) usually appears in midseason. The small leaves are opposite and frequently have a red blotch in the center. The stem oozes a milky sap when broken. SA, D

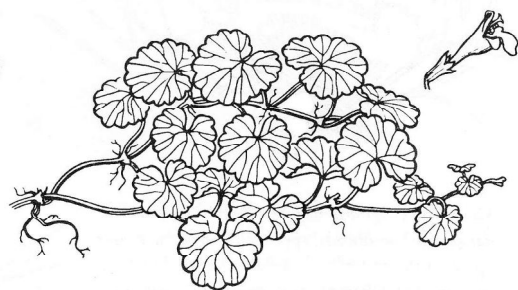

Ground ivy or creeping-charlie (*Nepeta hederacea*) forms dense patches in turf. Its bright-green leaves are round with scalloped edges. Bluish-purple flowers are borne on four-sided stems. This plant grows well in shady areas where soils are poorly drained. (Sometimes confused with mallow). P, E



Violet (*Viola* spp.) has heart-shaped leaves with toothed edges and usually violet flowers. A or P, E



White clover (*Trifolium repens*) competes aggressively with established turfgrasses, especially under moist conditions in soils with low fertility. It can be identified by its three short-stalked leaflets and round, white flowers. Note: Creeping oxalis may be confused with clover. P, E



CHAPTER 7

Reducing Bird and Other Wildlife Damage in Berries and Grapes

Birds

Birds can be a major threat to many small fruit crops, particularly blueberries and certain grape cultivars. Growers may see 10% to 30% of a crop destroyed. A flock of 5,000 starlings can consume 1 ton of food over a 10-day period. It has been observed that mid-season ripening blueberries can be the most heavily damaged. Robins (young aggressive types), starlings, finches, orioles, and cedar waxwings have been identified in order of importance as birds that cause problems in fruit crops. Bird populations are increasing due to changes in weather and migration patterns (Fraser *et al.*, 1998).

Bird damage patterns can vary from year to year and can be localized depending on the source. Birds can fly 10 to 15 miles from a resting site to feed. It is difficult to stop birds from feeding once they start. They can establish their home territory in late April and May and remain until the crop ripens. Crops near resting areas, wooded lots, and ponds are most vulnerable. Birds generally feed before sunrise and again late in the day or slightly after sunset. Even with the best effort and control equipment, bird damage will still occur.

Large flocks of birds are easier to scare than small ones. They feed on whatever is available and will fly more than 12 miles from a roosting site to feed. In some cases, they begin feeding two weeks before harvest or as berries and grapes change color. However, new data indicates they may start three to four weeks before harvest. The top 10 most desirable grape cultivars for birds, in order, are: Marechal Foch, Baco Noir, Sovereign Coronation, Zweigeltrebe, Pinot Noir, Merlot, Gewurztraminer, Chambourcin, Muscat, and Auxerrois.

Types of Bird Repellent

1. Physical Barrier

Netting, either plastic or rope (known as tobacco netting) has generally been recommended,

however, it takes a lot of labor to put in place, and birds can get under or eat through it. Nets offer nearly 100% protection, particularly in high-valued crops. Placing the netting over the crop is best. Full field netting must be removed before winter because the ice load breaks it. Ultraviolet light also breaks down the material. Netting may be most effective for blueberries. It is not recommended for late harvest or ice wine systems.

2. Sound Devices

A. Propane cannons.

These cannons give unexpected blasts and should be set at intervals greater than one blast per three minutes. Fully electronic randomized, rotating multi-shot units are most effective since timing and direction of the blast keep birds off balance. However, neighbors who work early or late shifts and rest during the day may become angry if these are used. Timers can be used to provide flexibility and turn off the cannon during the off feeding periods.

When using propane field cannons, the following is suggested:

- Set intervals greater than three minutes.
- Use between sunrise and sunset.
- Operate on no more than five acres.
- Ensure propane tank valves do not leak.
- Move units around.
- Use electronic timers to shut off automatically.

B. Electronic Sound Devices.

Some devices simply disrupt bird communications. Other devices use digital electronic sound to produce distress calls. Several “chips” of different calls are available on one device. Some reports say that these devices can attract hawks and more hawks scare birds away. These devices discourage birds from nesting in nearby trees in the spring. They are less objectionable to neighbors.

3. Pistol Cartridges and Other Sound Devices.

Special cartridges launched from handguns,



which explode high in the air near birds, can quickly clear a field or wooded lot and can be an effective manual scare device.

Shotguns are often used but are generally ineffective. In some cases, protected species can be harmed.

4. Visual Repellents

Aluminum pie plates, firecrackers, and Mylar humming lines may work for a few days and are best just before harvest. The same is true of artificial hawks, stuffed owls, or snakes.

5. Flavors or Sugar

Several studies, using grape flavor extracts, have found that some may be unacceptable on wine grapes because residual flavors arise on wine grapes during fermentation. In some cases, leaves can be burned and may have a short residual period.

Another test using household sugar (10 lbs/gallon) plus sticker (some leave no mark) kept blueberry fruit loss to less than 10% as compared to 40% in unsprayed plantings. Four applications (\$200 to \$240/acre/season) are necessary since sugar washes off easily. Sugar for blueberries can be mixed at 230 lbs of table (cane) sugar in 21 gallons of hot water giving 40 gallons of syrup plus Olympic Spreader Sticker at 310 ppm. Other stickers did not work well. It must be reapplied after periods of heavy rain (Pritts, 2001).

Use an Integrated Approach

One deterrent system usually does not work; therefore, use a combination of methods. Creating random unexpected noise, positioning devices near perimeters and flight patterns, using scare devices near the fruit planting, and encouraging predators can be effective.

Here are some tips:

1. Start bird control methods 10 to 30 days before the crop ripens. Watch and be aware of the birds' habits and their reaction.
2. Change the method of control. Move devices once per week and change the type of noise.
3. Control birds 30 minutes before sunrise to early morning and into late afternoon to 30 minutes after sunset.
4. Consider the amount of fruit loss compared to the cost of equipment or material and labor to control birds.

Remember

Once birds start to eat the crop, they are difficult to remove. Control is based on knowing how birds behave. Start controls before the fruit starts to turn from green to pink, red, or blue. Use several methods and change positions once per week.

Wild Turkey

Wild turkeys are appearing with ever-increasing numbers in vineyards. As more vineyards are planted, wild turkeys tend to move through these areas in flocks looking for food and shelter. Unless preventative measures are taken to restrict their entry into a vineyard, little can be done to prevent them from decimating a grape crop. Wild turkeys, unlike domestic turkeys, can take flight and are often seen roosting in surrounding trees and brush. As with other birds, turkeys do not like loud and/or distressing sounds.

Types of Wild Turkey Repellents

- **Physical Barriers.** Standard bird netting can be used, although turkeys are more powerful and may tear the netting trying to get the fruit. High fencing can be used to turn back the turkeys.
- **Sound Repellent.** Propane cannons will have some effect in the short term, but, as with other fruit-eating birds, turkeys become accustomed to the sound and within a few days may pay little attention. Shotgun and pyrotechnic guns may provide some means of distraction to wild turkeys so they are less likely to settle in the vineyard.

Deer

Deer, like other wildlife, pose a serious threat to Midwest vineyards. Many times deer have been observed foraging on young succulent grapevine shoots in early spring. They continue this feeding behavior into early summer. Food sources are scarce during budbreak, and deer are naturally attracted to any green tissue that emerges. Several different kinds of approaches have been used to mitigate the damage that deer cause in vineyards and other small fruit plantings.

- **Odor Repellents.** Materials (human hair, dog hair, and soap) that are commonly used to deter deer are used because they smell unnatural or



have the smell of a predator. These materials can be used effectively to prevent deer from entering vineyards. There is some interest in using coyote hair to create a negative environment for deer. Coyotes are the main predators of white-tail deer in Ohio, and it has been reported that deer do not like to come near feeding areas that have been baited with coyote hair. As with the bird populations, deer can acclimate very quickly, and they can become familiar with a new odor. However, deer appear to avoid the area baited with coyote hair for several weeks, even when the bait is removed, according to APHIS Research Scientists.

- **Sound Repellents.** Deer can be startled by unfamiliar sounds, and they are less likely to stay in an area in which strange, unnatural sounds are emanating. Propane cannons and distress signals can be used to send deer to flight. Moving the noisemakers around the inside and outside of the vineyard can help to dissuade the deer from entering the vineyard and make the situation somewhat less familiar. This should keep the deer on edge and less interested in foraging on the tender vegetation of the vines.
- **Physical Barriers.** Grow tubes and mesh vinyl screens can be quite effective in protecting young vines from being fed upon by foraging deer.

The cost will vary, depending on the number of tubes and screens you purchase. They can be easily placed around the plants to protect the newly emerging tissue. One problem is that these devices only protect plants when first established in the vineyard. The vines will quickly grow out of the tubes and mesh screen, and then deer are able to reach shoots growing out of the top.

Fencing is one of the best means of keeping deer from entering a vineyard. The expense for some owners can be cost prohibitive. Poly Tape electric fence, commonly used to keep horses and cattle in pasture, is being used to control deer around vineyards. Some producers are using this in place of standard single-strand electrical fence. It has been observed that deer will not enter pasture with this type of fence surrounding it. The Poly Tape (1-1/2-in. wide) works well at a height of 5 to 6 feet, with four to five strands from top to bottom. Generally, only the first through third strands from the ground are charged. Peanut butter on aluminum foil placed on the electrical wire is used to bait the deer. T-posts are used to fasten the tape in place within the fence row. With an electric fence, grass and weeds must be kept under control or the fence could short out. Weed whacker or burn-down herbicides can be used to keep vegetation under control.



CHAPTER 8

Using Pesticides in Small Fruit Production

Pesticide Application

Pesticide Labels

A pesticide label is a legal document. Each user is required by law to apply any pesticide only in a manner that is consistent with label directions. If for any reason, use rates or application guidelines presented in this publication or other references are not consistent with instructions on the label, users are reminded that the label takes precedence and must be obeyed. It is, however, LEGAL to apply pesticides at lower concentrations, at lower rates, and less frequently than the label instructs. In some state, including Ohio, pesticides may be used legally to control pests not named on the label if the target crop and site (for example, field vs. greenhouse) is listed on the label and other restrictions are observed. Growers can check with their state department of agriculture officials to clarify this policy in their state.

It is ILLEGAL to apply pesticides using less water than the label instructs (increasing the concentration), at a higher rate per acre than the label instructs, or more frequently than the label instructs. Specified preharvest intervals (minimum number of days between the last application and crop harvest) also must be obeyed.

Pesticide Formulations

Pesticide products contain at least one active ingredient that is combined with liquid or solid carriers to produce formulations that are safer or more practical to apply than the active ingredient alone. Common formulations include wettable powders, liquid concentrates, emulsifiable concentrates, dry flowable formulations, flowable liquids, soluble powders, dusts, and granules.

Wettable powders (WP) are dry formulations of pesticides that are to be mixed with water for application. The toxicant is mixed with specific powders; wetting agents are added to make the

mixture blend readily with water. Wettable powders form a suspension that must be kept agitated in the spray tank. Sprays prepared from wettable powders are less likely than other sprays to cause injury to fruit or foliage.

Liquid concentrates (L or LC) are formulations containing toxicants that are water soluble. No emulsifying agents or organic solvents are required. **Note:** The designations L and LC are sometimes used by formulators on emulsifiable concentrates that are not water soluble.

Emulsifiable concentrates (EC) contain a pesticide and an emulsifying agent in a solvent. ECs form suspensions when they are diluted with water for application as sprays. They leave much less visible residue than WP formulations but are more likely to injure fruit and foliage.

Dry Flowable (DF) formulations are similar to wettable powders, but the powders (clay particles) are formed into small particles. They do not readily cake together, so they flow easily from the product container. Another name for this type of formulation is **Water Dispersible Granule** (WDG) (WG).

Flowable (F) formulations are a liquid or viscous concentrate of suspended pesticide in water. They usually cause less injury to fruit and foliage than EC formulations and generally, but not always, are as safe as WP formulations.

Soluble powders (SP) are powder formulations that dissolve in water. A few pesticides and many fertilizers are prepared as soluble powders.

Dusts (D) are usually made by mixing a chemical toxicant with finely ground talc, clay, or dried plant materials.

Granules (G) are formed by saturating an inert material such as sand or clay with a pesticide. Particles (granules) range in size from 30 to 60 mesh. Granules are applied as dry material, usually to soil or water.



Spray Adjuvants

Several types of additives are available to improve the effectiveness of spray applications. Known collectively as adjuvants, they include:

Activators — Materials that increase the effect of a pesticide by increasing the penetration of a spray solution through leaf hairs or a waxy cuticle and into a leaf or fruit.

Acidifiers — Materials that lower the pH of alkaline spray water to reduce the potential breakdown of certain pesticides in the spray tank.

Buffers — Materials that change the pH of spray water, then hold it at the desired degree of acidity.

De-Foamers — Materials that, when added to the spray tank, break down or prevent the formation of foam.

Elasticizers or Drift Control Agents — Materials that reduce the breakup of spray droplets into very fine particles and thereby minimize drift.

Surfactants, Spreaders, and Wetting Agents — Different names for products that reduce the surface tension around a spray droplet, allowing it to spread out more evenly on the surface of a leaf or fruit.

CAUTION: Some surfactants used in combination with certain pesticides can function as activators, causing plant injury. Consult labels or chemical suppliers for more information.

Stickers — Materials that cause a pesticide to stick to the surface after the spray dries, thereby reducing the potential for loss from rain or overhead irrigation.

Spreader-Stickers — A term commonly misused when referring to a surfactant or spreader. A true spreader-sticker combines the characteristics of a surfactant with that of a sticker.

A note of caution on adjuvants: Do not use an adjuvant with any pesticide without first consulting the specific pesticide label. Improper selection or use can result in crop injury or reduced effectiveness, particularly when adjuvants are mixed with emulsible concentrates.

Conversion of Label Formulation Rates to Actual Toxicant Rates

Pesticide recommendations often list amounts of active ingredient for use on a per-acre or per-hectare basis. This is done so that a single listing summarizes the correct use rate for several formulations of a particular pesticide. However, commercial formulations contain formulating agents, not just active ingredients. For example, in a 50% WP (a wettable powder formulation), the active ingredient makes up only 50% of the package's net weight. In a 4 EC formulation, the emulsifiable concentrate contains 4 pounds active ingredient per gallon. For metric conversion, see Tables 8-1, 8-2, and 8-3. Use Table 8-4 to convert from large volumes (100 gallons) to small volumes (1 gallon) of spray mixtures.

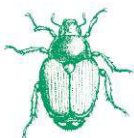

Table 8-1. Conversion Factors for Weights and Measures: Proportions.	
Proportions	
Metric	U.S.
100 g/ha	1.4 oz/acre
1 kg/ha	0.9 lb/acre
1 ton(metric)/ha	0.446 tons (US)/acre
1 l/ha	0.4 qt/acre
1 kg/1000 l	1 lb/100 gal
g/1000 kg	1 ppm
1 km/hr	0.6 mph
U.S.	Metric
1 oz/acre	70 g/ha
1 lb/acre	1.12 kg/ha
1 ton (US)/acre	2.24 tons (metric)/ha
1 fl oz/acre	73 ml/ha
1 gal/acre	9.39 l/ha
1 lb/100 gal	1 kg/1000 l
1 ppm	1 g/1000 kg
1 mph	1.6 km/hr

Table 8-2. Conversion Factors for Weights and Measures: Temperatures.	
Temperatures	
Celsius (Centigrade)	Fahrenheit
-30	-22
-20	-4
-10	14
0	32
10	50
20	68
30	86
40	104
Fahrenheit	Celsius (Centigrade)
0	-18
10	-12
20	-7
30	-1
40	4
50	10
60	16
70	21
80	27
90	32



Table 8-3. Conversion Factors for Weights and Measures: Equivalents.		
Common Equivalents		
	Metric	U.S.
Length	1 Millimeter	0.039 in.
	1 Centimeter (10 mm)	0.39 in.
	1 Meter (100 cm)	39.4 in.
	1 Kilometer (1,000 m)	0.62 mi.
Area	1 Square Centimeter	0.155 sq. in.
	1 Square Meter	1.2 sq. yd.
	1 Hectare (10,000 sq m)	2.47 acres
	1 Sq. Kilometer (100 ha)	247 acres
Weight	1 Gram	0.035 ounces
	1 Kilogram (1,000 g)	2.2 pounds
	1 Ton (metric) 1,00 kg)	1.1 tons (US)
Volume	1 Milliliter	0.034 fluid oz.
	1 Liter (1,000 ml)	1.056 quarts
	1 Cubic Meter (1,000 l)	264.17 gal. (US)
	U.S.	Metric
Length	1 Inch	2.54 centimeters
	1 Foot (12 in.)	30.5 centimeters
	1 Yard (3 ft.)	0.91 meters
	1 Mile (5,280 ft.)	1.6 kilometers
Area	1 Square Inch	6.5 square centimeters
	1 Square Foot (1.44 sq. in.)	930 square centimeters
	1 Square Yard (9 sq. ft.)	0.84 square meters
	1 Acre (43,560 sq. ft.)	0.405 hectares
	1 Square Mile (640 acres)	259 hectares
Weight	1 Ounce	28.3 grams
	1 Pound (16 oz.)	0.454 kilograms
	1 Ton (US) 2,000 lb.)	0.907 tons (metric)
Volume	1 Tablespoon (3 teaspoons)	14.79 milliliters
	1 Fluid ounce (2 tablespoons)	29.6 milliliters
	1 Cup (8 fl. oz.)	0.237 liters
	1 Pint (2 cups)	0.473 liters
	1 Quart (4 cups)	0.946 liters
	1 Gallon (US) (4 qts)	3.8 liters
	1 Cubic Foot	28.3 liters
Metric Abbreviations: mm - millimeter; cm - centimeter; m - meter; km - kilometer; ha - hectare; mg - milligram; g - gram; kg - kilogram; ml - milliliter; l - liter.		



Table 8-4. Approximate Dilutions for Small Volumes of Spray Mixes.				
Type of Equivalent Rates for Different Quantities of Water				
Formulation	100 gallons	5 gallons	3 gallons	1 gallon
Wettable Powder	5 pounds	15 tablespoons	9 tablespoons	3 tablespoons
	4 pounds	13 tablespoons	8 tablespoons	8 teaspoons
	3 pounds	10 tablespoons	6 tablespoons	2 tablespoons
	2 pounds	8 tablespoons	4 tablespoons	4 teaspoons
	1 pound	3 tablespoons	6 teaspoons	2 teaspoons
	1/2 pound	5 teaspoons	1 tablespoon	1 teaspoon
Emulsifiable Concentrate	5 gallons	1 quart	1-1/4 pints	13 tablespoons
	4 gallons	1-1/2 pints	1 pint	10 tablespoons
	3 gallons	1-1/4 pints	3/4 pint	1/4 pint
	2 gallons	3/4 pint	1/2 pint	5 tablespoons
	1 gallon	1/2 pint	8 tablespoons	3 tablespoons
	1 quart	3 tablespoons	2 tablespoons	2 teaspoons
	1 pint	5 teaspoons	1 tablespoon	1 teaspoon

When necessary, converting recommendations from an active ingredient basis to a formulation basis is quite simple and can be done in the manner described in these examples:

Example 1: A recommendation calls for 1 lb active ingredient per acre and the label calls for a range of 1 to 2 quarts of 4 EC per acre. The number preceding the letters EC tells how many pounds of active ingredient are in a gallon of this product. Remember that there are 8 pints in a gallon. In this case, the lower end of the label range, 1 qt (= 2 pints) of 4 EC, matches the recommendation of 1 pound active ingredient per acre.

The formula for this conversion is:

$$\text{Pints of EC (liquid)} = \frac{\text{amount of active ingredient/gal} \times 8 \text{ (a constant)}}{\text{lbs active ingredient/gal of formulation}}$$

In this example:

$$= \frac{1 \text{ lb} \times 8}{4}$$

$$= 2 \text{ pts (= 1 qt)}$$

Example 2: A recommendation calls for 2.25 lbs of active ingredient per acre and the product that you are using is a 75% WP. Use the following formula to determine how much of the 75% WP formulation to use in order to match the recommended rate.

$$\text{Lbs dry formulation} = \frac{\text{recommended lbs. of active ingredient} \times 100 \%}{\text{active ingredient (from label)}}$$

In this example:

$$= \frac{2.25 \times 100}{75} = 3 \text{ lbs.}$$



Calibrating Single Nozzle and Boom Sprayers

Calibration is an essential step in the use of any application equipment. For boom sprayers, a satisfactory spray pattern can be achieved only if the output from individual nozzles does not differ more than 10 percent.

Owner's manuals for sprayers contain specific instructions for calibration and adjustment. A good time to calibrate is in early spring, right after the sprayer has been reassembled and is being readied for early season operations. Check for worn disks and be sure that all nozzle tips have the same angle and capacity rating. The use of wettable powder sprays enlarges nozzle openings, so calibration of each nozzle is essential. Use only clean water when calibrating sprayers. Start the season with a calibrated sprayer, and depending upon the number of gallons sprayed and on the cleanliness of the water you have used, calibrate the sprayer again according to intervals specified in the owner's manual (or no later than halfway through the spray season).

To Check Nozzle Uniformity

1. Hang a container under each nozzle.
2. Operate the sprayer at the usual application pressure until about a pint of water has been collected in each of the containers.
3. Measure and record the output of each nozzle. Measurements can be made by a "dip stick" method, but the use of a graduated cylinder with indications for fluid ounces or milliliters is better.
4. Determine the total output collected from all the nozzles.
5. Determine the average per nozzle by dividing the total output by the number of nozzles on the boom.
6. Multiply the average by 5% (0.05).
7. Subtract this figure from the average. This will be the lower limit of the 10% allowable spread.
8. Add this 5% figure to the average. This will be the upper limit of the 10% allowable spread.
9. The allowable 10% spread is between the low figure (7) and the high figure (8).
10. Compare the output of each nozzle to these low and high figures.

- a. Take apart and clean or replace all nozzles with outputs less than the lower limit.
- b. Replace all nozzles with outputs greater than the upper limit.

11. After cleaning or replacing nozzles, repeat steps 1 through 10 to make sure that your repairs have been successful. Output of new nozzles often fails to match the average of existing nozzles.

Spray Pattern Alignment

Single and double spray patterns can be aligned on a driveway or other flat surface. The edges of a single spray pattern should overlap only very slightly and be offset just enough that the sprays from adjacent nozzles do not collide.

Alignment of nozzles in a double spray or double overlap pattern requires that adjacent nozzle angles be offset slightly so that the area to be treated receives spray from two nozzles, yet the spray patterns do not collide. Remember, a double or overlapping spray pattern will use twice as much spray per acre as a single spray pattern if pump pressure and sprayer speed remain the same. A double spray pattern is most useful for treating dense or tall vegetation.

Calibration of Air-Blast Sprayers

Accurate calibration is the only way to ensure that a sprayer is applying the intended amount of chemical. The operator must know the amount of water that will be applied per unit of area in order to make a proper spray mix. Failure to calibrate a sprayer can result in crop injury, creation of a hazardous situation, and wasted money. Frequent calibration identifies worn nozzles and keeps the operator aware of factors affecting application rate such as travel speed, pressure, and type of nozzle in use.

Precalibration Check

Before calibrating, check the sprayer carefully. Be sure the nozzle tips are clean. Replace all worn or damaged nozzles. Check all hoses and fittings for leaks and aging. Make sure the pressure is constant and the tank is free of dirt and debris.

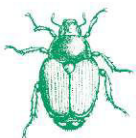

Determining Sprayer Speed

The rate of travel needed for proper distribution of spray within the canopy can be determined by trial by placing water sensitive spray paper at various locations within the trellis. For proper pesticide application, the air within the canopy must be completely replaced with spray-laden air from the sprayer. In general, a travel speed of 1 to 3 miles per hour has proved to be satisfactory, depending on the size and density of the canopy and capacity of the sprayer.

Before a sprayer can be calibrated, the travel speed must be determined in miles per hour (mph). To determine the travel speed, load the sprayer with clear water and make a test run in the vineyard. Always make the test run in the vineyard or on similar ground as tractor speed changes dramatically from soft to firm surfaces. Set the tractor throttle at a level sufficient to operate the sprayer (pto speed) and select an appropriate gear. Remember or mark these settings. Speed can be calculated by measuring the time required to travel any measured distance. A good conversion factor to remember is that 1 mph = 88 feet/min. A convenient test length is 176 ft because it is a multiple (2X) of 88. The following formula can be used to determine travel speed:

$$\text{Speed (mph)} = \frac{\text{distance (ft)} \times 60}{\text{time (sec)} \times 88}$$

For example, if it requires 60 seconds to travel a measured distance of 176 ft, the travel speed is:

$$\text{mph} = \frac{176 \times 60}{60 \times 88} = \frac{10,560}{5,280} = 2 \text{ mph}$$

Table 8-5 can be used to determine tractor speed on a course 176 feet long.

Determining Nozzle Flow Rate

To select the correct nozzle and whirlplate sizes, the total gallons per minute (gpm) of output for each particular application must be determined.

To determine the gpm it is necessary to know the travel speed of the sprayer (mph), the gallons per acre (gpa) to be applied, and the spacing (W) between the rows of vines. Once these three variables are measured or selected, a simple equation can be used to calculate the gpm. This equation is for one side of the sprayer manifold only. Double the calculated answer if both sides of the sprayer are to be used. Once the nozzle and whirlplate combinations are determined, place the same size nozzles and whirlplates in both sides of the sprayer if both sides are to be used.

Step 1: Calculate the total gpm required per side:

$$\text{gpm (per side)} = \frac{\text{gpa} \times \text{mph} \times \text{W}}{1,000}$$

gpm = gallons per minute (per side)

gpa = gallons per acre

mph = speed in miles per hour

W = spacing between rows in feet

Example: You have decided to apply 70 gpa while traveling 2 mph, and the rows are spaced 10 ft apart. What would the gpm per side be?

$$\text{gpm} = \frac{70 \times 2 \times 10}{1,000} = \frac{1,400}{1,000} = 1.4 \text{ gpm}$$

Step 2: Select the correct nozzle-whirlplate combination and operating pressure. Air-blast sprayers normally use disk-core-type cone spray tips. The correct size nozzles and whirlplates can be selected by using a table, which indicates the

Time (seconds)	Travel Distance (feet)	Speed (mph)
120	176	1.0
60	176	2.0
50	176	2.4
40	176	3.0
30	176	4.0
20	176	6.0

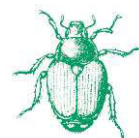

nozzle size and gallons per minute output at various pressures using specific whirlplates. These tables can be found in the sprayer manufacturer's literature or in nozzle catalogs.

The arrangement of nozzles in the sprayer manifold should be such that approximately $\frac{2}{3}$ of the total flow comes from nozzles in the upper half of the manifold and $\frac{1}{3}$ from nozzles in the lower half. This should be adjusted to provide uniform coverage throughout the canopy. It should provide adequate penetration to the top and center of the trellis while avoiding excess application rate in the lower outside areas.

Step 3. Install the nozzles in their proper outlets. Inspect and clean all nozzles and outlets and determine that the sprayer is operating correctly. Nozzles are a very important part of the sprayer; if any defects or wear are showing in the nozzles, they should be replaced.

Step 4. Measure the total gpm from all the nozzles selected in Step 2. Fill the sprayer tank at least half full. Prime the sprayer system and check all the nozzles to make sure none are clogged or partially clogged. Record the exact level of water in the spray tank. Bring the sprayer up to the desired pressure and turn the nozzles on. Use a stop watch to record the amount of time the sprayer is running. The sprayer should be operated for at least three minutes. Record the new level in the tank or measure the amount of water needed to refill the tank to the original level.

Example: The spray tank is filled to the 100-gallon level. It was predetermined from the manufacturer's tables that the nozzles selected would give a total gpm output of 4. The sprayer was operated for five minutes at 150 psi on the gauge. After the five minutes, the sight gauge was read and found to be at a level of 75 gals.

The actual output was:

$$100 \text{ gals. (start)} - 75 \text{ gals. (stop)} = 25 \text{ gal per } 5 \text{ min or } 5 \text{ gpm}$$

The theoretical output from table information, however, was 4 gpm.

When the actual output is different from the calculated output, adjustments can be made by changing the pressure (when the difference is small) or changing the nozzle sizes (when the difference

is large). Experiment with the pressure to see if the output can be fine tuned. Refer to manufacturer's tables for recommended operating pressures for nozzles. Never operate above or below recommended pressures.

Repeat these calibration procedures whenever changes are made in the speed, gallons per acre, or row spacing. Periodically check the output from the nozzles during the spraying season. Remember, the effectiveness of the spray material is directly dependent on your skill as an operator.

Field test to confirm calculations:

$$\text{gpa (gallons per acre)} = \frac{\text{gal. sprayed} \times 43,560 \text{ ft}^2}{\text{distance traveled (ft.)} \times \text{row width (ft.)}}$$

Example:

A field test is run in which 10 rows, each 200-ft long, were sprayed. Row spacing was 10 ft. It took 35 gal to refill the sprayer to the original level. What was the gpa?

$$\frac{35 \text{ gal} \times 43,560 \text{ ft}^2}{2,000 \text{ ft} \times 10 \text{ ft}} = 76 \text{ gpa}$$

Determining the Amount of Spray to Apply per Acre

Always do calibration trials by driving the spray rig over terrain that is similar to that which will be sprayed.

1. Fill the tank with water.
2. Operate the sprayer at the usual pump pressure and tractor speed for a minimum distance of 500 to 800 feet.
3. Determine the square footage in the swath treated by multiplying the measured distance traveled by the length of the boom spray pattern. (Be sure to subtract the few inches that the end nozzle patterns will overlap.)
Example: distance = 730 feet and boom length = 21 feet. The square footage of the swath treated is 15,330.
4. Determine the amount of water that was sprayed on the swath by refilling the tank. Example: 6.4 gallons.
5. Divide 43,560 (there are 43,560 square feet in an acre) by the square footage of the treated swath



(example = 15,330). The answer (example = 2.84) tells how many treated swaths would comprise 1 acre.

- Determine the amount of water needed to cover an acre by multiplying 2.84 by the amount of water used (example = 6.4 gallons). The result is 18.18 gallons, a little less than the 20 gallons per acre that is generally recommended.
- To attain the 20-gallon-per-acre rate, it would be better to slow down the rate of travel rather than increase pump pressure. Increased pump pressure usually results in finer droplets that are more likely to drift. Caution: Decreasing pump pressure will result in larger droplets, poorer coverage, and less effective control.

Remember: Should different types or sizes of nozzles be needed for a particular spray job, the entire sprayer must be recalibrated.

How Much Pesticide Is Needed per Tank?

If your spray rig has a 350-gallon tank and has been calibrated to apply 20 gallons per acre, you will be able to treat 17.5 acres with each full tank of mixed spray. If the label of a 2-pound-per-gallon pesticide formulation calls for 1.5 pounds active ingredient per acre, you will need to add 13.12 gallons per tankful. Explanation:

- Determine the number of acres each spray tank will treat by dividing the tank capacity (350 gallons) by the number of gallons the sprayer applies per acre (20).
 $350 \text{ divided by } 20 = 17.5 \text{ acres}$
- Calculate how many pounds of active ingredient must be added to each full tank by multiplying the number of acres the tank will treat by the pounds of active ingredient per acre.
 $17.5 \text{ acres} \times 1.5 \text{ lbs per acre} = 26.25 \text{ pounds}$
- Determine how many gallons of 2 EC must be added to the tank by dividing the pounds of active ingredient to be added to each full tank by 2 pounds per gallon.
 $26.26 \text{ pounds} \times 2 \text{ pounds per gallon} = 13.12 \text{ gallons of the 2 EC formulation}$

Cleaning Spray Equipment

After each day's use, thoroughly flush and rinse the sprayer, inside and out, with water to prevent accumulation of pesticides. Choose a cleanup area where discharged cleaning water will not contaminate ground water, surface water, crops, or injure other plants. Discharge water should not form puddles that are accessible to children, livestock, pets, or wildlife.

When you change pesticides or finish spraying for the season, clean the sprayer thoroughly, both inside and out. For thorough cleaning, follow these steps:

- Hose down the inside of the tank completely, then fill it half-full with water. Flush the cleaning water through the boom and nozzles by operating the sprayer.
- Repeat the procedure in Step 1.
- Remove nozzle tips and screens and clean them in kerosene or in a detergent solution, using a soft brush. Do not use a knife, wire, or other hard device to clean nozzle tips. The finely machined surfaces of nozzle tips can be damaged easily, causing distortion of spray patterns and an increased rate of application. Reassemble nozzles and attach them to the boom.
- Again, fill the tank about half-full with water and add about 1 tablespoon of detergent for every 3 gallons of water.
- Run the sprayer to flush the detergent solution through the boom and nozzles.
- If you have used 2,4-D or an organophosphorus insecticide:
 - Fill tank about half-full with water and add 1 pint of ammonia for every 25 gallons of water.
 - Operate the pump to circulate the ammonia solution through the sprayer for about five minutes, then discharge a small amount through the boom and nozzles.
 - Keep the remaining solution in the sprayer overnight. The next morning:
 - Flush the ammonia solution through the boom and nozzles by operating the sprayer.
- Fill tank about half-full with clean water while rinsing it (inside and outside); then flush this final rinse through boom and nozzles.

When you have finished with the sprayer for the season, remove and store the nozzle tips, strainers,



and screens in light oil. Store the sprayer in a clean, dry shed. If the pump cannot be drained completely, store the sprayer where it cannot freeze. Support the sprayer on blocks to take the weight off the tires.

Pesticide Safety

Toxicity of Pesticides

Pesticides are manufactured to be toxic, or poisonous, to pests. Because many pesticides are toxic to a broad range of organisms, they are potentially hazardous to humans, livestock, and other animals. Because the toxicity of different pesticides varies greatly, people who use pesticides should have a general knowledge of the relative toxicity of the chemicals that they apply.

The acute toxicity of a particular pesticide is determined by subjecting test animals (usually rats, mice, rabbits, and dogs) to different dosages of the active ingredient in the pesticide product. In the most common of these tests, the active ingredient may be administered orally, by feeding the chemical to test animals, or dermally, by applying the chemical to the animals' skin. (Other methods of exposure may also be tested.) Results are analyzed to produce an estimate of an LD₅₀ — the lethal dose that kills 50% of the test animals. LD₅₀ values are expressed as mg of pesticide per kg of the test animal's weight.

Based on LD₅₀ values and similar estimates of acute toxicity, pesticide labels contain signal words that categorize the pesticide's acute toxicity. Labels for highly toxic pesticides (those with very low LD₅₀ values) display the words DANGER — POISON and a skull-and-crossbones symbol. Moderately

toxic pesticides have the word WARNING on the label, and the least toxic pesticides are labeled with the signal word CAUTION. Table 8-6 summarizes the relationships among pesticide toxicity ratings, LD₅₀ estimates, and estimated lethal doses for adult humans. All pesticide labels bear the statement: KEEP OUT OF REACH OF CHILDREN.

Table 8-7 summarizes LD₅₀ estimates for several common pesticides used in small fruit production. LD₅₀ values are useful indicators of danger, but they do not describe all aspects of pesticide toxicity. They do not, for example, indicate risks of eye injury, throat or lung irritation, chemical burns, or neurological damage. Additionally, the chronic effects of repeated low-dose exposures to pesticides are difficult to assess. As a result, applicators are urged to apply pesticides only when necessary and to use protective clothing and equipment to avoid exposures by oral, dermal, or inhalation routes.

Pesticide Applicator Certification

The United States Environmental Protection Agency (EPA) has classified certain pesticides as Restricted-Use Pesticides. Growers who wish to use these pesticides must be certified as private applicators. A fruit grower may become certified as a private applicator by attending training sessions conducted by the Extension Service in each state. Training at these sessions covers pesticide labeling; safety factors, including employee safety; environmental concerns; identification of common pests; pesticides and their use; equipment and application techniques; and state and federal regulations. Extension staff members

Table 8-6. Oral, Dermal, and Inhalation Toxicity Ratings of Pesticides.¹

Toxicity Rating	Label Signal Words	Oral LD ₅₀ (Mg/kg)	Dermal LD ₅₀ (Mg/kg)	Lethal Oral Dose, 150-Pound Man
High	Danger-Poison	0 - 50	0 - 200	few drops to teaspoon
Moderate	Warning	50 - 500	200 - 2,000	1 teaspoon to 1 ounce (2 tablespoons)
Low	Caution	500 - 5,000	2,000 - 20,000	1 ounce to 1 pint, or 2 pounds
Very low	Caution	5,000+	20,000+	1 pint or more, or 2 pounds or more

¹ Note that values in these categories indicate LETHAL (deadly) doses; much lower doses may cause severe injury or chronic health effects.



Table 8-7. LD₅₀ Values for Common Small Fruit Pesticides.			
Trade Name™	Common Name	Oral LD₅₀¹ mg/kg	Dermal LD₅₀¹ mg/kg
Fungicides			
Aliette	fosetyl-AL	2860	>2,000
Bayleton	triadimefon	1,020	>5,000
Benlate	benomyl	>10,000	>10,000
Captan	captan	9,000	--
Dithane M45	mancozeb	11,200	>15,000
Dyrene	anilazine	>5,000	>5,000
Funginex	triforine	6,000	>2,000
Karathane	dinocap	980	--
Manzate 200	mancozeb	11,200	>15,000
Nova	myclobutanil	1,600 to 2,290	>5,000
Penncozeb	mancozeb	11,200	>15,000
Ridomil	metalaxyl	669	>3,100
Ronilan	vinclozolin	>10,000	--
Rovral	iprodione	4,400	>2,000
Rubigan	fenarimol	2,500	--
Sulfur	sulfur	--	--
Thiram	thiram	780	>5,000
Topsin-M	thiophanate-methyl	7,500	--
Zineb	zineb	>5,200	>10,000
Herbicides			
Casoron	dichlobenil	603 to 3160	1,350
Dacthal	DCPA	>10,000	>10,000
Devrinol	napropamide	>5,000	>4,640
Dual	metolachlor	2,780	>10,000
2,4-D	2,4-D	300-1,000	--
Fusilade	fluazifop	2,712	>2,420
Goal	oxyfluorfen	>5,000	>10,000
Gramoxone Extra	paraquat	100	--
Karmex	diuron	3,400	>5,000
Kerb	pronamide	5,620	>3,160
Poast	sethoxydim	2,676	--
Princep	simazine	>5,000	>10,000
Prowl	pendimethalin	3,956	>2,200
Roundup	glyphosate	5,400	>5,000
Sinbar	terbacil	>5,000	>5,000
Snapshot	asoxaben/oryzalin	>5,000	--
Solicam	norfluazon	>10,000	>20,000
Surflan	oryzalin	>10,000	--
Touchdown	sulfosate	--	--



Table 8-7 (Continued). LD₅₀ Values for Common Small Fruit Pesticides.			
Trade NameTM	Common Name	Oral LD₅₀¹ mg/kg	Dermal LD₅₀¹ mg/kg
Insecticides			
Acramite	bifenazate	>5000	>5000
Admire	imidacloprid	4143-4870	>2000
Agri-Mek	abamectin	300	>1,800
Asana	esfenvalerate	458	>2000
Assail	acetamiprid	1064	>2000
Brigade	bifenthrin	375	>2,000
Capture	bifenthrin	262	>2000
Confirm	tebufenozide	>5000	>5000
Danitol	fenpropathrin	71-164	>2,000
Diazinon	diazinon	300-400	3,600
Dibrom	naled	191	360
Dipel ²	<i>Bacillus thuringiensis</i>	Nontoxic	Nontoxic
Entrust	spinosad	>5000	>2000
Esteem	pyriproxyfen	>5000	>5000
Furadan	carbofuran	7	6783
Guthion	azinphosmethyl	5-20	220
Imidan	phosmet	147-316	>4,640
Intrepid	methoxyfenozide	>5000	>2000
Kelthane	dicofol	820-960	2,100
Lannate	methomyl	17-24	5,880
Lorsban	chlorpyrifos	96-270	2,000
Malathion	malathion	1,000-2,800	4,100
Metaldehyde	metaldehyde	630	--
M-Pede	fatty acid soap	16,500	Nontoxic
Neemix	azadirachtin	13,000	--
Provado	imidacloprid	4143-3870	>2000
Pyramite, Nexter	pyridaben	1930	>2000
Pyrellin	pyrethrins + rotenone	1620	NA
Pyronyl	pyrethrins	2370	>2000
Rotenone	rotenone	132-1,500	940-3,000
Savey	hexythiazox	>5000	>5000
Sevin	carbaryl	246-283	>2,000
Spintor	spinosad	>5000	>5000
Surround	kaolin	>5000	NA
Thiodan	endosulfan	160	359
Vendex	fenbutatin-oxide	2,631	>2,000
Zeal	etoxazole	>5000	>5000
TM Where names are used, no discrimination is intended and no endorsement by Extension is implied.			
¹ Expressed in milligrams of pesticide product per kilogram of body weight in mammalian tests.			
² Other trade names include Agree, Cutlass, and Javelin.			



usually conduct these training meetings, and a test may be required in addition to or in lieu of attending training sessions. Contact local Extension personnel for more information.

Among the pesticides registered for use in small fruit, those classified for Restricted Use include:

- Agri-Mek (abamectin)
- Asana (esfenvalerate)
- Brigade (bifenthrin)
- Capture (bifenthrin)

- Danitol (fenprothrin)
- Diazinon
- Gramoxone Extra (paraquat)
- Guthion (azinphosmethyl)
- Lannate (methomyl)
- Lorsban 4E (chlorpyrifos)
- All soil fumigants (see Table 8-8).

There are no Restricted-Use fungicides at the present time.

Table 8-8. Fumigant Rates and Spectrums of Activity.						
Common Name	Trade Name	Rates/ Acre	Level of Control ^a			Comments
			Nema- todes	Fungi	Weeds	
D-D Mixture ^b	Telone II	16-20 gal	4	1	0	Slight suppression of some soil-borne organisms
D-D Mixture ^b + chloropicrin	Telone C17	30-40 gal	4	5	1	Effective against most soil-borne diseases; some weed seed suppression.
	Terr-O-cide 15D	30-40 gal	4	5	1	
	Terr-O-cide 30D	25-35 gal	4	5	1	
methyl isothiocyanate compounds	Vapam	50-100 gal	4	4	3	Most effective when applied through over-head irrigation; incorporate thoroughly in soil.
	Basamid 99G	250-350 lb	4	4	3	
methyl bromide	Brom-O-Gas	275-350 lb	5	4	4-5	Requires a plastic seal; highly toxic to humans; weak against some Pythium species.
methyl bromide +	Terr-O-Gas 67	275-350 lb	5	5	4-5	Most effective for control of weeds, chloropicrin soil-borne disease; nema todes, and insects; requires plastic seal; highly toxic.
^a 0 = no control; 5 = excellent control.						
^b Mixture of dichloropropanes and dichloropropenes in various ratios.						
Courtesy of Rutgers University. Used with permission.						



Record Keeping, Worker Protection, and Reentry Times

EPA regulations enacted in 1994 and 1995 include specific requirements for pesticide record-keeping and a Worker Protection Standard that covers worker training and reentry intervals (time periods, after pesticide application, during which unprotected workers are not to enter treated areas). Growers must keep records of applications of Restricted-Use Pesticides. Records must include:

- The brand name or product name and the EPA registration number of the pesticide.
- The total amount of the product (formulated material, not active ingredient) applied.
- The location of the application.
- The size of the treated area.
- The crop, commodity, or site treated.
- The month, day, and year of the application.
- The name and certification or license number of the applicator.

Although these record-keeping rules cover only Restricted-Use Pesticides, growers are urged to keep complete records on all pesticide applications.

The Worker Protection Standard requires that:

- Workers be trained in pesticide safety.
- Growers display pesticide information at a location accessible to all workers.
- Workers be notified of pesticide applications and any reentry restrictions that apply.
- Unprotected workers be kept out of treated areas until the reentry restrictions have elapsed.
- Growers provide appropriate protective equipment to workers.
- Wash water, soap, and single-use towels be provided at a clean site for decontamination.
- Growers provide emergency assistance to workers who are poisoned or injured in a work-related pesticide exposure.

Growers must comply with the worker protection and reentry requirements stated on pesticide labels. Training programs for pesticide applicator certification include details on record-keeping and worker protection. Contact local Extension personnel for information on training programs.

Pesticide Safety and Use

A few simple but important rules should be followed in all pesticide applications:

1. **USE PESTICIDES ONLY WHEN NECESSARY** and only at the recommended rates and times so that residues on crops do not exceed tolerances set by law.
2. **READ AND FOLLOW ALL PESTICIDE LABEL DIRECTIONS.**
3. Use the right pesticide. Consult up-to-date spray guides and check the pesticide label to be sure that what you spray is registered for the intended use and likely to control the target pest.
4. Avoid spray or dust drift from the target crop.
5. Wear protective clothing and use protective equipment according to instructions on the pesticide label. Never eat, drink, or smoke while applying pesticides.
6. Keep pesticides off your skin and clothing; wash immediately with soap and water and change clothing if accidents result in exposures to pesticides.
7. Bathe and change all clothing after applying pesticides. Wash clothing after each day's use.
8. See a physician immediately if pesticide poisoning is suspected. Show the physician the label from the pesticide suspected of causing the poisoning. Physicians should phone a Poison Control Center for complete information on treatment.

Protecting the Birds and the Bees

Most fungicides and herbicides are only slightly toxic to birds, but many insecticides are highly toxic to birds. Labels for the following pesticides present warnings that poisonings may occur if birds feed in treated areas: azinphosmethyl (Guthion), carbofuran (Furadan), diazinon (Diazinon), endosulfan (Thiodan), fenamiphos (Nemacur), methomyl (Lannate), and oxydemeton-methyl (Metasystox-R). To reduce the risk of bird poisoning, granular insecticides should be incorporated during or immediately after application. Always read and follow label directions for precautions that protect birds and other wildlife.

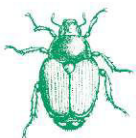

Honey bees, several species of wild bees, and many other insects aid in pollination of small fruits and countless other crop and noncrop plants. Poor pollination results in smaller, misshapen, or crumbly berries, depending on crop species. Lower yields can result. This is particularly true for raspberries and blueberries. Although wind pollination plays an important role in strawberry fruit set, insect pollination also appears to be important in this crop as well.

The importance of honey bees to the small fruit industries demands that certain guidelines be used whenever a pesticide is considered, *particularly when the crop is in bloom*. The major ways to avoid poisoning bees are summarized here:

- Move honey bee colonies into berry fields only after prebloom insecticides have been applied. Remove colonies as soon as pollination is completed.
- Do not apply insecticides that are toxic to bees to fruit crops, cover crops, adjacent crops, or interplantings if these crops are blooming. Similarly, do not apply insecticides that will kill bees to fruit plantings if blooming weeds will be treated. Mowing or otherwise controlling weeds is necessary if such insecticides must be used.
- In aerial applications, do not repeatedly turn the aircraft or transport insecticides across blooming fields. Ground application is generally less hazardous to bees than aerial application.
- Apply most insecticides (and other pesticides according to label directions) in late evening, at night, or early in the morning while few or no bees are foraging (generally between 6 p.m. and 7 a.m. in the north and 8:30 p.m. to 4 a.m. in the south). Evening applications are generally less hazardous to bees than early morning applications. When high temperatures cause bees to start foraging earlier or continue later than usual (5:30 a.m. to 8 p.m.), shift application times accordingly.
- Do not apply insecticides when temperatures are expected to be unusually low following treatment or on nights when heavy dew forms. Residues will remain toxic to bees for a longer time under such conditions.
- Use insecticides that are least hazardous to bees whenever possible (see Table 8-9).

- Choose the least hazardous insecticide formulations. Tests consistently indicate that dusts are more hazardous than sprays of the same insecticide. Emulsifiable (liquid) formulations usually have a shorter residual toxicity to bees than do wettable powders. Granular formulations are generally low in hazard to bees. Sevin XLR, a formulation that includes a sticker, is less hazardous to bees after application than wettable powder formulations of Sevin (carbaryl).
- Ask beekeepers to remove colonies from the area (or keep bees confined during and shortly after application) before applying hazardous pesticides.

Ground Water and Surface Water Protection

Ground water and surface water are invaluable natural resources. They are vulnerable to contamination, however, and pesticides have been detected in water resources in all states. To protect water supplies from contaminants, pesticide applicators must adopt sound practices that include site-specific selection of pesticides; adherence to label directions; accurate calibration and mixing; spill and back-siphon prevention; proper disposal; integrated pest management; and an overall pattern of judicious use of pesticides.

Many factors affect the movement of chemicals and their likelihood of reaching water supplies. Consideration of these factors can minimize contamination problems.

Solubility: Chemicals that are highly soluble in water are easily leached. To minimize leaching, use the least soluble chemicals at the lowest effective rates (see Table 8-10). Nitrogen (N) fertilizers are easily leached. Apply only the needed amount of N. Split applications are most effective for many crops and can reduce leaching because less N is applied at any one time, allowing the crop to use it more efficiently. Winter cover crops also take up leftover N, reducing leaching and erosion. Among pesticides that are now used or that have been used in recent years in small fruits, the insecticides Furadan (carbofuran) and Lannate (methomyl), the fungicides Ridomil

Continued



Table 8-9. Categories of Pesticide Toxicity to Honey Bees.

EXTREMELY TOXIC:

DO NOT apply on blooming crops or weeds.

Asana (esfenvalerate)	Imidan (phosmet)
Danitol (fenpropathrin)	Lannate (methomyl)
Diazinon	Lorsban (chlorpyrifos)
Furadan (carbofuran)	Malathion D or WP
Guthion (azinphos methyl)	Sevin (carbaryl)

HIGHLY TOXIC:

Apply ONLY during late evening.

Admire (imidacloprid)	Malathion EC
Confirm (tebufenozide)	Provado (imidacloprid)
Dibrom EC (naled)	Thiodan (endosulfan)

MODERATELY TOXIC:

Apply ONLY during late evening, night, or early morning.

Fusilade (fluaizifop-P-butyl)	Pyramite (pyridaben)
Neemix (azadirachtin)	Pyrellin
Oil sprays (superior types)	Rotenone
Princep (simazine)	Spintor (spinosad)

SLIGHTLY TOXIC OR NONTOXIC:

Can be applied at any time with reasonable safety to bees.

<i>Bacillus thuringiensis</i>	Kyrocide (cryolite)
Benlate (benomyl)	lime-sulfur
Bordeaux mixture	M-Pede (insecticidal soap)
Captan	Metaldehyde baits
Ethrel (ethephon)	Naturalis (<i>Beauveria</i>)
Funginex (triforine)	Paraquat/Gramoxone
Karmex (diuron)	Savey (hexythiazox)
Kelthane (dicofol)	Sinbar (terbacil)
Kerb (pronamide)	Vendex (fenbutatin-oxide)

D = Dust; EC = Emulsifiable Concentrate; WP = Wettable Powder.

Caution: Information is unavailable on the hazards posed to honey bees by pesticides not listed in this table.



Table 8-10. Physical Characteristics of Common Small Fruit Pesticides¹.				
Trade Name	Common Name	Solubility (ppm)²	Soil Adsorption (K_{oc})³	Soil 1/2-Life (days)
Fungicides				
Aliette	fosetyl-AL	122	-- ¹	--
Bayleton	tradimefon	260	273	21
Benlate	benomyl	2	190	240
Bordeaux		--	--	--
Captan	captan	4	100	3
Carbamate	ferbam	120	300	17
Fixed copper	fixed copper	--	--	--
Funginex	triforine	6	--	--
Manzate (also Dithane, Penncozeb)	mancozeb	0.5	2,000	70
Nova	myclobutanil	142	--	--
Ridomil	metalaxyl	7,100	16	21
Ronilan	vinclozolin	3	43,000	20
Rovral	iprodione	13.9	1,000	14
Rubigan	fenarimol	14	600	360
Sulfur	sulfur	--	--	--
Syllit	dodine	630	1,000,000	10
Topsin-M	thiophanate methyl	3.5	1,000	10
Thiram	thiram	30	--	--
Herbicides				
Casoron, Norosac	dichlobenil	18	224	60
Dacthal	DCPA	0.5	5,000	100
Devrinol	napropamide	73	--	--
Dual	metalochlor	530	200	20
2,4-D amine	2,4-D amine	796,000	20	10
2,4-D ester	2,4-D ester	1	1,000	10
Fusilade	fluazifop	2	3,000	20
Goal	oxyfluorfen	0.1	1000,000	35
Gramoxone Extra	paraquat	1,000,000	100,000	--
Karmex	diuron	42	--	--
Kerb	pronamide	15	990	60
Poast	sethoxydim	pH	pH	10
Princep	simiazine	6.2	138	75
Prowl	pendimethalin	0.28	24,000	90
Roundup	glyphosate	900,000	24,000	47
Sinbar	terbacil	710	55	120
Snapshot	asoxaben plus	--	--	--
	oryzalin	2.5	600	20



Table 8-10 (Continued). Physical Characteristics of Common Small Fruit Pesticides¹.				
Trade Name	Common Name	Solubility (ppm)²	Soil Adsorption (K_{OC})³	Soil 1/2-Life (days)
Solicam	norfluazon	28	--	24
Surflan	oryzalin	2.5	600	20
Touchdown	sulfosate	430	--	--
Insecticides				
Agri-Mek	abamectin	5	5,000	28
Asana	esgfenvalerate	0.002	5,300	35
Brigade	bifenthrin	0.1	240,000	26
Capture	bifenthrin	0.1	240,000	26
Danitrol	fenpropathrin	0.33	5,000	5
Diazinon	diazinon	60	1,000	40
Dibrom	naled	2000	180	1
Dipel, others	<i>Bacillus thuringiensis</i>	--	--	--
Furadan	carbofuran	351	22	50
Guthion	aziphosmethyl	29	1,000	10
Imidan	phosmet	20	820	19
Kelthane	dicofol	0.8	>5,000	45
Lannate	methomyl	58,000	72	30
Lorsban	chlorpyrifos	0.4	6,070	30
Malathion	malathion	130	1,800	1
Metaldehyde	metaldehyde	230	240	10
M-Pede	fatty acids (soaps)	--	--	--
Neemix	azadirachtin	--	--	--
pyrethrins	pyrethrins	0.001	100,000	12
Rotenone	rotenone	0.2	10,000	3
Savey	hexythiazox	0.5	6,200	30
Sevin	carbaryl	120	300	10
Thiodan	endosulfan	0.32	12,040	50
Vendex	fenbutatin-oxide	0.0127	2,300	90
¹ Denotes that information was unavailable. ² Water solubility expressed in parts per million. ³ Higher K _{OC} values indicate greater soil adsorption and a lower potential to leach.				



(metalaxyl) and Syllit (dodine), and the herbicides Dual (metolachlor), Gramoxone Extra (paraquat), Roundup (glyphosate), Sinbar (terbacil), Touchdown (sulfosate), and 2,4-D amine are moderately to highly soluble. Not all of these compounds are equally likely to leach into groundwater; however, their use patterns, persistence, and soil sorption characteristics also influence leaching and movement in surface waters.

Adsorption: Some chemicals are tightly attached (adsorbed) to soil particles or organic matter and are not easily moved. Nitrogen in the ammonium form attaches to soil particles, whereas nitrogen in the nitrate form does not. The use of ammonium N is acceptable in many situations and can reduce leaching. Pesticides with high soil adsorption values (see Table 8-10) are less likely to leach than those that do not attach tightly to soil. Pesticides that are bound to soil particles can contaminate surface water, if water or wind erosion carries soil particles and attached pesticide molecules into streams, rivers, or other bodies of water.

Persistence: Persistent chemicals break down slowly and, therefore, have more time to move into surface water and ground water. Many pesticides are broken down by sunlight (photodegradation) and/or microbial action, but incorporation of pesticides into soil reduces or eliminates photodegradation, and microbial activity declines at greater depths in the soil. See Table 8-10 for a listing of the soil half-lives (time required for the half of the original amount of the chemical to break down) of pesticides used in small fruits.

Soil Characteristics: Soil texture and organic matter content greatly influence the movement of pesticides and fertilizers. Fine-textured soils and those with high amounts of organic matter retain more water and allow greater adsorption of agricultural chemicals. Conversely, sandy soils are more permeable to water and allow less adsorption. Highly permeable soils with permeable underlying layers allow rapid downward movement of water and dissolved chemicals, leading to groundwater contamination.

Water Table: High water tables are especially vulnerable to contamination because chemicals must travel only a short distance to reach groundwater. In areas with high water tables, highly soluble or

persistent pesticides should not be applied directly to bare soils.

In summary, some risk of groundwater or surface water contamination exists whenever pesticides are used. Where risks are particularly high (coarse soils, low organic matter, high water table, bare soil, or slopes that favor runoff), producers should not apply directly to soil any pesticides that are likely to leach. In general, pesticides with a water solubility of greater than 30 ppm, a soil sorption index of less than 300 to 500, and/or a soil half-life of greater than 21 days are most likely to leach. To protect surface water, do not apply pesticides directly to soil if slopes favor runoff. To slow runoff, maintain vegetation in waterways and ditches.

Safe Storage of Pesticides

- Store pesticides in a clean, cool, dry, well-ventilated building. The building should be locked so that children and other unauthorized people cannot gain access to pesticides. Mark the storage facility with an appropriate warning sign.
- Storages should be equipped with absorbent materials such as clay, sawdust, paper, or kitty litter. Other equipment should include a fire extinguisher (ABC rated), a shovel, broom, dustpan, detergent, hand cleaner, and water. All of this equipment should be dedicated exclusively to the pesticide storage area.
- Never store herbicides alongside other pesticides; the danger of cross-contamination is too great.
- Do not store pesticides where food, water, feed, seeds, fertilizers, or pesticide safety equipment (such as respirators) can become contaminated.
- Store all pesticides in their original containers.
- Check containers frequently for leaks and breaks.
- Clean up spilled chemicals promptly and properly. If the spill is large, inform your state and local emergency response office. Dispose of broken or damaged containers and any pesticide waste in an approved and safe manner.
- Keep an inventory of all chemicals. Mark each container with the year of purchase. Do not remove labels.
- Inform your local fire department and Emergency Response Office of any agricultural chemicals (including fertilizers) stored in large quantity.



- Conform with federal and state regulations concerning reportable quantities of hazardous materials. Consult with your pesticide dealer or local Extension office for further information.
- READ THE LABEL for specific storage instructions and precautions.

Winter Storage of Pesticides

Emulsifiable concentrates should not be subjected to freezing temperatures. Freezing will destroy the emulsion, resulting in loss of effectiveness and increased likelihood of plant injury if the product is applied. Signs of deterioration due to freezing or other poor storage conditions include:

Emulsifiable concentrate (EC): Sludge, sediment, or other evidence of separation of components.

Oils: Milky appearance does not develop when water is added.

Wettable powder (WP): Excessive lumping; powder does not suspend in water.

Dry flowable (DF): Excessive lumping or caking.

If a pesticide is damaged by freezing, move it to a warm storage (50°F to 80°F) area and shake or roll the container every few hours to mix the components and eliminate layering. If layering persists or if crystals do not dissolve completely, do not use the pesticide. If you are unsure about the quality of a pesticide, call the manufacturer.

Safe Disposal of Pesticides

- Avoid disposal problems associated with excess amounts of pesticides by purchasing only the amount of pesticides that you need for planned applications (or at most, for the current growing season). DO NOT STOCKPILE.
- Follow disposal instructions on the pesticide containers. READ AND FOLLOW LABEL DIRECTIONS.
- Use proper safety equipment when disposing of pesticide wastes and containers.
- Mix only as much pesticide as you will need for a particular application. If you mix too much, it is best to apply the spray mix in the recommended manner to one of the crops listed on the label.
- Do not dump pesticides on the ground or pour them down sinks, toilets, or other drains.

- Rinse empty pesticide containers three times with water and pour the rinse water into the spray tank.
- After metal, plastic, or glass containers are rinsed, they should be punctured, broken, or crushed. Disposal of properly rinsed containers in a sanitary landfill is permissible if in accordance with local regulations.
- Combustible containers can be burned according to instructions on the label if local ordinances permit. Do not burn pesticide containers near residential areas or where people will be exposed to the smoke. Avoid smoke from burning pesticide packages; it is likely to contain toxic vapors.
- Large metal drums should be returned to pesticide suppliers for recycling or sent to a reconditioning company.
- Never reuse empty pesticide containers for any purpose.
- Wash thoroughly after handling and disposing of pesticides.

Fungicides and Insecticides for Small Fruits

Fungicides

Several fungicides are labelled for use on small fruits, and each may be very effective against some diseases and yet have little or no effect against others. Most fungicides are effective primarily as protectants — they must be applied before infection to prevent damage. Some locally systemic fungicides have curative activity, which provides some control of infections that have already started. These include Bayleton, Nova, Procure, Ridomil, and Rubigan. Table 8-11 summarizes general information on the fungicides currently registered for use on small fruits; see product labels and an up-to-date annual spray guide for further details on rates, restrictions, and application methods.



Table 8-11. Small Fruit Fungicides.				
Trade Name	Common Name	Formulations	For Use On	Comments
Abound	Azoxystrobin	2.08F	Grapes Blueberries Strawberries Brambles	Controls black rot, powdery mildew, downy mildew and is moderately effective against Botrytis bunch rot. Same fungicide as Quadris.
Aliette	fosetyl-Al	80 WDG	Brambles, Strawberries	Controls Phytophthora root rot of brambles; leather rot and red stele in strawberries.
Bayleton	triadimefon	50 DG	Grapes	Controls black rot and powdery mildew of grapes, but not downy mildew. Some “kickback” curative activity. Tank mix with another fungicide if downy mildew control is needed.
Bordeaux Mix		See comments	Grapes	Controls downy mildew, and powdery mildew of grapes. Provides fair control of black rot. Copper sulfate + hydrated lime may cause plant injury; incompatible with most other pesticides. Most effective if prepared fresh by mixing 2 lbs copper sulfate (“snow form”) and 6 lbs lime per 100 gallons water. Vigorous agitation required.
Cabrio	pyraclostrobin	20 EG	Blueberries Brambles Strawberry	Controls anthracnose, spur blight, leaf spot, powdery mildew and rusts on brambles. On blueberry it controls alternaria leaf spot and fruit rot, leaf blotch, phomopsis twig blight and powdery mildew. On strawberry it controls anthracnose fruit rot, leaf spot, and powdery mildew.
Captan	captan	50 WP, 80WP, 4L	Blueberries Grapes Strawberries	Controls stem canker and stem blight of blueberries; Phomopsis cane and leaf spot, downy mildew, and bitter rot in grapes; and is useful in tank mixes with Rovral, Elevate, Switch, or Topsin-M for the control of Botrytis gray mold, leaf spot, and anthracnose fruit rot in strawberries.
Carbamate	ferbam	76 WP	Grapes	Controls black rot but not downy mildew or powdery mildew in grapes. Because the black wettable powder leaves unsightly residues, late-season use is rarely recommended.
Elevate	fenheximide	50 WG	Brambles Strawberry Grapes	Controls Botrytis fruit rot on strawberry and brambles, and Botrytis bunch rot on grapes.
Elite	tebuconazole	45 DF	Grapes	Controls black rot and powdery mildew on grapes, but not downy mildew. Some “kickback” curative activity. Tank mix with another fungicide if downy mildew control is needed.
Endura	boscalid	70WG	Grapes	Provides excellent control of powdery mildew and moderate to good control of Botrytis bunch rot. Has little or no activity on the other grape diseases.



Table 8-11 (Continued). Small Fruit Fungicides.				
Trade Name	Common Name	Formulations	For Use On	Comments
"Fixed" Copper		See comments	Grapes	Controls black rot, downy mildew, and powdery mildew of grapes. Fixed copper sprays are relatively insoluble in water and are less injurious to plants than Bordeaux; use is limited by incompatibility with other pesticides and tendency to injure plants. Usually prepared by mixing 2 lbs spray lime with 1 lb fixed copper.
Flint	trifloxystrobin	50 WG	Grapes	Controls black rot and powdery mildew. Not highly effective for downy mildew. Do not apply to Concord grapes.
Potassium Salts Armcarb 100 Nutrol Kaligreen	Potassium Salts	See comments	Grapes Various other small fruits	Armcarb 100 and Kaligreen are formulations of potassium bicarbonate. Nutrol is a formulation of monopotassium phosphate. All of these products are registered for use on grape, and some are registered on other small fruit crops as well (see the label). They have been reported to provide good control of powdery mildew but provide little or no control of other diseases.
Phosphorous Acid ProPhyt Phostrol Agri-Fos	Phosphorous Acid	See comments	Blueberry Brambles Grape Strawberry	Various phosphorous acid products (also called phosphite or phosphonate) are currently registered in various formulations as a fungicide. They provide good to excellent control of downy mildew on grapes. Most are also registered for use as a foliar spray to control phytophthora root rot on blueberry and brambles, and are registered for control of red stele root rot and leather rot on strawberry.
Pristine	pyraclostrobin plus boscalid	38WG	Blueberries Brambles Strawberries Grapes	Controls Alternaria fruit rot, Botrytis gray mold, mummy berry, Phomopsis twig blight and fruit rot, and powdery mildew on blueberry. On brambles, it controls Anthracnose, Botrytis gray mold, leaf spot, powdery mildew, rust diseases, and spur blight. On strawberry, it controls Anthracnose, Botrytis gray mold, leaf spot, and powdery mildew. On grapes, it controls angular leaf spot, Anthracnose, black rot, downy mildew, Phomopsis cane and leaf spot, powdery mildew, and ripe rot.
Mancozeb	See comments	80% WP, 75% DF	Grapes	Controls black rot, Phomopsis cane and leaf spot, and downy mildew of grape. Some common trade names are Dithane M-45, Manzate 200, and Penncozeb. Long pre-harvest interval (66 days) limits use to early season.



Table 8-11 (Continued). Small Fruit Fungicides.				
Trade Name	Common Name	Formulations	For Use On	Comments
Nova	myclobutanil	40 WP	Brambles Grapes Strawberry	Controls black rot and powdery mildew of grapes. Some “kickback” or curative activity. Controls powdery mildew, leaf spot and leaf blight on strawberry, and rust diseases, leaf spot, and powdery mildew on brambles.
Procure	triflumizole	50 WSP	Grapes Strawberry	Controls black rot and powdery mildew on grapes, but not downy mildew. Some “kickback” curative activity. Tank mix with another fungicide if downy mildew control is needed. Controls powdery mildew on strawberry.
Ridomil Gold	mefanoxam	EC, WP	Blueberry Brambles Grapes Strawberry	Controls phytophthora root rot on blueberries and brambles, and red stele root rot and leather rot. Does not control Verticillium wilt. On grapes, Ridomil Gold MZ and Ridomil Gold/Copper are wettable powder formulations registered as a foliar application for control of downy mildew.
Rovral	iprodione	50 WP, 4 F	Brambles Grapes Strawberries	Controls Botrytis bunch rot or gray mold of grapes. Also controls Botrytis fruit rot of brambles and strawberries. Tank mix with other fungicides to slow the development of resistant strains of fungi.
Rubigan	fenarimol	1 EC	Grapes	Controls powdery mildew on grapes. Provides moderate control of black rot. Will not control downy mildew.
Sovran	kresoxim-methyl	50 WG	Grapes	Controls black rot and powdery mildew on grapes. Provides good to moderate control of downy mildew if used at higher rates. Moderately effective against Botrytis bunch rot.
Sulfur		See comments	Blueberries Brambles Grapes Strawberries	Available as wettable powder and flowable formulations for control of powdery mildew on brambles, grapes, and strawberries. On strawberry and brambles, alternative fungicides are preferred for powdery mildew control. Important on grape for powdery mildew control, but can damage some cultivars such as Concord (see Table 5-2). Can cause plant damage if applied at temperatures of 85°F or above.
Switch	cyprodinil plus fludioxinil	62.5 WG	Brambles Strawberries	Controls Botrytis fruit rot on strawberry. Has moderate activity against anthracnose fruit rot.
Syllit	dodine	65 WP	Strawberries	Controls leaf spot, leaf scorch, and leaf blight of strawberries.



Trade Name	Common Name	Formulations	For Use On	Comments
Topsin-M	thiophanate-methyl	70 WP	Strawberries	Controls leaf blight, leaf scorch, and Botrytis fruit rot (gray mold) of strawberries. Does not control leather rot. Always tank mix Topsin-M with other fungicides to slow the development of resistant strains of fungi.
Thiram	thiram	65 WP	Strawberries	Controls leaf spot and fruit rot (gray mold) of strawberries; can be tank-mixed with Rovral, Topsin-M, Elevate, or Switch.
JMS Stylet-oil		See comments	Grapes	A highly refined petroleum distillate registered for control of powdery mildew on grapes. Cannot be mixed with Captan or Sulfur and should not be applied within 2 weeks of a Captan or Sulfur application.
Liquid Lime Sulfur		29% solution	Brambles Grapes	Controls anthracnose, cane blight, and spur blight on brambles if applied at the delayed dormant stage (1/4- to 1/2-inch green). A very important spray for these diseases. Also registered as a dormant application on grapes for control of anthracnose and powdery mildew. Not registered for use on any other small fruit crop.
Vanguard	cyprodinil	75 WG	Grapes	Controls Botrytis bunch rot on grapes.
Ziram	ziram	76 DF	Grapes	Provides good control of black rot and moderate control of downy mildew and Phomopsis cane and leaf spot on grapes.

Insecticides

Insecticides and miticides also differ greatly in effectiveness against specific pests and in toxicity to beneficial insects. Most insecticides are contact poisons that offer some residual effectiveness for a few days after application by killing insects that contact the residues that remain after spraying. Some insecticides, however, must be eaten by insects to be effective. Among these are formulations of *Bacillus thuringiensis* (*Bt*); *Bt* products used in small fruits kill

only caterpillars that consume *Bt* spores or toxins. Fatty acid insecticides (insecticidal soaps), such as M-Pede, are effective only if insects are contacted by the spray solution while it is still wet. This limits the effectiveness of such sprays but also reduces mortality in nontarget beneficial insects. Table 8-12 summarizes general information on the insecticides currently registered for use on small fruits.



Table 8-12. Small Fruit Insecticides.					
Family	Trade Name	Common Name	Formulations	For Use On	Comments
Organo-phosphates	Diazinon	diazinon	50 WP, AG 500 (4EC), AG600	Blueberries Grapes Strawberries	Controls fruitworms and blueberry maggot on blueberries; fruit flies, grape berry moth, leafhoppers on grapes; aphids, leafrollers on strawberries.
	Dibrom	naled	8 EC	Grapes Strawberries	Controls fruit flies on grapes; spittlebugs, plant bugs on strawberries.
	Guthion, Sniper	azinphos-methyl	50 WP 2L	Blueberries Brambles Grapes Strawberries	Controls grape berry moth, leafrollers, leafhoppers, grape cane girdler on grapes; leafrollers, spittlebug on strawberries; leafroller on brambles; curculio, fruitworms, maggot on blueberries.
	Imidan (by 24c in some states)	phosmet	70 WP	Blueberries Grapes	Controls grape berry moth, leafrollers, Japanese beetle, leafhoppers on grapes; some plum curculio, fruitworms, Japanese beetle, blueberry maggot on blueberries.
	Lorsban	chlorpyrifos	4 EC 75 WG	Grapes Strawberries	Controls grape root borer on grapes; bud weevil (clipper) on strawberries.
	Malathion	malathion	8 EC, 8 F, 5 EC, ULV (95%)	Blueberries Brambles Grapes Strawberries	Controls fruit flies, leafhoppers, Japanese beetle, mealybug on grapes; Japanese beetle on brambles; maggot, fruitworms, curculio, tip borer on blueberries.
Organo-chlorines	Kelthane	dicofol	50 WP	Grapes Strawberries	Controls two-spotted spider mite, European red mite, cyclamen mite.
	Thiodan, Thionex, Phaser	endosulfan	50 WP, 3 EC	Blueberries Grapes Strawberries	Controls phylloxera, leafhoppers, rose chafer on grapes; spittlebug, tarnished plant bug, cyclamen mite on strawberries. Used for post-harvest control of blueberry bud mite.
Carbamates	Furadan (by 24c in some states)	carbofuran	4 F	Strawberries	Controls root weevils when used post-harvest.
	Lannate	methomyl	90 SP, LV (2.4 EC)	Blueberries Grapes Strawberries	Controls grape berry moth, leafhoppers on grapes; plant bugs on strawberries; fruitworms on blueberries.
	Sevin	carbaryl	XLR (4EC), 80 S, 4F	Blueberries Brambles Grapes Strawberries	Controls Japanese beetle, rose chafer, leafhoppers, flea beetle, cutworms, 8-spotted forester, spittlebug, fruitworms.
Pyrethroids	Asana	esfen-valerate	0.66 EC	Blueberries Brambles	Controls fruitworms, blueberry maggot
	Brigade	bifenthrin	10 WP	Strawberries	Controls plant bugs, spittlebug, clipper, sap beetle, spider mites, root weevil.
	Capture	bifenthrin	2 EC	Grapes Brambles	Controls leafrollers and root weevils.
	Danitol	fenpro-pathrin	2.4 EC	Grapes Strawberries	Controls leafhoppers, flea beetle, berry moth, phylloxera (foliar), Japanese beetle, rose chafer, spider mites on grapes; spittlebug, tarnished plant bug, spider mites on strawberries.



Table 8-12 (Continued). Small Fruit Insecticides.					
Family	Trade Name	Common Name	Formulations	For Use On	Comments
Neonico- tinoids	Assail	acetamiprid	70 WP	Grapes	Controls leafhoppers.
	Provado, Admire	imidacloprid	75 WP 1.6 F 2 F	Grapes Strawberries Blueberries	Controls leafhoppers and mealybugs. Has some systemic activity.
Insect Growth Regulators	Applaud	buprofezin	70 WP	Grapes	Controls leafhopper nymphs.
	Confirm	tebufen- ozide	2 F	Blueberries Brambles	Controls fruitworms, leafrollers, gypsy moth.
	Esteem	pyriproxyfen	35 WP	Blueberries	Controls fruitworms.
	Intrepid	methoxy- fenozide	2 F	Grapes	Controls grape berry moth.
Microbials	Biobit Condor CryMax Deliver DiPel Javelin Lepinox	<i>Bacillus thuringiensis</i> , subspecies kurstaki	DF, WG, oil flowable	Blueberries Brambles Grapes Strawberries	Controls caterpillars such as gypsy moth, leafrollers. Pests must eat treated plants. Works best on young caterpillars.
	Agree Ketch XenTari	<i>Bacillus thuringiensis</i> , subspecies aizawai	DF, WG	Blueberries Brambles Grapes Strawberries	Controls caterpillars such as gypsy moth, leafrollers. Pests must eat treated plants. Works best on young caterpillars.
	Mycotrol	<i>Beauveria bassiana</i>	ES	Blueberries Brambles Grapes Strawberries	Controls whiteflies, aphids, mealybugs, leafhoppers, beetles, plant bugs, weevils.
Botanicals	Aza-Direct Ecozin Neemix	azadirachtin	EC	Blueberries Brambles Grapes Strawberries	Controls plant bugs, leafhoppers, beetles, caterpillars, thrips.
	Pyronyl	pyrethrins	EC	Blueberries Brambles Grapes Strawberries	Controls Japanese beetle, yellowjackets, sap beetles, vinegar fruit flies, many other pests.
	Pyrellin	pyrethrins + rotenone	EC	Blueberries Brambles Grapes Strawberries	Controls Japanese beetle, aphids, caterpillars, leafhoppers, thrips, many other pests.
	Rotenone	rotenone	D, WP	Blueberries Brambles Grapes Strawberries	Controls Japanese beetle, flea beetles, rose chafer, fruitworms, cane borers, blueberry maggot.
Miscel- laneous	Acramite	bifenazate	50 WP	Grapes Strawberries	Controls two-spotted spider mite
	Agri-Mek	abamectin	0.15 EC	Grapes Strawberries	Controls two-spotted spider mite.
	Deadline MPs	metalde- hyde	Mini-pellet bait	Blueberries Brambles Grapes Strawberries	Controls slugs. Apply as a soil surface treatment.

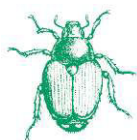
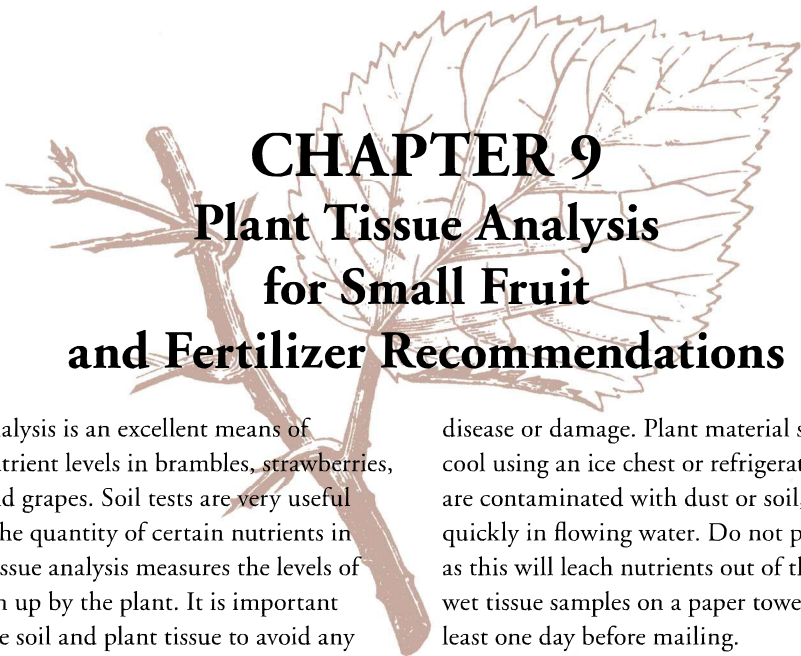

Table 8-12 (Continued). Small Fruit Insecticides.					
Family	Trade Name	Common Name	Formulations	For Use On	Comments
Miscellaneous (continued)	M-Pede	soap	Liquid concentrates	Blueberries Brambles Grapes Strawberries	Controls aphids, leafhoppers, spider mites. Thorough coverage required.
	Pyramite, Nexter	pyridaben	60 WP	Grapes	Controls European red mite, two-spotted spider mite, leafhoppers.
	Savey	hexythiazox	50 DF	Brambles Strawberries	Controls two-spotted spider mite.
	Sluggo	iron phosphate	1% Bait	All	Controls slugs.
	SpinTor, Entrust	spinosad	2 SC	Blueberries Brambles Grapes Strawberries	Controls caterpillars and thrips.
	Vendex	fenbutatin-oxide	50 WP	Grapes Strawberries	Controls European red mite, two-spotted spider mite.
	Zeal	etoxazole	5 WG	Strawberries	Controls two-spotted spider mite, European spider mite.





CHAPTER 9

Plant Tissue Analysis for Small Fruit and Fertilizer Recommendations

Plant tissue analysis is an excellent means of monitoring nutrient levels in brambles, strawberries, blueberries, and grapes. Soil tests are very useful to determine the quantity of certain nutrients in the soil, and tissue analysis measures the levels of nutrients taken up by the plant. It is important to test both the soil and plant tissue to avoid any potential problems in a planting. Nutrient levels can be corrected when analysis indicates that abnormal levels exist. Target ranges of soil test results by crop are shown in Table 9-1.

Leaf analysis is used to evaluate nutritional abnormalities in brambles, strawberries, and blueberries, and leaf petiole analysis is commonly used in grapes. Excessive levels of certain elements can be detected along with deficiencies. Tissue analysis allows a grower to detect macro and micronutrient deficiencies before a plant's health is impaired or yields are reduced.

Fresh whole leaves or petioles should be collected for analysis. Samples should be healthy and free of

disease or damage. Plant material should be kept cool using an ice chest or refrigeration. If samples are contaminated with dust or soil, wash gently and quickly in flowing water. Do not prolong the washing as this will leach nutrients out of the leaves. Air dry wet tissue samples on a paper towel in a cool area at least one day before mailing.

A soil sample should also be collected from the area where the plant tissue sample was collected to help in interpreting the results.

Ship to a lab as soon after sampling as possible. Record all foliar nutrient sprays in case the results are influenced by foliar fertilizer or pesticide applications.

Contact your county Extension office for information on where to send your leaf and soil samples for analysis. Be sure to read and follow all instructions regarding the completion of the record sheet submitted with each sample.

Table 9-1. Desirable Range of pH, Organic Matter, and Elements from Soil Test for Small Fruits.

	Brambles ^{a,b}	Blueberries ^b	Grapes ^b	Strawberries ^b
pH	5.8 to 6.2	4.5-5.2	5.5 to 6.5 ^c	5.8 to 6.5
Organic Matter	2 to 4%	4 to 7%	2 to 3%	2 to 3%
Phosphorus	40 to 50	40 to 50	40 to 50	60 to 80
Potassium	280 to 320	250 to 300	250 to 300	280 to 320
Magnesium	200 to 250	225 to 350	200 to 250	250
Boron	1.5 to 2.0	1.5 to 2.0	1.5 to 2.0	1.5 to 2.0
Zinc	8 to 10	6 to 8	8 to 10	10 to 12

^a Phosphorus given in actual pounds of available phosphorus, manganese, boron, and zinc and as exchangeable potassium, calcium, and magnesium, per acre.

^b Desirable range will vary with soil type (sand, silt, or clay), organic matter already present in the soil, and pH. Soil levels may need to be changed to correct deficiencies or excesses as they are accessed.

^c The recommended pH range for grapes varies with the type of grape — American, 5.5 to 6.5; French hybrid, around 6.5; European, 6.5 to 7.0.



Sampling

Sample Dates (Table 9-2)

Strawberries: In the first year, take 60 leaves between June 15 and July 1. In a renewed planting, sample the first fully expanded leaves after renovation, about July 15 to August 15.

Raspberries and Blackberries: Sample leaves on non-fruiting canes between August 1 and 20.

Blueberries: Sample leaves during the first week of harvest or from June 15 to August 15, depending on harvest date.

Grapes: Sample petioles from July 1 to August 15 and in June for N availability.

Sample Time

Try to collect all samples in the morning before temperatures heat up by mid-day. This will assure that turgor pressure is at its highest, and leaf tissue will be freshest for handling and shipping.

Number of Leaves Sampled

A minimum of 50 leaves (raspberries and strawberries), 80 to 100 leaves (blueberries), or 60 to 80 petioles (grapes) should be collected by cultivar for analysis. Do not mix plant tissue samples from different cultivars. Leaves and petioles should be

sampled from growth that is not too old or young. Samples should be gathered from fully expanded leaves.

Location of Plants in the Field

Be sure to collect leaves and petioles randomly throughout the planting. A single sample should be from the same cultivar but should be taken from a number of plants. There may be a situation (*i.e.*, poor growing plants) in which you desire to collect individual samples for analysis. If you suspect that there may be a localized nutrient deficiency, try to keep this plant material separate from the rest.

Process Samples

Detach leaves from plants for brambles, strawberries, and blueberries. Detach the petioles and remove leaves for grapes. Place leaves in a dry paper bag and label immediately. Be sure to include the date, cultivar, and field location.

Interpretation of Results

When you receive results from leaf or petiole tissue, consult the tables presented here for interpretation. The final decision requires a soil test taken from the same area as the tissue. Therefore, compare your results with Tables 9-3 through 9-6.

Crop	Sampling Date	Leaf Number	Part Sampled
STRAWBERRIES New and second season plasticulture plantings. Renewed matted row plantings.	June 15 – July 1	60	Youngest fully expanded mature leaves.
	July 15 – Aug. 15	60	First fully expanded leaves after renovation.
BLUEBERRIES	June 15 – Aug. 15	80-100	Sample leaves during first week of harvest.
GRAPES	July 1 – Aug. 15	60-80	Select only the first fully expanded leaves on fruiting shoots located halfway between the ground and the highest trellis wire. Detach petioles from leaf blades and send in only the petioles.
BLACKBERRIES and RASPBERRIES	Aug. 1-20	60	Fully matured leaves from mid-portion of non-fruiting canes.



These values are a composite of the best nutrition information currently available in small fruit. This assumes that the plant root system is healthy and that the soil pH is within optimal ranges for each crop (strawberries 5.8 to 6.5, brambles 5.8 to 6.2, grapes 5.5 to 6.5, and blueberries 4.5 to 5.2). If either of these assumptions is not true, do not attempt to use this information.

Remember these are guidelines and additional information from a horticulturist may be required. For example, high organic matter plus a high pH may reduce zinc uptake even when the soil shows adequate zinc. Foliar zinc sprays may be the best choice. Optimum soil-test ranges can be found in Table 9-1. Soil-test results listed in ppm can be converted to lbs/acre by multiplying each number by two.

Recommendations for Strawberries

Nitrogen (N)

Low N (if N is below 1.8). Increase rate of nitrogen application by 10% for each 0.1 that the sample is below the desired level. Apply nitrogen at renovation and again in mid-August.

N within desired range, but N/K ratio >1.5. To improve the balance between N and K in the plants,

decrease the N application by 10%. Apply nitrogen at renovation and again in mid-August.

High N (if N is above 2.80). Reduce the rate of N application by 10% for each 0.1% that the sample exceeds desired level. Apply nitrogen at renovation and again in August.

Phosphorus (P)

Low P (if P is below 0.25). Apply 200 lbs/acre 45% superphosphate at any time to the soil surface.

High P (if P is above 0.40). Omit phosphate from fertilizer program.

Potassium (K)

Low K (if K is below 1.5). Apply 45, 50, 70, 90, or 100 lbs/acre actual potassium for soil management groups I (clay), II, III, IV, and V (sand), respectively. If Mg is also low, sulfate of potash-magnesia (sul-po-mag) can be used as a source of K at 5 times the above rates.

High K (if K is above 2.50). Discontinue use of K fertilizer for one year.

K within range, but N/K ratio > than 1.5 and K/Mg ratio <3.00. To improve the balance between N and K, increase K to a total of 80 lbs actual K.

K within range, but N/K ratio 4.00. To improve the balance between K and Mg, omit K from your fertilization program.

Element	Deficient	Below Normal	Normal	Above Normal	Excessive
N (%)	1.50	1.80	2.00	2.80	>2.80
P (%)	0.20	0.25	0.30	0.40	>0.40
K (%)	1.00	1.50	1.60	2.50	>2.50
Ca (%)	0.60	0.69	0.70	1.70	>1.70
Mg (%)	0.25	0.29	0.30	0.50	>0.50
Mn (ppm)	40	49	50	150	>250
Fe (ppm)	30	59	60	150	>150
Cu (ppm)	5	6	7	20	>20
B (ppm)	19	24	25	35	>35
Zn (ppm)	15	20	35	50	>50

Source: Ohio State University Extension Bulletin 436 and University of Kentucky (personal communication) for leaves taken after renovation July 15 to August 15.



Calcium (Ca)

Low Ca (if Ca is below 0.70). Apply lime if pH is less than 6.00. See soil-test recommendations for adjustment of soil pH. If pH is greater than 6.00, then apply 1,000 lbs/acre calcium sulfate.

High Ca (if Ca is above 1.70). May indicate improper soil pH. See soil-test recommendations for adjustment.

Magnesium (Mg)

Low Mg (if Mg is below 0.30)

1. Apply magnesium sulfate (Epsom salts) to the soil surface in late fall or spring at 200 lbs/acre.
2. Sulfate of potash-magnesia (sul-po-mag) can be used if potassium is also low. Use at same rate as magnesium sulfate.
3. Apply dolomitic limestone according to soil-test recommendation if pH is above 5.5.
4. Three foliar sprays of magnesium sulfate (MgSO_4) or magnesium oxide at two-week intervals beginning after renovation will temporarily correct deficiency (15 lbs MgSO_4 /100 gal/acre or 3 lbs MgO /100 gal/acre).

Mg is within range, but K/Mg ratio >5.00. To improve the balance between K and Mg, increase Mg application to a total of 80 lbs/acre actual Mg.

High Mg (if Mg is above 0.50). Omit addition of Mg.

Manganese (Mn)

Low Mn (if Mn is below 50.0). Apply a foliar spray of manganese sulfate (2 lbs/100 gal/acre) or manganese chelate (6 lbs/100 gal/acre) prior to September 15. Check for high soil pH.

High Mn (if Mn is above 200.0). May indicate a low soil pH or contamination by fungicide or irrigation water. Consult soil-test recommendations to determine need for lime. Contamination from sprays may give artificially high readings.

Iron (Fe)

Low Fe (if Fe is below 60). Apply 4 lbs/100 gal/acre ferrous sulfate or 8 lbs/100 gal/acre iron chelate as

a foliar spray prior to September 15. If condition persists for several consecutive years and the soil pH is within the desired range, apply 25 lb/acre iron chelate or 15 lb/acre ferrous sulfate to soil in early spring.

High Fe. May be toxic if levels exceed 500 ppm. Contamination from sprays may give artificially high readings.

Copper (Cu)

Low Cu (if Cu is below 7). Apply copper chelate (4 lbs/100 gal/acre) in a foliar spray prior to May 15. If the condition persists for several consecutive years and the soil pH is within the desired range, apply 20 lb/acre copper sulfate to soil in late fall.

High Cu (if Cu is above 20.0). May indicate a low soil pH or contamination from sprays. Consult soil-test recommendations to determine the need for lime.

Boron (B)

Low B (if B is below 30). Apply Solubor to the soil at the rate of 4.0 lbs/acre in early spring or late fall, or apply a foliar spray of Solubor (20% actual boron) at the rate of 1.5 lb product/100 gal/acre in early spring and again after renovation.

High B (if B is above 70). Discontinue use of boron. Toxicity can occur if levels exceed 100 ppm.

Zinc (Zn)

Low Zn (if Zn is below 20). Apply zinc chelate (2 lbs/100 gal/acre) once after renovation and again in early May of the following year. If the condition persists for several consecutive years and the soil pH is within the desired range, apply 10 lb/acre zinc sulfate to soil in the fall.

Zn in desired range, but P/Zn ratio >140. To improve the balance between phosphorus and zinc, apply 2 lbs of zinc chelate/100 gal/acre four times during the growing season. Follow label instructions.

High Zn (if Zn is above 50). May indicate fungicide contamination. Toxicity can occur if levels exceed 300 ppm.



Recommendations for Brambles

Nitrogen (N)

Low N (if N is below 2.00). Increase the rate of nitrogen application by 10% for each 0.1% that the sample is below the desired level. The best source of nitrogen is ammonium nitrate. Fall fruit types should be near the high end of the range. Apply nitrogen prior to April 20 (Table 9-4).

High N (if N is above 3.00). Reduce the rate of the nitrogen application by 10% for each 0.1% that sample exceeds desired level.

Phosphorus (P)

Low P (if P is below 0.25). Apply 200 lbs/acre 45% superphosphate at any time to the soil surface.

High P (if P is above 0.40). Omit phosphate from the fertilizer program.

Potassium (K)

Low K (if K is below 1.50). Apply 90, 100, 140, 180, or 200 lbs/acre potassium sulfate for soil management groups I, II, III, IV, and V, respectively (I = clay; V = sand). If Mg is also low, sulfate of potash-magnesia (sul-po-mag) may be used at 2.5 times the above rates. Do not use muriate of potash.

High K (if K is above 2.50). Discontinue use of potassium fertilizer.

Calcium (Ca)

High Ca (if Ca is below 0.60). Apply lime as needed if pH is less than 6.0. See soil test recommendations for adjustment of the soil pH. If pH is greater than 6.0, apply 1,000 lbs/acre calcium sulfate.

Low Ca (if Ca is above 2.50). May indicate improper soil pH. See soil-test recommendations for adjustment.

Magnesium (Mg)

Low Mg (if Mg is below 0.30). If pH is below 6.0, apply dolomitic limestone according to soil-test recommendations. If not, apply 200 lbs/acre magnesium sulfate (Epsom salts) OR sulfate of potash-magnesia (sul-po-mag) to soil surface in late fall or early spring. Three foliar sprays of magnesium sulfate at 15 lbs/100 gal/acre or MgO at 3 lb/100 gal/acre at leaf expansion, after harvest, and in late summer will temporarily correct the deficiency.

High Mg (if Mg is above 0.90). Omit use of magnesium.

Manganese (Mn)

Low Mn (if Mn is below 50). Apply a spray of manganese sulfate (2 lbs/100 gal/acre) or manganese

Table 9-4. Specific Element Recommendations for Brambles from Leaves.

Element	Deficient	Below Normal	Normal	Above Normal	Excessive
N (%)	1.80	2.00	2.50	3.00	>3.00
P (%)	0.24	0.25	0.35	0.40	>0.40
K (%)	1.45	1.50	2.00	2.50	>2.50
Ca (%)	0.59	0.60	1.70	2.50	>2.50
Mg (%)	0.29	0.30	0.70	0.90	>0.90
Mn (ppm)	45	50	150	200	>200
Fe (ppm)	48	50	150	200	>200
Cu (ppm)	6	7	30	50	>50
B (ppm)	24	25	40	50	>50
Zn (ppm)	18	20	35	50	>50

Source: Cornell University. Used with permission.



chelate (6 lbs/100 gal/acre) after harvest, but before September 15. Check soil pH. For fall fruiting types, apply in June.

High Mn (if Mn is above 200). May indicate a low soil pH or contamination by fungicide or irrigation water. Consult soil-test recommendations to determine need for lime.

Iron (Fe)

Low Fe (if Fe is below 50). Apply 4 lbs/100 gal/acre ferrous sulfate or 8 lbs/100 gal/acre iron chelate as a foliar spray between harvest and September 15. For fall fruiting types, apply in June. If the condition persists for several consecutive years and the soil pH is within the desired range, apply 25 lb/acre iron chelate or 15 lb/acre ferrous sulfate to soil in early spring.

High Fe (if Fe is above 200). Toxicity may occur if levels exceed 250 ppm. Contamination from sprays may give artificially high readings.

Copper (Cu)

Low Cu (if Cu is below 7). Apply copper chelate (4 lbs/100 gal/acre) in a foliar spray during leaf expansion in May. If the condition persists for several consecutive years and soil pH is within the desired range, apply 20 lb/acre copper sulfate to the soil in late fall.

High Cu (if Cu is above 50). A low soil pH or contamination from sprays may be indicated. Consult soil test recommendations to determine the need for lime.

Boron (B)

Low B (if B is below 25). Apply Solubor to the soil in early spring at 4.0 lbs/acre OR apply a foliar spray of Solubor (20% actual Boron) at the rate of 1.5 lb. product/100 gal/acre in early spring. For summer bearers, apply again after harvest.

High B. Discontinue use of Boron. Toxicity may occur if levels exceed 100 ppm.

Zinc (Zn)

Low Zn (if Zn is below 20). Apply 3 lb/100 gal/acre zinc chelate at leaf expansion and after harvest

in foliar sprays. For all fruit types, apply in May and early July. If the condition persists for several consecutive years and soil pH is within the desired range, apply 10 lb/acre zinc sulfate to the soil in the fall.

High Zn (if Zn is above 50). May be indicative of fungicide contamination. Toxicity may occur if levels exceed 300 ppm.

Recommendations for Blueberries

Nitrogen (N)

Low N (if N is below 1.70). Increase the rate of nitrogen application by 10% for each 0.1% that sample is below the desired level. If soil pH is above 5.0, use ammonium sulfate; if below 5.0, use urea. Do not use ammonium nitrate or chloride fertilizers. Apply no later than April 20 (Table 9-5).

High N (if N is above 2.10). Reduce the rate of nitrogen application by 10% for each 0.1% that the sample exceeds the desired level. If the soil pH is above 5.0, use ammonium sulfate; if below 5.0, use urea. Do not use ammonium nitrate or chloride fertilizers.

Phosphorus (P)

Low P (below 0.10). Apply 180 lbs/acre 45% superphosphate at any time.

High P (above 0.18). Omit phosphate from the fertilizer program.

Potassium (K)

Low K (below 0.35). Apply 400 lbs/acre potassium magnesium sulfate or 160 lbs/acre potassium sulfate in fall or early spring.

Calcium (Ca)

Low Ca (below 0.40). Refer to the soil test and apply lime as needed, if soil pH is below 4.0. Apply 1,000 lbs/acre calcium sulfate in fall or early spring if pH is above 4.0.

High Ca (above 0.80). Refer to the soil test recommendations for pH adjustment.



Table 9-5. Specific Element Recommendations for Blueberries from Leaves.

Element	Deficient	Below Normal	Normal	Above Normal	Excessive
N (%)	1.65	1.70	1.90	2.60	>2.60
P (%)	0.10	0.11	0.15	0.28	>0.28
K (%)	0.35	0.40	0.55	0.85	>0.85
Ca (%)	0.35	0.40	0.60	0.80	>0.80
Mg (%)	0.18	0.20	0.25	0.30	>0.30
Mn (ppm)	45	50	150	500	>500
Fe (ppm)	65	70	200	300	>300
Cu (ppm)	6	7	11	25	> 25
B (ppm)	19	20	30	50	> 50
Zn (ppm)	14	15	25	30	> 30

Source: Cornell University, with adjustments in boron. Used with permission.

Magnesium (Mg)

Low Mg (below 0.20). Refer to soil test results and apply dolomitic limestone if pH is below 4.0. If pH is above 4.0, apply 250 lbs/acre Mg sulfate or use sul-po-mag (400 lbs/acre) if K is also low. Apply in fall or early spring.

Mg in range and K/Mg ratio is > 5.00. To improve the balance between K and Mg, increase Mg application to a total of 80 lbs/acre actual Mg.

High Mg (above 0.30). This may indicate a high soil pH. Refer to soil-test recommendations.

Manganese (Mn)

Low Mn (below 45). Apply a foliar spray of 6 lbs/100 gal/acre manganese chelate twice during the growing season. If the product label is different from this recommendation, follow the label recommendations.

High Mn (above 500). Refer to soil test for possible pH adjustment.

Iron (Fe)

Low Fe (below 70). Apply a foliar spray of 6 lbs/100 gal/acre iron chelate in late summer and again after bloom the following year but check product label and follow its recommendations. If the conditions persist for several consecutive years and soil pH is within the desired range (4.5 to 5.0), apply 25 lbs/acre iron chelate or 15 lbs/acre ferrous sulfate to soil in early

spring. If the product label is different from this recommendation, follow label recommendations.

High Fe (above 300). No application necessary.

Copper (Cu)

Low Cu (below 7). Apply a post-bloom and post-harvest spray of 2.0 lbs/100 gal/acre copper chelate. If product label is different from this recommendation, follow label recommendation.

High Cu (above 30). No application necessary.

Boron (B)

Low B (below 20). Apply 1.5 lbs/100 gal/acre Solubor as a foliar spray in late summer and again during early bloom. If the product label is different from this recommendation, follow label recommendations. If the condition persists for several consecutive years and soil pH is within the desired range (4.5 to 5.0), apply 5 lbs/acre Solubor to the soil surface in early spring.

High B (above 50). Consult fruit agent or fruit Extension specialist if over 100 ppm.

Zinc (Zn)

Low Zn (below 15 ppm). Apply 2.0 lbs/100 gal/acre zinc chelate post-bloom, postharvest, and in late summer. If the product label is different from this recommendation, follow the label recommendations. If the condition persists for several consecutive years



and soil pH is within desired range (4.5 to 5.0), apply 10 lbs/acre zinc sulfate to the soil surface in early spring.

High Zn (above 30). No application is necessary.

Recommendations for Grapes

Nitrogen (N)

Deficient (if N is below 0.70). (1) Apply 80 to 100 lbs. of actual nitrogen/acre (240 to 300 lbs. of ammonium nitrate) in early spring. Or: (2) Apply 0.8 lb. of actual nitrogen/100 sq. ft. of soil area (spread uniformly in an area approximately 4-feet wide beneath the trellis row). Or: (3) Make a foliar application of N as: (a) Urea fertilizer at 5 lbs/100gal., or 10 lbs/acre/application, (b) or use other commercial products, containing primarily N, at the recommended manufacturer's rate. Repeat applications may be necessary but generally will not supply total N requirement for the season.

Below Normal (if N is 0.70 to 0.90). (1) Apply 60 to 80 lbs. of actual nitrogen/acre (180 to 240 lbs. of ammonium nitrate) in early spring. Or: (2) Apply 0.7 lb. of actual nitrogen/100 sq. ft. of soil area spread uniformly in an area approximately 4-feet wide beneath trellis row). Or: (3) Make foliar application(s) of N as: (a) Urea fertilizer at 5 lbs/100 gal., or 10 lbs/acre/application. Or: (b) Other commercial products, containing primarily N, at the manufacturer's recommended rates. Repeat applications may be necessary but generally will not supply total N requirement for the season.

Normal (if N is 1.5 to 2.5). (1) Apply 40 to 60 lbs. of actual nitrogen/acre (120 to 180 lbs. of ammonium nitrate) in early spring. Or: (2) Apply 0.6 lb. of actual nitrogen/100 sq. ft. of soil area (spread uniformly in an area approximately 4-feet wide beneath trellis row). Or: (3) Make foliar application(s) of N as: (a) Urea fertilizer at 5 lbs/100 gal., or 10 lbs/acre/application. Or: (b) Use other commercial products, containing primarily N, at the manufacturer's recommended rates. Repeat applications may be necessary but generally will not supply total N requirement for the season.

High (if N is above 2.0). (1) A fertilizer application containing nitrogen is optional (may not be required next year) depending on the previous nutritional history of this vineyard, cultivar, or cultural practices. A token application rate would be 20 to 40 lbs. of actual nitrogen/acre (60 to 120 lbs. of ammonium nitrate) in early spring or 0.5 lb. of actual nitrogen/100 sq. ft. of soil area (spread uniformly in an area approximately 4-feet wide beneath trellis). (2) Foliage of young, nonbearing vines frequently have higher nitrogen content than mature vines.

Phosphorus (P)

Deficient (if P is below 0.13). (1) Apply 130 to 160 lbs. of P/acre (280 to 350 lbs. of 46% concentrated super phosphate). Or: (2) Apply 1.0 to 1.2 lb. of P_2O_5 /100 sq. ft. of soil area (spread uniformly in an area approximately 4-feet wide beneath trellis row). Or: (3) Make foliar application(s) of P as: (a) A soluble (20%) P fertilizer at 5 lbs/100 gal. Or: (b) Other commercial products, containing primarily P, at the manufacturer's recommended rates. Repeat applications may be necessary but may not supply the total P requirement for more than one season. (4). Low soil moisture may depress uptake of phosphorus.

Below Normal (if P is 0.13 to 0.15). (1) Apply 80 to 130 lbs. of P_2O_5 /acre (175 to 280 lbs. of 46% concentrated super phosphate). Or: (2) Apply 0.8 to 1.0 lb. of P_2O_5 /100 sq. ft. of soil area (spread uniformly in an area approximately 4-feet wide beneath trellis row). Or: (3) Make foliar application(s) of P as: (a) A soluble (20%) P fertilizer at 5 lbs/100 gal. Or: (b) Other commercial products containing primarily P at the manufacturer's recommended rates. Repeat applications may be necessary but may not supply the total P requirement for more than one season. Or: (4) Low soil moisture may depress uptake of phosphorus.

Normal (if P is 0.16 to 0.29). (1) No application of phosphorus is necessary at this time. (2) High to excess levels of this element may depress the uptake and concentration of one or more heavy metals such as zinc, copper, iron, or manganese.

Potassium (K)

Deficient (if K is 0.5 to 1.0). (1) Apply 300 lbs. K_2O (500 lbs. of sulfate or muriate of potash) per acre, any time. Or: (2) Apply 2.0 lb. of K_2O /100 sq. ft. of



soil area (spread uniformly in an area approximately 4-foot wide beneath trellis row). Or: (3) Make foliar application(s) of K as: (a) Sulfate of potash at 5 to 8 lbs/100 gal. Or: (b) Other commercial products, containing primarily K, at the manufacturer's recommended rates. Repeat applications may be necessary but may not supply the total K requirement for more than one season. (4). Low soil moisture and/or high Mg tends to depress uptake of K.

Potassium compounds tend to be fixed and unavailable to the vines, particularly in clay soils with a pH near 7.0, than in sandy soils with a pH near 5.0. Thus, potash applications may need to be greater on clay soils if the pH is above 6.5. Response to potash is greatest when the application is made in a 2-foot wide band beneath the trellis.

Below Normal (if K is 1.1 to 1.4). (1) Apply 240 lbs. K₂O (400 lbs. of sulfate or muriate of potash) per acre anytime. Or: (2) Apply 1.7 lb. of K₂O/100 sq. ft. of soil area (spread uniformly in an area approximately 4-foot wide beneath trellis row). Or: (3) Make foliar application(s) of K as: (a) Sulfate of potash at 5 to 8 lbs/100 gal. Or: (b) Other commercial products containing primarily K, at the manufacturer's recommended rates. Repeat applications may be necessary but may not supply the total K requirement for more than one season. (4) Low soil moisture and/or high Mg tends to depress uptake of K.

Normal (if K is 1.5 to 2.5). (1) Application of potash is optional depending on the previous history of the vineyard. A routine maintenance application is 120 lbs. K₂O/acre (200 lbs/acre of muriate or sulfate of potash or as a mixed fertilizer). (2) Commercial products containing maintenance rates of potassium may also be applied at the manufacturer's recommended rates.

Above Normal (if K is above 4.5). Applications of potassium are not required and should not be applied. Look for deficiencies of other elements, especially magnesium, caused by this abnormally high potassium level.

Calcium (Ca)

Deficient (if Ca is 0.5 to 0.8). (1) If soil pH is below the recommended level (6.5), then apply agricultural ground limestone at rates recommended by soil tests. Also correct other soil conditions, which can be associated with poor calcium uptake such as excessive, or deficient, soil moisture, poor drainage, or other nutrient elements present in excessive amounts. (2) Many commercial products containing calcium are available. Apply each according to manufacturer's recommendations. (3) For additional information, refer to Extension bulletins and state publications.

Below Normal (if Ca is 0.8 to 1.1). (1) If soil pH is below recommended level (6.5), then apply

Element ^a	Deficient	Below Normal	Normal	Above Normal	Excessive
N (%)	0.3 - 0.7	0.7 - 0.9	0.9 - 1.3	1.4 - 2.0	2.1+
P (%)	0.12	0.13 - 0.15	0.16 - 0.29	0.30 - 0.50	0.51+
K (%)	0.5 - 1.0	1.1 - 1.4	1.5 - 2.5	2.6 - 4.5	4.6+
Ca (%)	0.5 - 0.8	0.8 - 1.1	1.2 - 1.8	1.9 - 3.0	3.1+
Mg (%)	0.14	0.15 - 0.25	0.26 - 0.45	0.46 - 0.80	0.81+
Mn (ppm)	10 - 24	25 - 30	31 - 150	150 - 700	700+
Fe (ppm)	10 - 20	21 - 30	31 - 50	51 - 200	200+
Cu (ppm)	0 - 2	3 - 4	5 - 15	15 - 30	31+
B (ppm)	14 - 19	20 - 25	25 - 50	51 - 100	100+
Zn (ppm)	0 - 15	16 - 29	30 - 50	51 - 80	80+

^a Values may differ among species for optimal growth. Values from leaves will vary significantly. For petioles taken between July 15 to August 15.



agricultural ground limestone at rates recommended by soil tests. Also correct other soil conditions, which can be associated with poor calcium uptake such as excessive, or deficient, soil moisture, poor drainage, and nutrient elements present in excessive amounts. (2) Many commercial products containing calcium are available. Apply each according to manufacturer's recommendations. (3) For additional information refer to Extension bulletins and other state publications.

Normal (if Ca is 1.2 to 1.8). Continue present cultural practices. Application of calcium is not required at this time.

Above Normal (if Ca is 1.9 to 3.0). Continue present cultural practices. Application of calcium is not required at this time.

Magnesium (Mg)

Deficient (if Mg is 0.14). (1) If soil pH is below the recommended level (6.5), then apply dolomitic limestone at rates recommended by soil tests. Or: (2) Apply agricultural grade magnesium sulfate to the soil at 300 to 400 lbs/acre, or foliar grade magnesium sulfate as a spray at the rate of 10 lbs/acre. Repeat applications may be necessary. Or: (3) Apply suitable commercial products containing magnesium and recommended for soil or foliar application.

Below Normal (if Mg is 0.15 to 0.25). (1) If soil pH is below the recommended level (6.5), then apply dolomitic limestone at rates recommended by soil tests. Or: (2) Apply agricultural grade magnesium sulfate to the soil at 200 to 300 lbs/acre, or foliar grade magnesium sulfate as spray at the rate of 10 lbs/acre. Repeat applications may be necessary. Or: (3) Apply suitable commercial products containing magnesium and recommended for soil or foliar application.

Normal (0.26 to 0.45). Continue present cultural practices. Application of magnesium is not required at this time.

Above Normal (if Mg is 0.46 to 0.80). (1) Continue present cultural practices. Application of magnesium is not required at this time. Look for deficiencies of other elements, especially potassium, caused by this abnormally high magnesium level.

Manganese (Mn)

Deficient (if Mn is 10 to 24). (1) Apply a commercial formulation of manganese sulfate (24% Mn) as a foliar spray at the rate of 5 lbs/acre, in early spring before growth starts. Or: (2) Commercial products containing manganese are also available. Apply according to manufacturer's recommendations.

Below Normal (if Mn is 25 to 30). (1) Apply a commercial formulation of manganese sulfate (24% Mn) as a foliar spray at the rate of 5 lbs/acre, in early spring before growth starts. Or: (2) Commercial products containing Mn are also available. Apply according to manufacturer's recommendations.

Normal (if Mn is 31 to 150). (1) Continue present cultural practices. Application of manganese is not required at this time.

Above Normal (if Mn is 150 to 700). (1) Application of manganese is not required at this time. (2) Contamination from or absorption of fungicides containing manganese may be the cause of this high level.

Iron (Fe)

Deficient (if Fe is 10 to 20). Apply commercial formulations containing iron in available forms, such as chelates, at recommended rates. Verify iron deficiencies by the presence of foliar symptoms.

Below Normal (if Fe is 21 to 30). Apply commercial formulations containing iron in available forms, such as chelates, at recommended rates. Verify iron deficiencies by the presence of foliar symptoms.

Normal (if Fe is 31 to 50). Continue present cultural practices. Application of iron is not required at this time.

Above Normal (if Fe is 51 to 200). Application of iron is not required at this time.

Copper (Cu)

Deficient (if Cu is 0 to 2). Apply a commercial formulation of copper sulfate (22% Cu) as a foliar spray in early spring before growth starts. An annual application rate should not exceed 4 to 6 lbs/acre.

Below (if Cu is 3 to 4). An application of a commercial formulation of copper sulfate (22% Cu) is optional. Make application as a foliar spray in early



spring before growth starts. An annual application rate should not exceed 4 to 6 lbs/acre.

Normal (if Cu is 5 to 15). Continue present cultural practices. Application of copper is not required at this time.

Above Normal (if Cu is 15 to 30). Application of copper is not required at this time.

Boron (B)

Deficient (if B is 14 to 19). Make two foliar spray applications of Solubor between bloom and first cover. Apply 0.4 to 0.8 lbs/acre of actual boron per application (2 to 4 lbs. Solubor/acre/application or 4 to 8 lbs. total Solubor/acre).

Below Normal (if B is 20 to 25). Make two foliar spray applications of Solubor between bloom and first cover. Apply 0.4 to 0.8 lbs/acre of actual boron per application (2 to 4 lbs. Solubor/acre/application or 4 to 8 lbs. total Solubor/acre).

Normal (if B is 25 to 50). Continue present cultural practices. Application of boron is optional or not required at this time.

Above Normal (if B is 51 to 100). Application of boron is not required at this time.

Zinc (Zn)

Deficient (if Zn is 0 to 15). Apply a commercial formulation of zinc sulfate (89%) as a foliar spray in early spring before growth starts, at a rate of 5.5 lbs/acre.

Below Normal (if Zn is 16 to 29). Apply a commercial formulation of zinc sulfate (89%) as a foliar spray in early spring before growth starts, at a rate of 5.5 lbs/acre.

Normal (if Zn is 30 to 50). Continue present cultural practices. Application of zinc is not required at this time.

High Zn (if Zn is 51 to 80). (1) Application of zinc is not required at this time. (2) Contamination from or absorption of fungicides containing zinc may be the cause of this high level.



REFERENCES

- Anonymous. 1973. *Strawberry insects: how to control them*. U.S. Department of Agriculture, Farmers Bulletin No. 2184. 17 pp.
- Anonymous. 1992. *Integrated pest management for Iowa commercial fruit and vegetable growers* (strawberries, apples, cucurbits, sweet corn, tomatoes, potatoes). Iowa State University and the Leopold Center, No. PDO-83. ISU Extension Distribution, Printing and Publications Building, Ames IA 50011. \$28.00. 175 pp.
- Anonymous. 1993. *Integrated pest management in strawberries: a training video for growers*. Minnesota Fruit and Vegetable Growers Association, 1207 Constance Blvd NE, Ham Lake MN 55304. \$16.50. 17.5 minutes.
- Anonymous. 1993. *What you should know about controlling pest mites with predatory mites*. Central Coast Insectary, 391 Hames Rd., Watsonville CA 95076. 32 pp.
- Anonymous. 1980-1989. Grape fact sheet set. Cornell Cooperative Extension Pub. 102FSG. Resource Center-GP, 7 Cornell Business and Technology Park, Ithaca NY 14850. \$18.35. 15 sheets.
- Anonymous. 1985-1991. Small fruit fact sheet set. Cornell Cooperative Extension Pub. 102FSSF. Resource Center-GP, 7 Cornell Business and Technology Park, Ithaca NY 14850. \$4.00. 8 sheets.
- Antonelli, A. L., C. H. Shanks Jr., and G. C. Fisher. 1991. *Small fruit pests: biology, diagnosis, and management*. Washington State University, Cooperative Extension, Bulletin EB1388. Extension Bulletins Office, Cooper Publications Building, Washington State University, Pullman WA 99164-2857. \$5.00. 20 pp.
- Brown, H. L., and A. A. Ismail. 1981. *1980 Blueberry integrated pest management program*. University of Maine at Orono, Cooperative Extension Service, Bulletin 639. 19 pp.
- Caruso, F. L., and Ramsdell, D. C. 1995. *Compendium of blueberry and cranberry diseases*. American Phytopathological Society, APS Press, 3340 Pilot Knob Rd., St. Paul, MN 55121-2097. \$30.00. 100 pp.
- Cahoon, G. A., M. A. Ellis, R. N. Williams, and L. Lockshin. 1991. *Grapes: production, management, and marketing*. Ohio State University Extension Bulletin 815. Media Distribution, The Ohio State University, 385 Kottman Hall, 2021 Coffey Road, Columbus OH 43210-1044.
- Cooley, D. R. and S. G. Schloemann (eds). 1991. *Integrated pest management for strawberries in the Northeastern United States: a manual for growers and scouts*. University of Massachusetts Cooperative Extension System, No. C211. Bulletin Center, Cottage A, Thatcher Way, Amherst MA 01003. \$7.00. 50 pp.
- Cushing, N. and M. E. Whalon. 1986. *Rearing predator mites for orchards and glasshouses*. Extension Bulletin E-1872. Bulletin Office, 10-B Agriculture Hall, Michigan State University, East Lansing MI 48824-1039. \$1.60. 12 pp.
- Dill, J. F. *Monitoring for the blueberry maggot*. University of Maine at Orono, Cooperative Extension Service, Fact Sheet No. 201. 4 pp.
- Eck, P. and N. F. Childers (eds). 1989. *Blueberry culture*. Rutgers, New Brunswick, N.J. 338 pp.
- Ellis, M. A., R. H. Converse, R. N. Williams, and B. Williamson. 1991. *Compendium of raspberry and blackberry diseases and insects*. American Phytopathological Society, APS Press, 3340 Pilot Knob Rd., St. Paul, MN 55121-2097. \$30.00. 100 pp.
- Fraser, H. W., K. H. Fisher, and I. Frensch. 1998. *Bird Control on Grape and Tender Fruit Farms*. Fact Sheet 98-035. Ministry of Agriculture, Ontario, Canada.
- Funt, R. C., Ellis, M. A., Williams, R. N., Doohan, D., Scheerens, J. C., and Welty, C. 2001. *Brambles — Production, Management, and Marketing*. Ohio State University Extension Bulletin 782. Media Distribution, The Ohio State University, 385 Kottman Hall, 2021 Coffey Road, Columbus OH 43210-1044. \$9.25. 92 pp.
- Funt, R. C., B. L. Goulart, C. K. Chandler, J. D. Utzinger, M. A. Ellis, R. M. Riedel, R. N. Williams, and M. A. Palmer. 1985. *Ohio strawberry production, management, and marketing manual*. Ohio State University Extension Bulletin 436. Media Distribution, The Ohio State University, 385 Kottman Hall, 2021 Coffey Road, Columbus OH 43210-1044. \$5.00. 43 pp.
- Galletta, G. and D. G. Himelrick (eds). 1990. *Small fruit and crop management*. Prentice Hall, Englewood Cliffs, N.J. 601 pp.
- Goulart, B. (ed.). 1991. *Small fruit production and pest management guide, 1996/98*. Pennsylvania State University, Bulletin AGRS-53. College of Agriculture, Publications Distribution Center, 112 Agricultural Administration Building, University Park, PA 16802. \$8.00. 103 pp.

- Henn, T. and R. Weinzierl. 1990. *Beneficial insects and mites*. University of Illinois, Circular No. 1298. Office of Agricultural Communications and Education, Information Services, 67-C4 Mumford Hall, 1301 West Gregory Drive, Urbana IL 61801. \$2.00. 24 pp.
- Higley, L. and W. Wintersteen. 1987. *Using degree days in an integrated pest management program*. Iowa State University Extension No. Pm-1296. Publications Distribution Center, Printing and Publications Building, Iowa State University, Ames IA 50011. \$0.25. 4 pp.
- Horton, D., P. Bertrand, and G. Krewer. 1989. *Small fruit pest management and culture*. Georgia Cooperative Extension Service, Bulletin 1022. Agricultural Business Office, Room 215, Conner Hall, University of Georgia, Athens GA 30602. \$15.00. 116 pp.
- Kovach, J., W. Wilcox, A. Agnello, and M. Pritts. 1993. *Strawberry scouting procedures: a guide to sampling for common pests in New York State*. Cornell Cooperative Extension, New York State Integrated Pest Management Program, No. 102IPM203. \$10.00. 33 pp.
- Maas, J. L. (ed). 1984. *Compendium of strawberry diseases*. American Phytopathological Society, APS Press, 3340 Pilot Knob Rd., St. Paul, MN 55121-2097. \$30.00. 138 pp.
- MacNab, A. A. and R. C. Tetrault. 1985. *Identifying bramble problems*. Pennsylvania State University, Extension Service, Special Circular 232. College of Agriculture, Publications Distribution Center, 112 Agricultural Administration Building, University Park, PA 16802. 16 pp.
- Mahr, D. L. and N. M. Ridgway. 1993. *Biological control of insects and mites: an introduction to beneficial natural enemies and their use in pest management*. North Central Regional Pub. 481. University of Wisconsin, Cooperative Extension Publications, Room 245, 30 N. Murray St., Madison WI 53715. \$11.00. 92 pp.
- Olsen, L. G., M. E. Whalon, and J. G. Hamilton. *Insect traps for home fruit insect control*. North Central Regional Extension Publication 359. Bulletin Office, 10-B Agriculture Hall, Michigan State University, East Lansing MI 48824-1039. \$0.75. 7 pp.
- Pearson, R. C. and A. C. Goheen (eds). 1988. *Compendium of grape diseases*. American Phytopathological Society, APS Press, 3340 Pilot Knob Rd., St. Paul, MN 55121-2097. \$30.00. 121 pp.
- Pritts, M. and P. Handley. 1994. *Bramble production guide*. Northeast Regional Agricultural Engineering Service, Ithaca, N.Y. 14853, NRAES35. \$38.00. 188 pp.
- Pritts, M. P. 2001. Bye Bye Birdie: Repelling birds from fruit plantings. *New York Fruit Quarterly*. 9(4) 5-7.
- Pritts, M. P. and J. F. Hancock (eds). 1992. *Highbush blueberry production guide*. NRAES-55, Northeast Regional Agricultural Engineering Service. Ithaca, NY 14853. \$38.00. 200 pp.
- Shetlar, D. J. 1994. *Identification of white grubs in turfgrass*. Ohio State University Extension Fact Sheet HYG-2510-94. Ohio State University, Entomology, 1991 Kenny Road, Columbus OH 43210. 2 pp.
- Strand, L. L. 1994. *Integrated pest management for strawberries*. University of California, Statewide Integrated Pest Management Project, Pub. 3351. Publications, Division of Agriculture and Natural Resources, 6701 San Pablo Ave., Oakland CA 94608-1239. \$30.00. 142 pp.
- Taft, W. H., D. Smitley, and J. W. Snow. 1991. *A guide to the clearwing borers (Sesiidae) of the North Central United States*. North Central Regional Extension Publication 394. Bulletin Office, 10-B Agriculture Hall, Michigan State University, East Lansing MI 48824-1039. \$7.50. 30 pp.
- Weinzierl, R. A., G. C. Fisher, and J. D. Calkin. 1984. *Selecting and monitoring pheromone traps in insect pest management*. Oregon State University, Extension Circular No. 1207. \$1.00. 8 pp.
- Weinzierl, R. and T. Henn. 1989. *Microbial insecticides*. University of Illinois, Circular No. 1295. Office of Agricultural Communications and Education, Information Services, 67-C4 Mumford Hall, 1301 West Gregory Drive, Urbana IL 61801. \$1.00. 12 pp.
- Williams, R. N. and R. W. Rings. 1980. *Insect pests of strawberries in Ohio*. Ohio State University Extension Bulletin 667. Media Distribution, The Ohio State University, 385 Kottman Hall, 2021 Coffey Road, Columbus OH 43210-1044. \$1.50. 19 pp.
- Williams, R. N., D. M. Pavuk, and R. W. Rings. 1986. *Insect and mite pests of grapes in Ohio*. Ohio State University, Extension Bulletin 730. Media Distribution, The Ohio State University, 385 Kottman Hall, 2021 Coffey Road, Columbus OH 43210-1044. \$2.75. 25 pp.
- Williams, R. N. 1995. *Integrated pest management guidelines for grapes in Ohio*. Ohio State University, Ohio Agricultural Research and Development Center, Entomology Department Series No. 1. Ohio Agricultural Research and Development Center, Section of Communications and Technology, The Ohio State University, Wooster OH 44691. 32 pp.

