

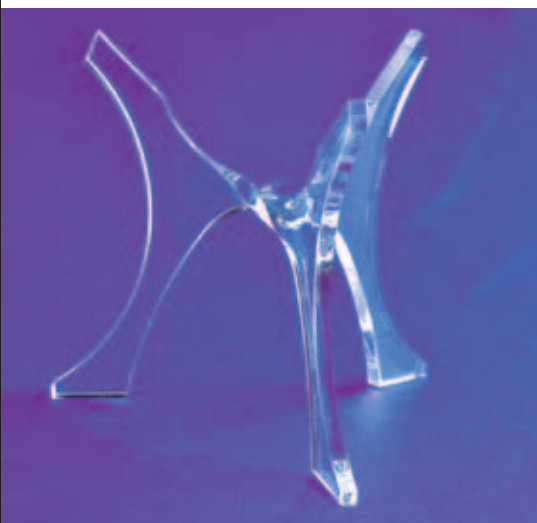

# PLEXI DISPLAYS®

Specialized Acrylic & Plexiglas® Fabrication



*Featuring our Full Line of products:*

**Countertop Displays**

**Locking Showcases**

**Literature Holders**

**Jewelry Displays**

**Food and Bulk Dispensers**

**Slatwall Accessories**

**Easels**

**Mineral, Fossil and Seashell Displays**

**Egg and Sphere Displays**

**Display Blocks and Bases**

**Ornament Displays**

**Eyewear Displays**

**Turntables and Light Bases**

**Cosmetic, Apparel and Shoe Displays**

**Everything Else**

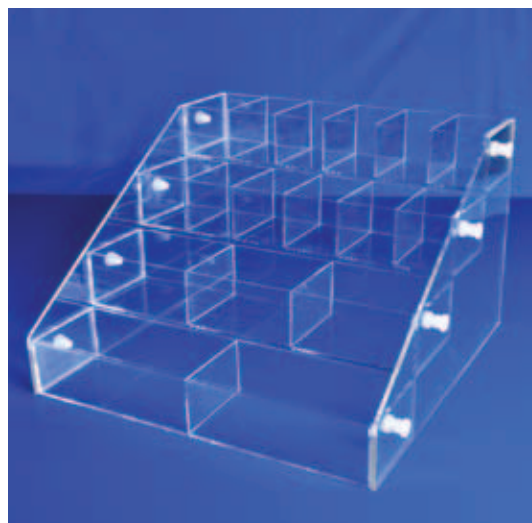

**Made in the  
USA**



# Table of Contents

<b>GENERAL COUNTERTOP DISPLAYS .....</b>	<b>2-33</b>
<i>Risers, Stairs, Multi-Platform Displays, Countertop Shelves, Box Cases, Glass Domes, Bin Systems, Mirrors, Countertop Trays, Compact Disc/DVD Shelves</i>	
<b>LOCKING SHOWCASES .....</b>	<b>34-40</b>
<i>Locking Case with Rotating Shelves, Knock-Down Locking Cases, Non-Locking Floor Unit, Hexagonal Locking Cases, Rectangular Locking Cases, Sliding Door Cases, Locking Countertop Trays, Locking Case for Slatwall Shelves</i>	
<b>LITERATURE HOLDERS .....</b>	<b>41-64</b>
<i>Molded Economy Brochure, Outdoor Brochure, Handmade Brochure, Multi-Pocket Brochure, Add-On Pockets, Multi-Tiered Brochure, Economy, Multi-Level, Countertop Brochure Rotators, Countertop Card Racks, Wall-Mounting Literature, Countertop Acrylic Frames, Business Card, Custom Silk Screening, Poster Frames, Countertop Book Displays, Ballot Boxes, Sign &amp; Label Clips</i>	
<b>JEWELRY DISPLAYS.....</b>	<b>65-75</b>
<i>Acrylic Ring Fingers, Ring Clips, Jewelry Tray Cases, Rotating Jewelry Displays, Double Locking-Door Ring Case, Earring Card Displays, Earring Displays, Watch Displays, Necklace and Bracelet Displays, Necklace Security Cases</i>	
<b>FOOD AND BULK DISPENSERS .....</b>	<b>76-78</b>
<i>Food Trays, Bulk Bins, Stackable Bulk Bins, Bulk Dispensers, Cone Holders</i>	
<b>SLATWALL ACCESSORIES .....</b>	<b>79-92</b>
<i>Slatwall Shelves, J-Shelves, Trays, Hosiery Bins, Media Shelf, Sign Holders, Brochure Holders, Bin Trays, Cell Phone Displays, Literature Displays, Easels, Eyewear Displays, Apparel Displays, Jewelry Displays, Hooks</i>	
<b>EASELS .....</b>	<b>93-101</b>
<i>Miniature, Small, Hinged, Adjustable, Wire-Back Folding, Double-Bend, Bowl, Platform, Single-Bend, Label, Lighted, Tiered</i>	
<b>MINERAL, FOSSIL, &amp; SEASHELL .....</b>	<b>102-107</b>
<i>Gold-Plated Calipers, Agate Slice Displays, Slice Racks, Geode Stands, Paired Geode Halves Displays, Cradles, Micro-Mount Boxes, Perky Boxes, Brass and Acrylic Easels, Nautilus Easels, Lighted Shell Displays</i>	
<b>EGG AND SPHERE DISPLAYS .....</b>	<b>108-111</b>
<i>Tripod Style, Dimple Blocks, Molded Rings, Handmade Rings with Bevel, Specialty Displays, Egg and Sphere Stairs</i>	
<b>DISPLAY BLOCKS AND BASES .....</b>	<b>112-115</b>
<i>Solid Blocks, Solid Columns, Round Bases, Square Bases, Label Bases, Economy Bases, Walnut Bases, Mounting Products</i>	
<b>EYEWEAR DISPLAYS.....</b>	<b>116-117</b>
<i>Saddle-Type Frame Rests, J-Shelf Frame Rests, Multi-Frame Displays, Revolving Multi-Frame Displays</i>	
<b>LIGHT BASES AND TURNTABLES.....</b>	<b>118-120</b>
<i>Small / Large / Walnut Bases; Compact / Large / Lighted Turntables; Lighted Stairs, Cords and Bulbs, Revolving Platforms</i>	
<b>COSMETICS, APPAREL, AND SHOE DISPLAYS.....</b>	<b>121-124</b>
<i>Body Outline, Belt Display, Shirt Displays, Headband/Scarf Displays, Purse Displays, Hosiery Bins, Shoe Displays, Floor Mirror, Lipstick Displays, Nail Polish Rack</i>	
<b>EVERYTHING ELSE.....</b>	<b>125-129</b>
<i>Cell Phone Displays, Pen Displays, Ornament Displays, Place Setting/Knife Displays, Acrylic Cleaning Products</i>	
<b>CATEGORY INDEX.....</b>	<b>130-131</b>
<b>PRODUCT NUMBER INDEX.....</b>	<b>132-136</b>

# General Countertop Displays

**RISERS**

*Standard three-sided risers are available in five different shapes: square, long, short, tall and narrow. For greater stability and a quality look, larger sizes are made of thicker acrylic material. All risers have finely polished edges.*

## Square Risers

Product No.	H x W x D	Thickness
R1	1 x 1 <sup>3</sup> / <sub>8</sub> x 1	<sup>3</sup> / <sub>32</sub>
R2	2 x 2 x 2	<sup>3</sup> / <sub>32</sub>
R3	3 x 3 x 3	<sup>1</sup> / <sub>8</sub>
R4	4 x 4 x 4	<sup>1</sup> / <sub>8</sub>
R5125	5 x 5 x 5	<sup>1</sup> / <sub>8</sub>
R6125	6 x 6 x 6	<sup>1</sup> / <sub>8</sub>
R7125	7 x 7 x 7	<sup>1</sup> / <sub>8</sub>
R8125	8 x 8 x 8	<sup>1</sup> / <sub>8</sub>
R5	5 x 5 x 5	<sup>3</sup> / <sub>16</sub>
R6	6 x 6 x 6	<sup>3</sup> / <sub>16</sub>
R7	7 x 7 x 7	<sup>1</sup> / <sub>4</sub>
R8	8 x 8 x 8	<sup>1</sup> / <sub>4</sub>
R9	9 x 9 x 9	<sup>1</sup> / <sub>4</sub>
R10	10 x 10 x 10	<sup>3</sup> / <sub>8</sub>
R11	11 x 11 x 11	<sup>3</sup> / <sub>8</sub>
R12	12 x 12 x 12	<sup>3</sup> / <sub>8</sub>
R14	14 x 14 x 14	<sup>3</sup> / <sub>8</sub>
R16	16 x 16 x 16	<sup>3</sup> / <sub>8</sub>
R18	18 x 18 x 18	<sup>3</sup> / <sub>8</sub>
R20	20 x 20 x 20	<sup>3</sup> / <sub>8</sub>

## Long Risers

Product No.	H x W x D	Thickness
R1L	1 x 1 <sup>3</sup> / <sub>8</sub> x 1	<sup>3</sup> / <sub>32</sub>
R2L	2 x 3 x 2	<sup>3</sup> / <sub>32</sub>
R3L	3 x 4 <sup>1</sup> / <sub>2</sub> x 3	<sup>1</sup> / <sub>8</sub>
R4L	4 x 6 x 4	<sup>1</sup> / <sub>8</sub>
R5L	5 x 7 <sup>1</sup> / <sub>2</sub> x 5	<sup>3</sup> / <sub>16</sub>
R6L	6 x 9 x 6	<sup>3</sup> / <sub>16</sub>
R7L	7 x 10 <sup>1</sup> / <sub>2</sub> x 7	<sup>1</sup> / <sub>4</sub>
R8L	8 x 12 x 8	<sup>1</sup> / <sub>4</sub>
R9L	9 x 13 <sup>1</sup> / <sub>2</sub> x 9	<sup>1</sup> / <sub>4</sub>
R10L	10 x 15 x 10	<sup>3</sup> / <sub>8</sub>
R12L	12 x 18 x 12	<sup>3</sup> / <sub>8</sub>
R14L	14 x 21 x 14	<sup>3</sup> / <sub>8</sub>

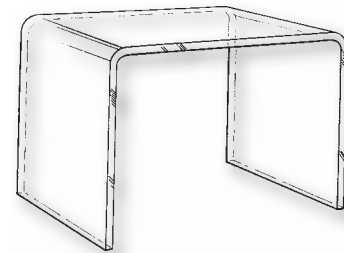

# General Countertop Displays



## Short Risers

Product No.	H x W x D	Thickness
R2S	1 x 2 x 2	$\frac{3}{32}$
R3S	1 $\frac{1}{2}$ x 3 x 3	$\frac{1}{8}$
R4S	2 x 4 x 4	$\frac{1}{8}$
R5S	2 $\frac{1}{2}$ x 5 x 5	$\frac{3}{16}$
R6S	3 x 6 x 6	$\frac{3}{16}$
R7S	3 $\frac{1}{2}$ x 7 x 7	$\frac{1}{4}$
R8S	4 x 8 x 8	$\frac{1}{4}$
R9S	4 $\frac{1}{2}$ x 9 x 9	$\frac{1}{4}$
R10S	5 x 10 x 10	$\frac{3}{8}$
R12S	6 x 12 x 12	$\frac{3}{8}$
R14S	7 x 14 x 14	$\frac{3}{8}$
R16S	8 x 16 x 16	$\frac{3}{8}$
R18S	9 x 18 x 18	$\frac{3}{8}$



## Tall Risers

Product No.	H x W x D	Thickness
R1T	1 $\frac{1}{2}$ x 1 $\frac{3}{8}$ x 1	$\frac{3}{32}$
R2T	3 x 2 x 2	$\frac{3}{32}$
R3T	4 $\frac{1}{2}$ x 3 x 3	$\frac{1}{8}$
R4T	6 x 4 x 4	$\frac{1}{8}$
R5T	7 $\frac{1}{2}$ x 5 x 5	$\frac{3}{16}$
R6T	9 x 6 x 6	$\frac{3}{16}$
R7T	10 $\frac{1}{2}$ x 7 x 7	$\frac{1}{4}$
R8T	12 x 8 x 8	$\frac{1}{4}$
R9T	13 $\frac{1}{2}$ x 9 x 9	$\frac{1}{4}$
R10T	15 x 10 x 10	$\frac{3}{8}$
R12T	18 x 12 x 12	$\frac{3}{8}$
R14T	21 x 14 x 14	$\frac{3}{8}$



## Narrow Risers

Product No.	H x W x D	Thickness
R2N	2 x 2 x 1	$\frac{3}{32}$
R3N	3 x 3 x 1 $\frac{1}{2}$	$\frac{1}{8}$
R4N	4 x 4 x 2	$\frac{1}{8}$
R5N	5 x 5 x 2 $\frac{1}{2}$	$\frac{3}{16}$
R6N	6 x 6 x 3	$\frac{3}{16}$
R7N	7 x 7 x 3 $\frac{1}{2}$	$\frac{1}{4}$
R8N	8 x 8 x 4	$\frac{1}{4}$
R9N	9 x 9 x 4 $\frac{1}{2}$	$\frac{1}{4}$
R10N	10 x 10 x 5	$\frac{3}{8}$
R12N	12 x 12 x 6	$\frac{3}{8}$
R14N	14 x 14 x 7	$\frac{3}{8}$

# General Countertop Displays

Risers

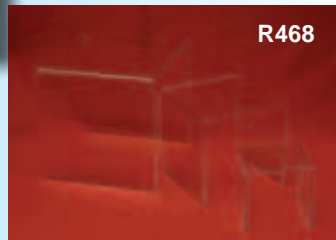

## Riser Sets

Product No.	H x W x D	Thickness
R6810	6 x 6 x 6	1/4
	8 x 8 x 8	1/4
	10 x 10 x 10	1/4
R6812	6 x 6 x 6	1/4
	8 x 8 x 8	1/4
	10 x 10 x 10	1/4
	12 x 12 x 12	1/4
R6666	6 x 6 x 6	1/4
	9 x 6 x 6	1/4
	12 x 6 x 6	1/4
	3 x 12 x 6	1/4
	3 x 6 x 6	1/4
RM25	3 1/4 x 4 x 4	1/4
	3 3/4 x 4 3/4 x 4	1/4
	5 1/2 x 4 1/4 x 4	1/4
R468	4 x 4 x 4	1/8
	6 x 6 x 6	1/8
	8 x 8 x 8	1/8
R600	4 x 6 x 10	1/4
	6 x 8 x 6	1/4
	8 x 10 x 6	1/4
RB25	2 1/2 x 4 3/4 x 4	1/4
	3 1/2 x 6 1/2 x 4	1/4
	4 1/2 x 7 1/2 x 4	1/4
R4316	3 1/4 x 4 x 4	3/16
	3 3/4 x 4 3/4 x 4	3/16
	5 1/2 x 4 1/4 x 4	3/16
	6 1/8 x 4 3/4 x 4	3/16
	6 3/4 x 5 1/2 x 4	3/16
	7 3/8 x 6 x 4	3/16

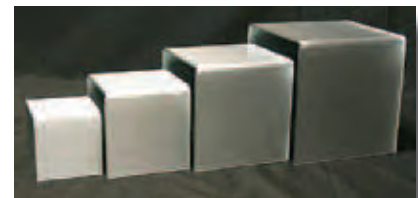

## Brushed metal-look acrylic riser set

Set of Four Risers

### Product No

850-1210	3 x 3 x 3
	4 x 4 x 4
	5 x 5 x 5
	6 x 6 x 6

# General Countertop Displays

## Tray Risers

Product No.	H x W x D	Thickness
RTY1	3 x 12 x 8	1/4
RTY2	4 x 15 x 10	1/4
RTY3	4 x 18 x 12	3/8
RTY4	5 x 21 x 14	3/8
RTY5	6 x 24 x 16	3/8



## Beveled Green "Glass-Look" Risers

Product No.	H x W x D	Thickness
GR4	4 x 4 x 4	1/4
GR5	5 x 5 x 5	1/4
GR6	6 x 6 x 6	1/4
GR7	7 x 7 x 7	1/4
GR8	8 x 8 x 8	1/4
GR9	9 x 9 x 9	1/4
GR10	10 x 10 x 10	1/4



## Mirrored Acrylic Risers

Product No.	H x W x D	Thickness
RM2	2 x 2 x 2	1/8
RM3	3 x 3 x 3	1/8
RM4	4 x 4 x 4	1/8
RM5	5 x 5 x 5	3/16
RM6	6 x 6 x 6	3/16



## Sign-Holder Risers

These risers have a built-in sign space in the front to identify merchandise by sliding in a sign or label.

Product No.	H x W x D	Sign Space
LR05	1 1/4 x 1 1/4 x 1 3/4	1 x 1 1/4
LR1	1 1/4 x 1 3/4 x 2 1/4	1 x 1 3/4
LR2	1 1/4 x 2 1/2 x 2 3/4	1 x 2 1/2
LRR2	1 1/4 x 5 x 2 1/2	1 x 5
LR3	1 3/4 x 3 1/2 x 4 1/4	2 x 3 1/2
LRR3	1 3/4 x 6 x 3 1/2	1 1/2 x 6
LR4	2 1/4 x 4 1/2 x 5 1/4	2 x 4 1/2
LR5	2 3/4 x 5 1/2 x 6 3/4	2 1/2 x 5 1/2
LR6	3 1/4 x 6 1/2 x 8 1/4	3 x 6 1/2

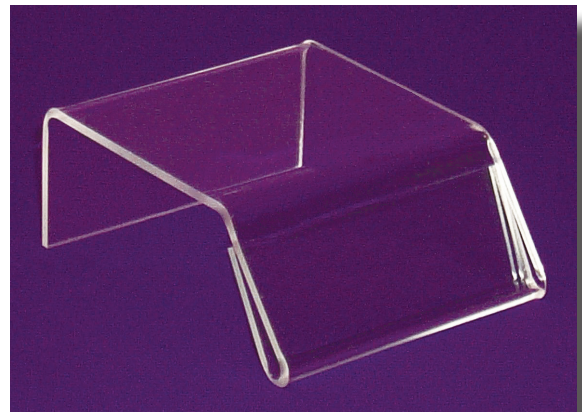

# General Countertop Displays

Risers

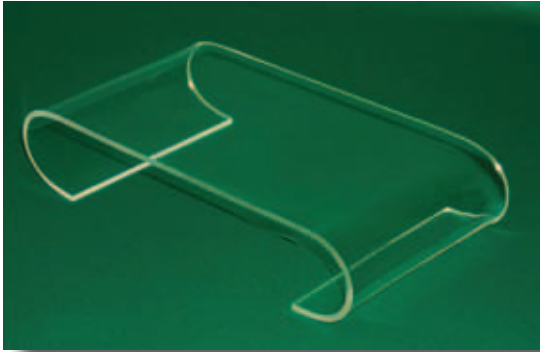

## Scroll Risers

Product No.	H x W x D
J1	1 <sup>1</sup> / <sub>4</sub> x 4 <sup>1</sup> / <sub>8</sub> x 2 <sup>1</sup> / <sub>2</sub>
J2	1 <sup>1</sup> / <sub>2</sub> x 6 <sup>1</sup> / <sub>2</sub> x 3 <sup>1</sup> / <sub>2</sub>
J3	1 <sup>3</sup> / <sub>4</sub> x 8 <sup>1</sup> / <sub>2</sub> x 4 <sup>1</sup> / <sub>2</sub>
J4	2 x 10 <sup>3</sup> / <sub>4</sub> x 5 <sup>1</sup> / <sub>2</sub>
J5	3 x 12 x 7
J6	4 x 15 x 9

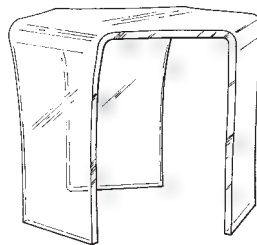
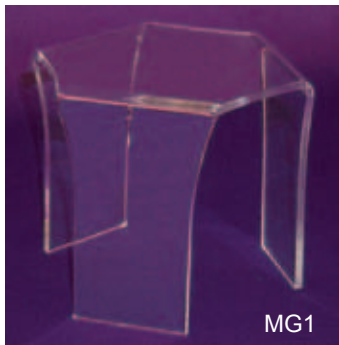

## Three-Legged Risers

Product No.	H x W x D
MG1	2 <sup>3</sup> / <sub>4</sub> x 4 <sup>1</sup> / <sub>4</sub> x 3 <sup>3</sup> / <sub>4</sub>
MG2	4 <sup>3</sup> / <sub>4</sub> x 6 x 5
MG3	6 <sup>1</sup> / <sub>4</sub> x 8 <sup>3</sup> / <sub>4</sub> x 7 <sup>1</sup> / <sub>2</sub>
MG4	7 <sup>3</sup> / <sub>4</sub> x 11 x 9 <sup>1</sup> / <sub>2</sub>

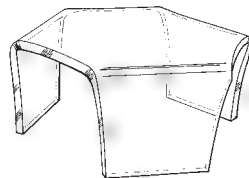
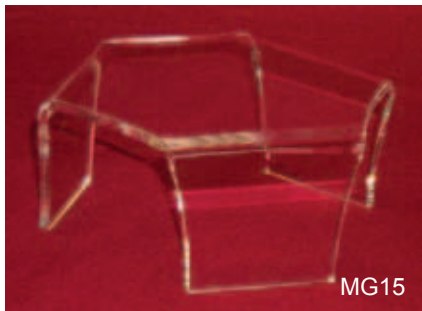

## Short Three-Legged Risers

Product No.	H x W x D
MG15	1 <sup>1</sup> / <sub>4</sub> x 4 <sup>1</sup> / <sub>4</sub> x 3 <sup>3</sup> / <sub>4</sub>
MG25	2 <sup>1</sup> / <sub>2</sub> x 6 x 5
MG35	3 <sup>1</sup> / <sub>2</sub> x 8 <sup>3</sup> / <sub>4</sub> x 7 <sup>1</sup> / <sub>2</sub>
MG45	4 x 11 x 9 <sup>1</sup> / <sub>8</sub>

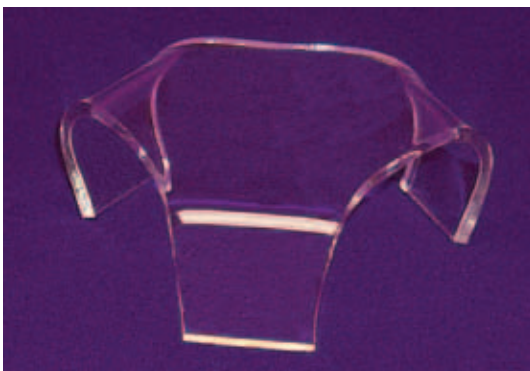

## Small Three-Legged Risers

Product No.	H x W x D
711	3 <sup>3</sup> / <sub>4</sub> x 2 x 1 <sup>3</sup> / <sub>4</sub>
7151	1 x 2 <sup>3</sup> / <sub>4</sub> x 2 <sup>1</sup> / <sub>4</sub>
721	1 <sup>1</sup> / <sub>4</sub> x 3 <sup>1</sup> / <sub>4</sub> x 3
731	1 <sup>5</sup> / <sub>8</sub> x 4 <sup>1</sup> / <sub>2</sub> x 3 <sup>3</sup> / <sub>4</sub>
741	1 <sup>3</sup> / <sub>4</sub> x 5 <sup>1</sup> / <sub>4</sub> x 4 <sup>3</sup> / <sub>4</sub>
751	2 <sup>1</sup> / <sub>8</sub> x 6 <sup>1</sup> / <sub>2</sub> x 5 <sup>3</sup> / <sub>4</sub>

# General Countertop Displays

## Thick Beveled Square Risers

All sizes of these risers are  $\frac{3}{8}$ " thick.

Product No.	H x W x D
R6BT	6 x 6 x 6
R7BT	7 x 7 x 7
R8BT	8 x 8 x 8
R9BT	9 x 9 x 9
R10BT	10 x 10 x 10
R11BT	11 x 11 x 11
R12BT	12 x 12 x 12
R14BT	14 x 14 x 14
R16BT	16 x 16 x 16



Risers



Legs detach for easy packing.



## Round Countertop Tables

Product No.	H x W x D
RT06	8 x 6
RT08	8 x 8
RT12	8 x 12
RT16	8 x 16
RT20	8 x 20

## Rectangular Countertop Tables

Product No.	H x W x D
RT48	4 x 8 x 4
RT66	6 x 6 x 6
RT88	8 x 8 x 8
RT1212	8 x 12 x 12
RT1616	8 x 16 x 16
RT812	8 x 12 x 8
RT1016	8 x 16 x 10

## Black Rectangular Bases

Product No.	H x W x D
BRK12	2 x 12 x 2
BRK14	3 x 14 x 4
BRK16	4 x 16 x 6

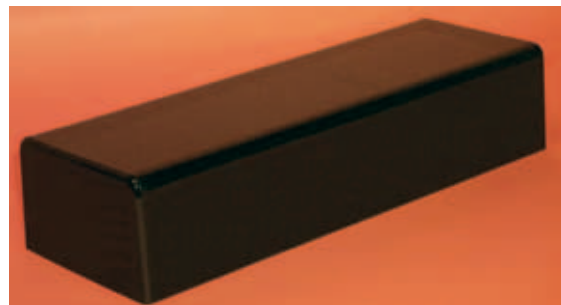



# General Countertop Displays

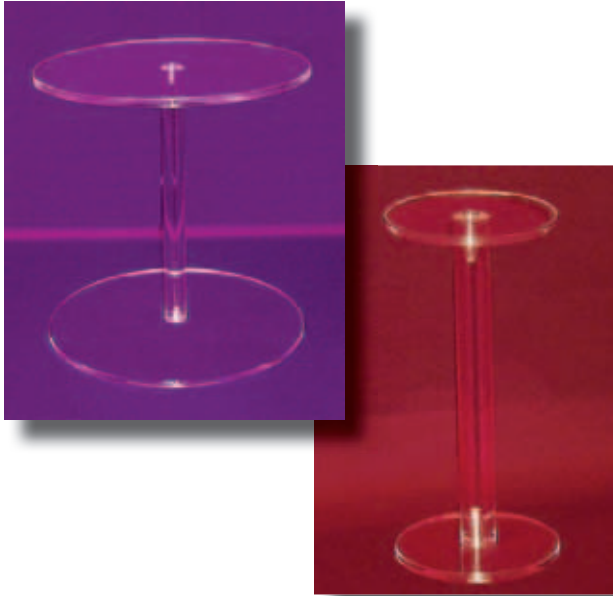

## Round Barbell Risers

These risers are made of acrylic platforms ranging from 3" to 12" in diameter and round acrylic rods. They assemble with stainless steel screws. Shipped unassembled.

<u>Product No.</u>	<u>H x Dia.</u>	<u>Thickness</u>
BBR1	4 <sup>1</sup> / <sub>4</sub> x 3	<sup>3</sup> / <sub>16</sub>
BBR2	4 <sup>1</sup> / <sub>4</sub> x 4 <sup>1</sup> / <sub>2</sub>	<sup>3</sup> / <sub>16</sub>
BBR3	6 <sup>3</sup> / <sub>8</sub> x 3	<sup>3</sup> / <sub>16</sub>
BBR4	6 <sup>3</sup> / <sub>8</sub> x 4 <sup>1</sup> / <sub>2</sub>	<sup>3</sup> / <sub>16</sub>
BBR5	8 x 6	<sup>1</sup> / <sub>4</sub>
BBR6	8 x 7 <sup>1</sup> / <sub>2</sub>	<sup>1</sup> / <sub>4</sub>
BBR7	9 <sup>1</sup> / <sub>2</sub> x 6	<sup>1</sup> / <sub>4</sub>
BBR8	9 <sup>1</sup> / <sub>2</sub> x 7 <sup>1</sup> / <sub>2</sub>	<sup>1</sup> / <sub>4</sub>
BBR9	12 <sup>3</sup> / <sub>4</sub> x 9	<sup>3</sup> / <sub>8</sub>
BBR10	12 <sup>3</sup> / <sub>4</sub> x 12	<sup>3</sup> / <sub>8</sub>
BBR11	16 <sup>3</sup> / <sub>4</sub> x 9	<sup>3</sup> / <sub>8</sub>
BBR12	16 <sup>3</sup> / <sub>4</sub> x 12	<sup>3</sup> / <sub>8</sub>

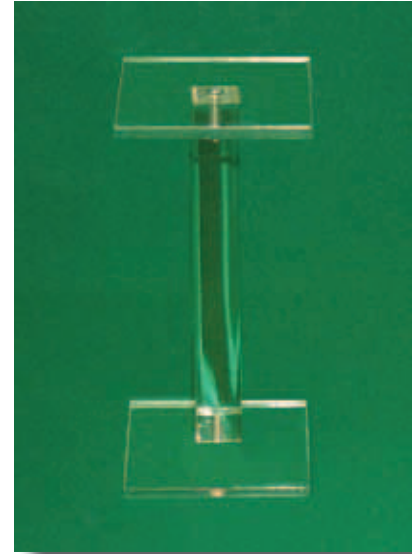

## Square Barbell Risers

These 3", 4", and 6" square acrylic platforms and square acrylic rods are assembled with stainless steel screws. Shipped unassembled.

<u>Product No.</u>	<u>H x W x D</u>	<u>Thickness</u>
3SQBB2	2 <sup>1</sup> / <sub>4</sub> x 3 x 3	<sup>3</sup> / <sub>16</sub>
3SQBB4	4 <sup>3</sup> / <sub>8</sub> x 3 x 3	<sup>3</sup> / <sub>16</sub>
3SQBB6	6 <sup>3</sup> / <sub>8</sub> x 3 x 3	<sup>3</sup> / <sub>16</sub>
3SQBB8	8 <sup>3</sup> / <sub>8</sub> x 3 x 3	<sup>3</sup> / <sub>16</sub>
3SQBB10	10 <sup>1</sup> / <sub>2</sub> x 3 x 3	<sup>1</sup> / <sub>4</sub>
4SQBB4	4 <sup>1</sup> / <sub>2</sub> x 4 x 4	<sup>1</sup> / <sub>4</sub>
4SQBB6	6 <sup>1</sup> / <sub>2</sub> x 4 x 4	<sup>1</sup> / <sub>4</sub>
4SQBB8	8 <sup>1</sup> / <sub>2</sub> x 4 x 4	<sup>1</sup> / <sub>4</sub>
4SQBB10	10 <sup>1</sup> / <sub>2</sub> x 4 x 4	<sup>1</sup> / <sub>4</sub>
4SQBB12	12 <sup>1</sup> / <sub>2</sub> x 4 x 4	<sup>1</sup> / <sub>4</sub>
6SQBB6	6 <sup>1</sup> / <sub>2</sub> x 6 x 6	<sup>1</sup> / <sub>4</sub>
6SQBB8	8 <sup>1</sup> / <sub>2</sub> x 6 x 6	<sup>1</sup> / <sub>4</sub>
6SQBB10	10 <sup>1</sup> / <sub>2</sub> x 6 x 6	<sup>1</sup> / <sub>4</sub>
6SQBB12	12 <sup>1</sup> / <sub>2</sub> x 6 x 6	<sup>1</sup> / <sub>4</sub>



## Double Riser

This tall riser features a fixed shelf at one third of the height. Acrylic is <sup>3</sup>/<sub>8</sub>" thick.

<u>Product No.</u>	<u>H x W x D</u>
DR3010	30 x 10 x 10

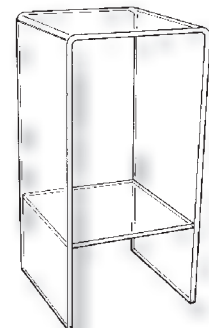

# General Countertop Displays



## Acrylic Cylinder Risers

Clear acrylic cylinders with clear acrylic tops can be used as risers or inverted to serve as containers.

Product No.	H x Dia.
RRC2	2 x 2
RRC25	1½ x 2
RRC3	3 x 3
RRC35	1½ x 3
RRC4	4 x 4
RRC45	2 x 4
RRC5	4 x 5
RRC55	2 x 5
RRC6	4 x 6
RRC65	2 x 6
RRC7	4 x 7
RRC75	2 x 7
RRC8	6 x 8
RRC85	3 x 8
RRC10	6 x 10
RRC105	3 x 10

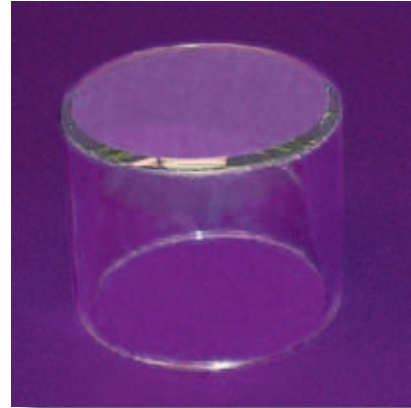

## Round Mirror Risers

These clear acrylic cylinders are topped with beveled glass mirrors.

Product No.	H x Dia.
MT151	1 x 1½
MT152	2 x 1½
MT21	1 x 2
MT22	2 x 2
MT251	1 x 2½
MT252	2 x 2½
MT32	2 x 3
MT33	3 x 3
MT42	2 x 4
MT44	4 x 4
MT52	2 x 5
MT54	4 x 5
MT62	2 x 6
MT64	4 x 6
MT72	2 x 7
MT74	4 x 7
MT82	2 x 8
MT84	4 x 8
MT102	2 x 10
MT104	4 x 10



## Oval Shelf Unit

Three acrylic shelves are assembled with clear acrylic rods in this shelf unit. There are 6" between the shelves.

Product No.	H x W x D
GJS2	12¼ x 18 x 10
GJS3	18½ x 18 x 10

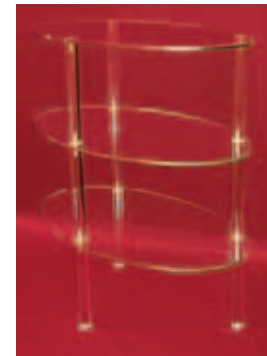

# General Countertop Displays

## STAIRS

Stairs

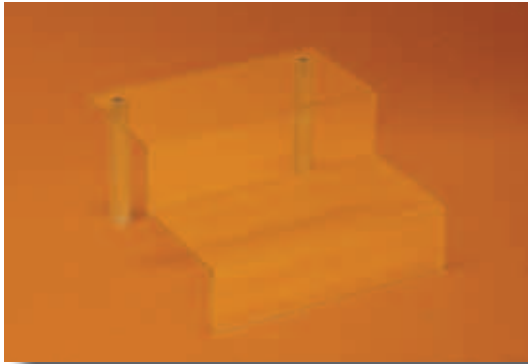

### Two-Step Stairs

Product No.	Finish	H x W x D	Stair Depth
ST3	Clear	4 <sup>1</sup> / <sub>4</sub> x 8 x 8 <sup>1</sup> / <sub>2</sub>	4
ST3B	Black	4 <sup>1</sup> / <sub>4</sub> x 8 x 8 <sup>1</sup> / <sub>2</sub>	4
ST3F	Frosted	4 <sup>1</sup> / <sub>4</sub> x 8 x 8 <sup>1</sup> / <sub>2</sub>	4
ST5	Clear	6 <sup>1</sup> / <sub>4</sub> x 12 x 10 <sup>1</sup> / <sub>4</sub>	5
ST5B	Black	6 <sup>1</sup> / <sub>4</sub> x 12 x 10 <sup>1</sup> / <sub>4</sub>	5
ST5F	Frosted	6 <sup>1</sup> / <sub>4</sub> x 12 x 10 <sup>1</sup> / <sub>4</sub>	5
ST6	Clear	6 <sup>1</sup> / <sub>4</sub> x 18 x 10 <sup>1</sup> / <sub>2</sub>	5
ST6B	Black	6 <sup>1</sup> / <sub>4</sub> x 18 x 10 <sup>1</sup> / <sub>2</sub>	5
ST6F	Frosted	6 <sup>1</sup> / <sub>4</sub> x 18 x 10 <sup>1</sup> / <sub>2</sub>	5



### Three-Step Stairs

Product No.	Finish	H x W x D	Stair Depth
ST4	Clear	6 <sup>3</sup> / <sub>8</sub> x 12 x 12 <sup>5</sup> / <sub>8</sub>	4
ST4B	Black	6 <sup>3</sup> / <sub>8</sub> x 12 x 12 <sup>5</sup> / <sub>8</sub>	4
ST4F	Frosted	6 <sup>3</sup> / <sub>8</sub> x 12 x 12 <sup>5</sup> / <sub>8</sub>	4
ST7	Clear	6 <sup>1</sup> / <sub>4</sub> x 6 x 6 <sup>1</sup> / <sub>2</sub>	2
ST7B	Black	6 <sup>1</sup> / <sub>4</sub> x 6 x 6 <sup>1</sup> / <sub>2</sub>	2
ST7F	Frosted	6 <sup>1</sup> / <sub>4</sub> x 6 x 6 <sup>1</sup> / <sub>2</sub>	2
ST75	Clear	7 <sup>3</sup> / <sub>4</sub> x 10 x 8	2 <sup>1</sup> / <sub>2</sub>
ST75B	Black	7 <sup>3</sup> / <sub>4</sub> x 10 x 8	2 <sup>1</sup> / <sub>2</sub>
ST75F	Frosted	7 <sup>3</sup> / <sub>4</sub> x 10 x 8	2 <sup>1</sup> / <sub>2</sub>
ST8	Clear	9 <sup>1</sup> / <sub>2</sub> x 12 x 9 <sup>1</sup> / <sub>2</sub>	3
ST8B	Black	9 <sup>1</sup> / <sub>2</sub> x 12 x 9 <sup>1</sup> / <sub>2</sub>	3
ST8F	Frosted	9 <sup>1</sup> / <sub>2</sub> x 12 x 9 <sup>1</sup> / <sub>2</sub>	3
ST85	Clear	9 <sup>1</sup> / <sub>2</sub> x 18 x 9 <sup>1</sup> / <sub>2</sub>	3
ST85B	Black	9 <sup>1</sup> / <sub>2</sub> x 18 x 9 <sup>1</sup> / <sub>2</sub>	3
ST85F	Frosted	9 <sup>1</sup> / <sub>2</sub> x 18 x 9 <sup>1</sup> / <sub>2</sub>	3
ST9	Clear	12 <sup>1</sup> / <sub>4</sub> x 18 x 12 <sup>1</sup> / <sub>4</sub>	4
ST9B	Black	12 <sup>1</sup> / <sub>4</sub> x 18 x 12 <sup>1</sup> / <sub>4</sub>	4
ST9F	Frosted	12 <sup>1</sup> / <sub>4</sub> x 18 x 12 <sup>1</sup> / <sub>4</sub>	4



### Large Four-Step Stairs

Product No.	Rise	H x W x D	Stair Depth
ST1235	3"	20 <sup>1</sup> / <sub>4</sub> x 12 x 20	5
ST1246	4"	16 <sup>1</sup> / <sub>4</sub> x 12 x 24	6
ST1835	3"	20 <sup>1</sup> / <sub>4</sub> x 18 x 20	5
ST1846	4"	16 <sup>1</sup> / <sub>4</sub> x 18 x 24	6

# General Countertop Displays

## Sign Attachment for Stairs

Insert a sign or photo into this one-piece sign holder that attaches to any of our rod-leg stairs. When assembling the stairs, simply insert the sign holder between the rods and the stair.

Sign attachment and stairs are sold separately.

Product No.	For Stair	H x W
SAT6	ST7	4 1/2 X 6
SAT8	ST3	4 1/2 X 8
SAT10	ST75	4 1/2 X 10
SAT12	ST4, ST5, ST8	4 1/2 X 12
SAT18	ST6, ST85, ST9	4 1/2 X 18
SAT212	ST1235, ST1246	4 1/2 X 12
SAT218	ST1835, ST1846	4 1/2 X 18



## Solid-Back Stairs

Product No.	Finish	H x W x D	Stair Depth
BST1	Clear	8 1/4 x 6 x 8 3/4	4
BST1B	Black	8 1/4 x 6 x 8 3/4	4
BST1F	Frosted	8 1/4 x 6 x 8 3/4	4
BST5	Clear	8 1/4 x 6 x 6 1/2	3
BST5B	Black	8 1/4 x 6 x 6 1/2	3
BST5F	Frosted	8 1/4 x 6 x 6 1/2	3
BST3	Clear	3 1/2 x 18 x 6 1/2	3
BST3B	Black	3 1/2 x 18 x 6 1/2	3
BST3F	Frosted	3 1/2 x 18 x 6 1/2	3
BST6	Clear	8 1/4 x 18 x 8 1/2	4
BST6B	Black	8 1/4 x 18 x 8 1/2	4
BST6F	Frosted	8 1/4 x 18 x 8 1/2	4
BST9	Clear	5 1/2 x 18 x 8	2 1/2

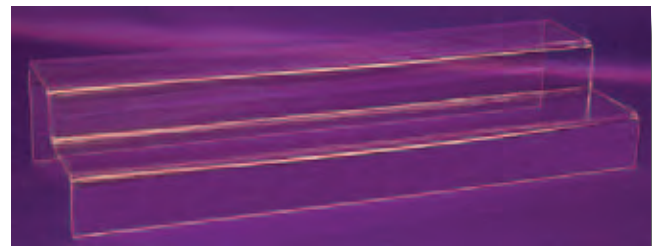

Product No.	Finish	H x W x D	Stair Depth
BST9B	Black	5 1/2 x 18 x 8	2 1/2
BST9F	Frosted	5 1/2 x 18 x 8	2 1/2
BST8	Clear	6 3/4 x 16 x 9 3/4	3
BST8B	Black	6 3/4 x 16 x 9 3/4	3
BST8F	Frosted	6 3/4 x 16 x 9 3/4	3

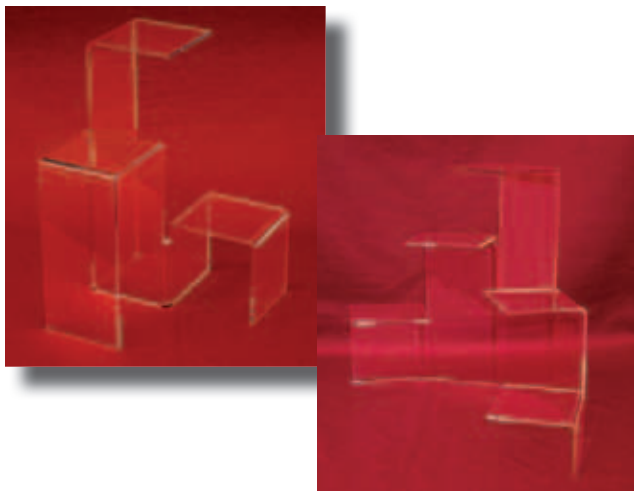

## Tiered Platform Stairs

Three-tier, one-piece bent riser with 4"-square platforms.

Product No.	H x W x D	Platform
PRM3	12 1/8 x 8 1/4 x 8 1/4	4"

Platforms are at 4", 8" and 12" high

Five tier, one-piece bent risers with 4" or 6" square platforms.

Product No.	H x W x D	Platform
PRM5	12 1/8 x 8 1/4 x 8 1/4	4"

Platforms are at 3", 6", 9", 12" and 18" high

PRM55	18 1/4 x 25 x 15	6"
-------	------------------	----

Platforms are at 2", 4", 6", 8" and 12" high

# General Countertop Displays



## Four-Step Flanged Stairs

The front-edge lip on these stairs makes them good for displaying boxed or packaged items. Shipped fully assembled.

Product No.	H x W x D	Stair Depth
STL55	8 <sup>1</sup> / <sub>4</sub> x 10 <sup>1</sup> / <sub>4</sub> x 8 <sup>1</sup> / <sub>8</sub>	1 <sup>3</sup> / <sub>4</sub>
STL66	9 x 12 <sup>1</sup> / <sub>2</sub> x 9 <sup>1</sup> / <sub>4</sub>	2
STL77	10 <sup>1</sup> / <sub>2</sub> x 10 <sup>3</sup> / <sub>16</sub> x 11	2 <sup>1</sup> / <sub>2</sub>
STL88	13 x 12 <sup>1</sup> / <sub>4</sub> x 13	3
STL88W	13 x 18 x 13	3
STL99	17 <sup>1</sup> / <sub>2</sub> x 19 x 17 <sup>1</sup> / <sub>2</sub>	3

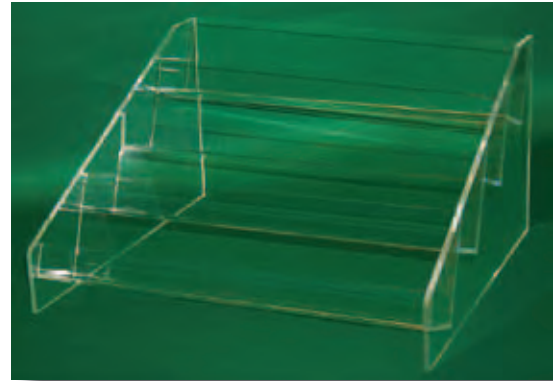

## Four-Step Tilted Flanged Stairs

The shelves of these stairs are angled back for easy viewing of boxed or packaged items. Shipped fully assembled.

Product No.	H x W x D	Stair Depth
STL55A	6 <sup>1</sup> / <sub>2</sub> x 10 <sup>1</sup> / <sub>4</sub> x 10	1 <sup>3</sup> / <sub>4</sub>
STL66A	6 <sup>3</sup> / <sub>4</sub> x 12 <sup>1</sup> / <sub>2</sub> x 11 <sup>1</sup> / <sub>2</sub>	2
STL77A	8 <sup>1</sup> / <sub>2</sub> x 10 <sup>1</sup> / <sub>2</sub> x 13 <sup>3</sup> / <sub>4</sub>	2 <sup>1</sup> / <sub>2</sub>
STL88A	10 <sup>1</sup> / <sub>2</sub> x 12 <sup>1</sup> / <sub>2</sub> x 1 <sup>3</sup> / <sub>4</sub>	3
STL88WA	10 <sup>1</sup> / <sub>2</sub> x 18 <sup>1</sup> / <sub>2</sub> x 16 <sup>3</sup> / <sub>4</sub>	3



## Four-Step Stairs without Front Lip

Product No.	H x W x D	Stair Depth
STG2	8 <sup>1</sup> / <sub>4</sub> x 10 <sup>1</sup> / <sub>4</sub> x 8 <sup>1</sup> / <sub>8</sub>	1 <sup>3</sup> / <sub>4</sub>
STG3	9 x 12 <sup>3</sup> / <sub>8</sub> x 9 <sup>1</sup> / <sub>4</sub>	2
STG4	13 x 18 <sup>3</sup> / <sub>8</sub> x 13	3
STG5	11 <sup>1</sup> / <sub>4</sub> x 10 <sup>1</sup> / <sub>4</sub> x 10 <sup>5</sup> / <sub>8</sub>	2 <sup>1</sup> / <sub>2</sub>
STG6	13 x 12 <sup>1</sup> / <sub>4</sub> x 13 <sup>1</sup> / <sub>4</sub>	3
STG7	16 <sup>1</sup> / <sub>4</sub> x 18 <sup>1</sup> / <sub>4</sub> x 16 <sup>1</sup> / <sub>4</sub>	3

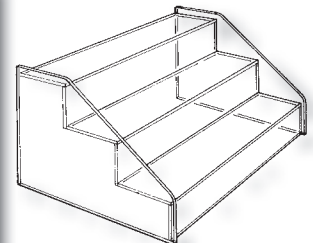
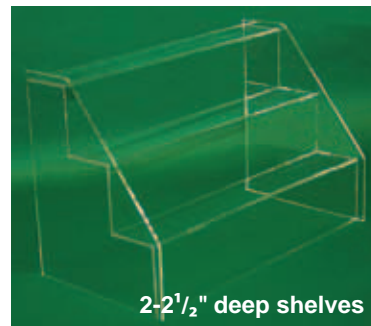

## Three-Step Versa Stairs

These stairs are constructed so that they can be used in two ways. Standing upright on the short side provides narrower shelves with a higher rise; standing on the long side provides deeper shelves with a low rise. Shipped fully assembled.

Product No.	Finish	H x W x D
STV1	Clear	8 x 12 <sup>1</sup> / <sub>4</sub> x 6 <sup>1</sup> / <sub>2</sub>
STV1B	Black	8 x 12 <sup>1</sup> / <sub>4</sub> x 6 <sup>1</sup> / <sub>2</sub>
STV2	Clear	9 <sup>1</sup> / <sub>4</sub> x 14 <sup>1</sup> / <sub>4</sub> x 6 <sup>1</sup> / <sub>2</sub>
STV2B	Black	9 <sup>1</sup> / <sub>4</sub> x 14 <sup>1</sup> / <sub>4</sub> x 6 <sup>1</sup> / <sub>2</sub>
STV3	Clear	11 x 18 <sup>1</sup> / <sub>2</sub> x 7 <sup>3</sup> / <sub>4</sub>
STV3B	Black	11 x 18 <sup>1</sup> / <sub>2</sub> x 7 <sup>3</sup> / <sub>4</sub>

# General Countertop Displays

## Mini Three-Step Stairs

Product No.	Finish	H x W x D	Stair Depth
STM2	Clear	3 <sup>3</sup> / <sub>4</sub> x 12 <sup>1</sup> / <sub>4</sub> x 3 <sup>3</sup> / <sub>4</sub>	1 <sup>1</sup> / <sub>8</sub>
STM2B	Black	3 <sup>3</sup> / <sub>4</sub> x 12 <sup>1</sup> / <sub>4</sub> x 3 <sup>3</sup> / <sub>4</sub>	1 <sup>1</sup> / <sub>8</sub>
STM4	Clear	5 x 16 <sup>1</sup> / <sub>4</sub> x 5	1 <sup>1</sup> / <sub>2</sub>
STM4B	Black	5 x 16 <sup>1</sup> / <sub>4</sub> x 5	1 <sup>1</sup> / <sub>2</sub>
STM6	Clear	6 <sup>1</sup> / <sub>2</sub> x 20 <sup>1</sup> / <sub>4</sub> x 6 <sup>1</sup> / <sub>2</sub>	2
STM6B	Black	6 <sup>1</sup> / <sub>2</sub> x 20 <sup>1</sup> / <sub>4</sub> x 6 <sup>1</sup> / <sub>2</sub>	2

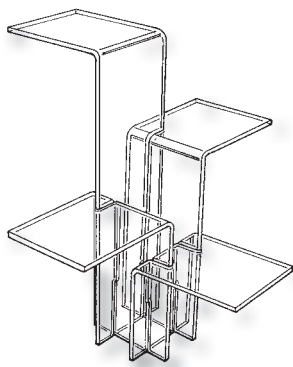
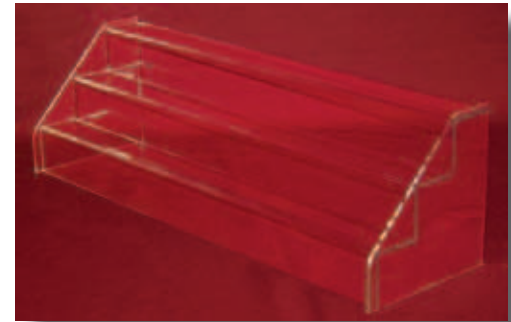

## Interlocking Four-Way Riser

Shipped unassembled, this multi-platform riser slides together quickly. Slots are precision laser cut.

Product No.	H x W x D	Platform Size
KDR12	12 <sup>3</sup> / <sub>8</sub> x 12 <sup>1</sup> / <sub>4</sub> x 12 <sup>1</sup> / <sub>4</sub>	4 x 4
KDR15	15 <sup>3</sup> / <sub>8</sub> x 15 <sup>1</sup> / <sub>4</sub> x 15 <sup>1</sup> / <sub>4</sub>	5 x 5
KDR18	18 <sup>3</sup> / <sub>8</sub> x 18 <sup>3</sup> / <sub>8</sub> x 18 <sup>3</sup> / <sub>8</sub>	6 x 6

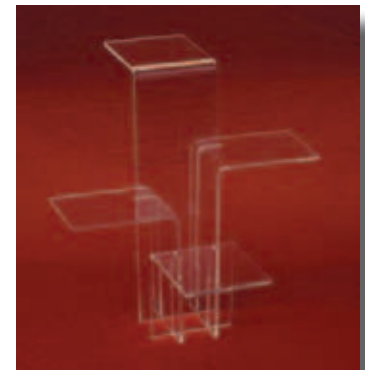

## Five-Shelf Tower

Constructed with round acrylic rods and stainless steel screws, this five-platform tower can be assembled in many configurations. It is easy to stagger or change the number of the platforms. Shipped unassembled.

Product No.	H x Dia.	Shelf Diameter
TWR5	21 x 10	6



## Interlocking Stair Display

Made of 3/8"-thick acrylic. Packs flat in six pieces and assembles by sliding together.

Product No.	H x W x D	Stair Depth
SST9	13 x 22 x 13	4
SST10	13 x 26 x 13	5

# General Countertop Displays

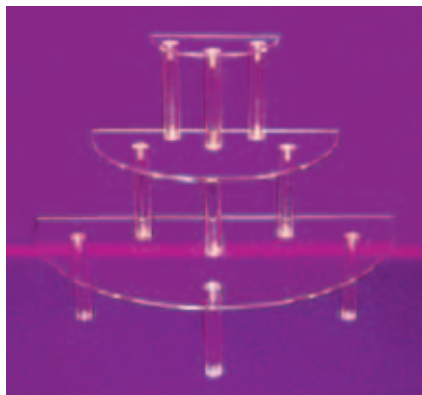

**Three-Tiered Half-Round Shelves**  
 Constructed with round acrylic rods and stainless steel screws. Shipped unassembled.

Product No.	H x W x D
50R1	14 x 18 x 9
Three shelves are 18" x 9", 12" x 6" and 6" x 3"	
50R2	18½ x 24⅛ x 12
Three shelves are 24" x 12", 18" x 9" and 12" x 6"	



## PEDESTAL RISERS



### Semi-Circle Base Risers

Constructed with round acrylic rods and stainless steel screws. Shipped unassembled.

Product No.	H x W x D	Pedestal Dia.
KR12	12½ x 16½ x 9	4
Pedestal heights are 4", 8" and 12"		
KR18	18½ x 25 x 13	6
Pedestal heights are 6", 12" and 18"		
KR24	24½ x 33 x 17½	8
Pedestal heights are 8", 16" and 24"		



### Round Base Risers

Constructed with round acrylic rods and stainless steel screws. Shipped unassembled.

Product No.	H x Base Dia.	Pedestal Dia.
3PED	5 x 8	3
Pedestal heights are 2½", 3½" and 4¾"		
4PED	6 x 8	3
Pedestal heights are 2½", 3½", 4¾" and 5¾"		
5PED	7 x 10	3
Pedestal heights are 2½", 3½", 4¾", 5¾" and 6¾"		

# General Countertop Displays

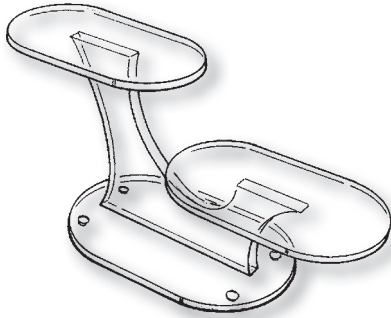

## Oval Two-Platform Risers

With two ovals. Shipped fully assembled.

Product No.	H x W x D	Platform Size
MPO2S	3 <sup>1</sup> / <sub>2</sub> x 5 <sup>3</sup> / <sub>4</sub> x 2 <sup>1</sup> / <sub>2</sub>	1 <sup>1</sup> / <sub>2</sub> x 3
MPO2M	5 <sup>3</sup> / <sub>8</sub> x 11 <sup>3</sup> / <sub>8</sub> x 4	3 x 6
MPO2L	7 <sup>1</sup> / <sub>2</sub> x 13 <sup>1</sup> / <sub>2</sub> x 5	4 x 7

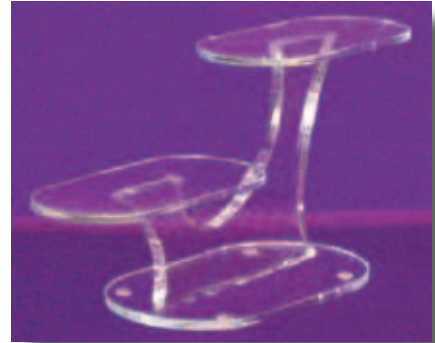

## Oval Three-Platform Riser

With three ovals. Shipped fully assembled.

Product No.	H x W x D	Platform Size
MPO3	8 x 19 <sup>1</sup> / <sub>2</sub> x 5	4 x 7



## Oval Five-Platform Riser

V-shaped version of the oval riser with five platforms. Shipped fully assembled.

Product No.	H x W x D	Platform Size
MPO5	7 <sup>3</sup> / <sub>4</sub> x 25 <sup>1</sup> / <sub>2</sub> x 14 <sup>3</sup> / <sub>4</sub>	4 x 7



## Adjustable Platform Risers

Constructed with S-shaped round acrylic rods and stainless steel screws. Can be positioned in a variety of configurations. Shipped unassembled.

Product No.	H x W x D	Platform Size
OP1	6 <sup>1</sup> / <sub>4</sub> x 14 <sup>1</sup> / <sub>2</sub> x 10 <sup>1</sup> / <sub>4</sub>	7 x 4
Pedestal heights are two at 4", one at 6"		
OP3	8 <sup>3</sup> / <sub>4</sub> x 19 x 15	9 x 5 <sup>1</sup> / <sub>2</sub>
Pedestal heights are two at 4", one at 6"		
OP5	10 <sup>1</sup> / <sub>4</sub> x 25 <sup>1</sup> / <sub>2</sub> x 20	11 x 7
Pedestal heights are two at 4 <sup>1</sup> / <sub>4</sub> ", two at 7", one at 9 <sup>3</sup> / <sub>4</sub> "		



# General Countertop Displays



## Mini-Platform Stairs

Available in clear or frosted acrylic and in a special version that has a mirrored base and black platforms. Platform sizes indicated are sides and center. Shipped fully assembled.

Product No.	Finish	H x W x D	Platform Sizes
MPV1	Clear	4 <sup>1</sup> / <sub>8</sub> x 14 x 6	1 <sup>1</sup> / <sub>2</sub> x 2, 2 x 4
MPV1F	Frosted	4 <sup>1</sup> / <sub>8</sub> x 14 x 6	1 <sup>1</sup> / <sub>2</sub> x 2, 2 x 4
MPV1MB	Mirror/Black	4 <sup>1</sup> / <sub>8</sub> x 14 x 6	1 <sup>1</sup> / <sub>2</sub> x 2, 2 x 4
MPV3	Clear	6 <sup>1</sup> / <sub>8</sub> x 21 x 7	2 x 3, 3 x 6
MPV3F	Frosted	6 <sup>1</sup> / <sub>8</sub> x 21 x 7	2 x 3, 3 x 6
MVP3MB	Mirror/Black	6 <sup>1</sup> / <sub>8</sub> x 21 x 7	2 x 3, 3 x 6
MPV5	Clear	8 <sup>1</sup> / <sub>8</sub> x 28 x 9	3 x 4, 4 x 8
MPV5F	Frosted	8 <sup>1</sup> / <sub>8</sub> x 28 x 9	3 x 4, 4 x 8
MPV5MB	Mirror/Black	8 <sup>1</sup> / <sub>8</sub> x 28 x 9	3 x 4, 4 x 8



## Tiered Stairs

Product No.	Finish	H x W x D
ST1	Clear	6 <sup>1</sup> / <sub>4</sub> x 11 <sup>3</sup> / <sub>4</sub> x 6
ST1B	Black	6 <sup>1</sup> / <sub>4</sub> x 11 <sup>3</sup> / <sub>4</sub> x 6
ST1F	Frosted	6 <sup>1</sup> / <sub>4</sub> x 11 <sup>3</sup> / <sub>4</sub> x 6

Side steps are 3" wide, top is 5" wide

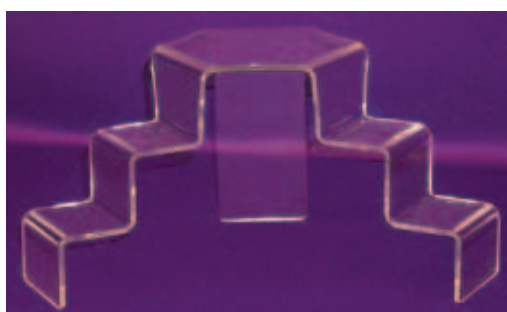
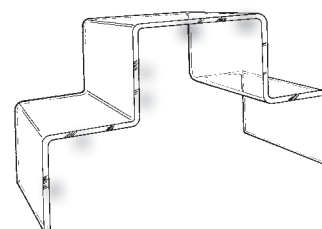

## Cascading Tiered Stairs

Product No.	Finish	H x W x D
MGA	Clear	5 <sup>1</sup> / <sub>4</sub> x 11 <sup>1</sup> / <sub>2</sub> x 6 <sup>1</sup> / <sub>2</sub>
MGAF	Frosted	5 <sup>1</sup> / <sub>4</sub> x 11 <sup>1</sup> / <sub>2</sub> x 6 <sup>1</sup> / <sub>2</sub>
Side steps are 2" x 2", top is 4" x 4"		
MGB	Clear	6 <sup>1</sup> / <sub>2</sub> x 14 x 8
MGBF	Frosted	6 <sup>1</sup> / <sub>2</sub> x 14 x 8
Side steps are 2" x 3", top is 5 <sup>1</sup> / <sub>2</sub> " x 5 <sup>1</sup> / <sub>2</sub> "		
MGC	Clear	6 <sup>1</sup> / <sub>2</sub> x 14 x 10
MGCF	Frosted	6 <sup>1</sup> / <sub>2</sub> x 14 x 10
Side steps are 3" x 4 <sup>1</sup> / <sub>4</sub> ", top is 8" x 8"		



## Tapered Stairs

Product No.	Finish	H x W x D
SGA	Clear	6 <sup>1</sup> / <sub>2</sub> x 6 x 7
SGAF	Frosted	6 <sup>1</sup> / <sub>2</sub> x 6 x 7
SGB	Clear	9 <sup>1</sup> / <sub>4</sub> x 9 x 9 <sup>3</sup> / <sub>4</sub>
SGBF	Frosted	9 <sup>1</sup> / <sub>4</sub> x 9 x 9 <sup>3</sup> / <sub>4</sub>
SGC	Clear	12 x 12 x 12 <sup>1</sup> / <sub>2</sub>
SGCF	Frosted	12 x 12 x 12 <sup>1</sup> / <sub>2</sub>

# General Countertop Displays

## MULTI-PLATFORM DISPLAYS

Easy to adjust into a variety of positions, the six-platform display comes with either rectangular or oval-shaped shelves in either clear or mirrored acrylic. Constructed with round acrylic rods and stainless steel screws. All units are packaged unassembled for easy shipping.

### Rectangular Platform Displays

Product No.	Finish	H x W	Platform Size
TS05	Clear	10 <sup>1</sup> / <sub>4</sub> x 26	3 x 6
TS05M	Mirror	10 <sup>1</sup> / <sub>4</sub> x 26	3 x 6
TS1	Clear	18 <sup>3</sup> / <sub>4</sub> x 39	4 <sup>1</sup> / <sub>2</sub> x 9
TS1M	Mirror	18 <sup>3</sup> / <sub>4</sub> x 39	4 <sup>1</sup> / <sub>2</sub> x 9
For a shorter (14" high) version of #TS1, order #TS1S.			
TS2	Clear	18 <sup>3</sup> / <sub>4</sub> x 54	8 x 12
TS2M	Mirror	18 <sup>3</sup> / <sub>4</sub> x 54	8 x 12

For a shorter (14" high) version of #TS2, order #TS2S.



### Oval Platform Displays

Product No.	Finish	H x W	Platform Size
TR05	Clear	10 <sup>1</sup> / <sub>4</sub> x 26	3 x 6
TR05M	Mirror	10 <sup>1</sup> / <sub>4</sub> x 26	3 x 6
TR1	Clear	14 <sup>3</sup> / <sub>4</sub> x 39	4 x 7
TR1M	Mirror	14 <sup>3</sup> / <sub>4</sub> x 39	4 x 7
For a taller (18 <sup>3</sup> / <sub>4</sub> " high) version of #TR1, order #TR1T.			
TR2	Clear	14 x 49	7 x 11
TR2M	Mirror	14 x 49	7 x 11

For a taller (18<sup>3</sup>/<sub>4</sub>" high) version of #TR2, order #TR2T.



### Extra-Large Rectangular Platform Displays

Platforms are beveled, <sup>3</sup>/<sub>8</sub>"-thick acrylic, and the unit is constructed of 1<sup>1</sup>/<sub>4</sub>"-round acrylic rods and stainless steel screws.

Product No.	H x W	Platform Size
TSX3	25 x 61 <sup>3</sup> / <sub>4</sub>	9 x 14, 14 x 18

For a shorter (19" high) version of #TSX3, order #TSX3S.



# General Countertop Displays



## Extra-Large Oval Platform Displays

Platforms are beveled,  $\frac{3}{8}$ "-thick acrylic, and the unit is constructed of  $1\frac{1}{4}$ "-round acrylic rods and stainless steel screws.

Product No.	H x W	Platform Size
TRX3	19 x 62	9 x 14, 14 x 17 $\frac{1}{2}$

For a taller (25" high) version of #TRX3, order #TRX3T.

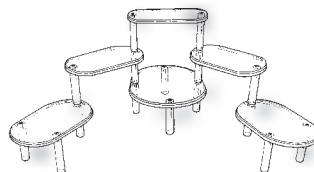

## Super-Sized Platform Displays

Available with either rectangular or oval-shaped shelves. All units are packaged unassembled for easy shipping.

Product No.	Shape	H x W	Platform Size
-------------	-------	-------	---------------

**These units have 12 platforms:**

TR12	Oval	14 $\frac{3}{8}$ x 55	4 x 7
TS12	Rectangle	14 $\frac{3}{8}$ x 73	4 $\frac{1}{2}$ x 9

**These units have 17 platforms:**

TR17	Oval	24 x 55	4 x 7
TS17	Rectangle	24 x 73	4 $\frac{1}{2}$ x 9



## Beveled Three-Shelf Displays

$\frac{3}{8}$ "-thick clear acrylic. Shipped unassembled.

Product No.	H x W x D	Platform Size
OP610	10 x 19 $\frac{1}{4}$ x 7 $\frac{1}{4}$	6
OP812	12 x 28 x 10 $\frac{1}{4}$	8



## Beveled Three-Shelf Towers

$\frac{3}{8}$ "-thick clear acrylic. Shipped unassembled.

Product No.	H x W x D	Platform Size
TW6	16 $\frac{1}{2}$ x 13 $\frac{1}{4}$ x 7	6
TW8	19 $\frac{1}{2}$ x 17 $\frac{1}{4}$ x 10	8
TWD8	19 $\frac{1}{2}$ x 19 x 19	8

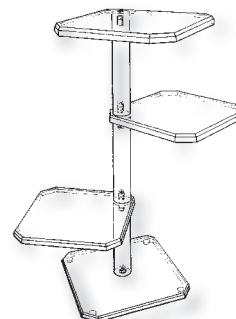

# General Countertop Displays

## Four-Tier Spiral Displays

Available in clear or mirrored acrylic. Can be assembled for left or right spiral. Shipped unassembled.

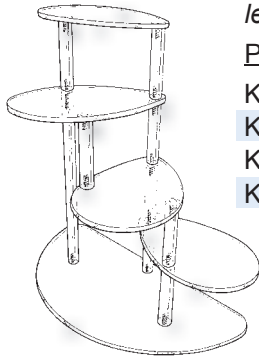

Product No.	Finish	H x W x Base	Platform Size
KS1	Clear	14 x 14 <sup>1</sup> / <sub>4</sub> x 7	7 <sup>3</sup> / <sub>4</sub> x 5
KS1M	Mirror	14 x 14 <sup>1</sup> / <sub>4</sub> x 7	7 <sup>3</sup> / <sub>4</sub> x 5
KS2	Clear	19 x 19 <sup>3</sup> / <sub>4</sub> x 10	11 x 7
KS2M	Mirror	19 x 19 <sup>3</sup> / <sub>4</sub> x 10	11 x 7



## Round Interlocking Risers

These displays pack flat for easy shipping, but can be assembled quickly.

Product No.	H x Diameter	Shelf Diameters
WCR1	11 <sup>1</sup> / <sub>2</sub> x 10 Shelves are 2 <sup>5</sup> / <sub>8</sub> " apart.	4, 6, 8, 10
WCR2	16 x 14 Shelves are 3 <sup>3</sup> / <sub>4</sub> " apart.	5, 6, 11, 14
WCR3	21 <sup>3</sup> / <sub>4</sub> x 19 Shelves are 5 <sup>1</sup> / <sub>4</sub> " apart.	7, 11, 15, 19
WCR4	27 <sup>1</sup> / <sub>2</sub> x 24 Shelves are 6 <sup>1</sup> / <sub>2</sub> " apart.	9, 14, 19, 24
WCR5	34 <sup>1</sup> / <sub>4</sub> x 30 Shelves are 8" apart.	12, 18, 24, 30



## Square Interlocking Risers

These displays pack flat for easy shipping, but can be assembled quickly.

Product No.	H x W x D	Shelf Sizes
WCS1	11 <sup>1</sup> / <sub>2</sub> x 8 <sup>1</sup> / <sub>2</sub> x 8 <sup>1</sup> / <sub>2</sub> Shelves are 2 <sup>1</sup> / <sub>2</sub> " apart.	4 <sup>1</sup> / <sub>4</sub> , 5 <sup>5</sup> / <sub>8</sub> , 7, 8 <sup>1</sup> / <sub>2</sub>
WCS2	16 x 11 <sup>1</sup> / <sub>2</sub> x 11 <sup>1</sup> / <sub>2</sub> Shelves are 3 <sup>3</sup> / <sub>4</sub> " apart.	5, 7, 9, 11 <sup>1</sup> / <sub>2</sub>
WCS3	21 <sup>3</sup> / <sub>4</sub> x 15 x 15 Shelves are 5 <sup>1</sup> / <sub>4</sub> " apart.	6 <sup>1</sup> / <sub>4</sub> , 9, 12, 15
WCS4	27 <sup>1</sup> / <sub>2</sub> x 18 <sup>1</sup> / <sub>2</sub> x 18 <sup>1</sup> / <sub>2</sub> Shelves are 6 <sup>1</sup> / <sub>2</sub> " apart.	7 <sup>3</sup> / <sub>4</sub> , 11 <sup>1</sup> / <sub>4</sub> , 15, 18 <sup>1</sup> / <sub>2</sub>
WCS5	34 <sup>1</sup> / <sub>4</sub> x 22 <sup>3</sup> / <sub>4</sub> x 22 <sup>3</sup> / <sub>4</sub> Shelves are 8" apart.	10, 14 <sup>1</sup> / <sub>4</sub> , 18 <sup>1</sup> / <sub>2</sub> , 22 <sup>3</sup> / <sub>4</sub>



# General Countertop Displays



KDBS21

## Clip-Together Shelf Units

Made of heavy-duty, 1/4"-thick acrylic. These units are shipped unassembled and put together with special shelf clips and screws (included).

Product No.	H x W x D	Shelf Size	# of Shelves
KDBS21	21 <sup>1</sup> / <sub>4</sub> x 24 <sup>1</sup> / <sub>2</sub> x 8 <sup>1</sup> / <sub>4</sub>	6 <sup>3</sup> / <sub>4</sub>	2
KDBS31	31 <sup>1</sup> / <sub>2</sub> x 24 <sup>1</sup> / <sub>2</sub> x 8 <sup>1</sup> / <sub>4</sub>	6 <sup>3</sup> / <sub>4</sub>	3
KDCT18	18 x 18 <sup>1</sup> / <sub>2</sub> x 9 <sup>3</sup> / <sub>4</sub>	9 <sup>1</sup> / <sub>4</sub>	4
KDCT18A	18 x 18 <sup>1</sup> / <sub>2</sub> x 11 <sup>1</sup> / <sub>2</sub>	4 <sup>3</sup> / <sub>4</sub> - 10 <sup>3</sup> / <sub>4</sub>	4

Space between shelves is 10<sup>1</sup>/<sub>2</sub>".  
Space between shelves is 10<sup>1</sup>/<sub>2</sub>".  
Space between shelves is 4<sup>3</sup>/<sub>4</sub>".  
Angled Front. Space between shelves is 4<sup>3</sup>/<sub>4</sub>".



KDCT18

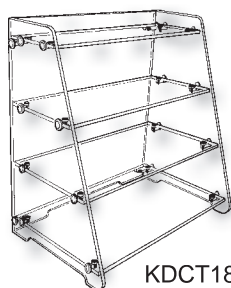

KDCT18A



KDBS31



## Folding Three-Shelf Units

Acrylic shelves slide into slotted hinged panels. Packs flat.

Product No.	H x W x D	Shelf Depth
FS1	11 <sup>1</sup> / <sub>4</sub> x 14 <sup>1</sup> / <sub>2</sub> x 6 <sup>5</sup> / <sub>8</sub>	5
FS2	14 x 18 x 8 <sup>1</sup> / <sub>4</sub>	6
FS3	20 x 20 x 9 <sup>1</sup> / <sub>2</sub>	7

Space between shelves is 4".  
Space between shelves is 5".  
Space between shelves is 6<sup>3</sup>/<sub>8</sub>".

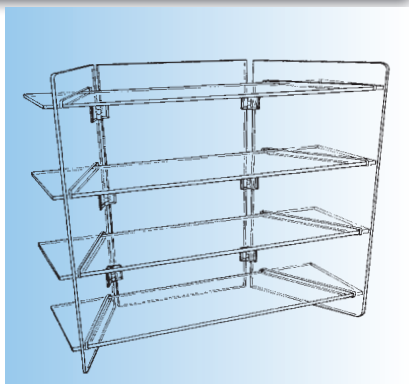

## Folding Four-Shelf Units

Product No.	H x W x D	Shelf Depth
FS4	24 x 24 x 10 <sup>1</sup> / <sub>4</sub>	8

Space between shelves is 6".

# General Countertop Displays

## ACRYLIC BOX CASES

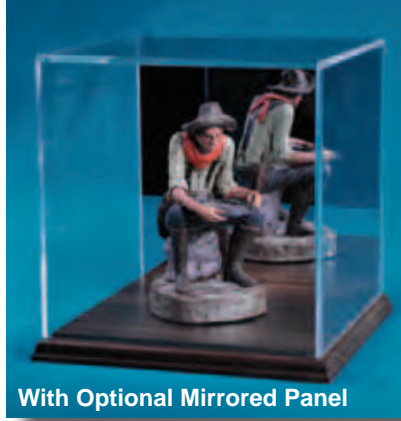

### Box Cases without Bases

Product No.	H x W x D
CJ04	4 x 4 x 4
CJ045	6 x 4 x 4
CJ1	6 x 6 x 6
CJ15	9 x 6 x 6
CJ2	8 x 8 x 8
CJ25	12 x 8 x 8
CJ3	10 x 10 x 10
CJ35	15 x 10 x 10
CJ4	12 x 12 x 12
CJ45	18 x 12 x 12

### Box Cases with Hardwood Bases

Acrylic boxes have bevel-cut edges and solid walnut bases. Height includes base.

Product No	H x W x D	With Mirror
CJ04W	4 <sup>1</sup> / <sub>2</sub> x 4 x 4	CJ04WM
CJ045W	6 <sup>1</sup> / <sub>2</sub> x 4 x 4	CJ045WM
CJ1W	6 <sup>1</sup> / <sub>2</sub> x 6 x 6	CJ1WM
CJ15W	9 <sup>1</sup> / <sub>2</sub> x 6 x 6	CJ15WM
CJ2W	8 <sup>1</sup> / <sub>2</sub> x 8 x 8	CJ2WM
CJ25W	12 <sup>1</sup> / <sub>2</sub> x 8 x 8	CJ25WM
CJ3W	10 <sup>1</sup> / <sub>2</sub> x 10 x 10	CJ3WM
CJ35W	15 <sup>1</sup> / <sub>2</sub> x 10 x 10	CJ35WM
CJ4W	12 <sup>1</sup> / <sub>2</sub> x 12 x 12	CJ4WM
CJ45W	18 <sup>1</sup> / <sub>2</sub> x 12 x 12	CJ45WM

### Mirrored Option

You can order any of our square, rectangular, or angled-front box cases with a mirrored acrylic back panel to add all-around viewing of special pieces. Go online or call for pricing and ordering information.

### Frosted Pedestal Option

All of our square and rectangular acrylic cases can be turned into white pedestal display bases. The price is the same; just add "F" for frosted to the product number when ordering (for example, #CJ04F).

### Rectangular Box Cases without Bases

Product No.	H x W x D
CJR46	4 x 6 x 4
CJR66	6 x 6 x 4
CJR69	6 x 9 x 6
CJR99	9 x 9 x 6
CJR82	8 x 12 x 8
CJR12	12 x 12 x 8



# General Countertop Displays

## Rectangular Box Cases with Hardwood Bases

Height includes base.

<u>Product No.</u>	<u>H x W x D</u>	<u>With Mirror</u>
CJR46W	4 $\frac{1}{2}$ x 6 x 4	CJR46WM
CJR66W	6 $\frac{1}{2}$ x 6 x 4	CJR66WM
CJR69W	6 $\frac{1}{2}$ x 9 x 6	CJR69WM
CJR99W	9 $\frac{1}{2}$ x 9 x 6	CJR99WM
CJR82W	8 $\frac{1}{2}$ x 12 x 8	CJR82WM
CJR12W	12 $\frac{1}{2}$ x 12 x 8	CJR12WM



## Long Rectangular Box Cases without Bases

<u>Product No.</u>	<u>H x W x D</u>
LRB9	3 x 9 x 3 $\frac{1}{2}$
LRB10	5 x 10 x 5
LRB612	6 x 12 x 6
LRB816	8 x 16 x 10
LRB920	9 $\frac{1}{2}$ x 20 x 12



## Long Rectangular Box Cases with Hardwood Bases

Height includes base.

<u>Product No.</u>	<u>H x W x D</u>	<u>With Mirror</u>
LRB9W	3 $\frac{1}{2}$ x 9 x 3 $\frac{1}{2}$	LRB9WM
LRB10W	5 $\frac{1}{2}$ x 10 x 5	LRB10WM
LRB612W	6 $\frac{1}{2}$ x 12 x 6	LRB612WM
LRB816W	8 $\frac{1}{2}$ x 16 x 10	LRB816WM
LRB920W	9 $\frac{1}{2}$ x 20 x 12	LRB920WM

## Square Angled-Front Box Cases without Bases

<u>Product No.</u>	<u>H x W x D</u>
ACJ04	4 x 4 x 4
ACJ1	6 x 6 x 6
ACJ2	8 x 8 x 8
ACJ3	10 x 10 x 10
ACJ4	12 x 12 x 12



# General Countertop Displays



## Square Angled-Front Box Cases with Hardwood Bases

Acrylic boxes have bevel-cut edges and solid walnut bases. Height includes base.

Product No.	H x W x D	With Mirror
ACJ04W	4½ x 4 x 4	ACJ04WM
ACJ1W	6½ x 6 x 6	ACJ1WM
ACJ2W	8½ x 8 x 8	ACJ2WM
ACJ3W	10½ x 10 x 10	ACJ3WM
ACJ4W	12½ x 12 x 12	ACJ4WM



## Rectangular Angled-Front Box Cases without Bases

Product No.	H x W x D
ACJR46	4 x 6 x 4
ACJR69	6 x 9 x 6
ACJR82	8 x 12 x 8

### Mirrored Option

You can order any of our square, rectangular, or angled-front box cases with a mirrored acrylic back panel to add all-around viewing of special pieces. Go online or call for pricing and ordering information.



## Rectangular Angled-Front Box Cases with Hardwood Bases

Acrylic boxes have bevel-cut edges and solid walnut bases. Height includes base.

Product No.	H x W x D	With Mirror
ACJR46W	4½ x 6 x 4	ACJR46WM
ACJR69W	6½ x 9 x 6	ACJR69WM
ACJR82W	8½ x 12 x 8	ACJR82WM

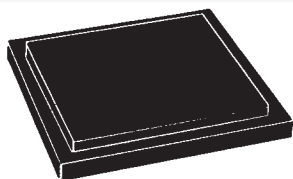
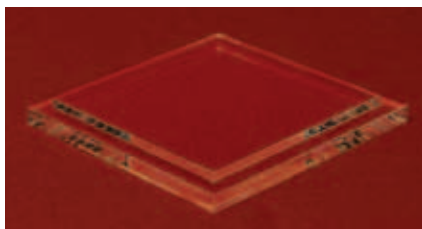

## Acrylic Bases for Box Cases

Clear or black acrylic bases are available for our most popular sizes of both the square and rectangular box cases on preceding pages. All are ½"-thick acrylic.

Product No.	Finish	W x D	Product No.	Finish	W x D
CJ04B	Clear	4 x 4	CJ4B	Clear	12 x 12
CJ04BB	Black	4 x 4	CJ4BB	Black	12 x 12
CJ1B	Clear	6 x 6	CJR46B	Clear	6 x 4
CJ1BB	Black	6 x 6	CJR46BB	Black	6 x 4
CJ2B	Clear	8 x 8	CJR69B	Clear	9 x 6
CJ2BB	Black	8 x 8	CJR69BB	Black	9 x 6
CJ3B	Clear	10 x 10	CJR82B	Clear	12 x 8
CJ3BB	Black	10 x 10	CJR82BB	Black	12 x 8



# General Countertop Displays



## Square Box with Hinged Lid

Product No.	H x W x D
LCJ4	4 x 4 x 4
LCJ6	6 x 6 x 6
LCJ8	8 x 8 x 8
LCJ10	10 x 10 x 10
LCJ12	12 x 12 x 12



## Angled-Top Box with Hinged Lid

Product No.	Height	
	Front & Back	H x W x D
LCJA4	3 & 4	4 x 4
LCJA6	4½ & 6	6 x 6
LCJA8	6 & 8	8 x 8
LCJA10	7½ & 10	10 x 10
LCJA12	9½ & 12	12 x 12



## Rectangular Box with Hinged Lid

Product No.	Height	
	Front & Back	H x W x D
880-1435	2½ & 8½	12 x 11
880-1436	2½ & 8½	16 x 11
880-1437	2½ & 8½	20 x 11



## Hexagonal Open Shelf Displays

Six-sided displays are open on three sides so that open and closed sections alternate. Shelves are fixed in place.

Product No.	# Shelves	Shelf Clearance	H x W x D
HX1	1	6"	12 x 9½ x 8¼
HX102	2	4"	12 x 9½ x 8¼
HX2	2	6"	18 x 9½ x 8¼
HX4	2	8"	24 x 9½ x 8¼
HX5	3	6"	24 x 9½ x 8¼

# General Countertop Displays

## GLASS DOMES



### Glass Domes with Hardwood Bases

*Height includes base.*

Product No.	H x Base Dia.
DM07W	4 x 1 <sup>7</sup> / <sub>8</sub>
DM1W	4 <sup>1</sup> / <sub>2</sub> x 3
DM2W	7 <sup>1</sup> / <sub>2</sub> x 4
DM25W	8 <sup>1</sup> / <sub>2</sub> x 4 <sup>1</sup> / <sub>2</sub>
DM3W	10 <sup>3</sup> / <sub>4</sub> x 5 <sup>1</sup> / <sub>2</sub>
DM4W	12 <sup>1</sup> / <sub>2</sub> x 8



### Glass Domes without Bases

Product No.	H x Base Dia.
DM07NB	3 <sup>1</sup> / <sub>2</sub> x 1 <sup>7</sup> / <sub>8</sub>
DM1NB	4 x 3
DM2NB	7 x 4
DM25NB	8 x 4 <sup>1</sup> / <sub>2</sub>
DM3NB	10 <sup>1</sup> / <sub>8</sub> x 5 <sup>1</sup> / <sub>2</sub>
DM4NB	12 x 8



### Glass Domes with Round Shelves

Product No.	H x Base Dia.
DM1WS	4 <sup>1</sup> / <sub>2</sub> x 3
DM2WS	7 <sup>1</sup> / <sub>2</sub> x 4
DM3WS	10 <sup>3</sup> / <sub>4</sub> x 5 <sup>1</sup> / <sub>2</sub>
DM4WS	12 <sup>1</sup> / <sub>2</sub> x 8



### Glass Domes with Black Acrylic Bases

*Height includes base.*

Product No.	H x Base Dia.
DM07	3 <sup>5</sup> / <sub>8</sub> x 1 <sup>7</sup> / <sub>8</sub>
DM1	4 <sup>1</sup> / <sub>8</sub> x 3
DM2	7 <sup>1</sup> / <sub>8</sub> x 4
DM25	8 <sup>1</sup> / <sub>8</sub> x 4 <sup>1</sup> / <sub>2</sub>
DM3	10 <sup>1</sup> / <sub>4</sub> x 5 <sup>1</sup> / <sub>2</sub>
DM4	12 <sup>1</sup> / <sub>8</sub> x 8

# General Countertop Displays

## ACRYLIC BIN SYSTEMS

Create the perfect display for beads, marbles, tumbled stones or other small items that take up a lot of counter space. Instead of hiding merchandise in boxes and baskets, use these all-clear acrylic bins to give visibility and let light through.

We have several different sized bin systems to meet your needs. Each system is made up of two endpieces and a selection of trays. The trays all have different numbers of glued-in dividers.

### To order bin systems, you need to:

1. Choose which size system you want: Standard, Wide, Narrow, Extra-Large, or Mini. The tray size is the main difference between the systems.
2. Choose how many tiers of trays you want in the system. (From two – six)
3. Choose from the divided-tray options listed with each system to get the trays with the compartment sizes that you need.



### Standard Bins

Our standard bin system is made up of 16"-wide trays that are  $2\frac{5}{8}$ " high and 4" deep. The system includes the trays; choose the tray style (number of compartments) from Standard Tray options below. All systems pack unassembled for easy shipping and come with nylon thumb screws for assembly.

Product No.	H x W x D	# of Trays
YAA	$5\frac{1}{2} \times 16\frac{1}{2} \times 8\frac{1}{8}$	2
YA	$8 \times 16\frac{1}{4} \times 12\frac{1}{8}$	3
YB	$10\frac{1}{2} \times 16\frac{1}{4} \times 16\frac{1}{8}$	4
YC	$13 \times 16\frac{1}{4} \times 20$	5
YD	$15\frac{3}{4} \times 16\frac{1}{4} \times 24$	6

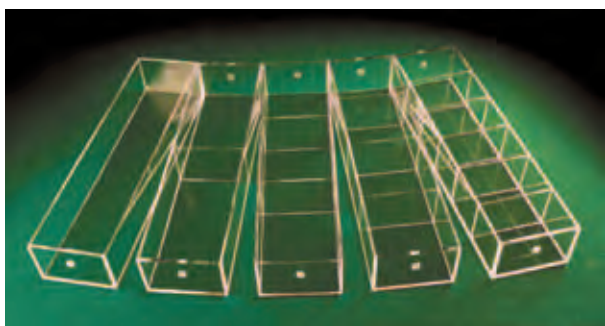

### Standard Trays

Product No.	H x W x D	# Compartments	Width
T1R	$2\frac{5}{8} \times 15\frac{7}{8} \times 4$	1	$15\frac{7}{8}$
T2R	$2\frac{5}{8} \times 15\frac{7}{8} \times 4$	2	$7\frac{1}{2}$
T3R	$2\frac{5}{8} \times 15\frac{7}{8} \times 4$	3	5
T4R	$2\frac{5}{8} \times 15\frac{7}{8} \times 4$	4	$3\frac{3}{4}$
T6R	$2\frac{5}{8} \times 15\frac{7}{8} \times 4$	6	$2\frac{1}{2}$

If you wish to order these trays by themselves, and you would prefer to not have the holes in the ends, add "NH" to the product number when ordering. For example: #T1RNH

# General Countertop Displays

## Wide Bins

The wide bin system is made up of 24"-wide trays that are 2" high and 2½" deep. The system includes the trays; choose the tray style (number of compartments) from Wide Tray options below.

Product No.	H x W x D	# of Trays
YK	8¼ x 24¼ x 9 <sup>5</sup> / <sub>8</sub>	4
YL	12¼ x 24¼ x 14 <sup>3</sup> / <sub>8</sub>	6
YM	16¼ x 24¼ x 19 <sup>1</sup> / <sub>4</sub>	8
YP	20¼ x 24¼ x 23 <sup>3</sup> / <sub>4</sub>	10

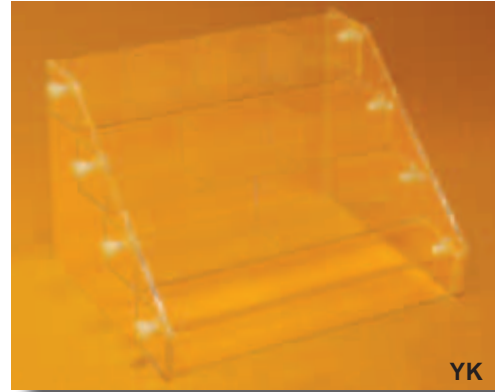
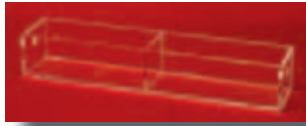

YK

## Wide Trays

Product No.	H x W x D	# Compartments	Width
T1L	2 x 24 x 2½	1	24
T2L	2 x 24 x 2½	2	11 <sup>7</sup> / <sub>8</sub>
T3L	2 x 24 x 2½	3	7 <sup>3</sup> / <sub>4</sub>
T4L	2 x 24 x 2½	4	5 <sup>3</sup> / <sub>4</sub>
T6L	2 x 24 x 2½	6	3 <sup>3</sup> / <sub>4</sub>
T12L	2 x 24 x 2½	12	1 <sup>3</sup> / <sub>4</sub>

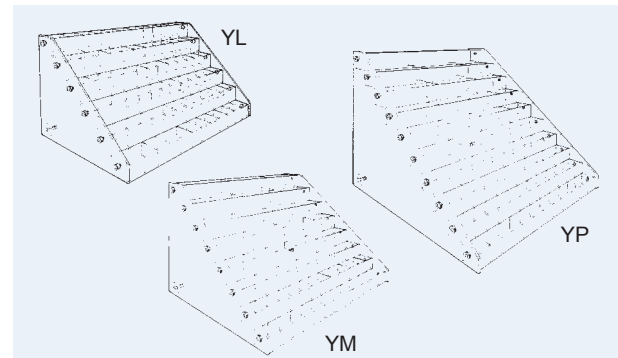

If you wish to order these trays by themselves, and you would prefer to not have the holes in the ends, add "NH" to the product number when ordering. For example: #T1RNH

## Narrow Bins

The narrow bin system is made up of 12"-wide trays that are 2" high and 2½" deep. The unit includes the trays; choose the tray style (number of compartments) from Narrow Tray options below.

Product No.	H x W x D	# of Trays
YV	8¼ x 12¼ x 9 <sup>5</sup> / <sub>8</sub>	4
YW	12¼ x 12¼ x 14 <sup>3</sup> / <sub>8</sub>	6
YX	16¼ x 12¼ x 19 <sup>1</sup> / <sub>4</sub>	8
YZ	20¼ x 12¼ x 23 <sup>3</sup> / <sub>4</sub>	10



YV

## Narrow Trays

Product No.	H x W x D	# Compartments	Width
T1S	2 x 12 x 2½	1	11 <sup>3</sup> / <sub>4</sub>
T2S	2 x 12 x 2½	2	5 <sup>3</sup> / <sub>4</sub>
T3S	2 x 12 x 2½	3	3 <sup>3</sup> / <sub>4</sub>
T4S	2 x 12 x 2½	4	2 <sup>3</sup> / <sub>4</sub>
T6S	2 x 12 x 2½	6	1 <sup>3</sup> / <sub>4</sub>

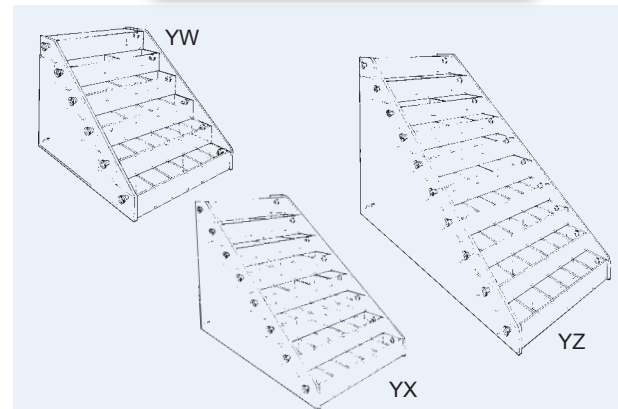

# General Countertop Displays



## Extra-Large Bins

This extra-large bin system is ideal for organizing bulky, light items such as purses, toys, scarves, or even CDs. This system is made up of 30"-wide trays that are 4" high and 6" deep. The unit includes the trays; choose the tray style (number of compartments) from Extra-Large Tray options below.

Product No.	H x W x D	# of Trays
YF	12 <sup>1</sup> / <sub>4</sub> x 30 <sup>1</sup> / <sub>4</sub> x 17 <sup>7</sup> / <sub>8</sub>	3
YG	16 <sup>1</sup> / <sub>2</sub> x 30 <sup>1</sup> / <sub>4</sub> x 23 <sup>3</sup> / <sub>4</sub>	4
YH	20 <sup>1</sup> / <sub>4</sub> x 30 <sup>1</sup> / <sub>4</sub> x 29 <sup>1</sup> / <sub>2</sub>	5

## Extra-Large Trays

Product No.	H x W x D	# Compartments	Width
T3X	4 x 30 x 6	3	9 <sup>3</sup> / <sub>4</sub>
T4X	4 x 30 x 6	4	7 <sup>1</sup> / <sub>4</sub>
T5X	4 x 30 x 6	5	5 <sup>3</sup> / <sub>4</sub>
T6X	4 x 30 x 6	6	4 <sup>3</sup> / <sub>4</sub>

If you wish to order these trays by themselves, and you would prefer to not have the holes in the ends, add "NH" to the product number when ordering. For example: #T1RNH

## Mini Bins

Extra-small compartments make it easy to keep tiny items stocked in this bin unit. The mini bin system is made up of 10"-wide trays that are 1<sup>1</sup>/<sub>8</sub>" high and 2" deep. The unit price includes the trays; choose the tray style (number of compartments) from Mini Tray options below.

Product No.	H x W x D	# of Trays
MY4	4 <sup>7</sup> / <sub>8</sub> x 10 <sup>1</sup> / <sub>4</sub> x 8	4
MY6	7 <sup>1</sup> / <sub>4</sub> x 10 <sup>1</sup> / <sub>4</sub> x 12	6
MY8	9 <sup>1</sup> / <sub>2</sub> x 10 <sup>1</sup> / <sub>4</sub> x 15 <sup>1</sup> / <sub>2</sub>	8

## Mini Trays

Product No.	H x W x D	# Compartments	Width
T1M	1 x 10 x 1 <sup>3</sup> / <sub>4</sub>	1	9 <sup>3</sup> / <sub>4</sub>
T2M	1 x 10 x 1 <sup>3</sup> / <sub>4</sub>	2	4 <sup>3</sup> / <sub>4</sub>
T3M	1 x 10 x 1 <sup>3</sup> / <sub>4</sub>	3	3
T4M	1 x 10 x 1 <sup>3</sup> / <sub>4</sub>	4	2 <sup>1</sup> / <sub>4</sub>
T6M	1 x 10 x 1 <sup>3</sup> / <sub>4</sub>	6	1 <sup>3</sup> / <sub>4</sub>



If you wish to order these trays by themselves, and you would prefer to not have the holes in the ends, add "NH" to the product number when ordering. For example: #T1RNH

# General Countertop Displays

## Tray Dividers for Acrylic Bin Systems

Make custom adjustable compartments with removable dividers designed for use with our Standard Trays, Narrow Trays and Extra-Large Trays.

Product No.	H x W x D
TDS	$1\frac{7}{8} \times 1\frac{7}{8} \times 2\frac{13}{16}$ Use with Narrow Trays: T1S, T2S, T3S, T4S, T6S
TDR	$2\frac{1}{2} \times 2\frac{1}{2} \times 3\frac{3}{4}$ Use with Standard Trays: T1R, T2R, T3R, T4R, T6R
TDX	$3\frac{7}{8} \times 3\frac{7}{8} \times 5\frac{3}{4}$ Use with Extra Large Trays: T3X, T4X, T5X, T6X

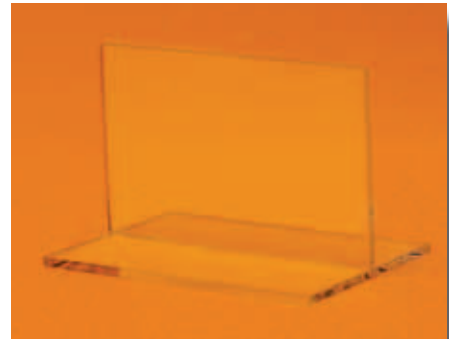

Bins

## Multi-Story Display Bins

These towers come in two different sizes. One has six tiers and a total of 96 compartments while the other has eight tiers and offers 192 compartments. All compartments are 2" high,  $1\frac{3}{4}$ " wide and  $2\frac{1}{2}$ " deep. Both sizes are mounted on a lazy-Susan base.

Product No.	H x Square	# Tiers
QB96	$23\frac{5}{8} \times 10\frac{1}{2}$ Each tier forms a 16-compartment square.	6
QB192	$32 \times 14\frac{1}{2}$ Each tier forms a 24-compartment square.	8

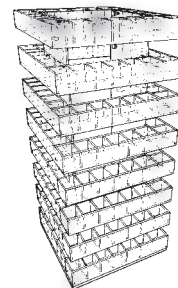

QB192

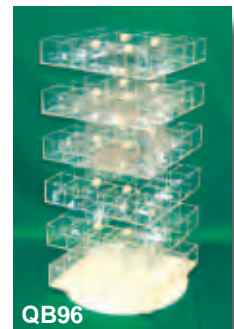

QB96

## Vertical Cylinder Rotator

Six 4"-high cylinders on this display are fixed on a lazy-Susan base while a 6"-high removable cylinder sits in the center. All cylinders are 4" in diameter.

Product No.	H x Dia.
3337	$6\frac{3}{4} \times 12$

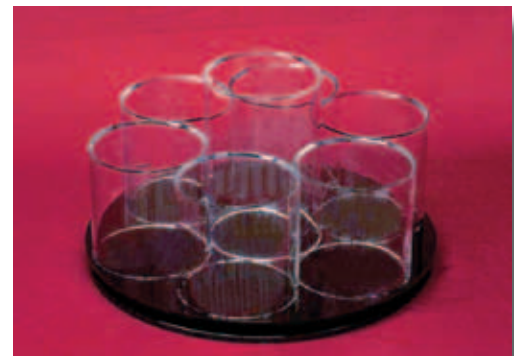
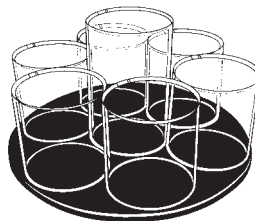

## Adjustable Bin Trays

Interlocking clear acrylic partitions make up the bins of these trays. They are available in 24 or 54 compartment sizes, with or without lids. The partitions are removable so compartment size can be adjusted from 2" x 2" to 2" x 4" or 4" x 4".

Product No.	Compartments	H x W x D
FLY1L	24 With hinged clear acrylic lid with handle.	$2\frac{3}{4} \times 12 \times 8$
FLY1	24 Open (without lid).	$2\frac{1}{2} \times 12 \times 8$
FLY2L	54 With hinged clear acrylic lid with handle.	$2\frac{3}{4} \times 18 \times 12$
FLY2	54 Open (without lid).	$2\frac{1}{2} \times 18 \times 12$

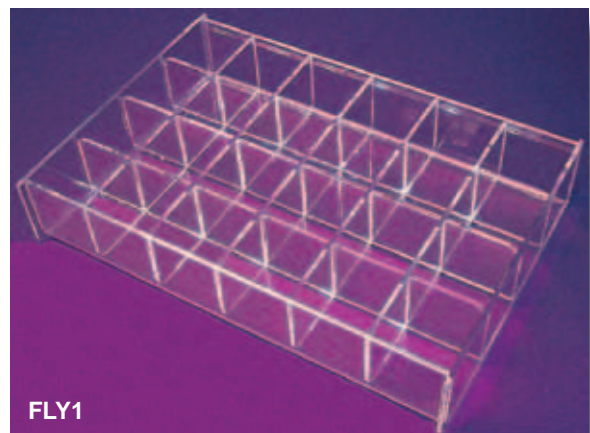

FLY1

# General Countertop Displays

Mirrors

## MIRRORS

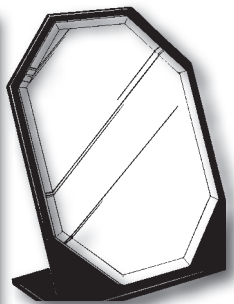

Mirror lays flat on countertops

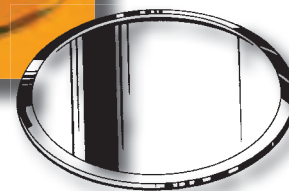

### Black-Backed Countertop Mirrors

Product No.	Style	H x W x D
CMAHX79	Octagonal	9 $\frac{1}{2}$ x 7 $\frac{1}{2}$ x 3
CMAOV79	Oval	9 x 7 $\frac{1}{2}$ x 3 $\frac{5}{8}$
CMA6	Round	6 $\frac{1}{4}$ x 7 x 4
CMA8	Round	8 $\frac{3}{4}$ x 9 x 4
CMA10	Round	10 $\frac{1}{2}$ x 11 x 7
850-1265	Rounded Top	11 $\frac{1}{2}$ x 8 x 3 $\frac{5}{8}$

### Round Beveled Glass Mirrors

Product No.	Dia.	Product No.	Dia.
MR15	1 $\frac{1}{2}$	MR5	5
MR2	2	MR6	6
MR25	2 $\frac{1}{2}$	MR7	7
MR3	3	MR8	8
MR35	3 $\frac{1}{2}$	MR10	10
MR4	4		

### Countertop Mirrors

These beveled glass mirrors pivot on clear acrylic bases.

Product No.	H x W x D
CMS6	8 $\frac{1}{8}$ x 7 x 2 $\frac{1}{2}$
CMS8	10 $\frac{1}{8}$ x 9 x 3
CMS10	12 $\frac{1}{8}$ x 11 x 3 $\frac{1}{2}$

The glass mirror insert in this countertop fixture is removable for easy cleaning or replacement.

Product No.	H x W x D
850-1170	14 x 6 $\frac{1}{4}$ x 6
850-1171	14 x 9 $\frac{1}{4}$ x 9

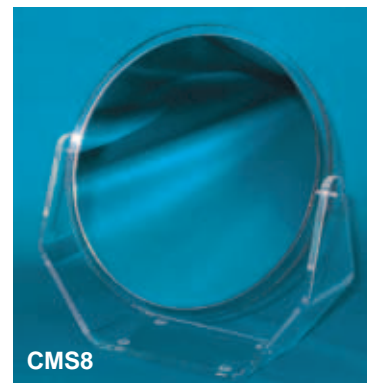

### Acrylic Countertop Mirrors

Product No.	Style	H x W x D
ML1	Rectangle	9 x 7 x 3
ML2	Rectangle	12 x 11 x 4
MLC9	Oval	9 x 8 x 3 $\frac{3}{8}$
MLC12	Oval	12 x 8 x 3 $\frac{3}{8}$



# General Countertop Displays

## Mirrored Cubes

Product No.	H x W x D
MCM4	4 x 4 x 4
MCM6	6 x 6 x 6
MCM8	8 x 8 x 8
MCM10	10 x 10 x 10
MCM12	12 x 12 x 12
MCMR46	4 x 6 x 4
MCMR69	6 x 9 x 6
MCMR82	8 x 12 x 8



## Tiered Display Trays

This unit features one-piece bent trays without dividers and is available with three or four tiers and in two different widths. All units pack unassembled for easy shipping and come with transparent two-piece fasteners for assembly.

Product No.	Tiers	H x W x D
MRK1	3	6 <sup>3</sup> / <sub>4</sub> x 18 <sup>3</sup> / <sub>8</sub> x 11 <sup>7</sup> / <sub>8</sub> Each tray is 18" x 2" x 4" (W x H x D)
MRK11	4	8 <sup>3</sup> / <sub>4</sub> x 18 <sup>3</sup> / <sub>8</sub> x 15 <sup>3</sup> / <sub>4</sub> Each tray is 18" x 2" x 4" (W x H x D)
MRK2	3	6 <sup>3</sup> / <sub>4</sub> x 12 <sup>3</sup> / <sub>8</sub> x 11 <sup>7</sup> / <sub>8</sub> Each tray is 12" x 2" x 4" (W x H x D)
MRK22	4	8 <sup>3</sup> / <sub>4</sub> x 12 <sup>3</sup> / <sub>8</sub> x 15 <sup>3</sup> / <sub>4</sub> Each tray is 12" x 2" x 4" (W x H x D)



## Open Countertop Trays

Product No.	H x W x D	Product No.	H x W x D
OCT1	2 x 6 x 6	OCT5	4 x 14 x 14
OCTR1	2 <sup>3</sup> / <sub>4</sub> x 7 <sup>1</sup> / <sub>2</sub> x 8 <sup>1</sup> / <sub>2</sub>	OCT6	4 x 18 x 18
OCT2	2 x 9 x 9	OCT7	6 x 12 x 12
OCT3	2 x 12 x 12	OCT8	6 x 18 x 18
OCT4	4 x 10 x 10	OCTR8	3 x 24 x 18
OCTR4	2 <sup>3</sup> / <sub>4</sub> x 14 <sup>1</sup> / <sub>2</sub> x 8 <sup>1</sup> / <sub>2</sub>		

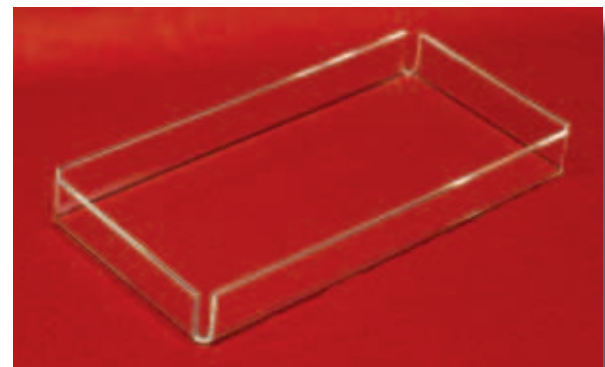

## One-Piece Trays

Made of <sup>3</sup>/<sub>16</sub>" clear acrylic.

Product No.	H x W x D
BDT69	1 <sup>1</sup> / <sub>4</sub> x 6 x 9
BDT612	1 <sup>1</sup> / <sub>4</sub> x 6 x 12
BDT810	1 <sup>1</sup> / <sub>4</sub> x 8 x 10
BDT812	1 <sup>1</sup> / <sub>4</sub> x 8 x 12
BDT812D	2 <sup>1</sup> / <sub>2</sub> x 8 x 12
BDT815	1 <sup>1</sup> / <sub>4</sub> x 8 x 15
BDT912	2 x 9 x 12



# General Countertop Displays

## COMPACT DISC/DVD SHELVES



### Tray Style Displays

For displaying CDs face forward, these countertop bins are available in three or four tiers, with single or double compartment trays. Endpieces and trays are separate, so you can order four different configurations. Ships unassembled and comes with transparent two-piece fasteners for assembly. Price includes the trays.

Product No.	H x W x D
CDB3	12 <sup>1</sup> / <sub>8</sub> x 6 <sup>5</sup> / <sub>8</sub> x 18
CDB32	12 <sup>1</sup> / <sub>8</sub> x 12 <sup>5</sup> / <sub>8</sub> x 18
CDB4	16 <sup>1</sup> / <sub>4</sub> x 6 <sup>5</sup> / <sub>8</sub> x 23 <sup>1</sup> / <sub>2</sub>
CDB42	16 <sup>1</sup> / <sub>4</sub> x 12 <sup>5</sup> / <sub>8</sub> x 23 <sup>1</sup> / <sub>2</sub>

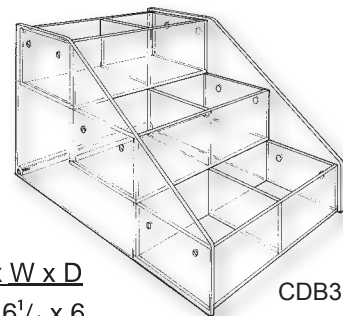

### Single Trays

Product No.	# Compartments	H x W x D
T1CD	1	4 x 6 <sup>1</sup> / <sub>4</sub> x 6
T2CD	2	4 x 12 <sup>1</sup> / <sub>4</sub> x 6

CDB32



CD1



CCD2

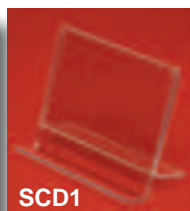

Single Case Display

### Shelves

Product No.	Shelves	H x W x D
CD1	1	5 <sup>1</sup> / <sub>4</sub> x 11 <sup>7</sup> / <sub>8</sub> x 6 <sup>1</sup> / <sub>2</sub>
CD2	2	12 x 11 <sup>7</sup> / <sub>8</sub> x 6 <sup>1</sup> / <sub>2</sub>
SCD1	1	4 <sup>1</sup> / <sub>2</sub> x 6 x 3
CCD1	1	5 x 6 x 4 <sup>7</sup> / <sub>8</sub>
CCD2	2	8 x 6 x 9



### Tiered Shelves

This display presents CDs or DVDs front-facing on two tiers and holds four cases per tier.

Product No.	H x W x D
850-1048	14 <sup>1</sup> / <sub>4</sub> x 6 x 10

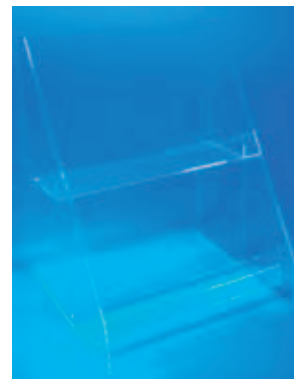

Double-wide CD/DVD shelves are available with one or two tiers.

Product No.	Shelves	H x W x D
850-1440	1	7 x 12 x 10
850-1441	2	14 <sup>1</sup> / <sub>4</sub> x 12 x 10

# General Countertop Displays

## DISPLAY BINS

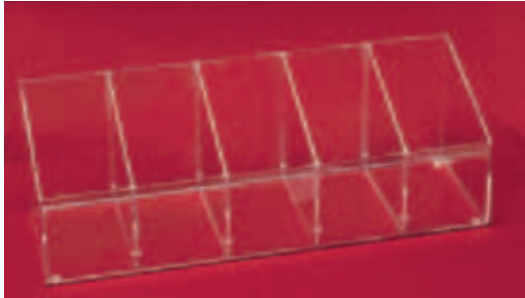

### Divided Bin Display

Four removable dividers provide adjustable compartments in this angled-front bin display. The 24"-wide display is made of  $\frac{1}{8}$ "-thick acrylic and the 30"-wide display is  $\frac{3}{16}$ " acrylic.

Product No.	Compartment Size	H x W x D
ABD24	$4\frac{5}{8}$	8 x 24 x 8
ABD30	$5\frac{7}{8}$	12 x 30 x 12



### Divided Hexagonal Bins

Glued-in dividers provide separate spaces for display. Opening size is  $4\frac{1}{2}$ " by  $5\frac{3}{4}$ ". Both three and four-bin units come with clear, stick-on feet that can be positioned so that the bins are front opening or top opening.

Product No.	Bins	H x W x D
DHB18	3	8 x 18 x $9\frac{1}{2}$
DHB24	4	8 x 24 x $9\frac{1}{2}$

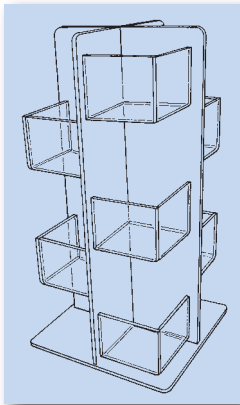

### Ten-Pocket Rotating Display

White acrylic base and center.

Product No.	Pocket Size	H x W x D
TPRD4	3 x 4 x 4 Space between pockets is 4"	$18\frac{3}{4}$ x $9\frac{3}{4}$ x $9\frac{3}{4}$
TPRD6	3 x 6 x 6 Space between pockets is 5"	$20\frac{3}{4}$ x $13\frac{3}{4}$ x $13\frac{3}{4}$



### Double-Wide Tiered Bin Display

Two and three-level units. Shipped fully assembled. Bin compartments are all 4" high and 4" deep. The DWTB2 and DWTB3 compartments are 6" wide; the DWTB2H and DWTB3H compartments are  $7\frac{1}{2}$ " wide.

Product No.	Bin Size	# Bins	H x W x D
DWTB2	4 x 4 x 6	4	$8\frac{5}{8}$ x $12\frac{3}{8}$ x 9
DWTB2H	4 x 4 x $7\frac{1}{2}$	4	$8\frac{5}{8}$ x $15\frac{1}{2}$ x 9
DWTB3	4 x 4 x 6	6	$12\frac{5}{8}$ x $12\frac{3}{8}$ x 13
DWTB3H	4 x 4 x $7\frac{1}{2}$	6	$12\frac{5}{8}$ x $15\frac{1}{2}$ x 13

# Locking Showcases

## LOCKING SHOWCASES



### Locking Case with Rotating Shelves

This acrylic case offers both rotating display and locking security. The hand-turning knob on top allows all-around viewing of merchandise on four round shelves (including base shelf). Shelves are 4<sup>1</sup>/<sub>4</sub>" apart.

Product No.

H x W x D

HXW2

19<sup>1</sup>/<sub>4</sub> x 8<sup>1</sup>/<sub>4</sub> x 9<sup>1</sup>/<sub>2</sub>

A larger version of the security case with hand-turning knob has four 11"-diameter shelves (including base shelf) that are 4<sup>1</sup>/<sub>2</sub>" apart.

Product No.

H x W x D

HXW22

21<sup>1</sup>/<sub>4</sub> x 13 x 12

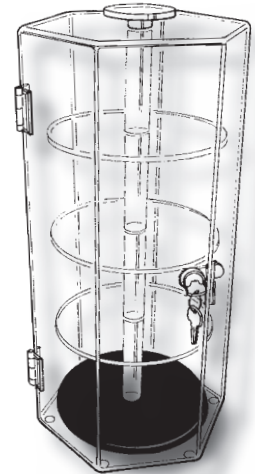

Cam locks and two keys are included with all locking cases

Many of the locking hexagonal cases are available with or without a rotating lazy-Susan base.



HX12

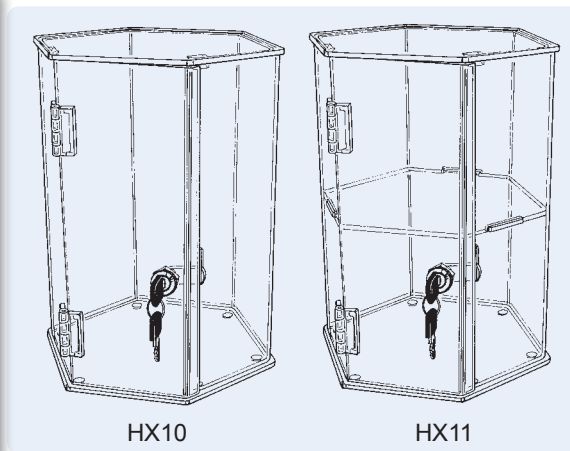

HX10

HX11



HX22

### 12" Tall Cases

<u>Product No.</u>	<u>Shelves</u>	<u>H x W x D</u>
HX10	None	12 x 9 <sup>1</sup> / <sub>2</sub> x 8 <sup>1</sup> / <sub>4</sub>
HX10R *	None	12 <sup>3</sup> / <sub>4</sub> x 9 <sup>1</sup> / <sub>2</sub> x 8 <sup>1</sup> / <sub>4</sub>
HX11	One	12 x 9 <sup>1</sup> / <sub>2</sub> x 8 <sup>1</sup> / <sub>4</sub>
HX11R *	One	12 <sup>3</sup> / <sub>4</sub> x 9 <sup>1</sup> / <sub>2</sub> x 8 <sup>1</sup> / <sub>4</sub>
HX12	Two	12 x 9 <sup>1</sup> / <sub>2</sub> x 8 <sup>1</sup> / <sub>4</sub>
HX12R *	Two	12 <sup>3</sup> / <sub>4</sub> x 9 <sup>1</sup> / <sub>2</sub> x 8 <sup>1</sup> / <sub>4</sub>

\* With rotating base.

### 18" Tall Cases

<u>Product No.</u>	<u>Shelves</u>	<u>H x W x D</u>
HX20	None	18 x 9 <sup>1</sup> / <sub>2</sub> x 8 <sup>1</sup> / <sub>4</sub>
HX20R *	None	18 <sup>3</sup> / <sub>4</sub> x 9 <sup>1</sup> / <sub>2</sub> x 8 <sup>1</sup> / <sub>4</sub>
HX21	One	18 x 9 <sup>1</sup> / <sub>2</sub> x 8 <sup>1</sup> / <sub>4</sub>
HX21R *	One	18 <sup>3</sup> / <sub>4</sub> x 9 <sup>1</sup> / <sub>2</sub> x 8 <sup>1</sup> / <sub>4</sub>
HX22	Two	18 x 9 <sup>1</sup> / <sub>2</sub> x 8 <sup>1</sup> / <sub>4</sub>
HX22R *	Two	18 <sup>3</sup> / <sub>4</sub> x 9 <sup>1</sup> / <sub>2</sub> x 8 <sup>1</sup> / <sub>4</sub>

\* With rotating base.

# Locking Showcases

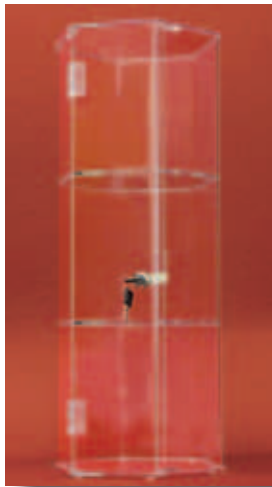

## 24" Tall Cases

<u>Product No.</u>	<u>Shelves</u>	<u>H x W x D</u>
HX44	Two	24 x 9 <sup>1</sup> / <sub>2</sub> x 8 <sup>1</sup> / <sub>4</sub>
HX44R *	Two	24 x 9 <sup>1</sup> / <sub>2</sub> x 8 <sup>1</sup> / <sub>4</sub>
HX55	Three	24 x 9 <sup>1</sup> / <sub>2</sub> x 8 <sup>1</sup> / <sub>4</sub>
HX55R *	Three	24 x 9 <sup>1</sup> / <sub>2</sub> x 8 <sup>1</sup> / <sub>4</sub>

\* With rotating base.



## Wide 12" Tall Cases

<u>Product No.</u>	<u>Shelves</u>	<u>H x W x D</u>
HX50	None	12 <sup>1</sup> / <sub>4</sub> x 12 <sup>1</sup> / <sub>2</sub> x 13 <sup>1</sup> / <sub>2</sub>
HX51	One	12 <sup>1</sup> / <sub>4</sub> x 12 <sup>1</sup> / <sub>2</sub> x 13 <sup>1</sup> / <sub>2</sub>

Locking Showcases

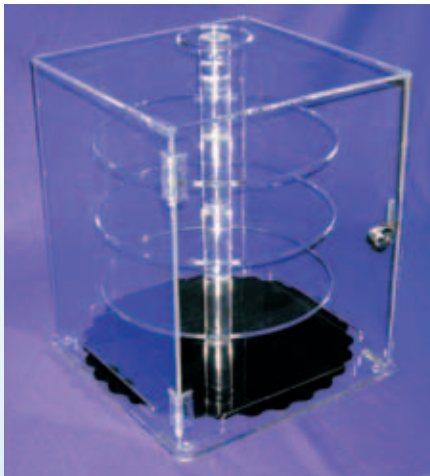

## Square Short-Rise Locking Case with Rotating Shelves

The shelves inside this case can be rotated by turning the knob on the top or the knurled bottom shelf. Four shelves (including the base shelf) are 3<sup>1</sup>/<sub>4</sub>" apart.

<u>Product No.</u>	<u>H x W x D</u>
RRLC	14 x 12 x 12



## Large Hexagonal Cases

<u>Product No.</u>	<u>Shelves</u>	<u>H x W x D</u>
HX30	None	20 <sup>1</sup> / <sub>2</sub> x 12 <sup>1</sup> / <sub>2</sub> x 13 <sup>1</sup> / <sub>2</sub>
HX31	One	20 <sup>1</sup> / <sub>2</sub> x 12 <sup>1</sup> / <sub>2</sub> x 13 <sup>1</sup> / <sub>2</sub>
HX32	Two	20 <sup>1</sup> / <sub>2</sub> x 12 <sup>1</sup> / <sub>2</sub> x 13 <sup>1</sup> / <sub>2</sub>

# Locking Showcases

## KNOCK-DOWN LOCKING CASES



### Flat Shelf Knock Down Case

This innovative case clips together easily, but knocks down for compact shipping or traveling to shows. Unit comes with three shelves, which are adjustable with seven possible positions.

<u>Product No.</u>	<u>Shelves</u>	<u>H x W x D</u>
860-1231	Three	23 x 24 x 12



### "J" Shelf Knock Down Case

This case features J-rack shelves for boxed merchandise.

<u>Product No.</u>	<u>Shelves</u>	<u>H x W x D</u>
860-1235	Five	23 x 24 x 12

All cases on this page have cam locks with two keys.

## RECTANGULAR LOCKING CASES

These all-acrylic countertop cases can be ordered with either a clear or mirrored back piece. With the clear back, the case can be used with the doors either facing the clerk or the customer.



### Hinged Front Door Cases

<u>Product No.</u>	<u>Shelves</u>	<u>H x W x D</u>
HF171	One	16 <sup>1</sup> / <sub>2</sub> x 16 <sup>1</sup> / <sub>4</sub> x 7
HF172	Two	16 <sup>1</sup> / <sub>2</sub> x 16 <sup>1</sup> / <sub>4</sub> x 7
HF173	Three	16 <sup>1</sup> / <sub>2</sub> x 16 <sup>1</sup> / <sub>4</sub> x 7
HF131	One	13 x 21 x 7 <sup>1</sup> / <sub>2</sub>
HF132	Two	13 x 21 x 7 <sup>1</sup> / <sub>2</sub>
HF133	Three	13 x 21 x 7 <sup>1</sup> / <sub>2</sub>
HF121	One	12 x 16 x 7
HF122	Two	12 x 16 x 7
HF1271	One	12 <sup>3</sup> / <sub>4</sub> x 10 <sup>1</sup> / <sub>4</sub> x 5
HF1272	Two	12 <sup>3</sup> / <sub>4</sub> x 10 <sup>1</sup> / <sub>4</sub> x 5
HF1273	Three	12 <sup>3</sup> / <sub>4</sub> x 10 <sup>1</sup> / <sub>4</sub> x 5

These cases are available with a mirrored insert in back. To order simply add an "M" to the end of the product number; i.e. HF171M.

# Locking Showcases

## Sliding Door Cases

Product No.	Shelves	H x W x D
SBC131	One	13 x 21 x 7 <sup>1</sup> / <sub>2</sub>
SBC132	Two	13 x 21 x 7 <sup>1</sup> / <sub>2</sub>
SBC161	One	16 x 22 x 8 <sup>1</sup> / <sub>2</sub>
SBC162	Two	16 x 22 x 8 <sup>1</sup> / <sub>2</sub>
SBC163	Three	16 x 22 x 8 <sup>1</sup> / <sub>2</sub>
SBC181	One	18 x 26 x 10
SBC182	Two	18 x 26 x 10
SBC183	Three	18 x 26 x 10

These cases are available with a mirrored insert in back. To order simply add an "M" to the end of the product number; i.e. SBC131M.



The sliding back piece on these cases is available in clear or mirrored acrylic. Cam lock and two keys are included.



## Sliding Back Locking Cases

Shelves are fixed in place, and all cases ship fully assembled. Sliding back piece is fully removable if desired.

Product No.	Shelves	H x W x D
SD121	One	12 <sup>3</sup> / <sub>4</sub> x 10 <sup>1</sup> / <sub>4</sub> x 5
SD122	Two	12 <sup>3</sup> / <sub>4</sub> x 10 <sup>1</sup> / <sub>4</sub> x 5
SD123	Three	12 <sup>3</sup> / <sub>4</sub> x 10 <sup>1</sup> / <sub>4</sub> x 5
SD151	One	15 <sup>3</sup> / <sub>4</sub> x 10 <sup>1</sup> / <sub>4</sub> x 5
SD152	Two	15 <sup>3</sup> / <sub>4</sub> x 10 <sup>1</sup> / <sub>4</sub> x 5
SD153	Three	15 <sup>3</sup> / <sub>4</sub> x 10 <sup>1</sup> / <sub>4</sub> x 5
SD171	One	16 <sup>1</sup> / <sub>2</sub> x 16 <sup>1</sup> / <sub>4</sub> x 7
SD172	Two	16 <sup>1</sup> / <sub>2</sub> x 16 <sup>1</sup> / <sub>4</sub> x 7
SD173	Three	16 <sup>1</sup> / <sub>2</sub> x 16 <sup>1</sup> / <sub>4</sub> x 7
SD200	None	20 <sup>3</sup> / <sub>4</sub> x 12 <sup>1</sup> / <sub>4</sub> x 10
SD201	One	20 <sup>3</sup> / <sub>4</sub> x 12 <sup>1</sup> / <sub>4</sub> x 10
SD202	Two	20 <sup>3</sup> / <sub>4</sub> x 12 <sup>1</sup> / <sub>4</sub> x 10
SD212	Two	21 <sup>3</sup> / <sub>4</sub> x 13 <sup>1</sup> / <sub>4</sub> x 7 <sup>1</sup> / <sub>2</sub>
SD213	Three	21 <sup>3</sup> / <sub>4</sub> x 13 <sup>1</sup> / <sub>4</sub> x 7 <sup>1</sup> / <sub>2</sub>



## Dormer Window Cases

Product No.	Shelves	H x W x D
DW121	One	12 <sup>3</sup> / <sub>4</sub> x 10 <sup>1</sup> / <sub>2</sub> x 5 <sup>1</sup> / <sub>2</sub>
DW122	Two	12 <sup>3</sup> / <sub>4</sub> x 10 <sup>1</sup> / <sub>2</sub> x 5 <sup>1</sup> / <sub>2</sub>
DW123	Three	12 <sup>3</sup> / <sub>4</sub> x 10 <sup>1</sup> / <sub>2</sub> x 5 <sup>1</sup> / <sub>2</sub>
DW161	One	16 <sup>1</sup> / <sub>2</sub> x 16 <sup>1</sup> / <sub>2</sub> x 8 <sup>1</sup> / <sub>2</sub>
DW162	Two	16 <sup>1</sup> / <sub>2</sub> x 16 <sup>1</sup> / <sub>2</sub> x 8 <sup>1</sup> / <sub>2</sub>
DW163	Three	16 <sup>1</sup> / <sub>2</sub> x 16 <sup>1</sup> / <sub>2</sub> x 8 <sup>1</sup> / <sub>2</sub>

These cases are available with a mirrored sliding back door. To order simply add an "M" to the end of the product number; i.e. DW121M.

# Locking Showcases

Locking Showcases



## Double Locking-Door Ring Case

This case has five angled shelves with 1" lip and is designed to hold up to 120 ring boxes. There is a door on either side, and the case revolves on a white lazy-Susan base. Two cam locks and four keys are included.

Product No.	H x W x D
LRC22	22 x 13 <sup>1</sup> / <sub>4</sub> x 7



## Square Front-Opening Cases

Cam lock and two keys are included.

Product No.	Shelves	H x W x D
SQFC12	None	12 x 6 x 6
SQFC121	One	12 x 6 x 6
SQFC16	None	16 x 8 x 8
SQFC161	One	16 x 8 x 8
SQFC20	None	20 x 10 x 10
SQFC201	One	20 x 10 x 10



## Slanted-Front Three-Shelf Cases

Sliding back panel can be ordered in clear or mirrored acrylic. Cam lock and two keys are included.

Product No.	Shelves	H x W x D
ACAS7	Three	13 <sup>3</sup> / <sub>4</sub> x 14 x 7 <sup>3</sup> / <sub>4</sub>
BCAS7	Three	16 x 16 x 10

These cases are available with a mirrored sliding back door. To order simply add an "M" to the end of the product number; i.e. ACAS7M.



## Angled-Shelf Cases

The sliding back panel on these cases is available in clear or mirrored acrylic. Cam lock and two keys are included.

Product No.	Shelves	H x W x D
LRC1	Three	12 <sup>3</sup> / <sub>4</sub> x 10 <sup>1</sup> / <sub>4</sub> x 5
LRC2	Three	15 <sup>3</sup> / <sub>4</sub> x 10 <sup>1</sup> / <sub>4</sub> x 5
LRC3	Three	16 <sup>1</sup> / <sub>2</sub> x 16 <sup>1</sup> / <sub>4</sub> x 7
LRC4	Three	20 <sup>3</sup> / <sub>4</sub> x 12 <sup>1</sup> / <sub>4</sub> x 10
LRC5	Three	21 <sup>3</sup> / <sub>4</sub> x 13 <sup>1</sup> / <sub>4</sub> x 7 <sup>1</sup> / <sub>2</sub>

These cases are available with a mirrored sliding back door. To order simply add an "M" to the end of the product number; i.e. LRC1M.

# Locking Showcases

## Slanted-Front Cases with Straight Shelves

These cases have either an open space or one or two shelves, and the sliding back panel can be ordered in clear or mirrored acrylic. Cam lock and two keys are included.

Product No.	Shelves	H x W x D
ACAS6	None	13 <sup>3</sup> / <sub>4</sub> x 14 x 7 <sup>3</sup> / <sub>4</sub>
ACAS81	One	13 <sup>3</sup> / <sub>4</sub> x 14 x 7 <sup>3</sup> / <sub>4</sub>
ACAS8	Two	13 <sup>3</sup> / <sub>4</sub> x 14 x 7 <sup>3</sup> / <sub>4</sub>
ACAS16	None	16 x 16 x 10
ACAS161	One	16 x 16 x 10
ACAS162	Two	16 x 16 x 10

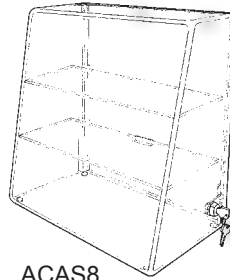

ACAS8



ACAS6

These cases are available with a mirrored sliding back door. To order simply add an "M" to the end of the product number; i.e. ACAS6M.

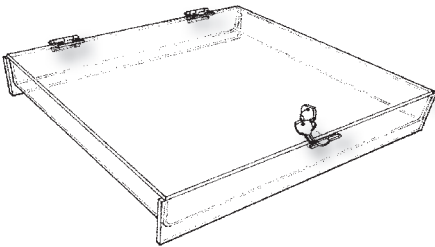

Cam locks and two keys are included with each tray.



## Locking Countertop Trays

Product No.	H x W x D	Product No.	H x W x D
LCT1	2 x 6 x 6	LCT8	6 x 18 x 18
LCT2	2 x 9 x 9	LCTR1	2 <sup>3</sup> / <sub>4</sub> x 7 <sup>1</sup> / <sub>2</sub> x 8 <sup>1</sup> / <sub>2</sub>
LCT3	2 x 12 x 12	LCTR2	2 <sup>3</sup> / <sub>4</sub> x 12 x 8
LCT4	4 x 10 x 10	LCTR4	2 <sup>3</sup> / <sub>4</sub> x 14 <sup>1</sup> / <sub>2</sub> x 8 <sup>1</sup> / <sub>2</sub>
LCT5	4 x 14 x 14	LCTR55	2 <sup>3</sup> / <sub>4</sub> x 15 x 17
LCT6	4 x 18 x 18	LCTR6	2 <sup>3</sup> / <sub>4</sub> x 18 x 12
LCT7	6 x 12 x 12	LCTR8	3 x 24 x 18

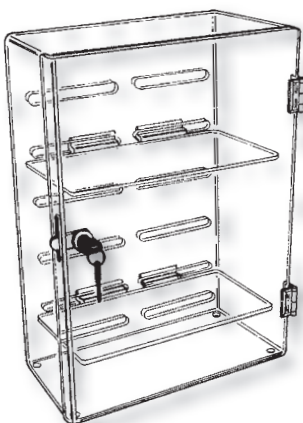
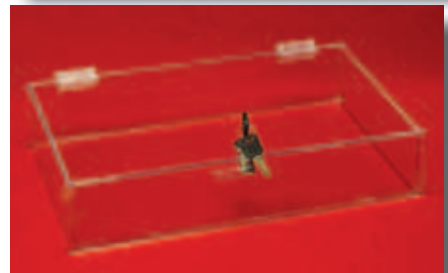

## Locking Case for Slatwall Shelves

Slatwall shelves and other slatwall accessories can be used inside this case. See the Slatwall Chapter of this catalog for more accessories. Cam lock, two keys and two slatwall shelves are included.

Product No.	H x W x D	# of Slots
SWC18	18 <sup>1</sup> / <sub>2</sub> x 13 <sup>3</sup> / <sub>4</sub> x 6 <sup>3</sup> / <sub>4</sub>	12
SWC24	24 x 13 <sup>3</sup> / <sub>4</sub> x 6 <sup>3</sup> / <sub>4</sub>	14

Two Z126E slatwall shelves are included.

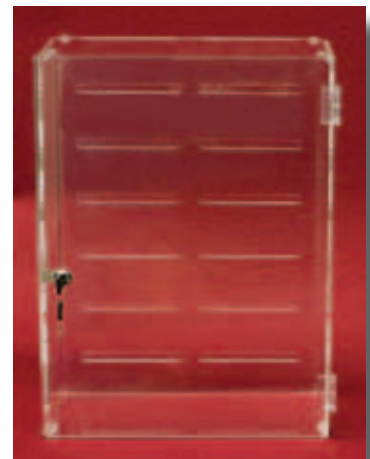



# Locking Showcases

## NON-LOCKING FLOOR UNIT



### Rotating Slatwall Floor Unit

This versatile rotating tower can hold up to 24 slatwall shelves or bins. Also look in the Slatwall Chapter of this catalog for a huge variety of other slatwall accessories that will enhance this display. Just some of the possibilities (sold separately) are shown below. Base is 16" high white expanded PVC.

Product No.	# of Slots	H x W x D
870-1366	16	52 x 10 x 10
870-1365	24	64 x 10 x 10

Here are some of the slatwall accessories that work well in the rotating slatwall floor unit. In addition, any slatwall accessories that are less than 10" wide will fit.

### Slatwall Shelves for Rotating Floor Display

(sold separately from floor unit)

Product No.	H x W x D	Style
Z84E	2 x 8 x 4	Shelf
Z8EL	2 x 8 x 3 1/2	Shelf
Z84ESLP	2 x 8 x 4	Shelf
890-1475	2 x 8 x 4	Tray
890-1476	2 x 8 x 4	Tray



Z84E



Z84ESLP - Label Front



Z8EL



890-1475 - Straight tray



890-1476 - Angled tray

# Literature Holders

## MOLDED ECONOMY BROCHURE HOLDERS

Many of our literature holders are also available with attachments for slatwall, gridwall, or pegboard mounting, and some are available with holes drilled for wall mounting.

These products are marked with the symbols below:

- Z** if you would like to order an accessory with slatwall mount, add a "Z" to the **beginning** of the product number;
- G** for gridwall mounts, add a "G" to the **end** of product number;
- P** for pegboard, add a "P" to the **end** of product number;
- W** for wall mounting, add "WM" to the **end** of product number.

Prices are the same as for the countertop version.

Any of our brochure holders can be imprinted with your logo or other camera-ready artwork.

- 50-piece minimum
- One-time screen charge
- Cost per color per piece



Wallmount

### Tri-Fold Brochure Holders

Pocket size of both countertop and wallmount styles is 4<sup>1</sup>/<sub>8</sub>" wide and 1<sup>1</sup>/<sub>4</sub>" deep. Wallmount style has two mounting holes.

Product No.	Style	H x W x D
B1E	Countertop	7 <sup>1</sup> / <sub>4</sub> x 4 <sup>1</sup> / <sub>2</sub> x 2 <sup>1</sup> / <sub>2</sub>
B1WET	Wallmount	7 <sup>1</sup> / <sub>4</sub> x 4 <sup>1</sup> / <sub>2</sub> x 1 <sup>7</sup> / <sub>8</sub>

**Z W G P**

Countertop

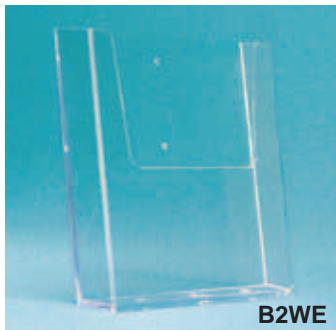

B2WE

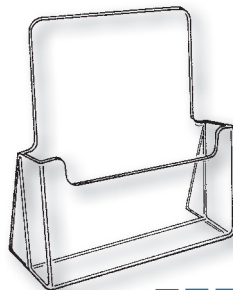

**Z W G P**

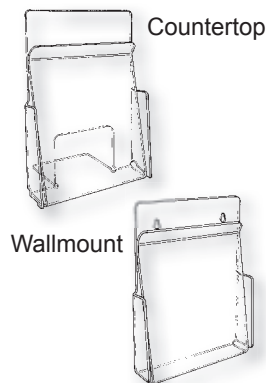

Countertop

Wallmount



### 8<sup>1</sup>/<sub>2</sub> x 11 Catalog Holders

Pocket size of both countertop and wallmount styles is 8<sup>3</sup>/<sub>4</sub>" wide and 1<sup>1</sup>/<sub>2</sub>" deep. Wallmount style has two mounting holes.

Product No.	Color	Style	H x W x D
B2E	Clear	Countertop	10 <sup>1</sup> / <sub>4</sub> x 9 <sup>3</sup> / <sub>4</sub> x 3 <sup>3</sup> / <sub>4</sub>
B2WE	Clear	Wallmount	10 <sup>1</sup> / <sub>4</sub> x 9 <sup>3</sup> / <sub>4</sub> x 1 <sup>7</sup> / <sub>8</sub>
WB2E	White	Countertop	10 <sup>1</sup> / <sub>4</sub> x 9 <sup>3</sup> / <sub>4</sub> x 3 <sup>3</sup> / <sub>4</sub>
WB2WE	White	Wallmount	10 <sup>1</sup> / <sub>4</sub> x 9 <sup>3</sup> / <sub>4</sub> x 1 <sup>7</sup> / <sub>8</sub>

### Hold-Down Style Brochure Holders

A special tension tab keeps sheets in place in these brochure holders.

Product No.	Paper Size	H x W x D
HTF1	Tri-Fold	8 <sup>3</sup> / <sub>8</sub> x 4 <sup>1</sup> / <sub>2</sub> x 4
HTF3	Half-Sheet	8 <sup>1</sup> / <sub>2</sub> x 6 <sup>3</sup> / <sub>4</sub> x 4
HTF2	8 <sup>1</sup> / <sub>2</sub> x 11	11 x 4 <sup>1</sup> / <sub>4</sub> x 5

# Literature Holders

Any of our brochure holders can be imprinted with your logo or other camera-ready artwork.

- 50-piece minimum
- One-time screen charge
- Cost per color per piece

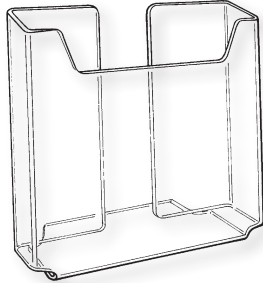

## Economy Handmade Countertop Brochure Holders

This style is available in four sizes, single pocket only.

Product No.	Paper Size	H x W x D
BEC1	Tri-Fold	6 x 4 $\frac{1}{2}$ x 3
BEC3	Half-Sheet	6 x 6 $\frac{1}{4}$ x 3
BEC2	8 $\frac{1}{2}$ x 11	8 x 9 x 3 $\frac{1}{2}$
BEC2H	11 x 8 $\frac{1}{2}$	8 x 11 $\frac{1}{2}$ x 3 $\frac{1}{2}$

For 8 $\frac{1}{2}$  x 11 paper in a horizontal orientation.

Z W G P

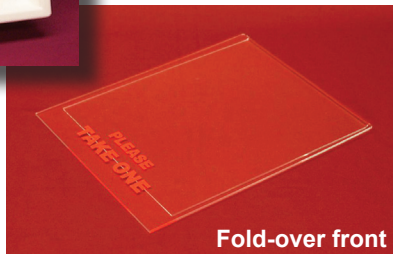

Fold-over front

## Outdoor Brochure/Flyer Holders

For 8 $\frac{1}{2}$  x 11 sheets, these wall-mounting holders feature a weather-resistant lid. Available with or without a fold-over front that always retains one copy of a flyer. Both models can be customized with silkscreening.

Product No.	H x W x D
OBH3	13 x 9 $\frac{1}{4}$ x 2
OBH5 *	13 x 9 $\frac{1}{4}$ x 2

These models are silkscreened with "Please Take One" on the front:

OBH3P	13 x 9 $\frac{1}{4}$ x 2
OBH5P *	13 x 9 $\frac{1}{4}$ x 2

\* With fold-over front

## Premier Handmade Brochure Holders

Pockets are 1 $\frac{5}{8}$ " deep (front to back), except for the BBH5, which is 3" deep.

Product No.	Paper Size	H x W x D
BBH1	Tri-Fold	8 $\frac{1}{8}$ x 4 $\frac{1}{2}$ x 3 $\frac{1}{2}$
BBH3	Half-Sheet	8 x 6 $\frac{3}{8}$ x 3 $\frac{1}{2}$
BBH2	8 $\frac{1}{2}$ x 11	10 $\frac{1}{2}$ x 9 $\frac{1}{4}$ x 4 $\frac{1}{2}$
BBH2H	11 x 8 $\frac{1}{2}$	8 x 12 x 4 $\frac{1}{4}$
BBH6	Magazine	10 $\frac{1}{4}$ x 11 $\frac{1}{4}$ x 4 $\frac{3}{4}$
BBH5	Oversize Magazine	11 x 9 $\frac{3}{4}$ x 6

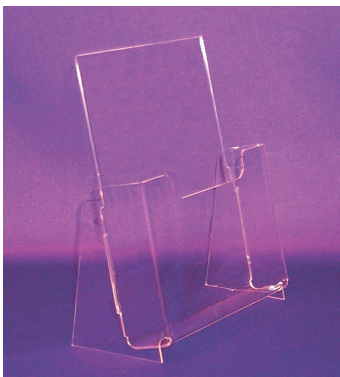

# Literature Holders

## Premier Elevated Brochure Holders

The same style as the BBH series, with laser-cut quality and a taller base for better visibility. Pockets are 1<sup>5</sup>/<sub>8</sub>" deep (front to back), except for the BBHE5, which is 3" deep.

Product No.	Paper Size	H x W x D
BBHE1	Tri-Fold	10 <sup>1</sup> / <sub>8</sub> x 4 <sup>1</sup> / <sub>2</sub> x 4
BBHE3	Half-Sheet	10 x 6 <sup>3</sup> / <sub>8</sub> x 4
BBHE2	8 <sup>1</sup> / <sub>2</sub> x 11	12 <sup>1</sup> / <sub>2</sub> x 9 <sup>3</sup> / <sub>8</sub> x 4 <sup>1</sup> / <sub>2</sub>
BBHE2H	11 x 8 <sup>1</sup> / <sub>2</sub>	10 x 12 x 4 <sup>1</sup> / <sub>4</sub>
BBHE6	Magazine	13 x 11 <sup>1</sup> / <sub>4</sub> x 5
BBHE5	Oversize Magazine	13 x 9 <sup>3</sup> / <sub>4</sub> x 6 <sup>1</sup> / <sub>4</sub>

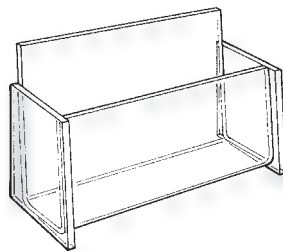
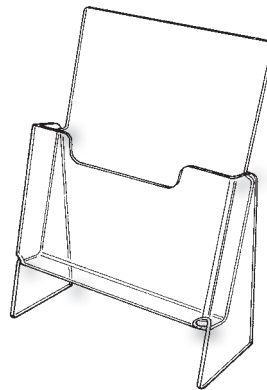

## Handmade Deluxe Brochure Holders

Extra styling with thicker endpieces. Pockets are 1<sup>3</sup>/<sub>4</sub>" deep (front to back), except for the BX5, which is 3" deep.

Product No.	Paper Size	H x W x D
BX1	Tri-Fold	8 <sup>1</sup> / <sub>4</sub> x 4 <sup>3</sup> / <sub>4</sub> x 3 <sup>1</sup> / <sub>2</sub>
BX2	8 <sup>1</sup> / <sub>2</sub> x 11	11 <sup>1</sup> / <sub>4</sub> x 9 <sup>1</sup> / <sub>4</sub> x 3 <sup>1</sup> / <sub>2</sub>
BX3	Half-Sheet	8 <sup>1</sup> / <sub>4</sub> x 6 <sup>1</sup> / <sub>4</sub> x 3 <sup>1</sup> / <sub>2</sub>
BX4	Postcards	4 <sup>1</sup> / <sub>4</sub> x 6 <sup>3</sup> / <sub>4</sub> x 3 <sup>1</sup> / <sub>2</sub>
BX5	Magazine	11 <sup>1</sup> / <sub>4</sub> x 9 <sup>3</sup> / <sub>4</sub> x 4 <sup>1</sup> / <sub>4</sub>

## Deluxe Multi-Pocket Brochure Holders

Pockets are 2" deep.

Product No.	Paper Size/Compartments	H x W x D
BX12	Tri-Fold / 2	8 <sup>1</sup> / <sub>4</sub> x 9 x 3 <sup>1</sup> / <sub>2</sub>
BX13	Tri-Fold / 3	8 <sup>1</sup> / <sub>4</sub> x 13 <sup>1</sup> / <sub>4</sub> x 3 <sup>1</sup> / <sub>2</sub>
BX22	8 <sup>1</sup> / <sub>2</sub> x 11 / 2	11 <sup>1</sup> / <sub>4</sub> x 18 x 3 <sup>1</sup> / <sub>2</sub>

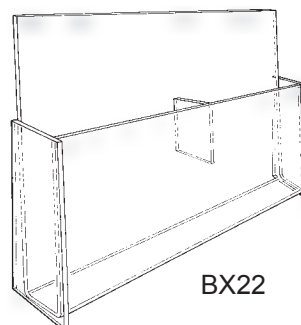
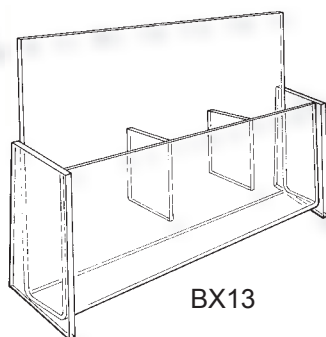
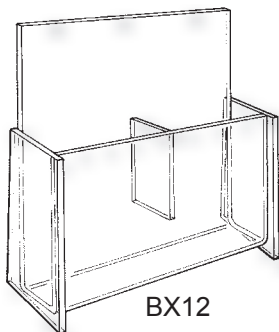

# Literature Holders

## MULTI-POCKET BROCHURE HOLDERS WITH REMOVABLE DIVIDERS



### For Tri-Fold Brochures

Each pocket is 4<sup>1</sup>/<sub>4</sub>" wide by 1<sup>5</sup>/<sub>8</sub>" deep.

Product No.	# Pockets	H x W x D
B1MP2	2	8 <sup>1</sup> / <sub>8</sub> x 9 x 3 <sup>1</sup> / <sub>2</sub>
B1MP3	3	8 <sup>1</sup> / <sub>8</sub> x 13 <sup>1</sup> / <sub>2</sub> x 3 <sup>1</sup> / <sub>2</sub>
B1MP4	4	8 <sup>1</sup> / <sub>8</sub> x 17 <sup>3</sup> / <sub>4</sub> x 3 <sup>1</sup> / <sub>2</sub>
B1MP5	5	8 <sup>1</sup> / <sub>8</sub> x 22 <sup>1</sup> / <sub>4</sub> x 3 <sup>1</sup> / <sub>2</sub>
B1MP6	6	8 <sup>1</sup> / <sub>8</sub> x 26 <sup>1</sup> / <sub>2</sub> x 3 <sup>1</sup> / <sub>2</sub>



### For 8<sup>1</sup>/<sub>2</sub> x 11 Literature

Each pocket is 9" wide by 1<sup>1</sup>/<sub>2</sub>" deep.

Product No.	# Pockets	H x W x D
B2MP2	2	10 <sup>5</sup> / <sub>8</sub> x 18 <sup>3</sup> / <sub>8</sub> x 4 <sup>1</sup> / <sub>4</sub>
B2MP3	3	10 <sup>5</sup> / <sub>8</sub> x 27 <sup>1</sup> / <sub>2</sub> x 4 <sup>1</sup> / <sub>4</sub>



### For Half-Sheets or Greeting Cards

Each pocket is 6" wide by 1<sup>5</sup>/<sub>8</sub>" deep.

Product No.	# Pockets	H x W x D
B3MP2	2	8 <sup>1</sup> / <sub>8</sub> x 13 x 3 <sup>1</sup> / <sub>2</sub>
B3MP3	3	8 <sup>1</sup> / <sub>8</sub> x 18 x 3 <sup>1</sup> / <sub>2</sub>
B3MP4	4	8 <sup>1</sup> / <sub>8</sub> x 24 <sup>1</sup> / <sub>4</sub> x 3 <sup>1</sup> / <sub>2</sub>



### Add-On Pockets

We can add a pocket to any acrylic product. Ideal for sign frames, brochure holders or even ballot boxes and print bins. The add-on pocket will be affixed to the lower right hand corner of the companion piece unless otherwise specified.

Product No.	Description	Depth
BA1	Horizontal Business Card	7 <sup>7</sup> / <sub>8</sub>
BA2	Horizontal Literature Holder	7 <sup>7</sup> / <sub>8</sub>
BA3	Cell Phone	1
BA4	Vertical Business Card	7 <sup>7</sup> / <sub>8</sub>

# Literature Holders

## DELUXE MULTI-TIERED BROCHURE HOLDERS

### For Tri-Fold Brochures

Product No.	Levels	H x W x D
B1MT2	Two	11 <sup>1</sup> / <sub>2</sub> x 5 x 4 <sup>7</sup> / <sub>8</sub>
B1MT3	Three	14 <sup>1</sup> / <sub>8</sub> x 5 x 6 <sup>7</sup> / <sub>8</sub>
B1MT4	Four	16 <sup>7</sup> / <sub>8</sub> x 5 x 9 <sup>1</sup> / <sub>8</sub>



B1MT3



B1MT2



B1MT4

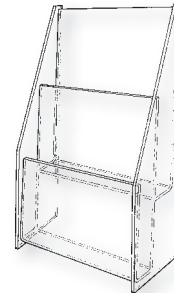

### For 8<sup>1</sup>/<sub>2</sub> x 11 Literature

Product No.	Levels	H x W x D
B2MT2	Two	15 <sup>5</sup> / <sub>8</sub> x 9 <sup>3</sup> / <sub>8</sub> x 5
B2MT3	Three	19 <sup>1</sup> / <sub>4</sub> x 9 <sup>3</sup> / <sub>8</sub> x 7
B2MT4	Four	22 <sup>7</sup> / <sub>8</sub> x 9 <sup>3</sup> / <sub>8</sub> x 9 <sup>1</sup> / <sub>8</sub>



### For Half-Sheets or Greeting Cards

Product No.	Levels	H x W x D
B3MT2	Two	11 <sup>1</sup> / <sub>2</sub> x 6 <sup>1</sup> / <sub>2</sub> x 5
B3MT3	Three	14 <sup>1</sup> / <sub>8</sub> x 6 <sup>1</sup> / <sub>2</sub> x 7
B3MT4	Four	16 <sup>7</sup> / <sub>8</sub> x 6 <sup>1</sup> / <sub>2</sub> x 9 <sup>1</sup> / <sub>8</sub>



### For Post Cards

Product No.	Levels	H x W x D
B4MT2	Two	5 x 6 <sup>1</sup> / <sub>2</sub> x 4 <sup>1</sup> / <sub>4</sub>
B4MT3	Three	6 <sup>3</sup> / <sub>8</sub> x 6 <sup>1</sup> / <sub>2</sub> x 6 <sup>1</sup> / <sub>4</sub>
B4MT4	Four	7 <sup>5</sup> / <sub>8</sub> x 6 <sup>1</sup> / <sub>2</sub> x 8 <sup>1</sup> / <sub>4</sub>

# Literature Holders

## MULTI-TIERED, MULTI-POCKET BROCHURE HOLDERS

For countertop or wall mounting All styles have lock-in partitions. Made of 1/8"-thick clear acrylic.



### For Tri-Fold Brochures

Product No.	Levels	# Pockets	H x W x D
B1MTP22	Two	Two	11 <sup>1</sup> / <sub>2</sub> x 9 <sup>1</sup> / <sub>8</sub> x 5
B1MTP23	Two	Three	11 <sup>1</sup> / <sub>2</sub> x 13 <sup>1</sup> / <sub>2</sub> x 5
B1MTP24	Two	Four	11 <sup>1</sup> / <sub>2</sub> x 17 <sup>7</sup> / <sub>8</sub> x 5
B1MTP25	Two	Five	11 <sup>1</sup> / <sub>2</sub> x 22 <sup>1</sup> / <sub>4</sub> x 5
B1MTP33	Three	Three	14 <sup>1</sup> / <sub>8</sub> x 13 <sup>1</sup> / <sub>2</sub> x 7
B1MTP34	Three	Four	14 <sup>1</sup> / <sub>8</sub> x 17 <sup>7</sup> / <sub>8</sub> x 7
B1MTP35	Three	Five	14 <sup>1</sup> / <sub>8</sub> x 22 <sup>1</sup> / <sub>4</sub> x 7



### For 8 1/2 x 11 Literature

Product No.	Levels	# Pockets	H x W x D
B2MTP22	Two	Two	15 <sup>1</sup> / <sub>2</sub> x 18 <sup>5</sup> / <sub>8</sub> x 5
B2MTP23	Two	Three	15 <sup>1</sup> / <sub>2</sub> x 27 <sup>3</sup> / <sub>4</sub> x 5
B2MTP32	Three	Two	19 <sup>1</sup> / <sub>8</sub> x 18 <sup>5</sup> / <sub>8</sub> x 7
B2MTP33	Three	Three	19 <sup>1</sup> / <sub>8</sub> x 27 <sup>3</sup> / <sub>4</sub> x 7



### For Greeting Cards

For cards up to 6" wide.

Product No.	Levels	# Pockets	H x W x D
B3MTP22	Two	Two	11 x 12 <sup>5</sup> / <sub>8</sub> x 4 <sup>7</sup> / <sub>8</sub>
B3MTP23	Two	Three	11 x 18 <sup>3</sup> / <sub>4</sub> x 4 <sup>7</sup> / <sub>8</sub>
B3MTP24	Two	Four	11 x 24 <sup>7</sup> / <sub>8</sub> x 4 <sup>7</sup> / <sub>8</sub>
B3MTP33	Three	Three	13 <sup>7</sup> / <sub>8</sub> x 18 <sup>3</sup> / <sub>4</sub> x 6 <sup>7</sup> / <sub>8</sub>
B3MTP34	Three	Four	13 <sup>7</sup> / <sub>8</sub> x 24 <sup>7</sup> / <sub>8</sub> x 6 <sup>7</sup> / <sub>8</sub>
B3MTP35	Three	Five	13 <sup>7</sup> / <sub>8</sub> x 31 x 6 <sup>7</sup> / <sub>8</sub>

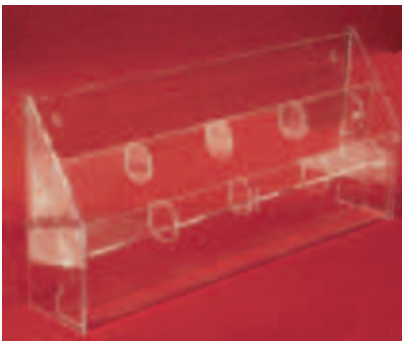

### For Post Cards

For cards up to 6" wide, 4" tall.

Product No.	Levels	# Pockets	H x W x D
B4MTP22	Two	Two	5 x 12 <sup>5</sup> / <sub>8</sub> x 4 <sup>1</sup> / <sub>4</sub>
B4MTP23	Two	Three	5 x 18 <sup>3</sup> / <sub>4</sub> x 4 <sup>1</sup> / <sub>4</sub>
B4MTP24	Two	Four	5 x 24 <sup>7</sup> / <sub>8</sub> x 4 <sup>1</sup> / <sub>4</sub>
B4MTP33	Three	Three	6 <sup>3</sup> / <sub>8</sub> x 18 <sup>3</sup> / <sub>4</sub> x 6 <sup>1</sup> / <sub>4</sub>
B4MTP34	Three	Four	6 <sup>3</sup> / <sub>8</sub> x 24 <sup>7</sup> / <sub>8</sub> x 6 <sup>1</sup> / <sub>4</sub>
B4MTP35	Three	Five	6 <sup>3</sup> / <sub>8</sub> x 31 x 6 <sup>1</sup> / <sub>4</sub>

### Economy Multi-Level Holders



#### Trifold Style 4 levels

Product No.	Levels
B14E	4

H x W x D  
10 x 4<sup>3</sup>/<sub>4</sub> x 6<sup>1</sup>/<sub>4</sub>



#### For 8 1/2 x 11s 3 levels

Product No.	Levels
B23E	3

H x W x D  
11<sup>3</sup>/<sub>4</sub> x 9<sup>1</sup>/<sub>2</sub> x 6

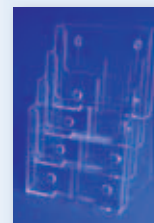

#### For 8 1/2 x 11s 4 levels

Product No.	Levels
B24E	4

H x W x D  
13<sup>1</sup>/<sub>2</sub> x 9<sup>1</sup>/<sub>4</sub> x 7

# Literature Holders

## COUNTERTOP BROCHURE ROTATORS



### For Tri-Fold Brochures

Product No.	Pockets	H x Diam.
RBH13	Three	10 x 7 $\frac{1}{2}$
RBH14	Four	10 x 9
RBH16	Three x Two High	20 x 7 $\frac{1}{2}$
RBH18	Four x Two High	20 x 9

Multi-pocket and multi-level displays revolve on lazy-Susan bases. Pockets are clear acrylic and bases are white acrylic.



## COUNTERTOP CARD RACKS

Three- or four-tiered styles feature one-piece trays of clear acrylic. All units pack unassembled for easy shipping and come with two-piece fasteners for assembly.



### Straight-Rack Card Displays

All trays are 2" high in the front, 4 $\frac{1}{2}$ " high in the back and 2" deep.

Product No.	Tiers	Pocket Width	H x W x D
K3	Three	21"	13 $\frac{3}{8}$ x 21 $\frac{1}{4}$ x 7 $\frac{1}{4}$
K34	Four	21"	17 $\frac{3}{4}$ x 21 $\frac{1}{4}$ x 9 $\frac{1}{2}$
K3N	Three	14"	13 $\frac{3}{8}$ x 14 $\frac{1}{4}$ x 7 $\frac{1}{4}$
K34N	Four	14"	17 $\frac{3}{4}$ x 14 $\frac{1}{4}$ x 9 $\frac{1}{2}$



### Tilted-Rack Card Displays

All trays are 3" high in the front, 7" high in the back and 3" deep.

Product No.	Tiers	Pocket Width	H x W x D
K4T	Three	24"	19 $\frac{3}{4}$ x 24 $\frac{3}{8}$ x 14 $\frac{1}{4}$
K44T	Four	24"	26 x 24 $\frac{3}{8}$ x 19 $\frac{1}{2}$
K4TN	Three	16"	19 $\frac{3}{4}$ x 16 $\frac{3}{8}$ x 14 $\frac{1}{4}$
K44TN	Four	16"	26 x 16 $\frac{3}{8}$ x 19 $\frac{1}{2}$

Card Racks

### Shelf Dividers

Adjustable dividers for any of our J-shelves. Blade is 1 $\frac{1}{4}$ " high and 1 $\frac{3}{4}$ " long. Sold by the dozen.

Product No.  
LDIV

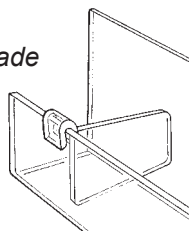

Examples of products that could use shelf dividers.

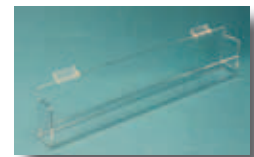

Use shelf dividers on all the card racks on this page to customize your display.



# Literature Holders



K54A

## Angled-Rack Card Displays

These card racks have trays that angle downward. All trays are 3" high in the front, 4" high in the back and 3" deep.

Product No.	Tiers	Pocket Width	H x W x D
K5A	Three	21"	15 <sup>3</sup> / <sub>8</sub> x 21 <sup>3</sup> / <sub>8</sub> x 9
K54A	Four	21"	20 <sup>7</sup> / <sub>8</sub> x 21 <sup>3</sup> / <sub>8</sub> x 11 <sup>7</sup> / <sub>8</sub>

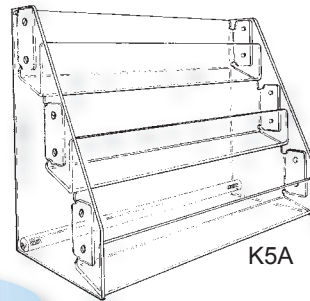

K5A

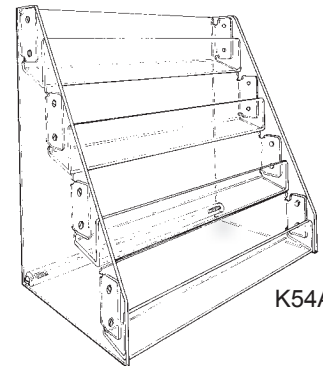

K54A

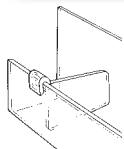

Use shelf dividers on all the card racks on this page to customize your display.

(See page 47 for details)



BMD20LB

## Bookmark Displays

Four-tiered displays for bookmarks up to 2<sup>1</sup>/<sub>4</sub>" wide are available with either 2 or 4 pockets across.

Product No.	Pockets per Tier	Total Pockets	H x W x D
BMD8	Two	Eight	11 <sup>3</sup> / <sub>8</sub> x 4 <sup>7</sup> / <sub>8</sub> x 8 <sup>3</sup> / <sub>8</sub>
BMD12	Three	Twelve	11 <sup>3</sup> / <sub>8</sub> x 7 <sup>1</sup> / <sub>4</sub> x 8 <sup>3</sup> / <sub>8</sub>
BMD16	Four	Sixteen	11 <sup>3</sup> / <sub>8</sub> x 9 <sup>1</sup> / <sub>2</sub> x 8 <sup>3</sup> / <sub>8</sub>
BMD20LB	Five	Twenty	11 <sup>3</sup> / <sub>8</sub> x 11 <sup>7</sup> / <sub>8</sub> x 8 <sup>3</sup> / <sub>8</sub>

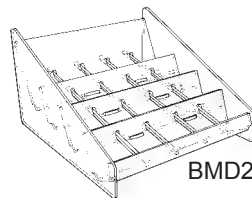

BMD20LB

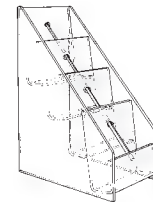

BMD8



## Card Box Displays

This four-tiered card rack is ideal for boxed cards. The shelves are 2" deep.

Product No.	H x W x D
K64N	12 <sup>3</sup> / <sub>4</sub> x 15 <sup>1</sup> / <sub>2</sub> x 11

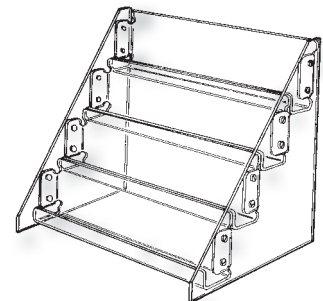

Card Racks

# Literature Holders

## WALL-MOUNTING LITERATURE HOLDERS

### Single-Pocket Wall-Mounting Holders

Two 1/4" holes are drilled in these brochure holders for wall mounting. Pocket depth is 1 5/8".

Product No.	Style	H x W x D
BH1W	Tri-Fold	8 1/8 x 4 1/2 x 2
BH3W	Half Sheet	8 1/8 x 6 1/4 x 2
BH2W	8 1/2 x 11 Catalogs	9 1/4 x 10 1/2 x 2
BH2WH	11 x 8 1/2	8 1/8 x 11 3/4 x 2
BH5W	Magazines	11 3/4 x 10 7/8 x 2

Z W G P

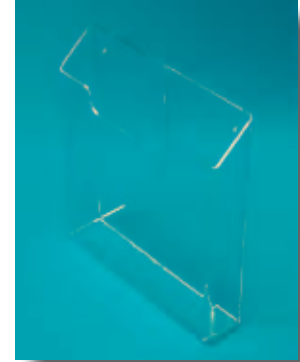

### Multi-Pocket Wall Mounting

Two 1/4" holes are drilled in these brochure holders for wall mounting. Pocket depth is 1 5/8".

Product No.	# Pockets	Style	H x W x D
BH12W	Two	Tri-Fold	8 1/4 x 9 x 2
BH13W	Three	Tri-Fold	8 1/4 x 13 x 2
BH14W	Four	Tri-Fold	8 1/4 x 17 3/4 x 2
BH15W	Five	Tri-Fold	8 1/4 x 22 x 2
BH22W	Two	8 1/2 x 11	10 3/4 x 18 1/2 x 2
BH23W	Three	8 1/2 x 11	10 3/4 x 27 5/8 x 2

Z W G P

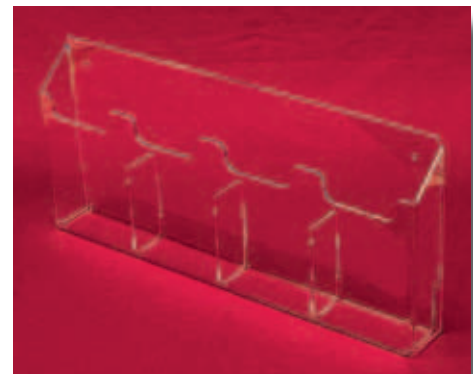

### Double-Deep Multi-Pocket Wall Mounting

Two of our multi-pocket displays are fastened together in an overlapping style. Front piece is attached with two-piece fasteners.

Product No.	# Pockets	Style	H x W x D
BH12W2D	Four	Tri-Fold	12 x 9 x 2
BH13W2D	Six	Tri-Fold	12 x 13 x 2
BH14W2D	Eight	Tri-Fold	12 x 17 3/4 x 2
BH15W2D	Ten	Tri-Fold	12 x 22 x 2
BH22W2D	Four	8 1/2 x 11	17 1/2 x 18 1/2 x 2
BH23W2D	Six	8 1/2 x 11	17 1/2 x 27 5/8 x 2

Z W G P

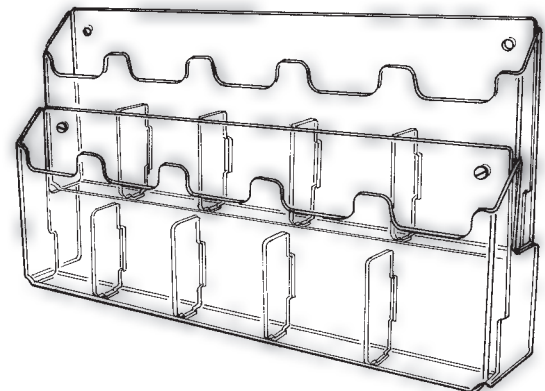

This tension clip attaches to the front of most literature holders to keep materials from falling forward.

Product No.  
ACC1

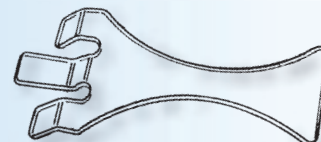

Wall Mounting

# Literature Holders



## Wall-Mounting Displays with Hold-Down Flap

The front of these literature displays is designed to hold materials securely.

Product No.	H x W x D
HTF1WM	8 <sup>3</sup> / <sub>8</sub> x 4 <sup>1</sup> / <sub>2</sub> x 2
HTF2WM	11 x 9 <sup>1</sup> / <sub>4</sub> x 2
HTF2HWM	8 <sup>1</sup> / <sub>2</sub> x 11 <sup>3</sup> / <sub>4</sub> x 2
HTF5WM	11 x 15 <sup>3</sup> / <sub>4</sub> x 2

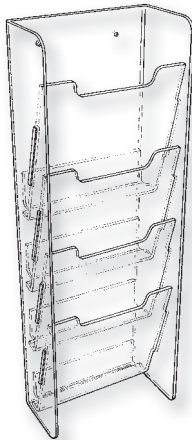

BPW2

## Vertical Multi-Pocket Displays

Overlapping style.

Product No.	# Pockets	Style	H x W x D
BPW1	Five	Tri-Fold	24 x 4 <sup>1</sup> / <sub>2</sub> x 4
BPW2	Four	8 <sup>1</sup> / <sub>2</sub> x 11	26 x 9 <sup>1</sup> / <sub>4</sub> x 4 <sup>3</sup> / <sub>4</sub>
BPW3	Five	Greeting Card	24 x 6 <sup>3</sup> / <sub>8</sub> x 4 <sup>1</sup> / <sub>4</sub>
BPW4	Seven	Post Card	23 x 6 <sup>3</sup> / <sub>8</sub> x 2 <sup>1</sup> / <sub>4</sub>
BPW5	Four	Magazine	30 x 11 <sup>1</sup> / <sub>4</sub> x 6
BPW6	Six	Tri-Fold	28 x 9 <sup>1</sup> / <sub>4</sub> x 4 <sup>3</sup> / <sub>4</sub>

Z W G P

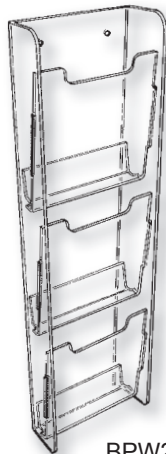

BPW2FX3

BPW2L

## Long Vertical Multi-Pocket Displays

Overlapping style:

Product No.	# Pockets	Style	H x W x D
BPW2L	Seven	8 <sup>1</sup> / <sub>2</sub> x 11	39 <sup>1</sup> / <sub>2</sub> x 9 <sup>1</sup> / <sub>2</sub> x 4 <sup>3</sup> / <sub>4</sub>
BPW5L	Six	Magazine	40 x 11 <sup>1</sup> / <sub>4</sub> x 6

Full-view style:

Product No.	# Pockets	Style	H x W x D
BPW1FX3	Three	Tri-Fold	26 <sup>1</sup> / <sub>8</sub> x 4 <sup>1</sup> / <sub>2</sub> x 3 <sup>1</sup> / <sub>4</sub>
BPW1FX5	Five	Tri-Fold	40 <sup>1</sup> / <sub>4</sub> x 4 <sup>1</sup> / <sub>2</sub> x 3 <sup>1</sup> / <sub>4</sub>
BPW3FX5	Five	Greeting Card	40 <sup>1</sup> / <sub>4</sub> x 6 <sup>3</sup> / <sub>8</sub> x 3 <sup>1</sup> / <sub>4</sub>
BPW2FX2	Two	8 <sup>1</sup> / <sub>2</sub> x 11	21 <sup>1</sup> / <sub>4</sub> x 9 <sup>3</sup> / <sub>8</sub> x 3 <sup>1</sup> / <sub>2</sub>
BPW2FX3	Three	8 <sup>1</sup> / <sub>2</sub> x 11	31 x 9 <sup>3</sup> / <sub>8</sub> x 3 <sup>1</sup> / <sub>2</sub>
BPW2FX4	Four	8 <sup>1</sup> / <sub>2</sub> x 11	40 <sup>3</sup> / <sub>4</sub> x 9 <sup>3</sup> / <sub>8</sub> x 3 <sup>1</sup> / <sub>2</sub>

Z W G P

Wall Mounting

# Literature Holders



Z W G P

## Wall-Mounting Newspaper Rack

Five pockets are angled out and feature cutouts for easy access. The 2"-deep pockets have about a quarter overlap. Made of all clear acrylic.

<u>Product No.</u>	<u>H x W x D</u>
NPR5	43 x 16 <sup>1</sup> / <sub>2</sub> x 5 <sup>3</sup> / <sub>4</sub>

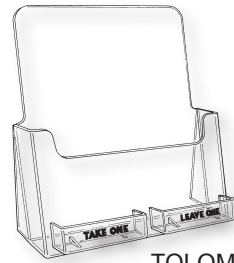

TOLOM



TOLO

## "Take One, Leave One" Flyer/Card Holder

Perfect for realtor open houses. Business card pockets let agents take the listing agent's card and leave their own. A 1<sup>1</sup>/<sub>2</sub>"-deep front pocket holds house spec. brochures and the sign space in the back makes sure that one flyer is left in place. Also excellent for trade shows.

<u>Product No.</u>	<u>H x W x D</u>
TOLO	11 x 8 <sup>1</sup> / <sub>2</sub> x 5

Our 8<sup>1</sup>/<sub>2</sub> x 11 brochure holder is also available with "take one/leave one" pockets:

TOLOM	10 <sup>1</sup> / <sub>4</sub> x 9 <sup>3</sup> / <sub>4</sub> x 3 <sup>3</sup> / <sub>4</sub>
-------	--

## BUSINESS CARD AND POST CARD HOLDERS

### Machine-Molded Business Card Holders

Economical card holders are available in clear or white. Other colors are available with a 1000-piece minimum order. Holds approximately 60 business cards.

<u>Product No.</u>	<u>Color</u>	<u>H x W x D</u>
MBCC	Clear	2 x 3 <sup>7</sup> / <sub>8</sub> x 1 <sup>3</sup> / <sub>8</sub>

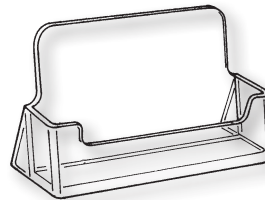

### Handmade Business Card Holders

<u>Product No.</u>	<u>Orientation</u>	<u>H x W x D</u>
BC5	Horizontal	2 <sup>1</sup> / <sub>2</sub> x 4 x 2 <sup>7</sup> / <sub>8</sub>
BC7	Vertical	3 <sup>3</sup> / <sub>4</sub> x 2 <sup>3</sup> / <sub>8</sub> x 2 <sup>1</sup> / <sub>4</sub>



BC5



BC7

These two card holders include a display area for one business card in front.

<u>Product No.</u>	<u>Orientation</u>	<u>H x W x D</u>
BC6	Horizontal	2 x 3 <sup>1</sup> / <sub>2</sub> x 3
BC8	Vertical	3 <sup>1</sup> / <sub>2</sub> x 2 <sup>3</sup> / <sub>8</sub> x 3 <sup>1</sup> / <sub>2</sub>



BC8

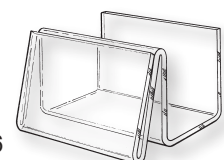

BC6

Business Card Holders

# Literature Holders

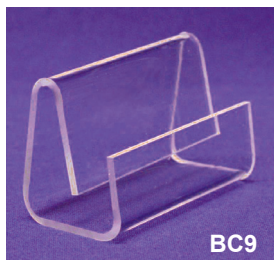

BC9



BC10

## Business Card/Post Card Holders

A handful of regular or oversized business cards, or even postcards, fit in these open-ended card holders. The angled back supports keep cards in place.

Product No.	Finish	H x W x D
BC9	Clear	2 <sup>1</sup> / <sub>8</sub> x 3 <sup>1</sup> / <sub>2</sub> x 1 <sup>7</sup> / <sub>8</sub>
BC9W	White	2 <sup>1</sup> / <sub>8</sub> x 3 <sup>1</sup> / <sub>2</sub> x 1 <sup>7</sup> / <sub>8</sub>
BC10 *	Clear	4 x 6 x 4

\*Specifically for post cards—features a front display area.



## Revolving Multi-Pocket Card Holders

<sup>7</sup>/<sub>8</sub>"-deep business card pockets on white acrylic with a lazy-Susan base in 6 or 8 pocket styles.

Product No.	# Pockets	H x Dia.
RBC3	Six	7 x 6 <sup>1</sup> / <sub>4</sub>
RBC4	Eight	7 x 7 <sup>3</sup> / <sub>4</sub>

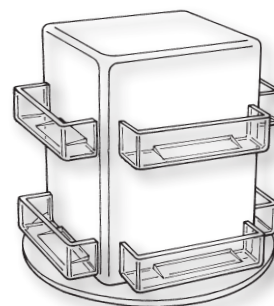

## Countertop Multi-Pocket Business Card Holders

For horizontal or vertical cards in various configurations.



Product No.	# Pockets	Tiers	Orientation	H x W x D
MBCH3	Three	Three	Horizontal	4 x 4 x 5 <sup>1</sup> / <sub>4</sub>
MBCH6	Six	Three	Horizontal	4 x 7 <sup>7</sup> / <sub>8</sub> x 5 <sup>1</sup> / <sub>4</sub>
MBCH6V	Six	Three	Vertical	8 <sup>5</sup> / <sub>8</sub> x 4 <sup>3</sup> / <sub>4</sub> x 5 <sup>7</sup> / <sub>8</sub>
MBCH4	Four	Two	Horizontal	3 <sup>1</sup> / <sub>2</sub> x 4 <sup>3</sup> / <sub>4</sub> x 4
MBCH8	Eight	Four	Horizontal	4 <sup>3</sup> / <sub>4</sub> x 8 x 6 <sup>1</sup> / <sub>4</sub>
MBCH8V	Eight	Four	Vertical	10 <sup>7</sup> / <sub>8</sub> x 4 <sup>3</sup> / <sub>4</sub> x 7 <sup>1</sup> / <sub>2</sub>



STCH3

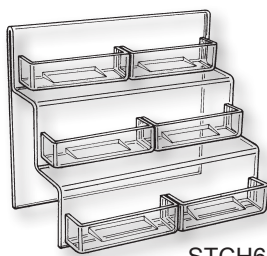

STCH6

## Stairstep Multi-Pocket Card Holders

<sup>7</sup>/<sub>8</sub>"-deep business card pockets on three-tiered stairs are available in single-wide and double-wide styles.

Product No.	# Pockets	H x W x D
STCH3	Three	6 <sup>3</sup> / <sub>4</sub> x 4 <sup>3</sup> / <sub>8</sub> x 4 <sup>3</sup> / <sub>4</sub>
STCH6	Six	6 <sup>3</sup> / <sub>4</sub> x 8 <sup>1</sup> / <sub>4</sub> x 4 <sup>3</sup> / <sub>4</sub>



WBCH6

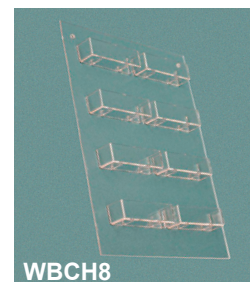

WBCH8

## Wall-Mounting Multi-Pocket Card Holders

<sup>7</sup>/<sub>8</sub>"-deep business card pockets on an acrylic backplate with holes for wall mounting.

Product No.	# Pockets	H x W x D
WBCH3	Three	10 x 6 x 1 <sup>1</sup> / <sub>8</sub>
WBCH6	Six	10 x 10 x 1 <sup>1</sup> / <sub>8</sub>
WBCH8	Eight	13 x 10 x 1 <sup>1</sup> / <sub>8</sub>
WBCH12	Twelve	19 x 10 x 1 <sup>1</sup> / <sub>8</sub>
WBCH18	Eighteen	19 x 14 x 1 <sup>1</sup> / <sub>8</sub>
WBCH24	Twenty-four	19 x 18 <sup>3</sup> / <sub>8</sub> x 1 <sup>1</sup> / <sub>8</sub>

# Literature Holders

## Sign and Pocket Combos

These acrylic displays combine an 8½ x 11 sign holder with a tri-fold brochure pocket or 8½ x 11 sheet pockets.

Product No.	Pocket Style	# Pockets	H x W x D
MA8511P	Tri-Fold	One	10 <sup>5</sup> / <sub>8</sub> x 13 x 5
MA8511P2	Tri-Fold	Two	10 <sup>5</sup> / <sub>8</sub> x 17 <sup>1</sup> / <sub>2</sub> x 5
MA8511SP	8½ x 11	One	11 x 18 <sup>3</sup> / <sub>8</sub> x 5 <sup>3</sup> / <sub>4</sub>

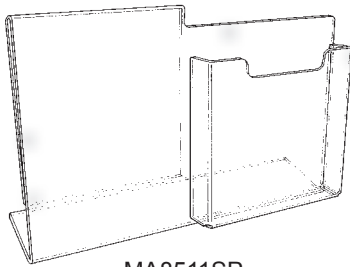

MA8511SP

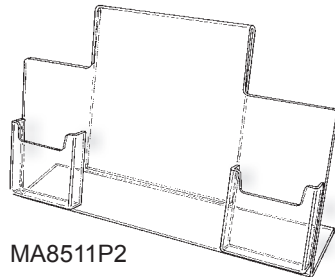

MA8511P2

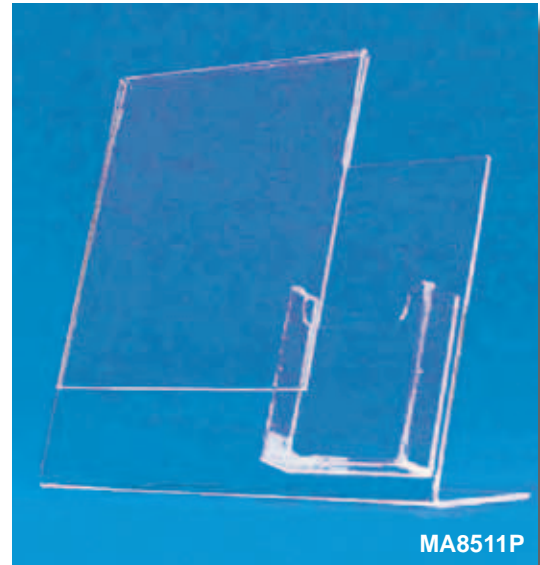

MA8511P

## Add-On Pockets

Add a business card pocket, tri-fold brochure pocket or cell phone pocket to any of our acrylic products. Ideal for sign frames, brochure holders or even ballot boxes or print bins.

Product No.	Style	H x W x D
BA1	Business Cards	1 x 4 x 7/8
BA2	Tri-Fold	4 1/8 x 4 x 1
BA3	Cell Phone	3 1/8 x 3 1/4 x 1 3/4
BA4	Vertical Business Cards	1 x 4 x 7/8

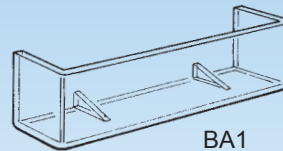

BA1

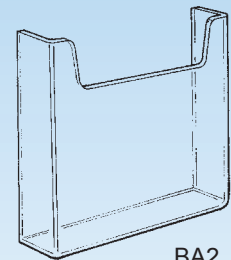

BA2

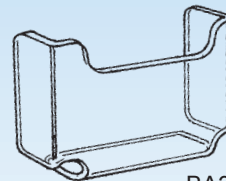

BA3

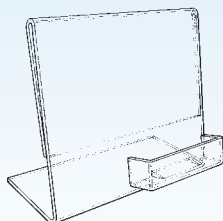

BA1 on a horizontal sign holder

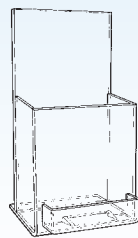

BA1 on a tri-fold brochure holder



BA1 on a vertical sign holder

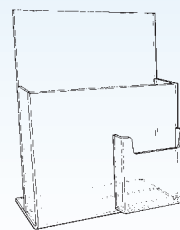

BA2 on a brochure holder



BA2 on a vertical sign holder

Add-On Pockets

## Custom Silk Screening

Any of our acrylic frames can be imprinted with your logo or other camera-ready artwork.

- There is a 50-piece minimum order for custom silk screening.
- A one-time screen charge will apply.
- There is cost per color per piece

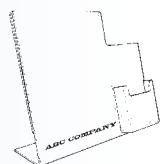

# Literature Holders

## COUNTERTOP ACRYLIC FRAMES



### Bottom-Loading Acrylic Frames

Measurements are the insert size by width and height.

Product No.	W x H	Product No.	W x H
MB3050	3 x 5	MB8060	8 x 6
MB5030	5 x 3	MB6090	6 x 9
MB3520	3½ x 2	MB9060	9 x 6
MB3550	3½ x 5	MB7011	7 x 11
MB5035	5 x 3½	MB1170	11 x 7
MB3555	3½ x 5½	MB1035	10 x 3½
MB5535	5½ x 3½	MB1070	10 x 7
MB4050	4 x 5	MB7010	7 x 10
MB5040	5 x 4	MB8010	8 x 10
MB4060	4 x 6	MB1080	10 x 8
MB6040	6 x 4	MB8511	8½ x 11
MB5070	5 x 7	MB1185	11 x 8½
MB7050	7 x 5	MB8514	8½ x 14
MB7090	7 x 9	MB1485	14 x 8½
MB9070	9 x 7	MB9012	9 x 12
MB5570	5½ x 7	MB1290	12 x 9
MB7055	7 x 5½	MB1114	11 x 14
MB5585	5½ x 8½	MB1411	14 x 11
MB8555	8½ x 5½	MB1711	17 x 11
MB6080	6 x 8	MB1117	11 x 17



### Top-Loading Acrylic Frames

Measurements are the insert size by width and height.

Product No.	W x H	Product No.	W x H
MC3050	3 x 5	MC6080	6 x 8
MC5030	5 x 3	MC6090	6 x 9
MC3520	3½ x 2	MC9060	9 x 6
MC3550	3½ x 5	MC7011	7 x 11
MC5035	5 x 3½	MC1170	11 x 7
MC3555	3½ x 5½	MC1035	10 x 3½
MC5535	5½ x 3½	MC1070	10 x 7
MC4050	4 x 5	MC8010	8 x 10
MC5040	5 x 4	MC1080	10 x 8
MC4060	4 x 6	MC8511	8½ x 11
MC6040	6 x 4	MC1185	11 x 8½
MC5070	5 x 7	MC8514	8½ x 14
MC7050	7 x 5	MC9012	9 x 12
MC7090	7 x 9	MC1290	12 x 9
MC5570	5½ x 7	MC1114	11 x 14
MC7055	7 x 5½	MC1411	14 x 11
MC5585	5½ x 8½	MC1711	17 x 11
MC8555	8½ x 5½	MC1117	11 x 17

# Literature Holders

## Angled Acrylic Frames

Measurements are the insert size by width and height.

<u>Product No.</u>	<u>W x H</u>	<u>Product No.</u>	<u>W x H</u>
MA2015	2 x 1 <sup>1</sup> / <sub>2</sub>	MA5585	5 <sup>1</sup> / <sub>2</sub> x 8 <sup>1</sup> / <sub>2</sub>
MA3520	3 <sup>1</sup> / <sub>2</sub> x 2	MA8555	8 <sup>1</sup> / <sub>2</sub> x 5 <sup>1</sup> / <sub>2</sub>
MA2535	2 <sup>1</sup> / <sub>2</sub> x 3 <sup>1</sup> / <sub>2</sub>	MA6080	6 x 8
MA3535	3 <sup>1</sup> / <sub>2</sub> x 3 <sup>1</sup> / <sub>2</sub>	MA6090	6 x 9
MA3050	3 x 5	MA9060	9 x 6
MA5030	5 x 3	MA7011	7 x 11
MA3550	3 <sup>1</sup> / <sub>2</sub> x 5	MA1170	11 x 7
MA5035	5 x 3 <sup>1</sup> / <sub>2</sub>	MA1035	10 x 3 <sup>1</sup> / <sub>2</sub>
MA3555	3 <sup>1</sup> / <sub>2</sub> x 5 <sup>1</sup> / <sub>2</sub>	MA1070	10 x 7
MA5535	5 <sup>1</sup> / <sub>2</sub> x 3 <sup>1</sup> / <sub>2</sub>	MA8010	8 x 10
MA4015	4 x 1 <sup>1</sup> / <sub>2</sub>	MA1080	10 x 8
MA4050	4 x 5	MA8511	8 <sup>1</sup> / <sub>2</sub> x 11
MA5040	5 x 4	MA1185	11 x 8 <sup>1</sup> / <sub>2</sub>
MA4060	4 x 6	MA8514	8 <sup>1</sup> / <sub>2</sub> x 14
MA6040	6 x 4	MA9012	9 x 12
MA5070	5 x 7	MA1290	12 x 9
MA7050	7 x 5	MA1114	11 x 14
MA7090	7 x 9	MA1411	14 x 11
MA5570	5 <sup>1</sup> / <sub>2</sub> x 7	MA1117	11 x 17
MA7055	7 x 5 <sup>1</sup> / <sub>2</sub>	MA1711	17 x 11

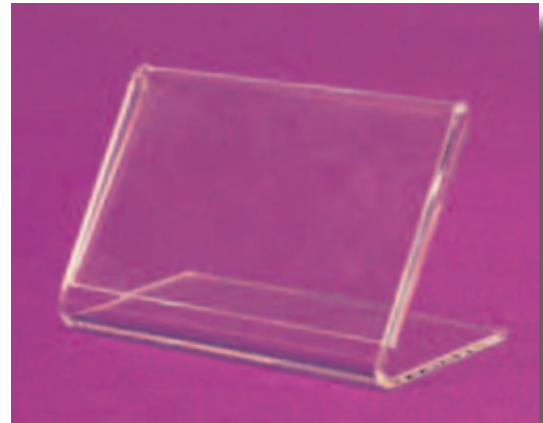

## Side-Loading Vertical Acrylic Frames

Measurements are the insert size by width and height.

<u>Product No.</u>	<u>W x H</u>	<u>Product No.</u>	<u>W x H</u>
MS3050	3 x 5	MS6080	6 x 8
MS5030	5 x 3	MS8060	8 x 6
MS3550	3 <sup>1</sup> / <sub>2</sub> x 5	MS6090	6 x 9
MS5035	5 x 3 <sup>1</sup> / <sub>2</sub>	MS9060	9 x 6
MS3555	3 <sup>1</sup> / <sub>2</sub> x 5 <sup>1</sup> / <sub>2</sub>	MS7011	7 x 11
MS5535	5 <sup>1</sup> / <sub>2</sub> x 3 <sup>1</sup> / <sub>2</sub>	MS1170	11 x 7
MS4060	4 x 6	MS8010	8 x 10
MS6040	6 x 4	MS1080	10 x 8
MS5070	5 x 7	MS8511	8 <sup>1</sup> / <sub>2</sub> x 11
MS7050	7 x 5	MS1185	11 x 8 <sup>1</sup> / <sub>2</sub>
MS5570	5 <sup>1</sup> / <sub>2</sub> x 7	MS8514	8 <sup>1</sup> / <sub>2</sub> x 14
MS7055	7 x 5 <sup>1</sup> / <sub>2</sub>	MS1485	14 x 8 <sup>1</sup> / <sub>2</sub>





# Literature Holders



2M5070

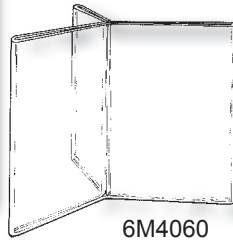

6M4060

## Multi-Panel Frames

Product No.	Panels	W x H
2M4060	Two	4 x 6
2M5070	Two	5 x 7
2M8511	Two	8½ x 11
6M4060	Six	4 x 6
6M5070	Six	5 x 7



## Three-Sign Triangle Frames

Product No.	W x H
3TM3550	3½ x 5
3TM4060	4 x 6
3TM5070	5 x 7
3TM8511	8½ x 11

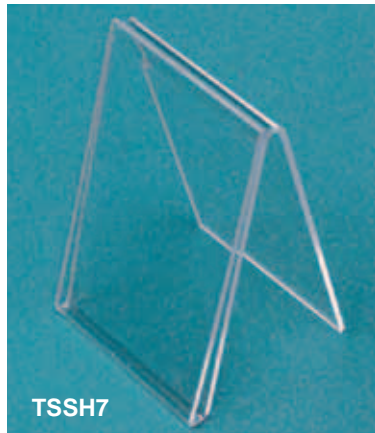

TSSH7

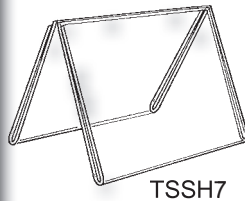

TSSH7

## Tent-Style Acrylic Frames

Tented signs are available with a single or double sign space.

Product No.	Single/Double	H x W x D
TSSH30	Single	3½ x 3½ x 3
TSSH7	Single	5 x 7 x 4½
TSSH3DS	Double	3½ x 3½ x 3
TSSH7DS	Double	5 x 7 x 4½
TSSH85DS	Double	11 x 8½ x 6

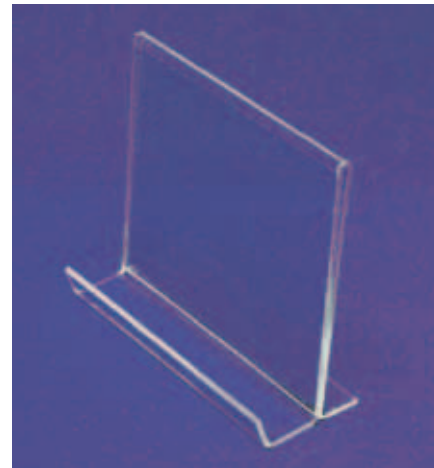

## "Take One" Front-Pocket Frames

Avoid being completely out of "take one" cards by having one in the sign area behind the front stock. Space in front is 1½" deep.

Product No.	H x W x D
HFP4	6 x 4 x 2⅞
HFP7	5½ x 7 x 2⅞
HFP8	11 x 8½ x 3¼

Sign Holders

# Literature Holders

## Wall-Mounting Acrylic Frames

Measurements are the insert size by width and height.

Product No.	W x H	Product No.	W x H
MW4060	4 x 6	MW1114	11 x 14
MW6040	6 x 4	MW1411	14 x 11
MW5070	5 x 7	MW1711	17 x 11
MW7050	7 x 5	MW1117	11 x 17
MW5570	5½ x 7		
MW7055	7 x 5½	<b>Poster Sizes:</b>	
MW6090	6 x 9	MW1422	14 x 22
MW9060	9 x 6	MW1624	16 x 24
MW7011	7 x 11	MW1824	18 x 24
MW8010	8 x 10	MW2228	22 x 28
MW1080	10 x 8	MW2822	28 x 22
MW8511	8½ x 11		
MW1185	11 x 8½		

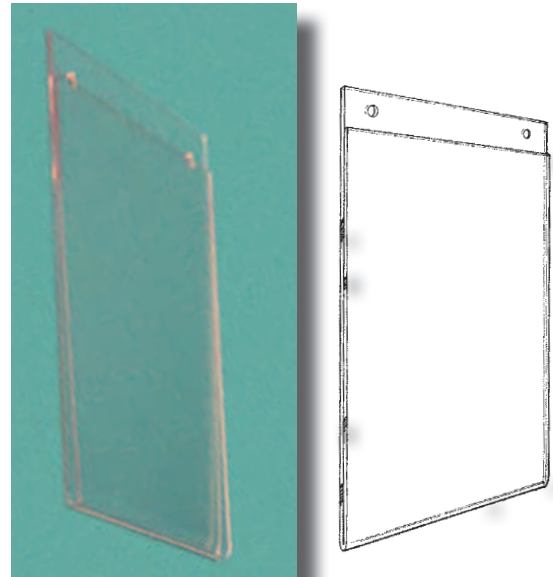

## Top-Fold Wall-Mounting Frames

The top of this sign holder folds over and has a notch so that the nail head is hidden when mounted.

Product No.	W x H	Product No.	W x H
TF4060	4 x 6	TF7011	7 x 11
TF6040	6 x 4	TF8010	8 x 10
TF5070	5 x 7	TF1080	10 x 8
TF7050	7 x 5	TF8511	8½ x 11
TF5570	5½ x 7	TF1185	11 x 8½
TF7055	7 x 5½	TF1114	11 x 14
TF6090	6 x 9	TF1411	14 x 11
TF9060	9 x 6	TF1711	17 x 11

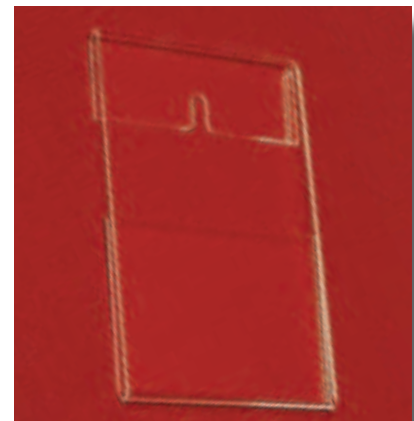

Wall-Mounting Frames

## Custom Silk Screening

Any of our acrylic frames can be imprinted with your logo or other camera-ready artwork.

- There is a 50-piece minimum order for custom silk screening.
- A one-time screen charge will apply.
- There is cost per color per piece

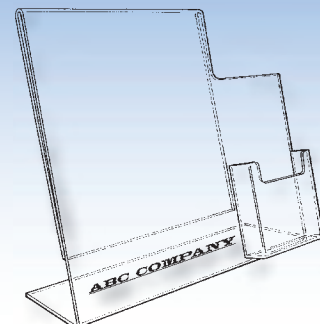
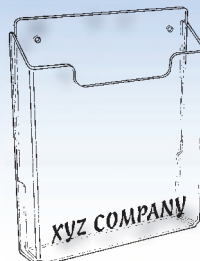

# Literature Holders

## POSTER FRAMES



### Poster Stand

This two-sided floor frame is made of heavy-duty,  $\frac{3}{16}$ "-thick acrylic. Holds posters 22" wide x 28" high.

Product No.	H x W x D
PDLS32	32 x 22 x 8 $\frac{1}{4}$



### Ceiling Hanging Poster Frames

Acrylic poster frames come with two 6-foot lengths of chain and special hooks that attach to acoustical ceiling gridwork. Chain can be cut as desired.

Product No.	W x H	Product No.	W x H
MW1117CH	11 x 17	MW1824CH	18 x 24
MW1711CH	17 x 11	MW2228CH	22 x 28
MW1422CH	14 x 22	MW2822CH	28 x 22
MW1624CH	16 x 24		

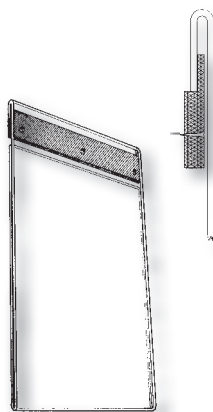

### Poster Frames with Wall-Mounting Bracket

The top of this acrylic frame is folded over to mount on a bracket that is secured to the wall with screws. Bracket and screws are included.

Product No.	W x H
PFB1422	14 x 22
PFB1624	16 x 24
PFB1824	18 x 24
PFB2228	22 x 28
PFB2822	28 x 22

### Folded Acrylic Frames

Product No.	W x H	Product No.	W x H
FLB1	1 $\frac{3}{4}$ x 2 $\frac{1}{4}$	FLB64	6 x 4
FLB2	2 x 2 $\frac{3}{4}$	FLB7	5 x 7
FLB3	2 $\frac{1}{2}$ x 3 $\frac{1}{2}$	FLB8	6 $\frac{1}{2}$ x 2 $\frac{1}{4}$
FLB4	3 $\frac{1}{2}$ x 3 $\frac{1}{2}$	FLB9	7 $\frac{1}{2}$ x 5
FLB5	3 $\frac{1}{2}$ x 5	FLB10	8 $\frac{1}{2}$ x 11
FLB6	4 x 6	FLB11	11 x 8 $\frac{1}{2}$
FLB5035	5 x 3 $\frac{1}{2}$		

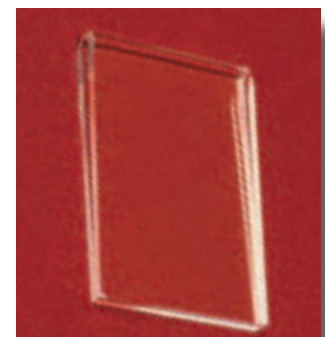

# Literature Holders

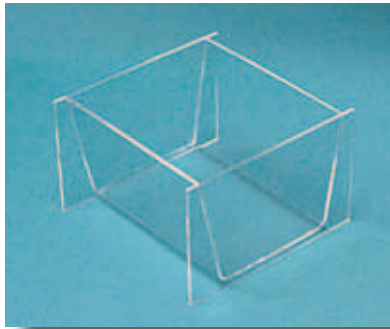

## Browser Bins

For flipping through matted prints or photos.

Product No.	Mat Size	H x W x D
PRB46	4 x 6	4 x 6 $\frac{1}{2}$ x 6 $\frac{1}{2}$
PRB57	5 x 7	5 x 7 $\frac{1}{2}$ x 7 $\frac{1}{2}$
PRB810	8 x 10	8 x 10 $\frac{1}{2}$ x 10 $\frac{1}{2}$
PRB1114	11 x 14	11 x 14 $\frac{1}{2}$ x 14 $\frac{1}{2}$
PRB1620	16 x 20	16 x 20 $\frac{1}{2}$ x 20 $\frac{1}{2}$

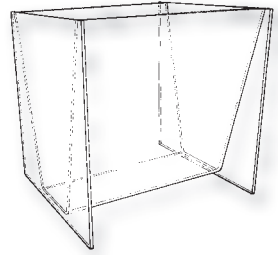

## COUNTERTOP BOOK DISPLAYS

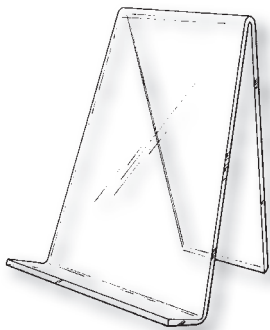

With Front Lip

### Standard Book Easels

Product No.	Ledge	Lip	H x W x D
SG04	1 $\frac{1}{4}$	No	4 x 2 $\frac{3}{8}$ x 3 $\frac{1}{4}$
SG1	1 $\frac{1}{8}$	No	4 $\frac{7}{8}$ x 3 $\frac{5}{8}$ x 4 $\frac{1}{4}$
SG2	1 $\frac{1}{8}$	No	7 $\frac{1}{4}$ x 6 x 5
SG3	1 $\frac{7}{8}$	No	10 $\frac{3}{4}$ x 8 $\frac{1}{4}$ x 7 $\frac{3}{4}$
SG11	1 $\frac{1}{4}$	Yes	4 $\frac{3}{4}$ x 3 $\frac{5}{8}$ x 4 $\frac{1}{2}$
SG12	1 $\frac{3}{8}$	Yes	7 $\frac{1}{4}$ x 6 x 5 $\frac{1}{2}$
SG13	1 $\frac{7}{8}$	Yes	10 $\frac{3}{4}$ x 8 $\frac{1}{4}$ x 8

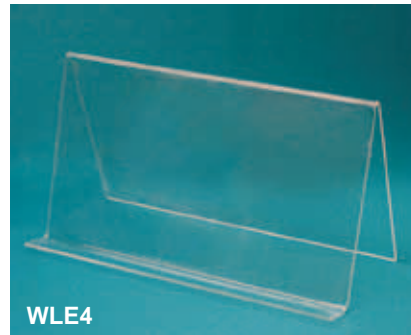

WLE4

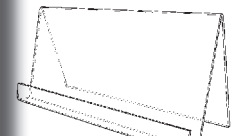

WLE4L

### Wide-Style Ledge Easels

Available with or without front lip in two different heights and two different widths.

Product No.	Ledge	Lip	H x W x D
WLE3L	1 $\frac{3}{4}$	Yes	10 $\frac{3}{4}$ x 19 x 8 $\frac{1}{4}$
WLE4L	1 $\frac{3}{4}$	Yes	10 $\frac{3}{4}$ x 24 x 8 $\frac{1}{4}$
WLE7L	2 $\frac{3}{4}$	Yes	12 $\frac{3}{4}$ x 19 x 10 $\frac{3}{4}$
WLE8L	2 $\frac{3}{4}$	Yes	12 $\frac{3}{4}$ x 24 x 10 $\frac{3}{4}$
WLE3	1 $\frac{7}{8}$	No	10 $\frac{3}{4}$ x 19 x 8 $\frac{1}{2}$
WLE4	1 $\frac{7}{8}$	No	10 $\frac{3}{4}$ x 24 x 8 $\frac{1}{2}$
WLE7	2 $\frac{7}{8}$	No	12 $\frac{3}{4}$ x 19 x 11
WLE8	2 $\frac{7}{8}$	No	12 $\frac{3}{4}$ x 24 x 11

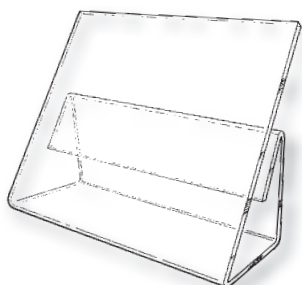

### Cookbook Displays

Product No.	H x W x D
SG21	7 $\frac{3}{4}$ x 9 $\frac{3}{4}$ x 4 $\frac{3}{8}$
SG22	10 x 12 x 5 $\frac{3}{8}$



# Literature Holders

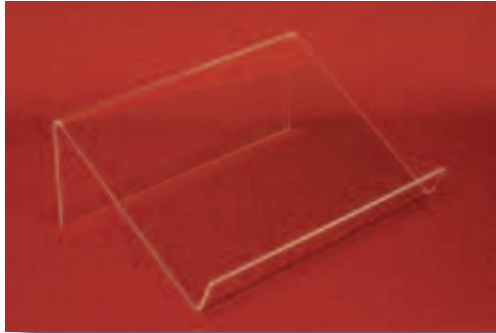

## Laid-Back Easels

This versatile laid-back easel will display closed or open books, but is also ideal for presenting soft goods (ties, shirts, etc.).

Product No.	Ledge	H x W x D
SG31	1½	4½ x 12 x 9
SG32	2	6 x 18 x 12
SG33	2	6 x 24 x 12



## Tilted Open Book Displays

This attractive display piece holds a large book open so that its pages lay flat at a good viewing angle.

Product No.	Ledge	H x W x D
SG40	1	6 x 11 <sup>5</sup> / <sub>8</sub> x 7
SG41	1¼	8 x 15 x 9¼
SG42	2	10¾ x 19 x 12¼
SG43	2½	13 x 22½ x 14½

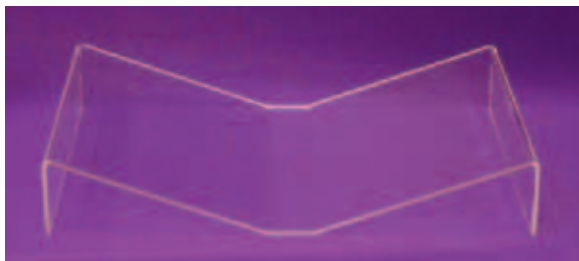

## Flat Open Book Display

Product No.	H x W x D
SG52	3½ x 20 X 12



## Book Stacking Tray

Stack books or magazines in a face-forward view, with a slight tilt up.

Product No.	Shelf Depth	H x W x D
BKSU8	6½	9 x 8¼ x 7
BKSU10	7¾	11 x 10 x 8¼



## Elevated Book Easels

Mini-podium style display will show small to large closed books.

Product No.	Ledge	H x W x D
EBE8	1	7¾ x 5 <sup>5</sup> / <sub>8</sub> x 7
EBE10	1¼	9¾ x 8 x 8¾
EBE12	1½	11½ x 8½ x 10½



## Book Shelf Tray

Display books or magazines with spines facing outward.

Product No.	Shelf Depth	H x W x D
BKS10	6½	9½ x 10 <sup>3</sup> / <sub>8</sub> x 8¼

Book Displays

## COLLECTION/BALLOT BOXES



### Ballot Boxes

Product No.	Locking	H x W x D
BALCJ6L	Yes	6 x 6 x 6
BALCJ8L	Yes	8 x 8 x 8
BALCJ10L	Yes	10 x 10 x 10
BALCJ12L	Yes	12 x 12 x 12
BALCJ6	No	6 x 6 x 6
BALCJ8	No	8 x 8 x 8
BALCJ10	No	10 x 10 x 10
BALCJ12	No	12 x 12 x 12

Locking units include a cam lock and two keys.



### Cube-Style Collection Boxes

These collection boxes are available in clear or white acrylic. Includes cam lock and two keys.

Product No.	Finish	H x W x D
BAL12	Clear	12 x 12 x 12
BAL12W	White	12 x 12 x 12

To add an optional 8 1/2 x 11 sign holder to the front of the cube-style collection box, order product number OPT8511.



BAL05

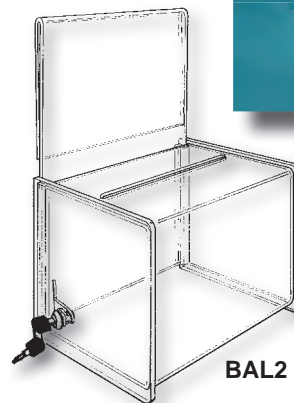

BAL2

### Sign-Backed Collection Boxes

These collection boxes are available in clear or white acrylic. Includes cam lock and two keys.

Product No.	Finish	H x W x D
BAL05	Clear	6 x 4 x 4
BAL05W	White	6 x 4 x 4
Height with sign is 10", sign is 3 1/2" x 4" (W x H).		
BAL08	Clear	6 x 6 1/4 x 4 1/2
BAL08W	White	6 x 6 1/4 x 4 1/2
Height with sign is 11", sign is 5 3/4" x 5" (W x H).		
BAL2	Clear	7 x 8 x 6 1/2
BAL2W	White	7 x 8 x 6 1/2
Height with sign is 12", sign is 7 1/2" x 5" (W x H).		
BAL3	Clear	9 x 5 x 5
BAL3W	White	9 x 5 x 5
Height with sign is 14", sign is 4 1/2" x 5" (W x H).		
BAL4	Clear	11 x 7 x 7
BAL4W	White	11 x 7 x 7
Height with sign is 18", sign is 6 1/2" x 7" (W x H).		

# Literature Holders

## Raffle Drawing Rotators

The two-panel hinged door in the top allows easy ticket removal on these drawing rotators. Brass knurl knob system prevents the bin from turning when reaching in for tickets. The heavy-duty base includes non-skid, clear stick-on feet. Shipped assembled.



Product No.	H x W x D
RDR50	14 x 13 x 14
RDR20	14 x 21 <sup>1</sup> / <sub>4</sub> x 14



## Tall Collection Boxes

Available in clear or white acrylic, this box has a locking hinged back, and can be ordered with or without an 8<sup>1</sup>/<sub>2</sub> x 11 sign in the front.



Product No.	Finish	H x W x D
BAL6	Clear	11 <sup>1</sup> / <sub>2</sub> x 9 x 6 <sup>1</sup> / <sub>2</sub>
BAL6W	White	11 <sup>1</sup> / <sub>2</sub> x 9 x 6 <sup>1</sup> / <sub>2</sub>
BAL6S *	Clear	11 <sup>1</sup> / <sub>2</sub> x 9 x 6 <sup>1</sup> / <sub>2</sub>
BAL6WS *	White	11 <sup>1</sup> / <sub>2</sub> x 9 x 6 <sup>1</sup> / <sub>2</sub>

\* These units have an 8<sup>1</sup>/<sub>2</sub> x 11 sign front.

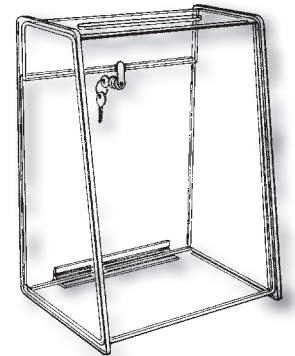

## Wall-Mounting Collection Boxes

These clear or white acrylic boxes have a hinged front door with cam lock and can be ordered with or without an 8<sup>1</sup>/<sub>2</sub>" wide by 5<sup>1</sup>/<sub>2</sub>"-high sign in the back. Designed for wall mounting or countertop use.



BAL8S

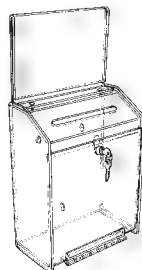

\* With sign back

Product No.	Finish	H x W x D
BAL8	Clear	11 <sup>3</sup> / <sub>8</sub> x 9 x 4 <sup>1</sup> / <sub>2</sub>
BAL8W	White	11 <sup>3</sup> / <sub>8</sub> x 9 x 4 <sup>1</sup> / <sub>2</sub>
BAL8S*	Clear	17 x 9 x 4 <sup>1</sup> / <sub>2</sub>
BAL8WS*	White	17 x 9 x 4 <sup>1</sup> / <sub>2</sub>



BAL8

# Literature Holders

## SIGN CLIPS AND SIGN EASELS

### Clear Economy Sign Clips with Adhesive

Front-facing or base-mounting styles are available in different lengths. These clips have double-faced tape with permanent adhesive for attaching. Sold by the dozen.

Product No.	Max. Sign Thickness	L x W
DP9291	$\frac{1}{16}$	$\frac{1}{2} \times 1$
DP9293	$\frac{1}{16}$	$\frac{1}{2} \times 3$
DP9296	$\frac{1}{16}$	$\frac{1}{2} \times 6$
DP0503	$\frac{1}{8}$	1 x 3
DP0506	$\frac{1}{8}$	1 x 6
DP3423	$\frac{1}{16}$	$1\frac{3}{4} \times 3$
DP3426	$\frac{1}{16}$	$1\frac{3}{4} \times 3$

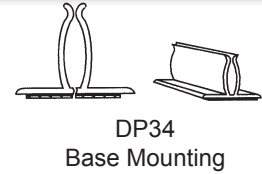
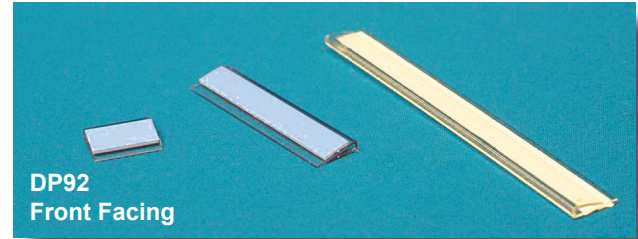

### Machine-Molded Sign Clip

For paper signs up to .036" thick. Sold by the dozen.

Product No.	H x W x D
MSC	$\frac{1}{2} \times 2 \times 2$

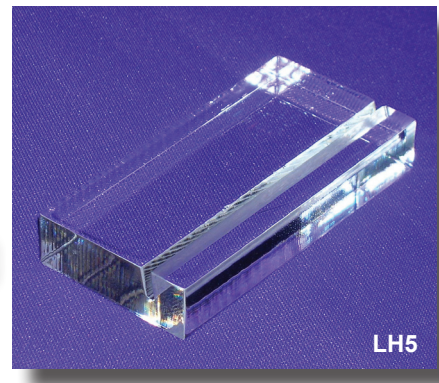
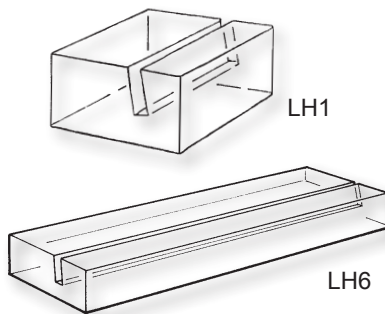
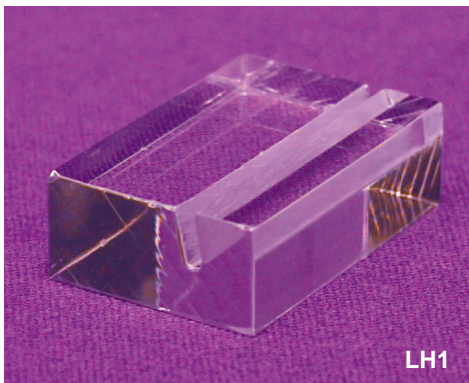
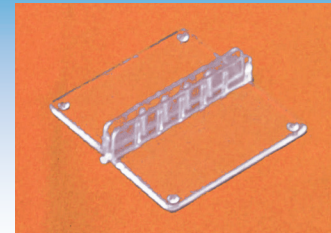
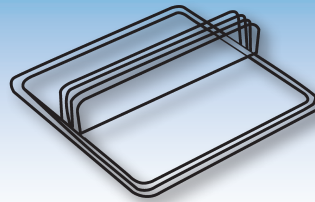

### Slotted Sign Blocks

These polished clear acrylic blocks for small signs and cards also make excellent displays for earring and pin cards or even small matted prints.

Product No.	H x W x D	Product No.	H x W x D
LH1	$\frac{3}{8} \times 1\frac{1}{4} \times 1$	LH4	$\frac{3}{8} \times 2 \times 1$
LH2	$\frac{1}{2} \times 1\frac{1}{2} \times 1$	LH5	$\frac{1}{2} \times 3 \times 1\frac{1}{2}$
LH3	$\frac{3}{4} \times 1\frac{3}{4} \times 1$	LH6	$\frac{1}{2} \times 5 \times 1\frac{1}{2}$



# Literature Holders

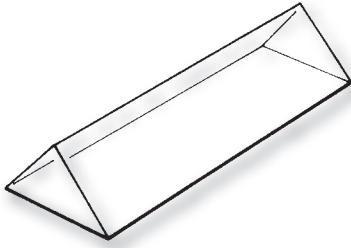

## Label Triangles

A simple and elegant way to affix a small sign or label.

Product No.	H x W x D
ISL2	$\frac{3}{4} \times 2 \times \frac{3}{4}$
ISL4	$\frac{3}{4} \times 4 \times \frac{3}{4}$
ISL6	$\frac{3}{4} \times 6 \times \frac{3}{4}$
ISL8	$\frac{3}{4} \times 8 \times \frac{3}{4}$

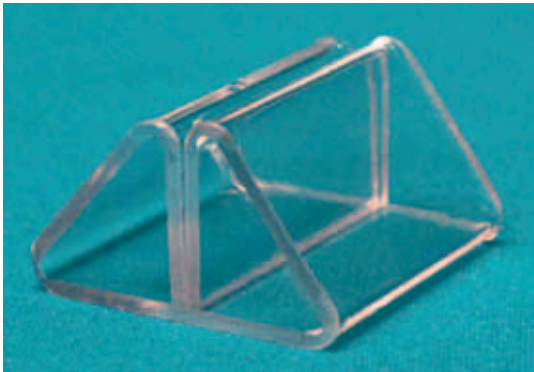

## Label-Front Pinch Sign Clips

These handy clear acrylic sign clips can pinch material up to  $\frac{1}{8}$ " thick, so they can be used for a variety of signs or even matted prints and photos. The angled front makes a good space for a label.

Product No.	Label Space	H x W x D
TH15	$1\frac{1}{8} \times 2$	$1\frac{1}{4} \times 2 \times 1\frac{7}{8}$
TH2	$1\frac{1}{8} \times 4$	$1\frac{1}{4} \times 4 \times 1\frac{7}{8}$
TH3	$1\frac{1}{4} \times 6$	$1\frac{1}{2} \times 6 \times 2\frac{1}{2}$



## Narrow Pinch Clip

Will hold materials up to  $\frac{1}{8}$ " thick.

Product No.	H x W x D
TH1	$1\frac{1}{4} \times 1\frac{1}{2} \times 2\frac{1}{2}$



## Stackable Display Bins

Create organization and display with these classic stackable book cubbies. Open in the front and back with nicely polished edges, these compartments can be arranged in almost unlimited combinations to show off products from books to soft goods. Clear stick-on feet keep the units from sliding.

Product No.	H x W x D
850-1044	12 x 12 x 12

# Jewelry Displays

## JEWELRY DISPLAYS

### Acrylic Ring Fingers

Solid acrylic tapered ring displays are available in clear, black or frosted.

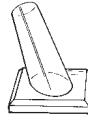
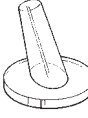
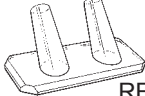
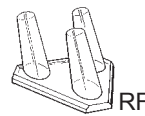
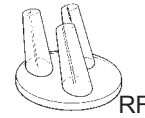
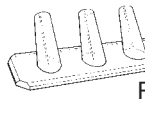
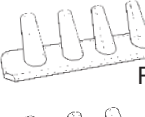
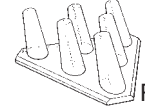
Product No.	Finish	Base Style	# Fingers	H x W x D	
RF1	Clear	Square	One	1 <sup>3</sup> / <sub>4</sub> x 2 x 2 <sup>1</sup> / <sub>4</sub>	
RF1B	Black	Square	One	1 <sup>3</sup> / <sub>4</sub> x 2 x 2 <sup>1</sup> / <sub>4</sub>	
RF1F	Frosted	Square	One	1 <sup>3</sup> / <sub>4</sub> x 2 x 2 <sup>1</sup> / <sub>4</sub>	
RF1R	Clear	Round	One	1 <sup>3</sup> / <sub>4</sub> x 2 x 2	
RF1RB	Black	Round	One	1 <sup>3</sup> / <sub>4</sub> x 2 x 2	
RF1RF	Frosted	Round	One	1 <sup>3</sup> / <sub>4</sub> x 2 x 2	
RF2	Clear	Rectangle	Two	1 <sup>3</sup> / <sub>4</sub> x 3 <sup>3</sup> / <sub>4</sub> x 2 <sup>1</sup> / <sub>4</sub>	
RF2B	Black	Rectangle	Two	1 <sup>3</sup> / <sub>4</sub> x 3 <sup>3</sup> / <sub>4</sub> x 2 <sup>1</sup> / <sub>4</sub>	
RF2F	Frosted	Rectangle	Two	1 <sup>3</sup> / <sub>4</sub> x 3 <sup>3</sup> / <sub>4</sub> x 2 <sup>1</sup> / <sub>4</sub>	
RF3	Clear	Triangle	Three	1 <sup>3</sup> / <sub>4</sub> x 3 <sup>3</sup> / <sub>4</sub> x 3 <sup>1</sup> / <sub>4</sub>	
RF3B	Black	Triangle	Three	1 <sup>3</sup> / <sub>4</sub> x 3 <sup>3</sup> / <sub>4</sub> x 3 <sup>1</sup> / <sub>4</sub>	
RF3F	Frosted	Triangle	Three	1 <sup>3</sup> / <sub>4</sub> x 3 <sup>3</sup> / <sub>4</sub> x 3 <sup>1</sup> / <sub>4</sub>	
RF3R	Clear	Round	Three	1 <sup>3</sup> / <sub>4</sub> x 3 x 3	
RF3RB	Black	Round	Three	1 <sup>3</sup> / <sub>4</sub> x 3 x 3	
RF3RF	Frosted	Round	Three	1 <sup>3</sup> / <sub>4</sub> x 3 x 3	
RF4	Clear	Rectangle	Four	1 <sup>3</sup> / <sub>4</sub> x 6 <sup>3</sup> / <sub>4</sub> x 2 <sup>1</sup> / <sub>4</sub>	
RF4B	Black	Rectangle	Four	1 <sup>3</sup> / <sub>4</sub> x 6 <sup>3</sup> / <sub>4</sub> x 2 <sup>1</sup> / <sub>4</sub>	
RF4F	Frosted	Rectangle	Four	1 <sup>3</sup> / <sub>4</sub> x 6 <sup>3</sup> / <sub>4</sub> x 2 <sup>1</sup> / <sub>4</sub>	
RF5	Clear	Rectangle	Five	1 <sup>3</sup> / <sub>4</sub> x 8 <sup>1</sup> / <sub>4</sub> x 2 <sup>1</sup> / <sub>4</sub>	
RF5B	Black	Rectangle	Five	1 <sup>3</sup> / <sub>4</sub> x 8 <sup>1</sup> / <sub>4</sub> x 2 <sup>1</sup> / <sub>4</sub>	
RF5F	Frosted	Rectangle	Five	1 <sup>3</sup> / <sub>4</sub> x 8 <sup>1</sup> / <sub>4</sub> x 2 <sup>1</sup> / <sub>4</sub>	
RF6	Clear	Triangle	Six	1 <sup>3</sup> / <sub>4</sub> x 5 x 5	
RF6B	Black	Triangle	Six	1 <sup>3</sup> / <sub>4</sub> x 5 x 5	
RF6F	Frosted	Triangle	Six	1 <sup>3</sup> / <sub>4</sub> x 5 x 5	

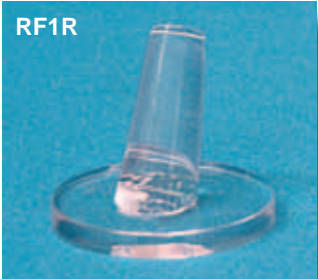

### Ring Clips

In sparkling clear or shiny black, these ring clips are made with a tough material that stands up to frequent use. A discount is available for boxes of 288 pieces.

Product No.	Finish	H x W x D
GPT	Clear	3/8 x 5/8 x 1
GPTB	Black	3/8 x 5/8 x 1

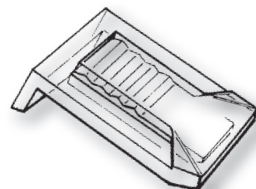

# Jewelry Displays

## JEWELRY TRAY CASES

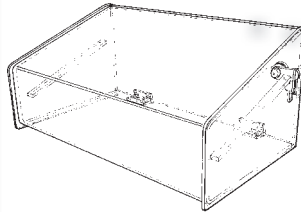

### Double Hidden-Tray Cases

This unit displays one tray above with space to hide an inventory tray below. This locking case has a hinged door in back with a cam lock and two keys.

Product No.

FPH2

H x W x D

7 x 15<sup>3</sup>/<sub>8</sub> x 9

### Double-Tray Cases

Two open trays can be displayed in this case, with the back tray at a 45° angle for good viewing. The separate cover slides over the case and has a lock hasp in the back. (Lock not included.)

Product No.

DTH2

H x W x D

9 x 15<sup>1</sup>/<sub>4</sub> x 16<sup>1</sup>/<sub>4</sub>

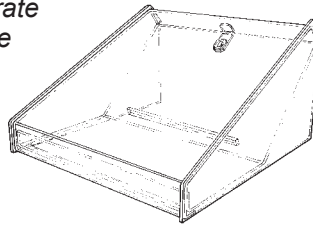

### Locking Top-Opening Tray Cases

Rectangular sizes are all 2<sup>3</sup>/<sub>4</sub>" high. Cam lock and two keys are included.

Product No.

LCTR4

LCTR55

H x W x D

2<sup>3</sup>/<sub>4</sub> x 14<sup>1</sup>/<sub>2</sub> x 8<sup>1</sup>/<sub>2</sub>

2<sup>3</sup>/<sub>4</sub> x 15 x 17



### Folding Ring Circle

Simple, elegant and barely visible, this flexible display fits almost any size ring, showing it at a 45° angle. Sturdy enough to be used over and over.

Product No.

FRH

Dia.

1<sup>3</sup>/<sub>8</sub>



# Jewelry Displays

## ROTATING JEWELRY DISPLAYS

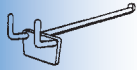

Two-inch-long clear pegboard hooks fit in standard pegboard holes.

Product No.  
PEGHK2  
Also in Black

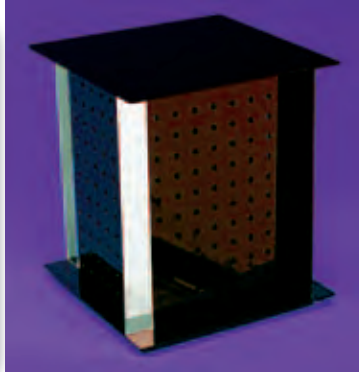

### Four-Sided Pegboard Hook Display

Rotating display has panels to fit pegboard hooks for hanging loose or packaged jewelry. Hooks not included; will accept standard pegboard hooks, or order our #PEGHK2.

Product No.	H x W x D
PEGR12	12 <sup>3</sup> / <sub>4</sub> x 11 <sup>1</sup> / <sub>8</sub> x 11 <sup>1</sup> / <sub>8</sub>



### J-Hook Rotators

For keychains, jewelry cards or small bracelets, these two- and four-sided displays with attached 2" J-hooks revolve on lazy-Susan bases.

Product No.	# of Hooks	H x W x D
JHR2	18	12 <sup>3</sup> / <sub>8</sub> x 7 <sup>3</sup> / <sub>4</sub> x 6 <sup>1</sup> / <sub>4</sub>
JHR4	36	12 <sup>3</sup> / <sub>8</sub> x 10 x 10



### Hook Attachment for J-Bar

Product No.	Length
JHK15	1 <sup>1</sup> / <sub>2</sub>
JHK3	3

### Inserts for Rotating Towers



Foam ring board insert has 36 ring slots.

Product No.	H x W x D
CPDR	9 <sup>1</sup> / <sub>2</sub> x 4 <sup>1</sup> / <sub>2</sub> x 2



J-Bar inserts are made of black acrylic with J-bar attached for 1<sup>1</sup>/<sub>2</sub>"-long slide-on hooks. Can also be used without hooks for jewelry cards. Two hooks are included with each row.

Product No.	Rows	H x W x D
CPDJ2	2	9 <sup>1</sup> / <sub>2</sub> x 4 <sup>1</sup> / <sub>2</sub> x 2
CPDJ3	3	9 <sup>1</sup> / <sub>2</sub> x 4 <sup>1</sup> / <sub>2</sub> x 2



### Locking Double-High Rotating Tower with Changeable Inserts

Double-high style will hold either eight gray foam ring boards or acrylic inserts with J-bars, which can be for jewelry cards or J-hooks. (Only the 1<sup>1</sup>/<sub>2</sub>" hooks can be used with the J-bar inserts when inside the locking case). Customer is able to turn the display with the knurled base plate. Attention-getting acrylic mirrors accent the corners. Cam lock and two keys are included.

Product No.	H x W x D
CPDCR1*	20 x 12 x 12

\*Inserts sold separately. Choose eight from the selection at left to complete the unit.

# Jewelry Displays

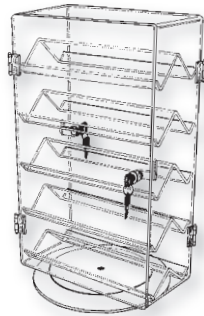

## Double Locking-Door Ring Case

This case has five angled shelves with 1" lip and is designed to hold up to 120 ring boxes. There is a door on either side and the case revolves on a lazy-Susan base. Two cam locks and four keys are included.

Product No.	H x W x D
LRC22	22 x 13 <sup>1</sup> / <sub>4</sub> x 7

## EARRING CARD DISPLAYS

These popular displays for earring or other jewelry cards have ladder-style bars with 9 bars each. Each bar holds four 2-inch cards or two 2<sup>1</sup>/<sub>2</sub>- or 3-inch cards. Available with clear or black ladders.

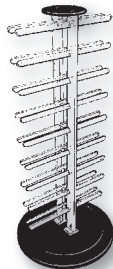
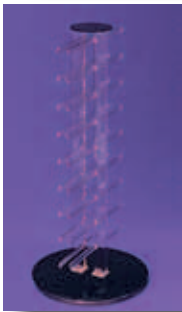

## Two-Sided Rotating Earring Card Display

Holds a total of 72 two-inch cards. Base and top are black acrylic. Ladders are available in clear or black. Shipped unassembled.

Product No.	Ladders	H x Dia.
EJ72R	Clear	19 <sup>1</sup> / <sub>2</sub> x 9
EJ72RB	Black	19 <sup>1</sup> / <sub>2</sub> x 9

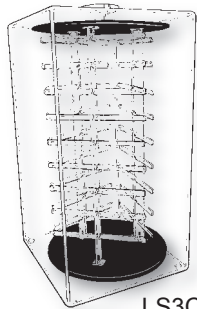

LS3C



LS3

## Three-Sided Rotating Earring Card Display

Holds a total of 108 two-inch cards. Base and top are black acrylic. Ladders are available in clear or black. Shipped unassembled.

Product No.	Ladders	H x Dia.
LS3	Clear	19 <sup>3</sup> / <sub>4</sub> x 11
LS3B	Black	19 <sup>3</sup> / <sub>4</sub> x 11

The LS3 is also available in a locking case with a top handle for turning the card display. Cam lock and two keys included.

LS3C	Clear	21 <sup>1</sup> / <sub>2</sub> x 12 <sup>1</sup> / <sub>2</sub>
LS3CB	Black	21 <sup>1</sup> / <sub>2</sub> x 12 <sup>1</sup> / <sub>2</sub>

## Four-Sided Rotating Earring Card Display

Holds a total of 144 two-inch cards. Base and top are black acrylic. Ladders are available in clear or black. Shipped unassembled.

Product No.	Ladders	H x Dia.
LS4	Clear	19 <sup>3</sup> / <sub>4</sub> x 13 <sup>1</sup> / <sub>2</sub>
LS4B	Black	19 <sup>3</sup> / <sub>4</sub> x 13 <sup>1</sup> / <sub>2</sub>

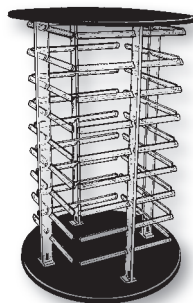

# Jewelry Displays

## Deluxe Earring Card Cases

Both open and locking styles hold 70 two-inch earring or jewelry cards. Mirrored acrylic side pieces accent these laser-cut displays. Locking case has doors on both sides and includes cam locks and keys.

Product No.	Style	H x W x D
EJ70	Open	19½ x 13 x 4¼
EJ70K	Locking	19½ x 13 x 4¼

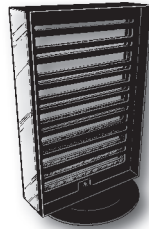

EJ70



EJ70K



## Hook Attachment for J-Bar

Product No.	Length
JHK15	1½
JHK3	3

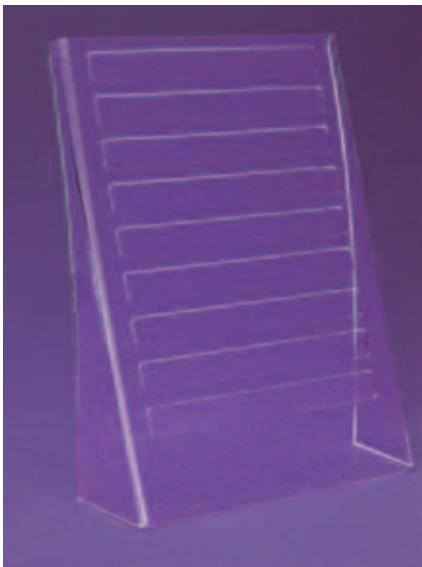

## Earring Card Display

Laser-cut openings in this one-piece display allow for flexible spacing of up to 20 two-inch cards.

Product No.	# Cards	H x W x D
ECD1	20	14½ x 10 <sup>3</sup> / <sub>8</sub> x 5

## Economy Earring Card Displays

Countertop card displays have J-bar for earring cards and can be used with or without J-bar hooks for added flexibility.

With 2" Spacing between J-bar.

Product No.	# Cards	H x W x D
AB1	20	12¼ x 8 x 4½
AB12	40	12¼ x 16 x 4½
AB2	36	14¼ x 12 x 5¼
AB4	72	19 <sup>5</sup> / <sub>8</sub> x 18 x 6½

With 3" Spacing between J-bar.

Product No.	# Cards	H x W x D
AB3	20	13¼ x 15 x 5¼
AB5	30	16½ x 18 x 6½

# Jewelry Displays



## Single Pair Earring Displays

For single pairs; available in clear, black, or frosted acrylic.

Product No.	Hanging Space	Finish	H x W x D
CX1	2 <sup>1</sup> / <sub>2</sub>	Clear	3 x 2 <sup>7</sup> / <sub>8</sub> x 1 <sup>1</sup> / <sub>2</sub>
CX1B	2 <sup>1</sup> / <sub>2</sub>	Black	3 x 2 <sup>7</sup> / <sub>8</sub> x 1 <sup>1</sup> / <sub>2</sub>
CX1F	2 <sup>1</sup> / <sub>2</sub>	Frosted	3 x 2 <sup>7</sup> / <sub>8</sub> x 1 <sup>1</sup> / <sub>2</sub>
CX2	3 <sup>1</sup> / <sub>2</sub>	Clear	4 x 2 <sup>7</sup> / <sub>8</sub> x 1 <sup>3</sup> / <sub>4</sub>
CX2B	3 <sup>1</sup> / <sub>2</sub>	Black	4 x 2 <sup>7</sup> / <sub>8</sub> x 1 <sup>3</sup> / <sub>4</sub>
CX2F	3 <sup>1</sup> / <sub>2</sub>	Frosted	4 x 2 <sup>7</sup> / <sub>8</sub> x 1 <sup>3</sup> / <sub>4</sub>
CX3	4 <sup>1</sup> / <sub>2</sub>	Clear	5 x 2 <sup>7</sup> / <sub>8</sub> x 2
CX3B	4 <sup>1</sup> / <sub>2</sub>	Black	5 x 2 <sup>7</sup> / <sub>8</sub> x 2
CX3F	4 <sup>1</sup> / <sub>2</sub>	Frosted	5 x 2 <sup>7</sup> / <sub>8</sub> x 2



This flag style will accommodate a jewelry card or hanging wires.

Product No.	Hanging Space	Finish	H x W x D
EF4	3 <sup>1</sup> / <sub>8</sub>	Clear	4 x 2 <sup>3</sup> / <sub>8</sub> x 3
EF4B	3 <sup>1</sup> / <sub>8</sub>	Black	4 x 2 <sup>3</sup> / <sub>8</sub> x 3
EF4F	3 <sup>1</sup> / <sub>8</sub>	Frosted	4 x 2 <sup>3</sup> / <sub>8</sub> x 3
EF5	4 <sup>1</sup> / <sub>8</sub>	Clear	5 x 2 <sup>3</sup> / <sub>8</sub> x 3 <sup>1</sup> / <sub>2</sub>
EF5B	4 <sup>1</sup> / <sub>8</sub>	Black	5 x 2 <sup>3</sup> / <sub>8</sub> x 3 <sup>1</sup> / <sub>2</sub>
EF5F	4 <sup>1</sup> / <sub>8</sub>	Frosted	5 x 2 <sup>3</sup> / <sub>8</sub> x 3 <sup>1</sup> / <sub>2</sub>
EF6	5 <sup>1</sup> / <sub>8</sub>	Clear	6 x 2 <sup>3</sup> / <sub>8</sub> x 4
EF6B	5 <sup>1</sup> / <sub>8</sub>	Black	6 x 2 <sup>3</sup> / <sub>8</sub> x 4
EF6F	5 <sup>1</sup> / <sub>8</sub>	Frosted	6 x 2 <sup>3</sup> / <sub>8</sub> x 4

Many of our jewelry displays are available in a very elegant black matte finish. Please call for details.

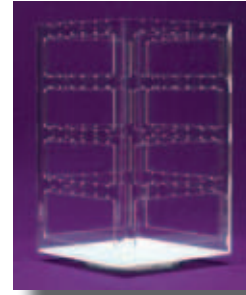

## Four-Sided Rotating Earring Display

Three rows on each side have hanging space of 2"; bottom row has 2<sup>1</sup>/<sub>2</sub>". Holds 72 pairs. Rotates on a lazy-Susan base.

Product No.	Finish	H x W x D
ER72	Clear	13 x 7 <sup>1</sup> / <sub>2</sub> x 7 <sup>1</sup> / <sub>2</sub>
ER72B	Black	13 x 7 <sup>1</sup> / <sub>2</sub> x 7 <sup>1</sup> / <sub>2</sub>



## Circular Tiered Rotating Earring Display

Also good for small ornaments. Holes are spaced by pairs for up to 48 pairs. Constructed with clear acrylic rods and stainless steel screws. Turns on a white lazy-Susan base. Shipped unassembled.

Product No.	H x Dia.
RDE14	14 <sup>3</sup> / <sub>4</sub> x 10

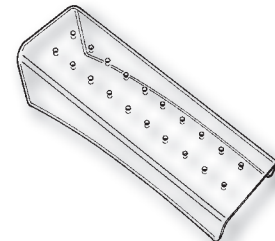

Laid-back position

## Post Earring Display

These wing-back displays for 10 post earring pairs can be used in an upright or laid-back position. Available in clear or frosted acrylic.

Product No.	Finish	H x W x D
ERS10	Clear	6 <sup>3</sup> / <sub>4</sub> x 2 <sup>1</sup> / <sub>2</sub> x 3
ERS10F	Frosted	6 <sup>3</sup> / <sub>4</sub> x 2 <sup>1</sup> / <sub>2</sub> x 3

# Jewelry Displays

## Hanging Pair Earring Displays

For one pair of earrings, two small pair, or matching post and dangle sets.

Product No.	Hanging Space	Finish	H x W x D
FE1	2 <sup>1</sup> / <sub>4</sub>	Clear	3 <sup>3</sup> / <sub>8</sub> x 2 <sup>1</sup> / <sub>2</sub> x 2 <sup>1</sup> / <sub>8</sub>
FE1B	2 <sup>1</sup> / <sub>4</sub>	Black	3 <sup>3</sup> / <sub>8</sub> x 2 <sup>1</sup> / <sub>2</sub> x 2 <sup>1</sup> / <sub>8</sub>
FE1F	2 <sup>1</sup> / <sub>4</sub>	Frosted	3 <sup>3</sup> / <sub>8</sub> x 2 <sup>1</sup> / <sub>2</sub> x 2 <sup>1</sup> / <sub>8</sub>
FE2	2 <sup>3</sup> / <sub>4</sub>	Clear	4 x 2 <sup>7</sup> / <sub>8</sub> x 2 <sup>3</sup> / <sub>8</sub>
FE2B	2 <sup>3</sup> / <sub>4</sub>	Black	4 x 2 <sup>7</sup> / <sub>8</sub> x 2 <sup>3</sup> / <sub>8</sub>
FE2F	2 <sup>3</sup> / <sub>4</sub>	Frosted	4 x 2 <sup>7</sup> / <sub>8</sub> x 2 <sup>3</sup> / <sub>8</sub>
FE3	3 <sup>1</sup> / <sub>4</sub>	Clear	4 <sup>3</sup> / <sub>4</sub> x 3 <sup>1</sup> / <sub>4</sub> x 2 <sup>3</sup> / <sub>4</sub>
FE3B	3 <sup>1</sup> / <sub>4</sub>	Black	4 <sup>3</sup> / <sub>4</sub> x 3 <sup>1</sup> / <sub>4</sub> x 2 <sup>3</sup> / <sub>4</sub>
FE3F	3 <sup>1</sup> / <sub>4</sub>	Frosted	4 <sup>3</sup> / <sub>4</sub> x 3 <sup>1</sup> / <sub>4</sub> x 2 <sup>3</sup> / <sub>4</sub>



## WATCH DISPLAYS

### Economy Watch Pedestals

Single watch displays on 1/2"-thick acrylic square and round bases.

Product No.	Finish	Base	H x W x D
WPS1	Clear	Square	4 x 3 x 3
WPC1	Clear	Round	8 x 3

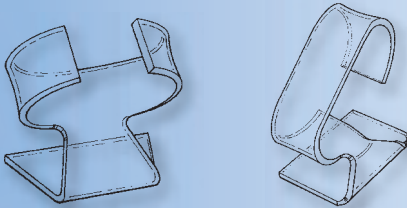

### Watch Cuff Displays

Product No.	Wrap Length	Orientation	H x W x D
WL3V	7 <sup>1</sup> / <sub>4</sub>	Vertical	3 <sup>1</sup> / <sub>4</sub> x 1 <sup>3</sup> / <sub>4</sub> x 3
WL3H	7 <sup>1</sup> / <sub>2</sub>	Horizontal	3 x 2 <sup>3</sup> / <sub>4</sub> x 2

### Curved Single Watch Display

Product No.	H x W x D
WL6	3 <sup>1</sup> / <sub>8</sub> x 1 <sup>1</sup> / <sub>2</sub> x 2 <sup>1</sup> / <sub>4</sub>



### Deluxe Watch Pedestal

Single watch display is highlighted with a 2"-thick acrylic cube.

Product No.	H x W x D
WDPS1	5 <sup>1</sup> / <sub>2</sub> x 2 x 2

### Watch Towers

These towers rotate and allow easy access to both sides. Two cam locks and four keys are included.

Product No.	H x W x D
LRC22	25 x 11 <sup>3</sup> / <sub>8</sub> x 11 <sup>3</sup> / <sub>8</sub>

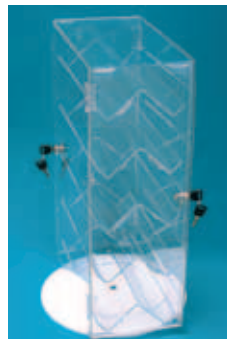



# Jewelry Displays

## NECKLACE DISPLAYS

### One-Piece Necklace Displays

Displays for single or multiple necklaces. All these displays are also available in a special black matte finish.

Product No.	Finish	H x W x D
NE55	Clear	5 <sup>1</sup> / <sub>2</sub> x 4 <sup>5</sup> / <sub>8</sub> x 3
NE55B	Black	5 <sup>1</sup> / <sub>2</sub> x 4 <sup>5</sup> / <sub>8</sub> x 3
NE55F	Frosted	5 <sup>1</sup> / <sub>2</sub> x 4 <sup>5</sup> / <sub>8</sub> x 3
NE55M	Mirrored	5 <sup>1</sup> / <sub>2</sub> x 4 <sup>5</sup> / <sub>8</sub> x 3

NE1	Clear	11 <sup>3</sup> / <sub>4</sub> x 8 x 4
NE1B	Black	11 <sup>3</sup> / <sub>4</sub> x 8 x 4
NE1F	Frosted	11 <sup>3</sup> / <sub>4</sub> x 8 x 4
NE1M	Mirrored	11 <sup>3</sup> / <sub>4</sub> x 8 x 4

NE2	Clear	11 <sup>1</sup> / <sub>2</sub> x 8 <sup>1</sup> / <sub>2</sub> x 4
NE2B	Black	11 <sup>1</sup> / <sub>2</sub> x 8 <sup>1</sup> / <sub>2</sub> x 4
NE2F	Frosted	11 <sup>1</sup> / <sub>2</sub> x 8 <sup>1</sup> / <sub>2</sub> x 4
NE2M	Mirrored	11 <sup>1</sup> / <sub>2</sub> x 8 <sup>1</sup> / <sub>2</sub> x 4

NE25	Clear	7 <sup>1</sup> / <sub>4</sub> x 8 <sup>1</sup> / <sub>2</sub> x 4
NE25B	Black	7 <sup>1</sup> / <sub>4</sub> x 8 <sup>1</sup> / <sub>2</sub> x 4
NE25F	Frosted	7 <sup>1</sup> / <sub>4</sub> x 8 <sup>1</sup> / <sub>2</sub> x 4
NE25M	Mirrored	7 <sup>1</sup> / <sub>4</sub> x 8 <sup>1</sup> / <sub>2</sub> x 4

CST3	Clear	11 <sup>3</sup> / <sub>4</sub> x 10 <sup>5</sup> / <sub>8</sub> x 4
CST3B	Black	11 <sup>3</sup> / <sub>4</sub> x 10 <sup>5</sup> / <sub>8</sub> x 4
CST3F	Frosted	11 <sup>3</sup> / <sub>4</sub> x 10 <sup>5</sup> / <sub>8</sub> x 4
CST3M	Mirrored	11 <sup>3</sup> / <sub>4</sub> x 10 <sup>5</sup> / <sub>8</sub> x 4

CST1	Clear	13 <sup>1</sup> / <sub>2</sub> x 10 <sup>5</sup> / <sub>8</sub> x 4
CST1B	Black	13 <sup>1</sup> / <sub>2</sub> x 10 <sup>5</sup> / <sub>8</sub> x 4
CST1F	Frosted	13 <sup>1</sup> / <sub>2</sub> x 10 <sup>5</sup> / <sub>8</sub> x 4
CST1M	Mirrored	13 <sup>1</sup> / <sub>2</sub> x 10 <sup>5</sup> / <sub>8</sub> x 4

NE3	Clear	7 <sup>1</sup> / <sub>4</sub> x 8 <sup>1</sup> / <sub>2</sub> x 3
NE3B	Black	7 <sup>1</sup> / <sub>4</sub> x 8 <sup>1</sup> / <sub>2</sub> x 3
NE3F	Frosted	7 <sup>1</sup> / <sub>4</sub> x 8 <sup>1</sup> / <sub>2</sub> x 3
NE3M	Mirrored	7 <sup>1</sup> / <sub>4</sub> x 8 <sup>1</sup> / <sub>2</sub> x 3



NE55



NE1



NE2



NE25

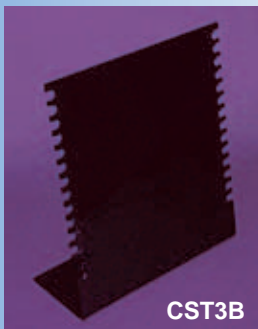

CST3B



CST1



NE3

Any of our one-piece necklace displays are available in a special black matte finish. Add "BM" to the item number (for example, NE3BM)

# Jewelry Displays

## NECKLACE AND BRACELET DISPLAYS



BT1

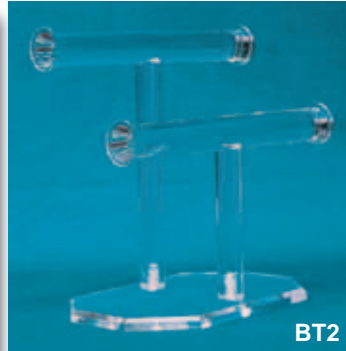

BT2



BT3



BT4

### Necklace and Bracelet Bar Displays

All of our round T-bar necklace and bracelet displays are made with endcaps on the bars to prevent jewelry from slipping off. All bases are beveled, polished acrylic. Bases on BT2, BT3, and BT4 detach for easy shipping.

Product No.	Bar Heights	H x W x D	Product No.	Bar Heights	H x W x D
BT1	5 <sup>3</sup> / <sub>4</sub>	6 <sup>3</sup> / <sub>4</sub> x 8 x 2	BT3	5 <sup>3</sup> / <sub>4</sub> , 8 <sup>1</sup> / <sub>4</sub> & 10 <sup>3</sup> / <sub>4</sub>	10 <sup>3</sup> / <sub>4</sub> x 8 x 8
BT2	5 <sup>3</sup> / <sub>4</sub> & 8 <sup>1</sup> / <sub>4</sub>	8 <sup>3</sup> / <sub>4</sub> x 8 x 5	BT4	5 <sup>3</sup> / <sub>4</sub> , 8 <sup>1</sup> / <sub>4</sub> , & 16	16 x 12 x 8

### Necklace Bars

In four heights, all have glued-on endcaps to keep necklaces in place. Bases detach for easy shipping.

Product No.	H x W x D
NE5	10 <sup>3</sup> / <sub>4</sub> x 8 x 5
NE6	18 x 12 x 5
NE7	23 x 16 x 5
NE15	15 x 15 x 5



NE15

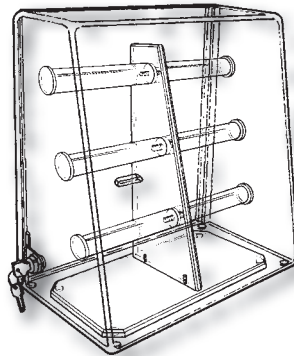

### Bracelet Bar Display and Case

This three-tiered bracelet display is specially designed to fit in our all-acrylic locking case. The case has a slide-up door with cam lock and two keys. Case and display are sold separately.

Product No.	H x W x D	Product No.	H x W x D
BCAS6 (Display)	13 x 12 <sup>1</sup> / <sub>2</sub> x 6 <sup>1</sup> / <sub>2</sub>	ACAS6 (Case)	13 <sup>3</sup> / <sub>4</sub> x 14 x 7 <sup>3</sup> / <sub>4</sub>

# Jewelry Displays

## NECKLACE SECURITY DISPLAY CASES



### Hexagonal Locking Necklace Case

For an attractive, rotating display and locking security, this acrylic case has a hand-turning knob on top for easy all-around viewing. A cam lock on the hinged door provides security and two keys are included. This case has a hand-turning necklace hanger with 23 notches to hang necklaces up to 30" long.

Product No.	H x W x D
HXN12	12 <sup>1</sup> / <sub>4</sub> x 8 <sup>1</sup> / <sub>4</sub> x 9 <sup>1</sup> / <sub>2</sub>
HXN2	19 <sup>1</sup> / <sub>4</sub> x 8 <sup>1</sup> / <sub>4</sub> x 9 <sup>1</sup> / <sub>2</sub>

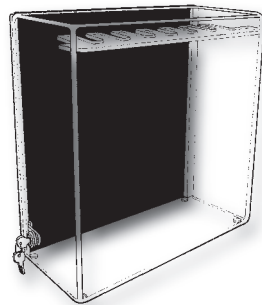

### Rectangular Locking Necklace Case

There are seven 3" long, 1/4" wide flat pegs to hang necklaces in this case with a built-in rack. A sliding black acrylic door in the back gives easy access and has a cam lock in the door for security. Two keys are included. Hanging space is 15".

Product No.	H x W x D
NCAS4	16 <sup>3</sup> / <sub>4</sub> x 16 <sup>1</sup> / <sub>4</sub> x 6 <sup>3</sup> / <sub>4</sub>

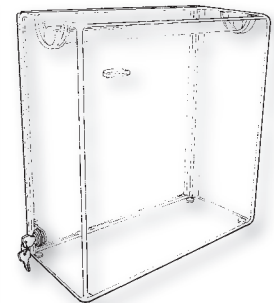

### Single-Bar Locking Necklace Case

Hang necklaces in this case on a removable 1"-diameter rod. A clear acrylic sliding door provides access in the back and has a cam lock for security. Two keys are included. 15" hanging space, including the rod.

Product No.	H x W x D
NCAS5	16 <sup>3</sup> / <sub>4</sub> x 16 <sup>1</sup> / <sub>4</sub> x 6 <sup>3</sup> / <sub>4</sub>

## COUNTERTOP ROTATING DISPLAYS



### Round-Top Rotators

Tops are 6<sup>3</sup>/<sub>4</sub>" diameter with 23 notches. Thumbscrews on top of these displays allows them to be turned to view hanging necklaces. Tops and bases detach for easy shipping.

Product No.	H x W x D
RNR12	13 x 8 x 8
RNR18	19 x 8 x 8
RNR20	21 x 8 x 8



# Jewelry Displays



## Clasp Style Necklace Rotators

For extra security, necklaces can be clasped through the holes in the circular top of these displays. The 7"-diameter top has 17 holes. Thumbscrews on top of these displays allows them to be turned to view hanging necklaces. Tops and bases detach for easy shipping.

<u>Product No.</u>	<u>H x W x D</u>
DNR12	12 $\frac{1}{2}$ x 8 x 8
DNR18	18 $\frac{1}{2}$ x 8 x 8



## Necklace/Keychain Rotators

Tops are 6 $\frac{3}{4}$ " diameter with 8 notches. Thumbscrews on top of these displays allows them to be turned to view hanging necklaces. Tops and bases detach for easy shipping.

<u>Product No.</u>	<u>H x W x D</u>
KCR12	13 x 8 x 8
KCR18	19 x 8 x 8
KCR20	21 x 8 x 8



## Square-Rod Necklace Tree

Four  $\frac{3}{4}$ "-square acrylic rods are capped on the ends to prevent necklaces from slipping off. Base and arms detach for easy shipping.

<u>Product No.</u>	<u>H x W x D</u>
NAR22	22 x 13 x 13

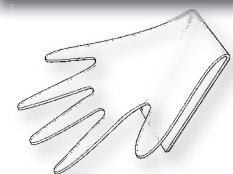

HA2 flipped

## Acrylic Hands

This multi-purpose display is a fanciful way to show off rings, bracelets, necklaces, or gloves. Flip the HA2 to really highlight a bracelet.

<u>Product No.</u>	<u>H x W x D</u>
HA1	9 $\frac{1}{4}$ x 5 $\frac{1}{2}$ x 3
HA2	5 $\frac{1}{4}$ x 5 $\frac{1}{2}$ x 5

# Food & Bulk Dispensers

## TRAYS

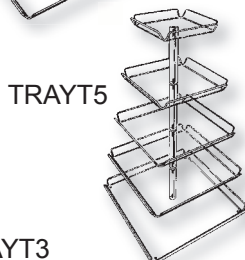
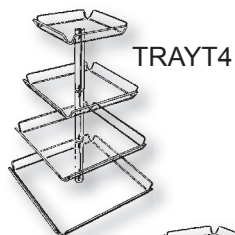

### Tray Towers

These three, four, and five-tiered towers have 8" of space between each tier. Shipped unassembled.

Product No.	Tiers	H x W x D
TRAYT3	Three	26 x 15 $\frac{1}{2}$ x 15 $\frac{1}{2}$
TRAYT4	Four	34 x 18 $\frac{1}{2}$ x 18 $\frac{1}{2}$
TRAYT5	Five	42 x 22 x 22



### Display Trays

Made of  $\frac{3}{16}$ " clear acrylic.

Product No.	H x W x D
BDT69	1 $\frac{1}{4}$ x 6 x 9
BDT612	1 $\frac{1}{4}$ x 6 x 12
BDT810	1 $\frac{1}{4}$ x 8 x 10
BDT812	1 $\frac{1}{4}$ x 8 x 12
BDT812D	2 $\frac{1}{2}$ x 8 x 12
BDT815	1 $\frac{1}{4}$ x 8 x 15
BDT912	2 x 9 x 12



### Angled-Front Single-Tray Cabinet

The angled front of this cabinet is hinged for front access.

Product No.	H x W x D
AFST18	8 x 18 $\frac{1}{2}$ x 14

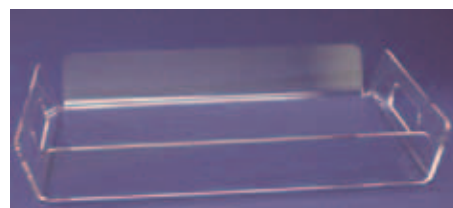

### Display/Service Trays

Made of  $\frac{3}{16}$ " acrylic, these trays have angled sides and integrated cut-out handles.

Product No.	Finish	H x W x D
TRAYH18	Clear	2 x 18 x 15
TRAYH24	Clear	2 x 24 x 19



### Open-Bottom Tray/Plate Guard

Four-sided cover for serving trays or food plates has access in the back.

Product No.	H x W x D
OBG19	8 $\frac{7}{8}$ x 19 $\frac{1}{8}$ x 10 $\frac{1}{4}$

# Food & Bulk Dispensers

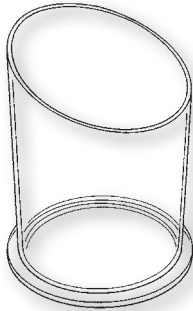

## Angle-Cut Food Display Tubes

Product No.	H x Dia.
FDTA86	8 x 6
FDTA126	12 x 6
FDTA168	16 x 8
FDTA2010	20 x 10



## BULK BINS

### Stackable Bulk Bins

Three sizes can be used alone or together, stacked as a graduated unit or using the same unit on top of itself. The angled front is hinged. Sold separately or as a set of three graduated units.

Product No.	H x W x D
SBB11	9 <sup>7</sup> / <sub>8</sub> x 8 x 11 <sup>1</sup> / <sub>4</sub>
SBB16	9 <sup>7</sup> / <sub>8</sub> x 8 x 16 <sup>1</sup> / <sub>4</sub>
SBB21	9 <sup>7</sup> / <sub>8</sub> x 8 x 21 <sup>1</sup> / <sub>4</sub>
SBBSET	Set of all three sizes.

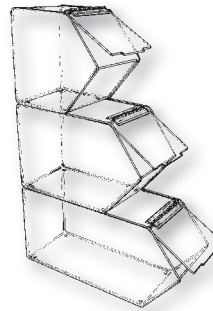

### Stackable Bagel Bins

Larger size bulk bin is excellent for bagels as well as many other bulk foods. These can stack as graduated sizes, or stack the same size.

Product No.	H x W x D
SBBB12	12 x 12 x 11 <sup>1</sup> / <sub>2</sub>
SBBB18	12 x 12 x 18



### Mini Stackable Bins

These stackable bins work well for small candies, ice-cream toppings, etc. These can stack as graduated sizes, or stack the same size.

Product No.	H x W x D
MSB5	5 x 5 x 9 <sup>1</sup> / <sub>2</sub>
MSB6	5 x 5 x 11 <sup>1</sup> / <sub>2</sub>
MSB7	5 x 5 x 13 <sup>1</sup> / <sub>2</sub>

# Food & Bulk Dispensers

## BULK DISPENSERS

### Gravity-Feed Bulk Dispensers

This style bulk dispenser has a hinged lid on top for filling and a front lid for customer use. Neatly display contents with the removable false-front.

Product No.	H x W x D
BFFF12	12 x 6 <sup>3</sup> / <sub>8</sub> x 12 <sup>1</sup> / <sub>4</sub>
BFFF16	16 x 8 <sup>3</sup> / <sub>8</sub> x 16 <sup>1</sup> / <sub>4</sub>

### Hinged-Top Gravity-Feed Bulk Dispensers

Tall bulk dispenser has a hinged lid on top for filling and a front lid for customer use.

Product No.	H x W x D
BFGF15	15 <sup>1</sup> / <sub>4</sub> x 5 x 10
BFGF19	19 x 6 <sup>1</sup> / <sub>4</sub> x 12 <sup>1</sup> / <sub>2</sub>
BFGF22	22 <sup>5</sup> / <sub>8</sub> x 7 <sup>3</sup> / <sub>8</sub> x 15

### Open-Top Gravity-Feed Bulk Dispensers

Single, double, and quadruple wide versions. Top and dispensing area are open.

Product No.	Style	H x W x D
GFPD1	Single	12 x 4 <sup>3</sup> / <sub>8</sub> x 8 <sup>1</sup> / <sub>4</sub>
GFPD2	Double	12 x 8 <sup>5</sup> / <sub>8</sub> x 8 <sup>1</sup> / <sub>4</sub>
GFPD4	Quadruple	12 x 17 x 8 <sup>1</sup> / <sub>4</sub>



BFFF12



BFGF15



GFPD1

## CONE HOLDERS

### Cone Holder with Guard

Sizes for five sugar cones or waffle cones with a protective guard. Sugar cone styles have a 1<sup>1</sup>/<sub>2</sub>"-diameter hole; waffle cones are 1<sup>3</sup>/<sub>4</sub>".

Product No.	Cone Type	H x W x D
CHG1	Sugar	12 x 19 <sup>1</sup> / <sub>2</sub> x 6 <sup>1</sup> / <sub>8</sub>
CHG2	Waffle	12 x 19 <sup>1</sup> / <sub>2</sub> x 6 <sup>1</sup> / <sub>8</sub>

### Cone Risers

Eight holes with bottom-hole shelf for stabilizing cones. Sizes for sugar or waffle cones.

Product No.	Cone Type	H x W x D
CHR1	Sugar	5 <sup>1</sup> / <sub>8</sub> x 2 <sup>3</sup> / <sub>8</sub> x 6
CHR2	Waffle	5 <sup>1</sup> / <sub>8</sub> x 2 <sup>3</sup> / <sub>8</sub> x 6

### Cone Pedestals

Sizes for four sugar or waffle cones.

Product No.	Cone Type	H x W x D
CHP1	Sugar	5 <sup>1</sup> / <sub>8</sub> x 2 <sup>3</sup> / <sub>8</sub> x 6
CHP2	Waffle	5 <sup>1</sup> / <sub>8</sub> x 2 <sup>3</sup> / <sub>8</sub> x 6

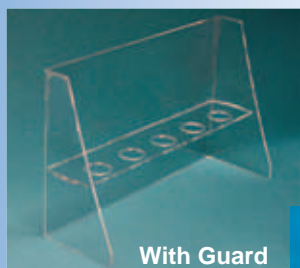

With Guard



Riser Style

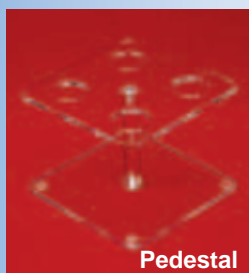

Pedestal

# Slatwall Accessories

Many of our slatwall accessories are also available for either gridwall or pegboard, and some are available with holes drilled for wall mounting. These products are marked with these symbols. If you would like to order an accessory with slatwall mount, add a "Z" to the beginning of the product number; for gridwall mounts, add a "G" to the end of product number; for pegboard, add a "P" to the end of product number; for wall mounting, add "WM" to the end of product number. Prices are the same as for slatwall.

- Z** Slat wall
- W** Wall Mount
- G** Grid wall
- P** Peg Board

## Angled Shelves

45° angle,  $\frac{3}{16}$ "-thick acrylic.

Product No.	Lip	H x W
ZSG1	1½	8 x 6
ZSG2	1½	8 x 12
ZSG3	2	11 x 9
ZSG4	2	10 x 18
ZSG5	3	13 x 12
ZSG6	3	13 x 24

**Z W G P**

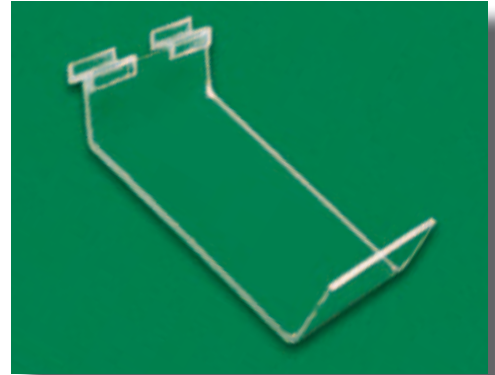

## Angled Shelves with Braces

45° angle,  $\frac{3}{16}$ "-thick acrylic.

Product No.	Lip	H x W
ZS108	1½	10 x 8
ZS1110	1½	11 x 10
ZS1024	2	10 x 24
ZS1032	2	10 x 32
ZS1212	2	12 x 12
ZS1218	2	12 x 18
ZS1424	2	14 x 24
ZS1436	2	14 x 36

**Z G P**



## Straight Shelves without Braces

No braces;  $\frac{3}{16}$ "-thick acrylic.

Product No.	W x D
Z65N	6 x 5
Z93N	9 x 3
Z104N	10 x 4
Z108N	10 x 8
Z124N	12 x 4
Z126N	12 x 6
Z128N	12 x 8
Z168N	16 x 8
Z1612N	16 x 12
Z248N	24 x 8
Z2412N	24 x 12

**Z W G P**





# Slatwall Accessories

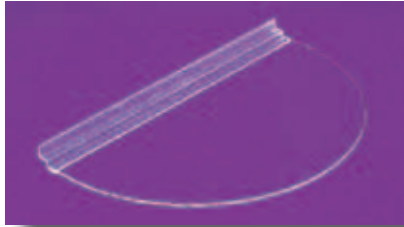

Z W G P

## Semi-Circular Shelves

Product No.	W x D
ZSC12	12 x 6 $\frac{1}{2}$
ZSC14	14 x 7 $\frac{1}{2}$
ZSC16	16 x 8 $\frac{1}{2}$

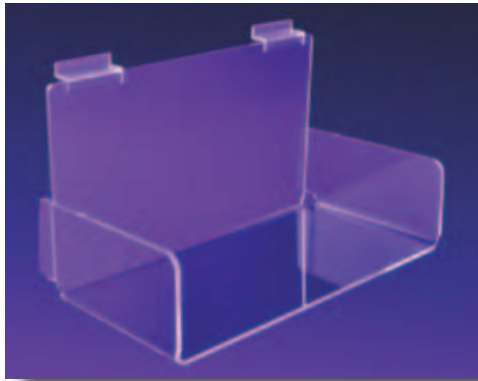

Z G P

## Braced Angled Shelves

Shelves for books are also excellent for videos, CDs, boxed merchandise or shirts. The front is tilted up to keep items from slipping forward.

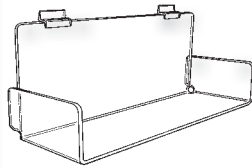

Product No.	H x W x D
ZBL12	7 x 12 $\frac{3}{8}$ x 7
ZBL18	7 x 18 $\frac{3}{8}$ x 7
ZBL24	7 x 24 $\frac{3}{8}$ x 7
ZBL12TW	12 x 12 $\frac{1}{2}$ x 9
ZBL18TW	12 x 18 $\frac{1}{2}$ x 9
ZBL24TW	12 x 24 $\frac{1}{2}$ x 9

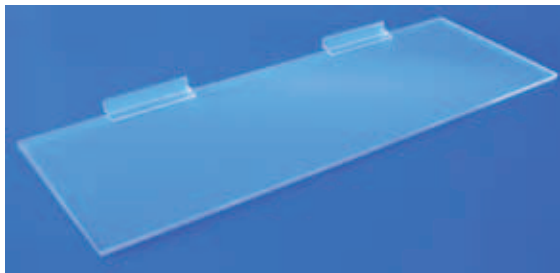

Z W G P

## Flat Shelves

Multi-purpose shelves made of  $\frac{1}{4}$ " acrylic.

Product No.	W x D
ZFS244	24 x 4
ZFS484	48 x 4
ZFS246	24 x 6
ZFS248	24 x 8
ZFS488	48 x 8



Z W G P

## Braced Shelves

$\frac{3}{16}$ "-thick acrylic.

Product No.	W x D
Z126U	12 x 6
Z168U	16 x 8
Z208U	20 x 8
Z248U	24 x 8
Z810U	8 x 10
Z1010U	10 x 10
Z1610U	16 x 10
Z2410U	24 x 10
Z2412U	24 x 12

Z Slat wall    W Wall Mount  
G Grid wall    P Peg Board

# Slatwall Accessories

## Braced Shelves with Lip

$\frac{3}{16}$ "-thick acrylic.

Z W G P

Product No.	W x D
Z810L	8 x 10
Z1010L	10 x 10
Z1610L	16 x 10
Z2410L	24 x 10



## Molded Economy Shelves

Z

Product No.	W x D
<i>Straight shelves:</i>	
Z84E	8 x 4
Z104E	10 x 4
Z106E	10 x 6
Z126E	12 x 6
<i>With raised front lip:</i>	
Z8EL	8 x 3 $\frac{1}{2}$
Z10EL	10 x 3 $\frac{1}{2}$
Z105EL	10 x 5 $\frac{1}{2}$
Z12EL	12 x 5 $\frac{1}{2}$
<i>With braced edges:</i>	
ZJ1610	16 x 10
<i>With front label space:</i>	
Z84ESLP	8 x 4
Z94ESLP	9 x 4

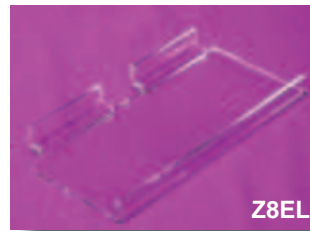
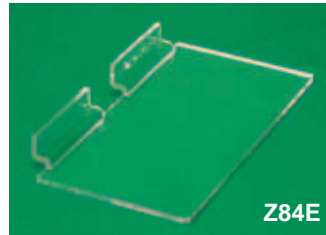

Slatwall Shelves

## Shelves for Slatwall Brackets

Use our  $\frac{1}{4}$ "-thick clear acrylic with polished edges to create slatwall shelves on top of metal brackets. Available in 6, 8, 10 and 12 inch widths and 12, 18, 24, 36 and 48 inch lengths.

Product No.	W x L	Product No.	W x L	Product No.	W x L
ZFS126	12 x 6	ZFS186	18 x 6	ZFS246	24 x 6
ZFS128	12 x 8	ZFS188	18 x 8	ZFS248	24 x 8
ZFS1210	12 x 10	ZFS1810	18 x 10	ZFS2410	24 x 10
ZFS1212	12 x 12	ZFS1812	18 x 12	ZFS2412	24 x 12

Product No.	W x L	Product No.	W x L
ZFS366	36 x 6	ZFS486	48 x 6
ZFS368	36 x 8	ZFS488	48 x 8
ZFS3610	36 x 10	ZFS4810	48 x 10
ZFS3612	36 x 12	ZFS4812	48 x 12



# Slatwall Accessories



Z G P

## Large J-Shelves

Made of  $\frac{3}{16}$ "-thick acrylic with a  $1\frac{1}{2}$ " lip. Tilted style has a spacer in the back to tilt the front up.

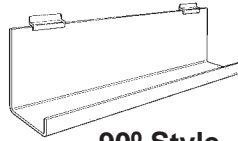

90° Style

Product No.	Style	H x W x D
ZL12	90°	6 $\frac{1}{2}$ x 12 x 5 $\frac{1}{4}$
ZL18	90°	6 $\frac{1}{2}$ x 18 x 5 $\frac{1}{4}$
ZL24	90°	6 $\frac{1}{2}$ x 24 x 5 $\frac{1}{4}$
ZL36	90°	6 $\frac{1}{2}$ x 36 x 5 $\frac{1}{4}$
ZL48	90°	6 $\frac{1}{2}$ x 48 x 5 $\frac{1}{4}$
ZL12S	Tilted	6 $\frac{1}{2}$ x 12 x 5 $\frac{1}{4}$
ZL18S	Tilted	6 $\frac{1}{2}$ x 18 x 5 $\frac{1}{4}$
ZL24S	Tilted	6 $\frac{1}{2}$ x 24 x 5 $\frac{1}{4}$
ZL36S	Tilted	6 $\frac{1}{2}$ x 36 x 5 $\frac{1}{4}$
ZL48S	Tilted	6 $\frac{1}{2}$ x 48 x 5 $\frac{1}{4}$

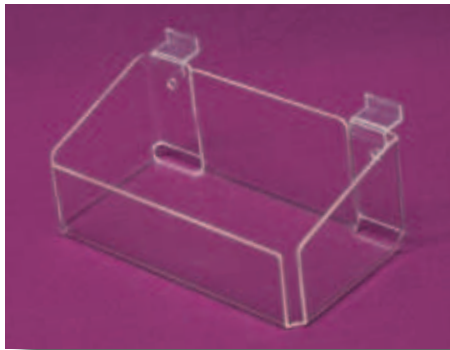

Z W G P

## Economy Trays

One-piece design makes these trays economical and durable.

Product No.	Tray Size	H x W x D
ZBT48	4 x 8	3 x 8 $\frac{1}{4}$ x 4 $\frac{1}{4}$
ZBT412	4 x 12	3 x 12 $\frac{1}{4}$ x 4 $\frac{1}{4}$
ZBT812	8 x 12	3 x 12 $\frac{1}{4}$ x 8 $\frac{1}{4}$
ZBT816	8 x 16	3 x 16 $\frac{1}{4}$ x 8 $\frac{1}{4}$
ZBT912	9 x 12	3 x 12 $\frac{1}{4}$ x 9 $\frac{1}{4}$
ZBT1018	10 x 18	3 x 18 $\frac{1}{4}$ x 10 $\frac{1}{4}$



Z W G P

## Hosiery Bins

Pockets are  $7\frac{1}{2}$ " wide.



Product No.	# Pockets	H x W x D
D2420	1	6 $\frac{7}{8}$ x 7 $\frac{3}{4}$ x 4 $\frac{3}{4}$
D2421	2	6 $\frac{7}{8}$ x 15 $\frac{3}{8}$ x 4 $\frac{3}{4}$



Z G P

## Media Shelf

Shelves for books are also excellent for videos, CDs, boxed merchandise or shirts.

Product No.	H x W x D
ZCB44	4 $\frac{1}{4}$ x 6 $\frac{1}{8}$ x 2 $\frac{3}{16}$
ZCB64	6 $\frac{1}{2}$ x 6 $\frac{1}{8}$ x 2 $\frac{3}{16}$

# Slatwall Accessories

## Braced Ledges

Z G P

Dimensions are shelf size.

Product No.	H x W x D
ZABL612	6 x 12 x 6
ZABL624	6 x 24 x 6
ZABL636	6 x 36 x 6
ZABL912	9 x 12 x 9



## Flat-Bottom J-Shelves

Z W G P

Available with end caps and/or a spacer to tilt the shelf.

Product No.	Ends	Spacer	H x W x D
ZQ12	No	No	2 1/2 x 12 x 2 1/4
ZQ18	No	No	2 1/2 x 18 x 2 1/4
ZQ24	No	No	2 1/2 x 24 x 2 1/4
ZQ36	No	No	2 1/2 x 36 x 2 1/4
ZQ48	No	No	2 1/2 x 48 x 2 1/4
ZQ12E	Yes	No	2 1/2 x 12 x 2 1/4
ZQ18E	Yes	No	2 1/2 x 18 x 2 1/4
ZQ24E	Yes	No	2 1/2 x 24 x 2 1/4
ZQ36E	Yes	No	2 1/2 x 36 x 2 1/4
ZQ48E	Yes	No	2 1/2 x 48 x 2 1/4
ZQ12S	No	Yes	2 1/2 x 12 x 2 1/4
ZQ18S	No	Yes	2 1/2 x 18 x 2 1/4
ZQ24S	No	Yes	2 1/2 x 24 x 2 1/4
ZQ36S	No	Yes	2 1/2 x 36 x 2 1/4
ZQ48S	No	Yes	2 1/2 x 48 x 2 1/4
ZQ12SE	Yes	Yes	2 1/2 x 12 x 2 1/4
ZQ18SE	Yes	Yes	2 1/2 x 18 x 2 1/4
ZQ24SE	Yes	Yes	2 1/2 x 24 x 2 1/4
ZQ36SE	Yes	Yes	2 1/2 x 36 x 2 1/4
ZQ48SE	Yes	Yes	2 1/2 x 48 x 2 1/4

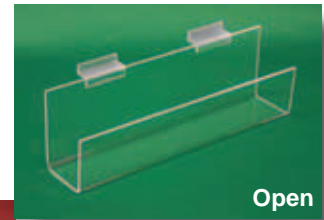

Slatwall Tray Shelves

## Angled-Bottom J-Shelves

Z W G P

Available with or without end caps.

Product No.	Ends	H x W x D
ZQ12A	No	2 1/2 x 12 x 2 1/4
ZQ18A	No	2 1/2 x 18 x 2 1/4
ZQ24A	No	2 1/2 x 24 x 2 1/4
ZQ36A	No	2 1/2 x 36 x 2 1/4
ZQ48A	No	2 1/2 x 48 x 2 1/4
ZQ12AE	Yes	2 1/2 x 12 x 2 1/4
ZQ18AE	Yes	2 1/2 x 18 x 2 1/4
ZQ24AE	Yes	2 1/2 x 24 x 2 1/4
ZQ36AE	Yes	2 1/2 x 36 x 2 1/4
ZQ48AE	Yes	2 1/2 x 48 x 2 1/4

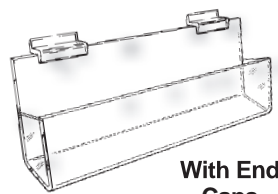
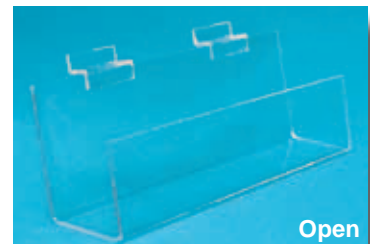

Z Slat wall W Wall Mount  
G Grid wall P Peg Board

## SIGN HOLDERS



ZGP

### Acrylic Frames

This folded frame can be fitted for slatwall, gridwall or peg-board; for wall-mounting frames, see the Literature Holder chapter of this catalog. Measurements are the insert size by width and height.

Product No.	W x H	Product No.	W x H
ZM4060	4 x 6	ZM1114	11 x 14
ZM6040	6 x 4	ZM1411	14 x 11
ZM5070	5 x 7	ZM1711	17 x 11
ZM7050	7 x 5	ZM1117	11 x 17
ZM5570	5½ x 7		
ZM7055	7 x 5½	<b>Poster Sizes:</b>	
ZM6090	6 x 9	ZM1422	14 x 22
ZM9060	9 x 6	ZM1624	16 x 24
ZM7011	7 x 11	ZM1824	18 x 24
ZM8010	8 x 10	ZM2228	22 x 28
ZM1080	10 x 8	ZM2822	28 x 22
ZM8511	8½ x 11		
ZM1185	11 x 8½		



### One-Piece Acrylic Frames

This folded frame is for slatwall only. Measurements are the insert size by width and height.

Product No.	W x H	Product No.	W x H
EM4060	4 x 6	EM1114	11 x 14
EM6040	6 x 4	EM1411	14 x 11
EM5070	5 x 7	EM1711	17 x 11
EM7050	7 x 5	EM1117	11 x 17
EM5570	5½ x 7		
EM7055	7 x 5½	<b>Poster Sizes:</b>	
EM6090	6 x 9	EM1422	14 x 22
EM9060	9 x 6	EM1624	16 x 24
EM7011	7 x 11	EM1824	18 x 24
EM8010	8 x 10	EM2228	22 x 28
EM1080	10 x 8	EM2822	28 x 22
EM8511	8½ x 11		
EM1185	11 x 8½		

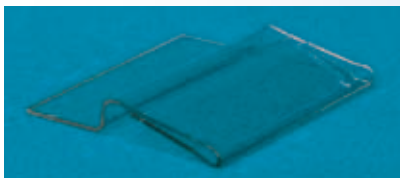

### Slatwall Label Holders

Product No.	Width
LABEL1	2
LABEL2	4
LABEL3	6

These holders for price labels or signs fit perfectly in slatwall.

## BROCHURE HOLDERS



### Tri-Fold Brochure Holders

Pocket size is  $4\frac{1}{8}$ " wide and  $1\frac{1}{8}$ " deep. One style has a backpiece that kicks the bottom out from the wall. The other style fits flat against the wall. Molded of clear styrene.

Product No.	Style	H x W x D
ZB1E	Kicked out	$7\frac{1}{4} \times 4\frac{1}{2} \times 2\frac{1}{2}$
ZB1WE	Flush mount	$7\frac{1}{4} \times 4\frac{1}{2} \times 2\frac{1}{2}$

Z W G P



### $8\frac{1}{2} \times 11$ Brochure Holders

Pocket size is  $8\frac{3}{4}$ " wide and  $1\frac{1}{2}$ " deep. In two styles—flat mounting or with a backpiece to angle out.

Product No.	Style	H x W x D
ZB2E	Kicked out	$10\frac{1}{4} \times 9\frac{1}{4} \times 3\frac{3}{4}$
ZB2WE	Flush mount	$10\frac{1}{4} \times 9\frac{1}{4} \times 1\frac{7}{8}$

Z W G P

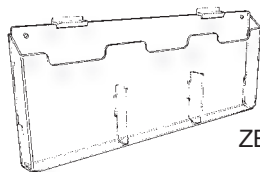

ZBH13W



ZBH15W

### Multi-Pocket Brochure Holders

Pocket depth is  $1\frac{5}{8}$ ".

Product No.	# Pockets	Style	H x W x D
ZBH13W	Three	Tri-Fold	$8\frac{1}{4} \times 13 \times 2$
ZBH15W	Five	Tri-Fold	$8\frac{1}{4} \times 22 \times 2$
ZBH22W	Two	$8\frac{1}{2} \times 11$	$10\frac{3}{4} \times 18\frac{1}{2} \times 2$
ZBH23W	Three	$8\frac{1}{2} \times 11$	$10\frac{3}{4} \times 27\frac{5}{8} \times 2$

Z W G P



### Literature Displays with Hold-Down Flap

The front of these literature displays is designed to hold materials securely.

Product No.	H x W x D
ZHTF1WM	$8\frac{3}{8} \times 4\frac{1}{2} \times 2$
ZHTF2WM	$11 \times 9\frac{1}{4} \times 2$
ZHTF2HWM	$8\frac{1}{2} \times 11\frac{3}{4} \times 2$
ZHTF5WM	$11 \times 15\frac{3}{4} \times 2$

Z W G P

# Slatwall Accessories

## SLATWALL TRAYS



ZT4R



ZT3X

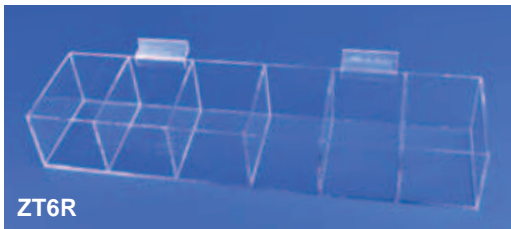

ZT6R

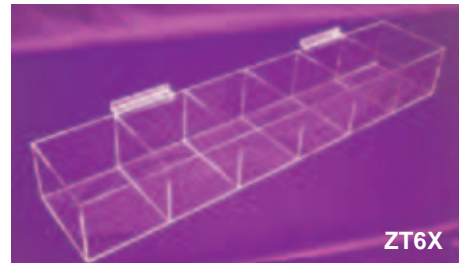

ZT6X

### Standard Bin Trays **Z G P**

All trays measure 2<sup>5</sup>/<sub>8</sub>" x 15<sup>7</sup>/<sub>8</sub>" x 4" (H x W x D).

Product No.	# Compartments/Width
ZT1R	One 15 <sup>3</sup> / <sub>4</sub>
ZT2R	Two 7 <sup>1</sup> / <sub>2</sub>
ZT3R	Three 5
ZT4R	Four 3 <sup>3</sup> / <sub>4</sub>
ZT6R	Six 2 <sup>1</sup> / <sub>2</sub>

### Large Bin Trays **Z G P**

All trays measure 2<sup>5</sup>/<sub>8</sub>" x 15<sup>7</sup>/<sub>8</sub>" x 4" (H x W x D).

Product No.	# Compartments/Width
ZT3X	Three 9 <sup>3</sup> / <sub>4</sub>
ZT4X	Four 7 <sup>1</sup> / <sub>4</sub>
ZT5X	Five 5 <sup>3</sup> / <sub>4</sub>
ZT6X	Six 4 <sup>3</sup> / <sub>4</sub>



### Straight Trays **Z G P**

Product No.	H x W x D
ZT1	2 x 8 x 4
ZT2	2 x 12 x 9
ZT3	2 x 16 x 8
ZT4	2 x 24 x 8
ZT5	4 x 8 x 4
ZT6	4 x 12 x 4

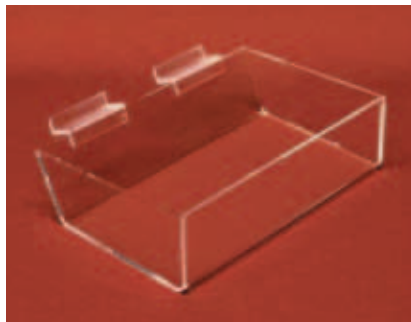

### Slanted Trays **Z G P**

These trays angle down 20°.

Product No.	H x W x D
ZT201	2 x 8 x 4
ZT202	2 x 12 x 9
ZT203	2 x 16 x 8



### Cell Phone Displays

Product No.	H x W x D
ZCP2	6 x 2 <sup>1</sup> / <sub>4</sub> x 1 <sup>1</sup> / <sub>4</sub>
ZCP3	8 x 3 x 2

**Z** Slat wall    **G** Grid wall    **W** Wall Mount    **P** Peg Board

# Slatwall Accessories

## Low Front Trays

Z G P

Product No.	Height		W x D
	Front	Back	
ZAT5129	3	5	12 x 9
ZAT6189	4	6	18 x 9
ZAT6249	4	6	24 x 9
ZAT6309	4	6	30 x 9
ZAT6369	4	6	36 x 9

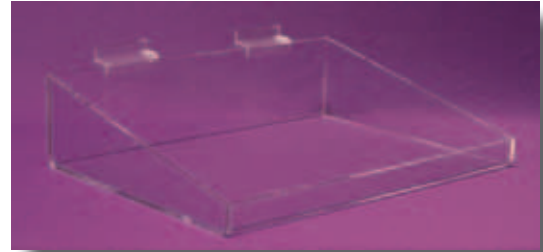

## Square Bins

Z

Product No.	H x W x D
ZCJ04	4 x 4 x 4
ZCJ1	6 x 6 x 6
ZCJ2	8 x 8 x 8
ZCJ3	10 x 10 x 10
ZCJ4	12 x 12 x 12



## Angled Deep Bins

Z

Product No.	H x W x D
ZACJR69	6 x 9 x 6
ZACJ04	4 x 4 x 4
ZACJ1	6 x 6 x 6
ZACJ2	8 x 8 x 8
ZACJ3	10 x 10 x 10
ZACJ4	12 x 12 x 12



## "V" Bins

Z

Product No.	H x W x D
ZVB56	5 x 6 x 4 <sup>1</sup> / <sub>2</sub>
ZVB86	8 x 6 x 6
ZVB512	5 x 12 x 4 <sup>1</sup> / <sub>2</sub>
ZVB812	8 x 12 x 6

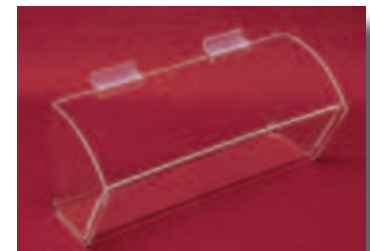

## Paper Tray

Z

Designed to hold a ream of 8<sup>1</sup>/<sub>2</sub> x 11 paper at a 20° angle. The front lip is notched for easy access.

Product No.	H x W x D
ZAPT	2 <sup>3</sup> / <sub>4</sub> x 9 <sup>1</sup> / <sub>4</sub> x 13 <sup>1</sup> / <sub>4</sub>





# Slatwall Accessories



Z G P

## Divided Bin Display

Four removable dividers provide adjustable compartments in this angled-front bin display. The 24"-wide display is made of  $\frac{1}{8}$ "-thick acrylic; the 30"-wide is  $\frac{3}{16}$ " acrylic.

Product No.	Compartment Size	H x W x D
ZABD24	4 $\frac{5}{8}$	8 x 24 x 8
ZABD30	5 $\frac{7}{8}$	12 x 30 x 12



ZBPW4

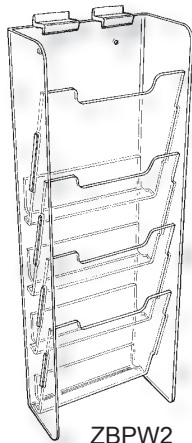

ZBPW2

Z G P

## Vertical Multi-Pocket Displays

Product No.	Style	# Pockets	H x W x D
ZBPW1	Tri-fold	5	24 x 4 $\frac{1}{2}$ x 4
ZBPW2	8 $\frac{1}{2}$ x 11	4	26 x 9 $\frac{1}{4}$ x 4 $\frac{3}{4}$
ZBPW3	Half-sheet	5	24 x 6 $\frac{3}{8}$ x 4 $\frac{1}{4}$
ZBPW4	Post card	7	23 x 6 $\frac{3}{8}$ x 2 $\frac{1}{4}$
ZBPW5	Magazine	4	30 x 11 $\frac{1}{4}$ x 6
ZBPW6	Tri-fold	4	30 x 11 $\frac{1}{4}$ x 6

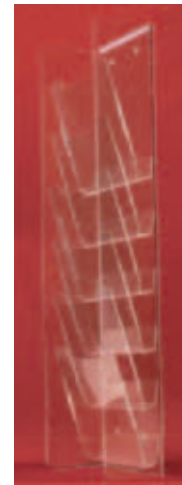

Z G P

## Long Vertical Multi-Pocket Displays

ZBPW2L is appropriate for small magazines and ZBPW5L is for larger magazines.

Product No.	Style	# Pockets	H x W x D
ZBPW2L	8 $\frac{1}{2}$ x 11	4	39 $\frac{1}{2}$ x 9 $\frac{1}{2}$ x 4 $\frac{3}{4}$
ZBPW5L	Magazine	4	40 x 11 $\frac{1}{4}$ x 6



Z G P

## Slatwall Endpieces

Create a display for wrapping paper or any variable-length object by bracketing an item within these endpieces. Sold by the pair.

Product No.	H x W x D
ZENDP	2 $\frac{3}{4}$ x 2 $\frac{1}{8}$ x 6 $\frac{3}{4}$



Z

## Slatwall Hangers

Hang metal frames quickly and easily on slatwall using this specially made TrackMaster® brand hanger. Also gives great flexibility in moving pictures around on slatwall.

Product No.
TMSW

# Slatwall Accessories

## Easels

Z W G P

Product No.	H x W x D
ZGE6	6 x 4 x 3 <sup>1</sup> / <sub>4</sub>
ZGE7.5	7 <sup>1</sup> / <sub>2</sub> x 5 <sup>3</sup> / <sub>8</sub> x 4 <sup>1</sup> / <sub>4</sub>
ZGE9	9 x 6 <sup>3</sup> / <sub>4</sub> x 5 <sup>1</sup> / <sub>4</sub>
ZGE12	12 x 8 <sup>1</sup> / <sub>4</sub> x 6 <sup>3</sup> / <sub>4</sub>

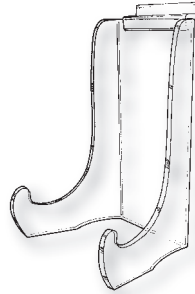

Slatwall Easels/Eyewear

## EYEWEAR DISPLAYS



Z G P

### Vertical Eyewear Frame Saddles

Product No.	# Saddles	H x W
ZOSD1	One	2 x 1 <sup>1</sup> / <sub>2</sub>
ZOSD3	Three	9 x 1 <sup>1</sup> / <sub>2</sub>
ZOSD6	Six	19 <sup>1</sup> / <sub>2</sub> x 1 <sup>1</sup> / <sub>2</sub>

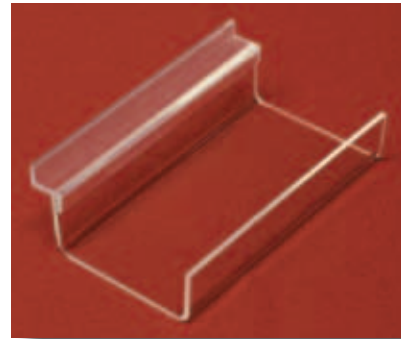

Z

### Eyewear Frame Shelves

Angled and flat shelves to display single or multiple frames.

Product No.	Style	H x W
ZOSH6A	Single	3 <sup>1</sup> / <sub>4</sub> x 6 x 2 <sup>1</sup> / <sub>2</sub>
ZOSH24A	Multiple	3 <sup>1</sup> / <sub>4</sub> x 24 x 2 <sup>1</sup> / <sub>2</sub>
ZOSH6F *	Single	1 <sup>3</sup> / <sub>4</sub> x 6 x 3

\* Flat shelf

### Open-Frame Eyewear Display

Rests for nosepiece and sidepieces allow frames to be displayed in an open position.

Product No.	H x W x D
ZJ401570	1 <sup>1</sup> / <sub>4</sub> x 6 x 6 <sup>1</sup> / <sub>2</sub>

Z

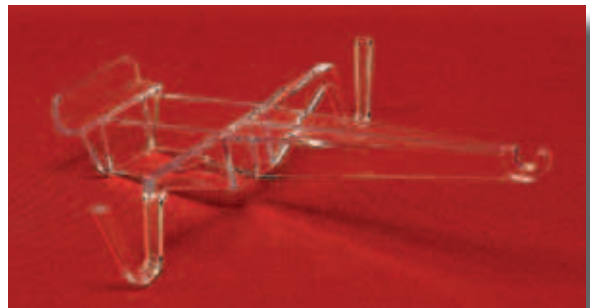

# Slatwall Accessories

## APPAREL DISPLAYS



**Z G P**

### Scarf Display

*Semi-circle holds 9 scarves. Holes are 1" diameter.*

Product No.                      H x W x D  
ZSR9                                      1 x 14 x 6 $\frac{1}{2}$

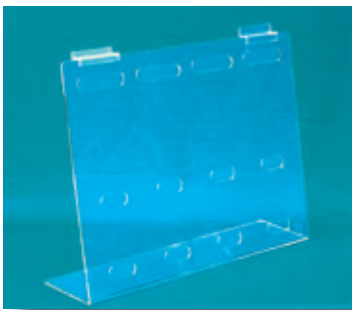

**Z P**

### Necktie Display

*Show off four folded neckties on this display.*

Product No.                      H x W x D  
ZNTD                                      13 $\frac{1}{2}$  x 19 x 4 $\frac{1}{4}$

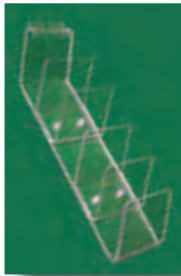

**Z W G P**

### Clutch Bag Displays

*These displays are perfect for displaying clutch bags, as well as books or boxed merchandise.*

<u>Product No.</u>	<u># Bags</u>	<u>H x W x D</u>
ZCB1	1	8 x 5 x 3
ZCBR	5	13 x 4 x 9 $\frac{1}{4}$



**Z G P**

### Clothes Hanger

*Strap cutouts give this acrylic hanger extra versatility.*

Product No.                      H x W x D  
ZCH1                                      7 x 17 x 3 $\frac{1}{2}$



**Z**

### Multi-Purpose Curved Displays

*Display belts, scarves and headbands perfectly.*

Product No.                      H x W x D  
D2398                                      11 $\frac{1}{8}$  x 17 $\frac{3}{8}$  x 6 $\frac{3}{4}$

**Z** Slat wall

**G** Grid wall

**W** Wall Mount

**P** Peg Board

# Slatwall Accessories

## Hinged Front-Door Cases

Z G P

Product No.	Shelves	H x W x D
ZHF172	Two	16 $\frac{1}{2}$ x 16 $\frac{1}{4}$ x 7
ZHF173	Three	16 $\frac{1}{2}$ x 16 $\frac{1}{4}$ x 7
ZHF132	Two	13 x 21 x 7 $\frac{1}{2}$

These cases are available with a mirrored back insert. To order, simply add an "M" to the end of the product number; i.e. ZHP171M.



## JEWELRY DISPLAYS

### Necklace Displays

Solid bar displays also work for bracelets, scarves or ties. Neck style can also be used on a countertop.

Z W G P

Product No.	H x W x D
<b>Bar Style:</b>	
ZNE7	2 x 8 x 2
ZNE12	2 x 12 x 2
ZNE15	2 x 16 x 2

<b>Neck Style:</b>	
ZNS7	7 $\frac{1}{4}$ x 9 x 7
ZNS7F (frosted)	7 $\frac{1}{4}$ x 9 x 7

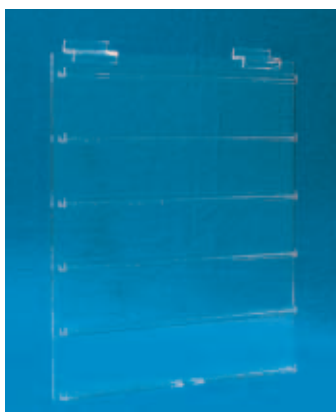
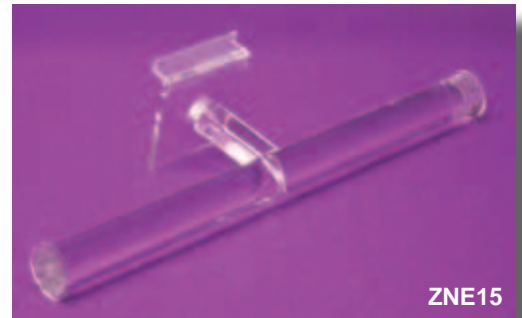
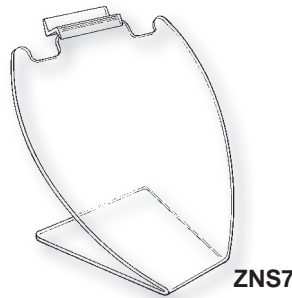

Z W G P

### J-Bar Style Earring Card Displays

Product No.	# Cards	Card Style	H x W
ZAB1	20	Two inch	10 $\frac{1}{4}$ x 8
ZAB2	36	Two inch	12 $\frac{1}{2}$ x 12
ZAB5	30	Three inch	14 x 18



Z

### Slatwall Watch Clip

Product No.	H x W x D
ZWCH1	2 $\frac{3}{4}$ x 1 $\frac{1}{2}$ x 1 $\frac{3}{4}$



Z G P

### Acrylic Mirrors

Product No.	Style	H x W
ZML1	Rectangular	9 x 7
ZML2	Rectangular	12 x 11
ZML9	Oval	9 x 6
ZML12	Oval	12 x 9

# Slatwall Accessories

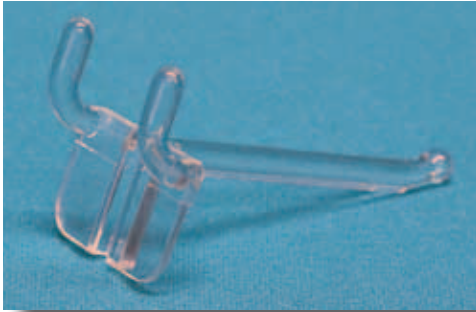

Z W G P

## Pegboard Hooks

Sturdy molded hooks fit standard pegboard. Available in clear or black.

Product No.	Finish	Length
PEGHK2	Clear	2
PEGHK2B	Black	2
PEGHK3	Clear	3
PEGHK3B	Black	3
PEGHK4	Clear	4
PEGHK4B	Black	4



ZJ40102



ZJ40106

## Molded Slatwall Hooks

For carded merchandise using hooks.

Product No.	Length
ZJ40102	1 $\frac{1}{4}$
ZJ40104	4
ZJ40106	6



## Rod Pegs

1" diameter acrylic rod has an endcap.

Product No.	Rod Length	H x W x D
ZPG1	1 $\frac{1}{2}$	1 $\frac{1}{2}$ x 1 $\frac{1}{2}$ x 1 $\frac{1}{2}$
ZPG3	3	1 $\frac{1}{2}$ x 3 x 1 $\frac{1}{2}$
ZPG4	4 $\frac{1}{2}$	1 $\frac{1}{2}$ x 4 $\frac{1}{2}$ x 1 $\frac{1}{2}$
ZPG6	6	1 $\frac{1}{2}$ x 6 x 1 $\frac{1}{2}$



## Hook Displays

1 $\frac{1}{2}$ "-long hooks on an acrylic backpiece.

Product No.	# Pegs	H x W x D
ZNH1	One	2 x 2 x 1 $\frac{3}{8}$
ZNH3	Three	2 x 9 x 1 $\frac{3}{8}$
ZNH6	Six	2 x 18 x 1 $\frac{3}{8}$

Z Slat wall

G Grid wall

W Wall Mount

P Peg Board

## EASELS

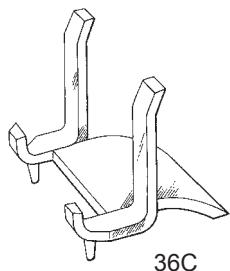

36C

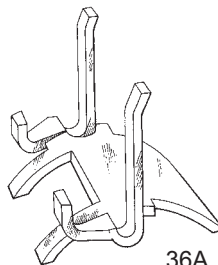

36A



### Miniature Slice Easels

These easels were designed to display mineral agate slices, but have been “discovered” as a way to show framed miniatures, tiles and many other small, flat items. Also good for clocks—the #36A easel is designed to accommodate a standard battery-clock motor between the upright legs. Stackable for compact shipping. These displays are sold in dozens; a discount is available for boxes of 288 pieces.

<u>Product No.</u>	<u>Will hold max. thickness</u>	<u>H x W x D</u>
36C	1/2	2 1/8 x 2 x 2 1/8
36A	3/4	2 1/4 x 3 x 2 3/8

### Miniature Easels

Originally designed for stone and gem cabochons, these triangular easels are excellent for coins, framed miniatures, medallions, sand dollars, stamps and much more. Stackable for compact shipping. These displays are sold in dozens; a discount is available for boxes of 288 pieces.

<u>Product No.</u>	<u>H x W x D</u>
CAB2	1 1/2 x 1 1/4 x 1 1/2
CAB3	2 1/8 x 1 3/4 x 2
CAB4	3 3/8 x 3 1/8 x 1 7/8

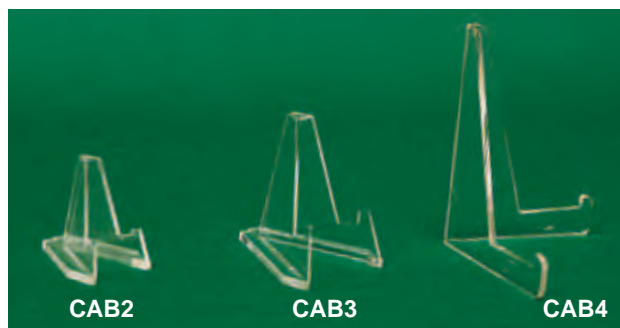

CAB2

CAB3

CAB4

Miniature Easels

### Hinged Miniature Easels

This easel folds flat and is perfect for packaging with a product or selling as a resale item. Available in clear or black. These displays are sold in dozens; a discount is available for boxes of 288 pieces.

<u>Product No.</u>	<u>Finish</u>	<u>H x W x D</u>
DK218	Clear	2 1/8 x adj. x 1 5/8
DK218B	Black	2 1/8 x adj. x 1 5/8
DK278	Clear	2 7/8 x adj. x 2 1/8
DK278B	Black	2 7/8 x adj. x 2 1/8





35



38 for collector plates



### 38-Series Easels

With five sizes of these versatile easels you can display a wide range of products. Laser cut for superior edge finish. These easels are best for flat items. Sold in dozens.

Product No.	H x W x D
35A	1 <sup>3</sup> / <sub>4</sub> x 1 <sup>3</sup> / <sub>4</sub> x 1 <sup>3</sup> / <sub>4</sub>
35B	2 <sup>3</sup> / <sub>8</sub> x 2 <sup>1</sup> / <sub>4</sub> x 2 <sup>1</sup> / <sub>8</sub>
35	3 x 2 <sup>7</sup> / <sub>8</sub> x 2 <sup>1</sup> / <sub>2</sub>
38	3 <sup>1</sup> / <sub>2</sub> x 3 <sup>7</sup> / <sub>8</sub> x 3 <sup>1</sup> / <sub>8</sub>
39	4 <sup>5</sup> / <sub>8</sub> x 4 <sup>7</sup> / <sub>8</sub> x 4 <sup>1</sup> / <sub>4</sub>

### 37-Series Easels

The 37-Series of easels is made to accommodate thicker items than the 38 Series. Sold in dozens.

Product No.	H x W x D
37AA	2 x 1 <sup>3</sup> / <sub>4</sub> x 2 <sup>1</sup> / <sub>8</sub>
37A	2 <sup>5</sup> / <sub>8</sub> x 2 <sup>1</sup> / <sub>4</sub> x 2 <sup>3</sup> / <sub>4</sub>
37B	3 <sup>1</sup> / <sub>2</sub> x 2 <sup>3</sup> / <sub>4</sub> x 3 <sup>1</sup> / <sub>2</sub>
37C	4 <sup>5</sup> / <sub>8</sub> x 3 <sup>7</sup> / <sub>8</sub> x 4 <sup>5</sup> / <sub>8</sub>
37D	5 <sup>1</sup> / <sub>8</sub> x 4 <sup>5</sup> / <sub>8</sub> x 6

37D is made of <sup>3</sup>/<sub>16</sub>"-thick acrylic

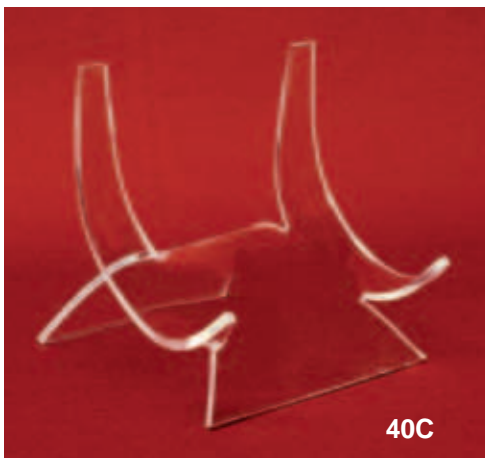

40C

### 40-Series Easels

These large easels are made of <sup>3</sup>/<sub>16</sub>" thick acrylic. #40C is specially formed to hold deeper, irregularly shaped items that don't need the front hooks of the #40.

Product No.	H x W x D
40	5 <sup>5</sup> / <sub>8</sub> x 5 <sup>7</sup> / <sub>8</sub> x 5 <sup>1</sup> / <sub>4</sub>
40C	5 <sup>5</sup> / <sub>8</sub> x 5 <sup>7</sup> / <sub>8</sub> x 5 <sup>1</sup> / <sub>4</sub>

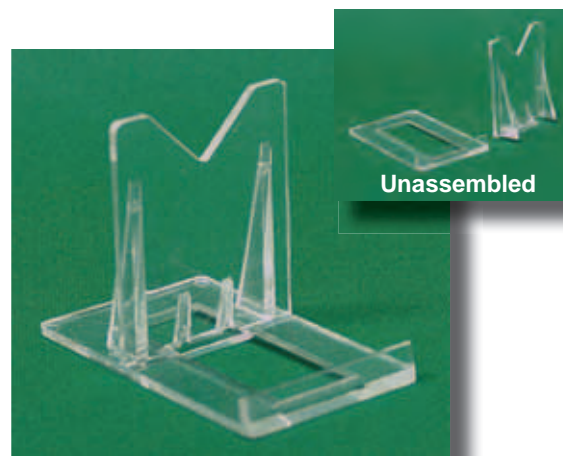

Unassembled

### Two-Part Easels

The sliding top piece on these two-part easels makes their depth adjustable. These economical, injection-molded stands also pack flat for easy shipping or packaging. Sold in dozens; a discount is available for full box purchases.

Product No.	H x W x D	Box Qty.
LG99	2 x 1 <sup>1</sup> / <sub>2</sub> x 2 <sup>5</sup> / <sub>8</sub>	288
LG101	3 <sup>1</sup> / <sub>8</sub> x 2 <sup>1</sup> / <sub>4</sub> x 3 <sup>1</sup> / <sub>2</sub>	144

## Adjustable Easels

Adjustable, injection-molded folding easels.  
Available in clear or black.

Product No.	Finish	H x W x D
LG2000	Clear	3 x 2 <sup>3</sup> / <sub>8</sub> x 3 <sup>1</sup> / <sub>2</sub>
LG2000B	Black	3 x 2 <sup>3</sup> / <sub>8</sub> x 3 <sup>1</sup> / <sub>2</sub>
LG2020	Clear	3 <sup>1</sup> / <sub>2</sub> x 3 <sup>1</sup> / <sub>4</sub> x 5
LG2020B	Black	3 <sup>1</sup> / <sub>2</sub> x 3 <sup>1</sup> / <sub>4</sub> x 5



## Wire-Back Folding Easels

Adjustable, vinyl-coated wire back.

Product No.	Base finish	H x W x D
LW2020	Clear	4 <sup>1</sup> / <sub>2</sub> x 3 <sup>1</sup> / <sub>4</sub> x 5
LW2020B	Black	4 <sup>1</sup> / <sub>2</sub> x 3 <sup>1</sup> / <sub>4</sub> x 5
LW2040	Clear	6 <sup>1</sup> / <sub>2</sub> x 5 x 7 <sup>1</sup> / <sub>2</sub>
LW2040B	Black	6 <sup>1</sup> / <sub>2</sub> x 5 x 7 <sup>1</sup> / <sub>2</sub>



## Handmade Hinged Easels

For plates or square, flat items.

Product No.	Plate Size	H x W x D
GK4	6-7"	4 x adj. x 2 <sup>7</sup> / <sub>8</sub>
GK5	8"	5 x adj. x 3 <sup>1</sup> / <sub>2</sub>
GK6	9"	6 x adj. x 4
GK8	12"	7 <sup>1</sup> / <sub>2</sub> x adj. x 5
GK9	14"	9 x adj. x 6
GK12	18"	12 x adj. x 8
GK15	22"	15 x adj. x 10 <sup>1</sup> / <sub>4</sub>
GK18	25"	18 x adj. x 12 <sup>1</sup> / <sub>2</sub>





## DOUBLE-BEND EASELS

The double-bend construction of these clear acrylic easels gives them extra stability. Their rounded lines and highly polished edges also make them the unobtrusive choice for displaying everything from plates and platters to prints and framed pictures, or even heavy pieces such as petrified wood or fossil plates.



### Shallow Bowl Easels

Designed to tilt a plate, platter or shallow bowl back slightly.

Product No.	H x W x D
GA3	3 x 2 <sup>1</sup> / <sub>2</sub> x 2 <sup>1</sup> / <sub>4</sub>
GA4.5	4 <sup>1</sup> / <sub>2</sub> x 3 <sup>1</sup> / <sub>2</sub> x 3 <sup>1</sup> / <sub>2</sub>
GA6	6 x 5 <sup>1</sup> / <sub>8</sub> x 5
GA7.5	7 <sup>1</sup> / <sub>2</sub> x 6 <sup>3</sup> / <sub>8</sub> x 6 <sup>1</sup> / <sub>4</sub>
GA9	9 x 7 <sup>1</sup> / <sub>2</sub> x 7 <sup>1</sup> / <sub>4</sub>
GA12	12 x 10 x 9 <sup>3</sup> / <sub>4</sub>
GA15	15 x 12 <sup>1</sup> / <sub>2</sub> x 12
GA18	18 x 15 <sup>1</sup> / <sub>4</sub> x 14 <sup>1</sup> / <sub>4</sub>

### Extra-Thick Shallow Bowl Easels

Made of <sup>3</sup>/<sub>8</sub>"-thick acrylic for heavier loads.

Product No.	H x W x D
GA12T	12 x 10 x 9 <sup>3</sup> / <sub>4</sub>
GA15T	15 x 12 <sup>1</sup> / <sub>2</sub> x 12
GA18T	18 x 15 <sup>1</sup> / <sub>4</sub> x 14 <sup>1</sup> / <sub>4</sub>



### Upright Easels

The fairly short leg on the GE series allows you to display flat pieces in an upright position.

Product No.	H x W x D
GE3	3 x 2 <sup>3</sup> / <sub>8</sub> x 2 <sup>1</sup> / <sub>4</sub>
GE4.5	4 <sup>1</sup> / <sub>2</sub> x 3 <sup>3</sup> / <sub>8</sub> x 2 <sup>3</sup> / <sub>4</sub>
GE6	6 x 4 x 3 <sup>1</sup> / <sub>4</sub>
GE7.5	7 <sup>1</sup> / <sub>2</sub> x 5 <sup>3</sup> / <sub>8</sub> x 4 <sup>1</sup> / <sub>4</sub>
GE9	9 x 6 <sup>3</sup> / <sub>4</sub> x 5 <sup>1</sup> / <sub>4</sub>
GE12	12 x 8 <sup>1</sup> / <sub>4</sub> x 6 <sup>3</sup> / <sub>4</sub>
GE15	15 x 10 <sup>1</sup> / <sub>4</sub> x 8 <sup>3</sup> / <sub>4</sub>
GE18	18 x 14 x 10 <sup>1</sup> / <sub>4</sub>

### Extra-Thick Upright Easels

Made of <sup>3</sup>/<sub>8</sub>"-thick acrylic for heavier loads.

Product No.	H x W x D
GE12T	12 x 8 <sup>1</sup> / <sub>4</sub> x 6 <sup>3</sup> / <sub>4</sub>
GE15T	15 x 10 <sup>1</sup> / <sub>4</sub> x 8 <sup>3</sup> / <sub>4</sub>
GE18T	18 x 14 x 10 <sup>1</sup> / <sub>4</sub>

All GA and GE easels are available with holes for wall mounting. To order, simply add an "H" to the end of the product number; i.e. GA9H.



# Easels

## Deep Bowl Easels

The extra-long legs and defined hook of the GW series make these easels the perfect choice for displaying bowls of all sizes. A deep bowl will sit more upright and a shallow bowl will tilt back.

Product No.	H x W x D
GW3	3 x 3 <sup>1</sup> / <sub>8</sub> x 4
GW4.5	4 <sup>1</sup> / <sub>2</sub> x 4 x 5 <sup>3</sup> / <sub>4</sub>
GW6	6 x 6 <sup>3</sup> / <sub>8</sub> x 7 <sup>1</sup> / <sub>2</sub>
GW8	8 x 7 x 10
GW10	10 x 9 <sup>1</sup> / <sub>4</sub> x 12 <sup>1</sup> / <sub>2</sub>

## Extra-Thick Deep Bowl Easels

Made of <sup>3</sup>/<sub>8</sub>"-thick acrylic for heavier loads.

Product No.	H x W x D
GW8T	8 x 7 x 10
GW10T	10 x 9 <sup>1</sup> / <sub>4</sub> x 12 <sup>1</sup> / <sub>2</sub>

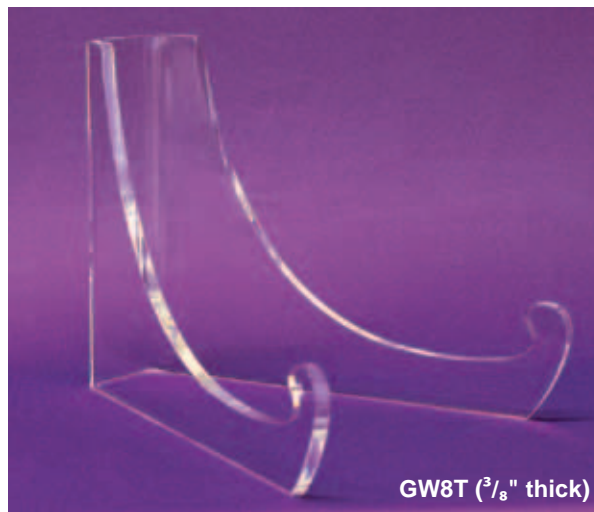

All GW easels are available with holes for wall mounting. To order, simply add an "H" to the end of the product number; i.e. GW8H.

Double Bend Easels

## Platform Easels

This unique adaptation of our GA series of easels allows you to add height to displays of plates or shallow bowls. These easels will also show off heart-shaped items because there's plenty of room for the heart "tip" in the front.

Product No.	H x W x D
PGA3	4 <sup>1</sup> / <sub>4</sub> x 2 <sup>1</sup> / <sub>2</sub> x 2 <sup>1</sup> / <sub>4</sub>
PGA4.5	6 <sup>1</sup> / <sub>4</sub> x 3 <sup>1</sup> / <sub>2</sub> x 3 <sup>1</sup> / <sub>2</sub>
PGA6	8 <sup>3</sup> / <sub>8</sub> x 5 <sup>1</sup> / <sub>8</sub> x 5
PGA7.5	10 <sup>1</sup> / <sub>2</sub> x 6 <sup>3</sup> / <sub>8</sub> x 6 <sup>1</sup> / <sub>4</sub>
PGA9	12 <sup>5</sup> / <sub>8</sub> x 7 <sup>1</sup> / <sub>2</sub> x 7 <sup>1</sup> / <sub>4</sub>
PGA12	16 <sup>3</sup> / <sub>4</sub> x 10 x 9 <sup>3</sup> / <sub>4</sub>
PGA12T*	16 <sup>3</sup> / <sub>4</sub> x 10 x 9 <sup>3</sup> / <sub>4</sub>

\* PGA12T is made of extra-thick, <sup>3</sup>/<sub>8</sub>" acrylic



## SINGLE-BEND EASELS

These easels are bent at a 60° angle and feature the same quality polished acrylic as our double-bend easels.



### GS Series Easels

The GS series is used to display flat pieces in an upright position.

Product No.	H x W x D
GS4.5	4 <sup>1</sup> / <sub>2</sub> x 3 <sup>1</sup> / <sub>4</sub> x 2 <sup>1</sup> / <sub>2</sub>
GS6	6 x 4 <sup>1</sup> / <sub>2</sub> x 3 <sup>1</sup> / <sub>2</sub>
GS7.5	7 <sup>1</sup> / <sub>2</sub> x 5 <sup>3</sup> / <sub>4</sub> x 4 <sup>3</sup> / <sub>4</sub>
GS9	9 x 7 x 5 <sup>3</sup> / <sub>4</sub>
GS12	12 x 8 <sup>3</sup> / <sub>4</sub> x 7 <sup>1</sup> / <sub>4</sub>
GS15	15 x 10 <sup>3</sup> / <sub>4</sub> x 9
GS18	18 x 12 <sup>1</sup> / <sub>4</sub> x 10 <sup>1</sup> / <sub>2</sub>

### Extra-Thick GS Series Easels

Made of <sup>3</sup>/<sub>8</sub>"-thick acrylic for heavier loads.

Product No.	H x W x D
GS12T	12 x 8 <sup>3</sup> / <sub>4</sub> x 7 <sup>1</sup> / <sub>4</sub>
GS15T	15 x 10 <sup>3</sup> / <sub>4</sub> x 9
GS18T	18 x 12 <sup>1</sup> / <sub>4</sub> x 10 <sup>1</sup> / <sub>2</sub>



### GT Series Easels

The GT easels have a longer leg than the GS easels so that plates, platters or shallow bowls will tilt back slightly.

Product No.	H x W x D
GT3	3 x 3 <sup>5</sup> / <sub>8</sub> x 2 <sup>1</sup> / <sub>2</sub>
GT4.5	4 <sup>1</sup> / <sub>2</sub> x 4 <sup>1</sup> / <sub>2</sub> x 3 <sup>1</sup> / <sub>2</sub>
GT6	6 x 5 <sup>3</sup> / <sub>4</sub> x 4 <sup>3</sup> / <sub>4</sub>
GT7.5	7 <sup>1</sup> / <sub>2</sub> x 7 x 5 <sup>3</sup> / <sub>4</sub>
GT9	9 x 9 x 7 <sup>1</sup> / <sub>4</sub>
GT12	12 x 10 <sup>5</sup> / <sub>8</sub> x 8 <sup>3</sup> / <sub>4</sub>
GT12T*	12 x 10 <sup>5</sup> / <sub>8</sub> x 8 <sup>3</sup> / <sub>4</sub>

\*GT12T is made of extra-thick, <sup>3</sup>/<sub>8</sub>" acrylic



### Label Easels

These easels are designed to hold a label or sign in front of a displayed piece.

Product No.	Label Space	H x W x D
KG4.5	1 x 2 <sup>1</sup> / <sub>2</sub>	4 <sup>1</sup> / <sub>2</sub> x 3 <sup>1</sup> / <sub>8</sub> x 4 <sup>1</sup> / <sub>4</sub>
KG6	1 x 2 <sup>1</sup> / <sub>2</sub>	6 x 3 <sup>3</sup> / <sub>4</sub> x 5
KG7.5	1 x 3 <sup>1</sup> / <sub>8</sub>	7 <sup>1</sup> / <sub>2</sub> x 5 <sup>1</sup> / <sub>4</sub> x 6 <sup>1</sup> / <sub>4</sub>
KG9	1 x 3 <sup>5</sup> / <sub>8</sub>	9 x 6 <sup>1</sup> / <sub>4</sub> x 7 <sup>1</sup> / <sub>2</sub>

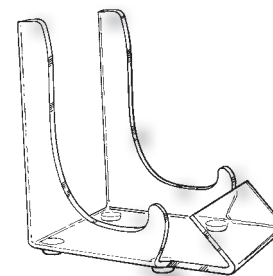

## Lighted Easels

These specialty easels are available in a variety of sizes to display stained glass, agate slices or any collectible that would be enhanced by back-lighting. All of the lighted easels include a six-foot cord with in-line switch and bulb.

Product No.	Bulb	H x W x D
GE4.5L	7-watt	4 <sup>1</sup> / <sub>2</sub> x 3 <sup>3</sup> / <sub>8</sub> x 2 <sup>3</sup> / <sub>4</sub>
GE6L	7-watt	6 x 4 x 3 <sup>1</sup> / <sub>4</sub>
GE7.5L	20-watt	7 <sup>1</sup> / <sub>2</sub> x 5 <sup>3</sup> / <sub>8</sub> x 4 <sup>1</sup> / <sub>4</sub>
GE9L	20-watt	9 x 6 <sup>3</sup> / <sub>4</sub> x 5 <sup>1</sup> / <sub>4</sub>
35Z	7-watt	3 x 2 <sup>7</sup> / <sub>8</sub> x 3 <sup>1</sup> / <sub>8</sub>
38Z	7-watt	3 <sup>1</sup> / <sub>2</sub> x 3 <sup>7</sup> / <sub>8</sub> x 3 <sup>1</sup> / <sub>8</sub>
39Z	7-watt	4 <sup>5</sup> / <sub>8</sub> x 4 <sup>7</sup> / <sub>8</sub> x 4 <sup>1</sup> / <sub>4</sub>



38Z



GE6L



## Specialty Easels

Designed especially for minerals and fossils, these easels are the best way to display a crystal cluster or thick fossil piece. The "snub-nose" design is not recommended for bowls, but it supports thick items that don't need front hooks to hold them in place.

Product No.	H x W x D
GM3	3 x 3 x 3 <sup>1</sup> / <sub>4</sub>
GM4.5	4 <sup>1</sup> / <sub>2</sub> x 5 <sup>1</sup> / <sub>4</sub> x 4 <sup>1</sup> / <sub>2</sub>
GM6	6 x 7 <sup>1</sup> / <sub>4</sub> x 6
GM8	8 x 9 <sup>3</sup> / <sub>4</sub> x 8 <sup>1</sup> / <sub>4</sub>
GM10	10 x 11 x 10 <sup>1</sup> / <sub>2</sub>
GM12	12 x 13 <sup>1</sup> / <sub>2</sub> x 12

## Extra-Thick Specialty Easels

Made of <sup>3</sup>/<sub>8</sub>"-thick acrylic for heavier loads.

Product No.	H x W x D
GM8T	8 x 9 <sup>3</sup> / <sub>4</sub> x 8 <sup>1</sup> / <sub>4</sub>
GM10T	10 x 11 x 10 <sup>1</sup> / <sub>2</sub>
GM12T	12 x 13 <sup>1</sup> / <sub>2</sub> x 12

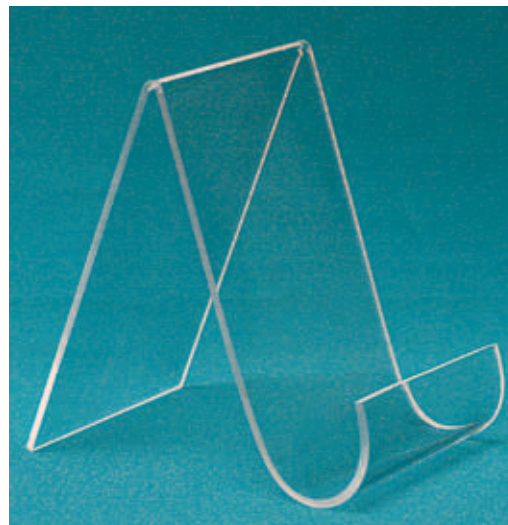

## J-Easels

The rounded front opening of these easels makes them a great choice for purses, clutch bags and other soft items.

Product No.	H x W x D
J3555	5 <sup>1</sup> / <sub>2</sub> x 3 <sup>1</sup> / <sub>2</sub> x 5 <sup>1</sup> / <sub>2</sub>
J5506	6 x 5 <sup>1</sup> / <sub>2</sub> x 6 <sup>1</sup> / <sub>2</sub>
J7508	8 x 7 <sup>1</sup> / <sub>2</sub> x 8 <sup>1</sup> / <sub>2</sub>
J9510	10 x 9 <sup>1</sup> / <sub>2</sub> x 10 <sup>1</sup> / <sub>2</sub>

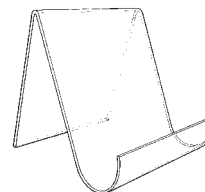

# Easels

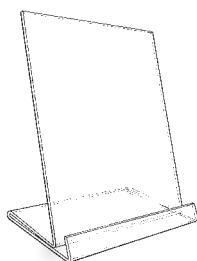
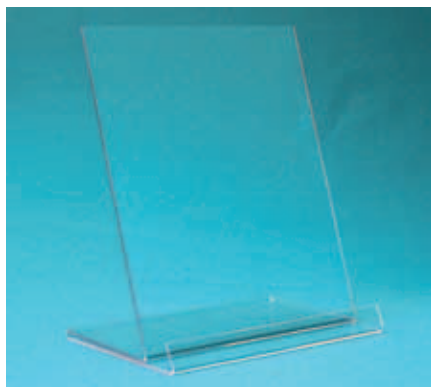

## Flat Display Easel

Flat items, such as packaged shirts, display well on this easel.

<u>Product No.</u>	<u>Front Ledge</u>	<u>H x W x D</u>
CE11	1"	11 <sup>1</sup> / <sub>4</sub> x 10 x 6 <sup>1</sup> / <sub>4</sub>



## Box Easels

The deep front ledge on these easels allows them to display boxed items, such as computer software or puzzle boxes.

<u>Product No.</u>	<u>Front Ledge</u>	<u>H x W x D</u>
SGS15	1 <sup>1</sup> / <sub>2</sub> "	4 x 3 x 4
SGS20	2"	5 <sup>1</sup> / <sub>2</sub> x 4 x 5
SGS25	2 <sup>1</sup> / <sub>2</sub> "	7 <sup>1</sup> / <sub>4</sub> x 6 x 7
SGS30	3"	10 x 7 x 8
SGS35	3 <sup>1</sup> / <sub>2</sub> "	12 <sup>1</sup> / <sub>2</sub> x 8 x 9



## Rod Easels

<u>Product No.</u>	<u>H x W x D</u>
RE3	3 x 2 <sup>3</sup> / <sub>4</sub> x 3 <sup>1</sup> / <sub>2</sub>
RE4	4 <sup>1</sup> / <sub>8</sub> x 3 <sup>1</sup> / <sub>2</sub> x 5
RE5	5 x 4 <sup>1</sup> / <sub>2</sub> x 7



## Ribbon Easels

<u>Product No.</u>	<u>Front Ledge</u>	<u>H x W x D</u>
SK2	1"	1 <sup>7</sup> / <sub>8</sub> x 1 <sup>3</sup> / <sub>4</sub> x 2 <sup>5</sup> / <sub>8</sub>
SK3	1 <sup>1</sup> / <sub>8</sub> "	2 <sup>7</sup> / <sub>8</sub> x 2 <sup>1</sup> / <sub>2</sub> x 3 <sup>1</sup> / <sub>2</sub>
SK4	1 <sup>3</sup> / <sub>4</sub> "	4 <sup>1</sup> / <sub>4</sub> x 3 <sup>3</sup> / <sub>4</sub> x 5 <sup>1</sup> / <sub>4</sub>
SK6	2 <sup>5</sup> / <sub>8</sub> "	6 <sup>1</sup> / <sub>8</sub> x 4 x 6 <sup>1</sup> / <sub>2</sub>
SK8	2 <sup>1</sup> / <sub>4</sub> "	7 <sup>3</sup> / <sub>4</sub> x 4 x 6 <sup>1</sup> / <sub>2</sub>
SK6D	3 <sup>3</sup> / <sub>4</sub> "	6 <sup>1</sup> / <sub>4</sub> x 4 <sup>1</sup> / <sub>4</sub> x 7 <sup>3</sup> / <sub>4</sub>

## TIERED EASELS

Make the most of counter space by displaying anything from plates to soft goods on our selection of tiered easels. Constructed with acrylic rods so they pack flat for easy shipping and traveling.

### Three-Tier Easels

For plates or square, flat items.

Product No.	Plate Size	H x W x D
ME1	6-7 <sup>1</sup> / <sub>2</sub> "	10 <sup>1</sup> / <sub>2</sub> x 3 <sup>1</sup> / <sub>2</sub> x 6 <sup>3</sup> / <sub>4</sub>
ME2	8-9"	13 <sup>1</sup> / <sub>8</sub> x 4 <sup>7</sup> / <sub>8</sub> x 8 <sup>1</sup> / <sub>2</sub>
ME3	10-12"	15 <sup>3</sup> / <sub>4</sub> x 6 <sup>1</sup> / <sub>2</sub> x 10 <sup>1</sup> / <sub>8</sub>
ME3T*	10-12"	15 <sup>3</sup> / <sub>4</sub> x 6 <sup>3</sup> / <sub>4</sub> x 10 <sup>1</sup> / <sub>8</sub>

\*ME3T is made of extra-thick, <sup>3</sup>/<sub>8</sub>" acrylic

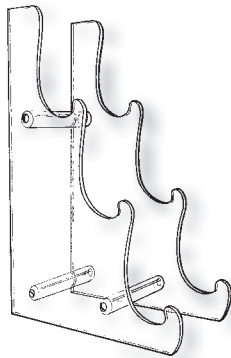

### Six-Tier Easels

Product No.	Plate Size	H x W x D
MSP4	6-7"	8 <sup>1</sup> / <sub>2</sub> x 3 <sup>1</sup> / <sub>2</sub> x 7 <sup>3</sup> / <sub>4</sub>
MSP5	7 <sup>1</sup> / <sub>2</sub> -9"	14 <sup>1</sup> / <sub>4</sub> x 4 <sup>7</sup> / <sub>8</sub> x 13
MSP6	10-12"	19 <sup>1</sup> / <sub>2</sub> x 6 <sup>1</sup> / <sub>2</sub> x 18

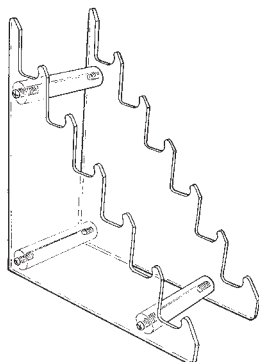

# Mineral, Fossil, & Seashell Displays

*This chapter contains just some of our special mineral and fossil displays, many of which are also good for displaying seashells. Also, see the Easels Chapter for the many different styles of easels that hold everything from cabochons to agate slabs to orthoceres plates. An excellent variety of mineral and fossil stands can be found in our Egg and Spheres Chapter. Countertop Displays offers the perfect organizational displays for beads or tumbled stones. Turntables and Light Bases contains a selection of attention-getting displays for clear spheres and crystals. And for a huge variety of mounting bases, see our Display Blocks and Bases.*



## Gold-Plated Calipers

*The sleek design of these gold-plated calipers gives them a very elegant look. They are plated over solid brass and come with rubber pads on the inside screw tips.*

Product No.	Opening	Height
AU3	$\frac{1}{4}$ — $1\frac{1}{4}$	$3\frac{3}{8}$
AU4	$\frac{3}{8}$ — $1\frac{3}{4}$	4
AU5	$\frac{1}{2}$ — $2\frac{1}{4}$	$4\frac{1}{2}$
AU6	1 — $3\frac{3}{4}$	6
AU7	$2\frac{1}{8}$ — $4\frac{5}{8}$	7
AU8	$2\frac{5}{8}$ — $5\frac{1}{4}$	8



## Slotted V Stand

*Holds  $\frac{1}{4}$ "-thick slices.*

Product No.	H x W x D
V7	1 x 3 x $3\frac{1}{4}$
V9	1 x $4\frac{1}{2}$ x 4

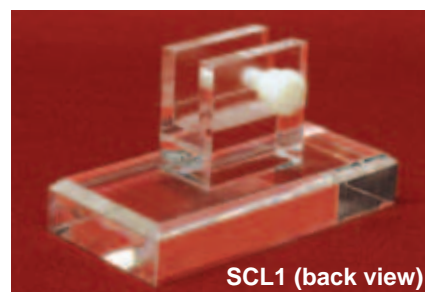

SCL1 (back view)

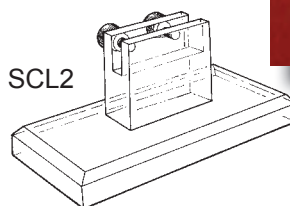

SCL2

## Vertical Slice Support

*This all-acrylic display, set on a beveled pedestal, gives a clear view of the entire agate slice. A nylon thumbscrew in the back clamps slices up to  $\frac{3}{8}$ " thick. The large size has two thumbscrews; the small size has one.*

Product No.	H x W x D
SCL1	$2\frac{1}{8}$ x 4 x 2
SCL2	$2\frac{3}{4}$ x 6 x 3

*Many other displays for slices of agate, as well as fish plates, petrified wood slabs, etc., can be found in the Easel Chapter of this catalog.*

# Mineral, Fossil, & Seashell Displays

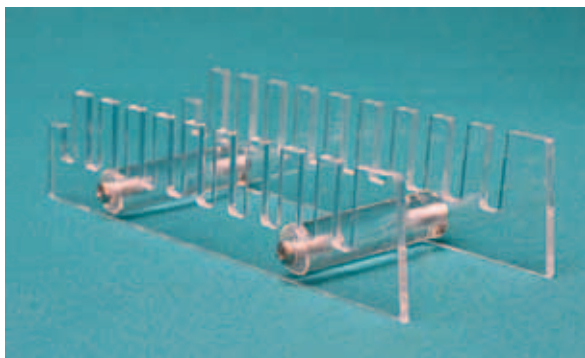

Great displays for tiles



## Horizontal Slice Racks

Excellent for displaying several agate slices for easy viewing. These racks have ten display slots.

Product No.	Slot Depth	H x W x D
MS4H	1/4"	1 3/4 x 2 1/2 x 8
MS6H	3/8"	2 1/2 x 3 5/8 x 11
MS7H	1/2"	3 1/8 x 4 1/8 x 14
MS8H	5/8"	4 x 4 7/8 x 18

## Diagonal Slice Racks

Arrange agate slices in this display that presents a good view of each slice, and allows light to shine through. These racks have eight display slots.

Product No.	Slot Depth	H x W x D
MS4D	1/4"	7 3/4 x 2 1/2 x 7 3/4
MS6D	3/8"	11 x 3 5/8 x 10 3/4
MS7D	1/2"	12 1/2 x 4 1/8 x 12 1/2
MS8D	5/8"	14 1/4 x 4 7/8 x 14

## GEODE STANDS

### Deluxe Three-Peg Displays

Create a designer piece from a geode, cluster or sphere with these elegant display bases with pegs. The 3/4"-thick base is corner-cut, beveled clear acrylic.

Product No.	H x W x D
NG600	2 3/4 x 8 x 6
NG700	3 1/4 x 10 x 7

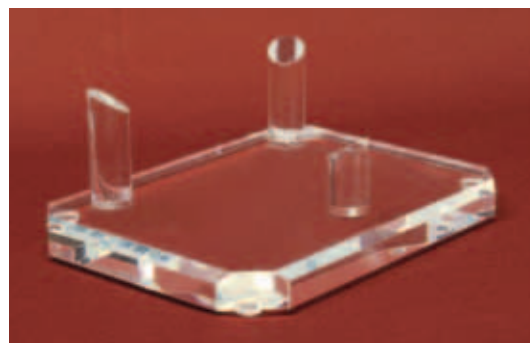

### Deluxe Three-Peg Triangles

The base is 3/4"-thick corner-cut, beveled clear acrylic.

Product No.	H x W x D
NGT1	1 5/8 x 3 1/8 x 2 3/4
NGT2	2 x 3 3/4 x 3 1/4
NGT3	2 1/4 x 5 x 4 1/4
NGT4	2 3/4 x 6 1/2 x 5 5/8
NGT5	3 1/8 x 7 3/8 x 6 1/2

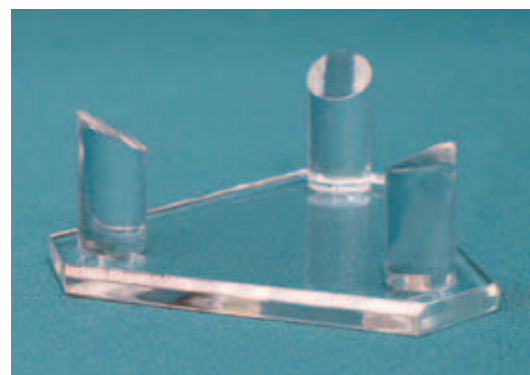

Agate Slice/Geode Displays



# Mineral, Fossil, & Seashell Displays

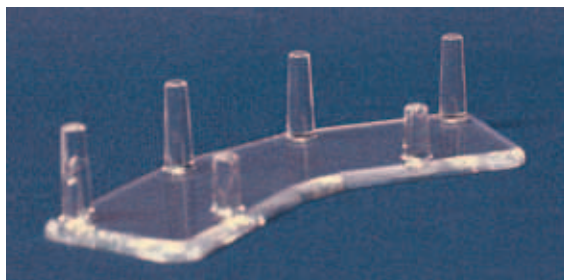

## Paired Halves Displays

This display is specially designed to highlight a split geode pair. These displays are sold in dozens; a discount is available for full boxes.

Product No.	H x W x D	Box Qty.
NX100	$\frac{7}{8} \times 4\frac{1}{2} \times 2$	144
NX300	$1\frac{1}{2} \times 8 \times 3\frac{1}{2}$	72

## Geode Triangles

Sold in dozens; a discount is available for full boxes of the #910 only.

Product No.	H x W x D	Box Qty.
910	$\frac{3}{4} \times 1\frac{1}{2} \times 1\frac{1}{4}$	288
911	$1 \times 2 \times 2\frac{3}{8}$	N/A
912	$1\frac{1}{4} \times 2\frac{1}{2} \times 3\frac{1}{4}$	N/A
913	$1\frac{3}{4} \times 3 \times 3\frac{3}{4}$	N/A
914	$2 \times 3\frac{3}{8} \times 4\frac{1}{2}$	N/A

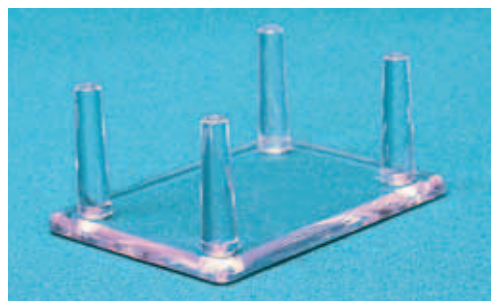

## Four-Peg Displays

Sold in dozens; a discount is available for full boxes.

Product No.	H x W x D	Box Qty.
N3400	$1\frac{1}{2} \times 3\frac{3}{8} \times 2\frac{1}{2}$	288
N4000	$1\frac{3}{4} \times 4\frac{1}{4} \times 3\frac{1}{2}$	144
N5000	$2\frac{1}{4} \times 6\frac{1}{4} \times 4\frac{1}{2}$	72
N4600	$1\frac{5}{8} \times 4 \times 4$	144

## SL Series Four-Peg Displays

The SL series features thinner legs for a more delicate look. Sold in dozens; a discount is available for full boxes.

Product No.	H x W x D	Box Qty.
SL4	$1\frac{1}{2} \times 3 \times 2$	288
SL6	$1\frac{3}{8} \times 3\frac{1}{2} \times 2\frac{1}{2}$	288

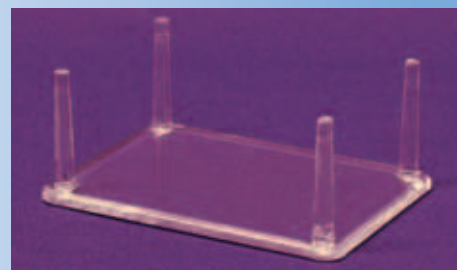

## SL Series Peg Triangles

Sold in dozens; a discount is available for full boxes.

Product No.	H x W x D	Box Qty.
SL3	$1 \times 1\frac{1}{2} \times 1\frac{1}{2}$	288
SL5	$1\frac{3}{8} \times 2\frac{1}{2} \times 2\frac{1}{2}$	288



# Mineral, Fossil, & Seashell Displays



## Lotus Triangles

Product No.	H x Dia.
921	1 <sup>1</sup> / <sub>4</sub> x 1 <sup>7</sup> / <sub>8</sub>
922	1 <sup>5</sup> / <sub>8</sub> x 2 <sup>3</sup> / <sub>8</sub>
923	2 x 3 <sup>1</sup> / <sub>4</sub>
924	2 <sup>1</sup> / <sub>4</sub> x 3 <sup>7</sup> / <sub>8</sub>

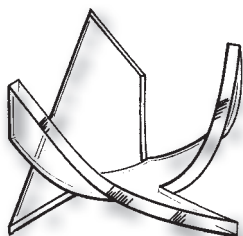

## Three-Peg Displays

These economical three-peg stands feature a half-height front peg. Sold in dozens; a discount is available for full boxes.

Product No.	H x W x D	Box Qty.
NG100	7 <sup>7</sup> / <sub>8</sub> x 2 x 1 <sup>1</sup> / <sub>2</sub>	288
NG200	1 x 2 <sup>1</sup> / <sub>2</sub> x 2	288
NG300	1 <sup>1</sup> / <sub>2</sub> x 3 <sup>3</sup> / <sub>8</sub> x 2 <sup>1</sup> / <sub>2</sub>	288
NG400	1 <sup>3</sup> / <sub>4</sub> x 4 <sup>1</sup> / <sub>4</sub> x 3 <sup>1</sup> / <sub>2</sub>	144
NG500	2 <sup>1</sup> / <sub>8</sub> x 6 x 4 <sup>1</sup> / <sub>2</sub>	72

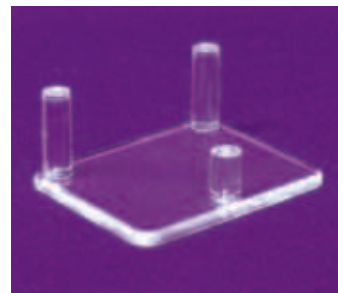

## Peg Triangles

Sold in dozens; a discount is available for full boxes.

Product No.	H x W x D	Box Qty.
SL35	1 x 1 <sup>1</sup> / <sub>2</sub> x 1 <sup>1</sup> / <sub>2</sub>	288
SL55	1 <sup>3</sup> / <sub>8</sub> x 2 <sup>1</sup> / <sub>2</sub> x 2 <sup>1</sup> / <sub>2</sub>	288

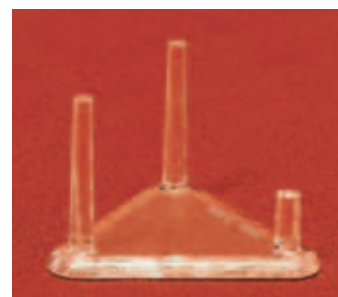

## Cradles

Product No.	H x W x D
22	1 <sup>1</sup> / <sub>2</sub> x 1 <sup>3</sup> / <sub>4</sub> x 1 <sup>3</sup> / <sub>4</sub>
23S	1 <sup>3</sup> / <sub>4</sub> x 2 x 2 <sup>3</sup> / <sub>8</sub>
33	1 <sup>3</sup> / <sub>4</sub> x 2 <sup>7</sup> / <sub>8</sub> x 2 <sup>3</sup> / <sub>8</sub>
34S	2 <sup>1</sup> / <sub>2</sub> x 2 <sup>7</sup> / <sub>8</sub> x 3
24	2 <sup>1</sup> / <sub>2</sub> x 3 <sup>7</sup> / <sub>8</sub> x 3
34L	1 <sup>3</sup> / <sub>4</sub> x 3 <sup>7</sup> / <sub>8</sub> x 2 <sup>3</sup> / <sub>8</sub>

## Low-Profile Cluster Displays

For clusters with or without matrix, this series of V-shaped easels makes it easy to display a variety of irregular shapes.

Product No.	H x W x D
VR1	1 <sup>3</sup> / <sub>4</sub> x 2 <sup>1</sup> / <sub>2</sub> x 2 <sup>1</sup> / <sub>2</sub>
VR2	1 <sup>3</sup> / <sub>4</sub> x 4 <sup>1</sup> / <sub>2</sub> x 4 <sup>1</sup> / <sub>2</sub>
VR3	2 <sup>3</sup> / <sub>4</sub> x 5 <sup>1</sup> / <sub>2</sub> x 5 <sup>1</sup> / <sub>2</sub>
VR4	3 <sup>3</sup> / <sub>4</sub> x 6 <sup>1</sup> / <sub>2</sub> x 6 <sup>1</sup> / <sub>2</sub>
VR5	4 <sup>3</sup> / <sub>4</sub> x 7 <sup>1</sup> / <sub>2</sub> x 7 <sup>1</sup> / <sub>2</sub>



## V-Cradles

For geodes or round-bottom pottery.

Product No.	H x W x D
C050	7 <sup>7</sup> / <sub>8</sub> x 2 x 1 <sup>1</sup> / <sub>2</sub>
C075	7 <sup>7</sup> / <sub>8</sub> x 2 x 1 <sup>1</sup> / <sub>2</sub>
C100	1 <sup>1</sup> / <sub>2</sub> x 3 <sup>1</sup> / <sub>4</sub> x 2 <sup>5</sup> / <sub>8</sub>
C200	1 <sup>7</sup> / <sub>8</sub> x 5 x 3 <sup>7</sup> / <sub>8</sub>
C300	2 <sup>5</sup> / <sub>8</sub> x 5 <sup>7</sup> / <sub>8</sub> x 4 <sup>1</sup> / <sub>2</sub>
C500	2 <sup>3</sup> / <sub>4</sub> x 7 <sup>3</sup> / <sub>4</sub> x 6 <sup>1</sup> / <sub>4</sub>



# Mineral, Fossil, & Seashell Displays



## Fossil Cradles

The angled piece of acrylic at the front of this display gives you a space to identify specimens or give collection information. The backless design is excellent for bones or clusters.

Product No.	Label Space	H x W x D
FC4	1 x 2	1 <sup>3</sup> / <sub>8</sub> x 4 x 2 <sup>3</sup> / <sub>4</sub>
FC6	1 <sup>1</sup> / <sub>2</sub> x 3 <sup>1</sup> / <sub>2</sub>	2 <sup>3</sup> / <sub>8</sub> x 6 <sup>1</sup> / <sub>8</sub> x 4 <sup>3</sup> / <sub>4</sub>
FC8	2 x 5	3 <sup>3</sup> / <sub>8</sub> x 8 x 6 <sup>3</sup> / <sub>4</sub>



## Clock Display

Create clocks from agate slabs, sand dollars, or other natural items with this clear acrylic clock stand. A standard battery clock motor stem fits into any one of the three holes.

Product No.	H x W x D
CL7	5 x 3 x 3



## Mirrored Displays

Reflect the back and the base of an interesting piece with this unique mirrored display. Available with or without pegs.

Product No.	Pegs	H x W x D
NGMR1	None	4 <sup>1</sup> / <sub>2</sub> x 4 <sup>1</sup> / <sub>2</sub> x 5
NGMR3 *	Three	4 <sup>1</sup> / <sub>2</sub> x 4 <sup>1</sup> / <sub>2</sub> x 5

\* Peg spacing is 2".



## Micro-Mount Boxes

The lid of this box has a built-in magnifying lens.

Product No.	H x W x D
MICRO1	1 x 1 x 1
MICRO2	1 <sup>1</sup> / <sub>2</sub> x 1 <sup>1</sup> / <sub>2</sub> x 1 <sup>1</sup> / <sub>2</sub>



## Perky Box

Product No.	H x W x D
PERK1	1 <sup>1</sup> / <sub>4</sub> x 1 <sup>1</sup> / <sub>4</sub> x 1 <sup>1</sup> / <sub>4</sub>

# Mineral, Fossil, & Seashell Displays

## BRASS AND ACRYLIC EASELS



**Adjustable Single-Post Back**

Product No.	Arm Length	Base	H
BPA1	1 <sup>1</sup> / <sub>4</sub>	1 <sup>3</sup> / <sub>4</sub> x 1 <sup>3</sup> / <sub>4</sub>	2 <sup>3</sup> / <sub>4</sub>
BPA2	1 <sup>5</sup> / <sub>8</sub>	2 <sup>1</sup> / <sub>2</sub> x 2 <sup>1</sup> / <sub>2</sub>	3 <sup>1</sup> / <sub>2</sub>
BPA3	2	2 <sup>1</sup> / <sub>2</sub> x 2 <sup>1</sup> / <sub>2</sub>	3 <sup>1</sup> / <sub>2</sub>
BPA4	2 <sup>3</sup> / <sub>8</sub>	3 <sup>1</sup> / <sub>4</sub> x 3 <sup>1</sup> / <sub>4</sub>	3 <sup>3</sup> / <sub>4</sub>
BPA5	2 <sup>1</sup> / <sub>2</sub>	3 <sup>1</sup> / <sub>4</sub> x 3 <sup>1</sup> / <sub>4</sub>	3 <sup>3</sup> / <sub>4</sub>
BPA6	3	3 <sup>1</sup> / <sub>2</sub> x 3 <sup>1</sup> / <sub>2</sub>	4 <sup>1</sup> / <sub>4</sub>



**Adjustable Round Back**

Product No.	Arm Length	Base	H
BPR05	1 <sup>1</sup> / <sub>2</sub>	3 <sup>1</sup> / <sub>8</sub> x 2 <sup>1</sup> / <sub>2</sub>	4 <sup>1</sup> / <sub>8</sub>
BPR1	1 <sup>1</sup> / <sub>2</sub>	4 x 3	3 <sup>5</sup> / <sub>8</sub>
BPR2	2 <sup>1</sup> / <sub>4</sub>	5 x 4	5
BPR3	3 <sup>1</sup> / <sub>2</sub>	7 x 5	6 <sup>1</sup> / <sub>2</sub>

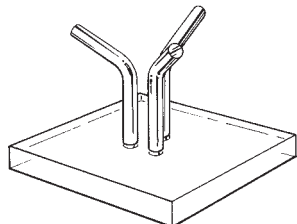

### Tri-Pegs

For spheres, geodes or clusters.

Product No.	H x W x D
BPT1	2 x 2 x 1 <sup>1</sup> / <sub>2</sub>
BPT2	3 x 3 x 2
BPT3	4 x 4 x 2 <sup>1</sup> / <sub>2</sub>

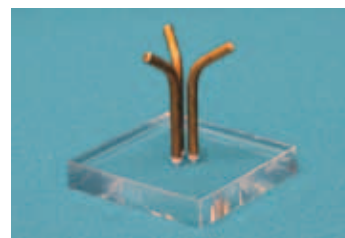

## SEASHELL DISPLAYS



### Tapered-Cup Nautilus Easels

These tapered cup displays securely hold nautilus shells in a natural position.

Product No.	Shell Size	H x W x D
FL1	Less than 5"	1 <sup>5</sup> / <sub>8</sub> x 2 <sup>3</sup> / <sub>8</sub> x 2 <sup>5</sup> / <sub>8</sub>
FL2	5" to 7"	2 <sup>3</sup> / <sub>8</sub> x 2 <sup>3</sup> / <sub>4</sub> x 3 <sup>5</sup> / <sub>8</sub>
FL3	7"+	2 <sup>3</sup> / <sub>4</sub> x 3 <sup>7</sup> / <sub>8</sub> x 4 <sup>5</sup> / <sub>8</sub>



### Lighted Shell Displays

Designed for sea urchins and other shells, these bases are suitable for illuminating any hollow, translucent item. Six-foot cord with in-line switch and 7-watt bulb included.

Product No.	H x W x D
72L	3 <sup>1</sup> / <sub>4</sub> x 3 x 3
SE103	3 <sup>1</sup> / <sub>4</sub> x 3 <sup>1</sup> / <sub>2</sub> x 3 <sup>1</sup> / <sub>2</sub>

# Egg & Sphere Displays

## TRIPOD STYLE DISPLAYS



### Three-Prong Tulip Stands

Our injection-molded tulip stands are available in three sizes. Box quantity discounts are available.

Product No.	H x Dia.	Box Qty.
161	1 $\frac{1}{2}$ x 2	288
162	1 $\frac{7}{8}$ x 2 $\frac{1}{2}$	288
163	2 $\frac{1}{8}$ x 3	288



### Acrylic Tri-Rods

Solid acrylic rods form a simple, elegant sphere display.

Product No.	H x Dia.
AR1	1 $\frac{1}{2}$ x 1 $\frac{1}{4}$
AR3	2 x 1 $\frac{1}{2}$
AR5	2 $\frac{1}{2}$ x 2

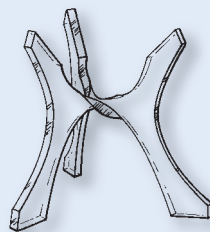

### Triple Twisters

The unique center-twist design of these acrylic tripods gives them a delicate look.

Product No.	H x Dia.
TT11	1 $\frac{1}{4}$ x 1 $\frac{1}{4}$
TT12	2 x 1 $\frac{3}{4}$
TT13	2 $\frac{3}{4}$ x 2 $\frac{1}{2}$
TT14	3 $\frac{3}{8}$ x 3
TT21	4 x 3 $\frac{1}{4}$
TT22	4 $\frac{3}{4}$ x 3 $\frac{1}{2}$



### Deluxe Tulip Displays

Deluxe styles of the three-prong displays are handmade, laser-cut, polished acrylic.

Product No.	H x Dia.
160	1 $\frac{3}{8}$ x 1 $\frac{3}{4}$
164	2 $\frac{1}{2}$ x 4
165	3 x 5
167	3 $\frac{3}{4}$ x 6



### Acrylic Tri-Rods with Bases

Product No.	H x W x D
ARB7	2 $\frac{3}{8}$ x 3 $\frac{1}{4}$ x 2 $\frac{3}{4}$
ARB9	2 $\frac{7}{8}$ x 5 x 4 $\frac{3}{8}$

# Egg & Sphere Displays

## DIMPLE BLOCKS

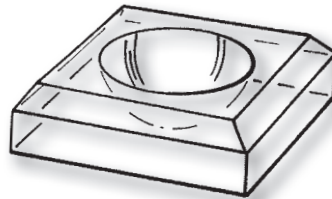

### Square Dimple Blocks

These blocks feature a rounded indentation to hold a sphere or egg. Available in many different sizes and thicknesses, and in clear or black acrylic. All have beveled edges and are polished throughout.

Product No.	Finish	Dimple Dia.	H x W x D	Product No.	Finish	Dimple Dia.	H x W x D
541	Clear	1/2	1/4 x 7/8 x 7/8	590	Clear	1 1/2	3/4 x 2 x 2
541B	Black	1/2	1/4 x 7/8 x 7/8	590B	Black	1 1/2	3/4 x 2 x 2
561	Clear	3/4	3/8 x 1 1/4 x 1 1/4	591	Clear	1 1/2	3/4 x 3 x 3
561B	Black	3/4	3/8 x 1 1/4 x 1 1/4	591B	Black	1 1/2	3/4 x 3 x 3
581	Clear	7/8	1/2 x 1 1/2 x 1 1/2	592	Clear	1 7/8	3/4 x 3 1/2 x 3 1/2
581B	Black	7/8	1/2 x 1 1/2 x 1 1/2	592B	Black	1 7/8	3/4 x 3 1/2 x 3 1/2
582	Clear	1 1/8	1/2 x 2 x 2				
582B	Black	1 1/8	1/2 x 2 x 2				

### Round Dimple Blocks

Sold by the dozen.

Product No.	Finish	Dimple Dia.	H x Dia.
551	Clear	1 3/16	1/2 x 2
551B	Black	1 3/16	1/2 x 2
552	Clear	1 1/2	3/4 x 3
552B	Black	1 1/2	3/4 x 3



### Inch-Thick Dimple Blocks

An elegant display option in highly polished clear acrylic.

Product No.	Dimple Dia.	H x Dia.
571	7/8	1 x 1 1/2 x 1 1/2
572	1 1/8	1 x 2 1/2 x 2 1/2

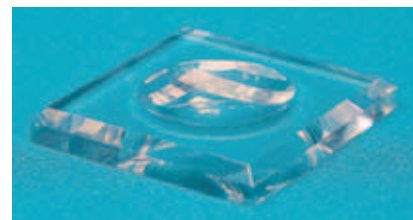

### Large Dimple Blocks

In half-inch and three-quarter inch thicknesses, all polished clear acrylic.

Product No.	Dimple Dia.	H x W x D
583	2	1/2 x 3 1/2 x 3 1/2
593	2 1/2	3/4 x 3 1/2 x 3 1/2
594	2 1/2	3/4 x 4 x 4

# Egg & Sphere Displays



## Molded Display Rings

Display everything from marbles to bowling balls on our ring-shaped displays. Sold in dozens; a discount is available for full boxes.

Product No.	Finish	H x Dia.	Box Qty.
005	Clear	1/4 x 5/8	288
005B	Black	1/4 x 5/8	288
01	Clear	1/2 x 1	288
01B	Black	1/2 x 1	288
015	Clear	3/4 x 1 1/4	288
015B	Black	3/4 x 1 1/4	288
03	Clear	1 x 1 5/8	288
03B	Black	1 x 1 5/8	288

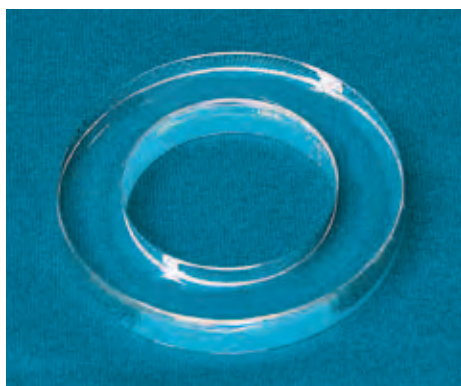

## Low-Profile Sphere Ring

A very unobtrusive way to display spheres, these laser-cut, polished rings will hold spheres 7/8" to 6 3/4" in diameter.

Product No.	Thickness	Inside /Outside Dia.
101	3/16	3/4 / 1 1/4
102	3/16	1 1/4 / 1 3/4
103	1/4	3/4 / 1 1/2
104	1/4	1 1/2 / 2 1/2
105	3/8	1 1/2 / 2 1/2
106	3/8	2 1/2 / 3 1/2
107	3/8	3 1/2 / 5



## Handmade Acrylic Rings with Bevel

These are also useful for showing shallow pottery bowls.

Product No.	H x Dia.	Product No.	H x Dia.
035	1 x 2	08	1 3/4 x 5
04	1 x 2 1/2	09	2 x 6
05	1 1/4 x 3	095	2 1/2 x 7
06	1 1/4 x 3 1/2	010	3 x 8
07	1 1/2 x 4	011	3 x 10



## Half-Height Ring

Half the height of the #03 ring. Sold in dozens; a discount is available for full boxes.

Product No.	Finish	H x Dia.	Box Qty.
03R	Clear	1/2 x 1 5/8	288



## Reversible Cone

This reversible cone has a 3/4" top and 1 1/4" bottom and can be inverted. Sold in dozens; a discount is available for full boxes.

Product No.	Finish	H x Dia.	Box Qty.
02	Clear	3/4 x 1 1/4	288
02B	Black	3/4 x 1 1/4	288

# Egg & Sphere Displays

## Reversible Three-Leg Displays

Use the hole on top of these displays to show an egg or sphere, or turn the display over for larger items.

Product No.	H x Dia.
71	$\frac{3}{4} \times 2$
715	$1 \times 2\frac{1}{2}$
72	$1\frac{1}{4} \times 3\frac{1}{2}$
73	$1\frac{5}{8} \times 4\frac{1}{2}$
74	$1\frac{3}{4} \times 5\frac{1}{2}$
75	$2\frac{1}{8} \times 6\frac{1}{2}$

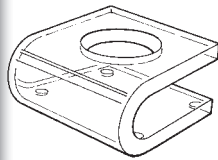
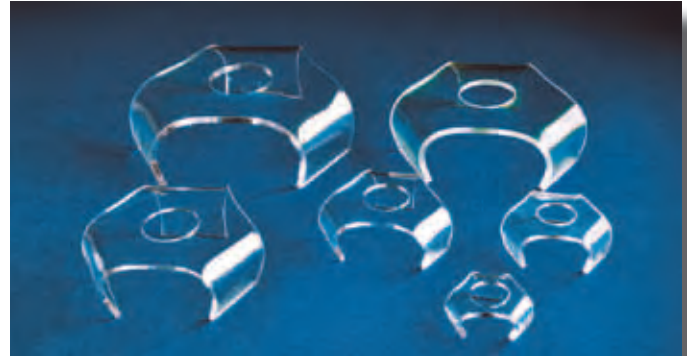

## Sphere Risers

This style sphere display is made of  $\frac{3}{8}$ "-thick acrylic and is polished throughout. For spheres up to  $2\frac{3}{8}$ " in diameter.

Product No.	H x W x D
FOH1	$1\frac{3}{4} \times 3 \times 3\frac{1}{4}$



## Revolving Walnut Dimple Bases

A built-in ball-bearing spinner allows you to turn this walnut base.

Product No.	Dimple Dia.	H x Dia.
WNSD3	$1\frac{1}{2}$	$1\frac{1}{8} \times 3\frac{1}{8}$
WNSD4	2	$1\frac{1}{8} \times 4$
WNSD5	$2\frac{1}{2}$	$1\frac{1}{8} \times 5$



## Marble Display

Three  $3\frac{1}{2}$ "-diameter shelves fit inside a glass dome with twenty-one  $\frac{5}{8}$ " diameter holes to display marbles. Dome and walnut base are included.

Product No.	H x Dia.
MBL1	$7\frac{1}{2} \times 4$



## Egg and Sphere Stairs

Twelve  $1\frac{1}{4}$ "-diameter holes on these display stairs hold eggs or spheres up to 2" in diameter. Available in clear or black.

Product No.	Finish	H x W x D
HB8	Clear	$9\frac{1}{8} \times 8\frac{3}{4} \times 6\frac{1}{2}$
HB8B	Black	$9\frac{1}{8} \times 8\frac{3}{4} \times 6\frac{1}{2}$



# Display Blocks and Bases

*A base is often the important finishing touch for a collectible or item of merchandise. Many companies use bases to permanently mount their products, such as minerals, fossils or seashells, or temporarily mount special items. (See the end of this chapter for adhesive and mounting tack.) A base can give a piece a finished look or call attention to its uniqueness. Rough-edged items may benefit from a base. You can create a grouping of several items on a single base and bases of various heights can create interesting arrangements.*



## Extra-Large Acrylic Blocks 3" and 4" thick

Product No.	H x W x D
F44	4 x 4 x 4
F64	4 x 6 x 6
F84	4 x 8 x 8
F844	4 x 4 x 8
F1244	4 x 4 x 12
F33	3 x 3 x 3
F35	3 x 3 x 4
F36	3 x 3 x 6

## Large Acrylic Blocks

### 1" thick:

Product No.	H x W x D
F21	1 x 2 x 2
F31	1 x 3 x 3
F41	1 x 4 x 4
F51	1 x 5 x 5
F61	1 x 6 x 6
F81	1 x 8 x 8
F101	1 x 10 x 10

### 1 1/2" thick:

Product No.	H x W x D
F1515	1 1/2 x 1 1/2 x 1 1/2
F153	1 1/2 x 1 1/2 x 3
F315	1 1/2 x 3 x 3
F415	1 1/2 x 4 x 4
F515	1 1/2 x 5 x 5
F615	1 1/2 x 6 x 6
F815	1 1/2 x 8 x 8

### 2" thick:

Product No.	H x W x D
F22	2 x 2 x 2
F23	2 x 2 x 3
F24	2 x 2 x 4
F25	2 x 2 x 5
F26	2 x 2 x 6
F32	2 x 3 x 3
F42	2 x 4 x 4
F62	2 x 6 x 6
F82	2 x 8 x 8

*Highly polished, crystal clear bases. You may also order most of our clear acrylic blocks and bases with a frosted finish. The price is the same, but you need to indicate your choice by adding an "F" to the item number (for example, #F44F).*



## Solid Acrylic Columns

Product No.	H x Diameter
CR11	1 1/2 x 1 1/2
CR12	3 x 1 1/2
CR13	4 1/2 x 1 1/2
CR21	1 1/2 x 2
CR22	3 x 2
CR23	4 1/2 x 2
CR31	1 1/2 x 2 1/2
CR32	3 x 2 1/2
CR33	4 1/2 x 2 1/2

## Beveled Round Bases

Product No.	H x Diameter
BR31	1 x 3
BR51	1 x 5
BR71	1 x 7
BR91	1 x 9

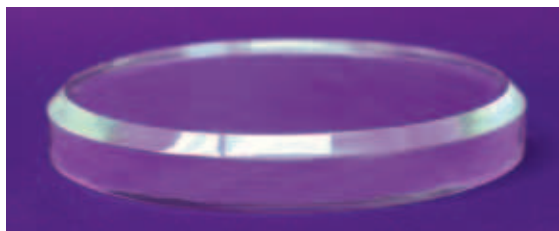
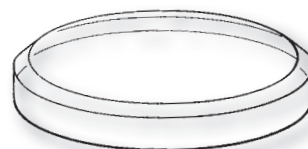

# Display Blocks and Bases

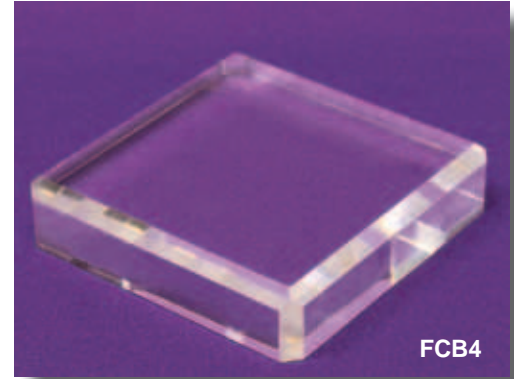
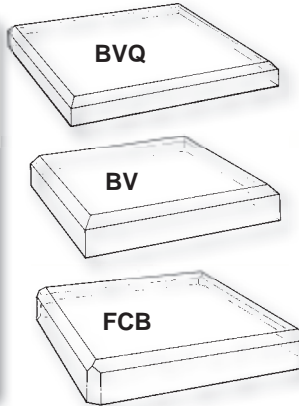
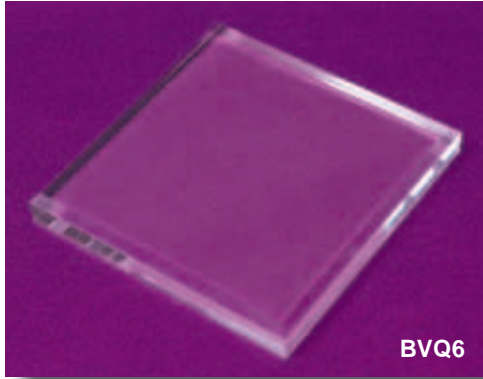

## Top-Beveled Bases

Product No.	$\frac{1}{2}$ " thick	
	Finish	H x W x D
BVQ1	Clear	$\frac{1}{2} \times \frac{1}{2} \times \frac{1}{2}$
BVQ1B	Black	$\frac{1}{2} \times \frac{1}{2} \times \frac{1}{2}$
BVQ2	Clear	$\frac{1}{2} \times 2 \times 2$
BVQ2B	Black	$\frac{1}{2} \times 2 \times 2$
BVQ3	Clear	$\frac{1}{2} \times 3 \times 3$
BVQ3B	Black	$\frac{1}{2} \times 3 \times 3$
BVQ4	Clear	$\frac{1}{2} \times 4 \times 4$
BVQ4B	Black	$\frac{1}{2} \times 4 \times 4$
BVQ5	Clear	$\frac{1}{2} \times 5 \times 5$
BVQ5B	Black	$\frac{1}{2} \times 5 \times 5$
BVQ6	Clear	$\frac{1}{2} \times 6 \times 6$
BVQ6B	Black	$\frac{1}{2} \times 6 \times 6$
BVQ7	Clear	$\frac{1}{2} \times 7 \times 7$
BVQ7B	Black	$\frac{1}{2} \times 7 \times 7$
BVQ8	Clear	$\frac{1}{2} \times 8 \times 8$
BVQ8B	Black	$\frac{1}{2} \times 8 \times 8$
BVQ9	Clear	$\frac{1}{2} \times 9 \times 9$
BVQ9B	Black	$\frac{1}{2} \times 9 \times 9$
BVQ10	Clear	$\frac{1}{2} \times 10 \times 10$
BVQ10B	Black	$\frac{1}{2} \times 10 \times 10$
BVQ24	Clear	$\frac{1}{2} \times 4 \times 2$
BVQ24B	Black	$\frac{1}{2} \times 4 \times 2$
BVQ36	Clear	$\frac{1}{2} \times 6 \times 3$
BVQ36B	Black	$\frac{1}{2} \times 6 \times 3$
BVQ46	Clear	$\frac{1}{2} \times 6 \times 4$
BVQ46B	Black	$\frac{1}{2} \times 6 \times 4$
BVQ68	Clear	$\frac{1}{2} \times 8 \times 6$
BVQ68B	Black	$\frac{1}{2} \times 8 \times 6$

Bases that are  $\frac{3}{4}$ " thick or less (except economy bases) come with four clear, stick-on feet, so you can choose to attach them or not. We also sell the clear, stick-on feet separately. (Please see the last page of this chapter.)

Product No.	$\frac{3}{4}$ " thick	
	Finish	H x W x D
BV2	Clear	$\frac{3}{4} \times 2 \times 2$
BV2B	Black	$\frac{3}{4} \times 2 \times 2$
BV3	Clear	$\frac{3}{4} \times 3 \times 3$
BV3B	Black	$\frac{3}{4} \times 3 \times 3$
BV4	Clear	$\frac{3}{4} \times 4 \times 4$
BV4B	Black	$\frac{3}{4} \times 4 \times 4$
BV5	Clear	$\frac{3}{4} \times 5 \times 5$
BV5B	Black	$\frac{3}{4} \times 5 \times 5$
BV6	Clear	$\frac{3}{4} \times 6 \times 6$
BV6B	Black	$\frac{3}{4} \times 6 \times 6$
BV7	Clear	$\frac{3}{4} \times 7 \times 7$
BV7B	Black	$\frac{3}{4} \times 7 \times 7$
BV8	Clear	$\frac{3}{4} \times 8 \times 8$
BV8B	Black	$\frac{3}{4} \times 8 \times 8$
BV9	Clear	$\frac{3}{4} \times 9 \times 9$
BV9B	Black	$\frac{3}{4} \times 9 \times 9$
BV10	Clear	$\frac{3}{4} \times 10 \times 10$
BV10B	Black	$\frac{3}{4} \times 10 \times 10$
BV24	Clear	$\frac{3}{4} \times 4 \times 2$
BV24B	Black	$\frac{3}{4} \times 4 \times 2$
BV36	Clear	$\frac{3}{4} \times 6 \times 3$
BV36B	Black	$\frac{3}{4} \times 6 \times 3$
BV46	Clear	$\frac{3}{4} \times 6 \times 4$
BV46B	Black	$\frac{3}{4} \times 6 \times 4$
BV68	Clear	$\frac{3}{4} \times 8 \times 6$
BV68B	Black	$\frac{3}{4} \times 8 \times 6$

Product No.	1" thick	
	Finish	H x W x D
FCB2	Clear	1 x 2 x 2
FCB3	Clear	1 x 3 x 3
FCB4	Clear	1 x 4 x 4
FCB5	Clear	1 x 5 x 5
FCB6	Clear	1 x 6 x 6
FCB8	Clear	1 x 8 x 8
FCB10	Clear	1 x 10 x 10

# Display Blocks and Bases

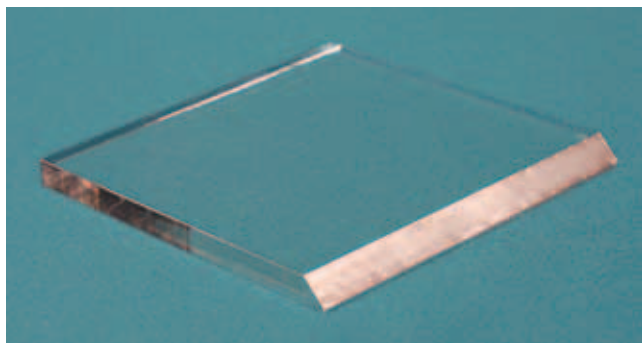

## Label Bases

The angled area on the front of these bases is for an identifying label or plaque. Label space is  $\frac{3}{8}$ " high.

Product No.	Finish	H x W x D
KF2	Clear	$\frac{3}{8}$ x 2
KF2B	Black	$\frac{3}{8}$ x 2
KF3	Clear	$\frac{3}{8}$ x 3
KF3B	Black	$\frac{3}{8}$ x 3
KF4	Clear	$\frac{3}{8}$ x 4
KF4B	Black	$\frac{3}{8}$ x 4
KF5	Clear	$\frac{3}{8}$ x 5
KF5B	Black	$\frac{3}{8}$ x 5



## Economy Bases

Saw-cut polished edges,  $\frac{1}{4}$ "-thick. Shipped with paper masking to prevent scratching. No feet included. Not available in frosted.

Product No.	H x W x D	Product No.	H x W x D
PB1	$\frac{1}{4}$ x $1\frac{1}{4}$ x $1\frac{1}{4}$	PB3.5	$\frac{1}{4}$ x $3\frac{1}{2}$ x $3\frac{1}{2}$
PB1.5	$\frac{1}{4}$ x $1\frac{1}{2}$ x $1\frac{1}{2}$	PB4	$\frac{1}{4}$ x 4 x 4
PB2	$\frac{1}{4}$ x 2 x 2	PB153	$\frac{1}{4}$ x 3 x $1\frac{1}{2}$
PB2.5	$\frac{1}{4}$ x $2\frac{1}{2}$ x $2\frac{1}{2}$	PB24	$\frac{1}{4}$ x 4 x 2
PB3	$\frac{1}{4}$ x 3 x 3		



## Deluxe $\frac{1}{4}$ " Economy Bases

Smooth polished edges,  $\frac{1}{4}$ " thick. Shipped with paper masking to prevent scratching. No feet included. Not available in frosted.

Product No.	H x W x D	Product No.	H x W x D
PBD2	$\frac{1}{4}$ x 2 x 2	PBD6	$\frac{1}{4}$ x 6 x 6
PBD3	$\frac{1}{4}$ x 3 x 3	PBD68	$\frac{1}{4}$ x 8 x 6
PBD4	$\frac{1}{4}$ x 4 x 4	PBD7	$\frac{1}{4}$ x 7 x 7
PBD5	$\frac{1}{4}$ x 5 x 5	PBD8	$\frac{1}{4}$ x 8 x 8
PBD24	$\frac{1}{4}$ x 4 x 2	PBD9	$\frac{1}{4}$ x 9 x 9
PBD36	$\frac{1}{4}$ x 6 x 3	PBD10	$\frac{1}{4}$ x 10 x 10
PBD46	$\frac{1}{4}$ x 6 x 4		



## Round Economy Bases

Shipped with paper masking to prevent scratching. No feet included. Not available in frosted.

$\frac{1}{4}$ " Thick		$\frac{3}{8}$ " Thick	
Product No.	Diameter	Product No.	Diameter
POB1	1	POB22	2
POB1.5	$1\frac{1}{2}$	POB33	3
POB2	2	POB44	4
POB2.5	$2\frac{1}{2}$	POB55	5
POB3	3		
POB4	4		

# Display Blocks and Bases

## SOLID WALNUT BASES



### Square Bases

Product No.	H x W x D
WBS04	$\frac{3}{4}$ x 4 x 4
WBS1	$\frac{3}{4}$ x 6 x 6
WBS2	$\frac{3}{4}$ x 8 x 8
WBS3	$\frac{3}{4}$ x 10 x 10
WBS4	$\frac{3}{4}$ x 12 x 12

### Rectangular Bases

Product No.	H x W x D
WBS64	$\frac{3}{4}$ x 6 x 4
WBS93	$\frac{3}{4}$ x 9 x $3\frac{1}{2}$
WBS96	$\frac{3}{4}$ x 9 x 6
WBS105	$\frac{3}{4}$ x 10 x 5
WBS126	$\frac{3}{4}$ x 12 x 6
WBS128	$\frac{3}{4}$ x 12 x 8
WBS1610	$\frac{3}{4}$ x 16 x 10
WBS2012	$\frac{3}{4}$ x 20 x 12

### Round Bases

Product No.	H x Dia.
WBR05	$\frac{3}{4}$ x $1\frac{1}{8}$
WBR1	$\frac{3}{4}$ x 3
WBR2	$\frac{3}{4}$ x 4
WBR25	$\frac{3}{4}$ x $4\frac{1}{2}$
WBR3	$\frac{3}{4}$ x $5\frac{1}{2}$
WBR4	$\frac{3}{4}$ x 8

Walnut Bases  
Mounting Products

## MOUNTING PRODUCTS

### Adhesive

For permanent mounting of most materials to acrylic, this clear adhesive provides a very strong bond.

Product No.	Description
EX6000	3.7 ounce tube



### Mounting Tack

For non-permanent mounting of items, such as gems or mineral specimens, position them on acrylic bases with this white clay-like tack.

Product No.	Description
WXMT	3 ounces



### Clear, Stick-on Feet

Protect blocks or bases from scratching or sliding with these self-adhesive, non-skid, clear stick-on feet. Easy to apply.

Product No.	H x Dia.
BMP1	$\frac{1}{16}$ x $\frac{3}{8}$
BMP2	$\frac{1}{8}$ x $\frac{1}{2}$



# Eyewear Displays



OSD4V



OSD3

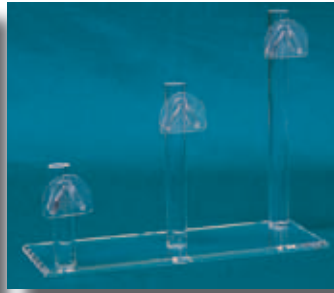

OSD3X

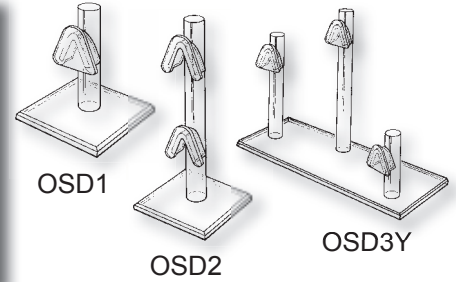

OSD1

OSD2

OSD3Y

## Saddle-Type Frame Rests

These eyewear frame rests are on acrylic rods with 1/4" thick beveled acrylic bases.

Product No.	# Rests	Rest Heights	Base	Product No.	# Rests	Rest Heights	Base
OSD1	One	3 1/4	3 x 3	OSD3Y	Three	3, 7, 5	9 x 3
OSD2	Two	6 1/4	3 x 3	OSD3X	Three	3, 5, 7	9 x 3
OSD3	Three	9 1/4	3 x 3	OSD4V	Four	2, 4, 6, 8	9 x 3
OSD3D	Three	3, 5, 7	3 x 9				

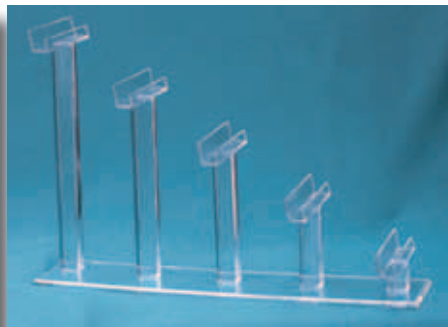

## J-Shelf Frame Rests

J-style shelves on square rods and acrylic bases are available in single and multiple frame styles.

Product No.	# Rests	Rest Heights
OSJ1	One	4
OSJ2	One	6
OSJ3	One	8
OSJ3D	Three	4, 6, 8
OSJ4D	Four	2, 4, 6, 8
OSJ5D	Five	2, 4, 6, 8, 10

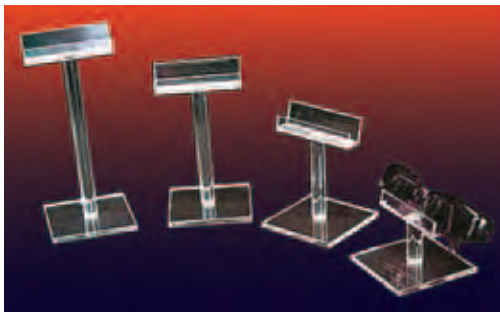

## Single-Frame Rests

Product No.	H x W x D
950-1575	2 5/8 x 3 x 3
950-1576	4 x 3 x 3
950-1577	5 1/2 x 3 x 3
950-1578	7 1/2 x 3 x 3
950-1579	Set of all 4

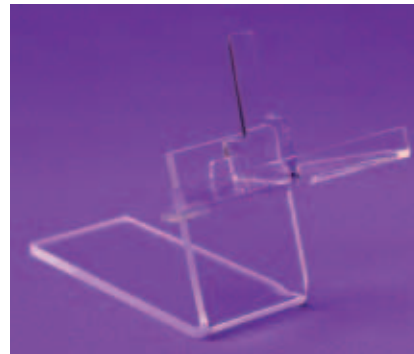

## Bar Frame Rests

Product No.	# Rests	H x W x D
ORD1	One	3 3/4 x 3 1/2 x 5 1/4
ORD2	Two	6 1/4 x 3 1/2 x 5 1/4
ORD3	Three	9 x 3 1/2 x 5 1/4
ORD4	Four	11 1/2 x 3 1/2 x 5 1/4

# Eyewear Displays



## Six-Frame Displays

Freestanding displays for six eyewear frames;  $5\frac{3}{16}$ " between holes. Available in clear or white acrylic.

Product No.	Finish	H x W x D
OMH6	Clear	17 x 7 x $5\frac{1}{4}$
OMH6W	White	17 x 7 x $5\frac{1}{4}$



## Eyewear Tower

Interlocking pieces of  $\frac{1}{8}$ "-thick acrylic create a countertop display for 15 eyewear frames. Available in clear or white acrylic.

Product No.	Finish	H x W x D
OSY1	Clear	24 x $5\frac{3}{4}$ x $5\frac{3}{4}$
OSY1W	White	24 x $5\frac{3}{4}$ x $5\frac{3}{4}$

OSY1W



## Wall Mount Frame Display

Wall mounting pocket rack will hold seven eyewear frames and is available with or without a locking door. Locking style includes a cam lock and two keys.

Product No.	Style	H x W x D
OWP1	Open	23 x $6\frac{1}{4}$ x 3
OWP1L	Locking	23 x $6\frac{1}{4}$ x 3

OWP1

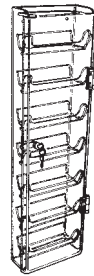

OWP1L



## White Acrylic Frame Display

Center nosepiece rests allows frames to be displayed in an open position. Top is accentuated with acrylic mirrors.  $5\frac{3}{16}$ " width between holes.

Product No.	# Frames	H x W x D
OFN1	24	22 x 14 x 14

## Revolving Frame Displays



OFM22



OMH22

This 22-frame display combines frosted acrylic material and frame saddles with mirrors on top. Rotates on lazy-Susan base.

Product No.	# Frames	H x W x D
OFM22	22	21 $\frac{1}{2}$ x 8 x 8

Acrylic mirrors border the top of this white acrylic display on a white lazy-Susan base.  $5\frac{3}{16}$ " width between holes.

Product No.	# Frames	H x W x D
OMH22	22	21 $\frac{1}{2}$ x 12 x 12



OPS

## Pocket-Shelf Display

Display 28 frames on this four-sided clear acrylic pocket style turner on a lazy-Susan base. Locking style includes cam locks and keys.

Product No.	Style	H x W x D
OPS	Open	24 x 10 x 10
OPSL	Locking	24 x 10 x 10

Multi-Frame Displays

# Light Bases & Turntables

*Lighting transforms clear or translucent items into attention-getting merchandise. Glassware, crystalware, paperweights, glass or crystal figures, mineral carvings and glass spheres are just some of the things that you can highlight with one of our lighted display bases.*



LB1



LB4

## Small Light Boxes

Our 4"-square light box has a slightly textured plastic surface and is available with a variety of different acrylic tops. All come packaged and assembled with a 6-foot cord with an in-line switch and 7-watt bulb. The height of the box is 1<sup>3</sup>/<sub>4</sub>". 110 volt.

Product No.	Description
LB1	No hole/translucent white
LB2	1 <sup>1</sup> / <sub>4</sub> " hole/black
LB3	1 <sup>1</sup> / <sub>4</sub> " hole/bronze mirror
LB4	1 <sup>1</sup> / <sub>4</sub> " hole/translucent white
LB5	1 <sup>1</sup> / <sub>4</sub> " hole/chrome mirror

All of the four-inch-square light boxes are also available with a 220-volt cord and bulb. To order, add an "E" to the product number. For example, LB2E.

All of our small light boxes come with a 7-watt bulb. If colored light is desired, just substitute your own 7-watt "Christmas tree" bulb.

## Walnut Lighted Base

This wooden lighted display features quality one-piece construction with rounded edges. It comes with a 7-watt bulb and 6-foot cord with in-line switch. Center hole is 1<sup>1</sup>/<sub>4</sub>" diameter.

Product No.	H x W x D
LB2WD	1 <sup>3</sup> / <sub>4</sub> x 4 x 4



## Large Light Boxes

For greater illumination than the 4"-square light boxes, our 6<sup>1</sup>/<sub>2</sub>"-square light box has a special low-heat bulb that has a brightness equivalent to 75 watts. Each of the four different styles has a smooth black 3"-high acrylic base.

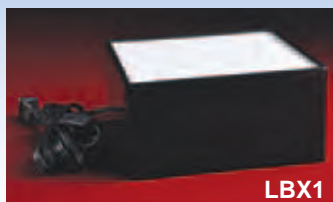

LBX1

Product No.	Description
LBX1	No hole/translucent white
LBX2	2 <sup>1</sup> / <sub>2</sub> " hole/black
LBX4	2 <sup>1</sup> / <sub>2</sub> " hole/translucent white
LBX5	2 <sup>1</sup> / <sub>2</sub> " hole/chrome mirror



LBX2

# Light Bases & Turntables

## Large Turntables

The 6½"-square turntable is 3½" high and made of all smooth black acrylic. The top is 5½" in diameter, holds up to 25 pounds and revolves at 1 rpm. Fully assembled with 6-foot cord with in-line switch.

Product No.

TNX6



## Compact Turntables

This compact electric turntable is 4" square and 2¼" high. The box is a slightly textured black plastic and the top is a smooth black acrylic. The top revolves at 4 rpm and holds up to 8 pounds. Fully assembled with 6-foot cord with in-line switch.

Product No.

TN1



Add a mirrored accent to our turntables with a beveled glass mirror top. Order separately.

Product No.

Diameter

MR4

4

MR6

6

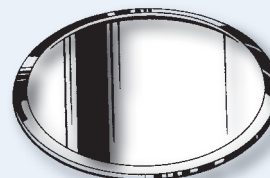

Combine light and motion with this 6½"-square lighted turntable made of all smooth black acrylic. Light comes through a 1¾" center hole in the 5½"-diameter top. Revolves at 1 rpm and has a weight capacity of 25 pounds. The light source is a special low-heat bulb with a brightness equivalent to 75 watts. Available for 110 volt only.



## Rotator with White Light

Product No.

LBTX6

H x W x D

3½ x 6½ x 6½



## Three-Step Lighted Stair Display

A low-heat bulb with a brightness equivalent to 75 watts glows through translucent white steps. The sides are black acrylic and there is a solid, slide-up back. Shipped fully assembled.

Product No.

ST9CL

H x W x D

12½ x 18¼ x 12½

Stair Depth

4



# Light Bases & Turntables

## LIGHTING ACCESSORIES



EXZ



EXW5

### White Light Cords

Six-foot white cords with an in-line switch. Available with a two-part locknut ring or a snap-in metal clip.

Product No.	Socket Style
EXZ	Two-part locknut ring
EXW5	Snap-in black metal clip



### Black Light Cord

Six-foot black cord with in-line switch and metal clip on the socket.

Product No.	Socket Style
EXB	110 volt; snap-in metal clip



EX20

EXH

EX13Q

EX4,7

### Replacement Light Bulbs

Product No.	Description
EX4	110 volt, 4-watt
EX7	110 volt, 7-watt
EXE	220 volt, 7-watt
EX13Q	110 volt, 13-watt low heat
EX20	110 volt, 20-watt
EXH	110 volt, 20-watt halogen bulb

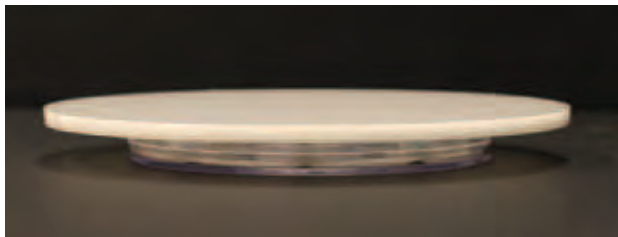

### Revolving Platforms

All these single platforms on lazy-Susan bases are  $\frac{3}{4}$ " high. Available in white or black acrylic.

Product No.	Finish	Diameter
RTW6	White	6
RTW6B	Black	6
RTW8	White	8
RTW8B	Black	8
RTW10	White	10
RTW10B	Black	10



### Body Outline

Made of durable PETG material, this outline features a hook for easy hanging and versatile strap cutouts. In two sizes to accommodate women and children's clothes.

<u>Product No.</u>	<u>Dimensions</u>
BOL1808	18 high, 8 waist
BOL2810	28 high, 10 waist



### Shirt Folding Boards

This 1/8"-thick acrylic board is a handy tool for quickly and neatly folding shirts for display. Just fold a shirt around the board and slip it out using the hand slot. In small, medium and large sizes.

<u>Product No.</u>	<u>H x W</u>
SB1285	12 x 8 1/2
SB1210	12 x 10
SB1211	12 x 11



### Countertop Belt Display

Side cutouts will display 6 belts up to 2" wide.

<u>Product No.</u>	<u>H x W x D</u>
BELT15	15 x 13 1/2 x 6

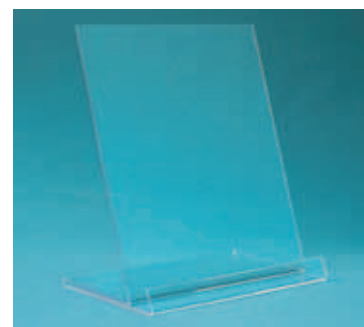

### Single Folded-Shirt Display

A 1" front lip holds a packaged or folded shirt.

<u>Product No.</u>	<u>H x W x D</u>
CE11	11 1/4 x 10 x 6 1/4

### Headband/Scarf Countertop Displays

Two styles to choose from—either one will make a great presentation of your merchandise.

<u>Product No.</u>	<u>Style</u>	<u>H x W x D</u>
D1098	Horizontal	6 3/4 x 12 x 7
D1098V	Vertical	12 x 6 3/4 x 7

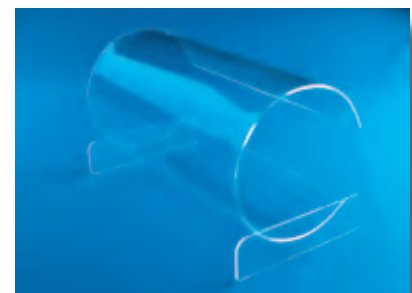

# Cosmetics, Apparel, & Shoe Displays

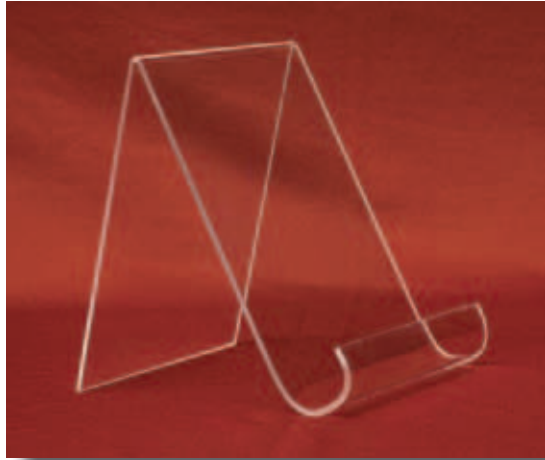

## J-Easels

For bulkier folded garments, this easel has a rounded front lip that also makes it excellent for purses, clutch bags, etc.

Product No.	H x W x D
J3555	5½ x 3½ x 5½
J5506	6 x 5½ x 6½
J7508	8 x 7½ x 8½
J9510	10 x 9½ x 10½



## Hosiery Bins

Two and three-level units. Shipped fully assembled. Bin compartments are all 4" high, 4" deep and 7½" wide.

Product No.	Bin Size	H x W x D
DWTB2H	4 x 4 x 7½	8 <sup>5</sup> / <sub>8</sub> x 15½ x 9
DWTB3H	4 x 4 x 7½	12 <sup>3</sup> / <sub>8</sub> x 15½ x 13



## Clutch Bag Display

For displaying wallets, clutch bags and other soft goods. Spaces are 2½" apart.

Product No.	H x W x D
CBR	8 x 4 x 11¼



## Hanging Bag Displays

The base on these displays is constructed to balance any strapped bag or other hanging merchandise.

Product No.	H x W x D
980-1640	14 <sup>3</sup> / <sub>4</sub> x 3¼ x 8½ x 8½
981-1641	21 <sup>3</sup> / <sub>8</sub> x 8½ x 8½

## SHOE DISPLAYS



**Heel-Rest Shoe Risers**  
*Elevated Style*

Product No.	H x W x D
FWS5	5 <sup>1</sup> / <sub>4</sub> x 3 x 9
FWS7	7 <sup>1</sup> / <sub>4</sub> x 3 x 9
FWS9	9 <sup>1</sup> / <sub>4</sub> x 3 x 9



**Heel-Rest Shoe Risers**  
*"Z" Style*

Product No.	H x W x D
FWZ5	5 <sup>1</sup> / <sub>4</sub> x 3 x 5 <sup>1</sup> / <sub>2</sub>
FWZ6	6 x 3 x 5 <sup>1</sup> / <sub>2</sub>
FWZ8	7 <sup>3</sup> / <sub>4</sub> x 3 x 6 <sup>1</sup> / <sub>4</sub>



**Floor Mirror**

*This tough acrylic mirror is the essential shoe sales accessory.*

Product No.	H x W x D
MLC1218	18 x 12 x 5

### High-Heel Displays

Product No.	Style	H x W x D
D1213	U-Notch	2 <sup>1</sup> / <sub>2</sub> x 1 x 2 <sup>1</sup> / <sub>2</sub>
D1214	U-Notch	3 <sup>1</sup> / <sub>2</sub> x 1 <sup>3</sup> / <sub>8</sub> x 3
D1238	Toe-V	8 x 2 <sup>3</sup> / <sub>4</sub> x 4

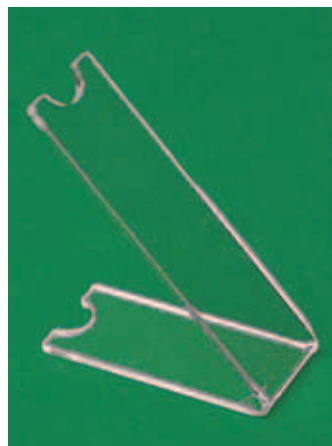

### Shoe Ribbon

*Supports women's strapped high-heels for display.*

Product No.	H x W x D
SR1B1	6 x 5 <sup>5</sup> / <sub>8</sub> x 8



### Scroll-Style Shoe Risers

Product No.	H x W x D
FW1	5 x 3 x 3 <sup>1</sup> / <sub>4</sub>
FW2	5 x 7 x 3 <sup>1</sup> / <sub>4</sub>
FW3 *	3 <sup>1</sup> / <sub>4</sub> x 7 x 5

\*Features a heel stop.

## COSMETICS DISPLAYS

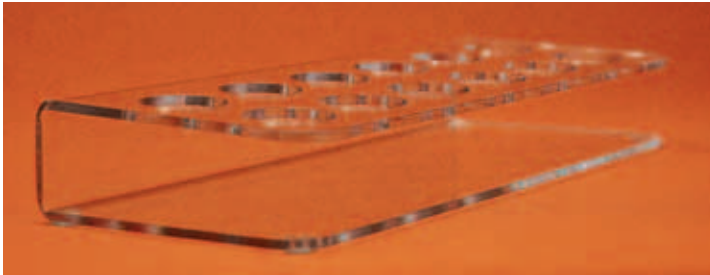

### Folded Lipstick Displays

Folded over 1/8"-thick acrylic provides a simple display for either 12 or 18 lipstick tubes. Holes are 1" diameter.

Product No.	# Tubes	H x W x D
LST12	12	1 1/2 x 9 1/2 x 4
LST18	18	1 1/2 x 9 1/2 x 5 1/2



### Tiered Lipstick Displays

Step-tiered displays for 24 round or square lipstick tubes. Holes are 1" diameter.

Product No.	Holes	H x W x D
LSTR	Round	3 x 9 1/2 x 7 1/2
LSTS	Square	3 x 9 1/2 x 7 1/2

Any of our lipstick displays can be ordered with slightly different sized holes to accommodate lip gloss or other cosmetics.



LST36

### Revolving Tiered Lipstick Displays

Single- and double-tiered lipstick tube displays turn on lazy-Susan bases. The single-tier model will hold 36 tubes and the double-tier model will hold 72. Holes are 1" diameter.

Product No.	# Tubes	H x Dia.
LST36	36	2 x 9
LST72	72	9 3/4 x 9



### Three-Tier Nail Polish Display

Angled shelves enable sliding-feed for polish bottles up to 4" tall. Each shelf has 6 slots. Space between shelves is 3".

Product No.	H x W x D
NP36	16 x 12 x 9 1/2

# Everything Else

## CELL PHONE DISPLAYS



CPLB

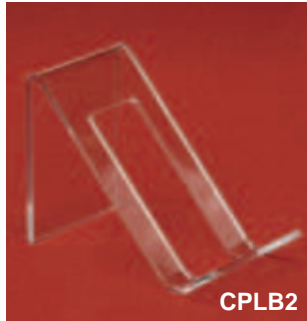

CPLB2



CP3

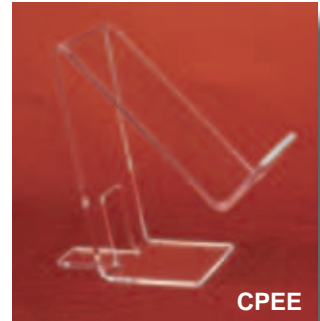

CPEE

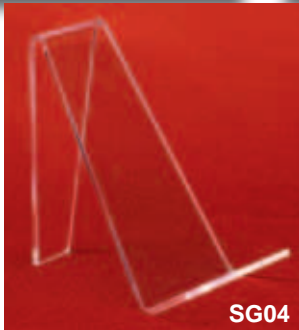

SG04



CPBP



CPIP

### CPIP

I-Pod friendly with bottom lip opening for power cords.

### CPBP

Wider for Blackberries and Palms.

Cell Phone Displays

## Handheld Gadget Displays

These displays are styled to accommodate slim to bulky cellular phones, PDAs, GPS receivers, MP3 players and many other handheld electronics.

Product No.	H x W x D	Product No.	H x W x D
CPLB	4 $\frac{1}{2}$ x 2 $\frac{1}{2}$ x 5	SG04	4 x 2 $\frac{3}{8}$ x 3 $\frac{1}{4}$
CPLB2	2 x 2 $\frac{3}{4}$ x 3 $\frac{1}{4}$	CPBP	5 $\frac{1}{4}$ x 3 $\frac{3}{4}$ x 5
CP3	5 $\frac{1}{4}$ x 2 $\frac{3}{4}$ x 5	CPIP	5 x 3 $\frac{1}{2}$ x 5 $\frac{1}{2}$
CPEE	5 x 2 $\frac{1}{2}$ x 5		



### Locking Cell Phone Display

Design shows several cellular phones securely.

Product No.	# Phones	H x W x D
CPCAS4	Four	9 $\frac{5}{8}$ x 6 $\frac{1}{2}$ x 5 $\frac{5}{8}$
CPCAS6	Six	14 $\frac{3}{8}$ x 6 $\frac{1}{2}$ x 5 $\frac{5}{8}$



### Brochure/Cell Phone Combination

Perfect for displaying service information brochures along with a cell phone. The brochure pocket is 4" wide and 1" deep.

Product No.	H x W x D
CP4P	7 $\frac{1}{4}$ x 7 $\frac{3}{4}$ x 5 $\frac{1}{2}$

## PEN DISPLAYS

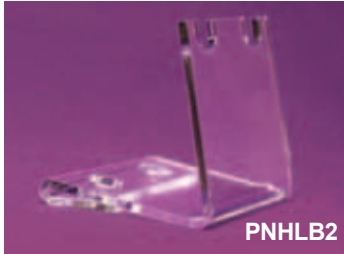

PNHLB2

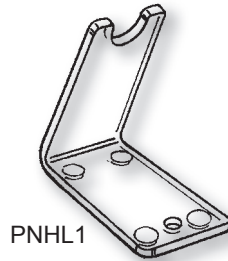

PNHL1

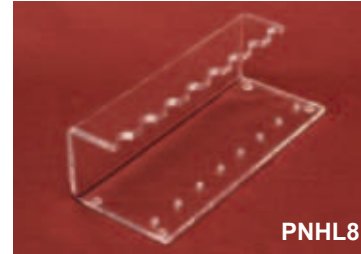

PNHL8

### Economy Pen Displays

Product No.	# Pens	H x W x D
PNHL1	One	2 <sup>1</sup> / <sub>2</sub> x 1 <sup>1</sup> / <sub>2</sub> x 2 <sup>1</sup> / <sub>2</sub>
PNHL2	Two	2 <sup>1</sup> / <sub>2</sub> x 3 x 2 <sup>1</sup> / <sub>2</sub>
PNHL3	Three	2 <sup>1</sup> / <sub>2</sub> x 4 <sup>1</sup> / <sub>2</sub> x 2 <sup>1</sup> / <sub>2</sub>
PNHL8	Eight	2 <sup>1</sup> / <sub>2</sub> x 12 x 2

For Blunt-Ended Pens:

Product No.	# Pens	H x W x D
PNHLB1	One	2 <sup>1</sup> / <sub>2</sub> x 1 <sup>1</sup> / <sub>2</sub> x 2 <sup>1</sup> / <sub>2</sub>
PNHLB2	Two	2 <sup>1</sup> / <sub>2</sub> x 3 x 2 <sup>1</sup> / <sub>2</sub>
PNHLB3	Three	2 <sup>1</sup> / <sub>2</sub> x 4 <sup>1</sup> / <sub>2</sub> x 2 <sup>1</sup> / <sub>2</sub>



### Deluxe Circular Pen Display

Deluxe rod construction makes a beautiful arrangement of twelve pens.

Product No.	H x W x D
PNH12	2 <sup>5</sup> / <sub>8</sub> x 14 x 5

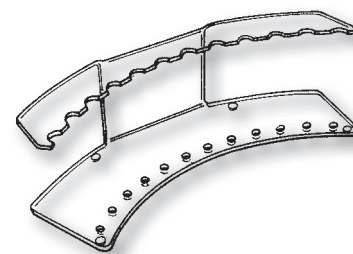

### One-Piece Pen Display

Economical one-piece construction for twelve pens.

Product No.	H x W x D
PNH12B	2 <sup>5</sup> / <sub>8</sub> x 14 x 5

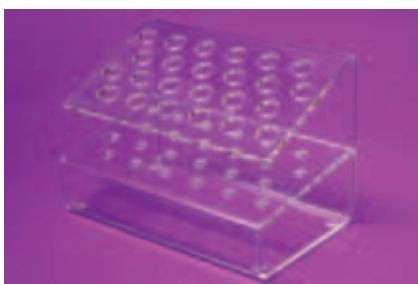

### Angled Multi-Pen Displays

Pens go through a 1/2"-diameter hole on top to rest in a 1/4"-diameter hole in this compact one-piece display.

Product No.	H x W x D
PNH24	4 <sup>1</sup> / <sub>2</sub> x 6 <sup>1</sup> / <sub>2</sub> x 3 <sup>3</sup> / <sub>4</sub>
PNH36	4 <sup>1</sup> / <sub>2</sub> x 9 <sup>1</sup> / <sub>2</sub> x 3 <sup>3</sup> / <sub>4</sub>
PNH48	4 <sup>1</sup> / <sub>2</sub> x 12 <sup>1</sup> / <sub>2</sub> x 3 <sup>3</sup> / <sub>4</sub>



### Horizontal Multi-Pen Display

Display ten pens on this rack with slots that are 1/2" wide and 3/16" deep.

Product No.	H x W x D
PNVP10	5 <sup>3</sup> / <sub>4</sub> x 2 <sup>3</sup> / <sub>4</sub> x 5 <sup>1</sup> / <sub>4</sub>

# Everything Else

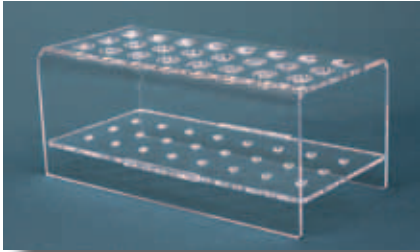

## Countertop Pen Risers

Holes in this display are  $\frac{1}{2}$ " in diameter. For 24 or 36 pens.

Product No.	# Pens	H x W x D
PNR24	Twenty-four	$3\frac{1}{8} \times 7\frac{3}{8} \times 3\frac{3}{4}$
PNR36	Thirty-six	$3\frac{1}{8} \times 8\frac{1}{4} \times 4\frac{1}{4}$



## Tilted-Back Multi-Pen Displays

Slots are  $\frac{1}{2}$ " wide.

Product No.	# Pens	H x W x D
PNTB8	Eight	$3\frac{1}{2} \times 8 \times 3\frac{1}{4}$
PNTB12	Twelve	$3\frac{1}{2} \times 12 \times 3\frac{1}{4}$

## ORNAMENT DISPLAYS



## Acrylic Rod Ornament Hangers

There are two styles of our clear acrylic rod hangers; some are made with  $\frac{1}{4}$ "-diameter rod, and some with  $\frac{3}{16}$ "-diameter rod for lighter items and a more delicate look.

Product No.	Rod Dia.	Hanging Space	Height
HB6	$\frac{3}{16}$	3	$3\frac{3}{4}$
HB1	$\frac{1}{4}$	$4\frac{1}{2}$	$5\frac{1}{8}$
HB4	$\frac{3}{16}$	$4\frac{1}{2}$	$5\frac{1}{8}$
HB81	$\frac{1}{4}$	6	$6\frac{5}{8}$
HB82	$\frac{3}{16}$	6	$6\frac{5}{8}$
HB3	$\frac{1}{4}$	$7\frac{3}{4}$	$8\frac{1}{4}$



## Spiral Hanging Display

This very popular ceiling hanger comes with bendable soft wire hooks. Add interest to displays with constant motion provided by the battery operated turner (sold separately).

Product No.	# Ornaments	H x Dia.
HBO	Twelve	$27\frac{1}{2} \times 8\frac{1}{2}$

## Gold-Plated Hangers

Two different height wires snap fit into  $3\frac{1}{4}$ "-square clear bases. Shipped unassembled.

Product No.	Hanging Space	Height
WH1	$4\frac{1}{2}$	$5\frac{1}{2}$
WH3	6	$7\frac{1}{2}$



## Battery Operated Turner

Call attention to displays with motion by hanging them on this battery operated turner. Uses one "D" battery (not included). Holds up to 5 pounds.

Product No.	Height
RVBT1	$6\frac{1}{2}$





# Everything Else



3PS

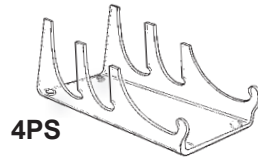

4PS

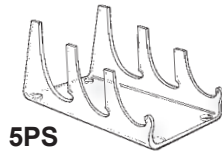

5PS

## Place Setting Displays

<u>Product No.</u>	<u># Pieces</u>	<u>H x W x D</u>
3PS	Three	3 <sup>1</sup> / <sub>4</sub> x 3 <sup>1</sup> / <sub>2</sub> x 5 <sup>3</sup> / <sub>8</sub>
4PS	Four	3 <sup>1</sup> / <sub>4</sub> x 3 <sup>1</sup> / <sub>2</sub> x 8 <sup>3</sup> / <sub>4</sub>
5PS	Five	3 <sup>1</sup> / <sub>4</sub> x 3 <sup>1</sup> / <sub>2</sub> x 7 <sup>1</sup> / <sub>2</sub>
5PSCP *	Five	3 <sup>1</sup> / <sub>4</sub> x 3 <sup>1</sup> / <sub>2</sub> x 7 <sup>1</sup> / <sub>2</sub>

\*The 5PSCP has a round platform in front for a cup and saucer.

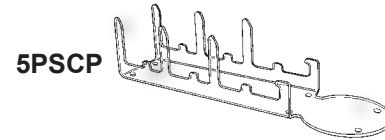

5PSCP

## Silverware Displays

Three, four or five-piece silverware settings can be displayed resting in <sup>7</sup>/<sub>8</sub>" diameter holes.

<u>Product No.</u>	<u>Style</u>	<u>H x W x D</u>
SWD3	3-piece	3 <sup>1</sup> / <sub>4</sub> x 4 <sup>1</sup> / <sub>2</sub> x 3
SWD4	4-piece	3 <sup>1</sup> / <sub>4</sub> x 5 <sup>3</sup> / <sub>4</sub> x 3
SWD5	5-piece	3 <sup>1</sup> / <sub>4</sub> x 7 x 3

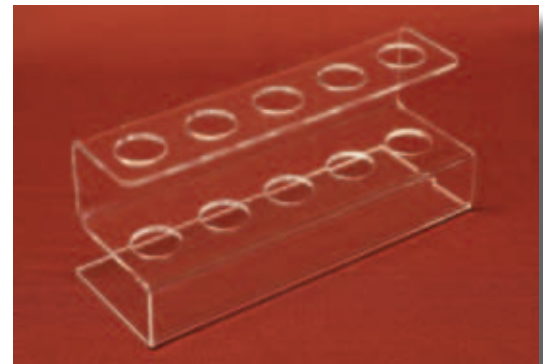

## Knife Display

This one-piece bent acrylic display holds 7 knives securely with slots to alternate handles on one side and blades on the other.

<u>Product No.</u>	<u>H x W x D</u>
KNF12	12 <sup>1</sup> / <sub>2</sub> x 7 x 7 <sup>3</sup> / <sub>4</sub>



## Thimble Display

Three 3<sup>1</sup>/<sub>2</sub>"-diameter shelves fit inside a glass dome to display 21 thimbles. Dome and base are included.

<u>Product No.</u>	<u>H x Dia.</u>
DM2WS	7 <sup>1</sup> / <sub>2</sub> x 4

# Everything Else

## ACRYLIC CLEANING PRODUCTS



Acrylic Cleaning

### Novus No. 1

*This spray cleans without scratching or "crazing," and it helps to repel dust by decreasing static.*

Product No.

NOV1

Size

8 oz. Bottle

### Novus No. 2

*This paste can help remove fine scratches, haziness and abrasions from most plastics.*

Product No.

NOV2

Size

8 oz. Bottle

### Novus No. 3

*To remove heavy scratches and abrasions from most plastics, this paste requires use of Novus No. 2 for a final finish.*

Product No.

NOV3

Size

8 oz. Bottle

## ACRYLIC CLEANING TIPS

*To prevent scratching, always use a soft cloth in conjunction with a special plastic cleaner or soap and water.*

**Do not use paper towels.**

**Do not clean acrylic with alcohol or ammonia-based cleaners, as they will "craze" the material.**

# Category Index

## A

Acrylic Blocks  
  Extra-Large 112  
  Large 112  
Acrylic Cleaners  
  Novus No. 1 129  
  Novus No. 2 129  
  Novus No. 3 129  
Acrylic Columns 112  
Agate Slice Racks 103  
Agate Slice Support 102  
Apparel Displays  
  Slatwall  
    Multi-Purpose 90  
Apparel Hook  
  Body Outline 121

## B

Bagel Bins  
  Stackable 77  
Bases  
  Black Rectangular 7  
  Economy 114  
  Label 114  
  Round  
    Beveled 112  
    Top-Beveled 113  
  Walnut 115  
Belt Display  
  Countertop 121  
Bin Displays  
  Divided 33  
  Double-Wide Tiered 33  
Bins  
  for Prints 59  
  Divided Hexagonal 33  
  Hosiery 122  
  Multi-Story Display 29  
  Stackable Mini 77  
Bin Systems 26—28  
Bin Trays  
  Adjustable 29  
  Slatwall 86  
Blocks  
  Extra-Large 112  
  Large 112  
Book Displays  
  Countertop 59, 61  
  Open 60  
Book Easels  
  Elevated 60  
  Standard 59  
Bookmark Displays 48  
Book Shelf Tray 60  
Book Stacking Tray 60  
Box Cases  
  Acrylic Bases for 23  
  Long Rectangular 22  
    with Hardwood Bases 22  
  Rectangular 21  
    with Hardwood Bases 22  
  Rectangular Angled-Front 23  
    with Hardwood Bases 23  
  Square 21  
    with Hardwood Bases 21

  Square Angled-Front 22  
    with Hardwood Bases 23  
Boxes  
  Ballot 61  
  Collection  
    Cube-Style 61  
    Sign-Backed 61  
    Tall 62  
    Wall-Mounting 62  
  Micro-Mount 106  
  Perky 106  
  With Hinged Lids 24  
Bracelet Bar Display and Case 73  
Bracelet Displays 73  
Brass and Acrylic Displays 107  
Brochure/Cell Phone Display 125  
Brochure/Flyer Holders  
  Outdoor 42  
Brochure Holders  
  8½ x 11 44, 45, 46  
  Countertop  
    Handmade 42  
  Economy  
    Tri-Fold 41  
    Multi-level 46  
  Greeting Cards 46  
  Half-Sheets/Greeting Cards 44, 45  
  Handmade Deluxe 43  
  Hold-Down Style 41  
  Multi-Pocket  
    Deluxe 43  
    with Removable Dividers 44  
  Multi-Tiered  
    Deluxe 45  
  Multi-Tiered, Multi-Pocket 46  
  Post Cards 45, 46  
  Premier Elevated 43  
  Premier Handmade 42  
  Slatwall  
    8½ x 11 85  
    Multi-Pocket 85  
    Tri-Fold 85  
  Tri-Fold 44, 45, 46  
Brochure Rotators  
  Countertop 47  
Bulk Bins  
  Stackable 77  
Bulk Food Dispensers 78  
Business Card Holders 51  
  Multi-Pocket  
    Countertop 52  
    Revolving 52  
    Stairstep 52  
    Wall-Mounting 52  
Business Card/Post Card Holders  
  51, 52

## C

Calipers  
  Gold-Plated 102  
Card Box Displays 48  
Card Displays  
  Angled-Rack 48  
  Straight-Rack 47  
  Tilted-Rack 47  
Card Holder  
  Take One, Leave One 51  
Card Racks  
  Countertop 47  
Card Rack Shelf Dividers 47

## Cases

  Locking 12" Tall 34  
  Locking 18" Tall 34  
  Locking 24" Tall 35  
  Locking Angled-Shelf 38  
  Locking Dormer Window 37  
  Locking Double-Door  
    Ring Case Display 38  
  Locking Knock-Down 36  
  Locking Large Hexagonal 35  
  Locking Rectangular 36  
  Locking with Rotating Shelves  
    34, 35  
  Locking Slanted-Front 38, 39  
  Locking for Slatwall Shelves 39  
  Locking Sliding Back 37  
  Locking Sliding Door 37  
  Locking Square 38

## Catalog Holders

  Economy  
    8½ x 11 41  
CD/DVD Displays  
  Tray Style 32  
Cell Phone/Brochure Display 125  
Cell Phone Display  
  Locking 125

Cell Phone Displays  
  Slatwall 86  
Clock Display 106  
Clothes Hanger  
  Slatwall 90

Cluster Displays  
  Low-Profile 105  
Clutch Bag Display 122  
Clutch Bag Displays  
  Slatwall 90

Columns  
  Solid Acrylic 112  
Cookbook Displays 59  
Countertop Tables 7  
Countertop Trays  
  Open 31

Cradles 105  
  Fossil 106  
Cubes  
  Mirrored 31  
Curio Displays  
  Mirrored 106

Cushions  
  Solid Acrylic 112  
Cushions  
  Solid Acrylic 112  
Cushions  
  Solid Acrylic 112

Cushions  
  Solid Acrylic 112  
Cushions  
  Solid Acrylic 112  
Cushions  
  Solid Acrylic 112

Cushions  
  Solid Acrylic 112  
Cushions  
  Solid Acrylic 112  
Cushions  
  Solid Acrylic 112

Cushions  
  Solid Acrylic 112  
Cushions  
  Solid Acrylic 112  
Cushions  
  Solid Acrylic 112

Cushions  
  Solid Acrylic 112  
Cushions  
  Solid Acrylic 112  
Cushions  
  Solid Acrylic 112

Cushions  
  Solid Acrylic 112  
Cushions  
  Solid Acrylic 112  
Cushions  
  Solid Acrylic 112

Cushions  
  Solid Acrylic 112  
Cushions  
  Solid Acrylic 112  
Cushions  
  Solid Acrylic 112

Cushions  
  Solid Acrylic 112  
Cushions  
  Solid Acrylic 112  
Cushions  
  Solid Acrylic 112

Cushions  
  Solid Acrylic 112  
Cushions  
  Solid Acrylic 112  
Cushions  
  Solid Acrylic 112

Cushions  
  Solid Acrylic 112  
Cushions  
  Solid Acrylic 112  
Cushions  
  Solid Acrylic 112

Cushions  
  Solid Acrylic 112  
Cushions  
  Solid Acrylic 112  
Cushions  
  Solid Acrylic 112

Cushions  
  Solid Acrylic 112  
Cushions  
  Solid Acrylic 112  
Cushions  
  Solid Acrylic 112

## E

Earring Card Cases  
  Locking 69  
Earring Card Displays  
  Countertop 69  
  Laser-Cut 69  
  Rotating 68  
  Slatwall 100  
Earring Displays  
  Hanging Pair 70, 71  
  Post 70  
  Rotating 70  
  Single Pair 70  
Easels  
  37-Series 94  
  38-Series 94  
  40-Series 94  
  Adjustable 95  
  Box 100  
  Brass and Acrylic 107  
  Deep Bowl 97  
  Double-Bend 96, 97  
    GM Series 99  
  Folding 93, 95  
  Hinged 93, 95  
  Hinged Miniature 93  
  J Style 99, 122  
  Label 98  
  Laid-Back 60  
  Lighted 99  
  Miniature 93  
  Nautilus 107  
  Platform 97  
  Ribbon Style 100  
  Rod Style 100  
  Shallow Bowl 96  
  Single-Bend  
    GS Series 98  
    GT Series 98  
  Six-Tier 101  
  Slatwall 89  
  Three-Tier 101  
  Two-Part 94  
Electronic Gadget Displays 125  
Endpieces  
  Slatwall 88  
Eyewear Displays  
  Pocket-Shelf 117  
  Revolving 117  
  Six-Frame 117  
  Slatwall  
    Open-Frame 89  
    Vertical 89  
    Wall Mount 117  
    White Acrylic 117  
Eyewear Frame Rests 116  
Eyewear Frame Rests  
  Slatwall 89  
Eyewear Rests  
  Single-Frame 116  
Eyewear Tower 117

## F

Five Shelf Tower 13  
Floor Unit  
  Rotating Slatwall 40  
Folding Shirt Boards 121  
Food Display Trays 76  
Food Display Tubes 77

Food Service Trays 76  
 Food Tray Cabinet 76  
 Food Tray/Plate Guard 76  
 Food Tray Towers 76  
 Four-Peg Displays 104  
 SL Series 104  
 Frames  
 Countertop  
 Angled 55  
 Bottom-Loading 54  
 Multi-Panel 56  
 Side-Loading Vertical 55  
 Sign 54—57  
 Three-Sign Triangle 56  
 Top-Loading 54  
 Folded 58  
 Poster 58  
 Ceiling Hanging 58  
 with Wall-Mounting Bracket 58  
 “Take One” Front-Pocket 56  
 Tent-Style 56  
 Wall-Mounting 57

**G**

Geode Halves Displays 104  
 Geode Triangles 104

**H**

Handbag Displays  
 Hanging 122  
 Hands  
 Acrylic 75  
 Hanging Display Turner 127  
 Headband/Scarf Countertop Displays 121  
 Hook Display  
 Four-Sided Pegboard 67

**I**

Ice-Creme Cone Holders 78

**J**

J-Bar  
 Hook Attachment for 67, 69  
 Jewelry Cases 66  
 Double Hidden-Tray 66  
 Double-Tray 66  
 Locking Tray 66

**K**

Knife Display 128

**L**

Label Holders  
 Slatwall 84  
 Label Triangles 64  
 Light Boxes 118  
 Light Bulbs  
 Replacement 120  
 Light Cords 120  
 Lighted Base  
 Walnut 118  
 Lipstick Displays 124  
 Literature/Cell Phone Pockets  
 Add-On 53  
 Literature Displays  
 Slatwall  
 Multi-Pocket Vertical 88

with Hold-Down Flap 85  
 Literature Holders  
 Multi-Pocket 50  
 Wall Mounting  
 Multi-Pocket 49  
 Wall-Mounting 49  
 Single-Pocket 49  
 with Hold-Down Flap 50

**M**

Marble Display 111  
 Mirrors  
 Countertop 30  
 Floor 123  
 Glass 30  
 Slatwall 91  
 Mounting Products 115

**N**

Nail Polish Display 124  
 Necklace/Bracelet Bar Displays 73  
 Necklace Cases  
 Locking 74  
 Necklace Displays 72—75  
 One-Piece 72  
 Slatwall 91  
 Necklace Rotators 74, 75  
 Necklace Tree 75  
 Necktie Display  
 Slatwall 90  
 Newspaper Rack  
 Wall-Mounting 51

**O**

Ornament Hangers  
 Acrylic Rod 127  
 Gold-Plated 127  
 Ornament Hanging Display  
 Spiral 127

**P**

Pegboard Hooks  
 Slatwall 92  
 Peg Triangles 105  
 SL Series 104  
 Pen Displays  
 Circular 126  
 Economy 126  
 Horizontal 126  
 Multi 126, 127  
 Pen Risers 127  
 Picture Frame Hangers  
 Slatwall 88  
 Place Setting Displays 128  
 Platform Displays 17, 18  
 Platforms  
 Revolving 120  
 Poster Frames 57, 58  
 Poster Stand 58

**R**

Raffle Bin Rotator 62  
 Revolving Platforms 120  
 Ring Case  
 Double Locking-Door 68  
 Ring Circle  
 Folding 66  
 Ring Clips 65

Ring Fingers 65  
 Risers  
 Adjustable Platform 15  
 Barbell 8  
 Cylinder 9  
 Double 8  
 Green “Glass-Look” 5  
 Interlocking 13  
 Interlocking Towers 19  
 Long 2  
 Mirrored Acrylic 4, 5  
 Narrow 3  
 Oval Platform 15  
 Pedestal 14  
 Round Mirror 9  
 Scroll 6  
 Short 3  
 Sign-Holder 5  
 Sphere 111  
 Square 2  
 Tall 3  
 Thick Beveled 7  
 Three-Legged 6  
 Tray 5  
 Riser Sets 4  
 Rotating Countertop Display  
 Ten-Pocket 33  
 Rotating Necklace Displays 74, 75  
 Rotating Tower  
 Locking with Changeable Inserts 67  
 Rotator  
 Vertical Cylinder 29  
 Rotators  
 J-Hook 67  
 Necklace/Keychain 75  
 Raffle Drawing 62

**S**

Scarf Display  
 Slatwall 90  
 Shelf Unit  
 Oval 9  
 Shelf Units  
 Clip-Together 20  
 Shell Displays  
 Lighted 107  
 Shelves  
 Three-Tiered Half-Round 14  
 Shirt Display 121  
 Shirt Folding Boards 121  
 Shoe Displays 123  
 Showcases  
 Locking 34—39  
 Sign and Pocket Combos 53  
 Sign Blocks 63  
 Sign Clips 63  
 Clear Economy 63  
 Label-Front 64  
 Sign Frames  
 Slatwall 84  
 Silk Screening  
 Custom 41, 42, 53, 57  
 Silverware Displays 128  
 Slatwall Bin Displays 87, 88  
 Slatwall Brackets  
 Shelves for 81  
 Slatwall Hook Displays 92  
 Slatwall J-Shelves 83  
 Slatwall Ledges 83  
 Slatwall Paper Tray 87

Slatwall Shelves 79—83  
 Media 82  
 Molded Economy 81  
 Slatwall Trays 82, 86  
 Sphere Dimple Bases  
 Walnut 111  
 Sphere Dimples 109  
 Sphere Displays  
 Three-Leg 111  
 Tri-Rod 108  
 Sphere Rings 110  
 Sphere Stands  
 Triple Twisters 108  
 Tulip 108  
 Spiral Displays  
 Four-Tier 19  
 Stair Displays  
 Interlocking 13  
 Lighted 119  
 Stairs 10—13, 16  
 Cascading 16  
 Egg and Sphere 111  
 Four-Step 10, 12  
 Mini-Platform 16  
 Mini Three-Step 13  
 Sign Attachment for 11  
 Solid-Back 11  
 Three-Step 10  
 Three-Step Versa 12  
 Tiered 16  
 Tiered Platform 11  
 Two-Step 10  
 Stick-on Feet 115

**T**

Tension Clip  
 for Literature Holders 49  
 Thimble Display 128  
 Three-Peg Displays 105  
 Three-Peg Triangles 103—105  
 Three-Shelf Displays 18  
 Three-Shelf Towers 18  
 Three-Shelf Units  
 Folding 20  
 Trays  
 Locking Countertop 39  
 One-Piece 31  
 Triangles 103—105  
 Turntables 119  
 Lazy-Susan style 120

**V**

V-Cradles 105  
 V Stand 102

**W**

Watch Clip  
 Slatwall 89  
 Watch Displays 71  
 Watch Display Towers 71

**Product  
Number  
Index**

01	110	4SQBB12	8	950-1578	116	B2MT4	45	BBR3	8	BPW1	50
01B	110	4SQBB4	8	950-1579	116	B2MTP22	46	BBR4	8	BPW1FX3	50
02	110	4SQBB6	8	980-1640	122	B2MTP23	46	BBR5	8	BPW1FX5	50
02B	110	4SQBB8	8	981-1641	122	B2MTP32	46	BBR6	8	BPW2	50
03	110	541	109	<b>A</b>		B2MTP33	46	BBR7	8	BPW2FX2	50
03B	110	551	109	AB1	69	B2WE	41	BBR8	8	BPW2FX3	50
03R	110	552	109	AB12	69	B3MP2	44	BBR9	8	BPW2FX4	50
035	110	561	109	AB2	69	B3MP3	44	BC10	52	BPW2L	50
04	110	571	109	AB3	69	B3MP4	44	BC5	51	BPW3	50
005	110	572	109	AB4	69	B3MT2	45	BC6	51	BPW3FX5	50
005B	110	581	109	AB5	69	B3MT3	45	BC7	51	BPW4	50
05	110	582	109	ABD24	33	B3MT4	45	BC8	51	BPW5	50
06	110	583	109	ABD30	33	B3MTP22	46	BC9	52	BPW5L	50
07	110	590	109	ACAS16	39	B3MTP23	46	BCAS6	73	BPW6	50
08	110	591	109	ACAS161	39	B3MTP24	46	BCAS7	38	BR31	112
09	110	592	109	ACAS162	39	B3MTP33	46	BDT612	31	BR51	112
095	110	593	109	ACAS6	39	B3MTP34	46	BDT612	76	BR71	112
010	110	594	109	ACAS6	73	B3MTP35	46	BDT69	31	BR91	112
011	110	590R1	14	ACAS7	38	B4MT2	45	BDT69	76	BRK12	7
015	110	590R2	14	ACAS8	39	B4MT3	45	BDT810	31	BRK14	7
015B	110	541B	109	ACAS81	39	B4MT4	45	BDT810	76	BRK16	7
101	110	551B	109	ACC1	49	B4MTP22	46	BDT812	31	BST1	11
102	110	552B	109	ACJ04	22	B4MTP23	46	BDT812	76	BST1B	11
103	110	561B	109	ACJ04W	23	B4MTP24	46	BDT812D	31	BST1F	11
104	110	581B	109	ACJ1	22	B4MTP33	46	BDT812D	76	BST3	11
105	110	582B	109	ACJ1W	23	B4MTP34	46	BDT815	31	BST3B	11
106	110	590B	109	ACJ2	22	B4MTP35	46	BDT815	76	BST3F	11
107	110	591B	109	ACJ2W	23	BA1	44	BDT912	31	BST5	11
160	108	592B	109	ACJ3	22	BA1	53	BDT912	76	BST5B	11
161	108	5PED	14	ACJ3W	23	BA2	44	BEC1	42	BST5F	11
162	108	5PS	128	ACJ4	22	BA2	53	BEC2	42	BST6	11
163	108	5PSCP	128	ACJ4W	23	BA3	44	BEC2H	42	BST6B	11
164	108	6M4060	56	ACJR46	23	BA3	53	BEC3	42	BST6F	11
165	108	6M5070	56	ACJR46W	23	BA4	44	BELT15	121	BST8	11
166	108	6SQBB10	8	ACJR46WM	23	BA4	53	BFFF12	78	BST8B	11
167	108	6SQBB12	8	ACJR69	23	BAL05	61	BFFF16	78	BST8F	11
22	105	6SQBB6	8	ACJR69W	23	BAL05W	61	BFGF15	78	BST9	11
23S	105	6SQBB8	8	ACJR69WM	23	BAL08	61	BFGF19	78	BST9B	11
24	105	71	111	ACJR82	23	BAL08W	61	BFGF22	78	BST9F	11
2M4060	56	7151	6	ACJR82W	23	BAL12	61	BH12W	49	BT1	73
2M5070	56	72	111	ACJR82WM	23	BAL12W	61	BH12W2D	49	BT2	73
2M8511	56	72L	107	AFST18	76	BAL2	61	BH13W	49	BT3	73
33	105	73	111	AR1	108	BAL2W	61	BH13W2D	49	BT4	73
3337	29	74	111	AR3	108	BAL3	61	BH14W	49	BV10	113
35	94	75	111	AR5	108	BAL3W	61	BH14W2D	49	BV10B	113
38	94	711	6	AR5	108	BAL4	61	BH15W	49	BV2	113
39	94	715	111	ARB7	108	BAL4W	61	BH15W2D	49	BV24	113
34L	105	721	6	ARB9	108	BAL6	62	BH1W	49	BV24B	113
34S	105	731	6	AU3	102	BAL6S	62	BH22W	49	BV2B	113
35A	94	741	6	AU4	102	BAL6W	62	BH22W2D	49	BV3	113
35B	94	751	6	AU5	102	BAL6WS	62	BH23W	49	BV36	113
35Z	99	850-1044	64	AU6	102	BAL8	62	BH23W2D	49	BV36B	113
36A	93	850-1048	32	AU7	102	BAL8S	62	BH2W	49	BV3B	113
36C	93	850-1170	30	AU8	102	BAL8W	62	BH2WH	49	BV4	113
37A	94	850-1171	30	<b>B</b>		BAL8WS	62	BH3W	49	BV46	113
37AA	94	850-1210	4	B14E	46	BALCJ10	61	BH5W	49	BV46B	113
37B	94	850-1265	30	B1E	41	BALCJ10L	61	BKS10	60	BV4B	113
37C	94	850-1440	32	B1MP2	44	BALCJ12	61	BKSU10	60	BV5	113
37D	94	850-1441	32	B1MP3	44	BALCJ12L	61	BKSU8	60	BV5B	113
38Z	99	860-1231	36	B1MP4	44	BALCJ6	61	BMD12	48	BV6	113
39Z	99	860-1235	36	B1MP5	44	BALCJ6L	61	BMD16	48	BV68	113
3PED	14	870-1365	40	B1MP6	44	BALCJ8	61	BMD20LB	48	BV68B	113
3PS	128	870-1366	40	B1MT2	45	BALCJ8L	61	BMD8	48	BV6B	113
3SQBB10	8	880-1435	24	B1MT3	45	BBH1	42	BMP1	115	BV7	113
3SQBB2	8	880-1436	24	B1MT4	45	BBH2	42	BMP2	115	BV7B	113
3SQBB4	8	880-1437	24	B1MTP22	46	BBH2H	42	BOL1808	121	BV8	113
3SQBB6	8	890-1475	40	B1MTP23	46	BBH3	42	BOL2810	121	BV8B	113
3SQBB8	8	890-1476	40	B1MTP24	46	BBH5	42	BPA1	107	BV9	113
3TM3550	56	910	104	B1MTP25	46	BBH6	42	BPA2	107	BV9B	113
3TM4060	56	911	104	B1MTP33	46	BBHE1	43	BPA3	107	BVQ1	113
3TM5070	56	912	104	B1MTP34	46	BBHE2	43	BPA4	107	BVQ10	113
3TM8511	56	913	104	B1MTP35	46	BBHE2H	43	BPA5	107	BVQ10B	113
40	94	914	104	B1WET	41	BBHE3	43	BPA6	107	BVQ1B	113
40C	94	921	105	B23E	46	BBHE5	43	BPR05	107	BVQ2	113
4PED	14	922	105	B24E	46	BBHE6	43	BPR1	107	BVQ24	113
4PS	128	923	105	B2E	41	BBR1	8	BPR2	107	BVQ24B	113
4SQBB10	8	924	105	B2MP2	44	BBR10	8	BPR3	107	BVQ2B	113
		950-1575	116	B2MP3	44	BBR11	8	BPT1	107	BVQ3	113
		950-1576	116	B2MT2	45	BBR12	8	BPT2	107	BVQ36	113
		950-1577	116	B2MT3	45	BBR2	8	BPT3	107	BVQ36B	113

BVQ3B	113	CJ4BB	23	DK218B	93	EM5570	84	FLB1	58	GM8	99
BVQ4	113	CJ4W	21	DK278	93	EM6040	84	FLB10	58	GM8T	99
BVQ46	113	CJR12	21	DK278B	93	EM6090	84	FLB11	58	GPT	65
BVQ46B	113	CJR12W	22	DM07	25	EM7011	84	FLB2	58	GPTB	65
BVQ4B	113	CJR46	21	DM07NB	25	EM7050	84	FLB3	58	GR10	5
BVQ5	113	CJR46B	23	DM07W	25	EM7055	84	FLB4	58	GR4	5
BVQ5B	113	CJR46BB	23	DM1	25	EM8010	84	FLB5	58	GR5	5
BVQ6	113	CJR46W	22	DM1NB	25	EM8511	84	FLB5035	58	GR6	5
BVQ68	113	CJR66	21	DM1W	25	EM9060	84	FLB6	58	GR7	5
BVQ68B	113	CJR66W	22	DM1WS	25	ER72	70	FLB64	58	GR8	5
BVQ6B	113	CJR69	21	DM2	25	ER72B	70	FLB7	58	GR9	5
BVQ7	113	CJR69B	23	DM25	25	ERS10	70	FLB8	58	GS12	98
BVQ7B	113	CJR69BB	23	DM25NB	25	ERS10F	70	FLB9	58	GS12T	98
BVQ8	113	CJR69W	22	DM25W	25	EX13Q	120	FLY1	29	GS15	98
BVQ8B	113	CJR82	21	DM2NB	25	EX20	120	FLY1L	29	GS15T	98
BVQ9	113	CJR82B	23	DM2W	25	EX4	120	FLY2	29	GS18	98
BVQ9B	113	CJR82BB	23	DM2WS	25	EX6000	115	FLY2L	29	GS18T	98
BX1	43	CJR82W	22	DM2WS	128	EX7	120	FOH1	111	GS4.5	98
BX12	43	CJR99	21	DM3	25	EXB	120	FPH2	66	GS6	98
BX13	43	CJR99W	22	DM3NB	25	EXE	120	FRH	66	GS7.5	98
BX2	43	CL7	106	DM3W	25	EXH	120	FS1	20	GS9	98
BX22	43	CMA10	30	DM3WS	25	EXW5	120	FS2	20	GT12	98
BX3	43	CMA6	30	DM4	25	EXZ	120	FS3	20	GT12T	98
BX4	43	CMA8	30	DM4NB	25	<b>F</b>		FS4	20	GT3	98
BX5	43	CMAHX79	30	DM4W	25	F101	112	FW1	123	GT4.5	98
<b>C</b>		CMAOV79	30	DM4WS	25	F1244	112	FW2	123	GT6	98
C050	105	CMS10	30	DNR12	75	F1515	112	FW3	123	GT7.5	98
C075	105	CMS6	30	DNR18	75	F153	112	FWS5	123	GT9	98
C100	105	CMS8	30	DP0503	63	F21	112	FWS7	123	GW10	97
C200	105	CP3	125	DP0506	63	F22	112	FWS9	123	GW10T	97
C300	105	CP4P	125	DP3423	63	F23	112	FWZ5	123	GW3	97
C500	105	CPBP	125	DP3426	63	F24	112	FWZ6	123	GW4.5	97
CAB2	93	CPCAS4	125	DP9291	63	F25	112	FWZ8	123	GW6	97
CAB3	93	CPCAS6	125	DP9293	63	F26	112	<b>G</b>		GW8	97
CAB4	93	CPDCR1	67	DP9296	63	F31	112	GA12	96	GW8T	97
CBR	122	CPDJ2	67	DR3010	8	F315	112	GA12T	96	<b>H</b>	
CCD1	32	CPDJ3	67	DTH2	66	F32	112	GA15	96	HA1	75
CCD2	32	CPDR	67	DW121	37	F33	112	GA15T	96	HA2	75
CD1	32	CPEE	125	DW122	37	F35	112	GA18	96	HB1	127
CD2	32	CPIP	125	DW123	37	F36	112	GA18T	96	HB3	127
CDB3	32	CPLB	125	DW161	37	F41	112	GA3	96	HB4	127
CDB32	32	CPLB2	125	DW162	37	F415	112	GA4.5	96	HB6	127
CDB4	32	CR11	112	DW163	37	F42	112	GA6	96	HB8	111
CDB42	32	CR12	112	DWTB2	33	F44	112	GA7.5	96	HB81	127
CE11	100	CR13	112	DWTB2H	33	F51	112	GA9	96	HB82	127
CE11	121	CR21	112	DWTB2H	122	F515	112	GE12	96	HB8B	111
CHG1	78	CR22	112	DWTB3	33	F61	112	GE12T	96	HBO	127
CHG2	78	CR23	112	DWTB3H	33	F615	112	GE15	96	HF121	36
CHP1	78	CR31	112	DWTB3H	122	F62	112	GE15T	96	HF122	36
CHP2	78	CR32	112	<b>E</b>		F64	112	GE18	96	HF1271	36
CHR1	78	CR33	112	EBE10	60	F81	112	GE18T	96	HF1272	36
CHR2	78	CST1	72	EBE12	60	F815	112	GE3	96	HF1273	36
CJ04	21	CST1B	72	EBE8	60	F82	112	GE4.5	96	HF131	36
CJ045	21	CST1F	72	ECD1	69	F844	112	GE4.5L	99	HF132	36
CJ045W	21	CST1M	72	EF4	70	FC4	106	GE6	96	HF133	36
CJ04B	23	CST3	72	EF4B	70	FC6	106	GE6L	99	HF171	36
CJ04BB	23	CST3B	72	EF4F	70	FC8	106	GE7.5	96	HF172	36
CJ04W	21	CST3F	72	EF5	70	FCB10	113	GE7.5L	99	HF173	36
CJ1	21	CST3M	72	EF5B	70	FCB2	113	GE9	96	HFP4	56
CJ15	21	CX1	70	EF5F	70	FCB3	113	GE9L	99	HFP7	56
CJ15W	21	CX1B	70	EF6	70	FCB4	113	GFPD1	78	HFP8	56
CJ1B	23	CX1F	70	EF6B	70	FCB5	113	GFPD2	78	HTF1	41
CJ1BB	23	CX2	70	EF6F	70	FCB6	113	GFPD4	78	HTF1WM	50
CJ1W	21	CX2B	70	EJ70	69	FCB8	113	GJS2	9	HTF2	41
CJ2	21	CX2F	70	EJ70K	69	FDTA126	77	GJS3	9	HTF2HWM	50
CJ25	21	CX3	70	EJ72R	68	FDTA168	77	GK12	95	HTF2WWM	50
CJ25W	21	CX3B	70	EJ72RB	68	FDTA2010	77	GK15	95	HTF3	41
CJ2B	23	CX3F	70	EM1080	84	FDTA86	77	GK18	95	HTF5WM	50
CJ2BB	23	<b>D</b>		EM1114	84	FE1	71	GK4	95	HX1	24
CJ2W	21	D1098	121	EM1117	84	FE1B	71	GK5	95	HX10	34
CJ3	21	D1098V	121	EM1185	84	FE1F	71	GK6	95	HX102	24
CJ35	21	D1213	123	EM1411	84	FE2	71	GK8	95	HX10R	34
CJ35W	21	D1214	123	EM1422	84	FE2B	71	GK9	95	HX11	34
CJ3B	23	D1238	123	EM1624	84	FE2F	71	GM10	99	HX11R	34
CJ3BB	23	D2398	90	EM1711	84	FE3	71	GM10T	99	HX12	34
CJ3W	21	D2420	82	EM1824	84	FE3B	71	GM12	99	HX12R	34
CJ4	21	D2421	82	EM2228	84	FE3F	71	GM12T	99	HX2	24
CJ45	21	DHB18	33	EM2822	84	FL1	107	GM3	99	HX20	34
CJ45W	21	DHB24	33	EM4060	84	FL2	107	GM4.5	99	HX20R	34
CJ4B	23	DK218	93	EM5070	84	FL3	107	GM6	99	HX21	34

HX21R	34	KR24	14	LRC22	71	MB3555	54	ME2	101	MS8060	55
HX22	34	KS1	19	LRC3	38	MB4050	54	ME3	101	MS8511	55
HX22R	34	KS1M	19	LRC4	38	MB4060	54	ME3T	101	MS8514	55
HX30	35	KS2	19	LRC5	38	MB5030	54	MG1	6	MS8D	103
HX31	35	KS2M	19	LRR2	5	MB5035	54	MG15	6	MS8H	103
HX32	35	<b>L</b>		LRR3	5	MB5040	54	MG2	6	MS9060	55
HX4	24	LABEL1	84	LS3	68	MB5070	54	MG25	6	MSB5	77
HX44	35	LABEL2	84	LS3B	68	MB5535	54	MG3	6	MSB6	77
HX44R	35	LABEL3	84	LS3C	68	MB5570	54	MG35	6	MSB7	77
HX5	24	LB1	118	LS3CB	68	MB5585	54	MG4	6	MSC	63
HX50	35	LB2	118	LS4	68	MB6040	54	MG45	6	MSP4	101
HX51	35	LB2WD	118	LS4B	68	MB6080	54	MGA	16	MSP5	101
HX55	35	LB3	118	LST12	124	MB6090	54	MGAFF	16	MSP6	101
HX55R	35	LB4	118	LST18	124	MB7010	54	MGB	16	MT102	9
HXN12	74	LB5	118	LST36	124	MB7011	54	MGBF	16	MT104	9
HXN2	74	LBTX6	119	LST72	124	MB7050	54	MGC	16	MT151	9
HXW2	34	LBX1	118	LSTR	124	MB7055	54	MGCF	16	MT152	9
HXW22	34	LBX2	118	LSTS	124	MB7090	54	MICRO1	106	MT21	9
<b>I</b>		LBX4	118	LW2020	95	MB8010	54	MICRO2	106	MT22	9
ISL2	64	LBX5	118	LW2020B	95	MB8060	54	ML1	30	MT251	9
ISL4	64	LCJ10	24	LW2040	95	MB8511	54	ML2	30	MT252	9
ISL6	64	LCJ12	24	LW2040B	95	MB8514	54	MLC12	30	MT32	9
ISL8	64	LCJ4	24	<b>M</b>		MB8555	54	MLC1218	123	MT33	9
<b>J</b>		LCJ6	24	MA1035	55	MB9012	54	MLC9	30	MT42	9
J1	6	LCJ8	24	MA1070	55	MB9060	54	MPO2L	15	MT44	9
J2	6	LCJA10	24	MA1080	55	MB9070	54	MPO2M	15	MT52	9
J3	6	LCJA12	24	MA1114	55	MBCC	51	MPO2S	15	MT54	9
J3555	99	LCJA4	24	MA1117	55	MBCH3	52	MPO3	15	MT62	9
J3555	122	LCJA6	24	MA1170	55	MBCH4	52	MPO5	15	MT64	9
J4	6	LCJA8	24	MA1185	55	MBCH6	52	MPV1	16	MT72	9
J5	6	LCT1	39	MA1290	55	MBCH6V	52	MPV1F	16	MT74	9
J5506	99	LCT2	39	MA1411	55	MBCH8	52	MPV1MB	16	MT82	9
J5506	122	LCT3	39	MA1711	55	MBCH8V	52	MPV3	16	MT84	9
J6	6	LCT4	39	MA2015	55	MBCW	51	MPV3F	16	MVP3MB	16
J7508	99	LCT5	39	MA2535	55	MBL1	111	MPV5	16	MW1080	57
J7508	122	LCT6	39	MA3050	55	MC1035	54	MPV5F	16	MW1114	57
J9510	99	LCT7	39	MA3520	55	MC1070	54	MPV5MB	16	MW1117	57
J9510	122	LCT8	39	MA3535	55	MC1080	54	MR10	30	MW1117CH	58
JHK15	67	LCTR1	39	MA3550	55	MC1114	54	MR15	30	MW1185	57
JHK3	67	LCTR2	39	MA3555	55	MC1117	54	MR2	30	MW1411	57
JHR2	67	LCTR4	39	MA4015	55	MC1170	54	MR25	30	MW1422	57
JHR4	67	LCTR4	66	MA4050	55	MC1185	54	MR3	30	MW1422CH	58
<b>K</b>		LCTR55	39	MA4060	55	MC1290	54	MR35	30	MW1624	57
K3	47	LCTR55	66	MA5030	55	MC1411	54	MR4	30	MW1624CH	58
K34	47	LCTR6	39	MA5035	55	MC1711	54	MR4	119	MW1711	57
K34N	47	LCTR8	39	MA5040	55	MC3050	54	MR5	30	MW1711CH	58
K3N	47	LDIV	47	MA5070	55	MC3520	54	MR6	30	MW1824	57
K44T	47	LG101	94	MA5535	55	MC3550	54	MR6	119	MW1824CH	58
K44TN	47	LG2000	95	MA5570	55	MC3555	54	MR7	30	MW2228	57
K4T	47	LG2000B	95	MA5585	55	MC4050	54	MR8	30	MW2228CH	58
K4TN	47	LG2020	95	MA6040	55	MC4060	54	MRK1	31	MW2822	57
K54A	48	LG2020B	95	MA6080	55	MC5030	54	MRK11	31	MW2822CH	58
K5A	48	LG99	94	MA6090	55	MC5035	54	MRK2	31	MW4060	57
K64N	48	LH1	63	MA7011	55	MC5040	54	MRK22	31	MW5070	57
KCR12	75	LH2	63	MA7050	55	MC5070	54	MS1080	55	MW5570	57
KCR18	75	LH3	63	MA7055	55	MC5535	54	MS1170	55	MW6040	57
KCR20	75	LH4	63	MA7090	55	MC5570	54	MS1185	55	MW6090	57
KDBS21	20	LH5	63	MA8010	55	MC5585	54	MS1485	55	MW7011	57
KDBS31	20	LH6	63	MA8511	55	MC6040	54	MS3050	55	MW7050	57
KDCT18	20	LR05	5	MA8511P	53	MC6080	54	MS3550	55	MW7055	57
KDCT18A	20	LR1	5	MA8511P2	53	MC6090	54	MS3555	55	MW8010	57
KDR12	13	LR2	5	MA8511SP	53	MC7011	54	MS4060	55	MW8511	57
KDR15	13	LR3	5	MA8514	55	MC7050	54	MS4D	103	MW9060	57
KDR18	13	LR4	5	MA8555	55	MC7055	54	MS4H	103	MY4	28
KF2	114	LR5	5	MA9012	55	MC7090	54	MS5030	55	MY6	28
KF2B	114	LR6	5	MA9060	55	MC8010	54	MS5035	55	MY8	28
KF3	114	LRB10	22	MB1035	54	MC8511	54	MS5070	55	<b>N</b>	
KF3B	114	LRB10W	22	MB1070	54	MC8514	54	MS5535	55	N3400	104
KF4	114	LRB612	22	MB1080	54	MC8555	54	MS5570	55	N4000	104
KF4B	114	LRB612W	22	MB1114	54	MC9012	54	MS6040	55	N4600	104
KF5	114	LRB816	22	MB1117	54	MC9060	54	MS6080	55	N5000	104
KF5B	114	LRB816W	22	MB1170	54	MCM10	31	MS6090	55	NAR22	75
KG4.5	98	LRB9	22	MB1185	54	MCM12	31	MS6D	103	NCAS4	74
KG6	98	LRB920	22	MB1290	54	MCM4	31	MS6H	103	NCAS5	74
KG7.5	98	LRB920W	22	MB1411	54	MCM6	31	MS7011	55	NE1	72
KG9	98	LRB9W	22	MB1485	54	MCM8	31	MS7050	55	NE15	73
KNF12	128	LRC1	38	MB1711	54	MCMR46	31	MS7055	55	NE1B	72
KR12	14	LRC2	38	MB3050	54	MCMR69	31	MS7D	103	NE1F	72
KR18	14	LRC22	38	MB3520	54	MCMR82	31	MS7H	103	NE1M	72
		LRC22	68	MB3550	54	ME1	101	MS8010	55	NE2	72

NE25	72	OSJ1	116	PRB810	59	R8125	2	RT16	7	SGA	16
NE25B	72	OSJ2	116	PRM3	11	R8BT	7	RT1616	7	SGAF	16
NE25F	72	OSJ3	116	PRM5	11	R8L	2	RT20	7	SGB	16
NE25M	72	OSJ3D	116	PRM55	11	R8N	3	RT48	7	SGBF	16
NE2B	72	OSJ4D	116	<b>Q</b>		R8S	3	RT66	7	SGC	16
NE2F	72	OSJ5D	116	QB192	29	R8T	3	RT812	7	SGCF	16
NE2M	72	OSY1	117	QB96	29	R9	2	RT88	7	SGS15	100
NE3	72	OSY1W	117	<b>R</b>		R9BT	7	RTW10	120	SGS20	100
NE3B	72	OWP1	117	R1	2	R9L	2	RTW10B	120	SGS25	100
NE3F	72	OWP1L	117	R10	2	R9N	3	RTW6	120	SGS30	100
NE3M	72	<b>P</b>		R10BT	7	R9S	3	RTW6B	120	SGS35	100
NE5	73	PB1	114	R10L	2	R9T	3	RTW8	120	SK2	100
NE55	72	PB1.5	114	R10N	3	RB25	4	RTW8B	120	SK3	100
NE55B	72	PB153	114	R10S	3	RBC3	52	RTY1	5	SK4	100
NE55F	72	PB2	114	R10T	3	RBC4	52	RTY2	5	SK6	100
NE55M	72	PB2.5	114	R11	2	RBH13	47	RTY3	5	SK6D	100
NE6	73	PB24	114	R11BT	7	RBH14	47	RTY4	5	SK8	100
NE7	73	PB3	114	R12	2	RBH16	47	RTY5	5	SL3	104
NG100	105	PB3.5	114	R12BT	7	RBH18	47	RVBT1	127	SL35	105
NG200	105	PB4	114	R12L	2	RDE14	70	<b>S</b>		SL4	104
NG300	105	PB4	114	R12N	3	RDR20	62	SAT10	11	SL5	104
NG400	105	PBD10	114	R12S	3	RDR50	62	SAT12	11	SL55	105
NG500	105	PBD6	114	R12T	3	RE3	100	SAT18	11	SL6	104
NG600	103	PBD68	114	R14	2	RE4	100	SAT18	11	SQFC12	38
NG700	103	PBD7	114	R14BT	7	RE5	100	SAT212	11	SQFC121	38
NGMR1	106	PBD8	114	R14L	2	RF1	65	SAT218	11	SQFC16	38
NGMR3	106	PBD9	114	R14N	3	RF1B	65	SAT6	11	SQFC161	38
NGT1	103	PDLS32	58	R14S	3	RF1F	65	SAT8	11	SQFC20	38
NGT2	103	PEGHK2	92	R14T	3	RF1R	65	SB1210	121	SQFC201	38
NGT3	103	PEGHK2B	92	R16	2	RF1RB	65	SB1211	121	SR1B1	123
NGT4	103	PEGHK3	92	R16BT	7	RF1RF	65	SB1285	121	SST10	13
NGT5	103	PEGHK3B	92	R16S	3	RF2	65	SBB11	77	SST9	13
NOV1	129	PEGHK4	92	R18	2	RF2B	65	SBB16	77	ST1	16
NOV2	129	PEGHK4B	92	R18S	3	RF2F	65	SBB21	77	ST1235	10
NOV3	129	PEGR12	67	R1L	2	RF3	65	SBBB12	77	ST1246	10
NP36	124	PERK1	106	R2	2	RF3B	65	SBBB18	77	ST1835	10
NPR5	51	PFB1422	58	R20	2	RF3F	65	SBBSET	77	ST1846	10
NX100	104	PFB1624	58	R22	2	RF3R	65	SBC131	37	ST1846	10
NX300	104	PFB1824	58	R2L	2	RF3RB	65	SBC132	37	ST1B	16
<b>O</b>		PFB2228	58	R2N	3	RF3RF	65	SBC161	37	ST1F	16
OBG19	76	PFB2822	58	R2S	3	RF4	65	SBC162	37	ST3	10
OBH3	42	PGA12	97	R2T	3	RF4B	65	SBC163	37	ST3B	10
OBH3P	42	PGA12T	97	R3	2	RF4F	65	SBC181	37	ST3F	10
OBH5	42	PGA3	97	R3L	2	RF5	65	SBC182	37	ST4	10
OBH5P	42	PGA4.5	97	R3N	3	RF5B	65	SBC183	37	ST4B	10
OCT1	31	PGA6	97	R3S	3	RF5F	65	SCD1	32	ST4F	10
OCT2	31	PGA7.5	97	R3T	3	RF6	65	SCL1	102	ST5	10
OCT3	31	PGA9	97	R4	2	RF6B	65	SCL2	102	ST5B	10
OCT4	31	PNH12	126	R4316	4	RF6F	65	SD121	37	ST5F	10
OCT5	31	PNH12B	126	R468	4	RM2	5	SD122	37	ST6	10
OCT6	31	PNH24	126	R4L	2	RM25	4	SD123	37	ST6B	10
OCT7	31	PNH36	126	R4N	3	RM3	5	SD151	37	ST6F	10
OCT8	31	PNH48	126	R4S	3	RM4	5	SD152	37	ST7	10
OCTR1	31	PNHL1	126	R4T	3	RM5	5	SD153	37	ST75	10
OCTR4	31	PNHL2	126	R5	2	RM6	5	SD171	37	ST75B	10
OCTR8	31	PNHL3	126	R5125	2	RNR12	74	SD172	37	ST75F	10
OFM22	117	PNHL8	126	R5L	2	RNR18	74	SD173	37	ST7B	10
OFN1	117	PNHLB1	126	R5N	3	RNR20	74	SD200	37	ST7F	10
OMH22	117	PNHLB2	126	R5S	3	RRC10	9	SD201	37	ST8	10
OMH6	117	PNHLB3	126	R5T	3	RRC25	9	SD202	37	ST85	10
OMH6W	117	PNR24	127	R6	2	RRC3	9	SD212	37	ST85B	10
OP1	15	PNR36	127	R600	4	RRC2	9	SD213	37	ST85F	10
OP3	15	PNTB12	127	R6125	2	RRC25	9	SE103	107	ST8B	10
OP5	15	PNTB8	127	R6666	4	RRC3	9	SG04	59	ST8F	10
OP610	18	PNVP10	126	R6810	4	RRC35	9	SG04	125	ST9	10
OP812	18	POB1	114	R6812	4	RRC4	9	SG1	59	ST9B	10
OPS	117	POB1.5	114	R6BT	7	RRC45	9	SG11	59	ST9CL	119
OPSL	117	POB2	114	R6L	2	RRC5	9	SG12	59	ST9F	10
ORD1	116	POB2.5	114	R6N	3	RRC55	9	SG13	59	STCH3	52
ORD2	116	POB22	114	R6S	3	RRC6	9	SG2	59	STCH6	52
ORD3	116	POB3	114	R6T	3	RRC65	9	SG21	59	STG2	12
ORD4	116	POB33	114	R7	2	RRC7	9	SG22	59	STG3	12
OSD1	116	POB4	114	R7125	2	RRC75	9	SG3	59	STG4	12
OSD2	116	POB44	114	R7BT	7	RRC8	9	SG31	60	STG5	12
OSD3	116	POB55	114	R7L	2	RRC85	9	SG32	60	STG6	12
OSD3D	116	PRB1114	59	R7N	3	RRLC	35	SG33	60	STG7	12
OSD3X	116	PRB1620	59	R7S	3	RT06	7	SG40	60	STL55	12
OSD3Y	116	PRB46	59	R7T	3	RT08	7	SG41	60	STL55A	12
OSD4V	116	PRB57	59	R8	2	RT1016	7	SG42	60	STL66	12
						RT12	7	SG43	60	STL66A	12
						RT1212	7	SG52	60	STL77	12



STL77A	12	TPRD6	33	WCR5	19	Z93N	79	ZFS3612	81	ZQ12	83
STL88	12	TR05	17	WCS1	19	Z94ESLP	81	ZFS366	81	ZQ12A	83
STL88A	12	TR05M	17	WCS2	19	ZAB1	91	ZFS368	81	ZQ12AE	83
STL88W	12	TR1	17	WCS3	19	ZAB2	91	ZFS4810	81	ZQ12E	83
STL88WA	12	TR12	18	WCS4	19	ZAB5	91	ZFS4812	81	ZQ12S	83
STL99	12	TR17	18	WCS5	19	ZABD24	88	ZFS484	80	ZQ12SE	83
STM2	13	TR1M	17	WDPS1	71	ZABD30	88	ZFS486	81	ZQ18	83
STM2B	13	TR2	17	WH1	127	ZABL612	83	ZFS488	80	ZQ18A	83
STM4	13	TR2M	17	WH3	127	ZABL624	83	ZFS488	81	ZQ18AE	83
STM4B	13	TRAYH18	76	WL3H	71	ZABL636	83	ZGE12	89	ZQ18E	83
STM6	13	TRAYH24	76	WL3V	71	ZABL912	83	ZGE6	89	ZQ18S	83
STM6B	13	TRAYT3	76	WL6	71	ZACJ04	87	ZGE7.5	89	ZQ18SE	83
STV1	12	TRAYT4	76	WLE3	59	ZACJ1	87	ZGE9	89	ZQ24	83
STV1B	12	TRAYT5	76	WLE3L	59	ZACJ2	87	ZHF132	91	ZQ24A	83
STV2	12	TRX3	18	WLE4	59	ZACJ3	87	ZHF172	91	ZQ24AE	83
STV2B	12	TS05	17	WLE4L	59	ZACJ4	87	ZHF173	91	ZQ24E	83
STV3	12	TS05M	17	WLE7	59	ZACJR69	87	ZHTF1WM	85	ZQ24S	83
STV3B	12	TS1	17	WLE7L	59	ZAPT	87	ZHTF2HWM	85	ZQ24SE	83
SWC18	39	TS12	18	WLE8	59	ZAT5129	87	ZHTF2WM	85	ZQ36	83
SWC24	39	TS17	18	WLE8L	59	ZAT6189	87	ZHTF5WM	85	ZQ36A	83
SWD3	128	TS1M	17	WNSD3	111	ZAT6249	87	ZJ1610	81	ZQ36AE	83
SWD4	128	TS2	17	WNSD4	111	ZAT6309	87	ZJ40102	92	ZQ36E	83
SWD5	128	TS2M	17	WNSD5	111	ZAT6369	87	ZJ40104	92	ZQ36S	83
<b>T</b>		TSSH30	56	WPC1	71	ZB1E	85	ZJ40106	92	ZQ36SE	83
T12L	27	TSSH3DS	56	WPS1	71	ZB1WE	85	ZJ401570	89	ZQ48	83
T1CD	32	TSSH7	56	WXMT	115	ZB2E	85	ZL12	82	ZQ48A	83
T1L	27	TSSH7DS	56	<b>Y</b>		ZB2WE	85	ZL12S	82	ZQ48AE	83
T1M	28	TSSH85DS	56	YA	26	ZBH13W	85	ZL18	82	ZQ48E	83
T1R	26	TSX3	17	YAA	26	ZBH15W	85	ZL18S	82	ZQ48S	83
T1S	27	TT11	108	YB	26	ZBH22W	85	ZL24	82	ZQ48SE	83
T2CD	32	TT12	108	YC	26	ZBH23W	85	ZL24S	82	ZS1024	79
T2L	27	TT13	108	YD	26	ZBL12	80	ZL36	82	ZS1032	79
T2M	28	TT14	108	YF	28	ZBL12TW	80	ZL36S	82	ZS108	79
T2R	26	TT21	108	YG	28	ZBL18	80	ZL48	82	ZS1110	79
T2S	27	TT22	108	YH	28	ZBL18TW	80	ZL48S	82	ZS1212	79
T3L	27	TW6	18	YK	27	ZBL24	80	ZM1080	84	ZS1218	79
T3M	28	TW8	18	YL	27	ZBL24TW	80	ZM1114	84	ZS1424	79
T3R	26	TWD8	18	YM	27	ZBPW1	88	ZM1117	84	ZS1436	79
T3S	27	TWR5	13	YP	27	ZBPW2	88	ZM1185	84	ZSC12	80
T3X	28	<b>V</b>		YV	27	ZBPW2L	88	ZM1411	84	ZSC14	80
T4L	27	V7	102	YW	27	ZBPW3	88	ZM1422	84	ZSC16	80
T4M	28	V9	102	YX	27	ZBPW4	88	ZM1624	84	ZSG1	79
T4R	26	VR1	105	YZ	27	ZBPW5	88	ZM1711	84	ZSG2	79
T4S	27	VR2	105	<b>Z</b>		ZBPW5L	88	ZM1824	84	ZSG3	79
T4X	28	VR3	105	Z1010L	81	ZBPW6	88	ZM2228	84	ZSG4	79
T5X	28	VR4	105	Z1010U	80	ZBT1018	82	ZM2822	84	ZSG5	79
T6L	27	VR5	105	Z104E	81	ZBT412	82	ZM4060	84	ZSG6	79
T6M	28	<b>W</b>		Z104E	81	ZBT48	82	ZM5070	84	ZSR9	90
T6R	26	WB2E	41	Z104N	79	ZBT812	82	ZM5570	84	ZT1	86
T6S	27	WB2WE	41	Z105EL	81	ZBT816	82	ZM6040	84	ZT1R	86
T6X	28	WBCH12	52	Z106E	81	ZBT912	82	ZM6090	84	ZT2	86
TDR	29	WBCH18	52	Z108N	79	ZCB1	90	ZM7011	84	ZT201	86
TDS	29	WBCH24	52	Z10EL	81	ZCB44	82	ZM7050	84	ZT202	86
TDX	29	WBCH3	52	Z124N	79	ZCB64	82	ZM7055	84	ZT203	86
TF1080	57	WBCH6	52	Z126E	81	ZCBR	90	ZM8010	84	ZT2R	86
TF1114	57	WBCH8	52	Z126N	79	ZCH1	90	ZM8511	84	ZT3	86
TF1185	57	WBR05	115	Z126U	80	ZCJ04	87	ZM9060	84	ZT3R	86
TF1411	57	WBR1	115	Z128N	79	ZCJ1	87	ZML1	91	ZT3X	86
TF1711	57	WBR2	115	Z12EL	81	ZCJ2	87	ZML12	91	ZT4	86
TF4060	57	WBR25	115	Z1610L	81	ZCJ3	87	ZML2	91	ZT4R	86
TF5070	57	WBR3	115	Z1610U	80	ZCJ4	87	ZML9	91	ZT4X	86
TF5570	57	WBR4	115	Z1612N	79	ZCP2	86	ZNE12	91	ZT5	86
TF6040	57	WBS04	115	Z168N	79	ZCP3	86	ZNE15	91	ZT5X	86
TF6090	57	WBS1	115	Z168U	80	ZENDP	88	ZNE7	91	ZT6	86
TF7011	57	WBS105	115	Z208U	80	ZFS1210	81	ZNH1	92	ZT6R	86
TF7050	57	WBS126	115	Z2410L	81	ZFS1212	81	ZNH3	92	ZT6X	86
TF7055	57	WBS128	115	Z2410U	80	ZFS126	81	ZNH6	92	ZVB512	87
TF8010	57	WBS1610	115	Z2412N	79	ZFS128	81	ZNS7	91	ZVB56	87
TF8511	57	WBS2	115	Z2412U	80	ZFS1810	81	ZNS7F	91	ZVB812	87
TF9060	57	WBS2012	115	Z248N	79	ZFS1812	81	ZNTD	90	ZVB86	87
TH1	64	WBS3	115	Z248U	80	ZFS186	81	ZOSD1	89	ZWCH1	91
TH15	64	WBS4	115	Z65N	79	ZFS188	81	ZOSD3	89		
TH2	64	WBS64	115	Z810L	81	ZFS2410	81	ZOSD6	89		
TH3	64	WBS93	115	Z810U	80	ZFS2412	81	ZOSH24A	89		
TMSW	88	WBS96	115	Z84E	40	ZFS244	80	ZOSH6A	89		
TN1	119	WCR1	19	Z84E	81	ZFS246	80	ZOSH6F	89		
TNX6	119	WCR2	19	Z84ESLP	40	ZFS246	81	ZPG1	92		
TOLO	51	WCR3	19	Z84ESLP	81	ZFS248	80	ZPG3	92		
TOLOM	51	WCR4	19	Z8EL	40	ZFS248	81	ZPG4	92		
TPRD4	33			Z8EL	81	ZFS3610	81	ZPG6	92		

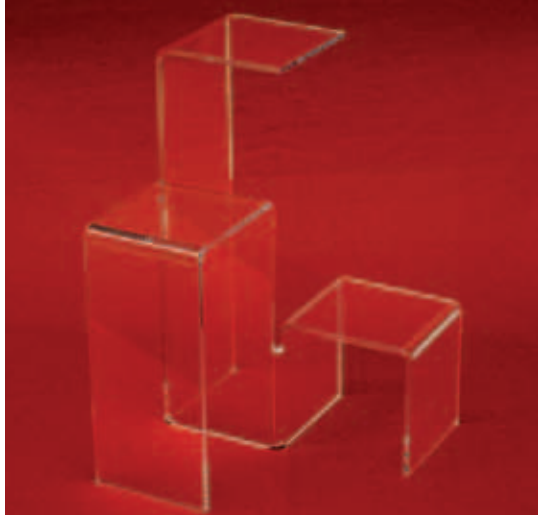

**PLEXI DISPLAYS®**  
Specialized Acrylic & Plexiglas® Fabrication

