



PREFORMED LINE PRODUCTS
The connection you can count on.

COMMUNICATIONS Product Catalog



COMMUNICATIONS



ENERGY



SPECIAL INDUSTRIES



SOLAR



Fiber Optic, Copper,
Demarcation, Bonding, Strand
and Cable Solutions for the
Communications Industry.

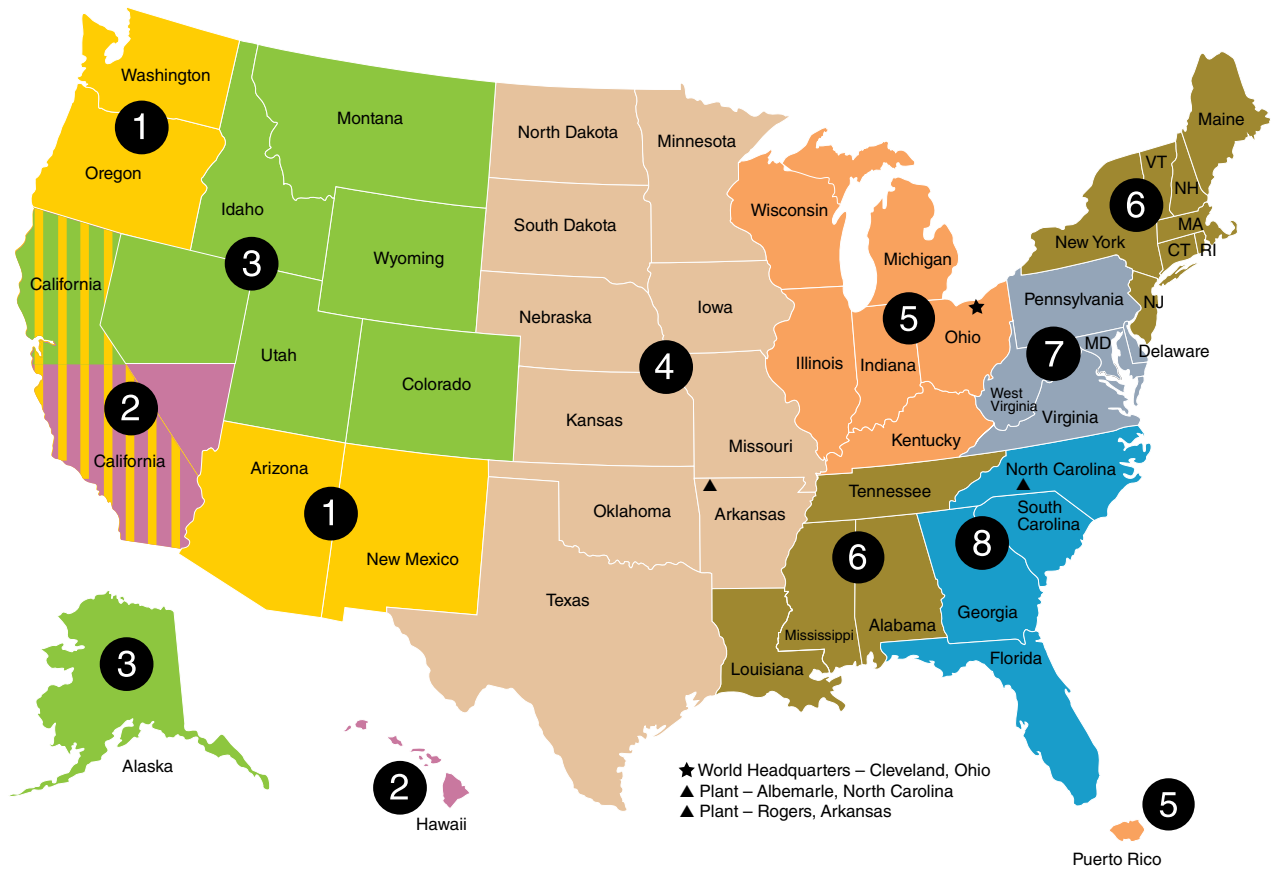

Communication Sales Representative Locator

<p>John Hofstetter VP Sales and Global Communications Markets (440) 461-5200 jhofstetter@preformed.com</p>	<p>Dan Levac National Sales Manager Communications Markets (216) 513-5589 dlevac@preformed.com</p>
---	--

1	<p>Steve Ball, Field Sales Manager (909) 522-1938 sball@preformed.com</p>	5	<p>Brad Lenzian – Field Sales Representative (216) 409-4876 blendzian@preformed.com</p>
2	<p>Larry Gerst – Federal Markets - West (626) 216-1592 lgerst@preformed.com</p>	6	<p>Bill Upton – Eastern Region Sales Manager (440) 715-5147 bupton@preformed.com</p>
3	<p>Mell Petersen, Field Sales Manager (216) 308-3493 mpetersen@preformed.com</p>	7	<p>Rick Sebastian, Field Sales Manager (412) 848-5692 rsebastian@preformed.com</p>
4	<p>Brendan O’Boyle, National Accounts Manager (216) 509-6705 boboyle@preformed.com</p>	8	<p>Art Reiter, Field Sales Manager (216) 644-5260 areiter@preformed.com</p>

Contact PLP area managers for your nearest Manufacturers Representative Agency.



PREFORMED LINE PRODUCTS

Communications Product Catalog

Fiber Optics

Section 1 – COYOTE® Closure Series	Page	Section 6 – FIBERLIGN® Hardware for ADSS Continued	Page
COYOTE Closure Overview	1-2	FIBERLIGN Lite Support for ADSS	6-9
COYOTE Splice Tray & Closure Capacity Charts	1-4	FIBERLIGN Dielectric Support for ADSS	6-12
COYOTE Closure	1-7	FIBERLIGN Aluminum Support for ADSS	6-14
COYOTE PUP Closure	1-9	FIBERLIGN Aluminum Suspension for ADSS	6-16
COYOTE RUNT Closure	1-10	FIBERLIGN Dielectric Suspension for ADSS	6-18
COYOTE Closure End Plates and Accessories	1-11		
Specialty Closures		Section 7 – Hardware Accessories for OPGW and/or ADSS	
COYOTE Cross-Connect and Cross-Connect/Express Closure	1-14	ADSS-CORONA™ Coil	7-2
COYOTE Closures for High Fiber Count Applications	1-16	FIBERLIGN® Cable Abrasion Protector & Cable Marker	7-3
COYOTE Retrofit Closure	1-17	FIBERLIGN® Downlead Cushion	7-4
COYOTE Closures (ADOBE™ Series)	1-18	FIBERLIGN® Motion Control Products	
COYOTE Aerial Drop Closure	1-19	FIBERLIGN® Spiral Vibration Damper	7-7
COYOTE Taut Closure	1-20	VORTX™ Vibration Damper	7-7
COYOTE Silicone Grommet Kits	1-21	FIBERLIGN® Dielectric Damper	7-7
COYOTE Drop Cable Closure	1-22	FIBERLIGN® Air Flow Spoiler	7-7
		FIBERLIGN® Cable Storage Systems	
Section 2 – COYOTE® Splice Case Series		CLAS Storage System	7-8
COYOTE Splice Case	2-2	In-Span Storage System	7-12
Capacities	2-4	(FDC8) Drop Cable Storage Bracket	7-13
Accessories	2-5	In-Span Aluminum Storage System	7-14
Tools	2-7	Cable Storage Systems	7-16
COYOTE Splice Case for Hi-Count Applications	2-8	COYOTE® Defender	7-18
COYOTE Splice Case (ADOBE™ Series)	2-9	COYOTE® Defender 2	7-20
COYOTE Splice Case for Vault Applications	2-11		
		Section 8 – FIBERLIGN® Hardware for Aerial FTTP Applications	
Section 3 – FIBERLIGN® Closure Series		FIBERLIGN Products for ADSS Applications	
FIBERLIGN Splice Trays	3-2	FIBERLIGN ADSS Drop Cable Dead-end	8-3
FIBERLIGN Organizers	3-3	FIBERLIGN Midspan Drop	8-5
FIBERLIGN UNI-CLOSURE	3-8	FIBERLIGN Lite Support	8-6
FIBERLIGN Fiber Safe	3-11	FIBERLIGN Tangent Support	8-7
		FIBERLIGN Products for Figure 8 Drop Cable Applications	
Section 4 – FIBERLIGN® Splice Case Series		FIBERLIGN Figure 8 Drop Cable Dead-end	8-9
Splice Case	4-2	FIBERLIGN Lite Support for Figure 8 Drop Cables	8-10
		FIBERLIGN Tangent Support for Figure 8 Drop Cables	8-11
Section 5 – FIBERLIGN® Hardware for OPGW			
Fiber Optic Product Layout for OPGW	5-2	Section 9 – Fiber Optics: COYOTE® Closures & Splice Cases for OPGW & ADSS	
FIBERLIGN Dead-end for OPGW	5-3	COYOTE Closures for OPGW & ADSS	9-2
FIBERLIGN Formed Wire Dead-end for OPGW	5-6	COYOTE Closures for OPGW & ADSS	
Ground Clamps	5-10	COYOTE PUP for OPGW & ADSS	
Optical Tension Device (OTD)	5-11	COYOTE RUNT for OPGW & ADSS	
FIBERLIGN Suspension for OPGW	5-12	COYOTE Splice Case for OPGW & ADSS	9-4
FIBERLIGN Cushion Clamp for OPGW	5-17	COYOTE Long Trays and Closures for OPGW & ADSS	9-5
FIBERLIGN Repair Rods for OPGW	5-20	COYOTE Short Trays and Closures for OPGW & ADSS	9-6
		COYOTE Dome Closures for ADSS	9-7
Section 6 – FIBERLIGN® Hardware for ADSS		COYOTE Dome Splice Trays for ADSS & OPGW	9-8
Fiber Optic Product Layout for ADSS	6-2	COYOTE Grommet Selection Guide	9-9
FIBERLIGN Lite Tension Dead-end for ADSS	6-3	COYOTE Dome Closures for OPGW	9-10
FIBERLIGN Dielectric Dead-end for ADSS	6-5	COYOTE Dome Closure Cable Restraint Bracket (CRB) System for OPGW	9-11
		COYOTE Defender	Refer to Section 7-18



Copper Products

Section 10 – ARMADILLO® Stainless Series	Page	Section 11 – REDDI™ Seal & Aerial REDDI Closures	Page
Series Overview	10-2	REDDI Seal.....	11-2
ARMADILLO Selection Guide.....	10-4	Aerial REDDI Closure and Heat Shield	11-4
ARMADILLO Stainless Kits	10-5	Aerial REDDI Closure	11-5
ARMADILLO Sealing Washer End Plates.....	10-6	REDDI Seal and Aerial REDDI Closure	11-6
ARMADILLO Drillable End Plate Kits	10-7	Section 12 – Buried Service Wire Closures	
ARMADILLO Stainless Shell Kits	10-9	Ranger SERVICEAL® Closure.....	12-2
ARMADILLO Series Accessories	10-10	Super SERVICEAL® Closure	12-3
ARMADILLO Series Installation		BLACK-JACK™ 25/50-Pair Closures	12-4
Materials/Spare Parts	10-12	Section 13 – Sub-surface Ready Access Terminal Closures	
ARMADILLO Bolt and Torque Bars.....	10-14	Tri-Seal Closure	13-2
ARMADILLO Tools	10-15	Omni-Seal Closure.....	13-3
ARMADILLO Stainless		Section 14 – Environmentally Sealed Coax Drop Wire Closure	
with Fire Retardant Drilled End Plates	10-17	Coax Drop Wire Closure.....	14-2
PLP® Vault Closure Ordering Form	10-18		
ARMADILLO Stainless for Vault Applications	10-19		
RD™ Encapsulant/Resin Kits			
for Buried Applications.....	10-21		
Spacer Mat/Re-Encapsulation Kits			
for Buried Applications.....	10-22		

Demarcation Products

Section 15 – Cable Demarcation Enclosure	Page
Cable Demarcation Enclosure	15-2
Section 16 – COYOTE® Axxcess Solutions™ Products	
COYOTE® Pre-Terminated Cabinets	
Wall and Rack Mounted	16-2
COYOTE Passive Optical Components	16-3
COYOTE Splice Trays.....	16-4
Section 17 – COYOTE® Den Enclosure	
COYOTE Den Demarcation Enclosure	17-2

Bonding Products

Section 18 – Bonding Connectors & Bonding Kits	Page	Section 19 – Pair Protectors & Bonding Accessories	Page
MULTI-BOND™ Shield Connector.....	18-2	Pair Protector	19-2
MORAY™ & MINI-MORAY™ Shield Connectors	18-2	Pair Protector Strip.....	19-2
SERVI-BOND™ Shield Connector.....	18-3	Bonding Accessories	19-3
SURE-GRIP™ Shield Connector & Bonding Kit.....	18-4	Bonding Braid	19-3
Pipe Plug Bonding Kit	18-5	Plastic Roll Tubing.....	19-3
		Bonding Ferrules	19-3
		Shield Bonding Kit.....	19-4

Strand and Cable Products

Section 20 – Dead-end & Accessories	Page	Section 22 – Splices	Page
Figure-8 Messenger Dead-end.....	20-2	Open Wire Splice	22-2
GUY-GRIP® Dead-end.....	20-3	Strand Splice.....	22-3
GUY-LOCK	20-6	Reducing Splice	22-4
Big-Grip Dead-end.....	20-7		
False Dead-end.....	20-9	Section 23 – Motion Control Products	
Open Wire Dead-end	20-10	Air Flow Spoiler	23-2
Drop Wire/C-Rural/Buried Line Wire Dead-end	20-11	Spiral Vibration Damper.....	23-3
Telegrip	20-12		
Custom Coaxial Dead-end.....	20-13	Section 24 – Spacers & Support	
Pulling Eye	20-13	Communication Spacers.....	24-2
Safety Guy-Wire Dispenser	20-14	Tangent Supports	24-3
Section 21 – Guards, Moldings & Markers		Section 25 – Lashing Rods	
Tree Guards	21-2	Lashing Rods	25-2
Guy Markers.....	21-5		
Classic Guy Markers.....	21-7		
Economy Guy Markers	21-8		
Wrap-Around Guy Markers.....	21-9		
Fiber Optic Cable Marker.....	21-10		
Pedestal Marker	21-10		
Ground Wire Molding	21-11		
BIRD-FLIGHT™ Diverter.....	21-12		
SWAN-FLIGHT™ Diverter	21-14		
BIRD-FLIGHT™/SWAN-FLIGHT™ Diverter Spacing.....	21-15		

Appendix

Section 26 – Reference & Sales Information	Page
Index by Part Number.....	26-2
Standard Terms and Conditions of Sale.....	26-26





PREFORMED LINE PRODUCTS

Section 1 – COYOTE® Closure Series

Table of Contents	Page
COYOTE Closure Overview	1-2
COYOTE Splice Tray & Closure Capacity Charts	1-4
COYOTE Closure	1-7
COYOTE PUP Closure	1-9
COYOTE RUNT Closure	1-10
COYOTE Closure End Plates and Accessories	1-11
 Specialty Closures	
COYOTE Cross-Connect and Cross-Connect/Express Closure	1-14
COYOTE Closures for High Fiber Count Applications	1-16
COYOTE Retrofit Closure	1-17
COYOTE Closures (ADOBE™ Series)	1-18
COYOTE Aerial Drop Closure	1-19
COYOTE Taut Closure	1-20
COYOTE Silicone Grommet Kits	1-21
COYOTE Drop Cable Closure	1-22



COYOTE® Closure Overview

Choose a member of the COYOTE Closure Family that Best Suits your Application.....



It all began with the development of a new breed of fiber optic closure. Craft friendly. Easily installed. Competitively priced. And designed to go wherever fiber optic cable takes you. Over the years the philosophy has remained constant, and the family has grown with each successive member

offering its own unique solutions to the varied requirements of an ever-evolving fiber optic network. From aerial to underground to every step of the last mile, the COYOTE family of fiber optic closures is there to provide performance you can count on.

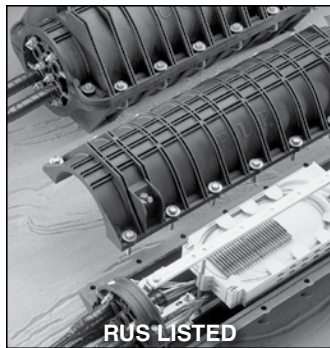

COYOTE Closure (Page 1-7)

Setting the bar against which all other fiber closures are measured was no small task for our design team. But years of research & development eventually paid off in the form of a rugged and reliable design that has become legend. After over ten years of field use and several hundred thousand units sold, the original COYOTE Closure still remains one of the most highly regarded and widely used fiber optic closures in the industry.



COYOTE PUP Closure (Page 1-9)

The COYOTE PUP Closure offers the perfect choice for low fiber count distribution applications involving butt and inline installations. The compact size and rugged design allow the closure to be applied in below grade, aerial and buried installations. Supported by a full line of COYOTE accessories, this closure can grow along with your network.

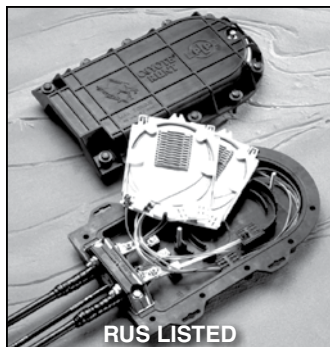

COYOTE RUNT Closure (Page 1-10)

The compact COYOTE RUNT Closure is ideal for low fiber count, (up to 48 splices), end-of-the-line, node and fiber-to-the-curb installations. It will easily fit into most pedestals and hand holes, and the rugged design allows it to be used in all environments.

COYOTE® Closure Overview



COYOTE Cross-Connect and Cross-Connect/Express Closure (Page 1-14)

The COYOTE Cross-Connect Closure was designed for applications requiring connectorization or cross connecting in the outside plant network. Additionally, the COYOTE Cross-Connect/Express Closure was configured to allow for convenient and safe storage of uncut buffer tubes in the feeder cable, while providing individual connectivity to the fibers of the drop cables.

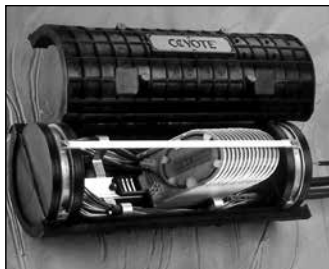

COYOTE Retrofit Closure (Page 1-17)

The COYOTE Retrofit Closure is the right choice for replacement or expansion of existing fiber optic closures.



COYOTE Aerial Drop Closure (Page 1-19)

The COYOTE Aerial Drop Closure is a value priced solution. Features include its compact size and ease of installation – no special tools needed. It is capable of higher splice capacities and is designed for PLP's easy-to-use grommet system. Included is the universal mounting bracket, which permits pole mounting with straps, strand mounting with strand clamps or suspension from "J" hooks secured to a pole.













COYOTE Taut Closure (Page 1-20)

The COYOTE Taut Closure simplifies branch cable taps or repairs of taut fiber optic cables. Features the innovative End Plate from the Dome Closure and full line of multi hole grommets.



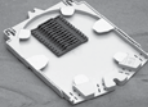

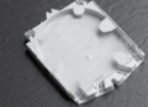











COYOTE® Short Trays and Closure Capacity Chart

Short Splice Trays & Closures	 COYOTE RUNT	 COYOTE Expanded RUNT	 COYOTE In-Line RUNT ¹	 COYOTE Terminal (Single Chamber) ¹	 COYOTE Terminal (Dual Chamber) ^{1,2}	 6.5"x17" COYOTE Dome	 COYOTE PUP
 Low Profile Tray (12 splice count) 80807701  Cat. # (80807769 blank)	3 Trays 36 Max Splice count	6 Trays 72 Max Splice count	4 Trays 48 Max Splice count	4 Trays 48 Max Splice count	8 Trays 96 Max Splice count	6 Trays 72 Max Splice count	6 Trays 72 Max Splice count
 Standard Tray (12 splice count) 80806033  Cat.# (80806182 blank)	2 Trays 24 Max Splice count	4 Trays 48 Max Splice count	2 Trays 24 Max Splice count	2 Trays 24 Max Splice count	4 Trays 48 Max Splice count	4 Trays 48 Max Splice count	4 Trays 48 Max Splice count
 Ribbon Tray (72 splice count) 80807114  Cat. # (80808160 blank)	1 Tray 72 Max Splice count	2 Trays 144 Max Splice count	2 Trays 144 Max Splice count	2 Trays 144 Max Splice count	4 Trays 288 Max Splice count	3 Trays 216 Max Splice count	2 Trays 144 Max Splice count

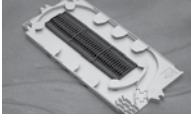
¹ 24 count Low Profile Tray (Cat. # 8003468) is available for COYOTE In-Line, COYOTE Terminal (Single Chamber), & COYOTE Terminal (Dual Chamber) closures. Tray Conversion Kit (Cat. # 8003757) is required to use this tray in these closures.

² The maximum splice count for the COYOTE Terminal (Dual Chamber) requires trays to be installed in both chambers of the closure.

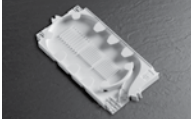
COYOTE® Long Trays and Closure Capacity Chart

<p>Long Splice Trays & Closures</p>	 6.5"x22" COYOTE Dome	 6.5"x22" COYOTE	 8.5"x22" COYOTE	 6.5"x22" COYOTE Splice Case	 8"x28" COYOTE Splice Case	 9.5"x28" COYOTE Splice Case
 Low Profile Tray (36 splice count) Cat. # 8001127 (w/plastic splice blocks)  8001130 (blank)	6 Trays 216 Max Splice count	6 Trays 216 Max Splice count	11 Trays 396 Max Splice count	6 Trays 216 Max Splice count	9 Trays 324 Max Splice count	13 Trays 468 Max Splice count
 Standard Tray (36 splice count) Cat. # 8080514 (w/elastomer splice block)  80805110 (w/rigid slots)  80805509 (blank)	4 Trays 144 Max Splice count	4 Trays 144 Max Splice count	8 Trays 288 Max Splice count	5 Trays 180 Max Splice count	7 Trays 252 Max Splice count	10 Trays 360 Max Splice count
 Ribbon Tray (144 splice count) Cat. # 8080515 (w/elastomer splice blocks)  80805146 (w/rigid slots)  80805510 (blank)	3 Trays 432 Max Splice count	2 Trays 288 Max Splice count	4 Trays 576 Max Splice count	2 Trays 288 Max Splice count	5 Trays 720 Max Splice count	6 Trays 864 Max Splice count



COYOTE® Closure

PLP Feature Focus

©2009 Preformed Line Products

Film available at
www.preformed.com

Origin of the Species...

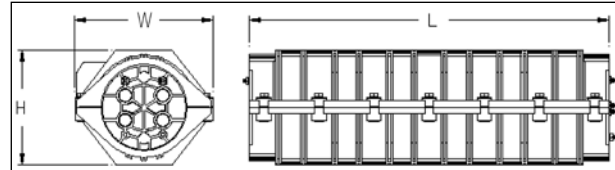
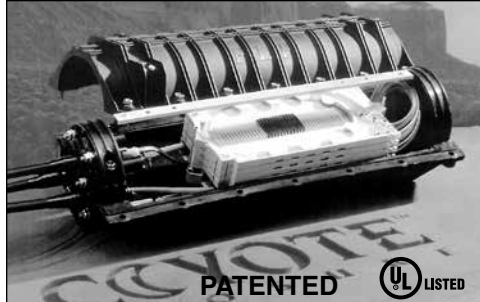

Size	L (cm)	W (cm)	H (cm)
6.0" x 22"	22" (56)	8-1/2" (22)	7" (18)
8.5" x 22"	22" (56)	10-3/4" (27)	9-1/4" (24)

See pages 1-4 and 1-5 for Trays and Splice information

Setting the bar against which all other fiber closures are measured was no small task for our design team. But years of research & development eventually paid off in the form of a rugged and reliable design that has become legend.

After over ten years of field use and several hundred thousand units sold, the original COYOTE Closure still remains one of the most highly regarded and widely used fiber optic closures in the industry.

Key Features:

- **Sizes:**
 - 6.0" x 22" (15 cm x 56 cm)
 - 8.5" x 22" (22 cm x 56 cm)
- **End plate options: 4 Port and 6 Port**
 - 6 Port provides (4) 7/8" (22 mm) ports and (2) 3/4" (19 mm) ports
 - 4 Port provides (2) 1-1/4" (32 mm) ports and (2) 1" (25 mm) ports
- **Splice Capacity:**
 - Up to 396 with single fusion, 576 with mass fusion
- **Configuration:** Butt or In-line applications
- Organizers designed for loose buffer tube and ribbon applications
- Compact size allows for mounting in smaller locations
- Provided with LOCK-TAPE Sealant System
- Accepts a wide variety of grommets for multi drop applications
- Field proven permanent neoprene gasket system
- No re-entry kits required
- Future cable ports provide capability for future cable installation, without end plate removal
- Integrated air valve to confirm integrity of final assembly
- Full line of mounting hardware
- **UL Approved and RUS Listed**
- Tested in accordance to Telcordia GR-771 CORE

User options for COYOTE Closure Three-Section End Plate

Three-Section Six Port End Plate
(Cat. No. 80805105)

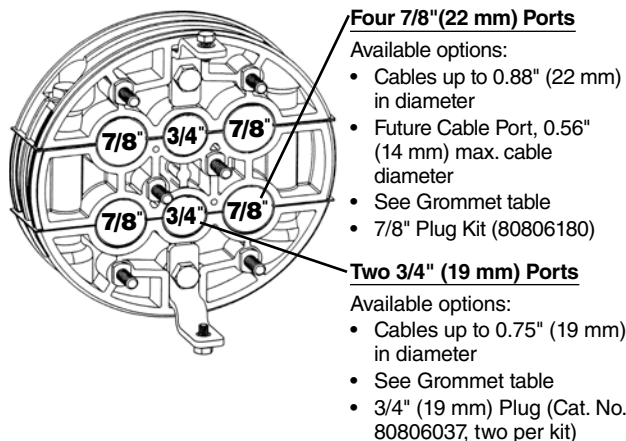

Three-Section Four Port End Plate
(Cat. No. 80805739)

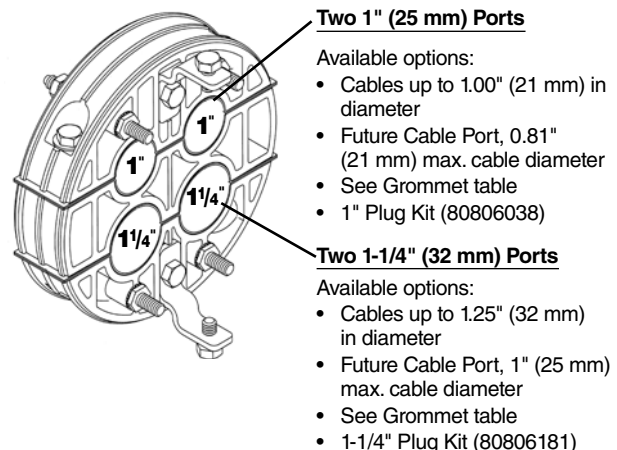

Note: Three-Section Six Port End Plate Kits include three 7/8" (22 mm) Plugs, two (2) 3/4" (19 mm) Plugs and two Strength Member Brackets.



COYOTE® Closure

COYOTE Closure Kits		
Catalog Number		
6 Port End Plate	4 Port End Plate	Description
8006560	8006633	Buffer Tube: 6" x 22" COYOTE Closure, includes (1) 3 section end plate, (1) blank end plate, organizer and LOCK-TAPE sealant
8006540	8006631	Unitube Transition Compartment: 6" x 22" COYOTE Closure, includes (1) 3 section end plate, (1) blank end plate, organizer, transport tube kit, transition tube kit and LOCK-TAPE sealant
8006587	8006635	Express Buffer Tube: 6" x 22" COYOTE Closure, includes (1) 3 section end plate, (1) blank end plate, express organizer and LOCK-TAPE sealant
8006659		Buffer Tube: RUS LISTED - 6" x 22" COYOTE Closure, includes (1) 3 section end plate, (1) blank end plate, organizer, LOCK-TAPE sealant and (2) RUS listed shield connectors
8006561	8006634	Buffer Tube: 8.5" x 22" COYOTE Closure, includes (1) 3 section end plate, (1) blank end plate, organizer and LOCK-TAPE sealant
8006541	8006632	Unitube Transition Compartment: 8.5" x 22" COYOTE Closure, includes (1) 3 section end plate, (1) blank end plate, organizer, transport tube kit, transition tube kit and LOCK-TAPE sealant
8006588	8006636	Express Buffer Tube: 8.5" x 22" COYOTE Closure, includes (1) 3 section end plate, (1) blank end plate, express organizer and LOCK-TAPE sealant
8006660		Buffer Tube: RUS LISTED - 8.5" x 22" COYOTE Closure, includes (1) 3 section end plate, (1) blank end plate, organizer, LOCK-TAPE sealant and (2) RUS listed shield connectors

UL Approved, RUS Listed, Patented

Splice Tray Installation Materials Kits	
Catalog Number	Description
80808187	40 mm heat shrink protector (12 per kit)
8003717	60 mm heat shrink protector (50 per kit)
8003381	12-Count soft elastomer splice block kit (3 per kit)
80807989	Transport tube kit (bulk) – 100 ft coil of transport tube 0.170" I.D. – will contain (6) 12 fiber ribbons
80807991	Transport tube kit (bulk) – 100 ft coil of transport tube 0.250" I.D. – will contain (12) 12 fiber ribbons
8003285	Transport tube kit, color coded, includes (6) transport tubes 0.135" I.D.

Miscellaneous Accessories	
Catalog Number	Description (mm)
80805260	Blank End Plate Kit
80805107	Strength Member Bracket Kit – two per kit
80805431	Extended Strength Member Bracket Kit – two per Kit
8003386	Heat Shield for 6.0" (152) x 22.0" (559) COYOTE Closure
8003387	Heat Shield for 8.5" (216) x 22.0" (559) COYOTE Closure
8003385	Flame-Retardant Blanket for 6.0" (152) x 22.0" (559) COYOTE Closure
8003388	Flame-Retardant Blanket for 8.5" (216) x 22.0" (559) COYOTE Closure
8003280	Transition Tube Kit Used to transition fibers from the top section of the End Plate to the Transition Compartment.
8000475	COYOTE Closure End Plate Removal Tool
80805293	Transport Tube Kit .135" ID: includes six 34" long transPort with Hardened Adapter tubes, used to bring fiber from transition compartment to splice tray
80806439	Transport Tube Kit .25" ID: includes six 34" long transPort with Hardened Adapter tubes, used to bring fiber from transition compartment to splice tray

Bonding and Grounding Kits	
Catalog Number	Description (mm)
8003281	External bond clip kit
8003360	External bond braid kit
8003463	External isolation terminal kit, includes (2) isolation terminals with 7" long #6 cable stub and splice sleeve
8003464	External isolation terminal kit, includes (2) isolation terminals with 7" long #6 cable stub and quick disconnect
8003465	Quick disconnect kit (2 per kit)
80806750	External isolation connector for COYOTE Closures
80803989	Fiber optic shield connector, RUS Listed 3M #4460-D/FO (1 per kit)
80806743	Fiber optic shield connector for up to .5" (13mm) cable O.D.
80806744	Fiber optic shield connector for .5" to .8" (13 - 20mm) cable O.D.
80806745	Fiber optic shield connector for .8" to 1.6" (20 - 41mm) cable O.D.
80805286	Adapter bracket kit for AT&T bond connector (4 per kit)
8003322	Isolated ground kit for 0.27" to .31" (7 - 8mm)
8003424	Strength member bracket isolation kit, includes (6) nylon washers and bushings
80806179	Bonding Braid, .5" W x 7" L with (2) eyelets spaced 6" apart

COYOTE Closure Splice Tray Kits			
Catalog Number	Description	6.5" x 17" or Smaller	6" x 22" or Larger
80807701	12 Count Low Profile Tray w/plastic splice block – single fusion splices	X	
80807769	12 Count Low Profile Tray (Blank) No Splice Block	X	
80806033	12 Count Standard Tray w/elastomeric splice block – Fusion & mechanical splices	X	
80806182	12 Count Standard Tray (Blank) – No Splice Block	X	
80808290	12 Count Bare Fiber Splice Trays	X	
80807114	72 Count Ribbon Tray w/Elastomeric Splice Block for Mass Fusion	X	
80808160	Ribbon Tray (Blank) No splice Block	X	
8001127	36 Count Low Profile Tray w/plastic splice block – single fusion splices		X
80807531	Blank Low Profile Splice Tray		X
8001130	Blank Low Profile Splice Tray		X
80805514	36 Count Standard Tray w/elastomeric splice blocks – Fusion & mechanical splices		X
80805110	36 Count Standard Tray w/ fixed rigid slots		X
80805509	36 Count Standard Tray (Blank) – No Splice Block		
80808289	36 Count Bare Fiber Splice Trays		X
80805146	144 Count Ribbon Tray w/ fixed rigid slots		X
80805515	144 Count Ribbon Tray w/2 elastomeric splice blocks		X
80805510	144 Count Ribbon Tray (Blank) – No splice blocks		X

*Requires additional LITE-GRIP block kit to achieve maximum capacity.

COYOTE® PUP Closure

Refinement of the Breed...



The COYOTE PUP Closure offers the perfect choice for low fiber count distribution applications involving butt and inline installations. The compact size and rugged design allow the closure to be applied in below grade, aerial and buried installations. Supported by a full line of COYOTE accessories, this closure can grow along with your network.

Key Features:

- **Compact Size:** 17" L x 8.6" W x 7.2" H (43.2 cm x 21.9 cm x 18.4 cm)
- **End plate options: 4 Port and 6 Port**
 - 6 Port provides (4) 7/8" (22 mm) ports and (2) 3/4" (19 mm) ports
 - 4 Port provides (2) 1-1/4" (32 mm) ports and (2) 1" (25 mm) ports
- **Splice Capacity:** 72 Single Fusion
144 Ribbon/Mass Fusion
- **Configuration:** for butt or in-line applications
- Organizers designed for loose buffer tube and ribbon applications
- Size allows for mounting in small hand holes
- Provided with LOCK-TAPE™ Sealing System
- Accepts a wide variety of grommets for multi drop applications
- Permanent neoprene gasket system requires no re-entry kits
- Future cable ports provide capability for future cable installation, without end plate removal
- Integrated air valve to confirm integrity of final assembly
- Full line of mounting hardware
- **UL Approved, RUS Listed**
- Tested in accordance to Telcordia GR-771 CORE

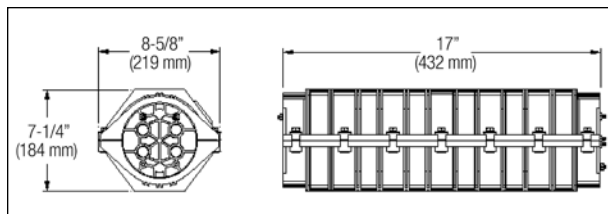

COYOTE PUP Closure Kits	
Catalog Number	Description
8006622	COYOTE PUP Closure Kit for Buffer Tube – includes (1) 3 section 6 Port End Plate, (1) blank end plate and organizer
8006621	COYOTE PUP Closure Kit for Unitube – includes (1) 3 section 6 Port End Plate, (1) blank end plate, transport tube kit and organizer
8006661	RUS Listed COYOTE PUP Closure Kit for Buffer Tube – includes (1) 3 section 6 Port End Plate, (1) blank end plate, organizer and (2) RUS listed shield connectors.
800011398	COYOTE PUP Closure Kit for Copper Applications with 6-Port End Plates
800011399	COYOTE PUP Closure Kit for Copper Applications with 4-Port End Plates
800010515	COYOTE PUP Closure for Buffer Tube Applications with 4-Port End Plate
Mounting Hardware Kits	
8003325	Aerial hanger bracket
8003279	Manhole support bracket
8003372	Pole/wall mount bracket (vertical)
Accessories Kits	
End Plate Grommets	See Grommet Chart in COYOTE Closure End Plate and Accessories Section
80805795	Shell Kit 6" x 17" (152 mm x 431 mm)
80805771	Buffer Tube Storage Compartment
80805775	Unitube Storage (Transition) Compartment
80805105	6 Port End Plate Kit, Includes (1) end plate assembly, (1) full set of plugs, and LOCK-TAPE™ Sealing material
80805739	4 Port End Plate Kit, Includes (1) end plate assembly, (1) full set of plugs, and LOCK-TAPE sealing material
80805260	Blank end plate kit
8003371	Future Cable Port Kit, Includes Future Cable Port for 7/8" port, plug and clamps for installation of future cable port during initial assembly
8003291	Future Cable Installation Kit, includes LOCK-TAPE Sealant, bead sealant and L-bracket for preparation of future cable up to .86" in diameter
8003289	Future Cable Port/Cable Installation Kit. Complete kit includes Cat. Nos. 8003289 and 8003291
80806037	3/4" Plug Kit (contains 2 plugs)
80806180	7/8" Plug Kit (contains 2 plugs)
80806038	1" Plug Kit (contains 2 plugs)
80806181	1-1/4" Plug Kit (contains 2 plugs)
80805293	Transport Tube Kit (contains 6 tubes)
8003280	Transition Tube Kit, used to transition fibers from top section of end plate to the transition compartment
8003418	Heat Shield for PUP Closure
Installation Materials	
80805238	C-Cement, 1 oz. tube
80805925	LOCK-TAPE Sealant 1" W x 15" L Roll

See pages 1-4 and 1-5 for Trays and Splice information.



COYOTE® RUNT Closure

Refinement of the Breed...

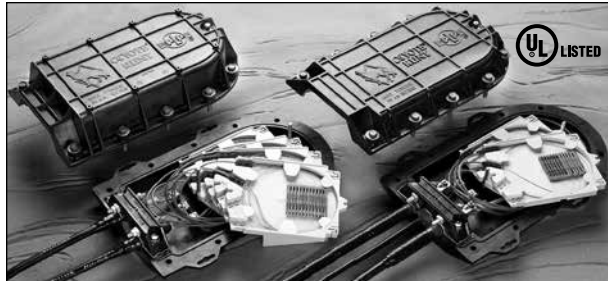

COYOTE RUNT Closures

The COYOTE RUNT Closure was specifically designed for fiber distribution networks. The small compact size of the COYOTE RUNT Closures make them an ideal fit for smaller hand holes and pedestals in the last fiber mile.

Key Features:

- **Compact Size:** 14.75" L x 8.5" W x 3" H (37.5 cm x 21.6 cm x 7.6 cm)
- **Expanded Size:** 14.75" L x 8.5" W x 4.75" H (37.5 cm x 21.6 cm x 10.8 cm)
- **Port Quantity:** 3 entrance ports; (2) 3/4" (19 mm) port and (1) 1" (25 mm) port
- **Splice Capacity:** STD: 36 Single Fusion
72 Ribbon/Mass Fusion
Expanded: 72 Single Fusion
144 Ribbon/Mass Fusion
- **Application:** Loose tube or ribbon fiber applications
- Size allows for mounting in small pedestals and hand holes
- Provided with LOCK-TAPE™ Sealing System
- Accepts a wide variety of grommets for multi drop applications – See grommet chart in COYOTE Closure End Plate and Accessories section
- Permanent neoprene gasket system requires no re-entry kits
- Future cable ports provide capability for future cable installation without end plate removal
- Standard cover can be replaced with expanded to increase splice capacity
- Integrated air valve to verify integrity of final assembly
- **UL Approved and RUS Listed**
- Tested in accordance to Telcordia GR-771 CORE

COYOTE RUNT & Expanded COYOTE RUNT Closure	
Catalog Number	Description
COYOTE RUNT Closure Kits	
8006671	COYOTE RUNT Closure Kit, Includes LOCK-TAPE™ Sealant, Bond Brackets and transport tubing
8006794	Expanded COYOTE RUNT Closure Kit, Includes LOCK-TAPE Sealant, Bond Brackets and transport tubing
8006692	RUS Listed COYOTE RUNT Closure Kit, Includes LOCK-TAPE Sealant, Bond Brackets and transport tubing
800011397	COYOTE RUNT Closure for Copper Application
8006916	Expanded COYOTE RUNT Cross Connect
Accessory Kits	
8003407	Future Cable Port Kit. Includes 1" port, plug and clamps
8003291	Future Cable Port Installation Kit. Includes LOCK-TAPE sealant, bead sealant and L-bracket for preparation of future cable up to 1" in diameter
8003408	Future Cable Port/Installation kit. Complete kit includes catalog nos. 8003407 and 8003291
80806037	3/4" Plug kit (contains 2 plugs)
80806038	1" Plug kit (contains 2 plugs)
80806112	Transport tube kit, contains 4 tubes
8003574	Shell expansion kit includes Expanded top shell and longer studs to increase tray capacity
Installation Materials	
80805238	C-Cement, 1 oz. Tube
80805925	LOCK-TAPE Sealant, 1" W x 15' L (0.254 m x 42.6 m) roll
Bonding Accessories	
80803989	Fiber Optic Shield Connector (1 per kit) 3M#4460-F/FO
8003281	External Bonding Clip
Mounting Hardware Kits	
8003467	Aerial Hanger Bracket
8003470	Manhole Support Bracket
8003523	Wall Mount Bracket
8003571	Universal Wall/Pole Mount Bracket

See pages 1-4 and 1-5 for Trays and Splice information.

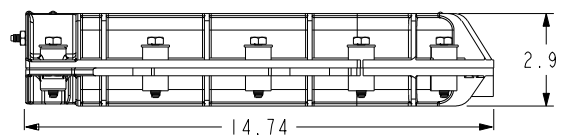
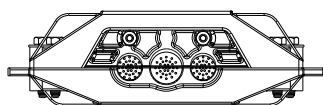

COYOTE RUNT End Plate

1" (25 mm) Ports

Available options:

- Cables up to 1.0" (25 mm) in diameter
- Future Cable Port, 0.81" (21 mm) max. cable diameter
- See Grommet table
- 1" Plug Kit (80806038)

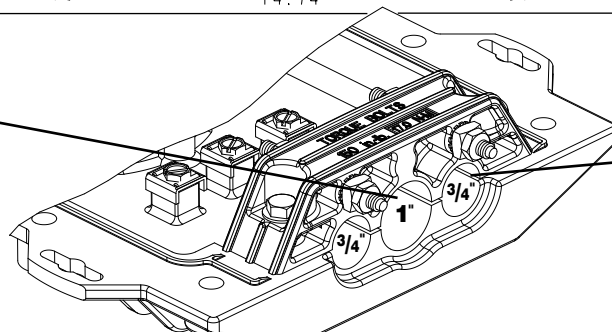

Two 3/4" (19 mm) Ports

Available options:

- Cables up to 0.75" (19 mm) in diameter
- See Grommet table
- 3/4" Plug (80806181) Two/Kit

COYOTE® Closure End Plates and Accessories

Future Cable Port Kit

When installed during the initial assembly, Future Cable Ports allow for the addition of branch cables in the future with no disruption to the existing cables and the fibers within them.



Future Cable Port Kits							
Catalog Number	Description	Port Size			End Plate Usage		
		7/8"	1.0"	1-1/4"	Runt	6 Port	4 Port
8003371	Future cable port kit for 7/8" Port, includes (1) cable port, (1) plug and (1) clamp	X				X	
8003407	Future cable port kit for 1" Port, includes (1) cable port, (1) plug and (1) clamp		X		X		X
8003409	Future cable port kit for 1-1/4" Port includes (1) cable port, (1) plug and (1) clamp			X			X
8003291	Future cable installation kit, includes LOCK-TAPE sealant, bead sealant and I-bracket	X	X	X	X	X	X
8003289	Future cable port for 7/8" port plus installation kit (8003291)	X				X	
8003408	Future cable port for 1" port plus installation kit (8003291)		X		X		
8003410	Future cable port for 1-1/4" port plus installation kit (8003291)			X			X

COYOTE Closure End Plate Grommets

End Plate Grommets expand the capacity of the COYOTE Closure Three-Section End Plates for applications with smaller diameter cables or insulated ground wires.

The grommets are manufactured from a weather-resistant urethane material that is designed to ensure a tight and permanent seal. A Silicone Sealant is provided to lubricate the grommet and cables for easy installation.

The entry holes in the multi-entry grommets are covered with a thin layer of urethane material to provide a choice of which entries are to be used for future cable entries.

See Grommet charts on pages 1-12 and 1-13.

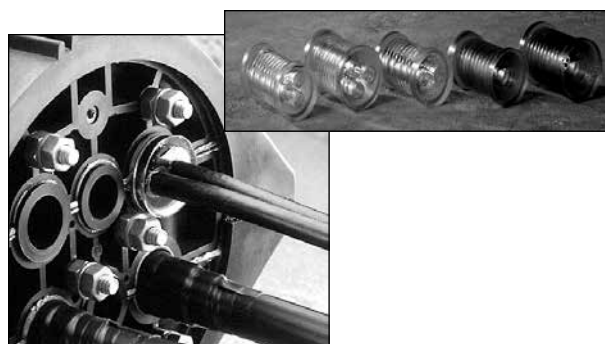























End Plate Installation Material Kits	
Catalog Number	Description
80805105	6 Port end plate kit, includes (1) end plate assembly, (1) full set of plugs and LOCK-TAPE sealant
80805739	4 Port end plate kit, includes (1) end plate assembly, (1) full set of plugs and LOCK-TAPE sealant
80806037	Plug Kit for 3/4" ports (2 per kit)
80806180	Plug Kit for 7/8" ports (2 per kit)
80806038	Plug Kit for 1.0" ports (2 per kit)
80806181	Plug Kit for 1-1/4" ports (2 per kit)



COYOTE® Closure End Plates and Accessories

Single Port Grommets										
Catalog Number (End Color)	Hole Pattern	Entries	Factory Slit	Accepted Cable Diameter Range inches (mm)	COYOTE RUNT Standard and Expanded Port Sizes		COYOTE 6 Port End Plate Port Sizes		COYOTE 4 Port End Plate Port Sizes	
					3/4"	1"	3/4"	7/8"	1"	1-1/4"
8003394 (Green)		1	NO	.31 - .38 (7.8 - 9.6)	X		X			
8003395 (Green)		1	NO	.31 - .38 (7.8 - 9.6)				X		
8003473 (Light Blue)		1	NO	.43 - .48 (11 - 12.2)		X			X	
8003494 (Yellow)		1	NO	.48 - .53 (12.2 - 13.5)		X			X	
8003495 (Gray)		1	NO	.53 - .58 (13.4 - 14.7)		X			X	
8003496 (Light Blue)		1	NO	.43 - .48 (11 - 12.2)						X
8003497 (Yellow)		1	NO	.48 - .53 (12.2 - 13.5)						X
8003498 (Gray)		1	NO	.53 - .58 (13.4 - 14.7)						X
8003500 (Orange)		1	NO	.38 - .43 (9.6 - 11)	X		X			
8003501 (Orange)		1	NO	.38 - .43 (9.6 - 11)				X		
8003596 (Light Blue)		1	NO	.43 - .48 (11 - 12.2)	X		X			
8003597 (Light Blue)		1	NO	.43 - .48 (11 - 12.2)				X		
8003598 (Yellow)		1	NO	.48 - .53 (12.2 - 13.5)	X		X			
8003599 (Yellow)		1	NO	.48 - .53 (12.2 - 13.5)				X		
8003600 (Gray)		1	NO	.53 - .58 (13.4 - 14.7)	X		X			
8003601 (Gray)		1	NO	.53 - .58 (13.4 - 14.7)				X		
8003497 (Yellow)		1	NO	.48 - .53 (12.2 - 13.5)						X
8003671 (Light Blue)		1	YES	.43 - .48 (11 - 12.2)	X		X			
8003674 (Gray)		1	YES	.53 - .58 (13.4 - 14.7)				X		
8003689 (Yellow)		1	YES	.48 - .53 (12.2 - 13.5)	X		X			
8003675 (Gray)		1	YES	.53 - .58 (13.4 - 14.7)	X		X			

COYOTE® Closure End Plates and Accessories

Multi-Port Grommets										
Catalog Number (End Color)	Hole Pattern	Entries	Factory Slit	Accepted Cable Diameter Range inches (mm)	COYOTE RUNT Standard and Expanded Port Sizes		COYOTE 6 Port End Plate Port Sizes		COYOTE 4 Port End Plate Port Sizes	
					3/4"	1"	3/4"	7/8"	1"	1-1/4"
8003392 (Red)		2	NO	.27 - .31 (6.8 - 7.8)	X		X			
8003393 (Green)		2	NO	.31 - .38 (7.8 - 9.6)				X		
8003399 (Orange)		2	NO	.38 - .43 (9.6 - 11)		X			X	
8003608 (Light Blue)		2	NO	Corning SST (Flat Drop)	X		X			
8003730 (Light Blue)		2	YES	Corning SST (Flat Drop)	X		X			
8003536 (Black)		3	NO	.18 - .24 (4.5 - 6.1)		X			X	
800010621 (Black)		3	NO	.18 - .24 (4.5 - 6.1)				X		
8003389 (Red)		3	NO	.27 - .31 (6.8 - 7.8)				X		
8003390 (Blue)		3	NO	.20 - .27 (5.1 - 6.8)				X		
8003391 (Blue)		3	NO	.20 - .27 (5.1 - 6.8)	X		X			
8003400 (Blue)		3	NO	.31 - .38 (7.8 - 9.6)		X			X	
8003402 (Red)		3	NO	.27 - .31 (6.8 - 7.8)		X			X	
8003403 (Orange)		3	NO	.38 - .43 (9.6 - 11)						X
8003609 (Light Blue)		3	NO	Corning SST (Flat Drop)				X		
8003401 (Blue)		4	NO	.20 - .27 (5.1 - 6.8)		X			X	
8003404 (Green)		4	NO	.31 - .38 (7.8 - 9.6)						X
8003405 (Blue)		4	NO	.20 - .27 (5.1 - 6.8)						X
8003406 (Red)		4	NO	.27 - .31 (6.8 - 7.8)						X
8003575 (Brown)		4	NO	.12 - .16 (3 - 4.1)				X		
8003607 (Red)		4	NO	.27 - .31 (6.8 - 7.8)		X			X	
8003610 (Light Blue)		4	NO	Corning SST (Flat Drop)		X			X	
8003576 (Brown)		6	NO	.12 - .16 (3 - 4.1)		X			X	
8003611 (Light Blue)		6	NO	Corning SST (Flat Drop)						X
8003582 (Brown)		10	NO	.12 - .16 (3 - 4.1)						X



COYOTE® Cross-Connect and Cross-Connect/Express Closures

Refinement of the Breed...

The COYOTE Cross-Connect Closure provides long-term peace of mind.

The COYOTE Cross-Connect and Cross-Connect/Express Closures allow you to splice up to 96 single fiber splices and cross connect up to 48 pigtails on both the office and distribution side. Consult PLP support for details on ribbon fiber splices. By redirecting fiber for outside plant, the COYOTE Cross-Connect Closure saves time and money: because you splice only once.

The COYOTE Cross-Connect and Cross-Connect/Express Closures are made from the same durable UV stabilized material as the COYOTE Closure.

The internal bulkhead is designed to accept a variety of connector styles. Place your order as soon as you have chosen the connector for your application and determined your pigtail requirements. This customization process saves time and money by limiting the order to only the parts required.

Each end plate allows for multiple entries. Isolated ground studs simplify troubleshooting, and provide additional support for strength member tie-off.

The family of COYOTE Cross Connect/Express Closures is configured to conveniently and safely store uncut buffer tubes of the feeder cable, while providing individual connectivity to the fibers of the drop cables.

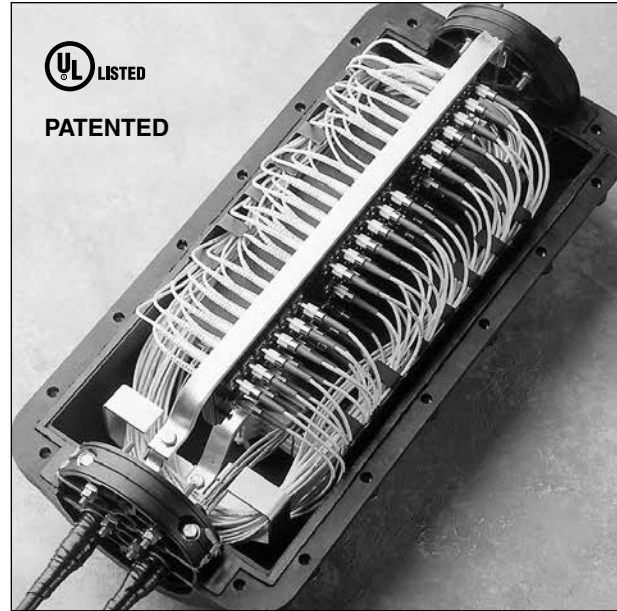

The COYOTE Cross-Connect Closure is waterproof and uses the revolutionary LOCK-TAPE™ Sealant System, providing field-proven durability. The neoprene gasket also aids in keeping the closure's contents accessible again and again without a costly re-entry kit. The COYOTE Closure is tested in accordance with Bellcore GR-771-CORE.

COYOTE Cross-Connect Closure components

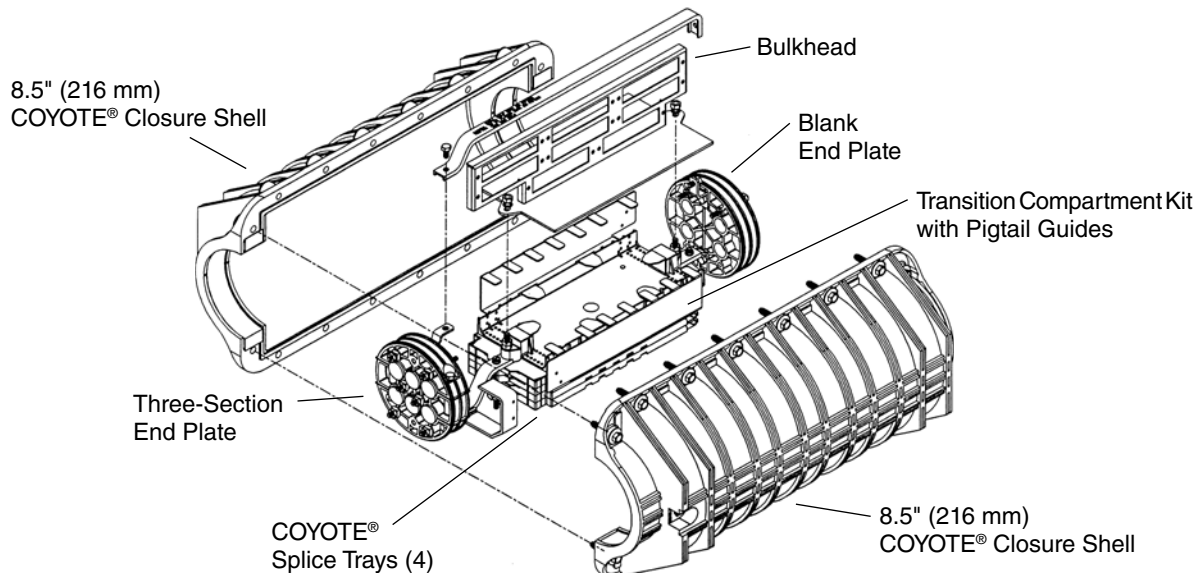

COYOTE® Cross-Connect and Cross-Connect/Express Closures

Refinement of the Breed...

Ordering Information

Included in all COYOTE Cross-Connect Closure Kits is one Three-Section End Plate, one Blank End Plate, Transition Compartment Kit with Pigtail Guides, Bulkhead, and four COYOTE Splice Trays (single fiber). ST, SC and FC Half-Loaded and Fully-Loaded Kits contain additional items which are described in the table below.



PATENTED

COYOTE Cross-Connect Closure	
Catalog Number	Description
8006572	COYOTE Cross Connect-Closure (Standard Unit) includes one three-section End Plate, one blank End Plate, transition compartment kit with pigtail guides, bulkhead, and four COYOTE Splice Trays (single fiber)
8006576	COYOTE Cross-Connect Closure – ST half loaded (24 count) includes standard unit, plus four (Bulkhead) coupler panels with six singlemode ST couplers, four field pigtail kits with ST connector (6) and transport tube, and four service pigtail kits with ST connector (6) and transport tube
8006577	COYOTE Cross-Connect Closure – ST fully loaded (48 count) includes standard unit, plus eight (Bulkhead) coupler panels with six singlemode ST couplers, eight field pigtail kits with ST connector (6) and transport tube, and eight service pigtail kits with ST connector (6) and transport tube
8006591	COYOTE Cross-Connect Closure – SC half loaded (24 count) includes standard unit, plus four (Bulkhead) coupler panels with six singlemode SC couplers, four field pigtail kits with SC connector (6) and transport tube, and four service pigtail kits with SC connector (6) and transport tube
8006592	COYOTE Cross-Connect Closure – SC fully loaded (48 count) includes standard unit, plus eight (Bulkhead) coupler panels with six singlemode SC couplers, eight field pigtail kits with SC connector (6) and transport tube, and eight service pigtail kits with SC connector (6) and transport tube
8006593	COYOTE Cross-Connect Closure – FC half loaded (24 count) includes standard unit, plus four (Bulkhead) coupler panels with six singlemode FC couplers, four field pigtail kits with FC connector (6) and transport tube, and four service pigtail kits with FC connector (6) and transport tube
8006594	COYOTE Cross-Connect Closure – FC fully loaded (48 count) includes standard unit, plus eight (Bulkhead) coupler panels with six singlemode FC couplers, eight field pigtail kits with FC connector (6) and transport tube, and eight service pigtail kits with FC connector (6) and transport tube
8006670	COYOTE Cross-Connect Closure – AP/SC fully loaded (48 count) includes standard unit, plus eight (Bulkhead) coupler panels with six singlemode AP/SC couplers, eight field pigtail kits with AP/SC connector (6) and transport tube, and eight service pigtail kits with AP/SC connector (6) and transport tube

Capacities Adapter				
Closure	Max. Feeder Cable	No. of Adapter Plates	No. of Splice Trays	Splices per Tray
Expanded RUNT	48-fiber	1	1	12
PUP	144-fiber	2	2	12
6" x 22"	144-fiber	3	2	36
8.5" x 22"	288-fiber	8	4	36

Adapter Plates		
Catalog Number	Connector	Adapter
6SMSC	SC	6
6SCAPC	SC/APC	6
12SMDS	SC	6 Duplex
8SMSC	SC	8
6SMST	ST	6
8SMST	ST	8
6SMFC	FC	6
8SMFC	FC	8
6FCAPC	FC/APC	6
6SMSC	LC	3 Duplex
12SMSC	LC	6 Duplex
600	Blank	-

Catalog Number	Description
80805605	(Bulkhead) Coupler Panel with six holes for ST Feed-Thru Adapters
80805606	(Bulkhead) Coupler Panel with six holes for SC Feed-Thru Adapters
80805607	(Bulkhead) Coupler Panel with six holes for FC Feed-Thru Adapters

COYOTE Cross-Connect/Express Closure	
Catalog Number	Description
8006916	Expanded COYOTE RUNT Cross-Connect/Express Closure, Includes one 12 count splice tray
8006920	COYOTE PUP Cross-Connect/Express Closure, with 6-port end plate, includes two 12 count splice trays
8006921	COYOTE PUP Cross-Connect/Express Closure, with 4-port end plate, includes two 12 count splice trays
8006911	6" x 22" (152 mm x 431 mm) COYOTE Cross-Connect/Express Closure, with 6-port end plate, includes two 36 count splice trays
8006912	6" x 22" (152 mm x 431 mm) Cross-Connect/Express Closure, with 4-port end plate, includes two 36 count splice trays
8006612	8.5" x 22" (215 mm x 431 mm) COYOTE Cross-Connect/Express Closure, with 6-port end plate, includes two 36 count splice trays
8006915	8.5" x 22" (215 mm x 431 mm) COYOTE Cross-Connect/ Express Closure, with 4-port end plate, includes two 36 count splice trays

Pigtail Kits and Accessories	
Catalog Number	Description
8003292	Pigtail Kit with ST Singlemode Connector (6) and Transport Tube, FIELD
8003314	Pigtail Kit with SC Singlemode Connector (6) and Transport Tube, FIELD
8003316	Pigtail Kit with FC Singlemode Connector (6) and Transport Tube, FIELD
8003293	Pigtail Kit with ST Singlemode Connector (6) and Transport Tube, SERVICE
8003315	Pigtail Kit with SC Singlemode Connector (6) and Transport Tube, SERVICE
8003317	Pigtail Kit with FC Singlemode Connector (6) and Transport Tube, SERVICE
8003368	Pigtail Transition Tube Kit, includes one Transport Tube with Transition and Reducing Tubes



COYOTE® Closures for High Fiber Count Applications

Refinement of the Breed...

Larger sizes for High Fiber Count Metropolitan Networks.

COYOTE Closures are now available in 9.5" x 28" (241 mm x 711 mm) and 9.5" x 38" (241 mm x 965 mm) for high fiber count applications.

These larger COYOTE Closures use the same drillable end plates and fiber management systems as the COYOTE Splice Case (see section 2).



COYOTE Hi-Count Closure
Catalog Number 800010810

COYOTE Closure Kits	
Catalog Number	Description (mm)
Closure Kits	
800010810	9.5" x 28" (241 x 711) COYOTE Hi-Count Closure for buffer tube applications, up to 432 single fiber splices, holds up to eighteen 24-count splice trays
8003469	24-count Splice Tray for COYOTE Hi-Count Closure (heat shrink protector only)
800010897	9.5" x 28" (241 x 711) COYOTE Closure, unitube version, holds up to six 144-fiber ribbon splice trays (mass fusion), 864-fiber capacity or ten 36 fiber single fiber splice trays, 360-fiber capacity, for use with central core ribbon fiber cables
800010884	9.5" x 28" (241 x 711) COYOTE Closure, buffer tube version, holds up to six 144-fiber ribbon splice trays (mass fusion), 864-fiber capacity or ten 36 fiber single fiber splice trays, 360-fiber capacity, for use with flexible buffered ribbon fiber cables
8006765	9.5" x 38" (241 x 965) COYOTE Closure, unitube version, holds up to nine 144-fiber ribbon splice trays (mass fusion), 1296-fiber capacity or sixteen 36-fiber single fiber splice trays, 576-fiber capacity, for use with central core ribbon fiber cables
Splice Tray Kits	
80805146	144 Count Ribbon Tray w/fixed rigid slots
80805515	144 Count Ribbon Tray w/2 elastomeric splice blocks
80805514	36 Count Standard Tray w/elastomeric splice blocks – fusion & mechanical splices
8001127	36 Count Low Profile Tray w/plastic splice block – single fusion splices
Installation Accessories	
8006792	9.5" x 28" (241 x 711) COYOTE Closure Shell Kit
8006793	9.5" x 38" (241 x 965) COYOTE Closure Shell Kit

COYOTE® Retrofit Closure

Refinement of the Breed...

The ideal Closure for replacement or expansion

The COYOTE Retrofit Closure contains a versatile Fiber Management System which makes simple work out of retrofitting existing fiber optic closures for either closure replacement or closure capacity expansion.

Specifically, the COYOTE Retrofit Closure will accommodate the existing fiber management systems (slack buffer tubes or fiber and splice trays) from closures manufactured by Lucent Technologies (UCB Series), 3M (2178 Series) and other suppliers.

In addition to accommodating the existing splice trays and fiber storage, the COYOTE Retrofit Closure will hold up to four single fiber splice trays, six low-profile trays or up to two ribbon fiber trays. The total added capacity of the COYOTE Splice Trays is 216 single fiber, or 288 mass fusion.

As part of the family of COYOTE Closures, the COYOTE Retrofit Closure uses the permanent neoprene gasket in the shell halves and the proven LOCK-TAPE™ Sealing System for the End Plate and cable seals. These features mean that the COYOTE Retrofit Closure will meet the same performance standards as the COYOTE Closure in aerial, underground and buried applications. The COYOTE Closure has been tested in accordance with the requirements of Telcordia GR-771-CORE.

In addition, the COYOTE Retrofit Closure uses the same accessories as available for the COYOTE Closure, including Future Cable Ports, End Plate Grommets, Aerial or Manhole Brackets and Splice Trays. See COYOTE Accessories section for catalog numbers for accessories.

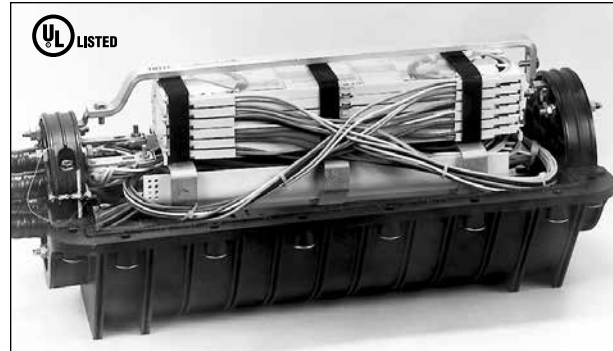

Closure Kits	
Catalog Number	Description
Closure Kit	
8006638	8.5" x 22.0" (216 x 559 mm) COYOTE Retrofit Closure. Includes two (2) Three-Section Six Port End Plates, hybrid Fiber Management System, Ten (10) End Plate Plugs and four (4) L-Brackets
Splice Tray Kits	
80805514	36 Count Standard Tray w/elastomeric splice blocks – Fusion & mechanical splices
80805146	144 Count Ribbon Tray w/fixed rigid slots
8001127	36 Count Low Profile Tray w/plastic splice block – single fusion splices



COYOTE® Closures (ADOBE™ Series)

Refinement of the Breed...

Low profile ADOBE™ Series Trays allow more splices to be stored in groups of 12 or 24

For applications which require a limited number of splices per splice tray, the COYOTE® Closure configured for 12-count or 24-count ADOBE Splice Trays provides the answer. The low profile ADOBE Splice Trays combined with the versatile buffer tube management system of the COYOTE Closure organize and protect the buffer tubes and fibers while maintaining maximum overall storage capacity.

See the COYOTE Closure End Plates, End Plate Grommets, Future Cable Port Kits, Mounting Brackets and other common COYOTE Closure accessories.

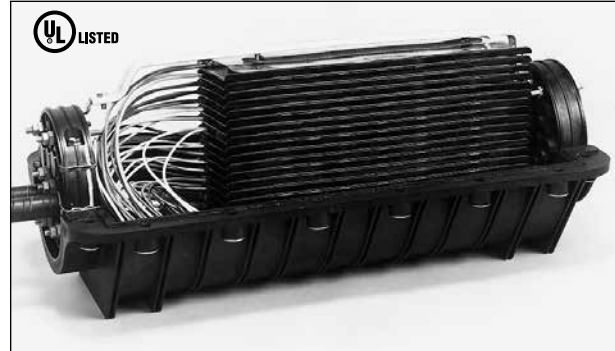

See page 1-4 and 1-5 for COYOTE Closure dimensions.

COYOTE Closure (ADOBE Series) Kit		
Catalog Numbers		Description (mm)
6-Port End Plate	4-Port End Plate	
8006684	8006688	6.0" x 22" (152 x 559) COYOTE Closure Kit configured for ADOBE-12 or ADOBE-24 splice trays. Includes: 1 Three-Section End Plate, 1 Blank End Plate, and Buffer Tube Storage Compartment
8006685	8006686	8.5" x 22" (216 x 559) COYOTE Closure Kit configured for ADOBE-12 or ADOBE-24 splice trays. Includes: 1 Three-Section End Plate, 1 Blank End Plate, and Buffer Tube Storage Compartment
8006806	8006820	6.0" x 22" (152 x 559) COYOTE Express Closure Kit configured for ADOBE-12 or ADOBE-24 splice trays. Includes: 1 Three-Section End Plate, 1 Blank End Plate, and Express Buffer Tube Storage Compartment
8006807	8006819	8.5" x 22" (216 x 559) COYOTE Express Closure Kit configured for ADOBE-12 or ADOBE-24 splice trays. Includes: 1 Three-Section End Plate, 1 Blank End Plate, and Express Buffer Tube Storage Compartment

ADOBE Series Splice Trays	
Catalog Number	Description
8001122	ADOBE-12 Splice Tray (12 Count) with Heat Shrink Splice Block. Includes: Tray, Cover, Tie Wraps and Felt Strips
8001096	ADOBE-12 Splice Tray (12 Count) with Molded-in Splice Block. Includes: Tray, Cover, Tie Wraps and Felt Strips
8001120	ADOBE-12 Splice Tray Blank. Includes: Tray, Cover, Tie Wraps and Felt Strips
8001121	ADOBE-24 Splice Tray (24 Count) with 2 Heat Shrink Splice Blocks. Includes: Tray, Cover, Tie Wraps and Felt Strips
8001119	ADOBE-24 Splice Tray Blank. Includes: Tray, Cover, Tie Wraps and Felt Strips

ADOBE-12 Splice Trays are 13" L x 3¹⁵/₁₆" W x 1¹/₃₂" H (330 x 100 x 9 mm)
 ADOBE-24 Splice Trays are 13" L x 4³/₄" W x 1¹/₃₂" H (330 x 121 x 9 mm)

Capacities					
Closure (mm)	Splice Tray Catalog No	Useable Splice Protectors	Splice Capacity Per Tray	Max. Number of Trays Per Closure	Max. Closure Splice Capacity
6.0" x 22" (152 x 559)	8001122	Heat Shrink Only	12	12	144
	8001096	Protected Fusion	12	12	144
	8001121	Heat Shrink Only	24	6	144
8.5" x 22" (216 x 559)	8001122	Heat Shrink Only	12	18	216
	8001096	Protected Fusion	12	18	216
	8001121	Heat Shrink Only	24	12	288

Note: Maximum number of trays per closure and closure capacity for COYOTE Express Closure Kits (8006806, 8006807, 8006819 and 8006820) are reduced by 50%.

COYOTE® Aerial Drop Closure

A Simple Solution, a Breed Apart

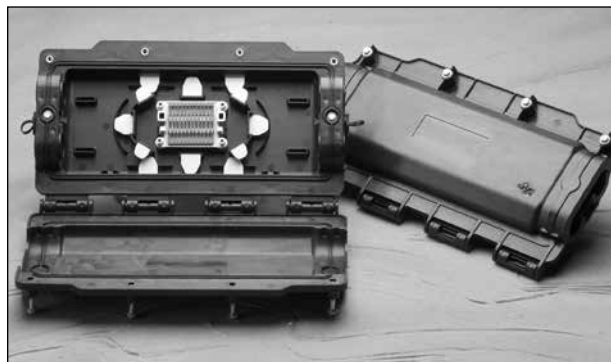

The COYOTE® Aerial Drop Closure



Kit Components

Key Features:

- Compact Size – 9" W x 16.5" L x 2.5" D (228 x 419 x 63.5 mm)
- Feature rich and value priced solution
- Easy to install – no special tools required
- Easy-to-use grommet sealing system
- Includes splicing platform
- Accepts 2 splice platforms for a splice capacity of 24 fibers
- Capable of higher splice capacities with alternative splice holders. Consult a PLP representative for details.
- Includes universal mounting bracket with features to permit pole mounting with straps, strand mounting with strand clamps or suspension from "J" hooks secured to a pole.

PLP Reliability

The COYOTE Fiber Optic Aerial Drop Closure is manufactured in accordance with ISO 9001-2008 procedures to assure quality and is backed by the experience and field support that Preformed Line Products has been noted for in fiber optic closures for over 20 years.

COYOTE Aerial Fiber Drop Closure Kits	
Catalog Number	Description
COYDAC03	COYOTE Aerial Fiber Drop Closure Kit Includes: Cover, Base and components shown above
COYOTE Splice Platform Kits	
8003792	Splice Plate Kit – 12 Count Splice Block – Single Fusion
8003751	Splice Plate Kit – 12 Count Splice Block – Unprotected Single Fusion
8003793	Splice Plate Kit – 24 Count LITE-GRIP Splice Block – Single Fusion
8003794	Splice Plate Kit – 72 Count LITE-GRIP Splice Block – Ribbon
COYOTE Aerial Fiber Drop Accessory Kits	
80808256	12 Entry Grommet Kit with Bobbin
8003753	End Plate Kit – includes (2) End Plates, Bolts and Tether
8003777	Strength Member Bracket Kit for Single Cable Entry
80808257	Fiber Organizer Clip Kit
8003775	Hanger Bracket Kit



COYOTE® Taut Closure

Refinement of the Breed...

A single closure that simplifies branch cable taps or repairs of taut fiber optic cables.

The 6.5" x 38" (165 x 965 mm) COYOTE Taut Closure organizes and protects up to 12 branch splices in either or both directions, or up to 12 pairs of fiber splices for repairing damaged cable.

The end plates are the same innovative design used in the COYOTE Dome Closure and employ the easy-to-use grommet system which can also be used in the COYOTE Taut Closure.

The unique mainframe assembly protects the fibers being "expressed" through the closure and organizes the splices on those fibers being spliced to the branch cables. Slack fibers from the branch cables or slack fibers between repair splices are stored in the center region of the mainframe. The entire splice is protected by our rugged plastic COYOTE shells.















Catalog Number	Description
8006947	6.5" x 38" (165 x 965 mm) COYOTE Taut Closure Kit

COYOTE® Silicone Grommet Kits



Film available at
www.preformed.com

COYOTE® Silicone Grommet Kits for use in COYOTE GLC, LCC, Aerial Drop, In-Line RUNT, Terminal, Dome and Taut Closures			
Catalog Number	Cable Range Inches (mm)	Description	Grommets
8003691	.40 - .60 (10.7 - 15.2)	1-hole grommet	
8003692	.60 - .85 (15.2 - 21.6)	1-hole grommet	
8003693	.85 - 1.0 (21.6 - 25.4)	1-hole grommet	
8003694	1.0 - 1.25 (25.4 - 31.6)	1-hole grommet	
8003663	.42 - .60 (10.7 - 15.2)	2-hole grommet	
8003990	.50 - .60 (12.7 - 15.2) .125 - .25 (3.2 - 6.4) and Flat Drop	4-hole grommet	
8003664	.30 - .43 (7.6 - 10.9)	4-hole grommet	
8003989	Flat Drop Only	4-hole grommet	
8003665	.125 - .25 (3.2 - 6.4) and Flat Drop	6-hole grommet	
8003676	.42 - .60 (10.7 - 15.2) .125 - .25 (3.2 - 6.4) and Flat Drop	7-hole grommet	
8003677	.125 - .25 (3.3 - 6.4) and Flat Drop	8-hole grommet	
8003796	Flat Drop Only	12-hole grommet	

Note: Grommet Kit contains (1) Grommet, (1) Cable Measure Tape, (1) Silicone Lubricant Pack, (1) Set of Plugs (where applicable).



COYOTE® Drop Cable Closure

Refinement of the Breed...

The perfect solution to the splicing or repair of low fiber count drop cables

The COYOTE Drop Cable Closure is a re-enterable (not re-usable), encapsulant filled closure for splicing buried fiber optic drop cables (up to 6-fiber).

The COYOTE Drop Cable Closure will accept either dielectric or shielded fiber optic drop cables with an outside diameter of up to 0.5" (13 mm).

Each Closure body is factory filled with field proven (over 14 years) POLY-BEE™ Sealant to provide a protective barrier around the sealed splice tray assembly.

The sealed splice tray assembly has an integral bond clamp which provides both conductivity between the cable shields and cable restraint.

The splice block on the splice tray assembly holds up to six heat-shrink fusion splice protectors. Six 40 mm long protectors are provided.

Assembly is simple:

- Prepare & secure cables to splice tray
- Splice fibers
- Seal splice tray
- Place splice tray in encapsulated closure
- Secure closure with closing clamp

Unfilled version for aerial fiber optic drop cables (up to 6-fiber) are available. Cable entries and closure seams are still sealed to prevent the ingress of wind-driven rain and dust.

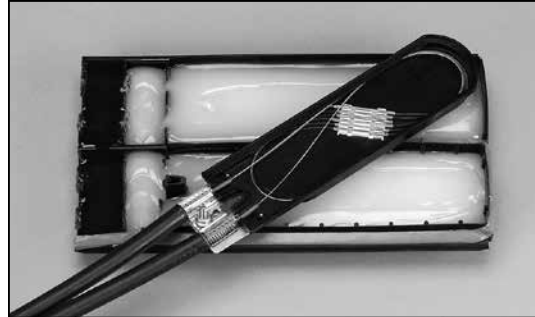

Catalog Number	Description
8006876	COYOTE Drop Cable Closure, includes sealed splice tray assembly and six (6) heat shrink splice protectors.
8006914	COYOTE Drop Cable Closure unfilled includes splice tray assembly & six (6) heat shrink splice protectors.



Length (mm)	Height (mm)	Width (mm)
12" (305)	3" (76)	3.5" (89)



PREFORMED LINE PRODUCTS

Section 2 – COYOTE® Splice Case Series

Table of Contents	Page
COYOTE Splice Case	2-2
Capacities	2-4
Accessories	2-5
Tools.....	2-7
COYOTE Splice Case for Hi-Count Applications.....	2-8
COYOTE Splice Case (ADOBE™ Series).....	2-9
COYOTE Splice Case for Vault Applications	2-11



COYOTE® Splice Case

Value conscious and benefit-packed: The COYOTE Splice

The COYOTE Splice Case combines the field-proven performance of the PREFORMED™ Splice Case (stainless steel) with the high capacity and craft-friendly COYOTE Fiber Management System to create a feature-packed splice case for demanding applications.

COYOTE
FIBER OPTICS



The COYOTE Splice Case family is designed for all applications (aerial, underground, buried and vault) and for all fiber optic types (loose tube, unitube, ADSS and OPGW). With sizes ranging from 4" x 25" (102 x 635 mm) to 12.5" x 38" (318 x 965 mm) and splicing capacities ranging from 24 fibers to 1728 fibers, nearly any splicing network configuration can be accommodated.

Marks on End Plates denote useable area of cable entrance holes.

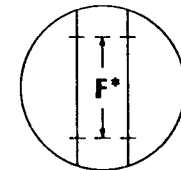
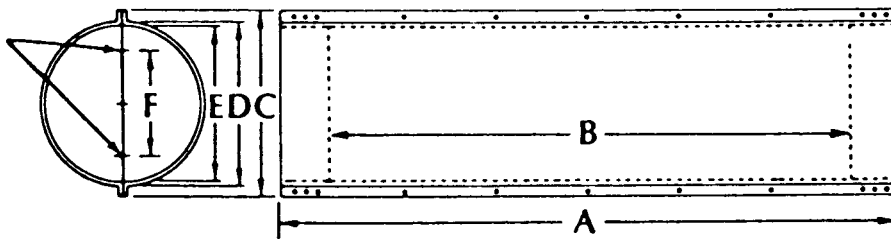

Three-Section End Plates

Dimensions (mm)						
Splice Case	A	B	C	D	E	F
4.0" x 25"	25.8" (655)	20.3" (516)	6.0" (152)	4.5" (114)	4.0" (102)	2.2" (56)
6.5" x 22"	22.0" (558)	16.2" (412)	9.25" (235)	7.0" (178)	6.5" (165)	4.1" (104)
6.5" x 28"	28.4" (721)	22.7" (577)	9.25" (235)	7.0" (178)	6.5" (165)	4.1" (104)
6.5" x 38"	38.4" (975)	32.7" (831)	9.25" (235)	7.0" (178)	6.5" (165)	4.1" (104)
8.0" x 28"	28.4" (721)	22.7" (567)	10.5" (267)	8.5" (216)	8.0" (203)	5.6" (142)
8.0" x 38"	38.4" (975)	32.7" (831)	10.5" (267)	8.5" (216)	8.0" (203)	5.6" (142)
9.5" x 28"	28.4" (721)	21.6" (549)	12.5" (318)	10.0" (254)	9.5" (241)	7.1" (180)
9.5" x 38"	38.4" (975)	31.6" (813)	12.5" (318)	10.0" (254)	9.5" (241)	7.1" (180)
9.5" x 45"	45.2" (1148)	38.6" (980)	12.5" (316)	10.0" (254)	9.5" (241)	7.1" (180)
12.5" x 28"	28.4" (721)	21.6" (549)	15.5" (394)	13.0" (330)	12.5" (318)	9.3" (236)
12.5" x 38"	38.4" (975)	31.6" (803)	15.5" (394)	13.0" (330)	12.5" (318)	9.3" (236)

*Spacing of 1/4" required between holes drilled along the seams of two and three section end plate in the "usable area."

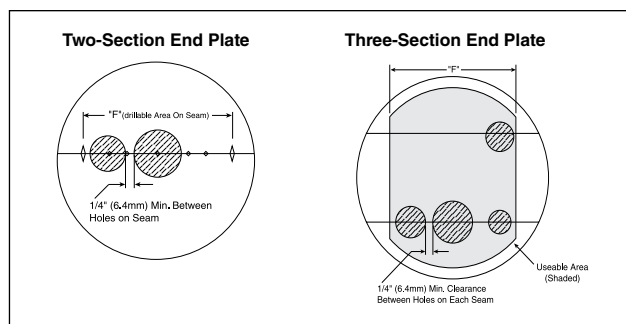

COYOTE® Splice Case

COYOTE Splice Case Ordering Chart	
Catalog Number	Description (mm)
8006548	4"x 25" (102 x 635), for unitube applications, includes two (2) Two-Section End Plates, and one (1) Mainframe.
8006549	4"x 25" (102 x 635), DLX, for unitube applications, includes one (1) Two-Section End Plate with three grounding inserts, one (1) Two-Section End Plate, one (1) Mainframe, one (1) Transport Tube Kit, and three (3) "L" Brackets.
8006550	6.5"x 22" (165 x 559), for unitube applications, butt splice only, includes one (1) Two-Section End Plate, one (1) Three-Section End Plate, one (1) Transition Assembly, and one (1) Transport Tube Kit.
8006551	6.5"x 22" (165 x 559), DLX, for unitube applications, butt splice only, includes one (1) Two-Section End Plate, one (1) Three-Section End Plate with six grounding inserts, one (1) Transition Assembly, one (1) Transport Tube Kit, and four (4) "L" Brackets.
8006615	6.5"x 22" (165 x 559), for buffer tube applications, butt splice only, includes one (1) Two-Section End Plate, one (1) Three-Section End Plate, and one (1) Storage Assembly.
8006616	6.5"x 22" (165 x 559) DLX, for buffer tube applications, butt splice only, includes one (1) Two-Section End Plate, one (1) Three-Section End Plate with six grounding inserts, one (1) Storage Assembly, and four (4) "L" Brackets.
8006552	6.5"x 28" (165 x 711), for unitube applications, includes one (1) Two-Section End Plate, one (1) Three-Section End Plate, one (1) Transition Assembly, and one (1) Transport Tube Kit.
8006553	6.5"x 28" (165 x 711) DLX, for unitube applications, includes one (1) Two-Section End Plate, one (1) Three-Section End Plate with six grounding inserts, one (1) Transition Assembly, one (1) Transport Tube Kit, and four (4) "L" Brackets.
8006617	6.5"x 28" (165 x 711), for buffer tube applications, includes one (1) Two-Section End Plate, one (1) Three-Section End Plate, and one (1) Storage Assembly.
8006618	6.5"x 28" (165 x 711) DLX, for buffer tube applications, includes one (1) Two-Section End Plate, one (1) Three-Section End Plate with six grounding inserts, one (1) Storage Assembly, and four (4) "L" Brackets.
8006656	6.5"x 28" (165 x 711) DLX - Express version, for buffer tube applications, includes one (1) Two-Section End Plate, one (1) Three-Section End Plate with six grounding inserts, one (1) Storage Assembly, and four (4) "L" Brackets.
8006625	8"x 28" (203 x 711) DLX, for unitube applications, includes one (1) Two-Section End Plate, one (1) Three-Section End Plate with six grounding inserts, one (1) Transition Assembly, one (1) Transport Tube Kit, and four (4) "L" Brackets.
8006626	8"x 28" (203 x 711) DLX, for buffer tube applications, includes one (1) Two-Section End Plate, one (1) Three-Section End Plate with six grounding inserts, one (1) Storage Assembly, and four (4) "L" Brackets.
8006657	9.5"x 28" (241 x 711) DLX, for unitube applications, includes one (1) Two-Section End Plate, one (1) Three-Section End Plate with six grounding inserts, one (1) Transition Assembly, and one (1) Transport Tube Kit, and four (4) "L" Brackets.
8006627	9.5"x 28" (241 x 711) DLX, for buffer tube applications, includes one (1) Two-Section End Plate, one (1) Three-Section End Plate with six grounding inserts, one (1) Storage Assembly, and four (4) "L" Brackets.
8006755	9.5"x 38" (241 x 975) DLX, for unitube/buffer tube applications, includes one (1) Two-Section End Plate, one (1) Three-Section End Plate with six grounding inserts, one (1) Transition/Buffer Storage Assembly, and four (4) "L" Brackets.
8006628	9.5"x 45" (241 x 1143) DLX, for buffer tube applications, includes one (1) Two-Section End Plate, one (1) Three-Section End Plate with six grounding inserts, one (1) Dual Buffer Tube Storage Assembly, and four (4) "L" Brackets.
8006753	12.5"x 28" (318 x 711) DLX for buffer tube applications, includes one (1) assembled Three-Section End Plate, one (1) Three-Section End Plate with eight grounding inserts, one (1) Dual Tube Storage Assembly, and six (6) "L" Brackets.
8006752	12.5"x 28" (318 x 711) DLX for unitube applications, includes one (1) assembled Three-Section End Plate, one (1) Three-Section End Plate with eight grounding inserts, one (1) Dual Transition Assembly, one (1) Transport Tube Kit and six (6) "L" Brackets.
8006702	12.5"x 38" (318 x 975) DLX, for buffer tube applications, includes one (1) assembled Three-Section End Plate, one (1) Three-Section End Plate with eight grounding inserts, one (1) Dual Tube Storage Assembly, and six (6) "L" Brackets.
8006703	12.5"x 38" (318 x 975) DLX, for unitube applications, includes one (1) assembled Three-Section End Plate, one (1) Three-Section End Plate with eight grounding inserts, one (1) Dual Transition Assembly, one (1) Transport Tube Kit and six (6) "L" Brackets.



COYOTE® Splice Case Capacities

Splice Tray Catalog Number	Description	Useable Connectors	Type	Splice Capacity Per Tray	Max. No. of Trays Per Closure	Max. Closure Splice Capacity
4" x 25" (102 x 635 mm) COYOTE Splice Case						
8001021	12 Count Single Fiber	Protected Fusion Single Mechanical	S	12	2	24
8001044	18 Count Single Fiber	Protected Fusion Single Mechanical	S	18	2	36
8001041	12 Count Mechanical	3M Fibelok Siecor Lightbridge	S	12	2	24
8001098	12 Count Mechanical	3M Fibelok Siecor Lightbridge	A	12	2	24
8001085	Mass Fusion	Protected Mass Fusion	S	36	2	72
6.5" x 22" (165 x 559 mm) and 6.5" x 28" (165 x 711 mm) COYOTE Splice Case						
80805514	36 Count Elastomer Blocks	Protected Fusion Single Mechanical		36	5	180
8001127	36 Count	Single Fusion		36	6	216
80805146	Ribbon Fiber Splice Tray	Protected Mass Single Mechanical		144	2	288
8" x 28" (203 x 711 mm) COYOTE Splice Case						
80805514	36 Count Elastomer Blocks	Protected Fusion Single Mechanical		36	6	216
8001127	36 Count	Single Fusion		36	8	288
80805146	Ribbon Fiber Splice Tray	Protected Mass Fusion		144	4	576
9.5" x 28" (241 x 711 mm) COYOTE Splice Case						
80805514	36 Count Elastomer Blocks	Protected Fusion Single Mechanical		36	10	360
8001127	36 Count	Single Fusion		36	13	468
80805146	Ribbon Fiber Splice Tray	Protected Mass Fusion		144	6	864
9.5" x 38" (241 mm x 1 m) COYOTE Splice Case						
80805514	36 Count Elastomer Blocks	Protected Fusion Single Mechanical		36	20	720
8001127	36 Count	Single Fusion		36	26	936
80805146	Ribbon Fiber Splice Tray	Protected Mass Fusion		144	9	1296
9.5" x 45" (241 mm x 1.1 m) COYOTE Splice Case						
80805514	36 Count Elastomer Blocks	Protected Fusion Single Mechanical		36	18	648
8001127	36 Count	Single Fusion		36	24	864
12.5" x 28" (318 mm x 711 mm) COYOTE Splice Case						
80805514	36 Count Elastomer Blocks	Protected Fusion Single Mechanical		36	16	576
8001127	36 Count	Single Fusion		36	21	756
80805146	Ribbon Fiber Splice Tray	Protected Mass Fusion		144	10	1440
12.5" x 38" (318 mm x 1 m) COYOTE Splice Case						
80805514	36 Count Elastomer Blocks	Protected Fusion Single Mechanical		36	24	864
8001127	36 Count	Single Fusion		36	32	1152
80805146	Ribbon Fiber Splice Tray	Protected Mass Fusion		144	12	1728

(A) signifies an ADOBE™ Splice Tray

(S) signifies a standard thermal-formed splice tray

(M) signifies a metallic splice tray

NOTE: Maximum number of trays per closure and closure capacity for 6.5" x 28" DLX Express version (Cat. No. 8006656) are reduced by 50 percent.

COYOTE® Splice Case Accessories

End Plates (one per kit)	
Catalog Number	Description (mm)
8003277	4.0" (102) Standard Two-Section End Plate Kit
80804985	4.0" (102) DLX Two-Section End Plate Kit with three (3) Grounding Inserts and three (3) "L" Brackets.
8003274	4.0" (102) DLX Two-Section End Plate Kit with one (1) 1/2" (13) factory-installed Cable Ports [0.56 (14 mm) max. cable], three (3) Grounding Inserts, and three (3) "L" Brackets.
8003275	4.0" (102) DLX Two-Section End Plate Kit with two (2) 1/2" (13) factory-installed Cable Ports [0.56 (14 mm) max. cable], two (2) Grounding Inserts, and two (2) "L" Brackets. (No space for field-drilled cable entries.)
8003252	6.5" (165) Standard Two-Section End Plate Kit
8000361	6.5" (165) Standard Three-Section End Plate Kit
80804986	6.5" (165) DLX Three-Section End Plate Kit with six (6) Grounding Inserts and four (4) L-Brackets.
8003282	8.0" (203) Standard Two-Section End Plate Kit
8003396	8.0" (203) DLX Three-Section End Plate Kit with six (6) Grounding Inserts and four (4) L-Brackets.
8003283	9.5" (241) Standard Two-Section End Plate Kit
8003397	9.5" (241) DLX Three-Section End Plate Kit with six (6) Grounding Inserts and four (4) L-Brackets.
8003537	12.5" (318) DLX Three-Section End Plate Kit with eight (8) Grounding Inserts and six (6) L-Brackets.

Future Cable Port Kits

Future Cable Port COYOTE Splice Cases (all sizes)	
Catalog Number	Description (mm)
8003412	3/4"(19) Future Cable Port Kit, Includes: Future Cable Port, Plug and Clamp. For installation of Future Cable Port during initial assembly of end plate. Max. Cable is 0.8"(20) diameter.
8003413	1"(25) Future Cable Port Kit, includes: Future Cable Port, Plug and Clamp. For installation of Future Cable Port during initial assembly of end plate. Max. Cable is 1.0"(25) diameter.
8003420	Future Cable Port Installation Kit, Includes: LOCK-TAPE™ Sealant, Bead Sealant, L-Bracket and Bolt. Required for preparation of Future Cable.
8003421	3/4"(19) Future Cable Port/Cable Installation Kit. Complete Kit includes: Catalog #800412 and Catalog # 8003420
8003422	1"(25) Future Cable Port/Cable Installation Kit. Complete Kit Includes: Catalog #8003413 and Catalog # 8003420



Future Cable Ports allow the addition of branch cables



Unitube and Buffer Tube Storage Compartments	
Catalog Number	Description (mm)
80805150	Transition Assembly for 4.0" (102) x 25" (635) COYOTE Splice Case
80805690	Transition Compartment Kit for 6.5" (165) x 22" (559) COYOTE Splice Case
80805691	Loose Buffer Tube Storage Assembly for 6.5" (165) x 22" (559) COYOTE Splice Case
80805571	Transition Compartment Kit for 6.5" (165) x 28" (635) COYOTE Splice Case
80805574	Loose Buffer Tube Storage Assembly for 6.5" (165) x 28" (635) COYOTE Splice Case
80805913	Loose Buffer Tube (Express) Storage Assembly for 6.5" (165) x 28" (635) COYOTE Splice Case.
80805812	Transition Compartment Kit for 8.0" (203) x 28" (635) COYOTE Splice Case
80805814	Loose Buffer Tube Storage Assembly for 8.0" (203) x 28" (635) COYOTE Splice Case
80805815	Loose Buffer Tube Storage Assembly for 9.5" (241) x 28" (635) COYOTE Splice Case
80805915	Transition Compartment Kit for 9.5" (241) x 28" (635) COYOTE Splice Case
80805801	Dual Loose Buffer Tube Storage Assembly for 9.5" (241) x 45" (1.1) COYOTE Splice Case
80806629	Loose Buffer Tube Storage Assembly for 12.5" (318) x 28" (635) COYOTE Splice Case
80806704	Transition Compartment Kit for 12.5" (318) x 28" (635) COYOTE Splice Case



Transition Compartment and Splice Tray for a 4" x 25" (102 x 635 mm) COYOTE Splice Case

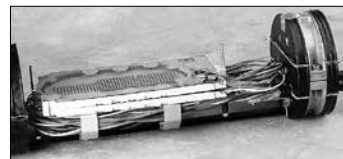

Buffer Tube Management System for a 6.5" x 22" (165 x 559 mm) COYOTE Splice Case

End Plate Grommet Kits for Drillable End Plates

COYOTE End Plate Grommet Kits – 9.5" (241) and 12.5" (318) Only				
Catalog Number	Hole Pattern	Entries	Accepted Cable Diameter Range Inches (mm)	Blade Size
8003622 (Blue)		4	.20 - .27 (5 - 7)	H
8003623 (Red)		4	.27 - .31 (7 - 8)	H
8003586 (Green)		4	.31 - .38 (8 - 10)	J
8003588 (Green)		6	.31 - .38 (8 - 10)	K
8003583 (Orange)		2	.38 - .43 (10 - 11)	G
8003584 (Orange)		4	.38 - .43 (10 - 11)	J
8003573 (Orange)		5	.38 - .43 (10 - 11)	K
8003585 (Light Blue)		4	.43 - .48 (11 - 12)	J
8003660 (Light Blue)		4	Corning SST	G



COYOTE® Splice Case Accessories

Mounting Bracket/Supports	
Catalog Number	Description
8003426	Adjustable Aerial Hanger Bracket Kit
8003156	Aerial Strand Clamps (set of two)
8003527	Manhole Support Kit (both ends of Splice Case)
8003472	Vertical Mounting Bracket for 6.5", 8" and 9.5" Splice Cases

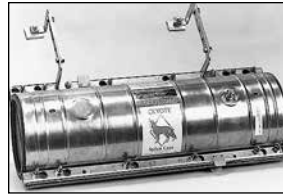

Adjustable Aerial Hanger Brackets



Manhole Support Kit

Installation Materials	
Catalog Number	Description (mm)
80805238	C-Cement, 1 oz. tube
80802377	C-Cement, 4 oz. can
80803448	Moisture Blocking Sealant, 3 oz. tube
8003490	Felt Strips (blue) 1-1/8" (29) x 9" (229), 6 strips
80802567	LOCK-TAPE™ Sealant, 3/4" W x 12' L (19 W x 3.7 L)
80801954R	LOCK-TAPE™ Sealant, 2-1/2" W x 12' L (64 W x 3.7 L)
80801955R	LOCK-TAPE™ Sealant, 3" W x 12' L (76 W x 3.7 L)
8003092	Fusion Splice Protectors, Non-heat Shrink 250/250 Micron, pack of 20
8003425	Mass Fusion Splice Protectors, pack of 12
8003509	60 mm Heat Shrink Splice Protectors, pack of 12

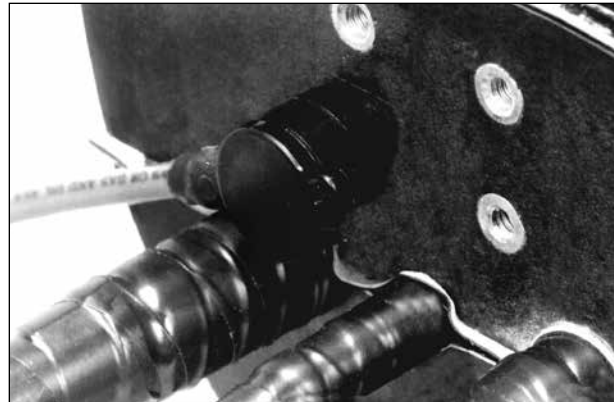

External Isolation Terminal

Bonding and Grounding Materials	
Catalog Number	Description (mm)
8003416	Isolated Strength Member Bracket Kit, two per kit.
8003463	External Isolation Terminal Kit, Includes: two (2) Isolation Terminals with 7" (178) long, #6 Cable Stub and Splice Sleeve.
8003464	External Isolation Terminal Kit, Includes: two (2) Isolation Terminals with 7" (178) long, #6 Cable Stub and Quick Disconnect.
8003465	Quick Disconnect Kit, two per kit
80806759	External Isolation Connector for COYOTE Splice Cases
80803989	Fiber Optic Shield Connector, 3M #4460/D/FO, 1 each, RUS Listed
80806743	Fiber Optic Shield Connector [up to 0.5" (13) cables]
80806744	Fiber Optic Shield Connector [up to 0.5"-0.8" (13-20) cables]
80806745	Fiber Optic Shield Connector [up to 0.8"-1.6" (20-41) cables]
8003281	External Bond Clip Kit, two per kit
80806179	Bonding Braid, 0.5" x 7" (13 x 178) with eyelets spaced at 6" (152) apart

Misc. Accessories	
Catalog Number	Description (mm)
8003175	Strength Member Bracket Kit, four per kit
8003176	Transport Tube Kit (8 tubes, 34" [864] long)
8003280	Transition Tube Kit, used to transition fiber from the top seam of the End Plate to the transition compartment
8003411	Green Sealant Kit (required for OPGW applications)
80806439	Transport Tube Kit (0.25" [6] O.D. Tube, 34" [864] long), includes six tubes, used for 24-fiber ribbon applications
80805937	Air Valve for Stainless Steel Cases

COYOTE® Splice Case – Tools

Power End Plate Cutter and Accessories		
Catalog Number	Description	Standard Carton Qty.
8000452	Power End Plate Cutter (only)	1 Unit
8000454	Power End Plate Cutter and Case with Blade Kit	1 Kit
8000455	Power End Plate Cutter with Blade Kit	1 Kit
8000445	Carrying Case	1 Unit
8000453	Blade Kit (Blades A-Z)	1 Set
8000417A-DD	Individual Blades (A-DD)	1 Unit
80803377	Cutting Blade Adapter	1 Unit
80851659	Electric Drill With Socket	1 Unit
80801944	Drill Motor Adapter (For other than PREFORMED Drill)	1 Unit
8000468	Power End Plate Cutter Lift Kit, allows drilling of 9.5" and 12.5" End Plates with future cable entry ports	1 Set

Power End Plate Cutter Kit – 8000454

The Power End Plate Cutter comes standard with 26 blades from .375" (10 mm) up to 3.50" (89 mm) in diameter (4 additional blades for larger sizes are available for holes up to 4.00" [102 mm]). It provides a fast and convenient way for cutting precise cable access holes in the End Plates of PREFORMED re-enterable closures: Splice Case, FIBERLIGN Fiber Safe and FIBERLIGN Splice Case.

The complete Power End Plate Cutter Kit includes:

1. Power End Plate Cutter for use in drilling 4" to 12.5" (102 mm to 318 mm) PREFORMED End Plates.
2. Complete blade kit. Includes blades A through Z, drill motor adapter, CABLE Mea-SURE™ Tape, key for chuck adapter, areas for storing other parts and a complete label guide for reordering parts, all stored in a plastic case.
3. Metal Carrying Case for Power End Plate Cutter.



Carrying Case (8000445)



Blade Kit (8000453)



Power End Plate Cutter (8000452)



80801151

80803967

80803968

80803969

80801150

Socket Tool Kit Accessories		
Catalog Number	Description	Standard Carton Qty.
8000428	Socket tool kit (with torque wrench)	1 Unit
8000420	Socket tool kit (without torque wrench)	1 Kit
80803967	Torque wrench with ratchet head 3/8" drive	1 Unit
80803968	Ratchet type socket wrench 3/8" drive	1 Unit
80801150	7/16" deep well socket	1 Unit
80801151	1/2" deep well socket	1 Unit
80803969	6" extension	1 Unit

End Plate Removal Tool

The End Plate Removal Tool is made of durable galvanized steel. It is specially designed to facilitate End Plate removal from the cable during procedures that necessitate new End Plates, i.e. for use with the PREFORMED Splice Case.



Catalog Number
8000432



COYOTE® Splice Case for Hi-Count Applications



Up to 432 Single Fiber Splices in a Compact Size Splice Case

The **COYOTE Hi-Count Fiber Splice Case** uses a unique 24-count Splice Tray and Fiber Management System to accommodate up to 432 single fiber splices in a 9.5" x 28" Splice Case (241 x 711 mm).

The 24-Count Splice Tray utilized in the COYOTE Hi-Count Splice Case is specifically designed for the larger 24-Count buffer tubes commonly used in high count loose tube fiber cables. The splice blocks on the tray accept heat shrink protected fusion splices only.

Up to 18 splice trays are stored in the organizer assembly in a tilted arrangement to provide maximum storage capacity. Each splice tray snaps out of the organizer for easy access.

See pages 2-5 through 2-7 for End Plate, Future Cable Port Kits, Mounting Brackets and other common COYOTE Splice Case accessories and tools.

See page 2-2 for COYOTE Splice Case Dimensions.

COYOTE Hi-Count Splice Case Kit	
Catalog Number	Description (mm)
8006683	9.5" x 28" (241 x 711) COYOTE Hi-Count Splice Case Kit, Includes one Three-section DLX End Plate, one Two-section End Plate, Buffer Tube Storage Assembly and four L-Brackets

24-Count Splice Tray	
Catalog Number	Description
8003469	24-Count Splice Tray for Hi-Count COYOTE Splice Case (Heat-Shrink Protector Only)

Splice Tray: 9-1/4" L x 5-3/4" W x 11/32" H (235 L x 146 W x 9 H mm)					
Closure Catalog Number	Splice Tray Catalog Number	Useable Splice Protectors	Splice Capacity Per Tray	Max. Number of Trays Per Closure	Max. Closure Splice Capacity
8006683	8003469	Heat Shrink Only	24	18	432

COYOTE® Splice Case (ADOBE™ Series)

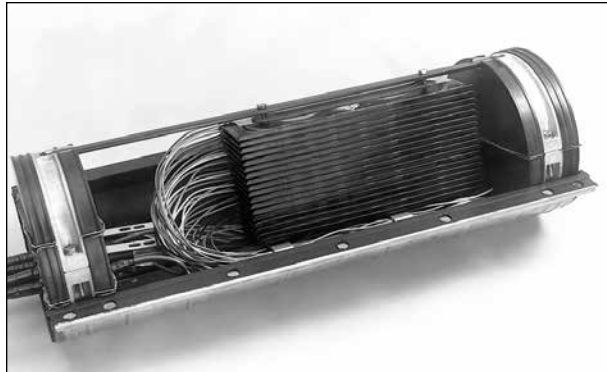

Low profile ADOBE™ Series Splice Trays allow more splices to be stored in groups of 12 or 24

For applications which require a limited number of splices per splice tray, the COYOTE Splice Case configured for 12-Count or 24-Count ADOBE Splice Trays provides the answer. The low profile ADOBE Splice Trays combined with the versatile buffer tube management system of the COYOTE Splice Case, organize and protect the buffer tubes and fibers while maintaining maximum overall storage capacity.

See pages 2-5 through 2-7 for End Plate, Future Cable Port Kits, Mounting Brackets and other common COYOTE Splice Case accessories and tools.

COYOTE Splice Case (ADOBE Series) Kit	
Catalog Number	Description (mm)
8006687	6.5" x 28" (165 x 711) COYOTE Splice Case Kit, configured for ADOBE-12 or ADOBE-24 Splice Trays. Includes: One Three-Section DLX End Plate, One Two-Section End Plate, Buffer Tube Storage Compartment and Four L-Brackets.
8006689	8.0" x 28" (203 x 711) COYOTE Splice Case Kit, configured for ADOBE-12 or ADOBE-24 Splice Trays. Includes: One Three-Section DLX End Plate, One Two-Section End Plate, Buffer Tube Storage Compartment and Four L-Brackets.
8006839	8.0" x 28" (203 x 711) COYOTE Express Splice Case Kit, configured for ADOBE-12 or ADOBE-24 Splice Trays. Includes: One Three-Section DLX End Plate, One Two-Section End Plate, Buffer Tube Storage Compartment and Four L-Brackets.
8006691	9.5" x 28" (241 x 711) COYOTE Splice Case Kit, configured for ADOBE-12 or ADOBE-24 Splice Trays. Includes: One Three-Section DLX End Plate, one Two-Section End Plate, Buffer Tube Storage Compartment and Four L-Brackets.
8006840	9.5" x 28" (291 x 711) COYOTE Express Splice Case Kit, configured for ADOBE-12 or ADOBE-24 Splice Trays. Includes: One Three-Section DLX End Plate, One Two-Section End Plate, Buffer Tube Storage Compartment and Four L-Brackets.
8006788	12.5" x 28" (318 x 711) COYOTE Splice Case Kit, configured for ADOBE-24 Splice Trays. Includes: one Three-Section DLX End Plate, one Two-Section End Plate, Buffer Tube Storage Compartment and Six L-Brackets.

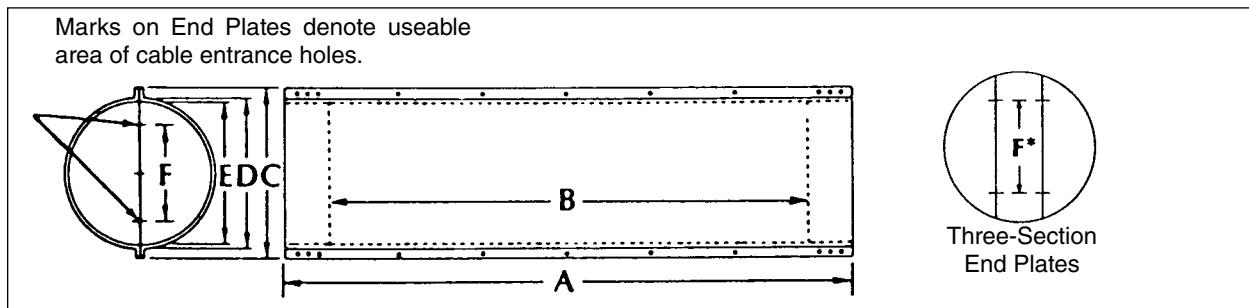

*Spacing of 1/4" required between holes drilled along the seams of two and three section end plate in the "usable area".

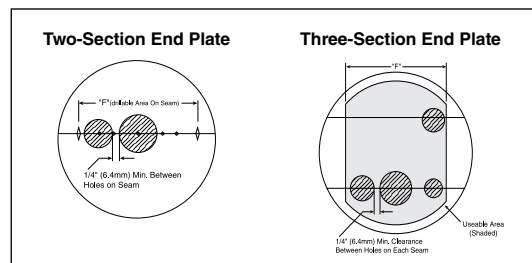

Dimensions (mm)						
Splice Case	A	B	C	D	E	F
6.5" x 28"	28.4" (721)	22.7" (577)	9.25" (235)	7.0" (178)	6.5" (165)	4.1" (104)
8.0" x 28"	28.4" (721)	22.7" (567)	10.5" (267)	8.5" (216)	8.0" (203)	5.6" (142)
9.5" x 28"	28.4" (721)	21.6" (549)	12.5" (318)	10.0" (254)	9.5" (241)	7.1" (180)



COYOTE® Splice Case (ADOBE™ Series)

ADOBE Splice Trays	
Catalog Number	Description
8001122	ADOBE-12 Splice Tray (12-Count) with Heat Shrink Splice Block Includes: tray, cover, tie wraps, and felt strips
8001096	ADOBE-12 Splice Tray (12-Count) with Molded-In Splice Block Includes: tray, cover, tie wraps, and felt strips
8001120	ADOBE-12 Splice Tray — Blank Includes: tray, cover, tie wraps, and felt strips
8001121	ADOBE-24 Splice Tray (24-Count) with Heat Shrink Splice Block Includes: tray, cover, tie wraps, and felt strips
8001119	ADOBE-24 Splice Tray — Blank Includes: tray, cover, tie wraps, and felt strips

ADOBE-12 Splice Trays are 13" (330 mm) L x 3-15/16" (100 mm) W x 15/16" (9 mm) H
 ADOBE-24 Splice Trays are 13" (330 mm) L x 4-3/4" (121 mm) W x 11/32" (9 mm) H

Capacity					
Splice Tray Catalog Number	Closure (mm)	Useable Splice Protectors	Splice Capacity per Tray	Max. Number of Trays per Closure	Max. Closure Splice Capacity
8001122	6.5" x 28" (165 x 711)	Heat Shrink Only	12	12	144
8001096		Protected Fusion	12	12	144
8001121		Heat Shrink Only	24	8	192
8001122	8.0" x 28" (203 x 711)	Heat Shrink Only	12	16	192
8001096		Protected Fusion	12	16	192
8001121		Heat Shrink Only	24	12	288
8001122	9.5" x 28" (241 x 711)	Heat Shrink Only	12	18	216
8001096		Protected Fusion	12	18	216
8001121		Heat Shrink Only	24	14	336
8001121	12.5" x 28" (318 x 711)	Heat Shrink Only	24	18	432

For 9.5" x 28" (241mm x 721mm) Splice Case with 24 splices per splice tray, also see COYOTE Hi-Count Splice Case (page 2-8).

Note: Maximum number of trays per closure and closure capacity for Express versions (8006839 and 8006840) are reduced by 50 percent.

COYOTE® Splice Case for Vault Applications

Meets fire resistance requirements for vault applications

COYOTE Splice Case for vault applications meets the requirements of Bellcore GR-771-CORE.

Each kit contains two fire retardant Three-Section End Plates for typical in-line vault application. Additional fire resistant tape is provided to cover the cables where they enter the end plates.

The Organizer included with each Splice Case accommodates standard COYOTE Splice Trays. For capacities see COYOTE Splice Case Capacities on page 2-4. Unitube versions include transport tubes in kit.



Catalog Number	Description (mm)
8006760	6.5" x 28" (165 x 711) COYOTE Splice Case for vault applications, unitube version
8006767	6.5" x 28" (165 x 711) COYOTE Splice Case for vault applications, buffer tube version
8006761	8.0" x 28" (203 x 711) COYOTE Splice Case for vault applications, unitube version
8006766	8.0" x 28" (203 x 711) COYOTE Splice Case for vault applications, buffer tube version
8006762	9.5" x 28" (241 x 711) COYOTE Splice Case for vault applications, unitube version
8006764	9.5" x 28" (241 x 711) COYOTE Splice Case for vault applications, buffer tube version
8006763	9.5" x 38" (241 x 965) COYOTE Splice Case for vault applications, unitube/buffer tube version

Factory drilling of End Plates is available at no additional charge.





PREFORMED LINE PRODUCTS

Section 3 – FIBERLIGN® Closure Series

Table of Contents	Page
FIBERLIGN Splice Trays	3-2
FIBERLIGN Organizers	3-3
FIBERLIGN UNI-CLOSURE	3-8
FIBERLIGN Fiber Safe	3-11



FIBERLIGN® Splice Trays

Splice Trays for PREFORMED™ Splice Cases

FIBERLIGN Fiber Optic Splice Trays are suitable for use in all PLP® Splice Cases and splicing applications. The storage trays provide ample room for storing fiber and allow for a generous bend radius designed to assure long term optical performance. There are now two types of trays offered. The standard thermal-formed tray is available for all closures and splice applications. The ADOBE™ Splice Tray is available as a lower cost alternative and is interchangeable with many of the thermal-formed trays. Both versions of the splice tray include a clear snap-on cover, felt tape for protecting buffer tubes, and tie wraps to secure the buffer or transport tubes to the tray. To find splice trays for a specific closure and specific splicing application, refer to the desired closure section of the catalog.

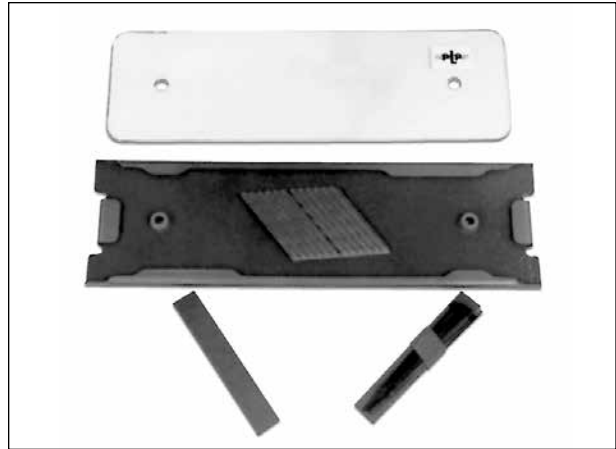

Standard Thermal-Formed Splice Tray

The standard thermal-formed tray is lined with felt to cushion optical fibers and provide a contrasting background for splicing colored fibers.



ADOBE™ Splice Tray

The ADOBE Splice Tray is an injection-molded tray which comes without the felt lining.

FIBERLIGN® Organizers

For Fusion Splices (Protected and Unprotected) and Mechanical Splices

FIBERLIGN Fiber Optic Organizers are designed to help organize, secure, support and protect delicate optical fibers before, during and after splicing. There are splice tray organizers to fit all of PLP's Splice Cases ranging from the 4.0" x 25.8" (102 x 655 mm) to the 9.5" x 38.4" (241 x 975 mm).

The FIBERLIGN Fiber Optic Organizers consist of a mainframe assembly, into which are inserted splice trays, each consisting of a splice tray and a snap-on clear cover. A grooved splice block on the tray holds and cushions the splices.

The splice trays are designed to accept most types of single, mass mechanical or mass fusion splices.

Features:

- An all-dielectric method to organize, secure, store and protect delicate optic fibers
- Individual trays can be removed to facilitate splicing
- Large excess buffer storage area
- Substantial cost savings

Use the selection chart below to choose the Splice Case and splice tray organizer which meet the requirements for your application.

Splice Case Dimensions (mm)	4.0" x 25.8" (102 x 655)	6.5" x 22.0" (165 x 559)	6.5" x 28.4" (165 x 721)	6.5" x 28.4" (165 x 721) or 8.0" x 28.4" (203 x 721)	6.5" x 28.4" (165 x 721) or 8.0" x 28.4" (203 x 721)	6.5" x 38.4" (165 x 965) or 8.0" x 38.4" (203 x 965)	9.5" x 28.4" (241 x 721) or 12.5" x 28.4" (318 x 721)	9.5" x 38.4" (241 x 965) or 12.5" x 38.4" (318 x 965)
Splice Tray Capacity	3	6	8	6	8	8	16	16
Organizer Capacity = Splice Tray Capacity x Number of Splices/Tray	36	72	96 (144)*	72 (108)*	96 (144)*	192	192 (288)*	384
Organizer Tray Arrangement	8000193 Horizontal	8001072 Vertical	8000185 Horizontal	8001025 Vertical	8001059 Vertical	8001036 Vertical	8001043 Vertical	8001049 Vertical

*Maximum splice capacity for 18 count splice trays or mass fusion trays.

FIBERLIGN Splice Trays come in various sizes and types to accommodate all of the different PLP Splice Cases and splicing applications being used. The storage trays provide ample room for storing fiber and allow for a generous bend radius designed to assure long term optical performance. There are now two types of trays offered. The standard thermal-formed tray is available for all closures and splice applications. The ADOBE™ Splice Tray is available as a

lower cost alternative and is interchangeable with many of the thermal-formed trays. Both versions come with a clear snap on cover, felt tape for protecting buffer tubes, and tie wraps to secure the buffer tubes to the tray.

The following pages describe the specific splice trays for the mainframe and closure you have selected.



FIBERLIGN® Organizers

Catalog #8000193

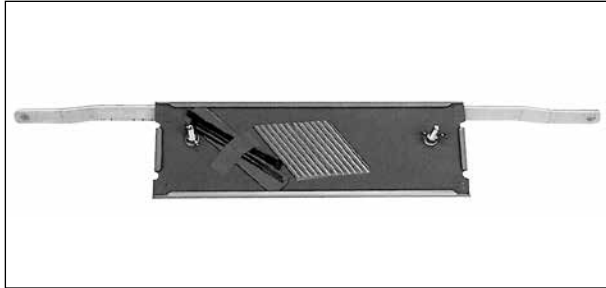

Horizontal organizer for 4.0" x 25.8" (102 x 655 mm) Splice Case. Accommodates up to three splice trays.

Catalog #8001072

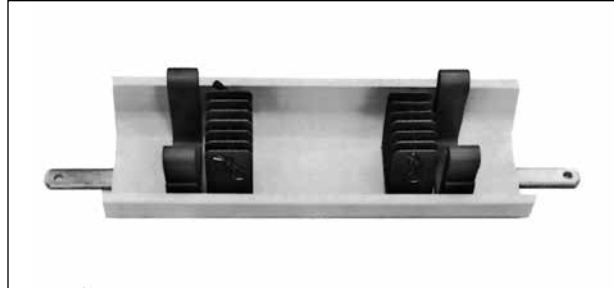

Vertical organizer for 6.5" x 22.0" (165 x 559 mm) Splice Case. Accommodates up to six splice trays.

Catalog Number	Splice Type for:	No. of Splice Trays	Splice Tray Capacity	
8000192	Protected Fusion Amp Optimate Norland	3	12	S
8000182	Unprotected Fusion	3	12	S
8001050	3M Fibrolok Amp FingerSplice Siecor CamSplice Northern Telecom Lightbridge	3	12	S
-	Protected Mass Fusion Splice	-	-	-
-	3M Mass Connector	-	-	-
-	Reliance Corelink	-	-	-

Catalog Number	Splice Type for:	No. of Splice Trays	Splice Tray Capacity	
8001071	Protected Fusion Amp Optimate Norland	6	12	S
-	Unprotected Fusion	-	-	-
8001082	3M Fibrolok Amp FingerSplice Siecor CamSplice Northern Telecom Lightbridge	6	12	S
-	Protected Mass Fusion Splice	-	-	-
-	3M Mass Connector	-	-	-
-	Reliance Corelink	-	-	-

(S) signifies a standard size thermal-formed splice tray

FIBERLIGN® Organizers

Catalog #8000185



Horizontal stacking organizer for 6.5" x 28.4" (165 x 721 mm) Splice Case. Accommodates up to eight splice trays unless otherwise noted.

Catalog #8001025



Vertical organizer for 6.5" x 28.4" (165 x 724 mm) or 8.0" x 28.4" (203 x 721 mm) Splice Case. Accommodates up to six splice trays.

Catalog Number	Splice Type for:	No. of Splice Trays	Splice Tray Capacity	
8000184	Protected Fusion Amp Optimate Norland	8	12	W
8001021		8	12	S
8001044		8	18	S
8001095		8	18	A,W
8001096		8	18	A
8000182	Unprotected Fusion	8	12	S
8001024		8	12	S
8001042	3M Fibrlok Amp FingerSplice Siecor CamSplice Northern Telecom Lightbridge	8	12	W
8001041		8	12	S
8001099		8	12	A,W
8001098		8	12	A
8001085	Protected Mass Fusion Splice	8	48	S
8001091	Reliance Corelink	8	12	S

Catalog Number	Splice Type for:	No. of Splice Trays	Splice Tray Capacity	
8001095	Protected Fusion Amp Optimate Norland	6	12	S
8000184		6	12	W
8001095	Unprotected Fusion	6	18	A,W
8000182	3M Fibrlok Amp FingerSplice Siecor CamSplice Northern Telecom Lightbridge	6	12	S
8001042		6	12	W
8001099	Protected Mass Fusion Splice	6	12	A,W
-	3M Mass Connector	-	-	-
-	Reliance Corelink	-	-	-

- (A) Signifies an ADOBE™ Splice Tray
- (S) Signifies a standard size thermal-formed splice tray
- (W) Signifies a wide thermal-formed splice tray, 13" long x 4¾" wide (330 x 121 mm), instead of the standard 13" long x 3¹⁵⁄₁₆" wide (330 x 100 mm)



FIBERLIGN® Organizers

Catalog #8001059

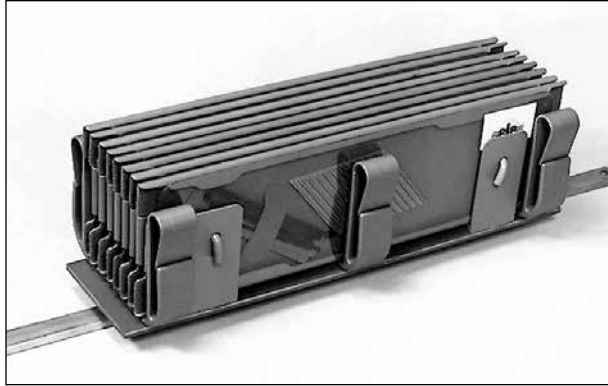

Vertical organizer for 6.5" x 28.4" (165 x 727 mm) or 8.0" x 28.4" (203 x 721 mm) Splice Case. Accommodates up to eight splice trays unless otherwise noted.

Catalog #8001036

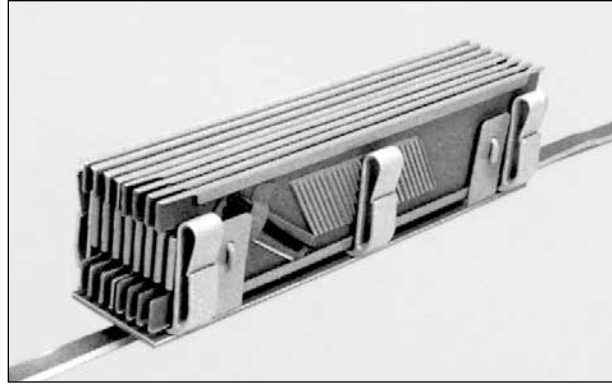

Vertical organizer for 6.5" x 38.4" (165 x 975 mm) or 8.0" x 38.4" (203 x 975 mm) Splice Case. Accommodates up to eight splice trays.

Catalog Number	Splice Type for:	No. of Splice Trays	Splice Tray Capacity	
8001021	Protected Fusion Amp Optimate Norland	8	12	S
8001044		8	18	S
8001096		8	18	A
8001109*		8	18	A
8001024	Unprotected Fusion	8	12	S
8001041	3M Fibrok Amp FingerSplice Siecor CamSplice Northern Telecom Lightbridge	8	12	S
8001098		8	12	A
8001085	Protected Mass FusionSplice	8	48	S
8001091	Reliance Corelink	8	12	S

(A) signifies an ADOBE™ Splice Tray.
(S) signifies a standard size thermal-formed splice tray.
*ADOBE™ Splice Tray with Felt.

Catalog Number	Splice Type for:	No. of Splice Trays	Splice Tray Capacity	
8001028	Protected Fusion Amp Optimate Norland	8	24	S
-	Unprotected Fusion	-	-	-
8001052	3M Fibrok Amp FingerSplice Siecor CamSplice Northern Telecom Lightbridge	8	24	S
8001026	AT&T Rotary AT&T CSL	8	24	S
-	Protected Mass FusionSplice	-	-	-
-	3M Mass Connector	-	-	-
-	Reliance Corelink	-	-	-

FIBERLIGN® Organizers

Catalog #8001043

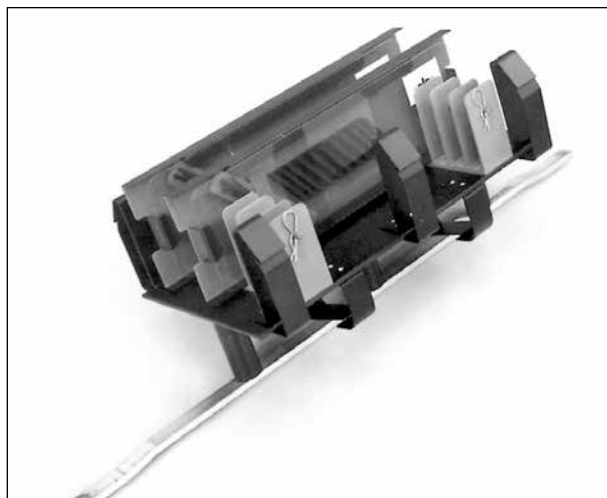

Vertical organizer for 9.5" x 28.4" (241 x 721 mm) Splice Case. Accommodates up to sixteen splice trays unless otherwise noted.

Catalog #8001049



Vertical organizer for 9.5" x 38.4" (241 x 975 mm) Splice Case. Accommodates up to sixteen splice trays.

Catalog Number	Splice Type for:	No. of Splice Trays	Splice Tray Capacity	
8001021	Protected Fusion Amp Optimate Norland	16	12	S
8001044		16	18	S
8001096		16	18	A
8001109*		16	18	A
8001024	Unprotected Fusion	16	12	S
8001041	3M Fibrok Amp FingerSplice Siecor CamSplice Northern Telecom Lightbridge	16	12	S
8001098		16	12	A
8001085	Protected Mass FusionSplice	16	48	S
8001091	Reliance Corelink	16	12	S

Catalog Number	Splice Type for:	No. of Splice Trays	Splice Tray Capacity	
8001028	Protected Fusion Amp Optimate Norland	16	24	S
-	Unprotected Fusion	-	-	-
8001052**	3M Fibrok Amp FingerSplice Siecor CamSplice Northern Telecom Lightbridge	16	24	S
8001026	AT&T Rotary AT&T CSL	16	24	S
-	Protected Mass FusionSplice	-	-	-
-	3M Mass Connector	-	-	-
-	Reliance Corelink	-	-	-

(A) signifies an ADOBE™ Splice Tray.

(S) signifies a standard size thermal-formed splice tray.

*ADOBE™ Splice Tray with Felt.

**If splicing 900 micron tip cable, splice tray will accommodate only 12 splices.



FIBERLIGN® UNI-CLOSURE

The Versatile, Re-enterable Closure Engineered for Unitube or Loose Buffer Tube Fiber Optic Cable Installation

The FIBERLIGN UNI-CLOSURE provides an airtight, watertight system that is designed to protect, store, route and organize fibers from unitube or buffer tube cables in any environment. Whether you are splicing cable above or below ground, the FIBERLIGN UNI-CLOSURE is designed to provide an airtight seal in wet, dry, cold or hot weather.

Available in three sizes, 6.5" x 28" (165 x 711 mm), 8.0" x 28" (203 x 711 mm), and 9.5" x 28" (241 x 711 mm), the FIBERLIGN UNI-CLOSURE accommodates 8-16 splice trays (see Splice Tray Capacity chart), each of which protects, secures, and organizes up to 12 or 18 fiber splices. Splice Trays are also available for protected mass fusion splices, and mass mechanical connectors. The transition tray allows you to store excess fiber for easy fiber count changes in the future.

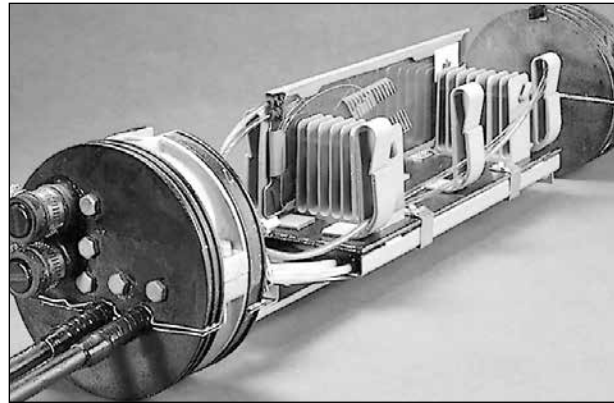

Splice Tray Capacity	
6.5" x 28" (165 x 711 mm)	8
8.0" x 28" (203 x 711 mm)	10
9.5" x 28" (241 x 711 mm)	16

FIBERLIGN® UNI-CLOSURE

FIBERLIGN UNI-CLOSURE

Design Features:

Future Cable Entry with Factory-Installed Cable Entrance Ports:

The FIBERLIGN UNI-CLOSURE utilizes End Plates made from engineered plastic filled with rigid polyurethane foam. The 6.5" x 28" (165 x 721 mm) and the 8.0" x 28" (203 x 721 mm) FIBERLIGN UNI-CLOSURES are designed to have three cable entries drilled on-site with the Power End Plate Cutter. These closures are also equipped with two factory-installed cable ports for future cable entry. This allows for easy grounding, simple strength member tie-off, and easy installation of future cables. The 9.5" x 28" (241 x 721 mm) FIBERLIGN UNI-CLOSURE is designed for eight field-drilled cable entries without any factory-installed cable ports. A replacement End Plate is available for the 9.5" x 28" (241 x 721 mm) FIBERLIGN UNI-CLOSURE with four factory-installed cable ports and room for eight field-drilled cable entries.

LOCKBAR™ Fastening

The LOCKBAR System utilizes front and back bars that fit into the flanges on both the Splice Case and the inner closure assembly. With factory-assembled nuts and bolts, and special sizing, no special tools are needed for installation. This simplified installation, saves time, and allows for easy re-entry without using re-entry kits.

Transition Tray and Organizer Ensure the Integrity of Fibers:

This uniquely engineered and field proven assembly accommodates continuous and cut fibers. The transition tray is designed to allow ample room for storing fiber. It provides a generous bending radius designed to assure long-term optical performance.

6.5" (165 mm) FIBERLIGN UNI-CLOSURE	
IF UNITUBE CABLE IS:	ORGANIZER WILL ACCOMMODATE:
1. Continuous Loop (uncut cable)	-Ribbon type 72 fibers -Loose fiber type 96 fibers -Loose buffer tube 96 fibers
2. Cut Cables	-Ribbon type 144 fibers -Loose fiber 96 fibers -Loose buffer tube 96 fibers

8" (203 mm) FIBERLIGN UNI-CLOSURE	
IF UNITUBE CABLE IS:	ORGANIZER WILL ACCOMMODATE:
1. Continuous Loop (uncut cable)	-Ribbon type 144 fibers -Loose fiber type 216 fibers -Loose buffer tube 216 fibers
2. Cut Cable	-Ribbon type 216 fibers -Loose fiber 216 fibers -Loose buffer tube 216 fibers

9.5" (241 mm) FIBERLIGN UNI-CLOSURE	
IF UNITUBE CABLE IS:	ORGANIZER WILL ACCOMMODATE:
1. Continuous Loop (uncut cable)	-Ribbon type 288 fibers -Loose fiber type 384 fibers -Loose buffer tube 288 fibers
2. Cut Cables	-Ribbon type 432 fibers -Loose fiber 432 fibers -Loose buffer tube 384 fibers

FIBERLIGN UNI-CLOSURE Ordering Chart	
Catalog Number	Dimensions (mm)
8006443	6.5" x 28" (165 x 721) FIBERLIGN UNI-CLOSURE for butt splice applications. Includes: One Two-Section End Plate, one Three-Section End Plate with two factory-installed cable ports [for future cable entry, cables up to 0.8" (20) diameter], five bonding/grounding inserts, five "L" brackets for cable shield isolation/strength member tie-off, organizer, transition compartment and transport tubes.
8006450	8.0" x 28" (203 x 721) FIBERLIGN UNI-CLOSURE for butt splice applications. Includes: one Two-Section End Plate, one Three-Section End Plate with two factory-installed cable ports [for future cable entry, cables up to 0.8" (20) diameter], five bonding/grounding inserts, five "L" brackets for cable shield isolation/strength member tie-off, organizer, transition compartment and transport tubes.
8006542	9.5" x 28" (241 x 721) FIBERLIGN UNI-CLOSURE for butt splice applications. Includes: one Two-Section End Plate, one Three-Section End Plate with eight bonding/grounding inserts (no factory-installed cable ports), eight "L" brackets for cable shield isolation/strength member tie-off, organizer, transition compartment and transport tubes.



FIBERLIGN® UNI-CLOSURE

Splice Trays

Splice Trays for the FIBERLIGN UNI-CLOSURE are 13" 330 mm) long by 3¹⁵/₁₆" (100 mm) wide. There are now two types of trays offered. The Standard Tray is available for all UNI-CLOSURES and for all splicing applications. Standard Trays are fully-lined to cushion fibers and provide a contrasting background when selecting or matching varied colored fibers. The ADOBE™ Splice Tray is available as a lower cost alternative and is interchangeable with many of the Standard Trays. Both versions come with a clear snap-on cover, felt tape for protecting buffer tubes, and tie wraps to secure the buffer tubes to the trays.

FIBERLIGN UNI-CLOSURE Splice Tray Ordering Chart (mm)						
Catalog Number	Splice Type for:	Maximum No. of Trays per Closure			Splice Tray Capacity	
		6.5" (165)	8.0" (203)	9.5" (241)		
8001041	3M Fibrok	8	10	16	12	S
8001098	Amp FingerSplice Siecor CamSplice Northern Telecom Lightbridge	8	10	16	12	A
8001085	Protected Mass Fusion Splice	8	10	16	48	S
8001021	Protected Fusion Amp Optimate Norland	8	10	16	12	S
8001044		8	10	16	18	S
8001096		8	10	16	18	A

(A) signifies ADOBE™ Splice Tray

(S) signifies a standard size thermal-formed splice tray

FIBERLIGN UNI-CLOSURE Replacement End Plates and Accessories	
Catalog Number	Description (mm)
8003178	6.5" (165) Diameter Three-Section End Plate with five bonding/grounding inserts, two factory-installed cable ports (for future cable entry, cables up to 0.8" diameter) supplied with five "L" brackets for cable shield isolation/strength member tie-off.
8003213	8.0" (203) Diameter Three-Section End Plate with five bonding/grounding inserts, two factory-installed cable ports [for future cable entry, cables up to 0.8" (20) diameter] supplied with five "L" brackets for cable shield isolation/strength member tie-off.
8003226	6.5" (165) Diameter Three-Section End Plate with six bonding/grounding inserts (no factory-installed cable ports), supplied with six "L" brackets for cable shield isolation/strength member tie-off.
8003227	8" (165) Diameter Three-Section End Plate with six bonding/grounding inserts (no factory-installed cable ports), supplied with six "L" brackets for cable shield isolation/strength member tie-off.
80805166	9.5" (241) Diameter Three-Section End Plate with eight bonding/grounding inserts (four 3/4" Carrier inserts), supplied with eight "L" brackets for cable shield isolation/strength member tie-off.
80805120	9.5" (241) Diameter Three-Section End Plate with twelve bonding/grounding inserts (no factory-installed cable ports), supplied with eight "L" brackets for cable shield isolation/strength member tie-off.
8003175	L-Bracket Bonding Kit (4) bonding brackets and retainer clips
8003176	Transport tube kit [8 tubes, 34" long (863 mm)] for 6.5" x 28" (165 x 711 mm) and 8.0" x 28" (203 x 711 mm) closures.
8003265	Transport tube kit [8 tubes, 40" long (1016 mm)] for 9.5" x 28" (241 x 711 mm) closure

FIBERLIGN® Fiber Safe

The Encapsulated, Re-enterable Closure Assembly

The FIBERLIGN® Fiber Safe is designed for protecting underground, buried and aerial fiber optic splices. More versatile and flexible than other fiber optic closures, the FIBERLIGN Fiber Safe incorporates a closure within a closure for double protection. The FIBERLIGN Fiber Safe can accommodate butt splice applications or in-line configurations using various End Plate and Splice Case

combinations. Re-enterable encapsulant fills the void between the inner closure and outer Splice Case assembly to provide an additional barrier against moisture. The FIBERLIGN Fiber Safe is easily re-enterable. Unique LOCKBAR™ Fastening allows rapid re-entry for system additions. The closure is filled and refilled through an exterior port in the Splice Case.

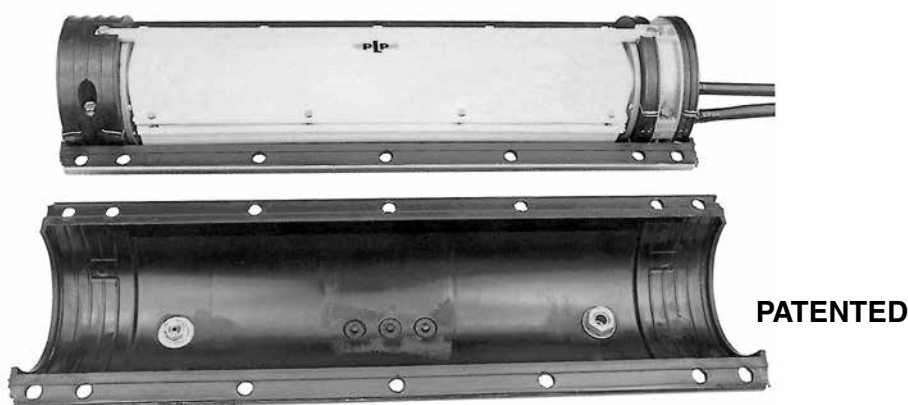

Design Features:

Butt Splice Applications

The FIBERLIGN Fiber Safe utilizes a preassembled 6.5" (165 mm) End Plate and a variety of cable entry End Plates for butt entry applications. 28" (711 mm) Splice Case shells are provided for these applications.

In-line Splice Applications

For in-line configurations, the FIBERLIGN Fiber Safe is designed with two 6.5" (165 mm) Three-Section End Plates and 38" (975 mm) Splice Case shells are provided.

Cable Entry End Plates

A variety of cable entry End Plates are available which provide simple cable entry for both initial construction and future entry. External bonding capability is provided throughout.

Splice Trays

The FIBERLIGN Fiber Safe accommodates 6 splice trays holding 12 or 18 splices per tray. An expanded capacity closure is available for butt splice applications which utilizes up to 6 splice trays holding 24 splices per tray (Cat. No.: 8001004). Splice trays are available for both fusion and mechanical splices.

Vertical Filing

The PREFORMED™ vertical file system allows trays to be individually removed, easily reworked and securely repositioned. The snap-on lid assures additional protection to each tray.

Expressing Fibers

Provisions are made for expressing uncut fibers through the inner closure.

LOCKBAR™ Fastening

The LOCKBAR System utilizes front and back bars that fit into the flange on both the Splice Case and the inner closure assembly. With factory-assembled nuts and bolts and special sizing, no special tools are needed for a fast, dependable closure. The dual closure system is designed to assure maximum system integrity, with outstanding accessibility and ease of re-entry.

Protective Collar

An innovative collar attaches to the End Plate inside the closure which provides an additional watertight seal and acts as a substrate to which resin will bond.



FIBERLIGN® Fiber Safe

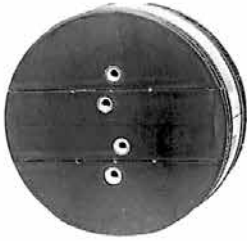

Three-Section End Plate (provided with FIBERLIGN Fiber Safe Closures 8001001, 8001002, 8001003, 8001004, 8001005, and 8001006)

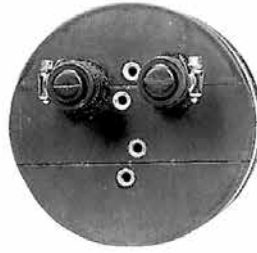

End Plate with two factory-installed inserts for future entry (provided with FIBERLIGN Fiber Safe Closure 8001007)

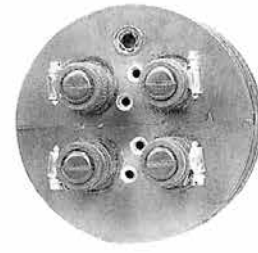

End Plate with four factory-installed inserts (provided with FIBERLIGN Fiber Safe Closure 8001008)

How to order FIBERLIGN Fiber Safe and Accessories

1. Specify 8001001, 8001003, 8001004, 8001005, 8001007 or 8001008 FIBERLIGN Fiber Safe for butt splice applications or specify 8001002 or 8001006 FIBERLIGN Fiber Safe for in-line splice applications.
2. Specify 8000310 Non Re-enterable Resin Kit (preferred) for filling the cup; two required for in-line or specify 80803316 Re-enterable Encapsulant Kit (optional) for filling the cup; two required for in-line.
3. Specify 80802829 Re-enterable Encapsulant for filling the 8001001, 8001003, 8001005, 8001007 or 8001008 FIBERLIGN Fiber Safe or specify 80802826 Re-enterable Encapsulant for filling the 8001002, 8001004, or 8001006 FIBERLIGN Fiber Safe.
4. Order appropriate Fiber Optic Splice Trays. Each Fiber Optic Splice Tray is supplied with snap-on clear cover and will accommodate up to 12 or up to 18 fiber optic splices.
5. Order additional End Plate Kits as needed.

Encapsulant Ordering Chart				
FIBERLIGN Fiber Safe Catalog Number	Type of Splice	Protective Collar Encapsulant		FIBERLIGN Fiber Safe Encapsulant
		Re-enterable	Non Re-enterable	
8001001 8001003 8001005 8001007 8001008	Butt	80803316	8000310	80802829
8001004	Butt	80803316	8000310	80802826
8001002 8001006	In-line	80803316 (2 kits)	8000310 (2 kits)	80802826

FIBERLIGN Fiber Safe	
Catalog Number	Description (mm)
8001003	6.5" x 28" (165 x 711) FIBERLIGN Fiber Safe for butt splice applications. Includes: One Two-Section End Plate and one Three-Section End Plate.
8001002	6.5" x 38" (165 x 965) FIBERLIGN Fiber Safe for in-line splice applications. Includes: Two Three-Section End Plates.
8001001	6.5" x 28" (165 x 711) FIBERLIGN Fiber Safe for butt splice applications. Includes: One Two-Section End Plate and one Three-Section End Plate and one Fiber Optic Splice Tray with cover (8001021).
8001004	6.5" x 38" (165 x 965) FIBERLIGN Fiber Safe for butt splice applications. (Up to 144 Splices) Includes: One Two-Section End Plate and one Three-Section End Plate.
8001005	6.5" x 28" (165 x 711) FIBERLIGN Fiber Safe for butt splice applications. Includes: One Two-Section End Plate, one Three-Section End Plate and RUS listed shield connectors. (RUS LISTED)
8001006	6.5" x 38" (165 x 965) FIBERLIGN Fiber Safe for in-line splice applications. Includes: Two Three-Section End Plates, and RUS listed shield connectors. (RUS LISTED)
8001007	6.5" x 28" (165 x 711) FIBERLIGN Fiber Safe for butt splice applications. Includes: One Two-Section End Plate and one Three-Section End Plate with two factory-installed inserts (cables up to 0.8" diameter) for future entry.
8001008	6.5" x 28" (165 x 711) FIBERLIGN Fiber Safe for butt splice applications. Includes: Two Two-Section End Plates; one blank and one with four factory-installed inserts (cables up to 0.8" [20 mm] diameter).
8001010	6.5" x 28" (165 x 711) FIBERLIGN Fiber Safe for butt splice applications. Includes: One Two-Section End Plate, one Three-Section End Plate and RUS listed shield connectors. (RUS LISTED Flame Retardant End Plates)

FIBERLIGN® Fiber Safe

SPLICE TRAYS for all Closures except 8001004

The Splice Trays for all FIBERLIGN Fiber Safe Closures, except the 8001004, are 13" long by 3-15/16" wide (330 x 100 mm), and each is supplied with a snap-on clear cover. There are now two types of splice trays offered. The Standard Thermal-formed Tray is available for all closures and splicing applications. The ADOBE™ Splice Tray is available as a lower cost alternative and is interchangeable with many of the thermal-formed trays. Select the appropriate catalog number from the chart below.

Catalog Number	Splice Type for:	No. of Splice Trays	Splice Tray Capacity	
8001021	Protected Fusion Amp Optimate Norland	6	12	S
8001044		6	18	S
8001096		6	18	A
8001109*		6	18	A
8001024	Unprotected Fusion	6	12	S
8001041	3M Fibrlok Amp FingerSplice	6	12	S
8001098	Siecor CamSplice Northern Telecom Lightbridge	6	12	A

(A) signifies ADOBE™ Splice Tray.

(S) signifies a standard size thermal-formed splice tray.

* ADOBE™ Splice Tray with Felt.

SPLICE TRAYS for 8001004 Closure

The Splice Trays for the 8001004 FIBERLIGN Fiber Safe are 17-3/8" long by 3-15/16" wide (441 x 100 mm), and each is supplied with a snap-on clear cover. The Splice Trays accommodate 24 fiber splices.

Catalog Number	Splice Type for:	No. of Splice Trays	Splice Tray Capacity	
8001028	Protected Fusion Amp Optimate Norland	6	24	S
8001026	AT&T Rotary AT&T LightSplice	6	24	S
8001052	3M Fibrlok Amp FingerSplice Siecor CamSplice Northern Telecom Lightbridge	6	24	S

(S) signifies a standard size thermal-formed splice tray.

C-Cement

C-Cement is required for both cable preparation and End Plate preparation, but is not supplied with Splice Cases or End Plate Kits.

C-CEMENT		
C-Cement	80805238	1 oz. tube
C-Cement	80802377	4 oz. can



FIBERLIGN® Fiber Safe

Accessories

FIBERLIGN Fiber Safe (mm)	
Catalog Number	Encapsulant Description
8000310	8 oz. Resin Kit (non-re-enterable) for filling cup.
80803316	300 Gram Kit RD Encapsulant (re-enterable) for filling cup.
80802829	5500 Gram Kit RD Encapsulant (re-enterable) for filling 8001003, 8001001, 8001005, 8001007 or 8001008 FIBERLIGN Fiber Safe.
80802826	8000 Gram Kit RD Encapsulant (re-enterable) for filling 8001002, 8001004, or 8001006 FIBERLIGN Fiber Safe.
Catalog Number	Replacement Parts Description
80803149	One Two-Section End Plate with protective collar assembly for cable blocking.
80803148	One Three-Section End Plate with protective collar assembly for cable blocking.
80803695	One Three-Section End Plate with two factory-installed ports (for future cable entry, for cables up to 0.8" [20] in diameter), four bonding/grounding inserts, four modified brackets for cable shield isolation/strength member tie-off, and protective collar assembly for cable blocking. Designed for two field-drilled cable holes.
80803668	One Two-Section End Plate with four factory-installed ports (for future cable entry, for cables up to 0.8" [20] in diameter), four bonding/grounding inserts, four modified brackets for cable shield isolation/strength member tie-off, and protective collar assembly for cable blocking. No room for field-drilled cable holes.
8001032	Re-entry kit for 6.5" x 28" (165 x 711) FIBERLIGN Fiber Safe. Includes: Gaskets for collars and inner closure and a replacement flange clamp assembly.
8001033	Re-entry kit for 6.5" x 38" (165 x 965) FIBERLIGN Fiber Safe. Includes: Gaskets for collars and inner closure and a replacement flange clamp assembly.



PREFORMED LINE PRODUCTS

Section 4 – FIBERLIGN® Splice Case Series

Table of Contents

Page

Splice Case4-2



FIBERLIGN® Splice Case

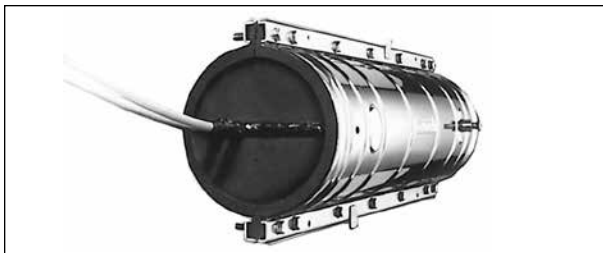

The PREFORMED™ Splice Case, the most effective Splice Case made, offers easy-to-use LOCKBAR™ Fastening. LOCKBAR Fastening reduces Splice Case installation and re-entry time by as much as 50%.

The PREFORMED Splice Case is versatile, accommodating a wide variety of fiber optic applications when used with FIBERLIGN Organizers. It effectively maintains an airtight, watertight seal around all types of fiber optic cable.

The closure is designed to remain secure whether the application is overhead or underground, and in hot, dry, warm, wet or cold environments. In addition, the PREFORMED Splice Case can be easily re-entered without a special kit or special tools.

LOCKBAR Fastening for Rapid Installation and Re-entry

The revolutionary LOCKBAR Fastening System—a PREFORMED exclusive—eliminates the need to individually assemble nuts and bolts to close the PREFORMED Splice Case. The LOCKBAR System features front and back bars that fit into the Splice Case flange. The back bar has factory assembled bolts and nuts; the front bar has keyholes that accept the bolt assemblies on the back bar. Once the bars mate through the flanges, the nuts simply lock into the keyhole and are torqued down in sets.

Maintains an Airtight, Watertight Seal

LOCK-TAPE™ Sealing is central to the Splice Case seal. When properly applied around the cable and laid in the cut End Plates, the LOCK-TAPE System creates a gasket-like seal that locks cables into place and provides for extra strong shear strength to resist cable pull-out.

Strong and Durable; Corrosion-Resistant

Shells of the PREFORMED Splice Case are precision formed of stainless steel with an inside liner of neoprene. LOCKBAR Fasteners, made from the same durable stainless steel, are lightweight and corrosion-resistant. End Plates are made from hard plastic and filled with a rigid polyurethane foam. Torque bars keep the End Plates secure and in alignment during installation and re-entry.

The Practical Re-enterable Case

The PREFORMED Splice Case with LOCKBAR Fastening can be easily re-entered without a special kit. Holes are easily cut in the End Plates to accommodate a variety of cable diameters and multiple entries. These holes can be cut quickly in the field with a Power End Plate Cutter.

Laboratory Tested, Field Proven

Engineering improvements and Splice Case Kit additions have created what is today the most effective, versatile and easy-to-install splice closure available. For comprehensive test data and field reports, contact Preformed Line Products Company.

FIBERLIGN® Splice Case

The FIBERLIGN Splice Case, End Plates, Organizers and Splice Trays are designed to fit your specific splicing application. The Splice Cases may be ordered as a kit with two standard End Plates included, or the Splice Case may be ordered without the End Plates. Ordering a Splice Case without the standard End Plates allows you to select

specific End Plates for specialized applications (see pages 4-4 to 4-6 for End Plate selection). A Power End Plate Cutter is required for field installation and a Torque/Socket Tool Kit is available for tightening the Splice Case. FIBERLIGN Organizers and Splice Trays must be ordered separately, see pages 3-2 to 3-7.

Splice Cases with two Standard End Plates Included (mm)							
Catalog Number	Splice Case Dimensions (mm)	A	B	C	D	E	F
8006282	4.0" x 25.8" (102 x 655)	25.8" (655)	20.3" (516)	6.0" (152)	4.5" (114)	4.0" (102)	2.2" (56)
8006377	6.5" x 22.0" (165 x 559)	22.0" (559)	16.2" (412)	9.25" (235)	7.0" (179)	6.5" (165)	4.1" (104)
8006192	6.5" x 28.4" (165 x 721)	28.4" (721)	22.7" (577)	9.25" (235)	7.0" (179)	6.5" (165)	4.1" (104)
8006024	6.5" x 38.4" (165 x 975)	38.4" (975)	32.7" (831)	9.25" (235)	7.0" (179)	6.5" (165)	4.1" (104)
8006261	8.0" x 28.4" (203 x 721)	28.4" (721)	22.7" (567)	10.5" (267)	8.5" (216)	8.0" (203)	5.6" (142)
8006262	8.0" x 38.4" (203 x 975)	38.4" (975)	32.7" (831)	10.5" (267)	8.5" (216)	8.0" (203)	5.6" (142)
8000661*	9.5" x 28.4" (241 x 721)	28.4" (721)	21.6" (549)	12.5" (318)	10.0" (254)	9.5" (241)	7.1" (180)
8000662*	9.5" x 38.4" (241 x 975)	38.4" (975)	31.6" (803)	12.5" (318)	10.0" (254)	9.5" (241)	7.1" (180)
8006251	12.5" x 28.4" (318 x 721)	28.4" (721)	21.6" (549)	15.5" (394)	13.0" (330)	12.5" (318)	9.3" (236)
8006252	12.5" x 38.4" (318 x 975)	38.4" (975)	31.6" (803)	15.5" (394)	13.0" (330)	12.5" (318)	9.3" (236)

*Includes one Two-Section End Plate and one Three-Section End Plate.

Marks on End Plates denote usable area for cable entrance holes.

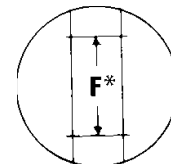
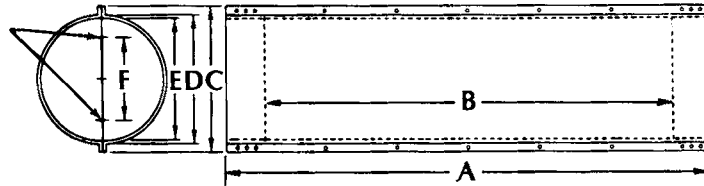

Three-Section End Plate

The following Splice Case Shell Kits include all materials necessary to install the Stainless Steel Shell halves, along with Aerial Hanger Brackets. All other material necessary for installation is included with the End Plates which are ordered separately.

Splice Case Shell Kits without End Plates Included (mm)							
Catalog Number	Splice Case Dimensions (mm)	A	B	C	D	E	F
8006559	4.0 x 25.8 (102 x 655)	25.8" (655)	20.3" (516)	6.0" (152)	4.5" (114)	4.0" (102)	2.2" (56)
8006510	6.5 x 22.0 (165 x 559)	22.0" (559)	16.2" (412)	9.25" (235)	7.0" (179)	6.5" (165)	4.1" (104)
8006041	6.5 x 28.4 (165 x 721)	28.4" (721)	22.7" (577)	9.25" (235)	7.0" (179)	6.5" (165)	4.1" (104)
8006043	6.5 x 38.4 (165 x 975)	38.4" (975)	32.7" (831)	9.25" (235)	7.0" (179)	6.5" (165)	4.1" (104)
8006387	8.0 x 28.4 (203 x 721)	28.4" (721)	22.7" (567)	10.5" (267)	8.5" (216)	8.0" (203)	5.6" (142)
8006388	8.0 x 38.4 (203 x 975)	38.4" (975)	32.7" (831)	10.5" (267)	8.5" (216)	8.0" (203)	5.6" (142)
8006186	9.5 x 28.4 (241 x 721)	28.4" (721)	21.6" (549)	12.5" (318)	10.0" (254)	9.5" (241)	7.1" (180)
8006187	9.5 x 38.4 (241 x 975)	38.4" (975)	31.6" (803)	12.5" (318)	10.0" (254)	9.5" (241)	7.1" (180)
8006268	12.5 x 28.4 (318 x 721)	28.4" (721)	21.6" (549)	15.5" (394)	13.0" (330)	12.5" (318)	9.3" (236)
8006269	12.5 x 38.4 (318 x 975)	38.4" (975)	31.6" (803)	15.5" (394)	13.0" (330)	12.5" (318)	9.3" (236)



FIBERLIGN® Splice Case

End Plate Kits

A variety of End Plate combinations are available for use with the PREFORMED™ Splice Case. Each Kit includes the LOCK-TAPE™ Sealant, Cue Card, and CABLE Mea-SURE™ Tape required for installation. The End Plates shown are

examples of configurations for the 4.0" (102 mm), 6.5" (165 mm), 8.0" (203 mm), 9.5" (241 mm), and 12.5" (318 mm) End Plates used with the FIBERLIGN Splice Cases.



Standard Two-Section End Plate



Standard Three-Section End Plate

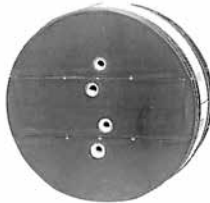

End Plate with factory-installed bonding/grounding inserts*



End Plate with factory-installed cable entry ports



End Plate with factory-installed bonding/grounding inserts* and cable entry ports

*Bonding/grounding inserts are also used for strength member tie-off for fiber optic cables.

4.0" (102 mm) FIBERLIGN Splice Case End Plates	
Catalog Number	Description
8003277	One Standard Two-Section End Plate
8003103	Two Standard Two-Section End Plates
80804985	One Two-Section End Plate with three inserts for bonding/grounding, and three "L" Brackets for cable shield isolation/strength member tie-off.
8003275	One Two-Section End Plate with two factory-installed 1/2" (13) cable ports for future entry 0.56" (14) max. cable, two inserts for bonding/grounding, two "L" Brackets for cable shield isolation/strength member tie-off. No space for field drilled cable entries.
8003274	One Two-Section End Plate with one factory-installed 1/2" (13) cable port for future entry 0.56" (14) max. cable, three inserts for bonding/grounding, three "L" Brackets for cable shield isolation/strength member tie-off, and space for two field-drilled cable entrances 0.6" (15) max.cables.

FIBERLIGN Splice Case Accessories	
Catalog Number	Description
8003175	"L" Bracket Bonding Kit – (4) bonding brackets and retainer clips

FIBERLIGN® Splice Case

6.5" (165 mm) FIBERLIGN Splice Case End Plates	
Catalog Number	Description
8003252	One Standard Two-Section End Plate
8000361	One Standard Three-Section End Plate
8003018	Two Standard Two-Section End Plates
8003278	One Two-Section End Plate with two bonding/grounding inserts and two "L" Brackets for cable shield isolation/strength member tie-off.
8003163	One Three-Section End Plate with four bonding/grounding inserts and four "L" Brackets for cable shield isolation/strength member tie-off.
8003093	One Three-Section End Plate with two factory-installed cable ports [for future cable entry, cables up to 0.8" (20) diameter], four bonding/grounding inserts, and four "L" brackets for cable shield isolation/strength member tie-off.
8003112	One Two-Section End Plate with four factory-installed cable ports [for future cable entry, cables up to 0.8" (20) diameter], four bonding/grounding inserts, and four "L" brackets for cable shield isolation/strength member tie-off.
8003225	One solid End Plate with six factory-installed cable ports [for future cable entry, cable up to 0.8" (20) diameter], and no space for field drilled cable entries.
8003226	One Three-Section End Plate with six bonding/grounding inserts, and six "L" Brackets for cable shield isolation/strength member tie-off.
8003178	One Three-Section End Plate with two factory-installed cable ports [for future cable entry, cables up to 0.8" (20) diameter], five bonding/grounding inserts, and five "L" Brackets for cable shield isolation/strength member tie-off.

8.0" (203 mm) FIBERLIGN Splice Case End Plates	
Catalog Number	Description
8003282	One Standard Two-Section End Plate
8003110	One Standard Three-Section End Plate
8003098	Two Standard Two-Section End Plates
8003213	One Three-Section End Plate with two factory-installed cable port [for future cable entry, accepts cables up to 0.8" (20) diameter], five bonding/grounding inserts, and five "L" brackets for cable shield isolation/strength member tie-off.
8003227	One Three-Section End Plate with six bonding/grounding inserts, and six "L" brackets for cable shield isolation/strength member tie-off.

FIBERLIGN Splice Case Accessories	
Catalog Number	Description
8003175	"L" Bracket Bonding Kit – (4) bonding brackets and retainer clips



FIBERLIGN® Splice Case

9.5" (241 mm) FIBERLIGN Splice Case End Plates	
Catalog Number	Description
8003283	One Standard Two-Section End Plate
8000381	Two Standard Two-Section End Plates
800081098	One Standard Three-Section End Plate
8000352	One solid End Plate with four factory-installed cable ports [for future cable entry, 1" (25) cable diameter], and no space for field drilled cable entries.
8000353	One solid End Plate with six factory-installed cable ports [for future cable entry, 1" (25) cable diameter], and no space for field drilled cable entries.
8000354	One solid End Plate with eight factory-installed cable ports [for future cable entry, 1" (25) cable diameter], and no space for field drilled cable entries.
80805166	One Three-Section End Plate with eight bonding/grounding inserts and eight "L"-Brackets for cable shield isolation/strength member tie-off.
80805120	One Three-Section End Plate with twelve bonding/grounding inserts, four factory-installed cable ports [for future cable entry, 0.8" (20) cable diameter], and 12 "L"-Brackets for cable shield isolation/strength member tie-off.

12.5" (381 mm) FIBERLIGN Splice Case End Plates	
Catalog Number	Description
8003284	One Standard Two-Section End Plate
8003055	One Standard Three-Section End Plate

FIBERLIGN Splice Case Accessories	
Catalog Number	Description
8003175	"L" Bracket Bonding Kit – (4) bonding brackets and retainer clips



PREFORMED LINE PRODUCTS

Section 5 – FIBERLIGN® Hardware for OPGW

Table of Contents	Page
Fiber Optic Product Layout for OPGW	5-2
FIBERLIGN Dead-end for OPGW.....	5-3
FIBERLIGN Formed Wire Dead-end for OPGW	5-6
Ground Clamps.....	5-10
Optical Tension Device (OTD).....	5-11
FIBERLIGN Suspension for OPGW.....	5-12
FIBERLIGN Cushion Clamp for OPGW.....	5-17
FIBERLIGN Repair Rods for OPGW	5-20



Fiber Optic Products

OPGW Product Layout

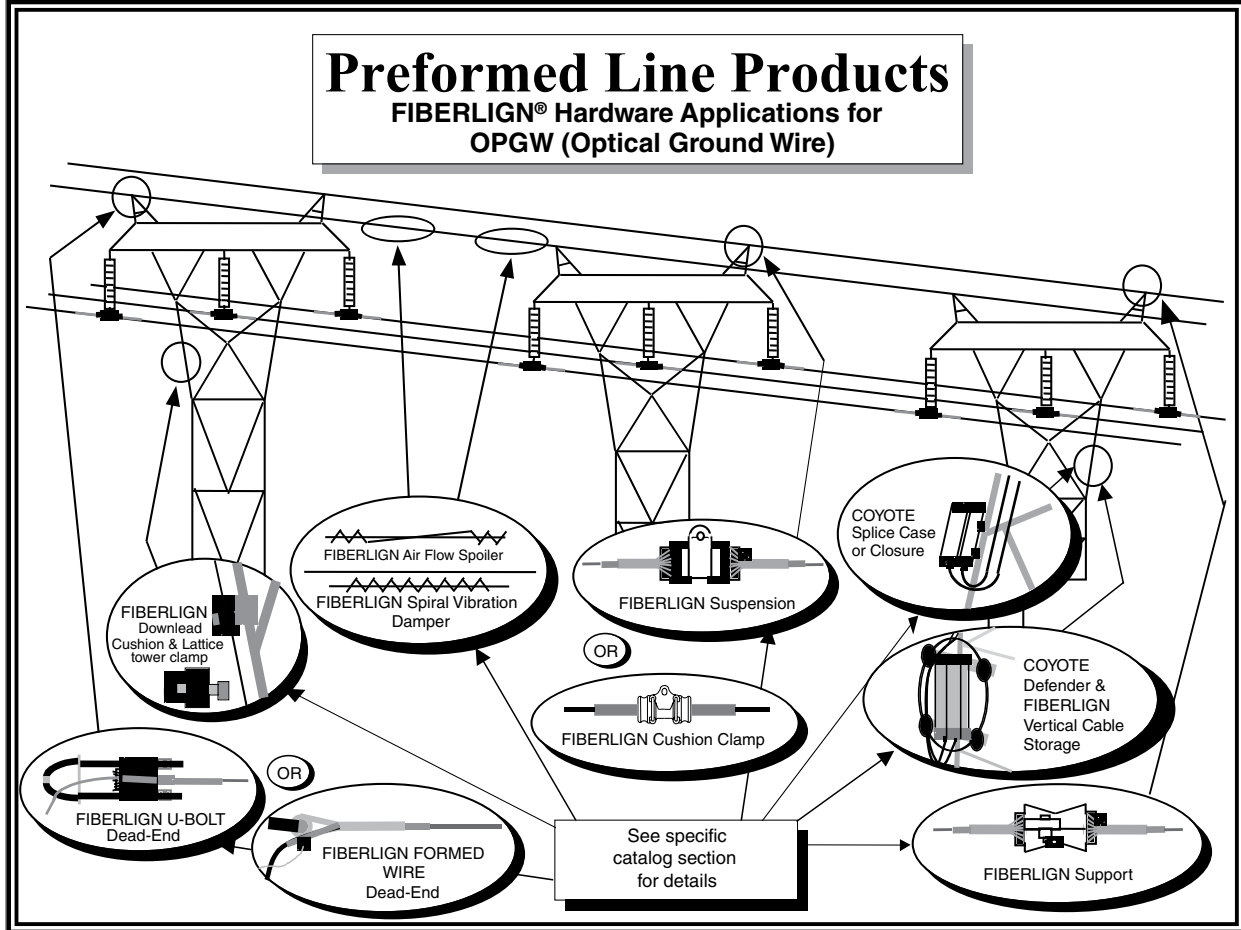

Note: Some OPGW hardware accessories can be found in section 7.

FIBERLIGN® Dead-end for OPGW

Retaining Rods: Aluminum Covered Steel, with Conductive Grit Applied.

Nuts: Galvanized Steel

U-bolt, Spacer Bar: Galvanized Steel

Housing: Galvanized Iron

Wedges: Aluminum Alloy

Grounding Bolt And Lock Washer: (included but not shown): Galvanized Steel

APPLICATION

The FIBERLIGN Dead-end is designed to terminate Optical Ground Wire (OPGW) while minimizing any compression stresses that may be transferred to the core or optical elements within. The Retaining Rods act with the Wedge and Housing to distribute the axial and compressive loading over a large area of the OPGW. Standard units have left-hand lay rods.

The FIBERLIGN® Dead-end sketch at the bottom of this page includes reference to the exposed rod length " L_E " or the rod length beyond the housing. This dimension is listed in the catalog table to help with VORTX™ Damper placement.

The slotted Housing design allows for the application of the FIBERLIGN Dead-end at any location on the OPGW.

Bonding: Provisions for electrically bonding the OPGW to the supporting structure or ground lead are an integral part of the Housing. A 1" x 1/2"-13 UNC, 2A galvanized Grounding Bolt and Lock Washer are provided.

Grounding Wire Assembly Options: A 4' ground wire assembly can be connected from the FIBERLIGN Dead-end to the ground lead in your system. Two types of ground materials are offered (copper or aluminum). To included the preferred ground wire assembly in the same carton with the Dead-end, add the appropriate suffix code to the Dead-end catalog number.

Adjustment: The U-Bolt provides up to 18 inches of take-up to allow for tension adjustment and extra clearance distance without the need for external hardware such as a turnbuckle or extension links.

Component Strength: The value shown in the table on the following page reflects the strength of the standard housing and U-bolt. Higher strength requirements can be accommodated. Contact PLP® for more information.

Holding Strength: Specific holding strengths on an OPGW cable will depend upon that cable's internal construction design and composition of the materials used for the individual strands. The highest holding capabilities exist with cables that use all aluminum clad steel strands in a single layer. Use of multiple layers and/or aluminum alloy strands may reduce holding capabilities. Consult PLP for information regarding holding abilities of the FIBERLIGN OPGW Dead-end for a specific OPGW design.

NOMENCLATURE

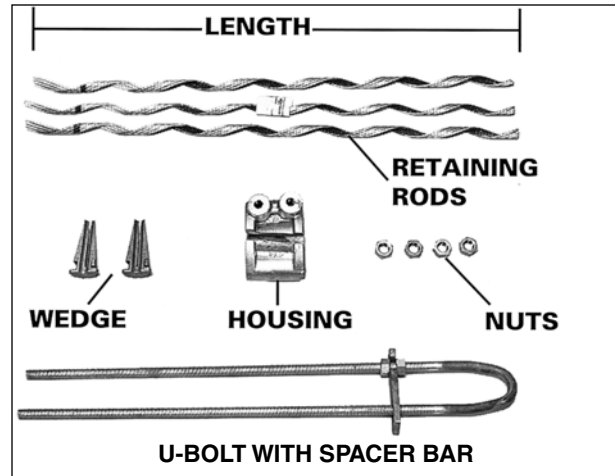

Lay Direction: Left-hand lay is standard. Custom right-hand lay units are available. Contact PLP with cable specifications for further information.

Attachment Fittings: The dead-end U-bolt component should be applied over pins, sheave wheels, or other fittings that have smooth contours, appropriate diameters and adequate strength for proper fit and support under loading conditions.

- For 5/8" U-bolts used in standard dead-ends designed for cable diameters less than or equal to .749" diameter – Adequate fitting or pin diameters range from 5/8" to 1-7/8".
- For 3/4" U-bolts used in standard dead-ends designed for cable diameters greater than .749" diameter cable - Adequate fitting or pin diameters range from 5/8" to 13/16".
- For either U-bolt size connected to a vang or structure plate, the holes in the plate should be chamfered - an example of an acceptable plate is maximum thickness of 1-1/16" (27 mm), Hole diameter 1" (25 mm), Chamfer 1/8" x 450) (3.2 mm x 450), and Installation clearance 1-15/16" (24 mm).

Consult PLP® for installation to other plates or fittings.

Component Reuse: The retaining rods and wedges may be reused once for retensioning after initial installation. The hardware components may be reused as desired if in good condition. Do not modify any component.

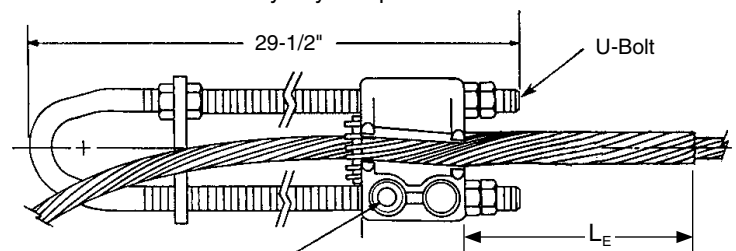

Threaded Hole (1/2"-13 UNC, 7/8" deep) to fit class 2A Galvanized Bolt for Grounding Connection.



FIBERLIGN® Dead-end for OPGW

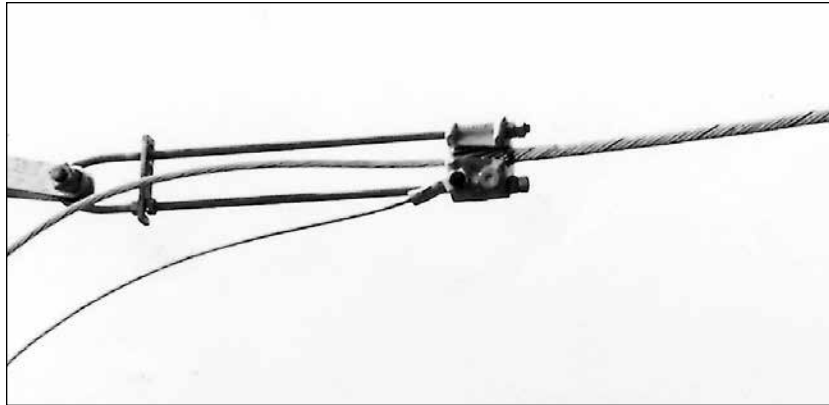

FIBERLIGN Dead-end for OPTICAL GROUND WIRE (OPGW) Patented

Ordering Instructions:

Select the appropriate FIBERLIGN Dead-end from the catalog table in this section. Consult PLP® for designs for OPGW diameters, strengths, or lay directions not shown. Also call PLP for availability of all sizes and designs.

Accessories:

Accessories may be included in the same container with the Dead-end by adding the appropriate suffix code. Ex. 2801312G, includes Dead-end with ground wire assembly, #710010016.

Catalog Number	Suffix Code	Description
710010016	G	4' long (1.2 m) #4 (7W) copper ground wire with terminal on one end.
710010294	GA	4' (1.2 m) long 4/0 (7W) aluminum ground wire with terminal on one end.
710011205	GA2	5' (1.5 m) long 95 mm ² (19W) aluminum ground wire with terminals at both ends.

CAUTION: Determine the appropriate material and size wire necessary to provide adequate grounding for your system before ordering the ground wire assemblies. For proper performance and personal safety be sure to select the proper ground wire before application.

FIBERLIGN® Dead-end for OPGW

Catalog Number	Diameter Range				Overall Rod Length (in)	Rods per set	Subset	Color Code	Components Rated Strength (lbs)	Exposed Rod Length for (L _E) VORTX™ Placement	
	Min. (in)	Max. (in)	Min. (mm)	Max. (mm)						Damper (in)	Placement (mm)
280110266	.358	.374	9.1	9.5	24	9	3-3-3	Blue	25,000	21	533
2801300	.375	.391	9.5	9.9	24	9	3-3-3	Pink	25,000	21	533
2801301	.392	.410	10.0	10.3	24	9	3-3-3	Pink	25,000	21	533
2801302	.411	.425	10.4	10.7	26	10	3-3-4	White	25,000	23	584
2801303	.426	.443	10.8	11.2	26	10	3-3-4	White	25,000	23	584
2801304	.444	.460	11.3	11.6	27	10	3-3-4	Brown	25,000	24	609
2801305	.461	.477	11.7	12.0	27	10	3-3-4	Brown	25,000	24	609
2801306	.478	.494	12.1	12.5	29	11	3-4-4	Purple	25,000	26	660
2801307	.495	.511	12.6	12.9	29	11	3-4-4	Purple	25,000	26	660
2801308	.512	.528	13.0	13.3	31	12	3-3-3-3	Yellow	25,000	28	711
2801309	.529	.545	13.4	13.8	31	12	3-3-3-3	Yellow	25,000	28	711
2801310	.546	.562	13.9	14.2	32	12	3-3-3-3	Blue	25,000	29	737
2801311	.563	.579	14.3	14.6	32	12	3-3-3-3	Blue	25,000	29	737
2801312	.580	.596	14.7	15.1	34	12	3-3-3-3	Orange	25,000	31	787
2801313	.597	.613	15.2	15.5	34	12	3-3-3-3	Orange	25,000	31	787
2801314	.614	.630	15.6	15.9	36	11	3-4-4	Red	25,000	33	838
2801315	.631	.647	16.0	16.4	36	11	3-4-4	Red	25,000	33	838
2801316	.648	.664	16.5	16.9	38	12	3-3-3-3	Black	25,000	35	889
2801317	.665	.681	17.0	17.2	38	12	3-3-3-3	Black	25,000	35	889
2801318	.682	.698	17.3	17.7	40	12	3-3-3-3	Green	25,000	37	938
2801319	.699	.715	17.8	18.0	40	12	3-3-3-3	Green	25,000	37	938
2801320	.716	.732	18.1	18.5	41	12	3-3-3-3	Brown	25,000	38	965
2801321	.733	.749	18.6	18.9	41	12	3-3-3-3	Brown	25,000	38	965
2801322	.750	.766	19.0	19.4	59	12	3-3-3-3	Purple	45,000	56	1422
2801323	.767	.783	19.5	19.8	59	12	3-3-3-3	Purple	45,000	56	1422
2801324	.784	.800	19.9	20.2	64	12	3-3-3-3	Yellow	45,000	61	1549
2801325	.801	.817	20.3	20.7	64	12	3-3-3-3	Yellow	45,000	61	1549
2801326	.818	.834	20.8	21.1	66	13	3-3-3-4	Blue	45,000	63	1600
2801327	.835	.851	21.2	21.5	66	13	3-3-3-4	Blue	45,000	63	1600
2801328	.852	.868	21.6	22.0	70	12	3-3-3-3	Orange	45,000	67	1701
2801329	.869	.885	22.1	22.4	70	12	3-3-3-3	Orange	45,000	67	1701
2801330	.886	.902	22.5	22.8	72	12	3-3-3-3	Red	45,000	69	1753
2801331	.903	.919	22.9	23.2	72	12	3-3-3-3	Red	45,000	69	1753
2801332	.920	.936	23.3	23.8	74	13	3-3-3-4	Black	45,000	71	1803

See figure on page 5-3.



FIBERLIGN® Formed Wire Dead-end for OPGW

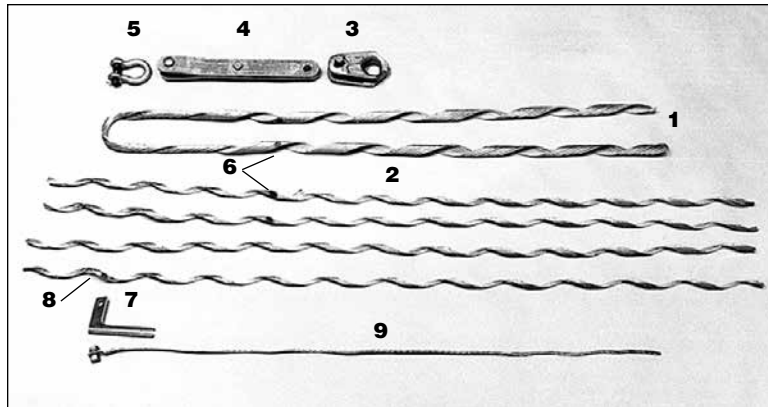

NOMENCLATURE

- 1. Dead-End Component:** Aluminum Covered Steel with Grit Applied
- 2. Structural Reinforcing Rods:** Aluminum Covered Steel with Grit
- 3. Thimble Clevis:** Galvanized Ductile Iron
- 4. Extension Link (option):** Extension Link & Pin are galvanized steel or galvanized ductile iron. A stainless steel cotter key is provided to capture the pin
- 5. Anchor Shackle (option):** Galvanized steel forging
- 6. Color Code And Crossover Marks**
- 7. Current Transfer Tab:** High Strength Aluminum Alloy
- 8. Current Transfer Tab Location Mark**
- 9. Grounding Wire Assembly (option):** Copper or aluminum conductor with aluminum compatible lug

APPLICATION

The FIBERLIGN Formed Wire Dead-end offers an alternate method for dead-ending OPGW. Unlike the FIBERLIGN® Dead-end “U-Bolt Type” design shown at the beginning of this section, the Formed Wire Dead-end uses two helically shaped formed wire components: an inner layer of Structural Reinforcing Rods and an outer layer Dead-end component. The FIBERLIGN® Formed Wire Dead-end does not provide take-up adjustment.

The formed wire inner and outer layer components are designed to transfer axial tensile loads and distribute radial compressive forces over the surface in contact with the OPGW to minimize effects on the central core and internal optical fibers.

Standard designs offered for left-hand lay single layer strand OPGW are listed in the table in this section. The standard Structural Reinforcing Rod component is right-hand lay and the standard Dead-end Component is left-hand lay.

The rated breaking strength of OPGW with multi-layer strand construction may exceed the rated holding strength of a Formed Wire Dead-end. Consult PLP before using this product for multi-layer applications.

Useful dimensions for VORTX™ damper placement are listed in the catalog table and shown in a reference drawing above the catalog table.

FIBERLIGN® Formed Wire Dead-end for OPGW



FIBERLIGN Formed Wire Dead-end Installed

Current Transfer Tab:

The Current Transfer Tab provides direct electrical bonding between the OPGW and a ground lead. The Structural Reinforcing Rod Layer conveniently applies proper compression to retain the current transfer tab against the OPGW without fasteners. The current transfer tab has a 1/2" diameter bolt hole to accommodate a standard 1/2"-13, UNC bolt for compatible ground lug attachment.

The standard current transfer tab accommodates left-hand lay OPGW and is rated for 80 kA²S to 150 kA²S depending on size of dead-end unit. Right-hand lay units for special applications are also available. Consult PLP for specifics.

Grounding Wire Assembly Options:

A 4' long ground wire with compression terminal, 1/2"-13 x 1" long bolt, 1/2"-13 nut, and lock washer can be provided. Two types of ground wire material are offered (copper or aluminum). To order the ground wire assembly with the Formed Wire Dead-end, add the appropriate suffix code to the catalog number (see catalog table in this section).

Component Strength:

The strength of the thimble clevis, extension link, and anchor shackle are designed to meet or exceed the maximum rated holding strength of 25,000 pounds.

Holding Strength:

Specific holding strengths on an OPGW cable will depend upon that cable's internal construction design and composition of the materials used for the individual strands. The highest holding capabilities exist with cable that use all aluminum clad steel strands in a single layer. Use of multi-layer and/or aluminum alloy strands may reduce holding capabilities. Consult PLP for information regarding holding abilities of the FIBERLIGN Formed Wire Dead-end for a specific OPGW design.

Lay Direction:

Left-hand lay is standard. Right-hand lay units for right-hand lay OPGW are available. Contact PLP with cable specifications for further information.

Attachment Fittings:

Dimensions of the thimble clevis provided (cat. no. TC-6F) are shown below. These are provided for proper selection of an extension link. PLP offers a 14" extension link as listed in the accessories section following the catalog table.

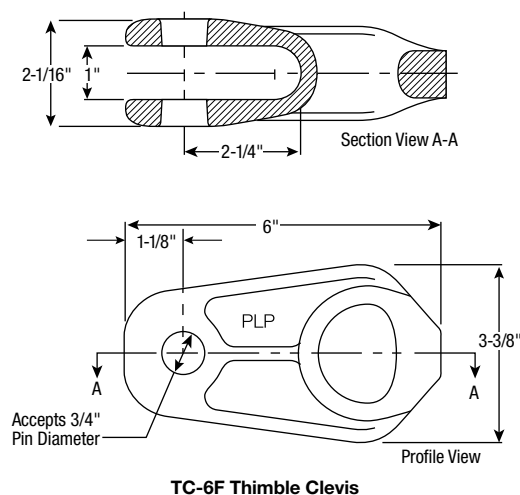

TC-6F Thimble Clevis

Component Reuse:

Once installed, structural reinforcing rods and dead-end components may be removed and reinstalled once for repositioning purposes; do not reuse after this initial installation. The hardware components may be reused as long as they are in good condition. Do not modify any components.



FIBERLIGN® Formed Wire Dead-end for OPGW

Ordering Instructions:

Select the appropriate FIBERLIGN Formed Wire Dead-end for OPGW from the following table in this section.

Accessories:

Ground wire assemblies and other hardware accessories may be ordered with the Formed Wire Dead-end by adding the appropriate SUFFIX CODE from the adjacent table. Note: Suffix code C4 is part of standard equipment and is included in the catalog number. The sequence for remaining accessory suffix codes is Extension Link "E2" followed by Anchor Shackle "S2" followed by Ground Wire Assembly "G" or "GA". Example – 2890001C4E2S2G includes a Formed Wire Dead-end with standard thimble clevis (C4), 14" extension link (E2), Anchor Shackle (S2) and copper ground wire assembly (G).

Suffix Code	Description
E2	14" (356 mm) Extension Link (Catalog no. 00060132), 25,000#
S2	Anchor Shackle (Catalog. no. 72905002), 25,000#
G	4' (1.212 m) long #4 (7W) Copper Ground Wire with terminal on one end. 1/2"-13x1-1/2" long galvanized steel bolt, hex nut and lock washer are included for attachment. (Catalog. no. 710010015). Rated for 35 kA ² S.
GA	4' (1.212 m) long 4/0 (7W) Aluminum Ground Wire with terminal on one end. 1/2"-13x1-1/2" long galvanized steel bolt, hex nut and lock washer are included for attachment. (Catalog. no. 710010293). Rated for 80 kA ² S.
GA2	5' (1.5 m) long 95 mm ² (19w) Aluminum Ground wire with terminals at both ends.

CAUTION: Determine appropriate material and size wire necessary to provide adequate grounding for your system before ordering the ground wire assemblies. For proper performance and personal safety be sure to select the proper ground wire before application.

Catalog Number	Diameter Range				Color Code	Rated Holding Strength* (Pounds)	Overall Structural Reinforcing Rod (SRR) Length in. (M)	Useful Dimensions for VORTX™ Damper Placement		
	Min. (in)	Max. (in)	Min. (mm)	Max. (mm)				SRR Rod Diameter in. (mm)	Dead-end Component Length "L1" in. (mm)	Partial SRR Length "L2" in. (mm)
2890020C4	0.355	0.399	9.0	10.1	Blue	20,000	44 (1.12)	.114 (2.9)	34 (863)	37.0 (939)
2890001C4	0.4	0.449	10.2	11.4	Blue	20,000	49 (1.24)	.114 (2.9)	36 (914)	40.5 (1028)
2890002C4	0.45	0.504	11.5	12.8	Red	25,000	54 (1.37)	.114 (2.9)	39 (990)	45.0 (1143)
2890003C4	0.505	0.555	12.9	14.1	Orange	25,000	58 (1.47)	.114 (2.9)	42 (1066)	47.5 (1206)
2890004C4	0.556	0.61	14.2	15.5	Black	25,000	63 (1.60)	.128 (3.2)	45 (1143)	51.5 (1308)
2890005C4	0.611	0.68	15.6	17.2	Green	25,000	68 (1.73)	.128 (3.2)	49 (1244)	56.0 (1422)
2890006C4	0.681	0.755	17.3	19.1	Pink	25,000	85 (2.16)	.144 (3.7)	64 (1625)	71.5 (1816)
2890007C4	0.756	0.83	19.2	21.1	Yellow	25,000	91 (2.31)	.144 (3.7)	68 (1727)	76.0 (1930)
2890008C4	0.831	0.925	21.2	23.5	Brown	25,000	98 (2.49)	.144 (3.7)	73 (1854)	81.5 (2057)
2890009C4	0.926	1.03	23.6	26.2	Purple	25,000	107 (2.72)	.144 (3.7)	79 (2006)	89.5 (2273)

*Based on OPGW with all aluminum clad steel strands in a single layer. Left hand lay standard.

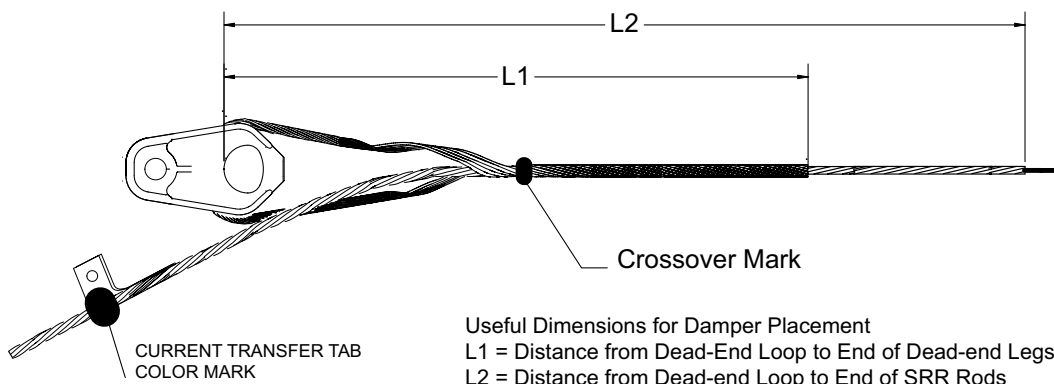

FIBERLIGN® Formed Wire Dead-end for OPGW

FIBERLIGN Formed Wire Dead-end Accessories

Extension Link with Pin and Cotter Key
suffix code **E2**, catalog number **LCE-66-14**

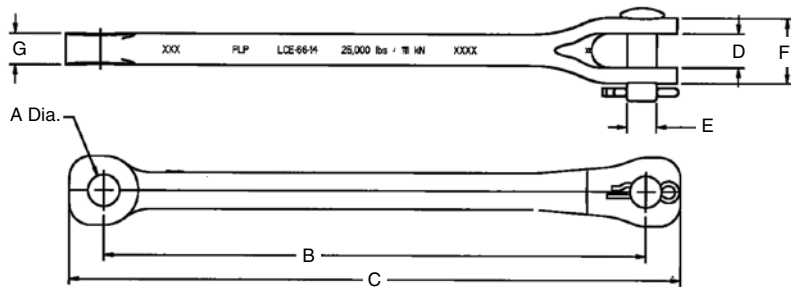

A (Dia.) In. (mm)	B In. (mm)	C In. (mm)	D In. (mm)	E In. (mm)	F In. (mm)	G In. (mm)	Ultimate Tensile Strength (lbs.)
13/16 (20.6)	14 (356)	16-1/2 max. (419)	7/8 (22.2)	3/4 (19.1)	1-43/64 (42.5)	51/64 max. (20.2)	25,000

Anchor Shackle
suffix code **S2**, catalog number **AS-5L**

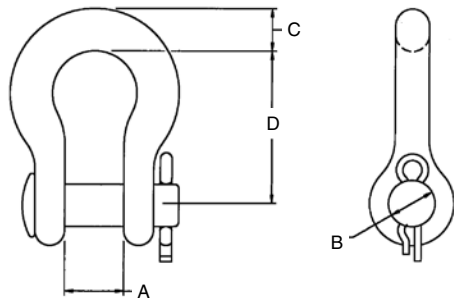

A Max. Width of Opening Inches (mm)	B Max. Pin Diameter Inches (mm)	C Shackle Thickness Inches (mm)	D Inches (mm)	Ultimate Strength (kN)
7/8" (22.2)	5/8" (15.9)	1/2" (12.7)	2-23/32 (69.1)	25,000 (111)

Grounding Wire Assemblies

Catalog Number	Suffix Code	Dimensions Inches				Conductor		Attachment Ground Bolt Size (supplied w/nut and lock washer)
		L Length	D Conductor Diameter	d Lug Hole Diameter	e Lug Hole Diameter	Material	Type	
710010015	G	48 (1.2 m)	.232 (6 mm)	9/16 (14 mm)	-	Copper	#4 (7W)	1/2"-13 x 1-1/2" long
710010293	GA	48 (1.2 m)	.522 (13 mm)	9/16 (14 mm)	-	Aluminum	4/0 (7W)	1/2"-13 x 1-1/2" long
710011205	GA2	60 (1.5 m)	.495 (12.5)	17/32 (13.5 mm)	11/16 (17.5 mm)	Aluminum	95 mm ² (19W)	M12 x 30 mm long M16 x 38 mm long
710012417	-	60 (1.5 m)	.528 (13.4)	17/32 (13.5 mm)	53/64 (21 mm)	Aluminum	4/0 (19W)	M18 x 40 mm long

Copper

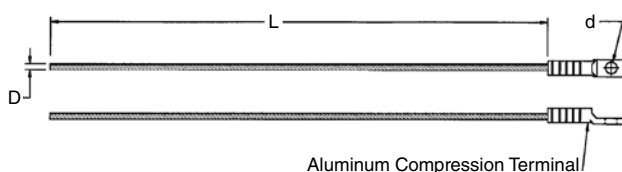

Aluminum

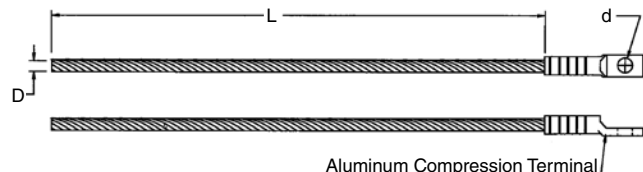

Light Duty Lattice Tower Clamp

Catalog No. 700011045

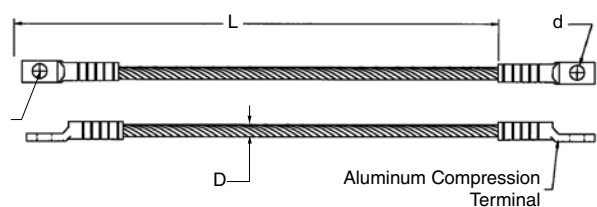
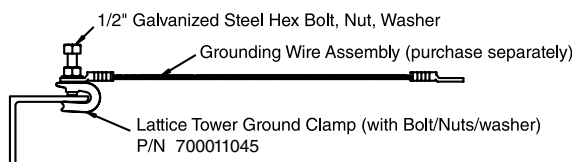



Ground Clamps

GENERAL RECOMMENDATIONS

- Designed For OPGW cable
- Installation torque: 25 ft.-lbs.
- Groove contains oxide inhibitor
- Aluminum alloy material
- 2 Grooves

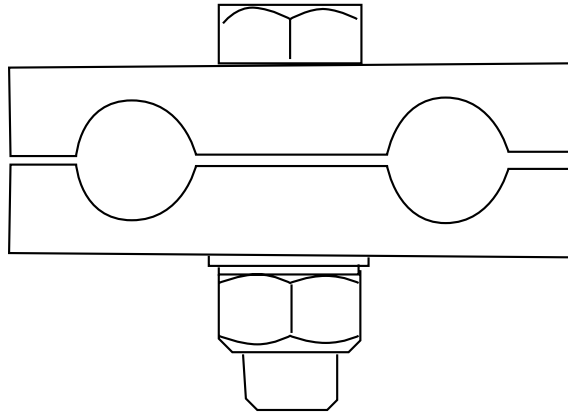

Groove A:		
OPGW Diameter	Range mm	Inches
A	8.3 – 9.3	0.328 – 0.372
B	9.4 – 10.6	0.373 – 0.418
C	10.7 – 11.8	0.419 – 0.464
D	11.9 – 12.9	0.465 – 0.510
E	13.0 – 14.1	0.511 – 0.557
F	14.2 – 15.2	0.558 – 0.600
H	15.3 – 16.5	0.601 – 0.646
I	16.6 – 17.5	0.647 – 0.690
J	17.6 – 18.3	0.691 – 0.720
K	18.4 – 19.0	0.721 – 0.750
L	19.1 – 20.2	0.751 – 0.796

Groove B:		
Ground Wire	Range mm	Inches
1	3.9 – 5.1	.155 – .203
2	5.2 – 9.8	.204 – .385
3	9.9 – 10.6	.386 – .418
4	10.7 – 11.8	.419 – .464
5	11.9 – 13.0	.465 – .512
6	13.1 – 14.1	.513 – .557
7	14.2 – 15.2	.558 – .600
8	15.3 – 16.4	.601 – .646
9	16.5 – 17.5	.647 – .690

Ordering Guidelines **GC – XX**

Groove A Diameter _____

Groove B Ground Wire _____

Optical Tension Device (OTD)

For OPGW Fiber Cable

Material

Body: High strength aluminum alloy

Bolts: High strength forged steel

Bail: High strength steel

The Optical Tension Device is designed for pulling OPGW fiber cable to final sag tension. Once the final sag has been achieved, a permanent type dead-end device should be installed promptly, followed by the removal of the tensioning device. This device should not be subjected to sag tension for an extended time period and it should never be utilized as a permanent dead-end device.

When installing the unit, partially tighten successive eye bolts in the following torque sequence:

First Sequence to 20 ft/lbs.

Second Sequence to 30 ft/lbs.

Final Torque to 40 ft/lbs.

OPGW Cable Range

8.890 – 20.820 mm

0.350 – 0.820 inches

Load Rating

50% of the rated cable breaking strength or 5000 lbs. (22.4 kN) whichever is less.

Safety Tips

- Check for cracks and chipped areas along the cable groove and eyebolt areas. Do not reuse if any of these conditions exist
- Eyebolts should be kept clean and lubricated
- Conductor grooves should be clean and dry

After six months use and prior to each job, all Optical Tension Devices should be subjected to a pull test equal to its rated strength. If any damage is found the device should be disposed of or sent to PLP for possible rework and re-qualification.



Ordering Guidelines OTD – X – XXX

OPGW Supplier _____

- A – AFL
- B – Brugg
- C – Siemens
- P – Prysmian
- S – SFPOC
- O – Other

Cable Diameter _____
(in inches)



FIBERLIGN® Suspension for OPGW

NOMENCLATURE

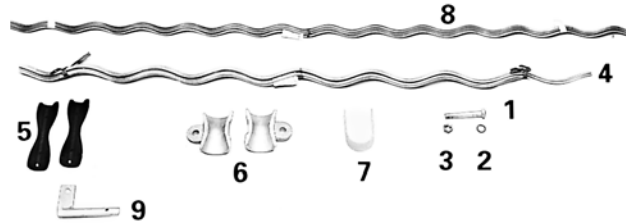

- 1. Bolt
- 2. Lock washer
- 3. Lock nut
- 4. Outer Rods
- 5. Insert
- 6. Housing
- 7. Strap
- 8. Structural Reinforcing Rods
- 9. Current Transfer Tab (for OPGW only)



Single FIBERLIGN Suspension for Optical Ground Wire (OPGW)

Bolt, Washer, Lock Nut: Galvanized Steel.

Strap: High-strength Aluminum Alloy.

Insert: An elastomer specifically formulated for resistance to ozone attack, weathering, extreme high and low temperature variations, and compression set. An Aluminum Alloy reinforcement is molded into the elastomer.

Housing: High-strength aluminum alloy casting

Structural reinforcing rods and outer rods: High-strength Aluminum Alloy.

Current Transfer Tab: (Supplied for OPGW Applications only) High Strength Aluminum Alloy.

APPLICATION

The FIBERLIGN Suspension provides superior cable and fiber protection at the support point. The combination of Structural Reinforcing Rods, Outer Rods, boltless housing and resilient inserts reduces compression, clamping, and bending stresses on cable. Negative weather related cable motion, such as aeolian vibration, galloping, and wind sway are also minimized.

The FIBERLIGN Suspension is specially designed for supporting all installations of Optical Ground Wire (OPGW). Due to different performance requirements and cable characteristics OPGW and ADSS cables require different design FIBERLIGN Suspension Units.

For trunnion or bracket mounting, a FIBERLIGN Trunnion Support for OPGW is available. This unit has a housing designed to fit a trunnion cap or bracket with dimensions consistent with those specified in ANSI C29.7-1986, Class 57. Consult PLP® for specific information.

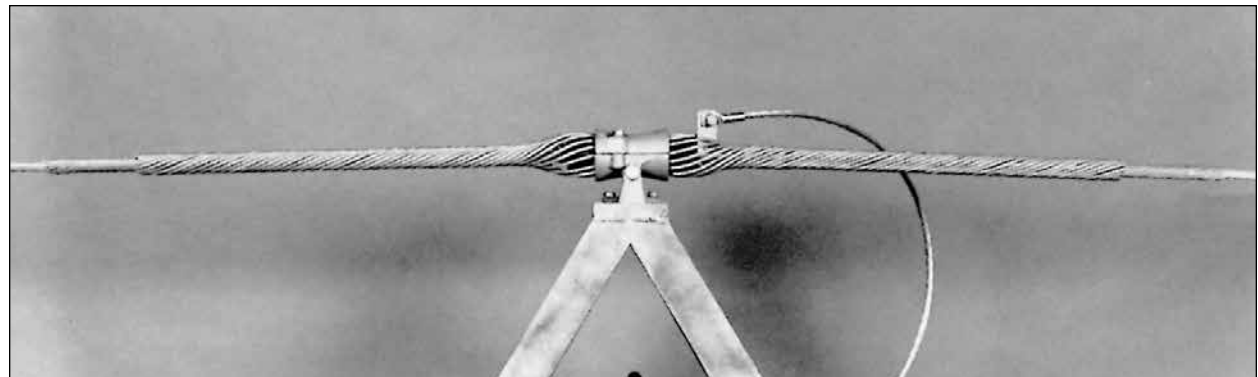

Trunnion mount FIBERLIGN Support for OPGW

FIBERLIGN® Suspension for OPGW

Double FIBERLIGN Suspension for Optical Ground Wire (OPGW)

The Current Transfer Tab provides direct electrical bonding between OPGW and a ground lead. The current transfer tab eliminates current transfer through components of the suspension unit. The standard current transfer tab accommodates left-hand lay OPGW. Right-hand lay and larger units for special applications are also available. Consult PLP for specifics.

The current transfer tab is not required or supplied for ADSS applications.

Grounding Wire Assembly Options:

A 4' ground wire with compression terminal can be provided. This assembly can be connected from the FIBERLIGN Suspension to the ground lead in your system. Two types of ground wire materials are offered (copper or aluminum). To include the preferred ground wire assembly in the same carton with the current transfer tab, add the appropriate suffix code to the suspension catalog number (see table on next page).

Ultimate Vertical Strength & Housing & Fitting Dimensions:

Refer to dimensional table in this section.

Lay Direction:

Left-hand lay is standard although FIBERLIGN Suspension or Support units for OPGW may be used on right-hand lay OPGW at reduced slip loads, or custom ordered right-hand lay units are available.

Slip Load:

When initially installed, the FIBERLIGN Suspension has a slip load of approximately 10-20% of a standard OPGW rated strength, but significantly higher loads can be expected after the unit has been in service for a period of time.



Line Angles:

The maximum recommended line angle for a single FIBERLIGN Suspension is 30°. For OPGW line angles between 30° and 60°, the FIBERLIGN Suspension: Double is recommended, although double dead-ending is another option. Double units for ADSS cable are available on custom order although double dead-ends are also an option.

Fittings:

An appropriate fitting such as a Y-clevis or clevis eye may be required to attach the Suspension unit to the structure or other hardware. These fittings must match the dimensions of the suspension housing. (See dimensional tables on next page)

Fitting Suffix Codes:

To include the Y-clevis and clevis eye fittings in the same carton with the suspensions, add the appropriate suffix code to the suspension catalog number (see table on next page).

Component Reuse:

Once installed, do not reuse the rod components. The hardware components may be reused as desired as long as they are in good condition. Do not modify any components.



FIBERLIGN® Suspension for OPGW

Single and Double FIBERLIGN Suspensions for OPGW

Ordering Instructions:

Select the appropriate FIBERLIGN Suspension for OPGW from the following table. Consult PLP® for trunnion or bracket type mounting OPGW applications and for the availability of all sizes and designs.

Accessories and Fittings:

Ground wire assemblies and fittings may be included in the same container with the suspension by adding the appropriate SUFFIX CODE from the adjacent table. **Note:** the suffix sequence is grounding wire first and fittings second. Example—4300100GYC includes a 4300100 single suspension with copper ground wire assembly (G) and Y-clevis eye (YC).

Suffix Code	Description
G	4' (1.2 m) long #4 (7W) Copper with terminal on one end. Catalog #710010015
GA	4' (1.2 m) long 4/0 (19W) Aluminum conductor with terminal on one end. Catalog #710010293
GA2	5' (1.5 m) long 95 mm ² (7w) Aluminum Ground wire with terminals at both ends

CAUTION: Determine appropriate material and size wire necessary to provide adequate grounding for your system before ordering the ground wire assemblies. For proper performance and personal safety be sure to select the proper ground wire before application.

S2	Anchor Shackle (Catalog no 72905002), 25,000#
YC	One (1) Y-clevis to fit selected suspension. Single suspension applications.
CE	One (1) clevis eye to fit selected suspension. Single suspension applications.
CEYP	Two (2) clevis eyes with yoke plate to fit selected suspension. Double suspension applications.

Catalog Number		Diameter Range				Structural Reinforcement Rods					Outer Rods				
Single	Double	Min. (in)	Max. (in)	Min. (mm)	Max. (mm)	Single Length (in)	Double Length (in)	Rod Dia. (in)	Rods per set	Color Code	Single Length (in)	Double Length (in)	Rod Dia. (in)	Rods per set	Color Code
4300100	4300200	.354	.381	8.9	9.6	66	84	.146	9	Blue	42	60	.204	11	Blue
4300101	4300201	.382	.398	9.7	10.1	66	84	.146	9	Green	42	60	.204	11	Green
4300102	4300202	.399	.418	10.2	10.6	66	84	.146	10	Yellow	42	60	.204	11	Yellow
4300103	4300203	.419	.439	10.7	11.1	67	84	.146	10	Black	42	60	.204	11	Black
4300104	4300204	.440	.458	11.2	11.6	68	84	.146	11	White	43	61	.204	11	White
4300105	4300205	.459	.461	11.7	11.7	72	90	.167	10	Purple	46	64	.250	10	Orange
4300106	4300206	.462	.476	11.8	12.0	72	90	.167	10	Purple	46	64	.250	10	Purple
4300107	4300207	.477	.503	12.1	12.7	73	90	.146	11	Orange	46	64	.250	10	Orange
4300108	4300208	.504	.511	12.8	12.9	76	90	.146	12	Red	46	64	.250	10	Purple
4300109	4300209	.512	.536	13.0	13.6	76	94	.167	11	Blue	49	67	.250	11	Blue
4300110	4300210	.537	.559	13.7	14.1	77	94	.167	11	Green	49	67	.250	11	Green
4300111	4300211	.560	.565	14.2	14.3	77	94	.167	11	Green	49	67	.250	11	Green
4300112	4300212	.566	.573	14.4	14.5	79	102	.182	11	Black	54	76	.250	12	Black
4300113	4300213	.574	.598	14.6	15.1	79	102	.182	11	Black	54	76	.250	12	White
4300114	4300214	.599	.625	15.2	15.8	81	102	.182	11	Brown	54	76	.250	12	Brown
4300116	4300216	.626	.632	15.9	16.0	94	120	.204	11	Red	63	89	.310	11	Red
4300117	4300217	.633	.666	16.1	16.9	94	120	.204	11	Red	63	89	.310	11	Blue
4300118	4300218	.667	.682	17.0	17.3	94	120	.204	11	Yellow	63	89	.310	11	Green
4300119	4300219	.683	.710	17.4	18.0	94	120	.204	11	Yellow	63	89	.310	11	Yellow
4300120	4300220	.711	.728	18.1	18.4	94	120	.204	12	White	63	89	.310	12	Black
4300121	4300221	.729	.744	18.5	18.8	94	120	.204	12	White	63	89	.310	12	White
4300122	4300222	.745	.750	18.9	18.9	94	120	.204	12	White	63	89	.310	12	White
4300123	4300223	.751	.786	19.0	19.9	94	120	.204	12	Brown	63	89	.310	12	Brown
4300124	4300224	.787	.814	20.0	20.6	100	129	.250	11	Green	72	101	.365	11	Green
4300125	4300225	.815	.845	20.7	21.4	100	129	.250	11	Yellow	72	101	.365	11	Yellow
4300126	4300226	.846	.855	21.5	21.6	100	129	.250	11	Blue	72	101	.365	12	Blue
4300127	4300227	.856	.894	21.7	22.6	100	132	.250	12	Black	80	112	.365	12	Black
4300128	4300228	.895	.907	22.7	22.9	100	132	.250	12	White	80	112	.365	12	White
4300129	4300229	.908	.916	23.0	23.2	100	132	.250	12	Purple	80	112	.365	12	Purple
4300153	4300253	.917	.929	23.3	23.5	100	132	.250	12	Brown	80	112	.365	12	Brown
4300154	4300254	.930	.942	23.6	23.9	100	132	.250	12	Red	80	112	.365	12	Red
4300155	4300255	.943	.977	24.0	24.7	100	132	.250	13	Orange	80	112	.365	13	Orange

Left-hand lay standard

FIBERLIGN® Suspension Housing Dimensions & Fittings

FIBERLIGN Suspension – Dimensional Tables

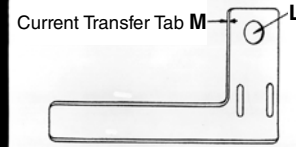
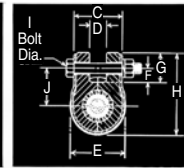
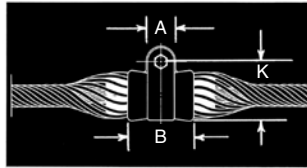

OPGW or ADSS Cable Diameter Range Inches (mm)		Dimensions Inches (mm)													Ultimate Vertical Strength (Lbs.)
Min.	Max.	A	B	C	D	E	F	G	H	I Bolt Dia.	J	K	L	M	
.354 (9)	.458 (11.6)	1-3/4 (44.5)	3-3/4 (95.3)	2-1/4 (57.2)	3/4 (19.1)	2-3/16 (55.6)	1 (25.4)	1-7/8 (47.6)	4-7/16 (112.7)	5/8 (15.9)	2-5/32 (54.8)	3-9/16 (90.5)	9/16 (14.3)	.090 (2.3)	15,000
.459 (11.7)	.565 (14.3)	2 (50.8)	4-17/32 (115.1)	2-11/16 (68.3)	7/8 (22.2)	3-5/16 (84.1)	1 (25.4)	2 (50.8)	5 (127)	5/8 (15.9)	2-11/32 (59.5)	4 (101.6)	9/16 (14.3)	.090 (2.3)	20,000
.566 (14.4)	.625 (15.8)	2 (50.8)	5 (127)	2-15/16 (74.6)	7/8 (22.2)	3-11/16 (93.7)	1 (25.4)	2 (50.8)	5-3/8 (136.5)	5/8 (15.9)	2-17/32 (64.3)	4-3/8 (111.1)	9/16 (14.3)	.090 (2.3)	20,000
.626 (15.9)	.786 (19.9)	2-1/4 (57.2)	5-1/2 (139.7)	3-1/2 (88.9)	1-3/16 (30.2)	4-5/32 (105.6)	1 (25.4)	2-1/8 (54)	5-29/32 (150)	5/8 (15.9)	2-45/64 (68.7)	4-25/32 (121.4)	9/16 (14.3)	.090 (2.3)	25,000
.787 (20)	.977 (24.8)	2-1/4 (57.2)	6 (152.4)	3-5/8 (92.1)	1-1/4 (31.8)	4-13/16 (122.2)	1-1/4 (31.8)	2-3/8 (60.3)	6-11/16 (169.9)	3/4 (19.1)	3-5/32 (80.2)	5-9/16 (141.3)	9/16 (14.3)	.090 (2.3)	25,000
.978 (24.9)	1.016 (25.8)	2-1/4 (57.2)	6-1/2 (165.1)	4-1/8 (104.8)	1-3/8 (34.9)	5-1/16 (128.6)	1-1/8 (28.6)	2-1/4 (57.2)	6-5/8 (168.3)	3/4 (19.1)	2-21/32 (67.5)	5-1/2 (139.7)	N/A	N/A	25,000
1.017 (25.9)	1.057 (26.8)	2-1/4 (57.2)	6-1/2 (165.1)	4-1/8 (104.8)	1-3/8 (34.9)	5-1/16 (128.6)	1-1/8 (28.6)	2-1/4 (57.2)	6-5/8 (168.3)	3/4 (19.1)	2-21/32 (67.5)	5-1/2 (139.7)	N/A	N/A	25,000
1.058 (26.9)	1.079 (27.4)	2-1/2 (63.5)	7 (177.8)	4-11/16 (119.1)	2-1/4 (57.2)	5-19/32 (142.1)	1-1/8 (28.6)	2-3/8 (60.3)	7-1/4 (184.2)	3/4 (19.1)	3-3/16 (81)	6 (152.4)	N/A	N/A	25,000
1.08 (27.5)	1.112 (28.2)	2-1/2 (63.5)	7 (177.8)	4-11/16 (119.1)	2-1/4 (57.2)	5-19/32 (142.1)	1-1/8 (28.6)	2-3/8 (60.3)	7-1/4 (184.2)	3/4 (19.1)	3-3/16 (81)	6 (152.4)	N/A	N/A	25,000
1.113 (28.3)	1.149 (29.2)	2-1/2 (63.5)	7 (177.8)	4-11/16 (119.1)	2-1/4 (57.2)	5-19/32 (142.1)	1-1/8 (28.6)	2-3/8 (60.3)	7-1/4 (184.2)	3/4 (19.1)	3-3/16 (81)	6 (152.4)	N/A	N/A	25,000
1.15 (29.3)	1.19 (30.2)	2-1/2 (63.5)	7 (177.8)	4-11/16 (119.1)	2-1/4 (57.2)	5-19/32 (142.1)	1-1/8 (28.6)	2-3/8 (60.3)	7-1/4 (184.2)	3/4 (19.1)	3-3/16 (81)	6 (152.4)	N/A	N/A	25,000

Fittings

The dimensions of a fitting must correspond to some of the dimensions of the housing of the FIBERLIGN Suspension unit in order to provide proper fit. To select the proper size fitting, identify the outside diameter of the OPGW or ADSS

cable and select the appropriate fitting from these tables. DO NOT use the tables in the ARMOR-GRIP® Suspension section of this catalog.

Clevis Eye

Catalog Number	OPGW or ADSS Cable Diameter Range		General Dimensions							Ultimate Vertical Strength (Lbs.)
	Min.-Max. (in)	Min.-Max. (mm)	A in (mm)	B in (mm)	C in (mm)	D in (mm)	E in (mm)	F in (mm)	G in (mm)	
CE-5259	.354-.458	9-11.6	3-1/8 (79.4)	1/2 (12.7)	11/16 (17.5)	1-1/2 (38.1)	1-1/2 (38.1)	5/8 (15.9)	13/16 (20.6)	15,000
CE-5261	.459-.625	11.7-15.9	3-1/8 (79.4)	3/4 (19.1)	11/16 (17.5)	1-1/2 (38.1)	1-1/2 (38.1)	5/8 (15.9)	13/16 (20.6)	20,000
CE-5105	.626-1.057	16.0-26.8	3-1/8 (79.4)	1-1/16 (27)	13/16 (20.6)	1-1/2 (38.1)	1-1/2 (38.1)	5/8 (15.9)	13/16 (20.6)	25,000
CE-5106	1.058-1.208	26.9-30.7	3-1/8 (79.4)	2-1/8 (54)	13/16 (20.6)	1-1/2 (38.1)	1-1/2 (38.1)	5/8 (15.9)	13/16 (20.6)	25,000

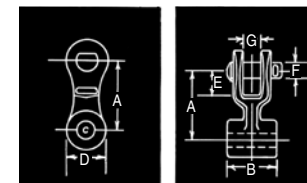
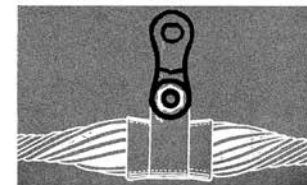

Y-Clevis Eye

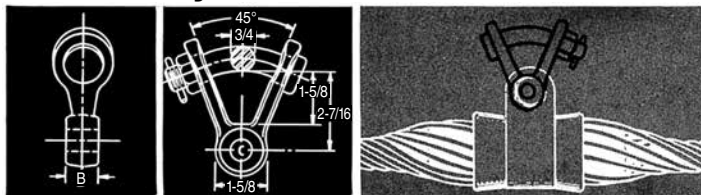

Catalog Number	OPGW or ADSS Cable Diameter Range		General Dimensions		Ultimate Vertical Strength (lbs.)
	Min.-Max. (in)	Min.-Max. (mm)	B in (mm)	C in (mm)	
YC-5206	.354-.458	9.0-11.6	5/8 (15.9)	11/16 (17.5)	15,000
YC-5207	.459-.625	11.7-15.9	3/4 (19.1)	11/16 (17.5)	20,000
YC-5209	.626-1.057	16.0-26.8	1-1/16 (27)	13/16 (20.6)	25,000
YC-5211	1.058-1.208	26.9-30.7	2-1/8 (54)	13/16 (20.6)	25,000



FIBERLIGN® Suspension Housing Dimensions & Fittings

FIBERLIGN Suspension: Double Dimensional Tables

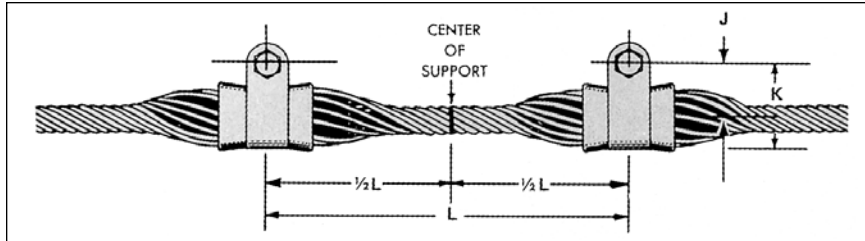

OPGW or ADSS Cable Diameter Range		Dimensions			Ultimate Vertical Strength (Lbs.)
Min.-Max. (in)	Min.-Max. (mm)	J in. (mm)	K in. (mm)	L in. (cm)	
.354-.458	9.0-11.6	2-5/32 (54.8)	3-9/16 (90.4)	18 (45.7)	30,000
.459-.565	11.7-14.4	2-11/32 (59.5)	4 (101.6)	18 (45.7)	40,000
.566-.625	14.5-15.9	2-17/32 (64.3)	4-3/8 (111.1)	22 (55.9)	40,000
.626-.786	16.0-20.0	2-45/64 (68.7)	4-25/32 (121.4)	26 (66.0)	50,000
.787-.855	20.1-21.7	3-5/32 (80.2)	5-9/16 (141.3)	29 (73.7)	50,000
.856-1.057	21.8-26.8	2-31/32 (75.4)	5-1/2 (139.7)	32 (81.3)	50,000
1.058-1.208	26.9-30.7	3-3/16 (81.0)	6 (152.4)	37 (94.0)	50,000

Fittings

The "L" dimension of a Yoke Plate must match the "L" dimension between the two housings of the Double Suspension unit. Identify the outside diameter of the OPGW or ADSS cable and select the proper "L" dimension and Yoke Plate from these tables. DO NOT use the tables in the ARMOR-GRIP® Suspension section of this catalog.

A Fitting, such as a Clevis Eye, is required between each Suspension housing and the Yoke Plate. Refer to the tables on for proper fitting selection. Another fitting may be required between the Yoke Plate and structure.

Yoke Plate

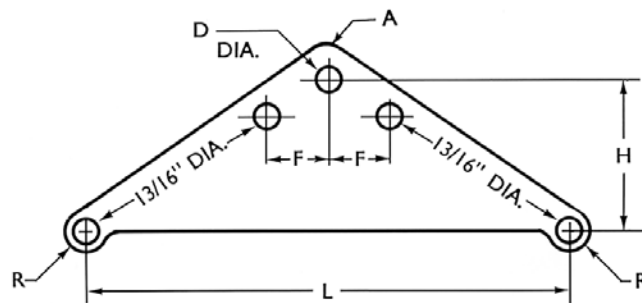
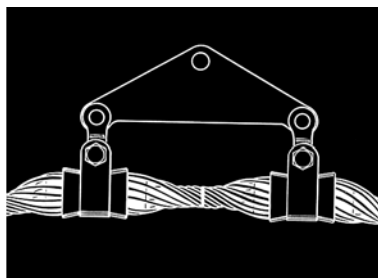

Catalog Number	OPGW or ADSS Cable Diameter Range		Dimensions						Plate Thickness in. (mm)
	Min.-Max. (in)	Min.-Max. (mm)	L in. (cm)	H in. (cm)	D in. (mm)	R in. (mm)	Radius A in. (mm)	F in. (cm)	
YP-5908	.354-.565	9.0-14.4	18 (45.7)	6-1/4 (15.9)	1 (25.4)	15/16 (23.8)	1-1/4 (31.8)	3-1/2 (8.9)	5/8 (15.9)
YP-5909	.566-.625	14.5-15.9	22 (55.9)	7-1/4 (18.4)	1 (25.4)	15/16 (23.8)	1-1/4 (31.8)	4-3/16 (10.6)	5/8 (15.9)
YP-5910	.626-.786	16.0-20.0	26 (66.0)	8-1/2 (21.6)	1 (25.4)	15/16 (23.8)	1-1/4 (31.8)	4-15/16 (12.5)	3/4 (19.1)
YP-5911	.787-.855	20.1-21.7	29 (73.7)	9-1/2 (24.1)	1 (25.4)	15/16 (23.8)	1-1/4 (31.8)	5-1/2 (14.0)	3/4 (19.1)
YP-5912	.856-1.057	21.8-26.8	32 (81.3)	10-1/2 (26.7)	1 (25.4)	15/16 (23.8)	1-1/4 (31.8)	6-1/8 (15.6)	3/4 (19.1)
YP-5913	1.058-1.208	26.9-30.7	37 (94.0)	11-3/4 (29.8)	1 (25.4)	15/16 (23.8)	1-1/4 (31.8)	7-1/16 (17.9)	3/4 (19.1)

FIBERLIGN® Cushion Clamp for OPGW

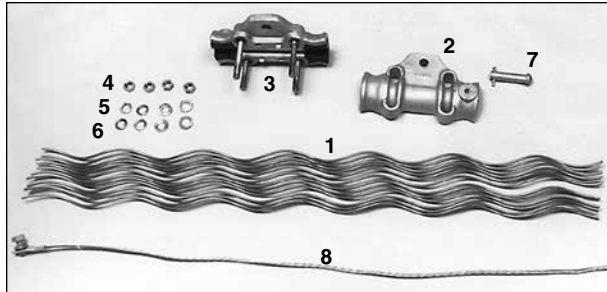

FIBERLIGN Cushion Clamp installed

NOMENCLATURE

- Structural Reinforcing Rods:** High strength aluminum alloy.
- Cushion Clamp (keeper half):** An aluminum alloy clamp half with two factory installed elastomer cushion inserts and a 1/2"-13 female threaded boss for ground wire attachment. A galvanized 1/2"-13 x 3/4" long grounding bolt and lock washer are provided.
- Cushion Clamp (U-bolt half):** An aluminum alloy clamp half with two factory installed elastomer cushion inserts and two captured 1/2"-13 galvanized steel U-bolts.
- 1/2"-13 Hex Nuts (4):** Galvanized steel.
- Lock Washers (4):** Galvanized steel.
- Flat Washers (4):** Galvanized steel.
- Pin and Cotter Key:** Pin is galvanized steel and Cotter Key is stainless steel.
- Grounding Wire Assembly (ordered separately)**

APPLICATION

The FIBERLIGN Cushion Clamp provides excellent protection to OPGW at support points. The combination of the Structural Reinforcing Rods and the elastomer inserts at the ends of the clamp body halves reduces bending stresses on the OPGW during aeolian vibration or galloping activity.

Bonding:

Provisions for electrically bonding the OPGW to the supporting structure or ground lead are an integral part of the keeper half. The 1/2"-13 x 3/4" long bolt and lock washer are provided with the keeper half for lug terminal attachment.

Grounding Wire Assembly Options:

A 4' ground wire with compression terminal can be provided. Two types of ground wire material are offered (copper or aluminum). The Ground Wire assemblies may be ordered with the Cushion Clamp by adding the appropriate suffix code (see next page).

Ultimate Vertical Strength & Dimensions:

The ultimate vertical strength of the Cushion Clamp body is 20,000 pounds (89 kN). See the table on page 5-19 for dimension of body and associated fittings.

Lay Direction:

The Cushion Clamp can accommodate either left-hand lay or right-hand lay OPGW.

Slip Load:

The Cushion Clamp has a slip load of approximately 10-20% of the OPGW rated strength.

Line Angles:

The maximum recommended line angle for a single FIBERLIGN Cushion Clamp is 30°. For OPGW line angles between 30° and 60°, the Cushion Clamp double is available, although double dead-ending is another option.

Fittings:

An appropriate fitting such as a Y-Clevis, Clevis Eye, or Anchor Shackle may be required to attach the Cushion Clamp to the structure or other hardware. To include these fittings, add the appropriate suffix code to the catalog number (see next page).

Component Reuse:

Once installed, do not reuse the Structural Reinforcing Rods. The hardware components may be reused as long as they are in good condition. Do not modify any components.



FIBERLIGN® Cushion Clamp for OPGW

Single and Double FIBERLIGN Cushion Clamp for OPGW

Ordering Instructions:

Select the appropriate FIBERLIGN Cushion Clamp for OPGW from the following table.

Accessories and Fittings:

Ground wire assemblies and fittings may be ordered with the Cushion Clamp by adding the appropriate SUFFIX CODE from the adjacent table. Note: the suffix sequence is ground wire first and fittings second. Example - 4700100GYC includes a 4700100 Single Cushion Clamp with copper ground wire assembly (G) and Y-Clevis (YC).

Suffix Code	Description
G	4' (1) long #4 (7W) Copper Ground Wire with terminal on one end. Catalog No. 710010016
GA	4' (1) long 4/0 (7W) Aluminum Ground Wire with terminal on one end. Catalog No. 710010294
GA2	5' (1.5) long 95 mm ² (19W) Aluminum Ground Wire with terminals at both ends

CAUTION: Determine appropriate material and size wire necessary to provide adequate grounding for your system before ordering the ground wire assemblies. For proper performance and personal safety be sure to select the proper ground wire before application.

S2	Anchor Shackle (Catalog no 72905002), 25,000#
YC	One (1) Y-clevis to fit selected suspension. Single suspension.
CE	One (1) clevis eye to fit selected suspension. Single suspension.
CEYP	Two (2) clevis eyes with yoke plate to fit selected suspension. Double suspension.

Catalog Number		Diameter Range				Structural Reinforcing Rods				Color Code
Single	Double	Min. (in)	Max. (in)	Min. (mm)	Max. (mm)	Single Length	Double Length	Rod Dia.	Rods per Set	
4700100	4700200	0.376	0.387	9.6	9.8	31	60	0.204	7	Orange
4700101	4700201	0.388	0.429	9.9	10.9	32	61	0.182	8	Red
4700102	4700202	0.430	0.459	11.0	11.6	33	62	0.167	9	Black
4700103	4700203	0.460	0.482	11.7	12.2	34	63	0.154	10	Green
4700104	4700204	0.483	0.507	12.3	12.8	35	64	0.182	10	Yellow
4700105	4700205	0.508	0.537	12.9	13.6	36	65	0.167	11	Purple
4700106	4700206	0.538	0.563	13.7	14.3	37	66	0.154	12	Pink
4700107	4700207	0.564	0.585	14.4	14.8	39	68	0.182	11	Brown
4700108	4700208	0.586	0.615	14.9	15.6	40	69	0.167	12	Blue
4700109	4700209	0.616	0.641	15.7	16.3	41	70	0.154	13	Orange
4700110	4700210	0.642	0.664	16.4	16.8	44	73	0.182	12	Red
4700111	4700211	0.665	0.694	16.9	17.6	45	74	0.167	13	Black
4700112	4700212	0.695	0.720	17.7	18.3	46	75	0.154	15	Green
4700113	4700213	0.721	0.742	18.4	18.8	48	77	0.182	13	Yellow
4700114	4700214	0.743	0.772	18.9	19.6	50	79	0.167	14	Purple
4700115	4700215	0.773	0.798	19.7	20.2	51	80	0.154	15	Pink
4700116	4700216	0.799	0.822	20.3	20.8	52	81	0.182	14	Brown
4700117	4700217	0.823	0.855	20.9	21.7	54	83	0.167	16	Blue
4700118	4700218	0.856	0.885	21.8	22.4	55	84	0.146	19	Orange
4700119	4700219	0.886	0.911	22.5	23.1	56	85	0.167	16	Red
4700120	4700220	0.912	0.941	23.2	23.9	57	86	0.154	19	Black
4700121	4700221	0.942	0.975	24.0	24.7	58	87	0.146	20	Green
4700122	4700222	0.976	1.005	24.8	25.5	60	89	0.167	18	Yellow
4700123	4700223	1.006	1.034	25.6	26.3	61	90	0.154	20	Purple

FIBERLIGN® Cushion Clamp for OPGW

FIBERLIGN Cushion Clamp Dimensions

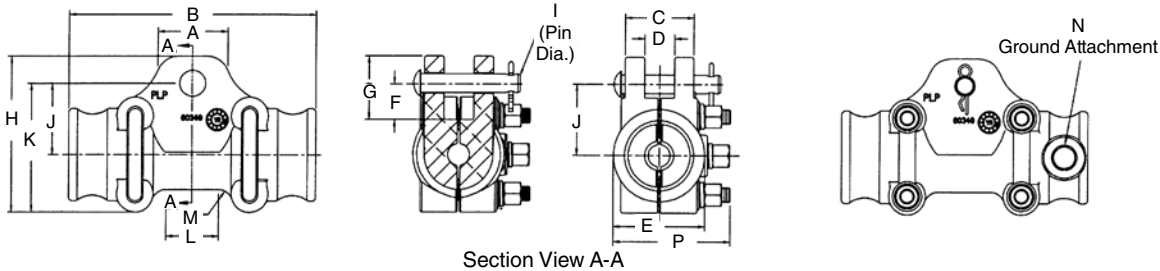

Dimensions Inches (mm)															Ultimate Vertical Strength (Single) lbs.
A	B	C	D	E	F	G	H	I	J	K	L	M	N	P	
2-23/64 (59.9)	8-11/32 (211.9)	2-11/32 (59.5)	13/16 (20.6)	3-7/64 (79.0)	1-5/32 (29.4)	2-1/8 (54.0)	5-1/4 (133.4)	5/8 (15.9)	2-11/32 (59.5)	3-41/64 (92.5)	1-25/32 (45.2)	31/64 (12.3)	1/2-13 UNC	3-15/16 (100.0)	20,000

FIBERLIGN Cushion Clamp: Double

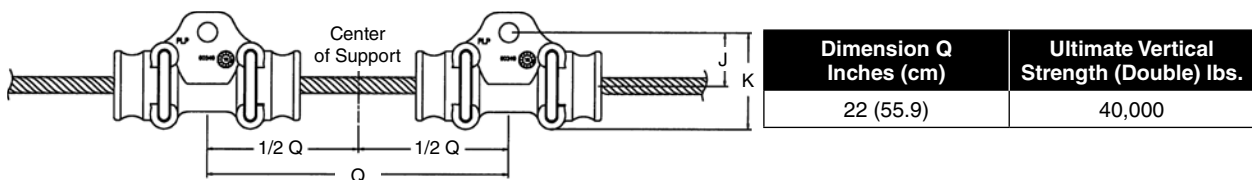

Fittings & Yoke Plate

Clevis Eye

Catalog Number	Dimensions Inches (mm)							Ultimate Vertical Strength (lbs.)
	A	B	C	D	E	F	G	
CE-5261	3-1/8 (79.4)	3/4 (19.1)	11/16 (17.5)	1-1/2 (38.1)	1-1/2 (38.1)	5/8 (15.9)	13/16 (20.6)	20,000

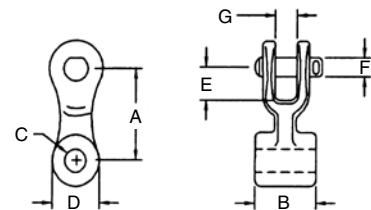

Yoke Plate

Catalog Number	Dimensions Inches (mm)						Plate Thickness
	L	H	D	R	Radius A	F	
YP-5909	22 (559)	7-1/4 (184)	1 (25.4)	15/16 (23.8)	1-1/4 (31.8)	4-3/16 (106)	5/8 (15.9 mm)

Y-Clevis Eye

Catalog Number	Dimensions Inches (mm)		Ultimate Vertical Strength (lbs.)
	B	C	
YC-5207	3/4 (19.1)	11/16 (17.5)	20,000

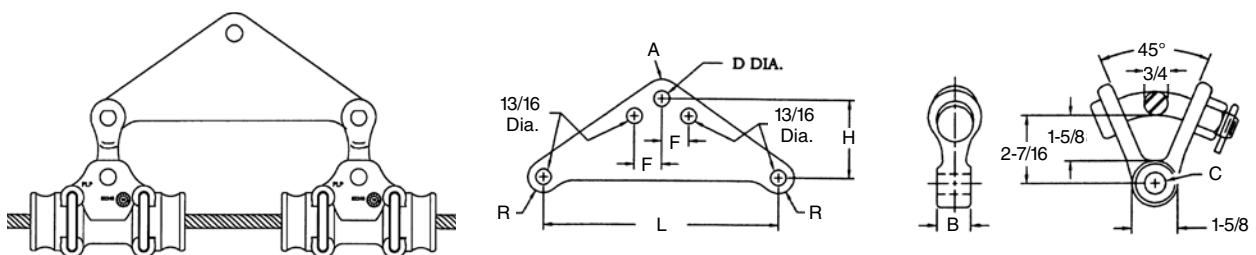



FIBERLIGN® Repair Rods for OPGW

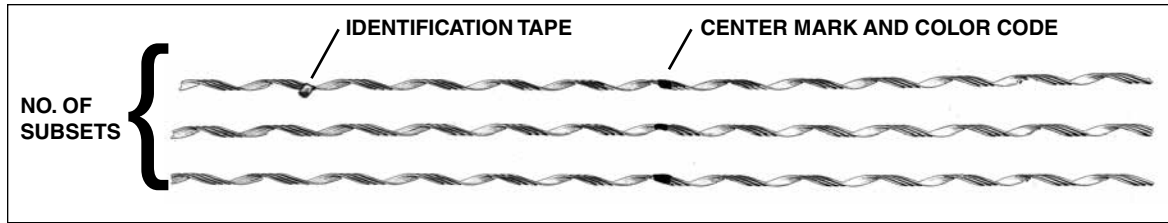

NOMENCLATURE

Subsets: Individual aluminum clad steel rods assembled into groups. The bore is coated with conductive grit.

Center Mark: Establishes recommended alignment of rods during application.

Color code: Provides identification for application of OPGW size that corresponds to the information appearing in the table below.

Identification Tape: Shows catalog number, nominal sizes.

GENERAL RECOMMENDATIONS

FIBERLIGN Repair Rods are designed as a single-component, outer layer assembly for use on OPGW and are intended for repair of the outer mechanical strand members on an OPGW cable. **This is not an optical repair product.**

These OPGW Repair Rods are not designed or tested as splices for use on all-metal overhead shield wire and are not intended for that application.

Restorative-Repair: These Repair Rods will provide varying levels of mechanical and electrical repair depending upon the specific construction, stranding and material of the OPGW.



The extent of mechanical damage that the product can repair for single layer OPGW is up to 50% of the cable rated strength. The 50% rating is established by PLP® based on repair rod performance. Contact the OPGW cable manufacturer to verify the extent of damage that the specific cable design can survive without jeopardizing the performance of the fiber optic elements. If the cable manufacturer limits the repair level to lower than 50%, limit the use of the repair rod to the lower level for that specific cable. Consult PLP for further details.

Lay direction of the Repair Rods should be the same as the outer strands of the OPGW. Left-hand lay is standard, consult PLP for right-hand lay designs.

Repair Rods					
Catalog Number	Diameter Range (inch)	Diameter Range (mm)	Color Code	Length	
				in	M
3600100	.354-.385	8.9-9.7	Red	45	1.14
3600101	.386-.422	9.8-10.7	Black	48	1.22
3600102	.423-.460	10.8-11.6	Orange	50	1.27
3600103	.461-.505	11.7-12.8	Green	54	1.37
3600104	.506-.550	12.9-13.9	Blue	61	1.55
3600105	.551-.602	14.0-15.2	Yellow	65	1.65
3600106	.603-.660	15.3-16.7	Brown	70	1.78
3600107	.661-.719	16.8-18.2	Purple	74	1.88
3600108	.720-.785	18.3-19.9	Pink	80	2.03
3600109	.786-.850	20.0-21.5	Red	86	2.18
3600110	.851-.933	21.6-23.6	Black	94	2.39
3600111	.934-1.020	23.7-25.9	Orange	102	2.59

Left-hand lay standard



PREFORMED LINE PRODUCTS

Section 6 – FIBERLIGN® Hardware for ADSS

Table of Contents	Page
Fiber Optic Product Layout for ADSS	6-2
FIBERLIGN Lite Tension Dead-end for ADSS.....	6-3
FIBERLIGN Dielectric Dead-end for ADSS	6-5
FIBERLIGN Lite Support for ADSS	6-9
FIBERLIGN Dielectric Support for ADSS.....	6-12
FIBERLIGN Aluminum Support for ADSS	6-14
FIBERLIGN Aluminum Suspension for ADSS.....	6-16
FIBERLIGN Dielectric Suspension for ADSS	6-18



ADSS Product Layout

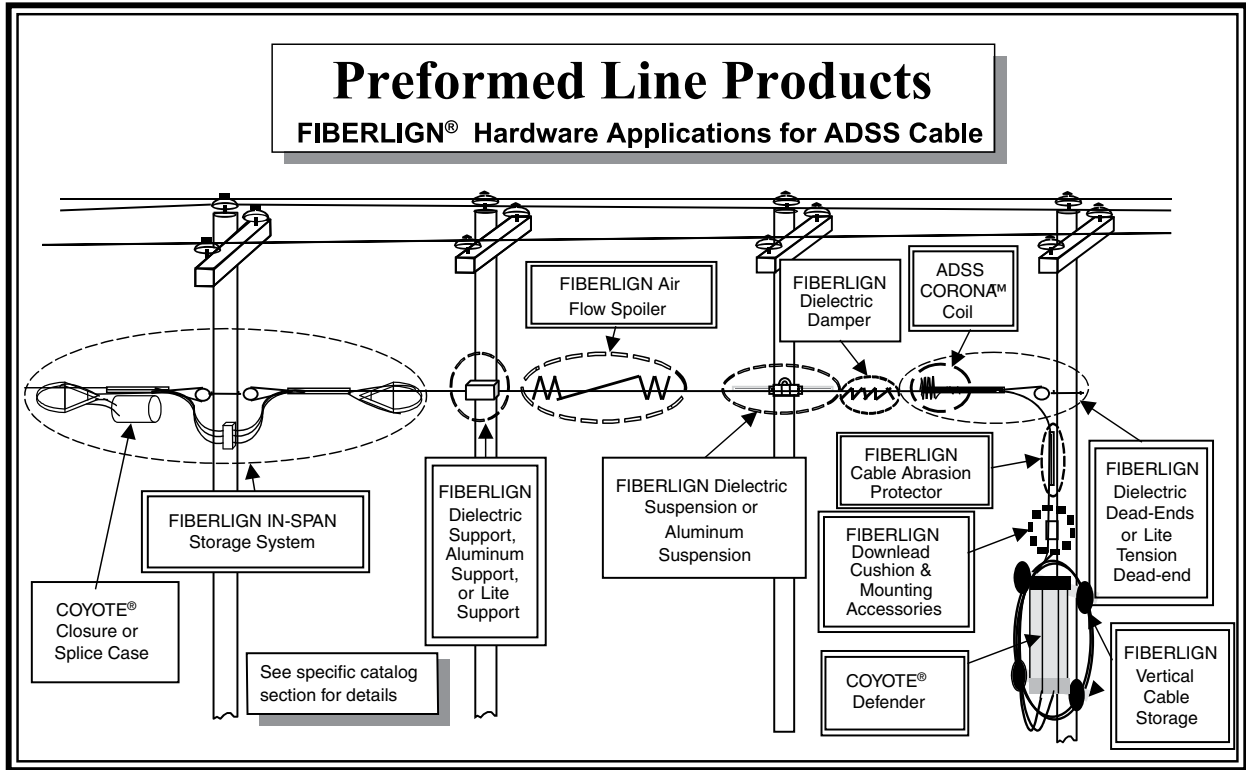

Note: For hardware accessories see section 7.

FIBERLIGN® Lite Tension Dead-end for ADSS

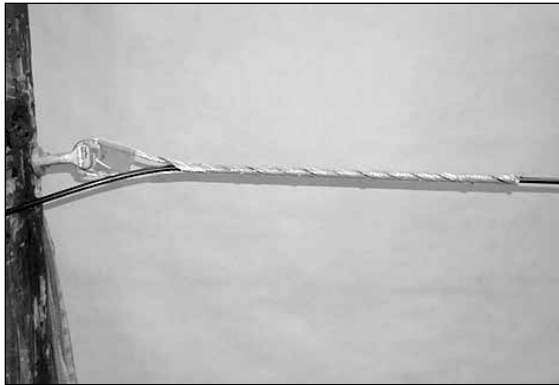

FIBERLIGN® Lite Tension Dead-end for All Dielectric Self-Supporting (ADSS) Fiber Optic Cable Installed

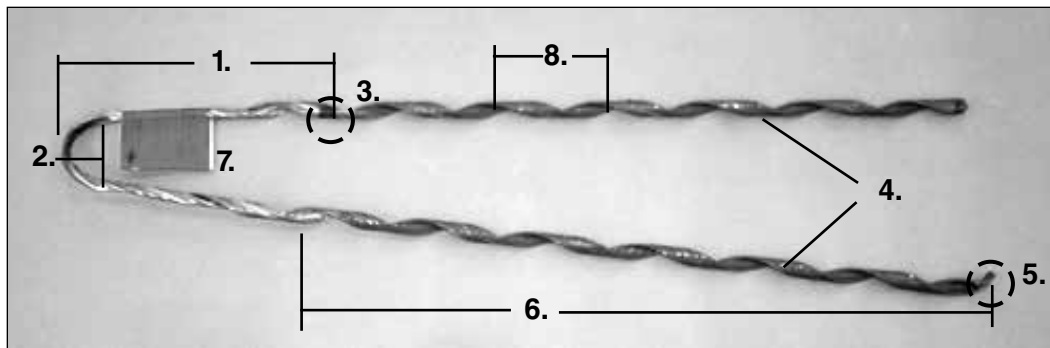

NOMENCLATURE

1. **Loop length:** Length from the color mark to the end of the loop.
2. **Loop diameter:** The loop has a formed diameter designed to interface with standard fittings.
3. **Color mark:** The dead-end color mark or crossover mark locates the beginning of dead-end contact with the cable during installation. It is used for identification as well.
4. **Dead-end legs:** The legs wrap onto the cable beginning at the crossover mark.
5. **Flared rod ends:** Special rod end treatment to prevent jacket damage.
6. **Latex coating:** Pliable coating applied over the dead-end legs.
7. **Product ID tag:** Red Tag includes product description and application information.
8. **Pitch length:** The distance along the leg that represents one complete wrap of the formed helix around the circumference of the cable (360 degrees).

APPLICATION

The FIBERLIGN Lite Tension Dead-end is a dielectric dead-end designed to terminate short span, low tension ADSS fiber optic cables in low voltage environments. Unlike the Limited, Medium, and High Tension FIBERLIGN® Dielectric Dead-end designs found later in this section, the Lite Tension Dead-end is reduced to a single layer component that offers an economical solution for very light loads. The product effectively transfers the low axial load on the cable at the end of the dead-end legs to low uniform radial compression near the dead-end loop.

Superior Fatigue Strength:

The small diameter wires that comprise each dead-end are a mixture of aluminum and aluminum clad steel to assure long term performance.



FIBERLIGN® Lite Tension Dead-end for ADSS

Dead-end performance depends upon a number of factors including cable brand and design, tension load requirements, temperature and environmental operating conditions among others.

The FIBERLIGN Lite Tension Dead-end has a pliable latex coating and flared rod end treatment that avoids possible damage to the cable jacket during and after installation.

Attaching to the Structure:

The loop diameter of the Lite Tension Dead-end will fit over a minimum diameter of 1.5" (38 mm) and a maximum diameter of 2-1/4" (57 mm). The Lite Tension Dead-end is designed to accept common guy wire dead-end pole fittings like thimble eyes and guy hooks.



Appropriate Fittings:

The extended loop of the dead-end reduces the need for an extension link; however, PLP can provide other FIBERLIGN® fittings including extension links (with thimble clevis) if desired. PLP offers the TC-5F Thimble Clevis, Thimble Eye, and LCE-55-14 Extension Link.

In general, Lite Tension Dead-ends are intended for use with these conditions and limitations:

- Light Tensions, approximately:
 - 600# (2.7 kN) maximum initial (stringing/nominal axial/long-term) tension
 - 800# (3.5 kN) maximum loaded (working/loaded axial/short-term) tension
- Short Spans:
 - 300' (91 m) maximum spans
 - not recommended for critical crossing spans (highways, rivers, etc.) see Medium or High Tension Dead-ends
- Very low strength cables
- "Standard" jackets
- Most cable brands
- No excessive operating conditions, cable motion or high temperatures

Lite Tension Dead-end features:

- Standard design parameters
- Broad cable OD ranges, listed on ID tags
- Economical single component design
- Optimized compact length
- Fast easy installation
- Accepts standard pole line fittings
- Latex coated with flared rod ends
- Uniform pressure design
- Superior fatigue strength wire design

Catalog* Number	Cable Diameter Range				Color Code	Overall Length	
	Min. (in)	Max. (in)	Min. (mm)	Max. (mm)		inches	meter
2875001	.375	.414	9.5	10.5	Red	28	.71
2875002	.415	.459	10.6	11.6	Orange	31	.79
2875003	.460	.505	11.7	12.8	Green	33	.84
2875004	.506	.557	12.9	14.1	Pink	37	.94
2875005	.558	.615	14.2	15.6	Yellow	42	1.07
2875006	.616	.680	15.7	17.3	Blue	45	1.14
2875007	.681	.750	17.4	19.1	Brown	49	1.24

*Add suffix code TE to include Thimble Eye (Cat. No. TE-5) Number – Mount with 5/8" or 16 m bolt and nut.

FIBERLIGN® Dielectric Dead-end for ADSS

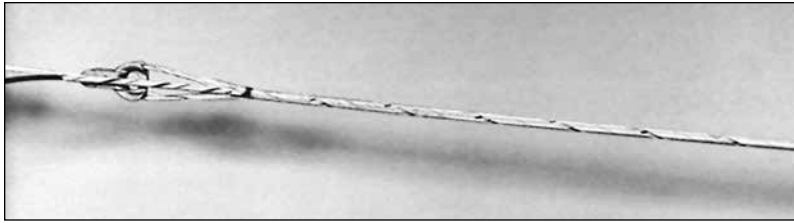

FIBERLIGN Dielectric Dead-end installed

NOMENCLATURE

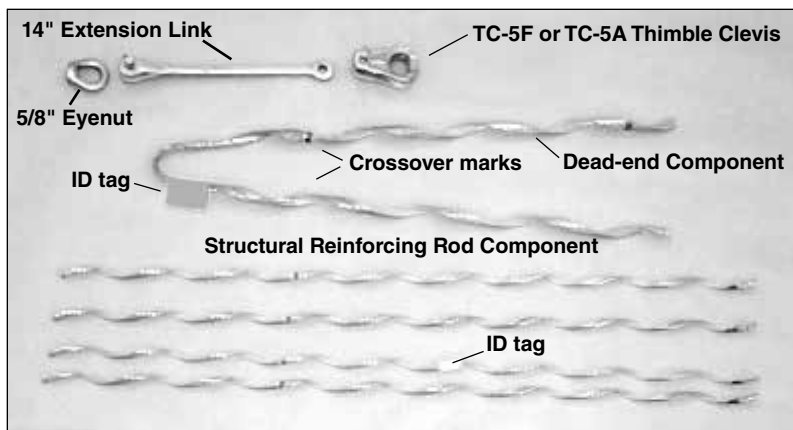

GENERAL INFORMATION

The FIBERLIGN Dielectric Dead-end product line has been designed to securely but gently terminate All Dielectric Self-Supporting (ADSS) aerial fiber optic cable. A two component design consisting of appropriate size and length of Structural Reinforcing Rods and dead-end component is required to transfer axial tensile loads and distribute radial compressive forces through the plastic jacket and onto the internal strength members without damaging the fragile plastic jacket or internal optical fibers.

APPLICATION & PRODUCT SELECTION

Specific dead-end design and performance depends upon a number of factors such as cable brand and design, strength member construction, jacket type, tension load requirements, temperature and environmental operating conditions, and so on. Due to these factors, three types of dead-ends are offered:

- Limited Tension Dielectric Dead-ends
- Medium Tension Dielectric Dead-ends
- High Tension Dielectric Dead-ends

Limited Tension Dead-ends:

Intended for relatively low tension application usually associated with short span construction. They are not cable or line design specific but are designed to fit broad diameter ranges. Holding performance will vary by specific cable brand and operating conditions. Therefore, no specific holding strength rating is possible.

In general, Limited Tension Dead-ends are intended for use with these conditions and limitations:

- Low tensions, approximately:
 - 1,000# (4.4kN) maximum initial (stringing/nominal axial/long-term) tension
 - 2,500# (11.1 kN) maximum loaded (working/loaded axial/short-term) tension
- Short spans:
 - 300' - 600' (91-183 m) typical maximum spans depending upon cable OD and tensions
 - not recommended for critical crossing spans (highways, rivers, etc.); see Medium or High Tension Dead-ends
- Low strength cables
- "Standard" jackets
- Most cable brands
- No excessive operating conditions, cable motion or high temperatures



FIBERLIGN® Dielectric Dead-end for ADSS

APPLICATION & PRODUCT SELECTION (cont.)

Limited Tension Dead-end features:

- Standard design parameters
- Broad cable OD ranges, listed on ID tags
- Short Structural Reinforcing Rods
- Short dead-end component
- Structural Reinforcing Rods and Dead-end components packaged in same carton
- Fast, easy installation
- Utilizes economical TC-5F Thimble Clevis

Limited Tension Dead-ends				
Catalog Number*	Cable O.D. Range (inch)	Cable O.D. Range (mm)	Overall Length in. (m)	Color Code
2872001	.400-.424	10.1-10.7	48 (1.2)	Black
2872002	.425-.451	10.7-11.4	48 (1.2)	Yellow
2872003	.452-.481	11.4-12.2	48 (1.2)	Green
2872004	.482-.510	12.2-12.9	48 (1.2)	Orange
2872005	.511-.542	12.9-13.7	48 (1.2)	Blue
2872006	.543-.577	13.7-14.6	48 (1.2)	White
2872007	.578-.613	14.6-15.5	48 (1.2)	Red
2872008	.614-.651	15.5-16.5	48 (1.2)	Black
2872009	.652-.692	16.6-17.5	48 (1.2)	Yellow
2872010	.693-.737	17.5-18.7	48 (1.2)	Green
2872011	.738-.784	18.7-19.9	48 (1.2)	Orange
2872012	.785-.834	19.9-21.1	48 (1.2)	Blue
2872013	.835-.889	21.2-21.5	48 (1.2)	White
2872014	.890-.945	22.6-24.0	48 (1.2)	Red
2872015	.946-1.007	24.0-25.5	48 (1.2)	Black
2872016	1.008-1.073	25.6-27.2	60 (1.5)	Yellow
2872017	1.074-1.140	27.2-28.9	60 (1.5)	Green
2872018	1.141-1.212	28.9-30.7	60 (1.5)	Orange
2872019	1.213-1.288	30.8-32.5	60 (1.5)	Blue

*To include accessories in same carton, add suffix code(s) to Dead-end catalog number. Example: Cat. No. 2872001C1E1 includes Dead-end #2872001, TC-5F Thimble Clevis and Extension Link #71002366 in the same carton. See Dielectric Dead-end accessories in this section.

CAUTION: Some ADSS cables are not suitable for use with Limited Tension Dead-ends. Limited Tension Dead-ends are not recommended for track-resistant jacket applications. Consult PLP for specifics.

Medium Tension Dead-ends:

Designed for medium tension applications. Holding performance will vary by specific cable brand and operating conditions; therefore no, specific holding rating is possible.

In general, Medium Tension Dead-ends are intended for use with these conditions:

- Moderate tensions, approximately
 - 2,000# (8.9 kN) maximum initial (everyday/stringing) tension
 - 4,000# (17.8 kN) maximum loaded (short-term/working) tension maximum span length is dependent on cable O.D. and tensions
- For “standard” and most “track-resistant” jacket types of ADSS cables. (Contact PLP to verify acceptable track-resistant cable.)
- For severe operating temperatures and conditions
- Structural Reinforcing Rod length ranges from 85" to 105" (2.2 m — 2.7 m)

Medium Tension Dead-end features:

- Standard design parameters
- Broad cable OD ranges, listed on ID tags
- Moderate length
- Structural Reinforcing Rods and Dead-end components packaged in same carton
- Utilize TC-5F (or TC-6F) Thimble Clevis
- Accessories can be ordered with Dead-end components using suffix codes

Medium Tension Dead-ends				
Catalog Number	Cable O.D. Range (inch)	Cable O.D. Range (mm)	Overall Length in. (m)	Color Code
2872099	.452-.481	11.5-12.2	85(2.2)	Green
2872100	.482-.510	12.2-12.9	85 (2.2)	Orange
2872101	.511-.542	12.9-13.7	85 (2.2)	Blue
2872102	.543-.577	13.7-14.6	85 (2.2)	White
2872103	.578-.613	14.6-15.5	85 (2.2)	Red
2872104	.614-.651	15.5-16.5	85 (2.2)	Black
2872105	.652-.692	16.5-17.5	85 (2.2)	Yellow
2872106	.693-.737	17.6-18.7	85 (2.2)	Green
2872107	.738-.784	18.7-19.9	85 (2.2)	Orange
2872108	.785-.834	19.9-21.1	90 (2.3)	Blue
2872109	.835-.889	21.2-22.5	90 (2.3)	White
2872110	.890-.945	22.6-24.0	95 (2.4)	Red
2872111	.946-1.007	24.0-25.5	95 (2.4)	Black
2872112	1.008-1.073	25.6-27.2	97 (2.5)	Purple
2872113	1.074-1.140	27.2-28.9	100 (2.5)	Pink
2872114	1.141-1.212	28.9-30.7	103 (2.6)	Brown
2872115	1.213-1.288	30.8-32.5	105 (2.7)	Orange

FIBERLIGN® Dielectric Dead-end for ADSS

High Tension Dead-ends:

Custom designed and manufactured for more stringent holding requirements and operating conditions than Limited and Medium Tension Dead-ends. Holding performance will vary depending upon the specific cable brand and operating conditions, therefore no general holding strength rating is possible. Consult PLP® for the proper dead-end application.

In general, High Tension Dead-ends are intended for use with these conditions:

- High tensions, approximately
 - over 2,000# (8.9 kN) initial (everyday/stringing) tension
 - over 4,000# (17.8 kN) loaded tension
- Long spans – varies according to cable OD and tensions
- High strength circular cables
- “Standard” and “track resistant” jackets
- All cable brands
- Selection and design considers excessive operating conditions, cable motion and high temperature environments

High Tension Dead-end features:

- Custom design parameters
- Designed for specific cable diameter and OD ranges, listed on ID tags
- Custom length Structural Reinforcing Rods and Dead-ends to match tension applications
- Structural Reinforcing Rods and Dead-end components packaged in same carton
- Utilizes either ATC-20M and TC-6F Thimble Clevis
- Accessories can be ordered with Dead-end components using suffix codes

Figure 8 Fiber Optic Cable:

For All-Dielectric messengers, the messenger with jacket intact is separated from the fiber bundle and a two piece Dielectric Dead-end is applied over the jacketed messenger. For metallic messengers, a conventional strand dead-end is applied directly to the bare messenger. Consult PLP for specifics for either style messenger.

Component Reuse:

Once installed, the structural reinforcing rods and formed dead-end components may be removed and reinstalled once for repositioning purposes; do not reuse after this initial installation. The hardware may be reused as desired if in good condition. Do not modify any component.

Ordering Instructions:

For Limited Tension and Medium Tension Dead-ends, use the appropriate table in this section if your installation meets the restrictions for this product. For all other dead-ends, contact PLP with cable specifications, line design details and advise of unusual operating conditions or high temperature environments so that proper dead-end designs can be selected.

To have accessories included with any Dead-end, add the appropriate suffix to the dead-end catalog number. Example: #2872001C1E1 includes Dead-end #2872001, Thimble Clevis TC-5F and Extension Link kit. See next page for available accessories.



FIBERLIGN® Dielectric Dead-end for ADSS

All Dielectric Dead-ends require a proper size and strength Thimble Clevis and may utilize an Extension Link.

To include accessories with dead-end, add suffix code(s) to Dead-end catalog number.

Thimble Clevis:

Limited and Medium Tension Dead-ends require the Catalog No. TC-5F Thimble Clevis (Rated Strength 26,900# (119 kN)) suffix Code "C1" or Cat No. TC-5A Thimble Clevis (Rated Strength 12,000# (53 kN)). The galvanized ductile iron #TC-5F is standard with a 2-1/4" minimum seat and 7/8" minimum groove diameter. The aluminum #TC-5A is optional with the same dimensional characteristics.

High Tension Dead-ends require at least the 20,000# (89 kN) ATC-20M Thimble Clevis (code C2) or equal with 3" minimum seat and 1-1/2" minimum groove diameters. For higher loads, use the 42,400# (188 kN) TC-6F (code C4) galvanized iron Thimble Clevis or equal with 2-1/2" minimum seat diameter and 1-1/16" minimum groove diameter.

Extension Link:

An optional 15,000# (67 kN) 14" (356 mm) Extension Link with 5/8" Eye Nut (Cat. #71002366, code E1) is suggested and sometimes recommended by cable suppliers to increase the cable bending radius and reduce stress to the optical fibers at Dead-end locations. This link kit can be used with any type FIBERLIGN Dielectric Dead-end.

For higher loads, use the 25,000# (111 kN), 14" (356 mm) Extension Link (Cat.# LCE-66-14 or P/N 00060132 or code E2).

Loads up to 36,000 pounds can be handled with Cat. No. 000601325 (not shown).

Banding Bracket:

Dielectric Dead-ends can be banded to concrete or steel structures using the 12Klb Banding Bracket Kit (Cat. #710010745, code B1). The kit includes a 5/8" – 11x2" long bolt, lockwasher, hex nut and banding bracket. This connects to the Extension Link with 5/8" eye nut referenced above (Cat #71002366). The bracket is rated for 12,000# (53 kN) and should be used with two high strength 1-1/4" steel bands (not supplied).



TC-5F Thimble Clevis (Code C1)



ATC-20M Thimble Clevis (Code C2)



TC-6F Thimble Clevis (Code C4)

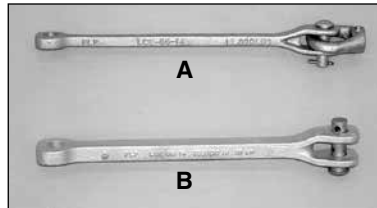

(A) 14" Extension Link with Eye Nut, 15K (Cat. No. 71002366, code E1)

(B) 25K EXTENSION LINK (Cat. No. LCE-66-14, code E2)

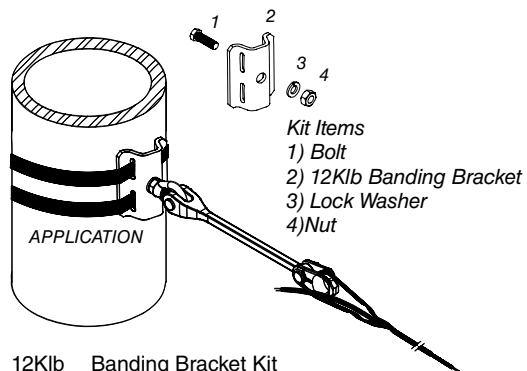

12Klb Banding Bracket Kit (Cat. No. 710010745, code B1)

FIBERLIGN® Lite Support for ADSS

FIBERLIGN Lite Support—Bolt Mounted

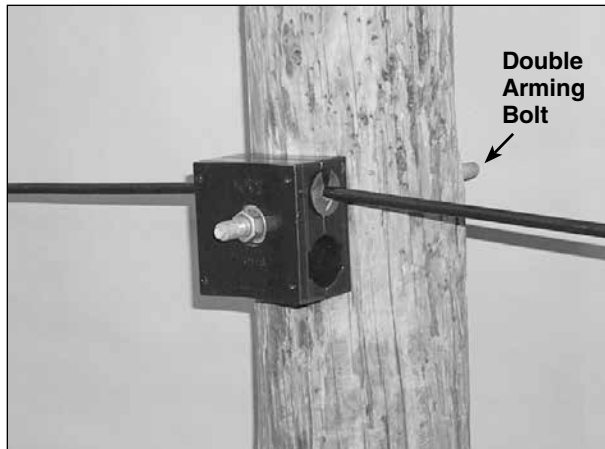

FIBERLIGN Lite Support—Band Mounted

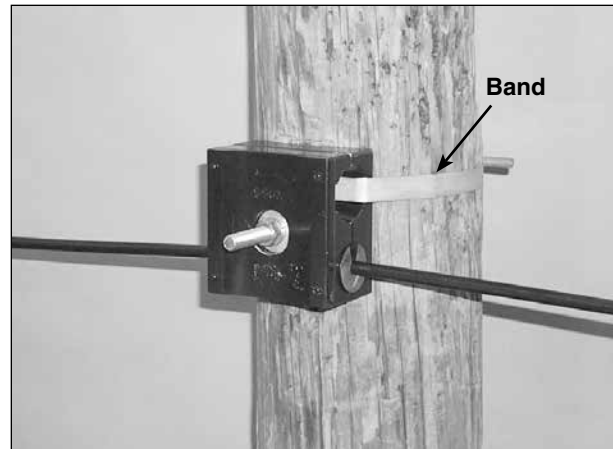

NOMENCLATURE

1. Housing Halves:

Urethane housings have molded cavities to accept cushion inserts. The small cavity accepts a small insert (Item 2a). The large cavity is designed for stringing in cable, capable of handling up to a 1-1/4" (32 mm) diameter mechanical swivel with pulling in grip. The large cavity will accept a large insert (Item 2b) for larger cables or if a dual cable application is desired.

2. Insert:

Softer material than the housing (item 1), one piece inserts are slotted to accept the cable as well as cushion the cable under load. The cable diameter range is molded along the hinge opposite the open slot for identification. The small cavity insert (Item 2a) will accept cable sizes up to .700" (17.8 mm) diameter. The large cavity insert (Item 2b) will accept cable sizes up to 1.03" (26 mm) diameter.

3. Hardware Kit (optional) for Banded Mount:

A 5/8"-11 UNC by 4" long carriage bolt, 5/8" round washer, Lock Washer, and 5/8"-11 UNC nut can be provided for banding applications. (Cat. No. 4800500)

FLS

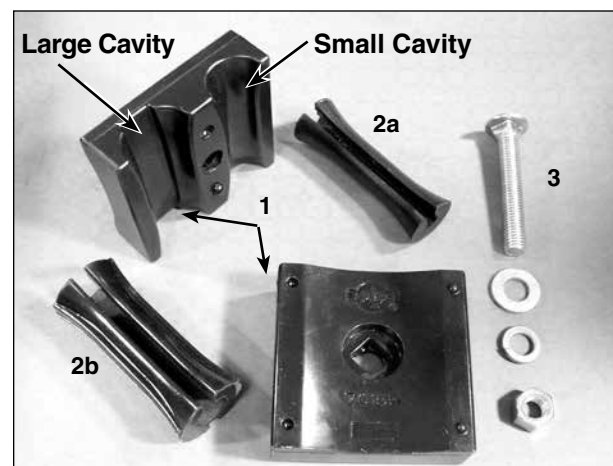



FIBERLIGN® Lite Support for ADSS

APPLICATION

The FIBERLIGN Lite Support (FLS) system is designed to gently but firmly support All Dielectric Self-Supporting (ADSS) cable. It is intended for tangent support installations (see "LINE ANGLES") on lines that feature low voltages, very short spans and low mechanical loads. For products with higher capabilities see the subsequent pages under FIBERLIGN® Dielectric Support, FIBERLIGN Aluminum Support, FIBERLIGN Aluminum Suspension, with and without rods and FIBERLIGN Dielectric Suspension. The two latter products can be used in higher voltage environments where track resistant ADSS cables are required.

Dual Insert Application:

The FLS with small and large inserts can support two cables. Existing FIBERLIGN Dielectric Support (FDS) installations (up to 300' spans) can be replaced or "retrofitted" using the FLS. This option increases capability from one to two cables within minimal pole space.

FTTP:

Fiber to the Premises drop cables can have round, flat and Figure 8 construction. Specially designed Lite Support inserts are available to accept all of these configurations. The catalog table includes these new sizes and detailed information can be found in Section 8.

Stacking:

Lite Support Housings are stackable to add more cables within the same pole space. This can offer a neat alternative to busy "J-Hook" clutter for FTTP drop cable distribution.

Maximum Span Lengths – 300 feet (91 m):

The maximum recommended span length for the FLS is dependent upon the specific cable OD, initial cable tension, ice and wind loading district (NESC), and other factors. It is intended for application on short spans where vertical loading does not exceed 1000# (4.4 kN) under the extreme case.

In general, the approximate recommended maximum span length for the FLS is 300 feet (91 m) under extreme loads (NESC Heavy). Consult PLP for specific span limitations.

STRINGING OPERATIONS

The dielectric material of the body provides a highly abrasive-resistant surface that allows the FLS housing assembly to be used as a stringing traveler at the structure. The smooth surfaces of the housing are designed with gentle contours and large radii that allow up to 10° line angles (20° in certain cases – consult PLP). This ability saves installation time and costs by eliminating the use of conventional stringing travelers.

Material:

The housing halves are made from a high-strength, dielectric urethane material. The cushioned inserts are made from a softer, pliable dielectric material that gently grips and cushions the ADSS cable within the clamped housing. The hardware (optional) for banded applications is zinc plated.

Mounting:

The housing halves are molded with smooth finish holes to accept a standard 5/8" thru-bolt.

Bolt Mount:

For wood pole or bolt mounting to any structure, a thru bolt can be fed through a hole in the structure leaving 4" to 5" (102-127 mm) of the bolt exposed to accept the FLS and allow for temporary housing separation during installation. At four (4) inches (102 mm), the nut and washers can be left on the end of the bolt while manipulating the housing halves to remove the cable after stringing or accept the insert during final installation.

Band Mount:

For concrete pole or band mounting to any structure, the housing halves have a molded groove that accepts 3/4" wide high-strength banding material. PLP provides the hardware kit (item 3 of the nomenclature) that is used to clamp the housing halves together after the unit is banded to the structure. The housings have a special recessed hole that keeps the carriage bolt from turning during assembly. To include the mounting hardware with the product add the suffix code H2 to the standard FLS catalog number. Banding material is not provided – Consult PLP for further information.

Line Angles:

For most applications, the maximum line angle recommended is 20°; consult PLP for exceptions.

Slip Loads:

The hourglass shape of the insert creates wedge-action holding on the cable when unbalanced loads exist. The wedge works in either direction. Holding capability is enhanced with a special knurled finish on the inserts inner diameter surface. Specific performance will depend upon the specific cable OD and design.

For stringing operations the large molded cavity will accept up to 1-1/4" diameter for pulling in hardware. If you are using cable greater than .699" (18 mm) diameter, you may have a large insert designed for the large molded cavity. If so, remove the large insert from its cavity and temporarily tighten the FLS housing halves against the pole. The small cavity insert can remain in the small cavity of the FLS during stringing.

FIBERLIGN® Lite Support for ADSS

FIBERLIGN Lite Support – Stringing

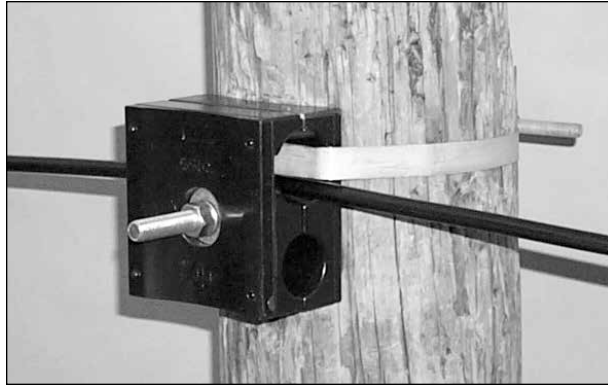

ORDERING INSTRUCTIONS

Refer to the catalog table and select the proper FLS for the cable's outside diameter. To include the carriage bolt hardware kit for Cat. no. 4800500 band mount, add suffix code H2 (banding material not included), EX: #4800110H2 will include hardware.

Large Cavity Inserts for Lower Cable Ranges				
Cable Diameter Range				Large Insert Number
Min. (in)	Max. (in)	Min. (mm)	Max. (mm)	
0.25	0.28	6.3	7	00070255
0.305	0.375	7.8	9.5	00070256
0.4	0.429	10.2	10.8	00070250
0.43	0.459	10.9	11.6	00070251
0.46	0.489	11.7	12.4	00070176
0.49	0.519	12.5	13.1	00070177
0.52	0.549	13.2	13.9	00070178
0.55	0.579	14	14.7	00070179
0.58	0.609	14.8	15.4	00070180
0.61	0.639	15.5	16.2	00070181
0.64	0.669	16.3	16.9	00070182
0.67	0.699	17	17.8	00070183

For Housing Only – Order #4800000
Large Cavity insert sizes for Lower Ranges are shown in the table for cable diameters from .250" to .699"

FIBERLIGN LITE SUPPORT – Single Insert Assemblies						
Catalog Number	Cable Diameter Range				Insert Component	
	Min. (in)	Max. (in)	Min. (mm)	Max. (mm)	Part Number	Sized For
4800107	.250	.280	6.3	7.0	00070257	S M A L L C A V I T Y
4800109	.305	.375	7.8	9.5	00070258	
4800110	.400	.429	10.2	10.8	00070216	
4800111	.430	.459	10.9	11.6	00070217	
4800112	.460	.489	11.7	12.4	00070218	
4800113	.490	.519	12.5	13.1	00070219	
4800114	.520	.549	13.2	13.9	00070220	
4800115	.550	.579	14.0	14.7	00070221	
4800116	.580	.609	14.8	15.4	00070222	
4800117	.610	.639	15.5	16.2	00070223	
4800118	.640	.669	16.3	16.9	00070224	
4800119	.670	.699	17.0	17.8	00070225	
4800120	.700	.723	17.9	18.3	00070184	
4800122	.724	.779	18.4	19.7	00070186	
4800124	.780	.834	19.8	21.1	00070188	
4800126	.835	.889	21.2	22.5	00070190	
4800128	.890	.944	22.6	23.9	00070192	
4800130	.945	.999	24.0	25.4	00070194	
4800132	1.000	1.054	25.5	26.8	00070195	

For Housing Only – Order #4800000
DUAL INSERT APPLICATION: Catalog Numbers are available for Small & Large Insert Combinations – Contact PLP
The maximum cable accepted in the small cavity is .699".



FIBERLIGN® Dielectric Support for ADSS

APPLICATION

The FIBERLIGN Dielectric Support (FDS) system is designed to gently, but firmly, support All-Dielectric Self-Supporting (ADSS) cable. It is intended for tangent support installations (see "LINE ANGLES") on lines that feature relatively low voltages, short spans and modest mechanical loads. For higher voltages (where "track resistant" ADSS cables are required), longer spans and/or higher loads, use either the FIBERLIGN Aluminum Suspension with Rods or the FIBERLIGN Dielectric Suspension — both products appear later in this section.

Maximum Span Lengths:

The maximum recommended span length for the FDS is dependent upon the specific cable OD, initial cable tension, ice and wind loading district (NESC), and other factors. It is intended for application on relatively short spans where vertical cable loading does not exceed approximately 1,000# (worst case). In general, the approximate recommended maximum span lengths for the FDS are:

- 600' for < 1.00" OD cable (NESC – heavy).
- 300' for ≥ 1.00" OD cable (NESC – heavy).

When in doubt, consult PLP for specific span limitations.

Material:

The body and top are made from a high-strength, engineered dielectric material. The cushioned inserts are made from a soft, pliable dielectric material that gently grips the ADSS cable. Two captured zinc plated bolts with washers secure the top to the body.

Mounting:

The body threads onto standard 5/8" 11-UNC hot dipped galvanized thru-bolt and may be mounted either horizontally or vertically. For horizontal mounting to a wood pole (or other structures with thru-holes) a double arming bolt (completely threaded—no head) is suggested instead of a fixed length machine bolt. This allows approximately 1-5/8" of bolt length to thread into the body regardless of pole diameter.

For mounting to concrete or steel structures without thru-holes, use a 5/8" threaded stud of appropriate length or banding system with a mounting bracket. See accessories in this section for details about the Limited Tension Banding Bracket.

FIBERLIGN Dielectric Support installed

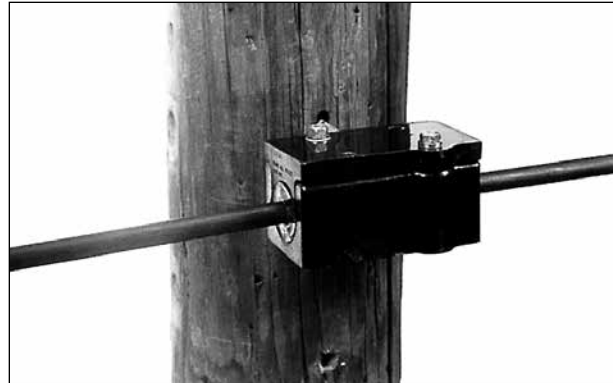

Line Angles:

For most applications, the maximum line angle recommended is 20°; consult PLP® for exceptions that allow 30° angles. When angles exceed 20° (or 30°) a double dead-end arrangement is usually preferred. A special double FDS unit can be designed for certain applications; consult PLP for details.

Slip Loads:

The cushioned inserts are designed to gently grip the cable while providing significant slip strength without causing cable jacket damage. Specific performance will depend upon the specific cable O.D. and design.

NOMENCLATURE

FDS

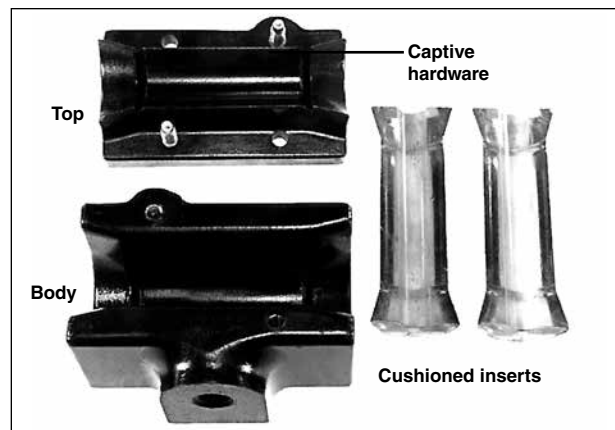

Patented

FIBERLIGN® Dielectric Support for ADSS

Stringing Operations:

The dielectric material of the body provides a highly abrasive-resistant surface that allows the FDS body to be used as a stringing traveler at the structure on up to 10° line angles (20° in certain cases—consult PLP®). This ability saves installation time and costs by eliminating the use of conventional stringing travelers.

For stringing operations, thread the FDS onto the appropriate bolt, remove the inserts and elevate the top as far away from the bottom as the bolts will allow, to provide as large an opening as possible. Then thread pulling-in cable through the opening.

Component Reuse:

All components of FDS may be reused as desired if in good condition. Do not modify any component.

Ordering Instructions:

For concentric ADSS cable, refer to the catalog table and select the proper FDS for the cable's outside diameter. For non-concentric profiles, such as Figure 8 or other cable sizes and profiles, consult PLP for custom designs. To include accessories with the FIBERLIGN Dielectric Support, add code number to catalog number (example: 44002144B1).

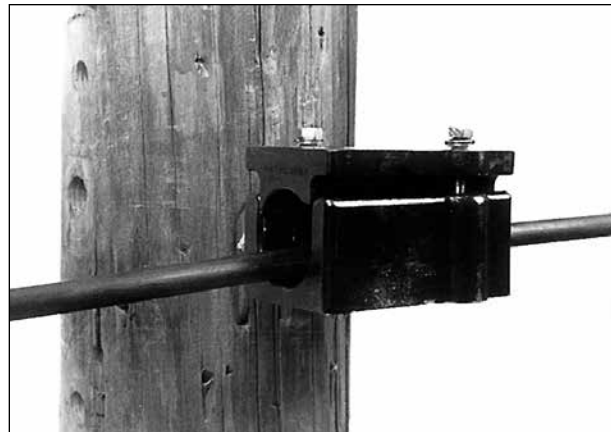

ACCESSORIES

The FIBERLIGN Dielectric Support may be banded to concrete or steel structures using the appropriate Limited Tension Banding Bracket Kit (Cat. #710010577, code B1). The kit includes a 5/8"-11 x 2-1/2" long bolt, lockwasher, hex nut and banding bracket. The bracket is rated for 1,200# vertical load and should be used with a high strength 1-1/4" steel band (band purchased separately).

FIBERLIGN® Dielectric Support for ADSS					
Catalog Number		ADSS Cable Range			
Complete Assembly	Inserts Only (2 Required)	Min. (in)	Max. (in)	Min. (mm)	Max. (mm)
44002144	00070061	0.275	0.325	7.0	8.3
44000691	00070052	0.326	0.375	8.4	9.5
44009998	00070056	0.376	0.425	9.6	10.8
44009949	00070059	0.426	0.475	10.9	12.1
44009952	00070107	0.476	0.525	12.2	13.3
44009823	00070088	0.526	0.575	13.4	14.6
44009798	00070108	0.576	0.625	14.7	15.9
44009776	00070109	0.626	0.675	16.0	17.1
44009799	00070110	0.676	0.750	17.2	19.1
44009878	00070111	0.751	0.825	19.2	21.0
44009963	00070112	0.826	0.900	21.1	22.9
44002213	00070113	0.901	0.950	23.0	24.1
44003915	00070147	0.951	1.000	24.2	25.4
440010296	00070154	1.001	1.050	25.5	26.6

Quantity 2 Inserts Required per Support
For Housing Only – Order #440000000



FIBERLIGN[®] Aluminum Support for ADSS



Through-Bolt Mounted



Band Mounted



Multi-Cable Stacking

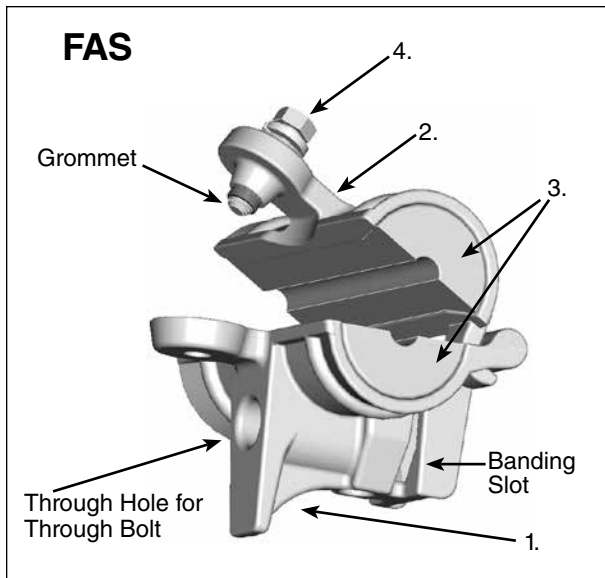

PATENT PENDING

NOMENCLATURE

1. Base
2. Keeper
3. Cushion Inserts
4. Captured Bolt, Lock Washer & Flat Washer (Captured with grommet)

Base and Keeper:

The aluminum alloy base and keeper have an **interlocking hinge** allowing easy access for pulling-in rope and ADSS cable. Closing the keeper captures the cable during stringing and subsequently secures the cable and cushion inserts for permanent installation. The base is designed to accept a 1-1/4" wide x .040" thick (32 mm x 1 mm) band or a 5/8" through bolt (M16) for mounting to the structure. **In multi-cable installations**, modular base surfaces at the mounting bolt and band entry areas provide stable engagement and stacking.

Captured Bolt and Bevel Washer:

Galvanized steel bolt, lock washer and washer captured with an elastomer grommet.

Cushion Inserts:

A soft pliable dielectric material that gently grips the ADSS cable. FAS is the acronym for FIBERLIGN Aluminum Support.

APPLICATION

The FIBERLIGN Aluminum Support (FAS) is designed to gently, but firmly support All-Dielectric Self-Supporting (ADSS) cable. The FAS features the following: Integrated bolt or band mount design, Hinged keeper and base, Single-bolt clamping, and Stackability for multi-cable installations. For higher voltages (where track resistant ADSS cables are required), longer spans and/or higher loads, use either the FIBERLIGN Aluminum Suspension w/rods or the FIBERLIGN Dielectric Suspension – both products appear later in this section.

Maximum Span Lengths:

The FAS was designed for short span applications where vertical loading does not exceed 1000# (4.4 kN). The maximum vertical load typically factors-in span length, cable OD, initial cable tension, ice and wind loading district (NESC), multi-cable stacking, etc. As a general idea, the following recommendations are approximate maximum span lengths for the FDS under NESC Heavy conditions:

- 600' (183 m) for < 1.00" (25 mm) OD cable (NESC Heavy)
- 300' (91 m) for > 1.00" (25 mm) OD cable (NESC Heavy)

Mounting:

The FAS can be bolted or banded to a structure. For mounting to wood poles (or other structures with through holes) a 5/8"-11 (M16) through-bolt or double-arming bolt may be used to capture the FAS against the structure. The width of the FAS accounts for about 3.2" (81 mm) of bolt length.

FIBERLIGN® Aluminum Support for ADSS

For mounting to concrete or steel structures without through holes, the FAS may be banded via the band slot cast in the base of the FAS. The band slot is designed to accept a 1-1/4" wide x 0.040" thick (32 mm x 1 mm) high strength band. Banding materials with 45,000 psi (310 MPa) yield strength and 95,000 psi (655 MPa) ultimate strength are recommended to achieve rated vertical load.

Line Angles:

For most applications, the maximum line angle recommended is 20° – consult PLP® for exceptions that allow 30° angles. When angles exceed 20° (or 30°) the FIBERLIGN Aluminum Suspension (found later in this section) as a single or double attachment may be considered as an alternative.

Longitudinal Holding Capability:

The cushioned inserts are designed to gently grip the cable – providing modest longitudinal holding strength without causing cable damage. Specific performance will depend upon the cable brand, internal construction, and outer diameter.

Stringing Operations:

The cable cavity of the FAS is contoured and smooth to allow the product to be used as a stringing traveler during stringing and sagging operations. The line angles during stringing may go up to 10° (20° in certain cases – consult PLP).

For stringing, the inserts are removed and the keeper should be fully closed with the bolt fully engaged.



STRINGING

Torque Level:

The keeper is fastened to the base with the 3/8"– 16 captured bolt and should be tightened until the lock washer is flat for proper torque level. This will require 10 foot pounds (120 inch-pounds or 13.5 Newton-meters) of force. DO NOT OVER-TORQUE.

Stacking – Multi-Cable Installation:

Multi-cable installations with the FAS save pole space as the first unit mounts against the pole and added units extend horizontally – captured with a common 5/8" (M16) bolt. The length of the bolt must accommodate the stacked FAS units – each width approximately 3.2" (81 mm). For installations of more than two cables, a brace should be used to help support the cantilever load on the through-bolt or band.

The FAS units stack in such a way that keep adjacent cables in staggered formation, thus reducing the possibility of cable collision due to wind induced cable sway.

ORDERING INSTRUCTIONS

Refer to the catalog table and select the appropriate FAS for the ADSS cable's outside diameter.

FIBERLIGN® Aluminum Support					
Catalog Number		ADSS Cable Range			
Complete Assembly	Inserts Only (2 Required)	Min. (in)	Max. (in)	Min. (mm)	Max. (mm)
4450095	00070241	0.226	0.275	5.7	6.9
4450096	00070236	0.276	0.325	7	8.2
4450097	00070237	0.326	0.375	8.3	9.4
4450098	00070238	0.376	0.425	9.5	10.7
4450099	00070239	0.426	0.475	10.8	12
4450100	00070125	0.476	0.525	12.1	13.3
4450101	00070126	0.526	0.575	13.4	14.6
4450102	00070127	0.576	0.625	14.7	15.9
4450103	00070128	0.626	0.675	16	17.1
4450104	00070129	0.676	0.75	17.2	19.1
4450105	00070130	0.751	0.825	19.2	21
4450106	00070131	0.826	0.9	21.1	22.9
4450107	00070132	0.901	0.975	23	24.8
4450108	00070133	0.976	1.05	24.9	26.7
4450109	00070134	1.051	1.25	26.8	28.6
4450110	00070135	1.126	1.2	28.7	30.5
4450111	00070136	1.201	1.275	30.6	32.4
4450112	00070137	1.276	1.35	32.5	34.3
4450113	00070138	1.351	1.425	34.4	36.2

Quantity 2 Inserts Required per Support
For Housing Only - Order #4450000



FIBERLIGN® Aluminum Suspension for ADSS

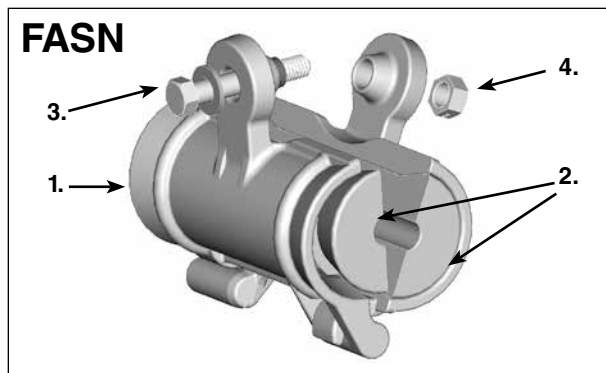

NOMENCLATURE

1. Keeper
2. Cushion Inserts (With or Without Grit)
3. Captured Bolt and Washer (Captured with Grommet)
4. Lock Nut
5. Anchor Shackle with Eye-nut (Optional not shown)
6. Structural Reinforcing Rods (optional, not shown)

Keeper:

The aluminum alloy keepers have an interlocking hinge for simple access and cable installation. Closing the keeper captures and secures the cushion inserts and ADSS cable. The keepers join together to form a clevis for attachment to the structure via Cat. No. AS-5L anchor shackle fitting or equivalent.

Cushion Inserts:

A soft pliable dielectric material that gently grips the ADSS cable – supplied either with or without grit on the inner diameter bore. Gritted inserts are applied over optional Structural Reinforcing Rods for medium span applications. The gritted inserts have a conductive aluminum strip located near the center for higher voltage environments.

Captured Bolt, Washer, and Lock Nut:

Galvanized steel bolt and washer captured with an elastomer o-ring. The galvanized steel Lock Nut has a stiff wire locking mechanism designed to engage with the thread of the mating bolt.

Structural Reinforcing Rods (SRR):

are preformed galvanized steel rods – subsetting and gritted. They are intended to provide additional protection to the cable jacket and increase longitudinal holding abilities of the unit.

FASN is the acronym for FIBERLIGN Aluminum Suspension.

APPLICATION

The FIBERLIGN Aluminum Suspension (FASN) is designed to gently, but firmly support All-Dielectric Self-Supporting (ADSS) cable. The FASN features the following: Interlocking Hinge, Single-bolt clamping, Short to

Medium Span Option, Low to High Voltage Environment acceptance. The addition of SRR allows the versatile FASN to go from a distribution environment to a transmission environment. Fittings and brackets are available for wood pole and concrete or metal structure applications.

Span Length Capability

1. For short spans without SRR:
<600' (183 m) maximum recommended span lengths.
2. For Intermediate spans with SRR:
<1200' (366 m) maximum recommended span lengths.

For additional cable jacket protection, longer spans and higher longitudinal holding requirements, the dual rod layer FIBERLIGN Dielectric Suspension (found later in this section) is recommended.



Anchor Shackle w/Eye Nut Option



FASN with Rods

Vertical Load Limit

The FASN has an ultimate vertical load capability of 7000 (31 kN) pounds.

Longitudinal Cable Holding Capabilities

Without SRR, modest longitudinal holding capabilities are provided via compression of the non-gritted inserts on the cable. Specific values are dependent upon cable brand, internal construction and diameter. Consult PLP for specifics. With SRR, substantial longitudinal holding capabilities are provided via insert compression and are enhanced by the grit on both the inserts and SRR. Contact PLP for specifics.

Rod End Treatment

In order to avoid scratching, gouging or nicking of the plastic jacket during installation, unbalanced loading, or cable motion, the ends of the SRR's are factory formed to flare away from the cable surface.

FIBERLIGN® Aluminum Suspension for ADSS

Grounding and Corona Protection:

If positive grounding of the cable and metallic components of the FASN is desired, a grounding wire can be attached to the 3/8" captured bolt. PLP can supply a 4' (1.2m) long #4 copper or 4/0 aluminum grounding wire assembly (Cat. No. 710010016 or 710010294 respectively).

For the FASN, the SRRs have been designed to accept the ADSS-CORONA™ Coil. The ADSS CORONA Coil reduces electrical stress at the ends of the metal rods. Further catalog information about this product can be found later in this section.

Mounting

- Bolted (Wood Poles): Adding suffix code "S" provides an anchor shackle with 5/8"-11 eye nut accessory (Cat. No. 710010357) for attachment to double arm bolts. The anchor shackle (Cat. No. AS-5L) may be purchased separately to attach to eyebolts.
- Banded (Steel, Concrete Poles): Banding Bracket (Cat. No. 710010577) is offered for low tension/short span support application only. The kit includes a 5/8"-11x 2-1/2" long bolt, lockwasher, hex nut and banding bracket. The bracket is rated for 1,200# (5.3 kN) vertical load and should be used with a high strength 1-1/4" (32 mm) steel band (band purchased separately).

Line Angles

The FASN maximum recommended line angle for a single suspension unit is 30° depending on cable brand. Two units can be combined to turn larger angles up to 60°, although double dead-ending is another option for large angles. Contact PLP for details.

Torque Level

The 3/8" captured bolt should be tightened UNTIL THE LOCK WASHER IS FLAT and the clevis halves are joined flush. This will require about 10 foot-pounds (120 inch-pounds or 13.5 Newton-meters) of force. DO NOT OVERTORQUE.

FASN Kit with Structural Reinforcing Rods					
Catalog Number*	ADSS Cable Range				Color Code
	Min. (mm)	Max. (mm)	Rod Length (mm)	Rod Dia. (mm)	
4470199	0.426" (10.8)	0.475" (12.0)	30" (762)	.100" (2.5)	Green
4470200	0.476" (12.1)	0.500" (12.7)	33" (838)	.100" (2.5)	Red
4470201	0.501" (12.8)	0.550" (14.0)	34" (864)	.100" (2.5)	Blue
4470202	0.551" (14.1)	0.625" (15.9)	34" (864)	.100" (2.5)	Black
4470203	0.626" (16.0)	0.700" (17.8)	35" (889)	.100" (2.5)	Orange
4470204	0.701" (17.9)	0.737" (18.7)	36" (914)	.119" (3)	Green
4470205	0.738" (18.9)	0.812" (20.6)	36" (914)	.119" (3)	Pink
4470206	0.813" (20.7)	0.887" (22.5)	37" (940)	.119" (3)	Purple
4470207	0.888" (22.6)	0.962" (24.4)	37" (940)	.119" (3)	White
4470208	0.963" (24.5)	1.037" (26.3)	37" (940)	.119" (3)	Yellow
4470209	1.038" (26.4)	1.112" (28.2)	38" (965)	.119" (3)	Brown
4470210	1.113 (28.3)	1.187" (30.1)	39" (991)	.119" (3)	Red

*Add Suffix "S" to Catalog No. to include one #AS-5L Anchor Shackle

FIBERLIGN® Aluminum Suspension Without Structural Reinforcing Rods					
Catalog Number*		ADSS Cable Range			
Complete Assembly	Inserts Only (2 Required)	Min. (in)	Max. (in)	Min. (mm)	Max. (mm)
4450195	00070241	0.226	0.275	5.7	6.9
4450196	00070236	0.276	0.325	7	8.2
4450197	00070237	0.326	0.375	8.3	9.4
4450198	00070238	0.376	0.425	9.5	10.7
4450199	00070239	0.426	0.475	10.8	12
4450200	00070125	0.476	0.525	12.1	13.3
4450201	00070126	0.526	0.575	13.4	14.6
4450202	00070127	0.576	0.625	14.7	15.9
4450203	00070128	0.626	0.675	16	17.1
4450204	00070129	0.676	0.75	17.2	19.1
4450205	00070130	0.751	0.825	19.2	21
4450206	00070131	0.826	0.9	21.1	22.9
4450207	00070132	0.901	0.975	23	24.8
4450208	00070133	0.976	1.05	24.9	26.7
4450209	00070134	1.051	1.25	26.8	28.6
4450210	00070135	1.126	1.2	28.7	30.5
4450211	00070136	1.201	1.275	30.6	32.4
4450212	00070137	1.276	1.35	32.5	34.3
4450213	00070138	1.351	1.425	34.4	36.2

Quantity 2 Inserts Required per Suspension For Housing Only - Order #4450001

*Add Suffix "S" to Catalog No. to include one #AS-5L Anchor Shackle and 5/8" Eye-Nut

ORDERING INSTRUCTIONS

Refer to the catalog tables (with or without rods) and select the appropriate FASN for the ADSS cables outside diameter.

Add suffix code "S" to include anchor shackle with 5/8" eye-nut (Cat. No. 710010357) option.

Order Cat. No. 710010577 to receive the Limited Tension Banding Bracket – see "Mounting" paragraph earlier in this section for details.

Order Cat. No. 710010016 to receive a 4' (1.3 m) long #4 (7W) copper with terminal on one end. Order Catalog No. 710010294 to receive a 4' (1.2 m) long 4/0 (7W) aluminum conductor with terminal on one end.



FIBERLIGN® Dielectric Suspension for ADSS

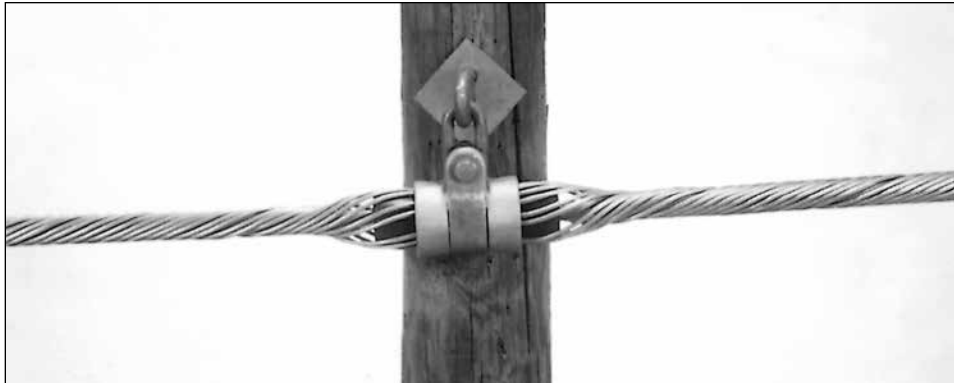

FIBERLIGN Dielectric Suspension for All-Dielectric Self-Supporting (ADSS) Cable

APPLICATION

The FIBERLIGN® Dielectric Suspension is specifically designed for installation on ADSS cables and is different than FIBERLIGN® Suspension for OPGW. Due to the relatively fragile nature of the plastic jackets and nonmetallic strength members of ADSS, special care and features are incorporated into the design of the FIBERLIGN Dielectric Suspension.

The unit does use a combination of Structural Reinforcing Rods, Outer Rods, boltless housing and resilient cable inserts to reduce compression clamping and bending stresses on the cable and glass fibers. Negative effects of wind induced cable motions such as aeolian vibration, galloping and wind sway are also minimized.

The double layer of rods also offers critical protection against tearing of the plastic jacket during unbalanced longitudinal loading of the cable while providing substantial holding strength. This holding strength can vary according to cable brand, jacket type, operating temperatures and other factors.

For further details about the product and its components, refer to FIBERLIGN Suspension for OPGW earlier in this section.

Rod End Treatment

In order to avoid scratching, gouging or nicking of the plastic jacket during installation, unbalanced loading, or cable motion, the Structural Reinforcing Rods are slightly flared away from the cable surface. Unflared rod ends can cause damage to the jacket which should be avoided.

Product Selection

As a general guideline, the FIBERLIGN Dielectric Suspension for ADSS is intended for long spans where suspension is desired regardless of span, where very high unbalanced longitudinal holding strengths are desired, or where very high vertical loads are expected.

PLP offers two other products for lighter load/shorter span applications in suspension and support modes. Refer to the FIBERLIGN Dielectric Support (FDS), FIBERLIGN Aluminum Support (FAS) and FIBERLIGN Aluminum Suspension (FASN) products that appear earlier in this section.

ULTIMATE VERTICAL STRENGTH & HOUSING & FITTING DIMENSIONS: Refer to dimensional tables in the FIBERLIGN Suspension for OPGW section of this catalog.

Line Angles

The maximum recommended line angle for a single suspension unit is 40°. A custom designed FIBERLIGN Dielectric Suspension Double for angles up to 80° is available. Double dead-ending for angles over 40° is another option.

Fittings

Fittings such as a Y-Clevis, Clevis Eye, Chain Link or Anchor Shackle may be required to attach the Suspension unit to the structure or other hardware. These fittings must match the dimensions of the suspension housing; refer to the dimensional tables and fittings pages in the FIBERLIGN Suspension for OPGW section of this catalog.

Component Reuse

Once installed, do not reuse the rod components. The hardware components may be reused as long as they are in good condition. Do not modify any components.

FIBERLIGN® Dielectric Suspension for ADSS

ORDERING INSTRUCTIONS

Select the appropriate FIBERLIGN Dielectric Suspension for ADSS by cable diameter from the table below. For FIBERLIGN Suspension for OPGW, refer to page 5-12 of this catalog. For trunnion or bracket-type mounting for ADSS or OPGW, consult PLP®.

Catalog Number	Diameter Range				Structural Reinforcement Rods						Outer Rods					
	Min.-Max. (in)		Min.-Max. (mm)		Length		Rod Diameter		Rods per set	Color Code	Length		Rod Diameter		Rods per set	Color Code
					(in)	(meters)	(in)	(mm)			(in)	(meters)	(in)	(mm)		
430010267	.354	.381	8.9	9.6	80	2.03	.146	3.7	9	Blue	42	1.07	.204	5.2	11	Blue
43003195	.399	.418	10.1	10.6	80	2.03	.146	3.7	10	Yellow	42	1.07	.204	5.2	11	Yellow
43001929	.419	.439	10.7	11.1	80	2.03	.146	3.7	10	Black	42	1.07	.204	5.2	11	Black
43009490	.440	.458	11.2	11.6	81	2.06	.146	3.7	11	White	43	1.09	.204	6.4	11	White
43003233	.459	.461	11.7	11.7	84	2.13	.167	4.2	10	Purple	46	1.17	.250	6.4	10	Orange
43003234	.462	.476	11.8	12.0	84	2.13	.167	4.2	10	Purple	46	1.17	.250	6.4	10	Purple
43004061	.477	.503	12.1	12.7	84	2.13	.146	3.7	12	Orange	46	1.17	.250	6.4	10	Orange
43004164	.504	.511	12.8	12.9	84	2.13	.146	3.7	12	Red	46	1.17	.250	6.4	10	Purple
43009922	.512	.536	13.0	13.6	87	2.21	.167	4.2	11	Blue	49	1.24	.250	6.4	11	Blue
43002246	.537	.559	13.7	14.1	87	2.21	.167	4.2	11	Green	49	1.24	.250	6.4	11	Green
43004100	.560	.565	14.2	14.3	87	2.21	.167	4.2	11	Green	49	1.24	.250	6.4	11	Green
43003235	.566	.573	14.4	14.5	92	2.34	.182	4.6	11	Black	54	1.37	.250	6.4	12	Black
43009945	.574	.598	14.6	15.1	92	2.34	.182	4.6	11	Black	54	1.37	.250	6.4	12	White
43009965	.599	.625	15.2	15.8	92	2.34	.182	4.6	12	Brown	54	1.37	.250	6.4	12	Brown
43003239	.626	.632	15.9	16.0	102	2.59	.204	5.2	11	Red	63	1.6	.310	7.9	11	Red
43009760	.633	.666	16.1	16.9	102	2.59	.204	5.2	11	Red	63	1.6	.310	7.9	11	Blue
43004965	.667	.682	17.0	17.3	102	2.59	.204	5.2	12	Yellow	63	1.6	.310	7.9	11	Green
43009947	.683	.710	17.4	18.0	102	2.59	.204	5.2	12	Yellow	63	1.6	.310	7.9	11	Yellow
43004991	.711	.728	18.1	18.4	102	2.59	.204	5.2	12	White	63	1.6	.310	7.9	12	Black
43009868	.729	.744	18.5	18.8	102	2.59	.204	5.2	12	White	63	1.6	.310	7.9	12	White
43006274	.745	.750	18.9	18.9	102	2.59	.204	5.2	12	White	63	1.6	.310	7.9	12	White
43009842	.751	.786	19.0	19.9	102	2.59	.204	5.2	13	White	63	1.6	.310	7.9	12	Brown
43003240	.787	.814	20.0	20.6	111	2.82	.250	6.4	11	Green	72	1.83	.365	9.3	11	Green
43003058	.815	.845	20.7	21.4	111	2.82	.250	6.4	12	Yellow	72	1.83	.365	9.3	11	Yellow
43003028	.846	.855	21.5	21.6	111	2.82	.250	6.4	12	Green	72	1.83	.365	9.3	12	Blue
43003230	.856	.894	21.7	22.6	119	3.02	.250	6.4	12	Black	80	2.03	.365	9.3	12	Black
43003079	.895	.907	22.7	22.9	119	3.02	.250	6.4	12	White	80	2.03	.365	9.3	12	White
43003241	.908	.916	23.0	23.2	119	3.02	.250	6.4	13	Purple	80	2.03	.365	9.3	12	Purple
43003242	.917	.929	23.3	23.5	119	3.02	.250	6.4	13	Brown	80	2.03	.365	9.3	12	Brown
43003243	.930	.942	23.6	23.9	119	3.02	.250	6.4	13	Red	80	2.03	.365	9.3	12	Red
43003244	.943	.977	24.0	24.7	119	3.02	.250	6.4	13	Orange	80	2.03	.365	9.3	13	Orange
430010305	.978	1.016	24.8	25.7	118	3.00	.250	6.4	13	Purple	80	2.03	.365	9.3	12	Purple
430010306	1.017	1.057	25.8	26.8	118	3.00	.250	6.4	14	Red	80	2.03	.365	9.3	12	Red
430010307	1.058	1.079	26.9	27.3	133	3.38	.250	6.4	14	Blue	95	2.41	.365	9.3	13	Blue
430010308	1.080	1.112	27.4	28.1	133	3.38	.250	6.4	14	Green	95	2.41	.365	9.3	13	Green
430010309	1.113	1.149	28.2	29.1	133	3.38	.250	6.4	15	Yellow	95	2.41	.365	9.3	13	Yellow
43003778	1.150	1.190	29.2	30.1	131	3.33	.250	6.4	15	Red	92	2.34	.365	9.3	15	Red





PREFORMED LINE PRODUCTS

Section 7 – FIBERLIGN® Hardware Accessories for OPGW and/or ADSS

Table of Contents	Page
ADSS CORONA™ Coil	7-2
FIBERLIGN® Cable Abrasion Protector & Cable Marker	7-3
FIBERLIGN® Downlead Cushion	7-4
FIBERLIGN® Motion Control Products	
FIBERLIGN® Spiral Vibration Damper	7-7
VORTX™ Vibration Damper	7-7
FIBERLIGN® Dielectric Damper	7-7
FIBERLIGN® Air Flow Spoiler	7-7
FIBERLIGN® Cable Storage Systems	
CLAS Storage System	7-8
In-Span Storage System	7-12
FIBERLIGN® (FDC8) Drop Cable Storage Bracket	7-13
In-Span Aluminum Storage System	7-14
Cable Storage Systems	7-16
COYOTE® Defender	7-18
COYOTE® Defender 2	7-20



ADSS-CORONA™ Coil

NOMENCLATURE

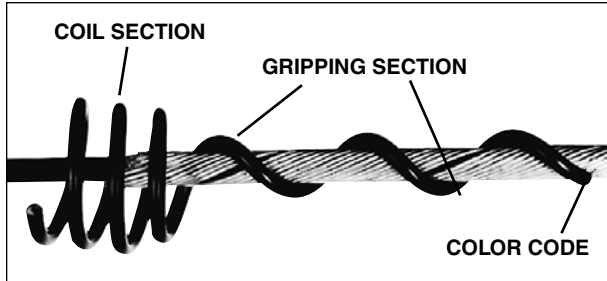

APPLICATION OPTIONS



Used with a FIBERLIGN® Dielectric Suspension



Used with a FIBERLIGN® Dielectric Dead-end



Used with a FIBERLIGN® Aluminum Suspension w/rods

GENERAL INFORMATION

ADSS-CORONA Coils are intended to reduce electrical stress at the ends of the metal rods of FIBERLIGN® Dielectric Dead-ends and Suspensions applied on ADSS cables installed in high voltage electrical fields. They are made from a light weight material and are designed to suppress electrical arcing at the ends of metal rods which can occur on some lines and may damage the plastic jacket of ADSS cables. Consult PLP® for specifics.

Application:

One unit is required at dead-end locations and two at suspension installations.

ADSS-CORONA Coils are designed and manufactured to be used only with FIBERLIGN Dielectric Dead-ends or Suspensions manufactured by Preformed Line Products. They should NOT be used with other dead-end or suspension devices.

Installation:

The Corona Suppression Coil section is centered over the ends of the metal rods for maximum stress reduction. The unit is secured in place by wrapping the unique gripping section directly over the Structural Reinforcing Rods of a dead-end and suspension. They will not interfere with the performance of the dead-end or the suspension.

They may be installed at the time of the original dead-end or suspension installation or are easily added later if desired. They can be quickly installed by hand or with conventional hot sticks.

Product Reuse:

Do not reuse ADSS-CORONA Coils once permanently installed. They may be removed and positioned during the initial installation.

Product Selection:

Consult PLP for application recommendations, catalog numbers and product availability.

FIBERLIGN® Cable Abrasion Protector & Cable Marker



FIBERLIGN ADSS Cable Abrasion Protector

The FIBERLIGN ADSS Cable Abrasion Protector is intended to protect ADSS cable jacket from abrasion from structures, trees or other cables. It is made from black, low density polyethylene for low cost and superior abrasion resistance. The tube comes in two lengths and three OD sizes. Either tube may be cut in the field to accommodate specific length needs.

Component Reuse:

ADSS Cable Abrasion Protectors may be reused as desired if in good condition.

ORDERING INSTRUCTIONS

Select the appropriate size from the catalog table in this section.

FIBERLIGN ADSS Cable Abrasion Protector

Catalog Number	Cable OD Range		Protector ID in (mm)	Protector Length
	(in)	(mm)		
PTG-0200	.238-.500	6.04-12.7	.5 (12.7)	8" (20.3 cm)
PTG-0201				6" (1.8 m)
PTG-0202	.501-1.000	12.8-25.4	1.0 (25.4)	8" (20.3 cm)
PTG-0203				6" (1.8 m)
PTG-0204	1.001-1.500	25.6-38.1	1.5 (38.1)	8" (20.3 cm)
PTG-0205				6" (1.8 m)



FIBERLIGN Fiber Optic Cable Marker

Intended Use:

The Fiber Optic Cable Marker is designed to visibly identify fiber optic cable at a wood utility pole or other structure. In addition to marking the cable with a distinct orange color, the word "CAUTION" is used to emphasize the cable type. The bright orange color is easily identifiable from ground level.

Material:

The fiber optic cable marker is manufactured from corrosion resistant, lightweight polyethylene. Polyethylene provides superior retention of physical characteristics over temperature ranges and exposure to ultraviolet radiation.

Catalog Number	Color	Cable Diameter Range Inches (mm)	Length Inches (mm)
500510903	Orange	0.7 - 1.1 (18-28)	8 (203)
The Fiber Optic Cable Marker is imprinted with the following information: "CAUTION FIBER OPTIC CABLE." The characters are printed in black lettering that is 5/16" high and located opposite the installation split.			



FIBERLIGN® Downlead Cushion for OPGW or ADSS

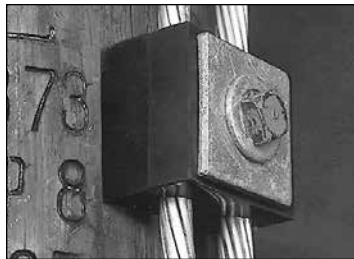

FIBERLIGN Downlead Cushion mounted to wood pole

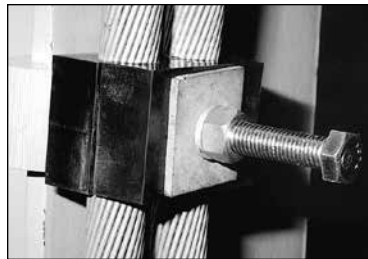

FIBERLIGN Downlead Cushion mounted to lattice tower – flush position

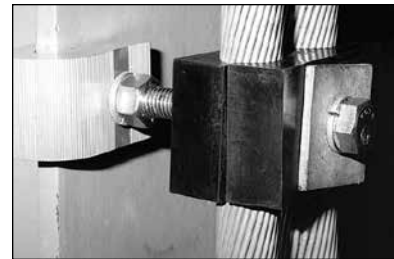

FIBERLIGN Downlead Cushion mounted to lattice tower – extended position

FIBERLIGN Downlead Cushion

GENERAL APPLICATION

The FIBERLIGN Downlead Cushion secures Optical Ground Wire (OPGW) downloads or ADSS cable downloads to structures while minimizing compressive clamping forces which could be transferred to the optical elements.

Material:

The FIBERLIGN downlead cushion is offered as an all urethane product for OPGW or ADSS applications, as well as an all aluminum alloy product for OPGW applications.

Description/Urethane:

The all urethane material is molded to form a base member and a top member, each containing two grooves which accommodate a specified range of OPGW or ADSS cable diameters. The base member can be applied to either curved pole surfaces or flat surfaces. The weather-resistant urethane is extremely durable yet pliable enough to firmly contain ADSS cable without damaging the plastic jacket.

Description/Aluminum:

The all aluminum product has identical top and bottom halves that are designed for flat surface mounting. The two grooves are machined to accommodate a specified range of OPGW. The aluminum material provides an electrical path from the OPGW cable to the structure for bonding purposes.

Mounting:

The downlead cushion is designed to accept up to 5/8" diameter bolts or screws for mounting purposes. For additional mounting options see the Mounting Accessories on the next page.

Other configurations are available. Consult PLP for availability.

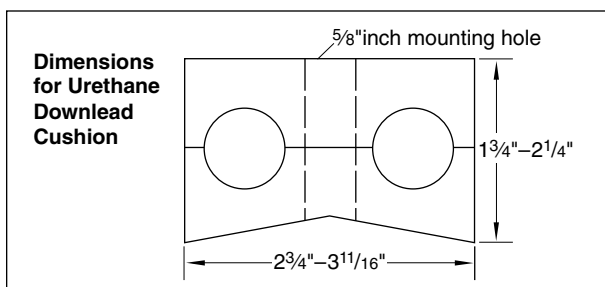

Urethane Downlead Cushion for ADSS or OPGW				
Catalog Number	Diameter Range			
	Inches		Millimeters	
	Min.	Max.	Min.	Max.
8003041	.375	.468	9.5	11.8
8003042	.469	.562	11.9	14.2
8003043	.563	.656	14.3	16.6
8003044	.657	.750	16.7	19.0
8003052	.751	.849	19.1	21.5
8003256	.850	.950	21.6	24.1
8003257	.951	1.050	24.2	26.6
8003379	1.051	1.190	26.7	30.2

Aluminum Downlead Cushion for OPGW				
Catalog Number	Diameter Range			
	Inches		Millimeters	
	Min.	Max.	Min.	Max.
8003644	.328	.374	8.3	9.5
8003654	.375	.422	9.5	10.7
8003653	.423	.468	10.7	11.9
8003266	.469	.515	11.7	13.0
8003267	.516	.562	13.1	14.2
8003268	.563	.609	14.3	15.4
8003269	.610	.656	15.5	16.6
8003270	.657	.703	16.7	17.8
8003271	.704	.750	17.9	19.0
8003477	.751	.797	19.1	20.2



To include Mounting Accessories, add respective suffix code to cushion catalog number:

- Suffix code H1 includes Hardware Kit for wood pole mount.
- Suffix code H3 includes 1/2-13 hex head bolt mounting kit for steel pole mount.
- Suffix code LTC1 or LTC2 includes Lattice Tower Clamp Kit for lattice tower mount.
- Suffix code B1 includes Limited Tension Banding Bracket Kit for concrete or steel structure mount.

FIBERLIGN® Downlead Cushion Mounting Accessories

MOUNTING ACCESSORIES

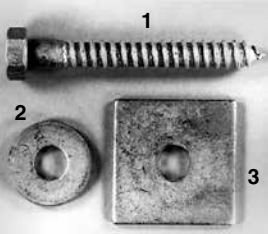
Mounting kits are offered for Wood Pole, Concrete Pole, Steel Pole, and Lattice Tower Structures. The following table lists the kits for the respective structures.

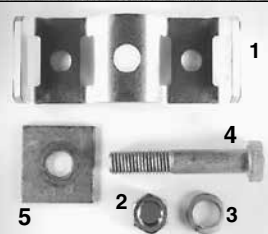
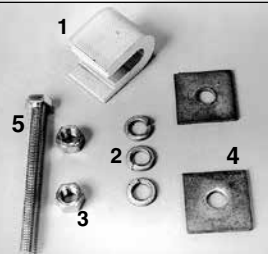
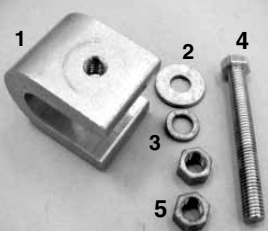
Downlead Cushion Mounting Accessories					
Catalog Number	Suffix Code	Product Name	Kit Contents	Nomenclature	Structure Application
710010017	H1	Wood Pole Hardware Kit		1. 1/2" X 4" long Lag Screw 2. Round Washer 3. Square Washer	Wood Pole
710011655	H3	1/2-13 UNC HEX Head Bolt Hardware Kit		1. 1/2-13 x 3" long Hex Head Bolt 2. Flat Washer 3. Lock Washer 4. Hex Nut	Metal or Concrete Pole with 1/2"-13 UNC Female interface
710010576	B1	Limited Tension Banding Bracket		1. Banding Bracket 2. Hex Nut 3. Lock Washer 4. 5/8-11 x 3-1/2" long Hex Head Bolt 5. Square Washer	Metal or Concrete Pole
7000400	LTC1	Lattice Tower Clamp with 6" (152mm) long bolt		1. Clamp 2. Lock Washer (3) 3. Hex Nut (2) 4. Square Washer (2) 5. 5/8-11 Hex Head Bolt	Lattice Tower
7000401	-	Lattice Tower Clamp with 10" (254 mm) long bolt			
7000402	-	Lattice Tower Clamp with 8" (203 mm) long bolt			
700011045	LTC2	Light-Duty Lattice Tower Clamp		1. Clamp 2. Round Washer 3. Lock Washer 4. 1/2-13 x 5" long Hex Head bolt 5. Hex Nut (2)	

ORDERING INSTRUCTIONS

Mounting Kits may be ordered independently by catalog number or included with Downlead Cushions by adding Suffix Code to Downlead Cushion Catalog Numbers found

on previous page. Ex. 8003042H1 includes a Urethane Downlead Cushion with Wood Pole Hardware Kit in the same carton.



FIBERLIGN® Downlead Cushion Mounting Accessories

MOUNTING KIT INSTALLATION NOTES

1/2-13 Hex Head Bolt Hardware Kit leaves approximately 1" (25 mm) of exposed thread for mounting engagement

Limited Tension Banding Brackets are used to mount downlead cushions without drilling holes. Using a 3/4" wide High Strength band (not supplied), the banding system will support a 500 pound (2.2 kN) vertical load. All components are galvanized steel.

Lattice Tower Clamps with 6", 10", or 8" long bolts can be Flush mount or Extended mount as shown below.

It is recommended to loosely pre-assemble the components for your application before transporting up the tower. The unit may be installed on any portion of the structure in any orientation.

The C-shaped clamp is designed to accept up to 1-1/8" (28.5 mm) thick tower members. The clamp is made from high strength aluminum and all other components are galvanized steel.

LIGHT DUTY Lattice Tower Clamp is provided with a C-Shaped clamp that will accept up to 1-1/8" (28.5 mm) thick tower members. The clamp is made from high strength aluminum and all other components are galvanized steel.

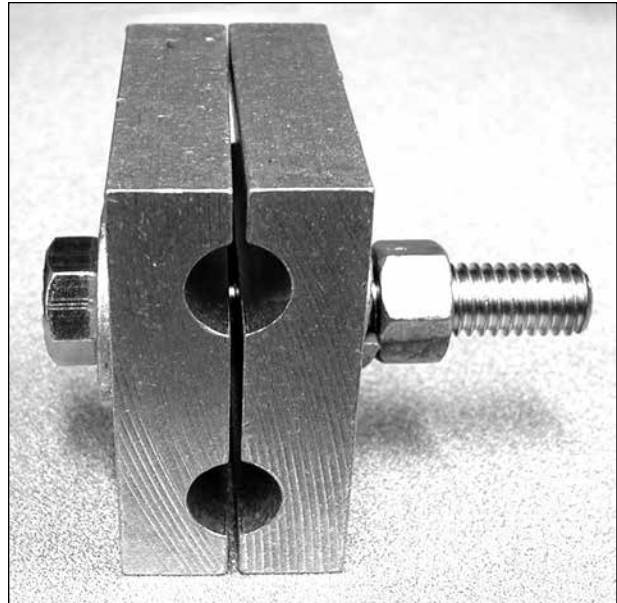

**Downlead Cushion shown with mounting kit
Catalog number 710011655, suffix code H3**

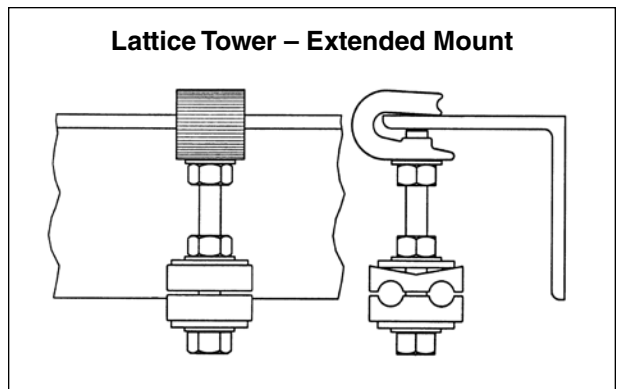
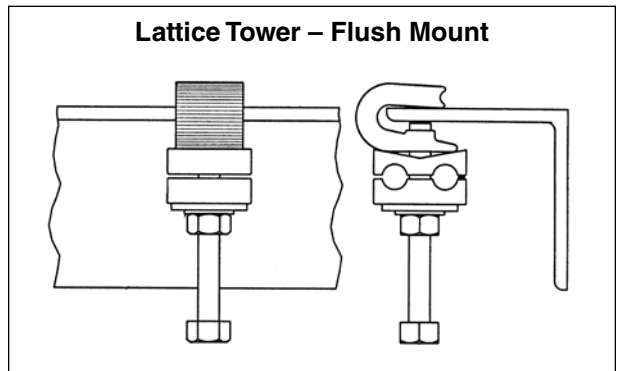

FIBERLIGN® Motion Control Products

FIBERLIGN Spiral Vibration Damper for OPGW



The FIBERLIGN Spiral Vibration Damper effectively reduces levels of aeolian vibration on Optical Ground Wire (OPGW) cables.

Each FIBERLIGN Spiral Vibration Damper has a helically formed dampening section sized for interplay of damper and cable, to provide the action/reaction motion that opposes the natural vibration wave. A smaller gripping section gently grips the cable so that cable and fiber are not damaged or distorted and there is no optical signal loss.

The degree of protection needed for a specific application depends on a number of factors such as cable type, line design, temperature, tension, and exposure to wind flow. Consult PLP® for specific recommendations.

FIBERLIGN Spiral Vibration Dampers for OPGW Cable					
Catalog Number	Diameter Range		Length inch (m)	Per Units	Carton Weight (lbs)
	inch	mm			
5050104	.327-.461	8.3-11.6	51 (1.3)	50	34
5050105	.462-.563	11.7-14.3	53 (1.3)	50	36
5050106	.564-.760	14.4-19.3	65 (1.65)	25	50

Note: Consult Preformed Line Products for recommendations on the number of dampers required per span.

VORTX™ Vibration Damper

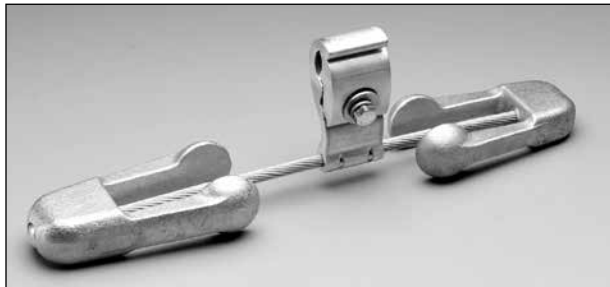

The VORTX Vibration Damper is a Stockbridge type damper. Consult Preformed Line Products for specific recommendations.

FIBERLIGN Dielectric Dampers for ADSS Cable



ADSS cables tend to vibrate at higher levels than other cables of comparable size, mainly due to their relatively lighter weight. Also, the “soft” nature of their jackets and internal construction requires special consideration.

A special damper, called the FIBERLIGN Dielectric Damper, has been developed specifically for application on ADSS cables. It utilizes the same dampening characteristics as the FIBERLIGN Spiral Vibration Damper, plus provides more gentle gripping.

FIBERLIGN Dielectric Damper for ADSS Cable					
Catalog Number	Cable Diameter Range (inches)	Cable Diameter Range (mm)	Length inches (m)	Units (per carton)	Carton Weight (lbs.)
50502393	.250-.326	6.3-8.2	49 (1.24)	50	26
50502272	.327-.461	8.3-11.6	51 (1.30)	50	28
50502274	.462-.563	11.7-14.3	53 (1.35)	50	30
50509862	.564-.770	14.3-19.5	65 (1.65)	50	46
50503057	.771-.876	19.5-22.2	71 (1.80)	25	30
50503576	.877-1.00	22.3-25.3	75 (1.91)	25	35
50503909	1.001-1.25	25.4-30.5	90 (2.29)	25	40

Note: Consult Preformed Line Products for recommendations on the number of dampers required per span.

FIBERLIGN Air Flow Spoiler

The central spoiling section of the FIBERLIGN Air Flow Spoiler suppresses galloping or dancing motion of OPGW or ADSS cables by providing a constantly changing aerodynamic profile.

Helical gripping sections on both ends of the FIBERLIGN Air Flow Spoiler secure the unit to the cable while minimizing compressive clamping forces.

The number and placement of FIBERLIGN Air Flow Spoilers in each span are determined by a computer program which considers the results of ongoing field and laboratory research.

Consult Preformed Line Products for specific recommendations.

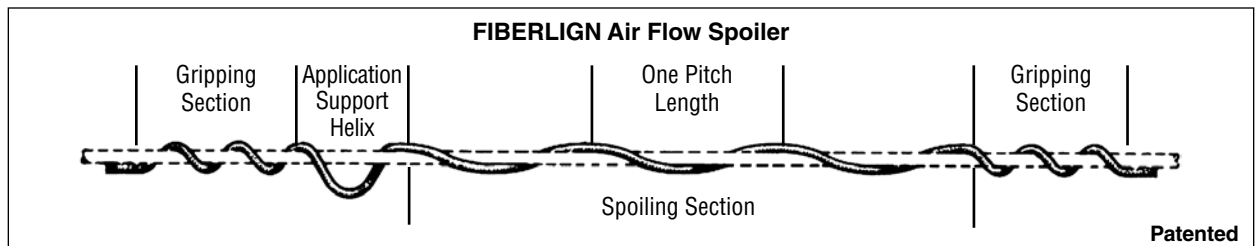



FIBERLIGN® CLAS (Center-Lock Aerial Slack) Storage

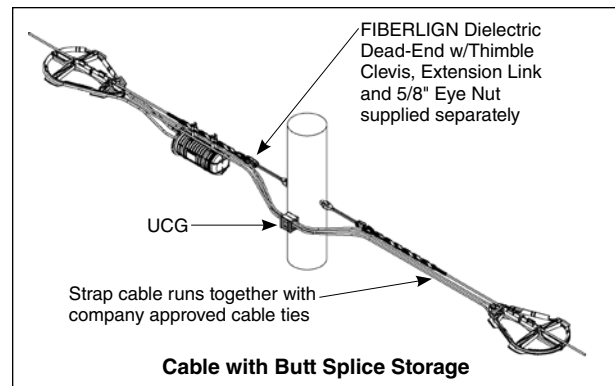
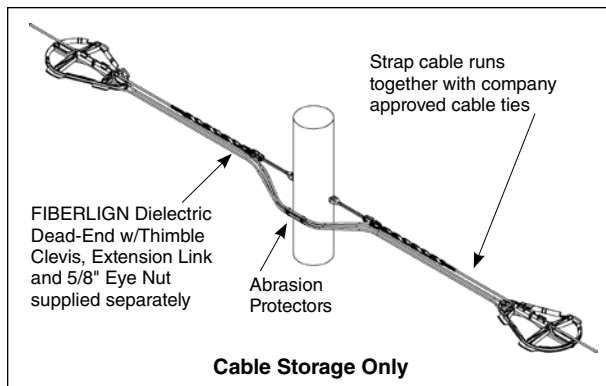

GENERAL INFORMATION

Storing slack fiber optic cable is necessary to reach the clean environment of a splicing van, allow expansion for future community development, and compensate for street widening or pole damage. The FIBERLIGN® CLAS Storage provides a flexible method of handling all system challenges at minimal cost — and an alternative solution for limited pole space or labor intensive underground vault storage.

FIBERLIGN CLAS Storage is designed to store fiber optic cable in span while maintaining minimum bend radius requirements for cables up to 1" diameter. Kits are packaged for "cable only" or cable with butt splice closure storage in span. A cable storage system includes 2 CLAS Storage brackets with bracket straps and cable guide or protection (for cable passing the pole). Appropriate splice case brackets are added for cable & butt splice closure storage. Optional heavy duty cable straps may be added to any kit selection.

Center-Lock Design Reduces Labor & Parts

Each FIBERLIGN® CLAS Storage bracket has a male and female half joined at the center-lock hinge. The hinge allows the bracket halves to swing open, rest onto the main cable, and close into storage position (butterfly motion) — thus eliminating excess attachment components and metal fasteners. Heavy-duty bracket straps simplify attachment to the main cable, and simultaneously lock the bracket while securing slack cable. Consequently, preparation time to build the center connection is eliminated, installation time is reduced, and no tools are required.

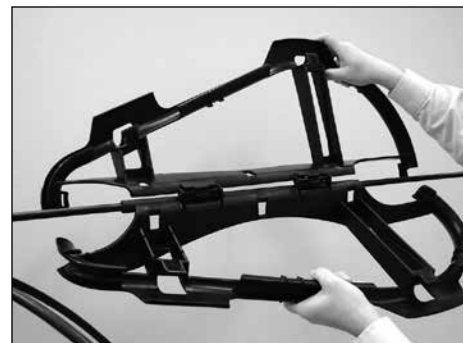

Center-Lock Hinge Swings Open

FEATURES

- Center-Lock Hinge allows CLAS Bracket to swing open and rest on top of main cable for convenient positioning and simple attachment.
- Extended hinge area distributes load along cable interface.
- Neatly organizes storage of cable and splice closures in the span instead of on the structure
- Minimizes infringement of poles space
- Maximum cable loop diameter support 20" (508 mm) with expansion tabs
- No limit to the amount of cable that can be stored.
- PLP Abrasion Protectors are offered as economical cable protection for cable passing the pole.
- Uni-Group Cable Guide (UCG) option can be used for low profile cable guide for cable passing the pole. Fasteners included
- Folds and separates at the Center-Lock Hinge for efficient storage.
- Safe all dielectric materials with superior system life.
- Heavy Duty Cable Straps can be ordered with kits or separately

FIBERLIGN® CLAS (Center-Lock Aerial Slack) Storage

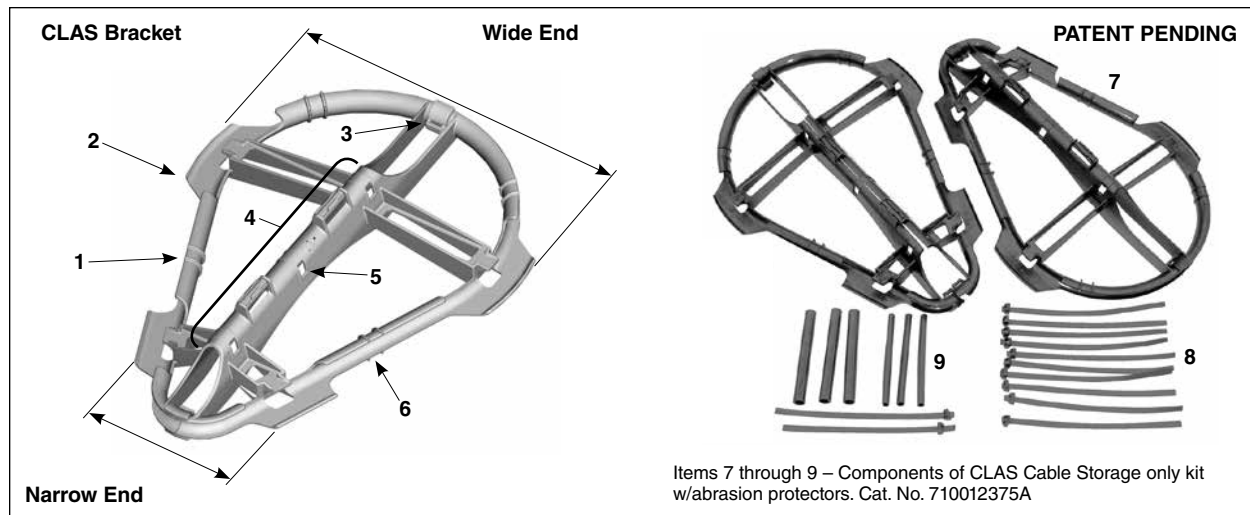

NOMENCLATURE

1. Cable strap locator
2. Expansion Tab for wider (20") storage options
3. Locking Slot – one at narrow end and wide end allows cable strap through
4. Center-Lock Hinge Area
5. Aperture – 3 openings to lace straps and secure to main cable
6. Slack/Surplus cable channel
7. 18" (457mm) CLAS Bracket male & female half
8. Heavy Duty (HD) 13" (330mm) long cable straps
9. 8" (203mm) Abrasion Protectors with 2 HD cable straps
10. ADSS Cable Clamp*
11. COYOTE® Closure Brackets for COYOTE® PUP, 6" X 22", and 8.5" X 22" Closures.
12. COYOTE® RUNT Brackets
13. COYOTE® Splice Case Brackets (or aerial hanger brackets) included with every Stainless Steel COYOTE Splice Case
14. Universal DOME Brackets for Domes up to 8" (203mm) OD Dome Closures includes two worm gear clamps
15. COYOTE® In-Line RUNT Brackets

*ADSS Clamps are supplied for respective COYOTE mounting hardware, items 11, 12, 13, 14 & 15. Catalog numbers for the combinations are found later in this section in the Aerial Closure Mounting Kits table.

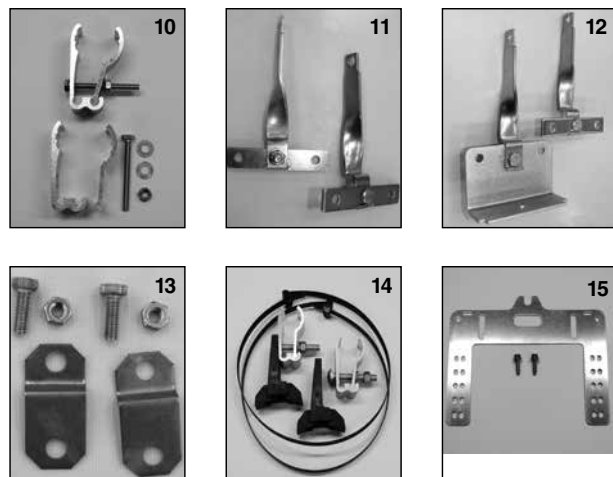

INSTALLATION INFORMATION

FIBERLIGN® CLAS Storage detailed application procedures are provided with the product and also found on PLP's website. Instructions are provided for cable storage only as well as cable storage with butt splice. Heavy duty cable straps are used to secure each CLAS bracket to the cable.

18" (457mm) cable loop diameters are stored against the cable channel. Expansion tabs provide support for A) an outer cable wrap in Butt Splice applications or B) for large cables stored in an over and under (the tab) cable loop configuration. Maximum Loop diameter using expansion tabs is 20" (508mm).



FIBERLIGN® CLAS (Center-Lock Aerial Slack) Storage

Kits include either the economical **cable abrasion protectors** or the low profile **Uni-Group Cable Guide (UCG)** for the cable passing by the pole. **Cable abrasion protectors** are 8" long polyethylene slit sleeves that slide over the cable – secure in place with 2 factory supplied cable straps. Two sizes of abrasion protectors are supplied to cover cables up to .5" diameter and from .501"-1.00". The **UCG** offers a controlled method of guiding the cable past the pole in tight pole space applications. This guide will capture up to 5 each 1" diameter cables within a 4-1/4" pole space. Either method can be used for any structure application. The UCG includes lag bolts for wood pole applications and machine bolts for banded applications on steel or concrete poles. The UCG will accept a maximum 3/4" (19mm) wide band – band is not supplied.



Cable straps are used to strap the cable to CLAS Storage brackets and cables together. PLP offers Heavy Duty 1/2" wide UV resistant cable straps with the kits as an option.

For relatively small diameter cables approaching 0.40" (10mm), an optional filler tube may be used to increase the outer diameter, which can help surface engagement with the cable straps. PLP offers filler tubes which are 20" long and slit for easy installation. See catalog number in ordering instructions.

ORDERING INSTRUCTIONS

FIBERLIGN® CLAS Storage Kits

The FIBERLIGN® CLAS Storage product has a suffix code system for ordering in various configurations. The main catalog number 710012375 identifies common components for kits with and without butt splice storage. Suffix codes are added to identify the type of Closure Bracket kit, the Pole Pass Type, and the option of 25 extra Cable Straps. Cable straps are used to strap the slack cable to CLAS Bracket and main cable. The ordering key is shown along with an example as follows:

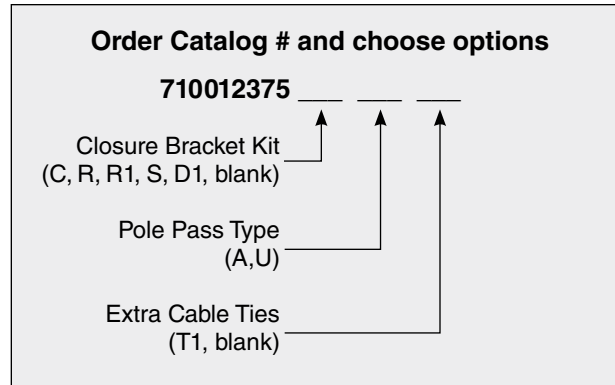

Aerial Closure Bracket Kits	Option
No Brackets – Cable Storage Only	Blank
Classic COYOTE PUP, 6" x 22", and 8.5" x 22"	C
Classic COYOTE RUNT	R
COYOTE In-Line RUNT Closure	R1
Stainless Steel Splice Case	S
Universal Dome Mounting Kit for 8" Max Dome O.D.	D1
Pole Pass Type	Option
Abrasion Protectors	A
Uni-Group Cable Guide	U
Extra Cable Ties	Option
No Extra Ties (10 included in kit)	Blank
25 Extra Heavy Duty Cable Ties (P/N80808917)	T1

Example: Cable Storage with BUTT Splice for 6.5" x 17" COYOTE® Dome and UCG:

Catalog No. **710012375D1U**

This kit includes:

- COMPONENTS of 710012375 (common to all kits)
 - 2 each FIBERLIGN CLAS Storage Brackets with bracket cable straps (5 per bracket)
- SUFFIX CODE "D1"
 - Universal Dome mounting brackets for Domes up to 8" Max O.D.
- SUFFIX CODE "U"
 - Uni-Group Cable Guide with fasteners.

Filler Tube	
Catalog Number	Description
699912980	Filler Tube for cables < .5" - 20" long, 10 pack

FIBERLIGN® CLAS (Center-Lock Aerial Slack) Storage

Aerial Closure Mounting Kits

Mounting kits are offered separately for Butt Splice products.

Catalog Number	Description
8003459	Mounting Kit for Classic COYOTE® Closures 6" x 22", 8.5" x 22", and COYOTE® PUP Closure for ADSS
8003474	Mounting Kit for Classic COYOTE® RUNT Closure for ADSS
8003460	Mounting Kit for COYOTE® Splice Cases (all sizes) includes ADSS Cable Clamps
8004035	Universal Mounting Kit for Dome Closures up to 8" Dia., for ADSS
8003864	Mounting Kit for COYOTE In-Line RUNT Closure for ADSS

ADSS Armor Rods

ADSS Armor Rods are available for ADSS cable protection at locations where Closure Mounting Brackets are installed away from Dead-ends. All sets have an overall length of 27" (.68 meters).

Catalog Number	Cable O.D. Range		Rod Dia. (mm)	Rods per set	Subsets	Color Code
	in	mm				
1000172	.400-.450	10.1-11.4	.102" (2.6)	15	5-5-5	Red
1000173	.451-.509	11.5-12.9	.102" (2.6)	15	5-5-5	Black
1000174	.510-.575	13.0-14.6	.102" (2.6)	16	4-4-4-4	Blue
1000175	.576-.649	14.7-16.4	.102" (2.6)	18	5-5-4-4	Orange
1000176	.650-.730	16.5-18.5	.121" (3)	17	5-4-4-4	Green
1000177	.731-.820	18.6-20.8	.121" (3)	19	5-5-5-4	Brown
1000178	.821-.920	20.9-23.3	.136" (3.5)	19	5-5-5-4	Yellow
1000179	.921-1.007	23.4-25.6	.136" (3.5)	20	5-5-5-5	Purple



FIBERLIGN® In-Span Storage System

GENERAL INFORMATION

The innovative Cable Capture Tabs of the FIBERLIGN® In-Span Storage (FIS) are designed to make aerial slack cable storage faster and easier. During installation, the cable is clipped into the tabs and then the storage bracket is pulled into its final position at the back of the cable loop.

The cable is secure and the installer's hands are free to apply cable ties.

Less cable ties are required, saving time and money. Adjustments to the cable loop or storage bracket are simple.



12" and 16" Bracket Sizes

KEY FEATURES

- Available with hanger brackets for either lashed messenger cable systems or ADSS
- Vertical stacking of multiple cables provides large storage capacity in a small profile
- Abrasion Protectors or Uni-Group Cable Guide are offered as pole pass options for cable slack against the pole
- Uni-Group Cable Guide guides cable through low profile applications between communication and utility zones

FIS for Lashed Messenger Cables		
Catalog Number	Description	Messenger Installation
FIS12M	Pair of 12" (30.5 cm) diameter storage brackets with messenger hanger brackets	
FIS16M	Pair of 16" (40.6 cm) diameter storage brackets with messenger hanger brackets	
FIS for ADSS Cables		
Catalog Number	Description	ADSS Installation
FIS12A	Pair of 12" (30.5 cm) diameter storage brackets with ADSS hanger brackets	
FIS16A	Pair of 16" (40.6 cm) diameter storage brackets with ADSS hanger brackets	

Optional Accessories		
FISxxx –		
Cable Ties		
25 Pack of Cable Ties	T	
No Cable Ties	Blank	
Pole Pass Option		
Uni-Group Cable Guide	U	
Abrasion Protectors	A	
None	Blank	
Sample Catalog Number		
FIS16A-TU		
Pair of 16" (40.6 cm) diameter storage brackets for ADSS, 25 cable ties, and Uni-Group Cable Guide		

Quick Installation	
Captures cable loop	Slides into final position



Abrasion Protectors



Uni-Group Cable Guide

FIBERLIGN® (FDC8) Drop Cable Storage Bracket

GENERAL INFORMATION

FIBERLIGN® Drop Cable Storage Bracket (FDC8) stores slack cables in aerial, pole mount, vault & wall entrance installations. The 8" diameter size will store round drop cable up to .400" OD and flat drop cables. Similar to the FIBERLIGN® In-Span Storage system (FIS), hanger brackets are used for ADSS and Lashed messenger cable. The injection molded plastic provides a durable, UV resistant design and capture tabs secure and protect the slack cable under high wind and/or ice loading conditions. Mounting options are provided for various applications in convenient kits.

KEY FEATURES

- 8" (203 mm) diameter slack storage – Flat and round drop cable applications
- All Dielectric UV resistant Material – Non-conductive and UV protected for safe long term use
- Kits for various applications – Aerial, Pole, Vault, and Wall mount kits
- Molded nut pockets & hanger guides – Simplify installation
- Stackable (with stacking kit) – Provides multi-level slack management
- Capture Tabs – Harness cable loops during installation for easier handling, minimized need for tie wraps, and allow easy cable manipulation between tabs (stacked or not).

ORDERING INSTRUCTIONS

Catalog numbers for FIBERLIGN® Drop Cable storage kits and various accessories can be found in the table below. The images show respective application of each single bracket kit.



FDC8



FDC8M



FDC8A



FDC8P



Stackable

FIBERLIGN® Drop Cable 8" Storage Bracket Kits

Catalog Number	Description	Application	Hardware Included
FDC8	FIBERLIGN® Drop Cable 8" Storage - Single Bracket	Vault or Wall Service Entrance	None
FDC8M	FIBERLIGN® Drop Cable 8" Storage "Messenger" - Single Bracket	Aerial Lashed Messenger Systems	Messenger bracket, clamp, 1/4" carriage bolt, 1/4" nylon lock nuts
FDC8A	FIBERLIGN® Drop Cable 8" Storage "ADSS" - Single Bracket	Aerial ADSS Systems	ADSS bracket, cable cushions, 1/4" carriage bolt, 1/4" nylon lock nut, cable strap
FDC8P	FIBERLIGN® Drop Cable Storage "Wood Pole" - Single Bracket	Wood Pole	1/4" x 3" long lag bolts, 1/4" washers, 1/4" nylon lock nuts
7400029	Messenger Mounting Bracket - One each	Aerial Lashed Messenger Systems	Messenger hanger bracket
7400028	ADSS Mounting Bracket - One each	Aerial ADSS Systems	ADSS hanger bracket with strap
7400030	FDC8 Stacking Kit - One kit	Aerial, Pole, Vault, Wall	Fasteners w/2 spacers, 1/4" x 3" long bolts, 1/4" washers, 1/4" nylon lock nuts

Applications:

Round cable outer diameter ≤ .400" (10.16 mm)

Flat cables: verify minimum bend diameter ≤ 8" (20.3 cm) per cable manufacturer



FIBERLIGN[®] In-Span Aluminum Storage Systems

GENERAL INFORMATION

FIBERLIGN In-Span Aluminum Storage Systems store slack ADSS and Lashed messenger cable. The conventional aluminum channel design covers a complete range of sizes from small diameter cable applications through large diameter ribbon cable applications. Convenient options can be added including durable cable straps, pole pass options, and wide channel for multi-cable storage.

KEY FEATURES

- Neatly organizes storage of cable in the span instead of on the structure.
- Complete range of sizes 10" through 30" storage loop brackets.
- Wide channel option captures multiple cables for more cable runs or butt splice applications
- Standard Black Powder Coat Finish
- Abrasion Protectors or Uni-Group Cable Guide pole pass options.
- Hanger brackets have simple one bolt /lock nut attachment
- ADSS aluminum hanger bracket includes plastic cushion and durable cable strap connection

BASE KIT CATALOG NUMBERS

FIBERLIGN In-Span Aluminum Storage (FISA) Sizes and Base Kit Catalog Numbers

Storage Bracket Size Inches (mm)	Max Cable OD ¹ Inches (mm)	Base Catalog Number	
		Messenger Kit	ADSS Kit
10 (254)	0.5 (12.7)	FISA10MB	FISA10AB
		FISA12MB	FISA12AB
12 (304)	0.6 (15.2)	FISA12MBW*	FISA12ABW*
		FISA16MB	FISA16AB
16 (406)	0.8 (20.3)	FISA16MBW*	FISA16ABW*
		FISA18MB	FISA18AB
18 (457)	0.9 (22.9)	FISA18MBW*	FISA18ABW*
		FISA20MB	FISA20AB
20 (508)	1 (25.4)	FISA24MB	FISA24AB
24 (609)	1.2 (30.5)	FISA30MB	FISA30AB
30 (762)	1.5 (38.1)		

¹For most Loose Tube Buffer Tube OD cables. Verify minimum cable bend diameter for Ribbon Cable applications.

*Wide Multi-Cable Channel available for these sizes

BASE KIT CONTENTS



Base Messenger Kit

Base kit for messenger applications includes 2 each cable storage brackets with hanger tap brackets to attach to messenger.



Base ADSS Kit

Base kit for ADSS applications includes 2 each cable storage brackets with cushioned hanger brackets and 4 cable straps to attach to ADSS main cable.

INSTALLATION



FISA "M" Bracket Installed Messenger Application



FISA "A" Bracket Installed ADSS Application

FIBERLIGN® In-Span Aluminum Storage Systems

ORDERING INSTRUCTIONS

FISA Catalog Number Code	FISA	12	A	B	-T	U
“FISA” FIBERLIGN® In-Span Aluminum Storage	↑	↑	↑	↑	↑	↑
Storage Bracket Loop Diameter Size (10, 12, 16, 18, 20, 24, 30) Size based on minimum bend diameter of cable		↑	↑	↑	↑	↑
Application “A” for ADSS, “M” for messenger Includes appropriate Hanger Bracket			↑	↑	↑	↑
Storage Bracket Color “B” for black (standard)				↑	↑	↑
Channel Width “W” wide, standard is blank					↑	↑
Cable Straps (25) included with kit “T”, blank is no straps					↑	↑
Pole Pass Option						↑
“ A ” Abrasion Protectors,						↑
“ U ” Uni-Group Cable Guide for confined pole space						↑
Blank is no pole pass						↑

The Catalog Number Code Example above is ordered as “FISA12AB-TU”

POLE PASS OPTIONS



Abrasion Protectors



Uni-Group Cable Guide



FIBERLIGN[®] Cable Storage Systems

FIBERLIGN Vertical Cable Storage Assemblies for ADSS or OPGW Fiber Optic Cable

GENERAL INFORMATION

FIBERLIGN Vertical Cable Storage Assemblies provide a method for storing ADSS or OPGW cable on wood poles, metal poles, concrete poles, and lattice towers. PLP offers two types of systems 1) Independent Crossarm and Spool System and 2) Fixed Crossarm System. Type 1 includes four basic kits can be combined into various configurations to suit your specific application. Type 2 kits have one configuration (see next page for Type 2). Cable ties (not supplied) can be used to neatly group cable and secure cable to spools or keepers if desired.

Cable Storage Type 1 – Independent Crossarm System

The fundamental component of each basic kit is a durable urethane storage spool that provides a smooth curved surface for proper support of the stored cable. The basic kit catalog numbers are found in the following table.

Independent Crossarm and Spool System					
Catalog Number	8003493	800011408	8003503	8003503B1	8003503LTC1
Kit Description	OPGW/ADSS Vertical Cable Storage Assembly	ADSS Vertical Cable Storage Assembly	Cable Storage Spool	Cable Storage Spool w/Banding Bracket	Cable Storage Spool & Lattice Tower Clamp
Image of Kit					
Application	For wood pole, metal pole, & lattice tower OPGW 5ft loop dia x 300 ft long with spools at extreme position.	For wood pole, metal pole, and lattice tower ADSS 2 ft loop dia x 130 ft. long.	Spool for wood pole mounting. Accepts 5/8" through bolt	Spool with Banding Bracket, Accepts 1-1/4" wide band - for Metal Pole mounting	Spool for lattice tower mounting. Clamp accepts 1.1 max thickness

ORDERING: Order catalog number combinations for suggested configurations below

Catalog Number (Quantity)	8003493 (1)	800011408 (1)	8003493 (1) 8003503 (1)	8003493 (1) 8003493B1 (1)	8003569 (1)	8003503LTC1 (3)	8003569 (1)
Image of Configuration							
	Single Arm	Triple Spool/ Single Arm	Banded Triple Spool/ Single Arm	Double Arm for OPGW	Triple Spool Lattice Tower	Double Arm on COYOTE [®] Defender (Defender not included)	Double Arm on COYOTE [®] Defender (Defender not included)

Note: 5/8" through bolts, 5/8" Double Arming Bolts (DA Bolts), bands, and Defender are not supplied with the kits. 5/8" through bolts and Double Arming bolts are typically used to mount crossarms and spools to wood poles.

KEY FEATURES

- Flexible Configurations with basic kits
- Mounting options conform to most structures
- Accommodates cable manufacturer suggested storage diameters
- Black Urethane Storage Spool provides soft curved support for cable
- Steel Components have Galvanized or zinc plated protection.
- COYOTE[®] Defender Application – Self Tapping Screw stops

FIBERLIGN® Cable Storage Systems

GENERAL INFORMATION (cont.)

Cable Storage Type 2 – Fixed Crossarm Systems.

Crossarms are bolted together with a vertical member that can be bolted or banded to the structure. The FIBERLIGN® ADSS Cable Storage supports a 33" Loop diameter and the FIBERLIGN® Cable Storage 2 for OPGW supports a 60" loop diameter.

KEY FEATURES

- Metal channel structural frame provides a durable lightweight design with ridged strength that is easy to install
- Corrosion Resistant Materials
 - Aluminum for ADSS frame
 - Galvanized Steel for OPGW frame
- Bolt together Crossarm packs in uniform low profile container that reduces shipping cost and is easier to inventory
- Multiple Keyholes adapt various Splice Cases
- Wide cable keepers avoid point loads and provide better cable support

FIBERLIGN Cable Storage Assemblies Fixed Crossarm Systems		
Catalog Number	8004072	80061195
Kit Description	FIBERLIGN® ADSS Cable Storage	FIBERLIGN® Cable Storage 2 for OPGW
Image of Kit		
Application	For wood pole, metal pole, & lattice tower. 2.75' loop dia x 150 ft long up to 3/4" dia. cable	For wood pole, metal pole, and lattice tower. 5 ft loop dia. x 300 ft long OPGW cable storage up to 3/4" dia. Cable.

Kits with Compatible Mounting on ADSS Cable Storage or OPGW Cable Storage 2

Catalog Number	Description	Fits Storage Catalog Number
COYW6xxyzzz*	Mounting Adapter included with COYOTE Dome Kits for OPGW	80061195
8004066	FIBERLIGN® ADSS Cable Storage Kit (same as 8004072) with COYOTE® Dome Mounting kit for 6.5" x 17" and 6.5" x 22"	N/A
80812352	Mounting Bracket Kit for COYOTE® Closures 6" x 17", 6" x 22", and 8.5" x 22"	80061195
8003472	Mounting Bracket Kit for COYOTE® Splice case 6.5" x 22", 6.5" x 28", 8.5" x 28", 9.5" x 28"	80061195
80061194	COYOTE® Defender 2	80061195

*Generic catalog number. Specific kit numbers can be found in section 9, page 8 (9-8).

ORDERING INSTRUCTIONS

Order the appropriate fixed crossarm FIBERLIGN® Cable Storage kit for ADSS cable or OPGW cable. OPGW cable is limited to the 60" loop diameter thus there is one option for fixed crossarm storage – Catalog no. 80061195. You

may also mount various closures or ballistic protection using mounting adapters if necessary – choose from those listed in the table above. For other applications, please contact PLP technical support.



COYOTE® Defender

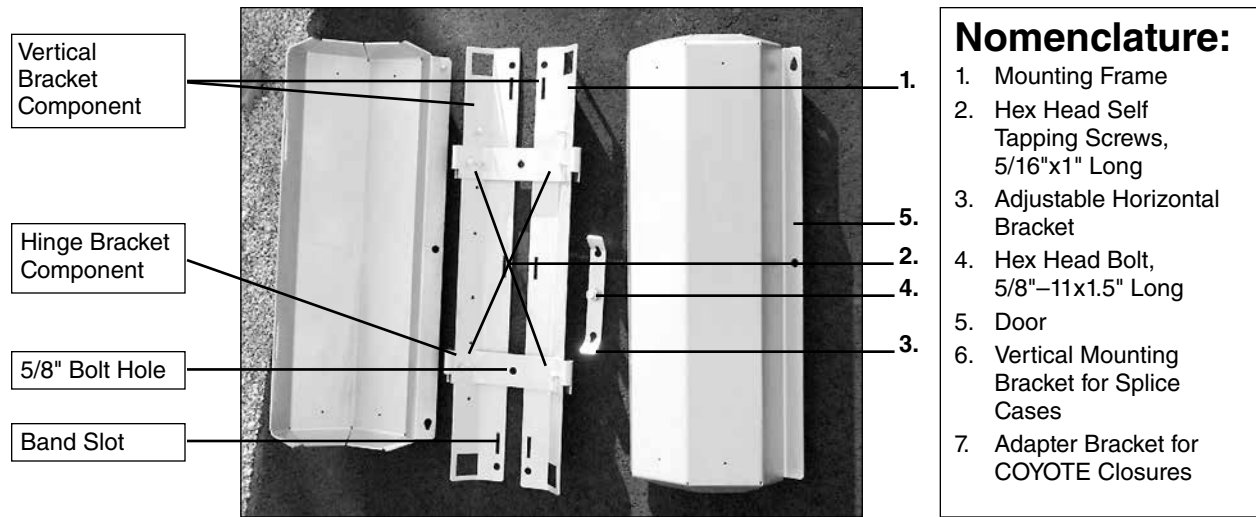

- Nomenclature:**
1. Mounting Frame
 2. Hex Head Self Tapping Screws, 5/16"x1" Long
 3. Adjustable Horizontal Bracket
 4. Hex Head Bolt, 5/8"-11x1.5" Long
 5. Door
 6. Vertical Mounting Bracket for Splice Cases
 7. Adapter Bracket for COYOTE Closures

GENERAL INFORMATION

The original COYOTE Defender provides added protection for most PLP splice enclosure products including the stainless steel COYOTE Splice Case up to 28" long, injection molded COYOTE® CLOSURES, and COYOTE® Dome Closures. The Mounting Frame comes assembled from the factory - Hinge Brackets and Vertical Bracket components are fastened with 5/16" x 1" long self tapping screws. The Hinge Brackets are positioned 19" apart to mount the 28" long COYOTE Splice Cases. All other Splice Case and Closures are accommodated with the Adjustable Horizontal Bracket. Two large Doors and the Mounting frame surround the closure or splice case and allow easy access for future maintenance or expansion. The frame can be installed first, followed by each door (Door Weight 38# each) thus reducing the chore of lifting a bulky steel unit - this makes the Lineman's task manageable and less hazardous.

If cable storage is necessary, the Defender mounting frame accepts the original FIBERLIGN® Crossarm Storage with Spool System. Slots provided near top and bottom of the frame allow the storage crossarms to slide into the frame and lock with self tapping screws.

MOUNTING OPTIONS: The COYOTE Defender can be mounted with through bolts, DA bolts, or banding. The frame will accept standard 5/8" through bolts and DA bolts. Use the mounting frame as a template to locate positions for drill through on wood pole structures. Double Arming bolts must not extend 1.5" beyond the Hinge Bracket surface to avoid splice case interference. Banding slots are provided in 6 positions along the frame. The band slots will accept up to 1.5" wide banding. For banding applications, 5/8" x 1.5" bolts are used to provide attachment to the mounting frame.

ORDERING INSTRUCTIONS

- 1) Select the COYOTE® Defender catalog kit number for the respective COYOTE Splice Case, COYOTE® Closure, or COYOTE® Dome application (see table of COYOTE® Defender catalog numbers and application). The Defender kits include the appropriate vertical mounting brackets to hang the respective splice case or closure.
- 2) Select Vertical Cable Storage Systems - If cable storage is required, simply order Catalog No. 8003569 for the double arm kit to fit into the frame. Other configurations may be selected from the Independent Crossarm and Spool System catalog table earlier in this section.

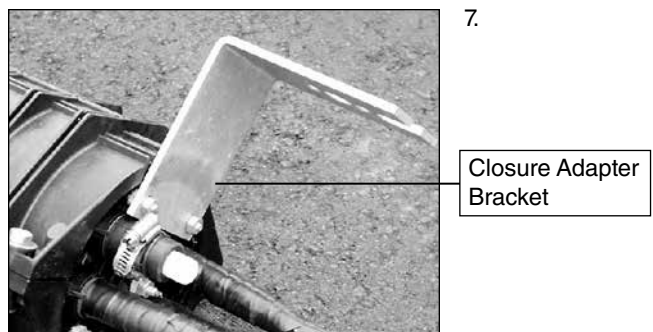
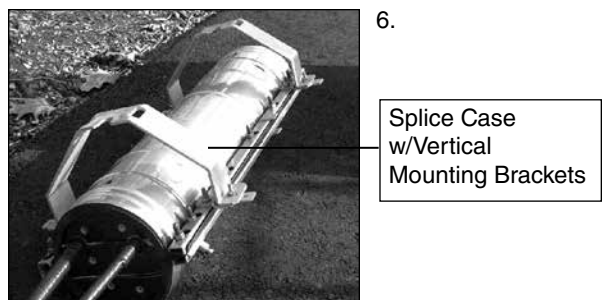

COYOTE® Defender

COYOTE Defender Catalog Numbers for Respective Splice Closure Application		
Catalog Number	Application	
	Type	Size (mm)
8003491	COYOTE Splice Case	6.5" x 22" (165 x 559)
8003491		6.5" x 28", 8" x 28", 9.5" x 28" (165 x 711, 203 x 711, 241 x 711)
8003492	COYOTE Closure	6" x 17" COYOTE PUP (152 x 432)
8003492		6" x 22", 8.5" x 22" (152 x 559, 216 x 559)"
800012162	COYOTE Dome Closure	6.5" x 17", 6.5" x 22"
800011916	COYOTE RUNT Closure	8.5" x 14.75"

Accessories:
 Vertical Cable Storage:
 Double Arm Configuration: Order 1 Ea. Catalog Number 8003569
 (See FIBERLIGN® Cable storage section for more assembly options)
Note: The Defender frame accepts the standard crossarm of vertical cable storage assemblies, 5/16" x 1" self tapping screws lock arms into place.

EXAMPLES

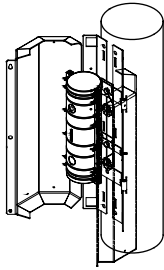
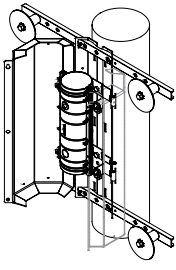
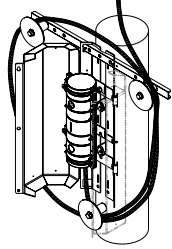
COYOTE Defender With and Without Vertical Cable Storage Accessories		
		
Basic Kit*	Kit With Double Arm Storage Assembly*	Kit With One Cable Storage Assembly and One Spool*
*Splice Case not included		



COYOTE® Defender 2

Ballistic Protection for the COYOTE® Dome Closure CRB System for OPGW

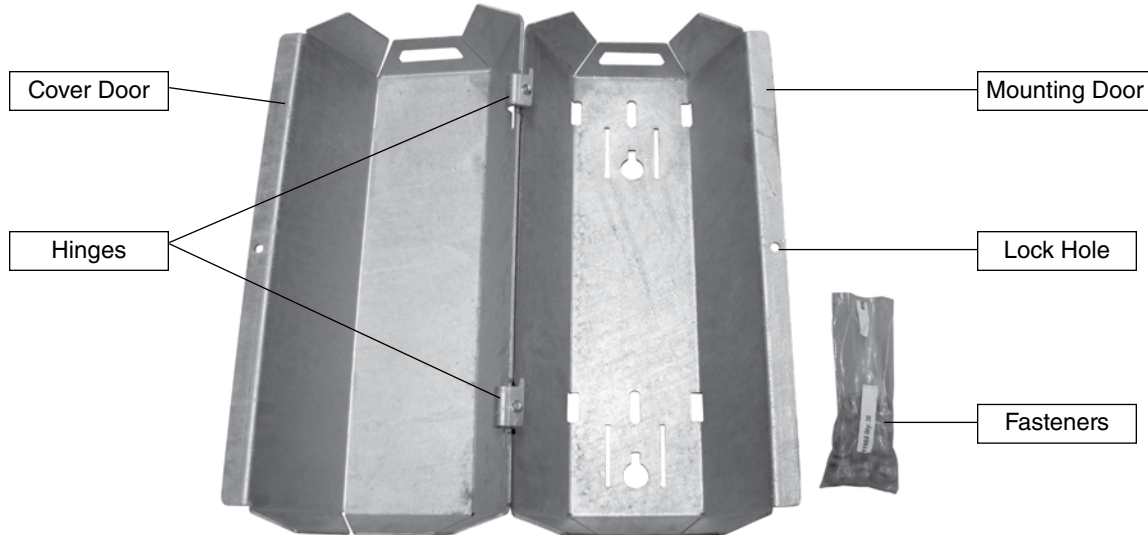

Catalog Number 80061194

GENERAL INFORMATION

The new COYOTE® Defender 2 is a condensed version of its predecessor as it is tailored to accommodate the COYOTE® Dome Closure CRB System for OPGW. In comparison to the original Defender, the Defender 2 reduces overall weight by 1/3 without sacrificing the level of ballistic protection as the 7 gauge steel thickness remains the same.

The Defender 2 has two hinged doors with one door that mounts against the structure and the cover door that swings open for easy access. Separating the doors during installation keeps the weight (37#/door) and size manageable and safe to handle.

MOUNTING OPTIONS: The Defender 2 can be mounted direct to the structure via 5/8" through bolts, DA bolts, or 1-1/4" wide band material. The Defender 2 can also be mounted to the FIBERLIGN® Cable Storage 2 at cable storage locations.

ORDERING INSTRUCTIONS

Order Catalog Number 80061194 to receive the COYOTE® Defender 2 kit shown above. As shown below, this kit can be mounted to the FIBERLIGN® Cable Storage 2 kit #80061195 (ordered separately). For more details about FIBERLIGN® Cable Storage 2, see earlier section.



Catalog Number	Cable Storage and Ballistic Protection**
80061195	FIBERLIGN® CABLE Storage 2 for OPGW, 60" Loop
80061194	COYOTE® DEFENDER 2 for 6.5" x 17" and 6.5" x 22" Domes

**COYOTE Dome Kits include a Mounting Adapter that can vertically mount the dome directly to wood poles or band to metal poles. The modular design of the mounting adapter can be mounted to the FIBERLIGN® CABLE Storage 2 and COYOTE Defender 2 as well.



PREFORMED LINE PRODUCTS

Section 8 – FIBERLIGN® Hardware for Aerial FTTP Applications

Table of Contents	Page
FIBERLIGN Products for ADSS Applications	
FIBERLIGN ADSS Drop Cable Dead-end	8-3
FIBERLIGN Midspan Drop	8-5
FIBERLIGN Lite Support.....	8-6
FIBERLIGN Tangent Support	8-7
FIBERLIGN Products for Figure 8 Drop Cable Applications	
FIBERLIGN Figure 8 Drop Cable Dead-end	8-9
FIBERLIGN Lite Support for Figure 8 Drop Cables	8-10
FIBERLIGN Tangent Support for Figure 8 Drop Cables.....	8-11



FIBERLIGN® Products for ADSS Applications

GENERAL INFORMATION

All Dielectric Self Supporting (ADSS) cables designed for the last mile are relatively small and have very low load requirements for pole-to-pole distribution and pole-to-premise service drops. Distribution span lengths are typically less than 300' and service drops are typically less than 150'. ADSS type drop cables are supported with non-metallic strength members and protected by an outer plastic sheath. This section covers attachment hardware products for ADSS cables followed by similar products for Figure 8 cables.

ADSS Drop cables are available in round and flat profile construction. FIBERLIGN® Products for ADSS are designed for both round and flat profile cables.

FIBERLIGN Products for ADSS include:

- FIBERLIGN ADSS Drop Cable Dead-end
- FIBERLIGN Midspan Drop
- FIBERLIGN Lite Support
- FIBERLIGN Tangent Support

FIBERLIGN® Products for ADSS Applications

FIBERLIGN® ADSS Drop Cable Dead-end

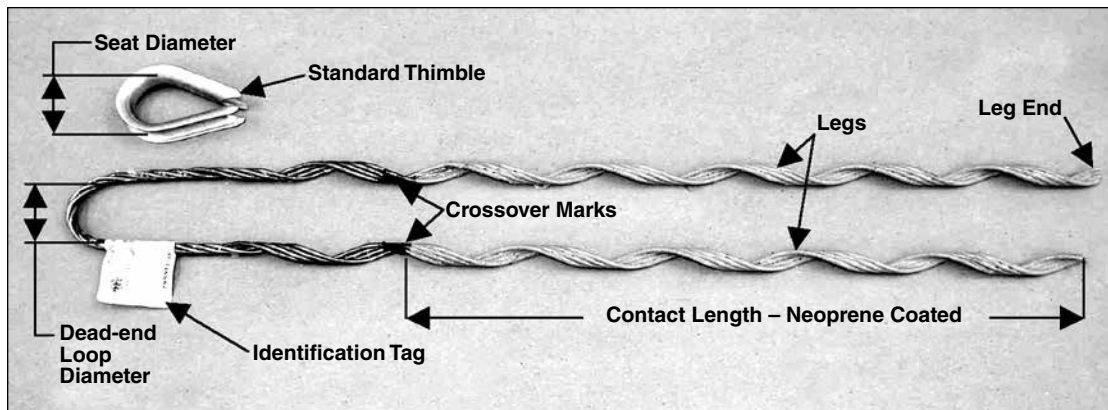

Formed Wire Design

Classified as a formed wire design, The FIBERLIGN® ADSS Drop Cable Dead-end is able to secure the soft pliable surface of a drop cable without causing attenuation. Unlike wedge type dead-ends, the formed wire dead-end effectively transfers the axial load on the cable at the end of the dead-end legs to a low uniform radial compression near the dead end loop. This transition of force is distributed over the length of the product thus allowing secure holding capability with minimized pressure on the cable or messenger.

It was determined through testing that traditional wedge clamps used on copper communications cables can cause fiber attenuation on ADSS drop cables due to concentrated loads from high localized pressure. In addition, the single wire bail of the wedge clamp has much less strength than the multi-wire loop section of the formed wire design. The FIBERLIGN® ADSS Drop Cable Dead-end is applied directly to the pliable surface of the cable without damage to the jacket or fiber signal. The corrosion resistant aluminum alloy dead-ends are neoprene coated to provide a compatible interface with the polyethylene cable jacket.

Drop Cable System Characteristics:

Due to the variety of cable designs from various manufacturers, the holding capabilities of drop cable dead-ends will vary as well. The following characteristics are presented for a general idea of the typical requirements for a drop cable application (see Caution Statement below).

- Distribution Max Span Length Approx. 300' (91 m)
- Service Drop Max Span Length Approx. 200' (61 m)
- Installation Load Approx. 70# to 100# (311 to 444 N)
- Loaded Tension Approx. 200# to 500# (890 to 2220N)

Caution: Contact the cable manufacturer for specific cable capabilities to determine proper sag and tension levels for your system.

Attachment Fittings:

The loop of the FIBERLIGN ADSS Drop Cable Dead-end will fit over a minimum diameter of 1.0" (25 mm) and a maximum diameter of 1-5/8" (41 mm). The dead-end is designed to fit over common guy wire dead-end pole fittings. Thimbles can be used for fittings that may cause high stress in the loop of the dead-end. PLP offers a 1/2" standard thimble P/N 00065474. Optimal fittings provide proper loop support without a thimble.

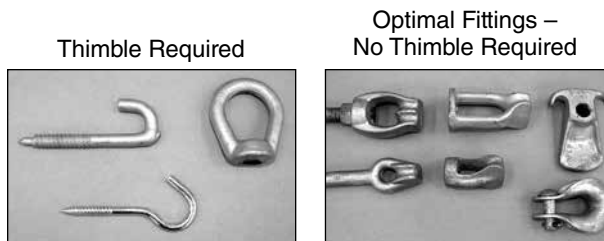



FIBERLIGN® Products for ADSS Applications

FIBERLIGN® ADSS Drop Cable Dead-end continued

ORDERING INSTRUCTIONS

- FIBERLIGN ADSS Drop Cable Dead-end (Round profile) – Select the appropriate FIBERLIGN ADSS Drop cable Dead-end based on the cable diameter – the first catalog table in this section lists the range for each dead-end. If your cable does not fall within any of the published ranges, please contact the PLP for further assistance. Add Suffix code “T” to receive a 1/2” Galvanized Steel Standard Thimble with the dead-end.
- FIBERLIGN ADSS Drop Cable Dead-end (Flat profile) – FIBERLIGN ADSS Drop Cable dead-ends are listed for the appropriate flat cable design. If your cable does not fall within any of the published ranges, please contact PLP for part number and further assistance. Add Suffix code “T” to receive a 1/2” Galvanized Steel Standard Thimble with the dead-end.

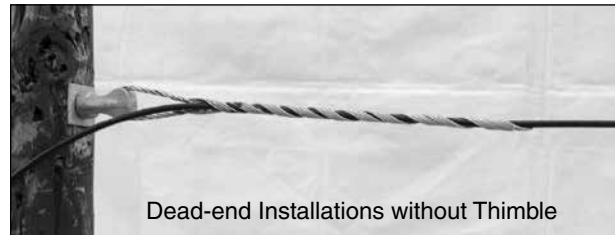

FIBERLIGN® ADSS Drop Cable Dead-ends – Round Profile						
ADSS Drop Dead-end Catalog Number ¹	Cable Diameter Range ²		Color Code	Length Inches	Units	Wt./Lbs.
	Inches	mm			Per Carton	
288811340	0.201 - 0.210	5.1 - 5.3	Blue	16	100	9
288811343	0.234 - 0.240	5.9 - 6.1	Brown	19	100	11
288811285	0.251 - 0.260	6.4 - 6.6	Red	18	100	10
288811346	0.271 - 0.280	6.9 - 7.1	Purple	19	100	11
288811337	0.301 - 0.310	7.6 - 7.9	Red	22	100	20
288811350	0.321 - 0.330	8.2 - 8.4	Black	23	100	20
288811352	0.341 - 0.350	8.7 - 8.9	Red	22	100	18
288811274	0.351 - 0.360	8.9 - 9.1	Black	24	100	21
288811269	0.361 - 0.370	9.2 - 9.4	Black	22	100	18
288811353	0.371 - 0.380	9.4 - 9.6	Yellow	27	100	27

FIBERLIGN® ADSS Drop Cable Dead-ends – Flat Profile						
ADSS Drop Dead-end Catalog Number ¹	Flat Cable Information ²		Color Code	Length Inches	Units	Wt./Lbs.
	Dimension ³ L x W inches (mm)	Manufacturing			Per Carton	
288811353	.330 x .172 (8.3 x 4.3)	Corning	Yellow	27	100	27
	.310 x .170 (7.8 x 4.3)	OFS				
	.330 x .20 (8.5 x 5.0)	Prysmian				
288811352	.31 x .15 (7.9 x 3.81)	DRAKA (6 fiber)	Red	22	100	23
288812284	.410 x .200 (10.4 x 5.1)	DRAKA (12 fiber)	Orange	27	100	27

¹ Add suffix code “T” to dead-end catalog number to receive P/N 00065474 Thimble. P/N 00065474 is a 1/2” standard thimble - weight is 0.12 lbs. each.

² Contact PLP for cable applications not shown

³ Dimensions L x W represent Length x Width of the Flat Cable Cross-section.

FIBERLIGN® Products for ADSS Applications

FIBERLIGN® ADSS Midspan Drop

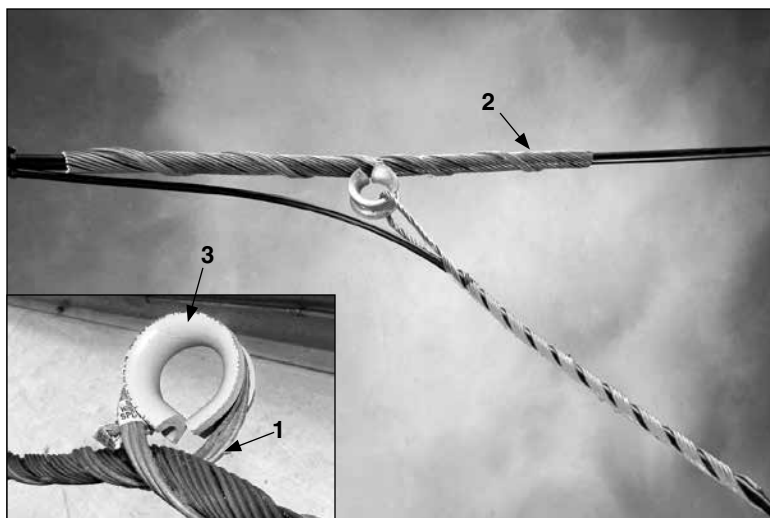

NOMENCLATURE

- 1. Midspan Connector
- 2. Structural Reinforcing Rods
- 3. Thimble

CAPABILITIES

- Connect up to two Cable Drops
- Supports FIBERLIGN® Drop Cable Dead-ends
- Maximum Perpendicular Load 500#

APPLICATION

If direct attachment from the pole to the premise is obstructed or restricted for clearance reasons, it may be beneficial to re-direct cable drops from mid-span. The FIBERLIGN® ADSS Midspan Drop (FAMD) can be applied anywhere along the backbone cable. The ADSS Backbone cable must be strong enough to endure the system side-load requirements. The FAMD can be loaded to 500# maximum perpendicular load.

The Structural Reinforcing Rods (SRR) protect the ADSS branch cable from excessive bending and allow side-loads without fiber attenuation. The Midspan Connector is installed over the SRR and provides the loop attachment point. A durable PVC thimble reinforces the loop area of the FAMD and provides proper loop support for the joining drop cable dead-ends. No tools are required for installation.

ORDERING INSTRUCTIONS

Select the appropriate FAMD based on the ADSS Branch Cable diameter.

ADSS Midspan Drop			
Catalog Number	Cable Range		Color Code
	Inches	mm	
3800005	.350-.399	8.9-10.1	White
3800006	.400-.450	10.2-11.4	Red
3800007	.451-.509	11.5-12.9	Black
3800008	.510-.575	13.0-14.6	Blue
3800009	.576-.649	14.7-16.5	Orange
3800010	.650-.730	16.6-18.5	Green
3800011	.731-.820	18.6-20.8	Brown
3800012	.821-.920	20.9-23.4	Yellow
3800013	.921-1.007	23.5-25.6	Purple

Overall Length = 27 inches, 685 mm.
Thimble Catalog Number 00070253



FIBERLIGN® Products for ADSS Applications

FIBERLIGN® Lite Support for ADSS Drop Cables

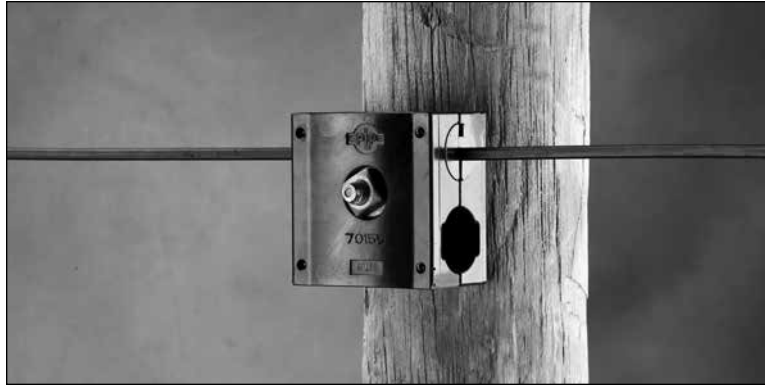

APPLICATION

As referenced in Section 6 of this catalog, the FIBERLIGN® Lite Support (FLS) sizes were expanded to accommodate drop cables. For service drops, the FLS can provide a solution for intermediate pole locations. The FLS is the perfect product for distribution of multiple drop cables in an FTTP system as each FLS can support two cables and the FLS has stackable housings. One 5/8" double arming bolt or through bolt can secure stacked FLS units within the same pole space. This keeps cables neatly secured to the pole.

ORDERING INSTRUCTIONS

- FIBERLIGN Lite Support (round profile) – Select the appropriate FIBERLIGN ADSS Lite Support based on the cable diameter. For sizes not listed, a table of complete sizes can be found in section 6. Add Suffix code "H2" to receive the banding hardware kit.
- FIBERLIGN Lite Support (flat profile) – for sizes from (.14" x .28") to (.18" x .44") use Catalog No. 4800107. Metric (3.5 mm x 7.1 mm) to (4.5 mm x 11.2 mm).

CAPABILITIES

- Accepts round and flat profile ADSS drop cables
- Span lengths up to 300' nesc heavy
- Line angles up to 20 degrees
- Multi-cable options
- Two cables per housing
- Unbalanced load up to 130 lbs. Depending on cable diameter.
- Stackable housings for 4 or more cables

Catalog Number	Insert Size	Cable Diameter Range ¹			
		Min. (in)	Max. (in)	Min. (mm)	Max. (mm)
4800107	SMALL	0.250	0.280	6.35	7.12
4800109		0.305	0.375	7.74	9.53
480011817	LARGE	0.250	0.280	6.35	7.12
480011818		0.281	0.304	7.13	7.73
480011819		0.305	0.375	7.74	9.53
480011820	DUAL (Small & Large)	0.250	0.280	6.35	7.12
480011821		0.281	0.304	7.13	7.73
480011822		0.305	0.375	7.74	9.53

¹ Round Profile Cable Diameter Range. Flat cables use Catalog No. 4800107. Sizes up to .700" for the Small Insert and 1.029" for the Large Insert can be found in the earlier section. Add Suffix Code H2 for banding hardware kit that includes Retaining bolt, washer and lock washer.

FIBERLIGN® Products for ADSS Applications

FIBERLIGN® Tangent Support for ADSS Drop Cables

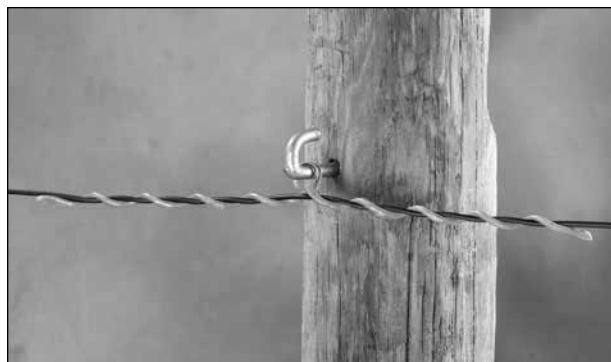

APPLICATION

The FIBERLIGN® Tangent Support (FTS) offers another method of supporting ADSS Drop Cables with excellent unbalance load capability and bend relief support. This product is designed to connect directly to J-hooks for a economical alternative. One FTS can reduce pole clutter by replacing two dead-end and j-hook connections.

For multi-cable attachments, a long loop version of the FTS can be provided. This will allow two vertically spaced cables to suspend from the same j-hook.

CAPABILITIES

- Accepts round and flat profile ADSS drop cables
- Span lengths up to 300' NESC heavy
- Line angles up to 20 degrees
- Multi-cable options
- Short loop design standard
- Long loop design for multi-cable
- Unbalanced load
- 100 To 200 lbs. Depending on cable dia.

FEATURES AND MATERIALS

- Corrosion Resistant Materials
- Relieved Rod ends – safe against cable jacket
- Elastomer Coating for soft pliable interface

ORDERING INSTRUCTIONS

- FIBERLIGN Tangent Support (Round profile) – Select the appropriate FIBERLIGN Tangent Support based on the cable diameter. Contact PLP technical support for sizes not listed.
- FIBERLIGN Tangent Support (Flat profile) – Select the appropriate FIBERLIGN Tangent Support based on the Cable information referenced. Contact PLP technical support for sizes not listed.

FIBERLIGN® Tangent Supports for Round Cable Profile							
Catalog Number	Cable Range (inches)		Cable Range (mm)		Color Code	Overall Length (inches)	Overall Length (mm)
6126001	.251	.260	6.4	6.6	Red	18	457
6126002	.261	.270	6.7	6.9	Blue	19	483
6126003	.271	.280	6.8	7.1	Green	19	483
6126004	.281	.290	7.2	7.4	None	20	508
6126005	.291	.300	7.5	7.6	Pink	20	508
6126006	.301	.310	7.7	7.9	Yellow	20	508
6126007	.311	.320	8.0	8.1	Orange	20	508
6126008	.321	.330	8.3	8.4	Red	23	584
6126009	.331	.341	8.5	8.7	Blue	23	584
6126010	.342	.350	8.8	8.9	Green	24	610
6126011	.351	.360	9.0	9.1	None	25	635
6126012	.361	.370	9.2	9.4	Pink	26	660
6126013	.371	.380	9.5	9.7	Yellow	27	686
6126014	.381	.390	9.8	9.9	Orange	27	686
6126015	.391	.400	9.9	10.2	Red	27	686

FIBERLIGN® Tangent Supports for Flat Cable Profile						
Catalog Number	Flat Cable Information Cable Range (mm)		Mfg.	Color Code	Overall Length (inches)	Overall Length (mm)
	Dimension LxW inches (mm)					
6126009	.31 x .15 (7.8 x 3.7)		DRAKA	Blue	23	584
6126010	.31 x .17 (7.8 x 4.3)		OFS	Green	24	610
6126012	.33 x .17 (8.5 x 4.3)		Corning	Purple	26	660
6126013	.33 x .20 (8.5 x 5.0)		Prysmian	Yellow	27	686
612612245	.410 x .200 (10.4 x 5.1)		DRAKA	Yellow	27	686
612612245	.460 x .195 (11.7 x 4.9)		REMEE	Yellow	27	686



FIBERLIGN[®] Products for Figure 8 Drop Cable Applications

GENERAL INFORMATION

Figure 8 cables designed for the last mile are relatively small and have very low load requirements for pole-to-pole distribution and pole-to-premise service drops. Distribution span lengths are typically less than 300' and service drops are typically less than 150'. Figure 8 type drop cables are typically supported with metallic strength members and protected by an outer plastic sheath. A web joins the messenger component to the fiber optic component. This section covers attachment hardware products for Figure 8 Drop cables.

Messenger materials vary from galvanized steel to stainless steel material.

FIBERLIGN Products for Figure 8 include:

- FIBERLIGN[®] Drop Cable Dead-end
- FIBERLIGN[®] Lite Support
- FIBERLIGN[®] Tangent Support

FIBERLIGN® Products for Figure 8 Drop Cable Applications

FIBERLIGN® Figure 8 Drop Cable Dead-end

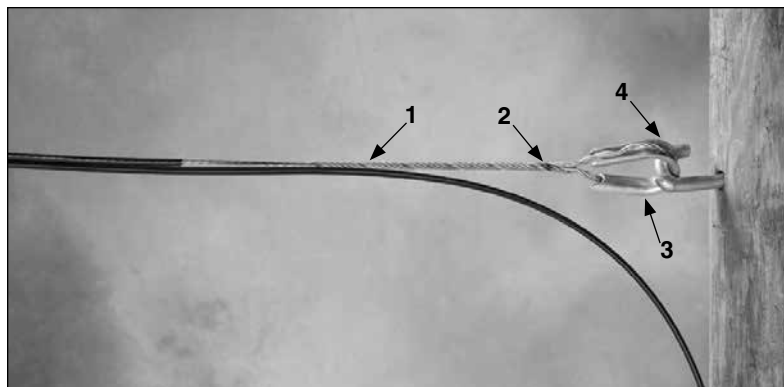

NOMENCLATURE

- 1. Dead-end
- 2. Crossover Mark
- 3. Thimble
- 4. Loop

APPLICATION

The FIBERLIGN® Figure 8 Drop Cable Dead-end has high strength in a light-weight package. Simple to install, the dead-end is applied on the messenger component of the Figure 8 cable after separating the fiber component at the web.

Depending on the jacket adherence, the dead-end may be applied over the jacket or onto the bare messenger after the jacket is removed.

Materials:

FIBERLIGN Figure 8 Drop Cable dead-ends are made from corrosion resistant materials that match the messenger strand material.

Attachment Fittings:

The loop of the FIBERLIGN Figure 8 Drop Cable Dead-end will fit over a minimum diameter of 1.0" (25 mm) and a maximum diameter of 1-5/8" (41 mm). The dead-end is designed to fit over common guy wire dead-end pole fittings. Thimbles can be used for fittings that may cause high stress in the loop of the dead-end. PLP offers a 1/2" standard thimble P/N 00065474. Optimal fittings provide proper loop support without a thimble.

ORDERING INSTRUCTIONS

Select the appropriate dead-end based on the cable diameter. If your cable does not fall within any of the published ranges, please contact the PLP for further assistance. Add Suffix code "T" to receive a 1/2" Galvanized Steel Standard Thimble with the dead-end.

FIBERLIGN® Figure 8 Drop Cable Dead-ends				
Catalog Number ¹	Cable Information ²		Color Code	Length Inches
	Dimension ³ L x W in. (mm)	Mfg.		
699911619 ⁴	.380 x .160 (9.6 x 4.1)	Corning	Yellow	13"
200811230	.300 x .170 (7.6 x 4.3)	Pirelli	Red	8"

1 Add suffix code "T" to dead-end catalog number to receive P/N 00065474 Thimble. P/N 00065474 is a 1/2" standard thimble – weight is 0.12 lbs. each.
 2 Contact PLP for cable applications not shown
 3 Dimensions L x W represent Length x Width of the Figure 8.
 4 Apply over jacket

Thimble Required



Optimal Fittings – No Thimble Required





FIBERLIGN® Products for Figure 8 Drop Cable Applications

FIBERLIGN® Lite Support for Figure 8 Drop Cables

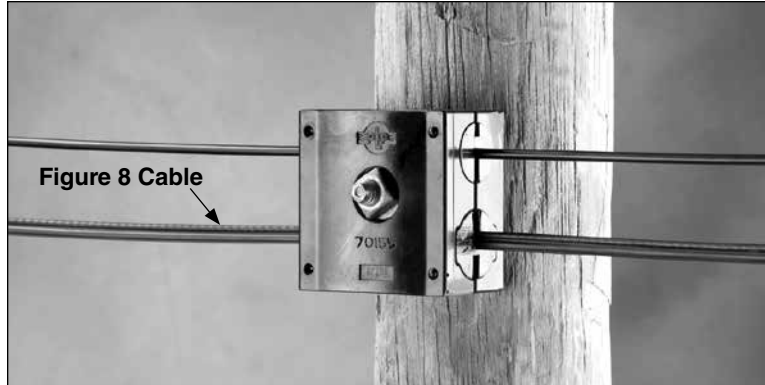

Lite Support with dual inserts showing Figure 8 and round drop cables.

APPLICATION

As referenced in Section 6 of this catalog, the FIBERLIGN® Lite Support (FLS) sizes were expanded to accommodate drop cables. For service drops, the FLS can provide a solution for intermediate pole locations. The FLS is the perfect product for distribution of multiple drop cables in an FTTP system as each FLS can support two cables and the FLS has stackable housings. One 5/8" double arming bolt or through bolt can secure stacked FLS units within the same pole space. This keeps cables neatly secured to the pole.

CAPABILITIES

- Secures most Figure 8 cable in soft one-piece insert.
- Span lengths up to 300' NESC heavy.
- Line angles up to 20 degrees.
- Two cables per housing.
- Stackable housings for 4 or more cables.

ORDERING INSTRUCTIONS

Small and Large inserts are offered. A Dual insert kit is available as well. Most all available Figure 8 cables can be accommodated with the insert designs listed below.

Catalog Number	Insert Size	Cable Dimension			
		Min. L X W (in)	Max. L X W (in)	Min. L X W (mm)	Max. L X W (mm)
4800107	SMALL	.3 x .16	.44 x .18	7.6 x 4.1	11.2 x 4.6
480011817	LARGE	.3 x .16	.44 x .18	7.6 x 4.1	11.2 x 4.6
480011820	DUAL (Small & Large)	.3 x .16	.44 x .18	7.6 x 4.1	11.2 x 4.6

Add Suffix Code H2 for banding hardware kit that includes retaining bolt, washer and lock washer.

FIBERLIGN® Products for Figure 8 Drop Cable Applications

FIBERLIGN® Tangent Support for Figure 8 Drop Cables

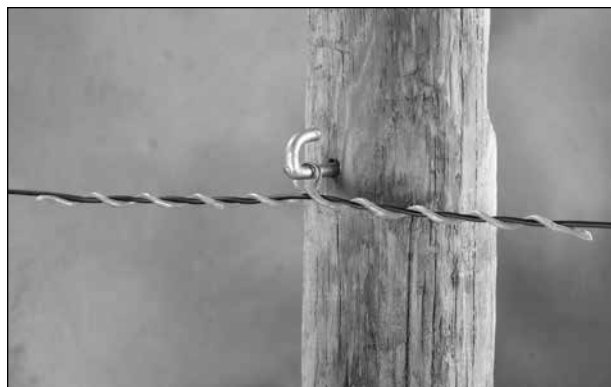

APPLICATION

The FIBERLIGN® Tangent Support (FTS) offers another method of supporting Figure 8 Drop Cables with excellent unbalance load capability and bend relief support. This product is designed to connect directly to J-hooks for an economical alternative. One FTS can reduce pole clutter by replacing two dead-end and J-hook connections.

For multi-cable attachments, a long loop version of the FTS can be provided. This will allow two vertically spaced cables to suspend from the same J-hook.

CAPABILITIES

- Accepts Figure 8 cable and flat profile ADSS drop cables
- Span lengths up to 300' NESC heavy
- Line angles up to 20 degrees
- Multi-cable options
- Short loop design standard
- Long loop design for multi-cable
- Unbalanced load
- 100 to 200 lbs. depending on cable diameter

FEATURES AND MATERIALS

- HIGH Strength Stainless Steel
- Relieved Rod ends – safe against cable jacket
- Elastomer Coating for soft pliable interface

ORDERING INSTRUCTIONS

Select the appropriate FIBERLIGN Tangent Support based on the cable diameter. Contact PLP technical support for sizes not listed.

FIBERLIGN® Tangent Supports for Figure 8 Cable				
Catalog Number	Cable Information Cable Range (mm)		Color Code	Overall Length inches (mm)
	Dimension LxW inches (mm)	Mfg.		
6126009	.300 x .170 (7.6 x 4.3)	Pirelli	Blue	23 (584)
6126015	.380 x .160 (9.6 x 4.1)	Corning	Red	27 (686)





PREFORMED LINE PRODUCTS

Section 9 – Fiber Optics:

COYOTE® Closures & Splice Cases for OPGW & ADSS

Table of Contents	Page
COYOTE Closures for OPGW & ADSS	9-2
COYOTE Closures for OPGW & ADSS	
COYOTE PUP for OPGW & ADSS	
COYOTE RUNT for OPGW & ADSS	
COYOTE Splice Case for OPGW & ADSS	9-4
COYOTE Long Trays and Closures for OPGW & ADSS	9-5
COYOTE Short Trays and Closures for OPGW & ADSS.....	9-6
COYOTE Dome Closures for ADSS	9-7
COYOTE Dome Splice Trays for ADSS & OPGW	9-8
COYOTE Grommet Selection Guide	9-9
COYOTE Dome Closures for OPGW.....	9-10
COYOTE Dome Closure Cable Restraint	
Bracket (CRB) System for OPGW	9-11
COYOTE Defender.....	Refer to Section 7-18



COYOTE® Closures for OPGW or ADSS

The COYOTE Closure Family features durable high-density thermoplastic shells that weigh less than their stainless steel counterparts. For loose tube buffer type fiber, the 6.5" x 22" COYOTE Closure handles up to 144 splices and the 8.5" x 22" COYOTE Closure handles up to 288 splices. The smaller 6" x 17" COYOTE PUP Closure can manage up to 48 fiber splices. The compact COYOTE RUNT Closure can manage up to 24 fiber splices.

The COYOTE PUP Closure allows future expansion or "growth" into a COYOTE Closure with minimal cost or disruption to the existing fibers.

Features of the COYOTE Closure and COYOTE PUP Closure:

- For either dielectric or OPGW cables.
- High strength, low weight, low cost, non-metallic shells.
- Permanent neoprene gasket and LOCK-TAPE™ Sealing System allows re-entry without re-entry kits/supplies.
- Roomy buffer tube storage system and fiber management trays allowing large bend radii
- Fiber management system for loose tube buffer (see table). Other versions are readily available (see Section 1).
- End Plate System for butt splicing:
 - one Blank End Plate at one end
 - one Three-Section End Plate with six premolded cable entry ports; four ports for up to 7/8" OD dielectric cables (.785" max. OPGW OD) and two ports for up to 3/4" OD dielectric cables (.660" max. OPGW OD). Drilling not required.
- Optional Three-Section Four Port End Plate is available for cables up to 1-1/4" (See next page).
- Optional Future Cable Port Kits allow for adding cables in the future without disassembling the End Plate. Kits must be ordered and installed during initial assembly.
 - Future cable port for 7/8" ports will accept cables up to .56"
 - Future cable port for 1" ports will accept cables up to .81"
 - Future cable port for 1-1/4" ports will accept cables up to 1"
- When adding future OPGW cables, order additional OPGW Strain Relief Bracket Kits.
- Closures are available that can accommodate other types of fiber optic cable.
- OPGW Strain Relief Bracket Kit provides brackets, clamps and moisture sealing tape required for installing two OPGW cables in End Plate.
- Splice Case Kits are available for OPGW with stainless steel loose-tube fiber bundles, consult factory for details.

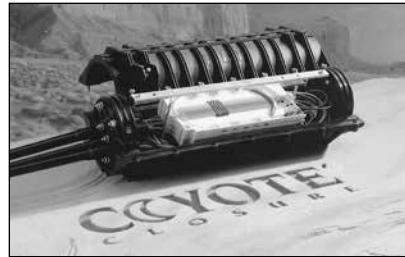

COYOTE Closure

- Two size closures available:
 - 6.5" x 22" accommodates up to 4 splice trays (up to 144 splices/closure)
 - 8.5" x 22" accommodates up to 8 splice trays (up to 288 splices/closure)
- Both size closures have 36 count splice trays with three 12-count elastomeric splice blocks to retain mechanical splices or protected fusion splices.



COYOTE PUP Closure

- One small size, 6" x 17".
- Twelve-count fiber splice tray with elastomeric splice block to retain mechanical splices or protected fusion splices.
- Forty-eight fiber splice capacity.

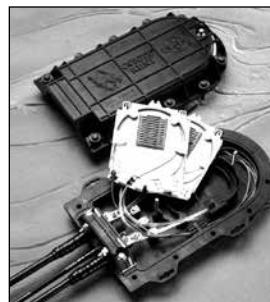

COYOTE RUNT Closure

- One compact size, 8.5" W x 3" H x 14.75" L
- Twelve-count fiber splice tray with elastomeric splice block to retain mechanical splices or protected fusion splices.
- Twenty-four fiber splice capacity.

COYOTE® Closures for OPGW or ADSS

To order, determine:

1. Number of fibers required now and in the future.
2. Cable size and type.
3. Structure type for mounting method.
4. Select catalog number from tables for appropriate items.

COYOTE Closures and Splice Tray Kits	
Catalog Number	Description
COYOTE00058	6.5" x 22" COYOTE Closure Kit for OPGW. Includes closure with organizer/storage compartment (Cat. No. 8006560); OPGW Strain Relief Bracket Kit (Cat. No. 8003296); all required supplies; plus one 36-count tray (Cat. No. 80805514). Will accommodate up to 4 trays per closure (144 maximum splice capacity).
COYOTE00059	8.5" x 22" COYOTE Closure Kit for OPGW. Includes closure with organizer/storage compartment (Cat. No. 8006561); OPGW Strain Relief Bracket Kit (Cat. No. 8003296); all required supplies; plus one 36-count tray (Cat. No. 80805514). Will accommodate up to 8 trays per closure (288 maximum splice capacity).
COYOTE00060	6.5" x 22" COYOTE Closure Kit for dielectric cables. Includes closure with organizer/storage compartment (Cat. No. 8006560); all required supplies plus one 36-count tray (Cat. No. 80805514). Will accommodate up to 4 trays per closure (144 maximum splice capacity).
COYOTE00061	8.5" x 22" COYOTE Closure Kit for dielectric cables. Includes closure with organizer/storage compartment (Cat. No. 8006561); all required supplies plus one 36-count tray (Cat. No. 80805514). Will accommodate up to 8 trays per closure (288 maximum splice capacity).
80805514	36-Count Splice Tray with Elastomer Splice Blocks for COYOTE Closure
80805110	36-Count Splice Tray with fixed
8001127	36-Count Low Profile Splice Tray

COYOTE PUP Closure Kits	
Catalog Number	Description
8006652	6" x 17" (152 x 432) COYOTE PUP Closure for OPGW. Includes OPGW Strain Relief Kit (Cat. No. 8003296) and one 12-count Splice Tray (Cat. No. 80806033)
8006653	6" x 17" (152 x 432) COYOTE PUP Closure for ADSS/Buried Cables. Includes one 12-count Splice Tray (Cat. No. 80806033)
80806033	Twelve-count Splice Tray for COYOTE PUP Closure
80807701	Twelve-count Low Profile Splice Tray

COYOTE RUNT Closure Kit	
Catalog Number	Description
8006695	COYOTE RUNT Closure for OPGW, includes OPGW Strain Relief Kit (Cat. No. 8003479) and one 12-count Splice Tray (Cat. No. 80806033)

COYOTE Closures and COYOTE PUP Closure Accessories	
Catalog Number	Description
80805739	Three-Section Four Port End Plate Kit
8003289	Future Cable Port/Cable Installation Kit for 7/8" cable ports(0.56" (14) max. cable). Kit includes Future Cable Port (Cat. No. 8003371) and Future Cable Preparation Kit (Cat. No. 8003291) which can be ordered separately.
8003408	Future Cable Port/Cable Installation Kit for 1" cable ports(0.81" (21) max. cable). Kit includes Future Cable Port (Cat. No. 8003407) and Future Cable Preparation Kit (Cat. No. 8003291) which can be ordered separately.
8003410	Future Cable Port/Cable Installation Kit for 1-1/4" cable ports(1.0" (25) max. cable). Kit includes Future Cable Port (Cat. No. 8003409) and Future Cable Preparation Kit (Cat. No. 8003291) which can be ordered separately.
8003092	FIBERLIGN Fusion Splice Protectors. Non-heat shrink protector closes over splice and fits snugly into elastomer splice blocks in Splice Tray (Cat. No. 80805514) Package of 20
Mounting Hardware Kits	
8003372	Vertical Pole/Structure Mounting Bracket Kit for COYOTE Closure and COYOTE PUP Closure
8003398	Adapter Bracket for Hughes Brothers Bullet Shield. Bracket mounts to grounding studs on COYOTE Closure End Plate and fastener holes in the Hughes Brothers hanger provided with the Bullet Shield. Fits COYOTE Closure and COYOTE PUP Closure
8003296	OPGW Strain Relief Bracket Kit



COYOTE[®] Splice Case for OPGW & ADSS

The enhanced COYOTE Splice Case with stainless steel shells now features the convenient COYOTE Fiber Management System found in the COYOTE Closure. The COYOTE Splice Case maintains the same air and watertight seal of our FIBERLIGN Stainless Steel Splice Case, but at less cost. For further information about the FIBERLIGN Stainless Steel Splice Case check with our customer service department. Key features of the COYOTE Splice Case include:

- For either ADSS or OPGW
- Impact and corrosion resistant stainless steel shells.
- LOCKBAR™ Sealing System allows re-entry without re-entry kits/supplies.
- High cable pull-out strength with LOCK-TAPE™ Sealant System.
- Fiber management system for loose tube buffer offered below. Other versions are readily available.
- 6.5" x 28" standard size (other sizes available for up to 648 splices).
- End Plate system available with blank End Plate at one end and one of the following:
 - One blank End Plate, or
 - One Three-section End Plate, field-drilled for any size/configuration.
- Standard size Splice Case accommodates up to four 36-count Splice Trays (144 max. splice capacity).
- Blank Splice Trays with three adhesive backed 12-count Elastomeric Splice Blocks (max. 36 fiber splices per tray).
- Elastomeric Splice Blocks firmly hold mechanical or protected fusion splices.
- Standard Splice Case can accommodate other types of fiber optic cables.
- Splice Case kits are available for OPGW with stainless steel loose-tube fiber bundles. Consult PLP for details.



COYOTE Splice Case



Vertical Mounting Bracket 8003472

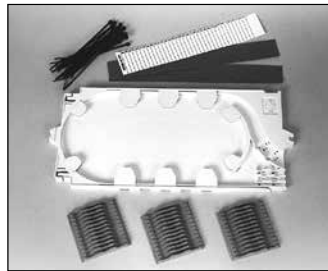

Splice Tray

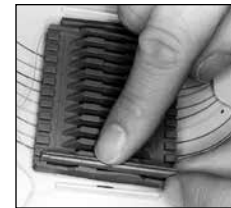



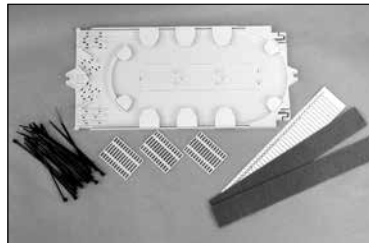





Fusion Splice Protector



Low Profile COYOTE Splice Tray

COYOTE Splice Case Kits for OPGW and ADSS	
Catalog Number	Description
8006654	6.5"x 28" COYOTE Splice Case for ADSS or OPGW.* Includes Splice Case Kit, Green Sealant Kit (Cat. No. 8003411), one 36-count Splice Tray (Cat. No. 80805514), one blank End Plate and one Three-Section End Plate (field drilled for specific cable configurations and ODS) and L-Brackets for strength member tie-off.
8003092	Fusion Splice Protector. Hinged plastic protector closes onto fusion splice area. The protector fits snugly into elastomer splice blocks (Cat. No. 80805514). Twenty (20) units per package.
80804986	Three-Section End Plate Kit for 6.5" (165) COYOTE Splice Cases. Field drilling required.
8003421	3/4" (19) Field-Installed Future Port/Cable Installation Kit [0.80" (20) max. cable]. Kit includes Future Cable Port (Cat. No. 8003412) and Future Cable Preparation Kit (Cat No. 8003420) which can be ordered separately.
8003422	1.0" (25) Field-Installed Future Port/Cable Installation Kit [1.0" (25) max. cable]. Kit includes Future Cable Port (Cat. No. 8003413) and Future Cable Preparation Kit (Cat No. 8003420) which can be ordered separately.
* Catalog No. 8006654 is suitable for OPGW cable with plastic loose tube buffer tubes that can be brought into the 36 count splice trays. Other metallic non-flexible buffer tubes may require a transition compartment. Contact PLP for more information.	
Mounting Hardware Kits	
8003472	Vertical Mounting Bracket for 6.5", 8" and 9.5" (165, 203, and 241) COYOTE Splice Cases. Includes two brackets and associated hardware (curved or flat surfaces).

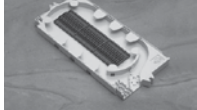



COYOTE® Long Trays and Closures for OPGW & ADSS

<p>Long Splice Trays & Closures</p>	 <p>6.5" x 22" COYOTE</p>	 <p>8.5" x 22" COYOTE</p>	 <p>6.5" x 22" COYOTE Splice Case</p>	 <p>8" x 28" COYOTE Splice Case</p>	 <p>9.5" x 28" COYOTE Splice Case</p>
 <p>Low Profile Tray (36 splice count) Cat. # 8001127 (w/plastic splice blocks) or 80807769 (blank)</p>	<p>6 Trays 216 Max Splice count</p>	<p>11 Trays 396 Max Splice count</p>	<p>6 Trays 216 Max Splice count</p>	<p>9 Trays 324 Max Splice count</p>	<p>13 Trays 468 Max Splice count</p>
 <p>Standard Tray (36 splice count) Cat. # 80805514 (w/elastomer splice block), 80805110 (w/rigid slots), or 80805509 (blank)</p>	<p>4 Trays 144 Max Splice count</p>	<p>8 Trays 288 Max Splice count</p>	<p>5 Trays 180 Max Splice count</p>	<p>7 Trays 252 Max Splice count</p>	<p>10 Trays 360 Max Splice count</p>
 <p>Ribbon Tray (144 splice count) Cat. # 80805515 (w/elastomer splice blocks), 80805146 (w/rigid slots), or 80805510 (blank)</p>	<p>2 Trays 288 Max Splice count</p>	<p>4 Trays 576 Max Splice count</p>	<p>2 Trays 288 Max Splice count</p>	<p>5 Trays 720 Max Splice count</p>	<p>6 Trays 864 Max Splice count</p>
 <p>LITE-GRIP® Long Tray (80 splice count) Cat. # LGSTS40 (Single Fusion)</p>	<p>Not Applicable</p>	<p>5 Trays 400 Max Splice count*</p>	<p>2 Trays 160 Max Splice count*</p>	<p>5 Trays 400 Max Splice count*</p>	<p>6 Trays 480 Max Splice count*</p>
 <p>LITE-GRIP Long Tray (216 splice count) Cat. # LGSTR216 (Mass Fusion/Ribbon)</p>	<p>Not Applicable</p>	<p>5 Trays 1,080 Max Splice count</p>	<p>2 Trays 432 Max Splice count</p>	<p>5 Trays 1,080 Max Splice count</p>	<p>6 Trays 1,296 Max Splice count</p>

*Each tray (Cat. # LGSTS40) is provided with splice blocks to support 40 single fusion splices. Splice Block Kit (Cat. # LGSBS8-5) is required for each tray to achieve maximum splice count.

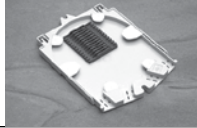
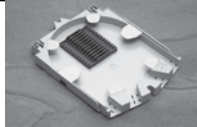

COYOTE[®] Short Trays and Closures for OPGW & ADSS

<p>Short Splice Trays & Closures</p>	 COYOTE RUNT	 COYOTE Expanded RUNT	 COYOTE In-Line RUNT	 COYOTE PUP
 <p>Low Profile Tray[*] (12 splice count) Cat. # 80807701 (w/splice blocks) or 8001130 (blank)</p>	<p>3 Trays 36 Max Splice count</p>	<p>6 Trays 72 Max Splice count</p>	<p>4 Trays 48 Max Splice count</p>	<p>6 Trays 72 Max Splice count</p>
 <p>Standard Tray (12 splice count) Cat. # 80806033 (w/splice block) or 80806182 (blank)</p>	<p>2 Trays 24 Max Splice count</p>	<p>4 Trays 48 Max Splice count</p>	<p>2 Trays 24 Max Splice count</p>	<p>4 Trays 48 Max Splice count</p>
 <p>Ribbon Tray (72 splice count) Cat. # 80807114 (w/splice block) or 80808160 (blank)</p>	<p>1 Tray 72 Max Splice count</p>	<p>2 Trays 144 Max Splice count</p>	<p>2 Trays 144 Max Splice count</p>	<p>2 Trays 144 Max Splice count</p>
 <p>LITE-GRIP[®] Short Tray (40 splice count) Cat. # LGSTS16 (Single Fusion)</p>	<p>1 Tray 40 Max Splice count</p>	<p>2 Trays 80 Max Splice count</p>	<p>2 Trays 80 Max Splice count</p>	<p>2 Trays 80 Max Splice count</p>
 <p>LITE-GRIP Short Tray (144 splice count) Cat. # LGSTR144 (Mass Fusion/Ribbon)</p>	<p>1 Tray 144 Max Splice count</p>	<p>2 Trays 216 Max Splice count</p>	<p>2 Trays 288 Max Splice count</p>	<p>2 Trays 288 Max Splice count</p>

*24 count Low Profile Tray (Cat. # 8003468) is available for COYOTE In-Line, Tray Conversion Kit (Cat. # 8003757) is required to use this tray in these closures.

COYOTE® Dome Closures for ADSS

Evolution of the Breed Continues...



Key Features:

- Available Sizes: 6.5" x 17", 6.5" x 22", 9.5" x 28"
- Patented segmented End Plate design provides independent access to every cable
- 6.5" End Plate: 4 entry ports accepting max cable diameter of 1¼" (32mm)
- 9.5" End Plate: 7 entry ports accepting max cable diameter of 1¼" (32mm)
- Fiber Organizers and End Plates come fully assembled – minimizing the parts to handle
- Simple to use multi hole and single hole grommets provide the ability to support high drop capacities
- No special tools or torque wrenches required for installation
- Collar system allows for quick re-entry
- Tested in accordance to Telcordia GR-771 CORE
- RUS listed for all applications. Contact PLP for further details
- Accepts a wide variety of PLP splice trays
- Patented End Plate Design

The COYOTE Dome Closure Family has increased in size! The new 9.5" x 28" High Capacity Dome Closure is available in three different configurations and can also be used with 9.5" ARMADILLO® Stainless shells, further expanding the possibilities to address your network needs. The innovative, segmented end plate design in the new 9.5" diameter offers 7 cable entrance ports capable of accepting cables with a maximum diameter of 1.25" (32 mm). The unique design allows each cable entrance to be accessed without disruption to the surrounding cables. The new end plate accepts the full line of multi-hole grommets designed to ensure the ultimate flexibility and high capacity to meet the demands of ever evolving communication networks.

The COYOTE Dome Closure was built from the ground up using the same craft-friendly fiber management technology that placed the COYOTE family among the most respected and reliable in the industry. Re-entry is quick and requires no special tools or re-entry kits. Both the 6.5" and 9.5" designs are also convertible to closure shells for in-line applications or to provide additional drop capacity. For connectivity solutions, the COYOTE Dome closures are also available in cross-connect configurations. By combining these features with a wide offering of splice trays and accessories, PLP has the ability to address virtually any network design.

The COYOTE Dome Closure is tested in accordance with the demanding requirements of the Telcordia GR-771-CORE specification for all aerial, buried and underground environments. Manufactured in accordance with ISO9001:2008 procedures to assure quality and backed by the experience and field support that PLP has been noted for since 1947.













COYOTE Dome Closure	
Catalog Number	Description
Closure Kits	
8006944	6.5" x 17" COYOTE Dome for Buffer Tube (loose tube)
8006945	6.5" x 17" COYOTE Dome for Unitube
8006988	6.5" x 17" COYOTE Dome Express
8006949	6.5" x 17" COYOTE Dome Cross-Connect Express
8006877	6.5" x 22" COYOTE Dome for Buffer Tube (loose tube)
8006878	6.5" x 22" COYOTE Dome for Unitube
8006946	6.5" x 22" COYOTE Dome Express*
8006941	6.5" x 22" COYOTE Dome Cross-Connect Express
8006879	6.5" x 28" COYOTE Inline Dome for Buffer Tube (loose tube)
8006880	6.5" x 28" COYOTE Inline Dome for Unitube
80061055	9.5" x 28" COYOTE Dome for Buffer Tube (loose tube)
80061056	9.5" x 28" COYOTE Dome for Unitube (Ribbon)
80061057	9.5" x 28" COYOTE Dome for High Capacity (max tray count)

COYOTE Dome Accessories	
Catalog Number	Description
Mounting Hardware Kits	
710012168	Aerial Hanger Bracket – Dome Mount (Delrin Strap)
8004035	Aerial Hanger Bracket – Dome only, 6.5 only
8003707	Swing Arm for Hand Holes
800012160	Pole/Wall Mount Bracket w/2 Lattice Tower Adapter
8003797	Aerial Drop Hanger Bracket
Accessory Kits	
	Grommet Kits – see grommet chart on page 9-10
8003681	End Plate Kit
80807383	Hardware bag for End Plate
80807848	End Plate Gasket for 6.5" Dome

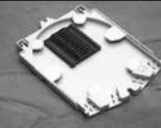
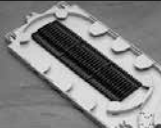
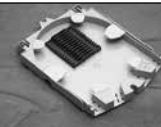
*50% more storage space for midsheath (express) applications, but 50% less splice capacity



COYOTE® Dome Splice Trays for ADSS & OPGW

Short Splice Trays for the 17" Dome	 6.5" x 17" COYOTE Dome	Long Splice Trays for 22", 28" Dome and In-Line Closures	 6.5" x 22" COYOTE Dome	 9.5" x 28" COYOTE Dome	 6.5" x 28" COYOTE In-Line Dome
 Low Profile Tray (12 splice count) Cat. # 80807701 (w/splice blocks) or #80807769 (blank)	6 Trays 72 Max Splice Count	 Low Profile Tray (36 splice count) Cat # 8001127 (w/plastic splice blocks) or 80807769 (blank)	6 Trays 216 Max Splice Count	PN: 80061055 12 Trays – 432 Max PN: 80061056 12 Trays – 432 Max PN: 80061057 18 Trays – 648 Max	6 Trays 216 Max Splice Count
 Standard Tray (12 splice count) Cat # 80806033 (w/splice block) or 80806182 (blank)	4 Trays 48 Max Splice Count	 Standard Tray (36 Splice count) Cat # 80805514 (w/elastomer splice block), 80805110 (w/rigid slots), or 80805509 (blank)	4 Trays 144 Max Splice Count	PN: 80061055 9 Trays – 324 Max PN: 80061056 9 Trays – 324 Max PN: 80061057 14 Trays – 504 Max	4 Trays 144 Max Splice Count
 Ribbon Tray (72 splice count) Cat # 80807114 (w/splice block) or 80808160 (blank)	3 Trays 216 Max Splice Count	 Ribbon Tray (144 splice count) Cat # 80805515 (w/elastomer splice blocks), 80805146 (w/rigid slots), or 80805510 (blank)	3 Trays 432 Max Splice Count	PN: 80061055 6 Trays – 864 Max PN: 80061056 6 Trays – 864 Max PN: 80061057 9 Trays – 1296 Max	3 Trays 432 Max Splice Count
 LITE-GRIP® Short Tray ¹ (40 splice count) Cat # LGSTS16 (single fusion)	3 Tray 120 Max Splice Count ¹	 LITE-GRIP® Long Tray ² (80 splice count) Cat # LGSTS40 (single fusion)	3 Trays 240 Max Splice Count ²	PN: 80061055 6 Trays – 480 Max ² PN: 80061056 6 Trays – 480 Max ² PN: 80061057 9 Trays – 720 Max ²	3 Trays 240 Max Splice Count ²
 LITE-GRIP Short Tray (144 splice count) Cat # LGSTR144 (mass fusion ribbon)	3 Tray 432 Max Splice Count	 LITE-GRIP Long Tray (216 splice count) Cat # LGSTR216 (mass fusion ribbon)	3 Trays 648 Max Splice Count	PN: 80061055 6 Trays – 1296 Max PN: 80061056 6 Trays – 1296 Max PN: 80061057 9 Trays – 1944 Max	3 Trays 648 Max Splice Count













1 Each tray (Cat #LGSTS16) is provided with splice blocks to support 16 single fusion splices. Splice Block Kit (Cat #LGSBS 8-5) is required for each tray to achieve maximum splice count.

2 Each tray (Cat. #LGSTS40) is provided with splice blocks to support 40 single fusion splices. Splice Block Kit (Cat #LGSBS8-5) is required for each tray to achieve maximum splice count.

COYOTE® Grommet Selection Guide



Film available at
www.preformed.com

COYOTE® Silicone Grommet Kits for use in COYOTE GLC, LCC, Aerial Drop, In-Line RUNT, Terminal, Dome and Taut Closures			
Catalog Number	Cable Range Inches (mm)	Description	Grommets
8003691	.40 - .60 (10.7 - 15.2)	1-hole grommet	
8003692	.60 - .85 (15.2 - 21.6)	1-hole grommet	
8003693	.85 - 1.0 (21.6 - 25.4)	1-hole grommet	
8003694	1.0 - 1.25 (25.4 - 31.6)	1-hole grommet	
8003663	.42 - .60 (10.7 - 15.2)	2-hole grommet	
8003990	.50 - .60 (12.7 - 15.2) .125 - .25 (3.2 - 6.4) and Flat Drop	4-hole grommet	
8003664	.30 - .43 (7.6 - 10.9)	4-hole grommet	
8003989	Flat Drop Only	4-hole grommet	
8003665	.125 - .25 (3.2 - 6.4) and Flat Drop	6-hole grommet	
8003676	.42 - .60 (10.7 - 15.2) .125 - .25 (3.2 - 6.4) and Flat Drop	7-hole grommet	
8003677	.125 - .25 (3.3 - 6.4) and Flat Drop	8-hole grommet	
8003796	Flat Drop Only	12-hole grommet	

Note: Grommet Kit contains (1) Grommet, (1) Cable Measure Tape, (1) Silicone Lubricant Pack, (1) Set of Plugs (where applicable).



COYOTE® Dome Closures for OPGW

Not only can the COYOTE® Dome accommodate ADSS cable, but can also accommodate various types of OPGW cable. Such types of OPGW that can be used in the COYOTE® DOME include:

- OPGW with stranded stainless steel (ridged) buffer tubes.
- OPGW with a slotted core and flexible plastic buffer tubes.
- OPGW with a central aluminum tube and flexible plastic buffer tubes.
- OPGW with a central aluminum tube and central stainless steel or hard plastic (ridged) buffer tubes.

- OPGW with a central aluminum tube but without central stainless steel or hard plastic (ridged) buffer tubes.

Selecting the proper COYOTE® Dome kit for your OPGW application depends on the fiber count, cable diameter, and the fiber package construction of the OPGW that you are using. The selection guide below can be used to determine which COYOTE® Dome kit for OPGW will best suit your needs.

COYOTE® Dome Closure Selection Guide for OPGW Cable Types												
OPGW Cable Information				COYOTE® DOME Closure Kits for OPGW Applications								
OPGW Description	Max Single Fusion Splices		OPGW Max diameter* Inches (mm)	Size Inches	Kit Catalog Number		Endplate	Trays Included with Kit	Fiber Count per tray	Organizer Type	Transition/Furcation ***	
	Using COYOTE® Standard Tray	Using COYOTE® Low Profile Tray			Closure w/ Standard Tray Kit**	Closure w/Low Profile Tray Kit**						
Stranded Stainless Steel (Ridged) Buffer Tube	48	72	1.25" (31.8)	6.5" X 17"	800012147	800012148	Segmented 4 Port *	1	12	Unitube	Yes	
	144	216	1.25" (31.8)	6.5" X 22"	800012149	800012150	Segmented 4 Port *	1	36	Unitube	Yes	
Slotted Core with Flexible Plastic Buffer Tube	48	72	1.25" (31.8)	6.5" X 17"	800012143	800012144	Segmented 4 Port *	1	12	Loose Tube Buffer Tube	No	
	144	216	1.25" (31.8)	6.5" X 22"	800012145	800012146	Segmented 4 Port *	1	36	Loose Tube Buffer Tube	No	
Central Aluminum Tube with Flexible Plastic Buffer Tubes	48	72	1.25" (31.8)	6.5" X 17"	800012143	800012144	Segmented 4 Port *	1	12	Loose Tube Buffer Tube	No	
	144	216	1.25" (31.8)	6.5" X 22"	800012145	800012146	Segmented 4 Port *	1	36	Loose Tube Buffer Tube	No	
Central Aluminum Tube with or w/o Stainless Steel/Hard Plastic (Ridged) Buffer Tubes	48	72	1.25" (31.8)	6.5" X 17"	800012147	800012148	Segmented 4 Port *	1	12	Unitube	Yes	
	144	216	1.25" (31.8)	6.5" X 22"	800012149	800012150	Segmented 4 Port *	1	36	Unitube	Yes	

*All Closures are provided with (2) 8003664 grommets, and (2) 8003691 and (2) 8003692 grommet kits for OPGW cable diameters .30" to .85" (8 mm - 22 mm). Optional grommets found in the grommet selection guide on the previous page can expand the number of cable entries per port and accommodate various sizes.

**Along with one tray, all closures kits include OPGW Sealant Kit #8003754 and Heat Shrink Splice Protectors.

***Closures with Unitube Organizers include Transition Furcation Kits 800011212 and 800011381 for Stainless Steel/Hard Plastic (Ridged) Buffer Tube Applications. See the Transition Furcation Kit Application Guide below for Transition Furcation kit sizes.

Transition Furcation Kit Application Guide for Stainless Steel/Hard Plastic (Ridged) Buffer Tube Sizes			
Catalog Number	Description	Closure Type	
		6.5" X 17"	6.5" X 22"
800011212	Furcation Kit for Buffer Tubes OD range .133" - .154"	X	X
800011381	Furcation Kit for Buffer Tubes OD range .118" - .126"	X	X
800011382	Furcation Kit for Buffer Tubes OD range .102" - .110"	X	X

NOTE: Contact PLP or refer to SP2963-4 for further information about Transition Furcation Kit Applications

Key Features

- Available sizes: 6.5" x 17" and 6.5" x 22"
- OPGW Strain Relief Bracket Kit (Cat. # 8003754) provides brackets, clamps, and flat sealant for installing two OPGW cables in the end plate
- When adding future OPGW cables, order additional Strain Relief Bracket Kits
- Transition Furcation Kits for OPGW with stainless steel (ridged) buffer tubes (see table above).
- Additional grommets may be ordered for OPGW applications using the grommet kit selection guide (see page 9-9)
- Splice Tray included in COYOTE® Dome Kit:
 - One Standard Splice Tray is included
- Additional splice trays may be ordered. See chart on page 1-4, 1-5.

COYOTE® Dome Closure Cable Restraint Bracket (CRB) System for OPGW

PLP is introducing the COYOTE® Dome Closure with the new Cable Restraint Bracket (CRB) System for OPGW.

GENERAL INFORMATION

The ORIGINAL COYOTE® Dome laid the foundation for innovative features including the Hinged Collar Quick Locking Dome, segmented end plates with independent cable port access, and simplified grommet sealing system that eliminates adhesives and epoxy cure times. All features help simplify installation and reduce labor without sacrificing a reliable hermetic seal that meets Telcordia Standard GR-771.

The COYOTE® Dome Closure CRB System for OPGW introduces the new Cable Restraint Bracket (CRB) helping the system exceed industry standards with improved cable retention and torque resistance similar to PLP’s robust stainless steel splice case.

The CRB is mounted to the face of the dome end plate and secures the OPGW cables with a robust range taking clamp (Nominal Cable OD 3/8" - 3/4"). The system includes a mounting adapter that slides into the CRB for direct pole mount or convenient modular attachment to the new FIBERLIGN® Cable Storage 2 bracket and COYOTE® Defender 2 ballistic protection.

Key Features:

- Dome Sizes 6.5" x 17" and 6.5" x 22" for 48 and 144 max splice capacity, respectively.
- Standard Dome Kits include all necessary materials for cable prep, fiber routing, mounting (to storage & Defender*), and splicing (one tray).
- Range taking design eliminates costly cable connectors and simplifies inventory.
- Robust CRB* has improved cable retention and torque resistance (two cable entries).
- Grommet expandable 4 port end plate.
- Segmented end plate allows future cables without disturbing occupied ports.
- Materials included for substation drop or added OPGW cable*.
- CRB provides electrical continuity between OPGW cables, and end plate studs allow bonds to other cables.

*COYOTE® Dome Closure CRB System only

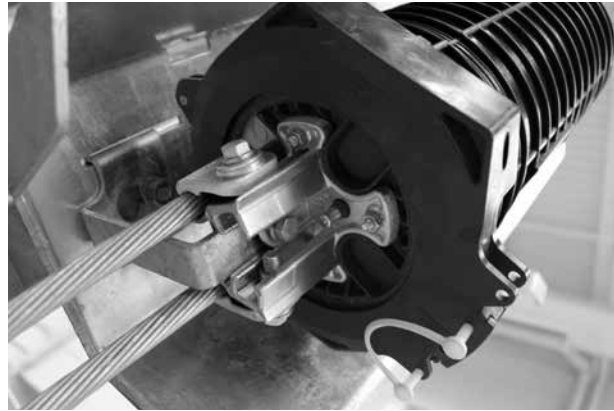

APPLICATION

OPGW cables have various designs that can be separated into two categories (a) Plastic Buffer Tube type and (b) Stainless Steel Buffer Tube type. The flexible Plastic Buffer tube can be coiled within the organizer of the Dome, whereas the ridged Stainless Steel buffer tube must be removed before coiling. The organizer for the Stainless Steel buffer tubes includes a transition compartment to help convert rigid tubes to flexible transport tubes and convenient fiber distribution into the splice trays.

Selecting the proper COYOTE® Dome (original or CRB System) for your OPGW application depends primarily on the fiber count, cable diameter, and buffer tube type of the OPGW. The tables below include a selection guide and cross reference for original and Dome Closure CRB System Kit details, and OPGW COYOTE® Dome accessories.

The original design will continue to be offered for customers having them on standards. The cross reference is provided to help transition from the original design to the CRB System – please contact PLP for help with the transition.

Selection Guide and Cross Reference for the Original and COYOTE® Dome Closure CRB System for OPGW				
OPGW Cable Application		Catalog Number		Dome Size
Buffer Tube Type	Max Single Fusion Fiber Capacity	Dome Closure CRB System for OPGW	Original Dome Closure for OPGW	Inches
Plastic (P)	48	COYW617P001	800012143	6.5" dia.x17" Long
	144	COYW622P001	800012145	6.5" dia.x22" Long
Stainless Steel (S)	48	COYW617S001	800012147	6.5" dia.x17" Long
	144	COYW622S001	800012149	6.5" dia.x22" Long

NOTE: Except for the Dome's new CRB, mounting adapter and maximum cable diameter of .75" (19mm), the Original COYOTE® Dome for OPGW includes common components and capabilities.



COYOTE® Dome Closure Cable Restraint Bracket (CRB) System for OPGW

ORDERING INSTRUCTIONS

1) DETERMINE DOME CLOSURE CAT. NO.:

Obtain the OPGW cable specification to determine cable diameter, buffer tube type (plastic or stainless steel) and fiber count. Use the Selection Guide on the previous page to determine your Dome Closure catalog number.

NOTE: If the cable diameter is greater than .75", you may use the Original COYOTE® Dome Closure for OPGW or contact PLP for further options.

2) DETERMINE NUMBER OF SPLICE TRAYS REQUIRED:

If the fiber count is greater than the single tray supplied with the Dome kit, order additional trays as required. Find the splice tray capacity and catalog number for respective dome kits in the following table.

3) DETERMINE INTERFACE FOR MOUNTING:

The Mounting Adapter is included with the COYOTE® Dome Closure CRB System kits. The mounting adapter may be installed directly to the structure, to the FIBERLIGN® Cable Storage 2, to the COYOTE Defender 2, or to the Cable Storage & COYOTE® Defender 2. See the table on page 9-13 for catalog numbers covering each option. Each mounting scenario can be bolted to a wood pole, banded to a metal pole, or clamped to a lattice tower.

COYOTE® Dome Closure CRB System for OPGW						
COYOTE® Dome Closure CRB System Kit Information ¹					Modular Accessories ³	
Catalog Number	Description	Splice Tray ²	Transition Furcation Kit	Organizer Type	FIBERLIGN® Vertical Cable Storage 2	COYOTE® Defender 2
Dome KITS FOR PLASTIC BUFFER TUBE APPLICATION					Catalog No. 80061195 60" (1.5m) Cable Storage Bracket (See Page 7-16)	Catalog No. 80061194 Ballistic Protection for 6.5" COYOTE® Domes (see Page 7-19)
COYW617P001	6.5" dia. x 17" Long – COYOTE® Dome Closure CRB System for OPGW with Plastic Buffer Tubes. Kit includes (1) Splice Tray, (1) Organizer for Plastic Buffer tubes and Cable Restraint Bracket, (1) OPGW Green Sealant Kit, (6) Grommets, (1) Mounting Adapter.	Standard 12 ct. Tray Cat. No. 80806033, 1 included (fit 4 max)	NA	U-Brackets for Plastic (Flexible) Buffer Tube		
COYW622P001	6.5" dia. x 22" Long – COYOTE® Dome Closure CRB System for OPGW with Plastic Buffer Tubes. Kit includes (1) Splice Tray, (1) Organizer for Plastic Buffer tubes and Cable Restraint Bracket, (1) OPGW Green Sealant Kit, (6) Grommets, (1) Mounting Adapter.	Standard 36 ct. Tray Cat. No. 80805514, 1 included (fit 4 max)	NA	U-Brackets for Plastic (Flexible) Buffer Tube		
Dome KITS FOR STAINLESS STEEL BUFFER TUBE APPLICATION						
COYW617S001	6.5" dia. x 17" Long – COYOTE® Dome Closure CRB System for OPGW with Stainless Steel Buffer tubes. Kit includes (1) Splice Tray, (1) Organizer for SS Buffer tubes and Cable Restraint Bracket, (1) OPGW Green Sealant Kit, (6) Grommets, (1) Mounting Adapter, and Furcation Kits	Standard 12 ct. Tray Cat. No. 80806033, 1 included (fit 4 max)	Included	Transition Compartment for Stainless Steel (Rigid) Buffer tube		
COYW622S001	6.5" dia. x 22" Long – COYOTE® Dome Closure CRB System for OPGW with Stainless Steel Buffer tubes. Kit includes (1) Splice Tray, (1) Organizer for SS Buffer tubes and Cable Restraint Bracket, (1) OPGW Green Sealant Kit, (6) Grommets, (1) Mounting Adapter, and Furcation Kits	Standard 36 ct. Tray Cat. No. 80805514, 1 included (fit 4 max)	Included	Transition Compartment for Stainless Steel (Rigid) Buffer tube		

¹All Standard Closures are provided with (2) 8003691 grommets, (2) 8003692 grommets, and (2) small OD grommet kits for OPGW cable diameters .30" to .75" (8 mm - 19 mm).
Catalog Code COYWxxxxzzz, COYW = COYOTE® Dome Closure CRB System for OPGW, x = Closure size, y = buffer tube type (P or S), and z = kit no. (standard = 001) Optional grommets found in the grommet selection guide in this section can expand the number of cable entries per port and accommodate various sizes.

²Along with one tray, all closure kits include OPGW Sealant Kit #80812321 and Heat Shrink Splice Protectors to match tray count.

³See catalog sections covering FIBERLIGN® Cable storage and COYOTE® Defender Ballistic protection for further information.
Downlead Cushions for training cable down the structure can be found in the FIBERLIGN® OPGW & ADSS accessories section.

COYOTE® Dome Closure Cable Restraint Bracket (CRB) System for OPGW

OPGW COYOTE® DOME CLOSURE ACCESSORIES	
Catalog Number	Description
SPLICE TRAYS	
80806033	Standard Short Splice Tray, 12 splice count for 6.5" x 17" Dome
80805514	Standard Long Splice Tray, 36 splice count for 6.5" x 22" Dome
TRANSITION FURCATION KITS FOR STAINLESS STEEL BUFFER TUBE*	
800011212	Furcation Kit for SS buffer tubes O.D. range .133" - .154"
800011381	Furcation Kit for SS buffer tubes O.D. range .118" - .126"
800011382	Furcation Kit for SS buffer tubes O.D. range .102" - .110"
800011563	Furcation Kit for SS buffer tubes O.D. range .063" - .098"
*Contact PLP or refer to SP2963 for further information about Transition Furcation Kit Applications. Each kit includes materials sufficient for 2 OPGW cable entries with 3 buffer tubes each.	
OPGW CABLE PREP AND FIBER MATERIALS	
80812321	CRB System OPGW Green Sealant Kit and Attachment Kit, includes long & short strength member brackets
8003509	60 mm Heat Shrink Splice Protectors, 12 pack
8003280	Transition Tube kit, (protects fiber routed from SS buffer tube to transition tray)
80805293	Transport Tube kit, (protects fiber routed from transition tray to splice trays)
CABLE STORAGE & BALLISTIC PROTECTION**	
80061195	FIBERLIGN® Cable Storage 2 for OPGW, 60" Loop
80061194	COYOTE® Defender 2 for 6.5" Dome applications, Galvanized Steel 7 Gauge
80812335	COYOTE® Dome Closure CRB System "Direct" Mounting Clamp for 6.5" Dome. Secures top end of Dome
7000400	FIBERLIGN® Lattice Tower Clamp – 2 required for Defender or Direct Mount to Lattice Tower.
**COYOTE® Dome Kits include a Mounting Adapter that can vertically mount the Dome directly to wood poles or band to metal poles. The modular design of the mounting adapter can be mounted to the FIBERLIGN® Cable Storage 2 and COYOTE Defender 2 as well.	
OTHER ORIGINAL DOME ACCESSORIES	
80003754	Original OPGW Dome Green Sealant Kit and Attachment Kit, includes long & short strength member brackets
8003702	Original COYOTE® Dome Vertical Mounting Bracket
800012162	COYOTE® Defender for the Original COYOTE® Dome
8003569	FIBERLIGN® Cable Storage for the Original COYOTE® Dome Closure



CRB System including Defender 2 and Cable Storage 2



CRB engages Mounting Adapter





PREFORMED LINE PRODUCTS

Section 10 – ARMADILLO® Stainless Series

Table of Contents	Page
Series Overview.....	10-2
ARMADILLO Selection Guide.....	10-4
ARMADILLO Stainless Kits	10-5
ARMADILLO Sealing Washer End Plates.....	10-6
ARMADILLO Drillable End Plate Kits.....	10-7
ARMADILLO Stainless Shell Kits.....	10-9
ARMADILLO Series Accessories	10-10
ARMADILLO Series Installation Materials/Spare Parts.....	10-12
ARMADILLO Bolt and Torque Bars	10-14
ARMADILLO Tools	10-15
ARMADILLO Stainless with Fire Retardant Drilled End Plates.....	10-17
PLP® Vault Closure Ordering Form.....	10-18
ARMADILLO Stainless for Vault Applications.....	10-19
RD™ Encapsulant/Resin Kits for Buried Applications	10-21
Spacer Mat/Re-Encapsulation Kits for Buried Applications	10-22



ARMADILLO® Overview



**Born Tough...
Bred Smart
Tames Costs as Well as Nature**

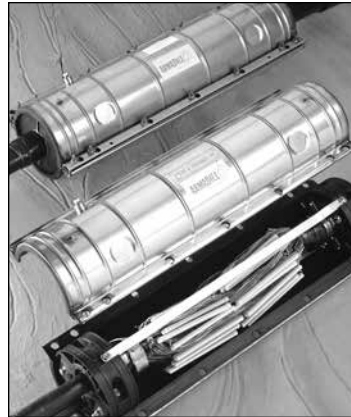

ARMADILLO Stainless:

For over 30 years, our Stainless Steel Splice Case has been the industry standard, with millions of successful applications around the world, protecting communications cables under even the most severe conditions. The PREFORMED Stainless Steel Splice Case is now the ARMADILLO Stainless. It is our premium series for the most demanding applications that is designed to offer superior performance and versatility for virtually any application.

The ARMADILLO Stainless is your best choice when...

- Stainless steel is required for more demanding applications.
- Fire retardant stainless is required for vault applications.
- Exceeding Bell System standards may be necessary.
- Maintaining 15 psi (103kPA) is required (when used with drillable End Plates).

Design Features:

- Re-usable
- Re-enterable
- Craft-friendly
- Re-entry kits not required
- Utilize torque bar for end plate positioning
- Accepts both end plate designs
- Used in underground, aerial or buried applications
- Feature captive hardware
- Made of corrosion resistant materials
- Utilize ARMADILLO Coupling for expanding cable opening

ARMADILLO® Overview & Capacities



A Whole New Species for Copper Cable



ARMADILLO Sealing Washer End Plates:

With the introduction of the ARMADILLO Series comes a new end plate design. The ARMADILLO Sealing Washer End Plates eliminate major tooling costs, field drilling and does not require extensive training.

The ARMADILLO Sealing Washer End Plate is your best choice when...

- Your application does not require more than one, two or three cable entry ports.
- No power source for field drilling is available.
- Mastic sealing tapes are used that do not require C-Cement making these End Plates re-usable.

ARMADILLO Drillable End Plates:

The ARMADILLO Series features a compatibility that includes the field proven Drillable End Plate. This end plate system can accommodate a variety of cables, cable sizes and cable configurations with either a two-section or a three-section end plate design.

The ARMADILLO Drillable End Plate is your best choice when...

- Field flexibility to custom drill the end plates on the job site is necessary and a power source is available.
- You have a demanding application that requires the LOCK-TAPE™ Sealing System providing exceptional pull-out strength.
- You have vault applications.

Design Features:

These new end plates have no external fasteners, utilize the proven PREFORMED™ Torque Bar for positioning, and have universal inserts that enable grounding connections and air pressurization through the end plate. They also feature a unique strengthened, two-piece sealing washer that is available in the same sizes as competitive units and is interchangeable.

Interchangeable and Compatible:

Both ARMADILLO End Plate styles are available in two and three section designs for use with 4", 6.5", 8.0", 9.5" and 12.5" (drillable only) diameter shell kits. They are compatible for use with the ARMADILLO Stainless shells. They will also accept a hybrid application utilizing both End Plate styles in the same closure.

Design Features:

ARMADILLO Drillable End Plates can be field configured to meet your application requirements. Less stock is required with this design, because any bond connector can be used, and fixed sheath opening dimensions do not depend on bond connector placement. They are available with grounding and air valve inserts for air pressurization, aerial support and grounding through the end plate.

End Plate Similarities:

- No exposed fastener hardware
- Grounding through end plate
- Torque bar used for positioning
- Craft-friendly



ARMADILLO® Selection Guide

Just follow these simple steps:

STEP ONE

Use this table to select the size of our ARMADILLO Stainless required based on the pair count.

ARMADILLO Stainless Capacities	
Pair Count of Cables	ARMADILLO Stainless Size (mm)
50 thru 300	4" x 25" (102 x 635)
300 thru 600	6.5" x 22" (165 x 559)
300 thru 1100	6.5" x 28" (165 x 711)
900 thru 1500	6.5" x 38" (165 x 965)
900 thru 2100	8" x 28" (203 x 711)
1200 thru 2400	8" x 38" (203 x 965)
1500 thru 2700	8" x 45" (203 x 1143)
1500 thru 2700	9.5" x 28" (241 x 711)
1800 thru 3600	9.5" x 38" (241 x 965)
2100 thru 4200	9.5" x 45" (241 x 1143)
2100 thru 4200	9.5" x 53" *(241 x 1356)
2400 thru 3000	12.5" x 28" (318 x 711)
2700 thru 3600	12.5" x 38" (318 x 965)
3000 thru 4200	12.5" x 45" (318 x 1143)
3000 thru 4800	12.5" x 65" *(318 x 1651)

NOTE: Capacities based on 24 gauge wire and industry standard splice modules.

*Shells are welded

STEP TWO

Choose from one of the ARMADILLO Stainless Kits with drilled end plates or the ARMADILLO Stainless Filling Flange Kits with drilled end plates.

These are the original PREFORMED™ Splice Case Kits and PREFORMED Splice Case with Filling Flange Kits that you are familiar with.

STEP THREE

Select and order the individual components you need.

All components are interchangeable. You can have a closure with a Sealing Washer End Plate on one end and a Drilled End Plate on the other.

C-Cement

Used to prepare cable for LOCK-TAPE™ Sealant in ARMADILLO Drillable End Plates.

C-Cement is required to install in an ARMADILLO Splice Case.

Catalog Number	Description
80802377	4 oz. Can C-Cement
80805238	1 oz. Tube C-Cement

ARMADILLO® Stainless Kits

Kits include top & bottom shell halves, LOCKBAR™ Assemblies, Torque Bars and two 2-section End Plate kits (except 3-section End Plates with 12.5"). Bonding kit (where included) includes shield connectors, pair protectors and bonding braid.

ARMADILLO Stainless Kits with Drillable End Plates			
Catalog Number		Size (mm)	Weight (kg)
With Bonding	Without Bonding		
8000624	8006021	4" x 25" (102 x 635)	15# (6.8)
8006326	8006319	6.5" x 22" (165 x 559)	24# (10.9)
8000626	8006022	6.5" x 28" (165 x 711)	29# (13.2)
8006320	8006261	8" x 28" (203 x 711)	34# (15.4)
8000630	8006023	9.5" x 28" (241 x 711)	41# (18.6)
8006219	8006251	12.5" x 28" (318 x 711)	58# (26.3)
8000634	8006024	6.5" x 38" (165 x 965)	37# (16.8)
8006321	8006262	8" x 38" (203 x 965)	45# (20.4)
8000635	8006025	9.5" x 38" (241 x 965)	51# (23.1)
8006220	8006252	12.5" x 38" (318 x 965)	77# (34.9)
8006322	8006263	8" x 45" (203 x 1143)	50# (22.7)
8006176	8006177	9.5" x 45" (241 x 1143)	59# (26.8)
8006221	8006253	12.5" x 45" (318 x 1143)	84# (38.1)
8006668	8006669	9.5" x 53" (241 x 1346)	66# (29.9)
	8006509**	12.5" x 65" (318 x 1651)*	146# (66.2)

**Shell Kit only

*Shells are welded

ARMADILLO Stainless Filling Flange Kits with Drillable End Plates			
Catalog Number Splice Case with Filling Flange		Size (mm)	Shipping Weight (kg)
With Bonding	Without Bonding		
8006366	8006283	4" x 25" (102 x 635)	15# (6.8)
8006429	8006394	6.5" x 22" (165 x 559)	24# (10.9)
8006367	8006239	6.5" x 28" (165 x 711)	29# (13.2)
8006410	8006395	8" x 28" (203 x 711)	34# (15.4)
8006368	8006240	9.5" x 28" (241 x 711)	41# (18.6)
8006372	8006271	12.5" x 28" (318 x 711)	58# (26.3)
8006369	8006241	6.5" x 38" (165 x 965)	37# (16.8)
8006411	8006396	8" x 38" (203 x 965)	45# (20.4)
8006370	8006242	9.5" x 38" (241 x 965)	51# (23.1)
8006373	8006272	12.5" x 38" (318 x 965)	77# (34.9)
8006412	8006397	8" x 45" (203 x 1143)	50# (22.7)
8006371	8006249	9.5" x 45" (241 x 1143)	59# (26.8)
8006701	8006700	9.5" x 53" (241 x 1346)	66# (22.9)
8006374	8006273	12.5" x 45" (318 x 1143)	84# (38.1)

ARMADILLO Stainless Capacities	
Pair Count of Cables	ARMADILLO Stainless Size (mm)
50 thru 300	4" x 25" (102 x 635)
300 thru 600	6.5" x 22" (165 x 559)
300 thru 1100	6.5" x 28" (165 x 711)
900 thru 1500	6.5" x 38" (165 x 965)
900 thru 2100	8" x 28" (203 x 711)
1200 thru 2400	8" x 38" (203 x 965)
1500 thru 2700	8" x 45" (203 x 1143)
1500 thru 2700	9.5" x 28" (241 x 711)
1800 thru 3600	9.5" x 38" (241 x 965)
2100 thru 4200	9.5" x 45" (241 x 1143)
2100 thru 4200	9.5" x 53" (241 x 1356)*
2400 thru 3000	12.5" x 28" (318 x 711)
2700 thru 3600	12.5" x 38" (318 x 965)
3000 thru 4200	12.5" x 45" (318 x 1143)
3000 thru 4800	12.5" x 65" (318 x 1651)*

NOTE: Capacities based on 24 gauge wire and industry standard splice modules

*Shells are welded

Recommended RD Encapsulant for ARMADILLO Stainless and REDDI™ Seal Closures	
Size (mm)	Amount (grams)
4" x 25" (102 x 635)	3,800
6.5" x 22" (165 x 559)	8,800
6.5" x 28" (165 x 711)	11,000
6.5" x 38" (165 x 965)	16,000
8" x 28" (203 x 711)	18,000
8" x 38" (203 x 965)	24,000
8" x 45" (203 x 1143)	30,000
9.5" x 28" (241 x 711)	23,000
9.5" x 38" (241 x 965)	33,000
9.5" x 45" (241 x 1143)	41,000
9.5" x 53" (241 x 1346)	46,000
12.5" x 28" (318 x 711)	39,000
12.5" x 38" (318 x 965)	57,000
12.5" x 45" (318 x 1143)	69,000

NOTE: Based on 10% of closure volume being occupied by splices.



ARMADILLO® Sealing Washer End Plates

ARMADILLO Sealing Washer End Plates

With the introduction of the ARMADILLO Series comes a new end plate design. The ARMADILLO Sealing Washer End Plate eliminates major tooling costs, field drilling and extensive personnel training.

The ARMADILLO Sealing Washer End Plate does not have any exposed fastener hardware, offers grounding through the end plate and utilizes the torque bar for end plate positioning.

When selecting an end plate, the ARMADILLO Sealing Washer End Plate may be used for most OSP applications that do not require more than one, two or three cable entry ports. End plates feature a fixed number of entry ports that do not require a power source or major tooling for field drilling and are designed to maintain 10 psi. This design also utilizes Mastic sealing tapes that do not require the use of C-Cement and allow the end plates to be re-used.

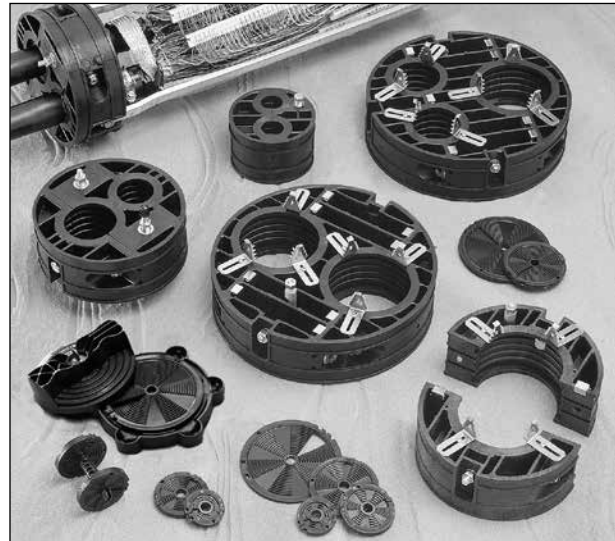

ARMADILLO Sealing Washer End Plates

Design Features:

The ARMADILLO Sealing Washer End Plates incorporate universal inserts that allow grounding connections and air pressurization through the end plate. In addition, this design includes a cable entry plug spool for plugging unused ports while allowing for future use. ARMADILLO Sealing Washer End Plates also feature a two-piece sealing washer that is stronger and eliminates the seam on sealing washers. These sealing washers are available in the same diameters as competitive units and may be cut on the job site with our easy and safe washer cutter tool or they may be cut with competitive cutters.

Interchangeable and Compatible:

ARMADILLO Sealing Washer End Plates are available in one to three cable entry port designs for use with 4" (102 mm), 6.5" (165 mm), and 9.5" (241 mm) diameter shell kits.

Cable Capacities:

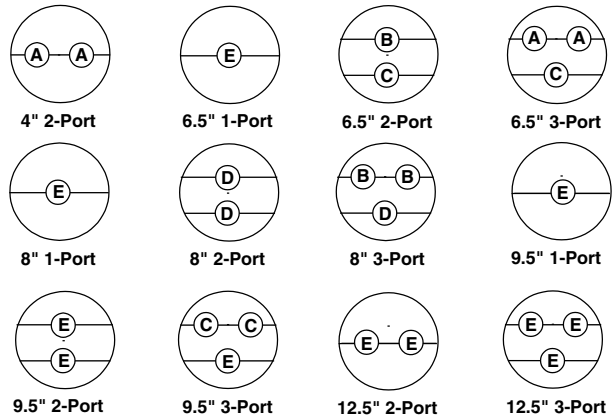

Maximum Cable Diameter (mm)
 A = 1.0" (25.4) D = 2.8" (71.1)
 B = 1.6" (40.6) E = 3.4" (86.4)
 C = 2.2" (55.9)

ARMADILLO Sealing Washer End Plate Kits			
Catalog Number	Size (mm)	Ports	Shipping Wt (kg)
8003514	4.0" (102)	2-Port	4# (2)
8003515	6.5" (165)	1-Port	4# (2)
8003516	6.5" (165)	2-Port	4# (2)
8003517	6.5" (165)	3-Port	4# (2)
8003518	8.0" (203)	1-Port	6# (3)
8003519	8.0" (203)	2-Port	6# (3)
8003520	8.0" (203)	3-Port	6# (3)
8003630*	9.5" (241)	1-Port	8# (4)
8003521	9.5" (241)	2-Port	7# (3)
8003522	9.5" (241)	3-Port	7# (3)
8003621*	12.5" (318)	2-Port	12# (5)
8003620*	12.5" (318)	3-Port	12# (5)

* Uses Drillable End Plate design with factory sealing washer pockets

ARMADILLO® Drillable End Plate Kits

ARMADILLO Drillable End Plates

These end plates offer a more rugged design that is designed to take on your most demanding environments. They are designed to maintain 15 psi when installed with ARMADILLO Stainless shells and are the choice for vault applications. ARMADILLO Drillable End Plates also feature the LOCK-TAPE™ sealing system which has consistently provided superior cable sealing and pullout strength for more than 20 years.

These end plates are your best option for applications that require field flexibility as they accept almost any size cable and will accommodate a wide variety of cable configurations. Also, any bond connector can be used and fixed sheath opening dimensions do not depend on bond connector placement. However, electric service is needed for the Power End Plate Cutter to field drill the End Plates, and these End Plates cannot be reused.

Design Features:

The ARMADILLO Drillable End Plates can accommodate a variety of cables, cable sizes and cable configurations and feature two-section and three-section designs. They are available with grounding and air valve inserts for air pressurization, aerial support and grounding through the end plate.

Interchangeable:

ARMADILLO Drillable End Plates are available in two and three sections designs for use with 4" (102 mm), 6.5" (165 mm), 8.0" (203 mm), 9.5" (241 mm), and 12.5" (318 mm) diameter shell kits.

Two-Section End Plate

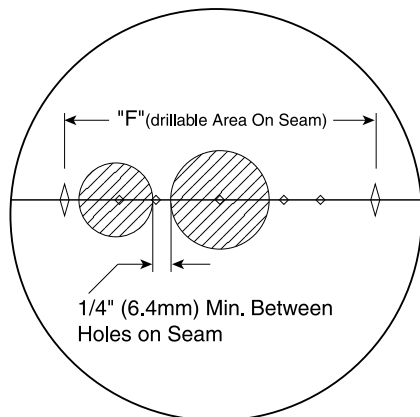

End Plate Size	"F" (mm)
4.0" (102)	2.2" (56)
6.5" (165)	4.1" (104)
8.0" (203)	5.6" (142)
9.5" (241)	7.1" (180)
12.5" (318)	9.3" (236)

Three-Section End Plate

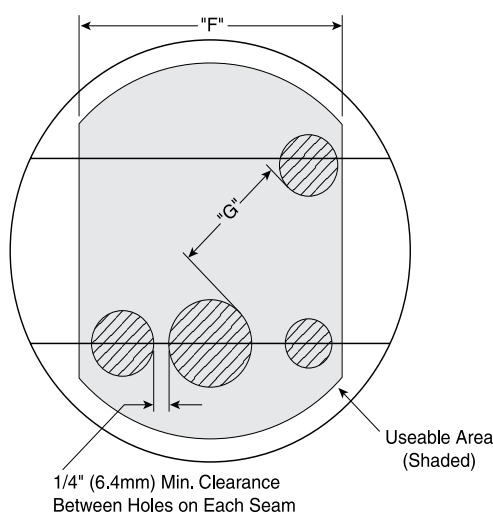

End Plate Size (mm)	Maximum Combined Cable Diameters (mm)			
	1 Cable	2 Cables	3 Cables	4 Cables
4.0" (102)	2.2" (56)	1.95" (50)	1.70" (43)	1.45" (37)
6.5" (165)	4.1" (104)	3.85" (98)	3.60" (91)	3.35" (85)
8.0" (203)	5.6" (142)	5.35" (136)	5.10" (130)	4.85" (123)
9.5" (241)	7.1" (180)	6.85" (174)	6.60" (168)	6.35" (161)
12.5" (318)	9.3" (236)	9.05" (230)	8.80" (224)	8.55" (217)





Minimum distance between holes on opposite seam ("G")

End Plate Size (mm)	G (mm)
6.5" (165)	3/8" (10)
8.0" & 9.5" (203 & 241)	1/2" (13)
12.5" (318)	3/4" (19)







ARMADILLO® Drillable End Plate Kits

Two-Section End Plates: One per kit

Size (mm)	Catalog Number				Shipping Weight (kg)
	Inserts				
	None	Ground Only	Air Valve Only	Ground & Air Valve	
					
4.0" (102)	8003539	8003550	8003555	8003560	3# (1)
6.5" (165)	8003540	8003551	8003556	8003561	4# (2)
8.0" (203)	8003541	8003552	8003557	8003562	6# (3)
9.5" (241)	8003542	8003553	8003558	8003563	8# (4)
12.5" (318)	8003284	8003554	8003559	8003564	12# (5)

Three-Section End Plates: One per kit

Size (mm)	Catalog Number				Shipping Weight (kg)
	Inserts				
	None	Ground Only	Air Valve Only	Ground & Air Valve	
					
6.5" (165)	8000361	8003094	80805422	80805365	4# (2)
8.0" (203)	8003110	8003532	8003137	8003533	6# (3)
9.5" (241)	800081098	8003013	8003121	80805376	8# (4)
12.5" (318)	8003055	8003534	8003122	8003367	12# (5)

ARMADILLO® Stainless Shell Kits

ARMADILLO Stainless Shell Kits

ARMADILLO Stainless shells are precision-formed of stainless steel with an inside liner of neoprene. They feature a permanent gasket-sealing system that requires no re-entry kit or cleaning upon re-entry, and an integral air flange and grounding lead that allow pressurization and grounding through the shell. The LOCKBAR™ Fastening system features corrosion-resistant stainless steel front and back bars that mate through the flange area and lock into position to reduce installation time.

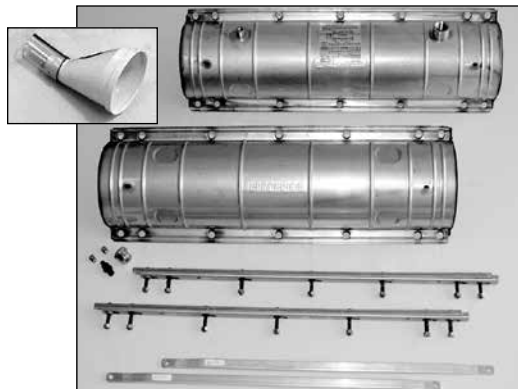

Standard Shell Kit

Stainless Shell Kit							
Size (mm)	Catalog Number		Dimensions (mm)			Sheath Opening	Shipping Weight (kg)
	Standard	Filling Flange	A	B	C		
4.0" x 25" (102 x 635)	8006750	8006756	25.8 (655)	4.5 (114)	6.0 (152)	16.8 (427)	12# (5)
6.5" x 22" (165 x 559)	8006510	8006390	22.0 (559)	7.0 (178)	9.3 (235)	12.7 (322)	15# (7)
6.5" x 28" (165 x 711)	8006474	8006244	28.4 (721)	7.0 (178)	9.3 (235)	19.2 (488)	26# (12)
6.5" x 38" (165 x 965)	8006751	8006246	38.4 (975)	7.0 (178)	9.3 (235)	29.2 (742)	33# (15)
8.0" x 28" (203 x 711)	8006776	8006391	28.4 (721)	8.5 (216)	10.5 (267)	19.2 (488)	24# (11)
8.0" x 38" (203 x 965)	8006777	8006392	38.4 (975)	8.5 (216)	10.5 (267)	29.2 (742)	35# (16)
8.0" x 45" (203 x 1143)	8006778	8006393	45.2 (1148)	8.5 (216)	10.5 (267)	36.2 (919)	57# (26)
9.5" x 28" (241 x 711)	8006779	8006245	28.4 (721)	10.0 (254)	12.5 (318)	18.1 (460)	32# (15)
9.5" x 38" (241 x 965)	8006780	8006247	38.4 (975)	10.0 (254)	12.5 (318)	28.1 (714)	40# (18)
9.5" x 45" (241 x 1143)	8006781	8006250	45.2 (1148)	10.0 (254)	12.5 (318)	36.2 (919)	52# (24)
9.5" x 53" (241 x 1346)	8003461	8006758	53.3 (1354)	10.0 (254)	12.5 (318)	43.2 (1097)	56# (25)
12.5" x 28" (318 x 711)	8006782	8006274	28.4 (721)	13.0 (330)	15.5 (394)	18.1 (460)	41# (19)
12.5" x 38" (318 x 965)	8006783	8006275	38.4 (975)	13.0 (330)	15.5 (394)	28.1 (714)	51# (23)
12.5" x 45" (318 x 1143)	8006784	8006276	45.2 (1148)	13.0 (330)	15.5 (394)	36.2 (919)	60# (27)
12.5" x 65" (318 x 1651)	8006509	n/a	65.0 (1651)	13.0 (330)	15.5 (394)	54.9 (1394)	146# (66)

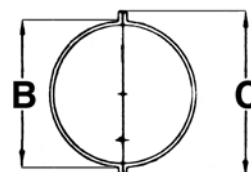
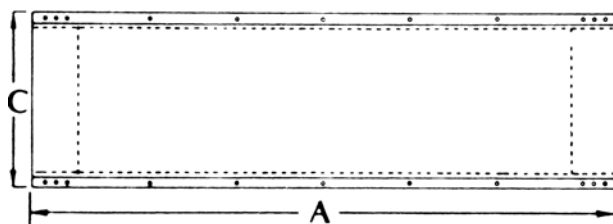



ARMADILLO® Series Accessories

ARMADILLO Bonding Kits

The Bonding Kits for the ARMADILLO Stainless each contain one long insulated Bonding Braid, three SURE-GRIP™ Shield Connectors, four Pair Protectors.

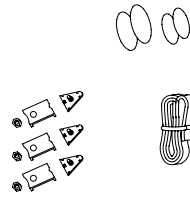

Catalog Number	Description (mm)
80802797	Bonding Kit for 22" & 25" (559 & 635) ARMADILLO Stainless
80802798	Bonding Kit for all 28" (711) ARMADILLO Stainless
80802803	Bonding Kit for all 38" (965) ARMADILLO Stainless
80802802	Bonding Kit for all 45" & 53" (1143 & 1346) ARMADILLO Stainless
8003652	ARMADILLO External Bonding Kit

ARMADILLO Coupling

The ARMADILLO Coupling allows the joining of two 6.5" or 9.5" ARMADILLO Stainless shell kits end to end. The result is an increased cable opening area for special applications or for cable repair applications. Any length combination of 6.5" or 9.5" shells may be joined, but it is recommended that no more than two shell kits be joined.



The ARMADILLO Coupling uses the standard torque bars that come with the shell kits to be joined. Pre-cut and punched LOCK-TAPE™ Sealant gaskets are applied to all mating surfaces of the ARMADILLO Coupling halves.

Catalog Number	Description (mm)	Standard Carton Qty.
8003089	6.5" (165) ARMADILLO Coupling Kit	1 Per Carton
8003031	9.5" (241) ARMADILLO Coupling Kit	1 Per Carton

ARMADILLO Manhole Support

ARMADILLO Manhole Supports are generally used in manhole applications where there is no cable present at one end of the shell or when the cables are inadequate in size for proper support.

- Effective yet inexpensive.
- Made from durable plastic.
- V-Notched for easy application over the shell flange.

Note: Tie Wraps are not included. Each kit contains two supports. NOT recommended for filled closures

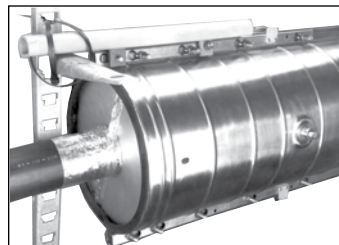

Catalog Number	Description
8003527	Manhole Support Kit for ARMADILLO Stainless Shell Kits

BUNDLE-LOCK™ Kit

The BUNDLE-LOCK Kit is used to wrap the splice bundle in unfilled closures. The universal kit contains a single, cut-to-size, clear plastic sheet and four cable ties designed for use with any size ARMADILLO Closure, ARMADILLO Stainless shell kit or REDDI™ Seal Closure. The individual sized kits contain 25 BUNDLE-LOCK sheets (no tie wrap) in a single carton.

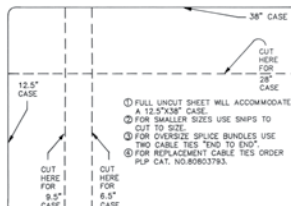

Universal Kit

Catalog Number	Description (quantity in box)
80006264	Universal BUNDLE-LOCK Kit (1)
80807120	BUNDLE-LOCK Kit for 4" x 25" Closures (25)
80807121	BUNDLE-LOCK Kit for 28" Closures (25)
80807122	BUNDLE-LOCK Kit for 38" Closures (25)

ARMADILLO® Series Accessories

Cable Sheath Reinforcing Kit

The Cable Sheath Reinforcing Kit is made up of one plastic cable insert and one plastic shim. Both are inserted between the metallic cable shield and the core wrap prior to applying any mechanical telecommunications closure. Cable Sheath Reinforcing Kit provides added integrity under areas that must withstand clamping pressures. The kit comes in two sizes to accommodate a range of cable sizes.



Features:

- Prevents crimps in the cable sheath
- Protects cable during any closure application
- Can be used with any type of closure

Catalog Number	Range (mm)	Thickness (mm)	Standard Carton Quantity
80009802	2.95" (75) and larger	.062" (2)	10
80004096	2.40" - 2.94" (61- 75)	.062" (2)	10

Double Sheath Cable Blocking Kit

PREFORMED Double Sheath Cable Blocking Kit is used on double sheath cable in an ARMADILLO Closure or ARMADILLO Stainless case. Kit contains plastic envelopes and sealing tapes for fastening polyurethane resin mold around inner and outer sheaths. Special sealant rings and resin block prevent water from entering and air from escaping between cable sheaths. Application procedure includes instructions for preparing both single and branch cable openings.

Catalog Number	Standard Carton Quantity
8000314	1 Kit

1. Two plastic envelopes
2. Resin kit (dual component)
3. Resin stirring stick
4. Sealant tape
5. Application procedure

Pressure Wrap Kit

The Pressure Wrap Kit, when used with the REDDI™ Seal, ARMADILLO Stainless forces the encapsulant into the splice and up into the cable core to help prevent moisture penetration and cable pull-out while maintaining electrical continuity. Kit Components:

1. Web liner
- 1-3/4" sealant tape (8' roll)
3. Cable ties
4. Grounding bar with braid

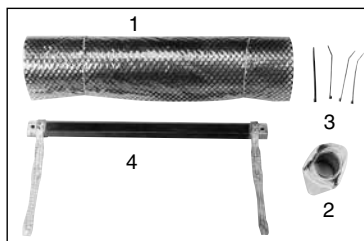

Note: Pressure Wrap Stretch Tape not provided.

ARMADILLO Stainless

Closure Diameter (mm)	Length of Closure		
	Standard (28.4") (721 mm)	Stretch (38.4") (975 mm)	SuperStretch (45.2") (1143 mm)
4.0" (102)	8003032	—	—
6.5" (165)	8003035	8003036	—
8.0" (203)	8003202	8003203	8003204
9.5" (241)	8003037	8003038	8003034
12.5" (318)	8003160	8003161	8003162

Catalog Number	Description
8000450	Bracket Standoff Kit



Pressure Wrap Collar

The Pressure Wrap Collar is used with the Pressure Wrap Kit for branch or multi-cable entries. It is not needed for single cable entry applications. One kit is needed for one End Plate. The Pressure Wrap Kit, when used in conjunction with either the REDDI™ Seal or ARMADILLO Stainless, forces the encapsulant into the splice and up into the cable core.



Pressure Wrap Collar (All lengths)	
Catalog Number	Case Diameter (mm)
8003124	6.5" (165)
8003125	9.5" (241)
8003383	12.5" (318)
8003619	8" (203)



ARMADILLO® Series Installation Materials

ARMADILLO Sealing Washers

Each sealing washer kit contains four sealing washer halves of the same size, the quantity required for one cable entry port of an ARMADILLO Sealing Washer End Plate.

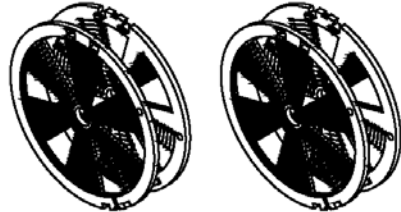

Catalog Number	Description (mm)	Standard Carton Quantity
8003543	1.0" (25) Sealing Washer Kit	25
8003544	1.6" (41) Sealing Washer Kit	25
8003545	2.2" (56) Sealing Washer Kit	25
8003546	2.8" (71) Sealing Washer Kit	25
8003547	3.4" (86) Sealing Washer Kit	25

Prep Tape

Used to wrap cables (single wrap) in ARMADILLO Sealing Washer End Plates to prepare cable surface for Cable R-Sealant.

Catalog No. 80806592 (1-1/2" W x 25" L, one roll)

Cable R-Sealant

Used to seal cables in ARMADILLO Sealing Washer End Plates.

Catalog No. 80806434 (1-1/2" W x 72" L, one roll)

End Plate Sealant

Used to seal End Plate sections.

Catalog No. 8003602 (12" roll)

LOCK-TAPE™ Sealant for ARMADILLO Drillable End Plates

Catalog Number	Description
80801953	1½"W x 12'L (38mm x 3.6m), one roll
80801954R	2½"W x 12'L (64mm x 3.6m), one roll
80801955R	3"W x 12'L (76mm x 3.6m), one roll
8000375	LOCK-TAPE™ Sealant Kit for 4.0" x 25" (102mm x 635mm) ARMADILLO Stainless
8000376	LOCK-TAPE™ Sealant Kit for 6.5" (165mm) ARMADILLO Stainless
8003118	LOCK-TAPE™ Sealant Kit for 8.0" x 28" (203mm x 711mm), ARMADILLO Stainless
8003119	LOCK-TAPE™ Sealant Kit for 8.0" x 38" & 8.0" x 45" (203mm x 965mm & 203mm x 1143mm) ARMADILLO Stainless
8000377	LOCK-TAPE™ Sealant Kit for 9.5" x 28" (241 x 711mm) ARMADILLO Stainless
8000378	LOCK-TAPE™ Sealant Kit for 9.5" x 38" & 9.5" x 45" (241 x 965mm & 241 x 1143mm) ARMADILLO Stainless
8003120	LOCK-TAPE™ Sealant Kit for 12.5" (318) ARMADILLO Stainless



Sealant kits include the materials shipped with standard ARMADILLO Stainless Shell Kits, one or two rolls of 1-1/2" wide LOCK-TAPE Sealant and the LOCK-TAPE Sealant strips used between End Plate Sections (Two-Section End Plates).

ARMADILLO® Series Installation Materials/Spare Parts

ARMADILLO Plug Spool Kit

Used to minimize the amount of R-Sealant required to plug the larger size cable entries in a Sealing Washer End Plate.



Catalog Number	Description (mm)
8003624	Plug Spool for 1.6" (41) or 2.2" (56) Cable Entries. Kit contains six spools
8003625	Plug Spool for 2.8" (71) or 3.4" (86) Cable Entries. Kit contains six spools

Shell Lubricant

Used to coat permanent gaskets in shell halves of ARMADILLO Stainless.

Accessories

Catalog Number	Product	Description	Approx. Unit Weight Lbs	General Appearance
80801566	Shell Lubricant	Used to coat permanent gaskets in shell halves of ARMADILLO Stainless	6 oz.jar	
80805937	Air Valve	For Stainless Steel Cases		

LOCKBAR™ Fastening System for ARMADILLO Stainless Shells

Catalog Number	Description (mm)
80802790	LOCKBAR Assemblies for 4.0" x 25" (102 x 635) ARMADILLO Stainless
80804050	LOCKBAR Assemblies for 6.5" x 22" (152 x 559) ARMADILLO Stainless
80802789	LOCKBAR Assemblies for 28" (711) ARMADILLO Stainless
80802791	LOCKBAR Assemblies for 38" (965) ARMADILLO Stainless
80802792	LOCKBAR Assemblies for 45" (1143) Stainless
80805989	LOCKBAR Assemblies for 9.5" x 53" (241 x 1346) ARMADILLO Stainless
80804938	LOCKBAR Assemblies for 12.5" x 65" (318 x 1651) ARMADILLO Stainless
8003025	Replacement stud with nut for 4" ARMADILLO Stainless (1 each)
8003026	Replacement stud with nut for 6.5", 8", 9.5" & 12.5" ARMADILLO (1 each)



ARMADILLO® Bolt and Torque Bars

Torque Bars for ARMADILLO Stainless

Catalog Number	Description (mm)
80851245	Torque Bar for 4.0" x 25" (102 x 635) ARMADILLO Stainless, one bar
80803994	Torque Bar for 6.5" x 22" (165 x 559) ARMADILLO Stainless and ARMADILLO Closure, one bar
80850952	Torque Bar for 28" (711) ARMADILLO Closure and ARMADILLO Stainless (6.5", 8.0" & 9.5") (165, 203, 241), one bar
80803788	Torque Bar for 12.5" x 28" (318 x 711) ARMADILLO Stainless, one bar
80850985	Torque Bar for 38" (965) ARMADILLO Closure and ARMADILLO Stainless (6.5", 8.0" & 9.5") (165, 203, 241), one bar
80802591	Torque Bar for 45" (1143) ARMADILLO Stainless (8.0", 9.5" & 12.5") (203, 241, 318), one bar
80805986	Torque Bar for 9.5" x 53" (241 x 1346) ARMADILLO Stainless, one bar
80804935	Torque Bar for 12.5" x 65" (318 x 1651) ARMADILLO Stainless, one bar
80803792	Stiffener Bar for 12.5" x 28" (318 x 711) ARMADILLO Stainless, one bar
80803799	Stiffener Bar for 12.5" x 38" (318 x 965) ARMADILLO Stainless, one bar
80803877	Stiffener Bar for 12.5" x 45" (318 x 1143) ARMADILLO Stainless, one bar
80804937	Stiffener Bar for 12.5" x 65" (318 x 1651) ARMADILLO Stainless, one bar
8003525	Customer Name Plaque Kit (includes one plaque and required fasteners)

ARMADILLO® Tools

Socket Tool Kit

Socket Tool Kit contains tools for installing the ARMADILLO Stainless. Standard screwdriver not included.



Catalog Number	Description
80803967	Torque Wrench with Ratchet Head 3/8" Drive
80803968	Ratchet Type Socket Wrench 3/8" Drive
80801150	7/16" Deep Well Socket
80801151	1/2" Deep Well Socket
80803969	6" Extension
8000428	Tool Kit With Torque Wrench in Box
8000420	Tool Kit Without Torque Wrench in Box
80805937	Air Valve for Stainless Steel Cases

ARMADILLO Sealing Washer Cutter Tool

The ARMADILLO Sealing Washer Cutter Tool is simple to use, made of durable materials and designed specifically for ARMADILLO Sealing Washers.



Catalog Number	Description
8000480	Sealing Washer Cutter Kit, Includes Washer Cutter, Spare Blade & Tote Bag
8000481	Blades for Washer Cutter, 3 Blades

Power End Plate Cut Kit for ARMADILLO Drillable End Plates

The Power End Plate Cutter comes standard with 26 blades from .375" up to 3.50" in diameter (4 additional blades for larger sizes are available for holes up to 4.00"). It provides a fast and convenient way for cutting through material forming precise cable access holes in the ARMADILLO Drillable End Plates.

The complete Power End Plate Cutter Kit includes:

1. Power End Plate Cutter for use in drilling 3" to 12.5" ARMADILLO Drillable End Plates.
2. Complete blade kit. Includes blades A through Z, drill motor adapter, CABLE Mea-SURE™ Tape, areas for storing other parts and a complete guide for re-ordering parts, all stored in a plastic case.
3. Metal Carrying Case for Power End Plate Cutter and Blade Kit.

Power End Plate Cutter and Accessories		
Catalog Number	Description	Standard Carton Qty.
8000452	Power End Plate Cutter (only), includes 80803377	1 Unit
8000454	Power End Plate Cutter and Case with Blade Kit	1 Kit
8000455	Power End Plate Cutter with Blade Kit	1 Kit
8000468	Power End Plate Cutter Lift Kit	1 Kit
8000445	Carrying Case	1 Unit
8000453	Blade Kit (Blades A-Z), includes 80801944	1 Set
8000417A-DD	Individual Blades (A-DD)	1 Unit
80851659	Electric Drill With Socket	1 Unit
80801944	Drill Motor Adapter (For other than PREFORMED Drill)	1 Unit
80803377	Cutting Blade Adapter	1 Unit



CARRYING CASE



BLADE KIT



POWER END PLATE CUTTER



ARMADILLO® Tools

Cable Shaper Tool

The PREFORMED™ Cable Shaper is designed for cable shaping applications encountered in all splicing installations. Adjustable jaws accommodate all cable sizes. The unit is designed to be effectively used in restricted areas to assure proper cable shaping. Coated handles provide a firm gripping surface during use. This tool is ideal for use with all PREFORMED re-enterable closures as well as many other applications requiring shaped cable.

Features:

- Adjustable jaws accommodate all cable sizes.
- Coated handles for firm gripping.
- Sturdy forged construction.
- Ideal for numerous cable shaping applications.



Catalog No. 8000422

Unique design of the PREFORMED Cable Shaper makes this tool extremely useful for cable shaping during installation of all splice closures.



End Plate Removal Tool

The End Plate Removal Tool is made of durable galvanized steel. It is specially designed to facilitate End Plate removal from the cable during procedures that necessitate new End Plates, i.e., for use with the ARMADILLO Stainless, REDDI™ Seal, REDDI Closure.

Catalog No. 8000432



ARMADILLO® Stainless (with Fire Retardant Drillable End Plates)

ARMADILLO Stainless with Fire Retardant Drillable End Plates

PLP Feature Focus
©2009 Preformed Line Products

Film available at
www.preformed.com

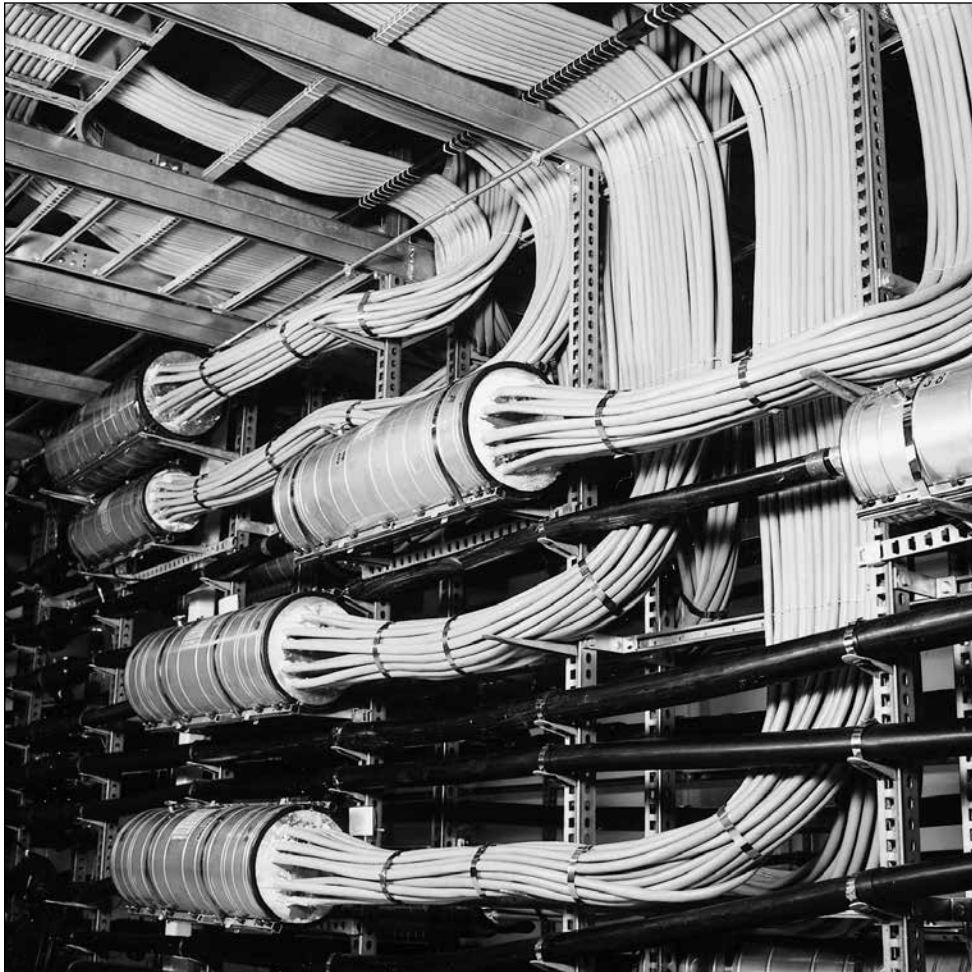

The ARMADILLO Stainless with Fire Retardant Drillable End Plates is a custom system designed to upgrade existing vault closures without disturbing the splices or interrupting the service. This system can also be used for new construction.

Each ARMADILLO Stainless Vault Closure is customized in our factory for the specific splice and shipped in a single carton with the location and closure identification clearly marked.

Simply fill out a PLP Vault Closure Ordering Form for each vault splice. Contact PLP if you need assistance with filling out the form.

Each ARMADILLO Stainless Vault Closure comes with all the materials required for installation and the End Plates have been custom-drilled in our factory which eliminates any field drilling.

The ARMADILLO Stainless Vault Closure System is designed to remain watertight for water depth up to 10 feet. Each closure is also designed to meet or exceed the industry standards for fire retardancy.





PLP® Vault Closure Ordering Form

Company Name _____ Person to contact _____

Vault location (or physical address) _____

Cable & count _____ Contact phone No. _____
(This must be a valid daytime contact number)

Required arrival date _____ P.O. No. _____

This order form should accompany the Purchase Order to the supplier/distributor.

IT MUST BE FAXED TO PLP IN CLEVELAND, OHIO AT: 440-442-8816.

Your company's MATERIAL CODE #, TONES # or PID #, etc. MUST BE ON THIS ORDER FORM

Field/Central Office
(Circle correct side)

Closure Identification
No. _____

Field/Central Office
(Circle correct side)

End Plate Outside Surface

Indicate cable measurement at desired hole locations

Diameter	Closure Length			
	25"	28"	38"	45"
4"				
6.5"				
8"				
9.5"				
12.5"				

End Plate Outside Surface

Indicate cable measurement at desired hole locations

Splice Case Coupling available for extra long openings

Check and identify if cable sheath is lead

Check and identify if cable sheath is lead

Vault Closure End Plate Designs (typical*)

1 or 2 TIP
4"

6 TIP
6.5", 8" or 9.5"

9 TIP
8" or 9.5"

12 TIP
8", 9.5" or 12.5"

15 TIP
8", 9.5" or 12.5"

18 TIP
8", 9.5" or 12.5"

21 TIP
9.5" or 12.5"

24 TIP
9.5" or 12.5"

3 TIP
1 FEEDER
9.5" or 12.5"

6 TIP
1 FEEDER
9.5" or 12.5"

9 TIP
1 FEEDER
9.5" or 12.5"

11 TIP
1 FEEDER
9.5" or 12.5"

27 TIP
12.5"

30 TIP
12.5"

36 TIP
12.5"

42 TIP
12.5"
(1.06 maximum)

*NOTE: These are custom-drilled End Plates. Only the most common combinations are shown. Since the End Plates are custom-drilled, almost any combination is possible. Contact PLP for a TIP CABLE Mea-SURE™ Tape P/N 80802922 at the sales office at: 440-461-5200.

©2013 Preformed Line Products. All rights reserved.

ARMADILLO® Stainless for Vault Applications

Vault Closure End Plate Measuring Procedures

The ARMADILLO Stainless Vault Closure consists of three major components, the Stainless shells and two end plates. One end plate is utilized for the feeder cable and the other for the tip cables. Each of these components has an associated PLP part number and your company's ordering number (i.e., Material Code, TONE. PID, etc.).

The tip and feeder end plates must be custom drilled to match the vault splice since a combination of sizes and pair counts are possible. Two measure tapes are required to determine the exact diameter needed for each cable entering the vault splice, a CABLE Mea-SURE™ Tape for the feeder cable and a CABLE Mea-SURE Tape for the central office tip/riser cables. A circumference measure tape may be substituted if either of the recommended tapes is not available. **Note:** any changes in measuring devices must be noted on the order form to insure proper fit of the cables.

The CABLE Mea-SURE tape determines the size of the hole and the number of half-lapped layers of tape to make an air tight seal. This tape is identified by its alpha-numeric markings and index line/with arrow. **Note:** when completing the PLP Vault Closure Ordering Form, the blade size and number of half lapped layers of LOCK-TAPE™ indicated with the CABLE Mea-SURE tape must be indicated at its desired location within the end plate circles shown on the form. Also, if applicable, one of the vault closure end plate designs shown on the Ordering Form can be referenced by circling the desired end plate design.

The following specifies the procedures for measuring the cables:

Feeder Cables

To obtain this measurement, the tape must be wrapped around the cable at the location where the end plate will be placed. The index line (labeled) must be viewed at a location where the alpha-numeric markings can be readily viewed. At this point the desired measurement may be obtained by wrapping the trailing end of the tape around the cable and recording the alpha/numeric designation that appears at this location. In the event that the index line falls on the line, read in the direction that the arrow points and use that figure as your measurement.

The presence of lead cables must be noted for each end plate by placing an "x" in the square box shown below each end plate circle on the Ordering Form. Prior to taking the measurements on lead type cable, the lead sheath must be scuffed, 'C' cement applied and allowed to dry, and two half-lapped layers of LOCK-TAPE applied prior to measuring the cable.

Tip Cables

The tip CABLE Mea-SURE tape is designed to allow for the proper sealing of the space around the tip cables utilizing a silicone sealant. The closure may be pressurized to 5 psi if the tip cables have been properly measured and the silicone sealant has cured.

The tip cable procedure is similar to the feeder cable measuring procedure with the exception of the type of CABLE Mea-SURE Tape being used. The tip cable tape is in numeric form.

To obtain this measurement, place the CABLE Mea-SURE tape on the cable with the index line (labeled) in a position on the cable that can be readily viewed. Wrap the trailing end of the tape around the cable, lining up the numeric designation with the index line. This is the size of the tip cable.

In the event that the index line falls on a line between the numbers, read in the direction of arrow and select that measurement.

NOTE: Always measure several of the tip cables and average the readings if they vary less than three divisions. For example, if the measurements are, one cable measures 6, another one measures 7 and another one measures 8 and these figures are consistent on all cables, then it is reasonable to consider the average to be a number 7 for all tip cables. The averaging requirement is necessary due to the manufacturers design tolerances.



ARMADILLO® Stainless (with Urethane End Plates for Vaults)

ARMADILLO Stainless for New Construction in Vaults

For new construction in vaults a 21-hole urethane End Plate is available to provide the required fire resistance. The end plate will accommodate tip cables ranging from 0.88" to 1.06" in diameter. End Plate Plugs are available to seal unused holes.

Fire Retardant Closure Kits and Parts		
Catalog Number	Description (mm)	Standard Carton Quantity
*	Fire Retardant Closure Replacement Kits to include a PREFORMED™ Splice Case, Fire Retardant feeder cable End Plate and Four-Section or Six-Section End Plate.	1 Kit
8003053	12.5" (318) PREFORMED Two-section Fire Retardant End Plate. For Fire Retardant Closure application only.	1 Kit
8003033	Flame Retardant Tape Kit, 1-1/2" wide x 9 yards (38 x 8230)	1 Kit

*These are customized Fire Retardant Closure Replacement Kits with End Plates that are pre-drilled at the factory. The catalog numbers are also specially formulated to completely describe each custom order. Consult with your local PREFORMED representative, distributor or contact the factory directly for more information.

Note: For 12.5" requirements, consult the factory.

RD™ Encapsulant/Resin Kits for Buried Applications

Re-Enterable

Preformed Line Products' RD Encapsulant is a two-component polyurethane compound providing excellent moisture and electrical insulation protection for telecommunications cable splices.

RD Encapsulant offers numerous features and benefits, including:

- Easy to mix and pour
- Fast setting
- Room temperature curing
- Excellent splice penetration
- Easy to re-enter
- Bonds to itself when closures are refilled
- High impact strength, low water absorption
- Superior hydrolytic stability
- Low weight loss, nonexpanding
- High volume resistivity
- Minimal exotherm
- Contains no TDI or MOCA

Recommended RD Encapsulant for ARMADILLO® Stainless, and REDDI™ Seal Closures	
Size	Amount
4" x 25" (102 x 635)	3,800
6.5" x 22" (165 x 559)	8,800
6.5" x 28" (165 x 711)	11,000
6.5" x 38" (165 x 965)	16,000
8" x 28" (203 x 711)	18,000
8" x 38" (203 x 965)	24,000
8" x 45" (203 x 1143)	30,000
9.5" x 28" (241 x 711)	23,000
9.5" x 38" (241 x 965)	33,000
9.5" x 45" (241 x 1143)	41,000
9.5" x 53" (241 x 1346)	46,000
12.5" x 28" (318 x 711)	39,000
12.5" x 38" (318 x 965)	57,000
12.5" x 45" (318 x 1143)	69,000

Note: Based on 10% of closure volume being occupied by splices.

Packaging (standard can kits)				
Catalog Number	Nominal Kit Net Wt. (grams)	Part A (polyol) Can size	Part B (pre-polymer) Can size	Kits Per Carton
80802437	600	1 qt.	½ pt.	12
80802820	750	1 qt.	½ pt.	12
80802438	1200	½ gal.	½ pt.	6
80802821	1500	½ gal.	1 pt.	6
80802822	2600	1 gal.	1 pt.	4
80802439	3000	1 gal.	1 pt.	4
80802823	6000	2½ gal. pail	1 qt.	1
80802440	7800	2½ gal. pail	½ gal.	1
80802826	8000	2½ gal. pail	½ gal.	1
80802827	9000	4 gal. pail - Includes Part B	See Part A	1



Spacer Mat/Re-Encapsulation Kits for Buried Applications

Non Re-Enterable

The PREFORMED™ Polyurethane Resin Kit offers these outstanding distinctive features:

- Comes in three sizes for most economical usage
- Use of cans allows longer shelf life and “one mix—one pour” application
- Excellent electrical properties
- Low exotherm
- Low viscosity
- Easy to mix
- Good working life with short cure time
- Hard set in 15-20 minutes
- Resilient and tough
- Shelf life 18 months
- Meets OSHA specifications, contains no MDA, MOCA, or TDI
- Adhesion promoters are available upon request



Packaging (Standard Can Kits)		
Catalog Number	Description	Standard Carton Qty.
8000310	Resin Kit 8 oz. (227grams) kit	1 Kit
8000311	Resin Kit 15 oz. (425 grams) kit	1 Kit
8000312	Resin Kit 33 oz. (936 grams) kit	1 Kit

Spacer Mat

PREFORMED Spacer Mat is an open-cell, polyurethane foam material ideal for splice closures using solid-cast polyurethane resin as an encapsulant. The spacer is used to maintain at least ¼" of the resin around the splice. Spacer Mat can be also used to wipe excess grease off cable pairs prior to splicing filled cable.

Open-cell Polyurethane Foam		
Catalog Number	Description	Standard Carton Qty.
8000657	2½" x ¼" x 80" (318 x 6 x 2032)	50 units
8000653	4" x ¼" x 80" (102 x 6 x 2032)	50 units
8000658	18" x ¼" x 80" (457 x 6 x 2032)	10 units



Re-encapsulation Kit

The Re-encapsulation Kit includes a check valve and funnel with tubing which allows for refilling and filling flange stainless steel closures.

Catalog No.: 8003105





PREFORMED LINE PRODUCTS

Section 11 – REDDI™ Seal & Aerial REDDI Closures

Table of Contents	Page
REDDI Seal	11-2
Aerial REDDI Closure and Heat Shield	11-4
Aerial REDDI Closure	11-5
REDDI Seal and Aerial REDDI Closure	11-6



REDDI™ Seal

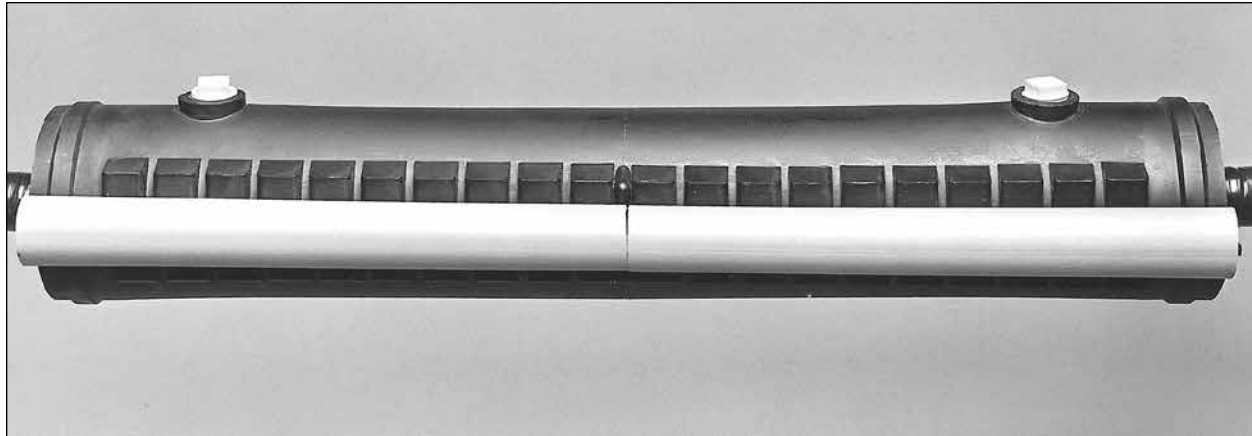

Preformed Line Products' REDDI™ Seal is designed to be applied to non-pressurized filled cable. It must be filled with resin and will not hold air. REDDI Seal provides a reliable and cost-efficient way to encapsulate splice bundles whether the application is aerial, manhole, or buried. A rugged construction is designed to keep moisture out, prevent cable pull-out, and maintain electrical continuity.

Accommodates Underground, Overhead, and Buried Plant
REDDI Seal accommodates a variety of resin-filled applications where strong cable pull-out strength is a necessity. Ultraviolet stabilizers in the shell resist the effects of ozone and sunlight in aerial plant.



Easily Applied, Easily Re-entered

Holes are easily cut in the End Plates to accommodate a variety of cable diameters and multiple cable entries. These holes can be cut quickly in the field with a Power End Plate Cutter. The one-piece plastic shell is closed without tools by simply sliding the plastic closing clamps over the flange. Re-entry is accomplished by removing the closing clamps, opening the shell, and removing whatever resin is required.

The Reliability of the PREFORMED Splice Case in Plastic Re-enterable Closure.

REDDI Seal utilizes the same basic foam-filled End Plates, torque bar assembly, and End Plate sealing system as the ARMADILLO® Stainless. Many of the accessories and tools are also interchangeable.

It also includes the performance-proven LOCK-TAPE™ Sealing System.

Proper application will seal End Plates and lock them to the cable, which is designed to provide extra strong shear strength and help resist cable pull-out.

Unique End Plate Insert Design

A metallic grounding insert enables the REDDI Seal to be grounded through the End Plates and facilitates aerial applications. Shells can be applied and removed without disturbing the continuity of the ground. Hanger brackets are designed for attachment to the insert, providing strong quick aerial applications.

Durable One-piece Plastic Shell

Durable polyethylene resists the effects of moisture, gas and weather extremes. The closure is designed to remain chemically inert, resist corrosion and cracking, and have good dielectric properties.

Re-enterable Resin

RD Encapsulant or other re-enterable resin pours through entry ports and is sealed with threaded plugs.

Laboratory Tested. Field Tried

Consult with Preformed Line Products for complete testing data.

REDDI™ Seal

(Shown is a REDDI™ Seal kit with bonding.)

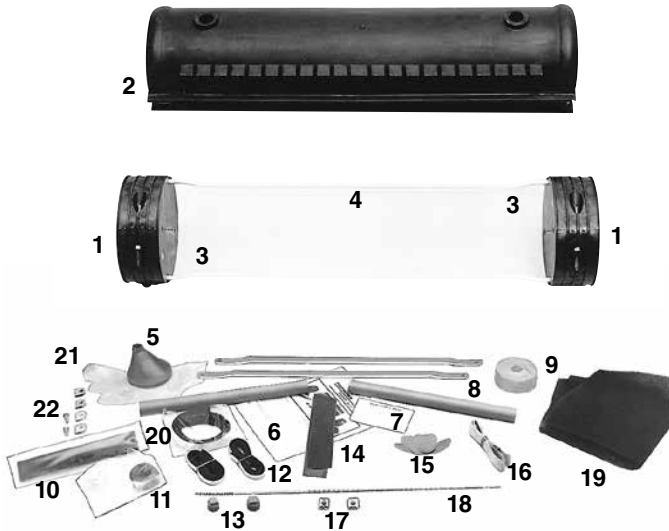

The complete REDDI Seal kit is shown. Power End Plate Cutter, vinyl tape, C-Cement, and resin must all be obtained separately.

1. Standard Two-Section End Plates
2. Shell
3. End Plate insert (grounding)
4. Torque bars
5. Funnel
6. Application procedure
7. Cue Card
8. Closing clamps
9. LOCK-TAPE™ Sealant roll
10. End Plate LOCK-TAPE Sealant strips
11. Moisture barrier sealant
12. End seals
13. Threaded plastic plugs
14. Emery cloth (for scuffing sheath)
15. Pair Protectors
16. Cable bonding braid
17. SURE-GRIP™ Shield Connectors
18. CABLE Mea-SURE™ Tape
19. Spacer Mat
20. Flange seal
21. Gloves
22. Bonding clamps

Standard REDDI Seal Catalog Entries*			
Catalog Number* (With Bonding)	Catalog Number (Without Bonding)	Closure Size (mm)	Carton Quantity
8006068	8006143	4.0" x 25.8" (102 x 655)	1
8006085	8006145	6.5" x 28.4" (165 x 721)	1
8006087	8006147	9.5" x 28.4" (241 x 721)	1
8006185	8006216	6.5" x 38.5" (165 x 978)	1
8006227	8006229	9.5" x 38.5" (241 x 978)	1

*For variations consult PLP support.

REDDI Seal Parts					
Part Description	For Use With a 4 (102) REDDI Seal (8006068)	For Use With a 6.5 (165) REDDI Seal (8006085)	For Use With a 9.5 (241) REDDI Seal (8006087)	For Use With a 6.5 (165) S-T-R-E-T-C-H REDDI Seal (8006185)	For use with a 9-5 (241) S-T-R-E-T-C-H REDDI Seal (8006227)
End Plate Kits	8000388	8000389	8000390	8000389	8000390
Torque Bars [2 per closure]	80851245	80850952	80850952	80850985	80850985
Funnel	80802250	80802250	80802250	80802250	80802250
Closing Clamps [2 per closure]	80802176	80802613	80802613	80802136**	80802136**
LOCK-TAPE Supply	8000375	8000376	8000377	8000376	8000378
Moisture Barrier Sealant 1 ft. (305 mm)	80801796	80801796	80801796	80801796	80801796
Plastic Plugs (2 per closure)	80802143	80802143	80802143	80802143	80802143
Emery Cloth [24 strips, 2 x 18] (50 X 457)	8000429	8000429	8000429	8000429	8000429
Spacer Mat [80" roll, 18" x ¼"] (2032 X 457 X 6)	8000658	8000658	8000658	8000658	8000658
Hanger Bracket [2 per closure]	80802510	80802510	80802510	80802510	80802510

**Three closing clamps (per closure) are required.



Aerial REDDI™ Closure and Heat Shield

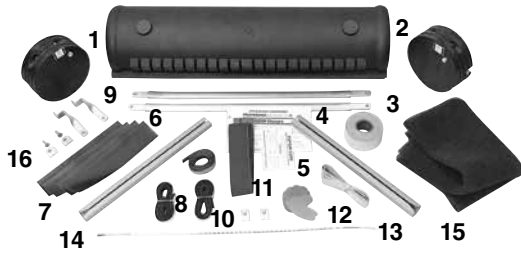

(Shown is an Aerial REDDI™ Closure Kit with bonding.)

- | | |
|------------------------------------|---------------------------------------|
| 1. Standard Two-Section End Plates | 9. Hanger (2) |
| 2. Shell | 10. SURE-GRIP™ Shield Connectors (2) |
| 3. Torque bars | 11. Emery cloth (for scuffing sheath) |
| 4. Application procedure | 12. Pair Protectors |
| 5. Cue Card | 13. Cable bonding braid |
| 6. Closing clamps | 14. CABLE Mea-SURE™ Tape |
| 7. LOCK-TAPE™ Sealant strips | 15. Spacer Mat |
| 8. End seals | 16. Bonding clamps |

Catalog No.* (With Bonding)	Catalog No. (Without Bonding)	Closure Size (mm)	Carton Quantity
8006170	8006171	4.0" x 25.8" (102 x 655)	1
8006172	8006173	6.5" x 28.4" (76 x 655)	1
8006174	8006175	9.5" x 28.4" (241 x 721)	1
8006183	8006182	6.5" x 38.5" (165 x 978)	1
8006181	8006180	9.5" x 38.5" (241 x 978)	1

*Kit includes SURE-GRIP Shield Connectors and Bonding Braid

PREFORMED™ Heat Shield

The Heat Shield fits easily around the Aerial REDDI Closure. It's designed to dramatically reduce the temperature inside the closure, and protect cable pair insulation from premature degradation in extremely hot environments.

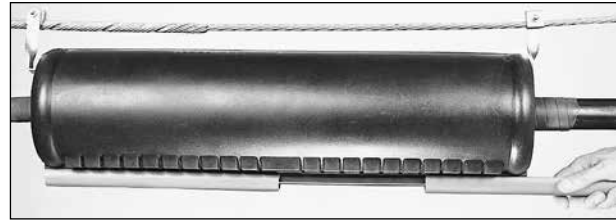

The Aerial REDDI Closure is designed specifically for free-breathing aerial use. It utilizes the same performance-proven LOCK-TAPE Sealant System as the PREFORMED Splice Case and the REDDI Seal and the same foam-filled End Plates as the REDDI Seal. A durable one-piece plastic shell with closing clamps is easily applied and re-entered.

A metallic grounding insert enables the REDDI Closure to be grounded through the End Plates and facilitates aerial applications. Shells are applied and removed without disturbing the continuity of the ground. Hanger brackets are designed for attachment to the insert, providing strong, quick aerial application.

Features:

- Designed specifically for free-breathing aerial use.
- Proven LOCK-TAPE Sealant System provides strong cable pull-out protection.
- 6.5" and 9.5" S-T-R-E-T-C-H REDDI Closures are well suited for use as repair closures.
- End Plate insert design grounds through the End Plates and facilitates aerial applications.
- Easily applied and re-entered.

PREFORMED Heat Shield	
Catalog Number	Closure Size (mm)
80804366	4.0 x 25.8 (102 x 655)
80804367	6.5 x 28.4 (165 x 721)
80804368	9.5 x 28.4 (241 x 721)
80804397	6.5 x 38.5 (165 x 978)
80804398	9.5 x 38.5 (241 x 978)

Aerial REDDI™ Closure

LOCK-TAPE™ System

LOCK-TAPE Sealant is supplied for both the cut End Plate and the cable. When properly applied, a gasket-like seal will be formed, locking the End Plate to the cable. LOCK-TAPE Sealant strips and rolls are supplied with the PREFORMED Splice Case Kit, REDDI Seal Kit and REDDI Closure Kit. It is also available in replacement kits or in individual rolls. (Refer to the REDDI Closure Parts chart.)



Two-Section End Plate Kit

Standard Two-Section End Plate Kits with external grounding in the End Plates are available in 4", 6.5" and 9.5" diameter sizes. (REDDI Closure Two-Section End Plate Kits are also interchangeable with the REDDI Seal.)

Three-Section End Plate

Three-Section End Plates with grounding and suspension inserts are also available in 6.5" and 9.5" sizes. Refer to table below for catalog numbers. "Left" and "right" refers to orientation of suspension inserts for Aerial REDDI Closure installations.

These kits are primarily for use as replacement parts when adding branch cable to an existing splice.

Two-Section End Plate Kit includes:

1. Two End Plates with grounding insert
2. LOCK-TAPE Sealant supply
3. Cue Cards
4. CABLE Mea-SURE™ Tape
5. Emery cloth (for scuffing sheath)

REDDI Closure Parts And Accessories					
Part Description	For use with 4" (102 mm) Diameter (8006170)	For use with 6.5" (165 mm) Diameter (8006172)	For use with 9.5" (241 mm) Diameter (8006174)	For use with a 6.5" (165 mm) S-T-R-E-T-C-H Diameter (8006183)	For use with a 9.5" (241 mm) S-T-R-E-T-C-H Diameter (8006181)
Two-Section End Plate Kits	8000388	8000389	8000390	8000389	8000390
Three-Section End Plate Kits	—	8003094	8003013	—	—
Torque Bar [2 per closure]	80851255	80850968	80850968	80850985	80850985
Closing Clamp [2 per closure]	80802136	80802176	80802176	80802136*	80802136*
LOCK-TAPE Sealant Supply	8000375	8000376	8000377	8000376	8000378
Emery Cloth [24 Strips, 2" x 18"] (50 x 457)	8000429	8000429	8000429	8000429	8000429
Spacer Mat [80 roll, 18" x 1/4"] (3032, 457 x 6)	8000658	8000658	8000658	8000658	8000658
Hanger Bracket [2 per closure]	80802510	80802510	80802510	80802510	80002510

*Three closing clamps (per closure) are required.



REDDI™ Seal and Aerial REDDI™ Closure

Use the following charts to select proper size REDDI Seal and REDDI Closure for splice bundle diameter, cable opening and End Plate cable capacity.

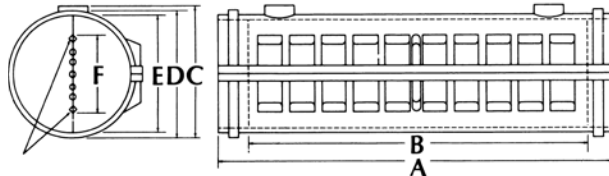

F. Marks on End Plates denoting area for cable entrance holes.

Cable Opening Chart (mm)	
REDDI Seal/ Closure Diameters	*Maximum Cable Opening
4.0 x 25.8 (102 x 655)	16.5" (419)
6.5 x 28.4 (165 x 721)	19.0" (483)
9.5 x 28.4 (241 x 721)	18.0" (457)
6.5 x 38.5 (165 x 978)	29.0" (737)
9.5 x 38.5 (241 x 978)	28.0" (711)

Maximum End Plate Cable Capacity* (mm)				
REDDI Seal/Closure Size	1 Cable	2 Cables	3 Cables	4 Cables
4.0" x 25.8" (102 x 655)	2.2" (56)	1.95" (50)	1.70" (43)	1.45" (37)
6.5" x 28.4" (165 x 721)	4.1" (104)	3.85" (98)	3.60" (91)	3.35" (85)
9.5" x 28.4" (241 x 721)	7.1" (180)	6.85" (174)	6.60" (168)	6.35" (161)
6.5" x 38.5" (165 x 978)	4.1" (104)	3.85" (98)	3.60" (91)	3.35" (85)
9.5" x 38.5" (241 x 978)	7.1" (180)	6.85" (174)	6.60" (168)	6.35" (161)

*Always allow 1/4" (6.4 mm) clearance between cable holes. This clearance is allowed for in the above charts. These dimensions indicate the maximum combined cable diameters that can be accommodated in one end of the entire splice closure.

Case Dimensions (mm)						
REDDI Seal/ Closure Size	A	B	C	D	E	F
4.0" x 25.8" (102 x 655)	25.8" (655)	20.3" (516)	4.6" (117)	4.4" (112)	4.0" (102)	2.2" (56)
6.5" x 28.4" (165 x 721)	28.4" (721)	22.7" (567)	7.1" (180)	6.8" (173)	6.5" (165)	4.1" (104)
9.5" x 28.4" (241 x 721)	28.4" (721)	21.7" (551)	10.1" (257)	9.8" (249)	9.5" (241)	7.1" (180)
6.5" x 38.5" (165 x 978)	38.5" (978)	32.8" (833)	7.1" (180)	6.8" (173)	6.5" (165)	4.1" (104)
9.5" x 38.5" (241 x 978)	38.5" (978)	31.8" (808)	10.1" (257)	9.8" (249)	9.5" (241)	7.1" (180)

REDDI Seal Resin Capacity (mm)		
REDDI Seal Diameters	Resin	
	Grams ⁽¹⁾	Grams ⁽²⁾
4.0" x 25.8" (102 x 655)	4,200	3,780
6.5" x 28.4" (165 x 721)	12,300	11,070
9.5" x 28.4" (241 x 721)	25,000	22,500
6.5" x 38.5" (165 x 978)	17,800	16,020
9.5" x 38.5" (241 x 978)	36,800	33,120

⁽¹⁾ Amount of resin required to fill entire closure without splice.

⁽²⁾ Recommended amount of resin assuming 10% of closure is occupied by splice.

REDDI™ Seal and Aerial REDDI™ Closure



Re-entry Kits

When re-entry of the REDDI Seal is required, a separate kit must be purchased to assure a proper seal. Kits are available for all four diameter sizes of REDDI Seal: 4", 6.5" and 9.5" (standard and S-T-R-E-T-C-H). Re-entry kits are not interchangeable with the REDDI Closure.

Kit includes:

1. End seal
2. LOCK-TAPE™ Sealant supply
3. Flange seal
4. Cue Cards
5. Funnel
6. Disposable plastic gloves
7. Closing clamps

LOCK-TAPE System

LOCK-TAPE Sealant is supplied for both the cut End Plate and the cable. When properly applied, a gasket-like seal will be formed, actually locking the End Plate to the cable. LOCK-TAPE Sealant strips and rolls are supplied with the PREFORMED Splice Case Kit, REDDI Seal Kit and REDDI Closure Kit. It is also available in replacement kits or in individual rolls. (Refer to the REDDI Seal Parts chart.)

REDDI Seal Re-entry Kits	
Catalog Number	REDDI Seal/Closure Size (mm)
8003020	4" x 25.8" (102 x 655)
8003021	6.5" x 25.8" (165 x 655)
8003022	9.5" x 25.8" (241 x 655)
8003030	6.5" x 38.5" (165 x 978)
8003057	9.5" x 38.5" (241 x 978)





PREFORMED LINE PRODUCTS

Section 12 – Buried Service Wire Closures

Table of Contents	Page
Ranger SERVICEAL® Closure	12-2
Super SERVICEAL® Closure	12-3
BLACK-JACK™ 25/50-Pair Closures	12-4

Note: Refer to COYOTE® Fiber Optic Closures Catalog for the COYOTE® LCC (Low Count Closure) Copper Version



Ranger SERVICEAL® Closure



Enhanced!

The Enhanced Ranger SERVICEAL Closure provides long-term protection for buried service wire splices up to six pairs (0.500" [13mm] cable diameter).

Installation of the Ranger SERVICEAL Closure is fast and easy. After preparing the service wires, simply lay them within the grooves in the cap, lay the exposed cable shield within the Bonding Connector and tighten. Splices on the individual pairs are easily organized around the integral Insertion Ram. A twist and a snap secures the pre-filled vial over the splices.

Features:

- Only two components, pre-filled vial and cap with integral Insertion Ram and Bonding Connector
- Vial pre-filled with field proven POLY-BEE™ Sealant for maximum protection
- Octagon shaped Vial for ease of application and maximum splicing capacity
- Enhanced, integral Bonding Connector
- Positive locking feature to insure proper application and to discourage re-use



Kit Components

1. Cap with integral Insertion Ram & Bonding Connector
2. Sealant-filled vial

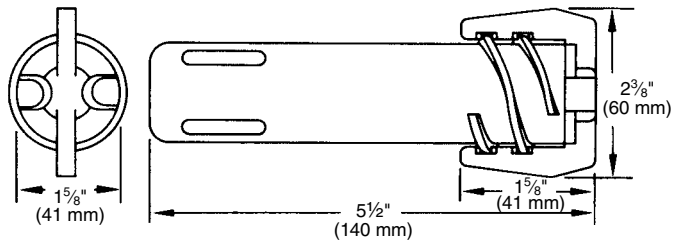

RUS Listed

Catalog Number	Groove Diameter	Standard Carton Qty.
8006137	Up to .500" (13 mm)	12 Kits

Catalog Number	Description	Standard Carton Qty.
80008946	Vial Replacement Kit	As needed

Super SERWISEAL® Closure



Enhanced!

The enhanced Super SERWISEAL Closure provides the same long-term protection and features of the Ranger SERWISEAL® Closure, in a larger size. Accommodates buried service wire splices up to twelve pairs and cable diameters from 0.4" (10 mm) to 0.6" (15 mm).



Kit Components

1. Cap with integral Insertion Ram & Bonding Connector
2. Sealant-filled vial

RUS Listed

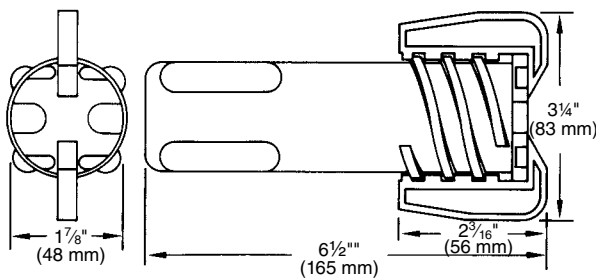

Catalog Number	Groove Diameter	Standard Carton Qty.
8006039	.4" to Cable (10mm to 15mm)	6 Kits

Catalog Number	Description	Standard Carton Qty.
80851909	Vial Replacement Kit	As needed



BLACK-JACK™ 25/50-Pair Closures

Effectively Protects Cable

The BLACK-JACK 25-Pair and BLACK-JACK™ Plus 50-Pair Closures are filled with POLY-BEE™ Sealant to provide long-term protection for direct buried cable splices (individual or modular connection). The sealant is designed to form a barrier to protect splices against the harsh elements of nature.

The closure designs incorporate a water-block system that consists of a soft cable grommet and a gasket seam seal. The soft grommet is designed to effectively seal around cables within the accepted diameter range. The gasket seals the halves of the closure to further ensure protection.

Two Designs Available

The BLACK-JACK 25-Pair Cable Closure is available in both the in-line butt splice version design. The 50-pair cable closure is designed to incorporate both butt and in-line capabilities with one design. The in-line version can be used for straight through or branch splice applications. Both designs offer the same reliable service, are easily re-entered and must be replaced after re-entry.

No Resin Required

The one-piece closure shell is shipped with the entire water-block system in place. The unit is pre-filled with POLY-BEE Sealant, so there is no resin mixing required.

Without resin, preparation time is greatly reduced. Set-up time is also eliminated. This means the closure can be buried immediately after installation. Working without resin eliminates toxic material concerns and inventory waste because shelf-life is never an issue.

Fast, Easy Application

Several design features make installation easy. The hinge on the shell is flexible allowing the closure to be squeezed shut by hand. The flexible hinge is also helpful during re-entry.

The closing clamp which slides over the closure flanges has a V-notch on the back to make initial hand installation easier. A narrow horizontal slide along the closing clamp provides leverage to bring the halves together. The kit comes with bonding hardware that fits over the studs of the bond connectors to provide shield continuity. This bonding hardware also assures proper alignment of the cables in the closure.

Holds Cables Securely

Cables ranging from 22 to 26 gauge are held securely inside the BLACK-JACK 25-Pair and 50-Pair Cable Closure. The features on the top closure half exert pressure on the cables to keep them centered. The features on the bottom closure half allow the closures to adjust for a range of cable diameters. The bonding bridge(s) included with the kits prevent cable pull-out. Closing clamps are used to hold halves together.

RUS Listed

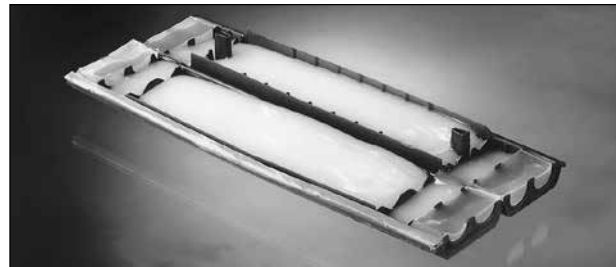

25-Pair In-line, Cat. No. 8006508
50-Pair In-Line/Butt Version, Cat No. 8006681



25-Pair Butt Version, Cat. No 8006318

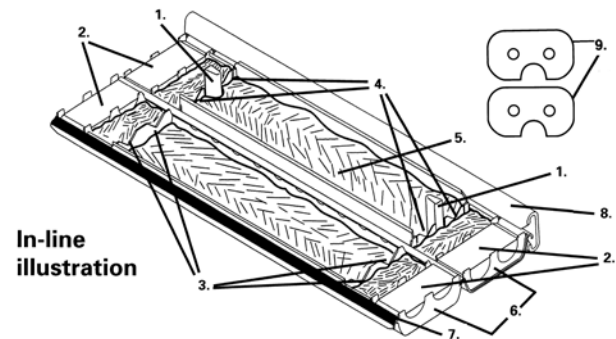

In-line illustration

Catalog Number	Description	Measurements
8006508	25-Pair In-Line	16.25"L x 3.5"W x 3"H
8006318	25-Pair Butt	12"L x 3.5"W x 3"H
8006681	50-Pair In-Line	17.5"L x 4.5"W x 4.75"H

Black-Jack Closure Parts:

- | | |
|----------------------------|--|
| 1. Restraining post(s) | 7. Gasket |
| 2. Soft grommet(s) | 8. Closing clamp |
| 3. Fixed V-notches | 9. Bonding bridge(s) |
| 4. Hinged V-notch flaps | 10. Gloves (included but not shown) |
| 5. POLY-BEE™ sealant | 11. Bonding Links (In-line version only, included but not shown) |
| 6. One-piece closure shell | |

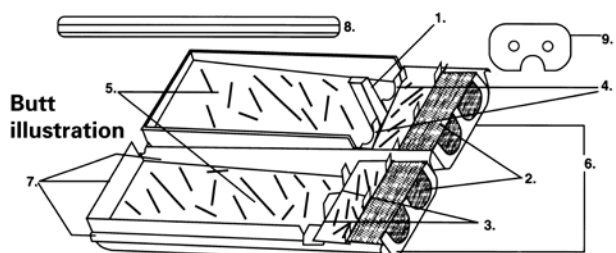

Butt illustration



PREFORMED LINE PRODUCTS

Section 13 – Sub-surface Ready Access Terminal Closures

Table of Contents	Page
Tri-Seal Closure	13-2
Omni-Seal Closure	13-3



Tri-Seal Closure



The Tri-Seal is designed for butt splice and/or subsurface terminal use. It can be used where the exact number of service connections are to be made on a continuing basis such as a new or developing residential area or mobile home park.

Flexibility is provided by a unique oval port and two additional side ports allowing re-entry of additional cables or service wires.

Features:

- Quickly and easily applied
- Seals out moisture and corrosion
- Unaffected by soil conditions, even where acid and alkali prevail
- Clear cap is available for hand holes and allows visual inspection
- Kit comes complete

Catalog No. 8000565 shown here

1. Base (two hose clamps included)
2. Clear cap
3. Resin mixer
4. Polyurethane resin
5. Application procedure
6. Pair Protectors
7. Emery cloth (for scuffing sheath)
8. Cable bonding braid
9. SURE-GRIP™ Shield Connectors
10. Sealing tape
11. Service wire bond connectors
12. Funnel
13. Gasket
14. Gloves (not shown)



CAPACITY
 Any number of wires and cables or service wires with a total bundle diameter of 3.5" (89 mm). Each side port will accommodate a single cable or group of service wires up to 1/2" (13 mm).

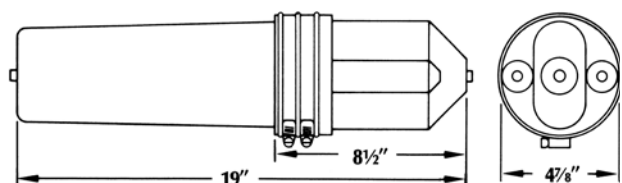

Catalog Number	Description	Standard Carton Qty.
8000565	Tri -Seal complete with resin and bonding	2 Kits
8000566	Tri-Seal base and cap only with air flange no resin or bonding	2 Kits
8000568	Tri-Seal complete with resin without cable bonding	2 Kits
8000574	Tri-Seal with connector block mounting bar	2 Kits

Omni-Seal Closure



The Omni-Seal is designed specifically for sub-surface ready access terminal use when a large number of drops will be used. It can accommodate a looped cable up to 1.6" in diameter, six 2-pair service wires and four 5-pair service wires. Drop wire application is permitted during the initial installation, or at a later date for future construction.

The Omni-Seal may incorporate an additional terminal block. This terminal block would provide for fixed count use and aid in drop wire installation. Drop wires are easily applied through the nipples under the base. A pre-stubbed version with a 12 pair block mounted to the base is also available.

Features:

- Ideal as a sub-surface terminal when drops are prevalent
- Easily applied, easily re-entered
- Resin filled base and unique sealing system combine to provide a watertight seal
- Available with either a clear cap for immediate visual inspection, or a black cap for direct buried and serial applications
- Omni-Seal is durably built to withstand weathering and various soil conditions, even acid and alkali
- Kits come complete as ordered
- Optional terminal block provides for fixed count and pre-stub use.

Kit Materials

1. Base (4 hose clamps included)
2. Clear cap with air flange
3. Resin mixer
4. Polyurethane resin (dual component)
5. Application procedure
6. Pair protectors
7. Emery cloth (for scuffing sheath)
8. SURE-GRIP™ Shield Connectors
9. Green sealing tape
10. Black sealing tape
11. Support bar assembly (terminal block, option)
12. Funnel
13. Lubricant
14. Plastic gloves
15. Bonding braid
16. Plastic rod plugs

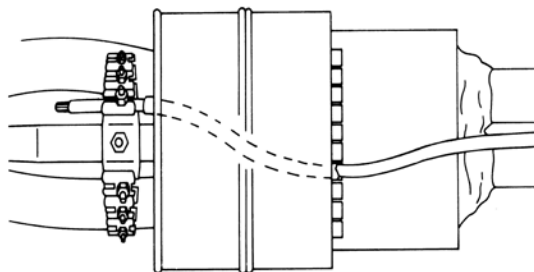

Catalog Number	Description	Standard Carton Qty.
8000557	No Blocks	2 Kits





PREFORMED LINE PRODUCTS

Section 14 – Environmentally Sealed Coax Drop Wire Closure

Table of Contents	Page
Coax Drop Wire Closure	14-2



Coax Drop Wire Closure

Time-saving reliability in a convenient unit – the Coax Drop Wire Closure incorporates the superior standards and reliability of our other closures, and is an excellent solution for coax cable repairs. The Coax Drop Wire Closure is convenient, timesaving and dependable – qualities you can always count on from Preformed Line Products.

Designed for direct buried splicing of coax cable, the Coax Drop Wire Closure is available in two sizes and holds a variety of standard coax connectors and couplers.

Acting as a superior water-block, POLY-BEE™ Sealant is used in the closure for maximum environmental protection. POLY-BEE Sealant has a superior track record for guarding against the harsh elements of nature. The unit is pre-filled and ready to use.

Installation of the unit is as easy as 1-2-3. Once installed, cable alignment tabs keep the cable straight and the unit securely in place. The halves simply snap together – no special tools are required. The design offers reliable service and is easily re-entered.

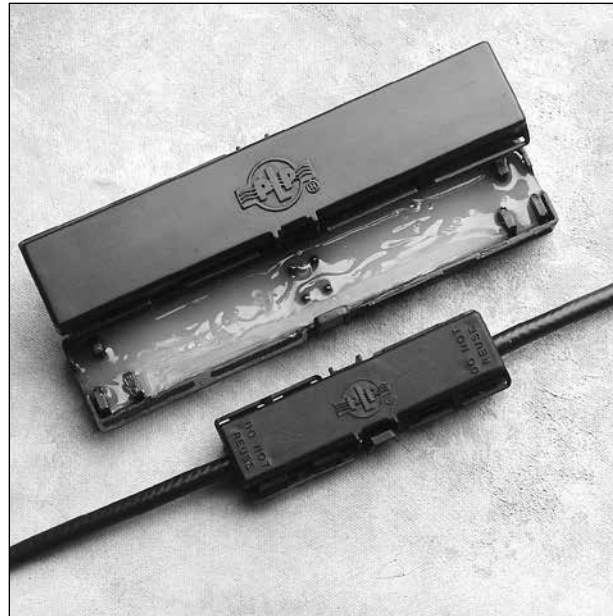

Features:

- Universal closure halves
- Craft-friendly
- Fast, easy assembly
- Saves time
- Secure
- Watertight
- POLY-BEE Sealant protection

Catalog Number	Description (mm)
8006589	Coax Drop Wire Closure. Small closure accepts coax drops to .3" (8) in diameter and associated connectors (RG6, RG59).
8006667	Coax/Twisted Pair Drop Wire Closure accepts coax drops to 0.45" (11) and associated connectors (RG6, RG59, RG7 and RG11) and one-pair service wire up to 0.188" (5). Includes connectors for splicing service wire.



PREFORMED LINE PRODUCTS

Section 15 – Cable Demarcation Enclosure

	Page
Table of Contents	
Cable Demarcation Enclosure.....	15-2



Cable Demarcation Enclosure



Maximum Protection

The enclosure is molded of rugged impact-resistant thermoplastic resin that offers superior protection from vandalism and also has a padlock tab for extra security. We've included UV inhibitors that protect the enclosure from sun degradation and color shifts, plus the entrance and exit grommets keep the enclosure free from insects.

Fast, Easy Installation

The large interior accommodates common traps, filters, splitters, and amplifiers. For a fast and secure connection, the conduit ports have twist tie clamps. The enclosure also offers a wide profile for covering damage that may be left from removal of other devices. The side hinged door stays in an open position or may be removed and re-installed.

Superior Performance

The large interior is ideal for storing excess cable and maintaining the proper bend radius for the cables. The unit also has interior strain relief tie off points for added convenience.

Colors

Consult PLP for custom color options.

Cable Demarcation Enclosures				
Catalog Number	Description	Interior Dimensions (mm)	Carton Quantity	Carton Weight (kg)
CDE75	Cable Demarcation Enclosure (Gray) single port includes grommet and hardware	7.1"H x 5.5"W x 2.9"D (181 x 140 x 74)	36	25 lbs. (11.5)
CDE96	Cable Demarcation Enclosure (Gray) single port includes grommet and hardware	9.0"H x 6.1"W x 3.1"D (229 x 155 x 79)	30	25 lbs. (11.5)
CDE117	Cable Demarcation Enclosure (Gray) three port includes grommets and hardware	10.3"H x 7.7"W x 4.2"D (262 x 196 x 107)	12	30 lbs. (14)
CTVEG	Cable Demarcation Enclosure (Gray) two port includes grommet and hardware	10.9"H x 8.7"W x 1.7"D (277 x 220 x 44)	10	10lbs. (5)
CTVEGD	Cable Demarcation Enclosure High Capacity (Gray) two port includes grommets and hardware	10.9"H x 8.7"W x 3.1"D (277 x 220 x 79)	6	7.5 lbs. (3)
CDE139	Cable Demarcation Enclosure (Gray) two port includes grommets and hardware	13.0"H x 9.2"W x 4.1"D (330 x 234 x 104)	10	22 lbs. (10)

Accessories							
Catalog Number	Description	Carton Quantity	Carton Weight (kg)	CDE75	CDE96	CDE117	CDE139
P140SC	Mounting Clip	100	7lbs (3)	X	X		X
P140CA	3/4" Conduit Adapter	100	2.5lbs (1.1)	X	X	X	X
P140CA1	1" Conduit Adapter	100	3lbs (1.5)	X	X	X	X



PREFORMED LINE PRODUCTS

Section 16 – COYOTE® Access Solutions™ Products

Table of Contents	Page
COYOTE® Pre-Terminated Cabinets	
Wall and Rack Mounted	16-2
COYOTE® Passive Optical Components	16-3
COYOTE Splice Trays	16-4



COYOTE® Access Solutions™ Products

COYOTE® Pre-Terminated Cabinets

Customized to meet your needs

Pre-Terminated cabinets not only saves time, they also save on installation labor costs. Fiber assemblies are 100% tested and labeled under ISO certified procedures. Units are ready for splicing right out of the carton.

All COYOTE fiber cabinets are made from rugged 16 gauge steel, protected with a durable powder-coat finish and accommodate standard COYOTE Splice Trays and Adapter Modules. Cabinets are available in two colors – almond or black.

Features & Benefits

- Craft-friendly COYOTE splice trays
- Integral fiber storage
- High-density splicing & patching in single cabinet
- Assembled to your exact specifications
- 100% tested & labeled
- UPC or APC fiber polishes
- Color coded pigtailed

Wall Mount Cabinets

The Wall Mount Cabinets provide protected fiber splicing and connectivity. A lockable inner door secures the splicing compartment. Each cabinet may be ordered empty or pre-terminated to your exact specification.

All cabinets include mounting hardware, tie-off brackets, grounding posts, grommets and hardware to secure splice trays.

Wall Mount Cabinets (Empty)				
Catalog Number	Description	Height (mm)	Width (mm)	Depth (mm)
WDC2_*	Wall Mount Cabinet up to 24 Fiber Connections and Splices**	10" (254)	13" (330)	3.5" (89)
WDC4_*	Wall Mount Cabinet up to 48 Fiber Connections and Splices**	14" (356)	13" (330)	3.5" (89)
WDC8_*	Wall Mount Cabinet up to 96 Fiber Connections and Splices**	17" (432)	13" (330)	5.5" (140)
WDC12_*	Wall Mount Cabinet up to 144 Fiber Connections and Splices**	12" (305)	17" (432)	11" (279)

*Add "A" for Almond or "B" for Black to catalog number
**Maximum connection capacity only achieved with duplex adapters

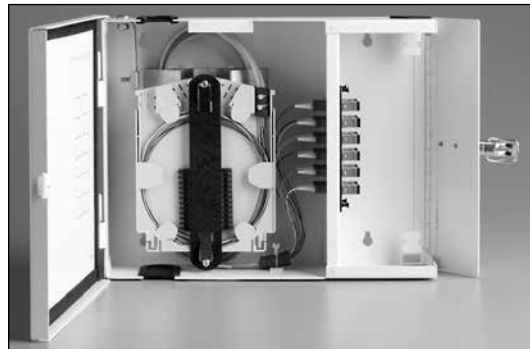

Pre-terminated Solution shown above
(See following pages to order your preterminated solutions)

Rack Mount Cabinets

Universal mounting brackets to fit 19" or 23" racks or enclosures are included. Clear front door and access panels are removable for easy entry. Each cabinet may be ordered empty or pre-terminated to your exact specifications.

All Rack Mount Cabinets have key hole slots for optional wall mounting.

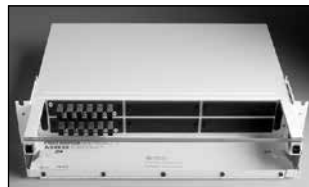
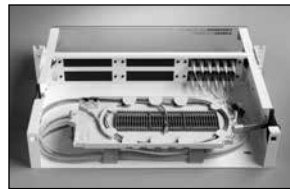

Rack Mount Cabinets (Empty)				
Catalog Number	Description	Rack Units	Width (mm)	Depth (mm)
RDC2_*	Rack Mount Cabinet up to 12 Fiber Connections and Splices	1	17 (432)	14 (356)
RDC3_*	Rack Mount Cabinet up to 36 Fiber Connections and Splices	2	17 (432)	14 (356)
RDC6_*	Rack Mount Cabinet up to 72 Fiber Connections and Splices	2	17 (432)	14 (356)
RDC12_*	Rack Mount Cabinet up to 144 Fiber Connections and Splices	3	17 (432)	14 (356)
RDC12X_*	Rack Mount Cabinet up to 144 Fiber Connections and splices**	4	17 (432)	14 (356)
RDC24_*	Rack Mount Cabinet up to 288 Fiber Connections and splices**	8	17 (432)	14 (356)

*Add "A" for Almond or "B" for Black to catalog number
**Maximum connection capacity only achieved with duplex adapters

COYOTE® Access Solutions™ Products

Passive Optical Components

Adapter Modules

Modular Plates fit any COYOTE cabinet and offer the ultimate in design flexibility.

6-port, 8-port and 12-port snap-in Adapter Plates come pre-loaded and ready for installation into COYOTE Fiber Cabinets. All adapter styles (ST, SC, FC, and LC) feature precision ceramic alignment sleeves.

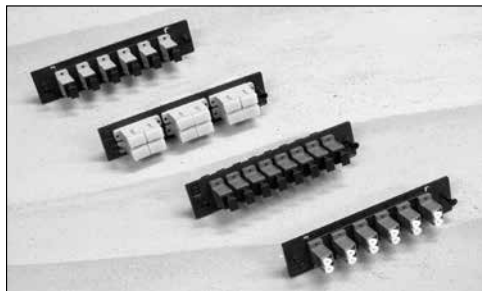

Adapter Modules			
Catalog Number	Connector	Adapters	Sleeve
6SMSC	SC	6	Ceramic
6SCAPC	SC/APC	6	Ceramic
8SCAPC	SC/APC	8	Ceramic
12SMDSC	SC	12 (6 Duplex)	Ceramic
8SMSC	SC	8	Ceramic
6SMST	ST	6	Ceramic
8SMST	ST	8	Ceramic
6SMFC	FC	6	Ceramic
8SMFC	FC	8	Ceramic
6FCAPC	FC/APC	6	Ceramic
6SMLC	LC	6 (3 Duplex)	Ceramic
12SMLC	LC	12 (6 Duplex)	Ceramic
600	Blank Plate	–	–

Pigtail Cable Assemblies

Six or twelve fiber color-coded 900 Micron SM bundles, in yellow braided sleeve. Ribbon fan outs and jacketed cable stubs also available. Contact PLP for additional options.



Factory Polishes		
	Return Loss	Insertion Loss
UPC	-55 dB min.	0.2 typ 0.3 max
APC	-65 dB min.	0.3 max

Pigtail Cable Assemblies Bundled 900 Micron Fibers in Yellow Sleeve		
Catalog Number	Connector	Fiber Count
P6SCU_*	SC/UPC	6
P12SCU_*	SC/UPC	12
P6SCA_*	SC/APC	6
P12SCA_*	SC/APC	12
P6ST_*	ST	6
P12ST_*	ST	12
P6FC_*	FC	6
P12FC_*	FC	12
P6LC_*	LC	6
P12LC_*	LC	12

*Add cable length (in meters) to catalog number. Three meters standard. Contact PLP for other options

Jumper Cable Assemblies

High Performance Singlemode Fiber Optic Jumpers feature UPC and APC terminations to handle the most demanding transmission speeds. Each jumper is 100% tested, for insertion and return loss and visually inspected.

2 mm or 3 mm Jacketed Cables available.



Jumper Cable Assemblies – 3 mm Jacketed	
Catalog Number	Connector
JSCU_*	SC/UPC
JSCA_*	SC/APC
JST_*	ST
JFC_*	FC
JLC_*	LC

*Add cable length (in meters) to catalog number. Contact PLP for other options



COYOTE® Access Solutions™ Products

COYOTE Splice Trays

User friendly splice trays for all applications

Five types of standard splice trays are available, four for single fiber splices and one for mass fiber splices.

These injection-molded trays have hinged, clear plastic covers for maximum fiber protection that allows for visible inspection of the fibers.

A series of tabs along the tray perimeter are easily removed to simplify routing of the fiber. When replaced, they retain the fiber.

COYOTE Splice Trays for single and mass fiber.



COYOTE Splice Trays	
Catalog Number	Description
80807701	12 Count Low Profile Tray w/plastic splice block – single fusion splices
80806033*	12 Count Standard Tray w/elastomeric splice block – Fusion & mechanical splices
8001127	36 Count Low Profile Tray w/plastic splice block – single fusion splices
80807769	Blank Low Profile Splice Tray
80805514*	36 Count Standard Tray w/elastomeric splice blocks – Fusion & mechanical splices
80805515	144 Count Ribbon Tray w/2 elastomeric splice blocks

*To increase splicing capacity by 50% – replace (2) Standard trays with (3) Low Profile trays.

Pre-terminated Cabinets

Ordering is as easy as 1-2-3!

When ordering standard COYOTE Pre-terminated Cabinets follow these easy steps

1. Select the type of cabinet, and color

Example; RDC24A __ __

Almond Rack Mount Cabinet with 24 slots for up to 288 connections (24 x 12)

2. Select number of fiber adapters or ports

Example; RDC24A96 __

Loaded with 96 adapters (standard 6 pack modules)

3. Select fiber connector style and length of pigtails

Example; RDC24A96SCU3

SMSC UPC polish 3 meter length Pigtails

Contact a PLP sales representative for assistance with other pre-terminated cabinet options.



PREFORMED LINE PRODUCTS

Section 17 – COYOTE® Den Enclosure

Table of Contents

Page

COYOTE Den Demarcation Enclosure 17-2



COYOTE® Den Demarcation Enclosure

COYOTE DEN Provides Superior Protection for Electronics at Network Demarcation Point

Fast, Easy Installation

- Mounts in the wall between 2 x 4 studs
- Reversible and removable hinged door
- Perimeter sealing flange
- Pass through openings to feed cables directly into wall
- Drill point guides for drop cable entrance
- Flange mounting
- Equipment panel mounting bosses

Versatile

- Large interior accommodates ONT, battery back-up, interface and structured wiring components
- Thermally protects lower cost, non-hardened electronics by venting to home's interior
- Electrical box mounting and standard receptacle to provide internal power
- Compatible with COYOTE fiber management hardware and splice trays

Superior Equipment Protection

- Double wall, foam insulated construction
- Molded of flame-retardant, impact and UV resistant thermoplastic
- Gasketed/lockable exterior door seals against pressure washers
- In the wall mounting protects drop and premise wiring cables

Customize to Your Exact Requirements

- Accommodates custom interior equipment panel designs
- Option to engrave company logo on front door



Patent Pending

The COYOTE DEN is UL/CSA listed and meets NEMA 4 requirements for the most demanding environmental conditions.

Catalog Number	Description
COYDEN21	COYOTE DEN Insulated Outdoor Equipment Enclosure
80807859	Ventilation Kit includes: Elbow, Transition Fitting and Enclosure Adapter (2" conduit not supplied)
80807949	Equipment Chassis with Lockable Swing Panel
COYDEN21D	COYOTE DEN Insulated Outdoor Equipment Enclosure – expanded capacity

Catalog Number	Dimensions (H x W x D)		
	Overall Exterior (mm)	Flange (mm)	Interior Front (mm)
COYDEN21	18.5" x 15.5" x 9.0" (457.2 x 393.7 x 228.6)	21" x 17.5" (533.4 x 444.5)	16" x 13" x 7" (406.4 x 330.2 x 177.8)
COYDEN21D	18.5" x 15.5" x 11.5" (457.2 x 393.7 x 292.1)	21" x 17.5" (533.4 x 444.5)	16" x 13" x 9" (406.4 x 330.2 x 228.6)



PREFORMED LINE PRODUCTS

Section 18 – Bonding Connectors & Bonding Kits

Table of Contents	Page
MULTI-BOND™ Shield Connector	18-2
MORAY™ & MINI-MORAY™ Shield Connectors	18-2
SERVI-BOND™ Shield Connector	18-3
SURE-GRIP™ Shield Connector & Bonding Kit	18-4
Pipe Plug Bonding Kit.....	18-5



MULTI-BOND™ and MORAY™ Shield Connectors

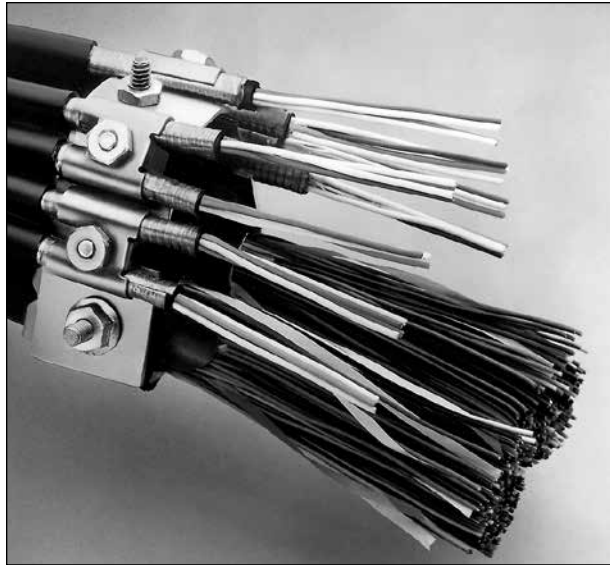

MULTI-BOND Shield Connector

The MULTI-BOND Shield Connector offers you a reliable bonding harness for organizing telecommunications buried service wires and achieving an electrical bond between the cables and ground. The compact MULTI-BOND Shield Connector is designed to be used in multiple service distribution. It's a simple, sure and safe cable organizer.

Each kit includes a lug, clamps, five screws and nuts, and a bonding support plate.

Catalog Number	Description	Standard Carton Qty.
8003072	Bonding support plate, lug, clamps, five screws and nuts	15

MORAY™ and MINI-MORAY™ Shield Connector

Connect shield with confidence with the MORAY Shield Connector and the MINI-MORAY Shield Connector. The specially designed teeth penetrate the polymer coating on the cable shield to provide excellent pull-out strength and electrical contact. The tooth design resembles a “reverse-rake” pattern that allows teeth to “bite” into the cable shield. Two teeth under the “spring-action” connector top are designed to keep it from letting go of the cable sheath.

Constant Electrical Contact

The MORAY and MINI-MORAY Shield Connector with a “spring-action” top plate remain in contact with the shield at all times. The “spring-action” design is flexible enough to handle the expansion and contraction of the cable sheath that results from varying temperature ranges, yet strong enough to maintain constant electrical contact.

All Cable Sizes

With the addition of the MINI-MORAY Shield Connector, PLP can offer the flexibility of using the same reliable MORAY Shield Connector design for smaller diameter cables.



MORAY Shield Connector

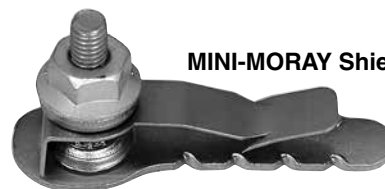

MINI-MORAY Shield Connector

(Bonding nuts supplied, but not shown)

MORAY Shield Connector
Catalog No. 8000745
MINI-MORAY Shield Connector
Catalog No. 8000751



SERVI-BOND™ Shield Connector

Catalog Number (mm)	Spring Clamp Color Code	Maximum Service Wire Diameter inches (mm)	Service Cable Range
8000733* (long neck)	Silver	0.30 (8)	2-Pair or 3-Pair (Armored and Non-Armored)
8000734 (long neck)	Yellow	0.36 (9)	5-Pair or 6-Pair (Non-Armored)
	Black	0.41 (10)	5-Pair or 6-Pair (Armored)
8000735 (short neck)	Silver	0.30 (8)	2-Pair or 3-Pair (Armored and Non-Armored)
8000736 (short neck)	Yellow	0.36 (9)	5-Pair or 6-Pair (Non-Armored)
	Black	0.41 (10)	5-Pair or 6-Pair (Armored)
8000737 4.5" (114) harness (floating hook terminal)	Silver	0.30 (8)	2-Pair or 3-Pair (Armored and Non-Armored)
8000738 4.5" (114) harness (floating hook terminal)	Yellow	0.36 (9)	5-Pair or 6-Pair (Non-Armored)
	Black	0.41(10)	5-Pair or 6-Pair (Armored)
800011296 4.5" (114) harness (floating hook terminal w/¼" stud hole)	Yellow	0.36 (9)	5-Pair or 6-Pair (Non-Armored)
	Black	0.41 (10)	5-Pair or 6-Pair (Armored)
8000739 7" (177) harness (floating hook terminal)	Silver	0.30 (8)	2-Pair or 3-Pair (Armored and Non-Armored)
8000740 (long neck)	Silver	0.30 (9)	2-Pair or 3-Pair (Armored and Non-Armored)
	Black	0.41 (10)	5-Pair or 6-Pair (Armored and Non-Armored)
8000744* 7" (177) harness (floating hook terminal)	Yellow	0.36 (9)	5-Pair or 6-Pair (Armored and Non-Armored)
	Black	0.41 (10)	5-Pair or 6-Pair (Armored and Non-Armored)
8000746 14" (365) harness (floating hook terminal)	Silver	0.30 (8)	2-Pair or 3-Pair (Armored and Non-Armored)
8000747 14" (365) harness (floating hook terminal)	Yellow	0.36 (9)	5-Pair or 6-Pair (Armored and Non-Armored)
	Black	0.41(10)	5-Pair or 6-Pair Double Sheath Armored and Non-Armored)
8000748 2.75" (69) harness (floating special)	Black	0.41 (10)	5-Pair or 6-Pair (Armored and Non-Armored)
8000749 4.5" (114) harness (floating ring terminal)	Silver	0.30 (8)	2-Pair or 3-Pair
8000750 4.5" (114) harness (floating ring terminal)	Yellow	0.36 (9)	5-Pair or 6-Pair
	Black	0.41(10)	5-Pair or 6-Pair (Armored and Non-Armored)
8000752 4.5" (114) harness (floating hook terminal)	Aluminum	0.56 (14)	12-Pair (Armored and Non-Armored)
8000753 7" (178) (floating ring terminal)	Black	0.43 (11)	Fiber Optic Drop Cables

*RUS Listed

SERVI-BOND Shield Connector

The SERVI-BOND Shield Connector is designed to assure shield continuity to a point of ground for buried telephone service wires. The shield connector is easily installed and requires no special tools.

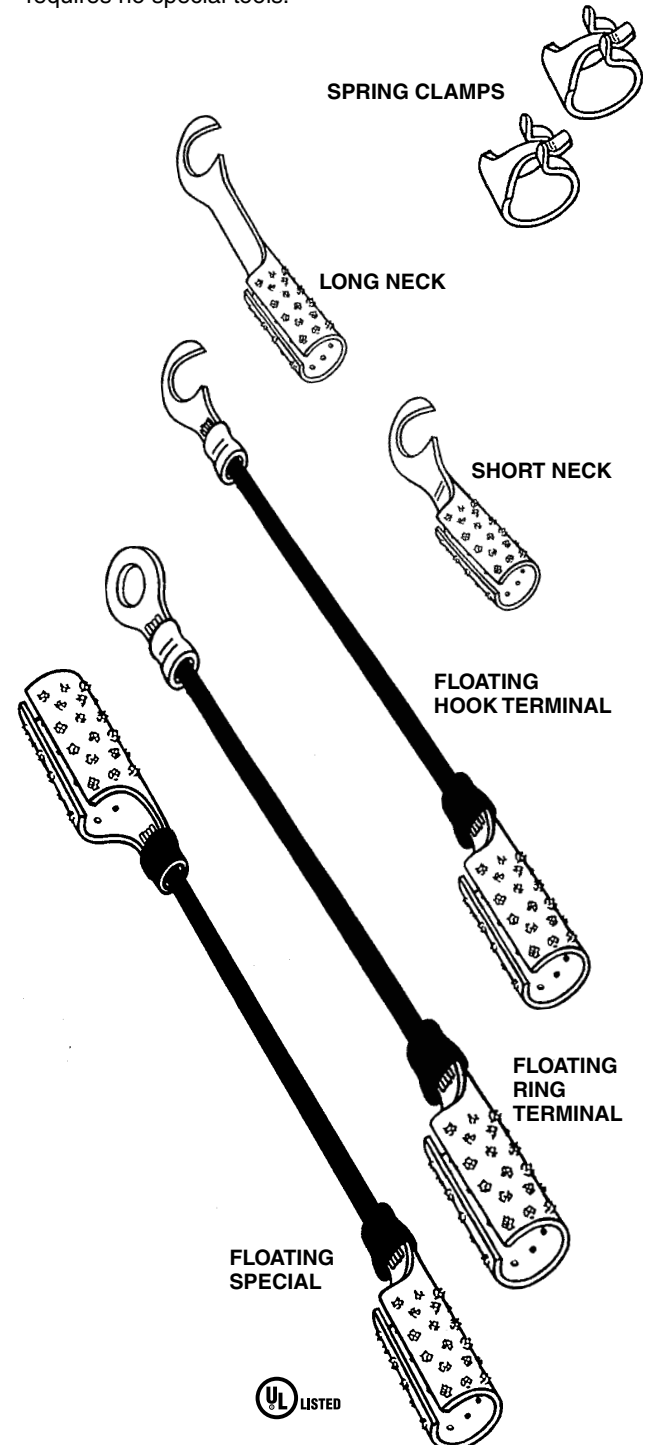



SURE-GRIP™ Shield Connector & Bonding Kit

SURE-GRIP Shield Connectors

SURE-GRIP Shield Connectors are designed to provide fault-free connections in underground and above-ground cable openings in pedestal. Positive electrical continuity is provided across splices and shield openings in pedestal terminals and in overhead and underground cable. They fit any cable, can be used on either lead or plastic-sheath types, and won't move, even in a floating bond.

“No-turn” Head Eliminates Static

As the nut is tightened, bending stress on the top plate imposes high locking pressure on the connection to prevent the shield connector from moving during or after installation. Sawteeth in the bottom plate are forced into the shield to provide a conductor path from the metallic shield to the shield connector. The prong in the bottom plate penetrates the heavy metal braid to provide an additional current-carrying path across the cable opening.

Legs in the top plate compress the shield firmly against the sawteeth in the bottom plate to prevent the top from moving when the nut is tightened. Noise that is annoying on voice circuit is minimized and heavy electrical surges, large enough to burn out other types of shield connectors, are carried safely across the conductor path.

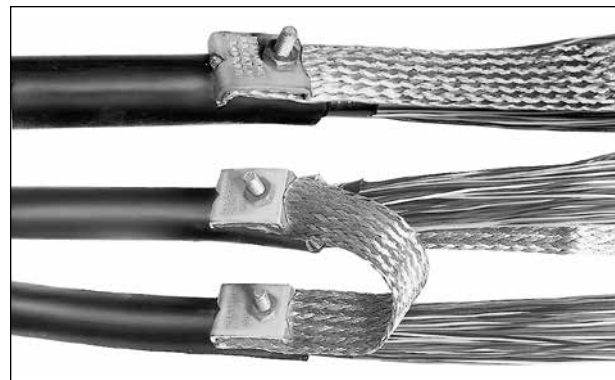
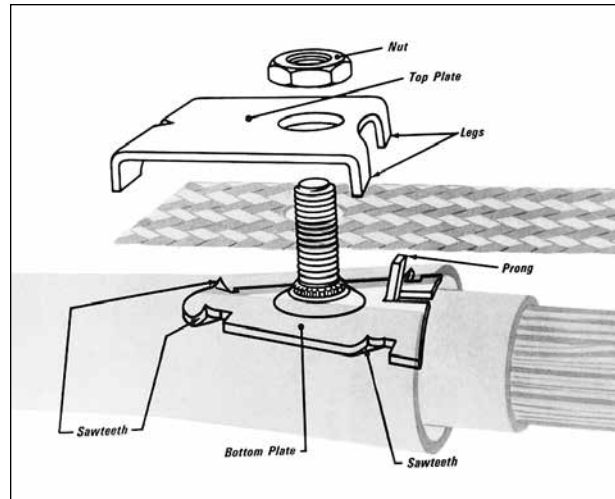

Catalog Number	Description (mm)	Specifications	No. Per Carton
8000711	For cables 3/4" (19) and larger	Top plate – Medium carbon steel, copper plate, tin flash bottom plate stud and nut – tin plated brass	100 Units

Pipe Plug Bonding Kit

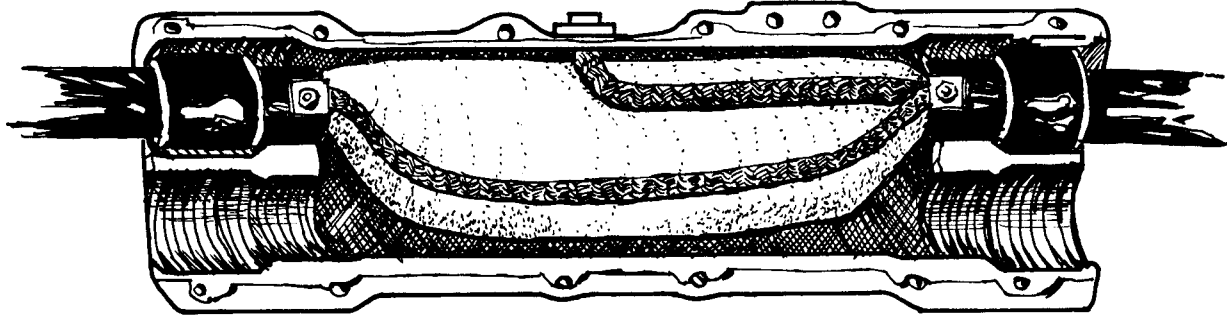

The PREFORMED™ Pipe Plug Bonding Kit, when applied with Shield Connectors, provides a low-resistance, non-fluctuating, high-current capacity bond and ground connection in cast iron and aluminum splice cases. Kit consists of heavy, flexible braid securely connected to a specially designed pipe plug. Braid is fed through plug hole and plug is securely tightened in place. Free end of braid is joined to cable sheath by Shield Connector. Additional braid is used to connect all cable sheaths to pipe plug, completing permanent bond and ground connection. Special pipe plug has a bright yellow tab to identify it as a ground connection.

Catalog Number	Description (mm)	Standard Carton Qty.
8000714	18" (457) of #6 Bonding Braid with pipe plug, 42" (1067) of #6 Bonding Braid, 5 ferrules, bolt, nut and 2 locknuts	50 units
8000723	18" (457) of #9 insulated Bonding Braid with pipe plug	50 units
8000729	18" (457) of #6 insulated Bonding Braid, "piggyback" pipe plug, external bonding ribbon, lockwasher, nut	50 units

Catalog No.: 8000714

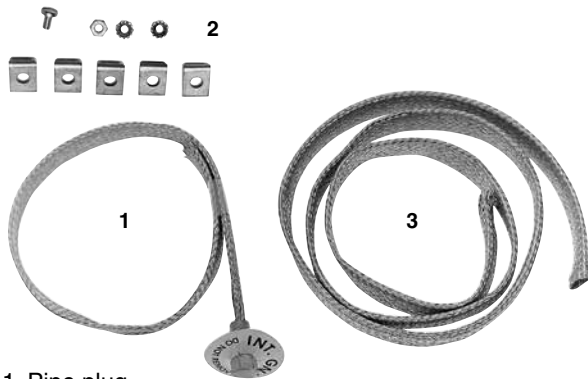

1. Pipe plug
2. Ferrules, bolt, nut and locknuts
3. Braid

Catalog No. 8000723



Pipe Plug External Bond Kit

The "piggyback" Pipe Plug Bonding Kit is a specially designed adaptation of the External Bond Kit for plastic splice cases. An 18" #6 bonding braid and external bond ribbon mate at the "piggyback" plug, bringing cable shield bonds out of the plastic case and providing proper ground connection.

Catalog No.: 8000729

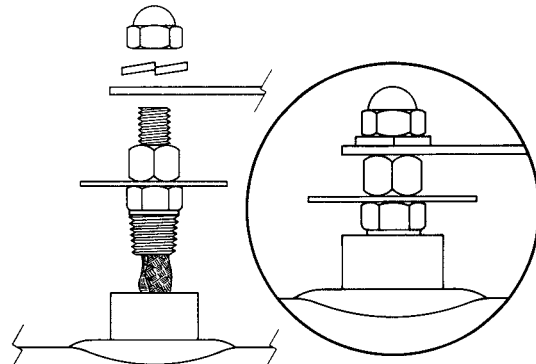





PREFORMED LINE PRODUCTS

Section 19 – Pair Protectors & Bonding Accessories

Table of Contents	Page
Pair Protector	19-2
Pair Protector Strip	19-2
Bonding Accessories	19-3
Bonding Braid	19-3
Plastic Roll Tubing	19-3
Bonding Ferrules	19-3
Shield Bonding Kit	19-4



Pair Protector

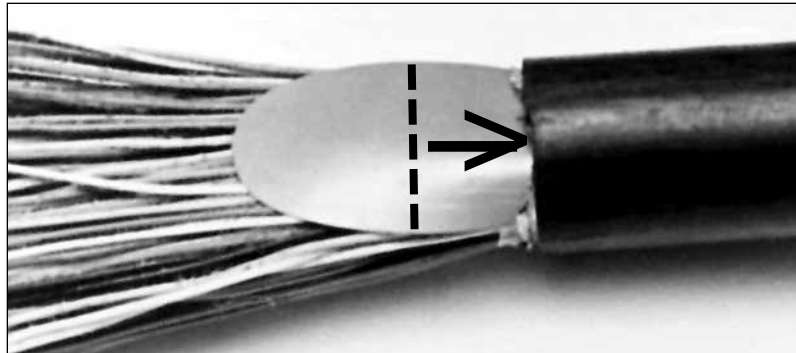

The Pair Protector is a plastic shim that is inserted between the cable shield and the core wrap prior to bonding or tabbing. It allows easy insertion of the bottom shoe of most common shield connectors, and eliminates the danger of cut pairs while cutting tabs in the cable sheath.

Features:

- Eliminates tape collars
- Protects cable pairs during tabbing operation
- Fits any size cable
- Allows use of any type of shield connector without damage to cable pairs
- A real time-saver and trouble-saver

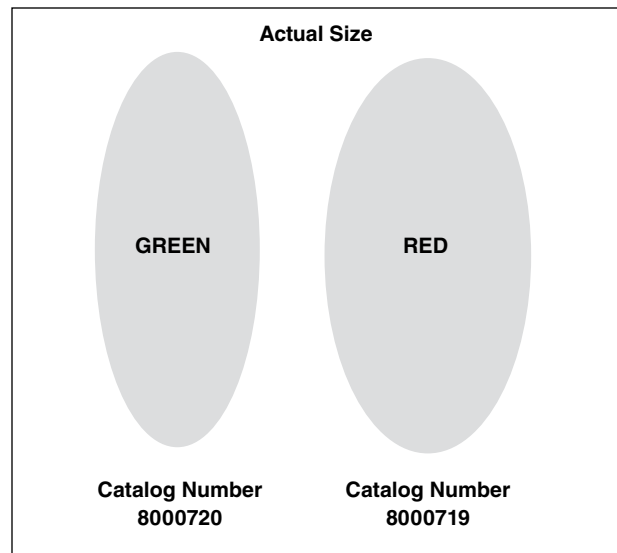

Catalog Number	Description (mm)	Standard Carton Qty.
8000719	1.25" W x 2.5" L Red (32 x 64)	100 units
8000720	1.0" W x 2.5" L Green (25.4 x 64)	100 units

Pair Protector Strip

Pair Protector Strip is a sturdy plastic shim for application between the cable shield and inner core wrapper. Conveniently packaged, (25' long, 1½" wide) it can be custom fit to any diameter cable.

Features:

- Replaces tape collars
- Made of durable plastic (.020" thickness)
- Provides 360° of cable pair protection
- Easily applied

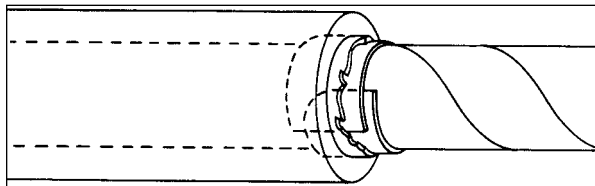

Catalog Number	Description (mm)	Standard Carton Qty.
8000731	25' (762) long roll, 1½" (38) wide	1 roll

Bonding Accessories

Preformed Line Products' bonding accessories can be purchased separately, as shown, or as part of various kits displayed in this section.

When properly applied they will provide a low resistance, non-fluctuating, high-current capacity bond.

Catalog Number	Description	Standard Carton Qty.
800081002	100' (30 m) Coil of #6 Bonding Braid	1 unit
8000391	200' (60 m) Plastic Roll Tubing insulation for Bonding Braid	1 unit
80801303	Bonding Ferrules – tin plated copper attachments for #6 Bonding Braid to Shield Connector Studs	200 units

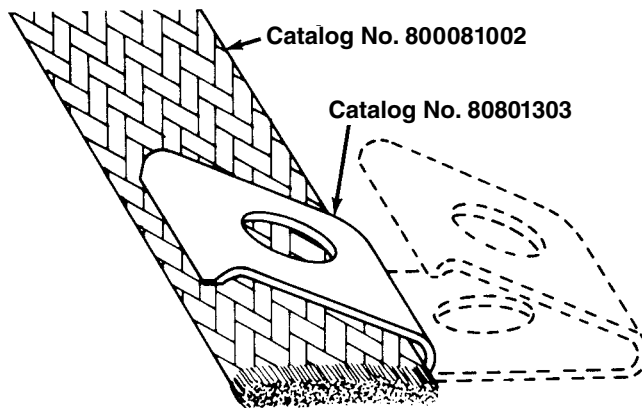
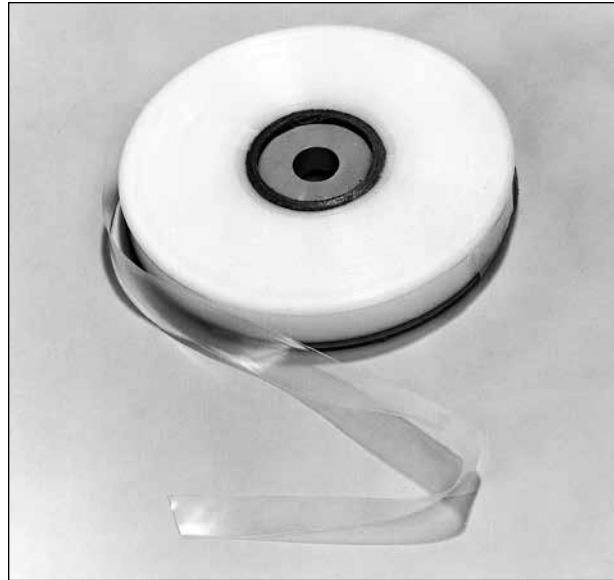

Catalog No. 800081002



Shield Bonding Kit



Handy Shield Bonding Kit

Handy shield bonding will make bonding and grounding connections in splice closures and pedestal terminals on telephone cable. Order kit with braid and shield connectors or order shield connectors separately.

Catalog Number	Description (mm)	Specifications	No. Per Carton
8000725	For cables 3/4" (19) and larger	10 ft. (3.05 m) braid – #6 equivalent tinned copper 10 Shield Connectors Includes Pair Protectors Top plate – Medium carbon steel, copper plate, tin flash Bottom plate –Tin plated brass	6 Kits



PREFORMED LINE PRODUCTS

Section 20 – Dead-end & Accessories

Table of Contents	Page
Figure-8 Messenger Dead-end	20-2
GUY-GRIP® Dead-end	20-3
GUY-LOCK	20-6
Big-Grip Dead-end.....	20-7
False Dead-end	20-9
Open Wire Dead-end	20-10
Drop Wire/C-Rural/Buried Line Wire Dead-end	20-11
Telegrip.....	20-12
Custom Coaxial Dead-end	20-13
Pulling Eye	20-13
Safety Guy-Wire Dispenser	20-14



Dead-ends for Figure-8 Messenger

Dead-ends for Figure-8 Drop Wire Messenger

There is no quicker, easier way to attach Figure-8 drop wire or cable than with PREFORMED™ Dead-ends for Figure-8 RG-59/U coaxial cable messenger. Strip the messenger to accommodate the Dead-end and wrap on for a secure and permanent installation. The helical shape will insure low distribution of holding stresses and prevent premature fatigue breakage. If required, False or Double Dead-ending can be accomplished without cutting the wire, a feature that is exclusive with all helically designed PREFORMED Dead-ends.



Catalog Number	Material	Cable Diameter	Units	Wt./Lbs.
			Per Carton	
DE-2525	Galvanized Steel	.051"	200	7
DE-2505	Galvanized Steel	.063"	200	8
DE-2506	Galvanized Steel	.083"	200	8
GDE-2501	Galvanized Steel	.109"	100	9
GDE-2503	Galvanized Steel	.134"	100	15
DE-8500	Stainless Steel	.063"	200	5
DE-8501	Stainless Steel	.083"	200	5

GUY-GRIP® Dead-end

GUY-GRIP Dead-ends, installed at the top, the breaker and the anchor, provide today's most effective method for securing guy strand. This unique, one-piece dead-end is neat in appearance and free from bolts or high-stress holding devices. The GUY-GRIP Dead-end was the first to offer the cabled loop, a feature that provides more durability, easier tensioning and adaptability to multiple guying.

GUY-GRIP Dead-ends are made of the same material as the strand to which they are applied. They should be used on hardware that is held in a fixed position. The fitting should not be allowed to rotate or spin about the axis of the strand. They should not be used as tools including come-alongs, pulling-in grips, etc.

NOMENCLATURE

Cross-over Marks:

(A)—Indicates starting point for application on smaller diameter fittings.

(B)—Indicates alternate starting point for application on larger diameter fittings.

Cabled Loop: Furnished as standard, all sizes.

Pitch Length: One complete wrap.

Short Leg-Long Leg: Identifies rods belonging to each leg, after application.

Color Code and Length: Assists in identification of strand size, corresponding to tabular information appearing on price page.

Identification Tape: Shows catalog number, nominal sizes.

Nomenclature

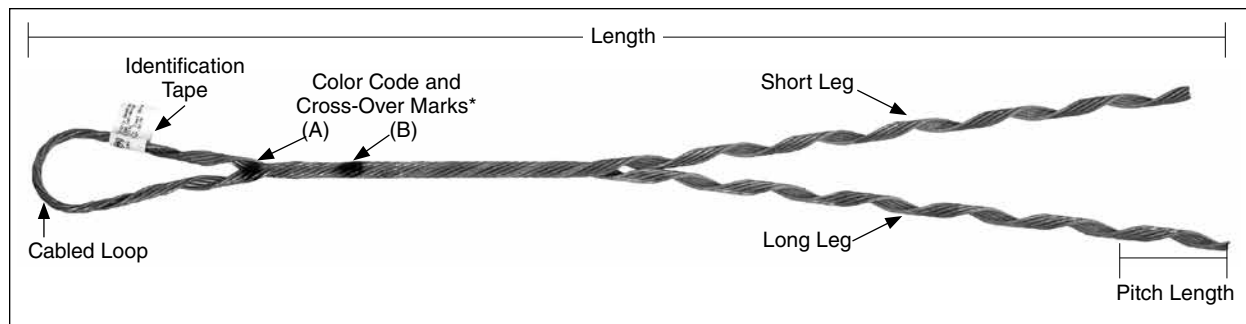

Suggested hardware dimensions for cabled-loop GUY-GRIP Dead-ends

Dead-end dia. Range (in.)		Nominal Strand Sizes (in.)		Seat Dimensions (Figures 1 & 2) (in.)			Minimum Groove dia. (in.) (fig. 2)	Minimum Hole dia.* (in.) (fig. 3)
Min.	Max.	Galvanized Steel	Aluminum-clad Steel	Min. seat dia. at first cross-over mark	Max. seat dia. at first cross-over mark	Max. seat dia. at second cross-over mark		
.123	.143	1/8	—	3/4	1-3/4	—	3/16	1/4
.144	.173	5/32	—	3/4	1-3/4	2-1/2	1/4	5/16
.174	.203	3/16	—	1-0	1-3/4	2-1/2	1/4	3/8
.204	.230	7/32	3 #10, 4M3	1-1/8	1-3/4	2-1/2	5/16	3/8
.231	.259	1/4	7 #12, 6M	1-1/8	1-3/4	2-1/2	5/16	7/16
.260	.291	9/32	7 #11, 8M	1-1/8	1-3/4	2-1/2	3/8	1/2
.292	.336	5/16	7 #10, 10M	1-1/4	1-3/4	2-1/2	3/8	9/16
.337	.394	3/8	7 #8, 14M, 16M	1-3/8	1-3/4	2-1/2	7/16	5/8
.395	.474	7/16	7 #7, 18M, 20M	1-3/8	2-3/8	—	1/2	11/16
.475	.515	**	7 #6	1-3/8	2-3/8	—	9/16	3/4
.516	.570	**	7 #5, 25M	1-1/2	2-5/8	—	5/8	15/16

* Depending on geometric shape of the hole, a hole diameter less than specified may be acceptable.

** Use Big-Grip Dead-ends. (Refer to page 20-7)

Figure 1

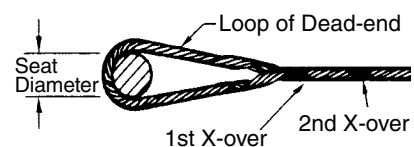

Figure 2

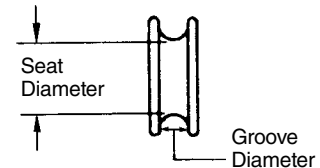
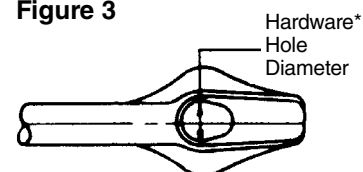



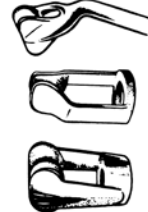
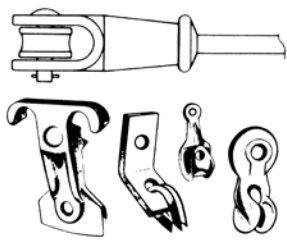

Figure 3





GUY-GRIP® Dead-end

Acceptable Fittings

ANCHOR RODS  Anchor Rod Diam. <table border="1"> <tr> <td>1/2"</td> <td>5/8"</td> <td>3/4"</td> <td>1"</td> <td>1-1/4"</td> </tr> </table> Loop Diameters 1" to 1-7/8"	1/2"	5/8"	3/4"	1"	1-1/4"	THIMBLE EYE-BOLTS, EYENUTS & EYES  <table border="1"> <tr> <td>3/8"</td> <td>7/16"</td> <td>1/2"</td> <td>9/16"</td> <td>5/8"</td> <td>3/4"</td> </tr> </table> Loop Diameters 1" to 2"	3/8"	7/16"	1/2"	9/16"	5/8"	3/4"	POLE FITTINGS  Loop Diameters 1" to 2-3/8"	GUY-STRAIN INSULATORS  <table border="1"> <thead> <tr> <th>NEMA</th> <th>D</th> </tr> </thead> <tbody> <tr> <td>54-1</td> <td>1-3/4"</td> </tr> <tr> <td>54-2</td> <td>2-1/8"</td> </tr> <tr> <td>54-3</td> <td>2-3/8"</td> </tr> <tr> <td>54-4</td> <td>2-3/8"</td> </tr> </tbody> </table> Loop Diameters 1-3/4" to 2-3/8"	NEMA	D	54-1	1-3/4"	54-2	2-1/8"	54-3	2-3/8"	54-4	2-3/8"
1/2"	5/8"	3/4"	1"	1-1/4"																				
3/8"	7/16"	1/2"	9/16"	5/8"	3/4"																			
NEMA	D																							
54-1	1-3/4"																							
54-2	2-1/8"																							
54-3	2-3/8"																							
54-4	2-3/8"																							

For Use on Galvanized Steel Strand								
Catalog Number		Size (mm)	Strand Construction	Mean Diameter (mm)	Length (mm)	Color Code	Units Per Carton	Wt./Lbs. Per Carton
B-Coat	C-Coat							
GDE-1102	GDE-2102	3/16" (4.7)	7W	.186" (4.7)	20" (508)	Red	100	30
			7W	.195" (4.7)				
GDE-1104	GDE-2104	1/4" (6.3)	3W	.259" (6.5)	25" (635)	Yellow	50	24
			7W	.240" (6.0)				
GDE-1106	GDE-2106	5/16" (7.9)	3W	.312" (7.9)	31" (788)	Black	50	39
			7W	.312" (7.9)				
			7W	.327" (7.9)				
GDE-1107	GDE-2107	3/8" (9.5)	3W	.356" (7.9)	35" (788)	Orange	50	51
			7W	.360" (9.1)				
GDE-1108	GDE-2108	7/16" (11.0)	7W	.435" (11.0)	38" (965)	Green	25	40

Bezinal® Strand*							
Catalog Number	Size (mm)	Strand Construction	Mean Diameter (mm)	Length (mm)	Color Code	Units Per Carton	Wt./Lbs. Per Carton
BDE-9102	3/16" (4.7)	7W	.186" (5)	20" (508)	Red	100	30
		7W	.195" (5)				
BDE-9104	1/4" (6.3)	3W	.259" (7)	25" (635)	Yellow	50	24
		7W	.240" (6)				
BDE-9106	5/16" (7.9)	3W	.312" (8)	31" (788)	Black	50	39
		7W	.312" (8)				
		7W	.327" (8)				
BDE-9107	3/8" (9.5)	3W	.356" (8)	35" (788)	Orange	50	51
		7W	.360" (9)				
BDE-9108	7/16" (11.0)	7W	.435" (11)	38" (965)	Green	25	40

Notes:

Left hand lay standard.

Big-Grip Dead-end recommended for guying metal towers and antennas.

*Dead-ends manufactured from Bezinal® Material. Bezinal is a registered trademark of the Bekaert Company.

GUY-GRIP® Dead-end

Aluminum-Clad Steel						
Catalog Number	Mean Diameter (mm)	Nominal Strand Size	Length (mm)	Color Code	Units Per Carton	Wt./Lbs. Per Carton
AWDE-4108	.220" (5.5) .220" (5.5)	4M 3 #10	21" (533)	Green	50	20
AWDE-4110	.242" (6.1) .247" (6.2)	6M 3 #9	24" (610)	Yellow	50	20
AWDE-4113	.272" (6.9) .277" (7.0)	8M 3 #8	24" (610)	Blue	50	22
AWDE-4116	.306" (7.7) .306" (7.7) .311" (7.8)	5/16"—7 #10 10M 3 #7	26" (660)	Black	50	29
AWDE-4119	.343" (8.7) .343" (8.7) .349" (8.8)	11/32"—7 #10 12.5M 3 #6	29" (737)	Yellow	50	41
AWDE-4120	.363" (9.2)	14M	31" (787)	Blue	50	53
AWDE-4122	.385" (9.7) .386" (9.8) .392" (9.9)	3/8"—7 #8 16M 3 #5	32" (812)	Orange	50	55
AWDE-4124	.417" (10.5)	18M	34" (864)	Black	25	37
AWDE-4125	.433" (10.9)	7/16"—7 #7	36" (914)	Green	25	40
AWDE-4126	.444" (11.2)	20M	37" (940)	Yellow	10	22

Note: Left hand lay standard. Nominal strand size indicates one of various conductors within each range. Big-Grip Dead-end is recommended for guying metal towers and antennas.

Catalog Number	Size (mm)	Strand Construction	Mean Diameter (mm)	Length (mm)	Color Code	Units Per Carton	Wt./Lbs. Per Carton	Percent of Strand Rated Breaking Strength
Stainless Steel for Type 302 Strand and Type 430 Strand								
SDE-5101	7/32" (5.5)	3W 7W	.224" (5.6) .216" (5.4)	22" (559)	Blue	100	30	100%
SDE-5102	1/4" (6.3)	3W 7W	.259" (6.5) .249" (6.3)	26" (660)	Yellow	50	25	100%
SDE-5103	9/32" (7.1)	7W	.279" (7.0)	27" (686)	Black	50	26	90%
SDE-5104	15/16" (23.7)	3W 7W	.312" (7.9) .312" (7.9)	31" (787)	Orange	50	41	93%
SDE-5105	3/8" (9.5)	3W 7W	.356" (9.0) .360" (9.1)	37" (940)	Green	50	66	83%
SDE-5106	7/16" (11.0)	7W	.435" (11.0)	43" (1092)	Red	25	53	85%
Stainless Steel for Type 316 Strand								
SDE-6101	7/32" (5.5)	3W 7W	.224" (5.6) .216" (5.4)	22" (559)	Blue	100	29	100%
SDE-6102	1/4" (6.3)	3W 7W	.259" (6.5) .249" (6.3)	26" (660)	Yellow	50	25	100%
SDE-6103	9/32" (7.1)	7W	.279" (7.0)	27" (686)	Black	50	26	90%
SDE-6504*	8/16" (7.9)	3W 7W	.312" (7.9) .312" (7.9)	31" (787)	Orange	50	41	93%
SDE-6105	3/8" (9.5)	3W 7W	.356" (9.0) .360" (9.1)	37" (940)	Green	50	66	87%
SDE-6107	1/2" (12.7)	7W	.500" (12.7)	53" (1346)	Blue	10	52	85%

Note: Left hand lay standard. GUY-GRIP Dead-ends for copper-covered steel are also available.

*These Dead-ends utilize the open helix loop design.



GUY-LOCK

NOMENCLATURE

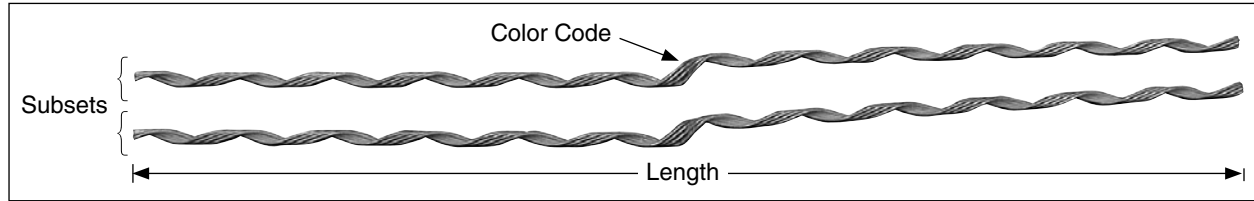

Length: Indicates length of GUY-LOCK before installation.

Color Code: Provides strand size identification and indicates cross-over point for starting application.

Subset: GUY-LOCK consists of subsets of helically formed galvanized steel wires, bonded together and coated internally with an abrasive material.

GENERAL RECOMMENDATIONS

The GUY-LOCK is intended for use on single wood poles associated with distribution constructions.

RATED HOLDING STRENGTH: The GUY-LOCK is rated at 100% of the strands published rated breaking strength.

The GUY-LOCK is designed to perform the same function as GUY-GRIP® dead-ends, but are for those who prefer a “wrap around” guy at the pole. The GUY-LOCK is recommended for any size pole and neatly secures the tail of the guy strand to the load portion of the down guy. The GUY-LOCK can also be used to secure the down guy at the anchor location.

This product is intended for a single (one-time) use and for the specified application although it may be reapplied twice for retensioning within 90 days of initial installation. **CAUTION: DO NOT MODIFY OR REUSE THIS PRODUCT AFTER 90 DAYS UNDER ANY CIRCUMSTANCES.**

Catalog Number	Size (Inches)	Construction	Mean Diameter (Inches)	Length (Inches)	Color Code	Rated Holding Strength (Lbs.)
GL-1104*	1/4	7W 3W	.259 .240	33	Yellow	6,650
GL-1106*	5/16	7W 3W	.312 .327	35	Black	11,200
GL-1107*	3/8	7W 3W	.356 .360	42	Orange	15,400
GL-1108	7/16	7W	.435	44	Green	20,800
GL-1109	1/2	7W 19W	.495 .500	46	Blue	26,900

*Denotes a single subset design

Big-Grip Dead-end

Big-Grip Dead-ends are designed for use with antenna, communications tower, microwave and various guyed structures that require use of large guy strand. They are effective at both the structure top and the anchor bottom.

Big-Grip Dead-ends are left hand lay standard and are applied to the same basic materials as the strand (galvanized strand, aluminum covered strand, except where noted differently).

The Big-Grip Dead-end is designed to be applied quickly in the field, without tools, and usually by one person.

Concentrated stresses in the anchor area are minimized by the cabled loop. Long length helical gripping distributes other stresses uniformly and evenly.

For more detailed information concerning installation guidelines contact Preformed Line Products.

Galvanized Strand

For use on:

- Extra High Strength
- High Strength
- Siemens Martin
- Utilities Grade



Catalog Number	Size (mm)	Strand Construction	Actual Diameter (mm)	BG Per Carton		Approx. Length (m)	Color Code	Rated Holding Strength	% of Strand's Rated Breaking Strength
				Units	Wt/ Lbs				
BG-2115	1/2" (12.7)	7W or 19W	.495"(12.5) or .500"(12.7)	20	63	49" (1.24)	Blue	26,900#	(100%)
BG-2116	9/16" (14.2)	7W or 19W	.564"(14.3) or .565" (14.3)	10	48	55" (1.39)	Yellow	35,000#	(100%)
BG-2111	5/8" (15.8)	7W or 19W	.621"(15.7) or .625"(15.8)	10	65	64" (1.62)	Black	40,200#	(100%)
BG-2112	3/4" (19.0)	19W	.750"(19.0)	5	54	76" (1.93)	Orange	58,300#	(100%)
*BGMS7023	7/8" (22.2)	19W	.885"(22.4)	5	47	90" (2.28)	Green	79,700#	(100%)
*BGMS7047	1" (25.4)	19W or 37W	1.000"(25.4) or 1.001"(25.4)	3	76	125" (3.17)	Blue	104,5000# 92,430#	(100%) (90%)

Note: Left Hand Lay Standard.

*Manufactured or Alumoweld® material. Alumoweld is a registered trademark of the Copperweld Co.

Strand Diameter (mm)	Nominal Strand (mm)	Seat Dimensions		Minimum Groove Diameter (mm)	Minimum Hardware Hole Diam. (mm)	Thimble Size (mm)	Pin Diameters		Double Extra Strong Weight Pipe		
		Min. (mm)	Max. (mm)				Min. (mm)	Max. (mm)	Nominal Size (mm)	O.D.	I.D.
.475"-.515" (12-18)	1/2" (12.7)	1 3/8" (34.9)	2 3/8" (60.3)	9/16" (14.2)	3/4" (19.0)	5/8" (15.8)	1" (25.4)	1 1/8" (41.2)	1 1/4" (31.7)	1.66	.896
.516"-.570" (13-14)	9/16" (14.2)	1 1/2" (38.1)	2 5/8" (66.6)	5/8" (15.8)	15/16" (23.7)	5/8" (15.8)	1 1/8" (28.5)	1 5/8" (41.2)	1 1/4" (31.7)	1.66	.896
.571"-.635" (15-16)	5/8" (15.8)	2" (50.8)	2 5/8" (66.6)	3/4" (19.0)	1" (25.4)	3/4" (19.0)	1 1/2" (38.1)	1 7/8" (47.6)	1 1/4" (31.7)	1.66	.896
.636"-.772" (16-20)	3/4" (19.0)	2 1/2" (63.5)	3 1/8" (79.3)	7/8" (22.2)	1 3/16" (30.1)	7/8" (22.0)	1 7/8" (47.6)	2 1/8" (53.9)	1 1/2" (38.1)	1.9	1.1
.773"-.868" (20-22)	-	2 1/2" (63.5)	3 5/8" (92.0)	1" (25.4)	1 3/8" (34.9)	1" (25.4)	2" (50.8)	2 3/8" (60.3)	2" (50.8)	2.375	1.503
.869"-.1024" (22-26)	1" (25.4)	3" (76.2)	4 1/8" (104.7)	1" (25.4)	1 3/8" (34.9)	1 1/8"-1 1/4" (28.5-31.7)	2 3/8" (60.3)	2 3/4" (69.8)	2" (50.8)	2.375	1.503
1.025"-.127" (26-32)	-	3 1/2" (88.9)	5 1/8" (130.1)	1 3/8" (34.9)	1 3/4" (44.4)	1 1/4"-1 3/8" (31.7-34.9)"	2 3/4" (69.8)	3 1/4" (82.5)	2 1/2" (63.5)	2.875	1.771
1.30" (33)	-	4" (101.6)	5 1/8" (130.1)	1 3/8" (34.9)	1 15/16" (49.1)	1 3/8"-1 1/2" (34.9-38.1)	2 7/8" (73.0)	3 3/8" (85.7)	2 1/2" (63.5)	2.875	1.771

Figure 1. 	Figure 2. 	Figure 3. 	Figure 4. 	Figure 5. 	Figure 6.
---------------	---------------	---------------	---------------	---------------	---------------



Big-Grip Dead-end

For Use On: Aluminum Covered Steel Strand										
Catalog Number	Strand Diameter Range		Nominal Strand Size	BG Per Carton		Approx. Length		Color Code	Rated Holding Strength	% of Strand's Rated Breaking Strength
	Min. Inches	Max. Inches		Units	Wt./Lbs.	Inches	Meters			
BG-4168	.475	.494	7#6	25	60	42	1.06	Blue	22,730#	(100%)
BG-4169	.495	.515	19#10	25	62	44	1.11	Green	27,190#	(100%)
BG-4170	.516	.536	25M	20	66	47	1.19	Red	25,000#	(100%)
BG-4171	.537	.555	7#5	20	67	48	1.21	Yellow	27,030#	(100%)
BG-4172	.556	.570	—	15	68	49	1.24	Blue	33,330#	—
BG-4173	.571	.591	19#9	20	68	50	1.27	Orange	34,290#	(100%)
BG-4174	.592	.612	—	15	50	50	1.27	Green	34,500#	—
BG-4175	.613	.635	—	10	49	54	1.37	Yellow	45,000#	—
BG-4176	.636	.661	19#8	10	50	56	1.42	Black	43,240#	(100%)
BG-4177	.662	.686	19 x .1363"	10	66	59	1.49	Blue	47,400#	(100%)
BG-4178	.687	.712	—	10	68	61	1.54	Red	54,200#	—
BG-4179	.713	.741	19#7 37#10	10	70	63	1.60	Black	51,730# 50,300#	(100%) (95%)
BG-4180	.742	.772	19 x .1499"	5	41	71	1.80	Yellow	54,300#	—
Catalog Number	Actual Diameter Inches		Nominal Strand Size	BG Per Carton		Approx. Length		Color Code	Rated Holding Strength	% of Strand's Rated Breaking Strength
				Units	Wt./Lbs.	Inches	Inches			
BG-4181	.792		19 x .1584"	5	50	80	2.03	Blue	59,000#	—
BG-4183	.801, .810, .827		37#9 19#6 19 x .1660"	5	69	84	2.13	Green	63,430# 61,700# 63,000#	(95%) (100%) (100%)
BG-4185	.849, .850, .866		37 x .1213" 19 x .170" 19 x .1732" 37 x .1237"	5	68	87	2.21	Black	71,250# 66,000# 68,500# 74,100#	(95%) (100%) (100%) (95%)
BG-4186	.899		37#8	5	76	91	2.31	Yellow	80,000#	(95%)
BG-4187	.910, .934		19#5 19 x .1868"	5	78	93	2.36	Blue	73,350# 75,000#	(100%) (100%)
BG-4188	.981		37# .1401"	4	55	95	2.41	Red	90,250#	(95%)
BG-4189	1.01		37#7	4	85	106	2.74	Green	90,600#	(90%)
BG-4190	1.10		37 x .1571"	3	87	117	2.97	Black	101,700#	(90%)
BG-4191	1.134		37#6	3	86	120	3.04	Yellow	108,200#	(90%)
BG-4192	1.27		37#5	2	87	151	3.83	Red	127,000#	(89%)

Note: Left Hand Lay Standard.

False Dead-end

False Dead-ends

PREFORMED False Dead-ends are a fast, safe, and economical method for false dead-ending strand. They are designed to be easily applied without any special tools, and because False Dead-ends are made from the same material as the strand, they will hold the same published rated breaking strength.

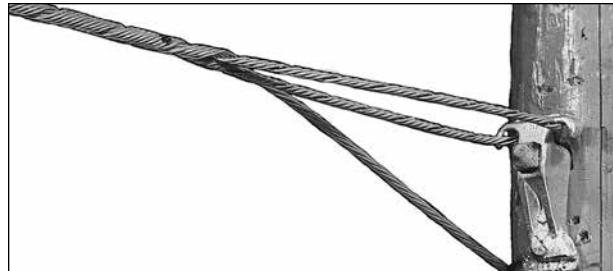

Galvanized Steel, C-Coat for use on Extra High Strength or Utility Grade Strands						
Catalog Number	Strand 7-Wire	Mean Diameter	Length	Color Code	Units Per Carton	Wt./Lbs. Per Carton
GFDE-2121	¼"	.240"	36"	Yellow	25	17
GFDE-2123	5/16"	.327"	39"	Black	25	24
GFDE-2124	3/8"	.360"	42"	Orange	25	30
GFDE-2125	7/16"	.435"	48"	Green	25	52
GFDE-2126	1/2"	.495"	50"	Blue	25	71

Note: Left Hand Lay Standard.

For use on Bezinal® Strand						
Catalog Number	Strand 7-Wire	Mean Diameter	Length	Color Code	Units Per Carton	Wt./Lbs. Per Carton
BFDE-9121	¼"	.240"	36"	Yellow	25	17
BFDE-9123	5/16"	.327"	39"	Black	25	24
BFDE-9124	3/8"	.360"	42"	Orange	25	30
BFDE-9125	7/16"	.435"	48"	Green	25	52
BFDE-9126	1/2"	.495"	50"	Blue	25	71

Note: Left Hand Lay Standard.

Manufactured from Bezinal® Material. Bezinal is a registered trademark of the Bekaert Corporation



Open Wire Dead-end

Open Wire Dead-ends

PREFORMED™ Dead-ends for Open Wire are designed to be applied by hand in seconds without tools. They exert uniform, positive, gentle gripping. Holding power extends throughout their full length and prevents the concentration of stress points that cause premature line failure. Trim and modern in appearance, they are made of the same material as the conductor to which they are applied and are performance proven even under various climate extremes.

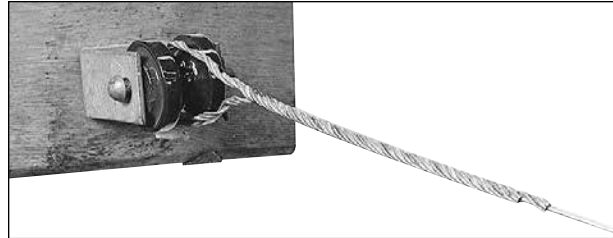

Catalog Number	Wire Gauge	Wire Size	Length	Color Code	Units Per Carton	Wt./Lbs. Per Carton
Galvanized Steel						
GDE-2500	BWG-14	.083"	12"	Yellow	100	6
GDE-2501	BWG-12	.109"	12"	Black	100	9
GDE-2503	BWG-10	.134"	14"	Orange	100	15
Aluminum Clad Steel						
2004511	AWG-11	.091"-.095"	11"	Green	100	7
Copper-Clad Steel						
CWDE-5507	AWG-12	.080"-.081"	11"	Green	100	8
CWDE-5508	AWG-11	.091"-.095"	12"	Red	100	9
CWDE-5509	AWG-10	.102"-.104"	12"	Blue	100	12
CWDE-5510	AWG-9	.114"	13"	Orange	100	13
CWDE-5511	AWG-8	.128"	13"	Black	100	16
CWDE-5512	AWG-6	.162"	16"	Green	100	21

Drop Wire/C-Rural/Buried Line Wire Dead-ends

Drop Wire Dead-ends

PREFORMED™ Drop Wire Dead-ends provide an easy, low-cost way to support service drop wire without bail failures or stripping of the insulation. Rapidly applied by hand without tools, they are adjusted to exert firm uniform holding power throughout their length, without crushing or damaging drop wire. Wrap-on design prevents potentially damaging stress points. PREFORMED Drop Wire Dead-ends present a trim, neat appearance, and are manufactured of neoprene-coated stainless steel for added protection against the elements.



Stainless Steel Neoprene Coated					
Catalog Number	Manufacturer	Manufacturer's Designation	Color Code	Units Per Carton	Wt./Lbs. Per Carton
NDE-9500	Alphaduct	PDCW Parallel (N-182)	Black	100	9
	Alphaduct	PDCW Parallel Dumbbell (NE-182)	Black	100	9
	Alphaduct	PDCW Parallel Reinforced (NR-182)	Black	100	9
	Whitney-Blake	TCWP Parallel (2#18)	Black	100	9
	Whitney-Blake	TBP Parallel Reinforced (2#17)	Black	100	9
NDE-9501	AT&T	Bell Reinforced (2#18)	Green	100	9
	Whitney-Blake	TBP-R Parallel Reinforced (2#17)	Green	100	9

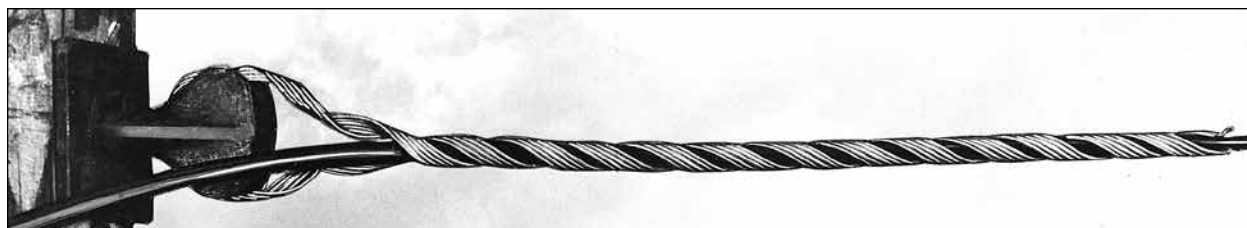

C-Rural Dead-ends

PREFORMED™ C-Rural Wire Dead-ends are an inexpensive way of safely dead-ending one pair aerial distribution wire to a drive hook or eye bolt. They are designed to keep the lines up and costs down by simple hand application without tools of any kind. Their design assures long maintenance free service life.

Buried Line Wire Dead-ends

Buried Line Wire Dead-ends are used for overhead construction applications of buried line wire.

Catalog Number	Wire Sizes	Length	Color Code	Units Per Carton	Wts./Lbs. Per Carton
Buried Line Wire Dead-ends					
NDE-8500	2 #19 Copper	21" (533)	Red	100	17
NDE-8501	2 #16 Copper	23" (584)	Blue	100	26
C-Rural Dead-ends					
NDE-8502*	2 #14 CW	22" (559)	White	200	30
NDE-8503*	2 #12 CW (or .083 Steel)	30" (762)	Yellow	250	55
NDE-9502*	2 #14 CW	15" (381)	Orange	500	50

*Note: Attachments specifically designed for use with High Density Linear Polyethylene One-Pair Aerial Distribution Wire also may be used with conventional polyethylene covered C-Rural Wire.



Telegrip

Telegrip

Telegrips are designed for service drop applications of coaxial cables. Flexible but firm, Telegrips exceed mechanical holding requirements for coaxial cable. The long length design reduces stress levels and eliminates the possibility of crushing the cable or affecting its dielectric properties. Also, its unique gripping principle prevents bending that can cause "snow" or distortion of the television picture.

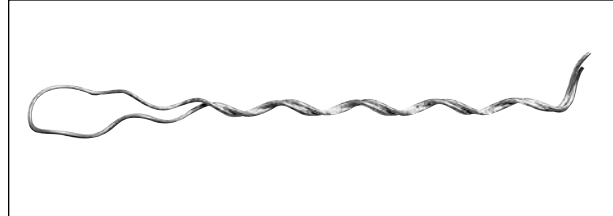

Telegrip			
Catalog Number	Cable Type (mm)	Units Per Carton	Wt/Lbs Per Carton
DE-1500	.242" (6) RG59/U .275" (7) RG6/U	500	23
DE-1600	.242" X .504" (6 x 13) DUAL RG59U	500	25
	.275" X .546" (7 x 14) DUAL RG6/U	500	25
DE-1601	.312" - .315" (8 - 8) QUAD RG6/U	500	25

Consult PLP for requirements not listed.

Custom Coaxial Dead-end

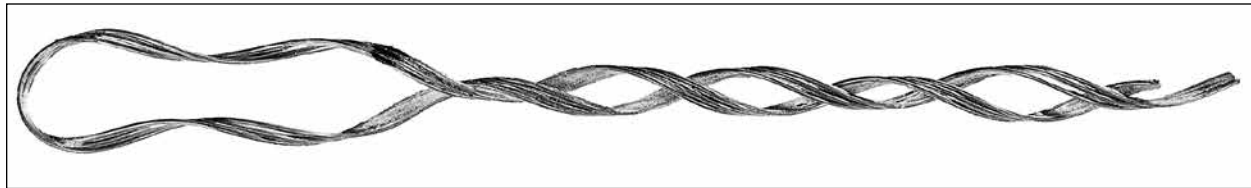

Coaxial Dead-ends

Custom Coaxial and Dual Coaxial Dead-ends are performance-proven dead-end designs for RG-59/U, Dual RG-59/U, Dual RG-6/U, and RG-11/U coaxial cable. In addition to the inherent benefits of the basic Telegrip, these premium products feature twin leg construction which cushion and relieve gripping stresses created by unusually high winds and heavy ice loading. They are especially recommended for foam insulated coaxial cable and areas where there are extreme corrosive and demanding environmental conditions.

Catalog Number	Cable Type (mm)	Units Per Carton	Wt./Lbs. Per Carton
Custom Coaxial Dead-End			
DE-3329*	RG59/U .242" (6.1)	200	9
Dual Coaxial Dead-End			
DE-2519	DUAL RG59/U .242" X .504" (6.1 x 12.8)	200	20
DE-2520	DUAL RG6/U .275" X .546" (6.9 x 13.8)	200	43
Coaxial Dead-End			
DE-2518	RG11/U .405" (10.2)	200	22

*Manufactured from stainless steel

Pulling Eye

Pulling Eye

PREFORMED™ Pulling Eye is the fastest, most practical means of installing GUY-GRIP® Dead-ends at the anchor rod. The large eye is designed to avoid conflict with the chain hoist. The keeper bolt is adjustable for rod size. Pulling Eye is made of corrosion-resistant nodular iron, finished in orange vinyl coating for added durability against bad weather and rough handling. The keeper bolt is made of specially heat-treated extra high strength steel. The PREFORMED Pulling Eye capacity is 3,000 lbs.



Catalog Number	Description	Standard Carton
Anchor Rod Application		
PE-0300	Pulling Eye	4 Units
Replacement Parts		
PE-A-0002	Pulling Eye: Keeper	As Required
PE-B-2019	Pulling Eye: Bolt	As Required
PE-C-0607	Pulling Eye: Nut	As Required



Safety Guy-Wire Dispenser

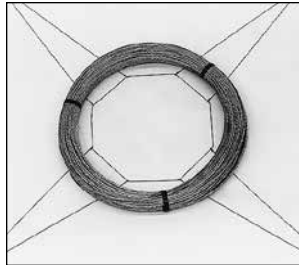

1. Fold out legs.

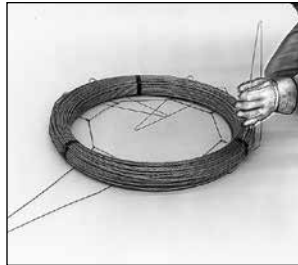

2. Bend legs over coil.



3. Twist at least two inches of legs together until wire cage is tight.



4. Turn wire cage over and pay-out from side. Tuck end back into the cage.

Safety Guy-Wire Dispenser

NO MORE RUNAWAYS. PREFORMED™ Safety Guy-Wire Dispenser is designed to provide safe, easy, completely controlled handling and paying-out of strand coils up to 500 ft. in length, including EHS strand. It also can be used with wire, wire rope, cable, conductor, etc. Eliminate weight lifting, handling struggle, and the hazards of “runaway” coil ends. Small and light in weight (a carton of 50 weighs only 22 pounds), the Safety Guy-Wire Dispenser occupies minimal truck space. No banding or

taping of coils is necessary. Saves personnel cost (only one person to pay out a loaded coil) and reduces inventory (just one universal size).

PREFORMED Safety Guy-Wire Dispenser accommodates any size coil, provided at least two inches of the end of each leg can be twisted. Designed to withstand the free-fall impact of a 200 pound coil from 15 ft.

Catalog Number	Standard Carton Quantity	Typical Size Coils Accommodated	Leg Length (mm)	Wire Size
SGD-0700 (Standard Size)	50	500' $\frac{7}{16}$ " 250' $\frac{1}{2}$ " Strand 23" by 9" Triplex Coils	24" (610)	14 gauge
SGD-0701 (Jumbo Size)	25	500' $\frac{1}{2}$ " Strand	30" (762)	12 gauge



PREFORMED LINE PRODUCTS

Section 21 – Guards, Moldings & Markers

Table of Contents	Page
Tree Guards	21-2
Guy Markers.....	21-5
Classic Guy Markers	21-7
Economy Guy Markers	21-8
Wrap-Around Guy Markers.....	21-9
Fiber Optic Cable Marker	21-10
Pedestal Marker	21-10
Ground Wire Molding	21-11
BIRD-FLIGHT™ Diverter.....	21-12
SWAN-FLIGHT™ Diverter.....	21-14
BIRD-FLIGHT™/SWAN-FLIGHT™ Diverter Spacing.....	21-15



Tree Guards

NOMENCLATURE

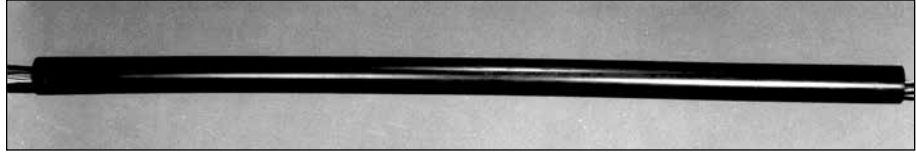

POLYETHYLENE
Slit Longitudially

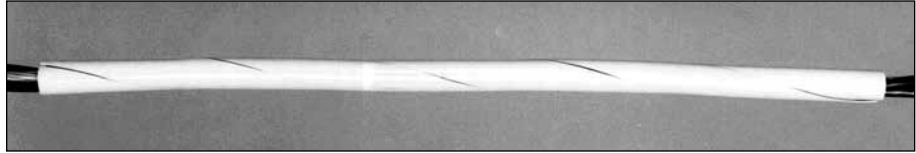

PVC
Spiral Slit

Length: Standard lengths are shown in separate tables on the catalog pages.
Wall Thickness: Provides a barrier, preventing physical contact with the conductor or its covering.
Color: PVC = Light Gray
Polyethylene = Black

GENERAL RECOMMENDATIONS

PROTECTION. Tree Guards are designed to protect bare conductors and fabric or plastic covered cables against mechanical abrasion caused by tree limbs or other obstructions.

MATERIAL. Tree Guards are manufactured from a high-impact polyvinyl chloride or polyethylene. These materials are resistant to extreme abrasion and have strong weathering endurance. Although the plastics have high dielectric properties, Tree Guards are not designed for insulation purposes.

LENGTHS. PVC Tree Guards come in 3 ft. and 6 ft. lengths and Polyethylene Tree Guards come in 8 inch and 6 ft. lengths. Tree Guards can be butted together with other tree guards of like materials to achieve a combination of lengths.

SIZE SELECTION. Tree Guard size is determined by the effective diameter of single or grouped conductors. To select the proper size for two or more conductors, arrange the cables to provide a bundle with the smallest possible diameter. The diameter of this bundle, when located within a range on the catalog page, will provide the proper size Tree Guard.

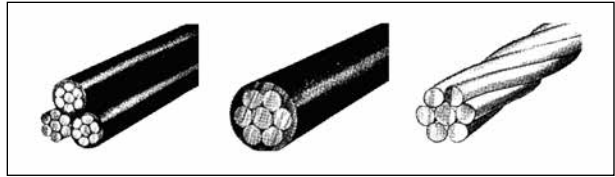

SAFETY CONSIDERATIONS

1. This product may be reused if in good condition.
2. This product is intended for use by trained craftspeople only. This product **SHOULD NOT BE USED** by anyone who is not familiar with and trained in the use of it.
3. When working in the area of energized lines with this product, **EXTRA CARE** should be taken to prevent accidental electrical contact.
4. For **PROPER PERFORMANCE AND PERSONAL SAFETY** be sure to select the proper size **PREFORMED™** Tree Guards before application.
5. **PREFORMED™** Tree Guards are precision devices. To insure proper performance, they should be stored in cartons under cover and handled carefully.

Tree Guards

Tree Guards

PREFORMED™ Tree Guards are designed to protect bare conductors, fabric-covered or plastic-covered cables and fiber optic cables against mechanical abrasion caused by tree limbs or other obstructions. Tree Guards provide fast, easy application without disconnecting the wire. Tree guards are applied around the wire, and taped at each end.

Polyethylene – Slit Longitudinally

Catalog Number	Diameter Range		Units Per Carton	Wt./Lbs. Per Carton
	Min.	Max.		
Tree Guards 6 Ft. (1.8 m) Length				
PTG-0201	.238"	.500"	150	46
PTG-0203	.501"	.1.00"	60	39
PTG-0205	1.01"	1.50"	25	25
PTG-0207	1.51"	2.00"	20	26
PTG-0208	2.01"	3.00"	12	25
Tree Guards 8 In. (203 mm) Length				
PTG-0200	.238"	.500"	1,000	35
PTG-0202	.501"	1.00"	500	34
PTG-0204	1.01"	1.50"	250	30
PTG-0206	1.51"	2.00"	175	25

These guards are black in color.

PVC – Spiral Slit

Catalog Number	Diameter Range		Length	Wall Thickness	Units Per Carton	Wt./Lbs. Per Carton
	Min.	Max.				
Tree Guards 6 Ft. Length						
PTG-0104	.267"	.297"	6'	1/16"	100	26
PTG-0107	.296"	.328"	6'	1/16"	100	28
PTG-0113	.359"	.389"	6'	1/16"	100	32
PTG-0116	.390"	.421"	6'	1/16"	100	34
PTG-0122	.454"	.478"	6'	1/16"	75	30
PTG-0125	.479"	.511"	6'	1/16"	75	32
PTG-0128	.512"	.542"	6'	1/16"	75	32
PTG-0137	.599"	.641"	6'	5/64"	75	48
PTG-0140	.642"	.706"	6'	5/64"	75	52
PTG-0143	.707"	.762"	6'	3/32"	50	46
PTG-0146	.763"	.820"	6'	3/32"	50	48
PTG-0149	.821"	.882"	6'	3/32"	50	52
PTG-0152	.883"	.947"	6'	3/32"	50	56
PTG-0155	.948"	1.010"	6'	3/32"	50	58
Tree Guards 3 Ft. Length						
PTG-0118	.422"	.453"	3'	1/16"	100	20
PTG-0121	.454"	.478"	3'	1/16"	100	20
PTG-0130	.543"	.568"	3'	5/64"	100	30
PTG-0139	.642"	.706"	3'	5/64"	100	34
PTG-0142	.707"	.762"	3'	3/32"	100	46
PTG-0154	.948"	1.010"	3'	3/32"	100	58

These guards are gray in color.



Tree Guards

GENERAL RECOMMENDATIONS

Size Selection: In selecting the proper size PVC Tree Guard it is necessary to determine the smallest circumscribing circle that will enclose the messenger and cables.

For grouping only one cable with messenger, add the diameters and multiply by a factor of .850.

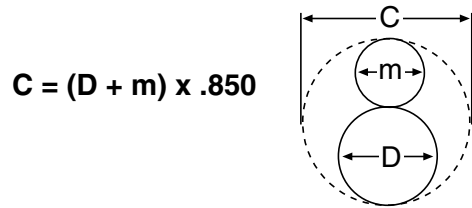

$$C = (D + m) \times .850$$

For grouping three equal diameter cables, multiply the diameter of one cable times 2.155. Then to find the diameter of the maximum messenger that will fit in the interstices of the cables multiply the diameter of one cable times .483.

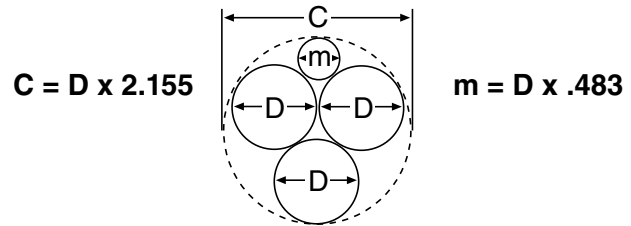

$$C = D \times 2.155$$

$$m = D \times .483$$

For grouping two equal diameter cables, multiply the diameter of one cable times 2.00. Then find the diameter of the maximum messenger that will fit in the interstices of the cables, multiply the diameter of one cable times .666.

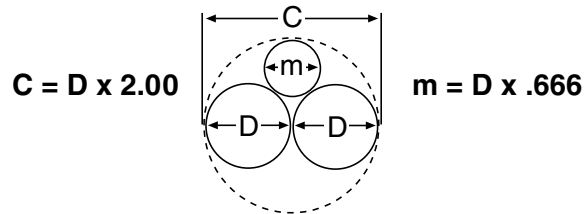

$$C = D \times 2.00$$

$$m = D \times .666$$

For grouping four equal diameter cables; multiply the diameter of one cable times 2.414. Then to find the diameter of the maximum messenger that will fit in the interstices of the cables multiply the diameter of one cable times .414.

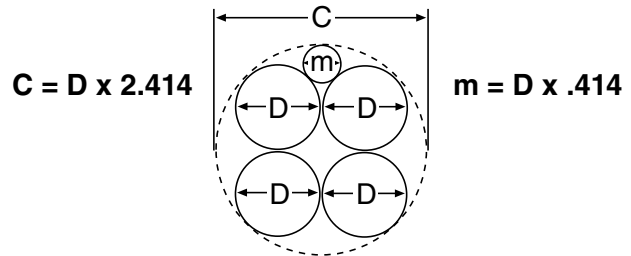

$$C = D \times 2.414$$

$$m = D \times .414$$

For grouping unequal diameter cables or messengers too large to fit into the interstices above, the minimum diameter grouping can best be determined by a graphic layout scale.

Guy Markers

PREFORMED™ Guy Markers are used for identifying Down Guys or other wire and cable installations where anchoring devices are exposed to pedestrian and/or vehicular traffic.

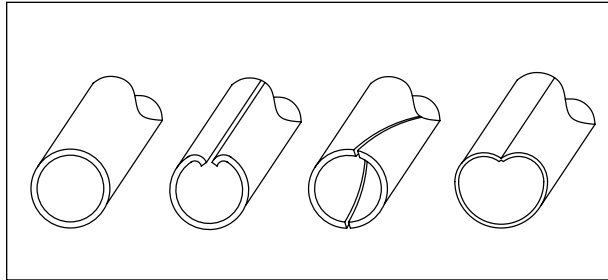

Profile Options

PREFORMED™ Guy Markers are available in four basic profiles:

- Full Round – 1-1/2" and 1-1/4" OD (Outer Diameter)
- "B" Profile "heart shape" – 1-1/2" effective OD
- Two Piece Spiral Round – 1-1/4" OD, helically slit to create two halves
- Round-Overlapping – 1-1/2" OD

Material

Guy Markers are available in Polyethylene and PVC materials as shown in the tables. All materials employ UV inhibitors to enhance life span performance.

Color

Guy Markers are available in yellow, orange, and gray. For other available colors and combinations of colors, consult PLP.

Reflective tape is available as an option. If the desired configuration is not shown in the catalog tables, contact PLP.

Attachment Devices

PREFORMED™ Guy Markers utilize four basic attachment devices. These are:

- Cable Tie/Universal Cable Tie
- LOOP LOCK® Pin (patented)
- Integral Helical Pigtail (used in conjunction with Short Lock Strap or Cable Tie)
- Stainless Steel Clamp



LOOP LOCK® Pin:

A unique, one-way method that applies through the marker's tube and loop of a GUY-GRIP® Dead-end. Once applied, the tube is "locked" onto the Dead-end and cannot be removed easily by vandals. Removal and reinstallation of the marker by authorized personnel is possible with a new pin, which can be supplied separately.



Integral Helical Pigtail:

Attached to the inside of the marker tube and wraps on to secure to the strand. Generally fits a strand range of 3/16" – 1/2" diameters and provides a unique one-way slip down motion for ease of installation. The installed pigtail resists upward movement. The pigtail is made from specially formulated material designed to provide high strength, tear resistance, and no corrosion.

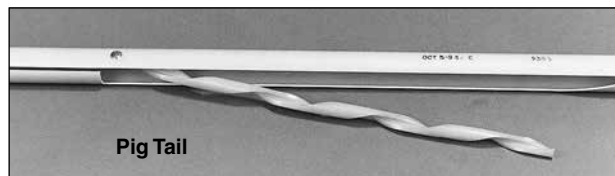

Universal Cable Tie:

A positive locking device to deter vandalism. Recommended on dead-end hardware that restricts the use of the LOOP LOCK® Pin.





Guy Markers

Attachment Devices Continued

Short Lock Strap and Cable Tie:

The Short Lock Strap is used with the pigtail device and helps deter vandalism. The **Cable Tie** is supplied as an alternative to the Short Lock Strap where hardware restricts its application.

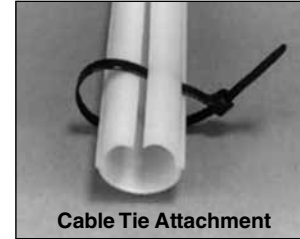

Stainless Steel Clamp:

The stainless steel clamp is riveted to one end of the guy marker. The clamp's position gives linemen an option to install the guy marker with the clamp on top or bottom of the tube. The stainless steel clamp quickly and easily secures the guy marker to down-guy wire by tightening the 9/16" bolt, included in the clamp assembly. This guy marker features a collapsible profile that wraps on itself when installed on down-guy wire.

Universal Marker



Two Piece Spiral Round Markers:

Designed to provide increased visibility for many guying or cable applications. It can provide coverage from the ground line, around fittings and above normal reach depending upon installation.

The addition of a third Helical section can provide up to 360° coverage for diameters over 1". This method may require special application techniques as outlined in the application procedure.

Limited coverage is possible for diameters over 1-5/8" or over large, non-circular fittings. Consult the application procedure for special techniques.

Catalog Number	Length		Color	Material	Tube OD		Attachment Type	Carton Information	
	Feet	Meters			Inches	(mm)		Units	Wt./Lbs.
PG-5750	8	2.4	Orange/ Yellow	Poly	1-1/4	32	2-CT	25	30
PG-5752	8	2.4	Orange	Poly	1-1/4	32	2-CT	25	30

Guy Markers

Classic Guy Markers



Attachment Devices

PT	Helical Pigtail
SLS	Short Lock Strap - used in conjunction with the Helical Pigtail
CT	Cable Tie - used in conjunction with the Helical Pigtail
LLP	LOOP LOCK® Pin (patented)
UCT	Universal Cable Tie
SC	Stainless Steel Clamp

Catalog Number	Color	Material	Tube Profile	Tube OD	Attachment Type	Carton Information	
						Units	Wt./Lbs.
PG-5718	Yellow	Poly	Round	1.5"	PT/SLS	25	39
PG-5718P	Yellow	Poly	"B"	1.5"	PT/CT	25	35
PG-5518	Yellow	PVC	Round	1.5"	PT/SLS	25	33
PGMS3921	Yellow	Poly	Round	1.5"	UCT	25	33
PGMS4072	Yellow	Poly	"B"	1.5"	UCT	25	35
PG-5405	Yellow	Poly	Round	1.5"	LLP	25	36
PG-5423	Yellow	Poly	"B"	1.5"	LLP	25	33
PG-5462	Yellow	Poly	"B"	1.5"	2 LLP	25	36
RPG-5618	Yellow/Reflective Tape	PVC	Round	1.5"	PT/SLS	25	33
RPGMS12030	Yellow/Reflective Tape	Poly	"B"	1.5"	UCT	25	36
RPGMS10469	Yellow/Reflective Tape	Poly	"B"	1.5"	LLP	25	36
PG-5738	Orange	Poly	Round	1.5"	PT/SLS	25	34
PG-5708	Gray	Poly	Round	1.5"	PT/SLS	25	34
PG-5708P	Gray	Poly	"B"	1.5"	PT/CT	25	36
PGMS7578	Yellow	Poly	Round	2"	PT/SLS	25	49
PG-6500	Yellow	Poly	Round	2"	None	25	34
PG-6600	Orange	Poly	Round	2"	None	25	34
PG-6500SC	Yellow	Poly	Round	2"	SC	25	42
PG-6600SC	Orange	Poly	Round	2"	SC	25	42
PG-6500PIN	Yellow	Poly	Round	2"	LLP	25	39
PG-6600PIN	Orange	Poly	Round	2"	LLP	25	39
PG-6500TIE	Yellow	Poly	Round	2"	UCT	25	38
PG-6600TIE	Orange	Poly	Round	2"	UCT	25	38

Note: For different lengths, attachments, and/or the addition of reflective tape, contact your PLP representative or Preformed Line Products.

Package options: Bagged – add suffix code B;
Bulk – add suffix code BULK



Guy Markers

Economy Guy Markers



Do not let the word “Economy” fool you. PLP Economy Guy Markers are made in the USA of the same quality, UV stabilized Polyethylene material as our standard guy markers. We have merely simplified the designs to create a streamline manufacturing process. All PLP Economy Guy Markers are 1-1/4" diameter, round, 8 feet long, and are available with choice of attachments; LOOP-LOCK pin, Universal Cable Tie or a tube with no attachment device.

Features

- One piece designs
- Lightweight
- Easily installed on strand sizes 3/16" – 1/2" (4.7 – 12.7 mm)
- Installs on down guys in seconds
- Ships in boxes, bags or bulk on pallets
- Special pallet pricing available

Material

- Manufactured out of Polyethylene
- Premium UV inhibitors for a long life span
- Nylon pin or cable tie

Attachment Devices

UCT	Universal Cable Tie
LLP	LOOP LOCK® Pin

Catalog Number	Color	Attachment Type	Carton Information	
			Units	Wt./Lbs.
PG-5414	Yellow	LLP	25	32
PG-5411	Gray	LLP	25	32
PGMS4988	Yellow	None	30	38
PGMS3830	Orange	None	30	38
PGMS9838	Yellow	UCT	30	39

Package options: **Bagged** – add suffix code **B**;
Bulk – add suffix code **BULK**

Guy Markers

Wrap-Around Guy Marker

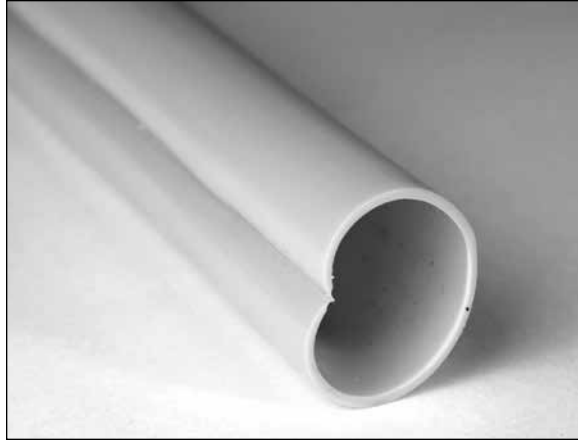

The PREFORMED™ Wrap-Around Guy Marker is designed to identify down guys or other wire and cable installations where anchoring devices are exposed to pedestrian and/or vehicular traffic. The Wrap-Around Guy Marker is available with a choice of three attachment devices; Universal Cable Tie, LOOP LOCK Pin, Stainless Steel Clamp or just as a plain tube.

Features

- 8 foot length
- Larger 2.75" profile ideal for covering exposed anchor
- One piece design
- Lightweight
- Easily installed on strand sizes 3/6" – 5/8" (4.7 – 15.9 mm)
- Standard 1.5" diameter profile and large 2.75" diameter
- Reflective options available
- Deters vandalism
- Installs on down guys in seconds
- Special pallet pricing available

Material

- Manufactured out of Polyethylene
- Premium UV inhibitors for a long life span
- Nylon pin or cable tie

Attachment Devices

UCT	Universal Cable Tie
LLP	LOOP LOCK® Pin (Patented)
SC	Stainless Steel Clamp

Catalog Number	Orange Catalog Number	Tube OD	Attachment Type	Carton Information	
				Units	Wt./Lbs
PG-6000	PG-6100	1.5"	None	25	32
PG-6000PIN	PG-6100PIN	1.5"	LLP	25	32
PG-6000SC	PG-6100SC	1.5"	SC	25	32
PG-6000TIE	PG-6100TIE	1.5"	UCT	25	32
NEW PG-8000	PG-8100	2.75"	None	15	34
PG-8000SC	PG-8100SC	2.75"	SC	15	34
PG-8000TIE	PG-8100TIE	2.75"	UCT	15	34

Note: For different lengths, attachments, and/or the addition of reflective tape, contact your PLP representative or Preformed Line Products.



Universal Cable Tie



LOOP LOCK® Pin (LLP)



Stainless Steel Clamp



Fiber Optic Cable Marker/Pedestal Marker

Fiber Optic Cable Marker

The Fiber Optic Cable Marker is designed to visibly identify Fiber Optic cable location on a wood utility pole. The identification can be determined from the ground due to the marker's bright orange color.

The Fiber Optic Cable Marker is manufactured from a corrosion resistant, lightweight polyethylene. Polyethylene provides superior retention of physical characteristics over temperature ranges and exposure to ultraviolet radiation.



Catalog Number	Color	Tube ID	Length	Per Carton	
				Units	Wt./Lbs.
5005500	Orange	.86"	8"	450	34

Standard Fiber Optic Cable Marker is imprinted with the following information: FIBER OPTIC CATV. The characters are printed in black lettering that is 3/16" high and located opposite the installation slit. Custom printing and alternate colors are available. Contact Preformed Line Products for price and availability.

Pedestal Marker

Pedestal Markers are designed to identify and protect pedestals in deep snow by alerting highway snow removal crews of pedestal position.

Made from high impact polyethylene, Pedestal Markers are available in various lengths and in a highly visible yellow color. Each Pedestal Marker comes with two hose clamps and can be applied to the pedestal quickly, easily, and with standard tools.

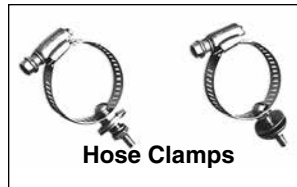

Catalog Number	Length	Color	Per Carton	
			Units	Wt./Lbs.
PM-6114	4'	Yellow	20	13
PM-6115	5'	Yellow	20	16
PM-6116	6'	Yellow	20	19
PM-6117	7'	Yellow	20	22
PM-6118	8'	Yellow	20	25



Ground Wire Molding

Ground Wire Molding

Ground Wire Molding is designed to protect and cover surface-mounted cable, wire, or conductor on wood poles, etc. The soft grey color blends naturally in industrial or urban settings.

Ground Wire Molding is made from lightweight polyethylene and is available in standard 8 ft. lengths of various diameters. It is corrosion resistant and retains good physical characteristics over wide temperature ranges. Application with standard tools i.e., hammer and staples.

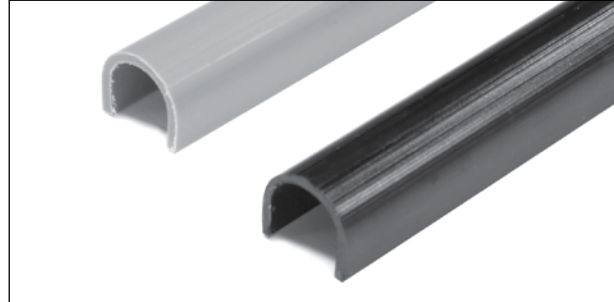

Catalog Number	Length	Color	Diameter	Per Carton	
				Units	Wt./Lbs.
5' Lengths					
GWM-7103	5'	Grey	½"	125	32
GWM-7104	5'	Grey	¾"	100	38
GWM-7105	5'	Grey	1"	50	31
GWM-7203	5'	Black	½"	125	32
GWM-7204	5'	Black	¾"	100	38
GWM-7205	5'	Black	1"	50	31
8' Lengths					
GWM-7100	8'	Grey	½"	125	51
GWM-7101	8'	Grey	¾"	100	60
GWM-7102	8'	Grey	1"	50	50
GWM-7200	8'	Black	½"	125	51
GWM-7201	8'	Black	¾"	100	60
GWM-7202	8'	Black	1"	50	50

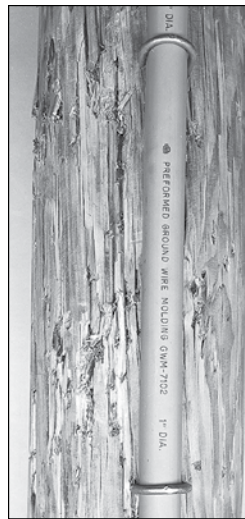



BIRD-FLIGHT™ Diverter

NOMENCLATURE

PLASTIC BIRD-FLIGHT DIVERTER

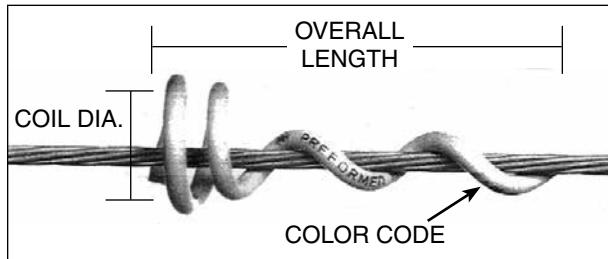

Length: Distance product covers the conductor.

Color Code: Identifies conductor range, corresponding to tabular information on the following page.

Color: Yellow, Gray or Black

Material: Outdoor grade PVC

Coil Diameter: Internal diameter of diverter coil

Thermal Rating: 125°C Continuous

Application Voltage: Gray and Yellow – 230kV and below
Semi-Conductive Black – 345kV

ALUMINUM BIRD-FLIGHT DIVERTER

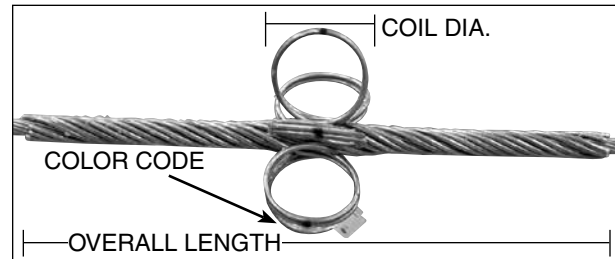

Length: Distance product covers the conductor.

Color Code: Identifies conductor range, corresponding to tabular information on the following page.

Color: Silver

Material: Aluminum Alloy

Coil Diameter: Approximately 4"

Thermal Rating: 250°C Continuous

Application Voltage: 230kV and below

GENERAL RECOMMENDATIONS

The BIRD-FLIGHT Diverter is designed to make overhead lines and guyed structures visible to birds and provides an economical means of reducing the hazard to both lines and birds. For low and medium voltage construction, the BIRD-FLIGHT Diverter is applied to the phase conductors (bare or jacketed). For high voltages, it is used on the shield wire.

The BIRD-FLIGHT Diverter is lightweight, offers little wind resistance and is easily and quickly applied by hand or by hot stick. The positive grip on the conductor ensures that the Bird-Flight Diverter remains in the applied position and cannot move along the span under aeolian vibration or other conditions.

Visibility: The diverter section increases the visible profile of the cable or conductor to a degree necessary to ensure safety, but avoids an undesirably bulky outline.

Materials: The plastic BFD is manufactured from rigid .375" and .500" high impact polyvinyl chloride (PVC) possessing excellent chemical resistance and tensile strength properties. The BIRD-FLIGHT Diverter will retain good physical characteristics within a range of extreme temperatures. Aging tests confirm the material does not deteriorate in function or appearance from the effects of severe weather conditions. Industrial fumes and salt water cannot seriously degrade the properties of rigid PVC.

The Aluminum BFD is manufactured from a high strength, corrosive resistant aluminum alloy material. It is ideal for use on conductors operated at elevated temperatures.

APPLICATIONS

Ensure the correct size BIRD-FLIGHT Diverter is used. For a detailed installation description, refer to the application instructions. Hot stick application is fast and simple with standard equipment.

Spacing: For optimum results, spacing distances are generally recommended at 15' intervals depending upon local conditions. Since wind resistance is very limited, sufficient BIRD-FLIGHT Diverter can be used to ensure adequate visibility without creating stresses on the line. When marking adjacent spans, overall visibility is improved by staggering the application.

Voltage: For applications on the phase conductors, any of the BIRD-FLIGHT Diverter (BFD) can be used at 3 phase voltages of 230kV and below. For applications of the BFD at 345kV, the black BFD which utilizes a semi-conductive polymer layer, can be used. The aluminum BFD should not be used above 230 kV due to the issues of RIV.

Temperature: The Plastic BIRD-FLIGHT Diverter can be used on conductors operating at 125°C or below. For operational temperatures above 125°C, the Aluminum BIRD-FLIGHT Diverter should be used if the voltage level is appropriate.

BIRD-FLIGHT™ Diverter

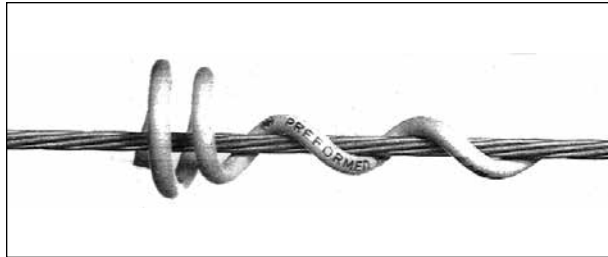

**For use on:
Bare and Jacketed Conductors & Strand**

Catalog Number	Material Color	Conductor Range (Inches)		Overall Length (Inches)	Diameter of Diverter Coil (Inches)	Color Code	Units Per Carton
		Min	Max				
BFD-MS-3331	Yellow	0.175	0.249	7.00	2.25	Black	200
BFD-MS-3346	Gray						
BFD-MS-3155	Yellow	0.250	0.349	8.50	2.50	Blue	200
BFD-MS-2921	Gray						
BFD-MS-3164	Yellow	0.350	0.449	9.50	2.75	Brown	75
BFD-MS-3355	Gray						
BFD-MS-10022	Black						
BFD-MS-11135	Yellow			12.375	4.25		
BFD-MS-11060	Gray						
BFD-MS-11134	Black						
BFD-MS-3341	Yellow	0.450	0.599	14.625	4.25	Green	75
BFD-MS-3366	Gray						
BFD-MS-10023	Black						
BFD-MS-3344	Yellow	0.600	0.770	17.00	4.25	Purple	75
BFD-MS-3371	Gray						
BFD-MS-3345	Yellow	0.771	0.858	15.00	4.25	Red	75
BFD-MS-3376	Gray						
BFD-MS-3405	Yellow	0.859	0.970	16.50	4.50	Orange	75
BFD-MS-11699	Gray						
BFD-MS-11111	Yellow	0.971	1.121	15.50	4.25	Pink	40
BFD-MS-12290	Gray						
BFD-MS-10277	Black						
BFD-MS-11430	Yellow	1.122	1.306	16.25	4.38	Gray	40
BFD-MS-11110	Yellow	1.307	1.530	17.00	4.70	Black	40
BFD-MS-12351	Yellow	1.531	1.786	20.00	4.88	White	40
BFD-MS-11566	Yellow	1.787	2.100	23.00	5.25	Purple	40
BFD-MS-12603	Yellow	2.101	2.500	26.00	5.25	Orange	40



SWAN-FLIGHT™ Diverter

NOMENCLATURE

PLASTIC SWAN-FLIGHT DIVERTER

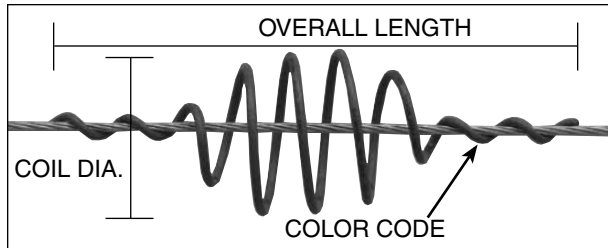

Length: Distance product covers the conductor.

Color Code: Identifies conductor range, corresponding to tabular information on the following page.

Color: Yellow or Gray

Material: Outdoor grade High Impact PVC

Coil Diameter: Outside diameter of diverter coil

GENERAL RECOMMENDATIONS

The Preformed Line Products SWAN-FLIGHT Diverter is designed for use on conductor/strand to create greater visibility for avian flight paths on overhead lines and tower down guys. Offering little wind resistance, it reduces hazards to both lines and birds. For construction up to 230kV, the SWAN-FLIGHT Diverter can be applied to phase conductors (bare or jacketed). For EHV voltages, it is typically installed on the shield wire.

The SWAN-FLIGHT Diverter is lightweight, offers little wind resistance and is easily and quickly applied by hand or hot stick. The positive grip on the conductor ensures that the SWAN-FLIGHT Diverter remains in the applied location and cannot move along the span under Aeolian vibration or other conditions.

Visibility:

The diverter section increases the visible profile of the cable or conductor to a degree necessary to ensure safety, but avoids an undesirably bulky outline.

Materials:

The SWAN-FLIGHT Diverter (SFD) is manufactured from rigid .375" and .500" high impact polyvinyl chloride (PVC) possessing excellent chemical resistance and tensile strength properties. The SFD will retain good physical characteristics within range of extreme temperatures.

Aging tests confirm the material does not deteriorate in function or appearance from the effects of severe weather conditions. Industrial fumes and salt water cannot seriously degrade the properties of rigid PVC.

APPLICATIONS

Ensure the correct size SWAN-FLIGHT Diverter is used.

For detailed installation description, refer to the application procedure. Hot stick application is fast and simple with standard equipment.

Spacing:

For optimal results, spacing distances are generally recommended at 15' intervals depending upon local conditions. Since wind resistance is very limited, a sufficient quality of SWAN-FLIGHT Diverter can be used to ensure adequate visibility without creating stresses on the line. When marking adjacent spans, overall visibility is improved by the staggering application.

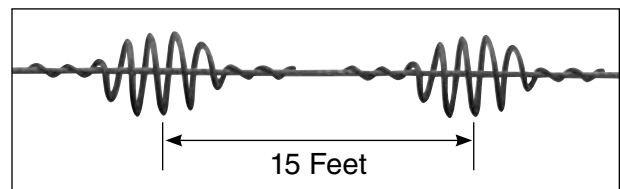

Catalog Number	Conductor Range (Inches)		Overall Length (Inches)	Diameter of Diverter Coil (Inches)	Diameter of PVC Rod (Inches)	Approximate Weight/Unit (Lbs)	Color Code	Units per Carton
	Min	Max						
SFD-0445	0.175	0.249	20	7.0	0.375	0.40	Black	35
SFD-0635	0.250	0.349	23	7.0	0.375	0.46	Blue	35
SFD-0890	0.350	0.449	25	7.5	0.375	0.50	Brown	35
SFD-1140	0.450	0.599	35	8.0	0.375	0.70	Green	15
SFD-1520	0.600	0.770	38	8.0	0.500	1.40	Purple	15
SFD-1960	0.771	0.858	38	8.0	0.500	1.40	Red	15
SFD-2220	0.859	0.970	40	8.0	0.500	1.50	Orange	10
SFD-2460	0.971	1.121	40	8.0	0.500	1.50	Pink	10
SFD-2700	1.122	1.306	40	8.0	0.500	2.00	Gray	10
SFD-3035	1.307	1.530	46	8.0	0.500	2.00	Black	10

NOTE: Add suffix -Y to the catalog number for yellow color (i.e.: SFD-1140-Y).
Add suffix -B to the catalog number for black semi-conductive layer for applications @ 230kV (i.e.: SFD-2460-B).

Explanatory Notes:

For field study results, consult Preformed Line Products.

BIRD-FLIGHT™/SWAN-FLIGHT™ Diverter Spacing

Horizontal Line Layouts

Medium Voltage

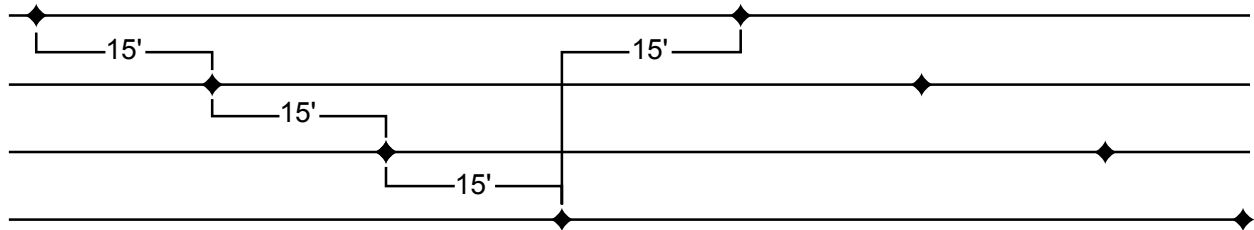

Three Phase

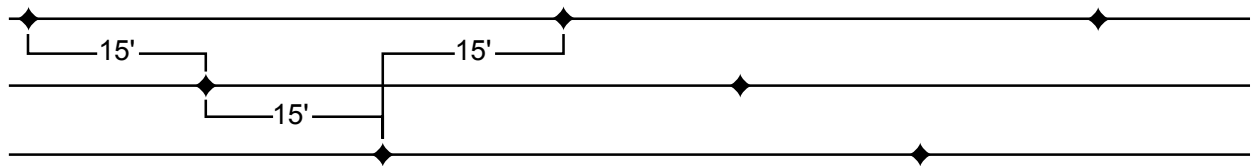

One phase

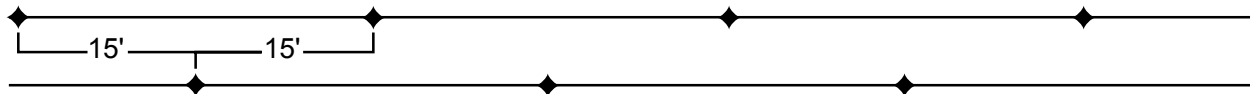

Generally at 15' intervals minimum

- ◆ BIRD-FLIGHT™/SWAN-FLIGHT™ Diverter position





PREFORMED LINE PRODUCTS

Section 22 – Splices

	Page
Table of Contents	
Open Wire Splice	22-2
Strand Splice.....	22-3
Reducing Splice.....	22-4



Open Wire Splice

Open Wire Splice

PREFORMED™ Open Wire Splices are used for mid-span splicing during new construction and for repair of abraded or severed wire at tie points. Provides armoring at the tie that is designed to protect the conductor from damaging effects of chafing and fretting. Open Wire Splices wrap on easily by hand without a need for wire cutting. They are designed to permanently restore the full mechanical strength and conductivity of the conductor to which they are applied.

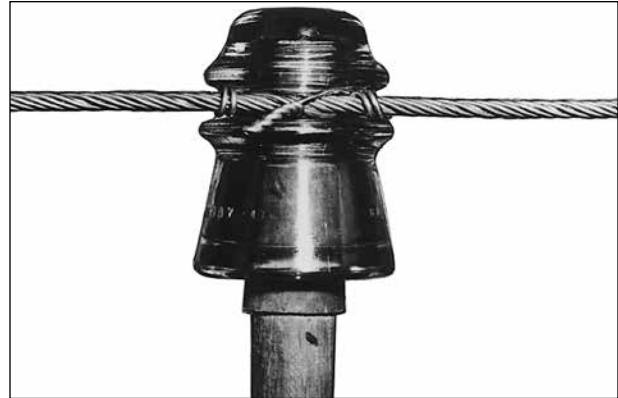

Catalog Number	Wire		Number of Subsets	Length	Color Code	Per Carton	
	Gauge	Size				Units	Wt./Lbs.
Galvanized Steel							
GLS-3101	BWG-12	.109"	3	12"	Black	100	9
GLS-3103	BWG-10	.134"	3	14"	Orange	100	15
Aluminum Clad Steel							
AWLS-5101	AWG-11	.091"-.095"	2	12"	Green	100	7

Strand Splice

Strand Splice

PREFORMED™ Strand Splices are used to repair strand or messenger simply and economically. All applications can be checked visually — no guesswork involved. Because of its superior design, the Strand Splice provides maximum strength and excellent fatigue characteristics resulting in longer life for both strand and messenger.



Galvanized Steel, C-Coat								
Catalog Number	Size	Strand Construction	Mean Diameter	Length	No. of Subsets	Color Code	Units Per Carton	Wt./Lbs. Per Carton
Utility Grade C-Coat								
GLS-2115	3/16"	7W	.195"	22"	3	Red	100	20
GLS-2117	5/16"	7W	.327"	29"	3	Black	50	26
GLS-2118	3/8"	7W	.360"	34"	3	Orange	50	42
GLS-2119	7/16"	7W	.435"	41"	3	Green	25	37
Extra High Strength C-Coat								
GLS-2102	3/16"	7W	.186"	27"	2	Red	100	30
GLS-2104	1/4"	7W	.240"	35"	2	Yellow	50	34
GLS-2106	5/16"	7W	.312"	42"	3	Black	50	46
GLS-2107	3/8"	7W	.360"	50"	3	Orange	25	38
GLS-2108	7/16"	7W	.435"	56"	3	Green	25	57
GLS-2109	1/2"	7W	.495"	63"	3	Blue	10	34

NOTE: Left hand lay standard

Bezinal® Strand*								
Catalog Number	Size	Strand Construction	Mean Diameter	Length	No. of Subsets	Color Code	Units Per Carton	Wt./Lbs. Per Carton
BLS-9102	3/16"	7W	.186"	27"	2	Red	100	30
BLS-9104	1/4"	7W	.240"	35"	2	Yellow	50	34
BLS-9106	5/16"	7W	.312"	42"	3	Black	50	46
BLS-9107	3/8"	7W	.360"	50"	3	Orange	25	38
BLS-9108	7/16"	7W	.435"	56"	3	Green	25	57
BLS-9109	1/2"	7W	.495"	63"	3	Blue	10	34

NOTE: Left hand lay standard

*Manufactured from Bezinal Material. Bezinal is a registered trademark of the Bekaert Corporation.



Reducing Splice

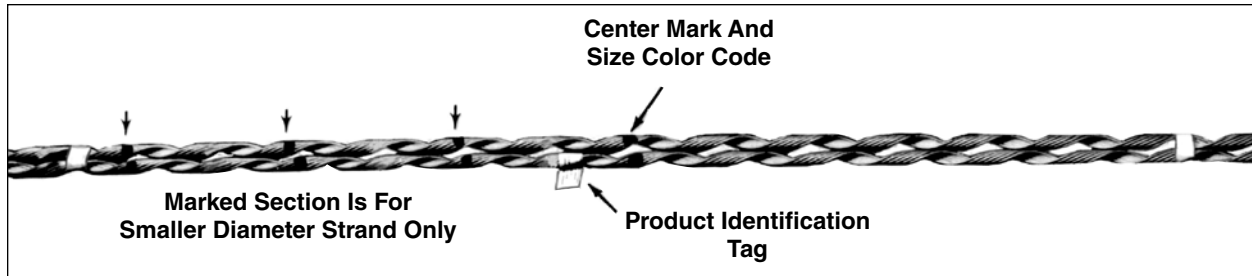

Reducing Splice

PREFORMED™ Reducing Splices are intended to permanently join two strands of different diameters. Application by hand—no tools required—is fast, easy, uniform and can be visually checked to assure proper application. Without any loose parts, jaws to seat, or teeth to bite into the strand, the Reducing Splice is designed to permit spinner-free travel without adjusting the gates or lifting the spinner over the splice.

The PREFORMED Reducing Splice is made of material completely compatible with the strand to which it is applied and can be used in any environment.

Galvanized Steel, C-Coat for use on Extra High Strength or Utility Grade Strands							
Catalog Number	Standard Size		Length	Reduced End Color Code	Per Carton		Non-Reduced End Color Code
	From	To			Units	Wt./Lbs.	
LSR-2122	5/16"	1/4"	35"	Yellow	50	33	Black
LSR-2123	3/8"	5/16"	42"	Black	25	25	Orange
LSR-2124	7/16"	3/8"	50"	Orange	25	39	Green
LSR-2125	3/8"	1/4"	42"	Yellow	50	41	Orange

NOTE: Left Hand Lay Standard



PREFORMED LINE PRODUCTS

Section 23 – Motion Control Products

	Page
Table of Contents	
Air Flow Spoiler	23-2
Spiral Vibration Damper.....	23-3



Air Flow Spoilers for Telecommunications Cables

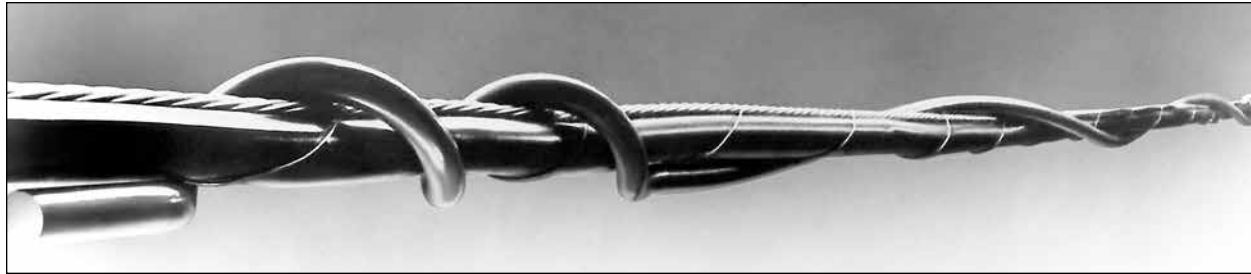

Air Flow Spoilers

Air Flow Spoilers are designed to counteract a damaging wind-related phenomenon known as galloping. Galloping is a low frequency, high amplitude motion that can cause trip-outs, service interruptions, cable damage, and damage to the supporting structures and hardware at their point of connection.

Air Flow Spoilers are designed to maintain aerodynamic stability by continually changing the profile of the cable to the wind. The one-piece helically formed rod, made of rigid, non-corrosive, non-metallic plastic, controls motion problems that can damage lines. The three-section structure of the Air Flow Spoiler enables it to grip the cable or conductor firmly.

Air Flow Spoilers have proven effective in the field, significantly reducing galloping, abrasion and fatigue, and extending the life of the line.

Span Length		Spoilers Per Span	Span Length		Spoilers Per Span
feet	meters		feet	meters	
0-120	0-36.6	2	551-600	167.9-182.9	11
120-180	36.6-54.9	3	601-650	182.9-198.1	12
181-240	55.2-73.2	4	651-700	198.4-213.4	13
241-300	73.5-91.4	5	701-750	213.7-228.6	14
301-350	91.7-106.7	6	751-800	228.9-243.8	15
351-400	106.9-121.9	7	801-850	244.1-259.1	16
401-450	122.2-137.2	8	851-900	259.4-274.3	17
451-500	137.5-152.4	9	901-950	274.6-289.6	18
501-550	152.7-167.6	10	951-1000	289.9-304.8	19

Catalog Number	Self Supporting Single Cable Diameter Range	1/4" Messenger Plus Single Telephone Cable within Range Shown Below	5/16" Messenger Plus Single Telephone Cable within Range Shown Below	3/8" Messenger Plus Single Telephone cable Within Range Shown Below	Multiple Lashed Cables All Messenger Sizes	Carton Quantity
5058102*	.462"-.563"	.319"-.434"	.319"-.372"	—	.448"-.574"	25
5058103*	.564"-.760"	.435"-.619"	.373"-.565"	.319"-.495"	.575"-.717"	25
5058104*	.761"-.926"	.620"-.828"	.566"-.765"	.496"-.716"	.718"-.896"	15
5058105*	.927"-.1019"	.829"-.1000"	.766"-.954"	.717"-.891"	.897"-.1041"	15
50589317	—	1.001"-.1.165"	.955"-.1.100"	.892"-.1.040"	1.042"-.1.200"	15
50588710	—	1.166"-.1.350"	1.101"-.1.280"	1.041"-.1.250"	1.201"-.1.371"	15
50589318	—	1.351"-.1.560"	1.281"-.1.480"	1.251"-.1.470"	1.372"-.1.542"	15
50589319	—	1.561"-.1.770"	1.481"-.1.670"	1.471"-.1.670"	1.543"-.1.686"	15
50588867	—	1.771"-.1.970"	1.671"-.1.850"	1.671"-.1.850"	1.687"-.1.839"	15
50589291	—	1.971"-.2.250"	1.851"-.2.150"	1.851"-.2.100"	1.840"-.2.200"	15

* Application Support Helix gripping sections are standard on one end of these Air Flow Spoilers. All other Air Flow Spoilers have conventional gripping sections on both ends.
Contact PLP for recommendations on coaxial type cables.

Notes:

1. If Figure 8 cable or more than one cable is lashed to a messenger, furnish diameter of each cable (prefer dimensions taken with a diameter tape) and the messenger as well as a cross sectional diagram of the cable bundle, and PLP® will provide the catalog number of the AIR FLOW SPOILER to be used.
2. For estimating quantity purchase, approximately 100 Air Flow Spoilers are required per cable mile. In order to achieve satisfactory protection against cable dancing at least 20% of the span should be covered with Air Flow Spoilers.
3. Larger size Air Flow Spoilers are available on special orders.

Spiral Vibration Damper

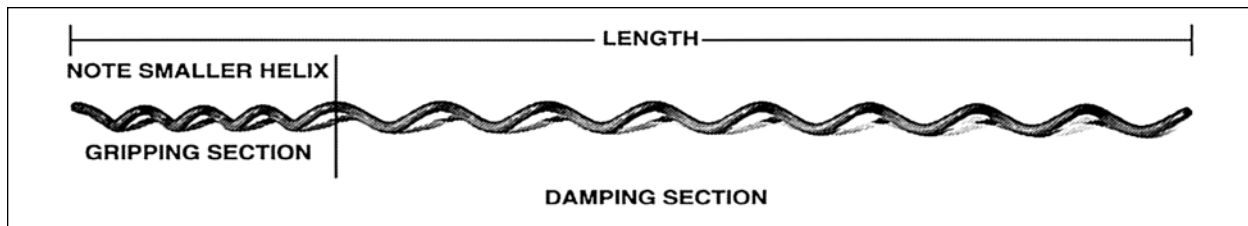

NOMENCLATURE

Length: Assists in identification of conductor size, corresponding to tabular information appearing on following page.

Damping Section: Helically scaled for interplay of damper and conductor, to provide the action/reaction motion that opposes the natural vibration wave.

Gripping Section: Has a smaller helix designed to the grip conductor.

GENERAL RECOMMENDATIONS

Damping devices are designed for the single purpose of reducing vibration. This single function is entirely different from that of protecting against (1) stress concentrations, (2) fretting or abrasion, and (3) arc-over burning. Because of this, damping devices should be considered only as supplemental to WRAPLOCK® Tie, Armor Rod, Side Tie, Spool Tie, or other hardware at tangent supports. Dampers are also used as supplemental protection at dead-ends.

The degree of protection needed on a specific line depends upon a number of factors such as line design, temperature, tension, exposure to wind flow, and vibration history on similar construction in the same area.

Spiral Vibration Dampers are also effective on certain size overhead shield wires and OPGW. Consult PLP for specifics.

For damper applications on ADSS cable, refer to the FIBERLIGN® Fiber Optic Products section under motion control.

Consult your PREFORMED™ Sales Representative for placement and installation guidelines.

Material:

The solid polyvinyl chloride helical rod material is noncorrosive and has a surface hardness which does not abrade the conductor.

Application Inspection:

The Gripping Section should be installed approximately one hand's width from the ends of Armor Rod or other hardware. It is not necessary to make engineering calculations as to placement.

Standard Usage Recommendations for Standard Length Spiral Vibration Dampers on Bare Conductor, Shield Wire.

Span Length	0-800'	801'-1600'	1601'-2400'
Number of SVDs per Span	2	4	6

Note: Water/Canyon Crossings – due to the increased potential of laminar wind flow, an additional 50% more dampers per span should be added to the standard recommendations above for adequate protection.

In areas that are prone to high levels of vibration where conductor tension is in excess of 18% RBS, consult PLP for specific recommendations.



Spiral Vibration Damper

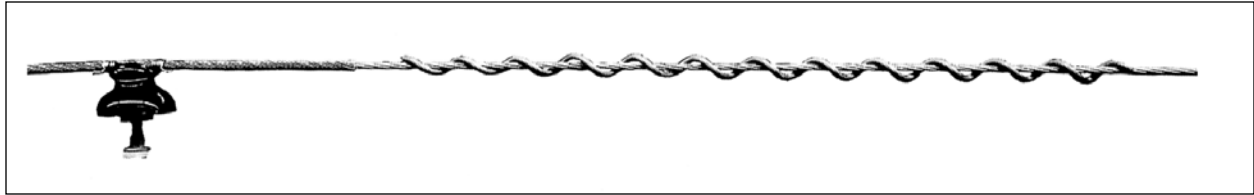

For use on:
Bare Conductors, Shield Wires

Catalog Number	Diameter Range (Inches)		Units Per Carton	Wt/Lbs Per Carton	Length (Inches)
	Min.	Max.			
5050102	.174	.249	50	29	46
5050103	.250	.326	50	31	49
5050104	.327	.461	50	34	51
5050105	.462	.563	50	36	53
5050106	.564	.760	25	50	65

Spiral Vibration Damper – High Mass

For use on: Bare Conductors, Shield Wires

The Hi Mass Spiral Vibration Damper (HMSVD) has a damping section close to double that of the standard SVD. By extending the length of the damping section, one Hi Mass SVD is designed to provide the effectiveness of two standard SVDs.

- Fewer points of installation.
- Fewer components on the line.

Catalog Number	Diameter Range (Inches)		Units Per Carton	Wt/Lbs. Per Carton	Length (Inches)
	Min.	Max.			
5050200	.250	.326	50	55	87
5050201	.327	.461	50	60	91
5050202	.462	.563	50	65	94
5050203	.564	.760	15	55	97





PREFORMED LINE PRODUCTS

Section 24 – Spacers & Support

	Page
Table of Contents	
Communication Spacers	24-2
Tangent Supports.....	24-3



Communications Spacers

Communications Spacers

PREFORMED™ Communications Spacers provide an inexpensive way of eliminating mid-span hits on open wire. Spacers keep open wires in their place and prevent lines from "going dead" and momentary shorts and crosses.

Made from rigid, solid 3/8", high-impact, PVC, Communications Spacers possess excellent strength properties. They are designed with a suitable inside diameter for direct application to mid-span locations, and are easily wrapped onto adjacent wires.



Catalog Number	Spacing	Wire Size	Color Code	Units Per Carton	Wt./Lbs. Per Carton
PSU-0106	6"	.080"	Green	300	31
PSU-0107	8"	.102"	Green	300	35
PSU-0108	10"	.109"	Green	30	390
PSU-0109	12"	.109"	Green	300	41

Tangent Supports

Tangent Supports

Standard Loop and Elongated Loop Tangent Supports are intended to protect and separate one-pair aerial wires on a common drive hook. They accomplish this in the safest, easiest way possible: just wrap them on and hang them up. Because they wrap on in seconds without tools, they keep installation expense down and provide long, trouble-free service at the lowest possible cost.

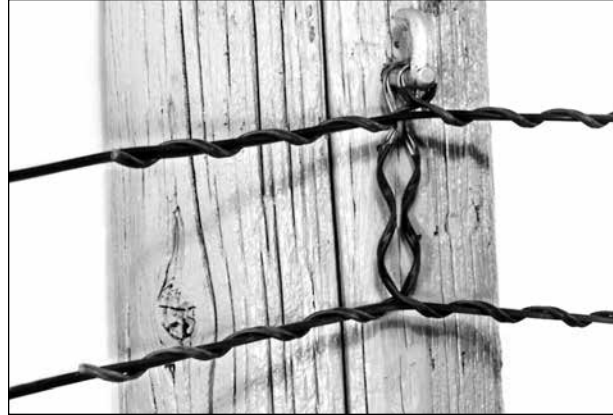

Catalog Number	Conductor Type	Color Code	Units Per Carton	Wt./Lbs. Per Carton
Standard Loop				
TS-2100	2 #14 CW	White	400	30
TS-2103	2 #12 CW (or .083 Steel)	Yellow	400	30
TS-3100	2 #14 CW	Orange	500	30
Elongated				
ETS-2104	2 #12 CW (or .083 Steel)	Yellow	350	35
ETS-3101	2 #14 CW	Orange	400	34





PREFORMED LINE PRODUCTS

Section 25 – Lashing Rods

	Page
Lashing Rods.....	25-2



Lashing Rods

Lashing Rods

PREFORMED™ Lashing Rods can be used on all types of messengered overhead cables. Lashing Rods are particularly adaptable to spans obstructed by trees or short spans over traffic intersections. Once applied, they provide a permanently snug fit and trim, modern appearance. Made

from the same basic material as the messenger, PREFORMED Lashing Rods feature overall low cost and simple installation.

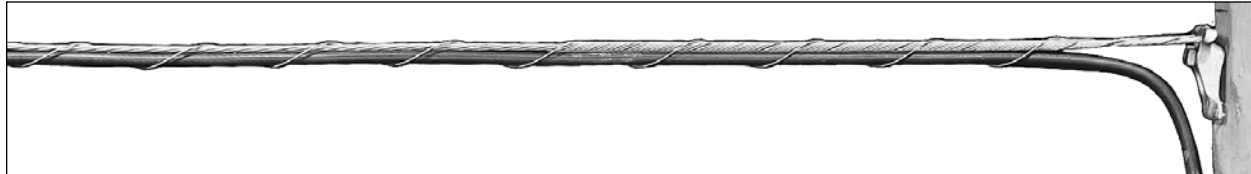

Size Selection:

In selecting the proper size Lashing Rod it is necessary to determine the smallest circumscribing circle that will enclose the messenger and cables.

For grouping only one cable with messenger, add the diameters and multiply by a factor of .850.

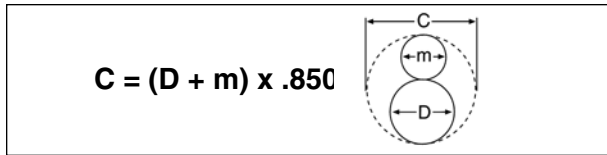

For grouping two equal diameter cables, multiply the diameter of one cable times 2.00. Then to find the diameter of the maximum messenger that will fit in the interstices of the cables multiply the diameter of one cable times .666.

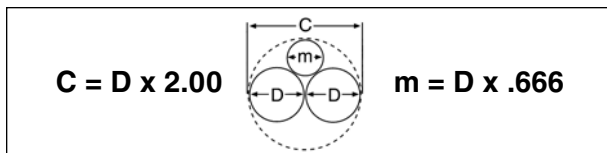

For grouping three equal diameter cables, multiply the diameter of one cable times 2.155. Then to find the diameter of the maximum messenger that will fit in the interstices of the cables, multiply the diameter of one cable times .483.

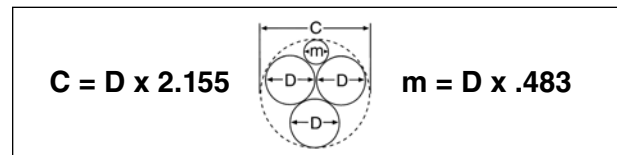

For grouping four equal diameter cables, multiply the diameter of one cable times 2.414. Then to find the diameter of the maximum messenger that will fit in the interstices of the cables, multiply the diameter of one cable times .414.

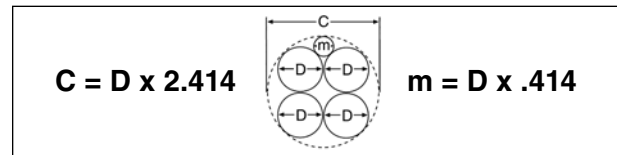

For grouping unequal diameter cables or messengers too large to fit into the interstices above, the minimum diameter grouping can best be determined by a graphic layout scale.

C-Coat Galvanized Steel Messengered Cable							
Catalog Number	Diameter Range		Length	Rod Diameter	Color Code	Per Carton	
	Min.	Max.				Units	Wt./Lbs.
LR-6105	.670"	.749"	5'	.100"	White	100	17
LR-6106	.750"	.839"	5'	.100"	Red	100	17
LR-6107	.840"	.939"	5'	.100"	White	100	17
LR-6108	.940"	1.049"	5'	.100"	Orange	100	17
LR-6109	1.050"	1.169"	5'	.119"	Green	100	24
LR-6110	1.170"	1.309"	5'	.119"	Yellow	100	24
LR-6111	1.310"	1.459"	5'	.119"	White	100	24
LR-6112	1.460"	1.629"	5'	.138"	Red	100	37
LR-6113	1.630"	1.819"	5'	.138"	White	100	37
LR-6114	1.820"	2.039"	5'	.138"	Orange	100	37



PREFORMED LINE PRODUCTS

Section 26 – Appendix

Table of Contents	Page
Index by Part Number.....	26-2
Standard Terms and Conditions of Sale	26-26





Index by Part Number

Catalog Number	Product Description	Section-Page	Catalog Number	Product Description	Section-Page		
600	Adapter Modules	16-5, 6	2872001	FIBERLIGN Lite Dielectric Dead-end for	6-6		
1000172	Armor Rods for ADSS	7-11	2872002	ADSS – Limited Tension			
1000173				2872003			
1000174				2872004			
1000175				2872005			
1000176				2872006			
1000177				2872007			
1000178				2872008			
1000179				2872009			
2004511			Open Wire Dead-end	20-10	2872010		
2801300			FIBERLIGN Dead-end for OPTICAL GROUND WIRE (OPGW)	5-5	2872011		
2801301		2872012					
2801302		2872013					
2801303		2872014					
2801304		2872015					
2801305		2872016					
2801306		2872017					
2801307		2872018					
2801308		2872019					
2801309		2872099					
2801310		2872100					
2801311		2872101					
2801312	FIBERLIGN Dead-end for OPTICAL GROUND WIRE (OPGW)	5-5			2872102		
2801313						2872103	
2801314				2872104			
2801315				2872105			
2801316				2872106			
2801317				2872107			
2801318				2872108			
2801319				2872109			
2801320				2872110			
2801321				2872111			
2801322				2872112	FIBERLIGN Lite Dielectric Dead-end for	6-6	
2801323				2872113	ADSS - Medium Tension		
2801324				2872114			
2801325				2872115			
2801326		2875001	FIBERLIGN Lite Tension Dead-end	6-4			
2801327		2875002	for ADSS				
2801328		2875003					
2801329		2875004					
2801330		2875005					
2801331		2875006					
2801332		2875007					
		3600100	FIBERLIGN Repair Rods for OPGW	5-20			
		3600101					
		3600102					
		3600103					
		3600104					
		3600105					
		3600106					
		3600107					
		3600108					
		3600109					
		3600110					
		3600111					
		3800005	ADSS Midspan Drop	8-5			
		3800006					
		3800007					
		3800008					
		3800009					
		3800010					
		3800011					
		3800012					
		3800013					



Index by Part Number

Catalog Number	Product Description	Section-Page	Catalog Number	Product Description	Section-Page				
4700100	Single FIBERLIGN Cushion Clamp for OPGW	5-18	4800122	FIBERLIGN Lite Support for ADSS	6-11				
4700101									
4700102									
4700103									
4700104									
4700105									
4700106									
4700107									
4700108									
4700109									
4700110									
4700111									
4700112									
4700113									
4700114									
4700115									
4700116									
4700117									
4700118									
4700119									
4700120									
4700121									
4700122									
4700123									
4700200	Double FIBERLIGN Cushion Clamp for OPGW	5-18	4800500	Hardware Kit for Banded Mount	6-9				
4700201									
4700202									
4700203									
4700204									
4700205									
4700206									
4700207									
4700208									
4700209									
4700210									
4700211									
4700212									
4700213									
4700214									
4700215									
4700216									
4700217									
4700218									
4700219									
4700220									
4700221									
4700222									
4700223									
4800107	FIBERLIGN Lite Support for ADSS	6-11; 8-6, 8-10	5050500	Fiber Optic Cable Marker	21-10				
4800109	FIBERLIGN Lite Support for ADSS	6-11; 8-6	5050102	Spiral Vibration Damper	23-4				
4800110	FIBERLIGN Lite Support for ADSS	6-11	5050103	FIBERLIGN Spiral Vibration Damper for OPGW	7-7; 23-4				
4800111									
4800112									
4800113	FIBERLIGN Lite Support for ADSS	6-11	5050104	Spiral Vibration Damper – Hi Mass	23-5				
4800114									
4800115									
4800116									
4800117									
4800118									
4800119									
4800120									
4800122			FIBERLIGN Tangent Support			8-7	5050201	Air Flow Spoiler	23-2
4800123									
4800124									
4800125									
4800126									
4800127									
4800128									
4800129									
4800130									
4800131									
4800132	FIBERLIGN Tangent Support	8-7	5050202	FIBERLIGN Tangent Support	8-7; 8-11				
4800133									
4800134									
4800135									
4800136									
4800137									
4800138									
4800139									
4800140									
4800141									
4800142	FIBERLIGN Tangent Support	8-7	5050203	FIBERLIGN Tangent Support	8-7				
4800143									
4800144									
4800145									
4800146									
4800147									
4800148									
4800149									
4800150									
4800151									
4800152	FIBERLIGN Tangent Support	8-7; 8-11	5058102	ADSS Mounting Bracket	7-13				
4800153									
4800154									
4800155									
4800156									
4800157									
4800158									
4800159									
4800160									
4800161									
4800162	ADSS Mounting Bracket	7-13	5058103	Messenger Mounting Bracket	7-13				
4800163									
4800164									
4800165									
4800166									
4800167									
4800168									
4800169									
4800170									
4800171									
4800172	Messenger Mounting Bracket	7-13	5058104	FDC8 Stacking Kit	7-13				
4800173									
4800174									
4800175									
4800176									
4800177									
4800178									
4800179									
4800180									
4800181									
4800182	FDC8 Stacking Kit	7-13	5058105	Lattice Tower Clamp with 6" (152 mm) long bolt	7-5; 9-9				
4800183									
4800184									
4800185									
4800186									
4800187									
4800188									
4800189									
4800190									
4800191									
4800192	Lattice Tower Clamp with 10" (254 mm) long bolt	7-5	6126001	Lattice Tower Clamp with 8" (203 mm) long bolt	7-5				
4800193									
4800194									
4800195									
4800196									
4800197									
4800198									
4800199									
4800200									
4800201									
4800202	Lattice Tower Clamp with 8" (203 mm) long bolt	7-5	6126002	FIBERLIGN Organizer - 3M Fibriok Amp FingerSplice Siecor CamSplice Northern Telecom Lightbridge - Unprotected Fusion	3-4, 3-5				
4800203									
4800204									
4800205									
4800206									
4800207									
4800208									
4800209									
4800210									
4800211									
4800212	FIBERLIGN Organizer - Protected Fusion Amp Optimate Norland	3-5	6126003	FIBERLIGN Organizer - Horizontal stacking organizer for 6.5" x 28.4" (165 x 721 mm) Splice Case. Accommodates up to eight splice trays unless otherwise noted.	3-5				
4800213									
4800214									
4800215									
4800216									
4800217									
4800218									
4800219									
4800220									
4800221									
4800222	FIBERLIGN Organizer - Protected Fusion Amp OptimateNorland	3-4	6126004	FIBERLIGN Organizer - Protected Fusion Amp OptimateNorland	3-4				
4800223									
4800224									
4800225									
4800226									
4800227									
4800228									
4800229									
4800230									
4800231									
4800232	FIBERLIGN Organizer - Protected Fusion Amp OptimateNorland	3-4	6126005	FIBERLIGN Organizer - Protected Fusion Amp OptimateNorland	3-4				
4800233									
4800234									
4800235									
4800236									
4800237									
4800238									
4800239									
4800240									
4800241									
4800242	FIBERLIGN Organizer - Protected Fusion Amp OptimateNorland	3-4	6126006	FIBERLIGN Organizer - Protected Fusion Amp OptimateNorland	3-4				
4800243									
4800244									
4800245									
4800246									
4800247									
4800248									
4800249									
4800250									
4800251									
4800252	FIBERLIGN Organizer - Protected Fusion Amp OptimateNorland	3-4	6126007	FIBERLIGN Organizer - Protected Fusion Amp OptimateNorland	3-4				
4800253									
4800254									
4800255									
4800256									
4800257									
4800258									
4800259									
4800260									
4800261									
4800262	FIBERLIGN Organizer - Protected Fusion Amp OptimateNorland	3-4	6126008	FIBERLIGN Organizer - Protected Fusion Amp OptimateNorland	3-4				
4800263									
4800264									
4800265									
4800266									
4800267									
4800268									
4800269									
4800270									
4800271									
4800272	FIBERLIGN Organizer - Protected Fusion Amp OptimateNorland	3-4	6126009	FIBERLIGN Organizer - Protected Fusion Amp OptimateNorland	3-4				
4800273									
4800274									
4800275									
4800276									
4800277									
4800278									
4800279									
4800280									
4800281									
4800282	FIBERLIGN Organizer - Protected Fusion Amp OptimateNorland	3-4	6126010	FIBERLIGN Organizer - Protected Fusion Amp OptimateNorland	3-4				
4800283									
4800284									
4800285									
4800286									
4800287									
4800288									
4800289									
4800290									
4800291									
4800292	FIBERLIGN Organizer - Protected Fusion Amp OptimateNorland	3-4	6126011	FIBERLIGN Organizer - Protected Fusion Amp OptimateNorland	3-4				
4800293									
4800294									
4800295									
4800296									
4800297									
4800298									
4800299									
4800300									
4800301									
4800302	FIBERLIGN Organizer - Protected Fusion Amp OptimateNorland	3-4	6126012	FIBERLIGN Organizer - Protected Fusion Amp OptimateNorland	3-4				
4800303									
4800304									
4800305									
4800306									
4800307									
4800308									
4800309									
4800310									
4800311									
4800312	FIBERLIGN Organizer - Protected Fusion Amp OptimateNorland	3-4	6126013	FIBERLIGN Organizer - Protected Fusion Amp OptimateNorland	3-4				
4800313									
4800314									
4800315									
4800316									
4800317									
4800318									
4800319									
4800320									
4800321									
4800322	FIBERLIGN Organizer - Protected Fusion Amp OptimateNorland	3-4	6126014	FIBERLIGN Organizer - Protected Fusion Amp OptimateNorland	3-4				
4800323									
4800324									
4800325									
4800326									
4800327									
4800328									
4800329									
4800330									
4800331									
4800332	FIBERLIGN Organizer - Protected Fusion Amp OptimateNorland	3-4	6126015	FIBERLIGN Organizer - Protected Fusion Amp OptimateNorland	3-4				
4800333									
4800334									
4800335									
4800336									
4800337									
4800338									
4800339									
4800340									
4800341									
4800342	FIBERLIGN Organizer - Protected Fusion Amp OptimateNorland	3-4	7400028	ADSS Mounting Bracket	7-13				
4800343									
4800344									
4800345									
4800346									
4800347									
4800348									
4800349									
4800350									
4800351									
4800352	ADSS Mounting Bracket	7-13	7400029	Messenger Mounting Bracket	7-13				
4800353									
4800354									
4800355									
4800356									
4800357									
4800358									
4800359									
4800360									
4800361									
4800362	Messenger Mounting Bracket	7-13	7400030	FDC8 Stacking Kit	7-13				
4800363									
4800364									
4800365									
4800366									
4800367									
4800368									
4800369									
4800370									
4800371									
4800372	FDC8 Stacking Kit	7-13	7000400	Lattice Tower Clamp with 6" (152 mm) long bolt	7-5; 9-9				
4800373									
4800374									
4800375									
4800376									
4800377									
4800378									
4800379									
4800380									
4800381									
4800382	Lattice Tower Clamp with 6" (152 mm) long bolt	7-5; 9-9	7000401	Lattice Tower Clamp with 10" (254 mm) long bolt	7-5				
4800383									
4800384									
4800385									
4800386									
4800387									
4800388									
4800389									
4800390									
4800391									
4800392	Lattice Tower Clamp with 10" (254 mm) long bolt	7-5	7000402	Lattice Tower Clamp with 8" (203 mm) long bolt	7-5				
4800393									
4800394									
4800395									
4800396									
4800397									
4800398									
4800399									
4800400									
4800401									
4800402	Lattice Tower Clamp with 8" (203 mm) long bolt	7-5	8000182	FIBERLIGN Organizer - 3M Fibriok Amp FingerSplice Siecor CamSplice Northern Telecom Lightbridge - Unprotected Fusion	3-4, 3-5				
4800403									
4800404									
4800405									
4800406									
4800407									
4800408									
4800409									
4800410									
4800411									
4800412	FIBERLIGN Organizer - 3M Fibriok Amp FingerSplice Siecor CamSplice Northern Telecom Lightbridge - Unprotected Fusion	3-4, 3-5	8000184	FIBERLIGN Organizer - Protected Fusion Amp Optimate Norland	3-5				
4800413									
4800414									
4800415									
4800416									
4800417									
4800418									
4800419									
4800420									
4800421									
4800422	FIBERLIGN Organizer - Protected Fusion Amp Optimate Norland	3-5	8000185	FIBERLIGN Organizer - Horizontal stacking organizer for 6.5" x 28.4" (165 x 721 mm) Splice Case. Accommodates up to eight splice trays unless otherwise noted.	3-5				
4800423									
4800424									
4800425									
4800426									
4800427									
4800428									
4800429									
4800430									
4800431									
4800432	FIBERLIGN Organizer - Horizontal stacking organizer for 6.5" x 28.4" (165 x 721 mm) Splice Case. Accommodates up to eight splice trays unless otherwise noted.	3-5	8000192	FIBERLIGN Organizer - Protected Fusion Amp OptimateNorland	3-4				
4800433									
4800434									
4800435									
4800436									
4800437									
4800438									
4800439									
4800440									
4800441									
4800442	FIBERLIGN Organizer - Protected Fusion Amp OptimateNorland	3-4							

Index by Part Number

Catalog Number	Product Description	Section-Page	Catalog Number	Product Description	Section-Page
8000193	FIBERLIGN Organizer - Horizontal organizer for 4.0" x 25.8" (102 x 655 mm) Splice Case. Accommodates up to (3) splice trays	3-4	8000480	Sealing Washer Cutter Kit, Includes Washer Cutter, Spare Blade & Tote Bag	10-15
8000310	Resin Kit 8 oz. (227 grams) kit	3-14; 10-22	8000481	Blades for Washer Cutter, 3 Blades	10-15
8000311	Resin Kit 15 oz. (425 grams) kit	10-22	8000557	Omni-Seal – No Blocks	13-3
8000312	Resin Kit 33 oz. (936 grams) kit	10-23	8000565	Tri-Seal complete with resin and bonding	13-2
8000314	ARMADILLO Double Sheath Cable Blocking Kit	10-11	8000566	Tri-Seal base and cap only with air flange no resin or bonding	13-2
8000352	FIBERLIGN Splice Case, 9.5" (241 mm) End Plates	4-6; 10-20	8000568	Tri-Seal complete with resin without cable bonding	13-2
8000353 8000354	FIBERLIGN Splice Case, 9.5" (241 mm) End Plates	4-6	8000574	Tri-Seal with connector block mounting bar	13-2
8000361	FIBERLIGN Splice Case, 6.5" (165 mm) End Plates/Armadillo Standard Three-Section End Plate	2-5; 4-5, 10-8	8000624	ARMADILLO Stainless Kits with Drillable End Plates – With Bonding	10-5
8000375	LOCK-TAPE™ Sealant Kit for 4.0" x 25" (102mm x 635mm) ARMADILLO Stainless	10-12; 11-3, 11-5	8000626 8000630 8000634 8000635	ARMADILLO Stainless Kits with Drillable End Plates – With Bonding	10-5
8000376	LOCK-TAPE™ Sealant Kit for 6.5" (165mm) ARMADILLO Stainless	10-12; 11-3, 11-5	8000653 8000657	Spacer Mat	10-22
8000377	LOCK-TAPE™ Sealant Kit for 9.5" x 28" (241 x 711mm) ARMADILLO Stainless	10-12; 11-3, 11-5	8000658	REDDI Seal Spacer Mat [80" roll, 18" x 1/4"] (2032 X 457 X 6mm)	10-22; 11-3, 5
8000378	LOCK-TAPE™ Sealant Kit for 9.5" x 38" & 9.5" x 45" (241 x 965mm & 241 x 1143mm) ARMADILLO Stainless	10-12; 11-3, 11-5	8000661 8000662	Splice Cases with (2) Standard End Plates Included	4-3
8000381	FIBERLIGN Splice 9.5" (241 mm) Case End Plates	4-6	8000711	SURE-GRIP Shield Connector	18-4
8000388 8000389 8000390	REDDI Closure Two-Section End Plate Kits	11-3, 11-5	8000714	Pipe Plug Bonding Kit 18" (457mm) of #6 Bonding Braid with pipe plug, 42" (1067mm) of #6 Bonding Braid, 5 ferrules, bolt, nut and 2 locknuts	18-5
8000391	200' (60 m) Plastic Roll Tubing insulation for Bonding Braid	19-3	8000719 8000720	Pair Protector	19-2
8000420	Socket Tool Kit Without Torque Wrench in Box	2-7; 10-15	8000723	Pipe Plug Bonding Kit 18" (457mm) of #9 insulated Bonding Braid with pipe plug	18-5
8000422	Cable Shaper Tool	10-16	8000725	Shield Bonding Kit	19-4
8000428	Socket Tool Kit With Torque Wrench in Box	2-7; 10-15	8000729	Pipe Plug Bonding Kit 18" (457mm) of #6 insulated Bonding Braid, "piggyback" pipe plug, external bonding ribbon, lockwasher, nut	18-5
8000429	REDDI Seal Emery Cloth [24 strips, 2 x 18] (50 X 457)	11-3, 11-5	8000731	Pair Protector Strip	19-2
8000432	End Plate Removal Tool	10-16	8000733 8000734 8000735 8000736 8000737 8000738 8000739 8000740 8000744	SERVI-BOND Shield Connector	18-3
8000445	Carrying Case	2-7; 10-15	8000745	MORAY Shield Connector	18-2
8000452	Power End Plate Cutter (only)	2-7; 10-15	8000746 8000747 8000748 8000749 8000750	SERVI-BOND Shield Connector	18-3
8000453	Blade Kit (Blades A-Z)	2-7; 10-15	8000751	MINI-MORAY Shield Connector	18-3
8000454	Power End Plate Cutter and Case with Blade Kit	2-7; 10-15	8000752	SERVI-BOND Shield Connector	18-3
8000455	Power End Plate Cutter with Blade Kit	2-7; 10-15	8000753		
8000468	Power End Plate Cutter Lift Kit, allows drilling of 9.5" and 12.5" End Plates with future cable entry ports	2-7; 10-15			
8000475	COYOTE Closure End Plate Removal Tool	1-8			



Index by Part Number

Catalog Number	Product Description	Section-Page	Catalog Number	Product Description	Section-Page
8001001	FIBERLIGN Fiber Safe for butt splice applications. 6.5" x 28" (165 x 711mm) Includes: (1) Two-Section End Plate and (1) Three-Section End Plate and (1) Fiber Optic Splice Tray with cover (8001021).	3-12	8001032	FIBERLIGN Fiber Safe. Re-entry kit for 6.5" x 28" (165 x 711mm) Includes: Gaskets for collars and inner closure and a replacement flange clamp assembly.	3-14
8001002	FIBERLIGN Fiber Safe for in-line splice applications. 6.5" x 38" (165 x 965mm) Includes: (2) Three-Section End Plates.	3-12	8001033	FIBERLIGN Fiber Safe. Includes: Gaskets Re-entry kit for 6.5"x38"(165 x 965mm) for collars and inner closure and a replacement flange clamp assembly.	3-14
8001003	FIBERLIGN Fiber Safe for butt splice applications. 6.5" x 28" (165 x 711mm) Includes: (1) Two-Section End Plate and (1) Three-Section End Plate.	3-12	8001036	FIBERLIGN Organizer – Vertical organizer for 6.5" x 38.4" (165 x 975mm) or 8.0" x 38.4" (203 x 975 mm) Splice Case. Accommodates up to eight splice trays	3-6
8001004	FIBERLIGN Fiber Safe for butt splice applications. 6.5" x 38" (165 x 965mm) (Up to 144 Splices) Includes: (1) Two-Section End Plate and (1) Three-Section End Plate.	3-11, 12	8001041	FIBERLIGN Splice Tray – 3M Fibrlok Amp FingerSplice	2-4; 3-5,6,7, 10, 13
8001005	FIBERLIGN Fiber Safe for butt splice applications. 6.5" x 28" (165 x 711mm) Includes: (1) Two-Section End Plate, (1) Three-Section End Plate and RUS listed shield connectors. (RUS LISTED)	3-12	8001042	FIBERLIGN Organizer – 3M Fibrlok Amp FingerSplice Siecor CamSplice Northern Telecom Lightbridge	3-5
8001006	FIBERLIGN Fiber Safe for in-line splice applications. 6.5" x 38" (165 x 965mm) Includes: (2) Three-Section End Plates, and RUS listed shield connectors. (RUS LISTED)	3-12	8001043	FIBERLIGN Organizer – Vertical organizer for 9.5" x 28.4" (241 x 721 mm) Splice Case. Accommodates up to sixteen splice trays unless otherwise noted	3-7
8001007	FIBERLIGN Fiber Safe for butt splice applications. 6.5" x 28" (165 x 711mm) Includes: (1) Two-Section End Plate and (1) Three-Section End Plate with (2) factory-installed inserts (cables up to 0.8" diameter) for future entry.	3-12	8001044	FIBERLIGN Splice Tray – Protected Fusion Amp Optimate Norland	2-4, 3-5, 6,7, 10,13
8001008	FIBERLIGN Fiber Safe for butt splice applications. 6.5" x 28" (165 x 711mm) Includes: (2) Two-Section End Plates; (1) blank and (1) with four factory-installed inserts (cables up to 0.8" [20 mm] diameter).	3-12	8001049	FIBERLIGN Organizer – Vertical organizer for 9.5" x 38.4" (241 x 975 mm) Splice Case. Accommodates up to sixteen splice trays	3-7
8001010	FIBERLIGN Fiber Safe for butt splice applications. 6.5" x 28" (165 x 711mm) Includes: (1) Two-Section End Plate, (1) Three-Section End Plate and RUS listed shield connectors. (RUS LISTED Flame Retardant End Plates)	3-12	8001050	FIBERLIGN Organizer – 3M Fibrlok Amp FingerSplice Siecor CamSplice Northern Telecom Lightbridge	3-4
8001021	FIBERLIGN Splice Tray (12 Count) and Cover	2-4; 3-5, 6,7,10, 13	8001052	FIBERLIGN Organizer – 3M Fibrlok Amp FingerSplice Siecor CamSplice Northern Telecom Lightbridge	3-6, 3-7, 3-13
8001024	FIBERLIGN Tray – Unprotected Fusion	3-5,6, 7,13	8001059	FIBERLIGN Organizer – Vertical organizer for 6.5" x 28.4" (165 x 727 mm) or 8.0" x 28.4" (203 x 721 mm) Splice Case. Accommodates up to eight splice trays unless otherwise noted	3-6
8001025	FIBERLIGN Organizer – Vertical organizer for 6.5" x 28.4" (165 x 724 mm) or 8.0" x 28.4" (203 x 721 mm) Splice Case. Accommodates up to six splice trays.	3-5	8001071	FIBERLIGN Organizer – Protected Fusion Amp OptimateNorland	3-4
8001026	FIBERLIGN 24ct Tray – AT&T Rotary AT&T CSL	3-6, 3-7, 3-13	8001072	FIBERLIGN Organizer – Vertical organizer for 6.5" x 22.0" (165 x 559 mm) Splice Case. Accommodates up to six splice trays	3-4
8001028	FIBERLIGN Tray - Protected Fusion Amp Optimate Norland	3-6, 3-7, 3-13	8001082	FIBERLIGN Organizer – 3M Fibrlok Amp FingerSplice Siecor CamSplice Northern Telecom Lightbridge	3-4
			8001085	FIBERLIGN Splice Tray Assembly for Mass Fusion Splicing	2-4; 3-5, 6, 7,10
			8001091	FIBERLIGN Organizer – Reliance Corelink	3-5; 3-6; 3-7
			8001095	FIBERLIGN Organizer – Protected Fusion Amp Optimate Norland	3-5

Index by Part Number

Catalog Number	Product Description	Section-Page	Catalog Number	Product Description	Section-Page
8001096	ADOBE-12 Splice Tray (12 Count) with Molded-in Splice Block. Includes: Tray, Cover, Tie Wraps and Felt Strips	1-18; 2-10; 3-5,6,7, 10,13	8003055	12.5" (381 mm) Three-Section End Plates	4-6; 10-8
8001098	FIBERLIGN Splice Tray – Siecor CamSplice Northern Telecom Lightbridge	2-4; 3-5,6, 7,10,13	8003057	REDDI Seal Re-entry Kit	11-7
8001099	FIBERLIGN Organizer – 3M Fibrlok Amp FingerSplice Siecor CamSplice Northern Telecom Lightbridge	3-5	8003072	MULTI-BOND Shield Connector – Bonding support plate, lug, clamps, five screws and nuts	18-2
8001109	FIBERLIGN Splice Tray – Protected Fusion Amp Optimate Norland	3-5; 3-6; 3-13	8003089	ARMADILLO Coupling Kit 6.5" (165mm)	10-10
8001119	ADOBE-24 Splice Tray Blank. Includes: Tray, Cover, Tie Wraps and Felt Strips	1-18; 2-10	8003092	Splice protector (single fusion), NON heat shrink, 250/250 micron (20 per kit)	2-6; 9-3; 9-4
8001120	ADOBE-12 Splice Tray Blank. Includes: Tray, Cover, Tie Wraps and Felt Strips	1-18; 2-10	8003093	FIBERLIGN Splice Case End Plates, 6.5" (165 mm)	4-5
8001121	ADOBE-24 Splice Tray (24 Count) with 2 Heat Shrink Splice Blocks. Includes: Tray, Cover, Tie Wraps and Felt Strips	1-18; 2-10	8003094	Three-Section End Plates – Ground Only	10-8; 11-5
8001122	ADOBE-12 Splice Tray (12 Count) with Heat Shrink Splice Block. Includes: Tray, Cover, Tie Wraps and Felt Strips	1-18; 2-4; 2-10	8003098	8.0" (203 mm) FIBERLIGN Splice Case End Plates	4-5
8001127	Low Profile COYOTE Splice Tray with (3) snap-in 12 count splice blocks (fusion splice only)	1-5, 8, 16, 17; 2-4; 9-3, 9-5,8 16-4	8003103	4.0" (102 mm) FIBERLIGN Splice Case End Plates	4-4
8001130	Low Profile COYOTE Splice Tray (12 splice count) (blank)	1-5, 8, 9-6	8003105	Re-encapsulation Kit	10-22
8003013	ARMADILLO – Three-Section End Plates – Ground Only	10-8; 11-5	8003110	8.0" (203 mm) Three-Section End Plates	4-5; 10-8
8003018	FIBERLIGN Splice Case End Plates, 6.5" (165 mm)	4-5	8003112	FIBERLIGN Splice Case, 6.5" (165 mm) End Plates	4-5
8003020 8003021 8003022	REDDI Seal Re-entry Kit	11-7	8003118	LOCK-TAPE™ Sealant Kit for 8.0" x 28" (203mm x 711mm), ARMADILLO Stainless	10-12
8003025	ARMADILLO Stainless replacement stud with nut for 4" (1 each)	10-13	8003119	LOCK-TAPE™ Sealant Kit for 8.0" x 38" & 8.0" x 45" (203mm x 965mm & 203mm x 1143mm) ARMADILLO Stainless	10-12
8003026	ARMADILLO Stainless replacement stud with nut for 6.5", 8", 9.5" & 12.5" (1 each)	10-13	8003120	LOCK-TAPE™ Sealant Kit for 12.5" (318) ARMADILLO Stainless	10-12
8003030	REDDI Seal Re-entry Kit	11-7	8003121 8003122	ARMADILLO – Three-Section End Plates – Air Valve Only	10-5
8003031	ARMADILLO Coupling Kit 9.5" (241mm)	10-10	8003124 8003125	ARMADILLO – Pressure Wrap Collar	10-11
8003032	ARMADILLO Pressure Wrap Kit	10-11	8003137	ARMADILLO – Three-Section End Plates – Air Valve Only	10-8
8003033	Flame Retardant Tape Kit, 1-1/2" wide x 9 yards (38 x 8230)	10-20	8003156	COYOTE Splice Case Aerial Strand Clamps (set of (2))	2-6
8003034	ARMADILLO Pressure Wrap Kit	10-11	8003160 8003161 8003162	ARMADILLO Pressure Wrap Kit	10-11
8003035 8003036 8003037 8003038	ARMADILLO Pressure Wrap Kit	10-12	8003163	FIBERLIGN Splice Case End Plates 6.5" (165 mm)	4-5
8003041 8003042 8003043 8003044 8003052	FIBERLIGN Urethane Downlead Cushion for ADSS or OPGW	7-4	8003175	"L" Bracket Bonding Kit (4) bonding brackets and retainer clips	2-6; 3-10; 4-4; 4-5; 4-6
8003053	12.5" (318mm) PREFORMED Two-section Fire Retardant End Plate. For Fire Retardant Closure application only.	10-20	8003176	Transport tube kit [8 tubes, 34" long (863mm)] for 6.5" x 28" (165 x 711 mm) and 8.0" x 28" (203 x 711 mm) closures.	2-6; 3-10
			8003178	FIBERLIGN 6.5" (165mm) Diameter Three-Section End Plate with five bonding/grounding inserts, (2) factory-installed cable ports (for future cable entry, cables up to 0.8" diameter) supplied with five "L" brackets for cable shield isolation/strength member tie-off.	3-10; 4-5
			8003202	ARMADILLO Pressure Wrap Kit	10-11



Index by Part Number

Catalog Number	Product Description	Section-Page	Catalog Number	Product Description	Section-Page
8003203 8003204	ARMADILLO Pressure Wrap Kit	10-12	8003317	Pigtail Kit with FC Singlemode Connector (6) and Transport Tube, SERVICE	1-15
8003213	FIBERLIGN Splice Case End Plates 8.0" (203 mm)	3-10; 4-5	8003322	Isolated ground kit for 0.27" to .31" (7 - 8mm)	1-8
8003225	FIBERLIGN Splice Case End Plates 6.5" (165 mm)	4-5	8003325	Adjustable Aerial Hanger Bracket Kit	1-9
8003226	FIBERLIGN Splice Case End Plates 6.5" (165 mm)	3-10; 4-5	8003360	External bond braid kit	1-8
8003227	FIBERLIGN Splice Case End Plates 8.0" (203 mm)	3-10; 4-5	8003367	ARMADILLO – Three-Section End Plates – Ground & Air Valve	10-8
8003252	6.5"(165mm) Standard Two-Section End Plate Kit	2-5; 4-5	8003368	Pigtail Transition Tube Kit, includes (1) Transport Tube with Transition and Reducing Tubes	1-15
8003256 8003257	FIBERLIGN Urethane Downlead Cushion for ADSS or OPGW	7-4	8003371	Future Cable Port Kit, Includes Future Cable Port for 7/8" port, plug and clamps for installation of future cable port during initial assembly	1-9, 11
8003265	Transport tube kit [8 tubes, 40" long (1016mm)] for 9.5" x 28" (241 x 711 mm) closure	3-10	8003372	Vertical Pole/Structure Mounting Bracket Kit (for 6.0" (152mm) or 8.5"(216mm) COYOTE Closure or 6.0" (152mm) COYOTE PUP Closure)	1-9; 9-3
8003266 8003267 8003268 8003269 8003270 8003271	FIBERLIGN Aluminum Downlead Cushion for OPGW	7-4	8003379	FIBERLIGN Urethane Downlead Cushion for ADSS or OPGW	7-4
8003274 8003275 8003277	FIBERLIGN Splice Case End Plates 4.0" (102 mm)	2-5; 4-4	8003381	12-Count soft elastomer splice block kit (3 per kit)	1-8
8003278	FIBERLIGN Splice Case End Plates 6.5" (165 mm)	4-5	8003383	ARMADILLO – Pressure Wrap Collar	10-11
8003279	Manhole Support Bracket Kit	1-9	8003385	COYOTE Closure Flame-Retardant Bracket for 6.0" (152mm) x 22.0" (559mm)	1-8
8003280	Transition Tube Kit, used to transition fibers from top section of End Plate to the transition compartment	1-8, 9; 2-6; 9-13	8003386	COYOTE Closure Heat Shield for 6.0" (152mm) x 22.0" (559mm)	1-8
8003281	External Bond Clip Kit, (2) per kit	1-8, 10; 2-6	8003387	COYOTE Closure Heat Shield for 8.5" (216mm) x 22.0" (559mm)	1-8
8003282	8.0"(203) Standard Two-Section End Plate Kit	2-5; 4-5	8003388	COYOTE Closure Flame-Retardant Bracket for 8.5" (216mm) x 22.0" (559mm)	1-8
8003283	9.5"(241) Standard Two-Section End Plate Kit	2-5; 4-6	8003389	Multi-Port Grommet	1-13
8003284	12.5"(381 mm) Two-Section End Plates	4-6	8003390 8003391 8003392 8003393	Single-Port Grommets	1-12
8003285	Transport tube kit, color coded, includes (6) transport tubes 0.135" I.D.	1-8	8003394 8003395	8.0"(203mm) DLX Three-Section End Plate Kit with (6) Grounding Inserts and (4) "L" Brackets.	2-5
8003289	Future cable port for 7/8" port plus installation kit (8003291)	1-9, 11; 9-3	8003397	9.5"(241mm) DLX Three-Section End Plate Kit with (6) Grounding Inserts and (4) "L" Brackets.	2-5
8003291	Future cable installation kit, includes LOCK-TAPE sealant, bead sealant and "L" Bracket	1-9, 10, 11	8003398	Adapter Bracket for Hughes Brothers Bullet Shield. Bracket mounts to grounding studs on COYOTE Closure End Plate and fastener holes in the Hughes Brothers hanger provided with the Bullet Shield. Fits COYOTE Closure and COYOTE PUP Closure	9-3
8003292	Pigtail Kit with ST Singlemode Connector (6) and Transport Tube, FIELD	1-15	8003399 8003400 8003401 8003402 8003403 8003404 8003405 8003406	Multi-Port Grommet	1-13
8003293	Pigtail Kit with ST Singlemode Connector (6) and Transport Tube, SERVICE	1-15			
8003296	OPGW Strain Relief Bracket Kit	9-3			
8003314	Pigtail Kit with SC Singlemode Connector (6) and Transport Tube, FIELD	1-15			
8003315	Pigtail Kit with SC Singlemode Connector (6) and Transport Tube, SERVICE	1-15			
8003316	Pigtail Kit with FC Singlemode Connector (6) and Transport Tube, FIELD	1-15			

Index by Part Number

Catalog Number	Product Description	Section-Page	Catalog Number	Product Description	Section-Page
8003407	Future Cable Port Kit. Includes Future Cable Port for 1" port, plug and clamps for installation of future cable port during initial assembly	1-10, 11	8003463	External Isolation Terminal Kit, Includes: (2) Isolation Terminals with 10" (254) long, #6 Cable Stub and Splice Sleeve.	1-8; 2-6
8003408	Future cable port for 1" port plus installation kit (8003291)	1-10, 11; 9-3	8003464	External Isolation Terminal Kit, Includes: (2) Isolation Terminals with 10" (254) long, #6 Cable Stub and Quick Disconnect.	1-8; 2-6
8003409	Future cable port kit for 1-1/4" Port includes (1) cable port, (1) plug and (1) clamp	1-11	8003465	Quick disconnect kit (2 per kit)	1-8; 2-6
8003410	Future Cable Port/Cable Installation Kit for 1-1/4" cable ports(1.0" (25) max. cable). Kit includes Future Cable Port (Cat. No. 8003409) and Future Cable Preparation Kit (Cat. No. 8003291) which can be ordered separately.	1-11; 9-3	8003467	Aerial Hanger Bracket	1-10
8003411	Green Sealant Kit (required for OPGW applications)	2-6	8003468	24 Count Low Profile Splice Tray	1-4; 16-4
8003412	COYOTE Splice Case 3/4"(19mm) Future Cable Port Kit, Includes: Future Cable Port, Plug and Clamp. For installation of Future Cable Port during initial assembly of End Plate. Max. Cable is 0.8"(20mm) diameter.	2-5	8003469	24-count Splice Tray for COYOTE Hi-Count Closure (heat shrink protector only)	1-16; 2-8
8003413	COYOTE Splice Case 1"(25mm) Future Cable Port Kit, includes: Future Cable Port, Plug and Clamp. For installation of Future Cable Port during initial assembly of End Plate. Max. Cable is 1.0"(25mm) diameter.	2-5	8003470	Manhole Support Bracket	1-10
8003416	Isolated Strength Member Bracket Kit, two per kit.	2-6	8003472	Vertical Mounting Bracket for 6.5", 8" and 9.5" Splice Cases	2-6; 7-17; 9-4
8003418	Heat Shield for COYOTE PUP Closure	1-9	8003473	Single-Port Grommets	1-12
8003420	COYOTE Splice Case Future Cable Port Installation Kit, Includes: LOCK-TAPE™ Sealant, Bead Sealant, "L" Bracket and Bolt. Required for preparation of Future Cable.	2-5	8003474	Mounting Kit for COYOTE RUNT Closure	7-11
8003421	COYOTE Splice Case 3/4"(19mm) Future Cable Port/Cable Installation Kit. Complete Kit includes: Catalog #800412 and Catalog # 8003420	2-5; 9-4	8003477	FIBERLIGN Aluminum Downlead Cushion for OPGW	7-4
8003422	COYOTE Splice Case 1"(25mm) Future Cable Port/Cable Installation Kit. Complete Kit Includes: Catalog #8003413 and Catalog # 8003420	2-5; 9-4	8003490	Felt strips (blue) 1-1/8" (29mm) x 9" (229mm), 6 strips	2-6
8003424	Strength member bracket isolation kit, includes (6) nylon washers and bushings	1-8	8003491	COYOTE Defender	7-19
8003425	Splice protector (mass fusion), NON heat shrink (12 per kit)	2-6	8003492	COYOTE Defender	7-19
8003426	Adjustable Aerial Hanger Bracket Kit	2-6	8003493	FIBERLIGN Cable Storage Assemblies – Vertical Cable Storage Assembly	7-16
8003459	Mounting Kit for COYOTE Closures (including COYOTE® PUP Closure), includes (2) End Plate brackets and (1) Universal Mounting Kit	7-11	8003494	Single-Port Grommets	1-12
8003460	Mounting Kit for COYOTE Splice Cases (all sizes), includes (1) Universal Mounting Kit	7-11	8003495		
8003461	ARMADILLO Stainless - Standard	10-9	8003496		
			8003497		
			8003498		
			8003500		
			8003501		
			8003503	FIBERLIGN Cable Storage Assemblies – Cable Storage Spool	7-16
			8003509	60 mm heat shrink splice protector (12 per kit)	2-6; 9-13
			8003514	ARMADILLO Sealing Washer	10-6
			8003515	End Plate Kits	
			8003516		
			8003517		
			8003518		
			8003519		
			8003520		
			8003521		
			8003522		
			8003523	Wall Mount Bracket	1-10
			8003525	Customer Name Plaque Kit (includes (1) plaque and required fasteners)	10-14
			8003527	Manhole Support Kit (both ends of Splice Case)	2-6; 10-10
			8003532	ARMADILLO – Three-Section End Plates – Ground Only	10-8
			8003533	ARMADILLO – Three-Section End Plates – Ground & Air Valve	10-8



Index by Part Number

Catalog Number	Product Description	Section-Page	Catalog Number	Product Description	Section-Page
8003534	ARMADILLO – Three-Section End Plates – Ground Only	10-8	8003607	Multi-Port Grommet	1-13
8003536	Multi-Port Grommet	1-13	8003608		
8003537	COYOTE Splice Case 12.5"(318) DLX Three-Section End Plate Kit with (8) Grounding Inserts and (6) "L" Brackets.	2-5	8003609		
8003539	ARMADILLO – Two-Section End Plates	10-8	8003610		
8003540			8003611		
8003541	ARMADILLO – Two-Section End Plates	10-8	8003619	ARMADILLO - Pressure Wrap Collar	10-11
8003542			8003620	ARMADILLO Sealing Washer	10-6
8003543	ARMADILLO 1.0" (25) Sealing Washer Kit	10-12	8003621	End Plate Kits	
8003544	ARMADILLO 1.6" (41) Sealing Washer Kit	10-12	8003622	End Plate Grommet Kit (Blue)	2-5
8003545	ARMADILLO 2.2" (56) Sealing Washer Kit	10-12	8003623	End Plate Grommet Kit (Red)	2-5
8003546	ARMADILLO 2.8" (71) Sealing Washer Kit	10-12	8003624	Plug Spool for 1.6" (41mm) or 2.2" (56mm) Cable Entries. Kit contains (6) spools	10-13
8003547	ARMADILLO 3.4" (86) Sealing Washer Kit	10-12	8003625	Plug Spool for 2.8"(71mm) or 3.4"(86mm) Cable Entries. Kit contains (6) spools	10-13
8003550	ARMADILLO – Two-Section End Plates – Ground Only	10-8	8003630	ARMADILLO Sealing Washer End Plate Kits	10-6
8003551			8003644	FIBERLIGN Aluminum Downlead Cushion for OPGW	7-4
8003552			8003652	ARMADILLO External Bonding Kit	10-10
8003553			8003644	FIBERLIGN Aluminum Downlead Cushion for OPGW	7-4
8003554			8003653		
8003555	ARMADILLO – Two-Section End Plates – Air Valve Only	10-8	8003654		
8003556			8003660	End Plate Grommet Kit (Light Blue)	2-5
8003557			8003663	2-entry grommet	1-21; 9-9
8003558			8003664	4-entry grommet	1-21; 9-9
8003559			8003665	6-entry grommet	1-21; 9-9
8003560	ARMADILLO – Two-Section End Plates – Ground & Air Valve	10-8	8003671	Single-Port Grommets	1-12
8003561			8003674		
8003562			8003675		
8003563			8003676	7-entry grommet	1-21; 9-9
8003564			8003677	8-entry grommet	1-21; 9-9
8003569	FIBERLIGN Vertical Cable Storage Kit – Double Arm Application	7-16; 9-13	8003681	End Plate Kit	9-7
8003571	Universal Wall/Pole Mount Bracket	1-10	8003689	Single-Port Grommets	1-12
8003573	End Plate Grommet Kit (Orange)	2-5	8003691	1-entry grommet	1-21;
8003574	Shell expansion kit includes Expanded top shell and longer studs to increase tray capacity	1-10	8003692	1-entry grommet	9-6,
8003575	Multi-Port Grommet	1-13	8003693	1-entry grommet	9-12
8003576			8003694	1-entry grommet	
8003581	Manhole Bonding Kit for all ARMADILLO Closures	10-10	8003702	COYOTE® Dome Vertical Mounting Bracket	9-13
8003582	Multi-Port Grommet	1-13	8003707	Swing Arm for Handholes	9-7
8003583	End Plate Grommet Kit (Orange)	2-5	8003717	60 mm heat shrink protector (50 per kit)	1-8
8003584			8003730	Multi-Port Grommet	1-13
8003585	End Plate Grommet Kit (Light Blue)	2-5	8003751	Splice Case Kit – 12 ct. Splice Block	1-19
8003586	End Plate Grommet Kit (Green)	2-5	8003753	End Plate Kit – includes (2) End Plates, Bolts and Tether	1-19
8003588			8003754	OPGW Strain Relief Bracket Kit	9-10
8003596	Single-Port Grommets	1-12	8003757	24 Count, Low Profile Splice Tray Conversion Kit	1-4
8003597			8003775	Hanger Bracket Kit	1-19
8003598					
8003599					
8003600					
8003601					

Index by Part Number

Catalog Number	Product Description	Section-Page	Catalog Number	Product Description	Section-Page
8003777	Strength member bracket kit for Single Cable Entry	1-19	8006180	Aerial REDDI Seal Closure Kit without Bonding	11-4
8003792	Splice Tray Kit – 12 Count Splice Block – Single Fusion	1-19	8006181	Aerial REDDI Seal Closure Kit with Bonding	11-4
8003793	Splice Plate Kit – 724 Count LITE-GRIP Splice Block – Single Fusion	1-19	8006182	Aerial REDDI Seal Closure Kit without Bonding	11-4
8003794	Splice Plate Kit – 72 Count LITE-GRIP Splice Block – Ribbon	1-19; 16-3	8006183	Aerial REDDI Seal Closure Kit with Bonding	11-4
8003796	COYOTE Silicone Grommet Kit – Flat Drop Only	1-21; 9-9	8006185	REDDI Seal With Bonding	11-3
8003797	Aerial Hanger Bracket	9-7	8006186	Splice Case Shell Kits without End Plates Included	4-3
8003864	Mounting Kit for COYOTE In-Line RUNT Closure for ADSS	7-11	8006187		
8003989	4-entry grommet	1-21; 9-10	8006192	Splice Cases with (2) Standard End Plates Included	4-3
8003990	4-entry grommet	1-21; 9-9	8006216	REDDI Seal Without Bonding	11-3
8004035	Aerial Mounting Bracket – Dome Only, 6.5 Only	7-11; 9-7	8006219	ARMADILLO Stainless Kits with Drillable End Plates - With Bonding	10-5
8004065	4-entry grommet	9-9	8006220		
8004066	FIBERLIGN® ADSS Cable Storage Kit	7-17	8006221		
8004072	FIBERLIGN® ADSS Cable Storage w/ COYOTE Dome Mounting Kit for 6.5 x 17" and 6.5 x 22"	7-17	8006222	REDDI Seal With Bonding	11-3
8006021	ARMADILLO Stainless Kits with Drillable End Plates - Without Bonding	10-10	8006227	REDDI Seal Without Bonding	11-3
8006022	ARMADILLO Stainless Kits with Drillable End Plates - Without Bonding	10-10	8006229	REDDI Seal Without Bonding	11-3
8006023			8006239	ARMADILLO Stainless Filling Flange Kits with Drillable End Plates – Without Bonding	10-5
8006024	ARMADILLO Stainless Kits with Drillable End Plates - Without Bonding	4-3; 10-5	8006240		
8006025	ARMADILLO Stainless Kits with Drillable End Plates - Without Bonding	10-5	8006241	ARMADILLO Stainless Filling Flange Kits with Drillable End Plates – Without Bonding	10-10
8006039	Super SERVICEAL Closure	12-3	8006242		
8006041	Splice Case Shell Kits without End Plates Included	4-3	8006244	ARMADILLO Stainless – Filling Flange	10-9
8006043			8006245		
8006068	REDDI Seal With Bonding	11-3	8006246		
8006085			8006247		
8006087			8006249	ARMADILLO Stainless Filling Flange Kits with Drillable End Plates – Without Bonding	10-5
8006137	Ranger SERVICEAL Closure	12-2	8006250	ARMADILLO Stainless - Filling Flange	10-9
8006143	REDDI Seal Without Bonding	11-3	8006251	ARMADILLO Stainless Kits with Drillable End Plates – Without Bonding	4-3; 10-5
8006145			8006252		
8006147			8006253	ARMADILLO Stainless Kits with Drillable End Plates – Without Bonding	10-5
8006170	Aerial REDDI Seal Closure Kit with Bonding	11-4	8006261	ARMADILLO Stainless Kits with Drillable End Plates – Without Bonding	4-3; 10-5
8006171	Aerial REDDI Seal Closure Kit without Bonding	11-4	8006262		
8006172	Aerial REDDI Seal Closure Kit with Bonding	11-4	8006263	ARMADILLO Stainless Kits with Drillable End Plates – Without Bonding	10-5
8006173	Aerial REDDI Seal Closure Kit without Bonding	11-4	8006268	Splice Case Shell Kits without End Plates Included	4-3
8006174	Aerial REDDI Seal Closure Kit with Bonding	11-4	8006269		
8006175	Aerial REDDI Seal Closure Kit without Bonding	11-4	8006271	ARMADILLO Stainless Filling Flange Kits with Drillable End Plates – Without Bonding	10-5
8006176	ARMADILLO Stainless Kits with Drillable End Plates - With Bonding	10-5	8006272		
8006177	ARMADILLO Stainless Kits with Drillable End Plates - Without Bonding	10-5	8006273		
			8006274	ARMADILLO Stainless – Filling Flange	10-9
			8006275		
			8006276		
			8006282	Splice Cases with (2) Standard End Plates Included	4-3
			8006283	ARMADILLO Stainless Filling Flange Kits with Drillable End Plates – Without Bonding	10-5
			8006318	BLACK-JACK Cable Closure 25-Pair Butt	12-4



Index by Part Number

Catalog Number	Product Description	Section-Page	Catalog Number	Product Description	Section-Page
8006319	ARMADILLO Stainless Kits with Drillable End Plates – Without Bonding	10-5	8006540	COYOTE Closure, 6" x 22" includes (1) Three-Section End Plate, (1) blank End Plate, organizer, transport tube kit, transition tube kit and LOCK-TAPE sealing materials (6 Port End Plate)	1-8
8006320	ARMADILLO Stainless Kits with Drillable End Plates – With Bonding	10-5	8006541	COYOTE Closure, 8.5" x 22" includes (1) Three-Section End Plate, (1) blank End Plate, organizer, transport tube kit, transition tube kit and LOCK-TAPE sealing materials (6 Port End Plate)	1-8
8006321					
8006322					
8006326					
8006366					
8006367	ARMADILLO Stainless Filling Flange Kits with Drillable End Plates – With Bonding	10-5	8006542	FIBERLIGN UNI-CLOSURE for butt splice applications. 9.5" x 28" (241 x 721mm) Includes: (1) Two-Section End Plate, (1) Three-Section End Plate with eight bonding/grounding inserts (no factory-installed cable ports), (8) "L" brackets for cable shield isolation/strength member tie-off, organizer, transition compartment and transport tubes.	3-9
8006368					
8006369					
8006370					
8006371					
8006372					
8006373					
8006374					
8006377	Splice Cases with (2) Standard End Plates Included	4-3	8006548	COYOTE Splice Case 4"x 25" (102 x 635mm), for unitube applications, includes (2) Two-Section End Plates, and (1) Mainframe.	2-3
8006387	Splice Case Shell Kits without End Plates Included	4-3			
8006388	ARMADILLO Stainless – Filling Flange	10-9	8006549	COYOTE Splice Case 4"x 25" (102 x 635mm), DLX, for unitube applications, includes (1) Two-Section End Plate with (3) grounding inserts, (1) Two-Section End Plate, (1) Mainframe, (1) Transport Tube Kit, and (3) "L" Brackets.	2-3
8006390					
8006391					
8006392					
8006393					
8006394	ARMADILLO Stainless Filling Flange Kits with Drillable End Plates – Without Bonding	10-5	8006550	COYOTE Splice Case 6.5"x 22" (165 x 559mm), for unitube applications, butt splice only, includes (1) Two-Section End Plate, (1) Three-Section End Plate, (1) Transition Assembly, and (1) Transport Tube Kit.	2-3
8006395					
8006396					
8006397					
8006410	ARMADILLO Stainless Filling Flange Kits with Drillable End Plates – With Bonding	10-5	8006551	COYOTE Splice Case 6.5"x 22" (165 x 559mm), DLX, for unitube applications, butt splice only, includes (1) Two-Section End Plate, (1) Three-Section End Plate with six grounding inserts, (1) Transition Assembly, (1) Transport Tube Kit, and (4) "L" Brackets.	2-3
8006411					
8006412					
8006429					
8006443	FIBERLIGN UNI-CLOSURE for butt splice applications. 6.5" x 28" (165 x 721mm) Includes: (1) Two-Section End Plate, (1) Three-Section End Plate with (2) factory-installed cable ports [for future cable entry, cables up to 0.8" (20mm) diameter], (5) bonding/grounding inserts, (5) "L" brackets for cable shield isolation/strength member tie-off, organizer, transition compartment and transport tubes.	3-9	8006552	COYOTE Splice Case 6.5"x 28" (165 x 711mm), for unitube applications, includes (1) Two-Section End Plate, (1) Three-Section End Plate, (1) Transition Assembly, and (1) Transport Tube Kit.	2-3
8006450	FIBERLIGN UNI-CLOSURE for butt splice applications. 8.0" x 28" (203 x 721mm) Includes: (1) Two-Section End Plate, (1) Three-Section End Plate with (2) factory-installed cable ports [for future cable entry, cables up to 0.8" (20mm) diameter], (5) bonding/grounding inserts, (5) "L" brackets for cable shield isolation/strength member tie-off, organizer, transition compartment and transport tubes.	3-9			
8006474	ARMADILLO Stainless – Standard	10-9	8006553	COYOTE Splice Case 6.5"x 28" (165 x 711mm) DLX, for unitube applications, includes (1) Two-Section End Plate, (1) Three-Section End Plate with six grounding inserts, (1) Transition Assembly, (1) Transport Tube Kit, and (4) "L" Brackets.	2-3
8006508	BLACK-JACK Cable Closure 25-Pair In-Line	12-4			
8006509	ARMADILLO Stainless Kits with Drillable End Plates – Without Bonding	10-5, 10-9	8006559	Splice Case Shell Kits without End Plates Included	4-3
8006510	Splice Case Shell Kits without End Plates Included	4-3, 10-9	8006560	COYOTE Closure, 6" x 22" includes (1) Three-Section End Plate, (1) blank End Plate, organizer and LOCK-TAPE sealing materials (6 Port End Plate)	1-8
			8006561	COYOTE Closure, 8.5" x 22" includes (1) Three-Section End Plate, (1) blank End Plate, organizer and LOCK-TAPE sealing materials (6 Port End Plate)	1-8

Index by Part Number

Catalog Number	Product Description	Section-Page	Catalog Number	Product Description	Section-Page
8006572	COYOTE Cross-Connect Closure (Standard Unit) includes (1) Three-Section End Plate, (1) blank End Plate, transition compartment kit with pigtail guides, bulkhead, and (4) COYOTE Splice Trays (single fiber)	1-15	8006594	COYOTE Cross-Connect Closure – FC fully loaded (48 count) includes standard unit, plus (8) (Bulkhead) coupler panels with six singlemode FC couplers, (8) field pigtail kits with FC connector (6) and transport tube, and (8) service pigtail kits with FC connector (6) and transport tube	1-15
8006576	COYOTE Cross-Connect Closure – ST half loaded (24 count) includes standard unit, plus (4) (Bulkhead) coupler panels with six singlemode ST couplers, (4) field pigtail kits with ST connector (6) and transport tube, and (4) service pigtail kits with ST connector (6) and transport tube	1-15	8006612	COYOTE Cross-Connect/Express Closure with 6-port End Plate, 8.5" x 22" includes (2) 36 count splice trays	1-15
8006577	COYOTE Cross-Connect Closure – ST fully loaded (48 count) includes standard unit, plus (8) (Bulkhead) coupler panels with six singlemode ST couplers, (8) field pigtail kits with ST connector (6) and transport tube, and (8) service pigtail kits with ST connector (6) and transport tube	1-15	8006615	COYOTE Splice Case 6.5"x 22" (165 x 559mm), for buffer tube applications, butt splice only, includes (1) Two-Section End Plate, (1) Three-Section End Plate, and (1) Storage Assembly.	2-3
8006587	COYOTE Closure, 6" x 22" includes (1) Three-Section End Plate, (1) blank End Plate, express organizer and LOCK-TAPE sealing materials (6 Port End Plate)	1-8	8006616	COYOTE Splice Case 6.5"x 22" (165 x 559mm) DLX, for buffer tube applications, butt splice only, includes (1) Two-Section End Plate, (1) Three-Section End Plate with six grounding inserts, (1) Storage Assembly, and (4) "L" Brackets.	2-3
8006588	COYOTE Closure, 8.5" x 22" includes (1) Three-Section End Plate, (1) blank End Plate, express organizer and LOCK-TAPE sealing materials (6 Port End Plate)	1-8	8006617	COYOTE Splice Case 6.5"x 28" (165 x 711mm), for buffer tube applications, includes (1) Two-Section End Plate, (1) Three-Section End Plate, and (1) Storage Assembly.	2-3
8006589	Coax Drop Wire Closure. Small closure accepts coax drops to .3" (8) in diameter and associated connectors (RG6, RG59).	14-2	8006618	COYOTE Splice Case 6.5"x 28" (165 x 711mm) DLX, for buffer tube applications, includes (1) Two-Section End Plate, (1) Three-Section End Plate with six grounding inserts, (1) Storage Assembly, and (4) "L" Brackets.	2-3
8006591	COYOTE Cross-Connect Closure – SC half loaded (24 count) includes standard unit, plus (4) (Bulkhead) coupler panels with six singlemode SC couplers, (4) field pigtail kits with SC connector (6) and transport tube, and (4) service pigtail kits with SC connector (6) and transport tube	1-15	8006621	COYOTE PUP Closure Kit for Unitube – includes (1) Three-section 6 Port End Plate, (1) blank End Plate, transport tube kit and organizer	1-9
8006592	COYOTE Cross-Connect Closure – SC fully loaded (48 count) includes standard unit, plus (8) (Bulkhead) coupler panels with six singlemode SC couplers, (8) field pigtail kits with SC connector (6) and transport tube, and (8) service pigtail kits with SC connector (6) and transport tube	1-15	8006622	COYOTE PUP Closure Kit for Buffer Tube – includes (1) Three-section 6 Port End Plate, (1) blank End Plate and organizer	1-9
8006593	COYOTE Cross-Connect Closure – FC half loaded (24 count) includes standard unit, plus (4) (Bulkhead) coupler panels with six singlemode FC couplers, (4) field pigtail kits with FC connector (6) and transport tube, and (4) service pigtail kits with FC connector (6) and transport tube	1-15	8006625	COYOTE Splice Case 8"x 28" (203 x 711mm) DLX, for unitube applications, includes (1) Two-Section End Plate, (1) Three-Section End Plate with six grounding inserts, (1) Transition Assembly, (1) Transport Tube Kit, and (4) "L" Brackets.	2-3
			8006626	COYOTE Splice Case 8"x 28"(203 x 711mm) DLX, for buffer tube applications, includes (1) Two-Section End Plate, (1) Three-Section End Plate with six grounding inserts, (1) Storage Assembly, and (4) "L" Brackets.	2-3
			8006627	COYOTE Splice Case 9.5"x 28"(241 x 711mm) DLX, for buffer tube applications, includes (1) Two-Section End Plate, (1) Three-Section End Plate with six grounding inserts, (1) Storage Assembly, and (4) "L" Brackets.	2-3



Index by Part Number

Catalog Number	Product Description	Section-Page	Catalog Number	Product Description	Section-Page
8006628	COYOTE Splice Case 9.5"x 45"(241 x 1143mm) DLX, for buffer tube applications, includes (1) Two-Section End Plate, (1) Three-Section End Plate with six grounding inserts, (1) Dual Buffer Tube Storage Assembly, and (4) "L" Brackets.	2-3	8006657	COYOTE Splice Case 9.5"x 28" (241 x 711mm) DLX, for unitube applications, includes (1) Two-Section End Plate, (1) Three-Section End Plate with six grounding inserts, (1) Transition Assembly, and (1) Transport Tube Kit, and (4) "L" Brackets.	2-3
8006631	COYOTE Closure, 6" x 22" includes (1) Three-Section End Plate, (1) blank End Plate, organizer, transport tube kit, transition tube kit and LOCK-TAPE sealing materials (4 Port End Plate)	1-8	8006659	COYOTE Closure, RUS LISTED - 6" x 22" includes (1) Three-Section End Plate, (1) blank End Plate, organizer, LOCK-TAPE sealing materials and (2) RUS listed shield connectors (6 Port End Plate)	1-8
8006632	COYOTE Closure, 8.5" x 22" includes (1) Three-Section End Plate, (1) blank End Plate, organizer, transport tube kit, transition tube kit and LOCK-TAPE sealing materials (4 Port End Plate)	1-8	8006660	COYOTE Closure, RUS LISTED, 8.5" x 22" includes (1) Three-Section End Plate, (1) blank End Plate, organizer, LOCK-TAPE sealing materials and (2) RUS listed shield connectors (6 Port End Plate)	1-8
8006633	COYOTE Closure, 6" x 22" includes (1) Three-Section End Plate, (1) blank End Plate, organizer and LOCK-TAPE sealing materials (4 Port End Plate)	1-8	8006661	COYOTE PUP Closure Kit, RUS Listed for Buffer Tube – includes (1) Three-Section 6 Port End Plate, (1) blank End Plate, organizer and (2) RUS listed shield connectors.	1-9
8006634	COYOTE Closure, 8.5" x 22" includes (1) Three-Section End Plate, (1) blank End Plate, organizer and LOCK-TAPE sealing materials (4 Port End Plate)	1-8	8006667	Coax/Twisted Pair Drop Wire Closure accepts coax drops to 0.45" (11) and associated connectors (RG6, RG59, RG7 and RG11) and one-pair service wire up to 0.188" (5). Includes connectors for splicing service wire.	14-2
8006635	COYOTE Closure, 6" x 22" includes (1) Three-Section End Plate, (1) blank End Plate, express organizer and LOCK-TAPE sealing materials (4 Port End Plate)	1-8	8006668	ARMADILLO Stainless Kits with Drillable End Plates - With Bonding	10-5
8006636	COYOTE Closure, 8.5" x 22" includes (1) Three-Section End Plate, (1) blank End Plate, express organizer and LOCK-TAPE sealing materials (4 Port End Plate)	1-8	8006669	ARMADILLO Stainless Kits with Drillable End Plates - Without Bonding	10-5
8006638	COYOTE Retrofit Closure 8.5" x 22" (216 x 559mm). Includes (2) Three-Section Six Port End Plates, hybrid Fiber Management System, (10) End Plate Plugs and (4) "L" Brackets	1-17	8006670	COYOTE Cross-Connect Closure – AP/SC fully loaded (48 count) includes standard unit, plus (8) (Bulkhead) coupler panels with six singlemode AP/SC couplers, (8) field pigtail kits with AP/SC connector (6) and transport tube, and (8) service pigtail kits with AP/SC connector (6) and transport tube	1-15
8006652	COYOTE PUP Closure 6" x 17" (152 x 432mm) for OPGW. Includes OPGW Strain Relief Kit (Cat. No. 8003296) and (1) 12-count Splice Tray (Cat. No. 80806033)	9-3	8006671	COYOTE RUNT Closure Kit, Includes LOCK-TAPE Sealant, Bond Brackets and transport tubing	1-10
8006653	COYOTE PUP Closure 6" x 17" (152 x 432mm) Closure for ADSS/Buried Cables. Includes (1) 12-count Splice Tray (Cat. No. 80806033)	9-3	8006681	BLACK-JACK Cable Closure 50-Pair In-Line	12-4
8006654	COYOTE Splice Case 6.5" x 28" (165 x 711mm) for ADSS or OPGW. Includes Splice Case Kit, Green Sealant Kit (Cat. No. 8003411), (1) 36-count Splice Tray (Cat. No. 80805514), (1) blank End Plate and (1) Three-Section End Plate (field drilled for specific cable configurations and ODs) and "L" Brackets for strength member tie-off.	9-4; 9-8	8006683	COYOTE Hi-Count Splice Case Kit, 9.5" x 28" (241 x 711) Includes (1) Three-Section DLX End Plate, (1) Two-Section End Plate, Buffer Tube Storage Assembly and "L" Brackets	2-8
8006656	COYOTE Splice Case 6.5" x 28" (165 x 711mm) DLX - Express version, for buffer tube applications, includes (1) Two-Section End Plate, (1) Three-Section End Plate with six grounding inserts, (1) Storage Assembly, and (4) "L" Brackets.	2-3	8006684	COYOTE Closure Kit 6.0" x 22" (152 x 559mm) configured for ADOBE-12 or ADOBE-24 splice trays. Includes: (1) Three-Section End Plate, (1) Blank End Plate, and Buffer Tube Storage Compartment (6 Port End Plate)	1-18
			8006685	COYOTE Closure Kit 8.5" x 22" (216 x 559mm) configured for ADOBE-12 or ADOBE-24 splice trays. Includes: (1) Three-Section End Plate, (1) Blank End Plate, and Buffer Tube Storage Compartment (6 Port End Plate)	1-18

Index by Part Number

Catalog Number	Product Description	Section-Page	Catalog Number	Product Description	Section-Page
8006686	COYOTE Closure Kit 8.5" x 22" (216 x 559mm) configured for ADOBE-12 or ADOBE-24 splice trays. Includes: (1) Three-Section End Plate, (1) Blank End Plate, and Buffer Tube Storage Compartment (4 Port End Plate)	1-18	8006753	COYOTE Splice Case 12.5"x 28" (318 x 711mm) DLX for buffer tube applications, includes (1) assembled Three-Section End Plate, (1) Three-Section End Plate with eight grounding inserts, (1) Dual Tube Storage Assembly, and (6) "L" Brackets.	2-3
8006687	COYOTE Splice Case Kit 6.5" x 28" (165 x 711mm) configured for ADOBE-12 or ADOBE-24 Splice Trays. Includes: (1) Three-Section DLX End Plate, (1) Two-Section End Plate, Buffer Tube Storage Compartment and (4) "L" Brackets.	2-9	8006755	COYOTE Splice Case 9.5"x 38" (241 x 975mm) DLX, for unitube/buffer tube applications, includes (1) Two-Section End Plate, (1) Three-Section End Plate with six grounding inserts, (1) Transition/Buffer Storage Assembly, and (4) "L" Brackets.	2-3
8006688	COYOTE Closure Kit 6.0" x 22" (152 x 559mm) configured for ADOBE-12 or ADOBE-24 splice trays. Includes: (1) Three-Section End Plate, (1) Blank End Plate, and Buffer Tube Storage Compartment (4 Port End Plate)	1-18	8006756 8006758	ARMADILLO Stainless – Filling Flange	10-9
8006689	COYOTE Splice Case Kit, 8.0" x 28" (203 x 711mm) configured for ADOBE-12 or ADOBE-24 Splice Trays. Includes: (1) Three-Section DLX End Plate, (1) Two-Section End Plate, Buffer Tube Storage Compartment and (4) "L" Brackets.	2-9	8006760	COYOTE Splice Case for vault applications, 6.5" x 28" (165 x 711mm) unitube version	2-11
8006691	COYOTE Splice Case Kit, 9.5" x 28" (241 x 711mm) configured for ADOBE-12 or ADOBE-24 Splice Trays. Includes: (1) Three-Section DLX End Plate, (1) Two-Section End Plate, Buffer Tube Storage Compartment and (4) "L" Brackets.	2-9	8006761	COYOTE Splice Case for vault applications, 8.0" x 28" (203 x 711mm) unitube version	2-11
8006692	COYOTE RUNT Closure Kit, RUS Listed Includes LOCK-TAPE Sealant, Bond Brackets and transport tubing	1-10	8006762	COYOTE Splice Case for vault applications, 9.5" x 28" (241 x 711mm) unitube version	2-11
8006695	COYOTE RUNT Closure for OPGW, includes OPGW Strain Relief Kit (Cat. No. 8003479) and (1) 12-count Splice Tray (Cat. No. 80806033)	9-3	8006763	COYOTE Splice Case for vault applications, 9.5" x 38" (241 x 965mm) unitube/buffer tube version	2-11
8006700	ARMADILLO Stainless Filling Flange Kits with Drillable End Plates – Without Bonding	10-5	8006764	COYOTE Splice Case for vault applications, 9.5" x 28" (241 x 711mm) buffer tube version	2-11
8006701	ARMADILLO Stainless Filling Flange Kits with Drillable End Plates – With Bonding	10-5	8006765	COYOTE Closure, 9.5" x 38" (241 x 965mm) unitube version, holds up to nine 144-fiber ribbon splice trays (mass fusion), 1296-fiber capacity or sixteen 36-fiber single fiber splice trays, 576-fiber capacity, for use with central core ribbon fiber cables	1-16
8006702	COYOTE Splice Case 12.5"x 38" (318 x 975mm) DLX, for buffer tube applications, includes (1) assembled Three-Section End Plate, (1) Three-Section End Plate with eight grounding inserts, (1) Dual Tube Storage Assembly, and (6) "L" Brackets.	2-3	8006766	COYOTE Splice Case for vault applications, 8.0" x 28" (203 x 711mm) buffer tube version	2-11
8006703	COYOTE Splice Case 12.5"x 38" (318 x 975mm) DLX, for unitube applications, includes (1) assembled Three-Section End Plate, (1) Three-Section End Plate with eight grounding inserts, (1) Dual Transition Assembly, (1) Transport Tube Kit and (6) "L" Brackets.	2-3	8006767	COYOTE Splice Case for vault applications, 6.5" x 28" (165 x 711mm) buffer tube version	2-11
8006752	COYOTE Splice Case 12.5"x 28" (318 x 711mm) DLX for unitube applications, includes (1) assembled Three-Section End Plate, (1) Three-Section End Plate with eight grounding inserts, (1) Dual Transition Assembly, (1) Transport Tube Kit and (6) "L" Brackets.	2-3	8006769	ARMADILLO – Blank Shells	10-9
			8006770	ARMADILLO – Shell w/air valve	10-9
			8006771	ARMADILLO – Filling Flange Shell	10-9
			8006772	ARMADILLO – Blank Shells	10-9
			8006773	ARMADILLO – Shell w/air valve	10-9
			8006774	ARMADILLO – Filling Flange Shell	10-9
			8006776	ARMADILLO Stainless – Standard	10-9
			8006777		
			8006778		
			8006779		
			8006780		
			8006781		
			8006782		
			8006783		
			8006784		



Index by Part Number

Catalog Number	Product Description	Section-Page	Catalog Number	Product Description	Section-Page
8006788	COYOTE Splice Case Kit, 12.5" x 28" (318 x 711mm) configured for ADOBE-24 Splice Trays. Includes: (1) Three-Section DLX End Plate, (1) Two-Section End Plate, Buffer Tube Storage Compartment and (6) "L" Brackets.	2-9	8006879	COYOTE In-Line Dome 6.5" x 28" for Buffer Tube (loose tube)	9-7
8006792	COYOTE Closure Shell Kit 9.5" x 28" (241 x 711mm)	1-16	8006880	COYOTE In-Line Dome 6.5" x 28" for Unitube	9-7
8006793	COYOTE Closure Shell Kit 9.5" x 38" (241 x 965mm)	1-16	8006911	COYOTE Cross-Connect/ Express Closure 6" x 22" with 6-port End Plate, includes (2) 36 count splice trays	1-15
8006794	Expanded COYOTE RUNT Closure Kit, Includes LOCK-TAPE Sealant, Bond Brackets and transport tubing	1-10	8006912	Cross-Connect/Express Closure, 6" x 22" with 4-port End Plate, includes (2) 36 count splice trays	1-15
8006806	COYOTE Express Closure Kit 6.0" x 22" (152 x 559mm) configured for ADOBE-12 or ADOBE-24 splice trays. Includes: (1) Three-Section End Plate, (1) Blank End Plate, and Express Buffer Tube Storage Compartment (6 Port End Plate)	1-18	8006914	COYOTE Drop Cable Closure, unfilled, includes splice tray assembly & (6) heat shrink splice protectors.	1-22
8006807	COYOTE Express Closure Kit 8.5" x 22" (216 x 559mm) configured for ADOBE-12 or ADOBE-24 splice trays. Includes: (1) Three-Section End Plate, (1) Blank End Plate, and Express Buffer Tube Storage Compartment (6 Port End Plate)	1-18	8006915	COYOTE Cross-Connect/ Express Closure, 8.5" x 22" with 4-port End Plate, includes (2) 36 count splice trays	1-15
8006819	COYOTE Express Closure Kit 8.5" x 22" (216 x 559mm) configured for ADOBE-12 or ADOBE-24 splice trays. Includes: (1) Three-Section End Plate, (1) Blank End Plate, and Express Buffer Tube Storage Compartment (4 Port End Plate)	1-18	8006916	Expanded COYOTE RUNT Cross-Connect/Express Closure, includes (1) 12 count splice tray	1-10, 15
8006820	COYOTE Express Closure Kit 6.0" x 22" (152 x 559mm) configured for ADOBE-12 or ADOBE-24 splice trays. Includes: (1) Three-Section End Plate, (1) Blank End Plate, and Express Buffer Tube Storage Compartment (4 Port End Plate)	1-18	8006920	COYOTE PUP Cross-Connect/Express Closure, with 6-port End Plate, includes (2) 12 count splice trays	1-15
8006839	COYOTE Express Splice Case Kit, 8.0" x 28" (203 x 711mm) configured for ADOBE-12 or ADOBE-24 Splice Trays. Includes: (1) Three-Section DLX End Plate, (1) Two-Section End Plate, Buffer Tube Storage Compartment and (4) "L" Brackets.	2-9	8006921	COYOTE PUP Cross-Connect/Express Closure, with 4-port End Plate, includes (2) 12 count splice trays	1-15
8006840	COYOTE Express Splice Case Kit, 9.5" x 28" (291 x 711mm) configured for ADOBE-12 or ADOBE-24 Splice Trays. Includes: (1) Three-Section DLX End Plate, (1) Two-Section End Plate, Buffer Tube Storage Compartment and (4) "L" Brackets.	2-9	8006941	COYOTE Dome Cross-Connect/Express Closure, 6.5" x 22" includes (2) 12 count splice trays	9-7
8006876	COYOTE Drop Cable Closure, includes sealed splice tray assembly and (6) heat shrink splice protectors.	1-22	8006944	COYOTE Dome for Buffer 6.5" x 17" Tube (loose tube)	9-7
8006877	COYOTE Dome for Buffer 6.5" x 22" Tube (loose tube)	9-7	8006945	COYOTE Dome 6.5" x 17" for Unitube	9-7
8006878	COYOTE Dome for Unitube 6.5" x 22"	9-7	8006946	COYOTE Dome 6.5" x 22" Express*	9-7
			8006947	COYOTE Taut 6.5" x 38" Closure Kit	1-20
			8006949	COYOTE Dome 6.5 x 17" Cross-Connect Express	9-7
			8006988	COYOTE Dome Express 6.5" x 17"	9-7
			8126010	FIBERLIGN Tangent Supports for Flat Cable Profile	8-7
			00070255	Large Cavity Inserts	6-11
			00070256	for Lower Cable Ranges	
			00070250		
			00070251		
			00070176		
			00070177		
			00070178		
			00070179		
			00070180		
			00070181		
			00070182		
			00070183		
			00070184		
			00070186		
			00070188		
			00070190		
			00070192		
			00070194		
			00070195		



Index by Part Number

Catalog Number	Product Description	Section-Page	Catalog Number	Product Description	Section-Page
80008946	Ranger SERVICEAL Vial Replacement Kit	12-2	80802790	ARMADILLO Stainless LOCKBAR Assemblies for 4.0" x 25" (102 x 635mm) ARMADILLO Stainless	10-13
80009802	ARMADILLO Cable Sheath Reinforcing Kit	10-11	80802791	ARMADILLO Stainless LOCKBAR Assemblies for 38" (965mm)	10-13
80061055	COYOTE Dome for Buffer Tube 9.5" x 28" (Loose Tube)	9-7, 8	80802792	ARMADILLO Stainless LOCKBAR Assemblies for 45" (1143mm)	10-13
80061056	COYOTE Dome for 9.5" x 28" Unitube (Ribbon)	9-7, 8	80802797	ARMADILLO Stainless Bonding Kit for 22" & 25" (559 & 635mm)	10-10
80061057	COYOTE Dome for High 9.5" x 28" Capacity (Max Tray Count)	9-7, 8	80802798	ARMADILLO Stainless Bonding Kit for all 28" (711mm)	10-10
80801150	7/16" Deep Well Socket	2-7; 10-15	80802802	ARMADILLO Stainless Bonding Kit for all 45" & 53" (1143 & 1346mm)	10-10
80801151	1/2" Deep Well Socket	2-7; 10-15	80802803	ARMADILLO Stainless Bonding Kit for all 38" (965mm)	10-10
80061194	COYOTE® Defender 2 for 6.5" x 17" Dome Closure	7-17, 20; 9-13	80802820	RD Encapsulant for ARMADILLO Stainless, and REDDI Seal Closures	10-21
80061195	FIBERLIGN® Cable Storage 2 for OPGW	7-17, 20; 9-13	80802821	RD Encapsulant for ARMADILLO Stainless, and REDDI Seal Closures	10-21
80801303	Bonding Ferrules – tin plated copper attachments for #6 Bonding Braid to Shield Connector Studs	19-3	80802822	RD Encapsulant for ARMADILLO Stainless, and REDDI Seal Closures	10-21
80801566	ARMADILLO Shell Lubricant	10-13	80802823	RD Encapsulant for ARMADILLO Stainless, and REDDI Seal Closures	10-21
80801796	REDDI Seal Moisture Barrier Sealant 1 ft. (305 mm)	11-3	80802826	FIBERLIGN Fiber Safe. 8000 Gram Kit RD Encapsulant (re-enterable) for filling 8001002, 8001004, or 8001006	3-14; 10-21
80801944	Drill Motor Adapter (For other than PREFORMED Drill)	2-7; 10-15	80802829	FIBERLIGN Fiber Safe. 5500 Gram Kit RD Encapsulant (re-enterable) for filling 8001003, 8001001, 8001005, 8001007 or 8001008	3-14
80801953	1-1/2" W x 12' L (38mm x 3.6m), one roll	10-12	80802922	Tip CABLE Mea-SURE™ Tape	10-18
80801954R	LOCK-TAPE™ Sealant, 2 1/2" W x 12' L (64 W x 3.7 L)	2-6; 10-12	80803148	(1) Three-Section End Plate with protective collar assembly for cable blocking.	3-14
80801955R	LOCK-TAPE™ Sealant, 3" W x 12' L (76 W x 3.7 L)(76mm x 3.6m)	2-6; 10-12	80803149		
80802136	REDDI Seal Closing Clamps [2 per closure]	11-3; 11-5	80803316	300 Gram Kit RD Encapsulant (re-enterable) for filling cup.	3-14
80802143	REDDI Seal Plastic Plugs (2 per closure)	11-3	80803377	Cutting Blade Adapter	2-7; 10-15
80802176	REDDI Closure Closing Clamp [2 per closure]	11-3; 11-5	80803448	Moisture Blocking Sealant, 3 oz. tube	2-6
80802250	REDDI Seal Funnel	11-3	80803668	FIBERLIGN Fiber Safe. (1) Two-Section End Plate with four factory-installed ports (for future cable entry, for cables up to 0.8" [20] in diameter), (4) bonding/grounding inserts, (4) modified brackets for cable shield isolation/strength member tie-off, and protective collar assembly for cable blocking. No room for field-drilled cable holes.	3-14
80802377	C-Cement, 4 oz. can	2-6; 3-13; 10-4	80803695	FIBERLIGN Fiber Safe. (1) Three-Section End Plate with (2) factory-installed ports (for future cable entry, for cables up to 0.8" [20] in diameter), (4) bonding/grounding inserts, (4) modified brackets for cable shield isolation/strength member tie-off, and protective collar assembly for cable blocking. Designed for (2) field-drilled cable holes.	3-14
80802437	RD Encapsulant for ARMADILLO Stainless, and REDDI Seal Closures	10-21	80803788	ARMADILLO Stainless, Torque Bar for 12.5" x 28" (318 x 711mm) (1) bar	10-14
80802438			80803792		
80802439					
80802440					
80802510	REDDI Seal Hanger Bracket [2 per closure]	11-3; 11-5			
80802567	LOCK-TAPE™ Sealant, 3/4" W x 12' L (19 W x 3.7 L)	2-6			
80802591	ARMADILLO Stainless Torque Bar for 45" (1143) (8.0", 9.5" & 12.5") (203, 241, 318mm), one bar	10-14			
80802613	REDDI Seal Closing Clamps [2 per closure]	11-3			
80802789	ARMADILLO Stainless LOCKBAR Assemblies for 28" (711mm)	10-13			

Index by Part Number

Catalog Number	Product Description	Section-Page	Catalog Number	Product Description	Section-Page
80803799	ARMADILLO Stainless, Stiffener Bar for 12.5" x 38" (318 x 965mm) (1) bar	10-14	80805293	Transport tube kit, includes (6) transport tubes 0.135" I.D. x 34" long	1-8, 9; 9-13
80803877	ARMADILLO Stainless, Stiffener Bar for 12.5" x 45" (318 x 1143mm) (1) bar	10-14	80805365	ARMADILLO – Three-Section End Plates – Ground & Air Valve	10-8
80803967	Torque Wrench with ratchet head 3/8" Drive	2-7; 10-15	80805376	ARMADILLO – Three-Section End Plates – Air Valve Only	10-8
80803968	Ratchet Type Socket Wrench 3/8" Drive	2-7; 10-15	80805422	ARMADILLO – Three-Section End Plates – Air Valve Only	10-8
80803969	6" extension	2-7; 10-15	80805431	Extended Strength Member Bracket Kit – (2) per Kit	1-8
80803989	Fiber Optic Shield Connector, 3M #4460/D/FO, (1) each, RUS Listed	1-8, 10; 2-6	80805509	Blank Standard Splice Tray kit	1-5, 8; 9-5,8
80803994	ARMADILLO Closure, Torque Bar for 6.5" x 22" (165 x 559mm) ARMADILLO Stainless and (1) bar	10-14	80805510	Blank Ribbon Splice Tray Kit	1-5, 8; 9-3; 9-5; 9-8
80804050	ARMADILLO Stainless LOCKBAR Assemblies for 4.0" x 25" (102 x 635mm)	10-13	80805514	COYOTE Splice Tray Kit (single fiber) with (3) Elastomer Splice Blocks (12 splices/block)	1-5, 8, 16, 17; 2-4; 9-3,5,8, 12; 13; 16-4
80804366	PREFORMED Heat Shield	11-4	80805515	144 Count ribbon tray (blank), with (2) elastomeric splice blocks	1-5, 8, 16; 9-5, 8; 16-4
80804367			80805571	COYOTE Splice Case Transition Compartment Kit for 6.5" (165mm) x 28" (635mm)	2-5
80804368			80805574	COYOTE Splice Case Loose Buffer Tube Storage Assembly for 6.5" (165mm) x 28" (635mm)	2-5
80804397			80805605	(Bulkhead) Coupler Panel with six holes for ST Feed-Thru Adapters	1-15
80804398			80805606	(Bulkhead) Coupler Panel with six holes for SC Feed-Thru Adapters	1-15
80804935	ARMADILLO Stainless, Torque Bar for 12.5" x 65" (318 x 1651mm) (1) bar	10-14	80805607	(Bulkhead) Coupler Panel with six holes for FC Feed-Thru Adapters	1-15
80804937	ARMADILLO Stainless LOCKBAR Assemblies for 12.5" x 65" (318 x 1651mm)	10-13	80805690	COYOTE Splice Case Transition Compartment Kit for 6.5" (165mm) x 22" (559mm)	2-5
80804938	ARMADILLO Stainless LOCKBAR Assemblies for 12.5" x 65" (318 x 1651mm)	10-13	80805691	COYOTE Splice Case Loose Buffer Tube Storage Assembly for 6.5" (165mm) x 22" (559mm)	2-5
80804985	4.0" (102mm) DLX Two-Section End Plate Kit with (3) Grounding Inserts and (3) "L" Brackets.	2-5; 4-4	80805739	Three-Section Four Port End Plate Kit	1-7, 9, 11; 9-3
80804986	6.5" (165mm) DLX Three-Section End Plate Kit with (6) Grounding Inserts and (4) "L" Brackets.	2-5; 9-4	80805771	Buffer Tube Storage Compartment	1-9
80805105	6 Port End Plate Kit, Includes (1) End Plate assembly, (1) full set of plugs, and LOCK-Tape Sealing material	1-7, 9, 11	80805775	Unitube Storage (Transition) Compartment	1-9
80805107	Strength Member Bracket Kit – (2) per kit	1-8	80805795	Shell Kit 6" x 17"	1-9
80805110	36 Count Standard Splice Tray Kit with fixed slots	1-5, 8; 9-3, 5, 8	80805801	COYOTE Splice Case Dual Loose Buffer Tube Storage Assembly for 9.5" (241mm) x 45" (1.1mm)	2-5
80805120	FIBERLIGN Splice Case End Plates, 9.5" (241 mm)	3-10; 4-6	80805812	COYOTE Splice Case Transition Compartment Kit for 8.0" (203mm) x 28" (635mm)	2-5
80805146	144 Count COYOTE Ribbon Splice Tray with fixed rigid slots	1-5, 8, 16, 17; 2-4; 9-5, 9-8	80805814	COYOTE Splice Case Loose Buffer Tube Storage Assembly for 8.0" (203mm) x 28" (635mm)	2-5
80805150	COYOTE Splice Case Transition Assembly for 4.0" (102mm) x 25" (635mm)	2-5	80805815	COYOTE Splice Case Loose Buffer Tube Storage Assembly for 9.5" (241mm) x 28" (635mm)	2-5
80805166	FIBERLIGN Splice Case End Plates 9.5" (241 mm)	3-10; 4-6			
80805238	C-Cement, 1 oz. Tube	1-9,10; 2-6; 3-13; 10-4			
80805260	Blank End Plate Kit	1-8, 9			
80805286	Adapter bracket kit for AT&T bond connector (4 per kit)	1-8			



Index by Part Number

Catalog Number	Product Description	Section-Page	Catalog Number	Product Description	Section-Page
80805913	COYOTE Splice Case Loose Buffer Tube Storage Assembly for (Express) 6.5" (165mm) x 28" (635mm)	2-5	80807122	BUNDLE-LOCK Kit for 38" Closures (25)	10-10
80805915	COYOTE Splice Case Transition Compartment Kit for 9.5" (241mm) x 28" (635mm)	2-5	80807383	Hardware bag for End Plate	9-7
80805925	LOCK-TAPE™ Sealant 1" (25mm) W x 15' (4 m) L	1-9, 10	80807531	Blank Low Profile Splice Tray	1-8
80805937	Air Valve for Stainless Case	2-6	80807701	12 Count Low Profile Tray with rigid plastic splice block – single fusion splices	1-4, 8; 9-3, 6, 8; 16-4
80805986	ARMADILLO Stainless, Torque Bar for 9.5" x 53" (241 x 1346mm) (1) bar	10-14	80807769	12 Count Low Profile Blank Splice Tray Kit (Blank)	1-8; 9-5, 9-8; 16-4
80805989	ARMADILLO Stainless LOCKBAR Assemblies for 9.5" x 53" (241 x 1346mm)	10-13	80807848	End Plate Gasket	9-7
80806033	12-Count Standard Tray with elastomeric splice block for fusion & mechanical splices	1-4, 8; 9-3, 6, 8, 12, 13; 16-4	80807859	Ventilation Kit includes: Elbow, Transition Fitting and Enclosure Adapter (2" conduit not supplied)	17-2
80806037	Plug Kit for 3/4" ports (2 per kit)	1-7, 9, 10, 11	80807949	Equipment Chassis with Lockable Swing Panel	17-2
80806038	Plug Kit for 1.0" ports (2 per kit)	1-7, 9, 10, 11	80807989	Transport Tube 100' coil 0.170" ID	1-8
80806112	Transport tube kit, contains (4) tubes	1-10	80807991	Transport Tube 100' coil 0.25" ID	1-8
80806179	Bonding Braid, 0.5" x 7" (13 x 178mm) with eyelets spaced at 6" (152mm) apart.	1-8; 2-6	80808160	Ribbon Tray (Blank) for COYOTE RUNT/PUP	1-4, 8; 9-6, 8
80806180	Plug Kit for 7/8" ports (2 per kit)	1-7, 9, 11	80808187	40 mm Heat Shrink Protector	1-8
80806181	Plug Kit for 1-1/4" ports (2 per kit)	1-7, 9, 10, 11	80808256	12 Entry Grommet Kit with Bobbin	1-19
80806182	12 Count Standard Tray Kit Blank, No Splice Block	1-4, 8; 9-6, 8, 16-4	80808257	Fiber Organizer Clip Kit	1-19
80806434	ARMADILLO Cable R-Sealant	10-12	80808289	36 ct. Bare Fiber Splice Tray	1-8
80806439	Transport Tube Kit (0.25" [6mm] O.D. Tube, 34" [864mm] long), includes (6) tubes	1-8; 2-6	80808290	12 ct. Bare Fiber Splice Tray	1-8
80806592	ARMADILLO Prep Tape	10-12	80808917	FIBERLIGN® In-Span Storage 25 Extra Heavy Duty Cable Ties	7-10
80806629	COYOTE Splice Case Loose Buffer Tube Storage Assembly for 12.5" (241mm) x 28" (635mm)	2-5	80812321	OPGW Sealant Kit	9-12, 13
80806704	Transition Compartment Tray	2-5	80812335	COYOTE Dome Closure CRB System	9-13
80806743	Fiber optic shield connector for up to .5" (13mm) cable O.D.	1-8; 2-6	80812352	Mounting Bracket Kit for COYOTE® Closures 6" x 17", 6" x 22", and 8.5" x 22"	7-17
80806744	Fiber optic shield connector for .5" to .8" (13 - 20mm) cable O.D.	1-8; 2-6	80850952	ARMADILLO Stainless Torque Bar for 28" (711mm) (6.5", 8.0" & 9.5") (165mm, 203mm, 241mm), (1) bar	10-14; 11-3
80806745	Fiber optic shield connector for .8" to 1.6" (20 - 41mm) cable O.D.	1-8; 2-6	80850968	REDDI Closure Torque Bar [2 per closure]	11-5
80806750	COYOTE Closures External isolation connector	1-8	80850985	ARMADILLO Stainless Torque Bar for 38" (965mm) (6.5", 8.0" & 9.5") (165mm, 203mm, 241mm), (1) bar	10-14; 11-3, 5
80806759	COYOTE Splice Cases External Isolation Connector	2-6	80851245	ARMADILLO Stainless, Torque Bar for 4.0" x 25" (102 x 635mm) (1) bar	10-14; 11-3
80807114	72 Count Ribbon Tray with soft elastomer splice block	1-4, 8; 9-6, 8	80851255	REDDI Closure Torque Bar [2 per closure]	11-5
80807120	BUNDLE-LOCK Kit for 4" x 25" Closures (25)	10-10	80851659	Electric Drill With Socket	2-7; 10-15
80807121	BUNDLE-LOCK Kit for 28" Closures (25)	10-10	80851909	Super SERVICEAL Vial Replacement Kit	12-3
			200811230	FIBERLIGN Figure 8 Drop Cable Dead-ends	8-9
			280110266	FIBERLIGN Dead-end for OPTICAL GROUND WIRE (OPGW)	5-5

Index by Part Number

Catalog Number	Product Description	Section-Page	Catalog Number	Product Description	Section-Page
288811269	FIBERLIGN ADSS Drop Cable	8-4	800010884	COYOTE Closure, buffer tube version, 9.5" x 28" (241 x 711mm) holds up to (6) 144-fiber ribbon splice trays (mass fusion), 864-fiber capacity or (10) 36 fiber single fiber splice trays, 360-fiber capacity, for use with flexible buffered ribbon fiber cables.	1-16
288811274	Dead-ends – Round Profile				
288811285					
288811337					
288811340					
288811343					
288811346					
288811350			800010897	COYOTE Closure, unitube version, 9.5" x 28" (241 x 711mm) holds up to (6) 144-fiber ribbon splice trays (mass fusion), 864-fiber capacity or (10) 36 fiber single fiber splice trays, 360-fiber capacity, for use with central core ribbon fiber cables	1-16
288811352					
288811353	FIBERLIGN ADSS Drop Cable	8-4			
288812284	Dead-ends – Flat Profile				
430010267	FIBERLIGN Dielectric Suspension for ADSS	6-19	800011212	Furcation Kit for Buffer Tubes OD range .133" - .154"	9-10, 13
430010305					
430010306			800011296	SERVI-BOND Shield Connector	18-3
430010307					
430010308			800011381	Furcation Kit for Buffer Tubes OD range .118" - .126"	9-10, 13
430010309					
440010296	FIBERLIGN Dielectric Support for ADSS	6-13			
480011817	FIBERLIGN LITE Support for ADSS / FIGURE 8 Drop Cables	8-6; 8-10	800011382	Furcation Kit for Buffer Tubes OD range .102" - .110"	9-10, 13
480011818	FIBERLIGN LITE Support for ADSS Drop Cables	8-6			
480011819			800011397	COYOTE RUNT Closure Kit for Copper Applications	1-10
480011820	FIBERLIGN LITE Support for ADSS/ FIGURE 8 Drop Cables	8-6; 8-10			
480011821	FIBERLIGN LITE Support for ADSS Drop Cables	8-6	800011398	COYOTE PUP Closure Kit for Copper Applications with 6-Port End Plates	1-9
480011822		8-6			
500510903	FIBERLIGN Fiber Optic Cable Marker	7-3	800011399	COYOTE PUP Closure Kit for Copper Applications with 4-Port End Plates	1-9
612612245	FIBERLIGN Tangent Support	8-7			
699911619	FIBERLIGN Figure 8 Drop Cable Dead-ends	8-9	800011408	ADSS Vertical Cable Storage Assembly	7-16
699912980	Filler Tube for Cable <.5 - 20" long	7-10	800011563	Furcation Kit for Buffer Tubes OD range 063" - .098"	9-13
700011045	Light-Duty Lattice Tower Clamp	5-9, 7-5			
710010015	Grounding Wire Assemblies	5-9	800011741	COYOTE Splice Tray with Integrated Couplers – Low Profile Splice Tray – 12 Count	16-5
710010016	4' Long Copper Ground Wire w/terminal on end	5-4	800011742		
710010294	4' Long Aluminum Grounding Wire w/terminal on end	5-4	800011916	COYOTE RUNT Closure	7-19
710010017	Wood Pole Hardware Kit	7-5			
710010293	Grounding Wire Assemblies	5-9	800012143	Closure w/Standard Tray Kit	9-6, 10
710010576	Limited Tension Banding Bracket	7-5	800012145		
710011205	Grounding Wire Assemblies	5-4, 9	800012147		
710012417			800012149		
710011655	1/2-13 UNC HEX Head Bolt Hardware Kit	7-5	800012144	Closure w/Low Profile Tray Kit	9-6, 10
710012168	Aerial Hanger Bracket	9-7	800012146		
710012375A	CLAS Cable Storage Kit	7-9	800012148		
800010515	COYOTE PUP Closure for Buffer Tube Applications	1-9	800012150		
800010621	Multi-Port Grommet	1-13	800012160	Pole/Wall Mount Bracket	9-7
800010810	COYOTE Hi-Count Closure for buffer tube applications, 9.5" x 28" (241 x 711mm) up to 432 single fiber splices, holds up to (18) 24-count splice trays	1-16	800012162	COYOTE Dome Closure	7-19; 9-13
			800081002	100 (30 m) Coil of #6 Bonding Braid	19-3
			800081098	9.5" (241 mm) Three-Section End Plates	4-6
			80801954R	LOCK-TAPE Sealant	2-6
			80801955R		
			12SMDSC	Adapter Modules	16-3
			12SMLC	Adapter Modules	16-3
			2890001C4	FIBERLIGN Formed Wire Dead-end	5-8
			2890002C4		
			2890003C4		
			2890004C4		
			2890005C4		
			2890006C4		
			2890007C4		
			2890008C4		
			2890009C4		
			2890020C4		



Index by Part Number

Catalog Number	Product Description	Section-Page	Catalog Number	Product Description	Section-Page
6FCAPC	Adapter Modules	16-3	BFD-MS-2921	BIRD-FLIGHT Diverter	21-13
6SCAPC					
6SMFC					
6SMLC					
6SMSC					
6SMST					
710012375D1U	FIBERLIGN CLAS	7-10	BFD-MS-3155		
8000417A-DD	Individual Blades (A-DD)	2-7;	BFD-MS-3164		
		10-15	BFD-MS-3331		
8003503B1	FIBERLIGN Vertical Cable Storage Kit – Banded Triple Spool/ Single Arm	7-16	BFD-MS-3341		
8003503LTC1	FIBERLIGN Vertical Cable Storage Kit – Lattice Tower Clamped Triple Spool	7-16	BFD-MS-3344		
808012335	COYOTE® Dome Closure CRB System Direct Mounting Clamp for 6.5" Dome	9-9	BFD-MS-3345		
6SMFC	Adapter Modules	16-3	BFD-MS-3346		
6SMLC	Adapter Modules	16-3	BFD-MS-3355		
6SMSC	Adapter Modules	16-3	BFD-MS-3366		
6SMST	Adapter Modules	16-3	BFD-MS-3371		
6FCAPC	Adapter Modules	16-3	BFD-MS-3376		
6SCAPC	Adapter Modules	16-3	BFD-MS-3405		
8SCACP	Adapter Modules	16-3	BFD-MS-10022		
8SMFC	Adapter Modules	16-3	BFD-MS-10023		
8SMSC	Adapter Modules	16-3	BFD-MS-10277		
8SMST	Adapter Modules	16-3	BFD-MS-11060		
12SMDSC	Adapter Modules	16-3	BFD-MS-11110		
12SMLC	Adapter Modules	16-3	BFD-MS-11111		
AS-5L	Anchor Shackle	5-9	BFD-MS-11134		
ATC-20M	Thimble Clevis	6-8	BFD-MS-11135		
AWDE-4108	GUY-GRIP Dead-end	20-5	BFD-MS-11430		
AWDE-4110					
AWDE-4113					
AWDE-4116					
AWDE-4119					
AWDE-4120					
AWDE-4122					
AWDE-4124					
AWDE-4125					
AWDE-4126					
AWLS-5101			Open Wire Splice	22-2	BFD-MS-11566
BDE-9102	GUY-GRIP Dead-end	20-4	BFD-MS-11699		
BDE-9104					
BDE-9106					
BDE-9107					
BDE-9108					
BFDE-9121			False Dead-end	20-9	BFD-MS-12290
BFDE-9123					
BFDE-9124					
BFDE-9125					
BFDE-9126					
			BFD-MS-12351		
			BFD-MS-12603		
			BG-2111	Big-Grip Dead-end	20-7
			BG-2112		
			BG-2115		
			BG-2116		
			BG-4168	Big-Grip Dead-end	20-8
			BG-4169		
			BG-4170		
			BG-4171		
			BG-4172		
			BG-4173		
			BG-4174		
			BG-4175		
			BG-4176		
			BG-4177		
			BG-4178		
			BG-4179		
			BG-4180		
			BG-4181		
			BG-4183		
			BG-4185		
			BG-4186		
			BG-4187		
			BG-4188		
			BG-4189		
			BG-4190		
			BG-4191		
			BG-4192		
			BGMS7023	Big-Grip Dead-end	20-7
			BGMS7047		
			BLS-9102	Strand Splice	22-3
			BLS-9104		
			BLS-9106		
			BLS-9107		
			BLS-9108		
			BLS-9109		
			CDE117	Cable Demarcation Enclosure (Gray) three port includes grommets and hardware	15-2
			CDE139		

Index by Part Number

Catalog Number	Product Description	Section-Page	Catalog Number	Product Description	Section-Page
CDE75 CDE96	Cable Demarcation Enclosure (Gray) single port includes grommet and hardware	15-2	DE-1500 DE-1600 DE-1601	Telegrip	20-12
CE-5105 CE-5106 CE-5259	Clevis Eye	5-15	DE-2505 DE-2506	Dead-ends for Figure-8 Drop Wire Messenger	20-2
CE-5261	Clevis Eye	5-15, 19	DE-2518 DE-2519 DE-2520	Coaxial Dead-end	20-13
COYDAC03	COYOTE Aerial Fiber Drop Closure Kit	1-19	DE-2525	Dead-ends for Figure-8 Drop Wire Messenger	20-2
COYDEN21	COYOTE DEN Insulated Outdoor Equipment Enclosure	17-2	DE-3329	Coaxial Dead-end	20-13
COYOTE00058	COYOTE Closure Kit for OPGW. 6.0" x 22.0" (152 x 559mm) Includes closure with organizer/storage compartment (Cat. No. 8006560); OPGW Strain Relief Bracket Kit (Cat. No. 8003296); all required supplies; plus (1) 36-count tray (Cat. No. 80805514). Will accommodate up to (4) trays per closure (144 maximum splice capacity).	9-3	DE-8500 DE-8501	Dead-ends for Figure-8 Drop Wire Messenger	20-2
COYOTE00059	COYOTE Closure Kit for OPGW. 8.5" x 22.0" (216 x 559mm) Includes closure with organizer/storage compartment (Cat. No. 8006561); OPGW Strain Relief Bracket Kit (Cat. No. 8003296); all required supplies; plus (1) 36-count tray (Cat. No. 80805514). Will accommodate up to (8) trays per closure (288 maximum splice capacity).	9-3	ETS-2104 ETS-3101	Tangent Support	24-3
COYOTE00060	COYOTE Closure Kit for dielectric cables. 6.0" x 22.0" (152 x 559mm) Includes closure with organizer/storage compartment (Cat. No. 8006560); all required supplies plus (1) 36-count tray (Cat. No. 80805514). Will accommodate up to (4) trays per closure (144 maximum splice capacity).	9-3	FDC8	FIBERLIGN Drop Cable 8" Storage Single Bracket	7-13
COYOTE00061	COYOTE Closure Kit for dielectric cables. 8.5" x 22.0" (216 x 559mm) Includes closure with organizer/storage compartment (Cat. No. 8006561); all required supplies plus (1) 36-count tray (Cat. No. 80805514). Will accommodate up to (8) trays per closure (288 maximum splice capacity).	9-3	FDC8A	FIBERLIGN Drop Cable 8" Storage ADSS - Single Bracket	7-13
COYW617P001 COYW622P001	COYOTE® Dome Closure CRB System for OPGW Plastic	9-11, 12	FDC8M	FIBERLIGN Drop Cable 8" Storage Messenger - Single Bracket	7-13
COYW617S001 COYW622S001	COYOTE® Dome Closure CRB System for OPGW Stainless Steel	9-11, 12	FDC8P	FIBERLIGN Drop Cable 8" Storage Wood Pole - Single Bracket	7-13
CTVEG	Cable Demarcation Enclosure (Gray) Two Port includes grommet and hardware	15-2	FIS12A	FIS for ADSS Cables	7-12, 14
CTVEGD	Cable Demarcation Enclosure High Capacity (Gray) Two Port includes grommets and hardware	15-2	FIS12M	FIS for Lashed Messenger Cables	7-12, 14
CWDE-5507 CWDE-5508 CWDE-5509 CWDE-5510 CWDE-5511 CWDE-5512	Open Wire Dead-end	20-10	FIS16A	FIS for ADSS Cables	7-12, 14
			FIS16M	FIS for Lashed Messenger Cables	7-12, 14
			FISA10AB FISA12AB FISA16AB FISA18AB FISA20AB FISA24AB FISA30AB FISA12ABW FISA16ABW FISA18ABW FISA10MB FISA12MB FISA16MB FISA18MB FISA20MB FISA24MB FISA30MB FISA12MBW FISA16MBW FISA18MBW	FIBERLIGN In-Span Aluminum Storage (FISA)	7-14
			GDE-1102 GDE-1104 GDE-1106 GDE-1107 GDE-1108 GDE-2102 GDE-2104 GDE-2106 GDE-2107 GDE-2108	GUY-GRIP Dead-end	20-4
			GDE-2500	Open Wire Dead-end	20-10
			GDE-2501 GDE-2503	Dead-ends for Figure-8 Drop Wire Messenger/Open Wire Dead-end	20-2, 10



Index by Part Number

Catalog Number	Product Description	Section-Page	Catalog Number	Product Description	Section-Page
GFDE-2121	False Dead-end	20-9	LR-6105	Lashing Rods	25-2
GFDE-2123					
GFDE-2124					
GFDE-2125					
GFDE-2126					
GL-1104	GUY-LOCK	20-6	LR-6106		
GL-1106					
GL-1107					
GL-1108					
GL-1109					
GLS-2102	Strand Splice	22-3	LR-6107		
GLS-2104					
GLS-2106					
GLS-2107					
GLS-2108					
GLS-2109					
GLS-2115					
GLS-2117					
GLS-2118					
GLS-2119					
GLS-3101	Open Wire Splice	22-2	LR-6108		
GLS-3103					
GWM-7103	5' Length Ground Wire Molding	21-11	LR-6109		
GWM-7104					
GWM-7105					
GWM-7203					
GWM-7204					
GWM-7205					
GWM-7100	8' Length Ground Wire Molding	21-11	LR-6110		
GWM-7101					
GWM-7102					
GWM-7200					
GWM-7201					
GWM-7202					
JFC_			Jumper Cable Assemblies – 3 mm Jacketed	16-3	LR-6111
JLC_					
JSCA_					
JSCU_					
JST_					
LCE-66-14	Extension Link w/ Cotter Pin	5-9	LR-6112		
LGSBR3-5	LITE-GRIP Splice Block for Ribbon	16-3	LR-6113		
LGSBS8-5	LITE-GRIP Splice Block for Fusion	9-8; 16-3	LR-6114		
LGSTS16	16/40 Ct. Tray w/LITE-GRIP Splice Blocks	9-6, 8	LSR-2122	Reducing Splice	22-4
LGSTS40	40/80 Ct. Tray with LITE-GRIP Splice Blocks	9-5, 8	LSR-2123		
LGSTR144	144/80 Ct. Tray with Ribbon Splices	9-6, 8	LSR-2124		
LGSTR216	216/80 Ct. Tray with Ribbon Splices	9-5	LSR-2125		
			NDE-8500	Buried Line Wire Dead-end	20-11
			NDE-8501		
			NDE-8502	C-Rural Dead-end	20-11
			NDE-8503		
			NDE-9500	Drop Wire Dead-end	20-11
			NDE-9501		
			NDE-9502	C-Rural Dead-end	20-11
			P12FC_	Pigtail Cable Assemblies - Bundled 900 Micron Fibers in Yellow Sleeve	16-3
			P12LC_		
			P12SCA_		
			P12SCU_		
			P12ST_		
			P6FC_		
			P6LC_		
			P6SCA_		
			P6SCU_		
			P6ST_		
			P140SC	Mounting Clip	15-2
			P140CA	3/4" Conduit Adapter	15-2
			P140CA1	1" Conduit Adapter	15-2
			PE-0300	Pulling Eye	20-13
			PE-A-0002	Pulling Eye: Keeper	20-13
			PE-B-2019	Pulling Eye: Bolt	20-13
			PE-C-0607	Pulling Eye: Nut	20-13
			PG-5405	Guy Markers - Classic	21-7
			PG-5411	Guy Markers - Economy	21-8
			PG-5414		
			PG-5423	Guy Markers - Classic	21-7
			PG-5462		
			PG-5518		
			PG-5708		
			PG-5708P		
			PG-5718		
			PG-5718P		
			PG-5738		
			PG-5750	Universal Markers - Two Piece Spiral Round	21-6
			PG-5752		
			PG-6000	Guy Markers - Wrap-Around	21-9

Index by Part Number

Catalog Number	Product Description	Section-Page	Catalog Number	Product Description	Section-Page
PG-6500 PG-6600	Guy Markers - Classic	21-7	RDC12_	Rack Mount Cabinet up to 144 Fiber Connections and Splices	16-2
PG-8000	Guy Markers - Wrap-Around	21-9	RDC12X_	Rack Mount Cabinet up to 144 Fiber Connections and Splices	16-2
PG-5708P PG-5718P	Guy Markers - Classic	21-7	RDC12_	Rack Mount Cabinet up to 144 Fiber Connections and Splices	16-2
PG-6000PIN	Guy Markers - Wrap-Around	21-9	RDC2_	Rack Mount Cabinet up to 12 Fiber Connections and Splices	16-2
PG-6500PIN PG-6600PIN	Guy Markers - Classic	21-7	RDC24_	Rack Mount Cabinet up to 288 Fiber Connections and splices	16-2
PG-6000SC	Guy Markers - Wrap-Around	21-9	RDC3_	Rack Mount Cabinet up to 36 Fiber Connections and Splices	16-2
PG-6500SC PG-6600SC	Guy Markers - Classic	21-7	RDC6_	Rack Mount Cabinet up to 72 Fiber Connections and Splices	16-2
PG-8000SC	Guy Markers - Wrap-Around	21-9	RPG-5618 RPGMS10469 RPGMS12030	Guy Markers – Classic	21-7
PG-6000TIE	Guy Markers - Wrap-Around	21-9	SDE-5101	GUY-GRIP Dead-end	20-5
PG-6500TIE PG-6600TIE	Guy Markers - Classic	21-7	SDE-5102		
PG-8000TIE	Guy Markers - Wrap-Around	21-9	SDE-5103		
PGMS3830	Guy Markers - Economy	21-8	SDE-5104		
PGMS3921 PGMS4072	Guy Markers - Classic	21-7	SDE-5105		
PGMS4988	Guy Markers - Economy	21-8	SDE-5106		
PGMS7578	Guy Markers - Classic	21-7	SDE-6101		
PGMS9838	Guy Markers - Economy	21-8	SDE-6102		
PM-6114 PM-6115 PM-6116 PM-6117 PM-6118	Pedestal Marker	21-10	SDE-6103		
PSU-0106 PSU-0107 PSU-0108 PSU-0109	Communications Spacer	24-2	SDE-6105		
PTG-0104 PTG-0107 PTG-0113 PTG-0116 PTG-0118 PTG-0121 PTG-0122 PTG-0125 PTG-0128 PTG-0130 PTG-0137 PTG-0139 PTG-0140 PTG-0142 PTG-0143 PTG-0146 PTG-0149 PTG-0152 PTG-0154 PTG-0155	Tree Guard	21-3	SDE-6504		
PTG-0200 PTG-0201 PTG-0202 PTG-0203 PTG-0204 PTG-0205	FIBERLIGN ADSS Cable Abrasion Protector/Tree Guard	7-3; 21-3	SFD-0445	SWAN-FLIGHT Diverter	21-14
PTG-0206 PTG-0207 PTG-0208	Tree Guard	21-3	SFD-0635		
			SFD-0890		
			SFD-1140		
			SFD-1520		
			SFD-1960		
			SFD-2220		
			SFD-2460		
			SFD-2700		
			SFD-3035		
			SGD-0700 SGD-0701	Safety Guy-Wire Dispenser – Standard Size	20-14
			TC-5F	Thimble Clevis	6-6, 7, 8
			TC-6F	Thimble Clevis	5-7; 6-6, 8
			TS-2100 TS-2103 TS-3100	Tangent Support	24-3
			WDC2_	Wall Mount Cabinet up to 24 Fiber Connections and Splices	16-2
			WDC4_	Wall Mount Cabinet up to 48 Fiber Connections and Splices	16-2
			WDC8_	Wall Mount Cabinet up to 96 Fiber Connections and Splices	16-2
			WDC12_	Wall Mount Cabinet up to 144 Fiber Connections and Splices	16-2
			YC-5206 YC-5209 YC-5211	Y-Clevis Eye	5-15
			YC-5207	Y-Clevis Eye	5-15, 19
			YP-5908 YP-5909 YP-5910 YP-5911 YP-5912 YP-5913	Yoke Plate	5-16, 19



Standard Terms and Conditions of Sale

Effective December 1, 2016

1. APPLICABILITY OF TERMS AND CONDITIONS. These Terms and Conditions will govern all sales by Preformed Line Products Company ("PLP") of Goods ("Goods"), unless otherwise agreed to in writing, signed by PLP by an authorized agent in Cleveland, Ohio. Terms and conditions contained in Buyer's purchase order or any other documents that are different than or in addition to these Terms and Conditions are objected to and will not be binding on PLP. Buyer will be deemed to have agreed to these Terms and Conditions by Buyer's issuing a purchase order number, PLP's receipt of a written acknowledgement of Buyer's placement of an order, or PLP's commencement of performance. Buyer's acceptance of these Terms and Conditions will be deemed to have occurred on the date such performance commences. PLP reserves the right to change these Terms and Conditions, or issue new terms, at any time, and all subsequent orders shall be bound thereof. If for any reason PLP's Quotation is deemed an acceptance of an offer made by Buyer, such acceptance is expressly conditioned on Buyer's assent to these Terms and Conditions, which assent will be evidenced by the earlier of Buyer's acceptance of Goods delivered by PLP or any other performance by Buyer. PLP will sell Goods only if Buyer assents to these Terms and Conditions.

2. QUOTATIONS, ORDERS AND PRICES. All prices and specifications contained on the face of PLP's Quotation are subject to change without notice, unless indicated otherwise on the face of the Quotation. All quotations on PLP's standard catalog items are made subject to prior sale of such Goods. The minimum billing charge on any order is \$500.00 plus freight, handling and delivery charges. Any additions to orders already placed by Buyer will be considered as new orders.

3. BROKEN PACKAGE CHARGE. A \$25.00 broken package charge will be applicable to all Goods ordered in quantities other than standard carton increments as published in PLP's catalogs.

4. TAXES. PLP's prices do not include any Federal, state or local taxes or fees or any custom, export, import, wharfage or associated dues or duties, and any such taxes or fees now in effect or hereafter levied will be in addition to such prices and will be paid by the Buyer. Buyer agrees to defend, indemnify and hold PLP harmless from and against any and all such taxes and fees, including, without limitation, any cost, expense, attorneys' fees, interest or penalties assessed against or incurred by PLP as a result of Buyer's failure to pay any such taxes or fees.

5. SHIPMENTS, FREIGHT AND DELIVERY. *FORMED WIRE PRODUCTS AND OTHER NON-CLOSURE ITEMS AND ACCESSORIES:* PLP will pay freight via cheapest way to any domestic common carrier points, excluding Alaska, Hawaii and Puerto Rico, on orders or releases of net invoice value of \$3,500 or more, specified for shipment to one location at one time. Only the value of the Formed Wire Products and other non-closure items and accessories applies towards the \$3,500 minimum value for prepaid freight. On all other orders or releases, Buyer is responsible for freight, handling and delivery charges. *SPLICE CASES, CLOSURES AND ACCESSORIES:* PLP does not pay freight, handling and delivery charges. *SOLAR PRODUCTS:* PLP does not pay freight, handling and delivery charges.

ALL PRODUCTS: Buyer will pay any special packaging, shipping and transportation charges resulting from compliance with its request for use of a method of transportation other than the method that PLP designates. PLP's placement of the purchased Goods at the point of shipment in the possession of a trucking company, railroad company or other common carrier or on Buyer's vehicle will constitute delivery to Buyer, and thereafter Buyer will bear all expenses and risk of loss. Product quantity shipped may be +/- 5%.

6. SHIPPING ESTIMATES. Shipping estimates made to Buyer will date from PLP's receipt of Buyer's complete written instructions. Shipping date of Goods requiring Buyer's inspection before shipment will be extended by the time consumed by any such inspection.

7. TERMS. Net thirty (30) days from date of PLP's invoice. A service charge of one and one-half percent (1.5%) per month will be added to all past due invoices, not to exceed the maximum permitted by law.

8. FINANCIAL RESPONSIBILITY. Notwithstanding anything herein to the contrary, Buyer's financial responsibility is at all times subject to approval of PLP's Credit Department, and PLP at any time may require payment in advance or satisfactory security or guarantee that invoices will be paid promptly when due. If Buyer fails to comply with any terms of payment, PLP may withhold any further deliveries or terminate this Agreement and may declare any unpaid amount to be due and owing immediately.

9. ACCEPTANCE. Buyer shall notify PLP, in writing, of any defect, error or shortage in any Goods it received, within thirty (30) days of delivery, and such written notice must state the applicable PLP Order Number and must be accompanied by any documents that substantiate the alleged defect, error or shortage. If Buyer fails to provide PLP with such written notice, documents and the applicable PLP Order Number, within the required time, Buyer will be deemed to have waived the defect, error or shortage and to have accepted the Goods delivered.

10. BUYER'S AGREEMENT TO DEFEND. If PLP manufactures or sells any Goods to meet Buyer's instructions, specifications or any other requirements, and such Goods are not included among PLP's standard catalog items offered by it to the trade generally in the usual course of its business, Buyer agrees to defend, indemnify and hold PLP harmless from and against any and all loss, cost, damage, liability or expense (including, without limitation, any penalties or punitive damages, attorneys' fees and expenses and costs of suit) arising out of the manufacture, sale or use of such Goods, including, without limitation, claims for actual or alleged infringements of any United States or foreign patent or copyright, or any actual or alleged unfair competition resulting from similarity in design, trademark or appearance.

PLP shall supply Buyer with catalogs, specifications, instructions and recommended installation procedures pertaining to the Goods; however, Buyer alone shall be responsible for the proper training, instruction and supervision of its contractors, employees, agents or purchasers with respect to the safe and correct use and application of such Goods. If Buyer uses any Goods from PLP not in accordance with PLP's catalogs, specifications, instructions or recommended installation procedures, Buyer agrees to defend, indemnify and hold PLP harmless from and against any and all loss, cost, damage, liability or expense (including, without limitation, costs of suit and attorneys' fees and expenses) arising out of or relating to or resulting in any way from such use by Buyer.

11. NOTICE OF ACCIDENT OR MALFUNCTION. Buyer will notify PLP in writing, no later than thirty (30) days from any accident or malfunction involving the Goods that result in personal injury or damage to property, and will cooperate fully with PLP in investigating and determining the cause of such accident or malfunction. If Buyer fails to give such written notice or fails to so cooperate, Buyer agrees to defend, indemnify and hold PLP harmless from and against any and all loss, cost, damage, liability or expense (including, without limitation, costs of suit and attorneys' fees and expenses) arising out of or relating to or resulting in any way from such accident or malfunction.

12. TOLERANCES AND VARIATIONS. Except as specified by Buyer and agreed to in writing by PLP, the Goods will be produced in accordance with PLP's standard practices. All Goods, however, including those produced to meet an exact specification, will be subject to tolerances and variations consistent with good manufacturing practices in regard to dimension, weight, section, composition, mechanical and electrical properties; to normal variations in surface and internal conditions and in quality; and to deviations from tolerances and variations consistent with practical testing and inspection methods. PLP has no obligation to evaluate adjacent building or equipment geometry that may affect the wind dynamics and pressures exerted on the solar array.

13. WARRANTY AND DISCLAIMERS OF WARRANTY. PLP warrants to Buyer that the Goods supplied hereunder will be free from defects in material and workmanship under normal and proper usage for a period of 1 year from the date of shipment by PLP (*SOLAR PRODUCTS term is 10 years*). The foregoing warranty will not cover and PLP makes no warranties with respect to (i) any Goods subjected to abuse, misuse, misapplication, neglect, alteration or accident; to improper and incorrect installation or maintenance; or to abnormal conditions of use, temperature, moisture, dirt or corrosive matter; and (ii) any materials, parts, goods or other components that are manufactured by an entity other than PLP.

Standard Terms and Conditions of Sale

THE FOREGOING WARRANTY IS EXCLUSIVE AND IN LIEU OF ALL OTHER WARRANTIES, WHETHER EXPRESS, IMPLIED OR OTHERWISE ARISING BY OPERATION OF LAW, TRADE, USAGE OR COURSE OF DEALING, INCLUDING, WITHOUT LIMITATION, THE IMPLIED WARRANTIES OF MERCHANTABILITY AND FITNESS FOR A PARTICULAR PURPOSE.

Buyer agrees to provide PLP with written notice of any breach of the above warranty within thirty (30) days after Buyer discovers, or should have discovered, the alleged breach. Time is of the essence herein, and Buyer's failure to provide written notice to PLP within the required time of any alleged breach of the foregoing warranty will release and discharge PLP from any obligation or liability for that breach of warranty. The foregoing warranty extends only to Buyer and to no other person or entity. Buyer agrees to give PLP full access to all Buyer's relevant records and data. PLP's obligation to perform may be delayed, at PLP's sole option, until PLP has been paid in full for all goods purchased by the Buyer.

14. REMEDIES AND LIMITATIONS ON REMEDIES. In the event of any material breach of the above warranty, PLP will, at its sole option, credit Buyer's account or repair any defective Goods or furnish a replacement part or Goods, all subject to Buyer providing written notice of the alleged breach within the time required.

THE REMEDIES SET FORTH HEREIN SHALL BE THE SOLE AND EXCLUSIVE REMEDIES AVAILABLE TO BUYER SO THAT PLP'S CREDIT OF BUYER'S ACCOUNT OR REPAIR OR REPLACEMENT IS A FULFILLMENT OF ALL PLP'S OBLIGATIONS. PLP SHALL NOT BE LIABLE FOR ANY CONSEQUENTIAL OR INCIDENTAL DAMAGES OF ANY KIND, NOR UNDER ANY CIRCUMSTANCE SHALL PLP BE LIABLE FOR DAMAGES BEYOND THE PRICE OF THE GOODS PURCHASED BY BUYER, WHETHER IN CONTRACT, IN TORT OR UNDER ANY WARRANTY OR OTHER USE, AND WHETHER OR NOT SAID LOSS, COST, PENALTY OR DAMAGE WAS REASONABLY FORESEEABLE.

If PLP requests, the Goods alleged to be defective will be returned to PLP, at its direction and expense, for examination. No Goods are to be returned to PLP without its prior written authorization. If PLP discovers that any Goods so returned are not covered by the foregoing warranty, PLP reserves the right to charge Buyer for all transportation costs and expenses incurred by PLP in examining, processing or handling such Goods. Any controversy or claim arising out of or relating to this contract or the breach hereof, must be commenced within two (2) years after the cause of action has accrued.

15. DEFAULT OR DELAY. PLP will not be liable for any default or delay in the production or delivery of any Goods when such default or delay results either directly or indirectly from: (a) accidents to, or breakdowns or mechanical failure of, PLP's plant machinery or equipment; strikes or other labor troubles or labor shortages; fire; flood; wars; acts of the public enemy; acts of God; delays by any supplier; delays in transportation or lack of transportation facilities; embargoes; shortages of, or reductions in, energy sources; priorities, allocations, limitations, restrictions or other acts required or requested by Federal, state or local governments, or any subdivision, bureau or agency thereof; or (b) any other cause beyond PLP's control.

16. CANCELLATION. Buyer cannot cancel orders for delays in delivery or other cause until PLP has received written notification of such intention. In any event, Buyer shall be obligated to accept and pay for any Goods previously shipped and to pay cancellation charges based on expenses incurred or commitments made by PLP for any Goods which are in the process of manufacture for Buyer. PLP reserves the right to apply a minimum cancellation charge of the greater of \$50.00 or 25% of the purchase price of the unshipped portion of the order, on any orders for standard stock items Buyer cancels.

17. RETURNS. No Goods may be returned without first having secured prior written authorization from PLP's Cleveland, Ohio office. Only non-obsolete standard stock items in original cartons may be returned, freight prepaid. Return requests must be initiated within one year from date of original shipment. Such requests follow the same channels as order placement. Returns will be subject to factory inspection for resalability and for quantity before credit, which will be applicable to replacement or future purchases by Buyer, is issued. PLP reserves the right to apply a minimum restocking charge of the greater of \$100.00 or 30% of the purchase price of the returned materials, plus original freight charges to all returns.

18. NOTICES. Any notice to PLP required or permitted hereunder will be deemed to have been effectively delivered if in writing and served by personal delivery to PLP or sent by registered or certified mail with return receipt requested (or such form of mail as may be substituted therefor by postal authorities), postage prepaid, to PLP at the address specified on the front page hereof and marked ATTN: Marketing Administration.

19. CONFIDENTIALITY. Buyer agrees that all information furnished by or obtained from PLP in connection with the sale of Goods hereunder will be confidential, and Buyer agrees not to (i) disclose any such information to any other person, or (ii) use such information for any purpose, other than performing this contract.

20. SECURITY INTEREST. PLP retains a security interest in all Goods and all proceeds and products thereof until all amounts due or to become due hereunder have been paid. Any repossession and removal of Products shall be without prejudice to any of PLP's other remedies at law or in equity. Buyer agrees, without further consideration, at any time to do or cause to be done, executed and delivered, all such further acts and instruments as PLP may reasonably request in order to perfect PLP's security interest.

21. INTELLECTUAL PROPERTY. PLP shall own all intellectual property embodied in the Goods, and Buyer shall assist PLP, at no cost, with filing any documentation necessary to demonstrate PLP's ownership. PLP shall defend Buyer against any claim of infringement and shall pay any resulting damages finally awarded, provided that (a) Buyer promptly notifies PLP in writing of any claim, and (b) PLP has sole control of the defense and all related settlement negotiations. This obligation does not apply to claims arising out of combinations of Goods with goods provided by others, or to claims resulting from compliance of the goods with Buyer's design or specifications, or which Buyer assumes and shall hold PLP harmless for any claims thereof.

22. MISCELLANEOUS. The failure of either party to insist upon performance of any term or condition herein or to exercise any right or privilege shall not thereafter waive the future performance of such term, condition, right or privilege or of any other terms, conditions, rights or privileges, whether of the same or similar type. The rights herein and the construction of these Terms and Conditions shall be governed by the laws of the State of Ohio, without giving effect to principles of conflict of laws. These Terms and Conditions shall be binding upon and inure to the benefit of the parties hereto and their respective successors and assigns. Each provision hereof shall be severable, and in the event any provision hereof is held to be contrary to law, invalid or unenforceable, the remaining provisions shall not be affected thereby, but shall remain in full force and effect. The paragraph headings herein are solely for the convenience of and reference by the parties and do not constitute any part of these Terms and Conditions. Buyer may not assign its rights or delegate its obligations hereunder without PLP's prior written consent.

23. The Buyer and any of its subcontracts shall abide by the requirements of 41 CFR §§ 60-1.4(a), 60-300.5(a) and 60-741.5(a). These regulations prohibit discrimination against qualified individuals based on their status as protected veterans or individuals with disabilities, and prohibit discrimination against all individuals based on their race, color, religion, sex or national origin. Moreover, these regulations require that covered entities take affirmative action to employ and advance in employment individuals without regard to race, color, religion, sex, national origin, protected veteran status or disability.

24. ETHICAL BEHAVIOR. Buyer, its employees, officers, agents, representatives and Subcontractors ("Agents") shall at all times maintain the highest ethical standards and avoid conflicts of interest in its performance hereunder. In conjunction with its performance hereunder, Buyer and its Agents shall comply with all applicable laws, statutes, regulations and other requirements, including, but not limited to, those prohibiting bribery, corruption, kick-backs or similar unethical practices such as, without limitation, the United States Foreign Corrupt Practices Act and PLP's Code of Conduct available on its website. Buyer shall indemnify and hold PLP harmless from all fines, penalties, expenses or other losses sustained by PLP as a result of Buyer's breach hereof.





PREFORMED
LINE PRODUCTS

World Headquarters
660 Beta Drive
Cleveland, Ohio 44143

Mailing Address:
P.O. Box 91129
Cleveland, Ohio 44101

Telephone: 440.461.5200
Fax: 440.442.8816
Web Site: www.preformed.com
E-mail: inquiries@preformed.com

© 2017 Preformed Line Products
All rights reserved.
May not be duplicated without prior permission.
Printed in the U.S.A.
CO-CA-1001-8
06-17-1.5 M