

Section 13

Axles and Hardware 29-38

Hubs & Hub Caps.....16,26-28

Rims 12-13

Spokes14-15

Tires

 Avon 5-7

 Bridgestone 7

 Dunlop 2-4

 Kenda 9

 Metzeler 7-8

 Pirelli.....9

 Shinko 9

Tubes 10

Wheels19-25

 Wheel Weights11

 Wide Tire Kits26

Speed Rating													
	J	L	M	P	Q	R	S	T	H	V/VB	(V)/(VB)	W	(W)
MPH	62	74	81	93	100	106	112	118	130	149	149+	168	168+
KM/H	100	120	130	150	160	170	180	190	210	240	240+	270	270+

Load Rating- Maximum load capacity in pounds at the pressure (psi) indicated on the tire.													
Rating	Lbs.	Rating	Lbs.	Rating	Lbs.	Rating	Lbs.	Rating	Lbs.	Rating	Lbs.	Rating	Lbs.
47	386	53	454	59	536	65	639	71	761	77	908	83	1074
48	397	54	467	60	551	66	661	72	783	78	937	84	1102
49	408	55	481	61	567	67	677	73	805	79	963	85	1135
50	414	56	494	62	584	68	694	74	827	80	992	86	1168
51	430	57	507	63	600	69	716	75	853	81	1019	87	1202
52	441	58	520	64	617	70	739	76	882	82	1047		

SAFETY WARNING: MAINTAIN RECOMMENDED TIRE PRESSURE AND FOLLOW OWNERS MANUAL

All tires should be mounted only by trained personnel. Consult tire manufacturer's publication(s) for information on tire care, safety, maintenance, mounting, manufacturer's warranty and other information found in the manufacturer's brochure(s) and on manufacturer's website(s).

Failure to follow manufacturer's recommendations and requirements can cause tire failure resulting in serious injury or death.

Make sure to select a tire that meets the load and speed requirements for the application it is intended for.

Tires

Dunlop D402 (HD Logo)

They're fitted as Original Equipment to 2000 and later Harley-Davidson® motorcycles, and are approved for use on many models as far back as 1980. Both front and rear sizes feature new computer optimized tread patterns which provide dramatic improvements in wet-road performance. They feature three-ply polyester carcasses that are reinforced with two fiberglass belts. Tube/tubeless construction.

Front		
PCP	Size	Load/Speed
97935	MT90B16 BLK	72H
97936	MT90B16 SWS	72H
97900	MT90B16 WWW	72H
97939	MH90-21 BLK	54H
Rear		
97943	MU85B16 WWW	77H
97941	MU85B16 BLK	77H
97942	MU85B16 SWS	77H
97937	MT90B16 BLK	74H
97938	MT90B16 SWS	74H
97905	MT90B16 WWW	74H
H rated for speeds up to 210 KPH (130 MPH)		



Dunlop D401 Tire with HD Logo

Cruising tire with an advanced tread pattern and compound for improved wet and dry road grip. They are fitted to 1991 and later Harley-Davidson® models. The front tread pattern is specifically designed for even wear and extended mileage. The rear tires feature three nylon plies and two fiberglass belts. Tube/tubeless construction.

Front		
PCP	Size	Load/Speed
97956	100/90-19 BLK	57H
Rear		
97957	130/90B16 BLK	73H
97958	150/80B16 BLK	71H
97903**	150/80B16 MWB	71H
97904*	160/70B17 BLK	73H
H rated for speeds up to 210 KPH (130 MPH) V rated for speeds up to 240 KPH (149 MPH) *OE on H-D Switchback ** OE on H-D 72		



Dunlop American Elite Touring/Cruiser Tires

- H-D replacement tire designed, tested and made in America
- Multi-Tread (MT) rear tire built with long wearing compound in center of tread and lateral-grip compound in each shoulder to maximize cornering performance
- Tread design provides even tread wear and quiet operation in all conditions, both wet and dry
- H-Rated for speeds up to 210 km/h (130 mph) or V-rated for speeds up to 240 km/h (149 mph)

Front			
PCP	Size	Load/Speed	TL/TT
97981	MT90B16 BLK	72H	TL
97982	130/90B16 WWW	67H	TL
97977	130/80B17 BLK	65H	TL
97979	140/75R17 BLK	67V	TL
97985	130/70B18 BLK	65H	TL
97968	100/90-19 BLK	57H	TL
97986	MH90-21 BLK	54H	T/L

Rear			
PCP	Size	Load/Speed	TL/TT
97987	MT90B16 BLK	74H	TL
97995	MT90B16 NWS	74H	TL
97996	MT90B16 WWW	74H	TL
97993	MU85B16 BLK	77H	TL
97998	MU85B16 WWW	77H	TL
97994	150/80B16 BLK	77H	TL
97978	180/65B16 BLK	81H	TL
97991	180/65B16 WWW	81H	T/L
97980	200/55R17 BLK	78V	T/L

SAFETY WARNING: MAINTAIN RECOMMENDED TIRE PRESSURE AND FOLLOW OWNERS MANUAL

All tires should be mounted only by trained personnel. Consult tire manufacturer's publication(s) for information on tire care, safety, maintenance, mounting, manufacturer's warranty and other information found in the manufacturer's brochure(s) and on manufacturer's website(s).

Failure to follow manufacturer's recommendations and requirements can cause tire failure resulting in serious injury or death.

Make sure to select a tire that meets the load and speed requirements for the application it is intended for.

Dunlop D404

Tread compound delivers excellent balance of mileage and grip, delivering outstanding water evacuation. Off centre groove gives excellent straight line stability. Bias-ply construction is designed to deliver a smooth ride with excellent load-carrying capacity.

Front		
PCP	Size	Load/Speed
97959	100/90-19 BLK	57H
97960	110/90-19 BLK	62H
97961	80/90-21 BLK	48H
Rear		
97962	130/90-16 BLK	67H
97963	140/90-16 BLK	71H
97964	150/80-16 BLK	71H

H rated for speeds up to 210 KPH (130 MPH)



Dunlop K591 V-Rated

The latest technology to meet the demands of today's riders. The matching front and rear directional tread patterns offer better wet grip, cornering and traction for optimum performance, wet or dry. Available in blackwall only with tube/tubeless construction.

Front		
PCP	Size	Load/Speed
97933	100/90-19 BLK	51V
Rear		
97940	130/90B16 BLK	64V
97932	150/80B16 BLK	71V
97934	160/70B17 BLK	73V

V rated for speeds up to 240 KPH (149 MPH)



Dunlop Sportmax Q2

New profile tire puts down a bigger footprint at extreme lean angle, higher corner speeds with better grip and handling. Intuitive Response Profile (IRP) technology rear tires provides rider linear steering at all lean angles. Multi-tread technology with a durable center compound and lateral grip compound for better cornering. Jointless band construction utilizes a continuously wound aramid belt to reduce distortion.

Front		
PCP	Size	Load/Speed
97911	120/70ZR-17	58W
Rear		
97912	170/60ZR-17	72W
97914	190/50ZR-17	73W
97915	200/50ZR-17	75W

W rated for speeds of 270+ KPH (168+ MPH)



Dunlop Roadsmart

Multi-tread technology with a durable center compound and lateral grip compound for better cornering and even wear. Remarkable wet weather performance, handling and mileage. Micro size carbon particles offer dry grip under acceleration. Qualifier like profile for better cornering and deep, long lateral grooves for greater water evacuation. Blackwall tires.

Front		
PCP	Size	Load/Speed
97906	120/70ZR-17 BLK	58W
Rear		
97907	170/60ZR-17 BLK	72W
97908	180/55ZR-17 BLK	73W
97909	190/50ZR-17 BLK	73W

W rated for speeds of 270+ KPH (168+ MPH)



Dunlop Qualifier

Ultra high performance port radial tire brings racing technology to the street. Race profile offers quick handling, better grip and footprint when leaned over.

Front		
PCP	Size	Load/Speed
97916	120/70ZR-17	58W
Rear		
97918	190/50ZR-17	73W

W rated for speeds up to 270 KPH (168 MPH)



SAFETY WARNING: MAINTAIN RECOMMENDED TIRE PRESSURE AND FOLLOW OWNERS MANUAL

All tires should be mounted only by trained personnel. Consult tire manufacturer's publication(s) for information on tire care, safety, maintenance, mounting, manufacturer's warranty and other information found in the manufacturer's brochure(s) and on manufacturer's website(s).

Failure to follow manufacturer's recommendations and requirements can cause tire failure resulting in serious injury or death.

Make sure to select a tire that meets the load and speed requirements for the application it is intended for.

Tires



Dunlop Elite III TL or TT (All Blackwall)

Next generation long-distance tire with improved performance and longer wear. E3 tread design provides even wear and quiet operation in wet and dry conditions.

Front		
PCP	Size	Load/Speed
97966	MB90B-16 bias-ply	72H
97973	120/70R-19 radial D208 OE for V-ROD	60W
97975	90/90-21 bias-ply	54H
Rear		
97971	MV85B-15 bias-ply	77H
97969	MT90B-16 bias-ply	74H
97970	MU90B-16 bias-ply	78H
97967	200/50R-18 radial	76H
97976	240/40R-18 radial	79V
97972	250/40R-18 radial	81V
H rated for speeds up to 210 KPH (130 MPH) V rated for speeds up to 240 KPH (149 MPH)		

Dunlop F11 Qualifiers

The F11 features a semi-ribbed tread pattern which does an excellent job of channelling water in wet weather riding. The F11 front should be used with the K627 rear for a top-performing street combination. All tires are tube/tubeless construction with raised white letters.

Front
6921 110/90H (3.75) x 19"



Dunlop GT 501 Sport Bias Tires

GT 501 Sport tires feature bias-ply construction and radial tyle tread pattern for a larger footprint and contemporary styling. An optimized profile creates a larger contact patch for increased cornering confidence, with smooth side-to-side transitions. Higher tread-to-void ratio delivers superior grip in dry conditions, with no loss of grip in wet weather. Increased centre tread depth provides improved wear characteristics and enhanced water clearance. Improved rear compound increases wear resistance for longer tread life.

Front		
PCP	Size	Load/Speed
Rear		
97948	140/90-16 BLK	71V
97949	150/80B16 BLK	71V
V rated for speeds of 240 KPH (149 MPH)		



MOTORCYCLE STREET TIRE SIZE CONVERSION CHART

FRONT TIRES

METRIC	ALPHA	INCH
80/90	MH90	2.50/2.75
90/90	MJ90	2.75/3.00
100/90	MM90	3.25/3.50
110/90	MN90	3.75/4.00
120/80		4.25/4.50
120/90	MR90	4.25/4.50
130/90	MT90	5.00/5.10

REAR TIRES

METRIC	ALPHA	INCH
110/90	MP85	4.50/4.75
120/90	MR90	4.50/4.75
130/80		5.00/5.10
130/90	MT90	5.00/5.10
140/80		5.50/6.00
140/90	MU90	5.50/6.00
150/80	MV85	6.00/6.25
150/90	MV85	6.00/6.25

SAFETY WARNING:

MAINTAIN RECOMMENDED TIRE PRESSURE AND FOLLOW OWNERS MANUAL

All tires should be mounted only by trained personnel. Consult tire manufacturer's publication(s) for information on tire care, safety, maintenance, mounting, manufacturer's warranty and other information found in the manufacturer's brochure(s) and on manufacturer's website(s).

Failure to follow manufacturer's recommendations and requirements can cause tire failure resulting in serious injury or death.

Make sure to select a tire that meets the load and speed requirements for the application it is intended for.



Avon Roadrunner Universal Tube Type

Designed for use on front and rear wheels, Roadrunner Universal is H-rated to meet the performance demands of machines capable of speeds of up to 130 mph. The low-profile design of the Roadrunner gives a bike excellent stability through corners, and during rapid acceleration and braking. Avon's acclaimed high hysteresis tread compound ensures the best grip in all road and weather conditions. Generous grooves improve water drainage, helping to give Roadrunner Universal its reputation for superb wet road adhesion.

Front or Rear

97621 4.10H 19 Blackwall



Avon "Gangster" Roadrunners

This tire features a classic 2 3/4" wide whitewall. Manufactured with a 4-ply construction. A perfect tire for classics and restorations. The "Gangster" features state of the art dual rubber compound, blending performance and vintage styling. H-rated for speeds of up to 130 MPH (180 KLM/H)

Front and Rear

97645 510-16 (MT90x16) WWW



Avon "Safety Mileage" MK 11 Rear Tube Type

The MK 11 is a full height and profile tire for all Big Twins with 4 full ply construction for rear fitment. S-rated for speeds up to 113 MPH (180 KLM/H) and features continuous centre rib, flanked with interlocking studs, providing excellent traction, safe handling and a smooth ride. This tire is the perfect complement for the Speedmaster Ribbed front tire.

97615 500 S 16 B/W

97616 400 S 18 B/W



Avon Speedmaster Rib Front Tube Type

Positive steering and excellent lateral stability make the Speedmaster a good choice for front wheel fitment. The Speedmaster is S-rated for speeds up to 113 mph (180 kph). Continuous, siped and interrupted ribs in "cling tread rubber" tread compounded give the Speedmaster very good braking and handling characteristics, particularly wet.

The ideal complement is the SM Mk II rear. Tube-type tire

97600 3.25 S x 19" B/W

97605 3.50 S x 19" B/W

97610 3.00 S x 21" B/W

SAFETY WARNING:

MAINTAIN RECOMMENDED TIRE PRESSURE AND FOLLOW OWNERS MANUAL

All tires should be mounted only by trained personnel. Consult tire manufacturer's publication(s) for information on tire care, safety, maintenance, mounting, manufacturer's warranty and other information found in the manufacturer's brochure(s) and on manufacturer's website(s).

Failure to follow manufacturer's recommendations and requirements can cause tire failure resulting in serious injury or death.

Make sure to select a tire that meets the load and speed requirements for the application it is intended for.

Tires



VBD-Variable Belt Density

Avon's Venom cruising/high load touring tires feature the patented VBD construction to give you unparalleled mileage, constant handling, outstanding braking and phenomenal grip. With VBD, the Venom's ultra strong Aramid fiber plies are widely spaced on the shoulders and closely spaced around the centre section, giving the best performance at every lean angle.

Avon Venom AM41 & AM42

Unique sequential pattern produces an exceptionally quiet ride on Venom bias, bias-belted and radial tires. Cooler running, high mileage tire provides outstanding grip and features a multi-arc tread contour for light, neutral turn in and cornering stability. Venom tires feature a sidewall snake head logo.

Avon Venom AM41 Front T/L Bias Ply Blackwall

Front	Size	Load/Speed
97683	MT90B-16	74H Wide whitewall
97661	150/80-16	71H
97653	140/70B-18	67V
97651	120/90-18	71H

Avon Venom AM42 Rear T/L Bias Ply Blackwall

Rear	Size	Load/Speed
97688	MT90B-16	74H Narrow whitewall
97692	160/80B-16	81H (reinforced)
97668	150/70B-18	70V (reinforced)



Avon Cobra AV 71 & AV 72 Tires

- Offers grip, stability, optimal water dispersion, and great handling at all speeds
- Advanced Variable Belt Density (A-VBD) rear construction for stability, wear and great mileage
- Venom tires feature a sidewall snake head logo.

Avon Cobra AV71 Front T/L Bias Ply

Front	Size	Load/Speed
97681	MT90B-16	74H (reinforced)
97684	100/90-19	57H Black

Avon Cobra AV72 Rear T/L Bias Ply

Rear	Size	Load/Speed
97687	MT90B-16	74H Black (reinforced)
97689	MT90B-16	74H Wide whitewall (reinforced)
97690	140/90B-16	77H Black (reinforced)
97691	150/80B-16	77V Black (reinforced)
97695	180/65B-16	81H Black (reinforced)



Avon Tires ROADRIDER AM 26 T/L Tires

These tires feature an interrupted centre groove that resists tracking, a large contact patch and a special rubber compound designed to provide excellent grip. Tires feature bias-ply construction and are V-speed rated at 149mph/240kph.

Front	Size	Rating
97626	90/90-19	52V
97627	3.25-19	54V
97628	90/90-21	54V
Rear		
97629	MT90-16	74V
97630	150/80-16	71V

SAFETY WARNING: MAINTAIN RECOMMENDED TIRE PRESSURE AND FOLLOW OWNERS MANUAL

All tires should be mounted only by trained personnel. Consult tire manufacturer's publication(s) for information on tire care, safety, maintenance, mounting, manufacturer's warranty and other information found in the manufacturer's brochure(s) and on manufacturer's website(s).

Failure to follow manufacturer's recommendations and requirements can cause tire failure resulting in serious injury or death.

Make sure to select a tire that meets the load and speed requirements for the application it is intended for.



Avon Roadrunner Tires

Avon's Roadrunner tires are designed for both the cruising and touring rider. These are high-mileage, H-rated tires that run cooler, last longer under a heavy load and feature deep high-mileage tread grooves in the central pattern area where tires wear the fastest.

AM 20 Front Tires

- 97664** 130/90H x 16" Blackwall
- 97650** 90/90H (3.00) x 19" BW (fits under stock fender)

AM 21 Rear Tires

- 97665** 130/90H (5.10) x 16" Blackwall
- 97666** 230/60H x 15" Blackwall



Bridgestone Spitfire S11 Sport Touring Tires

Dual tread construction. Resilient centre rubber compound delivers sport-quality traction when cornering. Tubeless (with tube type rims tubes must be used).

Front

- 97806** 100/90H 19" Blackwall
- 97801** 130/90 16" Blackwall

Rear

- 97810** 130/90H 16" Blackwall
- 97821** 150/80B 16" Blackwall
- 97822** 150/80B 16" Raised white letters

97161



Metzeler ME55A 'Metronic' Rear Tire

Superior rear sport touring tire that is a perfect compliment to a ME 33 Laser front tire.

- 97160** 130/90 V16
- 97161** 150/80 VB16



97153

Metzeler ME99A 'Perfect' Rear Tire

Premium sport touring tire that combines perfectly with ME 33 Laser front tires.

- 97153** 150/80 VB16

SAFETY WARNING:

MAINTAIN RECOMMENDED TIRE PRESSURE AND FOLLOW OWNERS MANUAL

All tires should be mounted only by trained personnel. Consult tire manufacturer's publication(s) for information on tire care, safety, maintenance, mounting, manufacturer's warranty and other information found in the manufacturer's brochure(s) and on manufacturer's website(s).

Failure to follow manufacturer's recommendations and requirements can cause tire failure resulting in serious injury or death.

Make sure to select a tire that meets the load and speed requirements for the application it is intended for.

Metzler



Metzler ME 888 'Marathon' T/L Ultra Tires

- Ultra high mileage, performance and smooth handling
- Outstanding high and low speed stability
- H rated for speeds up to 210 KM/H (130 MPH)

Front	Size	Load/Speed
97165	MT90B-16	72H B/W
97139	MT90B-16	72H WWW
97170	130/90-16	67H B/W
97155	130/80B-17	65H B/W
97140	130/80B-17	65H WWW
97141	130/70B-18	63H B/W
97172	100/90-19	57H B/W
97142	MH90-21	54H B/W
97143	130/60-23	65H B/W

Rear

97180	130/90B-16	73H B/W (reinforced)
97147	130/90B-16	73H WWW (reinforced)
97188	MT90B-16	74H B/W
97152	MT90B-16	74H WWW (reinforced)
97197	MU85B-16	77H B/W
97148	140/90B-16	77H B/W (reinforced)
97149	140/90B-16	77H WWW (reinforced)
97182	150/80B-16	77H B/W (reinforced)
97164	150/80B-16	77H WWW
97156	180/65B-16	81H B/W (reinforced)

ME 880 Rim Selection Chart

Size	F/R	Rim	Range	Max. Width
130/90H16	F	3.00	2.50-3.50	142
150/80H16	F	3.50	3.00-4.00	161
100/90H19	F	2.50	2.15-2.75	108
110/90H19	F	2.50	2.15-3.00	116
80/90H21 TT	F	1.85	1.60-2.15	80
130/90HB16	R	3.00	2.50-3.50	137
140/90HB16	R	3.50	2.75-3.75	146
150/80HB16	R	3.50	3.00-4.00	153
160/80HR16	R	4.00	3.50-5.00	166
240/50VR16	R	7.50	7.00-8.00	243
240/40VR18	R	8.50	8.00-9.50	243

Metzler ME 880 'Marathon' T/L Tires

- High mileage for cruising and heavy touring bikes
- Exceptional stability at all speeds and heavy loads
- Front tires feature rounded tread for smooth neutral steering
- Rear tires have flatter tread profile for better traction and mileage
- Excellent handling under wet or hard braking conditions

Front	Size	Load/Speed
97175	150/80-16	71H WWW
97162*	130/80B-17	65H B/W
97158	140/70B-18	73H B/W
97176	90/90-21	54H B/W
97168	MH90-21	54H B/W
97177	120/70-21	62V B/W

*For 09-11 Touring models originally fitted with this size tire

Rear	Size	Load/Speed
97192	130/90B-16	73H WWW (reinforced)
97199	MU85B-16	77H NWS (reinforced)
97198	MU85B-16	77H WWW (reinforced)
97193	140/90B-16	77H WWW (reinforced)
97194	150/80B-16	71H WWW for 2008-* Indian M/C
97184	200/60R-16	84V B/W
97159	150/70B-18	76H B/W (reinforced)
97186	200/50R-18	76W B/W for 5.50" to 6.50" rim
97187	240/40R-18	79V B/W for 8.00" to 9.00" rim
97195	280/35R-18	84V B/W for 9.50" to 10.50" rim

*Do not use on Polaris Victory MC with 5" rim

SAFETY WARNING:

MAINTAIN RECOMMENDED TIRE PRESSURE AND FOLLOW OWNERS MANUAL

All tires should be mounted only by trained personnel. Consult tire manufacturer's publication(s) for information on tire care, safety, maintenance, mounting, manufacturer's warranty and other information found in the manufacturer's brochure(s) and on manufacturer's website(s).

Failure to follow manufacturer's recommendations and requirements can cause tire failure resulting in serious injury or death.

Make sure to select a tire that meets the load and speed requirements for the application it is intended for.



Shinko 712 & 200 High Value "H" Tire

Rated to carry full loads at speeds up to 130 mph for highway speeds. Large tread blocks resist irregular wear and provide excellent wet weather grip. Tubeless construction, four ply nylon construction with advanced dual crown radius profile offers larger footprint with smooth cornering transitions.

Front
PCP **Size**
97866 100/90 H 19 200



Shinko 230 Series "V" Tires

The 230 series is capable of carrying high loads for long distances in wet or dry weather. Features belted construction for great handling and ride comfort; the staggered tread works well in the rain and offers a quiet ride.

Front
PCP **Application**
97861 100/90 V 19

Pirelli MT66 "Route" Tires (Tubeless)

Great cruising tire provides high mileage without compromising comfort and grip in any weather condition. Features 4-ply nylon construction with deep tread depth. **H-rated tire has raised black lettering** with an aggressive tread design. This is a conventional tire that is tailored for your chopper or cruiser bike.

Rear		
97885	140/90-16	71HTT
H rated for speeds up to 210 KPH (130 MPH)		



Kenda K-657 Challenger Series

Street tires are 'H' rated for good load capacity, high mileage, and excellent rain dispersion at a low price.

Front
97850 130/90 H16
97851 100/90 H19 TL
97854 90/100-21 TL

Rear
97852 130/90 H16 TL
97853 140/90 H16 TL

SAFETY WARNING: MAINTAIN RECOMMENDED TIRE PRESSURE AND FOLLOW OWNERS MANUAL

All tires should be mounted only by trained personnel. Consult tire manufacturer's publication(s) for information on tire care, safety, maintainance, mounting, manufacturer's warranty and other information found in the manufacturer's brochure(s) and on manufacturer's website(s).

Failure to follow manufacturer's recommendations and requirements can cause tire failure resulting in serious injury or death.

Make sure to select a tire that meets the load and speed requirements for the application it is intended for.

Inner Tubes

3491



3492



3490



3496



Metzeler 'Rubber' Tube

Multi-fit, heavy-duty, natural rubber tube resists punctures better than butyl. (TR-4 90 degree steel stems)

97001 130/90-16 to 160/80-16, 15" or 16"



97000



TR-15 VALVE
STEM



TR-6 VALVE
STEM

3519



3525



3505



3507



Heavy Duty Tubes

Inner tubes are available for all types and sizes of tires. Made of butyl rubber for good air retention, carefully molded for uniformity and precision quality to provide for the finest service, long wear.

Inner Tubes -NEW SIZES

Available in side (SV) or center valve (CV).

PCP	Size	Item	Stem	Type	Valve
3491	16"	5.10-16	Rubber	SV	TR15
3492	16"	5.10-16	Metal	SV	TR6
3490	16"	5.10-16	Metal	CV	TR4
97008	16"	140/160/80	Metal	CV	
97000	16"	180/65	Metal	CV	
97005	16"	180-200mm	Metal	CV	
97013	16"	200/60	Metal	CV	
97018	17"	120/130/90	Metal	CV	
97007	17"	130/80	Metal	CV	
97009	17"	160/70 & 180/60	Metal	CV	
97017	17"	200/55R17	Metal	CV	
97011	18"	180/55	Metal	CV	TR6
97006	18"	170/200mm	Metal	CV	
97012	18"	240/40	Metal	CV	
3496	18"	3.00/3.50	Metal	CV	TR6
3497	18"	3.75/4.00	Rubber	CV	TR6
97010	18"	500/520	Metal	CV	
3504	19"	275/300			TR6
3505	19"	325/350	Metal	CV	TR6
3506	19"	350/400			TR6
97014	21"	MH80/90 x 2 (3.00)	Metal	CV	
3508	21"	100/90-21 (3.50)	Metal	CV	TR6
97015	21"	120/70-21	Metal	CV	
3507	21"	275/300	Metal	CV	TR6
97016	23"	130/160-23	Metal	CV	

Rim Strips

Heavy, thick, rubber rim strips that offer maximum protection for any size inner tube.

PCP	Size	Stem	Rim	U/M
3519	16"	Side	3"	10 Pack (40575-77)
3527	16"	Center	3"	10 Pack
21760	16"	Side	4"	Pair
21785	17"	Center	4"	10 Pack
3521	18"	Center	3"	10 Pack (40576-77)
21793	18"	Center	5"	10 Pack
21794	18"	Center	6"	10 Pack
3523	19"	Center	2.5"	10 Pack (40577-77)
3525	21"	Center	2.50"/1.85"	10 Pack (40578-80)

Valve Stem



Valve Stem Assembly FXSTC 1999-on
16582 43157-83A



Chrome Plated Brass Valve Stem Caps

Designed to completely cover threads on steel stems. Offered in two lengths with chrome plated brass lock nuts. Each kit has two covers and two nuts.

- 72194** Medium length
- 72210** Long length



Chrome Valve Stem Cover

Chrome cover for inner tube valve stems. Sold as 5 pack.

- 2452** Rubber valve stem type
- 2453** Steel valve stem type



Chrome Steel Wheel Balance Weights

For use with spoke wheels. Sold in 10 packs.

- | PCP | Oz. |
|--------------|-----|
| 73622 | 1/2 |
| 73645 | 3/4 |
| 73683 | 1 |



Tubeless Tire Valves

Replacement tubes for mag style tubeless tire rims.

PCP	OEM	Thread O.D.
73664	43150-83 (5 pack)	.400
73665	43157-83A (5 pack)	.300
73666	40999-87 (5 pack)	.300
73668	Chrome inner type (each)	.300
73621	Chrome outer type (each)	.300
73669	Chrome angle type (each)	



Skull Valve Stem Cover

Chrome with black eyes

- 44081** Pair

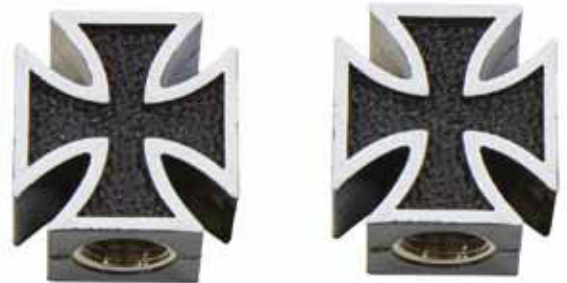

Maltese Cross Valve Stem Cover

Matte black finish with raised white border.

- 44140** Pair



Mag Wheel Tape-A-Weight

PCP	Oz.	Finish
21722	5g	Chrome, steel (360 pc.)
21723	1/4	Chrome, steel (360 pc.)

Rims



6280

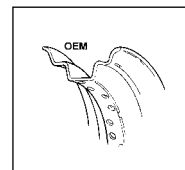

OEM Factory Style Chrome Rims "A"

Original drop centre design with deep indent for safety beads.

PCP Diameter x Width

- 6280 16" x 3.0 (as OEM w/lrg hole)
- 70735 16" x 3.0 Black powder coat (as OEM w/lrg hole)
- 70752 16" x 3.0 (as OEM w/sm. hole)
- 70753 16" x 4.0 (as OEM w/large hole)

OEM Factory Style Front Chrome Rim "D"

2.50" x 19" drop-centre 40 hole front rim with safety bead. OEM 43001-79 and 43018-73.

6278 19" Drop centre

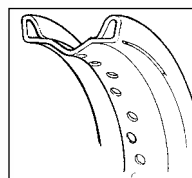
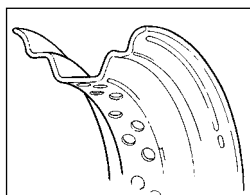
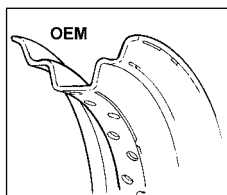

70720

Chrome Steel Wheel Rims

Drop centre style with rolled edges on 19" & 21" with high quality chrome plating. Features OEM style spoke dimple pattern and rim width for easy lacing and truing.

PCP Size

70720 19" x 2.5" (DC) (43001-79)

70721 21" x 2.15" (43662-80B)



Conventional Chrome Rims "B" style

This type is flat or English style. It will fit front tires only, available in the following sizes.

PCP Diameter Width

6276 21 Inches 1.85"

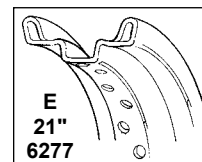
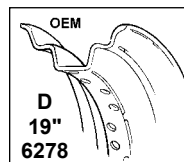
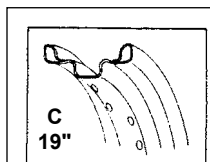
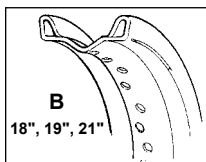
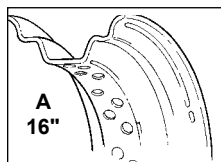
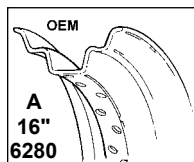



21" Drop Centre Rim "E"

Chrome plated rim with rolled edge as the H-D 21" wheel.
(OEM 43662-80B)

PCP	Width
6277	2.15"
70706	2.15" 40 spoke

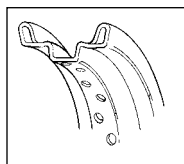

70754

Black Rim

Black 40 spoke rims have an 8.5mm center valve stem hole.

PCP	Size
70762	18" x 2.15"
70764	19" x 2.5"
70754	16" x 3" For XL-XLH 2010-on with side valve hole for small metal valve stem



Chrome Rear Drop Center Rim

- Rear 16"x 4" wheel rim with 40 spoke holes
- 15mm Side valve hole for rubber stemmed tube

70742



Chrome 16" x 5" Wide Rear Rim

Chrome plated rim uses 20 long and 20 short spokes. For use with 180-200 tires. Fits FLT 2009-on.

70711

Deluxe Spoke Wrench

Rowe spoke wrench to fit spoke nipples, sized one to six.

5849

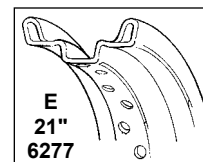
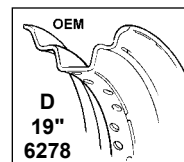
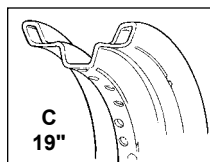
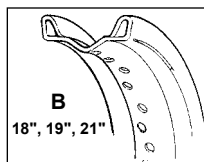
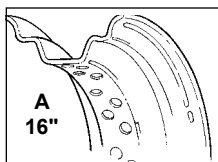
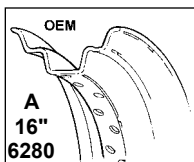

Spokes

Spoke Sets From Preston Cycle

We are able to offer a full selection of top quality chromed carbon-steel, polished or chromed stainless steel spoke sets. All our spoke sets feature 6/8 guage construction, and our polished stainless steel sets have spokes and nipples made from different types of stainless material to minimize their seizing to each other. We do suggest the use of anti-seize compound on stainless steel spoke sets.

Spoke Buying Guide

We show you the variety of stock and custom rims available from Preston Cycle for custom wheel building. Using our illustrations will help you determine which parts you have and then assist you to the spoke set you need. For example; if you have an aluminum 1978-83 FX model front hub, and you want to lace it with chrome steel spokes to the 21" drop centre rim from an FXWG (OEM 43662-80B or PC# 6277) which is shown in illustration "A", then you would need to use a PC# 925 spoke set. The rim illustration shows the basic rim shape, and the position of the spoke holes in relation to each other.



Diamond and Twirled Spokes

Chrome Diamond PCP	Chrome Twirled PCP	Stainless Twisted PCP	Use
3714	3710	43700	16 "DC (F & R) "A" 1936-04
3716	3712	43702	21" DC/steel + alloy FXST, Wide Glide hub "B & E"



Stainless Steel Twisted 16" Steel Spokes

A set of stainless steel spokes for 16" drop center rims. A new style of twist similar to our "Twirled" spokes.
43700 Set of 40 spokes and nipples 1936-04



6/8 Gauge Nipple Set

Sold in packs of 40 to fit our spoke sets.

- 43096** Chrome standard
- 43097** As above stainless
- 43098** Chrome extended
- 43099** As above stainless

Note: When PC spoke kits are laced to 19" OEM #43001-79 rims PCP 43098 extended chrome spoke nipples must be used as the inside diameter of this rim is larger than others.

Spoke Sets

S.S	Application
43706	16" Drop centre, steel spools 1936-04
43716*	18" "B" rim & 19" "C & D" rim

*Buchanan



T/L Stock (Zinc) Spoke Sets-USA 1936-04

43715 21" spoke set (43057-80B)

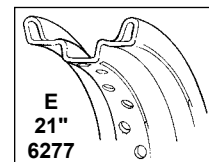
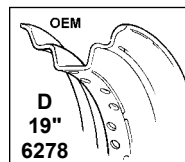
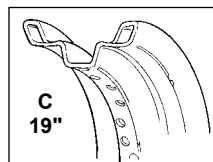
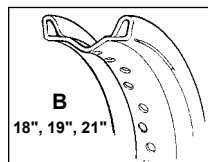
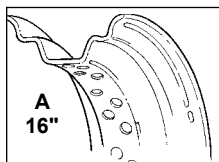
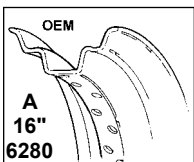

Spokes

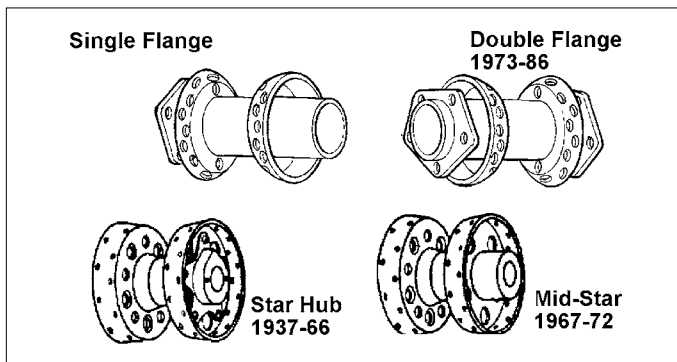

For Use With Spool Hub

Chrome	Stainless	Rim Size"	Illustration Rim Type
916*	3605	16	A (DC Rim)
924	3606	18	B
919	3607	19	B
924	3606	19	C & D
920	3608	21	B & E

*Front 1980-13 FLT, 1986-07 FLST, 1984-10 FXST, 1993-13 FXDWG, 1980-86 FXWG, Rear 1936-on FL, FX, XL

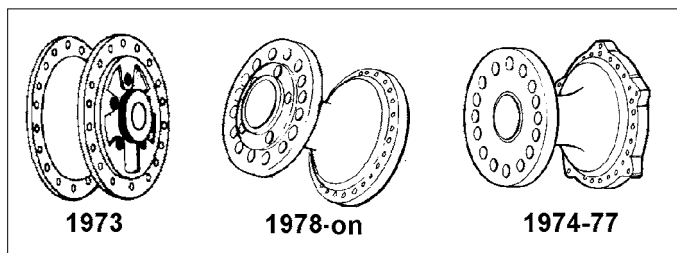

For Use With FX-XL Front Disc Brake Hub

Chrome	Stainless	Rim Size"	Rim Type
929	3609	19	C & D
926	3610	19	B
925	3611	21	B & E
43701		16	XL, XLH 2010-on

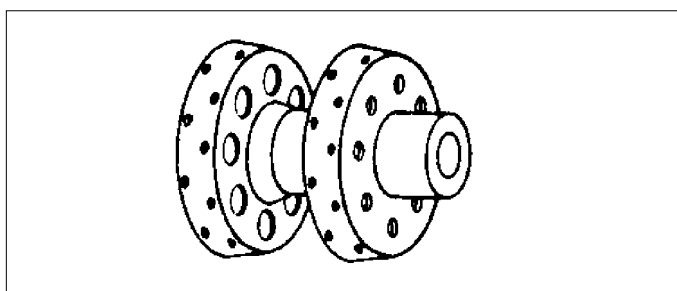

For Use With Sportster Rear Wheel Spool Hub

Chrome	Stainless	Rim Size"	Rim Type
916	3605	16	A
930	3612	18	A
924	3606	18	B



Replacement Spoke Sets

Heavy duty 6-8 wire gauge spoke set for all twins. Available in either chrome plated with chrome nipples or stainless with stainless nipples. Complete sets of 40 spokes and nipples.

NOTE: Use hub illustrations to select proper spoke sets. Note spokes available in chrome or full stainless.



Chromed Steel 16" Twisted Spokes

40 chromed steel spokes and nipples for 16" drop center rims. A new style of twist similar to our "Twirled" spokes.

43704 Set for 16" rims 1936-04

43705 Set for 21" rims (Steel hubs)



Chromed 23" Spoke Sets

Spoke set includes 20 short, 20 long and 40 spoke nipples. The short spokes are for horizontal flanged hubs.

PCP Application

43709 Front conventional center rim w/short shanks for flat flange hub

43710 FLT 1980-on, FXST 1984on, FLST 1986-on with 20 long and 20 short shank spokes

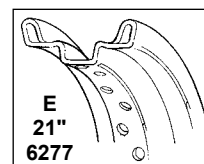
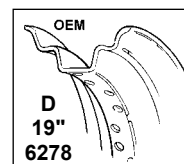
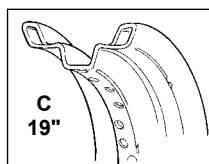
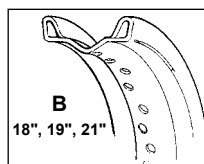
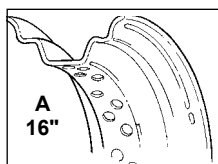
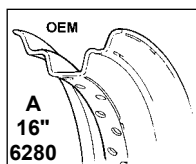

Wheel Hubs



Front Hubs

PCP	Application
5050	(E) 84-95 FXST, FXSTC, 91-95 FXDWG, (43672-84)
59837	(I) 86-99 FXST (43672-84A)
53004	(E) 86-99 FLST, FLSTC single disc (43053-86)
5067	(G) 84-94 FXR/S, 91-99 FXD, 84-99 XL and FXEF single disc (43619-84)
59839	(G) As above, dual disc
59843	(L) 00-03 FXDL, 00-07 XL single disc 21" (43610-00)
59841	(L) As above, chrome single disc/dual disc
59844	(E) 88-99 FXSTS, FLSTS (43677-88)
53011	(D) 87-99 FLT (43404-87A)
59845	(K) 00-07 FLT (40988-00)
59848	(K) 04-05 FXD (43877-04)

Rear Hubs

PCP	Application
59831	(H) Billet 86-99 FXR, FXRS, FXST, FXSTC, FLST (40976-86A)
53014	(D) Steel 86-99 FXR/S, FXST/C, FLST, XL (40976-86)
53012	1987-99 FLT (41020-86A)
59832	(B) 00-07 FXST, 00-05 FXD Standard, 00-01 FLT, 00-04 XL (40976-00)



Chrome Inner Hub Covers

Covers fill area between pulley or rotor mount flange and spoke hole flange on hub for smooth appearance and easy cleaning. Front models fit rotor side, rear kit fits both sides.

PCP	Type	Qty	Application
45494	Front	1	1987-93 FXST
45495	Rear	2	1986-95 FLST-FXST

Rear Hub Rebuild Kits

PCP	Application
43090	FXST-FLST 84-90, FXR 87-91
43091	FXST-FLST-FXD 87-91, XL 92-99
43092	Cast wheels FXST-FXD-XL 92-99, FLST 87-99
43093	FXST-FLST 00-06 front, XL 00-04 F&R, FXD 00-05 front, FLT 00-03 front, FLST 00-07 rear with 3/4 bearing (9267)



Adjustable Inner Hub Spacer 1973-99

Fits 1973-99 wire wheels and most custom wheel applications. 73633

Hub Parts



Front Wheel Bearing, Race and Seal Kit

Each kit contains two each, bearing, race and proper seals. Three kits available.

PCP Application

- 3510** 1980-on FXWG laced wheel
- 3512** 1984-94 FXR's F&R cast or wire wheel
1984-99 FXST-FLSTF&R. FLT 79-99 front, FLT 86-99 rear, XL 73-99 front, XL 79-99, Dyna F&R 91-99, FXST 84-99 F&R



Wheel Bearing Race and Seal Kit

Kits include two each of, bearings, races and seals. Kit fits:
Front or Rear: 84-94 FXR, 84-99 FXST, FXD 91-99
Front: 79-99 FLT, 73-99 XL
Rear: 86-99 FLT, 79-99 XL

43135



BT Rear Hub Rebuild Kit

Kits include bearings, races, seals, snap rings, seal retainer washers and seal spacers. Hub and internal bearing spacer not included. Fits 1986-94 FXR, 1986-99 FXST, FLST, 86-94 XL.

43139



Late Wheel Seal 1983-99

Replaces OEM #47519-83A. Used on all 1983-99 models with cast or wire wheels. Sold in 10 packs.

- 14069** .250"
- 14107** .411"



Front Wheel Hub Service Kit

Each kit contains two each, bearing, race, seal and one seal spacer. Also included for certain applications only are two each snap ring and seal retainer washers. Internal bearing spacer is not included. This may be ordered separately. Check listing. (Does not include hub.)

PCP	Fits	Wheel Type
3514	1984-86 FXWG	Wire (steel hub)
3515*	1984-85 FXST	Wire (steel hub)
43087*	1986-99 FXST	Wire
	1993-99 FXDWG	
43088	1992-99 FLSTF	Cast
43089	1986-91 FLST	Cast

* Does not include snap rings and seal washers.

Wheel Bearing Kits



All Balls Wheel Bearing and Seal Kits

Model	Year	Front	Rear
FLH, FLT	1982-99	43141	43141
	2000-07	43147	43147
	2008	43149*	
	2009-16	43149*	43148*
	2008-16 with ABS	43152	43153
Softail FLS, FXS	1980-99	43141	43141
	2000-06	43144	43144
	2007	43149*	43144
FLS, FXSW	2008-16 with ABS	43152	43152
Softail Springer	2007	43144	43144
	2008	43144	43149
FX, FXD, FXR	1973-99	43140	43141
FXD Dyna	2000-03	43144	43144
	2004-07	43147	43147
	2008-16	43149*	43149*
	2008-16 with ABS	43152	43152
FXWG, FXDWG	1980-99	43141	43141
Sportster	1979-99	43140	43141
	2000-04	43144	43144
	2005-07	43144	43147
	2008-16	43149*	43149*
V-Rod 1" Axle	2002-07	43147	43147
V-Rod 25mm Axle	2008-16	43149*	43149*
	2008-16 with ABS	43152	43152

*Not for use with ABS models



Rear Wheel Hub Bearing Kit

PCP	Fitment	I.D.
43085	XL 2005-07	1"
43086	XL 2008-on	25mm



Sealed Wheel Bearings all 2000-on

Lubricated ball type wheel bearings include dual seals on each side. Fits all BT and XL models 2000-on.

15749 Front 3/4" I.D. Softail 2000-06, FXD 00-03
XL 2000-07 (9267) (each)
Rear, FXST-FLST 2000-07, FXD 2000-05
FLT 2000-01, XL 2000-04

15750 1" I.D. (9247) (pair) front FLT 2000-07 F&R
FXD 00-07 front, rear 2006-07
FXDWG 06-07 front & rear
XL rear 2005-07
VRSC 2002-07 front, rear 2005-07

15751 25mm I.D. Bearing (9276) (pair) **without ABS**
FLT 2008-13 front
FXST/B/C-FLST/F/N-FXSTD 2007-on front
FXST/B/C-FLST/C/N 2007-on front
FXD 2008-on front & rear
FXST/B/C-FLST/C/F/N- 2008-on rear
FLSTFB 2008-on rear
FLT 2008-on rear with out ABS brakes
XL 2008-on front & rear
V-ROD 2008-on front & rear

15754 This bearing set includes 1 ABS bearing and 1 standard bearing for models with front and rear ABS brakes. ABS type red sealed bearing. Set of 2 25mm i.d. by 18mm wide bearings. Includes #9252 (ABS type with internal magnet) and #9276 (9252) (pair)
FLT 2008-on front & rear
FXST-FLST 2011-on front & rear
FXD-FXDWG 2012-on
VRSC 2008-on
XL 2008-on

Front Wheel

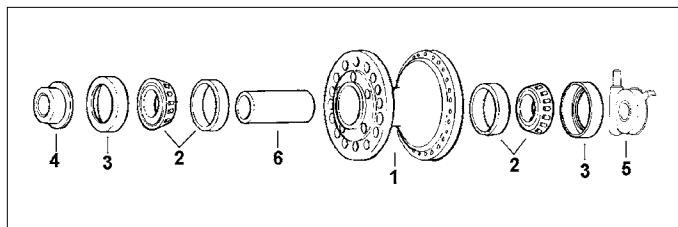

FX & Sportster Front Hub & Parts 1978-99

- | PCP | Description |
|---------|---|
| 1 5067 | Chrome single disc hub assembly FXR, RS, XLS-FXS 1984-99 (43619-84) |
| 2 15504 | Bearing & race FX, XL, 1973-99 (9052) |
| 3 14069 | .250 Wheel seal FX-XL 83-99 (47519-83A) (10) |
| 79412 | James as above (DL) (5 pack) |
| 79411 | James .411 wheel seal L85-99 (5 pack) |
| 14107 | As above, Preston (10 pack) |
| 5 3722 | Speedo drive unit, FXR, FXRT, FXSB, FXE-80, XL, XLS, XLX 1984-94 (67127-84A) |
| 2542 | Speedo drive unit, FX 84-86, FXST 1984-95 (67120-84B) |
| 4072 | Speedo drive unit, FXLR 1987-94 (67132-85A) |
| 6 3305 | Wheel bearing spacer, violet 2.564" long, FX 78-86, XL 78-99, FXR 84-94, FXD 91-99 (43623-78) |



Late FX-XL Front Wheel

Complete front wheel assembly for FXR 84-94, FXD 91-99, XL 84-99. Laced and trued with all new components. Chrome plated.

- 6143** 19" OEM (drop centre rim)
6144 21" Custom 2.15 rim
 The 2.50" OEM rim is the stock factory type 43018-73.



70877



70919



Front Wheels for 1984-94 FXR, FXD 91-99, XL 84-99

Single disc fits 35mm and 39mm forks.

- 70876** 19" D.C. in diameter and 2.50" width
70877 21" in diameter and 2.15" width



Front Hub Kit FX, FXE, XL, FXR

Includes all internal parts for complete rebuilding of all alloy front hubs. Includes inner spacer, bearings, races, seals and seal spacer. Hub is not included.

- | PCP | Type | Application |
|--------|-----------------|---|
| 43136 | Single | 1984-91 FX, FXR, 1984-91 XL |
| 43137* | | 1992-94 FXR, 1992-99 FXDL |
| 43138 | Single/
Dual | 2000-07 FXD, XL Cast or wire wheel
(w/2-3/4 bearing) |

*Order spacer shims separately.

Front Wheel Assembly FXD 2004-05

Laced and trued wheels feature chrome hub with internal bearings installed, choice of chrome or stainless steel spokes and chrome drop centre rim.

Chrome Spokes	S.S. Spokes	Rim Diam.	Rim Width
70919	70920	19"	2.50"
70921	70922	21"	2.15"



Front Inner Hub Bearing Tube Spacer

May be used in some cast mag wheel applications, when flange is removed. Check for proper length fit.

- 16602** Front XL, FXD 2000-03 (43613-00)

Wheels



70850

FXST & XL & FXR Rear Wheel Assembly

Chromed 16" to fit 1986-99 FXR, FXRS, FXST, FXSTC, & FLST and Sportster 1986-99 Note: FXR applications must use PC# 5063 seal spacers. Hub only is #53014. Wheels are 16" x 3.5" wide.

- 70850 With chrome spokes
- 70851 With stainless spokes

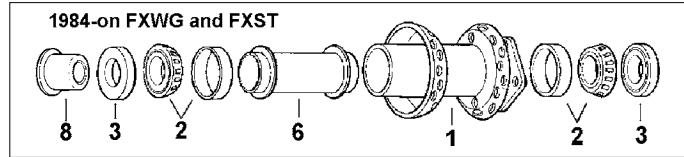

Wheel Hub Parts 1984-on FXST,FXDWG,FXWG

- | PCP | Description |
|---------|---|
| 1 5050 | Chrome complete 1984-on 1 Flange (5/16 brake holes) (43672-84) |
| 2 15504 | Bearing & race 1973-99 (9052) (1 set) |
| 3 14069 | Wheel Seal .250 1983-99 (47519-83A) (10 pack) |
| 79411 | As above, James .411 L85-99 (5 pk) |
| 14107 | As above, Preston (10 pack) |
| 6 2529 | Wheel bearing spacer 1973-on orange 4.420 (43601-73) |
| 2530 | Wheel bearing spacer 1973-on yellow 4.434 (43602-73) |
| 2531 | Wheel bearing spacer 1973-on white 4.448 (43603-73) |
| 8 2261 | Spacer R/S bearing FXST 1984-95 (40910-84A) FLT 86-on, FLST/S/FXSTS 86-99 |



Rear Wheel Spacers

Fits BT 1982-99 models.

- 16580 4.308" spacer for wide hub and FLT front 82-99
- 16581 Spacer washer (43650-82)



**NEW ITEM
COMING SOON**

Double Row Retro Wheel Bearing Kit

Double row wheel bearings eliminate wheel play, have a longer wear life, require no adjustment and are prepacked with SR1-2 grease. All kits include two bearings, centre spacer & stainless spacers. Fits models with Timken bearings.

Rear Bearing Kits

- 43084 1984-99 FXST, FLST, 1991-99 FXD, XL



Chrome Rear Wheel Spacer Set

Fits 2002-07 FLT/HT models that utilize a 1" diameter axle.

- 16610 41163-04

Front Wheel Hub Spacer

- | PCP | Application | |
|-------|---|--------|
| 16353 | 1988-99 FLSTS, accepts hubcap | Chrome |
| 16354 | 2000-06 FLSTS, 2007 FLSTSC, 2008-11 FLSTSB (43360-00) | Zinc |
| 16355 | 2000-06 FXSTS (44029-00) | |
| 16356 | 2000-06 FXST (40910-00A) | Zinc |

70867



70856



Chrome Front Wire Wheel Assemblies

For BT models with 41mm forks.

FXSTS 1988-06

16" 21" Drop Center Rim
70852 70856 Chrome spokes

FXST, FXDWG 1984-95, FXWG 1984-85

70863 70865 Chrome spokes

FXST, FLSTS, FXDWG 1996-99

70867 70869 Chrome spokes
70868 - Stainless steel spokes

FLST 1986-96

- 70872 Chrome spokes



6144

21" Chrome Wheel Assemblies

21" Wheels give Harleys the late FXST-FXWG look. Laced and trued, complete with $\frac{3}{4}$ " bearings. Ready to install. Rim is not drop center.

PCP	Years	Type
6144	1984-99 FXE-FXR-XL's	Disc (1)
70865	1984-95 FXST, 1984-85 FXWG 1991-95 FXDWG	Disc (1) 2.15" x 21"
70866	1984-99 FXWG	Disc (2) 2.15" x 21"



Chrome 23" Front Spoke Wheel FLT 1984-99

Front dual disc 23"x 3.00" wheel features 40 chrome spokes, chrome hubs and chrome rim. Includes $\frac{3}{4}$ " bearings.
70770



Rear Pulley Bearing

Fits rear FLT 2008-on. Replaces 9285.
15762



70796

FLT Wheels 1987-99

Chrome 16" front wheel assembly features a drop centre 16" x 3" rim laced with chrome or stainless steel spokes. Complete with $\frac{3}{4}$ " bearings, seals and internal components. Fits FLT, FLHT, FLHS, and Road King models 1987-99.

Front Wheels-Dual Disc

70796 Chrome spokes (43403-87)

Rear Wheels 1986-99

70798 Chrome spokes (41010-86)

Wheels



FXD, FXST, FLST Rear Wheels 1997-99

Wheels feature an updated rear hub with smooth flange area.
Fits 1997-99 (40975-86A)

Chrome Spokes	Stainless Spokes	Rim Diam.	Rim Width
70783	70784	16"	3.0

Wheels With 40 Chromed Twirled Spokes

Assembled and trued wheels include chrome hubs with internals, chrome rim, and chrome twirled spokes.

- 70842** 16" x 3.00" Rear, 1986-99 FXST, FLST, XL, 1991-99 FXD
- 70843** 21" X 2.15" Front single, 1984-95 FXST, 1991-95 FXDWG
- 70845** 19" x 2.50" Front single or dual 1984-99 XL, 1984-94 FXR, 1991-99 FXD



FLST 1986-96 Wheels with Chrome Spokes

PCP	Size
70854	16" x 3.00" Front wheel with 3/4" bearings
70872	21" x 2.15" Front wheel with 3/4" bearings



Late XL Rear Wheel Assembly

16" x 3.00" Chrome rear wheel assembly for all 1982-85 XL's. Laced and trued with new components. Assembly includes all internals.

PCP	OEM	Years
6126	40951-82	1982-85 XL, FXR, FXST and 1982-84 FXE

Chopper Style Wheels For Custom App's

In spool or 3" wide mini brake design which includes anchor bar and cable. Both include 5/8" I.D. bearings.

PCP	Type
70776	Mini-brake wheel 21" x 1.85"
16099	Shoes for above
70777	Spool style wheel 21" x 2.15"
15519	Bearing for above (pair)
27381	5/8" x 9" Acorn style axle
27382	5/8" x 9" Pike style axle



Note:

All spokes on wheels need to be inspected and re-torqued after 500 miles on original installation.



Front Wheels for 41mm Forks

Chrome Spokes	Stainless Spokes	Rim Diam.xWidth	Fitment
70915	70916	16"x3.00"	FLST, FLSTS 2000-06 single disc
70917	70918	16"x3.00"	FLT 2005-on dual disc

2000-on Front Wheel Assemblies

Wheel assemblies feature a chrome alloy hub with sealed bearings and spacer tube installed. Wheel comes laced and trued with choice of chrome or polished stainless steel spokes and a chrome drop centre rim. Wheel is easily installed using existing stock hardware.



XL 2000-07, FXD 2000-03 with 39mm forks, XL STD Hugger, 1200-FXD, FXDL with 39mm forks and single disc.

Chrome Spokes	Stainless Spokes	Rim Diameter	Rim Width
70882	70884	19"	2.50"
70883	70885	21"	2.15"

FXD 2004-05 for single or dual disc

70919	70920	19" DC	2.50"
70921	70922	21" DC	2.15"

FXST-FXDWG 2000-06 with 41mm forks and single disc

70886	70887	21"	2.15"
-------	-------	-----	-------

FLSTS 2000-on with 41mm forks and single disc

70888	70889	16"	3.00"
-------	-------	-----	-------

FXD Rear Wheels 2006-07

Chrome Spokes	Stainless Spokes	Rim Diam.	Rim Width
70924	70925	17"	4.75"

FLSTS 2000-on with 41mm forks and single disc

70888	70889	16"	3.00"
-------	-------	-----	-------



FXST & XL & FXR Rear Wheel Assembly

Chromed 16" to fit 1986-99 FXR, FXRS, FXST, FXSTC, & FLST and Sportster 1986-99 Note: FXR applications must use PC# 5063 seal spacers. Hub only is #53014. Wheels are 16" x 3.5" wide.

- 70850 With chrome spokes
- 70851 With stainless spokes

2000-04 Rear Wheel Assemblies

Rear wheels fit FXST, FLST, FXD, FXDWG and XL models. Assemblies feature a chromed alloy hub with sealed bearing and spacer tube installed. Complete wheel is laced and trued with choice of chrome or polished stainless steel spokes and a chrome drop centre rim. Wheel easily installs using existing stock components.

Chrome Spokes	Stainless Spokes	Rim Diameter	Rim Width
70890	70892	16"	3.00"
70891	70893	16"	4.00"

Wheels



FLT Chrome Front 40 Spoke Wheels

• Laced and trued wheel assembly with chrome rim, spokes and hub

PCP	Size	Bearings	Fitment	Notes
70795	16" x 3.0"	3/4" Installed	1984-99	Smoothie profile rim
70790	21" x 3.25"	Installed	1987-99	3/8" brake disc mount holes
70793	21" x 3.25"	Installed	2008	Front dual disc
70794	21" x 3.25"	Installed	2009-on	Front dual disc
70772	23" x 3.0"	Installed	2000-04	Front dual disc
70774	23" x 3.0"	Installed	2009-on	Front dual disc



Chrome 21" Front 4 Spoke Wheel

• 21" x 2.15" chrome drop center rim, spokes and hub
• Fits FLT 1984-99

70713



26" Front 60 Spoke Wheel

• 26" x 3.5" front dual disc wheel with polished aluminum hub
• 1" bearing installed
• May require brake rotor spacing
• Fits FLT 2000-07

70714

Chrome 80 Spoke Twin Cam Wheel Assemblies from Paughco

80 Spoke design with 6/8 gauge round spokes and custom nipples. Chromed steel rims and chrome forged billet hubs with diamond facets. 3/4" or 1" sealed wheel bearings with center spacers preinstalled. Front wheels available in single disc and dual disc versions. Includes a rim strip for tube type applications only.

Front Wheels

PCP	Size	Disc	Application
70613	18"x3.50"	Dual	2000-07 Touring (1" axle)
70614	16"x3.50"	Single	2000-06 FL Softails (except Springers)
70615	18"x3.50"	Single	2000-06 FL Softails (except Springers)

Rear Wheels

PCP	Size	Application
70620	18"x3.50"	2000-01 Touring models, 2000-04 Sportsters, 2000-05 Dynas, and 2000-02 Softails (except Deuce and FLSTS)
70622	18"x3.50"	2003-06 Softails (except Deuce and 2006 models with 17"x6" cast wheel)



T/L Chrome 16" Front Wheel 2000-06

Bolt-on wheels fit 2000-06 FLST/C/F/N models.

70728 Slotted (41022-00)



4.5" x 18" Chrome Rear Wheels

Accept 150 thru 180 series tires.

PCP	Application
70800	FXST/C-FLST-FXDG-XL 1986-96
70802	FXST-FLST 00-07, XL 00-04, FXD 00-05 Standard

Wide Tire Related



Primary Spacer for Wide Tire Kit

Plain finished spacers fit between the engine and the inner primary when installing a wide tire. The appropriate transmission mounting plate and sprocket shaft extension are required.

PCP	Size
76456	.250"
76457	.500"
76458	.750"
76459	1.00"
76500	1.250"
76501	1.500"
76502	1.750"
76503	2.000"



BT Rear Wheel Spacers (BDL)

PCP	Size	BDL
76427	.250"	RPS-0250
76428	.375"	RPS-0375
76429	.500"	RPS-0500
76430	.750"	RPS-0750
76431	.937"	RPS-0937 for use with BDL 1" pulley
76432	.937"	RPS-1100 for use with CCI wheels
76433	1.250"	RPS-1250



Polished Pulley Spacers

Use these threaded spacers to adapt pulley to hub. This version offers extra support by mounting with 2 sets of bolts.

1980-99	Thickness
11880	1/2"



Spacer for BT Belt Drive Models 1980-85

This .200 thick spacer will allow the proper spacing between the rear belt pulley and the wheel. It can also be used to install custom wheels on BT and XL models 1983-85.

11855 40932-81

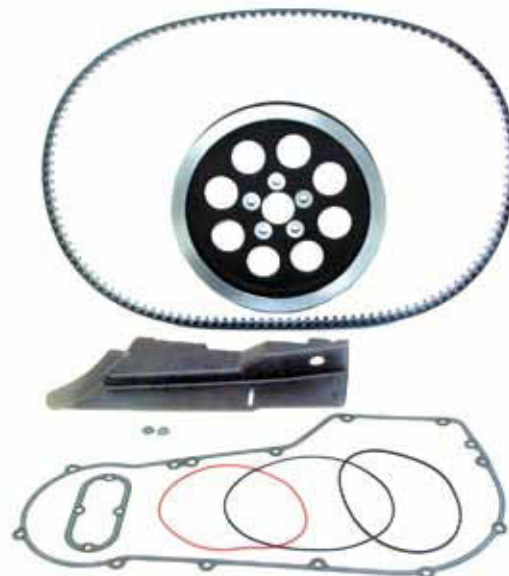

Narrow Belt Kit

This kit allows the use of a wider tire on 1996-99 FXDWG models. Kit includes belt, pulley, and black lower belt guard.

Replaces 40264-00
91805



Wide Tire Kits FLST 2000-02

Kits come with a 150 series Dunlop tire, brake caliper, splash guard, wheel spacer and hardware. Kit includes saddlebag hangers and isolators. Installation should be completed by a qualified shop.

91803 FLST/C/F/S (44490-00)

Hub Caps



Chrome Die Cast Hubcaps

Allen type, features counter bored holes with socket head screws. Front attaches by 2 screws on FXWG-FXST, rear attaches by 5 pulley allen screws (included). Rear fits cast or solid wheel on 1980-on with belt drive. Slotted front style attaches by 2 set screws for FXST-FXSTS models.

PCP	Type	Style
45016	Front	Allen
45017	Rear	Allen
45052	Front	Slotted



6644



6645

Chrome FL Front Wheel Hubcaps 8"

Full 8" dresser hub cap for wire wheels on 1949-on wide glide type forks.

PCP	Fits
6644	1984-90 FXWG, 1984-90 FXST
6645	1986-96 FLST Single Disc 16" wheel held by snap ring (43067-86)



Jammer Slotted Hub Cover

Use to cover the spoke flange on single disc front ends. Aluminum with hardware to fit FXST and FLST 1984-99 with single flange steel hub.

45328

45013



45321



4 1/2" Chrome Hub Caps

Fits between hub and axle without additional hardware.

PCP Application

45015	Rear 1984-99 FXST-FLST
45013	Front 1986-96 FXST-FXWG (4-5/8")
45321	Front, Mag 1984-96 FX-XL-FXR, FXD 1991-95

Flat Mini Hub Caps for Late Model Wheels

Measuring just over 2" in diameter, each one is held in place between the axle or swingarm and the wheel spacer. **Sold each.**

PCP Description

45318	Fits the right side of all single disc FX, FXR or Sportster® models with Narrow Glide front ends 1984-99
44096	1996-on



19" Wheel Conversion - USA

For customizing flexibility, this kit adapts 19"-21" narrow glide wheels from 1977-02 and spaces it out to fit a 41mm front end. With the custom spacers and the specially designed axle, you can mount any dual disc wheel to any wide glide front end. Kit includes 1" aluminum disc spacers, (as needed), axle, axle spacers and all mounting hardware. Spacers are polished and chrome plated. Axle and steel spacers are cadmium plated.

53501	1984-99 FXWG for single disc
43107	Extra spacer for #53501 to use dual rotors
53502	2000-03 FXWG
43119	Extra spacer for #53502

Hub Caps



"Baby Moon" Chrome Rear Hub Cap

45280 1993-04 (43200-99A)



19" Single Disc Front Wheel Hubcap

4-3/4" chromed steel front wheel hubcap will fit all single disc 19" cast wheels on models with 9-spoke mag wheels from 1984-on. Replaces standard wheel hub plate and screws, and is held stationary between the front wheel hub's external bearing spacer and the front axle.

800 44467-88T

Chrome Hubcaps for FLST

PC #45013 small hub caps simply press onto the wheel hub. 4-1/2" Diameter hub cap fits front wheel on FLST models 1986-96

45013

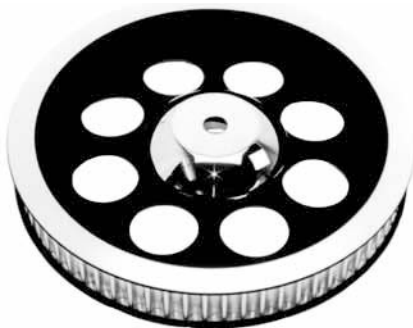

Chrome Rear Hubcap for Belt Drive Models

Hides stock mounting hardware on the rear pulley area of all Big Twin belt drive models. Held in place between the axle spacer and swingarm. The PC 4-1/2" hub cap looks great with stock pulleys but better yet when installed with PCP chrome inserts and beltguard.

45015 Fits all BT models with rear belt drive 1984-99



Chrome Hub Cap Kit

Kit includes chrome hub cap, spacer sleeve, spacer and snap rings.

PCP **Application**

- 45283** 1986-99 FLST
- 45243** 2000-06 FLST (43155-00)
- 45245** 2007-on FLSTC (41510-07)
- 45287** 1997-99 FLSTS (43162-97)
- 45288** 2000-07 FLSTS (43295-01)
- 45285** 1993-99 FXDWG, 1997-99 FXST
- 45286** 1996-99 FXSTS, left
- 45284** 2000-06 FXDWG, FXST, FXSTD, FXSTS



Front Hub Cap Adapter Spacer Kit

Zinc adapter spacer and retaining.

PCP **Application** **Side**

- 16357** 1986-99 FLST Right
- 16361** 1997-99 FLSTS Right (includes bronze washer)
- 16360** 1996-99 FXSTS Left
- 16359** 1993-99 FXDWG Right, 21" wheel
- 1997-99 FXST Left, 21" wheel
- 16358** 2000-06 FXDWG Right, 21" laced wheel
- 2000-06 FXST/D/S Right, 21" laced wheel

Front Axle

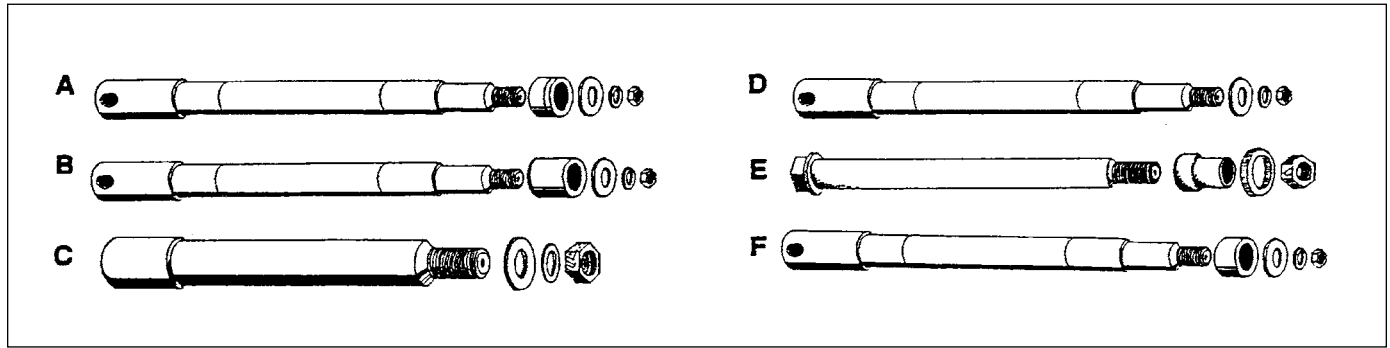

Chrome Front Axle Kits: Includes plated axle, nuts, spacer and hardware. Axle sleeve included when required

Application	Kit	Spacer	Nut Kit	Axle	Axle OEM	Fork (mm)	#	O.D.
1984-86 FXWG 1984-06 FXST	43329	2261	5360	3677	43346-83B	41	B	.750"
2007-on FXST	43269				41547-07	41	B	25mm
1984-99 FLT	43270		9989	3677	43346-83B	41	B	.750"
2002-07 FLT	43271		72036		43364-00	41	B	1"
2008-on FLT	43290					41	C	25mm
2000-onFXST-FXDWG	43243		72022	3677	43346-83B	41	B	.750"
2006-on FXDWG				43272	40923-06	49		1"
2000-06 FXSTD				43248	43354-00	41		
1984-86 FXE 1986-87 FXR-FXRS-XL	43333		2057	3679	43883-84	35	C	.750"
1988-99 FXR-FXD-XL	43334		2057	43210	43895-87	39	D	.750"
2000-03 FXD				43245	43895-00	39		.750"
2004-05 FXD	43273			66013*	43758-04	39	D	1"
2006-07 FXD	43291					49	H	1"
1988-99 FXSTS	43335	16573	12736 16108* (WASHER)	43212	41109-88		E	.750"
2000-on FXSTS	43274		72032	43212	41109-88		E	.750"
1987-95 FLST-FLSTF	43336	16574	5360	43211	41584-86A	41	F	.750"
1996-99 FLSTF	43275	16586	5360	43211	41584-86A	41	F	.750"
2000-06 FLSTF	43247	72029		43211	41584-86A	41	F	.750"
1996-99 FLST	43276	43018	5360	43211	41584-86A	41	F	.750"
2000-06 FLST	43246		72034	43211	41584-86A	41	F	.750"
2007-on FLST	43277				41545-07	41		25mm
2005-07 FLSTSC 1997-03 FLSTS	43362			43363*	41116-97	41	F	.750"
2007-on FXSTD	43292					41	K	25mm

*Stock Finish



FXST Pike Front Axle 1984-99

Fits 41mm fork legs.

43375



Chrome Castle Nut

Includes cotter pin for rear axles 1989-99 (replaces 7987 & 511)

12618 Kit

Front Axle



Front Axles Chrome (except where noted)

Size is measured from inside of head to start of threads. Axles only.

PCP	OEM	Fits	Size
43211	41584-86	1987-06 FLST/I-FLSTF/N/I	9 1/4"
43278	41545-07A	2007-11 FLST/C/F, FLSTF/N	9 1/4"
43363	41116-97	1997-07 FLSTS/C/I, Zinc	11"
3677	43346-83B	1984-99 all FLT 1993-05 FXDWG/I 1984-06 FXST/I, FXSB/I	9 3/4"
43249	43364-00	2000-07 FLT, zinc	8"
43251	41547-07A	2008-up FLT, 2008 FXDWG ANNY 2009-12 FXDC, FXDF 2007-11 FXST/B/C, FXS/B 2012 FXST 103	8"
43210	43895-87B (39mm forks)	1988-99 FXR, 1987-99 FXD/L/X, XL	6-3/16"
43245	43895-00	2000-03 FXD/L/X, 2005-05 XL	6-3/4"
66013	43758-04	2004-05 FXD, zinc	6-1/2"
43286	40928-06	2006-07 FXD/L, FXDB, FXDC	6-3/4"
43287	41628-08	2008-10 FXD/L, FXDB, FXDC 2010-on XL, XL1200X	6-7/8"
66012	40936-06	2006-up FXDWG (1"), zinc	9-3/4"
43272	40923-06	2006-up FXDWG (1"), zinc	9-1/2"
43248	43354-00	2000-06 FXSTD/I (3/4" for 41mm forks, with acorn nuts)	9-3/4"
43279	41549-07	2007 FXSTD	9-3/4"
43212	41109-88	1988-on FXSTS/I, 2009-11 FLSTSB	9-1/8"
3679	43883-84 (35mm forks)	1984-86 FXE 1986-87 All XL-XLS 1986-87 All FXR-FXRS	6 1/2"

Chrome Flush Mount Front Axles

PCP	Application
43368	2000-07 FLT (1")
43369	1984-99 FLT
43370	1988-94 FXR 1991-03 FXD (39mm)
43371	1984-06 FXST 1991-06 FXDWG
43372	1986-06 FLST



Chrome Front Axle Caps FLHT/R 2000-07

44312 Set



Chrome Front Pike Axle Covers

Fits most 1/2-20 threaded axles on 1980-on FL, FLHT, 1980-86 FXWG, 1984-on Softail (except Springer), 1988-94 FXR, 1991-on Dyna (except Wide Glide).

72263

Chrome Axle Nut Cap Set

Features an internal hex to allow more thickness for the set screw threads which eliminates thread stripping. Fits front axle 1984-on FXST/FXWG, FL 1972-99, FXR 1988-94, XL 1988-03, Dyna 1991-on (except FXDWG)

44316

FLH Axle Nut

Cad plated stock type front axle nut. Replaces OEM # 7734W. Each.

12507



Rear Axle

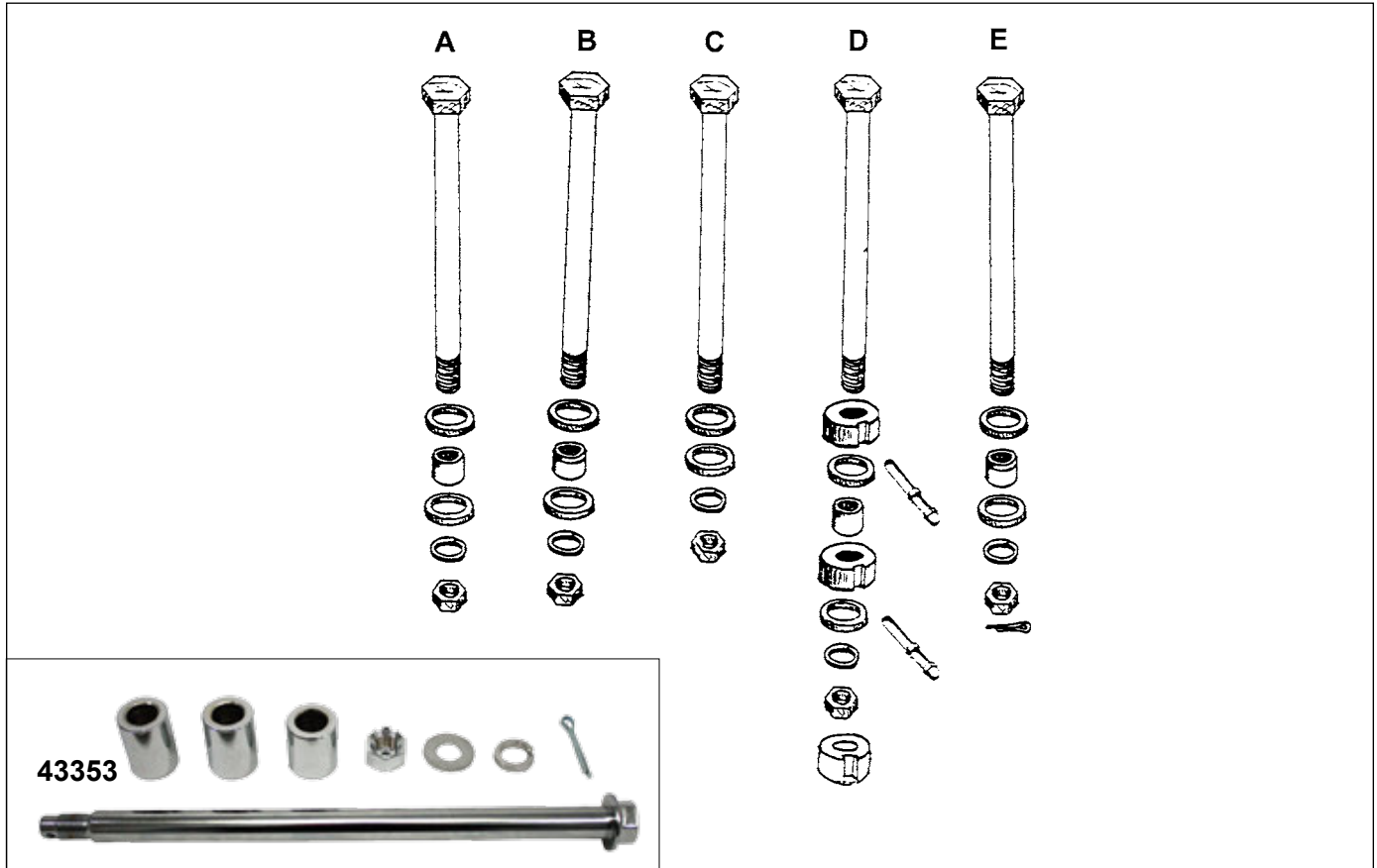

Rear Axle Kits

Kits contain: chrome axle, nuts, sleeves, and spacers for each application. Nut kit includes chrome axle nuts and outer sleeve. Sleeve is included in items A, B, and C.

#	Compl. Kit	Spacer	Nut Kit	Axle	OEM#	Description
A	43347	16593	5306	2052	41552-73	FX-FL 1973-85
B	43348	16571	5306	3683	41580-79	FL -FX 4 speed w/rear belt 1984-86 & 1984-85 FXST
C	43350		5306	5072	41563-77	XL 1979-99
	43319					FLT 2002-07
D	43314	43013	5306	5071	41110-79A	FXST 1986-92 (13 pc kit)
D	43316	43013	5306	5071	41110-79A	FXST 1993-99 (14 pc kit)
	43253	72026		5071	41110-79A	FXST 2000-06
	43383					FXST-FLST 2007
	43384					FXST-FLST 2008-on
	43254				41110-79A	FXSTD 2000-05
E	43352	16572	5306	5071	41110-79A	FXR 1982-94
E	43353	16583	9812	43315	41114-90	FXD 1990-99 (12" from bolt head to threads)
	43320	72038			41114-90	FXD 2000-05
	43337			43378	41114-90	FXD 2006-07
	43338				41114-90	FXD 2008-on

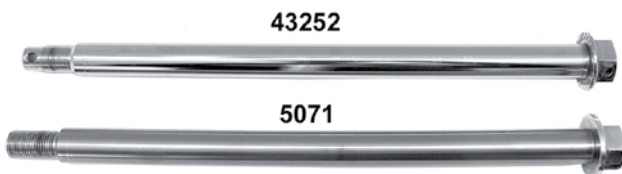

Chrome Axle Spacer Sets

Features a 3/4" I.D. for front or rear wheel use.

PCP	Size
16603	1/8"
16604	3/8"
16605	1/2"
16606	5/8"
16607	1-1/4"

Chrome Softtail Rear Axle Only

PCP	Application
5071	1984-99
43252	1984-06 FXST, FLST with cotter key hole 11.5" (41110-79A)

Rear Axles



Chrome Rear Axles (Zinc, where noted)

Size is measured from inside head to start of threads.

PCP	OEM	Fits	Size
2052	41552-73	73-85 FL, FLH, FX (Chain)	10 3/4"
3683	41580-79	80-86 FL, FX (Belt) 84-86 FXWG 80-86 FXB-FXSB	11 1/4"
5071	41110-79A	82-87 FXR (not '84 FXRT) 86-06 FXST 80-99 FLT	11-3/8"
43385	41110-89	00-01 FLT, 2004 XL 2007-FLST-FXST	11-3/8"
43387	41641-08	08-on FXST (exc. FXCW/C)	12"
43376	41056-02	02-07 FLT, zinc	11-1/4"
43386	41056-08	2008 only FLT	
43377*	41110-79A	00-06 Softail	11"
43315	41114-90	91-05 FXD	12"
43378	41114-06A	06-up FXD/I, FXDCI, FXDLI, FXDWG, zinc	12-5/8"
5072	41563-77	79-02 XL	10 1/4"

*Note: Includes spacers and nut.



Rigid Frame Disc Brake Rear Axle

For use when 1973-on rear disc brake units are installed on rigid frames. Kit includes .750 diameter axle, nut, special spacer and washers. Other axles sold separately. Spacers may have to be cut to length. Length includes threads.

PCP	Item	Length	Type
3687	Kit	10.5"	BT rigid chain, XL
43318	Axle	11-3/8"	Rigid with belt
43374	Axle	11"	Rigid w/chain or belt
3689	Axle	11.5"	Rigid chain
43313	Axle	12.5"	Rigid frame w. disc brake
5073	Collar	1 5/16"	Long (pair)
43104	Collar	1 13/16"	Long (each)
43106	Collar	2 3/4"	Long (each)
43367	Axle	12 3/4"	Rigid frame with disc brake



FXST Rear Axle Kit

All parts chromed for 1986-on FXST-FLST. Items are also offered separately

43314	Kit 1986-92
43316	Kit 1993-99
5071	Axle (41110-79A)
16569	Spacer (41595-86)
5306	Nut kit with washers
43103	Adjuster kit 1987-92 (47579-86)
8934	1986-92 Bolts only (47579-86) (pr)
9515	1993-99 Bolts only (47579-93) (pr)
72023	2000-07 Bolts only (47579-00) (pr)
72517	2008-on Bolts only (2517-2) (pr)

Chrome Rear Wheel Spacer Set

Fits 2002-07 Touring models that utilize a 1" diameter axle.

16610	41163-04
-------	----------



Chrome Axle Spacers

Features 3/4" ID for front or rear wheel use. Sold each.

PCP	Length
16569	7/32"
16593	27/32" (.843)
16594	1/4"
16522	.650"
16595	3/4" (zinc)
16596	1"
72202	1" x 1-1/8" O.D.
16597	1 1/4" (zinc)
16598	1 3/16"
16583	1 7/16"
16576	Rear 2000-07 FXST
16524	1 15/64" front or rear
16599	1 15/64" rear

Rear Axle Nut & Washer Kit

Chrome plated heavy duty machined steel washers prevent distortion of square swingarms on all Big Twins 1973-on and Sportster 1979-on.

5306 Kit



Axle Hardware



Chrome Axle Spacers

Sold each.

PCP	OEM	ID	Length
43002	43617-95	.750	.930
43003	40915-94	.720	1.253
43004	43674-95	.725	1.412
43005	43683-97	.730	1.350
43006	41591-90	.740	1.435
43007	43654-86A	.750	.750
43008	40910-84A	.750	1.255
43009	43358-83A	.750	.370
43010	41594-73	.745	.655
43011	41595-73	.750	.830
43012	41592-79	.745	1.210
43013	41595-86	.750	.1225
43014	41607-83	.735	.510
43015	47517-58	.745	.380
43016	41591-81	.710	1.265
43017	43648-86	.735	1.270
43018	43657-89	.725	1.010
43019	40910-00	.740	.900
43020	41595-00	.750	1.980
43021	43683-00	.740	.990
43022	43654-00	.750	.470 w/groove
43023	43617-00	.750	.520
43026	43613-00	.755	3.040
43025	43608-00	.745	4.810 (raw finish, not chrome)
43024	43517-00	1.00	4.810 (raw finish, not chrome)



Rear Axle Seal Spacers 1973-on (Sold Each)

PCP	Application
5063	1982-86 FXR's cast or wire wheel 1984-on FL cast wheel only 1984-86 FXST wire wheel, 1982-86 FXWG wire wheel, and 1982-86 FXB, FXSB cast wheel (40906-82)
3517	1983-86 FLH-80 wire wheel (41196-83)
16574	1987-99 FLT, FXST, FXR, 1968-99 all XL (43654-86A)



Smoothie Front Axle Spacer Set

PCP	Size	Application
44128	1"	2000-07 FLT
44129	3/4"	2000-on FLSTF



Colony Chrome Dome Axle Covers

Chrome plated domed covers add a smooth finished look when easily installed with a set screw. Sold in a set of 2.

Front

PCP	Application
72120	1980-99 FL, FLHT, 1980-86 FXWG, 1988-94 FXR, 1984-06 Softail (except Springer), 1991-03 Dyna (except Wide Glide). Fits most 1/2-20 threaded axles
72392	2000-07 Touring, 2004-07 Dyna (except 2004-05 FXDWG, 2007 FXDSE)
72535	2008-on Touring, XL, Dyna and 2007-on Softail
72519	1988-2007 Sportster, 1991-05 Dyna

Rear

PCP	Application
72443	1989-04 Sportster, 1991-05 Dyna
72445	2005-07 Sportster
72725	2008-12 Sportster
72121	1984-07 Softail
72408	2008-on Dyna and Softail, 2013-on XL



FXST Rear Axle Nut Covers 1984-07

44317 Pair



Rear Axle Spacers

Allow wheels with 1" I.D. bearings to fit 3/4" axle.

Part	Collar"	OAL"	Finish
16611	1-1/16	1.655	Chrome
16614	1.060 fits 25mm to 3/4"	1.060	Raw

Axle Hardware



Wheel Hub Inner Bearing Spacer Tube

Available for all 1935-on Twins.

PCP Fits

- 3305** 1978-99 FX, XL front only 2.564" long (43623-78)
- 2531** 1973-on FL front & rear (43603-73)
- 1973-on rear all FX models
- 1980-on FXWG front
- 1982-on XL rear



Front Axle Nut & Washer Kit

Chrome plated machined steel washer, hex nut, and stainless steel lockwasher fits Harley Wide Glide, FX, or Sportster.

- 5360** Wideglide 1972-on



Front Axle Spacers (sold Each)

PCP Right Side Application

- 2261** FXWG 1984-85, FXST 1984-99 zinc (40910-84A)
- 2252** FXST 1984-on (43358-83A)
- 16573** FXSTS 1988-96 ground zinc (44029-88)
- 16584** FXSTS 1997-99 raw (44029-97)
- 16586** FLSTF 1989-99 zinc (43657-89)
- 16362** FLSTS 2000-06, FLSTSC 2007 zinc (43624-00)

PCP Left Side Application

- 2056** FL 1973-86, FXWG Classic 1980-83 zinc (41594-73)
- 43002** FXD, FXDL 1997-99 chrome (43617-95)
- 43003** FLT 1995-98 chrome (40915-94)
- 16574** FLST 1986-95 zinc (43654-86A)
- 43005** FLST 1996-99 chrome (43683-97)
- 16363** FLSTS 2000-06 zinc (43360-00)

Speedo Drive Spacer

Replaces speedo drive on all 1973-on FX-XL-FXR when front wheel drive is omitted.

- 5068** FX, XL 1973-on
- 16575** FXST 1984-95



Chrome Rear XL Axle Kit

Kits includes 11-1/4" bearing surface length axle, nuts and spacers

PCP	Axle Length	Fitment
43302	11-1/4"	1986-99
43303	11-1/4"	2000-03
43304	12-1/2"	2004
43305	12-1/2"	2005-07



Rear Axle Spacer (Outer)

PCP Fits

- 2053** FXST cast/wire 1984-86, FXE-80 wire 1981-86, FX cast 1973-86 zinc (41595-73)
- 43013** FXST, FLST 1986-99 (41595-86)
- 16571** FLH-80 1983-on cast or wire, FXWG 1984-86 wire, FXB, FXSB 1980-86 cast wheel zinc (41592-79)
- 16572** FXR 1981-91 left side cast or wire wheel, FXRT 1985-on cast wheel zinc (41591-81)
- 43003** FXD 1998-99 chrome (41905-94)
- FLT L/S 1995-98



Chrome Rear Axle

Replaces 41056-09 on 2009-on FLT.

- 43296**

Axle Hardware



Pike Axle Covers

Chrome plated and easy to install with set screws. Set of 2.

Front

PCP Application

- 72393** 2000-07 Touring, 2004-07 Dyna (except 2004-05 FXDWG and 2007 FXDSE)
72536 2008-on Touring, XL, Dyna, 2007-on Softail (not FXCWC)
72264 1988-07 Sportster, 1991-03 Dyna (not FXDWG)
72263 1980-99 FL, FLHT, 1980-86 FXWG, 1984-06 Softail (except Springer), 1988-94 FXR, 1991-03 Dyna (except Wide Glide). Fits most 1/2-20 threaded holes

Rear

- 72260** 1989-04 Sportster
72447 2005-07 Sportster
72487 1984-07 Softail
72726 2008-12 Sportster



Chrome Axle Nut Caps Set

For both axle nut and axle head where required, set screws and hex key wrench. Each cap has an internal hex to allow more thickness for the set screws thread, to eliminate thread stripping.

Note: These axle caps will not work on late model rear axles with cotter key locking devices.

Front

- 61223** 2000-07 FXSTD (44122-03)
44154 2000-07 Touring & 2004-07 Dyna (not 04-05 FXDWG or 07 FXDSE) (43062-04)

Rear

- 44152** 2000-07 FXST (44256-01)



Rear Axle Kit

Includes axle, pyramid adjuster blocks and chrome nuts. Replaces 41552-73 on 1973-84 chain drive FLH-FX.

43355



Chome Rear Axle for Softails

1986-99 models. Include 3/4" x 12 3/8" bearing surface length

- 43360** Pike style
43361 Acorn style



FXST, FLST Chrome Rear Axle Kit

Kits includes 3/4" axle, 1-3/4" long chrome spacer, chrome nut kit and adjuster kit.

PCP	Axle Length	Fitment
43383	12-1/2"	2007
43384	13"	2008



Grease Fittings 5/16 x 32 Thread

PCP	Description
10526	Chrome 1938-on (9851) (10 pack)
10511	Zinc 1938-on (9851) (10 pack)
10512	Chrome, as above
10513	Zinc, angle 1938-on (5 pack)
10515	Zinc 1979-84 (10 pack)

Axle Hardware



Chrome Axle Cap Kits

Each kit contains the necessary number of chrome axle caps required for your application.

Front

PCP Description

44310 1 Piece, FX 4 speed (except FXWG/FXST) 1981-85, FXR 1982-87 (not FXLR or Sport Edition), XL 1973-87

44312 2 Pieces FLT/HR 2000-on

Rear

PCP Description

44315 2 Piece FL 4 speed 1981-88, FX 4 speed 1981-85, FXST 1984-88, FXR 1982-88 (not Sport Edition), XL 1981-88, FXWG 1982-86, FLH/T 1980-88



Chrome Rear Axle Covers

Chrome plated dome style rear axle covers to fit 2008-12 XL.
72725



FXST-FLST Chrome Rear Axle Adjuster Kit

Kit includes collars and adjuster screws with nuts. Fits FXST, FLST 2008-on.

43127 41694-08



Colony Rear Axle Nut Kits

Mounting kits for the rear axle on Big Twin models 1973-88, and Sportster® models 1979-88. Available in acorn or custom cap-nut style.

5278 Acorn style

5279 Cap-nut style

XL Rear Axle Cover

Customizes the rear axle and swing arm end on XL except 1200S models. Will not fit with rigid saddlebags.

64010 2000-03 (45328-00)



Custom Rear Axle Spacer

Rear axle short style spacer allows wheels with 1" inner diameter bearings to fit 3/4" axle. Spacer has an overall length of 1-1/16". Spacers outer lip measures .127" and has a thickness of 3.2mm. For custom applications. Sold in pairs

27403



XL Zinc Rear Axle Adjuster Set 2005-07

Fits XL 2005-07 1" axle.

43132 41573-05

Axle Hardware



Sportster Rear Axle Adjuster Covers

Chrome plated domed or chopper style pike covers hide the factory hardware and easily install with set screws.

PCP	Years	Type
72446	1993-04	Domed
72261	1993-04	Pike
72448	2005-0n	Domed
72444	2005-on	Pike



44155



44150

Chrome FXST Rear Axle Caps 1987-99

Customize with a clean and simple set of rear axle caps. You'll eliminate an eyesore like the cotter-pinned axle nut on the Softail frame and streamline the rear axle assembly. Easy to install without removing the cotter-pin or re-adjusting the axle.

44150	Smooth
44155	Maltese



Axle Adjuster Kits For Softails

Includes collars and adjuster screws with nuts.

43122	1993
43123	1994-99
43124	2000-07
43127	2008-on (41694-08)



3/4" Axle Spacer Saver

Use to hold axle spacers in place during rear wheel installation.

43359



3/4" Threaded Axles

Features 1 inch of 3/4" x 16" thread at each end. Use with acorn, pike or nyloc nuts as required.

43356	12-3/4" in length (no thread length 10 7/8")
43357	13.5" in length
43358	14.0" in length
43396	15" OAL
43397	16" OAL
44004	Acorn nut set
44095	Pike nut set



Chrome Rear Axle Adjuster and Nut Kit

Kit includes adjuster, collars, axle nut washer and rounded chrome cover. Kit allows use of existing nut and cotter pin.

73521	1986-92
73522	1993-99
73523	2000-07

Colony Axle Hardware

Chrome Front Axle Spacer Kits

Includes axle nut, machined washer, lockwasher and 1 or 2 spacers, depending on application.

Softail Models

PCP Application

- 9823** FXSTS 1988-96 grooved spacer (40910-84A)
- 72031** FXSTS 2000-on grooved spacer (43683-00)
- 72032** As above smooth spacer
- 9925** FLSTF 1990-95 smooth spacer (43657-89)
- 9922** FLSTF 1996-99 grooved (43657-89, 43674-95)
- 9923** As above smooth spacer
- 72029** FLSTF/I 2000-06 grooved (43617-00, 43683-00)
- 72030** As above smooth spacer
- 9994** FLSTC 1997-99 grooved spacer (43683-97)
- 9995** As above smooth spacer
- 72034** FLSTC 2000-06 smooth spacer (43683-00)
- 9825** FXST/C/B 1984-96 grooved spacer (40910-84A/B)
- 9992** FXST/C/B 1997-99 grooved spacer (43683-97)
- 9993** As above smooth spacer
- 72021** FXST/B/I 2000-06 grooved (43683-00, 40910-00)
- 72022** As above smooth spacer

FLT Models

PCP Application

- 9825** All models except FLHR/CI 1984-99 grooved spacer (40910-84A/B)
- 9988** FLHR, FLHRCI 1994-99 grooved (40910-84A)
- 9989** As above smooth spacer
- 72035** All models 2000-06 grooved (43520-00, 43521-00)
- 72036** As above smooth spacer
- 72507** Smooth spacer FLH/FLT 2008-on



Dyna Models

PCP Application

- 9825** FXDWG 1984-94 grooved spacer (40910-84A/B)
- 9991** FXDWG 1995-96 smooth (40910-84A, 43674-95)
- 9992** FXDWG 1997-99 grooved (40910-84B, 43683-97)
- 9993** As above smooth spacer
- 72021** FXDWG/I 2000-05 grooved (43683-00, 40910-00)
- 72022** As above smooth spacer
- 9974** All models except FXDWG 1995-99 grooved spacer (43617-95)
- 9975** As above smooth spacer
- 72027** All models 2000-03 except FXDWG/I 00-03 grooved spacer (43358-00, 43617-00)

Sportster Models

PCP Application

- 9974** All models 1995-99 grooved spacer (43617-95)
- 9975** As above smooth spacer
- 72027** All models 2000-07 grooved (43358-00, 43617-00)

9811



Rear Axle Nut and Spacer Kit

Includes chrome plated, slotted nut and a decorative spacer
Fits all Dyna Glide 1991-99 (41591-90)

- 9811** Grooved spacer
- 9812** Smooth spacer
- Fits Dyna 2000-on (43654-00, 41591-00)
- 72038** Smooth spacer
- Fits XL 2000-on (40910-00, 43654-00)
- 72039** Grooved spacer

9809



Rear Axle Nut and Spacer Kit

Customize the rear axle on all Softails 1986-99 with the use of this kit that includes chrome plated, slotted nut and 3 decorative spacers.

- Fits Softails 1986-99 (47577-86, 47577-94, 41591-90)
- 9809** Grooved spacers
- 9810** Smooth spacers
- Fits Softails 2000-on (41595-00, 43654-00, 47577-00)
- 72025** Grooved spacers
- 72026** Smooth spacers

Rear Axle Chrome Spring Clip

Fits all 1991-on FL, FX, XL models.

- 72042** 5 pack

