

EXPED

REFINED GEAR
FOR ADVENTURE



WORKBOOK 2023

MATS | PILLOWS | BACKPACKS | GEAR BAGS | STORAGE |
TENTS | TARPS | SLEEPING BAGS | LINERS | BOOTIES |
HAMMOCKS | PONCHOS | BIVYBAGS



REFINED GEAR FOR ADVENTURE



Explore the wild world.
Discover its mysteries,
climb its peaks,
roam its forests and set
out on its waters.
Adventure awaits!

EXPED INNOVATIONS

2023

ICEFALL

- > alpine touring pack in a class of its own
- > exclusive UHMPE ripstop fabric



2021

VERGLAS

- > lightweight alpine day touring pack
- > signature pack shape



2019

WHITEOUT

- > minimalist gear hauler in Dyneema® Composite fabric
- > sophisticated construction techniques



2009

FLAT VALVE

- > invention of FlatValve design: durable, reliable, flexible



2006

SYNMAT

- > development of first micro-fiber insulated mat
- > proprietary dual-welding technology



1998

DREAMWALKER

- > the most versatile sleeping bag around
- > sleeping bag and parka in one



2022

MATS: ULTRA, DURA, VERSA

- > fresh colors
- > recycled fabrics
- > use-specific naming scheme



2020

WATERBLOC PRO

- > water-repellent down sleeping bag
- > 30% lighter: welded instead of sewn



2014

MEGAMAT DUO

- > development of double-wide MegaMat



2007

MOUNTAIN PRO

- > refined to the basics
- > first weatherproof alpine pack



2001

DOWNMAT

- > patented down-insulated sleeping mat
- > best possible insulation at minimal weight



1997

ORION

- > ridge-tunnel design introduced
- > flat pole sleeve technology





ABOUT US

Explore the wild world. Discover its mysteries, climb its peaks, roam its forests and set out on its waters. Adventure awaits! EXPED develops high-performance outdoor gear that enables the maximum outdoor experience with minimal means. Without gimmicks – nor an ounce too many.

EXPED's history is closely linked to the life story of Heidi and Andi Brun, who set off to fulfill their common dream of experiencing solitude in the wilderness. The experience they gained turned them into extraordinary innovators.

After selecting a location, they embarked on their voyage to Canada with the bare necessities and had to build a log cabin by themselves with the bare necessities and built a log cabin by themselves with only a hatchet and saw blade as tools - and this at the end of August in northern Canada, not far from the Arctic Circle. Hunting, fishing and plant foraging enabled them to feed themselves directly from nature. Improvising with minimal means every day set in motion their lifelong fascination with practical outdoor equipment. At the end of 9 months, they tore down their cabin and left no trace in the natural surroundings they had encountered.

“Andi Brun says that few things are of real importance, good ties with the people one knows, humility and finding oneself in the absolute solitude of nature while being fully relaxed.” The maximum outdoor experience with minimal means. The goal is to live with nature, not exploit it.

In 1983 Heidi and Andi founded EXPED AG and gradually took over the distribution of renowned outdoor brands. In 1997 motivated by outdoor colleagues and full of product ideas, EXPED launched its own products for the first time and transitioned

Today EXPED products are distributed in 25 countries exclusively through specialized outdoor retail stores. The team with its 25 employees is a small, lean, innovative group that strives for a good work-life-balance between profession and outdoor leisure time. EXPED does not want to big. EXPED wants to remain agile, small, innovative and personal.

In the meantime, Heidi and Andi have retired to the board of directors and are spending time on the road again, exploring the world. The management now consists of three long-time employees with comprehensive outdoor experience; in addition, a new generation of young and highly motivated team members have joined EXPED.

EXPED Innovations

Since the introduction of our first products in 1997 we have launched a multitude of innovations and received numerous awards for them. Without the partnership in product development with you, our clients, with consumers and our factory partners, this would never have been achieved. We are a global team that believes in partnership, because only in this spirit can the best quality be achieved. Social and environmental responsibility are a matter of course to us.



SUSTAINABILITY

Sustainability has been a core principle at EXPED from the beginning. Durability, reliability and repairability of our products are key focus areas in their development. Long-standing and close cooperation with our partner factories is essential in reaching our goals, as is the careful selection to materials, components and resources used.

ECOLOGICAL FOOTPRINT AND CLIMATE NEUTRALITY

Carbon neutral with myclimate

Our sleeping mats, pillows, sleeping bags, liners, booties as well as our operations are carbon offset with myclimate. In 2021 our mats were the first and only climate neutral ones on the market. Tents, backpacks, gear bags, packsacks and the accessories will follow. Our goal is to be completely climate neutral by 2024.

Together with myclimate, we analyze and quantify the footprint of our product range and our company. This helps us find opportunities for reduction and implement improvement measures.

For a climate-neutral product, all climate-impacting emissions along the life cycle are taken into account. This means from the production of the raw materials to the use of the product and the subsequent disposal or recycling. The amount of CO₂ equivalents (global warming potential) calculated in this way is reduced in high-quality myclimate carbon offset projects. The computation of our footprint with myclimate also enables us to further reduce our emissions.

Myclimate is an internationally operating non-profit foundation with Swiss roots and is one of the quality

leaders of voluntary CO₂ offsetting measures. With projects of the highest quality, myclimate promotes climate protection and sustainable development.

No single use plastic

All EXPED packaging is reduced to a minimum and is made of FSC certified recyclable paper and cardboard. This reduces the amount of resources used, contributes to cleaner air as packaging does not require incineration and does not add to the huge amount of plastics that contaminate our oceans. Certain accessories in our range are packaged in reusable zippered pouches. Only a few products, that need additional protection, come in individual polybags.

ETHICS AND TRANSPARENCY

Cooperative Partnership

The people behind our products are valuable to us. We have been working in partnership with our suppliers for decades. We see this continuity as the basis for sustainable development in our supply chain. We always develop our production planning in collaboration with our suppliers. This enables the factory to operate with little overtime and ensures that no labor is outsourced to production facilities unknown to us. We visit all factories regularly and maintain an extensive exchange. By respecting our manufacturers and their cost structures, we believe that as a small brand with limited resources we can still play an important role.

Guaranteed animal welfare

The down used in our products is certified in accordance with the Responsible Down Standard (RDS) and is fully traceable. RDS adheres to the strictest animal welfare guidelines and guarantees species-appropriate animal husbandry without live plucking or forced feeding. Down,

100%

...climate neutral by 2024. This is a bold statement, but we're more than half way there: 70% of our products are already climate neutral.

85%

...of our range is PFC free- we will reach 100% by 2024.

97%

...of our products use Oekotex 100 or bluesign certified fabrics, buckles and zippers.

100%

...of our range is FR-free*

*except for products sold in Canada, where FR (fire retardant) treatment is required by law.



as a natural product, is almost indestructible. The down from non-repairable products is recycled and flows back into our new products.

Fairtrade organic cotton

With the new Sleepwell liners, EXPED is breaking new ground in the outdoor gear market. The series of newly

designed hut and travel liners is made of Fairtrade certified and recycled materials. The same is now true for the Mat Sheets. The cotton originates from India, is 100% cultivated by Fairtrade producers, and is certified and traded according to Fairtrade standards. Fairtrade promotes better working and living conditions for cotton producers as well as environmental protection.

Labels and Certifications





SERVICE AND CIRCULARITY

Despite all the new recycling methods available, it is still best to keep a product functional for as long as possible. This is why we not only source the most durable materials, but also do maintenance and repair of products, allowing us to extend the life of EXPED gear.

Warranty

All EXPED products carry a five-year warranty on defects, materials and workmanship. At its discretion, EXPED will repair or replace any part that fails due to a manufacturing defect. Failures due to normal wear, negligence, accidents and acts of nature can be repaired for a nominal charge.

Repair instead of discarding

All EXPED products are designed for maximum longevity. We repair products in our specialized workshops - even if it is not always economically viable.

We process warranty cases and repairs with professional team in our own workshops. The feedback and data gathered is a valuable source of information for future improvements and innovations - and for long-lasting products.

With the mat testing equipment in our repair workshops, our repair team can find even the smallest puncture. We are pleased to be able to offer our customers exceptional and reliable service.

2nd hand and donations

Test samples and items repaired due to malfunction or production errors are sold as 2nd hand products or donated.

«To keep them in use as long as possible, we design our products according to their intended use and repair them whenever possible instead of replacing them.»

Muriel Weber, Sustainability Manager



CONTENTS

MATS	8 - 26
EXPEDITION FAST + LITE TREKKING BASE CAMP TRAVEL MAT ACCESSORIES	
PILLOWS	27 - 29
FAST + LITE TREKKING BASE CAMP TRAVEL PILLOW ACCESSORIES	
BACKPACKS	30 - 53
BACKPACK ACCESSORIES ALPINE TREKKING HIKING EVERYDAY URBAN	
GEAR BAGS	54 - 59
URBAN EVERYDAY TRAVEL	
STORAGE	60 - 67
DRYBAGS COMPRESSION DRYBAGS TRAVEL ORGANISERS STUFFSACKS	
TENTS	68 - 79
EXPEDITION FAST + LITE TREKKING TENT ACCESSORIES	
TARPS	80 - 81
FAST + LITE TREKKING	
SLEEPING BAGS	82 - 96
EXPEDITION FAST + LITE TREKKING BASE CAMP SLEEPING BAG ACCESSORIES	
LINERS	97 - 101
TRAVEL	
BOOTIES	102 - 103
HAMMOCKS	104 - 108
FAST + LITE TRAVEL HAMMOCK ACCESSORIES	
PONCHOS	109 - 111
BIVYBAGS	112 - 114
POP MARKETING	115 - 117
POP WEB & SOCIAL MEDIA	





MATS

Since the introduction of the industry-changing DownMat in 2001, EXPED sleeping mats have been the most innovative on the market. EXPED's sleeping mats are known for their great features, high quality construction and comfort.

Sustainability

As part of EXPED's longstanding commitment to responsible manufacturing and sustainability, our entire sleeping mat line is certified climate neutral – an unprecedented achievement in the industry. Our new ULTRA, DURA and VERSA series sleeping mats utilize recycled materials. Using recycled polyester keeps plastic out of landfills and uses less water, energy and carbon to produce. Moreover, EXPED's fabrics are bluesign® or OEKO-TEX® accredited, meeting the highest levels of environmental protection.



5 Years warranty

Defects in materials and workmanship will be repaired or replaced at Exped's discretion.

100% Quality control

We go the extra mile to make sure every mat that leaves the factory is airtight.

Stress tests

Each mat model endures our 15,000 cycle 80 kg roller test, and 200 cycle 60 kg dropper test, to ensure our mats are up to your next expedition.

R-value

We think the most important factor in a comfortable and warm night's sleep for backpacking mats is R-value: the amount of insulation a mat provides from the ground. Just as our sleeping bags are differentiated by their temperature rating according to the ISO 23537 standard, our sleeping mats are now differentiated by their own standard, ASTM F3340, which was launched in 2020.

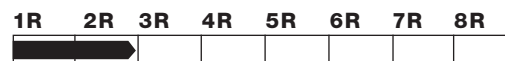

Summer 3-Season All-Season Extreme Cold

EXPED DESIGN PRINCIPALS

Highest quality materials paired with excellent workmanship and innovative designs create comfortable sleep-systems for any environment and intended use.

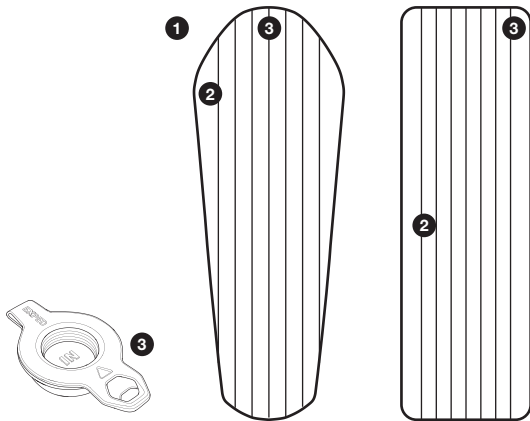

1 Airmat, Synmat and Downmat Technology

The right insulation for any application, whether summer, 3 season or winter.





2 Comfort Cradle



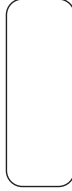

Air chambers run head-to-toe, fully supporting the body for an unrivaled night's sleep and increased durability. EXPED's Comfort Cradle side rails center and secure the sleeper on the mat.

3 Flat Valve

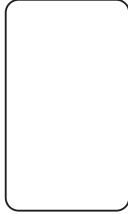
Pioneered by EXPED. Industry-leading durability, reliability and intuitive performance.

SLEEPING MAT SIZES

MAT SIZE RECTANGULAR					
	SMALL	MEDIUM	MEDIUM WIDE	LONG WIDE	DUO
					
	S 163 x 52 cm	M 183 x 52 cm	MW 183 x 65 cm	LW 197 x 65 cm	M 183 x 105 cm LW 197 x 125 cm LW + 197 x 132 cm Queen 203 x 152 cm

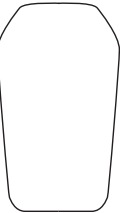
MAT SIZE CONTOURED				
	MEDIUM	MEDIUM WIDE	LONG WIDE	DUO
				
	M 183 x 52 cm	MW 183 x 65 cm	LW 197 x 65 cm	M 183 x 105 cm LW 197 x 125 cm

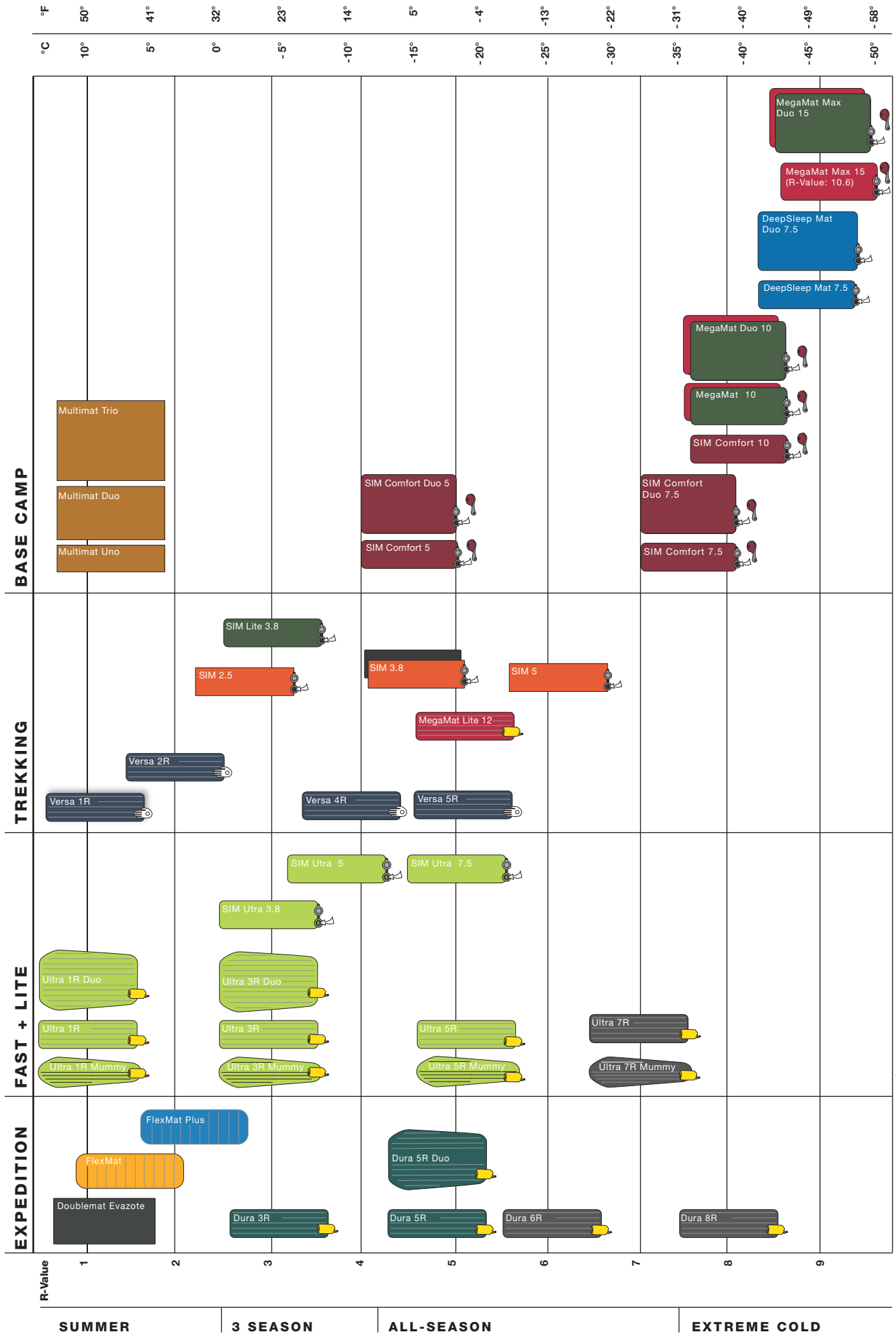

°F 50° 41° 32° 23° 14° 5° -4° -13° -22° -31° -40° -49° -58°

°C 10° 5° 0° -5° -10° -15° -20° -25° -30° -35° -40° -45° -50°

R-Value

SUMMER

3 SEASON

ALL-SEASON

EXTREME COLD

Minipump included | inklusive
 Schmozzel | Pumpbag included | inklusive
 Integrierte-Pumpe
 Self-inflating | Selbstaufblasend

ULTRA

ULTRA 1R

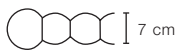
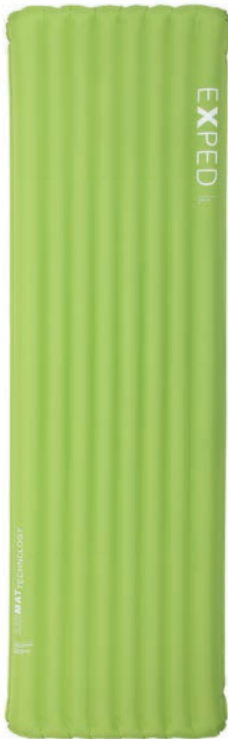

rectangular/Mummy/Duo

ULTRA 3R



rectangular/Mummy/Duo

ULTRA 5R



rectangular/Mummy

ULTRA 1R

AIRMAT TECHNOLOGY™

ASTM R-Value 1.3, Temp. + 10°C

FAST + LITE

Material Recycled 20D ripstop polyester, Oeko-Tex® 100 certified
Insulation Air

Prod. No	Name	Dimension	Weight	Packed
7640445454384	Ultra 1R M	183 × 52 × 7 cm	395 g	23 × 9.5 cm
7640445454391	Ultra 1R MW	183 × 65 × 7 cm	450 g	27 × 10.0 cm
7640445454407	Ultra 1R LW	197 × 65 × 7 cm	490 g	27 × 10.5 cm
7640445454414	Ultra 1R M Mummy	183 × 52 × 7 cm	310 g	17 × 9.5 cm
7640445454421	Ultra 1R MW Mummy	183 × 65 × 7 cm	375 g	19 × 10.0 cm
7640445454438	Ultra 1R LW Mummy	197 × 65 × 7 cm	405 g	19 × 10.5 cm
7640445454445	Ultra 1R Duo M	183 × 105 × 7 cm	720 g	20 × 12.5 cm
7640445454452	Ultra 1R Duo LW	197 × 130 × 7 cm	970 g	22 × 13.5 cm

ULTRA 3R

SYNMAT TECHNOLOGY™

ASTM R-Value 2.9, Temp. - 5°C

FAST + LITE

Material Recycled 20D ripstop polyester, Oeko-Tex® 100 certified
Insulation 60 g/m³ Texpedloft microfiber, bluesign® certified

Prod. No	Name	Dimension	Weight	Packed
7640445454469	Ultra 3R S	160 × 52 × 7 cm	405 g	23 × 10.5 cm
7640445454476	Ultra 3R M	183 × 52 × 7 cm	465 g	23 × 11.0 cm
7640445454483	Ultra 3R MW	183 × 65 × 7 cm	520 g	27 × 11.5 cm
7640445454490	Ultra 3R LW	197 × 65 × 7 cm	560 g	27 × 12.0 cm
7640445454506	Ultra 3R M Mummy	183 × 52 × 7 cm	365 g	21 × 10.5 cm
7640445454513	Ultra 3R MW Mummy	183 × 65 × 7 cm	440 g	21 × 11.0 cm
7640445454520	Ultra 3R LW Mummy	197 × 65 × 7 cm	465 g	21 × 11.5 cm
7640445454537	Ultra 3R Duo M	183 × 105 × 7 cm	845 g	20 × 14.5 cm
7640445454544	Ultra 3R Duo LW	197 × 130 × 7 cm	1155 g	22 × 16.5 cm

ULTRA 7R



rectangular/Mummy

ULTRA-LIGHTWEIGHT, COMPACT SLEEPING MATS

Ultra-lightweight mats for human-powered adventures, including backpacking, thru-hiking, bikepacking and alpinism.

Carbon neutral

EXPED measures, reduces and fully offsets CO₂ from manufacturing and shipping this product.



Recycled 20D ripstop Polyester face fabric

Recycled polyester keeps plastic out of landfills and uses less water, energy and carbon to produce.

Flat Valve

Pioneered by EXPED. Industry-leading durability, reliability and intuitive performance.

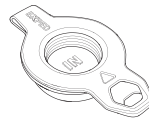

Airmat, Synmat, Downmat Technology

The right insulation for any application, whether summer, 3 season or winter.

Comfort cradle

Air chambers run head-to-toe, fully supporting the body for an unrivaled night's sleep and increased durability. EXPED's Comfort Cradle side rails center and secure the sleeper on the mat.

Schnozzel pumpbag included

Rapid, moisture-free mat inflation: lung-power not required!



ULTRA 5R SYNMAT TECHNOLOGY™

ASTM R-Value 4.8, Temp. -20°C

FAST + LITE

Material Recycled 20D ripstop polyester, Oeko-Tex® 100 certified
Insulation 160 g/m³ Texpedloft microfiber, bluesign® certified

Prod. No	Name	Dimension	Weight	Packed
7640445454551	Ultra 5R M	183 × 52 × 7cm	585 g	23 × 12.5 cm
7640445454568	Ultra 5R MW	183 × 65 × 7cm	655 g	27 × 13.0 cm
7640445454575	Ultra 5R LW	197 × 65 × 7cm	700 g	27 × 14.0 cm
7640445454582	Ultra 5R M Mummy	183 × 52 × 7cm	445 g	23 × 12.5 cm
7640445454599	Ultra 5R MW Mummy	183 × 65 × 7cm	535 g	23 × 13.0 cm
7640445454605	Ultra 5R LW Mummy	197 × 65 × 7cm	555 g	27 × 13.5 cm

ULTRA 7R DOWNMAT TECHNOLOGY™

ASTM R-Value 7.1, Temp. -30°C

FAST + LITE

Material Recycled 20D ripstop polyester, Oeko-Tex® 100 certified
Insulation 700 cuin/oz Down, RDS certified

Prod. No	Name	Dimension	Weight	Packed
7640445454612	Ultra 7R M	183 × 52 × 9cm	650 g	23 × 14.0 cm
7640445454629	Ultra 7R MW	183 × 65 × 9cm	790 g	27 × 14.0 cm
7640445454636	Ultra 7R LW	197 × 65 × 9cm	855 g	27 × 15.0 cm
7640445454728	Ultra 7R M Mummy	183 × 52 × 9cm	495 g	23 × 12.5 cm
7640445454735	Ultra 7R MW Mummy	183 × 65 × 9cm	655 g	23 × 13.5 cm
7640445454742	Ultra 7R LW Mummy	197 × 65 × 9cm	690 g	27 × 14.0 cm

DURA

DURA 3R

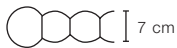

rectangular

DURA 5R



rectangular/Duo

DURA 6R

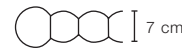

rectangular

DURA 3R

SYNMAT TECHNOLOGY™

ASTM R-Value 2.9, Temp. -5°C

EXPEDITION

Material 75D/170D recycled polyester, Oeko-Tex® 100 certified

Insulation 60 g/m³ Texpedloft microfiber, bluesign® certified

Prod. No	Name	Dimension	Weight	Packed
7640445454247	Dura 3R M	183 × 52 × 7 cm	715 g	23 × 13.0 cm
7640445454254	Dura 3R MW	183 × 65 × 7 cm	840 g	27 × 13.5 cm
7640445454261	Dura 3R LW	197 × 65 × 7 cm	910 g	27 × 14.5 cm

DURA 5R

SYNMAT TECHNOLOGY™

ASTM R-Value 4.8, Temp. -20°C

EXPEDITION

Material 75D/170D recycled polyester, Oeko-Tex® 100 certified

Insulation 160 g/m³ Texpedloft microfiber, bluesign® certified

Prod. No	Name	Dimension	Weight	Packed
7640445454278	Dura 5R M	183 × 52 × 7 cm	855 g	23 × 14.0 cm
7640445454285	Dura 5R MW	183 × 65 × 7 cm	960 g	27 × 14.5 cm
7640445454292	Dura 5R LW	197 × 65 × 7 cm	1045 g	27 × 15.0 cm
7640445454308	Dura 5R Duo M	183 × 105 × 7 cm	1470 g	27 × 19.0 cm
7640445454315	Dura 5R Duo LW	197 × 130 × 7 cm	2010 g	30 × 20.0 cm

DURA 8R



rectangular

SUPER DURABLE EXPEDITION MATS

Durable, extra-warm mats for demanding adventures, including extended outings in alpine and polar regions, rugged paddling trips and overlanding.

Carbon neutral

EXPED measures, reduces and fully offsets CO₂ from manufacturing and shipping this product.



Recycled 75D/170D brushed Polyester face fabric:

Recycled polyester keeps plastic out of landfills and uses less water, energy and carbon to produce.

Flat Valve

Pioneered by EXPED. Industry-leading durability, reliability and intuitive performance.



Synmat and Downmat Technology

The right insulation for 3 season, winter, or extreme cold.

Comfort cradle

Air chambers run head-to-toe, fully supporting the body for an unrivaled night's sleep and increased durability. EXPED's Comfort Cradle side rails center and secure the sleeper on the mat.

Schnozzel pumpbag included

Rapid, moisture-free mat inflation: lung-power not required!



DURA 6R

DOWNMAT TECHNOLOGY™

ASTM R-Value 5.8, Temp. - 25°C

EXPEDITION

Material 75D/170D recycled polyester, Oeko-Tex® 100 certified

Insulation 700 cuin/oz Down, RDS certified

Prod. No	Name	Dimension	Weight	Packed
7640445454322	Dura 6R M	183 × 52 × 7cm	850 g	23 × 14.5 cm
7640445454339	Dura 6R MW	183 × 65 × 7cm	990 g	27 × 16.0 cm
7640445454346	Dura 6R LW	197 × 65 × 7cm	1060 g	27 × 17.0 cm

DURA 8R

DOWNMAT TECHNOLOGY™

ASTM R-Value 7.8, Temp. - 40°C

EXPEDITION

Material 75D/170D recycled polyester, Oeko-Tex® 100 certified

Insulation 700 cuin/oz Down, RDS certified

Prod. No	Name	Dimension	Weight	Packed
7640445454353	Dura 8R M	183 × 52 × 9 cm	965 g	23 × 15.5 cm
7640445454360	Dura 8R MW	183 × 65 × 9 cm	1140 g	27 × 16.5 cm
7640445454377	Dura 8R LW	197 × 65 × 9 cm	1235 g	27 × 17.5 cm

VERSA

VERSA 1R



rectangular

VERSA 2R



rectangular

VERSA 4R



rectangular

VERSA 1R

AIRMAT TECHNOLOGY™
ASTM R-Value 1.4, Temp. +10°C

TREKKING

Material 75 D recycled polyester, Oeko-Tex® 100 certified
Insulation Air

Prod. No	Name	Dimension	Weight	Packed
7640445454131	Versa 1R M	183 × 52 × 5 cm	545 g	20 × 11.0 cm
7640445454148	Versa 1R LW	197 × 65 × 5 cm	710 g	27 × 13.5 cm

VERSA 2R

SYNMAT TECHNOLOGY™
ASTM R-Value 2.4, Temp. 0°C

TREKKING

Material 75 D recycled polyester, Oeko-Tex® 100 certified
Insulation 60 g/m³ Texpedloft microfiber, bluesign® certified

Prod. No	Name	Dimension	Weight	Packed
7640445454155	Versa 2R M	183 × 52 × 5 cm	595 g	23 × 12.5 cm
7640445454162	Versa 2R LW	197 × 65 × 5 cm	770 g	27 × 14.5 cm

VERSA 5R



rectangular

VERSATILE SLEEPING MAT FOR ANY ADVENTURE

Versatile, multi-use mats for a variety of adventures, including camping, backpacking and adventure travel.

Carbon neutral

EXPED measures, reduces and fully offsets CO₂ from manufacturing and shipping this product.



Recycled 75D Polyester face fabric

Recycled polyester keeps plastic out of landfills and uses less water, energy and carbon to produce.

Flat Valve

Pioneered by EXPED. Industry-leading durability, reliability and intuitive performance.



Integrated pump

Makes inflation swift and simple – Lung power not required!

Airmat and Synmat Technology

The right insulation for 3 season, winter, or extreme cold.

Comfort cradle

Air chambers run head-to-toe, fully supporting the body for an unrivaled night's sleep and increased durability. EXPED's Comfort Cradle side rails center and secure the sleeper on the mat.

VERSA 4R

SYNMAT TECHNOLOGY™

ASTM R-Value 3.7, Temp. -10°C

TREKKING

Material 75D recycled polyester, Oeko-Tex® 100 certified

Insulation 160 g/m³ Texpedloft microfiber, bluesign® certified

Prod. No	Name	Dimension	Weight	Packed
7640445454179	Versa 4R M	183 × 52 × 7 cm	715 g	25 × 13.5 cm
7640445454209	Versa 4R LW	197 × 65 × 7 cm	885 g	25 × 17.0 cm

VERSA 5R

SYNMAT TECHNOLOGY™

ASTM R-Value 5.2, Temp. -20°C

TREKKING

Material 75D recycled polyester, Oeko-Tex® 100 certified

Insulation 200 g/m³ Texpedloft microfiber, bluesign® certified

Prod. No	Name	Dimension	Weight	Packed
7640445454216	Versa 5R M	183 × 52 × 9 cm	840 g	23 × 17.0 cm
7640445454223	Versa 5R MW	183 × 65 × 9 cm	1005 g	27 × 16.5 cm
7640445454230	Versa 5R LW	197 × 65 × 9 cm	1090 g	27 × 17.0 cm

MEGAMAT

MEGAMAT 10



MEGAMAT DUO 10



MEGAMAT 10 | MEGAMAT DUO 10

BASE CAMP

Material

Top 50 D tricot polyester, TPU polyether film laminate, hydrolysis resistant, honeycomb embossed, Oeko-Tex® 100 certified, DWR-free

Bottom 75 D polyester, TPU polyether film laminate, hydrolysis resistant, Oeko-Tex® 100 certified, DWR-free

Insulation 16 kg/m³ PU foam, Oeko-Tex® 100 certified

Prod. No	Name	Size	Color	Dimension	Weight	Packed	R-Value	Temp.	Pump
7640147769731	MegaMat 10	MW	ruby red	183 x 65 x 10 cm	2070 g	67 x 20 cm	8.1	-40 °C	Self inflation/Mini Pump
7640147769748	MegaMat 10	LW	ruby red	197 x 65 x 10 cm	2275 g	67 x 22 cm	8.1	-40 °C	Self inflation/Mini Pump
7640147769755	MegaMat 10	LXW	ruby red	197 x 77 x 10 cm	2600 g	79 x 25 cm	8.1	-40 °C	Self inflation/Mini Pump
7640147769762	MegaMat 10	MW	green	183 x 65 x 10 cm	2070 g	67 x 20 cm	8.1	-40 °C	Self inflation/Mini Pump
7640147769779	MegaMat 10	LW	green	197 x 65 x 10 cm	2275 g	67 x 22 cm	8.1	-40 °C	Self inflation/Mini Pump
7640147769786	MegaMat 10	LXW	green	197 x 77 x 10 cm	2600 g	79 x 25 cm	8.1	-40 °C	Self inflation/Mini Pump
7640171993386	MegaMat Duo 10	M	ruby red	183 x 104 x 10 cm	3340 g	56 x 28 cm	8.1	-40 °C	Self inflation/Mini Pump
7640147769809	MegaMat Duo 10	LW+	ruby red	197 x 132 x 10 cm	4630 g	70 x 30 cm	8.1	-40 °C	Self inflation/Mini Pump
7640171993393	MegaMat Duo 10	M	green	183 x 104 x 10 cm	3340 g	56 x 28 cm	8.1	-40 °C	Self inflation/Mini Pump
7640147769670	MegaMat Duo 10	LW+	green	197 x 132 x 10 cm	4630 g	70 x 30 cm	8.1	-40 °C	Self inflation/Mini Pump
7640445457804	MegaMat Duo 10	QUEEN	green	203 x 152 x 10 cm	5390 g	80 x 30 cm	8.1	-40 °C	Self inflation/Mini Pump
7640445455114	MegaMat Duo 10	TXY	ruby red	197 x 104/132 x 10 cm	3855 g	70 x 30 cm	8.1	-40 °C	Self inflation/Mini Pump

MEGAMAT LITE 12



MEGAMAT MAX 15

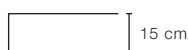

MEGAMAT 10 | DUO 10

The world's most comfortable basecamp mat

- > proven sell-through and field performance
- > stretch tricot surface for maximum comfort
- > air-core-channeled foam insulation reduces weight, bulk
- > separate inflation/deflation FlatValves, extra-large deflation valve
- > MiniPump for top-off inflation
- > sold with easy-to-pack SideWinder™ stuff sack
- > durable construction
- > 2 sizes fit trucks, SUVs, minivans, etc.



MEGAMAT LITE 12

MegaMat comfort in a portable, lightweight package

- > ultra-thick 12 cm for maximum comfort, evens out rocky ground
- > innovative 3-D construction for edge-to-edge sleeping surface
- > cozy brushed tricot top, extra large deflation valve
- > incl. Schnozzel Pumpbag doubles as waterproof stuffsack
- > light enough for backpacking trips
- > fits in many cars and camper vans



MEGAMAT MAX 15

EXPED's famous MegaMat built 50% thicker

- > luxurious 15 cm-thick open-cell foam support
- > stretch tricot surface for maximum comfort
- > air-core-channeled foam reduces weight and bulk
- > extra-large deflation valve for maximum air flow
- > sold with easy-to-pack SideWinder™ stuff sack



MEGAMAT LITE 12

TREKKING

Material

Top 50 D tricot polyester, TPU polyether film laminate, hydrolysis resistant, honeycomb embossed, Oeko-Tex® 100 certified, DWR-free

Bottom 75 D polyester, TPU polyether film laminate, hydrolysis resistant, Oeko-Tex® 100 certified, DWR-free

Insulation 200 g/m³ Texpedloft microfiber, bluesign® certified

Prod. No	Name	Size	Color	Dimension	Weight	Packed	R-Value	Temp.	Pump
7640171993256	MegaMat Lite	MW	ruby red	183 x 65 x 12 cm	1130 g	27 x 16 cm	5.2	-20 °C	Schnozzel Pumpbag UL
7640171993263	MegaMat Lite	LW	ruby red	197 x 65 x 12 cm	1190 g	27 x 16 cm	5.2	-20 °C	Schnozzel Pumpbag UL
7640171993270	MegaMat Lite	LXW	ruby red	197 x 77 x 12 cm	1385 g	31 x 16 cm	5.2	-20 °C	Schnozzel Pumpbag UL

MEGAMAT MAX 15

BASE CAMP

Material

Top 50 D tricot polyester, TPU polyether film laminate, hydrolysis resistant, honeycomb embossed, Oeko-Tex® 100 certified, DWR-free

Bottom 75 D polyester, TPU polyether film laminate, hydrolysis resistant, Oeko-Tex® 100 certified, DWR-free

Insulation 16 kg/m³ PU foam, Oeko-Tex® 100 certified

Prod. No	Name	Size	Dimension	Weight	Packed	R-Value	Temp.	Pump
7640445451659	MegaMat Max 15	LXW	197 x 77 x 15 cm	3355 g	79 x 28 cm	10.6	-55 °C	Self inflation/Mini Pump
7640445452519	MegaMat Max 15	DUO LW+	197 x 132 x 15 cm	5970 g	75 x 35 cm	10.6	-55 °C	Self inflation/Mini Pump

DEEPSLEEP

DEEPSLEEP MAT 7.5

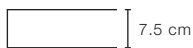

DEEPSLEEP MAT DUO 7.5

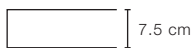

DEEPSLEEP MAT 7.5

Price-point feature set and edge-to-edge comfort

- > brushed 75 D fabric is quiet and soft against skin
- > 7.5 cm/3" of open-cell foam provides excellent support
- > extra-large deflation valve for maximum air flow
- > oversized stuff sack and velcro strap ease packing
- > pump and repair kit sold separately



DEEPSLEEP MAT DUO 7.5

Price-point feature set and edge-to-edge comfort for couples

- > Duo mat dimensions, #sleeptogether comfort
- > brushed 75 D fabric is quiet and soft against skin
- > 7.5 cm/3" of open-cell foam provides excellent support
- > extra-large deflation valve for maximum air flow
- > oversized stuff sack and velcro strap ease packing
- > pump and repair kit sold separately



DEEPSLEEP MAT 7.5

BASE CAMP

Material

Top 75 D polyester, brushed, TPU polyether film laminate, hydrolysis resistant, Oeko-Tex® 100 certified, DWR-free

Bottom 75 D polyester, TPU polyether film laminate, hydrolysis resistant, Oeko-Tex® 100 certified, DWR-free

Insulation 16 kg/m³ PU foam, Oeko-Tex® 100 certified

Prod. No	Name	Size	Dimension	Weight	Packed	R-Value	Temp.	Pump
7640445451994	DeepSleep Mat 7.5	M	183 × 52 × 7.5 cm	1640 g	55 × 20 cm	9.0	-45°C	none - self inflating
7640445451635	DeepSleep Mat 7.5	MW	183 × 65 × 7.5 cm	2040 g	67 × 20 cm	9.0	-45°C	none - self inflating
7640445452007	DeepSleep Mat 7.5	LW	197 × 65 × 7.5 cm	2200 g	67 × 22 cm	9.0	-45°C	none - self inflating
7640445452014	DeepSleep Mat 7.5	LXW	197 × 77 × 7.5 cm	2575 g	79 × 25 cm	9.0	-45°C	none - self inflating
7640445452021	DeepSleep Mat Duo 7.5	M	183 × 104 × 7.5 cm	3020 g	56 × 28 cm	9.0	-45°C	none - self inflating
7640445452038	DeepSleep Mat Duo 7.5	LW+	197 × 132 × 7.5 cm	4445 g	70 × 30 cm	9.0	-45°C	none - self inflating

FLEXMAT

EXPEDITION

MATS

Rapidly deployed, durable and versatile closed-cell-foam mat

- > light, durable and versatile
- > minimalist or entry level sleeping mat
- > provides protection and added R-Value for inflatable mats
- > high quality and more eco-friendly IXPE foam



SitPad Flex

Material closed-cell foam, DWR-free

Prod. No	Name	Size	Dimension	Weight	Packed	R-Value	Temp.
7640445452069	FlexMat	XS	120 × 52 × 1.8 cm	225 g	13 × 52 × 11 cm	1.5	+5°C
7640445451673	FlexMat	M	183 × 52 × 1.8 cm	325 g	13 × 52 × 15 cm	1.5	+5°C
7640445454988	FlexMat	LW	197 × 65 × 1.8 cm	475 g	14 × 65 × 13.5 cm	1.5	+5°C
7640445452458	SitPad Flex		40 × 30 × 1.8 cm	50 g	30 × 13.5 × 3.5 cm	1.5	+5°C

FLEXMAT PLUS

EXPEDITION

The thickest, most comfortable closed-cell foam mat

- > extra thick: 1.5" / 3.8 cm of foam for alpinism and extreme applications
- > highly versatile: for standalone use or puncture protection for inflatable mats
- > rapidly deployed folding form
- > high quality and more eco-friendly IXPE foam



Material closed-cell foam, DWR-free

Prod. No	Name	Size	Dimension	Weight	Packed	R-Value	Temp.
7640445452076	FlexMat Plus	XS	120 × 52 × 3.8 cm	315 g	13 × 52 × 13 cm	2.2	0°C
7640445451680	FlexMat Plus	M	183 × 52 × 3.8 cm	480 g	15 × 52 × 18 cm	2.2	0°C
7640277840744	FlexMat Plus	LW	197 × 65 × 1.8 cm	645 g	16 × 65 × 18 cm	2.2	0°C

MULTIMAT

BASE CAMP

COLOR UPDATE

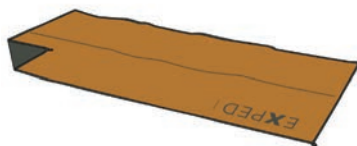

The multi-tool for comfort anywhere

- > 3 mm thickness, tough top fabric, slip-reduction floor fabric
- > snaps along edges to connect multiple mats or secure folded mat
- > versatile: ultralight sleeping mat, tent carpet, dog mat, picnic mat, tarp, vestibule liner, canoe liner, etc.
- > works as moisture and insulative barrier on wet and cold ground
- > lightweight and affordable
- > integrated elastic storage loops

Material Top: 50 D recycled Nylon ripstop **Material bottom:** 70 D Nylon, PU coated

Prod. No	Name	Dimension	Weight	Packed	R-Value	Temp.
7640277842939	MultiMat Uno	200 × 50 cm	275 g	32 × 50 cm	1.4	+10°C
7640277842946	MultiMat Duo	200 × 100 cm	525 g	55 × 55 cm	1.4	+10°C
7640277842953	MultiMat Trio	200 × 150 cm	760 g	47 × 50 cm	1.4	+10°C

DOUBLEMAT EVAZOTE

EXPEDITION

Extremely durable, versatile, lightweight and affordable

- > 4 mm thick
- > extremely tough
- > versatile
- > ultralight
- > affordable
- > Evazote foam – an environmentally friendly material



Material closed-cell ethylenecopolymer foam (Evazote®), density of 35 kg/m³, DWR-free

Prod. No	Name	Dimension	Weight	Packed	R-Value	Temp.
7640120112905	Doublemat Evazote	200 × 100 × 0.4 cm	260 g	51 × 15 cm	1.2	+10°C

SIM MAT

COLOR UPDATE

SIM ULTRA

SIM 2.5 | SIM 3.8 | SIM 5

SIM LITE 3.8



SIM ULTRA

FAST + LITE

Material

Top 20 D recycled polyester, TPU polyether film laminate, hydrolysis resistant, Oeko-Tex® 100 certified, DWR-free

Bottom 20 D recycled polyester, TPU polyether film laminate, hydrolysis resistant, Oeko-Tex® 100 certified, DWR-free

Insulation 13 kg/m³ PU foam, Oeko-Tex® 100 certified

Prod. No	Name	Size	Dimension	Weight	Packed	R-Value	Temp.	Pump
7640277842878	SIM Ultra 3.8	M	183 × 50 × 3.8 cm	580 g	27 × 15 cm	3.1	-5 °C	none - selfinflating
7640277842885	SIM Ultra 3.8	LW	197 × 62 × 3.8 cm	790 g	33 × 16 cm	3.1	-5 °C	none - selfinflating
7640277842892	SIM Ultra 5	M	183 × 50 × 5.0 cm	640 g	27 × 17 cm	4.0	-10 °C	none - selfinflating
7640277842908	SIM Ultra 5	LW	197 × 62 × 5.0 cm	870 g	33 × 18 cm	4.0	-10 °C	none - selfinflating
7640277842915	SIM Ultra 7.5	M	183 × 50 × 7.5 cm	915 g	27 × 19 cm	4.5	-15 °C	none - selfinflating
7640277842922	SIM Ultra 7.5	LW	197 × 62 × 7.5 cm	1305 g	33 × 20 cm	4.5	-15 °C	none - selfinflating

SIM 2.5 | SIM 3.8 | SIM 5 | SIM LITE 3.8

TREKKING

Material

Top 75 D recycled polyester, TPU polyether film laminate, hydrolysis resistant, honeycomb embossed, Oeko-Tex® 100 certified, DWR-free

Bottom 75 D recycled polyester, TPU polyether film laminate, hydrolysis resistant, honeycomb embossed, Oeko-Tex® 100 certified, DWR-free

Insulation 14 kg/m³ PU foam, Oeko-Tex® 100 certified

Prod. No	Name	Size	Dimension	Weight	Packed	R-Value	Temp.	Pump
7640277840959	SIM 2.5	M flame	183 × 50 × 2.5 cm	690 g	26 × 16.0 cm	2.8	-5 °C	Self inflation/Mini Pump
7640277840966	SIM 3.8	M flame	183 × 50 × 3.8 cm	860 g	26 × 18.0 cm	4.6	-15 °C	Self inflation/Mini Pump
7640277840973	SIM 3.8	M black	183 × 50 × 3.8 cm	860 g	26 × 18.0 cm	4.6	-15 °C	Self inflation/Mini Pump
7640277840980	SIM 3.8	LW flame	197 × 65 × 3.8 cm	1185 g	33 × 19.0 cm	4.6	-15 °C	Self inflation/Mini Pump
7640277840997	SIM 3.8	LW black	197 × 65 × 3.8 cm	1185 g	33 × 19.0 cm	4.6	-15 °C	Self inflation/Mini Pump
7640277841000	SIM 5	M flame	183 × 50 × 5.0 cm	1010 g	26 × 20.0 cm	6.1	-25 °C	Self inflation/Mini Pump
7640277841031	SIM 5	LW flame	197 × 65 × 5.0 cm	1415 g	33 × 22.0 cm	6.1	-25 °C	Self inflation/Mini Pump
7640277841048	SIM Lite 3.8	M	183 × 50 × 3.8 cm	750 g	26 × 16.0 cm	3.1	-5 °C	Self inflation/Mini Pump
7640277841055	SIM Lite 3.8	LW	197 × 65 × 3.8 cm	1005 g	33 × 21.5 cm	3.1	-5 °C	Self inflation/Mini Pump

SIM COMFORT 5 | 7.5 | 10 | DUO 5 | 7.5



SIM ULTRA

Self inflating, compact and super lightweight

- > self inflating
- > extremely lightweight and compact
- > convenient inflation and deflation valves
- > anti-slip GripSkin coating
- > warm foam-insulated core



SIM 2.5 | SIM 3.8 | SIM 5 | SIM LITE 3.8

Exped-quality, self-inflating mat for the budget adventurer

- > foam-block core for warmth, comfort
- > self inflating
- > durable



SIM COMFORT 5 | 7.5 | 10

Comfortable, warm, self-inflating and durable

- > stretch tricot surface for maximum comfort
- > air-core-channeled foam insulation reduces weight, bulk
- > separate inflation/deflation FlatValves; MiniPump for top-off inflation
- > sold with easy-to-pack SideWinder™ stuff sack
- > durable construction

DUO 5 | 7.5 Double-wide, 4-season mat for 2

- > stretch tricot surface for maximum comfort
- > air-core-channeled foam insulation reduces weight, bulk
- > separate inflation/deflation FlatValves; MiniPump for top-off inflation
- > sold with easy-to-pack SideWinder™ stuff sack
- > durable construction



SIM COMFORT 5 | 7.5 | 10 | DUO 5 | 7.5

BASE CAMP

Material

Top 50 D recycled tricot polyester, TPU polyether film laminate, hydrolysis resistant, honeycomb embossed, Oeko-Tex® 100 certified, DWR-free

Bottom 75 D recycled tricot polyester, TPU polyether film laminate, hydrolysis resistant, Oeko-Tex® 100 certified, DWR-free

Insulation 16 kg/m³ PU foam, Oeko-Tex® 100 certified

Prod. No	Name	Size	Dimension	Weight	Packed	R-Value	Temp.	Pump
7640277841062	SIM Comfort 5	M	183 x 50 x 5.0 cm	1120 g	26 x 21 cm	4.3	-15 °C	Self inflation
7640277841079	SIM Comfort 5	LW	197 x 65 x 5.0 cm	1590 g	33 x 23 cm	4.3	-15 °C	Self inflation
7640277841086	SIM Comfort Duo 5	LW	197 x 125 x 5.0 cm	3015 g	63 x 20 cm	4.3	-15 °C	Self inflation/Mini Pump
7640277841093	SIM Comfort 7.5	LW	197 x 65 x 7.5 cm	1955 g	67 x 18 cm	7.6	-35 °C	Self inflation/Mini Pump
7640277841109	SIM Comfort Duo 7.5	LW	197 x 125 x 7.5 cm	3375 g	63 x 22 cm	7.6	-35 °C	Self inflation/Mini Pump
7640277841116	SIM Comfort 10	LW	197 x 65 x 10.0 cm	2095 g	67 x 20 cm	8.1	-40 °C	Self inflation/Mini Pump

CHAIR KIT

COLOR UPDATE



Protective mat cover doubles as camp chair

- > 3 positions: chair, lounge or mat
- > simple switch from sitting to sleeping position
- > can be coupled with additional Chair Kits
- > zipper for easy access to mat
- > skin-friendly top fabric and waterproof floor
- > detachable poles



Material

top: 50 D recycled Nylon ripstop, S-PU coated,

bottom: 50 D recycled Nylon ripstop, S-PU coated

Prod. No	Name	Size	Weight	for rectangular Mat size
7640445457811	Chair Kit	M	440 g	M
7640445457828	Chair Kit	MW	475 g	MW
7640445457835	Chair Kit	LW	495 g	LW
7640445457842	MegaMat Chair Kit	LXW	595 g	LXW

MAT COVER

COLOR UPDATE



Protective cover for rectangular Exped Mats

- > comfortable next-to-skin top fabric and waterproof floor
- > can be coupled with additional Mat Covers
- > zipper for easy access to mat



Material

top: 50 D recycled Nylon ripstop, S-PU coated,

bottom: 50 D recycled Nylon ripstop, S-PU coated

Prod. No	Name	Size	Weight	for rectangular Mat size
7640277841680	Mat Cover	M	185 g	M
7640277841697	Mat Cover	MW	220 g	MW
7640277841703	Mat Cover	LW	230 g	LW

SLEEPWELL ORGANIC COTTON MAT COVER

Bed linen for rectangular Exped sleeping mats

- > organic, fair trade cotton
- > dirt protection, washable
- > breathable comfort for warm weather



Material 100% Organic, fair trade cotton

Prod. No	Name	Size	Weight	for rectangular Mats size
7640445457880	Sleepwell Organic Cotton Mat Cover	M	200 g	M
7640445458238	Sleepwell Organic Cotton Mat Cover	MW	250 g	MW
7640277840331	Sleepwell Organic Cotton Mat Cover	LW	300 g	LW
7640277840348	Sleepwell Organic Cotton Mat Cover	LXW	355 g	LXW
7640277840355	Sleepwell Organic Cotton Mat Cover	Duo M	360 g	Duo M
7640277840362	Sleepwell Organic Cotton Mat Cover	Duo LW	465 g	Duo LW
7640277840034	Sleepwell Organic Cotton Mat Cover	Duo LW+	490 g	Duo LW+
7640277840379	Sleepwell Organic Cotton Mat Cover	Duo QUEEN	585 g	Duo QUEEN

SCHNOZZEL PUMPBAG

UPDATE



Ultra-light pump bag for rapid mat inflation

- > quickly inflates Exped Mats
- > doubles as waterproof compression stuffsack or pack liner
- > **Material UL: 20 D recycled Nylon ripstop, PU coated**
- > **Material regular: 70 D recycled Nylon, PU coated**

Prod. No	Name	Colour	Dimension	Weight
7640277841659	Schnozzel Pumpbag	pine	S 60 x 20 x 17 cm	80 g
7640445457859	Schnozzel Pumpbag UL	sunshine	S 60 x 20 x 17 cm	40 g
7640277841666	Schnozzel Pumpbag	pine	M 69 x 39 x 17 cm	110 g
7640445457866	Schnozzel Pumpbag UL	sunshine	M 69 x 39 x 17 cm	60 g
7640277841673	Schnozzel Pumpbag	pine	L 80 x 40 x 30 cm	175 g
7640445457873	Schnozzel Pumpbag UL	sunshine	L 80 x 40 x 30 cm	95 g

MINI PUMP

COLOR UPDATE



Lightest-weight mat-inflation device

- > super lightweight and compact when stowed
- > easy mat inflation by hand or foot
- > fabric eyelet for securing

Prod. No	Dimension	Weight
7640120118624	Ø 12 cm x 9 cm	45 g

FIELD REPAIR KIT



High end repair kit for mats

- > UV curing glue dries in 30 seconds under UV light
- > Key chain mini UV light included
- > 2 transparent TPU patches
- > 2 alcohol wipes
- > Reusable zip pouch

Prod. No	Weight
7640445452427	Field Repair Kit 45 g
7640445452762	Field Repair Kit (5 pcs)

WIDGET PUMP



Electric inflation pump with built in lamp and powerbank

- > convenient, moisture-free inflation for Exped mats
- > electric pump with 2 inflation modes:
 - fast mode and quiet mode
- > integrated 100 lumen lamp
- > integrated 3600 mAh powerbank
- > rechargeable lithium battery

Prod. No	Name	Dimension	Weight
7640445454995	Widget Pump	6 x 6 x 7 cm	190 g

PILLOW PUMP



Doubles as ergonomically shaped pillow

- > easy mat inflation by hand or foot
- > comfortable ergonomic pillow
- > tricot polyester for next-to-skin comfort
- > fabric eyelets for securing pillow to mat

Prod. No	Dimension	Weight
7640120117368	35 x 17 x 10 cm	140 g

UNIVERSAL MAT COUPLER KIT

UPDATE



Couples 2 single mats for side-by-side sleeping

- Material** 75 D/170 D recycled Polyester
- > fits all single mats
- > kit includes 2 coupler loops

Prod. No	Weight
7640277841840	50 g

SCHNOZZEL

UPDATE



Converts Exped packsacks to mat pumps

Material 70 D recycled Nylon, PU coated
 > attaches to Exped Drybags with purge valve
 > Adapter available for 30 mm FlatValves

Prod. No	Weight
7640277841857	25 g

UNIVERSAL VALVE ADAPTER



Valve adapter for any mat

> any mat, also from other brands, can be attached to Exped pumps: Schnozzel Pumpbag, MiniPump, Pillowpump and Schnozzel

Prod. No	Weight
7640171991160	10 g

FLATVALVE ADAPTER



The Adapter for large valves

> Adapter for older mats with large 30 mm FlatValves

Prod. No	Weight
7640147761162	5 g

AIRSEAT



Ultralight air seat

> ultra compact, ultralight, ultra comfortable
 > 2 fabric eyelets for securing
 > combination FlatValve for inflation/deflation
 > stable baffle construction

Material 50 D tricot nylon, TPU Polyether film laminate, hydrolysis resistant, honeycomb embossed

Prod. No	Dimension	Weight
7640147761070	43 x 33 x 5 cm	120 g

SIT PAD

UPDATE



Foam insulated sit pad for all conditions

> self-inflating
 > combination FlatValve for inflation/deflation

Material
 75 D/170 D recycled Polyester, TPU Polyether film laminate, hydrolysis resistant

Prod. No	Color	Dimension	Weight
7640277841833	cypress	40 x 30 x 3.8 cm	125 g
7640277841826	greygoose	40 x 30 x 3.8 cm	125 g

ULTRA PILLOW

FAST + LITE



The ultimate lightweight air pillow

- > comfortable recycled 20 D stretch fabric
- > ultra light and ultra compact air pillow
- > combo valve with one-way flap and deflation pin
- > anatomically shaped and height adjustable
- > fabric eyelets allow attachment to a mat

Material 20 D recycled stretch polyester, TPU Polyether film laminate, hydrolysis resistant, Oeko-Tex®100 certified

Prod. No	Size	Color	Dimension	Weight
7640277840270	M	greygoose	38 x 27 x 10 cm	50 g
7640445457897	M	lichen	38 x 27 x 10 cm	50 g
7640277840287	L	greygoose	46 x 30 x 12 cm	65 g
7640445457903	L	lichen	46 x 30 x 12 cm	65 g

VERSA PILLOW

FAST + LITE



Affordable and robust air pillow

- > durable 75 D recycled polyester
- > light and compact
- > combo valve with one-way flap and deflation pin
- > anatomically shaped and height adjustable
- > fabric eyelets allow attachment to a mat

Material 75 D recycled polyester, TPU Polyether film laminate, hydrolysis resistant, Oeko-Tex®100 certified

Prod. No	Size	Color	Dimension	Weight
7640445454643	M	navy	38 x 27 x 10 cm	65 g
7640445454650	L	navy	46 x 30 x 12 cm	80 g

REM PILLOW

BASECAMP

COLOR UPDATE



Air-core pillow with foam topper

- > 3-D design, height adjustable
- > foam topper support
- > combo valve with one-way flap and deflation pin
- > fabric eyelets allow attachment to a mat
- > cover and air-core can be used individually, or separated for washing and repair

Material recycled brushed tricot nylon

Topper upcycled PU foam chips

Prod. No	Size	Color	Dimension	Weight
7640277841864	M	cypress	38 x 25 x 13 cm	130 g
7640277841871	M	navy	38 x 25 x 13 cm	130 g
7640277843349	M	navy mountain	38 x 25 x 13 cm	130 g
7640277843356	M	lichen forest	38 x 25 x 13 cm	130 g
7640277841888	L	cypress	49 x 26 x 15 cm	190 g
7640277841895	L	navy	49 x 26 x 15 cm	190 g
7640277843325	L	navy mountain	49 x 26 x 15 cm	190 g
7640277843332	L	lichen forest	49 x 26 x 15 cm	190 g

DOWN PILLOW

TREKKING

COLOR UPDATE



Ergonomic air-core pillow with down topper

- > ergonomic 3-D design, height adjustable
- > luxurious down-filled cover
- > ergonomically shaped
- > combo valve with one-way flap and deflation pin
- > fabric eyelets allow attachment to a mat
- > cover and air-core can be used individually or separated for washing and repair

Material recycled brushed tricot nylon

Topper 700 cuin down, RDS certified

Prod. No	Size	Color	Dimension	Weight
7640277841901	M	cypress	38 x 28 x 13 cm	150 g
7640277841918	M	navy	38 x 28 x 13 cm	150 g
7640277843288	M	navy mountain	38 x 28 x 13 cm	150 g
7640277843295	M	lichen forest	38 x 28 x 13 cm	150 g
7640277841925	L	cypress	48 x 29 x 15 cm	190 g
7640277841932	L	navy	48 x 29 x 15 cm	190 g
7640277843264	L	navy mountain	48 x 29 x 15 cm	190 g
7640277843271	L	lichen forest	48 x 29 x 15 cm	190 g

MEGA PILLOW

BASECAMP



Mega in comfort and size

- > extra-large, fleece-padded air-core pillow in 3-D design, ideal for MegaMats
- > velvety soft, great next-to-skin
- > combo valve with one-way flap and deflation pin
- > fabric eyelets allow attachment to a mat
- > cover and air-core can be used individually, or separated for washing and repair

Material recycled brushed tricot nylon

Topper Texpedloft synthetic fleece, bluesign® certified

Prod. No	Color	Dimension	Weight
7640171995380	ruby red	38 x 32 x 12 cm	170 g
7640171996417	moss green	38 x 32 x 12 cm	170 g

DEEPSLEEP PILLOW

TREKKING



Ergonomically designed foam-support pillow

- > soft, "up-cycled" comfort-foam filling
- > cozy brushed tricot shell
- > ergonomic 3-D design

Material recycled brushed tricot nylon

Filling upcycled PU foam chips

Prod. No	Size	Color	Dimension	Weight
7640277841949	M	navy	38 x 28 x 13 cm	180 g
7640277841956	M	cypress	38 x 28 x 13 cm	180 g
7640277843240	M	navy mountain	38 x 28 x 13 cm	180 g
7640277843257	M	lichen forest	38 x 28 x 13 cm	180 g
7640277841963	L	navy	48 x 29 x 15 cm	260 g
7640277841970	L	cypress	48 x 29 x 15 cm	260 g
7640277843226	L	navy mountain	48 x 29 x 15 cm	260 g
7640277843233	L	lichen forest	48 x 29 x 15 cm	260 g

NECK PILLOW DELUXE

TRAVEL

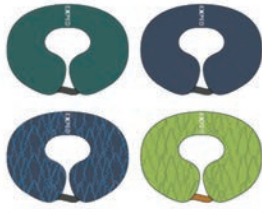

Luxurious, supportive neck pillow

- > cozy brushed tricot cover is removable and washable
- > perfect support during seated sleeping in trains, buses and airplanes
- > chin strap for additional head support
- > TPU air core is easy to remove for repair

Material recycled brushed tricot nylon

Topper Texpedloft synthetic fleece, bluesign® certified

Prod. No	Color	Dimension	Weight
7640277842007	cypress	38 x 32 x 12 cm	85 g
7640277842014	navy	38 x 32 x 12 cm	85 g
7640277843301	navy mountain	38 x 32 x 12 cm	85 g
7640277843318	lichen forest	38 x 32 x 12 cm	85 g

TRAILHEAD PILLOW

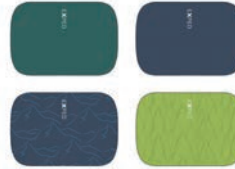

Luxurious basecamp pillow with memory-foam topper

- > upcycled foam chip filling
- > memory foam topper
- > cozy and breathable, recycled outer fabric

Material recycled brushed tricot nylon

Filling upcycled PU foam chips

Prod. No	Color	Dimension	Weight
7640277841987	cypress	52 x 33 x 18 cm	450 g
7640277841994	navy	52 x 33 x 18 cm	450 g
7640277843202	navy mountain	52 x 33 x 18 cm	450 g
7640277843219	lichen forest	52 x 33 x 18 cm	450 g

SLEEPWELL ORGANIC COTTON PILLOW CASE



Breathable, comfortable pillow case for Exped pillows

- > organic, fair trade cotton
- > dirt protection, washable
- > breathable comfort for warm weather

Material Fairtrade, organic, 40s cotton

Prod. No	Size	Color	Weight
7640277840386	M	natural	70 g
7640277840393	L	natural	90 g
7640277840409	Mega	natural	110 g





BACKPACKS

What makes Exped packs unique? Clean and functional design paired with reduction to the basics and removal of the unnecessary. This ultimately leads to a reduction in weight and resources. Less is more.

ALPINE

- > for alpine terrain
- > next-to-body fit
- > weatherproof and 100% waterproof models available

Refined alpine packs developed in cooperation with professional mountain guides. Packs that distinguish themselves through superb load control, smart features, excellent functionality and light weight. Weatherproof packs feature factory-taped seams.

HIKING

- > for day and multi-day use
- > slim and well ventilated
- > organization made easy

Trim hiking packs that offer excellent back ventilation and arm movement even when side pockets are filled with water bottles. The angled base places the pack's weight, even when only partially filled, against the back for load control. Outstanding comfort on any trail.

URBAN

- > for the urban jungle
- > Refined and cleanly designed
- > for office, campus and daily tasks

These packs combine Exped functionality with a classy, urban appearance. They are perfect for the commute between home, office and leisure activities.

TREKKING

- > for multi-day adventures
- > refined and extremely lightweight
- > excellent load control

Streamlined packs for multi-day backpacking adventures. Fully focused on the necessary, these packs combine light weight with superb load-bearing properties and solid load control.

EVERYDAY

- > for outings and shopping
- > extremely versatile
- > lightweight and practical

Packs designed for day trips into the great outdoors or for everyday needs, for travels, for the weekend or any day out.

EXPED'S SUSPENSION SYSTEM

Depending on pack volume and intended use, the suspension system of a backpack can be the most important component. Defining torso length is not necessarily critical for a lightly loaded daypack, but crucial on backpacking or mountaineering packs where only precise fit will efficiently transfer weight to the hips. For large loads and/or internal frame packs, the center of

the hip belt "wings" ideally rests on the hip bone crest (pelvis) and the lumbar pad on the bones of the sacrum. But sometimes a shorter pack length is better, such as in mountaineering situations where a higher-riding pack allows easy access to the climbing harness and/or when unrestricted head movement is needed.

How is torso length defined?

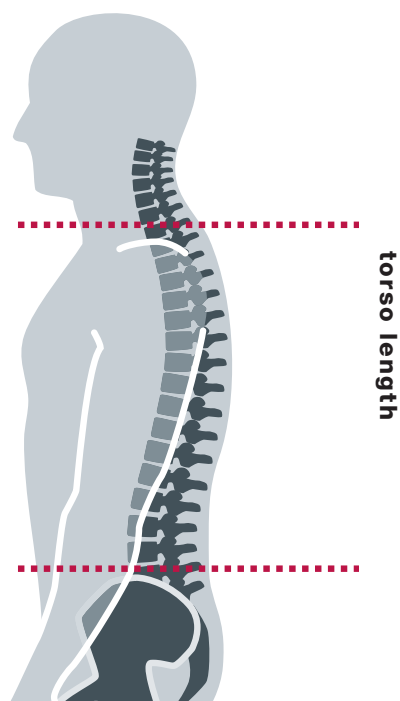

Use a measuring tape to determine the distance between the top edge of the shoulders or the C7 vertebra (the one that protrudes where the neck meets the spine) and the top of the iliac crest (pelvic crest).

A rough guide to pack sizing and torso lengths:

extra short (XS) = 36 – 41 cm / 14 – 16 inches

short (S) = 42 – 47 cm / 16.5 – 18.5 inches

medium (M) = 48 – 52 cm / 19 – 20.5 inches

long (L) = 53 – 58 cm / 21 – 23 inches

Note: The Lightning and Thunder series packs feature torso-length-adjustable suspension systems that cover sizes S – L for men's packs and XS – M for women's versions.

EXPED DESIGN PRINCIPALS

The concepts and design behind Exped packs originate from personal experience in the Swiss Alps and other great mountain regions of the world. Signature reduced-to-the-max Swiss design distinguishes Exped packs along with their precise functionality and clever details derived from real-world use.



1 Rapide Alu Hooks

Lid closure with breakproof aluminum Rapide Hooks.

2 Velcro Tidies

Loose and flapping webbing ends are a thing of the past. These can be easily rolled up and secured with tidies.



3 Weatherproof Construction

Almost all Exped pack categories feature models that are waterproof or weatherproof.

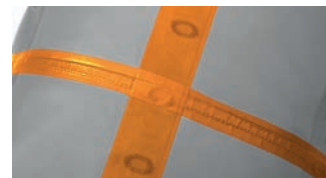

4 Free-standing

Most of our packs stand upright on their own with no need for a tree or rock to lean on.

5 Top Access

A large opening to the main compartment allows for efficient loading and unpacking.

6 Signature Pack Shape

The tapered pack body profile leads to an improved close to body fit.

7 Inner Coatings

Light grey or white inner coatings increase contrast and visibility within the pack.





Ski touring pack with back access and countless smart features

- > durable and sustainable: all materials are recycled and PFC free
- > dark lava: good visibility in alpine surroundings
- > bright color inside the main compartment for good visibility and contrast
- > can be placed in the snow and opened without the back upholstery getting wet
- > quick access to avalanche safety equipment
- > 2 removable ice axe attachment possibilities can be positioned individually
- > compatible with EXPED Mesh Helmet Holder (not included)

Intended use

Ski-, snowboard- and snowshoe adventures



- 1 clean front for easy fixation of equipment
- 2 touch points are highlighted with color
- 3 front and base reinforced with EVA foam
- 4 the lid closure is on the carrying side for easy handling
- 5 top loader with 270° zippered back access
- 6 beefy hipbelt with 2 stretch mesh pockets

Main fabric Recycled 420 D ripstop nylon carbonate PU, 1'500 mm water column, Oeko-Tex® 100 certified, PFC-free
 recycled 600 D polyester PU, 1'500mm water column, bluesign® certified, PFC-free

Lining fabric Recycled 150 D polyester, PU coated, 3'000 mm water column, PFC-free

Frame Spring steel U-frame

Prod. No	Name	Color	Volume	Dimensions	min. Weight	max. Weight	Fits Torso	Load limit
7640445456494	Couloir 30	black	30 l	31 x 56 x 22 cm	1190 g	1500 g	45 – 52 cm	13 kg
7640445456500	Couloir 30	dark lava	30 l	31 x 56 x 22 cm	1190 g	1500 g	45 – 52 cm	13 kg
7640445456548	Couloir 30 Wmns	navy	30 l	31 x 56 x 22 cm	1190 g	1500 g	42 – 50 cm	13 kg
7640445456517	Couloir 40	black	40 l	31 x 61 x 24 cm	1290 g	1600 g	45 – 52 cm	14 kg
7640445456531	Couloir 40	dark lava	40 l	31 x 61 x 24 cm	1290 g	1600 g	45 – 52 cm	14 kg
7640445456555	Couloir 40 Wmns	navy	40 l	31 x 61 x 24 cm	1290 g	1600 g	42 – 50 cm	14 kg



Weatherproof and agile all-season alpine pack

- > weatherproof, minimalist winter-specific roll-top pack
- > taped seams, waterproof fabric, water-resistant zippers
- > direct load transfer due to slim and compact design
- > durable fabric, white inner coating for bright interior

Intended use

4-season mountaineering and touring



- 1 zippered front pocket for shovel blade, skins, etc.
- 2 long side access to main compartment via welded side zip
- 3 low-profile daisy chains and axe/ski loops
- 4 removable 40 mm waist strap

Main fabric 400 D ripstop nylon, TPU film laminate, 10'000 mm water column, PFC-free

Frame removable crosslinked PE foam board

Prod. No	Name	Color	Volume	Dimensions	min. Weight	max. Weight	Fits Torso	Load limit
7640445452175	Serac 25	chili	25 l	55 x 25 x 21 cm	585 g	765 g	42 – 47 cm	13 kg
7640445452212	Serac 25	forest	25 l	55 x 25 x 21 cm	585 g	765 g	42 – 47 cm	13 kg
7640147767805	Serac 25	black	25 l	55 x 25 x 21 cm	585 g	765 g	42 – 47 cm	13 kg
7640445452182	Serac 35 S	chili	35 l	62 x 30 x 23 cm	640 g	820 g	42 – 47 cm	14 kg
7640445452229	Serac 35 S	forest	35 l	62 x 30 x 23 cm	640 g	820 g	42 – 47 cm	14 kg
7640445452199	Serac 35 M	chili	35 l	62 x 30 x 23 cm	655 g	845 g	48 – 52 cm	14 kg
7640445452236	Serac 35 M	forest	35 l	62 x 30 x 23 cm	655 g	845 g	48 – 52 cm	14 kg
7640147766631	Serac 35 M	black	35 l	62 x 30 x 23 cm	655 g	845 g	48 – 52 cm	14 kg
7640171995441	Serac 35 L	black	35 l	62 x 30 x 23 cm	665 g	865 g	53 – 57 cm	14 kg
7640445452205	Serac 45 M	chili	45 l	69 x 32 x 25 cm	690 g	880 g	48 – 52 cm	15 kg
7640445452243	Serac 45 M	forest	45 l	69 x 32 x 25 cm	690 g	880 g	48 – 52 cm	15 kg
7640147767836	Serac 45 M	black	45 l	69 x 32 x 25 cm	690 g	880 g	48 – 52 cm	15 kg
7640171995465	Serac 45 L	black	45 l	69 x 32 x 25 cm	700 g	900 g	53 – 57 cm	15 kg

NEW



Alpine touring pack in a class of its own – a reliable and weatherproof all-season companion

- > bluesign® certified UHMPE ripstop fabric – lightweight yet extremely abrasion and tear resistant
- > vertically positioned zippered side access to main compartment
- > removable side compression straps
- > low profile ice tool and ski configuration for secure attachment of tools and skis
- > weatherproof construction
- > roll-top closure with durable alloy carabiners for both roll-top or lateral top down closure
- > white pack color increases visibility and overview of contents packed

Intended use

alpine, all season use, expeditions



- 1** generously dimensioned front pocket for shovel, ski skins etc.
- 2** vertically positioned zippered side access to main compartment
- 3** zippered pocket accessible from the outside
- 4** minimal daisy chains for endless attachment options
- 5** hydration system tube port
- 6** removable 40 mm waist belt
- 7** Exclusive ripstop fabric made of ultra high-modulus polyethylene
- 8** removable ice tool attachment strap

Main fabric bluesign® certified 200D RipStop UHMPE fabric, TPU-film laminate, 20'000 mm water column, PFC-free

Frame removable PE foam board with EVA foam padding

Prod. No	Name	Color	Volume	Dimensions	min. Weight	max. Weight	Fits Torso	Load limit
7640171998459	Icefall 30 S	white	28 l	57 x 26 x 23 cm	600 g	860 g	42–47 cm	13 kg
7640277843172	Icefall 30 M	white	30 l	58 x 27 x 23 cm	620 g	880 g	48–52 cm	13 kg
7640445450256	Icefall 40 S	white	38 l	64 x 30 x 25 cm	660 g	920 g	42–47 cm	14 kg
7640445450775	Icefall 40 M	white	38 l	64 x 30 x 25 cm	670 g	940 g	48–52 cm	14 kg
7640445450829	Icefall 40 L	white	38 l	64 x 30 x 25 cm	690 g	960 g	53–57 cm	14 kg
7640445450836	Icefall 50 M	white	49 l	69 x 32 x 27 cm	705 g	975 g	48–52 cm	14 kg
7640445450843	Icefall 50 L	white	49 l	69 x 32 x 27 cm	720 g	995 g	53–57 cm	14 kg

UPDATE

Kletterer
EMPFEHLUNG
02/2019



Extremely lightweight, tough and waterproof alpine pack in bluesign® certified 200D RipStop UHMPE fabric

- > minimalist gear hauler for serious mountaineering and expedition use
- > streamlined backpack with roll-top main opening
- > fully seam taped main body construction
- > excellent load transfer due to body-hugging fit
- > direct load transfer due to slim cushioned back pad

Update

- > bluesign® certified UHMPE ripstop fabric – lightweight yet extremely abrasion and tear resistant
- > low profile ice tool configuration for snug attachment of alpine tools

Intended use

Mountaineering, climbing, expeditions



BACKPACKS



1 100% seam taped, waterproof main compartment

2 removable 40 mm waist strap

3 outer pocket with zipper for maps, sun screen, etc.

4 minimal yet versatile daisy chains for many attachment options

5 padded PE foam board

6 removable ice tool attachment strap

Main fabric bluesign® certified 200D RipStop UHMPE fabric, TPU-film laminate, 20'000 mm water column, PFC-free

Frame removable PE foam board

Prod. No	Name	Size	Color	Volume	Dimensions	min. Weight	max. Weight	Fits Torso	Load limit
7640277843134	Whiteout 30	S	white	28 l	55 × 26 × 21 cm	580 g	720 g	42 – 47 cm	13 kg
7640277843141	Whiteout 30	M	white	30 l	57 × 27 × 22 cm	605 g	750 g	48 – 52 cm	13 kg
7640277843158	Whiteout 45	M	white	45 l	69 × 32 × 25 cm	670 g	830 g	48 – 52 cm	15 kg
7640277843165	Whiteout 45	L	white	45 l	69 × 32 × 25 cm	685 g	860 g	53 – 57 cm	15 kg



Clean, mean, waterproof climbing machine

- > waterproof, roll-top main compartment, weatherproof outer pocket
- > direct load transfer due to slim cushioned back pad
- > sophisticated construction techniques save weight
- > durable fabric – white inner coating for bright interior

Intended use

Mountaineering, climbing, expeditions



1 daisy chain and ice axe loops for straight-forward tool/gear attachments

2 long top compression strap with Rapide alloy hook

3 100% seam taped, waterproof main compartment

4 weatherproof pocket with zipper for maps, sun screen, etc.

5 removable 40 mm waist strap

Main fabric 400 D ripstop nylon, TPU film laminate, 10'000 mm water column, PFC-free

Frame removable crosslinked PE foam board

Prod. No	Name	S	Color	Volume	Dimensions	min. Weight	max. Weight	Fits Torso	Load limit
7640445452090	Black Ice 30	S	forest	30 l	55 × 27 × 21 cm	570 g	710 g	42 – 47 cm	13 kg
7640147765696	Black Ice 30	M	black	30 l	57 × 27 × 22 cm	595 g	740 g	48 – 52 cm	13 kg
7640445452120	Black Ice 30	M	forest	30 l	57 × 27 × 22 cm	595 g	740 g	48 – 52 cm	13 kg
7640445452106	Black Ice 30	M	chili	30 l	57 × 27 × 22 cm	595 g	740 g	48 – 52 cm	13 kg
7640147765726	Black Ice 45	M	black	45 l	69 × 32 × 25 cm	660 g	820 g	48 – 52 cm	15 kg
7640445452137	Black Ice 45	M	forest	45 l	69 × 32 × 25 cm	660 g	820 g	48 – 52 cm	15 kg
7640445452151	Black Ice 45	M	chili	45 l	69 × 32 × 25 cm	660 g	820 g	48 – 52 cm	15 kg
7640171995458	Black Ice 45	L	black	45 l	69 × 32 × 25 cm	675 g	850 g	53 – 57 cm	15 kg



Compact freerider, climbing and all-around mountain pack

- > splashproof 4-season pack, waterproof fabric, taped seams
- > access to main compartment through water-resistant zipper
- > compact design for great load control and comfort
- > body hugging thermo formed back
- > large front pocket for wet skins, shovel blade, guide books, etc.
- > 4 daisy chains for numerous attachment options
- > anatomically shaped EVA padded shoulder harness

Intended use

Mountaineering, climbing, ski touring, daypack/day trips



Main fabric 420 D oxford nylon, PU coated, 3'000 mm water column, Oeko-Tex® 100 certified, DWR C6

Frame removable crosslinked PE foam board

Prod. No	Name	Color	Volume	Dimensions	min. Weight	max. Weight	Fits Torso	Load limit
7640171993553	Mountain Pro 20	black	20 l	50 x 29 x 17 cm	730 g	1120 g	one size	10 kg
7640171993560	Mountain Pro 20	bark brown	20 l	50 x 29 x 17 cm	730 g	1120 g	one size	10 kg

MOUNTAIN PRO 30 | 40



4-season mountain pack refined to the basics

- > weatherproof, roll-top main compartment, weatherproof lid pocket
- > close-to-body fit, superb freedom of movement
- > unrestricted head movement even with helmet
- > extensive range of removable features saves up to 400 g
- > 5 daisy chains for multiple attachment options
- > anatomically shaped EVA padded shoulder harness

Intended use

Mountaineering, climbing, ski touring, expeditions



Main fabric 420 D oxford nylon, PU coated, 3'000 mm water column, Oeko-Tex® 100 certified, DWR C6

Frame removable crosslinked PE foam board

Prod. No	Name	Size	Color	Volume	Dimensions	min. Weight	max. Weight	Fits Torso	Load limit
7640171993591	Mountain Pro 30		black	32 l	58 x 30 x 24 cm	900 g	1290 g	45 – 51 cm	13 kg
7640171993607	Mountain Pro 30		mossgreen	32 l	58 x 30 x 24 cm	900 g	1290 g	45 – 51 cm	13 kg
7640171993638	Mountain Pro 30 Wmns	S	deep sea blue	30 l	58 x 28 x 23 cm	860 g	1250 g	42 – 47 cm	13 kg
7640171993645	Mountain Pro 40	M	black	42 l	62 x 32 x 26 cm	990 g	1390 g	48 – 52 cm	14 kg
7640171993669	Mountain Pro 40	M	mossgreen	42 l	62 x 32 x 26 cm	990 g	1390 g	48 – 52 cm	14 kg
7640171993683	Mountain Pro 40 Wmns	S	deep sea blue	38 l	62 x 29 x 24 cm	860 g	1350 g	42 – 47 cm	14 kg
7640171993690	Mountain Pro 40	L	black	44 l	64 x 32 x 27 cm	1010 g	1410 g	53 – 57 cm	14 kg



Lightweight alpine day touring pack

- > easily modified: side compression, ice axe loop and Tool Blade can be removed or repositioned
- > direct access to low lying gear through the zippered side access
- > signature pack shape: low profile pack body concept for a close to body fit
- > Verglas 40 Wmns: women's version with shorter back and shoulder straps
- > removable padded hip belt with 2 hip belt pockets

Intended use

Alpine touring, climbing, via ferrata



- 1 quick access lid to main compartment
- 2 minimized and thoughtfully positioned daisy chains
- 3 internal mesh pocket can be reached through the side access
- 4 Tool Blade can be removed or repositioned
- 5 padded base section for improved stability and abrasion resistance
- 6 removable padded hip belt with 2 hip belt pockets
- 7 thermo moulded back panel

Main fabric Recycled 210 D/420 D robic HD ripstop nylon carbonate, PU coated, 1'500 mm water column, Oeko-Tex® 100 certified, PFC-free

Lining fabric Recycled 150 D polyester, PU coated, 3'000 mm water column, PFC-free

Frame removable crosslinked PE foam board

Prod. No	Name	Size	Color	Volume	Dimensions	min. Weight	max. Weight	Fits Torso	Load limit
7640445453264	Verglas 30		black	30 l	55 x 30 x 21 cm	720 g	1050 g	45 – 51 cm	13 kg
7640445453271	Verglas 30		burgundy	30 l	55 x 30 x 21 cm	720 g	1050 g	45 – 51 cm	13 kg
7640445453288	Verglas 30		dark lava	30 l	55 x 30 x 21 cm	720 g	1050 g	45 – 51 cm	13 kg
7640445453295	Verglas 40	M	black	40 l	63 x 32 x 26 cm	800 g	1140 g	48 – 52 cm	13 kg
7640445453301	Verglas 40	M	burgundy	40 l	63 x 32 x 26 cm	800 g	1140 g	48 – 52 cm	13 kg
7640445453318	Verglas 40	M	dark lava	40 l	63 x 32 x 26 cm	800 g	1140 g	48 – 52 cm	13 kg
7640445453325	Verglas 40	L	black	40 l	64 x 32 x 26 cm	805 g	1145 g	53 – 57 cm	13 kg
7640445453332	Verglas 40 Wmns	S	black	37 l	60 x 30 x 26 cm	795 g	1135 g	42 – 47 cm	13 kg
7640445453349	Verglas 40 Wmns	S	dark lava	37 l	60 x 30 x 26 cm	795 g	1135 g	42 – 47 cm	13 kg



Athletic companion for ambitious tours and day hikes

- > versatile touring backpack with huge zippered main opening
- > excellent load transfer due to body-hugging fit
- > recycled, abrasion-resistant ripstop nylon
- > double, lightly padded base for form stability and durability
- > inner zippered mesh pocket and pockets for drinking bottles
- > hydration-system compatible
- > 15 l version: with removable waist strap
- > 20 l / 30 l version: with padded, removable hip belt with 2 hip belt pockets
- > outer pocket with zipper for sun screen etc.
- > versatile attachment points on front and side
- > outer mesh pockets made of strong nylon tricot
- > cord compression with toggle system: freely placeable or removable
- > thermo-formed back panel

Intended use

Alpine touring, hiking, cycling/MTBiking, via ferrata



Main fabric Recycled 210 D robic HD ripstop nylon carbonate PU, 1'500 mm water column, Oeko-Tex® 100 certified, PFC-free

Lining fabric Recycled 150 D polyester, PU coated, 3'000 mm water column, PFC-free

Frame removable PE foam board

Prod. No	Name	Color	Volume	Dimensions	min. Weight	max. Weight	Fits Torso	Load limit
7640445451123	Impulse 15	black	16 l	50 × 27 × 17 cm	440 g	620 g	one size	10 kg
7640445451147	Impulse 15	burgundy	16 l	50 × 27 × 17 cm	440 g	620 g	one size	10 kg
7640445451130	Impulse 15	navy	16 l	50 × 27 × 17 cm	440 g	620 g	one size	10 kg
7640445451161	Impulse 20	black	20 l	52 × 27 × 18 cm	600 g	880 g	one size	10 kg
7640445451178	Impulse 20	burgundy	20 l	52 × 27 × 18 cm	600 g	880 g	one size	10 kg
7640445451154	Impulse 20	navy	20 l	52 × 27 × 18 cm	600 g	880 g	one size	10 kg
7640445451185	Impulse 30	black	29 l	55 × 30 × 21 cm	720 g	1010 g	45 – 51 cm	13 kg
7640445451208	Impulse 30	burgundy	29 l	55 × 30 × 21 cm	720 g	1010 g	45 – 51 cm	13 kg
7640445451192	Impulse 30	navy	29 l	55 × 30 × 21 cm	720 g	1010 g	45 – 51 cm	13 kg

CORE 25 | 35



Core 25

Core 35



Extremely durable minimalist mountain pack

- > sustainable materials: recycled, certified and PFC-free
- > slim, compact design
- > 2 lid pockets: key fob in internal pocket
- > flat double-layer base for durability and stability
- > hydro system compatible
- > removable side compression straps
- > Tool Blade can be removed or repositioned
- > internal mesh bottle holder and sleeve for avalanche probe or shovel
- > quick access with super solid single carabiner closure
- > lid zipper: long and burly for easy access and packing
- > minimized and thoughtfully positioned daisy chains
- > 4 removable compression and attachment straps
- > removable 38 mm strap hipbelt

Intended use

Alpine touring, climbing, via ferrata



Main fabric Recycled 600 D oxford nylon, PU coated, 1'500 mm water column, PFC free, bluesign® certified

Lining fabric Recycled 150 D polyester, PU coated, 3'000 mm water column, PFC-free

Frame removable crosslinked PE foam board

Prod. No	Name	Color	Volume	Dimensions	min. Weight	max. Weight	Fits Torso	Load limit
7640277840201	Core 25	black	26 l	53 × 27 × 19 cm	580 g	780 g	one size	10 kg
7640277840218	Core 25	dark lava	26 l	53 × 27 × 19 cm	580 g	780 g	one size	10 kg
7640277840225	Core 35	black	35 l	62 × 30 × 22 cm	680 g	880 g	48 – 52 cm	10 kg
7640277840232	Core 35	dark lava	35 l	62 × 30 × 22 cm	680 g	880 g	48 – 52 cm	10 kg



Featherlight on the trail and ready for multi-day adventures

- > light: narrower webbing and improved construction
- > more comfort: comfy padding and strong aluminum stay
- > minimal back contact points for good venting
- > stretch pockets on sides and hipbelt
- > full pack body compression system
- > women's version: female-specific hipbelt and shoulder straps

Intended use

Trekking, hiking, long distance hiking



- 1** very light top-loader with roll-top closure
- 2** tough: abrasion resistant resistant, recycled 600 D polyester
- 3** excellent load transfer over central aluminium stay anchored to the hip belt
- 4** sophisticated suspension system with easy length adjustment

Main fabric 210 D HMPE ripstop nylon, PU coated, 1'500 mm water column, PFC-free, Oeko-Tex® 100 certified
 Recycled 600 D oxford polyester, PU coated, 1'500 mm water column, bluesign® certified, PFC-free
Frame 6061-T6 series aluminum stay

Prod. No	Name	Color	Volume	Dimensions	Weight	Fits Torso	Load limit
7640445451291	Lightning 45	black	45 l	72 x 32 x 25 cm	1180 g	41 – 58 cm	24 kg
7640445457934	Lightning 45	forest	45 l	72 x 32 x 25 cm	1180 g	41 – 58 cm	24 kg
7640445451314	Lightning 45 Wmns	black	45 l	72 x 32 x 25 cm	1040 g	36 – 53 cm	24 kg
7640445457941	Lightning 45 Wmns	forest	45 l	72 x 32 x 25 cm	1040 g	36 – 53 cm	24 kg
7640445451338	Lightning 60	black	60 l	75 x 34 x 27 cm	1220 g	41 – 58 cm	24 kg
7640445457958	Lightning 60	forest	60 l	75 x 34 x 27 cm	1220 g	41 – 58 cm	24 kg
7640445451352	Lightning 60 Wmns	black	60 l	75 x 34 x 27 cm	1180 g	36 – 53 cm	24 kg
7640445457965	Lightning 60 Wmns	forest	60 l	75 x 34 x 27 cm	1180 g	36 – 53 cm	24 kg

Extremely comfortable lightweight pack with multiple access options

- > light: narrower webbing and improved construction
- > tough: highly water and abrasion resistant nylon fabric
- > comfy padding and strong aluminum stay
- > versatile main compartment access: top, front and sides
- > women's version: female-specific hipbelt and shoulder straps

Intended use

Trekking, hiking, multiday adventures



- 1 floating lid with dual compartments
- 2 durable mesh stretch pockets on front, sides and hipbelt
- 3 precise load transfer via single aluminum stay and ergonomic hipbelt
- 4 sophisticated suspension system with easy length adjustment
- 5 compression straps for both side and front compression use

Main fabric Recycled 210 D robic HD ripstop nylon carbonate PU, 1'500 mm water column, Oeko-Tex 100® certified, PFC-free

Frame 6061-T6 series aluminum stay

Prod. No	Name	Color	Volume	Dimensions	Weight	Fits Torso	Load limit
7640445451215	Thunder 50	black	50 l	75 × 33 × 25 cm	1570 g	41 – 58 cm	24 kg
7640445451222	Thunder 50	navy	50 l	75 × 33 × 25 cm	1570 g	41 – 58 cm	24 kg
7640445451246	Thunder 50 Wmns	navy	50 l	75 × 33 × 25 cm	1520 g	36 – 53 cm	24 kg
7640445451253	Thunder 70	black	70 l	84 × 36 × 29 cm	1600 g	41 – 58 cm	24 kg
7640445451260	Thunder 70	navy	70 l	84 × 36 × 29 cm	1600 g	41 – 58 cm	24 kg
7640445451284	Thunder 70 Wmns	navy	70 l	84 × 36 × 29 cm	1590 g	36 – 53 cm	24 kg



NEW

Lightweight, waterproof roll-top backpack for athletic excursions

- > extremely versatile and compact
- > waterproof, seam taped construction
- > efficient front compression of the pack sack
- > clever, removable inner mesh pocket
- > modular, removable sternum strap/hip belt system keeps the load close to the back at all times
- > wide, vapour-permeable mesh shoulder straps with stretch pockets
- > contents stay dry even during the most sweaty activities
- > unique waterproof hydration system exit design in roll-top style

Intended use

Trailrunning, climbing, (speed)hiking, biking, travel



1 large and easy-to-use front elastic webbing

2 unique waterproof hydration system exit design in roll-top style

3 airy, contoured mesh shoulder straps with mesh pockets

4 modular, removable sternum strap/hip belt system

5 lightly padded and ventilating mesh back for support and comfort

Main fabric Recycled 70 D taffeta nylon, PU coated (white pigment), 7'000 mm water column, fully seam taped, bluesign® certified, PFC-free

Frame EVA foam back pad

Prod. No	Name	Color	Volume	Dimensions	Weight	Fits torso	Load limit
7640277840904	Stormrunner 9	dark lava	9 l	39 x 18 x 12 cm	270 g	one size	< 5 kg
7640277842960	Stormrunner 9	moraine	9 l	39 x 18 x 12 cm	270 g	one size	< 5 kg
7640445458580	Stormrunner 15	moraine	15 l	42 x 20 x 15 cm	290 g	one size	< 5 kg
7640445458597	Stormrunner 15	lichen	15 l	42 x 20 x 15 cm	290 g	one size	< 5 kg
7640445458603	Stormrunner 15	dark lava	15 l	42 x 20 x 15 cm	290 g	one size	< 5 kg
7640445458610	Stormrunner 25	moraine	25 l	53 x 28 x 20 cm	320 g	one size	< 5 kg
7640445458689	Stormrunner 25	lichen	25 l	53 x 28 x 20 cm	320 g	one size	< 5 kg
7640445458696	Stormrunner 25	dark lava	25 l	53 x 28 x 20 cm	320 g	one size	< 5 kg



The first waterproof child-specific adventure pack available

- > 100% waterproof with fully seam taped internal liner
- > water and dirt-repellant outer fabric
- > liner can be turned inside out for instant cleaning
- > cool and functional: fits like a glove and is super lightweight
- > made of high quality materials (same as adult models)
- > durable fabric withstands daily adventures
- > reflective print for high visibility
- > 2 stretch pockets and daisy chains
- > safety sternum strap buckle self-releases under pressure

Intended use

Little outdoor adventures, forest kindergarten



Main fabric Recycled 210 D robic HD ripstop nylon carbonate, PU coated, 1'500 mm water column, Oeko-Tex® 100 certified, PFC-free

Lining fabric Recycled 150 D polyester, PU coated, 3'000 mm water column, PFC-free

Frame Air Mesh backpack

Prod. No	Name	Color	Volume	Dimensions	Weight	Fits torso	Load limit
7640445453448	Kid's Typhoon 15	forest	13 l	36 x 20 x 15 cm	310 g	one size	< 5 kg
7640445453455	Kid's Typhoon 15	burgundy	13 l	36 x 20 x 15 cm	310 g	one size	< 5 kg

TYPHOON 15 | 25



Durable lightweight roll-top daypack with full weather protection

- > integrated waterproof liner for full weather protection
- > fully taped seams: 100% waterproof
- > durable fabric withstands a day in the crags
- > zippered inner pocket
- > anchor point for bike light
- > comfy mesh back panel
- > single handed operated chest strap
- > comfortable shoulder straps
- > removable hipstrap
- > 2 stretch pockets and daisy chains

Intended use

Hiking, leisure, travel, climbing, via ferrata



Main fabric Recycled 210 D robic HD ripstop nylon carbonate, PU coated, 1'500 mm water column, Oeko-Tex® 100 certified, PFC-free

Lining fabric Recycled 150 D polyester, PU coated, 3'000 mm water column, PFC-free

Frame Air Mesh backpack

Prod. No	Name	Color	Volume	Dimensions	Weight	Fits torso	Load limit
7640445453356	Typhoon 15	black	15 l	42 x 20 x 15 cm	380 g	one size	< 5 kg
7640445453363	Typhoon 15	burgundy	15 l	42 x 20 x 15 cm	380 g	one size	< 5 kg
7640445453387	Typhoon 15	forest	15 l	42 x 20 x 15 cm	380 g	one size	< 5 kg
7640445453394	Typhoon 15	navy	15 l	42 x 20 x 15 cm	380 g	one size	< 5 kg
7640445453400	Typhoon 25	black	24 l	49 x 29 x 20 cm	450 g	one size	< 5 kg
7640445453417	Typhoon 25	burgundy	24 l	49 x 29 x 20 cm	450 g	one size	< 5 kg
7640445453424	Typhoon 25	forest	24 l	49 x 29 x 20 cm	450 g	one size	< 5 kg
7640445453431	Typhoon 25	navy	24 l	49 x 29 x 20 cm	450 g	one size	< 5 kg



Lightweight, durable and versatile day hiker

- > internal lid pocket with key hook
- > large zippered access to main compartment
- > ice axe/trekking pole attachment
- > hydration system compatible
- > stretch side pocket for water bottle, energy bars etc.
- > 2 practical daisy chains on the front

Intended use

Hiking, leisure, travel, climbing, via ferrata



- 1 asymmetrical, extra-long zipper opening for easy access to the base of the pack
- 2 bright raincover included in stowaway bottom pocket

- 3 padded S-shaped shoulder straps with stretch mesh pockets for sunglasses or mobile phone
- 4 removable waist strap

Main fabric Recycled 600 D oxford polyester, PU coated, 1'500 mm water column, PFC-free, bluesign® certified

Lining fabric Recycled 150 D polyester, PU coated, 3'000 mm water column, PFC-free

Frame Air Mesh backpad

Prod. No	Name	Color	Volume	Dimensions	min. Weight	max. Weight	Fits torso	Load limit
7640277840157	Summit Hike 15	black	15 l	49 × 25 × 18 cm	350 g	440 g	one size	10 kg
7640277840164	Summit Hike 15	navy	15 l	49 × 25 × 18 cm	350 g	440 g	one size	10 kg
7640277840010	Summit Hike 15	forest	15 l	49 × 25 × 18 cm	350 g	440 g	one size	10 kg
7640277840171	Summit Hike 25	black	25 l	50 × 28 × 19 cm	520 g	640 g	one size	10 kg
7640277840188	Summit Hike 25	navy	25 l	50 × 28 × 19 cm	520 g	640 g	one size	10 kg
7640277840195	Summit Hike 25	forest	25 l	50 × 28 × 19 cm	520 g	640 g	one size	10 kg

SUMMIT LITE 15 | 25

EVERYDAY



Ultralight, stowable summit pack

- > lightweight yet durable recycled 100D Triple Ripstop nylon fabric
- > ice axe / trekking pole loop
- > quick zippered access to main compartment
- > shoulder straps with stretch pockets and sternum strap
- > internal lid pocket with key clip
- > hydration system compatible
- > removable chest strap
- > stretch side pocket for water bottle, energy bars etc.
- > front daisy chains for multiple attachments
- > stowable in its side pocket or top lid pocket
- > removable waist strap

Intended use

Travel, sport and leisure



Main fabric Recycled 100 D robic triple ripstop nylon UTS, 1'500 mm, PFC-free, Oeko-Tex® 100 certified

Frame frameless

Prod. No	Name	Color	Volume	Dimensions	min. Weight	max. Weight	Fits Torso	Load limit
7640445458719	Summit Lite 15	black	18 l	45 x 25 x 18 cm	280 g	310 g	one size	< 5 kg
7640445458702	Summit Lite 15	gold	18 l	45 x 25 x 18 cm	280 g	310 g	one size	< 5 kg
7640277840249	Summit Lite 15	sage	18 l	45 x 25 x 18 cm	280 g	310 g	one size	< 5 kg
7640277840256	Summit Lite 25	black	25 l	50 x 28 x 19 cm	310 g	340 g	one size	< 5 kg
7640277840263	Summit Lite 25	gold	25 l	50 x 28 x 19 cm	310 g	340 g	one size	< 5 kg
7640445458795	Summit Lite 25	sage	25 l	50 x 28 x 19 cm	310 g	340 g	one size	< 5 kg

CLOUDBURST 15 | 25

EVERYDAY



Ultralight, waterproof roll-top pack

- > practical roll-top closure
- > extremely versatile, lightweight and stowable
- > airy mesh shoulder straps, removable waist strap
- > single-pull, zig-zag shock cord secures helmet, jacket, etc.
- > EVA foam back pad for enhanced comfort
- > fully taped seams

Intended use

Travel, watersports, mountain sports, daytrips, biking, leisure and backup pack



Main fabric Recycled 70 D taffeta nylon, PU coated (white pigment), 7'000 mm water column, fully seam taped, bluesign® certified, PFC-free

Frame EVA foam back pad

Prod. No	Name	Color	Volume	Dimensions	Weight	Fits Torso	Load limit
7640445458467	Cloudburst 15	gold	15 l	42 x 18 x 15 cm	250 g	one size	< 5 kg
7640445458474	Cloudburst 15	sage	15 l	42 x 18 x 15 cm	250 g	one size	< 5 kg
7640445458481	Cloudburst 15	black	15 l	42 x 18 x 15 cm	250 g	one size	< 5 kg
7640445458498	Cloudburst 15	navy	15 l	42 x 18 x 15 cm	250 g	one size	< 5 kg
7640445458504	Cloudburst 15	burgundy	15 l	42 x 18 x 15 cm	250 g	one size	< 5 kg
7640445458511	Cloudburst 15	forest	15 l	42 x 18 x 15 cm	250 g	one size	< 5 kg
7640445458528	Cloudburst 25	gold	25 l	53 x 28 x 20 cm	270 g	one size	< 5 kg
7640445458535	Cloudburst 25	sage	25 l	53 x 28 x 20 cm	270 g	one size	< 5 kg
7640445458542	Cloudburst 25	black	25 l	53 x 28 x 20 cm	270 g	one size	< 5 kg
7640445458559	Cloudburst 25	navy	25 l	53 x 28 x 20 cm	270 g	one size	< 5 kg
7640445458566	Cloudburst 25	burgundy	25 l	53 x 28 x 20 cm	270 g	one size	< 5 kg
7640445458573	Cloudburst 25	forest	25 l	53 x 28 x 20 cm	270 g	one size	< 5 kg

Waterproof roll-top stuffsack with shoulder straps

- > super light and packable to the smallest possible
- > waterproof construction
- > wearable as daypack or shoulder bag
- > updated with recycled fabric
- > white PU coating for good interior visibility
- > super versatile

Intended use

Travel, watersports, river floating, leisure, backup pack



Main fabric Recycled 70 D taffeta nylon, PU coated (white pigment), 7'000 mm water column, fully seam taped, bluesign® certified, PFC-free
Frame frameless

Prod. No	Name	Color	Volume	Dimensions	Weight	Fits Torso	Load limit
7640445458627	Splash 15	gold	16 l	41 x 25 x 16 cm	100 g	one size	< 5 kg
7640445458634	Splash 15	sage	16 l	41 x 25 x 16 cm	100 g	one size	< 5 kg
7640445458641	Splash 15	black	16 l	41 x 25 x 16 cm	100 g	one size	< 5 kg
7640445458658	Splash 15	navy	16 l	41 x 25 x 16 cm	100 g	one size	< 5 kg
7640445458665	Splash 15	burgundy	16 l	41 x 25 x 16 cm	100 g	one size	< 5 kg
7640445458672	Splash 15	forest	16 l	41 x 25 x 16 cm	100 g	one size	< 5 kg

TORRENT 20

Waterproof, rugged and compact roll-top daypack

- > high-frequency welded seams and roll-top closure
- > comfort suspension system
- > notebook/tablet-compatible padded inner pocket
- > weatherproof outer zip pocket
- > contoured shoulder harness, removable hip strap
- > bike light attachment loop
- > roll-top or fold-down closure system with durable alloy carabiners
- > reflective print for high visibility (olive grey non-reflective)



Main fabric 840 D oxford nylon, TPU film laminated, 10'000 mm water column, Oeko-Tex® 100 certified, PFC-free
Frame HDPE framesheet

Prod. No	Name	Color	Volume	Dimensions	Weight	Fits Torso	Load limit
7640171997711	Torrent 20	black	20 l	50 x 27 x 17 cm	980 g	one size	10 kg
7640171997704	Torrent 20	lime	20 l	50 x 27 x 17 cm	980 g	one size	10 kg
7640147768468	Torrent 20	olive grey	20 l	50 x 27 x 17 cm	980 g	one size	10 kg

TORRENT 30 | 45

EVERYDAY



Waterproof, rugged, do-anything pack

- > high-frequency welded roll-top pack in a versatile design
- > large top opening: simple packing and unpacking
- > minimalist design, lightweight yet durable
- > comfortable suspension system, ergonomic shoulder straps
- > removable padded hipbelt
- > shoulder straps wrap pack base for superior load control
- > reflective print for high visibility (olive grey non-reflective)



Main fabric 840 D oxford nylon, TPU film laminated, 10'000 mm water column, Oeko-Tex® 100 certified, PFC-free

Frame HDPE framesheet

Prod. No	Name	Color	Volume	Dimensions	Weight	Fits Torso	Load limit
7640171997728	Torrent 30	black	30 l	55 x 27 x 20 cm	1100 g	one size	12 kg
7640171997735	Torrent 30	lime	30 l	55 x 27 x 20 cm	1100 g	one size	12 kg
7640147768475	Torrent 30	olive grey	30 l	55 x 27 x 20 cm	1100 g	one size	12 kg
7640171997742	Torrent 45	black	45 l	68 x 29 x 20 cm	1200 g	48 – 52 cm	13 kg
7640171997759	Torrent 45	lime	45 l	68 x 29 x 20 cm	1200 g	48 – 52 cm	13 kg
7640171997766	Torrent 45	olive grey	45 l	68 x 29 x 20 cm	1200 g	48 – 52 cm	13 kg

WORK & RESCUE PACK 50

EVERYDAY



Waterproof top loader for rope-access work and more

- > clean and compact design with roll-top closure
- > highly durable fabric and construction
- > internal dual-rope compartment system (removable)
- > numerous gear loops and anchor points for ropes and gear
- > padded ergonomic shoulder straps
- > removable 40 mm waist strap
- > designed for professional rope-access work



Main fabric 840 D oxford nylon, TPU film laminated, 10'000 mm water column, Oeko-Tex® 100 certified, PFC-free

Frame HDPE framesheet

Prod. No	Name	Color	Volume	Dimensions	Weight	Fits Torso	Load limit
7640120116415	Work & Rescue Pack 50	black - yellow	50 l	65 x 36 x 26 cm	1330 g	> 45 cm	14 kg
7640120116408	Work & Rescue Pack 50	orange - yellow	50 l	65 x 36 x 26 cm	1330 g	> 45 cm	14 kg



Weatherproof urban adventure pack

- > waterproof fabric, welded construction
- > large access to main compartment via water-repellent zipper
- > internal laptop sleeve (13") with mesh pocket
- > quick-access front pocket with water-repellent zipper
- > dual side-compression straps, sturdy haul loop
- > comfortable suspension system with removable waist strap
- > flat, double-layer base for durability and stability
- > bike light anchor point

Intended use

Office, university, daypack



Main fabric 600 D oxford polyester, TPU film laminated, 10'000 mm water column, Oeko-Tex® 100 certified, PFC-free

Frame HDPE framesheet

Prod. No	Name	Color	Volume	Dimensions	Weight	Fits Torso	Load limit
7640445452397	Cascade 20	black melange	20 l	47 x 27 x 16 cm	910 g	one size	10 kg



Weatherproof urban adventure pack with laptop access

- > waterproof fabric, welded construction
- > large access to main compartment via water-repellent zipper
- > Side access to laptop compartment (15") via water-resistant zipper
- > quick-access front pocket (DIN A4) with water-repellent zipper
- > sturdy top haul loop and convenient side handle
- > comfortable suspension system with removable waist strap
- > flat, double-layer base for durability and stability
- > bike light anchor point

Intended use

Office, university, daypack



Main fabric 600 D oxford polyester, TPU film laminated, 10'000 mm water column, Oeko-Tex® 100 certified, PFC-free

Frame HDPE framesheet

Prod. No	Name	Color	Volume	Dimensions	Weight	Fits Torso	Load limit
7640445451437	Cascade 25	grey melange	27 l	48 x 29 x 20 cm	930 g	one size	10 kg
7640445452403	Cascade 25	black melange	27 l	48 x 29 x 20 cm	930 g	one size	10 kg



Sleek roll-top daypack with padding for everyday use

- > minimalist but functionally equipped companion for urban and school use
- > bluesign® certified and robust ripstop polyester fabric
- > surprisingly light yet fully featured for the urban outdoor enthusiast
- > ergonomically shaped shoulder straps
- > removable, reflective webbing
- > anchor point for bike light
- > thermo-formed back panel
- > zippered and rapidly accessible laptop compartment fits 15" notebooks
- > single handed operated chest strap
- > 2 side pockets and one front pocket for easy organization
- > removable waist strap
- > easy-use roll-top/fold closure for quick access to the main compartment

Intended use

Office, university, school, daypack, leisure



Main fabric 600 D ripstop polyester, PU coated, 1'200 mm water column, bluesign® certified, PFC-free

Lining fabric 150 D recycled polyester, PU coated, 3'000 mm water column, PFC-free

Frame thermo molded back panel

Prod. No	Name	Color	Volume	Dimensions	Weight	Fits Torso	Load limit
7640445450782	Metro 20	grey melange	20 l	50 x 28 x 17 cm	720 g	one size	10 kg
7640445450799	Metro 20	black melange	20 l	50 x 28 x 17 cm	720 g	one size	10 kg
7640445453523	Metro 20	burgundy melange	20 l	50 x 28 x 17 cm	720 g	one size	10 kg
7640445450805	Metro 30	grey melange	28 l	56 x 29 x 19 cm	800 g	one size	10 kg
7640445450812	Metro 30	black melange	28 l	56 x 29 x 19 cm	800 g	one size	10 kg
7640445453530	Metro 30	burgundy melange	28 l	56 x 29 x 19 cm	800 g	one size	10 kg

CENTRUM 20 | 30



Versatile zipper-access commuter pack

- > top-loading zipper access; large opening
- > multiple internal and external pockets
- > padded laptop sleeve inside fits 15" notebooks
- > removable, reflective webbing
- > sustainable fabrics: main fabric: bluesign® certified,
- > liner fabric: recycled polyester
- > removable waist strap
- > thermo moulded back for clean look and close to body fit
- > ergonomic, low-profile shoulder straps that can handle a long day out
- > inside and outside pockets for small items
- > spacious, zippered main access with small inner and outer pockets
- > single-hand operated chest strap
- > 2 side pockets for bottles, umbrellas, newspapers etc.
- > micro daisy chains for bike light attachment

Intended use

Office, university, school, daypack, leisure



Main fabric 600 D ripstop polyester, PU coated, 1'200 mm water column, bluesign® certified, PFC-free

Lining fabric 150 D recycled polyester, PU coated, 3'000 mm water column, PFC-free

Frame thermo molded back panel

Prod. No	Name	Color	Volume	Dimensions	Weight	Fits Torso	Load limit
7640445453462	Centrum 20	black melange	20 l	52 x 27 x 18 cm	720 g	one size	10 kg
7640445453486	Centrum 20	grey melange	20 l	52 x 27 x 18 cm	720 g	one size	10 kg
7640445453479	Centrum 20	burgundy melange	20 l	52 x 27 x 18 cm	720 g	one size	10 kg
7640445453493	Centrum 30	black melange	30 l	55 x 30 x 21 cm	770 g	one size	13 kg
7640445453516	Centrum 30	grey melange	30 l	55 x 30 x 21 cm	770 g	one size	13 kg
7640445453509	Centrum 30	burgundy melange	30 l	55 x 30 x 21 cm	770 g	one size	13 kg

MESH HELMET HOLDER



Lightweight mesh helmet holder

- > Lightweight mesh helmet holder attaches to daisy chains
- > robust, stretchable mesh material with silicone print inside for slip-proof, snug and steady hold
- > rapidly hooks to daisy chains of all Exped packs
- > can be stowed in integrated stuff pocket for easy transportation

Prod. No	Color	Dimensions	Weight
7640445456579	black	18 x 20 cm	35 g

FLASH PACK POCKET



Ultralight accessory pocket for Lightning packs

- > flexible external «volume enhancer» pocket for Lightning packs
- > plastic hooks allow easy attachment and removal from the pack
- > PU-coated nylon fabric for weather protection on one side and an airy mesh side for wet gear and tent flies

Prod. No	Color	Dimensions	Weight
7640147764620	black	43 x 33 cm	75 g

PACK ACCESSORY CARABINER



High-quality accessory carabiner

- > lightweight aluminum carabiner with 20 mm webbing slot
- > quality construction
- > for closing pack lids and roll-top closures
- > not for climbing or safety use

Prod. No	Color	Dimensions	Weight
7640171998169	grey	6 x 3.2 cm	12 g

RAIN COVER

5



Waterproof cover for popular pack sizes

- > tailored rain shield for all non-weatherproof packs
- > perimeter elastic draw cord tightens rain cover to pack
- > good theft protection in city use
- > 70D taffeta nylon fabric is Oeko-Tex® 100 certified

Prod. No	Size	Color	for backpack size	Weight
7640147763333	S	charcoal	< 25 l	70 g
7640147762503	M	lime	25 – 35 l	95 g
7640147763340	M	charcoal	25 – 35 l	95 g
7640147762510	L	lime	35 – 45 l	110 g
7640147763357	L	charcoal	35 – 45 l	110 g
7640147765337	XL	charcoal	50 – 75 l	130 g

ACCESSORY STRAP



Multifunctional lightweight webbing strap

- > extremely versatile and strong webbing with anodized aluminum hook
- > secures gear to packs
- > available in 10 mm (UL) and 20 mm webbing widths
- > 2 convenient lengths and 2 hook colors

Prod. No	Width	Length	Color	Weight	
7640147761674	UL	10 mm	60 cm	grey-grey	2 x 6 g
7640147761681	UL	10 mm	120 cm	grey-terracotta	2 x 11 g
7640147763692		20 mm	60 cm	grey-grey	2 x 17 g
7640147763685		20 mm	120 cm	grey-terracotta	2 x 27 g

TOOL BLADE



Freely positionable attachment for ice tools and axes

- > attaches to any daisy chain or loop
- > rapidly secures new-school ice tools to all packs with loops
- > simplified handling with gloves thanks to minimal cord grip
- > patent pending

Prod. No	Color	Dimensions	Weight
7640445451598	grey	6.8 x 1.2 cm	4 g





GEAR BAGS

The gear bag series consists of companions for home and office, for work and leisure, for travels, for family outings and sport activities.

	URBAN	EVERYDAY	TRAVEL	LITER
1 DAY 1 TAG		Radical Lite 25 Radical 30		20 30
2 TO 4 DAYS 2 BIS 4 TAGE	Cruiser 35 Cruiser 45 Cruiser 55	Radical Lite 50 Radical 45	Radical 60	40 50 60
5+ DAYS 5+ TAGE			Radical 80 Tempest 70	80
LONG TRIPS LANGE REISEN			Tempest 100 Transfer Wheelie Tempest 140	100 120 140

Wasserdicht | Waterproof



organizational features



quickly converts from backpack to bag

Organization talent for the mobile workspace; on campus, everyday life or travel

- > ideal carrying comfort as a shoulder bag or as a backpack with hip belt and adjustable back length (35 l + 45 l versions only)
- > padded laptop, tablet, main and side compartments protect the contents
- > tidy and clean design, for urban use in everyday life and when traveling
- > organizational features include six separate internal pockets in main and secondary compartments; large, easy-to-view main compartment with 270° opening
- > quickly converts from backpack to bag, shoulder straps and carry strap stowable or removable for luggage check-in
- > high level of theft protection: access only from the carrier side and main and side compartments can be locked together

Intended use

Office and campus, daily commute and weekend trips



GEAR BAGS



- 1 fully padded duffle bag for easy packing and great protection of contents
- 2 side pocket/bottle holder
- 3 generous zipper to main compartment with 270° opening
- 4 comfortable carry system with removable hipbelt
- 5 shoulder straps and carry strap stowable or removable for luggage check-in

Main fabric Recycled 840 D oxford nylon, TPU laminated, 10000 mm water column, bluesign® certified, PFC-free
600 D cation ripstop polyester, PU coated, 1200 mm water column, bluesign® certified, PFC-free

Lining fabric Recycled 150 D polyester, PU coated, 3000 mm water column, PFC-free

Frame EVA padding

Prod. No	Name	Color	Volume	Dimensions	min. Weight	max. Weight	Fits Torso	Load limit
7640445453547	Cruiser 35	black melange	34 l	49 x 33 x 23 cm	1100 g	1250 g	46 – 57 cm	13 kg
7640445453561	Cruiser 45	black melange	42 l	54 x 33 x 26 cm	1150 g	1300 g	48 – 61 cm	13 kg
7640445453585	Cruiser 55	black melange	55 l	63 x 34 x 29 cm	1350 g	1500 g	53 cm	15 kg



quickly converts from backpack to bag

Fully padded organization talent for the mobile workspace; on campus, everyday life or travel.

- > great carry comfort with padded back and beefy shoulder straps
- > all straps and features are detachable and stowable
- > easy organisation with large practical pockets
- > internal rack loops: double function as practical attachment loops for just about anything (keys, belt pouches etc.)
- > 2 large side pockets: 1x with key clip, mesh pocket material and direct access to main compartment; 1x with water repellant liner to store sweaty sportswear
- > shoulder straps are easily stowed in side pockets or prolonged to be used as a carry on shoulder strap. Smart repositioning possible with aluminium toggle system.

Intended use

Leisure and sports, travel, climbing gym and crag



- 1** fully padded duffel bag for easy packing and great protection of contents
- 2** 2 compression straps: upper strap can be used for easy attachment of jacket or rope

- 3** enhanced visibility due to reflective logo print
- 4** 2 large side pockets, one of which offers direct internal access to main compartment, doubling as inside pocket

- 5** main zipper: long and burly for easy access and packing
- 6** shoulder straps are easily stowed in side pockets

Main fabric Recycled 210 D Robic HD ripstop nylon carbonate, PU coated, 1'500 mm water column, Oeko-Tex® 100 certified, PFC-free
 Recycled 600 D oxford polyester, PU coated, 1'500 mm water column, PFC-free, bluesign® certified

Lining fabric Recycled 150 D polyester, PU coated, 3'000 mm water column, PFC-free

Frame EVA padding

Prod. No	Name	Color	Volume	Dimensions	min. Weight	max. Weight	Fits Torso	Load limit
7640445453608	Radical 30	black	30 l	56 × 30 × 23 cm	550 g	700 g	one size	13 kg
7640445453622	Radical 30	forest	30 l	56 × 30 × 23 cm	550 g	700 g	one size	13 kg
7640445453639	Radical 30	navy	30 l	56 × 30 × 23 cm	550 g	700 g	one size	13 kg
7640445453646	Radical 45	black	43 l	64 × 34 × 23 cm	680 g	830 g	one size	13 kg
7640445453660	Radical 45	forest	43 l	64 × 34 × 23 cm	680 g	830 g	one size	13 kg
7640445453677	Radical 45	navy	43 l	64 × 34 × 23 cm	680 g	830 g	one size	13 kg

RADICAL LITE 25 | 50

EVERYDAY



Simple, super-lightweight duffle bag with straightforward backpack carry option

- > super-lightweight yet durable recycled 100 D triple ripstop nylon fabric
- > packs extremely small and stows in its side pocket
- > duffelbag that can be carried as a backpack
- > good compressibility with 2 compression straps
- > high level of theft protection: access only from the carrier side
- > extremely lightweight
- > easy organization with large practical side pocket with key clip
- > minimal yet comfortable shoulder straps
- > removable chest strap and hip belt

Intended use

Leisure and sports, travel, short trips, organizer within a larger piece of luggage



GEAR BAGS

Main fabric Recycled 100 D Robic triple ripstop UTS, 1'500 mm, PFC-free, Oeko-Tex® 100 certified

Lining fabric Recycled 150 D polyester, PU coated, 3'000 mm water column, PFC-free

Frame frameless

Prod. No	Name	Color	Volume	Dimensions	min. Weight	max. Weight	Fits Torso	Load limit
7640277840133	Radical Lite 25	black	25 l	56 × 30 × 23 cm	260 g	300 g	one size	< 5 kg
7640277840119	Radical Lite 25	gold	25 l	56 × 30 × 23 cm	260 g	300 g	one size	< 5 kg
7640277840126	Radical Lite 25	sage	25 l	56 × 30 × 23 cm	260 g	300 g	one size	< 5 kg
7640277840140	Radical Lite 50	black	50 l	64 × 34 × 23 cm	300 g	340 g	one size	< 8 kg

RADICAL 60 | 80

TRAVEL



Roomy yet lightweight dufflebag - easy to pack, comfy to carry

- > great carry comfort with padded back and beefy shoulder straps
- > all Straps and Features are detachable and stowable
- > easy organisation with large practical pockets
- > internal rack loops: double function as practical attachment loops for just about anything (keys, belt pouches etc.)
- > Shoulder straps are easily stowed in separate side pockets or prolonged to be used as a carry on shoulder strap. Smart repositioning with aluminium toggle system.

Intended use

Leisure, sports and travel



quickly converted from backpack mode to bag

great overview and organisation

Main fabric Recycled 420 D Robic ripstop nylon carbonate PU, 1'500 mm water column, Oeko-Tex® 100 certified, PFC-free

Recycled 600 D polyester PU, 1'500 mm water column, bluesign® certified, PFC-free

Lining fabric Recycled 150 D polyester, PU coated, 3000 mm water column, PFC-free

Frame EVA padding

Prod. No	Name	Color	Volume	Dimensions	min. Weight	max. Weight	Fits Torso	Load limit
7640445453684	Radical 60	black	64 l	74 × 32 × 30 cm	900 g	1050 g	one size	20 kg
7640445455039	Radical 80	black	85 l	80 × 40 × 32 cm	1125 g	1275 g	one size	20 kg



Quickly converted from backpack mode to bag



Fully waterproof, lightweight travel and expedition duffels with backpack carry option

- > 100% waterproof, yet not designed for submersion
- > high-frequency welded construction
- > outstanding weight-to-volume ratio
- > dual-layer base for enhanced durability
- > 6 external tie down or attachment loops
- > beefy zipper pullers and counter loops for convenient access
- > internal compression straps and attachment points
- > removable shoulder straps may be elongated for use as carry-on shoulder strap. Smart repositioning with aluminium toggle system
- > large and durable grab handle on each side
- > waterproof high quality zipper

Intended use

Travel, expedition, paddle sports



Main fabric 840 D oxford nylon, TPU film laminated, 10'000 mm water column, Oeko-Tex® 100 certified, PFC-free

Frame no padding

Prod. No	Name	Color	Volume	Dimensions	min. Weight	max. Weight	Fits Torso	Load limit
7640277840300	Tempest 70	black-olive grey	70 l	70 x 30 x 34 cm	630 g	850 g	one size	25 kg
7640277840317	Tempest 100	black-olive grey	100 l	80 x 33 x 38 cm	730 g	950 g	one size	25 kg
7640277840027	Tempest 140	black-olive grey	140 l	90 x 40 x 43 cm	880 g	1100 g	one size	25 kg

TRANSFER WHEELIE BAG



Clever transport and protection bag on wheels for packs and duffels

- > converts any type of bag or pack to a roller duffel
- > roll-top allows volume adjustment for packs 40 – 80 l
- > the backpack's suspension system is accessible through a zippered opening
- > durable aluminum grab handle and strong side handles
- > durable, silent wheels
- > small packed size when empty: 36 x 30 x 24 cm
- > excellent in combination with Exped Tempest Duffel 100



Main fabric 210 D HD ripstop nylon, PU coated, 1'500 mm water column, Oeko-Tex 100® certified, DWR C6

Prod. No	Name	Color	Volume	Dimensions	Weight	Load limit
7640277840577	Transfer Wheelie Bag	black	60 – 100 l	90 x 36 x 30 cm	1690 g	25 kg

Spacious hipbelt pouch

- > 2 visible front pockets, 1 hidden back pocket, 1 hidden interior pocket
- > bright lining fabric for improved contrast and overview
- > internal pen holder
- > holds passports, airline tickets and travel documents



Main fabric: grey/black/burgundy melange

600 D ripstop Polyester, PU coated, 1'200 mm water column, bluesign® certified, PFC free

Main fabric: black/navy

Recycled 600 D oxford polyester, PU coated, 1'500 mm water column, PFC-free, bluesign® certified

Prod. No	Color	Dimensions	Volume	Weight
7640277840539	black	31 x 15 x 10 cm	3 l	125 g
7640277840546	grey melange	31 x 15 x 10 cm	3 l	125 g
7640277840553	black melange	31 x 15 x 10 cm	3 l	125 g
7640277840607	burgundy melange	31 x 15 x 10 cm	3 l	125 g
7640277840614	navy	31 x 15 x 10 cm	3 l	125 g

MINI BELT POUCH

Compact, lightweight hipbelt pouch

- > smaller version of Travel Belt Pouch
- > 2 visible front pockets, 1 hidden back pocket, 1 hidden interior pocket
- > bright lining fabric for improved contrast and overview
- > internal pen holder



Main fabric: grey/black/burgundy melange

600 D ripstop Polyester, PU coated, 1'200 mm water column, bluesign® certified, PFC free

Main fabric: black/navy

Recycled 600 D oxford polyester, PU coated, 1'500 mm water column, PFC-free, bluesign® certified

Prod. No	Color	Dimensions	Volume	Weight
7640277840492	black	31 x 9 x 10 cm	1.5 l	100 g
7640277840515	grey melange	31 x 9 x 10 cm	1.5 l	100 g
7640277840522	black melange	31 x 9 x 10 cm	1.5 l	100 g
7640277840621	burgundy melange	31 x 9 x 10 cm	1.5 l	100 g
7640277840508	navy	31 x 9 x 10 cm	1.5 l	100 g



STORAGE

Stuff sacks and dry bags are often the last defense against moisture and dirt. This is why no matter how simple an Exped storage sack may seem, every detail is designed with care and manufactured with quality and durability in mind.

■ DRYBAGS

- > protection against moisture, dirt and dust
- > Roll-top closure enables volume adjustability
- > range of fabrics - ultralight to ultra-durable

Exped drybags are manufactured with the best fabrics and seam tapes, for highest performance in their intended use. All seam tapes used are manufactured by the market leaders in the field and are customized to the fabrics and coatings/laminations used in the product.

■ COMPRESSION DRYBAGS

- > protection against moisture and dust
- > Roll-top allows variable compression
- > vertical and horizontal compression solutions

FlatValves (made of flexible PU material) allow maximum air purging and easy compression of bags and clothing. They are easy to use, lightweight and durable. Exped waterproof compression bags are shaped a bit wider, making it easier to reach items at the bottom of the bag without the need to empty all contents.

■ TRAVEL ORGANISERS

- > Hyper-organization of packs and duffles
- > Padded options for gear protection
- > Transparent options for overview of contents

A light-grey PU coating, bright interior fabrics or transparent side panels are used to increase visibility of contents within the bags and pouches. We use only high-quality cord stoppers and zippers from the market leaders in the field.

		FEATURES				FABRIC				VOLUME			CLOSURE			possible contents
		compression straps	flat valve: Schnozzel compatible	padded protection	additional anchor points	ultra light	extra strong	translucent	transparent	low volume < 10 l	medium volume 10 – 30 l	high volume > 30 l	roll-top closure	zipper / zip-lock closure	cord closure	
DRYBAG	Fold Drybag UL					●		●		●	●	●	●			sleeping bags, apparel, travel gear, books, stationery, dried food, first-aid kit, moisture-sensitive equipment, dirty and smelly items
	Fold Drybag / Fold Drybag BS									●	●	●	●			
	Fold Drybag CS				●				●	●	●	●	●			
	Fold Drybag Endura		●		●					●	●	●	●			
	Fold Drybag First Aid				●					●			●			
	Waterproof Compression Bag	●	●								●	●	●			
	Waterproof Telecompression Bag	●	●								●	●	●			
	Shrink Bag Pro		●		●		●			●	●	●				
	Crush Drybag			●						●			●			
	Zip Seal				●				●	●				●		
Seal Sleeve				●	●			●	●				●			
TRAVEL ORGANISERS	Padded Tablet Sleeve			●	●					●			●			toiletry items, maps, pens, documents
	Padded Zip Pouch			●						●			●			
	Clear Cube				●				●	●			●			
	Zip Pack UL				●	●				●	●		●			
	Vista Organiser				●					●			●			
	Mesh Organiser UL				●	●				●	●		●			
	Mesh Bag					●				●	●			●		
	Cord Drybag UL					●			●	●	●			●	●	
Packsack					●				●	●			●	●	apparel, kitchenware, personal items	

electronics, tablets, phones

STORAGE

EXPED PACKAGING

- > environmentally friendly, FSC certified cardboard packaging with trilingual descriptions
- > for demonstration purposes products can be removed and repacked
- > product fabrics can be touched even when packed

 Packed in Cardboard. Cardboard is sustainable. Plastic packaging pollutes.



FOLD DRYBAG UL

DRYBAGS



Ultralight drybags with roll top closure

- > translucent fabric (contents can be distinguished)
- > bright colors and 7 sizes make organizing gear simple
- > Nylon fabric, outer silicone coating, internal transparent PU coating
- > rounded, rectangular shape for space-efficient packing
- > protection against splashing water and dust

Material 15 D ripstop nylon, silicone/PU coated, fully seam taped
Oeko-Tex® 100 certified, PFC-free

Prod. No	Size	Color	Dimensions	Volume	Weight
7640171993737	XXS	lime	16 x 14 x 7 cm	1 l	13 g
7640171993744	XS	orange	25 x 15 x 10 cm	3 l	16 g
7640171993751	S	yellow	31 x 17 x 12 cm	5 l	20 g
7640171993768	M	red	35 x 19 x 14 cm	8 l	23 g
7640171993775	L	blue	44 x 23 x 16 cm	13 l	30 g
7640171993782	XL	emerald green	51 x 26 x 19 cm	22 l	34 g
7640171993799	XXL	cyan	56 x 37 x 24 cm	40 l	49 g
7640171993805	4 Pack	assorted	XS – L		

FOLD DRYBAG

DRYBAGS



Lightweight drybags with roll-top closure

- > light-grey inner coating for bright interior
- > grab handle at base (except XXS) and in 7 practical colors/sizes
- > versatile in use and durable in construction
- > rounded, rectangular shape for space-efficient packing
- > protection against splashing water and dust

Material 70 D taffeta nylon, PU coated, fully seam taped
Oeko-Tex® 100 certified, DWR C6

Prod. No	Size	Color	Dimensions	Volume	Weight
7640171993812	XXS	sand	16 x 14 x 7 cm	1 l	20 g
7640171993829	XS	green	25 x 15 x 10 cm	3 l	30 g
7640171993836	S	corn yellow	31 x 17 x 12 cm	5 l	40 g
7640171993843	M	terracotta	35 x 19 x 14 cm	8 l	45 g
7640171993850	L	sky blue	44 x 23 x 16 cm	13 l	60 g
7640171993867	XL	ruby red	51 x 26 x 19 cm	22 l	78 g
7640171993881	XXL	charcoal grey	56 x 37 x 24 cm	40 l	105 g
7640171993904	4 Pack	assorted	XS – L		

FOLD DRYBAG CS

DRYBAGS



Fold Drybags with see-through panel

- > transparent see-through panel of durable TPU film
- > grab handle, roll-top closure with D-ring
- > 4 fresh colors/sizes, transparent panel for viewing interior
- > rounded, rectangular shape for space-efficient packing
- > protection against splashing water and dust

Material 70 D taffeta nylon, PU coated, fully seam taped
Oeko-Tex® 100 certified, DWR C6 (nylon fabric)

Prod. No	Size	Color	Dimensions	Volume	Weight
7640171994024	XS	orange	25 x 15 x 10 cm	3 l	36 g
7640171994055	S	yellow	31 x 17 x 12 cm	5 l	46 g
7640171994079	M	red	35 x 19 x 14 cm	8 l	56 g
7640171994093	L	blue	44 x 23 x 16 cm	13 l	75 g
7640171994147	4 Pack	assorted	XS – L		

FOLD DRYBAG BS

DRYBAGS



Fold Drybags in bright colors

- > white inner coating for excellent overview, fully seam taped
- > grab handle at base (except size XXS), roll-top closure and 7 sizes
- > colorful selection for ease of organization
- > rounded, rectangular shape for space-efficient packing
- > protection against splashing water and dust

Material 70 D taffeta nylon, PU coated, fully seam taped
Oeko-Tex® 100 certified, DWR C6

Prod. No	Size	Color	Dimensions	Volume	Weight
7640171993928	XXS	lime	16 x 14 x 7 cm	1 l	20 g
7640171993935	XS	orange	25 x 15 x 10 cm	3 l	30 g
7640171993942	S	yellow	31 x 17 x 12 cm	5 l	40 g
7640171993959	M	red	35 x 19 x 14 cm	8 l	45 g
7640171993966	L	blue	44 x 23 x 16 cm	13 l	60 g
7640171993973	XL	emerald green	51 x 26 x 19 cm	22 l	78 g
7640171993980	XXL	cyan	56 x 37 x 24 cm	40 l	105 g
7640171994000	4 Pack	assorted	XS – L		

FOLD DRYBAG ENDURA

DRYBAGS



Ultra-durable roll-top drybags

- > slim and compact oval base shape
- > durable carabiner roll-top closure, integrated FlatValve
- > daisy chains for multiple attachment options
- > extremely durable ripstop fabric with white TPU film laminate
- > rounded, rectangular shape for space-efficient packing
- > reliable protection against splashing water and dust
- > white inner coating for excellent overview and contrast

Material 420 D ripstop laminated nylon fabric, fully seam taped, PFC-free

Prod. No	Size	Color	Dimensions	Volume	Weight
7640147764378	5	black	35 × 17 × 11 cm	5 l	125 g
7640147764385	15	black	45 × 23 × 16 cm	15 l	180 g
7640147764392	25	black	55 × 25 × 19 cm	25 l	220 g
7640147764408	50	black	67 × 35 × 25 cm	50 l	320 g

CLEAR CUBE FIRST AID

TRAVEL ORGANISERS



Ultralight see-through first-aid pouches

- > welded construction for excellent weather resistance
- > dual transparent TPU panels for viewing contents
- > easy access through weatherproof zipper
- > 2 practical sizes for daytrips and extended adventures
- > protection against spraying water - penetration of dust possible
- > sold without contents

Material 30 D ripstop polyester, TPU film laminated and clear TPU film Oeko-Tex® 100 certified, PFC-free

Prod. No	Size	Color	Dimensions	Volume	Weight
7640171993478	S	red	16.5 × 12 × 5 cm	1 l	24 g
7640171993485	M	red	23 × 12 × 8 cm	3 l	33 g

FOLD DRYBAG FIRST AID

DRYBAGS



Waterproof first-aid kit bags

- > 2 practical sizes: flat (size S) or oval 3-D design (size M)
- > size S ideal for daytrips, size M for extended adventures
- > white inner PU coating for bright interior
- > protection against splashing water and dust
- > sold without contents

Material 70 D taffeta nylon, PU coated, fully seam taped Oeko-Tex® 100 certified, DWR C6

Prod. No	Size	Color	Dimensions	Volume	Weight
7640147763180	S	red	18 × 13 cm	1.25 l	24 g
7640147763197	M	red	30 × 16 × 12 cm	5.5 l	38 g

WATERPROOF SHRINK BAG PRO

DRYBAGS



Waterproof heavy-duty compression bags

- > waterproof due to a special roll-top closure; welded construction
- > flat profile with numerous anchor points and FlatValve
- > durable fabric for versatile use
- > 100% waterproof (not submersible) and dustproof

Material 210 D nylon fabric, TPU film laminated, welded construction Oeko-Tex 100® certified, DWR C6

Prod. No	Size	Color	Dimensions	Volume	Weight
7640120116347	5	yellow	50 × 20 cm	5 l	110 g
7640120116354	15	red	65 × 35 cm	15 l	170 g
7640120116361	25	blue	80 × 40 cm	25 l	250 g

WATERPROOF COMPRESSION BAG

COMPRESSION DRYBAGS



Waterproof side-compression bags

- > waterproof compression of sleeping bags and apparel
- > FlatValve, 3 side compression straps and grab handle
- > compresses contents horizontally
- > round base shape
- > reliable protection against dirt and dust
- > white inner coating for excellent overview and contrast

Material 70 D taffeta nylon, PU coated, fully seam taped
Oeko-Tex® 100 certified, DWR C6

Prod. No	Size	Color	Dimensions	Volume	Weight
7640147768383	S	red	42 × 20 cm	13 l	80 g
7640147768390	M	blue	52 × 22 cm	19 l	90 g
7640147768406	L	green	65 × 28 cm	36 l	128 g

WATERPROOF TELECOMPRESSION BAG

COMPRESSION DRYBAGS



Waterproof top-down compression bags

- > waterproof compression of sleeping bags and apparel
- > with FlatValve, 4 top compression straps and grab handle
- > compresses contents vertically
- > round base shape
- > reliable protection against dirt and dust
- > white inner coating for excellent overview and contrast

Material 70 D taffeta nylon, PU coated, fully seam taped
Oeko-Tex® 100 certified, DWR C6

Prod. No	Size	Color	Dimensions	Volume	Weight
7640147768413	S	red	42 × 20 cm	13 l	90 g
7640147768420	M	blue	52 × 22 cm	19 l	110 g
7640147768437	L	green	65 × 28 cm	36 l	145 g

SEAL SLEEVE

DRYBAGS

IP 67

PFC FREE

Low-profile waterproof sleeves

- > weather and dust protection for electronics, documents, maps, books and similar gear
- > waterproof seal keeps contents dry
- > touch screens and buttons remain functional through TPU window
- > high-grade materials and welded construction
- > 3 sizes fit most smartphones, books and maps
- > protection against penetration of water and dust (IP 67)



Material 75 D Polyester, TPU film laminated and transparent TPU film, welded construction, Oeko-Tex® 100 certified, PFC-free

Prod. No	Name	Size	Color	Fits	Inner size	Dimensions	Weight
7640147768741	Seal Sleeve	4	transparent/grey	smart phones up to 4"	16.0 × 7.5 cm	20 × 10 cm	11 g
7640147768758	Seal Sleeve	5.5	transparent/grey	big screen phones	18.5 × 12.0 cm	24 × 14 cm	18 g
7640171993454	Seal Sleeve	A4	transparent	nautical charts + maps	30.0 × 20.5 cm	35 × 23 cm	46 g

ZIP SEAL

DRYBAGS



IP 67

PFC FREE

Waterproof, transparent storage for electronic devices, maps

- > reliable weather protection for electronic equipment, books or maps
- > quick access via unique zipper/zip lock combination for security
- > flexible flat design allows operation of buttons and touch screen
- > high-quality materials and workmanship, fully welded construction
- > 4 loops for multiple attachment options
- > wide opening allows full use of width
- > protection against penetration of water and dust (IP 67)

Material 75 D Polyester, TPU film laminated and transparent TPU film, welded construction, Oeko-Tex® 100 certified, PFC-free

Prod. No	Name	Size	Color	Fits	Inner size	Dimensions	Weight
7640147763715	Zip Seal	4	skyblue	smart phones up to 4"	16.0 x 7.5 cm	26 x 15 cm	24 g
7640147763654	Zip Seal	5.5	terracotta	big screen phones	18.5 x 12.0 cm	30 x 19 cm	32 g

CRUSH DRYBAG

DRYBAGS

STORAGE



Waterproof stuff sacks with foam padding

- > protects sensitive gear from shock and water
- > removable 4 mm EVA foam padding
- > multiple sizes fit many types of sensitive gear
- > reliable protection against dirt and dust

Material 70 D taffeta nylon, PU coated, fully seam taped; EVA foam Oeko-Tex® 100 certified, DWR C6

Prod. No	Size	Color	Dimensions	Volume	Weight
7640120116576	3XS	orange	17 x 13 x 3 cm	0.25 l	43 g
7640120116989	3XS	black	17 x 13 x 3 cm	0.25 l	43 g
7640120110284	2XS	corn yellow	17 x 16 x 3 cm	0.35 l	48 g
7640120110291	XS 2-Dim.	terracotta	23 x 16 x 4 cm	0.75 l	58 g
7640120110307	XS 3-Dim.	sky blue	23 x 14 cm	1.75 l	74 g
7640120110314	S	green	28 x 17 cm	2.75 l	110 g

PADDED TABLET SLEEVE

TRAVEL ORGANISERS



PFC FREE

Lightweight padded tablet and notebook cases

- > ultralight, perforated EVA foam protects contents
- > microfiber lining prevents scratches
- > 30 D ripstop shell in fresh colors and black
- > zipper closure on the top end for easy access
- > 3 versatile sizes hold standard tablets and ultra-books up to 13"

Material 30 D ripstop polyester and perforated EVA foam, PFC-free

Prod. No	Name	Size	Color	Fits	Inner size	Dimensions	Weight
7640147768796	Padded Tablet Sleeve	8"	red	iPad Mini + E-Readers	22.5 x 16 x 1 cm	23 x 16.5 x 2 cm	60 g
7640171994338	Padded Tablet Sleeve	8"	black	iPad Mini + E-Readers	22.5 x 16 x 1 cm	23 x 16.5 x 2 cm	60 g
7640147768802	Padded Tablet Sleeve	10"	lime	iPad + 10"-Tablets	27.0 x 20 x 1 cm	27 x 20.5 x 2 cm	78 g
7640171994345	Padded Tablet Sleeve	10"	black	iPad + 10"-Tablets	27.0 x 20 x 1 cm	27 x 20.5 x 2 cm	78 g
7640147768819	Padded Tablet Sleeve	13"	orange	13.3" Notebooks	35.0 x 24 x 1.5 cm	36.5 x 25 x 2.5 cm	130 g
7640171994352	Padded Tablet Sleeve	13"	black	13.3" Notebooks	35.0 x 24 x 1.5 cm	36.5 x 25 x 2.5 cm	130 g

PADDED ZIP POUCH

TRAVEL
ORGANISERS



Ultralight padded zip pouches

- > ultralight, perforated EVA foam protects contents against shock
- > generous zippered opening for quick access
- > ideal for electronics and items in need of shock protection
- > internal mesh zip pocket
- > 3 practical sizes for electronics, cables and other gadgets

Material 30 D ripstop polyester and perforated EVA foam, PFC-free

Prod. No	Size	Color	Dimensions	Volume	Weight
7640147765658	S	lime	16 x 8 x 5 cm	0.5 l	43 g
7640171994369	S	black	16 x 8 x 5 cm	0.5 l	43 g
7640147765665	M	orange	18 x 12 x 7 cm	1.5 l	55 g
7640171994376	M	black	18 x 12 x 7 cm	1.5 l	55 g
7640147765672	L	red	23 x 16 x 9 cm	3.5 l	85 g
7640171994383	L	black	23 x 16 x 9 cm	3.5 l	85 g

ZIP PACK UL

TRAVEL
ORGANISERS



Ultralight weatherproof organizers

- > weather-resistant top zipper
- > 5 practical sizes for all kinds of gear, fully seam taped
- > translucent lightweight fabric, contents can be distinguished
- > protection against spraying water - penetration of dust possible
- > Seam taped construction prevents leakage of liquids (e.g. shampoo) into the luggage

Material 15 D ripstop nylon, silicone/PU coated, fully seam taped Oeko-Tex® 100 certified, PFC-free

Prod. No	Size	Color	Dimensions	Volume	Weight
7640147763166	XS	cyan	18 x 8 x 10 cm	1.25 l	16 g
7640120119805	S	lime	20 x 13 x 13 cm	5.00 l	20 g
7640120119812	M	terracotta	25 x 15 x 14 cm	8.00 l	25 g
7640120119829	L	yellow	30 x 18 x 16 cm	13.00 l	30 g
7640147761698	XL	ruby red	36 x 20 x 19 cm	17.00 l	35 g

CLEAR CUBE

TRAVEL
ORGANISERS



Ultralight see-through organizers

- > welded construction for good weather resistance
- > dual transparent TPU panels for viewing interior
- > easy access through weatherproof zipper
- > 4 sizes: apparel, personal items, toiletries, etc.
- > premium lightweight construction
- > protection against spraying water - penetration of dust possible
- > Welded construction prevents leakage of liquids (e.g. shampoo) into the luggage

Material 30 D ripstop polyester, TPU film laminated and clear TPU film Oeko-Tex® 100 certified, PFC-free

Prod. No	Size	Color	Dimensions	Volume	Weight
7640147768703	S	yellow	16.5 x 12 x 5 cm	1 l	22 g
7640147768710	M	orange	23 x 12 x 8 cm	3 l	32 g
7640147768727	L	cyan	25 x 18 x 10 cm	6 l	51 g
7640147768734	XL	red	36 x 24 x 10 cm	12 l	79 g

VISTA ORGANISER

TRAVEL
ORGANISERS



Weatherproof and translucent organizers

- > quality materials and seam-taped construction = great protection
- > weather-resistant top zipper
- > 4 practical sizes hold medicines, toiletries, maps, etc.
- > protection against spraying water - penetration of dust possible
- > Seam taped construction prevents leakage of liquids (e.g. shampoo) into the luggage

Material TPU mesh film laminate, fully seam taped Oeko-Tex® 100 certified, PFC-free

Prod. No	Size	Dimensions	Weight
7640147768789	Mini	12.5 x 9.5 x 1 cm	14 g
7640120114688	A6	21.0 x 12.0 x 2 cm	25 g
7640120114695	A5	29.0 x 17.0 x 5 cm	38 g
7640120114701	A4	37.0 x 23.0 x 4 cm	55 g

CORD DRYBAG UL

STUFFSACKS



Seam-taped ultralight pack sacks

- > one hand operation draw cord closure for quick access
- > one color per size for color-coded organization
- > protection against spraying water - penetration of dust possible

Material 15 D ripstop nylon, silicone/PU coated, seam taped
Oeko-Tex® 100 certified, PFC-free

Prod. No	Size	Color	Dimensions	Volume	Weight
7640120119737	XXS	lime	22 × 13 × 8.0 cm	1.5 l	8 g
7640120119744	XS	orange	24 × 17 × 10 cm	2.7 l	10 g
7640120119751	S	yellow	31 × 20 × 12 cm	5.0 l	13 g
7640120119768	M	red	35 × 23 × 14 cm	8.0 l	17 g
7640120119775	L	blue	39 × 28 × 18 cm	13.0 l	20 g
7640120119799	XL	emerald green	42 × 31 × 20 cm	19.0 l	24 g
7640120119782	XXL	cyan	48 × 42 × 22 cm	31.0 l	29 g

PACKSACK

STUFFSACKS



Lightweight organizers

- > 4 colors and sizes keep things organized
- > practical one-hand-operated drawcord

Material 30 D ripstop polyester, drawcord closure, PFC-free

Prod. No	Size	Color	Dimensions	Volume	Weight
7640147768826	S	cyan	30 × 10 × 10 cm	3 l	15 g
7640147768833	M	lime	30 × 20 × 15 cm	8 l	22 g
7640147768840	L	orange	45 × 25 × 20 cm	20 l	30 g
7640147768857	XL	red	55 × 30 × 20 cm	26 l	44 g

MESH BAG

STUFFSACKS



Ultralight mesh bags

- > ultralight, air-permeable and transparent mesh bags
- > practical one-hand-operated drawcord
- > Size L can also be used as mosquito head net

Material Polyester mesh fabric, drawcord closure, PFC-free

Prod. No	Size	Color	Dimensions	Volume	Weight
7640120114435	S	corn yellow	30 × 10 × 10 cm	3 l	15 g
7640120114442	M	terracotta	30 × 20 × 15 cm	8 l	20 g
7640120114459	L	charcoal grey	45 × 25 × 20 cm	20 l	25 g

MESH ORGANISER UL

TRAVEL ORGANISERS



Quick-access mesh organizers

- > lightweight, air-permeable and transparent mesh organizers
- > large zipper opening for quick access
- > ideal for packing apparel, personal items, etc.

Material 30 D ripstop polyester, polyester mesh fabric, PFC-free

Prod. No	Size	Color	Dimensions	Volume	Weight
7640147764330	S	lime	16 × 14 × 6 cm	2.25 l	24 g
7640147764347	M	orange	28 × 17 × 13 cm	9 l	38 g
7640147764354	L	red	36 × 27 × 13 cm	18 l	50 g
7640147764361	XL	cyan	40 × 36 × 9 cm	20 l	58 g
7640147764811	4 Pack	assorted	S - XL		



TENTS AND TARPS

Tents and tarps for any adventure: unique and innovative designs and attention to the finest details set Exped tents apart. From solo trips in the tropics to month-long big-mountain expeditions, these truly deliver comfort anywhere.

EXPEDITION

- > safe in any weather and in all seasons
- > durable and long lasting
- > pole supported vestibules

Protection and safety is the main focus of these tents. Pole crossings, flat pole sleeves and extra-strong pole structure ensure stability in extreme weather conditions. Developed and tested in stormy Patagonia, the cold Himalayas and on long winter expeditions.

TREKKING

- > the right tent for every season
- > multiple setup options depending on preference
- > generous canopy dimensions

The trekking range offers models for hot and bug infested areas to humid and cold regions. Besides multiple set-up options, these tents feature refined details, protection from the elements, durable materials and generous storage space for gear. Backpackers and hikers appreciate the low weights and large floor space.

FAST + LITE









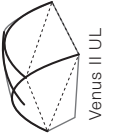

- > low weight and small packed size
- > quick and simple set-up
- > roomy despite low bulk

The trekking range offers models for hot and bug infested areas to humid and cold regions. Besides multiple set-up options, these tents feature refined details, protection from the elements, durable materials and generous storage space for gear. Backpackers and hikers appreciate the low weights and large floor space.

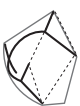
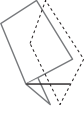
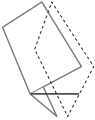
TARPS

- > reduced to the minimum
- > versatile
- > close to nature

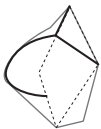
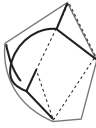
Lightweight alternatives to tents for however you hit the trail. Whether in a group, as a thru-hiker, car camper or paddler, tarps are versatile and deliver closeness to nature.

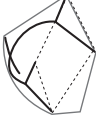
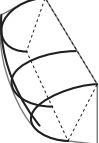
EXPEDITION	FAST + LITE	TREKKING	TREKKING
<p>4 - SEASON</p> 	<p>3 - SEASON</p>  <p>Mira I HL</p>	<p>3 - SEASON</p>  <p>Solo Tarp</p>  <p>Scout Tarp Extreme</p>  <p>Tarp II Extreme</p>  <p>Venus II UL</p>  <p>Lyra II</p>  <p>Outer Space II</p>  <p>Lyra II Extreme</p>  <p>Tarp II Versa</p>  <p>Tarp III Versa</p>	<p>4 - SEASON</p>  <p>Vela I Extreme</p>  <p>Venus II Extreme</p>  <p>Orion II UL</p>
<p>4 - SEASON</p> 	<p>3 - SEASON</p>  <p>Mira III HL</p>	<p>3 - SEASON</p>  <p>Tarp III Extreme</p>  <p>Venus III UL</p>  <p>Lyra III</p>  <p>Outer Space III</p>  <p>Lyra III Extreme</p>	<p>4 - SEASON</p>  <p>Orion III UL</p>  <p>Venus III Extreme</p>  <p>Venus III DLX</p>

EXPED DESIGN PRINCIPALS

Two decades of innovation and advancement in tent design in which refined details and the highest comfort merge with weight and bulk reduction.



1 Windward side

The windward side of the rainfly reaches the ground for full weather protection (dark green stake loops).

2 Ventilation

The leeward side of the rainfly features a ventilation gap for enhanced climate control (orange stake loops).

3 Dry canopy

The rainfly reaches out over the canopy to prevent rain from dripping into the tent.

4 Protected vestibule

EXPED designs respect the ever-present threat of harsh weather and always offer a rain and wind shelter vestibule for occupants and gear.

5 Slide Locks

Slide Locks allow quick and continuously adjustable tensioning of the tent.



6 Cord Stuffsack

Yellow Cord Stuffsacks enhance guyline visibility and prevent cords from tangling when stored.



7 Flat Pole Sleeves

Flat Pole Sleeve design minimizes wind resistance and increases stability.



8 Comprehensive accessories

All tents include additional cords, pegs and other maintenance parts.



POLARIS

Stormproof expedition tent

A super-sturdy single wall freestanding expedition tent. The Polaris has endured countless expeditions making it the tent of choice for tough endeavors. The generous vestibule for gear storage and snow melting is exceptional for a single wall tent. Polaris is wide enough to hold 3 sleepers if necessary and the headroom generous enough for 3 to sit out a storm.



UPDATE

- > new 3-layer fabric based on a membrane of electro spun PU nano fibers
- > tonal color scheme
- > 5 pre-mounted guylines
- > durable black colored mosquito mesh allows good visibility from within

Intended use

ideal for alpine use, expeditions

- 1 single-wall tent of vapor-permeable 3-layer fabric
- 2 free-standing exostructure design
- 3 generous vestibule and storage space at foot end
- 4 canopy fits to 2 M or LW mats
- 5 protected lookout on both sides
- 6 4-way guylines optimize wind force distribution

Polaris

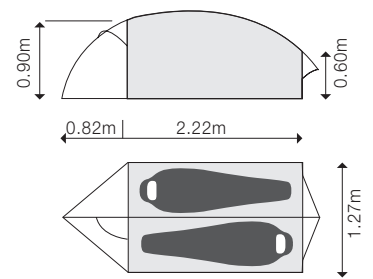

POLARIS

EXPEDITION

Material

Rainfly VentAir vapor-permeable 3-layer laminate, DWR C6, flame-retardant free

Vestibule 40 D ripstop nylon, silicone coated, Oeko Tex® 100 certified, PFC-free, flame-retardant free

Floor 70 D taffeta nylon, 10 000 mm water column, Oeko Tex® 100 certified, PFC-free, flame-retardant free

Poles DAC Featherlite NSL 9 mm TH72M, green anodizing

Prod. No	Name	Color	Persons	Floor size	Inner height	Canopy area	Vestibule area	minimum weight	packed weight	packed
7640277841710	Polaris	yellow	2	220 x 130 cm	105 cm	2.80 m ²	0.50 m ²	2.35 kg	2.75 kg	46 x 17 cm
7640445457002	Polaris Footprint (optional)							0.23 kg		

ORION

Freestanding tunnel tent

The full length ridge pole design reaches the ground enhancing wind stability and creating a freestanding structure. The high canopy offers comfortable living space. Two large vestibules hold loads of gear and two wide doors make entry and exit simple. Exostructure poles (pole in rainfly) allow quick setup. The Extreme version is characterized by its sturdiness and durability. The UL version has the same design but is trimmed for weight.

- 1 sturdy freestanding construction
- 2 pre-attached Dyneema core guylines
- 3 2 generous vestibules
- 4 ridge pole reaches ground



Orion Extreme



Orion UL



Sideview

Orion II Extreme | Orion II UL

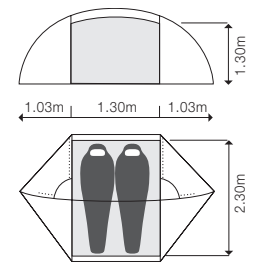

Orion III Extreme | Orion III UL

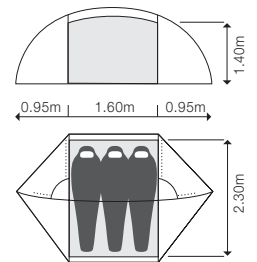

ORION EXTREME

EXPEDITION

Intended use

ideal for alpine use, expeditions, extended backpacking trips

Material

Rainfly

40 D ripstop nylon, silicone coated on both sides, Oeko Tex® 100 certified, PFC-free, flame-retardant free

Canopy

30 D ripstop nylon, 20 D No-See-Um mosquito mesh, Oeko Tex® 100 certified, PFC-free, flame-retardant free

Floor

70 D taffeta nylon, 10 000 mm water column, Oeko Tex® 100 certified, flame-retardant free

Poles

DAC Featherlite NSL 9.6 mm und NSL 10.25 mm TH72M, green anodizing



ORION UL

TREKKING
4-SEASON

Intended use

ideal for alpine use where weight is critical

Material

Rainfly

15 D ripstop nylon, silicone/PU coated, factory seam taped, Oeko Tex® 100 certified, PFC-free, flame-retardant free

Canopy

15 D ripstop nylon, 20 D No-See-Um mosquito mesh, Oeko Tex® 100 certified, PFC-free, flame-retardant free

Floor

40 D ripstop nylon laminated, 10 000 mm water column, Oeko Tex® 100 certified, PFC-free, flame-retardant free

Poles

DAC Featherlite NFL 9.3 mm TH72M, green anodizing

Prod. No	Name	Color	Persons	Floor size	Inner height	Canopy area	Vestibule area	minimum weight	packed weight	packed
7640445457019	Orion II Extreme	moss	2	230 x 130 cm	130 cm	3.00 m ²	2.20 m ²	3.25 kg	3.60 kg	40 x 20 cm
7640445457026	Orion II Extreme	dark lava	2	230 x 130 cm	130 cm	3.00 m ²	2.20 m ²	3.25 kg	3.60 kg	40 x 20 cm
canopy fits to 2 M or 2 LW mats										
7640445457057	Orion III Extreme	moss	2 – 3	230 x 160 cm	140 cm	3.70 m ²	2.30 m ²	3.60 kg	3.90 kg	40 x 25 cm
7640445457064	Orion III Extreme	dark lava	2 – 3	230 x 160 cm	140 cm	3.70 m ²	2.30 m ²	3.60 kg	3.90 kg	40 x 25 cm
canopy fits to 3 M or 2 LW mats										
7640445457569	Orion II UL	moss	2	230 x 130 cm	130 cm	2.85 m ²	2.20 m ²	2.50 kg	2.75 kg	40 x 17 cm
canopy fits to 2 M or 2 LW mats										
7640445457583	Orion III UL	moss	2 – 3	230 x 160 cm	140 cm	3.65 m ²	2.30 m ²	2.65 kg	3.00 kg	40 x 24 cm
canopy fits to 3 M or 2 LW mats										
7640445457033	Orion II Footprint (optional)							0.42 kg		
7640445457071	Orion III Footprint (optional)							0.58 kg		

VENUS

The Exped classic for all seasons

An excellent tent for travellers in all climate zones, Venus tents have seen it all. The combination of tunnel and dome tent designs results in a freestanding tent with generous space to weight ratio. Each occupant has a personal door and vestibule for comfortable access and storage. This is the ultimate backpacking and travel tent. The Venus is available in 2 options. The Extreme version is characterized by its sturdiness and durability. The UL version has the same design but is trimmed for weight.

- 1 virtually freestanding construction
- 2 pre-attached Dyneema core guylines
- 3 2 generous vestibules
- 4 internal pole sleeves



Venus UL



Venus Extreme



Sideview

Venus II Extreme | Venus II UL

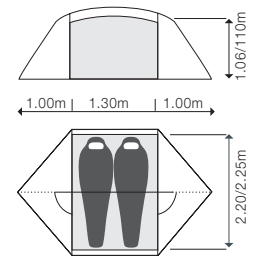

Venus III Extreme | Venus III UL

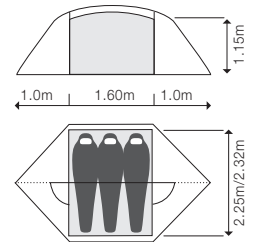

VENUS EXTREME

TREKKING
4-SEASON

Intended use

ideal for extended backpacking trips, cycle touring

Material

Rainfly

40 D ripstop nylon, silicone coated on both sides, Oeko Tex® 100 certified, PFC-free, flame-retardant free

Canopy

30 D ripstop nylon, 20 D No-See-Um mosquito mesh, Oeko Tex® 100 certified, PFC-free, flame-retardant free

Floor

70 D taffeta nylon, 10 000 mm water column, Oeko Tex® 100 certified, PFC-free, flame-retardant free

Poles DAC Featherlite NSL 9 mm und 10.25 mm TH72M, green anodizing

VENUS UL

TREKKING
3-SEASON

Einsatzbereich

fast and lite backpacking, micro adventures

Material

Rainfly

15 D ripstop nylon, silicone/PU coated, factory seam taped, Oeko Tex® 100 certified, PFC-free, flame-retardant free

Canopy

15 D ripstop nylon, 20 D No-See-Um mosquito mesh, Oeko Tex® 100 certified, PFC-free, flame-retardant free

Floor

40 D ripstop nylon laminated, 10 000 mm water column, Oeko Tex® 100 certified, PFC-free, flame-retardant free

Poles

DAC Featherlite NSL 9 mm und 10.25 mm TH72M, green anodizing

Prod. No	Name	Color	Persons	Floor size	Inner height	Canopy area	Vestibule area	minimum weight	packed weight	packed
7640445457484	Venus II extreme	moss	2	225 x 130 cm	106 cm	2.90 m ²	2.20m ²	2.80 kg	3.20 kg	40 x 19 cm
7640445457491	Venus II extreme	dark lava	2	225 x 130 cm	106 cm	2.90 m ²	2.20m ²	2.80 kg	3.20 kg	40 x 19 cm
	canopy fits to 2 M or 2 LW mats									
7640445457521	Venus III extreme	moss	2 – 3	232 x 160 cm	115 cm	3.70 m ²	2.40m ²	3.20 kg	3.60 kg	40 x 22 cm
7640445457538	Venus III extreme	dark lava	2 – 3	232 x 160 cm	115 cm	3.70 m ²	2.40m ²	3.20 kg	3.60 kg	40 x 22 cm
	canopy fits to 2 M or 2 LW mats									
7640445457231	Venus II UL	moss	2	220 x 131 cm	110 cm	2.85 m ²	2.20 m ²	2.10 kg	2.35 kg	40 x 18 cm
	canopy fits to 2 M or 2 LW mats									
7640445457255	Venus III UL	moss	2 – 3	225 x 160 cm	115 cm	3.70 m ²	2.40m ²	2.30 kg	2.50 kg	40 x 22 cm
	canopy fits to 2 M or 2 LW mats									
7640445457507	Venus II Footprint (optional)							0.50 kg		
7640445457545	Venus III Footprint (optional)							0.54 kg		

MIRA HL

Super-light shelter

The Mira HL series offer a balanced mix of space, comfort and low weight making them perfect for warm climates. They have a free-standing design and a ridge pole increasing head room for comfortable sitting. Because they are built with ultra-lightweight fabrics, we recommend the use of a footprint for floor protection.

- > virtually freestanding construction
- > doubles as freestanding mosquito mesh tent
- > multiple setup options

Intended Use

summer trips, fast and lite backpacking, thru-hiking, micro adventures, bikepacking

- 1 poles with hubs and clips: quick and easy to set up
- 2 fine mosquito mesh
- 3 wind and privacy shield
- 4 2 vestibules: Mira HL II, III

Mira HL I

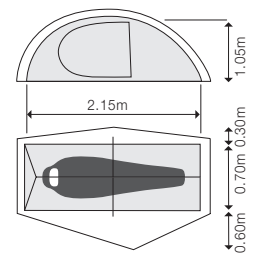

Mira HL II

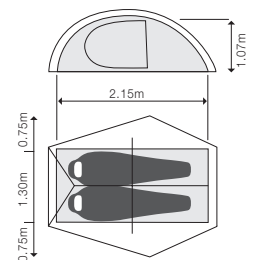

Mira HL III

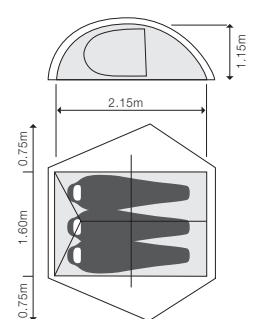

Canopy Mira HL



Sideview Mira HLII



Mira HL II

MIRA HL

FAST + LITE
3-SEASON

Material

Rainfly 10 D ripstop nylon, silicone/PU coated, factory seam taped, PFC-free, flame-retardant free

Canopy 15 D ripstop nylon, 15 D No-See-Um mosquito mesh, DWR C6, flame-retardant free

Floor 20 D ripstop nylon, silicone-/PU coated, 1 500 mm water column, factory seam taped, PFC-free, flame-retardant free

Poles DAC Featherlite NFL 9.3 mm and NSL 8.5 mm TH72M, green anodizing

Prod. No	Name	Color	Persons	Floor size	Inner height	Canopy area	Vestibule area	minimum weight	packed weight	packed weight
7640445457149	Mira I HL canopy fits one LW mat	meadow	1	215 x 70 cm	105 cm	1.50 m ²	1.10 m ²	0.87 kg	1.15 kg	37 x 13 cm
7640445457170	Mira II HL canopy fits 2 LW mats	meadow	2	215 x 130 cm	107 cm	2.80 m ²	1.70 m ²	1.15 kg	1.30 kg	40 x 12 cm
7640445457200	Mira III HL canopy fits 3 M or 2 LW mats	meadow	2 – 3	215 x 160 cm	115 cm	3.50 m ²	1.70 m ²	1.40 kg	1.70 kg	48 x 16 cm
7640445457156	Mira I HL Footprint (optional)							0.17 kg		
7640445457187	Mira II HL Footprint (optional)							0.31 kg		
7640445457217	Mira III HL Footprint (optional)							0.35 kg		

LYRA

The 3-season tent with multiple setup modes

The Lyra tents are built to provide lightweight, free-standing and affordable shelter for 2 or 3 people for backpacking and travel. The 2 doors and vestibules offer ample space and easy access. Multiple set-up and deployment modes allow Lyra to adapt to changing conditions and personal preferences for optimal comfort.

- > virtually freestanding construction
- > doubles as freestanding mosquito mesh tent
- > multiple setup options

- 1 poles with hubs and clips: quick and easy to set up
- 2 fine mosquito mesh
- 3 wind and privacy shield
- 4 2 vestibules



Stargazer mode



Sideview Lyra II



Lyra II

Lyra II | Lyra II Extreme

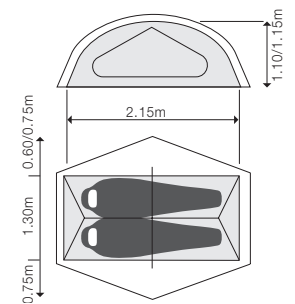

Lyra III | Lyra III Extreme

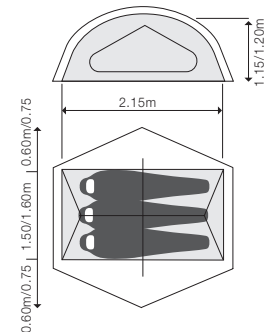

LYRA EXTREME

TREKING
3-SEASON

Intended Use

backpacking, micro adventures

Material

Rainfly

30 D ripstop nylon, silicone coated on both sides, PFC-free, flame-retardant free

Canopy

15 D ripstop nylon, 15 D No-See-Um mosquito mesh, DWR C6, flame-retardant free

Floor

40 D ripstop nylon, 5 000 mm water column, PFC-free, flame-retardant free

Poles DAC Featherlite NSL 9 mm TH72M, green anodizing

LYRA

TREKING
3-SEASON

Intended Use

camping, backpacking, micro adventures

MATERIAL

Rainfly

68 D polyester taffeta, PU coated, factory seam taped, DWR C6, flame-retardant free

Canopy

68 D polyester taffeta, 40 D No-See-Um mosquito mesh, DWR C6, flame-retardant free

Floor

68 D polyester taffeta, PU coated, 5 000 mm water column, factory seam taped, DWR C6, flame-retardant free

Poles

DAC Pf 9 mm TH72M, green anodizing

Prod. No	Name	Color	Persons	Floor size	Inner height	Canopy area	Vestibule area	minimum weight	packed weight	packed
7640445457415	Lyra II extreme canopy fits to 2 M or 2 LW mats	meadow	2	215 x 130 cm	115 cm	2.80 m ²	1.70m ²	1.57 kg	1.85 kg	46 x 16 cm
7640445457446	Lyra III extreme canopy fits to 2 M or 2 LW mats	meadow	2 – 3	215 x 160 cm	120 cm	3.40 m ²	1.70m ²	1.79 kg	2.10 kg	48 x 16 cm
7640445457279	Lyra II canopy fits to 2 M or 2 LW mats	meadow	2	215 x 130 cm	110 cm	2.80 m ²	1.35 m ²	1.95 kg	2.10 kg	45 x 19 cm
7640445457293	Lyra III canopy fits to 2 M or 2 LW mats	meadow	2 – 3	215 x 150 cm	115 cm	3.20 m ²	1.35 m ²	2.10kg	2.30 kg	50 x 19 cm
7640277840638	Lyra II extreme Footprint (optional)							0.31 kg		
7640445457453	Lyra III extreme Footprint (optional)							0.35 kg		
7640445450683	Lyra II Footprint (optional)							0.28 kg		
7640445450690	Lyra III Footprint (optional)							0.31 kg		

OUTER SPACE

Spacious 3-season tent with large vestibule

Outer Space tents are shape-shifting, multi-mode, take-anywhere tents with enough vestibule space for a party. Multiple set-up and deployment modes allow Outer Space to adapt to changing conditions and personal preferences for optimal comfort. The fly can easily be set up on its own, without the inner tent, or combined with a footprint for lightweight trips. Party Mode is made possible by the exostructure pole configuration, allowing the inner tent to be temporarily disconnected and pushed aside. Multiple chairs fit comfortably under the steep-walled fly-only shelter.

- > virtually freestanding
- > easy setup with attached canopy and fly
- > sideways and double as airy sun canopy

Intended Use

camping, canoeing, summer basecamp, family trips

- 1 spacious vestibule for cozy get-togethers
- 2 small rear vestibule
- 3 wind and privacy shield
- 4 fine mosquito mesh
- 5 the complete tent attaches to the pole structure with clips



Outer Space II

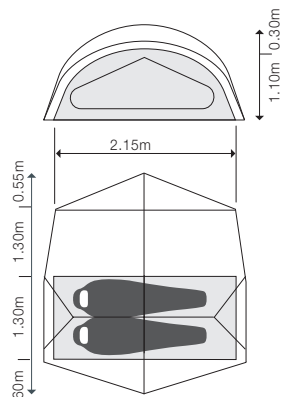

Outer Space III

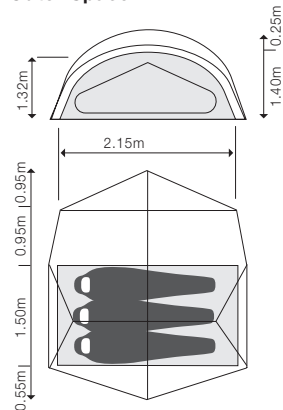

OUTER SPACE

TREKKING
3-SEASON

Material

Rainfly 40 D ripstop nylon, PU coated, factory seam taped, DWR C6, flame-retardant free

Canopy 40 D ripstop nylon, 15 D No-See-Um mosquito mesh, DWR C6, flame-retardant free

Floor 68 D polyester taffeta, PU coated, 5 000 mm water column, factory seam taped, DWR C6, flame-retardant free

Poles DAC Pf 9 mm TH72M, green anodizing

Prod. No	Name	Color	Persons	Floor size	Inner height	Canopy area	Vestibule area	minimum weight	packed weight	packed height
7640445457316	Outer Space II canopy fits up to 2 LW mats or one Duo mat	meadow	2	215 x 130 cm	110 cm	2.80 m ²	3.70 m ²	2.60 kg	2.80 kg	55 x 21 cm
7640445457385	Outer Space III suitable for up to 2 LW or one Duo mat	meadow	2 - 3	215 x 150 cm	140 cm	3.20 m ²	3.80 m ²	3.10 kg	3.30 kg	56 x 23 cm
7640445450720	Outer Space II Footprint (optional)							0.42 kg		
7640445450737	Outer Space III Footprint (optional)							0.47 kg		

VELA I EXTREME

TREKKING
4-SEASON

Solo tent for hard use

The Vela I extreme is a lightweight and sturdy 1 person tent for 4-season use. The Vela features generous living space and a large sheltered vestibule.

- > multiple setup options
- > roll-up fly
- > 245 cm sleeping length



Intended Use

demanding treks, hiking, cycle tours

- 1 protected vestibule with central zipper access
- 2 rainfly door can be pitched as awning
- 3 double layer canopy door for added insulation

Vela I

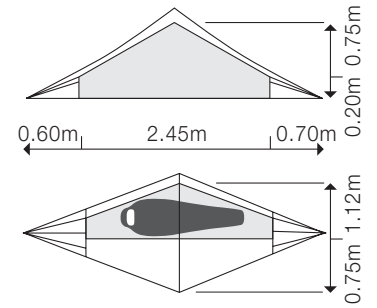

VELA I EXTREME

TREKKING
3-SEASON

Material

Rainfly 40 D ripstop nylon, PU coated, factory seam taped, PFC-free, flame-retardant free

Canopy 40 D ripstop nylon, 15 D No-See-Um mosquito mesh, PFC-free, flame-retardant free

Floor 68 D polyester taffeta, PU coated, 5 000 mm water column, factory seam taped, DWR C6, flame-retardant free

Poles DAC Pf 9 mm TH72M, green anodizing

Prod. No	Name	Color	Persons	Floor size	Inner height	Canopy area	Vestibule area	minimum weight	packed weight	packed
7640445457477	Vela I extreme	moss	1	245 x 112 cm	95 cm	1.95 m ²	1.00 m ²	1.65 kg	1.95 kg	40 x 15 cm
7640277840294	Vela I Footprint (optional)							0.31 kg		

VENUS III DLX EXTREME

TREKKING
4-SEASON

All weather basecamp tent with large vestibule

Welcome to the Exped hotel! A light triple or comfortable double tent that offers plenty of space and is quickly pitched. Three doors, a huge front vestibule as well as a smaller back door vestibule hold all the gear you need and offer sheltered space to sit out a rainy day.

- > virtually freestanding construction
- > fly only setup offers space for 6 people

Intended Use

camping, summer basecamp, family trips

- 1 huge front vestibule
- 2 smaller rear vestibule
- 3 comfortable canopy



Venus III DLX Extreme

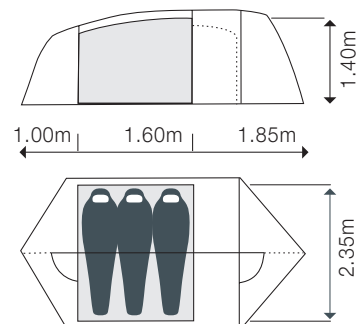

VENUS III DLX EXTREME

TREKKING
3-SEASON

Material

Rainfly 40 D ripstop nylon, silicone/PU coated, factory seam taped, Oeko Tex® 100 certified, PFC-free, flame-retardant free

Canopy 30 D ripstop nylon, 20 D No-See-Um mosquito mesh, Oeko Tex® 100 certified, PFC-free, flame-retardant free

Floor 70 D taffeta nylon, 10 000 mm water column, Oeko Tex® 100 certified, PFC-free, flame-retardant free

Poles DAC Featherlite NSL 9 mm and 10.25 mm TH72M, green anodizing

Prod. No	Name	Color	Persons	Floor size	Inner height	Canopy area	Vestibule area	minimum weight	packed weight	packed	
7640445457620	Venus III DLX extreme	moss	2 – 3	235 x 160 cm	140 cm	3.80 m ²	4.60 m ²	4.50 kg	4.90 kg	42 x 32 cm	
7640445457637	Venus III DLX extreme	dark lava	2 – 3	235 x 160 cm	140 cm	3.80 m ²	4.60 m ²	4.50 kg	4.90 kg	42 x 32 cm	
									canopy fits 3 M or 2 LW mats		
7640445457644	Venus III DLX Footprint (optional)								0.84 kg		

FOOTPRINTS

TENT
ACCESSORY



Tent floor protection

- > covers the tent floor and vestibules
- > reduces condensation rising from the ground
- > sized to prevent water collecting between tent and footprint

Material

Footprint HL 20 D Ripstop Nylon laminated, 1'500 mm water column

Footprint 70 D Taffeta Nylon taped, 3'000 mm water column

SNOW & SAND TENT ANCHOR

TENT
ACCESSORY



For tent setup in snow and sand

- > for tent setup in sand, snow and rocky ground
- > extremely lightweight and compact

Prod. No	Weight
7640277840485	5 x 22 g

SWISS PIRANHA RT 120

TENT
ACCESSORY



Featherweight tent peg made in Switzerland

- > ideal for forest and grassy ground
- > sinks flat into the ground preventing tripping and injury
- > made in Switzerland

Material high performance plastic

Prod. No	Dimensions	Weight
7640445452373	12 cm	5 x 5.9 g

TUBE PEG

TENT
ACCESSORY



Long stake for difficult anchoring conditions

- > lightweight, long and strong
- > works well for hard and soft ground
- > practical lanyard

Material TRX 7001 , acid-free anodizing

Prod. No	Dimensions	Weight
7640147767775	20 cm	5 x 16 g

TARP POLE 240

TENT
ACCESSORY

COLOR
UPDATE



Sturdy, adjustable tarp support in 2 lengths

- > ideal for all Exped Tarps
- > 100 cm adjustable

Material

Tarp Pole 240 6063-T5

Prod. No	Name	Length	Weight
7640147764989	Tarp Pole 240	140 – 240 cm	810 g

REFL. DYNEEMA TENTCORD

TENT
ACCESSORY



Super-strong reflective guyline

- > 200 kg tear strength
- > static cord
- > reflective thread for night visibility
- > made in Germany

Prod. No	Dimensions	Weight
7640120113605	15 m, Ø 1.8 mm	40 g

V-PEG

TENT
ACCESSORY

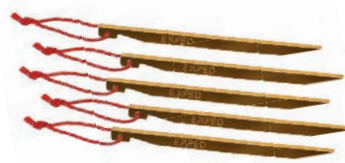

V-shaped stake for strength at low weight

- > central groove for use as anchor
- > 10 grams per stake

Material 7075, acid-free anodizing

Prod. No	Dimensions	Weight
7640147768055	16 cm	5 x 10 g

SOLO TARP

FAST + LITE



Ultralight tarp for all hammocks

- > extremely light and compact when packed
- > 4 integrated guyline
- > tarp for 1–2 users
- > 6 guylines included

Intended use

ultralight hammocking

PFC
FREE

Material 15 D ripstop nylon, silicone/PU coated, factory seam taped, Oeko-Tex® 100 certified, PFC-free, flame-retardant free

Prod. No	Name	Dimensions	Weight	Packed
7640445457095	Solo Tarp	300 x 190 cm	330 g	17 x 9 cm

HAMMOCK TREKKING TARP

FAST + LITE



Reliable weather protection for hammock and gear

- > asymmetrical design for ideal coverage
- > extremely lightweight and compact
- > can be used as 5 or 6 corner tarp
- > 100% fabric consumption, zero waste
- > 5 integrated guylines

Intended use

ultralight hammocking, bushcraft

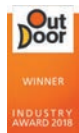

PFC
FREE

Material 15 D ripstop nylon, silicone/PU coated, factory seam taped, Oeko-Tex® 100 certified, PFC-free, flame-retardant free

Prod. No	Name	Dimensions	Weight	Packed
7640445457101	Hammock Trekking Tarp	360 x 440 cm	390 g	19 x 9 cm

SCOUT TARP EXTREME

FAST + LITE



Tent alternative for ultralight backpacking

- > adjustable shock cord in perimeter seam for variable tension
- > integrated pack and pole support sack
- > 12 guyline loops
- > quick set-up
- > 6 adjustable integrated guylines, 8 pegs

Intended use

hammocking, bushcraft

PFC
FREE

Material 40 D ripstop nylon, silicone coated, Oeko-Tex® 100 certified, PFC-free, flame-retardant free

Prod. No	Name	Dimensions	Min. Weight	Weight	Packed
7640445457118	Scout Tarp extreme	350 x 290 cm	780 g	980 g	25 x 15 cm



Versatile lightweight tarps

- > integrated guylines
- > reinforced central pole support
- > 8 adjustable guylines and 8 pegs included
- > 23 guyout loops (21 reinforced, 3 on upper side)

Intended use

hiking, backpacking, bushcraft, basecamp, micro adventures



Material 40 D ripstop nylon, silicone coated on both sides, Oeko-Tex® 100 certified, PFC-free, flame-retardant free

Prod. No	Name	Dimensions	Min. Weight	Weight	Packed
7640445457125	Tarp II extreme	350 x 290 cm	710 g	900 g	32 x 13 cm
7640445457132	Tarp III extreme	350 x 350 cm	850 g	1050 g	32 x 14 cm



Versatile and durable weather protection

- > tough fabric can also be used as ground sheet
- > reinforced central pole support
- > 8 adjustable guylines included
- > 18 guyout loops (16 reinforced, 3 on upper side)

Intended use

bushcraft, basecamp

Material 75 D taffeta polyester, PU coated, factory seam taped, DWR C6, flame-retardant free

Prod. No	Name	Dimensions	Weight	Weight	Packed
7640445457606	Tarp II Versa	350 x 290 cm	870 g	950 g	32 x 14 cm
7640445457613	Tarp III Versa	350 x 350 cm	1080 g	1160 g	33 x 14 cm





SLEEPING BAGS

Exped offers the right sleeping bag for any adventure. An assortment of bag dimensions, fit and materials allow everyone to find the ideal sleeping bag for their individual needs. The name of each bag identifies its usage and temperature range.

EXPEDITION

- > for extreme weather conditions
- > water resistant shells
- > unique production techniques

While everyone has their own definition of what amounts to an expedition, challenging conditions are always involved. These sleeping bags distinguish themselves with durable materials and important features that shield against humidity and low temperatures, offering the best possible protection against the extremes.

TREKKING

- > sophisticated 3-season bags
- > fully featured and comfortable
- > excellent functionality

A warm sleeping bag plays a huge part in a successful adventure. The Trekking Series bags cover a wide scope of uses and offer the demanding trekker a finely tuned sleeping bag for each season. The emphasis lies in refined details, comfort and functionality.

FAST + LITE

- > minimalist designs
- > maximum warmth-to-weight ratio
- > lightest and finest materials

The maximum outdoor experience with minimal means. These featherlight sleeping bags crafted from the highest quality, extremely lightweight fabrics combined with excellent functionality are the choice for those traveling fast and light. Built with minimal features and a trim fit they still offer the necessary comfort.

BASE CAMP

- > value focused designs
- > built for versatility
- > comfortable fit

The Base camp series pairs comfort with affordable pricing. These sleeping bags and quilts include signature Exped features and versatility, going from car camping to backpacking with ease. These are workhorse bags that will provide years of warm and comfortable nights.

EXPED DESIGN PRINCIPALS

Highest quality materials paired with excellent workmanship and innovative designs create comfortable sleep-systems for any environment and intended use. The details express perfection in materials and construction.



- 1 Comfort hood**
- 2 Infoprint und QR Code**
A QR code on each bag supplies information regarding down quality and contents
- 3 Anti-snap webbing**
- 4 3D Footbox**
Differential cut and 11 baffles prevent down shift and allow optimal down lofting
- 5 Differential cut**
Outer shell cut wider than inner liner for optimal down lofting
- 6 Tuck-stitch technology**
Multiple fabric layers stitched together and tucked away create stronger seams
- 7 Down**
Only RDS certified down from our German supplier is used in Exped sleeping bags

SIZE CHART

SMALL	MEDIUM	MEDIUM WIDE	LONG	LONG WIDE	EXTRA LONG	EXTRA LONG WIDE
S fits up to 170 cm	M fits up to 180 cm	MW fits up to 180 cm	L fits up to 195 cm	LW fits up to 195 cm	XL fits up to 210 cm	XLW fits up to 210 cm

	°F	°C
	50°	10°
	41°	5°
	32°	0°
	23°	-5°
	14°	-10°
	5°	-15°
	-4°	-20°
	-13°	-45°

	DOWN DAUNE	SYNTHETIC SYNTHETIK
EXPEDITION	<p>DOWN DAUNE</p> <p>QUILT Pro</p> <p>Dreamwalker Pro</p> <p>Waterbloc Pro -5°</p> <p>Waterbloc Pro -15°</p> <p>Winterlite -5° Wmns</p> <p>Winterlite -15° Wmns</p> <p>Ultra XP</p>	
FAST + LITE	<p>DOWN DAUNE</p> <p>Ultra 10°</p> <p>Ultra 0°</p> <p>Ultra -5°</p> <p>Ultra -10°</p>	
TREKKING	<p>DOWN DAUNE</p> <p>Comfort 0°</p> <p>Comfort -5°</p> <p>Comfort -5° Wmns</p> <p>Comfort -10°</p> <p>Comfort -10° Wmns</p> <p>Trekkinglite Wmns 0°</p> <p>Trekkinglite Wmns -5°</p> <p>Trekkinglite Wmns -10°</p> <p>Trekkinglite 0°</p> <p>Trekkinglite -5°</p> <p>Trekkinglite -10°</p>	
BASE CAMP	<p>DOWN DAUNE</p> <p>Trekkinglite Summer</p> <p>Trekkinglite Versa</p> <p>Versa Quilt</p> <p>Versa Quilt Duo</p>	<p>SYNTHETIC SYNTHETIK</p> <p>Mega Sleep 25 40</p> <p>Mega Sleep 25 40 Duo</p>

Weather Resistant | Wetterfest  Windproof | Winddicht  All sleeping bags include a waterproof stuffsack and a mesh storage bag, and are shipped uncompressed. Alle Schlafsäcke werden mit einem wasserdichten Packsack und Moskitonetz-Storebag ausgeliefert und unkomprimiert transportiert.

SLEEPING BAGS



Waterbloc PRO



Dreamwalker PRO

WATERBLOC PRO

The world's lightest water-repellent down sleeping bag

- > Welded instead of sewn: new STEALTH technology
- > differential cut and shoulder width adapted/bag size
- > beefy draft collar
- > newly developed anti-snag zipper webbing
- > 3D footbox with 11 individually down-filled baffles
- > fit provides good insulation performance



Intended Use

Ideal for humid and cold conditions under a tarp or in an igloo; ideal for bushcrafters, survivalists, expeditionists and micro adventurers

DREAMWALKER PRO

Water-repellent multi-featured and ultra versatile

- > converts into blanket, coat, sleeping bag and hammock quilt
- > water-repellent Pertex Quantum Pro fabric
- > tuck-stitch seam technology for enhanced durability and moisture protection
- > side arm exits
- > water-repellent zippers
- > draft collar with velcro closure
- > differential cut and shoulder width adapted/bag size
- > adjustable hood and numerous inner and outer pockets



Intended Use

Perfect for hunting and fishing or those who just want to hang out cozy and warm around camp.

WATERBLOC PRO

EXPEDITION

Material

Shell 20 D ripstop nylon, Pertex Quantum Pro, 1'000 mm water column, MVTR 7'000 g/m², bluesign® certified, DWR, PFC-free

Liner 15 D ripstop nylon, bluesign® certified, no DWR, PFC-free

Fill Min. 850 cuin/oz, European 90/10 (US-Standard) goose down, RDS certified, Oeko-Tex® 100 certified

	Size	Fill weight	Weight	Temp. Range	Inner girth Shoulder/Foot	Length	fits up to	Packed
WATERBLOC PRO -5°								
LEFT ZIP								
	S	520 g	845 g	-2°/-8°/-27°C	157 cm/100 cm	190 cm	170 cm	25 x 14 x 12 cm
	M	540 g	890 g	-2°/-8°/-27°C	157 cm/100 cm	205 cm	180 cm	25 x 14 x 13 cm
	L	590 g	960 g	-2°/-8°/-27°C	159 cm/100 cm	220 cm	195 cm	25 x 14 x 14 cm
WATERBLOC PRO -15°								
LEFT ZIP								
	S	830 g	1225 g	-6°/-13°/-33°C	157 cm/100 cm	190 cm	170 cm	27 x 17 x 15 cm
	M	850 g	1280 g	-6°/-13°/-33°C	157 cm/100 cm	205 cm	180 cm	27 x 17 x 16 cm
	L	890 g	1340 g	-6°/-13°/-33°C	159 cm/100 cm	220 cm	195 cm	27 x 17 x 17 cm

DREAMWALKER PRO

EXPEDITION

Material

Shell 30 D ripstop nylon, Pertex Quantum Pro, 1'000 mm water column, MVTR 7'000 g/m², bluesign® certified, DWR, PFC-free

Liner 15 D ripstop nylon, bluesign® certified, no DWR, PFC-free

Fill Min. 700 cuin/oz, European 90/10 (EN-Standard) duck down, RDS certified, Oeko-Tex® 100 certified

	Size	Fill weight	Weight	Temp. Range	Inner girth Shoulder/Foot	Length	fits up to	Packed
DREAMWALKER PRO								
	M	580 g	1150 g	+2°/-4°/-19°C	150 cm/130 cm	215 cm	180 cm	28 x 16 x 16 cm
	L	625 g	1250 g	+2°/-4°/-19°C	154 cm/130 cm	230 cm	195 cm	28 x 16 x 17 cm



Quilt PRO



Cover PRO

QUILT PRO

Water-repellent, multi-purpose and warm

- > full-fledged hoodless sleeping bag with contoured fit
- > used as liner, makes 3-season sleeping bags winter-capable
- > ideal as hammock underquilt
- > full length zipper allows use as blanket or cape
- > beefy end baffles with drawcord retain body heat



Intended Use

Extra-comfortable and affordable versatility in a car camp, on an overland expedition as well as human-powered adventures

COVER PRO

Lightweight protective sleeping bag cover for nights under a tarp in wet weather

- > extra-long sleeping bag cover - with storage space at the foot end
- > wide hood opening seals with drawcord
- > water-repellent zipper
- > temperature enhancement of up to 7°C



Intended Use

It also works very well for nights under a tarp in wet conditions and in snow caves.

SLEEPING BAGS

QUILT PRO

EXPEDITION

Material

Shell 30 D ripstop nylon, Pertex Quantum Pro, 1'000 mm water column, MVTR 7'000 g/m², bluesign® certified, DWR, PFC-free

Liner 15 D ripstop nylon, bluesign® certified, no DWR, PFC-free

Fill Min. 800 cuin/oz, European 90/10 (US-Standard) goose down, RDS certified, Oeko-Tex® 100 certified

	Size	Fill weight	Weight	Temp. Range	Inner girth Shoulder / Foot	Length	fits up to	Packed
QUILT PRO								
7640445450225	M	450 g	750 g	+5°/0°/-16°C	154 cm/99 cm	185 cm	180 cm	23 x 14 x 13 cm
7640445450249	L	500 g	790 g	+5°/0°/-16°C	157 cm/99 cm	210 cm	195 cm	23 x 14 x 14 cm

COVER PRO

EXPEDITION

Material

30 D ripstop nylon, Pertex Quantum Pro, 1'000 mm water column, MVTR 7'000 g/m², bluesign® certified, DWR, PFC-free

	Size	Weight	added temp.	Inner girth Shoulder / Foot	Length	fits up to	Packed
COVER PRO							
7640171999166	M	300 g	+7°C	178 cm/110 cm	220 cm	180 cm	11 x 8 x 10 cm
7640171999180	L	330 g	+7°C	178 cm/110 cm	240 cm	195 cm	11 x 8 x 11 cm

WINTERLITE



WINTERLITE WMNS Women's model for mountaineering and harsh environments

- > 10–15% more down in foot and torso sections
- > new fit provides better insulation performance
- > water-repellent, windproof and lightweight NEOVENT-S shell fabric
- > tuck-stitch seam technology for enhanced durability and moisture protection
- > beefy draft collar
- > newly developed anti-snag zipper webbing
- > 3D footbox with 11 individual down-filled baffles
- > new fit provides better insulation performance
- > differential cut and shoulder width adapted bag size

WINTERLITE For mountaineering and harsh environments

- > water-repellent, windproof and lightweight NEOVENT-S shell fabric
- > tuck-stitch seam technology for enhanced durability and moisture protection
- > beefy draft collar
- > newly developed anti-snag zipper webbing
- > 3D footbox with 11 individual down-filled baffles
- > new fit provides better insulation performance
- > differential cut and shoulder width adapted bag size



Intended Use

WinterLite an excellent choice for conditions where moisture is difficult to avoid (condensation in tents, drippy snow caves, cold-weather tarp camping).

WINTERLITE

EXPEDITION

Material

Shell 20 D ripstop nylon Neovent-S, 1 000 mm water column, MVTR 7 000 g/m², DWR, bluesign® certified

Liner 30 D nylon, Oeko-Tex® 100 certified, no DWR, PFC-free

Fill Min. 800 cuin/oz, European 90/10 (EN-Standard) goose down, RDS certified, Oeko-Tex® 100 certified

LEF ZIP	RIGHT ZIP	Size	Fill weight	Weight	Temp. Range	Loft	Inner girth Shoulder/Foot	Length	fits up to	Packed
WINTERLITE -5° WMNS										
7640171999289	7640171999302	S	530 g	1020 g	-1°/-7°/-24°C	79 mm	150 cm/97 cm	195 cm	170 cm	29 × 15 × 13 cm
7640171999326	7640171999340	M	550 g	1070 g	-1°/-7°/-24°C	79 mm	152 cm/97 cm	205 cm	180 cm	29 × 15 × 14 cm
WINTERLITE -15° WMNS										
7640171999456	7640171999470	S	840 g	1310 g	-8°/-16°/-37°C	105 mm	150 cm/97 cm	195 cm	170 cm	28 × 16 × 15 cm
7640171999500	7640171999524	M	860 g	1380 g	-8°/-16°/-37°C	105 mm	152 cm/97 cm	205 cm	180 cm	28 × 16 × 16 cm
WINTERLITE -5°										
7640171999203	7640171999227	M	540 g	1070 g	-1°/-7°/-24°C	78.6 mm	157 cm/100 cm	205 cm	180 cm	29 × 15 × 14 cm
7640171999241	7640171999265	L	580 g	1140 g	-1°/-7°/-24°C	78.6 mm	159 cm/100 cm	220 cm	195 cm	29 × 15 × 15 cm
WINTERLITE -15°										
7640171999371	7640171999395	M	850 g	1380 g	-8°/-16°/-37°C	105 mm	157 cm/100 cm	205 cm	180 cm	28 × 16 × 16 cm
7640171999418	7640171999432	L	890 g	1450 g	-8°/-16°/-37°C	105 mm	159 cm/100 cm	220 cm	195 cm	28 × 16 × 17 cm

ULTRA



Ultra XP



Ultra -20°

ULTRA XP

Top class expedition sleeping bag with excellent thermal performance

- > double zip cover
- > extra wide proportional differential cut
- > adjustable elliptical draft collar
- > comfortable triangle foot box
- > water repellent outer fabric



Intended Use

Expedition

ULTRA -20°

I am from head to toe prepared for snow (winter)

- > extra warm, lightweight and small packable winter sleeping bag
- > spacious proportional differential cut
- > adjustable elliptical draft collar
- > double zip cover
- > comfortable triangle foot box
- > water repellent outer fabric



Intended Use

Winter camping and trekking, dog sledging

ULTRA

EXPEDITION

Material

Shell 10 D ripstop nylon, recycled, PFC-free, bluesign® certified

Liner 15 D ripstop nylon no DWR, Oeko-Tex® 100 certified

Fill 850+ cuin/oz premium European 90/10 (EN-Standard) goose down, RDS certified, Oeko-Tex® 100 certified.

	Size	Fill weight	Weight	Temp. Range	Inner girth Shoulder/Foot	Length	fits up to	Packed
ULTRA XP								
7640445456920	S	1250 g	1750 g	-20°/-28°/-48°C	157cm/104cm	200 cm	170 cm	40 x 30 x 20 cm
7640445456944	MW	1350 g	1850 g	-20°/-28°/-48°C	164cm/110cm	205 cm	180 cm	40 x 30 x 25 cm
7640445456968	LW	1400 g	1950 g	-20°/-28°/-48°C	167cm/110cm	220 cm	195 cm	40 x 30 x 30 cm
ULTRA - 20°								
7640445456821	S	900 g	1300 g	-10°/-20°/-40°C	152cm/97cm	195 cm	170 cm	29 x 29 x 15 cm
7640445456845	M	928 g	1360 g	-10°/-20°/-40°C	156cm/100cm	203 cm	180 cm	29 x 29 x 16 cm
7640445456869	MW	1020 g	1430 g	-10°/-20°/-40°C	163cm/105cm	203 cm	180 cm	32 x 32 x 15 cm
7640445456883	L	999 g	1590 g	-10°/-20°/-40°C	159cm/103cm	218 cm	195 cm	29 x 29 x 18 cm
7640445456906	LW	1105 g	1495 g	-10°/-20°/-40°C	166cm/108cm	218 cm	195 cm	32 x 32 x 18 cm

ULTRA



Ultra -5°

Ultra -10°

ULTRA -5°

The extremely lightweight, compact three-season sleeping bag

- > warm three-season sleeping bag
- > very lightweight construction
- > downshift function for better heat distribution
- > recycled inner and outer fabric
- > adjustable elliptical thermal collar



Intended Use

Trekking, Thru-hikers, bivouac, hiking, canoeing

ULTRA -10°

The extremely lightweight, compact three-season sleeping bag

- > warm three-season sleeping bag
- > very lightweight construction
- > downshift function for better heat distribution
- > recycled inner and outer fabric
- > adjustable elliptical thermal collar



Intended Use

Trekking, thru-hikers, bivouac, hiking, canoeing

ULTRA

Material

Shell 10 D recycled ripstop nylon, PFC-free, bluesign® certified

Liner 15 D ripstop nylon no DWR, Oeko-Tex® 100 certified

Fill 850+ cuin/oz premium European 90/10 (EN-Standard) goose down, RDS certified, Oeko-Tex® 100 certified.

	Size	Fill weight	Weight	Temp. Range	Inner girth Shoulder/Foot	Length	fits up to	Packed
ULTRA -5°								
LEFT ZIP								
	S	425 g	790 g	+1°/-5°/-23°C	147cm/96 cm	195 cm	170 cm	17 × 17 × 27 cm
	M	450 g	820 g	+1°/-5°/-23°C	148 cm/96 cm	203 cm	180 cm	17 × 17 × 30 cm
	MW	540 g	930 g	+1°/-5°/-23°C	163 cm/99 cm	203 cm	180 cm	23 × 14 × 20 cm
	L	480 g	870 g	+1°/-5°/-23°C	151cm/99 cm	218 cm	195 cm	23 × 14 × 15 cm
	LW	595 g	990 g	+1°/-5°/-23°C	166 cm/99 cm	218 cm	195 cm	23 × 14 × 20 cm
	XL	650 g	1020 g	+1°/-5°/-23°C	165 cm/99 cm	230 cm	210 cm	23 × 15 × 22 cm
ULTRA -10°								
LEFT ZIP								
	S	595 g	935 g	-3°/-9°/-28°C	150 cm/96 cm	195 cm	170 cm	25 × 16 × 16 cm
	M	650 g	995 g	-3°/-9°/-28°C	155 cm/96 cm	203 cm	180 cm	25 × 20 × 16 cm
	MW	735 g	1125 g	-3°/-9°/-28°C	163 cm/100 cm	203 cm	180 cm	25 × 25 × 16 cm
	L	705 g	1060 g	-3°/-9°/-28°C	158 cm/96 cm	218 cm	195 cm	25 × 20 × 18 cm
	LW	790 g	1190 g	-3°/-9°/-28°C	166 cm/100 cm	218 cm	195 cm	25 × 25 × 18 cm

ULTRA



Ultra 10°



Ultra 0°

ULTRA 10°

The fulfilment of all lightweight dreams

- > can convert a three-season sleeping bag into a winter sleeping bag
- > can also be used as a summer sleeping bag
- > extremely light at 220 grams
- > extremely small pack size



Intended Use

Ultralite cabin sleepingbag or sleeping bag liner for hikers, bivouacers, bike packers

ULTRA 0°

Summer sleeping bag for nights down to the zero degree mark

- > weighs only 530 grams (size M)
- > downshift function for better heat distribution
- > passive draft collar
- > comfortable triangle foot box



Intended Use

Summer sleeping bag for mild climate use. Can double as a 3 season bag

SLEEPING BAGS

ULTRA

FAST+LITE

Material

Shell 10 D recycled ripstop nylon, PFC-free, bluesign® certified

Liner 10 D recycled ripstop nylon, no DWR, Oeko-Tex® 100, bluesign® certified

Fill 850+ cuin/oz premium European 90/10 (EN-Standard) goose down, RDS certified, Oeko-Tex® 100 certified.

	Size	Fill weight	Weight	Temp. Range	Inner girth Shoulder/Foot	Length	fits up to	Packed
ULTRA 10°								
LEFT ZIP								
7640445456708	M	100 g	220 g	+15°/+10°/-3°C	150 cm/88 cm	203 cm	180 cm	9 x 9 x 18 cm
7640445456722	L	115 g	260 g	+15°/+10°/-3°C	158 cm/94 cm	218 cm	195 cm	9 x 9 x 20 cm
ULTRA 0°								
LEFT ZIP								
7640445456746	S	225 g	510 g	+7°/+2°/-13°C	147 cm/94 cm	195 cm	170 cm	15 x 15 x 20 cm
7640445456258	M	275 g	530 g	+7°/+2°/-13°C	148 cm/96 cm	203 cm	180 cm	15 x 15 x 25 cm
7640445456272	MW	340 g	660 g	+7°/+2°/-13°C	158 cm/99 cm	203 cm	180 cm	17 x 17 x 30 cm
7640445456296	L	295 g	590 g	+7°/+2°/-13°C	151 cm/96 cm	218 cm	195 cm	17 x 17 x 30 cm
7640445456319	LW	370 g	690 g	+7°/+2°/-13°C	162 cm/99 cm	218 cm	195 cm	17 x 17 x 32 cm

COMFORT

COMFORT

The comfortable mummy sleeping bag – now even more versatile!

- > side arm openings for full flexibility
- > BlanketZip - converts into a down blanket thanks/the foot end zipper
- > differential cut and optimized fit at the foot end
- > Comfort Hood with extra wide cut
- > beefy draft collar
- > 3D triangular footbox with 11 individual down-filled baffles
- > tuck-stitch seam technology for enhanced durability and moisture protection

COMFORT WMNS

The comfortable mummy bag designed for women

- > 10-15% more down in foot and torso sections
- > side arm openings for full flexibility
- > BlanketZip - converts into a down blanket thanks/the foot end zipper
- > differential cut and optimized fit at the foot end
- > Comfort Hood with extra wide cut
- > beefy draft collar
- > 3D triangular footbox with 11 individual down-filled baffles
- > tuck-stitch seam technology for enhanced durability and moisture protection



Intended Use

versatile mummy bag built for maximum comfort from late spring through early fall



COMFORT

TREKKING

Material

Shell 20 D ripstop nylon, Oeko-Tex® 100 certified, PFC-free

Liner 30 D nylon, Oeko-Tex® 100 certified, no DWR, PFC-free

Fill Min. 700 cuin/oz, European 90/10 (EN-Standard) duck down, RDS certified, Oeko-Tex® 100 certified

Prod. Name	Prod. No Left zip	Prod. No Right zip	Size	Fill weight	Weight	Temp. Range	Loft	Inner girth Shoulder/Foot	Length	fits up to	Packed
Comfort -5° Wmns	7640445452601	7640445452625	S	430 g	930 g	+2°/-4°/-22°C	92 mm	148 cm/100 cm	195 cm	170 cm	23 x 14 x 13 cm
Comfort -5° Wmns	7640445452694	7640445452663	M	495 g	990 g	+2°/-4°/-22 °C	92 mm	152 cm/100 cm	205 cm	180 cm	23 x 14 x 14 cm
Comfort -10° Wmns	7640445452687	7640445452717	S	615 g	1120 g	-4°/-9°/-27°C	101 mm	148 cm/100 cm	195 cm	170 cm	24 x 15 x 16 cm
Comfort -10° Wmns	7640445452731	7640445452755	M	675 g	1190 g	-4°/-9°/-27°C	101 mm	152 cm/100 cm	205 cm	180 cm	24 x 17 x 17 cm
Comfort +0°	7640445452070	7640445452094	M	420 g	970 g	+6°/0°/-16°C	70.7 mm	178 cm/108 cm	205 cm	180 cm	23 x 14 x 14 cm
Comfort +0°	7640445453017	7640445450768	L	450 g	1030 g	+6°/0°/-16°C	70.7mm	178 cm/108 cm	220 cm	195 cm	23 x 14 x 15 cm
Comfort +0°	7640445453038		XL	490g	1080g	+6°/0°/-16°C	70.7mm	178 cm/108 cm	235 cm	210 cm	23 x 14 x 17 cm
Comfort -5°	7640445453086	7640445450409	M	590 g	1140 g	+2°/-4°/-22°C	87.3 mm	178 cm/108 cm	205 cm	180 cm	26 x 17 x 16 cm
Comfort -5°	7640445454023	76404454540447	L	630 g	1230 g	+2°/-4°/-22°C	87.3 mm	178 cm/108 cm	220 cm	195 cm	26 x 17 x 17 cm
Comfort -5°	76404454540461		XL	670 g	1290 g	+2°/-4°/-22°C	87.3 mm	178 cm/108 cm	235 cm	210 cm	26 x 17 x 19 cm
Comfort -10°	76404454540508	7640445450522	M	750 g	1290 g	-5°/-10°/-32°C	90 mm	178 cm/108 cm	205 cm	180 cm	26 x 17 x 16 cm
Comfort -10°	76404454540546	7640445450560	L	790 g	1370 g	-5°/-10°/-32°C	90 mm	178 cm/108 cm	220 cm	195 cm	26 x 17 x 17 cm
Comfort -10°	76404454540584		XL	830 g	1439 g	-5°/-10°/-32°C	90 mm	178 cm/108 cm	235 cm	210 cm	26 x 17 x 19 cm

TREKKINGLITE



Trekkinglite Summer



Trekkinglite Versa

TREKKINGLITE SUMMER

Trim summer bag and blanket that packs small

- > circumferential zipper YKK #3 enables blanket function
- > also perfect as sleeping bag liner for enhanced insulation
- > durable materials and small packed size
- > wide hood construction
- > proven box-baffle design
- > deal for hikers, short trips and mild summer nights



Intended Use

A lightweight sleeping bag for mild summer nights

TREKKINGLITE VERSA

The classic rectangular sleeping bag featuring the bare necessities

- > ideal for camping and van life
- > hood design offers more space
- > can be used blanket style
- > rectangular shape



Intended Use

Ideal for camping and van life

TREKKINGLITE SUMMER

TREKKING

Material

Aussen 20 D ripstop nylon, PFC-free

Innen 30 D nylon, Oeko-Tex® 100 certified, no DWR, PFC-free

Füllung Min. 700 cuin/oz, European 90/10 (EN-Standard) duck down, RDS certified, Oeko-Tex® 100 certified

	Size	Fill weight	Weight	Temp. Range	Loft	Inner girth Shouler/Foot	Length	fits up to	Packed
LEFT ZIP									
7640445450027	M	255 g	600 g	+10°/+5°/-7°C	50 mm	150cm/97 cm	203 cm	180 cm	23 x 12 x 12 cm
7640445450065	L	265 g	620 g	+10°/+5°/-7°C	50 mm	153 cm/99 cm	218 cm	195 cm	23 x 12 x 13 cm

TREKKINGLITE VERSA

BASE CAMP

Material

Shell 20 D ripstop nylon, Oeko-Tex® 100 certified, PFC-free

Liner 30 D nylon, Oeko-Tex® 100 certified, no DWR, PFC-free

Fill Min. 650 cuin/oz, European 90/10 (EN-Standard) duck down, RDS certified, Oeko-Tex® 100 certified

	Size	Fill weight	Weight	Temp. Range	Inner girth Shouler/Foot	Length	fits up to	Packed
LEFT ZIP								
7640445453189	M	510 g	1030 g	+3°/-3°/-14°C	178 cm/110 cm	205 cm	180 cm	23 x 15 x 15 cm
7640445453202	L	550 g	1080 g	+3°/-3°/-14°C	178 cm/110 cm	220 cm	195 cm	23 x 15 x 16 cm

TREKINGLITE



TREKINGLITE

Universal lightweights for worldwide use

- > optimized fit provides better insulating performance
- > tuck-stitch seam technology for enhanced durability and moisture protection
- > beefy draft collar
- > anti-snap zipper webbing
- > 3D triangular footbox with 11 individual down-filled baffles
- > differential cut and shoulder width adapted/bag size

TREKINGLITE WMNS

Universal lightweights for worldwide use – for women

- > 10–15% more down in foot and torso sections
- > optimized fit provides better insulating performance
- > tuck-stitch seam technology for enhanced durability and moisture protection
- > beefy draft collar
- > anti-snap zipper webbing
- > 3D triangular footbox with 11 individual down-filled baffles
- > differential cut and shoulder width adapted/bag size



Intended Use

This bag, with its added insulation and warmer rating is also an excellent choice for cold sleepers in spring and summer.

TREKINGLITE

TREKING

Material

Shell 20 D ripstop nylon, Oeko-Tex® 100 certified, PFC-free

Liner 30 D nylon, Oeko-Tex® 100 certified, no DWR, PFC-free

Fill Min. 700 cuin/oz, European 90/10 (EN-Standard) duck down, RDS certified, Oeko-Tex® 100 certified

Product	Left zip	Right zip	Size	Fill weight	Weight	Temp. Range	Inner girth Shoulder/Foot	Length	fits up to	Packed
Trekkinglite 0° Wmns	7640171999821	7640171999845	S	380 g	900 g	+3°/-2°/-18°C	147 cm/95 cm	195 cm	170 cm	23 x 12 x 12 cm
Trekkinglite 0° Wmns	7640171999869	7640171999883	M	400 g	950 g	+3°/-2°/-18°C	150 cm/97 cm	203 cm	180 cm	23 x 12 x 13 cm
Trekkinglite -5° Wmns	7640171999661	7640171999685	S	550 g	980 g	-2°/-8°/-27°C	147 cm/95 cm	195 cm	170 cm	23 x 14 x 14 cm
Trekkinglite -5° Wmns	7640171999708	7640171999722	M	580 g	1030 g	-2°/-8°/-27°C	150 cm/97 cm	203 cm	180 cm	23 x 14 x 15 cm
Trekkinglite -10° Wmns	7640171999982	7640445450003	S	730 g	1170 g	-5°/-11°/-32°C	147 cm/95 cm	195 cm	170 cm	26 x 17 x 16 cm
Trekkinglite -10° Wmns	7640445450102	7640445450126	M	770 g	1220 g	-5°/-11°/-32°C	150 cm/97 cm	203 cm	180 cm	26 x 17 x 17 cm
Trekkinglite 0°	7640171999746	7640171999760	M	390 g	870 g	+3°/-2°/-18°C	150 cm/97 cm	203 cm	180 cm	23 x 12 x 12 cm
Trekkinglite 0°	7640445458207		MW	420 g	960 g	+3°/-2°/-18°C	162cm/100cm	205 cm	180 cm	23 x 14 x 14 cm
Trekkinglite 0°	7640171999784	7640171999807	L	420 g	920 g	+3°/-2°/-18°C	153 cm/99 cm	218 cm	195 cm	23 x 12 x 12 cm
Trekkinglite 0°	7640445458221		LW	450 g	1290 g	+3°/-2°/-18°C	166cm/104cm	220 cm	195 cm	23 x 14 x 16 cm
Trekkinglite -5°	7640171999586	7640171999609	M	580 g	1100 g	0°/-6°/-23°C	150 cm/97 cm	203 cm	180 cm	23 x 14 x 13 cm
Trekkinglite -5°	7640445458122		MW	610 g	1100 g	0°/-6°/-23°C	162 cm/100 cm	205 cm	180 cm	23 x 14 x 13 cm
Trekkinglite -5°	7640171999623	7640171999647	L	610 g	1200 g	0°/-6°/-23°C	153 cm/99 cm	218 cm	195 cm	23 x 14 x 14 cm
Trekkinglite -5°	7640445458146		LW	630 g	1250 g	0°/-6°/-23°C	166 cm/104 cm	220 cm	195 cm	23 x 14 x 14 cm
Trekkinglite -10°	7640171999906	7640171999920	M	750 g	1250 g	-5°/-11°/-32°C	150 cm/97 cm	203 cm	180 cm	26 x 17 x 16 cm
Trekkinglite -10°	7640445458160		MW	770 g	1290 g	-5°/-11°/-32°C	162 cm/100 cm	205 cm	180 cm	26 x 17 x 16 cm
Trekkinglite -10°	7640171999944	7640171999968	L	770 g	1340 g	-5°/-11°/-32°C	153 cm/99 cm	218 cm	195 cm	26 x 17 x 17 cm
Trekkinglite -10°	7640445458184		LW	790 g	1380 g	-5°/-11°/-32°C	166 cm/104 cm	220 cm	195 cm	26 x 17 x 17 cm

VERSA QUILT

BASE CAMP

Compact quilt for 1 or 2 people

> for all outdoor adventures solo or as a couple



Material

Shell 30 D nylon, Oeko-Tex® 100 certified, PFC-free

Liner 30 D nylon, Oeko-Tex® 100 certified, no DWR, PFC-free

Fill Min. 650 cuin/oz, European 85/15 (EN-Standard) duck down, RDS certified, Oeko-Tex® 100 certified

	Size	Fill weight	Weight	Temp. Range	Inner girth Shouler/Foot	Length	up to body size	Packed
7640171992259	UNO	375 g	810 g	+10°/+5°/-7°C	135 x 210 cm	210 cm	195 cm	16 x 16 x 12 cm
7640171992273	DUO	530 g	1120 g	+10°/+5°/-7°C	180 x 210 cm	210 cm	195 cm	23 x 15 x 15 cm

MEGASLEEP

BASE CAMP

Multi-functional rectangular 4-1 sleeping bag

- > available in two temperature ratings
- > versatile 2-in-1 sleep solution: sleeping bag or blanket
- > roomy rectangular shape fits MegaMat
- > 3D anti-snap draft tube along full length of zipper
- > durable, warm, quick-drying polyester insulation
- > perfect fit for MegaMat and MegaMat Duo
- > DUO 25 includes MegaSleep 25 and MegaSleep 40 as top and bottom

SLEEPING BAGS



Material

Shell 40 D ripstop nylon, Oeko-Tex® 100 certified, PFC-free

Liner 40 D nylon, Oeko-Tex® 100 certified, no DWR

Fill 100 % polyester, Oeko-Tex® 100 certified

Prod. No	Name	Size	Temp. range	Weight	Size	fits up to	Packed
7640445452557	MegaSleep 25/40	M	+5°/-3°/-12°C	990 g	80 cm/200 cm	180 cm	6.0 l
7640445452571	MegaSleep 25/40	L	+5°/-3°/-12°C	1150 g	80 cm/210 cm	195 cm	8.0 l
7640445452533	MegaSleep DUO 25	M	+5°/-3°/-12°C	1990 g	160 cm/200 cm	180 cm	14.0 l
7640171997308	MegaSleep DUO 25	L	+5°/-3°/-12°C	2290 g	160 cm/210 cm	195 cm	14.0 l

MOSQUITONET STORAGE BAG



Sleeping bag storage sack

- > the best way to store a sleeping bag at home
- > doubles as a transparent stuff sack
- > included with select Exped sleeping bags

Prod. No	Dimension	Weight
7640120112363	70 x 58 x 30 cm	45 g

VBL LINERBAG UL

COLOR UPDATE



Sleeping bag liner for extreme cold

- > prevents body vapor from wetting sleeping bag insulation
- > eliminates evaporative cooling of the skin
- > works as emergency bivy bag

Prod. No	Length	Weight
7640120118945	185 cm	175 g

VBL SOCKS

COLOR UPDATE



Vapor barrier liner socks for cold weather

- > keeps shoe insulation dry
- > vapor proof
- > no heel and toe seam for comfort

Prod. No	Size	Shoe size (EU)	Weight
7640277842830	S	37 – 39	35 g
7640277842861	M	40 – 42	40 g
7640277842854	L	43 – 46	50 g



LINERS

EXPED is breaking new ground in the outdoor gear industry with its Sleepwell liners. The series of five completely re-imagined cabin and travel sleepliner bags are made from Fairtrade and recycled materials where possible and are completely recyclable. Five models made of different materials and in different shapes are available.

With the new, environmentally friendly Sleepwell series, EXPED once again proves its innovative strength and its will to enrich the outdoor market with genuine milestone products.

Fairtrade – a milestone in hut sleeping bags. Fairtrade is one of the “hot topics” - and will remain so. Fairtrade grants product producers stable minimum prices, a right of co-determination in shaping their trade relations, and buyers the good feeling that they have actually supported the producers with their purchase.

When it comes to Fairtrade hut sleeping bags and inlets, EXPED is a market pioneer with its Sleepwell series. The innovative inlets are offered in five different material blends: Pure silk, a fine silk-cotton blend, Egyptian cotton, organic cotton, and recycled Thermolite EcoMade®- a toasty warm, GRS-certified polyester fiber.

Thus, buyers can purchase the model optimally suited to their own needs in each case. Pure silk scores with maximum sleeping comfort and a tiny pack size, silk-cotton blend or Egyptian silk with increased durability, organic cotton with increased breathability and Thermolite EcoMade® with particularly good drying properties and the highest thermal performance.



SLEEPWELL ORGANIC COTTON

TRAVEL

- > Fairtrade certified organic cotton
- > high perspiration absorption and breathability
- > lightweight and durable fabric
- > rectangular shape: stretchy fit due to diagonal fabric alignment



Material 100% Organic Cotton Fairtrade certified

Prod. No	Name	Shape	Color	Dimensions	Weight	add Temp.
7640445453936	Sleepwell Org. Cotton navy	rectangular	navy	210 cm x 90 cm	440 g	2.9°C
7640445453950	Sleepwell Org. Cotton ruby	rectangular	ruby	210 cm x 90 cm	440 g	2.9°C
7640445454674	Sleepwell Org. Cotton natural	rectangular	natural	210 cm x 90 cm	440 g	2.9°C
7640445454698	Sleepwell Org. Cotton butterscotch	rectangular	butterscotch	210 cm x 90 cm	440 g	2.9°C
7640445454001	Sleepwell Org. Cotton navy	mummy	navy	195 cm x 79 cm	360 g	2.9°C
7640445454049	Sleepwell Org. Cotton ruby	mummy	ruby	195 cm x 79 cm	360 g	2.9°C
7640445455152	Sleepwell Org. Cotton natural	mummy	natural	195 cm x 79 cm	360 g	2.9°C
7640445455176	Sleepwell Org. Cotton butterscotch	mummy	butterscotch	195 cm x 79 cm	360 g	2.9°C

SLEEPWELL EGYPTIAN COTTON

TRAVEL

- > soft egyptian cotton
- > breathable and durable fabric
- > more packable than standard cotton
- > rectangular shape: stretchy fit due to diagonal fabric alignment



LINERS



Material 100% Egyptian Cotton

Prod. No	Name	Shape	Color	Dimensions	Weight	add Temp.
7640445453974	Sleepwell Egypt. Cotton navy	rectangular	navy	210 cm x 90 cm	280 g	3.9 °C
7640445453912	Sleepwell Egypt. Cotton ruby	rectangular	ruby	210 cm x 90 cm	280 g	3.9 °C
7640445455251	Sleepwell Egypt. Cotton natural	rectangular	natural	210 cm x 90 cm	280 g	3.9 °C
7640445455237	Sleepwell Egypt. Cotton butterscotch	rectangular	butterscotch	210 cm x 90 cm	280 g	3.9 °C
7640445454018	Sleepwell Egypt. Cotton navy	mummy	navy	195 cm x 79 cm	230 g	3.9 °C
7640445454063	Sleepwell Egypt. Cotton ruby	mummy	ruby	195 cm x 79 cm	230 g	3.9 °C
7640445455213	Sleepwell Egypt. Cotton natural	mummy	natural	195 cm x 79 cm	230 g	3.9 °C
7640445455190	Sleepwell Egypt. Cotton butterscotch	mummy	butterscotch	195 cm x 79 cm	230 g	3.9 °C

SLEEPWELL SILK

TRAVEL

- > finest silk, extremely smooth next to skin
- > extremely lightweight and compact
- > temperature regulating properties
- > rectangular shape: stretchy fit due to diagonal fabric alignment



myclimate
neutral
Product
myclimate.org/01-20-798878

Material 100% natural silk

Prod. No	Name	Shape	Color	Dimensions	Weight	add Temp.
7640445453851	Sleepwell Silk navy	rectangular	navy	210 cm x 90 cm	160 g	4.8 °C
7640445453837	Sleepwell Silk ruby	rectangular	ruby	210 cm x 90 cm	160 g	4.8 °C
7640445453899	Sleepwell Silk natural	rectangular	natural	210 cm x 90 cm	160 g	4.8 °C
7640445455138	Sleepwell Silk butterscotch	rectangular	butterscotch	210 cm x 90 cm	160 g	4.8 °C
7640445453257	Sleepwell Silk navy	mummy	navy	195 cm x 79 cm	140 g	4.8 °C
7640445453813	Sleepwell Silk ruby	mummy	ruby	195 cm x 79 cm	140 g	4.8 °C
7640445453806	Sleepwell Silk natural	mummy	natural	195 cm x 79 cm	140 g	4.8 °C
7640445454711	Sleepwell Silk butterscotch	mummy	butterscotch	195 cm x 79 cm	140 g	4.8 °C

SLEEPWELL SILK | COTTON

TRAVEL

- > more durable than pure silk
- > lightweight and compact
- > temperature regulating properties
- > rectangular shape: stretchy fit due to diagonal fabric alignment



Material Silk, Fairtrade Cotton

Prod. No	Name	Shape	Color	Dimensions	Weight	add Temp.
7640445454124	Sleepwell Silk/Cotton navy	rectangular	navy	210 cm x 90 cm	250 g	4.5 °C
7640445453875	Sleepwell Silk/Cotton ruby	rectangular	ruby	210 cm x 90 cm	250 g	4.5 °C
7640445454100	Sleepwell Silk/Cotton navy	mummy	navy	195 cm x 79 cm	190 g	4.5 °C
7640445453776	Sleepwell Silk/Cotton ruby	mummy	ruby	195 cm x 79 cm	190 g	4.5 °C

SLEEPWELL THERMOLITE

TRAVEL

- > cozy and warm
- > made of recycled polyester
- > excellent insulating properties



Material Thermolite EcoMade® 100% recycled Polyester

Prod. No	Name	Shape	Color	Dimensions	Weight	add Temp.
7640445454087	Sleepwell Thermolite navy	mummy	navy	195 cm x 79 cm	290 g	8 °C

BIVY BOOTY



The ultimate overshoe for base camp, winter hikes or doing chores around camp

- > the special heel cap, like the insole, is made of durable EVA foam and offers excellent insulation
- > high sole rand offers abrasion resistance
- > 1 cm thick EVA insole keeps feet warm and cushioned
- > integrated drawcords work well in snow and ice, or in the dark
- > attachment loop
- > 2 elastic loops included for storage
- > waterproof, welded construction



Material

Shell VentAir 2.5-layer laminate, seam-taped, 10'000 mm water column, PFC-free

Liner 15 D ripstop nylon, bluesign® certified, no DWR, PFC-free

Sole 420 D environmentally friendly recycled TPU, anti-slip, Oeko-Tex® 100 certified, PFC and PVC-free

Prod. No	Name	Size	Color	Shoe size (EUR)	Foot length	Weight
7640445455275	Bivy Booty S	S	olive grey	37 – 39	25.5 cm	215 g
7640445455299	Bivy Booty M	M	olive grey	40 – 42	27.5 cm	240 g
7640445455312	Bivy Booty L	L	olive grey	43 – 45	29.5 cm	260 g
7640445455336	Bivy Booty XL	XL	olive grey	46 – 47	31.0 cm	280 g

DOWN SOCK



Warm feet wherever you sleep

Cozy and warm down filled socks for cold nights or to warm your feet after a cold day out.



- > extremely lightweight, won't be noticed in your pack
- > tiny packed size: compress and pack with your sleeping bag
- > 7 individually filled H-baffles
- > elastic internal ankle strap and top closure for a snug fit
- > not designed for walking around
- > attachment loop
- > elastic closure for snug fit
- > separate down filled front baffle keeps toes warm



Material

Shell/Liner 30 D nylon, Oeko-Tex® 100 certified, PFC-free

Isolation Min. 700 cuin/oz European Duck Down, RDS certified, Oeko-Tex® 100 certified

Prod. No	Name	Size	Color	Shoe size (EUR)	Foot length	Weight
7640277841321	Down Sock S	S	lagoon	37 – 39	25.5 cm	115 g
7640277841345	Down Sock M	M	lagoon	40 – 42	27.5 cm	119 g
7640277841369	Down Sock L	L	lagoon	43 – 45	29.5 cm	129 g
7640445455404	Down Sock S	S	navy	37 – 39	25.5 cm	115 g
7640445455428	Down Sock M	M	navy	40 – 42	27.5 cm	119 g
7640445455442	Down Sock L	L	navy	43 – 45	29.5 cm	129 g
7640445455466	Down Sock S	S	charcoal	37 – 39	25.5 cm	115 g
7640445455480	Down Sock M	M	charcoal	40 – 42	27.5 cm	119 g
7640445455503	Down Sock L	L	charcoal	43 – 45	29.5 cm	129 g
7640445455527	Down Sock S	S	burgundy	37 – 39	25.5 cm	115 g
7640445455541	Down Sock M	M	burgundy	40 – 42	27.5 cm	119 g
7640445455565	Down Sock L	L	burgundy	43 – 45	29.5 cm	129 g

CAMP SLIPPER

COLOR UPDATE



The ultimate slipper, give your feet a break

Throw off your hiking boots and slip into the lightweight Camp Slippers. Wherever you set up camp, be it outdoors, in a hotel or hut, your feet will recover in the Camp Slipper.

- > the 4 mm thick EVA insole ensures a soft step and keeps feet nice and warm.
- > integrated elastic ankle strap for excellent fit
- > fast drying synthetic insulation



Material 50 D recycled polyester, Oeko-Tex® 100 certified, PFC-free

Sohle 420 D environmentally friendly, recycled TPU, anti-slip, PVC-free

Isolation 100% recycled polyester, Oeko-Tex® 100 certified

		Grösse				
7640277841468	Camp Slipper S	S	lagoon	37 – 39	25.5 cm	120 g
7640277841482	Camp Slipper M	M	lagoon	40 – 42	27.5 cm	136 g
7640445456012	Camp Slipper L	L	lagoon	43 – 45	29.5 cm	156 g
7640277841505	Camp Slipper XL	XL	lagoon	46 – 47	31.0 cm	170 g
7640445456036	Camp Slipper S	S	navy	37 – 39	25.5 cm	120 g
7640445456050	Camp Slipper M	M	navy	40 – 42	27.5 cm	136 g
7640445456074	Camp Slipper L	L	navy	43 – 45	29.5 cm	156 g
7640445456098	Camp Slipper XL	XL	navy	46 – 47	31.0 cm	170 g
7640445456111	Camp Slipper S	S	charcoal	37 – 39	25.5 cm	120 g
7640445456135	Camp Slipper M	M	charcoal	40 – 42	27.5 cm	136 g
7640445456159	Camp Slipper L	L	charcoal	43 – 45	29.5 cm	156 g
7640445456173	Camp Slipper XL	XL	charcoal	46 – 47	31.0 cm	170 g
7640445456197	Camp Slipper S	S	burgundy	37 – 39	25.5 cm	120 g
7640445456210	Camp Slipper M	M	burgundy	40 – 42	27.5 cm	136 g
7640445456982	Camp Slipper L	L	burgundy	43 – 45	29.5 cm	156 g

CAMP BOOTY

COLOR UPDATE



Lightweight in-camp footwear

This high, flexible and soft booty has excellent fit thanks to the elastic ankle strap and top closure. They allow you to spend a cozy evening out on the porch.

- > the 4 mm thick EVA insole ensures a soft step and keeps feet nice and warm.
- > integrated elastic ankle strap for excellent fit
- > fast drying synthetic insulation



Material 50 D recycled polyester, Oeko-Tex® 100 certified, PFC-free

Sohle 420 D environmentally friendly, recycled TPU, anti-slip, PVC-free

Isolation 100% recycled polyester, Oeko-Tex® 100 certified

Prod. No	Name	Size	Color	Shoe size (EUR)	Foot length	Weight
7640277841383	Camp Booty S	S	lagoon	37 – 39	25.5 cm	190 g
7640277841406	Camp Booty M	M	lagoon	40 – 42	27.5 cm	200 g
7640277841420	Camp Booty L	L	lagoon	43 – 45	29.5 cm	220 g
7640277841444	Camp Booty XL	XL	lagoon	46 – 47	31.0 cm	230 g
7640445455640	Camp Booty S	S	navy	37 – 39	25.5 cm	190 g
7640445455664	Camp Booty M	M	navy	40 – 42	27.5 cm	200 g
7640445455688	Camp Booty L	L	navy	43 – 45	29.5 cm	220 g
7640445455701	Camp Booty XL	XL	navy	46 – 47	31.0 cm	230 g
7640445455725	Camp Booty S	S	charcoal	37 – 39	25.5 cm	190 g
7640445455749	Camp Booty M	M	charcoal	40 – 42	27.5 cm	200 g
7640445455763	Camp Booty L	L	charcoal	43 – 45	29.5 cm	220 g
7640445455787	Camp Booty XL	XL	charcoal	46 – 47	31.0 cm	230 g
7640445455800	Camp Booty S	S	burgundy	37 – 39	25.5 cm	190 g
7640445455831	Camp Booty M	M	burgundy	40 – 42	27.5 cm	200 g
7640445455848	Camp Booty L	L	burgundy	43 – 45	29.5 cm	220 g



HAMMOCKS

Nothing beats the feeling of relaxing, swinging, dreaming, observing, and sleeping in nature. Exped hammocks make this experience possible for everyone. Blending into the surroundings, viewing wildlife, camping on boggy ground or steep slopes are all made possible with a hammock.

FAST + LITE

- > alternative to a tent
- > low weight and quick setup
- > overnight outside no matter what the ground looks like

With hammocks in this category you have the choice between complete sleep-systems in various weights or single components that allow you to put together a system of choice.

TRAVEL

- > compact when stowed
- > easy setup
- > stuff sack doubles as pocket

We offer these hammocks in two versions. The Kit version with included Suspension Kit and the regular version without. Various suspension kits and carabiners are available as accessories. The Slit Line (pat. pend) is available with the Suspension Kit or on its own, an extremely versatile accessory. The wide versions feature a wider cut offering more space for diagonal sleeping.

SCOUT HAMMOCK COMBI EXTREME

FAST + LITE



Full camp setup – hammock, tarp, bug net, suspension kit

- > Tarp of durable lightweight fabrics
- > mat sleeve in double floor
- > interior pockets and loops
- > 3 pole sleeves on the net to expand inner space
- > lightweight suspension system
- > hammock and tarp PFC-free, mesh treated with DWR C6
- > durable black colored mosquito net (mosquito-free)
- > Dyneema Ridge Line

Intended Use

fast and light backpacking, bushcraft, micro adventures

Material

Hammock 70 D ripstop nylon

Mosquito net 20 D No-See-Um mesh

Tarp 40 D ripstop nylon, silicone coated on both sides, Oeko-Tex® 100 certified, PFC-free, flame-retardant free

Prod. No	Name	Dimension	Sleep area	Dimension Tarp	Weight	Hammock	Cords	Tarp	Packed	Support
7640445457705	Scout Hammock Combi extreme	295 x 140 cm	215 x 140 cm	300 x 190 cm	1440 g	810 g	170 g	460 g	35 x 18 cm	150 kg

SCOUT HAMMOCK COMBI UL

FAST + LITE



Full camp setup in a lightweight version – hammock, tarp, bug net, suspension kit

- > Tarp of ultra lightweight fabrics
- > full bug net protection
- > mat sleeve in double floor
- > interior pockets and loops
- > 3 pole sleeves on the net to expand inner space
- > lightweight suspension system
- > hammock and tarp PFC-free, mesh treated with DWR C6
- > durable black colored mosquito net
- > Dyneema Ridge Line

Intended Use

fast and light backpacking, micro adventures

Material

Hammock 15 D ripstop nylon

Mosquito net 20 D No-See-Um mesh

Tarp 15 D ripstop nylon, silicone/PU coated, factory seam taped, Oeko-Tex® 100 certified, PFC-free, flame-retardant free

Prod. No	Name	Dimension	Sleep area	Dimension Tarp	Weight	Hammock	Cords	Tarp	Packed	Support
7640445457712	Scout Hammock Combi UL	295 x 140 cm	215 x 140 cm	300 x 190 cm	970 g	470 g	170 g	330 g	43 x 13 cm	120 kg

TREKKING HAMMOCK

FAST + LITE



Hammock with mat sleeve that can be expanded to a shelter system

- > extra long for comfortable diagonal sleeping
- > with mat sleeve
- > easily combined with: Tarp, mosquito net or suspension kit
- > with Exped Drip Clips
- > integrated stuff sack pocket

Intended Use

fast and light backpacking, Bushcraft, micro adventures

Material 70 D ripstop nylon, Oeko-Tex® 100 certified, PFC-free

Prod. No	Name	Color	Dimensions	Sleep area	Weight	Packed	Support
7640445457736	Trekking Hammock	olive grey	295 x 140 cm	215 x 140 cm	680 g	19 x 12 cm	150 kg

TRAVEL HAMMOCK LITE KIT

TRAVEL

COLOR UPDATE



The lightest full-featured fabric hammock

- > durable 4-fold stitching
- > includes Suspension Kit Extreme
- > integrated stuff sack pocket

Intended Use

trekking, Bushcraft, micro adventures

PFC FREE

Material 40 D ripstop nylon 6.6, Oeko-Tex® 100 certified, PFC-free

Prod. No	Name	Color	Dimensions	Sleep area	Weight	Packed	Support
7640277841796	Travel Hammock Lite Kit	sage	260 x 120 cm	215 x 120 cm	250 g	14 x 9 cm	150 kg
7640277841802	Travel Hammock Lite Kit	navy	260 x 120 cm	215 x 120 cm	250 g	14 x 9 cm	150 kg
7640277841819	Travel Hammock Lite Kit	burgundy	260 x 120 cm	215 x 120 cm	250 g	14 x 9 cm	150 kg
7640445452502	Travel Hammock Lite Kit	charcoal	260 x 120 cm	215 x 120 cm	250 g	14 x 9 cm	150 kg
7640445452496	Travel Hammock Lite Kit	lime	260 x 120 cm	215 x 120 cm	250 g	14 x 9 cm	150 kg

TRAVEL HAMMOCK KIT

TRAVEL

COLOR UPDATE



The complete travel hammock

- > includes Suspension Kit Extreme
- > comfortable dimensions
- > durable 4-fold stitching
- > lightweight and compact
- > integrated stuff sack pocket

Intended Use

travel, camping, leisure

PFC FREE

Material 70 D ripstop nylon, Oeko-Tex® 100 certified, PFC-free

Prod. No	Name	Color	Dimensions	Sleep area	Weight	Packed	Support
7640277841734	Travel Hammock Kit	gold	242 x 132 cm	216 x 132 cm	380 g	18 x 9 cm	150 kg
7640277841741	Travel Hammock Kit	forest	242 x 132 cm	216 x 132 cm	380 g	18 x 9 cm	150 kg
7640277841758	Travel Hammock Kit	burgundy	242 x 132 cm	216 x 132 cm	380 g	18 x 9 cm	150 kg
7640445451727	Travel Hammock Kit	meadow	242 x 132 cm	216 x 132 cm	380 g	18 x 9 cm	150 kg
7640445451734	Travel Hammock Kit	fire	242 x 132 cm	216 x 132 cm	380 g	18 x 9 cm	150 kg
7640445451710	Travel Hammock Kit	bluebird	242 x 132 cm	216 x 132 cm	380 g	18 x 9 cm	150 kg

TRAVEL HAMMOCK WIDE KIT

TRAVEL

COLOR UPDATE



Super-comfortable travel hammock

- > includes Suspension Kit Extreme
- > comfortable dimensions
- > durable 4 fold stitching
- > lightweight and compact
- > integrated stuff sack pocket

Intended Use

travel, camping, leisure

PFC FREE

Material 70 D ripstop nylon, Oeko-Tex® 100 certified, PFC-free

Prod. No	Name	Color	Dimension	Sleep area	Weight	Packed	Support
7640277841765	Travel Hammock Wide Kit	gold	295 x 210 cm	270 x 210 cm	615 g	18 x 13 cm	200 kg
7640277841772	Travel Hammock Wide Kit	forest	295 x 210 cm	270 x 210 cm	615 g	18 x 13 cm	200 kg
7640277841789	Travel Hammock Wide Kit	burgundy	295 x 210 cm	270 x 210 cm	615 g	18 x 13 cm	200 kg
7640445451772	Travel Hammock Wide Kit	meadow	295 x 210 cm	270 x 210 cm	615 g	18 x 13 cm	200 kg
7640445454759	Travel Hammock Wide Kit	bluebird	295 x 210 cm	270 x 210 cm	615 g	18 x 13 cm	200 kg
7640445454766	Travel Hammock Wide Kit	fire	295 x 210 cm	270 x 210 cm	615 g	18 x 13 cm	200 kg

TRAVEL HAMMOCK MESH KIT

FAST + LITE



One of the lightest travel hammock

- > durable mesh fabric lets the breeze through
- > includes Suspension Kit Extreme
- > comfortable dimensions
- > durable 4 fold stitching
- > lightweight and compact, integrated stuff sack pocket

Intended Use

travel, leisure

PFC
FREE

Material 20 D ripstop nylon 6.6 mesh, PFC-free

Prod. No	Name	Color	Dimension	Sleep area	Weight	Packed	Support
7640445457743	Travel Hammock Mesh Kit	black	242 x 132 cm	216 x 132 cm	210 g	18 x 9 cm	150 kg

TRAVEL HAMMOCK MESH WIDE KIT

FAST + LITE



One of the lightest travel hammocks

- > durable mesh fabric lets the breeze through
- > includes Suspension Kit Extreme
- > comfortable dimensions
- > durable 4 fold stitching
- > lightweight and compact, integrated stuff sack pocket

Intended Use

travel, leisure

PFC
FREE

Material 20 D ripstop nylon 6.6 mesh, PFC-free

Prod. No	Name	Color	Dimension	Sleep area	Weight	Packed	Support
7640445457750	Travel Hammock Mesh Wide Kit	black	295 x 210 cm	270 x 210 cm	330 g	18 x 13 cm	200 kg

HAMMOCK MOSQUITO NET

FAST + LITE



Mosquito net for hammocks

- > wards off mosquitoes and other bugs
- > fits all hammocks without netting
- > easy mosquito free access from below
- > generous dimensions with safety distance on all sides
- > numerous anchor points
- > made of fine and durable mesh

Intended Use

fast and light backpacking, bushcraft, micro adventures, travel

Material 15 D No-See-Um nylon mesh, Oeko-Tex® 100 certified, DWR C6

Prod. No	Name	Dimension	Weight	Packed
7640445455022	Hammock Mosquito Net	320 x 185 cm	245 g	30 x 15 cm

HAMMOCK SUSPENSION KIT

HAMMOCK
ACCESSORIES



Ingenious multi-purpose hammock suspension kit

- > tree-guard webbing
- > durable woven slit-cord, stretch-free (pat. pend.)
- > quick-and-easy hammock setup and tear down
- > versatile

Extreme version:

- > strong, light and compact (pat. pend.) – the lightest suspension kit in the world!
- > Slit-cord made of Dyneema
- > super-light HMPE/Polypropylene webbing strap

Material

Hammock Suspension Kit 5 x 3 mm Polyester line, 25 mm polyester webbing

Hammock Suspension Kit Extreme 2.75 mm Dyneema slit line, HMPE/Polypropylene webbing

Prod. No	Name	Length	Weight	Packed	Weight Support
7640147769113	Hammock Suspension Kit	2 x 3.5 m	195 g	20 x 6 cm	200 kg
7640171990132	Hammock Suspension Kit extreme	2 x 3.5 m	60 g	20 x 3 cm	450 kg

SLIT LINE

HAMMOCK
ACCESSORIES



Multi-purpose hammock suspension cord

- > durable woven slit-cord, stretch-free (pat. pend.) for easy handling
- > multiple uses for hammock suspension, washline, boatline, tie-out line

Extreme version: Dyneema

- > much lighter, much more compact and much stronger

Material

Slit Line 5 x 3 mm polyester line

Slit Line extreme 2.75 mm Dyneema (HMPE)

Prod. No	Name	Length	Weight	Packed	Weight Support
7640171995403	Slit Line	15 m	180 g	20 x 6 cm	200 kg
7640147766501	Slit Line extreme	15 m	75 g	20 x 3 cm	450 kg

DRIP CLIPS

HAMMOCK
ACCESSORIES



Carabiners with drip shields for a dry hang

- > 2 lightweight aluminum carabiners for fast set-up and tear-down of hammock
- > drip shields stop rain from dripping into the hammock
- > ideal in combination with the Hammock Suspension Kit or Slit Line
- > recommended for Travel Hammocks and Scout Hammock
- > Note: carabiners not suitable for climbing

Prod. No	Name	Material	Weight	Packed	Weight Support
7640147761773	Drip Clips (Set of 2)	7075 Aluminium, Hypalon	50 g	8 x 5 cm	1200 kg
7640147766662	Exped Carabine (Set of 2)	7075 Aluminium	2 x 21.5 g	8 x 5 cm	1200 kg



PONCHOS

They protect reliably against rain and wind, are extremely versatile, compact when packed and lightweight.

FAST + LITE

- > rain gear always at hand
- > lightweight and compact

Ultralight ponchos made of super light fabrics with the necessary durability.

TREKKING

- > versatile
- > practical details

Practical ponchos made of durable materials for demanding treks.

BIVY PONCHO UL

FAST + LITE



Swiss Army knife functionality – ultralight fabric

- > length adjustable
- > sides can be closed with snap buttons
- > multiple uses as bivybag, poncho, tarp
- > 8 corner and edge guy loops
- > anatomically shaped hood with cinch cord and visor
- > waist cord included
- > packs into chest pocket
- > fully taped seams

PFC
FREE

Material 15 D ripstop nylon, silicone/PU coated, factory seam taped, Oeko Tex® 100 certified, PFC-free

Prod. No	Name	Color	Dimensions	fits body size	Weight	Packed
7640277840416	Bivy Poncho UL	moss	240 x 150 cm	140 – 190 cm	310 g	30 x 25 x 2 cm

PACK PONCHO UL

FAST + LITE



Super lightweight pack poncho in multiple sizes

- > integrated zippered compartment for packs up to 100l
- > compact and lightweight
- > large, waterproof interior chest pocket
- > anatomically shaped hood with cinch cord and brim
- > 2 packing options: flat in chest pocket or compact in stuffsack

PFC
FREE

Material 15 D ripstop nylon, silicone/PU coated, factory seam taped, Oeko-TEX® 100 certified, PFC-free

Prod. No	Name	Color	Dimensions	fits body size	Weight	Packed
7640277840423	Pack Poncho UL	moss	S	150 – 165 cm	200 g	20 x 10 cm
7640277840041	Pack Poncho UL	moss	M	165 – 180 cm	215 g	20 x 10 cm
7640277840430	Pack Poncho UL	moss	L	180 – 210 cm	235 g	20 x 10 cm

DAYPACK & BIKE PONCHO UL

FAST + LITE



The cycling and hiking poncho

- > reflective stripes on sides and back
- > adjustable elastic loops for handlebars
- > hem with adjustable slit shock cord
- > anatomically shaped hood with visor
- > large inner pocket doubles as stuff sack
- > inner elastic waist strap

PFC
FREE

Material 15 D ripstop nylon, PU coated, outer siliconized, factory seam taped, Oeko-TEX® 100 certified, PFC-free

Prod. No	Name	Color	Dimensions	fits body size	Weight	Packed
7640277840447	Daypack & Bike Poncho UL	dark lava		160 – 200 cm	230 g	20 x 7 cm

BIVY PONCHO

TREKKING



Swiss Army knife functionality

- > length adjustable
- > sides can be closed with snap buttons
- > multiple uses as bivybag, poncho, tarp
- > 8 corner and edge guy loops
- > anatomically shaped hood with cinch cord and visor
- > waist cord included
- > packs into chest pocket
- > fully taped seams

SURVIVAL
TESTSIEGER

PFC
FREE

Material 40 D ripstop nylon, PU coated, fully seam taped, Oeko-Tex® 100 certified, PFC-free

Prod. No	Name	Color	Dimensions	fits body size	Weight	Packed
7640277840454	Bivy-Poncho	moss	240 x 150 cm	140 – 190 cm	450 g	30 x 25 x 3 cm

TARP PONCHO

TREKKING



The poncho for minimalists

- > made of durable fabric
- > length adjustable
- > sides can be closed with snap buttons
- > multiple uses as bivybag, poncho, tarp
- > 8 corner and edge guy loops
- > anatomically shaped hood with cinch cord and visor
- > waist cord included
- > packs into chest pocket
- > fully taped seams

PFC
FREE

Material 40 D ripstop nylon, PU coated, fully seam taped, Oeko-Tex® 100 certified, PFC-free

Prod. No	Name	Color	Dimensions	fits body size	Weight	Packed
7640277840461	Tarp Poncho	moss	260 x 145 cm	155 – 195 cm	370 g	18 x 10 cm



BIVYBAGS

What a hardshell rain jacket is for daytime, the bivy bag is at night: the protective layer for sleeping out in wet and cold conditions. A tent can stay at home, which significantly minimizes the weight of the equipment you need to take with you. In short, the ideal shelter for the lightweight trekker, expeditionist or alpinist.

A distinction is made between Bivy Bags with and without vapor permeable fabric. The Bivybag 100% VentAir and Bivybag VentAir/PU are both made of an extremely vapor permeable and waterproof 3-layer laminate called VentAir. The membrane of this laminate is composed of PU fibers (polyurethane) in the nano range.

The big advantage over PTFE membranes (polytetrafluoroethylene) is the environmentally friendly production, processing and disposal of the PU material.

Which one should be chosen for which specific use? For backpacking trips and general use we recommend the Bivybag VentAir/PU, its floor fabric is made of waterproof

PU nylon. It is ideal for those who wish to place a sleeping mat inside the bivy bag, which negates the need for breathable fabric on the bottom.

For expeditions to particularly cold and wet areas, Bivy Bag 100% VentAir is the better choice. By placing the sleeping mat on the outside of the bag, active sleepers who turn frequently in the night can rest assured that breathable VentAir fabric is always facing upward, reducing internal condensation to a minimum.

BIVYBAG 100% VENTAIR



Bivy bag made entirely of highly vapor-permeable fabric

- > 3-layer VentAir E5 laminate fabric top and bottom: extremely breathable, waterproof and lightweight
- > roomy design
- > wide zippered entry with mosquito mesh panel
- > flexible aluminum wire stiffener allows hood adjustment
- > roomy 3-D footbox
- > The sleeping mat can be placed both in or under the bivy bag

Material VentAir E5 3-layer-laminate, fully seam taped, 10 000 mm water column, MVTR: > 40 000 g/m²/24h

Prod. No	Name	Color	Dimension L x W shoulder x W feet	Weight	Weight Packsack	Packed	Temperature upgrade
7640147769328	Bivybag 100% VentAir	olive grey	240 x 95 x 80 cm	540 g	19 g	20 x 11 cm	7 °C

BIVYBAG VENTAIR / PU



Bivy bag built with highly vapor-permeable upper and coated nylon floor

- > 3-layer VentAir E5 laminate fabric on top side: extremely breathable, waterproof and lightweight
- > roomy design
- > wide zippered entry with mosquito mesh panel
- > flexible aluminum wire stiffener allows hood adjustment
- > roomy 3-D footbox
- > We recommend placing the sleeping mat inside the bivy bag, so that breathable layer is always on top.

Material VentAir E5 3-layer-laminate, fully seam taped, 10 000 mm water column, MVTR: > 40 000 g/m²/24h

Floor fabric 70 D Taffeta Nylon, PU coated, recycled, 7'000 mm water column, bluesign® certified

Prod. No	Name	Color	Dimension L x W shoulder x W feet	Weight	Weight Packsack	Packed	Temperature upgrade
7640445457675	Bivybag VentAir/PU	olive grey	240 x 95 x 80 cm	600 g	19 g	20 x 11 cm	7 °C

BIVYBAG LITE VENTAIR / PU



Bivy bag with a vapor-permeable upper side

- > Top side of VentAir T fabric, bottom of recycled fabric
- > vapor-permeable, waterproof and lightweight
- > wide and easy entry
- > We recommend placing the sleeping mat inside the bivy bag, so that breathable layer is always on top.
- > compact storage

PFC
FREE

Material VentAir T TPU 2-layer-laminate, fully seam taped, 3 200 mm water column, MVTR: > 8 000 g/m²/24h

Floor fabric 70 D Taffeta Nylon, PU coated, recycled, 7 000 mm water column, bluesign® certified

Prod. No	Name	Color	Dimension L x W shoulder x W feet	Weight	Packed	Temperature upgrade
7640445457668	Bivybag Lite Ventair/PU	olive grey/moraine	230 x 90 x 80 cm	440 g	29 x 10 cm	5 °C

BIVYBAG UNO UL



The ultralight emergency bivybag

- > anatomically shaped hood
- > hood with stiffener in brim
- > central water-resistant two way zipper
- > compact storage
- > fully seam taped
- > can be used as VBL bag

PFC
FREE

Material 15 D ripstop nylon, PU coated, siliconized, factory seam taped, PFC-free, Oeko-Tex®100

Prod. No	Name	Color	Dimension L x W shoulder x W feet	Weight	Weight Packsack	Packed	Temperature upgrade
7640445457682	Bivybag Uno UL	dark lava	205 x 89 x 65 cm	160 g	6 g	17 x 8 cm	5 °C

BIVYBAG DUO UL



Lightweight emergency bivy bag + comfort station

- > 2-person waterproof bivy bag
- > 3 vents reduce condensation
- > use as wind shield during breaks
- > poncho for 1 person
- > fully seam taped
- > reflective cords
- > integrated packsack

PFC
FREE

Material 15 D ripstop nylon, PU coated, siliconized, factory seam taped, PFC-free, Oeko-Tex®100

Prod. No	Name	Color	Dimension L x W shoulder x W feet	Weight	Packed	Temperature upgrade
7640445457699	Bivybag Duo UL	dark lava	200 x 140 x 140 cm	250 g	15 x 9 cm	5 °C

CARDBOARD DISPLAY



- > cardboard display with hook for backpack attachment
- > available in German, English and French

Name	Grösse
Cardboard Display Icefall	36 x 28 x 180 cm
Cardboard Display Coulair	36 x 28 x 180 cm

CARDBOARD DISPLAY



- > cardboard display, oval shaped
- > available in German, English and French

Name	Grösse
Cardboard Display Ultra -5°	70 x 200 cm

BACKPACK AIRBAG



- > these air-filled Airbags let any backpack look good
- > made of durable Exped Mat fabric (150D/75D Polyester)
- > available in 3 sizes

Prod. No	Name	Size
7640147762855	Backpack Airbag S	50 x 35 cm
7640147762862	Backpack Airbag M	50 x 60 cm
7640147762879	Backpack Airbag L	60 x 100 cm

MAXIMUM VOLUME HANGER



- > sleeping bag hanger for front face display
- > ideal for shop front display
- > integrated EXPED logo

Prod. No	Name
7640171996837	Maximum Volume Hanger

MINI MAT POP



- > mini-mat for easy product demonstration
- > clear windows show mat filling
- > with integrated pump where available

Prod. No	Name
7640445457781	Ultra MiniMat
7640445457774	Dura MiniMat
7640445457798	Versa MiniMat
7640277840102	Versa R5 MiniMat

TENT FLYER | POSTER



- > the complete tent range at a glance
- > image, sizing and technical specifications

Prod. No	Name
7640120117269	Exped Tentposter, 50 x 160 cm
7640147764248	Exped Tentflyer, 39 x 63 cm, folded to A6

LOGO BANNER



- > made of flag fabric, for short term outdoor use
- > with wooden bars in hemstitch top and bottom, 2 eyelets
- > size: 50 x 150 cm

Prod. No	Name
7640120114374	Exped Logo Banner

TENT WEIGHT BAG



- > easy tent display on smooth or slippery floors
- > Nylon shell and plastic liner can be filled with sand for weight
- > size: 21 cm diameter, 10 cm height

Prod. No	Name
7640147761230	Tent Weight Bag

EXPED STICKER



- > Exped logo sticker, contour cut 21 x 4.4 cm

Name	Farbe
Exped Sticker 21 cm	matt black
Exped Sticker 21 cm	shiny yellow
Exped Sticker 21 cm	shiny blue
Exped Sticker 21 cm	shiny red

EXPED CAP



- > Exped Cap with embroidered logo

Prod. No	Name	Farbe	Grösse
7640445455046	Exped Cap	navy-butterscotch	one size
7640445455053	Exped Cap	burgundy-charcoal	one size
7640445455060	Exped Cap	charcoal-terracotta	one size

WEB | SOCIAL MEDIA

EXPED WEBSITE



The EXPED website in the languages German, English and French contains all relevant technical information, photos and videos of our entire product range. The new, crisp and clear design allows the user to easily navigate the page and click directly through our product categories directly from the landing page. All product images of the current range are available in high resolution files on our photo database at photo.exped.com for your advertising purposes.



EXPED AND OUTTRA



EXPED distributes its products exclusively through specialized outdoor retailers. We cooperate with OUTTRA and their shop locator so interested consumers can find your store. For this purpose we have integrated a „Buy local“ button. With just one click, consumers can check the availability of a product in a specialty store in their vicinity. You as an Exped retailer have the opportunity to present your available stock and product competence online.



EXPED VIDEOS



Off the cuff, straightforward, helpful, and at times even funny: with our video content we want to share additional information about our products as well as give you useful tips and tricks. Many of them can be found directly on the product page of our website. All videos are also available on our YouTube channel. You are welcome to link them on your own channels (www.youtube.com/user/ExpedLLC).

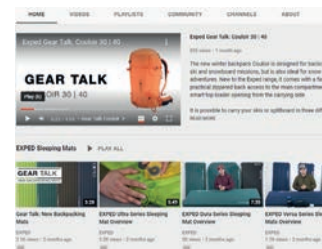

SOCIAL MEDIA



EXPED is also present in the social media universe. On Facebook and Instagram, we keep you informed about new products, provide useful tips and tricks or show inspiring images and videos on how our products travel the world. On Twitter you can stay up to date on our most current developments and on LinkedIn we provide insights into our company, introduce team members or report on our sustainability commitment. TikTok is the platform for entertaining videos and a different kind of insight. On social media, we live by the motto: Together, we can reach further. Tag us in your posts, we enjoy sharing them. You can also contact us at any time for cross-media campaigns,



LEGEND



Womens model

For sleeping bags: 10 – 15% additional down filling in the foot and torso sections.
For backpacks: Shorter back length and shoulder straps.



Animal welfare

RDS is the strictest standard for animal welfare in the production of down. EXPED uses 100% certified down in all down products.



PFC free

PFC is the abbreviation for Per- or poly fluorinated chemicals, also known as fluorocarbons. Non degradable and accumulating toxic chemicals used for waterproofing.



Recycled materials

An increasing number of EXPED products are made from recycled materials. Materials gained from previously made materials -such as PET-bottles or waste from the production of textiles.



Ski, snowboard and snowshoe touring.

This backpack features specific attachments for skis, snowboard or snowshoes.



Sleepwell-Warranty

Exchange your Exped sleeping bag for the next warmer one and pay only the difference. For more details see exped.com



Spray water protection

Through the materials used and the construction stored contents are protected against spray water. However, the ingress of dust is possible.



Submersible

This product is IP67 certified making it dustproof and is submersible down to a depth of 1m for a maximum of 30 minutes.



Waterproof

The special materials, the welded or taped seams as well as the roll-top closure make this product completely waterproof..



Weatherproof

This product is water repellent due to the materials used and the taped seams, but because of the zipper not completely waterproof.



Refillable

All Exped down sleeping bags can be refilled with down.



Windproof

The materials used are completely windproof.

Headquarter

Exped AG
 Hardstr. 81
 CH-8004 Zürich
 Tel +41 44 497 10 10
 info@exped.com
 www.exped.com

USA

Exped USA
 Tel. +1 866 326 4586
 service@expedusa.com
 www.expedusa.com

Switzerland | Germany |

Exped AG
 Hardstr. 81
 CH-8004 Zürich
 Tel +41 44 497 10 10
 info@exped.com
 www.exped.com

Austria

Thomas Miedl
 Uhl Günter - Exklusiv
 Sportartikelvertrieb GmbH
 Tel +43 664 357 73 99
 thomas.miedl@exped.com

United Kingdom | Ireland

Lyon Equipment Ltd.
 Tel. +44 15396 24040
 info@lyon.co.uk
 www.lyon.co.uk

Netherlands | Belgium

Jongejans Trading
 Tel. +31 182 60 59 59
 info@jongejanstrading.nl
 www.jongejanstrading.nl

Denmark

ODEX APS
 Tel. +45 7020 7579
 info@odex.dk
 www.odex.dk

France

Mountains & waves
 David Picamoles
 Tel. +33 067 647 30 15
 contact@mountains-waves.fr

Sweden | Iceland

New Element Scandinavia AB
 Tel. +46 8 552 45 900
 info@newelement.se
 www.newelement.se

Norway

UTE Depot AS
 Tel. +47 72411255
 post@utedepot.no
 www.utedepot.no

Finland

New Element Scandinavia AB
 Tel. +46 8 552 45 900
 info@newelement.se
 www.newelement.se

Poland

Crag Sport S.C
 Tel. +48 503 062 709
 info@cragssport.pl
 www.cragssport.pl

Russia

Mountech LLC
 Tel. +74 95 6579738
 sales@mountech.ru
 www.exped-outdoor.ru

Ukraine

Gorgany com Ltd.
 Tel. + 38 032 261 08 82
 wholesale@gorgany.com
 www.gorgany.eu

Canada

In-Sport Fashions Inc.
 Tel. +1 800 465 9637
 info@insport.ca
 www.insport.ca

Australia

Expedition Equipment
 Tel : +61 2 9417 5755
 sales@expeditionequipment.com.au
 www.expeditionequipment.com.au

New Zealand

Bivouac Outdoor
 Tel. +64 800 2486822
 shop@bivouac.co.nz
 www.bivouac.co.nz

Hong Kong

Re:echo Asia Pacific Ltd.
 Tel. +852 26486228
 joechan@acu.com.hk
 www.reecho.hk

Japan

Sohshin Co., LTD
 Tel. +81 3 3258 6211
 info_pro@axesquin.co.jp
 www.exped-jp.com

Korea

Synkey Group Inc.
 Tel. +82 2 784 6821
 ylah@synkey.com
 www.exped.co.kr

Nepal

Samatra Trading Ltd.
 Tel. +977 1 4355463
 office@samatra.com
 www.samatra.com

Singapore

Camper's Corner Outfitters
 Tel. +65 63374743
 enquiries@camperscorner.com.sg
 www.camperscorner.com.sg

Taiwan

Outdoor Adventure Int. Inc.
 Tel. +886 2 8076 5098
 kcliu@outdooradventure.com.tw
 www.oai.com.tw

