

A3 Programmable and configurable room controllers

From room controllers with integrated, configurable applications to the Saia PG5 freely programmable room controller allowing flexible and individual room solutions, a range of room controller products with various communication protocols is available. Even without a bus connection, full, independent functionality is guaranteed.



3.1 PG5 freely programmable S-Bus/Modbus room controllers for flexible and individual room solutions

▶ 3.1.1 Overview and advantages of the PCD7.LRxx-P5 system	Page 102
▶ 3.1.2 Programming	104
▶ 3.1.3 Product overview	105
▶ 3.1.4 Connection examples	106
▶ 3.1.5 Accessories for PCD7.LRxx-P5	107
▶ 3.1.6 Project planning information	108

3.2 PCD7.LRxx BACnet room controllers can be configured and commissioned via an Android app

▶ 3.2.1 Overview and advantages of the PCD7.LRxx system	Page 109
▶ 3.2.2 Set-up information with RoomUp and integration with the PG5	110
▶ 3.2.3 Application overview	113
▶ 3.2.4 Product overview and wiring examples	114
▶ 3.2.5 PCD7.LRxx accessories	116

3.1 PG5 freely programmable S-Bus/ Modbus room controllers for flexible and individual room solutions



3.1.1 Overview and advantages of the PCD7.LRxx-P5 system

Flexibility thanks to free programming capability

The freely programmable PCD7.LRxx-P5 room controller offers a high level of flexibility for scalable HVAC, lighting and shading solutions, allowing individual applications to be created. The programming is done via the Saia PG5 Controls Suite where the room controller can be teamed with other Saia PCD products and operated together. This means that a single software tool can be used to meet different requirements, from room management to building management, for efficient engineering.



Geared to individual customer requirements

With the help of the new room controller, HVAC, lighting and shading solutions become freely programmable. As a result, individual, cross-discipline plans, aimed at for example optimising energy consumption, can be drawn up for state-of-the-art hotel, hospital and office concepts. In order to create a tailored solution geared to the needs of customers and buildings, additional sensors and modules can be integrated – from programmable DALI modules and motion sensors to hotel-card reading devices. This high level of flexibility also allows special room and user experiences like those that play a role in the room concepts of hotels.



Efficient engineering

Via a USB connection, the room controller can be programmed in the Saia PG5 Controls Suite. Because SBC automation stations are compatible with this software, building management and room control can be done on a joint platform. This simplifies the programming process and increases its efficiency. Additional software solutions or hardware is not required.



Advantages

- ▶ 2 × RS-485 interfaces for S-Bus or Modbus communication and option of I/O expansion with E-Line RIO modules
- ▶ Room and building management requirements can be jointly controlled and fulfilled via one software tool (PG5)
- ▶ Programmable DALI and expansion modules which can be used for lighting and shading can easily be integrated
- ▶ Battery and maintenance-free wireless EnOcean sensor integration
- ▶ Reliable products with straightforward installation and maintenance processes thanks to removable terminals
- ▶ Thanks to their form factor, they can be installed in an electrical sub-distribution system.

Easily retrofittable

Interfaces

Two interfaces that can be configured as S-Bus or Modbus allow connection to higher-level building automation control systems as well as the integration of digital room operating devices and expansion modules. As a result, the room controller can be combined with existing SBC E-Line RIO modules which can be used as an I/O expansion for HVAC, lighting or shading control. In addition, a Sylk bus interface allows the integration of corresponding room operating devices with integrated sensors.

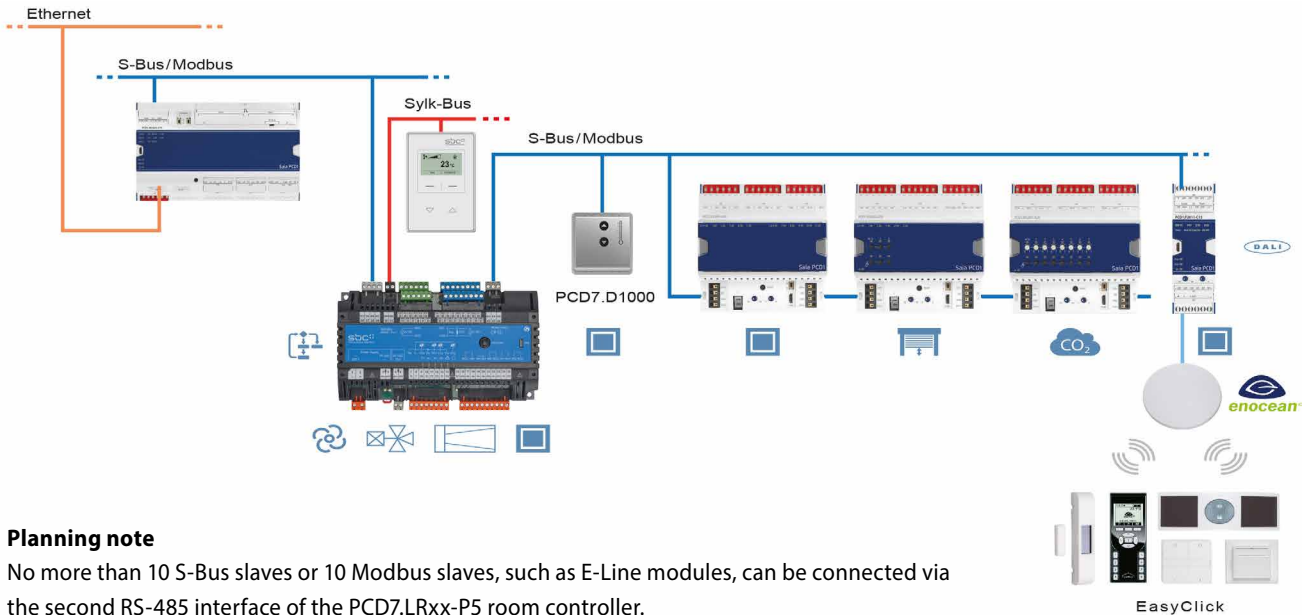

Planning note

No more than 10 S-Bus slaves or 10 Modbus slaves, such as E-Line modules, can be connected via the second RS-485 interface of the PCD7.LRxx-P5 room controller.

The following points must be observed in order to determine the feasible number of S-Bus/Modbus slaves:

- ▶ Bus cycle time → Use only for HVAC or, alternatively, lighting or shading
- ▶ Application program resource requirement
- ▶ The more E-Line modules there are connected to the second RS-485 interface of the PCD7.LRxx-P5, the less memory space there is for the application program. Further information and calculation aids can be found in the manual.

EnOcean

The RS-485 interface can also be used as an EnOcean gateway in order to connect a PEHA EnOcean antenna (PEHA ANT 450). As a result, battery and maintenance-free (PEHA Easyclick) EnOcean sensors (such as hotel-card switches, window contacts, movement sensors and operating devices) can be used.

In this system architecture, EnOcean switches should not be used for lighting or blinds via E-Line RIO modules connected to the primary RS-485 interface. If too many loads are connected to the RS-485 interface, the reaction time for a switching command could exceed 250 ms and would therefore be perceived as a disturbance.

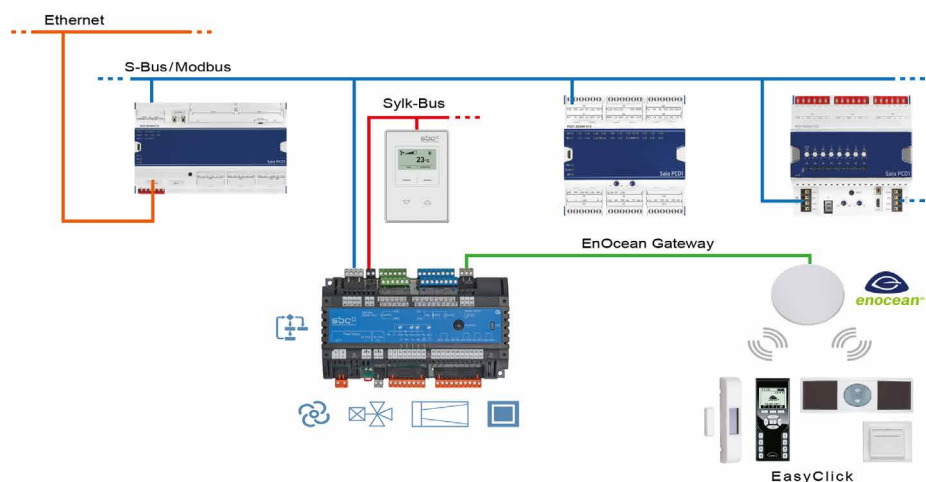

3.1.2 Programming

The modules are programmed with Saia PG5® using a master controller or directly via Micro-USB.

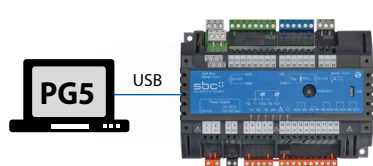

Programming directly via USB

PCD7.LRxx-P5 controllers have a Micro-USB port on the front of the module. Using a direct USB connection from the PC to the module, the user program can be loaded to the connected module or the firmware for the module can be updated. It is advisable to configure the S-Bus address prior to installation in the room controller to allow commissioning of the room controller and the downloading of the application program (and possibly a firmware update) via the RS-485 bus after installation.

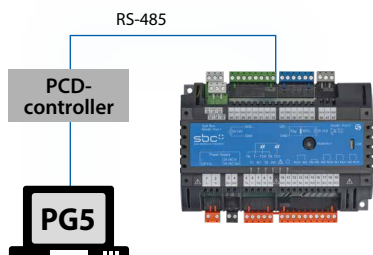

Programming using a master controller (PCDx.Mxxxx)

The master controller, which is connected to the freely programmable PCD7.LRxx-P5 room controller, uses the RS-485 bus (S-Bus) to load the user program or a firmware update for example to the corresponding modules. The master controller is used as a gateway in this case.

The modules are project-engineered with Saia PG5® using FBoxes or IL. A selection of FBoxes which make engineering easier is available for this purpose.

List of supported libraries:

PG5 standard FBox libraries

- ▶ Binary
- ▶ Blinker
- ▶ Block Control (no SB)
- ▶ Buffers
- ▶ Com.Text (not interpreted)
- ▶ Converter
- ▶ Counter
- ▶ DALI E-Line Driver (new)
- ▶ Data Block
- ▶ Data Buffer
- ▶ EIB Driver (partly)
- ▶ EnOcean (partly)
- ▶ Flip-Flop
- ▶ Floating Point (IEEE only)
- ▶ HVC (partly)
- ▶ Indirect
- ▶ Integer
- ▶ Ladder
- ▶ Move In/Out
- ▶ Modbus (E-Suite)
- ▶ Regulation (partly)
- ▶ Special, Sys Info (partly)
- ▶ Timer
- ▶ PHC

In addition to these libraries, a new library "E-Suite V2" is available for specific applications that can be implemented using the Saia PCD1 E-Line modules.

For electrical building services, for example: blind control, dimming of lighting etc.

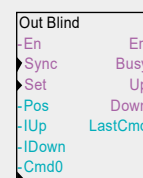
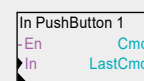
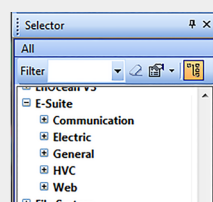

In order to be able to use the PCD7.LRxx-P5 controller with E-Line devices, the E-Line library V1.3 (or higher) must be installed in PG5. The required PCD, IRM and E-Line firmware versions are described in the FBox «Library Help».

Further information can be found in the V1.3 library help.

Program

Flash memory

Program blocks

COB	COB 0
XOB	XOB 10, 12, 13 and 16
PB/FB	100 with maximum hierarchy on 8 levels

Data types

ROM text/DB	50
-------------	----

Memory

Program memory	128 kB
----------------	--------

Media

Volatile memory (RAM) without battery backup

Data types

Registers	4000
Flag	4000
Timer / counter	400

Memory

Memory (RAM) for 50 texts / DB	10 kB
Memory (EEPROM) for parameter (media) backup	256 bytes
Cyclical synchronisation with PCD controller	Real time clock (RTC)

Compared to a PCDx.Mxxxx controller, not all functions are available. For example, these modules do not have an automation server.



Further information, including which FBoxes are supported can be found on our support page www.sbc-support.com.

3.1.3 Product overview

	Order number	Power supply	Analogue outputs	Universal inputs	Relays	Triacs (24/230 VAC)	Total I/Os	LED output	24 VAC outputs for field devices	Sylok	USB	2nd RS-485	Gold Cap 72 hours	Terminals
Large room controller 198 × 110 × 59 mm	PCD7.LRL2-P5	230 VAC	2	6	4	4	16	1	300 mA	Yes	Yes	Yes	Yes	All terminals removable
	PCD7.LRL4-P5	230 VAC	6	10	4	4	24	0	300 mA	Yes	Yes	Yes	Yes	
	PCD7.LRL5-P5	24 VAC	6	10	4	4	24	0	600 mA	Yes	Yes	Yes	Yes	
	IRM-RLC	Package including 10 large terminal covers												
Small room controller 162 × 110 × 59 mm	PCD7.LRS4-P5	230 VAC	4	4	4	2	14	0	300 mA	Yes	Yes	Yes	Yes	
	PCD7.LRS5-P5	24 VAC	4	4	4	2	14	0	600 mA	Yes	Yes	Yes	Yes	
	IRM-RSC	Package including 10 small terminal covers												

Controller example PCD7.LRL4-P5

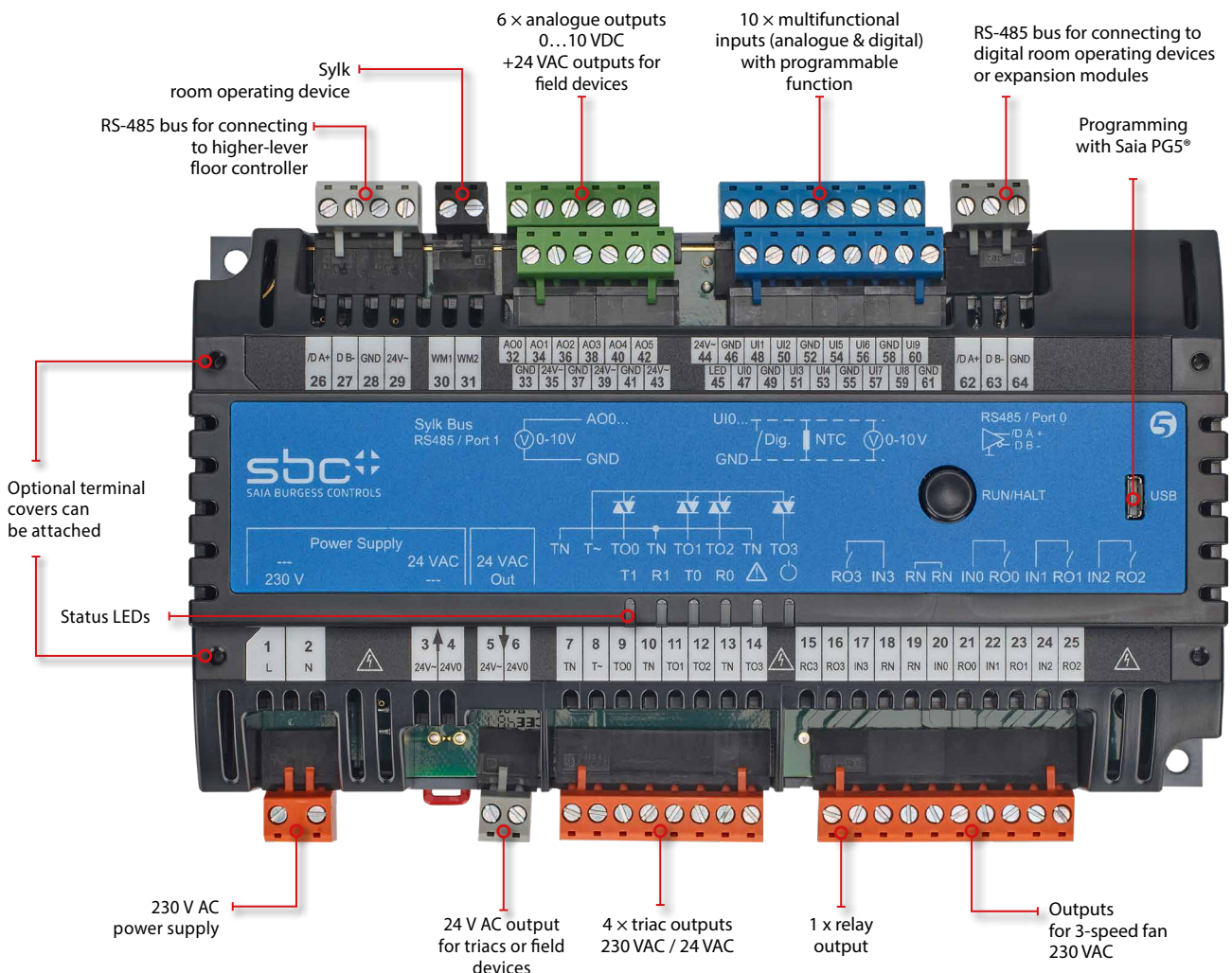

3.1.4 Connection examples

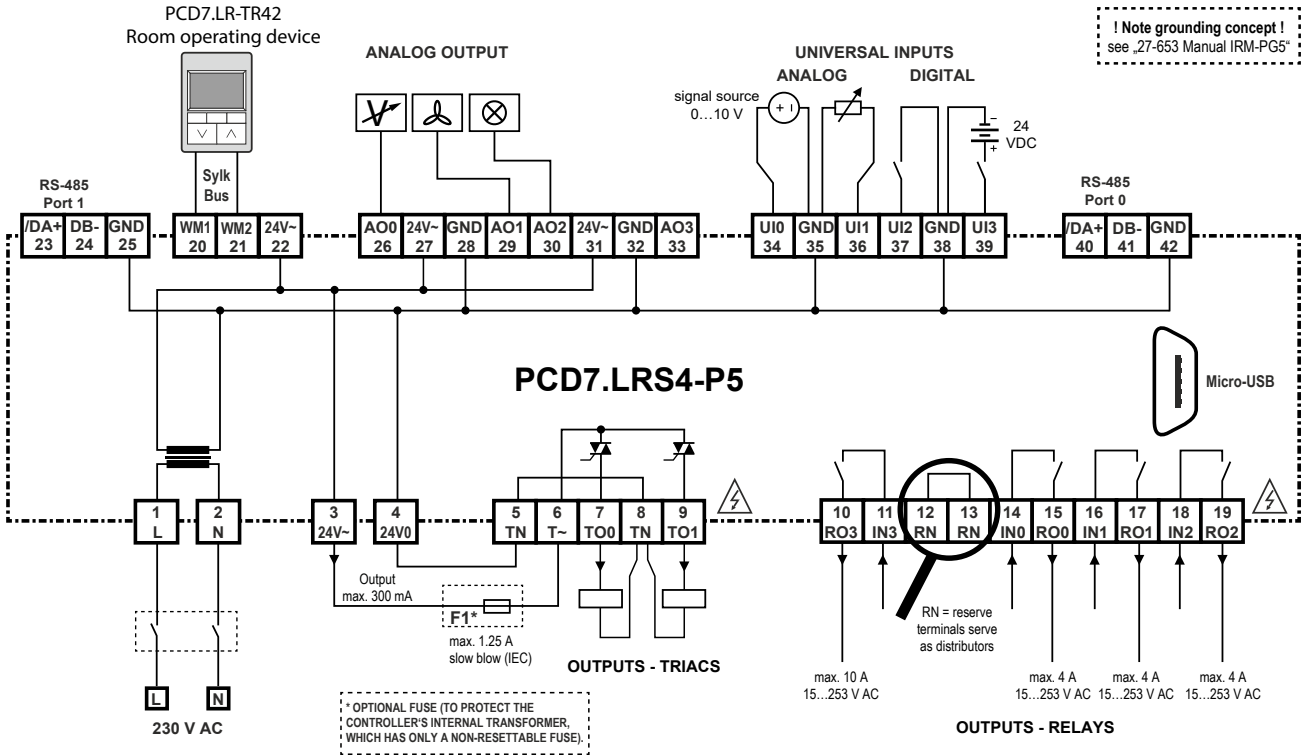

PCD7.LRS4-P5 wiring example

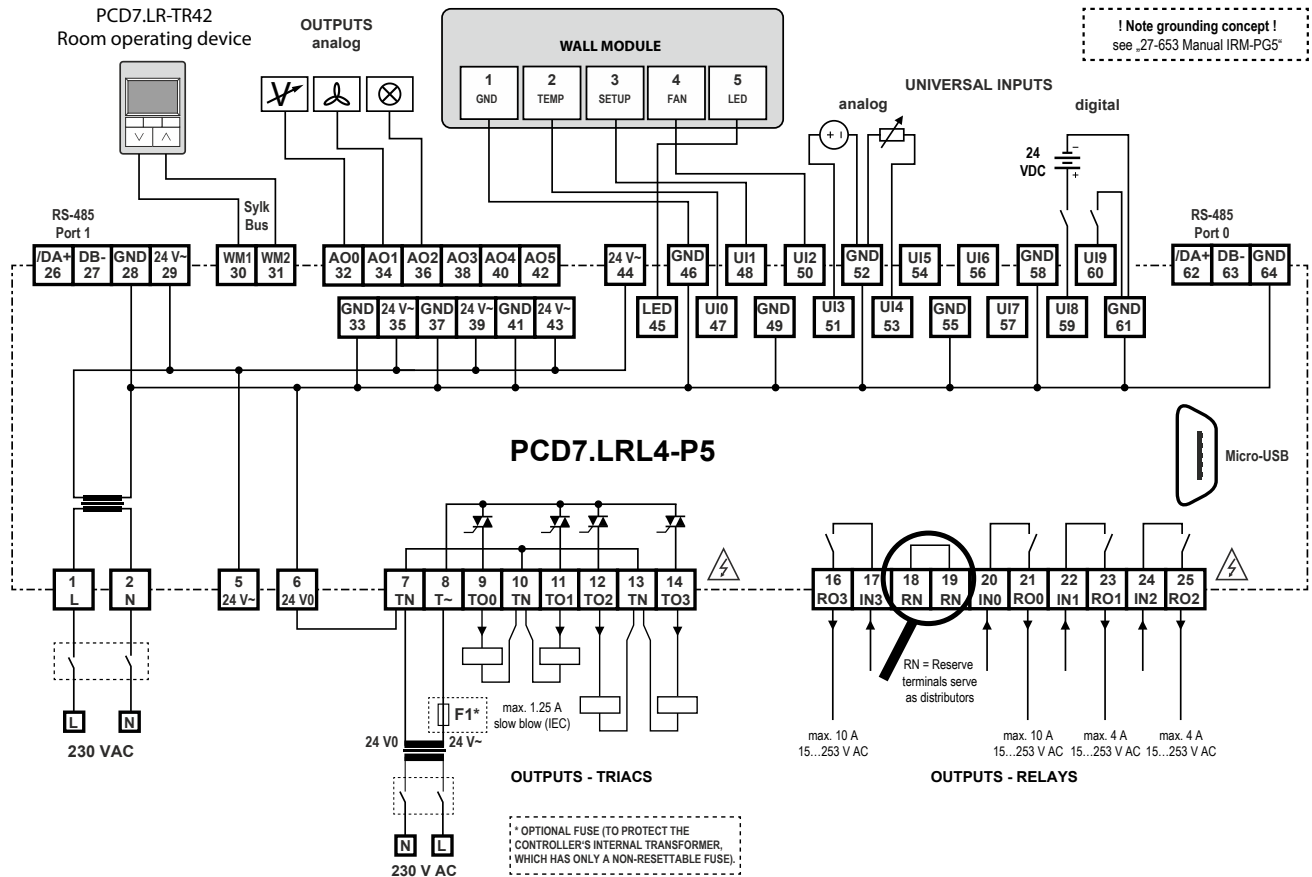

PCD7.LRL2-P5 wiring example

3.1.5 Accessories for PCD7.LRxx-P5

IRM-RSC/IRM-RLC

Terminal covers

Clip-on terminal covers (IP30 contact protection) for small or large controllers to prevent the user touching the 230 VAC terminals.

Optional for IP30

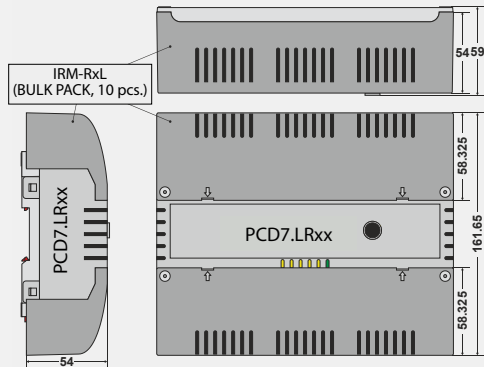

Compatible room operating devices

Sylk bus room operating devices

- ▶ Polarity-independent 2-wire bus with power and data transmission
- ▶ Types with integrated sensors for temperature, humidity and CO₂ sensor in one device
- ▶ Up to 4 room operating devices per PCD7.LRxx-P5 with a total cable length of up to 150 m

PCD7.LR-TR42

Room temperature sensor
+ setting option for setpoint,
presence and fan speed
+ LCD display
(+ humidity and CO₂ sensor)

Order number:
PCD7.LR-TR42
PCD7.LR-TR42-H
PCD7.LR-TR42-CO2
PCD7.LR-TR42-H-CO2



PCD7.LR-TR40

Room temperature sensor
(+ humidity and CO₂ sensor)
with Sylk bus connection
to the controller.

Order number:
PCD7.LR-TR40
PCD7.LR-TR40-H
PCD7.LR-TR40-CO2
PCD7.LR-TR40-H-CO2



PCD7.D1000

S-Bus / Modbus room operating device for room temperature measurement, setpoint offset setting

- ▶ Design in accordance with PEHA Dialog Aluminium
- ▶ Room temperature sensor 0...40 °C
- ▶ Setpoint offset control
± 3 K in 0.5 K steps
- ▶ 7 LEDs to indicate the setpoint offset
- ▶ 2 plug-in RJ9 connections for *Daisy Chain* and up to 6 room operating devices.

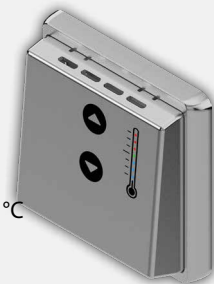

3.1.6 Project planning information

Bus terminating resistor and bus cable for serial S-Net (S-Bus/RS-485)

S-Bus cables must be installed as a line. Stub lines are not permitted and both ends of the cable must be terminated with a resistor (approx. 120 Ω) between the D and /D cables. The best signal quality is achieved using an active bus connection with a resistor to +5V and GND.

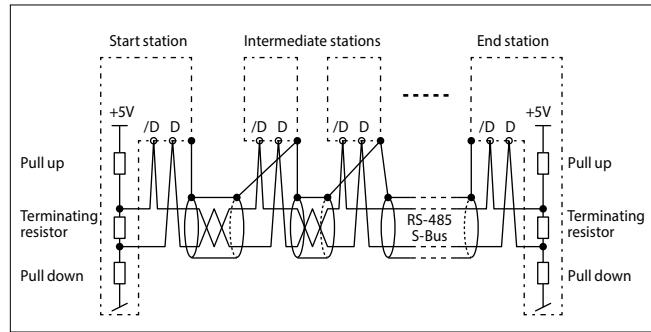

Schematic illustration of an S-Bus/ RS-485 bus



An external PCD7.T161/2 termination box can be used as bus termination resistor.

Bus cable: A 2-strand twisted and shielded bus cable with cable strands of at least 0.5 mm² must be used.

Bus shielding: The shielding of each S-Bus segment may only be connected with the electrical system ground at one point. To avoid problems with large potential differences between the room controllers, the shielding of the S-Bus cable should be connected with the GND of the room controller.

For more information, see S-Bus manual 26-739 (at www.sbc-support.com).

Types of use and modes of operation

The function of the room controller is based on various types of use or modes of operation.

Each of the selectable modes of operation can be assigned different control parameters.

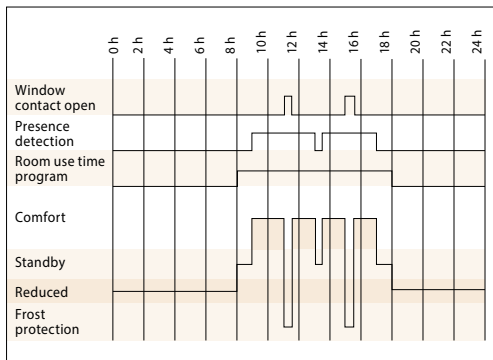

Example: Operating mode switchover

Safety mode/Frost protection

No heating or cooling energy is fed into the room. This state is desirable if a window is open. The room controller keeps the room temperature above the preset frost line of 8° C.



Non-use/reduced

Reduced operation mode which is used when the room is unoccupied for long periods. The specified setpoint value offset is not active in this operation mode.



Standby

The room is prepared for use but no presence has yet been registered in the room. As long as the room is not classified as occupied by the presence function, the room controller maintains the room temperature within the specified limits at the standby temperature.



Use/comfort

The room is used and should be brought to the comfort temperature.

This state can be reached by pressing the presence button, reacting to an external presence detector or a parameter on the network side.



Compact room controller installation information

- ▶ Do not install the compact room controller near windows or doors due to potential draughts. The recommended position is on an opposite wall at a height of approx. 1.5 m.
- ▶ Do not install it near to heat sources such as heating systems, fridges, lights, etc. Avoid direct sunlight or direct light from bright lighting.
- ▶ Do not locate the compact room controller in draughts produced by air conditioning and ventilation systems.

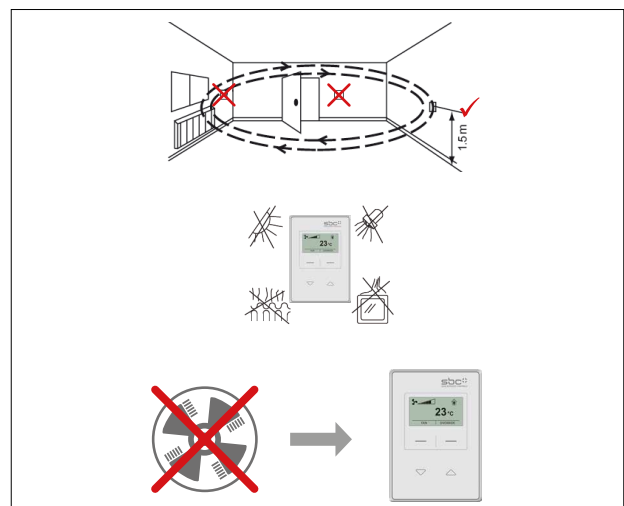

3.2 PCD7.LRxx BACnet room controllers can be configured and commissioned via an Android app

3.2.1 Overview and advantages of the PCD7.LRxx system

BTL®-listed PCD7.LRxx BACnet room controller

A new, easy way to commission room applications – via an Android device and the RoomUp app

The new BACnet room controller in the PCD7.LRxx series allows efficient, quick commissioning and testing of the connected actuators and sensors.

The room controllers have universal inputs that can be configured for a variety of functions, and their form factors also allow them to be installed in electrical sub-distribution systems. They also have a Sylk bus interface for connecting digital room operating devices.

The following applications can be configured:

- ▶ Fan convectors, fans with 1–3 speeds or fans with a variable speed
- ▶ Inlet air flap control with combined air quality monitoring and temperature control
- ▶ Cooled ceiling
- ▶ Under-floor heating
- ▶ Radiator heating
- ▶ A combination of the aforementioned applications

Advantages

No programming needed

Applications can be created quickly and easily because the controller comes supplied with pre-installed applications which can be configured via the app.

Quick installation of applications across projects – as soon as an individual room is configured, the application configuration can be extended to other rooms via the RoomUp app ("template concept").

Easier installation

In order to cater for various installation requirements, the controller can be mounted universally on DIN top hat rails, in small installation housings and on walls (including optional terminal covers).

Triac outputs can be controlled with 24 VAC or 230 VAC.

Easier commissioning

The solutions allow very efficient "commissioning by one person" via the "RoomUp" app with quick, straightforward and reliable test procedures on location thanks to the "RoomUp" app's guided testing and reporting.

Automatic MS/TP-MAC addressing by scanning a barcode.

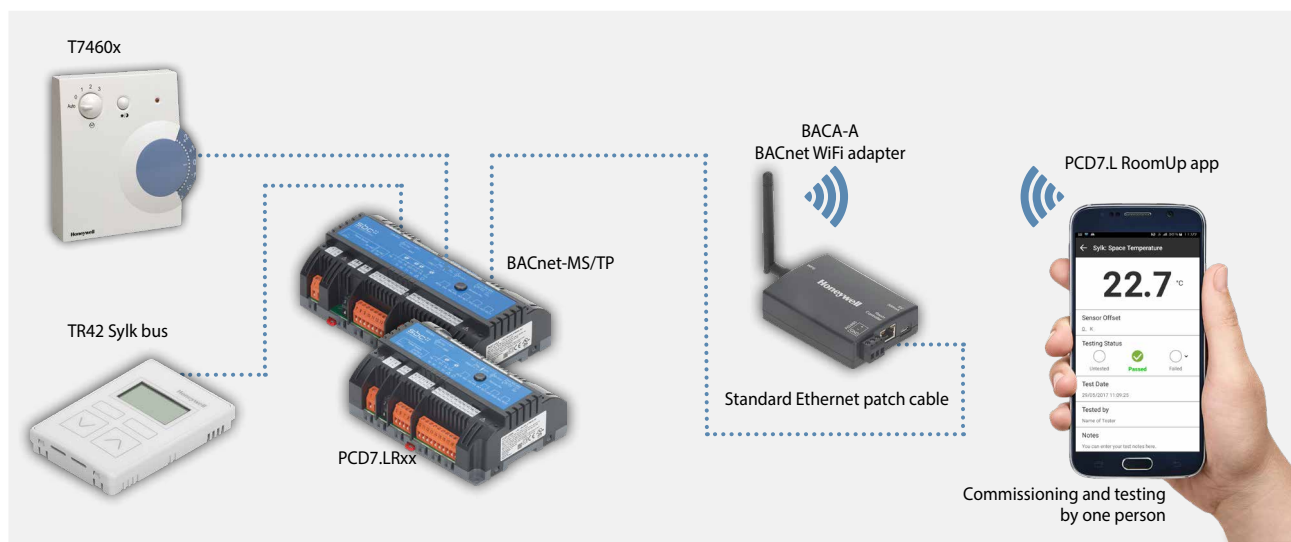

3.2.2 Set-up information with RoomUp and integration with the PG5

RoomUp

A unique commissioning experience

RoomUp is used to configure, commission and test the application.

RoomUp offers an entirely new way of commissioning room systems and carrying out final tests:

- ▶ Quick and easy commissioning by one person via a smartphone or tablet
- ▶ Easier, reliable tests on location thanks to the wireless connection with guided testing and integrated reporting
- ▶ Efficient, automatic device addressing
- ▶ Wireless communication allows commissioning before bus installation is complete

A template concept helps the user to determine the standard room types used in the building (templates). The template is used on all controllers for the relevant room type. A change to the template can easily be applied to all controllers with the same template.

The RoomUp app can be downloaded from the Google Play Store.

In order to activate the downloaded RoomUp app, a RoomUp licensing key with the order number PCD7.L-ROOMUP is required.

RoomUp is an Android app for smartphones and tablets running Android 5.0 or higher.



See for yourself the advantages.

RoomUp video
<http://sbc.do/Tc2kPraY>





Addressing

The person commissioning the system does not need to set addresses via address switches. PCD7.LRxx automatically uses an unused BACnet address (automatic MS/TP-MAC addressing). Assignment to a specific room is easily possible via the service button or by scanning the barcode label. 1 barcode label is placed on the controller and 1 barcode label can be removed and stuck to the layout.

Recommended system size with RoomUp

- ▶ Buildings can be analysed on the basis of the layout in order to select suitable divisions with system controllers
- ▶ The project is subdivided into a number of BACnet MS/TP segments with a maximum of 30 devices per segment
- ▶ Large systems should be subdivided into a number of RoomUp projects with 300 devices per project (maximum permitted size)
- ▶ A RoomUp project should be commissioned by one person

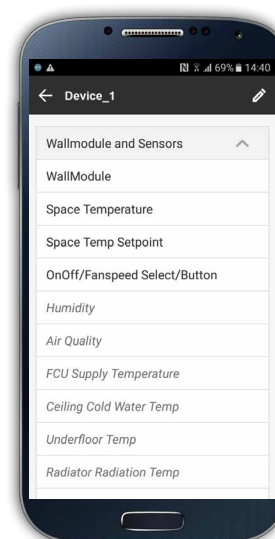
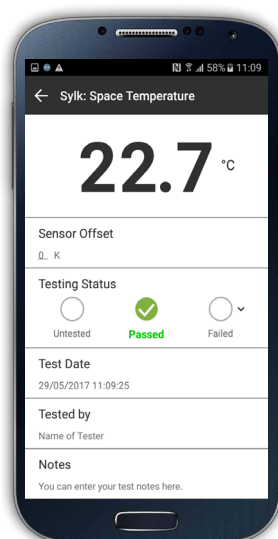
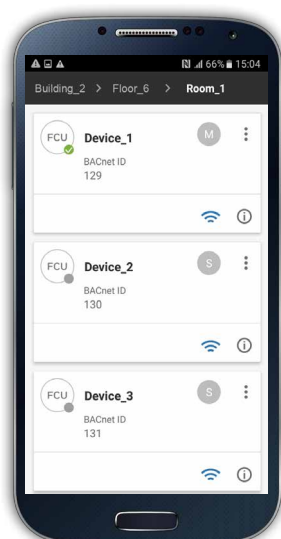
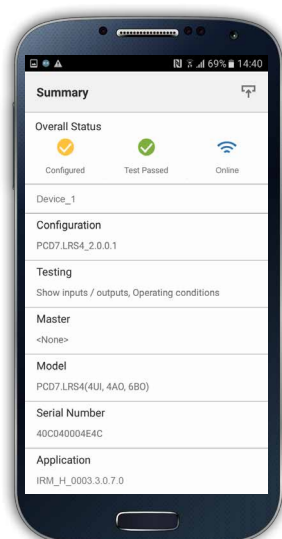

Wiring and device testing as well as an automatic test report for the project handover

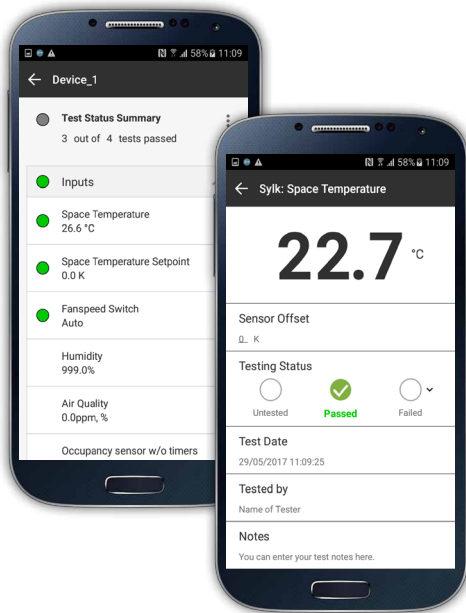

I/O report

Port	Signal	Comment
3	24 V	24 VAC supply inp./outp.
4	24 V0	24 VAC zero supply inp./outp.
5	TN	TN
6	T	T
7	TO1	RCU cooling
8	TN	Triacs N

Port	Signal	Comment
9	TO2	FCU heating
10	RO4	
11	IN4	Relay 4 L in
12	RN	Line N switched on/off
13	RN	Line N switched on/off
14	IN1	Relay 1 L in
15	RO1	1-speed fan
16	IN2	Relay 2 L in

Test report

Connection point type	Connection name	Data point name	Last value	Units	Sensor offset	Test status	Tested by	Test date	Re-remarks	Error message
Analogue input	Sylk	RmTemp	26.85674	°C		Passed	Johann Klempner	26.07.2016 16:24:48		
Analogue input	Sylk	RmTempSp	2.5	°C		Passed	Johann Klempner	26.07.2016 16:24:48		
Multi-level value	Sylk	WMFanManSwCmd	3				Johann Klempner	26.07.2016 16:24:48		
Analogue output	AOPWMTO1	FCUClgCtl	100	%		Passed	Johann Klempner	26.07.2016 16:24:48		
Analogue output	AOPWMTO2	FCUHTgCtl	0	%		Passed	Johann Klempner	26.07.2016 16:24:48		
Multi-level value		FCUFanStgCmd	2			Passed	Johann Klempner	26.07.2016 16:24:48		

If necessary, the reports generated can be sent straight to an e-mail address.

Typical system architecture

For BACnet MS/TP communication, the PCD requires the following modules (see chapter B2.6.1):

- ▶ BACnet MS/TP communication interface: PCD3.F215 or PCD2.F2150 (and an additional PCD7.F110S for a second BACnet MS/TP interface)
- ▶ BACnet optional module for firmware expansion: PCD7.R562 or PCD3.R562

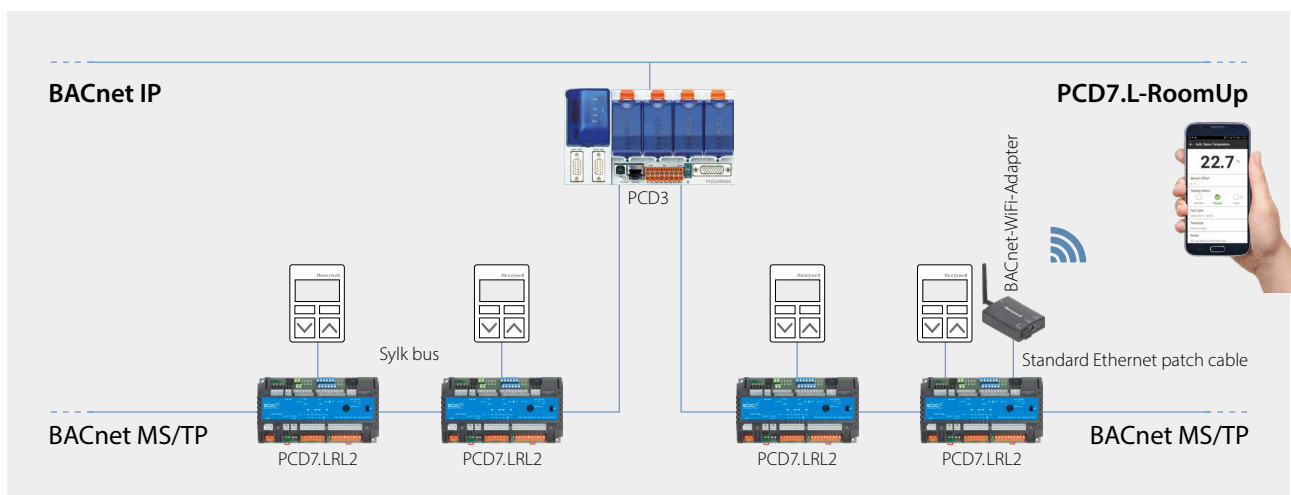

The following PCDs are compatible with the PCD7.LRxx controller:

PCD1

- ▶ PCD1.M2160
- ▶ PCD1.M2220-C15

PCD2

- ▶ PCD2.M4160, PCD2.M4560

PCD3

- ▶ PCD3.M3160, PCD3.M3360, PCD3.M5360
- ▶ PCD3.M5560
- ▶ PCD3.M6860, PCD3.M6880

Restrictions and performance

A maximum of 30 PCD7.LRxx controllers can be connected to an MS/TP line. Per PCD, up to 4 MS/TP lines can be used to connect the PCD7.LRxx controllers.

Performance of PCD3.M5560 at a communication speed of 38.4 kbits/s:

- ▶ Communication cycle time: With 30 PCD7.LRxx controllers on an MS/TP line, the token cycle time is 1.64 seconds
- ▶ With 30 PCD7.LRxx controllers, the maximum change of value per minute (COV/min) is 1,100 COV/min (this maximum value depends on the limits of the MS/TP network and the communication cycle time)

Importing application BACnet objects using the .ede file in PG5

Version PG5.2.2.200 or higher must be used. This version includes the BACnet Stack Rev. 14, the automatic assignment and creation of symbols and the BACShark tool for generating an .ede file.

Creating a BACnet configurator page

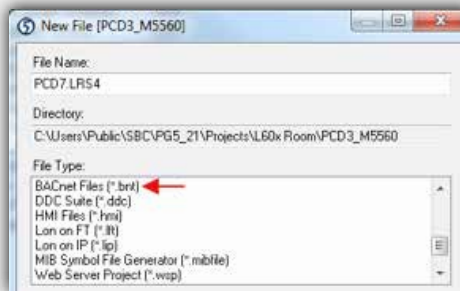

Importing the .ede file created by BACShark or BACeye

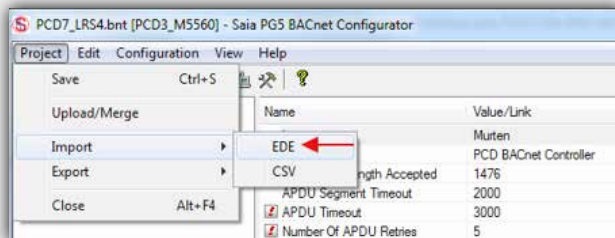

You can select the properties which are automatically assigned to flags and registered.

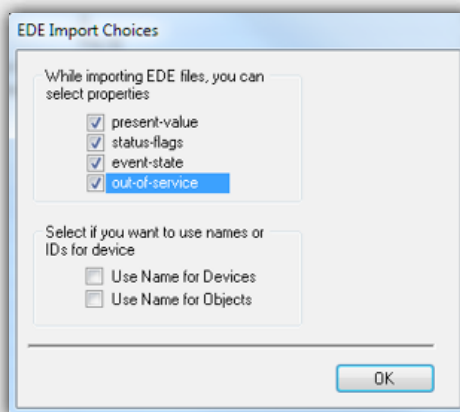

Multiple .ede files to be imported together into the BACnet Configurator can be selected. This automatically creates the global symbols for all BACnet objects in the "BAC" folder with the following structure: BAC.Device Name.Object Name

3.2.3 Application overview

Configurable application

Fan convector	Ceiling	Inlet air	Radiator	Under-floor heating
Device configurations				
Cooling the coolant	Cooling	Cooling	Heating	Heating
DX cooling	Heating	Inlet air flap		
Hot water heating				
Electric heating				
2-pipe switching or 4-pipe system	2-pipe switching, 4-pipe system or 6-way MID valve			
Control strategy modes				
Room temperature control	Room temperature control	Room temperature control	Room temperature control	Room temperature control
Cascade temperature control		Room temperature control with cooling with lower limit value	Room temperature control with heating with lower limit value	Room temperature control with heating with lower limit value
Room temperature control with lower limit values for heating and cooling		Air quality and cooling control (optionally with cooling with lower limit value)		
Fan with 1, 2 or 3 speeds				
Fan with variable speed		Air quality monitoring only		

Straightforward system-wide application installation

After configuring an individual room, the application configuration can be extended to other rooms via the RoomUp app ("template concept"). This "template concept" also allows an automatic adjustment of the application configuration for a room in any room which is assigned the same template. This saves significant amounts of time when planning, especially in the case of projects where many rooms/zones are similar and the same application is used. Via master/slave configurations, applications can easily be adapted to changes in room design over the life of the building.

The following diagram provides an overview of the applications supported. Functions can be added by clicking on symbols.

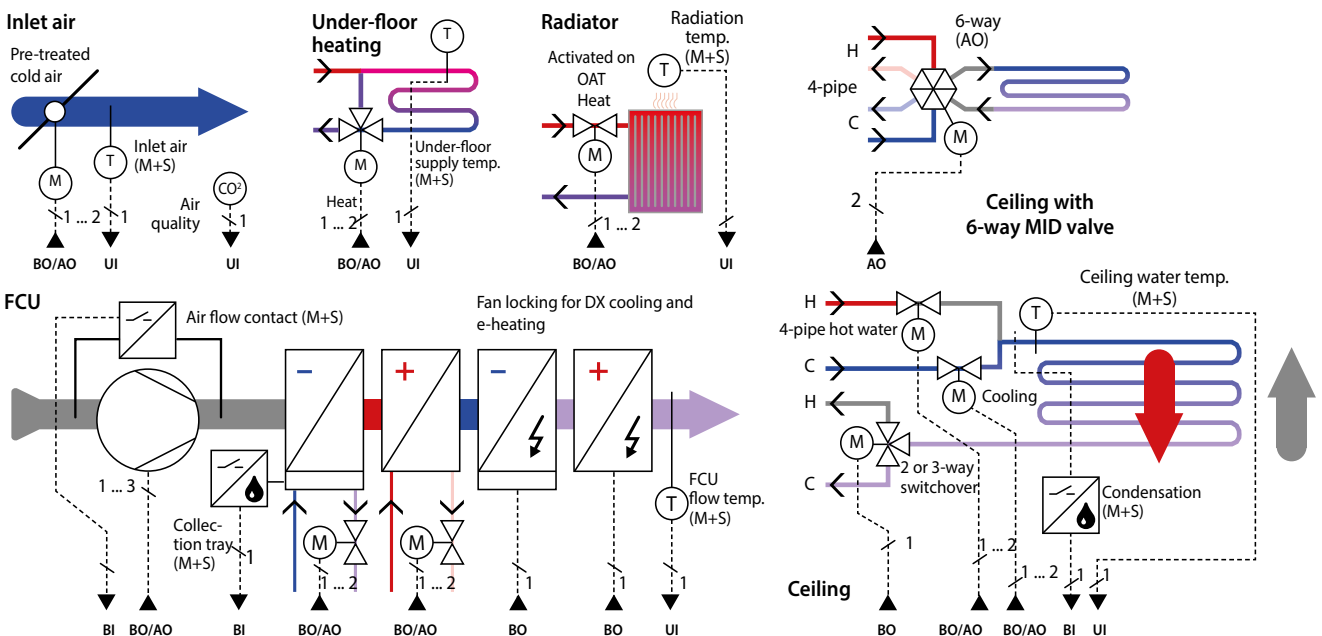

3.2.4 Product overview and wiring examples

PCD7.LRxx system overview

	Order number	Power supply	Analogue outputs	Universal inputs	Relays	Triacs (24 V or 230 V)	Total I/Os	LED output	24 V AC for field devices
Large controller 198 × 110 × 59 mm	PCD7.LRL2	230 V AC	2	6	4	4	16	1	300 mA
	IRM-RLC	Package including 10 large terminal covers							
Small controller 162 × 110 × 59 mm)	PCD7.LRS4	230 V AC	4	4	4	2	14	0	300 mA
	PCD7.LRS5	24 V AC	4	4	4	2	14	0	600 mA
	IRM-RSC	Package including 10 small terminal covers							
Commissioning	BACA-A	Wi-Fi adapter and RJ45 cable							
	PCD7.L-RoomUp	SBC RoomUp licence							
	RoomUp	Smartphone app for PCD7.LRxx commissioning requires Android 5.0 or higher. The app is available via the Play Store							
Room operating devices	Syk bus: TR40, TR40-CO2 without display / TR42, TR42-CO2 with display								
	Hard-wired to the controller's I/Os: T7460x								

Dimensions:



PCD7.LRL2 (large housing):
W × L × H = 110 × 198 × 59 mm



PCD7.LRSx (small housing):
W × L × H = 110 × 162 × 59 mm



PCD7.LRS4
+2 × IRM-RSC



PCD7.LRS5
+2 × IRM-RSC



PCD7.LRL2
+2 × IRM-RLC

PCD7.LRxx with
optional
covers
(covers are supplied
in sets of 10)

Controller example: PCD7.LRS4

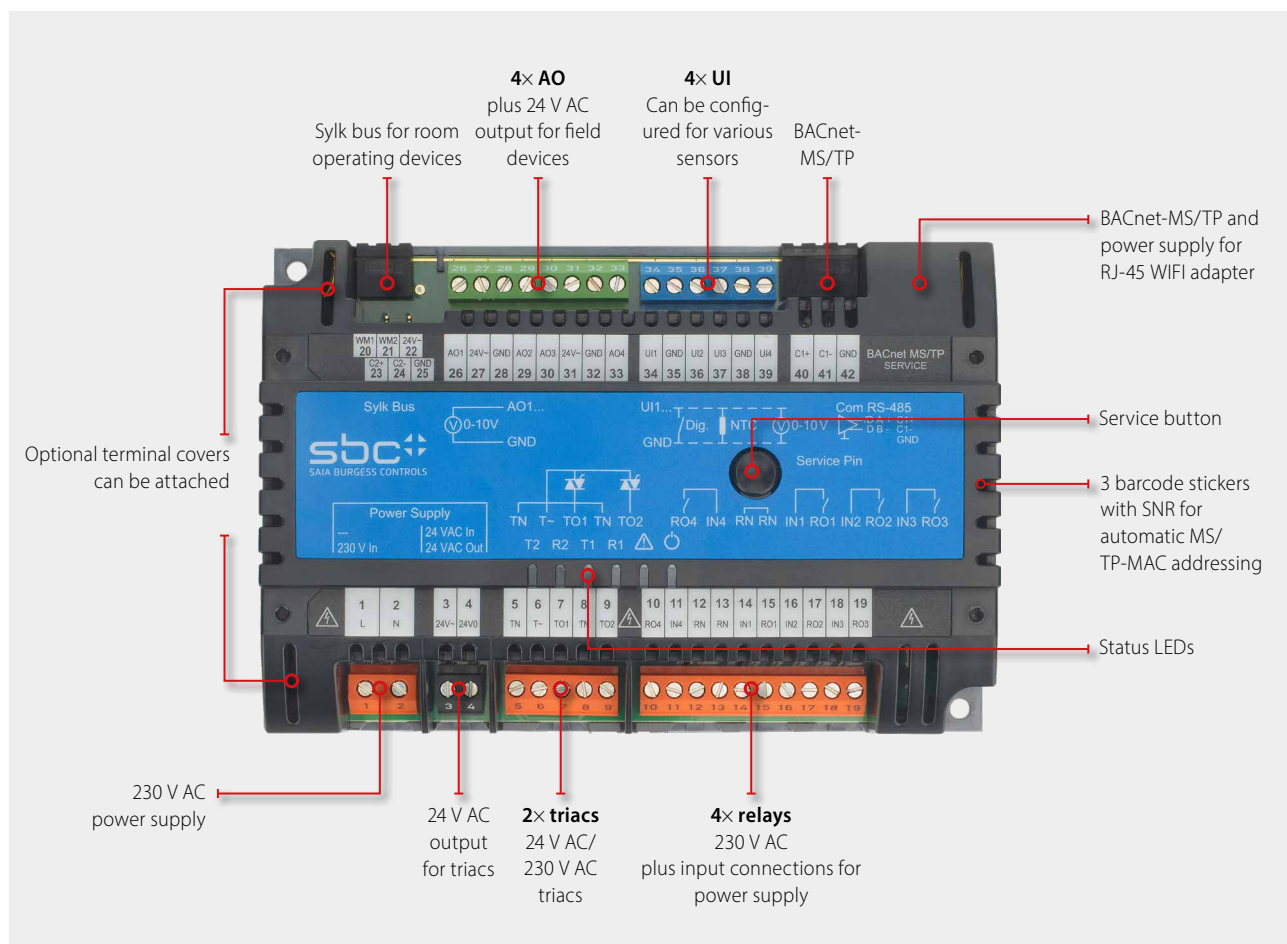

Automation stations

1

Operation and monitoring

2

Room controllers

3

Wiring example for a PCD7.LRS4 controller

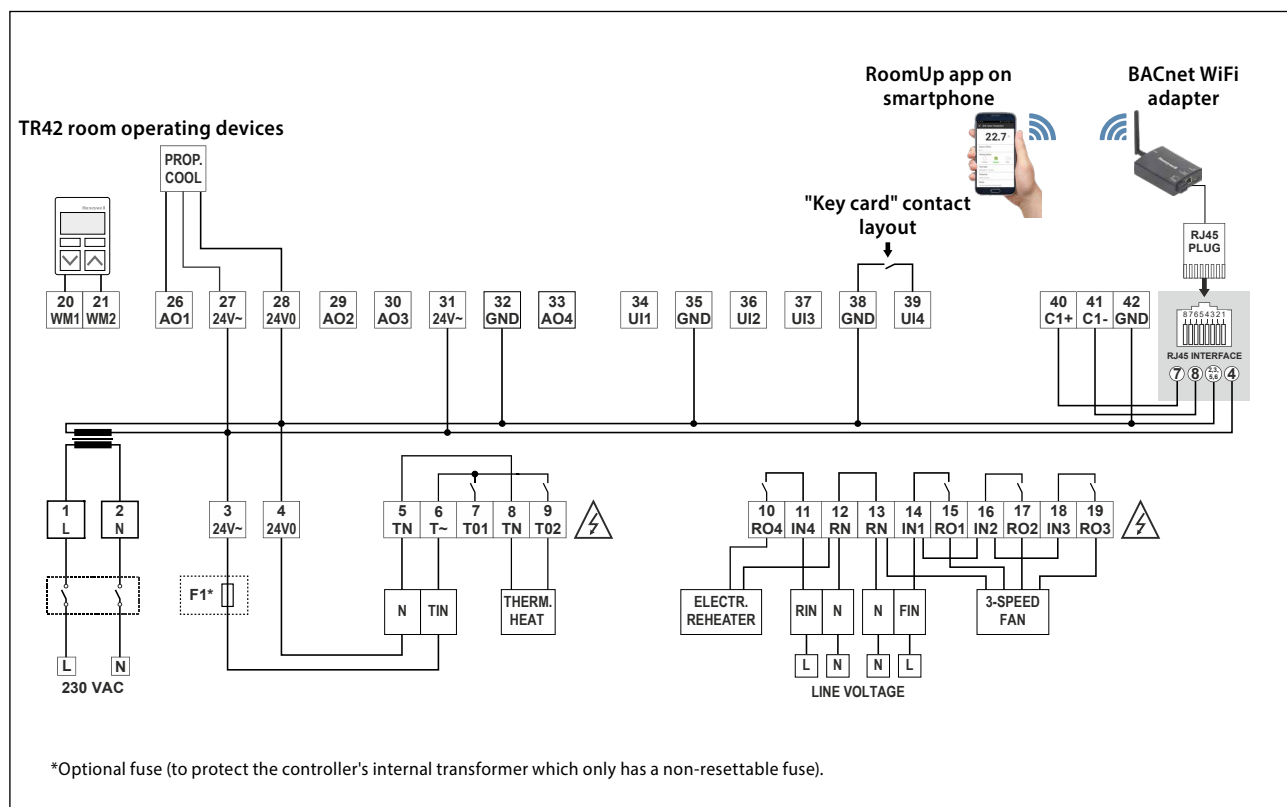

Consumer data acquisition

4

Switch cabinet components

5

3.2.5 PCD7.LRxx accessories

IRM-RSC/IRM-RLC

Terminal covers

Clip-on terminal covers (IP30 contact protection) for small or large controllers to prevent the user touching the 230 VAC terminals.

Optional for IP30

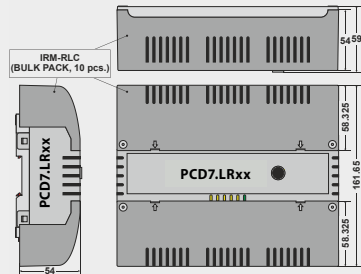

BACA-A

Mobile BACnet MS/TP access point for RoomUp

Straightforward one-cable connection to the PCD7.LRxx controller

Additional option for connecting MS/TP cables and power supply via mini-USB

Wi-Fi-protected setup (WPS) for quick device connection

Web interface for device configuration



Compatible room operating devices

Sylk bus room operating devices

- Types with integrated sensors for temperature, humidity and CO2 sensor in one device

PCD7.LR-TR42

Room temperature sensor
+ setting option for setpoint,
presence and fan speed
+ LCD display
(+ humidity and CO2 sensor)

Order number:

PCD7.LR-TR42
PCD7.LR-TR42-H
PCD7.LR-TR42-CO2
PCD7.LR-TR42-H-CO2



PCD7.LR-TR40

Room temperature sensor
(+ humidity and CO2 sensor)
with Sylk bus connection
to the controller.

Order number:

PCD7.LR-TR40
PCD7.LR-TR40-H
PCD7.LR-TR40-CO2
PCD7.LR-TR40-H-CO2



Wired room operating devices from Honeywell

T7460x

Room temperature sensor
+ setpoint setter
+ occupancy button
+ fan speed adjuster

Order number:

T7460A1001 T7460D1005
T7460B1009 T7460F1000
T7460C1007



Room operating devices with connectors for connecting to the controller inputs.