

CK3

Mobile Computer

CK3R, CK3X, CK3XNI



User Manual

Intermec by Honeywell
16201 25th Avenue West
Lynnwood, WA 98087
U.S.A.

www.intermec.com

The information contained herein is provided solely for the purpose of allowing customers to operate and service Intermec-manufactured equipment and is not to be released, reproduced, or used for any other purpose without written permission of Intermec by Honeywell.

Information and specifications contained in this document are subject to change without prior notice and do not represent a commitment on the part of Intermec by Honeywell.

© 2012–2018 Intermec by Honeywell. All rights reserved.

For patent information, please refer to www.hsmpats.com.

Wi-Fi is a registered certification mark of the Wi-Fi Alliance.

Microsoft, Windows, and the Windows logo are registered trademarks of Microsoft Corporation in the United States and/or other countries.

Bluetooth is a trademark of Bluetooth SIG, Inc., U.S.A.

This product includes software developed by the OpenSSL Project for use in the OpenSSL Toolkit (www.openssl.org).

This product includes cryptographic software written by Eric Young (EAY@cryptsoft.com).

This product uses Regex++, Index software during its operational phases. The owner of Regex++ has granted use of the software to anyone provided such use is accompanied by the following copyright and permission notice:

Regex++, Index. (Version 3.31, 16th Dec 2001)

Copyright © 1998-2001 Dr John Maddock

Permission to use, copy, modify, distribute and sell this software and its documentation for any purpose is hereby granted without fee, provided that the above copyright notice appear in all copies and that both that copyright notice and this permission notice appear in supporting documentation. Dr John Maddock makes no representations about the suitability of this software for any purpose. It is provided "as is" without express or implied warranty.

iTalkie is a trademark of TABLETmedia, Inc.

Contents

Before You Begin.....	viii
Safety Information.....	viii
Global Services and Support.....	viii
Warranty Information.....	viii
Web Support.....	ix
Telephone Support.....	ix
Who Should Read This Manual.....	ix
Related Documents.....	ix

1 About the Computer Features 1

About the CK3R and CK3X Mobile Computers.....	2
What’s New in this Release.....	3
About Language Provisioning.....	4
Turn On the CK3 for the First Time.....	4
Save Current Language when You Update the OS.....	4
About the Battery.....	5
Charge the Battery.....	5
Battery Charge Times.....	6
Change the Battery.....	6
About Battery Status.....	7
About Battery Life and Conservation.....	9
About the Status LEDs.....	10
About the Keypad.....	13
About the Color-Coded Keys.....	14
How to Capitalize Characters.....	15
About the Power Button.....	16
About the Screen Backlight.....	18
Configure the Screen Backlight Timeout.....	18
Configure the Screen Backlight Brightness.....	19
About the Audio Features.....	20
Adjust the Speaker Volume.....	20
About the Push-to-Talk Feature.....	20
Record Audio.....	20
Use the Computer as a Two-Way Radio.....	21

Contents

How to Read Bar Codes	21
Read Bar Codes with the Imager	21
Connect a Bluetooth Scanner	23
Connect a Tethered Scanner	24
Insert a microSD Card	24
How to Transfer Files	27
Set Up the Computer as a Mass Storage Device	27
CK3 Options and Accessories	28

2 About the User Interface and Intermec Applications 31

About the User Interface	32
About the Home Screen	32
About Screen Gestures	34
Title Bar Status Icons	34
Calibrate the Screen	36
About Intermec Applications	36
Intermec Applications on the Computer	36
Downloadable Intermec Applications for the Computer	38
About Features Demo	38
About Intermec Browser	38
About Intermec HTML5 Browser	38
About Intermec Launcher	39
About Intermec Terminal Emulator	39
About SmartSystems	39

3 Configure the Computer 41

How to Configure the Computer	42
About Intermec Settings on the Computer	42
Start Intermec Settings	43
About the Structure of Intermec Settings	43
How to Navigate in Intermec Settings	48
Enable Intermec Settings Password	49
Restore Default Settings	49
Configure the Computer Remotely with SmartSystems	50

About Network Communications	50
Configure 802.11 Radio Communications	51
About Bluetooth Communications	51
Turn On the Bluetooth Radio	52
Connect a Bluetooth Scanner	53
Create a Configuration Bar Code with EasySet	54
Connect to a Bluetooth Printer	54
Connect a Bluetooth Audio Device	56
Connect to a Wireless Reader	57
About Serial and USB Communications	57
About Wireless Security	58
Load a Certificate	58
How to Make Your Security Choice	60
Select a Funk Security Profile	60
Configure WPA or WPA2 Enterprise (802.1x) Security with Funk Security	61
Configure WPA or WPA2 Personal (PSK) Security with Funk Security	61
Configure 802.1x Security with Funk Security	62
Configure LEAP Security with Funk Security	63
Configure Static WEP Security with Funk Security	63
Use Open (No Security) Associations with Funk Security	64
Select Microsoft as Your Security Choice	64
Configure WPA or WPA2 Enterprise (802.1x) Security with Microsoft Security	65
Configure WPA or WPA2 Personal (PSK) Security with Microsoft Security	65
Configure 802.1x Security with Microsoft Security	66
Configure Static WEP Security with Microsoft Security	67
Use Open (No Security) Associations with Microsoft Security	67

4 Manage the Computer **69**

How to Manage the Computer in Your Network	70
How to Manage the Computer with CloneNGo	70
How to Manage the Computer with SmartSystems	70
How to Manage the Computer with Third-Party Software	71
How to Develop and Install Applications	71
How To Package Your Application	71
Install Applications with SmartSystems	72
Install Applications with Microsoft Synchronization Software	73
Install Applications with a microSD Card	73
How to Launch Applications Automatically	74

Contents

How to Update the System Software	74
Update the Computer with SmartSystems	74
Update the Computer with a microSD Card	75

5 Troubleshoot and Maintain the Computer **77**

About the Intermec Dashboard	78
About Troubleshooting the Computer	79
Wi-Fi Connection Problems	79
Check Wi-Fi Network Status	80
802.1x Security Problems	82
Troubleshoot the Scanner with Scan Diagnostics	83
Problems Reading Bar Codes	84
Problems Using the Computer	86
Call Product Support	86
Locate Your Configuration Number	87
Locate Your Operating System Version	87
How to Restart the Computer	88
Reboot the Computer	88
Cold Boot the Computer	88
Clean Boot the Computer	89
Clean the Computer	90

A Specifications **91**

Physical and Environmental Specifications	92
EA31 Typical Reading Distances - Extended Reading Range	95
EA31 Imager Minimum Reading Distances	96
EA31 Imager Typical Reading Distances	97
EA30 Typical Reading Distances - Extended Reading Range	99
EA30 Area Imager Minimum Reading Distances	100
EX25C Near-Far Range Area Imager Reading Distance	101
N5603 Extended Range Reading Distances	105

B Default Settings **107**

Default Configuration	108
Data Collection	108

RFID111
Communications113
Device Settings114
Core Messaging Service.....117
Device Monitor117
Virtual Wedge117
Location Services118

C Keypads and Keystrokes 119

Characters and Functions on Keypads120

Before You Begin

This section provides you with safety information, technical support information, and sources for additional product information.

Safety Information

Your safety is extremely important. Read and follow all warnings and cautions in this document before handling and operating Intermec equipment. You can be seriously injured, and equipment and data can be damaged if you do not follow the safety warnings and cautions.

This section explains how to identify and understand warnings, cautions, and notes that are in this document.



A warning alerts you of an operating procedure, practice, condition, or statement that must be strictly observed to avoid death or serious injury to the persons working on the equipment.



A caution alerts you to an operating procedure, practice, condition, or statement that must be strictly observed to prevent equipment damage or destruction, or corruption or loss of data.



Note: Notes either provide extra information about a topic or contain special instructions for handling a particular condition or set of circumstances.

Global Services and Support

Warranty Information

To understand the warranty for your Intermec product, visit the Intermec website at www.intermec.com and click **Support** > **Returns and Repairs** > **Warranty**.

Disclaimer of warranties: The sample code included in this document is presented for reference only. The code does not necessarily represent complete, tested programs. The code is provided “as is with all faults.” All warranties are expressly disclaimed, including the implied warranties of merchantability and fitness for a particular purpose.

Web Support

Visit the Intermec website at www.intermec.com to download our current manuals (in PDF).

Visit the Intermec technical knowledge base (Knowledge Central) at www.intermec.com and click **Support > Knowledge Central** to review technical information or to request technical support for your Intermec product.

Telephone Support

In the U.S.A. and Canada, call **1-800-755-5505**.

Outside the U.S.A. and Canada, contact your local Intermec representative. To search for your local representative, from the Intermec website, click **About Us > Contact Us**.

Who Should Read This Manual

This manual is for the person who is responsible for installing, configuring, and maintaining the CK3R and CK3X mobile computer.

This manual provides you with information about the features of the computer, and how to install, configure, operate, maintain, and troubleshoot it.

Before you work with the CK3R or CK3X, you should be familiar with your network and general networking terms, such as IP address.

Related Documents

Here are some related Intermec documents you might find useful:

- *Intermec Settings Command Reference Manual*
- *Intermec Developer Library (IDL) Resource Kit Developer's Guide*

The Intermec website at www.intermec.com contains our documents (as pdf files) that you can download for free.

To download documents

- 1** Visit the Intermec website at www.intermec.com.
- 2** Click the **Products** tab.
- 3** Using the **Products** menu, navigate to your product page. For example, to find the CK3X computer product page, click **Computers > Handheld Computers > CK3X**.
- 4** Click the **Manuals** tab.

If your product does not have its own product page, click **Support > Manuals**. Use the **Product Category**, the **Product Family**, and **Product** to find your documentation.

1

About the Computer Features

This chapter introduces the CK3R and CK3X Mobile Computers with Windows® Embedded Handheld operating system. Use this chapter to learn about basic computer features and functions, as well as the available accessories for it.

About the CK3R and CK3X Mobile Computers

The Intermec CK3R and CK3X Mobile Computers are ergonomically designed mobile computers built on the Microsoft® Windows® Embedded Handheld 6.5 operating system. The CK3R and CK3X are lightweight, easy-to-use, and run most software designed for the Windows Embedded platform. In this manual, computer refers to models CK3R, CK3X, and CK3XNI, unless specifically stated.

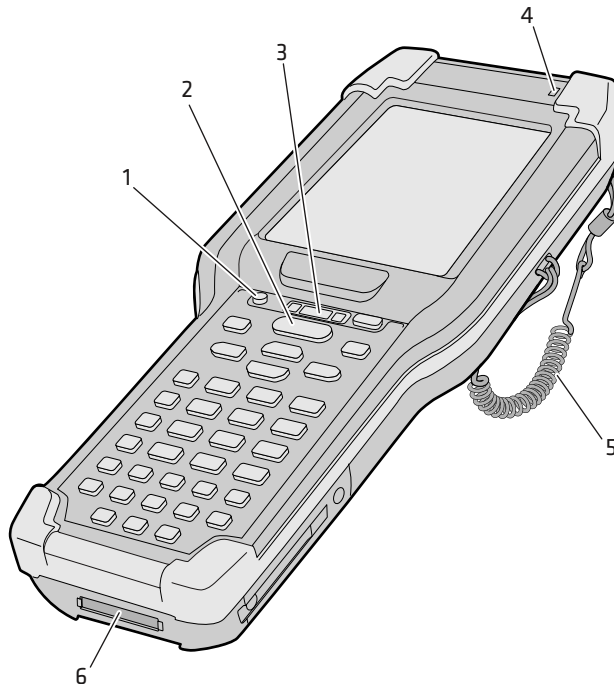

CK3 Mobile Computer Features

Callout	Description
1	Power button
2	Scan button
3	Status LEDs
4	Ambient light sensor
5	Tethered stylus
6	Docking connector



Note: The CK3R Mobile Computer with a DHIB 802.11b/g/n radio installed is Wi-Fi® certified for interoperability with other 802.11b/g/n wireless LAN devices.



Note: The CK3X Mobile Computer with a DDIB 802.11a/b/g/n radio installed is Wi-Fi® certified for interoperability with other 802.11a/b/g/n wireless LAN devices.

This table shows some of the key differences between the CK3R and CK3X:

Compare the CK3R and CK3X

Feature	CK3R	CK3X
Flash	512 MB	1 G
RAM	256 MB	256 MB
Accelerometer	No	Yes
802.11 Radio	b/g/n	a/b/g/n
Alphanumeric or Numeric Keypad	Yes	Yes
Microphone	No	Yes
Imager	EA31	EA30, EX25, 5603ER

What’s New in this Release



This version of the user manual contains these updates:

- Added CK3X support for the N5603 extended range scanner. For more information, see Appendix A.
- Added support for HanXin symbology.
- Added language persistence through an operating system update. For more information, see “Save Current Language when You Update the OS.”

About Language Provisioning

You may be prompted to select a language provision when the computer starts for the first time. It may take as long as 15 minutes to load your language. Once loaded, your selected language persists through all boot scenarios (warm, cold, or clean). You can also use Intermec Settings to save the selected language through an operating system update.

Turn On the CK3 for the First Time

- 1 Insert the battery into the CK3. The CK3 turns on and you are prompted to select a language.
- 2 Use the , , and **Enter** key to select a language and navigate through the screens.

The language you selected loads on the CK3. The computer restarts when it finishes configuring the device for your language.

Save Current Language when You Update the OS

You can use Intermec Settings to make your selected language persist through an operating system update.

- 1 Tap **Start > Settings > System > Intermec Settings**. The Intermec Settings Main Menu appears.
- 2 Tap **Device Settings > Language**.
- 3 Select the **Save current language when updating OS** checkbox.
- 4 Tap **OK**.

About the Battery



Warning: The battery used in this device may present a fire or chemical burn hazard if it is mistreated. Do not disassemble it, heat it above 100 °C (212 °F) or incinerate it. Dispose of used batteries promptly. Keep away from children.

The computer uses one of these rechargeable Lithium-ion battery packs as its main power source.

CK3R/CK3X Battery Packs

Battery Model	Description	Ships With
AB17	2000 mAH (7.4 Wh) battery	CK3R
AB18	5000 mAH (18.0 Wh) battery	CK3X
1001AB01	5500 mAH (20.0 Wh) battery, includes battery health monitoring	

You can use the battery status icon in the Title bar or the Intermec Dashboard to view the charging status of your battery.

The optional 5500 mAH battery provides higher performance with less power, improves cold temperature operation, and provides remote health monitoring if you are using SmartSystems.

Charge the Battery

Make sure you fully charge the battery before you use your computer. You can charge the battery before or after you install it in the computer. A fully discharged battery charges in approximately 4 (AB17) to 7 (AB18, 1001AB01) hours.

- Insert the battery into the battery bay of the AD20 single dock (AB17 or AB18 only), insert up to four batteries into the AC20 quad battery charger (AB17 or AB18 only), or insert batteries into the FlexDock battery cup 1002UC02 with the DX2 or DX4.
- Or,
- Install the battery in the CK3 and insert the CK3 into the AD20 single dock, AD21 Ethernet multidock, AD22 charge-only multidock, Universal Wall Mount Charger, or AV10 vehicle dock.

Battery Charge Times

Charge times for the batteries depend on the battery and the charging method.

Battery Charge Times

CK3 Charging Accessory	AB17 Charge Times	AB18 Charge Times	1001AB01 Charge Times
AC20 quad charger	up to 4 hours	up to 6 hours	
AD20 single dock	up to 4 hours	up to 6 or 7 hours	up to 6 hours (battery must be inserted in computer)
AD21 Ethernet multidock	up to 4 hours	up to 7 hours	up to 6 hours
AD22 charge-only multidock	up to 4 hours	up to 7 hours	up to 6 hours
AV10 vehicle dock	up to 4 hours	up to 7 hours	up to 6 hours
DX2 or DX4 with FlexDock cup 1002UC02	up to 4 hours	up to 7 hours	up to 6 hours
Universal wall mount charger	up to 4 hours	up to 6 hours	up to 6 hours

Change the Battery

Before you change the battery, you need to put the computer in Hibernate (battery swap) mode. Hibernate mode turns off the radios on the computer.





- 1 Save your files and close any open applications.
- 2 Press and hold the **Power** button for about 2 seconds until the Intermec Power Options screen appears.
- 3 From the Intermec Power Options screen, select **Hibernate**.
- 4 If necessary, disconnect the handstrap from the bottom of the computer.

- 5 Press the battery release tab toward the battery until the battery is released, and then remove the battery.
- 6 Insert the top end of a fully charged battery into the computer and press down firmly on the bottom of the battery. The battery release tab makes a clicking sound when the battery is completely installed.

About Battery Status

Use the battery icon on the Title bar to view the power status of the battery.

Battery Status Icons

Icon	Status
	Battery is fully charged.
	Battery has medium charge.
	Battery is low. You need to replace the battery soon.
	Battery is critically low. You need to replace the battery now.
	Battery is charging.

The Battery status LED below the computer screen indicates the charging status of the battery.

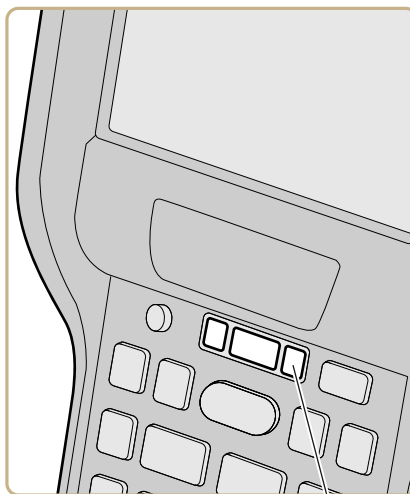

Battery status LED

Battery LED States

LED State	Description
Steady green	The computer is connected to a charger and the battery is more than 95% charged.
Blinking red	The battery is very low. The computer will soon go into Suspend mode. Charge or replace the battery.
Steady red	The computer is connected to a charger and the battery is charging.
Amber	There is a battery error. The battery is not charging because it is missing, faulty, or outside the allowable charging temperature range. If it is outside the charging temperature range, charging will resume when the battery temperature returns to the acceptable range of 5 °C to 35 °C (41 °F to 95 °F).
Off	The computer is not on external power and the battery is operating normally.

About Battery Life and Conservation

Batteries that are stored outside the computer for long periods of time slowly discharge. Intermec recommends storing the battery in a charger to maintain battery performance.

Battery Conservation Tips

When You Want to:	Do this to Save Battery Power:
Use the computer and the low battery status icon appears or the battery light turns on.	<ul style="list-style-type: none"> • Connect the computer to an external power source. • Or, save your data, press the Power button, and select Hibernate. After the computer turns off, remove the battery and insert a fully charged battery.
Stop using the computer for 5 minutes or longer.	<p>Make sure that the low battery status icon is not on the screen and the battery status LED is not on. Press the Power button and select Suspend to suspend the computer.</p> <p>If you have a CK3X, the accelerometer lets you lay the computer face down and it will automatically suspend.</p>
Store the computer for more than a day.	<ul style="list-style-type: none"> • If you are storing the computer for a few days, like over the weekend, install a charged battery or connect the computer to a power source. • If you are storing the computer for longer, remove and charge the battery, and then store both the battery and computer in a cool location. Do not place the charged battery in the computer, which runs the battery down over time even when the computer is not in use. • If you store the battery for several months, recharge the battery to keep it at peak performance.
Store the battery outside the computer.	Store the battery in a charger.

About the Status LEDs

The status LEDs turn on, turn off, or blink to indicate a specific activity on your computer.

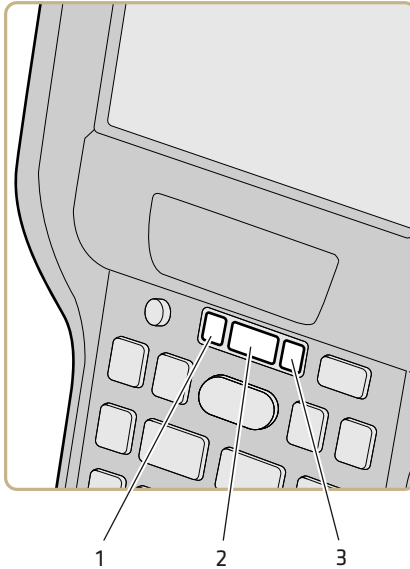

Status LED Locations

Main Status LED Descriptions

Callout	LED	Color	Description
1	Notification	Orange	Windows Mobile 6.5 notification.
2	Good Read	Green	Good read of a bar code.
		Blinking red	Bad read of a bar code.
		Blinking green	The data collection engine is processing or starting up.

Main Status LED Descriptions (Continued)

Callout	LED	Color	Description
2	Intermec Ready-to-Work™ indicator	Blue	If Intermec Terminal Emulator (ITE) is installed, the application is running and is connected to the host. If you do not have ITE, you can configure the Ready-to-Work indicator to turn on or off to indicate a healthy state.
		Blinking blue	ITE is running but not connected to the host. The computer is unhealthy.
		Off	ITE is not installed or not running. The computer is healthy.
3	Battery status	Steady green	The computer is connected to a charger and the battery is more than 95% charged.
		Blinking green	The computer is connected to a charger and the battery is between 60% and 95% charged.
		Pulsing green	The computer is connected to a charger and the battery is between 60% and 95% charged. Appears only when the Battery LED is set to 3 charging states (pulsing) in Intermec Settings.
		Steady red	The computer is connected to a charger and the battery is charging.
		Blinking red	The battery is very low, and the computer will go into Suspend mode soon. Charge or replace the battery.
		Amber	There is a battery error. The battery is not charging because it is missing, faulty, or outside the allowable charging temperature range. If it is outside the charging temperature range, charging will resume when the battery temperature returns to the acceptable range of 0 °C to 45 °C (32 °F to 113 °F).
		Off	The computer is not on external power and the battery is operating normally.

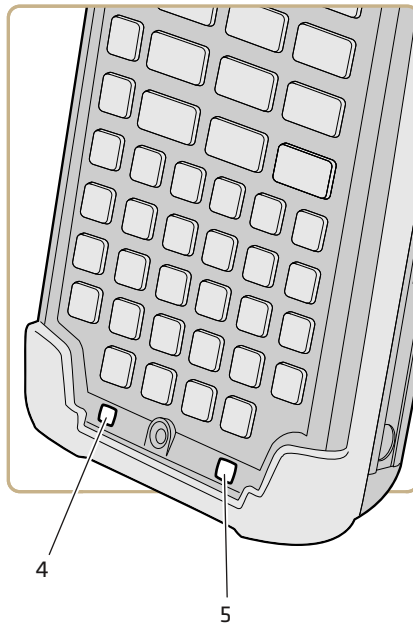

Location of Orange and Green Key LEDs

Orange and Green Key Status LEDs

Callout	LED	Color	Description
4	Orange key status	Orange	The Orange shift plane is enabled. You can type characters or access functions printed in orange on the keypad.
4	Orange/green key status	Orange or green	When the LED is orange, the Orange shift plane is enabled. You can type characters or access functions printed in orange on the keypad. When the LED is green, the Green shift plane is enabled. You can type characters or access functions printed in green on the keypad.
5	Green key status	Green	The Green shift plane is enabled. You can type characters or access functions printed in green on the keypad.

About the Keypad

The computer comes with either an alphanumeric keypad or a numeric keypad. In low light conditions, an ambient light sensor automatically turns on the keypad backlight. To conserve power, you can disable the keypad backlight. The CK3R keypads do not have the PTT key.



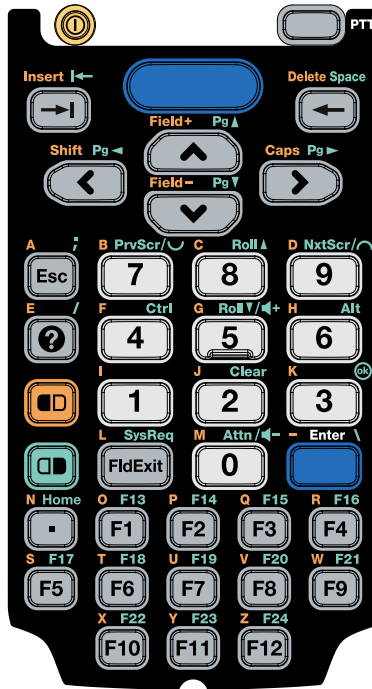

Alphanumeric Keypad

















Numeric Keypad

About the Color-Coded Keys

Use the orange  key and the green  key to access additional characters, symbols, and functions printed on the keypad overlay. After you understand how to use the color-coded keys and key sequences, you can access all of the additional features printed on the keypad overlay.

The default setting for the Green/Orange keys is **Press once to lock**. You can also set the keys to **Press twice to lock** if you do not want the Green/Orange keys to lock after pressing them one time. The information in this section assumes that you are using the default setting for the Green/Orange keys lock options. To change the setting for the Green/Orange keys, go to **Start > Settings > System > Intermec Settings > Device Settings > Keypad**.





How to Use the Color-Coded Keys

You Want to	Press	Example
Use an orange character or function printed above a key.	 key (LED turns on), and then the key with the character or function printed above it (LED stays on).	On the alphanumeric keypad, press  then  to open the device health dashboard. On the alphanumeric keypad, press  then  to type a zero (0).
Use a green character or function printed above a key.	 key (LED turns on), and then the key with the character or function printed above it (LED stays on).	On the alphanumeric keypad, press  and then  to select the ok function. On the numeric keypad, press  then  to type a backslash (\).
Unlock the green or orange key.	 or  once.	Press  or  once to unlock the key. The LED turns off.





How to Capitalize Characters

You can capitalize characters individually, or you can enable Caps Lock to type all capital letters.

To capitalize a single character

- On the alphanumeric keypad, press the  key, and then the  key to select the **Shift** function.
- On the numeric keypad, press the  key, and then the  key to select the **Shift** function.

To enable Caps Lock

- On the alphanumeric keypad, press the  key, and then the  key.
- On the numeric keypad, press the  key, and then the  key.

To disable Caps Lock

- When in Caps Lock mode, press  key to disable Caps Lock.

About the Power Button

When you press the **Power** button for about 2 seconds and hold it, the Intermec Power Options screen appears with a list of power options. If you do not select a power options setting, the currently selected action (the button outlined in bold) occurs after the timeout. Hibernate does not appear as an option if the computer is connected to external power.

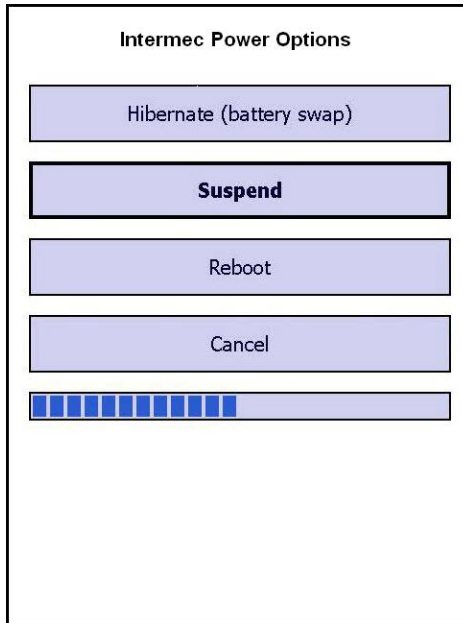

The Intermec Power Options Default Screen

Use the next table to understand the Intermec Power Options and what settings are available for your computer.

Intermec Power Options

Option	Description
Hibernate (battery swap)	High power saving mode. The computer saves the current system state, registry, and file system and then powers off all radios and internal devices. You can wake the computer by pressing the Power button or connecting the computer to external power.
Suspend	Medium power saving mode. When on battery power, Suspend mode saves the current system state and then turns off most radios and internal devices. The WWAN radio remains in a lower power state and can still receive calls. When the computer is connected to external power, Suspend mode turns off the screen but leaves all radios on. You can wake the computer by pressing the Power button, pulling the scanner trigger, or scheduling an event such as an alarm. If the computer is on battery power during Suspend mode, you can also wake the computer by connecting it to external power.
Reboot	The computer does not save the current system state, but the registry and file systems are saved. The computer shuts down all running processes and restarts.
Cancel	Cancels the Intermec Power Options menu.
Screen Off	Lowest power saving mode. The screen turns off, but the radios and internal devices stay on. Tap the screen to turn it back on.
Shutdown	Very high power saving mode. The computer turns off everything. You must press Power or apply external power to restart the computer.

If you are using WPA or 802.1x security, the computer may need to reauthenticate before it resumes your application. The Real Time Clock (RTC) will persist through all of the power options as long as it receives power from the Real Time Clock battery.

The Intermec Power Options screen is customizable. You can use Intermec Settings to determine which options are available to end users, the timeout until the default choice is selected, the default action if no option is selected, or to disable the Power Options Screen.

About the Screen Backlight

The computer has an ambient light sensor that automatically adjusts the brightness of the screen backlight to ensure that the screen is readable, while conserving power. By default, the screen turns off when there is no activity on the computer. To resume activity, press a key or tap the screen.

You can configure the brightness and the timeout of the screen backlight.

Configure the Screen Backlight Timeout

Use the Start menu to configure the timeout for the screen backlight. The Power option settings shown below suspend the device after a specific amount of time. To actually turn off the screen, go to **Start > Settings > System > Intermec Settings > Device Settings > Power Management > Battery Power > Screen turns off after**.

- 1 Tap **Start** > **Settings** > **Power**.
- 2 Tap **Advanced** on the horizontal scroll bar.

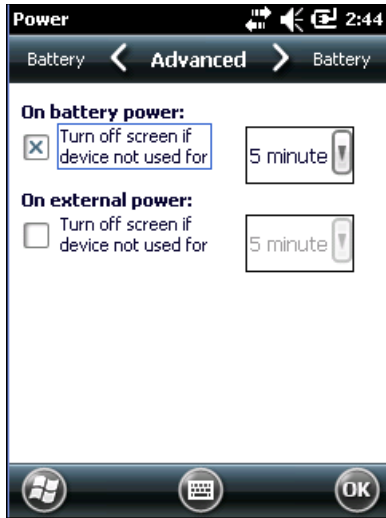

- 3 Select the screen power off settings that you want the computer to use when it is on battery power or external power.
- 4 Tap **OK**.

Configure the Screen Backlight Brightness

Use Intermec Settings to configure the brightness of the screen backlight. You can also set the amount of time that the backlight remains on before dimming automatically to save power.

- 1 Tap **Start** > **Settings** > **System** > **Intermec Settings**.
- 2 Tap **Device Settings** > **Backlight** > **Display**.
- 3 Select a brightness level. The default value is +1.
- 4 To set the amount of time that the screen backlight remains on before dimming automatically, select a setting from the **Dim backlight after (on power)** list. By default the backlight does not dim automatically.
- 5 Tap **OK** and exit Intermec Settings.

About the Audio Features

Your mobile computer has a speaker, a microphone(CK3X only), and several software tools for configuring the volume of sounds.

Adjust the Speaker Volume

The computer volume includes sounds you hear when you tap the screen or scan bar codes with a scanner.

- 1 Tap the Title bar at the top of the screen.
- 2 Tap the Volume icon .
- 3 Use your stylus to adjust the volume slider, or use the side volume buttons to change the volume setting.
- 4 Tap **OK**.

About the Push-to-Talk Feature

You can use the Push-to-Talk (PTT) feature on the CK3X to:

- record audio on your computer.
- use your computer as a two-way radio.

Record Audio

Use the Push-to-Talk (PTT) key to record audio on your computer.

- 1 If your computer is in suspend mode, press the **PTT** key to turn on the computer.
- 2 Press the **PTT** key to start the Notes application in audio note mode, and then tap the **Record** button to start recording.
Or, press and hold the **PTT** key to start the Notes application in audio note mode and start recording.
- 3 To stop recording, release the **PTT** key.

Use the Computer as a Two-Way Radio

Use the Push To Talk (PTT) feature with an audio application, such as iTalkie™, to communicate with other computers over the 802.11 radio network. For more information about the iTalkie application, go to www.tabletmedia.com/iTalkie.html.

- After you install an audio application, press and hold the **PTT** key to talk to another computer.

How to Read Bar Codes

The computer has an internal imager that can read 1D and 2D bar code symbologies, composite symbologies, and postal codes:

- The CK3R computer has an EA31 area imager.
- The CK3X computer has either an EA30 area imager, an EX25 near-far range area imager, or an 5603ER(extended range) area imager.

You can also connect the computer to these external scanners:

- Cordless scanners, such as the SF51, SG20, and SR61, using Bluetooth communications
- Tethered scanners, such as the SG10, SG20, SR30, and the SR61, using a CK3 RS-232 adapter (Model AA21)

Read Bar Codes with the Imager

All of the imagers support omni-directional scanning and include an aiming beam to help you correctly frame bar codes.

Before you start reading bar codes, use Intermec Settings to:

- enable only the bar code symbologies that you need.
- choose the predefined imager mode that best suits your environment.

Predefined Mode	For Scanning
1D	Only 1D labels.
1D and 2D Standard	(Default) All types of bar code labels.
1D and 2D Bright Environment	In high ambient light, such as outdoors in sunshine.
1D and 2D Reflective Surface	Glossy Labels.

- 1** Point the imager window at the bar code and hold the computer steady a few inches from the label.
- 2** Press the **Scan** button or pull the scan handle trigger. The illumination beam, laser pointer, or frame appear.

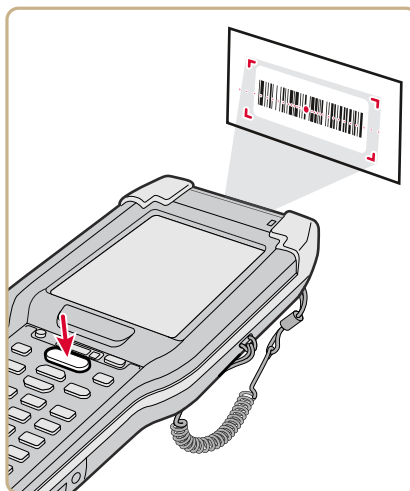

For near or close-in scanning distances of 30 cm (11.8 in) or less, use the laser pointer as a guide and aim slightly to the right of the center of the bar code. Make sure the illumination beam covers the bar code you are trying to decode.

For standard and long range scanning distances of 30 cm (11.8 in) or more, use the laser pointer as a guide and aim toward the middle

of the bar code. Make sure that the illumination beam covers the bar code you are trying to decode.

When the imager successfully reads a bar code label, you hear a high beep, and the Good Read LED turns on briefly.

- 3 Release the **Scan** button or trigger.

Connect a Bluetooth Scanner

You can connect the computer to an Intermec Bluetooth scanner, such as the SF51, SG20, or SR61. Make sure that the Bluetooth radio in the computer is turned on before you try to connect to a scanner.

- 1 Tap **Start > Settings > System > Wireless Scanning**.

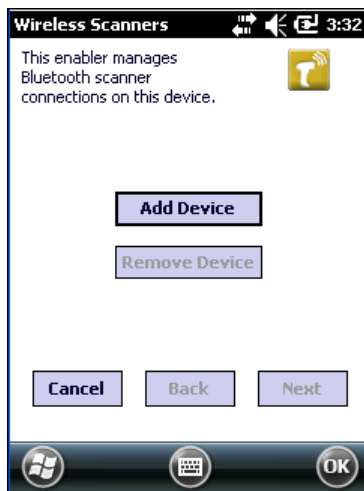

- 2 Tap **Add Device**.
- 3 Select **Quick Connect**, **Search**, or **Manual**. Follow the instructions on the screen to add a Bluetooth scanner.

After you add a Bluetooth scanner, you can configure scanner settings and parameters in Intermec Settings.

Connect a Tethered Scanner

To connect a tethered scanner to your computer, use a CK3 RS-232 Adapter (Model AA21) and scanner RS-232 interface cable. For more information, contact your local Intermec representative.

- 1** Connect the CK3 RS-232 adapter to the tethered scanner using the scanner RS-232 interface cable.
- 2** Connect the adapter to the CK3.
- 3** Tap **Start > Settings > System > Intermec Settings > Data Collection > Tethered Scanner** to configure the settings for the tethered scanner.

Insert a microSD Card

Insert a micro Secure Digital (SD) card to increase file storage and install software. The mobile computer supports microSD cards that hold up to 32 GB of information. The microSD card slot is located in the battery compartment.

- 1** Press the **Power** button to turn off the computer.
- 2** Remove the handstrap and the battery.

- 3 Open the card cover door.

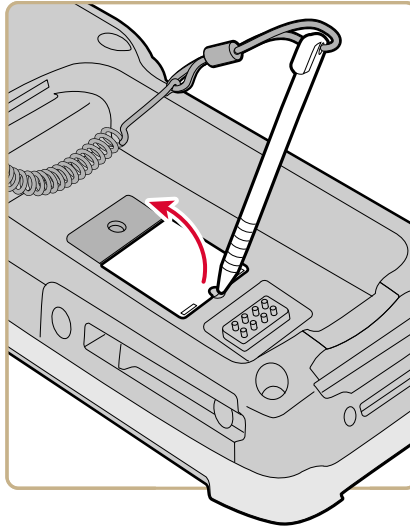

- 4 Slide the microSD card cover towards the OPEN position and lift the cover.

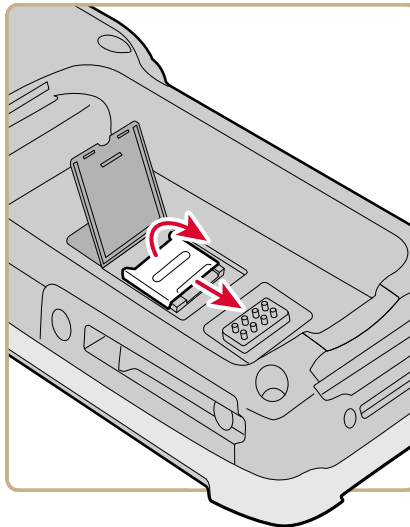

- 5 Insert the microSD card.

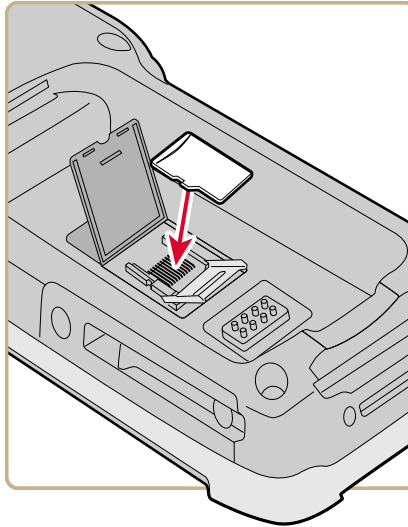

- 6 Close the microSD card cover and slide it towards the LOCK position.
- 7 Close the card cover.
- 8 Use the stylus to press the **Reset** button in the battery compartment.

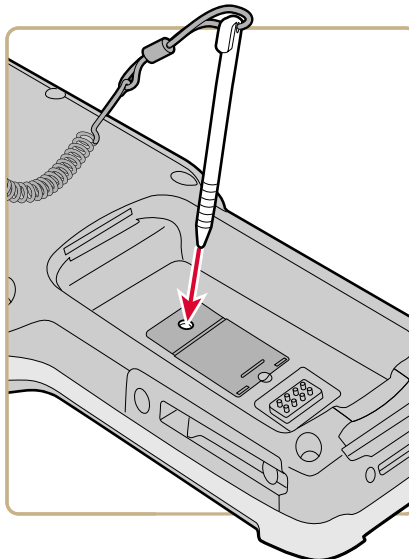

- 9 Install the battery. Press down firmly on the bottom of the battery, and make sure that the battery release tab is fully engaged.
- 10 Attach the handstrap.
- 11 Press the **Power** button. The computer cold boots.

How to Transfer Files

To transfer files you need to physically connect your mobile computer to your PC and install either Microsoft ActiveSync (Windows XP or earlier) or Windows Mobile Device Center (Windows Vista or Windows 7) on your PC. ActiveSync and Windows Mobile Device Center are free applications available from the Microsoft website at www.microsoft.com/downloads.

Use one of these accessories to connect your mobile computer to your PC:

- AD20 single dock
- USB cable (P/N 236-297-001)
- CN51 Desktop USB Adapter
- AD27 Single Dock

Set Up the Computer as a Mass Storage Device

Use the computer as a mass storage device so you can easily copy files to and from the mobile computer and your desktop PC.

- 1 Go to www.datalight.com and download the Reliance Nitro Windows Driver (RNWD).
- 2 Connect the mobile computer to your desktop PC using a USB cable or USB-capable accessory.
- 3 On the mobile computer, tap **Start > Settings > System > Intermec Settings**.
- 4 Tap **Device Settings > USB**.
- 5 From the USB function driver menu, select **Mass storage - Flash File Store** and tap **OK**.
- 6 Copy files to and from your desktop PC to the mobile computer.

CK3 Options and Accessories

You can use these accessories (sold and ordered separately) with the CK3. To order accessories, contact your local Intermec sales representative.

CK3 Options and Accessories

Accessory	Description
Battery (AB17, AB18, 1001AB01)	The AB17 standard battery, the AB18 extended battery, and the 1001AB01 smart battery, provide main power to the CK3.
Quad Charger (AC20)	The AC20 quad charger charges up to four AB17 or AB18 batteries at one time.
Single Dock (AD20)	The AD20 single dock powers your CK3 Mobile Computer and charges a spare battery (AB17 or AB18) separately. The single dock also provides client and host USB connectivity.
Ethernet Multidock (AD21)	The AD21 Ethernet multidock provides Ethernet connectivity and power to up to four CK3 computers at one time.
Charge-Only Multidock (AD22)	The AD22 charge-only multidock charges up to four CK3 computers at one time.
Vehicle Dock (AV10)	Use the AV10 vehicle dock to hold and charge your CK3 while you are using it on a vehicle.
Vehicle Battery Adapter (AE33)	Use the AE33 vehicle battery adapter to provide power to your CK3 from your vehicle. To use the vehicle battery adapter, you also need the AA23 power adapter.
FlexDock battery cup 1002UC02 with the DX2 or DX4	Use the DX2 or DX4 FlexDock with battery cup 1002UC02 to charge any of the supported CK3 batteries.
RS-232 Snap-On Adapter (AA21)	Use the RS-232 adapter to connect RS-232 devices to your CK3.
Power Snap-On Adapter (AA23)	Use the power adapter to provide power to your CK3 from an external power supply.

CK3 Options and Accessories (Continued)

Accessory	Description
Scan Handle	The scan handle provides you with an alternate way to hold the CK3 and scan bar code labels using a convenient scanning trigger.
Vehicle Holder	Use the vehicle holder to store your CK3 when you are not using it.
Holster	The holster provides you with a convenient way to carry your CK3 when you are not using it. There are holsters for a CK3 with a handle or without a handle.
IP30 and SR61 Battery Pack Adapter	The IP30 and SR61 battery pack adapter lets you charge an AB3 battery using the CK3 quad charger (AC20) or CK3 single dock (AD20).
CK3 With IP30 Vehicle Holder	If you attached an IP30 to your CK3, you can use the vehicle holder to store your CK3 when you are not using it.
Universal Wall Mount Charger Kit	Provides interchangeable country plugs to connect power to the computer for charging. Includes the USB charging cable (P/N 236-297-001).
Protective Boot	A rubber boot to protect the computer from damage.
Ethernet Adapter Model 1004UA01 (need the AD20)	Use the Ethernet adapter model 1004UA01 with the AD20 single dock to provide an Ethernet connection for the computer.
Modem Adapter Model 1004UA02 (need the AD20)	Use the modem adapter model 1004UA02 with the AD20 single dock to provide a modem connection for the computer.
USB Charging Cable (P/N 236-297-001)	Use the USB charging cable to connect your computer to the desktop using ActiveSync or to directly charge the computer.

2

About the User Interface and Intermec Applications

Use this chapter to learn about the Windows Embedded Handheld user interface and how to interact with the screen. You can also use this chapter to learn about the Intermec applications on your computer, as well as additional applications you can download.

About the User Interface

The Windows Embedded Handheld 6.5 operating system provides a touch-friendly and easy to navigate user interface.

About the Home Screen

When you turn on your mobile computer, the Home screen is the first screen that appears after language provisioning is complete.

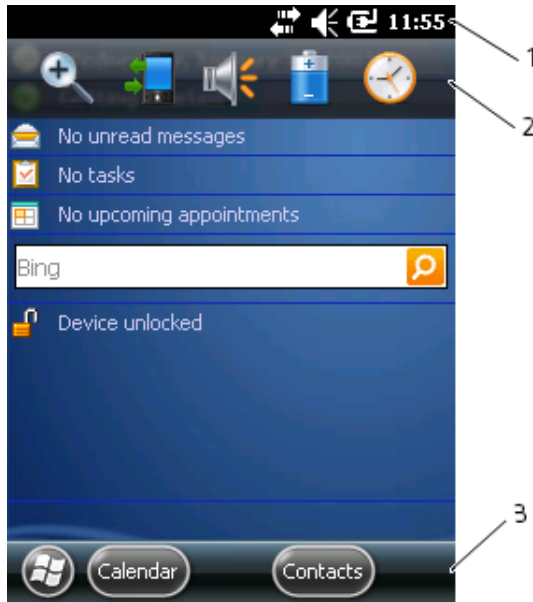

The Windows Embedded Handheld 6.5 Home Screen

Home Screen Navigation Bars

Callout	Navigation Bar	Description
1	Title bar	Use the Title bar icons to view the current status of information such as signal strength and battery power remaining.

Home Screen Navigation Bars (Continued)

Callout	Navigation Bar	Description
2	Horizontal scroll bar	A horizontal scroll bar appears when you tap the Title bar. The horizontal scroll bar makes it easy to access the applications associated with the Tile bar icons. The horizontal scroll bar also contains a magnifier which improves the touch experience by making parts of the screen large enough to tap with your finger. The horizontal scroll bar also replaces tabs within Windows screens and allows for easier navigation.
3	Tile bar	Use the Tile bar to access the Start menu, navigate within applications, and open the SIP.

The Clock & Alarms screen shows how the horizontal scroll bar appears when you open an application.

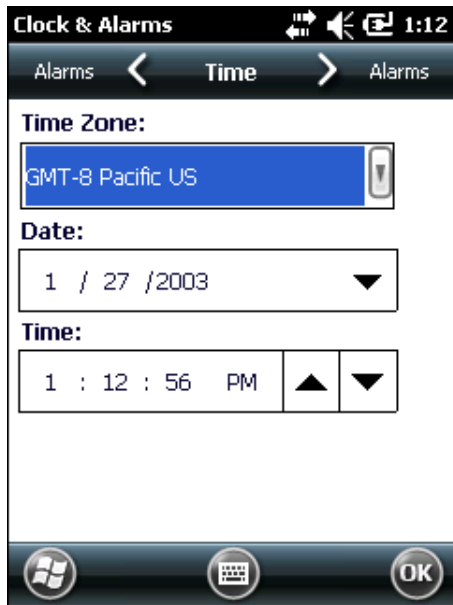

Clock & Alarms Screen with Horizontal Scroll Bar

About Screen Gestures

The Windows Embedded Handheld 6.5 interface supports the use of gestures with the finger or stylus to move around the screen.









Screen Gestures

Gesture	Description
Tap	Represents the left click of a mouse.
Double-tap	Represents the left double-click of a mouse.
Hold	Represents the right click of a mouse when you press and hold on the screen and a context menu appears.
Flick	Initiates scrolling in the direction (horizontal or vertical) the finger or stylus moves across the screen.
Pan	Press and hold on the screen and then drag in any direction.



















Title Bar Status Icons

Tappable icons on the Title bar immediately show you the status of your network, the volume, the battery, and the time.



Title Bar Status Icons

Icon	Description
	You have a new notification.
	You have a new text message.
	You have a new email message.
	You have a new instant message.
	An alarm is set.
	(CK3X)Microphone is on.
	Internet call is in progress.
	Bluetooth is on.

Title Bar Status Icons (Continued)

Icon	Description
	Bluetooth headset is detected.
	ActiveSync connection is established.
	ActiveSync synchronization is in progress.
	There is a problem with the ActiveSync synchronization.
	Connected to a Wi-Fi network.
	Connected to a Wi-Fi network, and other networks are detected.
	Wi-Fi synchronization is in progress.
	Other Wi-Fi networks are detected.
	Information about a new Wi-Fi network is available.
	Wi-Fi is on, but not connected to a network, and other networks are detected.
	Wi-Fi is on, but not connected to a network, and no networks are detected.
	A network connection is active.
	A network connection is inactive.
	The volume is on.
	The volume is off.
	The battery has full charge.
	The battery has a high charge.
	The battery has a medium charge.
	The battery has a low charge.

Title Bar Status Icons (Continued)

Icon	Description
	The battery has a very low charge.
	The computer is attached to external power and the battery is charging.
	No battery is installed in the computer.

Calibrate the Screen

If the touch screen does not respond as expected when you tap it with the stylus, you may need to calibrate the screen.

- 1 Tap **Start** > **Settings** > **Systems** > **Screen**.
- 2 Tap **Align Screen** and follow the instructions to align the screen.
- 3 Tap **OK**.

About Intermec Applications

Intermec provides several useful applications to help you configure, troubleshoot, and connect your computer to other devices and networks. You can also download additional applications from the Intermec website to help you use all of the features of your computer.











Intermec Applications on the Computer

Intermec applications help you configure, troubleshoot, and connect your computer to other devices and networks.

Intermec Applications Available on the Computer

Icon	Application	Description
	Bluetooth Audio	Use the Bluetooth Audio application to connect to a Bluetooth headset or hands-free device.

Intermec Applications Available on the Computer (Continued)

Icon	Application	Description
	CloneNGo	Use CloneNGo to configure basic device settings on multiple client computers from one master computer. For more information, see the CloneNGo User Guide .
	Intermec Settings	Use Intermec Settings to configure your computer. You can use Intermec Settings to individually configure a computer or you can use it through SmartSystems to configure all of your computers.
	ISpyWiFi	Use ISpyWiFi to check your 802.11 status and diagnose issues with the connection.
	Profile Settings	Use Profile Settings to easily configure the computer for a specific use. You can choose predefined values for the Power, Camera, and Scanning settings.
	ScanDiagnostic	Use the ScanDiagnostic application to troubleshoot problems with the internal or external scanner.
	Sensor Calibration	Use the Sensor Calibration application to demonstrate the accelerometer.
	Wireless Center	Use the Wireless Center to turn the phone and radios (Wi-Fi, Bluetooth) on and off and configure settings for each radio.
	Wireless Printing	Use the Wireless Printing application to connect to a Bluetooth printer.
	Wireless Readers	Use the Wireless Readers application to connect the computer to the IP30 RFID reader.
	Wireless Scanning	Use the Wireless Scanning application to connect to a Bluetooth scanner.

Downloadable Intermec Applications for the Computer

You can download Intermec applications to extend the capabilities of the computer. You may need to purchase an Intermec license to run some applications. To find an application, go to www.intermec.com > **Support** > **Downloads**.

About Features Demo

Intermec Features Demo provides a simple way to explore the key features of your mobile computer. Features Demo applications demonstrate scanning, document imaging, image capture, and printing functionality. Many of the applications that are part of Features Demo also have separate full-featured versions that you can download and license for your computer. For more information on Features Demo, see [Intermec Features Demo User Guide](#).

About Intermec Browser

Intermec Browser is a web browser designed for Intermec computers and is compatible with Microsoft® Internet Explorer® 6 (IE6) and Pocket Internet Explorer (PIE). This locked-down application deliberately limits normal web browser functionality. For example, users cannot exit the program, type URLs, or use the **Back** button. You can configure Intermec Browser for your specific application requirements and you can design your own web pages.

You can download and use Intermec Browser for free for a 60-day evaluation period. After the evaluation period expires, you need to purchase a license. For more information on Intermec Browser, see the [Intermec Browser User Manual](#).

About Intermec HTML5 Browser

Intermec HTML5 Browser provides a free open-platform application environment for Intermec computers. You can now run the same cross-platform web applications on an Intermec computer that you can run on iOS and Android devices. Intermec HTML5 Browser also lets you run applications while the computer is connected to the web or while it is offline. For more information on the HTML5 Browser, see the [Intermec HTML5 Browser User Guide](#).

About Intermec Launcher

Intermec Launcher is a Microsoft Windows application, designed for Intermec mobile computers, that provides a platform from which other applications may be launched while attempting to provide a locked-down environment. You can configure Intermec Launcher for your specific application requirements. You can download and use Intermec Launcher for a 60-day evaluation period. After the evaluation period expires, you will need to purchase a license. For more information on Intermec Launcher, see the [Intermec Launcher User Guide](#).

About Intermec Terminal Emulator

Intermec Terminal Emulator (ITE) is Intermec's popular terminal emulation client designed for enterprise-level data collection. In a single client, ITE supports multiple emulation protocols. Its features include session persistence, remote management and configuration, and multiple security options. ITE provides a consistent user interface and a common menu structure (Intermec Settings), simplifying the use and management of applications running on Intermec mobile computers.

You can download and use ITE for free for a 60-day demo period. During the demo period, a demo mode message box appears each time you launch ITE. Press **Enter** to close the message box. When the demo period expires, you need to purchase a license. For more information on ITE, see the [Intermec Terminal Emulator \(ITE\) User Guide](#).

About SmartSystems

Intermec SmartSystems™ is an easy-to-use centralized software platform. With SmartSystems, IT Administrators and Integrators can perform hands-free provisioning and deploy and manage Intermec devices.

SmartSystems provides a consistent way to manage Intermec devices located on-site or remotely to maximize IT resources and lower the total cost of ownership for Intermec data collection equipment. SmartSystems Foundation can be downloaded at no charge from the Intermec website. For more information, visit www.intermec.com/SmartSystems.

3

Configure the Computer

Use this chapter to learn about the available methods for configuring your computer and how to use Intermec Settings. You can also use this chapter to learn how to configure network communications and wireless security.

How to Configure the Computer

You can configure many parameters on the computer such as the bar code symbologies it decodes or the network settings. The values you set for these parameters determine how the computer operates.

There are several ways to configure the computer:

- Directly on the computer. You can use Intermec Settings directly on the computer to change only the settings on that computer.
- Remotely using Intermec SmartSystems. With SmartSystems, you can remotely configure all of your mobile computers as well as other SmartSystems-enabled Intermec devices and peripherals.
- Using a third-party device management product that supports the computer and Intermec Settings, such as Soti MobiControl or Wavelink Avalanche.
- Using configuration bundles that you create with SmartSystems.

About Intermec Settings on the Computer

Use Intermec Settings to configure parameters for Intermec applications on the computer, as well as some device-specific parameters like volume. You can configure parameters for important functions like data collection and communications. You can also password protect Intermec Settings to prevent users from making changes to the configuration settings.

Start Intermecc Settings

Use Intermecc Settings to configure parameters for Intermecc applications and some device-specific parameters. Intermecc Settings is located on the System screen.

- Tap **Start > Settings > System > Intermecc Settings**. The Intermecc Settings Main Menu appears.

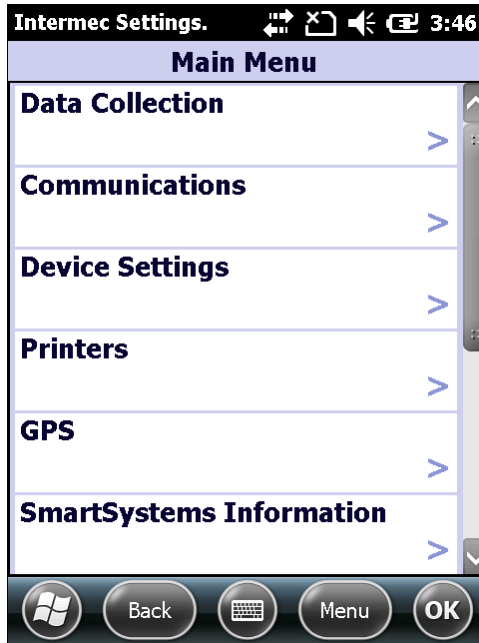

About the Structure of Intermecc Settings

Use the following tables to help find the parameters in Intermecc Settings that you want to configure. Each table contains the parameters for one of the Intermecc Settings Main Menu options.

Most parameters are saved as soon as you tap **OK**. Some settings, such as Security Choice, require you to reboot the computer for the changes to take effect.

Data Collection Menu

Data Collection Options	Parameters You Can Configure
Internal Scanner	<ul style="list-style-type: none"> • Enable Scanner Port • Symbologies • Scanner Settings • Imager Settings • Decode Security
Dock Tethered Scanner	<ul style="list-style-type: none"> • Tethered-Configure on Connect • Enable Scanner Port • Enable Scanner Auto-detect • Symbologies • Scanner Settings • Scanner Port Settings • Imager Settings • Decode Security
Bluetooth Scanner	<ul style="list-style-type: none"> • BT-Configure on Connect

Communications Menu

Communications Options	Parameters You Can Configure
Device Name	Device Name
802.11 Radio	<ul style="list-style-type: none"> • Radio Enabled • Security Choice • Security Settings (Funk or Microsoft) • IP Settings • Certificates • Radio Measurement • Radio Bands (CK3X only) • Allow Security Changes
Ethernet Adapter	IP Settings
Bluetooth	Bluetooth Settings

Device Settings

Device Settings Options	Parameters You Can Configure
Backlight	Display and Keypad Settings
Date and Time	Date and Time Settings
Good Read	<ul style="list-style-type: none"> • Internal Scanner • Tethered Scanner • Bluetooth Scanner • RFID Scanner
IDL Runtime Versions	Read-only
Keypad	Button Remapping
Language	Save Current Language When Updating OS
Power Management	<ul style="list-style-type: none"> • Power Button • Battery Power • External Power • Device Off Sensor (CK3X only)
Profile Settings Application	Whether these parameter options appear in Profile Settings: <ul style="list-style-type: none"> • Power • Scanning
Screen	<ul style="list-style-type: none"> • Screen Rotation • Screen Rotation Sensor (CK3X only)
Security	Enables or disables ActiveSync, the SD card, A USB external drive, and image capture.
Sounds	<ul style="list-style-type: none"> • Beeper and Voice • Headset Beeper • Screen Taps • Key Clicks
System Component Versions	Read-only
USB	USB Function Driver

Printers Menu

Printer Options	Parameters You Can Configure
Printer (connected through Bluetooth)	Printer Settings



Note: The Printers menu displays settings for Bluetooth connected printers. The settings that appear in the menu are dependent on the printer that is paired with the device. The printer needs to be using the Wireless Printing application.

Core Messaging Service Menu

Core Messaging Service Options	Parameters You Can Configure
Server IP	Read-only
Associated Server IP	Associated Server IP
Broadcast Name	Broadcast name
Port	Read-only
Keep Alive Ping Interval	Keep Alive Ping Interval

SmartSystems Information Menu

SmartSystems Information Options	Parameters You Can Configure
Identity	Identity Information (hardware version, firmware version, OS version, and so on) (Read-only)
Administrator	Administrator Settings (name, phone, and email)
Location	Location Settings (country, state, city, campus, and detail)
Information	Device Notes (Read-only)

Device Monitor Menu

Device Monitor Options	Parameters You Can Configure
Device Health Controls	<ul style="list-style-type: none"> • Enable Health Data Collection • Enable Device Health Application • Enable Blue Light (LED) • Set Rule File Location • Collect Abuse History • Set Data Refresh Periods
Device Health Screen Captures	<ul style="list-style-type: none"> • Directory • Screen Captures Allowed
Disabled Executables	Read-only
Device Wipe	<ul style="list-style-type: none"> • Enable Wipe • Interval

License Manager Menu

License Manager Options	Parameters You Can Configure
About	Read-only
License Vault	Read-only

Virtual Wedge Menu

Virtual Wedge Options	Parameters You Can Configure
Enable Virtual Wedge	Enable Virtual Wedge
Virtual Wedge Method	Virtual Wedge Method (Adapt to application, character mode, or block mode)
Bar Code Scanner Wedge	<ul style="list-style-type: none"> • Bar Code Scanner Grid • Label Encoding (Code page)
Magstripe Reader Wedge	Magstripe Reader Grid

Virtual Wedge Menu (Continued)

Virtual Wedge Options	Parameters You Can Configure
RFID Reader Wedge	<ul style="list-style-type: none">• Read Command• User-Defined Read Command• Date• Time• Tag Separator• User-Defined Tag Separator• End of Message• User-Defined End of Message• RFID Reader Grid

Location Services Menu

Location Services Options	Parameters You Can Configure
Server	<ul style="list-style-type: none">• Port• Enable Server
Virtual GPS	Virtual GPS Settings

RFID Menu

RFID Options	Parameters You Can Configure
Enable RFID Service	<ul style="list-style-type: none">• Enable RFID Service• Application Connection• Reader 1

How to Navigate in Intermec Settings

You can easily navigate through the screens in Intermec Settings to find the parameters you need to configure:

- Tap inside a text field to be able to enter text into it.
- Tap a field once to select it.
- If you see a ... next to a menu item, there is only one more screen available. Tap the menu item to access this screen.
- If you see a > next to a menu item, there are more screens available in the next level. Tap the menu item to access these screens.

- Use the up and down arrow keys to move up and down the menu.
- To move back a level in the menu, tap **Back** or **Cancel** on the Tile bar.
- To exit Intermec Settings, tap **Menu** > **Exit** or **OK**.

Enable Intermec Settings Password

You can protect Intermec Settings from other users by enabling a password.

- 1 Start Intermec Settings.
- 2 Tap **Menu** > **Enter Password**.
- 3 Select the **Enable password** checkbox.
- 4 Type your password in the **Enter:** text box.
- 5 Retype your password in the **Confirm:** text box.
- 6 (Optional) Select the **Use password to protect CAB Installation** if you want to restrict the installation of .cab files.
- 7 Tap **OK**.

Restore Default Settings

The easiest way to restore default settings on your computer is to use Intermec Settings. You can restore all default settings on your computer or restore default settings for a specific menu item in Intermec Settings.



Note: When you restore default settings, only the settings for visible menu items are restored. The settings for hidden menu items are not affected.

- 1 Start Intermec Settings.
- 2 Restore the default settings:
 - To restore all default settings, tap **Menu** > **Restore all Defaults**.
 - To restore default settings for one menu item, navigate to the menu and tap **Menu** > **Restore Menu Defaults**.

- 3 When prompted, tap **Yes** to restore the default settings.
If you are prompted to refresh the computer, tap **Yes**.

Configure the Computer Remotely with SmartSystems

You can use Intermec Settings from a SmartSystems console to remotely configure all the Intermec computers. For help using Intermec Settings, click **Help > Contents**. For information on all the parameters in Intermec Settings, see the [Intermec Settings Command Reference Manual](#).

- 1 In the SmartSystems console, select a computer and then right-click on it. A list appears.
- 2 Select **Start Intermec Settings**.
- 3 Configure the settings you want to change. As you select parameters, help for each parameter appears in the upper right pane.
- 4 When you are done making changes, select **File > Save Settings**.

About Network Communications

You can use the mobile computer in your wireless or wired data collection network. You can connect your computer using:

- 802.11 radio communications.
- Ethernet communications.
- Bluetooth communications.
- USB and serial communications.

Configure 802.11 Radio Communications

The CK3R has an 802.11b/g/n radio and the CK3X has an 801.11a/b/g/n radio to transfer data using wireless communications. Before you configure radio communications, you need to have your wireless network set up including your access points.

By default, the 802.11 radio is disabled. Use the following procedure to enable the Wi-Fi radio using Intermec Settings.

- 1 Tap **Start > Settings > System > Intermec Settings**.
- 2 From the Intermec Settings main menu, tap **Communications > 802.11 Radio > Radio Enabled**.
- 3 Select the **Radio Enabled** check box and tap **OK**. By default, the computer uses Funk security and enables DHCP.

To enable both the 2.4 GHz and 5.0 GHz bands for the 802.11a/b/g/n radio, from the Intermec Settings 802.11 Radio menu, tap **Radio Bands** and select **a/b/g (2.4 and 5.0 GHz)**.

- 4 Use Intermec Settings to configure the parameters you need to use for communications with your network.
- 5 Configure 802.11 security.

About Bluetooth Communications

The CK3 is Bluetooth-enabled, which lets you connect to other Bluetooth devices such as:

- scanners.
- printers.
- audio devices.
- wireless readers.

You need to turn on the Bluetooth radio before you can discover and connect to Bluetooth devices. By default, the radio is turned off.

The Bluetooth radio maintains its current state through a warm or cold boot and maintains virtual COM ports. If you clean boot the CK3, you must recreate pairings to devices.

You can also access Bluetooth settings using Intermec Settings.

Turn On the Bluetooth Radio

You need to turn on the Bluetooth radio in the mobile computer before you can discover and connect to Bluetooth devices. By default the radio is turned off.

- 1 Tap **Start > Settings > Bluetooth > Mode** tab.
- 2 Tap **Turn on Bluetooth**.

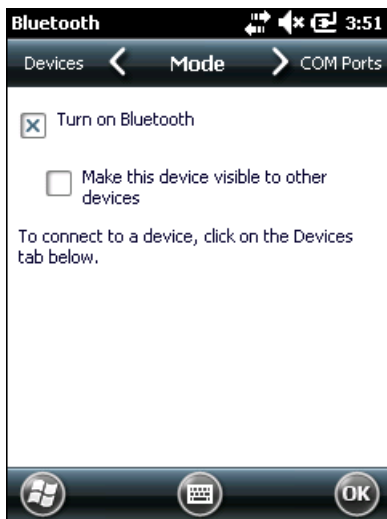

- 3 (Optional) If you want this computer to be visible to other Bluetooth devices, tap **Make this device visible to other devices**.
- 4 Tap **OK**.

Connect a Bluetooth Scanner

You can connect the computer to an Intermec Bluetooth scanner, such as the SF51, SG20, or SR61. Make sure that the Bluetooth radio in the computer is turned on before you try to connect to a scanner.

- 1 Tap **Start > Settings > System > Wireless Scanning**.

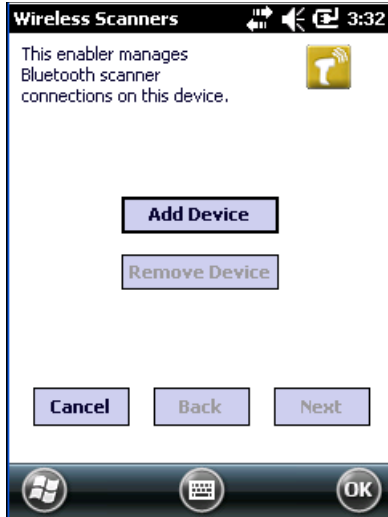

- 2 Tap **Add Device**.
- 3 Select **Quick Connect**, **Search**, or **Manual**. Follow the instructions on the screen to add a Bluetooth scanner.
After you add a Bluetooth scanner, you can configure scanner settings and parameters in Intermec Settings.

Create a Configuration Bar Code with EasySet

To connect a Bluetooth scanner to the computer, you can read a configuration bar code with the scanner. You create the bar code using Intermec EasySet.



Note: To create the configuration bar code, you need the computer Bluetooth address. The address is on the labels located on the outside of the computer shipping box, and on the packet of information that ships with the computer.

- 1 Go to the Intermec website at www.intermec.com.
- 2 Click the **Products** tab.
- 3 On the Products page, click **Computers > Handheld Computers > your computer model number > the Downloads tab > Easyset ver. 5.x.x.x**.
- 4 Follow the instructions to download and install EasySet.
- 5 Open EasySet and select **Interface > Bluetooth > Connect/disconnect > Compose BT address**. The Bluetooth - Connect/disconnect - Compose BT address screen appears.
- 6 Enter the BT address listed on the labels that shipped with your computer.
- 7 Click **OK**.

Connect to a Bluetooth Printer

You can connect the computer to a Bluetooth printer and use the computer to wirelessly print to the printer. Make sure that the Bluetooth radio in the computer is turned on before you try to connect to an Intermec Bluetooth printer, such as the PB21, PB50, or PR3. To configure your computer for printing wirelessly using Bluetooth, you need to:

- create an application that opens the wireless printing COM port on the computer. For help, see the Bluetooth Resource Kit, which is part of the Intermec Developer Library (IDL), available from the Intermec website at www.intermec.com/idl.
- select the current Bluetooth printer on the computer. For help, see the next procedure.



Note: You can also print wirelessly using Microsoft APIs with Bluetooth extensions for Winsock and Bluetooth virtual COM ports. For help, see the Bluetooth Resource Kit documentation.

1 Tap Start > Settings > System > Wireless Printing.

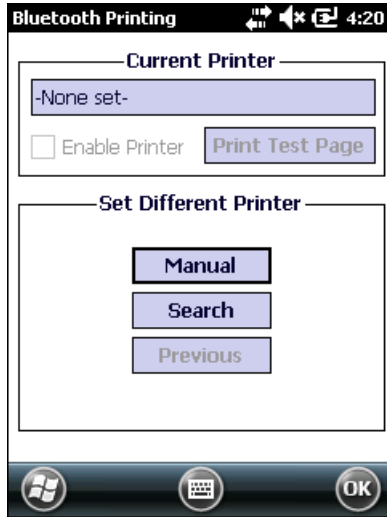

- 2 Tap Search** to find a printer, or tap **Manual** to enter a device address. Follow the onscreen instructions to select the current Bluetooth printer.
- 3 (Optional) Tap Print Test Page.** The printer prints out a test page.

Connect a Bluetooth Audio Device

Use the Bluetooth Audio applet to discover, activate, and connect to Bluetooth audio devices such as a headset.

- 1 Select **Start > Settings > System > Bluetooth Audio**. The Bluetooth Audio screen appears.

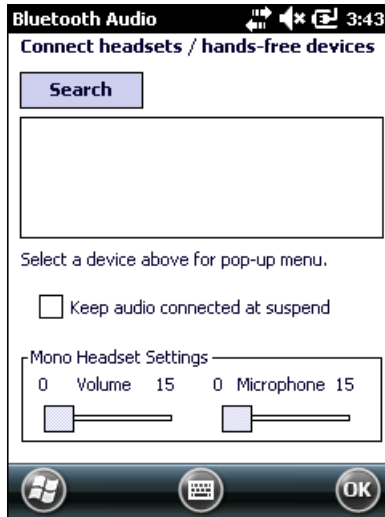

- 2 Follow the onscreen instructions to discover and connect to a Bluetooth audio device.



Note: If a wired audio device such as a headset is already connected to the computer, Bluetooth audio receives priority when a Bluetooth audio device is connected.

Connect to a Wireless Reader

You can connect the computer to a Bluetooth RFID reader, such as the IP30. Use Intermec Settings to configure or view information on your connected RFID readers.

- 1 Tap **Start > Settings > System > Wireless Readers**.

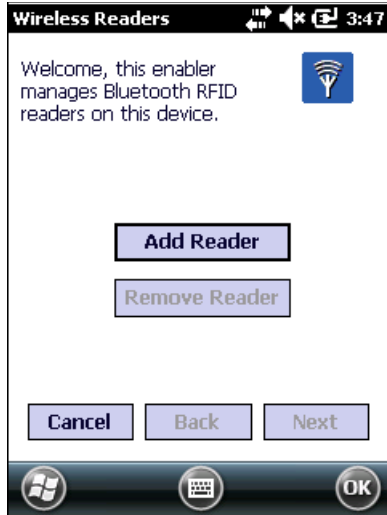

- 2 Tap **Add Reader**.
- 3 Select **Search** or **Manual**. Follow the onscreen instructions to add a wireless reader.

About Serial and USB Communications

You can use these accessories to transmit data to and receive data from another device through serial or USB communications:

- AD20 single dock
- AV10 vehicle dock
- AA21 RS-232 adapter
- Desktop USB adapter
- USB snap-on adapter
- RS-232 DEX adapter

For information on these accessories, contact your local sales representative.

About Wireless Security

The computer provides these security solutions for your wireless network:

- Wi-Fi Protected Access 2 (WPA2™)
- Wi-Fi Protected Access (WPA)
- 802.1x
- LEAP (Funk security only)
- WEP

You use either Funk or Microsoft security to implement your wireless security solution. Intermec recommends WPA2 security with PSK (Personal) or 802.1x (Enterprise) key management.

Before you set security, you need to enable the radio, set the date, and set the SSID on your computer. To use 802.1x security, you need to load a root certificate on your computer. To use transport layer security (TLS) with 802.1x security, you also need to load a user certificate.

Load a Certificate

To use transport layer security (TLS) with 802.1x security, you need a unique client certificate on the computer and a trusted root certificate authority (CA) certificate.

- 1 Start Intermec Settings.
- 2 Select **Communications > 802.11 Radio > Certificates**.

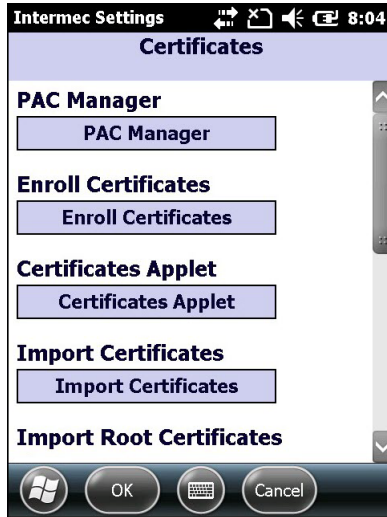

- 3 Tap **Import Certificates**.
- 4 To import a certificate chain:
 - a Tap the **Import PFX** tab.
 - b Next to the **Select pfx to import** field, tap <<<.
 - c Find and select the root certificate.
 - d If necessary, enter the **Password of pfx**.
 - e Tap **Import Certificate**.
- 5 To import user and root certificates from a Microsoft IAS server:
 - a Tap **Web Enrollment**.
 - b To log on to the server, enter the **User**, **Password**, and **Server** (IP Address).
 - c Tap **OK**.
 - d When you are prompted to load the root certificate, tap **OK**.
 - e When the message box appears to let you know the certificate has been added, tap **OK**.

How to Make Your Security Choice

The computer supports Funk and Microsoft® security. Your security choice depends on your network security needs:

- Choose Funk security if you use the computer in a static environment that requires a high level of security. Funk security provides CCX v4 compliance, support for LEAP and TTLS, and configuration for up to four profiles. Funk security is the default security setting on the computer.
- Choose Microsoft security if you primarily use the computer to connect to Wi-Fi hotspots.

Select a Funk Security Profile

You can define up to four profiles for Funk security. Different profiles let your computer communicate in different networks without having to change all your security settings. For example, you may want to set up one profile for the manufacturing floor and one for the warehouse. By default, the active profile is Profile 1.

- 1 Start Intermec Settings.
- 2 Select **Communications > 802.11 Radio > Funk Security**.
- 3 Tap a profile to expand it.
- 4 (Optional) In the **Profile Label** text box, enter a meaningful name for your profile.
- 5 Configure your security settings. For help, see the next sections.
- 6 Repeat Steps 3 through 5 for each profile you want to define.
- 7 To set the active profile, tap **Active Profile** and select a profile from the list.
- 8 Save your settings.

Configure WPA or WPA2 Enterprise (802.1x) Security with Funk Security

Before you set WPA-802.1x or WPA2-802.1x security with Funk, you need to configure your authentication server and authenticators. To use TLS protocol, you also need to load a user and root certificate. On your computer, you need to enable the radio and set the date.

- 1 Start Intermec Settings.
- 2 Select **Communications > 802.11 Radio > Funk Security**.
- 3 Select a Funk security profile to configure.
- 4 Enter the **SSID**.
- 5 For **Association**, select **WPA** or **WPA2**.
The default encryption is **TKIP** or **AES**, respectively.
- 6 For **8021x**, select **TTLS**, **PEAP**, **EAP-FAST**, or **TLS**.
- 7 If you selected **TTLS**, **PEAP**, or **EAP-FAST**:
 - a For **Prompt for Credentials**, select **Enter credentials now**.
 - b Enter a **User Name** and **User Password**.
- 8 If you selected **TLS**, enter a **User Name** and **Subject Name**.
- 9 For **Validate Server Certificate**, select **Yes**.
- 10 Tap **OK**.

Configure WPA or WPA2 Personal (PSK) Security with Funk Security

Before you set WPA or WPA2 Personal (PSK) security, you need to know the pre-shared key for your access point or passphrase for your authenticator. On your computer, you need to enable the radio and set the date.

- 1 Start Intermec Settings.
- 2 Select **Communications > 802.11 Radio > Funk Security**.
- 3 Select a Funk security profile to configure.
- 4 Enter the **SSID**.

5 For **Association**, select **WPA** or **WPA2**.

The default encryption is **TKIP** or **AES**, respectively.

6 For **802.1x**, select **None**.

7 For **Pre-Shared Key**, enter the pre-shared key or passphrase:

- Enter the pre-shared key (0x followed by 32 hexadecimal pairs) for your access point.
- Enter the passphrase (8 to 63 ASCII characters) for your authenticator. The computer internally converts the passphrase to a pre-shared key.

8 Tap **OK**.

Configure 802.1x Security with Funk Security

Before you set 802.1x-WEP security with Funk security, you need to enable the radio on your computer and set the date. To use TLS protocol, you also need to load a user and root certificate. Intermecc recommends that you use WPA2-802.1x instead of 802.1x-WEP if possible.

1 Start Intermecc Settings.

2 Select **Communications > 802.11 Radio > Funk Security**.

3 Select a Funk security profile to configure.

4 Enter the **SSID**.

5 For **Association**, select **Open**.

6 For **Encryption**, select **WEP**.

7 For **802.1x**, select **TTLS**, **PEAP**, or **TLS**.

8 If you selected **TTLS** or **PEAP**:

- a** For **Prompt for Credentials**, select **Enter credentials now**.
- b** Enter a **User Name** and a **User Password**.

9 If you selected **TLS**, enter a **User Name** and **Subject Name**.

10 For **Validate Server Certificate**, select **Yes**.

11 Tap **OK**.

Configure LEAP Security with Funk Security

Before you set LEAP security, you need to enable the radio and set the date on your computer.

- 1 Start Intermec Settings.
- 2 Select **Communications > 802.11 Radio > Funk Security**.
- 3 Select a Funk security profile to configure.
- 4 Enter the **SSID**.
- 5 For **Association**, select **Open**, **WPA**, **WPA2**, or **Network EAP**.
The default encryption is **TKIP** for **WPA**, **AES** for **WPA2**, and **WEP** for **Open** or **Network EAP**.
- 6 For **Prompt for Credentials**, select **Enter credentials now**.
- 7 Type a **User Name** and **User Password**.
- 8 Save your settings.

Configure Static WEP Security with Funk Security

Before you set static WEP security with Funk security, you need to enable the radio on your computer and set the date. Intermec recommends that you use WPA2-PSK instead of WEP if possible.

- 1 Start Intermec Settings.
- 2 Select **Communications > 802.11 Radio > Funk Security**.
- 3 Select a Funk security profile to configure.
- 4 Enter the **SSID**.
- 5 For **Association**, select **Open**.
- 6 For **Encryption**, select **WEP**.
- 7 For **8021x**, select **None**.

- 8** Enter an ASCII key or hex key value for each key you want to use (**Key 1** through **Key 4**):
 - For 64-bit WEP, enter a 5-byte value: 5 ASCII characters or 0x followed by 5 hexadecimal pairs.
 - For 128-bit WEP, enter a 13-byte value: 13 ASCII characters or 0x followed by 13 hexadecimal pairs.
- 9** Select the **Transmit key** you want to use to transmit data.
- 10** Tap **OK**.

Use Open (No Security) Associations with Funk Security

To create an open network, you can set no security with Funk security.

- 1** Start Intermec Settings.
- 2** Select **Communications > 802.11 Radio > Funk Security**.
- 3** Select the active Funk security profile.
- 4** Enter the **SSID**.
- 5** For **Association**, select **Open**.
- 6** For **Encryption**, select **WEP**.
- 7** Tap **OK**.

Select Microsoft as Your Security Choice

The default security setting is Funk. If you want to use Microsoft Wireless Zero Configuration (WZC) security, you need to select it as your security choice.

- 1** Start Intermec Settings.
- 2** Select **Communications > 802.11 Radio > Security Choice**.
- 3** Select **Microsoft Security**.
- 4** Tap **Yes** to save your settings and reboot the computer.

The computer reboots and starts with Microsoft Security as the Security Choice.

Configure WPA or WPA2 Enterprise (802.1x) Security with Microsoft Security

Before you set WPA-802.1x or WPA2-802.1x security with Microsoft, you need to configure your authentication server and authenticators. To use TLS protocol, you also need to load a user and root certificate. On your computer, you need to enable the radio and set the date.

- 1 Start Intermec Settings.
- 2 Select **Communications > 802.11 Radio > Microsoft Security**.
- 3 Enter the **Network name (SSID)**.
- 4 For **Infrastructure Mode**, select **Infrastructure**.
- 5 For **Network Authentication**, select **WPA** or **WPA2**.
The default encryption is **TKIP** or **AES**, respectively.
- 6 For **802.1X Authentication**, select **TLS** or **PEAP**.
- 7 Select **Hidden Network**.
- 8 Tap **OK**. The User Logon dialog box appears.
- 9 If you selected **PEAP**:
 - a Enter a **User Name**, **Password**, and **Domain**.
 - b If you want to save the password for future authentication sessions, select **Save Password**.
- 10 If you selected **TLS**, enter a **User Name** and **Domain**.
- 11 Tap **OK**.

Configure WPA or WPA2 Personal (PSK) Security with Microsoft Security

Before you set WPA or WPA2 Personal (PSK) security, you need to know the pre-shared key for your access point or passphrase for your authenticator. On your computer, you need to enable the radio and set the date.

- 1 Start Intermec Settings.
- 2 Select **Communications > 802.11 Radio > Microsoft Security**.
- 3 Enter the **Network name (SSID)**.

- 4** For **Infrastructure Mode**, select **Infrastructure**.
- 5** For **Association**, select **WPA-PSK** or **WPA2-PSK**.
The default encryption is **TKIP** or **AES**, respectively.
- 6** For **Pre-Shared Key**, enter the pre-shared key or passphrase:
 - Enter the pre-shared key (0x followed by 32 hexadecimal pairs) for your access point.
 - Enter the passphrase (8 to 63 ASCII characters) for your authenticator. The computer internally converts the passphrase to a pre-shared key.
- 7** Tap **OK**.

Configure 802.1x Security with Microsoft Security

Before you set 802.1x-WEP security with Microsoft security, you need to enable the radio on your computer and set the date. To use TLS protocol, you also need to load a user and root certificate. Intermec recommends that you use WPA2-802.1x instead of 802.1x-WEP if possible.

- 1** Start Intermec Settings.
- 2** Select **Communications > 802.11 Radio > Microsoft Security**.
- 3** Enter the **Network name (SSID)**.
- 4** For **Infrastructure Mode**, select **Infrastructure**.
- 5** For **Network Authentication**, select **Open**.
- 6** For **Data Encryption**, select **WEP**.
- 7** For **802.1X Authentication**, select **TLS** or **PEAP**.
- 8** Select **Hidden Network**.
- 9** Tap **OK**. The User Logon dialog box appears.
- 10** If you selected **PEAP**:
 - a** Enter a **User Name**, **Password**, and **Domain**.
 - b** If you want to save the password for future authentication sessions, select **Save Password**.

11 If you selected **TLS**, enter a **User Name** and **Domain**.

12 Tap **OK**.

Configure Static WEP Security with Microsoft Security

Before you set static WEP security with Microsoft security, you need to enable the radio on your computer and set the date. Intermec recommends that you use WPA2-PSK instead of WEP if possible.

1 Start Intermec Settings.

2 Select **Communications > 802.11 Radio > Microsoft Security**.

3 Enter the **Network name (SSID)**.

4 For **Network Authentication**, select **Open**.

5 For **Data Encryption**, select **WEP**.

6 For **802.1X Authentication**, select **Disabled**.

7 For **Network Key Value**, enter an ASCII key or hex key:

- For 64-bit WEP, enter a 5-byte value: 5 ASCII characters or 0x followed by 5 hexadecimal pairs.
- For 128-bit WEP, enter a 13-byte value: 13 ASCII characters or 0x followed by 13 hexadecimal pairs.

8 For **Network Key Index**, select the key you want to use to transmit data.

9 Tap **OK**.

Use Open (No Security) Associations with Microsoft Security

To create an open network, you can set no security with Microsoft security.

1 Start Intermec Settings.

2 Select **Communications > 802.11 Radio > Microsoft Security**.

3 Enter the **Network name (SSID)**.

4 For **Network Authentication**, select **Open**.

Chapter 3 – Configure the Computer

- 5** For **Data Encryption**, select **Disabled**.
- 6** Tap **OK**.

4

Manage the Computer

Use this chapter to learn how to remotely update, configure, and monitor your Intermec computers. You will also find information on installing and developing software applications as well as how to upgrade the system software.

How to Manage the Computer in Your Network

When you have multiple mobile computers and peripherals in your network, it is essential to have an easy way to manage updates, configure all the devices, and remotely troubleshoot problems. Intermec provides two free software solutions for managing your computers:

- CloneNGo™ is a peer-to-peer license-free way to easily clone settings from one computer to another.
- SmartSystems™ is a device management software platform that helps you manage your devices.
- You can also purchase third-party device management software through a vendor.

How to Manage the Computer with CloneNGo

Intermec CloneNGo is a software application that allows you to copy the settings and parameters from a master computer onto one or more client computers. Cloning reduces redundancy and error by providing an efficient and accurate way to copy and transmit settings from a master computer to one or more client computers through an adhoc wireless network. For more information on CloneNGo, see the [CloneNGo User Guide](#).

How to Manage the Computer with SmartSystems

Intermec SmartSystems is a software platform that lets you manage all of your SmartSystems-enabled devices simultaneously from a central server. From the Intermec website, you can download this application at no charge. For help, see www.intermec.com/SmartSystems.

The SmartSystems console displays all SmartSystems-enabled devices and peripherals in your network. Through the console, you can:

- drag-and-drop configuration bundles, operating system updates, and firmware upgrades to multiple computers.
- save configuration settings from a single device and deploy those settings to many devices simultaneously.
- remotely change settings on the computer and peripherals.

The SmartSystems console can report on asset locations and battery status, making it easier to manage your computers.

With a Provisioning license, SmartSystems can automatically push software, configuration settings, and other files to the computers. The license also enables ScanNGo, which makes connecting additional computers to your wireless network as easy as scanning bar codes. To purchase a Provisioning license, contact your local Intermec representative.

How to Manage the Computer with Third-Party Software

You can use third-party software such as Wavelink Avalanche to centrally manage your Intermec devices. Device management software enables you to update software, increase security, track your assets, and troubleshoot devices remotely. You can download the Wavelink enabler for the mobile computer from the Wavelink website. For more information, visit the Intermec website and search for Wavelink Avalanche or visit www.wavelink.com to download the enables.

How to Develop and Install Applications

Use the Intermec Resource Kits to develop applications to run on the mobile computer. The Resource Kits are a library of C++, .NET, Java, and web components grouped by functionality that you can use to create applications for the computer. The Resource Kits are part of the Intermec Developer Library (IDL), and can be downloaded from the Intermec website at www.intermec.com/idl.

How To Package Your Application

After you develop your application, you need to package it for installation on your mobile computer. For very simple applications, the executable file may be the only file you need to deploy. Typically, you will have a set of files to install. Intermec recommends using cabinet (.cab) files to install more complex applications. The computer uses standard Windows Mobile .cab files and will install third-party .cab files.

You can have your .cab file place the application in any of these memory locations on the computer:

- Object store (root directory)
- The non-volatile Flash File Store. Applications and data in the Flash File Store will persist through a clean boot or if you reflash the operating system image.
- The optional microSD card. Depending on available disk space, you may want to consider installing your application files on the microSD card. Using a card creates the Storage Card folder on the computer.

Files copied to any of these locations are safe when you cold boot the computer if the Autouser.dat file has been edited correctly. All .cab files in each CABFILES folder are automatically extracted after a cold boot. For more information about AutoRun, see the [Intermec Developer Library Resource Kit Developer Guide](#).

Install Applications with SmartSystems

You can use the SmartSystems console to drag-and-drop Intermec applications onto your mobile computer. The console is part of SmartSystems.

- 1** Download your application file from the Intermec website and unzip it on your desktop PC.
- 2** Double-click the application file to install it. The application file should appear in the Software Vault.
- 3** From the SmartSystems console in the Software Vault, drag-and-drop the application onto each mobile computer in your network, or drop the application on a group of computers contained in a folder.

Install Applications with Microsoft Synchronization Software

When you only have a few computers to update with applications, you can copy files using Microsoft synchronization software. This procedure assumes the Microsoft synchronization software is installed on your PC and is up and running.

- 1 Connect to the mobile computer through the synchronization software.
- 2 Copy the .cab files from your development PC to the mobile computer.
- 3 Reboot or cold boot the computer.
- 4 After the boot process is finished, browse to the .cab files and tap the files to install them.

Install Applications with a microSD Card

Use a microSD card to install applications on one computer at a time or if you do not have a network connection.

- 1 Copy your application file to the microSD card.
- 2 Insert the microSD card into the mobile computer.



Note: You need to manually reset the computer after you install the storage card.

- 3 On the mobile computer, browse to the SD Card folder and run your application.

How to Launch Applications Automatically

There are two ways to launch applications automatically on a cold boot:

- Set up your application .cab file to place a shortcut to the application in the \Windows\StartUp directory at install time.
- Use AutoRun to start your application at boot time. AutoRun ships on the computer and automates other operations. At boot time, AutoRun executes any commands found in its data file, Autouser.dat. For more information on using AutoRun, see the Readme.txt file located in the My Device\Flash File Store\2577 directory on the computer.

How to Update the System Software

The mobile computer uses SmartSystems bundles to update the operating system (OS) and the system software.

You can use these methods to update your mobile computer:

- You can update individual computers, or multiple computers at the same time, using the SmartSystems console. For help, see the next section.
- You can update individual computers using an SD card.

Update the Computer with SmartSystems

You can use the SmartSystems console to update the operating system or system software on your mobile computer. Before you can update the computer with this method, you need:

- SmartSystems. To download this software management tool, go to www.intermec.com/SmartSystems and click the Downloads tab.
- the SmartSystems bundles you want to install. Bundles that include the system software are available from www.intermec.com. Go to **Support > Downloads > OS/Firmware/Drivers** list.

After you locate these items, you can use SmartSystems to update the mobile computer.

- 1 Open SmartSystems.
- 2 Make sure the mobile computer is discovered.
- 3 Make sure the mobile computer is in a powered dock or that power management is disabled.
- 4 Download the SmartSystems bundle to your PC.
- 5 Double-click the SmartSystems bundle on your PC to extract the update files to the software vault.
- 6 From the SmartSystems console, locate the bundle to install and drag the bundle to each mobile computer (or group in a folder) you want to update. SmartSystems installs the update on your mobile computers.

After the download is complete, your mobile computer begins the update process and automatically performs a cold boot. The computer then boots into a special Update Loader mode where the computer has no network connections and is completely unusable.

This process can take anywhere from 30 seconds to 15 minutes depending on the update. After the update is complete, the computer boots again.



Note: While your mobile computer is offline, SmartSystems displays a red stop symbol in the console until the computer reboots and connects to the system.

Update the Computer with a microSD Card

You can update the computer using a microSD card. You need:

- a microSD card formatted to FAT32
- a microSD adapter card
- an SD card reader
- the AutoFlash.img file that contains the update you want to install. If you need this file, visit the Intermec website at www.intermec.com. Click the **Products** tab, navigate to the computer product page, click the **Downloads** tab, and then locate the download under OS/Firmware/Drivers.

The microSD card slot is located in the battery compartment.

- 1** Insert the microSD card into a microSD adapter card and then place it in the SD card reader connected to your PC.
- 2** On your desktop PC, navigate to the download location and select the folder with the AutoFlash.img file that contains the update you want to install. Typically, this directory is C:\Program Files\Intermec\SmartSystem\SS_Lib\Software\OS\
- 3** Copy the AutoFlash.img file to the root directory of the microSD card.
- 4** Remove the microSD card from the adapter card.
- 5** Turn off the computer and install the microSD card.
- 6** Press the **Reset** button.
- 7** Replace the battery and turn on the computer.

The update process begins. The computer may restart several times. When the update is complete, the Autoflash Complete message appears.
- 8** Press the **Power** button and choose to Suspend the computer.
- 9** Remove the microSD card. If you do not remove the microSD card, the update process repeats each time the computer restarts.
- 10** Replace the battery, turn on the computer, and follow the setup process.

5



Troubleshoot and Maintain the Computer

Use this chapter to find answers to any problems you may encounter while using the CK3computer. You will also find information on routine maintenance.

About the Intermec Dashboard

The Intermec Dashboard provides proactive monitoring of your computer to prevent downtime. Using Intermec Dashboard, you can easily see the health of the computer and help pinpoint the source of a problem to determine if it is hardware or software related. It is highly integrated with SmartSystems. You can also use SmartSystems to remotely monitor the health of your computers. For help, see the SmartSystems help.

Intermec Dashboard displays information, such as the status of network connection, battery usage and battery health, storage space, and internal devices. It also provides system information, such as the operating system, firmware, and hardware configuration.

- To access the Intermec Dashboard, press the Intermec Dashboard  button on the numeric keypad or press   on the alphanumeric keypad.



Intermec Dashboard Main Screen

About Troubleshooting the Computer

These troubleshooting tables may help you fix some common problems you may experience with your computer. These tables group solutions for the Wi-Fi connection, 802.1x security, the scanner, and general operation of the computer.



Note: If you send the computer in for service, it is your responsibility to save the computer data and its configuration. Intermec is only responsible for ensuring that the hardware matches the original configuration when repairing or replacing the computer.

Wi-Fi Connection Problems

Use this section to find possible solutions to Wi-Fi connection problems.

Wi-Fi Connection Problems and Possible Solutions

Problem	Possible Solution
When you turn on the, mobile computer after it was suspended for 10 to 15 minutes or longer, the mobile computer can no longer send or receive messages over the network.	The host may have deactivated or lost the current terminal emulation session. In a TCP/IP direct connect network, turn off the “Keep Alive” message from host to maintain the TCP session while the computer is suspended.
The computer is connected to the network, and you move to a new site to collect data. Now, your mobile computer is not connected to the network.	Move closer to an access point or to a different location to reestablish communications until you reconnect with the network. Any data collected while out of range is transmitted over the network.
The mobile computer appears to be connected to the network, but you cannot establish a terminal emulation session with the host computer.	Move closer to an access point or to a different location to reestablish communications until you reconnect with the network. Any data collected while out of range is transmitted over the network.
The mobile computer appears to be connected to the network, but the host computer is not receiving any information from the mobile computer.	There may be a problem with the connection between the access point and the host computer. Check with network administrator or use your access point user manual.

Check Wi-Fi Network Status

If you have trouble connecting to your Wi-Fi wireless network:

- Make sure you have correctly set network parameters on the computer.
- Check your wireless security settings.

Follow the next procedure to verify available access points and networks, check signal strength, and view other diagnostics. If you need to contact Intermec Product Support, this information can be helpful in troubleshooting wireless network connection issues.

1 Tap **Start** > **iSpyWiFi**. The iSpyWiFi application launches:

The iSpyWiFi tab shows:

- MAC address and IP address of the Wi-Fi radio.
- network association status, including the SSID and MAC address of the access point.
- security configuration.
- radio transmit power and signal strength information.

2 Tap the **Scan** tab to view a list of available Wi-Fi networks. The list includes the signal strength, channel, and MAC address for each network.

- Tap **Scan** to refresh the screen.

3 Tap the **Supp** tab to view radio supplicant information, including a list of supplicant events and authentication status.

- To verify the settings for the currently active security profile, tap **Configure Profile**. Intermec Settings launches for you to configure Wi-Fi radio settings.
- To try reconnecting to the network, tap **Reconnect**.
- To delete the events in the list, tap **Clear Events**.

- 4** Tap the **Ping** tab to run a ping test to the host.
 - a** In the **Host** field, enter the IP address of the host.
 - b** From the **Repetitions** list, choose the number of times the computer will ping the host.
 - c** Tap **Ping**. The graph shows the amount of time it takes for the host to return the ping. Tap **List** to see this information in a list format.

- 5** Tap the **RSSI** tab to view the received signal strength of the host signal.

The information box includes the current signal strength, host SSID name, MAC address, data rate, and transmit power.

- Tap **Mark** to place an arrow marker above the graph.
- 6** Tap the **Conf** tab to set up a log file that lists the RSSI history.

This screen includes the Wi-Fi radio driver version and available radio modes.

 - a** Check the **Log to File** check box.
 - b** (Optional) Change to the sample period and number of samples displayed.
 - c** Tap **Log file**. The **Save As** screen appears.
 - d** (Optional) Change the name of the saved log file, the folder to which the file to be saved, the content type (log or text), and the location.
 - e** Tap **OK**.

802.1x Security Problems

Use this section to find possible solutions to 802.1x security problems.

802.1x Security Problems and Possible Solutions

Problem	Possible Solution
The mobile computer indicates that it is authenticated, but it does not communicate with the host.	Make sure the mobile computer IP address, host IP address, subnet mask, and default router are configured for the network.
The mobile computer does not appear to be authenticating and a network connection icon does not appear on the toolbar.	<ul style="list-style-type: none">• The mobile computer may not be communicating with the access point. Make sure the mobile computer network name matches the access point network name (SSID).• The access point may not be communicating with the server. Ensure the access point is turned on, properly configured, and has 802.1x security enabled.
A network connection icon appears in the toolbar, but then disappears.	<ul style="list-style-type: none">• The mobile computer may not be communicating with the intended access point. Make sure that the network name matches the access point network name. The default network name is “INTERMEC.”• The access point may not be communicating with the server. Ensure the access point is turned on, properly configured, and has 802.1x security enabled.
You are setting up multiple access points in a network with different SSIDs, and the connection fails.	When you change the SSID, the WEP key values are not saved. Configure the WEP key values and save your changes.

802.1x Security Problems and Possible Solutions (Continued)

Problem	Possible Solution
<p>The mobile computer indicates it is not authenticated.</p>	<p>Make sure that:</p> <ul style="list-style-type: none"> • the User Name and Password parameters on the mobile computer match the user name and password on the authentication server. You may need to configure the password on both the mobile computer and the authentication server. • on your authentication server, the user and group are allowed and the group policy is allowed to log into the server. For help, see the documentation that shipped with your authentication server software. • the IP address and secret key for the access point match the IP address and secret key on the authentication server. You may need to configure the IP address and secret key on both your access point and authentication server. • the authentication server software is running on the server PC.
<p>You clean boot the mobile computer and this message appears, “The server certificate has expired or your system date is incorrect.”</p>	<p>When you clean boot the computer, the date and time are not saved. Configure the date and time and save your changes.</p>

Troubleshoot the Scanner with Scan Diagnostics

The ScanDiagnostic application helps troubleshoot problems, such as the inability to read a bar code or a scanner or imager that does not turn on.

- 1 Tap **Start > ScanDiagnostic**.
- 2 Select the scanner or imager you want to troubleshoot and tap **Diagnose**.

The application checks to make sure the scanner or imager is enabled and checks the settings to make sure they are optimized.

- 3 Aim the scanner or imager at a bar code and tap and hold **Press to Scan**.

After the computer reads the bar code, the computer beeps and the label data, data length, and symbology appear on the screen.

- 4 To view recommended settings, press the right arrow button.
- 5 To accept recommended settings, tap **Apply**.
- 6 Tap **OK**.

Problems Reading Bar Codes

You can troubleshoot problems that prevent you from reading bar codes, such as the appropriate symbology not being enabled. Before you call Intermec Product Support, look for your problem in the next table, and try the possible solutions.

Problems Reading Bar Codes

Problem	Possible Solution
You cannot see the illumination beam or frame from the imager when you press the Scan button and aim the imager at a bar code label.	<ul style="list-style-type: none">• You may be too far away from the bar code label. Try moving closer to the bar code label and scan it again.• You may be reading the bar code label “straight on.” Change the reading angle and try again.• The imager hardware trigger may be disabled. Start Intermec Settings and go to Data Collection > Scanner Settings. Make sure Hardware trigger is selected.
When you release the Scan button or scan handle trigger, the Good Read LED does not turn off.	If you configure the computer to use continuous/edge triggering, the Good Read LED stays on. If you configure the computer for level triggering and the Good Read LED stays on, there may be a problem. Press the Scan button or pull the trigger again without scanning a bar code label. If the LED is still on, contact Intermec.

Problems Reading Bar Codes (Continued)

Problem	Possible Solution
<p>The scanner or imager cannot read the bar code.</p>	<ul style="list-style-type: none"> • Position the scanner beam so that it crosses the entire bar code label in one pass. Try to vary the scanning angle. • Check the quality of the bar code label. Scan a bar code label that you know scans properly. Compare the quality of the two bar code labels. You may need to replace the label that you cannot scan. • Make sure the bar code symbology is enabled and configured correctly. Start Intermec Settings and go to Data Collection > Symbologies for the scanning device (scanner, virtual wedge) to check and enable symbologies. • Make sure the computer application is expecting input from a bar code. You may need to type this information instead. • The scanner may not be turned on or the scanner may be unable to scan a specific bar code. Run the ScanDiagnostic application.
<p>The scanner or imager cannot read the bar code quickly, or the scanning beam seems to be faint or obscured.</p>	<p>The scanner or imager window may be dirty. Clean the window with a solution of mild soap and water. Wipe dry. Do not allow abrasive material to touch the window.</p>
<p>You read a valid bar code label to enter data for your application. The data decoded by the scan module does not match the data encoded in the bar code label.</p>	<p>The computer may have decoded the bar code label in another symbology. Scan the bar code label again. Make sure you scan the entire label.</p>
<p>The input device attached to the computer does not work well or read bar code labels very quickly.</p>	<p>Set the Scanner Model command to the specific attached input device. Enable only the bar code symbologies being used.</p>

Problems Using the Computer

You can troubleshoot general problems while using the computer. Before you call Intermec Product Support, look for your problem in the next table, and try the possible solutions.

Problems Using the Computer

Problem	Possible Solution
You tap the screen and nothing happens.	Align the screen.
You press the Power button and nothing happens.	<ul style="list-style-type: none">• The battery may be completely drained. Replace or charge the battery.• Restart the computer.
The computer appears to be locked up, and you cannot enter data.	<ul style="list-style-type: none">• Press the Power button and select Suspend. Press the Power button again to turn the screen back on.• Press the Power button and select Reboot.• Cold boot the computer.• Reload the firmware.
You rotate the computer and the screen does not respond properly.	Run the Sensor Calibration application to calibrate the accelerometer.
You cannot type a character on the keypad, or you can only type uppercase or lowercase letters.	The orange modifier or green modifier key may be locked.

Call Product Support

If you are having trouble using your computer, you can:

- use the troubleshooting tables in this manual to find your problem and possible solutions.
- visit the Intermec technical knowledge base, Knowledge Central at intermec.custhelp.com.

If you still need help, you can call Intermec Product Support at:

1-800-755-5505



Before you call Product Support, have this information ready:

- Configuration number (CN) and serial number (SN), printed on a label inside the battery compartment or shown on the Device Health dashboard under **Information**.
- Operating system version
- Power management settings
- Wireless security settings
- SmartSystems Platform Bundle (SSPB) version
- Intermec Terminal Emulation (ITE) version and protocol, available from the ITE main screen.
Or, programming language of your custom application and tools used to create it.

Most information is available in Intermec Settings.



Locate Your Configuration Number

Before you call Intermec Product Support, you need to know the configuration number of your computer.

- 1** Open the Device Health Dashboard:
 - Press  on the numeric keypad.
 - Press   on the alphanumeric keypad.
- 2** In the Dashboard, scroll down and tap **Information**.
- 3** Scroll down until you see the Hardware Configuration number.
- 4** Exit the Device Health Dashboard.

Locate Your Operating System Version

Before you call Intermec Product Support, you need know the operating system version loaded on your computer.

- 1** Open the Device Health Dashboard:
 - Press  on the numeric keypad.
 - Press   on the alphanumeric keypad.
- 2** In the Dashboard, scroll down and tap **Information**.

- 3 Scroll down until you see the OS Version number.
- 4 Exit the Device Health Dashboard.

How to Restart the Computer

If the computer or an application locks up, or if the computer does not respond when you press the **Power** button, you may need to restart the computer.

The computer uses the configuration currently saved in flash memory during the boot process. Try these methods, in order, to restart the computer:

- **Reboot:** Restarts the computer and goes through the initialization process.
- **Cold boot:** Preserves configuration and network settings, but does not necessarily save cached disk data, which may result in data loss.
- **Clean boot:** Completely erases the computer memory, including all applications and data files, except those in the Flash File Store or any removable storage.

Reboot the Computer

You may need to restart the computer to correct conditions where an application stops responding to the system.

- Press the **Power** button and select **Reboot** from the menu.

Cold Boot the Computer

In some cases where the computer completely stops responding, it may be necessary to perform a cold boot. Because cold booting may result in data loss, use this method only if all other recovery methods have failed.

- 1 Press the **Power** button to suspend the computer.
- 2 Remove the handstrap and the battery pack.
- 3 Press the **Reset** button in the battery compartment on the back of the computer.

- 4 Replace the battery and the handstrap.
- 5 Press the **Power** button and wait for the computer to boot. When the cold boot is complete, the Home screen appears.

Clean Boot the Computer



Caution: A clean boot erases the memory in the mobile computer, including all applications and data files, with the exception of those found in the Flash File Store, or any removable storage.

If the computer seems to be locked up, try cold booting it. If this process does not work, use a clean boot to get the computer up and running for further troubleshooting.

- 1 Press and hold the **Power** button for about 2 seconds to suspend the computer.
- 2 Remove the battery pack from the back of the computer.
- 3 With a stylus, press the **Reset** button in the battery cavity.
- 4 Insert the battery pack into the computer and immediately press and hold the **Power** button.
- 5 Continue to hold the **Power** button until the “Release IO Button” prompt appears on the screen.
You will have to press two keys for the next part of this procedure. Our example uses key 6 and key 9, but you can press *any* two keys.
- 6 Release the button and the message “Enter first key in 20 seconds” appears on the screen. Press **9** on the keypad.
- 7 The message “Enter second key in 6 seconds” appears on the screen. Press **6** on the keypad.
- 8 The message “Reconfirm first key in 6 seconds” appears on the screen. Press **9** again.
- 9 The message “Reconfirm second key in 6 seconds” appears on the screen. Press **6** again.
- 10 The message “Cleanboot Confirmed” appears on the screen. The computer starts the process of clean booting.

Clean the Computer

To keep the computer in good working order, you may need to clean the scanner window, color camera window, and the touch screen. Clean the windows and the touch screen as often as needed for the environment in which you are using the computer. To clean the computer, use one of these recommended cleaning agents:

- Acetic acid, 10% in water
- Ethyl alcohol, 10% in water
- Mild soap solutions
- 5% to no more than 10% bleach or sodium hypochlorite with water



Caution: There are no user-serviceable parts inside the computer. Opening the computer will void the warranty and may cause damage to the internal components.



Note: Intermec recommends that you leave the battery installed when you clean the computer as described. Leaving the battery installed helps prevent fluids from entering the computer through the SIM card and microSD card connectors.

- 1** Press the **Power** button to suspend the computer.
- 2** Dip a clean cloth towel in the cleaning agent and wring out the excess.
- 3** Wipe off the scanner window, camera lens, and flash area. Do not allow any abrasive material to touch these surfaces.
- 4** Wipe dry.
- 5** Let the computer completely air dry before using again.

A

Specifications

Physical and Environmental Specifications

This section lists the physical and environmental specifications for the computer.

Physical Dimensions

Length:	21.6 cm (8.5 in)
Width (at widest part):	8.3 cm (3.3 in)
CK3R Height (at grip):	2.8 cm (1.1 in)
CK3X Height (at grip):	3.6 cm (1.4 in)
CK3R Weight (with 2000 mAh battery):	401 g (14.1 oz)
CK3X Weight (with 5000 mAh battery):	499 g (17.6 oz)

Tumble and Drop Specifications

CK3R Tumble Specification:	1,000 (0.5 m) tumbles per IEC 60068-2-32 specification.
CK3X Tumble Specification:	1,000 (1.0 m) tumbles per IEC 60068-2-32 specification.
CK3R Drop Specification:	Multiple 1.5 m (5 ft) drops to concrete at ambient temperature, multiple 1.2 m (4 ft) drops to concrete across the operating temperature range per MIL-STD 810G.
CK3X Drop Specification:	Multiple 1.5 m (5 ft) drops to concrete across the operating temperature range per MIL-STD 810G.

Power and Electrical Specifications

Operating battery:	Rechargeable lithium-ion battery
Backup battery:	Supercap supplies 10 minutes of bridge time while replacing the main battery (CK3X only).
Electrical rating:	⎓ 4,4 V, 2 A; ⎓ 4,7 V, 1,5 A

Temperature and Humidity Specifications

Operating temperature:	-10°C to 50°C (14°F to 122°F)
Storage temperature:	-20°C to 70°C (-4°F to 158°F)
Charging temperature:	5°C to 35°C (41°F to 95°F)
Relative humidity (operating):	0 to 95% non-condensing
Environmental rating:	IP54, Category 1

Screen Specifications

- 240 x 320 pixels, 16-bit RGB
- 8.9 cm (3.5 in) transmissive QVGA display
- LCD capable of both portrait and landscape operation (CK3X only)
- LED backlight
- Ambient light sensor

Keypad Options

- Alphanumeric and function keypad
- Numeric and function keypad

Bar Code Symbologies

- Australia Post*
- Aztec*
- BPO (British Post 4-state)*
- Canada Post
- Codabar
- Codablock A
- Codablock F
- Code 11
- Code 39
- Code 93
- Code 128/GS1-128
- DataMatrix*
- Dutch Post*
- EAN/UPC
- GS1 Composite*
- GS1 DataBar Expanded
- GS1 DataBar Limited
- GS1 DataBar Omni-Directional
- HanXin
- Infomail
- Intelligent Mail
- Interleaved 2 of 5
- JapanPost*
- Matrix 2 of 5
- Maxicode*
- Micro PDF417
- MSI
- PDF417*
- Planet*
- Plessey
- Postnet*
- QR Code*
- Standard 2 of 5
- SwedenPost
- Telepen
- TLC 39

* These symbologies are only available if your CK3 has an extended range area imager or a near-far area imager.

EA31 Typical Reading Distances - Extended Reading Range

These typical reading distances are measured in an office environment (250 lux) for the EA31 standard model with Extended Reading Range activated. Extended Reading Range is enabled by default.

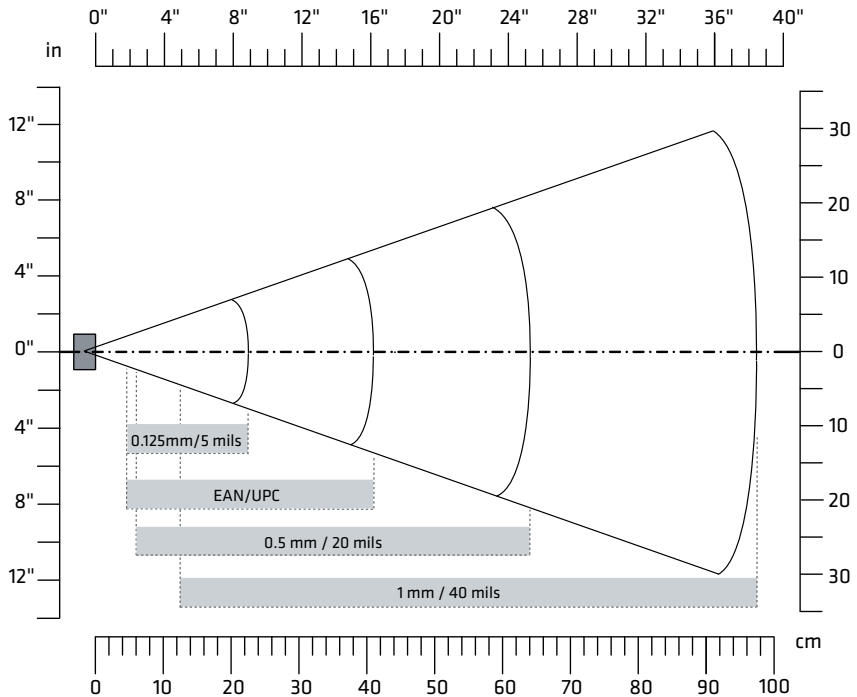

EA31 Typical Reading Distances - Extended Reading Range

EA31 Typical Reading Distances - Extended Reading Range Activated

Symbology	Density	Minimum Distance	Maximum Distance
Code 39	0.125 mm/5	4.50 cm/1.77	22.50 cm/8.86
	mils0.50 mm/20	in6.00 cm/2.36	in64.00 cm/25.20
	mils1 mm/40	in12.50 cm/4.92 in	in97.50 cm/38.39
	mils		in
EAN/UPC 100%	0.33 mm/13 mils	4.50 cm/1.77 in	41 cm/16.14 in

EA31 Imager Minimum Reading Distances

Minimum reading distances are measured in the dark (0 lux).

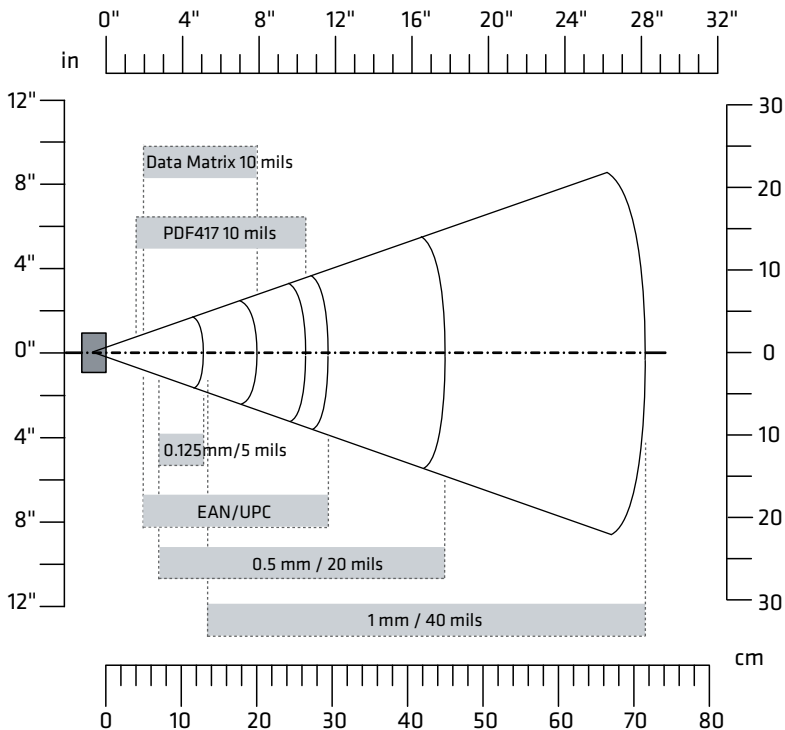

EA31 Minimum Reading Distances

EA31 Minimum Reading Distances

Symbology	Density	Minimum Distance	Maximum Distance
Code 39	0.10 mm/4 mils	8 cm/3.15 in	10 cm/3.94 in
	0.13 mm/5 mils	cm/2.76 in	cm/5.12 in
	0.20 mm/8 mils	cm/1.57 in	cm/7.87 in
	0.25 mm/10 mils	cm/1.5 in	cm/9.65 in
	0.50 mm/20 mils	cm/2.76 in	cm/17.72 in
	1 mm/40 mils	cm/5.31 in	cm/28.15 in
EAN/UPC 100%	0.33 mm/13 mils	5 cm/1.97 in	29.5 cm/11.61 in

EA31 Minimum Reading Distances (Continued)

Symbology	Density	Minimum Distance	Maximum Distance
DataMatrix	0.18 mm/7 mils0.25 mm/10 mils0.38 mm/15 mils	7 cm/2.76 in 5 cm/1.97 in 5.2 cm/2.05 in	14 cm/5.51 in 20 cm/7.87 in 29.5 cm/11.61 in
PDF417	0.17 mm/6.6 mils0.25 mm/10 mils0.38 mm/15 mils	5.8 cm/2.28 in 4 cm/1.57 in 4.9 cm/1.93 in	17.5 cm/6.89 in 26.5 cm/10.43 in 37 cm/14.57 in

EA31 Imager Typical Reading Distances

Minimum reading distances are measured in the dark (0 lux).

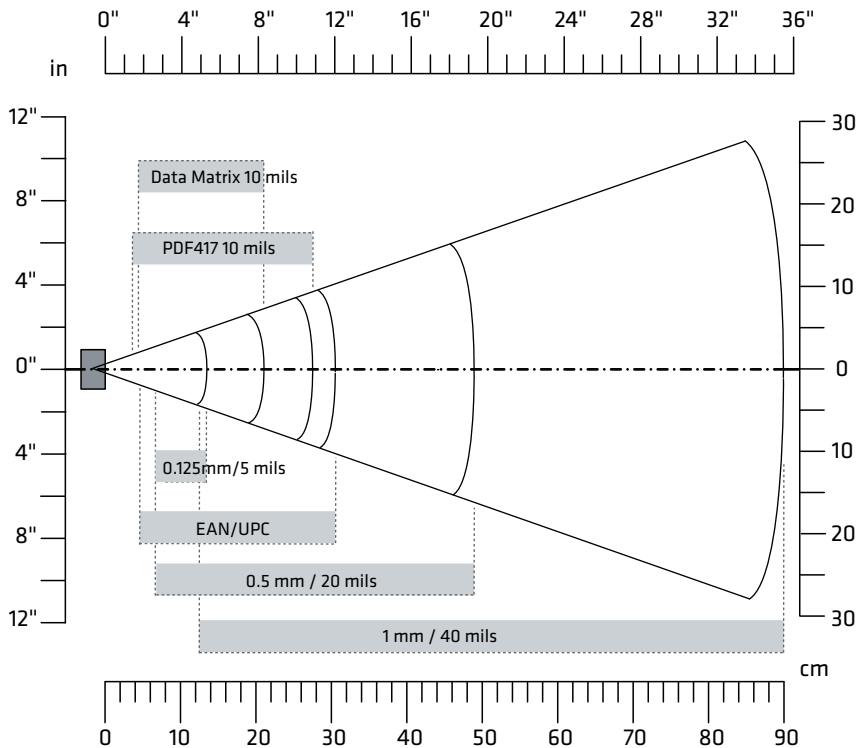

EA31 Typical Reading Distances

EA31 Typical Reading Distances

Symbology	Density	Minimum Distance	Maximum Distance
Code 39	0.10 mm/4	7.5 cm/2.95 in	6.5 cm/4.13 in
	0.13 mm/5	cm/2.56 in	4 cm/5.31 in
	0.20 mm/8	cm/1.57 in	3.5 cm/8.27 in
	0.25 mm/10	cm/1.38 in	6.5 cm/10 in
	0.50 mm/20	cm/2.56 in	12.5 cm/19.29 in
	1 mm/40	cm/4.92 in	cm/35.43 in
EAN/UPC 100%	0.33 mm/13	4.5 cm/1.77 in	30.5 cm/12.01 in
DataMatrix	0.18 mm/7	6.5 cm/2.56 in	4.5 cm/5.91 in
	0.25 mm/10	cm/1.77 in	4.7 cm/8.27 in
	0.38 mm/15	cm/1.85 in	cm/12.20 in
PDF417	0.17 mm/6.6	5 cm/1.97 in	3.7 cm/7.17 in
	0.25 mm/10	cm/1.46 in	4.5 cm/10.83 in
	0.38 mm/15	cm/1.77 in	cm/15.75 in

EA30 Typical Reading Distances - Extended Reading Range

These typical reading distances are measured in an office environment (250 lux) for the EA30 standard model with Extended Reading Range activated. Extended Reading Range is enabled by default.

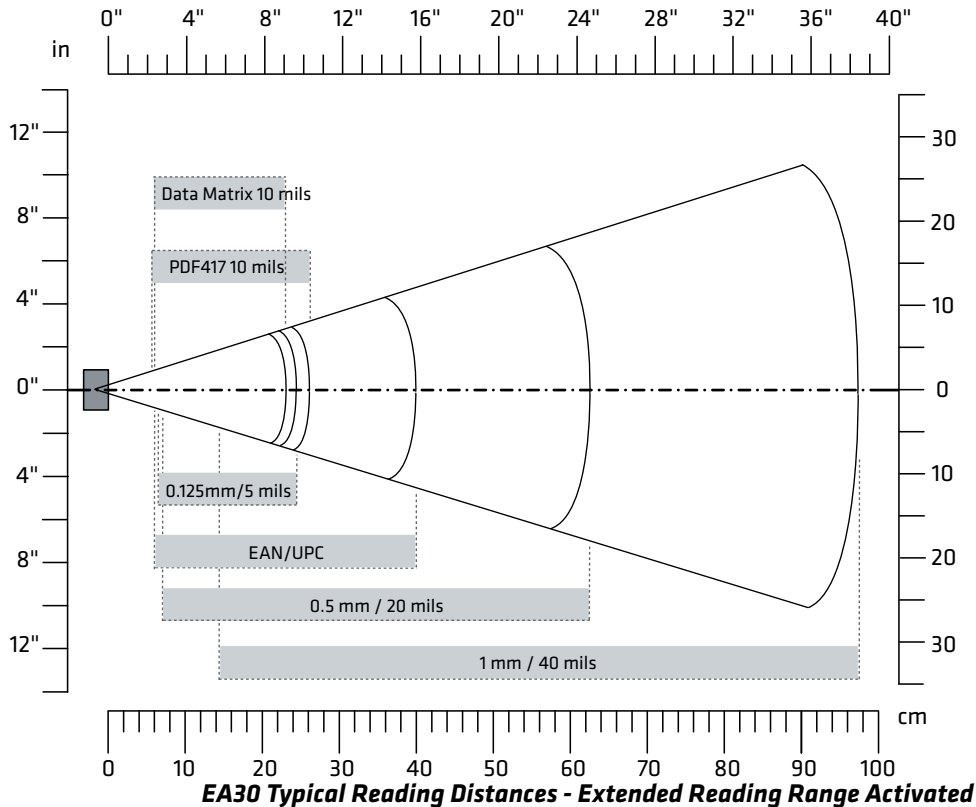

EA30 Typical Reading Distances - Extended Reading Range Activated

Symbology	Density	Minimum Distance	Maximum Distance
Code 39	0.125 mm/5 mils	6.50 cm/2.56 in	24.50 cm/9.65 in
	0.50 mm/20 mils	7.00 cm/2.76 in	62.50 cm/24.61 in
	1 mm/40 mils	14.50 cm/5.71 in	97.50 cm/38.39 in
EAN/UPC 100%	0.33 mm/13 mils	6 cm/2.36 in	40 cm/15.75 in

EA30 Area Imager Minimum Reading Distances

Minimum reading distances are measured in the dark (0 lux).

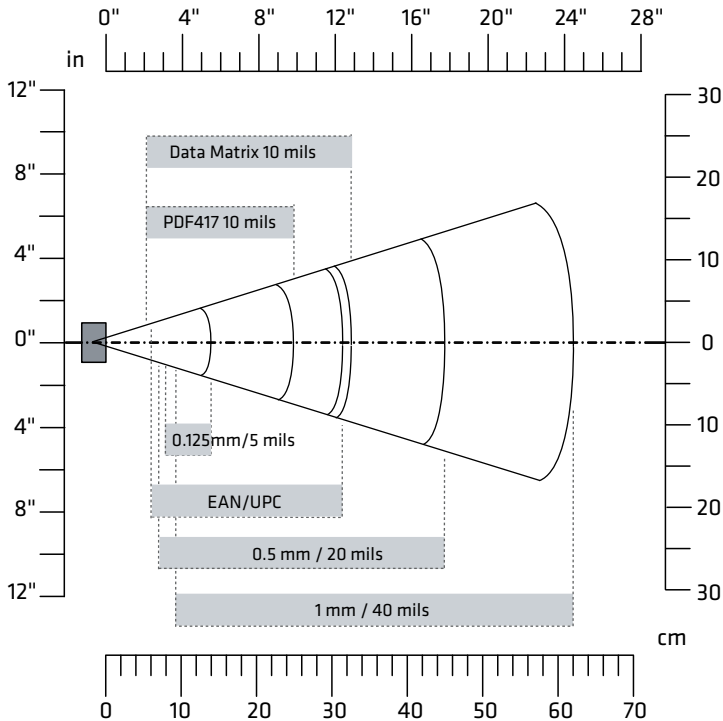

EA30 Minimum Reading Distances

EA30 Minimum Reading Distances

Symbology	Density	Minimum Distance	Maximum Distance
Code 39	0.10 mm/4 mils 0.13 mm/5 mils 0.50 mm/20 mils 1 mm/40 mils	9.5 cm/3.74 in 8 cm/3.15 in 7 cm/2.76 in 9.5 cm/3.74 in	10.5 cm/4.13 in 14 cm/5.51 in 45 cm/17.72 in 62 cm/24.41 in
EAN/UPC 100%	0.33 mm/13 mils	6 cm/2.36 in	31.5 cm/12.4 in

EA30 Minimum Reading Distances (Continued)

Symbology	Density	Minimum Distance	Maximum Distance
DataMatrix	0.18 mm/7 mils 0.25 mm/10 mils 0.38 mm/15 mils	8 cm/3.15 in 6.5 cm/2.56 in 5.5 cm/2.17 in	15.5 cm/6.1 in 21.5 cm/8.46 in 31.5 cm/12.4 in
PDF417	0.25 mm/10 mils 0.38 mm/15 mils	5.5 cm/2.17 in 7 cm/2.76 in	25 cm/9.84 in 34 cm/13.39 in

EX25C Near-Far Range Area Imager Reading Distance

Minimum reading distances are measured in the dark (0 lux).

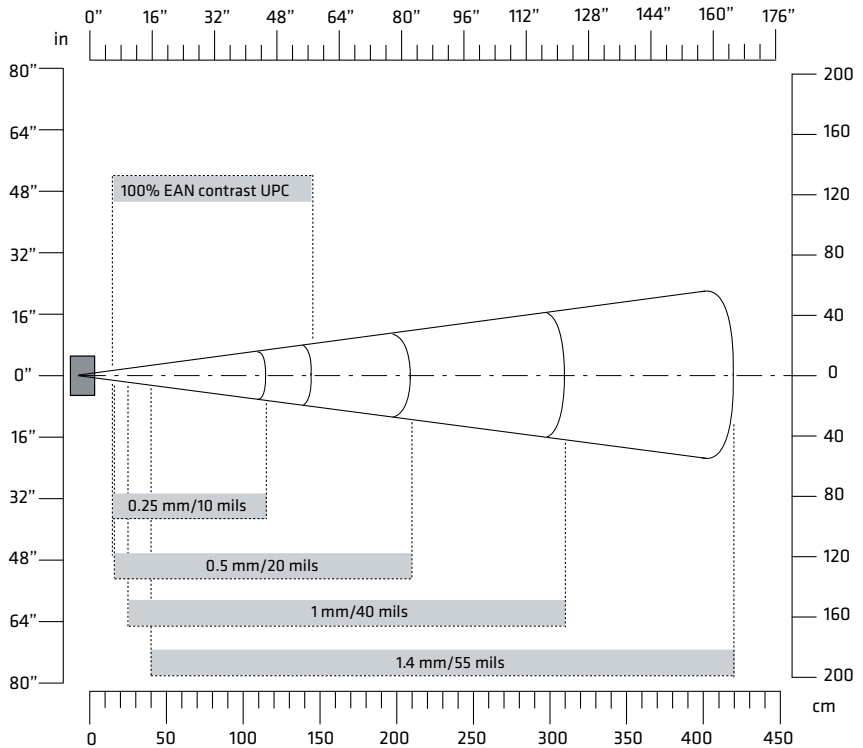

EX25C Near-Far Range Imager 1D Minimum Reading Distances

EX25C 1D Symbologies Minimum Reading Distances with 0.24 cm (0.09 in) Setback

Symbology	Density	Minimum Distance	Maximum Distance
Code 39	0.08 mm/3	15 cm/5.91 in	35 cm/13.78 in
	mils0.10 mm/3.8	cm/5.91 in	15 cm/5.91 in
	mils0.25 mm/10	cm/5.91 in	16 cm/6.30 in
	mils0.50 mm/20	cm/6.30 in	25 cm/9.84 in
	mils1 mm/40	cm/9.84 in	40 cm/15.75 in
	mils1.3 mm/51	cm/15.75 in	45 cm/17.72 in
EAN 100%	0.33 mm/13 mils	15 cm/5.91 in	145 cm/57.09 in

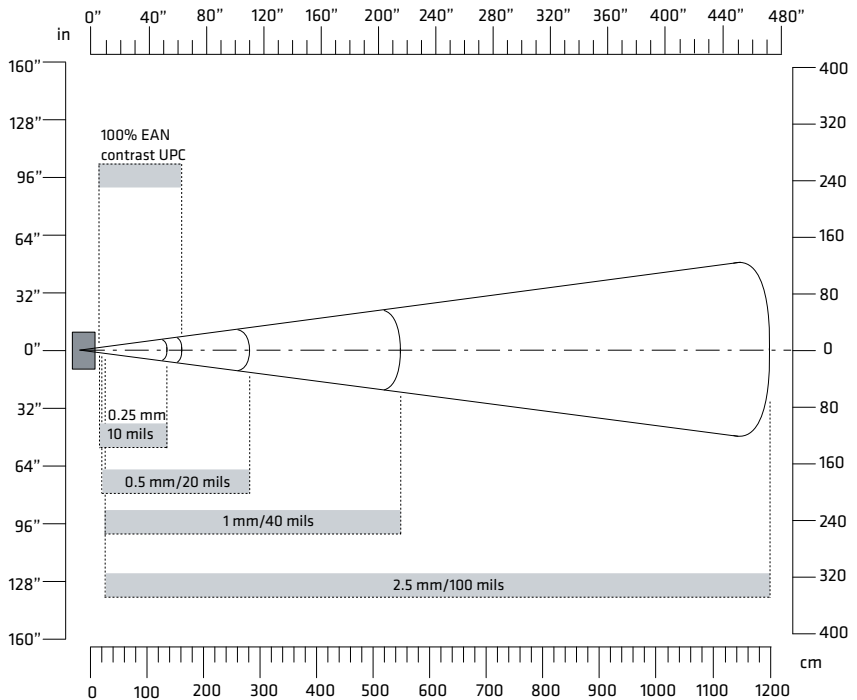

EX25C Near-Far Range Imager 1D Typical Reading Distances

EX25C 1D Symbologies Typical Reading Distances with 0.24 cm (0.09 in) Setback*

Symbology	Density	Minimum Distance	Maximum Distance
Code 39	0.25 mm/10 mils0.50 mm/20 mils1 mm/40 mils1.4 mm/55 mils2.5 mm/100 mils	15 cm/5.91 in16 cm/6.30 in25 cm/9.84 in40 cm/15.75 in**	135 cm/53.15 in280 cm/110.24 in550 cm/216.54 in720 cm/283.46 in1200 cm/472.44 in
Code 128 retro-reflective	2.5 mm/100 mils	**	1300 cm/511.81 in
EAN 100%	0.33 mm/13 mils	15 cm/5.91 in	160 cm/62.99 in

* Typical reading distances are measured in an office environment (200 lux).

** Minimum distance depends on bar code width and scan angle.

Appendix A – Specifications

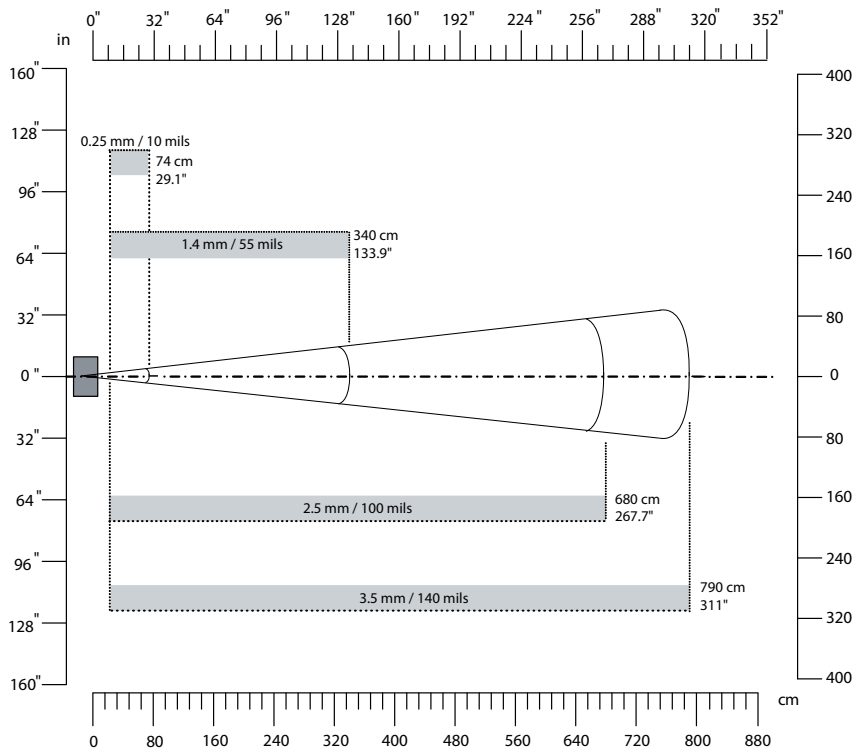

EX25C Near-Far Range Imager 2D Typical Reading Distances

EX25C 2D Symbologies Typical Reading Distances with 0.24 cm (0.09 in) Setback

Symbology	Density	Minimum Distance	Maximum Distance
DataMatrix	0.25 mm/10 mils	15 cm/5.91 in	25 cm/9.84 in
	0.76 mm/30 mils	25 cm/9.84 in	310 cm/122.05 in
	1.4 mm/55 mils		450 cm/177.17 in
	2.5 mm/100 mils		1100 cm/433.07 in
	3.5 mm/140 mils		

* Typical reading distances are measured in an office environment (200 lux).

** Minimum distance depends on bar code width and scan angle.

N5603 Extended Range Reading Distances

Minimum reading distances are measured in the dark (0 lux).

Red Illumination Monochrome and Monocolor Sensors - Guaranteed Specifications

Symbology	Near Distance	Far Distance	Delta
5 mil Code39/128	14.7 cm/5.8 in	22.4 cm/8.8 in	7.6 cm/3.0 in
7.5 mil Code 39/128	11.2 cm/4.4 in	33.2 cm/13 in	21.8 cm/8.6 in
10 mil Code 39/128	8.1 cm/3.2 in	40.9 cm/16.1 in	32.8 cm/12.9 in
15 mil Code 39/128	5.1 cm/2.0 in	48.3 cm/19.0 in	43.2 cm/17.0 in
20 mil Code 39/128	7.9 cm/3.1 in	57.9 cm/22.8 in	50 cm/16.2 in
100% UPC	7.1 cm/2.8 in	48.3 cm/19.0 in	41.2 cm/16.2 in
5 mil PDF417	15.5 cm/6.1 in	18.8 cm/7.4 in	3.3 cm/1.3 in
6.7 mil PDF417	11.9 cm/4.7 in	24.9 cm/9.8 in	13.0 cm/5.1 in
10 mil PDF417	6.1 cm/2.4 in	37.8 cm/14.9 in	31.8 cm/12.5 in
10 mil DataMatrix/Aztec	13.5 cm/5.3 in	25.4 cm/10.0 in	11.9 cm/4.7 in
20 mil DataMatrix	10.2 cm/4.0 in	40.6 cm/16.0 in	30.5 cm/12.0 in
10 mil QR Code	10.9 cm/4.3 in	26.4 cm/10.4 in	15.5 cm/6.1 in
20 mil QR Code	5.3 cm/2.1 in	45.0 cm/17.7 in	39.6 cm/15.6 in
32 mil Maxicode	10.7 cm/4.2 in	45.0 cm/17.7 in	34.3 cm/13.5 in

Minimum reading distances are measured at 535 lux.

Red Illumination Monochrome and Monocolor Sensors - Typical Specifications

Symbology	Near Distance	Far Distance	Delta
10 mil Code 39/128	6.1 cm/2.4 in	44.2 cm/17.4 in	38.1 cm/15.0 in
15 mil Code 39/128	3.8 cm/1.5 in	54.9 cm/21.6 in	51.1 cm/20.1 in
100% UPC	6.1 cm/2.4 in	53.3 cm/21.0 in	47.2 cm/18.6 in
10 mil PDF417	5.6 cm/2.2 in	39.6 cm/15.6 in	34.0 cm/13.4 in
32 mil Maxicode	7.9 cm/3.1 in	52.8 cm/20.8 in	44.9 cm/17.7 in

Field of View/Resolution

Focus	Extended Range (ER)
Horizontal Field Angle (degrees)	±15.8
Vertical Field Angle (degrees)	±12.2

B

Default Settings

Default Configuration

The following tables list the default values of the configuration commands supported on the CK3. If you restore the CK3 to factory default settings, the CK3 uses these values.

The commands are grouped by function and reflect the organization of Intermec Settings. For detailed information on most of the commands, see the [Intermec Settings Command Reference Manual](#), available from the Intermec website at www.intermec.com.

Data Collection

Data Collection Settings

Data Collection Setting	Default Value
Enable Scanner Port	Enable
Enable Scanner Auto-Detect	Enable
Scanner Port Baud Rate	38400

Symbology Settings

Symbology	Default Value
Australian Post	Disable
Aztec	Disable
BPO	Disable
CanadaPost	Disable
Codabar	Disable
Codablock A	Disable
Codablock F	Disable
Code 11	Disable
Code 39	Enable
Code 93	Disable
Code 128/GS1-128	Enable
DataMatrix	Enable
DutchPost	Disable

Symbology Settings (Continued)

Symbology	Default Value
EAN/UPC	Enable UPC A, UPC E, EAN 8, EAN 13
GS1 Composite	Disable
GS1 DataBar Expanded	Disable
GS1 DataBar Limited	Disable
GS1 DataBar Omni-Directional	Disable
HanXin	Disable
Infomail	Disable
Interleaved 2 of 5	Disable
JapanPost	Disable
Matrix 2 of 5	Disable
Maxicode	Disable
Micro PDF417	Disable
MSI	Disable
PDF417	Enable
Planet	Disable
Plessey	Disable
Postnet	Disable
QR Code	Disable
Standard 2 of 5	Disable
SwedenPost	Disable
Telepen	Disable
TLC 39	Disable

Symbology Option Setting

Symbology Option	Default Value
Preamble	None (disabled)
Postamble	None (disabled)
Symbology Identifier	Disable
Multicode	Disable

Scanner Settings

Scanner Setting	Default Value
Scanner Model	Internal Scanner
Trigger Mode	Level
Aimer Mode	Typical aimer
Hardware Trigger	Enable
Trigger Timeout (sec)	2
Aiming Duration (msec)	500
Turn Off After Good Read	Enable/One-shot
Scanner Firmware Version	Read-only

Imager Settings

Imager Setting	Default Value
Predefined Modes	1D and 2D Standard
Imager Decode Mode	2D Imager
Lighting Mode	Illumination LED Priority
Lighting Goal	42
Illumination Level	100
Initial 1D Search Area	Smart Raster
Direct Part Marking Mode	Disable
Damaged 1D Codes	Disable
Image File Location	\My Documents\MDI
Folder Memory Limit (MBytes)	13
Enable Tagging Location Data	Disable
Output Compression	Bitmap
Output Compression Quality	0
Edge Enhancement	None
Noise Reduction	0
Subsampling	None
Image Rotation	None
Image Lighting Correction	Disable

Decode Security Settings

Decode Security Setting	Default Value
Consecutive Data Validation	0
Identical Consecutive Timeout	300 ms
Different Consecutive Timeout	0
Center Decoding	Disable
Center Decoding Tolerance	Disable

RFID

RFID Settings

RFID Setting	Default Value
Enable RFID Service	Enable

Application Connection Settings

Application Connection Setting	Default Value
Allow External BRI Connections	Enable
BRI TCP Port	2189
Enable Logging	Disable

Reader 1 Settings

Reader 1 Setting	Default Value
Enable Reader	Off
Connected	Off
Reader Model	IP30
Device Address	000000000000

RFID Module Settings

RFID Module Setting	Default Value
Tag Type	EPC Class 1 Gen2

RFID Module Settings (Continued)

RFID Module Setting	Default Value
Dense Reader Mode	Off
LBT Channel	5
LBT Scan Enable	On
Field Separator	Space ()
ID Report	Off
No Tag Report	Off
Report Timeout	0 ms
Timeout Mode	Off
ID Timeout	100 ms
Antenna Timeout	50 ms
ID Tries	1
Antenna Tries	3
Read Tries	3
Write Tries	3
Initialization Tries	1
Lock Tries	3
Select Tries	1
Unselect Tries	1
Initial Q	4
Field Strength dB	30
Session	2
Enable Antenna Port 1	On
Enable Antenna Port 2	Off
Enable Antenna Port 3	Off
Enable Antenna Port 4	Off
Bluetooth Power Off	300 s

Communications

Communications Settings

Communications Setting	Default Value
Device Name	CK3xxxxxxxxxxxxxx

802.11 Radio Settings

802.11 Radio Setting	Default Value
Radio Enabled	Off
Security Choice	Funk Security
Radio Measurement	300
Radio Bands (CK3X only)	b/g (2.4 GHz)
Allow Security Changes	Enabled

Funk Security Settings

Funk Security Setting	Default Value
Active Profile	Profile 1
Hide Password Text	Enabled
Profile Label	Profile_1
Network Type	Infrastructure
Channel	3
SSID	INTERMEC
Power Mode	Enabled (FastPSP)
8021x	None
Association	Open
Encryption	None
Pre-Shared Key	Null
Transmit Key	Key1
Mixed Cell	On
Logging	Off

Ethernet Adapter Settings

IP Settings	Default Value
Current Device IP Address	0.0.0.0
DHCP	Enable
DHCP Client Identifier	Null
IP Address	Null
Subnet Mask	255.0.0.0
Default Router	Null
Primary DNS	Null
Secondary DNS	Null
Primary WINS	Null
Secondary WINS	Null

Bluetooth Settings

Bluetooth Setting	Default Value
Bluetooth Power	Off

Device Settings

Device Settings

Device Setting	Default Value
Date	Null
Time	Null
Save Current Language When Updating OS	Disabled
Enable ActiveSync	Enabled
Enable SD Card	Enabled
Enable USB External Drive	Enabled
Enable All Image Capture	Enabled
Enable a URL barcode to launch browser	Disabled
Beeper and Voice	Medium
Headset Beeper	Very Low
Screen Taps	Off

Device Settings (Continued)

Device Setting	Default Value
Key Clicks	Off
USB Function Driver	ActiveSync RNDIS Client
Good Read	One beep

Backlight Settings

Backlight Setting	Default Value
Normal Light Backlight Adjustment	Normal
Low Light Backlight Adjustment	Normal
Bright Light Backlight Adjustment	Normal
Keypad Backlight	Automatic
Automatic Ambient Light Sensitivity	Low light

Keypad Settings

Keypad Setting	Default Value
RFID handle trigger	RFID
Center Scan Button	Scanner
Green/Orange Keys Lock Options	Press Twice to Lock

Power Management Settings

Power Management Setting	Default Value
Enable Power Button Screen	On
Screen Off	Disabled
Hibernate (Battery Swap)	Enabled
Suspend	Enabled
Reboot	Enabled
Shutdown	Disabled
Screen Timeout (Seconds)	5
Screen Turns Off After (Battery Power)	Disabled
Device Turns Off After (Battery Power)	5 minutes

Power Management Settings (Continued)

Power Management Setting	Default Value
Screen Turns Off After (External Power)	Disabled
Device Turns Off After (External Power)	Disabled
Enable Device Sleep	Disabled
Sleep Face Down	Enabled
Sleep Portrait	Disabled
Sleep Reverse Portrait	Disabled

Profile Settings Application Settings

Profile Settings Application Setting	Default Value
Always On	Show Option in Profile Settings
Maximize Battery Life	Show Option in Profile Settings
Normal	Show Option in Profile Settings
1D Bar Codes Optimized	Show Option in Profile Settings
Bright Sunlight	Show Option in Profile Settings
Reflective Labels	Show Option in Profile Settings
Standards	Show Option in Profile Settings

Screen Settings

Screen Setting	Default Value
Screen Rotation	Portrait 0 Degrees
Enable Screen Rotation	Disabled
Rotate Portrait	Enabled
Rotate Landscape	Enabled
Rotate Signature Capture	Disabled

Core Messaging Service

Core Messaging Service Settings

Core Messaging Service Setting	Default Value
Server IP	Null
Associated Server IP	Null
Broadcast Name	INTERMEC
Port	62241
Keep Alive Ping Interval	30 Seconds

Device Monitor

Device Monitor Settings

Device Monitor Setting	Default Value
Enable Device Health Data Collection	On
Enable Device Health Application	On
Enable Blue Light (LED)	Off for Ready-to-Work
Set Rule File Location	\\SmartSystems\HealthRules.txt
Asset Message Send Period	0
System Device Health (Seconds)	90
Network Device Health (Seconds)	45
Printer Device Health (Seconds)	300
Directory	\\SmartSystems\ScreenCapture
Screen Captures Allowed	3
Enable Wipe	Disabled
Interval (in Days)	3

Virtual Wedge

Virtual Wedge Settings

Virtual Wedge Setting	Default Value
Enable Virtual Wedge	Enabled
Virtual Wedge Method	Adapt to Application

Virtual Wedge Settings (Continued)

Virtual Wedge Setting	Default Value
Bar Code Scanner Grid	Null
Label Encoding (Code Page)	1252(D)-ANSI Win3.1 US
Magstripe Reader Grid	Null
Read Command	READ REPORT = DIRECT
User-Defined Read Command	READ
Date (YYYY-MM-DD)	Disabled
Time (HH_MM_SS)	Disabled
Tag Separator	SP (space)
User-Defined Tag Separator	Null
End of Message	CRLF (Return-Line Feed)
User-Defined End of Message	Null
RFID Reader Grid	Null

Location Services

Location Services Settings

Location Services Setting	Default Value
Port	9569
Enable Server	Disable

C

















Keypads and Keystrokes

Characters and Functions on Keypads

Use these tables to learn how to enter standard characters as well as other available characters and functions with the keypad. If a character or function does not have a sequence of keystrokes, it is only available through the soft input panel (SIP). You can access the SIP by tapping the keyboard icon on the touch screen.

The information in the character and function tables assumes that the Green/Orange keys lock option in **Intermec Settings > Device Settings > Keypad** is set to the default of **Press once to lock**. The information in these tables will not work if you have this option set to **Press twice to lock**.

Alphanumeric Characters

Character	Alphanumeric Keypad	Numeric Keypad
a	A	 Esc
b	B	 7
c	C	 8
d	D	 9
e	E	 
f	F	 4
g	G	 5
h	H	 6
i	I	 1
j	J	 2
k	K	 3
l	L	 FldExit
m	M	 0
n	N	 .
o	O	 F1
p	P	 F2

Alphanumeric Characters (Continued)

Character	Alphanumeric Keypad	Numeric Keypad
q	Q	F3
r	R	F4
s	S	F5
t	T	F6
u	U	F7
v	V	F8
w	W	F9
x	X	F10
y	Y	F11
z	Z	F12
A	A A	Esc
B	A B	7
C	A C	8
D	A D	9
E	A E	
F	A F	4
G	A G	5
H	A H	6
I	A I	1
J	A J	2
K	A K	3
L	A L	FldExit
M	A M	0
N	A N	.
O	A O	F1
P	A P	F2
Q	A Q	F3

Alphanumeric Characters (Continued)

Character	Alphanumeric Keypad	Numeric Keypad
R		
S		
T		
U		
V		
W		
X		
Y		
Z		
0		
1		
2		
3		
4		
5		
6		
7		
8		
9		

Function Keys

Character	Alphanumeric Keypad	Numeric Keypad
F1		
F2		
F3		
F4		
F5		

Function Keys (Continued)

Character	Alphanumeric Keypad	Numeric Keypad
F6	E	
F7	F	
F8	G	
F9	H	
F10	I	
F11	J	
F12	K	
F13	L	F1
F14	M	F2
F15	N	F3
F16	O	F4
F17	P	F5
F18	Q	F6
F19	R	F7
F20	S	F8
F21	T	F9
F22	U	F10
F23	V	F11
F24	W	F12

Special Functions

Character	Alphanumeric Keypad	Numeric Keypad
Forward Tab		
Back Tab		
Space		
Backspace		
Shift	A	

Special Functions (Continued)

Character	Alphanumeric Keypad	Numeric Keypad
Caps Lock	B	>
Field Exit		
Up Arrow	A 8	
Down Arrow	A 2	
Left Arrow	A 4	
Right Arrow	A 6	
Control	I	4
Alt	Esc	6

















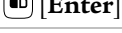

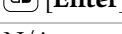











Depending on your computer model, some of the following characters or functions will not be printed on the keypad.

Other Available Characters and Functions

Character or Function	Alphanumeric Keypad	Numeric Keypad
!	A 1	< 1
@	A 2	< 2
#	A 3	< 3
\$	A 4	< 4
%	A 5	< 5
^	A 6	< 6
&	A 7	< 7
*	A 8	< 8
(A 9	< 9
)	A 0	< 0
–	X	< [Enter]
	A F4	< [Enter]
:	F1	< Esc



Other Available Characters and Functions (Continued)

Character or Function	Alphanumeric Keypad	Numeric Keypad
?		
;		
/		
-		
\		
=		N/A
'		N/A
+		N/A
[	N/A
.		
]		N/A
,		N/A
'		N/A
“		N/A
Volume Down		
OK		
Volume Up		
Soft Key 1		
Soft Key 2		

































The following ITE functions are only operational when you are using the ITE application.

Intermec Terminal Emulation (ITE) Functions

Character or Function	Alphanumeric Keypad	Numeric Keypad
Field Exit		

Intermec Terminal Emulation (ITE) Functions (Continued)

Character or Function	Alphanumeric Keypad	Numeric Keypad
System Request	 S	 FidExit
Home	 C	 .
Attention	 A	 0
Reset	 < 4	 1
Clear	 > 6	 2
Roll Down	 ∨ 2	 5
Previous Screen	 G	 7
Roll Up	 ^ 8	 8
Next Screen	 H	 9
Page Left	 U	 <
Page Up	 O	 ^
Page Down	 P	 ∨
Page Right	 V	 >
Field +	 7	 ^
Field -	 1	 ∨



16201 25th Avenue West
Lynnwood, Washington 98087
U.S.A.

www.honeywellaidc.com

CK3R and CK3X Mobile Computer User Manual



P/N 935-075-003