

# DMXrfNet<sup>III</sup>

Operation & Installation ■ ■ ■

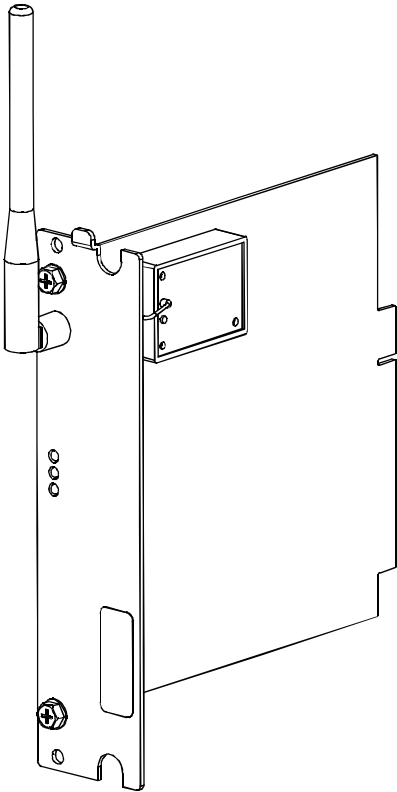

right by our customers. ■ ■ ■



datamax·o'neil



## Overview

---

This document describes the installation and use of the DMXrfNet<sup>III</sup> Card options for the H-Class and A-Class Mark II printers. After verifying the contents of the kit and the tools needed, follow the steps below to install and begin using the option. Keep this documentation for future reference.



*For your safety and to avoid equipment damage, always turn 'Off' power and unplug the printer's power cord before beginning this installation.*

## Contents of the Kit

---

**Note:** *If your card is already installed proceed to "Card Setup and Operation"*

This kit contains the following items:

- Network Card Assembly
- Rear Cover Plate
- Screws

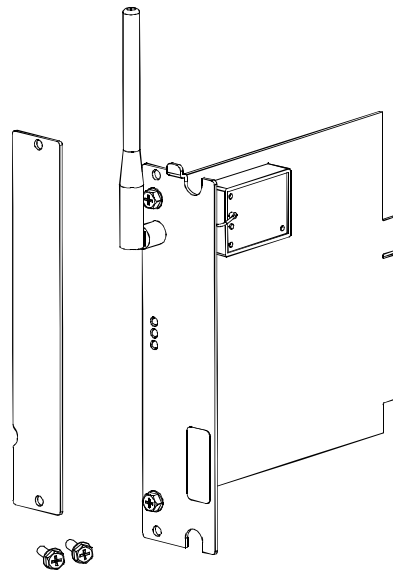

(Appearance may vary depending on card configuration.)



When handling the Network Card, observe proper electrostatic discharge precautions to prevent damage.

## Firmware Update Required

---

If you are installing this card into an existing printer, you must upgrade the printers firmware to support this network card. Updated firmware can be downloaded from the Datamax-O'Neil FTP site at <ftp.datamax-oneil.com>. Refer to the printers operator's manual for more information on updating the printers firmware. Be sure the firmware file that you download is:

All Models: **Version 14.033 or greater.**

Before installing new firmware verify (via a Configuration Label) that the printer bootloader is version **14.033** or greater.

## Card Installation

The following illustrations depict installation into an H-Class printer, other model installations are similar. On some A-Class models, the Network Card is installed upside-down.

1. Turn 'Off' the Power Switch and unplug the power cord from the AC Receptacle.

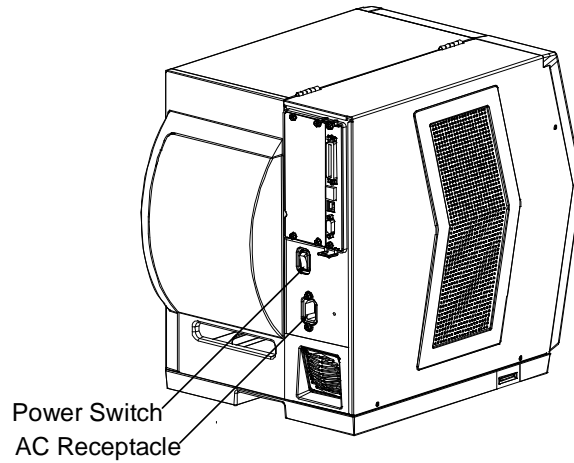

2. Remove the two Screws and Cover Plate from the rear of the printer.

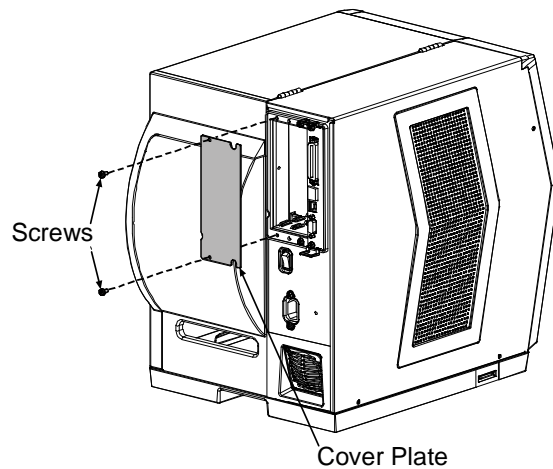

3. Slide the Wireless Card into the center slot of the printer. Be sure the Wireless Card is positioned between the Guides while inserting.
4. Secure using the two previously removed Screws.

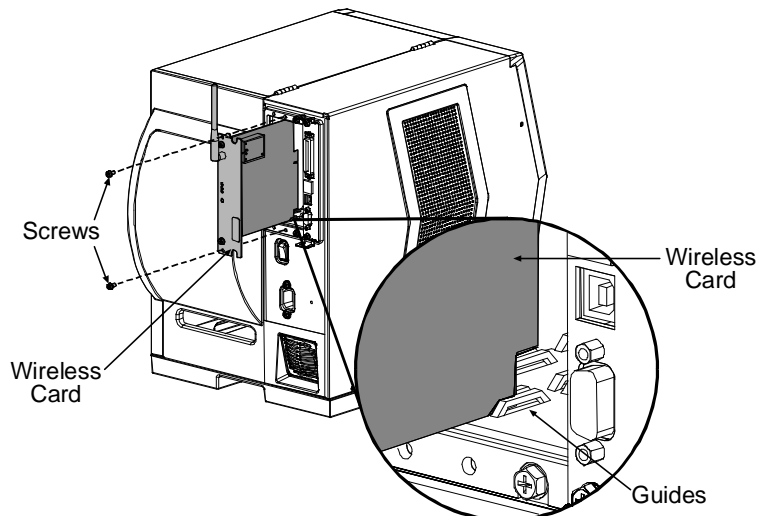

## Introduction

These network cards can be equipped in the following configurations:

- Wired and Wireless Ethernet
- Wireless Ethernet

## External Hardware Descriptions

The functions of the Interface Card's external hardware are defined below. Depending on the configuration of your card some items may not be present.

### Connectors

- **ANTENNA** is used to connect an antenna or coaxial cable for RF reception and transmission via this Multimedia Communication Exchange (MMCX) Reverse Pin type connector.
- **10/100 BaseT** is used to connect a 10/100 BaseT Ethernet cable via this RJ45 network connector.

### Indicator Lights

- **ACTIVITY** is a green indicator that flashes when the Card is not connected and scanning. The indicator will turn on when a connection is made.
- **LINK** is a yellow indicator that comes on when the Card is associated with an Access Point or Ad-hoc peer.
- **DATA** is a green indicator that flashes when there is data transmitted between the printer and Host access point.

### Label

This **Label** contains the MAC address of the Radio module on the network card and is not usually needed. The MAC address of the printer is listed on the printer's Configuration and Network Report test labels.

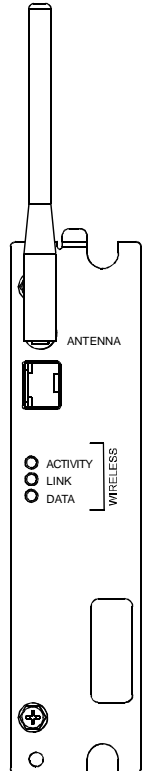

## Installing the Antenna

1. Extend the **Antenna** then align the **Base** to the **Connector**.
2. Turn the **Base** clockwise until fully seated and tight on the **Connector**.
3. Raise and position the **Antenna**.

*To avoid permanent damage, do not pull on the antenna when handling the Network Card.*

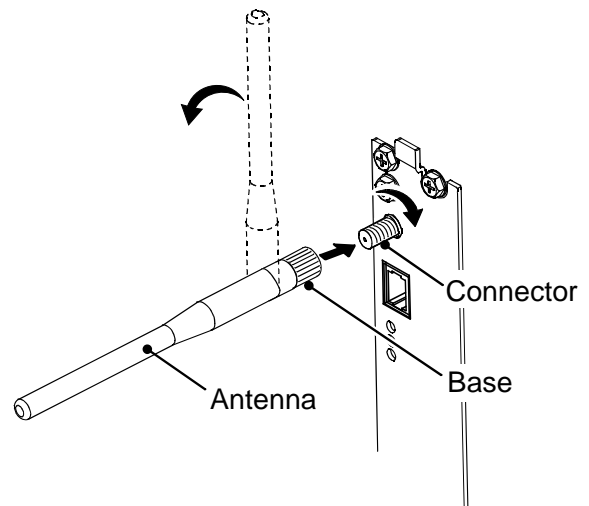

## Network Card Reset

---

It is recommended that the printer's communication settings be reset to factory defaults to avoid any conflicts in configuration. To reset the printer's communication settings:

1. Turn on the printer and press the **MENU BUTTON**.
2. Using the **DOWN BUTTON** scroll to 'COMMUNICATIONS' and press **ENTER**.
3. Using the **DOWN BUTTON** scroll to 'NIC ADAPTER' and press **ENTER**.
4. Using the **DOWN BUTTON** scroll to 'SET FACTORY DEFAULTS' and press **ENTER**. When prompted press the **YES KEY**. The printer will then reset and return to Ready Mode.
5. Once completed, turn the printer OFF.

## Network Card Setup

---

The Print Server makes IP requests at power-up, so before making a network connection to the printer consider how your IP addressing needs to be assigned. The IP addressing of the Internal Ethernet Print Server can be configured in one of two ways: Using a static IP Address or Using IP Discovery (DHCP, BootP, or RARP). **At factory default settings IP DISCOVERY is ENABLED.**

1. With Printer Off, connect the network cable then turn on Printer.
2. The printer will now search for a DHCP server. Once the printer has obtained an IP address the message "IP Address xxx.xxx.xxx.xxx" will be displayed briefly signifying that an IP address has been obtained. Allow up to 90 seconds for the printer to retrieve an IP address.
3. At this point it is recommended to print a Network Report. This Network Report is generated by the printer and lists important default information such as the IP and MAC Addresses as well as SSID for wireless equipped cards. To print the 'Network Report': Press the **PAUSE, FEED, CANCEL** buttons at the same time.
4. Verify the printer has obtained a valid IP address for your network. If a valid IP address was not obtained or you wish to use a different static address this can be set via the printer's front panel.

Enter the printer's menu and navigate to the Communications/NIC Adapter menu branch. Set the "IP Discovery" menu item to Disable, then set the "IP Address" menu item to desired value, continue the same procedure with "Subnet Mask" and "Gateway Address" menu items if necessary. Exit the printer's menu, When prompted to save changes press the **YES KEY**.

```
NETWORK REPORT
THU 03:14PM 27JAN2011
CURRENT PRINTER INFO
INTERFACE: WIRED
NETWORK STATE: OPERATING
MACM: 00-0D-70-03-8C-42
IP ADDRESS: 10.50.12.32
SUBNET MASK: 255.255.254.0
GATEWAY: 10.50.12.1
DHCP: ENABLED
SNMP: ENABLED
PORT NUMBER: 9100
```

*The information on this label will vary depending on your configuration and firmware version.*

Once the previous steps have been successfully completed you may now use the IP Address to:

> Install a printer driver, and start printing from your Windows applications. See section, **Installing the Printer Driver**.

-or-

> If your card is equipped with wireless capabilities, see section **Network Card Setup - Wireless** for setup.

-or-

> Browse to the printer's internal web pages for advanced configuration. See section, **Printer's Internal Web Pages**.

## Network Card Setup - Wireless (Infrastructure Mode)

After a successful setup is made via a wired connection, the Wireless connection (if equipped) can now be configured in infrastructure mode using a static or DHCP issued IP address.



1. Open your web browser. Type in the IP Address of the printer. The Default IP is: 192.168.10.26.

**Note:** If a different IP Address has been assigned to the printer, make sure to enter the correct IP Address.

2. A page similar to the right will appear:



3. Click on the TCP/IP Configuration menu item. Locate and set the following items:
  - > Select WIRELESS ETHERNET (WIFI 802.11) from the NETWORK INTERFACE drop down box.
  - > Select DMXrfNet3 from the WIFI OPTION TYPE drop down box.

Scroll down to the bottom of the page, enter the password (default is "sysadm") and click apply.

4. Click on the DMXrfNet3 menu item on the left side of the screen. Locate and set the following items:
  - > Select INFRASTRUCTURE from the WIRELESS TYPE drop down box.
  - > Set the SSID field to match the SSID of your access point.
  - > Set any WLAN Security Settings if necessary.

**For static IP setup:**

- > In the DHCP section, select the DISABLED radio button.
- > In the STATIC IP ADDRESSES section, enter valid static addresses for PRINTER IP ADDRESS, PRINTER SUBNET MASK, and PRINTER GATEWAY.

Scroll down to the bottom of the page, enter the password (default is "sysadm") and click apply.

5. Click on the Restart Network menu item, enter the password and click the Restart Network button.

Once the previous steps have been successfully completed you may now use the IP Address to:

> Install a printer driver, and start printing from your Windows applications. See section, **Installing the Printer Driver.**

**-or-**

> Browse to the printer's internal web pages for advanced configuration. See section, **Printer's Internal Web Pages.**

## Network Card Setup - Wireless (Adhoc Mode)

To configure the wireless card in Adhoc mode, you must configure your host computer to match the default settings of the printer. Your wireless network type must be Adhoc. Refer to your operating system's or your wireless network card documentation for information on how to configure your computer.



1. Power on the printer. Enter the printer's menu and navigate to the Communications/NIC Adapter/Quick Setup menu branch. Scroll down to the "WLAN RFNET 3 ADHOC" menu item and press the **ENTER** button. When prompted press the **YES KEY**. The printer will now be set to the following settings:

Wireless Mode: **Enabled**  
IP: **192.168.10.26**  
SSID: Blank; *none*  
Subnet Mask: **255.255.255.0**  
Gateway: **192.168.10.26**

2. Make sure your host computer's network IP settings are in the same range, (but not identical) to the printers IP address. (e.g. 192.168.10.20). Also be sure that Subnet Mask is set to 255.255.255.0 and the Gateway is set to 0.0.0.0 or the host computer's IP address, (in this case 192.168.10.20).
3. From Windows, you may now "View Wireless Networks". From the list of available wireless networks select the printer that you wish to connect to and then click on the Connect button.

If you do not see your printer listed be sure you have the host computer configured for Adhoc wireless networks.

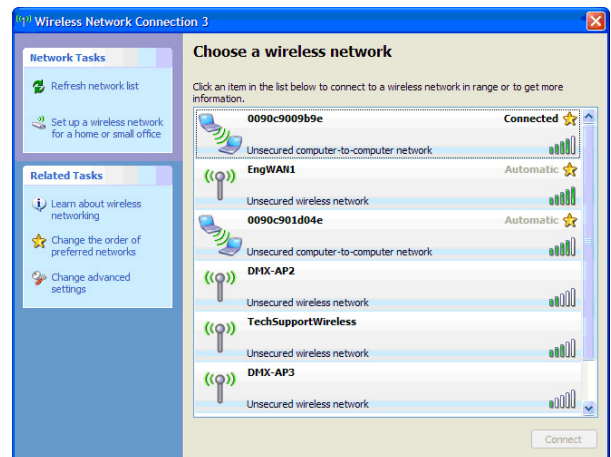

*This process will vary depending on your wireless device installed in your host computer and your operating system version.*

Once the previous steps have been successfully completed you may now use the IP Address to:

> Install a printer driver, and start printing from your Windows applications. See section, **Installing the Printer Driver**.

**-or-**

> Browse to the printer's internal web pages for advanced configuration. See section, **Printer's Internal Web Pages**.



## Printer's Internal Web Pages

1. Open your web browser. Type in the IP Address of the printer. The Default IP is: 192.168.10.26.

**Note:** If a different IP Address has been assigned to the printer, make sure to enter the correct IP Address.

2. The following page will appear:

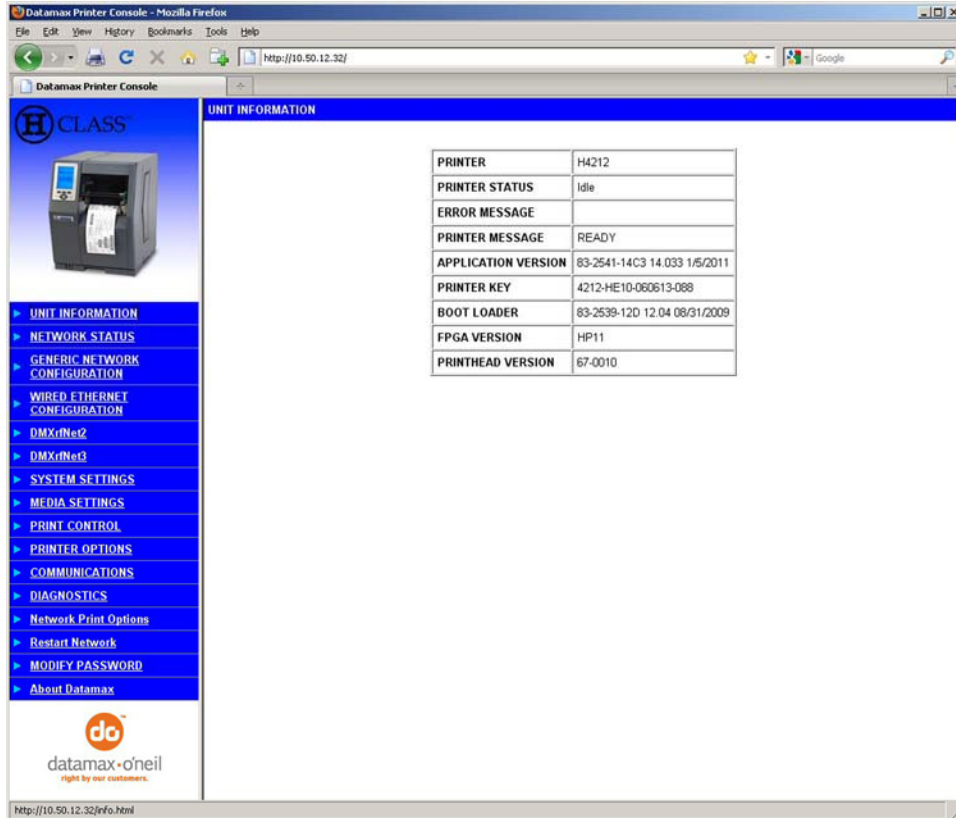

The printer's internal web pages are divided into 15 pages that are accessible via the navigation bar on the left-hand side.

Most of the items on these pages mimic the printer's internal menu. For more information on the function of these settings see the corresponding function in the Operator's Manual.

The **GENERIC NETWORK CONFIGURATION**, **WIRED ETHERNET CONFIGURATION**, and **DMXrfNet3** pages contain many items associated with the setup of the network card as well as wireless security settings. The following tables provide information on each of the items listed on these pages.

**Note:** You must provide a password to change any settings, the default password is "sysadm".

**Note:** After changes are sent to the printer, (on all web pages) the network card must be restarted in order for the changes to take effect. This can be done from the "Restart Network" page.

**Note:** If any address parameters were changed such as IP address, subnet or gateway, the printer might not be viewable from the current host if they are no longer on the same subnet.

## GENERIC NETWORK CONFIGURATION Page

NETWORK INTERFACE	
NETWORK INTERFACE	Selects WIRED ETHERNET (802.3) or WIRELESS ETHERNET (WIFI 802.11)

WIFI OPTION TYPE	
WIFI OPTION TYPE	Selects which model of the communication card. This setting must match the model installed in the printer; DMXrfNet2 or DMXrfNet3. The model of the card is shown in the upper right hand corner of the cards mounting plate.

NET BIOS SERVICES	
ENABLED/DISABLED	Enables or disables the NET BIOS SERVICES
NETBIOS NAME	Is the name used to reference the printer instead of the IP address. A WINS or DNS server is required for this capability.
PRIMARY WINS SERVER	The IP address of the primary WINS Server.
SECONDARY WINS SERVER	The IP address of a secondary WINS Server.

TCP PRINT SERVICES	
TCP PRINT SERVICES	Selects the Port to use for all network communications; Default is 9100

LPD PRINT SERVICES	
LPD PRINT SERVICES	Enables or disables the LPD SERVICES

SNMP SERVICES	
ENABLED/DISABLED	Enables or disables the SNMP SERVICES Allows management protocols, where: ENABLED = Sends messages to SNMP-compliant devices. DISABLED = Sends no messages.
SNMP SERVER ADDRESS	Is the address in standard octet format for SNMP services.
SNMP TRAP ADDRESS	Is the address in standard octet format where SNMP traps will be sent when SNMP service is installed on your receiver. When zeroed, no traps are sent.

TELNET SERVICES	
ENABLED/DISABLED	Enables or disables Telnet protocol to transfer data.

FTP SERVICES	
ENABLED/DISABLED	Enables or disables FTP protocol to transfer data.

HTTP (WWW) SERVICES	
ENABLED/DISABLED	Enables or Disables the HTTP SERVICES.

NETCENTER SERVICES	
ENABLED/DISABLED	Enables or Disables the NETCENTER SERVICES.

GRATUITOUS ARP	
GRATUITOUS ARP	Sets time interval for ARP transmission packets, where: (0-2048 minutes); Default is 0 (Disabled)

## WIRED ETHERNET CONFIGURATION Page

DHCP							
ENABLED/DISABLED	<p>Controls IP Address discovery, where:</p> <p>ENABLED: Broadcasts over the network to receive addresses from the responsible server at startup. Manual modifications to IP Address, Subnet Mask, or Gateway are not allowed; and, if no server is found, the specified static value will be used.</p> <p>DISABLED: Uses the stored static IP, Subnet Mask, and / or Gateway Address.</p>						
STATIC IP ADDRESSES							
PRINTER IP ADDRESS	These are the static address the printer will use when "DHCP" is set to disabled or a valid IP could not be retrieved from a DHCP server.						
PRINTER SUBNET MASK							
PRINTER GATEWAY							
ETHERNET PORT CONNECTION SETTINGS							
ETHERNET MODE	<p>Allows the User to specify the line duplex and speed of the wired Ethernet connection.</p> <table border="0"> <tr> <td>Auto-Negotiate (default)</td> <td>10 BaseT Full Duplex</td> </tr> <tr> <td>100 BaseT Full Duplex</td> <td>10 BaseT Half Duplex</td> </tr> <tr> <td>100 BaseT Half Duplex</td> <td></td> </tr> </table>	Auto-Negotiate (default)	10 BaseT Full Duplex	100 BaseT Full Duplex	10 BaseT Half Duplex	100 BaseT Half Duplex	
Auto-Negotiate (default)	10 BaseT Full Duplex						
100 BaseT Full Duplex	10 BaseT Half Duplex						
100 BaseT Half Duplex							
ADVERTISE CAPABILITIES	<p>Selects the method in which the Duplex Capability setting is advertised, where:</p> <p>Automatic (advertises the selected Duplex Capability setting)</p> <p>All Capabilities (advertises all capabilities)</p>						
MINIMUM TRANSMISSION UNIT (MTU)							
Max Transmission Units	<p>Sets the Maximum Transmission Unit packet size, where:</p> <p>Packet size, in bytes. (512-65515); Default is 1500</p>						

## DMXrfNet3 Page



DHCP	
ENABLED/DISABLED	<p>Controls IP Address discovery, where:</p> <p>ENABLED: Broadcasts over the network to receive addresses from the responsible server at startup. Manual modifications to IP Address, Subnet Mask, or Gateway are not allowed; and, if no server is found, the specified static value will be used.</p> <p>DISABLED: Uses the stored static IP, Subnet Mask, and / or Gateway Address.</p>
STATIC IP ADDRESSES	
PRINTER IP ADDRESS	These are the static address the printer will use when "DHCP" is set to disabled or a valid IP could not be retrieved from a DHCP server.
PRINTER SUBNET MASK	
PRINTER GATEWAY	
WIRELESS TYPE	
WIRELESS TYPE	<p>Specifies the type of network in which the Module will be used:</p> <p>INFRASTRUCTURE = connects to WLAN using an AP.</p> <p>ADHOC = used to connect two peer-to-peer devices.</p>

## DMXrfNet3 Page (continued...)

<b>ADHOC CHANNEL</b>															
ADHOC CHANNEL	When Wireless Network Type is Ad Hoc, selects the channel used for communication. The two peer-to-peer devices must use the same channel. Range is 1 to 14 channels. Default channel is 1.														
<b>WIFI REGION CODE</b>															
WIFI REGION CODE	Specifies the wireless channels allowed. The AP controls the channel used during Infrastructure mode. Default is US.														
<b>SSID</b>															
SSID	Service Set Identifier that identifies the Module to connect to an AP. To make this connection, the Module and AP must have the same SSID. The SSID cannot contain spaces. Default setting is the MAC address of the wireless module.														
<b>WIFI SECURITY</b>															
WIFI SECURITY	<p>Selects the WIFI SECURITY mode:</p> <table border="1"> <tr> <td>Disable</td> <td>WPA-PSK64</td> </tr> <tr> <td>WEP64</td> <td>WPA-PSK128</td> </tr> <tr> <td>WEP128</td> <td>WPA2-PSK</td> </tr> <tr> <td>WPA-PSK</td> <td>TLS</td> </tr> <tr> <td>WPA-LEAP</td> <td>PEAP</td> </tr> <tr> <td>WPA-LEAP64</td> <td>TTLS</td> </tr> <tr> <td>WPA-LEAP128</td> <td></td> </tr> </table>	Disable	WPA-PSK64	WEP64	WPA-PSK128	WEP128	WPA2-PSK	WPA-PSK	TLS	WPA-LEAP	PEAP	WPA-LEAP64	TTLS	WPA-LEAP128	
Disable	WPA-PSK64														
WEP64	WPA-PSK128														
WEP128	WPA2-PSK														
WPA-PSK	TLS														
WPA-LEAP	PEAP														
WPA-LEAP64	TTLS														
WPA-LEAP128															
<b>WIFI AUTHENTICATION</b>															
WIFI AUTHENTICATION	<p>Selects the WIFI authentication method: (not available for all WIFI SECURITY modes)</p> <p>AUTO = automatically detects the authentication. (default)</p> <p>OPEN = communicates the key across the network.</p> <p>SHARED KEY = allows communication only with devices with identical settings</p>														
<b>WEP SETTINGS</b>															
WEP KEY USED	Selects the default WEP Key from 1 – 4 if Shared Key or Both is selected for WEP Authentication. Default is WEP Key 1.														
WEP Key 1 through 4	<p>Specify up to four WEP key values:</p> <p>If WEP Encryption = 64, enter 10 hexadecimal digits for each key.</p> <p>If WEP Encryption = 128, enter 26 hexadecimal digits for each key.</p>														
<b>WPA SETTINGS</b>															
WPA Passphrase	WPA-PSK 8 to 63 characters or 64 hex digits														
<b>LEAP SETTINGS</b>															
LEAP USER ID	User ID for LEAP security mode; 1 to 32 characters														
LEAP PASSWORD	Password for LEAP security mode; 1 to 32 characters														
<b>EAP SETTINGS</b>															
EAP USER ID	User ID for EAP security mode; maximum of 64 ASCII characters														
EAP PASSWORD	Password for EAP security mode; maximum of 64 ASCII characters														
<b>PEAP SETTINGS</b>															
OUTER AUTHENTICATION	Selects PEAP v0 or PEAP v1														
INNER AUTHENTICATION	Selects MSCHAPv2, EAP MSCHAPv2, or EAP MD5														

# Installing the Printer Driver

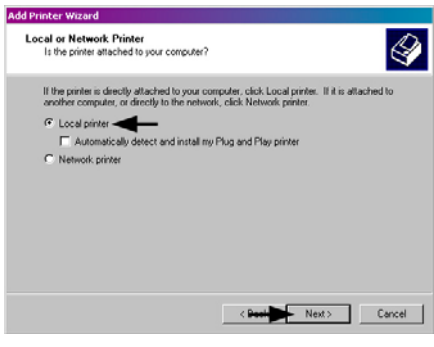
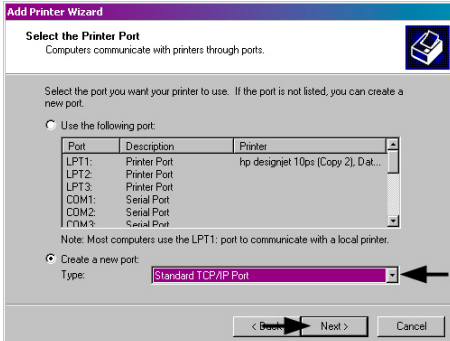
The following screen shots are taken from Windows 2000, other Windows versions will be similar.

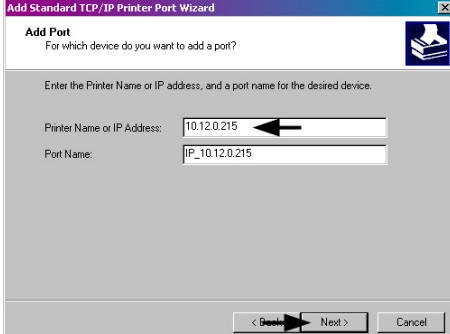
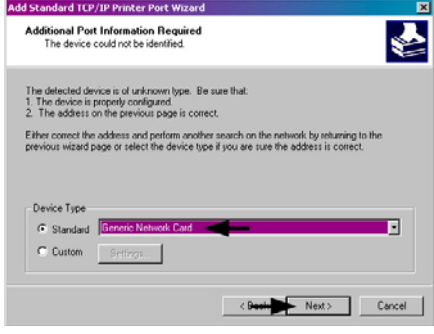
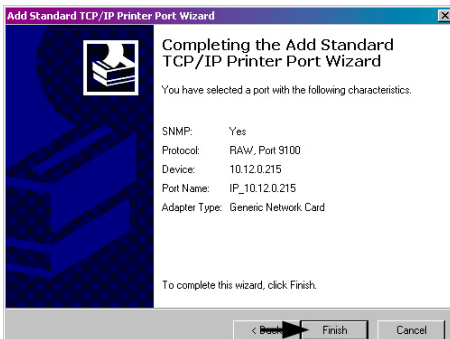
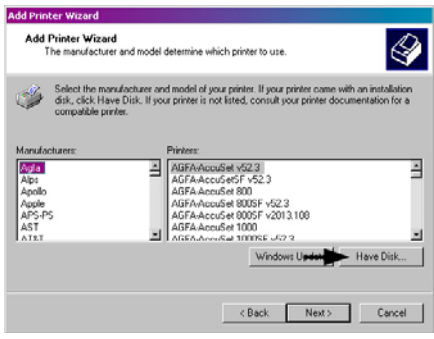
<p><b>1</b></p> <p>Start the Windows "Add Printer Wizard". The following screen should appear, click 'Next'.</p>	
<p><b>2</b></p> <p>Make sure that 'Local Printer' is selected and then click 'Next'.</p>	
<p><b>3</b></p> <p>Select on 'Create a new port:' and then select 'Standard TCP/IP Port' from the drop down menu. Click 'Next'</p>	
<p><b>4</b></p> <p>Click 'Next'.</p>	
<p><b>5</b></p> <p>In the 'Printer Name or IP Address:' field enter the IP address of your printer. The 'Port Name' field <u>does not</u> need to be changed. When finished click 'Next'.</p>	
<p><b>6</b></p> <p>Make sure 'Standard' is selected and then click 'Next'.</p>	
<p><b>7</b></p> <p>Confirm your settings and then click 'Finish'.</p>	
<p><b>8</b></p> <p>Click on 'Have Disk'.</p>	

9

Insert the Accessories CD-Rom and click 'Browse'.

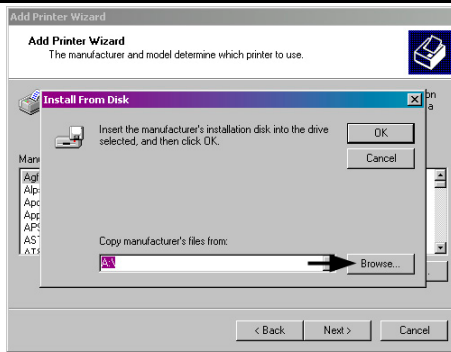

10

Browse to the "\DRIVERS\Seagull" folder on the CD-ROM, make sure the file "for 95, 98, me, 2000, and xp.inf" is selected and click 'OK'.

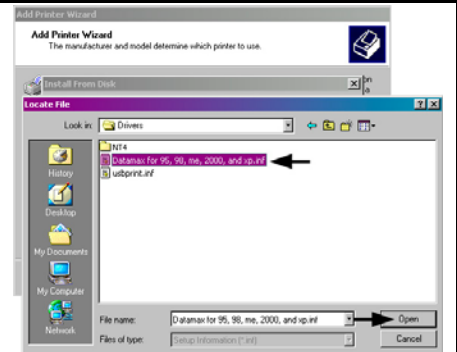

11

Click 'OK'.

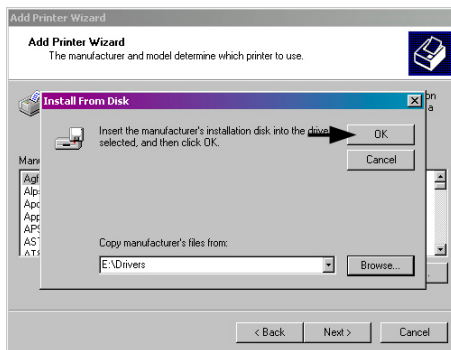

12

Choose your printer from the list and then click 'Next'.

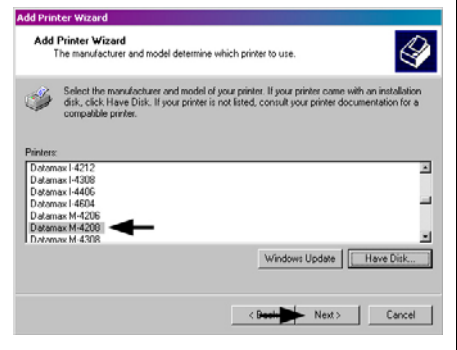

13

Name your printer in the 'Printer name:' field. Next select whether or not to set this printer as your default printer. Then Click 'Next'.

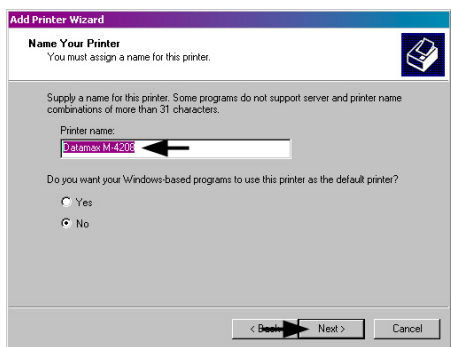

14

Select whether or not to share this printer on your network. Then Click 'Next'

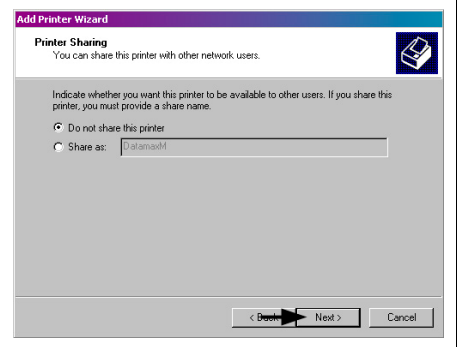

15

Select 'No' then Click 'Next'.

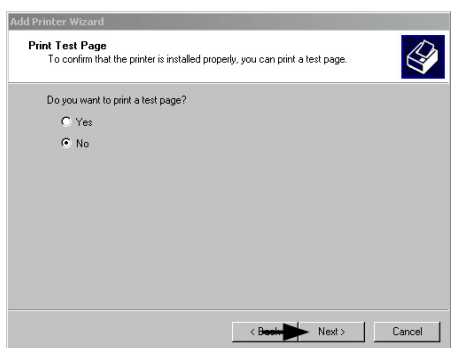

16

Confirm your settings and then click 'Finish'.

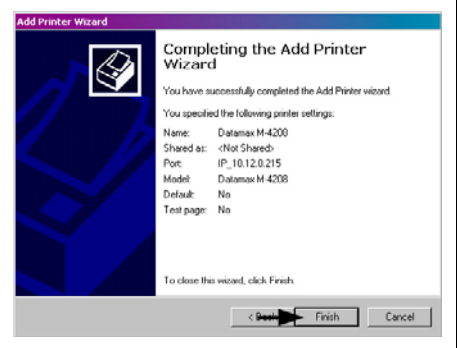

17

If prompted with the "Digital Signature Not Found" window, click 'Yes' to continue installation.

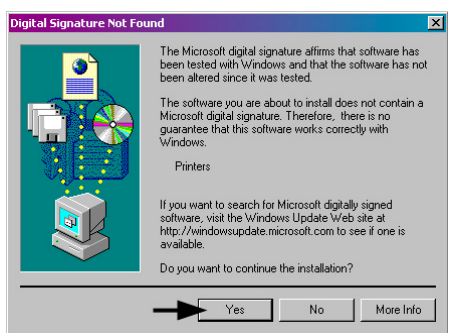

18

Your computer will now copy the necessary files from the CD-ROM. The driver and port installation is now complete. The printer can be selected through any Window's application.

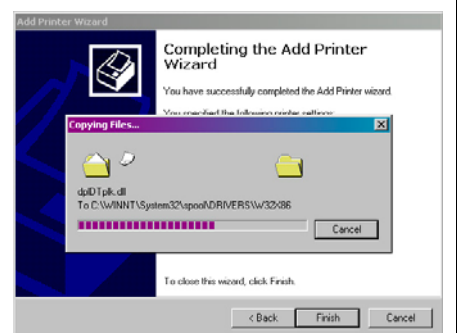

## Wireless and Wired Ethernet Specifications

The following list and table describes the key features and specifications of the wireless/wired card.

- 802.11b/g wireless LAN (Wi-Fi) standards-based technology
- Highly integrated module includes radio, baseband and MAC processor, and application processor
- Wired 10/100Mbps RJ-45 Ethernet port.
- Extended temperature and environmental specifications
- Built-in TCP/IP and UDP features provide flexible LAN connectivity options
- Built-in Web server enables remote configuration capabilities
- Built in WEP, WPA, WPA2, TLS, TTLS, and LEAP security protocols

Specification	Description
Technology	IEEE 802.11b/g DSSS, Wi-Fi compliant
Frequency	2.400 – 2.4835 GHz (US/Can/Japan/Europe) 2.471 – 2.497 GHz (Japan)
Modulation	DBPSK (1 Mbps), DQPSK (2 Mbps), and CCK (5.5 and 11 Mbps)
Channels	USA/Canada: 11 channels (1 – 11) Europe: 13 channels (1 – 13) Japan: 14 channels (1 – 14) France: 4 channels (10 – 13)
Data Rate	11, 5.5, 2, 1 Mbps (raw wireless rate)
RF Power	+15 dBm (typical) Approx.32 mW
Sensitivity	-82 dBm for 11 Mbps -86 dBm for 5.5 Mbps -88 dBm for 2 Mbps -90 dBm for 1 Mbps
Security	WEP64, WEP128, WPA-PSK, WPA-LEAP, WPA-LEAP64, WPA-LEAP128, WPA-PSK64, WPA-PSK128, WPA2-PSK, TLS, PEAP, TTLS
Antenna	One U.FL coaxial connector, 50 Ω, supports receive diversity
Operating Temperature	Industrial: -40°C +85°C (see Note 1 below) (Meets IEEE 802.11 industrial temperature range)

Note 1: Temperatures above +80°C reduce wireless performance. Module operates from -40°C cold start.



The Communications Card is designed to prevent damage to sensitive components due to electrostatic discharge during normal operation; however, when handling the card take proper static-control precautions to prevent damage.

## Optimize Your Wireless Network

For the best wireless coverage, consider where you place the access point, where you place the adapters, and how you adjust the antennas. Some recommendations are:

- Position the access point in line of sight to the wireless adapters, and in a central location within the area to be used for wireless communications. Try to position the access point in a place that is higher than networked computers and equipment.
- Position the access point away from other radio equipment operating at a frequency of 2.4 gigahertz (GHz), such as microwave ovens and cordless telephones.
- Keep your wireless equipment away from large metallic objects, such as computer cases, display monitors, and appliances, as well as other electromagnetic devices, such as televisions, radios, cordless telephones, and microwave ovens that might interfere with wireless transmissions.

Position your wireless equipment so that large masonry structures, such as fireplaces, are not obstructing the radio path. Building construction, such as metal framing, ultraviolet-resistant window film, metallic paint, concrete or masonry walls, or multiple floors and walls reduce radio signal strength.

