

# Mitel 6730a

USER GUIDE

Release# 1.0



## NOTICE

The information contained in this document is believed to be accurate in all respects but is not warranted by Mitel Networks™ Corporation (MITEL®). Mitel makes no warranty of any kind with regards to this material, including, but not limited to, the implied warranties of merchantability and fitness for a particular purpose. The information is subject to change without notice and should not be construed in any way as a commitment by Mitel or any of its affiliates or subsidiaries. Mitel and its affiliates and subsidiaries assume no responsibility for any errors or omissions in this document. Revisions of this document or new editions of it may be issued to incorporate such changes.

No part of this document can be reproduced or transmitted in any form or by any means - electronic or mechanical - for any purpose without written permission from Mitel Networks Corporation.

## TRADEMARKS

The trademarks, service marks, logos and graphics (collectively "Trademarks") appearing on Mitel's Internet sites or in its publications are registered and unregistered trademarks of Mitel Networks Corporation (MNC) or its subsidiaries (collectively "Mitel") or others. Use of the Trademarks is prohibited without the express consent from Mitel. Please contact our legal department at [legal@mitel.com](mailto:legal@mitel.com) for additional information. For a list of the worldwide Mitel Networks Corporation registered trademarks, please refer to the website: <http://www.mitel.com/trademarks>.

© Copyright 2018, Mitel Networks Corporation  
All rights reserved

Mitel 6730a User Guide  
Release # 1.0

Introduction .....	5
Phone Specification.....	5
Phone Parts .....	6
Key Panel.....	7
Bottom View .....	9
Basic Operation.....	10
Dial and Pre-dial .....	10
Dial.....	10
Pre-dial.....	10
Call by Handsfree .....	10
Call by Headset .....	10
Music on Hold.....	10
Mute.....	10
Goodbye Key .....	10
Redial .....	11
Menu Operation .....	11
Phone Setting.....	12
Set Language .....	12
Set Ring Volume.....	12
Set Ring Melody .....	12
Set Handset Volume.....	12
Set Handfree Volume .....	13
Set Headset Volume.....	13
Set Password.....	14
Set Lock state.....	14
LCD Contrast.....	14
Set Flash Time.....	14
Set Time/Date.....	14
Date Format.....	15
Time Format .....	15

---

Area Code Setting .....	15
<b>Call Records</b> .....	<b>16</b>
View Call Records .....	16
Delete Call Records.....	16
Save One-touch / Two-touch memory / Phonebook from Call Records .....	16
Dial Back from Call Records.....	16
Area Code Filter.....	16
<b>Alarm Setting</b> .....	<b>17</b>
Alarm Clock .....	17
Alarm Duration.....	17
Alarm ON/OFF.....	17
<b>Speed Dial Memory</b> .....	<b>18</b>
Save a Memory.....	18
Dial from a Memory .....	18
Delete Memory .....	18
<b>Message Waiting Memory (MWM)</b> .....	<b>19</b>
Save MWM .....	19
Dial from MWM.....	19
Delete MWM.....	19
Message Waiting LED .....	19
<b>Phonebook</b> .....	<b>20</b>
Save MWM .....	20
Search Phonebook .....	20
Add Phonebook .....	20
Delete Phonebook .....	20
<b>Caller ID display</b> .....	<b>21</b>

## Introduction

Mitel 6730a is an advanced line-powered analog phone. It supports multi-languages, call log management, volume adjustment, message waiting, configuration lock, and remote control through FSK signaling.

## Phone Specification

General	
Color	Charcoal
Signal	Analog
Line supported	Single

Features	
Volume control	Handset / Headset (4 levels) Handsfree (8 levels)
Flash button flash time programmable	100ms, 200ms, 300ms (default), 400ms, 600ms, 900 ms
Compatibility with hearing aid	Yes
DTMF dialing	Yes
Incoming call/MWI indicator	Yes
Call waiting display	Yes
Caller ID display	FSK - Type 1 & 2
Missed call + received call	50 call records
Outgoing Call Log	50 call records
Phone book	100 records
Call Timer	Yes
Greeting Message / Owner number	Yes
Real time clock	Yes
Alarm clock	Yes
Display language	6 languages and adjustable by PBX
Reset calling/redial list	Manageable by PBX
Delete calling/redial list	Manageable by PBX
Remote handfree speaking	Manageable by PBX
Configuration lock (4-digit passcode)	Phone book, speed-dial memory and critical phone settings are lockable

Hardware and Feature	
LED calling signalization	Support
Hold with key	Support
Release with key	Support
Speed dial keys	Support (up to 8)
Redial with key	last 1 number
Navigational key	Yes
Ringer melody	8 types
Ringer volume	2 levels
Ringer silence	Yes

Accessories	
Connection cable, RJ11/ RJ45	1 pcs, 2 meters
Number card	1 pcs
Wall mounting kit	screws & anchors included

## Phone Parts

When you unpack your phone, you should ensure that you have all the following items. If any part is missing, contact the supplier of your phone.



**Figure 1 : Phone Parts**

# Key Panel

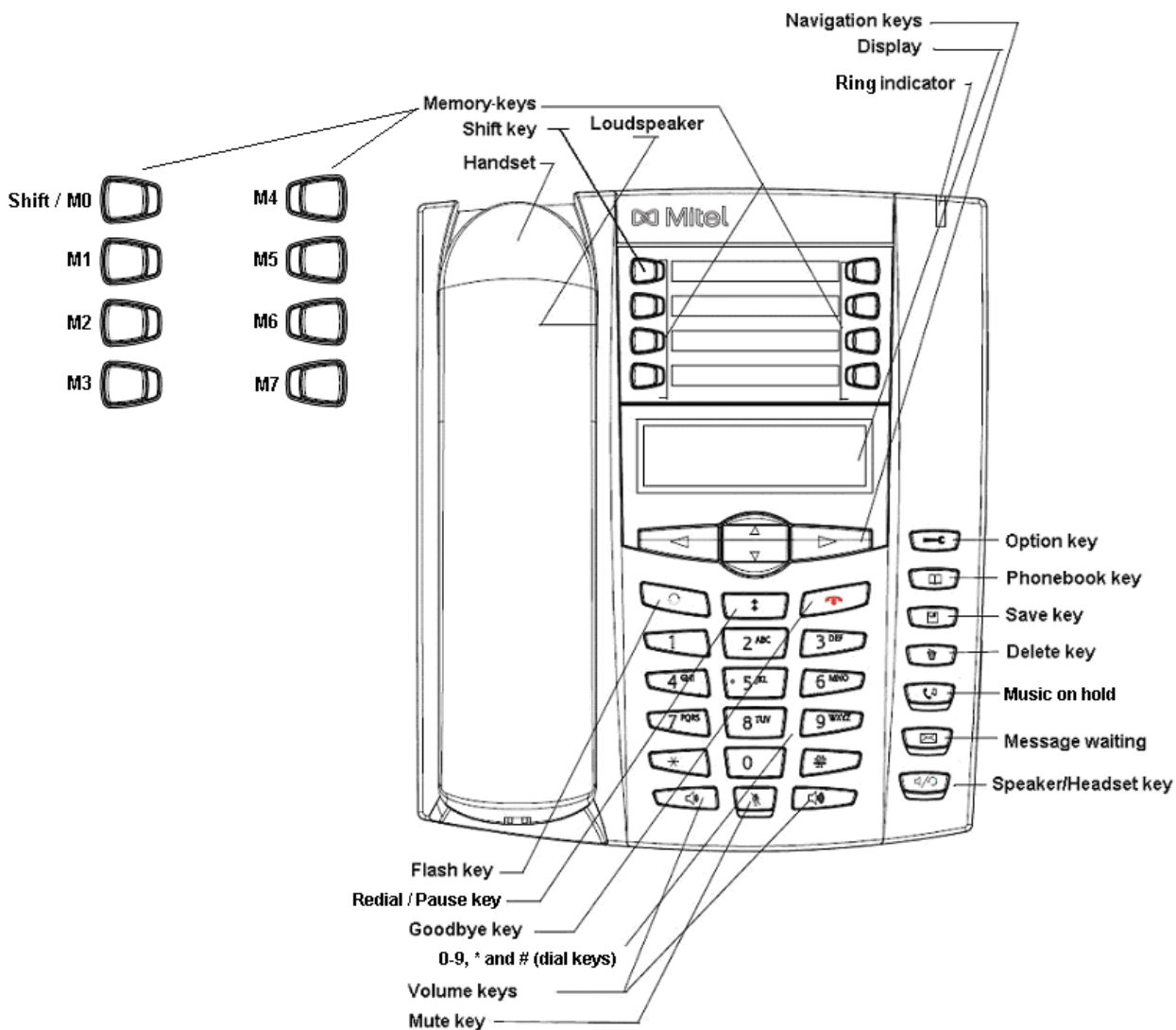
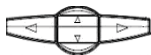

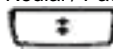

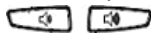

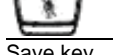

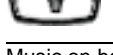
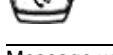
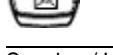



Figure 2 : Key Panel Overview

The following table describes about the Front view Key Panel components in 6 different languages.

Symbols / Keys	Français	Español	Deutsch	Português	Nederlands	Italiano
Speed-dial Shift / M0-M7	Numérotation abrégée Shift / M0-M7	Teclas programables Shift / M0-M7	Kurzwahl Shift / M0-M7	Marcação rápida Shift / M0-M7	Snel-kiezen Shift / M0-M7	Numeri brevi Shift / M0-M7
Navigation keys 	Touches de navigation	Teclas de navegación	Navigationsstasten	Teclas de navegação	Navigatie toets	Tasti di scorrimento
Flash key 	R - Flash	Tecla Flash	R-Taste	Flash	Haakcontact	Tasto Flash
Redial / Pause key 	Touche Bis/ Pause	Rellamada/ Pausa	Wahlwiederholung/ Pausentaste	Rechamar/Tecla de pausa	Nummerherhaling/ Pauzetoets	Bis/Pausa
Goodbye key 	Fin/Fin d'appel	Desconectar	Ende Taste	Desligar	Beëindigen	Tasto Riaggancio
0-9, * and # (dial keys)	0-9, * et # numérotation	0-9, * y # (digitos)	0-9, * und # (Zifferntasten)	0-9, * e # (teclas marcação)	0-9, * en # (bel toetsen)	0-9, * e # (tasti selezione)
Volume keys 	Réglage du volume	Volumen	Lautstärketasten	Volume	Volume toetsen	Tasti regolazione volume
Mute key 	Touche secret	(Mute) silencio	Stummtaste	Silencio	Mute-toets	Tasto mute
Option key 	Touche option	Tecla de opción	Optionswahltaste	Opções	Instellingen	Tasto opzioni
Phonebook key 	Répertoire	Agenda	Telefonbuchtaste	Agenda	Telefoonboek	Tasto Rubrica
Save key 	Sauvegarde	Salvar	Speichertaste	Guardar	Opslaan	Tasto salvataggio
Delete key 	Suppression	Borrado	Löschtaste	Excluir	Verwijderen	Tasto cancella
Music on hold 	Musique d'attente	Música en espera	Musik bei Warten	Música em espera	Muziek tijdens wachten	Musica d'attesa
Message waiting 	Message déposé	Mensaje en espera	Nachricht wartet	Mensagem em espera	Wachtend bericht	Messaggio Giacente
Speaker / Headset 	Haut-parleur / Casque	Altavoz / Tecla de manos libre	Lautsprecher / Kopfhörertaste	Alto-falante / Fone de ouvido	Luidspreker / hoofdtelefoon	Altoparlante / Cuffia



## Bottom View

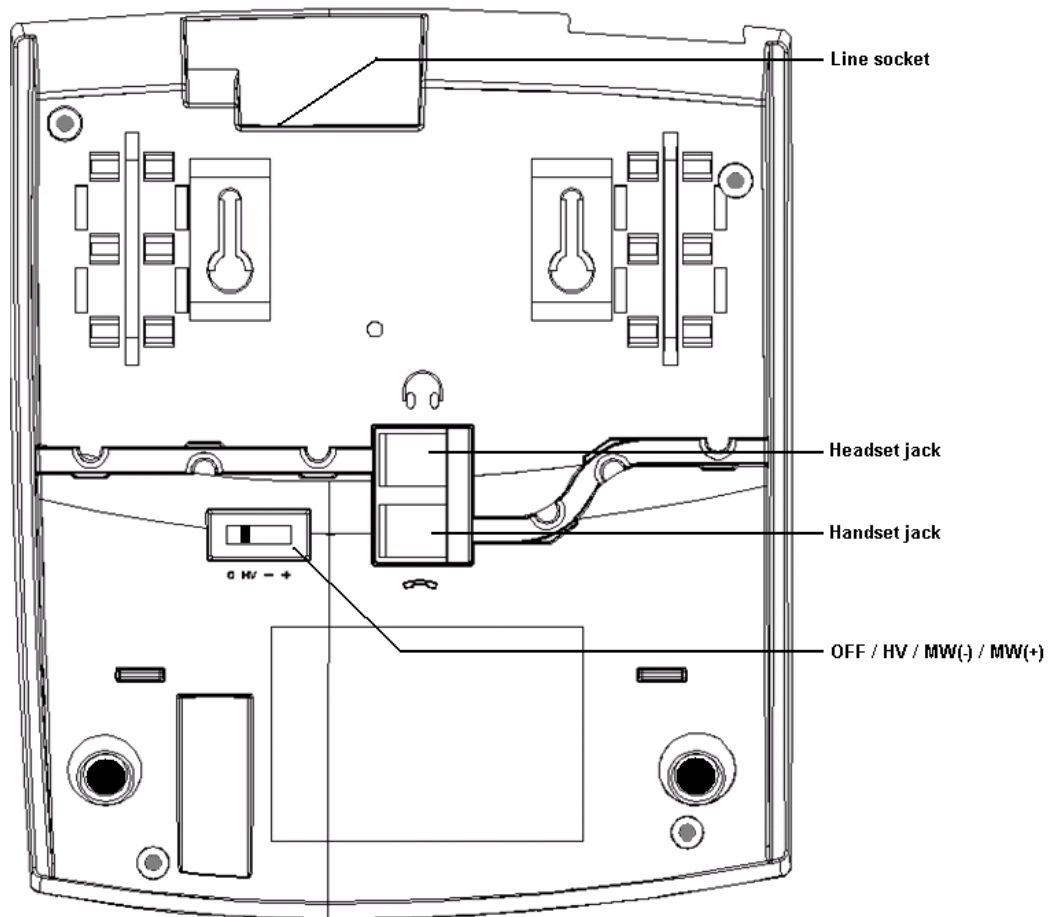

**Figure 3: Bottom View**

The following table describes about the Bottom view Key Panel components in six different languages.

Symbols / Keys	Français	Español	Deutsch	Português	Nederlands	Italiano
Line socket	Prise de ligne téléphonique	Puerto conexión de línea	Anschlussbuchse	Conector de linha telefônica	Lijnpoort	Presà linea telefonica
OFF / Hi Volt / MW (-) / MW (+)	Off / Haute Tension / MW (-) / MW (+)	DE / Alto voltaje / MW (-) / MW (+)	AUS/Spannung/ MW (-) / MW (+)	OFF / Hi Volt / MW (-) / MW (+)	UIT / Hi Volt / MW (-) / MW (+)	OFF / Alta Tensione / MW (-) / MW (+)
Handset Jack	Prise Casque	Puerto de auricular	Kopfhörerbuchse	Conector do fone de ouvido	Hoofdtelefoon aansluiting	Presà Cuffia
Handset Jack	Prise combiné	Puerto de microtelefono	Hörerbuchse	Conector do monofone	Telefoonhoorn aansluiting	Presà Microtelefono



## Basic Operation

### Dial and Pre-dial



#### Dial

Pick up the handset (or press [  ] for handsfree / headset operation) and press numeric key, [\*], [#] or [Pause] to dial out.



#### Pre-dial

During on-hook, press numeric key, [\*], [#] or [Pause] for the number to be dialed (max. 32 digits). Press [  ] or [  ] key or pick up the handset, the phone will dial out the number.



### Call by Handsfree

1. Press [  ] and enter the number by using the dial pad.
2. To hang up the phone, press [  ] again.
3. When you are talking on handset, you can switch to handsfree mode by pressing [  ].



### Call by Headset

1. Insert a headset to the phone
2. Press [  ] and enter the number using the dial pad.
3. To hang up the phone, press [  ] again.
4. When you are talking on handset, you can switch to headset mode by pressing [  ].



### Music on Hold

1. When a call is in progress, press [  ] to hold the call (LED on).
2. Press [  ] again or toggle the hook switch to resume the call (LED off).



### Mute

1. When a call is in progress, press [  ] to mute (LED flashing).
2. To speak to the caller, press [  ] again (LED off).





### Goodbye Key

1. During off-hook by handset, press [  ] to process another call.
2. During off-hook by handsfree/headset, press [  ] to hang up.

## Redial

1. Press [ \* ], the display shows the last number you have dialed.
2. There are up to 5 most recent redial number, press [▲] or [▼] to view the records.
3. Lift the handset or press either [  ] or [  ] to dial out.

## Menu Operation





1. Press [  ] to enter main menu.
2. Press [▲] or [▼] to scroll up and down for different options.
3. Press [  ] or [  ] to enter the submenu / confirm selection.
4. Pressing [  ] to visit the previous menu.

The following table describes about the Main Menu operations.





Main menu	Submenu	Settings	Default
PHONE SETTING	SET LANGUAGE	English, Français, Español, Deutsch, Português, Nederlands, Italiano	ENGLISH
	RING VOL	OFF / LOW / HIGH	HIGH
	RING MELODY	RING 1 ~ 8	RING 1
	SET HANDSET VOL	1 ~ 4	3
	SET HANDSFREE VOL	1 ~ 8	7
	SET PASSWORD	4 digits combination	0000
	SET LOCK STATE	LOCK / UNLOCK	UNLOCK
	LCD CONTRAST	1 ~ 4	2
	SET FLASH TIME	100ms / 200ms / 300ms / 400ms / 600ms / 900ms	300ms
	SET TIME/DATE	24H, MM/DD	00:00, 01/01
	DATE FORMAT	MM/DD or DD/MM	MM/DD
	TIME FORMAT	12/ 24 HOURS	12H
	LOCAL AREA CODE	3 ~ 5 digits combination	-----
	CALL RECORD	MISSED CALL	(View and/or delete)
DIALED CALL		(View and/or delete)	
ANSWERED CALL		(View and/or delete)	
ALARM SETTING	ALARM CLOCK	24H	00:00
	ALARM INTERVAL	5 / 10 / 15 / 30 min	10min
	ALARM ON/OFF	ON / OFF	OFF

## Phone Setting

### Set Language

1. Press [  ] > Phone Setting > Set Language.
2. Press [  ] or [  ] to choose the favourite language (English, Français, Español, Deutsch, Português, Nederlands, Italiano).
3. Press [  ] or [  ] to confirm.

### Set Ring Volume





1. Press [  ] > Phone Setting > Ring Volume.
2. Press [  ] or [  ] to adjust the ringer volume (OFF / LOW / HIGH).
3. Press [  ] or [  ] to confirm.

To disable the ring for incoming calls,



1. Press the 'Volume –' until reach **Ring Off** level or press [  ] during on-hook.
2. The Mute LED remains ON during on-hook to indicate the ring is now in silence.





**Note:** If the phone was locked, users cannot change to “**Ring Off**”. Only **High** and **Low** levels could be selected. To unlock the phone, please see “Phone unlock” in “Phone Setting”.



### Set Ring Melody

1. Press [  ] > Phone Setting > Ring Melody.
2. Press [  ] or [  ] to choose ring melody (MELODY 1 to 8).
3. Press [  ] or [  ] to confirm.





### Set Handset Volume









1. Press [  ] > Phone Setting > Set Handset Volume or Pick up the handset.
2. Press [  ] or [  ] to adjust the volume on the handset.



Handset Volume	Display Icon
Level 4 (max)	
Level 3	
Level 2	
Level 1 (min)	

3. Press [  ] or [  ] to confirm.



## Set Handfree Volume





1. Press [  ] > Phone Setting > Set Handfree Volume or press [  ] to activate handfree.
2. Press [  ] or [  ] to adjust the volume on the handfree loudspeaker.



Handfree Volume	Display Icon
Level 8 (Max.)	
Level 7	
Level 6	
Level 5	
Level 4	
Level 3	
Level 2	
Level 1 (Min.)	

3. Press [  ] or [  ] to confirm.







## Set Headset Volume

1. Plug in the headset.
2. Press [  ].
3. Press [  ] or [  ] to adjust the volume on the headset.

Headset Volume	Display Icon
Level 4	
Level 3	
Level 2	
Level 1 (Min.)	

4. Press [  ] or [  ] to confirm.

## Set Password

1. Press [  ] > Phone Setting > Set Password.
2. Press numeric keys to input the OLD password (default – '0000').
3. Press [  ] or [  ] to confirm the OLD password.
4. Press numeric keys to input the NEW password.
5. Press [  ] or [  ] to confirm the NEW password.
6. Enter the NEW password again for reconfirmation.
7. Press [  ] or [  ] to complete the setting.

## Set Lock state

1. Press [  ] > Phone Setting > Set Lock State.
2. When the display shows “ENTER PASSWORD”, enter the password.

If the phone is locked:





3. Display shows “UNLOCK?”.
4. Press [  ] or [  ] to unlock / Press [  ] or [  ] to quit without change.

If the phone is unlocked (default):





5. Display shows “LOCK?”.
6. Press [  ] or [  ] to lock / Press [  ] or [  ] to quit without change.

**Note:** The phone is unlocked by default. While the state is changed to ‘LOCK’, you need to enter password for deleting the calls record and phonebook or to change the settings which are lock protected (see “Menu Operation”).



## LCD Contrast







1. Press [  ] > Phone Setting > LCD Contrast.
2. Press [  ] or [  ] to adjust the display contrast.
3. Press [  ] or [  ] to confirm.

## Set Flash Time





1. Press [  ] > Phone Setting > Set Flash Time.
2. Press [  ] or [  ] to select the needed flash time.
3. Press [  ] or [  ] to confirm.

## Set Time/Date





1. Press [  ] > Phone Setting > Set Time/Date.
2. Press [  ] or [  ] to adjust the “time”.

3. Press [  ] or [  ] to confirm.
4. Press [  ] or [  ] to adjust the “date”.
5. Press [  ] or [  ] to confirm.





## Date Format

1. Press [  ] > Phone Setting > Date Format.
2. Press [  ] or [  ] to select the date format (MM/DD or DD/MM).
3. Press [  ] or [  ] to confirm.

## Time Format

1. Press [  ] > Phone Setting > Time Format.
2. Press [  ] or [  ] to select the time format (12 Hours or 24 Hours).
3. Press [  ] or [  ] to confirm.









## Area Code Setting

1. Press [  ] > Phone Setting > Local Area Code.
2. Press [  ] or [  ] to set each digit.
3. Press [  ] to confirm and move to next digit setting. The area code can be set in maximum 5 digits combination.
4. After finishing the setting press [  ] twice or move to the last digit and leave.

## Call Records









### View Call Records

Three levels of ring volume provided: **High, Low, Off.**





1. Press [  ] > Call Record.
2. Press [  ] or [  ] to select “MISSED CALL” / “DIALED CALL” / “ANSWERED CALL”.
3. Press [  ] or [  ] to view the calls list.
4. Press [  ] or [  ] to scroll the list.
5. Hold the [  ] / [  ] key for 3s could activate fast scrolling.

### Delete Call Records



To delete a call record,

1. Press [  ].
2. When you will see ‘DELETE?’, press [  ] to confirm or [  ] or [  ] to cancel the deletion.
3. If you want to delete ALL the records, press and hold [  ] for 3 seconds.
4. When you will see ‘DELETE ALL?’, press [  ] to confirm or [  ] or [  ] to cancel the deletion.

### Save One-touch / Two-touch memory / Phonebook from Call Records

1. Select the call record that you wish to save.
2. Press [  ] to confirm.
3. Name the input and press [  ] twice.
4. The display shows ‘M?  ?’, press (M1-M7) or SHIFT+(M0-M7) or [  ] to save.

### Dial Back from Call Records

1. Select the call record that you wish to call.
2. Lift the handset or press either [  ] or [  ].

### Area Code Filter

If area code was set (see “Area code setting”), the phone will compare and filter the initial digits of the incoming number.

For example: The area code is set to “755”. If the incoming call’s number is “755-12345678”. Then, the caller ID will be displayed “12345678” while “755” will be filtered.





**Note:** Only numbers with 7 digits or longer could be filtered the area code. Otherwise the complete number with area code will be displayed.



## Alarm Setting





### Alarm Clock

The alarm clock should be set as 24H, HH/MM and phone should activate the alarm in 5 second after the local clock reached the set time in alarm clock.





1. Press [  ] > Alarm Setting > Alarm Clock.
2. Press [  ] or [  ] to adjust the time.
3. Press [  ] or [  ] to confirm.

### Alarm Duration

The option for selecting the desired alarm interval.



1. Press [  ] key > Alarm Setting > Alarm Interval.
2. Press [  ] or [  ] to select the alarm duration (5 / 10 / 15 / 30 min; default 10 min).
3. Press [  ] or [  ] key to confirm.

### Alarm ON/OFF

1. Press [  ] key > Alarm Setting > Alarm ON / OFF.
2. Press [  ] or [  ] to select ON / OFF to enable / disable the alarm.
3. Press [  ] or [  ] key to confirm.

## Speed Dial Memory

### Save a Memory

1. Place the handset on the phone.
2. Press “one-touch” memory key (M1 to M7) or “two-touch” memory keys (Shift + M0 to M7).
3. Press [  ] and enter the number to be saved.
4. Press [  ] key again, enter the number to be saved and finish by Press [  ] key to complete saving.

### Dial from a Memory

1. Pick up the handset or press [  ].
2. Press “one-touch” memory key (M1 to M7) or “two-touch” memory keys (Shift + M0 to M7) to be dialed.

### Delete Memory

1. Place the handset on the phone.
2. Press “one-touch” memory key (M1 to M7) or “two-touch” memory keys (Shift + M0 to M7) to be deleted.
3. Press [  ].

**Note:** If the phone is locked, you need to enter the password to add, edit or delete entries in speed dial memory (see “Set Lock State”).

## Message Waiting Memory (MWM)

The message waiting memory normally stores the number to reach the voicemail box.

### Save MWM

1. Place the handset on the phone and press [✉].
2. Press [✉] and enter the number to be saved.
3. Press [✉] key again to complete saving.

### Dial from MWM

1. Pick up the handset or press 'Speaker/Handset'.
2. Press [✉].

### Delete MWM

1. Place the handset on the phone.
2. Press [✉].
3. Press [🗑️].

### Message Waiting LED

When there is a message awaiting to be read, the message waiting LED is lighted ON or flashed in red.



The Message Waiting switch (at the back of the phone) is used to select the appropriate MW mode (HV / + / -). Check the MW type of the connected PBX to work with the phone. Select OFF on the MW switch to deactivate the message waiting function.

# Phonebook



## Save MWM

1. Press [  ], the display shows "SEARCH".
2. Press [▲] or [▼] to select "SEARCH" or "ADD".





## Search Phonebook

1. Select SEARCH and press [  ] key to enter Phonebook viewing state.
2. Press [▲] or [▼] to view the records. Hold the [▲] / [▼] key for 3s could activate fast scrolling
3. Lift the handset or press either [  ] or [▶] to dial out.

## Add Phonebook

1. Select ADD and press [  ] key to enter into Phonebook modification state.
2. Enter the name you wish to record and press [  ] to save.
3. Enter the number using the dial pad and press [  ] to save.

## Delete Phonebook



1. In Phonebook viewing state, press [▲] or [▼] to find the record you want to delete.
2. Press [  ] and you will see 'DELETE?', then press [  ] to confirm the deletion.
3. If you want to delete all the records, press [  ] for 3 seconds. Then, you will see 'DELETE ALL?', and press [  ] to confirm.

**Note:** If the phone is locked, you need to enter the password to add, edit or delete entries in phonebook (see "Set Lock State").

## Caller ID display

After receiving a new incoming call, the number will display on LCD and hold for 10s, during this time, if received another new call, it will continue to display for 10s and display corresponding icon.

Incoming calls records include the Number, Name, Date/Time, Caller Timer, Repeated call icon, New missed call icon, missed call icon and Received call icon.

Repeated Call	New Call	Incoming call	Outgoing call	Missed Call	Received Call
REP	NEW	IN	OUT		

If the record is full, the next incoming call will replace the oldest record one by one.

After viewing new missed incoming calls, the “New call” icon will disappear, and “Missed call” icon will be shown.

# WALL MOUNT DRILLING TEMPLATE

PRINT IN SCALE 1:1

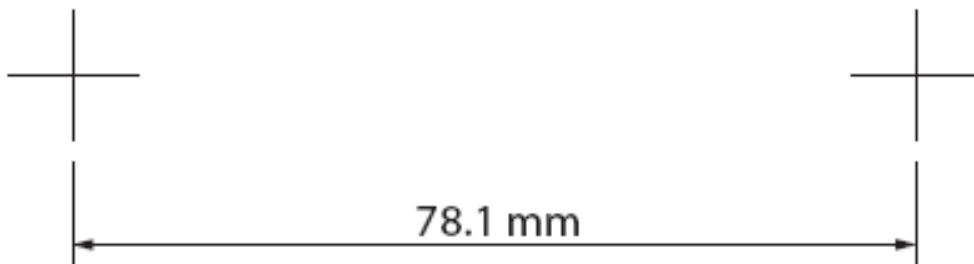

## EC-Declaration of conformity

*Déclaration de conformité CE*

*EG-Konformitätserklärung*

*Declaración de conformidad CE*



## **MITEL France (1 rue Arnold Schoenberg – 78280 Guyancourt – France) hereby declares that:**

This product, Mitel 6730a, equipment is in conformity with the essential requirements and other relevant provisions of the European Directive 1999/5/EC (R&TTE Directive)

*Le poste Mitel 6730a est conforme aux exigences essentielles de la directive 1999/5/EC*

*Dieses Gerät Mitel 6730a entspricht den grundlegenden Anforderungen der Richtlinie 1999/5/EG*

*Este equipo Mitel 6730a cumple con los requisitos esenciales de la directiva 1999/5/CE*

<http://www.mitel.com>