



Pro'sKit®

Professional Tool Solutions Since 1991



Vol. 30

INNOVATION • QUALITY • SERVICE



Pro'sKit® GLOBAL DISTRIBUTION CHANNEL

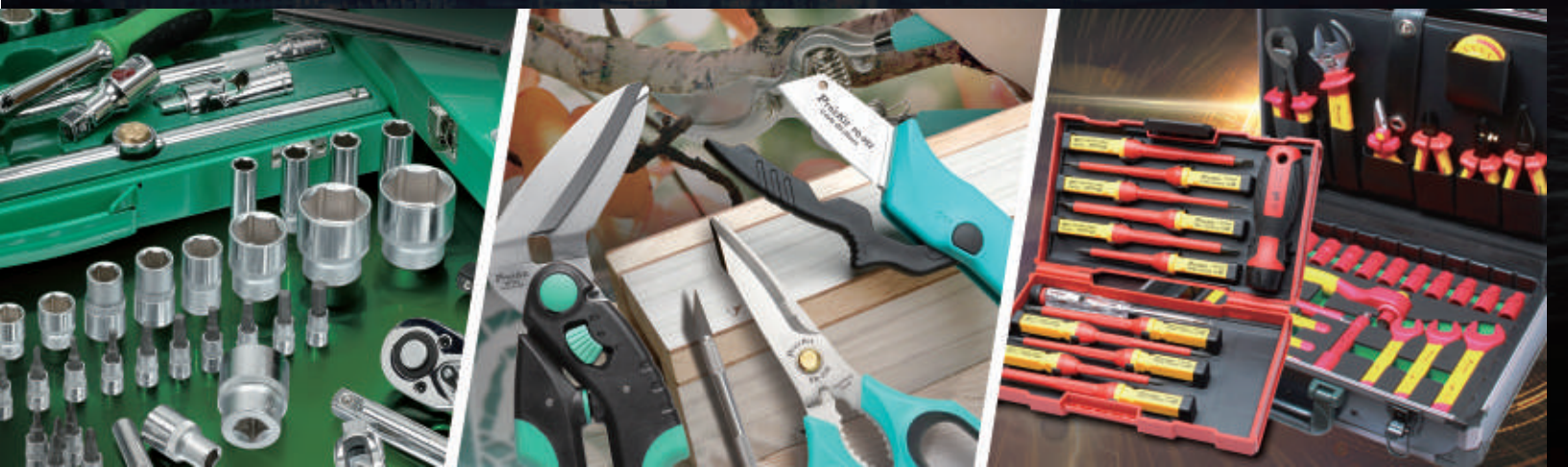



To our valued customers,

On January 6th, 2021, **Pro'sKit**® officially entered its 30th anniversary. We would like to express our deep appreciation to all of **Pro'sKit**® valuable customers for the continuous support and encouragement to **Pro'sKit**® in the past years, so **Pro'sKit**® was able to grow business year by year. **Pro'sKit**® started from 10 sets of tool kits and has extended to more than 4,000 products in 22 categories till now, covering education, communications, networking, optical fiber industries and more, to provide a total tool solution in the market.

Nowadays, **Pro'sKit**® distribution network has reached billions of people in more than 75 countries, and 30 of which served with **Pro'sKit**® authorized distributor. Yet, we will not be complacent about this, we will uphold the consistent policy- Innovation, Quality, Service, to improve ourselves by even higher and more strict standard to shine **Pro'sKit**® brand and win the greatest benefit together.

“Focus” is the core concept of **Pro'sKit**® 30th anniversary. In this new catalogue, we believe you may see the difference of **Pro'sKit**® from material upgrade, better product development plan, and greater marketing material support. Among the thousands of **Pro'sKit**® products, the tool kits are particularly noteworthy for the tool case enhancement as well as contents improvement; all these are once again emphasis on **Pro'sKit**® determination to “Focus” on providing greater products, and thus win the recognition from more users.

In recent years, e-commerce has risen rapidly; coupled with COVID-19 impact since year 2020, more and more consumers turn to on-line shopping, **Pro'sKit**® has also proposed solutions in response to this market trend, including product feature page, product videos, easy troubleshooting guide and e-catalog. In this catalog, each product comes with its corresponding QR CODE, which makes it easier for you to understand product features and selling points. Through the resources integration as well as instant service, we expect to help our customers who tend to develop e-commerce more quickly and conveniently.

To make **Pro'sKit**® as one of the world known tool brands is our vision that we are working hard toward. In the future, we will certainly focus on quality products, implement comprehensive quality assurance policy and provide pre-sales, in-sale and after-sale services as well as complete marketing support. We appreciate all **Pro'sKit**® partners for continuous support and look forward to work together to make **Pro'sKit**® the best outstanding tool brand and achieve more “30 glories”!

Pro'sKit® Symbols

	Wire spring		Insulated & non-insulated wire ferrules		Hex tamper proof		ESD safe		Continuity check
	Leaf spring		Non-insulated terminals & lugs		Nut		Non-magnetic		Diode test
	Flat		Open barrel, non-insulated terminals & lugs		Pozidriv		Magnetic		Transistor hEF test
	Half-round		D-Sub terminal & Non-Insulated Open Barrel Connectors		Triangle		Safety caution		LED test
	Round		Insulated terminals, Insulated & Uninsulated Flag		Spanner nut		Insulated		Battery check
	Stripping flat telephone cables		Insulated terminals		Spanner		1KV insulated protection		Backlight
	Stripping twisted pair round cables		RS-233 D-sub round barrel contact pins or sockets		Torq		Lead free		Maximum/Minimum value
	2 blade stripping coaxial cables		Insulated & non-insulated wire ferrules		Wing nut driver		Complied with IEC/EN 60529 IP54 test		Maximum value hold
	3 blade stripping coaxial cables		Hex type coaxial & fiber optic connectors		Phillips tamper proof		DC voltage		Data hold
	Mini bevel		Oval type coaxial & fiber optic connectors		Clutch		AC voltage		Auto power off
	Full flush		Square type coaxial connectors center contact pins		Spline		DC current		Low battery
	Extra full flush		Crimping pressure adjustment		Square		AC current		Zero-ohm adjuster
	Cross Cut		Ratcheting release knob		TRI-wing		Resistance		Output terminal
	Serrated		Ratcheting release trigger		Ball hex		Frequency		RS232C connector
	Smooth		Force-saving design		Star		Inductor check		USB connector
	Crosswise serrated		Ratcheting force-saving design		Square tamper proof		Capacitance		Hygrometer
	4 pin(RJ22) telephone handset plugs		Black tip		Torx® plus 5 star		Temperature °C/°F measurement		Thermometer
	6 pin(RJ11/RJ12) telephone plugs		Slotted		Square drive socket		Temperature °C measurement		Light meter
	8 pin(RJ45) modular plugs		Phillips		Bi-hexagon socket		Duty cycle		Sound level meter
	10 pin(RJ50) modular plugs		Torx®		Needle type bits		Relative reference		RoHS directive
	Telecom splice connectors		Torx tamper proof		Torx® plus socket		Continuity buzzer		
	Pin terminal, insulated & non-insulated ferrules		Hex		Pantalobe tip		Tri-point tips		

Pro'sKit® Standard plug of power supply cord

PLUG TYPE

• If you have any other issue about power cord, please contact our Sales Team.

Plug Type		Plug	Plug Type		Plug	Plug Type		Plug
	Voltage			Voltage			Voltage	
A	AC110~120V		D	AC220~240V		G	AC220~240V	
B	AC220~240V		E	AC110~120V		H	AC220~240V	
C	AC220~240V		F	AC220~240V		I	AC220~240V	

TOOL KITS

P.4-23



TEST INSTRUMENTS

P.24-45



SOCKET WRENCHES

P.149-155



SOLDERING & DESOLDERING

P.46-68



POWER TOOLS

P.156-160



FIBER OPTICS

P.69-80



ESD STATIC PROTECTION

P.161-163



CRIMPERS

P.81-93



VDE TOOLS

P.164-174



PRECISION PLIERS & CUTTERS

P.94-104



PRECISION TWEEZERS

P.175-179



ELECTRICAL PLIERS & CUTTERS

P.105-112



MAGNIFIER & LAMP

P.180-183



STRIPPERS

P.113-120



KNIVES & SCISSORS

P.184-188



PUNCH DOWN TOOLS

P.121-123



MISCELLANEOUS

P.189-196



ALIGNMENT TOOL & SCREWDRIVERS

P.124-144



INSTRUMENT CASES

P.197-201



HEX KEY WRENCHES

P.145-148



TOOL CASES

P.202-208



PK-1938M series Professional Telecom & Networking Tool Kit

CONNOISSEUR Choice!
More FLEXIBLE options,
SELECT by your DEMAND!



PK-1938M



- Case size: 458x330x150mm
- Individual packing: Inner Box & Color Label Shink

PK-1938M contents		Super Value Flexible Options	
PM-736	Long Nose Plier (132mm)	CP-505	Universal Stripping Tool (UTP/STP - RG-59/6/7/11)
PM-737	Diagonal Cutting Plier (109mm)	CP-751PA	7.5"Coax Connectors Crimping Tool
1PK-067DS	Dual Color Side Cutting Plier (165mm)	DK-2039	Utility Knife (3 Blades Self Loading)
1PK-108T	Reverse Action Tweezer (Self-Gripping) (165mm)	DK-2040	Measuring Tape (3M/10FT)
1PK-125T	Super Fine Tip Straight Tweezer (120mm)	HW-121M	8PCS Folding Hex Key Set(1.5,2,2.5,3,4,5,6,8mm)
1PK-3171	Spring Hook	MS-153C	Ø56mm Bulb Blower W/Brush
1PK-317N	Spring Hook	MS-391	Inspection Mirror
1PK-H026	Adjustable Wrench - 6"	SR-338	Multi-Purpose Shears
9SD-201A	Pro-Soft Screwdriver (3.0x75mm)	9PK-1900N-TP	Top Pallet For PK-1900N series
9SD-201B	Pro-Soft Screwdriver (#0x75mm)	9PK-1938-P	Pallet For PK-1938M series
9SD-202A	Pro-Soft Screwdriver (5x75mm)	TC-756	Deluxe Aluminium Frame Tool Case
9SD-202B	Pro-Soft Screwdriver (#1x75mm)		
9SD-207B	Pro-Soft Screwdriver (#2x100mm)		
9SD-200-T06H	Pro-Soft Screwdriver T06H 3.0x50mm		
9SD-200-T07H	Pro-Soft Screwdriver T07H 3.0x50mm		
9SD-200-T08H	Pro-Soft Screwdriver T08H 3.0x50mm		
9SD-200-T09H	Pro-Soft Screwdriver T09H 3.0x50mm		
9SD-200-T10H	Pro-Soft Screwdriver T10H 3.0x75mm		
9SD-200-T15H	Pro-Soft Screwdriver T15H 4.0x75mm		
9SD-200-M5	Pro-Soft Screwdriver 5mm		
9SD-200-M6	Pro-Soft Screwdriver 6mm		
908-607	Alignment Tool (200mm/2.0mm)		
9H075	Cable Tie		
AS-611	Wrist Strap 10FT		
CP-3001D	Precision Wire Stripper (AWG 30/28/26/24/22/20)		
CP-3141A	Krone Impact Terminal Tool with Lock		
CP-376TR	4P/6P/8P Telecom Crimping Tool		
		PK-1938M1	PK-1938M+MT-7063
		PK-1938M2	PK-1938M+MT-7029
		PK-1938M3	PK-1938M+MT-7063+MT-1707
		PK-1938M4	PK-1938M+MT-7063+MT-8001
		PK-1938M5	PK-1938M+MT-7029+MT-1707+MT-8001

• NOTE : For quality reason, we reserve the right to change the above specifications without notice.



Diamond Carve Surface

Aluminum Frame
Thick Frame 30mm

8 Corner Guards
Thick Corner 26mm

P.203

Ratchet Mechanism

P.88

P.85

Sharp Cutting Edge

P.106

Accurate Stripping
For stripping 0.2-0.8mm

P.114

Japan Made 420 I2
Stainless Steel

4mm Stainless Steel
Heavy Duty

P.185

P.125

▶ PK-1938M series Professional Telecom & Networking Tool Kit



PK-1938M1
With MT-7063
P.30

Anti-Noise
PoE Switches & STP Wire Tracing
Cable Mapping

3KM
300M



PK-1938M2
With MT-7029
P.28



PK-1938M3
With MT-7063+MT-1707

PoE Test
Cable Mapping
300m
Live Ethernet
Cable Test

P.30



True RMS
Full Function
CE Certified

P.32

P.30



P.26

PK-1938M4
With MT-7063+MT-8001

Weather Proof
High Impedance
Monitor
Advanced PBX
Pause



PK-1938M5
With MT-7029 P.28
MT-1707 P.32
MT-8001 P.26

• NOTE : For quality reason, we reserve the right to change the above specifications without notice.

▶ PK-4302AI/BM

PC Networking Tool Kit

PK-4302 is a professional PC networking tool kit, including digital multimeter, tester, crimper, stripper, pliers, punch down tool and soldering iron for system integrators and MIS engineers of computer repairing and networking installation



Model No.	Soldering voltage	Standard plug
PK-4302AI (Inch)	110V	A
PK-4302BM(Metric)	220V	B

PK-4302AI / PK-4302BM contents

1PK-067DS	Dual Color Side Cutting Plier (165mm)
1PK-709DS	Dual Color Long Nose Plier (166mm)
6PK-501	Wire Stripper Tool
9CP-246D8P	Die Set for RJ45/8P8C
9CP-346DC	Die Set for RG58/59/62/6
9CP-346DC2	Die Set for RG59/6,F Type
9CP-346DG	Die Set for Fiber Optic Connector
9DP-S001	Pen Solder 63%
9HW-002B	7 PCS Folding Type Hex Key Set
8PK-021NA	(Metric or inch)
9SD-201A	⊖ Pro-Soft Screwdriver (3.0x75mm)
9SD-201B	⊕ Pro-Soft Screwdriver (#0x75mm)
9SD-210A	⊕ Pro-Soft Screwdriver (5.5x100mm)
9SD-210B	⊕ Pro-Soft Screwdriver (#1x100mm)
9SD-200-M5	⊖ Pro-Soft Screwdriver
9SD-200-I1	5mm(metric) or 3/16"(inch)
9SD-200-M6	⊖ Pro-Soft Screwdriver
9SD-200-I2	6mm(metric) or 1/4"(inch)

CP-3141A	Krone Impact Terminal Tool with Lock
CP-080E	Wire Stripping Tool
CP-371	CrimpPro Crimp Frame Only (236mm)
DK-2039	Utility Knife (3 Blades Self Loading)
DK-2040	Measuring Tape (3M/10FT)
DP-366D	Desoldering Pump
MT-1210	3 1/2 Compact Digital Multimeter
MT-7031	Mini Lan Cable Tester
PD-2607	Ball Peen Hammer With Fiberglass Handle
SB-1912	Utility Component Storage Box (O.D.:187.5x117x22mm)
SI-130B-20	Ceramic Soldering Iron(220V or 110V)
SI-130A-20	
SR-332	All Purpose Snip (165mm)
9PK-4302-P	Pallet for PK-4302 series
9PK-4302-TP	Top Pallet for PK-4302 series
9PK-730N	Aluminium Frame Tool Case

- Case size: 458x330x150mm(O.D.)
- Individual packing: Color box

• NOTE : For quality reason, we reserve the right to change the above specifications without notice.

PK-4013 Network Installation Tool Kit

Combination of essential tools for network installation and maintenance.

PK-4013 contents	
1PK-067DS	Dual Color Side Cutting Plier (165mm)
6PK-501	Wire Stripper Tool
DK-2040	Measuring Tape (3M/10FT)
9FL-516	9PCS LED Flashlight
9SD-329H	Screwdriver Probe Voltage Tester
CP-148	Telecom Combi-Crimper/Plier
CP-302G	Precision Wire Stripper(AWG 20/18/16/14/12/10)
CP-3141	Impact Terminal Tool For Krone
CP-376KX	Professional Modular Crimps Strips & Cuts Tool (200mm)
DK-2039	Utility Knife (3 Blades Self Loading)
MT-7031	Mini Lan Cable Tester
SD-5101A	⊖ Line Color Screwdriver (3.0x 75mm)
SD-5101B	⊕ Line Color Screwdriver (#0 x 75mm)
SD-5107A	⊖ Line Color Screwdriver (6.0 x 100mm)
SD-5107B	⊕ Line Color Screwdriver (#2 x 100mm)
9ST-4013	Tool Bag

- Bag size : 340x222x60mm(O.D.)
- Individual packing : Color sleeve shrink

CP-148

Telecom Combi-Crimper/Plier

- Stripper, cutter, crimper, plier 4 in one P.91



MT-7031

Mini Lan Cable Tester

- One touch testing
- Multifunction
- Visual & audible dual indication P.31

CP-376KX

Professional Modular Crimps Strips & Cuts Tool

- Parallel action for accurate crimping
- Ratchet design for force saving
- For 8P8C/RJ-45,6P6C/RJ-12,6P4C/RJ-11 P.90



PK-2629 Telecom & Network Installer Tool Kits

Complete kit allows the professional installer or amateur enthusiast to handle cabling, terminating and troubleshooting with ease.



PK-2629 contents	
1PK-067DS	Dual Color Side Cutting Plier (165mm)
CP-148	Telecom Combi-Crimper/Plier
9SD-201A	⊖ Pro-Soft Screwdriver (3.0x75mm)
9SD-201B	⊕ Pro-Soft Screwdriver (#0x75mm)
CP-3141	Impact Terminal Tool For Krone
CP-376TR	4P/6P/8P Telecom Crimping Tool (190mm)
MT-1210	3 1/2 Compact Digital Multimeter
MT-7029	Noise-Filtering Network PoE Toner & Probe Kit
9ST-2628	Tool Bag

- Bag size:385x300x55mm
- Individual packing: Color sleeve shrink



MT-7029

Noise-Filtering Network PoE Toner & Probe Kit

- Strong anti-noise
- PoE switches & STP wire tracing
- Telephone line status / polarity P.28

MT-1210

3 1/2 Compact Digital Multimeter

- Diode test
- Continuity test
- Transistor test P.35



• NOTE : For quality reason, we reserve the right to change the above specifications without notice.

Networking / Telecom / CCTV / CATV

▶ PK-2633 Network Test Tool Kit



PK-2633 contents	
6PK-501	Wire Stripper Tool
CP-3141	Impact Terminal Tool For Krone
CP-393	Pro-Crimper Modular Tool (160mm)
MT-7031	Mini Lan Cable Tester
PD-513	Utility Knife
SD-5102A	⊖ Line Color Screwdriver (5.0x75mm)
SD-5102B	⊕ Line Color Screwdriver (#1x75mm)
SD-5107A	⊖ Line Color Screwdriver (6.0x100mm)
SD-5107B	⊕ Line Color Screwdriver (#2x100mm)
SR-332	All Purpose Snip (165mm)
ST-33	Tool Bag



RJ45 cable test



Continuity Test (Single End)



BNC cable test

- Bag size: 255x180x50mm
- Individual packing: Color sleeve shrink

▶ PK-2635 Network Installation Tool Kit



PK-2635 contents	
6PK-501	Wire Stripper Tool
CP-3141	Impact Terminal Tool For Krone
CP-335	CAT.7 Modular Plug Crimping Tool
DK-2039	Utility Knife (3 Blades Self Loading)
MT-7031	Mini Lan Cable Tester
SD-5107A	⊖ Line Color Screwdriver (6.0 x 100mm)
SD-5107B	⊕ Line Color Screwdriver (#2 x 100mm)
9ST-PK2636	Tool Bag



RJ45 cable test



One step to punch & cut



Parallel action

- Bag size: 280x190x63.5mm
- Individual packing: Color sleeve shrink

• NOTE : For quality reason, we reserve the right to change the above specifications without notice.

PK-2636
PK-2637

Professional Network Installation Tool Kit



Troubleshooting network cables for consistency **and errors is crucial for any home or office network.**

This network installation tool kit comes with the essential tools for installation, troubleshooting, and maintenance.



PK-2636



PK-2637

PK-2636 - Ideal for Cat. 5/6
PK-2637 - Ideal for Cat. 5/6/7

Model.	Product Name	PK-2637	PK-2636
1PK-067DS	Dual Color Side Cutting Plier (165mm)	•	•
9SD-207A	Pro-Soft Screwdriver (6x100mm)	•	•
9SD-207B	Pro-Soft Screwdriver (#2x100mm)	•	•
CP-3141A	Krone Impact Terminal Tool with lock	•	•
CP-376TA	CAT.7 Modular Plug Crimping Tool	•	
CP-376TR	4P/6P/8P Telecom Crimping Tool (190mm)		•
DK-2039	Utility Knife (3 Blades Self Loading)	•	•
MT-7063	PoE & LAN Cable Tester	•	•
9ST-PK2636	Tool Bag	•	•



- Bag size: 280x190x63.5mm
- Individual packing: Color sleeve shrink

6PK-330K Coaxial Crimping Tool Kit



Tackle of your compression crimping jobs with the kit !

It includes all the tools you need to prepare the cable and terminate any compression connector using RG cables.



6PK-330K contents	
Crimper tool	Rotary coaxial cable stripper
Round cable cutter	Screwdriver #1x125
DIE: .255", .213", .187", .068" (Hex) .319", .256", .213", .068" (Hex) .043" (SQ), .100", 213", 068", .137", .255" (Hex) .042" (SQ), .078", .151", .068", .128", .178" (Hex) .10", .128", .429"(Hex)	

- Carry case size: 305x210x58mm
- Individual packing: Color label shrink

• NOTE : For quality reason, we reserve the right to change the above specifications without notice.

▶ PK-2009A/B

Professional Electrical And Mechanical Tool Set



Every tool that technician needs for maintenance service



PK-2009A
With 8PK-SD016



PK-2009B
With HW-23801M



Model No.	Soldering voltage	Standard plug		
PK-2009A (Inch)	110V	A	9MS-153C	Ø56mm Bulb Blower
PK-2009B (Metric)	220V	B	MS-391	Inspection Mirror
PK-2009A / PK-2009B contents			MT-1707	3-5/6 True RMS Multimeter
103-132C	Utility Component Storage Box		NT-309	Smart Non-Contact Voltage Tester
1PK-051DS	Dual Color Lineman's Plier (205mm)		PD-2607	Ball Peen Hammer With Fiberglass Handle
1PK-108T	Reverse Action Tweezer (Self-Gripping) (165mm)		PD-992	Electrician's Knife
1PK-3171	Spring Hook		PM-736	Long Nose Plier (132mm)
1PK-317N	Spring Hook		PM-737	Diagonal Cutting Plier (109mm)
1PK-A001	10PCS Trimming Tool Set		PM-754	Flat Nose Plier (135mm)
1PK-H028	Adjustable Wrench - 8"		PM-755	Bent Nose Plier (128mm)
HW-121M	Folding Type Hex Key Set(Metric or Inch)		PN-P010N	Slip-Channel Pump Plier 10" (254mm)
8PK-021NA			SD-081-P2	⊕ Precision Screwdriver(#00x50mm)
8PK-249	Snap Ring Plier Set (155mm)		SD-081-P5	⊕ Precision Screwdriver(#0x75mm)
8PK-3161	7 in 1 Tool For AWG18/16/14/12/10		SD-081-P7	⊕ Precision Screwdriver(#1x150mm)
HW-23801M	6.3mm Driver Socket Tool Set or 1/4" Driver Socket Set		SD-081-S3	⊖ Precision Screwdriver(2.0x50mm)
8PK-SD016	Square Scraper/Stainless Steel Brush		SD-081-S6	⊖ Precision Screwdriver(2.4x75mm)
9DP-3616A	Slotted Shaft/Split 45 Lever		SD-081-S7	⊖ Precision Screwdriver(3.0x100mm)
9DP-3616B	Tapered Reamer/Tapered Needle		SI-130B-20	Ceramic Soldering Iron(220V or 110V)
9DP-3616C	Brush Black Handle		SI-130A-20	
9SD-201A	⊖ Pro-Soft Screwdriver (3.0x75mm)		9PK-1900N-P	Pallet For PK-1900N series
9SD-201B	⊕ Pro-Soft Screwdriver (#0x75mm)		9PK-1900N-TP	Top Pallet For PK-1900N series
9SD-202A	⊖ Pro-Soft Screwdriver (5x75mm)		TC-2009	ABS Carrying Tool Case With PK-2009 Pallet
9SD-202B	⊕ Pro-Soft Screwdriver (#1x75mm)			
9SD-207A	⊖ Pro-Soft Screwdriver (6x100mm)			
9SD-207B	⊕ Pro-Soft Screwdriver (#2x100mm)			
9SD-220A	⊖ Pro-Soft Screwdriver (6x40mm)			
9SD-220B	⊕ Pro-Soft Screwdriver (#2 6x40mm)			
9SD-222A	⊖ Pro-Soft Screwdriver (8x150mm)			
HW-609B	10PCS Electronic Combination Wrench (Metric or inch)			
HW-609A				

• Case size : 463x331x171mm(O.D.)
• Individual packing: Color box

True RMS Measurement
Full Range Function

P. 32



Japan Made
4034
Stainless Steel

P. 187

Pro'sKit PD-992
Cable Ø2-30mm

Sharp Cutting Edge

P. 106

Fast Heat Up
Low Power Consumption

P. 56

Combination Snap Ring Pliers

P. 110

Red LED & Audible alarm

P. 44

• NOTE : For quality reason, we reserve the right to change the above specifications without notice.

▶ PK-4046BM/BM2

Professional Electrician Repair Tool Set



Total solutions for electricians, all in one!!



Model No.	MT-1707
PK-4046BM	•
PK-406BM2	

PK-4046BM contents	
1PK-051DS	Dual Color Lineman's Plier (205mm)
1PK-067DS	Dual Color Side Cutting Plier (165mm)
1PK-709DS	Dual Color Long Nose Plier (166mm)
8PK-3161	7 in 1 Tool For AWG18/16/14/12/10
8PK-SD016	23PCS 1/4" Driver Socket Set
9DP-S001	Pen Solder 63%
9MS-001	PVC Insulated Tape
9SD-201A	⊕ Pro-Soft Screwdriver (3.0x75mm)
9SD-201B	⊕ Pro-Soft Screwdriver (#0x75mm)
9SD-202A	⊖ Pro-Soft Screwdriver (5x75mm)
9SD-202B	⊕ Pro-Soft Screwdriver (#1x75mm)
9SD-207A	⊖ Pro-Soft Screwdriver (6x100mm)
9SD-207B	⊕ Pro-Soft Screwdriver (#2x100mm)
9SD-214B	⊕ Pro-Soft Screwdriver (#2x200mm)
9SD-220A	⊖ Pro-Soft Screwdriver (6x40mm)
9SD-220B	⊕ Pro-Soft Screwdriver (#2x40mm)
9SD-222A	⊖ Pro-Soft Screwdriver (8x150mm)
9SD-222B	⊕ Pro-Soft Screwdriver (#3x150mm)

DK-2040	Measuring Tape (3M/10FT)
HW-010	Adjustable Wrenches - 10"
HW-229BL	9PCS Extra Long Arm Ball Point Hex Key Set(1.5,2,2.5,3,4,5,6,8,10mm)
HW-6514B	14PCS Combination Wrench(Metric)
MS-323	Telescopic Magnetic Pick-Up Tool
MT-1707	3-5/6 True RMS Multimeter
NT-309	Smart Non-Contact Voltage Tester
PD-2606	Heavy Duty Curved-Claw Hammer W/ Fiberglass Handle
PM-736	Long Nose Plier (132mm)
PM-737	Diagonal Cutting Plier (109mm)
PN-P010N	Slip-Channel Pump Plier 10" (254mm)
SI-129B-60	Soldering Iron 60W / 220-240V
SR-336	Multi Purpose Scissor
SW-201	Multi-Purpose Pruning Saw
9PK-1900N-TP	Top Pallet For PK-1900N series
9PK-4046-P	Pallette For PK-4046
TC-756	Deluxe Aluminium Frame Tool Case

- Bag size: 458x330x150mm
- Individual packing: Inner Box & Color Label Shink

• NOTE : For quality reason, we reserve the right to change the above specifications without notice.

PK-1990A/B

Professional Electrician & Electronic Tool Kit



The jumbo hybrid tool kit for both electronic & electrical field

TOOL KITS



PK-1990A
With 8PK-021NA



PK-1990B
With HW-121M



Model No.	Soldering voltage	Standard plug	9SD-200-M5	Pro-Soft Screwdriver 5mm(metric) or 3/16"(inch)
PK-1990A (Inch)	110V	A	9SD-200-11	Pro-Soft Screwdriver 6mm(metric) or 1/4"(inch)
PK-1990B (Metric)	220V	B	9SD-200-M6	Pro-Soft Screwdriver (3x75mm)
PK-1990A / PK-1990B contents				
103-132C	Utility Component Storage Box			
1PK-051DS	Dual Color Lineman's Plier(205mm)			
1PK-067DS	Dual Color Side Cutting Plier (165mm)			
1PK-108T	Reverse Action Tweezer (Self-Gripping) (165mm)			
1PK-125T	Super Fine Tip Straight Tweezer (120mm)			
1PK-317N	Spring Hook			
1PK-705	Diagonal Cutting Plier (128mm)			
1PK-706	Long Nose Plier (135mm)			
1PK-709DS	Dual Color Long Nose Plier (165mm)			
1PK-A001	10PCS Trimming Tool Set			
1PK-H026	Adjustable Wrench - 6"			
8PK-3161	7 in 1 Tool For AWG18/16/14/12/10			
8PK-366N-G	Desoldering Pump			
8PK-SD016	23PCS 1/4" Driver Socket Set			
908-609	IC Extractor			
9DP-031B	Desoldering Wick(2.0Mm)Length(1.5M)			
9DP-3616A	Square Scraper/Stainless Steel Brush			
9DP-3616B	Slotted Shaft/Split 45 Lever			
9DP-3616C	Tapered Reamer/Tapered Needle			
9DP-S001	Pen Solder 63%			
9H003	3 Prong Holder			
9K003A-1	Needle File Flat			
9K003B-1	Needle File Round			
9K003C-1	Needle File Square			
9K003D-1	Needle File Triangle			
9K003E-1	Needle File Semicircle			
9MS-001	PVC Insulated Tape			
9PK-153	Brush			
9S004	Heat Sink			
			AS-611	Wrist Strap 10FT
			DK-2040	Measuring Tape (3M/10FT)
			FL-506	LED Flash Light
			HW-121M	Folding Type Hex Key Set(Metric or inch)
			8PK-021NA	10PCS Electronic Combination Wrench (Metric or inch)
			HW-609B	Ø56mm Bulb Blower
			HW-609A	Inspection Mirror
			9MS-153C	Heavy Duty Curved-Claw Hammer W/ Fiberglass Handle
			MS-391	Flat Nose Plier (135mm)
			PD-2606	Bent Nose Plier (128mm)
			PM-754	Slip Joint Plier 6" (154mm)
			PM-755	3.6V Li-Ion USB Grinder Set
			PN-086N	⊕ Precision Screwdriver(#00 x 50mm)
			PT-5206U	⊕ Precision Screwdriver(#0 x 75mm)
			SD-081-P2	⊕ Precision Screwdriver(#1 x 150mm)
			SD-081-P5	⊕ Precision Screwdriver(2.0 x 50mm)
			SD-081-P7	⊕ Precision Screwdriver(2.4 x 75mm)
			SD-081-S3	⊕ Precision Screwdriver(3.0 x 100mm)
			SD-081-S6	
			SD-081-S7	
			SI-130B-20	Ceramic Soldering Iron(220V or 110V)
			SI-130A-20	
			9PK-1900N-P	Pallet For PK-1900N series
			9PK-1900N-TP	Top Pallet For PK-1900N series
			TC-756	Deluxe Aluminium Frame Tool Case
				• Case size : 458x330x150mm
				• Individual packing: Inner Box & Color Label Shink

* NOTE : For quality reason, we reserve the right to change the above specifications without notice.

▶ PK-1900NA/NB

Professional Electronic Repair Tool Kit



PK-1900NA
With 8PK-021NA



PK-1900NB
With HW-121M



Model No.	Soldering voltage	Standard plug		
PK-1900NA (Inch)	110V	A	9SD-202B	⊕ Pro-Soft Screwdriver (#1x75mm)
PK-1900NB (Metric)	220V	B	9SD-207A	⊕ Pro-Soft Screwdriver (6x100mm)
PK-1900NA / PK-1900NB contents			9SD-207B	⊕ Pro-Soft Screwdriver (#2x100mm)
103-132C	Utility Component Storage Box (O.D.:165x95x45mm)		9SD-217B	⊕ Pro-Soft Screwdriver (#2x250mm)
1PK-051DS	Dual Color Lineman's Plier(205mm)		SH-1025	Soldering Tip Cleaner
1PK-125T	Super Fine Tip Straight Tweezer (120mm)		AS-611	Wrist Strap 10FT
1PK-H026	Adjustable Wrench - 6"		DK-2039	Utility Knife (3 Blades Self Loading)
8PK-3161	7 in 1 Tool For AWG18/16/14/12/10		HW-121M	Folding Type Hex Key Set(Metric or inch)
8PK-366N-G	Desoldering Pump		8PK-021NA	10PCS Electronic Combination Wrench (Metric or inch)
908-609	IC Extractor		HW-609B	Flux Bottle (Unit:2PCS/Pack)
9DP-3616A	Square Scraper/Stainless Steel Brush		HW-609A	Ø56mm Bulb Blower
9DP-3616B	Slotted Shaft/Split 45 Lever		MS-035	3 1/2 Compact Digital Multimeter
9DP-3616C	Tapered Reamer/Tapered Needle		9MS-153C	Voltage Detector
9DP-S001	Pen Solder 63%		MT-1210	Hobby Vise (Jaw opening 40mm / width 60mm)
9H003	3 Prong Holder		NT-305	Long Nose Plier (132mm)
9K003A-1	Needle File Flat		PD-374	Diagonal Cutting Plier (109mm)
9K003B-1	Needle File Round		PM-736	Flat Nose Plier (135mm)
9K003C-1	Needle File Square		PM-737	Bent Nose Plier (128mm)
9K003D-1	Needle File Triangle		PM-754	3.6V Li-ion USB Grinder Set
9K003E-1	Needle File Semicircle		PM-755	⊕ Precision Screwdriver(#00 x 50mm)
9MS-001	PVC Insulated Tape		PT-5206U	⊕ Precision Screwdriver(#0 x 75mm)
9PK-153	Brush		SD-081-P2	⊕ Precision Screwdriver(#1 x 150mm)
9SD-200-M5	⊕ Pro-Soft Screwdriver 5mm(metric) or 3/16"(inch)		SD-081-P5	⊕ Precision Screwdriver(2.0 x 50mm)
9SD-200-M6	⊕ Pro-Soft Screwdriver 6mm(metric) or 1/4"(inch)		SD-081-P7	⊕ Precision Screwdriver(2.4 x 75mm)
9SD-200-I2	⊕ Pro-Soft Screwdriver (T10H 3.0x75mm)		SD-081-S3	⊕ Precision Screwdriver(3.0 x 100mm)
9SD-200-T10H	⊕ Pro-Soft Screwdriver (T15H 4.0x75mm)		SD-081-S6	Ceramic Soldering Iron(220V or 110V)
9SD-201A	⊕ Pro-Soft Screwdriver (3.0x75mm)		SD-081-S7	Multi Purpose Scissor
9SD-201B	⊕ Pro-Soft Screwdriver (#0x75mm)		SI-130B-20	Pallet For PK-1900N series
9SD-202A	⊕ Pro-Soft Screwdriver (5x75mm)		SI-130A-20	Top Pallet For PK-1900N series
			SR-336	Deluxe Aluminium Frame Tool Case
			9PK-1900N-TP	
			IC-756	

• Bag size: 458x330x150mm
• Individual packing: Inner Box & Color Label Shink

• NOTE : For quality reason, we reserve the right to change the above specifications without notice.

1M Drop Protection

LCD with Backlight

P. 35

CHARGING USB

P. 158

10,000/20,000rpm Dual Speed

Japan Made

420 I2

Stainless Steel

P. 185

CrMoV Steel Swivel Cap

P. 136

P. 125

Diamond Carve Surface

Aluminum Frame
Thick Frame 30mm

8 Corner Guards
Thick Corner 26mm

P. 203

▶ PK-1700NA/NB

Electronics Master Kit



**Fast Heat Up
Low Power
Consumption**

P.56



DIN Standard

P.152



P.100

P.106

Sharp Cutting Edge



**Diamond Carve
Surface**

Aluminum Frame
Thick Frame 30mm

8 Corner Guards
Thick Corner 26mm

P.203



**Curved Claw Offers
Maximum Nail-
pulling Leverage**

P.196

**CrMoV Steel
Swivel Cap**

P.136

PK-1700NA

With 8PK-021NA



PK-1700NB

With HW-121M



Model No.	Soldering voltage	Standard plug		
PK-1700NA (Inch)	110V	A	9SD-200-M5	Pro-Soft Screwdriver 5mm(metric) or 3/16"(inch)
PK-1700NB (Metric)	220V	B	9SD-200-I1	Pro-Soft Screwdriver 6mm(metric) or 1/4"(inch)
PK-1700NA / PK-1700NB contents			9SD-200-M6	Pro-Soft Screwdriver (3x75mm)
103-132C	Utility Component Storage Box	9SD-200-I2	9SD-201A	Pro-Soft Screwdriver (#0x75mm)
1PK-051DS	Dual Color Lineman's Plier(205mm)	9SD-201B	9SD-202A	Pro-Soft Screwdriver (#0x75mm)
1PK-067DS	Dual Color Side Cutting Plier (165mm)	9SD-202B	9SD-202B	Pro-Soft Screwdriver (#1x75mm)
1PK-108T	Reverse Action Tweezer (Self-Gripping) (165mm)	9SD-207A	9SD-207A	Pro-Soft Screwdriver (6x100mm)
1PK-709DS	Dual Color Long Nose Plier (166mm)	9SD-207B	9SD-207B	Pro-Soft Screwdriver (#2x100mm)
1PK-H026	Adjustable Wrench - 6"	9SD-220A	9SD-220A	Pro-Soft Screwdriver (6x40mm)
8PK-3161	7 In 1 Crimping Tool	9SD-220B	9SD-220B	Pro-Soft Screwdriver (#2x40mm)
8PK-366N-G	Desoldering Pump	SH-1025	SH-1025	Soldering Tip Cleaner
908-609	IC Extractor	DK-2039	DK-2039	Utility Knife (3 Blades Self Loading)
9DP-031B	Desoldering Wick(2.0mm)Length(1.5m)	DK-2040	DK-2040	Measuring Tape (3M/10FT)
9DP-3616A	Square Scraper/Stainless Steel Brush	HW-121M	HW-121M	Folding Type Hex Key Set(Metric or inch)
9DP-3616B	Slotted Shaft/Split 45 Lever	8PK-021NA	8PK-021NA	Inspection Mirror
9DP-3616C	Tapered Reamer/Tapered Needle	MS-391	MS-391	Voltage Detector
9DP-S001	Pen Solder 63%	NT-305	NT-305	Heavy Duty Curved-Claw Hammer W/ Fiberglass Handle
9H003	3 Prong Holder	PD-2606	PD-2606	Long Nose Plier (132mm)
9HW-7106B	Double Open End Wrench 6x7mm	PM-736	PM-736	Diagonal Cutting Plier (109mm)
9HW-7108B	Double Open End Wrench 8x10mm	PM-737	PM-737	Bent Nose Plier (128mm)
9HW-7111B	Double Open End Wrench 11x13mm	PM-755	PM-755	Slip-Channel Pump Plier 10" (254mm)
9HW-7112B	Double Open End Wrench 12x14mm	PN-P010N	PN-P010N	Precision Screwdriver(#00 x 50mm)
9HW-7114B	Double Open End Wrench 14x17mm	SD-081-P2	SD-081-P2	Precision Screwdriver(#0 x 75mm)
9HW-7117B	Double Open End Wrench 17x19mm	SD-081-P5	SD-081-P5	Precision Screwdriver(#1 x 150mm)
9K003A-1	Needle File Flat	SD-081-P7	SD-081-P7	Precision Screwdriver(2.0 x 50mm)
9K003B-1	Needle File Round	SD-081-S3	SD-081-S3	Precision Screwdriver(2.4 x 75mm)
9K003C-1	Needle File Square	SD-081-S6	SD-081-S6	Precision Screwdriver(3.0 x 100mm)
9K003D-1	Needle File Triangle	SD-081-S7	SD-081-S7	Ceramic Soldering Iron(220V or 110V)
9K003E-1	Needle File Semicircle	SI-130B-20	SI-130B-20	Multi Purpose Scissor
9MS-001	PVC Insulated Tape	SI-130A-20	SI-130A-20	Pallet For PK-1900N series
9PK-153	Brush Black Handle	SR-336	SR-336	Top Pallet For PK-1900N series
		9PK-1900N-P	9PK-1900N-P	Deluxe Aluminium Frame Tool Case
		9PK-1900N-TP	9PK-1900N-TP	
		TC-756	TC-756	

• Case size : 458x330x150mm
• Individual packing: Inner Box & Color Label Shink

• NOTE : For quality reason, we reserve the right to change the above specifications without notice.

▶ PK-1305NA/NB

Professional Engineer Repair Tool Set



PK-1305NA
With 8PK-021NA



PK-1305NB
With HW-121M



1M Drop Protection

LCD with Backlight

P.35



CrMoV Steel Swivel Cap

P.136



Sharp Cutting Edge

P.100



Fast Heat Up Low Power Consumption

P.56



Diamond Carve Surface

Aluminum Frame
Thick Frame 30mm

8 Corner Guards
Thick Corner 25mm

P.203



Model No.	Soldering voltage	Standard plug		
PK-1305NA (Inch)	110V	A	SH-1025	Soldering Tip Cleaner
PK-1305NB (Metric)	220V	B	DK-2039	Utility Knife (3 Blades Self Loading)
PK-1305NA / PK-1305NB contents			DK-2040	Measuring Tape (3M/10FT)
103-132C	Utility Component Storage Box		HW-121M	Folding Type Hex Key Set(Metric or inch)
1PK-108T	Reverse Action Tweezer (Self-Gripping) (165mm)		8PK-021NA	3 1/2 Compact Digital Multimeter
1PK-H026	Adjustable Wrench - 6"		MT-1210	Long Nose Plier (132mm)
8PK-366N-G	Desoldering Pump		PM-736	Diagonal Cutting Plier (109mm)
9DP-3616A	Square Scraper/Stainless Steel Brush		PM-737	Flat Nose Plier (135mm)
9DP-3616B	Slotted Shaft/Split 45 Lever		PM-754	Bent Nose Plier (128mm)
9DP-3616C	Tapered Reamer/Tapered Needle		PM-755	⊕ Precision Screwdriver (#00 x 50mm)
9DP-S001	Pen Solder 63%		SD-081-P2	⊕ Precision Screwdriver (#0 x 75mm)
9K003A-1	Needle File Flat		SD-081-P5	⊕ Precision Screwdriver (#1 x 150mm)
9K003B-1	Needle File Round		SD-081-P7	⊖ Precision Screwdriver (2.0 x 50mm)
9MS-001	PVC Insulated Tape		SD-081-S3	⊖ Precision Screwdriver (2.4 x 75mm)
9MS-153C	Ø56mm Bulb Blower		SD-081-S6	⊖ Precision Screwdriver (3.0 x 100mm)
9PK-153	Brush Black Handle		SD-081-S7	⊖ Precision Screwdriver (3.0 x 100mm)
9SD-200-M5	⊕ Pro-Soft Screwdriver 5mm(metric) or 3/16"(inch)		SI-130B-20	
9SD-200-I1	⊕ Pro-Soft Screwdriver 6mm(metric) or 1/4"(inch)		SI-130A-20	Ceramic Soldering Iron(220V or 110V)
9SD-200-M6	⊕ Pro-Soft Screwdriver (3x75mm)		SR-330	All Purpose Snip (165mm)
9SD-200-I2	⊖ Pro-Soft Screwdriver (#1x75mm)		9PK-1900N-P	Pallet For PK-1900N series
9SD-201A	⊕ Pro-Soft Screwdriver (#0x75mm)		9PK-1900N-TP	Top Pallet For PK-1900N series
9SD-201B	⊕ Pro-Soft Screwdriver (5x75mm)		TC-756	Deluxe Aluminium Frame Tool Case
9SD-202A	⊕ Pro-Soft Screwdriver (#1x75mm)			
9SD-202B	⊕ Pro-Soft Screwdriver (6x100mm)			
9SD-207A	⊕ Pro-Soft Screwdriver (#2x100mm)			
9SD-207B				

• Bag size: 458x330x150mm
• Individual packing: Inner Box & Color Label Shink

• NOTE : For quality reason, we reserve the right to change the above specifications without notice.

Electronic Tool Kit



Model No.	Soldering voltage	Standard plug	SH-1025	Soldering Tip Cleaner
PK-15307BM (Metric)	220V	B	CP-108	Wire Stripper Cutter (Stripping Wire from 10-30 AWG)
PK-15307EI (Inch)	110V	A	DK-2039	Utility Knife (3 Blades Self Loading)
PK-15307BM / PK-15307EI contents				
1PK-051DS	Dual Color Lineman's Plier (205mm)		DK-2040	Measuring Tape (3M/10FT)
1PK-067DS	Dual Color Side Cutting Plier (165mm)		DP-366P	Desoldering Pump
1PK-108T	Reverse Action Tweezer (Self-Gripping) (165mm)		HW-609B	10PCS Electronic Combination Wrench (Metric or inch)
1PK-125T	Super Fine Tip Straight Tweezer (120mm)		HW-609A	
1PK-709DS	Dual Color Long Nose Plier (166mm)		MS-035	Flux Bottle (Unit:2PCS/Pack)
1PK-H026	Adjustable Wrench - 6"		MT-1210	3 1/2 Compact Digital Multimeter
8PK-605A	5 PCS Needle File Set		PD-374	Hobby Vise (Jaw opening 40mm /width 60mm)
908-609	IC Extractor		PM-736	Long Nose Plier (132mm)
9DP-3616A	Square Scraper/Stainless Steel Brush		PM-737	Diagonal Cutting Plier (109mm)
9DP-3616B	Slotted Shaft/Split 45 Lever		PN-086N	Slip Joint Plier 6" (154mm)
9DP-3616C	Tapered Reamer/Tapered Needle		SB-1912	Utility Component Storage Box (O.D.:187.5x117x22mm)
9DP-S001	Pen Solder 63%		SD-081-P2	⊕ Precision Screwdriver(#00 x 50mm)
9HW-002B	Folding Type Hex Key Set(Metric or Inch)		SD-081-P5	⊕ Precision Screwdriver(#0 x 75mm)
8PK-021NA	Ø56mm Bulb Blower		SD-081-P7	⊕ Precision Screwdriver(#1 x 150mm)
9MS-153C	Brush		SD-081-S3	⊕ Precision Screwdriver(2.0 x 50mm)
9PK-153	Heat Sink		SD-081-S6	⊕ Precision Screwdriver(2.4 x 75mm)
9S004	Pro-Soft Screwdriver (3x75mm)		SD-081-S7	⊕ Precision Screwdriver(3.0 x 100mm)
9SD-201A	⊕ Pro-Soft Screwdriver (#0x75mm)		SI-130B-20	Ceramic Soldering Iron(220V or 110V)
9SD-201B	⊕ Pro-Soft Screwdriver (5x75mm)		SI-130A-20	
9SD-202A	⊕ Pro-Soft Screwdriver (#1x75mm)		SR-330	All Purpose Snip (165mm)
9SD-202B	⊕ Pro-Soft Screwdriver (#1x100mm)		9PK-15307-P	Pallet for PK-15307
9SD-207A	⊕ Pro-Soft Screwdriver (#2x100mm)		9PK-15307-TP	Top Pallet for PK-15307
9SD-207B	⊕ Pro-Soft Screwdriver (#2x250mm)		TC-756	Deluxe Aluminium Frame Tool Case
9SD-217B	⊕ Pro-Soft Screwdriver (6x40mm)		• Case size : 458x330x150mm	
9SD-220A	⊕ Pro-Soft Screwdriver (#2x40mm)		• Individual packing: Inner Box & Color Label Shink	
9SD-220B	⊕ Pro-Soft Screwdriver (#2x40mm)			

• NOTE : For quality reason, we reserve the right to change the above specifications without notice.

PK-710KA/KB Basic Electronic Tool Kit



Model No.	Soldering voltage	Standard plug
PK-710KA (Inch)	110	A
PK-710KB (Metric)	220	B

- Case size : 330x250x110mm(O.D.)
- Individual packing: Color box

PK-710KA
With 8PK-021NA



PK-710KB
With HW-121M



PK-710KA / PK-710KB contents	
1PK-067DS	Dual Color Side Cutting Plier (165mm)
1PK-125T	Super Fine Tip Straight Tweezer (120mm)
1PK-709DS	Dual Color Long Nose Plier (166mm)
8PK-3161	7 in 1 Tool For AWG18/16/14/12/10
8PK-366N-G	Desoldering Pump
9DP-031B	Desoldering Wick(2.0mmx1.5m)
9DP-3616A	Square Scraper/Stainless Steel Brush
9DP-3616B	Slotted Shaft/Split 45 Lever
9DP-3616C	Tapered Reamer/Tapered Needle
9DP-S001	Pen Solder 63%
9K003A-1	Needle File Flat
9K003B-1	Needle File Round
9MS-001	PVC Insulated Tape
9SD-201A	⊖ Pro-Soft Screwdriver (3x75mm)
9SD-201B	⊕ Pro-Soft Screwdriver (#0x75mm)
9SD-202A	⊖ Pro-Soft Screwdriver (5x75mm)
9SD-202B	⊕ Pro-Soft Screwdriver (#1x75mm)
9SD-207A	⊖ Pro-Soft Screwdriver (6x100mm)
9SD-207B	⊕ Pro-Soft Screwdriver (#2x100mm)
DK-2039	Utility Knife (3 Blades Self Loading)
HW-121M	Folding Type Hex Key Set (Metric or Inch)
8PK-021NA	
MT-1210	3 1/2 Compact Digital Multimeter
PM-736	Long Nose Plier (132mm)
PM-737	Diagonal Cutting Plier (109mm)
SI-130B-20	
SI-130A-20	Ceramic Soldering Iron(220V or 110V)
SR-336	Multi Purpose Scissor
9PK-710P	Deluxe Tool Case W/2 Pallets

PK-2002A/B Technician's Tool Kit



PK-2002A
With 8PK-021NA



PK-2002B
With HW-121M



Model No.	Soldering voltage	Standard plug
PK-2002A (Inch)	110	A
PK-2002B (Metric)	220	B

- Case size : 385x300x55mm
- Individual packing: Color sleeve shrink

PK-2002A / PK-2002B contents	
1PK-052DS	Dual Color Lineman's Plier (162mm)
1PK-108T	Reverse Action Tweezer (Self-Gripping) (165mm)
1PK-125T	Super Fine Tip Straight Tweezer (120mm)
1PK-H028	Adjustable Wrench - 8"
8PK-2061	6PCS Electronic Screwdriver Set
8PK-3161	7 in 1 Tool For AWG18/16/14/12/10
908-609	IC Extractor
9DP-3616A	Square Scraper/Stainless Steel Brush
9DP-3616B	Slotted Shaft/Split 45 Lever
9DP-3616C	Tapered Reamer/Tapered Needle
9DP-S001	Pen Solder 63%
8PK-605A	5 PCS Needle File Set
9PK-153	Brush
9SD-200-M5	⊖ Pro-Soft Screwdriver 5mm(metric) or 3/16"(inch)
9SD-200-M6	⊖ Pro-Soft Screwdriver 6mm(metric) or 1/4"(inch)
9SD-200-I2	⊕ Pro-Soft Screwdriver 6mm(metric) or 1/4"(inch)
AS-611	Wrist Strap 10FT
DK-2039	Utility Knife (3 Blades Self Loading)
DP-366P	Desoldering Pump
FL-506	LED Flash Light
HW-121M	Folding Type Hex Key Set(Metric or inch)
8PK-021NA	
PD-610	PLCC Extractor
PM-736	Long Nose Plier (132mm)
PM-737	Diagonal Cutting Plier (109mm)
PM-754	Flat Nose Plier (135mm)
PM-755	Bent Nose Plier (128mm)
SD-9820	10 in 1 Ratchet Screwdriver Kit
SI-130B-20	
SI-130A-20	Ceramic Soldering Iron(220V or 110V)
5ST-13-SS	Shoulder Strap
9ST-13	Tool Bag

• NOTE : For quality reason, we reserve the right to change the above specifications without notice.

PK-813A/B Electrical Appliances Repair Tool Set

PK-813A / PK-813B contents	
1PK-052DS	Dual Color Lineman's Plier (162mm)
1PK-067DS	Dual Color Side Cutting Plier (165mm)
1PK-125T	Super Fine Tip Straight Tweezer (120mm)
1PK-709DS	Dual Color Long Nose Plier (166mm)
1PK-H026	Adjustable Wrench - 6"
8PK-366N-G	Desoldering Pump
908-607	Alignment Tool (200mm/2.0mm)
9DP-031B	Desoldering Wick(2.0mmx1.5m)
9DP-S001	Pen Solder 63%
9K003A-1	Needle File Flat
9K003B-1	Needle File Round
9MS-001	PVC Insulated Tape
9SD-200-M5 9SD-200-I1	Pro-Soft Screwdriver 5mm(metric) or 3/16"(inch)
9SD-200-M6 9SD-200-I2	Pro-Soft Screwdriver 6mm(metric) or 1/4"(inch)
9SD-201A	Pro-Soft Screwdriver (3x75mm)
9SD-201B	Pro-Soft Screwdriver (#0x75mm)
9SD-202A	Pro-Soft Screwdriver (5x75mm)
9SD-202B	Pro-Soft Screwdriver (#1x75mm)
9SD-207A	Pro-Soft Screwdriver (6x100mm)
9SD-207B	Pro-Soft Screwdriver (#2x100mm)
9SD-213B	Pro-Soft Screwdriver (#2x150mm)
SI-130B-20 SI-130A-20	Ceramic Soldering Iron(220V or 110V)
9ST-PK813	Tool Bag

Compact size Multifunction

Basic tool kit for home appliances repair, comes with all essential tools.



Model No.	Soldering voltage	Standard plug
PK-813A (Inch)	110	A
PK-813B (Metric)	220	B

- Case size : 228x340x63.5mm
- Individual packing: Color sleeve shrink

PK-616A/B Professional Electronic Tool Kit

PK-616A / PK-616B contents	
1PK-052DS	Dual Color Lineman's Plier (162mm)
1PK-125T	Super Fine Tip Straight Tweezer (120mm)
8PK-2061	6PCS Electronic Screwdriver Set
908-609	IC Extractor
9DP-S002	Lead Free Solder Dispenser
9K003A-1	Needle File Flat
9K003B-1	Needle File Round
9MS-001	PVC Insulated Tape
AS-611	Wrist Strap 10FT
DP-366P	Desoldering Pump
HW-121M 8PK-021NA	Folding Type Hex Key Set(Metric or Inch)
MT-1210	3 1/2 Compact Digital Multimeter
PM-737	Diagonal Cutting Plier (109mm)
PM-746	Needle Nose Plier (150mm)
SD-5101A	Line Color Screwdriver (3x 75mm)
SD-5101B	Line Color Screwdriver (#0 x 75mm)
SD-5102A	Line Color Screwdriver (5 x 75mm)
SD-5102B	Line Color Screwdriver (#1 x 75mm)
SD-5107A	Line Color Screwdriver (6 x 100mm)
SD-5107B	Line Color Screwdriver (#2 x 100mm)
9108	Line Color Screwdriver Nut 3/16"
9109	Line Color Screwdriver Nut 1/4"
SI-130B-20 SI-130A-20	Ceramic Soldering Iron(220V or 110V)
9ST-13	Tool Bag

Basic line Easy storage

For electronic field basic maintenance, repair & service job, it comes with all essential tools.



Model No.	Soldering voltage	Standard plug
PK-616A (Inch)	110	A
PK-616B (Metric)	220	B

PK-616A
With 8PK-021NA

PK-616B
With HW-121M

- Case size : 385x300x55mm
- Individual packing: Color sleeve shrink



• NOTE : For quality reason, we reserve the right to change the above specifications without notice.

PK-2088A/B/BA PC Service Kit



PK-2088A/B



PK-2088BA With 8PK-AS07-1

- Bag size: 228x340x63.5mm
- Individual packing: Color sleeve shrink

Model No.	Soldering voltage	Standard plug
PK-2088A (Inch)	110V	A
PK-2088B (Metric)	220V	B



PK-2088A/PK-2088B contents	
1PK-108T	Reverse Action Tweezer (Self-Gripping) (165mm)
1PK-125T	Super Fine Tip Straight Tweezer (120mm)
1PK-H026	Adjustable Wrench - 6"
8PK-3161	7 in 1 Tool For AWG18/16/14/12/10
8PK-366N-G	Desoldering Pump
908-609	IC Extractor
9DP-S001	Pen Solder 63%
9S004	Heat Sink
9SD-200-M5 9SD-200-I1	Pro-Soft Screwdriver 5mm(metric) or 3/16"(inch)
9SD-200-M6 9SD-200-I2	Pro-Soft Screwdriver 6mm(metric) or 1/4"(inch)
9SD-200-T10H	Pro-Soft Screwdriver T10H (3.0x75mm)
9SD-200-T15H	Pro-Soft Screwdriver T15H (4.0x75mm)
9SD-201A	Pro-Soft Screwdriver (3x75mm)
9SD-201B	Pro-Soft Screwdriver (#0x75mm)
9SD-202A	Pro-Soft Screwdriver (5x75mm)
9SD-202B	Pro-Soft Screwdriver (#1x75mm)
AS-501A	Long Handle Static Brush (40mm)
AS-611	Wrist Strap 10FT
DP-033A	Anti-Hot Desoldering Wick
PD-610	PLCC Extractor
PM-736	Long Nose Plier (132mm)
PM-737	Diagonal Cutting Plier (109mm)
SD-081-T5H	Precision Screwdriver For Star Type W/ Temper Proof T5H
SD-081-T6H	Precision Screwdriver For Star Type W/ Temper Proof T6H
SD-081-T9H	Precision Screwdriver For Star Type W/ Temper Proof T9H
SI-130B-20 SI-130A-20	Ceramic Soldering Iron(220V or 110V)
9ST-PK2088	Tool Bag

PK-612NA/NB Electrician Repair Tool Kit



PK-612NA
With 8PK-021NA

PK-612NB
With HW-221M

Model No.	Soldering voltage	Standard plug
PK-612NA (Inch)	110V	A
PK-612NB (Metric)	220V	B

- Bag size: 340x222x60mm
- Individual packing: Color sleeve shrink



PK-612NA / PK-612NB contents	
1PK-125T	Super Fine Tip Straight Tweezer (120mm)
1PK-H026	Adjustable Wrench - 6"
8PK-3161	7 in 1 Tool For AWG18/16/14/12/10
8PK-366N-G	Desoldering Pump
908-607	Alignment Tool (200mm/2.0mm)
908-609	IC Extractor
9DP-S001	Pen Solder 63%
9H003	3 Prong Holder
9PK-153	Brush
9SD-201A	Pro-Soft Screwdriver (3x75mm)
9SD-201B	Pro-Soft Screwdriver (#0x75mm)
9SD-202A	Pro-Soft Screwdriver (5x75mm)
9SD-202B	Pro-Soft Screwdriver (#1x75mm)
9SD-207A	Pro-Soft Screwdriver (6x100mm)
9SD-207B	Pro-Soft Screwdriver (#2x100mm)
DK-2039	Utility Knife (3 Blades Self Loading)
HW-221M 8PK-021NA	Folding Type Hex Key Set(Metric or inch)
PM-736	Long Nose Plier (132mm)
PM-737	Diagonal Cutting Plier (109mm)
SI-130B-20 SI-130A-20	Ceramic Soldering Iron(220V or 110V)
ST-23	Tool Bag

• NOTE : For quality reason, we reserve the right to change the above specifications without notice.

PK-810A/B Basic PC & NB Repair Tool Set

PK-810A / PK-810B contents	
1PK-036S	Long Nose Plier (136mm)
1PK-037S	Diagonal Cutting Plier (110mm)
1PK-125T	Super Fine Tip Straight Tweezer (120mm)
1PK-H026	Adjustable Wrench - 6"
8PK-3161	7 in 1 Tool For AWG18/16/14/12/10
908-609	IC Extractor
9DP-031B	Desoldering Wick(2.0mmx1.5m)
9DP-3616A	Square Scraper/Stainless Steel Brush
9DP-3616B	Slotted Shaft/Split 45 Lever
9DP-3616C	Tapered Reamer/Tapered Needle
9DP-S001	Pen Solder 63%
9H003	3 Prong Holder
9PK-153	Brush Black Handle
9S004	Heat Sink
9SD030-2	8Pcs Bits Pack
9SD-202A	⊖ Pro-Soft Screwdriver (5x75mm)
9SD-202B	⊕ Pro-Soft Screwdriver (#1x75mm)
9SD-2320M-EXT	Extension Bar 100mm
9SD-9857M-HAN	Screwdriver Handle
DP-366D	Desoldering Pump
SI-130B-20	Ceramic Soldering Iron(220V or 110V)
SI-130A-20	
9ST-PK810	Tool Bag



Model No.	Soldering voltage	Standard plug
PK-810A (Inch)	110V	A
PK-810B (Metric)	220V	B

- Bag size: 180x305x67mm
- Individual packing: Color sleeve shrink

PK-2086A / B Basic Electrical Kit

PK-2086A / PK-2086B contents	
1PK-052	Lineman's Plier 165mm
1PK-067	Side Cutting Plier 160mm
1PK-709	Long Nose Plier 160mm
1PK-H026	Adjustable Wrench 6"
9DP-031B	Desoldering Wick
9DP-S001	Solder Core, 63% SN
9SD-205A	⊖ Pro-soft Screwdriver (3x100mm)
9SD-205B	⊕ Pro-soft Screwdriver (#0x100mm)
9SD-207B	⊕ Pro-soft Screwdriver (#2x100mm)
9SD-210A	⊖ Pro-soft Screwdriver (5x100mm)
9SD-210B	⊕ Pro-soft Screwdriver (#1x100mm)
SI-129B-60	
SI-130A-20	Soldering Iron 110V or 220V
1PK-125T	Fine Tip Straight Tweezer
ST-23	Zipper Carrying Bag



Model No.	Soldering voltage	Standard plug
PK-2086A (Inch)	110V	A
PK-2086B (Metric)	220V	B

- Bag size: 340x222x60mm
- Individual packing: Color sleeve shrink

1PK-635 Precision Electronic Tool Kit

1PK-635 contents	
1PK-125T	Fine Tip Straight Tweezer
1PK-258A	Side Cutter 125mm
1PK-258B	Long Nose Plier 138mm
SD-081-P2	⊕ Precision Screwdriver (#00x50mm)
SD-081-P3	⊕ Precision Screwdriver (#0x50mm)
SD-081-P4	⊕ Precision Screwdriver (#1x50mm)
SD-081-S2	⊖ Precision Screwdriver (1.6x50mm)
SD-081-S3	⊖ Precision Screwdriver (2.0x50mm)
SD-081-S4	⊖ Precision Screwdriver (2.4x50mm)
SD-081-S5	⊖ Precision Screwdriver (3.0x50mm)
9ST-43	Tool Bag



- Bag size: 130x207x35mm
- Individual packing: Inner box & Color label shrink

PK-2079 ESD Precision Tool Kit

PK-2079 contents	
1PK-102-E	Long Nose Plier
1PK-104-E	Flat Nose Plier
1PK-105-E	Bent Nose Plier
1PK-209	Clean Cut Micro Nipper
1PK-25P-E	Micro Cutting Plier
TZ-100A/B/C/D	4 PCS Conductive Tweezer Set
8PK-611	Wrist Strap 10Ft
SD-083-P2	⊕ ESD Precision Screwdriver (#00x50mm)
SD-083-P3	⊕ ESD Precision Screwdriver (#0x50mm)
SD-083-P4	⊕ ESD Precision Screwdriver (#1x50mm)
SD-083-S3	⊖ ESD Precision Screwdriver (2.0x50mm)
SD-083-S4	⊖ ESD Precision Screwdriver (2.4x50mm)
SD-083-S5	⊖ ESD Precision Screwdriver (3.0x50mm)
9ST-23	Tool bag



This precision pliers series made of high quality SK7, accurately machined design.



- Bag size: 340x222x60mm
- Individual packing: Inner box & Color label shrink

• NOTE : For quality reason, we reserve the right to change the above specifications without notice.

PK-2061 Solar MC3 & MC4 Crimping Tool Kit



- Bag size: 280x197x70mm
- Individual packing: Color Label Shink Parking

To open the locking device

To secure

To tighten the cable gland

Includes 2 pcs MC4 and MC4 PLUS open-end spanners and unlocking tools help you opening the locking device, securing and tightening the cable gland.



PK-2061 contents

8PK-A202	Forging Cable Cutter (160mm)
9HW-MC4	2 PCS open-end spanner and unlocking tool (MC4 and MC4 PLUS)
9SD-202A	Pro-Soft Screwdriver (5x75mm)
9SD-207B	Pro-Soft Screwdriver (#2x100mm)
CP-246	Universal solar cable stripper, for 2.5/4/6mm ² (AWG 14/12/10) solar cable
CP-3006F	Parallel Action Crimping Tool (Frame Only)
CP-5S1D	Die Set For MC 3 Solar Connector (Multi-Contact) & 2.5/4.0/6.0 mm ² (AWG 14/12/10) Solar Cable
CP-5S2D	Die Set For MC 4 Solar Connector (Multi-Contact) & 2.5/4.0/6.0 mm ² (AWG 14/12/10) Solar Cable
9Z-940KP	Tool Bag

PK-301 Mini Household Tool Kit
PK-324 Mini USB Soldering Iron Kit



PK-301

Art Work / File Edge / Basic Repair



PK-324

Convenient is Not a Slogan – It's The Mission

STORAGE BOX
Pretty & Dual Color
Compact & Easy Storage
Neat Placement



- Box size: 205x132x45mm
- Individual packing: Color Box

PK-301 contents	
9K003A-1	Needle File Flat
9K003B-1	Needle File Round
9SD-201A	Pro-Soft Screwdriver (3x75mm)
9SD-201B	Pro-Soft Screwdriver (#0x75mm)
9SB-395A	Dual Color TPR+PP Case

9TZ-025T	Super Fine Tip Straight Tweezer
DK-2039	Utility Knife (3 Blades Self Loading)
PM-736	Long Nose Plier (132mm)
PM-737	Diagonal Cutting Plier (109mm)

PK-324 contents	
SI-168U	USB Powered Soldering Iron
9MS-020A	Rosin Oil
DP-366I	Mini Desoldering Pump
9DP-S002	Lead Free Solder Dispenser
PM-736	Long Nose Plier (132mm)
PM-737	Diagonal Cutting Plier (109mm)
9TZ-025T	Super Fine Tip Straight Tweezer
9SB-395A	Dual Color TPR+PP Case

• NOTE : For quality reason, we reserve the right to change the above specifications without notice.

PK-2052TA/PK-2052TB Technician's Tool Kit

PK-2052TA / PK-2052TB contents	
1PK-052	Lineman's Plier (165mm)
1PK-067	Side Cutting Plier (160mm)
1PK-125T	Super Fine Tip Straight Tweezer (120mm)
1PK-709	Long Nose Plier (160mm)
9DK-2060	3M Auto Stop Measuring Tape
9DP-S001	Pen Solder 63%
9FL-516	9PCS LED Flashlight
9MS-001	PVC Insulated Tape
9PK-153	Brush
9SD-329H	Screwdriver Probe Voltage Tester
9SD-9608	30PCS Aluminum Handle Precision Screwdriver set
AS-611	Wrist Strap 10FT
CP-412G	Heavy Duty Wire Strippers/Crimpers(8")
DP-366D	Desoldering Pump
HW-008N	Adjustable Wrench - 8"
MT-1210	3 1/2 Compact Digital Multimeter
PD-2612	8 OZ Curved Claw Hammer
PD-513	Utility Knife
SD-5105A	⊖ Line Color Screwdriver (3x100mm)
SD-5105B	⊕ Line Color Screwdriver (#0x100mm)
SD-5107A	⊖ Line Color Screwdriver (6x100mm)
SD-5107B	⊕ Line Color Screwdriver (#2x100mm)
SI-130A-20	Ceramic Soldering Iron(220V or 110V)
SI-130B-20	
9SB-3935	Plastic Tool Box



Model No.	Soldering voltage	Standard plug
PK-2052TA (Inch)	110V	A
PK-2052TB (Metric)	220V	B

- Case size: 390x350x90mm
- Individual packing:Color sleeve shrink



PK-2051T General Household Tool Kit

PK-2051T contents	
1PK-067	Side Cutting Plier (160mm)
1PK-709	Long Nose Plier (160mm)
9DK-2060	3M Auto Stop Measuring Tape
9FL-516	9PCS LED Flashlight
9MS-001	PVC Insulated Tape
9SD-329H	Screwdriver Probe Voltage Tester
SD-9608	30PCS Aluminum Handle Precision Screwdriver set
HW-008N	Adjustable Wrench - 8"
HW-221M	8PCS Aluminum Case Folding He Key (1.5,2,2.5,3,4,5,6,8mm)
PD-513	Utility Knife
SD-5101A	⊖ Line Color Screwdriver (3x75mm)
SD-5101B	⊕ Line Color Screwdriver (#0x75mm)
SD-5107A	⊖ Line Color Screwdriver (6x100mm)
SD-5107B	⊕ Line Color Screwdriver (#2x100mm)
SR-330	All Purpose Snip (165mm)
9SB-207	Plastic Tool Box



- Case size: 320x260x60mm
- Individual packing:Color sleeve shrink



PK-618A/B Universal Electrician Repair Tool Set

PK-618A / PK-618B contents	
1PK-052DS	Dual Color Lineman's Plier (162mm)
1PK-067DS	Dual Color Side Cutting Plier (165mm)
1PK-125T	Super Fine Tip Straight Tweezer (120mm)
1PK-709DS	Dual Color Long Nose Plier (166mm)
1PK-H026	Adjustable Wrench - 6"
HW-221M	Folding Type Hex Key Set(Metric or Inch)
8PK-021NA	7 in 1 Tool For AWG18/16/14/12/10 Alignment Tool (200mm/2.0mm)
8PK-3161	
908-607	Desoldering wick(2.0mm)Length(1.5m)
9DP-031B	Needle File Flat
9K003A-1	Needle File Round
9K003B-1	PVC Insulated Tape
9MS-001	Pro-Soft Screwdriver 5mm (metric) or 3/16"(inch)
9SD-200-M5	
9SD-200-I1	
9SD-201A	
9SD-201B	
9SD-202A	Pro-Soft Screwdriver (#0x75mm)
9SD-207A	Pro-Soft Screwdriver (5x75mm)
9SD-207B	Pro-Soft Screwdriver (6x100mm)
DK-2039	Pro-Soft Screwdriver (#2x100mm)
DK-2040	Utility Knife (3 Blades Self Loading)
NT-305	Measuring Tape (3M/10FT)
NT-305	Voltage Detector
SI-130A-20	Ceramic Soldering Iron(220V or 110V)
SI-130B-20	
9ST-PK618	Tool Bag



Model No.	Soldering voltage	Standard plug
PK-618A (Inch)	110V	A
PK-618B (Metric)	220V	B

- Case size: 228x340x63.5mm
- Individual packing:Color sleeve shrink



PK-618A
With 8PK-021NA

PK-618B
With HW-221M



• NOTE : For quality reason, we reserve the right to change the above specifications without notice.

TEST INSTRUMENTS



Full Function
Accurate Measurement
Overload Protection



MORE THAN RELIABLE



High-Impedance Monitor

mode for minor noise output while operating.

A Smart Operation

unit for installer, repair technicians and other authorized personnel.

Drop Protection

Features

Line Voltage Test • Polarity LED Indicators • Line Continuity Test • Tone and Pulse Operation • Two-way Hands Free Speakerphone • PBX Pause

Electrical	
Loop limit	2 KΩ maximum at 48 VDC (nominal 20 mA minimum loop current)
DC resistance	
Talk mode	300Ω typical
Monitor impedance	39kΩ nominal at 1 kHz
Rotary dial output	
Pulsing rate	10pps+0.8pps
Percent break	61%±2%
Interdigit interval	1000 ms typical
Leakage during break	>50 kΩ
DTMF output	
Tone frequency error	±1.2% maximum
Tone level	-8±2dBm combined (typical)
High versus low tone difference	4 dB maximum
Memory dialing	
Memory capacity	13 memories including M1, last number redialing
Digit capacity	16 digits per memory
PBX pause duration	4 seconds
Line voltage test	5 Phase AC/DC voltage indication (under 24V, 24~100V, 101~150V, 151~200V, more than 200V)
Monitor amplifier power source	9V transistor, provides 25 hours continuous use, typical
Automatic power shut off	After 5 min. of no audio signal
Speaker phone levels	Electronically adjustable
Power source	Battery (9V) 6F22 (Not included)
Physical	
Measurement	230×82×89mm (9-1/16"×3-15/64"×3-1/2")
Weight	635g typical
Water resistance	Dust protection & Waterproof tested to an IEC/EN 60529 IP54 rating
Cord sets	Angled bed of nails and RJ11 plug
Environmental	
Temperature	Operating: 0 to 50°C
Altitude	To 10,000 feet (3,000M) max
Relative humidity	5 To 95%
Accessories	Angled Bed of Nails
Individual packing	Color box

IEC/EN 60529 IP54

Water proof and dust proof

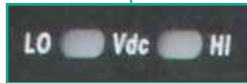

Line Voltage Test

Angled Bed of Nails



Line continuity test



Electronic Adjustable Volume

MT-8001

Butt Set

Weather Proof High Impedance Monitor Advanced PBX Pause

for easy insertion between digits of a stored number.



Features

Low Battery Indication • PBX Pause • Backlight • Polarity LED Indicators • Ringer and Voltage Indication • 32 Digits Phone Number Memory of Last Number Redial

Electrical	
Loop limit	2 K Ω maximum at 48 VDC (nominal 20 mA minimum loop current)
DC resistance	
Talk mode	300 Ω typical
Monitor impedance	39k Ω nominal at 1 kHz
Rotary dial output	
Pulsing rate	10pps+0.8pps
Percent break	61%±2%
Interdigit interval	1000 ms typical
Leakage during Break	>50 k Ω
DTMF output	
Tone frequency error	±1.2% maximum
Tone level	-8±2dBm combined (typical)
High versus low tone difference	4 dB maximum
Memory dialing	
Memory capacity	12 memories plus last number redialing
Digit capacity	16 digits per memory
PBX pause duration	4 seconds
Monitor amplifier power source	9V transistor; provides 25 hours continuous use, typical
Speaker levels	Low, medium high
Automatic power shut off	After 5 min. of no audio signal
Speaker phone levels	Low, medium high
Power source	Battery (9V) 6F22 (Not included)
Physical	
Measurement	260 x 70 x 89mm (10-1/4" x 2-3/4" x 3-1/2")
Weight	560g typical
Environmental	
Temperature	Operating: 0 to 50°C Storage: -40 to 66°C
Altitude relative humidity	To 10,000 feet 5 to 95%
Accessories	500mA/250V fuse x 2pcs
Individual packing	Color box

MT-8091

In-Line Modular Adapters

4/6/8P 3 in 1

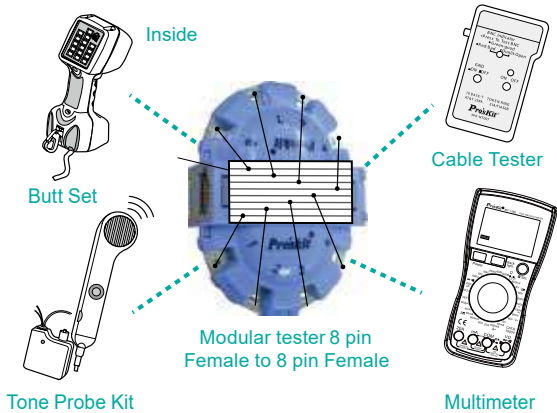

Features

- Allows in-line testing for any plug / jack combination.
- Applied to any brand of butt sets, lan cable testers, or tone generators.



	6 pin Female to 8pin Male		8 pin to 8 pin 205mm
	4 pin Female to 8pin Male		8 pin to 6 pin 205mm
			8 pin to 4 pin 205mm
Individual packing		Blister card	

▶ MT-7071 LCD Cable Length Toner & Probe Kit

Cable Mapping & Status Indication 610M
Cable Length Measurement 1200M
Wire Tracing 3000M



FAQ



MT-7071

Including transmitter, receiver and standard remote unit, RJ45 cable patch cord, RJ11/12 cable patch cord, alligator clips patch cord, earbud, carrying bag.



MT-7071K

Including standard MT-7071 set. and 8pcs remote unit (ID#1-ID#8).

Features

1-7 Calibration Parameters Setting • Max Support 8 Remote Units
 • 90~1000V NCV Detection • Input Protection: Voltage ≤DC 60V or AC 48V & Current ≤5mA • Router Test • Low Battery Display • Auto Power Off • Live Telecommunication Equipment Test



Verify LAN / Telephone / Coaxial cable condition



Detects AC Voltage

MT-7071 Toner specifications	
Cable types tested	RJ45 Lan cable Cat 5,5e,6(UTP/STP), RJ11/12 Telephone cable(2/4/6pin), Coaxial cable & normal solid/ Stranded wire by alligator clips patch cord
Cable test modes	2 note tones for location, wire mapping, open length tested
Measurement technology	Cable capacitance method
Max. distance to open for test	1,200m (4,000 ft / 1,300yd), approx
Min. distance to open for test	2 meter (6.8 ft / 2.2yd)
Typical accuracy of length test	2~10m(6.8~33 ft / 2.2~11yd) for reference 10~610m(33~2000 ft / 11~666yd): ±5.0% 610~1,200m (2000~4000ft / 666~1300 yd) for reference, Default measuring Cat.5e cable
Calibration accuracy of length test	10~610 m (33~2,000 ft/11~666 yd) ±3.0%, standard cable:10~50m(33~164 ft / 11~55 yd), Default measuring Cat.5e cable
Resolution & unit of length test	0.1 m / ft / yd, Rate:1~3 sec./time
Calibrating parameters memory	1~7 sets, allowing rewrite by new calibrating parameters
Max. distance of transmit	≥3 km (580/1160Hz)
Min / Max distance of cable map	Twisted pair:1m (3ft / 1yd), normal wire:1.25m (4ft / 1.35yd), 610m (2,000 ft / 666yd)
Cable map & shielded indication	LCD 1~8 & G
Battery type	DC 9V(NEDA 1604/6F22)X1pc(Not included)
Dimension (L×W×D)	138×80×35 mm
MT-7071 Receiver specification	
Signal status indication	580/1160 Hz
NCV indication	1 LED & Buzzer (AC90~1000V 50/60Hz)
LED illumination	1 LED
Dimension (L×W×D)	203×50×32 mm
MT-7071 Remote unit specifications	
Remote unit	1 pc, max. support to 8 pcs
Compatible connectors	RJ45(8 pin), RJ11/12(6 pin), BNC connectors
Remote unit dimension(LxWxD)	90×32×30mm
Individual packing	Color box

▶ MT-7029 Noise-Filtering Network PoE Toner & Probe Kit



Strong Anti-Noise

PoE Switches & STP Wire Tracing
3KM
Cable Mapping
Status Indication
300M



FAQ



PoE switches & wire tracing



STP wire tracing

▶ MT-7028 Network Toner & Probe Kit



Wire Tracing
3KM
Cable Mapping
Status Indication
300M



Verify LAN/ telephone cable condition



Wire tracing

Features

Telephone Line Status Check • 90~1000V NCV Detection • Polarity Indication • Low Battery Display • Router Test • Voltage Protection / DC 48V • Live Telecommunication Equipment Test • Auto Power Off

MT-7029 Transmitter specifications	
Tone frequency	130KHz
Max. distance of transmission & cable map	3km & 300m
Tone mode	Single tone
Compatible connectors	for RJ45(8 pin)/RJ11(6 pin) cable map test socket/RJ45 SCAN socket : for RJ45 locating Individual wire pairs/RJ11 SCAN socket: for RJ11 locating Individual wire pairs
Cable types tested	RJ45 Lan cable Cat 5,5e,6(UTP/ STP), RJ11/12 Telephone cable (6P/2C/4C/6C)
Continuity test	1 LED (≤300Ω), Coaxial cable & normal solid/ Stranded wire by alligator clips patch cord
Cable map & shielded indication	8 LEDs Fast/slow dual speed, 1 LED
Phone line polarity indication	1 Dual color LED
Telephone line status indication	1 Dual color LED
Network scan & PoE scan	1 LED & 1 LED
EMI filter(network scan & PoE scan)	YES
Battery type	DC 9V(NEDA 1604/6F22) x1pc(Not included)
Dimension (L×W×D)	138×80×35 mm
MT-7029 Receiver specifications	
Frequency	130KHz
Compatible connectors	RJ45 (8 pin) / RJ11(6 pin)
Signal status indication	1 dual color LED & buzzer, building ear jack
Cable map & shielded indication	8 LEDs & 1 LED
NCV indication	1 LED & Buzzer (AC 90V ~1000V 50/60Hz)
LED illumination	1 LED
Battery type	DC 9V (NEDA 1604/6F22) x1 pc (Not included)
Dimension (L×W×D)	203×50×32 mm
Accessories	RJ45 cable patch cords,RJ11 cable patch cords,RJ11 to alligator clips patch cord, earphone, storage bag, user manual
Individual packing	Color box

Features

90~1000V NCV Detection • Polarity Indication • Low Battery Display • Router Test • Voltage Protection / DC 48V • Auto Power Off • Live Telecommunication Equipment Test

MT-7028 Transmitter specifications	
Tone frequency	1KHz
Max. distance of transmission & cable map	3km & 300m
Tone mode	Hi / Low two-note tone
Compatible connectors	RJ45(8 pin)/RJ11(6 pin) compatible connectors, for RJ45(8 pin), RJ11/12(6P/2C/4C/6C) cable map and RJ45 tone, RJ-11(6 pin) connectors for RJ11/12(6P/2C/4C/6C) tone
Cable types tested	RJ45 Lan cable Cat 5,5e,6,7 (UTP/STP), RJ11/12 Telephone cable (6P/2C/4C/6C)
Continuity test	1 LED (≤300Ω), Coaxial cable & normal solid/ Stranded wire by alligator clips patch cord
Cable map & shielded indication	8 LEDs & 1 LED, Fast/Slow dual speed
Phone line polarity indication	1 Dual color LED
Battery type	DC 9V(NEDA 1604/6F22) x1pc(Not included)
Dimension (L×W×D)	138×80×35 mm
MT-7028 Receiver specifications	
Frequency	1KHz
Compatible connectors	RJ45 (8 pin) / RJ11(6 pin)
Signal status indication	1 LED & buzzer, building ear jack
Cable map & shielded indication	8 LEDs & 1 LED
NCV indication	1 LED & Buzzer (AC 90V ~1000V 50/60Hz)
LED illumination	1 LED
Battery type	DC 9V (NEDA 1604/6F22) x1 pc (Not included)
Dimension (L×W×D)	203×50×32 mm
Accessories	RJ45 cable patch cords, RJ11 cable patch cords, RJ11 to alligator clips patch cord, earphone, storage bag, user manual
Individual packing	Color box

▶ MT-7059

LCD Multifunction Cable Tester



LCD Display

Wire Tracing

2KM

Cable Mapping

250M



Cable mapping



Wire tracing

▶ 3PK-NT023N

Tone and Probe Kit



Basic and Popular Model

For de-energized AC wire, telephone/twisted pair wire, all voice and data category rated cable, virtually any cable or wire!



NCV detection



Phone line polarity indication and status check

Features

9 Different Tone Mode(Adjustable) • Continuity Test • Low Battery Display • Earphone Function • Volume Adjustment • Illumination

MT-7059 Transmitter specifications	
Indicator	LCD 53X25mm,with back light
Tone frequency	225kHz
Max. distance of transmission	2km
Max. distance of cable map	250m
Max. working current	≤70mA
Compatible connectors	RJ45(8 pin) / RJ11(6 pin) / BNC / USB / IEEE 1394
Max. signal voltage	1.5Vp-p
Function selection	3 Push button & 1 Power switch
Function and faults LCD	LCD display(Wiremap, Tone, Short, No adapter, UTP, STP, Low battery)
Cable map indication	LCD (#1~#8)
Shielded indication	LCD (#9)
Input protection	Voltage ≤DC 60V or AC 42V & Current ≤5mA
Battery type	DC 9.0V(NEDA 1604/6F22 DC9V)×1pc (Not included)
Dimension(LxWxD)	185 x 80 x 32mm
MT-7059 Receiver specifications	
Frequency	225kHz
The Max. working current	≤70mA
Battery type	DC 9.0V(NEDA 1604/ 6F22 DC9V)×1pc (Not included)
Dimension (LxWxD)	218x46x29mm
MT-7059 Remote unit	
Compatible connectors	RJ-45(8 pin), RJ-11(6 pin), BNC, USB, IEEE 1394
Dimension (LxWxD)	107x30x24mm
Accessories	Earphone, RJ-45 cable, pouch bag
Individual packing	Color box

Features

Rugged Industrial Design • Three Selectable Tone Outputs • Two-ling Polarity Indication • Continuity Test • Adjustable Volume Control • Visual Signal Strength Indication • Powerful Speaker

3PK-NT023N Tone Generator	
Tone frequency	1kHz
Max. testing distance	1.5km
Max. working current	≤20mA
Tone mode	One / Two-note tone
Connector port	RJ11(6 pin 2C), Alligator clips
Compatible connectors	De-energized AC wire, telephone / twisted pair wire, all voice and data category rated cable, virtually any cable or wire
Function selection	Tone / Off / Cont
Continuity test	1 LED(<500Ω), Coaxial cable & solid / stranded wire by alligator clips patch cord
Max. signal voltage	8V p-p
Power indicator	1 LED
Phone line polarity indication	1 LED
Telephone line status indication	1 LED
Live telecommunication equipment test and router test	Yes
Voltage protection	DC 48V
Low battery indication	7V
Battery type	DC 9.0V(NEDA 1604/6F22 DC 9V)×1pc, not included)
Dimension(L x W x H)	65x58x34mm
Weight	62g
Amplifier Probe	
Frequency	1kHz
Max. working current	≤70mA
Function selection	4 Position mode switch(LED, NCV, OFF, SCAN)
Earphone socket	1
Signal status indication	1 LED & Buzzer
NCV indication	1 LED (AC 90~1000V)
LED illumination	1 LED
Power indication	1 LED
Battery type	DC 9.0V(NEDA 1604/6F22 DC 9V)×1pc, not included)
Dimension(L x W x H)	230x56x25mm
Weight	80g
Individual packing	Color box

▶ MT-7063 PoE & LAN Cable Tester



PoE Test
Live Ethernet Cable Test



Cable Mapping 300M



POE test



Live Ethernet cable test

▶ MT-7064 PoE & LAN Cable Tester



Advanced Type

Easily identify IEEE 802.3af/at PoE standard and Midspan/Endspan

PoE Test

Cable Mapping 300M



POE test



Cable mapping

Features

- Easily tests Ethernet network for power over Ethernet existence • Quickly identify the type of power source equipment (Either Endspan or Midspan) • Check the RJ11/RJ12/RJ45 pin to pin cable map • Automatically runs all tests and checks for continuity, open, short and crossover wire pairs • Cable mapping up to 300M.

MT-7063 Specifications	
Max. distance of cable map	300m
Compatible connectors	RJ45(8 pin), RJ11/RJ12(6P6C/6P4C/6P2C), PoE
Cable types tested	RJ45 Lan cable Cat 5 / 5e / 6 / 7(UTP/STP), RJ11/12 Telephone Cable (6P/2C/4C/6C)
Cable map indication	8 LEDs & 1 LED, Fast / Slow dual speed
Shielded indication	LED(S)
PoE indication(Master)	power supply mode
	Mid-span End-span
Dimension (L×W×D)	123x66x35mm (Master: 94x66x35mm, Remote: 32x64x34mm)
Battery type	DC 9.0V (not included)
Weight	125g (Not included battery)
Individual packing	Color box

Features

- Detects if the IEEE 802.3af/at PoE voltage runs over the network cable and identify the type of Power Source Equipment (either Endspan or Midspan) for troubleshooting • Check the RJ11/RJ12/RJ45 pin to pin cable map • Automatically runs all tests and checks for continuity, open, short and crossover wire pairs • Cable mapping up to 300M.

MT-7064 Specifications	
Max. distance of cable map	300m
Compatible connectors	RJ45(8 pin), RJ11/RJ12(6P6C/6P4C/6P2C), PoE
Cable types tested	RJ45 Lan cable Cat 5 / 5e / 6 / 7(UTP/STP), RJ11/12 Telephone Cable (6P/2C/4C/6C)
Cable map indication	8 LEDs & 1 LED, Fast/Slow dual speed
Shielded indication	LED(S)
PoE indication(Master)	Power supply mode PoE standard
	Mid-span End-span 802.3af 802.3at
Dimension (L×W×D)	123x66x35mm (Master:94x66x35mm, Remote:32x64x34mm)
Battery type	DC 9.0V (not included)
Weight	125g (Not included battery)
Individual packing	Color box

▶ MT-7058 Mini Lan Cable Tester



Advanced Type

For RJ 11/12/22, RJ 45,BNC cable check and NCV detection

Pin to Pin Cable Indicator



Cable Status Analyzer

- Automatically detect good connections, opens, crossed wires & split pairs.
- Provides 2 scan modes (Automatic / Step by step) to detect cable status – good connection, open crossed wire or short. Traces wires with tone & remote lights allows one person operation.
- Long cable test up to 300 meters.

MT-7058 Specifications	
Cables tested	UTP and STP LAN cables Terminated in RJ-45 RJ-11/12 Cables with male connectors BNC Coaxial Cable with male connectors
Function	Cable mapping (1-8 LED), Shielded indicator (S) Automatic & Step by step scan mode. Straight cable indicator (Straight) Short Indicator (Short)
	Crossover indicator (Crossover) No connection indicator (No connection)
	Buzzer tone & LED indicator Low battery indicator (Power)
	Non-connector voltage detector (NCV) AC 60V~240V (50/60Hz)
Testing distance	300m (Max)
Battery	9V (6F22) x 1pce
Accessories	BNC-RJ45 Adaptor x1pce, Pouch bag x1pce
Dimension	140 x 70 x 35mm
Individual packing	Color box

▶ MT-7051N Multi-Modular Cable Tester



**For testing RJ45/
RJ11/RJ12/BNC Cable**



Pin to pin cable mapping



BNC connector is included

Features

- Tests RJ45 TIA568A/B (AT&T 258A), 10 Base-T, Token ring, RJ-11/ RJ-12 USOC and Coaxial BNC cable • Automatically check cable for continuity, short, open and crossed wire pairs • Coaxial cable port identifies cable conditions including shorts, shield opens and center conductor breaks • Main unit and remote allow one person testing.

MT-7051N specification	
Compatible connectors	RJ45 (8 pin), RJ11 (6 pin), BNC
Cable types tested	UTP, STP, Cat. 5e, Cat. 6, Cat. 7 telephone cable, RG6, RG58, RG59, CATV/CCTV coaxial cable
Test mode	3 modes
Cable mapping	8 LEDs
Shielded indication	Yes
Battery	NEDA 1604/ 6F22 DC9V ×1pce(Not included)
Size	105 x 65 x 28mm
MT-7051N Remote unit	
Compatible connectors	RJ45 (8 pin), RJ11 (6 pin), BNC
Cable version support	UTP, STP, Cat. 5e, Cat. 6, Cat. 7 telephone cable
Cable mapping	8 LEDs
Size	105 x 38 x 28mm
Accessories	BNC connector x1, Zipper bag x1
Individual packing	Blister card

▶ MT-7057N Cable Sniffer-Remote



**UTP/STP LAN
Cable Indication**

**Cable Test:
500M**



USB Cable test



RJ45 Lan cable test

Features

- Simple One Touch Operation • Detects Open, Short, Miswired, and Cross-Over Wired • Test for RJ45, RJ11, RJ12,USB,BNC • Visual and Audible Dual Indication

MT-7057N specification	
Functions	Test on RJ45 EIA/TIA-568A/B,AT&T258A, RJ11/12 USOC4/6/8, Ethernet 10 Base-T, Token Ring, Telephone, USB, BNC coaxial cable, Phone Net and cabling system. Low battery indication Beeper warning
Test distance	500M(1,640ft)
Battery	9V (NEDA 1604/ 6F22) battery x 1(not included)
Accessories	RJ45 to female BNC terminator, Carrying bag x1, Instruction Manual x1
Size	Approach 160 x 85 x 25mm
Individual packing	Color box

▶ MT-7031 Mini Lan Cable tester

- Comprehensive cable tester for RJ45, RJ11/12/22, BNC cable check.
- Long cable test up to 300 meters.
- Provides 2 scan modes (Slow /Fast) to detect cable status – good connection, open, crossed wire or short.

MT-7031 specification	
Cables Tested	UTP and STP LAN cables Terminated in RJ-45, RJ-11/12/ RJ22 cables with male connectors, BNC cables with male connectors.
Display	Main Unit
	Remote Unit
Max. Testing Distance	300m
Battery	12V 23Ax1pce
Dimension	112x60x25mm
Accessories	BNC-RJ45 Adaptor x1pce
Individual packing	Color box

**DC 60V Circuit
Protection**



**2 Scan Modes
(Slow /Fast)**



MULTIMETER SERIES

▶ MT-1708 3 5/6 Smart Digital Multimeter



**True-RMS
Full Function
Live Wire Test**



CE **RoHS COMPLIANT** **CAT III 600V**

The 3 5/6 Smart Digital Multimeter is a handheld digital multimeter with high reliability and portability; a perfect tool for the laboratory, factory and home.

LCD Display	3 5/6 5999 Counts		
DCV	6V / 60V / 600V±(0.8%+3d)		
ACV	6V / 60V / 600V±(1.2%+3d), TRUE-RMS(45-65Hz)		
DCA	600mA±(1.0%+3d)		
ACA	600mA±(1.5%+3d), TRUE-RMS(45-65Hz)		
Frequency	30~1000Hz±(0.5%+2d)		
Temperature	-20~1300°C±(1.0%+3d), -4°F~2372°F±(0.5%+ 2d)		
Resistance (Ω)	6kΩ / 60kΩ / 600kΩ±(1.0%+3d), 6MΩ / 10MΩ±(1.2%+5d)		
Capacitance	60nF / 600nF / 6μF / 60μF / 600μF / 6mF±(4%+5d)		
Continuity Buzzer	≤30Ω		
HFE Test	Yes <table border="1"><tr><td>LED Light</td><td>Yes</td></tr></table>	LED Light	Yes
LED Light	Yes		
Live Wire Test	Yes <table border="1"><tr><td>LCD Backlight</td><td>Yes</td></tr></table>	LCD Backlight	Yes
LCD Backlight	Yes		
NCV Detection	Yes <table border="1"><tr><td>Analog Scale Bar</td><td>Yes</td></tr></table>	Analog Scale Bar	Yes
Analog Scale Bar	Yes		
Data Hold	Yes <table border="1"><tr><td>Low Battery Indication</td><td>Yes</td></tr></table>	Low Battery Indication	Yes
Low Battery Indication	Yes		
Accessories	Fuse x 2pcs, Test Lead, K-type thermocouple, Manual		
Battery	1.5V AAA x 3		
Dimension	169 x 83 x 53mm		
Individual packing	Color box		

▶ MT-1707 3 5/6 True RMS Multimeter

CE **RoHS COMPLIANT**

**CAT III 1000V
CAT IV 600V**

**True RMS
Full Function
LED Light**



Continuity Test • Duty Cycle • Data Hold • Auto Power Off • LED Light • Low Battery Indication • Input Alert Protection • NCV Detection



▶ MT-1710 3 3/4 True-RMS Auto Range Multimeter

CE

CAT IV 600V

**True-RMS
Auto Range
hFE Test**



Continuity with Beeper • Diode Test • Transistor Test • Duty Cycle • Relative Reference • Data Hold • Auto Power Off • Low Battery Indication • Input Alert • LCD Backlight



DCV	600mV/6V/60V/600V/1000V ±(0.5%+3d)
ACV	6V/60V ±(0.8%+3d),600V/750V ±(1%+10d) Frequency Response:40Hz-1KHz True RMS
DCA	600uA/60mA/600mA±(0.8%+3d), 10.00A±(1.5%+10d)
ACA	60mA/600mA±(1%+3d),10.00A±(2%+10d) Frequency Response:40Hz-1KHz True RMS
Frequency	9.999Hz/99.99Hz/999.9Hz/9.999KHz/ 99.99KHz/999.9KHz/9.99MHz ±(1.0%+3d)
Resistance	600Ω/6kΩ/60kΩ/600kΩ±(0.8%+3d), 60MΩ/600MΩ±(1.2%+30d)
Capacitance	1nF±(4.0%+30d), 10nF/100nF/1μF/10μF/100μF/1mF±(2.5%+10d) 60mF ±(5.0%+30d)
Temperature	-20°C~1000°C/-4°F~1832°F±(1.0%+3d)
Fuse	F500mA/250V F10A/250V
Battery	6F22 9V x1 (Not included)
Weight	315g (Without battery)
Size	190 x89 x53mm
Accessories	Test lead, K-Type thermocouple
Individual packing	Color Box

DCV	400m/4/40/400V ±(0.5%+4d), 1000V ±(1.0%+6d)
ACV	40~1kHz(sine and triangular wave) and 40~200Hz(other wave) : 400mV ±(1.6%+8d), 4/40/400/750V ±(1.0%+10d), 200~1kHz(other wave):400m/4/40/400/750V ±(8.0%+15d)
DCA	400u/4000uA ±(1.0%+10d), 40m/400mA ±(1.2%+8d), 10A ±(1.2%+10d)
ACA	40~1kHz(sine and triangular wave) and 40~200Hz(other wave): 400u/4000u/40m/400mA ±(1.5%+10d), 10A ±(2.0%+15d) 200~1kHz(other wave):400u/4000u/40m/400m/10A ±(8.0%+15d)
Resistance	400Ω ±(0.8%+5d), 4k/40k/400k/4MΩ ±(0.8%+4d), 40MΩ ±(1.2%+10d)
Frequency	100Hz/1000Hz/10kHz/100kHz/1MHz/30MHz ±(0.5%+10d)
Capacitance	10n ±(5.0%+20d), 100n/1u/10u/100uF ±(3.5%+8d), 1/10/100mF ±(5.0%+10d)
Temperature	-20~400°C(-4~752°F) ±(1.0%+5d), 400~1000°C (752~1832°F) ±(1.5%+15d)
Battery	9V (NEDA 1640/6F22) x1 (Not included)
Size	190×95×45 mm
Accessories	Test lead, transistortest socket, thermocouple probe
Individual packing	Color box

▶ MT-1217 3 5/6 True RMS Digital Multimeter

6MF Large Capacitance True-RMS • Auto Range

Auto Power Off • Data Hold • Diode Test • Continuity with Beeper • Low Battery Indication • Transistor Test • Frequency • LED Indicator

DCV	600mV/6V/60V/600V±(0.5%+4d), 1000V±(1.0%+6d)		
ACV	600mV±(1.0%+10d), 6V/60V/600V±(0.8%+6d), 750V±(1.0%+10d), Frequency response: (40~1000)Hz True RMS		
DCA	600uA/6000uA/60mA/600mA±(1.0%+10d), 10A ±(1.2%+10d)		
ACA	600uA/6000uA/60mA/600mA±(1.5%+10d), 10A ±(2.5%+15d), Frequency response: (40~1000)Hz True RMS		
Resistance(Ω)	600Ω±(0.8%+5d), 6k/60k/600k/6MΩ±(0.8%+4d), 60MΩ±(1.2%+10d)		
Frequency	9.999Hz~20MHz±(1%+10d)		
Duty cycle	0.1-99% for your reference		
Capacitance(μF)	9.999nF±(5%+35d), 9.999nF~999.9uF ±(3.5%+8d), 999.9uF~6mF ±(3.5%+35d)		
Temperature	-20°C~1000°C;<400°C±(1.0%+5d), ≥400°C±(1.5%+15d) -4°F~1832°F;<752°F±(1.0%+5d), ≥752°F±(1.5%+15d)		
NCV Detection	Yes	Continuity w/ Beeper	Yes
Diode Test	Yes	Triode test	Yes
Low Battery Indication	Yes		
Battery	9V 6F22 x1 (Not included)		
Size	182×90×46mm		
Individual packing	Color box		

CAT III 1000V



TEST
INSTRUMENTS

▶ MT-1280 3 5/6 Digital True Rms Multimeter

True-RMS • 20A Large DCA / ACA Measurement

Auto Power Off • Data Hold • Diode Test • Continuity with Beeper • Low Battery Indication • Transistor Test • LED Indicator

DCV	600mV/6V/60V/600V±(0.5%+3d), 1000V±(0.8%+10d)				
ACV	6V/60V/600V ±(0.8%+5d), 750V ±(1.2%+10d), Frequency response: (40~1000)Hz True RMS				
DCA	600uA/6mA/60mA±(0.8%+10d), 600mA ±(1.2%+8d), 20.00A±(2%+5d)				
ACA	60mA±(1%+5d) , 600mA±(2%+5d), 20.00A±(3%+10d), Frequency response: (40~1000)Hz True RMS				
Resistance(Ω)	600Ω±(0.8%+5d), 6kΩ/60kΩ/600kΩ±(0.8%+3d), 60MΩ±(1%+25d), 600MΩ±(5%+10d)				
Frequency(Hz)	45~1000Hz±(1.0%+5d)				
Capacitance(μF)	9.999nF ±(5%+35d), 9.999nF~999.9uF ±(2.5%+20d), 999.9uF~2000uF ±(5%+35d)				
Temperature(°C/°F)	-20°C~1000°C, <400°C±(1.0%+5d), ≥400°C±(1.5%+15d) -4°F~1832°F, <752°F±(1.0%+5d), ≥752°F±(1.5%+15d)				
NCV Detection	Yes	Diode Test	Yes	Data Hold	Yes
Continuity w/ Beeper	Yes	Transistor	Yes	Low Battery Indication	Yes
Battery	9V(6F22)x1 (Not Included)				
Size	182 × 90 × 46mm				
Individual packing	Color box				

CAT III 1000V



▶ MT-1270 3 1/2 Digital Multimeter

Frequency • Capacitance Temperature

Temperature Test • Transistor Test • Auto Power Off • LCD Backlight • Diode Test • Low Battery Indication • Data Hold

DCV	200mV/2V/20V/200V ±(0.5%+3d)1000V ±(0.8%+10d)
ACV	2V/20V/200V ±(0.8%+5d), 750V ±(1.2%+10d)
DCA	2mA/20mA ±(0.8%+10d), 200mA ±(1.2%+8d), 10A ±(2.0%+5d)
ACA	20mA ±(1.0%+15d), 200mA ±(2.0%+5d), 10A ±(3.0%+10d)
Resistance	200Ω ±(0.8%+5d), 2K/20K/200K/2MΩ ±(0.8%+3d) 20MΩ ±(1.0%+25d), 200MΩ ±(5%+30d)
Frequency	20K Hz ±(3.0%+18d)
Capacitance	2nF / 20nF / 200nF / 2μF±(2.5%+20d), 20μF ±(5.0%+10d)
Temperature	-20°C~400°C±(1.0%+5d), 400°C~1000°C±(1.5%+15d)
Battery	9V(6F22)x1 (Not Included)
Size	182 x 90 x 46 mm
Accessories	Test lead(MT-9906), Transistor test socket, thermocouple probe
Individual packing	Color Box

CAT III 1000V



▶ MT-1236 3 5/6 True RMS Digital Multimeter



CAT II 600V



True RMS

Auto Range
ACV ACA True RMS Measurement

Overload Protection
Ensure user safety



Diode Test • NCV Detection • Data Hold • LCD Backlight • LED Light • Low Battery Indication

LCD Display	3 5/6 5999 Counts
DCV	600mV / 6V / 60V / 600V ±(0.5%+5d)
ACV	600mV / 6V / 60V / 600V ±(1%+4d) TRUE-RMS
DCA	60mA / 600mA ±(1.2%+5d), 10A ±(3.0%+5d)
ACA	60mA / 600mA ±(1.5%+5d), 10A ±(3.0%+5d) TRUE-RMS
Frequency	9.999Hz / 99.99Hz / 999.9Hz / 9.999KHz / 99.99KHz / 999.9KHz / 9.999MHz ±(1.5%+5d)
Duty Cycle	1%~99% ±(2.5%+5d)
Resistance Ω	600Ω / 6K / 60k / 600k / 6M / 60MΩ ±(0.8%+5d)
Capacitance	60nF / 600nF / 6uF / 60uF / 600uF / 6mF ±(4%+5d), 100mF ±(4%+10d)
Temperature	-20°C~1000°C ±(1%+3d), -4°F~2372°F ±(1%+3d)
Continuity Buzzer	≤30Ω, buzzer beeps
Accessories	Test lead, K-type thermocouple, Manual
Battery	1.5V AAA x 3pcs (not included)
Dimension	148 x 79 x 48mm
Weight	210g (without battery)
Individual packing	Color box

▶ MT-1225 3 1/2 Digital Multimeter



CAT II 600V



Additional Features

Temperature measurement

Overload Protection
Ensure user safety



Continuity Buzzer • Diode Test • Transistor Test • Data Hold • Low Battery Indication • NCV Detection • LED Light

Auto/Manual Range	Manual Range
LCD Display	3 1/2 1999 Counts
DCV	200mV / 2V / 20V / 200V ±(0.5%+5d), 600V ±(0.8%+5d)
ACV	200V±(1.0%+10d) / 600V ±(1.2%+10d)
DCA	20mA / 200mA ±(1.0%+5d), 10A±(3.0%+10d)
Resistance Ω	200Ω / 2K / 200k / 2MΩ ±(1%+3d), 20MΩ ±(1.5%+3d)
Temperature Test	-20°C~1000°C ±(1% +3d)
Accessories	Test lead, K-Type thermocouple, Manual
Battery	1.5V AAA x 3pcs (not included)
Dimension	148 x 79 x 48mm
Weight	210g (without battery)
Individual packing	Color box

▶ MT-1232 3 3/4 Auto Range Digital Multimeter



CAT III 600V



Auto Range

Full Function

Overload Protection
Ensure user safety



Diode Test • Continuity Test • Duty Cycle • Relative Value Measurement • Auto Power Off • Data Hold • Low Battery Indication • Backlight

DCV	400mV/4V/40V/400V ±(0.5%+4d), 600V ±(1.0%+4d)
ACV	4V/40V/400V ±(0.8%+6d), 600V ±(1.0%+6d)
DCA	400μA / 4000μA / 40mA/400mA ±(1.0%+10d), 10A±(1.2%+10d)
ACA	400μA/4000μA/40mA/400mA ±(1.5%+10d), 10 A±(2.5%+15d)
Resistance	400Ω ±(0.8%+5d), 4k/40k/400k/4MΩ ±(0.8%+4d), 40MΩ ±(1.2%+10d)
Frequency	1/10/100/1K/10K/100K/1M/10MHz ±(0.5%+10d)
Capacitance	4nF ±(5.0%+9d), 40nF/400nF/4μF/40μF ±(3.5%+8d), 100μF ±(5.0%+8d)
Temperature	(-20°C~1000°C) < 400°C±(1.0%+5d), (-20°C~1000°C) ≥ 400°C±(1.5%+15d)
Battery	1.5V AA x 2 (not included)
Size	147 x 78 x 41 mm
Accessories	Test lead, Thermocouple, Manual
Individual packing	Color box

▶ MT-1220 3 1/2 Digital Multimeter

Precise Measurement

2mA DCA measurement

Overload Protection

Ensure user safety

Continuity Buzzer • Diode Test • Transistor Test • NCV Detection • Data Hold • LED Light • LCD Backlight • Low Battery Indication

CAT II 600V



Auto/Manual Range	Manual Range
LCD Display	3 1/2 1999 Counts
DCV	200mV / 2V / 20V / 200V ±(0.5%+5d), 600V ±(0.8%+5d)
ACV	200V±(1.0%+10d) / 600V ±(1.2%+10d)
DCA	2mA / 20mA / 200mA ±(1.0%+5d), 10A±(3.0%+10d)
Resistance Ω	200Ω / 2K / 200k / 2MΩ ±(1%+3d), 20MΩ ±(1.5%+3d)
Accessories	Test Lead, Manual
Power	1.5V AAA x 3pcs (not included)
Dimension	148 x 79 x 48mm
Weight	210g (without battery)
Individual packing	Color box

▶ MT-1210 3 1/2 Compact Digital Multimeter

Best Value

User friendly interface is ideal for students, home use and DIY market.

Diode Test • Continuity Test • Transistor Test • Data Hold • Low Battery Indication • Backlight

CAT II 600V



DCV	200mV/2V/20V/200V ±(1.0%+2d), 500V ±(1.2%+5d)
ACV	200/500V ±(2.5%+10d)
DCA	200μA/2mA/20mA/200mA ±(2.0%+5d), 10A ±(3.0%+5d)
Resistance	200Ω/2K/20K/200KΩ ±(1.0%+5d), 2MΩ ±(1.5%+5d)
Battery check	1.5V
Battery	9V(6F22)×1 (Not included)
Size	147 × 74 × 35mm
Accessories	Test lead, Manual
Individual packing	Blister card

▶ MT-1233C 3 1/2 Digital Multimeter

CAT II 300V



Palm Size Temperature Test

Diode Test • Continuity Test • Data Hold • Low Battery Indication • Backlight



DCV	200m/2000m/20/200V ±(0.8%+3d), 500V ±(1.0%+3d)
ACV	200/500V ±(1.2%+5d)
DCA	2000u/20m/200mA ±(1.2%+5d), 10A ±(2.5%+5d)
Resistance	200Ω ±(1.5%+5d), 2000/20k/200kΩ ±(1.0%+3d), 20MΩ ±(1.0%+5d)
Temperature	-40~150°C ±(1.0%+3d), 150-1000°C ±(1.5%+15d), -40~302°F(1.0%+4d), 302-1832°F ±(1.5%+15d)
Battery	1.5V AAA x 2 (Not included)
Size	130 x 72 x 28mm
Accessories	Test lead, Thermocouple probe, Manual
Individual packing	Double blister

▶ MT-1233D 3 1/2 Digital Multimeter

CAT II 300V



High Resistance Test Square Signal Output

Diode Test • Continuity Test • Transistor Test Data Hold • Low Battery Indication • Backlight



DCV	200m/2000m/20/200V ±(0.8%+3d), 500V ±(1.0%+3d)
ACV	200/500V ±(1.2%+5d)
DCA	2000u/20m/200mA ±(1.2%+5d), 10A ±(2.5%+5d)
Resistance	200Ω ±(1.5%+5d), 2000/20k/200kΩ ±(1.0%+3d), 20MΩ ±(1.0%+5d), 200MΩ ±(1.0%+10d)
Square signal output	50Hz (3Vp-p, 50KΩ)
Battery	1.5V AAA x 2 (Not included)
Size	130 x 72 x 28mm
Accessories	Test lead, Manual
Individual packing	Double blister

▶ MT-1509 3 1/2 Pocket Autorange Multimeter



CE **RoHS COMPLIANT** **CAT III 600V**
One Touch
 Smart Measuring
NCV Detection
Auto Selection

- Continuity Test • Auto Power Off
- Low Battery Indication • Data Hold
- Over Range Indication • Backlight



NCV Detection



ACV measurement



DCV	2V/20V/200V±(0.5%+3d), 600V±(0.8%+5d)
ACV	2V/20V/200V±(0.8%+3d), 600V±(1.0%+5d)
Resistance	2kΩ/20kΩ/200kΩ/2MΩ±(1.0%+3d), 10MΩ±(1.2%+15d)
Battery	2x1.5V AAA (Not included)
Weight	140g (Not included battery)
Size	125 x 60 x 26 mm
Individual packing	Blister card

▶ MT-1508 3 1/2 Pocket Autorange Multimeter



CE **RoHS COMPLIANT** **CAT III 600V**
ACA/DCA
 Measurement
NCV Detection
Diode Test

- Diode Test • Continuity Test • Auto Power Off • Low Battery Indication
- Data Hold • Over Range Indication • Backlight



Resistance Measurement



ACV measurement



DCV	200mV/2V/20V/200V±(0.5%+3d), 600V±(0.8%+5d)
ACV	2V/20V/200V±(0.8%+3d), 600V±(1.0%+5d)
DCA	200μA/2000μA/20mA/200mA±(1.8%+5d)
ACA	200μA/2000μA/20mA/200mA±(2.0%+5d)
Resistance	200Ω/2kΩ/20kΩ/200kΩ/2MΩ±(1.0%+3d), 20MΩ±(1.2%+15d)
Battery	2x1.5V AAA (Not included)
Weight	152g (not included battery)
Individual packing	Blister card
Size	125 x 60 x 26 mm

▶ MT-1506 3 3/4 Pocket True-RMS Auto Range Multimeter



CE **CAT II 600V**
Mini Size **Easy Store**
 with Multifunction with Integrated Case and Built-In Test Lead

- Continuity Test • Diode Test • Duty Cycle • Low Battery Indication • Auto Power Off • Relative Reference

True RMS



DCV	400mV,4/40/400V ±(0.5%+4d), 600V ±(1%+4d)
ACV	400mV±(1.5%+6d), 4/40/400V ±(0.8%+6d), 600V ±(1.0%+6d) True-RMS
Resistance	400Ω ±(0.8%+5d), 4k/40k/400k/4MΩ ±(0.8%+4d), 40MΩ ±(1.2%+5d)
Frequency	100Hz/1000Hz/10kHz/100kHz/1MHz/10MHz ±(0.5%+4d)
Capacitance	4nF ±(5%+4d), 40n/400n/4μ/40μ ±(3.5%+8d), 2000μF ±(5%+8d)
Duty cycle	0.1~99.9% ±(0.5%+4d)
Continuity with beeper	50 ±30Ω
Diode test	Range: 0 ~ 1.5V Resolution: 1mV
Power source	2 x 1.5V AAA battery (Not included)
Size	124 x 80 x 20 mm
Individual packing	Color box

▶ MT-1630 3 1/2 Pen-Style Meter



CE **Pb**
Compact Size
Multifunction
Auto Range



- Diode Test • Continuity Test • Auto Power Off • Data Hold • Low Battery Indication • Over Range Indication • Penlight • Fuse protection



DCV	200mV/2V/20V/200V/600V±(0.8%+5d)
ACV	2V/20V/200V±(1%+3d), 600V±(1.2%+3d)
DCA	20mA/200mA±(1.5%+10d)
ACA	20mA/200mA±(3.0%+10d)
Resistance	200Ω±(1.0%+5d), 2kΩ/20kΩ/200kΩ/2MΩ±(1.0%+3d), 20MΩ±(1.2%+5d)
Battery	2 x LR44 (1.5V)
Weight	96g (not include battery)
Size	205x35x30mm
Individual packing	Blister card

▶ MT-1820 3 5/6 Dual Display DMM w/USB Connector

Data Log USB connection to PC Auto Range • Dual Display

Transistor Test • Duty Cycle • Relative Reference • Backlight • Data Hold • Max./Min. Hold • Continuity Test • Diode Test • Low Battery Indication • Auto Power Off



DCV	600m/6/60/600V ±(0.5%+4d), 1000V ±(1.0%+6d)
ACV	6/60/600V ±(0.8%+10d), 750V ±(1.0%+10d)
DCA	600μ/6000μ/60m/600mA ±(1.0%+10d), 6/10A ±(1.2%+10d)
ACA	600μ/6000μ/60m/600mA ±(1.5%+10d), 6/10A ±(2.0%+15d)
Resistance	600Ω ±(0.8%+5d), 6k/60k/600k/6MΩ ±(0.8%+4d), 60MΩ ±(1.2%+10d)
Frequency	100/1000/10k/100k/1M/30MHz ±(0.5%+4d)
Capacitance	40nF±(5%+30d), 400n/4μ/40μF±(3.5%+8d), 200μF±(5.0%+10d)
Temperature	-20~400°C(0~750°F) ±(1.0%+50d), 400~1000°C(750~1832°F) ±(1.5%+15d)
Power source	AAA(1.5V)×2pcs (Not included)
Size	192×95×48 mm
Individual packing	Color box
Accessories	Test lead, Temperature probe (K-Thermocouple), PC Interface cable, Software disk, Transistor test accessory



▶ MT-5211 3 1/2 Digital LCR Multimeter

LCR Meter • Full Function

Transistor Test • Backlight • Data Hold • Continuity Test • Diode Test • Low Battery Indication • Auto Power Off • Overload Indication



DCV	200mV/2V/20V/200V±(0.5%+3d),1000V±(1.0%+5d)
ACV	200mV±(1.2%+3d),2V/20V/200V±(0.8%+5d),750V±(1.2%+5d)
DCA	2mA/20mA±(0.8%+3d),200mA±(1.2%+4d),20A±(2.0%+5d)
ACA	2mA/20mA±(1.0%+5d),200mA±(2.0%+5d),20A±(3.0%+10d)
Resistance	200Ω±(0.8%+5d),2K/20K/200K/2MΩ±(0.8%+3d), 20MΩ±(1.0%+15d), 2000MΩ ±(5.0%(reading-10)+20d)
Capacitance	20nF/200nF/2uF±(2.5%+20d),20uF/200uF±(5.0%+5d)
Inductance	2mH/20mH/200mH/2H/20H±(2.5%+20d)
Temperature(-20~1000°C)	<400°C±(1.0%+4d), ≥400°C±(1.5%+15d)
Frequency	2k/20k/200k/2000K/10M Hz±(1.0%+10d)
Power source	9V 6F22 battery(Not included)
Size	189×97.5×35mm
Individual packing	Color box
Accessories	Test lead, thermocouple, test socket



▶ MT-5110 3 1/2 Capacitance Meter

200pF to 20,000μF Large Capacitance Range

Zero Knob for Low Capacitance Measurement

for Low Capacitance Measurement

Backlight • Low Battery Indication
• Input Overload Protection



Capacitance	200pF ±(0.5%+7d), 2n/20n/200n/2μ/20μ/200μF ±(0.5%+5d), 2,000μF ±(2.0%+5d), 20,000μF ±(3.0%+10d)
Zero adjustment	Manual (range:±20pF)
Over-input	Display shows "1"
Sampling time	0~5 second
Power source	NEDA1604/6F22 (9V) x 1pcce (Not included)
Size	182×90×46mm
Accessories	Test lead (Model. MT-9906), Test alligator clips, Test socket
Individual Packing	Color box



▶ MT-2019 Protective Multifunction Analog Multimeter



ACV test



DCA test



**Overload Protection
Continuity Check Buzzer**

DCV	0.1/2.5/10/50/250V ±3.0%FSD, 1000V ±4.0%FSD
ACV	10/50/250V ±4.0%FSD, 1000V±5.0%FSD
DCA	0.05/2.5/25/250 mA ±3.0%FSD
Resistance	×1(0.2~2kΩ)/ ×10(2~20kΩ)/ ×100(20~200kΩ)/ ×1k(200~2MΩ)/ ×10kΩ(2k~20MΩ) ±4.0%ARC of scale length
Capacitance	C(RX1K):2000uF (Approx.)Max
Battery check	1.5 / 9V
hFE	hFE: 0-1000
Contiunity with beeper	Yes
LED & Diode test	Yes
Battery	1.5V AAA x2 & 9V(NEDA1604) x1
Accessories	Test lead
Size	160x105x40mm
Individual packing	Color box

▶ MT-2017N Protective Function Analog Multimeter



ACV test



hFE test



**Overload Protection
Gilded Test Leads
Null DCV • Resettable fuses**

DCV	0.1/2.5/10/50/250V ±3.0%FSD, 1000V ±4.0%FSD
Null DCV	DC±5V, ±25V ±5.0%FSD
ACV	10/50/250V ±4.0%FSD, 1000V±5.0%FSD
DCA	50μ/2.5m/25m/250mA ±3.0%FSD, 10A ±4.0%FSD
Resistance	×1(0.2~2kΩ)/ ×10(2~20kΩ)/ ×100(20~200kΩ)/ ×1k(200~2MΩ)/ ×10kΩ(2k~20MΩ) ±4.0%ARC of scale length
Capacitance	C(R×1k): 2000μF(Approx.) Max
Battery check	1.5V/9V
Transistor check	Yes
Diode & LED test	Yes
Continuity with beeper	Yes
Front panel controls	Range selector switch with "OFF" position, 0Ω adjust knob
Battery	1.5V AAA x 2 and 9V(NEDA1604) x 1
Size	171 x 108 x 37mm
Individual packing	Color box

▶ MT-9905 Test Lead



Right-angle shrouded Banana plugs

- One pair comfort grip probes with protective cap for user comfort and safety.
- Durable quality PVC insulated test leads with right-angle shrouded banana plugs.
- Banana plugs are molded directly to the wire for superior pull strength.
- Needle tip test probe, allowing easy access of hard to reach test points.
- Compatible with most multimeters that accept safety style sheath banana plugs.

▶ MT-9906 / MT-9907 Test Lead

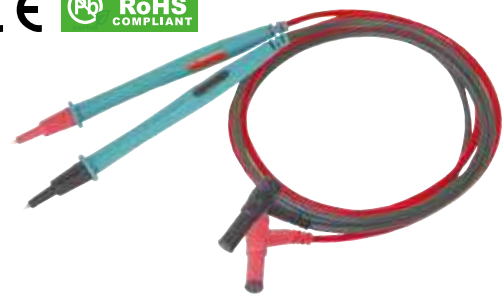

MT-9906



MT-9907

- One pair comfort grip probes with protective cap for user comfort and safety.
- Durable quality PVC insulated test leads with right-angle shrouded banana plugs.
- Needle tip test probe, allowing easy access of hard to reach test points.
- Compatible with most multimeters that accept safety style sheath banana plugs.

Specifications	Probe	Hand piece	Lead length	Plug	OAL	Weight	Individual Packing
MT-9905		125mm	1000mm		1200mm	75g	Blister card
MT-9906	Ø2x17mm	146mm	900mm	Ø4.2x15mm	1120mm	78.5g	
MT-9907		129mm			1100mm	74g	

CLAMP METER SERIES

3 5/6 AC/DC DIGITAL CLAMP METER

▶ **MT-3209**



MT-3209 – 3 5/6 AC/DC DIGITAL CLAMP METER – provides excellent performance & complete solution to professional electricians. With **True RMS, LoZ Volts & V.F.C.**, you will get nothing but more accurate result while measuring voltage & current. It's also equipped with NCV & LED light as standard assistive function. You can always count on MT-3209 to resolve your problems.

True RMS



NCV Detection



ACA Measurement



LoZ Volts

DCV	600mV / 6V / 60V ±(0.5%+5d), 600V ±(0.8%+5d)
ACV	6V / 60V ±(1.0%+5d), 600V ±(1.2%+10d) True RMS
LoZ DC/AC V	1-600V ±(2.0%+3d)
DCA	60A ±(3.0%+15d) / 600A ±(3.0%+5d)
ACA	60A / 600A ±(2.5%+5d) True RMS
ResistanceΩ	600Ω / 6K / 60K / 600K / 6M ±(0.8%+5d), 60MΩ ±(1.2%+5d)
Capacitance	6nF ±(5.0%+15d) / 60nF / 600nF / 6uF / 60uF / 600uF / 6mF ±(4.0%+5d), 100mF ±(5.0%+5d)
Temperature	-20°C~1000°C ±(1.0%+3d), -4°F~1832°F ±(1.0%+3d),
Frequency	(V) 600Hz / 6kHz / 60kHz / 600kHz ±(1.5%+5d), (A) 600Hz ±(1.5%+5d)
Battery	1.5V AAA x 2
Size	190 x 71 x 30 mm
Individual packing	Color box



▶ **MT-3202**

3 3/4 DIGITAL CLAMP METER

It's always a helpful & trustworthy tool to professional electricians. With True RMS & Complete Function, including DC/AC voltage, AC current, frequency, temperature, capacitance, resistance, non-contact voltage detection & LED lighting. You have no doubt to count on MT-3202 to finish your job.



NCV Detection



ACA Measurement

True RMS



DCV	400mV / 4V / 40V / 400V / 600V ±(0.8%+5d)
ACV	4V / 40V / 400V / 600V ±(1.2%+5d) True RMS
ACA	4A ±(3%+5d) ; 40A / 400A / 600A ±(2%+5d) True RMS
ResistanceΩ	400Ω / 4K / 40K / 400K / 4M / 40MΩ ±(1.2%+5d)
Capacitance	4nF ±(3%+15d) / 40nF / 400nF / 4uF / 40uF / 400uF / 4mF ±(3%+5d)
Temperature	-20°C~1000°C ±(3%+5d), -4°F~1832°F ±(3%+5d),
Frequency	(V) 4Hz / 40Hz / 400Hz / 4kHz / 40kHz ±(0.5%+5d), (A) 40Hz / 400Hz / 1KHz ±(0.5%+5d)
Battery	1.5V AAA x 2
Size	190 x 71 x 30 mm
Individual packing	Color box

▶ MT-3110 3 5/6 DIGITAL CLAMP METER



CAT III 600V



Max. jaw opening:
25mm

One Key measurement
Auto Selection smart operation
Dual Display
Simultaneous Measurement



▶ MT-3109 3 3/4 AC/DC Digital Clamp Multimeter



CAT II 600V



Max. jaw opening:
30mm

Capacitance measurement
Frequency measurement
AC/DC Current/Voltage Measurement



Non contact ACV detector



Simultaneous measurement



DCA measurement



ACA measurement

Features

NCV Detection • Continuity Test • Data Hold • Low Battery Indication • Backlight

ACA	6A /60A/400A±(2.5%+8d), 600A±(3.0%+10d), PEMAX: 900A ±(10%+10d)
ACV	6V /60V/600V ±(0.8%+5d)
DCV	6V /60V/600V ±(0.5%+3d)
Resistance	6K/60K/600K/6M/10MΩ ±(0.8%+3d)
Frequency	10~1KHz±(1.0%+5d)
NCV	90~1000V 50/60Hz
Extra functions	Data hold, LCD backlight, Low Battery, Auto power off
Battery	1.5V AAAx2 (not included)
Size	188 x 68 x 38 mm
Accessories	Test lead, Carry bag
Individual packing	Color box

Features

Duty Cycle • Diode Test • Continuity Test • Relative Reference • Data Hold • Auto Power Off • Low Battery Indication

DCV	400mV ±(1.0%+3d), 4V/40/400V ±(1.0%+1d), 600V ±(1.0%+5d)
ACV	4/40/400V ±(1.2%+5d), 600V ±(1.5%+5d)
DCA	40A ±(2.5%+5d), 400A ±(2.5%+3d)
ACA	40A ±(3.0%+8d), 400A ±(3.0%+5d)
Resistance	400Ω ±(1.2%+5d), 4K/40K/400KΩ ±(1.0%+5d), 4MΩ ±(1.2%+5d), 40MΩ ±(1.5%+5d)
Frequency	10/100/1K/10K/100K/1MHz ±(0.1%+5d), 10MHz (For reference only)
Capacitance	40n/400n/4μ/40μF ±(5.0%+10d), 100μF ±(6.0%+10d)
Battery	1.5V AAAx2 (not included)
Size	203 x 68 x 33 mm
Accessories	Test lead, Carry bag
Individual packing	Double blister

▶ **MT-3102**

3 1/2 2A Mini Digital Clamp Meter



CAT II 600V

Mini digital multimeter, easy and simple for one hand operation.

Max. jaw opening:

30mm

2A Small AC Current

Temperature
measurement



Temperature measurement



ACA measurement

▶ **MT-3266**

3 1/2 Hand Held Digital Clamp Meter



**CAT II DC1000V
CAT II AC750V**

A good helper to test appliances with larger DCV, ACV, and ACA.

Max. jaw opening:

50mm

1000A
Large current measurement



ACV measurement



ACA measurement

Features

Diode Test • Continuity Test • Maximum Value Hold • Data Hold • Auto Power Off • Low Battery Indication

ACA	2A ±(3.0%+15d) ≤ 0.4A ±(4.0%+20d), 20A ±(2.0%+10d) ≤ 0.4A ±(3.0%+15d), 200/400A ± (2.0%+5d)
ACV	2/20/200V ±(1.2%+5d), 600V ±(1.5%+5d)
DCV	200mV ±(0.8%+5d), 2/20/200V ±(0.8%+3d), 600V ±(1.0%+5d)
Resistance	200Ω ±(1.2%+5d), 2k/20k/200kΩ ±(1.0%+3d), 2MΩ ±(1.2%+5d), 20MΩ ±(1.5%+5d)
Temperature	-40~0°C ±(3.0%+4d), 0~400°C ±(1.0%+3d), 400~1000°C ±(2.0%+10d), -40~32°F ±(3.0%+8d), 32~752°F ±(1.0%+6d), 752~1832°F ±(2.0%+18d)
Battery	1.5V AAAx3 (not included)
Size	203 x 68 x 33 mm
Accessories	Test lead, Thermocouple probe
Individual packing	Double blister

Features

Continuity Test • Data Hold • Low Battery Indication

ACA	200/1,000A ±(3.0%+5d)
ACV	750V ±(1.2%+4d)
DCV	1,000V ±(0.8%+2d)
Resistance	200Ω ±(1.0%+3d), 20kΩ ±(1.0%+1d)
Battery	NEDA1604/6F22 (9V) x 1pcs(Not included)
Size	230 x 70 x 37 mm
Accessories	Test lead
Individual packing	Double blister

ENVIRONMENTAL METER SERIES

Ideal for measuring of mechanical, chemical, pottery, food, metallurgy, electric power, air condition, high-temperature heat treatment.

▶ MT-4606 Infrared Thermometer

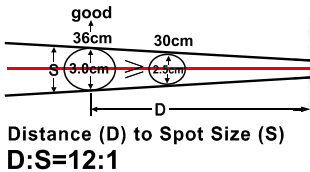

-50 to 550°C

Distance Spot Ratio 12:1

0.10 ~ 1.00 emissivity adjustable



Features

Auto Power Off • Low Battery Indication • Data Hold • Max. Record • Backlight • Color Screen

Temperature Range	-50~550°C (-58~1022°F)
Accuracy	≤100°C ±2°C, >100°C ±2%
Distance Spot Ratio	12 : 1
Emissivity	Adjustable (0.1 to 1.0)
Laser Class	Class II, <1mW
Repeatability	±1°C or ±1%
Unit Selection	°C / °F
Resolution	0.1°C (0.1°F)
Response Time	0.5S
Wavelength	8-14μm
Auto Power Off	Yes
Battery Indication	Yes
Data Hold	Yes
Max. Record	Yes
Storage Temperature	-20 to 50°C (-4~122°F)
Operating Temperature	0 to 50°C (32~122°F)
Battery	9V battery (6F22)
Size	152 x 87 x 40mm
Weight	118g (not include battery)
Individual packing	Color Box

▶ MT-4612 Infrared Thermometer

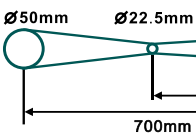

-50 to 580°C

Distance Spot Ratio 16:1

0.10 ~ 1.00 emissivity adjustable

Dual Laser for accurate aiming



Features

°C/°F Selection • Auto Power Off • Low Battery Indication • Data Hold • Max./Min./Average/Difference Record • High/Low Temperature Alarm • Backlight

Temperature range	-50°C~580°C(-58°F~1076°F)
Accuracy	±2°C or ±2%°C
Laser class	Class II, <1mW
Response time & Wavelength	500ms / 8-14μm
Repeatability	±1°C or ±1%°C
Resolution	0.1°C
data memory	9 memories
Laser target point	Dual Laser / can be selected on / off
Storage temperature	-20-50°C(-4~122°F)
Operating temperature	0~50°C, 10~95%RH
Battery	6F22(9V) (not included)
Size	175 x 130 x 45mm
Weight	204g (Not include battery)
Individual packing	Double blister

▶ MT-4615 Anemometer



Air Velocity and Air Volume measurement

One Hand Operation

Features

- Analog Bar Graphic • Variety of Units • Backlight • Max./Min. Value • Low Battery Indication • Auto Power Off • Data Hold



Measuring range	0.8~40m/s
Accuracy	0.8~30m/s, 1.4~108km/h, 1.3~98.5ft/s, 0.8~58.3knots, 0.9~67.2mil/h, 78~5900ft/m, $\pm(2.0\% + 50D)$ 30~40m/s, 108~144km/h, 98.5~131.2ft/s, 58.3~77.7 knots, 67.2~90mil/h, 5900~7874 ft/m, (only for reference)
Resolution	0.01m/s, 0.01km/h, 0.01 ft/s, 0.01knots, 0.01mile/h, 1ft/m
Unit	Air Velocity: m/s, km/h, mil/h, ft/m, ft/s, knots Air Volume: CMS (m ³ /s), CMM m ³ /min, CFM (ft ³ /min), 30~40m/s only for reference
Sensor	Conventional arm angle to the impeller
Sampling time	0.4s
Auto power off	10 minutes (adjustable)
Low battery indication	<7V
Operation environment	0~85%RH, 0°C~40°C(no condense)
Fan operation environment	0~95%RH, -20°C~80°C(no condense)
Storage environment	0~80%RH, -20°C~80°C(no condense)
Operating altitude	Max. 2000m
Battery	9V 6F22 (not included)
Size	170 x 85 x 40mm
Accessories	Pouch bag, user manual
Individual packing	Color Box

▶ MT-4617LED Light Intensity Meter

Quick Sampling Time

One Hand Operation

Features

- Auto and Manual Range • Zero Calibration • Relative Peak Value • Backlight • Max./Min. Value • Low Battery Indication • Auto Power Off • Data Hold • Over-load Indication



Range	20, 200, 2000, 20000, 200000 Lux, 20, 200, 2000, 20000 FC
Ring spectral range	320~730nm
Unit selection	Lux, FC (Footcandles)
Sensor	Silicon photodiode
Sampling time	≥ 2 times/sec.
Auto power off	10 min after no use
Operation sound	Selection
Low battery indicate	<7V
Operation environment	0~85%RH, -10~50°C(no condense)
Storage environment	0~70%RH, -10~50°C(no condense)
Operating altitude	Max. 2000m
Accuracy	$\pm 3\%$ (calibrated to standard incandescent lamp and LED at 2,854K), $\pm 6\%$ (calibrated at other visible light source)
Applications	For all visible light and LED white, red, yellow, green, blue, purple color
Battery	9V (Not included)
Size	170x85x45mm
Accessories	Storage bag, instruction manual
Individual packing	Color Box

▶ MT-4616 Temperature / Humidity / Dew Point Meter



3 Temperature Types measurement

User-Friendly Design

Features

- 99 Data Memories • °F/°C selection • Max./Min. Value • Low Battery Indication • Auto Power Off • Backlight • Data Hold



Temperature range	-20~60°C(- 4°F~140°F)
Temperature accuracy	$\pm 1^\circ\text{C}(0\sim 45^\circ\text{C})$, $\pm 1.5^\circ\text{C}(-20\sim 0^\circ\text{C}, 45\sim 60^\circ\text{C})$
Humidity range	0~100%RH
Humidity accuracy	$\pm 3\%$ (20%~80%), $\pm 4\%$ (0~20%, 80%~100%)
Wet Bulb temperature range	-20~60°C(-4~140°F)
Wet bulb temperature accuracy	$\pm 1^\circ\text{C}(0\sim 45^\circ\text{C})$, $\pm 1.5^\circ\text{C}(-20\sim 0^\circ\text{C}, 45\sim 60^\circ\text{C})$
Dew point range	-50~60°C(-58~140°F)
Dew point accuracy	$\pm 1^\circ\text{C}(0\sim 45^\circ\text{C})$, $\pm 1.5^\circ\text{C}(-50\sim 0^\circ\text{C}, 45\sim 60^\circ\text{C})$
Resolution	0.1C/F ; 0.1%
Data memory	Max. 99 of data
Unit selection	°C / °F
Auto power off	After 30mins, on/off selection
Battery	AAA 1.5V x 4 (Not included)
Size	184 x 60 x 29mm
Accessories	Storage bag, Instruction manual
Individual packing	Color Box

▶ MT-4618 Sound Level Meter

A&C Weighting Network Selection

Wide Range High Accuracy

Features

- Max./Min.value • Data Hold • Auto Range • Auto power off • Backlight • Good Anti-interference Performance



Range	30—130dBa, 35—130dBC 30—80db, 40—90db, 50—100db, 60—110db, 70—120db, 80—130db, 30~130 db is auto range
Accuracy	$\pm 1.5\text{dB}$ (94dB@1KHz), $\pm 5\text{dB}$ (94dB@8KHz)
Resolution	0.1dB
Response frequency	30Hz — 8KHz
Dynamic sound pressure	50 dB (at each range) FAST 125ms, SLOW 1sec
Frequency weighting	A and Ctype
Sensor	Polarized condenser microphone
Sampling time	2 times/sec., Analog 20 times/sec.
Operating environment	10~80%RH, 0°C~40°C (Non-condensing)
Storage environment	10~70%RH, -10°C~60°C (Non-condensing)
Low battery indication	<5V
Battery	1.5V AAA battery x 4 (Not included)
Size	193 x 60 x 29mm
Accessories	Storage bag, Instruction manual
Individual packing	Color Box

▶ NT-311 Digital Temperature Humidity Meter



5 in 1 Multifunction

• Temperature • Humidity • Clock • Alarm Colck • Calendar

Features

12-Hours / 24-Hours Display • Max./Min. Temp. & Humidity Memory • Wall Hanging or Desk-Top Stand Support • 8-Minutes Snooze • °C / °F Switch

Temperature range	-10°C to +50°C / 14°F to +122°F
Humidity range	20%RH to 90%RH
Accuracy	±1°C (±1.8°F) / ±5%RH
Resolution	0.1°C (0.1°F) / 1% RH
Battery	1.5V AAA x1 (not included)
Size	97 x 94 x 23.5mm
Individual packing	Blister card

▶ NT-312 Digital Temperature Humidity Meter



5 in 1 Multifunction

• Temperature • Humidity • Clock • Alarm Colck • Calendar

Features

12-Hours / 24-Hours Display • Max./Min. Temp. & Humidity Memory • Wall Hanging or Desk-Top Stand Support • 8-Minutes Snooze • °C / °F Switch

Temperature range	Indoor: -10°C to +50°C, (14°F to +122°F) ±1°C (±1.8°F) Outdoor: -50°C to +70°C, (-58°F~+158°F) ±1°C (±1.8°F)
Humidity range	20%RH to 90%RH
Accuracy	±1°C (±1.8°F) / ±5%RH
Resolution	0.1°C (0.1°F) / 1% RH
Battery	1.5V AAA x1 (not included)
Size	97 x 94 x 23.5mm
Individual packing	Blister card

▶ NT-309 Smart Non-Contact Voltage Tester

CAT III 1000V
safety rating
AC 12-1000V
Detection



Features

Voltage Level Indication • Non-Conductive Outer Surface • LED Illumination Light

Test Voltage range	12V~1000VAC, 50/60Hz
Auto power off	3 minutes
Alarm system	Flashing LED with Beeper alarm
Battery	2 x 1.5V AAA (Not included)
Overall length	156mm
Weight	35g
Individual packing	Blister card

▶ NT-306 Non-Contact Voltage Detector

CAT IV 1000V
safety rating
AC 90-1000V
Detection



Features

LED Illumination Light • Non-conductive Outer Surface

Test Voltage range	90V-1000V AC voltage
Handle material	ABS
Alarm system	LED light and beeper alarm
Battery	2 x 1.5VAAA(not included)
Overall length	153mm
Individual packing	Blister card

▶ NT-305 Voltage Detector

AC 70-250V
Detection
DC 12, 36, 55V
Detection



Features

Self Power Auto-detection • Circuit Continuity Test • LED Backlight

Test voltage range	70V-250V ACV 12, 36, 55 DCV
Handle material	ABS UL 940V-0
Alarm system	LED light
Battery	1 x CR927(3V) x 2
Overall length	140mm
Individual packing	Blister card

TE-5305B DC Power Supply



Single Output 30V/5A, Linear Mode

Applicable for school, production line, laboratory, repair center.

Features

- Protective Design • High Quality SMD Process • Two Level Control for Current & Voltage • Auto Temperature & Radiation System Control.

Specification	Power consumption	150W
	Display	3 digits green LED x2set
	Display error of voltage	±0.2%+2 digits
	Display error of current	±1.0%+2 digits
	Input voltage	AC220V ±10%, 50/60 HZ
Constant voltage	Output voltage	0~30V
	Line regulation	≤ 0.01%+3mV
	Load regulation	≤ 0.01%+5mV
	Ripple voltage	≤ 1.0mV(rms)
Constant current	Output current	0~5A
	Line regulation	≤ 0.2%+3mA
	Load regulation	≤ 0.2%+3mA
	Ripple current	3.0mA(rms)
Others	Weight(kg)	5.3kg
	Dimension	280x136x160mm
	Individual packing	Color box



TEST INSTRUMENTS

NT-1933 / NT-1934 Receptacle Testers



- Tests for correct wiring, open ground, reverse polarity, open hot, open neutral, hot on neutral, hot and ground reversed with open hot and ground fault interruption in 3-wire, 120VAC circuits.
- Proper operation GFI receptacles testing.
- Individual packing : Blister card



NT-1933



NT-1934



Light pattern indicates condition of wiring.

● Red is on ● Amber is on ● Light is off

OPEN GROUND
 ● ● ● Ground contact not connected

OPEN NEUTRAL
 ● ● ● Neutral contact not connected

OPEN HOT
 ● ● ● Hot contact not connected

HOT/GRD REVERSE
 ● ● ● Hot and ground contacts interchanged

OPEN NEUTRAL
 ● ● ● Hot and neutral contacts interchanged

CORRECT
 ● ● ● Receptacle is wired correctly

SOLDERING & DESOLDERING SERIES

From Basic to Professional types, *Pro'sKit* is always focusing on what you need.

6 IN 1 Multifunction Soldering & Desoldering Station

▶ SS-988 B/E



ONE FOR ALL

✓ SOLDERING IRON ▼

60W(Max.130W) (DC 18V) / 160°C ~ 480°C (320°F-896°F) / Ceramic heater (9SS-988-HT)

✓ DESOLDERING GUN ▼

Pump:50W/Suction capability:>600mm Hg / Ceramic heater(5SS-988-H)

✓ SMOKE ABSORBER ▼

Adjustable angle/ Air volume1.0m³/min

✓ LED LIGHT ▼

100Lm LED light offers an excellent working condition, making it more convenient and user-friendly

✓ USB POWER OUTPUT ▼

USB 5V/1A power supply allows to check repaired appliance immediately.

✓ SOLDERING IRON TIP CLEANER ▼

Comes with infrared sensor for smart detection, allowing automatic solder removal and oxide removal./ Solder removal Ø7mm / Oxide removal Ø10mm

Individual packing : Plain box



Adjustable Absorber
· Kill the smoke · Filter the noise



Auto Tip Cleaning
W/infrared sensor



FAQ

2 IN 1 SMD Hot Air Rework Station



- Smart Microprocessor Controlled with Calibration Function
- Energy Saving & Fast Heat Up
36 Second up to 300°C
- 2X Lifetime than Traditional Type

Power Consumption Soldering
700W 480°C 60W 480°C



Features

ESD safe design • Closed circuit sensor • Silicone hand-piece cord wire heat-resistant up to 200°C • AWG 18 UL certified wire • Individual function start • Auto cool off • Interchangeable hot air nozzle and tips with high commonality • All in one PCB design

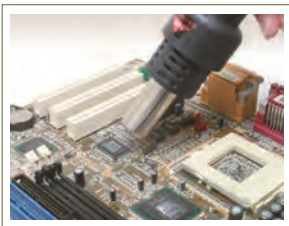

SMD Rework
High work efficiency.



Quick Change
Connectorized design for quick change heater.

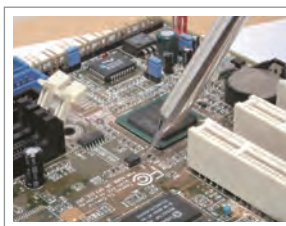

Soldering Iron
Heat fast, 36sec. up to 300°C

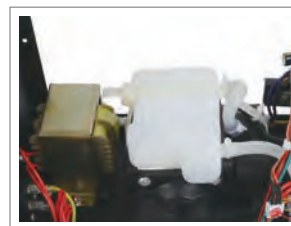

Big Air Volume
Diaphragm pump produces uniform air.

Specification	
Model No.	SS-989E SS-989B
Power consumption	700W
Soldering power	60W
Soldering iron temperature range	200°C ~ 480°C (392°F ~ 896°F)
Hot air temperature range	Room temperature ~ 480°C (896°F)
Heating element	Alumina ceramic heating element
Hot air heating element	Metal heating core
Pump/motor type	Diaphragm pump
Air capacity	24L/min (max)
Equipment noise	45dB
Temperature display	LED
Power input	AC110-120V, 60Hz AC220-240V, 50Hz
Standard plug	E B
Dimensions	255(L)x190(W)x140(H)mm
Weight	4200g
Accessories	
Soldering Iron (60W)	9SS-900N-SI(AC24V/60W) x 1pcs
Hot air gun	9SS-900NE-HG (AC110V~120V) 9SS-900NB-HG (AC220V~240V)
Soldering stand	1pce
Nozzle	9SS-900-A1 (ID:Ø2.2mm) x 1pc 9SS-900-A2 (ID:Ø6.6mm) x 1pc 9SS-900-A3 (ID:Ø8.5mm) x 1pc
Individual packing	Color box

Replacement Tips:

Please refer to 5SI-216N series Soldering tip on page.53

Replacement Accessories:

- Soldering Iron : 9SS-900N-SI
- Hot Air Gun : 9SS-900NE-HG(AC110~120V)
9SS-900NB-HG(AC220~240V)
- Soldering Iron Heater : 9SS-900N-HT
- Hot Air Gun Heater : 5SS-989NE-H(AC 110~120V)
5SS-989NB-H(AC 220~240V)

IC Package	IC(mm)	Model No.
Single 		9SS-900-A1
		9SS-900-A2
		9SS-900-A3
QFP (Quad Flat Pack) 	10x10	9SS-900-B
	14x14	9SS-900-C
	14x20	9SS-900-E
SOP (Small Outline Package) 	4.5x11.8	9SS-900-H
PLCC (Plastic Leaded Chip Carrier) 	17.5x17.5	9SS-900-L
	30x30	9SS-900-O

Smart Rework Station With Vacuum Pickup

Power Consumption
600W 480°C



- Smart Microprocessor Controlled with **Calibration Function**
- Excellent Suction Capacity 100g
- Auto Cool Off and Auto Sleep & Work Mode for Energy Saving

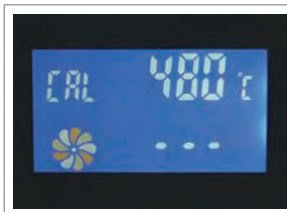

Accurate

Smart station with calibration function



100g Suction Power

with different accessories to meet more demands.



All in 1 PCB

Metal screws fixed.

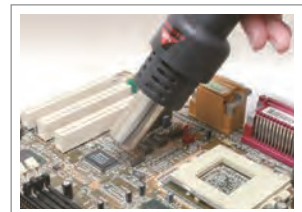

SMD Rework

High work efficiency.

Features

- ESD safe design
- Closed circuit sensor
- Large LCD display
- Silicone hand-piece cord wire heat-resistant up to 200°C
- AWG 18 UL certified wire
- All in one PCB design
- Interchangeable hot air nozzles with high commonality

IC Package	IC(mm)	Model No.
Single 		9SS-900-A1
		9SS-900-A2
		9SS-900-A3
QFP (Quad Flat Pack) 	10x10	9SS-900-B
	14x14	9SS-900-C
	14x20	9SS-900-E
SOP (Small Outline Package) 	4.5x11.8	9SS-900-H
PLCC (Plastic Leaded Chip Carrier) 	17.5x17.5	9SS-900-L
	30x30	9SS-900-O

Specification	
Model No.	SS-956B
Power consumption	600W
Temperature range	Room temperature~480°C(896°F)
Heating element	Metal heating core
Temperature calibration	0~699°C(0~999°F), adjustable
°C/°F switch	Yes
Pump / Motor type	Diaphragm pump
Air capacity	24L/min(Max)
Auto sleep function	YES
Auto cooling function	YES
Equipment noise	<50dB
Suction capacity	100g
Temperature display	LCD (60mm x 35mm, Backlight)
Power input	220V-240V~ 50Hz
Standard plug	B
Dimensions	250(L) x 230(W) x 170(H)mm (Handle, Holder for hot air gun & suction are included)
Weight	3200g
Accessories	
Heating element model	5SS-989NB-H
Hot air gun	9SS-968B-HG (AC220V~240V)
Suction cup	Ø12.5mm / Ø10mm / Ø6.5mm / Ø3mm x 1 pc
Opening lever(width)	15mm / 20mm x 1 pc
Nozzle	Nozzles:9SS-900-A1 (ID:Ø2.2mm) x 1pc 9SS-900-A2 (ID:Ø6.6mm) x 1pc 9SS-900-A3 (ID:Ø8.5mm) x 1pc Suction Cup:Ø12.5mm / Ø10mm / Ø6.5mm / Ø3mm x 1 pc Opening Lever(Width):15mm / 20mm x 1 pc
Individual packing	Color box

2 IN 1 SMD Hot Air Rework Station



FAQ

Heat Gun **700W 500°C** Soldering **60W 480°C**



- Dual Digital Display
- Individual Power Switch
- Alumina Ceramic Heater
- °C/°F Unit Selection



Accurate

Smart station with calibration function



Soldering Iron

Fast Heat Up & Temp. recovery
40 Sec.up to 300°C



Precise Output Control

Modular Design for Easy Repair



SMD Rework

High Work Efficiency.

Specification	
Model No.	SS-979B
Power input	220V-240V~50Hz
Power consumption	760W
Soldering power	60W
Soldering iron temperature	200-480°C
Hot air temperature	100-500°C
Soldering iron output voltage	24V~
Hot air output voltage	220V-240V~
Temperature display	LED
Soldering iron heating element	Alumina ceramic heater
Hot air heating element	Metal heating core
Air volume	120L/min(Max)
Equipment noise	<45dB
Plug type	B
Fuse type	250V / 5A
Certificate	CE, RoHS, ESD
Weight (with soldering iron)	2.5Kg
Dimension (mm)	170x170x140 (include bracket)
Accessories	
Heat air gun	5SS-969NB-HG(AC220~240V) (225 x 60 x 40mm / wire length 140cm)
Nozzle	9SS-969-A1 x 1pc (ID: Ø 4.3mm) 9SS-969-A2 x 1pc (ID: Ø 7.4mm) 9SS-969-A3 x 1pc (ID: Ø 11.2mm)
Individual packing	Color box

Features

Adjustable 8 Airflow Control • Hot air High Power 700W Consumption
• Low Noise Volume ≤ 45dB • Gentle Airflow No Damage to Component
• Auto Sleep • Turbo Fan • Fast Heat

unit:mm

	5SI-216N-B		5SI-216N-3.2D
	5SI-216N-B1.0		5SI-216N-1C
	5SI-216N-BC		5SI-216N-2C
	5SI-216N-0.8D		5SI-216N-3C
	5SI-216N-1.2D		5SI-216N-4C
	5SI-216N-1.6D		5SI-216N-I
	5SI-216N-2.4D		5SI-216N-K

▶ SS-968B LCD Smart Hot Air Rework Station

600W
480°C

Smart Microprocessor Controlled
Auto Cool Off & Auto Sleep & Work Mode
Quiet Operation



Accurate

Smart station with calibration function

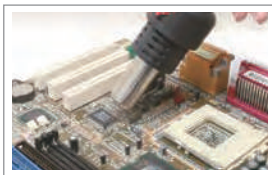

SMD Rework

High work efficiency.

Replacement

Nozzles:

Please refer to 9SS-900 series soldering nozzles on page.51



Features

ESD safe design • Closed circuit sensor • Large LCD display • Silicone hand-piece cord wire heat-resistant up to 200°C • AWG 18 UL certified wire • Interchangeable hot air nozzles with high commonality • Button adjustment • All in one PCB design

Specification	
Model No.	SS-968B
Power consumption	600W
Temperature range	Room temperature~480°C(896°F)
Heating element	Metal heating core
Temperature calibration	0~699°C(0~999°F) , adjustable
°C/°F switch	Yes
Pump/Motor type	Diaphragm pump
Air capacity	24L/min(Max)
Auto sleep function	YES
Auto cooling function	YES
Equipment noise	<50dB
Temperature display	LCD (60mm x 35mm, Backlight)
Plug type	B
Dimensions	250(L) x 215(W) x 170(H)mm
Weight	3200g
Accessories	
Hot air gun	9SS-968B-HG(AC220~240V)
Nozzle	9SS-900-A1 (ID:Ø2.2mm) x 1pc 9SS-900-A2 (ID:Ø6.6mm) x 1pc 9SS-900-A3 (ID:Ø8.5mm) x 1pc
Individual packing	Color box

▶ SS-969E / SS-969B SMD Rework Station

700W
450°C

Microprocessor Controlled
Auto Sleep & Work Mode
Quiet Operation



FAQ



Brushless motor

Turbo fan design/Noise less than 45dB



SMD Rework

High work efficiency.



Features

Closed circuit sensor • Silicone hand-piece cord wire heat-resistant up to 200°C • AWG 20 (0.5 mm²) UL certified wire • Interchangeable hot air nozzles with high commonality • Knob adjustment • All in one PCB design

Specification		
Model No.	SS-969E	SS-969B
Power consumption	700W	
Temperature range	100~450°C(212~842°F)	
Heating element	Metal heating core	
Equipment noise	<45dB	
Temperature display	LED	
Air volume	120L / min (Max.)	
Fuse type	250V / 8A	250V / 5A
Input voltage	AC110V~120V, 60Hz	AC220V~240V, 50Hz
Plug type	E	B
Machine size	170 x 170 x 140mm	
Overall package	280 x 185 x 170mm	
Weight	1.6 kgs	
Accessories		
Hot air gun	5SS-969NE-HG AC(110~120V)	5SS-969NB-HG (AC220~240V)
	(225 x 60 x 40mm / wire length 140cm)	
Nozzle	9SS-969-A1 x 1pc (ID: Ø 4.3mm) 9SS-969-A2 x 1pc (ID: Ø 7.4mm) 9SS-969-A3 x 1pc (ID: Ø 11.2mm)	
Individual packing	Color box	

▶ SS-331E/SS-331B LCD Desoldering Station

Features

Large LCD display • Built-in high power 600mm-Hg air pump • Vacuum indicator • °C and °F selection • Transparent solder tube

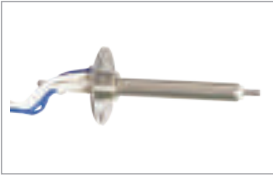

Comes with ceramic heater which provides fast heat up

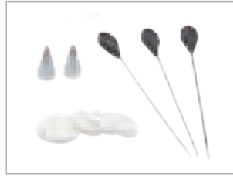

Complete accessories

Specification		
Model No	SS-331E	SS-331B
Voltage	120V~60Hz	220V-240V~50Hz
Soldering power	90W	
Power consumption	140W	
Temperature range	160°C ~ 480°C	
Control system	Microprocessor	
Vacuum pump system	Air pump motor	
Vacuum pressure	>600mm hg	
Heating element	Ceramic heater	
Sleep mode	Approximately 10 minutes if not use	
Connecting cord/ Hose length	105cm	
Power cord length	1.2m(3 core cord ground plug)	
Power plug	E	B
Station size	172 x 135 x 190mm	
Accessories		
Nozzle	5SS-331N-NZ1 x1 pc (ID: Ø 1.0mm) 5SS-331N-NZ2 x1 pc (ID: Ø 1.2mm) 5SS-331N-NZ3 x1 pc (ID: Ø 1.5mm)	
Accessories	Cleaning tool x 3 (Ø0.7 / Ø0.9 / Ø1.2mm) Filter sponge x 4 (Ø20.8x1+Ø16.8x3)	
Individual packing	Color box	



Microprocessor Controlled
Fast Heat Up with Ceramic Heater
Desolder & Pick-up 2 in 1

140W
480°C



FAQ



Replacement Accessories:
Desoldering Gun : 5SS-331N1-DG
Heater : 5SS-331N1-H
Nozzle Set : 5SS-331N-NZ

SOLDERING
& DESOLDERING

▶ SS-602E / SS-602B Hot Air SMD Rework Tool

Features

- Portable
- Temp. 200°C~500°C
- °C/°F selection
- Anti- return air protection
- Can be used for DIP/QFP/SOP/PLCC



Compatible with 9SS-900 series nozzles

Specification		
Model No	SS-602E	SS-602B
Voltage	110~120V	220~240V
Power consumption	300W	
Air volume	For 3 ranges, max. 22L/min(Max)	
Temperature	200°C~500°C	
Power plug	E	B
Standard nozzle	ø5mm, ø8mm, ø12mm	
Accessories		
Nozzle	9SS-602-A1 x 1pc (ID: Ø 5mm) 9SS-602-A2 x 1pc (ID: Ø 8mm) 9SS-602-A3 x 1pc (ID: Ø 12mm)	
Replacement heater	9SS-602E-H	9SS-602B-H
Individual packing	Color box	



Microprocessor Controlled
3 Ranges Air Volume
LCD Digital Setting

300W
500°C



LCD Smart

- Microprocessor controlled -



Soldering Station

- Resettable Fuse Protection
- Temperature Calibration Function
- USB Power Output
- Shuffle Knob Design for Quick Setting
- High Performance
- 3 Data Memories
- Auto Sleep and Wake Up Function



Performance Graph

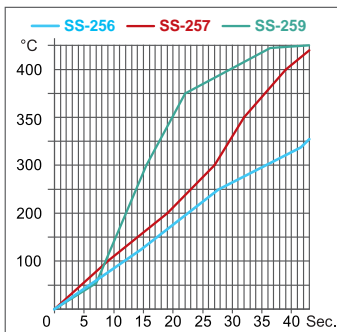

▶ SS-256E/B

60W 480°C
Standard model
• Alumina ceramic heater

▶ SS-257E/B

75W 500°C
Advanced model
• High end quad-wire heater
• 30 sec. reach 300°C

▶ SS-259E/B

90W 500°C
Professional model
• High end silver alloy heater
• Heat fast, 19 sec. reach 300°C

SS-256/257 Replacement Tips:
Please refer to 5SI-216N series soldering tip on page.53

SS-259 Replacement Tips:



5SI-259 series	
5SI-259-B	
5SI-259-I	
5SI-259-C	
5SI-259-D	
5SI-259-K	

Model No.	SS-256E	SS-256B	SS-257E	SS-257B	SS-259E	SS-259B
Power consumption	60W		75W		90W	
Input voltage	AC 110~120V 60Hz	AC 220~240V 50Hz	AC 110~120V 60Hz	AC 220~240V 50Hz	AC 110~120V 60Hz	AC 220~240V 50Hz
Temperature range	200~480°C(392°F~896°F)		30~500°C(86~932°F)		30~500°C(86~932°F)	
Temperature calibration	100~699°C(212~1290°F) Adjustable		0~699°C(32~1290°F) Adjustable		0~699°C(32~1290°F) Adjustable	
Heating element	Alumina ceramic		High end stainless Cr-Ni heater		High end silver alloy heater	
Sleep mode	OFF/1-240min adjustable		OFF/1-360min adjustment		OFF/1-360min adjustment	
Output voltage	24VAC		25VAC		25VAC	
Temperature of sleep mode	200°C(392°F)		30~400°C(86~752°F)		30~400°C(86~752°F)	
Replacement heater	9SS-900N-HT		9SS-257-HT		9SS-259-HT	
Soldering iron	9SS-256-SI		9SS-257-SI		9SS-259-SI	
Replacement tips	5SI-216N series		5SI-216N series		5SI-259 series	
Display	LCD 73mmX40mm, Backlight					
Control system	Microprocessor-controlled					
Temperature stability	±2°C/±36°F (no load)					
USB port output	DC 5V/1A					
Memory	3 sets					
Tip-to-Ground resistance/potential	≤2Ω / ≤2mV					
Individual packing	Color box					

Temperature-Controlled Soldering Station



Power Consumption

60W 480°C

- UL Certified Wires and Components
- Ceramic Heater , Long Service Life Time
- Lead Free Process
- Compact Size



Analog Type



Digital Type

Features

IC modular design • Temperature range 200°C ~ 480°C • Heat resistant hand-piece • Aerospace grade metal plug • °C and °F setting

Replacement tips:



OAL:43mm I.D.: 4.0mm O.D: 6.3mm



Modular design for easy repair



High quality assembly



Specification				
Model No.	SS-206B	SS-206E	SS-207B	SS-207E
Power consumption	60W			
Output voltage	24VAC			
Display	Analog		Digital	
Heater	Alumina ceramic heating element			
Temperature range	200°C- 480°C (392°F-896°F)			
Station size	145 x 90 x 120mm			
Voltage	220~240V 50Hz	110~120V 60Hz	220~240V 50Hz	110~120V 60Hz
Standard plug	B	E	B	E
Accessories				
Replacement heater	9SS-900N-HT			
Soldering iron	9SS-900N-SI			
Individual packing	Color Box			

unit:mm			
	5SI-216N-B		5SI-216N-3.2D
	5SI-216N-B1.0		5SI-216N-1C
	5SI-216N-BC		5SI-216N-2C
	5SI-216N-0.8D		5SI-216N-3C
	5SI-216N-1.2D		5SI-216N-4C
	5SI-216N-1.6D		5SI-216N-I
	5SI-216N-2.4D		5SI-216N-K

▶ SS-202A / SS-202F Mini Soldering Station

Palm Size • Low Power Consumption

10W 450°C



Palm size, easy to carry



For precision soldering/ desoldering work



Features

- Super slim pen-like style soldering iron.
- Ceramic heating element for fast heating up.

Specification

Model No.	SS-202A	SS-202F
Input voltage	110~120V	220~240V
Power consumption	10W	
Output voltage	AC12V	
Temperature	100°C~450°C (212~842°F)	
Heating element	Ceramic heater	
Plug	A	F
Accessories		
Replacement iron	9SS-202-SI	
Replacement tip	9SS-202-R0.3	
Station size	115x64x70mm	
Weight	570g	
Individual packing	Color box	

▶ SS-595B Smoke Absorber

9 Adjustable angles • 23W Brushless Motor

Adjustable Air Volume • Dual Function



2 IN 1
Absorber / Fan



Fan: to cool down objects



Absorber: remove smoke



Features

- Long service life • Stepless air volume • 9 Adjustable angles • Easy-to-change filter design • 2 ways placement

Specification

Model No.	SS-595B
Power supply	220-240V~ 50HZ
Power consumption	8~23W (Adjustable)
Power cord	B 1.3M
Capacity	0.2~1m³/min (Adjustable)
Dimension	220 x 220 x 145mm
Weight	1200g
Accessories	
Activated-carbon filter	5SS-593-F x 1pce, 130x130x10mm
Individual packing	Color box

▶ SS-593A / SS-593B Smoke Absorber

23W Brushless Motor • Classical Type



5SS-593-F

Filter is made of urethane foam with refined, activated, high absorption carbon



Features

- Fully adjustable fan • Portable and desktop design
• Low noise operation

Specification

Model No.	SS-593A	SS-593B
Power supply	110-120V~ 60HZ	220-240V~ 50HZ
Power consumption	23W	
Plug	A 1.3M	B 1.3M
Capacity	1m³/min(max)	
Dimension	220 x 270 x 168mm (O.D.)	
Accessories		
Activated-carbon filter	5SS-593-F x 2pcs, 130x130x10mm	
Individual packing	Color box	

▶ SS-562B Digital Lead Free Solder Pot

▶ SS-571B Digital Preheat Platform

PID Controlled with Temperature Compensation
Industrial Grade • Dual Digital Display

350W 600°C

300W 400°C

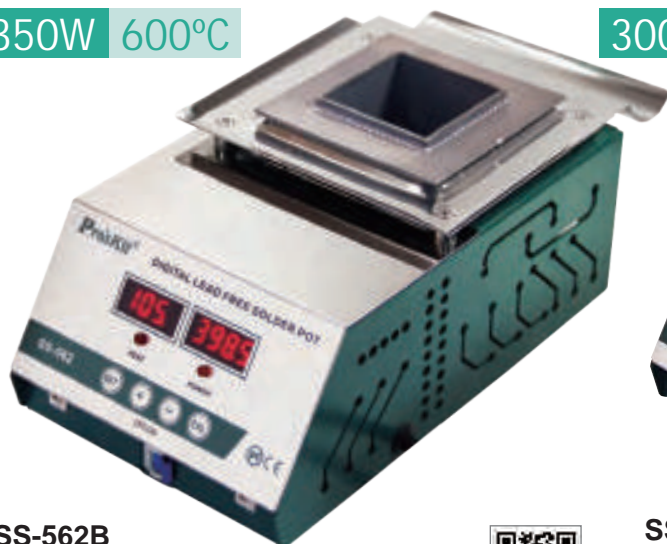

SS-562B
Rugged 2mm Titanium Crucible
Ceramic Heater



SS-571B
Aluminum Alloy Platform
Infrared Heater



Iron chromium aluminum wire heater with Ceramic heater insulated tube for quick heat up

Model No.	SS-562B	SS-571B
Power consumption	350W	300W
Temperature range	Room temp. ~600°C	Room temp. ~400°C
Temperature accuracy	±5°C	±5°C
Control system	PID Control	PID Control
Temperature compensation setting	-200~400°C	-200~400°C
Crucible size	Square type 55×55×45 (mm)	100×100×15 (mm)
Crucible material	2.0mm Titanium board	Aluminum alloy
Melting time (temp. 280°C)	Approx. 12 mins	Approx. 10 mins
Solder capacity	1.3Kg	-
Voltage	220V~240V 50/60Hz	220V~240V 50/60Hz
Standard plug	B	
Dimension (LxWxH)	280×145×115 (mm)	280×145×115 (mm)

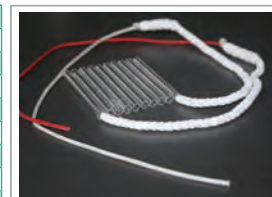

Infrared heater with ceramic insulated tube

Individual packing : Color box

▶ SS-55 Series Solder Pot

Electronic Control Board
Fight to Value Type



Individual packing : Color box



SS-551B



SS-552B



SS-553B



SS-554B



Ceramic heater insulated tube



Aluminosilicate heat preservation material

Model No.	SS-551B	SS-552B	SS-553B	SS-554B
Power consumption	150W	200W	250W	300W
Temperature range	100°C~600°C	100°C~550°C	100°C~450°C	100°C~450°C
Crucible size	Ø38x35Hmm	Ø50x35Hmm	Ø80x40Hmm	Ø100x40Hmm
Crucible material	Stainless steel with titanium plating			
Melting time (Max.setting)	Approx.10mins	Approx.10mins	Approx.20mins	Approx. 20 mins
Solder capacity	0.3kg	0.5kg	1.6kg	2.2kg
Voltage	220V~240V 50/60Hz			
Standard plug	B			
Dimension (LxWxH)	150x90x60mm	150x90x60mm	210x140x65mm	210x140x65mm

▶ SI-131B 80W Temperature Controller Soldering Iron

Adjustable Temperature 200~450°C
Fast Thermal Recovery



80W 450°C



Features

Stainless steel barrel • Ventilation hole • K type temperature control sensor • Ceramic heating element • Long life soldering tip

Replacement Tip: unit:mm

	5SI-131-3C		5SI-131-2C
	5SI-131-B		5SI-131-K

Power consumption	Temperature range	Heating element	Standard plug	Replacement heater	OAL
80W(±10%)	200°C ~ 450°C (±40°C)	Ceramic	B	5SI-131-HT	240mm

▶ SI-130A-20/SI-130B-20/SI-130B-25 Ceramic Soldering Iron

Energy Saving 60% than traditional type



12W 410°C SI-130-20



14W 450°C SI-130-25



Features

Stainless steel barrel • Ceramic heating element • Long life soldering tip • Supplied with iron support • Come with silicone protection cap

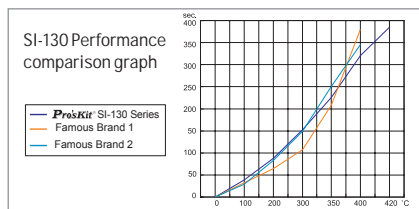

Model No.	Voltage	Consumption	Temperature	Heater	Handle color	Standard plug	OAL	Individual packing
SI-130A-20	110-120V	12W	410°C±10%	Ceramic heater	Green	A	170mm	Blister card
SI-130B-20	220-240V				Orange	B		
SI-130B-25	220-240V	14W	450°C±5%					

Replacement tips: Please follow up 5SI-216N series soldering tips. (as page.53)

▶ SI-129B-40/SI-129B-60 Soldering Iron



40W 450°C SI-129B-40



60W 500°C SI-129B-60



Features

Working indicator • Dual construction heater for better protection • Long life soldering tip • PA66 handle

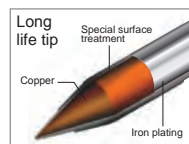

Replacement Tip: unit:mm

40W (10 pcs / 1 bag)			
	SI-S120T-5B		SI-S120T-5C
	SI-S120T-5BC		SI-S120T-5SB
60W (5 pcs / 1 bag)			
	SI-S120T-6B (Standard)		SI-S120T-6C
	SI-S120T-6SB		SI-S120T-6BC

Model No.	Consumption	Temperature	Handle color	Heating element	Standard plug	OAL (mm)	Individual packing
SI-129B-40	40W	450°C±10%	Orange	Ni-Cr 55I-129N-40H	B	240	Blister card
SI-129B-60	60W	500°C±10%	Yellow	55I-129N-60H		245	

SI-124B Series Soldering Iron



Ergonomically Triangular Shaped Handle
Long Service Life Tip



Features

Model No.	Consumption	Temperature	OAL.
SI-124B-30	30W	400°C±10%	225mm
SI-124B-40	40W	420°C±10%	245mm
SI-124B-60	60W	450°C±10%	260mm
SI-124B-100	100W	500°C±10%	275mm
Voltage	Standard plug		Individual packing
230V	B		Blister card

Replacement tips:

Please follow up SI-S120T series soldering tips. (as page.56/57)



SOLDERING
& DESOLDERING

8PK-S120N Series Soldering Iron



Ergonomic Handle • Long Service Life Tip



Features

Beehive heat sink aperture • Terminals added design • Ni-Cr heating element • PA66 handle



Beehive heat sink aperture



Replacement tip:

30W/40W

	SI-S120T-4B (Standard)
	SI-S120T-4BC
	SI-S120T-4C
	SI-S120T-4SB

• offered by 10 pcs in a bag

60W

	SI-S120T-6B (Standard)
	SI-S120T-6BC
	SI-S120T-6C
	SI-S120T-6SB

• offered by 5 pcs in a bag

unit:mm



Note:

8PK-S120 Series 30W/40W replacement tip, please refer to 30W replacement tip.

Model No.	Voltage	Consumption	OAL (mm)	Temperature	Standard plug	Replacement heater	Individual packing
8PK-S120NAD-30	110~120V	30W	250	440°C±10%	E	5PK-S120NA-30H	PVC folding box W/2 pcs tips (B & SB type)
8PK-S120NAD-40		40W		480°C±10%		5PK-S120NA-40H	
8PK-S120NAD-60		60W		520°C±10%		5PK-S120NA-60H	
8PK-S120NB-30	220~240V	30W	250	440°C±10%	B	5PK-S120NB-30H	PVC folding box
8PK-S120NB-40		40W		480°C±10%		5PK-S120NB-40H	
8PK-S120NB-60		60W		520°C±10%		5PK-S120NB-60H	
8PK-S120NBD-30		30W	250	440°C±10%		5PK-S120NB-30H	PVC folding box W/2 pcs tips (B & SB type)
8PK-S120NBD-40		40W		480°C±10%		5PK-S120NB-40H	
8PK-S120NBD-60		60W		520°C±10%		5PK-S120NB-60H	

▶ SI-139A/SI-139B Dual Wattage Soldering Iron

15W 300°C
30W 480°C



Features

- Displays working condition, avoid accident.
- 15W/30W two wattage allow to carry out work requiring temperatures.

unit:mm

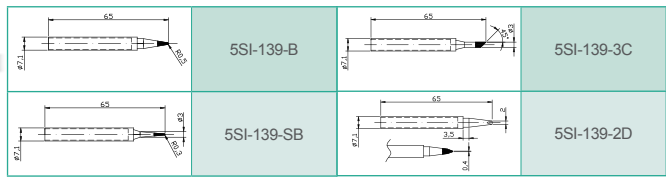

Model No.	Voltage	Consumption	Temperature	Standard plug	Replacement heater
SI-139A	110~120V	15W/30W	300°C/480°C±10%	A	9SI-139A-HT
SI-139B	220~240V			B	9SI-139B-HT

▶ 8PK-SC116NB Convertible Soldering Iron/Gun

20/40W 400°C



Features

- Wide range of applications from sheet metal to PC board.
- 20W/40W instant heat up control.

unit:mm

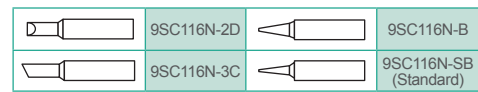

Voltage	Consumption	Temperature	OAL(mm)	Standard plug	Individual packing
220~240V	20/40 W	400°C±10%	185x110x23	B	Blister card

▶ 8PK-S118 Series Soldering Iron

30W 400°C
40W 440°C



Economic Type



Features

- Seamless stainless pipe • Long life tip • Heat isolated tube • Wire protection boot • Come with protection cap

unit:mm

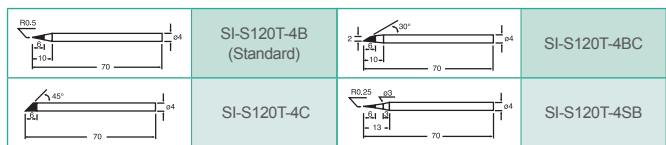

10 pcs / 1 bag

Model No.	Voltage	Consumption	Temperature	OAL.	Standard plug	Individual packing
8PK-S118A	110~120V	30W	400°C±10%	235mm	A	Blister card
8PK-S118B	220~240V				F	
8PK-S118A-40	110~120V	40W	440°C±10%		A	
8PK-S118B-40	220~240V				F	

▶ SI-168U / SI-169U Portable USB Soldering Iron / 3D Print Finish Tool

8W 480°C



8W Power Consumption
15 sec. Fast Heat Up
USB 5V Powered



Features

Auto sleep mode • 480°C high temperature • Replaceable long life tip • Metal touch switch control • Working indicator

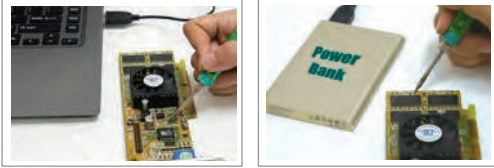

Specification	SI-169U	SI-168U
Power supply	USB input DC5V	
Power consumption	8W	
Temperature	480°C ± 10%	
Auto sleep mode	25S	
Indicator	LED Light	
USB wire length	1.5M	
Replacement tip	9SI-B162-T, 9SI-169U-K, 9SI-169U-I, 9SI-169U-S, SI-169U-P(4pcs/pack)	9SI-B162-T
Accessories	USB wire, Cap, Solder stand, Solder wire, Tip x3pcs	USB wire, Cap, Solder stand, Solder wire
Dimension	Ø19x163mm	
Individual packing	PET folding box	

Replacement tips:

	9SI-169U-I		9SI-B162-T
	9SI-169U-K		9SI-169U-S



SOLDERING & DESOLDERING

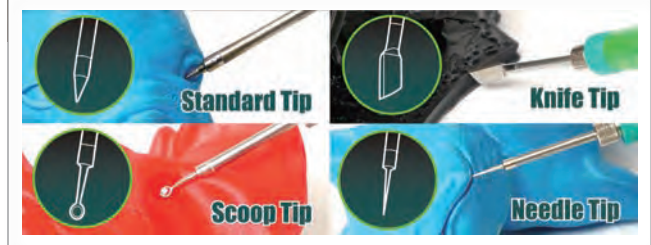

▶ 1PK-SC109NB Quick-heat Ceramic Soldering Iron

20/40W 400°C



- 20W/40W instant heat up control.
- Ideal for professional service or light electrical work.



Replacement tips:

	9SC116N-2D		9SC116N-B
	9SC116N-3C		9SC116N-SB (Standard)



Voltage	Consumption	Temperature	OAL.	Standard plug	Individual packing
220~240V	20/40W	400°C±10%	Ø28x260mm	B	Blister card

▶ SI-125A-20 Mini Soldering Iron

20W 410°C



- Ceramic heater • Ergonomic triangle shaped handle • Light weight
- Safe stopper design • Come with iron holder



Replacement tips:

	5SI-125T-B (Standard)		5SI-125T-SB		5SI-125T-D
--	-----------------------	--	-------------	--	------------

Voltage	Consumption	Temperature	Heater	Handle color	Standard plug	OAL.	Individual packing
110~120V	20W	410°C±10%	Ceramic heater	Orange	A	168mm	Blister card

▶ SI-B166 Wireless Power Soldering Iron

8W 500°C



USB Rechargeable
2200mAh Li-ion Battery



Adopting a built-in new responsive smart chip which can intelligently identify wireless fast charging device

Features

- 15sec. fast heat up, max. 500°C
- 1.5hr. operation time

Consumption	Temperature	Operation Time	Battery Model
Max. 8W	Max. 500°C	Approx. 1.5h	3.6V 2200mAh
Working Indicator	Accessories	Replacement tip	Individual packing
Red – Charging Green – Full charged Blue – In use	18650 Li-ion battery, USB cord, user manual	9SI-B166-T	Blister card

▶ SI-B162 Battery Operated Soldering Iron

8W 450°C



Safety Cap Detent
Fast Heat Up



Temperature up to 450°C / 840°F, maintains soldering temperature at least 300°C / 600°F for one hour (with alkaline battery)

Features

Work indicator • Comes with protection cap • safety slide switch



Auto power off
when cap attached

Battery	Accessories
3x1.5V alkaline AA (not included)	Lead free solder wire: 9SI-B162-W Replacement tip: 9SI-B162-T

Consumption	Temperature	Time to reach operating temp.	OAL.	Individual packing
Max. 8W	Max. 450°C (with alkaline battery)	15-20 seconds (with alkaline battery)	178mm (w/o cap)	Blister card

▶ SI-B161 Battery Operated Soldering Iron

9W 450°C



Fast Start Up, 12 sec. 185°C



160 joints capacity with full battery.

Features

30 min. continuous use • Work indicator • Come with protection cap • Long life tip

Battery	Approx. nos. of solder joints intermittently	Replacement tip		
1.5V alkaline AAx3 pcs (not included)	160 joints using new batteries	9SI-B161-T		
Consumption	Temperature	Time to reach operating temp.	OAL.	Individual packing
9W (max)	450°C (840°F)	185°C / 365°F in 12 seconds	190 x 38.3 x 21.8 mm (w/o cap)	Blister card

GS-23K Gas Soldering Iron Kit-Auto Ignition

Fight to Value Model • Auto Ignition • 7 in 1 Kit

TÜV RoHS COMPLIANT

Features

Complies with CPSC • TR90 nylon gas tank • See-through fuel window
• Ceramic heater • Adjustable flame control

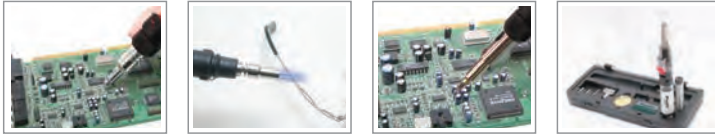

Soldering temperature	Hot blow temperature	Torch temperature	Fuel cap.	Time	Gas soldering size	Case size	Individual packing
500 °C	600 °C	1300 °C	15 ml	90 min	245×Ø29 mm	300 x 138 x 46mm	Color box



1PK-GS003 Portable Gas Soldering Tool Kit

Features

Long lasting catalytic tip • See-through fuel window • Adjustable flame control
• Come with soldering tip and soldering head

RoHS COMPLIANT



Soldering temperature	Hot blow temperature	Torch temperature	Fuel cap.	Time	Gas soldering size	Individual packing
210~400°C	650°C	1300 °C	8 ml	80 min	170×Ø24 mm	Blister card



8PK-101-2 Portable Soldering Tool Kit

Features

See-through fuel window • Come with soldering tip and soldering head • More optional tips are available.



Soldering temperature	Hot blow temperature	Torch temperature	Fuel cap.	Time	size	Replacement parts	Individual packing
370 °C	500 °C	1300 °C	6 ml	30~45 min	130×Ø 23 mm	5MT-T series	Blister card

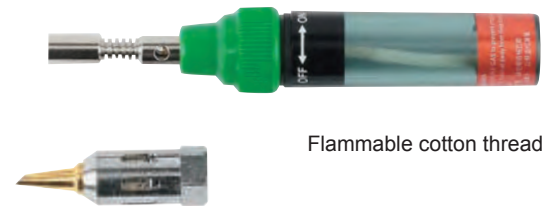

Flammable cotton thread



5MT-T Series Soldering Tip

• For 8PK-101-2



Model No.	Replacement parts	Model No.	Replacement parts
5MT-T-005N	Solder head	5MT-T-009	Soldering tip double sharp type
5MT-T-007	Soldering tip needle type	5MT-T-010	Soldering tip hot knife type
5MT-T-008	Soldering tip 2.4 type	5PK-101-2T	Solder head W/S-2.4mm Tip

Pro'sKit®

886-2-22183233
Sales support

pk@mail.prokits.com.tw
E-mail

www.prokits.com.tw
Global website

▶ SS-611A / SS-611B Heat Gun Set

Dual Temperature • Overheat Protection

1500W 500°C



Paint and varnish removal



Features

Overheat protection • Dual air volume • Ceramic heater • Double insulated



Accessories: Hook nozzle, slit nozzle, deflector nozzle, air concentration nozzle, scraping tool

Model No.	Voltage	Power	Air volume	Temperature range	Case size	Standard plug	Individual packing
SS-611A	110~120V 60Hz	I-750W	I: 280L/ min	I-300°C	300 x 280 x 90mm	A	Blowing case + Color sleeve shrink
SS-611B	230~240V 50Hz	II-1500W	II: 480L/ min	II-500°C		B	

⚠ Caution:

- For safety, after using this product for one hour, please shut-off for 10 minutes to cool down temperature
- If this product is overheating after shut-off, the protection function will be coercively booted and make this appliance off for 10 minutes. To prevent any overheating problem, never put the appliance down on its air outlet nozzle. Always keep its outlet nozzle upward or put it on one of its sides.

▶ SI-132A/SI-132B Wood Burning Hobby Kit

21 IN 1

Ergonomic Design
Fast Heat Up



25W 360°C

Features

Nickel-chrome heating element • Heat shields x2 for better protection

Model No.	Voltage	Power	Temperature	Plug	Accessories	Individual packing
SI-132A	110V~120V	25W	360°C	A	Solder tip x1, Blade x1, Wood burning tips x8, Embossing tips x11	Sleeve+ carrying case
SI-132B	220V~240V			B		

Solder tip	Universal Point		Tapered Point	
	Mini Universal Point		Dot Point	
Blade	Calligraphy Point		Flow Point	
	Shading Point		Mini Flow Point	

▶ SI-138A/SI-138B Wood Burning & Crystal Hotfix Kit

26 IN 1

Dual watt



10W 200°C 30W 400°C

Features

Nickel-chrome heating element • Heat shields x2 for better protection

Model No.	Voltage	Power	Temperature	Plug	Accessories	Individual packing
SI-138A	110V~120V 60Hz	10W/ 30W	200°C / 400°C	E	Solder tip x1, Blade x1, Crystal hot fix tips x5, Wood burning tips x8, Embossing tips x11	Sleeve+ carrying case
SI-138B	220V~240V 50Hz			B		

Solder tip	Universal Point		Tapered Point	
	Blade	Mini Universal Point	Dot Point	
Crystal hot fix tips	Calligraphy Point		Flow Point	
	Shading Point		Mini Flow Point	

GK-368 Battery Operated Glue Gun



Cordless Design
LED Light
Quick Warm Up



Power	Preheat time	Replacement glue stick	Flow of glue	Power source	Running time	Individual packing
7W/6V	3-4 minutes	Ø 7.5x100mm (3pcs/pack)	3g /min	1.5V AA battery x 4(not included)	45 minutes (Alkaline type)	Blister card

GK-361U 3.6V Li-ion USB Glue Gun



8W 130°C



Power	Input Voltage	Preheat time	Glue stick	Flow of glue	Free running time
8W	DC 5V	2-5min	Ø7mm	3g/min	1.5h
Melt temperature	Charging time	Battery	Accessory	Individual packing	
130°C	200min (5V/2A)	2000mAh Li-ion	USB power cord	Double blister	

GK-389B/GK-390B Professional Hot Melt Glue Gun



PTC Heating System • Non-Drip • Large Flow Amount • Quick Warm Up

80W 150°C

GK-390B
Ideal for DIY



100W 200°C

GK-389B
Ideal for Production Line



Model No.	Input voltage	Power	Melt temperature	Heating element	Preheat time	Flow of glue	Standard plug	Replacement glue stick	Individual packing
GK-389B	110~240V	100W	170°C (200°C)	PTC	2-5 min	15-25g /min	B	Ø11mm	Blister card
GK-390B		80W	150°C		3-6 min	15-20g /min			

GK-380A/GK-380B Hot Melt Glue Gun



80W 170°C

Features

Force-saving trigger • LED indicator • Spring-tensioned nozzle • Silicone sleeve



Models



Decoration model and more



Model No.	Standard plug
GK-380A	A
GK-380B	F

Model No.	Voltage	Power	Temperature	Preheat time	Flow of glue	Replacement glue stick	Individual packing
GK-380A	120V	30-80W	170-190°C	10 min	14-16g / min	Ø11mm	Blister card
GK-380B	230V	15-80W					

GK-360A/GK-360F Hot Melt Glue Gun



3 Mins Fast Heat
Drip-Proof
Eco-Friendly



Model No.	Standard plug
GK-360A	A
GK-360F	F

Power	Voltage	Fuse	Pre-heat	Melt Point	Flow of glue	Glue Stick Size	Individual packing
20W	110-240V	3A Ø3mm	3-5min	170°	3-5g/min	Ø7-Ø7.5mm	Blister card

61103 Glue Stick



• Unit: 1kg, 1kg=33pcs



GK-611160 Glue Stick



• Ø11x160 mm
• 10 pcs/1 bag



GK-607160 Glue Stick



• Ø7x160 mm
• 10 pcs/1 bag



DP-366I
MINI DESOLDERING PUMP

RoHS COMPLIANT **ESD SAFE**

COMPACT SIZE
 POWERFUL SUCTION
 ALUMINIUM BODY



5DP-366I-T

Body	Nozzle	Suction	Weight	OAL (Release)	OAL (Press)	Individual packing
Ø12.5mm	Ø1.8mm	30cm-Hg	25g	162mm	125mm	Blister card

▶ 8PK-366NA / 8PK-366N-B / 8PK-366N-G



Model No.	Material	Suction capacity	OAL	Individual packing
8PK-366NA	ABS	30cm-Hg	205mm	Blister card
8PK-366N-B				
8PK-366N-G				

5PK-366NA-T

▶ 8PK-366N-O / 8PK-366N-S / 8PK-366N-Y



Model No.	Material	Suction capacity	OAL	Individual packing
8PK-366N-O	ABS	30cm-Hg	205mm	Blister card
8PK-366N-S		35cm-Hg		
8PK-366N-Y		30cm-Hg		

5PK-366N-T

▶ 8PK-366D ▶ 908-366A ▶ DP-366C ▶ DP-366D ▶ DP-366J ▶ DP-366P



Model No.	Material	Suction capacity	OAL	Individual packing
8PK-366D	Aluminum	30cm-Hg	163mm	Blister card
908-366A		32cm-Hg	195mm	
DP-366C	ABS	34cm-Hg	195mm	
DP-366D		32cm-Hg	210mm	
DP-366P		40cm-Hg	330mm	
DP-366J	PC	32cm-Hg	210mm	

▶ SN-396 Soldering Helping Hand with LED Magnifier



16 SMD LEDs
Magnifiers



Magnifying lens size	Ø90mm & Ø20mm	
Magnification	2.5X(6D) + 6.25X(21D)	
Magnification material	Acrylic	
Light source	16 pcs SMD LEDs	
Neck length (for magnifier)	265mm	
Neck length (for alligator clips)	250mm	
Base size	190x170mm	
Power	Battery	1.5V AA x 4pcs batteries (not included)
	Adaptor	DC 6V 0.5A adaptor input (not included)
Individual packing	Color box	

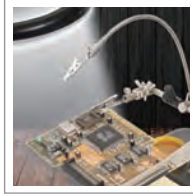

Accessories:
Sponge size(30 x 50mm), Solder flux x10g, Brass tip cleaner x17g

SOLDERING & DESOLDERING

▶ SN-394 Helping Hands Octopus Clamp Kit

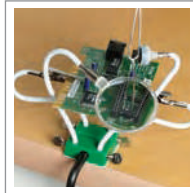

Multi-function



- Maximum thickness of table or bench edge: 1.5"(40mm)
- Including magnifier arm x1, magnet arm x1, stayput arms x4
- Individual packing: Blister card

▶ SN-392 Helping Hands



- The practical helper for electronics and model making.
- Holding clamps adjustable in many ways, complete with magnifying glass Ø 90mm(2.5X&4.5X).
- Individual packing: Blister card.

Helping Hands

▶ 608-391A



▶ 608-391E



▶ 608-391B



Model No.	Material			Magnification	Base OAL.	Color box
	Magnifer	Arm	Base			
608-391A	Glass	Low carbon steel	Cast-iron	Ø 60mm 8D(3X)	52x52x55mm	Color box
608-391E	Glass			Ø 60mm 8D(3X)	55x55x35mm	
608-391B	-			Non	52x52x55mm	

▶ SN-390 Adjustable Soldering Clamp Holder

Max. Open 200mm
Allow 360° Rotation



Features

- Rigid metal structure
- Rubber pad
- 2 adjustable ABS grip
- 4 different thicknesses
- Lightweight design



4 different thickness holders



Allows 360 degrees rotation and can be secured in any position

Material	Max. circuit board size	Circuit board thick	Dimensions	Individual packing
ABS arm + metal base	20 x 14 cm	1.2 / 1.8 / 2.0 / 3.0mm	30 x 16.5 x 12.5 cm	Color box

▶ 6S-2 ▶ SN-002 Soldering Stand



6S-2 SN-002

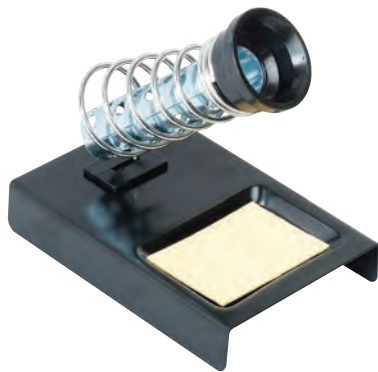

Model No.	6S-2	SN-002
Individual packing	Color box	Blister card

▶ 8PK-033ST Solder Reel Stand

- Holds up to 1kg roll of solder wire.
- Keep benches neat and draw out solder wire smoothly.



(Solder is not included)

Shaft diameter	Individual packing
15mm	Color box

▶ 8PK-362S Mini Soldering Stand

- 2 position iron holder stand
- Built-in sponge tray



Individual packing
Color box (2pcs/pack)

▶ SH-1025 Soldering Tip Cleaner



- No water necessary.
- Anti-slip pad.
- Made of low abrasive brass shavings.
- Cleans better than conventional sponges.
- No temperature drop as in conventional sponges.

Model No.	Description	Spec	Individual packing
SH-1025	#62 copper cleaner with iron base	ø83 x 27mm	Blister card
SH-1025-B	#62 copper cleaner	25g x 5 pcs	Hanger (5 pcs/pack)

▶ 1PK-3616 Soldering Aid Tools



Individual packing
Blister card



▶ DP-3616 Soldering Aid Tools

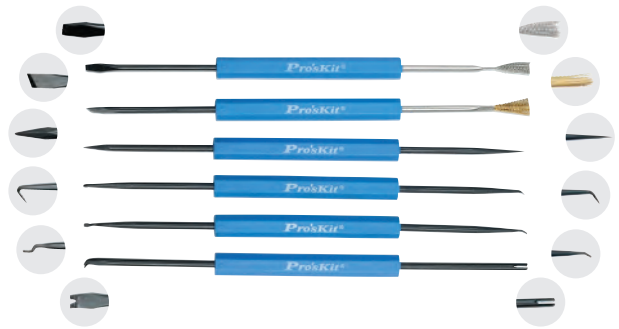

Individual packing
Blister card

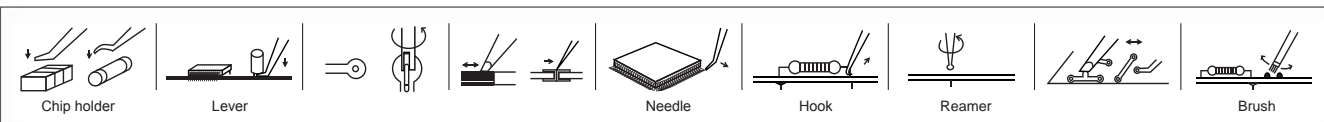

▶ 1PK-H074/9H084/9H085/9H086 Soldering Aid Tools



Model No.	Material	OAL.(mm)	Individual packing
1PK-H074	Nylon+Fiber	150	Blister card
9H084		155	Polybag
9H085		140	
9H086		173	

▶ 9DP-S002 Solder Wire
▶ 9S001/9S002/9SN-310G



for 9SN-310G/9DP-S002



Model No.	Weight(g)	Ingredients	Dia (mm)	Individual packing
9DP-S002	17	Sn 99.3% , Cu0.7%	1.0	Inner box
9SN-310G	15	Sn 99.3% , Cu0.7%	1.0	
9S002	15	2% Ag	0.8	
9S001	17	63% Sn	1.0	

▶ 8S005 Solder Paste



- Composed of metal powder activated flux and blending agents.
- The paste has a good diffusion and non-corrosion.
- No spot appears in non-soldered area.



Individual packing
Polybag

▶ DP-033 Series Anti-Hot Desoldering Wick



- Anti-scald Design
- Stainless Steel Mouth
- High Quality Desoldering Braid with unique no clean flux.

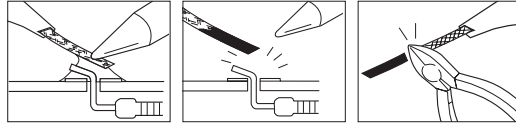

Model No.	Width	Length	Dimension
DP-033A	1.5mm	2m	101 x 47.5 x 18.5mm
DP-033B	2.0mm	2m	
DP-033C	2.5mm	2m	
DP-033D	3.0mm	1.5m	
DP-033E	3.5mm	1.5m	

▶ 8PK-033 Series Solder



Model No.	Weight(g)	Ingredients	Dia(mm)	Model No.	Weight(g)	Ingredients	Dia(mm)
8PK-033D	100	63% Sn	0.8	8PK-033K	250	63% Sn	1.0
8PK-033DD	100	2% Ag	0.8	8PK-033L	250	63% Sn	1.2
8PK-033DDS	100	2% Ag	0.6	8PK-033P	500	63% Sn	0.8
8PK-033DS	100	63% Sn	0.6	8PK-033PS	500	63% Sn	0.6
8PK-033E	100	63% Sn	1.0	8PK-033Q	500	63% Sn	1.0
8PK-033F	100	63% Sn	1.2	8PK-033R	500	63% Sn	1.2
8PK-033J	250	63% Sn	0.8	8PK-033RD	500	2% Ag	1.2
8PK-033JS	250	63% Sn	0.6				

▶ 8PK-031A/8PK-031B/ 8PK-031C Desoldering Wick



- High quality desoldering braid with unique no clean flux.
- Pure oxygen-free copper wire.



8PK-031A

1.5



8PK-031B

2.0



8PK-031C

2.5

Model No.	Width(mm)	Length(M)	Individual packing
8PK-031A	1.5	1.5	Inner box
8PK-031B	2.0	1.5	
8PK-031C	2.5	1.5	

FIBER OPTICS



From simple installation tools to advanced trouble shooting equipments, **Pro'sKit** total solution always got your back.



TE-8202A/F Fiber Optic Fusion Splicing Machine Kit

A complete kit contains all of the necessary tools required for optical fusion splicing, in a durable tool case for easy carrying and storage.



3 Working Mode

Manual/Semi-Auto/Full Auto

Core to Core

Alignment

10 Sec. Splicing Time

Heating Shrink Protection

- Suitable for 20/40/60mm tube
- Average tube-heat time: 30 seconds

Hi-resolution Output

- 5" colorful LCD display.
- Separately X or Y axis views with 300 times magnification.
- Cutting-edge technology for image processing.

Store 6000 Data

of latest splicing results.



USB Port B Type

For updates & result transfers

Removable and Rechargeable Li-ion Battery

(11.1V 5.2Ah)

TE-8202A/F-W Fiber Optic Fusion Splicing Machine with durable ABS toolbox.

TE-8202A/F Fiber Optic Fusion Splicing Machine Kit

contains fusion splicer, fiber cleaver, fiber stripper, leak proof dispenser in a rigid carrying box to satisfy terminal procedure as below.

STEP 1

Refer to P.82



Stripping

PVC jacket
8PK-326

STEP 2

Refer to P.81



Cutting

Fiber
FB-1688C

STEP 3

Refer to P.197



Cleaning

Fiber
MS-018

STEP 4



Fusion Splicing

TE-8202

Model. No	TE-8202A	TE-8202F
Applicable fibers	SM, MM, NZDS, EDF	
Average splice loss	0.02dB(SM), 0.01dB(MM), 0.04dB(NZDS), 0.04dB(EDF)	
Splice time (sec.)	10 sec. (for SM fiber)	
Return loss	≥60dB	
Diameter of fiber optic	Cladding diameter:80-150μm , Coating diameter:100-1000μm	
Tension test	2.0N(200gf)(Standard)	
Splicing program	50 groups	
Heat shrinkable tube	20mm, 40mm, 60mm	
Memory capacity	6000 memories	
Battery low indication	4pcs led light indication	
Environmental conditions	-10~+50°C (operation temperature), 0~95% RH(humidity), 0~5000m(altitude)	
Standard package	Fusion splicing machine, Fiber cleaver, Fiber stripper, Leak proof dispenser, AC adaptor, Battery(in the machine), Spare electrodes, 60mm Shrinkable tube 25pcs, Cooling tray, Quick reference guide, Carrying case with carrying strap	
Power supply	Lithium battery: 11.1V/5.2A Adapter: INPUT AC 100~240V 50/60Hz; OUTPUT: DC15V/5A	
Standard plug	A	F
Battery	11.1V 5.2AH	
Dimensions	155 x 145 x 155 mm	
Size	2.25kgs (include battery) / 1.88kgs (not include battery)	
Individual packing	ABS tool box + Color label	

▶ TE-6201F-W Fiber Optic Fusion Splicing



Heating Shrink Protection

- Suitable for 20/40/60mm tube
- Average tube-heat time: 15 seconds

High Quality Fusion Splicing

- 4mm short distance V-groove
- Manual / Semi-Auto / Full Auto
- Advanced core to core alignment
- Average splice time: 6 seconds

Hi-Resolution Output

- 4.3" colorful LCD display
- Separately X or Y axis views with 520 times magnification
- Cutting-edge technology for image processing

Removable and Rechargeable Li-ion Battery

Supports 220 times splicing and heating

USB Port

For updates & result transfers

Store 6000 Data

Of latest splicing results.



Model. No	TE-6201F-W
Applicable fibers	SM, MM, NZDS, EDF
Average splice loss	0.02dB(SM), 0.01dB(MM), 0.04dB(NZDS), 0.04dB(EDF)
Return loss	≥60dB
Splice time (sec.)	6 sec. (for SM fiber)
Diameter of fiber optic	Cladding diameter: 80-150μm, Coating diameter: 100-1000μm
Tension test	2.0N(200gf)(Standard)
Splicing program	50 groups
Electrode life	5000 times
Heat shrinkable tube	20mm/40mm/60mm
Memory capacity	6000 memories
Working light	1 LED light
Battery low indication	5pcs led light indication
Magnification	Separately X or Y axis views with 520 times magnification or 200 times for X and Y view
Standard package	Fusion splicing machine, AC adaptor, Battery(in the machine), Spare electrodes, 60mm Shrinkable tube 25pcs, Cooling tray, Quick reference guide, Carrying case with carrying strap
Environmental conditions	-10~+50°C (operation temperature), 0~95% RH(humidity), 0~5000m(altitude)
Power supply	AC adaptor: 100~240V input voltage, 50/60Hz; DC15V, 5A
Battery	11.1V 5.2AH
LCD display	4.3" colorful LCD display
Charging interface	Micro USB
Standard plug	F
Dimensions	145 x 135 x 142mm
Weight	1.7kgs(with battery), 1.35kgs(not included battery)
Individual packing	ABS tool box + Color label



High quality fusion splicing



Separately X or Y axis views with 520 times magnification or 200 times for X and Y view



Heating shrink protection

▶ MT-7610A/F Optical Time Domain Reflectometer



Automatic One-Button Testing

wavelength support 1310, 1550nm.

Visually Locate Events

to help quickly troubleshooting.

Accurate Detection

for short dead zone event.

High speed

signal processing, short test time and fast analysis.

Features

- Palm design and lightweight for easy carrying
- High contrast 3.5 inch color TFT LCD
- USB port connect to PC for software update and data output
- Built-in visual fault locator
- Rechargeable Li-Po battery, supporting max. 8 working hours
- Auto power off
- Backlight



Visually locate events to help quickly troubleshooting

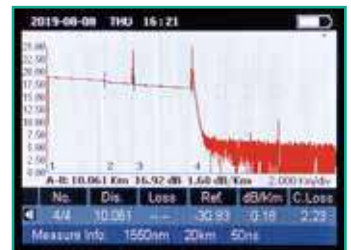

Measurement Interface

There are 10x10 grid in waveform region, horizontal grids mean distance, vertical grids mean dB value. As shown in figure, each horizontal grid represents 2KM, each vertical grid represents 2.5dB..

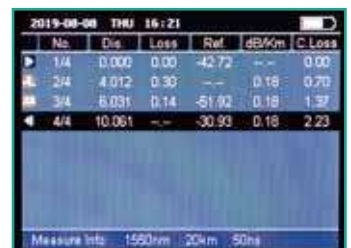

▶ Optic fiber start

◀ Reflection event

▮ Attenuation event

▮ Gain event

◀◀ Optic fiber ending

Model no.	MT-7610A	MT-7610F
Language(operation interface)	English	
Optical fiber type	SM optical fiber	
Dynamic range	24dB(1310nm) / 22dB(1550nm)	
Wavelength	1310nm±20nm, 1550nm±20nm	
Fiber optic connector	SC/PC (FC/PC,ST/PC Optional)	
Display	3.5 inch color LCD	
Display resolution	320x240	
Measuring distance (km)	0.1~100	
Distance uncertainty (m)	±(0.8+0.005% x distance+Sampling resolution)	
Pulse width	5ns~10us	
Measurement time	5s~180s	
Attenuation blind area	8m(@minimum plus width)	
Event blind area	3m(@minimum plus width)	
Loss threshold (db)	0.05dB	
Loss resolution (db)	0.01dB	
Sampling resolution (m)	0.32 to 20.48	
Sampling points	Up to 8000	
Typical real-time refresh (hz)	2	
Data storage	32MB Built-in storage(support external TF card storage. maximum 32G/ optional)	
Communication connector	micro USB	
VFL power	1mW(650nm±10nm)	
Power source	Rechargeable Lithium Polymer battery 7.4V 3100mAh	
Battery working time	standby>15hours, continuous measuring>8 hours	
Adaptor input	AC 100~240V 50/60Hz	
Adaptor output	DC 12V/2A	
Plug	A (I I)	F (◀ ▶)
Auto power off	Yes	
Low battery warning	Indication for low battery energy	
Operation voice prompts	Yes	
Backlight	Yes	
Operation temperature	0~+50°C; <90%RH	
Storage temperature	-20~+70°C; <90%RH	
Size	195mm x 110mm x 60mm	
Weight	600g	
Individual packing	Color Box	

▶ MT-7612F

Multifunction Optical Time Domain Reflectometer

3 in 1

Optical Time Domain Reflectometer Power Meter Visual Fault Locator



2400mAh Li-ion Battery

Ensure long working hour

Test Data Processing

Upload data to PC via USB for further analysis

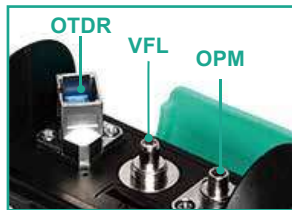

Support Multiple Connectors

FC/SC/ST & 2.5mm universal connectors
Optional LC 1.25mm connector (5MT-7601-LC)



Data Upload (Software)

Connect to Computer & Analyze Data



Charging Indication (Micro USB)

BASIC	
Display	3.2 Inch color LCD 320*480
Data storage	Internal storage 500 records.Maximum 32GTF Card
Beep	Passive electromagnetic buzzer
Backlight	10 levels of brightness
Power saving	Adjustable auto power off
Power supply	3.7V/2.4Ah Lithium Battery,standby > 7.5H ,measurement>4H
Temperature	Working 0~50 C,storage:-20~70C, <90% RH
OTDR	
Wavelength	1550 ± 20nm
Fiber optic connector	SC/PC (FC/PC, ST/PC Optional)
Dynamic range	20dB
Distance range	0.1~80km
Pulse width	5ns~20 μs
Measurement time	5~180s Adjustable
Attenuation blind area	8m
Event blind area	3m
Loss threshold	0.01dB
Loss resolution	0.001dB
Distance uncertainty	±(0.8+0.005% x distance+Sampling resolution)m
Input light detection	Yes
VFL	
Wavelength	650 ± 20nm
Output power	1mW
Blink	2Hz
OPM	
Detect range	-50~+26dBm
Detect wavelength	700~1700nm
Calibration wavelength	850,1300,1310,1490,1550,1625nm
Optical connector	ST/SC/FC & 2.5mm Universal
Accuracy	±0.2dB
Resolution	0.01dB
Ref function	Yes
Size and weight	168 x 82 x 40mm, 260g
Individual packing	Plain box

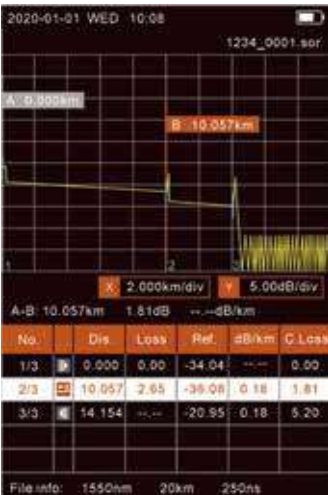

- ▶ **Optic fiber start**
- ◀ **Reflection event**
- ▭ **Attenuation event**
- ▭ **Gain event**
- ◀ **Optic fiber ending**

▶ MT-7901 Optical Fiber Identifier



Hood



Identify 270Hz, 1KHz, 2KHz with buzzer indication

One Press Signal Identification Macrobend Detection 4 in 1 Universal Module

No interface transmission during testing.

Adapts to 0.25 / 0.9 / 2 / 3mm fiber



Min. detectable power	250µm @1550nm=-30dBm / 250µm @1310nm=-25dBm 900µm @1550nm=-30dBm / 900µm @1310nm=-25dBm 2mm @1550nm=-30dBm / 2mm @1310nm=-25dBm 3mm @1550nm=-25dBm / 3mm @1310nm=-20dBm
Max. input	+5dBm
Sensitivity	>-30dBm@1550nm
Wavelength	800nm~1700nm
Frequency identify	270Hz/1KHz/2KHz
Fiber type	250µm,900µm,2mm,3mm with SM Fiber
Clamp loss	<2.5dB
Operation temperature	0~50°C
Storage temperature	-20~+70°C
Relative humidity	<90% (non-condensing)
Battery	1.5V AA x2
Dimension	43 x 47 x 230mm
Weight	200g (battery not included)
Individual packing	Plain box

▶ MT-7603 Fiber Optical Power Meter



• 850-1625nm Multi Wavelength Support • PC Link System • 1000 Data Memories



Features

- Universal interface for FC/PC
- LCD backlight • Auto power off
- USB port for updates & result transfers
- Low battery indication
- New REF user-defined • Visual fault locator
- Protective rubber boot
- Wavelength measurement calibration
- Modulation detection



Fiber optic power test

Detector type	InGaAs
Optical connector	FC / ST / SC & 2.5mm universal
Measurement range	+8~ -70dBm
Measurement wavelength	850, 1300, 1310, 1490, 1550, 1625nm
Resolution	0.01dB
Accuracy	±0.2dB
Measurement linearity	±2.0%
Display resolution	+8~ -60dBm: 0.01dB, -60~ -70dBm: 0.1dB
Power display units	dBm, mW, uW, nW,
Communication connector	USB
Data storage	1000 groups
Modulation detection	270Hz, 1kHz, 2KHz
Visual fault locator	1mW
Auto power Off	10 min (can be cancelled)
Low battery indication	Yes
Battery life	> 160 hours
Operation temperature	-10~+60°C; <90%RH
Storage temperature	-20~+70°C; <90%RH
Power source	AA 1.5V x3 (not include)
Size	170mm×97mm×38mm
Weight	330g
Optional accessory	LC adaptor (5MT-7601-LC), SC adaptor (5MT-7601-SC)
Accessory	Soft bag
Individual packing	Color box

▶ MT-7601 Fiber Optical Power Meter



850-1625nm Multi Wavelength Easy to use for Telecommunication networks & FTTx applications. Adapts to FC/SC/ST Connectors



Features

- New REF user-defined • Battery indication
- Auto power off • LCD backlight
- Protective rubber boot
- Body protection • Operation voice prompts
- Reference comparison value



Fiber optic power test

Detector type	InGaAs
Optical connector	FC / ST / SC & 2.5mm universal
Measurement wavelength	850, 1300, 1310, 1490, 1550, 1625
Measurement range	+6 ~ -70 dBm
Accuracy	(1550nm, 1310nm)±0.2dB/ (1490nm, 1625nm)±0.3dB/ (850nm, 1300nm)±0.4dB
Power measurement linearity	±2.0%
Display resolution	+6 ~ -60dBm:0.01 dB(-60 ~ -70dBm:0.1 dB)
Power display units	dBm, mW, µW
Modulation detection	270Hz, 1KHz, 2KHz (850, 1300, 1310, 1490, 1550, 1625)
Automatic power off	10 min.(Can be cancelled)
Low battery indication	Yes
Battery life	> 100 hours
Operation temperature	-10 ~ +60 °C, < 90%
Storage temperature	-20 ~ +70 °C, < 90%
Power source	AA 1.5V×2 (not included)
Size	165×80×35 mm
Weight	180g (without battery)
Optional accessory	LC adaptor (5MT-7601-LC), SC adaptor (5MT-7601-SC)
Accessory	Soft bag
Individual packing	Color box

▶ MT-7615/MT-7616

4 In 1 Fiber Optical Power Multimeter

Model. No	MT-7615	MT-7616
Detector Type	InGaAs	
Wavelength Range	700-1700nm	
Optical Connector	2.5mm Universal	
Measuring Wavelength	850 / 980 / 1300 / 1310 / 1490 / 1550 / 1625 / 1650nm	
Measuring Range	-70~+10dBm	
Resolution	0.01dB	
Accuracy	(1550,1310nm)±0.2dB/ (1490nm, 1625nm, 1650nm)±0.3dB/ (850nm, 980nm, 1300nm)±0.4dB	
Power Display Units	dBm, dBm, mW, uW, nW	
Modulation Detection	270/1k/2kHz	
Data Storage	500	
Wavelength ID	Yes (Only Work for Pro'sKit Products)	
Wavelength Memory	Yes	REF Value Yes
Self Calibration	Yes	Backlight Yes
Output Power	15mW	30mW
VFL Test Length	10-12km @Single Mode	14-16km @Single Mode
VFL Connector	2.5mm Universal	
VFL Wavelength	650±20nm	
VFL Laser Mode	Continuous / Flashing	
LAN Cable	UTP Cable	
LAN Cable Connector	RJ45(UTP / 8P8C)	
Cable Mapping	Yes	
Measuring Length	600m	
Assistive Light	LED	
Auto Power Off	Yes (10mins)	
Low Battery Indication	Yes	
Charging Port	Micro USB	
Working Hours	>50hrs (Power Meter Only)	
Battery	3.7V / 450mAh, Li-ion	
Working Environment	-10~50°C, <90%RH	
Dimension	98 x 59 x 27mm	
Weight	100g	
Individual packing	Color box	

4 in 1

Power Meter

Supports 8 wavelengths

LAN Cable Tester

600M test distance

Visual Fault Locator

MT-7615: 15mW output power

MT-7616: 30mW output power

LED Flash Light



MT-7615



MT-7616



CE

▶ MT-7617 / MT-7618

Mini Palm Fiber Optical Power Multimeter

Model. No	MT-7617	MT-7618
Detector Type	InGaAs	
Wavelength Range	700-1700nm	
Optical Connector	2.5mm Universal	
Measuring Wavelength	850 / 980 / 1300 / 1310 / 1490 / 1550 / 1625 / 1650nm	
Measuring Range	-70~+10dBm	
Resolution	0.01dB	
Accuracy	(1550,1310nm)±0.2dB/ (1490nm, 1625nm, 1650nm)±0.3dB/ (850nm, 980nm, 1300nm)±0.4dB	
Power Display Units	dBm, dBm, mW, uW, nW	
Modulation Detection	270/1k/2kHz	
Data Storage	500	
Wavelength ID	Yes (only applicable for Pro'sKit products)	
Wavelength Memory	Yes	REF Value Yes
Self Calibration	Yes	Backlight Yes
Output Power	-	1mW
VFL Test Distance	-	3-5 km single mode
VFL Connector	-	2.5mm Universal
VFL Wavelength	-	650 ± 20 nm
VFL Laser Mode	-	Continuous / Flashing
Assistive Light	LED	
Auto Power Off	Y (10 mins)	
Low Battery Indication	Yes	
Charging Port	Micro USB	
Working Hours	AAA battery > 100 hrs (power meter)	
Battery	1.5V AAA x 2	
Working Environment	-10~50°C, <90%RH	
Dimension	98 x 59 x 27 mm	
Weight	70g (battery not included)	
Individual packing	Color box	

MT-7617 2 in 1

Power Meter

Supports 8 wavelengths

LED Flash Light



MT-7617

MT-7618 3 in 1

All MT-7617 Function

Plus

Visual Fault Locator

1mW power output



MT-7618



CE

▶ MT-7602

4 In 1 Fiber Optic Power Multimeter

Optical Power Meter	Detector type	InGaAs
	Optical connector	ST/SC/FC & 2.5mm Universal
	Measurement wavelength	850/1300/1310/1490/1550/1625 nm
	Measurement range	+10 ~ -70 dBm
Accuracy		(1550nm, 1310nm)±0.2dB/ (1490nm, 1625nm)±0.3dB/ (850nm, 1300nm)±0.4dB
	Power measurement linearity	±2%
	Display resolution	+10~-60dBm(0.01dB)/-60~-70dBm(0.1dB)
	Power display units	dBm, uW, mW
Visual Fault Locator	Output power	<1mW
	Range	3~5 km @SM
	Connector	ST/SC/FC & 2.5mm Universal
	Laser safety rating	Class 2
LAN Cable Tester	Wavelength	650nm±20nm
	Output modes	Continuous (CW), 2 Hz pulsed
	Connector	RJ45 & RJ11
	Cable	UTP LAN cable(8P8C), Telecom cable(6P2C/6P4C/6P6C)
Measuring length max.	600 meter	
Automatic power off	10 min.(Can be cancelled)	
Low battery indication	Yes	
Battery life	>100H (Only OPN use alkaline battery)	
Power source	1.5V AA x 2 (Not included)	
Size	125x52x34 mm	
Optional accessory	LC adapter (5MT-7601-LC) SC adapter (5MT-7601-SC)	
Individual packing	Color box	

4 IN 1

1.Fiber Power Meter 2.Visual Fault Locator 3.Cable Tester 4.LED Flashlight



Fiber optic power test



Break in fiber test



Cable tester



LED flashlight

Features

- Battery indication
- Auto power off
- Built-in USB charging port
- Reverse battery protection



CE FDA

▶ MT-7801 / MT-7802

Fiber Optical Light Source



Features

- LCD backlight • Auto power off • 3 modulations selection • Single key for wavelength switch • DC5V power jack for rechargeable battery charging • Protective rubber boot



Fiber optical light source for test

Multi-Range Supply

- MT-7801 for 1310/1550 single mode
- MT-7802 for 850/1300 multi mode

WAVE ID

helps to identify the wavelength automatically.

Supports SC/PC

Model. No	MT-7801	MT-7802
Wavelength ±10nm	1310/1550nm	850/1300nm
Power stability	±0.05dB / 1hr : ±0.1dB / 8hrs	
Output power	>-5dBm	>-10dBm
Optical connector	SC/PC	
Modulation	270Hz, 1kHz, 2kHz	
Auto power off	10 minutes (could be reset)	
Battery charge	Yes (when use rechargeable battery), by micro USB	
Low battery indication	Yes	
Storage temperature	-20~+70°C; <90%RH	
Operation temperature	-10~+60°C; <90%RH	
Battery	2 x 1.5V AA batteries (Not included)	
Size	165x 80 x 35mm	
Weight	280g	
Accessory	Bag	
Individual packing	Color box	

▶ MT-7501 / MT-7510 / MT-7530

Fiber Optical Visual Fault Locator



1 mW

MT-7501

3-5 Km



10mW

MT-7510

8-10 Km



30mW

MT-7530

>20 Km



Continuity test



Locate break point



Accessory



Compatible connectors (LC with optional adaptor)

ST FC SC

1 Sec. Quick Illumination

To make checking work convenient

2 Operation Modes

To locate fault accurately

3 Supported Connectors

To give more versatile choice (FC/SC/ST)

Features

- Portable and durable • Both continuous and flashing mode • Supports 2.5mm universal connectors • Dust proof & crash proof cap

Model No.	MT-7501	MT-7510	MT-7530
Wavelength	650 nm±10 nm		
Output power	1 mW	10 mW	30 mW
Light source	CLASS II	CLASS IIIB	CLASS IIIB
Tested fiber length	3-5Km	8-10Km	>20Km
Power (batteries)	AA (1.5 V) x 2 (Not included)		
Connector	2.5mm universal connector for FC, ST and SC		
OAL	175mm		
Operation temperature	-10~55°C		
Storage temperature	-10~70°C		
Optional accessory	LC adaptor (5MT-7601-LC)		
Individual packing	Color box		

▶ MT-7501E

Fiber Optical Visual Fault Locator



1 Sec. Quick Illumination

To make checking work convenient

2 Operation Modes

To locate fault accurately

3 Supported Connectors

To give more versatile choice (FC/SC/ST)

Wavelength	650 nm±10 nm
Output	1mW
Laser class	CLASS II
Tested fiber length	3-5km
Power	AA (1.5 V) x 2(Not included)
Connector	2.5mm FC/ST/SC connector
OAL	180mm
Operation temp.	-10~55°C
Storage temp.	-10~70°C
Optional accessory	LC adaptor(5MT-7601-LC)
Individual packing	Color box



▶ MT-7508 MT-7509

Fiber Optical Visual Fault Locator

Measuring Distance : 8KM



MT-7508
for testing ST, SC,
FC connectors

Compatible connectors (LC with optional adaptor)



ST FC SC



MT-7509
for testing
LC connectors



LC

Model No.	MT-7508	MT-7509
Connector type	2.5mm (FC/SC/ST)	1.25mm (LC)
Light source	Class 3A laser diode	
Nominal wavelength	650±10nm	
Battery	1.5V AAA x2 (Not included)	
OAL	ø13.5x160mm	
Individual packing	Color box with black EVA inner case	

▶ FB-1688 / FB-1688C Fiber Cleaver



Cleaving 125µm cladding, 250µm -900µm coating



Cleaving FTTH drop cable



Cleaving patch cord



4 in 1 fiber holder

Cladding diameter	125 µm
Fiber count coating diameter	Single fiber 250µm & 900µm
Cleave length	5-20 mm
Dimensions	62 x 60 x 56 mm
Cleaver blade (5FB-1688-BLADE)	24 cutting points material: Tungsten steel
Individual packing	White box

4 in 1 Fiber Holder

for 125µm cladding, 250µm -900µm coating, patch cord and FTTH Drop Cable

Storage Space

for groove in the bottom of fiber holder

Blade lifetime up to **48000 Cleave**s

24 cutting points

for each blade.

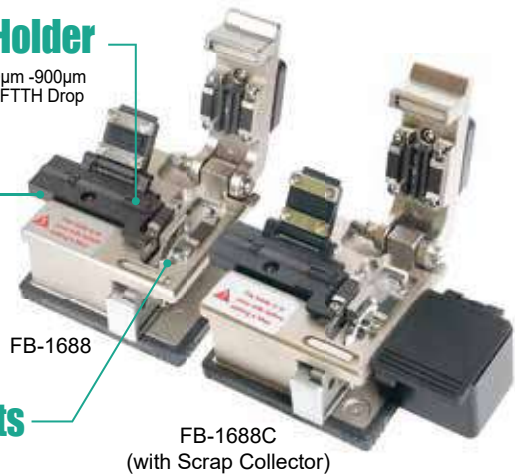

FB-1688

FB-1688C (with Scrap Collector)

▶ FB-1601 / FB-1602 Fiber Cleaver



Cleaving 250µm coating



Cleaving 900µm coating



Visual Fault Locator
Output Power: 1mW



Cleaving FTTH drop cable



FB-1602 only

Cladding Diameter	125 µm
Fiber Count Coating Diameter	Single fiber & 250µm & 900µm /3x2mm Drop cable
Cleaver Length	5-20mm
Dimensions	80 x 64 x 60mm
Weight (FB-1601/FB-1602)	~250g/280g
Cleaver Blade (5FB-1602-BLADE)	24 Points
VFL (FB-1602 only) :	
Wavelength	650nm+15nm
VFL Connector	2.5mm Universal Connector
Output Power	1mW
Operation Mode	CW/2Hz Glint
Power Source	3.7V/180mAh Li-ion
Charge	5V/0.2A
Accessories	Micro USB charging cable
Individual packing	Color box

FB-1602
(With Visual Fault Locator)



FB-1601

▶ CP-FB01 FTTH Drop Cable Stripper

- Universal Stripper for 3.1x2.0mm FTTH drop cables with steel wire or FRP strength member.
- Made of zinc alloy with PVC non-slip handle.
- Improve cable splicing, more efficient and easy to use.



Will not scratch or nick the glass fiber



Fixed scale design

Body	Zinc alloy
Blade	CR12, HRC:60±4°
Applications	For stripping FTTH drop cable, fiber cladding diameter: 125 µm
OAL(mm)	30 x 112 x 20mm
Individual packing	Color box



CP-328 5 in 1 Fiber Optic Stripper

Fit for Multiple Fibers
5 Cavity
Accurate



- ◆ Strip 2.8-3.0mm PVC Jacket
- ◆ Strip 2.0-3.0mm Loose Tube
- ◆ Strip 2.0-2.4mm PVC Jacket
- ◆ Strip 600-900µm Buffer Coating
- ◆ Strip 250µm Buffer / Acrylate

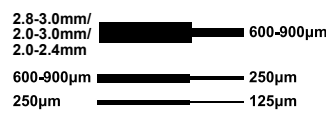

Material	Hardness	Length	Thickness	Weight	Individual packing
S50C	HRC48°±2°	153mm	3.2mm	100g	Blister card

8PK-326 Fiber Optic Stripper



Strips 125 micron glass fiber with 250 micron buffer coating without scratching or nicking glass fiber.



- ◆ Strip the 1.6-3.0mm fiber jacket down to the 600-900 micron buffer coating.
- ◆ Strip the 600-900 micron buffer coating down to the 250 micron coating.
- ◆ Strip the 250 micron cable down to the glass fiber without nicks or scratches.



Material	Hardness	Length	Individual packing
S50C	HRC48°±2°	148mm	Blister card

FB-C010 Fiber Optic Connector Cleaner



Refillable Cleaning Tape
Full Cleaning

for SC , FC, MU, LC, ST, D4, DIN connectors



The refillable cleaning tape:
Model No.5FB-C010-RPM

- Special non-alcohol high density textile fiber type eliminates the need for solvents.
- Indication see-through window for easy checking.

Material	Cleaning times	Applications	Dimensions	Individual packing
High density textile fibers	500/per box	For cleaning SC , FC , ST, MU, LC, D4, MT, DIN connector	115×79×32 mm	Blister card

8PK-MA009 Fiber Optic Viewing Scope Kit



- This fiber optic viewing scope kit makes it simple to view ST/SC/FC.
- Pre-encapsulated FDDI, and the ends of fiber before and after cleaving operations.



Magnification	Light source	Battery	OAL (mm)	Optional	Individual packing
200X Adjustable	Bulb 2.25V / 0.25A	1.5V AAx2pcs (not included)	148x46x25	9MA009-LC	Blister card

DK-2043 Fiber Optic Kevlar Cutter



- Serrated blade for gripping materials.
- Specially designed for cutting kevlar materials.



For cutting Kevlar fiber optic cable



Micro serrated



Handle material	Blade HRC	Hardness (Cutting edge)	OAL (mm)	Individual packing
TPR	60°~62°	HV1200	160	Blister card

8PK-C002 Foam Swabs Cleaning Kit



For clean up of organic & inorganic residue in clean room and other areas. Ideal for fiber optic clean work.

Individual packing
Blister card

▶ PK-9472A/B Fiber Optic & Telecom Installation Tool Kit

It's professional and ideal for

FIBER OPTIC & TELECOM installation and also comes with several useful tools, be able to perform excellent job with efficiency.

4 in 1

Power Meter

Supports 8 wavelengths

Cable Tester

600M test distance

Visual Fault Locator

MT-7615: 15mW output power

LED Flash Light



MT-7615
Refer to p.75



Strong Anti-Noise

PoE Switches & STP Wire Tracing

3KM

Cable Mapping Status Indication

300M



PoE switches & wire tracing



STP wire tracing



Refer to p.28



Model. No	PK-9472B	PK-9472A
1PK-067DS	Dual color side cutting plier(165mm)	
1PK-709DS	Dual color long nose plier(166mm)	
9SD-202A	⊖ Pro-soft screwdriver(5x75mm)	
9SD-202B	⊕ Pro-soft screwdriver(#1 5x75mm)	
9SD-207A	⊖ Pro-soft screwdriver(6x100mm)	
9SD-207B	⊕ Pro-soft screwdriver(#2 6x100mm)	
SI-129B-60	Soldering iron 60W / 220~240V	-
SI-130A-20	-	Soldering iron 12W / 110~120V
CP-3001D	Precision wire stripper (AWG 30/28/26/24/22/20)	
CP-3141	Impact terminal tool for krone	
CP-328	5 in 1 fiber optic stripper	
CP-376TR	4P/6p/8p telecom crimping tool (190mm)	
CP-FB01	Ftth drop cable stripper	
DK-2039	Utility knife (3 blades self loading)	
DK-2043	Fiber optic kevlar cutter	
FL-528	1W led head light	
MT-1210	3 1/2 Compact Digital Multimeter	
MT-7029	Noise-filtering networkpoe toner & probe	
MT-7615	4 in 1 fiber optical power multimeter	
NT-305	Voltage detector	
PD-2616	10 oz engineer's hammer	
TC-850-NP	ABS carrying tool case (435x310x145mm)	
Individual packing	Color box	

▶ PK-9461 Basic Fiber Optic Cleaning Kit

Ideal for removing and trapping contaminants of fiber optic connector end face in fiber optic installations.

cleaning kit provides a complete selection of fiber optic cleaning products, includes cleaning liquid, Lint free wipers, cleaner, bulb blower.



MS-153A	Bulb blower (ø42mm)
FB-C008	2.5mm fiber optic one click cleaner
FB-C009	1.25mm fiber optic one click cleaner
FB-C010	Fiber optic cleaning cassette
FB-C011	Lint free wiper
9C003	Cleaning liquid
8PK-MA009	Fiber optic viewing scope kit
9Z-940KP	Zipper carrying bag(280x197x70mm)
Individual packing	Color label shrink



▶ PK-9456 FTTH Fiber Optic Tool Kit

This tool kit is designed for especially used in the FTTH installation, it is simple, convenient and economic. This kit contains the essential tools for FTTH project, such as drop cable stripper, cleaver, cleaning tools and power meter.

SB-1592	Component storage box (145x92x40mm)
1PK-067DS	6" Dual color side cutting plier
1PK-709DS	6" Dual color long nose cutting plier
8PK-326	Fiber optic stripper
9SD-207A	⊖ Pro-soft screwdriver (6x100mm)
9SD-207B	⊕ Pro-soft screwdriver (#2x100mm)
CP-FB01	FTTH Drop cable stripper
PD-513	Utility knife
FB-1688	Fiber cleaver
MS-018	Leak proof dispenser pump bottle
MT-7501	1mW Fiber optic visual fault locator
MT-7601	Fiber Optic power meter
9ST-7610-BAG	Carry bag
Individual packing	Color box



▶ PK-9458 Professional FTTH Fiber Optic Tool Kit

CP-328 5 in 1 Fiber Optic Stripper

- Fit for multiple fibers
- Material : S50C

Refer to p.78



FB-1688C Fiber Cleaver

- 24 cutting location for each blade.
- Blade life up to 48000 times
- Blade: Tungsten
- Cladding Diameter: 125 μm
- Cleave length: 10~20 mm
- Cleave angle: ≤ 0.8°



CP-376TR 4P/6P/8P Telecom Crimping Tool

- Body: S45C
- Handle: Black:T.P.R Green:PP



FB-C008/FB-C009 2.5mm/1.25mm One Click Cleaner

- 800 cleans for FC/PC, ST, SC or LC Connectors
- Easy pushing motion
- 180° rotates cleaning system
- Extendable nozzle
- Indication window



MT-7602 4 in 1 Fiber Optic Power Multimeter

Refer to p.75

- Fiber optic power meter
- Network tester
- Visual fault locator
- LED flashlight



MT-7602	4 in 1 fiber optic power multimeter
FB-C008/FB-C009	2.5mm/1.25mm one click cleaner
FB-1688C	Fiber cleaver with Scrap Collector
CP-376TR	4P/6P/8P Telecom crimping tool
CP-FB01	FTTH drop cable stripper
CP-328	5 in 1 Fiber Optic Stripper
1PK-067DS	Dual color side cutting plier (165mm)
9SD-207B	⊕ Pro-soft screwdriver (#2x100mm)
9SD-201A	⊖ Pro-soft screwdriver (3.0X75mm)
DK-2043	Fiber optic kevlar cutter
DK-2040	Measuring tape (3M/10FT)

MS-018	Leak proof dispenser pump bottle
FL-528	1W LED head light
PD-2612	8 Oz curved claw hammer
SB-1592	Component storage box (145 x 92 x 40mm)
9MS-153A	Bulb blower (Ø42mm)
8PK-C002	Foam swabs cleaning kit
5MT-7601-LC	Fiber optical power meter LC adapter
9PK-153	Brush
9TC-756-NP	Deluxe Aluminium Frame Tool Case(458x330x150mm)
Individual packing	Inner box + Color label shrink

CRIMPERS



Best Connection, Less Effort.



Pro'sKit®

886-2-22183233
Sales support

pk@mail.prokits.com.tw
E-mail

www.prokits.com.tw
Global website

Interchangeable Ratcheting Crimper Series

- Made from high quality carbon steel with black oxide finish for corrosion resistance and durability.
- Energy saving ratcheting mechanism requires less handle force and ensures the crimping quality.
- Ergonomically shaped non-slip handles for user comfort.
- Interchangeable die sets for wide range of applications.



▶ CP-371 Crimp Pro Crimp Frame



30%
Force Saving



- Right angled head design prevents awkward wrist bending during operation.
- Interchangeable die with thumbscrews.

Change die with thumbscrews.

Ratcheting release trigger

(9" 236mm)

Individual packing:
Blister card



Crimping pressure adjustment

Elastomeric resin fitting exactly and double structure, non-slip.
Green:PP
Black:TPR

▶ CP-336F Lunar Crimp Frame



Compact
Design



- One hand operation.
- Compact size, easy to carry.

AISI 4140 Alloy steel
HRC: 43°±2°

Elastomeric resin fitting exactly and double structure. Non-slip.
Green: PP
Black: T.P.R

(8.5" 220mm)

Individual packing:
Blister card



S45C medium carbon steel
HRC: 45°±3°

Crimping pressure adjustment

Ratcheting release trigger

▶ 1PK-3003F Ergo-Lunar Crimp Frame



50%
Force Saving



- 40%~50% lower crimping force.
- Interchangeable die with thumbscrews.

Change die with thumbscrews.

Ratchet crimping action provides repeatable and reliable terminations

(10" 260mm)

Individual packing:
Blister card

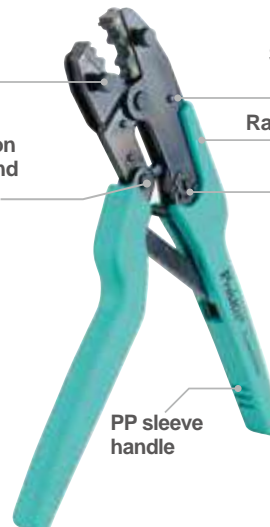

S45C medium carbon steel, HRC: 45°±3°

Ratching release trigger

Crimping pressure adjustment

PP sleeve handle

Model No.	Die Set	Crimp die profile	Application	Crimp Size	Terminals	Model No.	Die Set	Crimp die profile	Application	Crimp Size	Terminals
Coaxial Connectors						Fiber Optic Connectors					
CP-336DA4			RG58, RG59, RG62, RG174	HEX .068", .187", .213", .255", HEX 1.73, 4.75, 5.41, 6.48 mm		CP-336DF1			SMA, SRF, SMF fiber optic connectors	SQ .042", HEX .068", RND .133", .162", .195", SQ 1.07, HEX 1.73, RND 3.38, 4.11, 4.95 mm	
CP-336DC			RG58, RG59, RG62, RG6	HEX .068", .213", .266", .319", HEX 1.73, 5.41, 6.50, 8.10 mm		CP-336DF2			SMA, SMB, FC Biconic and SC & ST fiber optic connectors, RG58, RG174, Belden8218	SQ.042", HEX .068",.151", .178", .213" SQ 1.07 mm HEX1.73, 3.84, 4.52, 5.41 mm	
CP-336DI			RG58, RG59, RG6, RG174	HEX .067", .093", .211", .255", .315", HEX 1.73, 2.36, 5.36, 6.48, 8.00 mm		CP-336DF4			For FC,SC, ST,LC,SMA & MT-RJ fiber optic connectors	HEX .139", .151", .178", RND .134", .190", HEX 3.53, 3.84, 4.52 mm RND3.40, 4.83 mm	
CP-336DP1			RG type cables 55, 58, 59, 5, 6, 21,141, 142,143, 210,212, 222, 223, 303, 304, 400, Belden:8279, 8281, 9231& 9141	HEX .068", .098", .213", .255", .321", HEX 1.73, 5.41, 6.48, 8.15 mm		CP-336DV			SMA, SMB, SMC, MCX	SQ .043", HEX .069", .100", .128", .151", .213", SQ 1.09 mm HEX 1.75, 2.54, 3.25, 3.84, 5.41 mm	
1PK-3003D3			Cambridge CP-88,CP-89 BNC/TNC coax connectors with RG58, RG59, RG62/AU cables	SQ .068", HEX .228",.305", SQ 1.73 mm HEX 5.79, 7.75 mm		CP-336DG			RG58, RG59, RG62, RG174 fiber optic	SQ .043", HEX .068",.100", .137",.213", .255", SQ 1.09 mm HEX 1.73, 2.54, 3.48, 5.41, 6.48 mm	
1PK-3003D6			N-Series and RG8, RG11 Connectors	HEX .080", .100",.429", HEX 2.03, 2.54, 10.90 mm		CP-336DJ			RG174, RG179, Belden 8218 fiber optic	SQ .042", HEX .068",.078", .128", .151",.178", SQ 1.07,HEX 1.73, 1.98, 3.25, 3.84, 4.52 mm	
1PK-3003D8			RG58, RG6, RG174, Belden type RG8281 cables	HEX .068", .178",.324", HEX 1.73, 4.52, 8.23 mm		CP-336DK4			RG58, RG174, fiber optic	HEX .100", .128",.190", .213", HEX 2.54, 3.25, 4.83, 5.41 mm	
Electrical And Industrial Terminals						Electrical And Industrial Terminals					
1PK-3003D9			Plenum and teflon cables, RG58, RG59	HEX .042", .068",.190", .213", HEX 1.07, 1.73, 4.83, 5.41 mm		CP-236DR			Vinyl insulated W/O copper sleeve	AWG 22-18/16-14/12-10, DIN 0.5-1.0/1.5-2.5/4.0-6.0mm ² JIS 1.25/2.0/3.5-5.5mm ²	
1PK-3003D34			HDTV SMA true 75-ohm BNC/TNC & mini UHF RG174, RG59/62, mini coaxial & Belden 1855A	SQ .042", HEX .068",.178", .197", .255"SQ 1.07 mm HEX 1.73, 4.52, 5.00, 6.48 mm		1PK-3003D21			Insulated terminals & plugs for smaller wire barrel terminals	AWG 26-22/22-18/16 DIN 0.1-0.32/0.32-0.82/1.5mm ² JIS 0.1-0.30/0.30-0.75/1.25 mm ²	
1PK-3003D10			RG59, RG6, RG8281, F-type CATV Connectors	HEX .255", .320",.350", HEX 6.48, 8.13, 8.89 mm		1PK-3003D1			Insulated terminals/ color coded nests	AWG 22-18/16-14/12-10, DIN 0.5-1.0/1.5-2.5/4.0-6.0 mm ² JIS 1.25/2.0/5.5 mm ²	
Modular Plugs						Modular Plugs					
CP-236DM5			Molex 8P8C/RJ45 plug & cable O/D around ø5.2 mm			CP-236DN			Non-insulated terminals & plugs	AWG 20-18/16-14/12-10/8, DIN 1.5/2.5/6.0/10.0 mm ² JIS 1.25/2.0/3.5-5.5/8.0 mm ²	
1PK-3003D11			8P8C/RJ45 keyed modular plugs (excluding AMP)			CP-236DE1			Pin terminal insulated & non-insulated wire ferrules	AWG 10/8/6 DIN 6.0/10.0/16.0 mm ² JIS 5.5/8.0/14.0 mm ²	
1PK-3003D12			6P2C/6P4C/6P6C RJ11/RJ12 modular plugs			CP-236DE			Pin terminal insulated & non-insulated wire ferrules	AWG 22/20/18/16/14/12 DIN 0.5/0.75/1.0/1.5 2.5/4.0 mm ² JIS 0.35/0.5/0.9/1.25/2.0/3.5 mm ²	
1PK-3003D14			AMP 8P8C/RJ45 modular plugs. Primary strain relief crimp bar is located further back on die/ modular plugs			CP-236DU			Non-insulated open barrel connectors & D-SUB V.35 terminal	AWG 22/14 DIN 0.5/2.5 mm ² JIS 0.35/2.0 mm ²	
1PK-3003D16			RJ22 4P2C/4P4C handset modular plugs			CP-3003D45			Non-insulated open barrel connectors	AWG 22-18/16-14/12-10, DIN 0.5-1.0/1.5-2.5/4.0-6.0 mm ² JIS 0.5-0.9/1.25-2.0/3.5-5.5 mm ²	
Solar Terminals						Solar Terminals					
CP-5S1D			For MC 3 solar connector(Multi-Contact) &2.5/4.0/6.0 mm ² (AWG 14/12/10) solar cable	AWG 14/12/10 DIN 2.5/4.0/6.0mm ²		1PK-3003D36			Non-insulated open barrel connectors & D-SUB V.35 contact pins	AWG 30-24/22-18 DIN 0.05-0.25/0.50-1.0mm ² , JIS 0.05-0.25/0.35-0.9mm ²	
CP-5S2D			For MC 4 solar connector(Multi-Contact)& 2.5/4.0/6.0 mm ² (AWG 14/12/10) solar cable	AWG 14/12/10 DIN 2.5/4.0/6.0mm ²		1PK-3003D2			Non insulated open barrel connectors, commercial type	AWG 22-18/16-14/12-10, DIN 0.5-1.0/1.5-2.5/4.0-6.0 mm ² JIS 0.35-0.9/1.25-2.0/3.5-5.5 mm ²	

CRIMPERS

CP-3006 Series Parallel Action Crimping Tool

For open barrel terminals and solar connectors



Interchangeable crimp dies with one grip

Crimping pressure adjustment

Ratcheting release trigger



- **Reliable:** Parallel action crimping performance is consistent and accurate
- **Practical:** Safety crimp release helps eliminate rejected terminations due to incorrect positioning.
- **Comfortable:** Ergonomically shaped non-slip TPR handle for comfortable use in all conditions
- **Versatile:** Interchangeable die sets for wide range of applications.

Parallel crimping action

Material: S50C
HRC: 45°±3°

Non-slip TPR handle



Material		HRC	OAL.(mm)	Individual packing
Body	Handle			
S50C	TPR	45°±3°	254	Blister card

Model No.	DIE set	Crimp die profile	Application	Terminals
CP-3006FD2			Non-insulated open barrel connectors, commercial type AWG 22-18/16-14/12-10 DIN 0.5-1.0/1.5-2.5/4.0-6.0 mm ² JIS 0.35-0.9/1.25-2.0/3.5-5.5 mm ²	
CP-3006FD18			Pin terminal insulated or non-insulated ferrules, cord end terminals AWG 22/20/18/16/14/12 DIN 0.5/0.75/1.0/1.5/2.5/4.0 mm ² JIS 0.35/0.5/0.9/1.25/2.0/3.5 mm ²	
CP-3006FD36			Non-insulated open barrel connectors & D-SUB V.35 contact pins AWG 30-24/22-18 DIN 0.05-0.25/0.50-1.0 mm ² JIS 0.05-0.25/0.35-0.9 mm ²	
CP-3006FD45			Non-insulated open barrel connectors AWG 22-18/16-14/12-10 DIN 0.5-1.0/1.5-2.5/4.0-6.0 mm ² JIS 0.5-0.9/1.25-2.0/3.5-5.5 mm ²	
CP-3006FD47			Insulated open barrel connectors commercial type AWG 20-18/16-14/12-10 DIN 0.5-1.0/1.5-2.5/4.0-6.0 mm ² JIS 0.5-1.0/1.25-2.0/3.5-5.5 mm ²	
CP-3006FS1			For MC 3 solar connector (Multi-Contact) & 2.5/4.0/6.0 mm ² (AWG 14/12/10) solar cable AWG 14/12/10 DIN 2.5/4.0/6.0 mm ²	
CP-3006FS2			For MC 4 solar connector (Multi-Contact) & 2.5/4.0/6.0 mm ² (AWG 14/12/10) solar cable AWG 14/12/10 DIN 2.5/4.0/6.0 mm ²	

Crimping Tool



Elastomeric resin fitting exactly and double structure. Non-slip. Green: PP Black: T.P.R



AISI 4140 Alloy steel

S45C medium carbon steel
HRC 45° ±3°

Crimping pressure adjustment

Ratcheting release trigger



OAL.(mm)	Individual packing
220	Blister card

Model No.	Description	Crimp die profile	Application	Crimp Size
6PK-230C	Inter-locking & Non-insulated		Non-insulated terminals or open barrel terminals	AWG 20-18/16-14/12-10 DIN 0.5-1.0/1.5-2.5/4.0-6.0 mm ² JIS 0.5-0.9/1.25-2.0/3.5-5.5 mm ²
6PK-230PA	Coaxial connectors crimping tool		For crimping RG type cables 55, 58, 59, 5, 6, 21, 141, 142, 143, 210, 212, 222, 223, 303, 304, 400 Belden: 8279, 8281, 9231 & 9141	HEX .068", .098", .213", .255", .321" HEX 1.73, 2.49, 5.41, 6.48, 8.15 mm
6PK-301E	Usable for cord end terminals		Pin terminal insulated & non-insulated wire ferrules	AWG 22/20/18/16/14/12 DIN 0.5/0.75/1.0/1.5/2.5/4.0 mm ² JIS 0.35/0.5/0.9/1.25/2.0/3.5 mm ²
6PK-301H	Insulated terminals/color coded nests		Insulated terminals & plugs	AWG 22-18/16-14/12-10 DIN 0.5-1.0/1.5-2.5/4.0-6.0 mm ² JIS 1.25/2.0/3.5-5.5 mm ²
6PK-301N	Non-insulated terminals		Non-insulated terminals & plugs	AWG 20-18/16-14/12-10/8 DIN 1.5/2.5/6.0/10.0 mm ² JIS 1.25/2.0/3.5-5.5/8.0 mm ²
6PK-301R	Vinyl insulated W/O copper sleeve		Vinyl insulated W/O copper sleeve	AWG 22-18/16-14/12-10 DIN 0.5-1.0/1.5-2.5/4.0-6.0 mm ² JIS 1.25/2.0/3.5-5.5 mm ²
6PK-301S	Usable for cord end terminals		Pin terminal insulated & non-insulated wire ferrules	AWG 10/8/6 DIN 6.0/10.0/16.0 mm ² JIS 5.5/8.0/14.0 mm ²
6PK-301U	Non-insulated open barrel connectors & D-SUB V.35		Non-insulated open barrel connectors & D-SUB V.35 terminal	AWG 22/14 DIN 0.5/2.5 mm ² JIS 0.35/2.0 mm ²
8PK-301C	Coaxial crimping tool		RG58, RG59, RG62, RG6	HEX .068", .213", .256", .319" HEX 1.73, 5.41, 6.50, 8.10 mm
8PK-301J	Fiber optic crimping tool		RG174, RG179, Belden 8218 fiber optic	SQ .042", HEX .068", .078", .128", .151", .178" SQ 1.07, HEX 1.73, 1.98, 3.25, 3.84, 4.52 mm



For 6PK-230C



For 6PK-301N



For 6PK-301H



For 6PK-301S
6PK-301E



For 6PK-301R



For 6PK-301U



For 6PK-230PA
For 8PK-301C



For 8PK-301J

7.5" Compact Size Ratchet Mechanism Adjustable Crimping Pressure



RoHS
COMPLIANT



AISI 4140
Alloy Steel



S50C Carbon Steel
Black Oxided Anti Corrosion



Ratchet Design
Adjustable Crimping Pressure



TPR+PP Handle
Anti Slip Ergonomic Shape

PORTABLE SIZE

Only **190mm**



Model No.	Die set	Crimp die profile	Application	Terminals
CP-751A			Non-insulated open barrel connectors for piece width 2.0/2.54/3.96mm PH/XH/D-SUB/SM/EL/KF/VH/CH/5557/2.8/4.8 AWG: 30-24/22-18, DIN: 0.05-0.25/0.34-1.0mm ² , JIS: 0.05-0.25/0.35-0.9mm ²	
CP-751B			AWG: 16/14/12-10, DIN: 1.5/2.5/4.0-6.0mm ² , JIS: 1.25/2.0/3.5-5.5mm ²	
CP-751C			AWG: 20-18/16-14, DIN: 0.5-1.0/1.5-2.5mm ² , JIS: 0.5-0.9/1.25-2.0mm ²	
CP-751E			AWG: 20-18/17-16/14/12/10, DIN: 0.5-0.75/1.0-1.5/2.5/4.0/6.0mm ² , JIS: 0.5-0.75/0.9-1.25/2/3.5/5.5mm ²	
CP-751H			AWG: 24-20/20-16/16-14, DIN: 0.25-0.5/1.5/2.5mm ² , JIS: 0.3-0.5/1.25/2mm ²	
CP-751N			AWG: 22-18 / 18-16 / 16-14, DIN: 0.35-0.75/0.75-1.5/1.5-2.5mm ² , JIS: 0.35-0.75/0.75-1.25/1.25-2mm ²	
CP-751PA			HEX: 0.213", 0.256", 0.068", HEX: 5.41 / 6.5 / 1.73mm	

CRIMPERS

CP-200R/CP-376K/CP-376UR/CP-376VR

Professional Modular Crimp Strip & Cut Tool



CP-200R



- 10P10C
- AMP8P8C



CP-376K



CP-376UR



- Crimping section: plastic
- Cover plate: Black oxide finish

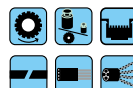

CP-376VR



- Crimping section: Zinc-aluminum alloy
- Cover plate: Chrome plating

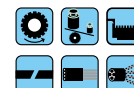

5CP-376U-BLADE
(6pcs/pack)

Features:

- For crimping modular plugs in parallel action.
- Cut, strip, and crimp modular plugs without changing modular (DIE) set.
- Smooth ratcheting mechanism ensures positive connections.
- Integrated with round cable stripper for stripping round wires effectively in one operation.
- Middle carbon steel frame, hardened & black oxide finish.
- Lightweight, durable and compact.

Model No.	Material	HRC	Handle	Application	Replacement blade	OAL.(mm)	Individual packing
CP-200R	S45C	45°±3°	Black:T.P.R Green:PP	10P10C, AMP 8P8C/RJ45, 6P6C/RJ12, 6P4C/RJ11, 4P4C & 4P2C/RJ22 plugs, and RJ11/6P6C DEC-Off set plugs	5CP-376U-BLADE (6pcs/pack)	205	Blister card
CP-376K				8P8C/RJ-45, 6P6C/RJ12, 6P4C/RJ11, 4P4C & 4P2C/RJ22 plugs, and RJ11/6P6C DEC-Off set plugs			
CP-376UR				8P8C/RJ45 modular plugs			
CP-376VR					195		

▶ CP-376N / CP-376M / CP-376ER / CP-376D

Modular Crimping Tool



End Pass Through



CP-376N

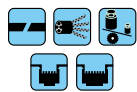

CP-376M



CP-376ER

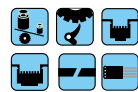

CP-376D

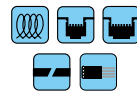

Crimping & Cutting



Stripping



Crimping



Cutting



Safety lock for easy storage



5CP-376N-6PB
5CP-376N-8PB
5CP-376N-BLADE
(1pc/pack)



508-376ER-B
(2pcs/pack)

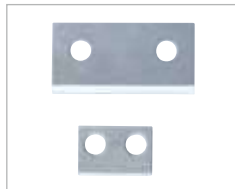

508-376E-B
(2pcs/pack)

Features:

- Accurate – Crimping performance is accurate.
- Practical – Ratchet, high leverage design for consistent and repeatable crimping
- Comfortable – Ergonomically shaped non-slip handle for comfortable use in all conditions
- Convenient – Cutting, stripping, and crimping all in one design for quick wiring installation

Model No.	Material	HRC	Handle	Application	Replacement blade	OAL. (mm)	Individual packing
CP-376N	S45C	45°±3°	Black:T.P.R Green:PP	8P8C/RJ45, 6P2C/6P4C/6P6C RJ11/RJ12 End Pass plugs	5CP-376N-6PB 5CP-376N-8PB 5CP-376N-BLADE	210	Blister card
CP-376M				8P8C/RJ45, 6P2C/6P4C/6P6C RJ11/RJ12 modular plugs, RJ22 4P2C/4P4C handset modular plugs	508-376ER-B (2pcs/pack)	225	
CP-376ER				8P8C/RJ45, 6P2C/6P4C/6P6C RJ11/RJ12 modular plugs	508-376ER-B (2pcs/pack)	216	
CP-376D					508-376E-B (2pcs/pack)	200	

CP-376TA CAT.7 Modular Plug Crimping Tool

CAT.5, 6, 7 3 in 1



- Designed for RJ45 CAT. 5, 6, 7, UTP, STP & 8P8C, capable for cutting, stripping & crimping.
- Made from high quality carbon steel with black oxide plating for anti-rust ability.
- Ergonomic shaped PP+TPR dual color non-slip handles provides user's comfort.
- Ratchet mechanism design for crimping force saving & pressure released.
- Additional baffle from blade for user's safety.



Crimp Metal Clip



Cutting Wires



Stripping Round Cable

Material	HRC	Application	Replacement Blade	OAL (mm)	Individual packing
Handle: PP+TPR Body: S50C	45 ±3°	8P8C / RJ45 (UTP / STP) CAT.5 / CAT.6 / CAT.7	5CP-376TA-B (6 pcs/pack)	190	Blister card

808-376H / 808-376I / CP-376TR Modular Crimping Tool

808-376H

for 6P/8P modular plug



808-376I

for 6P/8P modular plug



CP-376TR

for 4P/6P/8P modular

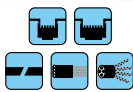

Ratchet Type

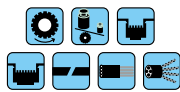

Ratchet Type

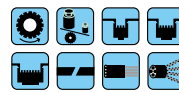

4/6/8P Crimping



Strips twisted pair wire



Cutting



Strips flat telephone wire

Model No.	Material	Hardness	Handle	Application	Replacement blade	OAL.(mm)	Individual packing
808-376H	Low carbon steel	HR30N 55-65	PP	8P8C/RJ45, 6P2C/6P4C/6P6C RJ11/ RJ12 modular plugs	5PK-376C-BLADE (6pcs/pack)	190	Blister card
808-376 I				8P8C/RJ45, 6P2C/6P4C/6P6C RJ11/ RJ12 modular plugs, RJ22 4P2C/4P4C handset modular plugs			
CP-376TR	S45C	HRC 45 ±3°	Black:T.P.R Green:PP	8P8C/RJ45, 6P2C/6P4C/6P6C RJ11/ RJ12 modular plugs, RJ22 4P2C/4P4C handset modular plugs			



5PK-376C-BLADE (6pcs/pack)

▶ CP-335 CAT.7 Modular Plug Crimping Tool



- Designed for crimping RJ-45 (UTP/STP 8P8C Cat.5/Cat.6/Cat.7), RJ12 (6P6C), and RJ11(6P4C/6P2C) modular plugs.
- Compact, rugged design provides good crimping result.
- Parallel action features precise crimping and force saving.
- Built-in security lock for easy storage

CAT.7 plug Parallel Action



Material		HRC	OAL (mm)	Individual packing
Handle	Body			
PVC	Medium carbon steel	RJ45 (UTP/STP 8P8C Cat.5/Cat.6/Cat.7), RJ12 (6P6C), RJ11(6P4C/6P2C)	137	Blister card



▶ CP-333 Modular Plug Crimping Tool

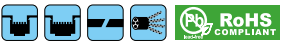

- For crimping RJ-45 (8P8C) and RJ-11/12 (6P6C/6P4C/6P2C) modular plugs.
- Reliable and consistent steel mechanical design with Parallel Action features precise crimping and force saving
- Built-in safety lock for safety and easy storage.
- Built-in eyelet for a lanyard provides convenient hanging.

Force Saving New Mechanism



Material		HRC	OAL (mm)	Individual packing
Handle	Body			
PVC	ABS + Carbon Steel	For stripping UTP/STP cable & cutting function For crimping RJ-45 (8P8C), RJ-11/12 (6P6C/6P4C/6P2C) modular plugs	143	Blister card



5CP-333-B (3pcs/pack)

▶ CP-373 Pro-Crimper Modular Tool

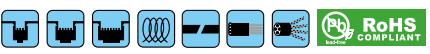

▶ CP-393 Pro-Crimper Modular Tool



Economic type



5PK-376C-BLADE (6pcs/pack)



Model No.	Material	Application	Replacement blade	OAL (mm)	Individual packing
CP-373	ABS+carbon steel	8P8C/RJ45, 6P2C/6P4C/6P6C RJ11 modular plugs, RJ-22 4P2C/4P4C handset modular plugs	5PK-376C-BLADE (6pcs/pack)	160	Blister card
CP-393			-		

▶ CP-376KX Pro-Crimper Modular Tool



Crimping



Cutting

Material	HRC	Handle	Application	OAL (mm)	Individual packing
Carbon Steel	45°±3°	TPR	8P8C/RJ-45, 6P6C, RJ12, 6P4C/RJ11, 4P4C & 4P2C/RJ22 plugs, & RJ11 / 6P6C DEC-Offset plugs	200	Blister card

▶ CP-376E Modular Crimping Tool

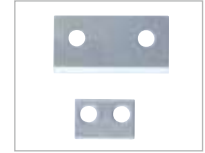
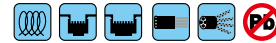

5CP-376E-B (2pcs/pack)

Material	Application	Replacement blade	OAL (mm)	Individual packing
Low carbon steel	8P8C/RJ45, 6P2C/6P4C/6P6C RJ11/RJ12 modular plugs	5CP-376E-B (2pcs/pack)	210	Blister card

▶ 808-376C Modular Crimping Tool



5PK-376C-BLADE (6pcs/pack)

Material	Hardness	Handle	Application
Low carbon steel	HR30N 55°~65°	PVC	8P8C RJ45 modular plugs
Replacement blade	OAL (mm)	Individual packing	
5PK-376C-BLADE (6pc/pack)	200	Blister card	

▶ 8PK-376FN Pro-Crimper Modular Tool

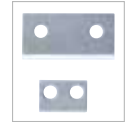

508-376E-B (2pcs/pack)

Material	Application	
Nylon + Fiber	8P8C/RJ45, 6P2C/6P4C/6P6C RJ11/RJ12 modular plugs, RJ22 4P2C/4P4C handset modular plugs	
Replacement blade	OAL (mm)	Individual packing
508-376E-B (2pcs/pack)	166	Blister card

▶ 8PK-CT004 Insertion/Extraction Tool



- RS-232 insertion & extraction use
- Red: insertion PIN, White: extraction PIN



Body	Handle	OAL (mm)	Individual packing
Metal	PP	102	Pouch

▶ 1PK-CT007 Double End Socket Can Wrench



- Uses to place fuses in cable terminals and connect wires to fuses and binding posts.
- 3/8" & 7/16" hex double end. Plastic handle.



Material	Handle	HRC	O.A.L (mm)	Individual packing
S45C	Plastic	45°±3°	180	Blister card

▶ CP-315/CP-313 Adjustable Compression Tool



RCA waterproof connectors



BNC waterproof connectors



F waterproof connectors



CP-315

CP-313



Material	HRC	Handle	Application	OAL (mm)	Individual packing
S45C	45°±5°	Nylon + Fiber	Connecting waterproof connectors BNC, F,RCA on RG58, RG59, RG6(3C, 4C, 5C) coaxial	120	Blister card

Material	HRC	Handle	Application	OAL (mm)	Individual packing
Carbon steel	40°±5°	ABS	Connecting waterproof connectors BNC, F,RCA on RG58, RG59, RG6(3C, 4C, 5C) coaxial	152	Blister card

▶ CP-147 4-In-1 Long Nose Electricians Plier



Aerospace Grade Steel Multi-function

Cutting / Stripping / Crimping /
Pulling / Gripping.

Material		HRC	
Body	Handle	Body	Cutting edge
55Cr-Ni Steel	PVC	43°±3°	60°±5°
Application		OAL. (mm)	Individual packing
Crimping: 1.25mm ² non-insulated terminals. Pulling & rolling: Ø1.6mm and Ø2.0mm copper Stripping: Ø1.2-1.6mm solid wire Cutting: Ø1.2mm hard steel, Ø2.0mm soft steel		163	Blister card



▶ CP-148 Telecom Combi-Crimper



- **Stripper:** 0.8 and 1.4mm stripping holes for AWG 24/22 & 20/18/16 (Ø0.5/0.6/0.8/1.0/1.3mm) wires.
- **Plier:** Long nose design for easy wire bending, pulling and holding.
- **Cutter:** Steel body with nick & black plating
- **Crimper:** For UR/UY/UG, AMP tel splice connector, 709 series connectors.



Material		HRC		OAL (mm)	Individual packing
Body	Handle	Body	Cutting edge		
S55C	PVC	42°-48°	55°-65°	168	Blister card



▶ 1PK-CT006 Splice & Crimp Tool



- Designed for UG, UR and UY connectors.
- A special stop behind cutout prevents connectors from damage.



Application	Crimp size
UR / UY / UG connectors	Solid copper wire UR:19 to 26 AWG UY:22 to 26 AWG UG:19 to 26 AWG
O.A.L (mm)	Individual packing
150	Blister card



▶ 8PK-CT005 Precision Crimping Tool W/Terminal



- Including terminal
- 0.5 x 6mm: 40pcs
 - 0.75 x 6mm: 40pcs
 - 1.0 x 6mm: 30pcs
 - 1.5 x 7mm: 20pcs
 - 2.5 x 7mm: 20pcs
- Terminal crimper



Material	HRC	Handle	OAL.(mm)
S45C	45°±3°	PVC	160
Application			Individual packing
Non-insulated cord end terminals AWG 23/22/20/18/17/15/13 DIN 0.25/ 0.34/0.5/ 0.75/1.0/1.5/2.5 mm ² JIS 0.25/0.3/0.5/0.75/1.0/1.25/2.5 mm ²			Blister card



▶ CP-806 Waterproof Connector Crimping Tool

- Compression tool for waterproof connectors such as RG-58, RG-59 & RG-6 (F, BNC, RCA) connectors.
- Advanced ratchet mechanism.
- Anti-slip handle for easy operation.



Material	Hardness	Handle	Application
SS41	HRC 45°±3°	TPR	Connecting waterproof connectors BNC,F,RCA on RG58, RG59, RG6 (3C, 4C, 5C) coaxial
OAL.(mm)		Individual packing	
205		Blister card	



▶ CP-384N D-Sub Contact Crimping Tool



30%
Force Saving



Crimp die profile	Application
	Non-insulated open barrel connectors for pipe width 2.0/2.54/3.96mm PH/XH/D-SUB/SM/EL/KF/ VH/CH/5557/2.8/4.8
Crimp size	OAL. (mm) Individual packing
AWG: 30-24/22-18 DIN/GB 0.05-0.25/0.5-1.0mm ² JIS 0.05-0.25/0.35-0.9mm ²	225 Blister card

▶ 608-384N D-Sub Contact Crimping Tool



For female & male D-SUB miniature contacts.



Material	HRC	Handle
AISI1050 DIE:AISI4140	45°±3°	PP
Crimp die profile	Application	
	Non-insulated open barrel connectors & D-SUB V.35 contact pins	
Crimp size	OAL. (mm) Individual packing	
AWG 30-24/22-18, DIN 0.05-0.25/0.50-1.0 mm ² JIS 0.05-0.25/0.35-0.9 mm ²	205 Blister card	

▶ 608-400 4 Way Indent Crimping Tool



- Used to crimp closed barrel, screw machine pin and socket style contacts.
- Performs a simultaneous 4 indent crimp for superior contact retention.



Material	HRC	Handle	Application
S50C	45°±3°	PVC	Crimping of closed-barrel RS-232 D-sub contacts. AWG 26-20 DIN 0.2-0.5 mm ² JIS 0.2-0.5 mm ²
OAL.(mm)	Individual packing		
162	Blister card		

▶ CP-463 D-Sub Contact Crimping Tool



4 Way to Crimping

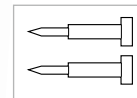

Material	HRC	Handle	Application
SPCC + carbon steel	45°±3°	PVC	Crimping of closed-barrel RS-232 D-sub contacts. AWG 20-12 DIN 0.5-4.0 mm ² JIS 0.5-3.5 mm ²
OAL.(mm)	Individual packing		
165	Blister card		

▶ CP-462G Wire Ferrule Crimp Tool-Square Crimp



Material	HRC	Handle	Application
S45C	45°±2°	PVC	Usable for cord end terminals AWG 28-7 DIN 0.08-10 mm ²
OAL.(mm)	Individual packing		
173	Blister card		

▶ 6PK-214 IDC Crimp Tool



For crimping IDC-type of connectors on ribbon cable.



Material	HRC	Handle	Application
Low Carbon steel Handle:PP	45°±3°	PP	IDC-type connectors
Crimp Size	OAL. (mm)	Individual packing	
Height: 6~27.5 mm Width(Max): 55 mm	240	Blister card	

▶ PM-804 Multi-Crimp Tool



- Wire cutter in nose.
- Plastic-coated handle.
- For crimping non-insulated terminals from 10 to 22 AWG.

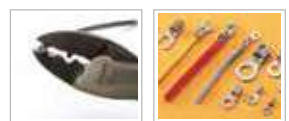

Material	Handle	HRC Body	Hard steel	Application	OAL. (mm)	Individual packing
S60C	PVC	42°±3°	ø1.6mm	Non-insulated terminal 10~22 AWG	248	Blister card

CP-353/CP-351B/CP-251B/CP-151B/CP-151A

Non-Insulated Terminals Ratchet Crimping Tool



35% Force Saving



CP-151A

CP-151B

CP-251B

CP-351B

CP-353



Material: AISI 4140
Hardness: HRC 40°~42°

Material: S45C
Hardness: HRC 43°~45°
Black oxide finished

Crimping pressure adjustment

Non-slip TPR handles

Ratcheting release trigger

Energy saving ratcheting design

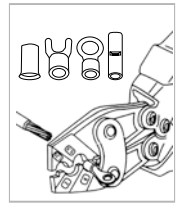

Wire size stamped on terminals

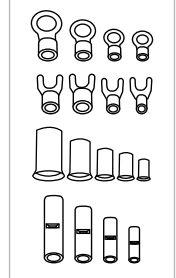

For non-insulated terminals

New Mechanism

Model No.	Material	HRC	Handle	Crimper die profile	Application	OAL (mm)	Individual packing
CP-151A	Frame: S45C Die: AISI 4140	40° - 42°	TPR		Non-insulated spade/ring terminals, AWG 20/16/14/12, DIN 0.75/1.5/2.5/4mm ² JIS 0.5/1.25/2.0/3.5mm ²	176	Blister card
CP-151B					Non-insulated spade/ring terminals, AWG 22-16/16-14/12/10, DIN 1.5/2.5/4.0/6.0 mm ² JIS 1.25/2.0/3.5/5.5 mm ²	176	
CP-251B					Non-insulated spade/ring terminals, AWG 22-16/16-14/12-10/8/6, DIN 1.5/2.5/6.0/10/16 mm ² JIS 1.25/2.0/5.5/8.0/14 mm ²	245	
CP-351B					Non-insulated spade/ring terminals, AWG 8/6/4/2, DIN 10/16/25/35 mm ² , JIS 8/14/22/38 mm ²	350	
CP-353					AWG 12-10 / 8 / 6 / 4, DIN 4-6 / 10 / 16 / 25 mm ² , JIS 5.5 / 8.0 / 14 / 22 mm ²	332	

8PK-CT120 / 8PK-CT150 Heavy Duty Crimping Tool



For terminating cable lugs from 10mm²-95mm² with non-ratchet screw adjustment design for aluminum AWG 8 to 4/0 and copper AWG 8 to 250 MCM (8PK-CT120) / 300MCM (8PK-CT150)

- The best crimping solution for heavy duty tinned terminals
- Adjustable crimp nests with clearly marked gauges
- Lightweighted and easy for operation
- Rugged cast steel construction for durability
- For terminating insulated and non-insulated cable lugs from AWG 8 to 250MCM copper and AWG 8 to 4/0 Aluminum



8PK-CT120



8PK-CT150



Model No.	Material	Handle	Crimper die profile	Application	OAL (mm)	Individual packing
8PK-CT120	Body: AISI 1021 Die: SCM440	FCD45		Cable lugs AWG 8, 6, 4, 2, 1/0, 2/0, 3/0, 250 MCM DIN 10, 16, 25, 35, 50, 70, 95, 120 mm ²	570	Color box
8PK-CT150	Body: Aluminum alloy Die: SCM 440	Iron pipe		Cable lugs AWG 8, 6, 4, 2, 1/0, 2/0, 3/0, 4/0, 5/0, 300MCM DIN 10, 16, 25, 35, 50, 70, 95, 120, 150mm ²	670	Inner box + Color label

PRECISION PLIERS & CUTTERS

Delicate Tool for Precise Work

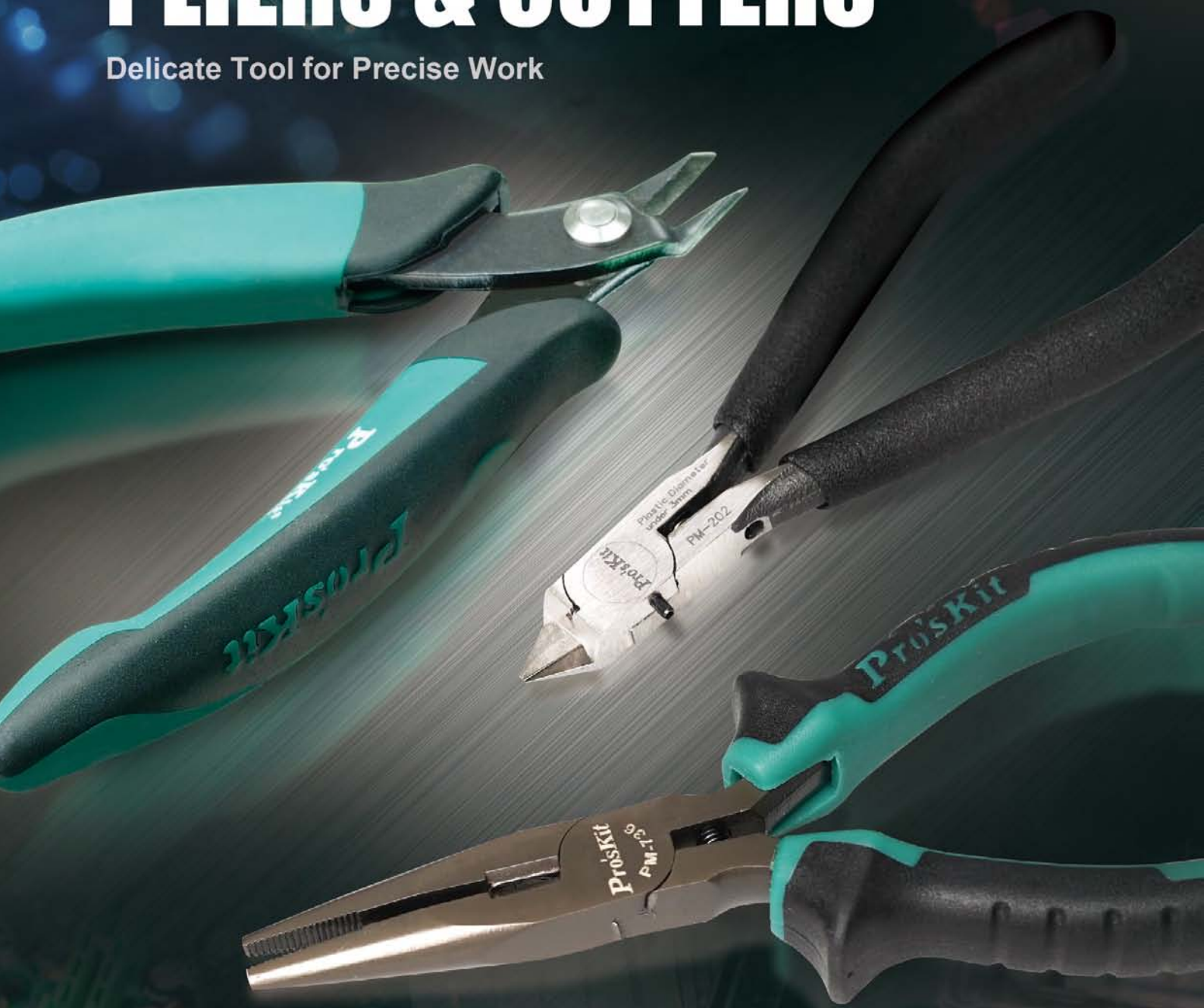

Pro'sKit[®]

886-2-22183233
Sales support

pk@mail.prokits.com.tw
E-mail

www.prokits.com.tw
Global website

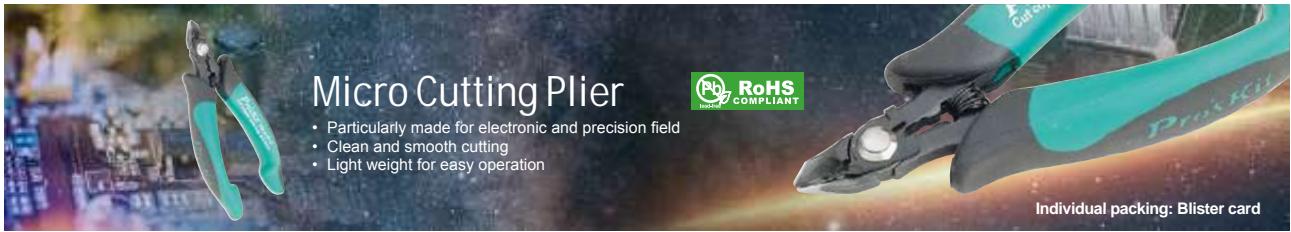

Micro Cutting Plier

- Particularly made for electronic and precision field
- Clean and smooth cutting
- Light weight for easy operation

Individual packing: Blister card

RoHS COMPLIANT

PM-5101-C Heavy Duty Cutting Plier



Safety clip
design prevents flying leads.

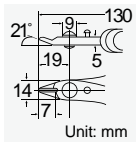

Material	HRC		Application Copper	OAL. (mm)
	Body	Cutting edge		
S50C	50'±3'	50'±3'	Ø 2.0mm	130

PM-30D Micro Cutting Plier

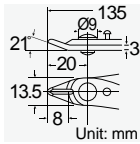

Material	HRC		Application Copper	OAL. (mm)
	Body	Cutting edge		
SK7	50'±3'	50'±3'	Ø 1.6mm	135

PM-101D Micro Cutting Plier

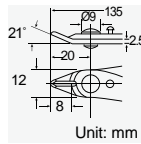

Material	HRC		Application Copper	OAL. (mm)
	Body	Cutting edge		
SK7	50'±3'	50'±3'	Ø 1.3mm	135

8PK-30D Micro Cutting Plier

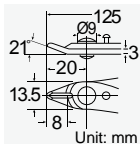

Material	HRC		Application Copper	OAL. (mm)
	Body	Cutting edge		
SK7	50'±3'	50'±3'	Ø 1.6mm	125

8PK-25PD Micro Cutting Plier

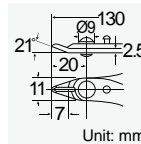

Material	HRC		Application Copper	OAL. (mm)
	Body	Cutting edge		
SK7	50'±3'	50'±3'	Ø 1.3mm	130

8PK-101D Micro Cutting Plier

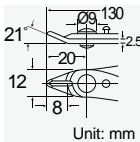

Material	HRC		Application Copper	OAL. (mm)
	Body	Cutting edge		
SK7	50'±3'	50'±3'	Ø 1.3mm	130

8PK-102D Long Nose Plier

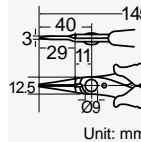

Material	HRC		OAL. (mm)
	Body	Cutting edge	
SK7	50'±3'		145

PRECISION PLIERS & CUTTERS



▶ 1PK-30-E Micro Cutting Plier

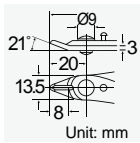

Material	HRC		Application	OAL. (mm)
	Body	Cutting edge		
SK7	50°±3°	50°±3°	Ø 1.6mm	125



▶ 1PK-211 Clean Cut Micro Nipper

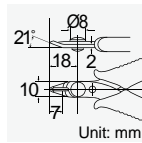

Material	HRC		Application	OAL. (mm)
	Body	Cutting edge		
SK7	50°±3°	50°±3°	Ø 0.8mm	120



▶ 1PK-209 Clean Cut Micro Nipper

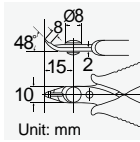

Material	HRC		Application	OAL. (mm)
	Body	Cutting edge		
SK7	50°±3°	50°±3°	Ø 0.6mm	120



▶ 1PK-101-E Micro Cutting Plier

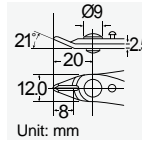

Material	HRC		Application	OAL. (mm)
	Body	Cutting edge		
SK7	50°±3°	50°±3°	Ø 1.3mm	130



▶ 1PK-5102-E Heavy Duty Long Nose Plier

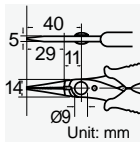

Material	HRC		Application	OAL. (mm)
	Body	Cutting edge		
S50C	50°±3°			140



▶ 1PK-5101-E Heavy Duty Cutting Plier

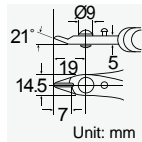

Material	HRC		Application	OAL. (mm)
	Body	Cutting edge		
S50C	50°±3°	50°±3°	Ø 2.0mm	125



▶ 1PK-5101-CE Heavy Duty Cutting Plier



Safety clip
design prevents flying leads.

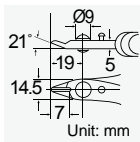

Material	HRC		Application	OAL. (mm)
	Body	Cutting edge		
S50C	50°±3°	50°±3°	Ø 2.0mm	125



▶ 1PK-25P-E Micro Cutting Plier

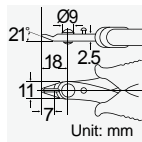

Material	HRC		Application	OAL. (mm)
	Body	Cutting edge		
SK7	50°±3°	50°±3°	Ø 1.3mm	130



▶ 1PK-25P-CE Micro Cutting Plier



Safety clip
design prevents flying leads.

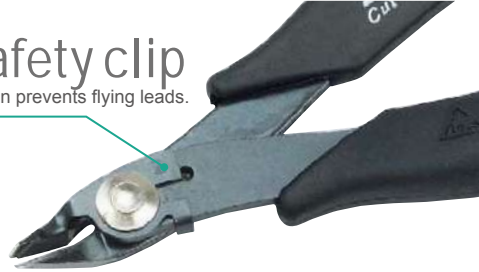
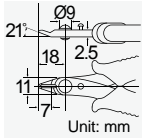

Material	HRC		Application Copper	OAL. (mm)
	Body	Cutting edge		
SK7	50 \pm 3 $^\circ$	50 \pm 3 $^\circ$	\varnothing 1.3mm	130

▶ 1PK-105-E Bent Nose Plier

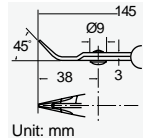

Material	HRC		OAL. (mm)
	Body		
SK7	50 \pm 3 $^\circ$		145

▶ 1PK-104-E Flat Nose Plier

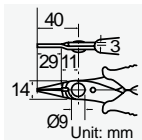

Material	HRC		OAL. (mm)
	Body		
SK7	50 \pm 3 $^\circ$		145

▶ 1PK-102-E Long Nose Plier

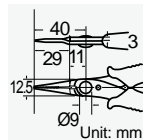

Material	HRC		OAL. (mm)
	Body		
SK7	50 \pm 3 $^\circ$		145

▶ PM-396H Stainless Flat Nose Plier

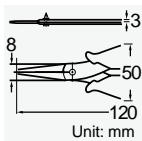

Material	HRC	OAL. (mm)
AISI 420	43 \pm 3 $^\circ$	120

▶ PM-396G Stainless Long Nose Plier

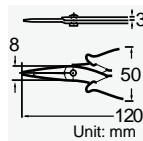

Material	HRC	OAL. (mm)
AISI 420	43 \pm 3 $^\circ$	120

▶ PM-396F Stainless Cutting Plier

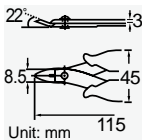

Material	HRC	Application	OAL. (mm)
		Copper	
AISI 420	48 \pm 3 $^\circ$	\varnothing 1.3mm	115

▶ PM-396I Stainless Bent Nose Plier

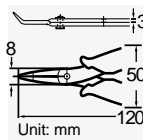

Material	HRC	OAL. (mm)
AISI 420	43 \pm 3 $^\circ$	120

PRECISION PLIERS & CUTTERS

PM-107C/PM-107 Micro Cutting Pliers



- Clean and smooth cutting
- Light for easy operation
- Particularly made for electronic and precision field

PM-107C

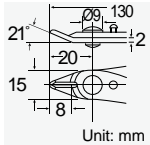

Safety clip
design prevents flying leads.

Made of high quality carbon steel
Material: SK5
Hardness: HRC50 \pm 3*



PM-107



Individual packing: Blister card

Model NO.	Material	HRC		Application		OAL. (mm)
		Body	Cutting edge	Soft Steel	Copper	
PM-107	SK5	50 \pm 3*	50 \pm 3*	Ø 0.8mm	Ø 1.6mm	130
PM-107C				Ø 0.8mm	Ø 1.6mm	

8PK-101KM Heavy Duty Cutting Plier

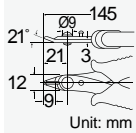

Individual packing: Blister card

Material	HRC		Application		OAL. (mm)
	Body	Cutting edge	Soft steel	Copper	
SAE 1085	55 \pm 3*	55 \pm 3*	Ø 1.2mm	Ø 2.3mm	145

1PK-066N 2 in 1 Wire Stripper/Cutter



Individual packing: Blister card

Material	HRC		Application	OAL. (mm)
	Body	Cutting edge		
AISI 420	48 \pm 3*	48 \pm 3*	Cutter: Ø 1.2mm Stripper: 0.4~1.6mm ² (26~14AWG)	130

8PK-101K Micro Cutting Plier

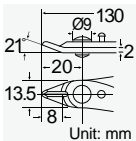

Individual packing: Blister card

Material	HRC		Application		OAL. (mm)
	Body	Cutting edge	Soft steel	Copper	
SK5	50 \pm 3*	55 \pm 3*	Ø 0.8mm	Ø 1.6mm	130

PA-101 Micro Cutting Plier

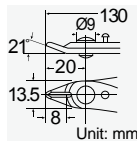

Individual packing: Blister card

Material	HRC		Application	OAL. (mm)
	Body	Cutting edge		
65Mn	50 \pm 2*	50 \pm 2*	Ø 1.3mm	130

1PK-396B Long Nose Plier

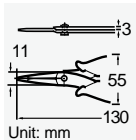

Individual packing: Blister card

Material	HRC		OAL. (mm)
	Body	Cutting edge	
420J2	48 \pm 3*	48 \pm 3*	130

1PK-396A Cutting Plier

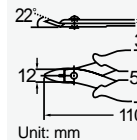

Individual packing: Blister card

Material	HRC		Application	OAL. (mm)
	Body	Cutting edge		
420J2	48 \pm 3*	48 \pm 3*	Ø 1.3mm	110

▶ 1PK-501E Micro Long Nose Plier

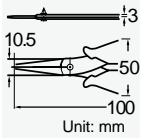

Individual packing: Blister card

Material	HRC Body	OAL. (mm)
420J2	48°±3°	100

▶ 1PK-501A Micro Cutting Plier

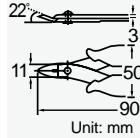

Individual packing: Blister card

Material	HRC Body	Application Copper	OAL. (mm)
420J2	48°±3°	Ø 1.3mm	90

▶ 1PK-501C Micro Bent Nose Plier

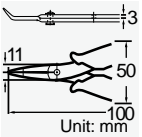

Individual packing: Blister card

Material	HRC Body	OAL. (mm)
420J2	48°±3°	100

▶ PM-251 Cutting Plier

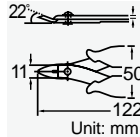

Individual packing: Blister card

Material	HRC Body	Application Copper	OAL. (mm)
420J2	48°±3°	Ø 1.3mm	122

▶ 1PK-258B Long Nose Plier

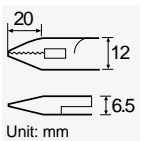
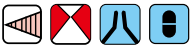

Individual packing: Blister card

Material	HRC Body	Application Copper	OAL. (mm)
S55C	43°±3°	53°±3°	Ø 1.0mm

▶ 1PK-258A Side Cutter

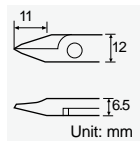

Individual packing: Blister card

Material	HRC Body	Application Copper	OAL. (mm)
S55C	43°±3°	53°±3°	Ø 1.0mm

▶ 1PK-5101 Heavy Duty Cutting Plier

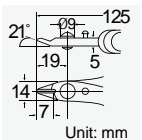

Individual packing: Blister card

Material	HRC Body	Application Copper	OAL. (mm)
S50C	50°±3°	50°±3°	Ø 2.0mm

▶ 1PK-5101-C Heavy Duty Cutting Plier



Safety clip design prevents flying leads.

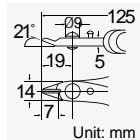

Individual packing: Blister card

Material	HRC Body	Application Copper	OAL. (mm)
S50C	50°±3°	50°±3°	Ø 2.0mm

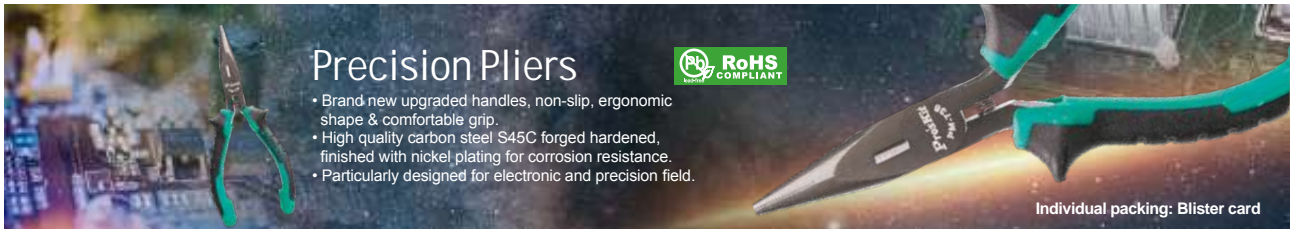

Precision Pliers



- Brand new upgraded handles, non-slip, ergonomic shape & comfortable grip.
- High quality carbon steel S45C forged hardened, finished with nickel plating for corrosion resistance.
- Particularly designed for electronic and precision field.

Individual packing: Blister card

▶ PM-731 Mini Lineman's Plier

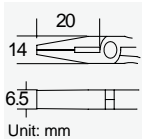

Material	HRC		Application	OAL. (mm)
	Body	Cutting edge	Copper	
S45C	43°±3°	50°~55°	Ø 1.0mm	118

▶ PM-736 Long Nose Plier

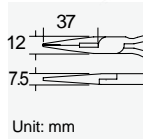

Material	HRC		Application	OAL. (mm)
	Body	Cutting edge	Copper	
S45C	43°±3°	50°~55°	Ø 1.0mm	132

▶ PM-737 Diagonal Cutting Plier

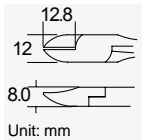

Material	HRC		Application	OAL. (mm)
	Body	Cutting edge	Copper	
S45C	43°±3°	50°~55°	Ø 1.0mm	109

▶ PM-746 Needle Nose Plier

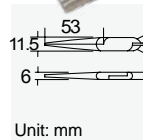

Material	HRC		OAL. (mm)
	Body		
S45C	43°±3°		150

▶ PM-754 Flat Nose Plier

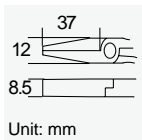

Material	HRC		OAL. (mm)
	Body		
S45C	43°±3°		135

▶ PM-755 Bent Nose Plier

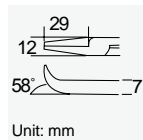

Material	HRC		OAL. (mm)
	Body		
S45C	43°±3°		128

PRECISION PLIERS & CUTTERS



Precision Pliers with Plastic Coated Handles

- Quality carbon steel S45C by hot drop forged.
- Cutting edge additionally hardened and tempered.



Aerospace Steel Pliers

- Made of 55Cr-Ni steel, the same grade of aerospace steel, which is hardened and tempered for strength and long time use.
- Ergonomically shaped double injected handle for user comfort.

Individual packing: Blister card

▶ 1PK-717 Micro Diagonal Cutting Plier

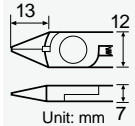

Material	Body	Handle	HRC		Application			OAL. (mm)
			Body	Cutting edge	Soft steel	Copper		
S55C		PVC	41°±4°	60°±2°	Ø 1.3mm	Ø 2.0mm	124	

▶ PM-071 Flush Diagonal Cutting Plier

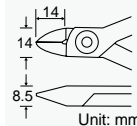

Material	Body	Handle	HRC		Application			OAL. (mm)
			Body	Cutting edge	Hard steel	Soft steel	Copper	
55Cr-Ni			43°±3°	60°±5°	Ø 0.8mm	Ø 1.3mm	Ø 1.6mm	117

▶ 1PK-706 Long Nose Plier

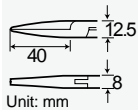

Material	Body	Handle	HRC		Application			OAL. (mm)
			Body	Cutting edge	Hard steel	Soft steel	Copper	
S45C		PVC	45°±3°	48°±3°	Ø 0.8mm	Ø 1.3mm	Ø 1.6mm	135

▶ PM-072 Long Nose Plier

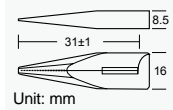

Material	Body	Handle	HRC		Application			OAL. (mm)
			Body	Cutting edge	Hard steel	Soft steel	Copper	
55Cr-Ni			43°±3°	60°±5°	Ø 0.8mm	Ø 1.6mm	135	

▶ 1PK-705 Diagonal Cutting Plier

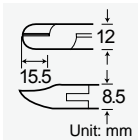

Material	Body	Handle	HRC		Application			OAL. (mm)
			Body	Cutting edge	Soft steel	Copper		
S55C		PVC	41°±4°	60°±2°	Ø 1.3mm	Ø 2.0mm	128	

▶ PM-073 Transverse End Cutting Plier

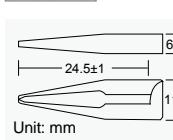

Material	Body	Handle	HRC		Application			OAL. (mm)
			Body	Cutting edge	Soft steel	Copper		
55Cr-Ni			43°±3°	60°±5°	Ø 0.8mm		123	

▶ PM-905F/PM-905FHC Diagonal Cutting Plier



- Hot drop forged quality carbon steel.
- Cutting edge is additionally hardened and tempered.
- Precision cutting edge for soft wire and hard wire.
- With wire spring for self-opening action provides smooth operation.



PM-905F

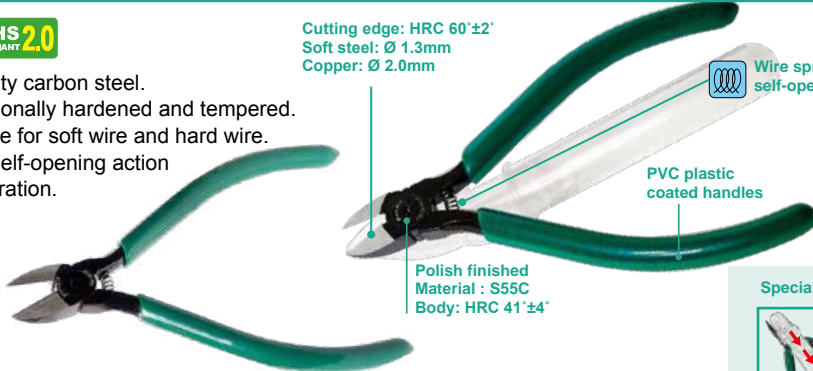

PM-905FHC
with cut lead catcher

Special design with Cut Lead Catcher



Connection with tube



For cutting and control IC pin ends

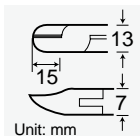

Model No.	Material	Body	HRC		Application			OAL. (mm)
			Body	Cutting edge	Hard steel	Soft steel	Copper	
PM-905F	S55C		41°±4°	60°±2°	Ø0.8mm	Ø1.3mm	Ø2.0mm	128
PM-905FHC								

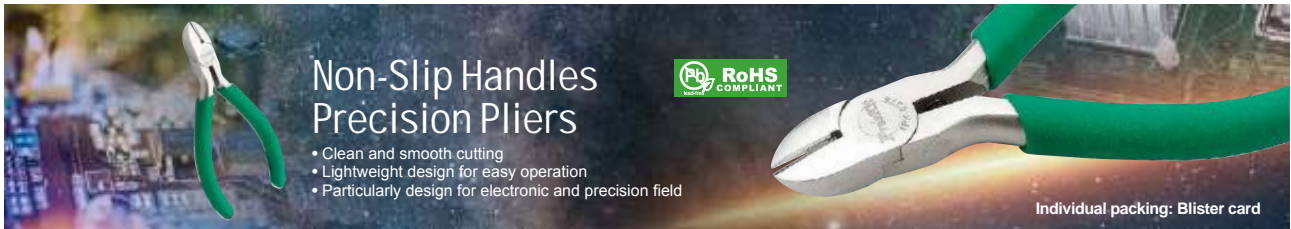

▶ 1PK-055S Bent Nose Plier

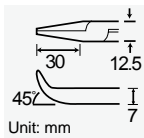

Material	HRC		OAL. (mm)
	Body	Body	
S45C	43'±3'		130

▶ 1PK-054S Flat Nose Plier

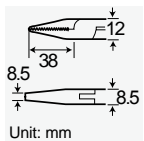

Material	HRC		OAL. (mm)
	Body	Body	
S45C	43'±3'		135

▶ 1PK-046S Needle Nose Plier

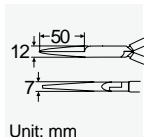

Material	HRC		OAL. (mm)
	Body	Body	
S45C	43'±3'		150

▶ PM-711 Precision Cutting Plier

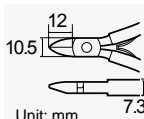

Material	HRC		Application	OAL. (mm)
	Body	Cutting edge		
AISI 6140	45'±3'	61'±3'	Ø 2.0mm	120

▶ 1PK-037S Diagonal Cutting Plier

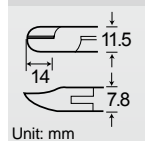

Material	HRC		Application			OAL. (mm)
	Body	Cutting edge	Hard steel	Soft steel	Copper	
S45C	43'±3'	48'±3'	Ø 0.8mm	Ø 1.3mm	Ø 1.6mm	110

▶ 1PK-036S Long Nose Plier

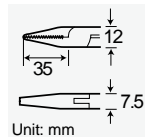

Material	HRC		Application		OAL. (mm)
	Body	Cutting edge	Hard steel	Copper	
S45C	43'±3'	48'±3'	Ø 0.8mm	Ø 1.6mm	136

▶ PM-712 Extra Long Nose Plier

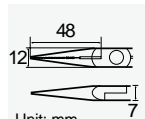

Material	HRC		Application		OAL. (mm)
	Body	Cutting edge	Hard steel	Copper	
AISI 6140	45'±3'	61'±3'	Ø 0.8mm	Ø 2.0mm	155

PRECISION PLIERS & CUTTERS



Tungsten Steel Cutters



Tungsten steel cutting edge, hardness of HRC up to 72 ±2* provides high durability, long service life and anti-rust.

Individual packing: Blister card

PM-956 Tungsten Diagonal Cutting Plier

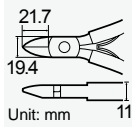

Material	HRC		Application			OAL. (mm)
	Body	Cutting edge	Piano wire	Soft steel	Copper	
SAE6140+ Tungsten	45° ±3°	72° ±2°	Ø0.5mm (under HRC: 50°)	Ø 1.6 mm	Ø 2.0 mm	160

PM-955 Tungsten Diagonal Cutting Plier

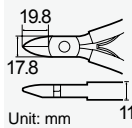

Material	HRC		Application			OAL. (mm)
	Body	Cutting edge	Piano wire	Soft steel	Copper	
SAE6140+ Tungsten	45° ±3°	72° ±2°	Ø0.5mm (under HRC: 50°)	Ø 1.6 mm	Ø 2.0 mm	130

PM-925 Tungsten Diagonal Cutting Plier

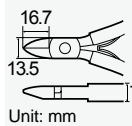

Material	HRC		Application			OAL. (mm)
	Body	Cutting edge	Piano wire	Soft steel	Copper	
SAE6140+ Tungsten	45° ±3°	72° ±2°	Ø0.5mm (under HRC: 50°)	Ø 1.6 mm	Ø 2.0 mm	125

1PK-705Y Side Cutting Plier

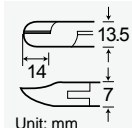
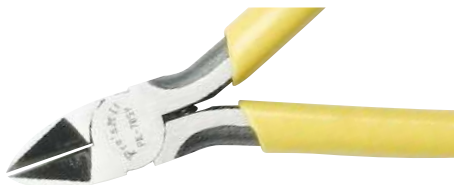

Material	HRC		Application			OAL. (mm)
	Body	Hard steel	Soft steel	Copper		
S45C	48° ±3°	Ø 0.8mm	Ø 1.6mm	Ø 2.0mm	125	

8PK-906 Long Nose Plier

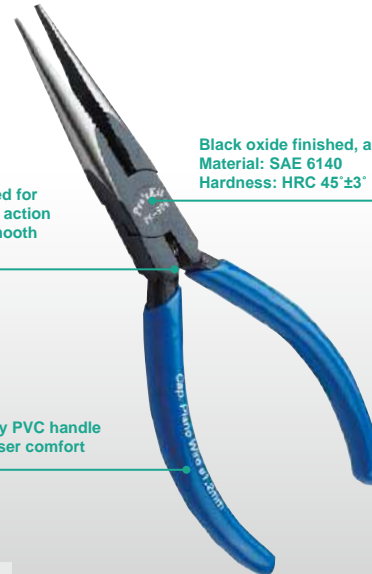

Black oxide finished, anti-rust
Material: SAE 6140
Hardness: HRC 45° ±3°

Spring-loaded for self-opening action to supply smooth operation

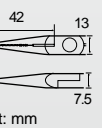

Material	HRC		Application		OAL. (mm)
	Body	Cutting edge	Piano wire		
SAE 6140	45° ±3°	62° ±3°	Ø1.2mm (under HRC: 45°)	140	

8PK-905 Cutting Plier

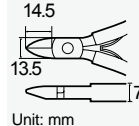

Material	HRC		Application		OAL. (mm)
	Body	Cutting edge	Piano wire		
SAE 6140	45° ±3°	62° ±3°	Ø0.5mm (under HRC: 45°)	125	

1PK-706Y Long Nose Plier

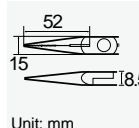

Material	HRC		Application			OAL. (mm)
	Body	Hard steel	Soft steel	Copper		
S55C	45° ±3°	Ø 0.8mm	Ø 1.6mm	Ø 2.0mm	160	

PRECISION PLIERS & CUTTERS

▶ PM-200/PM-202 Plastic Modeler Side Cutter/Single Blade Model Nipper



PM-200
Ultra Sharp
High Hardness

Special designed for plastic model kits.
Clean cuts PP, PS, PE, ABS, etc.

Individual packing: Blister card

PM-202
Extreme Sharp
Single Blade

⚠ Plastic Cutting Only

Model No.	Material		HRC	
	Body	Handle	Body	Cutting Edge
PM-200	SK5	TPR	54°±1°	54°±1°
PM-202	65CRM	PVC	44°±1°	62°±2°
Application			OAL. (mm)	
Plastic ≦ Ø 3.0mm (PP, PS, PE, ABS, etc.)			137	
			120	

▶ PM-805E Plastic Cutting Plier

⚠ Plastic Cutting Only
Individual packing: Blister card

19
17
8
Unit: mm

Material	HRC		Application	OAL. (mm)
	Body	Cutting edge		
S55C	45°±3°	55°±3°	Plastic	135

▶ PM-806E Plastic Cutting Plier

⚠ Plastic Cutting Only
Individual packing: Blister card

21
19
8.5
Unit: mm

Material	HRC		Application	OAL. (mm)
	Body	Cutting edge		
S55C	45°±3°	55°±3°	Plastic	160

▶ PM-807E Plastic Cutting Plier

⚠ Plastic Cutting Only
Individual packing: Blister card

25
23
10.5
Unit: mm

Material	HRC		Application	OAL. (mm)
	Body	Cutting edge		
S55C	45°±3°	55°±3°	Plastic	185

▶ PM-805F Plastic Cutting Plier

Individual packing: Blister card

19.5
16.5
9.5
Unit: mm

Material	HRC		Application		OAL. (mm)
	Body	Handle	Soft steel	Copper	
S55C	PVC	41°±4°	60°±2°	Ø 1.3mm Ø 2.0mm	130

▶ PM-806F Plastic Cutting Plier

Individual packing: Blister card

21.5
18.4
10.5
Unit: mm

Material	HRC		Application		OAL. (mm)
	Body	Handle	Soft steel	Copper	
S55C	PVC	41°±4°	60°±2°	Ø 1.3mm Ø 2.0mm	159

▶ PM-806A Plastic Oblique Cutting Plier

Individual packing: Blister card

19
18
22.5
10.2
Unit: mm

Material	HRC		Application	OAL. (mm)
	Body	Cutting edge		
S55C	45°±3°	61°±3°	Hard steel: Ø0.8mm Copper: Ø2.0mm	150

▶ PM-806B Plastic End Cutting Plier

Individual packing: Blister card

11.5
19.5
11
Unit: mm

Material	HRC		Application	OAL. (mm)
	Body	Cutting edge		
S55C	45°±3°	61°±3°	Hard steel: Ø0.8mm Copper: Ø2.0mm	150

ELECTRICAL PLIERS & CUTTERS

Sturdy, Force-Saving, makes your work easy.



Pro'sKit[®]

886-2-22183233
Sales support

pk@mail.prokits.com.tw
E-mail

www.prokits.com.tw
Global website

▶ 1PK-051DS/1PK-052DS/1PK-067DS/1PK-709DS Dual Color Lineman's Pliers



High Leverage Design
Non-Slip Handle
55 CrNi Steel



1PK-709DS



1PK-067DS



1PK-052DS



1PK-051DS

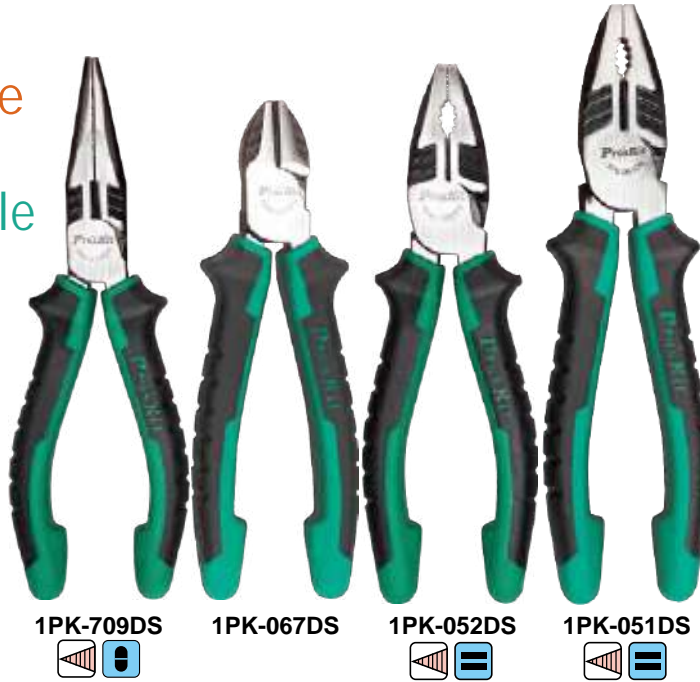

Model No.	Material	HRC		Application			OAL. (mm)	Individual packing
		Body	Cutting edge	Hard steel	Soft steel	Copper		
1PK-051DS	55CrNi	45°±3'	60°±5'	Ø2.5mm	Ø3.0mm	Ø3.2mm	205	Blister card
1PK-052DS				Ø2.0mm	Ø3.0mm	Ø3.2mm	162	
1PK-067DS				Ø2.0mm	Ø2.4mm	Ø3.2mm	165	
1PK-709DS				Ø1.8mm	Ø2.0mm	Ø2.6mm	166	

▶ PM-941/PM-942/PM-943 Angled Combination Plier



45° Angled Head
High Leverage Design
Forged Blade



PM-941



PM-942



PM-943

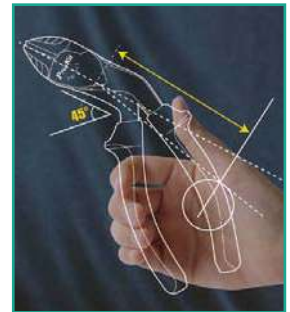
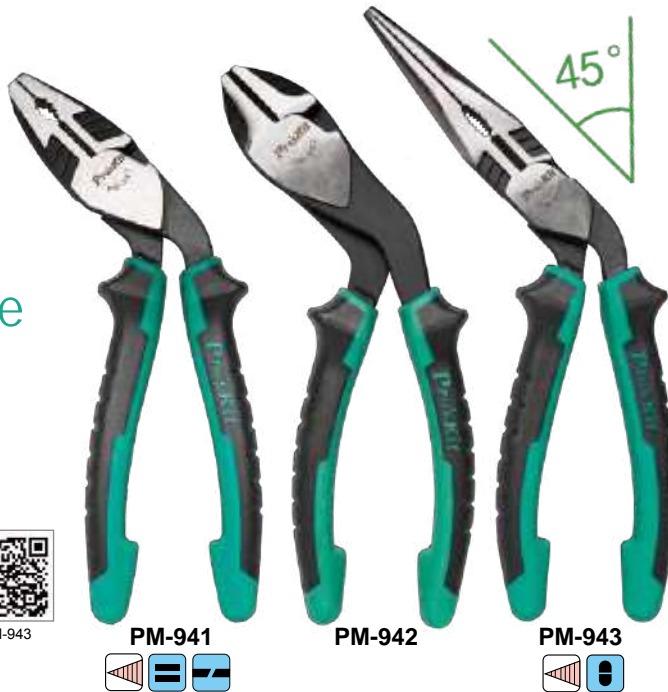

Model No.	Material	HRC		Application			OAL. (mm)	Individual packing
		Body	Cutting edge	Hard steel	Soft steel	Copper		
PM-941	55CrNi	45°±3'	60°±5'	Ø2.0mm	Ø3.0mm	Ø3.2mm	188	Blister card
PM-942				Ø2.0mm	Ø3.0mm	Ø3.2mm	170	
PM-943				Ø2.0mm	Ø2.6mm	Ø2.6mm	192	

ELECTRICAL PLIERS & CUTTERS

▶ PM-921 8" High Leverage Lineman's Plier

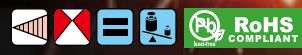

RoHS COMPLIANT



High leverage design requires 20% less force than traditional type

Aerospace Steel
high hardness and good corrosion resistance

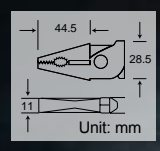

Individual packing: Blister card

Material	HRC		Application				OAL. (mm)
	Body	Cutting edge	Hard steel	Soft steel	Copper	Piano wire	
55Cr-Ni steel	44°±3°	60°±5°	Ø1.2mm	Ø2.6mm	Ø3.2mm	Ø2.0mm	207



Serrated jaw for firm gripping



Screw/unscrew specially for stripped thread



Cutting capability for 2.0mm Piano wire

▶ 1PK-709 Long Nose Plier

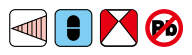

Individual packing: Blister card

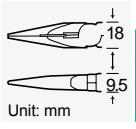

Material	HRC		Application			OAL. (mm)
	Body	Hard steel	Soft steel	Copper		
S60C	48°±3°	Ø1.2mm	Ø 2.0mm	Ø2.6mm	160	

▶ 1PK-067 Side Cutting Plier



Individual packing: Blister card

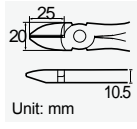

Material	HRC		Application			OAL. (mm)
	Body	Hard steel	Soft steel	Copper		
S60C	48°±3°	Ø1.2mm	Ø 2.0mm	Ø2.6mm	160	

▶ 1PK-051 Lineman's Plier

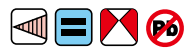

Individual packing: Blister card

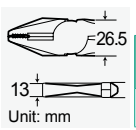

Material	HRC		Application			OAL. (mm)
	Body	Hard steel	Soft steel	Copper		
S60C	48°±3°	Ø1.2mm	Ø 2.6mm	Ø3.2mm	210	

▶ 1PK-052 Lineman's Plier



Individual packing: Blister card

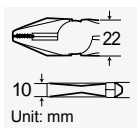

Material	HRC		Application			OAL. (mm)
	Body	Hard steel	Soft steel	Copper		
S60C	48°±3°	Ø1.2mm	Ø 2.2mm	Ø3.0mm	165	

ELECTRICAL PLIERS & CUTTERS

PM-901 / PM-903 Lineman's Plier

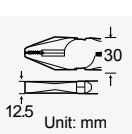
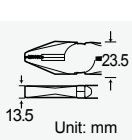

- **Quality Cr-V steel** guarantees longer service life time and good cutting performance.
- **High leverage** force saving design.



Individual packing: Blister card

Model No.	Material	HRC		Application	OAL. (mm)
		Body	Cutting edge		
PM-901	SAE 6150	45°±3°	60°±2°	Piano wire: Ø2.5mm (under HRC: 45°)	215
PM-903					225

PM-908 Side Cutting Plier



- 2 Skinning notches for stripping insulation wire Ø1.5, 2.0mm.
- TPR Handle for user comfort.



Individual packing: Blister card

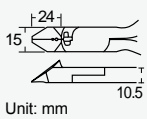

Material	HRC		Application	OAL. (mm)
	Body	Cutting edge		
SAE 6150	45°±3°	60°±2°	Ø 1.4mm	160

PM-909 Long Nose Plier



- Long nose plier with coarser-toothed midsection and crosswise serrated for firm gripping and more work application.



Individual packing: Blister card

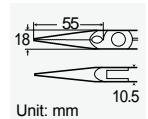

Material	HRC		Application	OAL. (mm)
	Body	Cutting edge		
SAE 6150	45°±3°	60°±2°	Piano wire: Ø1.2mm	170

PM-708Y Side Cutting Plier

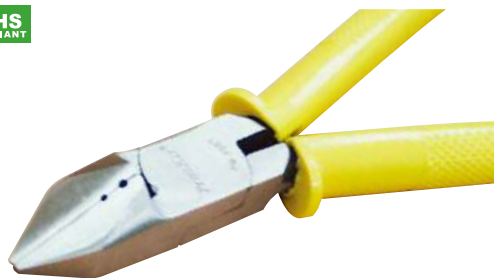

Individual packing: Blister card

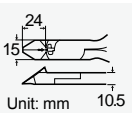

Material	HRC		Application	OAL. (mm)
	Body	Cutting edge		
S55C	45°±3°	55°±5°	Ø 1.6mm	158

1PK-709Y Long Nose Plier



Individual packing: Blister card

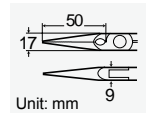

Material	HRC		Application			OAL. (mm)
	Body	Cutting edge	Hard steel	Soft steel	Copper	
S55C	45°±3°	55°±3°	Ø1.2mm	Ø2.0mm	Ø2.6mm	165

▶ PN-P110 Raptor 10" Pump Plier



2X Faster Positioning
Aerospace Steel
Force Saving

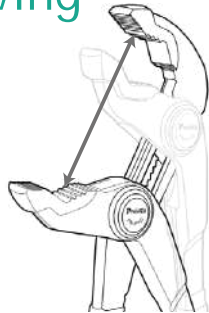

Individual packing: Blister card



Material	HRC		Jaw open (Max)	Jaw depth (Max)	OAL. (mm)
	Body	Jaw			
55Cr-Ni steel	38°±3°	55°±5°	45mm	37mm	253

▶ PN-P010N Slip-Channel Pump Plier



- Pearl-nickel plated.
- High quality carbon steel drop forged, hardened and tempered.
- Non-slip, plastic coated handle.
- 5-position milled jaws joint with pinch protection.

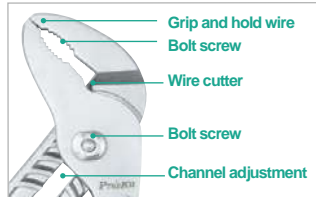

Individual packing: Blister card

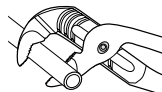

Versatile jaws to fit round tubes.

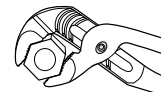

Adjustable jaw to accommodate with hex head screws.

Material	HRC	Handle	Channel adjustment	Max jaw open (A)	Max jaw open (B)	OAL. (mm)
	Body					
S45C	45°±3°	PVC	6 Position	42mm	32mm	254

▶ PN-086N Slip Joint Plier



- Slip joint pliers with wire cutter.
- High quality carbon steel drop forged, hardened and tempered.
- With 2-position milled jaws to meet different requirements.
- Plastic coated handles, non-slip.

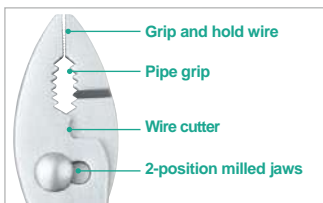

Individual packing: Blister card



Material	HRC	Handle	OAL.(mm)
	Body		
S45C	38°±3°	PVC	154

▶ PN-378D/PN-378E Adjustable Locking Plier 9" Long Nose Locking Plier 9"



PN-378D(9")
Individual packing:
Double blister



PN-378E(9")
Individual packing:
Double blister

Model No.	Material		HRC	Clamping width	OAL. (mm)
	Head	Handle	Body		
PN-378D	SAE 4140 Cr-Mo alloy steel	SAE 4135 Cr-Mo alloy steel	50°±3°	Round: Ø8.5-50mm, Hex: Ø8.5-43.3mm	224(9")
PN-378E	SAE 4140 Cr-Mo alloy steel	SAE 4135 Cr-Mo alloy steel	50°±3°	Round: Ø7.5-41mm, Hex: Ø7.5-35.41mm	225(9")

ELECTRICAL PLIERS & CUTTERS

▶ 608-330 Round Cable Cutter



• Safety lock for easy storage.



Individual packing: Blister card

Material	HRC Body	Handle	Application	OAL. (mm)
S45C	45°±3°	PVC	Cutting multi-conductor cable up to 0.5" (12.7mm) and stranded wire up to 8 AWG (10mm²)	165

▶ SR-015 Nibbling Tool



Individual packing: Blister card

Material	HRC Body	Application	Replacement blade	OAL. (mm)
Body:FCD45 Blade:S45C	45°±3°	Cut up to 18AWG soft steel, 1/16" copper, Aluminum and plastic	9SR-015-B	184

▶ 8PK-249 Snap Ring Plier Set



3 convertible tip jaws can be changed easily for 6 different internal-external purposes.



Individual packing: Blister card

Material	Handle	HRC Body	Application	OAL. (mm)
S45C	PVC	43°±3°	Effective range: 10-50mm	155

▶ 808-330A Round Cable Cutter



• Safety lock for easy storage.



Individual packing: Blister card

Material	HRC Body	Handle	Application	OAL. (mm)
S45C	45°±3°	PVC	Cutting thick wire up to 2/0 (70m²) cable, 100 pair group telephone cable RG-174/RG-9 coax size	215

▶ 8PK-CT006 Wire Rope And Cable Armour Cutter



• Special cutting action for cutting stranded cable armour, electric cable, metal wire and rods.
• Distortion free cut.



Individual packing: Poly bag

Material	Handle	Hardness Body	Application	OAL. (mm)
SK5	PVC	60°±4°	Cutting capability: wire rope Ø4mm spring wire Ø1.5mm	190

▶ CP-311 Strain Relief Bushing Assembly Tool



• Designed to install all sizes of strain relief bushing.
• Close lock and return spring function.



Individual packing: Blister card

Material	Handle	Hardness Body	Application	OAL. (mm)
Low carbon steel	PVC	HR30N58°	Thickness:3mm	170

▶ SR-363A/SR-363B 2 in 1 Round Cable Cutter & Stripper



• The stripper is processed by CNC machining process to ensure its accuracy.
• Ideal for cutting multi-conductor round cable up to 10.7mm (Ø 0.42") and stripping wire.



Cutting round cable



Stripping



SR-363A



SR-363B

Individual packing: Blister card

Model No.	Material		HRC Body	Application	OAL. (mm)
	Handle	Body			
SR-363A	TPR	SK5	54°±3°	Stripping AWG 14/12/10/8 Cutting round cable up to 10.7mm	168
SR-363B			54°±3°	Stripping AWG 20/18/16/14/12/10 Cutting round cable up to 10.7mm	168

▶ 8PK-A202/8PK-A203/8PK-A201A Forged Cable Cutter



- High-leverage jaw with shear-cut blades.
- Plastic coated handle.
- Do not cut steel or ACSR.



Cuts up to 70mm² aluminum and copper cables (8PK-A201A)



8PK-A202



8PK-A203



8PK-A201A



Individual packing: Blister card

Model No.	Material	HRC		Handle	Application		OAL.(mm)
		Body	Cutting edge		Copper cable	Aluminum cable	
8PK-A202	SCM 440	45°±3°	60°±5°	PVC	25mm ² flexible	25mm ² stranded	160
8PK-A203					38mm ² flexible	38mm ² stranded	210
8PK-A201A	S45C				16mm ² solid, 35mm ² stranded, 70mm ² flexible	70mm ² stranded	235

▶ 6PK-535 Round Cable Cutter



- Ratchet design for force saving.
- Cut up to 350 MCM copper 500 MCM Al-jacketed S.O. cord up to Ø32mm or up to 200 pair communication cable.



Individual packing: Blister card

Material	Blade	Hardness		Handle
		Body	Cutting edge	
Low carbon steel	SAE 4340	HR 30N 55°~70°	HRC 45°±3°	PVC
Application		Replacement blade		OAL.(mm)
Hard steel				
Ø32mm copper & aluminum cable		5PK-535-RB(Moving blade) 5PK-535-FB(Fixed blade)		254

▶ SR-538 Ratchet Cable Cutter



- Unique ratchet mechanism design ensures a non-slip cut, and increases cutting power on tough jobs
- For aluminum and soft copper cables up to Ø52mm



Cutting cables up to 700MCM (350mm²)



⚠ Not designed for cutting steel or ACSR

Individual packing: Blister card



Material	Blade	Cutting edge	Handle
S45C	SAE 4340	HRC 46°±2°	P.P
Application			OAL. (mm)
700MCM(350mm ²) Ø52mm Copper cable, 750MCM(380mm ²) Ø52mm Aluminum cable			335

ELECTRICAL PLIERS & CUTTERS

8PK-SR250/8PK-SR500 Cable Cutter



- SCM4 Chromium-Molybdenum-Steel forged, efficient and secure in operation.
- Alloy-aluminum handle, treated by T6 heat, strong durable and handy.



8PK-SR250

SCM4 Chromium-Molybdenum steel;
efficient and secure in operation



8PK-SR500

Aluminum handle with
non-fracture character

Soft rubber sleeves handle



Individual packing: Blister card

Model No.	HRC	Application	Replacement blade	OAL.(mm)
	Blade	Copper cable		
8PK-SR250	52'±2'	DIN 250mm ² , AWG 500	5PK-SR250-BS	600
8PK-SR500		DIN 500mm ² , AWG 1000	5PK-SR500-BS	800

ELECTRICAL PLIERS & CUTTERS

STRIPPERS



Strip Gently, Cut Neatly, Work Perfectly.



Pro'sKit[®]

886-2-22183233
Sales support

pk@mail.prokits.com.tw
E-mail

www.prokits.com.tw
Global website

▶ CP-3001D / CP-3002D
Precision Wire Stripper

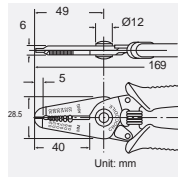

Stripping wires



Cutting

Model No.	Material		HRC	Application	OAL. (mm)	Individual packing
	Body	Handle				
CP-3001D	SK7	TPR	50 \pm 3 $^\circ$	AWG: 30, 28, 26, 24, 22, 20 / 0.2, 0.3, 0.4, 0.5, 0.6, 0.8 mm	169	Blister card
CP-3002D				AWG: 20, 18, 16, 14, 12, 10 / 0.8, 1.0, 1.3, 1.6, 2.0, 2.6 mm		

▶ CP-301G / CP-302G
Precision Wire Stripper



Heat-treated sharp angle w/fine laser marking



Safety lock design

Model No.	Material		HRC	Application	OAL. (mm)	Individual packing
	Body	Handle				
CP-301G	S50C	PVC	45 \pm 3 $^\circ$	AWG: 30,28,26,24,22,20 / 0.2,0.3,0.4,0.5,0.6,0.8 mm	165	Blister card
CP-302G				AWG: 20,18,16,14,12,10 / 0.8,1.0,1.3,1.6,2.0,2.6mm		

▶ 8PK-3001D / 8PK-3002D
Precision Wire Stripper

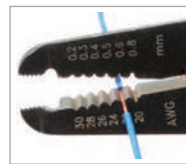
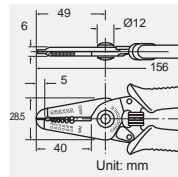

Stripping wires

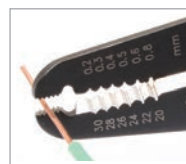

Gripping

Model No.	Material		HRC	Application	OAL. (mm)	Individual packing
	Body	Handle				
8PK-3001D	SK7	PVC	50 \pm 3 $^\circ$	AWG: 30, 28, 26, 24, 22, 20 / 0.2, 0.3, 0.4, 0.5, 0.6, 0.8 mm	156	Blister card
8PK-3002D				AWG: 20, 18, 16, 14, 12, 10 / 0.8, 1.0, 1.3, 1.6, 2.0, 2.6 mm		

▶ 1PK-3001E / 1PK-3002E
Precision Wire Stripper

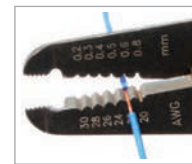
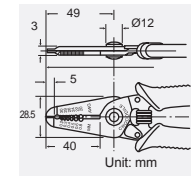

Stripping wires



Safety lock design

Model No.	Material		HRC	Application	OAL. (mm)	Individual packing
	Body	Handle				
1PK-3001E	SK7	TPR	50 \pm 3 $^\circ$	AWG: 30, 28, 26, 24, 22, 20 / 0.2, 0.3, 0.4, 0.5, 0.6, 0.8 mm	156	Blister card
1PK-3002E				AWG: 20, 18, 16, 14, 12, 10 / 0.8, 1.0, 1.3, 1.6, 2.0, 2.6 mm		

▶ CP-419 Multi Purpose Crimping Tool



- Crimp insulated & non-insulated terminals.
- Total length: 185mm.



3 in 1

Cutting/Stripping/Crimping

Dual Cutting Edge

Allows You to Cut Hard & Soft Wires

Precise Stripping

Capable to Strip the Wire Without Damaging



Material		Cutting		Stripping	Crimping		Individual packing
Body	Handle	Flat Edge	Beveled Edge		Insulated	Non-insulated	
S50C	TPR	AWG 10~30(5.5~0.05mm ²)	AWG 18~30(0.9~0.05mm ²)	AWG 10~28(5.5~0.08mm ²)	1.25~2.0mm ² /0.3~0.5mm ²	0.5/1.25/2.0/5.5mm ²	Blister card

▶ 8PK-3161 / 8PK-3162 / 8PK-3163 7 in 1 Tool

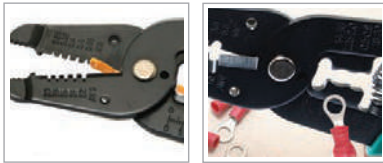

Model No.	Material		Hardness	Application	OAL. (mm)	Individual packing
	Body	Handle				
8PK-3161	Low carbon steel	PVC	HR30N 55~65	AWG: 18, 16, 14, 12, 10 / 0.9, 1.25, 2.0, 3.5, 5.5 mm ²	170	Blister card
8PK-3162				AWG: 26~24, 22, 20, 18, 16 / 0.2, 0.35, 0.5, 0.9, 1.25 mm ²		
8PK-3163				AWG: 30, 28, 26, 24, 22 / 0.25, 0.32, 0.4, 0.5, 0.65 mm		

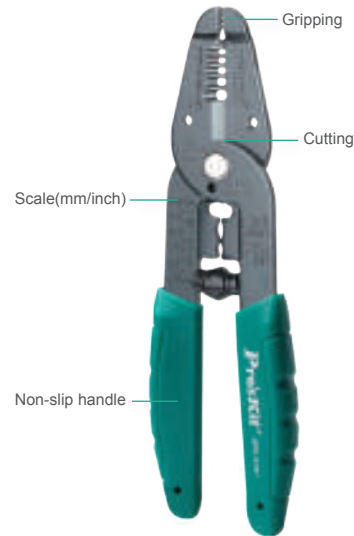

▶ CP-412G / CP-413G Heavy Duty Wire Stripper/Crimper



- Combination of cutting, stripping and crimping function.



Material		HRC	Individual packing	Application		
Body	Handle			Bolt cutter	Crimp insulated and non-insulated terminals	
S50C	PVC	45°±3°	Blister card			

Model No.	Application			OAL. (mm)
	Wire strip	Bolt cutter	Crimp	
CP-412G	Stranded wire: 24-22, 20, 18, 16, 14, 12 AWG Solid wire: 22-20, 18, 16, 14, 12, 10 AWG	4-40, 6-32, 8-32, 10-24, 10-32	Barrel-type insulated & Non-insulation: 22-18, 16-10 AWG	206
CP-413G	Stranded Wire: 26-24, 22-20, 18, 16, 14, 12, 10 AWG Solid Wire: 22-20, 18, 16, 14, 12, 10, 8 AWG	4-40, 10-32, 10-24, 8-32, 6-32	Insulation: 26-14, 12-10 AWG Non-insulation: 22-10 AWG	215

CP-412G



CP-413G



▶ 6PK-223 Wire Stripper Cutter

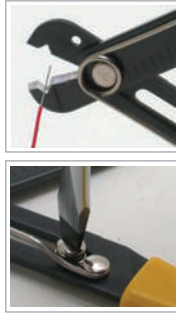

Material		HRC	Application	Accessory	OAL. (mm)	Individual packing
Body	Handle					
S45C	PVC	45°±3°	Stripping wire From 30~10 AWG (0.5~4mm)	5PK-223-1	127	Blister card

▶ CP-108 Wire Stripper Cutter



Material		HRC	Application	OAL. (mm)	Individual packing
Body	Handle				
65Mn	PVC	45°±3°	Stripping wire From 30~10 AWG (0.5~4mm)	127	Blister card

▶ 8PK-CT009 / 8PK-CT009A Multi-Purpose Crimping Tool



Material		HRC	OAL. (mm)	Individual packing
Body	Handle			
S45C	PVC	45°±3°	210	Blister card

Model No.	Application		
	Wire strip	Bolt cutter	Crimp
8PK-CT009 (Metric)	0.6, 0.8, 1.0, 1.3, 1.6, 2.0, 2.6 mm	M2.6, M3, M3.5, M4, M4.5, M5	Insulated & Non-insulated: 2.6~1.3, 1.0~0.6 mm
8PK-CT009A (Inch)	22, 20, 18, 16, 14, 12, 10, AWG	4-40, 5-40, 6-32, 8-32, 10-32, 10-24	Insulated & Non-insulated: 10~16, 18~22AWG

▶ 8PK-CT001 UTP/STP Cable Stripper



A simple tool for UTP/STP cable. Just stripping 3 circles to extract the jacket of cable. Also a function for 110 punch down tool.

Material	Application	OAL. (mm)	Individual packing
Poly-Resin	Stripping UTP/STP cable/ 110 Punch down	94	Blister card

▶ CP-511A Universal Stripping Tool



Stripping regular cable Stripping low volt cable

Material		Application	OAL. (mm)	Individual packing
Body	Handle			
SK5	ABS + TPR	Regular cable AWG 20/18/16/14/12/10 (0.5/1.0/2.5/4.0/6.0 mm ² , RG59/RG6 coaxial cable, Ø8~13mm low-volt cable)	125	Blister card

CP-380 Automatic Wire Stripper



- SPCC Blade
- For Stranded Wires
- AWG 16-8



Precisely Machined Holes

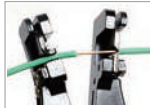

Fast Compound Wire Stripping Action



Material			Hardness	Application	OAL. (mm)	Individual packing
Body	Blade	Handle				
Alloy Zinc Steel	SPCC Steel -Plate-ColdRolled-Coil	TPR	HV500~800	For stripping AWG16-8, JIS 1.25-8mm ²	170	Blister card

CP-246 Solar Cable Stripper



- Reliable stripping without damage, particularly for solar cables (2.5- 6.0 mm²)



Fast Compound Wire Stripping Action



Adjustable Length Stop



Material			HRC	Application	OAL. (mm)	Individual packing
Body	Blade	Handle				
Zinc alloy	SK5	TPR	56 ^{±2}	For 2.5/4/6mm ² (AWG 14/12/10) solar cable	177	Blister card

608-369A / 608-369B / 608-369C Wire Stripping Tool



Material			Hardness
Body	Blade	Handle	
Zinc alloy	SS 41	PVC	Body: HV 450~800 Blade: HRC 45°~55°

Model No.	Application	OAL.(mm)	Individual packing
608-369A	0.5, 1.2, 1.6, 2.0mm	170	Blister card
608-369B	1.0,1.6,2.0,2.6,3.2mm		
608-369C	22,18-20,14-16,12,10,8(AWG) for solid wire		



608-369A
0.5, 1.2, 1.6, 2.0mm

608-369B
1.0, 1.6, 2.0, 2.6, 3.2mm

608-369C
22,18-20,14-16, 12,10,8(AWG)

CP-369AE / CP-369BE / CP-369CE Wire Stripping Tool



Economic type



Material			Hardness
Body	Blade	Handle	
Zinc alloy	S45C	PVC	Body: HV 450~800 Blade: HRC 45°~55°

Model No.	Application	OAL.(mm)	Individual packing
CP-369AE	0.5, 1.2, 1.6, 2.0mm	170	Blister card
CP-369BE	1.0,1.6,2.0,2.6,3.2mm		
CP-369CE	22,18-20,14-16,12,10,8(AWG) for solid wire		



CP-369AE
0.5, 1.2, 1.6, 2.0mm

CP-369BE
1.0, 1.6, 2.0, 2.6, 3.2mm

CP-369CE
22, 18-20, 14-16, 12, 10, 8 (AWG)

8PK-371/8PK-371D Automatic Wire Stripper & Crimper



8PK-371



8PK-371D



8PK-371



- Made by precision machines for a long-life usage.
- 15N 88~90 (HRC55°~60°) blade cuts wire fast and smoothly.



Stripping

Crimping



Stripping

Cutting

Material	HRC	OAL (mm)	Individual packing
Body	Blade	Handle	Cutting edge
SS 41	Powder metallurg	PVC	55°~60°
			52°~57°
			210
			Blister card

Application

Stripper range: AWG 10-24 (0.2~6.0mm²) For insulated terminals 22-10 AWG (0.5-6.0mm²) For non-insulated terminals 22-10 AWG (0.5-6.0mm²) For auto ignition terminals 7-8mm



8PK-371D



- Micro adjusting the swivel knob to strip electrical wire gauge smaller than AWG24 (0.2mm²)
- Adjustable stopper is swiveled if user does not use this function.



Stripping

Crimping

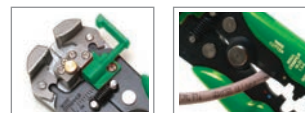

Micro adjuster knob & wire stopper

Cutting

Material	HRC	OAL (mm)	Individual packing
Body	Blade	Handle	Cutting edge
SS 41	Powder metallurg	ABS+TPR	55°~60°
			52°~57°
			210
			Blister card

Application

Stripper range: AWG 24-10 gauge (0.2~6.0mm²), For insulated terminals 22-10 AWG (0.5-6.0mm²) For non-insulated terminals 22-10 AWG (0.5-6.0mm²)

808-080 Wire Stripping Tool



- Nylon handle with S50C blade.
- Precise and durable.



Ideal for flat cable stripping

Material	HRC	OAL (mm)	Individual packing
Body	Blade	Handle	Application
Nylon & low carbon steel	S50C	45°~55°	Stripping flexible cable from 0.2~4mm ²
			172
			Blister card

CP-080E Wire Stripping Tool



Economic Type



Cutting

Material	HRC	OAL (mm)	Individual packing
Body	Blade	Handle	Application
Nylon & low carbon steel	65Mn	45°~55°	Stripping flexible cable from 0.2~4mm ²
			172
			Blister card

6PK-501 Wire Stripper Tool



Ideal for flat cable stripping
Replacement blade
5PK-376A-BLADE
(6 pcs/pack)

Material	OAL (mm)	Individual packing
Body	Blade	Application
ABS	SK5	For wire(UTP/STP) or wire & multiconductor cable from ø3.2-9mm max
		112
		Blister card

CP-508 Universal Stripping Tool



2 Blade Model
6.35 mm/1/4"



Cassette: 5CP-508-RG



Blade: 5CP-508-B
(2pcs/pack)

Material	OAL (mm)	Individual packing
Body	Blade	Application
ABS	SK5	UTP/STP, RG-59/6/7/11
		135
		Blister card

CP-512 Rotary Coaxial Cable Stripper



Black hook for folding back the braided shield



Quick strips
RG59/RG6/RG7/RG11



Replacement blade cassette: 5CP-505-RG (1pcs/pack)

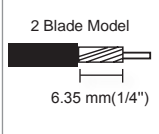

2 Blade Model
6.35 mm (1/4")



Material		Application	OAL. (mm)	Individual packing
Body	Blade			
ABS	SK5	RG-59/6/7/11	94	Blister card

6PK-312S Rotary Coaxial Cable Stripper

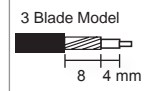

3 Blade Model
Stripper distance
8 4 mm



Replacement blade :
5PK-312B-B (6pcs/pack)



Material		Application	OAL. (mm)	Individual packing
Body	Blade			
ABS	SK5	For big cable O.D. around ϕ 10.5mm, Such as RG213	105	Blister card

6PK-332 Rotary Coaxial Cable Stripper



Replacement blade :
5PK-3321 (6pcs/pack)

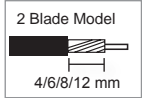

2 Blade Model
Stripper distance
4/6/8/12 mm



6PK-322 Rotary Coaxial Cable Stripper

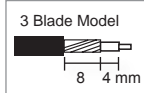

3 Blade Model
Stripper distance
8 4 mm



Material		Application	OAL. (mm)	Individual packing
Body	Blade			
ABS	SK5	Thinnest RG-58/59/6 coax cable & other cable size	108	Blister card

CP-505 Universal Stripping Tool



- Reversible stripping UTP/STP cable, flat telephone cable and coaxial cable with cutting function.
- Comes with black hook and loop for folding back the braided shield.



Cassette: 5CP-505-RG (1pcs/pack)



Blade: 5CP-505-B (4pcs/pack)



Black hook and loop for folding back the braided shield

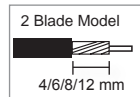

2 Blade Model
4/6/8/12 mm



Material		Application	OAL. (mm)	Individual packing
Body	Blade			
ABS	SK5	Stripping UTP/STP twisted pair round cable, flat telephone cable, RG-59/11/7/6 coaxial cable	125	Blister card

▶ 8PK-325 / 8PK-325B Round Cable Slitting And Ringing Tool



8PK-325



8PK-325B



8PK-325B

8PK-325

Adjustable Height

Make it easy to use with multiple cable size

Adjustable Blade Depth

To precisely match the thickness of the sheath

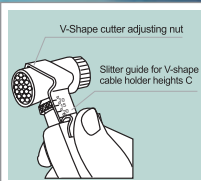

Strips neatly



Cable slitting and stripping



Adjustable Height

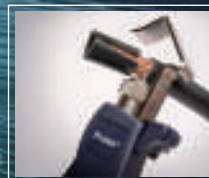

Easy to use

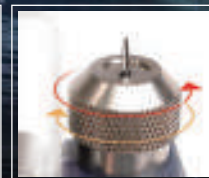

Adjustable Blade Depth



Replacement blade:
5PK-325-BL



Model No.	Material			Application	OAL. (mm)	Individual packing
	Body	Blade	Blade holder			
8PK-325	ABS + Fiber glass	SK5	Plastic	Strip cables from $\phi 4.5$ -25mm ($\phi 0.18$ "~1.0") diameter	150	Blister card
8PK-325B			Metal			

▶ 8PK-502 Round Cable Slitting Tool



Replacement blade:
5PK-502-B

▶ CP-326 Round Cable Slitting And Ringing Tool



Replacement blade:
5CP-326-B

Model No.	Material			Application	OAL. (mm)	Individual packing
	Body	Blade	Blade holder			
8PK-502	Nylon+Fiber	SWP spring stell	Metal	Single or multiple conductor cable up to $\phi 1.75$ " ($\phi 44.5$ mm) blade can be adjusted for jacket thickness up to 0.125" (3.2mm)	140	Blister card
CP-326	ABS	Steel 412JZ	-	Strips 4~28mm (0.16"~1.1") cable		

PUNCH DOWN TOOLS



Exposed wires can be dangerous and may cause your connections to short out. *Pro'sKit*® punch down tools ensure perfect wires.

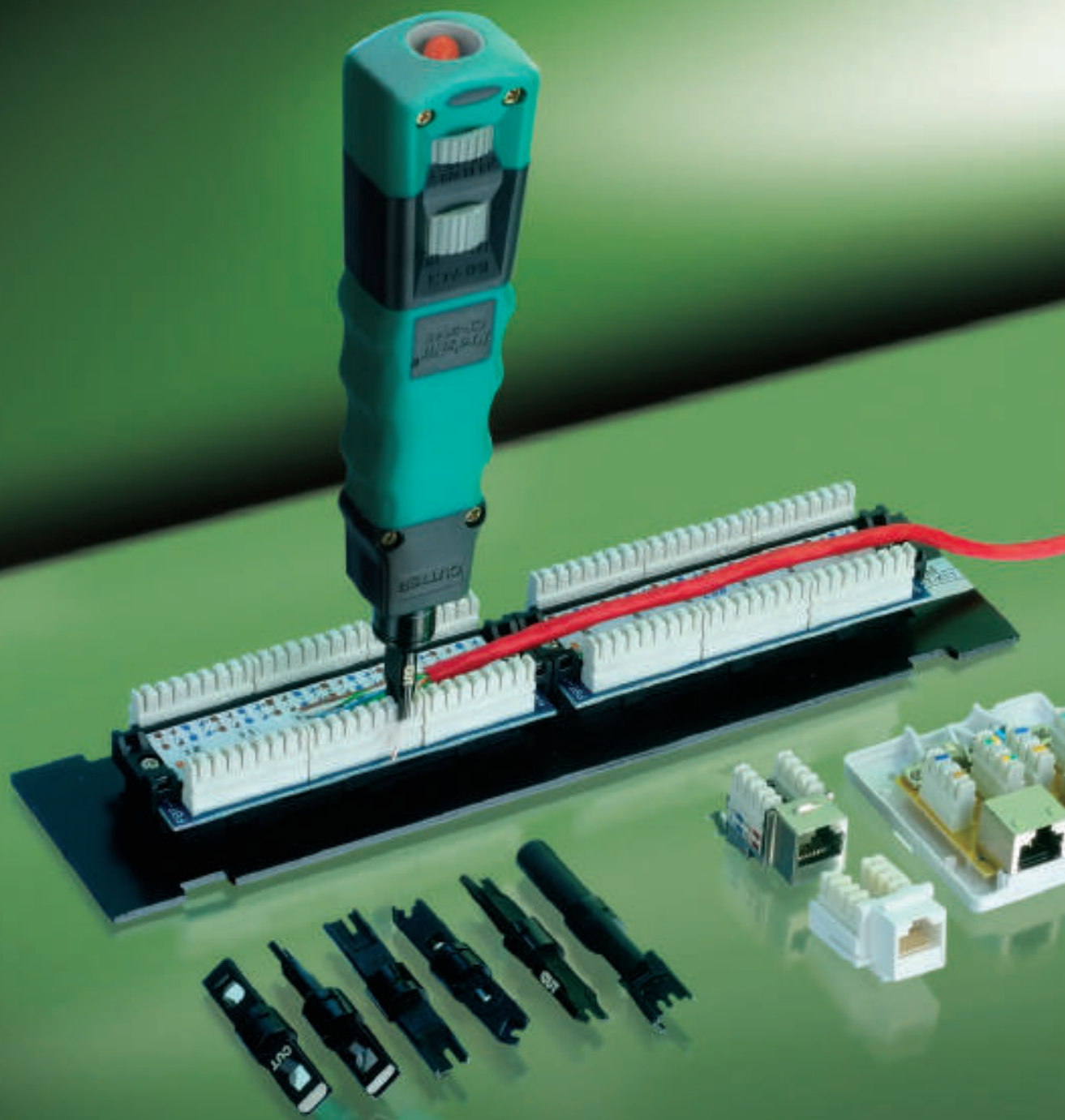

Pro'sKit®

886-2-22183233
Sales support

pk@mail.prokits.com.tw
E-mail

www.prokits.com.tw
Global website

CP-3148 Impact and Punch Down Tool



- Ergonomic cushion grip with duplex color design, molded to shape of hand provides comfort and easy operation, non-slip grip.
- Spare blade storage chamber in handle.
- Increased HI/LOW forces to meet demands of all category cables through Cat6.



Storage for a spare blade



Impact

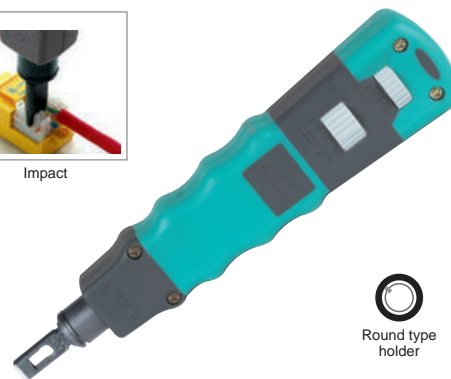

Round type holder

Model No.	Material		Application	Standard blade type	Optional blade	OAL. (mm)	Individual packing
	Blade	Body					
CP-3148	SAE 4140	ABS + TPR	Hi-low adjust pressure (Hi: 40lbs/178N, Low: 30lbs/133N)	110/88 & 66 (5CP-16A)	5CP-16 series	162 (w/o blade)	Blister card

* 40 lbs = 18kg, 30lbs = 13.6kg

CP-3151/CP-3152 Impact and Punch Down Tool



CP-3151



CP-3152

Storage chamber with latch cover design

Adjustable pressure

Hi: 15±2kg, Low: 10±2kg

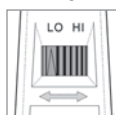

Nonslip handle

provides easy operation and user comfort



Round type



Replacement blade :
5CP-3152-110 for 110/88 type
5CP-3152-66 for 66 type



Storage for a spare blade



Punch and cut cable terminals

Model No.	Material		Application	Standard blade Type	OAL. (mm)	Individual packing
	Blade	Body				
CP-3151	40cr	ABS	Hi-Low adjust pressure (High: 15±2kg, Low: 10±2kg)	1pce 110/88 & 1pce 66 double end blade with cut function	146	Blister card
CP-3152				1pce 110/88 double end blade with cut function		
CP-3152-H			Handle Only			

CP-3140 Punch Down Tool with 110 Blades



Economic Type



Impact



Storage for a spare blade

Material	Blade	Body	Application	Standard blade type	OAL. (mm)	Individual packing
SAE 4140	ABS	Hi-low adjust pressure (Hi: 15±2kg) (Low: 10±2kg)	110/88 (5CP-3140-110)	160 (w/o blade)	Blister card	

5CP-16 Series / 5PK-3140N-BIX Spare Blades



For CP-3148 punch down tool



Round type



5CP-16



5CP-16A



5CP-16B



5CP-16BK



5PK-3140N-BIX

+ Individual packing: Bulk

Model No.	For terminal block
5CP-16	Dual 66 type, one end with cut function
5CP-16A	66, 110/88 type, both end with cut function
5CP-16B	Dual 110/88 type, one end with cut function

Model No.	For terminal block
5CP-16BK	Dual KRONE 110 type, one end with cut function
5PK-3140N-BIX	BIX, with cut function

▶ CP-3141A Krone Impact Terminal Tool with Lock



WIRE PUSH



WIRE PULL



IMPACT • PUNCH • CUT



Safety Lock
Assistive Tools
Adjustable Cut



Reliable



Easy



Multifunction



Service

Material		Application	Standard blade type	OAL. (mm)	Individual packing
Blade	Body				
Carbon Steel	ABS	For telephone and computer network installation and maintenance. Terminate wire and cuts off excess.	Krone	185	Blister card

▶ CP-3141 Impact Terminal Tool for Krone

▶ CP-3145B Punch Down Tool

▶ 8PK-324B Impact and Punch Down Tool



Economic Type



- Rotatable blade holder
- Blade on both ends



Punch and cut cable terminal

Model No.	Material		Application	Standard blade type	OAL. (mm)	Individual packing
	Blade	Body				
CP-3141	S45C	ABS	Combination impact and torque tool function. Both side (screwdriver & wire-pull function)	Krone	175	Blister card
CP-3145B	110/88 type: S45C 66 type: SAE 4140	ABS	-	66, 110/88 type, both ends with cut function	128	Blister card
8PK-324B	SAE 4140	ABS+Fiber	Impaction function	110/88	114 (w/o blade)	Blister card

ALIGNMENT TOOL & SCREWDRIVERS



The screwdriver is a basic tool that every man should have in his toolbox. *Pro'sKit*® screwdriver series serves all your needs.



Pro'sKit®

886-2-22183233
Sales support

pk@mail.prokits.com.tw
E-mail

www.prokits.com.tw
Global website

9SD-2 Series Pro-soft Screwdriver

 Elastomer resin fitting exactly and double structure. Non-slip.



New design fits in well with your hand in shape, providing comfort and power

High grade AISI 8660 chrome-molybdenum vanadium steel.

Exactly fit to screws and high accuracy hardened finished.

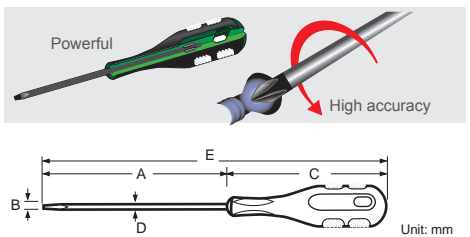

Model No.	A	B	C	D	E
9SD-201A	75	⊖	3.0	88	3.0 163
9SD-202A	75	⊖	5.0	109	5.0 184
9SD-205A	100	⊖	3.0	88	3.0 188
9SD-207A	100	⊖	6.0	121	6.0 221
9SD-210A	100	⊖	5.0	109	5.0 209
9SD-213A	150	⊖	6.0	121	6.0 271
9SD-214A	200	⊖	6.0	121	6.0 321
9SD-220A	40	⊖	6.0	58	6.0 98
9SD-222A	150	⊖	8.0	121	8.0 271

Model No.	A	B	C	D	E
9SD-201B	75	⊕	#0	88	3.0 163
9SD-202B	75	⊕	#1	109	5.0 184
9SD-205B	100	⊕	#0	88	3.0 188
9SD-207B	100	⊕	#2	121	6.0 221
9SD-210B	100	⊕	#1	109	5.0 209
9SD-213B	150	⊕	#2	121	6.0 271
9SD-214B	200	⊕	#2	121	6.0 321
9SD-216B	150	⊕	#1	109	5.0 259
9SD-217B	250	⊕	#2	121	6.0 371
9SD-220B	40	⊕	#2	58	6.0 98
9SD-222B	150	⊕	#3	121	8.0 271

Individual packing : Inner box

Model No.	A	B	C	D	E
9SD-200-T05H	50	⊗	T5H	88	3.0 159
9SD-200-T06H	50	⊗	T6H	88	3.0 159
9SD-200-T07H	50	⊗	T7H	88	3.0 159
9SD-200-T08H	50	⊗	T8H	88	3.0 159
9SD-200-T09H	50	⊗	T9H	88	3.0 159
9SD-200-T10H	75	⊗	T10H	88	3.0 184
9SD-200-T15H	75	⊗	T15H	88	4.0 184

Individual packing : Inner box

Model No.	A	B	C	D	E
9SD-200-M5	75	⊙	M5	110	5.8 185
9SD-200-M6	75	⊙	M6	110	7.1 185
9SD-200-I1	75	⊙	3/16"	110	5.8 185
9SD-200-I2	75	⊙	1/4"	110	7.1 185

Individual packing : Inner box

Individual packing : Inner box

SD-2301/SD-2302 Pro-soft Screwdriver Set



SD-2301



SD-2302



SD-2301 SD-2302

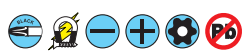

Model No.	Contents	Individual packing
SD-2301	<ul style="list-style-type: none"> ⊖ 3.0x75mm ⊖ 5.0x75mm ⊖ 6.0x100mm 	<ul style="list-style-type: none"> ⊕ #0x75mm ⊕ #1x75mm ⊕ #2x100mm <p>Color box</p>
SD-2302	<ul style="list-style-type: none"> ⊗ T5HX50mm ⊗ T6HX50mm ⊗ T7HX50mm ⊗ T8HX50mm 	<ul style="list-style-type: none"> ⊗ T9HX50mm ⊗ T10HX75mm ⊗ T15HX75mm <p>Color box</p>

894 Series Pro-Soft Screwdrivers



- The molded propylene handles feature insert molded blades for improved grip.



Molded propylene handle



Special inlayed blade insert; safe and durable

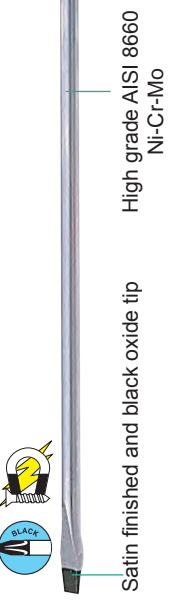

High grade AISI 8660 Ni-Cr-Mo

Satin finished and black oxide tip

Model No.	A	B	C	D	E	
89401A	75	⊖	3.2	85	3.2	160
89402A	75	⊖	5.0	110	5.0	185
89405A	100	⊖	3.2	85	3.2	185
89407A	100	⊖	6.0	110	6.0	210
89407A-L	57	⊖	6.0	153	6.0	210
89410A	100	⊖	5.0	110	5.0	210
89413A	107	⊖	6.0	153	6.0	260
89414A	157	⊖	6.0	153	6.0	310
89416A	150	⊖	5.0	110	5.0	260

Individual packing: Inner box

Model No.	A	B	C	D	E	
89401B	75	⊕	#0	85	3.2	160
89402B	75	⊕	#1	110	5.0	185
89405B	100	⊕	#0	85	3.2	185
89407B	100	⊕	#2	110	6.0	210
89407B-L	57	⊕	#2	153	6.0	210
89410B	100	⊕	#1	110	5.0	210
89412B	250	⊕	#1	110	5.0	360
89413B	107	⊕	#2	153	6.0	260
89414B	157	⊕	#2	153	6.0	310
89416B	150	⊕	#1	110	5.0	260
89417B	207	⊕	#2	153	6.0	360

Individual packing: Inner box

1PK-9401 8 PCS Pro-soft Screwdriver Set



Contents
 89401A, 89401B, 89402A, 89402B, 89407A, 89407B, 9SD-220A, 9SD-220B
 Case: 310x230x50mm
 Individual packing: Inner box + Color label shrink

19400-M Series Electronic Hex Nut Drivers



- Extra-thin walled, with duplex color rubber handles for hexagon nuts and bolts.



Molded propylene handle

Model No.	A	B	C	D	E	
19400-M3	70	⊙	3.0	85	4.0	155
19400-M3.5	70	⊙	3.5	85	4.0	155
19400-M4	70	⊙	4.0	85	4.0	155
19400-M4.5	70	⊙	4.5	85	4.0	155
19400-M5	70	⊙	5.0	85	4.0	155
19400-M5.5	70	⊙	5.5	85	4.0	155
19400-M6	70	⊙	6.0	85	4.0	155

Individual packing: Blister card

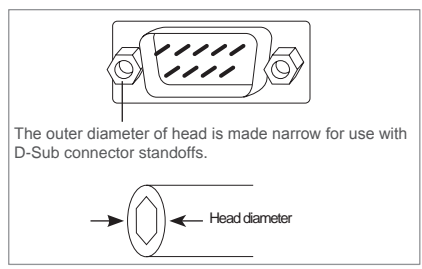
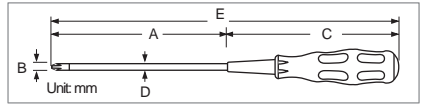

The outer diameter of head is made narrow for use with D-Sub connector standoffs.

High grade AISI 8660 Ni-Cr-Mo

SUM24L



1PK-9402 7 PCS Electronic Hex Nut Driver Set



Contents
 19400-M3, 19400-M3.5, 19400-M4, 19400-M4.5, 19400-M5, 19400-M5.5, 19400-M6
 Individual packing: Pouch

89400 Series Pro-Soft Screwdrivers



- Tamper-proof holes are provided for screws such as torx screws with a projection in the screw head.
- These screws are used in cases where tampering could be a problem.
- Select the size for working with mobile telephones, communication equipments, radios and precision equipments.

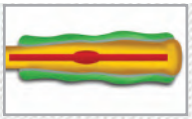

Special inlaid blade insert; safe and durable



Star Screwdriver Includes Tamper Proof Holes

Blade material: S2 Steel

Model No.	A	B	C	D	E
89400-T05	50	T5	85	4.0	135
89400-T06	50	T6	85	4.0	135
89400-T07	50	T7	85	4.0	135
89400-T08	80	T8	85	4.0	165
89400-T10	80	T10	85	4.0	165
89400-T15	80	T15	85	4.0	165
89400-T05H	50	T5H	85	4.0	135
89400-T06H	50	T6H	85	4.0	135
89400-T07H	50	T7H	85	4.0	135
89400-T08H	80	T8H	85	4.0	165
89400-T09H	80	T9H	85	4.0	165
89400-T10H	80	T10H	85	4.0	165
89400-T15H	80	T15H	85	4.0	165
89400-T10HL	100	T10H	85	4.0	185
89400-T15HL	100	T15H	85	4.0	185
89400-T10HLX	150	T10H	85	4.0	235

Individual packing : Inner box

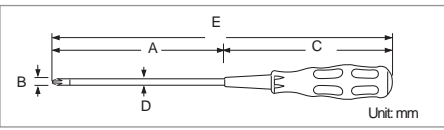

Hex Socket Type Screwdriver

Model No.	A	B	C	D	E
89400-H1.5	90	1.5	85	1.5	175
89400-H2	90	2.0	85	2.0	175
89400-H2.5	90	2.5	85	2.5	175
89400-H3	90	3.0	110	3.0	200

Individual packing: Inner box

Tri-wing Type Screwdriver

Model No.	A	B	C	D	E
89400-TRI	50	3.2	85	3.2	135

Individual packing : Blister card

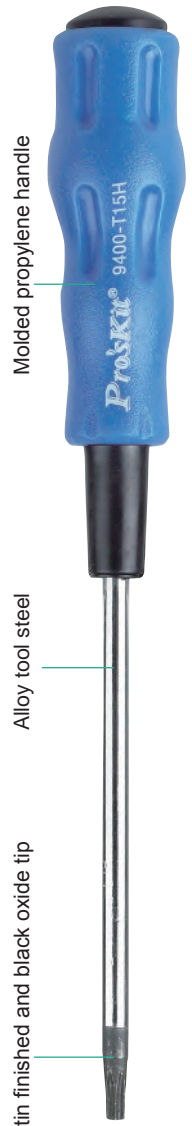

Molded propylene handle

Alloy tool steel

Satin finished and black oxide tip

SW-2125H 5 PCS Star Screwdriver Set



Contents
89400-T05H, 89400-T06H, 89400-T07H, 89400-T08H, 89400-T09H

Individual packing : Blister card



891 Series

High Quality Line Color Screwdriver

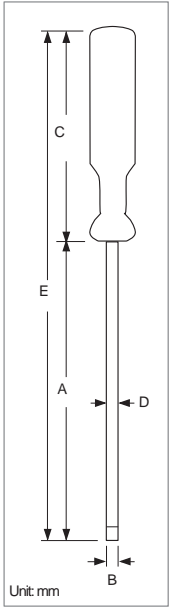

Model No.	A	B	C	D	E
89101A	75	⊖ 3.2	56	3.2	131
89102A	75	⊖ 5.0	80	5.0	155
89105A	100	⊖ 3.2	56	3.2	156
89107A	100	⊖ 6.0	90	6.0	190
89113A	150	⊖ 6.0	90	6.0	240
89120A	38	⊖ 6.0	45	6.0	83

Model No.	A	B	C	D	E
89101B	75	⊕ #0	56	3.2	131
89102B	75	⊕ #1	80	5.0	155
89105B	100	⊕ #0	56	3.2	156
89107B	100	⊕ #2	90	6.0	190
89110B	100	⊕ #1	80	5.0	180
89113B	150	⊕ #2	90	6.0	240
89115B	200	⊕ #1	80	5.0	280
89116B	150	⊕ #1	80	5.0	230
89117B	250	⊕ #2	90	6.0	340
89120B	38	⊕ #2	45	6.0	83
89121B	300	⊕ #2	90	6.0	390

Individual packing : Inner box

SW-9106

Line Color Screwdriver Set (6 PCS)

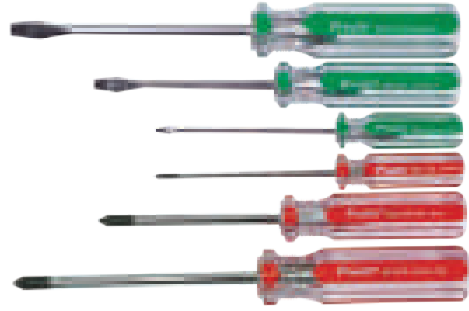
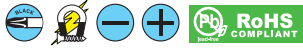

Contents	
⊖	89101A
⊖	89102A
⊖	89107A
⊕	89101B
⊕	89102B
⊕	89107B

Individual packing : Blister card

SW-9109D

10 in 1 Double End Reversible Screwdriver Set



Individual packing : Blister card

Contents		
1pc PVC handle with 1/4" bits holder, length: 100mm		
6 bits, material: AISI 6150 Cr-V, HRC 52°±2°		
	Length	
⊕ #2 ⊖ 6.0	110mm	
⊕ #2 ⊕ #2	110mm	
⊕ #2 ⊕ #2	65mm	
⊕ #2	100mm	
⊕ #1	100mm	
⊕ #2 ⊕ #2	150mm	

▶ SD-51 Series Line Color Screwdriver

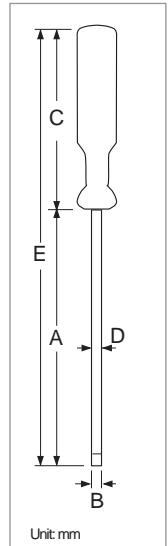

Model No.	A	B	C	D	E
SD-5101A	75	⊖ 3.0	57	3.0	132
SD-5102A	75	⊖ 5.0	80	5.0	155
SD-5105A	100	⊖ 3.0	57	3.0	157
SD-5106A	150	⊖ 3.0	57	3.0	207
SD-5107A	100	⊖ 6.0	90	6.0	190
SD-5110A	100	⊖ 5.0	80	5.0	180
SD-5113A	150	⊖ 6.0	90	6.0	240
SD-5116A	150	⊖ 5.0	80	5.0	230

Model No.	A	B	C	D	E
SD-5101B	75	⊕ #0	57	3.0	132
SD-5102B	75	⊕ #1	80	5.0	155
SD-5105B	100	⊕ #0	57	3.0	157
SD-5106B	150	⊕ #0	57	3.0	207
SD-5107B	100	⊕ #2	90	6.0	190
SD-5110B	100	⊕ #1	80	5.0	180
SD-5113B	150	⊕ #2	90	6.0	240
SD-5114B	200	⊕ #2	90	6.0	290
SD-5116B	150	⊕ #1	80	5.0	230
SD-5120B	38	⊕ #2	45	6.0	83

Individual packing : Inner box

▶ SW-9107D Double-end Reversible Screwdriver

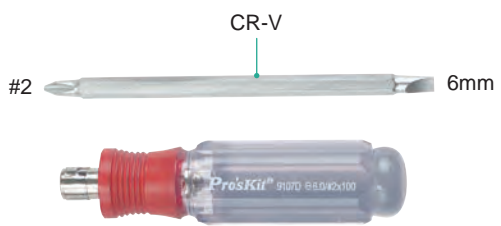

▶ SD-5107D Double-end Reversible Screwdriver

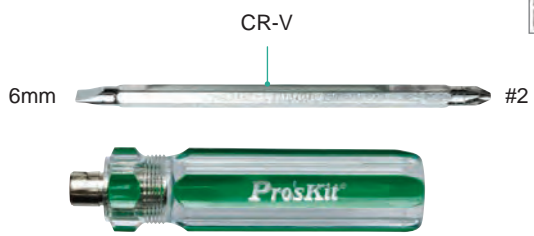
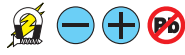

Material	HRC	Handle	Blade	Working length	Individual packing
AISI 6150	52°±2'	95mm	126mm	100mm	Blister card

Material	HRC	Handle	Blade	Working length	Individual packing
AISI 6150	48°±3'	108 mm	125 mm	100 mm	Blister card

SD-2800 Series Dual Color Grip Nut Driver



- Dual color, ergonomic cushion grip handles for maximum comfort.
- The handle is molded directly onto the blade for permanent bonding.
- Heavy duty deep head blades, hardened for maximum torque and wear resistance
- Precision heads for accurate fastener fit
- Handle end comes with screw type mark for easy identification

Dual color PP+TPR cushion grip handle



Anti-corrosion chrome finished

Material:
AISI 50BV30
Boron steel

Heavy duty deep head blade

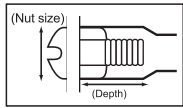

Model No.	Nut size & depth	Blade length	OAL
SD-2800-M5	5 x 25 mm	125 mm	235 mm
SD-2800-M5.5	5.5 x 25 mm	125 mm	235 mm
SD-2800-M7	7 x 25 mm	125 mm	235 mm
SD-2800-M8	8 x 25 mm	125 mm	235 mm
SD-2800-M10	10 x 25 mm	125 mm	235 mm
SD-2800-M13	13 x 25 mm	125 mm	245 mm

Individual packing : Double blister card

SD-2400 Series Spanner Type Security Screwdriver



- Made of Cr-Mo-V steel with chromium (Cr) plating for anti-rust
- Special inlayed blade molded into handle provides high torque and user comfort.

Fast turning swivel cap for easy operation

Dual color TPR and PP non-slip handle



S4 S6 S8 S10

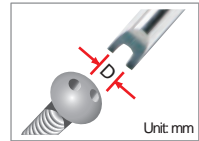

Made of AISI 8660 Cr-Mo-V steel with Cr plated for anti-rust HRC:55 \pm 2



Model No.	D	OAL (mm)
SD-2400-S4	1.5	186
SD-2400-S6	2.3	186
SD-2400-S8	2.5	186
SD-2400-S10	3.1	186
SD-2400	Contents: 4pcs Security Screwdriver Set. SD-2400-S4, SD-2400-S6, SD-2400-S8, SD-2400-S10	

Individual packing : Blister card

SD-9816

16 in 1 Reversible Ratchet Precision Screwdriver Set



- Click-stop ball clamp guarantees a secure hold and daily use comfort
- Reversible blades ensure perfect fit every time.
- Flexible & adjustable blade length.
- Hex retainer design for easy assembling.



Contents			
3 position ratchet handle, length: 155mm			
8pcs double end hex bits : $\phi 1/4"$ x 175mm Material: S2 Alloy steel			
	4.0 , 5.0		6.0, 7.0
	T20, T30		T25, T40
	H5.0 ,H6.0		HB5.0, HB6.0
	#1		#2
	PZ1		PZ2

Individual packing : Blister card

SD-2313

30PCS Do-It-All Kit



- Triangle magnetic bits storage case with a hanger.
- Magnetic extension handle.
- Compact and versatile set of bits.



Magnetic storage case



Triangle bits case



Bits	
TPR non-slip handle with bits holder, 30pcs hex bits: $\phi 1/4"$ x 25mm, Material: SAE 6150 Cr-V steel	
	SQ1, SQ2
	#0, #1, #2, #3
	PZ0, PZ1, PZ2, PZ3
	SL3.5, SL4.5, SL5.5, SL6, SL8
	H2, H2.5, H3, H4, H5, H6, H8
	T5, T6, T7, T8, T10, T15, T20, T35

Individual packing : Hanger

8PK-SD010

12 in 1 Ratchet Screwdriver Set



Bits holder



Easily holding screw



- Bits holder.
- Ergonomic TPR+PP handle for user comfort.
- Ratchet adjustment.
- Plastic tube for holding screw easily
- Magnetic bits holder for easy of positioning
- Made of S2 alloy steel
OAL.: 230mm

Contents	
Dual color TPR non-slip ratchet handle	
12pcs $\phi 1/4"$ x 25mm bits:	
	T6, T7, T8, T9, T10, T15
	#0, #1, #2
	3, 4.7, 6.3

Individual packing : Blister card

SD-9523

Oil Resistant Screwdriver



ULTIMATE NON-SLIP HANDLE

made of wood-resin composite, fitting your hand perfectly even in oily condition.



Magnetic Tips



S2 Steel



Shank	Handle	Shank Dia.	Spec. (mm)	OAL	Individual packing
S2	Outer: Wood Resin Inner: PP	$\phi 6.0$ mm	PH2x150 SL6.0x150	265mm	Blister card

SD-9820

10 in 1 Ratchet Screwdriver Kit



FULLY HARDENED

chrome vanadium steel and non-slip soft grip handle.



Detachable Handle



42 Gears Ratchet



Handle Size : $\phi 43$ x 105mm		Handle Material : PP+TPR	
Double End Blade x 4			
Material : Cr-V 6150		Hardness : 52°	
$\phi 6.35$ mm x 65mm x 2pcs	#1 / 5mm	#2 / 6mm	
$\phi 6.35$ mm x 110mm x 2pcs	#1 / 5mm	#2 / 6mm	
Single End Blade x 2			
$\phi 6.35$ mm x 126mm x 2pcs	#0	3mm	
Individual packing		Blister card	

SD-9857M 57 in 1 Driver Kit



4mm & 1/4" bits set contains most type of bits you need



Contents			
24pcs Cr-V Ø1/4" bits		30pcs Cr-V Ø4mm bits	
⊖ 4.0, 5.0, 6.0, 7.0mm	⊕ PH0, PH1, PH2, PH3	⊖ 1.5, 2.0, 2.5, 3.0, 3.5, 4.0mm	
⊕ 3.0, 4.0, 5.0, 6.0mm	⊖ S1, S2	⊖ T4, T5, T6, T7, T8, T10, T15, T20	
⊕ PZ0, PZ1, PZ2, PZ3	⊖ 2.6mm	⊖ 0.9, 1.3, 1.5, 2.0, 2.5, 3.0mm	
⊖ T25, T27, T30, T40	⊖ 1.0	⊖ 3.0	⊖ 3.0
100mm 1/4" Extension bar	⊖ 2.6mm	⊖ P2, P5	
1/4" to 4.0mm adapter			

Individual packing : Color box

SD-2320M 18 in 1 Mini T-handle Ratchet Set



3 Extension Length Adjustment Ratchet and Quick Release Design



Contents			
9pcs 1/4" bits, Material: Cr-V			
⊖ 3.0 / 5.0 / 6.0mm	⊕ PH1 / PH2 / PH3	⊖ T10 / T15 / T20	
6pcs 1/4" drive sockets, material: carbon steel			
⊖ 5.0 / 6.0 / 7.0 / 8.0 / 9.0 / 10.0mm			
1pce Mini T-Handle ratchet driver	1pce Extension bar	1pce Adapter	

Individual packing : Blister card

SD-9701M 20 in 1 T-handle Driver Sockets & Bits Set

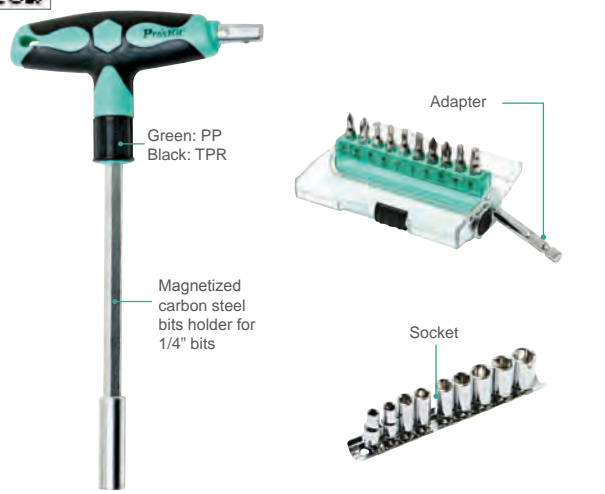

Contents			
PP+TPR non-slip T handle with bits holder (182mm)			
10pcs hex bits: ø1/4" x 25mm, Material: SAE 6150 Cr-V steel			
⊕ #1, #2	⊕ PZ1, PZ2	⊖ 4.0, 5.0mm	
⊖ 4.0, 5.0mm		⊖ T15, T20	
9 pcs ø1/4" DR.Socket bits,			
⊖ 5,6,7,8,9,10,11,12,13mm(3/16",1/4",9/32",5/16",11/32",3/8",7/16",1/2",9/16")			
65mm Adaptor	Carrying case:115x55x17mm		

Individual packing : Blister card

SD-2314M 25 in 1 Reversible Ratchet Screwdriver w/Bits & Sockets Set



High Torque

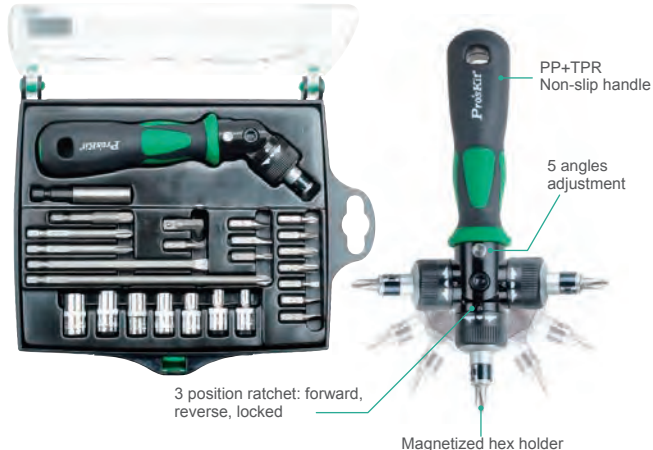

Contents			
3 position ratchet handle			
22pcs ø1/4" hex bits and socket : material: S2 alloy steel			
⊖ 3, 4, 5, 6, 7	⊕ #0, #1, #2, #3	⊖ T15, T20	
⊖ 4, 5, 6, 7, 8, 9, 10	⊕ #2 x 65mm x 2 pcs	⊖ 7.0 x 110 mm	
⊕ #2 x 150 mm			
ø1/4" x25mm Adapter,1/4"x50mm Adapter,ø1/4" x 60mm bits holder			
Carrying case:195x184x28mm			

Individual packing : Shrink

1PK-202A / 1PK-202B 17 PCS Offset Ratchet & Socket Drivers Set



Model No.	Contents
1PK-202A	1pc 2-way ratchet handle, 6pcs sockets (ø1/4" x 25mm, AISI 6150 Cr-V) ● 5, 6, 7, 8, 9, 10 (Metric size) 10pcs bits (ø1/4" x 30mm, AISI 6150 Cr-V): ⊖ 4, 5, 6mm ⊕ #1, #2 ⊕ PZ1, PZ2 ● T10, T15, T20
1PK-202B	1pc 2-way ratchet handle, 6pcs sockets (ø1/4" x 25mm, AISI 6150 Cr-V): ● 3/8", 11/32", 5/16", 1/4", 7/32", 3/16" (Inch size) 10pcs bits (ø1/4" x 30mm, AISI 6150 Cr-V): ⊖ 4, 5, 6mm ⊕ #1, #2 ⊕ PZ1, PZ2 ● T10, T15, T20

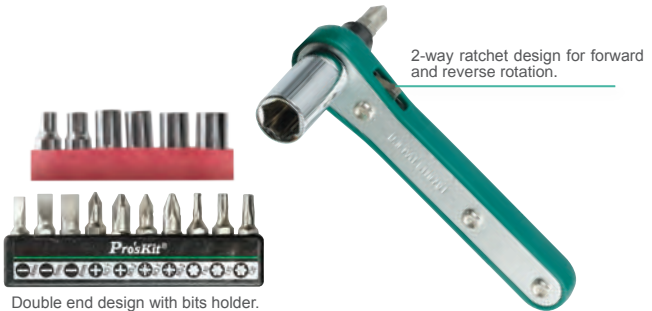

Individual packing : Blister card

SD-2318M 27PCS 1/4" Drive Socket & Screwdriver Set



Contents	
5pcs 1/4" Drive socket:	● 6, 7, 8, 10, 12mm
18pcs 1/4" Bits:	
⊖ 3.0, 4.0, 5.0, 6.0mm	⊕ #1, #2, #3
⊕ PZ1, PZ2, PZ3	● H3.0, H4.0, H5.0, H6.0
● T10, T15, T20, T25	
Magnetic bit adapter: 60mm(L)	
1pc 1/4" Hex(male) to 1/4" socket(male) adapter	
1/4" square drive(female) to 1/4" hex bit holder	
1/4" 72 Teeth stainless reversible ratchet handle	
Plastic case 130x90x40mm	

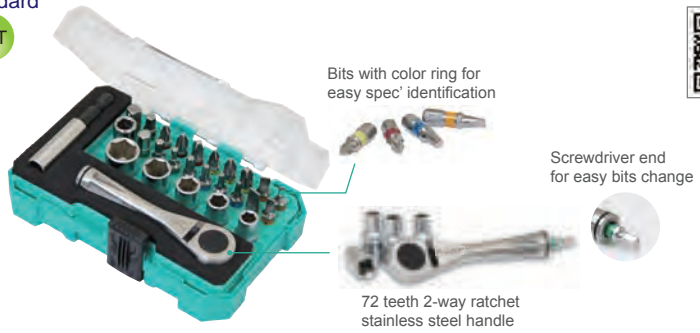

Individual packing : Color box

1PK-212 Twin Wrench Driver Set



Contents	
Both end handle 110mm	
10pcs ø1/4"x30mm AISI 6150 Cr-V steel bits:	
⊖ 4, 5, 6	⊕ PZ1, PZ2
⊕ #1, #2	● T10, T15, T20

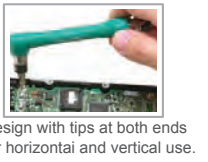

Individual packing : Blister card

1PK-212H Twin Wrench Driver Set



Contents	
Both end handle 110mm	
8pcs ø1/4"x30mm AISI 6150 Cr-V steel bits:	
● T6	
● T8H, T10H, T15H, T20H, T25H, T27H, T30H	
2pcs ø1/4"x37mm AISI 6150 Cr-V steel double end bits	
⊕ #1 - ⊖ 4.5	⊕ #2 - ⊖ 6.0

T8H to T30H have tamper proof holes for preventing tampering for cordless telephones and wireless equipment.

Individual packing : Blister card

1PK-201 Flexible Ratchet Driver Set



Contents	
10pcs ø1/4"x30mm AISI 6150 Cr-V steel bits:	
⊖ 4, 5, 6	⊕ #1, #2
⊕ PZ1, PZ2	● T10, T15, T20
Flexible shaft (190mm)	
Mini ratchet handle	



Individual packing : Blister card

8PK-SD009 8PK-SD009E 33 PCS Security Bit Kit

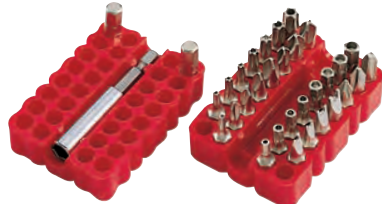

Contents	
1/4" Magnetic extension bar 60mm	
32pcs ø1/4"x30mm bits:	
Spec.	
● 5/64", 3/32", 7/64", 1/8", 9/64", 5/32", 3/16", 1/4"	⊖ 4, 6, 8, 10
● T8H, T10H, T15H, T20H, T25H, T27H, T30H, T35H, T40H	⊕ 1, 2, 3, 4
	● 6, 8, 10
	⊕ 1, 2, 3, 4

• 8PK-SD009E Bit material:SAE6150 CR-V steel

• 8PK-SD009 Bit material:S2 alloy steel

Individual packing : Blister card

SD-205

62 PCS Security Bit Set



- Ratchet force saving design
- Materials: SAE 6150 Cr-V Steel

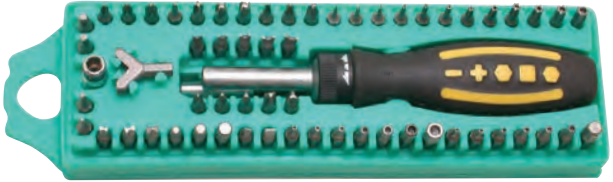

Contents			
58 pcs ø1/4" x 25mm bits:			
● M5, M6, M8	⊖ C1, C2, C3	⊖ 1/8", 3/16"	
▲ 2mm x 2mm x 2mm	⊖ S0, S1, S2, S3	▲ 1, 2, 3, 4, 5	
⊕ #0, #1, #2	⊖ Wing nut driver	⊕ 6, 8, 10	
⊕ PZ0, PZ1, PZ2	⊖ 4, 6, 8, 10, 12		
⊕ T5H, T6H, T7H, T8H, T9H, T10H, T15H, T20H, T25H, T27H, T30H, T40H			
● 2mm, 2.5mm, 3mm, 4mm, 5mm, 6mm, 8mm, 5/64", 3/32", 7/64", 1/8", 9/64", 5/32"			
1 pce 1/4" x 60mm magnetic bits holder		1 pce bits holder socket	
1 pce socket adapter		1 pce dual color TPR non-slip ratchet handle (190mm)	
Case :256x80x43mm			

Individual packing : Shrink packing

8PK-227

40 PCS Socket & Screwdriver Set



- Materials: SAE 6150 Cr-V Steel
- Ratchet force saving design

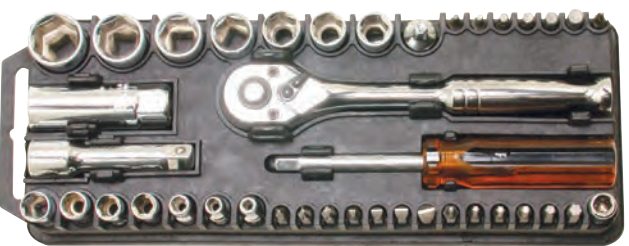

Contents			
14 pcs 1/4" DR sockets:			
● 4, 5, 6, 7, 8, 9, 10, 11, 12, 13, 14, 15, 17, 19mm			
20 pcs ø1/4" x 25 bits:			
⊖ 2.5, 3, 5, 6, 8	⊕ #0, #1, #2, #3		
● 3, 4, 5, 6, 8	⊕ T10, T15, T20, T25, T30, T40		
Ratchet handle	Handle driver		
16 mm spark plug socket	Extension bar		
Hexagon bit holder	Adapter		
Case: 273x97x46mm			

Individual packing : Shrink packing

SD-2309

40 PCS Reversible Ratchet Screwdriver W/Bits & Sockets Set



- Articulated handle allows adjusting angle up to 180 degree
- Ratchet force saving design
- Materials: SAE 6150 Cr-V Steel

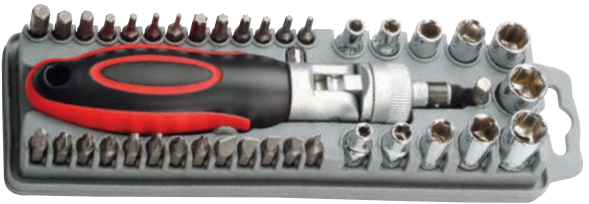

Contents			
11 pcs 1/4" DR sockets:			
● 4mm, 5mm, 5.5mm, 6mm, 7mm, 8mm, 9mm, 10mm, 11mm, 12mm, 13mm			
26 pcs ø1/4" x 25mm bits:			
⊕ #0, #1, #2, #3			
⊖ 3mm, 4mm, 5mm, 6mm, 8mm			
● 2mm, 2.5mm, 3mm, 4mm, 5mm, 6mm, 7mm			
⊕ T10, T15, T20, T25, T30, T40			
⊕ PZ0, PZ1, PZ2, PZ3			
1 pce adapter		1 pce magnetic bit holder 100mm	
1 pce 3-position reversible ratchet handle			
Case: 228x72x45mm			

Individual packing : Color sleeve + Shrink packing

SD-2310

100 PCS Assorted Power Bit Set



- Materials:SAE 6150 Cr-V Steel

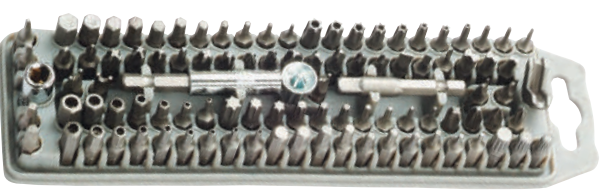

Contents			
96 pcs ø1/4" x 25mm bits:			
⊕ #1, #2	⊕ #0, #1, #2, #3		
⊖ C1, C2, C3	⊖ S0, S1, S2, S3		
▲ 1, 2, 3, 4, 5	⊕ 6, 8, 10		
⊕ PZ0, PZ1, PZ2, PZ3	▲ 2mm x 2mm x 2mm		
● M5, M6, M8	⊖ 2mm, 3mm, 5mm		
⊖ 4, 6, 8, 10, 12	⊖ Wing nut driver		
● 1.5mm, 2mm, 2.5mm, 3mm, 4mm, 4.5mm, 5mm, 5.5mm, 6mm, 7mm, 8mm, 1/16", 5/64", 3/32", 7/64", 1/8", 9/64", 5/32", 3/16", 7/32", 1/4"			
● 2mm, 3mm, 4mm, 5mm, 6mm, 7mm, 8mm, 5/64", 3/32", 7/64", 1/8", 9/64", 5/32", 3/16", 7/32", 1/4"			
⊕ T5H, T6H, T8H, T10H, T15H, T20H, T25H, T27H, T30H, T35H, T40H			
⊕ T5, T6, T8, T10, T15, T20, T25, T27, T30, T40			
1 pce sockets adapter		1 pce dry wall stopper	
1 pce bits holder		1 pce magnetic bit holder	
Case: 212x64x31mm			

Individual packing : Color sleeve + Shrink packing

SD-083 Series ESD Precision Screwdriver



ESD-Safe for maximum protection of static sensitive components



Pro'sKit Precision ESD Safe Screwdrivers are tested in accordance with ESD Association standard; meet the requirements for tools used in static sensitive areas. Surface resistance of handles is $10^7 \sim 10^9 \Omega$

Rotating Cap for precise control and screw turning with fingertip.
 Square shape handle with rubberized non-slip grip for efficient work.
 Tapered handle allows rapid rotation.
 Blade is made of strong chrome molybdenum vanadium steel,
 torx blade is made of S2 alloy steel.
 Black oxide tip for corrosion resistance & long service life.



Model No.	Spec.	B	D
SD-083-S3	⊖	2.0	2.0
SD-083-S4	⊖	2.4	2.4
SD-083-S5	⊖	3.0	3.0
SD-083-P2	⊕	#00	2.0
SD-083-P3	⊕	#0	2.4

Model No.	Spec.	B	D
SD-083-P4	⊕	#1	3.0
SD-083-T4	⊗	T4	3.0
SD-083-T5H	⊗	T5H	3.0
SD-083-T6H	⊗	T6H	3.0

Individual packing : Blister card

SD-0839 ESD Precision Screwdriver Set



- ESD Safe dissipative.
- Ergonomic soft handle.
- Exact fit machined tips.

Contents	
⊕	SD-083-P2, SD-083-P3, SD-083-P4
⊖	SD-083-S3, SD-083-S4, SD-083-S5
⊗	SD-083-T4
⊗	SD-083-T5H, SD-083-T6H

Individual packing : Pouch



SD-081 Series Precision Screwdriver/Nut Driver



Especially designed for Apple products



Model No.	Spec.	Working length
SD-081-S1	1.0	50
SD-081-S2	1.6	50
SD-081-S3	2.0	50
SD-081-S4	2.4	50
SD-081-S5	3.0	50
SD-081-S6	2.4	75
SD-081-S7	3.0	100
SD-081-S8	4.0	150
SD-081-P1	#000	50
SD-081-P2	#00	50
SD-081-P3	#0	50
SD-081-P4	#1	50
SD-081-P5	#0	75
SD-081-P6	#1	100
SD-081-P7	#1	150
SD-081-TA20	2.0	50
SD-081-TA23	2.3	50
SD-081-TA27	2.7	50
SD-081-TRI000	#000	50
SD-081-TRI00	#00	50
SD-081-TRI0	#0	50
SD-081-TRI1	#1	50

Model No.	Spec.	Working length
SD-081-T1	T1	50
SD-081-T2	T2	50
SD-081-T3	T3	50
SD-081-T4	T4	50
SD-081-T5	T5	50
SD-081-T6	T6	50
SD-081-T7	T7	50
SD-081-T8	T8	50
SD-081-T10	T10	50
SD-081-T20	T20	50
SD-081-T5H	T5H	50
SD-081-T6H	T6H	50
SD-081-T7H	T7H	50
SD-081-T8H	T8H	50
SD-081-T9H	T9H	50
SD-081-T10H	T10H	50
SD-081-T15H	T15H	50
SD-081-T20H	T20H	50
SD-081-A2	A2	50

Model No.	Spec.	Working length
SD-081-H2	0.9	50
SD-081-H3	1.3	50
SD-081-H4	1.5	50
SD-081-H5	2.0	50
SD-081-H7	3.0	50
SD-081-Z1	#000	50
SD-081-Z3	#0	50
SD-081-Z4	#1	50
SD-081-M5.5	M5.5	72
SD-081-TS1	P2	50
SD-081-PL5	P5	50
SD-081-PL6	P6	50
SD-081-TRIY06	TRIY06	50

SD-081-T Series : S2 Alloy steel

Individual packing: Blister card

- Pentalobe tips for Apple products
- Tri-Point tips for iPhone, Apple watch

SD-081F 3 PCS Triangle Precision Screwdriver Set



Contents	
	SD-081-TA20, SD-081-TA23, SD-081-TA27

Individual packing : Blister card

SD-081G 4 PCS TRI-wing Precision Screwdriver Set



Contents	
	SD-081-TRI000, SD-081-TRI00, SD-081-TRI0, SD-081-TRI1

Individual packing : Blister card

SD-9803 33 PCS Screwdriver Set w/Bits



Contents	
TPR non-slip handle with bits holder	
30pcs hex ø4 x 28mm, Material: AISI 8660 Cr-Mo-V steel	
+	PH000, PH00, PH0, PH1
-	SL1.0, SL1.5, SL2.0, SL2.5, SL3.0, SL3.5, SL4.0
⊕	T4, T5, T6, T7, T8, T9, T10, T15, T20
⊖	H0.7, H0.9, H1.3, H1.5, H2.0, H2.5, H3.0, H4.0
+	PZ1, PZ0
2 pcs ø4mm socket, material: AISI 6150 Cr-V steel	
⊙	Socket: M5, M6
Carrying case: 170x139x23mm	

Individual packing : Color Label + Plastic box

SD-081H 7 PCS Electronic Repair Set



Contents					
7pcs AISI 8660 Cr-Mo-V alloy steel with TPR non-slip handle screwdriver					
-	2.0	-	2.4	+	#000
+	#00	+	#0	⊕	TRIY06
⊕	TS1	Carry case:170x139x23mm			

Individual packing: Color box

SD-081A 7 PCS Electronic Screwdriver Set



Contents	
AISI 8660 Cr-Mo-V alloy steel with TPR handle screwdriver x 7pcs (OAL:147mm)	
-	1.6x50, 2.0x50, 2.4x50, 3.0x50
+	#00x50, #0x50, #1x50
Carrying case: 170x139x23mm	

Individual packing : Color box

SD-081B 14 in 1 Reversible Screwdriver Set



Contents			
TPR non-slip handle: 112mm			
7pcs hex ø4 x 120mm,Material: AISI 8660 Cr-Mo-V steel			
⊖2.0 - ⊕#00	⊖4.0 - ⊕#1	⊕#1 - ⊕#0	⊕#0 - ⊖3.0
⊖1.5 - ⊖3.0	⊖H2.5 - ⊖2.5	⊖H2 - ⊖2	
Carrying case: 170x139x23mm			

Individual packing : Color box

SD-9824 24 in 1 Screwdriver Set



Non-slip handle
3 Positions ratchet
Retainer
8660Cr-Mo-V steel
Adjustable length 28-129mm



Contents					
3 position ratchet handle: 130mm					
12pcs double end hex bits: ø4 x 160mm					
⊕ PZ1	⊕ PZ0	⊕ H2.5	⊕ H4.0	⊖ 4.0	
⊕ T8H	⊕ T10H	⊕ H2.0	⊕ H3.5	⊖ 3.0	
⊕ T7H	⊕ T9H	⊕ H1.5	⊕ H3.0	⊖ 2.0	
⊕ T6H	⊕ T15H	⊕ #1	⊕ #00	⊖ 1.5	
⊕ T5H	⊕ T20H	⊕ #0	⊕ #000		
Carrying case :192x130x26mm					

Individual packing : Color sleeve

SD-9804 15 in 1 Precision Electronic Screwdriver Set

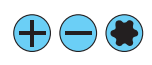

Non-slip TPR handle
Bits holder
110mm
120mm



Contents	
TPR non-slip handle: 110mm	
Extension bar: 110mm	
14pcs hex bits: ø4 x 28mm, Material: AISI 6150 Cr-V steel	
⊕ #000, #00, #0, #1	
⊖ 1.5, 2.0, 2.5, 3.0, 4.0mm	
⊕ T5, T6, T7, T8, T9	
Carrying case: 147x95x24mm	

Individual packing : Blister card

SD-9316 23 in 1 High Performance Screwdriver Set



• Ideal for mobile phone, PDA, PC & other applications.

Rotating cap for screw turning with fingertip
Anodized aluminum alloy handle
Extension bar holder
Pull out become 1/4" bits holder



Contents					
⊕ H2/H3/H4/H5	1/4"	⊕ PH1/PH0/PH00	4mm		
⊕ T15H/T20H/T25H		⊕ 1.5/2.0/2.5			
⊖ 6/8/10		⊕ T4/T5/T6/T7			
Extension bars: 4mm x 70mm, 1/4" x 70mm					
1pce anodized aluminum alloy handle					
Carrying case: 130x86x29mm					

Individual packing : Blister card

SD-9315 22 in 1 Precision Screwdriver Set



• Ideal for mobile phone, PDA, PC & other applications.

Rotating cap for screw turning with fingertip
Dual color PP+TPR anti-slip handle
Magnetic bit holder



Contents					
⊕ 2.5/3.0/3.5/4.0/4.5/5	4mm	⊕ PH1/PH0/PH00/PH000	4mm		
⊖ 1.0/1.5/2.0/2.5 /3.0		⊕ T4/T5/T6/T7/T8			
Extension bar: 4mm x 70mm					
1pce dual color PP+TPR handle					
Carrying case: 130x86x29mm					

Individual packing : Blister card

SD-9827M Precision Repair Tools Set

Precise Bits
Fit screws perfectly

Fine Tip Tweezers
Grip small parts and easy to reach narrow area

Contents	
Cr-V precision bits 4x28mm	⊖ SL1.2 / 2.0 / 2.5 / 3.0mm
	⊕ PH000 / PH00 / PH0 / PH1 / PH2
	⊖ T5 / T6 / T7 / T8 / T10
	⊖ U 2.6
40 Cr alloy steel sockets	⊖ M2.5 / M3 / M4 / M5
#60 carbon steel wrenches	M4 / M4.5 / M5 / M6
Tweezers x 1pc : 114x9.5 mm	Magnetizer demagnetizer x 1pc
Ratchet handle x 1pc : 122 x19 mm	Magnetic extension rod x 1pc : 75x4mm
Magnetic extension rod x 1pc : 75x4mm	
Carring case : 172 x 122 x 34mm	

Individual packing : Color box

SD-9826 33 in 1 Precision Electronic Screwdriver Set

Convenient
Versatile
Handy

Contents	
30pcs bits: Ø4x28mm Material: CRV 6150	
⊕ PH00, PH0, PH1, PH2	
⊖ 1.5 / 2.0 / 2.5 / 3.0 / 3.5 / 4.0	
⊖ T4 / T5 / T6 / T7 / T8 / T10 / T15 / T20	
⊖ 0.9 / 1.3 / 1.5 / 2.0 / 2.5 / 3.0 / 4.0	
⊖ 1.0	⊖ 2.6
⊕ 2.0	⊕ 3.0
TPR+PP non-slip handle: 105mm	
Extension bar: 60mm	
Tweezers: 114x10mm	
Carring case: 155x105x30mm	

Individual packing : Color box

SD-9802 31 in 1 Precision Electronic Screwdriver Set

- Smooth rotating cap for quick and easy screw/unscrew without lifting from screw
- Keyless chuck for easy adjustment of bits holder extension bar
- Adjustable bit holder design for easy work inside narrow or hard to reach places
- A versatile set for driving and retrieving very small screws

Contents	
TPR non-slip handle: 115mm	
Extension bar :110mm	
30pcs hex bits:ø4 x 28mm, Material: S2 steel	
⊕ #00, #0, #1, #2	⊖ 0.9, 1.3, 1.5, 2.0, 2.5, 3.0,4.0mm
⊖ T4, T5, T6, T7, T8, T10, T15,T20	⊕ 2mm , ⊖ Pin 1.0mm
⊖ 1.5, 2, 2.5, 3, 3.5, 4mm	Extension bar: 110mm
⊖ 3mm, ⊖ 2.6mm, ⊖ 3mm	TPR non-slip handle:115mm
Carring case: 212 x 142 x 30mm	

Individual packing : Double blister

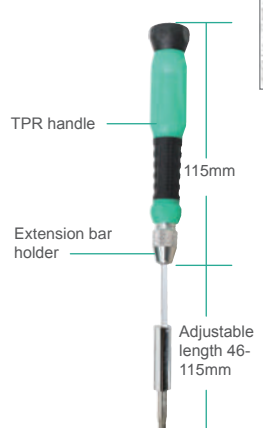

SD-9814 9 in 1 Aluminum Handle Precision Screwdriver Set

Bits storage chamber in handle

Handy pocket clip design

Anodized aluminum alloy handle

Comes with 9 Chrome Vanadium driver bits

110mm

20mm

ø15mm

Contents	
Anodized aluminum alloy steel handle: 110mm	
9pcs hex bits:ø4 x 28mm, Material: AISI 6150 Cr-V steel	
⊕ #000, #00, #0, #1	
⊖ 2.0, 3.0mm	
⊖ T4, T5, T6	

Individual packing : Blister card

SD-9608 30 PCS Aluminum Handle Precision Screwdriver Set

- Aluminum handle with rubber grip provides user comfort
- Linkage structure of bits tray for easy bits change and storage
- Covering most common use bits in a compact box

Contents		
4 mm	⊕ PH000,PH00,PH0,PH1	⊖ 1.0,1.2,1.5,1.8
	⊕ PZ000,PZ00,PZ0,PZ1	⊖ 0.7,0.9,1.3,1.5,2.0
	⊖ T4,T5,T6,T7	⊖ P2
	⊖ 2.0mm	⊖ 2.6
Extension bar : 4mm x 70mm		Aluminum alloy handle
Carring case : 148x74x28mm		

Individual packing : Color box

SD-9302 Miniature Electronic Screwdriver Set



Contents		159
⊖	1.6x65, 2.4x65, 2.0x65	
⊕	#0x65, #00x65, #000x65, #1x65	
⊗	T5x65, T6x65	
Carrying case: 195x184x28mm		

- Slender handle molded to blade and a finger tip swivel top for better control and quick fastening
- Material (Blade): AISI 8660 Cr-Mo-V alloy steel

Individual packing : Shrink

SD-9815 Precision Screwdriver Set

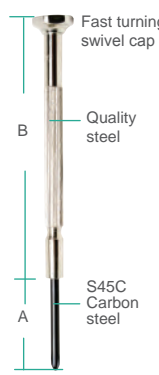

Bit size	A (mm)	B (mm)	OAL (mm)
⊕ #0	27	69	96
⊕ #1	28	81	109
⊖ 1.4mm	17	62	79
⊖ 1.8mm	21	68	89
⊖ 2.4mm	27	69	96
⊖ 3.0mm	28	81	109

Carrying case: 135x85x22mm

Individual packing : Color box

8PK-509 6 PCS Precision Screwdriver Set



- 6 piece screwdriver set with 3 slotted blades and 3 phillips screwdrivers.
- The screwdrivers have long shafts and are ideal for reaching recessed screws in electronic equipment.
- Handles are made from molded plastic and incorporate finger grips.
- Shafts are made from S45C steel.

Contents		Bit length
⊕	#0 (Ø 2.4)	75 mm
⊕	#1 (Ø 3.0)	100 mm
⊕	#1 (Ø 3.8)	150mm
⊖	2.4	75mm
⊖	3.0	100mm
⊖	3.8	150mm

Individual packing : Blister card

SD-9808N 58 PCS Precision Electronic Screwdriver Set



• Non-Magnetic for precision working application.



Contents	
TPR non-slip handle: 123mm	
Extension bar: 115mm	
56Pcs hex bits: Ø4 x 28mm, Material: AISI 8660 Cr-Mo-V steel	
⊕	#000, #00, #0, #1
⊖	1.0mm, 1.5mm, 2.0mm, 2.5mm, 3.0mm, 3.5mm, 4mm
⊗	T5H, T6H, T7H, T8H, T9H, T10H, T15H, T20H
⊗	T3, T4, T5, T6, T7, T8, T9, T10, T15
⊗	1.5mm, 2mm, 2.5mm, 3mm, 1/16", 5/64", 3/32"
⊗	2mm, 2.3mm, 2.5mm
⊗	0.7mm, 0.9mm, 1.3mm, 1.5mm, 2mm, 2.5mm, 3mm, 4mm 0.028", 0.035", 0.05", 1/16", 5/64", 3/32"
⊕	PZ0, PZ1
⊕	TRI1
⊕	2mm
Carrying case: 175x73x39mm	

Individual packing : Shrink pack + Color sleeve

8PK-SD002N 8 PCS Screwdriver Set

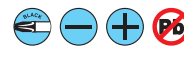

High Torque



Contents		Blade length
⊕	#0, #00, #1	60 mm
⊖	2.0, 2.5, 3.0, 3.5, 4.0	60 mm
OAL: 163mm		

Individual packing : Color box

SW-0118 15 PCS Precision Screwdriver Set



- Working length: 40mm
- Overall length: 132mm



Contents	
⊖	1.0x40, 2.0x40, 3.0x40, 3.5x40
⊕	#000x40, #00x40, #0x40
⊗	1.5x40, 2.0x40, 2.5x40, 3.0x40
⊗	T6x40, T8x40, T10x40, T15x40
Carrying case: 262x183x43mm	

Individual packing : Color label

SD-3502 6 PCS Star Screwdriver Set



Contents		Blade length
	T4	20 mm
	T5H, T6H, T7H, T8H, T9H	20 mm
Carrying case: 121x93x18mm		

Individual packing : Color box

8PK-2061 6 PCS Electronic Screwdriver Set



Contents		Blade length
	#0, #0, #1	20 mm
	1.4, 1.8, 2.4	20 mm
Carrying case: 121x93x18mm		

Individual packing : Color box

8PK-2062 6 PCS Electronic Screwdriver Set



Contents		Blade length
	1.4, 1.6, 1.8, 2.0, 2.4, 3.0	20 mm
Carrying case: 121x93x18mm		

Individual packing : Color box

8PK-2063 5 PCS Electronic Screwdriver Set



Contents		Blade length
	#0-4, #0-3, #00, #0, #1	20 mm
Carrying case: 121x93x18mm		

Individual packing : Color box

SD-803 4 in 1 Screwdriver Set



- Two double-ended, reversible tips
- Blade material: AISI 6150 Cr-V steel
- HRC: 52 ±3°
- Handle: ABS

1/8" 1/16" (3mm)(1.6mm)

Offered in 50pcs / display pack

Contents		O.A.L.(mm)
	1/16", 1/8"	131
	#00, #0	131
Display box: 213x123x144mm		

Individual packing : Display box

1PK-034 Series Ceramic Driver

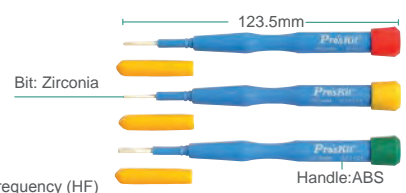

- No electromagnetic induction
- No eddy current loss in high frequency (HF)
- Electrically and thermally insulated
- Non-magnetic • Non-static
- Resistant to acid. (except hydrofluoric)

1PK-034NA		0.4x0.9mm	1PK-034NE		0.4x2.4mm	1PK-034NB		0.4x1.2mm
1PK-034NF		0.7x2.4mm	1PK-034NC		0.4x1.8mm	1PK-034NG		PH0
1PK-034ND		0.4x2.0mm	1PK-034NH		PH1.7			

Individual packing : Double blister

908-607 4 in 1 Screwdriver Set



- Ideal for handyman and TV technicians, this plastic
- screwdriver has a steel spring tip. Suitable for trimmers.

Model No.	Material	Blade diameter	Length
908-607	Tip: Stainless Body: K-gel Handle: PE		200



Individual packing : Bulk

1PK-A001 10 PCS Trimming Tool Set



Material	Spec.	OAL.(mm)
PC	As sketch	115

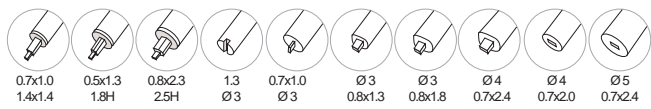

Individual packing : Blister card

3C Product Repair Tools

A "Real Friend" always know what you need

Nowadays, almost everyone cannot live without consumer electronics (3C) products, for which the integrated electronics are making it harder to fix things. Manufacturers of those electronic products keep restricting access to service documentation, parts, and software—which forces consumers into more expensive 'manufacturer-authorized' repairs or even purchase new ones alternatively. However, it is unreasonable to turn the consumer products into "often-consumable" products. Being a leading tool brand as **Pro'sKit** as well as a friend of all **Pro'sKit** fans, we decide to offer a fair shake: access and solution for basic maintenances.

A "Real Solution Provider" makes nothing impossible

There are many brands of consumer electronics in the market, and "Apple" is the most popular brand among them. However, Apple's products are notoriously difficult to open and repair. Apple parts and accessories are different from general ones – they are bizarre, and they even looks different between different Apple series. Here, according to **Pro'sKit** Apple Repair Series, is what's going down.

Pro'sKit develops the special screwdrivers and bits to tackle the hard tasks and make Apple repairs possible.



SD-9322M Precision Repair Screwdriver Set

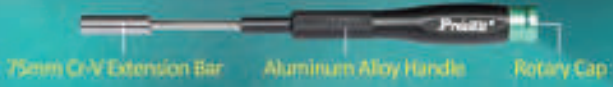

Contents		
CR-V Extension bar 75mm	SIM card tray opener 0.8mm	Suction cup Ø46
Opening lever 75mm, 80mm	Prying paddle 35mm	Tweezers
⊕ 3.0 ⊖ 1.0 ● 2.5 ⊕ 2.5 ⊕ T2, T3, T4, T5, T6		
⊕ T8H, T10H	● 1.5, 2.0	⊕ 0.8(P2) x 2, 1.2(P5), 1.5(P6)
⊕ Y06	⊕ Y00, Y0	⊕ PH000, PH00, PH0, PH1

Individual packing : Label +Shrink

1PK-3179 5 PCS Spudger/Prying Tool Assortment



- Ideal for most brands of smart phones, video games, notebooks, electronic devices.
- Opening and prying disconnecting small electronic components without damaging housing or parts.



Contents
1 pce Double-ended metal spudger OAL:185mm
1 pce Nylon aid tool, OAL:150mm
2 pcs Polyoxymethylene (POM) opening levers, OAL:84.4mm, 88.7mm
1 pce Prying paddle, 30.5x30.5x30.5mm

Individual packing : Blister card

MS-3176 4 PCS Open Repair Tool Set



- Ideal for most brands of smart phones, video games, notebooks, electronic devices.
- Opening and prying disconnecting small electronic components without damaging housing or parts.



Contents
Metal spudger tool (123 mm)
Point-blade solder aid tools (155 mm)
Spudger solder aid tools (140 mm)
Fork-blade solder aid tools (173 mm)

Individual packing : Blister card

SD-9314 17 in 1 Tool Kit For Apple Products

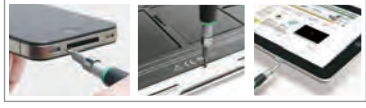

Contents
Dual color precision screwdriver handle: 110mm
12pcs 4mm precision screwdriver bits: Ø4x28mm, material: AISI 8660 Cr-Mo-V steel
⊕ P2, ⊕ PH000, ⊖ 1.5mm, ⊕ T4, T5, T6, T8, T10, T15, T20 ● H2.0mm, H1.5mm ⊖ 1.0
Polyoxymethylene (POM) opening lever x 2 OAL: 84.4mm, 88.7mm
Suction cup Ø36mm
Prying paddle 30.5mm x 30.5mm x 30.5mm

Individual packing : Sleeves



Carrying case :135x94x30mm

PK-9110 6 PCS iPhone Series Disassemble Set



Contents
⊕ P2X40mm : OAL91.5mm
⊕ #00X40mm : OAL91.5mm
Polyoxymethylene (POM) opening lever x 2 OAL: 84.4mm, 88.7mm
Suction cup Ø36mm
Prying paddle 30.5mm x 30.5mm x 30.5mm

Individual packing : Blister card

SD-9828 58 PCS Driver Kit



P2 / P5 / P6 pentalobe tips are special for Apple products.
TS3.8 / TS4.5 Torx plus® are special for Nintendo, Microsoft products.

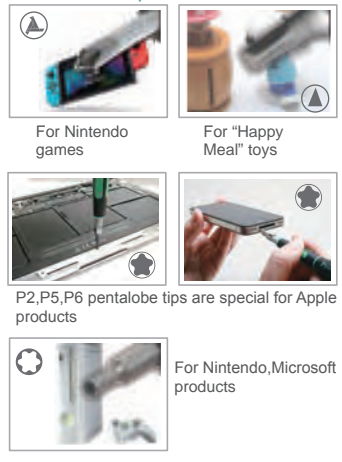

Ideal for smartphone opening of tablets, notebooks, electronic device cases and most branded video games such as Apple, HTC, Samsung, LG, Nokia, Sony, Microsoft, Nintendo, Play Station and more.

Contents			
42 pcs Ø4.0x28 mm, material : AISI 8660 Cr-Mo-V steel			
+	#000, #00, #0, #1, #2	+	#0, #1, #2
-	1.0, 1.3, 1.5, 2.0, 2.5, 3.0, 3.5, 4.0 mm	+	T3, T4
+	T5H, T6H, T7H, T8H, T9H, T10H, T15H, T20H		
+	0.7, 0.9, 1.3, 1.5, 2.0, 2.5, 3.0, 3.5, 4.0 mm		
+	#0, #1	+	3.0 mm
Pentalobe	P2, P5, P6 (iPhone, MacBook Air, MacBook Pro)		
6 pcs Ø4.0x30 mm, material : 50BV30 Cr-V steel			
+	2.5, 3.0, 3.5, 4.0, 4.5, 5.0 mm		
5 pcs Ø1/4"(6.3)x25 mm, material : AISI 6150 Cr-V steel			
+	#2	-	6.0 mm
+	4.5, 5.0, 6.0 mm		
2 pcs Ø1/4"(6.3)x38mm, material : AISI 6150 Cr-V steel			
Torx plus® socket	TS3.8, TS4.5		
1 pc Ø4.0mm to Ø1/4" adaptor 50 mm			
1 pc Ø4.0x125 mm extension bar		1 pc TPR non-slip handle	
Plastic case: 175x73x37mm			

Individual packing : Color sleeve

SD-9326M Consumer Electronic Equipment Repair Kit



P2 / P5 / P6 pentalobe tips are special for Apple products.



- Allows opening the most of branded smart phone, video game, notebook, electronic devices and more.
- Including P2,P5,P6 pentalobe bits for Apple products
- Features 30pcs selected bits and 10 pcs essential repair tools are available in an elegant and durable carrying case

Contents	
Non-slip handle with rotating cap	
+	P2, P5, P6, #000, #00, #0, #1
+	2.0mm, 2.5mm, 3.0mm, 4.0mm, H0.7mm, H1.5mm, H2.0mm, H3.0mm
+	PZ1, PZ0
+	Spanner 2.6
+	T4, T5, T6, T8, T10, T15, T20
+	TA2.0
+	TRI00, TRI0, TRI1
+	PIN
1 pce double-ended metal spudger OAL:185mm	
1 pce nylon aid tools, OAL:150mm	
2 pcs polyoxymethylene (POM) opening levers, OAL:84.4mm, 88.7mm	
1 pce prying paddle, 30.5x30.5x30.5mm	
Suction cup OAL:36mm	
Plastic case: 225x125.4x51.3mm	

Individual packing : Color sleeve

8PK-2065 7 PCS Cellular Phone Opener Set



Contents	
7pcs screwdrivers: 140mm, Material: AISI 8660 Cr-Mo-V steel	
+	#0
+	T5, T6, T7
-	Security screwdriver
+	1.0
Opening lever	
Carrying case: 170x132x21mm	

Individual packing : Color box

HEX KEY WRENCHES



Pro'sKit® provides a one-stop shopping experience for the handyman and his or her hex key wrench needs.



Pro'sKit®

886-2-22183233
Sales support

pk@mail.prokits.com.tw
E-mail

www.prokits.com.tw
Global website

▶ HW-230BL 9 PCS Color Code Extra Long Arm Ball Point Hex Key Set

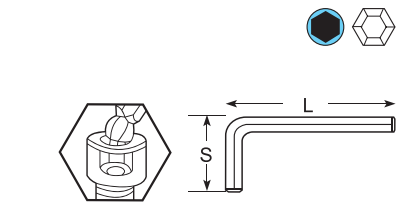

(mm)	Tip Size (mm)		Color
	S	L	
1.5	14	95	Black
2.0	16	107	White
2.5	20	118	Blue
3.0	23	132	Light yellow
4.0	28	147	Light blue
5.0	32	162	Green
6.0	36	185	Yellow
8.0	41	210	Orange
10	50	235	Red

Individual packing: Blister card

▶ HW-129 9 PCS Long Arm Hex Key Set



- Key material : SAE 6150 with satin finished

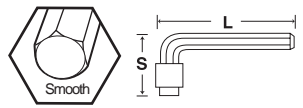

(mm)	Tip Size (mm)	
	S	L
1.5	15	79
2	18	84
2.5	20	91
3	22	101
4	28	108
5	32	121
6	37	144
8	43	166
10	49	178

Individual packing: Blister card

▶ 8PK-028 9 PCS Ball-Point Hex Key Set



- Key material : S2 alloy steel with blackened finished

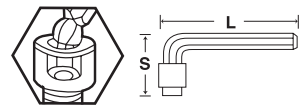

(mm)	Tip Size (mm)	
	S	L
1.5	16	79
2	18	86
2.5	21	93
3	23	99
4	29	109
5	32	119
6	37	140
8	43	162
10	50	180

Individual packing: Blister card

▶ HW-229B 9 PCS Ball Point Long Arm Hex Key Set



- Key material : SAE 6150 with satin finished

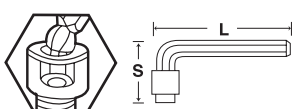

(mm)	Tip Size (mm)	
	S	L
1.5	15.5	63.5
2	18	76
2.5	20.5	85.5
3	23	91
4	29	102
5	33	118
6	38	139
8	44	155
10	50	177

Individual packing: Blister card

▶ HW-229BL 9 PCS Extra Long Arm Ball Point Hex Key Set



- Key material : SAE 6150 with satin finished

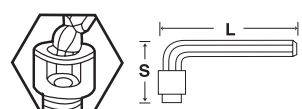

(mm)	Tip Size (mm)	
	S	L
1.5	15.5	90.5
2	18	101
2.5	20.5	112.5
3	23	127
4	29	142
5	33	163
6	38	184
8	44	205
10	50	231

Individual packing: Blister card

HW-0221 16 PCS Hex Key Wrench Set



- Portable packaging
- Case can be hung for storage or display
- Key material:SAE 6150 with satin finished (Inch) and blackened finished (Metric)

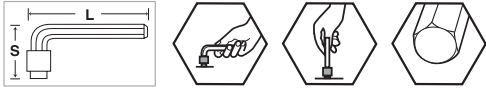

Tip size(Inch)	S (mm)	L (mm)	Tip size (mm)	S (mm)	L (mm)
1/16"	15	46	1.5	15	46
5/64"	18	52	2	17	52
3/32"	18	53	2.5	20	59
1/8"	21	58	3	23	66
5/32"	26	68	4	29	73
3/16"	28	74	5	32	84
7/32"	31	81	5.5	34	89
1/4"	34	89	6	38	96
Case size		127x87x20 mm			

Individual packing: Blister card

8PK-027 30 PCS Metric & Inch Combination Hex Key Set



- Portable packaging
- Case can be hung for storage or display
- Key Material:SAE 6150 with blackened finished

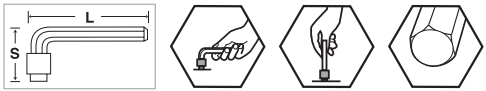

Tip size (Inch)	S (mm)	L (mm)	Tip size (mm)	S (mm)	L (mm)	Tip size (inch)	S (mm)	L (mm)	Tip size (mm)	S (mm)	L (mm)
0.028"	8	65	0.7	8	35	9/64"	23	105	4.5	30	79
0.035"	11	69	0.9	11	39	5/32"	24	108	5	32	85
0.050"	13	73	1.3	13	42	3/16"	28	118	5.5	34	90
1/16"	15	78	1.5	15	46	7/32"	31	129	6	37	95
5/64"	16	84	2	18	52	1/4"	34	141	7	40	102
3/32"	19	90	2.5	20	58	5/16"	39	159	8	43	107
7/64"	21	95	3	23	66	3/8"	43	179	10	49	121
1/8"	22	99	4	29	73	Case Size	132x93x32 mm				

Individual packing: Blister card

8PK-022 7 PCS Miniature L Shaped Hex Key Set



- Size range from 0.7~3 mm
- Key material:SAE 6150 with blackened finished

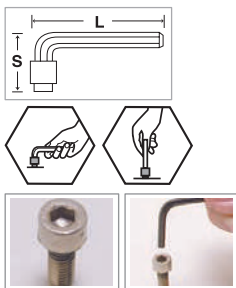

For hexagon screws

Tip Size (mm)	(mm)	S	L
	0.7	8	10
	0.9	12	14
	1.3	14	17
	1.5	17	19
	2	19	20
	2.5	35	38
	3	41	45
		50	56
		65	

Individual packing: Blister card

HW-023 8 PCS Ring Type Hex Key Set



- Long arm type
- Key material:SAE 6150 with blackened finished



Tip Size (mm)	(mm)	S	L
	1.5	15	17
	2	20	22
	2.5	22	28
	3	28	33
	4	33	35
	5	35	37
	5.5	45	52
	6	58	66
		73	85
		91	96

Individual packing: Blister card

▶ 8PK-021N/8PK-021NA 7 PCS Folding Hex Key Set



Model No	Contents
8PK-021N	● 1.5, 2, 2.5, 3, 4, 5, 6mm (Metric size)
8PK-021NA	● 1/16", 5/64", 3/32", 1/8", 5/32", 3/16", 1/4" (Inch size)

Key material	Case	Individual packing
SAE6150 with satin finished	Green lacquered	Blister card

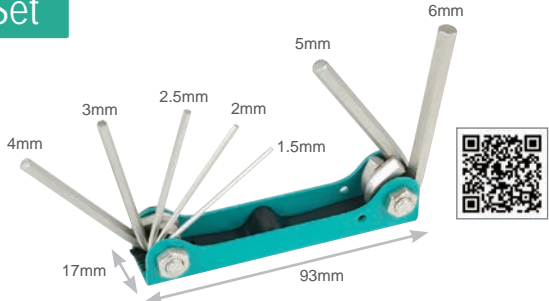

▶ 8PK-021T 8 PCS Folding Tamper-proof Star Key Wrench Set

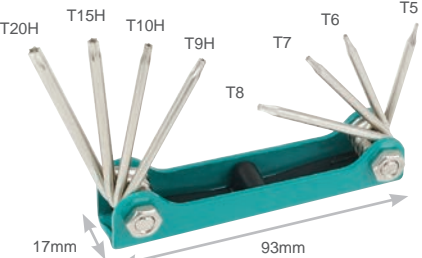

- Key material : SAE 6150 with satin finished
- Case: Green lacquered

Contents	
●	T5, T6, T7, T8
●	T9H, T10H, T15H, T20H

Individual packing: Blister card

▶ 8PK-021L 8 PCS Folding Tamper-proof Star Key Wrench Set

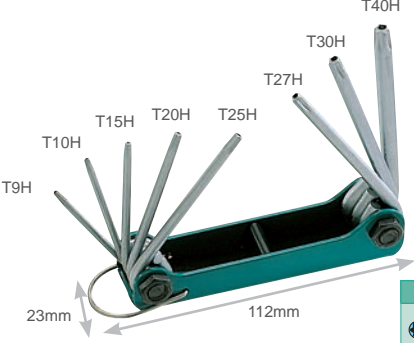

- Key material : SAE 8660 with satin finished
- Case: Green lacquered

Contents	
●	T9H, T10H, T15H, T20H, T25H, T27H, T30H, T40H

Individual packing: Blister card

▶ HW-121L 8 PCS Folding Tamper-proof Star Key Wrench Set



- Key material : SAE 6150 with satin finished
- Case: T.P.R. Anti-slip
- OAL.: 109x43x23 mm

Contents	
●	T9H, T10H, T15H, T20H, T25H, T27H, T30H, T40H

Individual packing: Hanger

▶ HW-121M 8 PCS Folding Hex Key Set



- Key material : SAE 6150 with satin finished
- Case: T.P.R. Anti-slip
- OAL.: 109x43x23 mm

Contents	
●	1.5, 2, 2.5, 3, 4, 5, 6, 8mm (Metric Size)

Individual packing: Hanger

▶ HW-221L 8 PCS Folding Tamper-proof Star Key Wrench Set

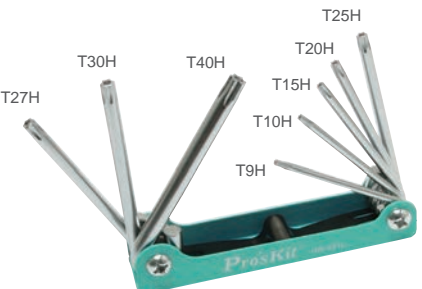

- Key material : SAE 6150 with satin finished
- Case: Lacquered finished
- OAL.: 109x30x25mm

Contents	
●	T9H, T10H, T15H, T20H, T25H, T27H, T30H, T40H

Individual packing: Blister card

▶ HW-221M 8 PCS Aluminum Case Folding Hex Key Set

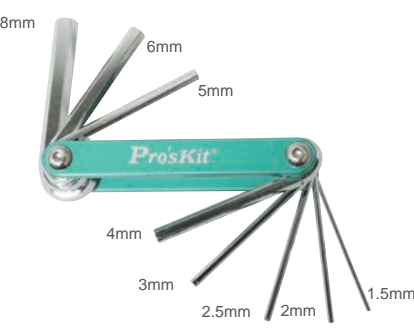

- Key material : SAE 6150 with satin finished
- Case: Anodized aluminum
- OAL.: 104x36x22mm

Contents	
●	1.5, 2, 2.5, 3, 4, 5, 6, 8mm (Metric size)

Individual packing: Blister card

SOCKET WRENCHES



You may think you're strong with a wrench, but a socket wrench can twist the head of a bolt right off.

Pro'sKit socket wrenches make tightening and removing bolts incredibly easy.

Pro'sKit

886-2-22183233
Sales support

pk@mail.prokits.com.tw
E-mail

www.prokits.com.tw
Global website

▶ HW-318 Multifunction Socket Wrench

360° ROTATION HEAD

GO-THROUGH DESIGN

T HANDLE DRIVE WRENCH

Adjustable for narrow place

12 Point 48 IN 1 Quickly Change Rotating Head

Material			Hardness	Torque
Body	Socket	Handle	HRC 43±5°	200N.m
S45C	40Cr	ABS+TPE		
Size Spec.			Weight	OAL
Metric: 8, 10, 11, 13, 14, 16, 17, 19mm			450±30g	255mm ±10mm
Inch: 5/16", 3/8", 7/16", 1/2", 9/16", 5/8", 11/16", 3/4"				

Individual packing: Blister card

▶ HW-T Series Adjustable Torque Wrench With Reversible Ratchet

Quick Release Design
Cw/CCw Torque Control

Reliable Mechanism

1/4", 3/8", 1/2" Square Drive

Dual Units Scale Indication

Easy Torque Adjustment Design

Non-slip Knurled Steel Handle, Durable and Comfortable

INDUSTRIAL GRADE

ASME B107.300-2010

DIN ISO 6789



- Accuracy of Torque ±3.0 %**
Each torque wrench laser serial no. and calibration certificate for future tracing.
- Dual Units Scale Indication**
Dual units N-m and lbf.in or lbf.ft scale indication.
- CW/CCW Torque Control**
Applied to both clockwise and counter clockwise bi-directional torque control. Signals by impulse when torque setting is reached.
- Easy Torque Adjustment**
Easy torque-adjusting design brings energy-saving benefit. Positive locking mechanism avoids accidental setting alterations.
- Quick Release Design**
Comes with quick release design, allows changing socket quickly.
- Reliable Mechanism**
Quality meets DIN ISO 6789 & ASME B107.300-2010.

Idea for motorcycle, bicycle, automobile, truck, heavy machinery, ship, cruise, aerospace industry, high-speed rail and more.

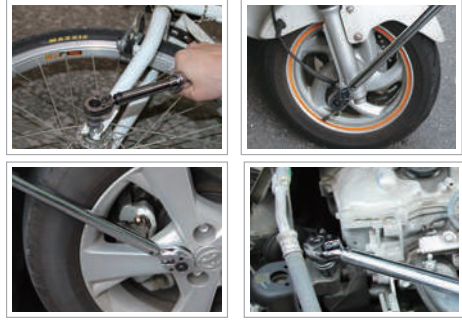

Spec.	HW-T41-315	HW-T41-525	HW-T83-20100	HW-T21-40200	HW-T21-60340
Drive	1/4"/6.35mm Square	1/4"/6.35mm Square	3/8"/9.53mm Square	1/2"/12.70mm Square	1/2"/12.70mm Square
Unit	N-m/lbf.ft Dual units	N-m/lbf.ft Dual units	N-m/lbf.ft Dual units	N-m/lbf.ft Dual units	N-m/lbf.ft Dual units
Torque range	3.0~15 N-m 31~128 lbf.ft	5.0~25 N-m 53~212 lbf.ft	20~100 N-m 16.6~71.9 lbf.ft	40~200 N-m 33~144 lbf.ft	60~340 N-m 52~243 lbf.ft
Accuracy	±3.0 %	±3.0 %	±3.0 %	±3.0 %	±3.0 %
Graduation	0.1 N-m	0.2 N-m	0.5 N-m	1.0 N-m	2.0 N-m
Gear teeth	64 T	64 T	32 T	32 T	32 T
OAL	210 mm (8.3")	248 mm (9.8")	433 mm (17")	530 mm (21")	610 mm (24")

Individual packing: Plastic box + Color Label

SD-T635 Series Adjustable Torque Screwdriver

INDUSTRIAL GRADE



ASME B107.300-2010

DIN ISO 6789

HEX KEY
WRENCHES

Accuracy of Torque $\pm 6.0\%$

Each torque wrench laser serial no. and calibration certificate for future tracing.

Dual Units Scale Indication

Dual units N.m and lbf.in or lbf.ft scale indication.

CW/CCW Torque Control

Applied to both clockwise and counter clockwise bi-directional torque control. Signals by impulse when torque setting is reached.

Easy Torque Adjustment

Easy torque-adjusting design brings energy-saving benefit. Positive locking mechanism avoids accidental setting alterations.

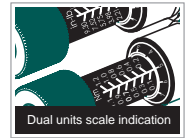

Model No.	SD-T635-0112	SD-T635-16	SD-T635-510
Drive	1/4"/6.35mm hexagon		
Unit	N-m/lbf.in dual units		
Torque range	0.1~1.2 N-m 1.33~10.18 lbf-in	1.0~6.0 N-m 13.28~48.68 lbf-in	5.0~10 N-m 48.68~84.08 lbf-in
Accuracy	$\pm 6.0\%$		
Graduation	0.01 N-m	0.1 N-m	
OAL	180 mm	200 mm	

Individual packing: Plastic box + Color Label

SD-T636 12 PCS Torque Screwdriver Set



Ergonomic Handle

Torque adjustable 1 - 6 N-m. Includes torque adjusting tool for torque setting easily.

Bits

Includes 10pcs double end bits, common use 20 bits size to satisfy most applications. Made by AISI 8660 Cr-Mo-V steel.

Application

For controlled fastening on electrical engineering installation and maintenance, and more.



Specification
Torque adjustable: 1~6 N-m, accuracy $\pm 6\%$, recommend calibration after 5000 cycle
Contents:
Dual Color PP/TPR/POM Handle, length:137mm
10pcs AISI 8660 double end hex bits, length:175mm: SL3.0+SL4.0, SL5.5+SL6.35, PH0+PH1, PH2+PZ2, PZ0+PZ1, T10H+T15H, T20H+T25H, H2H+H3H, H4HxH5H PZ/FL1+PZ/FL2
Square 8mm torque adjusting tool, length:99mm/40mm

Individual packing: Color box



Quick release design for speedy interchanging bit



Accurately torque adjustable 1 - 6 N-m

HW-T716-3 7/16" Preset Torque Spanner



- Proper connections at "F" connector interface with preset torque setting 30 lbf-in(3.4N-m).
- Narrow head design helps work in tight density space.
- Audible click sound alerts user when full pressure has been applied.
- Ergonomic & cushion handle for comfort and protection.

Material		Torque range	Drive	OAL(mm)
Handle	HEX			
TPR	AISI4140	30 lbf-in(3.4N-m)	7/16"(11.1mm)	163

Individual packing: Blister card



▶ HW-6509B/6514B Combination Wrench

Cr-V 50BV30 Tools Meet DIN Standard



HW-6509B



9PCS Combination Wrench (Metric)

Model No.	Spec.
HW-6509B	8, 10, 11, 12, 13, 14, 15, 17, 19mm

Individual packing: Color box

HW-6514B



14PCS Combination Wrench (Metric)

Model No.	Spec.
HW-6514B	8, 9, 10, 11, 12, 13, 14, 15, 16, 17, 18, 19, 22, 24mm

Individual packing: Color box

▶ HW-7509B/7513B Double Open End Wrench

Cr-V 50BV30 Tools Meet DIN Standard

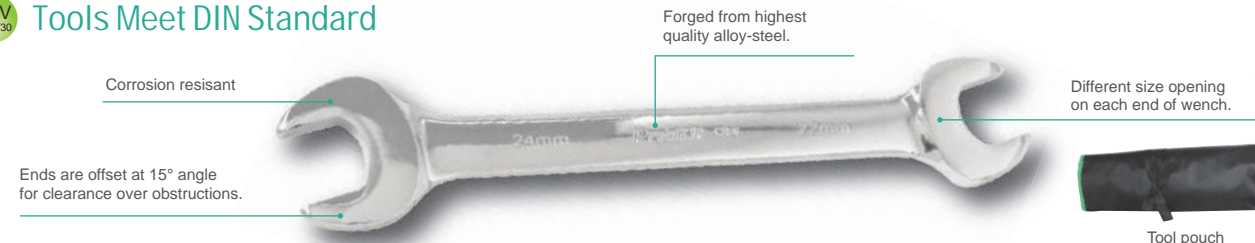

HW-7509B



9PCS Double Open End Wrench (Metric)

Model No.	Spec.
HW-7509B	6x7, 8x10, 11x13, 12x14, 14x17, 17x19, 21x23, 22x24, 24x27mm

Individual packing: Color box

HW-7513B



13PCS Double Open End Wrench (Metric)

Model No.	Spec.
HW-7513B	6x7, 8x10, 10x12, 11x13, 12x14, 14x17, 17x19, 19x21, 21x23, 22x24, 24x27, 27x30, 30x32mm

Individual packing: Color box

▶ HW-609A/HW-609B 10 PCS Electronic Combination Wrench



• 10 pcs electronic combination wrench set. Open box end wrench made from AISI 1045, drop forged heat-treated.



Model No.	Spec.
HW-609A (Inch Size)	Box end 7/16", 11/32", 3/8", 9/32", 5/16", 1/4", 15/64", 7/32", 5/32", 3/16"
	Open end 3/8", 5/16", 11/32", 1/4", 9/32", 15/64", 7/32", 13/64", 3/16", 5/32"
HW-609B (Metric Size)	Box end 11, 10, 9, 8, 7, 6, 6, 5.5, 4.5, 4mm
	Open end 10, 9, 8, 7, 6, 5.5, 5, 4, 4.5mm

Individual packing: Pouch

▶ 1PK-H&HW Series Adjustable Wrenches



- Precision machined jaws for exact fit and smooth adjustment
- Drop forged carbon steel construction, rust resistant polished chrome finished
- The hex jaw design allows for a more secure fit and reduces slippage
- PVC coated handles
- Handle hole for easy hanging or storage

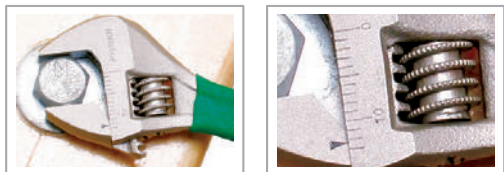

Model No.	Material	Jaw open (Max)	OAL
1PK-H026	S45C	13/16"(19mm)	6"(150mm)
1PK-H028	S45C	1"(25mm)	8"(200mm)
HW-010	S45C	1-3/16"(30mm)	10"(250mm)
HW-012	S45C	1-7/16"(36mm)	12"(300mm)

Individual packing: Blister card



1PK-H026



1PK-H028



HW-010



HW-012

HEX KEY
WRENCHES

▶ HW-5907M Flex Head Ratcheting Wrench



- Ratcheting box end set at 0°~180°
- Open end set at 15°
- Material: AISI 1045

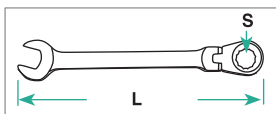

S(mm)	L(mm)
8	139
10	157
11	175
13	194
14	212
17	231
19	250



Individual packing: Plastic Box



▶ 8PK-SD016 23 PCS 1/4" Driver Socket Set



Contents	
●	18 pcs 1/4" DR 4, 5, 6, 7, 8, 9, 10, 11, 12mm 3/16", 7/32", 1/4", 9/32", 5/16", 11/32", 3/8", 7/16", 1/2"
	140mm ratchet handle
	Adaptor: 70, 150mm
	Steel box (214x84x44mm)

Individual packing: Color sleeve shrink



INDUSTRIAL GRADE Tools meet DIN standard

HEX KEY
WRENCHES

HW-22401M 24PCS 6.3mm Drive Socket Tool Set



Pb **GPT** **Cr-V 60BV30** **6.35mm** **72T**



Universal joint Spinner T handle Extension bar w/2 way

13pcs hand socket 4,4.5,5,5.5,6,7,8,9,10,11,12,13,14mm		
5pcs hand deep socket 8,10,11,12,13mm	Extension bar 55mm	
Extension bar w/wobble 2 way 100mm	Sliding T handle 115mm	
Universal joint	Spinner handle	
72 teeth reverse flat ratchet handle w/quick release		
Metal case 245x120x35mm		

Individual packing : Color sleeve shrink

HW-42601M 26PCS 12.7mm Drive Socket Tool Set



Pb **GPT** **Cr-V 60BV30** **12.7mm** **72T**



Teeth reverse flat ratchet handle Spark plug socket Sliding T handle with quick release

14pcs hand socket 10,12,13,14,15,16,17,18,19,22,24,27,30,32mm	
4pcs hand deep socket 12,14,17,19mm	2pcs spark plug socket w/magnetic 16,21mm
Extension bar w/quick release 125mm	Extension bar w/quick release 250mm
Sliding T handle w/quick release 250mm	
LED light adaptor	Universal joint
72 teeth reverse Flat ratchet handle w/quick release	
Metal case 445x185x50mm	

Individual packing : color sleeve shrink

HW-23801M 38PCS 6.3mm Drive Socket Tool Set



Pb **GPT** **Cr-V 60BV30** **6.35mm** **72T**

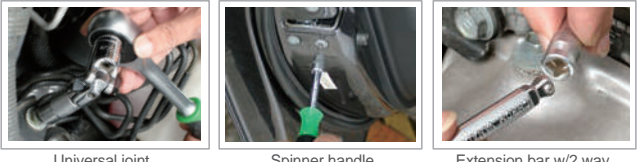

Universal joint Spinner handle Extension bar w/2 way

13pcs hand socket 4,4.5,5,5.5,6,7,8,9,10,11,12,13,14mm		
18pcs hand bits socket T10,T15,T20,T25,T30,T40,H3,H4,H5,H6,H8,PH1,PH2,PZ1,PZ2,SL4,SL5.5,SL6.5		
Extension bar 55mm	Extension bar w/wobble 2 way 100mm	
Sliding T handle 115mm	Universal joint	Adaptor 3/8" F x 1/4" M
Spinner handle	72 teeth reverse flat ratchet handle w/quick release	
Metal case 280x130x40mm		

Individual packing : Color sleeve shrink

HW-42401M 24PCS 12.7mm Drive Socket Tool Set



Pb **GPT** **Cr-V 60BV30** **12.7mm** **72T**

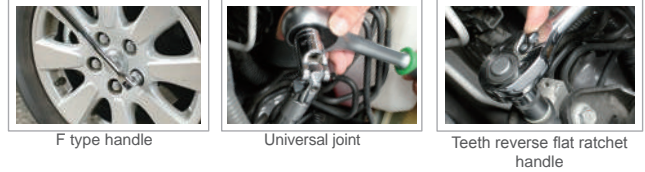

F type handle Universal joint Teeth reverse flat ratchet handle

18pcs hand socket 10,11,12,13,14,15,16,17,18,19,20,21,22,23,24,27,30,32mm		
Extension bar 125mm	Extension bar 250mm	Sliding T handle 250mm
F type handle 375mm	Universal joint	
72 teeth reverse flat ratchet handle w/quick release		
Metal case 445x185x50mm		

Individual packing : Color sleeve shrink

INDUSTRIAL GRADE Tools meet DIN standard

HW-612401M 124PCS 6.3mm, 12.7mm Drive Socket Tool Set



The HW-612401M 124pcs 1/2"-1/4" Dr. Socket tool set comes in an aluminum frame 3 drawers tool case for easy tool organization and contains most of popular tools to capability round out this versatile set.



HEX KEY
WRENCHES

3 1/2 Compact Digital Multimeter for DCV, ACV, DC current, resistance, diode and transistor hFE test.

High leverage pliers new mechanical design, up to 50% cutting force saving than regular pliers

Locking pliers features a compound action, non-slip lock and release lever for one-hand operation

Top Layer

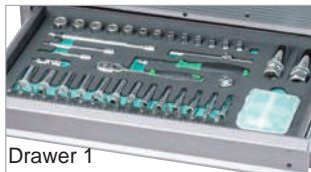

Drawer 1



Drawer 2

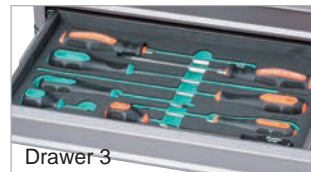

Drawer 3



Top Layer : OTR-612401MEVA-1

23pcs 1/2" hand socket 8,9,10,11,12,13,14,15,16,17,18,19,20,21,22,23, 24,25,27,28,29,30,32mm		
8pcs 1/2" hand deep socket 10,11,12,13,14,17,19,22mm	1/2" Extension bar w/quick release 125mm	
1/2" Extension bar w/quick release 250mm	1/2" Sliding T handle w/quick release 250mm	
1/2" LED light adapter	1/2" Universal joint	
1/2" 72 Teeth reverse flat ratchet handle w/quick release		

Drawer 1 : OTR-612401MEVA-2

14pcs 1/4" hand socket 1/4", 4,4.5,5,5.5,6,7,8,9,10,11,12,13,14mm		13pcs 1/4" hand deep socket 4,4.5,5,5.5,6,7,8,9,10,11,12,13,14mm	
18pcs 1/4" hand bits socket : T10,T15,T20,T25,T30,T40,H3,H6, H4,H5,H8,PH1,PH2,PZ1,PZ2,SL4,SL5.5,SL6.5			
2Pcs 1/2" spark plug socket w/magnetic 16,21mm		1/4" extension bar w/wobble 2 way 52mm	
1/4" extension bar w/wobble 2 way 100mm		1/4" extension bar w/quick release 150mm	1/4" sliding T handle 115mm
1/4" universal joint		1/4" spinner handle	1/4" 72 teeth reverse flat ratchet handle w/quick release
Adapter 3/8" F x 1/4" M		Multi-purpose box(OD 99x66x36mm)	

Drawer 2 : OTR-612401MEVA-3

9pcs ball-point long arm hex key 1.5,2,2.5,3,4,5,6,8,10mm	7pcs flex head gear wrench 8,10,11,13,14,17,19mm
---	--

Drawer 3 : OTR-612401MEVA-4

2pcs go-through screwdriver SL8x150mm,PH3x150mm	6pcs pro-soft screwdriver SL6x100mm,SL6x40mm,SL6x200mm,PH2x100mm,PH2x40mm,PH2x250mm
Telescopic magnetic pick up tool	

Cover:

3 1/2 compact digital multimeter	8.5" high leverage combination cutting plier	8" high leverage diagonal cutting plier
8" high leverage long nose plier	2pcs adjustable locking plier 9"(long nose)	Aluminum frame 3 drawers tool case 485x260x333mm

POWER TOOLS



Make anything possible, it's all the power you need!



▶ PT-1801A/F 18V Li-ion Impact Cordless Drill Driver

High Impact Force 19,200 ipm
High Speed 1200 rpm
Max. Torque 35N.m

- Dual gear speed 0-350/0-1200rpm for greater versatility.
- 16 torque setting with 3 rotary mode (screw/drill/impact).
- LED working light for improved visibility.
- Stepless variable speed.



230 x 220 x 95mm



Accessories :
 5PT-1801-DRI : HSS drills : \varnothing 2.0,2.5,3,4,5,6,1pc 6mm concrete drill bits
 5PT-1206-BIT : CRV bits: PH1, PH2, PZ1, PZ2, SL5, SL6 (L : 25mm) 60mm magnetic insert bits holder x1
 5PT-1801-BIT1 : SL6-PH2 double end driver bits x1
 5PT-1801-BAT : Battery x2, 5PT-1801-ADA/ADF:Adapter x1



Specifications	PT-1801A	AC 120V/60Hz
	PT-1801F	AC 230V/50Hz
Rated no load speed	0-350/0-1200 rpm	
Impact / min	0~19200 ipm	
Torque setting	16 torques	
	3 modes : screw/drill/impact	
Output torque	35N.m / 22N.m	
Drive	1/2" (13mm) keyless chuck	
Special function	2 gear speed switch forward & reverse switch, LED light	
Range of drill bit sizes	\varnothing 2.0~ \varnothing 13mm	
	Steel: \varnothing 8 mm	
Max. drilling capacity	Wood: \varnothing 20 mm	
	Concrete : \varnothing 10 mm	
Battery capacity	Includes 2pcs 18V 1500mAh LI-ion	
Individual packing	Blow box + Color sleeve	

▶ 5PT-1801-BAT Battery Pack

- 18V 1500mAh Li-ion battery complies with latest safety standard.
- No memory effect allows charge and discharge anytime.
- Compatible for PT-1801A/F.
- Individual packing : Color box.



▶ 5PT-1801-ADA/ADF Charging Adapter

- 40 min quick charge enables efficient work.
- Output voltage : DC 20V 2.4A



Model No.	Input voltage	Output voltage	Plug
5PT-1801-ADA	AC120V / 60Hz	DC 20V 2.4A	A
5PT-1801-ADF	AC 230V / 50Hz	DC 20V 2.4A	F

▶ PT-1206A/F 12V Li-ion Cordless Drill Driver

Dual Gear Speed
19 Torque Adjustment & 1 Drilling

- Dual gear speed tackles all common drilling & driving applications.
- Stepless speed control for enhancing handling safety and high efficiency.
- 22N.m/15N.m enough torque to drive most common fasteners and drill bits.
- Keyless chuck for fast, one-handed bit changes.



185 x 185 x 55mm



Accessories :
 5PT-1206-DRI : HSS drills : 1.5,2.5,3,4,5,6mm
 5PT-1206-BIT : CRV bits: PH1, PH2, PZ1, PZ2, SL5, SL6 (L:25mm), 60mm magnetic insert bits holder
 5PT-1206-BAT : Battery x1, 5PT-1206-ADA/ADF:Adapter x1



Specifications	PT-1206A	AC 120V/60Hz
	PT-1206F	AC 230V/50Hz
Rated no load speed	0-350/0-1300 rpm	
Torque setting	19 (drive)+1 (drill)	
Output torque	22N.m / 15N.m	
Drive	3/8" (10mm) keyless chuck	
Special function	2 gear speed switch forward & reverse switch, LED light	
Battery capacity	12V 1300mAh	
Range of drill size	\varnothing 0.8- \varnothing 10mm	
Max. drilling capacity	steel: \varnothing 6mm, wood: \varnothing 18mm	
Individual packing	Blow box + Color sleeve	

▶ 5PT-1206-BAT Battery Pack

- 12V 1300mAh Li-ion battery complies with latest safety standard.
- No memory effect allows charge and discharge anytime.
- Compatible for PT-1206A/F.
- Individual packing : Color box.



▶ 5PT-1206-ADA/ADF Charging Adapter

- 1 hour quick charge for efficient work.



Model No.	Input voltage	Output voltage	Plug
5PT-1206-ADA	AC120V / 60Hz	DC 12V 1.5A	A
5PT-1206-ADF	AC 230V / 50Hz	DC 12V 1.5A	F

USB POWER SERIES



▶ PT-036U 3.6V USB Li-ion Cordless Screwdriver



Complete Set

satisfy most of precision work.

USB Charging

easy to use in anywhere.

LED illumination

provides visibility when working in dark area.

Rated no load speed	100 rpm
Output torque	0.4 N.m
LED illumination	3 LED light
Battery	Rechargeable Li-ion battery 3.6V 350mAh
Charging time	1.5~2h (5V/0.5A~1A)
Free running time	30 min(unloading)
Dimension	160 x 25 x 22.5mm
Weight	60g
Individual packing	PET folding box

Accessories :

4mm bits x 7:#000, #00, #0, SL2.0, SL2.5, T5, T6, Micro USB charging cord x 1

▶ PT-5205U 3.7V USB Li-ion Mini Grinder set



USB Charging

easy to use in anywhere.

3 Speed

5000/1000/15000rpm for selection.

Compact and Cordless

break space limit.

Rated no load speed	5000/10000/15000 rpm
Drive	Ø2.4 / Ø3.2 mm
Battery	Rechargeable 3.7V 600mAh LI-ion
Charging Port	Micro USB
Battery charging indicator	Yes
Charging time	~2h (5V/0.5A)
Free running time	~100 min
Size	145x31mm
Weight	90g
Size	Ø31x145mm
Individual packing	Color box

Accessories :

Sanding band x2, Diamond bits x2, Grinding stones x2, Engraving bit x1, Nylon brush x1, Mandrel for sanding band x1, Ø 2.4mm collet x1, Ø3.2mm collet x1, Micro USB charging cord x 1

▶ PT-5206U 3.6V Li-Ion Usb Grinder Set



ULTRA CONVENIENT LOW VIBRATION

w/ USB rechargeable design.

ULTRA EFFICIENT

10000/20000 rpm dual speed selectable

Ideal for cutting, sanding, grinding, carving for any home improvement or crafting job.

Power	3.6V Li-ion 1500mAh
Rated no load speed	10,000 / 20,000 rpm
Charging time	2.5~5hr.
Drive	Ø2.4/ 3.2 mm
Charging interface	Micro USB
Free running time	55 min.
Weight	250g (Accessory is not included)
size	193x51x37mm(main body)
Individual packing	Color box

Accessories :

Micro USB charging cord x1, Wrench x1, Ø2.4mm colletx1, Ø3.2mm colletx1 (Assembled in body), Mandrel for sanding bandx1, Mandrel for cutting wheelx1, Sanding bands x 3, Diamond bit x 1, Grinding stones x 2, Cutting wheels x 2

▶ PT-1362U 3.6V USB Li-ion Cordless Screwdriver

- Full Metal Gear Box
- Li-ion Battery • USB Charging

- USB charging, easy to use in anywhere.
- Full metal gear box, durable and easy to carry.
- Li-ion battery offers high performance and service life.



Rated no load speed	200 rpm
Output torque	3.5 N.m
Special function	LED charging indicator
Overall length	140 x 110mm
Battery	Li-ion 3.6V 1500 mAh
Charging time	2~3 hours (5V/1A)
Free running time	~60 min
Size	135 x 127 x 46mm
Individual packing	Color box



Accessories :

4pcs 50mm driver bits: SL5.0, SL6.0, #1, #2, Micro USB charging cord x 1

▶ PT-5501I Variable Speed Rotary Tool Kit

10,000 to 32,000RPM variable speed.

- 40-piece accessories to meet most applications.
- Flexible shaft and cable attachment allows precision work.



Maximum output (Power)	135 W
No load speed	10,000-32,000 rpm
Collet chuck capacity	Ø3.2mm and 2.5mm
Voltage	230V, 50Hz
Plug	I
Carrying case size	285x235x80(mm)
Individual packing	Color sleeve shrink

Accessories :

Round needle tip x1, Flat tip x1, Mandrel for polishing felt x1, Diamond bits x10, Grinding bits x2, Mandrel for grinding wheel x1, Sanding wheel x8, Sanding paper x3, Hex key wrench x1, Polishing felt (Ø 12mm, Ø 21mm) each x2, Mandrel for sanding band x1, Sanding band x4, Collet (Ø 2.5, Ø 3.2) each x1, High speed drill (Ø 3.2, Ø 2.3) each x1, Whetstone x1, Wrench x1



▶ PT-5100 Rotary Tool Accessory Kits

complete kit
offer the breadth of accessories helpful
for wide assortment of tasks.

Suitable for: PT-5501, PT-5201 and PT-5202 series
and other most rotary type tools.



1pc HSS Cutter	10pcs felt polishing sheets	1pc mandrel for felt wheels
5pcs diamond wheel points	4pcs sanding bands	1pc mandrel for cut-off wheels
4pcs grinding wheels	40pcs sanding discs	2pcs mandrel for sanding bands
2pcs steel brush	36pcs cut-off wheels	1pc felt tip
2pcs collets: Ø3.2mm / Shank Ø4.8mm		
Size	220x128x46mm	Individual packing Sleeve



▶ PT-5202F Mini Grinder Set



- Build-in LED light provides illumination during use.
- Includes 19 accessories and 2 stencils for most tasks.
- Durable plastic storage case for easy organized.



Main body	Collet size	Max. Ø3.2mm
	No-load speed	15,000 rpm
	Working voltage	18V DC
	Acoustic pressure	<70dB
	Overall length	Ø43x127 mm
Switch adapter	Weight	123 g
	Input voltage	100~240VAC 50/60Hz 0.5A Max.
	Output voltage	18V DC 400mA
	Adapter plug	F
Accessories		19 accessories and 2 stencils
Carrying case		142x137x57mm (5.6"x5.4"x2.3")
Individual packing		Color Box

▶ PT-5201A/B Mini Grinder



- Naturally and comfortable operation body shape.
- The quick-change chuck is ideal for drilling, polishing, engraving, routing, shaping, sanding and milling.
- Low vibration, high torque & lightweight ergonomically design.

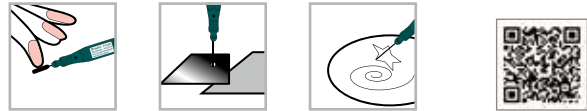

Model No.	PT-5201A	PT-5201B
Max. diameter	ø3.2mm	
No load speed	8000~18000 rpm adjustable	
Adapter voltage	Output: 18.5VDC 400mA Input: 100~240V 50/60Hz	
Adapter plug	A	F
Replacement accessories	9PT-5201-P2 (10 pcs/set)	
Replacement adapter	9PT-5201A-P	9PT-5201B-P
Individual packing	Double blister card	

Accessories : 2 pcs diamond bits, 2 pcs grinding stones, 2 pcs sanding bands, 2 pc collet (Ø 2.4/ Ø 3.2 mm), 1 pc nylon brush, 1 pc connective post for sanding band

▶ 1H055-T Accessories



High Speed Steel Drill Bits

designed for precision drilling applications in wood, non-ferrous metals and plastics. Available in pack, each containing 5 different drill sizes.



Model No.	1H055-T
Size (5pcs/set)	ø0.5mm
	ø1.0mm
	ø1.5mm
	ø2.5mm
	ø3.0mm
Individual packing	Plastic box

ESD STATIC



Pro'sKit® ESD series help you to get rid of static electricity problems.



AS-611 Wrist Strap



Band resistivity	Wrist strap resistivity	Band size	Cord size (feet)	Individual packing
10 ³ ~10 ⁶ Ω	10 ⁶ Ω	Fixed	10 (3M)	Blister card

8PK-611 Wrist Strap



Band resistivity	Wrist strap resistivity	Band size	Cord size (feet)	Individual packing
10 ³ ~10 ⁶ Ω	10 ⁶ Ω	Fixed	10 (3M)	Blister card

8PK-611D Wrist Strap



Band resistivity	Wrist strap resistivity	Band size type	Cord size (feet)	Individual packing
10 ³ ~10 ⁶ Ω	10 ⁶ Ω	Adjustable	10 (3M)	Blister card

608-611C Wrist Strap



Band resistivity	Wrist strap resistivity	Band size	Cord size (feet)	Individual packing
10 ³ ~10 ⁶ Ω	10 ⁶ Ω	Adjustable	10 (3M)	Blister card

AS-612F Quick-Fasten Wrist Band



608-611B/608-611B-6 Wrist Strap



Band resistivity	Wrist strap resistivity	Wrist belt	Cord size (feet)	Individual packing
10 ³ ~10 ⁶ Ω	10 ⁶ Ω	Adjustable	6 (1.8M)	Blister card

Model.No	Band resistivity	Wrist strap resistivity	Wrist belt	Cord size (feet)	Individual packing
608-611B	10 ³ ~10 ⁶ Ω	10 ⁶ Ω	Adjustable	10(3M)	Blister card
608-611B-6				6(1.5M)	

8PK-611W Replaceable Cordless Wrist Strap

- Cordless operation is not recommended for low humidity environment.
- For high humidity environment.



Band resistivity	Band size type	Individual packing
10 ³ ~10 ⁶ Ω	Adjustable	Blister card

AS-501 Series Static Brush



• Handle : Conductive p.p • Resistivity : 10³~10⁶Ω • Individual packing : Blister card



8PK-AS07-1 Field Service Kit



Material	Conductive PVC
Resistivity	$10^9 \sim 10^{11} \Omega$
Wrist belt	With 6ft wrist strap and 10ft grounding wire w/bottom
Size(mm)	650x600
Individual packing	Color box

8BM-401A/8BM-405A/8BM-612A Static-Dissipative Mat



Model No.	8BM-401A	8BM-405A	8BM-612A
Material	Face layer: 0.2mm laminated PVC, Center layer: 1.7mm PVC foam, Bottom layer: 0.1mm PVC foam, Combination layer: conductive drug		
Resistivity	Face & Center & Bottom, Layers: $10M \sim 1KM \Omega/SQ$ Combination layer: $1K \sim 1M \Omega/SQ$, Static decay time: less than 0.5sec		
Description	Static dissipative mat for CPU	Static dissipative mat for keyboard & mouse & touch	Static dissipative mat for OA desk-top
Size(mm)	500x600	600x600	600x1200
Individual packing	Color box		

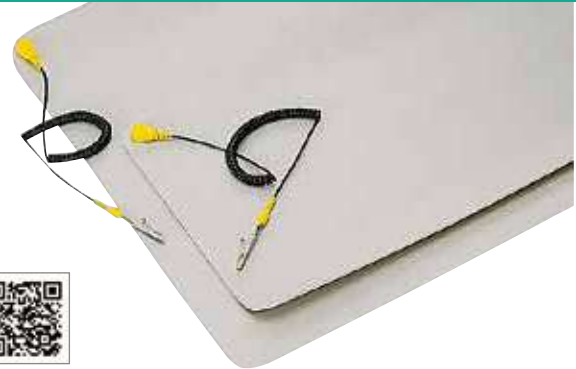

ESD STATIC PROTECTION

808-Q03-1 Anti-Dissipative Table Mat



Material	Rubber
Resistivity	Top layers: $10^9 \sim 10^{10} \Omega$, Bottom layer: $10^4 \sim 10^6 \Omega$
Size	10M x 1M, Thickness: 2mm
Individual packing	Bulk

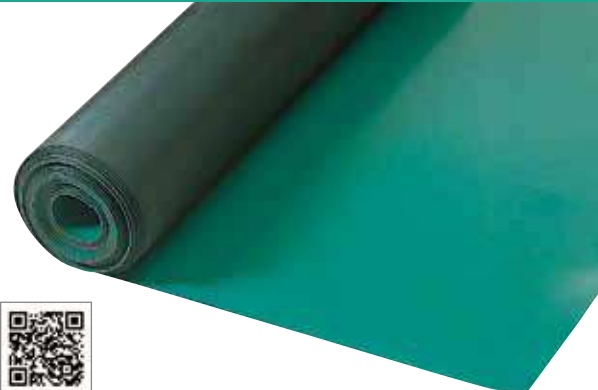

808-Q05 Foot & Heel Ground



These versatile heel grounders have a specially designed dual-layered cup construction for superior floor contact.



Resistivity	$10^6 \Omega$
Size	Adjustable
Individual packing	Blister card

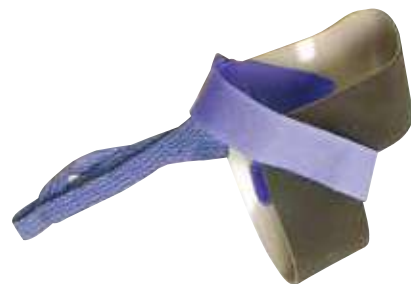

VDE INSULATION TOOLS



The great ability comes great responsibility. *Pro'sKit* VDE series are nothing but trust-worthy.

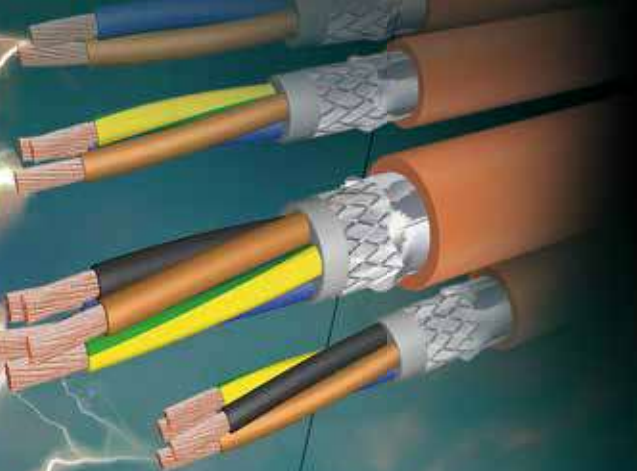

VDE 1000V Insulated Tools



Dielectric Strength Test

Individual immersion test at 10,000 Volt to guarantee safety working up to 1000 Volt.

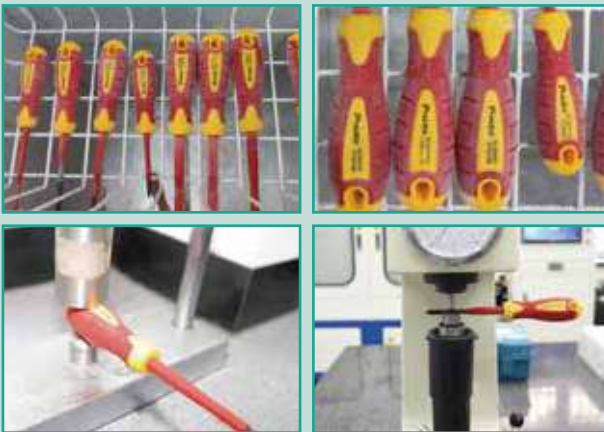

Low-temperature Impact Test

When the tools are cooled down to -40°C , proceed the insulated part with impact test. The insulation must retain the tough against breaking.



High-temperature Adhesive Power Test

After storage for 168 hours at 70°C , pull the insulated part with tensile force of 500Nm for 3 minutes. This test ensures that the insulation still stays firm and remain snug against the tool body.



Burning Behavior Test

Pro'sKit® insulated tools use flame-resistant plastics for insulation to protect users.

Pro'sKit® Insulation VDE Series come with high visibility molded ergonomic cushion handles for maximum comfort to ensure full force transfer through the grip. They also have been tested for dielectric strength under 10,000 Volt in a water bath in accordance with DIN EN 60900 (IEC 60900:2012) to encourage the users to trust a reliable insulation when live working up to 1,000 Volt. VDE tools are often used under extreme conditions, such as very low or very high temperature. **Pro'sKit**® Insulation VDE Series are made from high grade materials, which have been tested by low-temperature impact test, high-temperature adhesive power test and burning test to offer more safety to users.



VDE TOOLS

Safety Caution



- Please keep your insulated tools dry and clean.
- Wear protective goggles and gloves when working.
- Do not touch the non-insulated parts when working live.

INSULATED VDE PLIERS

- Certified to IEC 60900, VDE, DIN 1,000V safety standards and bear GS sign.
- High visibility molded ergonomic cushion handle for maximum comfort.
- Hard chrome finished with PTFE coating for anti-rust protection.
- Drop forged from special tool steel.







 Individual packing: Blister card

▶ PM-918 Insulated Long Nose Plier



Material	HRC	Application		OAL. (mm)
	Body	Hard steel	Soft steel	
AISI 6150	46°±4°	Ø2.2mm	Ø3.2mm	200

▶ PM-919 Insulated Long Nose Plier



Material	HRC	Application		OAL. (mm)
	Body	Hard steel	Soft steel	
AISI 6150	46°±4°	Ø1.6mm	Ø2.5mm	170

▶ PM-910 Insulated Wire Stripping Plier



Material	HRC	Application		OAL. (mm)
	Body	Solid wire	Stranded wire	
AISI 6150	46°±4°	Ø0-5mm	0~10mm²	160

▶ PM-911 Insulated Combination Plier



Material	HRC	Application		OAL. (mm)
	Body	Hard steel	Soft steel	
AISI 6150	46°±4°	Ø2.5mm	Ø3.8mm	195

▶ PM-912 Insulated Combination Plier



Material	HRC	Application		OAL. (mm)
	Body	Hard steel	Soft steel	
AISI 6150	46°±4°	Ø2.0mm	Ø3.1mm	175

▶ PM-916 Insulated Heavy Duty Side Plier



Material	HRC	Application		OAL. (mm)
	Body	Hard steel	Soft steel	
AISI 6150	46°±4°	Ø2.7mm	Ø3.8mm	190

▶ PM-917 Insulated Side Cutter



Material	HRC	Application		OAL. (mm)
	Body	Hard steel	Soft steel	
AISI 6150	46°±4°	Ø2.0mm	Ø2.8mm	165

SR-V206 SR-V210 VDE 1000V Insulated Cable Cutter



- Precision ground, hardened blades.
- Chrome molybdenum alloy steel, forged, oil-hardened.

SR-V206



SR-V210



SR-V537 VDE 1000V Insulated Ratchet Cable Cutter



- Precision ground, hardened blades.
- High-grade carbon steel, forged, oil-hardened.
- Clean and smooth cutting without crushing and deformation.
- Ratcheted with safety release for force saving.



Ratchet drive for easier cutting

Model No.	Material	HRC		Application: for cutting copper and aluminum cables.			OAL. (mm)	Individual packing
		Body	Cutting edge	Diameter	Cross-sectional area	AWG		
SR-V206	Cr-Mo	43°±3°	50°±2°	Ø5.2 mm	22mm ²	4	150	Blister card
SR-V210	Cr-Mo	43°±3°	50°±2°	Ø10.0 mm	80mm ²	3/0	250	
SR-V537	65Mn	38°~43°	48°~52°	Ø32 mm	240mm ²	500	240	

SR-V336 VDE 1000V Insulated Electricians Scissors



- Dual color, non-slip, insulating ergonomic handle for maximum comfort.
- Stainless steel, oil-hardened.

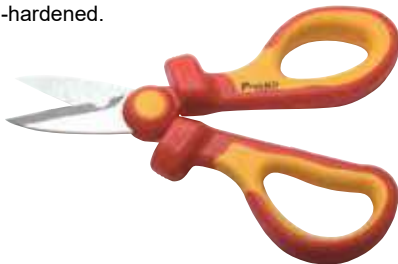

MS-V001 VDE 1000V Insulated Tape



Material	HRC	Blade length	OAL.	Individual packing
AISI 420J2	48°~52°	47mm	160mm	Blister card

Material	Width	OAL.	Individual packing
PVC	20mm	10m	Blister card

▶ SD-810 Series Insulated VDE Screwdriver



S2 Alloy Steel

Solid & High Torque

Heavy Insulated Shank

Ensure User's Safety

Ergonomic Handle

Comfortable Grip /
Extra Hanging Hole

Magnetized Tip

Easily Attach Screws



Model No.	Specification	Blade Length
SD-810-S2.5	⊖ 0.4 x 2.5	75mm
SD-810-S3.0	⊖ 0.5 x 3	100mm
SD-810-S4.0	⊖ 0.8 x 4	100mm
SD-810-S5.5	⊖ 1.0 x 5.5	125mm
SD-810-S6.5	⊖ 1.2 x 6.5	150mm
SD-810-P0	⊕ #0	60mm
SD-810-P1	⊕ #1	80mm
SD-810-P2	⊕ #2	100mm
Individual packing	Double blister card	

▶ SD-8012 7PCS Insulated VDE Screwdriver Set

S2 Alloy Steel

Solid & High Torque

Magnetized Tip

Easily Attach Screws

Heavy Insulated Shank

Ensure User's Safety

Ergonomic Handle

Comfortable Grip / Extra Hanging Hole



Model No.	Specification	Blade Length
SD-810-S2.5	⊖ 0.4 x 2.5	75mm
SD-810-S4.0	⊖ 0.8 x 4	100mm
SD-810-S5.5	⊖ 1.0 x 5.5	125mm
SD-810-S6.5	⊖ 1.2 x 6.5	150mm
SD-810-P0	⊕ #0	60mm
SD-810-P1	⊕ #1	80mm
SD-810-P2	⊕ #2	100mm
Individual packing	Color sleeve + Color label	

▶ 8PK-8100E Insulated Screwdriver Set



- Pass 1000V high voltage test.
- Ergonomic handle provides user comfort
- AISI8660 Cr-Mo-V steel hardened blade, durable and great torque performance.
- Most common used tips selection fulfill most demands.



⊖	2.5x85
⊖	4.0x100
⊖	5.5x125
⊖	6.5x150
⊕	#0x75
⊕	#1x100
⊕	#2x100
Individual packing: Color box	

TZ-V3 Series VDE 1000V Insulated Tweezers



- Stainless steel with antimagnetic.



TZ-V302A Sharp tip

Gripping surfaces with matt finished for optimum grip



TZ-V302B Curved tip

Gripping surfaces with fine transverse serration



TZ-V302C Round point

Gripping surfaces with fine transverse serration



TZ-V302D Wide tip

Gripping surfaces with fine transverse serration

Model No.	Material	HRC	Width (mm)	OAL. (mm)	Individual packing
TZ-V302A	AISI 304	35°~45°	15.6	134	Blister card
TZ-V302B			13.0	159	
TZ-V302C			13.0	160	
TZ-V302D			15.0	145	

PD-V Series VDE 1000V Insulated Cable Knife



- Stainless steel, oil-hardened.
- Suitable for round cables and sector cables.
- Including protective cap for safe storage.



PD-V003A Straight blade type



PD-V003B Hook blade type



PD-V003D Hook blade sickle shaped type

Plastic coating the back of blade to avoid short circuits



PD-V004A Straight blade type

Plastic coating the back of blade to avoid short circuits

Model No.	Material	HRC	Blade length (mm)	Radius (mm)	OAL. (mm)	Individual packing
PD-V003A	3Cr13	50°~58°	54	-	186	Blister card
PD-V003B			33	7	170	
PD-V003D			51	23.5	185	
PD-V004A			54	-	185	

HW-V6 Series VDE 1000V Insulated Adjustable Wrench



- Parallel smooth gripping jaw.
- With scaling for easy presetting.
- Chrome vanadium steel, forged, oil-hardened.



Model No.	Material	Jaw open (Max.) mm	Jaw depth (mm)	Jaw thickness (mm)	OAL. (mm)	Individual packing
HW-V608	50CrV	30	25	12~8	200	Blister card
HW-V610		34	30	14~9	250	
HW-V612		41	36	17~11	300	

▶ HW-V1 Series VDE 1000V Insulated Single Open End Wrench



- 15° angled jaw.
- Chrome vanadium steel, forged, oil-hardened.

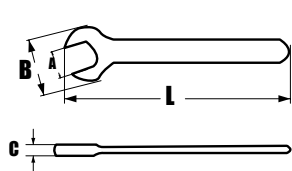

Model No.	Material	(A) Width across flats mm	(B) Head width Max. mm	(C) Head thickness Max. mm	(L) OAL ±2 mm	Individual packing
HW-V106B	50CrV	6	22	7.2	90	Blister card
HW-V107B		7	24	7.2	90	
HW-V108B		8	25	7.7	100	
HW-V109B		9	28	7.7	100	
HW-V110B		10	29	8.0	110	
HW-V111B		11	31	8.7	110	
HW-V112B		12	33	8.7	130	
HW-V113B		13	34	10.2	135	
HW-V114B		14	37	10.5	145	
HW-V115B		15	40	11.0	150	
HW-V116B		16	42	11.5	160	
HW-V117B		17	44	12.2	160	
HW-V119B		19	48	12.2	175	
HW-V122B		22	54	13.0	195	
HW-V124B	24	56	13.5	225		

▶ HW-V2 Series VDE 1000V Insulated Single Box End Wrench



- Chrome vanadium steel, forged, oil-hardened.
- Cranked.

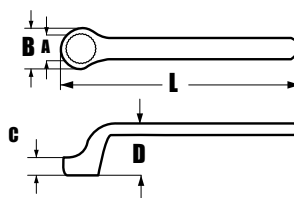

Model No.	Material	(A) Width across flats mm	(B) Head width Max. mm	(C) Head thickness Max. mm	(D) Depth of crank mm	(L) OAL ±2 mm	Individual packing
HW-V210B	50CrV	10	21.0	8.8	30	170	Blister card
HW-V213B		13	25.7	10.2	33	190	
HW-V214B		14	26.0	11.0	35	205	
HW-V217B		17	30.6	12.3	37	215	
HW-V219B		19	33.5	13.2	39	230	
HW-V222B		22	37.5	13.9	44	245	

▶ PK-2811M 15 PCS 1000V Insulated single Open End Wrench Set



- This roll tool set provides reliable 1000V tools which ensure users' safety when working in a hazardous environment such as, very low or very high temperature or high voltage.
- The tools come with dual color non-slip insulating handles for maximum user comfort. They are packaged in a rugged PVC (600D) tool bag for easy storage and convenient carrying.



600D tool roll bag:
305x635mm



Model No.	Material	(A) Width across flats mm	(B) Head width Max. mm	(C) Head thickness Max. mm	(L) OAL ±2 mm
HW-V106B	50CrV	6	22	7.2	90
HW-V107B		7	24	7.2	90
HW-V108B		8	25	7.7	100
HW-V109B		9	28	7.7	100
HW-V110B		10	29	8.0	110
HW-V111B		11	31	8.7	110
HW-V112B		12	33	8.7	130
HW-V113B		13	34	10.2	135
HW-V114B		14	37	10.5	145
HW-V115B		15	40	11.0	150
HW-V116B		16	42	11.5	160
HW-V117B		17	44	12.2	160
HW-V119B		19	48	12.2	175
HW-V122B		22	54	13.0	195
HW-V124B	24	56	13.5	225	

Individual packing

Color sleeve

▶ HW-V710 VDE 1000V Insulated Reverse Flat Ratchet Handle



- Reversible for clockwise and anti-clockwise directions.
- Extremely smooth action.
- Quick, easy and reliable locking of attached sockets.
- Chrome vanadium steel, forged, oil-hardened.



Model No.	Material		Square drive	Teeth	OAL. (mm)	Individual packing
	Body	Square drive				
HW-V710	AISI 6140	42CrMo	1/2"	36	235	Blister card

▶ SK-V752 VDE 1000V Insulated T Handle



- Quick, easy and reliable locking of attached sockets.
- Chrome vanadium steel, forged, oil-hardened.



Model No.	Material	Square drive	Handle length (mm)	Drive length (mm)	Individual packing
SK-V752	50BV30	1/2"	160	200	Blister card

▶ SK-V4 Series VDE 1000V Insulated 1/2" Drive Socket



- 1/2" Square Drive
- For metric hexagonal head screws.
- Chrome Vanadium steel.



Model No.	Material	Width across flats mm	Outside diameter Max. mm	Length mm	Individual packing
SK-V410B	50BV30	10	19.5	38.0	Blister card
SK-V411B		11	20.7		
SK-V412B		12	22.0		
SK-V413B		13	23.2		
SK-V414B		14	24.5		
SK-V416B		16	27.0		
SK-V417B		17	28.2		
SK-V418B		18	29.5		
SK-V419B		19	30.7		
SK-V422B		22	34.5		
SK-V424B		24	37.0		

▶ SK-V8 Series VDE 1000V Insulated Extension Bar



- With internal and external square.
- Quick, easy and reliable locking of attached sockets.
- Chrome vanadium steel, forged.



Model No.	Material	Square drive	OAL. (mm)	Individual packing
SK-V851	50BV30	1/2"	125	Blister card
SK-V852		1/2"	250	

▶ SD-V861 13PCS VDE Screwdriver Kit



Anti-Slip Handle

Soft & non-slip grip design.

High Quality

Insulated & CR-V steel.

Magnetic Tips

Allows screws holding easier black-oxide for corrosion resistance.



⊖	1.2 x 6.5 x 100	⊖	1 x 5.5 x 100	+	PZ2 x 100	+	PZ1 x 80
⊖	0.8 x 4 x 100	⊖	0.5 x 3 x 100	⊖	T10 x 100	⊖	T20 x 100
+	PH2 x 100	+	PH1 x 80	⊖	T15 x 100		
1 pc Voltage detector (AC110V-250V)				Storage Case: 210 x 131 x 44mm			
Individual packing				Color box			

▶ PK-2801 1000V Insulated Screwdriver & Plier Set



Contents	
SD-810-S2.5	⊖ 2.5x75mm
SD-810-S3.0	⊖ 3.0x100mm
SD-810-S5.5	⊖ 5.5x125mm
SD-810-P1	⊕ PH1x80mm
SD-810-P2	⊕ PH2x100mm
PM-910	Insulated wire stripping plier (160mm)
PM-917	Insulated side cutter (165mm)
PM-919	Insulated long nose plier (170mm)
9ST-33	Tool bag (255x172x55mm)
Individual packing	Color sleeve shrink

▶ PK-2802 1000V Insulated Plier & Screwdriver Set



Contents	
SD-810-S2.5	⊖ 2.5x75mm
SD-810-S4.0	⊖ 4.0x100mm
SD-810-S5.5	⊖ 5.5x125mm
SD-810-S6.5	⊖ 6.5x150mm
SD-810-P0	⊕ PH0x60mm
SD-810-P1	⊕ PH1x80mm
SD-810-P2	⊕ PH2x100mm
PM-911	Insulated combination plier (195mm)
PM-917	Insulated side cutter (165mm)
PM-918	Insulated long nose plier (200mm)
PM-919	Insulated long nose plier (170mm)
9Z-PK2802	Zipper carrying bag (294x240x50mm)
Individual packing	Color sleeve shrink

▶ PK-2813M 1000V Insulated Roll Tool Set

Contents	
PM-911	Insulated combination plier (195mm)
PM-917	Insulated side cutter(165mm)
PM-910	Insulated wire stripping plier (160mm)
PM-918	Insulated long nose plier(200mm)
SR-V206	Insulated cable cutter 150mm (22mm ²)
HW-V110B	Insulated single open end wrench 10mm
HW-V113B	Insulated single open end wrench 13mm
HW-V114B	Insulated single open end wrench 14mm
HW-V117B	Insulated single open end wrench 17mm
HW-V119B	Insulated single open end wrench 19mm
SD-810-S2.5	⊖ Insulated screwdriver (2.5x75)
SD-810-S4.0	⊖ Insulated screwdriver (4.0x100)
SD-810-S5.5	⊖ Insulated screwdriver (5.5x125)
SD-810-S6.5	⊖ Insulated screwdriver (6.5x150)
PD-V003A	Insulated straight blade cable knife 54x186mm
9Z-PK2813	Tool roll bag
Individual packing	Color sleeve



▶ PK-2810A / B 1000V Insulated Tool Kit

Contents	PK-2810A	PK-2810B
SD-810-P0	⊕ Insulated screwdriver (#0x60mm)	
SD-810-P1	⊕ Insulated screwdriver (#1x80mm)	
SD-810-P2	⊕ Insulated screwdriver (#2x100mm)	
SD-810-S2.5	⊖ Insulated screwdriver (2.5x75mm)	
SD-810-S4.0	⊖ Insulated screwdriver (4.0x100mm)	
SD-810-S5.5	⊖ Insulated screwdriver (5.5x125mm)	
SD-810-S6.5	⊖ Insulated screwdriver (6.5x150mm)	
PM-910	Insulated wire stripping plier (160mm)	
PM-911	Insulated combination plier (195mm)	
PM-917	Insulated side cutter (165mm)	
PM-919	Insulated long nose plier (170mm)	
SI-130A-20	Soldering iron(AC110-120V)	-
SI-130B-20	-	Soldering iron(AC220-240V)
9DP-S002	Lead free solder dispenser (sn99.3%,Cu0.7%)	
NT-305	Voltage detector	
HW-V608	Insulated 8" adjustable wrench	
SR-V336	Insulated electricians scissors (160mm)	
MS-V001	Insulated tape 20mm x 10m	
MT-1232	3 3/4 Digital multimeter	
DP-366J	Desoldering pump	
9ST-PK2810B	Zipper carrying bag (355x270x60mm)	



▶ PK-2809M 1000V Insulated Metric Tool Kit

PK-2809M tool kit is equipped with a range of 1000V insulated single open end wrenches, screwdrivers, pliers and cutters, T handle and 1/2" sockets in a durable tool box. Ideal for power plant, HVAC, automotive, military, aircraft field applications and more.



Contents	
PM-911	Insulated combination plier (195mm)
PM-917	Insulated side cutter(165mm)
HW-V110B	Insulated single open end wrench 10mm
HW-V111B	Insulated single open end wrench 11mm
HW-V112B	Insulated single open end wrench 12mm
HW-V113B	Insulated single open end wrench 13mm
HW-V114B	Insulated single open end wrench 14mm
HW-V117B	Insulated single open end wrench 17mm
HW-V119B	Insulated single open end wrench 19mm
SD-810-S2.5	⊖ Insulated screwdriver(2.5x75)
SD-810-S3.0	⊖ Insulated screwdriver(3.0x100)
SD-810-S4.0	⊖ Insulated screwdriver (4.0x100)
SD-810-S5.5	⊖ Insulated screwdriver (5.5x125)
SD-810-P0	⊕ Insulated screwdriver (#0x60)
SD-810-P1	⊕ Insulated screwdriver (#1x80)
SD-810-P2	⊕ Insulated screwdriver (#2x100)
SK-V752	Insulated 1/2" drive T handle 200mm
SK-V410B	Insulated 1/2" drive socket 10mm
SK-V411B	Insulated 1/2" drive socket 11mm
SK-V412B	Insulated 1/2" drive socket 12mm
SK-V413B	Insulated 1/2" drive socket 13mm
SK-V414B	Insulated 1/2" drive socket 14mm
SK-V417B	Insulated 1/2" drive socket 17mm
SK-V419B	Insulated 1/2" drive socket 19mm
PD-V003A	Insulated straight blade cable knife 54x186mm
PD-V003B	Insulated hook blade cable knife 33x170mm
9SB-3935	Plastic tool box (390x350x90mm)
Individual packing	Color sleeve



PK-2836M 1000V Insulated Metric Tool Kit



PK-2836M tool kit is equipped with a range of 1000V insulated single open end wrenches, single box end wrenches, adjustable wrenches, screwdrivers, knife, pliers and cutters, T handle, and 1/2" sockets in a durable aluminum frame tool case. Ideal for power plant, HVAC, automotive, military, aircraft field applications and more.



Contents	
PM-911	Insulated combination plier (195mm)
PM-917	Insulated side cutter(165mm)
PM-910	Insulated wire stripping plier (160mm)
SR-V210	Insulated cable cutter 250mm (80mm ²)
HW-V110B	Insulated single open end wrench 10mm
HW-V113B	Insulated single open end wrench 13mm
HW-V114B	Insulated single open end wrench 14mm
HW-V117B	Insulated single open end wrench 17mm
HW-V119B	Insulated single open end wrench 19mm
HW-V122B	Insulated single open end wrench 22mm
HW-V210B	Insulated single box end wrench 10mm
HW-V213B	Insulated single box end wrench 13mm
HW-V214B	Insulated single box end wrench 14mm
HW-V217B	Insulated single box end wrench 17mm
HW-V219B	Insulated single box end wrench 19mm
HW-V222B	Insulated single box end wrench 22mm
SD-810-S2.5	⊖ Insulated screwdriver(2.5×75)
SD-810-S4.0	⊖ Insulated screwdriver (4.0×100)
SD-810-S5.5	⊖ Insulated screwdriver (5.5×125)
SD-810-S6.5	⊖ Insulated screwdriver (6.5×150)
SD-810-P1	⊕ Insulated screwdriver (#1×80)
SD-810-P2	⊕ Insulated screwdriver (#2×100)
SK-V752	Insulated 1/2" drive T handle 200mm
HW-V710	Insulated 1/2" drive reverse flat ratchet handle 250mm
SK-V851	Insulated 1/2" drive extension bar 125mm
SK-V852	Insulated 1/2" drive extension bar 250mm
SK-V410B	Insulated 1/2" drive socket 10mm
SK-V411B	Insulated 1/2" drive socket 11mm
SK-V412B	Insulated 1/2" drive socket 12mm
SK-V413B	Insulated 1/2" drive socket 13mm
SK-V414B	Insulated 1/2" drive socket 14mm
SK-V416B	Insulated 1/2" drive socket 16mm
SK-V417B	Insulated 1/2" drive socket 17mm
SK-V418B	Insulated 1/2" drive socket 18mm
SK-V419B	Insulated 1/2" drive socket 19mm
SK-V422B	Insulated 1/2" drive socket 22mm
SK-V424B	Insulated 1/2" drive socket 24mm
PD-V003A	Insulated straight blade cable knife 54x186mm
SR-V336	Insulated electricians scissors 160mm
MS-V001	Insulated tape 20mm×10M
HW-V610	Insulated 10" adjustable wrench
TC-736	Expert & Elegant aluminum frame tool case (486x325x159mm)
9PK-2836M-TP	Top pallet for PK-2836M
9PK-2836M-P	Pallet for PK-2836M
Individual packing	Plain box + color label

PRECISION TWEEZERS



Tweezers are little more than two pieces of metal stuck together. Finding the perfect tweezers is not as easy as initially thought. *Pro'sKit*® offers the right option to simplify your work.



TZ-202N Super Fine Tip Straight Tweezer

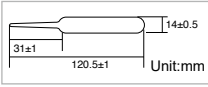

Material	Magnetic	OAL.(mm)	Individual packing
AISI 304	Non	120.5	Blister card

1PK-101T Insulated Tweezer

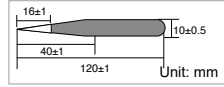

Material	Magnetic	OAL.(mm)	Individual packing
AISI 304	Non	120	Blister card

TZ-204N Fine Tip Curved Tweezer

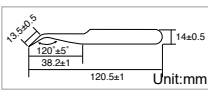

Material	Magnetic	OAL.(mm)	Individual packing
AISI 304	Non	120.5	Blister card

1PK-102T Super Fine Tip Straight Tweezer

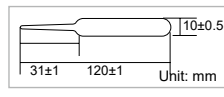

Material	Magnetic	OAL.(mm)	Individual packing
AISI 304	Non	120	Blister card

TZ-205N Fine Tip Straight Tweezer

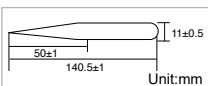

Material	Magnetic	OAL.(mm)	Individual packing
AISI 304	Non	140.5	Blister card

1PK-104T Fine Tip Curved Tweezer

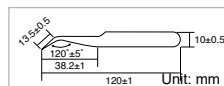

Material	Magnetic	OAL.(mm)	Individual packing
AISI 304	Non	120	Blister card

TZ-212N Extremely Fine And Sharp Tip Tweezer

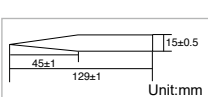

Material	Magnetic	OAL.(mm)	Individual packing
AISI 304	Non	129	Blister card

1PK-105T Fine Tip Straight Tweezer

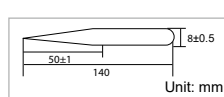

Material	Magnetic	OAL.(mm)	Individual packing
AISI 304	Non	140	Blister card

1PK-110T Cutting Tweezer

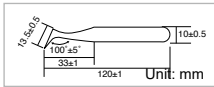

Material	Magnetic	OAL.(mm)	Individual packing
AISI 304	Non	120	Blister card

1PK-106T Universal Tweezer

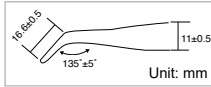

Material	Magnetize-able	OAL (mm)	Individual packing
AISI 410	Yes	175	Blister card

1PK-112T Extremely Fine And Sharp Tip Tweezer

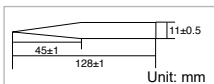

Material	Magnetic	OAL.(mm)	Individual packing
AISI 304	Non	128	Blister card

1PK-123T Heavy-Duty Tweezer

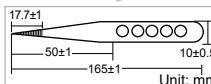

Material	Magnetize-able	OAL (mm)	Individual packing
AISI 410	Yes	165	Blister card

TZ-116 Blunt Flat Tip Tweezer

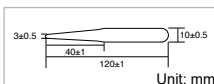

Material	Magnetic	OAL.(mm)	Individual packing
AISI 304	Non	120	Blister card

1PK-108T Reverse Action Tweezer

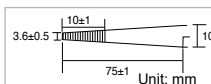

Material	Magnetize-able	OAL (mm)	Individual packing
AISI 410	Yes	165	Blister card

1PK-125T Super Fine Tip Straight Tweezer

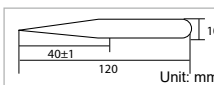

Material	Magnetic	OAL.(mm)	Individual packing
AISI 304	Non	120	Blister card

1PK-115T Long Nose Tweezer

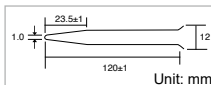

Material	Magnetize-able	OAL (mm)	Individual packing
AISI 410	Yes	200	Blister card

PRECISION
TWEEZERS

▶ 1PK-117T / 1PK-118T / 1PK-119T Wooden handle Tweezer



1PK-117T
Cross Leg Soldering Tweezer

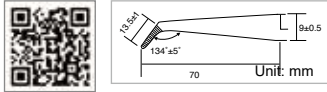

1PK-118T
Heavy Duty Tweezer

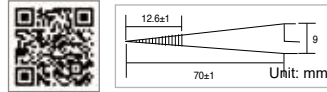

1PK-119T
Point Tweezer

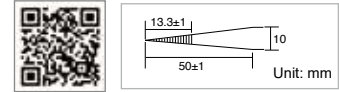

- Made of AISI410 stainless steel, acid resistant.
- The wooden handle design for user comfort and heat resistance.
- The tips are straight and serrated on the inside. The constant tension is great for holding parts without added finger strain.

Model No.	Material	Magnetize-able	OAL. (mm)	Individual packing
1PK-117T	AISI 410	Yes	164	Blister card
1PK-118T			165	
1PK-119T			200	

▶ 808-389 4 PCS Tweezer Set

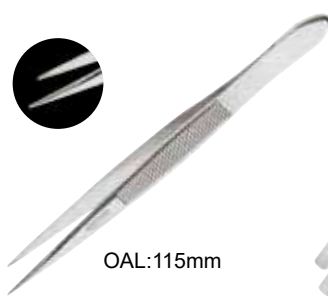

OAL:115mm

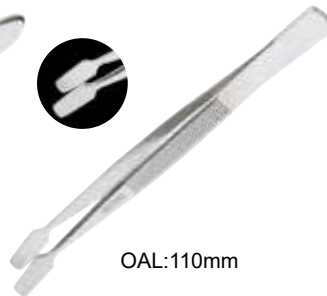

OAL:110mm



OAL:120mm

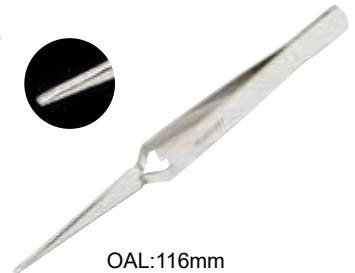

OAL:116mm

- 4 different style stainless steel tweezers for every need.
- Includes one self-locking; ideal for picking up small components in hard to reach places as well as component assembly one pc prototype boards.



Material	Magnetize-able	OAL.(mm)	Individual packing
AISI 430	Yes	110~120	Pouch

▶ 908-T301 2 PCS Tweezer Set



2 pcs economic type tweezers with insulated coating handle.

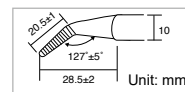
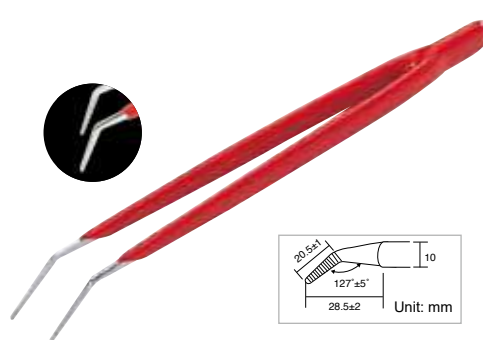
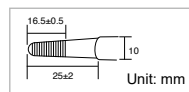
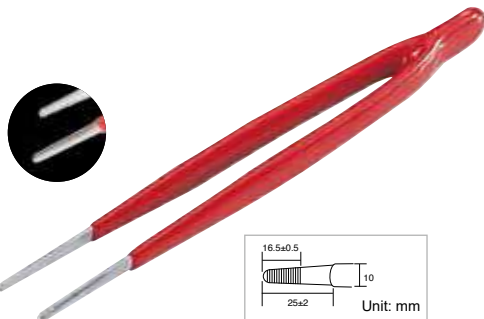

Model No.	Material	Magnetize-able	OAL. (mm)	Individual packing
908-T301	AISI 430	Yes	145	Blister card

TZ-300A / TZ-300B Static Dissipative Soft Tip Tweezer



TZ-300A

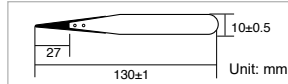

TZ-300B

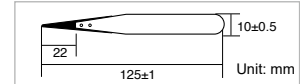

Model No.	Material		Resistance	Replacement tip	Magnetic	OAL. (mm)	Individual packing
	Handle	Tip					
TZ-300A	AISI 302	PPS-hb	<math><10^6\Omega</math>	5TZ-300A	Non	130	Blister card
TZ-300B				5TZ-300B		125	



TZ-100 Series Conductive Tweezer



TZ-100A

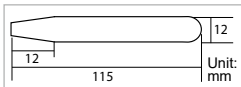

TZ-100B

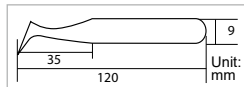

TZ-100C

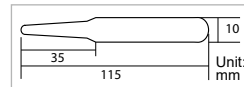

TZ-100D

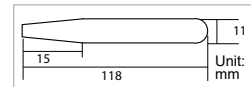

Model No.	Material	Resistance	Magnetic	OAL. (mm)	Individual packing
TZ-100A	PC + Carbon fiber	<math><10^6\Omega</math>	Non	115	Blister card
TZ-100B				120	
TZ-100C				115	
TZ-100D				118	



TZ-121 Ceramic Tip Tweezer



- Replaceable tips screw on stainless body.
- Made of fine ceramic (Zirconium) materials with non-magnetic surface.
- Ergonomic handle design with 0.5 mm tip makes the tweezers ideal for accessing in confined areas.
- Chemical-resistant.
- Heat-resistant.
- Anti-magnetic.

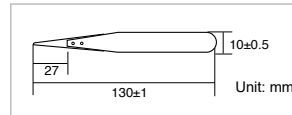

Material		Replacement tip	Magnetic	OAL. (mm)	Individual packing
Handle	Tip				
AISI 302	Ceramic (Zirconia)	9TZ-121-BIT	Non	130	Blister card + PP box with black EVA

MAGNIFIER & LAMP



Protect your eyes. Broaden your view.

▶ MA-1209LA / MA-1209LI

LED Table Clamp Magnifier Lamp



- Universal joint and adjustable arm for easy positioning where it is most needed.
- Standard mount: Desktop clamp.

Model No.	Voltage	Standard plug
MA-1209LA	AC 110V~120V	A
MA-1209LI	AC 220V~240V	I



Color temperature	Illumination	Lens material	Power consumption	Magnification	Lens size	Light source	Individual packing
6000~7000 Kelvin	700 Lumen	Glass	9W	5D(2.25X)	Ø127mm	56 pcs LEDs	Color box



MAX 65mm



▶ MA-1215CA / MA-1215CF

Table Clamp Magnifier With Workbench Lamp



- Shadow-free light make it easier for you to see and enjoy the activities longer.
- All metal housing mounted on a spring balanced arm that stays set in any position.
- Dust-proof cover for lens protection.

2.25X(5D)

Model No.	Voltage	Standard plug
MA-1215CA	AC 110V~120V	A
MA-1215CF	AC 220V~240V	I



Lens material	Magnification	Lens size	Light source	Individual packing
Glass	5D(2.25X)	Ø127mm	22W/T5 G10q	Color box



MAX 65mm

▶ MA-1010U

2 In 1 USB Magnifying LED Lamp



- Flexible goose neck helps to position the light and magnifier perfectly.
- Touch switch provides easy control.
- USB powered design breaks the space limit.



Lens material	Lens size	Input voltage	Power consumption	Light source	Color temperature	Illumination	Magnification	Max. opening of clamp
Glass	Ø100mm	DC 5V	Max. 2.5W	36pcs SMD LED (Cold, Warm light 18pcs/each)	Cold:6000-7000K, Warm:2700-3200K	250 Lumen	3D(1.75X)	Max. 5.5cm
Individual packing					Color box			



▶ MA-1225CF Gooseneck Magnifier Lamp



- Shadow-free light will make it easier for you to see and enjoy the activities longer.
- The flexible gooseneck allows you to angle and point the light to where you need it most.
- Dust-proof cover for lens protection.



Model No.	Lens material	Magnification	Lens size	Light source	Voltage	Standard plug
MA-1225CF	Glass	5D(2.25X)	Ø127mm	22W/T5 G10q	AC 220V~ 240V	A (I) / F (C)
Individual packing			Color box			

▶ MA-1004A MA-1004F LED Desk Type Magnifier Lamp



- The adjustable arm allows angling and pointing the light to where you need.
- Flip-down cover to keep the magnifier free of dust.



Model No.	Lens material	Magnification	Lens size	Light source	Color temp.	Luminance	Energy consumption	Voltage	Standard plug
MA-1004A	Glass	3D(1.75X)	127×79 mm	56 LEDs	6000~7000 Kelvin	650 lumen	9W	AC 110V~120V AC 220V~240V	A (I) / F (C)
Individual packing			Color box						

▶ MA-1003MA MA-1003MF Desk Type Magnifier Lamp



- Design with 3D(1.75X) large glass lens to provide high transmission for excellent view and 12D(4X) insert lens to inspect small parts and fine details.
- The adjustable arm allows angling and pointing the light to where you need.
- Flip-down cover to keep the magnifier free of dust.



1.75X (3D)
4X (12D)



Model No.	Lens material	Magnification	Lens size	Light source	Voltage	Standard plug
MA-1003MA	Glass	3D/12D (1.75X / 4X)	Ø100 mm	12W/T4 G10q	AC 110V~120V AC 220V~240V	A (I) / F (C)
Individual packing			Color box			

▶ MA-1013MA MA-1013MF LED Desk Type Magnifier Lamp



- Design with 3D(1.75X) large glass lens to provide high transmission for excellent view and 12D(4X) insert lens to inspect small parts and fine details.
- The adjustable arm allows angling and pointing the light to where you need.
- Flip-down cover to keep the magnifier free of dust.



Model No.	Lens material	Magnification	Lens size	Light source	Color temp.	Luminance	Voltage	Standard plug	
MA-1013MA	Glass	3D (1.75X) & 12D (4X)	Ø100mm	40 LEDs	6000~7000 Kelvin	550 lumen	AC 110V~120V AC 220V~240V	A (I) / F (C)	
Individual packing			Color box						

▶ MA-025

Folding & Handheld USB LED Magnifier

2 Power Supply Method 2 Brightness Levels

Firm base and handheld design to provide suitable lens position and store easily as well.



Lens material	Magnification	Lens size	Light source	Power supply	Individual packing
Acrylic	3.75X(11D) 7X(24D)	Ø70mm/19mm	8 LED light	USB powered or AAA battery x 3pcs (not included)	Color box

▶ MA-015

Foldable Magnifier



- Adjustable folding arms design for easy positioning.
- Great for working on hobbies, documents, and circuit boards, etc.



Lens material	Magnification	Lens size	Light source	Battery	Individual packing
Acrylic	2D (1.5X)	Ø130mm (5")	1 LED	LR1130 (AG10) x3 (Included)	Color box

▶ MA-016

Headband Magnifier



- Detachable LED light device.
- Adjustable LED light.
- Multiple lens provide better magnification.
- The belt size can be adjusted freely.

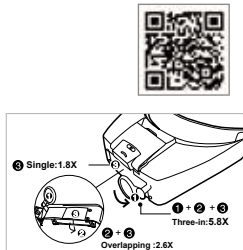

▶ 8PK-MA003N

Headband Magnifier



- Light weight. Frame is made of durable impact resistant material.
- The comfortable headband is fully adjustable to fit any size.
- Easy to adjusting visor to most comfortable position.

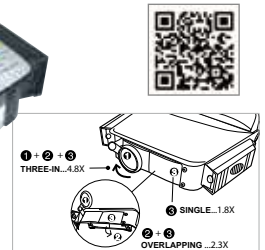

Model No.	Materials	Magnification	Lens size	Light source	Battery	Individual packing
MA-016	Acrylic	Single: 1.8X, Overlapping: 2.6X, Three-in: 5.8X	Round: Ø 28mm, Square: 89x29mm	1 pce high power LED	1.5V AAAx2 pcs (Not included)	Blister card
8PK-MA003N		Single: 1.8X, Overlapping: 2.3X, Three-in: 4.8X	Round: Ø 28mm, Square: 91x29mm	2 pcs Bulbs		

▶ 8PK-MA006

Illuminated Magnifier

4X w/Light

Optical quality lighted magnifier with 2-1/2" glass lens.



▶ 8PK-MA005

Folding Magnifier

Lenses combined for higher magnification.



▶ MA-014

8X LED Illuminated Magnifier



- Glass lens with hinged stainless cover.
- Great for very small objects, and jewelry work.



Model No.	Lens material	Magnification	Light source	Lens size	Battery	Individual packing
8PK-MA006	Glass	12D (4X)	1 Bulb	Ø62mm	1.5V AA x 2 pcs (Not included)	Blister card
8PK-MA005		Single: 16D (5X) Overlapping: 36D (10X)	-	Ø25mm		
MA-014		28D (8X)	1 LED	Ø21mm (0.82")	LR1130 (AG10) x 3	

▶ MA-029 Handheld LED Magnifier w/Currency Detecting Function

Dual Magnification

6D(2.5X) large 70mm lens provide high transmission for excellent view and 20D(6X) insert lens to inspect small parts and fine details.

UV Illumination

The magnifier still equipped with UV illumination for counterfeit identification of paper currency, passports, paintings, geology study.



Lens material	Magnification	Lens size	Light source	Battery	Individual packing
Acrylic Lens	2.5X(6D) 6X(20D)	Ø70mm / Ø19mm	8 LED light 1 UV light	1.5V AAA x 3pcs (not included)	Color box



▶ MA-019 3X Handheld LED Light Magnifier with Currency Detecting Function



8 LED + 1 UV light

Ideal for reading, PCB checking, insect observation, etc.



▶ MA-023 Handheld LED Light Magnifier



High quality 10D(3.5X)
Acrylic lens, Ø50mm

High quality 76D (20X)
Acrylic lens, Ø18mm

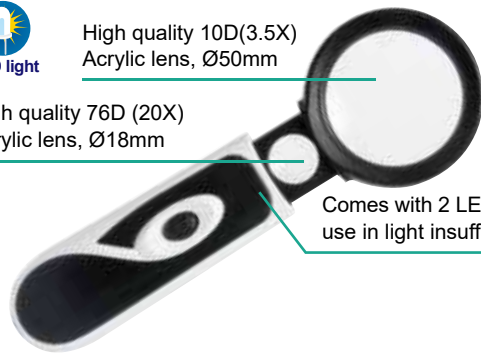

Comes with 2 LEDs allowing use in light insufficient place



Model No.	Lens material	Magnification	Lens size	Light source	Battery	Individual packing
MA-019	Glass	8D (3X)	Ø56mm	8+1 LEDs (1 UV LED)	1.5V AAA x3pcs (not included)	Blister card
MA-023	Acrylic	10D(3.5X) / 76D(20X)	Ø50mm / Ø18mm	2 LEDs	1.5V AAA x3pcs (not included)	

▶ MA-020 22X Handheld LED Magnifier



jewelry work



- Comes with 2 LED lights.
- Excellent for jewelry work.

▶ MA-021 3.5X Handheld LED Magnifier



PCB checking



- Comes with 2 LED lights
- Suitable for reading, PCB checking & more.

▶ MA-022 7.5X Handheld LED Magnifier w/ Currency Detecting Function



Currency detection



jewelry work



- Comes with 1 LED light
- Combine with UV light for currency or credit card detection.

Model No.	Lens material	Magnification	Lens size	Light source	Battery	Individual packing
MA-020	Glass	Object lens 16D; Eyepiece 13D (22X)	Ø 19mm	2 LEDs	1.5V AAA x3pcs (not included)	Blister card
MA-021		10D (3.5X)	Ø 46mm			
MA-022		26D (7.5X)	Ø 27mm	1+1LED (1UV LED)	CR2016 x 2pcs (not included)	

KNIVES & SCISSORS



Life is too short with a dull knife. *Pro'sKit* knives and scissors perfect your work.



SR-336 Multi Purpose Scissor

Stainless Steel

With curve blade design ensures steady.

Serrated Blade

Allows easy cutting and helps gripping onto papers, tubes, plastic, and even rubber.

Special Design

Wire cutter / Jar opener / Walnut clamp



Serrated Blade	Aluminum sheets	Up to 0.8mm
	Plastic sheets	Up to 1.2mm
	Copper sheets	Up to 0.5mm
	Galvanized / Tin sheets	Up to 0.4mm
	Rubber sheets	Up to 4.0mm
	Leather	Up to 5.0mm
	Ropes (Cotton/Nylon)	Up to Ø10mm
	Others Cardboards	Fabrics, Cartons CDs, Card, etc
Wire Cutter	Aluminum / Copper wires	Up to Ø2.5mm

Material	Handle	HRC Body	OAL(mm)	Individual packing
420 J2 Stainless Steel	PP+TPR	53°±2°	206	Blister card



SR-338 Multi-Purpose Shears

Stainless Blade

Durable and sharp.

Serrated Blade

Prevents slipping.

Storage Lock

Ensures user safety and convenient storage.



Material	Application
Aluminum sheets	Up to 1.0mm
Plastic sheets	Up to 2.0mm
Copper sheets	Up to 0.5mm
Tin sheets	Up to 0.4mm
Rubber sheets	Up to 5.0mm
Leather	Up to 5.0mm
Aluminum / Copper wires	Up to Ø 2.5mm
Copper stranded conductor	3C x 2mm ²
Power cables	5.5mm ²

Material	Handle	HRC Body	OAL (mm)	Individual packing
420 J2 Stainless Steel	PP+TPR	53°±2°	185	Blister card

SR-339 Multi Purpose Angled Scissor

Stainless Steel

Curve design provides force saving.

Adjustable Mechanism

Handles adjustable to fit large/small hands comfortably.

Angled Design

Offset handles allow easy cutting on flat surfaces.



Serrated Blade	Aluminum sheets	Up to 0.8mm
	Plastic sheets	Up to 1.2mm
	Copper sheets	Up to 0.5mm
	Galvanized / Tin sheets	Up to 0.4mm
	Rubber sheets	Up to 4.0mm
	Leather	Up to 5.0mm
	Ropes (Cotton/Nylon)	Up to Ø10mm
	Others Cardboards	Fabrics, Cartons, CDs, Card, etc
Wire Cutter	Aluminum / Copper Wires	Up to Ø2.5mm

Material	Handle	HRC Body	OAL(mm)	Individual packing
420 J2 Stainless Steel	PP+TPR	53°±2°	250	Blister card

SR-331/SR-332 All Purpose Snip

Cut cable, wire, cloth, carpet, leather, cardboard tin plate, branch, foam rubber and so on.



Leather



Aluminum sheet



Cable

Model No.	Material	Handle	Application	OAL. (mm)	Individual packing
SR-331	AISI 420	PP+T.P.R	Cardboard, PVC Leather, Rubber: thickness < 5mm.	165	Blister card
SR-332			Aluminum sheet, Copper sheet: thickness < 1mm Steel sheet: thickness < 0.5mm Cable, PVC water pipe, Plastic tube up to Ø10mm		



SR-331



SR-332

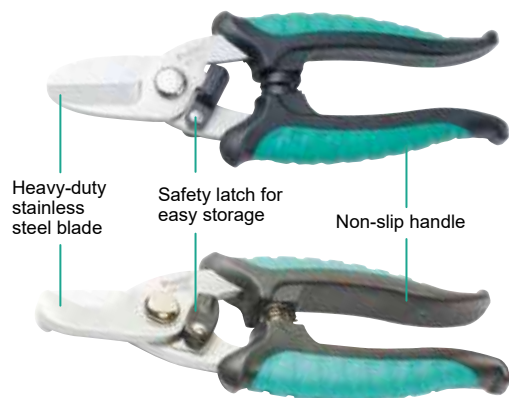

Heavy-duty stainless steel blade

Safety latch for easy storage

Non-slip handle

▶ SR-337 8" Pruning Shear



Spring-action design

Gently opens blades after each cut to reduce the strain

CNC Grinding

Sharp and durable

Sap Groove

Saves time and makes pruning easier by removing sap and debris after each cut



Material		HRC	Max. Cutting Capacity	OAL. (mm)	Individual packing
Body	Blade				
PVC coated	55# carbon steel	48°±3°	<Ø12mm(branches)	205	White box

▶ SR-330 All Purpose Snip



Stainless steel

Safety lock



Cable



Copper

Ideal for cutting cable, leather, cardboard, foam rubber and more.



Material	Handle	Application	OAL. (mm)	Individual packing
AISI 410	P.P+ T.P.R	Cardboard, PVC Leather, Rubber: thickness < 3mm. Aluminum sheet, Copper sheet: thickness <1mm PVC, PET, plastic : thickness <0.2mm Fixable flat cable: thickness <0.3mm	165	Blister card

▶ 8PK-SR007 All Purpose Snip



Safety lock



Material	Handle	Application	OAL. (mm)	Individual packing
SUS 420J2	P.P+ T.P.R	Cardboard, PVC Leather, Rubber: thickness < 3mm Aluminum sheet, Copper sheet: thickness <1mm PVC, PET, Plastic : thickness <0.2mm Fixable flat cable: thickness <0.3mm Carpet : thickness <10mm	200	Blister card

▶ SR-366 Ratcheting Plastic Pipe Cutter

Capacity max.
38mm/1.2 inch



V-shaped Blade

For accurate cutting and force saving.

Blade Quick Change

Tool free blade installation.

Ratchet Action

Ensures force saving.



Material		Application	Replacement blade	OAL. (mm)	Individual packing
Body	Blade				
Aluminum Alloy Steel	SK5	max.38mm(1.5inch)	5SR-366-B	195	Blister card

▶ SR-333 Micro Scissor



Safety cap



- Made of stainless steel to resist rust and corrosion.
- Return spring offers more smooth operation.



Material	Handle	Application	OAL. (mm)	Individual packing
AISI 420	ABS+ TPE	Copper, IC, component pin: thickness < 0.3mm. PVC, PET, plastic : thickness <0.2mm Fixable flat cable: thickness <0.3mm	120	Blister card

▶ DK-2047N Electricians Scissors



Stripping 18 & 22 AWG

- Designed for use in telephone and electrical service applications.
- Scraper and file on side edge of blade.



Material	Handle	Application	OAL. (mm)	Individual packing
AISI 420	Nylon+Filber	Stripping from AWG 18 and 22 wire Cutting up to AWG 16 solid wire and AWG 12 stranded wire	145	Blister card

▶ SW-201 / SW-202 Multi-Purpose Pruning Saw / 240mm Pipe Saw



SW-202



SW-201

Japanese Steel

High impulse hardened edge.



Impulse hardened teeth

Guarantees great hardness and longer lifespan.

3-Edge grinding teeth

Provides efficient cutting.

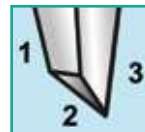
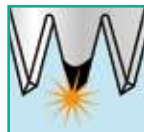

Model No.	Material	HRC	Thickness	Length	Tpi/Ppi	Handle	OAL	Replacement blade	Individual packing
SW-201	SK85	50°±2°	0.7mm	250mm	11/12	ABS+TPR	390mm	5SW-201	White box
SW-202			0.6mm	240mm	17/18		380mm	5SW-202	Blister card

▶ PD-998 Electrician's Knife



High quality stainless steel, large curved hawk bill blade offer durability and artistic appearance.



PVC, PE cable stripping

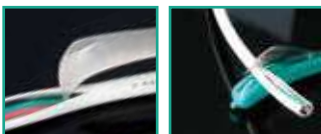

Handle	Blade	OAL.(mm)	Individual packing
ABS	3 Cr 13	190	Blister card

▶ PD-992 Electrician's Knife



The V-shaped groove of the cover is specially designed to position wire firmly to prevent sliding while peeling the sheathed wire.



Material		HRC	Application	OAL	Individual packing
Body	Handle	Body	V-shaped groove	(mm)	
4034 Stainless Steel	Nylon	58°±2°	Cable O.D. Ø3~30mm	190	Blister card

▶ DK-2112 Auto Loading Utility Knife



- Automatic blade reload for effortless and quick blade changes.
- Convenient blade storage compartment holds up to 6pcs blades (blades included)



Blade storage compartment



Handle	Blade	Replacement blade	OAL.(mm)	Individual packing
Zinc Alloy+TPR	SK5	5DK-2112-B(10PCS/Pack)	165	Blister card

▶ DK-2039 Utility Knife



- Blade in thickness: 0.5mm
- Includes 3 pcs blade inside



DK-2039-B10 (10pcs/pack)



Handle	Blade	Replacement blade	OAL.(mm)	Individual packing
ABS+TPR	SK4	DK-2039-B10 (10PCS/Pack)	170	Blister card

▶ PD-515 Wallpaper Snap Knife



Hardening Blade

sharp and durable.

Flexible Blade

makes easier work of cutting into awkward corners.

Ultra Thin Blade

glides through paper effortlessly without tearing or dragging.



Material		Blade length	Replacement blade	OAL.	Individual packing
Handle	Blade				
ABS+PP	SK4	83.5 x 12.5 x 0.2mm	5PD-515-B (20PCS/pack)	150mm	Blister card

▶ PD-398 14PCS Aluminium Handle Knife Kit



13pcs SK5 blades

Interchangeable blades

Compact box with hanger design

Aluminum handle

13pcs SK5 blades	
Aluminum alloy handle	
Plastic box size: 151x82x25mm	
Individual packing	Blister card



▶ PD-395A 30PCS Deluxe Hobby Knife Kit



Tweezer

Magnetic strip for easy blade storage

25pcs SK5 blades

Grindstone

3pcs TPR+PP dual color non-slip handles	
19pcs SK5 carving blades (3pcs in handle)	
2pcs awl blades	1pcs tweezers
4pcs shovel blades	1pcs grind stone
Dual color TPR+PP case (205x132x45mm)	
Individual packing	Blister card



▶ Precision Knife



8PK-394A

Ø8mm



8PK-394B

Ø11mm



▶ **PD-394A**

Ø8mm



- Surgically sharp knives with high-impact plastic safety cap.



508-394A-B
(10pcs/pack)



508-394B-B
(10pcs/pack)



5PD-394A-B
(10pcs/pack)

Model No.	Handle	Blade	Replacement blade	OAL.(mm)	Individual packing
8PK-394A	Aluminum	SK5	508-394A-B(10pcs/pack)	145	Blister card
8PK-394B			508-394B-B(10pcs/pack)	150	
PD-394A			5PD-394A-B(10pcs/pack)	145	

▶ PD-510 Quick Point Snap-Blade Knife



- Includes 2 pcs blade inside
- Locking slide



Handle	Blade	Replacement blade	OAL.(mm)	Individual packing
ABS	SK5	5PD-510-B(10Pcs/Pack)	140	Blister card

▶ PD-513 Utility Knife



- Lightweight and durable.



Handle	Blade	OAL.(mm)	Individual packing
ABS	SK4	155	Blister card

MISCELLANEOUS



Pro'sKit® Diversity is beyond your imagination.



▶ MS-C002 Mini Vacuum & Blowing Cleaner



Speed 25,000rpm

High speed rpm and easy-to-use handy vacuum cleaner with attachments for vacuuming / blowing / brushing off dirt and dust.

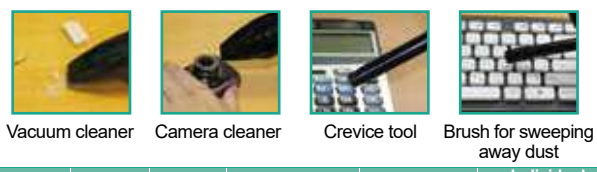

Speed	Torque	Output	Power	Body size	Individual packing
25,000 rpm	26 g-cm	5.15W 1.83A	DC 6.0V (AA 1.5V×4 pcs)	Ø45 × 130 × 90mm	Color box

▶ MS-C001 Mini Vacuum Cleaner



- Cleans keyboards, printer, photographic equipment, audio/visual equipment and all office electronics.
- Compact size design and powered by battery.

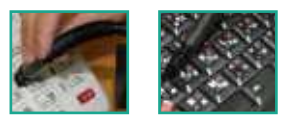

Material	Power	OAL.(mm)	Individual packing
Polypropylene	DC 6.0V (AA 1.5V x 4pcs)	128	Blister card

▶ MS-C005I Dust Blowing & Vacuum Cleaner



2 in 1
Vacuum cleaner
Blowing cleaner



- High power output 450W.
- Reusing washable dust bag.
- Easy operation and energy-saving.
- Large power trigger with conveniently located lock-on button.
- Maximum air volume of 2.3m³/min for faster clean up.



Accessories:
1 x Air flow tube
1 x Dust bag



High Power, Fast Clean
Reusing Washable Dust Bag

Power	450 W
Voltage	230V / 50Hz
No load speed	0-16000 rpm
Air volume	2.3m ³ /min
Weight	50 oz (1.4Kg)
Accessories	1 x Air flow tube, 1x Dust bag
Dimensions	240 x180 x170mm
Individual packing	Color box

▶ MS-153A / MS-153C Bulb Blower



Air valve made by copper with chrome plating

MS-153A

Comes with copper nozzle, providing high air pressure for removing dust safely and gently.



Air valve made by copper with chrome plating

MS-153C



Model No.	Material	Nozzle material	Nozzle size	Air valve Material	Pump capacity	OAL.(mm)	Individual packing
MS-153A	PVC	Copper with chrome plating	Ø2.2×14mm	Copper with chrome plating	50 ml	Ø42×94	Blister card
MS-153C		ABS	Ø5.0×30mm		110 ml	Ø56×140	

▶ PD-151 6" Electronic Caliper



- Hardened stainless steel.
- Thumb wheel for accuracy and ease with 4 measurement: inside, outside, depth and step.
- Precision-ground and lapped measuring surface.



Inside dimension measurement

Material	Range	Accuracy	Resolution	Power	Individual packing
Stainless steel	0~150mm / 0~6"	±0.02mm/0.001"(<100mm) ±0.03mm/0.001"(>100mm)	0.01mm / 0.0005"	LR44 (1.5V) ×1 pcs	Plastic box + Color label sleeve

▶ PD-161-C Multipurpose Laser Level Measuring Tape Ruler

3 Laser Mode Horizontal / Vertical / Cross line switch.

Triple Bubble Level

Vertical bubble / Horizontal bubble / 45° bubble



Laser mode	horizontal, vertical, cross line	Measuring tape length	2.5m/8ft (both metric and imperial standard)
Optimum distance	1.5m~2m	Standard ruler length	15cm/6" (both metric and imperial standard)
Laser Class	ClassIIIA (<5mW)	Power	1.5V LR44 x 3
Laser wavelength	630nm-680nm	Weight	180g
Bubble level	3pcs- horizontal, vertical, 45°	Dimension	191 x 62 x 28 mm
Individual packing		Color box	

▶ DK-2032 / DK-2033N / DK-2034N Fish Tape



DK-2032



DK-2033N



DK-2034N

Model No.	Container size	Steel tape size	Individual packing
DK-2032	Ø 214x27mm	15.2Mx3.2x1.6mm (50ft x 1/8" x 1/16")	PE shrink
DK-2033N	Ø 305x42mm	30.5Mx3.2x1.6mm (100ft x 1/8" x 1/16")	
DK-2034N	Ø 305x42mm	61.0Mx3.2x1.6mm (200ft x 1/8" x 1/16")	

- Made from flexible spring steel and black finished.
- Equipped with durable plastic container and slide handle.
- Easy to thread through the pipe and pull out the electric cable.



▶ DK-2060SET / DK-2040 / DK-2041 / DK-2042 Measuring Tape



Auto Stop



DK-2060SET (12pcs/SET)

DK-2040

DK-2042

DK-2041

Model No.	L (Max.)	W (Max.)	Thickness(mm)	Case	Individual packing
DK-2060SET	3M/10ft	16mm	0.11	ABS+PVC	Display box
DK-2040	3M/10ft	16mm	0.11		Blister card
DK-2041	5M/16ft	19mm	0.11		
DK-2042	7.5M/25ft	25mm	0.11		

- Magnetic end-hook for convenient measuring.
- Anti-slip and shockproof rubber case.
- Hi-rel power tape.



▶ MS-B126 Battery Operated SMD Vacuum Pick-Up Tool

CE It features built-in ultra-small vacuum pump, ideal for continuous work. ESD safe design is suitable for picking up current-sensitive components.



Suction capacity			Power	Weight	Dimension	Individual packing
Ø4mm suction cup	Ø6mm suction cup	Ø10mm suction cup				
10g	35g	80g	1.5V AAA x 1pc	27g	160 x 23 x 19mm	Blister card

▶ 8PK-610 PLCC Extractor



Material	OAL. (mm)	Individual packing
AISI 410 + POM	100x50	Blister card

A spring assisted chip carrier extraction tool, specially designed for the safe removal of PLCC's from sockets without damage to component parts.

▶ MS-121 Vacuum Pick-Up Tool

Pb Lightweight, portable and suitable for the picking and placing small components weight up to 50 grams and having a flat surface, dilly packages and surface mount components, etc.



Replacement caps	Dimension	Individual packing
9122-010 (3pcs/bag) Ø4, 6, 10mm	Ø10x132mm	Blister card

▶ PD-610 PLCC Extractor



Material	OAL (mm)	Individual packing
AISI 304 + POM	100x50	Blister card

▶ 908-609 IC Extractor



Stainless steel construction for removing dual in-line IC packages. (Insulated vinyl grip.)

Material	OAL (mm)	Individual packing
AISI 420J + PVC	105	Inner box

▶ MS-323 Telescopic Magnetic Pick-Up Tool



Maximum pick-up	Extension length	Individual packing
454g (1lb)	178-582mm	Blister card

▶ 1PK-390G Inspection Mirror

- All-angle ball joint mirror with stainless steel back.
- Visual inspection of hidden areas.
- Double ball joint links swivel mirrors for viewing to 360°.
- Made of tempered spring steel to move freely and hold desired position.
- Replaceable, plated, copper-backed, clear-view mirror.
- Non-rotating inner hex rods prevent mirror from swinging out of alignment.

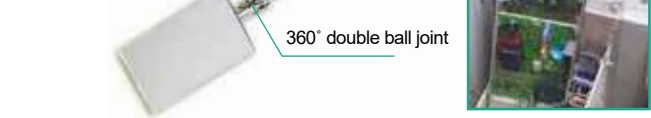

Lens size	OAL (mm)	Individual packing
50x90mm (2"x3-1/2")	216 ~ 490 (8-1/2"~19-1/4")	Blister card

▶ MS-391 Inspection Mirror

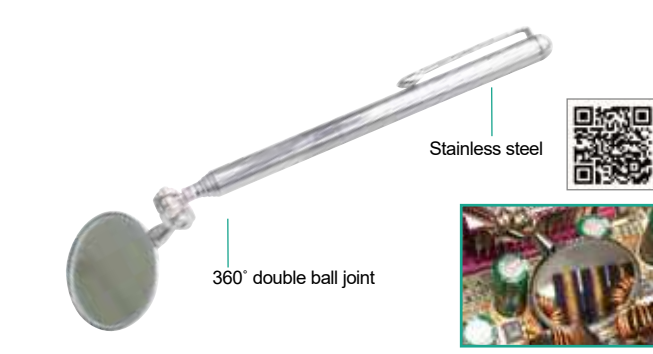

Lens size	Extension length	Individual packing
Ø30mm (1-1/5")	178-505mm	Blister card

▶ 8PK-H081 Automatic Center Punch



High speed steel (HSS)



Tip material	OAL. (mm)	Individual packing
HSS	133	Blister card

▶ MS-533 Pump-Action Drill Set



- Chuck rotates as spindle nut is depressed, spring automatically rewinds to top.
- Includes 2pcs collet jaws for bits 0.5mm and 1.0~1.5mm (Bits are not included).

For use with MICRO SIZED BITS

Drills automatically in a stroke, easy to use and efficient.

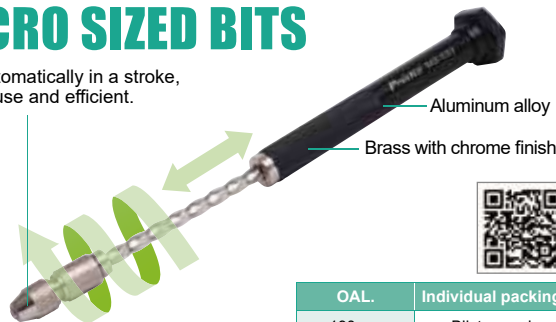

OAL.	Individual packing
190mm	Blister card

▶ OP-E351 Breadboard Accessory

- 350pcs of 22 AWG solid wires
- Pre-cut, pre stripped and pre-performed on each end.
- Variety of colors and completely reusable.



14 lengths x 25 pcs each
(2, 5, 7, 10, 12, 15, 17, 20, 22, 25, 50, 75, 100 and 125mm)



Case size (mm)	Individual packing
178x90x28	Poly bag + Hanger

▶ BX-412N Round Hole Breadboard



- Round hole designed for easy plug and pull.
- Wearproof material made of ABS & phosphor bronze with good flexibility and electric conductivity.

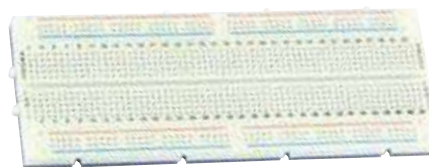

Case size (mm)	Tie points	Individual packing
64x171	840	Blister card

▶ BX-4123 / BX-4135 Round Hole Breadboard



- Round hole designed for easy plug and pull.
- Expandable by combining several boards together to meet your different requirement.
- Wearproof material made of ABS & phosphor bronze with good flexibility and electric conductivity.
- Used as a simulated layout for R&D and students.

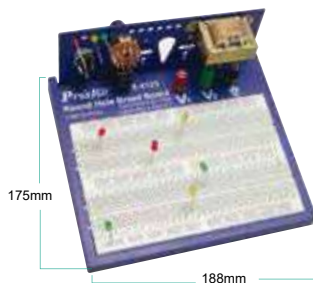

BX-4123
1580 tie points
(Demo only)

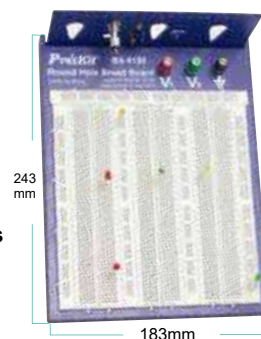

BX-4135
2420 tie points
(Demo only)

Model No.	Tie points	Individual packing
BX-4123	1580	Blister card
BX-4135	2420	

▶ MS-V308 Hook and Loop Cable Ties



Material	OAL. (mm)	Individual packing
Nylon /P.P	12x200	Poly bag (15 pcs/pack)

▶ MS-329 Push-button Pick-up Tool



- 600mm flexible stem with a small set of jaws at one end.
- Ideal for home, shop, garage, work place etc.

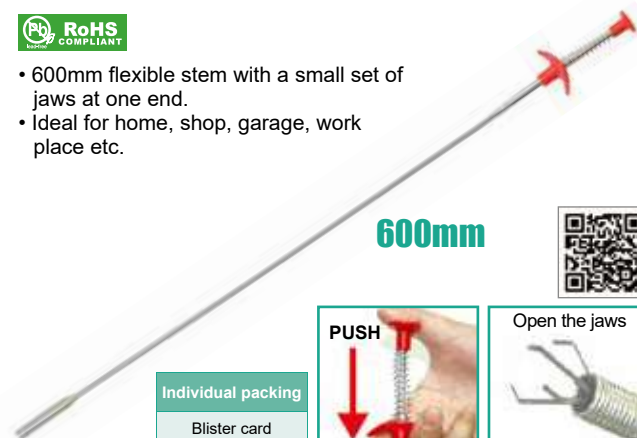

Individual packing
Blister card

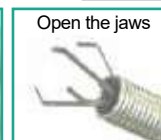



▶ 1PK-3171 / 1PK-317N Spring Hook

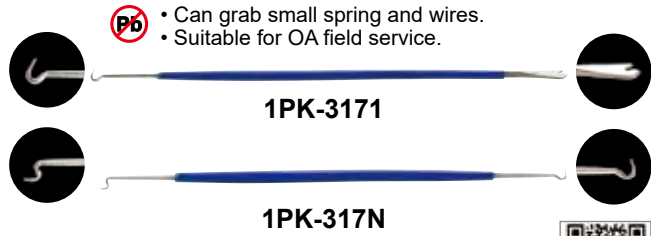

- Can grab small spring and wires.
- Suitable for OA field service.

Model No.	Material	OAL.(mm)	Individual packing
1PK-3171	AISI 410 + PVC	205	Blister card
1PK-317N			



▶ 8PK-605A 5 PCS Needle File Set

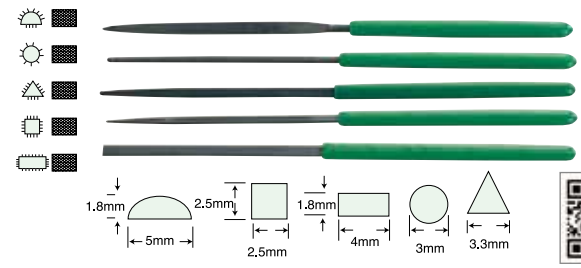

Material	HRC	Cut length	Handle O.D.	OAL.	Individual packing
SKS-8	60°	75mm	Ø 5mm	170mm	Pouch



▶ FL-528 1W LED Head Light



- 4 angles adjustment.
- High/Low/Flash modes.
- 60 Lumens brightness.
- 80,000 hours life.

4 angles adjustment



Lamp material	Light source	Illumination	Battery	Dimension (mm)	Individual packing
ABS	1W white micro LED	60 Lumens	3 x 1.5V AAA	73 x 45 x 65	Blister card

▶ FL-506 LED Flashlight



- Rugged design aluminum body & contoured body for firm grip.
- Light weight and easy to carry.
- Switch on/off control on the bottom.



Material	Light source	Battery	OAL.(mm)	Individual packing
Aluminum	LED	1.5V AA x 2pcs (Not included)	ø26.5x155	Blister card

▶ SW-106 Junior Multi-Purpose Saw



A perfect small saw for all the odd jobs found at work, replacement blades are available.

Handle	Body	Blade	OAL (mm)	Replacement saw	Individual packing
PP	Aluminum alloy	S55C	255 x 92 x 22	5SW-106-B (10pcs/Pouch)	Blister card

▶ 1PK-3178 4 PCS Probe Set

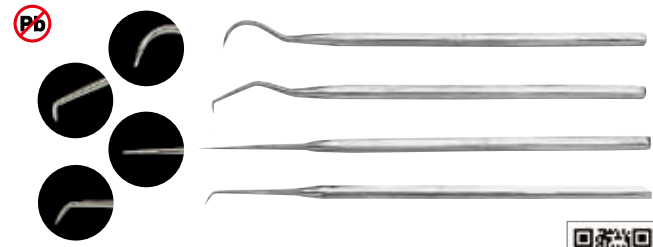

Material	OAL (mm)	Individual packing
AISI 410	Straight:145 Angled:140	Pouch



▶ 8PK-605L 5 PCS Needle File Set

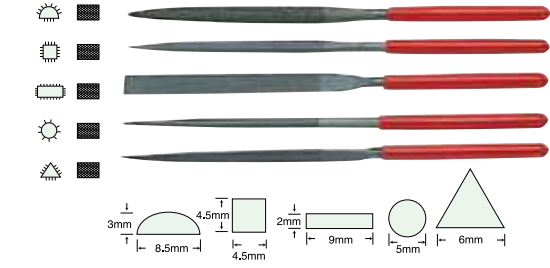

Material	HRC	Cut length	Handle O.D.	OAL (mm)	Individual packing
SKS-8	60°	85mm	Ø 7mm	180	Pouch



▶ MS-526 12-in-1 Multi-Tool

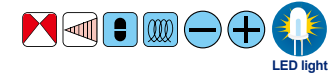

- Rugged stainless steel construction, corrosion-resistant.
- With non-slip rubber grip handle, more durable and comfortable.

Material	2Cr13
HRC Body	45°±3°
Application	Pliers, Scissor, Saw, Philips screwdriver, Bottle opener, Can opener, Knife, Flat file, Flat screwdriver, Awl, LED+flash light
OAL.(mm)	155
Individual packing	Double blister card



▶ FL-516 9 LED Flashlight



- Sturdy anodized aluminum construction, sealed at both ends with high grade rubber O-rings, water repellent and 1M drop protection.
- LEDs last up to 100,000 hours.



Material	Light source	Battery	OAL.(mm)	Individual packing
Aluminum	9pcs White LEDs	1.5V AAA x 3pcs (Not included)	ø27 x 92	Blister card



▶ MS-710 Anti-Fog UV Protective Glasses

UV 400 Resistant
Anti-Scratch
Anti-Fog

ANSI Z87.1-2003



Frame material	Nylon
Lens material	Polycarbonate
Product length (Temples folded)	147mm
Product width (Glasses included)	56.5mm
Temple length	117mm(MAX.)
Lens size	140 x 55mm
Lens thickness	2.0mm
Weight	34g
Individual packing	Poly bag



▶ CP-395 3 In 1 Heavy Duty Staple Gun

Easy Loading
Quick Jam Clear
Adjustable Pressure

600^{Pcs}
STAPLES
INCLUDED



Body material	Low carbon steel ST12	Model No.	CP-395-D	Type		Teeth (W)	1.2mm	Crown(C)	10.6mm/11.3mm	Leg(L)	4-14mm
Surface treatment	Chrome plated		CP-395-U	Type					6.3mm	10-12mm	
Accessories	CP-395-C		CP-395-T	Type				2mm	10-14mm		
Dimension	158x137x30mm										
Net weight	540g										
Individual packing	Blister card										
											Color box

▶ CP-382 Cable Tie Gun



- Neatly cuts end of cable tie off.
- Adjustable tension control.



Material		HRC	Application	OAL. (mm)	Individual packing
Body	Blade				
Aluminum	S45C	Cutter 48°±2°	Cable tie from 3/32"~3/16"(2.2~4.8mm) and thickness up to 1.6mm	160	Blister card

▶ MS-161 Heavy-Duty Suction Cup

- Ideal for open Imac, Ipad & glass-sheathed laptop displays.



ABS Handle

Capacity up to
10KG
(22lbs)



TPU Sucker

Size	Individual packing
Ø56mm x 68mm	Color box

▶ 8PK-220 Magnetizer Demagnetizer



- A convenient pocket sized tool, housed in a strong plastic case.
- Ideal for the general magnetizer demagnetizer of small hand tool i.e screwdriver, hexagon keys.



Individual packing
Blister card

▶ MS-035 Flux Bottle



- Dispenses flux evenly with a fine tipped needle.



Material	OAL.(mm)	Individual packing
PE	ø37x150	Poly bag + Hanger (2 pcs/pack)

▶ MS-018 Leak Proof Dispenser Pump Bottle

- Portable leak proof construction.
- Bottle scale indication.
- Anti dumping of cone design.



Material	Capacity	Individual packing
PE	180ml	Poly bag

▶ MS-004 MS-006 / MS-008 Liquid Dispenser Bottles



- Polyethylene bottles are not chemically reactive.
- Purity pump to prevent backwash of contaminants into container.



Model No.	Description	Individual packing
MS-004	4 oz/114 ml	Poly bag + Hanger
MS-006	6 oz/170 ml	
MS-008	8 oz/227 ml	

PD-376 Multi-Angle Swivel-Actions Vacu-Vise



- Swivels 360° and tilts 90° to desired angle.
- Equipped with slide-on rubber jaw for fragile work.
- 6 1/4" (158mm) triangular base.
- Aluminum die-cast construction.
- Light weight and durable.

Individual packing
Plain box+Color label

- Suction areas must be smooth, flat and clean.
- Adding a little water under vacuum base is recommended.

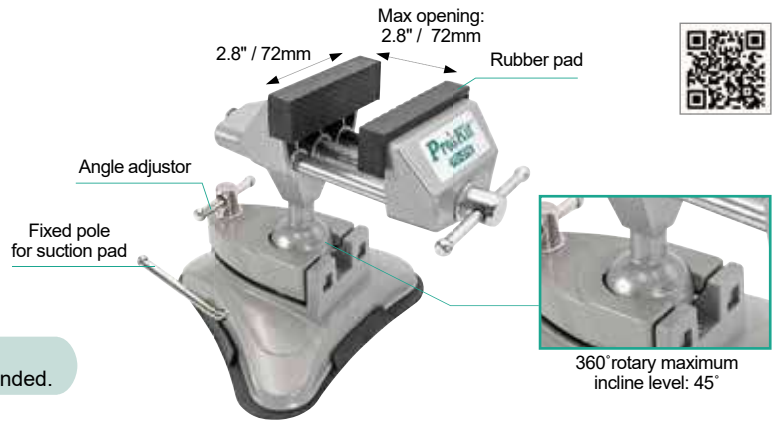

360° rotary maximum incline level: 45°

PD-374 Hobby Vise



Individual packing
Blister card



PD-372 Mini Vise

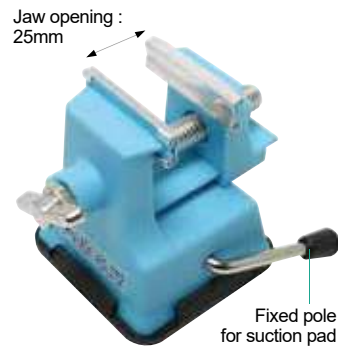

Individual packing
Blister card



MS-9328 3D Printer Palette Knives



Blade		Handle	OAL. (mm)	Individual packing
Material	Size			
Stainless steel	3"	PP+TPR	208	Blister card

PD-2616 10 OZ Engineer's Hammer



Material		Weight	OAL (mm)	Individual packing
Handle	Head			
FB +PP(TPR)	S45C	450g	298	Hanger

PD-2609 8 oz Curved Claw Hammer



Material		Weight	OAL (mm)	Individual packing
Handle	Head			
PIPE (PP+TPR)	S45C	340g	250	Hanger

PD-2612 8 oz Curved Claw Hammer



Material		Weight	OAL (mm)	Individual packing
Handle	Head			
PIPE (PVC)	S45C	340g	250	Hanger

PD-2606 Heavy Duty Curved-Claw



Material		Weight	OAL (mm)	Individual packing
Handle	Head			
FB +PP(TPR)	S45C	690g	330	Hanger

PD-2607 Ball Pen Hammer



Material		Weight	OAL (mm)	Individual packing
Handle	Head			
FB +PP(TPR)	S45C	630g	300	Hanger

INSTRUMENT CASES



Repair from place to place, instrument cases are your faithful friends.



Pro'sKit[®]

886-2-22183233
Sales support

pk@mail.prokits.com.tw
E-mail

www.prokits.com.tw
Global website

▶ TC-285 / TC-286 / TC-287 Heavy Duty Waterproof Case



Model No.	Material	Load capacity	O.D.	I.D.	Lid Height	Box Height	Weight(Foam included)	Individual packing
TC-285	Polypropylene	20kg	460x360x178mm	435x290x165mm	45mm	120mm	3.9kg	Color label shrink
TC-286	Polypropylene	15kg	340x300x150mm	312x236x145mm	40mm	105mm	2.1kg	
TC-287	Polypropylene	15kg	270x245x145mm	245x195x135mm	35mm	100mm	1.2kg	

▶ SB-1418 / SB-1718 / SB-1918 Strengthening Multi-Function Tool Box With Removable Tote Tray

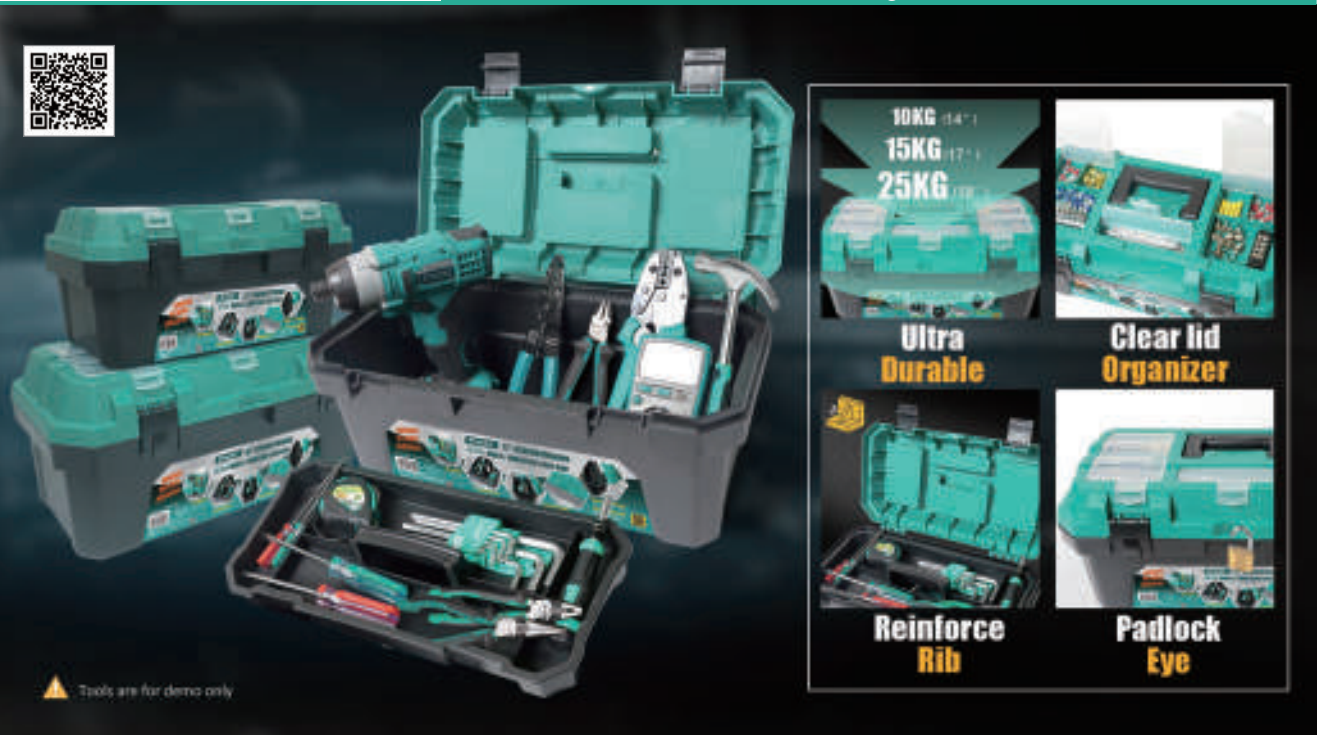

Model No.	Load capacity	Material	Dimension(O.D.)	Individual packing
SB-1418	10Kg	Polypropylene	350x200x165mm (14x8x7inch)	Color label shrink
SB-1718	15Kg		420x230x200mm (17x9x8inch)	
SB-1918	25Kg		470x230x220mm (19x9x8.6inch)	

▶ SB-3218 Multi-Function Tool Box With Removable Tote Tray



Impact Resistant

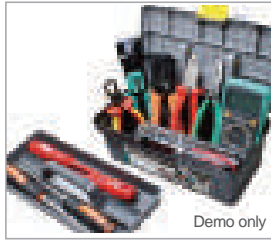
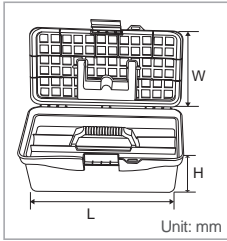

Large latch with padlock eye for better security and safety

Made of high-impact resistant polypropylene

Lift-out tray for small parts and tools

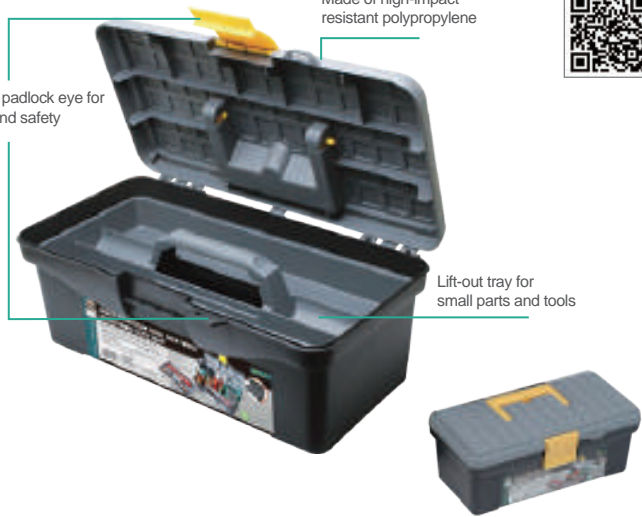

Material	Load capacity	Dimension (LxWxH)	Individual packing
Polypropylene	5 Kg	315x175x130mm	Color label shrink

▶ SB-2918 Multi-Function Tool Box With Storage Tray



Impact Resistant

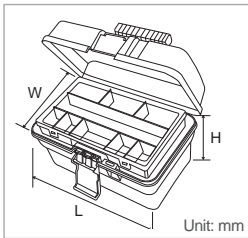

Portable lift-out box



Material	Load capacity	Dimension (LxWxH)	Individual packing
Polypropylene	5 Kg	290x175x175mm	Color label shrink

▶ SB-3428SB Service Case



Sturdy & Durable High Impact

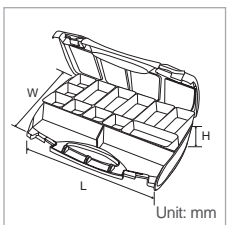

Double sided opening



Material	Dimension (LxWxH)	Individual packing
Polypropylene + Polystyrene	340x280x80mm	Color label shrink

- Properly divided spaces reach the different needs of any small components.
- Integrated handle and two locks for convenient carrying.
- Easy to store, easy to find.

SB-2419 Storage Box



- Tight seal between top and compartments prevents small components from being mixed while closed.

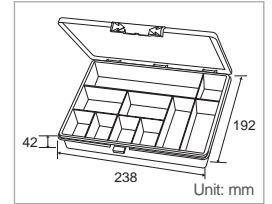

Material	Dimension(LxWxH)	Individual packing
Polypropylene	238x192x42mm	Color label shrink

SB-1592 Component Storage Box



103-132C Utility Component Storage Box

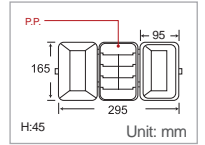

Material	Dimension(LxWxH)	Individual packing
Polypropylene	145x92x40mm	Color label shrink

Material	Dimension(LxWxH)	Individual packing
Polypropylene	165x95x45mm	Color label shrink

SB-1007K Multi-Purpose Box



Non-toxic

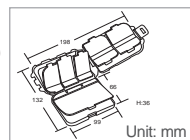

Unit: 2pcs/pack



903-133S Utility Component Storage Box

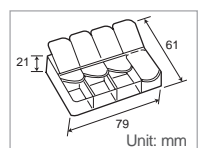

Material	Dimension(LxWxH)	Individual packing
Polypropylene	99x66x36mm	Poly bag (2pcs/pack)

Material	Dimension(LxWxH)	Individual packing
Polypropylene	79x61x21mm	Poly bag

▶ 103-132D Utility Component Storage Box

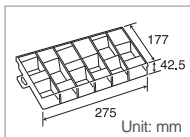

Material	Dimension (LxWxH)	Divider type	Optional divider	Individual packing
Polypropylene	275x177x42.5mm	Removable	503-132D-P (15 pcs/bag)	Shrink packing

▶ 203-132E Utility Component Storage Box

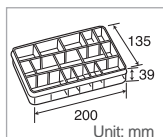

Material	Dimension (LxWxH)	Divider type	Optional divider	Individual packing
Polypropylene	200x135x39mm	Removable	503-132E-D12 (12 pcs/bag)	Shrink packing

▶ 203-132F Utility Component Storage Box

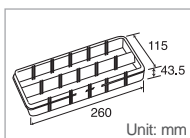

Material	Dimension (LxWxH)	Divider type	Optional divider	Individual packing
Polypropylene	260x115x43.5mm	Removable	503-132F-D10 (10 pcs/bag)	Shrink packing

▶ 203-132H Multi-Purpose Case

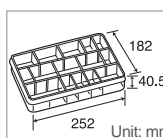

Material	Dimension (LxWxH)	Divider type	Optional divider	Individual packing
Polypropylene	252x182x40.5mm	Removable	503-132E-D12 (12 pcs/bag)	Shrink packing

▶ 203-132G Utility Component Storage Box

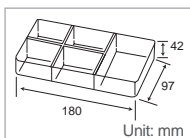

Material	Dimension (LxWxH)	Divider type	Individual packing
Polypropylene	180x97x42mm	Fixed	Shrink packing

▶ 203-132I Multi-Purpose Case

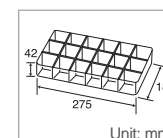

Material	Dimension (LxWxH)	Divider type	Individual packing
Polypropylene	275x183x42mm	Fixed	Shrink packing

▶ 903-132 Utility Component Storage Box

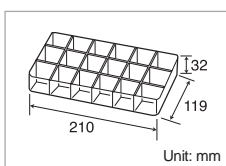

Material	Dimension (LxWxH)	Divider type	Individual packing
Polypropylene	210x119x32mm	Fixed	Poly bag

TOOL CASES



Everything is ready, except only one crucial item.



Thicker Frame 30mm
Thicker Corner 25mm

UPGRADE PROTECTION



SOLID BRACKET



METAL HINGES & LOCKS



DELUXE ALUMINIUM FRAME TOOL CASE

MULTIFUNCTION / LIGHT & STRONG

Details refer to TC-756

Pro'sKit®

886-2-22183233
Sales support

pk@mail.prokits.com.tw
E-mail

www.prokits.com.tw
Global website

▶ TC-756 Deluxe Aluminium Frame Tool Case W/1 Pallet

Aluminium Frame

Light & Durable

Extra Rivets

Stronger, Firmer & Stabler



Removable pallet

Aluminium frame

Removable divider



Model No.	Material	Size	L	W	H1	H2	A	Individual packing
TC-756	Frame: Aluminium	O.D (mm)	458	330	100	50	90°	White box
		I.D (mm)	440	310	95	40		

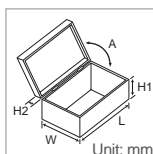

TOOL CASES

▶ 8PK-750N Aluminium Frame Tool Case W/1 Pallet

- Complete with one removable pallet and removable interior dividers
- Lining and partitions: EVA



Removable pallet

Aluminium frame

Removable divider



Bag with rivet design, more durable



3 hinges reinforce construction

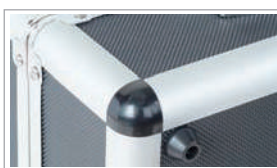

Heavy duty metal protective corners

Model No.	Material	Size	L	W	H1	H2	A	Individual packing
8PK-750N	Frame: Aluminium	O.D (mm)	458	330	90	60	97°	Color box
		I.D (mm)	434	308	82	53		

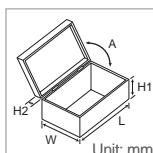

▶ TC-311 Heavy-Duty ABS Case With Wheels And Telescoping Handle



Key locks for maximum security



Standard equipment for easy opening and closing.

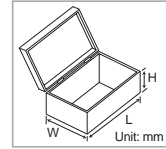

Material	Load capacity	Dimension (LxWxH)	Individual packing
ABS	12Kg	456x335x190mm	Color box

▶ TC-736 Expert & Elegant Aluminium Frame Tool Case W/2 Pallets



Standard equipment for easy opening and closing.

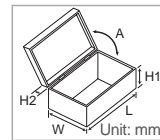

Material	Size	L	W	H1	H2	A	Individual packing
Frame: Aluminium	O.D (mm)	486	325	92	67	85°	Color box
	I.D (mm)	466	300	82	56		

▶ TC-850 ABS Carrying Tool Case W/2 Pallets

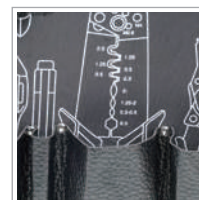

Bag with rivet design, more durable

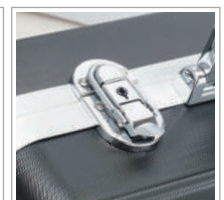

Key locks for maximum security

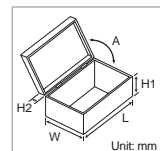

Material	Size	L	W	H1	H2	A	Individual packing
ABS	O.D (mm)	435	310	80	65	105°	Color box
	I.D (mm)	420	293	70	60		

▶ TC-755 Aluminium Frame Drawer Case

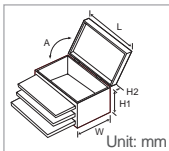

- Made of rugged plastic for strength and durability.
- Ball-bearing slides make drawer easy to open and close tightly.



Heavy duty metal protective corners



Ball-bearing slides make drawer easy to open and close tightly

Material	Size	L	W	H1	H2	A	Individual packing
Frame: Aluminium	O.D(mm)	485	260	280	53	90°	Color box
	I.D(mm)	465	242	260	40		
	I.D(Drawer) (mm)	397	220	50	-		

▶ 9PK-730N Aluminium Frame Tool Case W/1 Pallet

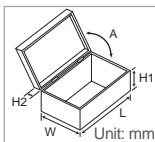

- Complete with one removable pallet and removable interior dividers.
- Lining and partitions: EVA.



Bag with rivet design, more durable

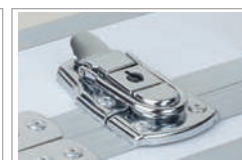

Key locks for maximum security

Material	Size	L	W	H1	H2	A	Individual packing
Frame: Aluminium	O.D	458	330	101	49	97°	Color box
	I.D	438	312	95	41		

▶ TC-2009 ABS Carrying Tool Case W/1 Pallet

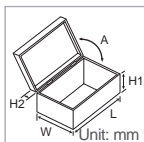

Key locks for maximum security



Heavy duty metal protective corners

Material	Size	L	W	H1	H2	A	Individual packing
ABS	O.D (mm)	463	331	96	75	98°	Color box
	I.D (mm)	453	323	90	67		



▶ 9PK-710P Deluxe Tool Case W/2 Pallets

Pb • With PK-710K pallets x2.

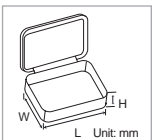

Material	L	W	H	Individual packing
PU leather	330mm	250mm	110mm	Color box

▶ ST-12B Tool Bag



Water repellent

- Multifunction bag with 4 inner layers.
- Ideal for storing tools, books, mobile, computers, clothes, etc.

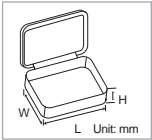

Material	L	W	H	Individual packing
600D Polyester	400mm	275mm	90mm	Poly bag

▶ ST-4029 Multi-Purpose Tool Bag

- Messenger bag
- handle case
- Backpack
- Laptop protection
- 15 kg loading capacity
- Water repellent



Material	L	W	H	Individual packing
600D polyester	400mm	90mm	275mm	Poly bag + Hanger

▶ ST-2012H Soft Sided Tool Pouch

- Pb** • Keep your tools and suppliers handy.
- Complete with universal tool best system.



Material	L	W	H	Individual packing
600D Polyester	305mm	235mm	95mm	Poly bag +Hanger

▶ ST-13S / 9ST-23 / 9ST-33 / 9ST-43 Tool Bag

Made of 400x300D Polyester



Micro injection plastic handle

Full logo stylish design around the bag

Heavy-duty zipper



ST-13S
Size:380x300x55mm



9ST-23
Size:340x222.5x60mm



9ST-33
Size:255x180x50mm



9ST-43
Size:207x130x35mm

Ultra Durable Tool Bag & Pouch Series



30KG / **Water**
Capacity / Repellent

Heavy Duty / Waterproof
Nothing but Convenient

▶ ST-5309

14" Deluxe Tool Bag

Demo only

10 pockets with 8 compartments for tool organize conveniently.



Dimension (LxWxH) :
330 x 225 x 240mm

Individual packing :
Poly bag + Color label shrink

▶ ST-5301

20" Heavy Duty Tool Bag

16 pockets with 4 mesh bags
for tool organize conveniently
telescopic handle & heavy duty wheel
for easy transportation.



Dimension (LxWxH) : 560 x 270 x 300mm
Individual packing : Polybag+Color label shrink

▶ ST-5302

16" Heavy Duty Tool Bag

14 pockets with 4 mesh bags
for tool organize conveniently.



Dimension (LxWxH) : 410 x 230 x 300mm
Individual packing : Polybag+Color label shrink

▶ ST-5310

14" Deluxe Tool Bag

7 pockets with 5 compartments
for tool organize conveniently.



Dimension (LxWxH) : 330 x 225 x 240mm
Individual packing : Polybag+Color label shrink



Demo only



Demo only



Demo only



▶ ST-5102 Multi Purpose Tool Pouch



5 kg Capacity | Repellent | 600D Polyester

Compact size great organizer



Dimension (LxWxH) : 250 x 250 x 170mm
Individual packing : Polybag+Hanger

▶ ST-5105 Multi Purpose Tool Pouch



5 kg Capacity | Repellent | 600D Polyester

2 style in 1
Open mouth & covered pouch



Dimension (LxWxH) : 200 x 160 x 250mm
Individual packing : Polybag+Hanger

▶ ST-5204 Tool Pouch



5 kg Capacity | Repellent | 600D Polyester

Great for small parts or mobile.



Dimension (LxWxH) : 115 x 70 x 140mm
Individual packing : Polybag+Hanger

▶ ST-5208 General Purpose Tool Pouch



4 kg Capacity | Repellent | 600D Polyester



Dimension (LxWxH) : 165 x 290 x 50mm
Individual packing : Polybag+Hanger

▶ ST-5502 7cm Wide Tool Belt



Demo only

▶ ST-5503 4cm Wide Tool Belt



Demo only

▶ ST-5504 Tool Belt With Safety Lock

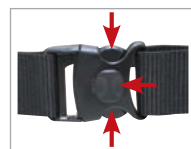

Extra lock design, prevent belt loosing

15KG Capacity



10KG Capacity



15KG Capacity



Model No.	Material	Loading capacity	Dimension	Individual packing
ST-5502	Polyester	15kg	Width: 7cm Length: 145cm	Poly bag+Hanger
ST-5503	Polyester	10kg	Width: 4cm Length: 115cm	Poly bag+Hanger
ST-5504	Polyester	15kg	Width: 5cm Length: 145cm	Poly bag+Hanger

Pro'sKit® Aftermarket Support

Come to **Pro'sKit®** for total solution!

Promote **Pro'sKit®** to get benefit!



unit:cm

Pro'sKit® 24 hours/7 days a week online technical support

Pro'sKit® owns a private internet server center providing e-Business system of e-procurement process, inquiry & sales analysis for worldwide distributors & customers of more than 75 countries in 5 continents. It also contains product database with technical information support including Product Video Demonstration buying guide to help customers make the best item selection and product utilization. Do you **Pro'sKit®** today? Please online now.



Official website

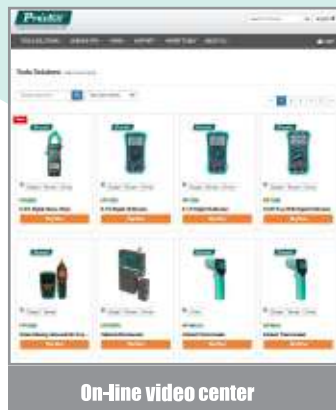

On-line video center



Private internet center



Pro'skit website



Pro'skit Youtube



Pro'skit video



Pro'skit Facebook