

Lenovo™ **Think**Products

PSREF



Product Specifications Reference

Version 507, May 2017

U.S.

Visit <http://psref.lenovo.com> for the latest version

Lenovo **ThinkPad** Laptops

PSREF



Product Specifications Reference

Version 506, May 2017

U.S.

Visit <http://psref.lenovo.com> for the latest version

Contents

Cover	1	ThinkPad E450 - TopSeller - 20DC - 3 of 4	35
Contents	2	ThinkPad E450 - TopSeller - 20DC - 4 of 4	36
Summary Of Change	5	ThinkPad E460	37
11e Series	6	ThinkPad E460 Platform Specifications	38
ThinkPad 11e (3rd Gen)	6	ThinkPad E460 - TopSeller - 20ET	39
ThinkPad 11e (3rd Gen) Platform Specifications	7	ThinkPad E465	40
ThinkPad 11e (3rd Gen) - TopSeller - 20GB	8	ThinkPad E465 Platform Specifications	41
ThinkPad 11e (4th Gen)	9	ThinkPad E465 - TopSeller - 20EX	42
ThinkPad 11e (4th Gen) Platform Specifications	10	ThinkPad E470	43
ThinkPad 11e (4th Gen) - TopSeller - 20HV	11	ThinkPad E470 Platform Specifications	44
ThinkPad 11e Chromebook (3rd Gen)	12	ThinkPad E470 - TopSeller - 20H1	45
ThinkPad 11e Chromebook (3rd Gen) Platform Specifications	13	ThinkPad E475	46
ThinkPad 11e Chromebook (3rd Gen) - TopSeller - 20GF	14	ThinkPad E475 Platform Specifications	47
ThinkPad 11e Chromebook (4th Gen)	15	ThinkPad E475 - TopSeller - 20H4	48
ThinkPad 11e Chromebook (4th Gen) Platform Specifications	16	ThinkPad E550	49
ThinkPad 11e Chromebook (4th Gen) - TopSeller - 20J0	17	ThinkPad E550 Platform Specifications	50
13 Series	18	ThinkPad E550 - TopSeller - 20DF - 1 of 4	51
ThinkPad 13	18	ThinkPad E550 - TopSeller - 20DF - 2 of 4	52
ThinkPad 13 Platform Specifications	19	ThinkPad E550 - TopSeller - 20DF - 3 of 4	53
ThinkPad 13 - TopSeller - 20GJ - 1 of 3	20	ThinkPad E550 - TopSeller - 20DF - 4 of 4	54
ThinkPad 13 - TopSeller - 20GJ - 2 of 3	21	ThinkPad E560	55
ThinkPad 13 - TopSeller - 20GJ - 3 of 3	22	ThinkPad E560 Platform Specifications	56
ThinkPad 13 - 20GJ	23	ThinkPad E560 - TopSeller - 20EV - 1 of 2	57
ThinkPad 13 (2nd Gen)	24	ThinkPad E560 - TopSeller - 20EV - 2 of 2	58
ThinkPad 13 (2nd Gen) Platform Specifications	25	ThinkPad E565	59
ThinkPad 13 (2nd Gen) - TopSeller - 20J1 - 1 of 2	26	ThinkPad E565 Platform Specifications	60
ThinkPad 13 (2nd Gen) - TopSeller - 20J1 - 2 of 2	27	ThinkPad E565 - TopSeller - 20EY - 1 of 2	61
ThinkPad 13 Chromebook	28	ThinkPad E565 - TopSeller - 20EY - 2 of 2	62
ThinkPad 13 Chromebook Platform Specifications	29	ThinkPad E570	63
ThinkPad 13 Chromebook - TopSeller - 20GL	30	ThinkPad E570 Platform Specifications	64
E Series	31	ThinkPad E570 - TopSeller - 20H5	65
ThinkPad E450	31	ThinkPad E575	66
ThinkPad E450 Platform Specifications	32	ThinkPad E575 Platform Specifications	67
ThinkPad E450 - TopSeller - 20DC - 1 of 4	33	ThinkPad E575 - TopSeller - 20H8	68
ThinkPad E450 - TopSeller - 20DC - 2 of 4	34	L Series	69

Contents

ThinkPad L460	69	ThinkPad P70 - TopSeller - 20ER - 1 of 2	103
ThinkPad L460 Platform Specifications	70	ThinkPad P70 - TopSeller - 20ER - 2 of 2	104
ThinkPad L460 - TopSeller - 20FU - 1 of 2	71	ThinkPad P71	105
ThinkPad L460 - TopSeller - 20FU - 2 of 2	72	ThinkPad P71 Platform Specifications	106
ThinkPad L470	73	ThinkPad P71 - TopSeller - 20HK - 1 of 2	107
ThinkPad L470 Platform Specifications	74	ThinkPad P71 - TopSeller - 20HK - 2 of 2	108
ThinkPad L470 - TopSeller - 20J4	75	T Series	109
ThinkPad L470 - TopSeller - 20JU	76	ThinkPad T460	109
ThinkPad L560	77	ThinkPad T460 Platform Specifications	110
ThinkPad L560 Platform Specifications	78	ThinkPad T460 - TopSeller - 20FN - 1 of 2	111
ThinkPad L560 - TopSeller - 20F1 - 1 of 2	79	ThinkPad T460 - TopSeller - 20FN - 2 of 2	112
ThinkPad L560 - TopSeller - 20F1 - 2 of 2	80	ThinkPad T460p	113
ThinkPad L570	81	ThinkPad T460p Platform Specifications	114
ThinkPad L570 Platform Specifications	82	ThinkPad T460p - TopSeller - 20FW	115
ThinkPad L570 - TopSeller - 20J8	83	ThinkPad T460s	116
P Series	84	ThinkPad T460s Platform Specifications	117
ThinkPad P50	84	ThinkPad T460s - TopSeller - 20F9 - 1 of 3	118
ThinkPad P50 Platform Specifications	85	ThinkPad T460s - TopSeller - 20F9 - 2 of 3	119
ThinkPad P50 - TopSeller - 20EN - 1 of 2	86	ThinkPad T460s - TopSeller - 20F9 - 3 of 3	120
ThinkPad P50 - TopSeller - 20EN - 2 of 2	87	ThinkPad T470	121
ThinkPad P50 - TopSeller - 20EQ	88	ThinkPad T470 Platform Specifications	122
ThinkPad P50s	89	ThinkPad T470 - TopSeller - 20HD	123
ThinkPad P50s Platform Specifications	90	ThinkPad T470 - TopSeller - 20JM	124
ThinkPad P50s - TopSeller - 20FL	91	ThinkPad T470p	125
ThinkPad P51	92	ThinkPad T470p Platform Specifications	126
ThinkPad P51 Platform Specifications	93	ThinkPad T470p - TopSeller - 20J6	127
ThinkPad P51 - TopSeller - 20HH - 1 of 2	94	ThinkPad T470s	128
ThinkPad P51 - TopSeller - 20HH - 2 of 2	95	ThinkPad T470s Platform Specifications	129
ThinkPad P51s	96	ThinkPad T470s - TopSeller - 20HF - 1 of 2	130
ThinkPad P51s Platform Specifications	97	ThinkPad T470s - TopSeller - 20HF - 2 of 2	131
ThinkPad P51s - TopSeller - 20HB - 1 of 2	98	ThinkPad T470s - TopSeller - 20JS	132
ThinkPad P51s - TopSeller - 20HB - 2 of 2	99	ThinkPad T560	133
ThinkPad P51s - TopSeller - 20JY	100	ThinkPad T560 Platform Specifications	134
ThinkPad P70	101	ThinkPad T560 - TopSeller - 20FH - 1 of 2	135
ThinkPad P70 Platform Specifications	102	ThinkPad T560 - TopSeller - 20FH - 2 of 2	136

Contents

ThinkPad T570	137
ThinkPad T570 Platform Specifications	138
ThinkPad T570 - TopSeller - 20H9	139
ThinkPad T570 - TopSeller - 20JW	140
X Series	141
ThinkPad X1 Carbon (4th Gen)	141
ThinkPad X1 Carbon (4th Gen) Platform Specifications	142
ThinkPad X1 Carbon (4th Gen) - TopSeller - 20FB - 1 of 5	143
ThinkPad X1 Carbon (4th Gen) - TopSeller - 20FB - 2 of 5	144
ThinkPad X1 Carbon (4th Gen) - TopSeller - 20FB - 3 of 5	145
ThinkPad X1 Carbon (4th Gen) - TopSeller - 20FB - 4 of 5	146
ThinkPad X1 Carbon (4th Gen) - TopSeller - 20FB - 5 of 5	147
ThinkPad X1 Carbon (5th Gen)	148
ThinkPad X1 Carbon (5th Gen) Platform Specifications	149
ThinkPad X1 Carbon (5th Gen) - TopSeller - 20HR - 1 of 2	150
ThinkPad X1 Carbon (5th Gen) - TopSeller - 20HR - 2 of 2	151
ThinkPad X1 Carbon (5th Gen) - TopSeller - 20K4	152
ThinkPad X260	153
ThinkPad X260 Platform Specifications	154
ThinkPad X260 - TopSeller - 20F6 - 1 of 4	155
ThinkPad X260 - TopSeller - 20F6 - 2 of 4	156
ThinkPad X260 - TopSeller - 20F6 - 3 of 4	157
ThinkPad X260 - TopSeller - 20F6 - 4 of 4	158
ThinkPad X270	159
ThinkPad X270 Platform Specifications	160
ThinkPad X270 - TopSeller - 20HN	161
ThinkPad X270 - TopSeller - 20K6	162
Legal Information	163

Summary of Changes

This section describes the technical changes made in this edition.

This edition might also include minor corrections and editorial changes which are not identified.

May 10, 2017 - Version 506

Additions in this update

▶ **New product(s)**

None

▶ **New model(s)**

ThinkPad L470 models announced May 2017

ThinkPad P51 models announced May 2017

ThinkPad P51s models announced May 2017

ThinkPad P71 models announced May 2017

ThinkPad X270 models announced May 2017

▶ **Others**

None

Withdrawals in this update

▶ **Withdrawn product(s)**

None



ThinkPad 11e (3rd Gen) Platform Specifications

Product Specifications Reference (PSREF)

Processor	Intel® Celeron® Processor, Intel Pentium® Processor, or 6th Generation Intel Core™ i3 Processor							Media reader	4-in-1 reader (MMC, SD, SDHC, SDXC)			
	Processor Number	# of Cores	# of Threads	Base Frequency	Burst Frequency	Cache	Memory Types	Processor Graphics	Ports	Two USB 3.0, HDMI, Ethernet (RJ-45)		
	Cel N3150	4	4	1.6 GHz	2.08 GHz	2MB	DDR3L-1600	Intel HD graphics	Control buttons	Power button, volume control button		
	Cel N3160			1.6 GHz	2.24 GHz	2MB		Intel HD graphics 400	Camera	HD720p resolution, low light sensitive, fixed focus	Audio support	HD Audio, Realtek® ALC3245 codec / stereo speakers, 2W x 2 / monaural digital microphone, combo audio/microphone jack
	Pen 4405U	2	4	2.1 GHz	-	2MB		Intel HD graphics 510				
i3-6100U	2.3 GHz			-	3MB	Intel HD graphics 520						
Graphics	Intel HD Graphics, Intel HD Graphics 510, or Intel HD Graphics 520 in processor, supports external digital monitor via HDMI™; supports dual independent display; Max resolution: 1920X1080 (HDMI)@30Hz							Security	Power-on password, hard disk password, supervisor password, security keyhole			
Chipset	Intel SoC (System on Chip) platform							Security chip	<i>Win7 model:</i> discrete TPM 1.2, TCG Certified			
Memory	2GB, 4GB, or 8GB / PC3-12800 1600MHz DDR3L, one DDR3L SO-DIMM socket							vPro	None			
Display	11.6" (295mm) HD (1366x768), anti-glare, LED backlight, 220 nits, 16:9 aspect ratio, 500:1 contrast ratio							Fingerprint reader	None			
Multi-touch	None							Battery	Integrated Lithium Polymer 3-cell (42Wh)			
Hinge	Normal hinge, 180 degree							Max battery life ¹⁰	<i>MobileMark® 2014:</i> 11.53 hr			
Storage	M.2 Solid State Drive (SSD), SATA 6.0Gb/s							AC adapter	45-watt AC adapter			
Optical	None							Preload	Windows 7 Professional 64 preinstalled through downgrade rights in Windows 10 Pro 64		<i>Some:</i> Windows 10 Home 64 <i>Some:</i> Windows 10 Pro 64	
Ethernet	Realtek RTL8111GUS-CG Gigabit Network Connection								• Lenovo Solution Center			• Lenovo Solution Center
WLAN ⁴	<i>One of the following, configurable by model:</i> • 11ac+BT, Intel Dual Band Wireless-AC 3165, 1x1, M.2 card • 11ac+BT, Intel Dual Band Wireless-AC 7265, 2x2, M.2 card								• ThinkVantage Product Recovery			• Lenovo Companion
Bluetooth™	Bluetooth 4.0 wireless, integrated in Wi-Fi + Bluetooth combo adapter								• Rescue and Recovery™			• Lenovo Setting
WWAN	None								• ThinkVantage System Update			• Microsoft Office preloaded;
Dimensions ³	<i>WxDxH:</i> 11.81" x 8.27" x 0.88"; 300mm x 210mm x 22.3mm							• Adobe® Reader®		purchase a product key to activate		
Weight ²	Starting at 3.3 lb (1.5kg)							• Microsoft® Office preloaded;		• McAfee® LiveSafe™ (30-day trial)		
Case color	<i>Display cover:</i> Graphite Black or Silver; <i>Bottom:</i> Graphite Black							• purchase a product key to activate				
Case material	<i>Display cover:</i> PC+40%GF+TPU; <i>Bottom:</i> PCC							• McAfee® LiveSafe™ (30-day trial)				
								Limited warranty ¹²	<i>One of the following, configurable by model:</i> • 1-year depot repair service • 3-year/1-yr battery depot repair service (US only)			
								Mil-Spec test	MIL-STD-810G military certification			
								Environment	EPEAT™ Gold (US only); ENERGY STAR® 6.1; RoHS-compliant			

ThinkPad 11e (3rd Gen) - TopSeller - 20GB

Product Specifications Reference (PSREF)

Model	Region	Processor	Graphics	Memory	Display	Multi-touch	Storage	Optical	WLAN + Bluetooth	Color	Camera	Keyboard	Finger-print Reader	TPM	Battery (internal)	Power Adapter	Operating System	Warranty	Ann Date (m/y)
20GB000JUS	US	Celeron N3150	Intel HD	4GBx1	11.6" HD (1366x768)	None	192GB SSD M.2	None	Intel 7265 ac, 2x2 + BT4.0	Black	720p	Non-backlit	None	dTPM1.2 + FW TPM2.0	3-cell (42Wh)	45W	Windows 10 Pro 64	1-year, Depot	02/16
20GB000KUS	US	Celeron N3150	Intel HD	8GBx1	11.6" HD (1366x768)	None	192GB SSD M.2	None	Intel 7265 ac, 2x2 + BT4.0	Black	720p	Non-backlit	None	dTPM1.2 + FW TPM2.0	3-cell (42Wh)	45W	Windows 10 Pro 64	1-year, Depot	02/16
20GB000LUS	US	Celeron N3150	Intel HD	8GBx1	11.6" HD (1366x768)	None	128GB SSD M.2	None	Intel 7265 ac, 2x2 + BT4.0	Black	720p	Non-backlit	None	dTPM1.2 + FW TPM2.0	3-cell (42Wh)	45W	Windows 10 Pro 64	1-year, Depot	02/16
20GB000MUS	US	Celeron N3150	Intel HD	8GBx1	11.6" HD (1366x768)	None	256GB SSD M.2 Opal2	None	Intel 7265 ac, 2x2 + BT4.0	Black	720p	Non-backlit	None	dTPM1.2 + FW TPM2.0	3-cell (42Wh)	45W	Windows 10 Pro 64	1-year, Depot	02/16
20GB000NUS	US	Celeron N3150	Intel HD	4GBx1	11.6" HD (1366x768)	None	128GB SSD M.2	None	Intel 7265 ac, 2x2 + BT4.0	Black	720p	Non-backlit	None	dTPM1.2 + FW TPM2.0	3-cell (42Wh)	45W	Windows 10 Pro 64	1-year, Depot	02/16
20GB000PUS	US	i3-6100U	Intel HD 520	4GBx1	11.6" HD (1366x768)	None	128GB SSD M.2	None	Intel 7265 ac, 2x2 + BT4.0	Black	720p	Non-backlit	None	dTPM1.2 + FW TPM2.0	3-cell (42Wh)	45W	Windows 10 Pro 64	1-year, Depot	02/16
20GB000QUS	US	i3-6100U	Intel HD 520	8GBx1	11.6" HD (1366x768)	None	128GB SSD M.2	None	Intel 7265 ac, 2x2 + BT4.0	Black	720p	Non-backlit	None	dTPM1.2 + FW TPM2.0	3-cell (42Wh)	45W	Windows 10 Pro 64	1-year, Depot	02/16
20GB000RUS	US	i3-6100U	Intel HD 520	8GBx1	11.6" HD (1366x768)	None	192GB SSD M.2	None	Intel 7265 ac, 2x2 + BT4.0	Black	720p	Non-backlit	None	dTPM1.2 + FW TPM2.0	3-cell (42Wh)	45W	Windows 10 Pro 64	1-year, Depot	02/16
20GB000SUS	US	i3-6100U	Intel HD 520	8GBx1	11.6" HD (1366x768)	None	256GB SSD M.2 Opal2	None	Intel 7265 ac, 2x2 + BT4.0	Black	720p	Non-backlit	None	dTPM1.2 + FW TPM2.0	3-cell (42Wh)	45W	Windows 10 Pro 64	1-year, Depot	02/16
20GB000UUS	US	i3-6100U	Intel HD 520	4GBx1	11.6" HD (1366x768)	None	192GB SSD M.2	None	Intel 7265 ac, 2x2 + BT4.0	Black	720p	Non-backlit	None	dTPM1.2 + FW TPM2.0	3-cell (42Wh)	45W	Windows 10 Pro 64	1-year, Depot	02/16
20GB001HUS	US	Celeron N3160	Intel HD 400	4GBx1	11.6" HD (1366x768)	None	128GB SSD M.2	None	Intel 7265 ac, 2x2 + BT4.0	Black	720p	Non-backlit	None	dTPM1.2 + FW TPM2.0	3-cell (42Wh)	45W	Windows 10 Pro 64	1-year, Depot	09/16
20GB001JUS	US	Celeron N3160	Intel HD 400	4GBx1	11.6" HD (1366x768)	None	256GB SSD M.2 Opal2	None	Intel 7265 ac, 2x2 + BT4.0	Black	720p	Non-backlit	None	dTPM1.2 + FW TPM2.0	3-cell (42Wh)	45W	Windows 10 Pro 64	1-year, Depot	09/16
20GB001KUS	US	Celeron N3160	Intel HD 400	8GBx1	11.6" HD (1366x768)	None	128GB SSD M.2	None	Intel 7265 ac, 2x2 + BT4.0	Black	720p	Non-backlit	None	dTPM1.2 + FW TPM2.0	3-cell (42Wh)	45W	Windows 10 Pro 64	1-year, Depot	09/16
20GB001LUS	US	Celeron N3160	Intel HD 400	8GBx1	11.6" HD (1366x768)	None	256GB SSD M.2 Opal2	None	Intel 7265 ac, 2x2 + BT4.0	Black	720p	Non-backlit	None	dTPM1.2 + FW TPM2.0	3-cell (42Wh)	45W	Windows 10 Pro 64	1-year, Depot	09/16



ThinkPad 11e (4th Gen) Platform Specifications

Product Specifications Reference (PSREF)

Processor	Intel® Celeron® processor or 7th Generation Intel Core™ i3 Processor								Media reader	4-in-1 reader (MMC, SD, SDHC, SDXC)
	Processor Number	# of Cores	# of Threads	Base Frequency	Burst Frequency	Cache	Memory Types	Processor Graphics	Ports	Two USB 3.1 Gen 1 / USB 3.0, HDMI 1.4b, Ethernet (RJ-45)
	Cel N3450	4	4	1.1 GHz	2.2 GHz	2MB	DDR3L-1600	Intel HD Graphics 500	Control buttons	Power button, volume control button
	i3-7100U	2	4	2.4 GHz	-	3MB	DDR4-2133	Intel HD Graphics 620	Camera	HD720p resolution, low light sensitive, fixed focus
Graphics	Intel HD Graphics 500 or 620 in processor, supports external digital monitor via HDMI™; supports dual independent display; Max resolution: 1920X1080 (HDMI) @60Hz								Audio support	HD Audio, Realtek® ALC3268 codec / stereo speakers, 2W x 2 / monaural digital microphone, combo audio/microphone jack
	Chipset	Intel SoC (System on Chip) platform								Keyboard
Memory	4GB or 8GB / 1600MHz DDR3L or 2133MHz DDR4, one DDR3L or DDR4 SO-DIMM socket								Touchpad	Buttonless touchpad below keyboard, multi-touch
Display	11.6" (295mm) HD (1366x768), anti-glare, LED backlight, 250 nits, 16:9 aspect ratio, 500:1 contrast ratio								Security	Power-on password, hard disk password, supervisor password, security keyhole
Multi-touch	None								Security chip	Discrete TPM 2.0, TCG Certified
Hinge	Normal hinge, 180 degree								vPro	None
Storage	M.2 Solid State Drive (SSD), SATA 6.0Gb/s								Fingerprint reader	None
Optical	None								Battery	Integrated Lithium Polymer 3-cell (42Wh)
Ethernet	Realtek RTL8111GUS-CG Gigabit Network Connection								Max battery life	MobileMark® 2014: 13.65 hr
WLAN	Intel Dual Band Wireless-AC 7265, Wi-Fi 2x2 802.11ac + BT4.1, M.2 card								AC adapter	45W AC adapter
Bluetooth™	Bluetooth 4.1 wireless, integrated in Wi-Fi + Bluetooth combo adapter								Preload	Some: Windows® 10 Home 64 Some: Windows 10 Pro 64 • Lenovo Companion • Lenovo Setting • Microsoft Office preloaded; purchase a product key to activate
WWAN	None								Limited warranty	One of the following, configurable by model: • 1-year depot repair service • 3-year/1-yr battery depot repair service
Dimensions	WxDxH: 11.81" x 8.27" x 0.88"; 300mm x 210mm x 22.3mm								Mil-Spec test	MIL-STD-810G military certification
Weight	Starting at 3.3 lb (1.52kg)								Environment	EPEAT™ Gold (US only); ENERGY STAR® 6.1; RoHS-compliant
Case color	Display cover: Graphite Black;				Bottom: Graphite Black					
Case material	Display cover: PC+40%GF+TPU;				Bottom: PC/ABS plastic					

ThinkPad 11e (4th Gen) - TopSeller - 20HV

Product Specifications Reference (PSREF)

Model	Region	Processor	vPro	Graphics	Memory	Display	Multi-touch	Storage(HDD/SSD)	Optical	WLAN + Bluetooth	Color	Camera	Key-board	Finger-print Reader	TPM	Battery (internal)	Power Adapter	Operating System	Warranty	Ann Date (m/y)
20HV0000US	US	i3-7100U	No	Intel HD 620	8GBx1 DDR4-2133	11.6" HD (1366x768)	None	128GB SSD M.2	None	Intel 7265 ac, 2x2 + BT4.1	Black	720p	Non-backlit	None	dTPM 2.0	3-cell (42Wh)	45W	Win10 Pro 64	1-year, Depot	03/17
20HV0001US	US	i3-7100U	No	Intel HD 620	4GBx1 DDR4-2133	11.6" HD (1366x768)	None	128GB SSD M.2	None	Intel 7265 ac, 2x2 + BT4.1	Black	720p	Non-backlit	None	dTPM 2.0	3-cell (42Wh)	45W	Win10 Pro 64	1-year, Depot	03/17
20HV000MUS	US	Celeron N3450	No	Intel HD 500	4GBx1 DDR3L-1600	11.6" HD (1366x768)	None	128GB SSD M.2	None	Intel 7265 ac, 2x2 + BT4.1	Black	720p	Non-backlit	None	dTPM 2.0	3-cell (42Wh)	45W	Win10 Pro 64	1-year, Depot	03/17
20HV000VUS	US	Celeron N3450	No	Intel HD 500	8GBx1 DDR3L-1600	11.6" HD (1366x768)	None	128GB SSD M.2	None	Intel 7265 ac, 2x2 + BT4.1	Black	720p	Non-backlit	None	dTPM 2.0	3-cell (42Wh)	45W	Win10 Pro 64	1-year, Depot	03/17
20HV000XUS	US	Celeron N3450	No	Intel HD 500	8GBx1 DDR3L-1600	11.6" HD (1366x768)	None	256GB SSD M.2 Opal2	None	Intel 7265 ac, 2x2 + BT4.1	Black	720p	Non-backlit	None	dTPM 2.0	3-cell (42Wh)	45W	Win10 Pro 64	1-year, Depot	03/17
20HV0015US	US	i3-7100U	No	Intel HD 620	8GBx1 DDR4-2133	11.6" HD (1366x768)	None	256GB SSD M.2 Opal2	None	Intel 7265 ac, 2x2 + BT4.1	Black	720p	Non-backlit	None	dTPM 2.0	3-cell (42Wh)	45W	Win10 Pro 64	1-year, Depot	03/17



ThinkPad 11e Chromebook (3rd Gen) Platform Specifications

Product Specifications Reference (PSREF)

Processor	Intel® Celeron® Processor								Dimensions ³	<i>WxDxH:</i> 11.81" x 8.27" x 0.88"; 300mm x 210mm x 22.3mm
	Processor Number	# of Cores	# of Threads	Base Frequency	Burst Frequency	Cache	Memory Types	Processor Graphics	Weight ²	Starting at 3.3 lb (1.5kg)
	Cel N3150	4	4	1.6 GHz	2.08 GHz	2MB	DDR3L-1600	Intel HD graphics	Case color	<i>Display cover:</i> Graphite Black or Silver; <i>Bottom:</i> Graphite Black
Cel N3160			1.6 GHz	2.24 GHz	2MB	Intel HD graphics 400		Case material	<i>Display cover:</i> PC+40%GF+TPU; <i>Bottom:</i> PCC	
Graphics	Intel HD Graphics or Intel HD Graphics 400 in processor, supports external digital monitor via HDMI™; supports dual independent display; Max resolution: 1920X1080 (HDMI)@30Hz								Media reader	4-in-1 reader (MMC, SD, SDHC, SDXC)
Chipset	Intel SoC (System on Chip) platform								Ports	Two USB 3.0 (one Always On), HDMI
Memory	2GB or 4GB / 1600MHz LPDDR3 / soldered to systemboard, no sockets								Control buttons	None
Display	11.6" (295mm) HD (1366x768), anti-glare, LED backlight, 220 nits, 16:9 aspect ratio, 500:1 contrast ratio								Camera	HD720p resolution, low light sensitive, fixed focus
Multi-touch	None								Audio support	Realtek® ALC5650 codec / stereo speakers, 2W x 2 / monaural digital microphone, combo audio/microphone jack
Hinge	Normal hinge, 180 degree								Keyboard	ThinkPad Chrome keyboard, 6-row, multimedia Fn keys
Storage	16GB eMMC (embedded Multi Media Card) flash memory on board								Touchpad	Buttonless touchpad below keyboard, multi-touch
Optical	None								Security	Security keyhole
Ethernet	None								Security chip	Discrete TPM 1.2, TCG Certified
WLAN ⁴	11ac+BT, Intel Dual Band Wireless-AC 7265, 2x2, M.2 card								vPro	None
Bluetooth™	Bluetooth 4.0 wireless, integrated in Wi-Fi + Bluetooth combo adapter								Fingerprint reader	None
WWAN	None								Battery	Integrated Lithium Polymer 3-cell (42Wh)
									Max battery life ¹⁰	Up to 12 hr
									AC adapter	45-watt AC adapter
									Preload	Google Chrome OS
									Limited warranty ¹²	1-year depot repair service
									Mil-Spec test	MIL-STD-810G military certification
									Environment	EPeAT™ Gold (US only); ENERGY STAR® 6.1; RoHS-compliant

ThinkPad 11e Chromebook (3rd Gen) - TopSeller - 20GF

Product Specifications Reference (PSREF)

Model	Region	Processor	Graphics	Memory (Soldered)	Display	Multi-touch	Storage	Optical	WLAN + Bluetooth	Color	Camera	Key-board	Finger-print Reader	TPM	Battery (internal)	Power Adapter	Operating System	Warranty	Ann Date (m/y)
20GF0001US	US	Celeron N3150	Intel HD	4GB Soldered	11.6" HD (1366x768)	None	16GB eMMC	None	Intel 7265 ac, 2x2 + BT4.0	Black	720p	Non-backlit	None	dTPM 1.2	3-cell (42Wh)	45W	Chrome OS	1-year, Depot	03/16
20GF0003US	US	Celeron N3160	Intel HD 400	4GB Soldered	11.6" HD (1366x768)	None	16GB eMMC	None	Intel 7265 ac, 2x2 + BT4.0	Black	720p	Non-backlit	None	dTPM 1.2	3-cell (42Wh)	45W	Chrome OS	1-year, Depot	10/16



ThinkPad 11e Chromebook (4th Gen) Platform Specifications

Product Specifications Reference (PSREF)

Processor	Intel® Celeron® Processor								Dimensions	WxDxH: 11.81" x 8.27" x 0.90"; 300mm x 210mm x 22.8mm	
	Processor Number	# of Cores	# of Threads	Base Frequency	Burst Frequency	Cache	Memory Types	Processor Graphics	Weight	from 3.2 lb (1.45kg)	
	Cel N3450	4	4	1.1 GHz	2.2 GHz	2MB	LPDDR4-2400	Intel HD Graphics 500	Case color	Display cover: Graphite Black; Bottom: Graphite Black	
									Case material	Display cover: PC+40%GF+TPU; Bottom: PC/ABS plastic	
Graphics	Intel HD Graphics 500 in processor								Media reader	MicroSD card reader (MMC, SD, SDHC, SDXC)	
Chipset	Intel SoC (System on Chip) platform								Ports	One USB 3.1 Gen 1 / USB 3.0, two USB Type-C	
Memory	4GB / 3200MHz LPDDR4 / soldered to systemboard, no sockets * System clocks down for processors with lower memory controller								Control buttons	None	
Display	11.6" (295mm) HD (1366x768), anti-glare, LED backlight, 250 nits, 16:9 aspect ratio, 500:1 contrast ratio								Camera	HD720p resolution, low light sensitive, fixed focus	
Multi-touch	None								Audio support	Dialog Semiconductor DA7219 audio codec / stereo speakers, 2W x 2 / monaural digital microphone, combo audio/microphone jack	
Hinge	Normal hinge, 180 degree								Keyboard	ThinkPad Chrome keyboard, 6-row, multimedia Fn keys	
Storage	32GB eMMC (embedded Multi Media Card) flash memory on board								Touchpad	Buttonless touchpad below keyboard, multi-touch	
Optical	None								Security	Security keyhole	
Ethernet	None								Security chip	Discrete TPM 2.0, TCG Certified	
WLAN	Intel Dual Band Wireless-AC 7265, Wi-Fi 2x2 802.11ac + BT4.1, M.2 card								vPro	None	
Bluetooth™	Bluetooth 4.1 wireless, integrated in Wi-Fi + Bluetooth combo adapter								Fingerprint reader	None	
WWAN	None								Battery	Integrated Lithium Polymer 3-cell (42Wh)	
								Max battery life	Up to 11.84 hr		
								AC adapter	45W USB Type-C AC adapter		
								Preload	Google Chrome OS		
								Limited warranty	1-year depot repair service		
								Mil-Spec test	MIL-STD-810G military certification		
								Environment	EPEAT™ Gold (US only); ENERGY STAR® 6.1; RoHS-compliant		

ThinkPad 11e Chromebook (4th Gen) - TopSeller - 20J0

Product Specifications Reference (PSREF)

Model	Region	Processor	vPro	Graphics	Memory (Soldered)	Display	Multi-touch	Storage	Optical	WLAN + Bluetooth	Color	Camera	Key-board	Finger-print Reader	TPM	Battery (internal)	Power Adapter	Operating System	Warranty	Ann Date (m/y)
20J00000US	US	Celeron N3450	No	Intel HD 500	4GB Soldered	11.6" HD (1366x768)	None	32GB eMMC	None	Intel 7265 ac, 2x2 + BT4.1	Black	720p	Non-backlit	None	dTPM 2.0	3-cell (42Wh)	45W USB-C	Chrome OS	1-year, Depot	04/17

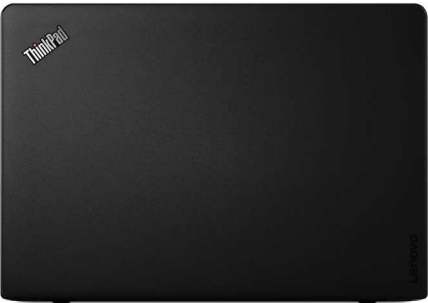

ThinkPad 13 Platform Specifications

Product Specifications Reference (PSREF)

Processor	Intel® Celeron® Processor or 6th Generation Intel Core™ i3 / i5 Processor								Smart card reader	None	
	Processor Number	# of Cores	# of Threads	Base Frequency	Max Turbo Frequency	Cache	Memory Types	Processor Graphics	Media reader Ports	4-in-1 reader (MMC, SD, SDHC, SDXC) Three USB 3.0 (one Always On), one USB Type-C, HDMI, Lenovo OneLink+ connector	
	Cel 3855U	2	2	1.6 GHz	-	2MB	DDR4-2133	Intel HD graphics 510	Camera Audio support	HD720p resolution, low light sensitive, fixed focus HD Audio, Realtek® ALC3245 codec / stereo speakers, 2W x 2 / dual array microphone, combo audio/microphone jack	
	i3-6100U			2.3 GHz	-	3MB		Intel HD graphics 520			
	i5-6200U			4	2.3 GHz	2.8 GHz			3MB		
i5-6300U	2.4 GHz				3.0 GHz	3MB					
i7-6500U	2.5 GHz	3.1 GHz	4MB								
Graphics	Intel HD Graphics 510 or 520 in processor, supports external digital monitor via HDMI or USB Type-C; supports three independent displays; Max resolution: 1920x1080 (HDMI)@60Hz, 3840X2160 (USB Type-C)@60Hz								Security Security chip	Power-on password, hard disk password, supervisor password, security keyhole <i>Win7 model:</i> discrete TPM 1.2, TCG Certified <i>Win10 model:</i> discrete TPM 1.2 TCG Certified and Firmware TPM 2.0 in chipset	
Chipset	Intel SoC (System on Chip) platform								vPro (optional)	Intel vPro Technology	
Memory	16GB max / 2133MHz DDR4, two DDR4 SO-DIMM sockets								Fingerprint reader	<i>Optional:</i> Swipe style fingerprint reader on the keyboard bezel	
Display	<i>Some:</i> 13.3" (338mm) HD (1366x768), anti-glare, LED backlight, 200 nits, 16:9 aspect ratio, 500:1 contrast ratio <i>Some:</i> 13.3" (338mm) FHD (1920x1080), anti-glare, LED backlight, IPS, 220 nits, 16:9 aspect ratio, 600:1 contrast ratio, 170° viewing angle								Battery	Integrated Lithium Polymer 3-cell (42Wh)	
Multi-touch	None								Max battery life ¹⁰	<i>MobileMark® 2014:</i> 11.6 hr	
Storage	M.2 SSD / SATA 6.0Gb/s								AC adapter	45-watt AC adapter	
Optical	None								Preload	<i>Some:</i> Genuine Windows® 7 Professional 64 <i>Some:</i> Windows 7 Professional 64 preinstalled through downgrade rights in Windows 10 Pro 64	
Ethernet	<i>Non-vPro model:</i> Intel Ethernet Connection I219-V (Jacksonville) <i>vPro model:</i> Intel Ethernet Connection I219-LM (Jacksonville)									<ul style="list-style-type: none"> • Lenovo Solution Center • Lenovo SHAREit • ThinkVantage Product Recovery • Rescue and Recovery™ • ThinkVantage System Update • Adobe® Reader® • Microsoft® Office preloaded; purchase a product key to activate • McAfee® LiveSafe™ (30-day trial) 	
WLAN ⁴	<i>One of the following, configurable by model:</i> <ul style="list-style-type: none"> • 11ac+BT4.0, Intel Dual Band Wireless-AC 3165, 1x1, M.2 card • 11ac+BT4.1, Intel Dual Band Wireless-AC 8260, 2x2, M.2 card 									<ul style="list-style-type: none"> • Lenovo Solution Center • Lenovo SHAREit • ThinkVantage Product Recovery • Rescue and Recovery™ • ThinkVantage System Update • Adobe® Reader® • Microsoft® Office preloaded; purchase a product key to activate • McAfee® LiveSafe™ (30-day trial) 	
Bluetooth™	Bluetooth 4.0 or 4.1 wireless, integrated in Wi-Fi + Bluetooth combo adapter									<ul style="list-style-type: none"> • Lenovo Solution Center • Lenovo SHAREit • ThinkVantage Product Recovery • Rescue and Recovery™ • ThinkVantage System Update • Adobe® Reader® • Microsoft® Office preloaded; purchase a product key to activate • McAfee® LiveSafe™ (30-day trial) 	
WWAN	None									<ul style="list-style-type: none"> • Lenovo Solution Center • Lenovo SHAREit • ThinkVantage Product Recovery • Rescue and Recovery™ • ThinkVantage System Update • Adobe® Reader® • Microsoft® Office preloaded; purchase a product key to activate • McAfee® LiveSafe™ (30-day trial) 	
Dimensions ³	<i>WxDxH (silver):</i> 12.69" x 8.77" x 0.75"; 322.4mm x 222.8mm x 19.1mm <i>WxDxH (black):</i> 12.69" x 8.77" x 0.78"; 322.4mm x 222.8mm x 19.8mm								Limited warranty ¹²	<i>One of the following, configurable by model:</i> <ul style="list-style-type: none"> • 1-year depot repair service • 3-year/1-yr battery depot repair service • 3-year/1-yr battery limited onsite service²⁴ 	
Weight ²	Starting at 3.17 lb / 1.44 kg								Mil-Spec test	MIL-STD-810G military certification	
Case color	Pure Black or Silver								Environment	EPEAT™ Gold (US only); ENERGY STAR® 6.1; RoHS-compliant	
Case material	<i>Black cover:</i> PC/ABS plastic; <i>Silver cover:</i> Aluminum										

Model	Region	Processor	vPro	Graphics	Memory	Display	Multi-touch	Storage	Optical	WLAN + Bluetooth	Color	Camera	Keyboard	Fingerprint Reader	TPM	Battery (internal)	Power Adapter	Operating System	Warranty	Ann Date (m/y)
20GJ0006US	US	Celeron 3855U	No	Intel HD 510	4GBx1	13.3" HD (1366x768)	None	128GB SSD M.2	None	Intel 8260 ac, 2x2 + BT4.1	Black	720p	Non-backlit	Fingerprint Reader	dTPM1.2 + FW TPM2.0	3-cell (42Wh)	45W	Windows 10 Pro 64	1-year, Depot	03/16
20GJ0007US	US	Celeron 3855U	No	Intel HD 510	4GBx1	13.3" FHD (1920x1080) IPS	None	128GB SSD M.2	None	Intel 8260 ac, 2x2 + BT4.1	Black	720p	Non-backlit	Fingerprint Reader	dTPM1.2 + FW TPM2.0	3-cell (42Wh)	45W	Windows 10 Pro 64	1-year, Depot	03/16
20GJ0008US	US	i5-6200U	No	Intel HD 520	8GBx2	13.3" FHD (1920x1080) IPS	None	512GB SSD M.2	None	Intel 8260 ac, 2x2 + BT4.1	Black	720p	Non-backlit	Fingerprint Reader	dTPM1.2 + FW TPM2.0	3-cell (42Wh)	45W	Windows 10 Pro 64	3-year, Depot	03/16
20GJ0009US	US	Celeron 3855U	No	Intel HD 510	4GBx2	13.3" HD (1366x768)	None	128GB SSD M.2	None	Intel 8260 ac, 2x2 + BT4.1	Black	720p	Non-backlit	Fingerprint Reader	dTPM1.2 + FW TPM2.0	3-cell (42Wh)	45W	Windows 10 Pro 64	3-year, Depot	03/16
20GJ000AUS	US	i3-6100U	No	Intel HD 520	4GBx1	13.3" FHD (1920x1080) IPS	None	128GB SSD M.2	None	Intel 8260 ac, 2x2 + BT4.1	Silver	720p	Non-backlit	None	dTPM 1.2	3-cell (42Wh)	45W	Windows 10 DG Windows 7 Pro 64	3-year, Depot	03/16
20GJ000DUS	US	i3-6100U	No	Intel HD 520	4GBx1	13.3" HD (1366x768)	None	128GB SSD M.2	None	Intel 8260 ac, 2x2 + BT4.1	Black	720p	Non-backlit	Fingerprint Reader	dTPM1.2 + FW TPM2.0	3-cell (42Wh)	45W	Windows 10 Pro 64	3-year, Depot	03/16
20GJ000EUS	US	i3-6100U	No	Intel HD 520	4GBx1	13.3" FHD (1920x1080) IPS	None	192GB SSD M.2	None	Intel 8260 ac, 2x2 + BT4.1	Black	720p	Non-backlit	Fingerprint Reader	dTPM1.2 + FW TPM2.0	3-cell (42Wh)	45W	Windows 10 Pro 64	3-year, Depot	03/16
20GJ000FUS	US	i3-6100U	No	Intel HD 520	4GBx2	13.3" HD (1366x768)	None	128GB SSD M.2	None	Intel 8260 ac, 2x2 + BT4.1	Silver	720p	Non-backlit	None	dTPM 1.2	3-cell (42Wh)	45W	Windows 10 DG Windows 7 Pro 64	3-year, Depot	03/16
20GJ000GUS	US	i3-6100U	No	Intel HD 520	4GBx2	13.3" HD (1366x768)	None	128GB SSD M.2	None	Intel 8260 ac, 2x2 + BT4.1	Silver	720p	Non-backlit	None	dTPM 1.2	3-cell (42Wh)	45W	Windows 10 DG Windows 7 Pro 64	3-year, Depot	03/16
20GJ000HUS	US	i3-6100U	No	Intel HD 520	4GBx1	13.3" FHD (1920x1080) IPS	None	128GB SSD M.2	None	Intel 8260 ac, 2x2 + BT4.1	Black	720p	Non-backlit	Fingerprint Reader	dTPM1.2 + FW TPM2.0	3-cell (42Wh)	45W	Windows 10 Pro 64	3-year, Depot	03/16
20GJ000JUS	US	i5-6200U	No	Intel HD 520	4GBx1	13.3" FHD (1920x1080) IPS	None	512GB SSD M.2	None	Intel 8260 ac, 2x2 + BT4.1	Black	720p	Non-backlit	Fingerprint Reader	dTPM1.2 + FW TPM2.0	3-cell (42Wh)	45W	Windows 10 Pro 64	3-year, Depot	03/16
20GJ000KUS	US	i3-6100U	No	Intel HD 520	4GBx2	13.3" HD (1366x768)	None	128GB SSD M.2	None	Intel 8260 ac, 2x2 + BT4.1	Black	720p	Non-backlit	Fingerprint Reader	dTPM1.2 + FW TPM2.0	3-cell (42Wh)	45W	Windows 10 Pro 64	3-year, Depot	03/16
20GJ000LUS	US	Celeron 3855U	No	Intel HD 510	4GBx1	13.3" FHD (1920x1080) IPS	None	128GB SSD M.2	None	Intel 8260 ac, 2x2 + BT4.1	Black	720p	Non-backlit	Fingerprint Reader	dTPM 1.2	3-cell (42Wh)	45W	Windows 7 Pro 64	3-year, Depot	03/16
20GJ000MUS	US	Celeron 3855U	No	Intel HD 510	4GBx1	13.3" FHD (1920x1080) IPS	None	128GB SSD M.2	None	Intel 8260 ac, 2x2 + BT4.1	Black	720p	Non-backlit	Fingerprint Reader	dTPM 1.2	3-cell (42Wh)	45W	Windows 10 DG Windows 7 Pro 64	3-year, Depot	03/16
20GJ000NUS	US	i5-6200U	No	Intel HD 520	4GBx2	13.3" FHD (1920x1080) IPS	None	512GB SSD M.2	None	Intel 8260 ac, 2x2 + BT4.1	Black	720p	Non-backlit	Fingerprint Reader	dTPM1.2 + FW TPM2.0	3-cell (42Wh)	45W	Windows 10 Pro 64	3-year, Depot	03/16
20GJ000PUS	US	i5-6200U	No	Intel HD 520	4GBx2	13.3" HD (1366x768)	None	256GB SSD M.2 Opal2	None	Intel 8260 ac, 2x2 + BT4.1	Black	720p	Non-backlit	Fingerprint Reader	dTPM1.2 + FW TPM2.0	3-cell (42Wh)	45W	Windows 10 Pro 64	3-year, Depot	03/16
20GJ000QUS	US	Celeron 3855U	No	Intel HD 510	4GBx2	13.3" FHD (1920x1080) IPS	None	128GB SSD M.2	None	Intel 8260 ac, 2x2 + BT4.1	Black	720p	Non-backlit	Fingerprint Reader	dTPM1.2 + FW TPM2.0	3-cell (42Wh)	45W	Windows 10 Pro 64	3-year, Depot	03/16
20GJ000RUS	US	i5-6200U	No	Intel HD 520	4GBx2	13.3" HD (1366x768)	None	128GB SSD M.2	None	Intel 8260 ac, 2x2 + BT4.1	Silver	720p	Non-backlit	None	dTPM 1.2	3-cell (42Wh)	45W	Windows 10 DG Windows 7 Pro 64	3-year, Depot	03/16
20GJ000SUS	US	i5-6200U	No	Intel HD 520	4GBx1	13.3" FHD (1920x1080) IPS	None	128GB SSD M.2	None	Intel 8260 ac, 2x2 + BT4.1	Black	720p	Non-backlit	Fingerprint Reader	dTPM1.2 + FW TPM2.0	3-cell (42Wh)	45W	Windows 10 Pro 64	3-year, Depot	03/16
20GJ000TUS	US	i5-6200U	No	Intel HD 520	4GBx1	13.3" HD (1366x768)	None	128GB SSD M.2	None	Intel 8260 ac, 2x2 + BT4.1	Black	720p	Non-backlit	Fingerprint Reader	dTPM1.2 + FW TPM2.0	3-cell (42Wh)	45W	Windows 10 Pro 64	3-year, Depot	03/16

Model	Region	Processor	vPro	Graphics	Memory	Display	Multi-touch	Storage	Optical	WLAN + Bluetooth	Color	Camera	Keyboard	Fingerprint Reader	TPM	Battery (internal)	Power Adapter	Operating System	Warranty	Ann Date (m/y)
20GJ000UUS	US	i3-6100U	No	Intel HD 520	4GBx2	13.3" FHD (1920x1080) IPS	None	128GB SSD M.2	None	Intel 8260 ac, 2x2 + BT4.1	Silver	720p	Non-backlit	None	dTPM 1.2	3-cell (42Wh)	45W	Windows 10 DG Windows 7 Pro 64	3-year, Depot	03/16
20GJ000VUS	US	i5-6200U	No	Intel HD 520	4GBx1	13.3" HD (1366x768)	None	128GB SSD M.2	None	Intel 8260 ac, 2x2 + BT4.1	Black	720p	Non-backlit	Fingerprint Reader	dTPM1.2 + FW TPM2.0	3-cell (42Wh)	45W	Windows 10 Pro 64	3-year, Depot	03/16
20GJ000WUS	US	i3-6100U	No	Intel HD 520	4GBx2	13.3" FHD (1920x1080) IPS	None	256GB SSD M.2 Opal2	None	Intel 8260 ac, 2x2 + BT4.1	Black	720p	Non-backlit	Fingerprint Reader	dTPM1.2 + FW TPM2.0	3-cell (42Wh)	45W	Windows 10 Pro 64	3-year, Depot	03/16
20GJ000XUS	US	Celeron 3855U	No	Intel HD 510	4GBx1	13.3" FHD (1920x1080) IPS	None	128GB SSD M.2	None	Intel 8260 ac, 2x2 + BT4.1	Silver	720p	Non-backlit	None	dTPM 1.2	3-cell (42Wh)	45W	Windows 10 DG Windows 7 Pro 64	3-year, Depot	03/16
20GJ000YUS	US	i5-6200U	No	Intel HD 520	4GBx2	13.3" HD (1366x768)	None	128GB SSD M.2	None	Intel 8260 ac, 2x2 + BT4.1	Black	720p	Non-backlit	Fingerprint Reader	dTPM1.2 + FW TPM2.0	3-cell (42Wh)	45W	Windows 10 Pro 64	3-year, Depot	03/16
20GJ0010US	US	Celeron 3855U	No	Intel HD 510	4GBx1	13.3" HD (1366x768)	None	128GB SSD M.2	None	Intel 8260 ac, 2x2 + BT4.1	Silver	720p	Non-backlit	None	dTPM 1.2	3-cell (42Wh)	45W	Windows 10 DG Windows 7 Pro 64	3-year, Depot	03/16
20GJ0011US	US	i5-6200U	No	Intel HD 520	4GBx2	13.3" FHD (1920x1080) IPS	None	128GB SSD M.2	None	Intel 8260 ac, 2x2 + BT4.1	Silver	720p	Non-backlit	None	dTPM 1.2	3-cell (42Wh)	45W	Windows 10 DG Windows 7 Pro 64	3-year, Depot	03/16
20GJ0012US	US	i3-6100U	No	Intel HD 520	4GBx1	13.3" HD (1366x768)	None	128GB SSD M.2	None	Intel 8260 ac, 2x2 + BT4.1	Silver	720p	Non-backlit	None	dTPM 1.2	3-cell (42Wh)	45W	Windows 10 DG Windows 7 Pro 64	3-year, Depot	03/16
20GJ0013US	US	i5-6200U	No	Intel HD 520	4GBx1	13.3" FHD (1920x1080) IPS	None	256GB SSD M.2 Opal2	None	Intel 8260 ac, 2x2 + BT4.1	Black	720p	Non-backlit	Fingerprint Reader	dTPM1.2 + FW TPM2.0	3-cell (42Wh)	45W	Windows 10 Pro 64	3-year, Depot	03/16
20GJ0014US	US	i5-6200U	No	Intel HD 520	4GBx2	13.3" FHD (1920x1080) IPS	None	256GB SSD M.2 Opal2	None	Intel 8260 ac, 2x2 + BT4.1	Black	720p	Non-backlit	Fingerprint Reader	dTPM1.2 + FW TPM2.0	3-cell (42Wh)	45W	Windows 10 Pro 64	3-year, Depot	03/16
20GJ0015US	US	i3-6100U	No	Intel HD 520	4GBx1	13.3" HD (1366x768)	None	192GB SSD M.2	None	Intel 8260 ac, 2x2 + BT4.1	Black	720p	Non-backlit	Fingerprint Reader	dTPM1.2 + FW TPM2.0	3-cell (42Wh)	45W	Windows 10 Pro 64	3-year, Depot	03/16
20GJ0016US	US	i3-6100U	No	Intel HD 520	4GBx2	13.3" FHD (1920x1080) IPS	None	128GB SSD M.2	None	Intel 8260 ac, 2x2 + BT4.1	Black	720p	Non-backlit	Fingerprint Reader	dTPM1.2 + FW TPM2.0	3-cell (42Wh)	45W	Windows 10 Pro 64	3-year, Depot	03/16
20GJ0019US	US	i5-6300U	vPro	Intel HD 520	4GBx1	13.3" FHD (1920x1080) IPS	None	256GB SSD M.2 Opal2	None	Intel 8260 ac, 2x2 + BT4.1	Black	720p	Non-backlit	Fingerprint Reader	dTPM 1.2	3-cell (42Wh)	45W	Windows 10 DG Windows 7 Pro 64	3-year, Depot	03/16
20GJ0031US	US	i5-6200U	No	Intel HD 520	4GBx1	13.3" FHD (1920x1080) IPS	None	128GB SSD M.2	None	Intel 8260 ac, 2x2 + BT4.1	Black	720p	Non-backlit	Fingerprint Reader	dTPM 1.2	3-cell (42Wh)	45W	Windows 10 DG Windows 7 Pro 64	3-year, Depot	03/16
20GJ0039US	US	i5-6300U	vPro	Intel HD 520	4GBx1	13.3" FHD (1920x1080) IPS	None	128GB SSD M.2	None	Intel 8260 ac, 2x2 + BT4.1	Black	720p	Non-backlit	Fingerprint Reader	dTPM 1.2	3-cell (42Wh)	45W	Windows 10 DG Windows 7 Pro 64	3-year, Depot	03/16
20GJ003AUS	US	i5-6300U	vPro	Intel HD 520	4GBx1	13.3" HD (1366x768)	None	128GB SSD M.2	None	Intel 8260 ac, 2x2 + BT4.1	Black	720p	Non-backlit	Fingerprint Reader	dTPM 1.2	3-cell (42Wh)	45W	Windows 10 DG Windows 7 Pro 64	3-year, Depot	03/16
20GJ003BUS	US	i5-6300U	vPro	Intel HD 520	8GBx1	13.3" FHD (1920x1080) IPS	None	128GB SSD M.2	None	Intel 8260 ac, 2x2 + BT4.1	Black	720p	Non-backlit	Fingerprint Reader	dTPM 1.2	3-cell (42Wh)	45W	Windows 10 DG Windows 7 Pro 64	3-year, Depot	03/16
20GJ003CUS	US	i5-6300U	vPro	Intel HD 520	8GBx1	13.3" FHD (1920x1080) IPS	None	256GB SSD M.2 Opal2	None	Intel 8260 ac, 2x2 + BT4.1	Black	720p	Non-backlit	Fingerprint Reader	dTPM 1.2	3-cell (42Wh)	45W	Windows 10 DG Windows 7 Pro 64	3-year, Depot	03/16
20GJ003WUS	US	i3-6100U	No	Intel HD 520	4GBx1	13.3" FHD (1920x1080) IPS	None	128GB SSD M.2	None	Intel 8260 ac, 2x2 + BT4.1	Black	720p	Non-backlit	Fingerprint Reader	dTPM 1.2	3-cell (42Wh)	45W	Windows 10 DG Windows 7 Pro 64	3-year, Depot	03/16
20GJ003XUS	US	i5-6200U	No	Intel HD 520	4GBx1	13.3" HD (1366x768)	None	128GB SSD M.2	None	Intel 8260 ac, 2x2 + BT4.1	Black	720p	Non-backlit	Fingerprint Reader	dTPM 1.2	3-cell (42Wh)	45W	Windows 10 DG Windows 7 Pro 64	3-year, Depot	03/16

Model	Region	Processor	vPro	Graphics	Memory	Display	Multi-touch	Storage	Optical	WLAN + Bluetooth	Color	Camera	Keyboard	Fingerprint Reader	TPM	Battery (internal)	Power Adapter	Operating System	Warranty	Ann Date (m/y)
20GJ003YUS	US	i3-6100U	No	Intel HD 520	4GBx1	13.3" FHD (1920x1080) IPS	None	128GB SSD M.2	None	Intel 8260 ac, 2x2 + BT4.1	Black	720p	Non-backlit	Fingerprint Reader	dTPM 1.2	3-cell (42Wh)	45W	Windows 10 DG Windows 7 Pro 64	3-year, Depot	03/16
20GJ0048US	US	i5-6200U	No	Intel HD 520	8GBx1	13.3" FHD (1920x1080) IPS	None	256GB SSD M.2 Opal2	None	Intel 8260 ac, 2x2 + BT4.1	Black	720p	Non-backlit	Fingerprint Reader	dTPM1.2 + FW TPM2.0	3-cell (42Wh)	45W	Windows 10 Pro 64	1-year, Depot	06/16
20GJ0055US	US	i5-6200U	No	Intel HD 520	8GBx1	13.3" HD (1366x768)	None	256GB SSD M.2 Opal2	None	Intel 8260 ac, 2x2 + BT4.1	Black	720p	Non-backlit	Fingerprint Reader	dTPM1.2 + FW TPM2.0	3-cell (42Wh)	45W	Windows 10 Pro 64	1-year, Depot	06/16
20GJ005EUS	US	i3-6100U	No	Intel HD 520	4GBx1	13.3" HD (1366x768)	None	128GB SSD M.2	None	Intel 8260 ac, 2x2 + BT4.1	Black	720p	Non-backlit	Fingerprint Reader	dTPM1.2 + FW TPM2.0	3-cell (42Wh)	45W	Windows 10 Pro 64	1-year, Depot	06/16
20GJ005FUS	US	i5-6200U	No	Intel HD 520	4GBx1	13.3" HD (1366x768)	None	128GB SSD M.2	None	Intel 8260 ac, 2x2 + BT4.1	Black	720p	Non-backlit	Fingerprint Reader	dTPM1.2 + FW TPM2.0	3-cell (42Wh)	45W	Windows 10 Pro 64	1-year, Depot	06/16
20GJ005JUS	US	i5-6300U	vPro	Intel HD 520	8GBx1	13.3" FHD (1920x1080) IPS	None	256GB SSD M.2 Opal2	None	Intel 8260 ac, 2x2 + BT4.1	Silver	720p	Non-backlit	None	dTPM 1.2	3-cell (42Wh)	45W	Windows 10 DG Windows 7 Pro 64	3-year, Depot	04/16
20GJ005KUS	US	i5-6200U	No	Intel HD 520	8GBx1	13.3" FHD (1920x1080) IPS	None	256GB SSD M.2 Opal2	None	Intel 8260 ac, 2x2 + BT4.1	Silver	720p	Non-backlit	None	dTPM 1.2	3-cell (42Wh)	45W	Windows 10 DG Windows 7 Pro 64	3-year, Depot	04/16
20GJ005LUS	US	i5-6300U	vPro	Intel HD 520	8GBx2	13.3" FHD (1920x1080) IPS	None	512GB SSD M.2	None	Intel 8260 ac, 2x2 + BT4.1	Silver	720p	Non-backlit	None	dTPM 1.2	3-cell (42Wh)	45W	Windows 10 DG Windows 7 Pro 64	3-year, Depot	04/16
20GJ006MUS	US	i5-6300U	vPro	Intel HD 520	8GBx1	13.3" FHD (1920x1080) IPS	None	512GB SSD M.2	None	Intel 8260 ac, 2x2 + BT4.1	Black	720p	Non-backlit	Fingerprint Reader	dTPM1.2 + FW TPM2.0	3-cell (42Wh)	45W	Windows 10 Pro 64	3-year, Depot	10/16

Model	Region	Processor	vPro	Graphics	Memory	Display	Multi-touch	Storage	Optical	WLAN + Bluetooth	Color	Camera	Keyboard	Fingerprint Reader	TPM	Battery (internal)	Power Adapter	Operating System	Warranty	Ann Date (m/y)
20GJ000BUS	US	Celeron 3855U	No	Intel HD 510	4GBx1	13.3" HD (1366x768)	None	128GB SSD M.2	None	Intel 8260 ac, 2x2 + BT4.1	Black	720p	Non-backlit	Fingerprint Reader	dTPM1.2 + FW TPM2.0	3-cell (42Wh)	45W	Windows 10 Pro 64	3-year, Depot	03/16
20GJ000CUS	US	Celeron 3855U	No	Intel HD 510	4GBx1	13.3" FHD (1920x1080) IPS	None	128GB SSD M.2	None	Intel 8260 ac, 2x2 + BT4.1	Black	720p	Non-backlit	Fingerprint Reader	dTPM1.2 + FW TPM2.0	3-cell (42Wh)	45W	Windows 10 Pro 64	3-year, Depot	03/16



ThinkPad 13 (2nd Gen) Platform Specifications

Product Specifications Reference (PSREF)

Processor	Intel® Celeron® Processor or 7th Generation Intel Core™ i3 / i5 / i7 Processor							Smart card reader	None	
	Processor Number	# of Cores	# of Threads	Base Frequency	Max Turbo Frequency	Cache	Memory Types	Processor Graphics	Media reader	4-in-1 reader (MMC, SD, SDHC, SDXC)
	Cel 3865U	2	4	1.8 GHz	-	2MB	DDR4-2133	Intel HD Graphics 610	Ports	Three USB 3.1 Gen 1 / USB 3.0 (one Always On), one USB Type-C, HDMI, Lenovo OneLink+ connector
	i3-7100U			2.4 GHz	-	3MB		Intel HD Graphics 620		
	i5-7200U			2.5 GHz	3.1 GHz	3MB				
	i5-7300U			2.6 GHz	3.5 GHz	3MB				
	i7-7500U			2.7 GHz	3.5 GHz	4MB				
Graphics	Intel HD Graphics 610 or 620 in processor, supports external digital monitor via HDMI or USB Type-C; supports three independent displays; Max resolution: 1920x1080 (HDMI)@60Hz, 3840x2160 (USB Type-C)@60Hz							Camera	HD720p resolution, low light sensitive, fixed focus	
Chipset	Intel SoC (System on Chip) platform							Security chip	Discrete TPM 2.0, TCG Certified	
Memory	32GB max / 2133MHz DDR4, two DDR4 SO-DIMM sockets							vPro (optional)	Intel vPro Technology	
Display	Some: 13.3" (338mm) HD (1366x768), anti-glare, LED backlight, 250 nits, 16:9 aspect ratio, 500:1 contrast ratio Some: 13.3" (338mm) FHD (1920x1080), anti-glare, LED backlight, IPS, 250 nits, 16:9 aspect ratio, 700:1 contrast ratio, 170° viewing angle							Fingerprint reader	Optional: swipe style fingerprint reader on the palm rest	
Multi-touch (opt)	On-cell touch, supports 10-finger gesture (FHD only)							Battery	Integrated Lithium Polymer 3-cell (42Wh)	
Storage	Some: M.2 SSD / SATA 6.0Gb/s (e.g. xxxG SSD) Some: M.2 SSD / PCIe NVMe, PCIe 3.0 x 4, 32Gb/s (e.g. xxxG SSD PCIe NVMe)							Max battery life	MobileMark® 2014: 14.56 hr	
Optical	None							AC adapter	45W AC adapter	
Ethernet	None							Preload	Some: Windows® 10 Home 64 Some: Windows 10 Pro 64 • Lenovo Companion • Lenovo Setting • Microsoft Office preloaded; purchase a product key to activate	
WWAN	None							Limited warranty	One of the following, configurable by model: • 1-year depot repair service • 3-year/1-yr battery depot repair service • 3-year/1-yr battery limited onsite service	
Dimensions	WxDxH (silver): 12.69" x 8.77" x 0.75"; 322.4mm x 222.8mm x 19.1mm WxDxH (black): 12.69" x 8.77" x 0.78"; 322.4mm x 222.8mm x 19.8mm							Mil-Spec test	MIL-STD-810G military certification	
Weight	Starting at 3.17 lb / 1.44 kg							Environment	EPEAT™ Gold (US only); ENERGY STAR® 6.1; RoHS-compliant	
Case color	Pure Black or Silver									
Case material	Black cover: PC/ABS plastic; Silver cover: Aluminum									

Model	Region	Processor	vPro	Graphics	Memory	Display	Multi-touch	Storage(HDD/SSD)	Optical	WLAN + Bluetooth	Color	Camera	Keyboard	Fingerprint Reader	TPM	Battery (internal)	Power Adapter	Operating System	Warranty	Ann Date (m/y)
20J10006US	US	i3-7100U	No	Intel HD 620	4GBx1	13.3" HD (1366x768)	None	128GB SSD M.2	None	Intel 8265 ac, 2x2 + BT4.1	Black	720p	Non-backlit	Fingerprint Reader	dTPM 2.0	3-cell (42Wh)	45W	Windows 10 Pro 64	1-year, Depot	12/16
20J1000AUS	US	i5-7200U	No	Intel HD 620	4GBx1	13.3" HD (1366x768)	None	256GB SSD M.2 Opal2	None	Intel 8265 ac, 2x2 + BT4.1	Black	720p	Non-backlit	Fingerprint Reader	dTPM 2.0	3-cell (42Wh)	45W	Windows 10 Pro 64	1-year, Depot	12/16
20J1000EUS	US	i5-7200U	No	Intel HD 620	8GBx1	13.3" HD (1366x768)	None	256GB SSD M.2 Opal2	None	Intel 8265 ac, 2x2 + BT4.1	Black	720p	Non-backlit	Fingerprint Reader	dTPM 2.0	3-cell (42Wh)	45W	Windows 10 Pro 64	1-year, Depot	12/16
20J1001BUS	US	i3-7100U	No	Intel HD 620	4GBx1	13.3" FHD (1920x1080) IPS	10-point Multi-touch	128GB SSD M.2	None	Intel 8265 ac, 2x2 + BT4.1	Black	720p	Non-backlit	Fingerprint Reader	dTPM 2.0	3-cell (42Wh)	45W	Windows 10 Pro 64	1-year, Depot	12/16
20J1001CUS	US	i5-7200U	No	Intel HD 620	8GBx1	13.3" FHD (1920x1080) IPS	10-point Multi-touch	256GB SSD M.2 Opal2	None	Intel 8265 ac, 2x2 + BT4.1	Black	720p	Backlit	Fingerprint Reader	dTPM 2.0	3-cell (42Wh)	45W	Windows 10 Pro 64	3-year, Depot	12/16
20J1001DUS	US	i5-7200U	No	Intel HD 620	4GBx1	13.3" FHD (1920x1080) IPS	10-point Multi-touch	128GB SSD M.2	None	Intel 8265 ac, 2x2 + BT4.1	Black	720p	Non-backlit	Fingerprint Reader	dTPM 2.0	3-cell (42Wh)	45W	Windows 10 Pro 64	1-year, Depot	12/16
20J1001EUS	US	i3-7100U	No	Intel HD 620	4GBx1	13.3" FHD (1920x1080) IPS	10-point Multi-touch	128GB SSD M.2	None	Intel 8265 ac, 2x2 + BT4.1	Silver	720p	Non-backlit	None	dTPM 2.0	3-cell (42Wh)	45W	Windows 10 Pro 64	1-year, Depot	12/16
20J1001FUS	US	i5-7200U	No	Intel HD 620	4GBx1	13.3" HD (1366x768)	None	128GB SSD M.2	None	Intel 8265 ac, 2x2 + BT4.1	Silver	720p	Non-backlit	None	dTPM 2.0	3-cell (42Wh)	45W	Windows 10 Pro 64	1-year, Depot	12/16
20J1001GUS	US	i5-7200U	No	Intel HD 620	8GBx1	13.3" FHD (1920x1080) IPS	10-point Multi-touch	256GB SSD M.2 Opal2	None	Intel 8265 ac, 2x2 + BT4.1	Silver	720p	Backlit	None	dTPM 2.0	3-cell (42Wh)	45W	Windows 10 Pro 64	3-year, Depot	12/16
20J1001HUS	US	i3-7100U	No	Intel HD 620	4GBx1	13.3" HD (1366x768)	None	128GB SSD M.2	None	Intel 8265 ac, 2x2 + BT4.1	Silver	720p	Non-backlit	None	dTPM 2.0	3-cell (42Wh)	45W	Windows 10 Pro 64	1-year, Depot	12/16
20J1001JUS	US	i5-7200U	No	Intel HD 620	8GBx1	13.3" FHD (1920x1080) IPS	10-point Multi-touch	256GB SSD M.2 Opal2	None	Intel 8265 ac, 2x2 + BT4.1	Silver	720p	Non-backlit	None	dTPM 2.0	3-cell (42Wh)	45W	Windows 10 Pro 64	1-year, Depot	12/16
20J10022US	US	i5-7200U	No	Intel HD 620	4GBx1	13.3" HD (1366x768)	None	180GB SSD M.2	None	Intel 8265 ac, 2x2 + BT4.1	Black	720p	Non-backlit	Fingerprint Reader	dTPM 2.0	3-cell (42Wh)	45W	Windows 10 Pro 64	1-year, Depot	01/17
20J10023US	US	i3-7100U	No	Intel HD 620	4GBx1	13.3" HD (1366x768)	None	180GB SSD M.2	None	Intel 8265 ac, 2x2 + BT4.1	Black	720p	Non-backlit	Fingerprint Reader	dTPM 2.0	3-cell (42Wh)	45W	Windows 10 Pro 64	1-year, Depot	01/17
20J10024US	US	i5-7300U	vPro	Intel HD 620	4GBx1	13.3" HD (1366x768)	None	180GB SSD M.2	None	Intel 8265 ac, 2x2 + BT4.1	Black	720p	Non-backlit	Fingerprint Reader	dTPM 2.0	3-cell (42Wh)	45W	Windows 10 Pro 64	3-year, Depot	03/17
20J10025US	US	i5-7300U	vPro	Intel HD 620	8GBx1	13.3" FHD (1920x1080) IPS	10-point Multi-touch	256GB SSD M.2 Opal2	None	Intel 8265 ac, 2x2 + BT4.1	Black	720p	Backlit	Fingerprint Reader	dTPM 2.0	3-cell (42Wh)	45W	Windows 10 Pro 64	3-year, Depot	03/17
20J10045US	US	Celeron 3865U	No	Intel HD 610	4GBx1	13.3" HD (1366x768)	None	128GB SSD M.2	None	Intel 8265 ac, 2x2 + BT4.1	Silver	720p	Non-backlit	None	dTPM 2.0	3-cell (42Wh)	45W	Windows 10 Pro 64	3-year, Depot	03/17
20J10046US	US	Celeron 3865U	No	Intel HD 610	4GBx1	13.3" HD (1366x768)	None	128GB SSD M.2	None	Intel 8265 ac, 2x2 + BT4.1	Black	720p	Non-backlit	Fingerprint Reader	dTPM 2.0	3-cell (42Wh)	45W	Windows 10 Pro 64	1-year, Depot	03/17
20J10047US	US	Celeron 3865U	No	Intel HD 610	4GBx1	13.3" FHD (1920x1080) IPS	10-point Multi-touch	128GB SSD M.2	None	Intel 8265 ac, 2x2 + BT4.1	Black	720p	Non-backlit	Fingerprint Reader	dTPM 2.0	3-cell (42Wh)	45W	Windows 10 Pro 64	3-year, Depot	03/17
20J10048US	US	Celeron 3865U	No	Intel HD 610	4GBx1	13.3" HD (1366x768)	None	128GB SSD M.2	None	Intel 8265 ac, 2x2 + BT4.1	Black	720p	Non-backlit	Fingerprint Reader	dTPM 2.0	3-cell (42Wh)	45W	Windows 10 Pro 64	3-year, Depot	03/17
20J10049US	US	Celeron 3865U	No	Intel HD 610	4GBx1	13.3" FHD (1920x1080) IPS	10-point Multi-touch	128GB SSD M.2	None	Intel 8265 ac, 2x2 + BT4.1	Silver	720p	Non-backlit	None	dTPM 2.0	3-cell (42Wh)	45W	Windows 10 Pro 64	3-year, Depot	03/17

Model	Region	Processor	vPro	Graphics	Memory	Display	Multi-touch	Storage(HDD/SSD)	Optical	WLAN + Bluetooth	Color	Camera	Keyboard	Fingerprint Reader	TPM	Battery (internal)	Power Adapter	Operating System	Warranty	Ann Date (m/y)
20J1004AUS	US	Celeron 3865U	No	Intel HD 610	4GBx1	13.3" FHD (1920x1080) IPS	10-point Multi-touch	128GB SSD M.2	None	Intel 8265 ac, 2x2 + BT4.1	Black	720p	Non-backlit	Fingerprint Reader	dTPM 2.0	3-cell (42Wh)	45W	Windows 10 Pro 64	1-year, Depot	03/17
20J1004BUS	US	Celeron 3865U	No	Intel HD 610	4GBx2	13.3" FHD (1920x1080) IPS	10-point Multi-touch	128GB SSD M.2	None	Intel 8265 ac, 2x2 + BT4.1	Black	720p	Backlit	Fingerprint Reader	dTPM 2.0	3-cell (42Wh)	45W	Windows 10 Pro 64	3-year, Depot	03/17
20J1004CUS	US	Celeron 3865U	No	Intel HD 610	4GBx2	13.3" HD (1366x768)	None	128GB SSD M.2	None	Intel 8265 ac, 2x2 + BT4.1	Black	720p	Backlit	Fingerprint Reader	dTPM 2.0	3-cell (42Wh)	45W	Windows 10 Pro 64	3-year, Depot	03/17



ThinkPad 13 Chromebook Platform Specifications

Product Specifications Reference (PSREF)

Processor	Intel® Celeron® Processor or 6th Generation Intel Core™ i3 / i5 Processor							Dimensions ³	<i>WxDxH:</i> 12.69" x 8.77" x 0.78"; 322.4mm x 222.8mm x 19.8mm	
	Processor Number	# of Cores	# of Threads	Base Frequency	Max Turbo Frequency	Cache	Memory Types	Processor Graphics	Weight ²	Starting at 3.1 lb / 1.41 kg
	Cel 3855U	2	2	1.6 GHz	-	2MB	LPDDR3-1866	Intel HD graphics 510	Case color	Pure Black
	i3-6100U		4	2.3 GHz	-	3MB		Intel HD graphics 520	Case material	PC/ABS plastic
i5-6300U	4		2.4 GHz	3.0 GHz	3MB					
								Smart card reader	None	
								Media reader	4-in-1 reader (MMC, SD, SDHC, SDXC)	
								Ports	Two USB 3.0 (Always On), two USB Type-C	
Graphics	Intel HD Graphics 510 or 520 in processor, supports external digital monitor via USB Type-C; supports three independent displays; Max resolution: 3840X2160 (USB Type-C) @60Hz							Camera	HD720p resolution, low light sensitive, fixed focus	
								Audio support	HD Audio, Nuvoton NAU88L25B codec / stereo speakers, 2W x 2 / dual array microphone, combo audio/microphone jack	
Chipset	Intel SoC (System on Chip) platform							Keyboard	ThinkPad Chrome keyboard, 6-row, multimedia Fn keys	
Memory	4GB or 8GB / 1866MHz LPDDR3 / soldered to systemboard, no sockets							Touchpad	Buttonless touchpad below keyboard, multi-touch	
Display	<i>Some:</i> 13.3" (338mm) HD (1366x768), anti-glare, LED backlight, 200 nits, 16:9 aspect ratio, 500:1 contrast ratio <i>Some:</i> 13.3" (338mm) FHD (1920x1080), anti-glare, LED backlight, IPS, 220 nits, 16:9 aspect ratio, 700:1 contrast ratio, 170° viewing angle <i>Some:</i> 13.3" (338mm) FHD (1920x1080), glossy, LED backlight, IPS, multi-touch, 250 nits, 16:9 aspect ratio, 800:1 contrast ratio, 170° viewing angle							Security	Security keyhole	
	Multi-touch (opt) Capacitive-type multi-touch, supports 10-finger gesture							Security chip	Discrete TPM 1.2, TCG Certified	
								vPro	None	
								Fingerprint reader	None	
								Battery	Integrated Lithium Polymer 3-cell (42Wh)	
								Max battery life ¹⁰	10 hr	
								AC adapter	USB Type-C 45-watt AC adapter	
								Preload	Google Chrome OS	
Storage	16GB or 32GB eMMC (embedded Multi Media Card) flash memory on board							Limited warranty ¹²	1-year depot repair service	
Optical	None							Mil-Spec test	MIL-STD-810G military certification	
Ethernet	None							Environment	EPEAT™ Gold (US only); ENERGY STAR® 6.1; RoHS-compliant	
WLAN ⁴	11ac+BT, Intel Dual Band Wireless-AC 7265, 2x2, M.2 card									
Bluetooth™	Bluetooth 4.0 wireless, integrated in Wi-Fi + Bluetooth combo adapter									
WWAN	None									

Model	Region	Processor	vPro	Graphics	Memory (Soldered)	Display	Multi-touch	Storage	Optical	WLAN + Bluetooth	Color	Camera	Keyboard	Fingerprint Reader	TPM	Battery (internal)	Power Adapter	Operating System	Warranty	Ann Date (m/y)
20GL0000US	US	Celeron 3855U	No	Intel HD 510	4GB Soldered	13.3" HD (1366x768) Anti-glare	None	16GB eMMC	None	Intel 7265 ac, 2x2 + BT4.0	Black	720p	Non-backlit	None	dTPM 1.2	3-cell (42Wh)	45W	Chrome OS	1-year, Depot	05/16
20GL0002US	US	i3-6100U	No	Intel HD 520	4GB Soldered	13.3" HD (1366x768) Anti-glare	None	16GB eMMC	None	Intel 7265 ac, 2x2 + BT4.0	Black	720p	Non-backlit	None	dTPM 1.2	3-cell (42Wh)	45W	Chrome OS	1-year, Depot	05/16
20GL0004US	US	i5-6300U	No	Intel HD 520	8GB Soldered	13.3" FHD (1920x1080) IPS Anti-glare	None	32GB eMMC	None	Intel 7265 ac, 2x2 + BT4.0	Black	720p	Non-backlit	None	dTPM 1.2	3-cell (42Wh)	45W	Chrome OS	1-year, Depot	05/16
20GL0005US	US	i5-6300U	No	Intel HD 520	8GB Soldered	13.3" HD (1366x768) Anti-glare	None	32GB eMMC	None	Intel 7265 ac, 2x2 + BT4.0	Black	720p	Non-backlit	None	dTPM 1.2	3-cell (42Wh)	45W	Chrome OS	1-year, Depot	05/16
20GL0006US	US	Celeron 3855U	No	Intel HD 510	4GB Soldered	13.3" FHD (1920x1080) IPS Glossy	10-point Multi-touch	16GB eMMC	None	Intel 7265 ac, 2x2 + BT4.0	Black	720p	Non-backlit	None	dTPM 1.2	3-cell (42Wh)	45W	Chrome OS	1-year, Depot	10/16
20GL0007US	US	i5-6300U	No	Intel HD 520	8GB Soldered	13.3" FHD (1920x1080) IPS Glossy	10-point Multi-touch	32GB eMMC	None	Intel 7265 ac, 2x2 + BT4.0	Black	720p	Non-backlit	None	dTPM 1.2	3-cell (42Wh)	45W	Chrome OS	1-year, Depot	10/16
20GL0008US	US	i3-6100U	No	Intel HD 520	4GB Soldered	13.3" FHD (1920x1080) IPS Glossy	10-point Multi-touch	16GB eMMC	None	Intel 7265 ac, 2x2 + BT4.0	Black	720p	Non-backlit	None	dTPM 1.2	3-cell (42Wh)	45W	Chrome OS	1-year, Depot	10/16



ThinkPad E450 Platform Specifications

Product Specifications Reference (PSREF)

Processor	4th or 5th Generation Intel® Core™ i3 / i5 / i7 Processor								Multicard Reader Ports	4-in-1 reader (MMC, SD, SDHC, SDXC)	
	Processor Number	# of Cores	# of Threads	Base Frequency	Max Turbo Frequency	Cache	Memory speed	Processor Graphics		Two USB 3.0, one USB 2.0 (Always On), Ethernet (RJ-45), external monitor (HDMI), Lenovo OneLink connector	
	i3-4005U	2	4	1.7 GHz	-	3MB	DDR3L-1600	HD4400		None	
	i3-5005U	2	4	2.0 GHz	-	3MB		HD5500		Camera	
	i5-5200U	2	4	2.2 GHz	2.7 GHz	3MB		HD5500		<i>Some:</i> 0.3-megapixel, fixed focus	
i7-5500U	2	4	2.4 GHz	3.0 GHz	4MB	HD5500		<i>Some:</i> HD720p resolution, fixed focus			
Graphics	Intel HD Graphics in processor only, or AMD Radeon R5 M240 Graphics, 1GB DDR3 memory, AMD Radeon R7 M260 Graphics, 2GB DDR3 memory, digital monitor support via HDMI™ (supporting HDCP to output protected content); supports dual independent display Max resolution: 1920x1080 (HDMI) @60Hz								Keyboard	6-row, spill-resistant, multimedia Fn keys	
Chipset Memory	Intel SoC (System on Chip) platform 16GB max ⁷ / PC3-12800 1600MHz DDR3L, non-parity, dual-channel capable, two 204-pin SO-DIMM sockets								UltraNav™	TrackPoint® pointing device and multi-touch with 3+2 buttons click pad	
	Display	Some: 14.0" (355mm) HD (1366x768) color, anti-glare, LED backlight, 200 nits, 16:9 aspect ratio								ThinkLight™	None
Multi-touch		Some: 14.0" (355mm) FHD (1920x1080) color, anti-glare, LED backlight, 220 nits, 16:9 aspect ratio								Security	Power-on password, hard disk password, supervisor password, security keyhole
	Storage	Some: SSD / SATA 6.0Gb/s, 2.5" wide, 7mm high, removable, upgradable								Security chip	TPM : Trusted Platform Module, TCG 1.2-compliant
Optical M.2 SSD		Some: HDD / SATA 6.0Gb/s, 2.5" wide, removable, upgradable, Shock Mounted Hard Drive, Active Protection System™								vPro Fingerprint reader	Soft : Software TPM enabled
	Some: Hybrid drive with 8GB NAND flash memory								None		
Ethernet	Intel WGI218V Gigabit Ethernet Connection								NFC	None	
Bluetooth™	Bluetooth 4.0 wireless, integrated in Wi-Fi + Bluetooth combo adapter									Battery type	Li-Ion 6-cell (47Wh)
WLAN	<i>One of the following, configurable by model:</i> • Intel Wireless-AC 3160, 1x1, Wi-Fi + Bluetooth combo adapter, M.2 Card • Intel Dual Band Wireless-AC 7265, 2x2, Wi-Fi + BT combo adapter, M.2 Card • RTL8723BE, Realtek 11b/g/n, 1x1, Wi-Fi + Bluetooth combo adapter, M.2 Card • BCM43162, Broadcom 11-AC, 1x1, Wi-Fi + BT combo adapter, M.2 Card								Battery life	6-cell (47Wh): up to 9.0 hr	
WWAN	None								AC adapter	<i>Some:</i> 45-watt AC adapter (Integrated Graphics)	
SIM card	None								Preload	<i>Some:</i> 65-watt AC adapter (Discrete Graphics)	
Smart Card Read ExpressCard	None									<i>Some:</i> No operating system	
Dimensions	<i>None Touch (WxDxH):</i> 13.35" x 9.41" x 0.94"; 339mm x 239mm x 24mm								<i>Some:</i> Windows® 7 Professional 64 preinstalled through downgrade rights in Windows 8.1 Pro 64-bit		
Weight	<i>6-cell None Touch:</i> from 4.00 lb (1.81kg)								• Lenovo Solution Center		
Case color	Graphite Black								• Lenovo SHAREit		
Case material	PolyCarbonate/Acrylonitrile-Butadiene-Styrene (PC/ABS) plastic								• Lenovo Companion		
									• ThinkVantage Product Recovery		
									• Rescue and Recovery™		
									• ThinkVantage System Update		
									• Microsoft® Office preloaded; purchase a product key to activate		
									• Norton™ Internet Security (30 days of virus definitions)		
									• Norton Internet Security (30 days of virus definitions)		
									<i>Some:</i> Windows 7 Professional preinstalled through downgrade rights in Windows 10 Pro 64		
									• Lenovo Solution Center		
									• Lenovo SHAREit		
									• Lenovo Companion		
									• Microsoft Office preloaded; purchase a product key to activate		
									• McAfee LiveSafe (30 days of virus definitions)		
Limited warranty									1-year - depot repair service / service upgrades available		
Environment									EPEAT™ Gold; ENERGY STAR®; RoHS-compliant		

Model	Region	Processor	vPro	Graphics	Memory	Display	Multi-touch	Storage(HDD/SSD)	Optical	WLAN + Bluetooth	WWAN	SIM Card	Color	Case Material	Camera	Keyboard	Fingerprint Reader	TPM	Battery	Power Adapter	Operating System	Warranty	Ann Date (m/y)
20DC003FUS	US	i3-4005U	No	Intel HD 4400	4GBx1	14" HD (1366x768)	None	500GB 7200rpm	None	Intel 3160 ac, 1x1 + BT4.0	None	None	Black	PC/ABS	720p	Non-backlit	None	dTPM 1.2	6-cell (47Wh)	45W	Win8.1 64-bit	1-year, Depot	01/15
20DC003JUS	US	i3-4005U	No	Intel HD 4400	4GBx1	14" HD (1366x768)	None	500GB 7200rpm	None	Intel 3160 ac, 1x1 + BT4.0	None	None	Black	PC/ABS	720p	Non-backlit	None	dTPM 1.2	6-cell (47Wh)	45W	Win8.1 Pro 64-bit	1-year, Depot	01/15
20DC003KUS	US	i3-4005U	No	Intel HD 4400	8GBx1	14" HD (1366x768)	None	500GB 7200rpm	None	Intel 3160 ac, 1x1 + BT4.0	None	None	Black	PC/ABS	720p	Non-backlit	Fingerprint Reader	dTPM 1.2	6-cell (47Wh)	45W	Win8.1 Pro 64-bit	1-year, Depot	01/15
20DC003LUS	US	i3-4005U	No	Intel HD 4400	8GBx1	14" HD (1366x768)	None	1TB 5400rpm	None	Intel 3160 ac, 1x1 + BT4.0	None	None	Black	PC/ABS	720p	Non-backlit	Fingerprint Reader	dTPM 1.2	6-cell (47Wh)	45W	Win8.1 Pro 64-bit	1-year, Depot	01/15
20DC003MUS	US	i3-5005U	No	Intel HD 5500	4GBx1	14" HD (1366x768)	None	500GB 7200rpm	None	Intel 3160 ac, 1x1 + BT4.0	None	None	Black	PC/ABS	720p	Non-backlit	Fingerprint Reader	dTPM 1.2	6-cell (47Wh)	45W	Win8.1 64-bit	1-year, Depot	01/15
20DC003NUS	US	i3-5005U	No	Intel HD 5500	4GBx1	14" HD (1366x768)	None	500GB 7200rpm	None	Intel 3160 ac, 1x1 + BT4.0	None	None	Black	PC/ABS	720p	Non-backlit	Fingerprint Reader	dTPM 1.2	6-cell (47Wh)	45W	Win8.1 Pro 64-bit	1-year, Depot	01/15
20DC003PUS	US	i3-5005U	No	Intel HD 5500	4GBx1	14" HD (1366x768)	None	1TB 5400rpm	None	Intel 3160 ac, 1x1 + BT4.0	None	None	Black	PC/ABS	720p	Non-backlit	Fingerprint Reader	dTPM 1.2	6-cell (47Wh)	45W	Win8.1 Pro 64-bit	1-year, Depot	01/15
20DC003QUS	US	i3-5005U	No	Intel HD 5500	8GBx1	14" HD (1366x768)	None	500GB 7200rpm	None	Intel 3160 ac, 1x1 + BT4.0	None	None	Black	PC/ABS	720p	Non-backlit	Fingerprint Reader	dTPM 1.2	6-cell (47Wh)	45W	Win8.1 Pro 64-bit	1-year, Depot	01/15
20DC003RUS	US	i3-5005U	No	Intel HD 5500	8GBx1	14" HD (1366x768)	None	1TB 5400rpm	None	Intel 3160 ac, 1x1 + BT4.0	None	None	Black	PC/ABS	720p	Non-backlit	Fingerprint Reader	dTPM 1.2	6-cell (47Wh)	45W	Win8.1 Pro 64-bit	1-year, Depot	01/15
20DC003SUS	US	i5-5200U	No	Intel HD 5500	4GBx1	14" HD (1366x768)	None	500GB 7200rpm	None	Intel 3160 ac, 1x1 + BT4.0	None	None	Black	PC/ABS	720p	Non-backlit	Fingerprint Reader	dTPM 1.2	6-cell (47Wh)	45W	Win8.1 Pro 64-bit	1-year, Depot	01/15
20DC003TUS	US	i5-5200U	No	Intel HD 5500	4GBx1	14" HD (1366x768)	None	1TB 5400rpm	None	Intel 3160 ac, 1x1 + BT4.0	None	None	Black	PC/ABS	720p	Non-backlit	Fingerprint Reader	dTPM 1.2	6-cell (47Wh)	45W	Win8.1 Pro 64-bit	1-year, Depot	01/15
20DC003UUS	US	i5-5200U	No	Intel HD 5500	8GBx1	14" HD (1366x768)	None	500GB 7200rpm	None	Intel 3160 ac, 1x1 + BT4.0	None	None	Black	PC/ABS	720p	Non-backlit	Fingerprint Reader	dTPM 1.2	6-cell (47Wh)	45W	Win8.1 Pro 64-bit	1-year, Depot	01/15
20DC003VUS	US	i5-5200U	No	Intel HD 5500	8GBx1	14" HD (1366x768)	None	1TB 5400rpm	None	Intel 3160 ac, 1x1 + BT4.0	None	None	Black	PC/ABS	720p	Non-backlit	Fingerprint Reader	dTPM 1.2	6-cell (47Wh)	45W	Win8.1 Pro 64-bit	1-year, Depot	01/15
20DC003WUS	US	i3-4005U	No	Intel HD 4400	4GBx1	14" HD (1366x768)	None	500GB 7200rpm	None	Intel 3160 ac, 1x1 + BT4.0	None	None	Black	PC/ABS	720p	Non-backlit	Fingerprint Reader	dTPM 1.2	6-cell (47Wh)	45W	Win8.1 DG Win7 Pro 64	1-year, Depot	01/15
20DC003XUS	US	i5-5200U	No	Intel HD 5500	4GBx1	14" HD (1366x768)	None	128GB SSD	None	Intel 7265 ac, 2x2 + BT4.0	None	None	Black	PC/ABS	720p	Non-backlit	Fingerprint Reader	dTPM 1.2	6-cell (47Wh)	45W	Win8.1 DG Win7 Pro 64	1-year, Depot	01/15
20DC003YUS	US	i7-5500U	No	AMD R7 M260 2GB	8GBx1	14" HD (1366x768)	None	128GB SSD	None	Intel 7265 ac, 2x2 + BT4.0	None	None	Black	PC/ABS	720p	Non-backlit	Fingerprint Reader	None	6-cell (47Wh)	65W	Win8.1 DG Win7 Pro 64	1-year, Depot	01/15
20DC0040US	US	i3-4005U	No	Intel HD 4400	4GBx1	14" HD (1366x768)	None	500GB 7200rpm	None	Intel 3160 ac, 1x1 + BT4.0	None	None	Black	PC/ABS	720p	Non-backlit	None	dTPM 1.2	6-cell (47Wh)	45W	Win8.1 DG Win7 Pro 64	1-year, Depot	01/15
20DC0041US	US	i3-4005U	No	Intel HD 4400	4GBx1	14" HD (1366x768)	None	1TB 5400rpm	None	Intel 3160 ac, 1x1 + BT4.0	None	None	Black	PC/ABS	720p	Non-backlit	Fingerprint Reader	dTPM 1.2	6-cell (47Wh)	45W	Win8.1 DG Win7 Pro 64	1-year, Depot	01/15
20DC0042US	US	i3-4005U	No	Intel HD 4400	8GBx1	14" HD (1366x768)	None	500GB 7200rpm	None	Intel 3160 ac, 1x1 + BT4.0	None	None	Black	PC/ABS	720p	Non-backlit	Fingerprint Reader	dTPM 1.2	6-cell (47Wh)	45W	Win8.1 DG Win7 Pro 64	1-year, Depot	01/15
20DC0043US	US	i3-4005U	No	Intel HD 4400	8GBx1	14" HD (1366x768)	None	1TB 5400rpm	None	Intel 3160 ac, 1x1 + BT4.0	None	None	Black	PC/ABS	720p	Non-backlit	Fingerprint Reader	dTPM 1.2	6-cell (47Wh)	45W	Win8.1 DG Win7 Pro 64	1-year, Depot	01/15

Model	Region	Processor	vPro	Graphics	Memory	Display	Multi-touch	Storage(HDD/SSD)	Optical	WLAN + Bluetooth	WWAN	SIM Card	Color	Case Material	Camera	Keyboard	Fingerprint Reader	TPM	Battery	Power Adapter	Operating System	Warranty	Ann Date (m/y)
20DC0044US	US	i3-5005U	No	Intel HD 5500	4GBx1	14" HD (1366x768)	None	500GB 7200rpm	None	Intel 3160 ac, 1x1 + BT4.0	None	None	Black	PC/ABS	720p	Non-backlit	Fingerprint Reader	dTPM 1.2	6-cell (47Wh)	45W	Win8.1 DG Win7 Pro 64	1-year, Depot	01/15
20DC0045US	US	i3-5005U	No	Intel HD 5500	4GBx1	14" HD (1366x768)	None	500GB 7200rpm	None	Intel 7265 ac, 2x2 + BT4.0	None	None	Black	PC/ABS	720p	Non-backlit	Fingerprint Reader	dTPM 1.2	6-cell (47Wh)	45W	Win8.1 DG Win7 Pro 64	1-year, Depot	01/15
20DC0046US	US	i3-5005U	No	Intel HD 5500	4GBx1	14" HD (1366x768)	None	1TB 5400rpm	None	Intel 3160 ac, 1x1 + BT4.0	None	None	Black	PC/ABS	720p	Non-backlit	Fingerprint Reader	dTPM 1.2	6-cell (47Wh)	45W	Win8.1 DG Win7 Pro 64	1-year, Depot	01/15
20DC0047US	US	i3-5005U	No	Intel HD 5500	8GBx1	14" HD (1366x768)	None	500GB 7200rpm	None	Intel 3160 ac, 1x1 + BT4.0	None	None	Black	PC/ABS	720p	Non-backlit	Fingerprint Reader	dTPM 1.2	6-cell (47Wh)	45W	Win8.1 DG Win7 Pro 64	1-year, Depot	01/15
20DC0048US	US	i3-5005U	No	Intel HD 5500	8GBx1	14" HD (1366x768)	None	500GB 7200rpm	None	Intel 7265 ac, 2x2 + BT4.0	None	None	Black	PC/ABS	720p	Non-backlit	Fingerprint Reader	dTPM 1.2	6-cell (47Wh)	45W	Win8.1 DG Win7 Pro 64	1-year, Depot	01/15
20DC0049US	US	i3-5005U	No	Intel HD 5500	8GBx1	14" HD (1366x768)	None	1TB 5400rpm	None	Intel 3160 ac, 1x1 + BT4.0	None	None	Black	PC/ABS	720p	Non-backlit	Fingerprint Reader	dTPM 1.2	6-cell (47Wh)	45W	Win8.1 DG Win7 Pro 64	1-year, Depot	01/15
20DC004CUS	US	i5-5200U	No	Intel HD 5500	4GBx1	14" HD (1366x768)	None	500GB 7200rpm	None	Intel 3160 ac, 1x1 + BT4.0	None	None	Black	PC/ABS	720p	Non-backlit	Fingerprint Reader	dTPM 1.2	6-cell (47Wh)	45W	Win8.1 DG Win7 Pro 64	1-year, Depot	01/15
20DC004DUS	US	i5-5200U	No	Intel HD 5500	4GBx1	14" HD (1366x768)	None	500GB 7200rpm	None	Intel 7265 ac, 2x2 + BT4.0	None	None	Black	PC/ABS	720p	Non-backlit	Fingerprint Reader	dTPM 1.2	6-cell (47Wh)	45W	Win8.1 DG Win7 Pro 64	1-year, Depot	01/15
20DC004EUS	US	i5-5200U	No	Intel HD 5500	4GBx1	14" FHD (1920x1080)	None	500GB 7200rpm	None	Intel 7265 ac, 2x2 + BT4.0	None	None	Black	PC/ABS	720p	Non-backlit	Fingerprint Reader	dTPM 1.2	6-cell (47Wh)	45W	Win8.1 DG Win7 Pro 64	1-year, Depot	01/15
20DC004FUS	US	i5-5200U	No	Intel HD 5500	4GBx1	14" FHD (1920x1080)	None	128GB SSD	None	Intel 7265 ac, 2x2 + BT4.0	None	None	Black	PC/ABS	720p	Non-backlit	Fingerprint Reader	dTPM 1.2	6-cell (47Wh)	45W	Win8.1 DG Win7 Pro 64	1-year, Depot	01/15
20DC004GUS	US	i5-5200U	No	Intel HD 5500	4GBx1	14" HD (1366x768)	None	1TB 5400rpm	None	Intel 3160 ac, 1x1 + BT4.0	None	None	Black	PC/ABS	720p	Non-backlit	Fingerprint Reader	dTPM 1.2	6-cell (47Wh)	45W	Win8.1 DG Win7 Pro 64	1-year, Depot	01/15
20DC004HUS	US	i5-5200U	No	Intel HD 5500	4GBx1	14" HD (1366x768)	None	1TB 5400rpm	None	Intel 7265 ac, 2x2 + BT4.0	None	None	Black	PC/ABS	720p	Non-backlit	Fingerprint Reader	dTPM 1.2	6-cell (47Wh)	45W	Win8.1 DG Win7 Pro 64	1-year, Depot	01/15
20DC004JUS	US	i5-5200U	No	Intel HD 5500	4GBx1	14" FHD (1920x1080)	None	1TB 5400rpm	None	Intel 7265 ac, 2x2 + BT4.0	None	None	Black	PC/ABS	720p	Non-backlit	Fingerprint Reader	dTPM 1.2	6-cell (47Wh)	45W	Win8.1 DG Win7 Pro 64	1-year, Depot	01/15
20DC004KUS	US	i5-5200U	No	Intel HD 5500	8GBx1	14" HD (1366x768)	None	500GB 7200rpm	None	Intel 3160 ac, 1x1 + BT4.0	None	None	Black	PC/ABS	720p	Non-backlit	Fingerprint Reader	dTPM 1.2	6-cell (47Wh)	45W	Win8.1 DG Win7 Pro 64	1-year, Depot	01/15
20DC004LUS	US	i5-5200U	No	Intel HD 5500	8GBx1	14" HD (1366x768)	None	500GB 7200rpm	None	Intel 7265 ac, 2x2 + BT4.0	None	None	Black	PC/ABS	720p	Non-backlit	Fingerprint Reader	dTPM 1.2	6-cell (47Wh)	45W	Win8.1 DG Win7 Pro 64	1-year, Depot	01/15
20DC004MUS	US	i5-5200U	No	Intel HD 5500	8GBx1	14" FHD (1920x1080)	None	500GB 7200rpm	None	Intel 7265 ac, 2x2 + BT4.0	None	None	Black	PC/ABS	720p	Non-backlit	Fingerprint Reader	dTPM 1.2	6-cell (47Wh)	45W	Win8.1 DG Win7 Pro 64	1-year, Depot	01/15
20DC004NUS	US	i5-5200U	No	Intel HD 5500	8GBx1	14" HD (1366x768)	None	128GB SSD	None	Intel 7265 ac, 2x2 + BT4.0	None	None	Black	PC/ABS	720p	Non-backlit	Fingerprint Reader	dTPM 1.2	6-cell (47Wh)	45W	Win8.1 DG Win7 Pro 64	1-year, Depot	01/15
20DC004PUS	US	i5-5200U	No	Intel HD 5500	8GBx1	14" FHD (1920x1080)	None	128GB SSD	None	Intel 7265 ac, 2x2 + BT4.0	None	None	Black	PC/ABS	720p	Non-backlit	Fingerprint Reader	dTPM 1.2	6-cell (47Wh)	45W	Win8.1 DG Win7 Pro 64	1-year, Depot	01/15
20DC004QUS	US	i5-5200U	No	Intel HD 5500	8GBx1	14" HD (1366x768)	None	1TB 5400rpm	None	Intel 3160 ac, 1x1 + BT4.0	None	None	Black	PC/ABS	720p	Non-backlit	Fingerprint Reader	dTPM 1.2	6-cell (47Wh)	45W	Win8.1 DG Win7 Pro 64	1-year, Depot	01/15
20DC004SUS	US	i5-5200U	No	Intel HD 5500	8GBx1	14" HD (1366x768)	None	1TB 5400rpm	None	Intel 7265 ac, 2x2 + BT4.0	None	None	Black	PC/ABS	720p	Non-backlit	Fingerprint Reader	dTPM 1.2	6-cell (47Wh)	45W	Win8.1 DG Win7 Pro 64	1-year, Depot	01/15

Model	Region	Processor	vPro	Graphics	Memory	Display	Multi-touch	Storage(HDD/SSD)	Optical	WLAN + Bluetooth	WWAN	SIM Card	Color	Case Material	Camera	Keyboard	Fingerprint Reader	TPM	Battery	Power Adapter	Operating System	Warranty	Ann Date (m/y)
20DC004TUS	US	i5-5200U	No	Intel HD 5500	8GBx1	14" FHD (1920x1080)	None	1TB 5400rpm	None	Intel 7265 ac, 2x2 + BT4.0	None	None	Black	PC/ABS	720p	Non-backlit	Fingerprint Reader	dTPM 1.2	6-cell (47Wh)	45W	Win8.1 DG Win7 Pro 64	1-year, Depot	01/15
20DC004UUS	US	i7-5500U	No	AMD R7 M260 2GB	4GBx1	14" FHD (1920x1080)	None	500GB 7200rpm	None	Intel 7265 ac, 2x2 + BT4.0	None	None	Black	PC/ABS	720p	Non-backlit	Fingerprint Reader	None	6-cell (47Wh)	65W	Win8.1 DG Win7 Pro 64	1-year, Depot	01/15
20DC004VUS	US	i7-5500U	No	AMD R7 M260 2GB	4GBx1	14" FHD (1920x1080)	None	128GB SSD	None	Intel 7265 ac, 2x2 + BT4.0	None	None	Black	PC/ABS	720p	Non-backlit	Fingerprint Reader	None	6-cell (47Wh)	65W	Win8.1 DG Win7 Pro 64	1-year, Depot	01/15
20DC004WUS	US	i7-5500U	No	AMD R7 M260 2GB	4GBx1	14" HD (1366x768)	None	1TB 5400rpm	None	Intel 7265 ac, 2x2 + BT4.0	None	None	Black	PC/ABS	720p	Non-backlit	Fingerprint Reader	None	6-cell (47Wh)	65W	Win8.1 DG Win7 Pro 64	1-year, Depot	01/15
20DC004XUS	US	i7-5500U	No	AMD R7 M260 2GB	4GBx1	14" FHD (1920x1080)	None	1TB 5400rpm	None	Intel 7265 ac, 2x2 + BT4.0	None	None	Black	PC/ABS	720p	Non-backlit	Fingerprint Reader	None	6-cell (47Wh)	65W	Win8.1 DG Win7 Pro 64	1-year, Depot	01/15
20DC004YUS	US	i7-5500U	No	AMD R7 M260 2GB	8GBx1	14" HD (1366x768)	None	500GB 7200rpm	None	Intel 7265 ac, 2x2 + BT4.0	None	None	Black	PC/ABS	720p	Non-backlit	Fingerprint Reader	None	6-cell (47Wh)	65W	Win8.1 DG Win7 Pro 64	1-year, Depot	01/15
20DC0050US	US	i7-5500U	No	AMD R7 M260 2GB	8GBx1	14" FHD (1920x1080)	None	128GB SSD	None	Intel 7265 ac, 2x2 + BT4.0	None	None	Black	PC/ABS	720p	Non-backlit	Fingerprint Reader	None	6-cell (47Wh)	65W	Win8.1 DG Win7 Pro 64	1-year, Depot	01/15
20DC0051US	US	i7-5500U	No	AMD R7 M260 2GB	8GBx1	14" FHD (1920x1080)	None	1TB 5400rpm	None	Intel 7265 ac, 2x2 + BT4.0	None	None	Black	PC/ABS	720p	Non-backlit	Fingerprint Reader	None	6-cell (47Wh)	65W	Win8.1 DG Win7 Pro 64	1-year, Depot	01/15
20DC0099US	US	i7-5500U	No	AMD R7 M260 2GB	4GBx1	14" HD (1366x768)	None	500GB 7200rpm	None	Intel 7265 ac, 2x2 + BT4.0	None	None	Black	PC/ABS	720p	Non-backlit	Fingerprint Reader	None	6-cell (47Wh)	65W	Win8.1 DG Win7 Pro 64	1-year, Depot	01/15
20DC00AVUS	US	i3-4005U	No	Intel HD 4400	4GBx1	14" HD (1366x768)	None	500GB 7200rpm	None	Intel 3160 ac, 1x1 + BT4.0	None	None	Black	PC/ABS	720p	Non-backlit	Fingerprint Reader	dTPM 1.2	6-cell (47Wh)	45W	Win10 DG Win7 Pro 64	1-year, Depot	07/15
20DC00AWUS	US	i7-5500U	No	AMD R7 M260 2GB	4GBx1	14" FHD (1920x1080)	None	500GB 7200rpm	None	Intel 7265 ac, 2x2 + BT4.0	None	None	Black	PC/ABS	720p	Non-backlit	Fingerprint Reader	None	6-cell (47Wh)	65W	Win10 Pro 64	1-year, Depot	07/15
20DC00AXUS	US	i7-5500U	No	AMD R7 M260 2GB	4GBx1	14" FHD (1920x1080)	None	500GB 7200rpm	None	Intel 7265 ac, 2x2 + BT4.0	None	None	Black	PC/ABS	720p	Non-backlit	Fingerprint Reader	None	6-cell (47Wh)	65W	Win10 DG Win7 Pro 64	1-year, Depot	07/15
20DC00AYUS	US	i7-5500U	No	AMD R7 M260 2GB	8GBx1	14" FHD (1920x1080)	None	192GB SSD	None	Intel 7265 ac, 2x2 + BT4.0	None	None	Black	PC/ABS	720p	Non-backlit	Fingerprint Reader	None	6-cell (47Wh)	65W	Win10 Pro 64	1-year, Depot	07/15
20DC00B0US	US	i5-5200U	No	Intel HD 5500	4GBx1	14" HD (1366x768)	None	500GB 7200rpm	None	Intel 3160 ac, 1x1 + BT4.0	None	None	Black	PC/ABS	720p	Non-backlit	Fingerprint Reader	dTPM 1.2	6-cell (47Wh)	45W	Win10 DG Win7 Pro 64	1-year, Depot	07/15
20DC00B1US	US	i5-5200U	No	Intel HD 5500	4GBx1	14" HD (1366x768)	None	500GB 7200rpm	None	Intel 3160 ac, 1x1 + BT4.0	None	None	Black	PC/ABS	720p	Non-backlit	Fingerprint Reader	dTPM 1.2	6-cell (47Wh)	45W	Win10 Pro 64	1-year, Depot	07/15
20DC00B2US	US	i3-4005U	No	Intel HD 4400	4GBx1	14" HD (1366x768)	None	500GB 7200rpm	None	Intel 3160 ac, 1x1 + BT4.0	None	None	Black	PC/ABS	720p	Non-backlit	Fingerprint Reader	dTPM 1.2	6-cell (47Wh)	45W	Win10 Pro 64	1-year, Depot	07/15
20DC00BVUS	US	i3-5005U	No	Intel HD 5500	4GBx1	14" HD (1366x768)	None	500GB 7200rpm	None	Intel 3160 ac, 1x1 + BT4.0	None	None	Black	PC/ABS	0.3MP	Non-backlit	None	dTPM 1.2	6-cell (47Wh)	45W	Win10 Pro 64	1-year, Depot	08/15
20DC00BWUS	US	i3-5005U	No	Intel HD 5500	4GBx1	14" HD (1366x768)	None	500GB 7200rpm	None	Intel 3160 ac, 1x1 + BT4.0	None	None	Black	PC/ABS	720p	Non-backlit	Fingerprint Reader	dTPM 1.2	6-cell (47Wh)	45W	Win10 Pro 64	1-year, Depot	08/15
20DC00BXUS	US	i3-5005U	No	Intel HD 5500	4GBx1	14" HD (1366x768)	None	500GB 7200rpm	None	Intel 3160 ac, 1x1 + BT4.0	None	None	Black	PC/ABS	720p	Non-backlit	Fingerprint Reader	dTPM 1.2	6-cell (47Wh)	45W	Win10 DG Win7 Pro 64	1-year, Depot	08/15
20DC00BYUS	US	i3-5005U	No	Intel HD 5500	4GBx1	14" HD (1366x768)	None	500GB 7200rpm	None	Intel 3160 ac, 1x1 + BT4.0	None	None	Black	PC/ABS	0.3MP	Non-backlit	None	dTPM 1.2	6-cell (47Wh)	45W	Win10 DG Win7 Pro 64	1-year, Depot	08/15

Model	Region	Processor	vPro	Graphics	Memory	Display	Multi-touch	Storage(HDD/SSD)	Optical	WLAN + Bluetooth	WWAN	SIM Card	Color	Case Material	Camera	Keyboard	Fingerprint Reader	TPM	Battery	Power Adapter	Operating System	Warranty	Ann Date (m/y)
20DC00C0US	US	i3-5005U	No	Intel HD 5500	4GBx1	14" HD (1366x768)	None	192GB SSD	None	Intel 3160 ac, 1x1 + BT4.0	None	None	Black	PC/ABS	0.3MP	Non-backlit	None	dTPM 1.2	6-cell (47Wh)	45W	Win10 DG Win7 Pro 64	1-year, Depot	08/15



ThinkPad E460 Platform Specifications

Product Specifications Reference (PSREF)

Processor	6th Generation Intel® Core™ i3 / i5 / i7 Processor								Smart Card Reader	None	
	Processor Number	# of Cores	# of Threads	Base Frequency	Max Turbo Frequency	Cache	Memory Types	Processor Graphics	ExpressCard	None	
	i3-6100U	2	4	2.3 GHz	-	3MB	DDR3L-1600	Intel HD Graphics 520	Multicard Reader	4-in-1 reader (MMC, SD, SDHC, SDXC)	
	i5-6200U			2.3 GHz	2.8 GHz	3MB			Ports	Three USB 3.0 (one Always On), HDMI, Ethernet (RJ-45), Lenovo OneLink connector, combo audio / microphone jack	
i7-6500U	2.5 GHz			3.1 GHz	4MB	Monitor cable			None		
Graphics	Intel HD Graphics in processor only, or AMD Radeon R5 M330 Graphics, 2GB DDR3 memory, or AMD Radeon R7 M360 Graphics, 2GB DDR3 memory, digital monitor support via HDMI™ (supporting HDCP to output protected content); supports dual independent displays; Max resolution: 1920x1080 (HDMI) @60Hz								Camera	<i>Some:</i> HD720p resolution, fixed focus	
Chipset	Intel SoC (System on Chip) platform								Audio support	HD Audio, Conexant® CX11852 codec, Dolby® Advanced Audio™ / stereo speakers, 2W x 2 / dual array microphone, combo audio / microphone jack	
Memory	16GB max / PC3-12800 1600MHz DDR3L, non-parity, dual-channel capable, two 204-pin SO-DIMM sockets								Keyboard	6-row, spill-resistant, multimedia Fn keys	
Display	<i>Some:</i> 14.0" (355mm) HD (1366x768) color, anti-glare, LED backlight, 220 nits, 16:9 aspect ratio <i>Some:</i> 14.0" (355mm) FHD (1920x1080) color, anti-glare, LED backlight, IPS, 250 nits, 16:9 aspect ratio								UltraNav™	TrackPoint® pointing device and multi-touch with 3+2 buttons click pad	
Multi-touch	None								ThinkLight™	None	
Storage	<i>Some:</i> SSD / SATA 6.0Gb/s, 2.5" wide, 7mm high, removable, upgradable <i>Some:</i> HDD / SATA 6.0Gb/s, 2.5" wide, removable, upgradable, Active Protection System™ <i>Some:</i> SSHD with 8GB NAND flash memory								Security	Power-on password, hard disk password, supervisor password, security keyhole	
Optical	None								Security chip	TPM2.0 : Trusted Platform Module, TPM2.0 FW (firmware)	
M.2 SSD	None								TPM1.2 :	Trusted Platform Module, TCG 1.2-compliant	
Ethernet	Gigabit Ethernet Connection								TPM :	TPM2.0 and TPM1.2	
Bluetooth™	Bluetooth wireless, integrated in Wi-Fi + Bluetooth combo adapter								vPro	None	
WLAN	<i>One of the following, configurable by model:</i> <ul style="list-style-type: none"> Intel Dual Band Wireless-AC 3165, 1x1, Wi-Fi + BT combo adapter, M.2 Card Intel Dual Band Wireless-AC 8260, 2x2, Wi-Fi + BT combo adapter, M.2 Card BCM, Broadcom Wireless-AC, 1x1, Wi-Fi + Bluetooth combo adapter, M.2 Card QCA, Qualcomm Wireless-AC, 2x2, Wi-Fi + Bluetooth combo adapter, M.2 Card 								Fingerprint reader	<i>Some:</i> Fingerprint reader on the keyboard bezel, swipe sensor	
WWAN	None								NFC	None	
SIM card	None								Battery type	Li-Ion 6-cell (47Wh)	
Dimensions	<i>Aluminum (WxDxH):</i> 13.35" x 9.41" x 0.90"; 339mm x 239mm x 22.9mm <i>PC/ABS (WxDxH):</i> 13.35" x 9.41" x 0.96"; 339mm x 239mm x 24.4mm								Battery life	6-cell (47Wh): up to 9.0 hr	
Weight	From 4.23 lb (1.92kg)								AC adapter	<i>Some:</i> 45-watt AC adapter (Integrated Graphics) <i>Some:</i> 65-watt AC adapter (Discrete Graphics)	
Case color	Graphite black								Preload	<i>Some:</i> No operating system <i>Some:</i> Windows® 7 Professional 64 preinstalled through downgrade rights in Windows 10 Pro 64 <ul style="list-style-type: none"> Lenovo Solution Center Lenovo SHAREit ThinkVantage Product Recovery Rescue and Recovery™ ThinkVantage System Update PC Device Stage Adobe® Reader® Microsoft® Office preloaded; purchase a product key to activate McAfee® Live Safe (30-day trial) 	<i>Some:</i> Windows 10 Pro 64 <i>Some:</i> Windows 10 Home 64 <ul style="list-style-type: none"> Lenovo Solution Center Lenovo REACHit Lenovo SHAREit Lenovo Companion Lenovo Settings ThinkVantage System Update Microsoft Office preloaded; purchase a product key to activate McAfee® Live Safe (30-day trial)
Case material	<i>Aluminum:</i> Aluminum display cover <i>PC/ABS:</i> PolyCarbonate/Acrylonitrile-Butadiene-Styrene (PC/ABS) plastic display cover								Limited warranty	1-year - depot repair service / service upgrades available	
									Mil-Spec test	None	
									Environment	EPEAT™ Gold; ENERGY STAR®; RoHS-compliant	

ThinkPad E460 - TopSeller - 20ET

Product Specifications Reference (PSREF)

Model	Region	Processor	vPro	Graphics	Memory	Display	Multi-touch	Storage	Optical	WLAN + Bluetooth	WWAN	SIM Card	Color	Case Material	Camera	Keyboard	Fingerprint Reader	TPM	Battery	Power Adapter	Operating System	Warranty	Ann Date (m/y)
20ET000YUS	US	i3-6100U	No	Intel HD 520	4GBx1	14" HD (1366x768)	None	500GB 7200rpm	None	Intel 3165 ac, 1x1 + BT4.0	None	None	Black	PC/ABS	720p	Non-backlit	Fingerprint Reader	dTPM 1.2	6-cell (47Wh)	45W	Win10 DG Win7 Pro 64	1-year, Depot	11/15
20ET0010US	US	i5-6200U	No	Intel HD 520	8GBx1	14" HD (1366x768)	None	192GB SSD	None	Intel 3165 ac, 1x1 + BT4.0	None	None	Black	PC/ABS	720p	Non-backlit	Fingerprint Reader	dTPM 1.2	6-cell (47Wh)	45W	Win10 DG Win7 Pro 64	1-year, Depot	11/15
20ET0011US	US	i3-6100U	No	Intel HD 520	4GBx1	14" HD (1366x768)	None	500GB 7200rpm	None	Intel 3165 ac, 1x1 + BT4.0	None	None	Black	PC/ABS	720p	Non-backlit	Fingerprint Reader	dTPM1.2 + FW TPM2.0	6-cell (47Wh)	45W	Win10 Pro 64	1-year, Depot	11/15
20ET0012US	US	i5-6200U	No	Intel HD 520	4GBx1	14" HD (1366x768)	None	500GB 7200rpm	None	Intel 3165 ac, 1x1 + BT4.0	None	None	Black	PC/ABS	720p	Non-backlit	Fingerprint Reader	dTPM1.2 + FW TPM2.0	6-cell (47Wh)	45W	Win10 Pro 64	1-year, Depot	11/15
20ET0013US	US	i7-6500U	No	AMD R7 M360 2GB	8GBx1	14" FHD (1920x1080) IPS	None	500GB 7200rpm	None	Intel 8260 ac, 2x2 + BT4.0	None	None	Black	Aluminum	720p	Non-backlit	Fingerprint Reader	FW TPM 2.0	6-cell (47Wh)	65W	Win10 DG Win7 Pro 64	1-year, Depot	11/15
20ET0014US	US	i5-6200U	No	Intel HD 520	4GBx1	14" HD (1366x768)	None	500GB 7200rpm	None	Intel 3165 ac, 1x1 + BT4.0	None	None	Black	PC/ABS	720p	Non-backlit	Fingerprint Reader	dTPM 1.2	6-cell (47Wh)	45W	Win10 DG Win7 Pro 64	1-year, Depot	11/15
20ET0015US	US	i3-6100U	No	Intel HD 520	4GBx1	14" HD (1366x768)	None	192GB SSD	None	Intel 3165 ac, 1x1 + BT4.0	None	None	Black	PC/ABS	720p	Non-backlit	Fingerprint Reader	dTPM 1.2	6-cell (47Wh)	45W	Win10 DG Win7 Pro 64	1-year, Depot	11/15
20ET0016US	US	i5-6200U	No	Intel HD 520	8GBx1	14" HD (1366x768)	None	192GB SSD	None	Intel 3165 ac, 1x1 + BT4.0	None	None	Black	PC/ABS	720p	Non-backlit	Fingerprint Reader	dTPM1.2 + FW TPM2.0	6-cell (47Wh)	45W	Win10 Pro 64	1-year, Depot	11/15
20ET0017US	US	i5-6200U	No	Intel HD 520	4GBx1	14" HD (1366x768)	None	192GB SSD	None	Intel 3165 ac, 1x1 + BT4.0	None	None	Black	PC/ABS	720p	Non-backlit	Fingerprint Reader	dTPM1.2 + FW TPM2.0	6-cell (47Wh)	45W	Win10 Pro 64	1-year, Depot	11/15
20ET0018US	US	i3-6100U	No	Intel HD 520	4GBx1	14" HD (1366x768)	None	192GB SSD	None	Intel 3165 ac, 1x1 + BT4.0	None	None	Black	PC/ABS	720p	Non-backlit	Fingerprint Reader	dTPM1.2 + FW TPM2.0	6-cell (47Wh)	45W	Win10 Pro 64	1-year, Depot	11/15
20ET0019US	US	i7-6500U	No	AMD R7 M360 2GB	8GBx1	14" FHD (1920x1080) IPS	None	192GB SSD	None	Intel 8260 ac, 2x2 + BT4.0	None	None	Black	Aluminum	720p	Non-backlit	Fingerprint Reader	FW TPM 2.0	6-cell (47Wh)	65W	Win10 DG Win7 Pro 64	1-year, Depot	11/15
20ET001AUS	US	i5-6200U	No	Intel HD 520	4GBx1	14" HD (1366x768)	None	192GB SSD	None	Intel 3165 ac, 1x1 + BT4.0	None	None	Black	PC/ABS	720p	Non-backlit	Fingerprint Reader	dTPM 1.2	6-cell (47Wh)	45W	Win10 DG Win7 Pro 64	1-year, Depot	11/15
20ET001BUS	US	i7-6500U	No	AMD R7 M360 2GB	8GBx1	14" FHD (1920x1080) IPS	None	192GB SSD	None	Intel 8260 ac, 2x2 + BT4.0	None	None	Black	Aluminum	720p	Non-backlit	Fingerprint Reader	FW TPM 2.0	6-cell (47Wh)	65W	Win10 Pro 64	1-year, Depot	11/15
20ET001CUS	US	i7-6500U	No	AMD R7 M360 2GB	8GBx1	14" FHD (1920x1080) IPS	None	500GB 7200rpm	None	Intel 8260 ac, 2x2 + BT4.0	None	None	Black	Aluminum	720p	Non-backlit	Fingerprint Reader	FW TPM 2.0	6-cell (47Wh)	65W	Win10 Pro 64	1-year, Depot	11/15
20ET004GUS	US	i7-6500U	No	AMD R7 M360 2GB	8GBx1	14" FHD (1920x1080) IPS	None	256GB SSD Opal2	None	Intel 8260 ac, 2x2 + BT4.0	None	None	Black	Aluminum	720p	Non-backlit	Fingerprint Reader	FW TPM 2.0	6-cell (47Wh)	65W	Win10 Pro 64	1-year, Depot	04/16
20ET004HUS	US	i7-6500U	No	AMD R7 M360 2GB	8GBx1	14" FHD (1920x1080) IPS	None	256GB SSD Opal2	None	Intel 8260 ac, 2x2 + BT4.0	None	None	Black	Aluminum	720p	Non-backlit	Fingerprint Reader	FW TPM 2.0	6-cell (47Wh)	65W	Win10 DG Win7 Pro 64	1-year, Depot	04/16
20ET004VUS	US	i5-6200U	No	Intel HD 520	4GBx1	14" HD (1366x768)	None	256GB SSD Opal2	None	Intel 8260 ac, 2x2 + BT4.0	None	None	Black	PC/ABS	720p	Non-backlit	Fingerprint Reader	dTPM 1.2	6-cell (47Wh)	45W	Win10 DG Win7 Pro 64	1-year, Depot	09/16
20ET004WUS	US	i5-6200U	No	Intel HD 520	8GBx1	14" FHD (1920x1080) IPS	None	256GB SSD Opal2	None	Intel 8260 ac, 2x2 + BT4.0	None	None	Black	Aluminum	720p	Non-backlit	Fingerprint Reader	dTPM 1.2	6-cell (47Wh)	45W	Win10 DG Win7 Pro 64	1-year, Depot	09/16
20ET0054US	US	i5-6200U	No	Intel HD 520	8GBx1	14" HD (1366x768)	None	500GB 7200rpm	None	Intel 3165 ac, 1x1 + BT4.0	None	None	Black	PC/ABS	720p	Non-backlit	Fingerprint Reader	dTPM1.2 + FW TPM2.0	6-cell (47Wh)	45W	Win10 Pro 64	1-year, Depot	10/16
20ET0055US	US	i5-6200U	No	Intel HD 520	8GBx1	14" FHD (1920x1080) IPS	None	500GB 7200rpm	None	Intel 3165 ac, 1x1 + BT4.0	None	None	Black	Aluminum	720p	Non-backlit	Fingerprint Reader	dTPM1.2 + FW TPM2.0	6-cell (47Wh)	45W	Win10 Pro 64	1-year, Depot	10/16



ThinkPad E465 Platform Specifications

Product Specifications Reference (PSREF)

Processor	AMD Accelerated Processor A6, A8, or A10 APU								Smart Card Reader	None
	Processor Number	# of Cores	# of Threads	Clock Speed	Max Turbo Frequency	Cache	Memory speed	Graphics	ExpressCard	None
	A6-8500P	2	6	1.6 GHz	3.0 GHz	1MB	DDR3L-1600	R5 Graphics	Multicard Reader	4-in-1 reader (MMC, SD, SDHC, SDXC)
	A6-8500P	2	6	1.6 GHz	3.0 GHz	1MB		R5 M330	Ports	Three USB 3.0 (one Always On), HDMI, Ethernet (RJ-45), Lenovo OneLink connector, combo audio / microphone jack
	A8-8600P	4	10	1.6 GHz	3.0 GHz	2MB		R6 M335DX (R6+R5 M330)	Monitor cable	None
	A10-8700P	4	10	1.8 GHz	3.2 GHz	2MB		R6 M340DX (R6+R5 M330)	Camera	HD720p resolution, fixed focus
Graphics	AMD Radeon™ R5 Graphics in processor only, or AMD Radeon R5 M330 Graphics, 2GB DDR3 memory, or Dual Graphics support for A8 and A10 APU digital monitor support via HDMI™ (supporting HDCP to output protected content); supports dual independent display Max resolution: 1920x1080 (HDMI) @60Hz								Audio support	HD Audio, Conexant® CX11852 codec, Dolby® Advanced Audio™ / stereo speakers, 2W x 2 / dual array microphone, combo audio / microphone jack
Chipset	AMD SoC (System on Chip) platform								Keyboard	6-row, spill-resistant, multimedia Fn keys
Memory	16GB max / PC3-12800 1600MHz DDR3L, non-parity, dual-channel capable, two 204-pin SO-DIMM sockets								UltraNav™	TrackPoint® pointing device and multi-touch with 3+2 buttons click pad
Display	Some: 14.0" (355mm) HD (1366x768) color, anti-glare, LED backlight, 220 nits, 16:9 aspect ratio Some: 14.0" (355mm) FHD (1920x1080) color, anti-glare, LED backlight, IPS, 250 nits, 16:9 aspect ratio								ThinkLight™	None
Multi-touch	None								Security	Power-on password, hard disk password, supervisor password, security keyhole
Storage	Some: SSD / SATA 6.0Gb/s, 2.5" wide, 7mm high, removable, upgradable Some: HDD / SATA 6.0Gb/s, 2.5" wide, removable, upgradable, Active Protection System™ Some: SSHD with 8GB NAND flash memory								Security chip	TPM2.0: Trusted Platform Module, TPM2.0 FW (firmware) TPM1.2: Trusted Platform Module, TCG 1.2-compliant TPM: TPM2.0 and TPM1.2
Optical	None								vPro	None
M.2 SSD	None								Fingerprint reader	Some: Fingerprint reader on the keyboard bezel, swipe sensor
Ethernet	Gigabit Ethernet Connection								NFC	None
Bluetooth™	Bluetooth wireless, integrated in Wi-Fi + Bluetooth combo adapter								Battery type	Li-Ion 6-cell (47Wh)
WLAN	One of the following, configurable by model: • BCM, Broadcom Wireless-AC, 1x1, Wi-Fi + Bluetooth combo adapter, M.2 Card • QCA, Qualcomm Wireless-AC, 2x2, Wi-Fi + Bluetooth combo adapter, M.2 Card								Battery life	Up to 6.5 hr
WWAN	None								AC adapter	Some: 45-watt AC adapter (Integrated Graphics) Some: 65-watt AC adapter (Discrete Graphics)
SIM card	None								Preload	Some: No operating system Some: Windows® 7 Professional 64 Some: Windows® 7 Professional 64 preinstalled through downgrade rights in Windows 10 Pro 64 • Lenovo Solution Center • Lenovo SHAREit • ThinkVantage Product Recovery • Rescue and Recovery™ • ThinkVantage System Update • PC Device Stage • Adobe® Reader® • Microsoft® Office preloaded; purchase a product key to activate • McAfee® Live Safe (30-day trial) Some: Windows 10 Pro 64 Some: Windows 10 Home 64 • Lenovo Solution Center • Lenovo REACHit • Lenovo SHAREit • Lenovo Companion • Lenovo Settings • ThinkVantage System Update • Microsoft Office preloaded; purchase a product key to activate • McAfee® Live Safe (30-day trial)
Dimensions	Aluminum (WxDxH):	13.35" x 9.41" x 0.90"; 339mm x 239mm x 22.9mm						Limited warranty	1-year - depot repair service / service upgrades available	
Weight	PC/ABS (WxDxH):	13.35" x 9.41" x 0.96"; 339mm x 239mm x 24.4mm						Environment	EPEAT™ Gold; ENERGY STAR®; RoHS-compliant	
Case color	Graphite black									
Case material	Aluminum:	Aluminum display cover								
	PC/ABS:	PolyCarbonate/Acrylonitrile-Butadiene-Styrene (PC/ABS) plastic display cover								

ThinkPad E465 - TopSeller - 20EX

Product Specifications Reference (PSREF)

Model	Region	Processor	vPro	Graphics	Memory	Display	Multi-touch	Storage	Optical	WLAN + Bluetooth	WWAN	SIM Card	Color	Case Material	Camera	Keyboard	Fingerprint Reader	TPM	Battery	Power Adapter	Operating System	Warranty	Ann Date (m/y)
20EX0008US	US	AMD A10-8700P	No	AMD R6 M340DX 2GB	4GBx1	14" HD (1366x768)	None	500GB 5400rpm	None	BCM43162 ac, 1x1 + BT4.0	None	None	Black	PC/ABS	720p	Non-backlit	None	FW TPM 2.0	6-cell (47Wh)	65W	Win10 DG Win7 Pro 64	1-year, Depot	11/15
20EX0009US	US	AMD A10-8700P	No	AMD R6 M340DX 2GB	8GBx1	14" HD (1366x768)	None	192GB SSD	None	BCM43162 ac, 1x1 + BT4.0	None	None	Black	PC/ABS	720p	Non-backlit	None	FW TPM 2.0	6-cell (47Wh)	65W	Win10 Pro 64	1-year, Depot	11/15
20EX000AUS	US	AMD A10-8700P	No	AMD R6 M340DX 2GB	4GBx1	14" HD (1366x768)	None	500GB 5400rpm	None	BCM43162 ac, 1x1 + BT4.0	None	None	Black	PC/ABS	720p	Non-backlit	None	FW TPM 2.0	6-cell (47Wh)	65W	Win10 Pro 64	1-year, Depot	11/15
20EX000BUS	US	AMD A10-8700P	No	AMD R6 M340DX 2GB	8GBx1	14" HD (1366x768)	None	500GB 5400rpm	None	BCM43162 ac, 1x1 + BT4.0	None	None	Black	PC/ABS	720p	Non-backlit	None	FW TPM 2.0	6-cell (47Wh)	65W	Win10 DG Win7 Pro 64	1-year, Depot	11/15
20EX000CUS	US	AMD A6-8500P	No	AMD R5 Graphics	4GBx1	14" HD (1366x768)	None	500GB 5400rpm	None	BCM43162 ac, 1x1 + BT4.0	None	None	Black	PC/ABS	720p	Non-backlit	None	dTPM 1.2	6-cell (47Wh)	45W	Win10 DG Win7 Pro 64	1-year, Depot	11/15
20EX000DUS	US	AMD A10-8700P	No	AMD R6 M340DX 2GB	8GBx1	14" HD (1366x768)	None	500GB 5400rpm	None	BCM43162 ac, 1x1 + BT4.0	None	None	Black	PC/ABS	720p	Non-backlit	None	FW TPM 2.0	6-cell (47Wh)	65W	Win10 Pro 64	1-year, Depot	11/15
20EX000EUS	US	AMD A10-8700P	No	AMD R6 M340DX 2GB	8GBx1	14" HD (1366x768)	None	192GB SSD	None	BCM43162 ac, 1x1 + BT4.0	None	None	Black	PC/ABS	720p	Non-backlit	None	FW TPM 2.0	6-cell (47Wh)	65W	Win10 DG Win7 Pro 64	1-year, Depot	11/15
20EX001JUS	US	AMD A10-8700P	No	AMD R6 M340DX 2GB	4GBx1	14" FHD (1920x1080) IPS	None	500GB 5400rpm	None	QCA435 ac, 1x1 + BT4.0	None	None	Black	Aluminum	720p	Non-backlit	None	FW TPM 2.0	6-cell (47Wh)	65W	Win10 Pro 64	1-year, Depot	06/16
20EX001KUS	US	AMD A10-8700P	No	AMD R6 M340DX 2GB	8GBx1	14" FHD (1920x1080) IPS	None	192GB SSD	None	QCA435 ac, 1x1 + BT4.0	None	None	Black	Aluminum	720p	Non-backlit	None	FW TPM 2.0	6-cell (47Wh)	65W	Win10 Pro 64	1-year, Depot	06/16
20EX001LUS	US	AMD A6-8500P	No	AMD R5 Graphics	4GBx1	14" HD (1366x768)	None	500GB 5400rpm	None	QCA435 ac, 1x1 + BT4.0	None	None	Black	PC/ABS	720p	Non-backlit	None	dTPM 1.2	6-cell (47Wh)	45W	Win10 DG Win7 Pro 64	1-year, Depot	06/16
20EX001MUS	US	AMD A10-8700P	No	AMD R6 M340DX 2GB	8GBx1	14" HD (1366x768)	None	192GB SSD	None	QCA435 ac, 1x1 + BT4.0	None	None	Black	PC/ABS	720p	Non-backlit	None	FW TPM 2.0	6-cell (47Wh)	65W	Win10 DG Win7 Pro 64	1-year, Depot	06/16
20EX001NUS	US	AMD A6-8500P	No	AMD R5 Graphics	4GBx1	14" HD (1366x768)	None	500GB 5400rpm	None	QCA435 ac, 1x1 + BT4.0	None	None	Black	PC/ABS	720p	Non-backlit	None	dTPM1.2 + FW TPM2.0	6-cell (47Wh)	45W	Win10 Pro 64	1-year, Depot	06/16
20EX001PUS	US	AMD A10-8700P	No	AMD R6 M340DX 2GB	8GBx1	14" HD (1366x768)	None	500GB 5400rpm	None	QCA435 ac, 1x1 + BT4.0	None	None	Black	PC/ABS	720p	Non-backlit	None	FW TPM 2.0	6-cell (47Wh)	65W	Win10 DG Win7 Pro 64	1-year, Depot	06/16
20EX001QUS	US	AMD A10-8700P	No	AMD R6 M340DX 2GB	8GBx1	14" FHD (1920x1080) IPS	None	500GB 5400rpm	None	QCA435 ac, 1x1 + BT4.0	None	None	Black	Aluminum	720p	Non-backlit	None	FW TPM 2.0	6-cell (47Wh)	65W	Win10 Pro 64	1-year, Depot	06/16
20EX001RUS	US	AMD A10-8700P	No	AMD R6 M340DX 2GB	4GBx1	14" HD (1366x768)	None	500GB 5400rpm	None	QCA435 ac, 1x1 + BT4.0	None	None	Black	PC/ABS	720p	Non-backlit	None	FW TPM 2.0	6-cell (47Wh)	65W	Win10 DG Win7 Pro 64	1-year, Depot	06/16

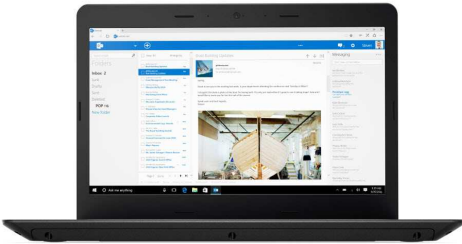

ThinkPad E470 Platform Specifications

Product Specifications Reference (PSREF)

Processor	7th Generation Intel® Core™ i3 / i5 / i7 Processor								Dimensions <i>Aluminum (WxDxH):</i> 13.35" x 9.53" x 0.88"; 339mm x 242mm x 22.4mm <i>PC/ABS (WxDxH):</i> 13.35" x 9.53" x 0.93"; 339mm x 242mm x 23.7mm
	Processor Number	# of Cores	# of Threads	Base Frequency	Max Turbo Frequency	Cache	Memory Controller	Processor Graphics	
	i3-6100U	2	4	2.3 GHz	-	3MB	DDR4-2133	Intel HD Graphics 520	
	i5-6200U			2.3 GHz	2.8 GHz	3MB			
	i7-6500U			2.5 GHz	3.1 GHz	4MB			
	i3-7100U			2.4 GHz	-	3MB	DDR4-2133	Intel HD Graphics 620	
	i5-7200U			2.5 GHz	3.1 GHz	3MB			
i7-7500U	2.7 GHz			3.5 GHz	4MB				

Graphics	Intel HD Graphics in processor only, or NVidia GeForce 920MX Graphics, 2GB DDR3 memory, or NVidia GeForce 940MX Graphics, 2GB DDR3 memory, digital monitor support via HDMI™ (supporting HDCP to output protected content); supports dual independent displays; Max resolution: 1920x1080 (HDMI)@60Hz	Keyboard UltraNav™ ThinkLight™	6-row, spill-resistant, multimedia Fn keys TrackPoint® pointing device and multi-touch with 3+2 buttons click pad None
Memory	32GB max / PC4-19200 2400MHz DDR4, non-parity, dual-channel capable, two 260-pin SO-DIMM sockets * System clocks down for processors with lower memory controller	Fingerprint reader NFC Security Security chip	<i>Some:</i> HD720p resolution, fixed focus HD Audio, Conexant® CX11852 codec, Dolby® Audio™ Premium / stereo speakers, 2W x 2 / dual array microphone, combo audio / microphone jack <i>Some:</i> Fingerprint reader on the keyboard bezel, swipe sensor None Power-on password, hard disk password, supervisor password, security keyhole <i>fTPM2.0:</i> Firmware TPM 2.0, integrated in chipset <i>dTPM2.0:</i> Discrete TPM 2.0, TCG Certified
Display	<i>Some:</i> 14.0" (355mm) HD (1366x768), anti-glare, LED backlight, 220 nits, 16:9 aspect ratio, 400:1 contrast ratio <i>Some:</i> 14.0" (355mm) FHD (1920x1080), anti-glare, LED backlight, IPS, 250 nits, 16:9 aspect ratio, 400:1 contrast ratio <i>Some:</i> 14.0" (355mm) FHD (1920x1080), anti-glare, LED backlight, 220 nits, 16:9 aspect ratio, 400:1 contrast ratio	vPro	No
Multi-touch	None	Battery type Battery life AC adapter	Li-Polymer 3-cell (45Wh) 3-cell (45Wh): up to 8.4 hr <i>Some:</i> 45-watt AC adapter <i>Some:</i> 65-watt AC adapter <i>Some:</i> 90-watt AC adapter
Storage	<i>Some:</i> SSD / SATA 6.0Gb/s, 2.5" wide, 7mm high, removable, upgradable <i>Some:</i> HDD / SATA 6.0Gb/s, 2.5" wide, removable, upgradable, Active Protection System™	Preload	<i>Some:</i> Windows 10 Pro 64 <i>Some:</i> Windows 10 Home 64 • Lenovo Companion • Lenovo Settings • Microsoft Office preloaded; purchase a product key to activate • McAfee® Live Safe (30-day trial)
M.2 SSD Optical	None None	Limited warranty	1-year - depot repair service / service upgrades available
Ethernet	Gigabit Ethernet Connection, Realtek R8111GUS	Mil-Spec test	None
WLAN	<i>One of the following, configurable by model:</i> • Intel Dual Band Wireless-AC 8265, 2x2, Wi-Fi + BT combo adapter, M.2 Card • QCA, Qualcomm 344A-AC, 2x2, Wi-Fi + Bluetooth combo adapter, M.2 Card • QCA, Qualcomm 435-AC, 1x1, Wi-Fi + Bluetooth combo adapter, M.2 Card	Environment	EPEAT™ Gold; ENERGY STAR®; RoHS-compliant
Bluetooth™	Bluetooth wireless, integrated in Wi-Fi + Bluetooth combo adapter		
WWAN SIM card	None None		
Smart Card Reader ExpressCard Dock Multicard Reader	None None None 4-in-1 reader (MMC, SD, SDHC, SDXC)		
Ports	Two USB 3.0 (one Always On), one USB 2.0, HDMI, Ethernet (RJ-45), combo audio / microphone jack		
Monitor cable	None		

ThinkPad E470 - TopSeller - 20H1

Product Specifications Reference (PSREF)

Model	Region	Processor	vPro	Graphics	Memory	Display	Multi-touch	Storage	Optical	WLAN + Bluetooth	WWAN	SIM Card	Color	Case Material	Camera	Keyboard	Fingerprint Reader	TPM	Battery	Power Adapter	Operating System	Warranty	Ann Date (m/y)
20H10038US	US	i3-7100U	No	Intel HD 620	4GBx1	14" HD (1366x768)	None	500GB 7200rpm	None	11ac, 1x1 + BT4.1	None	None	Black	PC/ABS	720p	Non-backlit	Fingerprint Reader	dTPM 2.0	3-cell (45Wh)	45W	Win10 Pro 64	1-year, Depot	09/16
20H10039US	US	i5-7200U	No	Intel HD 620	4GBx1	14" HD (1366x768)	None	500GB 7200rpm	None	11ac, 1x1 + BT4.1	None	None	Black	PC/ABS	720p	Non-backlit	Fingerprint Reader	dTPM 2.0	3-cell (45Wh)	45W	Win10 Pro 64	1-year, Depot	09/16
20H1003AUS	US	i5-7200U	No	Intel HD 620	8GBx1	14" HD (1366x768)	None	256GB SSD Opal2	None	11ac, 1x1 + BT4.1	None	None	Black	PC/ABS	720p	Non-backlit	Fingerprint Reader	dTPM 2.0	3-cell (45Wh)	45W	Win10 Pro 64	1-year, Depot	09/16
20H1003DUS	US	i3-6006U	No	Intel HD 520	4GBx1	14" HD (1366x768)	None	500GB 7200rpm	None	11ac, 1x1 + BT4.1	None	None	Black	PC/ABS	720p	Non-backlit	Fingerprint Reader	dTPM 2.0	3-cell (45Wh)	45W	Win10 Pro 64	1-year, Depot	11/16
20H1004RUS	US	i7-7500U	No	940MX 2GB	8GBx1	14" FHD (1920x1080) IPS	None	500GB 7200rpm	None	Intel 8265 ac, 2x2 + BT4.1	None	None	Black	PC/ABS	720p	Non-backlit	Fingerprint Reader	FW TPM 2.0	3-cell (45Wh)	65W	Win10 Pro 64	1-year, Depot	09/16
20H1004SUS	US	i5-7200U	No	Intel HD 620	8GBx1	14" FHD (1920x1080) IPS	None	256GB SSD Opal2	None	11ac, 1x1 + BT4.1	None	None	Black	PC/ABS	720p	Non-backlit	Fingerprint Reader	dTPM 2.0	3-cell (45Wh)	45W	Win10 Pro 64	1-year, Depot	09/16
20H1004TUS	US	i7-7500U	No	940MX 2GB	8GBx1	14" FHD (1920x1080) IPS	None	256GB SSD Opal2	None	Intel 8265 ac, 2x2 + BT4.1	None	None	Black	PC/ABS	720p	Non-backlit	Fingerprint Reader	FW TPM 2.0	3-cell (45Wh)	65W	Win10 Pro 64	1-year, Depot	09/16
20H10055US	US	i5-7200U	No	Intel HD 620	8GBx1	14" FHD (1920x1080) IPS	None	180GB SSD Opal2	None	11ac, 1x1 + BT4.1	None	None	Black	PC/ABS	720p	Non-backlit	Fingerprint Reader	dTPM 2.0	3-cell (45Wh)	45W	Win10 Pro 64	1-year, Depot	03/17
20H10059US	US	i3-7100U	No	Intel HD 620	4GBx1	14" HD (1366x768)	None	180GB SSD Opal2	None	11ac, 1x1 + BT4.1	None	None	Black	PC/ABS	720p	Non-backlit	Fingerprint Reader	dTPM 2.0	3-cell (45Wh)	45W	Win10 Pro 64	1-year, Depot	01/17
20H1005AUS	US	i5-7200U	No	Intel HD 620	4GBx1	14" HD (1366x768)	None	180GB SSD Opal2	None	11ac, 1x1 + BT4.1	None	None	Black	PC/ABS	720p	Non-backlit	Fingerprint Reader	dTPM 2.0	3-cell (45Wh)	45W	Win10 Pro 64	1-year, Depot	01/17
20H1005BUS	US	i5-7200U	No	Intel HD 620	8GBx1	14" HD (1366x768)	None	180GB SSD Opal2	None	11ac, 1x1 + BT4.1	None	None	Black	PC/ABS	720p	Non-backlit	Fingerprint Reader	dTPM 2.0	3-cell (45Wh)	45W	Win10 Pro 64	1-year, Depot	01/17
20H10065US	US	i3-6006U	No	Intel HD 520	4GBx1	14" HD (1366x768)	None	500GB 7200rpm	None	11ac, 1x1 + BT4.1	None	None	Black	PC/ABS	720p	Non-backlit	Fingerprint Reader	dTPM 2.0	3-cell (45Wh)	45W	Win10 DG Win7 Pro 64	1-year, Depot	03/17
20H10066US	US	i7-6500U	No	940MX 2GB	8GBx1	14" FHD (1920x1080) IPS	None	256GB SSD Opal2	None	Intel 8265 ac, 2x2 + BT4.1	None	None	Black	PC/ABS	720p	Non-backlit	Fingerprint Reader	FW TPM 2.0	3-cell (45Wh)	65W	Win10 DG Win7 Pro 64	1-year, Depot	03/17
20H10067US	US	i5-6200U	No	Intel HD 520	8GBx1	14" FHD (1920x1080) IPS	None	256GB SSD Opal2	None	11ac, 1x1 + BT4.1	None	None	Black	PC/ABS	720p	Non-backlit	Fingerprint Reader	dTPM 2.0	3-cell (45Wh)	45W	Win10 DG Win7 Pro 64	1-year, Depot	03/17
20H10068US	US	i7-6500U	No	940MX 2GB	8GBx1	14" FHD (1920x1080) IPS	None	500GB 7200rpm	None	Intel 8265 ac, 2x2 + BT4.1	None	None	Black	PC/ABS	720p	Non-backlit	Fingerprint Reader	FW TPM 2.0	3-cell (45Wh)	65W	Win10 DG Win7 Pro 64	1-year, Depot	03/17
20H10069US	US	i5-6200U	No	Intel HD 520	4GBx1	14" HD (1366x768)	None	500GB 7200rpm	None	11ac, 1x1 + BT4.1	None	None	Black	PC/ABS	720p	Non-backlit	Fingerprint Reader	dTPM 2.0	3-cell (45Wh)	45W	Win10 DG Win7 Pro 64	1-year, Depot	03/17
20H1006AUS	US	i5-6200U	No	Intel HD 520	8GBx1	14" HD (1366x768)	None	256GB SSD Opal2	None	11ac, 1x1 + BT4.1	None	None	Black	PC/ABS	720p	Non-backlit	Fingerprint Reader	dTPM 2.0	3-cell (45Wh)	45W	Win10 DG Win7 Pro 64	1-year, Depot	03/17
20H1006DUS	US	i5-7200U	No	Intel HD 620	8GBx1	14" FHD (1920x1080) IPS	None	500GB 7200rpm	None	11ac, 1x1 + BT4.1	None	None	Black	PC/ABS	720p	Non-backlit	Fingerprint Reader	dTPM 2.0	3-cell (45Wh)	45W	Win10 Pro 64	1-year, Depot	03/17
20H1006GUS	US	i3-6006U	No	Intel HD 520	4GBx1	14" HD (1366x768)	None	500GB 7200rpm	None	11ac, 1x1 + BT4.1	None	None	Black	PC/ABS	720p	Non-backlit	None	dTPM 2.0	3-cell (45Wh)	45W	Win10 DG Win7 Pro 64	1-year, Depot	03/17

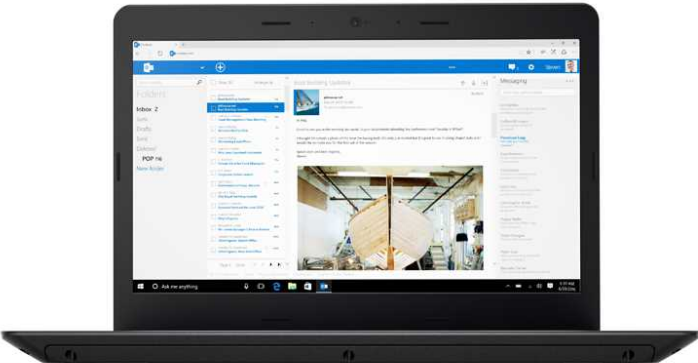

ThinkPad E475 Platform Specifications

Product Specifications Reference (PSREF)

Processor	AMD Accelerated Processor A6, or A10 APU								Dimensions Weight Case color Case material	<i>PC/ABS (WxDxH):</i> 13.35" x 9.53" x 0.93"; 339mm x 242mm x 23.7mm From 4.12 lb (1.87kg) Black <i>PC/ABS:</i> PolyCarbonate/Acrylonitrile-Butadiene-Styrene display cover
	Processor Number	# of Cores	# of Threads	Base Frequency	Max Turbo Frequency	Cache	Memory Types	Processor Graphics		
	A6-9500B	2	4	2.3 GHz	3.2 GHz	2MB	DDR4-1866	R5 Graphics		
A10-9600P	4	8	2.4 GHz	3.3 GHz	2MB					
Graphics	AMD Radeon™ R5 Graphics in processor only, or AMD Radeon R5 M430 Graphics, 2GB DDR3 memory, or digital monitor support via HDMI™ (supporting HDCP to output protected content); supports dual independent displays; Max resolution: 1920x1080 (HDMI)@60Hz								Camera	HD720p resolution, fixed focus
Chipset	AMD SoC (System on Chip) platform								Audio support	HD Audio, Conexant® CX11852 codec, Dolby® Audio™ Premium / stereo speakers, 2W x 2 / dual array microphone, combo audio / microphone jack
Memory	32GB max / PC4-19200 2400MHz DDR4, non-parity, dual-channel capable, two 260-pin SO-DIMM sockets *System automatically clocks down with 1866MHz DDR4 memory controller								Keyboard	6-row, spill-resistant, multimedia Fn keys
Display	Some: 14.0" (355mm) HD (1366x768), anti-glare, LED backlight, 220 nits, 16:9 aspect ratio, 400:1 contrast ratio								UltraNav™	TrackPoint® pointing device and multi-touch with 3+2 buttons click pad
Multi-touch	None								ThinkLight™	None
Storage	Some: SSD / SATA 6.0Gb/s, 2.5" wide, 7mm high, removable, upgradable Some: HDD / SATA 6.0Gb/s, 2.5" wide, removable, upgradable, Active Protection System™								Fingerprint reader	None
M.2 SSD	None								NFC	None
Optical	None								Security	Power-on password, hard disk password, supervisor password, security keyhole
Ethernet	Gigabit Ethernet Connection, Realtek R8111GUS								Security chip	<i>FW TPM2.0:</i> Firmware TPM 2.0, integrated in chipset <i>dTPM2.0:</i> Discrete TPM 2.0, TCG Certified
WLAN	One of the following, configurable by model: • QCA, Qualcomm 344A-AC, 2x2, Wi-Fi + Bluetooth combo adapter, M.2 Card • QCA, Qualcomm 435-AC, 1x1, Wi-Fi + Bluetooth combo adapter, M.2 Card								vPro	No
Bluetooth™	Bluetooth wireless, integrated in Wi-Fi + Bluetooth combo adapter								Battery type	Li-Polymer 3-cell (45Wh)
WWAN	None								Battery life	3-cell (45Wh): up to 6.5 hr
SIM card	None								AC adapter	Some: 45-watt AC adapter Some: 65-watt AC adapter
Smart Card Reader	None								Preload	Some: Windows 10 Pro 64 Some: Windows 10 Home 64 • Lenovo Companion • Lenovo Settings • Microsoft Office preloaded; purchase a product key to activate • McAfee® Live Safe (30-day trial)
ExpressCard	None								Limited warranty	1-year - depot repair service / service upgrades available
Dock	None								Mil-Spec test	None
Multicard Reader	4-in-1 reader (MMC, SD, SDHC, SDXC)								Environment	EPEAT™ Gold; ENERGY STAR®; RoHS-compliant
Ports	Two USB 3.0 (one Always On), one USB 2.0, HDMI, Ethernet (RJ-45), combo audio / microphone jack									
Monitor cable	None									

ThinkPad E475 - TopSeller - 20H4

Product Specifications Reference (PSREF)

Model	Region	Processor	vPro	Graphics	Memory	Display	Multi-touch	Storage(HDD/SSD)	Optical	WLAN + Bluetooth	WWAN	SIM Card	Color	Case Material	Camera	Keyboard	Fingerprint Reader	TPM	Battery	Power Adapter	Operating System	Warranty	Ann Date (m/y)
20H40006US	US	AMD A6-9500B	No	AMD R5 Graphics	4GBx1	14" HD (1366x768)	None	500GB 7200rpm	None	QCA435ac, 1x1 + BT4.1	None	None	Black	PC/ABS	720p	Non-backlit	None	dTPM 2.0	3-cell (45Wh)	45W	Windows 10 Pro 64	1-year, Depot	11/16
20H40007US	US	AMD A10-9600P	No	AMD R5 M430 2GB	8GBx1	14" HD (1366x768)	None	500GB 7200rpm	None	QCA435ac, 1x1 + BT4.1	None	None	Black	PC/ABS	720p	Non-backlit	None	FW TPM 2.0	3-cell (45Wh)	65W	Windows 10 Pro 64	1-year, Depot	11/16
20H40008US	US	AMD A10-9600P	No	AMD R5 M430 2GB	4GBx1	14" HD (1366x768)	None	500GB 7200rpm	None	QCA435ac, 1x1 + BT4.1	None	None	Black	PC/ABS	720p	Non-backlit	None	FW TPM 2.0	3-cell (45Wh)	65W	Windows 10 Pro 64	1-year, Depot	11/16
20H40009US	US	AMD A6-9500B	No	AMD R5 Graphics	8GBx1	14" HD (1366x768)	None	500GB 7200rpm	None	QCA435ac, 1x1 + BT4.1	None	None	Black	PC/ABS	720p	Non-backlit	None	dTPM 2.0	3-cell (45Wh)	45W	Windows 10 Pro 64	1-year, Depot	11/16
20H4000AUS	US	AMD A10-9600P	No	AMD R5 M430 2GB	8GBx1	14" HD (1366x768)	None	256GB SSD Opal2	None	QCA435ac, 1x1 + BT4.1	None	None	Black	PC/ABS	720p	Non-backlit	None	FW TPM 2.0	3-cell (45Wh)	65W	Windows 10 Pro 64	1-year, Depot	11/16
20H4000DUS	US	AMD A10-9600P	No	AMD R5 M430 2GB	8GBx1	14" HD (1366x768)	None	180GB SSD Opal2	None	QCA435ac, 1x1 + BT4.1	None	None	Black	PC/ABS	720p	Non-backlit	None	FW TPM 2.0	3-cell (45Wh)	65W	Windows 10 Pro 64	1-year, Depot	01/17



ThinkPad E550 Platform Specifications

Product Specifications Reference (PSREF)

Processor	4th or 5th Generation Intel® Core™ i3 / i5 / i7 Processor								Multicard Reader Ports Monitor cable Camera Audio support	4-in-1 reader (MMC, SD, SDHC, SDXC) Two USB 3.0 (one Always On), one USB 2.0, Ethernet (RJ-45), external monitor (VGA DB-15, HDMI), Lenovo OneLink connector None <i>Some:</i> 0.3-megapixel, fixed focus <i>Some:</i> HD720p resolution, fixed focus <i>Some:</i> 3D camera, Intel RealSense™ 3D Camera with MIC HD Audio, Conexant® CX20751 codec, Dolby® Advanced Audio™ v4 / stereo speakers or JBL speakers, 2W x 2 / dual array microphone, combo audio / microphone jack
	Processor Number	# of Cores	# of Threads	Base Frequency	Max Turbo Frequency	Cache	Memory speed	Processor Graphics		
	i3-4005U	2	4	1.7 GHz	-	3MB	DDR3L-1600	HD4400		
	i3-5005U	2	4	2.0 GHz	-	3MB		HD5500		
	i3-5015U	2	4	2.1 GHz		3MB		HD5500		
	i5-5200U	2	4	2.2 GHz	2.7 GHz	3MB		HD5500		
	i7-5500U	2	4	2.4 GHz	3.0 GHz	4MB		HD5500		
Graphics	Intel HD Graphics in processor only, or AMD Radeon R7 M260 Graphics, 2GB DDR3 memory, external analog monitor support via VGA DB-15 connector and digital monitor support via HDMI™ (supporting HDCP to output protected content); supports dual independent display Max resolution: 1920x1080 (HDMI)@60Hz								Keyboard UltraNav™ ThinkLight™	6-row, spill-resistant, multimedia Fn keys, numeric keypad TrackPoint® pointing device and multi-touch with 3+2 buttons click pad None
Chipset Memory	Intel SoC (System on Chip) platform 16GB max ⁷ / PC3-12800 1600MHz DDR3L, non-parity, dual-channel capable, two 204-pin SO-DIMM sockets								Security Security chip vPro Fingerprint reader NFC	Power-on password, hard disk password, supervisor password, security keyhole <i>Some:</i> Trusted Platform Module, TCG 1.2-compliant None <i>Some:</i> Fingerprint reader on the keyboard bezel, swipe sensor None
Display	<i>Some:</i> 15.6" (396mm) HD (1366x768) color, anti-glare, LED backlight, 200 nits, 16:9 aspect ratio <i>Some:</i> 15.6" (396mm) FHD (1920x1080) color, anti-glare, LED backlight, 220 nits, 16:9 aspect ratio								Battery type Battery life AC adapter	Li-Ion 6-cell (48Wh) 6-cell (48Wh): up to 9.0 hr <i>Some:</i> 45-watt AC adapter (Integrated Graphics) <i>Some:</i> 65-watt AC adapter (Discrete Graphics)
Multi-touch	<i>Some:</i> supports 10-finger gesture								Preload	<i>Some:</i> No operating system <i>Some:</i> Windows® 7 Professional 64 preinstalled through downgrade rights in Windows 8.1 Pro 64-bit • Lenovo Solution Center • Lenovo SHAREit • ThinkVantage Product Recovery • Rescue and Recovery™ • ThinkVantage System Update • Microsoft® Office preloaded; purchase a product key to activate • Norton™ Internet Security (30 days of virus definitions) <i>Some:</i> Windows 7 Professional preinstalled through downgrade rights in Windows 10 Pro 64 • Lenovo Solution Center • Lenovo SHAREit • ThinkVantage Product Recovery • Rescue and Recovery™ <i>Some:</i> Windows 10 Pro 64 <i>Some:</i> Windows 10 Home 64 • Lenovo Solution Center • Lenovo SHAREit • Lenovo Companion • Microsoft Office preloaded; purchase a product key to activate • McAfee LiveSafe (30 days of virus definitions)
Storage	<i>Some:</i> SSD / SATA 6.0Gb/s, 2.5" wide, 7mm high, removable, upgradable <i>Some:</i> HDD / SATA 6.0Gb/s, 2.5" wide, removable, upgradable, Shock Mounted Hard Drive, Active Protection System™ <i>Some:</i> Hybrid drive with 8GB NAND flash memory <i>Some:</i> DVD burner, 9.0mm high, removable <i>Some:</i> Blank Bezel None									
Optical										
M.2 SSD										
Ethernet	Intel WGI218V Gigabit Ethernet Connection									
Bluetooth™	Bluetooth 4.0 wireless, integrated in Wi-Fi + Bluetooth combo adapter									
WLAN	<i>One of the following, configurable by model:</i> • Intel Wireless-AC 3160, 1x1, Wi-Fi + Bluetooth combo adapter, M.2 Card • Intel Dual Band Wireless-AC 7265, 2x2, Wi-Fi + BT combo adapter, M.2 Card • RTL8723BE, Realtek 11b/g/n, 1x1, Wi-Fi + Bluetooth combo adapter, M.2 Card • BCM43162, Broadcom 11-AC, 1x1, Wi-Fi + BT combo adapter, M.2 Card									
WWAN	None									
SIM card	None									
Smart Card Read ExpressCard	None									
Dimensions	<i>None Touch(WxDxH):</i> 14.84" x 10.08" x 1.06"; 377mm x 256mm x 27mm									
Weight	<i>6-cell None Touch:</i> from 5.21 lb (2.35kg)									
Case color	Graphite Black									
Case material	PolyCarbonate/Acrylonitrile-Butadiene-Styrene (PC/ABS) plastic									
Limited warranty	1-year - depot repair service / service upgrades available									
Environment	EPEAT™ Gold; ENERGY STAR®; RoHS-compliant									

Model	Region	Processor	vPro	Graphics	Memory	Display	Multi-touch	Storage(HDD/SSD)	Optical	WLAN + Bluetooth	WWAN	SIM Card	Color	Case Material	Camera	Keyboard	Fingerprint Reader	TPM	Battery	Power Adapter	Operating System	Warranty	Ann Date (m/y)
20DF002WUS	US	i3-5005U	No	Intel HD 5500	4GBx1	15.6" HD (1366x768)	None	500GB 7200rpm	DVD±RW	Intel 3160 ac, 1x1 + BT4.0	None	None	Black	PC/ABS	720p	Non-backlit	Fingerprint Reader	dTPM 1.2	6-cell (48Wh)	45W	Win8.1 64-bit	1-year, Depot	01/15
20DF002XUS	US	i7-5500U	No	AMD R7 M260 2GB	8GBx1	15.6" HD (1366x768)	None	128GB SSD	DVD±RW	Intel 7265 ac, 2x2 + BT4.0	None	None	Black	PC/ABS	720p	Non-backlit	Fingerprint Reader	None	6-cell (48Wh)	65W	Win8.1 Pro 64-bit	1-year, Depot	01/15
20DF002YUS	US	i3-4005U	No	Intel HD 4400	4GBx1	15.6" HD (1366x768)	None	500GB 7200rpm	DVD±RW	Intel 3160 ac, 1x1 + BT4.0	None	None	Black	PC/ABS	720p	Non-backlit	Fingerprint Reader	dTPM 1.2	6-cell (48Wh)	45W	Win8.1 DG Win7 Pro 64	1-year, Depot	01/15
20DF0030US	US	i5-5200U	No	Intel HD 5500	4GBx1	15.6" HD (1366x768)	None	500GB 7200rpm	DVD±RW	Intel 3160 ac, 1x1 + BT4.0	None	None	Black	PC/ABS	720p	Non-backlit	Fingerprint Reader	dTPM 1.2	6-cell (48Wh)	45W	Win8.1 DG Win7 Pro 64	1-year, Depot	01/15
20DF0031US	US	i7-5500U	No	AMD R7 M260 2GB	4GBx1	15.6" HD (1366x768)	None	500GB 7200rpm	DVD±RW	Intel 7265 ac, 2x2 + BT4.0	None	None	Black	PC/ABS	720p	Non-backlit	Fingerprint Reader	None	6-cell (48Wh)	65W	Win8.1 DG Win7 Pro 64	1-year, Depot	01/15
20DF0032US	US	i7-5500U	No	AMD R7 M260 2GB	8GBx1	15.6" HD (1366x768)	None	128GB SSD	DVD±RW	Intel 7265 ac, 2x2 + BT4.0	None	None	Black	PC/ABS	720p	Non-backlit	Fingerprint Reader	None	6-cell (48Wh)	65W	Win8.1 DG Win7 Pro 64	1-year, Depot	01/15
20DF0033US	US	i3-4005U	No	Intel HD 4400	4GBx1	15.6" HD (1366x768)	None	500GB 7200rpm	DVD±RW	Intel 3160 ac, 1x1 + BT4.0	None	None	Black	PC/ABS	720p	Non-backlit	None	dTPM 1.2	6-cell (48Wh)	45W	Win8.1 64-bit	1-year, Depot	01/15
20DF0034US	US	i3-4005U	No	Intel HD 4400	4GBx1	15.6" HD (1366x768)	None	500GB 7200rpm	DVD±RW	Intel 3160 ac, 1x1 + BT4.0	None	None	Black	PC/ABS	720p	Non-backlit	None	dTPM 1.2	6-cell (48Wh)	45W	Win8.1 DG Win7 Pro 64	1-year, Depot	01/15
20DF0035US	US	i3-4005U	No	Intel HD 4400	4GBx1	15.6" HD (1366x768)	None	1TB 5400rpm	DVD±RW	Intel 3160 ac, 1x1 + BT4.0	None	None	Black	PC/ABS	720p	Non-backlit	Fingerprint Reader	dTPM 1.2	6-cell (48Wh)	45W	Win8.1 DG Win7 Pro 64	1-year, Depot	01/15
20DF0036US	US	i3-4005U	No	Intel HD 4400	8GBx1	15.6" HD (1366x768)	None	500GB 7200rpm	DVD±RW	Intel 3160 ac, 1x1 + BT4.0	None	None	Black	PC/ABS	720p	Non-backlit	Fingerprint Reader	dTPM 1.2	6-cell (48Wh)	45W	Win8.1 DG Win7 Pro 64	1-year, Depot	01/15
20DF0037US	US	i3-4005U	No	Intel HD 4400	8GBx1	15.6" HD (1366x768)	None	1TB 5400rpm	DVD±RW	Intel 3160 ac, 1x1 + BT4.0	None	None	Black	PC/ABS	720p	Non-backlit	Fingerprint Reader	dTPM 1.2	6-cell (48Wh)	45W	Win8.1 DG Win7 Pro 64	1-year, Depot	01/15
20DF0038US	US	i3-5005U	No	Intel HD 5500	4GBx1	15.6" HD (1366x768)	None	500GB 7200rpm	DVD±RW	Intel 3160 ac, 1x1 + BT4.0	None	None	Black	PC/ABS	720p	Non-backlit	Fingerprint Reader	dTPM 1.2	6-cell (48Wh)	45W	Win8.1 DG Win7 Pro 64	1-year, Depot	01/15
20DF0039US	US	i3-5005U	No	Intel HD 5500	4GBx1	15.6" HD (1366x768)	None	500GB 7200rpm	DVD±RW	Intel 7265 ac, 2x2 + BT4.0	None	None	Black	PC/ABS	720p	Non-backlit	Fingerprint Reader	dTPM 1.2	6-cell (48Wh)	45W	Win8.1 DG Win7 Pro 64	1-year, Depot	01/15
20DF003AUS	US	i3-5005U	No	Intel HD 5500	4GBx1	15.6" HD (1366x768)	None	1TB 5400rpm	DVD±RW	Intel 7265 ac, 2x2 + BT4.0	None	None	Black	PC/ABS	720p	Non-backlit	Fingerprint Reader	dTPM 1.2	6-cell (48Wh)	45W	Win8.1 DG Win7 Pro 64	1-year, Depot	01/15
20DF003BUS	US	i3-5005U	No	Intel HD 5500	4GBx1	15.6" HD (1366x768)	None	1TB 5400rpm	DVD±RW	Intel 3160 ac, 1x1 + BT4.0	None	None	Black	PC/ABS	720p	Non-backlit	Fingerprint Reader	dTPM 1.2	6-cell (48Wh)	45W	Win8.1 DG Win7 Pro 64	1-year, Depot	01/15
20DF003CUS	US	i3-5005U	No	Intel HD 5500	8GBx1	15.6" HD (1366x768)	None	500GB 7200rpm	DVD±RW	Intel 3160 ac, 1x1 + BT4.0	None	None	Black	PC/ABS	720p	Non-backlit	Fingerprint Reader	dTPM 1.2	6-cell (48Wh)	45W	Win8.1 DG Win7 Pro 64	1-year, Depot	01/15
20DF003DUS	US	i3-5005U	No	Intel HD 5500	8GBx1	15.6" HD (1366x768)	None	500GB 7200rpm	DVD±RW	Intel 7265 ac, 2x2 + BT4.0	None	None	Black	PC/ABS	720p	Non-backlit	Fingerprint Reader	dTPM 1.2	6-cell (48Wh)	45W	Win8.1 DG Win7 Pro 64	1-year, Depot	01/15
20DF003EUS	US	i3-5005U	No	Intel HD 5500	8GBx1	15.6" HD (1366x768)	None	1TB 5400rpm	DVD±RW	Intel 3160 ac, 1x1 + BT4.0	None	None	Black	PC/ABS	720p	Non-backlit	Fingerprint Reader	dTPM 1.2	6-cell (48Wh)	45W	Win8.1 DG Win7 Pro 64	1-year, Depot	01/15
20DF003FUS	US	i5-5200U	No	Intel HD 5500	4GBx1	15.6" HD (1366x768)	None	500GB 7200rpm	DVD±RW	Intel 7265 ac, 2x2 + BT4.0	None	None	Black	PC/ABS	720p	Non-backlit	Fingerprint Reader	dTPM 1.2	6-cell (48Wh)	45W	Win8.1 DG Win7 Pro 64	1-year, Depot	01/15
20DF003GUS	US	i5-5200U	No	Intel HD 5500	4GBx1	15.6" FHD (1920x1080)	None	500GB 7200rpm	DVD±RW	Intel 7265 ac, 2x2 + BT4.0	None	None	Black	PC/ABS	720p	Non-backlit	Fingerprint Reader	dTPM 1.2	6-cell (48Wh)	45W	Win8.1 DG Win7 Pro 64	1-year, Depot	01/15

Model	Region	Processor	vPro	Graphics	Memory	Display	Multi-touch	Storage(HDD/SSD)	Optical	WLAN + Bluetooth	WWAN	SIM Card	Color	Case Material	Camera	Keyboard	Fingerprint Reader	TPM	Battery	Power Adapter	Operating System	Warranty	Ann Date (m/y)
20DF003HUS	US	i5-5200U	No	Intel HD 5500	4GBx1	15.6" HD (1366x768)	None	128GB SSD	DVD±RW	Intel 7265 ac, 2x2 + BT4.0	None	None	Black	PC/ABS	720p	Non-backlit	Fingerprint Reader	dTPM 1.2	6-cell (48Wh)	45W	Win8.1 DG Win7 Pro 64	1-year, Depot	01/15
20DF003JUS	US	i5-5200U	No	Intel HD 5500	4GBx1	15.6" FHD (1920x1080)	None	128GB SSD	DVD±RW	Intel 7265 ac, 2x2 + BT4.0	None	None	Black	PC/ABS	720p	Non-backlit	Fingerprint Reader	dTPM 1.2	6-cell (48Wh)	45W	Win8.1 DG Win7 Pro 64	1-year, Depot	01/15
20DF003KUS	US	i5-5200U	No	Intel HD 5500	4GBx1	15.6" HD (1366x768)	None	1TB 5400rpm	DVD±RW	Intel 3160 ac, 1x1 + BT4.0	None	None	Black	PC/ABS	720p	Non-backlit	Fingerprint Reader	dTPM 1.2	6-cell (48Wh)	45W	Win8.1 DG Win7 Pro 64	1-year, Depot	01/15
20DF003LUS	US	i5-5200U	No	Intel HD 5500	4GBx1	15.6" HD (1366x768)	None	1TB 5400rpm	DVD±RW	Intel 7265 ac, 2x2 + BT4.0	None	None	Black	PC/ABS	720p	Non-backlit	Fingerprint Reader	dTPM 1.2	6-cell (48Wh)	45W	Win8.1 DG Win7 Pro 64	1-year, Depot	01/15
20DF003MUS	US	i5-5200U	No	Intel HD 5500	4GBx1	15.6" FHD (1920x1080)	None	1TB 5400rpm	DVD±RW	Intel 7265 ac, 2x2 + BT4.0	None	None	Black	PC/ABS	720p	Non-backlit	Fingerprint Reader	dTPM 1.2	6-cell (48Wh)	45W	Win8.1 DG Win7 Pro 64	1-year, Depot	01/15
20DF003NUS	US	i5-5200U	No	Intel HD 5500	8GBx1	15.6" HD (1366x768)	None	500GB 7200rpm	DVD±RW	Intel 3160 ac, 1x1 + BT4.0	None	None	Black	PC/ABS	720p	Non-backlit	Fingerprint Reader	dTPM 1.2	6-cell (48Wh)	45W	Win8.1 DG Win7 Pro 64	1-year, Depot	01/15
20DF003PUS	US	i5-5200U	No	Intel HD 5500	8GBx1	15.6" HD (1366x768)	None	500GB 7200rpm	DVD±RW	Intel 7265 ac, 2x2 + BT4.0	None	None	Black	PC/ABS	720p	Non-backlit	Fingerprint Reader	dTPM 1.2	6-cell (48Wh)	45W	Win8.1 DG Win7 Pro 64	1-year, Depot	01/15
20DF003QUS	US	i5-5200U	No	Intel HD 5500	8GBx1	15.6" FHD (1920x1080)	None	500GB 7200rpm	DVD±RW	Intel 7265 ac, 2x2 + BT4.0	None	None	Black	PC/ABS	720p	Non-backlit	Fingerprint Reader	dTPM 1.2	6-cell (48Wh)	45W	Win8.1 DG Win7 Pro 64	1-year, Depot	01/15
20DF003RUS	US	i5-5200U	No	Intel HD 5500	8GBx1	15.6" HD (1366x768)	None	128GB SSD	DVD±RW	Intel 7265 ac, 2x2 + BT4.0	None	None	Black	PC/ABS	720p	Non-backlit	Fingerprint Reader	dTPM 1.2	6-cell (48Wh)	45W	Win8.1 DG Win7 Pro 64	1-year, Depot	01/15
20DF003SUS	US	i5-5200U	No	Intel HD 5500	8GBx1	15.6" FHD (1920x1080)	None	128GB SSD	DVD±RW	Intel 7265 ac, 2x2 + BT4.0	None	None	Black	PC/ABS	720p	Non-backlit	Fingerprint Reader	dTPM 1.2	6-cell (48Wh)	45W	Win8.1 DG Win7 Pro 64	1-year, Depot	01/15
20DF003TUS	US	i5-5200U	No	Intel HD 5500	8GBx1	15.6" HD (1366x768)	None	1TB 5400rpm	DVD±RW	Intel 3160 ac, 1x1 + BT4.0	None	None	Black	PC/ABS	720p	Non-backlit	Fingerprint Reader	dTPM 1.2	6-cell (48Wh)	45W	Win8.1 DG Win7 Pro 64	1-year, Depot	01/15
20DF003UUS	US	i5-5200U	No	Intel HD 5500	8GBx1	15.6" HD (1366x768)	None	1TB 5400rpm	DVD±RW	Intel 7265 ac, 2x2 + BT4.0	None	None	Black	PC/ABS	720p	Non-backlit	Fingerprint Reader	dTPM 1.2	6-cell (48Wh)	45W	Win8.1 DG Win7 Pro 64	1-year, Depot	01/15
20DF003VUS	US	i5-5200U	No	Intel HD 5500	8GBx1	15.6" FHD (1920x1080)	None	1TB 5400rpm	DVD±RW	Intel 7265 ac, 2x2 + BT4.0	None	None	Black	PC/ABS	720p	Non-backlit	Fingerprint Reader	dTPM 1.2	6-cell (48Wh)	45W	Win8.1 DG Win7 Pro 64	1-year, Depot	01/15
20DF003WUS	US	i7-5500U	No	AMD R7 M260 2GB	4GBx1	15.6" FHD (1920x1080)	None	500GB 7200rpm	DVD±RW	Intel 7265 ac, 2x2 + BT4.0	None	None	Black	PC/ABS	720p	Non-backlit	Fingerprint Reader	None	6-cell (48Wh)	65W	Win8.1 DG Win7 Pro 64	1-year, Depot	01/15
20DF003XUS	US	i7-5500U	No	AMD R7 M260 2GB	4GBx1	15.6" FHD (1920x1080)	None	128GB SSD	DVD±RW	Intel 7265 ac, 2x2 + BT4.0	None	None	Black	PC/ABS	720p	Non-backlit	Fingerprint Reader	None	6-cell (48Wh)	65W	Win8.1 DG Win7 Pro 64	1-year, Depot	01/15
20DF003YUS	US	i7-5500U	No	AMD R7 M260 2GB	4GBx1	15.6" FHD (1920x1080)	None	1TB 5400rpm	DVD±RW	Intel 7265 ac, 2x2 + BT4.0	None	None	Black	PC/ABS	720p	Non-backlit	Fingerprint Reader	None	6-cell (48Wh)	65W	Win8.1 DG Win7 Pro 64	1-year, Depot	01/15
20DF0040US	US	i7-5500U	No	AMD R7 M260 2GB	8GBx1	15.6" FHD (1920x1080)	None	500GB 7200rpm	DVD±RW	Intel 7265 ac, 2x2 + BT4.0	None	None	Black	PC/ABS	720p	Non-backlit	Fingerprint Reader	None	6-cell (48Wh)	65W	Win8.1 DG Win7 Pro 64	1-year, Depot	01/15
20DF0041US	US	i7-5500U	No	AMD R7 M260 2GB	8GBx1	15.6" FHD (1920x1080)	None	128GB SSD	DVD±RW	Intel 7265 ac, 2x2 + BT4.0	None	None	Black	PC/ABS	720p	Non-backlit	Fingerprint Reader	None	6-cell (48Wh)	65W	Win8.1 DG Win7 Pro 64	1-year, Depot	01/15
20DF0042US	US	i7-5500U	No	AMD R7 M260 2GB	8GBx1	15.6" FHD (1920x1080)	None	1TB 5400rpm	DVD±RW	Intel 7265 ac, 2x2 + BT4.0	None	None	Black	PC/ABS	720p	Non-backlit	Fingerprint Reader	None	6-cell (48Wh)	65W	Win8.1 DG Win7 Pro 64	1-year, Depot	01/15
20DF0043US	US	i3-4005U	No	Intel HD 4400	4GBx1	15.6" HD (1366x768)	None	500GB 7200rpm	DVD±RW	Intel 3160 ac, 1x1 + BT4.0	None	None	Black	PC/ABS	720p	Non-backlit	None	dTPM 1.2	6-cell (48Wh)	45W	Win8.1 Pro 64-bit	1-year, Depot	01/15

Model	Region	Processor	vPro	Graphics	Memory	Display	Multi-touch	Storage(HDD/SSD)	Optical	WLAN + Bluetooth	WWAN	SIM Card	Color	Case Material	Camera	Keyboard	Fingerprint Reader	TPM	Battery	Power Adapter	Operating System	Warranty	Ann Date (m/y)
20DF0044US	US	i3-4005U	No	Intel HD 4400	8GBx1	15.6" HD (1366x768)	None	500GB 7200rpm	DVD±RW	Intel 3160 ac, 1x1 + BT4.0	None	None	Black	PC/ABS	720p	Non-backlit	None	dTPM 1.2	6-cell (48Wh)	45W	Win8.1 Pro 64-bit	1-year, Depot	01/15
20DF0045US	US	i3-4005U	No	Intel HD 4400	8GBx1	15.6" HD (1366x768)	None	1TB 5400rpm	DVD±RW	Intel 3160 ac, 1x1 + BT4.0	None	None	Black	PC/ABS	720p	Non-backlit	Fingerprint Reader	dTPM 1.2	6-cell (48Wh)	45W	Win8.1 Pro 64-bit	1-year, Depot	01/15
20DF0046US	US	i3-4005U	No	Intel HD 4400	8GBx1	15.6" HD (1366x768)	None	500GB 7200rpm	DVD±RW	Intel 3160 ac, 1x1 + BT4.0	None	None	Black	PC/ABS	720p	Non-backlit	Fingerprint Reader	dTPM 1.2	6-cell (48Wh)	45W	Win8.1 Pro 64-bit	1-year, Depot	01/15
20DF0047US	US	i3-5005U	No	Intel HD 5500	4GBx1	15.6" HD (1366x768)	None	500GB 7200rpm	DVD±RW	Intel 3160 ac, 1x1 + BT4.0	None	None	Black	PC/ABS	720p	Non-backlit	Fingerprint Reader	dTPM 1.2	6-cell (48Wh)	45W	Win8.1 Pro 64-bit	1-year, Depot	01/15
20DF0048US	US	i3-5005U	No	Intel HD 5500	4GBx1	15.6" HD (1366x768)	None	1TB 5400rpm	DVD±RW	Intel 3160 ac, 1x1 + BT4.0	None	None	Black	PC/ABS	720p	Non-backlit	Fingerprint Reader	dTPM 1.2	6-cell (48Wh)	45W	Win8.1 Pro 64-bit	1-year, Depot	01/15
20DF0049US	US	i3-5005U	No	Intel HD 5500	8GBx1	15.6" HD (1366x768)	None	500GB 7200rpm	DVD±RW	Intel 3160 ac, 1x1 + BT4.0	None	None	Black	PC/ABS	720p	Non-backlit	Fingerprint Reader	dTPM 1.2	6-cell (48Wh)	45W	Win8.1 Pro 64-bit	1-year, Depot	01/15
20DF004AUS	US	i3-5005U	No	Intel HD 5500	8GBx1	15.6" HD (1366x768)	None	1TB 5400rpm	DVD±RW	Intel 3160 ac, 1x1 + BT4.0	None	None	Black	PC/ABS	720p	Non-backlit	Fingerprint Reader	dTPM 1.2	6-cell (48Wh)	45W	Win8.1 Pro 64-bit	1-year, Depot	01/15
20DF004BUS	US	i5-5200U	No	Intel HD 5500	4GBx1	15.6" HD (1366x768)	None	500GB 7200rpm	DVD±RW	Intel 3160 ac, 1x1 + BT4.0	None	None	Black	PC/ABS	720p	Non-backlit	Fingerprint Reader	dTPM 1.2	6-cell (48Wh)	45W	Win8.1 Pro 64-bit	1-year, Depot	01/15
20DF004CUS	US	i5-5200U	No	Intel HD 5500	4GBx1	15.6" HD (1366x768)	None	1TB 5400rpm	DVD±RW	Intel 3160 ac, 1x1 + BT4.0	None	None	Black	PC/ABS	720p	Non-backlit	Fingerprint Reader	dTPM 1.2	6-cell (48Wh)	45W	Win8.1 Pro 64-bit	1-year, Depot	01/15
20DF004DUS	US	i5-5200U	No	Intel HD 5500	8GBx1	15.6" HD (1366x768)	None	500GB 7200rpm	DVD±RW	Intel 3160 ac, 1x1 + BT4.0	None	None	Black	PC/ABS	720p	Non-backlit	Fingerprint Reader	dTPM 1.2	6-cell (48Wh)	45W	Win8.1 Pro 64-bit	1-year, Depot	01/15
20DF004EUS	US	i5-5200U	No	Intel HD 5500	8GBx1	15.6" HD (1366x768)	None	1TB 5400rpm	DVD±RW	Intel 3160 ac, 1x1 + BT4.0	None	None	Black	PC/ABS	720p	Non-backlit	Fingerprint Reader	dTPM 1.2	6-cell (48Wh)	45W	Win8.1 Pro 64-bit	1-year, Depot	01/15
20DF00BXUS	US	i3-4005U	No	Intel HD 4400	4GBx1	15.6" HD (1366x768)	None	500GB 7200rpm	DVD±RW	Intel 3160 ac, 1x1 + BT4.0	None	None	Black	PC/ABS	720p	Non-backlit	Fingerprint Reader	dTPM 1.2	6-cell (48Wh)	45W	Win10 Pro 64	1-year, Depot	07/15
20DF00BYUS	US	i7-5500U	No	AMD R7 M260 2GB	8GBx1	15.6" FHD (1920x1080)	None	500GB 7200rpm	DVD±RW	Intel 7265 ac, 2x2 + BT4.0	None	None	Black	PC/ABS	720p	Non-backlit	Fingerprint Reader	None	6-cell (48Wh)	65W	Win10 Pro 64	1-year, Depot	07/15
20DF00C0US	US	i3-4005U	No	Intel HD 4400	4GBx1	15.6" HD (1366x768)	None	500GB 7200rpm	DVD±RW	Intel 3160 ac, 1x1 + BT4.0	None	None	Black	PC/ABS	720p	Non-backlit	Fingerprint Reader	dTPM 1.2	6-cell (48Wh)	45W	Win10 DG Win7 Pro 64	1-year, Depot	07/15
20DF00C1US	US	i7-5500U	No	AMD R7 M260 2GB	8GBx1	15.6" FHD (1920x1080)	None	192GB SSD	DVD±RW	Intel 7265 ac, 2x2 + BT4.0	None	None	Black	PC/ABS	720p	Non-backlit	Fingerprint Reader	None	6-cell (48Wh)	65W	Win10 Pro 64	1-year, Depot	07/15
20DF00C2US	US	i5-5200U	No	Intel HD 5500	4GBx1	15.6" HD (1366x768)	None	500GB 7200rpm	DVD±RW	Intel 3160 ac, 1x1 + BT4.0	None	None	Black	PC/ABS	720p	Non-backlit	Fingerprint Reader	dTPM 1.2	6-cell (48Wh)	45W	Win10 DG Win7 Pro 64	1-year, Depot	07/15
20DF00C3US	US	i7-5500U	No	AMD R7 M260 2GB	8GBx1	15.6" FHD (1920x1080)	None	500GB 7200rpm	DVD±RW	Intel 7265 ac, 2x2 + BT4.0	None	None	Black	PC/ABS	720p	Non-backlit	Fingerprint Reader	None	6-cell (48Wh)	65W	Win10 DG Win7 Pro 64	1-year, Depot	07/15
20DF00C4US	US	i5-5200U	No	Intel HD 5500	4GBx1	15.6" HD (1366x768)	None	500GB 7200rpm	DVD±RW	Intel 3160 ac, 1x1 + BT4.0	None	None	Black	PC/ABS	720p	Non-backlit	Fingerprint Reader	dTPM 1.2	6-cell (48Wh)	45W	Win10 Pro 64	1-year, Depot	07/15
20DF00CAUS	US	i7-5500U	No	AMD R7 M260 2GB	8GBx1	15.6" FHD (1920x1080)	None	192GB SSD	DVD±RW	Intel 7265 ac, 2x2 + BT4.0	None	None	Black	PC/ABS	3D Camera	Non-backlit	Fingerprint Reader	None	6-cell (48Wh)	65W	Win10 Pro 64	1-year, Depot	07/15
20DF00CQUS	US	i3-5005U	No	Intel HD 5500	4GBx1	15.6" HD (1366x768)	None	500GB 7200rpm	DVD±RW	Intel 3160 ac, 1x1 + BT4.0	None	None	Black	PC/ABS	720p	Non-backlit	Fingerprint Reader	dTPM 1.2	6-cell (48Wh)	45W	Win10 DG Win7 Pro 64	1-year, Depot	08/15

Model	Region	Processor	vPro	Graphics	Memory	Display	Multi-touch	Storage(HDD/SSD)	Optical	WLAN + Bluetooth	WWAN	SIM Card	Color	Case Material	Camera	Keyboard	Fingerprint Reader	TPM	Battery	Power Adapter	Operating System	Warranty	Ann Date (m/y)
20DF00EDUS	US	i3-5005U	No	Intel HD 5500	4GBx1	15.6" HD (1366x768)	None	500GB 7200rpm	DVD±RW	Intel 3160 ac, 1x1 + BT4.0	None	None	Black	PC/ABS	0.3MP	Non-backlit	None	dTPM 1.2	6-cell (48Wh)	45W	Win10 DG Win7 Pro 64	1-year, Depot	08/15
20DF00EEUS	US	i3-5005U	No	Intel HD 5500	4GBx1	15.6" HD (1366x768)	None	500GB 7200rpm	DVD±RW	Intel 3160 ac, 1x1 + BT4.0	None	None	Black	PC/ABS	0.3MP	Non-backlit	None	dTPM 1.2	6-cell (48Wh)	45W	Win10 Pro 64	1-year, Depot	08/15
20DF00EFUS	US	i3-5005U	No	Intel HD 5500	4GBx1	15.6" HD (1366x768)	None	500GB 7200rpm	DVD±RW	Intel 3160 ac, 1x1 + BT4.0	None	None	Black	PC/ABS	720p	Non-backlit	Fingerprint Reader	dTPM 1.2	6-cell (48Wh)	45W	Win10 Pro 64	1-year, Depot	08/15
20DF00EGUS	US	i3-5005U	No	Intel HD 5500	4GBx1	15.6" HD (1366x768)	None	192GB SSD	DVD±RW	Intel 3160 ac, 1x1 + BT4.0	None	None	Black	PC/ABS	0.3MP	Non-backlit	None	dTPM 1.2	6-cell (48Wh)	45W	Win10 DG Win7 Pro 64	1-year, Depot	08/15



ThinkPad E560 Platform Specifications

Product Specifications Reference (PSREF)

Processor	6th Generation Intel® Core™ i3 / i5 / i7 Processor and Celeron Processor								Smart Card Reader ExpressCard Multicard Reader Ports Monitor cable Camera Audio support Keyboard UltraNav™ ThinkLight™ Security Security chip vPro Fingerprint reader NFC Battery type Battery life AC adapter Preload Limited warranty Mil-Spec test Environment	None None 4-in-1 reader (MMC, SD, SDHC, SDXC) Three USB 3.0 (one Always On), VGA, HDMI, Ethernet (RJ-45), Lenovo OneLink connector, combo audio/microphone jack None <i>Some:</i> HD720p resolution, fixed focus <i>Some:</i> 3D camera, Intel RealSense™ 3D Camera with MIC HD Audio, Conexant® CX11852 codec, Dolby® Advanced Audio™ / stereo speakers or JBL speakers, 2W x 2 / dual array microphone, combo audio / microphone jack 6-row, spill-resistant, multimedia Fn keys, numeric keypad TrackPoint® pointing device and multi-touch with 3+2 buttons click pad None Power-on password, hard disk password, supervisor password, security keyhole <i>TPM2.0 :</i> Trusted Platform Module, TPM2.0 FW (firmware) <i>TPM1.2:</i> Trusted Platform Module, TCG 1.2-compliant <i>TPM :</i> TPM2.0 and TPM1.2 None <i>Some:</i> Fingerprint reader on the keyboard bezel, swipe sensor None Li-Ion 6-cell (48Wh) 6-cell (48Wh): up to 9.0 hr <i>Some:</i> 45-watt AC adapter (Integrated Graphics) <i>Some:</i> 65-watt AC adapter (Discrete Graphics) <i>Some:</i> No operating system <i>Some:</i> Windows® 7 Professional 64 preinstalled through downgrade rights in Windows 10 Pro 64 • Lenovo Solution Center • Lenovo SHAREit • ThinkVantage Product Recovery • Rescue and Recovery™ • ThinkVantage System Update • PC Device Stage • Adobe® Reader® • Microsoft® Office preloaded; purchase a product key to activate • McAfee® Live Safe (30-day trial) <i>Some:</i> Windows 10 Pro 64 <i>Some:</i> Windows 10 Home 64 • Lenovo Solution Center • Lenovo REACHit • Lenovo SHAREit • Lenovo Companion • Lenovo Settings • ThinkVantage System Update • Microsoft Office preloaded; purchase a product key to activate • McAfee® Live Safe (30-day trial) 1-year - depot repair service / service upgrades available None EPEAT™ Gold; ENERGY STAR®; RoHS-compliant
	Processor Number	# of Cores	# of Threads	Base Frequency	Max Turbo Frequency	Cache	Memory Types	Processor Graphics		
	Cel 3855U	2	2	1.6 GHz	-	2MB	DDR3L-1600	Intel HD Graphics 510		
	i3-6100U	2	4	2.3 GHz	-	3MB		Intel HD Graphics 520		
	i5-6200U			2.3 GHz	2.8 GHz	3MB				
i7-6500U	2.5 GHz			3.1 GHz	4MB					
Graphics	Intel HD Graphics in processor only, or AMD Radeon R7 M370 Graphics, 2GB GDDR5 memory, external analog monitor support via VGA DB-15 connector and digital monitor support via HDMI™ (supporting HDCP to output protected content); supports dual independent displays; Max resolution: 1920x1080 (HDMI)@60Hz									
Chipset Memory	Intel SoC (System on Chip) platform 16GB max / PC3-12800 1600MHz DDR3L, non-parity, dual-channel capable, two 204-pin SO-DIMM sockets									
Display	<i>Some:</i> 15.6" (396mm) HD (1366x768) color, anti-glare, LED backlight, 220 nits, 16:9 aspect ratio <i>Some:</i> 15.6" (396mm) FHD (1920x1080) color, anti-glare, LED backlight, IPS, 250 nits, 16:9 aspect ratio									
Multi-touch	None									
Storage	<i>Some:</i> SSD / SATA 6.0Gb/s, 2.5" wide, 7mm high, removable, upgradable <i>Some:</i> HDD / SATA 6.0Gb/s, 2.5" wide, removable, upgradable, Active Protection System™ <i>Some:</i> SSHD with 8GB NAND flash memory <i>Some:</i> DVD burner, 9.0mm high, removable <i>Some:</i> Blank Bezel									
Optical	None									
M.2 SSD	None									
Ethernet Bluetooth™	Gigabit Ethernet Connection Bluetooth wireless, integrated in Wi-Fi + Bluetooth combo adapter									
WLAN	<i>One of the following, configurable by model:</i> • Intel Dual Band Wireless-AC 3165, 1x1, Wi-Fi + BT combo adapter, M.2 Card • Intel Dual Band Wireless-AC 8260, 2x2, Wi-Fi + BT combo adapter, M.2 Card • BCM, Broadcom Wireless-AC, 1x1, Wi-Fi + Bluetooth combo adapter, M.2 Card • QCA, Qualcomm Wireless-AC, 2x2, Wi-Fi + Bluetooth combo adapter, M.2 Card									
WWAN	None									
SIM card	None									
Dimensions Weight Case color Case material	<i>All (WxDxH):</i> 14.84" x 10.04" x 1.07"; 377mm x 255mm x 27.1mm From 5.39 lb (2.45kg) Graphite Black PolyCarbonate/Acrylonitrile-Butadiene-Styrene (PC/ABS) plastic display cover									

Model	Region	Processor	vPro	Graphics	Memory	Display	Multi-touch	Storage(HDD/SSD)	Optical	WLAN + Bluetooth	WWAN	SIM Card	Color	Case Material	Camera	Keyboard	Fingerprint Reader	TPM	Battery	Power Adapter	Operating System	Warranty	Ann Date (m/y)
20EV0027US	US	i7-6500U	No	AMD R7 M370 2GB	8GBx1	15.6" FHD (1920x1080) IPS	None	192GB SSD	DVD±RW	Intel 8260 ac, 2x2 + BT4.0	None	None	Black	PC/ABS	3D Camera	Non-backlit	Fingerprint Reader	FW TPM 2.0	6-cell (48Wh)	65W	Win10 Pro 64	1-year, Depot	11/15
20EV002DUS	US	i3-6100U	No	Intel HD 520	4GBx1	15.6" HD (1366x768)	None	500GB 7200rpm	DVD±RW	Intel 3165 ac, 1x1 + BT4.0	None	None	Black	PC/ABS	720p	Non-backlit	Fingerprint Reader	dTPM 1.2	6-cell (48Wh)	45W	Win10 DG Win7 Pro 64	1-year, Depot	11/15
20EV002EUS	US	i3-6100U	No	Intel HD 520	4GBx1	15.6" HD (1366x768)	None	192GB SSD	DVD±RW	Intel 3165 ac, 1x1 + BT4.0	None	None	Black	PC/ABS	720p	Non-backlit	Fingerprint Reader	dTPM 1.2	6-cell (48Wh)	45W	Win10 DG Win7 Pro 64	1-year, Depot	11/15
20EV002FUS	US	i5-6200U	No	Intel HD 520	4GBx1	15.6" HD (1366x768)	None	500GB 7200rpm	DVD±RW	Intel 3165 ac, 1x1 + BT4.0	None	None	Black	PC/ABS	720p	Non-backlit	Fingerprint Reader	dTPM 1.2	6-cell (48Wh)	45W	Win10 DG Win7 Pro 64	1-year, Depot	11/15
20EV002GUS	US	i5-6200U	No	Intel HD 520	4GBx1	15.6" HD (1366x768)	None	192GB SSD	DVD±RW	Intel 3165 ac, 1x1 + BT4.0	None	None	Black	PC/ABS	720p	Non-backlit	Fingerprint Reader	dTPM 1.2	6-cell (48Wh)	45W	Win10 DG Win7 Pro 64	1-year, Depot	11/15
20EV002HUS	US	i5-6200U	No	Intel HD 520	8GBx1	15.6" HD (1366x768)	None	192GB SSD	DVD±RW	Intel 3165 ac, 1x1 + BT4.0	None	None	Black	PC/ABS	720p	Non-backlit	Fingerprint Reader	dTPM 1.2	6-cell (48Wh)	45W	Win10 DG Win7 Pro 64	1-year, Depot	11/15
20EV002JUS	US	i7-6500U	No	AMD R7 M370 2GB	8GBx1	15.6" FHD (1920x1080) IPS	None	500GB 7200rpm	DVD±RW	Intel 8260 ac, 2x2 + BT4.0	None	None	Black	PC/ABS	720p	Non-backlit	Fingerprint Reader	FW TPM 2.0	6-cell (48Wh)	65W	Win10 DG Win7 Pro 64	1-year, Depot	11/15
20EV002KUS	US	i7-6500U	No	AMD R7 M370 2GB	8GBx1	15.6" FHD (1920x1080) IPS	None	192GB SSD	DVD±RW	Intel 8260 ac, 2x2 + BT4.0	None	None	Black	PC/ABS	720p	Non-backlit	Fingerprint Reader	FW TPM 2.0	6-cell (48Wh)	65W	Win10 DG Win7 Pro 64	1-year, Depot	11/15
20EV002LLUS	US	i3-6100U	No	Intel HD 520	4GBx1	15.6" HD (1366x768)	None	500GB 7200rpm	DVD±RW	Intel 3165 ac, 1x1 + BT4.0	None	None	Black	PC/ABS	720p	Non-backlit	Fingerprint Reader	dTPM1.2 + FW TPM2.0	6-cell (48Wh)	45W	Win10 Pro 64	1-year, Depot	11/15
20EV002MUS	US	i3-6100U	No	Intel HD 520	4GBx1	15.6" HD (1366x768)	None	192GB SSD	DVD±RW	Intel 3165 ac, 1x1 + BT4.0	None	None	Black	PC/ABS	720p	Non-backlit	Fingerprint Reader	dTPM1.2 + FW TPM2.0	6-cell (48Wh)	45W	Win10 Pro 64	1-year, Depot	11/15
20EV002NUS	US	i5-6200U	No	Intel HD 520	4GBx1	15.6" HD (1366x768)	None	500GB 7200rpm	DVD±RW	Intel 3165 ac, 1x1 + BT4.0	None	None	Black	PC/ABS	720p	Non-backlit	Fingerprint Reader	dTPM1.2 + FW TPM2.0	6-cell (48Wh)	45W	Win10 Pro 64	1-year, Depot	11/15
20EV002PUS	US	i5-6200U	No	Intel HD 520	4GBx1	15.6" HD (1366x768)	None	192GB SSD	DVD±RW	Intel 3165 ac, 1x1 + BT4.0	None	None	Black	PC/ABS	720p	Non-backlit	Fingerprint Reader	dTPM1.2 + FW TPM2.0	6-cell (48Wh)	45W	Win10 Pro 64	1-year, Depot	11/15
20EV002QUS	US	i5-6200U	No	Intel HD 520	8GBx1	15.6" HD (1366x768)	None	192GB SSD	DVD±RW	Intel 3165 ac, 1x1 + BT4.0	None	None	Black	PC/ABS	720p	Non-backlit	Fingerprint Reader	dTPM1.2 + FW TPM2.0	6-cell (48Wh)	45W	Win10 Pro 64	1-year, Depot	11/15
20EV002RUS	US	i7-6500U	No	AMD R7 M370 2GB	8GBx1	15.6" FHD (1920x1080) IPS	None	500GB 7200rpm	DVD±RW	Intel 8260 ac, 2x2 + BT4.0	None	None	Black	PC/ABS	720p	Non-backlit	Fingerprint Reader	FW TPM 2.0	6-cell (48Wh)	65W	Win10 Pro 64	1-year, Depot	11/15
20EV002SUS	US	i7-6500U	No	AMD R7 M370 2GB	8GBx1	15.6" FHD (1920x1080) IPS	None	192GB SSD	DVD±RW	Intel 8260 ac, 2x2 + BT4.0	None	None	Black	PC/ABS	720p	Non-backlit	Fingerprint Reader	FW TPM 2.0	6-cell (48Wh)	65W	Win10 Pro 64	1-year, Depot	11/15
20EV003EUS	US	i7-6500U	No	AMD R7 M370 2GB	8GBx1	15.6" FHD (1920x1080) IPS	None	256GB SSD Opal2	DVD±RW	Intel 8260 ac, 2x2 + BT4.0	None	None	Black	PC/ABS	720p	Non-backlit	Fingerprint Reader	FW TPM 2.0	6-cell (48Wh)	65W	Win10 Pro 64	1-year, Depot	04/16
20EV003FUS	US	i7-6500U	No	AMD R7 M370 2GB	8GBx1	15.6" FHD (1920x1080) IPS	None	256GB SSD Opal2	DVD±RW	Intel 8260 ac, 2x2 + BT4.0	None	None	Black	PC/ABS	720p	Non-backlit	Fingerprint Reader	FW TPM 2.0	6-cell (48Wh)	65W	Win10 DG Win7 Pro 64	1-year, Depot	04/16
20EV003VUS	US	i5-6200U	No	Intel HD 520	4GBx1	15.6" HD (1366x768)	None	256GB SSD Opal2	DVD±RW	Intel 8260 ac, 2x2 + BT4.0	None	None	Black	PC/ABS	720p	Non-backlit	Fingerprint Reader	dTPM 1.2	6-cell (48Wh)	45W	Win10 DG Win7 Pro 64	1-year, Depot	09/16
20EV003WUS	US	i5-6200U	No	Intel HD 520	8GBx1	15.6" FHD (1920x1080) IPS	None	256GB SSD Opal2	DVD±RW	Intel 8260 ac, 2x2 + BT4.0	None	None	Black	PC/ABS	720p	Non-backlit	Fingerprint Reader	dTPM 1.2	6-cell (48Wh)	45W	Win10 DG Win7 Pro 64	1-year, Depot	09/16
20EV0043US	US	i5-6200U	No	Intel HD 520	8GBx1	15.6" FHD (1920x1080) IPS	None	500GB 7200rpm	DVD±RW	Intel 3165 ac, 1x1 + BT4.0	None	None	Black	PC/ABS	720p	Non-backlit	Fingerprint Reader	dTPM1.2 + FW TPM2.0	6-cell (48Wh)	45W	Win10 Pro 64	1-year, Depot	11/16

Model	Region	Processor	vPro	Graphics	Memory	Display	Multi-touch	Storage(HDD/SSD)	Optical	WLAN + Bluetooth	WWAN	SIM Card	Color	Case Material	Camera	Keyboard	Fingerprint Reader	TPM	Battery	Power Adapter	Operating System	Warranty	Ann Date (m/y)
20EVA05UUS	US	i5-6200U	No	Intel HD 520	8GBx1	15.6" HD (1366x768)	None	500GB 7200rpm	DVD±RW	Intel 3165 ac, 1x1 + BT4.0	None	None	Black	PC/ABS	720p	Non-backlit	Fingerprint Reader	dTPM1.2 + FW TPM2.0	6-cell (48Wh)	45W	Win10 Pro 64	1-year, Depot	10/16



ThinkPad E565 Platform Specifications

Product Specifications Reference (PSREF)

Processor	AMD Accelerated Processor A6, A8, A10, or FX APU								Smart Card Reader	None	
	Processor Number	# of Cores	# of Threads	Clock Speed	Max Turbo Frequency	Cache	Memory speed	Graphics	ExpressCard	None	
	A6-8500P	2	6	1.6 GHz	3.0 GHz	1MB	DDR3L-1600	R5 Graphics	Multicard Reader	4-in-1 reader (MMC, SD, SDHC, SDXC)	
	A8-8600P	4	10	1.6 GHz	3.0 GHz	2MB		R6 Graphics	Ports	Three USB 3.0 (one Always On), VGA, HDMI, Ethernet (RJ-45), Lenovo OneLink connector, combo audio/microphone jack	
	A8-8600P	4	10	1.6 GHz	3.0 GHz	2MB		R6 M335DX (R6+R5 M330)	Monitor cable	None	
	A10-8700P	4	10	1.8 GHz	3.2 GHz	2MB		R6 M340DX (R6+R5 M330)	Camera	HD720p resolution, fixed focus	
FX-8800P	4	12	2.1 GHz	3.4 GHz	2MB	R8 M350DX (R7+R5 M330)		Audio support	HD Audio, Conexant® CX11852 codec, Dolby® Advanced Audio™ / stereo speakers, 2W x 2 / dual array microphone, combo audio/microphone jack		
Graphics	AMD Radeon™ R5 or R6 Graphics in processor only, or AMD Radeon R5 M330 Graphics, 2GB DDR3 memory, or Dual Graphics support for A8, A10 and FX APU external analog monitor support via VGA DB-15 connector and digital monitor support via HDMI™ (supporting HDCP to output protected content); supports dual independent display								Keyboard	6-row, spill-resistant, multimedia Fn keys, numeric keypad	
Chipset	AMD SoC (System on Chip) platform								UltraNav™	TrackPoint® pointing device and multi-touch with 3+2 buttons click pad	
Memory	16GB max / PC3-12800 1600MHz DDR3L, non-parity, dual-channel capable, two 204-pin SO-DIMM sockets								ThinkLight™	None	
Display	<i>Some:</i> 15.6" (396mm) HD (1366x768) color, anti-glare, LED backlight, 220 nits, 16:9 aspect ratio <i>Some:</i> 15.6" (396mm) FHD (1920x1080) color, anti-glare, LED backlight, IPS, 250 nits, 16:9 aspect ratio								Security	Power-on password, hard disk password, supervisor password, security keyhole	
Multi-touch	None								Security chip	TPM2.0 : Trusted Platform Module, TPM2.0 FW (firmware) TPM1.2: Trusted Platform Module, TCG 1.2-compliant TPM : TPM2.0 and TPM1.2	
Storage	<i>Some:</i> SSD / SATA 6.0Gb/s, 2.5" wide, 7mm high, removable, upgradable <i>Some:</i> HDD / SATA 6.0Gb/s, 2.5" wide, removable, upgradable, Active Protection System™ <i>Some:</i> SSHD with 8GB NAND flash memory								vPro	None	
Optical	<i>Some:</i> DVD burner, 9.0mm high, removable <i>Some:</i> Blank Bezel								Fingerprint reader	<i>Some:</i> Fingerprint reader on the keyboard bezel, swipe sensor	
M.2 SSD	None								NFC	None	
Ethernet	Gigabit Network Connection								Battery type	Li-Ion 6-cell (48Wh)	
Bluetooth™	Bluetooth wireless, integrated in Wi-Fi + Bluetooth combo adapter								Battery life	Up to 6.5 hr <i>Some:</i> 45-watt AC adapter (Integrated Graphics) <i>Some:</i> 65-watt AC adapter (Discrete Graphics)	
WLAN	<i>One of the following, configurable by model:</i> • BCM, Broadcom Wireless-AC, 1x1, Wi-Fi + Bluetooth combo adapter, M.2 Card • QCA, Qualcomm Wireless-AC, 2x2, Wi-Fi + Bluetooth combo adapter, M.2 Card								AC adapter	<i>Some:</i> 45-watt AC adapter (Integrated Graphics) <i>Some:</i> 65-watt AC adapter (Discrete Graphics)	
WWAN	None								Preload	<i>Some:</i> No operating system <i>Some:</i> Windows® 7 Professional 64 preinstalled through downgrade rights in Windows 10 Pro 64 • Lenovo Solution Center • Lenovo SHAREit • ThinkVantage Product Recovery • Rescue and Recovery™ • ThinkVantage System Update • PC Device Stage • Adobe® Reader® • Microsoft® Office preloaded; purchase a product key to activate • McAfee® Live Safe (30-day trial)	<i>Some:</i> Windows 10 Pro 64 <i>Some:</i> Windows 10 Home 64 • Lenovo Solution Center • Lenovo REACHit • Lenovo SHAREit • Lenovo Companion • Lenovo Settings • ThinkVantage System Update • Microsoft Office preloaded; purchase a product key to activate • McAfee® Live Safe (30-day trial)
SIM card	None								Limited warranty	1-year - depot repair service / service upgrades available	
Dimensions	<i>All (WxDxH):</i> 14.84" x 10.04" x 1.07"; 377mm x 255mm x 27.1mm								Environment	EPEAT™ Gold; ENERGY STAR®; RoHS-compliant	
Weight	From 5.46 lb (2.48kg)										
Case color	Graphite black										
Case material	PolyCarbonate/Acrylonitrile-Butadiene-Styrene (PC/ABS) plastic display cover										

Model	Region	Processor	vPro	Graphics	Memory	Display	Multi-touch	Storage(HDD/SSD)	Optical	WLAN + Bluetooth	WWAN	SIM Card	Color	Case Material	Camera	Keyboard	Fingerprint Reader	TPM	Battery	Power Adapter	Operating System	Warranty	Ann Date (m/y)
20EY0006US	US	AMD A10-8700P	No	AMD R6 M340DX 2GB	8GBx1	15.6" FHD (1920x1080) IPS	None	500GB 5400rpm	DVD±RW	BCM43162 ac, 1x1 + BT4.0	None	None	Black	PC/ABS	720p	Non-backlit	None	FW TPM 2.0	6-cell (48Wh)	65W	Win10 Pro 64	1-year, Depot	11/15
20EY0007US	US	AMD A10-8700P	No	AMD R6 M340DX 2GB	4GBx1	15.6" FHD (1920x1080) IPS	None	192GB SSD	DVD±RW	BCM43162 ac, 1x1 + BT4.0	None	None	Black	PC/ABS	720p	Non-backlit	None	FW TPM 2.0	6-cell (48Wh)	65W	Win10 Pro 64	1-year, Depot	11/15
20EY0008US	US	AMD A6-8500P	No	AMD R5 Graphics	8GBx1	15.6" HD (1366x768)	None	500GB 5400rpm	DVD±RW	BCM43162 ac, 1x1 + BT4.0	None	None	Black	PC/ABS	720p	Non-backlit	None	dTPM 1.2	6-cell (48Wh)	45W	Win10 DG Win7 Pro 64	1-year, Depot	11/15
20EY0009US	US	AMD A10-8700P	No	AMD R6 M340DX 2GB	8GBx1	15.6" HD (1366x768)	None	500GB 5400rpm	DVD±RW	BCM43162 ac, 1x1 + BT4.0	None	None	Black	PC/ABS	720p	Non-backlit	None	FW TPM 2.0	6-cell (48Wh)	65W	Win10 Pro 64	1-year, Depot	11/15
20EY000AUS	US	AMD A6-8500P	No	AMD R5 Graphics	4GBx1	15.6" HD (1366x768)	None	500GB 5400rpm	DVD±RW	BCM43162 ac, 1x1 + BT4.0	None	None	Black	PC/ABS	720p	Non-backlit	None	dTPM 1.2	6-cell (48Wh)	45W	Win10 DG Win7 Pro 64	1-year, Depot	11/15
20EY000BUS	US	AMD A10-8700P	No	AMD R6 M340DX 2GB	8GBx1	15.6" HD (1366x768)	None	500GB 5400rpm	DVD±RW	BCM43162 ac, 1x1 + BT4.0	None	None	Black	PC/ABS	720p	Non-backlit	None	FW TPM 2.0	6-cell (48Wh)	65W	Win10 DG Win7 Pro 64	1-year, Depot	11/15
20EY000CUS	US	AMD A10-8700P	No	AMD R6 M340DX 2GB	4GBx1	15.6" HD (1366x768)	None	500GB 5400rpm	DVD±RW	BCM43162 ac, 1x1 + BT4.0	None	None	Black	PC/ABS	720p	Non-backlit	None	FW TPM 2.0	6-cell (48Wh)	65W	Win10 DG Win7 Pro 64	1-year, Depot	11/15
20EY000DUS	US	AMD A10-8700P	No	AMD R6 M340DX 2GB	8GBx1	15.6" FHD (1920x1080) IPS	None	192GB SSD	DVD±RW	BCM43162 ac, 1x1 + BT4.0	None	None	Black	PC/ABS	720p	Non-backlit	None	FW TPM 2.0	6-cell (48Wh)	65W	Win10 DG Win7 Pro 64	1-year, Depot	11/15
20EY000EUS	US	AMD A10-8700P	No	AMD R6 M340DX 2GB	8GBx1	15.6" FHD (1920x1080) IPS	None	500GB 5400rpm	DVD±RW	BCM43162 ac, 1x1 + BT4.0	None	None	Black	PC/ABS	720p	Non-backlit	None	FW TPM 2.0	6-cell (48Wh)	65W	Win10 DG Win7 Pro 64	1-year, Depot	11/15
20EY000FUS	US	AMD A6-8500P	No	AMD R5 Graphics	8GBx1	15.6" HD (1366x768)	None	500GB 5400rpm	DVD±RW	BCM43162 ac, 1x1 + BT4.0	None	None	Black	PC/ABS	720p	Non-backlit	None	dTPM1.2 + FW TPM2.0	6-cell (48Wh)	45W	Win10 Pro 64	1-year, Depot	11/15
20EY000GUS	US	AMD A10-8700P	No	AMD R6 M340DX 2GB	4GBx1	15.6" FHD (1920x1080) IPS	None	192GB SSD	DVD±RW	BCM43162 ac, 1x1 + BT4.0	None	None	Black	PC/ABS	720p	Non-backlit	None	FW TPM 2.0	6-cell (48Wh)	65W	Win10 DG Win7 Pro 64	1-year, Depot	11/15
20EY000HUS	US	AMD A10-8700P	No	AMD R6 M340DX 2GB	8GBx1	15.6" FHD (1920x1080) IPS	None	192GB SSD	DVD±RW	BCM43162 ac, 1x1 + BT4.0	None	None	Black	PC/ABS	720p	Non-backlit	None	FW TPM 2.0	6-cell (48Wh)	65W	Win10 Pro 64	1-year, Depot	11/15
20EY000JUS	US	AMD A10-8700P	No	AMD R6 M340DX 2GB	4GBx1	15.6" HD (1366x768)	None	500GB 5400rpm	DVD±RW	BCM43162 ac, 1x1 + BT4.0	None	None	Black	PC/ABS	720p	Non-backlit	None	FW TPM 2.0	6-cell (48Wh)	65W	Win10 Pro 64	1-year, Depot	11/15
20EY000KUS	US	AMD A6-8500P	No	AMD R5 Graphics	4GBx1	15.6" HD (1366x768)	None	500GB 5400rpm	DVD±RW	BCM43162 ac, 1x1 + BT4.0	None	None	Black	PC/ABS	720p	Non-backlit	None	dTPM1.2 + FW TPM2.0	6-cell (48Wh)	45W	Win10 Pro 64	1-year, Depot	11/15
20EY001EUS	US	AMD A10-8700P	No	AMD R6 M340DX 2GB	8GBx1	15.6" HD (1366x768)	None	500GB 5400rpm	DVD±RW	QCA435 ac, 1x1 + BT4.0	None	None	Black	PC/ABS	720p	Non-backlit	None	FW TPM 2.0	6-cell (48Wh)	65W	Win10 DG Win7 Pro 64	1-year, Depot	06/16
20EY001FUS	US	AMD A10-8700P	No	AMD R6 M340DX 2GB	8GBx1	15.6" FHD (1920x1080) IPS	None	500GB 5400rpm	DVD±RW	QCA435 ac, 1x1 + BT4.0	None	None	Black	PC/ABS	720p	Non-backlit	None	FW TPM 2.0	6-cell (48Wh)	65W	Win10 DG Win7 Pro 64	1-year, Depot	06/16
20EY001GUS	US	AMD A6-8500P	No	AMD R5 Graphics	4GBx1	15.6" HD (1366x768)	None	500GB 5400rpm	DVD±RW	QCA435 ac, 1x1 + BT4.0	None	None	Black	PC/ABS	720p	Non-backlit	None	dTPM1.2 + FW TPM2.0	6-cell (48Wh)	45W	Win10 Pro 64	1-year, Depot	06/16
20EY001HUS	US	AMD A6-8500P	No	AMD R5 Graphics	8GBx1	15.6" HD (1366x768)	None	500GB 5400rpm	DVD±RW	QCA435 ac, 1x1 + BT4.0	None	None	Black	PC/ABS	720p	Non-backlit	None	dTPM1.2 + FW TPM2.0	6-cell (48Wh)	45W	Win10 Pro 64	1-year, Depot	06/16
20EY001JUS	US	AMD A10-8700P	No	AMD R6 M340DX 2GB	8GBx1	15.6" FHD (1920x1080) IPS	None	192GB SSD	DVD±RW	QCA435 ac, 1x1 + BT4.0	None	None	Black	PC/ABS	720p	Non-backlit	None	FW TPM 2.0	6-cell (48Wh)	65W	Win10 DG Win7 Pro 64	1-year, Depot	06/16
20EY001KUS	US	AMD A10-8700P	No	AMD R6 M340DX 2GB	8GBx1	15.6" FHD (1920x1080) IPS	None	500GB 5400rpm	DVD±RW	QCA435 ac, 1x1 + BT4.0	None	None	Black	PC/ABS	720p	Non-backlit	None	FW TPM 2.0	6-cell (48Wh)	65W	Win10 Pro 64	1-year, Depot	06/16

Model	Region	Processor	vPro	Graphics	Memory	Display	Multi-touch	Storage(HDD/SSD)	Optical	WLAN + Bluetooth	WWAN	SIM Card	Color	Case Material	Camera	Keyboard	Fingerprint Reader	TPM	Battery	Power Adapter	Operating System	Warranty	Ann Date (m/y)
20EY001LUS	US	AMD A10-8700P	No	AMD R6 M340DX 2GB	4GBx1	15.6" FHD (1920x1080) IPS	None	192GB SSD	DVD±RW	QCA435 ac, 1x1 + BT4.0	None	None	Black	PC/ABS	720p	Non-backlit	None	FW TPM 2.0	6-cell (48Wh)	65W	Win10 DG Win7 Pro 64	1-year, Depot	06/16
20EY001MUS	US	AMD A10-8700P	No	AMD R6 M340DX 2GB	4GBx1	15.6" FHD (1920x1080) IPS	None	500GB 5400rpm	DVD±RW	QCA435 ac, 1x1 + BT4.0	None	None	Black	PC/ABS	720p	Non-backlit	None	FW TPM 2.0	6-cell (48Wh)	65W	Win10 DG Win7 Pro 64	1-year, Depot	06/16
20EY001NUS	US	AMD A10-8700P	No	AMD R6 M340DX 2GB	4GBx1	15.6" HD (1366x768)	None	500GB 5400rpm	DVD±RW	QCA435 ac, 1x1 + BT4.0	None	None	Black	PC/ABS	720p	Non-backlit	None	FW TPM 2.0	6-cell (48Wh)	65W	Win10 DG Win7 Pro 64	1-year, Depot	06/16
20EY001PUS	US	AMD A10-8700P	No	AMD R6 M340DX 2GB	8GBx1	15.6" HD (1366x768)	None	500GB 5400rpm	DVD±RW	QCA435 ac, 1x1 + BT4.0	None	None	Black	PC/ABS	720p	Non-backlit	None	FW TPM 2.0	6-cell (48Wh)	65W	Win10 Pro 64	1-year, Depot	06/16
20EY001QUS	US	AMD A10-8700P	No	AMD R6 M340DX 2GB	4GBx1	15.6" HD (1366x768)	None	500GB 5400rpm	DVD±RW	QCA435 ac, 1x1 + BT4.0	None	None	Black	PC/ABS	720p	Non-backlit	None	FW TPM 2.0	6-cell (48Wh)	65W	Win10 Pro 64	1-year, Depot	06/16
20EY001RUS	US	AMD A6-8500P	No	AMD R5 Graphics	8GBx1	15.6" HD (1366x768)	None	500GB 5400rpm	DVD±RW	QCA435 ac, 1x1 + BT4.0	None	None	Black	PC/ABS	720p	Non-backlit	None	dTPM 1.2	6-cell (48Wh)	45W	Win10 DG Win7 Pro 64	1-year, Depot	06/16
20EY001SUS	US	AMD A10-8700P	No	AMD R6 M340DX 2GB	8GBx1	15.6" FHD (1920x1080) IPS	None	192GB SSD	DVD±RW	QCA435 ac, 1x1 + BT4.0	None	None	Black	PC/ABS	720p	Non-backlit	None	FW TPM 2.0	6-cell (48Wh)	65W	Win10 Pro 64	1-year, Depot	06/16
20EY001TUS	US	AMD A10-8700P	No	AMD R6 M340DX 2GB	4GBx1	15.6" FHD (1920x1080) IPS	None	192GB SSD	DVD±RW	QCA435 ac, 1x1 + BT4.0	None	None	Black	PC/ABS	720p	Non-backlit	None	FW TPM 2.0	6-cell (48Wh)	65W	Win10 Pro 64	1-year, Depot	06/16
20EY001UUS	US	AMD A10-8700P	No	AMD R6 M340DX 2GB	4GBx1	15.6" FHD (1920x1080) IPS	None	500GB 5400rpm	DVD±RW	QCA435 ac, 1x1 + BT4.0	None	None	Black	PC/ABS	720p	Non-backlit	None	FW TPM 2.0	6-cell (48Wh)	65W	Win10 Pro 64	1-year, Depot	06/16
20EY001VUS	US	AMD A6-8500P	No	AMD R5 Graphics	4GBx1	15.6" HD (1366x768)	None	500GB 5400rpm	DVD±RW	QCA435 ac, 1x1 + BT4.0	None	None	Black	PC/ABS	720p	Non-backlit	None	dTPM 1.2	6-cell (48Wh)	45W	Win10 DG Win7 Pro 64	1-year, Depot	06/16

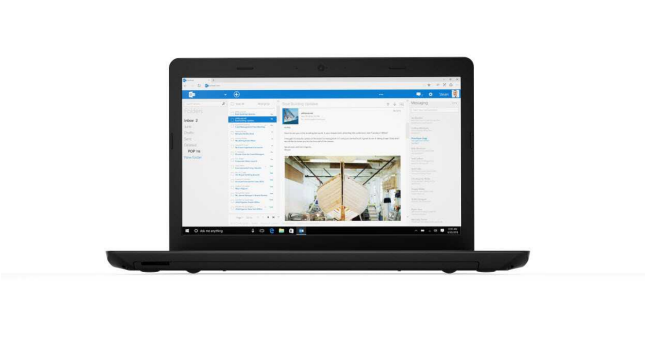

ThinkPad E570 Platform Specifications

Product Specifications Reference (PSREF)

Processor	7th Generation Intel® Core™ i3 / i5 / i7 Processor								Dimensions <i>Aluminum (WxDxH):</i> 14.92" x 10.28" x 0.94" 379mm x 261mm x 23.9mm <i>PC/ABS (WxDxH):</i> 14.92" x 10.28" x 1.00"; 379mm x 261mm x 25.4mm
	Processor Number	# of Cores	# of Threads	Base Frequency	Max Turbo Frequency	Cache	Memory Controller	Processor Graphics	
	i3-6100U	2	4	2.3 GHz	-	3MB	DDR4-2133	Intel HD Graphics 520	
	i5-6200U			2.3 GHz	2.8 GHz	3MB			
	i7-6500U			2.5 GHz	3.1 GHz	4MB			
	i3-7100U			2.4 GHz	-	3MB	DDR4-2133	Intel HD Graphics 620	
	i5-7200U			2.5 GHz	3.1 GHz	3MB			
	i7-7500U			2.7 GHz	3.5 GHz	4MB			

Graphics	Intel HD Graphics in processor only, or NVidia GeForce 940MX Graphics, 2GB DDR5 memory, or NVidia GeForce GTX 950M Graphics, 2GB DDR5 memory, external analog monitor support via VGA DB-15 connector and digital monitor support via HDMI™ (supporting HDCP to output protected content); supports dual independent displays; Max resolution: 1920x1080 (HDMI)@60Hz	Weight Case color	From 5.07 lb (2.30kg) <i>LCD Rear :</i> Black, Silver, Gold <i>Base Cover:</i> Black <i>Top Cover:</i> Black, Silver
Memory	32GB max / PC4-19200 2400MHz DDR4, non-parity, dual-channel capable, two 260-pin SO-DIMM sockets * System clocks down for processors with lower memory controller	Case material (<i>LCD Rear</i>)	<i>Aluminum:</i> Aluminum display cover <i>PC/ABS:</i> PolyCarbonate/Acrylonitrile-Butadiene-Styrene display cover
Display	Some: 15.6" (396mm) HD (1366x768), anti-glare, LED backlight, 220 nits, 16:9 aspect ratio, 400:1 contrast ratio Some: 15.6" (396mm) FHD (1920x1080), anti-glare, LED backlight, IPS, 250 nits, 16:9 aspect ratio, 600:1 contrast ratio Some: 15.6" (396mm) FHD (1920x1080), anti-glare, LED backlight, 250 nits, 16:9 aspect ratio, 600:1 contrast ratio	Camera Audio support	<i>Some:</i> HD720p resolution, fixed focus HD Audio, Conexant® CX11852 codec, Dolby® Audio™ Premium / stereo speakers, 2W x 2 / dual array microphone, combo audio / microphone jack
Multi-touch	None	Keyboard UltraNav™ ThinkLight™	6-row, spill-resistant, multimedia Fn keys TrackPoint® pointing device and multi-touch with 3+2 buttons click pad None
Storage	<i>Some:</i> M.2 SSD / SATA 6.0Gb/s <i>Some:</i> M.2 SSD / PCIe NVMe <i>Some:</i> HDD / SATA 6.0Gb/s, 2.5" wide, removable, upgradable, Active Protection System™	Fingerprint reader NFC	<i>Some:</i> Fingerprint reader on the keyboard bezel, swipe sensor None
Optical	<i>Some:</i> DVD burner, 9.0mm high, removable <i>Some:</i> Blank Bezel	Security Security chip	Power-on password, hard disk password, supervisor password, security keyhole <i>fTPM2.0:</i> Firmware TPM 2.0, integrated in chipset <i>dTPM2.0:</i> Discrete TPM 2.0, TCG Certified
Ethernet	Gigabit Ethernet Connection, Realtek R8111GUS	vPro	No
WLAN	<i>One of the following, configurable by model:</i> • Intel Dual Band Wireless-AC 8265, 2x2, Wi-Fi + BT combo adapter, M.2 Card • QCA, Qualcomm 344A-AC, 2x2, Wi-Fi + Bluetooth combo adapter, M.2 Card • QCA, Qualcomm 435-AC, 1x1, Wi-Fi + Bluetooth combo adapter, M.2 Card Bluetooth wireless, integrated in Wi-Fi + Bluetooth combo adapter	Battery type	<i>Some:</i> Li-Polymer 4-cell (32Wh) <i>Some:</i> Li-Ion 4-cell (41Wh)
Bluetooth™		Battery life	<i>Some:</i> Up to 5.0 hr for Li-Polymer 4-cell (32Wh) <i>Some:</i> Up to 7.0 hr for Li-Ion 4-cell (41Wh)
WWAN SIM card	None None	AC adapter	<i>Some:</i> 45-watt AC adapter <i>Some:</i> 65-watt AC adapter <i>Some:</i> 90-watt AC adapter
Smart Card Reader ExpressCard Dock	None None None	Preload	<i>Some:</i> Windows 10 Pro 64 <i>Some:</i> Windows 10 Home 64 <i>Some:</i> No operating system • Lenovo Companion • Lenovo Settings • Microsoft Office preloaded; purchase a product key to activate • McAfee® Live Safe (30-day trial)
Multicard Reader	4-in-1 reader (MMC, SD, SDHC, SDXC)	Limited warranty	1-year - depot repair service / service upgrades available
Ports	Two USB 3.0, one USB 2.0 (Always On), VGA, HDMI, Ethernet (RJ-45), combo audio / microphone jack, optional one USB 3.1 Type-C (standard for i5, i7 models in EMEA)	Mil-Spec test	None
Monitor cable	None	Environment	EPEAT™ Gold; ENERGY STAR®; RoHS-compliant

ThinkPad E570 - TopSeller - 20H5

Product Specifications Reference (PSREF)

Model	Region	Processor	vPro	Graphics	Optional Ports	Memory	Display	Multi-touch	Storage(HDD/SSD)	Optical	WLAN + Bluetooth	WWAN	SIM Card	Color (LCD_Rear, Top_Cover)	Case Material	Fingerprint Reader	TPM	Battery	Power Adapter	Operating System	Warranty	Ann Date (m/y)
20H50042US	US	i3-7100U	No	Intel HD 620	None	4GBx1	15.6" HD (1366x768)	None	500GB 7200rpm	DVD±RW	11ac, 1x1 + BT4.1	None	None	Black, Black	PC/ABS	Fingerprint Reader	dTPM 2.0	4-cell (41Wh)	45W	Win10 Pro 64	1-year, Depot	09/16
20H50043US	US	i7-7500U	No	GTX 950M 2GB	None	8GBx1	15.6" FHD (1920x1080) IPS	None	500GB 7200rpm	DVD±RW	Intel 8265 ac, 2x2 + BT4.1	None	None	Black, Black	PC/ABS	Fingerprint Reader	FW TPM 2.0	4-cell (41Wh)	90W	Win10 Pro 64	1-year, Depot	09/16
20H50044US	US	i3-6006U	No	Intel HD 520	None	4GBx1	15.6" HD (1366x768)	None	500GB 7200rpm	DVD±RW	11ac, 1x1 + BT4.1	None	None	Black, Black	PC/ABS	None	dTPM 2.0	4-cell (41Wh)	45W	Win10 Pro 64	1-year, Depot	11/16
20H50045US	US	i5-7200U	No	Intel HD 620	None	8GBx1	15.6" FHD (1920x1080) IPS	None	256GB SSD M.2 PCIe NVMe Opal2	DVD±RW	Intel 8265 ac, 2x2 + BT4.1	None	None	Black, Black	PC/ABS	Fingerprint Reader	dTPM 2.0	4-cell (41Wh)	45W	Win10 Pro 64	1-year, Depot	09/16
20H50047US	US	i7-7500U	No	GTX 950M 2GB	None	8GBx1	15.6" FHD (1920x1080) IPS	None	256GB SSD M.2 PCIe NVMe Opal2	DVD±RW	Intel 8265 ac, 2x2 + BT4.1	None	None	Black, Black	PC/ABS	Fingerprint Reader	FW TPM 2.0	4-cell (41Wh)	90W	Win10 Pro 64	1-year, Depot	09/16
20H50048US	US	i5-7200U	No	Intel HD 620	None	4GBx1	15.6" HD (1366x768)	None	500GB 7200rpm	DVD±RW	11ac, 1x1 + BT4.1	None	None	Black, Black	PC/ABS	Fingerprint Reader	dTPM 2.0	4-cell (41Wh)	45W	Win10 Pro 64	1-year, Depot	09/16
20H5007UUS	US	i3-7100U	No	Intel HD 620	None	4GBx1	15.6" HD (1366x768)	None	180GB SSD M.2 Opal2	DVD±RW	11ac, 1x1 + BT4.1	None	None	Black, Black	PC/ABS	Fingerprint Reader	dTPM 2.0	4-cell (41Wh)	45W	Win10 Pro 64	1-year, Depot	01/17
20H5007VUS	US	i5-6200U	No	940MX 2GB	None	8GBx1	15.6" HD (1366x768)	None	180GB SSD M.2 Opal2	DVD±RW	11ac, 1x1 + BT4.1	None	None	Black, Black	PC/ABS	Fingerprint Reader	FW TPM 2.0	4-cell (41Wh)	65W	Win10 Pro 64	1-year, Depot	01/17
20H5007WUS	US	i5-6200U	No	940MX 2GB	None	4GBx1	15.6" HD (1366x768)	None	180GB SSD M.2 Opal2	DVD±RW	11ac, 1x1 + BT4.1	None	None	Black, Black	PC/ABS	Fingerprint Reader	FW TPM 2.0	4-cell (41Wh)	65W	Win10 Pro 64	1-year, Depot	01/17
20H5009FUS	US	i3-6006U	No	Intel HD 520	None	4GBx1	15.6" HD (1366x768)	None	500GB 7200rpm	DVD±RW	11ac, 1x1 + BT4.1	None	None	Black, Black	PC/ABS	Fingerprint Reader	dTPM 2.0	4-cell (41Wh)	45W	Win10 DG Win7 Pro 64	1-year, Depot	03/17
20H5009GUS	US	i7-6500U	No	940MX 2GB	None	8GBx1	15.6" FHD (1920x1080) IPS	None	256GB SSD M.2 PCIe NVMe Opal2	DVD±RW	Intel 8265 ac, 2x2 + BT4.1	None	None	Black, Black	PC/ABS	Fingerprint Reader	FW TPM 2.0	4-cell (41Wh)	65W	Win10 DG Win7 Pro 64	1-year, Depot	03/17
20H5009HUS	US	i3-6006U	No	Intel HD 520	None	4GBx1	15.6" HD (1366x768)	None	500GB 7200rpm	DVD±RW	11ac, 1x1 + BT4.1	None	None	Black, Black	PC/ABS	None	dTPM 2.0	4-cell (41Wh)	45W	Win10 DG Win7 Pro 64	1-year, Depot	03/17
20H5009JUS	US	i7-6500U	No	940MX 2GB	None	8GBx1	15.6" FHD (1920x1080) IPS	None	128GB SSD M.2	DVD±RW	Intel 8265 ac, 2x2 + BT4.1	None	None	Black, Black	PC/ABS	Fingerprint Reader	FW TPM 2.0	4-cell (41Wh)	65W	Win10 DG Win7 Pro 64	1-year, Depot	03/17
20H5009KUS	US	i5-6200U	No	Intel HD 520	None	4GBx1	15.6" HD (1366x768)	None	128GB SSD M.2	DVD±RW	11ac, 1x1 + BT4.1	None	None	Black, Black	PC/ABS	Fingerprint Reader	dTPM 2.0	4-cell (41Wh)	45W	Win10 DG Win7 Pro 64	1-year, Depot	03/17
20H5009LUS	US	i5-6200U	No	Intel HD 520	None	8GBx1	15.6" FHD (1920x1080) IPS	None	256GB SSD M.2 PCIe NVMe Opal2	DVD±RW	Intel 8265 ac, 2x2 + BT4.1	None	None	Black, Black	PC/ABS	Fingerprint Reader	dTPM 2.0	4-cell (41Wh)	45W	Win10 DG Win7 Pro 64	1-year, Depot	03/17
20H5009MUS	US	i7-6500U	No	940MX 2GB	None	8GBx1	15.6" FHD (1920x1080) IPS	None	500GB 7200rpm	DVD±RW	Intel 8265 ac, 2x2 + BT4.1	None	None	Black, Black	PC/ABS	Fingerprint Reader	FW TPM 2.0	4-cell (41Wh)	65W	Win10 DG Win7 Pro 64	1-year, Depot	03/17
20H5009NUS	US	i5-6200U	No	Intel HD 520	None	4GBx1	15.6" HD (1366x768)	None	500GB 7200rpm	DVD±RW	11ac, 1x1 + BT4.1	None	None	Black, Black	PC/ABS	Fingerprint Reader	dTPM 2.0	4-cell (41Wh)	45W	Win10 DG Win7 Pro 64	1-year, Depot	03/17
20H500A9US	US	i5-7200U	No	Intel HD 620	None	8GBx1	15.6" FHD (1920x1080) IPS	None	180GB SSD M.2 Opal2	DVD±RW	11ac, 1x1 + BT4.1	None	None	Black, Black	PC/ABS	Fingerprint Reader	dTPM 2.0	4-cell (41Wh)	45W	Win10 Pro 64	1-year, Depot	03/17
20H500AAUS	US	i5-7200U	No	Intel HD 620	None	8GBx1	15.6" FHD (1920x1080) IPS	None	500GB 7200rpm	DVD±RW	11ac, 1x1 + BT4.1	None	None	Black, Black	PC/ABS	Fingerprint Reader	dTPM 2.0	4-cell (41Wh)	45W	Win10 Pro 64	1-year, Depot	03/17

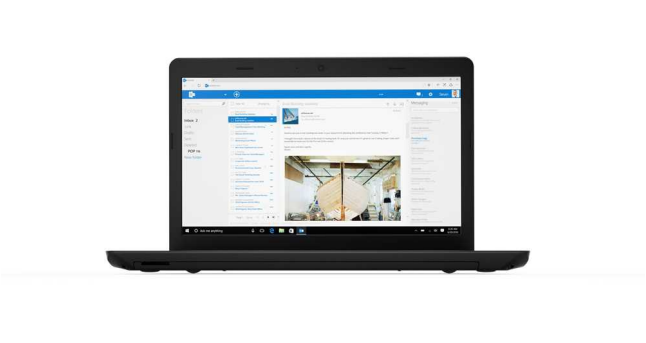

ThinkPad E575 Platform Specifications

Product Specifications Reference (PSREF)

Processor	AMD Accelerated Processor A6, A10, or A12 APU								Dimensions Weight Case color Case material	<i>PC/ABS (WxDxH):</i> 14.92" x 10.28" x 1.00"; 379mm x 261mm x 25.4mm From 5.07 lb (2.30kg) Black <i>PC/ABS:</i> PolyCarbonate/Acrylonitrile-Butadiene-Styrene display cover
	Processor Number	# of Cores	# of Threads	Base Frequency	Max Turbo Frequency	Cache	Memory Types	Processor Graphics		
	A6-9500B	2	4	2.3 GHz	3.2 GHz	2MB	DDR4-1866	R5 Graphics		
	A10-9600P	4	8	2.4 GHz	3.3 GHz	2MB		R5 Graphics		
A12-9700P	4	8	2.5 GHz	3.4 GHz	2MB	R7 Graphics				
Graphics	AMD Radeon™ R5 Graphics in processor only, or AMD Radeon R5 M430 Graphics, 2GB DDR3 memory, or external analog monitor support via VGA DB-15 connector and digital monitor support via HDMI™ (supporting HDCP to output protected content); supports dual independent displays; Max resolution: 1920x1080 (HDMI)@60Hz								Camera Audio support	<i>Some:</i> HD720p resolution, fixed focus HD Audio, Conexant® CX11852 codec, Dolby® Audio™ Premium / stereo speakers, 2W x 2 / dual array microphone, combo audio / microphone jack
Chipset	AMD SoC (System on Chip) platform								Keyboard	6-row, spill-resistant, multimedia Fn keys
Memory	32GB max / PC4-19200 2400MHz DDR4, non-parity, dual-channel capable, two 260-pin SO-DIMM sockets *System automatically clocks down with 1866MHz DDR4 memory controller								UltraNav™ ThinkLight™	TrackPoint® pointing device and multi-touch with 3+2 buttons click pad None
Display	Some: 15.6" (396mm) HD (1366x768), anti-glare, LED backlight, 220 nits, 16:9 aspect ratio, 400:1 contrast ratio Some: 15.6" (396mm) FHD (1920x1080), anti-glare, LED backlight, IPS, 250 nits, 16:9 aspect ratio, 600:1 contrast ratio								Fingerprint reader	None
Multi-touch	None								NFC	None
Storage	<i>Some:</i> SSD / SATA 6.0Gb/s, 2.5" wide, 7mm high, removable, upgradable <i>Some:</i> HDD / SATA 6.0Gb/s, 2.5" wide, removable, upgradable, Active Protection System™								Security	Power-on password, hard disk password, supervisor password, security keyhole
Optical	<i>Some:</i> DVD burner, 9.0mm high, removable <i>Some:</i> Blank Bezel								Security chip	<i>FW TPM2.0:</i> Firmware TPM 2.0, integrated in chipset <i>dTPM2.0:</i> Discrete TPM 2.0, TCG Certified
Ethernet	Gigabit Ethernet Connection, Realtek R8111GUS								vPro	No
WLAN	<i>One of the following, configurable by model:</i> • QCA, Qualcomm 344A-AC, 2x2, Wi-Fi + Bluetooth combo adapter, M.2 Card • QCA, Qualcomm 435-AC, 1x1, Wi-Fi + Bluetooth combo adapter, M.2 Card								Battery type	<i>Some:</i> Li-Ion 4-cell (41Wh)
Bluetooth™	Bluetooth wireless, integrated in Wi-Fi + Bluetooth combo adapter								Battery life	<i>Some:</i> Up to 6.5 hr
WWAN	None								AC adapter	<i>Some:</i> 45-watt AC adapter <i>Some:</i> 65-watt AC adapter
SIM card	None								Preload	<i>Some:</i> Windows 10 Pro 64 <i>Some:</i> Windows 10 Home 64 • Lenovo Companion • Lenovo Settings • Microsoft Office preloaded; purchase a product key to activate • McAfee® Live Safe (30-day trial) <i>Some:</i> No operating system
Smart Card Reader	None								Limited warranty	1-year - depot repair service / service upgrades available
ExpressCard	None								Mil-Spec test	None
Dock	None								Environment	EPEAT™ Gold; ENERGY STAR®; RoHS-compliant
Multicard Reader	4-in-1 reader (MMC, SD, SDHC, SDXC)									
Ports	Two USB 3.0, one USB 2.0 (Always On), VGA, HDMI, Ethernet (RJ-45), combo audio / microphone jack									
Monitor cable	None									

ThinkPad E575 - TopSeller - 20H8

Product Specifications Reference (PSREF)

Model	Region	Processor	vPro	Graphics	Memory	Display	Multi-touch	Storage(HDD/SSD)	Optical	WLAN + Bluetooth	WWAN	SIM Card	Color	Case Material	Camera	Keyboard	Fingerprint Reader	TPM	Battery	Power Adapter	Operating System	Warranty	Ann Date (m/y)
20H8000CUS	US	AMD A10-9600P	No	AMD R5 M430 2GB	4GBx1	15.6" HD (1366x768)	None	500GB 7200rpm	DVD±RW	QCA435ac, 1x1 + BT4.1	None	None	Black	PC/ABS	720p	Non-backlit	None	FW TPM 2.0	4-cell (41Wh)	65W	Windows 10 Pro 64	1-year, Depot	11/16
20H8000DUS	US	AMD A10-9600P	No	AMD R5 M430 2GB	8GBx1	15.6" FHD (1920x1080) IPS	None	500GB 7200rpm	DVD±RW	QCA435ac, 1x1 + BT4.1	None	None	Black	PC/ABS	720p	Non-backlit	None	FW TPM 2.0	4-cell (41Wh)	65W	Windows 10 Pro 64	1-year, Depot	11/16
20H8000EUS	US	AMD A10-9600P	No	AMD R5 M430 2GB	8GBx1	15.6" HD (1366x768)	None	500GB 7200rpm	DVD±RW	QCA435ac, 1x1 + BT4.1	None	None	Black	PC/ABS	720p	Non-backlit	None	FW TPM 2.0	4-cell (41Wh)	65W	Windows 10 Pro 64	1-year, Depot	11/16
20H8000FUS	US	AMD A6-9500B	No	AMD R5 Graphics	8GBx1	15.6" HD (1366x768)	None	500GB 7200rpm	DVD±RW	QCA435ac, 1x1 + BT4.1	None	None	Black	PC/ABS	720p	Non-backlit	None	dTPM 1.2	4-cell (41Wh)	45W	Windows 10 Pro 64	1-year, Depot	11/16
20H8000GUS	US	AMD A10-9600P	No	AMD R5 M430 2GB	8GBx1	15.6" FHD (1920x1080) IPS	None	256GB SSD Opal2	DVD±RW	QCA435ac, 1x1 + BT4.1	None	None	Black	PC/ABS	720p	Non-backlit	None	FW TPM 2.0	4-cell (41Wh)	65W	Windows 10 Pro 64	1-year, Depot	11/16
20H8000HUS	US	AMD A6-9500B	No	AMD R5 Graphics	4GBx1	15.6" HD (1366x768)	None	500GB 7200rpm	DVD±RW	QCA435ac, 1x1 + BT4.1	None	None	Black	PC/ABS	720p	Non-backlit	None	dTPM 1.2	4-cell (41Wh)	45W	Windows 10 Pro 64	1-year, Depot	11/16
20H8000QUS	US	AMD A10-9600P	No	AMD R5 M430 2GB	8GBx1	15.6" HD (1366x768)	None	180GB SSD Opal2	DVD±RW	QCA435ac, 1x1 + BT4.1	None	None	Black	PC/ABS	720p	Non-backlit	None	FW TPM 2.0	4-cell (41Wh)	65W	Windows 10 Pro 64	1-year, Depot	01/17



ThinkPad L460 Platform Specifications

Product Specifications Reference (PSREF)

Processor	Intel® Celeron® processor or 6th Generation Intel Core™ i3 / i5 / i7 Processor							Dimensions ³ Weight ²	WxDxH: 13.34" x 9.23" x 0.95"; 339mm x 235mm x 24.3mm						
	Processor Number	# of Cores	# of Threads	Base Frequency	Max Turbo Frequency	Cache	Memory Types		Processor Graphics	Models	3-cell	6-cell			
	Cel 3855U	2	4	1.6 GHz	-	2MB	DDR3L-1600	Intel HD Graphics 510	Integrated model	4.25 lb / 1.93 kg	4.45 lb / 2.02 kg				
	i3-6006U			2.0 GHz	-	3MB									
	i3-6100U			2.3 GHz	-	3MB									
	i5-6200U			2.3 GHz	2.8 GHz	3MB									
	i5-6300U			2.4 GHz	3.0 GHz	3MB									
	i7-6500U			2.5 GHz	3.1 GHz	4MB									
	i7-6600U			2.6 GHz	3.4 GHz	4MB			Intel HD Graphics 520		discrete model	4.3 lb / 1.95 kg	4.5 lb / 2.04 kg		
								Case material	PolyCarbonate/Acrylonitrile-Butadiene-Styrene (PC/ABS) plastic						
								Smart card reader	Optional: Smart card reader						
								Media reader	4-in-1 reader (MMC, SD, SDHC, SDXC)						
								Ports	Three USB 3.0 (one Always On), VGA, Mini DisplayPort, Ethernet (RJ-45), Dock connector (integrated models only)						
								Camera (optional)	HD720p resolution, low light sensitive, fixed focus						
								Audio support	HD Audio, Realtek® ALC3245 codec / stereo speakers, 2W x 2 / dual array microphone, combo audio/microphone jack						
Graphics	Intel HD Graphics 510 or 520 in processor only, or Intel HD Graphics 520 in processor and AMD Exo Pro Radeon R5, 2GB memory; supports external analog monitor via VGA and digital monitor via Mini DisplayPort; supports three independent displays; Max resolution: 3840x2160@60Hz (DP via mDP cable); 1920x1200@60Hz (VGA)							Keyboard	6-row, spill-resistant, multimedia Fn keys						
								UltraNav™	TrackPoint® pointing device and buttonless Mylar surface multi-touch touchpad						
Chipset	Intel SoC (System on Chip) platform							Security	Power-on password, hard disk password, supervisor password, security keyhole						
Memory	32GB max ⁷ / PC3-12800 1600MHz DDR3L, non-parity, dual-channel capable, two DDR3L SO-DIMM sockets							Security chip	Discrete TPM 1.2 TCG Certified and Firmware TPM 2.0 integrated in chipset						
								ThinkEngine	Delivers improved thermal and power efficiency, up to 30 day standby, faster resume time, enhanced security, as well as anti-tampering measures						
								vPro (optional)	Intel vPro Technology						
Display	Some: 14.0" (355mm) HD (1366x768), anti-glare, LED backlight, 220 nits, 16:9 aspect ratio, 400:1 or 500:1 contrast ratio Some: 14.0" (355mm) FHD (1920x1080), anti-glare, LED backlight, IPS, 250 nits, 16:9 aspect ratio, 600:1 or 700:1 contrast ratio, 170° viewing angle							Fingerprint reader	Optional: Swipe style fingerprint reader on the keyboard bezel						
Multi-touch	None							Battery	Li-Ion 3-cell (23Wh) or 6-cell (48Wh or 72Wh)						
Storage	Some: SSD / SATA 6.0Gb/s, 2.5" wide, 7mm high Some: HDD / SATA 6.0Gb/s, 2.5" wide, 7mm or 9.5mm high, Shock Mounted Hard Drive, Active Protection System™ Some: SSHD with 8GB NAND flash memory							Max battery life ¹⁰ (MobileMark® 2014)	Models	3-cell	6-cell 48Wh	6-cell 72Wh			
Optical	None							Max battery life	6.93 hr	12.7 hr	20.53 hr				
Ethernet	Non-vPro model: Intel Ethernet Connection I219-V (Jacksonville) vPro model: Intel Ethernet Connection I219-LM (Jacksonville)							AC adapter	45W or 65W AC adapter						
WLAN ⁴	One of the following, configurable by model: • 11ac+BT, Broadcom BCM4356, 2x2, M.2 card • 11ac+BT, Intel Dual Band Wireless-AC 8260, 2x2, M.2 card							Preload	Windows 7 Professional 64 preinstalled through downgrade rights in Windows 10 Pro 64	Windows 10 Pro 64	• Lenovo Solution Center	• Lenovo Companion			
Bluetooth™	Bluetooth 4.1 wireless, integrated in Wi-Fi + Bluetooth combo adapter								• Lenovo Solution Center	• ThinkVantage Product Recovery	• Rescue and Recovery™	• ThinkVantage System Update	• Adobe® Reader®	• Microsoft® Office preloaded; purchase a product key to activate	• McAfee® LiveSafe™ (30-day trial)
WWAN (optional)	One of the following, configurable by model: • Wireless WAN upgradable • Wireless WAN, Sierra Wireless EM7455, Qualcomm® 4G LTE-Advanced/DC-HSPA+/HSPA+/HSPA/UMTS/GNSS, M.2 card • Wireless WAN, HUAWEI ME906S, HUAWEI 4G LTE/WCDMA/HSPA/GSM/GPRS/EDGE/GNSS, M.2 card (WE only)							Limited warranty ¹²	One of the following, configurable by model: • 1-year depot repair service • 3-year/1-yr battery depot repair service • 3-year/1-yr battery limited onsite service ²⁴ • 3-year/1-yr battery limited onsite service, OID (Onsite International Delivery)						
SIM card (opt)	Micro-SIM card slot, optional Verizon LTE (US) or Lenovo Connect (WE) SIM card							Mil-Spec test	MIL-STD-810G military certification						
								Environment	EPEAT™ Gold (US only); ENERGY STAR® 6.1; GREENGUARD®; RoHS-compliant						

Model	Region	Processor	vPro	Graphics	Memory	Display	Multi-touch	Storage	Optical	WLAN + Bluetooth	WWAN	SIM Card	Smart Card Reader	Camera	Keyboard	Fingerprint Reader	Battery	Power Adapter	Operating System	Warranty	Ann Date (m/y)
20FU0014US	US	i5-6200U	No	Intel HD 520	8GBx1	14" HD (1366x768)	None	256GB SSD Opal2	None	Intel 8260 ac, 2x2 + BT4.1	WWAN Upgradable	None	None	720p	Non-backlit	None	6-cell (48Wh)	45W	Win10 DG Win7 Pro 64	3-year, Depot	01/16
20FU0015US	US	i5-6200U	No	Intel HD 520	8GBx1	14" FHD (1920x1080) IPS	None	256GB SSD Opal2	None	Intel 8260 ac, 2x2 + BT4.1	WWAN Upgradable	None	None	720p	Non-backlit	Fingerprint Reader	6-cell (48Wh)	45W	Win10 DG Win7 Pro 64	1-year, Depot	01/16
20FU0017US	US	i3-6100U	No	Intel HD 520	4GBx1	14" HD (1366x768)	None	192GB SSD	None	Intel 8260 ac, 2x2 + BT4.1	WWAN Upgradable	None	None	720p	Non-backlit	None	6-cell (48Wh)	45W	Win10 DG Win7 Pro 64	1-year, Depot	01/16
20FU0018US	US	i5-6200U	No	Intel HD 520	4GBx1	14" HD (1366x768)	None	192GB SSD	None	Intel 8260 ac, 2x2 + BT4.1	WWAN Upgradable	None	None	720p	Non-backlit	None	6-cell (48Wh)	45W	Win10 Pro 64	1-year, Depot	01/16
20FU001BUS	US	i5-6200U	No	Intel HD 520	8GBx1	14" HD (1366x768)	None	256GB SSD Opal2	None	Intel 8260 ac, 2x2 + BT4.1	WWAN Upgradable	None	None	720p	Non-backlit	None	6-cell (48Wh)	45W	Win10 Pro 64	3-year, Depot	01/16
20FU001CUS	US	i5-6200U	No	Intel HD 520	8GBx1	14" FHD (1920x1080) IPS	None	256GB SSD Opal2	None	Intel 8260 ac, 2x2 + BT4.1	WWAN Upgradable	None	None	720p	Non-backlit	Fingerprint Reader	6-cell (48Wh)	45W	Win10 Pro 64	1-year, Depot	01/16
20FU001DUS	US	i5-6200U	No	Intel HD 520	4GBx1	14" HD (1366x768)	None	192GB SSD	None	Intel 8260 ac, 2x2 + BT4.1	WWAN Upgradable	None	None	720p	Non-backlit	None	6-cell (48Wh)	45W	Win10 DG Win7 Pro 64	1-year, Depot	01/16
20FU001EUS	US	i3-6100U	No	Intel HD 520	4GBx1	14" HD (1366x768)	None	500GB 7200rpm	None	Intel 8260 ac, 2x2 + BT4.1	WWAN Upgradable	None	None	720p	Non-backlit	None	6-cell (48Wh)	45W	Win10 Pro 64	1-year, Depot	01/16
20FU001GUS	US	i3-6100U	No	Intel HD 520	4GBx1	14" HD (1366x768)	None	192GB SSD	None	Intel 8260 ac, 2x2 + BT4.1	WWAN Upgradable	None	None	720p	Non-backlit	None	6-cell (48Wh)	45W	Win10 Pro 64	1-year, Depot	01/16
20FU001HUS	US	i3-6100U	No	Intel HD 520	4GBx1	14" HD (1366x768)	None	500GB 7200rpm	None	Intel 8260 ac, 2x2 + BT4.1	WWAN Upgradable	None	None	720p	Non-backlit	None	6-cell (48Wh)	45W	Win10 DG Win7 Pro 64	1-year, Depot	01/16
20FU0024US	US	i5-6300U	vPro	Intel HD 520	8GBx1	14" FHD (1920x1080) IPS	None	256GB SSD Opal2	None	Intel 8260 ac, 2x2 + BT4.1	WWAN Upgradable	None	None	720p	Non-backlit	Fingerprint Reader	6-cell (48Wh)	45W	Win10 Pro 64	1-year, Depot	01/16
20FU0025US	US	i5-6300U	vPro	Intel HD 520	8GBx1	14" FHD (1920x1080) IPS	None	256GB SSD Opal2	None	Intel 8260 ac, 2x2 + BT4.1	WWAN Upgradable	None	None	720p	Non-backlit	Fingerprint Reader	6-cell (48Wh)	45W	Win10 DG Win7 Pro 64	1-year, Depot	01/16
20FU0026US	US	i5-6300U	vPro	Intel HD 520	4GBx1	14" HD (1366x768)	None	500GB 7200rpm	None	Intel 8260 ac, 2x2 + BT4.1	WWAN Upgradable	None	None	720p	Non-backlit	None	6-cell (48Wh)	45W	Win10 DG Win7 Pro 64	1-year, Depot	01/16
20FU0027US	US	i5-6300U	vPro	Intel HD 520	4GBx1	14" HD (1366x768)	None	500GB 7200rpm	None	Intel 8260 ac, 2x2 + BT4.1	WWAN Upgradable	None	None	720p	Non-backlit	None	6-cell (48Wh)	45W	Win10 Pro 64	1-year, Depot	01/16
20FU0028US	US	i5-6300U	vPro	Intel HD 520	4GBx1	14" HD (1366x768)	None	192GB SSD	None	Intel 8260 ac, 2x2 + BT4.1	WWAN Upgradable	None	None	720p	Non-backlit	Fingerprint Reader	6-cell (48Wh)	45W	Win10 DG Win7 Pro 64	3-year, Depot	02/16
20FU0029US	US	i5-6200U	No	AMD Exo Pro R5 2GB	4GBx1	14" HD (1366x768)	None	500GB 7200rpm	None	Intel 8260 ac, 2x2 + BT4.1	WWAN Upgradable	None	None	720p	Non-backlit	None	6-cell (48Wh)	65W	Win10 Pro 64	1-year, Depot	02/16
20FU002AUS	US	i5-6200U	No	Intel HD 520	4GBx1	14" HD (1366x768)	None	500GB 7200rpm	None	Intel 8260 ac, 2x2 + BT4.1	WWAN Upgradable	None	None	720p	Non-backlit	None	6-cell (48Wh)	45W	Win10 DG Win7 Pro 64	1-year, Depot	02/16
20FU002BUS	US	i5-6300U	vPro	Intel HD 520	4GBx1	14" HD (1366x768)	None	192GB SSD	None	Intel 8260 ac, 2x2 + BT4.1	WWAN Upgradable	None	None	720p	Non-backlit	Fingerprint Reader	6-cell (48Wh)	45W	Win10 Pro 64	3-year, Depot	02/16
20FU003PUS	US	i3-6100U	No	Intel HD 520	4GBx1	14" HD (1366x768)	None	256GB SSD Opal2	None	Intel 8260 ac, 2x2 + BT4.1	WWAN Upgradable	None	None	720p	Non-backlit	None	6-cell (48Wh)	45W	Win10 Pro 64	1-year, Depot	10/16
20FU003QUS	US	i5-6300U	vPro	Intel HD 520	4GBx1	14" HD (1366x768)	None	256GB SSD Opal2	None	Intel 8260 ac, 2x2 + BT4.1	WWAN Upgradable	None	None	720p	Non-backlit	Fingerprint Reader	6-cell (48Wh)	45W	Win10 DG Win7 Pro 64	3-year, Depot	10/16

Model	Region	Processor	vPro	Graphics	Memory	Display	Multi-touch	Storage	Optical	WLAN + Bluetooth	WWAN	SIM Card	Smart Card Reader	Camera	Keyboard	Fingerprint Reader	Battery	Power Adapter	Operating System	Warranty	Ann Date (m/y)
20FU003RUS	US	i5-6200U	No	Intel HD 520	4GBx1	14" HD (1366x768)	None	256GB SSD Opal2	None	Intel 8260 ac, 2x2 + BT4.1	WWAN Upgradable	None	None	720p	Non-backlit	None	6-cell (48Wh)	45W	Win10 DG Win7 Pro 64	1-year, Depot	10/16
20FU003SUS	US	i5-6200U	No	Intel HD 520	4GBx1	14" HD (1366x768)	None	256GB SSD Opal2	None	Intel 8260 ac, 2x2 + BT4.1	WWAN Upgradable	None	None	720p	Non-backlit	None	6-cell (48Wh)	45W	Win10 Pro 64	1-year, Depot	10/16
20FU003TUS	US	i5-6300U	vPro	Intel HD 520	4GBx1	14" HD (1366x768)	None	256GB SSD Opal2	None	Intel 8260 ac, 2x2 + BT4.1	WWAN Upgradable	None	None	720p	Non-backlit	Fingerprint Reader	6-cell (48Wh)	45W	Win10 Pro 64	3-year, Depot	10/16
20FU003UUS	US	i3-6100U	No	Intel HD 520	4GBx1	14" HD (1366x768)	None	256GB SSD Opal2	None	Intel 8260 ac, 2x2 + BT4.1	WWAN Upgradable	None	None	720p	Non-backlit	None	6-cell (48Wh)	45W	Win10 DG Win7 Pro 64	1-year, Depot	10/16
20FU004GUS	US	i5-6200U	No	Intel HD 520	4GBx1	14" HD (1366x768)	None	180GB SSD Opal2	None	Intel 8260 ac, 2x2 + BT4.1	WWAN Upgradable	None	None	720p	Non-backlit	None	6-cell (48Wh)	45W	Win10 Pro 64	1-year, Depot	11/16
20FU004HUS	US	i5-6300U	vPro	Intel HD 520	4GBx1	14" HD (1366x768)	None	180GB SSD Opal2	None	Intel 8260 ac, 2x2 + BT4.1	WWAN Upgradable	None	None	720p	Non-backlit	Fingerprint Reader	6-cell (48Wh)	45W	Win10 DG Win7 Pro 64	3-year, Depot	11/16
20FU004JUS	US	i5-6200U	No	Intel HD 520	4GBx1	14" HD (1366x768)	None	180GB SSD Opal2	None	Intel 8260 ac, 2x2 + BT4.1	WWAN Upgradable	None	None	720p	Non-backlit	None	6-cell (48Wh)	45W	Win10 DG Win7 Pro 64	1-year, Depot	11/16
20FU004LUS	US	i5-6300U	vPro	Intel HD 520	4GBx1	14" HD (1366x768)	None	180GB SSD Opal2	None	Intel 8260 ac, 2x2 + BT4.1	WWAN Upgradable	None	None	720p	Non-backlit	Fingerprint Reader	6-cell (48Wh)	45W	Win10 Pro 64	3-year, Depot	11/16



ThinkPad L470 Platform Specifications

Product Specifications Reference (PSREF)

Processor	6th Generation Intel® Core™ i3 / i5 / i7 Processor (i7 processor is not available in EMEA) or Intel Celeron® Processor or 7th Generation Intel Core i3 / i5 / i7 Processor	WWAN (optional) One of the following, configurable by model: • Wireless WAN upgradable • Integrated Mobile Broadband 4G LTE-A, Qualcomm® Snapdragon™ X7 LTE-A (Sierra Wireless EM7455), M.2 card • Integrated Mobile Broadband 4G LTE, Intel XMM™ 7160 (Fibocom L831-EAU), M.2 card (EMEA only) SIM card (opt) Micro-SIM card slot, opt Verizon LTE (US) or Lenovo® Connect (EMEA) SIM card																																														
	<table border="1"> <thead> <tr> <th>Processor Number</th> <th># of Cores</th> <th># of Threads</th> <th>Base Frequency</th> <th>Max Turbo Frequency</th> <th>Cache</th> <th>Memory Types</th> <th>Processor Graphics</th> </tr> </thead> <tbody> <tr> <td>i3-6006U</td> <td rowspan="4">2</td> <td rowspan="4">4</td> <td>2.0 GHz</td> <td>-</td> <td>3MB</td> <td rowspan="4">DDR4-2133</td> <td rowspan="4">Intel HD Graphics 520</td> </tr> <tr> <td>i5-6200U</td> <td>2.3 GHz</td> <td>2.8 GHz</td> <td>3MB</td> </tr> <tr> <td>i5-6300U</td> <td>2.4 GHz</td> <td>3.0 GHz</td> <td>3MB</td> </tr> <tr> <td>i7-6600U</td> <td>2.6 GHz</td> <td>3.4 GHz</td> <td>4MB</td> </tr> </tbody> </table>	Processor Number	# of Cores	# of Threads	Base Frequency	Max Turbo Frequency	Cache	Memory Types	Processor Graphics	i3-6006U	2	4	2.0 GHz	-	3MB	DDR4-2133	Intel HD Graphics 520	i5-6200U	2.3 GHz	2.8 GHz	3MB	i5-6300U	2.4 GHz	3.0 GHz	3MB	i7-6600U	2.6 GHz	3.4 GHz	4MB	Dimensions Weight																		
Processor Number	# of Cores	# of Threads	Base Frequency	Max Turbo Frequency	Cache	Memory Types	Processor Graphics																																									
i3-6006U	2	4	2.0 GHz	-	3MB	DDR4-2133	Intel HD Graphics 520																																									
i5-6200U			2.3 GHz	2.8 GHz	3MB																																											
i5-6300U			2.4 GHz	3.0 GHz	3MB																																											
i7-6600U			2.6 GHz	3.4 GHz	4MB																																											
	<table border="1"> <thead> <tr> <th>Processor Number</th> <th># of Cores</th> <th># of Threads</th> <th>Base Frequency</th> <th>Max Turbo Frequency</th> <th>Cache</th> <th>Memory Types</th> <th>Processor Graphics</th> </tr> </thead> <tbody> <tr> <td>Cel 3965U</td> <td rowspan="6">2</td> <td rowspan="6">4</td> <td>2.2 GHz</td> <td>-</td> <td>2MB</td> <td rowspan="6">DDR4-2133</td> <td>Intel HD Graphics 610</td> </tr> <tr> <td>i3-7100U</td> <td>2.4 GHz</td> <td>-</td> <td>3MB</td> <td rowspan="5">Intel HD Graphics 620</td> </tr> <tr> <td>i5-7200U</td> <td>2.5 GHz</td> <td>3.1 GHz</td> <td>3MB</td> </tr> <tr> <td>i5-7300U</td> <td>2.6 GHz</td> <td>3.5 GHz</td> <td>3MB</td> </tr> <tr> <td>i7-7500U</td> <td>2.7 GHz</td> <td>3.5 GHz</td> <td>4MB</td> </tr> <tr> <td>i7-7600U</td> <td>2.8 GHz</td> <td>3.9 GHz</td> <td>4MB</td> </tr> </tbody> </table>	Processor Number	# of Cores	# of Threads	Base Frequency	Max Turbo Frequency	Cache	Memory Types	Processor Graphics	Cel 3965U	2	4	2.2 GHz	-	2MB	DDR4-2133	Intel HD Graphics 610	i3-7100U	2.4 GHz	-	3MB	Intel HD Graphics 620	i5-7200U	2.5 GHz	3.1 GHz	3MB	i5-7300U	2.6 GHz	3.5 GHz	3MB	i7-7500U	2.7 GHz	3.5 GHz	4MB	i7-7600U	2.8 GHz	3.9 GHz	4MB	<table border="1"> <thead> <tr> <th>Models</th> <th>3-cell</th> <th>6-cell</th> </tr> </thead> <tbody> <tr> <td>Integrated model</td> <td>4.13 lb / 1.87 kg</td> <td>4.45 lb / 2.02 kg</td> </tr> <tr> <td>discrete model</td> <td>4.16 lb / 1.89 kg</td> <td>4.48 lb / 2.03 kg</td> </tr> </tbody> </table>	Models	3-cell	6-cell	Integrated model	4.13 lb / 1.87 kg	4.45 lb / 2.02 kg	discrete model	4.16 lb / 1.89 kg	4.48 lb / 2.03 kg
Processor Number	# of Cores	# of Threads	Base Frequency	Max Turbo Frequency	Cache	Memory Types	Processor Graphics																																									
Cel 3965U	2	4	2.2 GHz	-	2MB	DDR4-2133	Intel HD Graphics 610																																									
i3-7100U			2.4 GHz	-	3MB		Intel HD Graphics 620																																									
i5-7200U			2.5 GHz	3.1 GHz	3MB																																											
i5-7300U			2.6 GHz	3.5 GHz	3MB																																											
i7-7500U			2.7 GHz	3.5 GHz	4MB																																											
i7-7600U			2.8 GHz	3.9 GHz	4MB																																											
Models	3-cell	6-cell																																														
Integrated model	4.13 lb / 1.87 kg	4.45 lb / 2.02 kg																																														
discrete model	4.16 lb / 1.89 kg	4.48 lb / 2.03 kg																																														
Graphics	Intel HD Graphics 610 or 620 in processor only, or Intel HD Graphics 620 in processor and AMD Radeon™ R5 M430, 2GB memory; supports external analog monitor via VGA and digital monitor via Mini DisplayPort; supports three independent displays; Max resolution: 3840x2160@60Hz (DP via mDP cable); 1920x1200@60Hz (VGA)	Case color Black Case material PC/ABS plastic																																														
Chipset	Intel SoC (System on Chip) platform	Smart card reader Optional: Smart card reader																																														
Memory	32GB max / 2400MHz DDR4, dual-channel capable, two DDR4 SO-DIMM sockets * System clocks down for processors with lower memory controller	Media reader 4-in-1 reader (MMC, SD, SDHC, SDXC) Ports Three USB 3.1 Gen 1 / USB 3.0 (one Always On), VGA, Mini DisplayPort, Ethernet (RJ-45), Dock connector																																														
Display	Some: 14.0" (355mm) HD (1366x768), anti-glare, LED backlight, 220 nits, 16:9 aspect ratio, 500:1 contrast ratio Some: 14.0" (355mm) FHD (1920x1080), anti-glare, LED backlight, IPS, 250 nits, 16:9 aspect ratio, 700:1 contrast ratio, 170° viewing angle	Camera (optional) HD720p resolution, fixed focus Audio support HD Audio, Realtek ALC3268 codec / stereo speakers, 1W x 2 / dual array microphone, combo audio/microphone jack																																														
Multi-touch	None	Keyboard 6-row, spill-resistant, multimedia Fn keys UltraNav™ TrackPoint® pointing device and buttonless Mylar surface multi-touch touchpad																																														
Storage	System has one HDD slot or one M.2 2280 slot exclusively for storage Some: HDD / SATA 6.0Gb/s, 2.5" wide, 7mm or 9.5mm high, Active Protection System™ Some: SSD / SATA 6.0Gb/s, 2.5" wide, 7mm high (e.g. xxxGB SSD) Some: M.2 SSD / PCIe NVMe, PCIe 3.0 x 2, 16Gb/s Some: 128GB M.2 SSD / SATA 6.0Gb/s, in WWAN slot as 2nd Storage, mutually exclusive with WWAN	Security Power-on password, hard disk password, supervisor password, security keyhole Security chip Discrete TPM 2.0, TCG Certified vPro (optional) Intel vPro Technology Fingerprint reader Optional: Swipe style fingerprint reader on the keyboard bezel NFC None																																														
Optical	None	Battery Li-Ion 3-cell (24Wh) or 6-cell (48Wh or 72Wh) Max battery life ¹⁰ (MobileMark® 2014) <table border="1"> <thead> <tr> <th>Models</th> <th>3-cell</th> <th>6-cell 48Wh</th> <th>6-cell 72Wh</th> </tr> </thead> <tbody> <tr> <td>Integrated model</td> <td>7.24 hr</td> <td>14.48 hr</td> <td>21.72 hr</td> </tr> <tr> <td>discrete model</td> <td>4.34 hr</td> <td>8.68 hr</td> <td>13.02 hr</td> </tr> </tbody> </table>	Models	3-cell	6-cell 48Wh	6-cell 72Wh	Integrated model	7.24 hr	14.48 hr	21.72 hr	discrete model	4.34 hr	8.68 hr	13.02 hr																																		
Models	3-cell	6-cell 48Wh	6-cell 72Wh																																													
Integrated model	7.24 hr	14.48 hr	21.72 hr																																													
discrete model	4.34 hr	8.68 hr	13.02 hr																																													
Ethernet	Non-vPro model: Intel Ethernet Connection I219-V (Jacksonville) vPro model: Intel Ethernet Connection I219-LM (Jacksonville)	AC adapter 45W or 65W AC adapter																																														
WLAN	One of the following, configurable by model: • Realtek® RTL8822BE, Wi-Fi 2x2 802.11ac + BT4.1, M.2 card • Intel Dual Band Wireless-AC 8260, Wi-Fi 2x2 802.11ac + BT4.1, M.2 card • Intel Dual Band Wireless-AC 8265, Wi-Fi 2x2 802.11ac + BT4.1, M.2 card	Preload Windows® 7 Professional 64 preinstalled through downgrade rights in Windows 10 Pro 64 Some: Windows 10 Home 64 Some: Windows 10 Pro 64 • Lenovo Solution Center • Lenovo PowerEngage • ThinkVantage Product Recovery • ThinkVantage System Update • Adobe® Reader® • Microsoft® Office preloaded; purchase a product key to activate • McAfee® LiveSafe™ (30-day trial)																																														
Bluetooth™	Bluetooth 4.1 wireless, integrated in Wi-Fi + Bluetooth combo adapter * Intel 8265ac card supports BT4.2 but is limited to BT4.1 by Windows OS	Limited warranty One of the following, configurable by model: • 1-year depot repair service • 3-year/1-yr battery depot repair service • 3-year/1-yr battery limited onsite service																																														
		Mil-Spec test MIL-STD-810G military certification																																														
		Environment EPEAT™ Gold (US only); ENERGY STAR® 6.1; RoHS-compliant																																														

ThinkPad L470 - TopSeller - 20J4

Product Specifications Reference (PSREF)

Model	Region	Processor	vPro	Graphics	Memory	Display	Multi-touch	Storage(HDD/SSD)	Optical	WLAN + Bluetooth	WWAN	SIM Card	Smart Card Reader	Camera	Keyboard	Fingerprint Reader	TPM	Battery	Power Adapter	Operating System	Warranty	Ann Date (m/y)
20J4000RUS	US	i5-7200U	No	Intel HD 620	4GBx1	14" FHD (1920x1080) IPS	None	500GB 7200rpm	None	Intel 8265 ac, 2x2 + BT4.1	WWAN Upgradable	None	None	720p	Non-backlit	None	dTPM 2.0	6-cell (48Wh)	45W	Win10 Pro 64	1-year, Depot	01/17
20J4000SUS	US	i5-7200U	No	Intel HD 620	4GBx1	14" FHD (1920x1080) IPS	None	256GB SSD Opal2	None	Intel 8265 ac, 2x2 + BT4.1	WWAN Upgradable	None	None	720p	Non-backlit	None	dTPM 2.0	6-cell (48Wh)	45W	Win10 Pro 64	3-year, Depot	01/17
20J4000TUS	US	i5-7200U	No	Intel HD 620	4GBx1	14" HD (1366x768)	None	500GB 7200rpm	None	Intel 8265 ac, 2x2 + BT4.1	WWAN Upgradable	None	None	720p	Non-backlit	None	dTPM 2.0	6-cell (48Wh)	45W	Win10 Pro 64	1-year, Depot	01/17
20J4000UUS	US	i5-7200U	No	Intel HD 620	4GBx1	14" HD (1366x768)	None	256GB SSD Opal2	None	Intel 8265 ac, 2x2 + BT4.1	WWAN Upgradable	None	None	720p	Non-backlit	None	dTPM 2.0	6-cell (48Wh)	45W	Win10 Pro 64	3-year, Depot	01/17
20J40012US	US	i3-7100U	No	Intel HD 620	4GBx1	14" HD (1366x768)	None	500GB 7200rpm	None	Intel 8265 ac, 2x2 + BT4.1	WWAN Upgradable	None	None	720p	Non-backlit	None	dTPM 2.0	6-cell (48Wh)	45W	Win10 Pro 64	1-year, Depot	01/17
20J40013US	US	i5-7200U	No	Intel HD 620	8GBx1	14" FHD (1920x1080) IPS	None	256GB SSD Opal2	None	Intel 8265 ac, 2x2 + BT4.1	WWAN Upgradable	None	None	720p	Non-backlit	Fingerprint Reader	dTPM 2.0	6-cell (48Wh)	45W	Win10 Pro 64	1-year, Depot	01/17
20J40014US	US	i5-7300U	vPro	Intel HD 620	4GBx1	14" HD (1366x768)	None	500GB 7200rpm	None	Intel 8265 ac, 2x2 + BT4.1	WWAN Upgradable	None	None	720p	Non-backlit	None	dTPM 2.0	6-cell (48Wh)	45W	Win10 Pro 64	1-year, Depot	01/17
20J40015US	US	i5-7300U	vPro	Intel HD 620	8GBx1	14" FHD (1920x1080) IPS	None	256GB SSD Opal2	None	Intel 8265 ac, 2x2 + BT4.1	WWAN Upgradable	None	None	720p	Non-backlit	Fingerprint Reader	dTPM 2.0	6-cell (48Wh)	45W	Win10 Pro 64	1-year, Depot	01/17
20J40016US	US	i5-7200U	No	Intel HD 620	8GBx1	14" HD (1366x768)	None	256GB SSD Opal2	None	Intel 8265 ac, 2x2 + BT4.1	WWAN Upgradable	None	None	720p	Non-backlit	None	dTPM 2.0	6-cell (48Wh)	45W	Win10 Pro 64	3-year, Depot	01/17
20J4003EUS	US	i5-7200U	No	Intel HD 620	4GBx1	14" HD (1366x768)	None	500GB 7200rpm	None	Intel 8265 ac, 2x2 + BT4.1	Sierra EM7455	None	None	720p	Non-backlit	None	dTPM 2.0	6-cell (48Wh)	45W	Win10 Pro 64	3-year, Depot	04/17
20J4003FUS	US	i5-7300U	vPro	Intel HD 620	8GBx1	14" FHD (1920x1080) IPS	None	256GB SSD M.2 PCIe NVMe Opal2	None	Intel 8265 ac, 2x2 + BT4.1	WWAN Upgradable	None	None	720p	Non-backlit	Fingerprint Reader	dTPM 2.0	6-cell (48Wh)	45W	Win10 Pro 64	3-year, Depot	04/17
20J4003GUS	US	i5-7300U	vPro	Intel HD 620	8GBx1	14" FHD (1920x1080) IPS	None	256GB SSD Opal2	None	Intel 8265 ac, 2x2 + BT4.1	Sierra EM7455	None	None	720p	Non-backlit	Fingerprint Reader	dTPM 2.0	6-cell (48Wh)	45W	Win10 Pro 64	3-year, Depot	04/17

ThinkPad L470 - TopSeller - 20JU

Product Specifications Reference (PSREF)

Model	Region	Processor	vPro	Graphics	Memory	Display	Multi-touch	Storage(HDD/SSD)	Optical	WLAN + Bluetooth	WWAN	SIM Card	Smart Card Reader	Camera	Keyboard	Fingerprint Reader	TPM	Battery	Power Adapter	Operating System	Warranty	Ann Date (m/y)
20JU0008US	US	i5-6200U	No	Intel HD 520	4GBx1	14" FHD (1920x1080) IPS	None	500GB 7200rpm	None	Intel 8260 ac, 2x2 + BT4.1	WWAN Upgradable	None	None	720p	Non-backlit	None	dTPM 2.0	6-cell (48Wh)	45W	Win10 DG Win7 Pro 64	3-year, Depot	04/17
20JU0009US	US	i5-6200U	No	Intel HD 520	8GBx1	14" HD (1366x768)	None	180GB SSD Opal2	None	Intel 8260 ac, 2x2 + BT4.1	WWAN Upgradable	None	None	720p	Non-backlit	None	dTPM 2.0	6-cell (48Wh)	45W	Win10 DG Win7 Pro 64	3-year, Depot	04/17
20JU000AUS	US	i5-6200U	No	Intel HD 520	4GBx1	14" FHD (1920x1080) IPS	None	128GB SSD	None	Intel 8260 ac, 2x2 + BT4.1	WWAN Upgradable	None	None	720p	Non-backlit	None	dTPM 2.0	6-cell (48Wh)	45W	Win10 DG Win7 Pro 64	3-year, Depot	04/17
20JU000BUS	US	i5-6200U	No	Intel HD 520	8GBx1	14" FHD (1920x1080) IPS	None	180GB SSD Opal2	None	Intel 8260 ac, 2x2 + BT4.1	WWAN Upgradable	None	None	720p	Non-backlit	None	dTPM 2.0	6-cell (48Wh)	45W	Win10 DG Win7 Pro 64	3-year, Depot	04/17
20JU000CUS	US	i5-6200U	No	Intel HD 520	4GBx1	14" HD (1366x768)	None	128GB SSD	None	Intel 8260 ac, 2x2 + BT4.1	WWAN Upgradable	None	None	720p	Non-backlit	None	dTPM 2.0	6-cell (48Wh)	45W	Win10 DG Win7 Pro 64	3-year, Depot	04/17
20JU000DUS	US	i5-6200U	No	Intel HD 520	8GBx1	14" HD (1366x768)	None	256GB SSD Opal2	None	Intel 8260 ac, 2x2 + BT4.1	WWAN Upgradable	None	None	720p	Non-backlit	None	dTPM 2.0	6-cell (48Wh)	45W	Win10 DG Win7 Pro 64	3-year, Depot	04/17
20JU000EUS	US	i5-6200U	No	Intel HD 520	8GBx1	14" FHD (1920x1080) IPS	None	256GB SSD Opal2	None	Intel 8260 ac, 2x2 + BT4.1	WWAN Upgradable	None	None	720p	Non-backlit	None	dTPM 2.0	6-cell (48Wh)	45W	Win10 DG Win7 Pro 64	3-year, Depot	04/17
20JU000FUS	US	i5-6200U	No	Intel HD 520	4GBx1	14" HD (1366x768)	None	500GB 7200rpm	None	Intel 8260 ac, 2x2 + BT4.1	WWAN Upgradable	None	None	720p	Non-backlit	None	dTPM 2.0	6-cell (48Wh)	45W	Win10 DG Win7 Pro 64	3-year, Depot	04/17
20JU000QUS	US	i5-6200U	No	Intel HD 520	4GBx1	14" HD (1366x768)	None	500GB 7200rpm	None	Intel 8260 ac, 2x2 + BT4.1	Sierra EM7455	None	None	720p	Non-backlit	None	dTPM 2.0	6-cell (48Wh)	45W	Win10 DG Win7 Pro 64	3-year, Depot	04/17
20JU000RUS	US	i5-6200U	No	Intel HD 520	8GBx1	14" FHD (1920x1080) IPS	None	256GB SSD M.2 PCIe NVMe Opal2	None	Intel 8260 ac, 2x2 + BT4.1	WWAN Upgradable	None	None	720p	Non-backlit	Fingerprint Reader	dTPM 2.0	6-cell (48Wh)	45W	Win10 DG Win7 Pro 64	3-year, Depot	04/17
20JU000WUS	US	i5-6300U	vPro	Intel HD 520	8GBx1	14" FHD (1920x1080) IPS	None	256GB SSD Opal2	None	Intel 8260 ac, 2x2 + BT4.1	WWAN Upgradable	None	None	720p	Non-backlit	Fingerprint Reader	dTPM 2.0	6-cell (48Wh)	45W	Win10 DG Win7 Pro 64	1-year, Depot	05/17
20JU0018US	US	i5-6300U	vPro	Intel HD 520	4GBx1	14" HD (1366x768)	None	500GB 7200rpm	None	Intel 8260 ac, 2x2 + BT4.1	WWAN Upgradable	None	None	720p	Non-backlit	None	dTPM 2.0	6-cell (48Wh)	45W	Win10 DG Win7 Pro 64	1-year, Depot	05/17
20JU0019US	US	i5-6300U	vPro	Intel HD 520	4GBx1	14" HD (1366x768)	None	180GB SSD Opal2	None	Intel 8260 ac, 2x2 + BT4.1	WWAN Upgradable	None	None	720p	Non-backlit	Fingerprint Reader	dTPM 2.0	6-cell (48Wh)	45W	Win10 DG Win7 Pro 64	3-year, Depot	05/17



ThinkPad L560 Platform Specifications

Product Specifications Reference (PSREF)

Processor	Intel® Celeron® Processor or 6th Generation Intel Core™ i3 / i5 / i7 Processor								ExpressCard (opt) One slot (ExpressCard/34) Smart card reader Optional: Smart card reader Media reader 4-in-1 reader (MMC, SD, SDHC, SDXC) Ports <i>Cel 3855U model:</i> three USB 3.0, one USB 2.0 Always On; <i>Other model:</i> four USB 3.0 (one Always On), <i>All:</i> VGA, Mini DisplayPort, Ethernet (RJ-45), Dock connector
	Processor Number	# of Cores	# of Threads	Base Frequency	Max Turbo Frequency	Cache	Memory Types	Processor Graphics	
	Cel 3855U	2	4	1.6 GHz	-	2MB	DDR3L-1600	Intel HD graphics 510	
	i3-6006U			2.0 GHz	-	3MB		Intel HD graphics 520	
	i3-6100U			2.3 GHz	-	3MB			
	i5-6200U			2.3 GHz	2.8 GHz	3MB			
	i5-6300U			2.4 GHz	3.0 GHz	3MB			
i7-6600U	2.6 GHz			3.4 GHz	4MB				
Graphics	Intel HD Graphics 510 or 520 in processor, supports external analog monitor via VGA and digital monitor via Mini DisplayPort; supports three independent displays; Max resolution: 3840x2160@60Hz (DP via mDP cable); 1920x1200@60Hz (VGA)								Camera (optional) HD720p resolution, low light sensitive, fixed focus Audio support HD Audio, Realtek® ALC3245 codec / stereo speakers, 1.5W x 2 / dual array microphone, combo audio/microphone jack
Chipset	Intel SoC (System on Chip) platform								Keyboard 6-row, spill-resistant, multimedia Fn keys, numeric keypad UltraNav™ TrackPoint® pointing device and buttonless Mylar surface multi-touch touchpad
Memory	16GB max ⁷ / PC3-12800 1600MHz DDR3L, non-parity, dual-channel capable, two DDR3L SO-DIMM sockets								Security Power-on password, hard disk password, supervisor password, security keyhole Security chip Discrete TPM 1.2 TCG Certified and Firmware TPM 2.0 integrated in chipset ThinkEngine Delivers improved thermal and power efficiency, up to 30 day standby, faster resume time, enhanced security, as well as anti-tampering measures
Display	<i>Some:</i> 15.6" (396mm) HD (1366x768), anti-glare, LED backlight, 220 nits, 16:9 aspect ratio, 350:1 contrast ratio <i>Some:</i> 15.6" (396mm) FHD (1920x1080), anti-glare, LED backlight, IPS, 250 nits, 16:9 aspect ratio, 600:1 contrast ratio, 160° viewing angle								vPro (optional) Intel vPro Technology Fingerprint reader Optional: Swipe style fingerprint reader on the palm rest
Multi-touch	None								Battery Li-Ion 6-cell (48Wh) Max battery life ¹⁰ <i>MobileMark® 2014:</i> 11.2 hr AC adapter 45W AC adapter
Storage	<i>Some:</i> SSD / SATA 6.0Gb/s, 2.5" wide, 7mm high <i>Some:</i> HDD / SATA 6.0Gb/s, 2.5" wide, 7mm high, Shock Mounted Hard Drive, Active Protection System™ <i>Some:</i> SSHD with 8GB NAND flash memory								Preload Windows 7 Professional 64 preinstalled through downgrade rights in Windows 10 Pro 64 • Lenovo Solution Center • Lenovo Companion • Lenovo Setting • Microsoft Office preloaded; purchase a product key to activate • McAfee® LiveSafe™ (30-day trial)
Optical (optional)	DVD burner, 9mm high, fixed, not removable, tray-in								Limited warranty ¹² <i>One of the following, configurable by model:</i> • 1-year depot repair service • 3-year/1-yr battery depot repair service • 3-year/1-yr battery limited onsite service ²⁴ • 3-year/1-yr battery limited onsite service, OID (Onsite International Delivery)
Ethernet	<i>Non-vPro model:</i> Intel Ethernet Connection I219-V (Jacksonville) <i>vPro model:</i> Intel Ethernet Connection I219-LM (Jacksonville)								Mil-Spec test MIL-STD-810G military certification
WLAN ⁴	<i>One of the following, configurable by model:</i> • 11ac+BT, Broadcom BCM4356, 2x2, M.2 card • 11ac+BT, Intel Dual Band Wireless-AC 8260, 2x2, M.2 card								Environment EPEAT™ Gold (US); ENERGY STAR® 6.1; GREENGUARD®; RoHS-compliant
Bluetooth™	Bluetooth 4.1 wireless, integrated in Wi-Fi + Bluetooth combo adapter								
WWAN (optional)	<i>One of the following, configurable by model:</i> • Wireless WAN upgradable • Wireless WAN, Sierra Wireless EM7455, Qualcomm® 4G LTE-Advanced/DC-HSPA+/HSPA+/HSPA/UMTS/GNSS, M.2 card • Wireless WAN, HUAWEI ME906S, HUAWEI 4G LTE/WCDMA/HSPA/GSM/GPRS/EDGE/GNSS, M.2 card (WE only)								
SIM card (opt)	Micro-SIM card slot, optional Verizon LTE (US) or Lenovo Connect (WE) SIM card								
Dimensions ³	<i>WxDxH:</i> 14.84" x 9.75" x 1.08-1.21"; 377mm x 255mm x 27.6-30.85mm								
Weight ²	Starting at 5.25 lb / 2.38 kg								
Case material	PolyCarbonate/Acrylonitrile-Butadiene-Styrene (PC/ABS) plastic								

Model	Region	Processor	vPro	Graphics	Memory	Display	Multi-touch	Storage	Optical	WLAN + Bluetooth	WWAN	SIM Card	Smart Card Reader	Express-Card	Camera	Keyboard	Fingerprint Reader	Battery	Power Adapter	Operating System	Warranty	Ann Date (m/y)
20F1000PUS	US	i5-6200U	No	Intel HD 520	4GBx1	15.6" HD (1366x768)	None	192GB SSD	DVD±RW	Intel 8260 ac, 2x2 + BT4.1	None	None	None	None	720p	Non-backlit	None	6-cell (48Wh)	45W	Win10 Pro 64	1-year, Depot	02/16
20F1000QUS	US	i5-6300U	vPro	Intel HD 520	8GBx1	15.6" FHD (1920x1080) IPS	None	256GB SSD Opal2	DVD±RW	Intel 8260 ac, 2x2 + BT4.1	None	None	None	None	720p	Non-backlit	Fingerprint Reader	6-cell (48Wh)	45W	Win10 Pro 64	1-year, Depot	02/16
20F1000RUS	US	i5-6200U	No	Intel HD 520	4GBx1	15.6" HD (1366x768)	None	128GB SSD	DVD±RW	Intel 8260 ac, 2x2 + BT4.1	None	None	None	None	720p	Non-backlit	None	6-cell (48Wh)	45W	Win10 Pro 64	1-year, Depot	02/16
20F1000SUS	US	i5-6200U	No	Intel HD 520	4GBx1	15.6" HD (1366x768)	None	500GB 7200rpm	DVD±RW	Intel 8260 ac, 2x2 + BT4.1	None	None	None	None	720p	Non-backlit	None	6-cell (48Wh)	45W	Win10 Pro 64	1-year, Depot	02/16
20F1000TUS	US	i3-6100U	No	Intel HD 520	4GBx1	15.6" HD (1366x768)	None	500GB 7200rpm	DVD±RW	Intel 8260 ac, 2x2 + BT4.1	None	None	None	None	720p	Non-backlit	None	6-cell (48Wh)	45W	Win10 Pro 64	1-year, Depot	02/16
20F1000UUS	US	i5-6300U	vPro	Intel HD 520	4GBx1	15.6" HD (1366x768)	None	128GB SSD	DVD±RW	Intel 8260 ac, 2x2 + BT4.1	None	None	None	None	720p	Non-backlit	None	6-cell (48Wh)	45W	Win10 Pro 64	1-year, Depot	02/16
20F1000VUS	US	i5-6200U	No	Intel HD 520	8GBx1	15.6" FHD (1920x1080) IPS	None	256GB SSD Opal2	DVD±RW	Intel 8260 ac, 2x2 + BT4.1	None	None	None	None	720p	Non-backlit	Fingerprint Reader	6-cell (48Wh)	45W	Win10 Pro 64	1-year, Depot	02/16
20F1000WUS	US	i3-6100U	No	Intel HD 520	4GBx1	15.6" HD (1366x768)	None	192GB SSD	DVD±RW	Intel 8260 ac, 2x2 + BT4.1	None	None	None	None	720p	Non-backlit	None	6-cell (48Wh)	45W	Win10 Pro 64	1-year, Depot	02/16
20F1000XUS	US	i5-6300U	vPro	Intel HD 520	4GBx1	15.6" HD (1366x768)	None	500GB 7200rpm	DVD±RW	Intel 8260 ac, 2x2 + BT4.1	None	None	None	None	720p	Non-backlit	None	6-cell (48Wh)	45W	Win10 Pro 64	1-year, Depot	02/16
20F1001MUS	US	i3-6100U	No	Intel HD 520	4GBx1	15.6" HD (1366x768)	None	500GB 7200rpm	DVD±RW	Intel 8260 ac, 2x2 + BT4.1	None	None	None	None	720p	Non-backlit	None	6-cell (48Wh)	45W	Win10 DG Win7 Pro 64	1-year, Depot	02/16
20F1001NUS	US	i3-6100U	No	Intel HD 520	4GBx1	15.6" HD (1366x768)	None	192GB SSD	DVD±RW	Intel 8260 ac, 2x2 + BT4.1	None	None	None	None	720p	Non-backlit	None	6-cell (48Wh)	45W	Win10 DG Win7 Pro 64	1-year, Depot	02/16
20F1001PUS	US	i5-6200U	No	Intel HD 520	4GBx1	15.6" HD (1366x768)	None	500GB 7200rpm	DVD±RW	Intel 8260 ac, 2x2 + BT4.1	None	None	None	None	720p	Non-backlit	None	6-cell (48Wh)	45W	Win10 DG Win7 Pro 64	1-year, Depot	02/16
20F1001QUS	US	i5-6200U	No	Intel HD 520	8GBx1	15.6" FHD (1920x1080) IPS	None	256GB SSD Opal2	DVD±RW	Intel 8260 ac, 2x2 + BT4.1	None	None	None	None	720p	Non-backlit	Fingerprint Reader	6-cell (48Wh)	45W	Win10 DG Win7 Pro 64	1-year, Depot	02/16
20F1001RUS	US	i5-6200U	No	Intel HD 520	4GBx1	15.6" HD (1366x768)	None	128GB SSD	DVD±RW	Intel 8260 ac, 2x2 + BT4.1	None	None	None	None	720p	Non-backlit	None	6-cell (48Wh)	45W	Win10 DG Win7 Pro 64	1-year, Depot	02/16
20F1001SUS	US	i5-6200U	No	Intel HD 520	4GBx1	15.6" HD (1366x768)	None	192GB SSD	DVD±RW	Intel 8260 ac, 2x2 + BT4.1	None	None	None	None	720p	Non-backlit	None	6-cell (48Wh)	45W	Win10 DG Win7 Pro 64	1-year, Depot	02/16
20F1001TUS	US	i5-6300U	vPro	Intel HD 520	4GBx1	15.6" HD (1366x768)	None	500GB 7200rpm	DVD±RW	Intel 8260 ac, 2x2 + BT4.1	None	None	None	None	720p	Non-backlit	None	6-cell (48Wh)	45W	Win10 DG Win7 Pro 64	1-year, Depot	02/16
20F1001UUS	US	i5-6300U	vPro	Intel HD 520	4GBx1	15.6" HD (1366x768)	None	128GB SSD	DVD±RW	Intel 8260 ac, 2x2 + BT4.1	None	None	None	None	720p	Non-backlit	None	6-cell (48Wh)	45W	Win10 DG Win7 Pro 64	1-year, Depot	02/16
20F1001VUS	US	i5-6300U	vPro	Intel HD 520	8GBx1	15.6" FHD (1920x1080) IPS	None	256GB SSD Opal2	DVD±RW	Intel 8260 ac, 2x2 + BT4.1	None	None	None	None	720p	Non-backlit	Fingerprint Reader	6-cell (48Wh)	45W	Win10 DG Win7 Pro 64	1-year, Depot	02/16
20F1002AUS	US	i5-6300U	vPro	Intel HD 520	8GBx1	15.6" FHD (1920x1080) IPS	None	256GB SSD Opal2	DVD±RW	Intel 8260 ac, 2x2 + BT4.1	Sierra EM7455	None	None	None	720p	Non-backlit	Fingerprint Reader	6-cell (48Wh)	45W	Win10 DG Win7 Pro 64	1-year, Depot	04/16
20F1002BUS	US	i5-6200U	No	Intel HD 520	8GBx1	15.6" FHD (1920x1080) IPS	None	256GB SSD Opal2	DVD±RW	Intel 8260 ac, 2x2 + BT4.1	Sierra EM7455	None	None	None	720p	Non-backlit	Fingerprint Reader	6-cell (48Wh)	45W	Win10 Pro 64	1-year, Depot	04/16

Model	Region	Processor	vPro	Graphics	Memory	Display	Multi-touch	Storage	Optical	WLAN + Bluetooth	WWAN	SIM Card	Smart Card Reader	Express-Card	Camera	Keyboard	Fingerprint Reader	Battery	Power Adapter	Operating System	Warranty	Ann Date (m/y)
20F1002CUS	US	i5-6200U	No	Intel HD 520	8GBx1	15.6" FHD (1920x1080) IPS	None	256GB SSD Opal2	DVD±RW	Intel 8260 ac, 2x2 + BT4.1	Sierra EM7455	None	None	None	720p	Non-backlit	Fingerprint Reader	6-cell (48Wh)	45W	Win10 DG Win7 Pro 64	1-year, Depot	04/16
20F1002DUS	US	i5-6300U	vPro	Intel HD 520	8GBx1	15.6" FHD (1920x1080) IPS	None	256GB SSD Opal2	DVD±RW	Intel 8260 ac, 2x2 + BT4.1	Sierra EM7455	None	None	None	720p	Non-backlit	Fingerprint Reader	6-cell (48Wh)	45W	Win10 Pro 64	1-year, Depot	04/16
20F1003PUS	US	i3-6100U	No	Intel HD 520	4GBx1	15.6" HD (1366x768)	None	256GB SSD Opal2	DVD±RW	Intel 8260 ac, 2x2 + BT4.1	WWAN Upgradable	None	None	None	720p	Non-backlit	None	6-cell (48Wh)	45W	Win10 DG Win7 Pro 64	1-year, Depot	11/16
20F1003QUS	US	i3-6100U	No	Intel HD 520	4GBx1	15.6" HD (1366x768)	None	180GB SSD Opal2	DVD±RW	Intel 8260 ac, 2x2 + BT4.1	WWAN Upgradable	None	None	None	720p	Non-backlit	None	6-cell (48Wh)	45W	Win10 DG Win7 Pro 64	1-year, Depot	11/16
20F1003RUS	US	i5-6200U	No	Intel HD 520	4GBx1	15.6" HD (1366x768)	None	180GB SSD Opal2	DVD±RW	Intel 8260 ac, 2x2 + BT4.1	WWAN Upgradable	None	None	None	720p	Non-backlit	None	6-cell (48Wh)	45W	Win10 Home 64	1-year, Depot	11/16
20F1003SUS	US	i3-6100U	No	Intel HD 520	4GBx1	15.6" HD (1366x768)	None	180GB SSD Opal2	DVD±RW	Intel 8260 ac, 2x2 + BT4.1	WWAN Upgradable	None	None	None	720p	Non-backlit	None	6-cell (48Wh)	45W	Win10 Home 64	1-year, Depot	11/16
20F1003TUS	US	i5-6200U	No	Intel HD 520	4GBx1	15.6" HD (1366x768)	None	180GB SSD Opal2	DVD±RW	Intel 8260 ac, 2x2 + BT4.1	WWAN Upgradable	None	None	None	720p	Non-backlit	None	6-cell (48Wh)	45W	Win10 DG Win7 Pro 64	1-year, Depot	11/16
20F1003UUS	US	i5-6200U	No	Intel HD 520	4GBx1	15.6" HD (1366x768)	None	256GB SSD Opal2	DVD±RW	Intel 8260 ac, 2x2 + BT4.1	WWAN Upgradable	None	None	None	720p	Non-backlit	None	6-cell (48Wh)	45W	Win10 Home 64	1-year, Depot	11/16
20F1003VUS	US	i5-6200U	No	Intel HD 520	4GBx1	15.6" HD (1366x768)	None	256GB SSD Opal2	DVD±RW	Intel 8260 ac, 2x2 + BT4.1	WWAN Upgradable	None	None	None	720p	Non-backlit	None	6-cell (48Wh)	45W	Win10 DG Win7 Pro 64	1-year, Depot	11/16
20F1003WUS	US	i3-6100U	No	Intel HD 520	4GBx1	15.6" HD (1366x768)	None	256GB SSD Opal2	DVD±RW	Intel 8260 ac, 2x2 + BT4.1	WWAN Upgradable	None	None	None	720p	Non-backlit	None	6-cell (48Wh)	45W	Win10 Home 64	1-year, Depot	11/16
20F1004AUS	US	i3-6006U	No	Intel HD 520	4GBx1	15.6" HD (1366x768)	None	256GB SSD Opal2	DVD±RW	Intel 8260 ac, 2x2 + BT4.1	WWAN Upgradable	None	None	None	720p	Non-backlit	None	6-cell (48Wh)	45W	Win10 Pro 64	1-year, Depot	12/16
20F1004BUS	US	i3-6006U	No	Intel HD 520	4GBx1	15.6" HD (1366x768)	None	180GB SSD Opal2	DVD±RW	Intel 8260 ac, 2x2 + BT4.1	WWAN Upgradable	None	None	None	720p	Non-backlit	None	6-cell (48Wh)	45W	Win10 DG Win7 Pro 64	1-year, Depot	12/16
20F1004CUS	US	i3-6006U	No	Intel HD 520	4GBx1	15.6" HD (1366x768)	None	256GB SSD Opal2	DVD±RW	Intel 8260 ac, 2x2 + BT4.1	WWAN Upgradable	None	None	None	720p	Non-backlit	None	6-cell (48Wh)	45W	Win10 DG Win7 Pro 64	1-year, Depot	12/16
20F1004DUS	US	i3-6006U	No	Intel HD 520	4GBx1	15.6" HD (1366x768)	None	180GB SSD Opal2	DVD±RW	Intel 8260 ac, 2x2 + BT4.1	WWAN Upgradable	None	None	None	720p	Non-backlit	None	6-cell (48Wh)	45W	Win10 Pro 64	1-year, Depot	12/16



ThinkPad L570 Platform Specifications

Product Specifications Reference (PSREF)

Processor	6th Generation Intel® Core™ i3 / i5 / i7 Processor (i7 processor is not available in EMEA) or								WWAN (optional) <i>One of the following, configurable by model:</i> <ul style="list-style-type: none"> Wireless WAN upgradable Integrated Mobile Broadband 4G LTE-A, Qualcomm® Snapdragon™ X7 LTE-A (Sierra Wireless EM7455), M.2 card Integrated Mobile Broadband 4G LTE, Intel XMM™ 7160 (Fibocom L831-EAU), M.2 card (EMEA only) SIM card (opt) Micro-SIM card slot, opt Verizon LTE (US) or Lenovo® Connect (EMEA) SIM card
	Processor Number	# of Cores	# of Threads	Base Frequency	Max Turbo Frequency	Cache	Memory Types	Processor Graphics	
	i3-6006U	2	4	2.0 GHz	-	3MB	DDR4-2133	Intel HD Graphics 520	
	i3-6100U			2.3 GHz	-	3MB			
	i5-6200U			2.3 GHz	2.8 GHz	3MB			
	i5-6300U			2.4 GHz	3.0 GHz	3MB			
	i7-6500U			2.5 GHz	3.1 GHz	4MB			
	i7-6600U	2.6 GHz	3.4 GHz	4MB					
Processor	Intel Celeron® Processor or 7th Generation Intel Core i3 / i5 / i7 Processor								ExpressCard (opt) One slot (ExpressCard/34) Smart card reader <i>Optional:</i> Smart card reader Media reader 4-in-1 reader (MMC, SD, SDHC, SDXC) Ports Four USB 3.1 Gen 1 / USB 3.0 (one Always On), VGA, Mini DisplayPort, Ethernet (RJ-45), Dock connector Monitor cable <i>Optional:</i> Lenovo Mini-DisplayPort to DisplayPort Monitor Cable (MiniDP to DP) Camera (optional) HD720p resolution, fixed focus Audio support HD Audio, Realtek® ALC3245 codec / stereo speakers, 1.5W x 2 / dual array microphone, combo audio/microphone jack Keyboard 6-row, spill-resistant, multimedia Fn keys, numeric keypad UltraNav™ TrackPoint® pointing device and buttonless Mylar surface multi-touch touchpad
	Processor Number	# of Cores	# of Threads	Base Frequency	Max Turbo Frequency	Cache	Memory Types	Processor Graphics	
	Cel 3965U	2	4	2.2 GHz	-	2MB	DDR4-2133	Intel HD Graphics 610	
	i3-7100U			2.4 GHz	-	3MB			
	i5-7200U			2.5 GHz	3.1 GHz	3MB			
	i5-7300U			2.6 GHz	3.5 GHz	3MB			
	i7-7500U			2.7 GHz	3.5 GHz	4MB			
	i7-7600U	2.8 GHz	3.9 GHz	4MB					
Graphics	Intel HD Graphics 520, 610, or 620 in processor only; supports external analog monitor via VGA and digital monitor via Mini DisplayPort; supports three independent displays; Max resolution: 3840x2160@60Hz (DP via mDP cable); 1920x1200@60Hz (VGA)								Security Power-on password, hard disk password, supervisor password, security keyhole Security chip Discrete TPM 2.0, TCG Certified vPro (optional) Intel vPro Technology Fingerprint reader <i>Optional:</i> Swiipe style fingerprint reader on the palm rest NFC None
Chipset Memory	Intel SoC (System on Chip) platform 32GB max / 2133MHz DDR4, dual-channel capable, two DDR4 SO-DIMM sockets								Battery Li-Ion 6-cell (48Wh) Max battery life <i>MobileMark® 2014:</i> 14.8 hr AC adapter 45W AC adapter
Display	<i>Some:</i> 15.6" (396mm) HD (1366x768), anti-glare, LED backlight, 220 nits, 16:9 aspect ratio, 350:1 contrast ratio <i>Some:</i> 15.6" (396mm) FHD (1920x1080), anti-glare, LED backlight, 220 nits, 16:9 aspect ratio, 400:1 or 500:1 contrast ratio <i>Some:</i> 15.6" (396mm) FHD (1920x1080), anti-glare, LED backlight, IPS, 250 nits, 16:9 aspect ratio, 600:1 contrast ratio, 160° viewing angle								Preload Windows® 7 Professional 64 preinstalled through downgrade rights in Windows 10 Pro 64 <ul style="list-style-type: none"> Lenovo Solution Center Lenovo PowerEngage ThinkVantage Product Recovery ThinkVantage System Update Adobe® Reader® Microsoft® Office preloaded; purchase a product key to activate McAfee® LiveSafe™ (30-day trial) <i>Some:</i> Windows 10 Home 64 <i>Some:</i> Windows 10 Pro 64 <ul style="list-style-type: none"> Lenovo Companion Lenovo Setting Microsoft Office preloaded; purchase a product key to activate
Multi-touch	None								
Storage	<i>Some:</i> HDD / SATA 6.0Gb/s, 2.5" wide, 7mm high, Active Protection System™ <i>Some:</i> SSD / SATA 6.0Gb/s, 2.5" wide, 7mm high (e.g. xxxGB SSD) <i>Some:</i> M.2 SSD / PCIe NVMe, PCIe 3.0 x 2, 16Gb/s <i>Some:</i> 128GB M.2 SSD / SATA 6.0Gb/s, in WWAN slot as 2nd Storage, mutually exclusive with WWAN								Limited warranty <i>One of the following, configurable by model:</i> <ul style="list-style-type: none"> 1-year depot repair service 3-year/1-yr battery depot repair service 3-year/1-yr battery limited onsite service
Optical (optional)	DVD-ROM or DVD burner, 9mm high, fixed, not removable, tray-in								
Ethernet	<i>Non-vPro model:</i> Intel Ethernet Connection I219-V (Jacksonville) <i>vPro model:</i> Intel Ethernet Connection I219-LM (Jacksonville)								
WLAN	<i>One of the following, configurable by model:</i> <ul style="list-style-type: none"> Realtek® RTL8822BE, Wi-Fi 2x2 802.11ac + BT4.1, M.2 card (US only) Intel Dual Band Wireless-AC 8260, Wi-Fi 2x2 802.11ac + BT4.1, M.2 card Intel Dual Band Wireless-AC 8265, Wi-Fi 2x2 802.11ac + BT4.1, M.2 card Bluetooth™ 4.1 wireless, integrated in Wi-Fi + Bluetooth combo adapter * Intel 8265ac card supports BT4.2 but is limited to BT4.1 by Windows OS								Mil-Spec test MIL-STD-810G military certification Environment EPEAT™ Gold (US only); ENERGY STAR® 6.1; RoHS-compliant

ThinkPad L570 - TopSeller - 20J8

Product Specifications Reference (PSREF)

Model	Region	Processor	vPro	Graphics	Memory	Display	Multi-touch	Storage(HDD/SSD)	Optical	WLAN + Bluetooth	WWAN	SIM Card	Smart Card Reader	ExpressCard	Monitor Cable	Camera	Key-board	Fingerprint Reader	TPM	Battery	Power Adapter	Operating System	Warranty	Ann Date (m/y)
20J8000WUS	US	i3-7100U	No	Intel HD 620	4GBx1	15.6" HD (1366x768)	None	180GB SSD Opal2	DVD±RW	Intel 8265 ac, 2x2 + BT4.1	WWAN Upgradable	None	None	None	None	720p	Non-backlit	None	dTPM 2.0	6-cell (48Wh)	45W	Win10 Pro 64	1-year, Depot	03/17
20J8000XUS	US	i5-7300U	vPro	Intel HD 620	8GBx1	15.6" FHD (1920x1080) IPS	None	256GB SSD Opal2	DVD±RW	Intel 8265 ac, 2x2 + BT4.1	WWAN Upgradable	None	None	None	None	720p	Non-backlit	Fingerprint Reader	dTPM 2.0	6-cell (48Wh)	45W	Win10 Pro 64	1-year, Depot	03/17
20J8000YUS	US	i5-7300U	vPro	Intel HD 620	4GBx1	15.6" HD (1366x768)	None	128GB SSD	DVD±RW	Intel 8265 ac, 2x2 + BT4.1	WWAN Upgradable	None	None	None	None	720p	Non-backlit	None	dTPM 2.0	6-cell (48Wh)	45W	Win10 Pro 64	1-year, Depot	03/17
20J80010US	US	i5-7200U	No	Intel HD 620	4GBx1	15.6" HD (1366x768)	None	500GB 7200rpm	DVD±RW	Intel 8265 ac, 2x2 + BT4.1	WWAN Upgradable	None	None	None	None	720p	Non-backlit	None	dTPM 2.0	6-cell (48Wh)	45W	Win10 Pro 64	1-year, Depot	03/17
20J80011US	US	i5-7200U	No	Intel HD 620	4GBx1	15.6" HD (1366x768)	None	180GB SSD Opal2	DVD±RW	Intel 8265 ac, 2x2 + BT4.1	WWAN Upgradable	None	None	None	None	720p	Non-backlit	None	dTPM 2.0	6-cell (48Wh)	45W	Win10 Pro 64	1-year, Depot	03/17
20J80012US	US	i5-7200U	No	Intel HD 620	4GBx1	15.6" HD (1366x768)	None	128GB SSD	DVD±RW	Intel 8265 ac, 2x2 + BT4.1	WWAN Upgradable	None	None	None	None	720p	Non-backlit	None	dTPM 2.0	6-cell (48Wh)	45W	Win10 Pro 64	1-year, Depot	03/17
20J80013US	US	i5-7200U	No	Intel HD 620	8GBx1	15.6" FHD (1920x1080) IPS	None	256GB SSD Opal2	DVD±RW	Intel 8265 ac, 2x2 + BT4.1	WWAN Upgradable	None	None	None	None	720p	Non-backlit	None	dTPM 2.0	6-cell (48Wh)	45W	Win10 Pro 64	1-year, Depot	03/17
20J80014US	US	i5-7200U	No	Intel HD 620	4GBx1	15.6" HD (1366x768)	None	256GB SSD Opal2	DVD±RW	Intel 8265 ac, 2x2 + BT4.1	WWAN Upgradable	None	None	None	None	720p	Non-backlit	None	dTPM 2.0	6-cell (48Wh)	45W	Win10 Pro 64	1-year, Depot	03/17
20J80015US	US	i3-7100U	No	Intel HD 620	4GBx1	15.6" HD (1366x768)	None	256GB SSD Opal2	DVD±RW	Intel 8265 ac, 2x2 + BT4.1	WWAN Upgradable	None	None	None	None	720p	Non-backlit	None	dTPM 2.0	6-cell (48Wh)	45W	Win10 Pro 64	1-year, Depot	03/17
20J80016US	US	i3-7100U	No	Intel HD 620	4GBx1	15.6" HD (1366x768)	None	500GB 7200rpm	DVD±RW	Intel 8265 ac, 2x2 + BT4.1	WWAN Upgradable	None	None	None	None	720p	Non-backlit	None	dTPM 2.0	6-cell (48Wh)	45W	Win10 Pro 64	1-year, Depot	03/17
20J80017US	US	i5-7300U	vPro	Intel HD 620	4GBx1	15.6" HD (1366x768)	None	500GB 7200rpm	DVD±RW	Intel 8265 ac, 2x2 + BT4.1	WWAN Upgradable	None	None	None	None	720p	Non-backlit	None	dTPM 2.0	6-cell (48Wh)	45W	Win10 Pro 64	1-year, Depot	03/17
20J8002EUS	US	i5-7300U	vPro	Intel HD 620	8GBx1	15.6" FHD (1920x1080) IPS	None	256GB SSD Opal2	DVD±RW	Intel 8265 ac, 2x2 + BT4.1	Sierra EM7455	None	None	ExpressCard / 34	None	720p	Non-backlit	Fingerprint Reader	dTPM 2.0	6-cell (48Wh)	45W	Win10 Pro 64	3-year, Depot	04/17
20J8002FUS	US	i5-7200U	No	Intel HD 620	4GBx1	15.6" HD (1366x768)	None	500GB 7200rpm	DVD±RW	Intel 8265 ac, 2x2 + BT4.1	Sierra EM7455	None	None	ExpressCard / 34	None	720p	Non-backlit	None	dTPM 2.0	6-cell (48Wh)	45W	Win10 Pro 64	3-year, Depot	04/17
20J8002GUS	US	i5-7300U	vPro	Intel HD 620	8GBx1	15.6" FHD (1920x1080) IPS	None	256GB SSD M.2 PCIe NVMe Opal2	DVD±RW	Intel 8265 ac, 2x2 + BT4.1	WWAN Upgradable	None	None	ExpressCard / 34	None	720p	Non-backlit	Fingerprint Reader	dTPM 2.0	6-cell (48Wh)	45W	Win10 Pro 64	3-year, Depot	04/17



ThinkPad P50 Platform Specifications

Product Specifications Reference (PSREF)

Processor	6th Generation Intel® Core™ i7 Processor or Intel Xeon® Processor E3 v5 Family							Smart card reader ExpressCard Media reader Ports	Optional: Smart card reader One slot (ExpressCard/34) 4-in-1 reader (MMC, SD, SDHC, SDXC), supports UHS-II SD card Four USB 3.0 (one Always On), USB Type-C / Thunderbolt 3, Mini DisplayPort, HDMI, Ethernet (RJ-45), Dock connector									
	Processor Number	# of Cores	# of Threads	Base Frequency	Max Turbo Frequency	Cache	Memory Types			Processor Graphics Intel HD Graphics 530 Intel HD Graphics P530								
	i7-6700HQ	4	8	2.6 GHz	3.5 GHz	6MB	DDR4-2133											
	i7-6820HQ			2.7 GHz	3.6 GHz	8MB												
	E3-1505M v5			2.8 GHz	3.7 GHz	8MB												
E3-1535M v5	2.9 GHz			3.8 GHz	8MB													
Graphics	Intel HD Graphics 530 or P530 in processor and NVIDIA Quadro® M1000M (2GB or 4GB memory) or M2000M (4GB memory); supports external digital monitor via HDMI, Mini DisplayPort, or Thunderbolt™; supports four independent displays; Max resolution: 3840x2160@60Hz (DisplayPort via Mini DisplayPort cable); 3840x2160@60Hz (Thunderbolt); 3840x2160@30Hz (HDMI)							Camera (optional) Audio support	HD720p resolution, low light sensitive, fixed focus HD Audio, Realtek® ALC3268 codec / stereo speakers, 1.5W x 2 / dual array microphone, combo audio/microphone jack									
Chipset	Mobile Intel CM236 Chipset (Intel GL82CM236 PCH)							Keyboard UltraNav™	6-row, spill-resistant, multimedia Fn keys, numeric keypad, optional LED backlight 3-button TrackPoint® pointing device and 3-button crystal silk surface multi-touch touchpad									
Memory	64GB max ⁷ / 2133MHz DDR4, ECC or non-ECC (ECC function supported only on Xeon processor), dual-channel capable, four DDR4 SO-DIMM sockets							Security Security chip ThinkEngine	Power-on password, hard disk password, supervisor password, security keyhole Discrete TPM 1.2 TCG Certified and Firmware TPM 2.0 integrated in chipset Delivers improved thermal and power efficiency, up to 30 day standby, faster resume time, enhanced security, as well as anti-tampering measures									
Display	Some: 15.6" (396mm) FHD (1920x1080), anti-glare, LED backlight, IPS, 250 nits, 16:9 aspect ratio, 600:1 contrast ratio, 45% gamut, 160° viewing angle Some: 15.6" (396mm) 4K (3840x2160), anti-glare, LED backlight, IPS, 300 nits, 16:9 aspect ratio, 1000:1 contrast ratio, 100% gamut, 178° viewing angle							vPro (optional) Fingerprint reader Color calibration	Intel vPro Technology Touch style fingerprint reader on the palm rest Optional: Pantone® color calibrator by X-Rite® color calibration sensor in palm rest									
Multi-touch (opt) Pen (optional)	Capacitive-type multi-touch, supports 10-finger gesture, 220 nits ThinkPad Pen Pro, active pen for multi-touch display							Battery Max battery life ¹⁰ (MobileMark® 2014)	Lithium Polymer 4-cell (66Wh) or 6-cell (90Wh)									
Storage	Up to 3 drives (two M.2 SSD and one HDD) Some: M.2 SSD / SATA 6.0Gb/s (e.g. xxxG SSD) Some: M.2 SSD / PCIe NVMe, PCIe 3.0 x 4, 32Gb/s (e.g. xxxG SSD PCIe NVMe) Some: HDD / SATA 6.0Gb/s, 2.5" wide, 7mm high, Shock Mounted Hard Drive, Active Protection System™							<table border="1"> <thead> <tr> <th>Model</th> <th>4-cell</th> <th>6-cell</th> </tr> </thead> <tbody> <tr> <td>Discrete Graphics</td> <td>7.1 hr</td> <td>9.7 hr</td> </tr> <tr> <td>Hybrid Graphics</td> <td>9.6 hr</td> <td>13.2 hr</td> </tr> </tbody> </table>		Model	4-cell	6-cell	Discrete Graphics	7.1 hr	9.7 hr	Hybrid Graphics	9.6 hr	13.2 hr
Model	4-cell	6-cell																
Discrete Graphics	7.1 hr	9.7 hr																
Hybrid Graphics	9.6 hr	13.2 hr																
Optical	None							AC adapter	170W AC adapter									
Ethernet	Non-vPro model: Intel Ethernet Connection I219-V (Jacksonville) vPro model: Intel Ethernet Connection I219-LM (Jacksonville)							Preload	Some: Genuine Windows® 7 Professional 64 Some: Windows 7 Professional 64 preinstalled through downgrade rights in Windows 10 Pro 64 Windows 10 Pro 64 • Lenovo Solution Center • Lenovo SHAREit • Lenovo Companion • Lenovo Setting • Microsoft Office preloaded; purchase a product key to activate • McAfee® LiveSafe™ (30-day trial)									
WLAN ⁴ Bluetooth™	11ac+BT, Intel Dual Band Wireless-AC 8260, 2x2, M.2 card Bluetooth 4.1 wireless, integrated in Wi-Fi + Bluetooth combo adapter							• Lenovo Solution Center • Lenovo SHAREit • ThinkVantage Product Recovery • Rescue and Recovery™ • ThinkVantage System Update • Adobe® Reader® • Microsoft® Office preloaded; purchase a product key to activate • McAfee® LiveSafe™ (30-day trial) For ISV certifications, please visit www.lenovo.com/support/ISV										
WWAN (optional)	Wireless WAN, Sierra Wireless EM7455, Qualcomm® 4G LTE-Advanced/DC-HSPA+/HSPA+/HSPA/UMTS/GNSS, M.2 card							Limited warranty ¹² One of the following, configurable by model: • 3-year/1-yr battery depot repair service • 3-year/1-yr battery limited onsite service ²⁴ • 3-year/1-yr battery limited onsite service, OID (Onsite International Delivery)										
SIM card	Micro-SIM card slot							Mil-Spec test	MIL-STD-810G military certification									
Dimensions ³	WxDxH: 14.86" x 9.93" x 0.96-1.16"; 377.4mm x 252.3mm x 24.5-29.4mm WxDxH(Touch): 14.86" x 9.93" x 1.02-1.21"; 377.4mm x 252.3mm x 25.8-30.7mm							Environment	EPEAT™ Gold (US only); ENERGY STAR® 6.1; GREENGUARD®; RoHS-compliant									
Weight ²	<table border="1"> <thead> <tr> <th>Models</th> <th>4-cell</th> <th>6-cell</th> </tr> </thead> <tbody> <tr> <td>Non-touch</td> <td>5.6 lb / 2.55kg</td> <td>5.9 lb / 2.67kg</td> </tr> <tr> <td>Multi-touch</td> <td>6.2 lb / 2.82kg</td> <td>6.4 lb / 2.90kg</td> </tr> </tbody> </table>							Models	4-cell	6-cell	Non-touch	5.6 lb / 2.55kg	5.9 lb / 2.67kg	Multi-touch	6.2 lb / 2.82kg	6.4 lb / 2.90kg		
Models	4-cell	6-cell																
Non-touch	5.6 lb / 2.55kg	5.9 lb / 2.67kg																
Multi-touch	6.2 lb / 2.82kg	6.4 lb / 2.90kg																
Case material	Display cover: Glass-Fiber Reinforced Plastic; Bottom: Magnesium/Aluminum																	

Model	Region	Processor	vPro	Graphics	Memory	Display	Multi-touch	Pen	Storage(HDD/SSD)	RAID	Optical	WLAN + Bluetooth	WWAN	SIM Card	Smart Card Reader	Camera	Keyboard	Fingerprint Reader	Color Calibrator	Battery	Power Adapter	Operating System	Warranty	Ann Date (m/y)
20EN0012US	US	i7-6700HQ	No	M1000M 2GB	8GBx1 non-ECC	15.6" FHD (1920x1080) IPS	None	None	256GB SSD M.2 Opal2	No	None	Intel 8260 ac, 2x2 + BT4.1	None	None	None	720p	Backlit	Fingerprint Reader	None	6-cell (90Wh)	170W	Win10 DG Win7 Pro 64	3-year, Depot	11/15
20EN0013US	US	i7-6700HQ	No	M1000M 2GB	8GBx1 non-ECC	15.6" FHD (1920x1080) IPS	None	None	500GB 7200rpm	No	None	Intel 8260 ac, 2x2 + BT4.1	None	None	None	720p	Backlit	Fingerprint Reader	None	6-cell (90Wh)	170W	Win10 DG Win7 Pro 64	3-year, Depot	11/15
20EN0014US	US	i7-6700HQ	No	M1000M 2GB	8GBx1 non-ECC	15.6" FHD (1920x1080) IPS	None	None	1TB 5400rpm	No	None	Intel 8260 ac, 2x2 + BT4.1	None	None	None	720p	Backlit	Fingerprint Reader	None	6-cell (90Wh)	170W	Win10 DG Win7 Pro 64	3-year, Depot	11/15
20EN0015US	US	i7-6700HQ	No	M1000M 2GB	16GBx1 non-ECC	15.6" FHD (1920x1080) IPS	None	None	512GB SSD M.2 PCIe NVMe	No	None	Intel 8260 ac, 2x2 + BT4.1	None	None	None	720p	Backlit	Fingerprint Reader	None	6-cell (90Wh)	170W	Win10 DG Win7 Pro 64	3-year, Depot	11/15
20EN0016US	US	i7-6820HQ	vPro	M1000M 2GB	8GBx1 non-ECC	15.6" FHD (1920x1080) IPS	None	None	500GB 7200rpm	No	None	Intel 8260 ac, 2x2 + BT4.1	None	None	None	720p	Backlit	Fingerprint Reader	None	6-cell (90Wh)	170W	Win10 DG Win7 Pro 64	3-year, Depot	11/15
20EN0017US	US	i7-6820HQ	vPro	M1000M 2GB	8GBx1 non-ECC	15.6" FHD (1920x1080) IPS	None	None	1TB 5400rpm	No	None	Intel 8260 ac, 2x2 + BT4.1	None	None	None	720p	Backlit	Fingerprint Reader	None	6-cell (90Wh)	170W	Win10 DG Win7 Pro 64	3-year, Depot	11/15
20EN0018US	US	i7-6820HQ	vPro	M1000M 2GB	8GBx1 non-ECC	15.6" FHD (1920x1080) IPS	None	None	256GB SSD M.2 Opal2	No	None	Intel 8260 ac, 2x2 + BT4.1	None	None	None	720p	Backlit	Fingerprint Reader	None	6-cell (90Wh)	170W	Win10 DG Win7 Pro 64	3-year, Depot	11/15
20EN0019US	US	i7-6820HQ	vPro	M1000M 2GB	16GBx1 non-ECC	15.6" FHD (1920x1080) IPS	None	None	512GB SSD M.2 PCIe NVMe	No	None	Intel 8260 ac, 2x2 + BT4.1	None	None	None	720p	Backlit	Fingerprint Reader	None	6-cell (90Wh)	170W	Win10 DG Win7 Pro 64	3-year, Depot	11/15
20EN001AUS	US	i7-6820HQ	vPro	M2000M 4GB	8GBx1 non-ECC	15.6" FHD (1920x1080) IPS	None	None	500GB 7200rpm	No	None	Intel 8260 ac, 2x2 + BT4.1	None	None	None	720p	Backlit	Fingerprint Reader	None	6-cell (90Wh)	170W	Win10 DG Win7 Pro 64	3-year, Depot	11/15
20EN001BUS	US	i7-6820HQ	vPro	M2000M 4GB	8GBx1 non-ECC	15.6" FHD (1920x1080) IPS	None	None	256GB SSD M.2 Opal2	No	None	Intel 8260 ac, 2x2 + BT4.1	None	None	None	720p	Backlit	Fingerprint Reader	None	6-cell (90Wh)	170W	Win10 DG Win7 Pro 64	3-year, Depot	11/15
20EN001CUS	US	i7-6820HQ	vPro	M2000M 4GB	16GBx1 non-ECC	15.6" FHD (1920x1080) IPS	None	None	512GB SSD M.2 PCIe NVMe	No	None	Intel 8260 ac, 2x2 + BT4.1	None	None	None	720p	Backlit	Fingerprint Reader	None	6-cell (90Wh)	170W	Win10 DG Win7 Pro 64	3-year, Depot	11/15
20EN001DUS	US	i7-6820HQ	vPro	M2000M 4GB	16GBx1 non-ECC	15.6" 4K (3840x2160) IPS	None	None	500GB 7200rpm	No	None	Intel 8260 ac, 2x2 + BT4.1	None	None	None	720p	Backlit	Fingerprint Reader	X-Rite	6-cell (90Wh)	170W	Win10 DG Win7 Pro 64	3-year, Depot	11/15
20EN001EUS	US	i7-6820HQ	vPro	M2000M 4GB	16GBx1 non-ECC	15.6" 4K (3840x2160) IPS	None	None	256GB SSD M.2 Opal2	No	None	Intel 8260 ac, 2x2 + BT4.1	None	None	None	720p	Backlit	Fingerprint Reader	X-Rite	6-cell (90Wh)	170W	Win10 DG Win7 Pro 64	3-year, Depot	11/15
20EN001FUS	US	i7-6820HQ	vPro	M2000M 4GB	16GBx1 non-ECC	15.6" 4K (3840x2160) IPS	None	None	512GB SSD M.2 PCIe NVMe	No	None	Intel 8260 ac, 2x2 + BT4.1	None	None	None	720p	Backlit	Fingerprint Reader	X-Rite	6-cell (90Wh)	170W	Win10 DG Win7 Pro 64	3-year, Depot	11/15
20EN001GUS	US	i7-6700HQ	No	M1000M 2GB	8GBx1 non-ECC	15.6" FHD (1920x1080) IPS	10-point Multi-touch	None	500GB 7200rpm	No	None	Intel 8260 ac, 2x2 + BT4.1	None	None	None	720p	Backlit	Fingerprint Reader	X-Rite	6-cell (90Wh)	170W	Win10 Pro 64	3-year, Depot	11/15
20EN001HUS	US	i7-6700HQ	No	M1000M 2GB	8GBx1 non-ECC	15.6" FHD (1920x1080) IPS	10-point Multi-touch	None	256GB SSD M.2 Opal2	No	None	Intel 8260 ac, 2x2 + BT4.1	None	None	None	720p	Backlit	Fingerprint Reader	X-Rite	6-cell (90Wh)	170W	Win10 Pro 64	3-year, Depot	11/15
20EN001JUS	US	i7-6820HQ	vPro	M1000M 2GB	8GBx1 non-ECC	15.6" FHD (1920x1080) IPS	10-point Multi-touch	None	500GB 7200rpm	No	None	Intel 8260 ac, 2x2 + BT4.1	None	None	None	720p	Backlit	Fingerprint Reader	X-Rite	6-cell (90Wh)	170W	Win10 Pro 64	3-year, Depot	11/15
20EN001KUS	US	i7-6820HQ	vPro	M1000M 2GB	8GBx1 non-ECC	15.6" FHD (1920x1080) IPS	10-point Multi-touch	None	256GB SSD M.2 Opal2	No	None	Intel 8260 ac, 2x2 + BT4.1	None	None	None	720p	Backlit	Fingerprint Reader	X-Rite	6-cell (90Wh)	170W	Win10 Pro 64	3-year, Depot	11/15
20EN001LUS	US	i7-6820HQ	vPro	M2000M 4GB	16GBx1 non-ECC	15.6" FHD (1920x1080) IPS	10-point Multi-touch	None	256GB SSD M.2 Opal2	No	None	Intel 8260 ac, 2x2 + BT4.1	None	None	None	720p	Backlit	Fingerprint Reader	X-Rite	6-cell (90Wh)	170W	Win10 Pro 64	3-year, Depot	11/15
20EN001MUS	US	i7-6820HQ	vPro	M2000M 4GB	16GBx1 non-ECC	15.6" FHD (1920x1080) IPS	10-point Multi-touch	None	512GB SSD M.2 PCIe NVMe	No	None	Intel 8260 ac, 2x2 + BT4.1	None	None	None	720p	Backlit	Fingerprint Reader	X-Rite	6-cell (90Wh)	170W	Win10 Pro 64	3-year, Depot	11/15

Model	Region	Processor	vPro	Graphics	Memory	Display	Multi-touch	Pen	Storage(HDD/SSD)	RAID	Optical	WLAN + Bluetooth	WWAN	SIM Card	Smart Card Reader	Camera	Keyboard	Fingerprint Reader	Color Calibrator	Battery	Power Adapter	Operating System	Warranty	Ann Date (m/y)
20EN001NUS	US	Xeon E3-1505M v5	vPro	M2000M 4GB	16GBx1 non-ECC	15.6" FHD (1920x1080) IPS	10-point Multi-touch	None	256GB SSD M.2 Opal2	No	None	Intel 8260 ac, 2x2 + BT4.1	None	None	None	720p	Backlit	Fingerprint Reader	X-Rite	6-cell (90Wh)	170W	Win10 Pro 64	3-year, Depot	11/15
20EN001PUS	US	Xeon E3-1505M v5	vPro	M2000M 4GB	16GBx1 non-ECC	15.6" FHD (1920x1080) IPS	10-point Multi-touch	None	512GB SSD M.2 PCIe NVMe	No	None	Intel 8260 ac, 2x2 + BT4.1	None	None	None	720p	Backlit	Fingerprint Reader	X-Rite	6-cell (90Wh)	170W	Win10 Pro 64	3-year, Depot	11/15
20EN001QUS	US	Xeon E3-1505M v5	vPro	M2000M 4GB	16GBx1 non-ECC	15.6" 4K (3840x2160) IPS	None	None	256GB SSD M.2 Opal2	No	None	Intel 8260 ac, 2x2 + BT4.1	None	None	None	720p	Backlit	Fingerprint Reader	X-Rite	6-cell (90Wh)	170W	Win10 DG Win7 Pro 64	3-year, Depot	11/15
20EN001RUS	US	Xeon E3-1505M v5	vPro	M2000M 4GB	16GBx1 non-ECC	15.6" 4K (3840x2160) IPS	None	None	512GB SSD M.2 PCIe NVMe	No	None	Intel 8260 ac, 2x2 + BT4.1	None	None	None	720p	Backlit	Fingerprint Reader	X-Rite	6-cell (90Wh)	170W	Win10 DG Win7 Pro 64	3-year, Depot	11/15
20EN001SUS	US	Xeon E3-1505M v5	vPro	M2000M 4GB	16GBx1 non-ECC	15.6" FHD (1920x1080) IPS	None	None	256GB SSD M.2 Opal2	No	None	Intel 8260 ac, 2x2 + BT4.1	None	None	None	720p	Backlit	Fingerprint Reader	None	6-cell (90Wh)	170W	Win10 DG Win7 Pro 64	3-year, Depot	11/15
20EN001TUS	US	Xeon E3-1505M v5	vPro	M2000M 4GB	16GBx1 non-ECC	15.6" FHD (1920x1080) IPS	None	None	512GB SSD M.2 PCIe NVMe	No	None	Intel 8260 ac, 2x2 + BT4.1	None	None	None	720p	Backlit	Fingerprint Reader	None	6-cell (90Wh)	170W	Win10 DG Win7 Pro 64	3-year, Depot	11/15
20EN002FUS	US	i7-6700HQ	No	M1000M 2GB	16GBx1 non-ECC	15.6" FHD (1920x1080) IPS	None	None	500GB 7200rpm	No	None	Intel 8260 ac, 2x2 + BT4.1	None	None	None	720p	Backlit	Fingerprint Reader	None	6-cell (90Wh)	170W	Win10 DG Win7 Pro 64	3-year, Depot	11/15
20EN002GUS	US	i7-6700HQ	No	M1000M 2GB	16GBx1 non-ECC	15.6" FHD (1920x1080) IPS	None	None	500GB 7200rpm	No	None	Intel 8260 ac, 2x2 + BT4.1	None	None	None	720p	Backlit	Fingerprint Reader	None	6-cell (90Wh)	170W	Win10 Pro 64	3-year, Depot	11/15
20EN002HUS	US	i7-6700HQ	No	M1000M 2GB	16GBx1 non-ECC	15.6" FHD (1920x1080) IPS	None	None	256GB SSD M.2 Opal2	No	None	Intel 8260 ac, 2x2 + BT4.1	None	None	None	720p	Backlit	Fingerprint Reader	None	6-cell (90Wh)	170W	Win10 DG Win7 Pro 64	3-year, Depot	11/15
20EN002JUS	US	i7-6700HQ	No	M1000M 2GB	16GBx1 non-ECC	15.6" FHD (1920x1080) IPS	None	None	256GB SSD M.2 Opal2	No	None	Intel 8260 ac, 2x2 + BT4.1	None	None	None	720p	Backlit	Fingerprint Reader	None	6-cell (90Wh)	170W	Win10 Pro 64	3-year, Depot	11/15
20EN002KUS	US	i7-6820HQ	vPro	M1000M 2GB	16GBx1 non-ECC	15.6" FHD (1920x1080) IPS	None	None	256GB SSD M.2 Opal2	No	None	Intel 8260 ac, 2x2 + BT4.1	None	None	None	720p	Backlit	Fingerprint Reader	None	6-cell (90Wh)	170W	Win10 DG Win7 Pro 64	3-year, Depot	11/15
20EN002LUS	US	i7-6820HQ	vPro	M1000M 2GB	16GBx1 non-ECC	15.6" FHD (1920x1080) IPS	None	None	256GB SSD M.2 Opal2	No	None	Intel 8260 ac, 2x2 + BT4.1	None	None	None	720p	Backlit	Fingerprint Reader	None	6-cell (90Wh)	170W	Win10 Pro 64	3-year, Depot	11/15
20EN002MUS	US	i7-6820HQ	vPro	M2000M 4GB	16GBx1 non-ECC	15.6" FHD (1920x1080) IPS	None	None	256GB SSD M.2 Opal2	No	None	Intel 8260 ac, 2x2 + BT4.1	None	None	None	720p	Backlit	Fingerprint Reader	None	6-cell (90Wh)	170W	Win10 DG Win7 Pro 64	3-year, Depot	11/15
20EN002NUS	US	i7-6820HQ	vPro	M2000M 4GB	16GBx1 non-ECC	15.6" FHD (1920x1080) IPS	None	None	256GB SSD M.2 Opal2	No	None	Intel 8260 ac, 2x2 + BT4.1	None	None	None	720p	Backlit	Fingerprint Reader	None	6-cell (90Wh)	170W	Win10 Pro 64	3-year, Depot	11/15
20EN002PUS	US	Xeon E3-1505M v5	vPro	M2000M 4GB	16GBx1 non-ECC	15.6" FHD (1920x1080) IPS	None	None	256GB SSD M.2 Opal2	No	None	Intel 8260 ac, 2x2 + BT4.1	None	None	None	720p	Backlit	Fingerprint Reader	None	6-cell (90Wh)	170W	Win10 Pro 64	3-year, Depot	11/15
20EN002QUS	US	i7-6820HQ	vPro	M2000M 4GB	16GBx1 non-ECC	15.6" 4K (3840x2160) IPS	None	None	256GB SSD M.2 Opal2	No	None	Intel 8260 ac, 2x2 + BT4.1	None	None	None	720p	Backlit	Fingerprint Reader	X-Rite	6-cell (90Wh)	170W	Win10 Pro 64	3-year, Depot	11/15
20EN003LUS	US	i7-6820HQ	vPro	M1000M 4GB	8GBx4 non-ECC	15.6" FHD (1920x1080) IPS	None	None	512GB SSD M.2 PCIe NVMe	No	None	Intel 8260 ac, 2x2 + BT4.1	None	None	Smart Card Reader	720p	Backlit	Fingerprint Reader	None	6-cell (90Wh)	170W	Win10 Pro 64	3-year, Depot	07/16

ThinkPad P50 - TopSeller - 20EQ

Product Specifications Reference (PSREF)

Model	Region	Processor	vPro	Graphics	Memory	Display	Multi-touch	Pen	Storage(HDD/SSD)	RAID	Optical	WLAN + Bluetooth	WWAN	SIM Card	Smart Card Reader	Camera	Keyboard	Fingerprint Reader	Color Calibrator	Battery	Power Adapter	Operating System	Warranty	Ann Date (m/y)
20EQ002DUS	US	Xeon E3-1505M v5	vPro	M2000M 4GB	16GBx1 non-ECC	15.6" FHD (1920x1080) IPS	None	None	256GB SSD M.2 Opal2	No	None	Intel 8260 ac, 2x2 + BT4.1	None	None	None	720p	Backlit	Fingerprint Reader	X-Rite	6-cell (90Wh)	170W	Win10 Pro 64	3-year, Onsite	08/16
20EQ002EUS	US	i7-6700HQ	No	M1000M 4GB	8GBx1 non-ECC	15.6" FHD (1920x1080) IPS	None	None	500GB 7200rpm	No	None	Intel 8260 ac, 2x2 + BT4.1	None	None	None	720p	Backlit	Fingerprint Reader	None	6-cell (90Wh)	170W	Win10 Pro 64	3-year, Onsite	08/16
20EQ002FUS	US	Xeon E3-1505M v5	vPro	M2000M 4GB	16GBx1 non-ECC	15.6" FHD (1920x1080) IPS	None	None	256GB SSD M.2 Opal2	No	None	Intel 8260 ac, 2x2 + BT4.1	None	None	None	720p	Backlit	Fingerprint Reader	None	6-cell (90Wh)	170W	Win10 Pro 64	3-year, Onsite	08/16



ThinkPad P50s Platform Specifications

Product Specifications Reference (PSREF)

Processor	6th Generation Intel® Core™ i5 / i7 Processor								Smart card reader	Optional: Smart card reader								
	Processor Number	# of Cores	# of Threads	Base Frequency	Max Turbo Frequency	Cache	Memory Types	Processor Graphics	Media reader	4-in-1 reader (MMC, SD, SDHC, SDXC)								
	i5-6300U	2	4	2.4 GHz	3 GHz	3MB	DDR3L-1600	Intel HD Graphics 520	Ports	Three USB 3.0 (one Always On), MiniDP, HDMI, Ethernet (RJ-45), Dock connector								
	i7-6500U			2.5 GHz	3.1 GHz	4MB			Camera (optional)	HD720p resolution, low light sensitive, fixed focus								
i7-6600U	2.6 GHz			3.4 GHz	4MB	Audio support			HD Audio, Realtek® ALC3245 codec / stereo speakers, 1W x 2 / dual array microphone, combo audio/microphone jack									
Graphics	Intel HD Graphics 520 in processor and NVIDIA Quadro® M500M, 2GB memory; supports external digital monitor via HDMI or Mini DisplayPort; supports three independent displays; Max resolution: 3840x2160@60Hz (DisplayPort via Mini DisplayPort cable); 4096x2160@24Hz (HDMI)								Keyboard	6-row, spill-resistant, multimedia Fn keys, numeric keypad, optional LED backlight								
Chipset	Intel SoC (System on Chip) platform								UltraNav™	TrackPoint® pointing device and buttonless Mylar surface touchpad, multi-touch								
	Memory	32GB max ⁷ / PC3-12800 1600MHz DDR3L, non-parity, dual-channel capable, two DDR3L SO-DIMM sockets								Security	Power-on password, hard disk password, supervisor password, security keyhole							
Display	<i>Some:</i> 15.6" (396mm) FHD (1920x1080), anti-glare, LED backlight, IPS, 250 nits, 16:9 aspect ratio, 400:1 or 500:1 contrast ratio, 160° viewing angle <i>Some:</i> 15.5" (394mm) 3K (2880x1620), anti-glare, LED backlight, IPS, 350 nits, 16:9 aspect ratio, 1000:1 contrast ratio, 160° viewing angle								Security chip	Discrete TPM 1.2 TCG Certified and Firmware TPM 2.0 integrated in chipset								
									Multi-touch (opt)	In-cell touch, supports 10-finger gesture								ThinkEngine
Storage	<i>Some:</i> SSD / SATA 6.0Gb/s (e.g. xxxG SSD) <i>Some:</i> SSD / PCIe NVMe, PCIe 3.0 x 2, 16Gb/s (e.g. xxxG SSD PCIe NVMe) <i>Some:</i> HDD / SATA 6.0Gb/s, 2.5" wide, 7mm high, Shock Mounted Hard Drive, Active Protection System™ <i>Some:</i> SSHD with 8GB NAND flash memory								vPro (optional)	Intel vPro Technology								
									Optical	None								Fingerprint reader
Ethernet	<i>Non-vPro model:</i> Intel Ethernet Connection I219-V (Jacksonville) <i>vPro model:</i> Intel Ethernet Connection I219-LM (Jacksonville)								Internal battery	Optional: Integrated Li-Polymer 3-cell (44Wh)								
WLAN ⁴	<i>One of the following, configurable by model:</i> <ul style="list-style-type: none"> • 11ac+BT, Broadcom BCM4356, 2x2, M.2 card • 11ac+BT, Intel Dual Band Wireless-AC 8260, 2x2, M.2 card 								External battery	Li-Ion or Li-Polymer 3-cell (23Wh) or Li-Ion 6-cell (48Wh or 72Wh)								
Bluetooth™	Bluetooth 4.1 wireless, integrated in Wi-Fi + Bluetooth combo adapter								Max battery life ¹⁰	(MobileMark® 2014)								
WWAN (optional)	<i>One of the following, configurable by model:</i> <ul style="list-style-type: none"> • Wireless WAN upgradable • Wireless WAN, Sierra Wireless EM7455, Qualcomm® 4G LTE-Advanced/DC-HSPA+/HSPA+/HSPA/UMTS/GNSS, M.2 card • Wireless WAN, HUAWEI ME906S, HUAWEI 4G LTE/WCDMA/HSPA/GSM/GPRS/EDGE/GNSS, M.2 card (WE only) 								<table border="1"> <thead> <tr> <th>Models</th> <th>3 + 3-cell</th> <th>3 + 6-cell 48Wh</th> <th>3 + 6-cell 72Wh</th> </tr> </thead> <tbody> <tr> <td>Max battery life</td> <td>12.0 hr</td> <td>16.3 hr</td> <td>20.5 hr</td> </tr> </tbody> </table>		Models	3 + 3-cell	3 + 6-cell 48Wh	3 + 6-cell 72Wh	Max battery life	12.0 hr	16.3 hr	20.5 hr
Models	3 + 3-cell	3 + 6-cell 48Wh	3 + 6-cell 72Wh															
Max battery life	12.0 hr	16.3 hr	20.5 hr															
SIM card (opt)	Micro-SIM card slot, optional Verizon LTE (US) or Lenovo Connect (WE) SIM card								AC adapter	65W Slim AC adapter or 65W AC adapter								
Dimensions ³ Weight ²	WxDxH: 14.98" x 10.17" x 0.88"; 380.6mm x 258.2mm x 22.45mm								Preload	Windows 7 Professional 64 preinstalled through downgrade rights in Windows 10 Pro 64								
			No + 6-cell		3-cell + 3-cell		3-cell + 6-cell		<ul style="list-style-type: none"> • Lenovo Solution Center • Lenovo Companion • Lenovo Setting • Microsoft Office preloaded; purchase a product key to activate • McAfee® LiveSafe™ (30-day trial) 									
	Non-touch		5.27 lb / 2.39 kg		4.97 lb / 2.25 kg		5.44 lb / 2.47 kg		<ul style="list-style-type: none"> • Rescue and Recovery™ • ThinkVantage System Update • Adobe® Reader® • Microsoft® Office preloaded; purchase a product key to activate • McAfee® LiveSafe™ (30-day trial) 									
	Multi-touch		-		5.00 lb / 2.27 kg		5.42 lb / 2.46 kg		<i>For ISV certifications, please visit www.lenovo.com/support/ISV</i>									
Case material	Display cover: PPS; Bottom: Glass-Fiber Reinforced Plastic								Limited warranty ¹²	<i>One of the following, configurable by model:</i> <ul style="list-style-type: none"> • 3-year/1-yr battery depot repair service • 3-year/1-yr battery limited onsite service²⁴ • 3-year/1-yr battery limited onsite service, OID (Onsite International Delivery) 								
									Mil-Spec test	MIL-STD-810G military certification								
									Environment	EPPEAT™ Gold (US only); ENERGY STAR® 6.1; GREENGUARD®; RoHS-compliant								

ThinkPad P50s - TopSeller - 20FL

Product Specifications Reference (PSREF)

Model	Region	Processor	vPro	Graphics	Memory	Display	Multi-touch	Storage(HDD/SSD)	Optical	WLAN + Bluetooth	WWAN	SIM Card	Smart Card Reader	Camera	Keyboard	Fingerprint Reader	Battery (internal+external)	Power Adapter	Operating System	Warranty	Ann Date (m/y)
20FL000GUS	US	i7-6500U	No	M500M 2GB	8GBx2	15.6" FHD (1920x1080) IPS	None	256GB SSD Opal2	None	Intel 8260 ac, 2x2 + BT4.1	WWAN Upgradable	None	None	720p	Backlit	Fingerprint Reader	3-cell(44Wh) + 3-cell(23Wh)	65W	Win10 DG Win7 Pro 64	3-year, Depot	01/16
20FL000HUS	US	i5-6300U	vPro	M500M 2GB	8GBx1	15.6" FHD (1920x1080) IPS	None	256GB SSD Opal2	None	Intel 8260 ac, 2x2 + BT4.1	WWAN Upgradable	None	None	720p	Backlit	Fingerprint Reader	None + 6-cell(72Wh)	65W	Win10 DG Win7 Pro 64	3-year, Depot	01/16
20FL000JUS	US	i7-6500U	No	M500M 2GB	8GBx1	15.5" 3K (2880x1620) IPS	None	256GB SSD Opal2	None	Intel 8260 ac, 2x2 + BT4.1	WWAN Upgradable	None	None	720p	Backlit	Fingerprint Reader	3-cell(44Wh) + 3-cell(23Wh)	65W	Win10 DG Win7 Pro 64	3-year, Depot	01/16
20FL000KUS	US	i7-6500U	No	M500M 2GB	8GBx1	15.6" FHD (1920x1080) IPS	None	500GB 7200rpm	None	Intel 8260 ac, 2x2 + BT4.1	WWAN Upgradable	None	None	720p	Backlit	Fingerprint Reader	3-cell(44Wh) + 3-cell(23Wh)	65W	Win10 DG Win7 Pro 64	3-year, Depot	01/16
20FL000LUS	US	i7-6500U	No	M500M 2GB	8GBx1	15.6" FHD (1920x1080) IPS	None	1TB 5400rpm	None	Intel 8260 ac, 2x2 + BT4.1	WWAN Upgradable	None	None	720p	Backlit	Fingerprint Reader	None + 6-cell(48Wh)	65W	Win10 DG Win7 Pro 64	3-year, Depot	01/16
20FL000MUS	US	i7-6500U	No	M500M 2GB	8GBx2	15.6" FHD (1920x1080) IPS	None	512GB SSD	None	Intel 8260 ac, 2x2 + BT4.1	WWAN Upgradable	None	None	720p	Backlit	Fingerprint Reader	3-cell(44Wh) + 3-cell(23Wh)	65W	Win10 DG Win7 Pro 64	3-year, Depot	01/16
20FL000NUS	US	i7-6600U	vPro	M500M 2GB	8GBx2	15.5" 3K (2880x1620) IPS	None	512GB SSD	None	Intel 8260 ac, 2x2 + BT4.1	WWAN Upgradable	None	None	720p	Backlit	Fingerprint Reader	3-cell(44Wh) + 3-cell(23Wh)	65W	Win10 DG Win7 Pro 64	3-year, Depot	01/16
20FL0014US	US	i5-6300U	vPro	M500M 2GB	8GBx1	15.6" FHD (1920x1080) IPS	None	256GB SSD Opal2	None	Intel 8260 ac, 2x2 + BT4.1	WWAN Upgradable	None	None	720p	Backlit	None	3-cell(44Wh) + 6-cell(72Wh)	65W	Win10 Pro 64	3-year, Depot	08/16
20FL0015US	US	i7-6500U	No	M500M 2GB	8GBx1	15.6" FHD (1920x1080) IPS	None	1TB 5400rpm	None	Intel 8260 ac, 2x2 + BT4.1	WWAN Upgradable	None	None	720p	Backlit	None	3-cell(44Wh) + 6-cell(72Wh)	65W	Win10 Pro 64	3-year, Depot	08/16
20FL0016US	US	i7-6500U	No	M500M 2GB	8GBx1	15.5" 3K (2880x1620) IPS	None	256GB SSD Opal2	None	Intel 8260 ac, 2x2 + BT4.1	WWAN Upgradable	None	None	720p	Backlit	None	3-cell(44Wh) + 6-cell(72Wh)	65W	Win10 Pro 64	3-year, Depot	08/16
20FL0017US	US	i7-6500U	No	M500M 2GB	8GBx1	15.6" FHD (1920x1080) IPS	None	256GB SSD Opal2	None	Intel 8260 ac, 2x2 + BT4.1	WWAN Upgradable	None	None	720p	Backlit	None	3-cell(44Wh) + 6-cell(72Wh)	65W	Win10 Pro 64	3-year, Depot	08/16
20FL0018US	US	i7-6500U	No	M500M 2GB	8GBx1	15.6" FHD (1920x1080) IPS	None	512GB SSD	None	Intel 8260 ac, 2x2 + BT4.1	WWAN Upgradable	None	None	720p	Backlit	None	3-cell(44Wh) + 6-cell(72Wh)	65W	Win10 Pro 64	3-year, Depot	08/16
20FL0019US	US	i7-6500U	No	M500M 2GB	8GBx1	15.6" FHD (1920x1080) IPS	None	500GB 7200rpm	None	Intel 8260 ac, 2x2 + BT4.1	WWAN Upgradable	None	None	720p	Backlit	None	3-cell(44Wh) + 6-cell(72Wh)	65W	Win10 Pro 64	3-year, Depot	08/16
20FL001AUS	US	i7-6600U	vPro	M500M 2GB	8GBx1	15.6" FHD (1920x1080) IPS	None	512GB SSD	None	Intel 8260 ac, 2x2 + BT4.1	WWAN Upgradable	None	None	720p	Backlit	None	3-cell(44Wh) + 6-cell(72Wh)	65W	Win10 Pro 64	3-year, Depot	08/16
20FL001BUS	US	i7-6500U	No	M500M 2GB	16GBx1	15.5" 3K (2880x1620) IPS	None	1TB 5400rpm	None	Intel 8260 ac, 2x2 + BT4.1	WWAN Upgradable	None	None	720p	Backlit	None	3-cell(44Wh) + 6-cell(72Wh)	65W	Win10 Pro 64	3-year, Depot	08/16



ThinkPad P51 Platform Specifications

Product Specifications Reference (PSREF)

Processor	7th Generation Intel® Core™ i7 Processor or Intel Xeon® Processor E3 v6 Family							Dimensions <i>WxDxH:</i> 14.86" x 9.93" x 0.96-1.16"; 377.4mm x 252.3mm x 24.5-29.4mm <i>WxDxH(Touch):</i> 14.86" x 9.93" x 1.02-1.21"; 377.4mm x 252.3mm x 25.8-30.7mm										
	Processor Number	# of Cores	# of Threads	Base Frequency	Max Turbo Frequency	Cache	Memory Types		Weight <table border="1"> <thead> <tr> <th>Models</th> <th>4-cell</th> <th>6-cell</th> </tr> </thead> <tbody> <tr> <td><i>Non-touch</i></td> <td>5.6 lb / 2.55kg</td> <td>5.9 lb / 2.67kg</td> </tr> <tr> <td><i>Multi-touch</i></td> <td>6.2 lb / 2.82kg</td> <td>6.4 lb / 2.90kg</td> </tr> </tbody> </table>	Models	4-cell	6-cell	<i>Non-touch</i>	5.6 lb / 2.55kg	5.9 lb / 2.67kg	<i>Multi-touch</i>	6.2 lb / 2.82kg	6.4 lb / 2.90kg
	Models	4-cell	6-cell															
	<i>Non-touch</i>	5.6 lb / 2.55kg	5.9 lb / 2.67kg															
<i>Multi-touch</i>	6.2 lb / 2.82kg	6.4 lb / 2.90kg																
i7-7700HQ	4	8	2.8 GHz	3.8 GHz	6MB	DDR4-2400	Intel HD Graphics 630											
i7-7820HQ			2.9 GHz	3.9 GHz			Intel HD Graphics P630											
E3-1505M v6			3.0 GHz	4.0 GHz	8MB		Intel HD Graphics P630											
E3-1535M v6			3.1 GHz	4.2 GHz														

Graphics	Intel HD Graphics 630 or P630 in processor and NVIDIA Quadro® M1200M or M2200M, 4GB memory; supports external digital monitor via HDMI, Mini DisplayPort, or Thunderbolt™; supports four independent displays; Max resolution: 3840x2160@60Hz (DisplayPort via Mini DisplayPort cable); 3840x2160@60Hz (Thunderbolt); 4096x2160@24Hz (HDMI)	Smart card reader ExpressCard Media reader Ports	<i>Optional:</i> Smart card reader One slot (ExpressCard/34) 4-in-1 reader (MMC, SD, SDHC, SDXC), supports UHS-II SD card Four USB 3.1 Gen 1 / USB 3.0 (one Always On), USB Type-C / Thunderbolt 3, Mini DisplayPort 1.2a, HDMI 1.4b, Ethernet (RJ-45), Dock connector
----------	---	---	---

Chipset	Mobile Intel CM238 Chipset	Camera (<i>optional</i>)	HD720p resolution, fixed focus
Memory	64GB max ⁷ / 2400MHz DDR4, ECC or non-ECC (ECC function supported only on Xeon processor), dual-channel capable, four DDR4 SO-DIMM sockets	Audio support	HD Audio, Realtek® ALC3268 codec / stereo speakers, 2W x 2 / dual array microphone, combo audio/microphone jack

Display	<i>Some:</i> 15.6" (396mm) FHD (1920x1080), anti-glare, LED backlight, IPS, 250 nits, 16:9 aspect ratio, 700:1 contrast ratio, 160° viewing angle <i>Some:</i> 15.6" (396mm) 4K (3840x2160), anti-glare, LED backlight, IPS, 300 nits, 16:9 aspect ratio, 1000:1 contrast ratio, 100% gamut, 170° viewing angle	Keyboard UltraNav™	6-row, spill-resistant, multimedia Fn keys, numeric keypad, optional LED backlight 3-button TrackPoint® pointing device and 3-button Mylar surface multi-touch touchpad
---------	--	-----------------------	---

Multi-touch (<i>opt</i>) Pen (<i>optional</i>)	Capacitive-type multi-touch, supports 10-finger gesture, 220 nits (FHD only) ThinkPad Pen Pro, active pen for multi-touch display	Security Security chip vPro (<i>optional</i>)	Power-on password, hard disk password, supervisor password, security keyhole Discrete TPM 2.0, TCG Certified Intel vPro Technology
---	--	---	--

Storage	<i>Up to 3 drives (two M.2 SSD and one HDD)</i> <i>Some:</i> M.2 SSD / PCIe NVMe, PCIe 3.0 x 4, 32Gb/s <i>Some:</i> HDD / SATA 6.0Gb/s, 2.5" wide, 7mm high, Active Protection System™	Fingerprint reader	Touch style match on chip fingerprint reader on the palm rest
Optical	None	Color calibration NFC	<i>Optional:</i> Pantone® color calibrator by X-Rite® color calibration sensor in palm rest None

Ethernet	<i>Non-vPro model:</i> Intel Ethernet Connection I219-V (Jacksonville) <i>vPro model:</i> Intel Ethernet Connection I219-LM (Jacksonville)	Battery	Lithium Polymer 4-cell (66Wh) or 6-cell (90Wh)									
WLAN Bluetooth™	Intel Dual Band Wireless-AC 8265, Wi-Fi 2x2 802.11ac + BT4.1, M.2 card Bluetooth 4.1 wireless, integrated in Wi-Fi + Bluetooth combo adapter * Intel 8265ac card support BT4.2 but is limited to BT4.1 by Windows OS	Max battery life ¹⁰ (MobileMark® 2014)	<table border="1"> <thead> <tr> <th>Model</th> <th>4-cell</th> <th>6-cell</th> </tr> </thead> <tbody> <tr> <td><i>Discrete Graphics</i></td> <td>4.5 hr</td> <td>6.1 hr</td> </tr> <tr> <td><i>Hybrid Graphics</i></td> <td>6.5 hr</td> <td>8.9 hr</td> </tr> </tbody> </table>	Model	4-cell	6-cell	<i>Discrete Graphics</i>	4.5 hr	6.1 hr	<i>Hybrid Graphics</i>	6.5 hr	8.9 hr
Model	4-cell	6-cell										
<i>Discrete Graphics</i>	4.5 hr	6.1 hr										
<i>Hybrid Graphics</i>	6.5 hr	8.9 hr										

WWAN (<i>optional</i>)	<i>One of the following, configurable by model:</i> • Wireless WAN upgradable • Integrated Mobile Broadband 4G LTE-A, Qualcomm® Snapdragon™ X7 LTE-A (Sierra Wireless EM7455), M.2 card	AC adapter	170W AC adapter
--------------------------	--	------------	-----------------

SIM card (<i>opt</i>)	Micro-SIM card slot, opt Verizon LTE (US) or Lenovo® Connect (EMEA) SIM card	Preload	<i>Some:</i> Windows® 10 Home 64 <i>Some:</i> Windows 10 Pro 64 • Lenovo Companion • Lenovo Setting • Microsoft Office preloaded; purchase a product key to activate
-------------------------	--	---------	---

		Limited warranty	<i>One of the following, configurable by model:</i> • 1-year depot repair service • 3-year/1-yr battery depot repair service • 3-year/1-yr battery limited onsite service
--	--	------------------	--

		Mil-Spec test	MIL-STD-810G military certification
--	--	---------------	-------------------------------------

		Environment	EPPEAT™ Gold (US only); ENERGY STAR® 6.1; RoHS-compliant
--	--	-------------	--

Model	Region	Processor	vPro	Graphics	Chipset	Memory	Display	Multi-touch	Pen	Storage (HDD/SSD)	RAID	Optical	WLAN + Bluetooth	WWAN	SIM Card	Smart Card Reader	Camera	Key-board	Finger-print Reader	NFC	Color Calibrator	TPM	Battery	Power Adapter	Operating System	Warranty	Ann Date (mly)
20HH0004US	US	i7-7700HQ	No	M1200M 4GB	Intel CM238	8GBx1 non-ECC	15.6" FHD (1920x1080) IPS	None	None	512GB SSD M.2 PCIe NVMe Opal2	No	None	Intel 8265 ac, 2x2 + BT4.1	WWAN Upgradable	None	None	720p	Backlit	Finger-print Reader	None	None	dTPM 2.0	6-cell (90Wh)	170W	Win10 Pro 64	3-year, Depot	03/17
20HH0005US	US	Xeon E3-1505M v6	vPro	M2200M 4GB	Intel CM238	8GBx2 non-ECC	15.6" FHD (1920x1080) IPS	None	None	1TB 5400rpm	No	None	Intel 8265 ac, 2x2 + BT4.1	WWAN Upgradable	None	None	720p	Backlit	Finger-print Reader	None	None	dTPM 2.0	6-cell (90Wh)	170W	Win10 Pro 64	3-year, Depot	03/17
20HH0006US	US	Xeon E3-1535M v6	vPro	M2200M 4GB	Intel CM238	8GBx2 non-ECC	15.6" FHD (1920x1080) IPS	None	None	512GB SSD M.2 PCIe NVMe Opal2	No	None	Intel 8265 ac, 2x2 + BT4.1	WWAN Upgradable	None	None	720p	Backlit	Finger-print Reader	None	None	dTPM 2.0	6-cell (90Wh)	170W	Win10 Pro 64	3-year, Depot	03/17
20HH0007US	US	Xeon E3-1535M v6	vPro	M2200M 4GB	Intel CM238	8GBx2 non-ECC	15.6" FHD (1920x1080) IPS	None	None	256GB SSD M.2 PCIe NVMe Opal2	No	None	Intel 8265 ac, 2x2 + BT4.1	WWAN Upgradable	None	None	720p	Backlit	Finger-print Reader	None	None	dTPM 2.0	6-cell (90Wh)	170W	Win10 Pro 64	3-year, Depot	03/17
20HH0008US	US	Xeon E3-1535M v6	vPro	M2200M 4GB	Intel CM238	8GBx2 non-ECC	15.6" FHD (1920x1080) IPS	None	None	1TB SSD M.2 PCIe NVMe Opal2	No	None	Intel 8265 ac, 2x2 + BT4.1	WWAN Upgradable	None	None	720p	Backlit	Finger-print Reader	None	None	dTPM 2.0	6-cell (90Wh)	170W	Win10 Pro 64	3-year, Depot	03/17
20HH0009US	US	Xeon E3-1535M v6	vPro	M2200M 4GB	Intel CM238	8GBx2 non-ECC	15.6" FHD (1920x1080) IPS	10-point Multi-touch	None	512GB SSD M.2 PCIe NVMe Opal2	No	None	Intel 8265 ac, 2x2 + BT4.1	WWAN Upgradable	None	None	720p	Backlit	Finger-print Reader	None	X-Rite	dTPM 2.0	6-cell (90Wh)	170W	Win10 Pro 64	3-year, Depot	03/17
20HH000AUS	US	i7-7700HQ	No	M1200M 4GB	Intel CM238	8GBx2 non-ECC	15.6" FHD (1920x1080) IPS	None	None	1TB SSD M.2 PCIe NVMe Opal2	No	None	Intel 8265 ac, 2x2 + BT4.1	WWAN Upgradable	None	None	720p	Backlit	Finger-print Reader	None	None	dTPM 2.0	6-cell (90Wh)	170W	Win10 Pro 64	3-year, Depot	03/17
20HH000BUS	US	Xeon E3-1505M v6	vPro	M2200M 4GB	Intel CM238	8GBx2 non-ECC	15.6" FHD (1920x1080) IPS	None	None	512GB SSD M.2 PCIe NVMe Opal2	No	None	Intel 8265 ac, 2x2 + BT4.1	WWAN Upgradable	None	None	720p	Backlit	Finger-print Reader	None	None	dTPM 2.0	6-cell (90Wh)	170W	Win10 Pro 64	3-year, Depot	03/17
20HH000CUS	US	i7-7820HQ	vPro	M2200M 4GB	Intel CM238	8GBx2 non-ECC	15.6" 4K (3840x2160) IPS	None	None	512GB SSD M.2 PCIe NVMe Opal2	No	None	Intel 8265 ac, 2x2 + BT4.1	WWAN Upgradable	None	None	720p	Backlit	Finger-print Reader	None	X-Rite	dTPM 2.0	6-cell (90Wh)	170W	Win10 Pro 64	3-year, Depot	03/17
20HH000DUS	US	Xeon E3-1535M v6	vPro	M2200M 4GB	Intel CM238	8GBx2 non-ECC	15.6" 4K (3840x2160) IPS	None	None	512GB SSD M.2 PCIe NVMe Opal2	No	None	Intel 8265 ac, 2x2 + BT4.1	WWAN Upgradable	None	None	720p	Backlit	Finger-print Reader	None	X-Rite	dTPM 2.0	6-cell (90Wh)	170W	Win10 Pro 64	3-year, Depot	03/17
20HH000EUS	US	Xeon E3-1505M v6	vPro	M2200M 4GB	Intel CM238	8GBx2 non-ECC	15.6" FHD (1920x1080) IPS	10-point Multi-touch	None	1TB SSD M.2 PCIe NVMe Opal2	No	None	Intel 8265 ac, 2x2 + BT4.1	WWAN Upgradable	None	None	720p	Backlit	Finger-print Reader	None	X-Rite	dTPM 2.0	6-cell (90Wh)	170W	Win10 Pro 64	3-year, Depot	03/17
20HH000FUS	US	i7-7700HQ	No	M1200M 4GB	Intel CM238	8GBx1 non-ECC	15.6" FHD (1920x1080) IPS	None	None	1TB 5400rpm	No	None	Intel 8265 ac, 2x2 + BT4.1	WWAN Upgradable	None	None	720p	Backlit	Finger-print Reader	None	None	dTPM 2.0	6-cell (90Wh)	170W	Win10 Pro 64	3-year, Depot	03/17
20HH000GUS	US	i7-7820HQ	vPro	M1200M 4GB	Intel CM238	8GBx1 non-ECC	15.6" FHD (1920x1080) IPS	None	None	256GB SSD M.2 PCIe NVMe Opal2	No	None	Intel 8265 ac, 2x2 + BT4.1	WWAN Upgradable	None	None	720p	Backlit	Finger-print Reader	None	None	dTPM 2.0	6-cell (90Wh)	170W	Win10 Pro 64	3-year, Depot	03/17
20HH000HUS	US	Xeon E3-1535M v6	vPro	M2200M 4GB	Intel CM238	8GBx1 non-ECC	15.6" FHD (1920x1080) IPS	None	None	512GB SSD M.2 PCIe NVMe Opal2	No	None	Intel 8265 ac, 2x2 + BT4.1	WWAN Upgradable	None	None	720p	Backlit	Finger-print Reader	None	None	dTPM 2.0	6-cell (90Wh)	170W	Win10 Pro 64	3-year, Depot	03/17
20HH000JUS	US	Xeon E3-1535M v6	vPro	M2200M 4GB	Intel CM238	8GBx1 non-ECC	15.6" FHD (1920x1080) IPS	None	None	256GB SSD M.2 PCIe NVMe Opal2	No	None	Intel 8265 ac, 2x2 + BT4.1	WWAN Upgradable	None	None	720p	Backlit	Finger-print Reader	None	None	dTPM 2.0	6-cell (90Wh)	170W	Win10 Pro 64	3-year, Depot	03/17
20HH000KUS	US	Xeon E3-1505M v6	vPro	M2200M 4GB	Intel CM238	8GBx2 non-ECC	15.6" FHD (1920x1080) IPS	10-point Multi-touch	None	1TB 5400rpm	No	None	Intel 8265 ac, 2x2 + BT4.1	WWAN Upgradable	None	None	720p	Backlit	Finger-print Reader	None	X-Rite	dTPM 2.0	6-cell (90Wh)	170W	Win10 Pro 64	3-year, Depot	03/17
20HH000LUS	US	Xeon E3-1505M v6	vPro	M2200M 4GB	Intel CM238	8GBx2 non-ECC	15.6" 4K (3840x2160) IPS	None	None	512GB SSD M.2 PCIe NVMe Opal2	No	None	Intel 8265 ac, 2x2 + BT4.1	WWAN Upgradable	None	None	720p	Backlit	Finger-print Reader	None	X-Rite	dTPM 2.0	6-cell (90Wh)	170W	Win10 Pro 64	3-year, Depot	03/17
20HH000MUS	US	i7-7700HQ	No	M1200M 4GB	Intel CM238	8GBx1 non-ECC	15.6" FHD (1920x1080) IPS	None	None	1TB SSD M.2 PCIe NVMe Opal2	No	None	Intel 8265 ac, 2x2 + BT4.1	WWAN Upgradable	None	None	720p	Backlit	Finger-print Reader	None	None	dTPM 2.0	6-cell (90Wh)	170W	Win10 Pro 64	3-year, Depot	03/17
20HH000NUS	US	i7-7820HQ	vPro	M1200M 4GB	Intel CM238	8GBx1 non-ECC	15.6" FHD (1920x1080) IPS	None	None	512GB SSD M.2 PCIe NVMe Opal2	No	None	Intel 8265 ac, 2x2 + BT4.1	WWAN Upgradable	None	None	720p	Backlit	Finger-print Reader	None	None	dTPM 2.0	6-cell (90Wh)	170W	Win10 Pro 64	3-year, Depot	03/17
20HH000PUS	US	Xeon E3-1505M v6	vPro	M2200M 4GB	Intel CM238	8GBx1 non-ECC	15.6" FHD (1920x1080) IPS	None	None	256GB SSD M.2 PCIe NVMe Opal2	No	None	Intel 8265 ac, 2x2 + BT4.1	WWAN Upgradable	None	None	720p	Backlit	Finger-print Reader	None	None	dTPM 2.0	6-cell (90Wh)	170W	Win10 Pro 64	3-year, Depot	03/17

Model	Region	Processor	Pro	Graphics	Chipset	Memory	Display	Multi-touch	Pen	Storage (HDD/SSD)	RAID	Optical	WLAN + Bluetooth	WWAN	SIM Card	Smart Card Reader	Camera	Keyboard	Finger-print Reader	NFC	Color Calibrator	TPM	Battery	Power Adapter	Operating System	Warranty	Ann Date (m/y)
20HH000QUS	US	Xeon E3-1505M v6	vPro	M2200M 4GB	Intel CM238	8GBx1 non-ECC	15.6" FHD (1920x1080) IPS	None	None	256GB SSD M.2 PCIe NVMe Opal2	No	None	Intel 8265 ac, 2x2 + BT4.1	WWAN Upgradable	None	None	720p	Backlit	Finger-print Reader	None	None	dTPM 2.0	6-cell (90Wh)	170W	Win10 Pro 64	3-year, Depot	03/17
20HH000RUS	US	Xeon E3-1505M v6	vPro	M2200M 4GB	Intel CM238	8GBx1 non-ECC	15.6" FHD (1920x1080) IPS	None	None	512GB SSD M.2 PCIe NVMe Opal2	No	None	Intel 8265 ac, 2x2 + BT4.1	WWAN Upgradable	None	None	720p	Backlit	Finger-print Reader	None	None	dTPM 2.0	6-cell (90Wh)	170W	Win10 Pro 64	3-year, Depot	03/17
20HH000SUS	US	Xeon E3-1535M v6	vPro	M2200M 4GB	Intel CM238	8GBx2 non-ECC	15.6" FHD (1920x1080) IPS	None	None	512GB SSD M.2 PCIe NVMe Opal2	No	None	Intel 8265 ac, 2x2 + BT4.1	WWAN Upgradable	None	None	720p	Backlit	Finger-print Reader	None	None	dTPM 2.0	6-cell (90Wh)	170W	Win10 Pro 64	3-year, Depot	03/17
20HH000TUS	US	i7-7700HQ	No	M1200M 4GB	Intel CM238	8GBx2 non-ECC	15.6" FHD (1920x1080) IPS	None	None	512GB SSD M.2 PCIe NVMe Opal2	No	None	Intel 8265 ac, 2x2 + BT4.1	WWAN Upgradable	None	None	720p	Backlit	Finger-print Reader	None	None	dTPM 2.0	6-cell (90Wh)	170W	Win10 Pro 64	3-year, Depot	03/17
20HH000UUS	US	Xeon E3-1505M v6	vPro	M2200M 4GB	Intel CM238	8GBx2 non-ECC	15.6" FHD (1920x1080) IPS	None	None	512GB SSD M.2 PCIe NVMe Opal2	No	None	Intel 8265 ac, 2x2 + BT4.1	WWAN Upgradable	None	None	720p	Backlit	Finger-print Reader	None	None	dTPM 2.0	6-cell (90Wh)	170W	Win10 Pro 64	3-year, Depot	03/17
20HH000VUS	US	Xeon E3-1505M v6	vPro	M2200M 4GB	Intel CM238	8GBx1 non-ECC	15.6" FHD (1920x1080) IPS	None	None	1TB 5400rpm	No	None	Intel 8265 ac, 2x2 + BT4.1	WWAN Upgradable	None	None	720p	Backlit	Finger-print Reader	None	None	dTPM 2.0	6-cell (90Wh)	170W	Win10 Pro 64	3-year, Depot	03/17
20HH000WUS	US	i7-7700HQ	No	M1200M 4GB	Intel CM238	8GBx1 non-ECC	15.6" FHD (1920x1080) IPS	None	None	256GB SSD M.2 PCIe NVMe Opal2	No	None	Intel 8265 ac, 2x2 + BT4.1	WWAN Upgradable	None	None	720p	Backlit	Finger-print Reader	None	None	dTPM 2.0	6-cell (90Wh)	170W	Win10 Pro 64	3-year, Depot	03/17
20HH000XUS	US	i7-7700HQ	No	M1200M 4GB	Intel CM238	8GBx1 non-ECC	15.6" FHD (1920x1080) IPS	None	None	512GB SSD M.2 PCIe NVMe Opal2	No	None	Intel 8265 ac, 2x2 + BT4.1	WWAN Upgradable	None	None	720p	Backlit	Finger-print Reader	None	None	dTPM 2.0	6-cell (90Wh)	170W	Win10 Pro 64	3-year, Depot	03/17
20HH000YUS	US	i7-7700HQ	No	M1200M 4GB	Intel CM238	8GBx2 non-ECC	15.6" FHD (1920x1080) IPS	None	None	1TB 5400rpm	No	None	Intel 8265 ac, 2x2 + BT4.1	WWAN Upgradable	None	None	720p	Backlit	Finger-print Reader	None	None	dTPM 2.0	6-cell (90Wh)	170W	Win10 Pro 64	3-year, Depot	03/17
20HH0010US	US	Xeon E3-1505M v6	vPro	M2200M 4GB	Intel CM238	8GBx1 non-ECC	15.6" FHD (1920x1080) IPS	None	None	512GB SSD M.2 PCIe NVMe Opal2	No	None	Intel 8265 ac, 2x2 + BT4.1	WWAN Upgradable	None	None	720p	Backlit	Finger-print Reader	None	None	dTPM 2.0	6-cell (90Wh)	170W	Win10 Pro 64	3-year, Depot	03/17
20HH0011US	US	i7-7700HQ	No	M1200M 4GB	Intel CM238	8GBx1 non-ECC	15.6" FHD (1920x1080) IPS	None	None	500GB 7200rpm	No	None	Intel 8265 ac, 2x2 + BT4.1	WWAN Upgradable	None	None	720p	Backlit	Finger-print Reader	None	None	dTPM 2.0	6-cell (90Wh)	170W	Win10 Pro 64	3-year, Depot	03/17
20HH0012US	US	i7-7820HQ	vPro	M1200M 4GB	Intel CM238	8GBx1 non-ECC	15.6" FHD (1920x1080) IPS	None	None	1TB SSD M.2 PCIe NVMe Opal2	No	None	Intel 8265 ac, 2x2 + BT4.1	WWAN Upgradable	None	None	720p	Backlit	Finger-print Reader	None	None	dTPM 2.0	6-cell (90Wh)	170W	Win10 Pro 64	3-year, Depot	03/17
20HH0013US	US	Xeon E3-1505M v6	vPro	M2200M 4GB	Intel CM238	8GBx2 non-ECC	15.6" FHD (1920x1080) IPS	None	None	1TB SSD M.2 PCIe NVMe Opal2	No	None	Intel 8265 ac, 2x2 + BT4.1	WWAN Upgradable	None	None	720p	Backlit	Finger-print Reader	None	None	dTPM 2.0	6-cell (90Wh)	170W	Win10 Pro 64	3-year, Depot	03/17
20HH002LUS	US	i7-7820HQ	vPro	M2200M 4GB	Intel CM238	8GBx1 non-ECC	15.6" FHD (1920x1080) IPS	None	None	1TB SSD M.2 PCIe NVMe Opal2	No	None	Intel 8265 ac, 2x2 + BT4.1	WWAN Upgradable	None	None	720p	Backlit	Finger-print Reader	None	X-Rite	dTPM 2.0	6-cell (90Wh)	170W	Win10 Pro 64	3-year, Depot	05/17
20HH002MUS	US	i7-7700HQ	No	M1200M 4GB	Intel CM238	8GBx1 non-ECC	15.6" FHD (1920x1080) IPS	None	None	512GB SSD M.2 PCIe NVMe Opal2	No	None	Intel 8265 ac, 2x2 + BT4.1	WWAN Upgradable	None	None	720p	Backlit	Finger-print Reader	None	X-Rite	dTPM 2.0	6-cell (90Wh)	170W	Win10 Pro 64	3-year, Depot	05/17
20HH002NUS	US	i7-7820HQ	vPro	M2200M 4GB	Intel CM238	8GBx1 non-ECC	15.6" FHD (1920x1080) IPS	None	None	512GB SSD M.2 PCIe NVMe Opal2	No	None	Intel 8265 ac, 2x2 + BT4.1	WWAN Upgradable	None	None	720p	Backlit	Finger-print Reader	None	X-Rite	dTPM 2.0	6-cell (90Wh)	170W	Win10 Pro 64	3-year, Depot	05/17
20HH002PUS	US	i7-7820HQ	vPro	M2200M 4GB	Intel CM238	8GBx1 non-ECC	15.6" FHD (1920x1080) IPS	10-point Multi-touch	None	512GB SSD M.2 PCIe NVMe Opal2	No	None	Intel 8265 ac, 2x2 + BT4.1	WWAN Upgradable	None	None	720p	Backlit	Finger-print Reader	None	X-Rite	dTPM 2.0	6-cell (90Wh)	170W	Win10 Pro 64	3-year, Depot	05/17
20HH002QUS	US	i7-7700HQ	No	M1200M 4GB	Intel CM238	8GBx2 non-ECC	15.6" FHD (1920x1080) IPS	10-point Multi-touch	None	512GB SSD M.2 PCIe NVMe Opal2	No	None	Intel 8265 ac, 2x2 + BT4.1	WWAN Upgradable	None	None	720p	Backlit	Finger-print Reader	None	X-Rite	dTPM 2.0	6-cell (90Wh)	170W	Win10 Pro 64	3-year, Depot	05/17



ThinkPad P51s Platform Specifications

Product Specifications Reference (PSREF)

Processor	6th Generation Intel® Core™ i7 Processor							Dimensions WxDxH: 14.40" x 9.95" x 0.79-0.80"; 365.8mm x 252.8mm x 19.95-20.2mm
	Processor Number	# of Cores	# of Threads	Base Frequency	Max Turbo Frequency	Cache	Memory Types	
	i7-6500U	2	4	2.5 GHz	3.1 GHz	4MB	DDR4-2133	Intel HD Graphics 520
	i7-6600U			2.6 GHz	3.4 GHz	4MB		
	or 7th Generation Intel Core i5 / i7 Processor							
	Processor Number	# of Cores	# of Threads	Base Frequency	Max Turbo Frequency	Cache	Memory Types	Processor Graphics
	i5-7300U	2	4	2.6 GHz	3.5 GHz	3MB	DDR4-2133	Intel HD Graphics 620
	i7-7500U			2.7 GHz	3.5 GHz	4MB		
	i7-7600U			2.8 GHz	3.9 GHz	4MB		
Graphics	Intel HD Graphics 520 or 620 in processor and NVIDIA Quadro® M520M, 2GB 2.5GHz GDDR5 memory; supports external digital monitor via HDMI or USB Type-C; supports three independent displays; Max resolution: 4096x2304@60Hz (USB Type-C); 3840x2160@30Hz (HDMI)							Weight
Chipset	Intel SoC (System on Chip) platform							Smart card reader
Memory	32GB max / 2400MHz DDR4, dual-channel capable, two DDR4 SO-DIMM sockets * System clocks down for processors with lower memory controller							Media reader
Display	Some: 15.6" (396mm) FHD (1920x1080), anti-glare, LED backlight, IPS, 250 nits, 16:9 aspect ratio, 700:1 contrast ratio, 170° viewing angle Some: 15.6" (396mm) 4K (3840x2160), anti-glare, LED backlight, IPS, 300 nits, 16:9 aspect ratio, 1000:1 contrast ratio, 72% gamut, 170° viewing angle							Ports
Multi-touch (opt)	On-cell touch, supports 10-finger gesture (FHD only)							Optional: Smart card reader
Storage	System has one HDD slot or one M.2 2280 slot exclusively for storage Some: HDD / SATA 6.0Gb/s, 2.5" wide, 7mm high, Active Protection System™ Some: SSD / SATA 6.0Gb/s, 2.5" wide, 7mm high (e.g. xxxGB SSD) Some: M.2 SSD / PCIe NVMe, PCIe 3.0 x 2, 16Gb/s Some: 128GB M.2 SSD / SATA 6.0Gb/s, in WWAN slot as 2nd Storage, mutually exclusive with WWAN and WiGig							4-in-1 reader (MMC, SD, SDHC, SDXC), supports SD 3.0, UHS-I Three USB 3.1 Gen 1 / USB 3.0 (one Always On), USB 3.1 Type-C Gen 2 / Thunderbolt 3, HDMI 1.4b, Ethernet (RJ-45), Dock connector
Optical	None							WiGig dock (opt) ThinkPad WiGig dock
Ethernet	Non-vPro model: Intel Ethernet Connection I219-V (Jacksonville) vPro model: Intel Ethernet Connection I219-LM (Jacksonville)							Monitor cable HDMI to VGA: Lenovo HDMI to VGA Monitor Adapter (optional) USB-C to VGA: Lenovo USB-C to VGA Adapter
WLAN	One of the following, configurable by model (WiGig can coexist with WWAN): • Realtek® RTL8822BE, Wi-Fi 2x2 802.11ac + BT4.1, M.2 card • Intel Dual Band Wireless-AC 8260, Wi-Fi 2x2 802.11ac + BT4.1, M.2 card • Intel Dual Band Wireless-AC 8265, Wi-Fi 2x2 802.11ac + BT4.1, M.2 card • Intel Tri-Band Wireless-AC 18265, WiGig 802.11ad + Wi-Fi 2x2 802.11ac + BT4.1, M.2 card							Camera (optional) 720p: HD720p resolution, fixed focus IR & 720p: IR camera and HD720p camera (mutually exclusive with WiGig)
Bluetooth™	Bluetooth 4.1 wireless, integrated in Wi-Fi + Bluetooth combo adapter * Intel 8265ac / 18265ac card support BT4.2 but is limited to BT4.1 by Windows OS							Audio support
WWAN (optional)	One of the following, configurable by model (WWAN can coexist with WiGig): • Wireless WAN upgradable • Integrated Mobile Broadband 4G LTE-A, Qualcomm® Snapdragon™ X7 LTE-A (Sierra Wireless EM7455), M.2 card • Integrated Mobile Broadband 4G LTE, Intel XMM™ 7160 (Fibocom L831-EAU), M.2 card (EMEA only)							Keyboard
SIM card (opt)	Micro-SIM card slot, opt Verizon LTE (US) or Lenovo® Connect (EMEA) SIM card							6-row, spill-resistant, multimedia Fn keys, numeric keypad, optional LED backlight UltraNav™ TrackPoint® pointing device and buttonless Mylar surface multi-touch touchpad
								Security
								Power-on password, hard disk password, supervisor password, security keyhole
								Security chip
								Discrete TPM 2.0, TCG Certified
								vPro (optional)
								Intel vPro Technology
								Fingerprint reader
								Optional: Touch style match on chip fingerprint reader on the palm rest
								NFC (optional)
								Near Field Communication
								Internal battery
								Optional: Integrated Li-Polymer 4-cell (32Wh)
								External battery
								Li-Polymer 3-cell (24Wh) or Li-Ion 6-cell (48Wh or 72Wh)
								Max battery life
								(MobileMark® 2014)
								AC adapter
								65W AC adapter (slim tip), 65W USB Type-C AC adapter
								Preload
								Windows® 7 Professional 64 preinstalled through downgrade rights in Windows 10 Pro 64
								Some: Windows 10 Home 64
								Some: Windows 10 Pro 64
								• Lenovo Solution Center
								• Lenovo PowerEngage
								• ThinkVantage Product Recovery
								• ThinkVantage System Update
								• Adobe® Reader®
								• Microsoft® Office preloaded; purchase a product key to activate
								• McAfee® LiveSafe™ (30-day trial)
								Limited warranty
								One of the following, configurable by model:
								• 1-year depot repair service
								• 3-year/1-yr battery depot repair service
								• 3-year/1-yr battery limited onsite service
								Mil-Spec test
								MIL-STD-810G military certification
								Environment
								EPEAT™ Gold (US only); ENERGY STAR® 6.1; RoHS-compliant

Model	Region	Processor	vPro	Graphics	Memory	Display	Multi-touch	Storage(HDD/SSD)	Optical	WLAN + Bluetooth	WWAN	SIM Card	Smart Card Reader	Dock	Monitor Cable	Camera	Key-board	Finger-print Reader	NFC	TPM	Battery (internal+ external)	Power Adapter	Operating System	Warranty	Ann Date (m/y)
20HB0004US	US	i7-7500U	No	M520M 2GB	8GBx1	15.6" FHD (1920x1080) IPS	None	1TB 5400rpm	None	Intel 8265 ac, 2x2 + BT4.1	WWAN Upgradable	None	None	None	None	720p	Backlit	Finger-print Reader	None	dTPM 2.0	4-cell(32Wh) + 3-cell(24Wh)	65W	Win10 Pro 64	3-year, Depot	03/17
20HB000AUS	US	i7-7500U	No	M520M 2GB	8GBx1	15.6" FHD (1920x1080) IPS	None	256GB SSD M.2 PCIe NVMe Opal2	None	Intel 8265 ac, 2x2 + BT4.1	WWAN Upgradable	None	None	None	None	720p	Backlit	Finger-print Reader	None	dTPM 2.0	4-cell(32Wh) + 3-cell(24Wh)	65W	Win10 Pro 64	3-year, Depot	03/17
20HB000WUS	US	i7-7600U	vPro	M520M 2GB	8GBx1	15.6" FHD (1920x1080) IPS	None	256GB SSD M.2 PCIe NVMe Opal2	None	Intel 8265 ac, 2x2 + BT4.1	WWAN Upgradable	None	None	None	None	720p	Backlit	Finger-print Reader	None	dTPM 2.0	4-cell(32Wh) + 3-cell(24Wh)	65W	Win10 Pro 64	3-year, Depot	03/17
20HB000XUS	US	i5-7300U	vPro	M520M 2GB	8GBx1	15.6" FHD (1920x1080) IPS	10-point Multi-touch	256GB SSD M.2 PCIe NVMe Opal2	None	Intel 8265 ac, 2x2 + BT4.1	WWAN Upgradable	None	None	None	None	720p	Backlit	Finger-print Reader	None	dTPM 2.0	4-cell(32Wh) + 3-cell(24Wh)	65W	Win10 Pro 64	3-year, Depot	03/17
20HB000YUS	US	i5-7300U	vPro	M520M 2GB	8GBx1	15.6" 4K (3840x2160) IPS	None	1TB 5400rpm	None	Intel 8265 ac, 2x2 + BT4.1	WWAN Upgradable	None	None	None	None	IR &720p	Backlit	Finger-print Reader	None	dTPM 2.0	4-cell(32Wh) + 3-cell(24Wh)	65W	Win10 Pro 64	3-year, Depot	03/17
20HB0010US	US	i5-7300U	vPro	M520M 2GB	8GBx1	15.6" FHD (1920x1080) IPS	None	512GB SSD M.2 PCIe NVMe Opal2	None	Intel 8265 ac, 2x2 + BT4.1	WWAN Upgradable	None	None	None	None	720p	Backlit	Finger-print Reader	None	dTPM 2.0	4-cell(32Wh) + 3-cell(24Wh)	65W	Win10 Pro 64	3-year, Depot	03/17
20HB0011US	US	i7-7600U	vPro	M520M 2GB	8GBx2	15.6" FHD (1920x1080) IPS	None	1TB SSD M.2 PCIe NVMe Opal2	None	Intel 8265 ac, 2x2 + BT4.1	WWAN Upgradable	None	None	None	None	IR &720p	Backlit	Finger-print Reader	None	dTPM 2.0	4-cell(32Wh) + 3-cell(24Wh)	65W	Win10 Pro 64	3-year, Depot	03/17
20HB0012US	US	i7-7600U	vPro	M520M 2GB	8GBx2	15.6" FHD (1920x1080) IPS	None	512GB SSD M.2 PCIe NVMe Opal2	None	Intel 8265 ac, 2x2 + BT4.1	WWAN Upgradable	None	None	None	None	IR &720p	Backlit	Finger-print Reader	None	dTPM 2.0	4-cell(32Wh) + 3-cell(24Wh)	65W	Win10 Pro 64	3-year, Depot	03/17
20HB0013US	US	i7-7600U	vPro	M520M 2GB	8GBx1	15.6" 4K (3840x2160) IPS	None	256GB SSD M.2 PCIe NVMe Opal2	None	Intel 8265 ac, 2x2 + BT4.1	WWAN Upgradable	None	None	None	None	IR &720p	Backlit	Finger-print Reader	None	dTPM 2.0	4-cell(32Wh) + 3-cell(24Wh)	65W	Win10 Pro 64	3-year, Depot	03/17
20HB0014US	US	i5-7300U	vPro	M520M 2GB	8GBx1	15.6" FHD (1920x1080) IPS	None	256GB SSD M.2 PCIe NVMe Opal2	None	Intel 8265 ac, 2x2 + BT4.1	WWAN Upgradable	None	None	None	None	720p	Backlit	Finger-print Reader	None	dTPM 2.0	4-cell(32Wh) + 3-cell(24Wh)	65W	Win10 Pro 64	3-year, Depot	03/17
20HB0015US	US	i7-7500U	No	M520M 2GB	8GBx1	15.6" FHD (1920x1080) IPS	None	512GB SSD M.2 PCIe NVMe Opal2	None	Intel 8265 ac, 2x2 + BT4.1	WWAN Upgradable	None	None	None	None	720p	Backlit	Finger-print Reader	None	dTPM 2.0	4-cell(32Wh) + 3-cell(24Wh)	65W	Win10 Pro 64	3-year, Depot	03/17
20HB0016US	US	i7-7600U	vPro	M520M 2GB	8GBx1	15.6" FHD (1920x1080) IPS	10-point Multi-touch	1TB SSD M.2 PCIe NVMe Opal2	None	Intel 8265 ac, 2x2 + BT4.1	WWAN Upgradable	None	None	None	None	720p	Backlit	Finger-print Reader	None	dTPM 2.0	4-cell(32Wh) + 3-cell(24Wh)	65W	Win10 Pro 64	3-year, Depot	03/17
20HB0017US	US	i5-7300U	vPro	M520M 2GB	8GBx1	15.6" FHD (1920x1080) IPS	None	256GB SSD M.2 PCIe NVMe Opal2	None	Intel 8265 ac, 2x2 + BT4.1	WWAN Upgradable	None	None	None	None	720p	Backlit	Finger-print Reader	None	dTPM 2.0	4-cell(32Wh) + 6-cell(72Wh)	65W	Win10 Pro 64	3-year, Depot	03/17
20HB0018US	US	i5-7300U	vPro	M520M 2GB	8GBx1	15.6" FHD (1920x1080) IPS	None	500GB 7200rpm	None	Intel 8265 ac, 2x2 + BT4.1	WWAN Upgradable	None	None	None	None	720p	Backlit	Finger-print Reader	None	dTPM 2.0	4-cell(32Wh) + 3-cell(24Wh)	65W	Win10 Pro 64	3-year, Depot	03/17
20HB0019US	US	i5-7300U	vPro	M520M 2GB	8GBx1	15.6" FHD (1920x1080) IPS	None	1TB 5400rpm	None	Intel 8265 ac, 2x2 + BT4.1	WWAN Upgradable	None	None	None	None	720p	Backlit	Finger-print Reader	None	dTPM 2.0	4-cell(32Wh) + 3-cell(24Wh)	65W	Win10 Pro 64	3-year, Depot	03/17
20HB001AUS	US	i5-7300U	vPro	M520M 2GB	8GBx1	15.6" FHD (1920x1080) IPS	None	1TB SSD M.2 PCIe NVMe Opal2	None	Intel 8265 ac, 2x2 + BT4.1	WWAN Upgradable	None	None	None	None	720p	Backlit	Finger-print Reader	None	dTPM 2.0	4-cell(32Wh) + 3-cell(24Wh)	65W	Win10 Pro 64	3-year, Depot	03/17
20HB001BUS	US	i7-7600U	vPro	M520M 2GB	8GBx1	15.6" FHD (1920x1080) IPS	None	1TB 5400rpm	None	Intel 8265 ac, 2x2 + BT4.1	WWAN Upgradable	None	None	None	None	720p	Backlit	Finger-print Reader	None	dTPM 2.0	4-cell(32Wh) + 3-cell(24Wh)	65W	Win10 Pro 64	3-year, Depot	03/17
20HB001CUS	US	i7-7600U	vPro	M520M 2GB	8GBx2	15.6" FHD (1920x1080) IPS	None	256GB SSD M.2 PCIe NVMe Opal2	None	Intel 8265 ac, 2x2 + BT4.1	WWAN Upgradable	None	None	None	None	IR &720p	Backlit	Finger-print Reader	None	dTPM 2.0	4-cell(32Wh) + 3-cell(24Wh)	65W	Win10 Pro 64	3-year, Depot	03/17
20HB001DUS	US	i5-7300U	vPro	M520M 2GB	8GBx2	15.6" FHD (1920x1080) IPS	None	512GB SSD M.2 PCIe NVMe Opal2	None	Intel 8265 ac, 2x2 + BT4.1	WWAN Upgradable	None	None	None	None	IR &720p	Backlit	Finger-print Reader	None	dTPM 2.0	4-cell(32Wh) + 3-cell(24Wh)	65W	Win10 Pro 64	3-year, Depot	03/17
20HB001EUS	US	i7-7600U	vPro	M520M 2GB	8GBx1	15.6" FHD (1920x1080) IPS	None	1TB SSD M.2 PCIe NVMe Opal2	None	Intel 8265 ac, 2x2 + BT4.1	WWAN Upgradable	None	None	None	None	720p	Backlit	Finger-print Reader	None	dTPM 2.0	4-cell(32Wh) + 3-cell(24Wh)	65W	Win10 Pro 64	3-year, Depot	03/17

Model	Region	Processor	vPro	Graphics	Memory	Display	Multi-touch	Storage(HDD/SSD)	Optical	WLAN + Bluetooth	WWAN	SIM Card	Smart Card Reader	Dock	Monitor Cable	Camera	Key-board	Finger-print Reader	NFC	TPM	Battery (internal+ external)	Power Adapter	Operating System	Warranty	Ann Date (m/y)
20HB001FUS	US	i5-7300U	vPro	M520M 2GB	8GBx2	15.6" FHD (1920x1080) IPS	None	256GB SSD M.2 PCIe NVMe Opal2	None	Intel 8265 ac, 2x2 + BT4.1	WWAN Upgradable	None	None	None	None	IR &720p	Backlit	Finger-print Reader	None	dTPM 2.0	4-cell(32Wh) + 3-cell(24Wh)	65W USB-C	Win10 Pro 64	3-year, Depot	03/17
20HB001GUS	US	i7-7600U	vPro	M520M 2GB	8GBx1	15.6" FHD (1920x1080) IPS	None	512GB SSD M.2 PCIe NVMe Opal2	None	Intel 8265 ac, 2x2 + BT4.1	WWAN Upgradable	None	None	None	None	720p	Backlit	Finger-print Reader	None	dTPM 2.0	4-cell(32Wh) + 3-cell(24Wh)	65W USB-C	Win10 Pro 64	3-year, Depot	03/17
20HB001HUS	US	i5-7300U	vPro	M520M 2GB	4GBx1	15.6" FHD (1920x1080) IPS	None	500GB 7200rpm	None	Intel 8265 ac, 2x2 + BT4.1	WWAN Upgradable	None	None	None	None	720p	Backlit	Finger-print Reader	None	dTPM 2.0	4-cell(32Wh) + 3-cell(24Wh)	65W USB-C	Win10 Pro 64	3-year, Depot	03/17
20HB001JUS	US	i5-7300U	vPro	M520M 2GB	8GBx1	15.6" 4K (3840x2160) IPS	None	256GB SSD M.2 PCIe NVMe Opal2	None	Intel 8265 ac, 2x2 + BT4.1	WWAN Upgradable	None	None	None	None	IR &720p	Backlit	Finger-print Reader	None	dTPM 2.0	4-cell(32Wh) + 3-cell(24Wh)	65W USB-C	Win10 Pro 64	3-year, Depot	03/17
20HB001KUS	US	i7-7500U	No	M520M 2GB	8GBx1	15.6" FHD (1920x1080) IPS	None	500GB 7200rpm	None	Intel 8265 ac, 2x2 + BT4.1	WWAN Upgradable	None	None	None	None	720p	Backlit	Finger-print Reader	None	dTPM 2.0	4-cell(32Wh) + 3-cell(24Wh)	65W	Win10 Pro 64	3-year, Depot	03/17
20HB001NUS	US	i5-7300U	vPro	M520M 2GB	8GBx1	15.6" FHD (1920x1080) IPS	None	500GB 7200rpm	None	Intel 8265 ac, 2x2 + BT4.1	WWAN Upgradable	None	None	None	None	720p	Backlit	Finger-print Reader	None	dTPM 2.0	4-cell(32Wh) + 3-cell(24Wh)	65W	Win10 Pro 64	3-year, Depot	05/17
20HB001PUS	US	i7-7500U	No	M520M 2GB	16GBx1	15.6" FHD (1920x1080) IPS	10-point Multi-touch	500GB 7200rpm	None	Intel 8265 ac, 2x2 + BT4.1	WWAN Upgradable	None	None	None	None	720p	Backlit	Finger-print Reader	None	dTPM 2.0	4-cell(32Wh) + 3-cell(24Wh)	65W	Win10 Pro 64	3-year, Depot	05/17
20HB001QUS	US	i7-7500U	No	M520M 2GB	8GBx1	15.6" FHD (1920x1080) IPS	10-point Multi-touch	500GB 7200rpm	None	Intel 8265 ac, 2x2 + BT4.1	WWAN Upgradable	None	None	None	None	720p	Backlit	Finger-print Reader	None	dTPM 2.0	4-cell(32Wh) + 3-cell(24Wh)	65W	Win10 Pro 64	3-year, Depot	05/17
20HB001RUS	US	i5-7300U	vPro	M520M 2GB	8GBx1	15.6" FHD (1920x1080) IPS	10-point Multi-touch	500GB 7200rpm	None	Intel 8265 ac, 2x2 + BT4.1	WWAN Upgradable	None	None	None	None	720p	Backlit	Finger-print Reader	None	dTPM 2.0	4-cell(32Wh) + 3-cell(24Wh)	65W	Win10 Pro 64	3-year, Depot	05/17
20HB001SUS	US	i7-7500U	No	M520M 2GB	16GBx1	15.6" FHD (1920x1080) IPS	None	512GB SSD M.2 PCIe NVMe Opal2	None	Intel 8265 ac, 2x2 + BT4.1	WWAN Upgradable	None	None	None	None	IR &720p	Backlit	Finger-print Reader	None	dTPM 2.0	4-cell(32Wh) + 3-cell(24Wh)	65W	Win10 Pro 64	3-year, Depot	05/17
20HB001TUS	US	i7-7500U	No	M520M 2GB	8GBx1	15.6" FHD (1920x1080) IPS	10-point Multi-touch	256GB SSD M.2 PCIe NVMe Opal2	None	Intel 8265 ac, 2x2 + BT4.1	WWAN Upgradable	None	None	None	None	720p	Backlit	Finger-print Reader	None	dTPM 2.0	4-cell(32Wh) + 3-cell(24Wh)	65W	Win10 Pro 64	3-year, Depot	05/17
20HB001UUS	US	i7-7500U	No	M520M 2GB	16GBx1	15.6" FHD (1920x1080) IPS	10-point Multi-touch	512GB SSD M.2 PCIe NVMe Opal2	None	Intel 8265 ac, 2x2 + BT4.1	WWAN Upgradable	None	None	None	None	720p	Backlit	Finger-print Reader	None	dTPM 2.0	4-cell(32Wh) + 3-cell(24Wh)	65W	Win10 Pro 64	3-year, Depot	05/17
20HB001VUS	US	i7-7500U	No	M520M 2GB	16GBx1	15.6" FHD (1920x1080) IPS	None	512GB SSD M.2 PCIe NVMe Opal2	None	Intel 8265 ac, 2x2 + BT4.1	WWAN Upgradable	None	None	None	None	720p	Backlit	Finger-print Reader	None	dTPM 2.0	4-cell(32Wh) + 3-cell(24Wh)	65W	Win10 Pro 64	3-year, Depot	05/17
20HB001XUS	US	i7-7500U	No	M520M 2GB	16GBx1	15.6" FHD (1920x1080) IPS	None	512GB SSD M.2 PCIe NVMe Opal2	None	Intel 8265 ac, 2x2 + BT4.1	WWAN Upgradable	None	None	None	None	IR &720p	Backlit	Finger-print Reader	None	dTPM 2.0	4-cell(32Wh) + 3-cell(24Wh)	65W	Win10 Pro 64	3-year, Depot	05/17

ThinkPad P51s - TopSeller - 20JY

Product Specifications Reference (PSREF)

Model	Region	Processor	vPro	Graphics	Memory	Display	Multi-touch	Storage(HDD/SSD)	Optical	WLAN + Bluetooth	WWAN	SIM Card	Smart Card Reader	Dock	Monitor Cable	Camera	Key-board	Finger-print Reader	NFC	TPM	Battery (internal+external)	Power Adapter	Operating System	Warranty	Ann Date (m/y)
20JY0004US	US	i7-6500U	No	M520M 2GB	8GBx2	15.6" FHD (1920x1080) IPS	None	512GB SSD M.2 PCIe NVMe Opal2	None	Intel 8260 ac, 2x2 + BT4.1	WWAN Upgradable	None	None	None	None	720p	Backlit	Finger-print Reader	None	dTPM 2.0	4-cell(32Wh) + 3-cell(24Wh)	65W	Win10 DG Win7 Pro 64	3-year, Depot	03/17
20JY0005US	US	i7-6500U	No	M520M 2GB	8GBx2	15.6" FHD (1920x1080) IPS	None	256GB SSD M.2 PCIe NVMe Opal2	None	Intel 8260 ac, 2x2 + BT4.1	WWAN Upgradable	None	None	None	None	720p	Backlit	Finger-print Reader	None	dTPM 2.0	4-cell(32Wh) + 3-cell(24Wh)	65W	Win10 DG Win7 Pro 64	3-year, Depot	03/17
20JY0006US	US	i7-6500U	No	M520M 2GB	8GBx1	15.6" FHD (1920x1080) IPS	None	256GB SSD M.2 PCIe NVMe Opal2	None	Intel 8260 ac, 2x2 + BT4.1	WWAN Upgradable	None	None	None	None	720p	Backlit	Finger-print Reader	None	dTPM 2.0	4-cell(32Wh) + 3-cell(24Wh)	65W	Win10 DG Win7 Pro 64	3-year, Depot	03/17
20JY0007US	US	i7-6500U	No	M520M 2GB	8GBx2	15.6" 4K (3840x2160) IPS	None	256GB SSD M.2 PCIe NVMe Opal2	None	Intel 8260 ac, 2x2 + BT4.1	WWAN Upgradable	None	None	None	None	720p	Backlit	Finger-print Reader	None	dTPM 2.0	4-cell(32Wh) + 3-cell(24Wh)	65W	Win10 DG Win7 Pro 64	3-year, Depot	03/17
20JY0008US	US	i7-6500U	No	M520M 2GB	8GBx2	15.6" 4K (3840x2160) IPS	None	500GB 7200rpm	None	Intel 8260 ac, 2x2 + BT4.1	WWAN Upgradable	None	None	None	None	720p	Backlit	Finger-print Reader	None	dTPM 2.0	4-cell(32Wh) + 3-cell(24Wh)	65W	Win10 DG Win7 Pro 64	3-year, Depot	03/17
20JY0009US	US	i7-6500U	No	M520M 2GB	8GBx1	15.6" FHD (1920x1080) IPS	None	500GB 7200rpm	None	Intel 8260 ac, 2x2 + BT4.1	WWAN Upgradable	None	None	None	None	720p	Backlit	Finger-print Reader	None	dTPM 2.0	4-cell(32Wh) + 3-cell(24Wh)	65W	Win10 DG Win7 Pro 64	3-year, Depot	03/17
20JY000AUS	US	i7-6500U	No	M520M 2GB	16GBx2	15.6" FHD (1920x1080) IPS	None	1TB SSD M.2 PCIe NVMe Opal2	None	Intel 8260 ac, 2x2 + BT4.1	WWAN Upgradable	None	None	None	None	720p	Backlit	Finger-print Reader	None	dTPM 2.0	4-cell(32Wh) + 3-cell(24Wh)	65W	Win10 DG Win7 Pro 64	3-year, Depot	03/17
20JY000BUS	US	i7-6500U	No	M520M 2GB	8GBx2	15.6" 4K (3840x2160) IPS	None	512GB SSD M.2 PCIe NVMe Opal2	None	Intel 8260 ac, 2x2 + BT4.1	WWAN Upgradable	None	None	None	None	720p	Backlit	Finger-print Reader	None	dTPM 2.0	4-cell(32Wh) + 3-cell(24Wh)	65W	Win10 DG Win7 Pro 64	3-year, Depot	03/17
20JY000CUS	US	i7-6500U	No	M520M 2GB	16GBx2	15.6" FHD (1920x1080) IPS	None	512GB SSD M.2 PCIe NVMe Opal2	None	Intel 8260 ac, 2x2 + BT4.1	WWAN Upgradable	None	None	None	None	720p	Backlit	Finger-print Reader	None	dTPM 2.0	4-cell(32Wh) + 3-cell(24Wh)	65W	Win10 DG Win7 Pro 64	3-year, Depot	03/17



ThinkPad P70 Platform Specifications

Product Specifications Reference (PSREF)

Processor	6th Generation Intel® Core™ i7 Processor or Intel Xeon® Processor E3 v5 Family							Smart card reader ExpressCard Media reader Ports	Optional: Smart card reader One slot (ExpressCard/34) 4-in-1 reader (MMC, SD, SDHC, SDXC), supports UHS-II SD card Four USB 3.0 (one Always On), two USB Type-C / Thunderbolt 3, Mini DisplayPort, HDMI, Ethernet (RJ-45), Dock connector						
	Processor Number	# of Cores	# of Threads	Base Frequency	Max Turbo Frequency	Cache	Memory Types			Processor Graphics					
	i7-6700HQ	4	8	2.6 GHz	3.5 GHz	6MB	DDR4-2133			Intel HD Graphics 530					
	i7-6820HQ			2.7 GHz	3.6 GHz	8MB				Intel HD Graphics P530					
	E3-1505M v5			2.8 GHz	3.7 GHz	8MB				Intel Iris™ Pro Graphics P580					
E3-1575M v5	3 GHz			3.9 GHz											
Graphics	Intel HD Graphics 530, Intel HD Graphics P530, or Intel Iris™ Pro Graphics P580 in processor and NVIDIA Quadro® M600M (2GB memory), M3000M (4GB memory), M4000M (4GB memory), or M5000M (8GB memory); supports external digital monitor via HDMI, Mini DisplayPort, or Thunderbolt™; supports five independent displays; Max resolution: 3840x2160@60Hz (DisplayPort via Mini DisplayPort cable); 3840x2160@60Hz (Thunderbolt); 3840x2160@30Hz (HDMI)							Camera (optional) Audio support	HD720p resolution, low light sensitive, fixed focus HD Audio, Realtek® ALC3268 codec / stereo speakers, 2W x 2 / dual array microphone, combo audio/microphone jack						
Chipset	Mobile Intel CM236 Chipset (Intel GL82CM236 PCH)							Keyboard UltraNav™	6-row, spill-resistant, multimedia Fn keys, numeric keypad, optional LED backlight 3-button TrackPoint® pointing device and 3-button crystal silk surface multi-touch touchpad						
Memory	64GB max ⁷ / 2133MHz DDR4, ECC or non-ECC (ECC function supported only on Xeon processor), dual-channel capable, four DDR4 SO-DIMM sockets							Security Security chip ThinkEngine	Power-on password, hard disk password, supervisor password, security keyhole Discrete TPM 1.2 TCG Certified and Firmware TPM 2.0 integrated in chipset Delivers improved thermal and power efficiency, up to 30 day standby, faster resume time, enhanced security, as well as anti-tampering measures						
Display	Some: 17.3" (439mm) FHD (1920x1080), anti-glare, LED backlight, IPS, 300 nits, 16:9 aspect ratio, 800:1 contrast ratio, 72% gamut, 170° viewing angle Some: 17.3" (439mm) 4K (3840x2160), anti-glare, LED backlight, IPS, 300 nits, 16:9 aspect ratio, 800:1 contrast ratio, 90% gamut, 170° viewing angle							vPro (optional) Fingerprint reader Color calibration	Intel vPro Technology Touch style fingerprint reader on the keyboard bezel Optional: Pantone® color calibrator by X-Rite® color calibration sensor in palm rest						
Multi-touch (opt) Pen (optional)	Capacitive-type multi-touch, supports 10-finger gesture, 270 nits ThinkPad Pen Pro, active pen for multi-touch display							Battery Max battery life ¹⁰ (MobileMark® 2014)	Li-Ion 8-cell (96Wh) <table border="1"> <thead> <tr> <th>Mode</th> <th>Discrete Graphics</th> <th>Hybrid Graphics</th> </tr> </thead> <tbody> <tr> <td>Max battery life</td> <td>8.5 hr</td> <td>10.8 hr</td> </tr> </tbody> </table>	Mode	Discrete Graphics	Hybrid Graphics	Max battery life	8.5 hr	10.8 hr
Mode	Discrete Graphics	Hybrid Graphics													
Max battery life	8.5 hr	10.8 hr													
Storage	Up to 4 drives (two M.2 SSD and two HDD, one of which is in the optical bay) Some: M.2 SSD / SATA 6.0Gb/s (e.g. xxxG SSD) Some: M.2 SSD / PCIe NVMe, PCIe 3.0 x 4, 32Gb/s (e.g. xxxG SSD PCIe NVMe) Some: HDD / SATA 6.0Gb/s, 2.5" wide, 7mm high, Shock Mounted Hard Drive, Active Protection System™							AC adapter	170W or 230W AC adapter						
Optical (optional)	DVD burner, 9.5mm high, fixed, tray-in							Preload	Some: Genuine Windows® 7 Professional 64 Some: Windows 7 Professional 64 preinstalled through downgrade rights in Windows 10 Pro 64 • Lenovo Solution Center • Lenovo SHAREit • ThinkVantage Product Recovery • Rescue and Recovery™ • ThinkVantage System Update • Adobe® Reader® • Microsoft® Office preloaded; purchase a product key to activate • McAfee® LiveSafe™ (30-day trial) For ISV certifications, please visit www.lenovo.com/support/ISV						
Ethernet	Non-vPro model: Intel Ethernet Connection I219-V (Jacksonville) vPro model: Intel Ethernet Connection I219-LM (Jacksonville)							Limited warranty ¹²	One of the following, configurable by model: • 3-year/1-yr battery depot repair service • 3-year/1-yr battery limited onsite service ²⁴ • 3-year/1-yr battery limited onsite service, OID (Onsite International Delivery)						
WLAN ⁴ Bluetooth™	11ac+BT, Intel Dual Band Wireless-AC 8260, 2x2, M.2 card Bluetooth 4.1 wireless, integrated in Wi-Fi + Bluetooth combo adapter							Mil-Spec test	MIL-STD-810G military certification						
WWAN (optional)	Wireless WAN, Sierra Wireless EM7455, Qualcomm® 4G LTE-Advanced/DC-HSPA+/HSPA+/HSPA/UMTS/GNSS, M.2 card							Environment	EPEAT™ Gold (US only); ENERGY STAR® 6.1; GREENGUARD®; RoHS-compliant						
SIM card	Micro-SIM card slot														
Dimensions ³	WxDxH: 16.38" x 10.85" x 1.18-1.35"; 416mm x 275.5mm x 29.9-34.2mm WxDxH(Touch): 16.38" x 10.85" x 1.20-1.37"; 416mm x 275.5mm x 30.6-34.9mm														
Weight ²	Non-touch model: starting at 7.3 lb (3.3kg); Multi-touch model: starting at 8.1 lb (3.7kg)														
Case material	Display cover: Glass-Fiber + PPS; Bottom: Magnesium/Aluminum														

Model	Region	Processor	vPro	Graphics	Memory	Display	Multi-touch	Pen	Storage(HDD/SSD)	RAID	Optical	WLAN + Bluetooth	WWAN	SIM Card	Smart Card Reader	Camera	Keyboard	Fingerprint Reader	Color Calibrator	Battery	Power Adapter	Operating System	Warranty	Ann Date (m/y)
20ER000FUS	US	i7-6700HQ	No	M600M 2GB	8GBx1 non-ECC	17.3" FHD (1920x1080) IPS	None	None	500GB 7200rpm	No	DVD±RW	Intel 8260 ac, 2x2 + BT4.1	None	None	None	720p	Backlit	Fingerprint Reader	None	8-cell (96Wh)	170W	Win10 DG Win7 Pro 64	3-year, Depot	10/15
20ER000GUS	US	i7-6700HQ	No	M3000M 4GB	8GBx1 non-ECC	17.3" FHD (1920x1080) IPS	None	None	500GB 7200rpm	No	DVD±RW	Intel 8260 ac, 2x2 + BT4.1	None	None	None	720p	Backlit	Fingerprint Reader	None	8-cell (96Wh)	230W	Win10 DG Win7 Pro 64	3-year, Depot	10/15
20ER000HUS	US	i7-6820HQ	vPro	M600M 2GB	8GBx1 non-ECC	17.3" FHD (1920x1080) IPS	None	None	500GB 7200rpm	No	DVD±RW	Intel 8260 ac, 2x2 + BT4.1	None	None	None	720p	Backlit	Fingerprint Reader	None	8-cell (96Wh)	170W	Win10 DG Win7 Pro 64	3-year, Depot	10/15
20ER000JUS	US	i7-6820HQ	vPro	M3000M 4GB	8GBx1 non-ECC	17.3" FHD (1920x1080) IPS	None	None	500GB 7200rpm	No	DVD±RW	Intel 8260 ac, 2x2 + BT4.1	None	None	None	720p	Backlit	Fingerprint Reader	None	8-cell (96Wh)	230W	Win10 DG Win7 Pro 64	3-year, Depot	10/15
20ER000KUS	US	i7-6820HQ	vPro	M3000M 4GB	8GBx1 non-ECC	17.3" FHD (1920x1080) IPS	10-point Multi-touch	ThinkPad Pen Pro	256GB SSD M.2 Opal2	No	DVD±RW	Intel 8260 ac, 2x2 + BT4.1	None	None	None	720p	Backlit	Fingerprint Reader	X-Rite	8-cell (96Wh)	230W	Win10 DG Win7 Pro 64	3-year, Depot	10/15
20ER000LUS	US	Xeon E3-1505M v5	vPro	M600M 2GB	8GBx1 ECC	17.3" FHD (1920x1080) IPS	None	None	256GB SSD M.2 PCIe NVMe Opal2	No	DVD±RW	Intel 8260 ac, 2x2 + BT4.1	None	None	None	720p	Backlit	Fingerprint Reader	None	8-cell (96Wh)	170W	Win10 DG Win7 Pro 64	3-year, Depot	11/15
20ER000MUS	US	Xeon E3-1505M v5	vPro	M3000M 4GB	8GBx1 ECC	17.3" FHD (1920x1080) IPS	None	None	256GB SSD M.2 PCIe NVMe Opal2	No	DVD±RW	Intel 8260 ac, 2x2 + BT4.1	None	None	None	720p	Backlit	Fingerprint Reader	None	8-cell (96Wh)	230W	Win10 DG Win7 Pro 64	3-year, Depot	11/15
20ER000NUS	US	Xeon E3-1505M v5	vPro	M3000M 4GB	16GBx1 ECC	17.3" 4K (3840x2160) IPS	None	None	512GB SSD M.2 PCIe NVMe	No	DVD±RW	Intel 8260 ac, 2x2 + BT4.1	None	None	Smart Card Reader	720p	Backlit	Fingerprint Reader	X-Rite	8-cell (96Wh)	230W	Win10 DG Win7 Pro 64	3-year, Depot	11/15
20ER000PUS	US	i7-6820HQ	vPro	M600M 2GB	8GBx1 non-ECC	17.3" FHD (1920x1080) IPS	10-point Multi-touch	ThinkPad Pen Pro	500GB 7200rpm	No	DVD±RW	Intel 8260 ac, 2x2 + BT4.1	None	None	None	720p	Backlit	Fingerprint Reader	X-Rite	8-cell (96Wh)	170W	Win10 Pro 64	3-year, Depot	10/15
20ER000QUS	US	i7-6820HQ	vPro	M3000M 4GB	8GBx1 non-ECC	17.3" FHD (1920x1080) IPS	10-point Multi-touch	ThinkPad Pen Pro	256GB SSD M.2 Opal2	No	DVD±RW	Intel 8260 ac, 2x2 + BT4.1	None	None	None	720p	Backlit	Fingerprint Reader	X-Rite	8-cell (96Wh)	230W	Win10 Pro 64	3-year, Depot	10/15
20ER000RUS	US	i7-6820HQ	vPro	M3000M 4GB	16GBx1 non-ECC	17.3" 4K (3840x2160) IPS	None	None	512GB SSD M.2 PCIe NVMe	No	DVD±RW	Intel 8260 ac, 2x2 + BT4.1	None	None	Smart Card Reader	720p	Backlit	Fingerprint Reader	X-Rite	8-cell (96Wh)	230W	Win10 DG Win7 Pro 64	3-year, Depot	11/15
20ER000SUS	US	i7-6820HQ	vPro	M3000M 4GB	8GBx1 non-ECC	17.3" FHD (1920x1080) IPS	None	None	256GB SSD M.2 Opal2	No	DVD±RW	Intel 8260 ac, 2x2 + BT4.1	None	None	None	720p	Backlit	Fingerprint Reader	None	8-cell (96Wh)	230W	Win10 DG Win7 Pro 64	3-year, Depot	10/15
20ER000TUS	US	i7-6700HQ	No	M600M 2GB	8GBx1 non-ECC	17.3" FHD (1920x1080) IPS	None	None	1TB 5400rpm	No	DVD±RW	Intel 8260 ac, 2x2 + BT4.1	None	None	None	720p	Backlit	Fingerprint Reader	None	8-cell (96Wh)	170W	Win10 DG Win7 Pro 64	3-year, Depot	10/15
20ER000UUS	US	i7-6700HQ	No	M3000M 4GB	16GBx1 non-ECC	17.3" FHD (1920x1080) IPS	None	None	256GB SSD M.2 Opal2	No	DVD±RW	Intel 8260 ac, 2x2 + BT4.1	None	None	None	720p	Backlit	Fingerprint Reader	None	8-cell (96Wh)	230W	Win10 DG Win7 Pro 64	3-year, Depot	10/15
20ER000VUS	US	i7-6700HQ	No	M600M 2GB	8GBx1 non-ECC	17.3" FHD (1920x1080) IPS	None	None	500GB 7200rpm	No	Blank Bezel	Intel 8260 ac, 2x2 + BT4.1	None	None	None	720p	Backlit	Fingerprint Reader	None	8-cell (96Wh)	170W	Win10 DG Win7 Pro 64	3-year, Depot	10/15
20ER000WUS	US	i7-6820HQ	vPro	M4000M 4GB	16GBx1 non-ECC	17.3" 4K (3840x2160) IPS	None	None	512GB SSD M.2 PCIe NVMe	No	Blank Bezel	Intel 8260 ac, 2x2 + BT4.1	None	None	Smart Card Reader	720p	Backlit	Fingerprint Reader	X-Rite	8-cell (96Wh)	230W	Win10 DG Win7 Pro 64	3-year, Depot	11/15
20ER000XUS	US	Xeon E3-1505M v5	vPro	M4000M 4GB	16GBx1 ECC	17.3" 4K (3840x2160) IPS	None	None	512GB SSD M.2 PCIe NVMe	No	Blank Bezel	Intel 8260 ac, 2x2 + BT4.1	None	None	Smart Card Reader	720p	Backlit	Fingerprint Reader	X-Rite	8-cell (96Wh)	230W	Win10 DG Win7 Pro 64	3-year, Depot	11/15
20ER000YUS	US	i7-6820HQ	vPro	M3000M 4GB	8GBx1 non-ECC	17.3" FHD (1920x1080) IPS	None	None	1TB 5400rpm	No	DVD±RW	Intel 8260 ac, 2x2 + BT4.1	None	None	None	720p	Backlit	Fingerprint Reader	None	8-cell (96Wh)	230W	Win10 DG Win7 Pro 64	3-year, Depot	10/15
20ER002FUS	US	i7-6700HQ	No	M600M 2GB	8GBx1 non-ECC	17.3" FHD (1920x1080) IPS	None	None	500GB 7200rpm	No	DVD±RW	Intel 8260 ac, 2x2 + BT4.1	None	None	None	720p	Backlit	Fingerprint Reader	X-Rite	8-cell (96Wh)	170W	Win10 Pro 64	3-year, Depot	10/15
20ER002GUS	US	Xeon E3-1505M v5	vPro	M600M 2GB	16GBx1 non-ECC	17.3" FHD (1920x1080) IPS	None	None	256GB SSD M.2 Opal2	No	DVD±RW	Intel 8260 ac, 2x2 + BT4.1	None	None	None	720p	Backlit	Fingerprint Reader	None	8-cell (96Wh)	170W	Win10 DG Win7 Pro 64	3-year, Depot	10/15

Model	Region	Processor	vPro	Graphics	Memory	Display	Multi-touch	Pen	Storage(HDD/SSD)	RAID	Optical	WLAN + Bluetooth	WWAN	SIM Card	Smart Card Reader	Camera	Keyboard	Fingerprint Reader	Color Calibrator	Battery	Power Adapter	Operating System	Warranty	Ann Date (m/y)
20ER002HUS	US	Xeon E3-1505M v5	vPro	M3000M 4GB	16GBx1 non-ECC	17.3" FHD (1920x1080) IPS	None	None	256GB SSD M.2 Opal2	No	DVD±RW	Intel 8260 ac, 2x2 + BT4.1	None	None	None	720p	Backlit	Fingerprint Reader	None	8-cell (96Wh)	230W	Win10 Pro 64	3-year, Depot	10/15
20ER002JUS	US	i7-6820HQ	vPro	M3000M 4GB	16GBx1 non-ECC	17.3" FHD (1920x1080) IPS	None	None	256GB SSD M.2 Opal2	No	DVD±RW	Intel 8260 ac, 2x2 + BT4.1	None	None	None	720p	Backlit	Fingerprint Reader	None	8-cell (96Wh)	230W	Win10 Pro 64	3-year, Depot	10/15
20ER002KUS	US	i7-6700HQ	No	M600M 2GB	16GBx1 non-ECC	17.3" FHD (1920x1080) IPS	None	None	500GB 7200rpm	No	DVD±RW	Intel 8260 ac, 2x2 + BT4.1	None	None	None	720p	Backlit	Fingerprint Reader	None	8-cell (96Wh)	170W	Win10 DG Win7 Pro 64	3-year, Depot	10/15
20ER002LUS	US	i7-6820HQ	vPro	M3000M 4GB	16GBx1 non-ECC	17.3" FHD (1920x1080) IPS	None	None	256GB SSD M.2 Opal2	No	DVD±RW	Intel 8260 ac, 2x2 + BT4.1	None	None	None	720p	Backlit	Fingerprint Reader	None	8-cell (96Wh)	230W	Win10 DG Win7 Pro 64	3-year, Depot	10/15
20ER002MUS	US	Xeon E3-1505M v5	vPro	M3000M 4GB	16GBx1 non-ECC	17.3" FHD (1920x1080) IPS	None	None	256GB SSD M.2 Opal2	No	DVD±RW	Intel 8260 ac, 2x2 + BT4.1	None	None	None	720p	Backlit	Fingerprint Reader	None	8-cell (96Wh)	230W	Win10 DG Win7 Pro 64	3-year, Depot	10/15
20ER002NUS	US	i7-6700HQ	No	M600M 2GB	16GBx1 non-ECC	17.3" FHD (1920x1080) IPS	None	None	500GB 7200rpm	No	DVD±RW	Intel 8260 ac, 2x2 + BT4.1	None	None	None	720p	Backlit	Fingerprint Reader	X-Rite	8-cell (96Wh)	170W	Win10 Pro 64	3-year, Depot	10/15
20ER003KUS	US	Xeon E3-1575M v5	vPro	M3000M 4GB	16GBx2 non-ECC	17.3" FHD (1920x1080) IPS	None	None	1TB SSD M.2 PCIe NVMe	No	Blank Bezel	Intel 8260 ac, 2x2 + BT4.1	None	None	None	720p	Backlit	Fingerprint Reader	X-Rite	8-cell (96Wh)	230W	Win10 Pro 64	3-year, Depot	08/16



ThinkPad P71 Platform Specifications

Product Specifications Reference (PSREF)

Processor	7th Generation Intel® Core™ i7 Processor or Intel Xeon® Processor E3 v6 Family							Dimensions	WxDxH: 16.38" x 10.85" x 1.18-1.35"; 416mm x 275.5mm x 29.9-34.2mm								
	Processor Number	# of Cores	# of Threads	Base Frequency	Max Turbo Frequency	Cache	Memory Types	Processor Graphics	Weight	Starting at 7.3 lb (3.3kg)							
	i7-7700HQ	4	8	2.8 GHz	3.8 GHz	6MB	DDR4-2400	Intel HD Graphics 630	Case color	Black							
	i7-7820HQ			2.9 GHz	3.9 GHz			Case material	Display cover: Glass-Fiber + PPS; Bottom: Magnesium/Aluminum								
	E3-1505M v6			3.0 GHz	4.0 GHz	8MB		Intel HD Graphics P630	Smart card reader	Optional: Smart card reader							
E3-1535M v6	3.1 GHz			4.2 GHz	ExpressCard			One slot (ExpressCard/34)									
Graphics	Intel HD Graphics 630 or P630 in processor and NVIDIA Quadro® M620M (2GB memory), P3000M (6GB memory), P4000M (8GB memory), or P5000M (16GB memory); supports external digital monitor via HDMI, Mini DisplayPort, or Thunderbolt™; supports four independent displays; Max resolution: 3840x2160@60Hz (DisplayPort via Mini DisplayPort cable); 3840x2160@60Hz (Thunderbolt); 4096x2160@24Hz (HDMI)							Media reader	4-in-1 reader (MMC, SD, SDHC, SDXC), supports UHS-II SD card								
Chipset	Mobile Intel CM238 Chipset							Ports	Four USB 3.1 Gen 1 / USB 3.0 (one Always On), two USB Type-C / Thunderbolt 3, Mini DisplayPort 1.2a, HDMI 1.4b, Ethernet (RJ-45), Dock connector								
Memory	64GB max / 2400MHz DDR4, ECC or non-ECC (ECC function supported only on Xeon processor), dual-channel capable, four DDR4 SO-DIMM sockets							Camera (optional)	HD720p resolution, fixed focus								
Display	Some: 17.3" (439mm) FHD (1920x1080), anti-glare, LED backlight, IPS, 300 nits, 16:9 aspect ratio, 800:1 contrast ratio, 72% gamut, 170° viewing angle Some: 17.3" (439mm) 4K (3840x2160), anti-glare, LED backlight, IPS, 300 nits, 16:9 aspect ratio, 800:1 contrast ratio, 90% gamut, 170° viewing angle							Audio support	HD Audio, Realtek® ALC3268 codec / stereo speakers, 2W x 2 / dual array microphone, combo audio/microphone jack								
Multi-touch Pen	None							Keyboard	6-row, spill-resistant, multimedia Fn keys, numeric keypad, optional LED backlight								
Storage	Up to 4 drives (two M.2 SSD and two HDD, one of which is in the optical bay) Some: M.2 SSD / PCIe NVMe, PCIe 3.0 x 4, 32Gb/s Some: HDD / SATA 6.0Gb/s, 2.5" wide, 7mm high, Active Protection System™							UltraNav™	3-button TrackPoint® pointing device and 3-button Mylar surface multi-touch touchpad								
Optical (optional)	DVD burner, 9.5mm high, fixed, tray-in							Security	Power-on password, hard disk password, supervisor password, security keyhole								
Ethernet	Non-vPro model: Intel Ethernet Connection I219-V (Jacksonville) vPro model: Intel Ethernet Connection I219-LM (Jacksonville)							Security chip	Discrete TPM 2.0, TCG Certified								
WLAN Bluetooth™	Intel Dual Band Wireless-AC 8265, Wi-Fi 2x2 802.11ac + BT4.1, M.2 card Bluetooth 4.1 wireless, integrated in Wi-Fi + Bluetooth combo adapter * Intel 8265ac card support BT4.2 but is limited to BT4.1 by Windows OS							vPro (optional)	Intel vPro Technology								
WWAN (optional)	One of the following, configurable by model: • Wireless WAN upgradable • Integrated Mobile Broadband 4G LTE-A, Qualcomm® Snapdragon™ X7 LTE-A (Sierra Wireless EM7455), M.2 card							Fingerprint reader	Touch style match on chip fingerprint reader on the keyboard bezel								
SIM card (opt)	Micro-SIM card slot, opt Verizon LTE (US) or Lenovo® Connect (EMEA) SIM card							Color calibration	Optional: Pantone® color calibrator by X-Rite® color calibration sensor in palm rest								
								NFC	None								
								Battery	Li-Ion 8-cell (96Wh)								
								Max battery life (MobileMark® 2014)	<table border="1"> <thead> <tr> <th>Mode</th> <th>Discrete Graphics</th> <th>Hybrid Graphics</th> </tr> </thead> <tbody> <tr> <td>Max battery life</td> <td>9.8 hr</td> <td>14.25 hr</td> </tr> </tbody> </table>			Mode	Discrete Graphics	Hybrid Graphics	Max battery life	9.8 hr	14.25 hr
Mode	Discrete Graphics	Hybrid Graphics															
Max battery life	9.8 hr	14.25 hr															
								AC adapter	170W or 230W AC adapter								
								Preload	Some: Windows® 10 Home 64 Some: Windows 10 Pro 64 • Lenovo Companion • Lenovo Setting • Microsoft Office preloaded; purchase a product key to activate								
								Limited warranty	One of the following, configurable by model: • 1-year depot repair service • 3-year/1-yr battery depot repair service • 3-year/1-yr battery limited onsite service								
								Mil-Spec test	MIL-STD-810G military certification								
								Environment	EPEAT™ Gold (US only); ENERGY STAR® 6.1; RoHS-compliant								

Model	Region	Processor	Pro	Graphics	Chipset	Memory	Display	Multi-touch	Pen	Storage (HDD/SSD)	RAID	Optical	WLAN + Bluetooth	WWAN	SIM Card	Smart Card Reader	Camera	Key-board	Color Calibrator	Finger-print Reader	NFC	TPM	Battery	Power Adapter	Operating System	Warranty	Ann Date (m/y)
20HK000VUS	US	Xeon E3-1535M v6	vPro	P3000M 6GB	Intel CM238	8GBx2 ECC	17.3" 4K (3840x2160) IPS	None	None	512GB SSD M.2 PCIe NVMe Opal2	No	Blank Bezel	Intel 8265 ac, 2x2 + BT4.1	WWAN Upgradable	None	None	720p	Backlit	X-Rite	Finger-print Reader	None	dTPM 2.0	8-cell (96Wh)	230W	Win10 Pro 64	3-year, Depot	04/17
20HK000WUS	US	Xeon E3-1505M v6	vPro	P4000M 8GB	Intel CM238	16GBx2 ECC	17.3" FHD (1920x1080) IPS	None	None	1TB SSD M.2 PCIe NVMe Opal2	No	Blank Bezel	Intel 8265 ac, 2x2 + BT4.1	WWAN Upgradable	None	Smart Card Reader	720p	Backlit	None	Finger-print Reader	None	dTPM 2.0	8-cell (96Wh)	230W	Win10 Pro 64	3-year, Depot	04/17
20HK000XUS	US	Xeon E3-1535M v6	vPro	P5000M 16GB	Intel CM238	16GBx1 ECC	17.3" 4K (3840x2160) IPS	None	None	1TB SSD M.2 PCIe NVMe Opal2	No	Blank Bezel	Intel 8265 ac, 2x2 + BT4.1	WWAN Upgradable	None	None	720p	Backlit	X-Rite	Finger-print Reader	None	dTPM 2.0	8-cell (96Wh)	230W	Win10 Pro 64	3-year, Depot	04/17
20HK000YUS	US	Xeon E3-1535M v6	vPro	P4000M 8GB	Intel CM238	8GBx2 ECC	17.3" 4K (3840x2160) IPS	None	None	512GB SSD M.2 PCIe NVMe Opal2	No	Blank Bezel	Intel 8265 ac, 2x2 + BT4.1	WWAN Upgradable	None	None	720p	Backlit	X-Rite	Finger-print Reader	None	dTPM 2.0	8-cell (96Wh)	230W	Win10 Pro 64	3-year, Depot	04/17
20HK0010US	US	Xeon E3-1535M v6	vPro	P5000M 16GB	Intel CM238	16GBx1 ECC	17.3" FHD (1920x1080) IPS	None	None	512GB SSD M.2 PCIe NVMe Opal2	No	Blank Bezel	Intel 8265 ac, 2x2 + BT4.1	WWAN Upgradable	None	Smart Card Reader	720p	Backlit	None	Finger-print Reader	None	dTPM 2.0	8-cell (96Wh)	230W	Win10 Pro 64	3-year, Depot	04/17
20HK0011US	US	i7-7700HQ	No	M620M 2GB	Intel CM238	8GBx1 non-ECC	17.3" FHD (1920x1080) IPS	None	None	1TB 5400rpm	No	Blank Bezel	Intel 8265 ac, 2x2 + BT4.1	WWAN Upgradable	None	None	720p	Backlit	None	Finger-print Reader	None	dTPM 2.0	8-cell (96Wh)	170W	Win10 Pro 64	3-year, Depot	04/17
20HK0012US	US	Xeon E3-1535M v6	vPro	P4000M 8GB	Intel CM238	16GBx1 ECC	17.3" FHD (1920x1080) IPS	None	None	512GB SSD M.2 PCIe NVMe Opal2	No	Blank Bezel	Intel 8265 ac, 2x2 + BT4.1	WWAN Upgradable	None	Smart Card Reader	720p	Backlit	None	Finger-print Reader	None	dTPM 2.0	8-cell (96Wh)	230W	Win10 Pro 64	3-year, Depot	04/17
20HK0013US	US	i7-7700HQ	No	M620M 2GB	Intel CM238	8GBx1 non-ECC	17.3" FHD (1920x1080) IPS	None	None	500GB 7200rpm	No	Blank Bezel	Intel 8265 ac, 2x2 + BT4.1	WWAN Upgradable	None	None	720p	Backlit	None	Finger-print Reader	None	dTPM 2.0	8-cell (96Wh)	170W	Win10 Pro 64	3-year, Depot	04/17
20HK0014US	US	Xeon E3-1505M v6	vPro	P3000M 6GB	Intel CM238	8GBx2 ECC	17.3" FHD (1920x1080) IPS	None	None	1TB SSD M.2 PCIe NVMe Opal2	No	Blank Bezel	Intel 8265 ac, 2x2 + BT4.1	WWAN Upgradable	None	Smart Card Reader	720p	Backlit	None	Finger-print Reader	None	dTPM 2.0	8-cell (96Wh)	230W	Win10 Pro 64	3-year, Depot	04/17
20HK0015US	US	Xeon E3-1505M v6	vPro	M620M 2GB	Intel CM238	8GBx2 ECC	17.3" FHD (1920x1080) IPS	None	None	256GB SSD M.2 PCIe NVMe Opal2	No	Blank Bezel	Intel 8265 ac, 2x2 + BT4.1	WWAN Upgradable	None	Smart Card Reader	720p	Backlit	None	Finger-print Reader	None	dTPM 2.0	8-cell (96Wh)	170W	Win10 Pro 64	3-year, Depot	04/17
20HK0016US	US	Xeon E3-1505M v6	vPro	M620M 2GB	Intel CM238	8GBx1 ECC	17.3" FHD (1920x1080) IPS	None	None	256GB SSD M.2 PCIe NVMe Opal2	No	Blank Bezel	Intel 8265 ac, 2x2 + BT4.1	WWAN Upgradable	None	Smart Card Reader	720p	Backlit	None	Finger-print Reader	None	dTPM 2.0	8-cell (96Wh)	170W	Win10 Pro 64	3-year, Depot	04/17
20HK0017US	US	i7-7820HQ	vPro	M620M 2GB	Intel CM238	8GBx1 non-ECC	17.3" FHD (1920x1080) IPS	None	None	500GB 7200rpm	No	Blank Bezel	Intel 8265 ac, 2x2 + BT4.1	WWAN Upgradable	None	None	720p	Backlit	None	Finger-print Reader	None	dTPM 2.0	8-cell (96Wh)	170W	Win10 Pro 64	3-year, Depot	04/17
20HK0018US	US	i7-7700HQ	No	M620M 2GB	Intel CM238	8GBx2 non-ECC	17.3" FHD (1920x1080) IPS	None	None	512GB SSD M.2 PCIe NVMe Opal2	No	Blank Bezel	Intel 8265 ac, 2x2 + BT4.1	WWAN Upgradable	None	Smart Card Reader	720p	Backlit	X-Rite	Finger-print Reader	None	dTPM 2.0	8-cell (96Wh)	170W	Win10 Pro 64	3-year, Depot	04/17
20HK0019US	US	Xeon E3-1505M v6	vPro	P4000M 8GB	Intel CM238	8GBx2 ECC	17.3" FHD (1920x1080) IPS	None	None	1TB SSD M.2 PCIe NVMe Opal2	No	Blank Bezel	Intel 8265 ac, 2x2 + BT4.1	WWAN Upgradable	None	Smart Card Reader	720p	Backlit	None	Finger-print Reader	None	dTPM 2.0	8-cell (96Wh)	230W	Win10 Pro 64	3-year, Depot	04/17
20HK001AUS	US	Xeon E3-1535M v6	vPro	P3000M 6GB	Intel CM238	16GBx1 ECC	17.3" 4K (3840x2160) IPS	None	None	512GB SSD M.2 PCIe NVMe Opal2	No	Blank Bezel	Intel 8265 ac, 2x2 + BT4.1	WWAN Upgradable	None	None	720p	Backlit	X-Rite	Finger-print Reader	None	dTPM 2.0	8-cell (96Wh)	230W	Win10 Pro 64	3-year, Depot	04/17
20HK001BUS	US	Xeon E3-1505M v6	vPro	P3000M 6GB	Intel CM238	8GBx2 ECC	17.3" FHD (1920x1080) IPS	None	None	256GB SSD M.2 PCIe NVMe Opal2	No	Blank Bezel	Intel 8265 ac, 2x2 + BT4.1	WWAN Upgradable	None	Smart Card Reader	720p	Backlit	None	Finger-print Reader	None	dTPM 2.0	8-cell (96Wh)	230W	Win10 Pro 64	3-year, Depot	04/17
20HK001CUS	US	Xeon E3-1505M v6	vPro	P3000M 6GB	Intel CM238	8GBx2 ECC	17.3" FHD (1920x1080) IPS	None	None	512GB SSD M.2 PCIe NVMe Opal2	No	Blank Bezel	Intel 8265 ac, 2x2 + BT4.1	WWAN Upgradable	None	Smart Card Reader	720p	Backlit	None	Finger-print Reader	None	dTPM 2.0	8-cell (96Wh)	230W	Win10 Pro 64	3-year, Depot	04/17
20HK001DUS	US	Xeon E3-1535M v6	vPro	P3000M 6GB	Intel CM238	16GBx1 ECC	17.3" FHD (1920x1080) IPS	None	None	512GB SSD M.2 PCIe NVMe Opal2	No	Blank Bezel	Intel 8265 ac, 2x2 + BT4.1	WWAN Upgradable	None	Smart Card Reader	720p	Backlit	None	Finger-print Reader	None	dTPM 2.0	8-cell (96Wh)	230W	Win10 Pro 64	3-year, Depot	04/17
20HK001EUS	US	i7-7820HQ	vPro	M620M 2GB	Intel CM238	8GBx1 non-ECC	17.3" FHD (1920x1080) IPS	None	None	1TB 5400rpm	No	Blank Bezel	Intel 8265 ac, 2x2 + BT4.1	WWAN Upgradable	None	None	720p	Backlit	None	Finger-print Reader	None	dTPM 2.0	8-cell (96Wh)	170W	Win10 Pro 64	3-year, Depot	04/17
20HK001FUS	US	Xeon E3-1535M v6	vPro	P5000M 16GB	Intel CM238	16GBx2 ECC	17.3" 4K (3840x2160) IPS	None	None	1TB SSD M.2 PCIe NVMe Opal2	No	Blank Bezel	Intel 8265 ac, 2x2 + BT4.1	WWAN Upgradable	None	None	720p	Backlit	X-Rite	Finger-print Reader	None	dTPM 2.0	8-cell (96Wh)	230W	Win10 Pro 64	3-year, Depot	04/17

Model	Region	Processor	vPro	Graphics	Chipset	Memory	Display	Multi-touch	Pen	Storage(HDD/SSD)	RAID	Optical	WLAN + Bluetooth	WWAN	SIM Card	Smart Card Reader	Camera	Key-board	Color Calibrator	Finger-print Reader	NFC	TPM	Battery	Power Adapter	Operating System	Warranty	Ann Date (m/y)
20HK001GUS	US	i7-7700HQ	No	M620M 2GB	Intel CM238	8GBx2 non-ECC	17.3" FHD (1920x1080) IPS	None	None	512GB SSD M.2 PCIe NVMe Opal2	No	Blank Bezel	Intel 8265 ac, 2x2 + BT4.1	WWAN Upgradable	None	Smart Card Reader	720p	Backlit	None	Finger-print Reader	None	dTPM 2.0	8-cell (96Wh)	170W	Win10 Pro 64	3-year, Depot	04/17
20HK001HUS	US	Xeon E3-1535M v6	vPro	P5000M 16GB	Intel CM238	8GBx2 ECC	17.3" 4K (3840x2160) IPS	None	None	512GB SSD M.2 PCIe NVMe Opal2	No	Blank Bezel	Intel 8265 ac, 2x2 + BT4.1	WWAN Upgradable	None	None	720p	Backlit	X-Rite	Finger-print Reader	None	dTPM 2.0	8-cell (96Wh)	230W	Win10 Pro 64	3-year, Depot	04/17
20HK001JUS	US	i7-7700HQ	No	M620M 2GB	Intel CM238	8GBx2 non-ECC	17.3" FHD (1920x1080) IPS	None	None	256GB SSD M.2 PCIe NVMe Opal2	No	Blank Bezel	Intel 8265 ac, 2x2 + BT4.1	WWAN Upgradable	None	Smart Card Reader	720p	Backlit	None	Finger-print Reader	None	dTPM 2.0	8-cell (96Wh)	170W	Win10 Pro 64	3-year, Depot	04/17
20HK001KUS	US	i7-7820HQ	vPro	M620M 2GB	Intel CM238	8GBx1 non-ECC	17.3" FHD (1920x1080) IPS	None	None	512GB SSD M.2 PCIe NVMe Opal2	No	Blank Bezel	Intel 8265 ac, 2x2 + BT4.1	WWAN Upgradable	None	None	720p	Backlit	None	Finger-print Reader	None	dTPM 2.0	8-cell (96Wh)	170W	Win10 Pro 64	3-year, Depot	04/17
20HK001LUS	US	Xeon E3-1535M v6	vPro	P4000M 8GB	Intel CM238	16GBx2 ECC	17.3" 4K (3840x2160) IPS	None	None	1TB SSD M.2 PCIe NVMe Opal2	No	Blank Bezel	Intel 8265 ac, 2x2 + BT4.1	WWAN Upgradable	None	None	720p	Backlit	X-Rite	Finger-print Reader	None	dTPM 2.0	8-cell (96Wh)	230W	Win10 Pro 64	3-year, Depot	04/17
20HK001MUS	US	i7-7820HQ	vPro	M620M 2GB	Intel CM238	8GBx2 non-ECC	17.3" FHD (1920x1080) IPS	None	None	256GB SSD M.2 PCIe NVMe Opal2	No	Blank Bezel	Intel 8265 ac, 2x2 + BT4.1	WWAN Upgradable	None	None	720p	Backlit	None	Finger-print Reader	None	dTPM 2.0	8-cell (96Wh)	170W	Win10 Pro 64	3-year, Depot	04/17
20HK001PUS	US	Xeon E3-1505M v6	vPro	P3000M 6GB	Intel CM238	8GBx2 non-ECC	17.3" 4K (3840x2160) IPS	None	None	512GB SSD M.2 PCIe NVMe Opal2	No	Blank Bezel	Intel 8265 ac, 2x2 + BT4.1	WWAN Upgradable	None	None	720p	Backlit	X-Rite	Finger-print Reader	None	dTPM 2.0	8-cell (96Wh)	230W	Win10 Pro 64	3-year, Depot	05/17
20HK001QUS	US	i7-7820HQ	vPro	P3000M 6GB	Intel CM238	8GBx2 non-ECC	17.3" FHD (1920x1080) IPS	None	None	1TB SSD M.2 PCIe NVMe Opal2	No	Blank Bezel	Intel 8265 ac, 2x2 + BT4.1	WWAN Upgradable	None	None	720p	Backlit	None	Finger-print Reader	None	dTPM 2.0	8-cell (96Wh)	230W	Win10 Pro 64	3-year, Depot	05/17
20HK001RUS	US	i7-7820HQ	vPro	P3000M 6GB	Intel CM238	8GBx2 non-ECC	17.3" FHD (1920x1080) IPS	None	None	512GB SSD M.2 PCIe NVMe Opal2	No	Blank Bezel	Intel 8265 ac, 2x2 + BT4.1	WWAN Upgradable	None	None	720p	Backlit	None	Finger-print Reader	None	dTPM 2.0	8-cell (96Wh)	230W	Win10 Pro 64	3-year, Depot	05/17
20HK001SUS	US	i7-7820HQ	vPro	P3000M 6GB	Intel CM238	8GBx2 non-ECC	17.3" 4K (3840x2160) IPS	None	None	512GB SSD M.2 PCIe NVMe Opal2	No	Blank Bezel	Intel 8265 ac, 2x2 + BT4.1	WWAN Upgradable	None	None	720p	Backlit	X-Rite	Finger-print Reader	None	dTPM 2.0	8-cell (96Wh)	230W	Win10 Pro 64	3-year, Depot	05/17
20HK001TUS	US	i7-7820HQ	vPro	P3000M 6GB	Intel CM238	8GBx2 non-ECC	17.3" FHD (1920x1080) IPS	None	None	500GB 7200rpm	No	Blank Bezel	Intel 8265 ac, 2x2 + BT4.1	WWAN Upgradable	None	None	720p	Backlit	None	Finger-print Reader	None	dTPM 2.0	8-cell (96Wh)	230W	Win10 Pro 64	3-year, Depot	05/17



ThinkPad T460 Platform Specifications

Product Specifications Reference (PSREF)

Processor	6th Generation Intel® Core™ i3 / i5 / i7 Processor (i7-6500U for discrete models only)							Smart card reader <i>Optional</i> : Smart card reader	
	Processor Number	# of Cores	# of Threads	Base Frequency	Max Turbo Frequency	Cache	Memory Types	Processor Graphics	Media reader 4-in-1 reader (MMC, SD, SDHC, SDXC) Ports Three USB 3.0 (one Always On), MiniDP, HDMI, Ethernet (RJ-45), Dock connector WiGig dock (<i>opt</i>) WiGig dock, coexists with WWAN (WE only)
	i3-6100U	2	4	2.3 GHz	-	3MB	DDR3L-1600	Intel HD graphics 520	Camera (<i>optional</i>) HD720p resolution, low light sensitive, fixed focus
	i5-6200U			2.3 GHz	2.8 GHz	3MB			Audio support HD Audio, Realtek® ALC3245 codec / stereo speakers, 2W x 2 / dual array microphone, combo audio/microphone jack
	i5-6300U			2.4 GHz	3.0 GHz	3MB			Keyboard 6-row, spill-resistant, multimedia Fn keys, optional LED backlight
	i7-6500U			2.5 GHz	3.1 GHz	4MB			UltraNav™ TrackPoint® pointing device and buttonless Mylar surface multi-touch touchpad
	i7-6600U			2.6 GHz	3.4 GHz	4MB			Security Power-on password, hard disk password, supervisor password, security keyhole Security chip Discrete TPM 1.2 TCG Certified and Firmware TPM 2.0 integrated in chipset ThinkEngine Delivers improved thermal and power efficiency, up to 30 day standby, faster resume time, enhanced security, as well as anti-tampering measures
Graphics	Intel HD Graphics 520 in processor only, or Intel HD Graphics 520 in processor and NVIDIA GeForce® 940MX, 2GB memory (discrete graphics is only available in US); supports external digital monitor via HDMI or Mini DisplayPort; supports three independent displays; Max resolution: 3840x2160@60Hz (DisplayPort via Mini DisplayPort cable); 1920x1080@60Hz (HDMI)							vPro (<i>optional</i>) Intel vPro Technology Fingerprint reader <i>Optional</i> : Swipe style fingerprint reader on the keyboard bezel	
Chipset	Intel SoC (System on Chip) platform							Internal battery <i>Optional</i> : Integrated Li-Ion or Li-Polymer 3-cell (23Wh)	
Memory	32GB max ⁷ / PC3-12800 1600MHz DDR3L, non-parity, dual-channel capable, two DDR3L SO-DIMM sockets							External battery Li-Ion 3-cell (23Wh) or 6-cell (48Wh or 72Wh)	
Display	<i>Some</i> : 14.0" (355mm) HD (1366x768), anti-glare, LED backlight, 200 nits, 16:9 aspect ratio, 350:1 contrast ratio							<i>Models</i>	
	<i>Some</i> : 14.0" (355mm) FHD (1920x1080), anti-glare, LED backlight, IPS, 250 nits, 16:9 aspect ratio, 700:1 contrast ratio, 160° viewing angle							<i>Integrated model</i>	
Multi-touch (<i>opt</i>)	In-cell touch, supports 10-finger gesture, 250 nits							<i>discrete model</i>	
Storage	<i>Some</i> : SSD / SATA 6.0Gb/s (e.g. xxxG SSD) <i>Some</i> : SSD / PCIe NVMe, PCIe 3.0 x 2, 16Gb/s (e.g. xxxG SSD PCIe NVMe) <i>Some</i> : HDD / SATA 6.0Gb/s, 2.5" wide, 7mm or 9.5mm high, Shock Mounted Hard Drive, Active Protection System™ <i>Some</i> : SSHD with 8GB NAND flash memory (WE only)							AC adapter 45W or 65W Slim AC adapter	
Optical	None							Preload Windows 7 Professional 64 preinstalled through downgrade rights in Windows 10 Pro 64 • Lenovo Solution Center • Lenovo Companion • Lenovo Setting • ThinkVantage Product Recovery • Rescue and Recovery™ • ThinkVantage System Update • Adobe® Reader® • Microsoft® Office preloaded; purchase a product key to activate • McAfee® LiveSafe™ (30-day trial)	
Ethernet	<i>Non-vPro model</i> : Intel Ethernet Connection I219-V (Jacksonville) <i>vPro model</i> : Intel Ethernet Connection I219-LM (Jacksonville)								
WLAN ⁴	<i>One of the following, configurable by model (WiGig can coexist with WWAN):</i> • 11ac+BT, Broadcom BCM4356, 2x2, M.2 card • 11ac+BT, Intel Dual Band Wireless-AC 8260, 2x2, M.2 card • WiGig™+11ac+BT, Intel Tri-Band Wireless-AC 18260, 2x2 WLAN, WiGig, M.2 card							Limited warranty ¹² <i>One of the following, configurable by model:</i> • 1-year depot repair service • 3-year/1-yr battery depot repair service • 3-year/1-yr battery limited onsite service ²⁴ • 3-year/1-yr battery limited onsite service, OID (Onsite International Delivery)	
Bluetooth™	Bluetooth 4.1 wireless, integrated in Wi-Fi + Bluetooth combo adapter							Mil-Spec test MIL-STD-810G military certification	
WWAN (<i>optional</i>)	<i>One of the following, configurable by model (WWAN can coexist with WiGig):</i> • Wireless WAN upgradable • Wireless WAN, Sierra Wireless EM7455, Qualcomm® 4G LTE-Advanced/DC-HSPA+/HSPA+/HSPA/UMTS/GNSS, M.2 card • Wireless WAN, HUAWEI ME906S, HUAWEI 4G LTE/WCDMA/HSPA/GSM/GPRS/EDGE/GNSS, M.2 card (WE only)								Environment EPEAT™ Gold (US only); ENERGY STAR® 6.1; GREENGUARD®; RoHS-compliant
SIM card (<i>opt</i>)	Micro-SIM card slot, optional Verizon LTE (US) or Lenovo Connect (WE) SIM card								
Dimensions ³	<i>WxDxH</i> : 13.35" x 9.15" x 0.83"; 339mm x 232.5mm x 21mm								
Weight ²	<i>Models</i>	<i>No + 6-cell</i>		<i>3-cell + 3-cell</i>		<i>3-cell + 6-cell</i>			
	<i>Integrated Non-touch</i>	3.84 lb / 1.74 kg		3.82 lb / 1.73 kg		4.13 lb / 1.87 kg			
	<i>Integrated Multi-touch</i>	3.91 lb / 1.77 kg		3.88 lb / 1.76 kg		4.20 lb / 1.90 kg			
	<i>Discrete Non-touch</i>	3.86 lb / 1.75 kg		3.90 lb / 1.77 kg		4.22 lb / 1.91 kg			
	<i>Discrete Multi-touch</i>	3.93 lb / 1.78 kg		3.97 lb / 1.80 kg		4.28 lb / 1.94 kg			
Case material	Glass-Fiber Reinforced Plastic								

Model	Region	Processor	vPro	Graphics	Memory	Display	Multi-touch	Storage	Optical	WLAN + Bluetooth	WWAN	SIM Card	Smart Card Reader	Dock	Camera	Keyboard	Fingerprint Reader	Battery (internal+ external)	Power Adapter	Operating System	Warranty	Ann Date (m/y)
20FN002JUS	US	i5-6300U	vPro	Intel HD 520	8GBx1	14" FHD (1920x1080) IPS	None	256GB SSD Opal2	None	Intel 8260 ac, 2x2 + BT4.1	WWAN Upgradable	None	None	None	720p	Backlit	Fingerprint Reader	3-cell(23Wh) + 3-cell(23Wh)	45W	Win10 DG Win7 Pro 64	3-year, Depot	01/16
20FN002KUS	US	i7-6600U	vPro	Intel HD 520	8GBx2	14" FHD (1920x1080) IPS	None	512GB SSD	None	Intel 8260 ac, 2x2 + BT4.1	WWAN Upgradable	None	None	None	720p	Backlit	Fingerprint Reader	3-cell(23Wh) + 3-cell(23Wh)	45W	Win10 DG Win7 Pro 64	3-year, Depot	01/16
20FN002LUS	US	i7-6600U	vPro	Intel HD 520	8GBx2	14" FHD (1920x1080) IPS	10-point Multi-touch	512GB SSD	None	Intel 8260 ac, 2x2 + BT4.1	WWAN Upgradable	None	None	None	720p	Backlit	Fingerprint Reader	3-cell(23Wh) + 3-cell(23Wh)	45W	Win10 DG Win7 Pro 64	3-year, Depot	01/16
20FN002MUS	US	i5-6300U	vPro	Intel HD 520	8GBx1	14" FHD (1920x1080) IPS	None	180GB SSD Opal2	None	Intel 8260 ac, 2x2 + BT4.1	WWAN Upgradable	None	None	None	720p	Backlit	Fingerprint Reader	3-cell(23Wh) + 3-cell(23Wh)	45W	Win10 DG Win7 Pro 64	3-year, Depot	01/16
20FN002NUS	US	i5-6300U	vPro	Intel HD 520	8GBx1	14" FHD (1920x1080) IPS	None	500GB 7200rpm	None	Intel 8260 ac, 2x2 + BT4.1	WWAN Upgradable	None	None	None	720p	Backlit	Fingerprint Reader	3-cell(23Wh) + 3-cell(23Wh)	45W	Win10 DG Win7 Pro 64	3-year, Depot	01/16
20FN002PUS	US	i5-6300U	vPro	Intel HD 520	8GBx1	14" FHD (1920x1080) IPS	10-point Multi-touch	256GB SSD Opal2	None	Intel 8260 ac, 2x2 + BT4.1	WWAN Upgradable	None	None	None	720p	Backlit	Fingerprint Reader	3-cell(23Wh) + 3-cell(23Wh)	45W	Win10 Pro 64	3-year, Depot	01/16
20FN002QUS	US	i5-6300U	vPro	Intel HD 520	4GBx1	14" FHD (1920x1080) IPS	None	500GB 7200rpm	None	Intel 8260 ac, 2x2 + BT4.1	WWAN Upgradable	None	None	None	720p	Backlit	Fingerprint Reader	3-cell(23Wh) + 3-cell(23Wh)	45W	Win10 DG Win7 Pro 64	3-year, Depot	01/16
20FN002RUS	US	i7-6600U	vPro	Intel HD 520	8GBx2	14" FHD (1920x1080) IPS	10-point Multi-touch	512GB SSD	None	Intel 8260 ac, 2x2 + BT4.1	WWAN Upgradable	None	None	None	720p	Backlit	Fingerprint Reader	3-cell(23Wh) + 3-cell(23Wh)	45W	Win10 Pro 64	3-year, Depot	01/16
20FN002SUS	US	i5-6200U	No	Intel HD 520	4GBx1	14" HD (1366x768)	None	500GB 7200rpm	None	Intel 8260 ac, 2x2 + BT4.1	WWAN Upgradable	None	None	None	720p	Non-backlit	Fingerprint Reader	3-cell(23Wh) + 3-cell(23Wh)	45W	Win10 DG Win7 Pro 64	1-year, Depot	01/16
20FN002TUS	US	i5-6300U	vPro	Intel HD 520	4GBx1	14" HD (1366x768)	None	500GB 7200rpm	None	Intel 8260 ac, 2x2 + BT4.1	WWAN Upgradable	None	None	None	720p	Non-backlit	Fingerprint Reader	3-cell(23Wh) + 3-cell(23Wh)	45W	Win10 DG Win7 Pro 64	1-year, Depot	01/16
20FN002UUS	US	i5-6300U	vPro	Intel HD 520	4GBx1	14" FHD (1920x1080) IPS	None	180GB SSD Opal2	None	Intel 8260 ac, 2x2 + BT4.1	WWAN Upgradable	None	None	None	720p	Backlit	Fingerprint Reader	3-cell(23Wh) + 3-cell(23Wh)	45W	Win10 DG Win7 Pro 64	3-year, Depot	01/16
20FN002VUS	US	i7-6600U	vPro	Intel HD 520	8GBx1	14" FHD (1920x1080) IPS	None	256GB SSD Opal2	None	Intel 8260 ac, 2x2 + BT4.1	WWAN Upgradable	None	None	None	720p	Backlit	Fingerprint Reader	3-cell(23Wh) + 3-cell(23Wh)	45W	Win10 DG Win7 Pro 64	3-year, Depot	01/16
20FN003CUS	US	i5-6200U	No	Intel HD 520	8GBx1	14" HD (1366x768)	None	128GB SSD	None	Intel 8260 ac, 2x2 + BT4.1	WWAN Upgradable	None	None	None	720p	Backlit	Fingerprint Reader	3-cell(23Wh) + 3-cell(23Wh)	45W	Win10 DG Win7 Pro 64	3-year, Depot	01/16
20FN003DUS	US	i5-6200U	No	Intel HD 520	8GBx1	14" HD (1366x768)	None	192GB SSD	None	Intel 8260 ac, 2x2 + BT4.1	WWAN Upgradable	None	None	None	720p	Backlit	Fingerprint Reader	3-cell(23Wh) + 3-cell(23Wh)	45W	Win10 DG Win7 Pro 64	3-year, Depot	01/16
20FN003EUS	US	i5-6300U	vPro	Intel HD 520	8GBx1	14" FHD (1920x1080) IPS	None	240GB SSD Opal2	None	Intel 8260 ac, 2x2 + BT4.1	WWAN Upgradable	None	None	None	720p	Backlit	Fingerprint Reader	3-cell(23Wh) + 3-cell(23Wh)	45W	Win10 DG Win7 Pro 64	3-year, Depot	01/16
20FN003FUS	US	i5-6300U	vPro	Intel HD 520	8GBx1	14" FHD (1920x1080) IPS	None	192GB SSD	None	Intel 8260 ac, 2x2 + BT4.1	WWAN Upgradable	None	None	None	720p	Backlit	Fingerprint Reader	3-cell(23Wh) + 3-cell(23Wh)	45W	Win10 DG Win7 Pro 64	3-year, Depot	01/16
20FN003RUS	US	i5-6200U	No	Intel HD 520	4GBx2	14" HD (1366x768)	None	128GB SSD	None	Intel 8260 ac, 2x2 + BT4.1	WWAN Upgradable	None	None	None	720p	Backlit	Fingerprint Reader	3-cell(23Wh) + 3-cell(23Wh)	45W	Win10 DG Win7 Pro 64	3-year, Depot	01/16
20FN003SUS	US	i5-6200U	No	Intel HD 520	4GBx2	14" FHD (1920x1080) IPS	None	192GB SSD	None	Intel 8260 ac, 2x2 + BT4.1	WWAN Upgradable	None	None	None	720p	Backlit	Fingerprint Reader	3-cell(23Wh) + 3-cell(23Wh)	45W	Win10 DG Win7 Pro 64	3-year, Depot	01/16
20FN003TUS	US	i5-6300U	vPro	Intel HD 520	4GBx2	14" FHD (1920x1080) IPS	None	192GB SSD	None	Intel 8260 ac, 2x2 + BT4.1	WWAN Upgradable	None	None	None	720p	Backlit	Fingerprint Reader	3-cell(23Wh) + 3-cell(23Wh)	45W	Win10 DG Win7 Pro 64	3-year, Depot	01/16
20FN003UUS	US	i5-6300U	vPro	Intel HD 520	4GBx2	14" FHD (1920x1080) IPS	None	240GB SSD Opal2	None	Intel 8260 ac, 2x2 + BT4.1	WWAN Upgradable	None	None	None	720p	Backlit	Fingerprint Reader	3-cell(23Wh) + 3-cell(23Wh)	45W	Win10 DG Win7 Pro 64	3-year, Depot	01/16

Model	Region	Processor	vPro	Graphics	Memory	Display	Multi-touch	Storage	Optical	WLAN + Bluetooth	WWAN	SIM Card	Smart Card Reader	Dock	Camera	Keyboard	Fingerprint Reader	Battery (internal+ external)	Power Adapter	Operating System	Warranty	Ann Date (m/y)
20FN004UUS	US	i5-6300U	vPro	Intel HD 520	8GBx1	14" FHD (1920x1080) IPS	None	180GB SSD Opal2	None	Intel 8260 ac, 2x2 + BT4.1	WWAN Upgradable	None	None	None	720p	Backlit	Fingerprint Reader	3-cell(23Wh) + 3-cell(23Wh)	45W	Win10 Pro 64	3-year, Depot	08/16
20FN004VUS	US	i5-6200U	No	Intel HD 520	4GBx1	14" HD (1366x768)	None	500GB 7200rpm Opal2	None	Intel 8260 ac, 2x2 + BT4.1	WWAN Upgradable	None	None	None	720p	Non-backlit	Fingerprint Reader	3-cell(23Wh) + 3-cell(23Wh)	45W	Win10 Pro 64	1-year, Depot	08/16
20FN0056US	US	i5-6300U	vPro	Intel HD 520	8GBx1	14" FHD (1920x1080) IPS	None	256GB SSD Opal2	None	Intel 8260 ac, 2x2 + BT4.1	WWAN Upgradable	None	None	None	720p	Backlit	Fingerprint Reader	3-cell(23Wh) + 3-cell(23Wh)	45W	Win10 Pro 64	3-year, Depot	10/16
20FN0057US	US	i5-6200U	No	Intel HD 520	4GBx1	14" HD (1366x768)	None	500GB 7200rpm	None	Intel 8260 ac, 2x2 + BT4.1	WWAN Upgradable	None	None	None	720p	Non-backlit	Fingerprint Reader	3-cell(23Wh) + 3-cell(23Wh)	45W	Win10 Pro 64	1-year, Depot	10/16
20FN0059US	US	i5-6200U	No	Intel HD 520	8GBx1	14" FHD (1920x1080) IPS	10-point Multi-touch	256GB SSD Opal2	None	Intel 8260 ac, 2x2 + BT4.1	WWAN Upgradable	None	None	None	720p	Backlit	Fingerprint Reader	3-cell(23Wh) + 3-cell(23Wh)	45W	Win10 Pro 64	3-year, Depot	10/16
20FN005AUS	US	i5-6200U	No	Intel HD 520	8GBx1	14" HD (1366x768)	None	500GB 7200rpm	None	Intel 8260 ac, 2x2 + BT4.1	WWAN Upgradable	None	None	None	720p	Non-backlit	None	3-cell(23Wh) + 3-cell(23Wh)	45W	Win10 Pro 64	1-year, Depot	10/16
20FN005BUS	US	i5-6200U	No	Intel HD 520	8GBx1	14" FHD (1920x1080) IPS	None	256GB SSD Opal2	None	Intel 8260 ac, 2x2 + BT4.1	WWAN Upgradable	None	None	None	720p	Backlit	Fingerprint Reader	3-cell(23Wh) + 3-cell(23Wh)	45W	Win10 DG Win7 Pro 64	3-year, Depot	11/16
20FN005CUS	US	i5-6200U	No	Intel HD 520	4GBx1	14" FHD (1920x1080) IPS	None	180GB SSD Opal2	None	Intel 8260 ac, 2x2 + BT4.1	WWAN Upgradable	None	None	None	720p	Backlit	Fingerprint Reader	3-cell(23Wh) + 3-cell(23Wh)	45W	Win10 DG Win7 Pro 64	3-year, Depot	11/16
20FN005DUS	US	i5-6200U	No	Intel HD 520	4GBx1	14" FHD (1920x1080) IPS	None	256GB SSD Opal2	None	Intel 8260 ac, 2x2 + BT4.1	WWAN Upgradable	None	None	None	720p	Backlit	Fingerprint Reader	3-cell(23Wh) + 3-cell(23Wh)	45W	Win10 DG Win7 Pro 64	3-year, Depot	11/16
20FN005EUS	US	i5-6200U	No	Intel HD 520	8GBx1	14" FHD (1920x1080) IPS	None	180GB SSD Opal2	None	Intel 8260 ac, 2x2 + BT4.1	WWAN Upgradable	None	None	None	720p	Backlit	Fingerprint Reader	3-cell(23Wh) + 3-cell(23Wh)	45W	Win10 DG Win7 Pro 64	3-year, Depot	11/16
20FN005FUS	US	i5-6300U	vPro	Intel HD 520	4GBx1	14" FHD (1920x1080) IPS	None	256GB SSD Opal2	None	Intel 8260 ac, 2x2 + BT4.1	WWAN Upgradable	None	None	None	720p	Backlit	Fingerprint Reader	3-cell(23Wh) + 3-cell(23Wh)	45W	Win10 DG Win7 Pro 64	3-year, Depot	11/16
20FN005GUS	US	i5-6300U	vPro	Intel HD 520	4GBx1	14" FHD (1920x1080) IPS	None	500GB 7200rpm	None	Intel 8260 ac, 2x2 + BT4.1	WWAN Upgradable	None	None	None	720p	Non-backlit	Fingerprint Reader	3-cell(23Wh) + 3-cell(23Wh)	45W	Win10 DG Win7 Pro 64	1-year, Depot	12/16
20FN005HUS	US	i5-6200U	No	Intel HD 520	4GBx2	14" FHD (1920x1080) IPS	None	128GB SSD	None	Intel 8260 ac, 2x2 + BT4.1	WWAN Upgradable	None	None	None	720p	Backlit	Fingerprint Reader	3-cell(23Wh) + 3-cell(23Wh)	45W	Win10 DG Win7 Pro 64	3-year, Depot	12/16
20FN005JUS	US	i5-6200U	No	Intel HD 520	4GBx1	14" FHD (1920x1080) IPS	None	500GB 7200rpm	None	Intel 8260 ac, 2x2 + BT4.1	WWAN Upgradable	None	None	None	720p	Non-backlit	Fingerprint Reader	3-cell(23Wh) + 3-cell(23Wh)	45W	Win10 DG Win7 Pro 64	1-year, Depot	12/16
20FN005KUS	US	i5-6200U	No	Intel HD 520	8GBx1	14" FHD (1920x1080) IPS	None	500GB 7200rpm	None	Intel 8260 ac, 2x2 + BT4.1	WWAN Upgradable	None	None	None	720p	Non-backlit	Fingerprint Reader	3-cell(23Wh) + 3-cell(23Wh)	45W	Win10 Pro 64	1-year, Depot	12/16
20FN005LUS	US	i5-6200U	No	Intel HD 520	4GBx1	14" FHD (1920x1080) IPS	None	500GB 7200rpm	None	Intel 8260 ac, 2x2 + BT4.1	WWAN Upgradable	None	None	None	720p	Non-backlit	Fingerprint Reader	3-cell(23Wh) + 3-cell(23Wh)	45W	Win10 Pro 64	1-year, Depot	12/16
20FN005MUS	US	i5-6200U	No	Intel HD 520	4GBx1	14" FHD (1920x1080) IPS	None	500GB 7200rpm Opal2	None	Intel 8260 ac, 2x2 + BT4.1	WWAN Upgradable	None	None	None	720p	Non-backlit	Fingerprint Reader	3-cell(23Wh) + 3-cell(23Wh)	45W	Win10 Pro 64	1-year, Depot	12/16
20FNA04PUS	US	i7-6600U	vPro	Intel HD 520	8GBx1	14" FHD (1920x1080) IPS	None	256GB SSD Opal2	None	Intel 8260 ac, 2x2 + BT4.1	WWAN Upgradable	None	None	None	720p	Backlit	Fingerprint Reader	3-cell(23Wh) + 3-cell(23Wh)	45W	Win10 Pro 64	3-year, Depot	08/16



ThinkPad T460p Platform Specifications

Product Specifications Reference (PSREF)

Processor	6th Generation Intel® Core™ i5 / i7 Processor								Smart card reader <i>Optional</i> : Smart card reader																
	Processor Number	# of Cores	# of Threads	Base Frequency	Max Turbo Frequency	Cache	Memory Types	Processor Graphics	Media reader	4-in-1 reader (MMC, SD, SDHC, SDXC)															
	i5-6300HQ	4	4	2.3 GHz	3.2 GHz	6MB	DDR4-2133	Intel HD Graphics 530	Ports	Three USB 3.0 (one Always On), MiniDP, HDMI, Ethernet (RJ-45), Dock connector															
	i5-6440HQ			2.6 GHz	3.5 GHz				Camera (<i>optional</i>)	HD720p resolution, low light sensitive, fixed focus															
	i7-6700HQ			2.6 GHz	3.5 GHz	6MB			Audio support	HD Audio, Realtek® ALC3245 codec / stereo speakers, 1W x 2 / dual array microphone, combo audio/microphone jack															
i7-6820HQ	2.7 GHz			3.6 GHz	8MB	Keyboard			6-row, spill-resistant, multimedia Fn keys, LED backlight																
Graphics	Intel HD Graphics 530 in processor only, or Intel HD Graphics 530 in processor and NVIDIA GeForce® 940MX, 2GB memory; supports external digital monitor via HDMI or Mini DisplayPort; supports three independent displays; Max resolution: 3840x2160 @60Hz (DisplayPort via Mini DisplayPort cable); 4096x2160 @24Hz (HDMI)								UltraNav™	TrackPoint® pointing device and buttonless Mylar surface multi-touch touchpad															
Chipset	Mobile Intel QM170 Chipset								Security	Power-on password, hard disk password, supervisor password, security keyhole															
Memory	32GB max ⁷ / 2133MHz DDR4, dual-channel capable, two DDR4 SO-DIMM sockets								Security chip	Discrete TPM 1.2 TCG Certified and Firmware TPM 2.0 integrated in chipset															
Display	<i>Some</i> : 14.0" (355mm) FHD (1920x1080), anti-glare, LED backlight, IPS, 250 nits, 16:9 aspect ratio, 600:1 contrast ratio, 160° viewing angle <i>Some</i> : 14.0" (355mm) WQHD (2560x1440), anti-glare, LED backlight, IPS, 300 nits, 16:9 aspect ratio, 700:1 or 800:1 contrast ratio, 160° viewing angle								ThinkEngine	Delivers improved thermal and power efficiency, up to 30 day standby, faster resume time, enhanced security, as well as anti-tampering measures															
Multi-touch	None								vPro (<i>optional</i>)	Intel vPro Technology															
Storage	<i>Some</i> : SSD / SATA 6.0Gb/s (e.g. xxxG SSD) <i>Some</i> : SSD / PCIe NVMe, PCIe 3.0 x 2, 16Gb/s (e.g. xxxG SSD PCIe NVMe) <i>Some</i> : HDD / SATA 6.0Gb/s, 2.5" wide, 7mm or 9.5mm high, Shock Mounted Hard Drive, Active Protection System™								Fingerprint reader	<i>Optional</i> : Touch style fingerprint reader on the keyboard bezel															
Optical	None								Battery	Li-Ion 3-cell (23Wh) or 6-cell (48Wh or 72Wh)															
Ethernet	Intel Ethernet Connection I219-LM (Jacksonville)								Max battery life ¹⁰	<table border="1"> <thead> <tr> <th>Models</th> <th>3-cell</th> <th>6-cell 48Wh</th> <th>6-cell 72Wh</th> </tr> </thead> <tbody> <tr> <td>Integrated model</td> <td>4.34 hr</td> <td>8.58 hr</td> <td>13 hr</td> </tr> <tr> <td>discrete model</td> <td>4.1 hr</td> <td>8.5 hr</td> <td>13 hr</td> </tr> </tbody> </table>				Models	3-cell	6-cell 48Wh	6-cell 72Wh	Integrated model	4.34 hr	8.58 hr	13 hr	discrete model	4.1 hr	8.5 hr	13 hr
Models	3-cell	6-cell 48Wh	6-cell 72Wh																						
Integrated model	4.34 hr	8.58 hr	13 hr																						
discrete model	4.1 hr	8.5 hr	13 hr																						
WLAN ⁴	<i>One of the following, configurable by model:</i> • 11ac+BT, Broadcom BCM4356, 2x2, M.2 card • 11ac+BT, Intel Dual Band Wireless-AC 8260, 2x2, M.2 card								AC adapter	90W or 135W AC adapter															
Bluetooth™	Bluetooth 4.1 wireless, integrated in Wi-Fi + Bluetooth combo adapter								Preload	Windows 7 Professional 64 preinstalled through downgrade rights in Windows 10 Pro 64 • Lenovo Solution Center • Lenovo Companion • Lenovo Setting • ThinkVantage Product Recovery • Rescue and Recovery™ • ThinkVantage System Update • Adobe® Reader® • Microsoft® Office preloaded; purchase a product key to activate • McAfee® LiveSafe™ (30-day trial)															
WWAN (<i>optional</i>)	<i>One of the following, configurable by model:</i> • Wireless WAN upgradable • Wireless WAN, Sierra Wireless EM7455, Qualcomm® 4G LTE-Advanced/DC-HSPA+/HSPA+/HSPA/UMTS/GNSS, M.2 card • Wireless WAN, HUAWEI ME906S, HUAWEI 4G LTE/WCDMA/HSPA/GSM/GPRS/EDGE/GNSS, M.2 card (WE only)								Limited warranty ¹²	<i>One of the following, configurable by model:</i> • 1-year depot repair service • 3-year/1-yr battery depot repair service • 3-year/1-yr battery limited onsite service ²⁴ • 3-year/1-yr battery limited onsite service, OID (Onsite International Delivery)															
SIM card (<i>opt</i>)	Micro-SIM card slot, optional Verizon LTE (US) or Lenovo Connect (WE) SIM card								Mil-Spec test	MIL-STD-810G military certification															
Dimensions ³	WxDxH: 13.54" x 9.41" x 0.96"; 344mm x 239mm x 24.4mm								Environment	EPEAT™ Gold (US only); ENERGY STAR® 6.1; GREENGUARD®; RoHS-compliant															
Weight ²	<table border="1"> <thead> <tr> <th>Models</th> <th>3-cell</th> <th>6-cell</th> </tr> </thead> <tbody> <tr> <td>Integrated model</td> <td>3.99 lb / 1.81 kg</td> <td>4.70 lb / 2.13 kg</td> </tr> <tr> <td>discrete model</td> <td>4.04 lb / 1.83 kg</td> <td>4.75 lb / 2.15 kg</td> </tr> </tbody> </table>								Models	3-cell	6-cell	Integrated model	3.99 lb / 1.81 kg	4.70 lb / 2.13 kg	discrete model	4.04 lb / 1.83 kg	4.75 lb / 2.15 kg								
Models	3-cell	6-cell																							
Integrated model	3.99 lb / 1.81 kg	4.70 lb / 2.13 kg																							
discrete model	4.04 lb / 1.83 kg	4.75 lb / 2.15 kg																							
Case material	<i>Display cover</i> : PolyCarbonate/Acrylonitrile-Butadiene-Styrene (PC/ABS) plastic; <i>Bottom</i> : Magnesium alloy																								

Model	Region	Processor	vPro	Graphics	Memory	Display	Multi-touch	Storage	Optical	WLAN + Bluetooth	WWAN	SIM Card	Smart Card Reader	Camera	Keyboard	Fingerprint Reader	Battery	Power Adapter	Operating System	Warranty	Ann Date (m/y)
20FW000SUS	US	i5-6440HQ	vPro	Intel HD 530	8GBx1	14" FHD (1920x1080) IPS	None	192GB SSD	None	Intel 8260 ac, 2x2 + BT4.1	WWAN Upgradable	None	None	720p	Backlit	Fingerprint Reader	3-cell (23Wh)	90W	Win10 DG Win7 Pro 64	3-year, Depot	03/16
20FW000TUS	US	i7-6820HQ	vPro	940MX 2GB	16GBx1	14" FHD (1920x1080) IPS	None	512GB SSD	None	Intel 8260 ac, 2x2 + BT4.1	WWAN Upgradable	None	None	720p	Backlit	Fingerprint Reader	6-cell (48Wh)	135W	Win10 DG Win7 Pro 64	3-year, Depot	03/16
20FW000UUS	US	i5-6440HQ	vPro	Intel HD 530	8GBx1	14" FHD (1920x1080) IPS	None	192GB SSD	None	Intel 8260 ac, 2x2 + BT4.1	WWAN Upgradable	None	None	720p	Backlit	Fingerprint Reader	6-cell (72Wh)	90W	Win10 DG Win7 Pro 64	3-year, Depot	03/16
20FW000VUS	US	i5-6440HQ	vPro	Intel HD 530	8GBx1	14" FHD (1920x1080) IPS	None	256GB SSD Opal2	None	Intel 8260 ac, 2x2 + BT4.1	WWAN Upgradable	None	None	720p	Backlit	Fingerprint Reader	6-cell (48Wh)	90W	Win10 DG Win7 Pro 64	3-year, Depot	03/16
20FW000WUS	US	i7-6820HQ	vPro	940MX 2GB	8GBx1	14" FHD (1920x1080) IPS	None	256GB SSD Opal2	None	Intel 8260 ac, 2x2 + BT4.1	WWAN Upgradable	None	None	720p	Backlit	Fingerprint Reader	6-cell (48Wh)	135W	Win10 DG Win7 Pro 64	3-year, Depot	03/16
20FW002DUS	US	i5-6440HQ	vPro	Intel HD 530	8GBx1	14" FHD (1920x1080) IPS	None	256GB SSD Opal2	None	Intel 8260 ac, 2x2 + BT4.1	WWAN Upgradable	None	Smart Card Reader	720p	Backlit	Fingerprint Reader	6-cell (48Wh)	90W	Win10 Pro 64	3-year, Depot	03/16
20FW003QUS	US	i5-6440HQ	vPro	940MX 2GB	8GBx1	14" FHD (1920x1080) IPS	None	256GB SSD Opal2	None	Intel 8260 ac, 2x2 + BT4.1	WWAN Upgradable	None	None	720p	Backlit	Fingerprint Reader	6-cell (48Wh)	135W	Win10 Pro 64	3-year, Depot	04/16
20FW003RUS	US	i5-6440HQ	vPro	940MX 2GB	8GBx1	14" FHD (1920x1080) IPS	None	256GB SSD Opal2	None	Intel 8260 ac, 2x2 + BT4.1	WWAN Upgradable	None	None	720p	Backlit	Fingerprint Reader	6-cell (48Wh)	135W	Win10 DG Win7 Pro 64	3-year, Depot	04/16
20FW003SUS	US	i5-6440HQ	vPro	940MX 2GB	8GBx1	14" FHD (1920x1080) IPS	None	512GB SSD	None	Intel 8260 ac, 2x2 + BT4.1	WWAN Upgradable	None	None	720p	Backlit	Fingerprint Reader	6-cell (48Wh)	135W	Win10 DG Win7 Pro 64	3-year, Depot	04/16
20FW003TUS	US	i5-6440HQ	vPro	940MX 2GB	8GBx1	14" FHD (1920x1080) IPS	None	512GB SSD	None	Intel 8260 ac, 2x2 + BT4.1	WWAN Upgradable	None	None	720p	Backlit	Fingerprint Reader	6-cell (48Wh)	135W	Win10 Pro 64	3-year, Depot	04/16
20FW0054US	US	i5-6440HQ	vPro	Intel HD 530	8GBx1	14" FHD (1920x1080) IPS	None	180GB SSD Opal2	None	Intel 8260 ac, 2x2 + BT4.1	WWAN Upgradable	None	None	720p	Backlit	Fingerprint Reader	6-cell (48Wh)	90W	Win10 DG Win7 Pro 64	3-year, Depot	11/16
20FW0055US	US	i5-6440HQ	vPro	Intel HD 530	8GBx1	14" FHD (1920x1080) IPS	None	180GB SSD Opal2	None	Intel 8260 ac, 2x2 + BT4.1	WWAN Upgradable	None	None	720p	Backlit	Fingerprint Reader	3-cell (23Wh)	90W	Win10 DG Win7 Pro 64	3-year, Depot	11/16
20FW0056US	US	i5-6440HQ	vPro	Intel HD 530	8GBx1	14" FHD (1920x1080) IPS	None	256GB SSD Opal2	None	Intel 8260 ac, 2x2 + BT4.1	WWAN Upgradable	None	None	720p	Backlit	Fingerprint Reader	3-cell (23Wh)	90W	Win10 DG Win7 Pro 64	3-year, Depot	11/16
20FW0057US	US	i7-6820HQ	vPro	940MX 2GB	8GBx1	14" FHD (1920x1080) IPS	None	256GB SSD Opal2	None	Intel 8260 ac, 2x2 + BT4.1	WWAN Upgradable	None	None	720p	Backlit	Fingerprint Reader	6-cell (48Wh)	135W	Win10 Pro 64	3-year, Depot	12/16



ThinkPad T460s Platform Specifications

Product Specifications Reference (PSREF)

Processor	6th Generation Intel® Core™ i5 / i7 Processor							Smart card reader Media reader Ports WiGig dock (opt)	Optional: Smart card reader 4-in-1 reader (MMC, SD, SDHC, SDXC) Three USB 3.0 (one Always On), MiniDP, HDMI, Ethernet (RJ-45), Dock connector WiGig dock, mutually exclusive with WWAN	
	Processor Number	# of Cores	# of Threads	Base Frequency	Max Turbo Frequency	Cache	Memory Types			Processor Graphics
	i5-6200U	2	4	2.3 GHz	2.8 GHz	3MB	DDR4-2133			Intel HD Graphics 520
	i5-6300U			2.4 GHz	3 GHz	3MB				
i7-6600U	2.6 GHz			3.4 GHz	4MB					
Graphics	Intel HD Graphics 520 in processor only, or Intel HD Graphics 520 in processor and NVIDIA GeForce® 930M, 2GB memory (discrete graphics is only available in US); supports external digital monitor via HDMI or Mini DisplayPort; supports three independent displays; Max resolution: 3840x2160@60Hz (DisplayPort via Mini DisplayPort cable); 4096x2160@24Hz (HDMI)							Camera (optional) Audio support	HD720p resolution, low light sensitive, fixed focus HD Audio, Realtek® ALC3245 codec / stereo speakers, 1W x 2 / dual array microphone, combo audio/microphone jack	
Chipset	Intel SoC (System on Chip) platform							Keyboard	6-row, spill-resistant, multimedia Fn keys, optional LED backlight	
Memory	20GB or 24GB max ⁷ / 2133MHz DDR4, dual-channel capable, 4GB or 8GB memory soldered to systemboard, one DDR4 SO-DIMM socket							UltraNav™	TrackPoint® pointing device and buttonless crystal silk surface multi-touch touchpad	
Display	Some: 14.0" (355mm) FHD (1920x1080), anti-glare, LED backlight, IPS, 250 nits, 16:9 aspect ratio, 700:1 contrast ratio, 160° viewing angle Some: 14.0" (355mm) WQHD (2560x1440), anti-glare, LED backlight, IPS, 300 nits, 16:9 aspect ratio, 700:1 contrast ratio, 160° viewing angle							Security	Power-on password, hard disk password, supervisor password, security keyhole	
Multi-touch (opt)	In-cell touch, supports 10-finger gesture, 250 nits							Security chip	Discrete TPM 1.2 TCG Certified and Firmware TPM 2.0 integrated in chipset	
Storage	Some: M.2 SSD / SATA 6.0Gb/s (e.g. xxxG SSD) Some: M.2 SSD / PCIe NVMe, PCIe 3.0 x 4, 32Gb/s (e.g. xxxG SSD PCIe NVMe)							ThinkEngine	Delivers improved thermal and power efficiency, up to 30 day standby, faster resume time, enhanced security, as well as anti-tampering measures	
Optical	None							vPro (optional)	Intel vPro Technology	
Ethernet	Non-vPro model: Intel Ethernet Connection I219-V (Jacksonville) vPro model: Intel Ethernet Connection I219-LM (Jacksonville)							Fingerprint reader	Optional: Touch style fingerprint reader on the palm rest	
WLAN ⁴	One of the following, configurable by model (WiGig is mutually exclusive with WWAN): • 11ac+BT, Broadcom BCM4356, 2x2, M.2 card • 11ac+BT, Intel Dual Band Wireless-AC 8260, 2x2, M.2 card • WiGig™+11ac+BT, Intel Tri-Band Wireless-AC 18260, 2x2 WLAN, WiGig, M.2 card							Internal battery	Front Li-Polymer 3-cell (23Wh) and rear Li-Ion 3-cell (26Wh), both Integrated	
Bluetooth™	Bluetooth 4.1 wireless, integrated in Wi-Fi + Bluetooth combo adapter							Max battery life ¹⁰	MobileMark® 2014: up to 10.5 hr	
WWAN (optional)	One of the following, configurable by model (mutually exclusive with WiGig): • Wireless WAN upgradable • Wireless WAN, Sierra Wireless EM7455, Qualcomm® 4G LTE-Advanced/DC-HSPA+/HSPA+/HSPA/UMTS/GNSS, M.2 card • Wireless WAN, HUAWEI ME906S, HUAWEI 4G LTE/WCDMA/HSPA/GSM/GPRS/EDGE/GNSS, M.2 card (WE only)							AC adapter	45W or 65W AC adapter	
SIM card (opt)	Micro-SIM card slot, optional Verizon LTE (US) or Lenovo Connect (WE) SIM card							Preload	Windows 7 Professional 64 preinstalled through downgrade rights in Windows 10 Pro 64 • Lenovo Solution Center • Lenovo Companion • Lenovo Setting • Microsoft Office preloaded; purchase a product key to activate • McAfee® LiveSafe™ (30-day trial)	
Dimensions ³	WxDxH: 13.03" x 8.93" x 0.67-0.74"; 331mm x 226.8mm x 16.9-18.8mm							Limited warranty ¹²	One of the following, configurable by model: • 1-year depot repair service • 3-year/1-yr battery depot repair service • 3-year/1-yr battery limited onsite service ²⁴ • 3-year/1-yr battery limited onsite service, OID (Onsite International Delivery)	
Weight ²	Integrated model: starting at 3.0 lb (1.36kg); Discrete model: starting at 3.3 lb (1.50kg)							Mil-Spec test	MIL-STD-810G military certification	
Case material	Display cover: Carbon-Fiber Reinforced Plastic; Bottom: Magnesium alloy							Environment	EPEAT™ Gold (US only); ENERGY STAR® 6.1; GREENGUARD®; RoHS-compliant	

Model	Region	Processor	vPro	Graphics	Memory (Soldered +DIMM)	Display	Multi-touch	Storage(HDD/SSD)	Optical	WLAN + Bluetooth	WWAN	SIM Card	Smart Card Reader	Dock	Camera	Keyboard	Fingerprint Reader	Battery (internal)	Power Adapter	Operating System	Warranty	Ann Date (m/y)
20F90017US	US	i5-6200U	No	Intel HD 520	4GB + 4GB	14" FHD (1920x1080) IPS	None	256GB SSD M.2 Opal2	None	Intel 8260 ac, 2x2 + BT4.1	WWAN Upgradable	None	None	None	720p	Backlit	Fingerprint Reader	3-cell(23Wh) + 3-cell(26Wh)	45W	Win10 Pro 64	3-year, Depot	10/16
20F90018US	US	i5-6200U	No	Intel HD 520	4GB + 4GB	14" FHD (1920x1080) IPS	None	256GB SSD M.2 Opal2	None	Intel 8260 ac, 2x2 + BT4.1	WWAN Upgradable	None	None	None	720p	Backlit	Fingerprint Reader	3-cell(23Wh) + 3-cell(26Wh)	45W	Win10 DG Win7 Pro 64	3-year, Depot	10/16
20F90019US	US	i7-6600U	vPro	Intel HD 520	4GB + 8GB	14" WQHD (2560x1440) IPS	None	512GB SSD M.2	None	Intel 8260 ac, 2x2 + BT4.1	WWAN Upgradable	None	None	None	720p	Backlit	Fingerprint Reader	3-cell(23Wh) + 3-cell(26Wh)	45W	Win10 Pro 64	3-year, Depot	02/16
20F9001CUS	US	i7-6600U	vPro	Intel HD 520	4GB + 4GB	14" FHD (1920x1080) IPS	None	256GB SSD M.2 Opal2	None	Intel 8260 ac, 2x2 + BT4.1	WWAN Upgradable	None	None	None	720p	Backlit	Fingerprint Reader	3-cell(23Wh) + 3-cell(26Wh)	45W	Win10 Pro 64	3-year, Depot	02/16
20F9001DUS	US	i7-6600U	vPro	Intel HD 520	4GB + 8GB	14" FHD (1920x1080) IPS	None	512GB SSD M.2	None	Intel 8260 ac, 2x2 + BT4.1	WWAN Upgradable	None	None	None	720p	Backlit	Fingerprint Reader	3-cell(23Wh) + 3-cell(26Wh)	45W	Win10 DG Win7 Pro 64	3-year, Depot	02/16
20F90033US	US	i7-6600U	vPro	Intel HD 520	4GB + 4GB	14" WQHD (2560x1440) IPS	None	512GB SSD M.2	None	Intel 8260 ac, 2x2 + BT4.1	WWAN Upgradable	None	None	None	720p	Backlit	Fingerprint Reader	3-cell(23Wh) + 3-cell(26Wh)	45W	Win10 DG Win7 Pro 64	3-year, Depot	02/16
20F90034US	US	i5-6300U	vPro	Intel HD 520	4GB Soldered	14" FHD (1920x1080) IPS	None	128GB SSD M.2	None	Intel 8260 ac, 2x2 + BT4.1	WWAN Upgradable	None	None	None	720p	Non-backlit	Fingerprint Reader	3-cell(23Wh) + 3-cell(26Wh)	45W	Win10 DG Win7 Pro 64	3-year, Depot	02/16
20F90035US	US	i7-6600U	vPro	Intel HD 520	4GB + 4GB	14" FHD (1920x1080) IPS	None	512GB SSD M.2	None	Intel 8260 ac, 2x2 + BT4.1	WWAN Upgradable	None	None	None	720p	Backlit	Fingerprint Reader	3-cell(23Wh) + 3-cell(26Wh)	45W	Win10 DG Win7 Pro 64	3-year, Depot	02/16
20F90036US	US	i5-6300U	vPro	Intel HD 520	4GB + 4GB	14" FHD (1920x1080) IPS	None	128GB SSD M.2	None	Intel 8260 ac, 2x2 + BT4.1	WWAN Upgradable	None	None	None	720p	Backlit	Fingerprint Reader	3-cell(23Wh) + 3-cell(26Wh)	45W	Win10 DG Win7 Pro 64	3-year, Depot	02/16
20F90037US	US	i7-6600U	vPro	Intel HD 520	4GB + 4GB	14" FHD (1920x1080) IPS	None	180GB SSD M.2 Opal2	None	Intel 8260 ac, 2x2 + BT4.1	WWAN Upgradable	None	None	None	720p	Backlit	Fingerprint Reader	3-cell(23Wh) + 3-cell(26Wh)	45W	Win10 DG Win7 Pro 64	3-year, Depot	02/16
20F90038US	US	i5-6300U	vPro	Intel HD 520	4GB + 4GB	14" FHD (1920x1080) IPS	10-point Multi-touch	256GB SSD M.2 Opal2	None	Intel 8260 ac, 2x2 + BT4.1	WWAN Upgradable	None	None	None	720p	Backlit	Fingerprint Reader	3-cell(23Wh) + 3-cell(26Wh)	45W	Win10 Pro 64	3-year, Depot	02/16
20F90039US	US	i5-6200U	No	Intel HD 520	4GB Soldered	14" FHD (1920x1080) IPS	None	128GB SSD M.2	None	Intel 8260 ac, 2x2 + BT4.1	WWAN Upgradable	None	None	None	720p	Non-backlit	Fingerprint Reader	3-cell(23Wh) + 3-cell(26Wh)	45W	Win10 DG Win7 Pro 64	1-year, Depot	02/16
20F9003AUS	US	i7-6600U	vPro	Intel HD 520	4GB + 4GB	14" WQHD (2560x1440) IPS	None	256GB SSD M.2 Opal2	None	Intel 8260 ac, 2x2 + BT4.1	WWAN Upgradable	None	None	None	720p	Backlit	Fingerprint Reader	3-cell(23Wh) + 3-cell(26Wh)	45W	Win10 DG Win7 Pro 64	3-year, Depot	02/16
20F9003BUS	US	i5-6300U	vPro	Intel HD 520	4GB Soldered	14" FHD (1920x1080) IPS	None	180GB SSD M.2 Opal2	None	Intel 8260 ac, 2x2 + BT4.1	WWAN Upgradable	None	None	None	720p	Backlit	Fingerprint Reader	3-cell(23Wh) + 3-cell(26Wh)	45W	Win10 DG Win7 Pro 64	3-year, Depot	02/16
20F9003CUS	US	i7-6600U	vPro	Intel HD 520	4GB + 4GB	14" FHD (1920x1080) IPS	None	256GB SSD M.2 Opal2	None	Intel 8260 ac, 2x2 + BT4.1	WWAN Upgradable	None	None	None	720p	Backlit	Fingerprint Reader	3-cell(23Wh) + 3-cell(26Wh)	45W	Win10 DG Win7 Pro 64	3-year, Depot	02/16
20F9003DUS	US	i5-6300U	vPro	Intel HD 520	4GB + 4GB	14" FHD (1920x1080) IPS	None	192GB SSD M.2	None	Intel 8260 ac, 2x2 + BT4.1	WWAN Upgradable	None	None	None	720p	Backlit	Fingerprint Reader	3-cell(23Wh) + 3-cell(26Wh)	45W	Win10 DG Win7 Pro 64	3-year, Depot	02/16
20F9003EUS	US	i5-6300U	vPro	Intel HD 520	4GB + 4GB	14" FHD (1920x1080) IPS	None	128GB SSD M.2	None	Intel 8260 ac, 2x2 + BT4.1	WWAN Upgradable	None	None	None	720p	Non-backlit	Fingerprint Reader	3-cell(23Wh) + 3-cell(26Wh)	45W	Win10 DG Win7 Pro 64	3-year, Depot	02/16
20F9003FUS	US	i7-6600U	vPro	Intel HD 520	4GB + 4GB	14" FHD (1920x1080) IPS	10-point Multi-touch	256GB SSD M.2 Opal2	None	Intel 8260 ac, 2x2 + BT4.1	WWAN Upgradable	None	None	None	720p	Backlit	Fingerprint Reader	3-cell(23Wh) + 3-cell(26Wh)	45W	Win10 Pro 64	3-year, Depot	02/16
20F9003GUS	US	i5-6300U	vPro	Intel HD 520	4GB + 4GB	14" FHD (1920x1080) IPS	None	256GB SSD M.2 Opal2	None	Intel 8260 ac, 2x2 + BT4.1	WWAN Upgradable	None	None	None	720p	Backlit	Fingerprint Reader	3-cell(23Wh) + 3-cell(26Wh)	45W	Win10 DG Win7 Pro 64	3-year, Depot	02/16
20F9003HUS	US	i5-6300U	vPro	Intel HD 520	4GB + 4GB	14" FHD (1920x1080) IPS	None	180GB SSD M.2 Opal2	None	Intel 8260 ac, 2x2 + BT4.1	WWAN Upgradable	None	None	None	720p	Backlit	Fingerprint Reader	3-cell(23Wh) + 3-cell(26Wh)	45W	Win10 DG Win7 Pro 64	3-year, Depot	02/16

Model	Region	Processor	vPro	Graphics	Memory (Soldered +DIMM)	Display	Multi-touch	Storage(HDD/SSD)	Optical	WLAN + Bluetooth	WWAN	SIM Card	Smart Card Reader	Dock	Camera	Keyboard	Fingerprint Reader	Battery (Internal)	Power Adapter	Operating System	Warranty	Ann Date (m/y)
20F9003JUS	US	i5-6300U	vPro	Intel HD 520	4GB Soldered	14" FHD (1920x1080) IPS	None	128GB SSD M.2	None	Intel 8260 ac, 2x2 + BT4.1	WWAN Upgradable	None	None	None	720p	Backlit	Fingerprint Reader	3-cell(23Wh) + 3-cell(26Wh)	45W	Win10 DG Win7 Pro 64	3-year, Depot	02/16
20F9004DUS	US	i7-6600U	vPro	Intel HD 520	4GB + 8GB	14" FHD (1920x1080) IPS	None	512GB SSD M.2	None	Intel 8260 ac, 2x2 + BT4.1	WWAN Upgradable	None	None	None	720p	Backlit	Fingerprint Reader	3-cell(23Wh) + 3-cell(26Wh)	45W	Win10 Pro 64	3-year, Depot	02/16
20F9004EUS	US	i5-6300U	vPro	Intel HD 520	4GB + 4GB	14" FHD (1920x1080) IPS	None	192GB SSD M.2	None	Intel 8260 ac, 2x2 + BT4.1	WWAN Upgradable	None	None	None	720p	Backlit	Fingerprint Reader	3-cell(23Wh) + 3-cell(26Wh)	45W	Win10 Pro 64	3-year, Depot	02/16
20F9004FUS	US	i5-6200U	No	Intel HD 520	4GB + 4GB	14" FHD (1920x1080) IPS	None	192GB SSD M.2	None	Intel 8260 ac, 2x2 + BT4.1	WWAN Upgradable	None	None	None	720p	Backlit	Fingerprint Reader	3-cell(23Wh) + 3-cell(26Wh)	45W	Win10 DG Win7 Pro 64	3-year, Depot	02/16
20F9004GUS	US	i7-6600U	vPro	Intel HD 520	4GB + 8GB	14" WQHD (2560x1440) IPS	None	512GB SSD M.2	None	Intel 18260 ac, 2x2 + BT4.1	None	None	None	WiGig Dock	720p	Backlit	Fingerprint Reader	3-cell(23Wh) + 3-cell(26Wh)	45W	Win10 Pro 64	3-year, Depot	02/16
20F9004JUS	US	i5-6200U	No	Intel HD 520	4GB Soldered	14" FHD (1920x1080) IPS	None	128GB SSD M.2	None	Intel 8260 ac, 2x2 + BT4.1	WWAN Upgradable	None	None	None	720p	Non-backlit	Fingerprint Reader	3-cell(23Wh) + 3-cell(26Wh)	45W	Win10 Pro 64	1-year, Depot	02/16
20F9004LUS	US	i5-6200U	No	Intel HD 520	4GB + 4GB	14" FHD (1920x1080) IPS	None	192GB SSD M.2	None	Intel 8260 ac, 2x2 + BT4.1	WWAN Upgradable	None	None	None	720p	Backlit	Fingerprint Reader	3-cell(23Wh) + 3-cell(26Wh)	45W	Win10 Pro 64	3-year, Depot	02/16
20F9004MUS	US	i7-6600U	vPro	Intel HD 520	4GB + 8GB	14" WQHD (2560x1440) IPS	None	512GB SSD M.2	None	Intel 8260 ac, 2x2 + BT4.1	WWAN Upgradable	None	None	None	720p	Backlit	Fingerprint Reader	3-cell(23Wh) + 3-cell(26Wh)	45W	Win10 DG Win7 Pro 64	3-year, Depot	02/16
20F9004NUS	US	i5-6300U	vPro	Intel HD 520	4GB + 4GB	14" FHD (1920x1080) IPS	None	256GB SSD M.2 Opal2	None	Intel 8260 ac, 2x2 + BT4.1	WWAN Upgradable	None	None	None	720p	Backlit	Fingerprint Reader	3-cell(23Wh) + 3-cell(26Wh)	45W	Win10 Pro 64	3-year, Depot	02/16
20F9004PUS	US	i7-6600U	vPro	Intel HD 520	4GB + 8GB	14" WQHD (2560x1440) IPS	None	512GB SSD M.2	None	Intel 18260 ac, 2x2 + BT4.1	None	None	None	WiGig Dock	720p	Backlit	Fingerprint Reader	3-cell(23Wh) + 3-cell(26Wh)	45W	Win10 DG Win7 Pro 64	3-year, Depot	02/16
20F9005AUS	US	i7-6600U	vPro	Intel HD 520	4GB + 16GB	14" WQHD (2560x1440) IPS	None	512GB SSD M.2	None	Intel 8260 ac, 2x2 + BT4.1	WWAN Upgradable	None	None	None	720p	Backlit	Fingerprint Reader	3-cell(23Wh) + 3-cell(26Wh)	45W	Win10 Pro 64	3-year, Depot	03/16
20F9005BUS	US	i7-6600U	vPro	Intel HD 520	4GB + 16GB	14" WQHD (2560x1440) IPS	None	512GB SSD M.2	None	Intel 8260 ac, 2x2 + BT4.1	WWAN Upgradable	None	None	None	720p	Backlit	Fingerprint Reader	3-cell(23Wh) + 3-cell(26Wh)	45W	Win10 DG Win7 Pro 64	3-year, Depot	03/16
20F9005DUS	US	i7-6600U	vPro	Intel HD 520	4GB + 8GB	14" WQHD (2560x1440) IPS	None	256GB SSD M.2 Opal2	None	Intel 18260 ac, 2x2 + BT4.1	None	None	None	WiGig Dock	720p	Backlit	Fingerprint Reader	3-cell(23Wh) + 3-cell(26Wh)	45W	Win10 Pro 64	3-year, Depot	04/16
20F9005EUS	US	i5-6300U	vPro	930M 2GB	4GB + 4GB	14" FHD (1920x1080) IPS	None	256GB SSD M.2 Opal2	None	Intel 8260 ac, 2x2 + BT4.1	WWAN Upgradable	None	None	None	720p	Backlit	Fingerprint Reader	3-cell(23Wh) + 3-cell(26Wh)	65W	Win10 DG Win7 Pro 64	3-year, Depot	04/16
20F9005FUS	US	i7-6600U	vPro	930M 2GB	8GB Soldered	14" WQHD (2560x1440) IPS	None	512GB SSD M.2	None	Intel 8260 ac, 2x2 + BT4.1	WWAN Upgradable	None	None	None	720p	Backlit	Fingerprint Reader	3-cell(23Wh) + 3-cell(26Wh)	65W	Win10 DG Win7 Pro 64	3-year, Depot	04/16
20F9005GUS	US	i5-6300U	vPro	930M 2GB	4GB + 4GB	14" FHD (1920x1080) IPS	None	256GB SSD M.2 Opal2	None	Intel 8260 ac, 2x2 + BT4.1	WWAN Upgradable	None	None	None	720p	Backlit	Fingerprint Reader	3-cell(23Wh) + 3-cell(26Wh)	65W	Win10 Pro 64	3-year, Depot	04/16
20F9005HUS	US	i7-6600U	vPro	930M 2GB	8GB Soldered	14" FHD (1920x1080) IPS	None	256GB SSD M.2 Opal2	None	Intel 8260 ac, 2x2 + BT4.1	WWAN Upgradable	None	None	None	720p	Backlit	Fingerprint Reader	3-cell(23Wh) + 3-cell(26Wh)	65W	Win10 Pro 64	3-year, Depot	04/16
20F9005JUS	US	i7-6600U	vPro	930M 2GB	8GB Soldered	14" WQHD (2560x1440) IPS	None	512GB SSD M.2	None	Intel 8260 ac, 2x2 + BT4.1	WWAN Upgradable	None	None	None	720p	Backlit	Fingerprint Reader	3-cell(23Wh) + 3-cell(26Wh)	65W	Win10 Pro 64	3-year, Depot	04/16
20F9005KUS	US	i7-6600U	vPro	930M 2GB	8GB Soldered	14" FHD (1920x1080) IPS	None	256GB SSD M.2 Opal2	None	Intel 8260 ac, 2x2 + BT4.1	WWAN Upgradable	None	None	None	720p	Backlit	Fingerprint Reader	3-cell(23Wh) + 3-cell(26Wh)	65W	Win10 DG Win7 Pro 64	3-year, Depot	04/16
20F9005LUS	US	i7-6600U	vPro	Intel HD 520	4GB + 8GB	14" WQHD (2560x1440) IPS	None	256GB SSD M.2 Opal2	None	Intel 18260 ac, 2x2 + BT4.1	None	None	None	WiGig Dock	720p	Backlit	Fingerprint Reader	3-cell(23Wh) + 3-cell(26Wh)	45W	Win10 DG Win7 Pro 64	3-year, Depot	04/16

Model	Region	Processor	vPro	Graphics	Memory (Soldered +DIMM)	Display	Multi-touch	Storage(HDD/SSD)	Optical	WLAN + Bluetooth	WWAN	SIM Card	Smart Card Reader	Dock	Camera	Keyboard	Fingerprint Reader	Battery (internal)	Power Adapter	Operating System	Warranty	Ann Date (m/y)
20F9006XUS	US	i5-6200U	No	Intel HD 520	4GB + 4GB	14" FHD (1920x1080) IPS	None	180GB SSD M.2 Opal2	None	Intel 8260 ac, 2x2 + BT4.1	WWAN Upgradable	None	None	None	720p	Backlit	Fingerprint Reader	3-cell(23Wh) + 3-cell(26Wh)	45W	Win10 DG Win7 Pro 64	3-year, Depot	10/16
20F9006YUS	US	i5-6200U	No	Intel HD 520	4GB + 4GB	14" FHD (1920x1080) IPS	None	180GB SSD M.2 Opal2	None	Intel 8260 ac, 2x2 + BT4.1	WWAN Upgradable	None	None	None	720p	Backlit	Fingerprint Reader	3-cell(23Wh) + 3-cell(26Wh)	45W	Win10 Pro 64	3-year, Depot	10/16
20F90076US	US	i5-6200U	No	Intel HD 520	4GB + 4GB	14" WQHD (2560x1440) IPS	None	180GB SSD M.2 Opal2	None	Intel 8260 ac, 2x2 + BT4.1	WWAN Upgradable	None	None	None	720p	Backlit	Fingerprint Reader	3-cell(23Wh) + 3-cell(26Wh)	45W	Win10 DG Win7 Pro 64	3-year, Depot	10/16
20F90077US	US	i5-6300U	vPro	Intel HD 520	4GB + 4GB	14" FHD (1920x1080) IPS	None	180GB SSD M.2 Opal2	None	Intel 8260 ac, 2x2 + BT4.1	WWAN Upgradable	None	None	None	720p	Backlit	Fingerprint Reader	3-cell(23Wh) + 3-cell(26Wh)	45W	Win10 Pro 64	3-year, Depot	11/16



ThinkPad T470 Platform Specifications

Product Specifications Reference (PSREF)

Processor	<p>6th Generation Intel® Core™ i5 / i7 Processor (<i>i7-6500U is not available in EMEA</i>)</p> <table border="1"> <thead> <tr> <th>Processor Number</th> <th># of Cores</th> <th># of Threads</th> <th>Base Frequency</th> <th>Max Turbo Frequency</th> <th>Cache</th> <th>Memory Types</th> <th>Processor Graphics</th> </tr> </thead> <tbody> <tr> <td>i5-6200U</td> <td rowspan="4">2</td> <td rowspan="4">4</td> <td>2.3 GHz</td> <td>2.8 GHz</td> <td>3MB</td> <td rowspan="4">DDR4-2133</td> <td rowspan="4">Intel HD Graphics 520</td> </tr> <tr> <td>i5-6300U</td> <td>2.4 GHz</td> <td>3.0 GHz</td> <td>3MB</td> </tr> <tr> <td>i7-6500U</td> <td>2.5 GHz</td> <td>3.1 GHz</td> <td>4MB</td> </tr> <tr> <td>i7-6600U</td> <td>2.6 GHz</td> <td>3.4 GHz</td> <td>4MB</td> </tr> </tbody> </table> <p>or 7th Generation Intel Core i3 / i5 / i7 Processor</p> <table border="1"> <thead> <tr> <th>Processor Number</th> <th># of Cores</th> <th># of Threads</th> <th>Base Frequency</th> <th>Max Turbo Frequency</th> <th>Cache</th> <th>Memory Types</th> <th>Processor Graphics</th> </tr> </thead> <tbody> <tr> <td>i3-7100U</td> <td rowspan="5">2</td> <td rowspan="5">4</td> <td>2.4 GHz</td> <td>-</td> <td>3MB</td> <td rowspan="5">DDR4-2133</td> <td rowspan="5">Intel HD Graphics 620</td> </tr> <tr> <td>i5-7200U</td> <td>2.5 GHz</td> <td>3.1 GHz</td> <td>3MB</td> </tr> <tr> <td>i5-7300U</td> <td>2.6 GHz</td> <td>3.5 GHz</td> <td>3MB</td> </tr> <tr> <td>i7-7500U</td> <td>2.7 GHz</td> <td>3.5 GHz</td> <td>4MB</td> </tr> <tr> <td>i7-7600U</td> <td>2.8 GHz</td> <td>3.9 GHz</td> <td>4MB</td> </tr> </tbody> </table>	Processor Number	# of Cores	# of Threads	Base Frequency	Max Turbo Frequency	Cache	Memory Types	Processor Graphics	i5-6200U	2	4	2.3 GHz	2.8 GHz	3MB	DDR4-2133	Intel HD Graphics 520	i5-6300U	2.4 GHz	3.0 GHz	3MB	i7-6500U	2.5 GHz	3.1 GHz	4MB	i7-6600U	2.6 GHz	3.4 GHz	4MB	Processor Number	# of Cores	# of Threads	Base Frequency	Max Turbo Frequency	Cache	Memory Types	Processor Graphics	i3-7100U	2	4	2.4 GHz	-	3MB	DDR4-2133	Intel HD Graphics 620	i5-7200U	2.5 GHz	3.1 GHz	3MB	i5-7300U	2.6 GHz	3.5 GHz	3MB	i7-7500U	2.7 GHz	3.5 GHz	4MB	i7-7600U	2.8 GHz	3.9 GHz	4MB	Dimensions Weight <table border="1"> <tr> <td><i>WxDxH:</i></td> <td colspan="2">13.25" x 9.15" x 0.79"; 336.6mm x 232.5mm x 19.95mm</td> </tr> <tr> <td><i>Models</i></td> <td><i>3-cell or 3 + 3-cell</i></td> <td><i>6-cell or 3 + 6-cell</i></td> </tr> <tr> <td><i>Magnesium</i></td> <td>3.49 lb / 1.58 kg</td> <td>3.92 lb / 1.78 kg</td> </tr> <tr> <td><i>PPS</i></td> <td>3.63 lb / 1.65 kg</td> <td>4.35 lb / 1.85 kg</td> </tr> </table> Case color Case material <p>Black <i>Display cover:</i> Magnesium Hybrid or PPS; <i>Bottom:</i> Glass-Fiber Reinforced Plastic</p>	<i>WxDxH:</i>	13.25" x 9.15" x 0.79"; 336.6mm x 232.5mm x 19.95mm		<i>Models</i>	<i>3-cell or 3 + 3-cell</i>	<i>6-cell or 3 + 6-cell</i>	<i>Magnesium</i>	3.49 lb / 1.58 kg	3.92 lb / 1.78 kg	<i>PPS</i>	3.63 lb / 1.65 kg	4.35 lb / 1.85 kg
Processor Number	# of Cores	# of Threads	Base Frequency	Max Turbo Frequency	Cache	Memory Types	Processor Graphics																																																																			
i5-6200U	2	4	2.3 GHz	2.8 GHz	3MB	DDR4-2133	Intel HD Graphics 520																																																																			
i5-6300U			2.4 GHz	3.0 GHz	3MB																																																																					
i7-6500U			2.5 GHz	3.1 GHz	4MB																																																																					
i7-6600U			2.6 GHz	3.4 GHz	4MB																																																																					
Processor Number	# of Cores	# of Threads	Base Frequency	Max Turbo Frequency	Cache	Memory Types	Processor Graphics																																																																			
i3-7100U	2	4	2.4 GHz	-	3MB	DDR4-2133	Intel HD Graphics 620																																																																			
i5-7200U			2.5 GHz	3.1 GHz	3MB																																																																					
i5-7300U			2.6 GHz	3.5 GHz	3MB																																																																					
i7-7500U			2.7 GHz	3.5 GHz	4MB																																																																					
i7-7600U			2.8 GHz	3.9 GHz	4MB																																																																					
<i>WxDxH:</i>	13.25" x 9.15" x 0.79"; 336.6mm x 232.5mm x 19.95mm																																																																									
<i>Models</i>	<i>3-cell or 3 + 3-cell</i>	<i>6-cell or 3 + 6-cell</i>																																																																								
<i>Magnesium</i>	3.49 lb / 1.58 kg	3.92 lb / 1.78 kg																																																																								
<i>PPS</i>	3.63 lb / 1.65 kg	4.35 lb / 1.85 kg																																																																								
Graphics	<p>Intel HD Graphics 520 or 620 in processor only, or Intel HD Graphics 620 in processor and NVIDIA GeForce® 940MX, 2GB 2.5GHz GDDR5 memory (discrete models are NOT available in EMEA); supports external digital monitor via HDMI or USB Type-C; supports three independent displays; Max resolution: 4096x2304@60Hz (USB Type-C); 4096x2160@24Hz (HDMI)</p>	Smart card reader Media reader Ports WiGig dock (opt) Monitor cable Camera (optional) Audio support Keyboard UltraNav™ Security Security chip vPro (optional) Fingerprint reader NFC (optional)																																																																								
Chipset Memory	<p>Intel SoC (System on Chip) platform 32GB max / 2400MHz DDR4, dual-channel capable, two DDR4 SO-DIMM sockets * System clocks down for processors with lower memory controller</p>	720p: HD720p resolution, fixed focus <i>IR & 720p:</i> IR camera and HD720p camera (mutually exclusive with WiGig) HD Audio, Realtek ALC3268 codec / stereo speakers, 2W x 2 / dual array microphone, combo audio/microphone jack 6-row, spill-resistant, multimedia Fn keys, optional LED backlight TrackPoint® pointing device and buttonless Mylar surface multi-touch touchpad Power-on password, hard disk password, supervisor password, security keyhole Discrete TPM 2.0, TCG Certified Intel vPro Technology <i>Optional:</i> Touch style match on chip fingerprint reader on the keyboard bezel Near Field Communication																																																																								
Display Multi-touch (opt)	<p><i>Some:</i> 14.0" (355mm) HD (1366x768), anti-glare, LED backlight, 220 nits, 16:9 aspect ratio, 400:1 contrast ratio <i>Some:</i> 14.0" (355mm) FHD (1920x1080), anti-glare, LED backlight, 220 nits, 16:9 aspect ratio, 400:1 or 500:1 contrast ratio <i>Some:</i> 14.0" (355mm) FHD (1920x1080), anti-glare, LED backlight, IPS, 250 nits, 16:9 aspect ratio, 700:1 contrast ratio, 170° viewing angle</p> <p>On-cell touch, supports 10-finger gesture (FHD only)</p>	Internal battery External battery Max battery life (MobileMark® 2014) <table border="1"> <thead> <tr> <th><i>Models</i></th> <th><i>3-cell</i></th> <th><i>3 + 3-cell</i></th> <th><i>6-cell 48Wh</i></th> <th><i>6-cell 72Wh</i></th> <th><i>3 + 6-cell 48Wh</i></th> <th><i>3 + 6-cell 72Wh</i></th> </tr> </thead> <tbody> <tr> <td><i>Integrated</i></td> <td>6.9 hr</td> <td>13.9 hr</td> <td>13.9 hr</td> <td>20.9 hr</td> <td>20.9 hr</td> <td>27.1 hr</td> </tr> <tr> <td><i>Discrete</i></td> <td>6.9 hr</td> <td>13.9 hr</td> <td>14.3 hr</td> <td>21.6 hr</td> <td>21.2 hr</td> <td>28.6 hr</td> </tr> </tbody> </table>	<i>Models</i>	<i>3-cell</i>	<i>3 + 3-cell</i>	<i>6-cell 48Wh</i>	<i>6-cell 72Wh</i>	<i>3 + 6-cell 48Wh</i>	<i>3 + 6-cell 72Wh</i>	<i>Integrated</i>	6.9 hr	13.9 hr	13.9 hr	20.9 hr	20.9 hr	27.1 hr	<i>Discrete</i>	6.9 hr	13.9 hr	14.3 hr	21.6 hr	21.2 hr	28.6 hr																																																			
<i>Models</i>	<i>3-cell</i>	<i>3 + 3-cell</i>	<i>6-cell 48Wh</i>	<i>6-cell 72Wh</i>	<i>3 + 6-cell 48Wh</i>	<i>3 + 6-cell 72Wh</i>																																																																				
<i>Integrated</i>	6.9 hr	13.9 hr	13.9 hr	20.9 hr	20.9 hr	27.1 hr																																																																				
<i>Discrete</i>	6.9 hr	13.9 hr	14.3 hr	21.6 hr	21.2 hr	28.6 hr																																																																				
Storage Optical	<p><i>System has one HDD slot or one M.2 2280 slot exclusively for storage</i> <i>Some:</i> HDD / SATA 6.0Gb/s, 2.5" wide, 7mm high, Active Protection System™ <i>Some:</i> SSD / SATA 6.0Gb/s, 2.5" wide, 7mm high (e.g. xxxGB SSD) <i>Some:</i> M.2 SSD / PCIe NVMe, PCIe 3.0 x 2, 16Gb/s <i>Some:</i> 128GB M.2 SSD / SATA 6.0Gb/s, in WWAN slot as 2nd Storage, mutually exclusive with WWAN and WiGig</p> <p>None</p>	AC adapter Preload <p>45W or 65W AC adapter (slim tip), 45W or 65W USB Type-C AC adapter</p> <p>Windows® 7 Professional 64 preinstalled through downgrade rights in Windows 10 Pro 64 <i>Some:</i> Windows 10 Home 64 <i>Some:</i> Windows 10 Pro 64</p> <ul style="list-style-type: none"> • Lenovo Solution Center • Lenovo PowerEngage • ThinkVantage Product Recovery • ThinkVantage System Update • Adobe® Reader® • Microsoft® Office preloaded; purchase a product key to activate • McAfee® LiveSafe™ (30-day trial) 																																																																								
Ethernet WLAN	<p><i>Non-vPro model:</i> Intel Ethernet Connection I219-V (Jacksonville) <i>vPro model:</i> Intel Ethernet Connection I219-LM (Jacksonville)</p> <p><i>One of the following, configurable by model (WiGig can coexist with WWAN):</i></p> <ul style="list-style-type: none"> • Realtek® RTL8822BE, Wi-Fi 2x2 802.11ac + BT4.1, M.2 card • Intel Dual Band Wireless-AC 8260, Wi-Fi 2x2 802.11ac + BT4.1, M.2 card • Intel Dual Band Wireless-AC 8265, Wi-Fi 2x2 802.11ac + BT4.1, M.2 card • Intel Tri-Band Wireless-AC 18265, WiGig 802.11ad + Wi-Fi 2x2 802.11ac + BT4.1, M.2 card 	Limited warranty Mil-Spec test Environment <p><i>One of the following, configurable by model:</i></p> <ul style="list-style-type: none"> • 1-year depot repair service • 3-year/1-yr battery depot repair service • 3-year/1-yr battery limited onsite service <p>MIL-STD-810G military certification</p> <p>EPEAT™ Gold (US only); ENERGY STAR® 6.1; RoHS-compliant</p>																																																																								
Bluetooth™ WWAN (optional) SIM card (opt)	<p>Bluetooth 4.1 wireless, integrated in Wi-Fi + Bluetooth combo adapter * Intel 8265ac / 18265ac card support BT4.2 but is limited to BT4.1 by Windows OS</p> <p><i>One of the following, configurable by model (WWAN can coexist with WiGig):</i></p> <ul style="list-style-type: none"> • Wireless WAN upgradable • Integrated Mobile Broadband 4G LTE-A, Qualcomm® Snapdragon™ X7 LTE-A (Sierra Wireless EM7455), M.2 card • Integrated Mobile Broadband 4G LTE, Intel XMM™ 7160 (Fibocom L831-EAU), M.2 card (EMEA only) <p>Micro-SIM card slot, opt Verizon LTE (US) or Lenovo® Connect (EMEA) SIM card</p>																																																																									

ThinkPad T470 - TopSeller - 20HD

Product Specifications Reference (PSREF)

Model	Region	Processor	vPro	Graphics	Memory	Display	Multi-touch	Storage (HDD/SSD)	Optical	WLAN + Bluetooth	WWAN	SIM Card	Smart Card Reader	Dock	Monitor Cable	Case Material	Camera	Key-board	Finger-print Reader	NFC	TPM	Battery (internal-external)	Power Adapter	Operating System	Warranty	Ann Date (m/y)
20HD000QUS	US	i5-7200U	No	Intel HD 620	8GBx1	14" FHD (1920x1080) IPS	None	500GB 7200rpm	None	Intel 8265 ac, 2x2 + BT4.1	WWAN Upgradable	None	None	None	None	PPS	720p	Non-backlit	Finger-print Reader	None	dTPM 2.0	3-cell(24Wh) + 3-cell(24Wh)	45W	Win10 Pro	1-year, Depot	01/17
20HD000RUS	US	i5-7300U	vPro	Intel HD 620	8GBx1	14" FHD (1920x1080) IPS	None	256GB SSD M.2 PCIe NVMe Opal2	None	Intel 8265 ac, 2x2 + BT4.1	WWAN Upgradable	None	None	None	None	PPS	720p	Backlit	Finger-print Reader	None	dTPM 2.0	3-cell(24Wh) + 3-cell(24Wh)	45W	Win10 Pro	3-year, Depot	01/17
20HD000SUS	US	i5-7200U	No	Intel HD 620	8GBx1	14" FHD (1920x1080) IPS	None	128GB SSD	None	Intel 8265 ac, 2x2 + BT4.1	WWAN Upgradable	None	None	None	None	PPS	720p	Backlit	Finger-print Reader	None	dTPM 2.0	3-cell(24Wh) + 3-cell(24Wh)	45W	Win10 Pro	3-year, Depot	01/17
20HD000TUS	US	i5-7200U	No	Intel HD 620	8GBx1	14" HD (1366x768)	None	500GB 7200rpm	None	Intel 8265 ac, 2x2 + BT4.1	WWAN Upgradable	None	None	None	None	PPS	720p	Non-backlit	Finger-print Reader	None	dTPM 2.0	3-cell(24Wh) + 3-cell(24Wh)	45W	Win10 Pro	1-year, Depot	01/17
20HD000UUS	US	i5-7200U	No	Intel HD 620	8GBx1	14" HD (1366x768)	None	128GB SSD	None	Intel 8265 ac, 2x2 + BT4.1	WWAN Upgradable	None	None	None	None	PPS	720p	Backlit	Finger-print Reader	None	dTPM 2.0	3-cell(24Wh) + 3-cell(24Wh)	45W	Win10 Pro	3-year, Depot	01/17
20HD000VUS	US	i5-7300U	vPro	Intel HD 620	8GBx1	14" FHD (1920x1080) IPS	None	512GB SSD M.2 PCIe NVMe Opal2	None	Intel 8265 ac, 2x2 + BT4.1	WWAN Upgradable	None	None	None	None	PPS	720p	Backlit	Finger-print Reader	None	dTPM 2.0	3-cell(24Wh) + 3-cell(24Wh)	45W	Win10 Pro	3-year, Depot	01/17
20HD000WUS	US	i5-7200U	No	Intel HD 620	8GBx1	14" FHD (1920x1080) IPS	None	256GB SSD M.2 PCIe NVMe Opal2	None	Intel 8265 ac, 2x2 + BT4.1	WWAN Upgradable	None	None	None	None	PPS	720p	Backlit	Finger-print Reader	None	dTPM 2.0	3-cell(24Wh) + 3-cell(24Wh)	45W	Win10 Pro	3-year, Depot	01/17
20HD000XUS	US	i5-7300U	vPro	Intel HD 620	8GBx1	14" FHD (1920x1080) IPS	None	500GB 7200rpm	None	Intel 8265 ac, 2x2 + BT4.1	WWAN Upgradable	None	None	None	None	PPS	720p	Backlit	Finger-print Reader	None	dTPM 2.0	3-cell(24Wh) + 3-cell(24Wh)	45W	Win10 Pro	3-year, Depot	01/17
20HD004AUS	US	i5-7300U	vPro	Intel HD 620	8GBx1	14" HD (1366x768)	None	500GB 7200rpm	None	Intel 8265 ac, 2x2 + BT4.1	WWAN Upgradable	None	None	None	None	PPS	720p	Non-backlit	Finger-print Reader	None	dTPM 2.0	3-cell(24Wh) + 3-cell(24Wh)	45W	Win10 Pro	1-year, Depot	03/17
20HD004BUS	US	i5-7300U	vPro	Intel HD 620	8GBx1	14" FHD (1920x1080) IPS	None	180GB SSD Opal2	None	Intel 8265 ac, 2x2 + BT4.1	WWAN Upgradable	None	None	None	None	PPS	720p	Backlit	Finger-print Reader	None	dTPM 2.0	3-cell(24Wh) + 3-cell(24Wh)	45W	Win10 Pro	3-year, Depot	03/17
20HD0056US	US	i5-7300U	vPro	Intel HD 620	8GBx1	14" FHD (1920x1080) IPS	None	256GB SSD M.2 PCIe NVMe Opal2	None	Intel 8265 ac, 2x2 + BT4.1	WWAN Upgradable	None	None	None	None	Magnesium	IR & 720p	Backlit	Finger-print Reader	None	dTPM 2.0	3-cell(24Wh) + 3-cell(24Wh)	45W	Win10 Pro	3-year, Depot	04/17
20HD0057US	US	i7-7600U	vPro	Intel HD 620	8GBx1	14" FHD (1920x1080) IPS	None	256GB SSD M.2 PCIe NVMe Opal2	None	Intel 8265 ac, 2x2 + BT4.1	WWAN Upgradable	None	None	None	None	Magnesium	IR & 720p	Backlit	Finger-print Reader	None	dTPM 2.0	3-cell(24Wh) + 3-cell(24Wh)	45W	Win10 Pro	3-year, Depot	04/17
20HD0058US	US	i7-7600U	vPro	Intel HD 620	8GBx1	14" FHD (1920x1080) IPS	10-point Multi-touch	256GB SSD M.2 PCIe NVMe Opal2	None	Intel 8265 ac, 2x2 + BT4.1	WWAN Upgradable	None	None	None	None	PPS	720p	Backlit	Finger-print Reader	None	dTPM 2.0	3-cell(24Wh) + 3-cell(24Wh)	45W	Win10 Pro	3-year, Depot	04/17
20HD005AUS	US	i5-7300U	vPro	Intel HD 620	8GBx1	14" FHD (1920x1080) IPS	None	256GB SSD M.2 PCIe NVMe Opal2	None	Intel 8265 ac, 2x2 + BT4.1	WWAN Upgradable	None	None	None	None	PPS	720p	Backlit	Finger-print Reader	None	dTPM 2.0	3-cell(24Wh) + 3-cell(24Wh)	45W	Win10 Pro	3-year, Depot	04/17
20HD005BUS	US	i7-7600U	vPro	Intel HD 620	8GBx1	14" FHD (1920x1080) IPS	None	256GB SSD M.2 PCIe NVMe Opal2	None	Intel 8265 ac, 2x2 + BT4.1	Sierra EM7455	None	None	None	None	PPS	720p	Backlit	Finger-print Reader	None	dTPM 2.0	3-cell(24Wh) + 3-cell(24Wh)	45W	Win10 Pro	3-year, Depot	04/17
20HD005CUS	US	i5-7300U	vPro	Intel HD 620	8GBx1	14" FHD (1920x1080) IPS	None	256GB SSD M.2 PCIe NVMe Opal2	None	Intel 8265 ac, 2x2 + BT4.1	Sierra EM7455	None	None	None	None	PPS	720p	Backlit	Finger-print Reader	None	dTPM 2.0	3-cell(24Wh) + 3-cell(24Wh)	45W	Win10 Pro	3-year, Depot	04/17
20HD005DUS	US	i7-7600U	vPro	Intel HD 620	8GBx1	14" FHD (1920x1080) IPS	10-point Multi-touch	256GB SSD M.2 PCIe NVMe Opal2	None	Intel 8265 ac, 2x2 + BT4.1	Sierra EM7455	None	None	None	None	PPS	720p	Backlit	Finger-print Reader	None	dTPM 2.0	3-cell(24Wh) + 3-cell(24Wh)	45W	Win10 Pro	3-year, Depot	04/17
20HD005EUS	US	i7-7600U	vPro	Intel HD 620	16GBx1	14" FHD (1920x1080) IPS	10-point Multi-touch	512GB SSD M.2 PCIe NVMe Opal2	None	Intel 8265 ac, 2x2 + BT4.1	WWAN Upgradable	None	None	None	None	PPS	720p	Backlit	Finger-print Reader	None	dTPM 2.0	3-cell(24Wh) + 3-cell(24Wh)	45W	Win10 Pro	3-year, Depot	04/17
20HD005FUS	US	i7-7600U	vPro	Intel HD 620	8GBx1	14" FHD (1920x1080) IPS	10-point Multi-touch	256GB SSD M.2 PCIe NVMe Opal2	None	Intel 8265 ac, 2x2 + BT4.1	WWAN Upgradable	None	None	None	None	PPS	IR & 720p	Backlit	Finger-print Reader	None	dTPM 2.0	3-cell(24Wh) + 3-cell(24Wh)	45W	Win10 Pro	3-year, Depot	04/17
20HD005GUS	US	i7-7600U	vPro	Intel HD 620	16GBx1	14" FHD (1920x1080) IPS	None	512GB SSD M.2 PCIe NVMe Opal2	None	Intel 8265 ac, 2x2 + BT4.1	WWAN Upgradable	None	None	None	None	PPS	720p	Backlit	Finger-print Reader	None	dTPM 2.0	3-cell(24Wh) + 3-cell(24Wh)	45W	Win10 Pro	3-year, Depot	04/17

ThinkPad T470 - TopSeller - 20JM

Model	Region	Processor	vPro	Graphics	Memory	Display	Multi-touch	Storage(HDD/SSD)	Optical	WLAN + Bluetooth	WWAN	SIM Card	Smart Card Reader	Dock	Monitor Cable	Case Material	Camera	Key-board	Finger-print Reader	NFC	TPM	Battery (internal+external)	Power Adapter	Operating System	Warranty	Ann Date (m/y)
20JM0009US	US	i5-6300U	vPro	Intel HD 520	8GBx1	14" FHD (1920x1080) IPS	None	256GB SSD M.2 PCIe NVMe Opal2	None	Intel 8260 ac, 2x2 + BT4.1	WWAN Upgradable	None	None	None	None	PPS	720p	Backlit	Finger-print Reader	None	dTPM 2.0	3-cell(24Wh) + 3-cell(24Wh)	45W	Win10 DG Win7 Pro 64	3-year, Depot	03/17
20JM000AUS	US	i7-6600U	vPro	Intel HD 520	8GBx1	14" FHD (1920x1080) IPS	None	256GB SSD M.2 PCIe NVMe Opal2	None	Intel 8260 ac, 2x2 + BT4.1	WWAN Upgradable	None	None	None	None	PPS	720p	Backlit	Finger-print Reader	None	dTPM 2.0	3-cell(24Wh) + 3-cell(24Wh)	45W	Win10 DG Win7 Pro 64	3-year, Depot	03/17
20JM000BUS	US	i7-6500U	No	Intel HD 520	8GBx1	14" FHD (1920x1080) IPS	None	256GB SSD M.2 PCIe NVMe Opal2	None	Intel 8260 ac, 2x2 + BT4.1	WWAN Upgradable	None	None	None	None	PPS	720p	Backlit	Finger-print Reader	None	dTPM 2.0	3-cell(24Wh) + 3-cell(24Wh)	45W	Win10 DG Win7 Pro 64	3-year, Depot	03/17
20JM000CUS	US	i5-6200U	No	Intel HD 520	4GBx1	14" HD (1366x768)	None	500GB 7200rpm	None	Intel 8260 ac, 2x2 + BT4.1	WWAN Upgradable	None	None	None	None	PPS	720p	Non-backlit	Finger-print Reader	None	dTPM 2.0	3-cell(24Wh) + 3-cell(24Wh)	45W	Win10 DG Win7 Pro 64	1-year, Depot	03/17
20JM000EUS	US	i5-6300U	vPro	Intel HD 520	8GBx1	14" FHD (1920x1080) IPS	None	256GB SSD M.2 PCIe NVMe Opal2	None	Intel 8260 ac, 2x2 + BT4.1	WWAN Upgradable	None	None	None	None	PPS	720p	Backlit	Finger-print Reader	None	dTPM 2.0	3-cell(24Wh) + 3-cell(24Wh)	45W	Win10 DG Win7 Pro 64	3-year, Depot	04/17
20JM000FUS	US	i7-6600U	vPro	Intel HD 520	8GBx1	14" FHD (1920x1080) IPS	None	256GB SSD M.2 PCIe NVMe Opal2	None	Intel 8260 ac, 2x2 + BT4.1	WWAN Upgradable	None	None	None	None	PPS	720p	Backlit	Finger-print Reader	None	dTPM 2.0	3-cell(24Wh) + 3-cell(24Wh)	45W	Win10 DG Win7 Pro 64	3-year, Depot	04/17
20JM000GUS	US	i7-6600U	vPro	Intel HD 520	8GBx1	14" FHD (1920x1080) IPS	10-point Multi-touch	256GB SSD M.2 PCIe NVMe Opal2	None	Intel 8260 ac, 2x2 + BT4.1	WWAN Upgradable	None	None	None	None	PPS	720p	Backlit	Finger-print Reader	None	dTPM 2.0	3-cell(24Wh) + 3-cell(24Wh)	45W	Win10 DG Win7 Pro 64	3-year, Depot	04/17
20JM000HUS	US	i5-6300U	vPro	Intel HD 520	8GBx1	14" FHD (1920x1080) IPS	None	256GB SSD M.2 PCIe NVMe Opal2	None	Intel 8260 ac, 2x2 + BT4.1	Sierra EM7455	None	None	None	None	PPS	720p	Backlit	Finger-print Reader	None	dTPM 2.0	3-cell(24Wh) + 3-cell(24Wh)	45W	Win10 DG Win7 Pro 64	3-year, Depot	04/17
20JM000JUS	US	i7-6600U	vPro	Intel HD 520	8GBx1	14" FHD (1920x1080) IPS	10-point Multi-touch	256GB SSD M.2 PCIe NVMe Opal2	None	Intel 8260 ac, 2x2 + BT4.1	Sierra EM7455	None	None	None	None	PPS	720p	Backlit	Finger-print Reader	None	dTPM 2.0	3-cell(24Wh) + 3-cell(24Wh)	45W	Win10 DG Win7 Pro 64	3-year, Depot	04/17
20JM000KUS	US	i7-6600U	vPro	Intel HD 520	8GBx1	14" FHD (1920x1080) IPS	None	256GB SSD M.2 PCIe NVMe Opal2	None	Intel 8260 ac, 2x2 + BT4.1	Sierra EM7455	None	None	None	None	PPS	720p	Backlit	Finger-print Reader	None	dTPM 2.0	3-cell(24Wh) + 3-cell(24Wh)	45W	Win10 DG Win7 Pro 64	3-year, Depot	04/17
20JM000LUS	US	i7-6600U	vPro	Intel HD 520	16GBx1	14" FHD (1920x1080) IPS	10-point Multi-touch	512GB SSD M.2 PCIe NVMe Opal2	None	Intel 8260 ac, 2x2 + BT4.1	WWAN Upgradable	None	None	None	None	PPS	720p	Backlit	Finger-print Reader	None	dTPM 2.0	3-cell(24Wh) + 3-cell(24Wh)	45W	Win10 DG Win7 Pro 64	3-year, Depot	04/17
20JM000MUS	US	i7-6600U	vPro	Intel HD 520	16GBx1	14" FHD (1920x1080) IPS	None	512GB SSD M.2 PCIe NVMe Opal2	None	Intel 8260 ac, 2x2 + BT4.1	WWAN Upgradable	None	None	None	None	PPS	720p	Backlit	Finger-print Reader	None	dTPM 2.0	3-cell(24Wh) + 3-cell(24Wh)	45W	Win10 DG Win7 Pro 64	3-year, Depot	04/17



ThinkPad T470p Platform Specifications

Product Specifications Reference (PSREF)

Processor	7th Generation Intel® Core™ i5 / i7 Processor							Dimensions <i>FHD (WxDxH):</i> 13.35" x 9.25" x 0.94"; 339mm x 235mm x 24mm <i>WQHD (WxDxH):</i> 13.35" x 9.25" x 0.96"; 339mm x 235mm x 24.4mm										
	Processor Number	# of Cores	# of Threads	Base Frequency	Max Turbo Frequency	Cache	Memory Types		Weight <table border="1"> <tr> <td><i>Models</i></td> <td><i>3-cell</i></td> <td><i>6-cell</i></td> </tr> <tr> <td><i>Integrated model</i></td> <td>3.83 lb / 1.74 kg</td> <td>4.16 lb / 1.89 kg</td> </tr> <tr> <td><i>discrete model</i></td> <td>4.01 lb / 1.82 kg</td> <td>4.33 lb / 1.96 kg</td> </tr> </table>	<i>Models</i>	<i>3-cell</i>	<i>6-cell</i>	<i>Integrated model</i>	3.83 lb / 1.74 kg	4.16 lb / 1.89 kg	<i>discrete model</i>	4.01 lb / 1.82 kg	4.33 lb / 1.96 kg
	<i>Models</i>	<i>3-cell</i>	<i>6-cell</i>															
	<i>Integrated model</i>	3.83 lb / 1.74 kg	4.16 lb / 1.89 kg															
	<i>discrete model</i>	4.01 lb / 1.82 kg	4.33 lb / 1.96 kg															
i5-7300HQ	4	4	2.5 GHz	3.5 GHz	6MB	DDR4-2400	Intel HD Graphics 630											
i5-7440HQ			2.8 GHz	3.8 GHz	6MB													
i7-7700HQ		8	2.8 GHz	3.8 GHz	6MB													
i7-7820HQ			2.9 GHz	3.9 GHz	8MB													
Graphics	Intel HD Graphics 630 in processor only, or Intel HD Graphics 630 in processor and NVIDIA GeForce® 940MX, 2GB 2.5GHz GDDR5 memory; supports external digital monitor via HDMI or Mini DisplayPort; supports three independent displays; Max resolution: 4096x2304@60Hz (DisplayPort via Mini DisplayPort cable); 4096x2160@24Hz (HDMI)							Case color Case material										
Chipset	Mobile Intel QM175 Chipset							Smart card reader										
Memory	32GB max / 2400MHz DDR4, dual-channel capable, two DDR4 SO-DIMM sockets							Media reader										
Display	<i>Some:</i> 14.0" (355mm) FHD (1920x1080), anti-glare, LED backlight, IPS, 250 nits, 16:9 aspect ratio, 600:1 contrast ratio, 160° viewing angle <i>Some:</i> 14.0" (355mm) WQHD (2560x1440), anti-glare, LED backlight, IPS, 300 nits, 16:9 aspect ratio, 700:1 contrast ratio, 160° viewing angle							Ports										
Multi-touch (opt)	On-cell touch, supports 10-finger gesture (FHD only)							Monitor cable (optional)										
Storage	<i>System has one HDD slot or one M.2 2280 slot exclusively for storage</i> <i>Some:</i> HDD / SATA 6.0Gb/s, 2.5" wide, 7mm or 9.5mm high, Active Protection System™ <i>Some:</i> SSD / SATA 6.0Gb/s, 2.5" wide, 7mm high (e.g. xxxGB SSD) <i>Some:</i> M.2 SSD / PCIe NVMe, PCIe 3.0 x 2, 16Gb/s <i>Some:</i> 128GB M.2 SSD / SATA 6.0Gb/s, in WWAN slot as 2nd Storage, mutually exclusive with WWAN							Camera										
Optical	None							Audio support										
Ethernet	<i>Non-vPro model:</i> Intel Ethernet Connection I219-V (Jacksonville) <i>vPro model:</i> Intel Ethernet Connection I219-LM (Jacksonville)							Keyboard										
WLAN	<i>One of the following, configurable by model:</i> • Realtek® RTL8822BE, Wi-Fi 2x2 802.11ac + BT4.1, M.2 card • Intel Dual Band Wireless-AC 8265, Wi-Fi 2x2 802.11ac + BT4.1, M.2 card							UltraNav™										
Bluetooth™	Bluetooth 4.1 wireless, integrated in Wi-Fi + Bluetooth combo adapter * Intel 8265ac card support BT4.2 but is limited to BT4.1 by Windows OS							Security										
WWAN (optional)	<i>One of the following, configurable by model:</i> • Wireless WAN upgradable • Integrated Mobile Broadband 4G LTE-A, Qualcomm® Snapdragon™ X7 LTE-A (Sierra Wireless EM7455), M.2 card							Security chip										
SIM card (opt)	Micro-SIM card slot, opt Verizon LTE (US) or Lenovo® Connect (EMEA) SIM card							vPro (optional)										
								Fingerprint reader										
								NFC										
								Battery										
								Max battery life										
								AC adapter										
								Preload										
								Limited warranty										
								Mil-Spec test										
								Environment										

Model	Region	Processor	vPro	Graphics	Chipset	Memory	Display	Multi-touch	Storage(HDD/SSD)	Optical	WLAN + Bluetooth	WWAN	SIM Card	Smart Card Reader	Monitor Cable	Camera	Key-board	Finger-print Reader	NFC	TPM	Battery	Power Adapter	Operating System	Warranty	Ann Date (m/y)
20J6001BUS	US	i5-7440HQ	vPro	940MX 2GB	Intel QM175	8GBx1	14" FHD (1920x1080) IPS	10-point Multi-touch	512GB SSD M.2 PCIe NVMe Opal2	None	Intel 8265 ac, 2x2 + BT4.1	WWAN Upgradable	None	None	None	720p	Backlit	Finger-print Reader	None	dTPM 2.0	6-cell (48Wh)	135W	Win10 Pro 64	3-year, Depot	03/17
20J6001CUS	US	i5-7440HQ	vPro	940MX 2GB	Intel QM175	8GBx1	14" FHD (1920x1080) IPS	None	256GB SSD M.2 PCIe NVMe Opal2	None	Intel 8265 ac, 2x2 + BT4.1	WWAN Upgradable	None	None	None	720p	Backlit	Finger-print Reader	None	dTPM 2.0	6-cell (48Wh)	135W	Win10 Pro 64	3-year, Depot	02/17
20J6001DUS	US	i5-7440HQ	vPro	Intel HD 630	Intel QM175	4GBx2	14" FHD (1920x1080) IPS	10-point Multi-touch	256GB SSD M.2 PCIe NVMe Opal2	None	Intel 8265 ac, 2x2 + BT4.1	WWAN Upgradable	None	None	None	720p	Backlit	Finger-print Reader	None	dTPM 2.0	3-cell (24Wh)	90W	Win10 Pro 64	3-year, Depot	03/17
20J6001EUS	US	i5-7440HQ	vPro	940MX 2GB	Intel QM175	8GBx1	14" FHD (1920x1080) IPS	None	512GB SSD M.2 PCIe NVMe Opal2	None	Intel 8265 ac, 2x2 + BT4.1	WWAN Upgradable	None	None	None	720p	Backlit	Finger-print Reader	None	dTPM 2.0	6-cell (48Wh)	135W	Win10 Pro 64	3-year, Depot	02/17
20J6001FUS	US	i5-7440HQ	vPro	Intel HD 630	Intel QM175	4GBx2	14" FHD (1920x1080) IPS	None	256GB SSD M.2 PCIe NVMe Opal2	None	Intel 8265 ac, 2x2 + BT4.1	WWAN Upgradable	None	None	None	720p	Backlit	Finger-print Reader	None	dTPM 2.0	6-cell (48Wh)	90W	Win10 Pro 64	3-year, Depot	02/17
20J6001GUS	US	i5-7440HQ	vPro	Intel HD 630	Intel QM175	4GBx2	14" FHD (1920x1080) IPS	10-point Multi-touch	256GB SSD M.2 PCIe NVMe Opal2	None	Intel 8265 ac, 2x2 + BT4.1	WWAN Upgradable	None	None	None	720p	Backlit	Finger-print Reader	None	dTPM 2.0	6-cell (48Wh)	90W	Win10 Pro 64	3-year, Depot	03/17
20J6001HUS	US	i5-7440HQ	vPro	Intel HD 630	Intel QM175	4GBx2	14" FHD (1920x1080) IPS	None	256GB SSD M.2 PCIe NVMe Opal2	None	Intel 8265 ac, 2x2 + BT4.1	WWAN Upgradable	None	None	None	720p	Backlit	Finger-print Reader	None	dTPM 2.0	3-cell (24Wh)	90W	Win10 Pro 64	3-year, Depot	02/17
20J6001JUS	US	i5-7440HQ	vPro	940MX 2GB	Intel QM175	4GBx2	14" FHD (1920x1080) IPS	10-point Multi-touch	256GB SSD M.2 PCIe NVMe Opal2	None	Intel 8265 ac, 2x2 + BT4.1	WWAN Upgradable	None	None	None	720p	Backlit	Finger-print Reader	None	dTPM 2.0	6-cell (48Wh)	135W	Win10 Pro 64	3-year, Depot	03/17
20J6003JUS	US	i7-7820HQ	vPro	940MX 2GB	Intel QM175	16GBx1	14" WQHD (2560x1440) IPS	None	512GB SSD M.2 PCIe NVMe Opal2	None	Intel 8265 ac, 2x2 + BT4.1	WWAN Upgradable	None	None	None	720p	Backlit	Finger-print Reader	None	dTPM 2.0	6-cell (48Wh)	135W	Win10 Pro 64	3-year, Depot	04/17
20J6003KUS	US	i7-7820HQ	vPro	940MX 2GB	Intel QM175	16GBx1	14" FHD (1920x1080) IPS	None	512GB SSD M.2 PCIe NVMe Opal2	None	Intel 8265 ac, 2x2 + BT4.1	WWAN Upgradable	None	None	None	720p	Backlit	Finger-print Reader	None	dTPM 2.0	6-cell (48Wh)	135W	Win10 Pro 64	3-year, Depot	04/17
20J6003LUS	US	i7-7820HQ	vPro	940MX 2GB	Intel QM175	8GBx1	14" FHD (1920x1080) IPS	None	256GB SSD M.2 PCIe NVMe Opal2	None	Intel 8265 ac, 2x2 + BT4.1	WWAN Upgradable	None	None	None	720p	Backlit	Finger-print Reader	None	dTPM 2.0	6-cell (48Wh)	135W	Win10 Pro 64	3-year, Depot	04/17
20J6003MUS	US	i5-7440HQ	vPro	Intel HD 630	Intel QM175	8GBx1	14" FHD (1920x1080) IPS	None	256GB SSD M.2 PCIe NVMe Opal2	None	Intel 8265 ac, 2x2 + BT4.1	WWAN Upgradable	None	None	None	720p	Backlit	Finger-print Reader	None	dTPM 2.0	6-cell (48Wh)	90W	Win10 Pro 64	3-year, Depot	04/17
20J6003NUS	US	i5-7440HQ	vPro	Intel HD 630	Intel QM175	8GBx1	14" FHD (1920x1080) IPS	None	256GB SSD M.2 PCIe NVMe Opal2	None	Intel 8265 ac, 2x2 + BT4.1	Sierra EM7455	None	None	None	720p	Backlit	Finger-print Reader	None	dTPM 2.0	6-cell (48Wh)	90W	Win10 Pro 64	3-year, Depot	04/17
20J6003PUS	US	i7-7820HQ	vPro	940MX 2GB	Intel QM175	8GBx1	14" FHD (1920x1080) IPS	None	256GB SSD M.2 PCIe NVMe Opal2	None	Intel 8265 ac, 2x2 + BT4.1	Sierra EM7455	None	None	None	720p	Backlit	Finger-print Reader	None	dTPM 2.0	6-cell (48Wh)	135W	Win10 Pro 64	3-year, Depot	04/17



ThinkPad T470s Platform Specifications

Product Specifications Reference (PSREF)

Processor	6th Generation Intel® Core™ i5 / i7 Processor							Dimensions Weight Case color Case material	<i>WxDxH:</i> 13.03" x 8.93" x 0.67-0.74"; 331mm x 226.8mm x 16.9-18.8mm Starting at 2.9 lb (1.32kg) Black or Silver <i>Display cover:</i> CFRP Hybrid; <i>Bottom:</i> Magnesium
	Processor Number	# of Cores	# of Threads	Base Frequency	Max Turbo Frequency	Cache	Memory Types		
	i5-6300U	2	4	2.4 GHz	3.0 GHz	3MB	DDR4-2133	Intel HD Graphics 520	
	i7-6600U			2.6 GHz	3.4 GHz	4MB			
	or 7th Generation Intel Core i5 / i7 Processor							Smart card reader Media reader Ports	<i>Optional:</i> Smart card reader 4-in-1 reader (MMC, SD, SDHC, SDXC) Three USB 3.1 Gen 1 / USB 3.0 (one Always On), USB 3.1 Type-C Gen 2 / Thunderbolt 3, HDMI 1.4b, Ethernet (RJ-45), Dock connector
	Processor Number	# of Cores	# of Threads	Base Frequency	Max Turbo Frequency	Cache	Memory Types		
	i5-7200U	2	4	2.5 GHz	3.1 GHz	3MB	DDR4-2133	Intel HD Graphics 620	
	i5-7300U			2.6 GHz	3.5 GHz	3MB			
	i7-7500U			2.7 GHz	3.5 GHz	4MB			
	i7-7600U			2.8 GHz	3.9 GHz	4MB			
Graphics	Intel HD Graphics 520 or 620 in processor; supports external digital monitor via HDMI or USB Type-C; supports three independent displays; Max resolution: 4096x2304@60Hz (USB Type-C); 4096x2160@24Hz (HDMI)							WiGig dock (<i>opt</i>) Monitor cable (<i>optional</i>)	ThinkPad WiGig dock, mutually exclusive with WWAN HDMI to VGA: Lenovo HDMI to VGA Monitor Adapter USB-C to VGA: Lenovo USB-C to VGA Adapter
Chipset	Intel SoC (System on Chip) platform							Camera (<i>optional</i>)	HD720p resolution, fixed focus (models without camera are unavailable in EMEA)
Memory	20GB or 24GB max ⁷ / 2400MHz DDR4, dual-channel capable, 4GB or 8GB memory soldered to systemboard, one DDR4 SO-DIMM socket * System clocks down for processors with lower memory controller							Audio support	HD Audio, Realtek® ALC3268 codec / stereo speakers, 1W x 2 / dual array microphone, combo audio/microphone jack
Display	<i>Some:</i> 14.0" (355mm) FHD (1920x1080), anti-glare, LED backlight, IPS, 250 nits, 16:9 aspect ratio, 700:1 contrast ratio, 160° viewing angle <i>Some:</i> 14.0" (355mm) WQHD (2560x1440), anti-glare, LED backlight, IPS, 300 nits, 16:9 aspect ratio, 700:1 contrast ratio, 160° viewing angle							Keyboard UltraNav™	6-row, spill-resistant, multimedia Fn keys, optional LED backlight TrackPoint® pointing device and buttonless Mylar surface multi-touch touchpad
Multi-touch (<i>opt</i>)	On-cell touch, supports 10-finger gesture, 250 nits (FHD only)							Security Security chip vPro (<i>optional</i>) Fingerprint reader NFC (<i>optional</i>)	Power-on password, hard disk password, supervisor password, security keyhole Discrete TPM 2.0, TCG Certified Intel vPro Technology <i>Optional:</i> Touch style match on chip fingerprint reader on the palm rest Near Field Communication
Storage	<i>Some:</i> M.2 SSD / SATA 6.0Gb/s (e.g. xxxG SSD) <i>Some:</i> M.2 SSD / PCIe NVMe, PCIe 3.0 x 4, 32Gb/s (e.g. xxxG SSD PCIe NVMe)							Internal battery Max battery life AC adapter	Front Li-Polymer 3-cell (23Wh) and rear Li-Ion 3-cell (26Wh), both Integrated MobileMark® 2014: up to 10.5 hr 45W AC adapter (slim tip), 45W or 65W USB Type-C AC adapter
Optical	None							Preload	Windows® 7 Professional 64 preinstalled through downgrade rights in Windows 10 Pro 64 <ul style="list-style-type: none"> Lenovo Solution Center Lenovo PowerEngage ThinkVantage Product Recovery ThinkVantage System Update Adobe® Reader® Microsoft® Office preloaded; purchase a product key to activate McAfee® LiveSafe™ (30-day trial)
Ethernet	<i>Non-vPro model:</i> Intel Ethernet Connection I219-V (Jacksonville) <i>vPro model:</i> Intel Ethernet Connection I219-LM (Jacksonville)							Limited warranty	<i>Some:</i> Windows 10 Home 64 <i>Some:</i> Windows 10 Pro 64 <ul style="list-style-type: none"> Lenovo Companion Lenovo Setting Microsoft Office preloaded; purchase a product key to activate
WLAN	<i>One of the following, configurable by model (WiGig is mutually exclusive with WWAN):</i> <ul style="list-style-type: none"> Intel Dual Band Wireless-AC 8260, Wi-Fi 2x2 802.11ac + BT4.1, M.2 card Intel Dual Band Wireless-AC 8265, Wi-Fi 2x2 802.11ac + BT4.1, M.2 card Intel Tri-Band Wireless-AC 18265, WiGig 802.11ad + Wi-Fi 2x2 802.11ac + BT4.1, M.2 card 							Mil-Spec test	MIL-STD-810G military certification
Bluetooth™	Bluetooth 4.1 wireless, integrated in Wi-Fi + Bluetooth combo adapter * Intel 8265ac / 18265ac card support BT4.2 but is limited to BT4.1 by Windows OS							Environment	EPEAT™ Gold (US only); ENERGY STAR® 6.1; RoHS-compliant
WWAN (<i>optional</i>)	<i>One of the following, configurable by model (mutually exclusive with WiGig):</i> <ul style="list-style-type: none"> Wireless WAN upgradable Integrated Mobile Broadband 4G LTE-A, Qualcomm® Snapdragon™ X7 LTE-A (Sierra Wireless EM7455), M.2 card Micro-SIM card slot, opt Verizon LTE (US) or Lenovo® Connect (EMEA) SIM card 								
SIM card (<i>opt</i>)									

Model	Region	Processor	vPro	Graphics	Memory (Soldered +DIMM)	Display	Multi-touch	Storage(HDD/SSD)	Optical	WLAN + Bluetooth	WWAN	SIM Card	Smart Card Reader	Dock	Monitor Cable	Color	Camera	Key-board	Finger-print Reader	NFC	TPM	Battery (internal)	Power Adapter	Operating System	Warranty	Ann Date (m/y)
20HF0010US	US	i7-7600U	vPro	Intel HD 620	4GB + 8GB	14" WQHD (2560x1440) IPS	None	512GB SSD M.2 PCIe NVMe Opal2	None	Intel 8265 ac, 2x2 + BT4.1	WWAN Upgradable	None	None	None	None	Black	720p	Backlit	Finger-print Reader	None	dTPM 2.0	3-cell(23Wh) + 3-cell(26Wh)	45W	Win10 Pro 64	3-year, Depot	02/17
20HF0011US	US	i5-7300U	vPro	Intel HD 620	4GB + 4GB	14" FHD (1920x1080) IPS	None	256GB SSD M.2 PCIe NVMe Opal2	None	Intel 8265 ac, 2x2 + BT4.1	WWAN Upgradable	None	None	None	None	Black	720p	Backlit	Finger-print Reader	None	dTPM 2.0	3-cell(23Wh) + 3-cell(26Wh)	45W	Win10 Pro 64	3-year, Depot	02/17
20HF0012US	US	i5-7300U	vPro	Intel HD 620	4GB + 4GB	14" FHD (1920x1080) IPS	10-point Multi-touch	256GB SSD M.2 PCIe NVMe Opal2	None	Intel 8265 ac, 2x2 + BT4.1	WWAN Upgradable	None	None	None	None	Black	720p	Backlit	Finger-print Reader	None	dTPM 2.0	3-cell(23Wh) + 3-cell(26Wh)	45W	Win10 Pro 64	3-year, Depot	02/17
20HF0013US	US	i7-7600U	vPro	Intel HD 620	4GB + 4GB	14" FHD (1920x1080) IPS	None	256GB SSD M.2 PCIe NVMe Opal2	None	Intel 8265 ac, 2x2 + BT4.1	WWAN Upgradable	None	None	None	None	Black	720p	Backlit	Finger-print Reader	None	dTPM 2.0	3-cell(23Wh) + 3-cell(26Wh)	45W	Win10 Pro 64	3-year, Depot	02/17
20HF0014US	US	i5-7200U	No	Intel HD 620	4GB Soldered	14" FHD (1920x1080) IPS	None	128GB SSD M.2	None	Intel 8265 ac, 2x2 + BT4.1	WWAN Upgradable	None	None	None	None	Black	720p	Backlit	Finger-print Reader	None	dTPM 2.0	3-cell(23Wh) + 3-cell(26Wh)	45W	Win10 Pro 64	1-year, Depot	02/17
20HF0015US	US	i7-7600U	vPro	Intel HD 620	4GB + 4GB	14" FHD (1920x1080) IPS	10-point Multi-touch	256GB SSD M.2 PCIe NVMe Opal2	None	Intel 8265 ac, 2x2 + BT4.1	WWAN Upgradable	None	None	None	None	Black	720p	Backlit	Finger-print Reader	None	dTPM 2.0	3-cell(23Wh) + 3-cell(26Wh)	45W	Win10 Pro 64	3-year, Depot	02/17
20HF001DUS	US	i7-7600U	vPro	Intel HD 620	8GB + 16GB	14" FHD (1920x1080) IPS	None	1TB SSD M.2 PCIe NVMe Opal2	None	Intel 8265 ac, 2x2 + BT4.1	WWAN Upgradable	None	None	None	None	Black	720p	Backlit	Finger-print Reader	None	dTPM 2.0	3-cell(23Wh) + 3-cell(26Wh)	45W	Win10 Pro 64	3-year, Depot	04/17
20HF003QUS	US	i7-7600U	vPro	Intel HD 620	4GB + 8GB	14" WQHD (2560x1440) IPS	None	512GB SSD M.2 PCIe NVMe Opal2	None	Intel 8265 ac, 2x2 + BT4.1	WWAN Upgradable	None	None	None	None	Silver	720p	Backlit	Finger-print Reader	None	dTPM 2.0	3-cell(23Wh) + 3-cell(26Wh)	45W	Win10 Pro 64	3-year, Depot	02/17
20HF003RUS	US	i5-7200U	No	Intel HD 620	4GB + 4GB	14" WQHD (2560x1440) IPS	None	180GB SSD M.2 Opal2	None	Intel 8265 ac, 2x2 + BT4.1	WWAN Upgradable	None	None	None	None	Black	720p	Backlit	Finger-print Reader	None	dTPM 2.0	3-cell(23Wh) + 3-cell(26Wh)	45W	Win10 Pro 64	3-year, Depot	03/17
20HF003SUS	US	i5-7200U	No	Intel HD 620	4GB + 4GB	14" WQHD (2560x1440) IPS	None	180GB SSD M.2 Opal2	None	Intel 8265 ac, 2x2 + BT4.1	WWAN Upgradable	None	None	None	None	Silver	720p	Backlit	Finger-print Reader	None	dTPM 2.0	3-cell(23Wh) + 3-cell(26Wh)	45W	Win10 Pro 64	3-year, Depot	03/17
20HF003TUS	US	i7-7600U	vPro	Intel HD 620	4GB + 4GB	14" FHD (1920x1080) IPS	None	256GB SSD M.2 PCIe NVMe Opal2	None	Intel 8265 ac, 2x2 + BT4.1	WWAN Upgradable	None	None	None	None	Silver	720p	Backlit	Finger-print Reader	None	dTPM 2.0	3-cell(23Wh) + 3-cell(26Wh)	45W	Win10 Pro 64	3-year, Depot	02/17
20HF003UUS	US	i5-7300U	vPro	Intel HD 620	4GB + 4GB	14" FHD (1920x1080) IPS	10-point Multi-touch	256GB SSD M.2 PCIe NVMe Opal2	None	Intel 8265 ac, 2x2 + BT4.1	WWAN Upgradable	None	None	None	None	Silver	720p	Backlit	Finger-print Reader	None	dTPM 2.0	3-cell(23Wh) + 3-cell(26Wh)	45W	Win10 Pro 64	3-year, Depot	02/17
20HF003VUS	US	i5-7200U	No	Intel HD 620	4GB Soldered	14" FHD (1920x1080) IPS	None	128GB SSD M.2	None	Intel 8265 ac, 2x2 + BT4.1	WWAN Upgradable	None	None	None	None	Silver	720p	Backlit	Finger-print Reader	None	dTPM 2.0	3-cell(23Wh) + 3-cell(26Wh)	45W	Win10 Pro 64	1-year, Depot	02/17
20HF003WUS	US	i5-7300U	vPro	Intel HD 620	4GB + 4GB	14" FHD (1920x1080) IPS	None	256GB SSD M.2 PCIe NVMe Opal2	None	Intel 8265 ac, 2x2 + BT4.1	WWAN Upgradable	None	None	None	None	Silver	720p	Backlit	Finger-print Reader	None	dTPM 2.0	3-cell(23Wh) + 3-cell(26Wh)	45W	Win10 Pro 64	3-year, Depot	02/17
20HF005GUS	US	i5-7300U	vPro	Intel HD 620	8GB Soldered	14" FHD (1920x1080) IPS	None	256GB SSD M.2 PCIe NVMe Opal2	None	Intel 8265 ac, 2x2 + BT4.1	Sierra EM7455	None	None	None	None	Black	720p	Backlit	Finger-print Reader	None	dTPM 2.0	3-cell(23Wh) + 3-cell(26Wh)	45W	Win10 Pro 64	3-year, Depot	04/17
20HF005HUS	US	i7-7600U	vPro	Intel HD 620	8GB Soldered	14" FHD (1920x1080) IPS	10-point Multi-touch	256GB SSD M.2 PCIe NVMe Opal2	None	Intel 8265 ac, 2x2 + BT4.1	Sierra EM7455	None	None	None	None	Black	720p	Backlit	Finger-print Reader	None	dTPM 2.0	3-cell(23Wh) + 3-cell(26Wh)	45W	Win10 Pro 64	3-year, Depot	04/17
20HF005JUS	US	i7-7600U	vPro	Intel HD 620	8GB Soldered	14" FHD (1920x1080) IPS	None	256GB SSD M.2 PCIe NVMe Opal2	None	Intel 8265 ac, 2x2 + BT4.1	Sierra EM7455	None	None	None	None	Black	720p	Backlit	Finger-print Reader	None	dTPM 2.0	3-cell(23Wh) + 3-cell(26Wh)	45W	Win10 Pro 64	3-year, Depot	04/17
20HF005KUS	US	i7-7600U	vPro	Intel HD 620	8GB + 16GB	14" FHD (1920x1080) IPS	10-point Multi-touch	1TB SSD M.2 PCIe NVMe Opal2	None	Intel 8265 ac, 2x2 + BT4.1	WWAN Upgradable	None	None	None	None	Silver	720p	Backlit	Finger-print Reader	None	dTPM 2.0	3-cell(23Wh) + 3-cell(26Wh)	45W	Win10 Pro 64	3-year, Depot	04/17
20HF005LUS	US	i7-7600U	vPro	Intel HD 620	8GB + 16GB	14" FHD (1920x1080) IPS	10-point Multi-touch	1TB SSD M.2 PCIe NVMe Opal2	None	Intel 8265 ac, 2x2 + BT4.1	WWAN Upgradable	None	None	None	None	Black	720p	Backlit	Finger-print Reader	None	dTPM 2.0	3-cell(23Wh) + 3-cell(26Wh)	45W	Win10 Pro 64	3-year, Depot	04/17
20HF005MUS	US	i7-7600U	vPro	Intel HD 620	8GB + 16GB	14" WQHD (2560x1440) IPS	None	1TB SSD M.2 PCIe NVMe Opal2	None	Intel 8265 ac, 2x2 + BT4.1	WWAN Upgradable	None	None	None	None	Black	720p	Backlit	Finger-print Reader	None	dTPM 2.0	3-cell(23Wh) + 3-cell(26Wh)	45W	Win10 Pro 64	3-year, Depot	04/17

Model	Region	Processor	vPro	Graphics	Memory (Soldered +DIMM)	Display	Multi-touch	Storage(HDD/SSD)	Optical	WLAN + Bluetooth	WWAN	SIM Card	Smart Card Reader	Dock	Monitor Cable	Color Camera	Key-board	Finger-print Reader	NFC	TPM	Battery (internal)	Power Adapter	Operating System	War-ranty	Ann Date (m/y)
20HF005NUS	US	i5-7200U	No	Intel HD 620	4GB Soldered	14" FHD (1920x1080) IPS	None	180GB SSD M.2 Opal2	None	Intel 8265 ac, 2x2 + BT4.1	WWAN Upgradable	None	None	None	None	Black	720p Backlit	Finger-print Reader	None	dTPM 2.0	3-cell(23Wh) + 3-cell(26Wh)	45W	Win10 Pro 64	1-year, Depot	04/17

ThinkPad T470s - TopSeller - 20JS

Model	Region	Processor	vPro	Graphics	Memory (Soldered +DIMM)	Display	Multi-touch	Storage(HDD/SSD)	Optical	WLAN + Bluetooth	WWAN	SIM Card	Smart Card Reader	Dock	Monitor Cable	Color	Camera	Key-board	Finger-print Reader	NFC	TPM	Battery (internal)	Power Adapter	Operating System	Warranty	Ann Date (m/y)
20JS0004US	US	i7-6600U	vPro	Intel HD 520	4GB + 4GB	14" FHD (1920x1080) IPS	None	256GB SSD M.2 PCIe NVMe Opal2	None	Intel 8260 ac, 2x2 + BT4.1	WWAN Upgradable	None	None	None	None	Black	720p	Backlit	Finger-print Reader	None	dTPM 2.0	3-cell(23Wh) + 3-cell(26Wh)	45W	Win10 DG Win7 Pro 64	3-year, Depot	03/17
20JS0014US	US	i5-6300U	vPro	Intel HD 520	4GB Soldered	14" FHD (1920x1080) IPS	None	128GB SSD M.2	None	Intel 8260 ac, 2x2 + BT4.1	WWAN Upgradable	None	None	None	None	Black	720p	Backlit	Finger-print Reader	None	dTPM 2.0	3-cell(23Wh) + 3-cell(26Wh)	45W	Win10 DG Win7 Pro 64	1-year, Depot	03/17
20JS0015US	US	i5-6300U	vPro	Intel HD 520	4GB + 4GB	14" FHD (1920x1080) IPS	None	256GB SSD M.2 PCIe NVMe Opal2	None	Intel 8260 ac, 2x2 + BT4.1	WWAN Upgradable	None	None	None	None	Black	720p	Backlit	Finger-print Reader	None	dTPM 2.0	3-cell(23Wh) + 3-cell(26Wh)	45W	Win10 DG Win7 Pro 64	3-year, Depot	03/17
20JS0016US	US	i5-6300U	vPro	Intel HD 520	4GB Soldered	14" FHD (1920x1080) IPS	None	180GB SSD M.2 Opal2	None	Intel 8260 ac, 2x2 + BT4.1	WWAN Upgradable	None	Smart Card Reader	None	None	Black	720p	Backlit	Finger-print Reader	None	dTPM 2.0	3-cell(23Wh) + 3-cell(26Wh)	45W	Win10 DG Win7 Pro 64	1-year, Depot	03/17
20JS0017US	US	i5-6300U	vPro	Intel HD 520	4GB + 4GB	14" FHD (1920x1080) IPS	None	180GB SSD M.2 Opal2	None	Intel 8260 ac, 2x2 + BT4.1	WWAN Upgradable	None	Smart Card Reader	None	None	Black	720p	Backlit	Finger-print Reader	None	dTPM 2.0	3-cell(23Wh) + 3-cell(26Wh)	45W	Win10 DG Win7 Pro 64	3-year, Depot	03/17
20JS0018US	US	i5-6300U	vPro	Intel HD 520	4GB Soldered	14" FHD (1920x1080) IPS	None	180GB SSD M.2 Opal2	None	Intel 8260 ac, 2x2 + BT4.1	WWAN Upgradable	None	None	None	None	Black	720p	Backlit	Finger-print Reader	None	dTPM 2.0	3-cell(23Wh) + 3-cell(26Wh)	45W	Win10 DG Win7 Pro 64	1-year, Depot	03/17
20JS0019US	US	i5-6300U	vPro	Intel HD 520	4GB + 4GB	14" FHD (1920x1080) IPS	None	256GB SSD M.2 PCIe NVMe Opal2	None	Intel 8260 ac, 2x2 + BT4.1	Sierra EM7455	None	None	None	None	Black	720p	Backlit	Finger-print Reader	None	dTPM 2.0	3-cell(23Wh) + 3-cell(26Wh)	45W	Win10 DG Win7 Pro 64	3-year, Depot	04/17
20JS001AUS	US	i7-6600U	vPro	Intel HD 520	4GB + 4GB	14" FHD (1920x1080) IPS	None	256GB SSD M.2 PCIe NVMe Opal2	None	Intel 8260 ac, 2x2 + BT4.1	Sierra EM7455	None	None	None	None	Black	720p	Backlit	Finger-print Reader	None	dTPM 2.0	3-cell(23Wh) + 3-cell(26Wh)	45W	Win10 DG Win7 Pro 64	3-year, Depot	04/17
20JS001BUS	US	i7-6600U	vPro	Intel HD 520	4GB + 4GB	14" FHD (1920x1080) IPS	10-point Multi-touch	256GB SSD M.2 PCIe NVMe Opal2	None	Intel 8260 ac, 2x2 + BT4.1	Sierra EM7455	None	None	None	None	Black	720p	Backlit	Finger-print Reader	None	dTPM 2.0	3-cell(23Wh) + 3-cell(26Wh)	45W	Win10 DG Win7 Pro 64	3-year, Depot	04/17
20JS001CUS	US	i7-6600U	vPro	Intel HD 520	4GB + 16GB	14" FHD (1920x1080) IPS	10-point Multi-touch	1TB SSD M.2 PCIe NVMe Opal2	None	Intel 8260 ac, 2x2 + BT4.1	Sierra EM7455	None	None	None	None	Black	720p	Backlit	Finger-print Reader	None	dTPM 2.0	3-cell(23Wh) + 3-cell(26Wh)	45W	Win10 DG Win7 Pro 64	3-year, Depot	04/17
20JS001DUS	US	i7-6600U	vPro	Intel HD 520	4GB + 16GB	14" FHD (1920x1080) IPS	None	1TB SSD M.2 PCIe NVMe Opal2	None	Intel 8260 ac, 2x2 + BT4.1	Sierra EM7455	None	None	None	None	Black	720p	Backlit	Finger-print Reader	None	dTPM 2.0	3-cell(23Wh) + 3-cell(26Wh)	45W	Win10 DG Win7 Pro 64	3-year, Depot	04/17



ThinkPad T560 Platform Specifications

Product Specifications Reference (PSREF)

Processor	6th Generation Intel® Core™ i5 / i7 Processor								Smart card reader	Optional: Smart card reader																				
	Processor Number	# of Cores	# of Threads	Base Frequency	Max Turbo Frequency	Cache	Memory Types	Processor Graphics	Media reader	4-in-1 reader (MMC, SD, SDHC, SDXC)																				
	i5-6200U	2	4	2.3 GHz	2.8 GHz	3MB	DDR3L-1600	Intel HD Graphics 520	Ports	Three USB 3.0 (one Always On), MiniDP, HDMI, Ethernet (RJ-45), Dock connector																				
	i5-6300U			2.4 GHz	3 GHz	3MB																								
	i7-6500U			2.5 GHz	3.1 GHz	4MB																								
i7-6600U	2.6 GHz			3.4 GHz	4MB																									
Camera	optional) HD720p resolution, low light sensitive, fixed focus																													
Audio support	HD Audio, Realtek® ALC3245 codec / stereo speakers, 1W x 2 / dual array microphone, combo audio/microphone jack																													
Keyboard	6-row, spill-resistant, multimedia Fn keys, numeric keypad, optional LED backlight																													
UltraNav™	TrackPoint® pointing device and buttonless Mylar surface touchpad, multi-touch																													
Graphics	Intel HD Graphics 520 in processor only, or Intel HD Graphics 520 in processor and NVIDIA GeForce® 940MX, 2GB memory; supports external digital monitor via HDMI or Mini DisplayPort; supports three independent displays; Max resolution: 3840x2160 @60Hz (DisplayPort via Mini DisplayPort cable); 4096x2160 @24Hz (HDMI)								Security	Power-on password, hard disk password, supervisor password, security keyhole																				
Chipset	Intel SoC (System on Chip) platform								Security chip	Discrete TPM 1.2 TCG Certified and Firmware TPM 2.0 integrated in chipset																				
Memory	32GB max ⁷ / PC3-12800 1600MHz DDR3L, non-parity, dual-channel capable, two DDR3L SO-DIMM sockets								ThinkEngine	Delivers improved thermal and power efficiency, up to 30 day standby, faster resume time, enhanced security, as well as anti-tampering measures																				
Display	Some: 15.6" (396mm) HD (1366x768), anti-glare, LED backlight, 220 nits, 16:9 aspect ratio, 400:1 contrast ratio								vPro (optional)	Intel vPro Technology																				
	Some: 15.6" (396mm) FHD (1920x1080), anti-glare, LED backlight, IPS, 250 nits, 16:9 aspect ratio, 600:1 contrast ratio, 160° viewing angle								Fingerprint reader	Optional: Swipe style fingerprint reader on the palm rest																				
	Some: 15.5" (394mm) 3K (2880x1620), anti-glare, LED backlight, IPS, 350 nits, 16:9 aspect ratio, 1000:1 contrast ratio, 160° viewing angle								Internal battery	Optional: Integrated Li-Polymer 3-cell (44Wh)																				
Multi-touch (opt)	In-cell touch, supports 10-finger gesture								External battery	Li-Ion or Li-Polymer 3-cell (23Wh) or Li-Ion 6-cell (48Wh or 72Wh)																				
Storage	Some: SSD / SATA 6.0Gb/s (e.g. xxxG SSD)								Max battery life ¹⁰	(MobileMark® 2014)																				
	Some: SSD / PCIe NVMe, PCIe 3.0 x 2, 16Gb/s (e.g. xxxG SSD PCIe NVMe)								<table border="1"> <thead> <tr> <th>Models</th> <th>3 + 3-cell</th> <th>3 + 6-cell 48Wh</th> <th>3 + 6-cell 72Wh</th> </tr> </thead> <tbody> <tr> <td>Integrated model</td> <td>13.2 hr</td> <td>18.0 hr</td> <td>22.7 hr</td> </tr> <tr> <td>discrete model</td> <td>13.5 hr</td> <td>18.3 hr</td> <td>24.3 hr</td> </tr> </tbody> </table>		Models	3 + 3-cell	3 + 6-cell 48Wh	3 + 6-cell 72Wh	Integrated model	13.2 hr	18.0 hr	22.7 hr	discrete model	13.5 hr	18.3 hr	24.3 hr								
Models	3 + 3-cell	3 + 6-cell 48Wh	3 + 6-cell 72Wh																											
Integrated model	13.2 hr	18.0 hr	22.7 hr																											
discrete model	13.5 hr	18.3 hr	24.3 hr																											
	Some: HDD / SATA 6.0Gb/s, 2.5" wide, 7mm high, Shock Mounted Hard Drive, Active Protection System™								AC adapter	45W AC adapter, 65W Slim AC adapter, or 65W AC adapter																				
	Some: SSHD with 8GB NAND flash memory								Preload	Windows 7 Professional 64 preinstalled through downgrade rights in Windows 10 Pro 64																				
Optical	None									<ul style="list-style-type: none"> • Lenovo Solution Center • Lenovo Companion • Lenovo Setting • Microsoft Office preloaded; purchase a product key to activate • McAfee® LiveSafe™ (30-day trial) 																				
Ethernet	Non-vPro model: Intel Ethernet Connection I219-V (Jacksonville)																													
	vPro model: Intel Ethernet Connection I219-LM (Jacksonville)								Limited warranty ¹²	One of the following, configurable by model:																				
WLAN ⁴	One of the following, configurable by model:									<ul style="list-style-type: none"> • 1-year depot repair service • 3-year/1-yr battery depot repair service • 3-year/1-yr battery limited onsite service²⁴ • 3-year/1-yr battery limited onsite service, OID (Onsite International Delivery) 																				
Bluetooth™	Bluetooth 4.1 wireless, integrated in Wi-Fi + Bluetooth combo adapter								Mil-Spec test	MIL-STD-810G military certification																				
WWAN (optional)	One of the following, configurable by model:								Environment	EPEAT™ Gold (US only); ENERGY STAR® 6.1; GREENGUARD®; RoHS-compliant																				
	<ul style="list-style-type: none"> • Wireless WAN upgradable • Wireless WAN, Sierra Wireless EM7455, Qualcomm® 4G LTE-Advanced/DC-HSPA+/HSPA+/HSPA/UMTS/GNSS, M.2 card • Wireless WAN, HUAWEI ME906S, HUAWEI 4G LTE/WCDMA/HSPA/GSM/GPRS/EDGE/GNSS, M.2 card (WE only) 																													
SIM card (opt)	Micro-SIM card slot, optional Verizon LTE (US) or Lenovo Connect (WE) SIM card																													
Dimensions ³	WxDxH: 14.98" x 10.17" x 0.88"; 380.6mm x 258.2mm x 22.45mm																													
Weight ²	<table border="1"> <thead> <tr> <th>Models</th> <th>No + 6-cell</th> <th>3-cell + 3-cell</th> <th>3-cell + 6-cell</th> </tr> </thead> <tbody> <tr> <td>Integrated Non-touch</td> <td>5.18 lb / 2.35 kg</td> <td>4.88 lb / 2.22 kg</td> <td>5.35 lb / 2.43 kg</td> </tr> <tr> <td>Integrated Multi-touch</td> <td>-</td> <td>4.92 lb / 2.23 kg</td> <td>5.33 lb / 2.42 kg</td> </tr> <tr> <td>Discrete Non-touch</td> <td>5.27 lb / 2.39 kg</td> <td>4.97 lb / 2.25 kg</td> <td>5.44 lb / 2.47 kg</td> </tr> <tr> <td>Discrete Multi-touch</td> <td>-</td> <td>5.00 lb / 2.27 kg</td> <td>5.42 lb / 2.46 kg</td> </tr> </tbody> </table>								Models	No + 6-cell	3-cell + 3-cell	3-cell + 6-cell	Integrated Non-touch	5.18 lb / 2.35 kg	4.88 lb / 2.22 kg	5.35 lb / 2.43 kg	Integrated Multi-touch	-	4.92 lb / 2.23 kg	5.33 lb / 2.42 kg	Discrete Non-touch	5.27 lb / 2.39 kg	4.97 lb / 2.25 kg	5.44 lb / 2.47 kg	Discrete Multi-touch	-	5.00 lb / 2.27 kg	5.42 lb / 2.46 kg		
Models	No + 6-cell	3-cell + 3-cell	3-cell + 6-cell																											
Integrated Non-touch	5.18 lb / 2.35 kg	4.88 lb / 2.22 kg	5.35 lb / 2.43 kg																											
Integrated Multi-touch	-	4.92 lb / 2.23 kg	5.33 lb / 2.42 kg																											
Discrete Non-touch	5.27 lb / 2.39 kg	4.97 lb / 2.25 kg	5.44 lb / 2.47 kg																											
Discrete Multi-touch	-	5.00 lb / 2.27 kg	5.42 lb / 2.46 kg																											
Case material	Display cover: PPS; Bottom: Glass-Fiber Reinforced Plastic																													

Model	Region	Processor	vPro	Graphics	Memory	Display	Multi-touch	Storage	Optical	WLAN + Bluetooth	WWAN	SIM Card	Smart Card Reader	Camera	Keyboard	Fingerprint Reader	Battery (internal+external)	Power Adapter	Operating System	Warranty	Ann Date (m/y)
20FH001QUS	US	i5-6200U	No	Intel HD 520	4GBx1	15.6" HD (1366x768)	None	500GB 7200rpm	None	Intel 8260 ac, 2x2 + BT4.1	WWAN Upgradable	None	None	720p	Backlit	Fingerprint Reader	3-cell(44Wh) + 3-cell(23Wh)	45W	Win10 DG Win7 Pro 64	3-year, Depot	01/16
20FH001RUS	US	i5-6300U	vPro	Intel HD 520	8GBx1	15.6" FHD (1920x1080) IPS	None	256GB SSD Opal2	None	Intel 8260 ac, 2x2 + BT4.1	WWAN Upgradable	None	None	720p	Backlit	Fingerprint Reader	3-cell(44Wh) + 3-cell(23Wh)	45W	Win10 DG Win7 Pro 64	3-year, Depot	01/16
20FH001SUS	US	i5-6300U	vPro	Intel HD 520	4GBx1	15.6" HD (1366x768)	None	180GB SSD Opal2	None	Intel 8260 ac, 2x2 + BT4.1	WWAN Upgradable	None	None	720p	Backlit	Fingerprint Reader	3-cell(44Wh) + 3-cell(23Wh)	45W	Win10 DG Win7 Pro 64	3-year, Depot	01/16
20FH001TUS	US	i7-6600U	vPro	Intel HD 520	8GBx1	15.6" FHD (1920x1080) IPS	None	256GB SSD Opal2	None	Intel 8260 ac, 2x2 + BT4.1	WWAN Upgradable	None	None	720p	Backlit	Fingerprint Reader	3-cell(44Wh) + 3-cell(23Wh)	45W	Win10 DG Win7 Pro 64	3-year, Depot	01/16
20FH001UUS	US	i5-6300U	vPro	Intel HD 520	4GBx1	15.5" 3K (2880x1620) IPS	None	192GB SSD	None	Intel 8260 ac, 2x2 + BT4.1	WWAN Upgradable	None	None	720p	Backlit	Fingerprint Reader	3-cell(44Wh) + 3-cell(23Wh)	45W	Win10 DG Win7 Pro 64	3-year, Depot	01/16
20FH001VUS	US	i5-6300U	vPro	Intel HD 520	4GBx1	15.6" HD (1366x768)	None	500GB 7200rpm	None	Intel 8260 ac, 2x2 + BT4.1	WWAN Upgradable	None	None	720p	Backlit	Fingerprint Reader	3-cell(44Wh) + 3-cell(23Wh)	45W	Win10 DG Win7 Pro 64	3-year, Depot	01/16
20FH001WUS	US	i7-6600U	vPro	Intel HD 520	8GBx1	15.5" 3K (2880x1620) IPS	None	256GB SSD Opal2	None	Intel 8260 ac, 2x2 + BT4.1	WWAN Upgradable	None	None	720p	Backlit	Fingerprint Reader	3-cell(44Wh) + 3-cell(23Wh)	45W	Win10 DG Win7 Pro 64	3-year, Depot	01/16
20FH001XUS	US	i5-6300U	vPro	Intel HD 520	4GBx1	15.6" FHD (1920x1080) IPS	None	180GB SSD Opal2	None	Intel 8260 ac, 2x2 + BT4.1	WWAN Upgradable	None	None	720p	Backlit	Fingerprint Reader	3-cell(44Wh) + 3-cell(23Wh)	45W	Win10 DG Win7 Pro 64	3-year, Depot	01/16
20FH001YUS	US	i5-6300U	vPro	Intel HD 520	8GBx1	15.6" FHD (1920x1080) IPS	None	180GB SSD Opal2	None	Intel 8260 ac, 2x2 + BT4.1	WWAN Upgradable	None	None	720p	Backlit	Fingerprint Reader	3-cell(44Wh) + 3-cell(23Wh)	45W	Win10 DG Win7 Pro 64	3-year, Depot	01/16
20FH0020US	US	i5-6300U	vPro	Intel HD 520	4GBx1	15.6" HD (1366x768)	None	256GB SSD Opal2	None	Intel 8260 ac, 2x2 + BT4.1	WWAN Upgradable	None	None	720p	Backlit	Fingerprint Reader	3-cell(44Wh) + 3-cell(23Wh)	45W	Win10 DG Win7 Pro 64	3-year, Depot	01/16
20FH0021US	US	i5-6300U	vPro	Intel HD 520	8GBx1	15.5" 3K (2880x1620) IPS	None	256GB SSD Opal2	None	Intel 8260 ac, 2x2 + BT4.1	WWAN Upgradable	None	None	720p	Backlit	Fingerprint Reader	3-cell(44Wh) + 3-cell(23Wh)	45W	Win10 DG Win7 Pro 64	3-year, Depot	01/16
20FH002CUS	US	i5-6300U	vPro	Intel HD 520	8GBx1	15.6" FHD (1920x1080) IPS	None	256GB SSD Opal2	None	Intel 8260 ac, 2x2 + BT4.1	WWAN Upgradable	None	None	720p	Backlit	Fingerprint Reader	3-cell(44Wh) + 3-cell(23Wh)	45W	Win10 Pro 64	3-year, Depot	01/16
20FH002DUS	US	i5-6300U	vPro	Intel HD 520	8GBx1	15.6" FHD (1920x1080) IPS	10-point Multi-touch	256GB SSD Opal2	None	Intel 8260 ac, 2x2 + BT4.1	WWAN Upgradable	None	None	720p	Backlit	Fingerprint Reader	3-cell(44Wh) + 3-cell(23Wh)	45W	Win10 Pro 64	3-year, Depot	01/16
20FH002EUS	US	i5-6200U	No	Intel HD 520	4GBx1	15.6" HD (1366x768)	None	192GB SSD	None	Intel 8260 ac, 2x2 + BT4.1	WWAN Upgradable	None	None	720p	Backlit	Fingerprint Reader	3-cell(44Wh) + 3-cell(23Wh)	45W	Win10 DG Win7 Pro 64	3-year, Depot	01/16
20FH002FUS	US	i7-6600U	vPro	Intel HD 520	8GBx2	15.6" FHD (1920x1080) IPS	10-point Multi-touch	512GB SSD	None	Intel 8260 ac, 2x2 + BT4.1	WWAN Upgradable	None	None	720p	Backlit	Fingerprint Reader	3-cell(44Wh) + 3-cell(23Wh)	45W	Win10 Pro 64	3-year, Depot	01/16
20FH002GUS	US	i5-6200U	No	Intel HD 520	4GBx1	15.6" HD (1366x768)	None	500GB 7200rpm	None	Intel 8260 ac, 2x2 + BT4.1	WWAN Upgradable	None	None	720p	Backlit	Fingerprint Reader	3-cell(44Wh) + 3-cell(23Wh)	45W	Win10 Pro 64	3-year, Depot	01/16
20FH002HUS	US	i7-6600U	vPro	Intel HD 520	8GBx2	15.6" FHD (1920x1080) IPS	None	512GB SSD	None	Intel 8260 ac, 2x2 + BT4.1	WWAN Upgradable	None	None	720p	Backlit	Fingerprint Reader	3-cell(44Wh) + 3-cell(23Wh)	45W	Win10 Pro 64	3-year, Depot	01/16
20FH002JUS	US	i7-6600U	vPro	Intel HD 520	8GBx2	15.5" 3K (2880x1620) IPS	None	512GB SSD	None	Intel 8260 ac, 2x2 + BT4.1	WWAN Upgradable	None	None	720p	Backlit	Fingerprint Reader	3-cell(44Wh) + 3-cell(23Wh)	45W	Win10 Pro 64	3-year, Depot	01/16
20FH002KUS	US	i7-6600U	vPro	Intel HD 520	8GBx2	15.5" 3K (2880x1620) IPS	None	512GB SSD	None	Intel 8260 ac, 2x2 + BT4.1	WWAN Upgradable	None	None	720p	Backlit	Fingerprint Reader	3-cell(44Wh) + 3-cell(23Wh)	45W	Win10 DG Win7 Pro 64	3-year, Depot	01/16
20FH002LUS	US	i7-6600U	vPro	Intel HD 520	8GBx1	15.6" FHD (1920x1080) IPS	None	256GB SSD Opal2	None	Intel 8260 ac, 2x2 + BT4.1	WWAN Upgradable	None	None	720p	Backlit	Fingerprint Reader	3-cell(44Wh) + 3-cell(23Wh)	45W	Win10 Pro 64	3-year, Depot	01/16

Model	Region	Processor	vPro	Graphics	Memory	Display	Multi-touch	Storage	Optical	WLAN + Bluetooth	WWAN	SIM Card	Smart Card Reader	Camera	Keyboard	Fingerprint Reader	Battery (internal+external)	Power Adapter	Operating System	Warranty	Ann Date (m/y)
20FH002MUS	US	i5-6200U	No	Intel HD 520	4GBx1	15.6" HD (1366x768)	None	192GB SSD	None	Intel 8260 ac, 2x2 + BT4.1	WWAN Upgradable	None	None	720p	Backlit	Fingerprint Reader	3-cell(44Wh) + 3-cell(23Wh)	45W	Win10 Pro 64	3-year, Depot	01/16
20FH002NUS	US	i7-6600U	vPro	Intel HD 520	8GBx2	15.6" FHD (1920x1080) IPS	None	512GB SSD	None	Intel 8260 ac, 2x2 + BT4.1	WWAN Upgradable	None	None	720p	Backlit	Fingerprint Reader	3-cell(44Wh) + 3-cell(23Wh)	45W	Win10 DG Win7 Pro 64	3-year, Depot	01/16
20FH002WUS	US	i7-6600U	vPro	940MX 2GB	8GBx1	15.6" FHD (1920x1080) IPS	None	512GB SSD	None	Intel 8260 ac, 2x2 + BT4.1	WWAN Upgradable	None	None	720p	Backlit	Fingerprint Reader	3-cell(44Wh) + 3-cell(23Wh)	65W	Win10 DG Win7 Pro 64	3-year, Depot	04/16
20FH002XUS	US	i7-6600U	vPro	940MX 2GB	8GBx1	15.5" 3K (2880x1620) IPS	None	512GB SSD	None	Intel 8260 ac, 2x2 + BT4.1	WWAN Upgradable	None	None	720p	Backlit	Fingerprint Reader	3-cell(44Wh) + 3-cell(23Wh)	65W	Win10 DG Win7 Pro 64	3-year, Depot	04/16
20FH002YUS	US	i7-6600U	vPro	940MX 2GB	8GBx1	15.6" FHD (1920x1080) IPS	None	256GB SSD Opal2	None	Intel 8260 ac, 2x2 + BT4.1	WWAN Upgradable	None	None	720p	Backlit	Fingerprint Reader	3-cell(44Wh) + 3-cell(23Wh)	65W	Win10 DG Win7 Pro 64	3-year, Depot	04/16
20FH0030US	US	i5-6300U	vPro	940MX 2GB	8GBx1	15.6" FHD (1920x1080) IPS	None	256GB SSD Opal2	None	Intel 8260 ac, 2x2 + BT4.1	WWAN Upgradable	None	None	720p	Backlit	Fingerprint Reader	3-cell(44Wh) + 3-cell(23Wh)	65W	Win10 DG Win7 Pro 64	3-year, Depot	04/16
20FH0031US	US	i7-6600U	vPro	940MX 2GB	8GBx1	15.5" 3K (2880x1620) IPS	None	256GB SSD Opal2	None	Intel 8260 ac, 2x2 + BT4.1	WWAN Upgradable	None	None	720p	Backlit	Fingerprint Reader	3-cell(44Wh) + 3-cell(23Wh)	65W	Win10 DG Win7 Pro 64	3-year, Depot	04/16
20FH0032US	US	i5-6300U	vPro	940MX 2GB	8GBx1	15.6" FHD (1920x1080) IPS	None	512GB SSD	None	Intel 8260 ac, 2x2 + BT4.1	WWAN Upgradable	None	None	720p	Backlit	Fingerprint Reader	3-cell(44Wh) + 3-cell(23Wh)	65W	Win10 DG Win7 Pro 64	3-year, Depot	04/16
20FH003BUS	US	i5-6300U	vPro	Intel HD 520	8GBx1	15.6" FHD (1920x1080) IPS	None	500GB 7200rpm	None	Intel 8260 ac, 2x2 + BT4.1	WWAN Upgradable	None	None	720p	Backlit	Fingerprint Reader	3-cell(44Wh) + 3-cell(23Wh)	45W	Win10 DG Win7 Pro 64	3-year, Depot	07/16
20FH0043US	US	i5-6200U	No	Intel HD 520	8GBx1	15.6" FHD (1920x1080) IPS	10-point Multi-touch	256GB SSD Opal2	None	Intel 8260 ac, 2x2 + BT4.1	WWAN Upgradable	None	None	720p	Backlit	Fingerprint Reader	3-cell(44Wh) + 3-cell(23Wh)	45W	Win10 Pro 64	3-year, Depot	10/16
20FH0044US	US	i5-6300U	vPro	Intel HD 520	4GBx1	15.5" 3K (2880x1620) IPS	None	180GB SSD Opal2	None	Intel 8260 ac, 2x2 + BT4.1	WWAN Upgradable	None	None	720p	Backlit	Fingerprint Reader	3-cell(44Wh) + 3-cell(23Wh)	45W	Win10 DG Win7 Pro 64	3-year, Depot	11/16
20FH0045US	US	i5-6200U	No	Intel HD 520	4GBx1	15.6" HD (1366x768)	None	256GB SSD Opal2	None	Intel 8260 ac, 2x2 + BT4.1	WWAN Upgradable	None	None	720p	Backlit	Fingerprint Reader	3-cell(44Wh) + 3-cell(23Wh)	45W	Win10 Pro 64	3-year, Depot	11/16
20FH0046US	US	i5-6200U	No	Intel HD 520	4GBx1	15.6" HD (1366x768)	None	180GB SSD Opal2	None	Intel 8260 ac, 2x2 + BT4.1	WWAN Upgradable	None	None	720p	Backlit	Fingerprint Reader	3-cell(44Wh) + 3-cell(23Wh)	45W	Win10 Pro 64	3-year, Depot	11/16
20FH0047US	US	i5-6200U	No	Intel HD 520	4GBx1	15.6" HD (1366x768)	None	180GB SSD Opal2	None	Intel 8260 ac, 2x2 + BT4.1	WWAN Upgradable	None	None	720p	Backlit	Fingerprint Reader	3-cell(44Wh) + 3-cell(23Wh)	45W	Win10 DG Win7 Pro 64	3-year, Depot	11/16
20FH0048US	US	i5-6200U	No	Intel HD 520	4GBx1	15.6" HD (1366x768)	None	256GB SSD Opal2	None	Intel 8260 ac, 2x2 + BT4.1	WWAN Upgradable	None	None	720p	Backlit	Fingerprint Reader	3-cell(44Wh) + 3-cell(23Wh)	45W	Win10 DG Win7 Pro 64	3-year, Depot	11/16
20FH0049US	US	i5-6300U	vPro	Intel HD 520	4GBx1	15.5" 3K (2880x1620) IPS	None	256GB SSD Opal2	None	Intel 8260 ac, 2x2 + BT4.1	WWAN Upgradable	None	None	720p	Backlit	Fingerprint Reader	3-cell(44Wh) + 3-cell(23Wh)	45W	Win10 DG Win7 Pro 64	3-year, Depot	11/16
20FHA01KUS	US	i5-6300U	vPro	Intel HD 520	8GBx1	15.6" FHD (1920x1080) IPS	None	500GB 7200rpm	None	Intel 8260 ac, 2x2 + BT4.1	WWAN Upgradable	None	None	720p	Backlit	Fingerprint Reader	3-cell(44Wh) + 3-cell(23Wh)	45W	Win10 Pro 64	3-year, Depot	07/16



ThinkPad T570 Platform Specifications

Product Specifications Reference (PSREF)

Processor	6th Generation Intel® Core™ i5 / i7 Processor							Dimensions Weight Case color Case material	<i>WxDxH:</i> 14.40" x 9.95" x 0.79-0.80"; 365.8mm x 252.8mm x 19.95-20.2mm Starting at 4.34 lb / 1.97 kg Black <i>Display cover:</i> Glass-Fiber Reinforced Plastic (PPS); <i>Bottom:</i> Glass-Fiber Reinforced Plastic																		
	Processor Number	# of Cores	# of Threads	Base Frequency	Max Turbo Frequency	Cache	Memory Types			Processor Graphics																	
	i5-6300U	2	4	2.4 GHz	3.0 GHz	3MB	DDR4-2133	Intel HD Graphics 520																			
	i7-6600U			2.6 GHz	3.4 GHz	4MB																					
	or 7th Generation Intel Core i5 / i7 Processor							Smart card reader Media reader Ports	<i>Optional:</i> Smart card reader 4-in-1 reader (MMC, SD, SDHC, SDXC), supports SD 3.0, UHS-I Three USB 3.1 Gen 1 / USB 3.0 (one Always On), USB 3.1 Type-C Gen 2 / Thunderbolt 3, HDMI 1.4b, Ethernet (RJ-45), Dock connector ThinkPad WiGig dock (US only) <i>HDMI to VGA:</i> Lenovo HDMI to VGA Monitor Adapter <i>USB-C to VGA:</i> Lenovo USB-C to VGA Adapter																		
	Processor Number	# of Cores	# of Threads	Base Frequency	Max Turbo Frequency	Cache	Memory Types			Processor Graphics																	
	i5-7200U	2	4	2.5 GHz	3.1 GHz	3MB	DDR4-2133	Intel HD Graphics 620																			
	i5-7300U			2.6 GHz	3.5 GHz	3MB																					
	i7-7500U			2.7 GHz	3.5 GHz	4MB																					
	i7-7600U			2.8 GHz	3.9 GHz	4MB																					
Graphics	Intel HD Graphics 520 or 620 in processor only, or Intel HD Graphics 520 or 620 in processor and NVIDIA GeForce® 940MX, 2GB 2.5GHz GDDR5 memory; supports external digital monitor via HDMI or USB Type-C; supports three independent displays; Max resolution: 4096x2304@60Hz (USB Type-C); 4096x2160@24Hz (HDMI)							Camera (<i>optional</i>)	720p: HD720p resolution, fixed focus IR & 720p: IR camera and HD720p camera (mutually exclusive with WiGig)																		
Chipset	Intel SoC (System on Chip) platform							Audio support	HD Audio, Realtek ALC3268 codec / stereo speakers, 2W x 2 / dual array microphone, combo audio/microphone jack																		
Memory	32GB max / 2400MHz DDR4, dual-channel capable, two DDR4 SO-DIMM sockets * System clocks down for processors with lower memory controller							Keyboard	6-row, spill-resistant, multimedia Fn keys, numeric keypad, optional LED backlight																		
Display	Some: 15.6" (396mm) HD (1366x768), anti-glare, LED backlight, 220 nits, 16:9 aspect ratio, 400:1 contrast ratio Some: 15.6" (396mm) FHD (1920x1080), anti-glare, LED backlight, IPS, 250 nits, 16:9 aspect ratio, 700:1 contrast ratio, 170° viewing angle Some: 15.6" (396mm) 4K (3840x2160), anti-glare, LED backlight, IPS, 300 nits, 16:9 aspect ratio, 1000:1 contrast ratio, 72% gamut, 170° viewing angle							UltraNav™	TrackPoint® pointing device and buttonless Mylar surface multi-touch touchpad																		
Multi-touch (<i>opt</i>)	On-cell touch, supports 10-finger gesture (FHD only)							Security	Power-on password, hard disk password, supervisor password, security keyhole																		
Storage	System has one HDD slot or one M.2 2280 slot exclusively for storage Some: HDD / SATA 6.0Gb/s, 2.5" wide, 7mm high, Active Protection System™ Some: SSD / SATA 6.0Gb/s, 2.5" wide, 7mm high (e.g. xxxGB SSD) Some: M.2 SSD / PCIe NVMe, PCIe 3.0 x 2, 16Gb/s Some: 128GB M.2 SSD / SATA 6.0Gb/s, in WWAN slot as 2nd Storage, mutually exclusive with WWAN and WiGig							Security chip	Discrete TPM 2.0, TCG Certified																		
Optical	None							vPro (<i>optional</i>)	Intel vPro Technology																		
Ethernet	Non-vPro model: Intel Ethernet Connection I219-V (Jacksonville) vPro model: Intel Ethernet Connection I219-LM (Jacksonville)							Fingerprint reader	<i>Optional:</i> Touch style match on chip fingerprint reader on the palm rest																		
WLAN	One of the following, configurable by model (WiGig can coexist with WWAN): • Realtek® RTL8822BE, Wi-Fi 2x2 802.11ac + BT4.1, M.2 card (US only) • Intel Dual Band Wireless-AC 8260, Wi-Fi 2x2 802.11ac + BT4.1, M.2 card • Intel Dual Band Wireless-AC 8265, Wi-Fi 2x2 802.11ac + BT4.1, M.2 card • Intel Tri-Band Wireless-AC 18265, WiGig 802.11ad + Wi-Fi 2x2 802.11ac + BT4.1, M.2 card							NFC (<i>optional</i>)	Near Field Communication																		
Bluetooth™	Bluetooth 4.1 wireless, integrated in Wi-Fi + Bluetooth combo adapter * Intel 8265ac / 18265ac card support BT4.2 but is limited to BT4.1 by Windows OS							Internal battery	<i>Optional:</i> Integrated Li-Polymer 4-cell (32Wh)																		
WWAN (<i>optional</i>)	One of the following, configurable by model (WWAN can coexist with WiGig): • Wireless WAN upgradable • Integrated Mobile Broadband 4G LTE-A, Qualcomm® Snapdragon™ X7 LTE-A (Sierra Wireless EM7455), M.2 card • Integrated Mobile Broadband 4G LTE, Intel XMM™ 7160 (Fibocom L831-EAU), M.2 card (EMEA only)							External battery	Li-Polymer 3-cell (24Wh) or Li-Ion 6-cell (48Wh or 72Wh)																		
SIM card (<i>opt</i>)	Micro-SIM card slot, opt Verizon LTE (US) or Lenovo® Connect (EMEA) SIM card							Max battery life (<i>MobileMark® 2014</i>)	<table border="1"> <thead> <tr> <th>Models</th> <th>4 + 3-cell</th> <th>6-cell 48Wh</th> <th>6-cell 72Wh</th> <th>4 + 6-cell 48Wh</th> <th>4 + 6-cell 72Wh</th> </tr> </thead> <tbody> <tr> <td><i>Integrated</i></td> <td>13.8 hr</td> <td>12.5 hr</td> <td>18.5 hr</td> <td>20.3 hr</td> <td>27.1 hr</td> </tr> <tr> <td><i>discrete</i></td> <td>13.8 hr</td> <td>12.5 hr</td> <td>18.5 hr</td> <td>20.0 hr</td> <td>26.8 hr</td> </tr> </tbody> </table>	Models	4 + 3-cell	6-cell 48Wh	6-cell 72Wh	4 + 6-cell 48Wh	4 + 6-cell 72Wh	<i>Integrated</i>	13.8 hr	12.5 hr	18.5 hr	20.3 hr	27.1 hr	<i>discrete</i>	13.8 hr	12.5 hr	18.5 hr	20.0 hr	26.8 hr
Models	4 + 3-cell	6-cell 48Wh	6-cell 72Wh	4 + 6-cell 48Wh	4 + 6-cell 72Wh																						
<i>Integrated</i>	13.8 hr	12.5 hr	18.5 hr	20.3 hr	27.1 hr																						
<i>discrete</i>	13.8 hr	12.5 hr	18.5 hr	20.0 hr	26.8 hr																						
							AC adapter	45W or 65W AC adapter (slim tip), 45W or 65W USB Type-C AC adapter																			
							Preload	Windows® 7 Professional 64 preinstalled through downgrade rights in Windows 10 Pro 64 • Lenovo Solution Center • Lenovo PowerEngage • ThinkVantage Product Recovery • ThinkVantage System Update • Adobe® Reader® • Microsoft® Office preloaded; purchase a product key to activate • McAfee® LiveSafe™ (30-day trial)																			
							Limited warranty	One of the following, configurable by model: • 1-year depot repair service • 3-year/1-yr battery depot repair service • 3-year/1-yr battery limited onsite service																			
							Mil-Spec test	MIL-STD-810G military certification																			
							Environment	EPPEAT™ Gold (US only); ENERGY STAR® 6.1; RoHS-compliant																			

ThinkPad T570 - TopSeller - 20H9

Product Specifications Reference (PSREF)

Model	Region	Processor	vPro	Graphics	Memory	Display	Multi-touch	Storage(HDD/SSD)	Optical	WLAN + Bluetooth	WWAN	SIM Card	Smart Card Reader	Dock	Monitor Cable	Camera	Key-board	Finger-print Reader	NFC	TPM	Battery (internal+ external)	Power Adapter	Operating System	Warranty	Ann Date (m/y)
20H9000MUS	US	i5-7200U	No	Intel HD 620	8GBx1	15.6" FHD (1920x1080) IPS	None	256GB SSD M.2 PCIe NVMe Opal2	None	Intel 8265 ac, 2x2 + BT4.1	WWAN Upgradable	None	None	None	None	720p	Backlit	Finger-print Reader	None	dTPM 2.0	4-cell(32Wh) + 3-cell(24Wh)	45W	Win10 Pro 64	3-year, Depot	01/17
20H9000NUS	US	i7-7600U	vPro	Intel HD 620	8GBx1	15.6" FHD (1920x1080) IPS	None	256GB SSD M.2 PCIe NVMe Opal2	None	Intel 8265 ac, 2x2 + BT4.1	WWAN Upgradable	None	None	None	None	720p	Backlit	Finger-print Reader	None	dTPM 2.0	4-cell(32Wh) + 3-cell(24Wh)	45W	Win10 Pro 64	3-year, Depot	01/17
20H9000PUS	US	i5-7300U	vPro	Intel HD 620	8GBx1	15.6" FHD (1920x1080) IPS	None	256GB SSD M.2 PCIe NVMe Opal2	None	Intel 8265 ac, 2x2 + BT4.1	WWAN Upgradable	None	None	None	None	720p	Backlit	Finger-print Reader	None	dTPM 2.0	4-cell(32Wh) + 3-cell(24Wh)	45W	Win10 Pro 64	3-year, Depot	01/17
20H9000QUS	US	i5-7200U	No	Intel HD 620	4GBx1	15.6" FHD (1920x1080) IPS	10-point Multi-touch	500GB 7200rpm	None	Intel 8265 ac, 2x2 + BT4.1	WWAN Upgradable	None	None	None	None	720p	Backlit	Finger-print Reader	None	dTPM 2.0	4-cell(32Wh) + 3-cell(24Wh)	45W	Win10 Pro 64	3-year, Depot	01/17
20H9000RUS	US	i5-7200U	No	Intel HD 620	8GBx1	15.6" FHD (1920x1080) IPS	10-point Multi-touch	256GB SSD M.2 PCIe NVMe Opal2	None	Intel 8265 ac, 2x2 + BT4.1	WWAN Upgradable	None	None	None	None	720p	Backlit	Finger-print Reader	None	dTPM 2.0	4-cell(32Wh) + 3-cell(24Wh)	45W	Win10 Pro 64	3-year, Depot	01/17
20H9000SUS	US	i5-7200U	No	Intel HD 620	4GBx1	15.6" FHD (1920x1080) IPS	None	500GB 7200rpm	None	Intel 8265 ac, 2x2 + BT4.1	WWAN Upgradable	None	None	None	None	720p	Backlit	Finger-print Reader	None	dTPM 2.0	4-cell(32Wh) + 3-cell(24Wh)	45W	Win10 Pro 64	1-year, Depot	01/17
20H9000TUS	US	i7-7600U	vPro	Intel HD 620	8GBx1	15.6" FHD (1920x1080) IPS	10-point Multi-touch	256GB SSD M.2 PCIe NVMe Opal2	None	Intel 8265 ac, 2x2 + BT4.1	WWAN Upgradable	None	None	None	None	720p	Backlit	Finger-print Reader	None	dTPM 2.0	4-cell(32Wh) + 3-cell(24Wh)	45W	Win10 Pro 64	3-year, Depot	01/17
20H9000UUS	US	i5-7300U	vPro	Intel HD 620	8GBx1	15.6" FHD (1920x1080) IPS	10-point Multi-touch	256GB SSD M.2 PCIe NVMe Opal2	None	Intel 8265 ac, 2x2 + BT4.1	WWAN Upgradable	None	None	None	None	720p	Backlit	Finger-print Reader	None	dTPM 2.0	4-cell(32Wh) + 3-cell(24Wh)	45W	Win10 Pro 64	3-year, Depot	01/17
20H9004FUS	US	i5-7200U	No	Intel HD 620	4GBx1	15.6" FHD (1920x1080) IPS	None	500GB 7200rpm	None	Intel 8265 ac, 2x2 + BT4.1	WWAN Upgradable	None	None	None	None	720p	Backlit	Finger-print Reader	None	dTPM 2.0	4-cell(32Wh) + 3-cell(24Wh)	45W	Win10 Pro 64	3-year, Depot	03/17
20H9004NUS	US	i7-7600U	vPro	Intel HD 620	8GBx1	15.6" FHD (1920x1080) IPS	None	256GB SSD M.2 PCIe NVMe Opal2	None	Intel 8265 ac, 2x2 + BT4.1	WWAN Upgradable	None	None	None	None	IR & 720p	Backlit	Finger-print Reader	None	dTPM 2.0	4-cell(32Wh) + 3-cell(24Wh)	45W	Win10 Pro 64	3-year, Depot	04/17
20H9004PUS	US	i7-7600U	vPro	Intel HD 620	8GBx1	15.6" FHD (1920x1080) IPS	10-point Multi-touch	256GB SSD M.2 PCIe NVMe Opal2	None	Intel 8265 ac, 2x2 + BT4.1	WWAN Upgradable	None	None	None	None	IR & 720p	Backlit	Finger-print Reader	None	dTPM 2.0	4-cell(32Wh) + 3-cell(24Wh)	45W	Win10 Pro 64	3-year, Depot	04/17
20H9004QUS	US	i5-7300U	vPro	Intel HD 620	8GBx1	15.6" FHD (1920x1080) IPS	None	256GB SSD M.2 PCIe NVMe Opal2	None	Intel 8265 ac, 2x2 + BT4.1	WWAN Upgradable	None	None	None	None	IR & 720p	Backlit	Finger-print Reader	None	dTPM 2.0	4-cell(32Wh) + 3-cell(24Wh)	45W	Win10 Pro 64	3-year, Depot	04/17
20H9004RUS	US	i7-7600U	vPro	Intel HD 620	16GBx1	15.6" 4K (3840x2160) IPS	None	512GB SSD M.2 PCIe NVMe Opal2	None	Intel 8265 ac, 2x2 + BT4.1	WWAN Upgradable	None	None	None	None	IR & 720p	Backlit	Finger-print Reader	None	dTPM 2.0	4-cell(32Wh) + 3-cell(24Wh)	45W	Win10 Pro 64	3-year, Depot	04/17
20H9004SUS	US	i7-7600U	vPro	Intel HD 620	16GBx1	15.6" FHD (1920x1080) IPS	10-point Multi-touch	512GB SSD M.2 PCIe NVMe Opal2	None	Intel 8265 ac, 2x2 + BT4.1	WWAN Upgradable	None	None	None	None	720p	Backlit	Finger-print Reader	None	dTPM 2.0	4-cell(32Wh) + 3-cell(24Wh)	45W	Win10 Pro 64	3-year, Depot	04/17
20H9004TUS	US	i7-7600U	vPro	Intel HD 620	16GBx1	15.6" FHD (1920x1080) IPS	None	512GB SSD M.2 PCIe NVMe Opal2	None	Intel 8265 ac, 2x2 + BT4.1	WWAN Upgradable	None	None	None	None	720p	Backlit	Finger-print Reader	None	dTPM 2.0	4-cell(32Wh) + 3-cell(24Wh)	45W	Win10 Pro 64	3-year, Depot	04/17
20H9004UUS	US	i7-7600U	vPro	Intel HD 620	8GBx1	15.6" FHD (1920x1080) IPS	10-point Multi-touch	256GB SSD M.2 PCIe NVMe Opal2	None	Intel 8265 ac, 2x2 + BT4.1	Sierra EM7455	None	None	None	None	720p	Backlit	Finger-print Reader	None	dTPM 2.0	4-cell(32Wh) + 3-cell(24Wh)	45W	Win10 Pro 64	3-year, Depot	04/17
20H9004VUS	US	i5-7300U	vPro	Intel HD 620	8GBx1	15.6" FHD (1920x1080) IPS	None	256GB SSD M.2 PCIe NVMe Opal2	None	Intel 8265 ac, 2x2 + BT4.1	Sierra EM7455	None	None	None	None	720p	Backlit	Finger-print Reader	None	dTPM 2.0	4-cell(32Wh) + 3-cell(24Wh)	45W	Win10 Pro 64	3-year, Depot	04/17
20H9004WUS	US	i7-7600U	vPro	Intel HD 620	8GBx1	15.6" FHD (1920x1080) IPS	None	256GB SSD M.2 PCIe NVMe Opal2	None	Intel 8265 ac, 2x2 + BT4.1	Sierra EM7455	None	None	None	None	720p	Backlit	Finger-print Reader	None	dTPM 2.0	4-cell(32Wh) + 3-cell(24Wh)	45W	Win10 Pro 64	3-year, Depot	04/17

ThinkPad T570 - TopSeller - 20JW

Product Specifications Reference (PSREF)

Model	Region	Processor	vPro	Graphics	Memory	Display	Multi-touch	Storage(HDD/SSD)	Optical	WLAN + Bluetooth	WWAN	SIM Card	Smart Card Reader	Dock	Monitor Cable	Camera	Key-board	Finger-print Reader	NFC	TPM	Battery (internal+external)	Power Adapter	Operating System	Warranty	Ann Date (m/y)
20JW0004US	US	i7-6600U	vPro	Intel HD 520	8GBx1	15.6" FHD (1920x1080) IPS	None	256GB SSD M.2 PCIe NVMe Opal2	None	Intel 8260 ac, 2x2 + BT4.1	WWAN Upgradable	None	None	None	None	720p	Backlit	Finger-print Reader	None	dTPM 2.0	4-cell(32Wh) + 3-cell(24Wh)	45W	Win10 DG Win7 Pro 64	3-year, Depot	03/17
20JW0005US	US	i5-6300U	vPro	Intel HD 520	4GBx1	15.6" FHD (1920x1080) IPS	None	500GB 7200rpm	None	Intel 8260 ac, 2x2 + BT4.1	WWAN Upgradable	None	None	None	None	720p	Backlit	Finger-print Reader	None	dTPM 2.0	4-cell(32Wh) + 3-cell(24Wh)	45W	Win10 DG Win7 Pro 64	3-year, Depot	03/17
20JW0006US	US	i5-6300U	vPro	Intel HD 520	8GBx1	15.6" FHD (1920x1080) IPS	None	256GB SSD M.2 PCIe NVMe Opal2	None	Intel 8260 ac, 2x2 + BT4.1	WWAN Upgradable	None	None	None	None	720p	Backlit	Finger-print Reader	None	dTPM 2.0	4-cell(32Wh) + 3-cell(24Wh)	45W	Win10 DG Win7 Pro 64	3-year, Depot	03/17
20JW0007US	US	i7-6600U	vPro	Intel HD 520	16GBx1	15.6" FHD (1920x1080) IPS	None	512GB SSD M.2 PCIe NVMe Opal2	None	Intel 8260 ac, 2x2 + BT4.1	WWAN Upgradable	None	None	None	None	720p	Backlit	Finger-print Reader	None	dTPM 2.0	4-cell(32Wh) + 3-cell(24Wh)	45W	Win10 DG Win7 Pro 64	3-year, Depot	04/17
20JW0008US	US	i5-6300U	vPro	Intel HD 520	8GBx1	15.6" FHD (1920x1080) IPS	None	256GB SSD M.2 PCIe NVMe Opal2	None	Intel 8260 ac, 2x2 + BT4.1	Sierra EM7455	None	None	None	None	720p	Backlit	Finger-print Reader	None	dTPM 2.0	4-cell(32Wh) + 3-cell(24Wh)	45W	Win10 DG Win7 Pro 64	3-year, Depot	04/17
20JW0009US	US	i7-6600U	vPro	Intel HD 520	8GBx1	15.6" FHD (1920x1080) IPS	None	256GB SSD M.2 PCIe NVMe Opal2	None	Intel 8260 ac, 2x2 + BT4.1	Sierra EM7455	None	None	None	None	720p	Backlit	Finger-print Reader	None	dTPM 2.0	4-cell(32Wh) + 3-cell(24Wh)	45W	Win10 DG Win7 Pro 64	3-year, Depot	04/17



ThinkPad X1 Carbon (4th Gen) Platform Specifications

Product Specifications Reference (PSREF)

Processor	6th Generation Intel® Core™ i5 / i7 Processor								Media reader Ports WiGig dock (opt) Adapter (optional)	MicroSD card reader, supports UHS-II microSD card Three USB 3.0 (one Always On), MiniDP, HDMI, Lenovo OneLink+ connector WiGig dock, mutually exclusive with WWAN HDMI-VGA: Lenovo HDMI to VGA Monitor Cable mDP-VGA: Lenovo Mini DisplayPort to VGA Monitor Cable RJ45: ThinkPad OneLink+ to RJ45 adapter VGA/RJ45: ThinkPad OneLink+ to VGA/RJ45 adapter												
	Processor Number	# of Cores	# of Threads	Base Frequency	Max Turbo Frequency	Cache	Memory Types	Processor Graphics														
	i5-6200U	2	4	2.3 GHz	2.8 GHz	3MB	LPDDR3-1866	Intel HD Graphics 520														
	i5-6300U			2.4 GHz	3.0 GHz	3MB																
	i7-6500U			2.5 GHz	3.1 GHz	4MB																
i7-6600U	2.6 GHz			3.4 GHz	4MB																	
Graphics	Intel HD Graphics 520 in processor, external digital monitor support via Mini DisplayPort or HDMI™; supports three independent displays; Max resolution: 3840x2160 (Mini DisplayPort) @60Hz; 4096x2304 (HDMI) @24Hz								Camera Audio support	HD720p resolution, low light sensitive, fixed focus HD Audio, Conexant® CX11852 codec / stereo speakers, 1 watt x 2 / dual array microphone, combo audio/microphone jack												
Chipset Memory	Intel SoC (System on Chip) platform 4GB, 8GB, or 16GB / 1866MHz LPDDR3 / soldered to systemboard, no sockets								Keyboard UltraNav™	6-row, spill-resistant, multimedia Fn keys, LED backlight TrackPoint® pointing device and buttonless glass surface touchpad, multi-touch												
Display	Some: 14.0" (355mm) FHD (1920x1080), anti-glare, LED backlight, IPS, 300 nits, 16:9 aspect ratio, 700:1 contrast ratio, 170° viewing angle Some: 14.0" (355mm) WQHD (2560x1440), anti-glare, LED backlight, IPS, 300 nits, 16:9 aspect ratio, 700:1 contrast ratio, 72% gamut, 170° viewing angle								Security	Power-on password, hard disk password, supervisor password, security keyhole, reset switch												
Multi-touch Hinge	None Normal hinge, 180 degree								Security chip ThinkEngine	Discrete TPM 1.2 TCG Certified and Firmware TPM 2.0 integrated in chipset Delivers improved thermal and power efficiency, up to 30 day standby, faster resume time, enhanced security, as well as anti-tampering measures												
Storage	Some: M.2 SSD / SATA 6.0Gb/s (e.g. xxxG SSD) Some: M.2 SSD / PCIe NVMe, PCIe 3.0 x 4, 32Gb/s (e.g. xxxG SSD PCIe NVMe)								vPro (optional) Fingerprint reader	Intel vPro Technology Touch style fingerprint reader on the palm rest												
Optical	None								Battery	Integrated Lithium Polymer 4-cell (52Wh) RapidCharge battery												
Ethernet	Gigabit Ethernet via optional Ethernet (RJ-45) adapter (by native Intel Ethernet Connection I219-V (Non-vPro) or I219-LM (vPro))								Max battery life ¹⁰	MobileMark® 2014: 11 hr												
WLAN ⁴	One of the following, configurable by model (WiGig is mutually exclusive with WWAN): • 11ac+BT, Intel Dual Band Wireless-AC 8260, 2x2, M.2 card • WiGig™+11ac+BT, Intel Tri-Band Wireless-AC 18260, 2x2 WLAN, WiGig, M.2 card								AC adapter	45W AC adapter, 65W Slim AC adapter, or 65W AC adapter												
Bluetooth™	Bluetooth 4.1 wireless, integrated in Wi-Fi + Bluetooth combo adapter								RapidCharge	<table border="1"> <thead> <tr> <th>AC adapter</th> <th>45W</th> <th>65W Slim</th> <th>65W</th> </tr> </thead> <tbody> <tr> <td>Charge to 80%</td> <td>Not support</td> <td>1.0 hr</td> <td>1.0 hr</td> </tr> <tr> <td>Charge to 100%</td> <td>Not support</td> <td>2.5 hr</td> <td>2.5 hr</td> </tr> </tbody> </table>	AC adapter	45W	65W Slim	65W	Charge to 80%	Not support	1.0 hr	1.0 hr	Charge to 100%	Not support	2.5 hr	2.5 hr
AC adapter	45W	65W Slim	65W																			
Charge to 80%	Not support	1.0 hr	1.0 hr																			
Charge to 100%	Not support	2.5 hr	2.5 hr																			
WWAN (optional)	One of the following, configurable by model (mutually exclusive with WiGig): • Wireless WAN upgradable • Wireless WAN, Sierra Wireless EM7455, Qualcomm® 4G LTE-Advanced/DC-HSPA+/HSPA+/HSPA/UMTS/GNSS, M.2 card • Wireless WAN, HUAWEI ME906S, HUAWEI 4G LTE/WCDMA/HSPA/GSM/GPRS/EDGE/GNSS, M.2 card (WE only)								Preload	Windows 7 Professional 64 preinstalled through downgrade rights in Windows 10 Pro 64 Windows 10 Pro 64 • Lenovo Solution Center • Lenovo Companion • Lenovo Setting • Microsoft Office preloaded; purchase a product key to activate • McAfee® LiveSafe™ (30-day trial)												
SIM card (opt)	Micro-SIM card slot, optional Verizon LTE (US) or Lenovo Connect (WE) SIM card								Limited warranty ¹²	One of the following, configurable by model: • 1-year depot repair service • 3-year/1-yr battery depot repair service • 3-year/1-yr battery limited onsite service ²⁴ • 3-year/1-yr battery limited onsite service, OID (Onsite International Delivery)												
Dimensions ³ Weight ² Case material	WxDxH: 13.11" x 9.02" x 0.59-0.65"; 333.0mm x 229.0mm x 14.95-16.45mm Starting at 2.579 lb / 1.17 kg Display cover: Carbon-Fiber Reinforced Plastic; Bottom: Super magnesium								Mil-Spec test	MIL-STD-810G military certification												
									Environment	PEAT™ Gold (US only); ENERGY STAR® 6.1; GREENGUARD®; RoHS-compliant												

Model	Region	Processor	vPro	Graphics	Memory (Soldered)	Display	Multi-touch	Storage(HDD/SSD)	Optical	WLAN + Bluetooth	WWAN	SIM Card	Adapter	Dock	Camera	Keyboard	Fingerprint Reader	Battery (internal)	Power Adapter	Operating System	Warranty	Ann Date (m/y)
20FB002JUS	US	i5-6300U	vPro	Intel HD 520	8GB Soldered	14" FHD (1920x1080) IPS	None	256GB SSD M.2 PCIe NVMe Opal2	None	Intel 8260 ac, 2x2 + BT4.1	WWAN Upgradable	None	None	None	720p	Backlit	Fingerprint Reader	4-cell (52Wh)	65W	Win10 DG Win7 Pro 64	3-year, Depot	02/16
20FB002KUS	US	i5-6200U	No	Intel HD 520	8GB Soldered	14" FHD (1920x1080) IPS	None	256GB SSD M.2 PCIe NVMe Opal2	None	Intel 8260 ac, 2x2 + BT4.1	WWAN Upgradable	None	None	None	720p	Backlit	Fingerprint Reader	4-cell (52Wh)	65W	Win10 DG Win7 Pro 64	3-year, Depot	02/16
20FB002LUS	US	i7-6600U	vPro	Intel HD 520	16GB Soldered	14" WQHD (2560x1440) IPS	None	512GB SSD M.2	None	Intel 8260 ac, 2x2 + BT4.1	WWAN Upgradable	None	None	None	720p	Backlit	Fingerprint Reader	4-cell (52Wh)	65W	Win10 DG Win7 Pro 64	3-year, Depot	02/16
20FB002MUS	US	i5-6200U	No	Intel HD 520	8GB Soldered	14" FHD (1920x1080) IPS	None	128GB SSD M.2	None	Intel 8260 ac, 2x2 + BT4.1	WWAN Upgradable	None	None	None	720p	Backlit	Fingerprint Reader	4-cell (52Wh)	65W	Win10 DG Win7 Pro 64	3-year, Depot	02/16
20FB002NUS	US	i7-6600U	vPro	Intel HD 520	16GB Soldered	14" WQHD (2560x1440) IPS	None	256GB SSD M.2 PCIe NVMe Opal2	None	Intel 8260 ac, 2x2 + BT4.1	WWAN Upgradable	None	None	None	720p	Backlit	Fingerprint Reader	4-cell (52Wh)	65W	Win10 DG Win7 Pro 64	3-year, Depot	02/16
20FB002PUS	US	i5-6200U	No	Intel HD 520	8GB Soldered	14" FHD (1920x1080) IPS	None	512GB SSD M.2	None	Intel 8260 ac, 2x2 + BT4.1	WWAN Upgradable	None	None	None	720p	Backlit	Fingerprint Reader	4-cell (52Wh)	65W	Win10 DG Win7 Pro 64	3-year, Depot	02/16
20FB002QUS	US	i7-6600U	vPro	Intel HD 520	8GB Soldered	14" WQHD (2560x1440) IPS	None	256GB SSD M.2 Opal2	None	Intel 8260 ac, 2x2 + BT4.1	WWAN Upgradable	None	None	None	720p	Backlit	Fingerprint Reader	4-cell (52Wh)	65W	Win10 DG Win7 Pro 64	3-year, Depot	02/16
20FB002RUS	US	i5-6200U	No	Intel HD 520	8GB Soldered	14" FHD (1920x1080) IPS	None	256GB SSD M.2 Opal2	None	Intel 8260 ac, 2x2 + BT4.1	WWAN Upgradable	None	None	None	720p	Backlit	Fingerprint Reader	4-cell (52Wh)	65W	Win10 DG Win7 Pro 64	3-year, Depot	02/16
20FB002SUS	US	i7-6600U	vPro	Intel HD 520	8GB Soldered	14" WQHD (2560x1440) IPS	None	512GB SSD M.2	None	Intel 8260 ac, 2x2 + BT4.1	WWAN Upgradable	None	None	None	720p	Backlit	Fingerprint Reader	4-cell (52Wh)	65W	Win10 DG Win7 Pro 64	3-year, Depot	02/16
20FB0044US	US	i7-6600U	vPro	Intel HD 520	16GB Soldered	14" WQHD (2560x1440) IPS	None	180GB SSD M.2 Opal2	None	Intel 8260 ac, 2x2 + BT4.1	None	None	None	None	720p	Backlit	Fingerprint Reader	4-cell (52Wh)	65W	Win10 Pro 64	3-year, Depot	02/16
20FB0045US	US	i7-6600U	vPro	Intel HD 520	16GB Soldered	14" FHD (1920x1080) IPS	None	256GB SSD M.2 Opal2	None	Intel 8260 ac, 2x2 + BT4.1	WWAN Upgradable	None	None	None	720p	Backlit	Fingerprint Reader	4-cell (52Wh)	65W	Win10 DG Win7 Pro 64	3-year, Depot	02/16
20FB0046US	US	i7-6600U	vPro	Intel HD 520	8GB Soldered	14" FHD (1920x1080) IPS	None	256GB SSD M.2 Opal2	None	Intel 8260 ac, 2x2 + BT4.1	WWAN Upgradable	None	None	None	720p	Backlit	Fingerprint Reader	4-cell (52Wh)	65W	Win10 Pro 64	3-year, Depot	02/16
20FB0047US	US	i5-6300U	vPro	Intel HD 520	8GB Soldered	14" FHD (1920x1080) IPS	None	128GB SSD M.2	None	Intel 8260 ac, 2x2 + BT4.1	WWAN Upgradable	None	None	None	720p	Backlit	Fingerprint Reader	4-cell (52Wh)	65W	Win10 Pro 64	3-year, Depot	02/16
20FB0048US	US	i7-6600U	vPro	Intel HD 520	16GB Soldered	14" FHD (1920x1080) IPS	None	512GB SSD M.2	None	Intel 8260 ac, 2x2 + BT4.1	WWAN Upgradable	None	None	None	720p	Backlit	Fingerprint Reader	4-cell (52Wh)	65W	Win10 DG Win7 Pro 64	3-year, Depot	02/16
20FB0049US	US	i7-6600U	vPro	Intel HD 520	16GB Soldered	14" WQHD (2560x1440) IPS	None	256GB SSD M.2 Opal2	None	Intel 8260 ac, 2x2 + BT4.1	WWAN Upgradable	None	None	None	720p	Backlit	Fingerprint Reader	4-cell (52Wh)	65W	Win10 Pro 64	3-year, Depot	02/16
20FB004AUS	US	i5-6300U	vPro	Intel HD 520	8GB Soldered	14" FHD (1920x1080) IPS	None	128GB SSD M.2	None	Intel 8260 ac, 2x2 + BT4.1	WWAN Upgradable	None	None	None	720p	Backlit	Fingerprint Reader	4-cell (52Wh)	65W	Win10 DG Win7 Pro 64	3-year, Depot	02/16
20FB004BUS	US	i5-6300U	vPro	Intel HD 520	8GB Soldered	14" FHD (1920x1080) IPS	None	180GB SSD M.2 Opal2	None	Intel 8260 ac, 2x2 + BT4.1	WWAN Upgradable	None	None	None	720p	Backlit	Fingerprint Reader	4-cell (52Wh)	65W	Win10 DG Win7 Pro 64	3-year, Depot	02/16
20FB004CUS	US	i5-6300U	vPro	Intel HD 520	8GB Soldered	14" WQHD (2560x1440) IPS	None	256GB SSD M.2 PCIe NVMe Opal2	None	Intel 8260 ac, 2x2 + BT4.1	WWAN Upgradable	None	None	None	720p	Backlit	Fingerprint Reader	4-cell (52Wh)	65W	Win10 Pro 64	3-year, Depot	02/16
20FB004DUS	US	i7-6600U	vPro	Intel HD 520	8GB Soldered	14" FHD (1920x1080) IPS	None	192GB SSD M.2	None	Intel 8260 ac, 2x2 + BT4.1	WWAN Upgradable	None	None	None	720p	Backlit	Fingerprint Reader	4-cell (52Wh)	65W	Win10 Pro 64	3-year, Depot	02/16
20FB004EUS	US	i7-6600U	vPro	Intel HD 520	8GB Soldered	14" FHD (1920x1080) IPS	None	512GB SSD M.2	None	Intel 8260 ac, 2x2 + BT4.1	WWAN Upgradable	None	None	None	720p	Backlit	Fingerprint Reader	4-cell (52Wh)	65W	Win10 DG Win7 Pro 64	3-year, Depot	02/16

Model	Region	Processor	vPro	Graphics	Memory (Soldered)	Display	Multi-touch	Storage(HDD/SSD)	Optical	WLAN + Bluetooth	WWAN	SIM Card	Adapter	Dock	Camera	Keyboard	Fingerprint Reader	Battery (internal)	Power Adapter	Operating System	Warranty	Ann Date (m/y)
20FB004FUS	US	i5-6300U	vPro	Intel HD 520	8GB Soldered	14" WQHD (2560x1440) IPS	None	128GB SSD M.2	None	Intel 8260 ac, 2x2 + BT4.1	None	None	None	None	720p	Backlit	Fingerprint Reader	4-cell (52Wh)	65W	Win10 Pro 64	3-year, Depot	02/16
20FB004GUS	US	i5-6300U	vPro	Intel HD 520	8GB Soldered	14" WQHD (2560x1440) IPS	None	256GB SSD M.2 Opal2	None	Intel 8260 ac, 2x2 + BT4.1	None	None	None	None	720p	Backlit	Fingerprint Reader	4-cell (52Wh)	65W	Win10 Pro 64	3-year, Depot	02/16
20FB004HUS	US	i7-6600U	vPro	Intel HD 520	16GB Soldered	14" WQHD (2560x1440) IPS	None	240GB SSD M.2 Opal2	None	Intel 8260 ac, 2x2 + BT4.1	None	None	None	None	720p	Backlit	Fingerprint Reader	4-cell (52Wh)	65W	Win10 Pro 64	3-year, Depot	02/16
20FB004JUS	US	i5-6300U	vPro	Intel HD 520	8GB Soldered	14" FHD (1920x1080) IPS	None	256GB SSD M.2 Opal2	None	Intel 8260 ac, 2x2 + BT4.1	WWAN Upgradable	None	None	None	720p	Backlit	Fingerprint Reader	4-cell (52Wh)	65W	Win10 DG Win7 Pro 64	3-year, Depot	02/16
20FB004KUS	US	i7-6600U	vPro	Intel HD 520	8GB Soldered	14" WQHD (2560x1440) IPS	None	512GB SSD M.2 PCIe NVMe	None	Intel 8260 ac, 2x2 + BT4.1	None	None	None	None	720p	Backlit	Fingerprint Reader	4-cell (52Wh)	65W	Win10 Pro 64	3-year, Depot	02/16
20FB004LUS	US	i5-6200U	No	Intel HD 520	8GB Soldered	14" FHD (1920x1080) IPS	None	180GB SSD M.2 Opal2	None	Intel 8260 ac, 2x2 + BT4.1	WWAN Upgradable	None	None	None	720p	Backlit	Fingerprint Reader	4-cell (52Wh)	65W	Win10 DG Win7 Pro 64	3-year, Depot	02/16
20FB004MUS	US	i7-6600U	vPro	Intel HD 520	8GB Soldered	14" FHD (1920x1080) IPS	None	512GB SSD M.2 PCIe NVMe	None	Intel 8260 ac, 2x2 + BT4.1	WWAN Upgradable	None	None	None	720p	Backlit	Fingerprint Reader	4-cell (52Wh)	65W	Win10 DG Win7 Pro 64	3-year, Depot	02/16
20FB004NUS	US	i7-6600U	vPro	Intel HD 520	16GB Soldered	14" WQHD (2560x1440) IPS	None	512GB SSD M.2	None	Intel 8260 ac, 2x2 + BT4.1	WWAN Upgradable	None	None	None	720p	Backlit	Fingerprint Reader	4-cell (52Wh)	65W	Win10 Pro 64	3-year, Depot	02/16
20FB004PUS	US	i5-6300U	vPro	Intel HD 520	8GB Soldered	14" FHD (1920x1080) IPS	None	192GB SSD M.2	None	Intel 8260 ac, 2x2 + BT4.1	WWAN Upgradable	None	None	None	720p	Backlit	Fingerprint Reader	4-cell (52Wh)	65W	Win10 Pro 64	3-year, Depot	02/16
20FB004QUS	US	i7-6600U	vPro	Intel HD 520	16GB Soldered	14" FHD (1920x1080) IPS	None	512GB SSD M.2 PCIe NVMe	None	Intel 8260 ac, 2x2 + BT4.1	WWAN Upgradable	None	None	None	720p	Backlit	Fingerprint Reader	4-cell (52Wh)	65W	Win10 Pro 64	3-year, Depot	02/16
20FB004RUS	US	i7-6600U	vPro	Intel HD 520	16GB Soldered	14" FHD (1920x1080) IPS	None	256GB SSD M.2 PCIe NVMe Opal2	None	Intel 8260 ac, 2x2 + BT4.1	WWAN Upgradable	None	None	None	720p	Backlit	Fingerprint Reader	4-cell (52Wh)	65W	Win10 Pro 64	3-year, Depot	02/16
20FB004SUS	US	i5-6300U	vPro	Intel HD 520	8GB Soldered	14" WQHD (2560x1440) IPS	None	180GB SSD M.2 Opal2	None	Intel 8260 ac, 2x2 + BT4.1	None	None	None	None	720p	Backlit	Fingerprint Reader	4-cell (52Wh)	65W	Win10 Pro 64	3-year, Depot	02/16
20FB004TUS	US	i5-6300U	vPro	Intel HD 520	8GB Soldered	14" FHD (1920x1080) IPS	None	192GB SSD M.2	None	Intel 8260 ac, 2x2 + BT4.1	WWAN Upgradable	None	None	None	720p	Backlit	Fingerprint Reader	4-cell (52Wh)	65W	Win10 DG Win7 Pro 64	3-year, Depot	02/16
20FB004UUS	US	i7-6600U	vPro	Intel HD 520	8GB Soldered	14" FHD (1920x1080) IPS	None	512GB SSD M.2 PCIe NVMe	None	Intel 8260 ac, 2x2 + BT4.1	WWAN Upgradable	None	None	None	720p	Backlit	Fingerprint Reader	4-cell (52Wh)	65W	Win10 Pro 64	3-year, Depot	02/16
20FB004VUS	US	i5-6300U	vPro	Intel HD 520	8GB Soldered	14" WQHD (2560x1440) IPS	None	256GB SSD M.2 Opal2	None	Intel 8260 ac, 2x2 + BT4.1	WWAN Upgradable	None	None	None	720p	Backlit	Fingerprint Reader	4-cell (52Wh)	65W	Win10 Pro 64	3-year, Depot	02/16
20FB004WUS	US	i5-6300U	vPro	Intel HD 520	8GB Soldered	14" FHD (1920x1080) IPS	None	180GB SSD M.2 Opal2	None	Intel 8260 ac, 2x2 + BT4.1	WWAN Upgradable	None	None	None	720p	Backlit	Fingerprint Reader	4-cell (52Wh)	65W	Win10 Pro 64	3-year, Depot	02/16
20FB004XUS	US	i7-6600U	vPro	Intel HD 520	16GB Soldered	14" FHD (1920x1080) IPS	None	240GB SSD M.2 Opal2	None	Intel 8260 ac, 2x2 + BT4.1	WWAN Upgradable	None	None	None	720p	Backlit	Fingerprint Reader	4-cell (52Wh)	65W	Win10 Pro 64	3-year, Depot	02/16
20FB004YUS	US	i7-6600U	vPro	Intel HD 520	16GB Soldered	14" FHD (1920x1080) IPS	None	512GB SSD M.2	None	Intel 8260 ac, 2x2 + BT4.1	WWAN Upgradable	None	None	None	720p	Backlit	Fingerprint Reader	4-cell (52Wh)	65W	Win10 Pro 64	3-year, Depot	02/16
20FB0050US	US	i5-6300U	vPro	Intel HD 520	8GB Soldered	14" FHD (1920x1080) IPS	None	512GB SSD M.2	None	Intel 8260 ac, 2x2 + BT4.1	WWAN Upgradable	None	None	None	720p	Backlit	Fingerprint Reader	4-cell (52Wh)	65W	Win10 DG Win7 Pro 64	3-year, Depot	02/16
20FB0051US	US	i7-6600U	vPro	Intel HD 520	16GB Soldered	14" FHD (1920x1080) IPS	None	256GB SSD M.2 Opal2	None	Intel 8260 ac, 2x2 + BT4.1	WWAN Upgradable	None	None	None	720p	Backlit	Fingerprint Reader	4-cell (52Wh)	65W	Win10 Pro 64	3-year, Depot	02/16

Model	Region	Processor	vPro	Graphics	Memory (Soldered)	Display	Multi-touch	Storage(HDD/SSD)	Optical	WLAN + Bluetooth	WWAN	SIM Card	Adapter	Dock	Camera	Keyboard	Fingerprint Reader	Battery (internal)	Power Adapter	Operating System	Warranty	Ann Date (m/y)
20FB0052US	US	i7-6600U	vPro	Intel HD 520	16GB Soldered	14" WQHD (2560x1440) IPS	None	256GB SSD M.2 PCIe NVMe Opal2	None	Intel 8260 ac, 2x2 + BT4.1	WWAN Upgradable	None	None	None	720p	Backlit	Fingerprint Reader	4-cell (52Wh)	65W	Win10 Pro 64	3-year, Depot	02/16
20FB0053US	US	i5-6300U	vPro	Intel HD 520	8GB Soldered	14" WQHD (2560x1440) IPS	None	512GB SSD M.2 PCIe NVMe	None	Intel 8260 ac, 2x2 + BT4.1	None	None	None	None	720p	Backlit	Fingerprint Reader	4-cell (52Wh)	65W	Win10 Pro 64	3-year, Depot	02/16
20FB0054US	US	i7-6600U	vPro	Intel HD 520	16GB Soldered	14" WQHD (2560x1440) IPS	None	256GB SSD M.2 PCIe NVMe Opal2	None	Intel 8260 ac, 2x2 + BT4.1	None	None	None	None	720p	Backlit	Fingerprint Reader	4-cell (52Wh)	65W	Win10 Pro 64	3-year, Depot	02/16
20FB0055US	US	i5-6300U	vPro	Intel HD 520	8GB Soldered	14" WQHD (2560x1440) IPS	None	512GB SSD M.2	None	Intel 8260 ac, 2x2 + BT4.1	None	None	None	None	720p	Backlit	Fingerprint Reader	4-cell (52Wh)	65W	Win10 Pro 64	3-year, Depot	02/16
20FB0056US	US	i7-6500U	No	Intel HD 520	8GB Soldered	14" FHD (1920x1080) IPS	None	256GB SSD M.2 Opal2	None	Intel 8260 ac, 2x2 + BT4.1	WWAN Upgradable	None	None	None	720p	Backlit	Fingerprint Reader	4-cell (52Wh)	65W	Win10 Pro 64	3-year, Depot	02/16
20FB0057US	US	i7-6600U	vPro	Intel HD 520	8GB Soldered	14" FHD (1920x1080) IPS	None	256GB SSD M.2 PCIe NVMe Opal2	None	Intel 8260 ac, 2x2 + BT4.1	WWAN Upgradable	None	None	None	720p	Backlit	Fingerprint Reader	4-cell (52Wh)	65W	Win10 Pro 64	3-year, Depot	02/16
20FB0058US	US	i7-6600U	vPro	Intel HD 520	16GB Soldered	14" WQHD (2560x1440) IPS	None	240GB SSD M.2 Opal2	None	Intel 8260 ac, 2x2 + BT4.1	WWAN Upgradable	None	None	None	720p	Backlit	Fingerprint Reader	4-cell (52Wh)	65W	Win10 Pro 64	3-year, Depot	02/16
20FB0059US	US	i5-6300U	vPro	Intel HD 520	8GB Soldered	14" FHD (1920x1080) IPS	None	256GB SSD M.2 Opal2	None	Intel 8260 ac, 2x2 + BT4.1	WWAN Upgradable	None	None	None	720p	Backlit	Fingerprint Reader	4-cell (52Wh)	65W	Win10 Pro 64	3-year, Depot	02/16
20FB005AUS	US	i7-6600U	vPro	Intel HD 520	8GB Soldered	14" FHD (1920x1080) IPS	None	192GB SSD M.2	None	Intel 8260 ac, 2x2 + BT4.1	WWAN Upgradable	None	None	None	720p	Backlit	Fingerprint Reader	4-cell (52Wh)	65W	Win10 DG Win7 Pro 64	3-year, Depot	02/16
20FB005BUS	US	i7-6600U	vPro	Intel HD 520	16GB Soldered	14" WQHD (2560x1440) IPS	None	192GB SSD M.2	None	Intel 8260 ac, 2x2 + BT4.1	None	None	None	None	720p	Backlit	Fingerprint Reader	4-cell (52Wh)	65W	Win10 Pro 64	3-year, Depot	02/16
20FB005CUS	US	i7-6600U	vPro	Intel HD 520	8GB Soldered	14" FHD (1920x1080) IPS	None	128GB SSD M.2	None	Intel 8260 ac, 2x2 + BT4.1	WWAN Upgradable	None	None	None	720p	Backlit	Fingerprint Reader	4-cell (52Wh)	65W	Win10 DG Win7 Pro 64	3-year, Depot	02/16
20FB005DUS	US	i7-6500U	No	Intel HD 520	8GB Soldered	14" FHD (1920x1080) IPS	None	256GB SSD M.2 PCIe NVMe Opal2	None	Intel 8260 ac, 2x2 + BT4.1	WWAN Upgradable	None	None	None	720p	Backlit	Fingerprint Reader	4-cell (52Wh)	65W	Win10 Pro 64	3-year, Depot	02/16
20FB005EUS	US	i5-6300U	vPro	Intel HD 520	8GB Soldered	14" FHD (1920x1080) IPS	None	240GB SSD M.2 Opal2	None	Intel 8260 ac, 2x2 + BT4.1	WWAN Upgradable	None	None	None	720p	Backlit	Fingerprint Reader	4-cell (52Wh)	65W	Win10 Pro 64	3-year, Depot	02/16
20FB005FUS	US	i7-6500U	No	Intel HD 520	8GB Soldered	14" FHD (1920x1080) IPS	None	192GB SSD M.2	None	Intel 8260 ac, 2x2 + BT4.1	WWAN Upgradable	None	None	None	720p	Backlit	Fingerprint Reader	4-cell (52Wh)	65W	Win10 Pro 64	3-year, Depot	02/16
20FB005GUS	US	i7-6600U	vPro	Intel HD 520	16GB Soldered	14" WQHD (2560x1440) IPS	None	256GB SSD M.2 Opal2	None	Intel 8260 ac, 2x2 + BT4.1	None	None	None	None	720p	Backlit	Fingerprint Reader	4-cell (52Wh)	65W	Win10 Pro 64	3-year, Depot	02/16
20FB005HUS	US	i5-6300U	vPro	Intel HD 520	8GB Soldered	14" WQHD (2560x1440) IPS	None	128GB SSD M.2	None	Intel 8260 ac, 2x2 + BT4.1	WWAN Upgradable	None	None	None	720p	Backlit	Fingerprint Reader	4-cell (52Wh)	65W	Win10 Pro 64	3-year, Depot	02/16
20FB005JUS	US	i5-6300U	vPro	Intel HD 520	8GB Soldered	14" WQHD (2560x1440) IPS	None	512GB SSD M.2	None	Intel 8260 ac, 2x2 + BT4.1	WWAN Upgradable	None	None	None	720p	Backlit	Fingerprint Reader	4-cell (52Wh)	65W	Win10 Pro 64	3-year, Depot	02/16
20FB005KUS	US	i7-6600U	vPro	Intel HD 520	8GB Soldered	14" FHD (1920x1080) IPS	None	256GB SSD M.2 PCIe NVMe Opal2	None	Intel 8260 ac, 2x2 + BT4.1	WWAN Upgradable	None	None	None	720p	Backlit	Fingerprint Reader	4-cell (52Wh)	65W	Win10 DG Win7 Pro 64	3-year, Depot	02/16
20FB005LUS	US	i7-6600U	vPro	Intel HD 520	16GB Soldered	14" WQHD (2560x1440) IPS	None	512GB SSD M.2 PCIe NVMe	None	Intel 8260 ac, 2x2 + BT4.1	WWAN Upgradable	None	None	None	720p	Backlit	Fingerprint Reader	4-cell (52Wh)	65W	Win10 Pro 64	3-year, Depot	02/16
20FB005MUS	US	i5-6300U	vPro	Intel HD 520	8GB Soldered	14" FHD (1920x1080) IPS	None	512GB SSD M.2	None	Intel 8260 ac, 2x2 + BT4.1	WWAN Upgradable	None	None	None	720p	Backlit	Fingerprint Reader	4-cell (52Wh)	65W	Win10 Pro 64	3-year, Depot	02/16

Model	Region	Processor	vPro	Graphics	Memory (Soldered)	Display	Multi-touch	Storage(HDD/SSD)	Optical	WLAN + Bluetooth	WWAN	SIM Card	Adapter	Dock	Camera	Keyboard	Fingerprint Reader	Battery (internal)	Power Adapter	Operating System	Warranty	Ann Date (m/y)
20FB005NUS	US	i7-6600U	vPro	Intel HD 520	16GB Soldered	14" WQHD (2560x1440) IPS	None	512GB SSD M.2 PCIe NVMe	None	Intel 8260 ac, 2x2 + BT4.1	None	None	None	None	720p	Backlit	Fingerprint Reader	4-cell (52Wh)	65W	Win10 Pro 64	3-year, Depot	02/16
20FB005PUS	US	i7-6600U	vPro	Intel HD 520	16GB Soldered	14" FHD (1920x1080) IPS	None	256GB SSD M.2 PCIe NVMe Opal2	None	Intel 8260 ac, 2x2 + BT4.1	WWAN Upgradable	None	None	None	720p	Backlit	Fingerprint Reader	4-cell (52Wh)	65W	Win10 DG Win7 Pro 64	3-year, Depot	02/16
20FB005QUS	US	i5-6300U	vPro	Intel HD 520	8GB Soldered	14" WQHD (2560x1440) IPS	None	256GB SSD M.2 PCIe NVMe Opal2	None	Intel 8260 ac, 2x2 + BT4.1	None	None	None	None	720p	Backlit	Fingerprint Reader	4-cell (52Wh)	65W	Win10 Pro 64	3-year, Depot	02/16
20FB005RUS	US	i7-6600U	vPro	Intel HD 520	8GB Soldered	14" WQHD (2560x1440) IPS	None	512GB SSD M.2	None	Intel 8260 ac, 2x2 + BT4.1	None	None	None	None	720p	Backlit	Fingerprint Reader	4-cell (52Wh)	65W	Win10 Pro 64	3-year, Depot	02/16
20FB005SUS	US	i7-6600U	vPro	Intel HD 520	16GB Soldered	14" FHD (1920x1080) IPS	None	512GB SSD M.2 PCIe NVMe	None	Intel 8260 ac, 2x2 + BT4.1	WWAN Upgradable	None	None	None	720p	Backlit	Fingerprint Reader	4-cell (52Wh)	65W	Win10 DG Win7 Pro 64	3-year, Depot	02/16
20FB005TUS	US	i5-6200U	No	Intel HD 520	8GB Soldered	14" FHD (1920x1080) IPS	None	128GB SSD M.2	None	Intel 8260 ac, 2x2 + BT4.1	WWAN Upgradable	None	None	None	720p	Backlit	Fingerprint Reader	4-cell (52Wh)	65W	Win10 Pro 64	3-year, Depot	02/16
20FB005UUS	US	i7-6500U	No	Intel HD 520	8GB Soldered	14" FHD (1920x1080) IPS	None	512GB SSD M.2	None	Intel 8260 ac, 2x2 + BT4.1	WWAN Upgradable	None	None	None	720p	Backlit	Fingerprint Reader	4-cell (52Wh)	65W	Win10 Pro 64	3-year, Depot	02/16
20FB005VUS	US	i7-6600U	vPro	Intel HD 520	16GB Soldered	14" WQHD (2560x1440) IPS	None	512GB SSD M.2	None	Intel 8260 ac, 2x2 + BT4.1	None	None	None	None	720p	Backlit	Fingerprint Reader	4-cell (52Wh)	65W	Win10 Pro 64	3-year, Depot	02/16
20FB005WUS	US	i7-6600U	vPro	Intel HD 520	8GB Soldered	14" FHD (1920x1080) IPS	None	256GB SSD M.2 Opal2	None	Intel 8260 ac, 2x2 + BT4.1	WWAN Upgradable	None	None	None	720p	Backlit	Fingerprint Reader	4-cell (52Wh)	65W	Win10 DG Win7 Pro 64	3-year, Depot	02/16
20FB005XUS	US	i5-6300U	vPro	Intel HD 520	8GB Soldered	14" FHD (1920x1080) IPS	None	256GB SSD M.2 PCIe NVMe Opal2	None	Intel 8260 ac, 2x2 + BT4.1	WWAN Upgradable	None	None	None	720p	Backlit	Fingerprint Reader	4-cell (52Wh)	65W	Win10 Pro 64	3-year, Depot	02/16
20FB005YUS	US	i7-6500U	No	Intel HD 520	8GB Soldered	14" FHD (1920x1080) IPS	None	512GB SSD M.2 PCIe NVMe	None	Intel 8260 ac, 2x2 + BT4.1	WWAN Upgradable	None	None	None	720p	Backlit	Fingerprint Reader	4-cell (52Wh)	65W	Win10 Pro 64	3-year, Depot	02/16
20FB0060US	US	i7-6600U	vPro	Intel HD 520	8GB Soldered	14" FHD (1920x1080) IPS	None	128GB SSD M.2	None	Intel 8260 ac, 2x2 + BT4.1	WWAN Upgradable	None	None	None	720p	Backlit	Fingerprint Reader	4-cell (52Wh)	65W	Win10 Pro 64	3-year, Depot	02/16
20FB0061US	US	i5-6300U	vPro	Intel HD 520	8GB Soldered	14" WQHD (2560x1440) IPS	None	192GB SSD M.2	None	Intel 8260 ac, 2x2 + BT4.1	None	None	None	None	720p	Backlit	Fingerprint Reader	4-cell (52Wh)	65W	Win10 Pro 64	3-year, Depot	02/16
20FB0062US	US	i7-6600U	vPro	Intel HD 520	8GB Soldered	14" FHD (1920x1080) IPS	None	512GB SSD M.2	None	Intel 8260 ac, 2x2 + BT4.1	WWAN Upgradable	None	None	None	720p	Backlit	Fingerprint Reader	4-cell (52Wh)	65W	Win10 Pro 64	3-year, Depot	02/16
20FB0063US	US	i7-6600U	vPro	Intel HD 520	8GB Soldered	14" WQHD (2560x1440) IPS	None	256GB SSD M.2 PCIe NVMe Opal2	None	Intel 8260 ac, 2x2 + BT4.1	None	None	None	None	720p	Backlit	Fingerprint Reader	4-cell (52Wh)	65W	Win10 Pro 64	3-year, Depot	02/16
20FB0064US	US	i7-6600U	vPro	Intel HD 520	8GB Soldered	14" WQHD (2560x1440) IPS	None	256GB SSD M.2 Opal2	None	Intel 8260 ac, 2x2 + BT4.1	None	None	None	None	720p	Backlit	Fingerprint Reader	4-cell (52Wh)	65W	Win10 Pro 64	3-year, Depot	02/16
20FB0065US	US	i7-6600U	vPro	Intel HD 520	16GB Soldered	14" FHD (1920x1080) IPS	None	128GB SSD M.2	None	Intel 8260 ac, 2x2 + BT4.1	WWAN Upgradable	None	None	None	720p	Backlit	Fingerprint Reader	4-cell (52Wh)	65W	Win10 DG Win7 Pro 64	3-year, Depot	02/16
20FB006RUS	US	i7-6600U	vPro	Intel HD 520	8GB Soldered	14" WQHD (2560x1440) IPS	None	256GB SSD M.2 Opal2	None	Intel 8260 ac, 2x2 + BT4.1	Sierra EM7455	None	None	None	720p	Backlit	Fingerprint Reader	4-cell (52Wh)	65W	Win10 Pro 64	3-year, Depot	05/16
20FB006SUS	US	i7-6500U	No	Intel HD 520	8GB Soldered	14" FHD (1920x1080) IPS	None	256GB SSD M.2 Opal2	None	Intel 8260 ac, 2x2 + BT4.1	Sierra EM7455	None	None	None	720p	Backlit	Fingerprint Reader	4-cell (52Wh)	65W	Win10 Pro 64	3-year, Depot	05/16
20FB006TUS	US	i7-6500U	No	Intel HD 520	8GB Soldered	14" WQHD (2560x1440) IPS	None	256GB SSD M.2 PCIe NVMe Opal2	None	Intel 8260 ac, 2x2 + BT4.1	Sierra EM7455	None	None	None	720p	Backlit	Fingerprint Reader	4-cell (52Wh)	65W	Win10 Pro 64	3-year, Depot	05/16

Model	Region	Processor	vPro	Graphics	Memory (Soldered)	Display	Multi-touch	Storage(HDD/SSD)	Optical	WLAN + Bluetooth	WWAN	SIM Card	Adapter	Dock	Camera	Keyboard	Fingerprint Reader	Battery (internal)	Power Adapter	Operating System	Warranty	Ann Date (m/y)
20FB006UUS	US	i7-6600U	vPro	Intel HD 520	16GB Soldered	14" WQHD (2560x1440) IPS	None	512GB SSD M.2 PCIe NVMe	None	Intel 8260 ac, 2x2 + BT4.1	Sierra EM7455	None	None	None	720p	Backlit	Fingerprint Reader	4-cell (52Wh)	65W	Win10 Pro 64	3-year, Depot	05/16
20FB006VUS	US	i5-6300U	vPro	Intel HD 520	8GB Soldered	14" WQHD (2560x1440) IPS	None	256GB SSD M.2 Opal2	None	Intel 8260 ac, 2x2 + BT4.1	Sierra EM7455	None	None	None	720p	Backlit	Fingerprint Reader	4-cell (52Wh)	65W	Win10 Pro 64	3-year, Depot	05/16
20FB006WUS	US	i5-6200U	No	Intel HD 520	8GB Soldered	14" FHD (1920x1080) IPS	None	256GB SSD M.2 Opal2	None	Intel 8260 ac, 2x2 + BT4.1	Sierra EM7455	None	None	None	720p	Backlit	Fingerprint Reader	4-cell (52Wh)	65W	Win10 Pro 64	3-year, Depot	05/16
20FB006XUS	US	i7-6600U	vPro	Intel HD 520	16GB Soldered	14" WQHD (2560x1440) IPS	None	512GB SSD M.2	None	Intel 8260 ac, 2x2 + BT4.1	Sierra EM7455	None	None	None	720p	Backlit	Fingerprint Reader	4-cell (52Wh)	65W	Win10 Pro 64	3-year, Depot	05/16
20FB0071US	US	i7-6600U	vPro	Intel HD 520	8GB Soldered	14" WQHD (2560x1440) IPS	None	256GB SSD M.2 Opal2	None	Intel 18260 ac, 2x2 + BT4.1	None	None	None	WiGig Dock	720p	Backlit	Fingerprint Reader	4-cell (52Wh)	65W	Win10 Pro 64	3-year, Depot	07/16
20FB007DUS	US	i5-6300U	vPro	Intel HD 520	8GB Soldered	14" WQHD (2560x1440) IPS	None	256GB SSD M.2 Opal2	None	Intel 18260 ac, 2x2 + BT4.1	None	None	None	WiGig Dock	720p	Backlit	Fingerprint Reader	4-cell (52Wh)	65W	Win10 DG Win7 Pro 64	3-year, Depot	07/16
20FB007EUS	US	i7-6600U	vPro	Intel HD 520	16GB Soldered	14" WQHD (2560x1440) IPS	None	512GB SSD M.2	None	Intel 18260 ac, 2x2 + BT4.1	None	None	None	WiGig Dock	720p	Backlit	Fingerprint Reader	4-cell (52Wh)	65W	Win10 DG Win7 Pro 64	3-year, Depot	07/16
20FB007FUS	US	i7-6600U	vPro	Intel HD 520	8GB Soldered	14" WQHD (2560x1440) IPS	None	256GB SSD M.2 Opal2	None	Intel 18260 ac, 2x2 + BT4.1	None	None	None	WiGig Dock	720p	Backlit	Fingerprint Reader	4-cell (52Wh)	65W	Win10 DG Win7 Pro 64	3-year, Depot	07/16
20FB007GUS	US	i7-6600U	vPro	Intel HD 520	16GB Soldered	14" WQHD (2560x1440) IPS	None	512GB SSD M.2	None	Intel 18260 ac, 2x2 + BT4.1	None	None	None	WiGig Dock	720p	Backlit	Fingerprint Reader	4-cell (52Wh)	65W	Win10 Pro 64	3-year, Depot	07/16
20FB007HUS	US	i5-6300U	vPro	Intel HD 520	8GB Soldered	14" WQHD (2560x1440) IPS	None	256GB SSD M.2 Opal2	None	Intel 18260 ac, 2x2 + BT4.1	None	None	None	WiGig Dock	720p	Backlit	Fingerprint Reader	4-cell (52Wh)	65W	Win10 Pro 64	3-year, Depot	07/16
20FB007QUS	US	i5-6200U	No	Intel HD 520	8GB Soldered	14" FHD (1920x1080) IPS	None	180GB SSD M.2 Opal2	None	Intel 8260 ac, 2x2 + BT4.1	WWAN Upgradable	None	None	None	720p	Backlit	Fingerprint Reader	4-cell (52Wh)	65W	Win10 Pro 64	3-year, Depot	08/16
20FB007RUS	US	i5-6200U	No	Intel HD 520	8GB Soldered	14" FHD (1920x1080) IPS	None	256GB SSD M.2 Opal2	None	Intel 8260 ac, 2x2 + BT4.1	None	None	None	None	720p	Backlit	Fingerprint Reader	4-cell (52Wh)	65W	Win10 Pro 64	3-year, Depot	11/16
20FBA043US	US	i5-6200U	No	Intel HD 520	8GB Soldered	14" FHD (1920x1080) IPS	None	256GB SSD M.2 Opal2	None	Intel 8260 ac, 2x2 + BT4.1	WWAN Upgradable	None	None	None	720p	Backlit	Fingerprint Reader	4-cell (52Wh)	65W	Win10 Pro 64	3-year, Depot	08/16



ThinkPad X1 Carbon (5th Gen) Platform Specifications

Product Specifications Reference (PSREF)

Processor	6th Generation Intel® Core™ i5 / i7 Processor								Smart card reader None	Media reader MicroSD card reader, supports UHS-II microSD card	Ports Two USB 3.1 Gen 1 / USB 3.0 (one Always On), two USB 3.1 Type-C Gen 2 / Thunderbolt 3 (support data, video, and power delivery), HDMI 1.4b, Ethernet extension connector								
	Processor Number	# of Cores	# of Threads	Base Frequency	Max Turbo Frequency	Cache	Memory Types	Processor Graphics											
	i5-6200U	2	4	2.3 GHz	2.8 GHz	3MB	LPDDR3-1866	Intel HD Graphics 520	WiGig dock (opt) ThinkPad WiGig dock	Monitor cable (optional) HDMI to VGA: Lenovo HDMI to VGA Monitor Adapter USB-C to VGA: Lenovo USB-C to VGA Adapter USB-C to DP: Lenovo USB-C to DisplayPort Adapter									
	i5-6300U			2.4 GHz	3.0 GHz	3MB													
	i7-6500U			2.5 GHz	3.1 GHz	4MB													
	i7-6600U			2.6 GHz	3.4 GHz	4MB													
	or 7th Generation Intel Core i5 / i7 Processor								Camera (optional) 720p: HD720p resolution, fixed focus IR & 720p: IR camera and HD720p camera	Audio support HD Audio, Conexant® CX11871 codec / stereo speakers, 2W x 2 / dual array microphone, combo audio/microphone jack									
	Processor Number	# of Cores	# of Threads	Base Frequency	Max Turbo Frequency	Cache	Memory Types	Processor Graphics											
	i5-7200U	2	4	2.5 GHz	3.1 GHz	3MB	LPDDR3-1866	Intel HD Graphics 620	Keyboard 6-row, spill-resistant, multimedia Fn keys, LED backlight	UltraNav™ TrackPoint® pointing device and buttonless Glass surface multi-touch touchpad									
	i5-7300U			2.6 GHz	3.5 GHz	3MB													
	i7-7500U			2.7 GHz	3.5 GHz	4MB													
	i7-7600U			2.8 GHz	3.9 GHz	4MB													
Graphics	Intel HD Graphics 520 or 620 in processor; supports external digital monitor via HDMI or USB Type-C; supports three independent displays; Max resolution: 4096x2304@60Hz (USB Type-C); 4096x2160@24Hz (HDMI)								Security Security chip vPro (optional) Intel vPro Technology	Power-on password, hard disk password, supervisor password, security keyhole Discrete TPM 2.0, TCG Certified									
Chipset	Intel SoC (System on Chip) platform								Fingerprint reader NFC (optional)	Touch style match on chip fingerprint reader on the palm rest Near Field Communication									
Memory	8GB or 16GB / 1866MHz LPDDR3 / soldered to systemboard, no sockets								Battery	Integrated Li-Polymer 3-cell (57Wh) RapidCharge battery									
Display	Some: 14.0" (355mm) FHD (1920x1080), anti-glare, LED backlight, IPS, 300 nits, 16:9 aspect ratio, 700:1 contrast ratio, 170° viewing angle Some: 14.0" (355mm) WQHD (2560x1440), anti-glare, LED backlight, IPS, 300 nits, 16:9 aspect ratio, 700:1 contrast ratio, 170° viewing angle								Max battery life AC adapter RapidCharge	MobileMark® 2014: 15.5 hr 45W or 65W USB Type-C adapter									
Multi-touch	None								<table border="1"> <tr> <td>AC adapter</td> <td>45W USB-C</td> <td>65W USB-C</td> </tr> <tr> <td>Charge to 80%</td> <td>Not support</td> <td>1.0 hr</td> </tr> <tr> <td>Charge to 100%</td> <td>Not support</td> <td>2.5 hr</td> </tr> </table>		AC adapter	45W USB-C	65W USB-C	Charge to 80%	Not support	1.0 hr	Charge to 100%	Not support	2.5 hr
AC adapter	45W USB-C	65W USB-C																	
Charge to 80%	Not support	1.0 hr																	
Charge to 100%	Not support	2.5 hr																	
Storage	Some: M.2 SSD / SATA 6.0Gb/s (e.g. xxxG SSD) Some: M.2 SSD / PCIe NVMe, PCIe 3.0 x 4, 32Gb/s (e.g. xxxG SSD PCIe NVMe)								Preload	Windows® 7 Professional 64 preinstalled through downgrade rights in Windows 10 Pro 64 Some: Windows 10 Home 64 Some: Windows 10 Pro 64 • Lenovo Companion • Lenovo Setting • Microsoft Office preloaded; purchase a product key to activate									
Optical	None								• Lenovo Solution Center • Lenovo PowerEngage • ThinkVantage Product Recovery • ThinkVantage System Update • Adobe® Reader® • Microsoft® Office preloaded; purchase a product key to activate • McAfee® LiveSafe™ (30-day trial)										
Ethernet	Native Intel Ethernet Connection I219-V (Non-vPro) or I219-LM (vPro) via optional ThinkPad Ethernet Extension Cable								Limited warranty	One of the following, configurable by model: • 1-year depot repair service • 3-year/1-yr battery depot repair service • 3-year/1-yr battery limited onsite service									
WLAN	One of the following, configurable by model (WiGig can coexist with WWAN): • Intel Dual Band Wireless-AC 8260, Wi-Fi 2x2 802.11ac + BT4.1, M.2 card • Intel Dual Band Wireless-AC 8265, Wi-Fi 2x2 802.11ac + BT4.1, M.2 card • Intel Tri-Band Wireless-AC 18265, WiGig 802.11ad + Wi-Fi 2x2 802.11ac + BT4.1, M.2 card								Mil-Spec test	MIL-STD-810G military certification									
Bluetooth™	Bluetooth 4.1 wireless, integrated in Wi-Fi + Bluetooth combo adapter * Intel 8265ac / 18265ac card support BT4.2 but is limited to BT4.1 by Windows OS								Environment	EEPEAT™ Gold (US only); ENERGY STAR® 6.1; RoHS-compliant									
WWAN (optional)	Integrated Mobile Broadband 4G LTE-A, Qualcomm® Snapdragon™ X7 LTE-A (Sierra Wireless EM7455)																		
SIM card (opt)	Micro-SIM card slot, opt Verizon LTE (US) or Lenovo® Connect (EMEA) SIM card																		
Dimensions	WxDxH: 12.74" x 8.55" x 0.63"; 323.5mm x 217.1mm x 15.95mm																		
Weight	Starting at 2.49 lb / 1.13 kg																		
Case color	Black or Silver (silver is not available in EMEA)																		
Case material	Display cover: CFRP/GFRP hybrid; Bottom: magnesium alloy hybrid																		

Model	Region	Processor	vPro	Graphics	Memory (Soldered)	Display	Multi-touch	Storage(HDD/SSD)	Optical	WLAN + Bluetooth	WWAN	SIM Card	Dock	Monitor Cable	Adapter	Color	Camera	Key-board	Finger-print Reader	NFC	TPM	Battery (internal)	Power Adapter	Operating System	Warranty	Ann Date (m/y)
20HR000DUS	US	i5-7300U	vPro	Intel HD 620	8GB Soldered	14" FHD (1920x1080) IPS	None	256GB SSD M.2 PCIe NVMe Opal2	None	8265 ac, 2x2 + BT4.1	None	None	None	None	None	Black	720p	Backlit	Finger-print Reader	None	dTPM 2.0	3-cell (57Wh)	65W USB-C	Win10 Pro 64	3-year, Depot	02/17
20HR000EUS	US	i7-7600U	vPro	Intel HD 620	8GB Soldered	14" FHD (1920x1080) IPS	None	256GB SSD M.2 PCIe NVMe Opal2	None	8265 ac, 2x2 + BT4.1	None	None	None	None	None	Silver	720p	Backlit	Finger-print Reader	None	dTPM 2.0	3-cell (57Wh)	65W USB-C	Win10 Pro 64	3-year, Depot	03/17
20HR000FUS	US	i7-7600U	vPro	Intel HD 620	16GB Soldered	14" FHD (1920x1080) IPS	None	512GB SSD M.2 PCIe NVMe Opal2	None	8265 ac, 2x2 + BT4.1	None	None	None	None	None	Black	720p	Backlit	Finger-print Reader	None	dTPM 2.0	3-cell (57Wh)	65W USB-C	Win10 Pro 64	3-year, Depot	02/17
20HR000GUS	US	i5-7200U	No	Intel HD 620	8GB Soldered	14" FHD (1920x1080) IPS	None	256GB SSD M.2 PCIe NVMe Opal2	None	8265 ac, 2x2 + BT4.1	None	None	None	None	None	Silver	720p	Backlit	Finger-print Reader	None	dTPM 2.0	3-cell (57Wh)	65W USB-C	Win10 Pro 64	3-year, Depot	03/17
20HR000HUS	US	i7-7600U	vPro	Intel HD 620	8GB Soldered	14" FHD (1920x1080) IPS	None	256GB SSD M.2 PCIe NVMe Opal2	None	8265 ac, 2x2 + BT4.1	None	None	None	None	None	Black	720p	Backlit	Finger-print Reader	None	dTPM 2.0	3-cell (57Wh)	65W USB-C	Win10 Pro 64	3-year, Depot	02/17
20HR000JUS	US	i7-7600U	vPro	Intel HD 620	16GB Soldered	14" FHD (1920x1080) IPS	None	512GB SSD M.2 PCIe NVMe Opal2	None	8265 ac, 2x2 + BT4.1	None	None	None	None	None	Silver	720p	Backlit	Finger-print Reader	None	dTPM 2.0	3-cell (57Wh)	65W USB-C	Win10 Pro 64	3-year, Depot	03/17
20HR000KUS	US	i5-7300U	vPro	Intel HD 620	16GB Soldered	14" FHD (1920x1080) IPS	None	256GB SSD M.2 PCIe NVMe Opal2	None	8265 ac, 2x2 + BT4.1	None	None	None	None	None	Silver	720p	Backlit	Finger-print Reader	None	dTPM 2.0	3-cell (57Wh)	65W USB-C	Win10 Pro 64	3-year, Depot	03/17
20HR000LUS	US	i5-7300U	vPro	Intel HD 620	8GB Soldered	14" FHD (1920x1080) IPS	None	256GB SSD M.2 PCIe NVMe Opal2	None	8265 ac, 2x2 + BT4.1	None	None	None	None	None	Silver	720p	Backlit	Finger-print Reader	None	dTPM 2.0	3-cell (57Wh)	65W USB-C	Win10 Pro 64	3-year, Depot	03/17
20HR000MUS	US	i5-7300U	vPro	Intel HD 620	16GB Soldered	14" FHD (1920x1080) IPS	None	256GB SSD M.2 PCIe NVMe Opal2	None	8265 ac, 2x2 + BT4.1	None	None	None	None	None	Black	720p	Backlit	Finger-print Reader	None	dTPM 2.0	3-cell (57Wh)	65W USB-C	Win10 Pro 64	3-year, Depot	02/17
20HR000WUS	US	i5-7200U	No	Intel HD 620	8GB Soldered	14" FHD (1920x1080) IPS	None	256GB SSD M.2 PCIe NVMe Opal2	None	8265 ac, 2x2 + BT4.1	None	None	None	None	None	Black	720p	Backlit	Finger-print Reader	None	dTPM 2.0	3-cell (57Wh)	65W USB-C	Win10 Pro 64	3-year, Depot	02/17
20HR0011US	US	i5-7200U	No	Intel HD 620	8GB Soldered	14" FHD (1920x1080) IPS	None	128GB SSD M.2	None	8265 ac, 2x2 + BT4.1	None	None	None	None	None	Black	720p	Backlit	Finger-print Reader	None	dTPM 2.0	3-cell (57Wh)	65W USB-C	Win10 Pro 64	3-year, Depot	02/17
20HR003CUS	US	i5-7300U	vPro	Intel HD 620	16GB Soldered	14" FHD (1920x1080) IPS	None	512GB SSD M.2 PCIe NVMe Opal2	None	8265 ac, 2x2 + BT4.1	None	None	None	None	None	Black	720p	Backlit	Finger-print Reader	None	dTPM 2.0	3-cell (57Wh)	65W USB-C	Win10 Pro 64	3-year, Depot	02/17
20HR003DUS	US	i7-7600U	vPro	Intel HD 620	8GB Soldered	14" FHD (1920x1080) IPS	None	512GB SSD M.2 PCIe NVMe Opal2	None	8265 ac, 2x2 + BT4.1	None	None	None	None	None	Black	720p	Backlit	Finger-print Reader	None	dTPM 2.0	3-cell (57Wh)	65W USB-C	Win10 Pro 64	3-year, Depot	02/17
20HR003EUS	US	i5-7300U	vPro	Intel HD 620	8GB Soldered	14" FHD (1920x1080) IPS	None	512GB SSD M.2 PCIe NVMe Opal2	None	8265 ac, 2x2 + BT4.1	None	None	None	None	None	Black	720p	Backlit	Finger-print Reader	None	dTPM 2.0	3-cell (57Wh)	65W USB-C	Win10 Pro 64	3-year, Depot	02/17
20HR0053US	US	i7-7500U	No	Intel HD 620	8GB Soldered	14" WQHD (2560x1440) IPS	None	256GB SSD M.2 PCIe NVMe Opal2	None	8265 ac, 2x2 + BT4.1	None	None	None	None	None	Black	720p	Backlit	Finger-print Reader	None	dTPM 2.0	3-cell (57Wh)	65W USB-C	Win10 Pro 64	3-year, Depot	03/17
20HR0054US	US	i7-7500U	No	Intel HD 620	16GB Soldered	14" WQHD (2560x1440) IPS	None	512GB SSD M.2 PCIe NVMe Opal2	None	8265 ac, 2x2 + BT4.1	None	None	None	None	None	Black	720p	Backlit	Finger-print Reader	None	dTPM 2.0	3-cell (57Wh)	65W USB-C	Win10 Pro 64	3-year, Depot	03/17
20HR0057US	US	i7-7500U	No	Intel HD 620	8GB Soldered	14" FHD (1920x1080) IPS	None	256GB SSD M.2 PCIe NVMe Opal2	None	8265 ac, 2x2 + BT4.1	None	None	None	None	None	Black	720p	Backlit	Finger-print Reader	None	dTPM 2.0	3-cell (57Wh)	65W USB-C	Win10 Pro 64	3-year, Depot	03/17
20HR0058US	US	i7-7500U	No	Intel HD 620	8GB Soldered	14" FHD (1920x1080) IPS	None	512GB SSD M.2 PCIe NVMe Opal2	None	8265 ac, 2x2 + BT4.1	None	None	None	None	None	Black	720p	Backlit	Finger-print Reader	None	dTPM 2.0	3-cell (57Wh)	65W USB-C	Win10 Pro 64	3-year, Depot	03/17
20HR005FUS	US	i7-7600U	vPro	Intel HD 620	16GB Soldered	14" FHD (1920x1080) IPS	None	512GB SSD M.2 PCIe NVMe Opal2	None	8265 ac, 2x2 + BT4.1	Sierra EM7455	None	None	None	None	Black	720p	Backlit	Finger-print Reader	None	dTPM 2.0	3-cell (57Wh)	65W USB-C	Win10 Pro 64	3-year, Depot	04/17
20HR005HUS	US	i7-7600U	vPro	Intel HD 620	8GB Soldered	14" FHD (1920x1080) IPS	None	256GB SSD M.2 PCIe NVMe Opal2	None	8265 ac, 2x2 + BT4.1	Sierra EM7455	None	None	None	None	Black	720p	Backlit	Finger-print Reader	None	dTPM 2.0	3-cell (57Wh)	65W USB-C	Win10 Pro 64	3-year, Depot	04/17

Model	Region	Processor	vPro	Graphics	Memory (Soldered)	Display	Multi-touch	Storage(HDD/SSD)	Optical	WLAN + Bluetooth	WWAN	SIM Card	Dock	Monitor Cable	Adapter	Color	Camera	Key-board	Finger-print Reader	NFC	TPM	Battery (internal)	Power Adapter	Operating System	War-ranty	Ann Date (m/y)
20HR005KUS	US	i5-7300U	vPro	Intel HD 620	8GB Soldered	14" FHD (1920x1080) IPS	None	256GB SSD M.2 PCIe NVMe Opal2	None	8265 ac, 2x2 + BT4.1	Sierra EM7455	None	None	None	None	Black	720p	Backlit	Finger-print Reader	None	dTPM 2.0	3-cell (57Wh)	65W USB-C	Win10 Pro 64	3-year, Depot	04/17

ThinkPad X1 Carbon (5th Gen) - TopSeller - 20K4

Product Specifications Reference (PSREF)

Model	Region	Processor	vPro	Graphics	Memory (Soldered)	Display	Multi-touch	Storage(HDD/SSD)	Optical	WLAN + Bluetooth	WWAN	SIM Card	Dock	Monitor Cable	Adapter	Color	Camera	Key-board	Finger-print Reader	NFC	TPM	Battery (internal)	Power Adapter	Operating System	Warranty	Ann Date (m/y)
20K4001WUS	US	i5-6200U	No	Intel HD 520	8GB Soldered	14" FHD (1920x1080) IPS	None	512GB SSD M.2 PCIe NVMe Opal2	None	8260 ac, 2x2 + BT4.1	None	None	None	None	None	Black	720p	Backlit	Finger-print Reader	None	dTPM 2.0	3-cell (57Wh)	65W USB-C	Win10 DG Win7 Pro 64	3-year, Depot	03/17
20K4001XUS	US	i5-6300U	vPro	Intel HD 520	8GB Soldered	14" FHD (1920x1080) IPS	None	256GB SSD M.2 PCIe NVMe Opal2	None	8260 ac, 2x2 + BT4.1	None	None	None	None	None	Black	720p	Backlit	Finger-print Reader	None	dTPM 2.0	3-cell (57Wh)	65W USB-C	Win10 DG Win7 Pro 64	3-year, Depot	03/17
20K4001YUS	US	i7-6600U	vPro	Intel HD 520	8GB Soldered	14" FHD (1920x1080) IPS	None	256GB SSD M.2 PCIe NVMe Opal2	None	8260 ac, 2x2 + BT4.1	None	None	None	None	None	Black	720p	Backlit	Finger-print Reader	None	dTPM 2.0	3-cell (57Wh)	65W USB-C	Win10 DG Win7 Pro 64	3-year, Depot	03/17
20K40020US	US	i7-6600U	vPro	Intel HD 520	8GB Soldered	14" FHD (1920x1080) IPS	None	512GB SSD M.2 PCIe NVMe Opal2	None	8260 ac, 2x2 + BT4.1	None	None	None	None	None	Black	720p	Backlit	Finger-print Reader	None	dTPM 2.0	3-cell (57Wh)	65W USB-C	Win10 DG Win7 Pro 64	3-year, Depot	03/17
20K40021US	US	i5-6200U	No	Intel HD 520	8GB Soldered	14" FHD (1920x1080) IPS	None	256GB SSD M.2 PCIe NVMe Opal2	None	8260 ac, 2x2 + BT4.1	None	None	None	None	None	Black	720p	Backlit	Finger-print Reader	None	dTPM 2.0	3-cell (57Wh)	65W USB-C	Win10 DG Win7 Pro 64	3-year, Depot	03/17
20K4002RUS	US	i7-6500U	No	Intel HD 520	8GB Soldered	14" FHD (1920x1080) IPS	None	256GB SSD M.2 PCIe NVMe Opal2	None	8260 ac, 2x2 + BT4.1	None	None	None	None	None	Black	720p	Backlit	Finger-print Reader	None	dTPM 2.0	3-cell (57Wh)	65W USB-C	Win10 DG Win7 Pro 64	3-year, Depot	03/17
20K4002SUS	US	i7-6500U	No	Intel HD 520	8GB Soldered	14" FHD (1920x1080) IPS	None	512GB SSD M.2 PCIe NVMe Opal2	None	8260 ac, 2x2 + BT4.1	None	None	None	None	None	Black	720p	Backlit	Finger-print Reader	None	dTPM 2.0	3-cell (57Wh)	65W USB-C	Win10 DG Win7 Pro 64	3-year, Depot	03/17
20K4002TUS	US	i7-6500U	No	Intel HD 520	8GB Soldered	14" WQHD (2560x1440) IPS	None	512GB SSD M.2 PCIe NVMe Opal2	None	8260 ac, 2x2 + BT4.1	None	None	None	None	None	Black	720p	Backlit	Finger-print Reader	None	dTPM 2.0	3-cell (57Wh)	65W USB-C	Win10 DG Win7 Pro 64	3-year, Depot	03/17
20K4002UUS	US	i5-6200U	No	Intel HD 520	8GB Soldered	14" FHD (1920x1080) IPS	None	180GB SSD M.2 Opal2	None	8260 ac, 2x2 + BT4.1	None	None	None	None	None	Black	720p	Backlit	Finger-print Reader	None	dTPM 2.0	3-cell (57Wh)	65W USB-C	Win10 DG Win7 Pro 64	3-year, Depot	03/17



ThinkPad X260 Platform Specifications

Product Specifications Reference (PSREF)

Processor	6th Generation Intel® Core™ i3 / i5 / i7 Processor								Smart card reader	Optional: Smart card reader										
	Processor Number	# of Cores	# of Threads	Base Frequency	Max Turbo Frequency	Cache	Memory Types	Processor Graphics	Media reader	4-in-1 reader (MMC, SD, SDHC, SDXC)										
	i3-6006U	2	4	2.0 GHz	-	3MB	DDR4-2133	Intel HD graphics 520	Ports	Three USB 3.0 (one Always On), HDMI, MiniDP, Ethernet (RJ-45), Dock connector										
	i3-6100U			2.3 GHz	-	3MB			Monitor cable	None										
	i5-6200U			2.3 GHz	2.8 GHz	3MB			Camera (optional)	HD720p resolution, low light sensitive, fixed focus										
	i5-6300U			2.4 GHz	3.0 GHz	3MB			Audio support	HD Audio, Realtek® ALC3245 codec / stereo speakers, 1W x 2 / dual array microphone, combo audio/microphone jack										
	i7-6500U			2.5 GHz	3.1 GHz	4MB			Keyboard	6-row, spill-resistant, multimedia Fn keys, optional LED backlight										
	i7-6600U			2.6 GHz	3.4 GHz	4MB			UltraNav™	TrackPoint® pointing device and buttonless Mylar surface touchpad, multi-touch										
Graphics	Intel HD Graphics 520 in processor; supports external digital monitor via HDMI or Mini DisplayPort; supports three independent displays; Max resolution: 3840x2160@60Hz (DisplayPort via Mini DisplayPort cable); 1920x1080@60Hz (HDMI)								Security	Power-on password, hard disk password, supervisor password, security keyhole										
Chipset	Intel SoC (System on Chip) platform								Security chip	Discrete TPM 1.2 TCG Certified and Firmware TPM 2.0 integrated in chipset										
Memory	16GB max / 2133MHz DDR4, one DDR4 SO-DIMM socket								ThinkEngine	Delivers improved thermal and power efficiency, up to 30 day standby, faster resume time, enhanced security, as well as anti-tampering measures										
Display	<i>Some:</i> 12.5" (317.5mm) HD (1366x768), anti-glare, LED backlight, 200 nits, 16:9 aspect ratio, 300:1 contrast ratio <i>Some:</i> 12.5" (317.5mm) HD (1366x768), anti-glare, LED backlight, IPS, 300 nits, 16:9 aspect ratio, 700:1 contrast ratio, 170° viewing angle <i>Some:</i> 12.5" (317.5mm) FHD (1920x1080), anti-glare, LED backlight, IPS, 300 nits, 16:9 aspect ratio, 700:1 contrast ratio, 170° viewing angle								vPro (optional)	Intel vPro Technology										
Multi-touch	None								Fingerprint reader	Optional: Swipe style fingerprint reader on the keyboard bezel										
Storage	<i>Some:</i> SSD / SATA 6.0Gb/s (e.g. xxxG SSD) <i>Some:</i> SSD / PCIe NVMe, PCIe 3.0 x 2, 16Gb/s (e.g. xxxG SSD PCIe NVMe) <i>Some:</i> HDD / SATA 6.0Gb/s, 2.5" wide, 7mm or 9.5mm high, Shock Mounted Hard Drive, Active Protection System™ <i>Some:</i> SSHD with 8GB NAND flash memory								Internal battery	Optional: Integrated Li-Ion or Li-Polymer 3-cell (23Wh)										
Optical	None								External battery	Li-Ion 3-cell (23Wh) or 6-cell (48Wh or 72Wh)										
Ethernet	<i>Non-vPro model:</i> Intel Ethernet Connection I219-V (Jacksonville) <i>vPro model:</i> Intel Ethernet Connection I219-LM (Jacksonville)								Max battery life ¹⁰ (MobileMark® 2014)	<table border="1"> <thead> <tr> <th>Models</th> <th>No + 3-cell</th> <th>3-cell + 3-cell</th> <th>3-cell + 6-cell 48Wh</th> <th>3-cell + 6-cell 72Wh</th> </tr> </thead> <tbody> <tr> <td>Max battery life</td> <td>6 hr</td> <td>12 hr</td> <td>18.5 hr</td> <td>25 hr</td> </tr> </tbody> </table>	Models	No + 3-cell	3-cell + 3-cell	3-cell + 6-cell 48Wh	3-cell + 6-cell 72Wh	Max battery life	6 hr	12 hr	18.5 hr	25 hr
Models	No + 3-cell	3-cell + 3-cell	3-cell + 6-cell 48Wh	3-cell + 6-cell 72Wh																
Max battery life	6 hr	12 hr	18.5 hr	25 hr																
WLAN ⁴	<i>One of the following, configurable by model:</i> <ul style="list-style-type: none"> 11ac+BT, Broadcom BCM4356, 2x2, M.2 card 11ac+BT, Intel Dual Band Wireless-AC 8260, 2x2, M.2 card 								AC adapter	45W AC adapter										
Bluetooth™	Bluetooth 4.1 wireless, integrated in Wi-Fi + Bluetooth combo adapter								Preload	Windows® 7 Professional 64 preinstalled through downgrade rights in Windows 10 Pro 64 <ul style="list-style-type: none"> Lenovo Solution Center Lenovo SHAREit Lenovo Companion Lenovo Setting ThinkVantage Product Recovery Microsoft Office preloaded; purchase a product key to activate Rescue and Recovery™ McAfee® LiveSafe™ (30-day trial) ThinkVantage System Update Adobe® Reader® Microsoft® Office preloaded; purchase a product key to activate McAfee® LiveSafe™ (30-day trial) 										
WWAN (optional)	<i>One of the following, configurable by model (mutually exclusive with WiGig):</i> <ul style="list-style-type: none"> Wireless WAN upgradable Wireless WAN, Sierra Wireless EM7455, Qualcomm® 4G LTE-Advanced/DC-HSPA+/HSPA+/HSPA/UMTS/GNSS, M.2 card Wireless WAN, HUAWEI ME906S, HUAWEI 4G LTE/WCDMA/HSPA/GSM/GPRS/EDGE/GNSS, M.2 card (WE only) 								Limited warranty ¹²	<i>One of the following, configurable by model:</i> <ul style="list-style-type: none"> 1-year depot repair service 3-year/1-yr battery depot repair service 3-year/1-yr battery limited onsite service²⁴ 3-year/1-yr battery limited onsite service, OID (Onsite International Delivery) 										
SIM card (opt)	Micro-SIM card slot, optional Verizon LTE (US) or Lenovo Connect (WE) SIM card								Mil-Spec test	MIL-STD-810G military certification										
Dimensions ³	WxDxH: 12.03" x 8.21" x 0.80"; 305.5mm x 208.5mm x 20.3mm								Environment	EPPEAT™ Gold (US only); ENERGY STAR® 6.1; GREENGUARD®; RoHS-compliant										
Weight ²	<table border="1"> <thead> <tr> <th>Models</th> <th>No + 3-cell</th> <th>3-cell + 3-cell</th> <th>3 + 6-cell 48Wh</th> <th>3-cell + 6-cell 72Wh</th> </tr> </thead> <tbody> <tr> <td>Weight</td> <td>2.94 lb / 1.34 kg</td> <td>3.18 lb / 1.44 kg</td> <td>3.51 lb / 1.59 kg</td> <td>3.58 lb / 1.62 kg</td> </tr> </tbody> </table>								Models	No + 3-cell	3-cell + 3-cell	3 + 6-cell 48Wh	3-cell + 6-cell 72Wh	Weight	2.94 lb / 1.34 kg	3.18 lb / 1.44 kg	3.51 lb / 1.59 kg	3.58 lb / 1.62 kg	Case material	Glass-Fiber Reinforced Plastic
Models	No + 3-cell	3-cell + 3-cell	3 + 6-cell 48Wh	3-cell + 6-cell 72Wh																
Weight	2.94 lb / 1.34 kg	3.18 lb / 1.44 kg	3.51 lb / 1.59 kg	3.58 lb / 1.62 kg																

Model	Region	Processor	vPro	Graphics	Memory	Display	Multi-touch	Storage(HDD/SSD)	Optical	WLAN + Bluetooth	WWAN	SIM Card	Smart Card Reader	Camera	Keyboard	Fingerprint Reader	Battery (internal+ external)	Power Adapter	Operating System	Warranty	Ann Date (m/y)
20F6005EUS	US	i5-6200U	No	Intel HD 520	4GBx1	12.5" HD (1366x768)	None	500GB 7200rpm	None	Intel 8260 ac, 2x2 + BT4.1	WWAN Upgradable	None	None	720p	Backlit	Fingerprint Reader	3-cell(23Wh) + 3-cell(23Wh)	45W	Win10 DG Win7 Pro 64	3-year, Depot	01/16
20F6005FUS	US	i3-6100U	No	Intel HD 520	4GBx1	12.5" HD (1366x768) IPS	None	500GB 7200rpm	None	Intel 8260 ac, 2x2 + BT4.1	WWAN Upgradable	None	None	720p	Backlit	Fingerprint Reader	3-cell(23Wh) + 3-cell(23Wh)	45W	Win10 DG Win7 Pro 64	3-year, Depot	01/16
20F6005GUS	US	i5-6300U	vPro	Intel HD 520	8GBx1	12.5" HD (1366x768)	None	256GB SSD Opal2	None	Intel 8260 ac, 2x2 + BT4.1	WWAN Upgradable	None	None	720p	Backlit	Fingerprint Reader	3-cell(23Wh) + 3-cell(23Wh)	45W	Win10 DG Win7 Pro 64	3-year, Depot	01/16
20F6005HUS	US	i5-6200U	No	Intel HD 520	8GBx1	12.5" HD (1366x768)	None	500GB 7200rpm	None	Intel 8260 ac, 2x2 + BT4.1	WWAN Upgradable	None	None	720p	Backlit	Fingerprint Reader	3-cell(23Wh) + 3-cell(23Wh)	45W	Win10 DG Win7 Pro 64	3-year, Depot	01/16
20F6005JUS	US	i7-6600U	vPro	Intel HD 520	8GBx1	12.5" HD (1366x768)	None	512GB SSD	None	Intel 8260 ac, 2x2 + BT4.1	WWAN Upgradable	None	None	720p	Backlit	Fingerprint Reader	3-cell(23Wh) + 3-cell(23Wh)	45W	Win10 DG Win7 Pro 64	3-year, Depot	01/16
20F6005KUS	US	i7-6600U	vPro	Intel HD 520	8GBx1	12.5" HD (1366x768)	None	192GB SSD	None	Intel 8260 ac, 2x2 + BT4.1	WWAN Upgradable	None	None	720p	Backlit	Fingerprint Reader	3-cell(23Wh) + 3-cell(23Wh)	45W	Win10 DG Win7 Pro 64	3-year, Depot	01/16
20F6005LUS	US	i5-6300U	vPro	Intel HD 520	8GBx1	12.5" HD (1366x768)	None	128GB SSD	None	Intel 8260 ac, 2x2 + BT4.1	WWAN Upgradable	None	None	720p	Backlit	Fingerprint Reader	3-cell(23Wh) + 3-cell(23Wh)	45W	Win10 DG Win7 Pro 64	3-year, Depot	01/16
20F6005MUS	US	i7-6600U	vPro	Intel HD 520	16GBx1	12.5" HD (1366x768)	None	512GB SSD	None	Intel 8260 ac, 2x2 + BT4.1	WWAN Upgradable	None	None	720p	Backlit	Fingerprint Reader	3-cell(23Wh) + 3-cell(23Wh)	45W	Win10 DG Win7 Pro 64	3-year, Depot	01/16
20F6005NUS	US	i5-6300U	vPro	Intel HD 520	8GBx1	12.5" HD (1366x768)	None	192GB SSD	None	Intel 8260 ac, 2x2 + BT4.1	WWAN Upgradable	None	None	720p	Backlit	Fingerprint Reader	3-cell(23Wh) + 3-cell(23Wh)	45W	Win10 DG Win7 Pro 64	3-year, Depot	01/16
20F6005QUS	US	i3-6100U	No	Intel HD 520	4GBx1	12.5" HD (1366x768)	None	500GB 7200rpm	None	Intel 8260 ac, 2x2 + BT4.1	WWAN Upgradable	None	None	720p	Backlit	Fingerprint Reader	3-cell(23Wh) + 3-cell(23Wh)	45W	Win10 DG Win7 Pro 64	3-year, Depot	01/16
20F6005RUS	US	i7-6600U	vPro	Intel HD 520	8GBx1	12.5" HD (1366x768)	None	256GB SSD Opal2	None	Intel 8260 ac, 2x2 + BT4.1	WWAN Upgradable	None	None	720p	Backlit	Fingerprint Reader	3-cell(23Wh) + 3-cell(23Wh)	45W	Win10 DG Win7 Pro 64	3-year, Depot	01/16
20F6005SUS	US	i5-6300U	vPro	Intel HD 520	8GBx1	12.5" HD (1366x768)	None	500GB 7200rpm	None	Intel 8260 ac, 2x2 + BT4.1	WWAN Upgradable	None	None	720p	Backlit	Fingerprint Reader	3-cell(23Wh) + 3-cell(23Wh)	45W	Win10 DG Win7 Pro 64	3-year, Depot	01/16
20F60068US	US	i5-6200U	No	Intel HD 520	8GBx1	12.5" HD (1366x768) IPS	None	128GB SSD	None	Intel 8260 ac, 2x2 + BT4.1	WWAN Upgradable	None	None	720p	Backlit	Fingerprint Reader	3-cell(23Wh) + 3-cell(23Wh)	45W	Win10 Pro 64	3-year, Depot	03/16
20F60069US	US	i5-6300U	No	Intel HD 520	8GBx1	12.5" HD (1366x768) IPS	None	128GB SSD	None	Intel 8260 ac, 2x2 + BT4.1	WWAN Upgradable	None	None	720p	Backlit	Fingerprint Reader	3-cell(23Wh) + 3-cell(23Wh)	45W	Win10 Pro 64	3-year, Depot	03/16
20F6006AUS	US	i5-6300U	No	Intel HD 520	8GBx1	12.5" HD (1366x768) IPS	None	256GB SSD Opal2	None	Intel 8260 ac, 2x2 + BT4.1	WWAN Upgradable	None	None	720p	Backlit	Fingerprint Reader	3-cell(23Wh) + 3-cell(23Wh)	45W	Win10 Pro 64	3-year, Depot	03/16
20F6006BUS	US	i5-6200U	No	Intel HD 520	8GBx1	12.5" HD (1366x768) IPS	None	500GB SSHD 5400rpm	None	Intel 8260 ac, 2x2 + BT4.1	WWAN Upgradable	None	None	720p	Backlit	Fingerprint Reader	3-cell(23Wh) + 3-cell(23Wh)	45W	Win10 Pro 64	3-year, Depot	03/16
20F6006CUS	US	i5-6300U	No	Intel HD 520	8GBx1	12.5" HD (1366x768)	None	500GB SSHD 5400rpm	None	Intel 8260 ac, 2x2 + BT4.1	WWAN Upgradable	None	None	720p	Backlit	Fingerprint Reader	3-cell(23Wh) + 3-cell(23Wh)	45W	Win10 Pro 64	3-year, Depot	03/16
20F6006DUS	US	i5-6200U	No	Intel HD 520	8GBx1	12.5" HD (1366x768)	None	500GB SSHD 5400rpm	None	Intel 8260 ac, 2x2 + BT4.1	WWAN Upgradable	None	None	720p	Backlit	Fingerprint Reader	3-cell(23Wh) + 3-cell(23Wh)	45W	Win10 Pro 64	3-year, Depot	03/16
20F6006EUS	US	i5-6300U	No	Intel HD 520	8GBx1	12.5" HD (1366x768) IPS	None	500GB SSHD 5400rpm	None	Intel 8260 ac, 2x2 + BT4.1	WWAN Upgradable	None	None	720p	Backlit	Fingerprint Reader	3-cell(23Wh) + 3-cell(23Wh)	45W	Win10 Pro 64	3-year, Depot	03/16
20F6006FUS	US	i5-6200U	No	Intel HD 520	8GBx1	12.5" HD (1366x768)	None	256GB SSD Opal2	None	Intel 8260 ac, 2x2 + BT4.1	WWAN Upgradable	None	None	720p	Backlit	Fingerprint Reader	3-cell(23Wh) + 3-cell(23Wh)	45W	Win10 DG Win7 Pro 64	3-year, Depot	03/16

Model	Region	Processor	vPro	Graphics	Memory	Display	Multi-touch	Storage(HDD/SSD)	Optical	WLAN + Bluetooth	WWAN	SIM Card	Smart Card Reader	Camera	Keyboard	Fingerprint Reader	Battery (internal+external)	Power Adapter	Operating System	Warranty	Ann Date (m/y)
20F6006GUS	US	i7-6600U	vPro	Intel HD 520	16GBx1	12.5" HD (1366x768) IPS	None	512GB SSD	None	Intel 8260 ac, 2x2 + BT4.1	WWAN Upgradable	None	None	720p	Backlit	Fingerprint Reader	3-cell(23Wh) + 3-cell(23Wh)	45W	Win10 DG Win7 Pro 64	3-year, Depot	03/16
20F6006HUS	US	i5-6300U	vPro	Intel HD 520	8GBx1	12.5" HD (1366x768)	None	180GB SSD Opal2	None	Intel 8260 ac, 2x2 + BT4.1	WWAN Upgradable	None	None	720p	Backlit	Fingerprint Reader	3-cell(23Wh) + 3-cell(23Wh)	45W	Win10 DG Win7 Pro 64	3-year, Depot	03/16
20F6006JUS	US	i7-6600U	vPro	Intel HD 520	16GBx1	12.5" HD (1366x768)	None	192GB SSD	None	Intel 8260 ac, 2x2 + BT4.1	WWAN Upgradable	None	None	720p	Backlit	Fingerprint Reader	3-cell(23Wh) + 3-cell(23Wh)	45W	Win10 DG Win7 Pro 64	3-year, Depot	03/16
20F6006KUS	US	i7-6600U	vPro	Intel HD 520	16GBx1	12.5" HD (1366x768)	None	256GB SSD Opal2	None	Intel 8260 ac, 2x2 + BT4.1	WWAN Upgradable	None	None	720p	Backlit	Fingerprint Reader	3-cell(23Wh) + 3-cell(23Wh)	45W	Win10 DG Win7 Pro 64	3-year, Depot	03/16
20F6006LUS	US	i7-6600U	vPro	Intel HD 520	16GBx1	12.5" HD (1366x768) IPS	None	256GB SSD Opal2	None	Intel 8260 ac, 2x2 + BT4.1	WWAN Upgradable	None	None	720p	Backlit	Fingerprint Reader	3-cell(23Wh) + 3-cell(23Wh)	45W	Win10 DG Win7 Pro 64	3-year, Depot	03/16
20F6006NUS	US	i7-6600U	vPro	Intel HD 520	16GBx1	12.5" HD (1366x768) IPS	None	192GB SSD	None	Intel 8260 ac, 2x2 + BT4.1	WWAN Upgradable	None	None	720p	Backlit	Fingerprint Reader	3-cell(23Wh) + 3-cell(23Wh)	45W	Win10 DG Win7 Pro 64	3-year, Depot	03/16
20F6006PUS	US	i7-6600U	vPro	Intel HD 520	16GBx1	12.5" HD (1366x768)	None	180GB SSD Opal2	None	Intel 8260 ac, 2x2 + BT4.1	WWAN Upgradable	None	None	720p	Backlit	Fingerprint Reader	3-cell(23Wh) + 3-cell(23Wh)	45W	Win10 DG Win7 Pro 64	3-year, Depot	03/16
20F6006QUS	US	i5-6200U	No	Intel HD 520	8GBx1	12.5" HD (1366x768)	None	128GB SSD	None	Intel 8260 ac, 2x2 + BT4.1	WWAN Upgradable	None	None	720p	Backlit	Fingerprint Reader	3-cell(23Wh) + 3-cell(23Wh)	45W	Win10 DG Win7 Pro 64	3-year, Depot	03/16
20F6006RUS	US	i5-6300U	vPro	Intel HD 520	4GBx1	12.5" HD (1366x768)	None	500GB 7200rpm	None	Intel 8260 ac, 2x2 + BT4.1	WWAN Upgradable	None	None	720p	Backlit	Fingerprint Reader	3-cell(23Wh) + 3-cell(23Wh)	45W	Win10 DG Win7 Pro 64	3-year, Depot	03/16
20F6006SUS	US	i7-6600U	vPro	Intel HD 520	8GBx1	12.5" HD (1366x768) IPS	None	500GB 7200rpm	None	Intel 8260 ac, 2x2 + BT4.1	WWAN Upgradable	None	None	720p	Backlit	Fingerprint Reader	3-cell(23Wh) + 6-cell(48Wh)	45W	Win10 DG Win7 Pro 64	3-year, Depot	03/16
20F6006TUS	US	i7-6600U	vPro	Intel HD 520	16GBx1	12.5" HD (1366x768) IPS	None	500GB 7200rpm	None	Intel 8260 ac, 2x2 + BT4.1	WWAN Upgradable	None	None	720p	Backlit	Fingerprint Reader	3-cell(23Wh) + 3-cell(23Wh)	45W	Win10 DG Win7 Pro 64	3-year, Depot	03/16
20F6008GUS	US	i7-6600U	vPro	Intel HD 520	8GBx1	12.5" HD (1366x768) IPS	None	128GB SSD	None	Intel 8260 ac, 2x2 + BT4.1	WWAN Upgradable	None	None	720p	Non-backlit	Fingerprint Reader	3-cell(23Wh) + 3-cell(23Wh)	45W	Win10 DG Win7 Pro 64	3-year, Depot	04/16
20F6008HUS	US	i5-6200U	No	Intel HD 520	8GBx1	12.5" HD (1366x768) IPS	None	128GB SSD	None	Intel 8260 ac, 2x2 + BT4.1	WWAN Upgradable	None	None	720p	Non-backlit	Fingerprint Reader	3-cell(23Wh) + 3-cell(23Wh)	45W	Win10 DG Win7 Pro 64	3-year, Depot	04/16
20F6008JUS	US	i7-6500U	No	Intel HD 520	8GBx1	12.5" HD (1366x768) IPS	None	128GB SSD	None	Intel 8260 ac, 2x2 + BT4.1	WWAN Upgradable	None	None	720p	Non-backlit	Fingerprint Reader	3-cell(23Wh) + 3-cell(23Wh)	45W	Win10 DG Win7 Pro 64	3-year, Depot	04/16
20F6008KUS	US	i7-6500U	No	Intel HD 520	8GBx1	12.5" FHD (1920x1080) IPS	None	500GB 7200rpm	None	Intel 8260 ac, 2x2 + BT4.1	WWAN Upgradable	None	None	720p	Non-backlit	Fingerprint Reader	3-cell(23Wh) + 3-cell(23Wh)	45W	Win10 DG Win7 Pro 64	3-year, Depot	04/16
20F6008LUS	US	i7-6600U	vPro	Intel HD 520	8GBx1	12.5" FHD (1920x1080) IPS	None	256GB SSD PCIe NVMe Opal2	None	Intel 8260 ac, 2x2 + BT4.1	WWAN Upgradable	None	None	720p	Non-backlit	Fingerprint Reader	3-cell(23Wh) + 3-cell(23Wh)	45W	Win10 DG Win7 Pro 64	3-year, Depot	05/16
20F6008MUS	US	i7-6500U	No	Intel HD 520	8GBx1	12.5" FHD (1920x1080) IPS	None	256GB SSD Opal2	None	Intel 8260 ac, 2x2 + BT4.1	WWAN Upgradable	None	None	720p	Non-backlit	Fingerprint Reader	3-cell(23Wh) + 3-cell(23Wh)	45W	Win10 DG Win7 Pro 64	3-year, Depot	04/16
20F6008NUS	US	i5-6200U	No	Intel HD 520	8GBx1	12.5" HD (1366x768) IPS	None	256GB SSD Opal2	None	Intel 8260 ac, 2x2 + BT4.1	WWAN Upgradable	None	None	720p	Non-backlit	Fingerprint Reader	3-cell(23Wh) + 3-cell(23Wh)	45W	Win10 DG Win7 Pro 64	3-year, Depot	04/16
20F6008PUS	US	i5-6300U	vPro	Intel HD 520	8GBx1	12.5" HD (1366x768) IPS	None	128GB SSD	None	Intel 8260 ac, 2x2 + BT4.1	WWAN Upgradable	None	None	720p	Non-backlit	Fingerprint Reader	3-cell(23Wh) + 3-cell(23Wh)	45W	Win10 DG Win7 Pro 64	3-year, Depot	04/16
20F6008QUS	US	i3-6100U	No	Intel HD 520	8GBx1	12.5" HD (1366x768) IPS	None	128GB SSD	None	Intel 8260 ac, 2x2 + BT4.1	WWAN Upgradable	None	None	720p	Non-backlit	Fingerprint Reader	3-cell(23Wh) + 3-cell(23Wh)	45W	Win10 DG Win7 Pro 64	3-year, Depot	04/16

Model	Region	Processor	vPro	Graphics	Memory	Display	Multi-touch	Storage(HDD/SSD)	Optical	WLAN + Bluetooth	WWAN	SIM Card	Smart Card Reader	Camera	Keyboard	Fingerprint Reader	Battery (Internal+external)	Power Adapter	Operating System	Warranty	Ann Date (m/y)
20F6008RUS	US	i3-6100U	No	Intel HD 520	8GBx1	12.5" HD (1366x768) IPS	None	128GB SSD	None	Intel 8260 ac, 2x2 + BT4.1	WWAN Upgradable	None	None	720p	Non-backlit	Fingerprint Reader	3-cell(23Wh) + 3-cell(23Wh)	45W	Win10 DG Win7 Pro 64	3-year, Depot	04/16
20F6008SUS	US	i3-6100U	No	Intel HD 520	8GBx1	12.5" HD (1366x768) IPS	None	500GB 7200rpm	None	Intel 8260 ac, 2x2 + BT4.1	WWAN Upgradable	None	None	720p	Non-backlit	Fingerprint Reader	3-cell(23Wh) + 3-cell(23Wh)	45W	Win10 DG Win7 Pro 64	3-year, Depot	04/16
20F6008TUS	US	i7-6500U	No	Intel HD 520	8GBx1	12.5" HD (1366x768) IPS	None	256GB SSD Opal2	None	Intel 8260 ac, 2x2 + BT4.1	WWAN Upgradable	None	None	720p	Non-backlit	Fingerprint Reader	3-cell(23Wh) + 3-cell(23Wh)	45W	Win10 DG Win7 Pro 64	3-year, Depot	04/16
20F6008UUS	US	i5-6300U	vPro	Intel HD 520	8GBx1	12.5" HD (1366x768) IPS	None	256GB SSD Opal2	None	Intel 8260 ac, 2x2 + BT4.1	WWAN Upgradable	None	None	720p	Non-backlit	Fingerprint Reader	3-cell(23Wh) + 3-cell(23Wh)	45W	Win10 DG Win7 Pro 64	3-year, Depot	04/16
20F6008VUS	US	i7-6500U	No	Intel HD 520	8GBx1	12.5" HD (1366x768) IPS	None	500GB 7200rpm	None	Intel 8260 ac, 2x2 + BT4.1	WWAN Upgradable	None	None	720p	Non-backlit	Fingerprint Reader	3-cell(23Wh) + 3-cell(23Wh)	45W	Win10 DG Win7 Pro 64	3-year, Depot	04/16
20F6008WUS	US	i5-6200U	No	Intel HD 520	8GBx1	12.5" HD (1366x768) IPS	None	128GB SSD	None	Intel 8260 ac, 2x2 + BT4.1	WWAN Upgradable	None	None	720p	Non-backlit	Fingerprint Reader	3-cell(23Wh) + 3-cell(23Wh)	45W	Win10 DG Win7 Pro 64	3-year, Depot	04/16
20F6008XUS	US	i7-6600U	vPro	Intel HD 520	16GBx1	12.5" FHD (1920x1080) IPS	None	256GB SSD PCIe NVMe Opal2	None	Intel 8260 ac, 2x2 + BT4.1	WWAN Upgradable	None	None	720p	Non-backlit	Fingerprint Reader	3-cell(23Wh) + 3-cell(23Wh)	45W	Win10 DG Win7 Pro 64	3-year, Depot	05/16
20F60092US	US	i5-6300U	vPro	Intel HD 520	8GBx1	12.5" FHD (1920x1080) IPS	None	180GB SSD Opal2	None	Intel 8260 ac, 2x2 + BT4.1	WWAN Upgradable	None	None	720p	Backlit	Fingerprint Reader	3-cell(23Wh) + 3-cell(23Wh)	45W	Win10 DG Win7 Pro 64	3-year, Depot	05/16
20F60093US	US	i5-6300U	vPro	Intel HD 520	8GBx1	12.5" FHD (1920x1080) IPS	None	256GB SSD Opal2	None	Intel 8260 ac, 2x2 + BT4.1	WWAN Upgradable	None	None	720p	Backlit	Fingerprint Reader	3-cell(23Wh) + 3-cell(23Wh)	45W	Win10 DG Win7 Pro 64	3-year, Depot	05/16
20F60094US	US	i5-6300U	vPro	Intel HD 520	8GBx1	12.5" FHD (1920x1080) IPS	None	500GB 7200rpm	None	Intel 8260 ac, 2x2 + BT4.1	WWAN Upgradable	None	None	720p	Backlit	Fingerprint Reader	3-cell(23Wh) + 3-cell(23Wh)	45W	Win10 DG Win7 Pro 64	3-year, Depot	05/16
20F60095US	US	i5-6200U	No	Intel HD 520	8GBx1	12.5" FHD (1920x1080) IPS	None	256GB SSD Opal2	None	Intel 8260 ac, 2x2 + BT4.1	WWAN Upgradable	None	None	720p	Backlit	Fingerprint Reader	3-cell(23Wh) + 3-cell(23Wh)	45W	Win10 DG Win7 Pro 64	3-year, Depot	05/16
20F60096US	US	i7-6600U	vPro	Intel HD 520	8GBx1	12.5" FHD (1920x1080) IPS	None	256GB SSD Opal2	None	Intel 8260 ac, 2x2 + BT4.1	WWAN Upgradable	None	None	720p	Backlit	Fingerprint Reader	3-cell(23Wh) + 3-cell(23Wh)	45W	Win10 DG Win7 Pro 64	3-year, Depot	05/16
20F60097US	US	i7-6600U	vPro	Intel HD 520	16GBx1	12.5" FHD (1920x1080) IPS	None	256GB SSD Opal2	None	Intel 8260 ac, 2x2 + BT4.1	WWAN Upgradable	None	None	720p	Backlit	Fingerprint Reader	3-cell(23Wh) + 3-cell(23Wh)	45W	Win10 DG Win7 Pro 64	3-year, Depot	05/16
20F60098US	US	i5-6300U	vPro	Intel HD 520	8GBx1	12.5" HD (1366x768) IPS	None	180GB SSD Opal2	None	Intel 8260 ac, 2x2 + BT4.1	WWAN Upgradable	None	None	720p	Backlit	Fingerprint Reader	3-cell(23Wh) + 3-cell(23Wh)	45W	Win10 DG Win7 Pro 64	3-year, Depot	05/16
20F60099US	US	i7-6600U	vPro	Intel HD 520	8GBx1	12.5" HD (1366x768) IPS	None	256GB SSD Opal2	None	Intel 8260 ac, 2x2 + BT4.1	WWAN Upgradable	None	None	720p	Backlit	Fingerprint Reader	3-cell(23Wh) + 3-cell(23Wh)	45W	Win10 DG Win7 Pro 64	3-year, Depot	05/16
20F6009AUS	US	i5-6200U	No	Intel HD 520	8GBx1	12.5" HD (1366x768) IPS	None	500GB 7200rpm	None	Intel 8260 ac, 2x2 + BT4.1	WWAN Upgradable	None	None	720p	Backlit	Fingerprint Reader	3-cell(23Wh) + 3-cell(23Wh)	45W	Win10 DG Win7 Pro 64	3-year, Depot	05/16
20F6009BUS	US	i5-6300U	vPro	Intel HD 520	8GBx1	12.5" HD (1366x768) IPS	None	256GB SSD Opal2	None	Intel 8260 ac, 2x2 + BT4.1	WWAN Upgradable	None	None	720p	Backlit	Fingerprint Reader	3-cell(23Wh) + 3-cell(23Wh)	45W	Win10 DG Win7 Pro 64	3-year, Depot	05/16
20F6009CUS	US	i5-6200U	No	Intel HD 520	8GBx1	12.5" HD (1366x768) IPS	None	256GB SSD Opal2	None	Intel 8260 ac, 2x2 + BT4.1	WWAN Upgradable	None	None	720p	Backlit	Fingerprint Reader	3-cell(23Wh) + 3-cell(23Wh)	45W	Win10 DG Win7 Pro 64	3-year, Depot	05/16
20F6009DUS	US	i5-6200U	No	Intel HD 520	8GBx1	12.5" FHD (1920x1080) IPS	None	500GB 7200rpm	None	Intel 8260 ac, 2x2 + BT4.1	WWAN Upgradable	None	None	720p	Backlit	Fingerprint Reader	3-cell(23Wh) + 3-cell(23Wh)	45W	Win10 DG Win7 Pro 64	3-year, Depot	05/16
20F6009EUS	US	i5-6300U	vPro	Intel HD 520	8GBx1	12.5" HD (1366x768) IPS	None	500GB 7200rpm	None	Intel 8260 ac, 2x2 + BT4.1	WWAN Upgradable	None	None	720p	Backlit	Fingerprint Reader	3-cell(23Wh) + 3-cell(23Wh)	45W	Win10 DG Win7 Pro 64	3-year, Depot	05/16

Model	Region	Processor	vPro	Graphics	Memory	Display	Multi-touch	Storage(HDD/SSD)	Optical	WLAN + Bluetooth	WWAN	SIM Card	Smart Card Reader	Camera	Keyboard	Fingerprint Reader	Battery (internal+external)	Power Adapter	Operating System	Warranty	Ann Date (m/y)
20F600A8US	US	i7-6600U	vPro	Intel HD 520	16GBx1	12.5" FHD (1920x1080) IPS	None	256GB SSD Opal2	None	Intel 8260 ac, 2x2 + BT4.1	WWAN Upgradable	None	None	720p	Backlit	Fingerprint Reader	3-cell(23Wh) + 3-cell(23Wh)	45W	Win10 Pro 64	3-year, Depot	10/16
20F600A9US	US	i5-6300U	vPro	Intel HD 520	8GBx1	12.5" FHD (1920x1080) IPS	None	256GB SSD Opal2	None	Intel 8260 ac, 2x2 + BT4.1	WWAN Upgradable	None	None	720p	Backlit	Fingerprint Reader	3-cell(23Wh) + 3-cell(23Wh)	45W	Win10 Pro 64	3-year, Depot	10/16
20F600AAUS	US	i5-6200U	No	Intel HD 520	8GBx1	12.5" HD (1366x768) IPS	None	180GB SSD Opal2	None	Intel 8260 ac, 2x2 + BT4.1	WWAN Upgradable	None	None	720p	Backlit	Fingerprint Reader	3-cell(23Wh) + 3-cell(23Wh)	45W	Win10 Pro 64	3-year, Depot	10/16
20F600ABUS	US	i7-6600U	vPro	Intel HD 520	8GBx1	12.5" FHD (1920x1080) IPS	None	256GB SSD Opal2	None	Intel 8260 ac, 2x2 + BT4.1	WWAN Upgradable	None	None	720p	Backlit	Fingerprint Reader	3-cell(23Wh) + 3-cell(23Wh)	45W	Win10 Pro 64	3-year, Depot	10/16

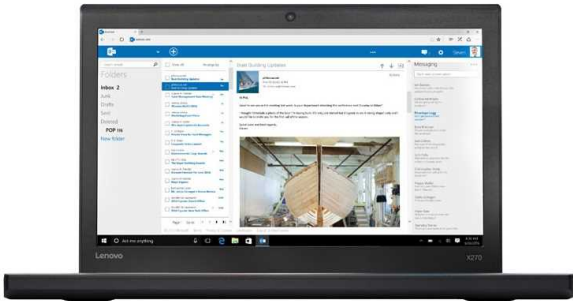

ThinkPad X270 Platform Specifications

Product Specifications Reference (PSREF)

Processor	6th Generation Intel® Core™ i3 / i5 / i7 Processor							WWAN (optional) <i>One of the following, configurable by model (mutually exclusive with WiGig):</i> <ul style="list-style-type: none"> Wireless WAN upgradable Integrated Mobile Broadband 4G LTE-A, Qualcomm® Snapdragon™ X7 LTE-A (Sierra Wireless EM7455) Integrated Mobile Broadband 4G LTE, Intel XMM™ 7160 (Fibocom L831-EAU) (EMEA only) SIM card (opt) Micro-SIM card slot, opt Verizon LTE (US) or Lenovo® Connect (EMEA) SIM card																											
	Processor Number	# of Cores	# of Threads	Base Frequency	Max Turbo Frequency	Cache	Memory Types		Processor Graphics	i3-6006U	2	4	2.0 GHz	-	3MB	DDR4-2133	Intel HD Graphics 520	i3-6100U	2.3 GHz	-	3MB	i5-6200U	2.3 GHz	2.8 GHz	3MB	i5-6300U	2.4 GHz	3.0 GHz	3MB	i7-6500U	2.5 GHz	3.1 GHz	4MB	i7-6600U	2.6 GHz
Processor Number	# of Cores	# of Threads	Base Frequency	Max Turbo Frequency	Cache	Memory Types	Processor Graphics																												
i3-6006U	2	4	2.0 GHz	-	3MB	DDR4-2133	Intel HD Graphics 520																												
i3-6100U			2.3 GHz	-	3MB																														
i5-6200U			2.3 GHz	2.8 GHz	3MB																														
i5-6300U			2.4 GHz	3.0 GHz	3MB																														
i7-6500U			2.5 GHz	3.1 GHz	4MB																														
i7-6600U			2.6 GHz	3.4 GHz	4MB																														
Processor	or 7th Generation Intel Core i3 / i5 / i7 Processor							Dimensions <i>WxDxH:</i> 12.03" x 8.21" x 0.80"; 305.5mm x 208.5mm x 20.3mm Weight <table border="1"> <thead> <tr> <th>Models</th> <th>No + 3-cell</th> <th>3-cell + 3-cell</th> <th>3 + 6-cell</th> </tr> </thead> <tbody> <tr> <td></td> <td>2.79 lb / 1.27 kg</td> <td>2.98 lb / 1.36 kg</td> <td>3.33 lb / 1.52 kg</td> </tr> </tbody> </table> Case color Black Case material Glass-Fiber Reinforced Plastic	Models	No + 3-cell	3-cell + 3-cell	3 + 6-cell		2.79 lb / 1.27 kg	2.98 lb / 1.36 kg	3.33 lb / 1.52 kg																			
	Models	No + 3-cell	3-cell + 3-cell	3 + 6-cell																															
	2.79 lb / 1.27 kg	2.98 lb / 1.36 kg	3.33 lb / 1.52 kg																																
Processor Number	# of Cores	# of Threads	Base Frequency	Max Turbo Frequency	Cache	Memory Types	Processor Graphics	i3-7100U	2	4	2.4 GHz	-	3MB	DDR4-2133	Intel HD Graphics 620	i5-7200U	2.5 GHz	3.1 GHz	3MB	i5-7300U	2.6 GHz	3.5 GHz	3MB	i7-7500U	2.7 GHz	3.5 GHz	4MB	i7-7600U	2.8 GHz	3.9 GHz	4MB				
Processor Number	# of Cores	# of Threads	Base Frequency	Max Turbo Frequency	Cache	Memory Types	Processor Graphics																												
i3-7100U	2	4	2.4 GHz	-	3MB	DDR4-2133	Intel HD Graphics 620																												
i5-7200U			2.5 GHz	3.1 GHz	3MB																														
i5-7300U			2.6 GHz	3.5 GHz	3MB																														
i7-7500U			2.7 GHz	3.5 GHz	4MB																														
i7-7600U			2.8 GHz	3.9 GHz	4MB																														
Graphics			Intel HD Graphics 520 or 620 in processor; supports external digital monitor via HDMI or USB Type-C; supports three independent displays; Max resolution: 4096x2160@60Hz (USB Type-C); 4096x2160@24Hz (HDMI)							Smart card reader <i>Optional:</i> Smart card reader Media reader 4-in-1 reader (MMC, SD, SDHC, SDXC) Ports Two USB 3.1 Type-A Gen 1 / USB 3.0 (one Always On), USB 3.1 Type-C Gen 1, HDMI 1.4b, Ethernet (RJ-45), Dock connector WiGig dock (opt) ThinkPad WiGig dock, mutually exclusive with WWAN (US only) Monitor cable (optional) <i>HDMI to VGA:</i> Lenovo HDMI to VGA Monitor Adapter <i>USB-C to VGA:</i> Lenovo USB-C to VGA Adapter <i>USB-C to DP:</i> Lenovo USB-C to DisplayPort Adapter																									
Chipset Memory	Intel SoC (System on Chip) platform 16GB max / 2400MHz DDR4, one DDR4 SO-DIMM socket * System clocks down for processors with lower memory controller							Camera (optional) HD720p resolution, fixed focus Audio support HD Audio, Realtek ALC3268 codec / stereo speakers, 1.5W x 2 / dual array microphone, combo audio/microphone jack																											
Display	<i>Some:</i> 12.5" (317.5mm) HD (1366x768), anti-glare, LED backlight, 200 nits, 16:9 aspect ratio, 500:1 contrast ratio <i>Some:</i> 12.5" (317.5mm) HD (1366x768), anti-glare, LED backlight, IPS, 300 nits, 16:9 aspect ratio, 800:1 contrast ratio, 170° viewing angle <i>Some:</i> 12.5" (317.5mm) FHD (1920x1080), anti-glare, LED backlight, IPS, 300 nits, 16:9 aspect ratio, 700:1 contrast ratio, 170° viewing angle							Keyboard 6-row, spill-resistant, multimedia Fn keys, optional LED backlight UltraNav™ TrackPoint® pointing device and buttonless Mylar surface multi-touch touchpad																											
Multi-touch	None							Security Power-on password, hard disk password, supervisor password, security keyhole Security chip Discrete TPM 2.0, TCG Certified vPro (optional) Intel vPro Technology Fingerprint reader <i>Optional:</i> Touch style match on chip fingerprint reader on the palm rest NFC (optional) Near Field Communication																											
Storage	System has one HDD slot or one M.2 2280 slot exclusively for storage <i>Some:</i> HDD / SATA 6.0Gb/s, 2.5" wide, 7mm high, Active Protection System™ <i>Some:</i> SSD / SATA 6.0Gb/s, 2.5" wide, 7mm high (e.g. xxxGB SSD) <i>Some:</i> M.2 SSD / PCIe NVMe, PCIe 3.0 x 2, 16Gb/s <i>Some:</i> 128GB M.2 SSD / SATA 6.0Gb/s, in WWAN slot as 2nd Storage, mutually exclusive with WWAN and WiGig							Internal battery <i>Optional:</i> Integrated Li-Ion or Li-Polymer 3-cell (23Wh) External battery Li-Ion 3-cell (23Wh) or 6-cell (48Wh or 72Wh) Max battery life <i>MobileMark® 2014:</i> 13.04 hr (3-cell + 3-cell) AC adapter 45W AC adapter (slim tip) or 45W USB Type-C AC adapter																											
Optical	None							Preload Windows® 7 Professional 64 preinstalled <i>Some:</i> Windows 10 Home 64 through downgrade rights in <i>Some:</i> Windows 10 Pro 64 Windows 10 Pro 64 <ul style="list-style-type: none"> Lenovo Solution Center Lenovo PowerEngage ThinkVantage Product Recovery ThinkVantage System Update Adobe® Reader® Microsoft® Office preloaded; purchase a product key to activate McAfee® LiveSafe™ (30-day trial) 																											
Ethernet	Non-vPro model: Intel Ethernet Connection I219-V (Jacksonville) vPro model: Intel Ethernet Connection I219-LM (Jacksonville)							Limited warranty <i>One of the following, configurable by model:</i> <ul style="list-style-type: none"> 1-year depot repair service 3-year/1-yr battery depot repair service 3-year/1-yr battery limited onsite service 																											
WLAN	One of the following, configurable by model (WiGig is mutually exclusive with WWAN): <ul style="list-style-type: none"> Realtek® RTL8822BE, Wi-Fi 2x2 802.11ac + BT4.1 Intel Dual Band Wireless-AC 8260, Wi-Fi 2x2 802.11ac + BT4.1 Intel Dual Band Wireless-AC 8265, Wi-Fi 2x2 802.11ac + BT4.1 Intel Tri-Band Wireless-AC 18265, WiGig 802.11ad + Wi-Fi 2x2 802.11ac + BT4.1 (US only) 							Mil-Spec test MIL-STD-810G military certification																											
Bluetooth™	Bluetooth 4.1 wireless, integrated in Wi-Fi + Bluetooth combo adapter * Intel 8265ac / 18265ac card support BT4.2 but is limited to BT4.1 by Windows OS							Environment EPEAT™ Gold (US only); ENERGY STAR® 6.1; RoHS-compliant																											

ThinkPad X270 - TopSeller - 20HN

Product Specifications Reference (PSREF)

Model	Region	Processor	vPro	Graphics	Memory	Display	Multi-touch	Storage(HDD/SSD)	Optical	WLAN + Bluetooth	WWAN	SIM Card	Smart Card Reader	Dock	Monitor Cable	Camera	Key-board	Finger-print Reader	NFC	TPM	Battery (internal+external)	Power Adapter	Operating System	Warranty	Ann Date (m/y)
20HN001FUS	US	i5-7200U	No	Intel HD 620	8GBx1	12.5" FHD (1920x1080) IPS	None	256GB SSD M.2 PCIe NVMe Opal2	None	Intel 8265 ac, 2x2 + BT4.1	WWAN Upgradable	None	None	None	None	720p	Backlit	Finger-print Reader	None	dTPM 2.0	3-cell(23Wh) + 3-cell(23Wh)	45W	Win10 Pro 64	3-year, Depot	02/17
20HN001GUS	US	i7-7600U	vPro	Intel HD 620	16GBx1	12.5" FHD (1920x1080) IPS	None	512GB SSD M.2 PCIe NVMe Opal2	None	Intel 8265 ac, 2x2 + BT4.1	WWAN Upgradable	None	None	None	None	720p	Backlit	Finger-print Reader	None	dTPM 2.0	3-cell(23Wh) + 3-cell(23Wh)	45W	Win10 Pro 64	3-year, Depot	02/17
20HN001HUS	US	i7-7500U	No	Intel HD 620	16GBx1	12.5" FHD (1920x1080) IPS	None	256GB SSD M.2 PCIe NVMe Opal2	None	Intel 8265 ac, 2x2 + BT4.1	WWAN Upgradable	None	None	None	None	720p	Backlit	Finger-print Reader	None	dTPM 2.0	3-cell(23Wh) + 3-cell(23Wh)	45W	Win10 Pro 64	3-year, Depot	02/17
20HN001JUS	US	i5-7300U	vPro	Intel HD 620	8GBx1	12.5" FHD (1920x1080) IPS	None	256GB SSD M.2 PCIe NVMe Opal2	None	Intel 8265 ac, 2x2 + BT4.1	WWAN Upgradable	None	None	None	None	720p	Backlit	Finger-print Reader	None	dTPM 2.0	3-cell(23Wh) + 3-cell(23Wh)	45W	Win10 Pro 64	3-year, Depot	02/17
20HN001KUS	US	i5-7200U	No	Intel HD 620	8GBx1	12.5" HD (1366x768) IPS	None	500GB 7200rpm	None	Intel 8265 ac, 2x2 + BT4.1	WWAN Upgradable	None	None	None	None	720p	Backlit	Finger-print Reader	None	dTPM 2.0	3-cell(23Wh) + 3-cell(23Wh)	45W	Win10 Pro 64	3-year, Depot	02/17
20HN001LUS	US	i5-7300U	vPro	Intel HD 620	8GBx1	12.5" HD (1366x768) IPS	None	256GB SSD M.2 PCIe NVMe Opal2	None	Intel 8265 ac, 2x2 + BT4.1	WWAN Upgradable	None	None	None	None	720p	Backlit	Finger-print Reader	None	dTPM 2.0	3-cell(23Wh) + 3-cell(23Wh)	45W	Win10 Pro 64	3-year, Depot	02/17
20HN001MUS	US	i7-7500U	No	Intel HD 620	16GBx1	12.5" FHD (1920x1080) IPS	None	512GB SSD M.2 PCIe NVMe Opal2	None	Intel 8265 ac, 2x2 + BT4.1	WWAN Upgradable	None	None	None	None	720p	Backlit	Finger-print Reader	None	dTPM 2.0	3-cell(23Wh) + 3-cell(23Wh)	45W	Win10 Pro 64	3-year, Depot	02/17
20HN001NUS	US	i7-7600U	vPro	Intel HD 620	16GBx1	12.5" FHD (1920x1080) IPS	None	256GB SSD M.2 PCIe NVMe Opal2	None	Intel 8265 ac, 2x2 + BT4.1	WWAN Upgradable	None	None	None	None	720p	Backlit	Finger-print Reader	None	dTPM 2.0	3-cell(23Wh) + 3-cell(23Wh)	45W	Win10 Pro 64	3-year, Depot	02/17
20HN001PUS	US	i3-7100U	No	Intel HD 620	4GBx1	12.5" HD (1366x768) IPS	None	500GB 7200rpm	None	Intel 8265 ac, 2x2 + BT4.1	WWAN Upgradable	None	None	None	None	720p	Backlit	Finger-print Reader	None	dTPM 2.0	3-cell(23Wh) + 3-cell(23Wh)	45W	Win10 Pro 64	3-year, Depot	02/17
20HN001QUS	US	i7-7600U	vPro	Intel HD 620	8GBx1	12.5" FHD (1920x1080) IPS	None	256GB SSD M.2 PCIe NVMe Opal2	None	Intel 8265 ac, 2x2 + BT4.1	WWAN Upgradable	None	None	None	None	720p	Backlit	Finger-print Reader	None	dTPM 2.0	3-cell(23Wh) + 3-cell(23Wh)	45W	Win10 Pro 64	3-year, Depot	02/17
20HN001RUS	US	i7-7500U	No	Intel HD 620	8GBx1	12.5" FHD (1920x1080) IPS	None	256GB SSD M.2 PCIe NVMe Opal2	None	Intel 8265 ac, 2x2 + BT4.1	WWAN Upgradable	None	None	None	None	720p	Backlit	Finger-print Reader	None	dTPM 2.0	3-cell(23Wh) + 3-cell(23Wh)	45W	Win10 Pro 64	3-year, Depot	02/17
20HN004UUS	US	i5-7200U	No	Intel HD 620	8GBx1	12.5" FHD (1920x1080) IPS	None	180GB SSD Opal2	None	Intel 8265 ac, 2x2 + BT4.1	WWAN Upgradable	None	None	None	None	720p	Backlit	Finger-print Reader	None	dTPM 2.0	3-cell(23Wh) + 3-cell(23Wh)	45W	Win10 Pro 64	3-year, Depot	03/17
20HN004VUS	US	i5-7200U	No	Intel HD 620	8GBx1	12.5" HD (1366x768) IPS	None	180GB SSD Opal2	None	Intel 8265 ac, 2x2 + BT4.1	WWAN Upgradable	None	None	None	None	720p	Backlit	Finger-print Reader	None	dTPM 2.0	3-cell(23Wh) + 3-cell(23Wh)	45W	Win10 Pro 64	3-year, Depot	03/17

ThinkPad X270 - TopSeller - 20K6

Product Specifications Reference (PSREF)

Model	Region	Processor	vPro	Graphics	Memory	Display	Multi-touch	Storage(HDD/SSD)	Optical	WLAN + Bluetooth	WWAN	SIM Card	Smart Card Reader	Dock	Monitor Cable	Camera	Key-board	Finger-print Reader	NFC	TPM	Battery (internal+external)	Power Adapter	Operating System	Warranty	Ann Date (m/y)
20K6000LUS	US	i7-6600U	vPro	Intel HD 520	16GBx1	12.5" FHD (1920x1080) IPS	None	512GB SSD M.2 PCIe NVMe Opal2	None	Intel 8260 ac, 2x2 + BT4.1	WWAN Upgradable	None	None	None	None	720p	Backlit	Finger-print Reader	None	dTPM 2.0	3-cell(23Wh) + 3-cell(23Wh)	45W	Win10 DG Win7 Pro 64	3-year, Depot	03/17
20K6000MUS	US	i5-6200U	No	Intel HD 520	8GBx1	12.5" FHD (1920x1080) IPS	None	256GB SSD M.2 PCIe NVMe Opal2	None	Intel 8260 ac, 2x2 + BT4.1	WWAN Upgradable	None	None	None	None	720p	Backlit	Finger-print Reader	None	dTPM 2.0	3-cell(23Wh) + 3-cell(23Wh)	45W	Win10 DG Win7 Pro 64	3-year, Depot	03/17
20K6000NUS	US	i7-6600U	vPro	Intel HD 520	8GBx1	12.5" FHD (1920x1080) IPS	None	256GB SSD M.2 PCIe NVMe Opal2	None	Intel 8260 ac, 2x2 + BT4.1	WWAN Upgradable	None	None	None	None	720p	Backlit	Finger-print Reader	None	dTPM 2.0	3-cell(23Wh) + 3-cell(23Wh)	45W	Win10 DG Win7 Pro 64	3-year, Depot	03/17
20K6000PUS	US	i5-6300U	vPro	Intel HD 520	8GBx1	12.5" HD (1366x768)	None	256GB SSD M.2 PCIe NVMe Opal2	None	Intel 8260 ac, 2x2 + BT4.1	WWAN Upgradable	None	None	None	None	720p	Backlit	Finger-print Reader	None	dTPM 2.0	3-cell(23Wh) + 3-cell(23Wh)	45W	Win10 DG Win7 Pro 64	3-year, Depot	03/17
20K6000QUS	US	i5-6300U	vPro	Intel HD 520	8GBx1	12.5" FHD (1920x1080) IPS	None	256GB SSD M.2 PCIe NVMe Opal2	None	Intel 8260 ac, 2x2 + BT4.1	WWAN Upgradable	None	None	None	None	720p	Backlit	Finger-print Reader	None	dTPM 2.0	3-cell(23Wh) + 3-cell(23Wh)	45W	Win10 DG Win7 Pro 64	3-year, Depot	03/17
20K6000RUS	US	i7-6500U	No	Intel HD 520	8GBx1	12.5" FHD (1920x1080) IPS	None	512GB SSD M.2 PCIe NVMe Opal2	None	Intel 8260 ac, 2x2 + BT4.1	WWAN Upgradable	None	None	None	None	720p	Backlit	Finger-print Reader	None	dTPM 2.0	3-cell(23Wh) + 3-cell(23Wh)	45W	Win10 DG Win7 Pro 64	3-year, Depot	03/17
20K6000SUS	US	i7-6500U	No	Intel HD 520	8GBx1	12.5" FHD (1920x1080) IPS	None	256GB SSD M.2 PCIe NVMe Opal2	None	Intel 8260 ac, 2x2 + BT4.1	WWAN Upgradable	None	None	None	None	720p	Backlit	Finger-print Reader	None	dTPM 2.0	3-cell(23Wh) + 3-cell(23Wh)	45W	Win10 DG Win7 Pro 64	3-year, Depot	03/17
20K6000TUS	US	i7-6600U	vPro	Intel HD 520	16GBx1	12.5" FHD (1920x1080) IPS	None	256GB SSD M.2 PCIe NVMe Opal2	None	Intel 8260 ac, 2x2 + BT4.1	WWAN Upgradable	None	None	None	None	720p	Backlit	Finger-print Reader	None	dTPM 2.0	3-cell(23Wh) + 3-cell(23Wh)	45W	Win10 DG Win7 Pro 64	3-year, Depot	05/17
20K6000UUS	US	i5-6200U	No	Intel HD 520	8GBx1	12.5" HD (1366x768)	None	500GB 7200rpm	None	Intel 8260 ac, 2x2 + BT4.1	WWAN Upgradable	None	None	None	None	720p	Backlit	Finger-print Reader	None	dTPM 2.0	3-cell(23Wh) + 3-cell(23Wh)	45W	Win10 DG Win7 Pro 64	3-year, Depot	03/17
20K6000VUS	US	i7-6500U	No	Intel HD 520	16GBx1	12.5" FHD (1920x1080) IPS	None	512GB SSD M.2 PCIe NVMe Opal2	None	Intel 8260 ac, 2x2 + BT4.1	WWAN Upgradable	None	None	None	None	720p	Backlit	Finger-print Reader	None	dTPM 2.0	3-cell(23Wh) + 3-cell(23Wh)	45W	Win10 DG Win7 Pro 64	3-year, Depot	03/17

This publication was developed for products and services offered in the United States and E.M.E.A countries. Lenovo may not offer the products, services or features discussed in this document in other countries. Lenovo may withdraw an offering at any time. Information is subject to change without notice. Consult your local representative for information on offerings available in your area.

Lenovo reserves the right to change specifications or other product information without notice. Lenovo is not responsible for photographic or typographical errors.

LENOVO PROVIDES THIS PUBLICATION "AS IS," WITHOUT WARRANTY OF ANY KIND, EITHER EXPRESS OR IMPLIED, INCLUDING THE IMPLIED WARRANTIES OF MERCHANTABILITY OR FITNESS FOR A PARTICULAR PURPOSE.

Some jurisdictions do not allow disclaimer of express or implied warranties in certain transactions, therefore this disclaimer may not apply to you.

Availability: All offers subject to availability. Lenovo reserves the right to alter product offerings and specifications at any time, without notice. Lenovo is not responsible for photographic or typographic errors.

General: Review key information provided by Microsoft that may apply to your system purchase, including details on Windows 10, Windows 8, Windows 7, and potential upgrades/downgrades. Lenovo makes no representation or warranty regarding third-party products or services.

Trademarks: Lenovo, ThinkPad, ThinkCentre, ThinkStation and the Lenovo logo are trademarks of Lenovo. Microsoft, Windows, Windows NT, and the Windows logo are trademarks of Microsoft Corporation. Ultrabook, Celeron, Celeron Inside, Core Inside, Intel, Intel Logo, Intel Atom, Intel Atom Inside, Intel Core, Intel Inside, Intel Inside Logo, Intel vPro, Itanium, Itanium Inside, Pentium, Pentium Inside, vPro Inside, Xeon, Xeon Phi, and Xeon Inside are trademarks of Intel Corporation in the U.S. and/or other countries. Other company, product or service names may be trademarks or service marks of others.

Warranty: For a copy of applicable warranties, write to: Lenovo Warranty Information, 1009 Think Place, Morrisville, NC, 27560. Lenovo makes no representation or warranty regarding third party products or services. The Lenovo Limited Warranty applies only to Lenovo hardware products purchased for your own use, and does not transfer upon resale.

Limited warranty: Support unrelated to a warranty issue may be subject to additional charges.

Lenovo Services:

Carry-in or Mail-in Service: Parts and labor repair coverage where the customer is responsible for shipping (including packaging) or delivery to authorized warranty provider or repair center.

Depot or Courier Service: Parts and labor repair coverage where shipping (including packaging) or delivery to the repair center is paid for by Lenovo.

Expedited Depot: Parts and labor coverage with expedited turnaround. Shipping (including packaging) or delivery to the repair center is paid for by Lenovo.

Onsite / In-home Service: Parts and labor repair coverage where labor is provided onsite at your place of business.

If Lenovo determines your product problem is covered by the product warranty and cannot be resolved over the telephone, a technician will be dispatched to arrive onsite, typically the next day.

International Warranty Service (IWS): PC repair coverage for customers who require a critical warranty repair while travelling internationally. Visit www.lenovo.com/internationalwarranty for details. Visit www.lenovo.com/warranty for Lenovo Warranty Services terms and conditions for complete details and restrictions.

Included software: may differ from its retail version (if available), and may not include user manuals or all program functionality. Software license agreements may apply.

Battery life: Battery life (and recharge times) will vary based on many factors including screen brightness, applications, features, power management, battery conditioning, and other customer preferences.

Visit <http://psref.lenovo.com/> for the latest version of Product Specifications Reference.

© Lenovo, 2017. All rights reserved.
Lenovo 1009 Think Place Morrisville, NC 27560 U.S.A.

Lenovo[™]

ThinkPad[®] Tablets
Convertibles

PSREF



Product Specifications Reference

Version 507, May 2017

U.S.

Visit <http://psref.lenovo.com> for the latest version

Contents

Cover		
Contents		
Summary Of Change		
ThinkPad Tablets		
ThinkPad 10 (2nd Gen)		
ThinkPad 10 (2nd Gen) Platform Specifications		
ThinkPad 10 (2nd Gen) - TopSeller - 20E3		
ThinkPad 10 (2nd Gen) - 20E4		
ThinkPad X1 Tablet		
ThinkPad X1 Tablet Platform Specifications		
ThinkPad X1 Tablet - TopSeller - 20GG - 1 of 2		
ThinkPad X1 Tablet - TopSeller - 20GG - 2 of 2		
ThinkPad X1 Tablet (2nd Gen)		
ThinkPad X1 Tablet (2nd Gen) Platform Specifications		
ThinkPad X1 Tablet (2nd Gen) - TopSeller - 20JB		
ThinkPad Yoga		
ThinkPad P40 Yoga		
ThinkPad P40 Yoga Platform Specifications		
ThinkPad P40 Yoga - TopSeller - 20GQ		
ThinkPad X1 Yoga (1st Gen)		
ThinkPad X1 Yoga (1st Gen) Platform Specifications		
ThinkPad X1 Yoga (1st Gen) - TopSeller - 20FQ - 1 of 3		
ThinkPad X1 Yoga (1st Gen) - TopSeller - 20FQ - 2 of 3		
ThinkPad X1 Yoga (1st Gen) - TopSeller - 20FQ - 3 of 3		
ThinkPad X1 Yoga (2nd Gen)		
ThinkPad X1 Yoga (2nd Gen) Platform Specifications		
ThinkPad X1 Yoga (2nd Gen) - TopSeller - 20JD		
ThinkPad X1 Yoga (2nd Gen) - TopSeller - 20JF		
ThinkPad Yoga 11e (3rd Gen)		
ThinkPad Yoga 11e (3rd Gen) Platform Specifications		
ThinkPad Yoga 11e (3rd Gen) - TopSeller - 20GA		
ThinkPad Yoga 11e (4th Gen)		
ThinkPad Yoga 11e (4th Gen) Platform Specifications		
ThinkPad Yoga 11e (4th Gen) - TopSeller - 20HU		
ThinkPad Yoga 11e Chromebook (3rd Gen)		
1 ThinkPad Yoga 11e Chromebook (3rd Gen) Platform Specifications	34	
2 ThinkPad Yoga 11e Chromebook (3rd Gen) - TopSeller - 20GE	35	
3 ThinkPad Yoga 11e Chromebook (4th Gen)	36	
4 ThinkPad Yoga 11e Chromebook (4th Gen) Platform Specifications	37	
4 ThinkPad Yoga 11e Chromebook (4th Gen) - TopSeller - 20HY	38	
5 ThinkPad Yoga 260	39	
6 ThinkPad Yoga 260 Platform Specifications	40	
7 ThinkPad Yoga 260 - TopSeller - 20FD - 1 of 2	41	
8 ThinkPad Yoga 260 - TopSeller - 20FD - 2 of 2	42	
9 ThinkPad Yoga 260 - TopSeller - 20FE	43	
10 ThinkPad Yoga 260 - TopSeller - 20GS	44	
11 ThinkPad Yoga 370	45	
12 ThinkPad Yoga 370 Platform Specifications	46	
13 ThinkPad Yoga 370 - TopSeller - 20JH - 1 of 2	47	
14 ThinkPad Yoga 370 - TopSeller - 20JH - 2 of 2	48	
15 ThinkPad Yoga 460	49	
15 ThinkPad Yoga 460 Platform Specifications	50	
16 ThinkPad Yoga 460 - TopSeller - 20EM - 1 of 2	51	
17 ThinkPad Yoga 460 - TopSeller - 20EM - 2 of 2	52	
18 Legal Information	53	

Summary of Changes

This section describes the technical changes made in this edition.

This edition might also include minor corrections and editorial changes which are not identified.

May 31, 2017 - Version 507

Additions in this update

▶ **New product(s)**

None

▶ **New model(s)**

ThinkPad X1 Yoga (2nd Gen) models announced May 2017

▶ **Others**

None

Changes in this update

▶ None

Withdrawals in this update

▶ **Withdrawn product(s)**

None



ThinkPad 10 (2nd Gen) Platform Specifications

Product Specifications Reference (PSREF)

Positioning	<i>Touchscreen tablet with a full PC experience and superior versatility</i>								Camera	<i>Front camera:</i> 1.2-megapixel, fixed focus <i>Rear camera:</i> 5.0-megapixel, auto focus, flash LED
Processor	Intel® Atom Processor								Video capture Audio support	1080p video capture
	Processor Number	# of Cores	# of Threads	Clock Speed	Burst Frequency	Cache	Memory Types	Processor Graphics		Realtek® ALC5672 codec / stereo speakers, 1.0 watt x 2 / 3 digital front microphones, combo audio/microphone jack
	x7-Z8700	4	4	1.60 GHz	2.40 GHz	2MB	LPDDR3-1600	Intel HD Graphics		Audio formats: MP3, AAC, AAC+, eAAC+, WAV, PCM, WMA Video formats: MPEG-4, H.263, H.264, VC-1, WMV9, Xvid
	x7-Z8750	4	4	1.60 GHz	2.56 GHz	2MB	LPDDR3-1600	Graphics		
Graphics	Intel HD Graphics in processor, supports 1080p video out via micro-HDMI™ connector, HDCP-compliant								Keyboard	<i>Non-pro:</i> Ultrabook keyboard, mechanical keyboard, pen holder Folio keyboard, thin keyboard, pen loop
Chipset	Intel Atom SoC (System on Chip) platform								Security	Kensington lock slot
Memory	<i>Some:</i> 2GB / 1600MHz LPDDR3, mobile DDR / soldered to systemboard <i>Some:</i> 4GB / 1600MHz LPDDR3, mobile DDR / soldered to systemboard <i>All:</i> no sockets, dual-channel capable								Security chip	<i>Some:</i> Firmware TPM 2.0, integrated in chipset <i>Some:</i> Discrete TPM 1.2, TCG Certified <i>Some:</i> Discrete TPM 1.2 TCG Certified and Firmware TPM 2.0 integrated in chipset
Display	10.1" (256.5mm) WUXGA (1920x1200) TFT color , anti-fingerprint display with Corning® Gorilla® Glass, WideView (170° viewing), LED backlight, 400 nits, 16:10 aspect ratio, 800:1 contrast ratio, IPS, Multi-touch screen, supports ten-finger gesture <i>Optional:</i> ThinkPad Pen Pro, supports pressure modes / two buttons for input / batteries required (no pen holder in form factor design)								vPro & iAMT	None
Multi-touch									Fingerprint reader	<i>Optional:</i> Fingerprint reader on the A Cover
Pen									NFC	<i>Optional:</i> Near Field Communication
Storage	64GB or 128GB / eMMC (embedded Multi Media Card) flash memory on board								Battery - type	Lithium polymer, 32Whr
Optical	None								Battery - life	up to 26 days (standby); up to 10 hr (local video playback)
Storage extension	One microSD card slot, supports up to 128GB								AC adapter	36-watt AC adapter
Ethernet	None								Light sensor	Ambient Light Sensor, InterSil ISL29035
Bluetooth™	Bluetooth 4.0 wireless, integrated in Wi-Fi + Bluetooth combo adapter								G-sensor	3D accelerometer
WLAN	11ac wireless, BCM4356, 802.11ac, 2x2, Wi-Fi + Bluetooth combo chip								Compass	3D compass
WWAN	<i>Optional:</i> Sierra Wireless EM7345, 4G LTE/HSPA/GSM/GPRS/EDGE, GPS								Gyroscope	3D gyrometer
SIM card (Micro)	None								GPS	GPS function is integrated into WWAN module
Smart Card Read	<i>Optional:</i> Smart card reader (SCR)								Preload	<i>Some:</i> Windows 10 Pro 64 <i>Some:</i> Windows 10 Home 64 <i>Some:</i> Windows 10 Home Single Language 64 • Lenovo Solution Center • Lenovo Companion (includes System Update) • Lenovo REACHit • Lenovo Settings • Lenovo SHAREit • Lenovo WRITEit • Microsoft® Office preloaded; purchase a product key to activate • McAfee LiveSafe (30 days of virus definitions)
Dimensions	10.09" x 6.96" x 0.36"; 256.5mm x 177.0mm x 9.10mm 10.09" x 6.96" x 0.67"; 256.5mm x 177.0mm x 17.10mm (with SCR)								Limited warranty	1-year - depot repair service/ service upgrades available
Weight	<i>WiFi only:</i> from 1.32 lb (0.597kg); <i>WiFi + WWAN:</i> from 1.36 lb (0.618kg); <i>WiFi + WWAN + SCR:</i> from 1.43 lb (0.648kg)								Mil-Spec test	MIL-STD-810G military certification
Case color	Graphite black								Environment	RoHS, GREENGUARD, Low Halogen
Case material	Polyamide and Glass Fiber Reinforced									
Media reader	One microSD card slot (SDXC/SDHC, UHS-I), supports up to 128GB									
Ports	One standard USB 3.0, one micro-HDMI, headphone/microphone combo jack, one Living Hinge Docking connector, one keyboard connector, one micro SIM slot									
Monitor cable	None									
Control buttons	Windows button, power button, volume control button, reset switch									

ThinkPad 10 (2nd Gen) - TopSeller - 20E3

Product Specifications Reference (PSREF)

Model	Region	Processor	Graphics	Memory	Display	Multi-touch	Storage	Optical	WLAN + Bluetooth	WWAN	SIM Card	Smart Card Reader	Camera (Front / Rear)	Keyboard Docking	Smart Cover	Pen	Finger-print Reader	NFC	TPM	Operating System	Warranty	Global	Ann Date (m/y)
20E3000QUS	US	Atom Z8700	Intel HD	2GB Soldered	10.1" WUXGA (1920x1200) IPS	10-point Multi-touch	64GB eMMC	None	11ac, 2x2 + BT4.0	None	None	None	1.2MP / 5.0MP	None	None	None	Finger-print Reader	None	FW TPM 2.0	Win10 Pro 64	1-year, Depot	No	07/15
20E3000RUS	US	Atom Z8700	Intel HD	2GB Soldered	10.1" WUXGA (1920x1200) IPS	10-point Multi-touch	64GB eMMC	None	11ac, 2x2 + BT4.0	Sierra EM7345	None	None	1.2MP / 5.0MP	Non-pro Keyboard	None	None	Finger-print Reader	None	FW TPM 2.0	Win10 Pro 64	1-year, Depot	No	07/15
20E3000SUS	US	Atom Z8700	Intel HD	2GB Soldered	10.1" WUXGA (1920x1200) IPS	10-point Multi-touch	64GB eMMC	None	11ac, 2x2 + BT4.0	None	None	None	1.2MP / 5.0MP	Non-pro Keyboard	None	None	Finger-print Reader	None	FW TPM 2.0	Win10 Pro 64	1-year, Depot	No	07/15
20E3000TUS	US	Atom Z8700	Intel HD	2GB Soldered	10.1" WUXGA (1920x1200) IPS	10-point Multi-touch	64GB eMMC	None	11ac, 2x2 + BT4.0	Sierra EM7345	None	None	1.2MP / 5.0MP	None	None	None	Finger-print Reader	None	FW TPM 2.0	Win10 Pro 64	1-year, Depot	No	07/15
20E3000UUS	US	Atom Z8700	Intel HD	4GB Soldered	10.1" WUXGA (1920x1200) IPS	10-point Multi-touch	128GB eMMC	None	11ac, 2x2 + BT4.0	Sierra EM7345	None	None	1.2MP / 5.0MP	None	None	None	Finger-print Reader	None	FW TPM 2.0	Win10 Pro 64	1-year, Depot	No	07/15
20E3000VUS	US	Atom Z8700	Intel HD	4GB Soldered	10.1" WUXGA (1920x1200) IPS	10-point Multi-touch	128GB eMMC	None	11ac, 2x2 + BT4.0	None	None	None	1.2MP / 5.0MP	None	None	None	Finger-print Reader	None	FW TPM 2.0	Win10 Pro 64	1-year, Depot	No	07/15
20E3000WUS	US	Atom Z8700	Intel HD	4GB Soldered	10.1" WUXGA (1920x1200) IPS	10-point Multi-touch	128GB eMMC	None	11ac, 2x2 + BT4.0	Sierra EM7345	None	None	1.2MP / 5.0MP	Non-pro Keyboard	None	None	Finger-print Reader	None	FW TPM 2.0	Win10 Pro 64	1-year, Depot	No	07/15
20E3000XUS	US	Atom Z8700	Intel HD	4GB Soldered	10.1" WUXGA (1920x1200) IPS	10-point Multi-touch	128GB eMMC	None	11ac, 2x2 + BT4.0	None	None	None	1.2MP / 5.0MP	Non-pro Keyboard	None	None	Finger-print Reader	None	FW TPM 2.0	Win10 Pro 64	1-year, Depot	No	07/15
20E3002DUS	US	Atom Z8700	Intel HD	2GB Soldered	10.1" WUXGA (1920x1200) IPS	10-point Multi-touch	64GB eMMC	None	11ac, 2x2 + BT4.0	Sierra EM7345	None	None	1.2MP / 5.0MP	Non-pro Keyboard	None	None	Finger-print Reader	NFC	FW TPM 2.0	Win10 Pro 64	1-year, Depot	No	11/15
20E3002EUS	US	Atom Z8700	Intel HD	2GB Soldered	10.1" WUXGA (1920x1200) IPS	10-point Multi-touch	64GB eMMC	None	11ac, 2x2 + BT4.0	Sierra EM7345	None	None	1.2MP / 5.0MP	None	None	None	Finger-print Reader	NFC	FW TPM 2.0	Win10 Pro 64	1-year, Depot	No	11/15
20E30031US	US	Atom Z8750	Intel HD	4GB Soldered	10.1" WUXGA (1920x1200) IPS	10-point Multi-touch	128GB eMMC	None	11ac, 2x2 + BT4.0	Sierra EM7345	None	Smart Card Reader	1.2MP / 5.0MP	None	None	None	Finger-print Reader	None	dTPM1.2 + FW TPM2.0	Win10 Pro 64	1-year, Depot	No	04/16
20E30032US	US	Atom Z8750	Intel HD	4GB Soldered	10.1" WUXGA (1920x1200) IPS	10-point Multi-touch	128GB eMMC	None	11ac, 2x2 + BT4.0	None	None	None	1.2MP / 5.0MP	None	None	None	Finger-print Reader	None	dTPM1.2 + FW TPM2.0	Win10 Pro 64	1-year, Depot	No	04/16
20E30033US	US	Atom Z8750	Intel HD	2GB Soldered	10.1" WUXGA (1920x1200) IPS	10-point Multi-touch	64GB eMMC	None	11ac, 2x2 + BT4.0	Sierra EM7345	None	None	1.2MP / 5.0MP	None	None	None	Finger-print Reader	NFC	dTPM1.2 + FW TPM2.0	Win10 Pro 64	1-year, Depot	No	04/16
20E30034US	US	Atom Z8750	Intel HD	4GB Soldered	10.1" WUXGA (1920x1200) IPS	10-point Multi-touch	128GB eMMC	None	11ac, 2x2 + BT4.0	Sierra EM7345	None	None	1.2MP / 5.0MP	None	None	None	Finger-print Reader	NFC	dTPM1.2 + FW TPM2.0	Win10 Pro 64	1-year, Depot	No	04/16
20E30035US	US	Atom Z8750	Intel HD	2GB Soldered	10.1" WUXGA (1920x1200) IPS	10-point Multi-touch	64GB eMMC	None	11ac, 2x2 + BT4.0	None	None	None	1.2MP / 5.0MP	None	None	None	Finger-print Reader	None	dTPM1.2 + FW TPM2.0	Win10 Pro 64	1-year, Depot	No	04/16
20E3003HUS	US	Atom Z8750	Intel HD	2GB Soldered	10.1" WUXGA (1920x1200) IPS	10-point Multi-touch	64GB eMMC	None	11ac, 2x2 + BT4.0	Sierra EM7345	None	None	1.2MP / 5.0MP	None	Cover	None	Finger-print Reader	None	dTPM1.2 + FW TPM2.0	Win10 Pro 64	1-year, Depot	No	11/16
20E3003JUS	US	Atom Z8750	Intel HD	4GB Soldered	10.1" WUXGA (1920x1200) IPS	10-point Multi-touch	128GB eMMC	None	11ac, 2x2 + BT4.0	Sierra EM7345	None	None	1.2MP / 5.0MP	None	None	None	Finger-print Reader	None	dTPM1.2 + FW TPM2.0	Win10 Pro 64	1-year, Depot	No	11/16

ThinkPad 10 (2nd Gen) - 20E4

Product Specifications Reference (PSREF)

Model	Region	Processor	Graphics	Memory	Display	Multi-touch	Storage	Optical	WLAN + Bluetooth	WWAN	SIM Card	Smart Card Reader	Camera (Front / Rear)	Keyboard Docking	Smart Cover	Pen	Finger-print Reader	NFC	TPM	Operating System	Warranty	Global	Ann Date (m/y)
20E40006US	US	Atom Z8700	Intel HD	2GB Soldered	10.1" WUXGA (1920x1200) IPS	10-point Multi-touch	64GB eMMC	None	11ac, 2x2 + BT4.0	None	None	None	1.2MP / 5.0MP	None	None	None	Finger-print Reader	None	FW TPM 2.0	Win10 Pro 64	1-year, Depot	No	07/15
20E40007US	US	Atom Z8700	Intel HD	2GB Soldered	10.1" WUXGA (1920x1200) IPS	10-point Multi-touch	64GB eMMC	None	11ac, 2x2 + BT4.0	None	None	None	1.2MP / 5.0MP	Non-pro Keyboard	None	None	Finger-print Reader	None	FW TPM 2.0	Win10 Pro 64	1-year, Depot	No	07/15
20E40008US	US	Atom Z8700	Intel HD	4GB Soldered	10.1" WUXGA (1920x1200) IPS	10-point Multi-touch	128GB eMMC	None	11ac, 2x2 + BT4.0	None	None	None	1.2MP / 5.0MP	None	None	None	Finger-print Reader	None	FW TPM 2.0	Win10 Pro 64	1-year, Depot	No	07/15
20E40009US	US	Atom Z8700	Intel HD	4GB Soldered	10.1" WUXGA (1920x1200) IPS	10-point Multi-touch	128GB eMMC	None	11ac, 2x2 + BT4.0	None	None	None	1.2MP / 5.0MP	Non-pro Keyboard	None	None	Finger-print Reader	None	FW TPM 2.0	Win10 Pro 64	1-year, Depot	No	07/15
20E4000AUS	US	Atom Z8700	Intel HD	2GB Soldered	10.1" WUXGA (1920x1200) IPS	10-point Multi-touch	64GB eMMC	None	11ac, 2x2 + BT4.0	Sierra EM7345	None	None	1.2MP / 5.0MP	None	None	None	Finger-print Reader	None	FW TPM 2.0	Win10 Pro 64	1-year, Depot	No	07/15
20E4000BUS	US	Atom Z8700	Intel HD	4GB Soldered	10.1" WUXGA (1920x1200) IPS	10-point Multi-touch	128GB eMMC	None	11ac, 2x2 + BT4.0	Sierra EM7345	None	None	1.2MP / 5.0MP	None	None	None	Finger-print Reader	None	FW TPM 2.0	Win10 Pro 64	1-year, Depot	No	07/15



ThinkPad X1 Tablet Platform Specifications

Product Specifications Reference (PSREF)

Processor	6th Generation Intel® Core™ M Processor								Ports	One standard USB 3.0, one USB Type-C, one Mini DisplayPort, headphone/microphone combo jack, one Pogo keyboard connector, one cartrige connector for optional modules, one nano-SIM slot	
	Processor Number	# of Cores	# of Threads	Clock Speed	Burst Frequency	Cache	Memory Types	Processor Graphics			vPro
	m3-6Y30	2	4	0.90 GHz	2.20 GHz	4MB	LPDDR3-1866	Intel HD Graphics 515			No
	m5-6Y54	2	4	1.10 GHz	2.70 GHz	4MB					No
	m5-6Y57	2	4	1.10 GHz	2.80 GHz	4MB					Yes
m7-6Y75	2	4	1.20 GHz	3.10 GHz	4MB	Yes					
Graphics	Intel HD Graphics 515 in processor, supports 1080p video out via Mini DisplayPort connector								Control buttons	Power button, volume control button, reset switch	
Chipset	Intel SoC (System on Chip) platform								WiGig dock	<i>Optional:</i> WiGig dock, mutually exclusive with IR camera	
Memory	<i>Some:</i> 4GB / 1866MHz LPDDR3, mobile DDR / soldered to systemboard								Monitor Cable	<i>mDP-HDMI:</i> Lenovo Mini DisplayPort to HDMI Monitor Cable	
	<i>Some:</i> 8GB / 1866MHz LPDDR3, mobile DDR / soldered to systemboard								Adapter (<i>optional</i>)	<i>mDP-VGA:</i> Lenovo Mini DisplayPort to VGA Monitor Cable	
	<i>Some:</i> 16GB / 1866MHz LPDDR3, mobile DDR / soldered to systemboard									<i>USB-RJ45:</i> USB 3.0 to RJ45 adapter	
	<i>All:</i> no sockets, dual-channel capable									<i>USB-C-VGA:</i> USB-C to VGA plus power adapter	
										<i>USB-C-HDMI:</i> USB-C to HDMI plus power adapter	
Display	12.0" (304.8mm) FHD+ (2160x1440), glare, LED backlight, IPS, anti-fingerprint display with Corning® Gorilla® Glass, WideView (170° viewing), 360 nits, 3:2 aspect ratio, 800:1 contrast ratio								Camera	<i>Front camera:</i> 2.0-megapixel, fixed focus	
Multi-touch	Capacitive touch panel, supports ten-finger gesture								Optional Cameras	<i>Rear camera:</i> 8.0-megapixel, auto focus, flash LED	
Pen	<i>Optional:</i> ThinkPad Pen Pro, active pen for multi-touch display								Video capture	1080p video capture	
Kick stand	Opening angle up to 90 degrees								Audio support	Realtek® ALC3268 codec / stereo speakers, 0.5 watt x 2 / three microphones, combo audio/microphone jack	
Storage	<i>Some:</i> M.2 SSD / SATA 6.0Gb/s								Pogo Keyboard	Magnetic attached thin keyboard, with TrackPoint® pointing device and buttonless Mylar surface touchpad, multi-touch	
Optical	None								Keyboard color	Black, red, and silver	
Storage extension	One microSD card slot, supports up to 64GB								Security	Kensington lock slot	
Ethernet	None								Security chip	Discrete TPM 1.2 TCG Certified and Firmware TPM 2.0 integrated in chipset	
WLAN	<i>One of the following, configurable by model (WiGig is mutually exclusive with IR camera):</i>								vPro (<i>optional</i>)	Intel vPro Technology	
	• 11ac+BT, Intel Dual Band Wireless-AC 8260, 2x2, M.2 Card								Fingerprint reader	<i>Optional:</i> Touch style Fingerprint reader	
	• WiGig™+11AC+BT, Intel Tri-Band Wireless-AC 18260, 2x2 WLAN, WiGig, M.2 Card								NFC	<i>Optional:</i> Near Field Communication, mutually exclusive IR camera	
Bluetooth™	Bluetooth wireless, integrated in Wi-Fi + Bluetooth combo adapter								Module	<i>One of the following, configurable by model</i>	
WWAN	<i>One of the following, configurable by model:</i>									• Dummy base cartridge	
	• Wireless WAN, Sierra Wireless EM7455,								Battery - type	Lithium polymer, 37Whr	
	Qualcomm® 4G LTE-Advanced/DC-HSPA+/HSPA+/HSPA/UMTS/GNSS, M.2 card								Battery - life	up to 10 hr (local video playback)	
SIM card	Nano-SIM, optional Lenovo Connect (WE) SIM card								AC adapter	45-watt USB Type-C adapter	
Dimensions	<i>Tablet only:</i> 11.48" x 8.25" x 0.34"; 291.5mm x 209.5mm x 8.75mm								Light sensor	Ambient Light Sensor	
Weight	<i>Tablet only:</i> from 1.69 lb, 767g;								G-sensor	3D accelerometer	
	<i>Tablet+keyboard:</i> from 2.35 lb, 1.07kg (767g+300g);								Compass	3D compass	
	<i>Tablet+keyboard+Productivity:</i> from 2.89 lb, 1.31kg (767g+300g+245g);								Gyroscope	3D gyrometer	
	<i>Tablet+Productivity:</i> from 2.23 lb, 1.01kg (767g+245g);								GPS	GPS function is integrated into WWAN module	
	<i>Tablet+Presenter:</i> from 2.15 lb, 0.98kg (767g+210g);								Preload	<i>Some:</i> Windows 10 Pro 64	
	<i>Tablet+3D Imaging:</i> from 2.06 lb, 0.94kg (767g+168g)									<i>Some:</i> Windows 10 Home 64	
Case color	Black									• Lenovo Solution Center	
Case material	Magnesium + PPS Hybrid injection									• Lenovo Companion	
Smart Card Read	<i>Optional:</i> NFC-compatible smart card reader via NFC									• Lenovo Settings	
Media reader	One microSD card slot (micro SD/SDXC/SDHC), supports up to 64GB									• Microsoft® Office preloaded;	
										purchase a product key to activate	
									Limited warranty	1-year - depot repair service/ service upgrades available	
										3-year - depot repair service/ service upgrades available	
									Mil-Spec test	MIL-STD-810G military certification	
									Environment	EPEAT™ Gold, RoHS, GREENGUARD, Low Halogen	

Model	Region	Processor	vPro	Graphics	Memory	Display	Multi-touch	Storage(HDD/SSD)	WLAN + Bluetooth	WWAN	SIM Card	Dock	Monitor Cable	Camera (Front / Rear)	Keyboard Docking	Pen	Fingerprint Reader	NFC	Module	Battery	Power Adapter	Operating System	Warranty	Ann Date (m/y)
20GG0000US	US	m3-6Y30	No	Intel HD 515	4GB Soldered	12" FHD+ (2160x1440) IPS	10-point Multi-touch	192GB SSD M.2	8260 ac, 2x2 + BT4.1	None	None	None	None	2.0MP / 8.0MP	Black Pogo Keyboard	ThinkPad Pen Pro	Fingerprint Reader	None	None	2-cell (37Wh)	45W	Windows 10 Pro 64	1-year, Depot	08/16
20GG001JUS	US	m5-6Y57	vPro	Intel HD 515	8GB Soldered	12" FHD+ (2160x1440) IPS	10-point Multi-touch	192GB SSD M.2	8260 ac, 2x2 + BT4.1	None	None	None	None	2.0MP / 8.0MP	Black Pogo Keyboard	ThinkPad Pen Pro	Fingerprint Reader	None	None	2-cell (37Wh)	45W	Windows 10 Pro 64	3-year, Depot	08/16
20GG001KUS	US	m5-6Y57	vPro	Intel HD 515	8GB Soldered	12" FHD+ (2160x1440) IPS	10-point Multi-touch	256GB SSD M.2 SATA3 Opal2	8260 ac, 2x2 + BT4.1	None	None	None	None	2.0MP / 8.0MP	Black Pogo Keyboard	ThinkPad Pen Pro	Fingerprint Reader	None	None	2-cell (37Wh)	45W	Windows 10 Pro 64	1-year, Depot	08/16
20GG001LUS	US	m5-6Y57	vPro	Intel HD 515	8GB Soldered	12" FHD+ (2160x1440) IPS	10-point Multi-touch	512GB SSD M.2	8260 ac, 2x2 + BT4.1	None	None	None	None	2.0MP / 8.0MP	Black Pogo Keyboard	ThinkPad Pen Pro	Fingerprint Reader	None	None	2-cell (37Wh)	45W	Windows 10 Pro 64	3-year, Depot	08/16
20GG001MUS	US	m3-6Y30	No	Intel HD 515	4GB Soldered	12" FHD+ (2160x1440) IPS	10-point Multi-touch	256GB SSD M.2 SATA3 Opal2	8260 ac, 2x2 + BT4.1	None	None	None	None	2.0MP / 8.0MP	Black Pogo Keyboard	ThinkPad Pen Pro	Fingerprint Reader	None	None	2-cell (37Wh)	45W	Windows 10 Pro 64	1-year, Depot	08/16
20GG001NUS	US	m7-6Y75	vPro	Intel HD 515	8GB Soldered	12" FHD+ (2160x1440) IPS	10-point Multi-touch	256GB SSD M.2 SATA3 Opal2	8260 ac, 2x2 + BT4.1	None	None	None	None	2.0MP / 8.0MP	Black Pogo Keyboard	ThinkPad Pen Pro	Fingerprint Reader	None	None	2-cell (37Wh)	45W	Windows 10 Pro 64	1-year, Depot	08/16
20GG001PUS	US	m7-6Y75	vPro	Intel HD 515	8GB Soldered	12" FHD+ (2160x1440) IPS	10-point Multi-touch	256GB SSD M.2 SATA3 Opal2	8260 ac, 2x2 + BT4.1	None	None	None	None	2.0MP / 8.0MP	Black Pogo Keyboard	ThinkPad Pen Pro	Fingerprint Reader	None	None	2-cell (37Wh)	45W	Windows 10 Pro 64	3-year, Depot	08/16
20GG001QUS	US	m7-6Y75	vPro	Intel HD 515	8GB Soldered	12" FHD+ (2160x1440) IPS	10-point Multi-touch	512GB SSD M.2	8260 ac, 2x2 + BT4.1	None	None	None	None	2.0MP / 8.0MP	Black Pogo Keyboard	ThinkPad Pen Pro	Fingerprint Reader	None	None	2-cell (37Wh)	45W	Windows 10 Pro 64	3-year, Depot	08/16
20GG001RUS	US	m7-6Y75	vPro	Intel HD 515	16GB Soldered	12" FHD+ (2160x1440) IPS	10-point Multi-touch	256GB SSD M.2 SATA3 Opal2	18260 ac, 2x2 + BT4.1	None	None	WiGig Dock	None	2.0MP / 8.0MP	Black Pogo Keyboard	ThinkPad Pen Pro	Fingerprint Reader	None	None	2-cell (37Wh)	45W	Windows 10 Pro 64	3-year, Depot	08/16
20GG001SUS	US	m7-6Y75	vPro	Intel HD 515	16GB Soldered	12" FHD+ (2160x1440) IPS	10-point Multi-touch	512GB SSD M.2	18260 ac, 2x2 + BT4.1	None	None	WiGig Dock	None	2.0MP / 8.0MP	Black Pogo Keyboard	ThinkPad Pen Pro	Fingerprint Reader	None	None	2-cell (37Wh)	45W	Windows 10 Pro 64	3-year, Depot	08/16
20GG001UUS	US	m3-6Y30	No	Intel HD 515	4GB Soldered	12" FHD+ (2160x1440) IPS	10-point Multi-touch	128GB SSD M.2	8260 ac, 2x2 + BT4.1	None	None	None	None	2.0MP / 8.0MP	Black Pogo Keyboard	ThinkPad Pen Pro	Fingerprint Reader	None	None	2-cell (37Wh)	45W	Windows 10 Pro 64	1-year, Depot	08/16
20GG001VUS	US	m5-6Y57	vPro	Intel HD 515	4GB Soldered	12" FHD+ (2160x1440) IPS	10-point Multi-touch	128GB SSD M.2	8260 ac, 2x2 + BT4.1	None	None	None	None	2.0MP / 8.0MP	Black Pogo Keyboard	ThinkPad Pen Pro	Fingerprint Reader	None	None	2-cell (37Wh)	45W	Windows 10 Pro 64	1-year, Depot	08/16
20GG002DUS	US	m5-6Y57	vPro	Intel HD 515	8GB Soldered	12" FHD+ (2160x1440) IPS	10-point Multi-touch	256GB SSD M.2 SATA3 Opal2	8260 ac, 2x2 + BT4.1	Sierra EM7455	None	None	None	2.0MP / 8.0MP	Black Pogo Keyboard	ThinkPad Pen Pro	Fingerprint Reader	NFC	None	2-cell (37Wh)	45W	Windows 10 Pro 64	3-year, Depot	05/16
20GG002EUS	US	m7-6Y75	vPro	Intel HD 515	8GB Soldered	12" FHD+ (2160x1440) IPS	10-point Multi-touch	256GB SSD M.2 SATA3 Opal2	8260 ac, 2x2 + BT4.1	Sierra EM7455	None	None	None	2.0MP / 8.0MP	Black Pogo Keyboard	ThinkPad Pen Pro	Fingerprint Reader	NFC	None	2-cell (37Wh)	45W	Windows 10 Pro 64	3-year, Depot	05/16
20GG002FUS	US	m7-6Y75	vPro	Intel HD 515	8GB Soldered	12" FHD+ (2160x1440) IPS	10-point Multi-touch	512GB SSD M.2	8260 ac, 2x2 + BT4.1	Sierra EM7455	None	None	None	2.0MP / 8.0MP	Black Pogo Keyboard	ThinkPad Pen Pro	Fingerprint Reader	NFC	None	2-cell (37Wh)	45W	Windows 10 Pro 64	3-year, Depot	05/16
20GG0031US	US	m7-6Y75	vPro	Intel HD 515	16GB Soldered	12" FHD+ (2160x1440) IPS	10-point Multi-touch	256GB SSD M.2 SATA3 Opal2	8260 ac, 2x2 + BT4.1	Sierra EM7455	None	None	None	2.0MP / 8.0MP	Black Pogo Keyboard	ThinkPad Pen Pro	Fingerprint Reader	NFC	None	2-cell (37Wh)	45W	Windows 10 Pro 64	1-year, Depot	04/16
20GG0032US	US	m7-6Y75	vPro	Intel HD 515	16GB Soldered	12" FHD+ (2160x1440) IPS	10-point Multi-touch	256GB SSD M.2 SATA3 Opal2	8260 ac, 2x2 + BT4.1	None	None	None	None	2.0MP / 8.0MP	Black Pogo Keyboard	ThinkPad Pen Pro	Fingerprint Reader	None	None	2-cell (37Wh)	45W	Windows 10 Pro 64	1-year, Depot	08/16
20GG0033US	US	m7-6Y75	vPro	Intel HD 515	16GB Soldered	12" FHD+ (2160x1440) IPS	10-point Multi-touch	512GB SSD M.2	8260 ac, 2x2 + BT4.1	Sierra EM7455	None	None	None	2.0MP / 8.0MP	Black Pogo Keyboard	ThinkPad Pen Pro	Fingerprint Reader	NFC	None	2-cell (37Wh)	45W	Windows 10 Pro 64	1-year, Depot	08/16
20GG0034US	US	m7-6Y75	vPro	Intel HD 515	16GB Soldered	12" FHD+ (2160x1440) IPS	10-point Multi-touch	512GB SSD M.2	8260 ac, 2x2 + BT4.1	None	None	None	None	2.0MP / 8.0MP	Black Pogo Keyboard	ThinkPad Pen Pro	Fingerprint Reader	None	None	2-cell (37Wh)	45W	Windows 10 Pro 64	1-year, Depot	08/16
20GG004XUS	US	m7-6Y75	vPro	Intel HD 515	16GB Soldered	12" FHD+ (2160x1440) IPS	10-point Multi-touch	512GB SSD M.2	8260 ac, 2x2 + BT4.1	Sierra EM7455	None	None	None	2.0MP / 8.0MP	Black Pogo Keyboard	ThinkPad Pen Pro	Fingerprint Reader	None	None	2-cell (37Wh)	45W	Windows 10 Pro 64	1-year, Depot	10/16

Model	Region	Processor	vPro	Graphics	Memory	Display	Multi-touch	Storage(HDD/SSD)	WLAN + Bluetooth	WWAN	SIM Card	Dock	Monitor Cable	Camera (Front / Rear)	Keyboard Docking	Pen	Fingerprint Reader	NFC	Module	Battery	Power Adapter	Operating System	Warranty	Ann Date (m/y)
20GG004YUS	US	m7-6Y75	vPro	Intel HD 515	8GB Soldered	12" FHD+ (2160x1440) IPS	10-point Multi-touch	256GB SSD M.2 SATA3 Opal2	8260 ac, 2x2 + BT4.1	Sierra EM7455	None	None	None	2.0MP / 8.0MP	Black Pogo Keyboard	ThinkPad Pen Pro	Fingerprint Reader	None	None	2-cell (37Wh)	45W	Windows 10 Pro 64	3-year, Depot	10/16
20GG0050US	US	m7-6Y75	vPro	Intel HD 515	16GB Soldered	12" FHD+ (2160x1440) IPS	10-point Multi-touch	256GB SSD M.2 SATA3 Opal2	8260 ac, 2x2 + BT4.1	Sierra EM7455	None	None	None	2.0MP / 8.0MP	Black Pogo Keyboard	ThinkPad Pen Pro	Fingerprint Reader	None	None	2-cell (37Wh)	45W	Windows 10 Pro 64	3-year, Depot	10/16
20GG0051US	US	m5-6Y57	vPro	Intel HD 515	8GB Soldered	12" FHD+ (2160x1440) IPS	10-point Multi-touch	256GB SSD M.2 SATA3 Opal2	8260 ac, 2x2 + BT4.1	Sierra EM7455	None	None	None	2.0MP / 8.0MP	Black Pogo Keyboard	ThinkPad Pen Pro	Fingerprint Reader	None	None	2-cell (37Wh)	45W	Windows 10 Pro 64	3-year, Depot	10/16
20GG0052US	US	m7-6Y75	vPro	Intel HD 515	16GB Soldered	12" FHD+ (2160x1440) IPS	10-point Multi-touch	512GB SSD M.2	8260 ac, 2x2 + BT4.1	Sierra EM7455	None	None	None	2.0MP / 8.0MP	Black Pogo Keyboard	ThinkPad Pen Pro	Fingerprint Reader	None	None	2-cell (37Wh)	45W	Windows 10 Pro 64	3-year, Depot	10/16
20GG0053US	US	m7-6Y75	vPro	Intel HD 515	16GB Soldered	12" FHD+ (2160x1440) IPS	10-point Multi-touch	256GB SSD M.2 SATA3 Opal2	8260 ac, 2x2 + BT4.1	Sierra EM7455	None	None	None	2.0MP / 8.0MP	Black Pogo Keyboard	ThinkPad Pen Pro	Fingerprint Reader	None	None	2-cell (37Wh)	45W	Windows 10 Pro 64	1-year, Depot	10/16
20GG0054US	US	m7-6Y75	vPro	Intel HD 515	8GB Soldered	12" FHD+ (2160x1440) IPS	10-point Multi-touch	512GB SSD M.2	8260 ac, 2x2 + BT4.1	Sierra EM7455	None	None	None	2.0MP / 8.0MP	Black Pogo Keyboard	ThinkPad Pen Pro	Fingerprint Reader	None	None	2-cell (37Wh)	45W	Windows 10 Pro 64	3-year, Depot	10/16



ThinkPad X1 Tablet (2nd Gen) Platform Specifications

Product Specifications Reference (PSREF)

Processor	7th Generation Intel® Core™ Processor	Ports	One standard USB 3.1 Gen 1 / USB 3.0, one Mini DisplayPort, one USB 3.1 Type-C Gen 1 / Power Delivery 2.0, one Pogo keyboard connector, one cartrige connector for optional modules, one nano-SIM slot																																							
	<table border="1"> <thead> <tr> <th>Processor Number</th> <th># of Cores</th> <th># of Threads</th> <th>Clock Speed</th> <th>Burst Frequency</th> <th>Cache</th> <th>Memory Types</th> <th>Processor Graphics</th> <th>vPro</th> </tr> </thead> <tbody> <tr> <td>m3-7Y30</td> <td>2</td> <td>4</td> <td>1.0 GHz</td> <td>2.6 GHz</td> <td>4MB</td> <td rowspan="4">LPDDR3-1866</td> <td rowspan="4">Intel HD Graphics 615</td> <td>No</td> </tr> <tr> <td>i5-7Y54</td> <td>2</td> <td>4</td> <td>1.2 GHz</td> <td>3.2 GHz</td> <td>4MB</td> <td>No</td> </tr> <tr> <td>i5-7Y57</td> <td>2</td> <td>4</td> <td>1.2 GHz</td> <td>3.3 GHz</td> <td>4MB</td> <td>Yes</td> </tr> <tr> <td>i7-7Y75</td> <td>2</td> <td>4</td> <td>1.3 GHz</td> <td>3.6 GHz</td> <td>4MB</td> <td>Yes</td> </tr> </tbody> </table>	Processor Number	# of Cores	# of Threads	Clock Speed	Burst Frequency	Cache	Memory Types	Processor Graphics	vPro	m3-7Y30	2	4	1.0 GHz	2.6 GHz	4MB	LPDDR3-1866	Intel HD Graphics 615	No	i5-7Y54	2	4	1.2 GHz	3.2 GHz	4MB	No	i5-7Y57	2	4	1.2 GHz	3.3 GHz	4MB	Yes	i7-7Y75	2	4	1.3 GHz	3.6 GHz	4MB	Yes	Control buttons WiGig dock Monitor Cable (optional) Adapter (optional)	Power button, volume control button, reset switch <i>Optional:</i> ThinkPad WiGig dock <i>mDP-HDMI:</i> Lenovo Mini DisplayPort to HDMI Monitor Cable <i>mDP-VGA:</i> Lenovo Mini DisplayPort to VGA Monitor Cable <i>USB-RJ45:</i> USB 3.0 to RJ45 adapter <i>USB-C-VGA:</i> USB-C to VGA plus power adapter <i>USB-C-HDMI:</i> USB-C to HDMI plus power adapter
Processor Number	# of Cores	# of Threads	Clock Speed	Burst Frequency	Cache	Memory Types	Processor Graphics	vPro																																		
m3-7Y30	2	4	1.0 GHz	2.6 GHz	4MB	LPDDR3-1866	Intel HD Graphics 615	No																																		
i5-7Y54	2	4	1.2 GHz	3.2 GHz	4MB			No																																		
i5-7Y57	2	4	1.2 GHz	3.3 GHz	4MB			Yes																																		
i7-7Y75	2	4	1.3 GHz	3.6 GHz	4MB			Yes																																		
Graphics	Intel HD Graphics 615 in processor, supports 1080p video out via Mini DisplayPort connector	Camera	<i>Front camera:</i> 2.0-megapixel, fixed focus <i>Rear camera:</i> 8.0-megapixel, auto focus, flash LED																																							
Chipset	Intel SoC (System on Chip) platform	Video capture	1080p video capture																																							
Memory	<i>Some:</i> 4GB / 1866MHz LPDDR3, mobile DDR / soldered to systemboard <i>Some:</i> 8GB / 1866MHz LPDDR3, mobile DDR / soldered to systemboard <i>Some:</i> 16GB / 1866MHz LPDDR3, mobile DDR / soldered to systemboard <i>All:</i> no sockets, dual-channel capable	Audio support	Realtek® ALC3268 codec / stereo speakers, 0.5 watt x 2 / three microphones, combo audio/microphone jack																																							
Display	12.0" (304.8mm) FHD+ (2160x1440), glossy, LED backlight, IPS, anti-fingerprint display with Corning® Gorilla® Glass, WideView (170° viewing), 360 nits, 3:2 aspect ratio, 800:1 contrast ratio	Pogo Keyboard	Magnetic attached thin keyboard, with TrackPoint® pointing device and buttonless Mylar surface touchpad, multi-touch																																							
Multi-touch	Capacitive touch panel, supports ten-finger gesture	Keyboard color	Black, red, and silver																																							
Pen	<i>Optional:</i> ThinkPad Pen Pro, active pen for multi-touch display	Security	Kensington lock slot																																							
Kick stand	Opening angle up to 90 degrees	Security chip	Discrete TPM 2.0 TCG Certified																																							
Storage	<i>Some:</i> M.2 SSD / SATA 6.0Gb/s <i>Some:</i> M.2 SSD / PCIe NVMe, PCIe 3.0 x 4, 32Gb/s	vPro (optional)	Intel vPro Technology																																							
Optical	None	Fingerprint reader	<i>Optional:</i> Touch style Fingerprint reader																																							
Storage extension	One microSD card slot, supports up to 64GB	NFC	None																																							
Ethernet	None	Module	<i>One of the following, configurable by model</i> <ul style="list-style-type: none"> Productivity module, USB3.0 x 1, HDMI, OneLink+, 5 hrs battery (24Whr) Presenter module, Pico projector, HDMI and 10Whr battery for presenter 																																							
WLAN(soldered)	Intel Dual Band Wireless-AC 8265, Wi-Fi 2x2, 802.11ac + BT4.1 <i>*Intel Wi-Fi card supports Bluetooth 4.2 but is limited to BT 4.1 by Windows OS</i>	Battery - type	Lithium polymer, 2 cell, 37Whr																																							
WiGig(soldered)	Intel Wireless Gigabit W11000, WiGig 802.11ad	Battery - life	up to 10 hr (local video playback)																																							
Bluetooth™	Bluetooth wireless, integrated in Wi-Fi + Bluetooth combo chip	AC adapter	<i>Some:</i> 45-watt USB Type-C adapter <i>Some:</i> 65-watt USB Type-C adapter																																							
WWAN	<i>One of the following, configurable by model:</i> <ul style="list-style-type: none"> Wireless WAN, Sierra Wireless EM7455, Qualcomm® 4G LTE-Advanced/DC-HSPA+/HSPA+/HSPA/UMTS/GNSS, M.2 card 	Light sensor	Ambient Light Sensor																																							
SIM card	Nano-SIM, optional Lenovo Connect (WE) SIM card	G-sensor	3D accelerometer																																							
Dimensions	<i>Tablet only:</i> 11.48" x 8.25" x 0.34"; 291.5mm x 209.5mm x 8.45mm	Compass	3D compass																																							
Weight	<i>Tablet only:</i> from 1.69 lb, 767g; <i>Tablet+keyboard:</i> from 2.35 lb, 1.07kg (767g+300g);	Gyroscope	3D gyrometer																																							
Case color	Black	GPS	GPS function is integrated into WWAN module																																							
Case material	Mg + PCGF Hybrid	Preload	<i>Some:</i> Windows 10 Pro 64 <i>Some:</i> Windows 10 Home 64 <ul style="list-style-type: none"> Lenovo Connect Lenovo Companion Lenovo Setting Microsoft® Office preloaded; purchase a product key to activate 																																							
Smart Card Read	None	Limited warranty	1-year - depot repair service/ service upgrades available 3-year - depot repair service/ service upgrades available																																							
Media reader	One microSD card slot (micro SD/SDXC/SDHC), supports up to 64GB	Mil-Spec test	MIL-STD-810G military certification																																							
		Environment	EPEAT™ Gold, RoHS, GREENGUARD, Low Halogen																																							

ThinkPad X1 Tablet (2nd Gen) - TopSeller - 20JB

Product Specifications Reference (PSREF)

Model	Region	Processor	vPro	Graphics	Memory	Display	Multi-touch	Storage(HDD/SSD)	WLAN + Bluetooth	WWAN	SIM Card	Dock	Monitor Cable	Camera (Front / Rear)	Keyboard Docking	Pen	Fingerprint Reader	Module	Power Adapter	Operating System	Warranty	Global	Ann Date (mm/yy)
20JB0027US	US	i5-7Y57	vPro	Intel HD 615	8GB Soldered	12" FHD+ (2160x1440) IPS	10-point Multi-touch	512GB SSD M.2 PCIe NVMe Opal2	8265 ac, 2x2 + BT4.1	None	None	None	None	2.0MP / 8.0MP	Black Pogo Keyboard	Pen Pro	Fingerprint Reader	None	45W	Win10 Pro 64	3-year, Depot	No	03/17
20JB0028US	US	i5-7Y57	vPro	Intel HD 615	4GB Soldered	12" FHD+ (2160x1440) IPS	10-point Multi-touch	256GB SSD M.2 PCIe NVMe Opal2	8265 ac, 2x2 + BT4.1	None	None	None	None	2.0MP / 8.0MP	Black Pogo Keyboard	Pen Pro	Fingerprint Reader	None	45W	Win10 Pro 64	1-year, Depot	No	03/17
20JB0029US	US	i7-7Y75	vPro	Intel HD 615	16GB Soldered	12" FHD+ (2160x1440) IPS	10-point Multi-touch	256GB SSD M.2 PCIe NVMe Opal2	8265 ac, 2x2 + BT4.1	None	None	None	None	2.0MP / 8.0MP	Black Pogo Keyboard	Pen Pro	Fingerprint Reader	None	45W	Win10 Pro 64	3-year, Depot	No	03/17
20JB002BUS	US	i7-7Y75	vPro	Intel HD 615	16GB Soldered	12" FHD+ (2160x1440) IPS	10-point Multi-touch	256GB SSD M.2 PCIe NVMe Opal2	8265 ac, 2x2 + BT4.1	Sierra EM7455	None	None	None	2.0MP / 8.0MP	Black Pogo Keyboard	Pen Pro	Fingerprint Reader	None	45W	Win10 Pro 64	3-year, Depot	No	03/17
20JB002CUS	US	i5-7Y54	No	Intel HD 615	8GB Soldered	12" FHD+ (2160x1440) IPS	10-point Multi-touch	256GB SSD M.2 PCIe NVMe Opal2	8265 ac, 2x2 + BT4.1	None	None	None	None	2.0MP / 8.0MP	Black Pogo Keyboard	Pen Pro	Fingerprint Reader	None	45W	Win10 Pro 64	1-year, Depot	No	03/17
20JB002DUS	US	i5-7Y54	No	Intel HD 615	8GB Soldered	12" FHD+ (2160x1440) IPS	10-point Multi-touch	512GB SSD M.2 PCIe NVMe Opal2	8265 ac, 2x2 + BT4.1	None	None	None	None	2.0MP / 8.0MP	Black Pogo Keyboard	Pen Pro	Fingerprint Reader	None	45W	Win10 Pro 64	1-year, Depot	No	03/17
20JB002EUS	US	i7-7Y75	vPro	Intel HD 615	16GB Soldered	12" FHD+ (2160x1440) IPS	10-point Multi-touch	512GB SSD M.2 PCIe NVMe Opal2	8265 ac, 2x2 + BT4.1	None	None	None	None	2.0MP / 8.0MP	Black Pogo Keyboard	Pen Pro	Fingerprint Reader	None	45W	Win10 Pro 64	3-year, Depot	No	03/17
20JB002FUS	US	i5-7Y57	vPro	Intel HD 615	8GB Soldered	12" FHD+ (2160x1440) IPS	10-point Multi-touch	256GB SSD M.2 PCIe NVMe Opal2	8265 ac, 2x2 + BT4.1	Sierra EM7455	None	None	None	2.0MP / 8.0MP	Black Pogo Keyboard	Pen Pro	Fingerprint Reader	None	45W	Win10 Pro 64	3-year, Depot	No	03/17
20JB002GUS	US	i5-7Y57	vPro	Intel HD 615	4GB Soldered	12" FHD+ (2160x1440) IPS	10-point Multi-touch	128GB SSD M.2	8265 ac, 2x2 + BT4.1	None	None	None	None	2.0MP / 8.0MP	Black Pogo Keyboard	Pen Pro	Fingerprint Reader	None	45W	Win10 Pro 64	1-year, Depot	No	03/17
20JB002JUS	US	i5-7Y57	vPro	Intel HD 615	8GB Soldered	12" FHD+ (2160x1440) IPS	10-point Multi-touch	256GB SSD M.2 PCIe NVMe Opal2	8265 ac, 2x2 + BT4.1	None	None	None	None	2.0MP / 8.0MP	Black Pogo Keyboard	Pen Pro	Fingerprint Reader	None	45W	Win10 Pro 64	3-year, Depot	No	03/17
20JB002KUS	US	i7-7Y75	vPro	Intel HD 615	8GB Soldered	12" FHD+ (2160x1440) IPS	10-point Multi-touch	512GB SSD M.2 PCIe NVMe Opal2	8265 ac, 2x2 + BT4.1	Sierra EM7455	None	None	None	2.0MP / 8.0MP	Black Pogo Keyboard	Pen Pro	Fingerprint Reader	None	45W	Win10 Pro 64	3-year, Depot	No	03/17
20JB002LUS	US	i7-7Y75	vPro	Intel HD 615	8GB Soldered	12" FHD+ (2160x1440) IPS	10-point Multi-touch	256GB SSD M.2 PCIe NVMe Opal2	8265 ac, 2x2 + BT4.1	None	None	None	None	2.0MP / 8.0MP	Black Pogo Keyboard	Pen Pro	Fingerprint Reader	None	45W	Win10 Pro 64	3-year, Depot	No	03/17
20JB002MUS	US	i7-7Y75	vPro	Intel HD 615	8GB Soldered	12" FHD+ (2160x1440) IPS	10-point Multi-touch	256GB SSD M.2 PCIe NVMe Opal2	8265 ac, 2x2 + BT4.1	Sierra EM7455	None	None	None	2.0MP / 8.0MP	Black Pogo Keyboard	Pen Pro	Fingerprint Reader	None	45W	Win10 Pro 64	3-year, Depot	No	03/17
20JB002NUS	US	i7-7Y75	vPro	Intel HD 615	8GB Soldered	12" FHD+ (2160x1440) IPS	10-point Multi-touch	256GB SSD M.2 PCIe NVMe Opal2	8265 ac, 2x2 + BT4.1	None	None	None	None	2.0MP / 8.0MP	Black Pogo Keyboard	Pen Pro	Fingerprint Reader	None	45W	Win10 Pro 64	1-year, Depot	No	03/17
20JB0035US	US	i7-7Y75	vPro	Intel HD 615	8GB Soldered	12" FHD+ (2160x1440) IPS	10-point Multi-touch	512GB SSD M.2 PCIe NVMe Opal2	8265 ac, 2x2 + BT4.1	None	None	None	None	2.0MP / 8.0MP	Black Pogo Keyboard	Pen Pro	Fingerprint Reader	None	45W	Win10 Pro 64	3-year, Depot	No	03/17



ThinkPad P40 Yoga Platform Specifications

Product Specifications Reference (PSREF)

Processor	6th Generation Intel® Core™ i7 Processor									Ports	Three USB 3.0 (one Always On), Mini DisplayPort, HDMI, Onelink+ connector, combo audio / microphone jack	
	Processor Number	# of Cores	# of Threads	Base Frequency	Max Turbo Frequency	Cache	Memory Types	Processor Graphics	vPro	Adapter (optional)	HDMI-VGA: Lenovo HDMI to VGA Monitor Cable mDP-VGA: Lenovo Mini DisplayPort to VGA Monitor Cable RJ45: ThinkPad Onelink+ to RJ45 adapter VGA/RJ45: ThinkPad Onelink+ to VGA/RJ45 adapter	
	i7-6500U	2	4	2.5 GHz	3.1 GHz	4MB	DDR3L-1600	Intel HD Graphics 520	No			
	i7-6600U			2.6 GHz	3.4 GHz	4MB		vPro				
Graphics	Intel HD Graphics 520 in processor and Nvidia Quadro M500M Graphics, 2GB DDR3 memory, supports external digital monitor via HDMI, or Mini DisplayPort; supports dual independent display; Max resolution: 3840x2160 (Mini DisplayPort)@60Hz; 1920x1080 (HDMI)@60Hz									Camera	HD720p resolution, fixed focus	
Chipset	Intel SoC (System on Chip) platform									Audio support	HD Audio, Conexant® CX11852 codec, Dolby® DAX2 / stereo speakers, 1.5W x 2 / dual array microphone, combo audio / microphone jack	
Memory	16GB max / 1600MHz DDR3L / one 204-pin SO-DIMM sockets									Keyboard	6-row, spill-resistant, multimedia Fn keys, LED backlit	
Display	Some: 14.0" (355mm) WQHD (2560x1440), glare, LED backlight, IPS, 300 nits, 16:9 aspect ratio, 700:1 contrast ratio Some: 14.0" (355mm) FHD (1920x1080), anti-glare, LED backlight, IPS, 250 nits, 16:9 aspect ratio, 700:1 contrast ratio									UltraNav™	TrackPoint® pointing device and buttonless Mylar surface touchpad, multi-touch	
Multi-touch	Capacitive touch panel, supports 10-finger gesture									Security	Power-on password, hard disk password, supervisor password, security keyhole	
Hinge	Yoga hinge, 360 degree									Security chip	Discrete TPM 1.2 TCG Certified and Firmware TPM 2.0 integrated in chipset	
Convert-mode	Laptop, tent, stand, and tablet									vPro (optional)	Intel vPro Technology	
Pen	ThinkPad Pen Pro, active pen for multi-touch display									Fingerprint reader	Swipe fingerprint reader under C cover	
Storage	SSD / SATA 6.0Gb/s, 2.5" wide, 7mm high									NFC	None	
Optical	None									Battery type	Li-Polymer 3-cell (53Wh)	
Ethernet	Gigabit Ethernet via optional Ethernet (RJ-45) adapter (by native Intel Ethernet Connection I219-V (Non-vPro) or I219-LM (vPro))									Battery life	Up to 8.0 hr	
WLAN	11ac+BT, Intel Dual Band Wireless-AC 8260, 2x2, M.2 Card									AC adapter	65W AC adapter	
Bluetooth™	Bluetooth wireless, integrated in Wi-Fi + Bluetooth combo adapter									Light sensor	Ambient Light Sensor	
WWAN (optional)	Wireless WAN, Sierra Wireless EM7455, Qualcomm® 4G LTE-Advanced/DC-HSPA+/HSPA+/HSPA/UMTS/GNSS, M.2 card									G-sensor	3D accelerometer	
SIM card	Micro-SIM card slot									Compass	3D compass	
Dimensions	WxDxH: 13.30" x 9.30" x 0.78"; 338.0mm x 236.3mm x 19.9mm									Gyroscope	3D gyrometer	
Weight	From 3.96 lb (1.80kg)									Preload	Windows® 7 Professional 64 preinstalled through downgrade rights in Windows 10 Pro 64 Some: Windows 10 Pro 64 Some: Windows 10 Home 64	
Case color	Black										<ul style="list-style-type: none"> • Lenovo Solution Center • Lenovo SHAREit • Lenovo Companion • Lenovo Settings • Microsoft Office preloaded; purchase a product key to activate • McAfee® Live Safe (30-day trial) 	
Case material	Carbon-Fiber Hybrid										<ul style="list-style-type: none"> • Microsoft® Office preloaded; purchase a product key to activate • McAfee® Live Safe (30-day trial) 	
Smart card reader	None										For ISV certifications, please visit www.lenovo.com/support/ISV	
Media reader	4-in-1 reader (MMC, SD, SDHC, SDXC)									Limited warranty	One of the following, configurable by model: <ul style="list-style-type: none"> • 1-year depot repair service • 3-year/1-yr battery depot repair service 	
										Mil-Spec test	MIL-STD-810G military certification	
										Environment	EPEAT™ Gold; ENERGY STAR®; RoHS-compliant	

ThinkPad P40 Yoga - TopSeller - 20GQ

Product Specifications Reference (PSREF)

Model	Region	Processor	vPro	Graphics	Memory	Display	Multi-touch	Case Material	Storage	Optical	WLAN + Bluetooth	WWAN	SIM Card	Monitor Cable	Adapter	Color	Camera	Keyboard	Pen	Finger-print Reader	NFC	TPM	Battery	Power Adapter	Operating System	Warranty	Global	Ann Date (m/y)
20GQ000BUS	US	i7-6500U	No	M500M 2GB	8GBx1	14" FHD (1920x1080) IPS AG	10-point Multi-touch	Carbon	256GB SSD Opal2	None	Intel 8260 ac, 2x2 + BT4.1	None	None	None	None	Black	720p	Backlit	Pen Pro	Finger-print Reader	None	dTPM1.2 + FW TPM2.0	3-cell (53Wh)	65W	Win10 Pro 64	1-year, Depot	No	02/16
20GQ000CUS	US	i7-6600U	vPro	M500M 2GB	8GBx1	14" FHD (1920x1080) IPS AG	10-point Multi-touch	Carbon	256GB SSD Opal2	None	Intel 8260 ac, 2x2 + BT4.1	None	None	None	None	Black	720p	Backlit	Pen Pro	Finger-print Reader	None	dTPM1.2 + FW TPM2.0	3-cell (53Wh)	65W	Win10 Pro 64	1-year, Depot	No	02/16
20GQ000EUS	US	i7-6600U	vPro	M500M 2GB	16GBx1	14" WQHD (2560x1440) IPS Gloss	10-point Multi-touch	Carbon	512GB SSD	None	Intel 8260 ac, 2x2 + BT4.1	None	None	None	None	Black	720p	Backlit	Pen Pro	Finger-print Reader	None	dTPM1.2 + FW TPM2.0	3-cell (53Wh)	65W	Win10 Pro 64	1-year, Depot	No	02/16

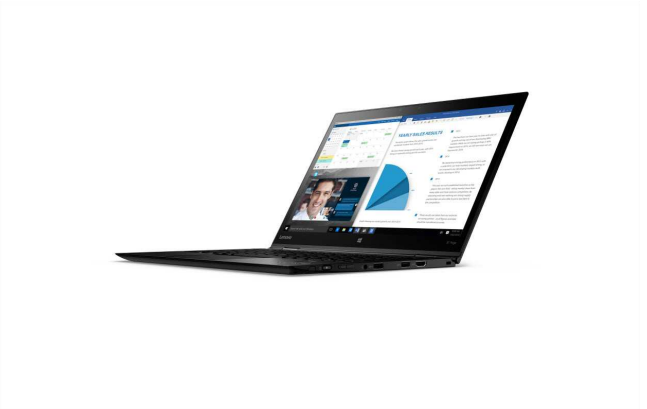

ThinkPad X1 Yoga Platform Specifications

Product Specifications Reference (PSREF)

Processor	6th Generation Intel® Core™ i3 / i5 / i7 Processor								Smart card reader	None		
	Processor Number	# of Cores	# of Threads	Base Frequency	Max Turbo Frequency	Cache	Memory Types	Processor Graphics	vPro	Media reader	Micro SD, supports UHS-II SD card	
	i5-6200U	2	4	2.3 GHz	2.8 GHz	3MB	LPDDR3-1866	Intel HD Graphics 520	No	Ports	Three USB 3.0 (one Always On), Mini DisplayPort, HDMI, Onelink+ connector, combo audio / microphone jack	
	i5-6300U			2.4 GHz	3.0 GHz	3MB		vPro				
	i7-6500U			2.5 GHz	3.1 GHz	4MB		No				
	i7-6600U			2.6 GHz	3.4 GHz	4MB		vPro				
Graphics	Intel HD Graphics 520 in processor only, supports external digital monitor via HDMI or Mini DisplayPort; supports dual independent displays; Max resolution: 3840x2160 (Mini DisplayPort) @60Hz; 4096x2160 (HDMI) @24Hz								WiGig dock Adapter (optional)	WiGig dock, mutually exclusive with WWAN HDMI-VGA: Lenovo HDMI to VGA Monitor Cable mDP-VGA: Lenovo Mini DisplayPort to VGA Monitor Cable RJ45: ThinkPad OneLink+ to RJ45 adapter VGA/RJ45: ThinkPad OneLink+ to VGA/RJ45 adapter		
Chipset	Intel SoC (System on Chip) platform								Camera	HD720p resolution, fixed focus		
Memory	16GB max / 1866MHz LPDDR3 / soldered to systemboard								Audio support	HD Audio, Conexant® CX11852 codec, Dolby® DAX2 / stereo speakers, 2W x 2 / dual array microphone, combo audio / microphone jack		
Display	<i>Some:</i> 14.0" (355mm) WQHD (2560x1440), glare, OLED, 300 nits, 16:9 aspect ratio, 2000000:1 contrast ratio <i>Some:</i> 14.0" (355mm) WQHD (2560x1440), anti-glare, LED backlight, IPS, 270 nits, 16:9 aspect ratio, 700:1 contrast ratio <i>Some:</i> 14.0" (355mm) FHD (1920x1080), anti-glare, LED backlight, IPS, 270 nits, 16:9 aspect ratio, 700:1 contrast ratio								Keyboard	6-row, spill-resistant, multimedia Fn keys, LED backlight UltraNav™ TrackPoint® pointing device and buttonless glass surface touchpad, multi-touch		
Multi-touch	Capacitive touch panel, supports 10-finger gesture								Security chip	Power-on password, hard disk password, supervisor password, security keyhole Discrete TPM 1.2 TCG Certified and Firmware TPM 2.0 integrated in chipset		
Hinge	Yoga hinge, 360 degree								vPro (optional)	Intel vPro Technology		
Convert-mode	Laptop, tent, stand, and tablet								Fingerprint reader	Touch style fingerprint reader on the keyboard bezel		
Pen (optional)	ThinkPad Pen Pro, active pen for multi-touch display								NFC	None		
Storage	<i>Some:</i> M.2 SSD / SATA 6.0Gb/s <i>Some:</i> M.2 SSD / PCIe NVMe, PCIe 3.0 x 4, 32Gb/s								Battery type	Li-Polymer 4-cell (52Wh) or 4-cell (56Wh, OLED models only)		
Optical	None								Battery life	Up to 11.0 hr		
Ethernet	Gigabit Ethernet via optional Ethernet (RJ-45) adapter (by native Intel Ethernet Connection I219-V (Non-vPro) or I219-LM (vPro))								AC adapter	45W or 65W AC adapter		
WLAN	<i>One of the following, configurable by model (WiGig is mutually exclusive with WWAN):</i> <ul style="list-style-type: none"> 11ac+BT, Intel Dual Band Wireless-AC 8260, 2x2, M.2 Card WiGig™+11AC+BT, Intel Tri-Band Wireless-AC 8260, 2x2 WLAN, WiGig, M.2 Card 								Light sensor	Ambient Light Sensor		
Bluetooth™	Bluetooth wireless, integrated in Wi-Fi + Bluetooth combo adapter								G-sensor	3D accelerometer and 3D magnetometer		
WWAN (optional)	<i>One of the following, configurable by model (mutually exclusive with WiGig):</i> <ul style="list-style-type: none"> Wireless WAN, Sierra Wireless EM7455, Qualcomm® 4G LTE-Advanced/DC-HSPA+/HSPA+/HSPA/UMTS/GNSS, M.2 card Wireless WAN, HUAWEI ME906S, HUAWEI 4G LTE/WCDMA/HSPA/GSM/GPRS/EDGE/GNSS, M.2 card (WE only) 								Compass	3D compass		
SIM card	Micro-SIM card slot, optional Verizon LTE (US) or Lenovo Connect (WE) SIM card								Gyroscope	3D gyrometer		
Dimensions	WxDxH: 13.11" x 9.02" x 0.66"; 333.0mm x 229.0mm x 16.8mm								Preload	Windows® 7 Professional 64 preinstalled through downgrade rights in Windows 10 Pro 64 <i>Some:</i> Windows 10 Pro 64 <i>Some:</i> Windows 10 Home 64		
Weight	From 3.00 lb (1.36kg)									<ul style="list-style-type: none"> Lenovo Solution Center Lenovo WRITEit Lenovo Companion Lenovo Settings Microsoft Office preloaded; purchase a product key to activate McAfee® Live Safe (30-day trial) 		
Case color	Black								Limited warranty	<i>One of the following, configurable by model:</i> <ul style="list-style-type: none"> 1-year depot repair service 3-year/1-yr battery depot repair service 3-year/1-yr battery limited onsite service 		
Case material	Carbon-Fiber Hybrid								Mil-Spec test	MIL-STD-810G military certification		
									Environment	EPEAT™ Gold; ENERGY STAR®; RoHS-compliant		

Model	Region	Processor	vPro	Graphics	Memory	Display	Multi-touch	Storage(HDD/SSD)	Optical	WLAN + Bluetooth	WWAN	SIM Card	Dock	Adapter	Camera	Keyboard	Pen	Finger-print Reader	NFC	Battery	Power Adapter	Operating System	Warranty	Global	Ann Date (m/y)
20FQ000QUS	US	i7-6500U	No	Intel HD 520	8GB Soldered	14" WQHD (2560x1440) IPS AG	10-point Multi-touch	512GB SSD M.2 SATA3	None	Intel 8260 ac, 2x2 + BT4.1	None	None	None	None	720p	Backlit	Pen Pro	Finger-print Reader	None	4-cell (52Wh)	65W	Win10 Pro 64	1-year, Depot	No	02/17
20FQ000RUS	US	i5-6200U	No	Intel HD 520	8GB Soldered	14" FHD (1920x1080) IPS AG	10-point Multi-touch	256GB SSD M.2 SATA3 Opal2	None	Intel 8260 ac, 2x2 + BT4.1	None	None	None	None	720p	Backlit	Pen Pro	Finger-print Reader	None	4-cell (52Wh)	65W	Win10 Pro 64	1-year, Depot	No	02/17
20FQ000SUS	US	i5-6200U	No	Intel HD 520	8GB Soldered	14" WQHD (2560x1440) IPS AG	10-point Multi-touch	512GB SSD M.2	None	Intel 8260 ac, 2x2 + BT4.1	None	None	None	None	720p	Backlit	Pen Pro	Finger-print Reader	None	4-cell (52Wh)	65W	Win10 Pro 64	1-year, Depot	No	01/16
20FQ000YUS	US	i5-6200U	No	Intel HD 520	8GB Soldered	14" FHD (1920x1080) IPS AG	10-point Multi-touch	192GB SSD M.2	None	Intel 8260 ac, 2x2 + BT4.1	None	None	None	None	720p	Backlit	Pen Pro	Finger-print Reader	NFC	4-cell (52Wh)	65W	Win10 Pro 64	3-year, Depot	No	02/16
20FQ0010US	US	i5-6200U	No	Intel HD 520	8GB Soldered	14" FHD (1920x1080) IPS AG	10-point Multi-touch	256GB SSD M.2 SATA3 Opal2	None	Intel 8260 ac, 2x2 + BT4.1	None	None	None	None	720p	Backlit	Pen Pro	Finger-print Reader	NFC	4-cell (52Wh)	65W	Win10 Pro 64	3-year, Depot	No	02/16
20FQ001VUS	US	i7-6500U	No	Intel HD 520	8GB Soldered	14" FHD (1920x1080) IPS AG	10-point Multi-touch	256GB SSD M.2 SATA3 Opal2	None	Intel 8260 ac, 2x2 + BT4.1	None	None	None	None	720p	Backlit	Pen Pro	Finger-print Reader	None	4-cell (52Wh)	65W	Win10 Pro 64	3-year, Depot	No	01/16
20FQ001WUS	US	i7-6500U	No	Intel HD 520	8GB Soldered	14" FHD (1920x1080) IPS AG	10-point Multi-touch	256GB SSD M.2 PCIe NVMe Opal2	None	Intel 8260 ac, 2x2 + BT4.1	None	None	None	None	720p	Backlit	Pen Pro	Finger-print Reader	None	4-cell (52Wh)	65W	Win10 Pro 64	3-year, Depot	No	01/16
20FQ002YUS	US	i7-6600U	vPro	Intel HD 520	16GB Soldered	14" WQHD (2560x1440) IPS AG	10-point Multi-touch	512GB SSD M.2	None	Intel 8260 ac, 2x2 + BT4.1	None	None	None	None	720p	Backlit	Pen Pro	Finger-print Reader	None	4-cell (52Wh)	65W	Win10 Pro 64	3-year, Depot	No	01/16
20FQ0030US	US	i7-6600U	vPro	Intel HD 520	8GB Soldered	14" WQHD (2560x1440) IPS AG	10-point Multi-touch	512GB SSD M.2 PCIe NVMe	None	Intel 18260 ac, 2x2 + BT4.1	None	None	WiGig Dock	None	720p	Backlit	Pen Pro	Finger-print Reader	None	4-cell (52Wh)	65W	Win10 Pro 64	3-year, Depot	No	03/16
20FQ0031US	US	i7-6600U	vPro	Intel HD 520	16GB Soldered	14" WQHD (2560x1440) IPS AG	10-point Multi-touch	512GB SSD M.2 PCIe NVMe	None	Intel 18260 ac, 2x2 + BT4.1	None	None	WiGig Dock	None	720p	Backlit	Pen Pro	Finger-print Reader	None	4-cell (52Wh)	65W	Win10 Pro 64	3-year, Depot	No	03/16
20FQ0032US	US	i7-6600U	vPro	Intel HD 520	16GB Soldered	14" WQHD (2560x1440) IPS AG	10-point Multi-touch	256GB SSD M.2 PCIe NVMe Opal2	None	Intel 8260 ac, 2x2 + BT4.1	None	None	None	None	720p	Backlit	Pen Pro	Finger-print Reader	None	4-cell (52Wh)	65W	Win10 Pro 64	3-year, Depot	No	01/16
20FQ0033US	US	i5-6300U	vPro	Intel HD 520	8GB Soldered	14" FHD (1920x1080) IPS AG	10-point Multi-touch	256GB SSD M.2 SATA3 Opal2	None	Intel 8260 ac, 2x2 + BT4.1	None	None	None	None	720p	Backlit	Pen Pro	Finger-print Reader	None	4-cell (52Wh)	65W	Win10 Pro 64	3-year, Depot	No	01/16
20FQ0034US	US	i7-6600U	vPro	Intel HD 520	8GB Soldered	14" WQHD (2560x1440) IPS AG	10-point Multi-touch	256GB SSD M.2 PCIe NVMe Opal2	None	Intel 18260 ac, 2x2 + BT4.1	None	None	WiGig Dock	None	720p	Backlit	Pen Pro	Finger-print Reader	None	4-cell (52Wh)	65W	Win10 Pro 64	3-year, Depot	No	03/16
20FQ0035US	US	i7-6600U	vPro	Intel HD 520	8GB Soldered	14" WQHD (2560x1440) IPS AG	10-point Multi-touch	512GB SSD M.2	None	Intel 18260 ac, 2x2 + BT4.1	None	None	WiGig Dock	None	720p	Backlit	Pen Pro	Finger-print Reader	None	4-cell (52Wh)	65W	Win10 Pro 64	3-year, Depot	No	03/16
20FQ0036US	US	i7-6600U	vPro	Intel HD 520	8GB Soldered	14" WQHD (2560x1440) IPS AG	10-point Multi-touch	256GB SSD M.2 SATA3 Opal2	None	Intel 8260 ac, 2x2 + BT4.1	None	None	None	None	720p	Backlit	Pen Pro	Finger-print Reader	None	4-cell (52Wh)	65W	Win10 Pro 64	3-year, Depot	No	01/16
20FQ0037US	US	i7-6600U	vPro	Intel HD 520	8GB Soldered	14" WQHD (2560x1440) IPS AG	10-point Multi-touch	512GB SSD M.2	None	Intel 8260 ac, 2x2 + BT4.1	None	None	None	None	720p	Backlit	Pen Pro	Finger-print Reader	None	4-cell (52Wh)	65W	Win10 Pro 64	3-year, Depot	No	01/16
20FQ0038US	US	i7-6600U	vPro	Intel HD 520	8GB Soldered	14" FHD (1920x1080) IPS AG	10-point Multi-touch	256GB SSD M.2 SATA3 Opal2	None	Intel 8260 ac, 2x2 + BT4.1	None	None	None	None	720p	Backlit	Pen Pro	Finger-print Reader	None	4-cell (52Wh)	65W	Win10 Pro 64	3-year, Depot	No	01/16
20FQ0039US	US	i5-6200U	No	Intel HD 520	8GB Soldered	14" FHD (1920x1080) IPS AG	10-point Multi-touch	192GB SSD M.2	None	Intel 8260 ac, 2x2 + BT4.1	None	None	None	None	720p	Backlit	Pen Pro	Finger-print Reader	None	4-cell (52Wh)	65W	Win10 Pro 64	3-year, Depot	No	01/16
20FQ003HUS	US	i5-6300U	vPro	Intel HD 520	8GB Soldered	14" FHD (1920x1080) IPS AG	10-point Multi-touch	240GB SSD M.2 SATA3 Opal2	None	Intel 8260 ac, 2x2 + BT4.1	None	None	None	None	720p	Backlit	Pen Pro	Finger-print Reader	None	4-cell (52Wh)	65W	Win10 Pro 64	3-year, Depot	No	02/16
20FQ003JUS	US	i5-6300U	vPro	Intel HD 520	8GB Soldered	14" WQHD (2560x1440) IPS AG	10-point Multi-touch	512GB SSD M.2	None	Intel 8260 ac, 2x2 + BT4.1	None	None	None	None	720p	Backlit	Pen Pro	Finger-print Reader	None	4-cell (52Wh)	65W	Win10 Pro 64	3-year, Depot	No	02/16

Model	Region	Processor	vPro	Graphics	Memory	Display	Multi-touch	Storage(HDD/SSD)	Optical	WLAN + Bluetooth	WWAN	SIM Card	Dock	Adapter	Camera	Keyboard	Pen	Finger-print Reader	NFC	Battery	Power Adapter	Operating System	Warranty	Global	Ann Date (m/y)
20FQ003KUS	US	i5-6300U	vPro	Intel HD 520	4GB Soldered	14" FHD (1920x1080) IPS AG	10-point Multi-touch	256GB SSD M.2 SATA3 Opal2	None	Intel 8260 ac, 2x2 + BT4.1	None	None	None	None	720p	Backlit	Pen Pro	Finger-print Reader	None	4-cell (52Wh)	65W	Win10 Pro 64	3-year, Depot	No	02/16
20FQ003LUS	US	i7-6600U	vPro	Intel HD 520	16GB Soldered	14" FHD (1920x1080) IPS AG	10-point Multi-touch	512GB SSD M.2 PCIe NVMe	None	Intel 8260 ac, 2x2 + BT4.1	None	None	None	None	720p	Backlit	Pen Pro	Finger-print Reader	None	4-cell (52Wh)	65W	Win10 Pro 64	3-year, Depot	No	02/16
20FQ003MUS	US	i7-6600U	vPro	Intel HD 520	16GB Soldered	14" WQHD (2560x1440) IPS AG	10-point Multi-touch	512GB SSD M.2 PCIe NVMe	None	Intel 8260 ac, 2x2 + BT4.1	None	None	None	None	720p	Backlit	Pen Pro	Finger-print Reader	None	4-cell (52Wh)	65W	Win10 Pro 64	3-year, Depot	No	02/16
20FQ003NUS	US	i5-6200U	No	Intel HD 520	4GB Soldered	14" FHD (1920x1080) IPS AG	10-point Multi-touch	256GB SSD M.2 SATA3 Opal2	None	Intel 8260 ac, 2x2 + BT4.1	None	None	None	None	720p	Backlit	Pen Pro	Finger-print Reader	None	4-cell (52Wh)	65W	Win10 Pro 64	3-year, Depot	No	02/16
20FQ003PUS	US	i5-6300U	vPro	Intel HD 520	8GB Soldered	14" FHD (1920x1080) IPS AG	10-point Multi-touch	180GB SSD M.2 SATA3 Opal2	None	Intel 8260 ac, 2x2 + BT4.1	None	None	None	None	720p	Backlit	Pen Pro	Finger-print Reader	None	4-cell (52Wh)	65W	Win10 Pro 64	3-year, Depot	No	02/16
20FQ003QUS	US	i5-6200U	No	Intel HD 520	8GB Soldered	14" FHD (1920x1080) IPS AG	10-point Multi-touch	256GB SSD M.2 SATA3 Opal2	None	Intel 8260 ac, 2x2 + BT4.1	None	None	None	None	720p	Backlit	Pen Pro	Finger-print Reader	None	4-cell (52Wh)	65W	Win10 Pro 64	3-year, Depot	No	02/16
20FQ003RUS	US	i5-6300U	vPro	Intel HD 520	8GB Soldered	14" FHD (1920x1080) IPS AG	10-point Multi-touch	128GB SSD M.2	None	Intel 8260 ac, 2x2 + BT4.1	None	None	None	None	720p	Backlit	Pen Pro	Finger-print Reader	None	4-cell (52Wh)	65W	Win10 Pro 64	3-year, Depot	No	02/16
20FQ003SUS	US	i7-6600U	vPro	Intel HD 520	16GB Soldered	14" FHD (1920x1080) IPS AG	10-point Multi-touch	256GB SSD M.2 PCIe NVMe Opal2	None	Intel 8260 ac, 2x2 + BT4.1	None	None	None	None	720p	Backlit	Pen Pro	Finger-print Reader	None	4-cell (52Wh)	65W	Win10 Pro 64	3-year, Depot	No	02/16
20FQ003TUS	US	i7-6600U	vPro	Intel HD 520	8GB Soldered	14" FHD (1920x1080) IPS AG	10-point Multi-touch	512GB SSD M.2	None	Intel 8260 ac, 2x2 + BT4.1	None	None	None	None	720p	Backlit	Pen Pro	Finger-print Reader	None	4-cell (52Wh)	65W	Win10 Pro 64	3-year, Depot	No	02/16
20FQ003UUS	US	i7-6600U	vPro	Intel HD 520	16GB Soldered	14" FHD (1920x1080) IPS AG	10-point Multi-touch	256GB SSD M.2 SATA3 Opal2	None	Intel 8260 ac, 2x2 + BT4.1	None	None	None	None	720p	Backlit	Pen Pro	Finger-print Reader	None	4-cell (52Wh)	65W	Win10 Pro 64	3-year, Depot	No	02/16
20FQ003VUS	US	i7-6600U	vPro	Intel HD 520	16GB Soldered	14" FHD (1920x1080) IPS AG	10-point Multi-touch	512GB SSD M.2	None	Intel 8260 ac, 2x2 + BT4.1	None	None	None	None	720p	Backlit	Pen Pro	Finger-print Reader	None	4-cell (52Wh)	65W	Win10 Pro 64	3-year, Depot	No	02/16
20FQ003WUS	US	i5-6300U	vPro	Intel HD 520	8GB Soldered	14" FHD (1920x1080) IPS AG	10-point Multi-touch	192GB SSD M.2	None	Intel 8260 ac, 2x2 + BT4.1	None	None	None	None	720p	Backlit	Pen Pro	Finger-print Reader	None	4-cell (52Wh)	65W	Win10 Pro 64	3-year, Depot	No	02/16
20FQ0054US	US	i7-6600U	vPro	Intel HD 520	16GB Soldered	14" WQHD (2560x1440) IPS AG	10-point Multi-touch	512GB SSD M.2	None	Intel 8260 ac, 2x2 + BT4.1	Sierra EM7455	Verizon	None	None	720p	Backlit	Pen Pro	Finger-print Reader	None	4-cell (52Wh)	65W	Win10 Pro 64	3-year, Depot	No	05/16
20FQ0055US	US	i5-6300U	vPro	Intel HD 520	8GB Soldered	14" WQHD (2560x1440) IPS AG	10-point Multi-touch	256GB SSD M.2 SATA3 Opal2	None	Intel 8260 ac, 2x2 + BT4.1	None	None	None	None	720p	Backlit	Pen Pro	Finger-print Reader	None	4-cell (52Wh)	65W	Win10 Pro 64	3-year, Depot	No	05/16
20FQ0056US	US	i7-6600U	vPro	Intel HD 520	16GB Soldered	14" WQHD (2560x1440) IPS AG	10-point Multi-touch	512GB SSD M.2	None	Intel 18260 ac, 2x2 + BT4.1	None	None	WiGig Dock	None	720p	Backlit	Pen Pro	Finger-print Reader	None	4-cell (52Wh)	65W	Win10 Pro 64	3-year, Depot	No	05/16
20FQ0057US	US	i7-6500U	No	Intel HD 520	8GB Soldered	14" WQHD (2560x1440) IPS AG	10-point Multi-touch	512GB SSD M.2	None	Intel 8260 ac, 2x2 + BT4.1	Sierra EM7455	None	None	None	720p	Backlit	Pen Pro	Finger-print Reader	None	4-cell (52Wh)	65W	Win10 Pro 64	3-year, Depot	No	05/16
20FQ0058US	US	i7-6500U	No	Intel HD 520	8GB Soldered	14" WQHD (2560x1440) IPS AG	10-point Multi-touch	256GB SSD M.2 PCIe NVMe Opal2	None	Intel 8260 ac, 2x2 + BT4.1	Sierra EM7455	None	None	None	720p	Backlit	Pen Pro	Finger-print Reader	None	4-cell (52Wh)	65W	Win10 Pro 64	3-year, Depot	No	05/16
20FQ0059US	US	i5-6200U	No	Intel HD 520	8GB Soldered	14" FHD (1920x1080) IPS AG	10-point Multi-touch	256GB SSD M.2 SATA3 Opal2	None	Intel 8260 ac, 2x2 + BT4.1	Sierra EM7455	None	None	None	720p	Backlit	Pen Pro	Finger-print Reader	None	4-cell (52Wh)	65W	Win10 Pro 64	3-year, Depot	No	05/16
20FQ005AUS	US	i5-6300U	vPro	Intel HD 520	8GB Soldered	14" WQHD (2560x1440) IPS AG	10-point Multi-touch	256GB SSD M.2 SATA3 Opal2	None	Intel 8260 ac, 2x2 + BT4.1	Sierra EM7455	None	None	None	720p	Backlit	Pen Pro	Finger-print Reader	None	4-cell (52Wh)	65W	Win10 Pro 64	3-year, Depot	No	05/16
20FQ005BUS	US	i7-6600U	vPro	Intel HD 520	8GB Soldered	14" WQHD (2560x1440) IPS AG	10-point Multi-touch	256GB SSD M.2 SATA3 Opal2	None	Intel 8260 ac, 2x2 + BT4.1	Sierra EM7455	None	None	None	720p	Backlit	Pen Pro	Finger-print Reader	None	4-cell (52Wh)	65W	Win10 Pro 64	3-year, Depot	No	05/16

Model	Region	Processor	vPro	Graphics	Memory	Display	Multi-touch	Storage(HDD/SSD)	Optical	WLAN + Bluetooth	WWAN	SIM Card	Dock	Adapter	Camera	Keyboard	Pen	Finger-print Reader	NFC	Battery	Power Adapter	Operating System	Warranty	Global	Ann Date (m/y)
20FQ005CUS	US	i7-6500U	No	Intel HD 520	8GB Soldered	14" FHD (1920x1080) IPS AG	10-point Multi-touch	256GB SSD M.2 SATA3 Opal2	None	Intel 8260 ac, 2x2 + BT4.1	Sierra EM7455	None	None	None	720p	Backlit	Pen Pro	Finger-print Reader	None	4-cell (52Wh)	65W	Win10 Pro 64	3-year, Depot	No	05/16
20FQ005DUS	US	i7-6600U	vPro	Intel HD 520	16GB Soldered	14" WQHD (2560x1440) IPS AG	10-point Multi-touch	512GB SSD M.2	None	Intel 8260 ac, 2x2 + BT4.1	Sierra EM7455	None	None	None	720p	Backlit	Pen Pro	Finger-print Reader	None	4-cell (52Wh)	65W	Win10 Pro 64	3-year, Depot	No	05/16
20FQ005EUS	US	i7-6600U	vPro	Intel HD 520	16GB Soldered	14" WQHD (2560x1440) IPS AG	10-point Multi-touch	512GB SSD M.2 PCIe NVMe	None	Intel 8260 ac, 2x2 + BT4.1	Sierra EM7455	None	None	None	720p	Backlit	Pen Pro	Finger-print Reader	None	4-cell (52Wh)	65W	Win10 Pro 64	3-year, Depot	No	05/16
20FQ005XUS	US	i7-6600U	vPro	Intel HD 520	8GB Soldered	14" WQHD (2560x1440) OLED Gloss	10-point Multi-touch	256GB SSD M.2 SATA3 Opal2	None	Intel 8260 ac, 2x2 + BT4.1	None	None	None	None	720p	Backlit	Pen Pro	Finger-print Reader	None	4-cell (56Wh)	65W	Win10 Pro 64	3-year, Depot	No	06/16
20FQ005YUS	US	i5-6300U	vPro	Intel HD 520	8GB Soldered	14" WQHD (2560x1440) OLED Gloss	10-point Multi-touch	256GB SSD M.2 SATA3 Opal2	None	Intel 8260 ac, 2x2 + BT4.1	None	None	None	None	720p	Backlit	Pen Pro	Finger-print Reader	None	4-cell (56Wh)	65W	Win10 Pro 64	3-year, Depot	No	06/16
20FQ0060US	US	i7-6600U	vPro	Intel HD 520	16GB Soldered	14" WQHD (2560x1440) OLED Gloss	10-point Multi-touch	512GB SSD M.2	None	Intel 8260 ac, 2x2 + BT4.1	None	None	None	None	720p	Backlit	Pen Pro	Finger-print Reader	None	4-cell (56Wh)	65W	Win10 Pro 64	3-year, Depot	No	06/16
20FQ0066US	US	i7-6600U	vPro	Intel HD 520	8GB Soldered	14" WQHD (2560x1440) IPS AG	10-point Multi-touch	256GB SSD M.2 SATA3 Opal2	None	Intel 18260 ac, 2x2 + BT4.1	None	None	WiGig Dock	None	720p	Backlit	Pen Pro	Finger-print Reader	None	4-cell (52Wh)	65W	Win10 Pro 64	3-year, Depot	No	07/16
20FQ0067US	US	i5-6300U	vPro	Intel HD 520	8GB Soldered	14" WQHD (2560x1440) IPS AG	10-point Multi-touch	256GB SSD M.2 SATA3 Opal2	None	Intel 18260 ac, 2x2 + BT4.1	None	None	WiGig Dock	None	720p	Backlit	Pen Pro	Finger-print Reader	None	4-cell (52Wh)	65W	Win10 Pro 64	3-year, Depot	No	07/16
20FQ006CUS	US	i5-6200U	No	Intel HD 520	8GB Soldered	14" FHD (1920x1080) IPS AG	10-point Multi-touch	180GB SSD M.2 SATA3 Opal2	None	Intel 8260 ac, 2x2 + BT4.1	None	None	None	None	720p	Backlit	Pen Pro	Finger-print Reader	None	4-cell (52Wh)	65W	Win10 Pro 64	1-year, Depot	No	08/16
20FQ006DUS	US	i5-6200U	No	Intel HD 520	8GB Soldered	14" FHD (1920x1080) IPS AG	10-point Multi-touch	256GB SSD M.2 SATA3 Opal2	None	Intel 8260 ac, 2x2 + BT4.1	None	None	None	None	720p	Backlit	Pen Pro	Finger-print Reader	None	4-cell (52Wh)	65W	Win10 Pro 64	1-year, Depot	No	08/16



ThinkPad X1 Yoga (2nd Gen) Platform

Product Specifications Reference (PSREF)

Processor	7th Generation Intel® Core™ i5 / i7 Processor	Smart card reader	None																																	
	<table border="1"> <thead> <tr> <th>Processor Number</th> <th># of Cores</th> <th># of Threads</th> <th>Base Frequency</th> <th>Max Turbo Frequency</th> <th>Cache</th> <th>Memory Types</th> <th>Processor Graphics</th> <th>vPro</th> </tr> </thead> <tbody> <tr> <td>i5-7200U</td> <td rowspan="4">2</td> <td rowspan="4">4</td> <td>2.5 GHz</td> <td>3.1 GHz</td> <td>3MB</td> <td rowspan="4">LPDDR3-1866</td> <td rowspan="4">Intel HD Graphics 620</td> <td>No</td> </tr> <tr> <td>i5-7300U</td> <td>2.6 GHz</td> <td>3.5 GHz</td> <td>3MB</td> <td>vPro</td> </tr> <tr> <td>i7-7500U</td> <td>2.7 GHz</td> <td>3.5 GHz</td> <td>4MB</td> <td>No</td> </tr> <tr> <td>i7-7600U</td> <td>2.8 GHz</td> <td>3.9 GHz</td> <td>4MB</td> <td>vPro</td> </tr> </tbody> </table>	Processor Number	# of Cores	# of Threads	Base Frequency	Max Turbo Frequency	Cache	Memory Types	Processor Graphics	vPro	i5-7200U	2	4	2.5 GHz	3.1 GHz	3MB	LPDDR3-1866	Intel HD Graphics 620	No	i5-7300U	2.6 GHz	3.5 GHz	3MB	vPro	i7-7500U	2.7 GHz	3.5 GHz	4MB	No	i7-7600U	2.8 GHz	3.9 GHz	4MB	vPro	Media reader	Micro SD, supports UHS-II SD card
Processor Number	# of Cores	# of Threads	Base Frequency	Max Turbo Frequency	Cache	Memory Types	Processor Graphics	vPro																												
i5-7200U	2	4	2.5 GHz	3.1 GHz	3MB	LPDDR3-1866	Intel HD Graphics 620	No																												
i5-7300U			2.6 GHz	3.5 GHz	3MB			vPro																												
i7-7500U			2.7 GHz	3.5 GHz	4MB			No																												
i7-7600U			2.8 GHz	3.9 GHz	4MB			vPro																												
Graphics	Intel HD Graphics 620 in processor only, supports external digital monitor via HDMI; supports dual independent displays; Max resolution: 4096x2160 (HDMI)@24Hz	Ports	Three USB 3.1 Gen 1 / USB 3.0 (one Always On), Mini RJ45, HDMI, two USB 3.1 Type-C Gen 2 / Thunderbolt 3 / PD 2 combo audio / microphone jack																																	
Chipset	Intel SoC (System on Chip) platform	WiGig dock Adapter (optional)	Mini RJ45-RJ45: Mini RJ45 to RJ45 adapter USB-C-VGA: USB-C to VGA adapter USB-C-DP: USB-C to DisplayPort adapter HDMI-VGA: Lenovo HDMI to VGA Monitor Cable																																	
Memory	16GB max / 1866MHz LPDDR3 / soldered to systemboard	Camera (optional)	720p: HD720p resolution, fixed focus IR & 720p: IR camera and HD720p camera (Narrow Bezel FHD panels only)																																	
Display	<p>Some: 14.0" (355mm) WQHD (2560x1440), glossy / anti-reflection, OLED, 300 nits, 16:9 aspect ratio, 54000:1 contrast ratio</p> <p>Some: 14.0" (355mm) WQHD (2560x1440), glossy / anti-reflection, LED backlight, 270 nits, 16:9 aspect ratio, 700:1 contrast ratio, IPS</p> <p>Some: 14.0" (355mm) FHD (1920x1080), glossy / anti-reflection, LED backlight, 270 nits, 16:9 aspect ratio, 700:1 contrast ratio, IPS</p> <p>Some: 14.0" (355mm) FHD (1920x1080), glossy / anti-reflection, LED backlight, 270 nits, 16:9 aspect ratio, 700:1 contrast ratio (Narrow Bezel FHD panel), IPS</p>	Audio support	HD Audio, Conexant® CX11771 codec, Dolby® Audio Premium / stereo speakers, 2W x 2 / dual array microphone, combo audio / microphone jack																																	
Multi-touch	Capacitive touch panel, supports 10-finger gesture	Keyboard	6-row wave keyboard (rise & fall), spill-resistant, multimedia Fn keys, LED backlit																																	
Hinge	Yoga hinge, 360 degree	UltraNav™	TrackPoint® pointing device and multi-touch with 3+2 buttons click pad, multi-touch																																	
Convert-mode	Laptop, tent, stand, and tablet	Security	Power-on password, hard disk password, supervisor password, security keyhole																																	
Pen (optional)	ThinkPad Pen Pro, active pen for multi-touch display	Security chip	Discrete TPM 2.0 TCG Certified																																	
Storage	<p>Some: M.2 SSD / SATA 6.0Gb/s</p> <p>Some: M.2 SSD / PCIe NVMe, PCIe 3.0 x 4, 32Gb/s</p>	vPro (optional)	Intel vPro Technology																																	
Optical	None	Fingerprint reader	Touch style fingerprint reader on the keyboard bezel																																	
Ethernet	Gigabit Ethernet via Mini RJ45 (by native Intel Ethernet Connection I219-V (Non-vPro) or I219-LM (vPro))	NFC (optional)	Near Field Communication																																	
WLAN	<p>One of the following, configurable by model (WiGig is mutually exclusive with WWAN):</p> <ul style="list-style-type: none"> Intel Dual Band Wireless-AC 8265, Wi-Fi 2x2, 802.11ac + BT4.1, M.2 Card Intel Tri-Band Wireless-AC 18265, WiGig™ 802.11ad + Wi-Fi 2x2, 802.11ac + BT4.1, M.2 Card 	Battery type	Li-Polymer 4-cell (56Wh)																																	
Bluetooth™	<p>*WiGig adapter is only available in selected countries*</p> <p>Bluetooth wireless, integrated in Wi-Fi + Bluetooth combo adapter</p> <p>*Intel Wi-Fi card supports Bluetooth 4.2 but is limited to BT 4.1 by Windows OS</p>	Battery life	Up to 15.5 hr																																	
WWAN (optional)	<p>One of the following, configurable by model (mutually exclusive with WiGig):</p> <ul style="list-style-type: none"> Wireless WAN, Sierra Wireless EM7455, Qualcomm® 4G LTE-Advanced/DC-HSPA+/HSPA+/HSPA/UMTS/GNSS, M.2 card 	AC adapter	<p>Some: 45-watt USB Type-C adapter</p> <p>Some: 65-watt USB Type-C adapter</p>																																	
SIM card	Micro-SIM card slot, Lenovo Connect (WE) SIM card	Light sensor	Ambient Light Sensor																																	
Dimensions	WxDxH: 13.11" x 9.02" x 0.69"; 333mm x 229mm x 17.4mm	G-sensor	3D accelerometer and 3D magnetometer																																	
Weight	From 2.99 lb (1.36kg) for OLED model; 3.15 lb (1.42kg) for other model	Compass	3D compass																																	
Case color	Black or silver	Gyroscope	3D gyrometer																																	
Case material	Carbon-Fiber Hybrid	Preload	<p>Some: Windows 10 Pro 64</p> <p>Some: Windows 10 Home 64</p> <ul style="list-style-type: none"> Lenovo Companion Lenovo Settings Microsoft Office preloaded; purchase a product key to activate McAfee® Live Safe (30-day trial) 																																	
		Limited warranty	<p>One of the following, configurable by model:</p> <ul style="list-style-type: none"> 1-year depot repair service 3-year/1-yr battery depot repair service 3-year/1-yr battery limited onsite service 																																	
		Mil-Spec test	MIL-STD-810G military certification																																	
		Environment	EPEAT™ Gold; ENERGY STAR®; RoHS-compliant																																	

ThinkPad X1 Yoga (2nd Gen) - TopSeller - 20JD

Product Specifications Reference (PSREF)

Model	Region	Processor	vPro	Graphics	Memory	Display	Multi-touch	Storage(HDD/SSD)	WLAN + Bluetooth	WWAN	SIM Card	Dock	Adapter	Color	Camera	Keyboard	Pen	Finger-print Reader	NFC	Power Adapter	Operating System	Warranty	Global	Ann Date (m/y)
20JD000PUS	US	i5-7300U	vPro	Intel HD 620	8GB Soldered	14" FHD (1920x1080) IPS NB	10-point Multi-touch	256GB SSD M.2 PCIe NVMe Opal2	Intel 8265 ac, 2x2 + BT4.1	None	None	None	None	Black	720p	Backlit	Pen Pro	Finger-print Reader	None	65W	Win10 Pro 64	3-year, Depot	No	04/17
20JD000QUS	US	i7-7600U	vPro	Intel HD 620	8GB Soldered	14" FHD (1920x1080) IPS NB	10-point Multi-touch	256GB SSD M.2 PCIe NVMe Opal2	Intel 8265 ac, 2x2 + BT4.1	None	None	None	None	Black	720p	Backlit	Pen Pro	Finger-print Reader	None	65W	Win10 Pro 64	3-year, Depot	No	04/17
20JD000RUS	US	i5-7300U	vPro	Intel HD 620	8GB Soldered	14" FHD (1920x1080) IPS Gloss	10-point Multi-touch	256GB SSD M.2 PCIe NVMe Opal2	Intel 8265 ac, 2x2 + BT4.1	Sierra EM7455	None	None	None	Black	720p	Backlit	Pen Pro	Finger-print Reader	None	65W	Win10 Pro 64	3-year, Depot	No	04/17
20JD000SUS	US	i7-7600U	vPro	Intel HD 620	16GB Soldered	14" WQHD (2560x1440) IPS Gloss	10-point Multi-touch	512GB SSD M.2 PCIe NVMe Opal2	Intel 8265 ac, 2x2 + BT4.1	Sierra EM7455	None	None	None	Black	720p	Backlit	Pen Pro	Finger-print Reader	None	65W	Win10 Pro 64	3-year, Depot	No	04/17
20JD000TUS	US	i7-7600U	vPro	Intel HD 620	16GB Soldered	14" WQHD (2560x1440) IPS Gloss	10-point Multi-touch	512GB SSD M.2 PCIe NVMe Opal2	Intel 8265 ac, 2x2 + BT4.1	None	None	None	None	Black	720p	Backlit	Pen Pro	Finger-print Reader	None	65W	Win10 Pro 64	3-year, Depot	No	04/17
20JD000UUS	US	i5-7300U	vPro	Intel HD 620	16GB Soldered	14" FHD (1920x1080) IPS NB	10-point Multi-touch	256GB SSD M.2 PCIe NVMe Opal2	Intel 8265 ac, 2x2 + BT4.1	None	None	None	None	Black	720p	Backlit	Pen Pro	Finger-print Reader	None	65W	Win10 Pro 64	3-year, Depot	No	04/17
20JD000VUS	US	i7-7600U	vPro	Intel HD 620	8GB Soldered	14" WQHD (2560x1440) IPS Gloss	10-point Multi-touch	512GB SSD M.2 PCIe NVMe Opal2	Intel 8265 ac, 2x2 + BT4.1	None	None	None	None	Black	720p	Backlit	Pen Pro	Finger-print Reader	None	65W	Win10 Pro 64	3-year, Depot	No	04/17
20JD000WUS	US	i7-7600U	vPro	Intel HD 620	16GB Soldered	14" WQHD (2560x1440) OLED Gloss	10-point Multi-touch	512GB SSD M.2 PCIe NVMe Opal2	Intel 8265 ac, 2x2 + BT4.1	None	None	None	None	Black	720p	Backlit	Pen Pro	Finger-print Reader	None	65W	Win10 Pro 64	3-year, Depot	No	04/17
20JD000XUS	US	i5-7200U	No	Intel HD 620	8GB Soldered	14" WQHD (2560x1440) IPS Gloss	10-point Multi-touch	512GB SSD M.2 PCIe NVMe Opal2	Intel 8265 ac, 2x2 + BT4.1	None	None	None	None	Black	720p	Backlit	Pen Pro	Finger-print Reader	None	65W	Win10 Pro 64	3-year, Depot	No	04/17
20JD000YUS	US	i5-7300U	vPro	Intel HD 620	16GB Soldered	14" FHD (1920x1080) IPS Gloss	10-point Multi-touch	256GB SSD M.2 PCIe NVMe Opal2	Intel 8265 ac, 2x2 + BT4.1	Sierra EM7455	None	None	None	Black	720p	Backlit	Pen Pro	Finger-print Reader	None	65W	Win10 Pro 64	3-year, Depot	No	04/17
20JD0015US	US	i5-7200U	No	Intel HD 620	8GB Soldered	14" FHD (1920x1080) IPS NB	10-point Multi-touch	256GB SSD M.2 PCIe NVMe Opal2	Intel 8265 ac, 2x2 + BT4.1	None	None	None	None	Black	720p	Backlit	Pen Pro	Finger-print Reader	None	65W	Win10 Pro 64	3-year, Depot	No	04/17
20JD0022US	US	i5-7200U	No	Intel HD 620	8GB Soldered	14" FHD (1920x1080) IPS NB	10-point Multi-touch	180GB SSD M.2 SATA3 Opal2	Intel 8265 ac, 2x2 + BT4.1	None	None	None	None	Black	720p	Backlit	Pen Pro	Finger-print Reader	None	65W	Win10 Pro 64	3-year, Depot	No	05/17
20JD004UUS	US	i7-7500U	No	Intel HD 620	8GB Soldered	14" WQHD (2560x1440) IPS Gloss	10-point Multi-touch	512GB SSD M.2 PCIe NVMe Opal2	Intel 8265 ac, 2x2 + BT4.1	None	None	None	None	Black	720p	Backlit	Pen Pro	Finger-print Reader	None	65W	Win10 Pro 64	3-year, Depot	No	05/17
20JD004VUS	US	i5-7300U	vPro	Intel HD 620	8GB Soldered	14" FHD (1920x1080) IPS NB	10-point Multi-touch	180GB SSD M.2 SATA3 Opal2	Intel 8265 ac, 2x2 + BT4.1	None	None	None	None	Black	720p	Backlit	Pen Pro	Finger-print Reader	None	65W	Win10 Pro 64	3-year, Depot	No	05/17

ThinkPad X1 Yoga (2nd Gen) - TopSeller - 20JF

Product Specifications Reference (PSREF)

Model	Region	Processor	vPro	Graphics	Memory	Display	Multi-touch	Storage(HDD/SSD)	WLAN + Bluetooth	WWAN	SIM Card	Dock	Adapter	Color	Camera	Keyboard	Pen	Finger-print Reader	NFC	Power Adapter	Operating System	Warranty	Global	Ann Date (m/y)
20JF000BUS	US	i5-7200U	No	Intel HD 620	8GB Soldered	14" FHD (1920x1080) IPS NB	10-point Multi-touch	256GB SSD M.2 PCIe NVMe Opal2	Intel 8265 ac, 2x2 + BT4.1	None	None	None	None	Silver	720p	Backlit Silver	Pen Pro	Finger-print Reader	None	65W	Win10 Pro 64	3-year, Depot	No	04/17
20JF000CUS	US	i5-7300U	vPro	Intel HD 620	16GB Soldered	14" FHD (1920x1080) IPS Gloss	10-point Multi-touch	256GB SSD M.2 PCIe NVMe Opal2	Intel 8265 ac, 2x2 + BT4.1	Sierra EM7455	None	None	None	Silver	720p	Backlit Silver	Pen Pro	Finger-print Reader	None	65W	Win10 Pro 64	3-year, Depot	No	04/17
20JF000DUS	US	i7-7600U	vPro	Intel HD 620	16GB Soldered	14" WQHD (2560x1440) IPS Gloss	10-point Multi-touch	512GB SSD M.2 PCIe NVMe Opal2	Intel 8265 ac, 2x2 + BT4.1	None	None	None	None	Silver	720p	Backlit Silver	Pen Pro	Finger-print Reader	None	65W	Win10 Pro 64	3-year, Depot	No	04/17
20JF000EUS	US	i7-7600U	vPro	Intel HD 620	8GB Soldered	14" FHD (1920x1080) IPS NB	10-point Multi-touch	256GB SSD M.2 PCIe NVMe Opal2	Intel 8265 ac, 2x2 + BT4.1	None	None	None	None	Silver	720p	Backlit Silver	Pen Pro	Finger-print Reader	None	65W	Win10 Pro 64	3-year, Depot	No	04/17
20JF000FUS	US	i5-7300U	vPro	Intel HD 620	16GB Soldered	14" FHD (1920x1080) IPS NB	10-point Multi-touch	256GB SSD M.2 PCIe NVMe Opal2	Intel 8265 ac, 2x2 + BT4.1	None	None	None	None	Silver	720p	Backlit Silver	Pen Pro	Finger-print Reader	None	65W	Win10 Pro 64	3-year, Depot	No	04/17
20JF000GUS	US	i5-7300U	vPro	Intel HD 620	8GB Soldered	14" FHD (1920x1080) IPS Gloss	10-point Multi-touch	256GB SSD M.2 PCIe NVMe Opal2	Intel 8265 ac, 2x2 + BT4.1	Sierra EM7455	None	None	None	Silver	720p	Backlit Silver	Pen Pro	Finger-print Reader	None	65W	Win10 Pro 64	3-year, Depot	No	04/17
20JF000HUS	US	i7-7600U	vPro	Intel HD 620	16GB Soldered	14" WQHD (2560x1440) OLED Gloss	10-point Multi-touch	512GB SSD M.2 PCIe NVMe Opal2	Intel 8265 ac, 2x2 + BT4.1	None	None	None	None	Silver	720p	Backlit Silver	Pen Pro	Finger-print Reader	None	65W	Win10 Pro 64	3-year, Depot	No	04/17
20JF000JUS	US	i7-7600U	vPro	Intel HD 620	8GB Soldered	14" WQHD (2560x1440) IPS Gloss	10-point Multi-touch	512GB SSD M.2 PCIe NVMe Opal2	Intel 8265 ac, 2x2 + BT4.1	None	None	None	None	Silver	720p	Backlit Silver	Pen Pro	Finger-print Reader	None	65W	Win10 Pro 64	3-year, Depot	No	04/17
20JF000KUS	US	i5-7200U	No	Intel HD 620	8GB Soldered	14" WQHD (2560x1440) IPS Gloss	10-point Multi-touch	512GB SSD M.2 PCIe NVMe Opal2	Intel 8265 ac, 2x2 + BT4.1	None	None	None	None	Silver	720p	Backlit Silver	Pen Pro	Finger-print Reader	None	65W	Win10 Pro 64	3-year, Depot	No	04/17
20JF000LUS	US	i5-7300U	vPro	Intel HD 620	8GB Soldered	14" FHD (1920x1080) IPS NB	10-point Multi-touch	256GB SSD M.2 PCIe NVMe Opal2	Intel 8265 ac, 2x2 + BT4.1	None	None	None	None	Silver	720p	Backlit Silver	Pen Pro	Finger-print Reader	None	65W	Win10 Pro 64	3-year, Depot	No	04/17
20JF000MUS	US	i7-7600U	vPro	Intel HD 620	16GB Soldered	14" WQHD (2560x1440) IPS Gloss	10-point Multi-touch	512GB SSD M.2 PCIe NVMe Opal2	Intel 8265 ac, 2x2 + BT4.1	Sierra EM7455	None	None	None	Silver	720p	Backlit Silver	Pen Pro	Finger-print Reader	None	65W	Win10 Pro 64	3-year, Depot	No	04/17



ThinkPad Yoga 11e (3rd Gen) Platform Specifications

Product Specifications Reference (PSREF)

Processor	Intel® Celeron® processor, Intel Pentium® Processor, or 6th Generation Intel Core™ i3 Processor								Media reader	4-in-1 reader (MMC, SD, SDHC, SDXC)	
	Processor Number	# of Cores	# of Threads	Base Frequency	Burst Frequency	Cache	Memory Types	Processor Graphics	Ports	Two USB 3.0, HDMI, Ethernet (RJ-45)	
	Cel N3150	4	4	1.6 GHz	2.08 GHz	2MB	DDR3L-1600	Intel HD graphics	Control buttons	Power button, volume control button	
	Cel N3160	4	4	1.6 GHz	2.24 GHz	2MB		Intel HD graphics	Camera	Audio support	HD720p resolution, low light sensitive, fixed focus HD Audio, Realtek® ALC3245 codec / stereo speakers, 2W x 2 / monaural digital microphone, combo audio/microphone jack
	Pen 4405U	2	4	2.1 GHz	-	2MB		Intel HD graphics 510			
i3-6100U	2.3 GHz			-	3MB	Intel HD graphics 520					
Graphics	Intel HD Graphics, Intel HD Graphics 510, or Intel HD Graphics 520 in processor, supports external digital monitor via HDMI™; supports dual independent display; Max resolution: 1920X1080 (HDMI) @30Hz								Security	Power-on password, hard disk password, supervisor password, security keyhole	
Chipset	Intel SoC (System on Chip) platform								Security chip	Trusted Platform Module, TCG 1.2-compliant	
Memory	2GB, 4GB, or 8GB / PC3-12800 1600MHz DDR3L, one DDR3L SO-DIMM socket								vPro	None	
Display	11.6" (295mm) HD (1366x768), glare, LED backlight, IPS 250 nits, 16:9 aspect ratio, 800:1 contrast ratio								Fingerprint reader	None	
MultiTouch	Yes, support 10 fingers								Battery	Integrated Lithium Polymer 3-cell (42Wh)	
Hinge	Yoga hinge, 360 degree										Max battery life ¹⁰
Convertible mode	Laptop, tent, stand and tablet								AC adapter	45-watt AC adapter	
Pen	Some: Active pen, batteries required								Preload	Some: Windows 10 Home 64 Some: Windows 10 Pro 64 • Lenovo Solution Center • Lenovo Companion • Lenovo Setting • Microsoft Office preloaded; purchase a product key to activate • McAfee® LiveSafe™ (30-day trial)	
Storage	M.2 Solid State Drive (SSD), SATA 6.0Gb/s										
Optical	None										
Ethernet	Realtek RTL8111GUS-CG Gigabit Network Connection										
WLAN ⁴	One of the following, configurable by model: • 11ac+BT, Intel Dual Band Wireless-AC 3165, 1x1, M.2 card • 11ac+BT, Intel Dual Band Wireless-AC 7265, 2x2, M.2 card										
Bluetooth™	Bluetooth 4.0 wireless, integrated in Wi-Fi + Bluetooth combo adapter								Limited warranty ¹²	One of the following, configurable by model: • 1-year depot repair service • 3-year/1-yr battery depot repair service (US only)	
WWAN	None								Mil-Spec test	MIL-STD-810G military certification	
Dimensions ³	WxDxH: 11.81" x 8.27" x 0.90"; 300mm x 210mm x 22.9mm								Environment	EPEAT™ Gold (US only); ENERGY STAR® 6.1; RoHS-compliant	
Weight ²	from 3.5 lb (1.59kg)										
Case color	Display cover: Graphite Black or Silver;				Bottom: Graphite Black						
Case material	Display cover: PC+40%GF+TPU;				Bottom: PCC						

ThinkPad Yoga 11e (3rd Gen) - TopSeller - 20GA

Product Specifications Reference (PSREF)

Model	Region	Processor	Graphics	Memory	Display	Multi-touch	Storage	Optical	WLAN + Bluetooth	Color	Camera	Pen	Finger-print Reader	Battery	Power Adapter	Operating System	Warranty	Global	Ann Date (m/y)
20GA000KUS	US	Celeron N3150	Intel HD	4GBx1	11.6" HD (1366x768) IPS	10-point Multi-touch	128GB SSD	None	Intel 7265 ac, 2x2 + BT4.0	Black	720p	None	None	3-cell (42Wh)	45W	Windows 10 Pro 64	1-year, Depot	No	03/16
20GA000LUS	US	Celeron N3150	Intel HD	8GBx1	11.6" HD (1366x768) IPS	10-point Multi-touch	128GB SSD	None	Intel 7265 ac, 2x2 + BT4.0	Black	720p	None	None	3-cell (42Wh)	45W	Windows 10 Pro 64	1-year, Depot	No	03/16
20GA000MUS	US	i3-6100U	Intel HD 520	8GBx1	11.6" HD (1366x768) IPS	10-point Multi-touch	128GB SSD	None	Intel 7265 ac, 2x2 + BT4.0	Black	720p	None	None	3-cell (42Wh)	45W	Windows 10 Pro 64	1-year, Depot	No	03/16
20GA000NUS	US	i3-6100U	Intel HD 520	8GBx1	11.6" HD (1366x768) IPS	10-point Multi-touch	256GB SSD Opal2	None	Intel 7265 ac, 2x2 + BT4.0	Black	720p	None	None	3-cell (42Wh)	45W	Windows 10 Pro 64	1-year, Depot	No	03/16
20GA000QUS	US	i3-6100U	Intel HD 520	8GBx1	11.6" HD (1366x768) IPS	10-point Multi-touch	192GB SSD	None	Intel 7265 ac, 2x2 + BT4.0	Black	720p	None	None	3-cell (42Wh)	45W	Windows 10 Pro 64	1-year, Depot	No	03/16
20GA000YUS	US	i3-6100U	Intel HD 520	4GBx1	11.6" HD (1366x768) IPS	10-point Multi-touch	192GB SSD	None	Intel 7265 ac, 2x2 + BT4.0	Black	720p	None	None	3-cell (42Wh)	45W	Windows 10 Pro 64	1-year, Depot	No	03/16
20GA001EUS	US	Celeron N3160	Intel HD	8GBx1	11.6" HD (1366x768) IPS	10-point Multi-touch	128GB SSD	None	Intel 7265 ac, 2x2 + BT4.0	Black	720p	None	None	3-cell (42Wh)	45W	Windows 10 Pro 64	1-year, Depot	No	09/16
20GA001FUS	US	Celeron N3160	Intel HD	4GBx1	11.6" HD (1366x768) IPS	10-point Multi-touch	128GB SSD	None	Intel 7265 ac, 2x2 + BT4.0	Black	720p	None	None	3-cell (42Wh)	45W	Windows 10 Pro 64	1-year, Depot	No	09/16



ThinkPad Yoga 11e (4th Gen) Platform Specifications

Product Specifications Reference (PSREF)

Processor	Intel® Celeron® processor, or 7th Generation Intel Core™ i3 / i5 Processor							Media reader	4-in-1 reader (MMC, SD, SDHC, SDXC)	
	Processor Number	# of Cores	# of Threads	Base Frequency	Burst Frequency	Cache	Memory Controller	Processor Graphics	Ports	Two USB 3.1 Gen 1 / USB 3.0, HDMI, Ethernet (RJ-45)
	Cel N3450	4	4	1.1 GHz	2.2 GHz	2MB	DDR3L-1866	Intel HD graphics 500	Control buttons	Power button, volume control button
	i3-7100U	2	4	2.4 GHz	-	3MB	DDR4-2133	Intel HD graphics 620	Camera	HD720p resolution, low light sensitive, fixed focus
i5-7200U	2.5 GHz			3.1 GHz	3MB	Audio support			HD Audio, Realtek® ALC3268 codec / stereo speakers, 2W x 2 / monaural microphone, combo audio/microphone jack	
Graphics	Intel HD Graphics 500, or Intel HD Graphics 620 in processor, supports external digital monitor via HDMI™; supports dual independent display; Max resolution: 1920X1080 (HDMI) @30Hz							Keyboard	ThinkPad Windows keyboard, 6-row, multimedia Fn keys	
Chipset	Intel SoC (System on Chip) platform 4GB or 8GB / 1600MHz DDR3L or 2133MHz DDR4, one DDR3L or DDR4 SO-DIMM socket * System clocks down for processors with lower memory controller							UltraNav™	Two buttons click pad below keyboard, multi-touch	
								Security	Power-on password, hard disk password, supervisor password, security keyhole	
Memory								Security chip	Discrete TPM 2.0, TCG Certified	
Display	11.6" (295mm) HD (1366x768), anti-glare, LED backlight, IPS 250 nits, 16:9 aspect ratio, 800:1 contrast ratio							vPro	None	
								Fingerprint reader	None	
MultiTouch	Yes, support 10 fingers							Battery	Integrated Lithium Polymer 3-cell (42Wh)	
Hinge	Yoga hinge, 360 degree							Max battery life	MobileMark® 2014: 11 hr	
Convertible mode	Laptop, tent, stand and tablet							AC adapter	45-watt AC adapter	
Pen	Some: Active pen, batteries required							Preload	Some: Windows 10 Home 64 Some: Windows 10 Pro 64 • Lenovo Connect • Lenovo Companion • Lenovo Setting • Microsoft Office preloaded; purchase a product key to activate	
Storage	M.2 Solid State Drive (SSD), SATA 6.0Gb/s							Limited warranty	One of the following, configurable by model: • 1-year depot repair service • 3-year depot repair service	
Optical	None							Mil-Spec test	MIL-STD-810G military certification	
Ethernet	Realtek RTL8111GUS-CG Gigabit Network Connection							Environment	EPEAT™ Gold; ENERGY STAR® 6.1; RoHS-compliant	
WLAN	One of the following, configurable by model: • 11ac+BT, QCA NFA435, 1x1, M.2 card • 11ac+BT, Intel Dual Band Wireless-AC 7265, 2x2, M.2 card									
Bluetooth™	Bluetooth 4.1 wireless, integrated in Wi-Fi + Bluetooth combo adapter *Intel 7265ac card supports Bluetooth 4.2 but is limited to BT 4.1 by Windows OS									
WWAN	None									
Dimensions	WxDxH: 11.81" x 8.27" x 0.90"; 300mm x 210mm x 22.9mm									
Weight	from 3.5 lb (1.59kg)									
Case color	Display cover: Graphite Black;			Bottom: Graphite Black						
Case material	Display cover: PC+40%GF+TPU;			Bottom: PC+ABS						

ThinkPad Yoga 11e (4th Gen) - TopSeller - 20HU

Product Specifications Reference (PSREF)

Model	Product	Region	Processor	Graphics	Memory	Display	Multi-touch	Color	Storage	Optical	WLAN + Bluetooth	Camera	Pen	Fingerprint Reader	Battery	Power Adapter	Operating System	Warranty	Global	Ann Date (mm/yy)
20HU0000US	ThinkPad Yoga 11e (4th Gen)	US	i3-7100U	Intel HD 620	8GBx1	11.6" HD (1366x768) IPS	10-point Multi-touch	Black	128GB SSD	None	Intel 7265 ac, 2x2 + BT4.1	720p	None	None	3-cell (42Wh)	45W	Windows 10 Pro 64	1-year, Depot	No	03/17
20HU0001US	ThinkPad Yoga 11e (4th Gen)	US	i3-7100U	Intel HD 620	8GBx1	11.6" HD (1366x768) IPS	10-point Multi-touch	Black	256GB SSD Opal2	None	Intel 7265 ac, 2x2 + BT4.1	720p	None	None	3-cell (42Wh)	45W	Windows 10 Pro 64	1-year, Depot	No	03/17
20HU0003US	ThinkPad Yoga 11e (4th Gen)	US	Celeron N3450	Intel HD 500	4GBx1	11.6" HD (1366x768) IPS	10-point Multi-touch	Black	128GB SSD	None	Intel 7265 ac, 2x2 + BT4.1	720p	None	None	3-cell (42Wh)	45W	Windows 10 Pro 64	1-year, Depot	No	03/17
20HU0004US	ThinkPad Yoga 11e (4th Gen)	US	Celeron N3450	Intel HD 500	8GBx1	11.6" HD (1366x768) IPS	10-point Multi-touch	Black	128GB SSD	None	Intel 7265 ac, 2x2 + BT4.1	720p	None	None	3-cell (42Wh)	45W	Windows 10 Pro 64	1-year, Depot	No	03/17



ThinkPad Yoga 11e Chromebook (3rd Gen) Platform Specifications

Product Specifications Reference (PSREF)

Processor	Intel® Celeron® processor							Dimensions ³ Weight ² Case color Case material	WxDxH: 11.81" x 8.27" x 0.88"; 300mm x 210mm x 22.3mm from 3.3 lb (1.50kg) Display cover: Graphite Black or Silver; Bottom: Graphite Black Display cover: PC+40%GF+TPU; Bottom: PCC	
	Processor Number	# of Cores	# of Threads	Base Frequency	Burst Frequency	Cache	Memory Types			Processor Graphics
	Cel N3150	4	4	1.6 GHz	2.08 GHz	2MB	LPDDR3-1600			Intel HD graphics
	Cel N3160	4	4	1.6 GHz	2.24 GHz	2MB	LPDDR3-1600	Intel HD graphics		
Graphics	Intel HD Graphics in processor, supports external digital monitor via HDMI™; supports dual independent display; Max resolution: 1920X1080 (HDMI) @30Hz							Media reader	4-in-1 reader (MMC, SD, SDHC, SDXC)	
								Ports	Two USB 3.0 (one Always On), HDMI	
								Control buttons	Power button, volume control button	
								Camera	HD720p resolution, low light sensitive, fixed focus	
								Audio support	Realtek® ALC5650 codec / stereo speakers, 2W x 2 / monaural digital microphone, combo audio/microphone jack	
Chipset	Intel SoC (System on Chip) platform							Keyboard	ThinkPad Chrome keyboard, 6-row, multimedia Fn keys	
Memory	2GB or 4GB / 1600MHz LPDDR3 / soldered to systemboard, no sockets							UltraNav™	Buttonless touchpad below keyboard, multi-touch	
Display	11.6" (295mm) HD (1366x768), glare, LED backlight, IPS 200 nits, 16:9 aspect ratio, 800:1 contrast ratio							Security	Security keyhole	
MultiTouch	Yes, support 10 fingers							Security chip	Trusted Platform Module, TCG 1.2-compliant	
Hinge	Yoga hinge, 360 degree							vPro	None	
Convertible mode	Laptop, tent, stand and tablet							Fingerprint reader	None	
Pen	None							Battery	Integrated Lithium Polymer 3-cell (42Wh)	
Storage	16GB eMMC (embedded Multi Media Card) flash memory on board							Max battery life ¹⁰	Up to 12 hr	
Optical	None							AC adapter	45-watt AC adapter	
Ethernet	None							Preload	Google Chrome OS	
WLAN ⁴	11ac+BT, Intel Dual Band Wireless-AC 7265, 2x2, M.2 card							Limited warranty ¹²	1-year depot repair service	
Bluetooth™	Bluetooth 4.0 wireless, integrated in Wi-Fi + Bluetooth combo adapter							Mil-Spec test	MIL-STD-810G military certification	
WWAN	None							Environment	EPEAT™ Gold (US only); ENERGY STAR® 6.1; RoHS-compliant	

ThinkPad Yoga 11e Chromebook (3rd Gen) - TopSeller - 20GE

Product Specifications Reference (PSREF)

Model	Region	Processor	Graphics	Memory	Display	Multi-touch	Storage	Optical	WLAN + Bluetooth	Color	Camera	Pen	Finger-print Reader	Battery	Power Adapter	Operating System	Warranty	Global	Ann Date (m/y)
20GE0002US	US	Celeron N3150	Intel HD	4GBx1	11.6" HD (1366x768) IPS	10-point Multi-touch	16GB eMMC	None	Intel 7265 ac, 2x2 + BT4.0	Black	720p	None	None	3-cell (42Wh)	45W	Chrome OS	1-year, Depot	No	03/16
20GE0003US	US	Celeron N3160	Intel HD	4GBx1	11.6" HD (1366x768) IPS	10-point Multi-touch	16GB eMMC	None	Intel 7265 ac, 2x2 + BT4.0	Black	720p	None	None	3-cell (42Wh)	45W	Chrome OS	1-year, Depot	No	10/16

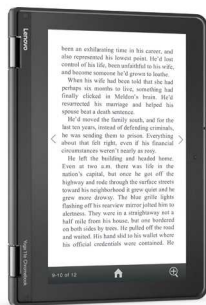

ThinkPad Yoga 11e Chromebook (4th Gen) Platform Specifications

Product Specifications Reference (PSREF)

Processor	Intel® Celeron® processor								Media reader	3-in-1 reader (SD, SDHC, SDXC)
	Processor Number	# of Cores	# of Threads	Base Frequency	Burst Frequency	Cache	Memory Controller	Processor Graphics	Ports	Two USB 3.1 Type-C Gen 1, one USB 3.1 Gen 1 / USB 3.0
	Cel N3450	4	4	1.1 GHz	2.2 GHz	2MB	LPDDR4-2400	Intel HD graphics 500	Control buttons	Power button, volume control button
Graphics	Intel HD Graphics 500 in processor								Camera	HD720p resolution, low light sensitive, fixed focus
Chipset	Intel SoC (System on Chip) platform								Audio support	HD Audio, DA7219 codec / stereo speakers, 2W x 2 / monaural microphone, combo audio/microphone jack
Memory	4GB or 8GB 3200MHz LPDDR4 / soldered to systemboard, no sockets * System clocks down for processors with lower memory controller								Keyboard	ThinkPad Chrome keyboard, 6-row, multimedia Fn keys
Display	11.6" (295mm) HD (1366x768), anti-glare, LED backlight, IPS 250 nits, 16:9 aspect ratio, 800:1 contrast ratio								UltraNav™	Two buttons click pad below keyboard, multi-touch
MultiTouch	Yes, support 10 fingers								Security	Power-on password, hard disk password, supervisor password, security keyhole
Hinge	Yoga hinge, 360 degree								Security chip	None
Convertible mode	Laptop, tent, stand and tablet								vPro	None
Pen	Some: Active pen, batteries required								Fingerprint reader	None
Storage	32GB eMMC (embedded Multi Media Card) flash memory on board								Battery	Integrated Lithium Polymer 3-cell (42Wh)
Optical	None								Max battery life	Up to 10 hr
Ethernet	None								AC adapter	45-watt USB Type-C adapter
WLAN	11ac+BT, Intel Dual Band Wireless-AC 7265, 2x2, M.2 card								Preload	Google Chrome OS
Bluetooth™	Bluetooth 4.2 wireless, integrated in Wi-Fi + Bluetooth combo adapter								Limited warranty	• 1-year depot repair service
WWAN	None								Mil-Spec test	MIL-STD-810G military certification
Dimensions	WxDxH: 11.81" x 8.27" x 0.92"; 300mm x 210mm x 23.4mm								Environment	EPEAT™ Gold; ENERGY STAR® 6.1; RoHS-compliant
Weight	from 3.5 lb (1.59kg)									
Case color	Display cover: Graphite Black;				Bottom: Graphite Black					
Case material	Display cover: PC+40%GF+TPU;				Bottom: PC+ABS					

ThinkPad Yoga 11e Chromebook (4th Gen) - TopSeller - 20HY

Product Specifications Reference (PSREF)

Model	Region	Processor	Graphics	Memory	Display	Multi-touch	Color	Storage	Optical	WLAN + Bluetooth	Camera	Pen	Finger-print Reader	Battery	Power Adapter	Operating System	Warranty	Global	Ann Date (m/y)
20HY0000US	US	Celeron N3450	Intel HD 500	4GB Soldered	11.6" HD (1366x768) IPS	10-point Multi-touch	Black	32GB eMMC	None	Intel 7265 ac, 2x2 + BT4.2	720p	None	None	3-cell (42Wh)	45W	Chrome OS	1-year, Depot	No	04/17

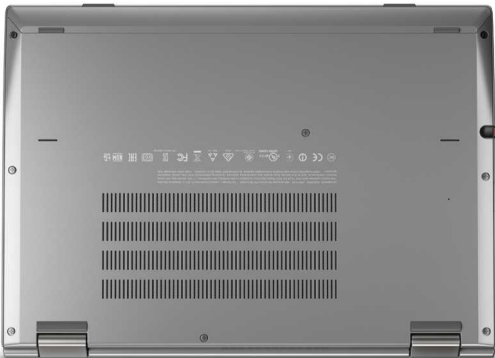

ThinkPad Yoga 260 Platform Specifications

Product Specifications Reference (PSREF)

Processor	6th Generation Intel® Core™ i3 / i5 / i7 Processor								Smart Card Reader ExpressCard Media reader Ports WiGig dock Camera Audio support	<i>Some:</i> Smart Card Reader None Micro SD, supports UHS-I SD card Two USB 3.0 (one Always On), Mini DisplayPort, HDMI, Onelink+ connector, combo audio / microphone jack <i>Optional:</i> WiGig dock, mutually exclusive with WWAN HD720p resolution, fixed focus HD Audio, Conexant® CX11852 codec, Dolby® Home Theater® v4 / stereo speakers, 2W x 2 / dual array microphone, combo audio / microphone jack	
	Processor Number	# of Cores	# of Threads	Base Frequency	Max Turbo Frequency	Cache	Memory Types	Processor Graphics			
	i3-6100U	2	4	2.3 GHz	-	3MB	DDR4-2133	Intel HD Graphics 520			
	i5-6200U			2.3 GHz	2.8 GHz	3MB					
	i5-6300U			2.4 GHz	3.0 GHz	3MB					
	i7-6500U			2.5 GHz	3.1 GHz	4MB					
i7-6600U	2.6 GHz			3.4 GHz	4MB						
Graphics	Intel HD Graphics 520 in processor only, supports external digital monitor via HDMI, Mini DisplayPort; supports dual independent display Max resolution: 3840x2160 (Mini DisplayPort) @60Hz 4096x2160 (HDMI) @24Hz								Keyboard UltraNav™ ThinkLight™	6-row, LED backlit, spill-resistant, multimedia Fn keys TrackPoint® pointing device and multi-touch with 3+2 buttons click pad None	
Chipset Memory	Intel SoC (System on Chip) platform 16GB max / 2133MHz DDR4, one DDR4 SO-DIMM socket (None WWAN models), or 8GB 2133MHz DDR4 soldered to systemboard for WWAN models								Security Security chip vPro Fingerprint reader NFC	Power-on password, hard disk password, supervisor password, security keyhole Discrete TPM 1.2 TCG Certified and Firmware TPM 2.0 integrated in chipset <i>Some:</i> Intel vPro Technology <i>Some:</i> Touch style fingerprint reader on the keyboard bezel <i>Some:</i> Near Field Communication	
Display	<i>Some:</i> 12.5" (317.5mm) HD (1366x768) color, anti-glare, LED backlight, IPS 300 nits, 16:9 aspect ratio, IPS <i>Some:</i> 12.5" (317.5mm) FHD (1920x1080) color, anti-glare, LED backlight, IPS 300 nits, 16:9 aspect ratio, IPS								Battery type Battery life AC adapter	Li-Polymer 4-cell (44Wh) Up to 10.0 hr <i>Some:</i> 45-watt AC adapter <i>Some:</i> 65-watt AC adapter	
Multi-touch Hinge Convert-mode Pen	Supports 10-finger gesture Yoga hinge, 360 degree Laptop, tent, stand and tablet <i>Some:</i> ThinkPad Pen Pro, active pen for multi-touch display								Light sensor G-sensor/ eCompass Gyroscope	Ambient Light Sensor 3D accelerometer and 3D magnetometer 3D compass 3D gyrometer	
Storage	<i>Some:</i> M.2 SSD / SATA 6.0Gb/s <i>Some:</i> M.2 SSD / PCIe NVMe 32Gb/s								Preload	<i>Some:</i> Windows® 7 Professional 64 <i>Some:</i> Windows® 7 Professional 64 preinstalled through downgrade rights in Windows 10 Pro 64 <ul style="list-style-type: none"> Lenovo Solution Center Lenovo SHAREit Lenovo Vantage Product Recovery Rescue and Recovery™ ThinkVantage System Update PC Device Stage Adobe® Reader® Microsoft® Office preloaded; purchase a product key to activate McAfee® Live Safe (30-day trial) 	<i>Some:</i> Windows 10 Pro 64 <i>Some:</i> Windows 10 Home 64 <ul style="list-style-type: none"> Lenovo Solution Center Lenovo REACHit Lenovo SHAREit Lenovo Companion Lenovo Settings Microsoft Office preloaded; purchase a product key to activate
Optical	None								Limited warranty	1-year - depot repair service / service upgrades available 3-year - depot repair service / service upgrades available 3-year - onsite repair service / service upgrades available	
Ethernet	Gigabit Ethernet via optional Ethernet (RJ-45) adapter (by native Intel Ethernet Connection I219-V (Non-vPro) or I219-LM (vPro))								Mil-Spec test	MIL-STD-810G military certification	
WLAN	<i>One of the following, configurable by model (WiGig is mutually exclusive with WWAN):</i> <ul style="list-style-type: none"> <i>BCM:</i> Broadcom Wireless-AC, 2x2, Wi-Fi + Bluetooth combo adapter, M.2 Card <i>no vPro:</i> Intel Dual Band Wireless-AC 8260, 2x2, Wi-Fi + BT, M.2 Card <i>vPro:</i> Intel Dual Band Wireless-AC 8260 with vPro, 2x2, Wi-Fi + BT, M.2 Card <i>WiGig:</i> WiGig™ +1 1AC+BT, Intel Tri-Band Wireless-AC 18260, 2x2 WLAN, 1x1 WiGig, M.2 Card <i>*WiGig adapter is only available in selected countries*</i>								Environment	EPEAT™ Gold; ENERGY STAR®; RoHS-compliant	
Bluetooth™	Bluetooth wireless, integrated in Wi-Fi + Bluetooth combo adapter										
WWAN (optional)	Wireless WAN, Sierra Wireless EM7455, Qualcomm® 4G LTE-Advanced/DC-HSPA+/HSPA+/HSPA/UMTS/GNSS, M.2 card <i>*WWAN models are only available with i5, i7 processors, 8GB soldered to systemboard memory and FHD display*</i>										
SIM card	Micro-SIM card slot, optional Lenovo Connect (WE) SIM card										
Dimensions	12.5" (WxDxH): 12.20" x 8.66" x 0.70" (309.9mm x 220mm x 17.8mm)										
Weight	From 2.90 lb (1.32kg)										
Case color	Midnight black or silver										
Case Material	Carbon-Fiber Hybrid										

Model	Region	Processor	vPro	Graphics	Memory	Display	Multi-touch	Storage	WLAN + Bluetooth	WWAN	SIM Card	Smart Card Reader	Dock	Adapter	Color	Case Material	Camera	Keyboard	Pen	Fingerprint Reader	NFC	Battery	Power Adapter	Operating System	Warranty	Ann Date (m/y)
20FD0000US	US	i5-6200U	No	Intel HD 520	4GBx1	12.5" HD (1366x768) IPS	10-point Multi-touch	192GB SSD	Intel 8260 ac, 2x2 + BT4.1	None	None	None	None	None	Black Carbon	Carbon	720p	Backlit	Pen Pro	Fingerprint Reader	None	4-cell (44Wh)	45W	Win10 Pro 64	1-year, Depot	11/15
20FD0001US	US	i3-6100U	No	Intel HD 520	4GBx1	12.5" HD (1366x768) IPS	10-point Multi-touch	128GB SSD	Intel 8260 ac, 2x2 + BT4.1	None	None	None	None	None	Black Carbon	Carbon	720p	Backlit	Pen Pro	Fingerprint Reader	None	4-cell (44Wh)	45W	Win10 Pro 64	1-year, Depot	11/15
20FD0002US	US	i5-6200U	No	Intel HD 520	4GBx1	12.5" FHD (1920x1080) IPS	10-point Multi-touch	192GB SSD	Intel 8260 ac, 2x2 + BT4.1	None	None	None	None	None	Black Carbon	Carbon	720p	Backlit	Pen Pro	Fingerprint Reader	None	4-cell (44Wh)	45W	Win10 Pro 64	1-year, Depot	11/15
20FD0003US	US	i3-6100U	No	Intel HD 520	4GBx1	12.5" FHD (1920x1080) IPS	10-point Multi-touch	128GB SSD	Intel 8260 ac, 2x2 + BT4.1	None	None	None	None	None	Black Carbon	Carbon	720p	Backlit	Pen Pro	Fingerprint Reader	None	4-cell (44Wh)	45W	Win10 Pro 64	1-year, Depot	11/15
20FD0004US	US	i5-6200U	No	Intel HD 520	8GBx1	12.5" FHD (1920x1080) IPS	10-point Multi-touch	256GB SSD Opal2	Intel 8260 ac, 2x2 + BT4.1	None	None	None	None	None	Black Carbon	Carbon	720p	Backlit	Pen Pro	Fingerprint Reader	None	4-cell (44Wh)	45W	Win10 Pro 64	1-year, Depot	11/15
20FD0029US	US	i7-6500U	No	Intel HD 520	16GBx1	12.5" FHD (1920x1080) IPS	10-point Multi-touch	512GB SSD	Intel 8260 ac, 2x2 + BT4.1	None	None	None	None	None	Black Carbon	Carbon	720p	Backlit	Pen Pro	Fingerprint Reader	None	4-cell (44Wh)	45W	Win10 Pro 64	1-year, Depot	01/16
20FD002AUS	US	i5-6200U	No	Intel HD 520	8GBx1	12.5" FHD (1920x1080) IPS	10-point Multi-touch	192GB SSD	Intel 8260 ac, 2x2 + BT4.1	None	None	None	None	None	Black Carbon	Carbon	720p	Backlit	Pen Pro	Fingerprint Reader	None	4-cell (44Wh)	45W	Win10 Pro 64	1-year, Depot	01/16
20FD002BUS	US	i5-6200U	No	Intel HD 520	8GBx1	12.5" FHD (1920x1080) IPS	10-point Multi-touch	180GB SSD Opal2	Intel 8260 ac, 2x2 + BT4.1	None	None	None	None	None	Black Carbon	Carbon	720p	Backlit	Pen Pro	Fingerprint Reader	None	4-cell (44Wh)	45W	Win10 Pro 64	1-year, Depot	01/16
20FD002DUS	US	i5-6200U	No	Intel HD 520	8GBx1	12.5" HD (1366x768) IPS	10-point Multi-touch	192GB SSD	Intel 8260 ac, 2x2 + BT4.1	None	None	None	None	None	Black Carbon	Carbon	720p	Backlit	Pen Pro	Fingerprint Reader	None	4-cell (44Wh)	45W	Win10 Pro 64	1-year, Depot	01/16
20FD002EUS	US	i5-6300U	vPro	Intel HD 520	8GBx1	12.5" FHD (1920x1080) IPS	10-point Multi-touch	192GB SSD	Intel 8260 ac, 2x2 + BT4.1	None	None	None	None	None	Black Carbon	Carbon	720p	Backlit	Pen Pro	Fingerprint Reader	None	4-cell (44Wh)	45W	Win10 Pro 64	1-year, Depot	01/16
20FD002FUS	US	i7-6600U	vPro	Intel HD 520	16GBx1	12.5" FHD (1920x1080) IPS	10-point Multi-touch	512GB SSD	Intel 8260 ac, 2x2 + BT4.1	None	None	None	None	None	Black Carbon	Carbon	720p	Backlit	Pen Pro	Fingerprint Reader	None	4-cell (44Wh)	45W	Win10 Pro 64	1-year, Depot	01/16
20FD002GUS	US	i5-6300U	vPro	Intel HD 520	8GBx1	12.5" FHD (1920x1080) IPS	10-point Multi-touch	180GB SSD Opal2	Intel 8260 ac, 2x2 + BT4.1	None	None	None	None	None	Black Carbon	Carbon	720p	Backlit	Pen Pro	Fingerprint Reader	None	4-cell (44Wh)	45W	Win10 Pro 64	1-year, Depot	01/16
20FD002HUS	US	i5-6300U	vPro	Intel HD 520	8GBx1	12.5" FHD (1920x1080) IPS	10-point Multi-touch	256GB SSD Opal2	Intel 8260 ac, 2x2 + BT4.1	None	None	None	None	None	Black Carbon	Carbon	720p	Backlit	Pen Pro	Fingerprint Reader	None	4-cell (44Wh)	45W	Win10 Pro 64	1-year, Depot	01/16
20FD002JUS	US	i5-6300U	vPro	Intel HD 520	8GBx1	12.5" HD (1366x768) IPS	10-point Multi-touch	192GB SSD	Intel 8260 ac, 2x2 + BT4.1	None	None	None	None	None	Black Carbon	Carbon	720p	Backlit	Pen Pro	Fingerprint Reader	None	4-cell (44Wh)	45W	Win10 Pro 64	1-year, Depot	01/16
20FD002KUS	US	i7-6600U	vPro	Intel HD 520	8GBx1	12.5" FHD (1920x1080) IPS	10-point Multi-touch	256GB SSD Opal2	Intel 8260 ac, 2x2 + BT4.1	None	None	None	None	None	Black Carbon	Carbon	720p	Backlit	Pen Pro	Fingerprint Reader	None	4-cell (44Wh)	45W	Win10 Pro 64	1-year, Depot	01/16
20FD002LUS	US	i5-6300U	vPro	Intel HD 520	8GBx1	12.5" FHD (1920x1080) IPS	10-point Multi-touch	512GB SSD	Intel 18260 ac, 2x2 + BT4.1	None	None	None	WiGig Dock	None	Black Carbon	Carbon	720p	Backlit	Pen Pro	Fingerprint Reader	None	4-cell (44Wh)	45W	Win10 Pro 64	1-year, Depot	04/16
20FD002MUS	US	i7-6600U	vPro	Intel HD 520	8GBx1	12.5" FHD (1920x1080) IPS	10-point Multi-touch	256GB SSD Opal2	Intel 18260 ac, 2x2 + BT4.1	None	None	None	WiGig Dock	None	Black Carbon	Carbon	720p	Backlit	Pen Pro	Fingerprint Reader	None	4-cell (44Wh)	45W	Win10 Pro 64	1-year, Depot	04/16
20FD002NUS	US	i5-6300U	vPro	Intel HD 520	8GBx1	12.5" FHD (1920x1080) IPS	10-point Multi-touch	256GB SSD Opal2	Intel 18260 ac, 2x2 + BT4.1	None	None	None	WiGig Dock	None	Black Carbon	Carbon	720p	Backlit	Pen Pro	Fingerprint Reader	None	4-cell (44Wh)	45W	Win10 Pro 64	1-year, Depot	04/16
20FD002PUS	US	i5-6300U	vPro	Intel HD 520	8GBx1	12.5" FHD (1920x1080) IPS	10-point Multi-touch	192GB SSD	Intel 18260 ac, 2x2 + BT4.1	None	None	None	WiGig Dock	None	Black Carbon	Carbon	720p	Backlit	Pen Pro	Fingerprint Reader	None	4-cell (44Wh)	45W	Win10 Pro 64	1-year, Depot	04/16
20FD002QUS	US	i7-6600U	vPro	Intel HD 520	8GBx1	12.5" FHD (1920x1080) IPS	10-point Multi-touch	512GB SSD	Intel 18260 ac, 2x2 + BT4.1	None	None	None	WiGig Dock	None	Black Carbon	Carbon	720p	Backlit	Pen Pro	Fingerprint Reader	None	4-cell (44Wh)	45W	Win10 Pro 64	1-year, Depot	04/16

Model	Region	Processor	vPro	Graphics	Memory	Display	Multi-touch	Storage	WLAN + Bluetooth	WWAN	SIM Card	Smart Card Reader	Dock Adapter	Color	Case Material	Camera	Keyboard	Pen	Fingerprint Reader	NFC	Battery	Power Adapter	Operating System	Warranty	Ann Date (m/y)
20FD003HUS	US	i7-6600U	vPro	Intel HD 520	8GB Soldered	12.5" FHD (1920x1080) IPS	10-point Multi-touch	256GB SSD Opal2	Intel 8260 ac, 2x2 + BT4.1	Sierra EM7455	None	None	None	None	Black Carbon	720p	Backlit	Pen Pro	Fingerprint Reader	NFC	4-cell (44Wh)	45W	Win10 Pro 64	3-year, Depot	05/16
20FD003JUS	US	i7-6600U	vPro	Intel HD 520	8GB Soldered	12.5" FHD (1920x1080) IPS	10-point Multi-touch	512GB SSD	Intel 8260 ac, 2x2 + BT4.1	Sierra EM7455	None	None	None	None	Black Carbon	720p	Backlit	Pen Pro	Fingerprint Reader	NFC	4-cell (44Wh)	45W	Win10 Pro 64	3-year, Depot	05/16
20FD003KUS	US	i5-6300U	vPro	Intel HD 520	8GB Soldered	12.5" FHD (1920x1080) IPS	10-point Multi-touch	256GB SSD Opal2	Intel 8260 ac, 2x2 + BT4.1	Sierra EM7455	None	None	None	None	Black Carbon	720p	Backlit	Pen Pro	Fingerprint Reader	NFC	4-cell (44Wh)	45W	Win10 Pro 64	3-year, Depot	05/16
20FD003RUS	US	i5-6200U	No	Intel HD 520	8GBx1	12.5" HD (1366x768) IPS	10-point Multi-touch	180GB SSD Opal2	Intel 8260 ac, 2x2 + BT4.1	None	None	None	None	None	Black Carbon	720p	Backlit	Pen Pro	Fingerprint Reader	None	4-cell (44Wh)	45W	Win10 Pro 64	1-year, Depot	08/16
20FD003SUS	US	i7-6600U	vPro	Intel HD 520	8GB Soldered	12.5" FHD (1920x1080) IPS	10-point Multi-touch	512GB SSD	Intel 8260 ac, 2x2 + BT4.1	Sierra EM7455	None	None	None	None	Black Carbon	720p	Backlit	Pen Pro	Fingerprint Reader	None	4-cell (44Wh)	45W	Win10 Pro 64	3-year, Depot	11/16
20FD003TUS	US	i5-6300U	vPro	Intel HD 520	8GB Soldered	12.5" FHD (1920x1080) IPS	10-point Multi-touch	256GB SSD Opal2	Intel 8260 ac, 2x2 + BT4.1	Sierra EM7455	None	None	None	None	Black Carbon	720p	Backlit	Pen Pro	Fingerprint Reader	None	4-cell (44Wh)	45W	Win10 Pro 64	3-year, Depot	11/16
20FD003UUS	US	i7-6600U	vPro	Intel HD 520	8GB Soldered	12.5" FHD (1920x1080) IPS	10-point Multi-touch	256GB SSD Opal2	Intel 8260 ac, 2x2 + BT4.1	Sierra EM7455	None	None	None	None	Black Carbon	720p	Backlit	Pen Pro	Fingerprint Reader	None	4-cell (44Wh)	45W	Win10 Pro 64	3-year, Depot	11/16
20FDA01WUS	US	i5-6200U	No	Intel HD 520	8GBx1	12.5" HD (1366x768) IPS	10-point Multi-touch	256GB SSD Opal2	Intel 8260 ac, 2x2 + BT4.1	None	None	None	None	None	Black Carbon	720p	Backlit	Pen Pro	Fingerprint Reader	None	4-cell (44Wh)	45W	Win10 Pro 64	1-year, Depot	08/16

Model	Region	Processor	vPro	Graphics	Memory	Display	Multi-touch	Storage	WLAN + Bluetooth	WWAN	SIM Card	Smart Card Reader	Dock Adapter	Color	Case Material	Camera	Keyboard	Pen	Fingerprint Reader	NFC	Battery	Power Adapter	Operating System	Warranty	Ann Date (m/y)
20FE0057US	US	i7-6600U	vPro	Intel HD 520	8GB Soldered	12.5" FHD (1920x1080) IPS	10-point Multi-touch	256GB SSD Opal2	Intel 8260 ac, 2x2 + BT4.1	Sierra EM7455	None	None	None	None	Black Carbon	720p	Backlit	Pen Pro	Fingerprint Reader	NFC	4-cell (44Wh)	45W	Win10 Pro 64	3-year, Depot	04/16
20FE0058US	US	i7-6600U	vPro	Intel HD 520	8GB Soldered	12.5" FHD (1920x1080) IPS	10-point Multi-touch	512GB SSD	Intel 8260 ac, 2x2 + BT4.1	Sierra EM7455	None	None	None	None	Black Carbon	720p	Backlit	Pen Pro	Fingerprint Reader	NFC	4-cell (44Wh)	45W	Win10 Pro 64	3-year, Depot	04/16
20FE0059US	US	i5-6300U	vPro	Intel HD 520	8GB Soldered	12.5" FHD (1920x1080) IPS	10-point Multi-touch	256GB SSD Opal2	Intel 8260 ac, 2x2 + BT4.1	Sierra EM7455	None	None	None	None	Black Carbon	720p	Backlit	Pen Pro	Fingerprint Reader	NFC	4-cell (44Wh)	45W	Win10 Pro 64	3-year, Depot	04/16

ThinkPad Yoga 260 - TopSeller - 20GS

Product Specifications Reference (PSREF)

Model	Region	Processor	vPro	Graphics	Memory	Display	Multi-touch	Storage	WLAN + Bluetooth	WWAN	SIM Card	Smart Card Reader	Dock Adapter	Color	Case Material	Camera	Keyboard	Pen	Fingerprint Reader	NFC	Battery	Power Adapter	Operating System	Warranty	Ann Date (m/y)
20GS0000US	US	i5-6200U	No	Intel HD 520	4GBx1	12.5" HD (1366x768) IPS	10-point Multi-touch	192GB SSD	Intel 8260 ac, 2x2 + BT4.1	None	None	None	None	None	Silver Carbon	720p	Backlit	Pen Pro	None	None	4-cell (44Wh)	45W	Win10 Pro 64	1-year, Depot	01/16
20GS0001US	US	i3-6100U	No	Intel HD 520	4GBx1	12.5" HD (1366x768) IPS	10-point Multi-touch	128GB SSD	Intel 8260 ac, 2x2 + BT4.1	None	None	None	None	None	Silver Carbon	720p	Backlit	Pen Pro	None	None	4-cell (44Wh)	45W	Win10 Pro 64	1-year, Depot	01/16
20GS0002US	US	i7-6500U	No	Intel HD 520	8GBx1	12.5" FHD (1920x1080) IPS	10-point Multi-touch	256GB SSD Opal2	Intel 8260 ac, 2x2 + BT4.1	None	None	None	None	None	Silver Carbon	720p	Backlit	Pen Pro	None	None	4-cell (44Wh)	45W	Win10 Pro 64	1-year, Depot	01/16
20GS0003US	US	i7-6500U	No	Intel HD 520	16GBx1	12.5" FHD (1920x1080) IPS	10-point Multi-touch	512GB SSD	Intel 8260 ac, 2x2 + BT4.1	None	None	None	None	None	Silver Carbon	720p	Backlit	Pen Pro	None	None	4-cell (44Wh)	45W	Win10 Pro 64	1-year, Depot	01/16
20GS0004US	US	i5-6200U	No	Intel HD 520	4GBx1	12.5" FHD (1920x1080) IPS	10-point Multi-touch	192GB SSD	Intel 8260 ac, 2x2 + BT4.1	None	None	None	None	None	Silver Carbon	720p	Backlit	Pen Pro	None	None	4-cell (44Wh)	45W	Win10 Pro 64	1-year, Depot	01/16
20GS0005US	US	i5-6200U	No	Intel HD 520	8GBx1	12.5" FHD (1920x1080) IPS	10-point Multi-touch	256GB SSD Opal2	Intel 8260 ac, 2x2 + BT4.1	None	None	None	None	None	Silver Carbon	720p	Backlit	Pen Pro	None	None	4-cell (44Wh)	45W	Win10 Pro 64	1-year, Depot	01/16
20GS0006US	US	i3-6100U	No	Intel HD 520	4GBx1	12.5" FHD (1920x1080) IPS	10-point Multi-touch	192GB SSD	Intel 8260 ac, 2x2 + BT4.1	None	None	None	None	None	Silver Carbon	720p	Backlit	Pen Pro	None	None	4-cell (44Wh)	45W	Win10 Pro 64	1-year, Depot	01/16
20GS0007US	US	i5-6200U	No	Intel HD 520	8GBx1	12.5" HD (1366x768) IPS	10-point Multi-touch	192GB SSD	Intel 8260 ac, 2x2 + BT4.1	None	None	None	None	None	Silver Carbon	720p	Backlit	Pen Pro	None	None	4-cell (44Wh)	45W	Win10 Pro 64	1-year, Depot	01/16
20GS0008US	US	i5-6300U	vPro	Intel HD 520	8GBx1	12.5" FHD (1920x1080) IPS	10-point Multi-touch	192GB SSD	Intel 8260 ac, 2x2 + BT4.1	None	None	None	None	None	Silver Carbon	720p	Backlit	Pen Pro	None	None	4-cell (44Wh)	45W	Win10 Pro 64	1-year, Depot	01/16
20GS0009US	US	i5-6300U	vPro	Intel HD 520	8GBx1	12.5" FHD (1920x1080) IPS	10-point Multi-touch	180GB SSD Opal2	Intel 8260 ac, 2x2 + BT4.1	None	None	None	None	None	Silver Carbon	720p	Backlit	Pen Pro	None	None	4-cell (44Wh)	45W	Win10 Pro 64	1-year, Depot	01/16
20GS000AUS	US	i5-6300U	vPro	Intel HD 520	8GBx1	12.5" FHD (1920x1080) IPS	10-point Multi-touch	256GB SSD Opal2	Intel 8260 ac, 2x2 + BT4.1	None	None	None	None	None	Silver Carbon	720p	Backlit	Pen Pro	None	None	4-cell (44Wh)	45W	Win10 Pro 64	1-year, Depot	01/16
20GS000BUS	US	i7-6600U	vPro	Intel HD 520	16GBx1	12.5" FHD (1920x1080) IPS	10-point Multi-touch	512GB SSD	Intel 8260 ac, 2x2 + BT4.1	None	None	None	None	None	Silver Carbon	720p	Backlit	Pen Pro	None	None	4-cell (44Wh)	45W	Win10 Pro 64	1-year, Depot	01/16
20GS000CUS	US	i7-6600U	vPro	Intel HD 520	8GBx1	12.5" FHD (1920x1080) IPS	10-point Multi-touch	256GB SSD Opal2	Intel 8260 ac, 2x2 + BT4.1	None	None	None	None	None	Silver Carbon	720p	Backlit	Pen Pro	None	None	4-cell (44Wh)	45W	Win10 Pro 64	1-year, Depot	01/16
20GS000FUS	US	i5-6200U	No	Intel HD 520	8GBx1	12.5" HD (1366x768) IPS	10-point Multi-touch	180GB SSD Opal2	Intel 8260 ac, 2x2 + BT4.1	None	None	None	None	None	Silver Carbon	720p	Backlit	Pen Pro	None	None	4-cell (44Wh)	45W	Win10 Pro 64	1-year, Depot	08/16
20GS000GUS	US	i5-6200U	No	Intel HD 520	8GBx1	12.5" HD (1366x768) IPS	10-point Multi-touch	256GB SSD Opal2	Intel 8260 ac, 2x2 + BT4.1	None	None	None	None	None	Silver Carbon	720p	Backlit	Pen Pro	None	None	4-cell (44Wh)	45W	Win10 Pro 64	1-year, Depot	08/16



ThinkPad Yoga 370 Platform Specifications

Product Specifications Reference (PSREF)

Processor	7th Generation Intel® Core™ i3 / i5 / i7 Processor								Smart Card Reader	Some: Smart Card Reader
	Processor Number	# of Cores	# of Threads	Base Frequency	Max Turbo Frequency	Cache	Memory Types	Processor Graphics	ExpressCard	None
	i3-7100U	2	4	2.4 GHz	-	3MB	DDR4-2133	Intel HD Graphics 620	Media reader	Micro SD, supports UHS-I SD card
	i5-7200U			2.5 GHz	3.1 GHz	3MB			Ports	Two USB 3.1 Gen 1 / USB 3.0 (one Always On), HDMI, Mini RJ45, one USB 3.1 Type-C Gen 2 / Thunderbolt 3
	i5-7300U			2.6 GHz	3.5 GHz	3MB			WiGig dock	Optional: ThinkPad WiGig dock
	i7-7500U			2.7 GHz	3.5 GHz	4MB			Adapter (optional)	Mini RJ45-RJ45: Mini RJ45 to RJ45 adapter
	i7-7600U			2.8 GHz	3.9 GHz	4MB				USB-C-VGA: USB-C to VGA adapter USB-C-DP: USB-C to DisplayPort adapter HDMI-VGA: Lenovo HDMI to VGA Monitor Cable
Graphics	Intel HD Graphics 620 in processor only, supports external digital monitor via HDMI; supports dual independent display Max resolution: 4096x2160 (HDMI)@24Hz								Camera	HD720p resolution, fixed focus
Chipset	Intel SoC (System on Chip) platform								Audio support	HD Audio, Conexant® CX11771 codec, Dolby® DAXII / stereo speakers, 2W x 2 / dual array microphone, combo audio / microphone jack
Memory	16GB max / 2133MHz DDR4, one DDR4 SO-DIMM socket (None WWAN models), or 8GB 2133MHz DDR4 soldered to systemboard for WWAN models								Keyboard	6-row, LED backlit, spill-resistant, multimedia Fn keys
Display	13.3" (337.8mm) FHD (1920x1080) color, glossy, LED backlight, IPS 300 nits, 16:9 aspect ratio, IPS								UltraNav™	TrackPoint® pointing device and multi-touch with 3+2 buttons click pad
Multi-touch	Supports 10-finger gesture								Keyboard color	Black or silver
Hinge	Yoga hinge, 360 degree								Security	Power-on password, hard disk password, supervisor password, security keyhole
Convert-mode	Laptop, tent, stand, yoga and tablet								Security chip	Discrete TPM 2.0 TCG Certified
Pen	Some: ThinkPad Pen Pro, active pen for multi-touch display, on-Board charging								vPro	Some: Intel vPro Technology
Storage	Some: M.2 SSD / SATA 6.0Gb/s Some: M.2 SSD / PCIe NVMe 32Gb/s								Fingerprint reader	Some: Touch style fingerprint reader on the keyboard bezel
Optical	None								NFC	Some: Near Field Communication
Ethernet	Gigabit Ethernet via Mini RJ45 (by native Intel Ethernet Connection I219-V (Non-vPro) or I219-LM (vPro))								Battery type	Li-Polymer 4-cell (51Wh)
WLAN	One of the following, configurable by model (WiGig is mutually exclusive with WWAN): • Intel Dual Band Wireless-AC 8265, Wi-Fi 2x2, 802.11ac + BT4.1, M.2 Card • Intel Tri-Band Wireless-AC 18265, WiGig™ 802.11ad + Wi-Fi 2x2, 802.11ac + BT4.1, M.2 Card								Battery life	Up to 12.5 hr
Bluetooth™	Bluetooth wireless, integrated in Wi-Fi + Bluetooth combo adapter *WiGig adapter is only available in selected countries* *Intel Wi-Fi card supports Bluetooth 4.2 but is limited to BT 4.1 by Windows OS								AC adapter	Some: 45-watt AC adapter Some: 65-watt AC adapter Some: 65-watt USB Type-C adapter
WWAN (optional)	Wireless WAN, Sierra Wireless EM7455, Qualcomm® 4G LTE-Advanced/DC-HSPA+/HSPA+/UMTS/GNSS, M.2 card *WWAN models are only available with i5, i7 processors, WWAN models is not available in North America*								Light sensor	Ambient Light Sensor
SIM card	Micro-SIM card slot, optional Lenovo Connect (WE) SIM card								G-sensor/ eCompass	3D accelerometer and 3D magnetometer 3D compass
Dimensions	13.3" (WxDxH): 12.30" x 8.75" x 0.70" (313.5mm x 222.2mm x 18.2mm)								Gyroscope	3D gyrometer
Weight	From 3.03 lb (1.37kg)								Preload	Some: Windows 10 Pro 64 Some: Windows 10 Home 64 • Lenovo Connect • Lenovo Companion • Lenovo Setting • Microsoft Office preloaded; purchase a product key to activate
Case color	Midnight black or silver								Limited warranty	1-year - depot repair service / service upgrades available 3-year - depot repair service / service upgrades available 3-year - onsite repair service / service upgrades available
Case Material	Carbon-Fiber Hybrid								Mil-Spec test	MIL-STD-810G military certification
									Environment	EPEAT™ Gold; ENERGY STAR®; RoHS-compliant

Model	Region	Processor	vPro	Graphics	Memory	Display	Case Material	Storage(HDD/SSD)	WLAN + Bluetooth	WWAN	SIM Card	Smart Card Reader	Dock Adapter	Color	Pen	Fingerprint Reader	NFC	TPM	Power Adapter	Operating System	Warranty	Global	Ann Date (mm/yy)	
20JH001VUS	US	i5-7300U	vPro	Intel HD 620	16GBx1	13.3" FHD (1920x1080) IPS	Carbon	512GB SSD PCIe NVMe Opal2	Intel 8265 ac, 2x2 + BT4.1	None	None	None	None	None	Silver	Pen Pro	Fingerprint Reader	None	dTPM 2.0	45W	Win10 Pro 64	1-year, Depot	No	03/17
20JH001WUS	US	i5-7200U	No	Intel HD 620	8GBx1	13.3" FHD (1920x1080) IPS	Carbon	256GB SSD PCIe NVMe Opal2	Intel 8265 ac, 2x2 + BT4.1	None	None	None	None	None	Silver	Pen Pro	Fingerprint Reader	None	dTPM 2.0	45W	Win10 Pro 64	1-year, Depot	No	03/17
20JH001XUS	US	i5-7300U	vPro	Intel HD 620	8GBx1	13.3" FHD (1920x1080) IPS	Carbon	256GB SSD PCIe NVMe Opal2	Intel 8265 ac, 2x2 + BT4.1	None	None	None	None	None	Silver	Pen Pro	Fingerprint Reader	None	dTPM 2.0	45W	Win10 Pro 64	1-year, Depot	No	03/17
20JH001YUS	US	i7-7600U	vPro	Intel HD 620	16GBx1	13.3" FHD (1920x1080) IPS	Carbon	512GB SSD PCIe NVMe Opal2	Intel 8265 ac, 2x2 + BT4.1	None	None	None	None	None	Silver	Pen Pro	Fingerprint Reader	None	dTPM 2.0	45W	Win10 Pro 64	1-year, Depot	No	03/17
20JH0020US	US	i7-7500U	No	Intel HD 620	8GBx1	13.3" FHD (1920x1080) IPS	Carbon	256GB SSD PCIe NVMe Opal2	Intel 8265 ac, 2x2 + BT4.1	None	None	None	None	None	Silver	Pen Pro	Fingerprint Reader	None	dTPM 2.0	45W	Win10 Pro 64	1-year, Depot	No	03/17
20JH0021US	US	i7-7500U	No	Intel HD 620	16GBx1	13.3" FHD (1920x1080) IPS	Carbon	512GB SSD PCIe NVMe Opal2	Intel 8265 ac, 2x2 + BT4.1	None	None	None	None	None	Silver	Pen Pro	Fingerprint Reader	None	dTPM 2.0	45W	Win10 Pro 64	1-year, Depot	No	03/17
20JH0022US	US	i7-7600U	vPro	Intel HD 620	8GBx1	13.3" FHD (1920x1080) IPS	Carbon	256GB SSD PCIe NVMe Opal2	Intel 8265 ac, 2x2 + BT4.1	None	None	None	None	None	Silver	Pen Pro	Fingerprint Reader	None	dTPM 2.0	45W	Win10 Pro 64	1-year, Depot	No	03/17
20JH0023US	US	i5-7200U	No	Intel HD 620	4GBx1	13.3" FHD (1920x1080) IPS	Carbon	128GB SSD	Intel 8265 ac, 2x2 + BT4.1	None	None	None	None	None	Silver	Pen Pro	Fingerprint Reader	None	dTPM 2.0	45W	Win10 Pro 64	1-year, Depot	No	03/17
20JH0024US	US	i5-7200U	No	Intel HD 620	8GBx1	13.3" FHD (1920x1080) IPS	Carbon	256GB SSD PCIe NVMe Opal2	Intel 8265 ac, 2x2 + BT4.1	None	None	None	None	None	Black	Pen Pro	Fingerprint Reader	None	dTPM 2.0	45W	Win10 Pro 64	1-year, Depot	No	03/17
20JH0025US	US	i5-7200U	No	Intel HD 620	4GBx1	13.3" FHD (1920x1080) IPS	Carbon	128GB SSD	Intel 8265 ac, 2x2 + BT4.1	None	None	None	None	None	Black	Pen Pro	Fingerprint Reader	None	dTPM 2.0	45W	Win10 Pro 64	1-year, Depot	No	03/17
20JH0026US	US	i5-7200U	No	Intel HD 620	8GBx1	13.3" FHD (1920x1080) IPS	Carbon	512GB SSD PCIe NVMe Opal2	Intel 8265 ac, 2x2 + BT4.1	None	None	None	None	None	Black	Pen Pro	Fingerprint Reader	None	dTPM 2.0	45W	Win10 Pro 64	1-year, Depot	No	03/17
20JH0027US	US	i7-7500U	No	Intel HD 620	16GBx1	13.3" FHD (1920x1080) IPS	Carbon	512GB SSD PCIe NVMe Opal2	Intel 8265 ac, 2x2 + BT4.1	None	None	None	None	None	Black	Pen Pro	Fingerprint Reader	None	dTPM 2.0	45W	Win10 Pro 64	1-year, Depot	No	03/17
20JH0028US	US	i7-7500U	No	Intel HD 620	16GBx1	13.3" FHD (1920x1080) IPS	Carbon	256GB SSD PCIe NVMe Opal2	Intel 8265 ac, 2x2 + BT4.1	None	None	None	None	None	Black	Pen Pro	Fingerprint Reader	None	dTPM 2.0	45W	Win10 Pro 64	1-year, Depot	No	03/17
20JH0029US	US	i7-7600U	vPro	Intel HD 620	16GBx1	13.3" FHD (1920x1080) IPS	Carbon	512GB SSD PCIe NVMe Opal2	Intel 8265 ac, 2x2 + BT4.1	None	None	None	None	None	Black	Pen Pro	Fingerprint Reader	None	dTPM 2.0	45W	Win10 Pro 64	1-year, Depot	No	03/17
20JH002AUS	US	i5-7300U	vPro	Intel HD 620	8GBx1	13.3" FHD (1920x1080) IPS	Carbon	256GB SSD PCIe NVMe Opal2	Intel 8265 ac, 2x2 + BT4.1	None	None	None	None	None	Black	Pen Pro	Fingerprint Reader	None	dTPM 2.0	45W	Win10 Pro 64	1-year, Depot	No	03/17
20JH002BUS	US	i5-7300U	vPro	Intel HD 620	16GBx1	13.3" FHD (1920x1080) IPS	Carbon	512GB SSD PCIe NVMe Opal2	Intel 8265 ac, 2x2 + BT4.1	None	None	None	None	None	Black	Pen Pro	Fingerprint Reader	None	dTPM 2.0	45W	Win10 Pro 64	1-year, Depot	No	03/17
20JH002CUS	US	i5-7200U	No	Intel HD 620	4GBx1	13.3" FHD (1920x1080) IPS	Carbon	256GB SSD PCIe NVMe Opal2	Intel 8265 ac, 2x2 + BT4.1	None	None	None	None	None	Black	Pen Pro	Fingerprint Reader	None	dTPM 2.0	45W	Win10 Pro 64	1-year, Depot	No	03/17
20JH002DUS	US	i7-7600U	vPro	Intel HD 620	8GBx1	13.3" FHD (1920x1080) IPS	Carbon	256GB SSD PCIe NVMe Opal2	Intel 8265 ac, 2x2 + BT4.1	None	None	None	None	None	Black	Pen Pro	Fingerprint Reader	None	dTPM 2.0	45W	Win10 Pro 64	1-year, Depot	No	03/17
20JH002FUS	US	i7-7500U	No	Intel HD 620	8GBx1	13.3" FHD (1920x1080) IPS	Carbon	256GB SSD PCIe NVMe Opal2	Intel 8265 ac, 2x2 + BT4.1	None	None	None	None	None	Black	Pen Pro	Fingerprint Reader	None	dTPM 2.0	45W	Win10 Pro 64	1-year, Depot	No	03/17
20JH002GUS	US	i5-7300U	vPro	Intel HD 620	8GBx1	13.3" FHD (1920x1080) IPS	Carbon	512GB SSD PCIe NVMe Opal2	Intel 8265 ac, 2x2 + BT4.1	None	None	None	None	None	Black	Pen Pro	Fingerprint Reader	None	dTPM 2.0	45W	Win10 Pro 64	1-year, Depot	No	03/17

Model	Region	Processor	vPro	Graphics	Memory	Display	Case Material	Storage(HDD/SSD)	WLAN + Bluetooth	WWAN	SIM Card	Smart Card Reader	Dock Adapter	Color	Pen	Fingerprint Reader	NFC	TPM	Power Adapter	Operating System	Warranty	Global	Ann Date (mm/yy)	
20JH002JUS	US	i7-7600U	vPro	Intel HD 620	8GBx1	13.3" FHD (1920x1080) IPS	Carbon	512GB SSD PCIe NVMe Opal2	Intel 8265 ac, 2x2 + BT4.1	None	None	None	None	None	Black	Pen Pro	Fingerprint Reader	None	dTPM 2.0	45W	Win10 Pro 64	1-year, Depot	No	03/17
20JH002WUS	US	i5-7200U	No	Intel HD 620	8GBx1	13.3" FHD (1920x1080) IPS	Carbon	180GB SSD Opal2	Intel 8265 ac, 2x2 + BT4.1	None	None	None	None	None	Black	Pen Pro	Fingerprint Reader	None	dTPM 2.0	45W	Win10 Pro 64	3-year, Depot	No	03/17
20JH002XUS	US	i5-7200U	No	Intel HD 620	8GBx1	13.3" FHD (1920x1080) IPS	Carbon	180GB SSD Opal2	Intel 8265 ac, 2x2 + BT4.1	None	None	None	None	None	Silver	Pen Pro	Fingerprint Reader	None	dTPM 2.0	45W	Win10 Pro 64	3-year, Depot	No	03/17



ThinkPad Yoga 460 Platform Specifications

Product Specifications Reference (PSREF)

Processor	6th Generation Intel® Core™ i5 / i7 Processor									Smart card reader	None
	Processor Number	# of Cores	# of Threads	Base Frequency	Max Turbo Frequency	Cache	Memory Types	Processor Graphics	vPro	Media reader	4-in-1 reader (MMC, SD, SDHC, SDXC)
	i5-6200U	2	4	2.3 GHz	2.8 GHz	3MB	DDR3L-1600	Intel HD Graphics 520	No	Ports	Three USB 3.0 (one Always On), Mini DisplayPort, HDMI, Onelink+ connector, combo audio / microphone jack
	i5-6300U			2.4 GHz	3.0 GHz	3MB				vPro	
	i7-6500U			2.5 GHz	3.1 GHz	4MB				No	
	i7-6600U			2.6 GHz	3.4 GHz	4MB				vPro	
Graphics	Intel HD Graphics 520 in processor, supports external digital monitor via HDMI or Mini DisplayPort; supports dual independent displays; Max resolution: 3840x2160 (Mini DisplayPort) @60Hz; 1920x1080 (HDMI) @60Hz									Adapter (optional)	HDMI-VGA: Lenovo HDMI to VGA Monitor Cable mDP-VGA: Lenovo Mini DisplayPort to VGA Monitor Cable RJ45: ThinkPad OneLink+ to RJ45 adapter VGA/RJ45: ThinkPad OneLink+ to VGA/RJ45 adapter
Chipset	Intel SoC (System on Chip) platform									Camera	HD720p resolution, fixed focus
Memory	16GB max / 1600MHz DDR3L / one 204-pin SO-DIMM sockets									Audio support	HD Audio, Conexant® CX11852 codec, Dolby® DAX2 / stereo speakers, 1.5W x 2 / dual array microphone, combo audio / microphone jack
Display	<i>Some:</i> 14.0" (355mm) WQHD (2560x1440), glare, LED backlight, IPS, 300 nits, 16:9 aspect ratio, 700:1 contrast ratio (only available in US) <i>Some:</i> 14.0" (355mm) FHD (1920x1080), anti-glare, LED backlight, IPS, 250 nits, 16:9 aspect ratio, 700:1 contrast ratio <i>Some:</i> 14.0" (355mm) FHD (1920x1080), glare, LED backlight, IPS, 250 nits, 16:9 aspect ratio, 700:1 contrast ratio									Keyboard	6-row, spill-resistant, multimedia Fn keys, LED backlit
Multi-touch	Capacitive touch panel, supports 10-finger gesture									UltraNav™	TrackPoint® pointing device and buttonless Mylar surface touchpad, multi-touch
Hinge	Yoga hinge, 360 degree									Security	Power-on password, hard disk password, supervisor password, security keyhole
Convert-mode	Laptop, tent, stand, and tablet									Security chip	<i>Some:</i> Firmware TPM 2.0, integrated in chipset <i>Some:</i> Discrete TPM 1.2, TCG Certified <i>Some:</i> Discrete TPM 1.2 TCG Certified and Firmware TPM 2.0 integrated in chipset
Pen (optional)	ThinkPad Pen Pro, active pen for multi-touch display									vPro (optional)	Intel vPro Technology
Storage	<i>Some:</i> SSD / SATA 6.0Gb/s <i>Some:</i> HDD / SATA 6.0Gb/s, 2.5" wide, removable, upgradable, Active Protection System™ <i>Some:</i> SSHD with 8GB NAND flash memory									Fingerprint reader	Swipe fingerprint reader under C cover
Optical	None									NFC	None
M.2 SSD(opt)	16GB									Battery type	Li-Polymer 3-cell (53Wh)
Ethernet	Gigabit Ethernet via optional Ethernet (RJ-45) adapter (by native Intel Ethernet Connection I219-V (Non-vPro) or I219-LM (vPro))									Battery life	Up to 8.0 hr
WLAN	11ac+BT, Intel Dual Band Wireless-AC 8260, 2x2, M.2 Card									AC adapter	45W or 65W AC adapter
Bluetooth™	Bluetooth wireless, integrated in Wi-Fi + Bluetooth combo adapter									Light sensor	Ambient Light Sensor
WWAN (optional)	<i>One of the following, configurable by model:</i> <ul style="list-style-type: none"> Wireless WAN, Sierra Wireless EM7455, Qualcomm® 4G LTE-Advanced/DC-HSPA+/HSPA+/HSPA/UMTS/GNSS, M.2 card Wireless WAN, HUAWEI ME906S, HUAWEI 4G LTE/WCDMA/HSPA/GSM/GPRS/EDGE/GNSS, M.2 card 									G-sensor	3D accelerometer and 3D magnetometer
SIM card	Micro-SIM card slot									Compass	3D compass
Dimensions	WxDxH: 13.30" x 9.29" x 0.74"; 338.0mm x 236.0mm x 19.0mm									Gyroscope	3D gyrometer
Weight	From 3.90 lb (1.80kg)									Preload	<i>Some:</i> Windows 10 Pro 64 <i>Some:</i> Windows 10 Home 64 <ul style="list-style-type: none"> Lenovo Solution Center Lenovo SHAREit Lenovo Companion Lenovo Settings Microsoft Office preloaded; purchase a product key to activate McAfee® Live Safe (30-day trial)
Case color	Black or Silver									Limited warranty	<i>One of the following, configurable by model:</i> <ul style="list-style-type: none"> 1-year depot repair service 3-year/1-yr battery depot repair service 3-year/1-yr battery limited onsite service
Case material	<i>Carbon:</i> Carbon-Fiber Hybrid display cover <i>Aluminum:</i> Aluminum display cover									Mil-Spec test	MIL-STD-810G military certification
										Environment	EPEAT™ Silver; ENERGY STAR®; RoHS-compliant

Model	Region	Processor	vPro	Graphics	Memory	Display	Multi-touch	Case Material	Storage	M.2 SSD	Optical	WLAN + Bluetooth	WWAN	SIM Card	Monitor Cable	Adapter	Color	Camera	Keyboard	Pen	Finger-print Reader	TPM	Battery	Power Adapter	Operating System	Warranty	Global	Ann Date (m/y)
20EM001JUS	US	i7-6600U	vPro	Intel HD 520	8GBx1	14" WQHD (2560x1440) IPS Gloss	10-point Multi-touch	Carbon	256GB SSD Opal2	None	None	Intel 8260 ac, 2x2 + BT4.1	None	None	None	None	Black	720p	Backlit	Pen Pro	Finger-print Reader	dTPM1.2 + FW TPM2.0	3-cell (53Wh)	45W	Windows 10 Pro 64	1-year, Depot	No	02/16
20EM001LUS	US	i5-6200U	No	Intel HD 520	8GBx1	14" FHD (1920x1080) IPS AG	10-point Multi-touch	Carbon	180GB SSD Opal2	None	None	Intel 8260 ac, 2x2 + BT4.1	None	None	None	None	Black	720p	Backlit	Pen Pro	Finger-print Reader	dTPM1.2 + FW TPM2.0	3-cell (53Wh)	45W	Windows 10 Pro 64	1-year, Depot	No	03/16
20EM001MUS	US	i7-6500U	No	Intel HD 520	8GBx1	14" FHD (1920x1080) IPS AG	10-point Multi-touch	Carbon	256GB SSD Opal2	None	None	Intel 8260 ac, 2x2 + BT4.1	None	None	None	None	Black	720p	Backlit	Pen Pro	Finger-print Reader	dTPM1.2 + FW TPM2.0	3-cell (53Wh)	45W	Windows 10 Pro 64	1-year, Depot	No	02/16
20EM001NUS	US	i5-6200U	No	Intel HD 520	8GBx1	14" FHD (1920x1080) IPS AG	10-point Multi-touch	Carbon	192GB SSD	None	None	Intel 8260 ac, 2x2 + BT4.1	None	None	None	None	Black	720p	Backlit	Pen Pro	Finger-print Reader	dTPM1.2 + FW TPM2.0	3-cell (53Wh)	45W	Windows 10 Pro 64	1-year, Depot	No	03/16
20EM001PUS	US	i5-6200U	No	Intel HD 520	4GBx1	14" FHD (1920x1080) IPS AG	10-point Multi-touch	Carbon	192GB SSD	None	None	Intel 8260 ac, 2x2 + BT4.1	None	None	None	None	Black	720p	Backlit	Pen Pro	Finger-print Reader	dTPM1.2 + FW TPM2.0	3-cell (53Wh)	45W	Windows 10 Pro 64	1-year, Depot	No	02/16
20EM001QUS	US	i5-6200U	No	Intel HD 520	4GBx1	14" FHD (1920x1080) IPS AG	10-point Multi-touch	Carbon	128GB SSD	None	None	Intel 8260 ac, 2x2 + BT4.1	None	None	None	None	Black	720p	Backlit	Pen Pro	Finger-print Reader	dTPM1.2 + FW TPM2.0	3-cell (53Wh)	45W	Windows 10 Pro 64	1-year, Depot	No	03/16
20EM001RUS	US	i5-6300U	vPro	Intel HD 520	8GBx1	14" FHD (1920x1080) IPS AG	10-point Multi-touch	Carbon	256GB SSD Opal2	None	None	Intel 8260 ac, 2x2 + BT4.1	None	None	None	None	Black	720p	Backlit	Pen Pro	Finger-print Reader	dTPM1.2 + FW TPM2.0	3-cell (53Wh)	45W	Windows 10 Pro 64	1-year, Depot	No	03/16
20EM001SUS	US	i5-6300U	vPro	Intel HD 520	8GBx1	14" FHD (1920x1080) IPS AG	10-point Multi-touch	Carbon	192GB SSD	None	None	Intel 8260 ac, 2x2 + BT4.1	None	None	None	None	Black	720p	Backlit	Pen Pro	Finger-print Reader	dTPM1.2 + FW TPM2.0	3-cell (53Wh)	45W	Windows 10 Pro 64	1-year, Depot	No	02/16
20EM001TUS	US	i5-6300U	vPro	Intel HD 520	8GBx1	14" FHD (1920x1080) IPS AG	10-point Multi-touch	Carbon	180GB SSD Opal2	None	None	Intel 8260 ac, 2x2 + BT4.1	None	None	None	None	Black	720p	Backlit	Pen Pro	Finger-print Reader	dTPM1.2 + FW TPM2.0	3-cell (53Wh)	45W	Windows 10 Pro 64	1-year, Depot	No	03/16
20EM001UUS	US	i5-6200U	No	Intel HD 520	8GBx1	14" FHD (1920x1080) IPS AG	10-point Multi-touch	Carbon	256GB SSD Opal2	None	None	Intel 8260 ac, 2x2 + BT4.1	None	None	None	None	Black	720p	Backlit	Pen Pro	Finger-print Reader	dTPM1.2 + FW TPM2.0	3-cell (53Wh)	45W	Windows 10 Pro 64	1-year, Depot	No	03/16
20EM001XUS	US	i5-6300U	vPro	Intel HD 520	8GBx1	14" FHD (1920x1080) IPS Gloss	10-point Multi-touch	Aluminum	192GB SSD	None	None	Intel 8260 ac, 2x2 + BT4.1	None	None	None	None	Silver	720p	Backlit	Pen Pro	None	dTPM1.2 + FW TPM2.0	3-cell (53Wh)	45W	Windows 10 Pro 64	1-year, Depot	No	03/16
20EM0023US	US	i7-6600U	vPro	Intel HD 520	8GBx1	14" WQHD (2560x1440) IPS Gloss	10-point Multi-touch	Aluminum	256GB SSD Opal2	None	None	Intel 8260 ac, 2x2 + BT4.1	None	None	None	None	Silver	720p	Backlit	Pen Pro	None	dTPM1.2 + FW TPM2.0	3-cell (53Wh)	45W	Windows 10 Pro 64	1-year, Depot	No	03/16
20EM0024US	US	i7-6600U	vPro	Intel HD 520	8GBx1	14" FHD (1920x1080) IPS Gloss	10-point Multi-touch	Aluminum	256GB SSD Opal2	None	None	Intel 8260 ac, 2x2 + BT4.1	None	None	None	None	Silver	720p	Backlit	Pen Pro	None	dTPM1.2 + FW TPM2.0	3-cell (53Wh)	45W	Windows 10 Pro 64	1-year, Depot	No	03/16
20EM0025US	US	i5-6200U	No	Intel HD 520	4GBx1	14" FHD (1920x1080) IPS Gloss	10-point Multi-touch	Aluminum	192GB SSD	None	None	Intel 8260 ac, 2x2 + BT4.1	None	None	None	None	Silver	720p	Backlit	Pen Pro	None	dTPM1.2 + FW TPM2.0	3-cell (53Wh)	45W	Windows 10 Pro 64	1-year, Depot	No	03/16
20EM0026US	US	i5-6200U	No	Intel HD 520	4GBx1	14" FHD (1920x1080) IPS Gloss	10-point Multi-touch	Aluminum	128GB SSD	None	None	Intel 8260 ac, 2x2 + BT4.1	None	None	None	None	Silver	720p	Backlit	Pen Pro	None	dTPM1.2 + FW TPM2.0	3-cell (53Wh)	45W	Windows 10 Pro 64	1-year, Depot	No	03/16
20EM0027US	US	i5-6300U	vPro	Intel HD 520	8GBx1	14" FHD (1920x1080) IPS Gloss	10-point Multi-touch	Aluminum	256GB SSD Opal2	None	None	Intel 8260 ac, 2x2 + BT4.1	None	None	None	None	Silver	720p	Backlit	Pen Pro	None	dTPM1.2 + FW TPM2.0	3-cell (53Wh)	45W	Windows 10 Pro 64	1-year, Depot	No	03/16
20EM0028US	US	i7-6500U	No	Intel HD 520	8GBx1	14" FHD (1920x1080) IPS Gloss	10-point Multi-touch	Aluminum	256GB SSD Opal2	None	None	Intel 8260 ac, 2x2 + BT4.1	None	None	None	None	Silver	720p	Backlit	Pen Pro	None	dTPM1.2 + FW TPM2.0	3-cell (53Wh)	45W	Windows 10 Pro 64	1-year, Depot	No	03/16
20EM0029US	US	i5-6200U	No	Intel HD 520	8GBx1	14" FHD (1920x1080) IPS Gloss	10-point Multi-touch	Aluminum	192GB SSD	None	None	Intel 8260 ac, 2x2 + BT4.1	None	None	None	None	Silver	720p	Backlit	Pen Pro	None	dTPM1.2 + FW TPM2.0	3-cell (53Wh)	45W	Windows 10 Pro 64	1-year, Depot	No	03/16
20EM002AUS	US	i5-6200U	No	Intel HD 520	8GBx1	14" FHD (1920x1080) IPS Gloss	10-point Multi-touch	Aluminum	180GB SSD Opal2	None	None	Intel 8260 ac, 2x2 + BT4.1	None	None	None	None	Silver	720p	Backlit	Pen Pro	None	dTPM1.2 + FW TPM2.0	3-cell (53Wh)	45W	Windows 10 Pro 64	1-year, Depot	No	03/16
20EM002BUS	US	i5-6200U	No	Intel HD 520	8GBx1	14" FHD (1920x1080) IPS Gloss	10-point Multi-touch	Aluminum	256GB SSD Opal2	None	None	Intel 8260 ac, 2x2 + BT4.1	None	None	None	None	Silver	720p	Backlit	Pen Pro	None	dTPM1.2 + FW TPM2.0	3-cell (53Wh)	45W	Windows 10 Pro 64	1-year, Depot	No	03/16

Model	Region	Processor	vPro	Graphics	Memory	Display	Multi-touch	Case Material	Storage	M.2 SSD	Optical	WLAN + Bluetooth	WWAN	SIM Card	Monitor Cable	Adapter	Color	Camera	Keyboard	Pen	Finger-print Reader	TPM	Battery	Power Adapter	Operating System	Warranty	Global	Ann Date (m/y)
20EM002CUS	US	i5-6300U	vPro	Intel HD 520	8GBx1	14" FHD (1920x1080) IPS Gloss	10-point Multi-touch	Aluminum	180GB SSD Opal2	None	None	Intel 8260 ac, 2x2 + BT4.1	None	None	None	None	Silver	720p	Backlit	Pen Pro	None	dTPM1.2 + FW TPM2.0	3-cell (53Wh)	45W	Windows 10 Pro 64	1-year, Depot	No	03/16
20EM002FUS	US	i7-6600U	vPro	Intel HD 520	8GBx1	14" FHD (1920x1080) IPS AG	10-point Multi-touch	Carbon	256GB SSD Opal2	None	None	Intel 8260 ac, 2x2 + BT4.1	Sierra EM7455	None	None	None	Black	720p	Backlit	Pen Pro	Finger-print Reader	dTPM1.2 + FW TPM2.0	3-cell (53Wh)	45W	Windows 10 Pro 64	1-year, Depot	No	04/16
20EM002GUS	US	i5-6300U	vPro	Intel HD 520	8GBx1	14" FHD (1920x1080) IPS AG	10-point Multi-touch	Carbon	256GB SSD Opal2	None	None	Intel 8260 ac, 2x2 + BT4.1	Sierra EM7455	None	None	None	Black	720p	Backlit	Pen Pro	Finger-print Reader	dTPM1.2 + FW TPM2.0	3-cell (53Wh)	45W	Windows 10 Pro 64	1-year, Depot	No	04/16

This publication was developed for products and services offered in the United States and E.M.E.A countries. Lenovo may not offer the products, services or features discussed in this document in other countries. Lenovo may withdraw an offering at any time. Information is subject to change without notice. Consult your local representative for information on offerings available in your area.

Lenovo reserves the right to change specifications or other product information without notice. Lenovo is not responsible for photographic or typographical errors.

LENOVO PROVIDES THIS PUBLICATION "AS IS," WITHOUT WARRANTY OF ANY KIND, EITHER EXPRESS OR IMPLIED, INCLUDING THE IMPLIED WARRANTIES OF MERCHANTABILITY OR FITNESS FOR A PARTICULAR PURPOSE.

Some jurisdictions do not allow disclaimer of express or implied warranties in certain transactions, therefore this disclaimer may not apply to you.

Availability: All offers subject to availability. Lenovo reserves the right to alter product offerings and specifications at any time, without notice. Lenovo is not responsible for photographic or typographic errors.

General: Review key information provided by Microsoft that may apply to your system purchase, including details on Windows 10, Windows 8, Windows 7, and potential upgrades/downgrades. Lenovo makes no representation or warranty regarding third-party products or services.

Trademarks: Lenovo, ThinkPad, ThinkCentre, ThinkStation and the Lenovo logo are trademarks of Lenovo. Microsoft, Windows, Windows NT, and the Windows logo are trademarks of Microsoft Corporation. Ultrabook, Celeron, Celeron Inside, Core Inside, Intel, Intel Logo, Intel Atom, Intel Atom Inside, Intel Core, Intel Inside, Intel Inside Logo, Intel vPro, Itanium, Itanium Inside, Pentium, Pentium Inside, vPro Inside, Xeon, Xeon Phi, and Xeon Inside are trademarks of Intel Corporation in the U.S. and/or other countries. Other company, product or service names may be trademarks or service marks of others.

Warranty: For a copy of applicable warranties, write to: Lenovo Warranty Information, 1009 Think Place, Morrisville, NC, 27560. Lenovo makes no representation or warranty regarding third party products or services. The Lenovo Limited Warranty applies only to Lenovo hardware products purchased for your own use, and does not transfer upon resale.

Limited warranty: Support unrelated to a warranty issue may be subject to additional charges.

Lenovo Services:

Carry-in or Mail-in Service: Parts and labor repair coverage where the customer is responsible for shipping (including packaging) or delivery to authorized warranty provider or repair center.

Depot or Courier Service: Parts and labor repair coverage where shipping (including packaging) or delivery to the repair center is paid for by Lenovo.

Expedited Depot: Parts and labor coverage with expedited turnaround. Shipping (including packaging) or delivery to the repair center is paid for by Lenovo.

Onsite / In-home Service: Parts and labor repair coverage where labor is provided onsite at your place of business.

If Lenovo determines your product problem is covered by the product warranty and cannot be resolved over the telephone, a technician will be dispatched to arrive onsite, typically the next day.

International Warranty Service (IWS): PC repair coverage for customers who require a critical warranty repair while travelling internationally. Visit www.lenovo.com/internationalwarranty for details. Visit www.lenovo.com/warranty for Lenovo Warranty Services terms and conditions for complete details and restrictions.

Included software: may differ from its retail version (if available), and may not include user manuals or all program functionality. Software license agreements may apply.

Battery life: Battery life (and recharge times) will vary based on many factors including screen brightness, applications, features, power management, battery conditioning, and other customer preferences.

Visit <http://psref.lenovo.com/> for the latest version of Product Specifications Reference.

© Lenovo, 2017. All rights reserved.
Lenovo 1009 Think Place Morrisville, NC 27560 U.S.A.

Lenovo™ **ThinkCentre**®

PSREF



Product Specifications Reference

Version 507, May 2017

U.S.

Visit <http://psref.lenovo.com> for the latest version

Contents

Cover	1	ThinkCentre M600 Tiny - TopSeller - 10G9 - 2 of 2	37
Contents	2	ThinkCentre M600 Tiny - TopSeller - 10GB	38
Summary Of Change	5	ThinkCentre M600 Tiny - TopSeller - 10KH - 1 of 2	39
M Series AIO	7	ThinkCentre M600 Tiny - TopSeller - 10KH - 2 of 2	40
ThinkCentre M700z AIO	7	ThinkCentre M600 Tiny - 10G8	41
ThinkCentre M700z AIO Platform Specifications	8	ThinkCentre M600 Tiny - 10GA	42
ThinkCentre M700z AIO - TopSeller - 10EY - 1 of 2	9	ThinkCentre M600 Tiny - 10GC	43
ThinkCentre M700z AIO - TopSeller - 10EY - 2 of 2	10	ThinkCentre M600 Tiny - 10GE	44
ThinkCentre M700z AIO - 10F1	11	ThinkCentre M700 SFF	45
ThinkCentre M800z AIO	12	ThinkCentre M700 SFF Platform Specifications	46
ThinkCentre M800z AIO Platform Specifications	13	ThinkCentre M700 SFF - TopSeller - 10GT - 1 of 3	47
ThinkCentre M800z AIO - TopSeller - 10ET - 1 of 2	14	ThinkCentre M700 SFF - TopSeller - 10GT - 2 of 3	48
ThinkCentre M800z AIO - TopSeller - 10ET - 2 of 2	15	ThinkCentre M700 SFF - TopSeller - 10GT - 3 of 3	49
ThinkCentre M800z AIO - TopSeller - 10EU - 1 of 2	16	ThinkCentre M700 Tiny	50
ThinkCentre M800z AIO - TopSeller - 10EU - 2 of 2	17	ThinkCentre M700 Tiny Platform Specifications	51
ThinkCentre M800z AIO - 10EW	18	ThinkCentre M700 Tiny - TopSeller - 10HY - 1 of 4	52
ThinkCentre M810z AIO	19	ThinkCentre M700 Tiny - TopSeller - 10HY - 2 of 4	53
ThinkCentre M810z AIO Platform Specifications	20	ThinkCentre M700 Tiny - TopSeller - 10HY - 3 of 4	54
ThinkCentre M810z AIO - TopSeller - 10NX	21	ThinkCentre M700 Tiny - TopSeller - 10HY - 4 of 4	55
ThinkCentre M810z AIO - TopSeller - 10NY - 1 of 2	22	ThinkCentre M700 Tiny - TopSeller - 10JQ	56
ThinkCentre M810z AIO - TopSeller - 10NY - 2 of 2	23	ThinkCentre M700 Tower	57
ThinkCentre M900z AIO	24	ThinkCentre M700 Tower Platform Specifications	58
ThinkCentre M900z AIO Platform Specifications	25	ThinkCentre M700 Tower - TopSeller - 10GR - 1 of 3	59
ThinkCentre M900z AIO - TopSeller - 10F2	26	ThinkCentre M700 Tower - TopSeller - 10GR - 2 of 3	60
ThinkCentre M900z AIO - TopSeller - 10F3	27	ThinkCentre M700 Tower - TopSeller - 10GR - 3 of 3	61
ThinkCentre M900z AIO - 10F4	28	ThinkCentre M710 SFF	62
ThinkCentre M900z AIO - 10F5	29	ThinkCentre M710 SFF Platform Specifications	63
ThinkCentre M910z AIO	30	ThinkCentre M710 SFF - TopSeller - 10M7 - 1 of 3	64
ThinkCentre M910z AIO Platform Specifications	31	ThinkCentre M710 SFF - TopSeller - 10M7 - 2 of 3	65
ThinkCentre M910z AIO - TopSeller - 10NR	32	ThinkCentre M710 SFF - TopSeller - 10M7 - 3 of 3	66
ThinkCentre M910z AIO - TopSeller - 10NS	33	ThinkCentre M710 Tiny	67
M Series Desktop	34	ThinkCentre M710 Tiny Platform Specifications	68
ThinkCentre M600 Tiny	34	ThinkCentre M710 Tiny - TopSeller - 10MR - 1 of 3	69
ThinkCentre M600 Tiny Platform Specifications	35	ThinkCentre M710 Tiny - TopSeller - 10MR - 2 of 3	70
ThinkCentre M600 Tiny - TopSeller - 10G9 - 1 of 2	36	ThinkCentre M710 Tiny - TopSeller - 10MR - 3 of 3	71

Contents

ThinkCentre M710 Tower	72	ThinkCentre M900 SFF - 10FG	107
ThinkCentre M710 Tower Platform Specifications			
ThinkCentre M710 Tower - TopSeller - 10M9 - 1 of 3	73	ThinkCentre M900 Tiny	108
ThinkCentre M710 Tower - TopSeller - 10M9 - 2 of 3	74	ThinkCentre M900 Tiny Platform Specifications	109
ThinkCentre M710 Tower - TopSeller - 10M9 - 3 of 3	75	ThinkCentre M900 Tiny - TopSeller - 10FM - 1 of 3	110
ThinkCentre M715 Tiny	76	ThinkCentre M900 Tiny - TopSeller - 10FM - 2 of 3	111
ThinkCentre M715 Tiny Platform Specifications	77	ThinkCentre M900 Tiny - TopSeller - 10FM - 3 of 3	112
ThinkCentre M715 Tiny - TopSeller - 10M3 - 1 of 2	78	ThinkCentre M900 Tiny - TopSeller - 10NE	113
ThinkCentre M715 Tiny - TopSeller - 10M3 - 2 of 2	79	ThinkCentre M900 Tiny - 10FL	114
ThinkCentre M79 SFF	80	ThinkCentre M900 Tower	115
ThinkCentre M79 SFF Platform Specifications	81	ThinkCentre M900 Tower Platform Specifications	116
ThinkCentre M79 SFF - TopSeller - 10CV	82	ThinkCentre M900 Tower - TopSeller - 10FD - 1 of 2	117
ThinkCentre M79 SFF - TopSeller - 10JB	83	ThinkCentre M900 Tower - TopSeller - 10FD - 2 of 2	118
ThinkCentre M79 SFF - 10CT	84	ThinkCentre M900 Tower - 10FC	119
ThinkCentre M79 SFF - 10CW	85	ThinkCentre M900x Tiny	120
ThinkCentre M79 Tower	86	ThinkCentre M900x Tiny Platform Specifications	121
ThinkCentre M79 Tower Platform Specifications	87	ThinkCentre M900x Tiny - TopSeller - 10LX	122
ThinkCentre M79 Tower - TopSeller - 10CN	88	ThinkCentre M910 SFF	123
ThinkCentre M79 Tower - TopSeller - 10J7	89	ThinkCentre M910 SFF Platform Specifications	124
ThinkCentre M79 Tower - 10CQ	90	ThinkCentre M910 SFF - TopSeller - 10MK - 1 of 2	125
ThinkCentre M79 Tower - 10CS	91	ThinkCentre M910 SFF - TopSeller - 10MK - 2 of 2	126
ThinkCentre M800 SFF	92	ThinkCentre M910 Tiny	127
ThinkCentre M800 SFF Platform Specifications	93	ThinkCentre M910 Tiny Platform Specifications	128
ThinkCentre M800 SFF - TopSeller - 10FY - 1 of 2	94	ThinkCentre M910 Tiny - TopSeller - 10MV - 1 of 3	129
ThinkCentre M800 SFF - TopSeller - 10FY - 2 of 2	95	ThinkCentre M910 Tiny - TopSeller - 10MV - 2 of 3	130
ThinkCentre M800 SFF - 10FX	96	ThinkCentre M910 Tiny - TopSeller - 10MV - 3 of 3	131
ThinkCentre M800 Tower	97	ThinkCentre M910 Tower	132
ThinkCentre M800 Tower Platform Specifications	98	ThinkCentre M910 Tower Platform Specifications	133
ThinkCentre M800 Tower - TopSeller - 10FW - 1 of 2	99	ThinkCentre M910 Tower - TopSeller - 10MM - 1 of 2	134
ThinkCentre M800 Tower - TopSeller - 10FW - 2 of 2	100	ThinkCentre M910 Tower - TopSeller - 10MM - 2 of 2	135
ThinkCentre M800 Tower - 10FV	101	ThinkCentre M910x Tiny	136
ThinkCentre M900 SFF	102	ThinkCentre M910x Tiny Platform Specifications	137
ThinkCentre M900 SFF Platform Specifications	103	ThinkCentre M910x Tiny - TopSeller - 10N0 - 1 of 2	138
ThinkCentre M900 SFF - TopSeller - 10FH - 1 of 2	104	ThinkCentre M910x Tiny - TopSeller - 10N0 - 2 of 2	139
ThinkCentre M900 SFF - TopSeller - 10FH - 2 of 2	105	Tiny-In-One	140
	106	ThinkCentre Tiny-In-One 22	140

Contents

ThinkCentre Tiny-In-One 22 Platform Specifications	141
ThinkCentre Tiny-In-One 22 - 10LK	142
ThinkCentre Tiny-In-One 24	143
ThinkCentre Tiny-In-One 24 Platform Specifications	144
ThinkCentre Tiny-In-One 24 - 10LL	145
X Series AIO	146
ThinkCentre X1 AIO	146
ThinkCentre X1 AIO Platform Specifications	147
ThinkCentre X1 AIO - TopSeller - 10KE	148
Legal Information	149

Contents

Summary of Changes	1	ThinkCentre M800z (10EU) - TopSeller - II	70
ThinkCentre - Lenovo Quick Pick Accessories Photography	2	ThinkCentre M800z (10ET) - TopSeller.....	71
ThinkCentre - Lenovo Quick Pick Accessories	3	ThinkCentre M800z (10ET) - TopSeller - II	72
ThinkCentre Chromebox	4	ThinkCentre M900 Tiny	73
ThinkCentre Chromebox Platform Specifications	5	ThinkCentre M900 Tiny Platform Specifications	74
ThinkCentre Chromebox (10H3) - TopSeller.....	6	ThinkCentre M900 Tiny (10FM) - TopSeller	75
ThinkCentre Chromebox (10H5) - TopSeller.....	7	ThinkCentre M900 Tiny (10FM) - TopSeller - II	76
ThinkCentre Tiny-in-One 22	8	ThinkCentre M900 Tiny (10FM) - TopSeller - III	77
ThinkCentre Tiny-in-One (TIO) 22	9	ThinkCentre M900 Tiny (10FM) - TopSeller - IV.....	78
ThinkCentre Tiny-in-One 23	10	ThinkCentre M900 Tiny (10NE) - TopSeller	79
ThinkCentre Tiny-in-One (TIO) 23	11	ThinkCentre M900x Tiny	80
ThinkCentre Tiny-in-One 24	12	ThinkCentre M900x Tiny Platform Specifications	81
ThinkCentre Tiny-in-One (TIO) 24	13	ThinkCentre M900x Tiny (10LX) - TopSeller	82
ThinkCentre M600 Tiny	14	ThinkCentre M900 SFF	83
ThinkCentre M600 Tiny Platform Specifications	15	ThinkCentre M900 SFF Platform Specifications	84
ThinkCentre M600 Tiny (10GB) - TopSeller	16	ThinkCentre M900 SFF (10FH) - TopSeller	85
ThinkCentre M600 Tiny (10G9) - TopSeller.....	17	ThinkCentre M900 SFF (10FH) - TopSeller - II	86
ThinkCentre M600 Tiny (10G9) - TopSeller - II	18	ThinkCentre M900 SFF (10FH) - TopSeller - III	87
ThinkCentre M600 Tiny (10KH) - Thin Client (TopSeller).....	19	ThinkCentre M900 Tower	88
ThinkCentre M600 Tiny (10KH) - Thin Client (TopSeller) - II.....	20	ThinkCentre M900 Tower Platform Specifications.....	89
ThinkCentre M700 Tiny	21	ThinkCentre M900 Tower (10FD) - TopSeller.....	90
ThinkCentre M700 Tiny Platform Specifications	22	ThinkCentre M900 Tower (10FD) - TopSeller - II.....	91
ThinkCentre M700 Tiny (10HY) - TopSeller	23	ThinkCentre M900 Tower (10FD) - TopSeller - III.....	92
ThinkCentre M700 Tiny (10HY) - TopSeller - II	24	ThinkCentre M900z All-In-One	93
ThinkCentre M700 Tiny (10HY) - TopSeller - III	25	ThinkCentre M900z Platform Specifications	94
ThinkCentre M700 Tiny (10HY) - TopSeller - IV	26	ThinkCentre M900z (10F3) - TopSeller	95
ThinkCentre M700 Tiny (10HY) - TopSeller - V.....	27	ThinkCentre M900z (10F2) - TopSeller	96
ThinkCentre M700 Tiny (10JQ) - Thin Client (TopSeller)	28	ThinkCentre M900z (10F2) - TopSeller - II.....	97
ThinkCentre M700 SFF	29	ThinkCentre X1	98
ThinkCentre M700 SFF Platform Specifications	30	ThinkCentre X1 Platform Specifications	99
ThinkCentre M700 SFF (10GT) - TopSeller	31	ThinkCentre X1 (10KE) - TopSeller.....	100
ThinkCentre M700 SFF (10GT) - TopSeller - II	32	ThinkCentre E63z All-In-One	101
ThinkCentre M700 SFF (10GT) - TopSeller - III	33	ThinkCentre E63z Platform Specifications.....	102
ThinkCentre M700 SFF (10GT) - TopSeller - III	34	ThinkCentre E63z (10D4) - TopSeller	103
ThinkCentre M700 Tower	35	ThinkCentre E63z (10D6) - Multi-touch (TopSeller).....	104
ThinkCentre M700 Tower Platform Specifications.....	36	ThinkCentre E63z (10E0) - TopSeller	105
ThinkCentre M700 Tower (10GR) - TopSeller	37	ThinkCentre E63z (10E2) - Multi-touch (TopSeller)	106
ThinkCentre M700 Tower (10GR) - TopSeller - II	38	ThinkCentre E63z (10D5)	107
ThinkCentre M700 Tower (10GR) - TopSeller - III	39	ThinkCentre E63z (10D7) - Multi-touch	108
ThinkCentre M700 Tower (10GR) - TopSeller - IV.....	40	ThinkCentre E63z (10E1)	109
ThinkCentre M700z All-In-One	41	ThinkCentre E63z (10E3) - Multi-touch	110
ThinkCentre M700z Platform Specifications	42	ThinkCentre - TopSeller Services	111
ThinkCentre M700z (10EY) - TopSeller	43	ThinkCentre - Lenovo Services	112
ThinkCentre M700z (10EY) - TopSeller - II	44	Withdrawn Product Books	113
ThinkCentre M79 SFF and Tower	45	Legal Information and Trademarks	114
ThinkCentre M79 SFF Platform Specifications	46		
ThinkCentre M79 Tower Platform Specifications.....	47		
ThinkCentre M79 SFF (10CV) - TopSeller	48		
ThinkCentre M79 SFF (10JB) - TopSeller	49		
ThinkCentre M79 SFF (10JB) - TopSeller - II.....	50		
ThinkCentre M79 Tower (10CN) - TopSeller.....	51		
ThinkCentre M79 Tower (10J7) - TopSeller	52		
ThinkCentre M79 Tower (10J7) - TopSeller - II.....	53		
ThinkCentre M79 SFF (10CT)	54		
ThinkCentre M79 SFF (10CW)	55		
ThinkCentre M79 Tower (10CQ)	56		
ThinkCentre M79 Tower (10CS).....	57		
ThinkCentre M800 SFF	58		
ThinkCentre M800 SFF Platform Specifications	59		
ThinkCentre M800 SFF (10FY) - TopSeller.....	60		
ThinkCentre M800 SFF (10FY) - TopSeller - II	61		
ThinkCentre M800 SFF (10FY) - TopSeller - III	62		
ThinkCentre M800 Tower	63		
ThinkCentre M800 Tower Platform Specifications.....	64		
ThinkCentre M800 Tower (10FW) - TopSeller	65		
ThinkCentre M800 Tower (10FW) - TopSeller - II	66		
ThinkCentre M800z All-In-One	67		
ThinkCentre M800z Platform Specifications	68		
ThinkCentre M800z (10EU) - TopSeller	69		

Summary of Changes

This section describes the technical changes made in this edition.

This edition might also include minor corrections and editorial changes which are not identified.

May 2017 - Version 507

Additions in this update

▶ **New product(s)**

None

▶ **New model(s)**

ThinkCentre M600 Tiny new models announced May 2017

Withdrawals in this update

▶ **Withdrawn product(s)**

None



ThinkCentre M700z Platform Specifications

Product Specifications Reference (PSREF)

Processor	Intel® Celeron®, Intel Pentium®, or 6th Generation Intel Core™ i3 / i5 / i7 Processor						Keyboard	<i>Some:</i> Preferred Pro USB Keyboard (USB connector), Lenovo logo <i>Some:</i> Lenovo Slim USB Keyboard (USB connector), black <i>Some:</i> Ultralim Plus Wireless Keyboard (2.4GHz via USB receiver), black <i>Some:</i> Enhanced Optical USB Mouse, black, Lenovo logo <i>Some:</i> Ultralim Plus Wireless Mouse (2.4GHz via USB receiver), black																		
	Processor	Cores / Threads	Frequency Base/Max(GHz)	Cache	Memory Types	Integrated Graphics	Mouse																			
	Celeron G3900T	2 / 2	2.6 G	2 MB	DDR4-2133	HD 510	Mechanical	<ul style="list-style-type: none"> • Business black color • Toolless stand • Support VESA mount (100mm) 																		
	Pentium G4400T	2 / 2	2.9 G	3 MB	DDR4-2133	HD 510		<table border="1"> <thead> <tr> <th></th> <th>Dimensions (WxDxH)</th> <th>Max weight (lb / kg)</th> <th>Adjustments</th> </tr> </thead> <tbody> <tr> <td>Without stand:</td> <td>19.8 X 1.5 X 13.5 (inch); 503 X 38 X 344 (mm)</td> <td>10.2 / 4.62</td> <td>N/A</td> </tr> <tr> <td>With Basic Monitor stand:</td> <td>19.8 X 9.6 X 16.2 (inch); 503 X 245 X 412 (mm)</td> <td>14.6 / 6.6</td> <td>Tilt: 45° back, -5° forward</td> </tr> <tr> <td>With Full Function Monitor stand:</td> <td>19.8 X 9.6 X 15.7 (inch); 503 X 245 X 400 (mm)</td> <td>14.9 / 6.77</td> <td>Tilt: 45° back, -5° forward; Lift: 110mm; Swivel: +/-45°</td> </tr> </tbody> </table>				Dimensions (WxDxH)	Max weight (lb / kg)	Adjustments	Without stand:	19.8 X 1.5 X 13.5 (inch); 503 X 38 X 344 (mm)	10.2 / 4.62	N/A	With Basic Monitor stand:	19.8 X 9.6 X 16.2 (inch); 503 X 245 X 412 (mm)	14.6 / 6.6	Tilt: 45° back, -5° forward	With Full Function Monitor stand:	19.8 X 9.6 X 15.7 (inch); 503 X 245 X 400 (mm)	14.9 / 6.77	Tilt: 45° back, -5° forward; Lift: 110mm; Swivel: +/-45°
		Dimensions (WxDxH)	Max weight (lb / kg)	Adjustments																						
	Without stand:	19.8 X 1.5 X 13.5 (inch); 503 X 38 X 344 (mm)	10.2 / 4.62	N/A																						
	With Basic Monitor stand:	19.8 X 9.6 X 16.2 (inch); 503 X 245 X 412 (mm)	14.6 / 6.6	Tilt: 45° back, -5° forward																						
	With Full Function Monitor stand:	19.8 X 9.6 X 15.7 (inch); 503 X 245 X 400 (mm)	14.9 / 6.77	Tilt: 45° back, -5° forward; Lift: 110mm; Swivel: +/-45°																						
Core i3-6100T	2 / 4	3.2 G	3 MB	DDR4-2133	HD 530	Power supply	120 watts adapter, autosensing, 89% PSU																			
Core i5-6400T	4 / 4	2.2 G / 2.8 G	6 MB	DDR4-2133	HD 530	Limited warranty ³	<i>Some:</i> 1-year or 3-year, depot repair service <i>Some:</i> 1-year or 3-year, limited onsite service <i>Some:</i> 3-years, limited onsite service, OID (Onsite International Delivery) / <i>For Lenovo service upgrade options, please go to S-TC sheet</i>																			
Core i5-6500T	4 / 4	2.5 G / 3.1 G	6 MB	DDR4-2133	HD 530	Preload	Preloaded operating system <i>Some:</i> Windows® 7 Professional 64 preinstalled through downgrade rights in Windows 10 Pro 64-bit <i>Some:</i> Windows 7 Professional 64 <i>Some:</i> Windows 10 Pro 64-bit <i>Some:</i> Windows 10 Home 64-bit Preloaded applications (only some listed) <ul style="list-style-type: none"> • Desktop Power Manager • Lenovo Solution Center • Lenovo REACHit • Lenovo SHAREit • Lenovo Bluetooth Lock (for models with Wi-Fi/BT card) • McAfee® LiveSafe™ (30-day trial) • Microsoft Office preloaded; purchase a product key to activate • PowerDVD Create (DVD±RW) • Lenovo ThinkVantage Tools - Only for Window 10 • Lenovo Companion • Cyberlink PowerDVD (DVD, DVD±RW) • Lenovo QuickOptimizer - Only for Window 7 • Rescue and Recovery • Password Manager • ThinkVantage System Update • Lenovo Message Center Plus • Adobe® Reader® 																			
Core i5-6600T	4 / 4	2.7 G / 3.5 G	6 MB	DDR4-2133	HD 530	Environment	EPEAT™ Gold rating; ENERGY STAR® 6.1; TCO Certified; ErP Lot 3; GREENGUARD® certified; RoHS-compliant																			
Core i7-6700T	4 / 8	2.8 G / 3.6 G	8 MB	DDR4-2133	HD 530	MIL-SPEC test	MIL-STD-810G military certification (Low Pressure [Altitude], High Temperature, Low Temperature, Temperature Shock, Humidity, Sand and Dust, Vibration, Shock)																			
Memory	32GB max, DDR4 2133, two 260-pin SO-DIMM sockets, dual-channel capable						Accessories	For compatible accessories, please go to TC-AQP sheet																		
Disk	<i>Some:</i> SATA 6.0Gb/s, 2.5" Wide, 5400 rpm or 7200 rpm <i>Some:</i> Solid State Hybrid Drive (SSHD) / with 8GB MLC NAND flash memory, SATA 6.0Gb/s, 2.5" Wide, 5400 rpm <i>Some:</i> Solid State Drive (SSD) / SATA 6.0Gb/s, 2.5" Wide																									
Optical	<i>Some:</i> DVD, SATA 1.5Gb/s, 9.5mm high <i>Some:</i> DVD burner, SATA 1.5Gb/s, 9.5mm high																									
Media reader	Optional 9-in-1 media card reader																									
Graphics	Intel HD Graphics 510/530 in processor, uses main memory, DirectX® 12, external monitor support via DisplayPort™; <i>Max resolution:</i> 4096x2304 (DP)@60Hz																									
Display	20" (508mm) HD+ (1600x900) TFT color , wide viewing angle 178° (Horizontal), LED backlight, 250 nits, 16:9 aspect ratio, 1000:1 contrast ratio, anti-glare																									
Light sensor	None																									
Multi-touch	None																									
Camera	Optional 1.0-megapixel camera, fixed focus, supports 720p, with digital microphone, LED indicator, physical switch on/off																									
Controls	Microphone mute, brightness up/down buttons, and power button																									
Chipset	Intel H110 Chipset																									
Rear ports	Four USB 2.0, ethernet (RJ-45), DisplayPort, optional serial (9-pin), Two USB 3.0 (one is Always On and fast charge), optional card reader, one headphone / microphone combo jack (3.5mm)																									
Side ports	One M.2 Card slot (for WLAN)																									
M.2 card slot	High Definition (HD) Audio, Realtek ALC233 / two internal stereo speakers (2W x 2), Dolby® Audio™ certified																									
Audio support	<i>Some:</i> 11ac wireless, M.2 Card, Qualcomm Atheros QCA9377 (dual band), Wi-Fi + Bluetooth 4.1 combo adapter, 1x1 <i>Some:</i> 11ac wireless, M.2 Card, Qualcomm Atheros QCA6174 (dual band), Wi-Fi + Bluetooth 4.1 combo adapter, 2x2 <i>Some:</i> 11ac wireless, M.2 Card, Intel Dual Band Wireless-AC 3165, Wi-Fi + Bluetooth 4.0 combo adapter, 1x1 <i>Some:</i> 11ac wireless, M.2 Card, Intel Dual Band Wireless-AC 8260, Wi-Fi + Bluetooth 4.1 combo adapter, 2x2																									
WLAN ¹³	<i>Some:</i> Bluetooth 4.0 or 4.1 wireless, integrated in Wi-Fi + Bluetooth combo adapter																									
Bluetooth™	Gigabit ethernet, Realtek RTL8111G, Wake on LAN®																									
Ethernet	None																									
Manageability	Trusted Platform Module (TPM 1.2-compliant)																									
Security chip	<ul style="list-style-type: none"> • Security slot (in rear for attachment of optional Kensington® MicroSaver® cable; Kensington lock also locks chassis) • Smart USB protection, allows keyboard/mouse only, blocks all storage devices • Power-on, admin, hard disk password • Boot sequence control • Boot without keyboard and mouse • Individual USB port disablement • Optional Chassis intrusion switch 																									
Security features																										

See footnotes for more detailed information

Model	Region	Processor	vPro	Graphics	Monitor Cable	Memory	Display	Multi-touch	Storage(HDD/SSD)	Optical	Media Reader	WLAN + Bluetooth	Optional Rear Ports	Camera	Chassis Intrusion Switch	Keyboard / Mouse	Stand	Power Supply	Operating System	Warranty	Ann Date (m/y)
10EY0006US	US	i3-6100T	No	Intel HD 530	None	8GBx1	20.0" HD+ (1600x900) WVA AG	None	256GB SSD	DVD±RW	9-in-1	3165 ac, 1x1 + BT4.0	None	720p	None	USB / USB	Monitor Stand	120W 89% Adapter	Win10 DG Win7 Pro 64	3-year, Onsite	12/15
10EY0007US	US	i3-6100T	No	Intel HD 530	None	4GBx1	20.0" HD+ (1600x900) WVA AG	None	120GB SSD	DVD±RW	9-in-1	3165 ac, 1x1 + BT4.0	None	720p	None	USB / USB	Monitor Stand	120W 89% Adapter	Win10 DG Win7 Pro 64	3-year, Onsite	12/15
10EY0008US	US	i5-6400T	No	Intel HD 530	None	4GBx1	20.0" HD+ (1600x900) WVA AG	None	120GB SSD	DVD±RW	9-in-1	3165 ac, 1x1 + BT4.0	None	720p	None	USB / USB	Monitor Stand	120W 89% Adapter	Win10 DG Win7 Pro 64	3-year, Onsite	12/15
10EY0009US	US	Celeron G3900T	No	Intel HD 510	None	4GBx1	20.0" HD+ (1600x900) WVA AG	None	500GB 7200rpm 2.5"	DVD±RW	9-in-1	3165 ac, 1x1 + BT4.0	None	720p	None	USB / USB	Monitor Stand	120W 89% Adapter	Win10 Pro 64	3-year, Onsite	12/15
10EY000AUS	US	i7-6700T	No	Intel HD 530	None	8GBx1	20.0" HD+ (1600x900) WVA AG	None	256GB SSD	DVD±RW	9-in-1	3165 ac, 1x1 + BT4.0	None	720p	None	USB / USB	Monitor Stand	120W 89% Adapter	Win10 DG Win7 Pro 64	3-year, Onsite	12/15
10EY000BUS	US	i3-6100T	No	Intel HD 530	None	8GBx1	20.0" HD+ (1600x900) WVA AG	None	500GB 7200rpm 2.5"	DVD±RW	9-in-1	3165 ac, 1x1 + BT4.0	None	720p	None	USB / USB	Monitor Stand	120W 89% Adapter	Win10 DG Win7 Pro 64	3-year, Onsite	12/15
10EY000CUS	US	i7-6700T	No	Intel HD 530	None	4GBx1	20.0" HD+ (1600x900) WVA AG	None	500GB 7200rpm 2.5"	DVD±RW	9-in-1	3165 ac, 1x1 + BT4.0	None	720p	None	USB / USB	Monitor Stand	120W 89% Adapter	Win10 Pro 64	3-year, Onsite	12/15
10EY000DUS	US	i7-6700T	No	Intel HD 530	None	4GBx1	20.0" HD+ (1600x900) WVA AG	None	120GB SSD	DVD±RW	9-in-1	3165 ac, 1x1 + BT4.0	None	720p	None	USB / USB	Monitor Stand	120W 89% Adapter	Win10 DG Win7 Pro 64	3-year, Onsite	12/15
10EY000EUS	US	i3-6100T	No	Intel HD 530	None	4GBx1	20.0" HD+ (1600x900) WVA AG	None	500GB 7200rpm 2.5"	DVD±RW	9-in-1	3165 ac, 1x1 + BT4.0	None	720p	None	USB / USB	Monitor Stand	120W 89% Adapter	Win10 DG Win7 Pro 64	3-year, Onsite	12/15
10EY000FUS	US	i5-6400T	No	Intel HD 530	None	8GBx1	20.0" HD+ (1600x900) WVA AG	None	500GB 7200rpm 2.5"	DVD±RW	9-in-1	3165 ac, 1x1 + BT4.0	None	720p	None	USB / USB	Monitor Stand	120W 89% Adapter	Win10 DG Win7 Pro 64	3-year, Onsite	12/15
10EY000GUS	US	i7-6700T	No	Intel HD 530	None	4GBx1	20.0" HD+ (1600x900) WVA AG	None	500GB 7200rpm 2.5"	DVD±RW	9-in-1	3165 ac, 1x1 + BT4.0	None	720p	None	USB / USB	Monitor Stand	120W 89% Adapter	Win10 DG Win7 Pro 64	3-year, Onsite	12/15
10EY000HUS	US	Pentium G4400T	No	Intel HD 510	None	4GBx1	20.0" HD+ (1600x900) WVA AG	None	500GB 7200rpm 2.5"	DVD±RW	9-in-1	3165 ac, 1x1 + BT4.0	None	720p	None	USB / USB	Monitor Stand	120W 89% Adapter	Win10 Pro 64	3-year, Onsite	12/15
10EY000JUS	US	i5-6400T	No	Intel HD 530	None	8GBx1	20.0" HD+ (1600x900) WVA AG	None	256GB SSD	DVD±RW	9-in-1	3165 ac, 1x1 + BT4.0	None	720p	None	USB / USB	Monitor Stand	120W 89% Adapter	Win10 DG Win7 Pro 64	3-year, Onsite	12/15
10EY000KUS	US	Celeron G3900T	No	Intel HD 510	None	4GBx1	20.0" HD+ (1600x900) WVA AG	None	500GB 7200rpm 2.5"	DVD±RW	9-in-1	3165 ac, 1x1 + BT4.0	None	720p	None	USB / USB	Monitor Stand	120W 89% Adapter	Win10 DG Win7 Pro 64	3-year, Onsite	12/15
10EY000LUS	US	i5-6400T	No	Intel HD 530	None	4GBx1	20.0" HD+ (1600x900) WVA AG	None	500GB 7200rpm 2.5"	DVD±RW	9-in-1	3165 ac, 1x1 + BT4.0	None	720p	None	USB / USB	Monitor Stand	120W 89% Adapter	Win10 DG Win7 Pro 64	3-year, Onsite	12/15
10EY000MUS	US	i3-6100T	No	Intel HD 530	None	4GBx1	20.0" HD+ (1600x900) WVA AG	None	500GB 7200rpm 2.5"	DVD±RW	9-in-1	3165 ac, 1x1 + BT4.0	None	720p	None	USB / USB	Monitor Stand	120W 89% Adapter	Win10 Pro 64	3-year, Onsite	12/15
10EY000NUS	US	i7-6700T	No	Intel HD 530	None	8GBx1	20.0" HD+ (1600x900) WVA AG	None	500GB 7200rpm 2.5"	DVD±RW	9-in-1	3165 ac, 1x1 + BT4.0	None	720p	None	USB / USB	Monitor Stand	120W 89% Adapter	Win10 DG Win7 Pro 64	3-year, Onsite	12/15
10EY000PUS	US	i5-6400T	No	Intel HD 530	None	4GBx1	20.0" HD+ (1600x900) WVA AG	None	500GB 7200rpm 2.5"	DVD±RW	9-in-1	3165 ac, 1x1 + BT4.0	None	720p	None	USB / USB	Monitor Stand	120W 89% Adapter	Win10 Pro 64	3-year, Onsite	12/15
10EY000QUS	US	Pentium G4400T	No	Intel HD 510	None	4GBx1	20.0" HD+ (1600x900) WVA AG	None	500GB 7200rpm 2.5"	DVD±RW	9-in-1	3165 ac, 1x1 + BT4.0	None	720p	None	USB / USB	Monitor Stand	120W 89% Adapter	Win10 DG Win7 Pro 64	3-year, Onsite	12/15
10EY002LUS	US	i5-6400T	No	Intel HD 530	None	8GBx1	20.0" HD+ (1600x900) WVA AG	None	256GB SSD Opal	DVD±RW	9-in-1	3165 ac, 1x1 + BT4.0	None	720p	None	USB / USB	Monitor Stand	120W 89% Adapter	Win10 DG Win7 Pro 64	3-year, Onsite	12/16

Model	Region	Processor	vPro	Graphics	Monitor Cable	Memory	Display	Multi-touch	Storage(HDD/SSD)	Optical	Media Reader	WLAN + Bluetooth	Optional Rear Ports	Camera	Chassis Intrusion Switch	Keyboard / Mouse	Stand	Power Supply	Operating System	Warranty	Ann Date (m/y)
10EY002MUS	US	i7-6700T	No	Intel HD 530	None	8GBx1	20.0" HD+ (1600x900) WVA AG	None	256GB SSD Opal	DVD±RW	9-in-1	3165 ac, 1x1 + BT4.0	None	720p	None	USB / USB	Monitor Stand	120W 89% Adapter	Win10 DG Win7 Pro 64	3-year, Onsite	12/16
10EY002NUS	US	i3-6100T	No	Intel HD 530	None	8GBx1	20.0" HD+ (1600x900) WVA AG	None	256GB SSD Opal	DVD±RW	9-in-1	3165 ac, 1x1 + BT4.0	None	720p	None	USB / USB	Monitor Stand	120W 89% Adapter	Win10 DG Win7 Pro 64	3-year, Onsite	12/16

Model	Region	Processor	vPro	Graphics	Monitor Cable	Memory	Display	Multi-touch	Storage(HDD/SSD)	Optical	Media Reader	WLAN + Bluetooth	Optional Rear Ports	Camera	Chassis Intrusion Switch	Keyboard / Mouse	Stand	Power Supply	Operating System	Warranty	Ann Date (m/y)
10F10001US	US	i5-6600T	No	Intel HD 530	None	4GBx2	20.0" HD+ (1600x900) WVA AG	None	120GB SSD	DVD±RW	9-in-1	8260 ac, 2x2, vPro + BT4.1	None	720p	Switch	2.4G / 2.4G	Monitor Stand	120W 89% Adapter	Win10 DG Win7 Pro 64	3-year, Onsite, OID	12/15
10F10002US	US	i5-6600T	No	Intel HD 530	None	4GBx2	20.0" HD+ (1600x900) WVA AG	None	128GB SSD	DVD±RW	9-in-1	8260 ac, 2x2, vPro + BT4.1	None	720p	Switch	2.4G / 2.4G	Monitor Stand	120W 89% Adapter	Win10 Pro 64	3-year, Onsite, OID	12/15
10F10003US	US	i5-6400T	No	Intel HD 530	None	4GBx1	20.0" HD+ (1600x900) WVA AG	None	1TB 5400rpm 2.5"	DVD±RW	9-in-1	8260 ac, 2x2, vPro + BT4.1	None	720p	Switch	USB / USB	Monitor Stand	120W 89% Adapter	Win10 DG Win7 Pro 64	3-year, Onsite, OID	12/15
10F10004US	US	i5-6400T	No	Intel HD 530	None	4GBx1	20.0" HD+ (1600x900) WVA AG	None	500GB 5400rpm 2.5"	DVD	None	3165 ac, 1x1 + BT4.0	None	720p	Switch	USB / USB	Basic Monitor Stand	120W 89% Adapter	Win10 DG Win7 Pro 64	3-year, Onsite, OID	12/15
10F10005US	US	i5-6400T	No	Intel HD 530	None	4GBx1	20.0" HD+ (1600x900) WVA AG	None	1TB 5400rpm 2.5"	DVD±RW	9-in-1	8260 ac, 2x2, vPro + BT4.1	None	720p	Switch	USB / USB	Monitor Stand	120W 89% Adapter	Win10 Pro 64	3-year, Onsite, OID	12/15
10F10006US	US	i5-6400T	No	Intel HD 530	None	4GBx1	20.0" HD+ (1600x900) WVA AG	None	500GB 5400rpm 2.5"	DVD	9-in-1	3165 ac, 1x1 + BT4.0	None	720p	Switch	USB / USB	Basic Monitor Stand	120W 89% Adapter	Win10 Pro 64	3-year, Onsite, OID	12/15



ThinkCentre M800z Platform Specifications

Product Specifications Reference (PSREF)

Processor	Intel® Celeron®, Intel Pentium®, or 6th Generation Intel Core™ i3 / i5 / i7 Processor	Keyboard	<i>Some:</i> Preferred Pro USB Keyboard (USB connector), Lenovo logo <i>Some:</i> Lenovo Slim USB Keyboard (USB connector), black <i>Some:</i> Ultralim Plus Wireless Keyboard (2.4GHz via USB receiver), black <i>Some:</i> Enhanced Optical USB Mouse, black, Lenovo logo <i>Some:</i> Ultralim Plus Wireless Mouse (2.4GHz via USB receiver), black																																																												
	<table border="1"> <thead> <tr> <th>Processor</th> <th>Cores / Threads</th> <th>Frequency Base/Max(GHz)</th> <th>Cache</th> <th>Memory Types</th> <th>Integrated Graphics</th> </tr> </thead> <tbody> <tr> <td>Celeron G3900</td> <td>2 / 2</td> <td>2.8 G</td> <td>2 MB</td> <td>DDR4-2133</td> <td>HD 510</td> </tr> <tr> <td>Pentium G4400</td> <td>2 / 2</td> <td>3.3 G</td> <td>3 MB</td> <td>DDR4-2133</td> <td>HD 510</td> </tr> <tr> <td>Pentium G4500</td> <td>2 / 2</td> <td>3.5 G</td> <td>3 MB</td> <td>DDR4-2133</td> <td>HD 530</td> </tr> <tr> <td>Core i3-6100</td> <td>2 / 4</td> <td>3.7 G</td> <td>3 MB</td> <td>DDR4-2133</td> <td>HD 530</td> </tr> <tr> <td>Core i3-6300</td> <td>2 / 4</td> <td>3.8 G</td> <td>4 MB</td> <td>DDR4-2133</td> <td>HD 530</td> </tr> <tr> <td>Core i5-6400</td> <td>4 / 4</td> <td>2.7 G / 3.3 G</td> <td>6 MB</td> <td>DDR4-2133</td> <td>HD 530</td> </tr> <tr> <td>Core i5-6500</td> <td>4 / 4</td> <td>3.2 G / 3.6 G</td> <td>6 MB</td> <td>DDR4-2133</td> <td>HD 530</td> </tr> <tr> <td>Core i5-6600</td> <td>4 / 4</td> <td>3.3 G / 3.9 G</td> <td>6 MB</td> <td>DDR4-2133</td> <td>HD 530</td> </tr> <tr> <td>Core i7-6700</td> <td>4 / 8</td> <td>3.4 G / 4.0 G</td> <td>8 MB</td> <td>DDR4-2133</td> <td>HD 530</td> </tr> </tbody> </table>	Processor	Cores / Threads	Frequency Base/Max(GHz)	Cache	Memory Types	Integrated Graphics	Celeron G3900	2 / 2	2.8 G	2 MB	DDR4-2133	HD 510	Pentium G4400	2 / 2	3.3 G	3 MB	DDR4-2133	HD 510	Pentium G4500	2 / 2	3.5 G	3 MB	DDR4-2133	HD 530	Core i3-6100	2 / 4	3.7 G	3 MB	DDR4-2133	HD 530	Core i3-6300	2 / 4	3.8 G	4 MB	DDR4-2133	HD 530	Core i5-6400	4 / 4	2.7 G / 3.3 G	6 MB	DDR4-2133	HD 530	Core i5-6500	4 / 4	3.2 G / 3.6 G	6 MB	DDR4-2133	HD 530	Core i5-6600	4 / 4	3.3 G / 3.9 G	6 MB	DDR4-2133	HD 530	Core i7-6700	4 / 8	3.4 G / 4.0 G	8 MB	DDR4-2133	HD 530	Mouse	
Processor	Cores / Threads	Frequency Base/Max(GHz)	Cache	Memory Types	Integrated Graphics																																																										
Celeron G3900	2 / 2	2.8 G	2 MB	DDR4-2133	HD 510																																																										
Pentium G4400	2 / 2	3.3 G	3 MB	DDR4-2133	HD 510																																																										
Pentium G4500	2 / 2	3.5 G	3 MB	DDR4-2133	HD 530																																																										
Core i3-6100	2 / 4	3.7 G	3 MB	DDR4-2133	HD 530																																																										
Core i3-6300	2 / 4	3.8 G	4 MB	DDR4-2133	HD 530																																																										
Core i5-6400	4 / 4	2.7 G / 3.3 G	6 MB	DDR4-2133	HD 530																																																										
Core i5-6500	4 / 4	3.2 G / 3.6 G	6 MB	DDR4-2133	HD 530																																																										
Core i5-6600	4 / 4	3.3 G / 3.9 G	6 MB	DDR4-2133	HD 530																																																										
Core i7-6700	4 / 8	3.4 G / 4.0 G	8 MB	DDR4-2133	HD 530																																																										
		Mechanical	<ul style="list-style-type: none"> • Business black color • Toolless stand • Support VESA mount (100mm) <table border="1"> <thead> <tr> <th></th> <th>Dimensions (WxDxH)</th> <th>Max weight (lb / kg)</th> <th>Adjustments</th> </tr> </thead> <tbody> <tr> <td>Without stand:</td> <td>21.1 X 1.8 X 14.3 (inch); 535 X 45 X 363 (mm)</td> <td>(Touch) 14.6 / 6.6 (Non-touch) 12.8 / 5.8</td> <td>N/A</td> </tr> <tr> <td>With Basic Monitor stand:</td> <td>21.1 X 9.6 X 17.0 (inch); 535 X 245 X 431 (mm)</td> <td>(Non-touch) 17.0 / 7.7</td> <td>Tilt: 45° back, -5° forward</td> </tr> <tr> <td>With UltraFlex II stand:</td> <td>21.1X 10.0 X 19.3 (inch); 535 X 253 X 489 (mm)</td> <td>(Touch) 20.3 / 9.2 (Non-touch) 18.3 / 8.3</td> <td>Tilt: 61° back, -5° forward; Lift: 160mm; Swivel: +/-45°</td> </tr> </tbody> </table>			Dimensions (WxDxH)	Max weight (lb / kg)	Adjustments	Without stand:	21.1 X 1.8 X 14.3 (inch); 535 X 45 X 363 (mm)	(Touch) 14.6 / 6.6 (Non-touch) 12.8 / 5.8	N/A	With Basic Monitor stand:	21.1 X 9.6 X 17.0 (inch); 535 X 245 X 431 (mm)	(Non-touch) 17.0 / 7.7	Tilt: 45° back, -5° forward	With UltraFlex II stand:	21.1X 10.0 X 19.3 (inch); 535 X 253 X 489 (mm)	(Touch) 20.3 / 9.2 (Non-touch) 18.3 / 8.3	Tilt: 61° back, -5° forward; Lift: 160mm; Swivel: +/-45°																																											
	Dimensions (WxDxH)	Max weight (lb / kg)	Adjustments																																																												
Without stand:	21.1 X 1.8 X 14.3 (inch); 535 X 45 X 363 (mm)	(Touch) 14.6 / 6.6 (Non-touch) 12.8 / 5.8	N/A																																																												
With Basic Monitor stand:	21.1 X 9.6 X 17.0 (inch); 535 X 245 X 431 (mm)	(Non-touch) 17.0 / 7.7	Tilt: 45° back, -5° forward																																																												
With UltraFlex II stand:	21.1X 10.0 X 19.3 (inch); 535 X 253 X 489 (mm)	(Touch) 20.3 / 9.2 (Non-touch) 18.3 / 8.3	Tilt: 61° back, -5° forward; Lift: 160mm; Swivel: +/-45°																																																												
Memory	32GB max, DDR4 2133, two 260-pin SO-DIMM sockets, dual-channel capable	Power supply	150 watts, autosensing, 85% PSU																																																												
Disk	<i>Some:</i> SATA 6.0Gb/s, 2.5" Wide, 5400 rpm or 7200 rpm <i>Some:</i> Solid State Hybrid Drive (SSHD) / with 8GB MLC NAND flash memory, SATA 6.0Gb/s, 2.5" Wide, 5400 rpm <i>Some:</i> Solid State Drive (SSD) / SATA 6.0Gb/s, 2.5" Wide	Limited warranty ³	<i>Some:</i> 1-year or 3-year, depot repair service <i>Some:</i> 1-year or 3-year, limited onsite service <i>Some:</i> 3-years, limited onsite service, OID (Onsite International Delivery) / <i>For Lenovo service upgrade options, please go to S-TC sheet</i>																																																												
Optical	<i>Some:</i> DVD, SATA 1.5Gb/s, 9.5mm high <i>Some:</i> DVD burner, SATA 1.5Gb/s, 9.5mm high	Preload	Preloaded operating system <i>Some:</i> Windows® 7 Professional 64 preinstalled through downgrade rights in Windows 10 Pro 64-bit <i>Some:</i> Windows 7 Professional 64 <i>Some:</i> Windows 10 Pro 64-bit <i>Some:</i> Windows 10 Home 64-bit																																																												
Media reader	Optional 9-in-1 media card reader		Preloaded applications (only some listed) <ul style="list-style-type: none"> • Desktop Power Manager • Lenovo Solution Center • Lenovo REACHit • Lenovo SHAREit • Lenovo Bluetooth Lock (for models with Wi-Fi/BT card) • McAfee® LiveSafe™ (30-day trial) • Microsoft Office preloaded; purchase a product key to activate • PowerDVD Create (DVD±RW) • Lenovo ThinkVantage Tools <ul style="list-style-type: none"> - Only for Window 10 • Lenovo Companion • Cyberlink PowerDVD (DVD, DVD±RW) • Lenovo QuickOptimizer - Only for Window 7 • Rescue and Recovery • Password Manager • ThinkVantage System Update • Lenovo Message Center Plus • Adobe® Reader® 																																																												
Graphics	Intel HD Graphics 510/530 in processor, uses main memory, DirectX® 12, external monitor support via DisplayPort™; <i>Max resolution:</i> 4096x2304 (DP)@60Hz																																																														
Display	21.5" (546.1mm) Full HD 1080p (1920x1080) TFT color , MVA panel, wide viewing angle (+/- 89°), LED backlight, 250 nits, 16:9 aspect ratio, 1000:1 contrast ratio, anti-glare for both touch models and non-touch models																																																														
Light sensor	None																																																														
Multi-touch	Optional Projected Capacitive Touch (PCT) technology, supports 10-point touch																																																														
Camera	Optional 1.0-megapixel camera, fixed focus, supports 720p, with digital microphone, LED indicator, physical switch on/off																																																														
Controls	Microphone mute, brightness up/down buttons, and power button																																																														
Chipset	Intel H110 Chipset																																																														
Rear ports	Four USB 2.0, ethernet (RJ-45), DisplayPort, optional serial (9-pin),																																																														
Side ports	Two USB 3.0 (one is Always On and fast charge), optional card reader, one headphone / microphone combo jack (3.5mm)																																																														
M.2 card slot	One M.2 Card slot (for WLAN)																																																														
Audio support	High Definition (HD) Audio, Realtek ALC233 / two internal stereo speakers (2W x 2), Dolby® Audio™ certified	Environment	EPEAT™ Gold rating; ENERGY STAR® 6.1; TCO Certified; ErP Lot 3; GREENGUARD® certified; RoHS-compliant																																																												
WLAN ¹³	<i>Some:</i> 11ac wireless, M.2 Card, Qualcomm Atheros QCA9377 (dual band), Wi-Fi + Bluetooth 4.1 combo adapter, 1x1 <i>Some:</i> 11ac wireless, M.2 Card, Qualcomm Atheros QCA6174 (dual band), Wi-Fi + Bluetooth 4.1 combo adapter, 2x2 <i>Some:</i> 11ac wireless, M.2 Card, Intel Dual Band Wireless-AC 3165, Wi-Fi + Bluetooth 4.0 combo adapter, 1x1 <i>Some:</i> 11ac wireless, M.2 Card, Intel Dual Band Wireless-AC 8260, Wi-Fi + Bluetooth 4.1 combo adapter, 2x2	MIL-SPEC test	MIL-STD-810G military certification (Low Pressure [Altitude], High Temperature, Low Temperature, Temperature Shock, Humidity, Sand and Dust, Vibration, Shock)																																																												
Bluetooth™	<i>Some:</i> Bluetooth 4.0 or 4.1 wireless, integrated in Wi-Fi + Bluetooth combo adapter	Accessories	For compatible accessories, please go to TC-AQP sheet																																																												
Ethernet	Gigabit ethernet, Realtek RTL8111G, Wake on LAN®																																																														
Manageability	None																																																														
Security chip	Trusted Platform Module (TPM 1.2-compliant)																																																														
Security features	<ul style="list-style-type: none"> • Security slot (in rear for attachment of optional Kensington® MicroSaver® cable; Kensington lock also locks chassis) • Smart USB protection, allows keyboard/ mouse only, blocks all storage devices • Power-on, admin, hard disk password • Boot sequence control • Boot without keyboard and mouse • Individual USB port disablement • Optional Chassis intrusion switch 																																																														

See footnotes for more detailed information

Model	Region	Processor	vPro	Graphics	Monitor Cable	Memory	Display	Multi-touch	Storage(HDD/SSD)	Optical	Media Reader	WLAN + Bluetooth	Optional Rear Ports	Camera	Chassis Intrusion Switch	Keyboard / Mouse	Stand	Power Supply	Operating System	Warranty	Ann Date (m/y)
10ET0002US	US	i5-6500	No	Intel HD 530	DP to HDMI	4GBx1	21.5" FHD (1920x1080) WVA AG	10-point Multi-touch	500GB 7200rpm 2.5"	DVD±RW	9-in-1	8260 ac, 2x2 + BT4.1	None	720p	None	USB / USB	UltraFlex II Stand	150W 85% Adapter	Win10 DG Win7 Pro 64	3-year, Onsite	11/15
10ET0003US	US	i7-6700	No	Intel HD 530	None	4GBx1	21.5" FHD (1920x1080) WVA AG	10-point Multi-touch	500GB 7200rpm 2.5"	DVD±RW	9-in-1	8260 ac, 2x2 + BT4.1	None	720p	None	USB / USB	UltraFlex II Stand	150W 85% Adapter	Win10 DG Win7 Pro 64	3-year, Onsite	11/15
10ET0004US	US	i5-6500	No	Intel HD 530	None	4GBx1	21.5" FHD (1920x1080) WVA AG	10-point Multi-touch	500GB 7200rpm 2.5"	DVD±RW	9-in-1	8260 ac, 2x2 + BT4.1	None	720p	None	USB / USB	UltraFlex II Stand	150W 85% Adapter	Win10 Pro 64	3-year, Onsite	11/15
10ET0005US	US	i7-6700	No	Intel HD 530	None	8GBx1	21.5" FHD (1920x1080) WVA AG	10-point Multi-touch	500GB 7200rpm 2.5"	DVD±RW	9-in-1	8260 ac, 2x2 + BT4.1	None	720p	None	USB / USB	UltraFlex II Stand	150W 85% Adapter	Win10 DG Win7 Pro 64	3-year, Onsite	11/15
10ET0007US	US	i5-6500	No	Intel HD 530	DP to HDMI	8GBx1	21.5" FHD (1920x1080) WVA AG	10-point Multi-touch	500GB 7200rpm 2.5"	DVD±RW	9-in-1	8260 ac, 2x2 + BT4.1	None	720p	None	USB / USB	UltraFlex II Stand	150W 85% Adapter	Win10 DG Win7 Pro 64	3-year, Onsite	11/15
10ET0009US	US	i5-6400	No	Intel HD 530	None	4GBx1	21.5" FHD (1920x1080) WVA AG	10-point Multi-touch	500GB 7200rpm 2.5"	DVD±RW	9-in-1	8260 ac, 2x2 + BT4.1	None	720p	None	USB / USB	UltraFlex II Stand	150W 85% Adapter	Win10 Pro 64	3-year, Onsite	11/15
10ET000AUS	US	i5-6400	No	Intel HD 530	None	4GBx1	21.5" FHD (1920x1080) WVA AG	10-point Multi-touch	500GB 7200rpm 2.5"	DVD±RW	9-in-1	8260 ac, 2x2 + BT4.1	None	720p	None	USB / USB	UltraFlex II Stand	150W 85% Adapter	Win10 DG Win7 Pro 64	3-year, Onsite	11/15
10ET000CUS	US	i5-6400	No	Intel HD 530	None	8GBx1	21.5" FHD (1920x1080) WVA AG	10-point Multi-touch	500GB 7200rpm 2.5"	DVD±RW	9-in-1	8260 ac, 2x2 + BT4.1	None	720p	None	USB / USB	UltraFlex II Stand	150W 85% Adapter	Win10 DG Win7 Pro 64	3-year, Onsite	11/15
10ET001AUS	US	Pentium G4400	No	Intel HD 510	None	4GBx1	21.5" FHD (1920x1080) WVA AG	10-point Multi-touch	500GB 7200rpm 2.5"	DVD±RW	9-in-1	8260 ac, 2x2 + BT4.1	None	720p	None	USB / USB	UltraFlex II Stand	150W 85% Adapter	Win10 DG Win7 Pro 64	3-year, Onsite	12/15
10ET001BUS	US	i7-6700	No	Intel HD 530	None	8GBx1	21.5" FHD (1920x1080) WVA AG	10-point Multi-touch	256GB SSD	DVD±RW	9-in-1	8260 ac, 2x2 + BT4.1	None	720p	None	USB / USB	UltraFlex II Stand	150W 85% Adapter	Win10 DG Win7 Pro 64	3-year, Onsite	11/15
10ET001CUS	US	i3-6100	No	Intel HD 530	None	4GBx1	21.5" FHD (1920x1080) WVA AG	10-point Multi-touch	120GB SSD	DVD±RW	9-in-1	8260 ac, 2x2 + BT4.1	None	720p	None	USB / USB	UltraFlex II Stand	150W 85% Adapter	Win10 DG Win7 Pro 64	3-year, Onsite	12/15
10ET001DUS	US	i3-6100	No	Intel HD 530	None	8GBx1	21.5" FHD (1920x1080) WVA AG	10-point Multi-touch	500GB 7200rpm 2.5"	DVD±RW	9-in-1	8260 ac, 2x2 + BT4.1	None	720p	None	USB / USB	UltraFlex II Stand	150W 85% Adapter	Win10 DG Win7 Pro 64	3-year, Onsite	12/15
10ET001EUS	US	i5-6400	No	Intel HD 530	None	8GBx1	21.5" FHD (1920x1080) WVA AG	10-point Multi-touch	256GB SSD	DVD±RW	9-in-1	8260 ac, 2x2 + BT4.1	None	720p	None	USB / USB	UltraFlex II Stand	150W 85% Adapter	Win10 DG Win7 Pro 64	3-year, Onsite	11/15
10ET001FUS	US	i3-6100	No	Intel HD 530	None	4GBx1	21.5" FHD (1920x1080) WVA AG	10-point Multi-touch	500GB 7200rpm 2.5"	DVD±RW	9-in-1	8260 ac, 2x2 + BT4.1	None	720p	None	USB / USB	UltraFlex II Stand	150W 85% Adapter	Win10 Pro 64	3-year, Onsite	12/15
10ET001GUS	US	Celeron G3900	No	Intel HD 510	None	4GBx1	21.5" FHD (1920x1080) WVA AG	10-point Multi-touch	500GB 7200rpm 2.5"	DVD±RW	9-in-1	8260 ac, 2x2 + BT4.1	None	720p	None	USB / USB	UltraFlex II Stand	150W 85% Adapter	Win10 DG Win7 Pro 64	3-year, Onsite	12/15
10ET001HUS	US	i7-6700	No	Intel HD 530	None	4GBx1	21.5" FHD (1920x1080) WVA AG	10-point Multi-touch	500GB 7200rpm 2.5"	DVD±RW	9-in-1	8260 ac, 2x2 + BT4.1	None	720p	None	USB / USB	UltraFlex II Stand	150W 85% Adapter	Win10 Pro 64	3-year, Onsite	11/15
10ET001JUS	US	i7-6700	No	Intel HD 530	None	4GBx1	21.5" FHD (1920x1080) WVA AG	10-point Multi-touch	120GB SSD	DVD±RW	9-in-1	8260 ac, 2x2 + BT4.1	None	720p	None	USB / USB	UltraFlex II Stand	150W 85% Adapter	Win10 DG Win7 Pro 64	3-year, Onsite	11/15
10ET001KUS	US	i5-6400	No	Intel HD 530	None	4GBx1	21.5" FHD (1920x1080) WVA AG	10-point Multi-touch	120GB SSD	DVD±RW	9-in-1	8260 ac, 2x2 + BT4.1	None	720p	None	USB / USB	UltraFlex II Stand	150W 85% Adapter	Win10 DG Win7 Pro 64	3-year, Onsite	11/15
10ET001LUS	US	i3-6100	No	Intel HD 530	None	8GBx1	21.5" FHD (1920x1080) WVA AG	10-point Multi-touch	256GB SSD	DVD±RW	9-in-1	8260 ac, 2x2 + BT4.1	None	720p	None	USB / USB	UltraFlex II Stand	150W 85% Adapter	Win10 DG Win7 Pro 64	3-year, Onsite	12/15
10ET001MUS	US	i3-6100	No	Intel HD 530	None	4GBx1	21.5" FHD (1920x1080) WVA AG	10-point Multi-touch	500GB 7200rpm 2.5"	DVD±RW	9-in-1	8260 ac, 2x2 + BT4.1	None	720p	None	USB / USB	UltraFlex II Stand	150W 85% Adapter	Win10 DG Win7 Pro 64	3-year, Onsite	12/15

Model	Region	Processor	vPro	Graphics	Monitor Cable	Memory	Display	Multi-touch	Storage(HDD/SSD)	Optical	Media Reader	WLAN + Bluetooth	Optional Rear Ports	Camera	Chassis Intrusion Switch	Keyboard / Mouse	Stand	Power Supply	Operating System	Warranty	Ann Date (m/y)
10ET0026US	US	i7-6700	No	Intel HD 530	None	8GBx1	21.5" FHD (1920x1080) WVA AG	10-point Multi-touch	256GB SSD Opal	DVD±RW	9-in-1	8260 ac, 2x2 + BT4.1	None	720p	None	USB / USB	UltraFlex II Stand	150W 85% Adapter	Win10 DG Win7 Pro 64	3-year, Onsite	12/16
10ET0027US	US	i5-6400	No	Intel HD 530	None	8GBx1	21.5" FHD (1920x1080) WVA AG	10-point Multi-touch	256GB SSD Opal	DVD±RW	9-in-1	8260 ac, 2x2 + BT4.1	None	720p	None	USB / USB	UltraFlex II Stand	150W 85% Adapter	Win10 DG Win7 Pro 64	3-year, Onsite	12/16
10ET0028US	US	i3-6100	No	Intel HD 530	None	8GBx1	21.5" FHD (1920x1080) WVA AG	10-point Multi-touch	256GB SSD Opal	DVD±RW	9-in-1	8260 ac, 2x2 + BT4.1	None	720p	None	USB / USB	UltraFlex II Stand	150W 85% Adapter	Win10 DG Win7 Pro 64	3-year, Onsite	12/16

Model	Region	Processor	vPro	Graphics	Monitor Cable	Memory	Display	Multi-touch	Storage(HDD/SSD)	Optical	Media Reader	WLAN + Bluetooth	Optional Rear Ports	Camera	Chassis Intrusion Switch	Keyboard / Mouse	Stand	Power Supply	Operating System	Warranty	Ann Date (m/y)
10EU001PUS	US	i5-6400	No	Intel HD 530	None	4GBx1	21.5" FHD (1920x1080) WVA AG	None	500GB 7200rpm 2.5"	DVD±RW	9-in-1	8260 ac, 2x2 + BT4.1	None	720p	None	USB / USB	Basic Monitor Stand	150W 85% Adapter	Win10 Pro 64	3-year, Onsite	11/15
10EU001QUS	US	i7-6700	No	Intel HD 530	None	4GBx1	21.5" FHD (1920x1080) WVA AG	None	500GB 7200rpm 2.5"	DVD±RW	9-in-1	8260 ac, 2x2 + BT4.1	None	720p	None	USB / USB	UltraFlex II Stand	150W 85% Adapter	Win10 DG Win7 Pro 64	3-year, Onsite	11/15
10EU001RUS	US	i7-6700	No	Intel HD 530	None	4GBx1	21.5" FHD (1920x1080) WVA AG	None	500GB 7200rpm 2.5"	DVD±RW	9-in-1	8260 ac, 2x2 + BT4.1	None	720p	None	USB / USB	Basic Monitor Stand	150W 85% Adapter	Win10 Pro 64	3-year, Onsite	11/15
10EU001SUS	US	i5-6400	No	Intel HD 530	None	4GBx1	21.5" FHD (1920x1080) WVA AG	None	500GB 7200rpm 2.5"	DVD±RW	9-in-1	8260 ac, 2x2 + BT4.1	None	720p	None	USB / USB	UltraFlex II Stand	150W 85% Adapter	Win10 Pro 64	3-year, Onsite	11/15
10EU001TUS	US	i5-6400	No	Intel HD 530	None	4GBx1	21.5" FHD (1920x1080) WVA AG	None	500GB 7200rpm 2.5"	DVD±RW	9-in-1	8260 ac, 2x2 + BT4.1	None	720p	None	USB / USB	UltraFlex II Stand	150W 85% Adapter	Win10 DG Win7 Pro 64	3-year, Onsite	11/15
10EU001UUS	US	i7-6700	No	Intel HD 530	None	4GBx1	21.5" FHD (1920x1080) WVA AG	None	500GB 7200rpm 2.5"	DVD±RW	9-in-1	8260 ac, 2x2 + BT4.1	None	720p	None	USB / USB	UltraFlex II Stand	150W 85% Adapter	Win10 Pro 64	3-year, Onsite	11/15
10EU001VUS	US	i7-6700	No	Intel HD 530	None	8GBx1	21.5" FHD (1920x1080) WVA AG	None	500GB 7200rpm 2.5"	DVD±RW	9-in-1	8260 ac, 2x2 + BT4.1	None	720p	None	USB / USB	UltraFlex II Stand	150W 85% Adapter	Win10 DG Win7 Pro 64	3-year, Onsite	11/15
10EU001WUS	US	i5-6400	No	Intel HD 530	None	8GBx1	21.5" FHD (1920x1080) WVA AG	None	500GB 7200rpm 2.5"	DVD±RW	9-in-1	8260 ac, 2x2 + BT4.1	None	720p	None	USB / USB	UltraFlex II Stand	150W 85% Adapter	Win10 DG Win7 Pro 64	3-year, Onsite	11/15
10EU002WUS	US	i7-6700	No	Intel HD 530	None	4GBx1	21.5" FHD (1920x1080) WVA AG	None	120GB SSD	DVD±RW	9-in-1	8260 ac, 2x2 + BT4.1	None	720p	None	USB / USB	UltraFlex II Stand	150W 85% Adapter	Win10 DG Win7 Pro 64	3-year, Onsite	11/15
10EU002XUS	US	i3-6100	No	Intel HD 530	None	8GBx1	21.5" FHD (1920x1080) WVA AG	None	256GB SSD	DVD±RW	9-in-1	8260 ac, 2x2 + BT4.1	None	720p	None	USB / USB	UltraFlex II Stand	150W 85% Adapter	Win10 DG Win7 Pro 64	3-year, Onsite	12/15
10EU002YUS	US	i5-6400	No	Intel HD 530	None	8GBx1	21.5" FHD (1920x1080) WVA AG	None	256GB SSD	DVD±RW	9-in-1	8260 ac, 2x2 + BT4.1	None	720p	None	USB / USB	UltraFlex II Stand	150W 85% Adapter	Win10 DG Win7 Pro 64	3-year, Onsite	11/15
10EU0030US	US	Pentium G4400	No	Intel HD 510	None	4GBx1	21.5" FHD (1920x1080) WVA AG	None	500GB 7200rpm 2.5"	DVD±RW	9-in-1	8260 ac, 2x2 + BT4.1	None	720p	None	USB / USB	UltraFlex II Stand	150W 85% Adapter	Win10 DG Win7 Pro 64	3-year, Onsite	12/15
10EU0031US	US	i3-6100	No	Intel HD 530	None	8GBx1	21.5" FHD (1920x1080) WVA AG	None	500GB 7200rpm 2.5"	DVD±RW	9-in-1	8260 ac, 2x2 + BT4.1	None	720p	None	USB / USB	UltraFlex II Stand	150W 85% Adapter	Win10 DG Win7 Pro 64	3-year, Onsite	12/15
10EU0032US	US	Celeron G3900	No	Intel HD 510	None	4GBx1	21.5" FHD (1920x1080) WVA AG	None	500GB 7200rpm 2.5"	DVD±RW	9-in-1	8260 ac, 2x2 + BT4.1	None	720p	None	USB / USB	UltraFlex II Stand	150W 85% Adapter	Win10 DG Win7 Pro 64	3-year, Onsite	03/16
10EU0033US	US	i5-6400	No	Intel HD 530	None	4GBx1	21.5" FHD (1920x1080) WVA AG	None	120GB SSD	DVD±RW	9-in-1	8260 ac, 2x2 + BT4.1	None	720p	None	USB / USB	UltraFlex II Stand	150W 85% Adapter	Win10 DG Win7 Pro 64	3-year, Onsite	11/15
10EU0034US	US	i3-6100	No	Intel HD 530	None	4GBx1	21.5" FHD (1920x1080) WVA AG	None	500GB 7200rpm 2.5"	DVD±RW	9-in-1	8260 ac, 2x2 + BT4.1	None	720p	None	USB / USB	UltraFlex II Stand	150W 85% Adapter	Win10 DG Win7 Pro 64	3-year, Onsite	12/15
10EU0035US	US	i3-6100	No	Intel HD 530	None	4GBx1	21.5" FHD (1920x1080) WVA AG	None	120GB SSD	DVD±RW	9-in-1	8260 ac, 2x2 + BT4.1	None	720p	None	USB / USB	UltraFlex II Stand	150W 85% Adapter	Win10 DG Win7 Pro 64	3-year, Onsite	12/15
10EU0036US	US	i7-6700	No	Intel HD 530	None	8GBx1	21.5" FHD (1920x1080) WVA AG	None	256GB SSD	DVD±RW	9-in-1	8260 ac, 2x2 + BT4.1	None	720p	None	USB / USB	UltraFlex II Stand	150W 85% Adapter	Win10 DG Win7 Pro 64	3-year, Onsite	11/15
10EU0037US	US	i3-6100	No	Intel HD 530	None	4GBx1	21.5" FHD (1920x1080) WVA AG	None	500GB 7200rpm 2.5"	DVD±RW	9-in-1	8260 ac, 2x2 + BT4.1	None	720p	None	USB / USB	UltraFlex II Stand	150W 85% Adapter	Win10 Pro 64	3-year, Onsite	12/15
10EU0048US	US	i7-6700	No	Intel HD 530	None	8GBx1	21.5" FHD (1920x1080) WVA AG	None	256GB SSD Opal	DVD±RW	9-in-1	8260 ac, 2x2 + BT4.1	None	720p	None	USB / USB	UltraFlex II Stand	150W 85% Adapter	Win10 DG Win7 Pro 64	3-year, Onsite	12/16

Model	Region	Processor	vPro	Graphics	Monitor Cable	Memory	Display	Multi-touch	Storage(HDD/SSD)	Optical	Media Reader	WLAN + Bluetooth	Optional Rear Ports	Camera	Chassis Intrusion Switch	Keyboard / Mouse	Stand	Power Supply	Operating System	Warranty	Ann Date (m/y)
10EU0049US	US	i3-6100	No	Intel HD 530	None	8GBx1	21.5" FHD (1920x1080) WVA AG	None	256GB SSD Opal	DVD±RW	9-in-1	8260 ac, 2x2 + BT4.1	None	720p	None	USB / USB	UltraFlex II Stand	150W 85% Adapter	Win10 DG Win7 Pro 64	3-year, Onsite	12/16
10EU004AUS	US	i5-6400	No	Intel HD 530	None	8GBx1	21.5" FHD (1920x1080) WVA AG	None	256GB SSD Opal	DVD±RW	9-in-1	8260 ac, 2x2 + BT4.1	None	720p	None	USB / USB	UltraFlex II Stand	150W 85% Adapter	Win10 DG Win7 Pro 64	3-year, Onsite	12/16

Model	Region	Processor	vPro	Graphics	Monitor Cable	Memory	Display	Multi-touch	Storage(HDD/SSD)	Optical	Media Reader	WLAN + Bluetooth	Optional Rear Ports	Camera	Chassis Intrusion Switch	Keyboard / Mouse	Stand	Power Supply	Operating System	Warranty	Ann Date (m/y)
10EW000UUS	US	i5-6400	No	Intel HD 530	None	4GBx1	21.5" FHD (1920x1080) WVA AG	None	1TB 5400rpm 2.5"	DVD±RW	9-in-1	8260 ac, 2x2 + BT4.1	None	720p	Switch	USB / USB	UltraFlex II Stand	150W 85% Adapter	Win10 DG Win7 Pro 64	3-year, Onsite, OID	11/15
10EW000VUS	US	i5-6400	No	Intel HD 530	None	4GBx1	21.5" FHD (1920x1080) WVA AG	None	1TB 5400rpm 2.5"	DVD±RW	9-in-1	8260 ac, 2x2 + BT4.1	None	720p	Switch	USB / USB	UltraFlex II Stand	150W 85% Adapter	Win10 Pro 64	3-year, Onsite, OID	11/15
10EW000WUS	US	i5-6400	No	Intel HD 530	None	4GBx1	21.5" FHD (1920x1080) WVA AG	None	500GB 5400rpm 2.5"	DVD	None	8260 ac, 2x2 + BT4.1	None	720p	Switch	USB / USB	Basic Monitor Stand	150W 85% Adapter	Win10 DG Win7 Pro 64	3-year, Onsite, OID	11/15
10EW000XUS	US	i5-6400	No	Intel HD 530	None	4GBx1	21.5" FHD (1920x1080) WVA AG	None	500GB 5400rpm 2.5"	DVD	None	8260 ac, 2x2 + BT4.1	None	720p	Switch	USB / USB	Basic Monitor Stand	150W 85% Adapter	Win10 Pro 64	3-year, Onsite, OID	11/15



ThinkCentre M810z Platform Specifications

Product Specifications Reference (PSREF)

Processor	Intel® Celeron®, Intel Pentium®, or 6th / 7th Gen Intel Core™ i3 / i5 / i7 Processor						Security features <ul style="list-style-type: none"> Security slot (in rear for attachment of optional Kensington® MicroSaver® cable; Kensington lock also locks chassis) Smart USB protection, allows keyboard/mouse only, blocks all storage devices Optional cable lock to physically lock keyboard and mouse Power-on, admin, hard disk password Boot sequence control Boot without keyboard and mouse Individual USB port disablement Optional Chassis intrusion switch
	Processor	Cores / Threads	Frequency Base/Max(GHz)	Cache	Memory Support (Up to)	Integrated Graphics	
	Pentium G4400	2 / 2	3.3G	3 MB	DDR4-2133	HD 510	
	Pentium G4560	2 / 4	3.5G	3 MB	DDR4-2400	HD 610	
	Pentium G4600	2 / 4	3.6G	3 MB	DDR4-2400	HD 630	
	Core i3-6100	2 / 4	3.7G	3 MB	DDR4-2133	HD 530	
	Core i5-6500	4 / 4	3.2G / 3.6G	6 MB	DDR4-2133	HD 530	
	Core i7-6700	4 / 8	3.4G / 4.0G	8 MB	DDR4-2133	HD 530	
	Core i3-7100	2 / 4	3.9G	3 MB	DDR4-2400	HD 630	
	Core i5-7400	4 / 4	3.0G / 3.5G	6 MB	DDR4-2400	HD 630	
Core i5-7500	4 / 4	3.4G / 3.8G	6 MB	DDR4-2400	HD 630		
Core i5-7600	4 / 4	3.5G / 4.1G	6 MB	DDR4-2400	HD 630		
Core i7-7700	4 / 8	3.6G / 4.2G	8 MB	DDR4-2400	HD 630		
Memory	32GB max, DDR4-2400*, two 260-pin SO-DIMM sockets, dual-channel capable * System clocks down for the processors with lower memory controller						
Storage	<i>Some:</i> Hard Drive / SATA 6.0Gb/s, 2.5", 5400 rpm or 7200 rpm <i>Some:</i> Solid State Drive (SSD) / SATA 6.0Gb/s, 2.5" <i>Some:</i> M.2 Solid State Drive (SSD) / PCIe NVMe, PCIe 3.0 x 4, 32Gb/s <i>Some:</i> Intel Optane™ Memory Ready (models with 7th gen Core processor), M.2 <i>Some:</i> DVD-ROM SATA 1.5Gb/s Drive, slim (9.5mm)						
Optical	<i>Some:</i> DVD Burner (DVD±RW), SATA 1.5Gb/s Drive, slim (9.5mm)						
Media reader	Optional 9-in-1 media card reader						
Graphics	Intel HD Graphics 510/530/610/630 in processor, uses main memory, DirectX® 12, external monitor support via DisplayPort™; <i>Max resolution:</i> 4096x2304 (DP)@60Hz, 1920x1080 (Panel)@60Hz						
Display	21.5" (546.1mm) Full HD 1080p (1920x1080) TFT color , MVA panel, wide viewing angle (+/- 89°), LED backlight, 250 nits, 16:9 aspect ratio, 1000:1 contrast ratio, anti-glare, support Low Blue Light Mode						
Multi-touch	Optional Projected Capacitive Touch (PCT) technology, supports 10-point touch						
Camera	Optional 1080p camera, fixed focus, with dual microphone, LED indicator, physical switch on/off						
Controls	Physical buttons for Microphone mute, brightness up/down, and power on/off						
Chipset	Intel B250 Chipset						
Rear ports	Four USB 3.1 Gen1, ethernet (RJ-45), DisplayPort, optional serial (9-pin),						
Side ports	Two USB 3.1 Gen1 (one is Always On and fast charge), optional card reader, one headphone / microphone combo jack (3.5mm)						
M.2 card slot	Two M.2 Card slots (one for WLAN, one for SSD/Optane)						
Audio support	High Definition (HD) Audio, Realtek ALC233 / two internal speakers (2W x 2), Dolby® Audio™ certified						
WLAN ¹³	<i>Some:</i> 11ac wireless, M.2 Card, Qualcomm Atheros QCA9377A (dual band), Wi-Fi + Bluetooth 4.1 combo adapter, 1x1 <i>Some:</i> 11ac wireless, M.2 Card, Qualcomm Atheros QCA6174A (dual band), Wi-Fi + Bluetooth 4.1 combo adapter, 2x2 <i>Some:</i> 11ac wireless, M.2 Card, Intel Dual Band Wireless-AC 3165, Wi-Fi + Bluetooth 4.1 combo adapter, 1x1 <i>Some:</i> 11ac wireless, M.2 Card, Intel Dual Band Wireless-AC 8265, Wi-Fi + Bluetooth 4.1 combo adapter, 2x2						
Bluetooth™	<i>Some:</i> Bluetooth 4.1 wireless, integrated in Wi-Fi + Bluetooth combo adapter						
Ethernet	Gigabit ethernet, Realtek RTL8111G, Wake on LAN®						
Manageability	None						
Security chip	TPM (Trusted Platform Module) 2.0, TCG Certified * Downgrade to TPM1.2 for the models with Win10 DG Win7 32 OS						
Keyboard	<i>Some:</i> Lenovo Calliope Keyboard (USB connector), black <i>Some:</i> Lenovo Traditional Keyboard (USB connector), black <i>Some:</i> Lenovo Calliope Wireless Keyboard (2.4GHz via USB receiver), black						
Mouse	<i>Some:</i> Lenovo Calliope Mouse (USB connector), black <i>Some:</i> Lenovo Calliope Wireless Mouse (2.4GHz via USB receiver), black						
Mechanical	<ul style="list-style-type: none"> Business black color Toolless stand Support VESA mount (100mm) 						
		Dimensions (WxDxH)		Max weight (lb / kg)		Adjustments	
	Without stand:	21.1 X 1.8 X 14.3 (inch); 535 X 45 X 363 (mm)		(Touch) 14.6 / 6.6 (Non-touch) 12.8 / 5.8		N/A	
	With Basic Monitor stand:	21.1 X 9.6 X 17.0 (inch); 535 X 245 X 431 (mm)		(Non-touch) 17.0 / 7.7		Tilt: 45° back, -5° forward	
	With UltraFlex II stand:	21.1X 10.0 X 19.3 (inch); 535 X 253 X 489 (mm)		(Touch) 20.3 / 9.2 (Non-touch) 18.3 / 8.3		Tilt: 61° back, -5° forward; Lift: 110mm; Swivel: +/-45°	
Power supply	150 watts, autosensing, 85% PSU						
Limited warranty ³	<i>Some:</i> 1-year or 3-year, depot repair service / service upgrades available <i>Some:</i> 1-year or 3-year, limited onsite service / service upgrades available						
Preload	Preloaded operating system <i>Some:</i> Windows® 7 Professional 32/64 preinstalled through downgrade rights in Windows 10 Pro 64-bit <i>Some:</i> Windows 10 Pro 64-bit <i>Some:</i> Windows 10 Home 64-bit			Preloaded applications (only some listed) <ul style="list-style-type: none"> Microsoft Office preloaded; purchase a product key to activate Cyberlink PowerDVD Create (DVD±RW) - Only for Window 10 <ul style="list-style-type: none"> Lenovo Companion Lenovo ID Lenovo Settings Cyberlink PowerDVD (DVD, DVD±RW) - Only for Window 7 <ul style="list-style-type: none"> Lenovo Solution Center Lenovo ThinkVantage Tools ThinkVantage System Update Create Recovery Media Adobe® Reader® 			
Environment	EPEAT™ Gold rating (North America); ENERGY STAR® 6.1; TCO AIO Computer Certified; ErP Lot 3; GREENGUARD® certified; RoHS-compliant						
MIL-SPEC test	MIL-STD-810G military certification (Low Pressure [Altitude], High Temperature, Low Temperature, Temperature Shock, Humidity, Sand and Dust, Vibration, Shock)						
Accessories	For compatible accessories, please go to http://www.lenovoquickpick.com						

See footnotes for more detailed information

Model	Region	Processor	Graphics	Monitor Cable	Memory	Display	Multi-touch	Power Supply	Storage(HDD/SSD)	Optical	Media Reader	USB Type-C	WLAN + Bluetooth	Optional Rear Ports	Camera	Chassis Intrusion Switch	Cable Lock	Keyboard / Mouse	Stand	Operating System	Warranty	Ann Date (m/y)	End of Support
10NX0000US	US	i5-7400	Intel HD 630	None	8GBx1	21.5" FHD (1920x1080) WVA AG	10-point Multi-touch	150W 85% Adapter	256GB SSD M.2 PCIe NVMe	DVD±RW	9-in-1	None	8265 ac, 2x2 + BT4.1	None	1080p	None	None	USB / USB	UltraFlex II Stand	Win10 Pro 64	3-year, Onsite	03/17	Apr 7, 2023
10NX0001US	US	i5-7500	Intel HD 630	None	8GBx1	21.5" FHD (1920x1080) WVA AG	10-point Multi-touch	150W 85% Adapter	256GB SSD M.2 PCIe NVMe	DVD±RW	9-in-1	None	8265 ac, 2x2 + BT4.1	None	1080p	None	None	USB / USB	UltraFlex II Stand	Win10 Pro 64	3-year, Onsite	03/17	Apr 7, 2023
10NX0002US	US	i5-7400	Intel HD 630	None	4GBx1	21.5" FHD (1920x1080) WVA AG	10-point Multi-touch	150W 85% Adapter	500GB 7200rpm 2.5" DVD±RW	DVD±RW	9-in-1	None	8265 ac, 2x2 + BT4.1	None	1080p	None	None	USB / USB	UltraFlex II Stand	Win10 Pro 64	3-year, Onsite	03/17	Apr 7, 2023
10NX0003US	US	i7-7700	Intel HD 630	None	8GBx1	21.5" FHD (1920x1080) WVA AG	10-point Multi-touch	150W 85% Adapter	512GB SSD M.2 PCIe NVMe	DVD±RW	9-in-1	None	8265 ac, 2x2 + BT4.1	None	1080p	None	None	USB / USB	UltraFlex II Stand	Win10 Pro 64	3-year, Onsite	03/17	Apr 7, 2023
10NX0005US	US	i7-7700	Intel HD 630	None	8GBx1	21.5" FHD (1920x1080) WVA AG	10-point Multi-touch	150W 85% Adapter	500GB 7200rpm 2.5" DVD±RW	DVD±RW	9-in-1	None	8265 ac, 2x2 + BT4.1	None	1080p	None	None	USB / USB	UltraFlex II Stand	Win10 Pro 64	3-year, Onsite	03/17	Apr 7, 2023
10NX0006US	US	i5-7400	Intel HD 630	None	8GBx1	21.5" FHD (1920x1080) WVA AG	10-point Multi-touch	150W 85% Adapter	500GB 7200rpm 2.5" DVD±RW	DVD±RW	9-in-1	None	8265 ac, 2x2 + BT4.1	None	1080p	None	None	USB / USB	UltraFlex II Stand	Win10 Pro 64	3-year, Onsite	03/17	Apr 7, 2023
10NX0007US	US	i5-7500	Intel HD 630	None	8GBx1	21.5" FHD (1920x1080) WVA AG	10-point Multi-touch	150W 85% Adapter	500GB 7200rpm 2.5" DVD±RW	DVD±RW	9-in-1	None	8265 ac, 2x2 + BT4.1	None	1080p	None	None	USB / USB	UltraFlex II Stand	Win10 Pro 64	3-year, Onsite	03/17	Apr 7, 2023
10NX0008US	US	i7-7700	Intel HD 630	None	8GBx1	21.5" FHD (1920x1080) WVA AG	10-point Multi-touch	150W 85% Adapter	256GB SSD M.2 PCIe NVMe	DVD±RW	9-in-1	None	8265 ac, 2x2 + BT4.1	None	1080p	None	None	USB / USB	UltraFlex II Stand	Win10 Pro 64	3-year, Onsite	03/17	Apr 7, 2023
10NX0009US	US	i5-7500	Intel HD 630	None	8GBx1	21.5" FHD (1920x1080) WVA AG	10-point Multi-touch	150W 85% Adapter	512GB SSD M.2 PCIe NVMe	DVD±RW	9-in-1	None	8265 ac, 2x2 + BT4.1	None	1080p	None	None	USB / USB	UltraFlex II Stand	Win10 Pro 64	3-year, Onsite	03/17	Apr 7, 2023
10NX000MUS	US	i5-7400	Intel HD 630	None	4GBx1	21.5" FHD (1920x1080) WVA AG	10-point Multi-touch	150W 85% Adapter	128GB SSD M.2 PCIe NVMe	DVD±RW	9-in-1	None	8265 ac, 2x2 + BT4.1	None	1080p	None	None	USB / USB	UltraFlex II Stand	Win10 Pro 64	3-year, Onsite	04/17	May 7, 2023
10NX000NUS	US	i5-7500	Intel HD 630	None	4GBx1	21.5" FHD (1920x1080) WVA AG	10-point Multi-touch	150W 85% Adapter	128GB SSD M.2 PCIe NVMe	DVD±RW	9-in-1	None	8265 ac, 2x2 + BT4.1	None	1080p	None	None	USB / USB	UltraFlex II Stand	Win10 Pro 64	3-year, Onsite	04/17	May 7, 2023
10NX000PUS	US	Pentium G4560	Intel HD 610	None	4GBx1	21.5" FHD (1920x1080) WVA AG	10-point Multi-touch	150W 85% Adapter	500GB 7200rpm 2.5" DVD±RW	DVD±RW	9-in-1	None	8265 ac, 2x2 + BT4.1	None	1080p	None	None	USB / USB	UltraFlex II Stand	Win10 Pro 64	3-year, Onsite	04/17	May 7, 2023
10NX000QUS	US	i3-7100	Intel HD 630	None	8GBx1	21.5" FHD (1920x1080) WVA AG	10-point Multi-touch	150W 85% Adapter	500GB 7200rpm 2.5" DVD±RW	DVD±RW	9-in-1	None	8265 ac, 2x2 + BT4.1	None	1080p	None	None	USB / USB	UltraFlex II Stand	Win10 Pro 64	3-year, Onsite	04/17	May 7, 2023
10NX000RUS	US	i3-7100	Intel HD 630	None	4GBx1	21.5" FHD (1920x1080) WVA AG	10-point Multi-touch	150W 85% Adapter	500GB 7200rpm 2.5" DVD±RW	DVD±RW	9-in-1	None	8265 ac, 2x2 + BT4.1	None	1080p	None	None	USB / USB	UltraFlex II Stand	Win10 Pro 64	3-year, Onsite	04/17	May 7, 2023

Model	Region	Processor	Graphics	Monitor Cable	Memory	Display	Multi-touch	Power Supply	Storage(HDD/SSD)	Optical	Media Reader	USB Type-C	WLAN + Bluetooth	Optional Rear Ports	Camera	Chassis Intrusion Switch	Cable Lock	Keyboard / Mouse	Stand	Operating System	Warranty	Ann Date (m/y)	End of Support
10NY0002US	US	i5-7500	Intel HD 630	None	8GBx1	21.5" FHD (1920x1080) WVA AG	None	150W 85% Adapter	512GB SSD M.2 PCIe NVMe	DVD±RW	9-in-1	None	8265 ac, 2x2 + BT4.1	None	1080p	None	None	USB / USB	UltraFlex II Stand	Win10 Pro 64	3-year, Onsite	03/17	Apr 7, 2023
10NY0003US	US	i7-7700	Intel HD 630	None	8GBx1	21.5" FHD (1920x1080) WVA AG	None	150W 85% Adapter	512GB SSD M.2 PCIe NVMe	DVD±RW	9-in-1	None	8265 ac, 2x2 + BT4.1	None	1080p	None	None	USB / USB	UltraFlex II Stand	Win10 Pro 64	3-year, Onsite	03/17	Apr 7, 2023
10NY0004US	US	i5-7500	Intel HD 630	None	8GBx1	21.5" FHD (1920x1080) WVA AG	None	150W 85% Adapter	256GB SSD M.2 PCIe NVMe	DVD±RW	9-in-1	None	8265 ac, 2x2 + BT4.1	None	1080p	None	None	USB / USB	UltraFlex II Stand	Win10 Pro 64	3-year, Onsite	03/17	Apr 7, 2023
10NY0005US	US	i7-7700	Intel HD 630	None	8GBx1	21.5" FHD (1920x1080) WVA AG	None	150W 85% Adapter	500GB 7200rpm 2.5" DVD±RW	DVD±RW	9-in-1	None	8265 ac, 2x2 + BT4.1	None	1080p	None	None	USB / USB	UltraFlex II Stand	Win10 Pro 64	3-year, Onsite	03/17	Apr 7, 2023
10NY0006US	US	i5-7400	Intel HD 630	None	8GBx1	21.5" FHD (1920x1080) WVA AG	None	150W 85% Adapter	500GB 7200rpm 2.5" DVD±RW	DVD±RW	9-in-1	None	8265 ac, 2x2 + BT4.1	None	1080p	None	None	USB / USB	UltraFlex II Stand	Win10 Pro 64	3-year, Onsite	03/17	Apr 7, 2023
10NY0007US	US	i5-7500	Intel HD 630	None	8GBx1	21.5" FHD (1920x1080) WVA AG	None	150W 85% Adapter	500GB 7200rpm 2.5" DVD±RW	DVD±RW	9-in-1	None	8265 ac, 2x2 + BT4.1	None	1080p	None	None	USB / USB	UltraFlex II Stand	Win10 Pro 64	3-year, Onsite	03/17	Apr 7, 2023
10NY0008US	US	i5-7400	Intel HD 630	None	4GBx1	21.5" FHD (1920x1080) WVA AG	None	150W 85% Adapter	500GB 7200rpm 2.5" DVD±RW	DVD±RW	9-in-1	None	8265 ac, 2x2 + BT4.1	None	1080p	None	None	USB / USB	UltraFlex II Stand	Win10 Pro 64	3-year, Onsite	03/17	Apr 7, 2023
10NY0009US	US	i5-7400	Intel HD 630	None	8GBx1	21.5" FHD (1920x1080) WVA AG	None	150W 85% Adapter	256GB SSD M.2 PCIe NVMe	DVD±RW	9-in-1	None	8265 ac, 2x2 + BT4.1	None	1080p	None	None	USB / USB	UltraFlex II Stand	Win10 Pro 64	3-year, Onsite	03/17	Apr 7, 2023
10NY000BUS	US	i7-7700	Intel HD 630	None	8GBx1	21.5" FHD (1920x1080) WVA AG	None	150W 85% Adapter	256GB SSD M.2 PCIe NVMe	DVD±RW	9-in-1	None	8265 ac, 2x2 + BT4.1	None	1080p	None	None	USB / USB	UltraFlex II Stand	Win10 Pro 64	3-year, Onsite	03/17	Apr 7, 2023
10NY000CUS	US	i5-7500	Intel HD 630	None	4GBx1	21.5" FHD (1920x1080) WVA AG	None	150W 85% Adapter	500GB 7200rpm 2.5" DVD±RW	DVD±RW	9-in-1	None	8265 ac, 2x2 + BT4.1	None	1080p	None	None	USB / USB	UltraFlex II Stand	Win10 Pro 64	3-year, Onsite	03/17	Apr 7, 2023
10NY000QUS	US	Pentium G4400	Intel HD 510	None	4GBx1	21.5" FHD (1920x1080) WVA AG	None	150W 85% Adapter	500GB 7200rpm 2.5" DVD±RW	DVD±RW	9-in-1	None	8265 ac, 2x2 + BT4.1	None	1080p	None	None	USB / USB	UltraFlex II Stand	Win10 DG Win7 Pro 64	3-year, Onsite	03/17	Apr 29, 2023
10NY000RUS	US	i5-6500	Intel HD 530	None	4GBx1	21.5" FHD (1920x1080) WVA AG	None	150W 85% Adapter	500GB 7200rpm 2.5" DVD±RW	DVD±RW	9-in-1	None	8265 ac, 2x2 + BT4.1	None	1080p	None	None	USB / USB	UltraFlex II Stand	Win10 DG Win7 Pro 64	3-year, Onsite	03/17	Apr 29, 2023
10NY000SUS	US	i5-7400	Intel HD 630	None	4GBx1	21.5" FHD (1920x1080) WVA AG	None	150W 85% Adapter	128GB SSD M.2 PCIe NVMe	DVD±RW	9-in-1	None	8265 ac, 2x2 + BT4.1	None	1080p	None	None	USB / USB	UltraFlex II Stand	Win10 Pro 64	3-year, Onsite	04/17	May 7, 2023
10NY000TUS	US	i5-6500	Intel HD 530	None	4GBx1	21.5" FHD (1920x1080) WVA AG	None	150W 85% Adapter	128GB SSD M.2 PCIe NVMe	DVD±RW	9-in-1	None	8265 ac, 2x2 + BT4.1	None	1080p	None	None	USB / USB	UltraFlex II Stand	Win10 DG Win7 Pro 64	3-year, Onsite	03/17	Apr 29, 2023
10NY000UUS	US	i7-6700	Intel HD 530	None	8GBx1	21.5" FHD (1920x1080) WVA AG	None	150W 85% Adapter	512GB SSD M.2 PCIe NVMe	DVD±RW	9-in-1	None	8265 ac, 2x2 + BT4.1	None	1080p	None	None	USB / USB	UltraFlex II Stand	Win10 DG Win7 Pro 64	3-year, Onsite	03/17	Apr 29, 2023
10NY000VUS	US	i7-6700	Intel HD 530	None	8GBx1	21.5" FHD (1920x1080) WVA AG	None	150W 85% Adapter	500GB 7200rpm 2.5" DVD±RW	DVD±RW	9-in-1	None	8265 ac, 2x2 + BT4.1	None	1080p	None	None	USB / USB	UltraFlex II Stand	Win10 DG Win7 Pro 64	3-year, Onsite	03/17	Apr 29, 2023
10NY000WUS	US	i7-6700	Intel HD 530	None	8GBx1	21.5" FHD (1920x1080) WVA AG	None	150W 85% Adapter	256GB SSD M.2 PCIe NVMe	DVD±RW	9-in-1	None	8265 ac, 2x2 + BT4.1	None	1080p	None	None	USB / USB	UltraFlex II Stand	Win10 DG Win7 Pro 64	3-year, Onsite	03/17	Apr 29, 2023
10NY000XUS	US	i5-6500	Intel HD 530	None	8GBx1	21.5" FHD (1920x1080) WVA AG	None	150W 85% Adapter	256GB SSD M.2 PCIe NVMe	DVD±RW	9-in-1	None	8265 ac, 2x2 + BT4.1	None	1080p	None	None	USB / USB	UltraFlex II Stand	Win10 DG Win7 Pro 64	3-year, Onsite	03/17	Apr 29, 2023
10NY000YUS	US	i3-6100	Intel HD 530	None	4GBx1	21.5" FHD (1920x1080) WVA AG	None	150W 85% Adapter	500GB 7200rpm 2.5" DVD±RW	DVD±RW	9-in-1	None	8265 ac, 2x2 + BT4.1	None	1080p	None	None	USB / USB	UltraFlex II Stand	Win10 DG Win7 Pro 64	3-year, Onsite	03/17	Apr 29, 2023
10NY0010US	US	i3-6100	Intel HD 530	None	8GBx1	21.5" FHD (1920x1080) WVA AG	None	150W 85% Adapter	500GB 7200rpm 2.5" DVD±RW	DVD±RW	9-in-1	None	8265 ac, 2x2 + BT4.1	None	1080p	None	None	USB / USB	UltraFlex II Stand	Win10 DG Win7 Pro 64	3-year, Onsite	03/17	Apr 29, 2023

Model	Region	Processor	Graphics	Monitor Cable	Memory	Display	Multi-touch	Power Supply	Storage(HDD/SSD)	Optical	Media Reader	USB Type-C	WLAN + Bluetooth	Optional Rear Ports	Camera	Chassis Intrusion Switch	Cable Lock	Keyboard / Mouse	Stand	Operating System	Warranty	Ann Date (m/y)	End of Support
10NY0011US	US	i5-7500	Intel HD 630	None	4GBx1	21.5" FHD (1920x1080) WVA AG	None	150W 85% Adapter	128GB SSD M.2 PCIe NVMe	DVD±RW	9-in-1	None	8265 ac, 2x2 + BT4.1	None	1080p	None	None	USB / USB	UltraFlex II Stand	Win10 Pro 64	3-year, Onsite	04/17	May 7, 2023
10NY0012US	US	i5-6500	Intel HD 530	None	8GBx1	21.5" FHD (1920x1080) WVA AG	None	150W 85% Adapter	500GB 7200rpm 2.5" DVD±RW	DVD±RW	9-in-1	None	8265 ac, 2x2 + BT4.1	None	1080p	None	None	USB / USB	UltraFlex II Stand	Win10 DG Win7 Pro 64	3-year, Onsite	03/17	Apr 29, 2023
10NY0013US	US	Pentium G4560	Intel HD 610	None	4GBx1	21.5" FHD (1920x1080) WVA AG	None	150W 85% Adapter	500GB 7200rpm 2.5" DVD±RW	DVD±RW	9-in-1	None	8265 ac, 2x2 + BT4.1	None	1080p	None	None	USB / USB	UltraFlex II Stand	Win10 Pro 64	3-year, Onsite	04/17	May 7, 2023
10NY0014US	US	i3-7100	Intel HD 630	None	8GBx1	21.5" FHD (1920x1080) WVA AG	None	150W 85% Adapter	500GB 7200rpm 2.5" DVD±RW	DVD±RW	9-in-1	None	8265 ac, 2x2 + BT4.1	None	1080p	None	None	USB / USB	UltraFlex II Stand	Win10 Pro 64	3-year, Onsite	04/17	May 7, 2023
10NY0015US	US	i3-7100	Intel HD 630	None	4GBx1	21.5" FHD (1920x1080) WVA AG	None	150W 85% Adapter	500GB 7200rpm 2.5" DVD±RW	DVD±RW	9-in-1	None	8265 ac, 2x2 + BT4.1	None	1080p	None	None	USB / USB	UltraFlex II Stand	Win10 Pro 64	3-year, Onsite	04/17	May 7, 2023

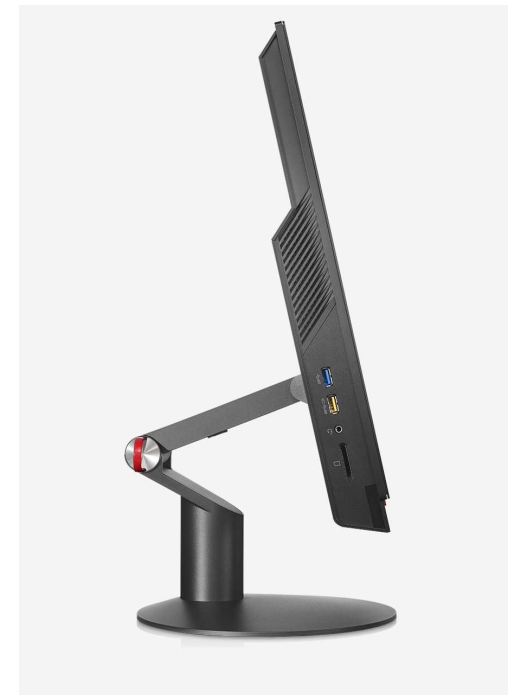
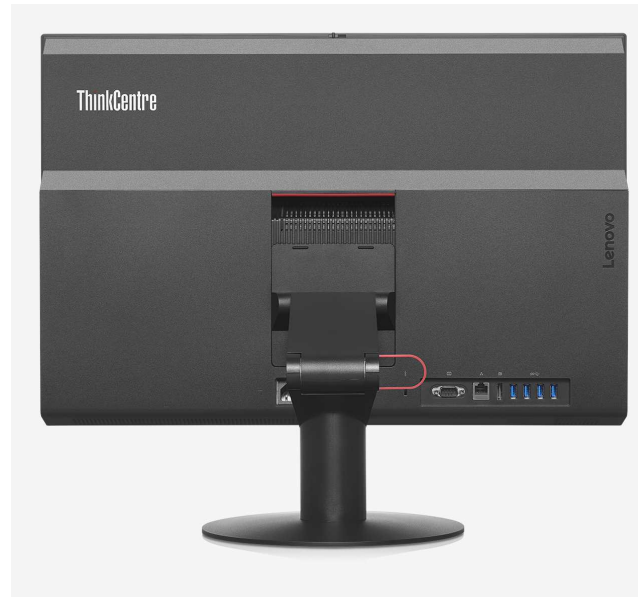
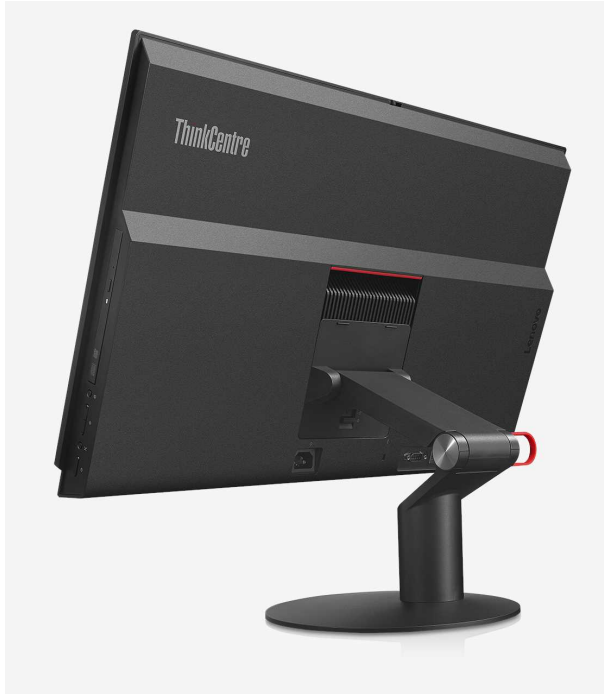

ThinkCentre M900z Platform Specifications

Product Specifications Reference (PSREF)

Processor	Intel® Celeron®, Intel Pentium®, or 6th Generation Intel Core™ i3 / i5 / i7 Processor							Security chip	Trusted Platform Module (TPM 1.2-compliant)																		
	Processor	Cores / Threads	Frequency Base/Max(GHz)	Cache	Memory Types	Integrated Graphics	Intel vPro	Security features	<ul style="list-style-type: none"> • Security slot (in rear for attachment of Kensington lock also locks chassis) • Smart USB protection, allows keyboard/mouse only, blocks all storage devices • Power-on, admin, hard disk password • Boot sequence control • Boot without keyboard and mouse • Individual USB port disablement • Optional Chassis intrusion switch 																		
	Pentium G4400	2 / 2	3.3G	3 MB	DDR4-2133	HD 510	No																				
	Pentium G4500	2 / 2	3.5G	3 MB	DDR4-2133	HD 530	No																				
	Core i3-6100	2 / 4	3.7 G	3 MB	DDR4-2133	HD 530	No																				
	Core i3-6300	2 / 4	3.8 G	4 MB	DDR4-2133	HD 530	No																				
	Core i5-6400	4 / 4	2.7 G / 3.3 G	6 MB	DDR4-2133	HD 530	No																				
	Core i5-6500	4 / 4	3.2 G / 3.6 G	6 MB	DDR4-2133	HD 530	vPro																				
Core i5-6600	4 / 4	3.3 G / 3.9 G	6 MB	DDR4-2133	HD 530	vPro																					
Core i7-6700	4 / 8	3.4 G / 4.0 G	8 MB	DDR4-2133	HD 530	vPro																					
Memory	32GB max, DDR4 2133, two 260-pin SO-DIMM sockets, dual-channel capable							Keyboard	<i>Some:</i> Preferred Pro USB Keyboard (USB connector), Lenovo logo <i>Some:</i> Lenovo Slim USB Keyboard (USB connector), black <i>Some:</i> Ultralim Plus Wireless Keyboard (2.4GHz via USB receiver), black																		
Disk	<i>Some:</i> SATA 6.0Gb/s, 2.5" Wide, 5400 rpm or 7200 rpm <i>Some:</i> Solid State Hybrid Drive (SSHD) / with 8GB MLC NAND flash memory, SATA 6.0Gb/s, 2.5" Wide, 5400 rpm <i>Some:</i> Solid State Drive (SSD) / SATA 6.0Gb/s, 2.5" Wide							Mouse	<i>Some:</i> Enhanced Optical USB Mouse, black, Lenovo logo <i>Some:</i> Ultralim Plus Wireless Mouse (2.4GHz via USB receiver), black																		
Optical	<i>Some:</i> DVD, SATA 1.5Gb/s, 9.5mm high <i>Some:</i> DVD burner, SATA 1.5Gb/s, 9.5mm high							Mechanical	<ul style="list-style-type: none"> • Business black color • Toolless back cover, stand, disk, memory removal • Support VESA mount (100mm) 																		
Media reader	Optional 9-in-1 media card reader								<table border="1"> <thead> <tr> <th></th> <th>Dimensions (WxDxH)</th> <th>Max weight (lb / kg)</th> <th>Adjustments</th> </tr> </thead> <tbody> <tr> <td>Without stand:</td> <td>23.0 X 1.8 X 15.4 (inch); 584 X 45 X 390 (mm)</td> <td>(Touch) 17.2 / 7.8 (Non-touch) 15.0 / 6.8</td> <td>N/A</td> </tr> <tr> <td>With Basic Monitor stand:</td> <td>23.0 X 9.6 X 18.0 (inch); 584 X 245 X 458 (mm)</td> <td>(Non-touch) 19.4 / 8.8</td> <td>Tilt: 45° back, -5° forward</td> </tr> <tr> <td>With UltraFlex II stand:</td> <td>23.0X 10.0 X 19.9 (inch); 584 X 253 X 505 (mm)</td> <td>(Touch) 22.7 / 10.3 (Non-touch) 20.7 / 9.4</td> <td>Tilt: 61° back, -5° forward; Lift: 160mm; Swivel: +/-45°</td> </tr> </tbody> </table>				Dimensions (WxDxH)	Max weight (lb / kg)	Adjustments	Without stand:	23.0 X 1.8 X 15.4 (inch); 584 X 45 X 390 (mm)	(Touch) 17.2 / 7.8 (Non-touch) 15.0 / 6.8	N/A	With Basic Monitor stand:	23.0 X 9.6 X 18.0 (inch); 584 X 245 X 458 (mm)	(Non-touch) 19.4 / 8.8	Tilt: 45° back, -5° forward	With UltraFlex II stand:	23.0X 10.0 X 19.9 (inch); 584 X 253 X 505 (mm)	(Touch) 22.7 / 10.3 (Non-touch) 20.7 / 9.4	Tilt: 61° back, -5° forward; Lift: 160mm; Swivel: +/-45°
	Dimensions (WxDxH)	Max weight (lb / kg)	Adjustments																								
Without stand:	23.0 X 1.8 X 15.4 (inch); 584 X 45 X 390 (mm)	(Touch) 17.2 / 7.8 (Non-touch) 15.0 / 6.8	N/A																								
With Basic Monitor stand:	23.0 X 9.6 X 18.0 (inch); 584 X 245 X 458 (mm)	(Non-touch) 19.4 / 8.8	Tilt: 45° back, -5° forward																								
With UltraFlex II stand:	23.0X 10.0 X 19.9 (inch); 584 X 253 X 505 (mm)	(Touch) 22.7 / 10.3 (Non-touch) 20.7 / 9.4	Tilt: 61° back, -5° forward; Lift: 160mm; Swivel: +/-45°																								
Graphics	Intel HD Graphics 510/530 in processor, uses main memory, DirectX® 12, external monitor support via DisplayPort™; <i>Max resolution: 4096x2304 (DP)@60Hz</i>							Power supply																			
Display	23.8" (604.5mm) Full HD 1080p (1920x1080) TFT color , WVA panel, wide viewing angle (+/- 89°), LED backlight, 250 nits, 16:9 aspect ratio, 1000:1 contrast ratio, anti-glare for both touch models and non-touch models, work as standalone monitor via DisplayPort (DP in / out combo)							150 watts, autosensing, 85% PSU Limited warranty ³ <i>Some:</i> 1-year or 3-year, depot repair service <i>Some:</i> 1-year or 3-year, limited onsite service <i>Some:</i> 3-years, limited onsite service, OID (Onsite International Delivery) / <i>For Lenovo service upgrade options, please go to S-TC sheet</i>																			
Light sensor	None							Preload	Preloaded operating system <i>Some:</i> Windows® 7 Professional 32/64 preinstalled through downgrade rights in Windows 10 Pro 64-bit <i>Some:</i> Windows 7 Professional 64 <i>Some:</i> Windows 10 Pro 64-bit <i>Some:</i> Windows 10 Home 64-bit																		
Multi-touch	Optional Projected Capacitive Touch (PCT) technology, supports 10-point touch								Preloaded applications (only some listed) <ul style="list-style-type: none"> • Desktop Power Manager • Lenovo Solution Center • Lenovo REACHit • Lenovo SHAREit • Lenovo Bluetooth Lock (for models with Wi-Fi/BT card) • McAfee® LiveSafe™ (30-day trial) • Microsoft Office preloaded; purchase a product key to activate • PowerDVD Create (DVD±RW) • Lenovo ThinkVantage Tools - Only for Window 10 • Lenovo Companion • Cyberlink PowerDVD (DVD, DVD±RW) • Lenovo QuickOptimizer - Only for Window 7 • Rescue and Recovery • Password Manager • ThinkVantage System Update • Lenovo Message Center Plus • Adobe® Reader® 																		
Camera	Optional 2.0-megapixel camera, fixed focus, supports 1080p, with dual array digital microphone, LED indicator, physical switch on/off, Skype for Business certified							Environment	EPEAT™ Gold rating; ENERGY STAR® 6.1; TCO Certified Edge; TUV Green Mark; ULE Gold; ErP Lot 3; GREENGUARD® certified; RoHS-compliant																		
Controls	Microphone mute, monitor mode switch, brightness up/down buttons, and power button								MIL-SPEC test MIL-STD-810G military certification (Low Pressure [Altitude], High Temperature, Low Temperature, Temperature Shock, Humidity, Sand and Dust, Vibration, Shock)																		
Chipset	Intel Q170 Chipset							Accessories																			
Rear ports	Four USB 3.0, ethernet (RJ-45), DisplayPort in/out combo port, optional serial (9-pin),							For compatible accessories, please go to TC-AQP sheet																			
Side ports	Two USB 3.0 (one is Always On and fast charge), optional card reader, one headphone / microphone combo jack (3.5mm)																										
M.2 card slot	One M.2 Card slot (for WLAN)																										
Audio support	High Definition (HD) Audio, Realtek ALC286 / two internal stereo speakers (3W x 2), Dolby® Audio™ certified, Skype for Business certified																										
WLAN ¹³	<i>Some:</i> 11ac wireless, M.2 Card, Qualcomm Atheros QCA9377 (dual band), Wi-Fi + Bluetooth 4.1 combo adapter, 1x1 <i>Some:</i> 11ac wireless, M.2 Card, Qualcomm Atheros QCA6174 (dual band), Wi-Fi + Bluetooth 4.1 combo adapter, 2x2 <i>Some:</i> 11ac wireless, M.2 Card, Intel Dual Band Wireless-AC 3165, Wi-Fi + Bluetooth 4.0 combo adapter, 1x1 <i>Some:</i> 11ac wireless, M.2 Card, Intel Dual Band Wireless-AC 8260, Wi-Fi + Bluetooth 4.1 combo adapter, 2x2 <i>Some:</i> 11ac wireless, M.2 Card, Intel Dual Band Wireless-AC 8260, Wi-Fi + Bluetooth 4.1 combo adapter, Intel vPro technology support, 2x2																										
Bluetooth™	<i>Some:</i> Bluetooth 4.0 or 4.1 wireless, integrated in Wi-Fi + Bluetooth combo adapter																										
Ethernet	Gigabit ethernet, Intel Ethernet Connection I219-LM (Jacksonville), Wake on LAN®																										
Manageability	Intel Active Management Technology 11.0 (Intel AMT 11.0); Intel vPro technology on some models (require choosing a vPro-support Wi-Fi adapter to enable vPro function through wireless connection)																										

See footnotes for more detailed information

Model	Region	Processor	vPro	Graphics	Monitor Cable	Memory	Display	Multi-touch	Storage(HDD/SSD)	Optical	Media Reader	WLAN + Bluetooth	Optional Rear Ports	Camera	Chassis Intrusion Switch	Keyboard / Mouse	Stand	Power Supply	Operating System	Warranty	Ann Date (m/y)
10F20005US	US	i7-6700	vPro	Intel HD 530	None	8GBx1	23.8" FHD (1920x1080) WVA AG	10-point Multi-touch	500GB 7200rpm 2.5"	DVD±RW	9-in-1	8260 ac, 2x2, vPro + BT4.1	None	1080p	Switch	USB / USB	UltraFlex II Stand	150W 85% Adapter	Win10 DG Win7 Pro 64	3-year, Onsite	11/15
10F20006US	US	i5-6500	vPro	Intel HD 530	None	8GBx1	23.8" FHD (1920x1080) WVA AG	10-point Multi-touch	500GB 7200rpm 2.5"	DVD±RW	9-in-1	8260 ac, 2x2, vPro + BT4.1	None	1080p	None	USB / USB	UltraFlex II Stand	150W 85% Adapter	Win10 DG Win7 Pro 64	3-year, Onsite	11/15
10F20008US	US	i5-6500	vPro	Intel HD 530	None	4GBx1	23.8" FHD (1920x1080) WVA AG	10-point Multi-touch	500GB 7200rpm 2.5"	DVD±RW	9-in-1	8260 ac, 2x2, vPro + BT4.1	None	1080p	None	USB / USB	UltraFlex II Stand	150W 85% Adapter	Win10 DG Win7 Pro 64	3-year, Onsite	11/15
10F20009US	US	i7-6700	vPro	Intel HD 530	None	4GBx1	23.8" FHD (1920x1080) WVA AG	10-point Multi-touch	500GB 7200rpm 2.5"	DVD±RW	9-in-1	8260 ac, 2x2, vPro + BT4.1	None	1080p	Switch	USB / USB	UltraFlex II Stand	150W 85% Adapter	Win10 DG Win7 Pro 64	3-year, Onsite	11/15
10F2000AUS	US	i5-6600	vPro	Intel HD 530	None	4GBx1	23.8" FHD (1920x1080) WVA AG	10-point Multi-touch	500GB 7200rpm 2.5"	DVD±RW	9-in-1	8260 ac, 2x2, vPro + BT4.1	None	1080p	None	USB / USB	UltraFlex II Stand	150W 85% Adapter	Win10 DG Win7 Pro 32	3-year, Onsite	11/15
10F2000YUS	US	i5-6500	vPro	Intel HD 530	None	4GBx1	23.8" FHD (1920x1080) WVA AG	10-point Multi-touch	500GB 7200rpm 2.5"	DVD±RW	9-in-1	8260 ac, 2x2, vPro + BT4.1	None	1080p	None	USB / USB	UltraFlex II Stand	150W 85% Adapter	Win10 Pro 64	3-year, Onsite	11/15
10F20010US	US	i7-6700	vPro	Intel HD 530	None	4GBx1	23.8" FHD (1920x1080) WVA AG	10-point Multi-touch	500GB 7200rpm 2.5"	DVD±RW	9-in-1	8260 ac, 2x2, vPro + BT4.1	None	1080p	None	USB / USB	UltraFlex II Stand	150W 85% Adapter	Win10 Pro 64	3-year, Onsite	11/15
10F2001BUS	US	i7-6700	vPro	Intel HD 530	None	4GBx2	23.8" FHD (1920x1080) WVA AG	10-point Multi-touch	128GB SSD	DVD±RW	9-in-1	8260 ac, 2x2, vPro + BT4.1	None	1080p	None	USB / USB	UltraFlex II Stand	150W 85% Adapter	Win10 Pro 64	1-year, Onsite	11/15
10F20022US	US	i5-6500	vPro	Intel HD 530	None	4GBx1	23.8" FHD (1920x1080) WVA AG	10-point Multi-touch	128GB SSD	DVD±RW	9-in-1	8260 ac, 2x2, vPro + BT4.1	None	1080p	None	USB / USB	UltraFlex II Stand	150W 85% Adapter	Win10 DG Win7 Pro 64	3-year, Onsite	03/16
10F20023US	US	i7-6700	vPro	Intel HD 530	None	4GBx1	23.8" FHD (1920x1080) WVA AG	10-point Multi-touch	128GB SSD	DVD±RW	9-in-1	8260 ac, 2x2, vPro + BT4.1	None	1080p	None	USB / USB	UltraFlex II Stand	150W 85% Adapter	Win10 Pro 64	3-year, Onsite	03/16
10F20024US	US	i7-6700	vPro	Intel HD 530	None	8GBx1	23.8" FHD (1920x1080) WVA AG	10-point Multi-touch	256GB SSD	DVD±RW	9-in-1	8260 ac, 2x2, vPro + BT4.1	None	1080p	None	USB / USB	UltraFlex II Stand	150W 85% Adapter	Win10 DG Win7 Pro 64	3-year, Onsite	03/16
10F20025US	US	i5-6500	vPro	Intel HD 530	None	4GBx1	23.8" FHD (1920x1080) WVA AG	10-point Multi-touch	128GB SSD	DVD±RW	9-in-1	8260 ac, 2x2, vPro + BT4.1	None	1080p	None	USB / USB	UltraFlex II Stand	150W 85% Adapter	Win10 Pro 64	3-year, Onsite	03/16
10F20026US	US	i7-6700	vPro	Intel HD 530	None	4GBx1	23.8" FHD (1920x1080) WVA AG	10-point Multi-touch	128GB SSD	DVD±RW	9-in-1	8260 ac, 2x2, vPro + BT4.1	None	1080p	None	USB / USB	UltraFlex II Stand	150W 85% Adapter	Win10 DG Win7 Pro 64	3-year, Onsite	03/16
10F20027US	US	i5-6500	vPro	Intel HD 530	None	8GBx1	23.8" FHD (1920x1080) WVA AG	10-point Multi-touch	256GB SSD	DVD±RW	9-in-1	8260 ac, 2x2, vPro + BT4.1	None	1080p	None	USB / USB	UltraFlex II Stand	150W 85% Adapter	Win10 Pro 64	3-year, Onsite	03/16
10F20028US	US	i5-6500	vPro	Intel HD 530	None	8GBx1	23.8" FHD (1920x1080) WVA AG	10-point Multi-touch	256GB SSD	DVD±RW	9-in-1	8260 ac, 2x2, vPro + BT4.1	None	1080p	None	USB / USB	UltraFlex II Stand	150W 85% Adapter	Win10 DG Win7 Pro 64	3-year, Onsite	03/16
10F20029US	US	i7-6700	vPro	Intel HD 530	None	8GBx1	23.8" FHD (1920x1080) WVA AG	10-point Multi-touch	256GB SSD	DVD±RW	9-in-1	8260 ac, 2x2, vPro + BT4.1	None	1080p	None	USB / USB	UltraFlex II Stand	150W 85% Adapter	Win10 Pro 64	3-year, Onsite	03/16
10F2002PUS	US	i7-6700	vPro	Intel HD 530	None	8GBx1	23.8" FHD (1920x1080) WVA AG	10-point Multi-touch	256GB SSD Opal	DVD±RW	9-in-1	8260 ac, 2x2, vPro + BT4.1	None	1080p	None	USB / USB	UltraFlex II Stand	150W 85% Adapter	Win10 DG Win7 Pro 64	3-year, Onsite	12/16
10F2002QUS	US	i5-6500	vPro	Intel HD 530	None	8GBx1	23.8" FHD (1920x1080) WVA AG	10-point Multi-touch	256GB SSD Opal	DVD±RW	9-in-1	8260 ac, 2x2, vPro + BT4.1	None	1080p	None	USB / USB	UltraFlex II Stand	150W 85% Adapter	Win10 Pro 64	3-year, Onsite	12/16
10F2002RUS	US	i5-6500	vPro	Intel HD 530	None	8GBx1	23.8" FHD (1920x1080) WVA AG	10-point Multi-touch	256GB SSD Opal	DVD±RW	9-in-1	8260 ac, 2x2, vPro + BT4.1	None	1080p	None	USB / USB	UltraFlex II Stand	150W 85% Adapter	Win10 DG Win7 Pro 64	3-year, Onsite	12/16
10F2002SUS	US	i7-6700	vPro	Intel HD 530	None	8GBx1	23.8" FHD (1920x1080) WVA AG	10-point Multi-touch	256GB SSD Opal	DVD±RW	9-in-1	8260 ac, 2x2, vPro + BT4.1	None	1080p	None	USB / USB	UltraFlex II Stand	150W 85% Adapter	Win10 Pro 64	3-year, Onsite	12/16

Model	Region	Processor	vPro	Graphics	Monitor Cable	Memory	Display	Multi-touch	Storage(HDD/SSD)	Optical	Media Reader	WLAN + Bluetooth	Optional Rear Ports	Camera	Chassis Intrusion Switch	Keyboard / Mouse	Stand	Power Supply	Operating System	Warranty	Ann Date (m/y)
10F30005US	US	i5-6500	vPro	Intel HD 530	None	4GBx1	23.8" FHD (1920x1080) WVA AG	None	500GB 7200rpm 2.5"	DVD±RW	9-in-1	8260 ac, 2x2, vPro + BT4.1	None	1080p	None	USB / USB	UltraFlex II Stand	150W 85% Adapter	Win10 DG Win7 Pro 64	3-year, Onsite	11/15
10F30006US	US	i5-6500	vPro	Intel HD 530	None	8GBx1	23.8" FHD (1920x1080) WVA AG	None	500GB 7200rpm 2.5"	DVD±RW	9-in-1	8260 ac, 2x2, vPro + BT4.1	None	1080p	None	USB / USB	UltraFlex II Stand	150W 85% Adapter	Win10 DG Win7 Pro 64	3-year, Onsite	11/15
10F30009US	US	i5-6500	vPro	Intel HD 530	None	4GBx1	23.8" FHD (1920x1080) WVA AG	None	500GB 7200rpm 2.5"	DVD±RW	9-in-1	8260 ac, 2x2, vPro + BT4.1	None	1080p	None	USB / USB	UltraFlex II Stand	150W 85% Adapter	Win10 Pro 64	3-year, Onsite	11/15
10F3000AUS	US	i7-6700	vPro	Intel HD 530	None	4GBx1	23.8" FHD (1920x1080) WVA AG	None	500GB 7200rpm 2.5"	DVD±RW	9-in-1	8260 ac, 2x2, vPro + BT4.1	None	1080p	None	USB / USB	UltraFlex II Stand	150W 85% Adapter	Win10 Pro 64	3-year, Onsite	11/15
10F3001FUS	US	i7-6700	vPro	Intel HD 530	None	4GBx1	23.8" FHD (1920x1080) WVA AG	None	128GB SSD	DVD±RW	9-in-1	8260 ac, 2x2, vPro + BT4.1	None	1080p	None	USB / USB	UltraFlex II Stand	150W 85% Adapter	Win10 Pro 64	3-year, Onsite	05/16
10F3001GUS	US	i5-6500	vPro	Intel HD 530	None	4GBx1	23.8" FHD (1920x1080) WVA AG	None	128GB SSD	DVD±RW	9-in-1	8260 ac, 2x2, vPro + BT4.1	None	1080p	None	USB / USB	UltraFlex II Stand	150W 85% Adapter	Win10 Pro 64	3-year, Onsite	05/16
10F3001HUS	US	i7-6700	vPro	Intel HD 530	None	8GBx1	23.8" FHD (1920x1080) WVA AG	None	256GB SSD	DVD±RW	9-in-1	8260 ac, 2x2, vPro + BT4.1	None	1080p	None	USB / USB	UltraFlex II Stand	150W 85% Adapter	Win10 Pro 64	3-year, Onsite	05/16
10F3001JUS	US	i5-6500	vPro	Intel HD 530	None	8GBx1	23.8" FHD (1920x1080) WVA AG	None	256GB SSD	DVD±RW	9-in-1	8260 ac, 2x2, vPro + BT4.1	None	1080p	None	USB / USB	UltraFlex II Stand	150W 85% Adapter	Win10 Pro 64	3-year, Onsite	05/16
10F30023US	US	i7-6700	vPro	Intel HD 530	None	8GBx1	23.8" FHD (1920x1080) WVA AG	None	256GB SSD Opal	DVD±RW	9-in-1	8260 ac, 2x2, vPro + BT4.1	None	1080p	None	USB / USB	UltraFlex II Stand	150W 85% Adapter	Win10 Pro 64	3-year, Onsite	12/16
10F30024US	US	i5-6500	vPro	Intel HD 530	None	8GBx1	23.8" FHD (1920x1080) WVA AG	None	256GB SSD Opal	DVD±RW	9-in-1	8260 ac, 2x2, vPro + BT4.1	None	1080p	None	USB / USB	UltraFlex II Stand	150W 85% Adapter	Win10 Pro 64	3-year, Onsite	12/16

Model	Region	Processor	vPro	Graphics	Monitor Cable	Memory	Display	Multi-touch	Storage(HDD/SSD)	Optical	Media Reader	WLAN + Bluetooth	Optional Rear Ports	Camera	Chassis Intrusion Switch	Keyboard / Mouse	Stand	Power Supply	Operating System	Warranty	Ann Date (m/y)
10F40013US	US	i7-6700	vPro	Intel HD 530	None	4GBx2	23.8" FHD (1920x1080) WVA AG	10-point Multi-touch	128GB SSD	DVD±RW	9-in-1	8260 ac, 2x2, vPro + BT4.1	None	1080p	Switch	2.4G / 2.4G	UltraFlex II Stand	150W 85% Adapter	Win10 Pro 64	3-year, Onsite, OID	11/15
10F40014US	US	i7-6700	vPro	Intel HD 530	None	4GBx2	23.8" FHD (1920x1080) WVA AG	10-point Multi-touch	128GB SSD	DVD±RW	9-in-1	8260 ac, 2x2, vPro + BT4.1	None	1080p	Switch	2.4G / 2.4G	UltraFlex II Stand	150W 85% Adapter	Win10 DG Win7 Pro 64	3-year, Onsite, OID	11/15

Model	Region	Processor	vPro	Graphics	Monitor Cable	Memory	Display	Multi-touch	Storage(HDD/SSD)	Optical	Media Reader	WLAN + Bluetooth	Optional Rear Ports	Camera	Chassis Intrusion Switch	Keyboard / Mouse	Stand	Power Supply	Operating System	Warranty	Ann Date (m/y)
10F5000XUS	US	i5-6500	vPro	Intel HD 530	None	4GBx1	23.8" FHD (1920x1080) WVA AG	None	1TB 5400rpm 2.5"	DVD±RW	9-in-1	8260 ac, 2x2, vPro + BT4.1	None	1080p	None	USB / USB	UltraFlex II Stand	150W 85% Adapter	Win10 Pro 64	3-year, Onsite, OID	11/15
10F5000YUS	US	i5-6500	vPro	Intel HD 530	None	4GBx1	23.8" FHD (1920x1080) WVA AG	None	1TB 5400rpm 2.5"	DVD±RW	9-in-1	8260 ac, 2x2, vPro + BT4.1	None	1080p	Switch	USB / USB	UltraFlex II Stand	150W 85% Adapter	Win10 DG Win7 Pro 64	3-year, Onsite, OID	11/15



ThinkCentre M910z Platform Specifications

Product Specifications Reference (PSREF)

Processor	Intel® Celeron®, Intel Pentium®, or 6th / 7th Gen Intel Core™ i3 / i5 / i7 Processor						Security chip TPM (Trusted Platform Module) 2.0, TCG Certified * Downgrade to TPM1.2 for the models with Win10 DG Win7 32 OS
	Processor	Cores / Threads	Frequency Base/Max(GHz)	Cache	Memory Support (Up to)	Integrated Graphics	
	Core i5-6500	4 / 4	3.2G / 3.6G	6 MB	DDR4-2133	HD 530	
	Core i7-6700	4 / 8	3.4G / 4.0G	8 MB	DDR4-2133	HD 530	
	Core i5-7400	4 / 4	3.0G / 3.5G	6 MB	DDR4-2400	HD 630	
	Core i5-7500	4 / 4	3.4G / 3.8G	6 MB	DDR4-2400	HD 630	
	Core i5-7600	4 / 4	3.5G / 4.1G	6 MB	DDR4-2400	HD 630	
Core i7-7700	4 / 8	3.6G / 4.2G	8 MB	DDR4-2400	HD 630		
Memory	32GB max, DDR4-2400*, two 260-pin SO-DIMM sockets, dual-channel capable * System clocks down for the processors with lower memory controller						Security features <ul style="list-style-type: none"> Security slot (in rear for attachment of optional Kensington® MicroSaver® cable; Kensington lock also locks chassis) Smart USB protection, allows keyboard/mouse only, blocks all storage devices Optional cable lock to physically lock keyboard and mouse Power-on, admin, hard disk password Boot sequence control Boot without keyboard and mouse Individual USB port disablement Optional Chassis intrusion switch
Storage	<i>Some:</i> Hard Drive / SATA 6.0Gb/s, 2.5", 5400 rpm or 7200 rpm <i>Some:</i> Solid State Drive (SSD) / SATA 6.0Gb/s, 2.5" <i>Some:</i> M.2 Solid State Drive (SSD) / PCIe NVMe, PCIe 3.0 x 4, 32Gb/s <i>Some:</i> Intel Optane™ Memory Ready (models with 7th gen Core processor), M.2 <i>Some:</i> DVD-ROM SATA 1.5Gb/s Drive, slim (9.5mm) <i>Some:</i> DVD Burner (DVD±RW), SATA 1.5Gb/s Drive, slim (9.5mm) Optional 9-in-1 media card reader						
Optical							
Media reader							
Graphics	Intel HD Graphics 510/530/610/630 in processor, uses main memory, DirectX® 12, external monitor support via DisplayPort™; <i>Max resolution:</i> 4096x2304 (DP) @60Hz, 1920x1080 (Panel) @60Hz						
Display	23.8" (604.5mm) Full HD 1080p (1920x1080) TFT color , WVA panel, wide viewing angle (+/- 89°), LED backlight, 250 nits, 16:9 aspect ratio, 1000:1 contrast ratio, anti-glare, support Low Blue Light Mode, work as standalone monitor via DisplayPort (DP in / out combo)						
Multi-touch Camera	Optional Projected Capacitive Touch (PCT) technology, supports 10-point touch Optional 1080p camera, fixed focus, with dual microphone, LED indicator, physical switch on/off						
Controls	Physical buttons for Microphone mute, monitor mode switch, brightness up/down, and power on/off						
Chipset	Intel Q270 Chipset						
Rear ports	Four USB 3.1 Gen1, ethernet (RJ-45), DisplayPort in/out combo port, optional serial (9-pin)						
Side ports	Two USB 3.1 Gen1 (one is Always On and fast charge), optional card reader, one headphone / microphone combo jack (3.5mm), optional USB 3.1 Type-C Gen1						
M.2 card slot	Two M.2 Card slots (one for WLAN, one for SSD/Optane)						
Audio support	High Definition (HD) Audio, Realtek ALC233 / two internal speakers (3W x 2), Dolby® Audio™ certified						
WLAN ¹³	<i>Some:</i> 11ac wireless, M.2 Card, Qualcomm Atheros QCA9377A (dual band), Wi-Fi + Bluetooth 4.1 combo adapter, 1x1 <i>Some:</i> 11ac wireless, M.2 Card, Qualcomm Atheros QCA6174A (dual band), Wi-Fi + Bluetooth 4.1 combo adapter, 2x2 <i>Some:</i> 11ac wireless, M.2 Card, Intel Dual Band Wireless-AC 3165, Wi-Fi + Bluetooth 4.1 combo adapter, 1x1 <i>Some:</i> 11ac wireless, M.2 Card, Intel Dual Band Wireless-AC 8265, Wi-Fi + Bluetooth 4.1 combo adapter, 2x2 <i>Some:</i> 11ac wireless, M.2 Card, Intel Dual Band Wireless-AC 8265, Wi-Fi + Bluetooth 4.1 combo adapter, Intel vPro technology support, 2x2						
Bluetooth™ Ethernet	<i>Some:</i> Bluetooth 4.1 wireless, integrated in Wi-Fi + Bluetooth combo adapter Gigabit ethernet, Intel Ethernet Connection I219-LM (Jacksonville), Wake on LAN®						
Manageability	Intel Active Management Technology 11.0 (Intel AMT 11.0); Intel vPro technology on some models (require choosing a vPro-support Wi-Fi adapter to enable vPro function through wireless connection)						
Keyboard	<i>Some:</i> Lenovo Calliope Keyboard (USB connector), black <i>Some:</i> Lenovo Traditional Keyboard (USB connector), black <i>Some:</i> Lenovo Calliope Wireless Keyboard (2.4GHz via USB receiver), black						
Mouse	<i>Some:</i> Lenovo Calliope Mouse (USB connector), black <i>Some:</i> Lenovo Calliope Wireless Mouse (2.4GHz via USB receiver), black						
Mechanical	<ul style="list-style-type: none"> Business black color Toolless back cover, stand, disk, memory removal Support VESA mount (100mm) 						
		Dimensions (WxDxH)	Max weight (lb / kg)	Adjustments			
	Without stand:	23.0 X 1.8 X 15.4 (inch); 584 X 45 X 390 (mm)	(Touch) 17.2 / 7.8 (Non-touch) 15.0 / 6.8	N/A			
	With Basic Monitor stand:	23.0 X 9.6 X 18.0 (inch); 584 X 245 X 458 (mm)	(Non-touch) 19.4 / 8.8	Tilt: 45° back, -5° forward			
	With UltraFlex II stand:	23.0X 10.0 X 19.9 (inch); 584 X 253 X 505 (mm)	(Touch) 22.7 / 10.3 (Non-touch) 20.7 / 9.4	Tilt: 61° back, -5° forward; Lift: 110mm; Swivel: +/-45°			
Power supply	150 watts, autosensing, 85% PSU						
Limited warranty ³	<i>Some:</i> 1-year or 3-year, depot repair service / service upgrades available <i>Some:</i> 1-year or 3-year, limited onsite service / service upgrades available						
Preload	Preloaded operating system <i>Some:</i> Windows® 7 Professional 32/64 preinstalled through downgrade rights in Windows 10 Pro 64-bit <i>Some:</i> Windows 10 Pro 64-bit <i>Some:</i> Windows 10 Home 64-bit			Preloaded applications (only some listed) <ul style="list-style-type: none"> Microsoft Office preloaded; purchase a product key to activate Cyberlink PowerDVD Create (DVD±RW) - Only for Window 10 Lenovo Companion Lenovo ID Lenovo Settings Cyberlink PowerDVD (DVD, DVD±RW) - Only for Window 7 Lenovo Solution Center Lenovo ThinkVantage Tools ThinkVantage System Update Create Recovery Media Adobe® Reader® 			
Environment	EPEAT™ Gold rating (North America); ENERGY STAR® 6.1; TCO AIO Computer Certified; ULE Gold; ErP Lot 3; GREENGUARD® certified; RoHS-compliant						
MIL-SPEC test	MIL-STD-810G military certification (Low Pressure [Altitude], High Temperature, Low Temperature, Temperature Shock, Humidity, Sand and Dust, Vibration, Shock)						
Accessories	For compatible accessories, please go to http://www.lenovoquickpick.com						

See footnotes for more detailed information

© Lenovo
(M910z-Spec) February 2017

Model	Region	Processor	vPro	Graphics	Monitor Cable	Memory	Display	Multi-touch	Power Supply	Storage(HDD/SSD)	Optical	Media Reader	USB Type-C	WLAN + Bluetooth	Optional Rear Ports	Camera	Chassis Intrusion Switch	Cable Lock	Keyboard / Mouse	Stand	Operating System	Warranty	Ann Date (m/y)	End of Support
10NR000HUS	US	i5-7500	vPro	Intel HD 630	None	8GBx1	23.8" FHD (1920x1080) WVA AG	10-point Multi-touch	150W 85% Adapter	256GB SSD M.2 PCIe NVMe Opal	DVD±RW	9-in-1	None	8265 ac, 2x2, vPro + BT4.1	None	1080p	None	None	USB / USB	UltraFlex II Stand	Win10 Pro 64	3-year, Onsite	02/17	Mar 28, 2023
10NR000KUS	US	i5-7500	vPro	Intel HD 630	None	8GBx1	23.8" FHD (1920x1080) WVA AG	10-point Multi-touch	150W 85% Adapter	512GB SSD M.2 PCIe NVMe Opal	DVD±RW	9-in-1	None	8265 ac, 2x2, vPro + BT4.1	None	1080p	None	None	USB / USB	UltraFlex II Stand	Win10 Pro 64	3-year, Onsite	02/17	Mar 28, 2023
10NR000LUS	US	i7-7700	vPro	Intel HD 630	None	8GBx1	23.8" FHD (1920x1080) WVA AG	10-point Multi-touch	150W 85% Adapter	256GB SSD M.2 PCIe NVMe Opal	DVD±RW	9-in-1	None	8265 ac, 2x2, vPro + BT4.1	None	1080p	None	None	USB / USB	UltraFlex II Stand	Win10 Pro 64	3-year, Onsite	02/17	Mar 28, 2023
10NR000MUS	US	i5-7500	vPro	Intel HD 630	None	8GBx1	23.8" FHD (1920x1080) WVA AG	10-point Multi-touch	150W 85% Adapter	500GB 7200rpm 2.5" DVD±RW	DVD±RW	9-in-1	None	8265 ac, 2x2, vPro + BT4.1	None	1080p	None	None	USB / USB	UltraFlex II Stand	Win10 Pro 64	3-year, Onsite	02/17	Mar 28, 2023
10NR000PUS	US	i7-7700	vPro	Intel HD 630	None	8GBx1	23.8" FHD (1920x1080) WVA AG	10-point Multi-touch	150W 85% Adapter	512GB SSD M.2 PCIe NVMe Opal	DVD±RW	9-in-1	None	8265 ac, 2x2, vPro + BT4.1	None	1080p	None	None	USB / USB	UltraFlex II Stand	Win10 Pro 64	3-year, Onsite	02/17	Mar 28, 2023
10NR000QUS	US	i7-7700	vPro	Intel HD 630	None	8GBx1	23.8" FHD (1920x1080) WVA AG	10-point Multi-touch	150W 85% Adapter	500GB 7200rpm 2.5" DVD±RW	DVD±RW	9-in-1	None	8265 ac, 2x2, vPro + BT4.1	None	1080p	None	None	USB / USB	UltraFlex II Stand	Win10 Pro 64	3-year, Onsite	02/17	Mar 28, 2023
10NR000RUS	US	i5-7500	vPro	Intel HD 630	None	4GBx1	23.8" FHD (1920x1080) WVA AG	10-point Multi-touch	150W 85% Adapter	500GB 7200rpm 2.5" DVD±RW	DVD±RW	9-in-1	None	8265 ac, 2x2, vPro + BT4.1	None	1080p	None	None	USB / USB	UltraFlex II Stand	Win10 Pro 64	3-year, Onsite	02/17	Mar 28, 2023
10NR0017US	US	i5-7500	vPro	Intel HD 630	None	4GBx1	23.8" FHD (1920x1080) WVA AG	10-point Multi-touch	150W 85% Adapter	128GB SSD M.2 PCIe NVMe	DVD±RW	9-in-1	None	8265 ac, 2x2, vPro + BT4.1	None	1080p	None	None	USB / USB	UltraFlex II Stand	Win10 Pro 64	3-year, Onsite	04/17	May 7, 2023
10NR0018US	US	i7-7700	vPro	Intel HD 630	None	8GBx1	23.8" FHD (1920x1080) WVA AG	10-point Multi-touch	150W 85% Adapter	128GB SSD M.2 PCIe NVMe	DVD±RW	9-in-1	None	8265 ac, 2x2, vPro + BT4.1	None	1080p	None	None	USB / USB	UltraFlex II Stand	Win10 Pro 64	3-year, Onsite	04/17	May 7, 2023

Model	Region	Processor	vPro	Graphics	Monitor Cable	Memory	Display	Multi-touch	Power Supply	Storage(HDD/SSD)	Optical	Media Reader	USB Type-C	WLAN + Bluetooth	Optional Rear Ports	Camera	Chassis Intrusion Switch	Cable Lock	Keyboard / Mouse	Stand	Operating System	Warranty	Ann Date (m/y)	End of Support
10NS0001US	US	i5-7500	vPro	Intel HD 630	None	4GBx1	23.8" FHD (1920x1080) WVA AG	None	150W 85% Adapter	500GB 7200rpm 2.5" DVD±RW	DVD±RW	9-in-1	None	8265 ac, 2x2, vPro + BT4.1	None	1080p	None	None	USB / USB	UltraFlex II Stand	Win10 Pro 64	3-year, Onsite	02/17	Mar 28, 2023
10NS0003US	US	i5-7500	vPro	Intel HD 630	None	8GBx1	23.8" FHD (1920x1080) WVA AG	None	150W 85% Adapter	256GB SSD M.2 PCIe NVMe Opal	DVD±RW	9-in-1	None	8265 ac, 2x2, vPro + BT4.1	None	1080p	None	None	USB / USB	UltraFlex II Stand	Win10 Pro 64	3-year, Onsite	02/17	Mar 28, 2023
10NS0004US	US	i7-7700	vPro	Intel HD 630	None	8GBx1	23.8" FHD (1920x1080) WVA AG	None	150W 85% Adapter	512GB SSD M.2 PCIe NVMe Opal	DVD±RW	9-in-1	None	8265 ac, 2x2, vPro + BT4.1	None	1080p	None	None	USB / USB	UltraFlex II Stand	Win10 Pro 64	3-year, Onsite	02/17	Mar 28, 2023
10NS0006US	US	i7-7700	vPro	Intel HD 630	None	8GBx1	23.8" FHD (1920x1080) WVA AG	None	150W 85% Adapter	500GB 7200rpm 2.5" DVD±RW	DVD±RW	9-in-1	None	8265 ac, 2x2, vPro + BT4.1	None	1080p	None	None	USB / USB	UltraFlex II Stand	Win10 Pro 64	3-year, Onsite	02/17	Mar 28, 2023
10NS0007US	US	i5-7500	vPro	Intel HD 630	None	8GBx1	23.8" FHD (1920x1080) WVA AG	None	150W 85% Adapter	500GB 7200rpm 2.5" DVD±RW	DVD±RW	9-in-1	None	8265 ac, 2x2, vPro + BT4.1	None	1080p	None	None	USB / USB	UltraFlex II Stand	Win10 Pro 64	3-year, Onsite	02/17	Mar 28, 2023
10NS0008US	US	i5-7500	vPro	Intel HD 630	None	8GBx1	23.8" FHD (1920x1080) WVA AG	None	150W 85% Adapter	512GB SSD M.2 PCIe NVMe Opal	DVD±RW	9-in-1	None	8265 ac, 2x2, vPro + BT4.1	None	1080p	None	None	USB / USB	UltraFlex II Stand	Win10 Pro 64	3-year, Onsite	02/17	Mar 28, 2023
10NS000AUS	US	i7-7700	vPro	Intel HD 630	None	8GBx1	23.8" FHD (1920x1080) WVA AG	None	150W 85% Adapter	256GB SSD M.2 PCIe NVMe Opal	DVD±RW	9-in-1	None	8265 ac, 2x2, vPro + BT4.1	None	1080p	None	None	USB / USB	UltraFlex II Stand	Win10 Pro 64	3-year, Onsite	02/17	Mar 28, 2023
10NS000UUS	US	i5-6500	vPro	Intel HD 530	None	8GBx1	23.8" FHD (1920x1080) WVA AG	None	150W 85% Adapter	128GB SSD M.2 PCIe NVMe	DVD±RW	9-in-1	None	8265 ac, 2x2, vPro + BT4.1	None	1080p	None	None	USB / USB	UltraFlex II Stand	Win10 DG Win7 Pro 64	3-year, Onsite	03/17	Apr 29, 2023
10NS000VUS	US	i7-6700	vPro	Intel HD 530	None	8GBx1	23.8" FHD (1920x1080) WVA AG	None	150W 85% Adapter	500GB 7200rpm 2.5" DVD±RW	DVD±RW	9-in-1	None	8265 ac, 2x2, vPro + BT4.1	None	1080p	None	None	USB / USB	UltraFlex II Stand	Win10 DG Win7 Pro 64	3-year, Onsite	03/17	Apr 29, 2023
10NS000WUS	US	i5-6500	vPro	Intel HD 530	None	8GBx1	23.8" FHD (1920x1080) WVA AG	None	150W 85% Adapter	256GB SSD M.2 PCIe NVMe Opal	DVD±RW	9-in-1	None	8265 ac, 2x2, vPro + BT4.1	None	1080p	None	None	USB / USB	UltraFlex II Stand	Win10 DG Win7 Pro 64	3-year, Onsite	03/17	Apr 29, 2023
10NS000XUS	US	i5-6500	vPro	Intel HD 530	None	4GBx1	23.8" FHD (1920x1080) WVA AG	None	150W 85% Adapter	500GB 7200rpm 2.5" DVD±RW	DVD±RW	9-in-1	None	8265 ac, 2x2, vPro + BT4.1	None	1080p	None	None	USB / USB	UltraFlex II Stand	Win10 DG Win7 Pro 64	3-year, Onsite	03/17	Apr 29, 2023
10NS000YUS	US	i7-6700	vPro	Intel HD 530	None	8GBx1	23.8" FHD (1920x1080) WVA AG	None	150W 85% Adapter	256GB SSD M.2 PCIe NVMe Opal	DVD±RW	9-in-1	None	8265 ac, 2x2, vPro + BT4.1	None	1080p	None	None	USB / USB	UltraFlex II Stand	Win10 DG Win7 Pro 64	3-year, Onsite	03/17	Apr 29, 2023
10NS0010US	US	i5-6500	vPro	Intel HD 530	None	8GBx1	23.8" FHD (1920x1080) WVA AG	None	150W 85% Adapter	500GB 7200rpm 2.5" DVD±RW	DVD±RW	9-in-1	None	8265 ac, 2x2, vPro + BT4.1	None	1080p	None	None	USB / USB	UltraFlex II Stand	Win10 DG Win7 Pro 64	3-year, Onsite	03/17	Apr 29, 2023
10NS0011US	US	i5-7500	vPro	Intel HD 630	None	8GBx1	23.8" FHD (1920x1080) WVA AG	None	150W 85% Adapter	128GB SSD M.2 PCIe NVMe	DVD±RW	9-in-1	None	8265 ac, 2x2, vPro + BT4.1	None	1080p	None	None	USB / USB	UltraFlex II Stand	Win10 Pro 64	3-year, Onsite	04/17	May 7, 2023
10NS0012US	US	i7-6700	vPro	Intel HD 530	None	8GBx1	23.8" FHD (1920x1080) WVA AG	None	150W 85% Adapter	512GB SSD M.2 PCIe NVMe Opal	DVD±RW	9-in-1	None	8265 ac, 2x2, vPro + BT4.1	None	1080p	None	None	USB / USB	UltraFlex II Stand	Win10 DG Win7 Pro 64	3-year, Onsite	03/17	Apr 29, 2023
10NS0013US	US	i7-7700	vPro	Intel HD 630	None	8GBx1	23.8" FHD (1920x1080) WVA AG	None	150W 85% Adapter	128GB SSD M.2 PCIe NVMe	DVD±RW	9-in-1	None	8265 ac, 2x2, vPro + BT4.1	None	1080p	None	None	USB / USB	UltraFlex II Stand	Win10 Pro 64	3-year, Onsite	04/17	May 7, 2023
10NS0014US	US	i5-6500	vPro	Intel HD 530	None	8GBx1	23.8" FHD (1920x1080) WVA AG	None	150W 85% Adapter	512GB SSD M.2 PCIe NVMe Opal	DVD±RW	9-in-1	None	8265 ac, 2x2, vPro + BT4.1	None	1080p	None	None	USB / USB	UltraFlex II Stand	Win10 DG Win7 Pro 64	3-year, Onsite	03/17	Apr 29, 2023
10NS0015US	US	i7-6700	vPro	Intel HD 530	None	8GBx1	23.8" FHD (1920x1080) WVA AG	None	150W 85% Adapter	128GB SSD M.2 PCIe NVMe	DVD±RW	9-in-1	None	8265 ac, 2x2, vPro + BT4.1	None	1080p	None	None	USB / USB	UltraFlex II Stand	Win10 DG Win7 Pro 64	3-year, Onsite	03/17	Apr 29, 2023
10NS0016US	US	i5-7500	vPro	Intel HD 630	None	4GBx1	23.8" FHD (1920x1080) WVA AG	None	150W 85% Adapter	128GB SSD M.2 PCIe NVMe	DVD±RW	9-in-1	None	8265 ac, 2x2, vPro + BT4.1	None	1080p	None	None	USB / USB	UltraFlex II Stand	Win10 Pro 64	3-year, Onsite	04/17	May 7, 2023
10NS0017US	US	i5-6500	vPro	Intel HD 530	None	4GBx1	23.8" FHD (1920x1080) WVA AG	None	150W 85% Adapter	128GB SSD M.2 PCIe NVMe	DVD±RW	9-in-1	None	8265 ac, 2x2, vPro + BT4.1	None	1080p	None	None	USB / USB	UltraFlex II Stand	Win10 DG Win7 Pro 64	3-year, Onsite	03/17	Apr 29, 2023



ThinkCentre M600 Tiny Platform Specifications

Product Specifications Reference (PSREF)

Processor	Intel® Celeron® Processor N3000 Series or Intel Pentium® Processor N3000 Series						Keyboard <i>Some:</i> PS/2 Keyboard (PS/2 connector), Lenovo logo <i>Some:</i> Preferred Pro USB Keyboard (USB connector), Lenovo logo <i>Some:</i> Lenovo USB Fingerprint Keyboard (USB connector) <i>Some:</i> Ultralim Plus Wireless Keyboard (2.4GHz via USB receiver), black
	Processor	Cores / Threads	Frequency (Base/Max)	Cache	Memory Types	Integrated Graphics	
	Celeron N3000	2 / 2	1.04 / 2.08 GHz	2MB	DDR3L-1600	Intel HD	
	Celeron N3010	2 / 2	1.04 / 2.24 GHz	2MB	DDR3L-1600	Intel HD 400	
	Celeron N3050	2 / 2	1.6 / 2.16 GHz	2MB	DDR3L-1600	Intel HD	
	Pentium N3700	4 / 4	1.6 / 2.4 GHz	2MB	DDR3L-1600	Intel HD	
Pentium J3710	4 / 4	1.6 / 2.64 GHz	2MB	DDR3L-1600	Intel HD 405	Mouse <i>Some:</i> PS/2 Optical Wheel Mouse, black, Lenovo logo <i>Some:</i> Enhanced Optical USB Mouse, black, Lenovo logo <i>Some:</i> Ultralim Plus Wireless Mouse (2.4GHz via USB receiver), black	
Chipset	Intel Architecture (IA) SoC that integrates Intel processor core, graphics, memory controller, and I/O interfaces into a single system-on-chip solution						Mechanical • Tiny (1L or 2L), black color; metal case
Graphics	Intel HD Graphics in processor, uses main memory, DirectX® 11.1, twoDisplayPort™, one optional 3rd DP (not support DP to HDMI dongle) or VGA, supports triple independent display; Maximum resolution: 3840x2160(DP)@30Hz; 1920x1200(optional VGA)@60Hz; 1920x1080(DP to VGA dongle)@60Hz; 1920x1080(DP to DVI dongle)@60Hz; 3840x2160(DP to HDMI dongle)@30Hz						
Monitor cable	Optional DP to VGA, DP to DVI-D (single link), or DP to HDMI 1.4 dongle						
Memory	8GB max / DDR3 Low Voltage, DDR3L-1600, non-parity, one 204-pin SO-DIMM socket						
Storage	<i>Some:</i> M.2 Solid State Drive (SSD), SATA interface <i>Some:</i> hard disk, 5400 or 7200 rpm, SATA 6.0Gb/s, 2.5" Wide <i>Some:</i> 500GB (5400 rpm) Solid State Hybrid Drive (SSHD) / with 8GB MLC NAND flash memory, SATA 6.0Gb/s, 2.5" wide						
Optical	<i>Some:</i> Solid State Drive (SSD) / SATA 6.0Gb/s, 2.5" Wide <i>Some:</i> external ODD box with DVD-ROM, 9.5mm high, via USB <i>Some:</i> external ODD box with DVD±RW, 9.5mm high, via USB <i>Some:</i> external ODD box (for TIO) with DVD-ROM, 9.5mm high, via USB <i>Some:</i> external ODD box (for TIO) with DVD±RW, 9.5mm high, via USB						
Onboard SATA Media reader	SATA 6.0Gb/s controller, one connectors on planar None						VESA mount Optional VESA mount bracket kit, supports VESA 75mm and 100mm Floor Stand Optional system floor stand for vertical orientation
Front ports	Two USB 3.0 (one is Always On and fast charge), one microphone (stereo, 3.5mm), one headphone / microphone combo jack (stereo, 3.5mm)						
Rear ports	Two USB 2.0, two USB 3.0 (optional external optical box or I/O box occupies one or two specific USB on some models), ethernet (RJ-45), two DisplayPort, one optional port (VGA, 3rd DP, or serial on some models), one headphone; additional four serial (9-pin), one parallel (25-pin), and two PS/2 ports on 2L models						Power supply 65 watts AC/DC adapter, autosensing, 88% PSU (not included for TIO models) 90 watts AC/DC adapter, autosensing, 88% PSU (only for models with I/O box)
I/O box	Optional external I/O box, extends two USB 2.0, two USB 3.0, and one serial on rear, two USB 2.0 on front, via USB (occupy two specific USB 3.0 of M600 Tiny)						
Audio support	High Definition (HD) Audio, Realtek ALC223 / optional internal speaker (1 watt)						Limited warranty ³ <i>Some:</i> 1-year or 3-year, depot service / service upgrades available <i>Some:</i> 1-year or 3-year, limited onsite service / service upgrades available <i>Some:</i> 3-year, limited onsite service, OID (Onsite International Delivery) / service upgrades available <i>For Lenovo service upgrade options, please go to S-TC sheet</i>
WLAN ¹³	<i>Some:</i> 11ac wireless, M.2 Card, Realtek RTL8821AE (dual band), Wi-Fi + Bluetooth 4.0 combo adapter, 1x1 <i>Some:</i> 11ac wireless, M.2 Card, Qualcomm Atheros QCA9377 (dual band), Wi-Fi + Bluetooth 4.1 combo adapter, 1x1 <i>Some:</i> 11ac wireless, M.2 Card, Qualcomm Atheros QCA6174 (dual band), Wi-Fi + Bluetooth 4.1 combo adapter, 2x2 <i>Some:</i> 11ac wireless, M.2 Card, Intel Dual Band Wireless-AC 3165, Wi-Fi + Bluetooth 4.0 combo adapter, 1x1 <i>Some:</i> 11ac wireless, M.2 Card, Intel Dual Band Wireless-AC 8260, Wi-Fi + Bluetooth 4.1 combo adapter, 2x2						
Bluetooth™	<i>Some:</i> Bluetooth 4.0 or 4.1 wireless, integrated in Wi-Fi + BT combo adapter						Preload <i>Some:</i> Windows® 7 Professional 64 preinstalled through downgrade rights in Windows 10 Pro 64-bit <i>Some:</i> Windows 7 Professional 64 <i>Some:</i> Windows 10 Pro 64-bit <i>Some:</i> Windows 10 Home 64-bit Preloaded applications (only some listed) • Desktop Power Manager • Lenovo Solution Center • Lenovo REACHit • Lenovo SHAREit • Lenovo Bluetooth Lock • McAfee® LiveSafe™ (30-day trial) • Microsoft Office preloaded; purchase a product key to activate • PowerDVD Create (DVD±RW) • Lenovo ThinkVantage Tools - Only for Window 10 • Lenovo Companion (Win10) • Cyberlink PowerDVD (DVD, DVD±RW) • Lenovo QuickOptimizer - Only for Window 7 • Rescue and Recovery • Password Manager • ThinkVantage System Update • Lenovo Message Center Plus • Adobe® Reader®
Ethernet Modem	One gigabit ethernet port, Realtek RTL8111GN, Wake on LAN® None						
Manageability	None						Environment ENERGY STAR® 6.0*, EPEAT™ Gold rating* (*for Windows models only); GREENGUARD®; RoHS-compliant; Cisco EnergyWise compatible; ErP Lot 3
Security chip	Trusted Platform Module, TCG 1.2-compliant						
Security features	<ul style="list-style-type: none"> • Security slot (in rear for optional Kensington® MicroSaver® cable) • Padlock loop • Smart USB protection, allows keyboard/mouse only, blocks all storage devices • Power-on password • Administrator password • Hard disk password • Boot sequence control • Boot without keyboard and mouse • Individual USB port disablement • Chassis intrusion switch 						Accessories For compatible accessories, please go to TC-AQP sheet

See footnotes for more detailed information

Model	Region	Case 1L/2L	Processor	vPro	Graphics	Monitor Cable	Memory	Storage	External Optical / I/O Box	WLAN + Bluetooth	Optional Rear Ports	Chassis Intrusion Switch	Kensington Cable Lock	Speaker	Adapter Cage	Toolless Chassis Screw	Keyboard / Mouse	VESA Mount	Stand	Power Supply	Operating System	Warranty	End of Support	Ann Date (m/y)
10G9000NUS	US	1L	Pentium N3700	No	Intel HD	None	4GBx1	500GB 7200rpm 2.5"	None	Intel 8260 ac, 2x2 + BT4.1	None	Switch	None	1Wx1	None	None	USB / USB	None	Floor Stand	65W Adapter 88%	Win10 DG Win7 Pro 64	1-year, Onsite	Oct 20, 2020	10/15
10G9000WUS	US	1L	Pentium N3700	No	Intel HD	None	4GBx1	500GB 7200rpm 2.5"	None	Intel 3165 ac, 1x1 + BT4.0	Serial	Switch	None	1Wx1	None	None	USB / USB	None	Floor Stand	65W Adapter 88%	Win10 DG Win7 Pro 64	1-year, Onsite	Apr 5, 2021	04/16
10G9000XUS	US	1L	Pentium N3700	No	Intel HD	None	4GBx1	500GB 7200rpm 2.5"	None	Intel 3165 ac, 1x1 + BT4.0	VGA	Switch	None	1Wx1	None	None	USB / USB	None	Floor Stand	65W Adapter 88%	Win10 DG Win7 Pro 64	1-year, Onsite	May 10, 2021	05/16
10G9000YUS	US	1L	Pentium N3700	No	Intel HD	None	4GBx1	500GB 7200rpm 2.5"	None	Intel 3165 ac, 1x1 + BT4.0	3rd DP	Switch	None	1Wx1	None	None	USB / USB	None	Floor Stand	65W Adapter 88%	Win10 Pro 64	1-year, Onsite	May 10, 2021	05/16
10G90010US	US	1L	Pentium N3700	No	Intel HD	None	4GBx1	500GB 7200rpm 2.5"	None	Intel 3165 ac, 1x1 + BT4.0	Serial	Switch	None	1Wx1	None	None	USB / USB	None	Floor Stand	65W Adapter 88%	Win10 Pro 64	1-year, Onsite	May 10, 2021	05/16
10G90011US	US	1L	Pentium N3700	No	Intel HD	None	4GBx1	128GB SSD	None	Intel 3165 ac, 1x1 + BT4.0	None	Switch	None	1Wx1	None	None	USB / USB	None	Floor Stand	65W Adapter 88%	Win10 Pro 64	1-year, Onsite	May 10, 2021	05/16
10G90012US	US	1L	Pentium N3700	No	Intel HD	None	4GBx1	500GB 7200rpm 2.5"	None	Intel 3165 ac, 1x1 + BT4.0	None	Switch	None	1Wx1	None	None	USB / USB	None	Floor Stand	65W Adapter 88%	Win10 Pro 64	1-year, Onsite	May 10, 2021	05/16
10G90013US	US	1L	Pentium N3700	No	Intel HD	None	4GBx1	128GB SSD	None	Intel 3165 ac, 1x1 + BT4.0	None	Switch	None	1Wx1	None	None	USB / USB	None	Floor Stand	65W Adapter 88%	Win10 DG Win7 Pro 64	1-year, Onsite	May 10, 2021	05/16
10G90014US	US	1L	Pentium N3700	No	Intel HD	None	4GBx1	500GB 7200rpm 2.5"	None	Intel 3165 ac, 1x1 + BT4.0	None	Switch	None	1Wx1	None	None	USB / USB	None	Floor Stand	65W Adapter 88%	Win10 DG Win7 Pro 64	1-year, Onsite	May 10, 2021	05/16
10G90015US	US	1L	Pentium N3700	No	Intel HD	None	4GBx1	500GB 7200rpm 2.5"	None	Intel 3165 ac, 1x1 + BT4.0	VGA	Switch	None	1Wx1	None	None	USB / USB	None	Floor Stand	65W Adapter 88%	Win10 Pro 64	1-year, Onsite	May 10, 2021	05/16
10G90016US	US	1L	Pentium N3700	No	Intel HD	None	4GBx1	500GB 7200rpm 2.5"	None	Intel 3165 ac, 1x1 + BT4.0	3rd DP	Switch	None	1Wx1	None	None	USB / USB	None	Floor Stand	65W Adapter 88%	Win10 DG Win7 Pro 64	1-year, Onsite	May 10, 2021	05/16
10G9001CUS	US	1L	Pentium J3710	No	Intel HD 405	None	4GBx1	128GB SSD	None	Intel 8260 ac, 2x2 + BT4.1	3rd DP	Switch	None	1Wx1	None	None	USB / USB	None	Floor Stand	65W Adapter 88%	Win10 Pro 64	1-year, Onsite	Aug 26, 2022	07/16
10G9001DUS	US	1L	Pentium J3710	No	Intel HD 405	None	4GBx1	500GB 7200rpm 2.5"	None	Intel 3165 ac, 1x1 + BT4.0	3rd DP	Switch	None	1Wx1	None	None	USB / USB	None	Floor Stand	65W Adapter 88%	Win10 Pro 64	1-year, Onsite	Aug 26, 2022	07/16
10G9001EUS	US	1L	Pentium J3710	No	Intel HD 405	None	4GBx1	500GB 7200rpm 2.5"	None	Intel 3165 ac, 1x1 + BT4.0	VGA	Switch	None	1Wx1	None	None	USB / USB	None	Floor Stand	65W Adapter 88%	Win10 Pro 64	1-year, Onsite	Aug 26, 2022	07/16
10G9001FUS	US	1L	Pentium J3710	No	Intel HD 405	None	4GBx1	500GB 7200rpm 2.5"	None	Intel 3165 ac, 1x1 + BT4.0	None	Switch	None	1Wx1	None	None	USB / USB	None	Floor Stand	65W Adapter 88%	Win10 Pro 64	1-year, Onsite	Aug 26, 2022	07/16
10G9001GUS	US	1L	Pentium J3710	No	Intel HD 405	None	4GBx1	128GB SSD	None	Intel 3165 ac, 1x1 + BT4.0	None	Switch	None	1Wx1	None	None	USB / USB	None	Floor Stand	65W Adapter 88%	Win10 Pro 64	1-year, Onsite	Aug 26, 2022	07/16
10G9001HUS	US	1L	Pentium J3710	No	Intel HD 405	None	4GBx1	500GB 7200rpm 2.5"	None	Intel 3165 ac, 1x1 + BT4.0	Serial	Switch	None	1Wx1	None	None	USB / USB	None	Floor Stand	65W Adapter 88%	Win10 Pro 64	1-year, Onsite	Aug 26, 2022	07/16
10G9001QUS	US	1L	Pentium J3710	No	Intel HD 405	None	4GBx1	500GB 7200rpm 2.5"	None	Intel 8260 ac, 2x2 + BT4.1	3rd DP	Switch	None	1Wx1	None	None	USB / USB	None	Floor Stand	65W Adapter 88%	Win10 DG Win7 Pro 64	1-year, Onsite	Sep 13, 2021	09/16
10G9001RUS	US	1L	Pentium J3710	No	Intel HD 405	None	4GBx1	128GB SSD	None	Intel 3165 ac, 1x1 + BT4.0	None	Switch	None	1Wx1	None	None	USB / USB	None	Floor Stand	65W Adapter 88%	Win10 DG Win7 Pro 64	1-year, Onsite	Sep 13, 2021	09/16
10G9001SUS	US	1L	Pentium J3710	No	Intel HD 405	None	4GBx1	500GB 7200rpm 2.5"	None	Intel 3165 ac, 1x1 + BT4.0	3rd DP	Switch	None	1Wx1	None	None	USB / USB	None	Floor Stand	65W Adapter 88%	Win10 DG Win7 Pro 64	1-year, Onsite	Sep 13, 2021	09/16

Model	Region	Case 1L/2L	Processor	vPro	Graphics	Monitor Cable	Memory	Storage	External Optical / I/O Box	WLAN + Bluetooth	Optional Rear Ports	Chassis Intrusion Switch	Kensington Cable Lock	Speaker	Adapter Cage	Toolless Chassis Screw	Keyboard / Mouse	VESA Mount	Stand	Power Supply	Operating System	Warranty	End of Support	Ann Date (m/y)
10G9001TUS	US	1L	Pentium J3710	No	Intel HD 405	None	4GBx1	128GB SSD	None	Intel 8260 ac, 2x2 + BT4.1	3rd DP	Switch	None	1Wx1	None	None	USB / USB	None	Floor Stand	65W Adapter 88%	Win10 DG Win7 Pro 64	1-year, Onsite	Sep 13, 2021	09/16
10G9001UUS	US	1L	Pentium J3710	No	Intel HD 405	None	4GBx1	500GB 7200rpm 2.5"	None	Intel 3165 ac, 1x1 + BT4.0	None	Switch	None	1Wx1	None	None	USB / USB	None	Floor Stand	65W Adapter 88%	Win10 DG Win7 Pro 64	1-year, Onsite	Sep 13, 2021	09/16
10G9001VUS	US	1L	Pentium J3710	No	Intel HD 405	None	4GBx1	500GB 7200rpm 2.5"	None	Intel 3165 ac, 1x1 + BT4.0	Serial	Switch	None	1Wx1	None	None	USB / USB	None	Floor Stand	65W Adapter 88%	Win10 DG Win7 Pro 64	1-year, Onsite	Sep 13, 2021	09/16
10G9001WUS	US	1L	Pentium J3710	No	Intel HD 405	None	4GBx1	500GB 7200rpm 2.5"	None	Intel 3165 ac, 1x1 + BT4.0	VGA	Switch	None	1Wx1	None	None	USB / USB	None	Floor Stand	65W Adapter 88%	Win10 DG Win7 Pro 64	1-year, Onsite	Sep 13, 2021	09/16

ThinkCentre M600 Tiny - TopSeller - 10GB

Product Specifications Reference (PSREF)

Model	Region	Case 1L/2L	Processor vPro	Graphics	Monitor Cable	Memory	Storage	External Optical / I/O Box	WLAN + Bluetooth	Optional Rear Ports	Chassis Intrusion Switch	Kensington Cable Lock	Speaker	Adapter Cage	Toolless Chassis Screw	Keyboard / Mouse	VESA Mount	Stand	Power Supply	Operating System	Warranty	End of Support	Ann Date (m/y)	
10GB000JUS	US	1L	Celeron N3050	No	Intel HD	None	4GBx1	500GB 7200rpm 2.5"	None	Intel 8260 ac, 2x2 + BT4.1	None	Switch	None	1Wx1	None	None	USB / USB	None	Floor Stand	65W Adapter 88%	Win10 Pro 64	3-year, Onsite	Oct 20, 2020	10/15
10GB000KUS	US	1L	Celeron N3050	No	Intel HD	None	4GBx1	500GB 7200rpm 2.5"	None	Intel 8260 ac, 2x2 + BT4.1	None	Switch	None	1Wx1	None	None	USB / USB	None	Floor Stand	65W Adapter 88%	Win10 DG Win7 Pro 64	3-year, Onsite	Oct 20, 2020	10/15
10GB000LUS	US	1L	Celeron N3050	No	Intel HD	None	4GBx1	120GB SSD	None	Intel 8260 ac, 2x2 + BT4.1	None	Switch	None	1Wx1	None	None	USB / USB	None	Floor Stand	65W Adapter 88%	Win10 DG Win7 Pro 64	3-year, Onsite	Oct 20, 2020	10/15
10GB000MUS	US	1L	Celeron N3050	No	Intel HD	None	4GBx1	120GB SSD	None	Intel 8260 ac, 2x2 + BT4.1	None	Switch	None	1Wx1	None	None	USB / USB	None	Floor Stand	65W Adapter 88%	Win10 Pro 64	3-year, Onsite	Oct 20, 2020	10/15

Model	Region	Case 1L/2L	Processor	vPro	Graphics	Monitor Cable	Memory	Storage	External Optical / I/O Box	WLAN + Bluetooth	Optional Rear Ports	Chassis Intrusion Switch	Kensington Cable Lock	Speaker	Adapter Cage	Toolless Chassis Screw	Keyboard / Mouse	VESA Mount	Stand	Power Supply	Operating System	Warranty	End of Support	Ann Date (m/y)
10KH0001US	US	1L	Celeron N3000	No	Intel HD	None	2GBx1	16GB SSD M.2	None	RTL8821AE ac, 1x1 + BT4.0	None	Switch	None	1Wx1	None	None	USB / USB	None	Floor Stand	65W Adapter 88%	WES 7	1-year, Onsite	Jan 29, 2021	01/16
10KH0003US	US	1L	Celeron N3000	No	Intel HD	None	4GBx1	16GB SSD M.2	None	RTL8821AE ac, 1x1 + BT4.0	VGA	Switch	None	1Wx1	None	None	USB / USB	None	Floor Stand	65W Adapter 88%	WES 7	1-year, Onsite	Jan 29, 2021	01/16
10KH0007US	US	1L	Celeron N3000	No	Intel HD	None	4GBx1	16GB SSD M.2	None	RTL8821AE ac, 1x1 + BT4.0	None	Switch	None	1Wx1	None	None	USB / USB	None	Floor Stand	65W Adapter 88%	WES 7	1-year, Onsite	Jan 29, 2021	01/16
10KH0008US	US	1L	Celeron N3000	No	Intel HD	None	4GBx1	16GB SSD M.2	None	RTL8821AE ac, 1x1 + BT4.0	3rd DP	Switch	None	1Wx1	None	None	USB / USB	None	Floor Stand	65W Adapter 88%	WES 7	1-year, Onsite	Jan 29, 2021	01/16
10KH000BUS	US	1L	Celeron N3000	No	Intel HD	None	2GBx1	16GB SSD M.2	None	RTL8821AE ac, 1x1 + BT4.0	None	Switch	None	1Wx1	None	None	USB / USB	None	Floor Stand	65W Adapter 88%	LeTOS	1-year, Onsite	Jan 29, 2021	01/16
10KH000CUS	US	1L	Celeron N3000	No	Intel HD	None	4GBx1	16GB SSD M.2	None	RTL8821AE ac, 1x1 + BT4.0	3rd DP	Switch	None	1Wx1	None	None	USB / USB	None	Floor Stand	65W Adapter 88%	LeTOS	1-year, Onsite	Jan 29, 2021	01/16
10KH000FUS	US	1L	Celeron N3000	No	Intel HD	None	4GBx1	16GB SSD M.2	None	RTL8821AE ac, 1x1 + BT4.0	None	Switch	None	1Wx1	None	None	USB / USB	None	Floor Stand	65W Adapter 88%	LeTOS	1-year, Onsite	Jan 29, 2021	01/16
10KH0023US	US	1L	Celeron N3010	No	Intel HD 400	None	2GBx1	16GB SSD M.2	None	RTL8821AE ac, 1x1 + BT4.0	None	Switch	None	1Wx1	None	None	USB / USB	None	Floor Stand	65W Adapter 88%	LeTOS	1-year, Onsite	Aug 26, 2022	07/16
10KH0024US	US	1L	Celeron N3010	No	Intel HD 400	None	4GBx1	16GB SSD M.2	None	RTL8821AE ac, 1x1 + BT4.0	VGA	Switch	None	1Wx1	None	None	USB / USB	None	Floor Stand	65W Adapter 88%	LeTOS	1-year, Onsite	Aug 26, 2022	07/16
10KH0025US	US	1L	Celeron N3010	No	Intel HD 400	None	4GBx1	16GB SSD M.2	None	RTL8821AE ac, 1x1 + BT4.0	None	Switch	None	1Wx1	None	None	USB / USB	None	Floor Stand	65W Adapter 88%	WES 7	1-year, Onsite	Aug 26, 2022	07/16
10KH0026US	US	1L	Celeron N3010	No	Intel HD 400	None	4GBx1	16GB SSD M.2	None	RTL8821AE ac, 1x1 + BT4.0	VGA	Switch	None	1Wx1	None	None	USB / USB	None	Floor Stand	65W Adapter 88%	WES 7	1-year, Onsite	Aug 26, 2022	07/16
10KH0027US	US	1L	Celeron N3010	No	Intel HD 400	None	4GBx1	16GB SSD M.2	None	RTL8821AE ac, 1x1 + BT4.0	Serial	Switch	None	1Wx1	None	None	USB / USB	None	Floor Stand	65W Adapter 88%	LeTOS	1-year, Onsite	Aug 26, 2022	07/16
10KH0028US	US	1L	Celeron N3010	No	Intel HD 400	None	4GBx1	16GB SSD M.2	None	RTL8821AE ac, 1x1 + BT4.0	3rd DP	Switch	None	1Wx1	None	None	USB / USB	None	Floor Stand	65W Adapter 88%	WES 7	1-year, Onsite	Aug 26, 2022	07/16
10KH0029US	US	1L	Celeron N3010	No	Intel HD 400	None	4GBx1	16GB SSD M.2	None	RTL8821AE ac, 1x1 + BT4.0	Serial	Switch	None	1Wx1	None	None	USB / USB	None	Floor Stand	65W Adapter 88%	WES 7	1-year, Onsite	Aug 26, 2022	07/16
10KH002VUS	US	1L	Celeron N3010	No	Intel HD 400	None	2GBx1	16GB SSD M.2	None	RTL8821AE ac, 1x1 + BT4.0	None	Switch	None	1Wx1	None	None	USB / USB	None	Floor Stand	65W Adapter 88%	LeTOS	1-year, Onsite	Jan 3, 2022	01/17
10KH002WUS	US	1L	Celeron N3010	No	Intel HD 400	None	4GBx1	16GB SSD M.2	None	RTL8821AE ac, 1x1 + BT4.0	None	Switch	None	1Wx1	None	None	USB / USB	None	Floor Stand	65W Adapter 88%	LeTOS	1-year, Onsite	Jan 3, 2022	01/17
10KH002XUS	US	1L	Celeron N3010	No	Intel HD 400	None	4GBx1	16GB SSD M.2	None	RTL8821AE ac, 1x1 + BT4.0	3rd DP	Switch	None	1Wx1	None	None	USB / USB	None	Floor Stand	65W Adapter 88%	LeTOS	1-year, Onsite	Jan 3, 2022	01/17
10KH002YUS	US	1L	Celeron N3010	No	Intel HD 400	None	4GBx1	32GB SSD M.2	None	RTL8821AE ac, 1x1 + BT4.0	VGA	Switch	None	1Wx1	None	None	USB / USB	None	Floor Stand	65W Adapter 88%	WES 7	1-year, Onsite	Jan 3, 2022	01/17
10KH0030US	US	1L	Celeron N3010	No	Intel HD 400	None	4GBx1	16GB SSD M.2	None	RTL8821AE ac, 1x1 + BT4.0	VGA	Switch	None	1Wx1	None	None	USB / USB	None	Floor Stand	65W Adapter 88%	LeTOS	1-year, Onsite	Jan 3, 2022	01/17
10KH0031US	US	1L	Celeron N3010	No	Intel HD 400	None	4GBx1	32GB SSD M.2	None	RTL8821AE ac, 1x1 + BT4.0	Serial	Switch	None	1Wx1	None	None	USB / USB	None	Floor Stand	65W Adapter 88%	WES 7	1-year, Onsite	Jan 3, 2022	01/17

Model	Region	Case 1L/2L	Processor	vPro	Graphics	Monitor Cable	Memory	Storage	External Optical / I/O Box	WLAN + Bluetooth	Optional Rear Ports	Chassis Intrusion Switch	Kensington Cable Lock	Speaker	Adapter Cage	Toolless Chassis Screw	Keyboard / Mouse	VESA Mount	Stand	Power Supply	Operating System	Warranty	End of Support	Ann Date (m/y)
10KH0032US	US	1L	Celeron N3010	No	Intel HD 400	None	4GBx1	16GB SSD M.2	None	RTL8821AE ac, 1x1 + BT4.0	Serial	Switch	None	1Wx1	None	None	USB / USB	None	Floor Stand	65W Adapter 88%	LeTOS	1-year, Onsite	Jan 3, 2022	01/17
10KH0033US	US	1L	Celeron N3010	No	Intel HD 400	None	4GBx1	32GB SSD M.2	None	RTL8821AE ac, 1x1 + BT4.0	3rd DP	Switch	None	1Wx1	None	None	USB / USB	None	Floor Stand	65W Adapter 88%	WES 7	1-year, Onsite	Jan 3, 2022	01/17
10KH0034US	US	1L	Celeron N3010	No	Intel HD 400	None	4GBx1	32GB SSD M.2	None	RTL8821AE ac, 1x1 + BT4.0	None	Switch	None	1Wx1	None	None	USB / USB	None	Floor Stand	65W Adapter 88%	WES 7	1-year, Onsite	Jan 3, 2022	01/17
10KH003MUS	US	1L	Celeron N3010	No	Intel HD 400	None	4GBx1	32GB SSD M.2	None	None	None	Switch	None	1Wx1	None	None	USB / USB	None	Floor Stand	65W Adapter 88%	Windows 10 IoT Enterprise	1-year, Onsite	Mar 30, 2022	03/17
10KH003PUS	US	1L	Celeron N3010	No	Intel HD 400	None	4GBx1	32GB SSD M.2	None	RTL8821AE ac, 1x1 + BT4.0	3rd DP	Switch	None	1Wx1	None	None	USB / USB	None	Floor Stand	65W Adapter 88%	Windows 10 IoT Enterprise	1-year, Onsite	Apr 18, 2022	04/17
10KH003QUS	US	1L	Celeron N3010	No	Intel HD 400	None	4GBx1	32GB SSD M.2	None	RTL8821AE ac, 1x1 + BT4.0	None	Switch	None	1Wx1	None	None	USB / USB	None	Floor Stand	65W Adapter 88%	Windows 10 IoT Enterprise	1-year, Onsite	Apr 18, 2022	04/17
10KH003RUS	US	1L	Celeron N3010	No	Intel HD 400	None	4GBx1	32GB SSD M.2	None	RTL8821AE ac, 1x1 + BT4.0	VGA	Switch	None	1Wx1	None	None	USB / USB	None	Floor Stand	65W Adapter 88%	Windows 10 IoT Enterprise	1-year, Onsite	Apr 18, 2022	04/17
10KH003SUS	US	1L	Celeron N3010	No	Intel HD 400	None	8GBx1	32GB SSD M.2	None	RTL8821AE ac, 1x1 + BT4.0	3rd DP	Switch	None	1Wx1	None	None	USB / USB	None	Floor Stand	65W Adapter 88%	Windows 10 IoT Enterprise	1-year, Onsite	Apr 18, 2022	04/17
10KH0047US	US	1L	Celeron N3010	No	Intel HD 400	None	4GBx1	32GB SSD M.2	None	RTL8821AE ac, 1x1 + BT4.0	3rd DP	Switch	None	1Wx1	None	None	USB / USB	None	Floor Stand	65W Adapter 88%	LeTOS	1-year, Onsite	May 16, 2022	05/17
10KH0048US	US	1L	Celeron N3010	No	Intel HD 400	None	4GBx1	32GB SSD M.2	None	RTL8821AE ac, 1x1 + BT4.0	None	Switch	None	1Wx1	None	None	USB / USB	None	Floor Stand	65W Adapter 88%	LeTOS	1-year, Onsite	May 16, 2022	05/17
10KH0049US	US	1L	Celeron N3010	No	Intel HD 400	None	2GBx1	32GB SSD M.2	None	RTL8821AE ac, 1x1 + BT4.0	None	Switch	None	1Wx1	None	None	USB / USB	None	Floor Stand	65W Adapter 88%	LeTOS	1-year, Onsite	May 16, 2022	05/17
10KH004AUS	US	1L	Celeron N3010	No	Intel HD 400	None	4GBx1	32GB SSD M.2	None	RTL8821AE ac, 1x1 + BT4.0	Serial	Switch	None	1Wx1	None	None	USB / USB	None	Floor Stand	65W Adapter 88%	LeTOS	1-year, Onsite	May 16, 2022	05/17
10KH004BUS	US	1L	Celeron N3010	No	Intel HD 400	None	4GBx1	32GB SSD M.2	None	RTL8821AE ac, 1x1 + BT4.0	VGA	Switch	None	1Wx1	None	None	USB / USB	None	Floor Stand	65W Adapter 88%	LeTOS	1-year, Onsite	May 16, 2022	05/17

Model	Region	Case 1L/2L	Processor	vPro	Graphics	Monitor Cable	Memory	Storage	External Optical / I/O Box	WLAN + Bluetooth	Optional Rear Ports	Chassis Intrusion Switch	Kensington Cable Lock	Speaker	Adapter Cage	Toolless Chassis Screw	Keyboard / Mouse	VESA Mount	Stand	Power Supply	Operating System	Warranty	End of Support	Ann Date (m/y)
10G8000QUS	US	1L	Pentium N3700	No	Intel HD	None	4GBx1	500GB 7200rpm 2.5"	DVD±RW	QCA6174 ac, 2x2 + BT4.1	None	Switch	None	1Wx1	None	None	USB / USB	VESA Mount	None	65W Adapter 88%	Win10 DG Win7 Pro 64	3-year, Onsite, OID	Oct 20, 2020	10/15
10G8000RUS	US	1L	Pentium N3700	No	Intel HD	None	4GBx1	500GB 7200rpm 2.5"	DVD±RW	QCA6174 ac, 2x2 + BT4.1	None	Switch	None	1Wx1	None	None	USB / USB	VESA Mount	None	65W Adapter 88%	Win10 Pro 64	3-year, Onsite, OID	Oct 20, 2020	10/15
10G8000SUS	US	1L	Pentium N3700	No	Intel HD	None	2GBx1	500GB 7200rpm 2.5"	None	QCA9377 ac, 1x1 + BT4.1	None	Switch	None	1Wx1	None	None	USB / USB	None	None	65W Adapter 88%	Win10 Pro 64	3-year, Onsite, OID	Oct 20, 2020	10/15
10G8000TUS	US	1L	Pentium N3700	No	Intel HD	None	2GBx1	500GB 7200rpm 2.5"	None	QCA9377 ac, 1x1 + BT4.1	None	Switch	None	1Wx1	None	None	USB / USB	None	None	65W Adapter 88%	Win10 DG Win7 Pro 64	3-year, Onsite, OID	Oct 20, 2020	10/15

ThinkCentre M600 Tiny - 10GA

Product Specifications Reference (PSREF)

Model	Region	Case 1L/2L	Processor	vPro	Graphics	Monitor Cable	Memory	Storage	External Optical / I/O Box	WLAN + Bluetooth	Optional Rear Ports	Chassis Intrusion Switch	Kensington Cable Lock	Speaker	Adapter Cage	Toolless Chassis Screw	Keyboard / Mouse	VESA Mount	Stand	Power Supply	Operating System	Warranty	End of Support	Ann Date (m/y)
10GA000JUS	US	1L	Celeron N3050	No	Intel HD	None	2GBx1	500GB 7200rpm 2.5"	None	None	None	Switch	None	1Wx1	None	None	USB / USB	None	None	65W Adapter 88%	Win10 DG Win7 Pro 64	3-year, Onsite, OID	Oct 20, 2020	10/15
10GA000KUS	US	1L	Celeron N3050	No	Intel HD	None	2GBx1	500GB 7200rpm 2.5"	DVD±RW	None	None	Switch	None	1Wx1	None	None	USB / USB	VESA Mount	None	65W Adapter 88%	Win10 Pro 64	3-year, Onsite, OID	Oct 20, 2020	10/15

ThinkCentre M600 Tiny - 10GC

Product Specifications Reference (PSREF)

Model	Region	Case 1L/2L	Processor	vPro	Graphics	Monitor Cable	Memory	Storage	External Optical / I/O Box	WLAN + Bluetooth	Optional Rear Ports	Chassis Intrusion Switch	Kensington Cable Lock	Speaker	Adapter Cage	Toolless Chassis Screw	Keyboard / Mouse	VESA Mount	Stand	Power Supply	Operating System	Warranty	End of Support	Ann Date (m/y)
10GC0001US	US	1L	Pentium N3700	No	Intel HD	None	4GBx1	500GB 7200rpm 2.5"	DVD±RW (TIO)	QCA6174 ac, 2x2 + BT4.1	None	Switch	None	1Wx1	None	None	USB / USB	None	None	None	Win10 Pro 64	3-year, Onsite, OID	Oct 20, 2020	10/15
10GC0002US	US	1L	Pentium N3700	No	Intel HD	None	4GBx1	500GB 7200rpm 2.5"	None	QCA6174 ac, 2x2 + BT4.1	None	Switch	None	1Wx1	None	None	USB / USB	None	None	None	Win10 DG Win7 Pro 64	3-year, Onsite, OID	Oct 20, 2020	10/15

ThinkCentre M600 Tiny - 10GE

Product Specifications Reference (PSREF)

Model	Region	Case 1L/2L	Processor	vPro	Graphics	Monitor Cable	Memory	Storage	External Optical / I/O Box	WLAN + Bluetooth	Optional Rear Ports	Chassis Intrusion Switch	Kensington Cable Lock	Speaker	Adapter Cage	Toolless Chassis Screw	Keyboard / Mouse	VESA Mount	Stand	Power Supply	Operating System	Warranty	End of Support	Ann Date (m/y)
10GE0001US	US	1L	Celeron N3050	No	Intel HD	None	2GBx1	500GB 7200rpm 2.5"	None	QCA9377 ac, 1x1 + BT4.1	None	Switch	None	1Wx1	None	None	USB / USB	None	None	None	Win10 DG Win7 Pro 64	3-year, Onsite, OID	Oct 20, 2020	10/15



ThinkCentre M700 SFF Platform Specifications

Product Specifications Reference (PSREF)

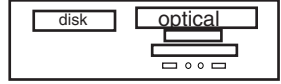
Processor	Intel® Celeron®, Intel Pentium®, or 6th Generation Intel Core™ i3 / i5 / i7 Processor	Security features	<ul style="list-style-type: none"> One lock to secure both cover and entire system to fixed object: <ul style="list-style-type: none"> -Padlock loop (in rear for opt padlock) -Security slot (in rear for optional Kensington® MicroSaver® cable) Optional cable lock to physically lock both keyboard and mouse <ul style="list-style-type: none"> Power-on password Administrator password Hard disk password Boot sequence control Boot without keyboard and mouse Individual USB port disablement Optional chassis intrusion switch 																																																												
	<table border="1"> <thead> <tr> <th>Processor</th> <th>Cores / Threads</th> <th>Frequency Base/Max(GHz)</th> <th>Cache</th> <th>Memory Types</th> <th>Integrated Graphics</th> </tr> </thead> <tbody> <tr> <td>Celeron G3900</td> <td>2 / 2</td> <td>2.8 G</td> <td>2 MB</td> <td>DDR4-2133</td> <td>HD 510</td> </tr> <tr> <td>Pentium G4400</td> <td>2 / 2</td> <td>3.3 G</td> <td>3 MB</td> <td>DDR4-2133</td> <td>HD 510</td> </tr> <tr> <td>Pentium G4500</td> <td>2 / 2</td> <td>3.5 G</td> <td>3 MB</td> <td>DDR4-2133</td> <td>HD 530</td> </tr> <tr> <td>Core i3-6100</td> <td>2 / 4</td> <td>3.7 G</td> <td>3 MB</td> <td>DDR4-2133</td> <td>HD 530</td> </tr> <tr> <td>Core i3-6300</td> <td>2 / 4</td> <td>3.8 G</td> <td>4 MB</td> <td>DDR4-2133</td> <td>HD 530</td> </tr> <tr> <td>Core i5-6400</td> <td>4 / 4</td> <td>2.7 G / 3.3 G</td> <td>6 MB</td> <td>DDR4-2133</td> <td>HD 530</td> </tr> <tr> <td>Core i5-6500</td> <td>4 / 4</td> <td>3.2 G / 3.6 G</td> <td>6 MB</td> <td>DDR4-2133</td> <td>HD 530</td> </tr> <tr> <td>Core i5-6600</td> <td>4 / 4</td> <td>3.3 G / 3.9 G</td> <td>6 MB</td> <td>DDR4-2133</td> <td>HD 530</td> </tr> <tr> <td>Core i7-6700</td> <td>4 / 8</td> <td>3.4 G / 4.0 G</td> <td>8 MB</td> <td>DDR4-2133</td> <td>HD 530</td> </tr> </tbody> </table>	Processor	Cores / Threads	Frequency Base/Max(GHz)	Cache	Memory Types	Integrated Graphics	Celeron G3900	2 / 2	2.8 G	2 MB	DDR4-2133	HD 510	Pentium G4400	2 / 2	3.3 G	3 MB	DDR4-2133	HD 510	Pentium G4500	2 / 2	3.5 G	3 MB	DDR4-2133	HD 530	Core i3-6100	2 / 4	3.7 G	3 MB	DDR4-2133	HD 530	Core i3-6300	2 / 4	3.8 G	4 MB	DDR4-2133	HD 530	Core i5-6400	4 / 4	2.7 G / 3.3 G	6 MB	DDR4-2133	HD 530	Core i5-6500	4 / 4	3.2 G / 3.6 G	6 MB	DDR4-2133	HD 530	Core i5-6600	4 / 4	3.3 G / 3.9 G	6 MB	DDR4-2133	HD 530	Core i7-6700	4 / 8	3.4 G / 4.0 G	8 MB	DDR4-2133	HD 530	Keyboard	<i>Some:</i> PS/2 Keyboard (PS/2 connector), Lenovo logo <i>Some:</i> Preferred Pro USB Keyboard (USB connector), Lenovo logo <i>Some:</i> Lenovo USB Fingerprint Keyboard (USB connector) <i>Some:</i> Ultralim Plus Wireless Keyboard (2.4GHz via USB receiver), black
Processor	Cores / Threads	Frequency Base/Max(GHz)	Cache	Memory Types	Integrated Graphics																																																										
Celeron G3900	2 / 2	2.8 G	2 MB	DDR4-2133	HD 510																																																										
Pentium G4400	2 / 2	3.3 G	3 MB	DDR4-2133	HD 510																																																										
Pentium G4500	2 / 2	3.5 G	3 MB	DDR4-2133	HD 530																																																										
Core i3-6100	2 / 4	3.7 G	3 MB	DDR4-2133	HD 530																																																										
Core i3-6300	2 / 4	3.8 G	4 MB	DDR4-2133	HD 530																																																										
Core i5-6400	4 / 4	2.7 G / 3.3 G	6 MB	DDR4-2133	HD 530																																																										
Core i5-6500	4 / 4	3.2 G / 3.6 G	6 MB	DDR4-2133	HD 530																																																										
Core i5-6600	4 / 4	3.3 G / 3.9 G	6 MB	DDR4-2133	HD 530																																																										
Core i7-6700	4 / 8	3.4 G / 4.0 G	8 MB	DDR4-2133	HD 530																																																										
		Mouse	<i>Some:</i> PS/2 Optical Wheel Mouse, black, Lenovo logo <i>Some:</i> Enhanced Optical USB Mouse, black, Lenovo logo <i>Some:</i> Ultralim Plus Wireless Mouse (2.4GHz via USB receiver), black																																																												
Memory	32GB max, UDIMM, DDR4 2133, two 288-pin DIMM sockets, dual-channel capable	Mechanical	<ul style="list-style-type: none"> SFF (9.7L), black color; metal case (WxDxH) 13.31" X 14.05" X 3.46"; 338mm X 357mm X 88mm 12.3 lb (5.6 kg) Toolless cover, disk, optical removal Toolless graphics, PCI adapter retention Optional dust filter  <p>Bay 1: N/A, 9.5mm high, external, std optical Bay 2: 3.5", 1" high, internal, std disk Bay 3: 2.5", N/A, internal, opt 2nd 2.5" disk (optional bay) Bay 4: N/A, N/A, external, opt reader Slot 1: Low Profile, PCI Express 3.0 x16 Slot 2: Low Profile, PCIe 2.0 x1 Slot 3: Low Profile, PCIe 2.0 x1</p>																																																												
Disk	<i>Some:</i> Hard disk, SATA 6.0Gb/s, 2.5"/ 3.5" wide, 5400 / 7200 rpm <i>Some:</i> Solid State Hybrid Drive (SSHD), 500GB (5400 rpm, 2.5") / 1TB or 2TB (7200 rpm, 3.5"), with 8GB NAND flash memory, SATA 6.0Gb/s <i>Some:</i> Solid State Drive (SSD) / SATA 6.0Gb/s, 2.5" Wide	Floor Stand	Optional system floor stand for vertical orientation																																																												
Optical	<i>Some:</i> DVD-ROM SATA 1.5Gb/s Drive <i>Some:</i> Super Multi-Burner DVD±RW SATA 1.5Gb/s Drive	Power supply	<i>Some:</i> 180 watts, autosensing, 85% PSU <i>Some:</i> 210 watts, autosensing, 85% PSU																																																												
Onboard SATA	Three onboard SATA 6.0Gb/s connectors	Limited warranty ³	<i>Some:</i> 1-year or 3-year, depot service / service upgrades available <i>Some:</i> 1-year or 3-year, limited onsite service / service upgrades available <i>Some:</i> 3-year, limited onsite service, OID (Onsite International Delivery) / service upgrades available <i>For Lenovo service upgrade options, please go to S-TC sheet</i>																																																												
Media reader	Optional 9-in-1 media reader	Preload	Preloaded operating system <i>Some:</i> Windows® 7 Professional 32/64 preinstalled through downgrade rights in Windows 10 Pro 64-bit <i>Some:</i> Windows 7 Professional 32/64 <i>Some:</i> Windows 10 Pro 64-bit <i>Some:</i> Windows 10 Home 64-bit																																																												
Graphics	Intel HD Graphics 510/530 in processor, uses main memory, DirectX® 12, one VGA, one DisplayPort™, supports two independent displays, works along with discrete graphics to support more displays; <i>Max resolution:</i> 4096x2304 (DP)@60Hz; 1920x1200 (VGA)@60Hz <i>Some:</i> NVIDIA® Quadro® K420 , DirectX 12, 2GB, PCIe 2.0 x16 adapter, one DVI-I, one DisplayPort, 41 watts; <i>Max resolution:</i> 3840x2160 (DisplayPort)@60Hz; 2560x1600 (DVI-I)@60Hz <i>Some:</i> NVIDIA GeForce® GT 720 , DirectX 12, 2GB, PCIe 2.0 x8 adapter, one VGA, one HDMI, 25 watts; <i>Max resolution:</i> 1920x1080 (HDMI)@60Hz; 2048x1536 (VGA)@85Hz <i>Some:</i> NVIDIA GeForce GT 720 , DirectX 12, 1GB, PCIe 2.0 x8 adapter, two DisplayPort, 25 watts; <i>Max resolution:</i> 3840x2160 (DisplayPort)@60Hz;		Preloaded applications (only some listed) <ul style="list-style-type: none"> Desktop Power Manager Lenovo Solution Center Lenovo REACHit Lenovo SHAREit Lenovo Bluetooth Lock (for models with Wi-Fi/BT card) McAfee® LiveSafe™ (30-day trial) Microsoft Office preloaded; purchase a product key to activate PowerDVD Create (DVD±RW) Lenovo ThinkVantage Tools <ul style="list-style-type: none"> - Only for Window 10 - Lenovo Companion - Cyberlink PowerDVD (DVD, DVD±RW) - Lenovo QuickOptimizer <ul style="list-style-type: none"> - Only for Window 7 - Rescue and Recovery - Password Manager - ThinkVantage System Update - Lenovo Message Center Plus - Adobe® Reader® 																																																												
DP cable	Optional DP to VGA, DP to DVI-D (single link), or DP to HDMI 1.4 dongle	Environment	ENERGY STAR® 6.0*, EPEAT™ Gold rating* (*Need 85% PSU and Windows OS); ErP Lot 3; GREENGUARD®; RoHS-compliant																																																												
Chipset	Intel H110 Chipset	Accessories	For compatible accessories, please go to TC-AQP sheet																																																												
Front ports	Two USB 3.0, two optional USB 2.0, microphone (3.5mm), headphone (3.5mm)																																																														
Rear ports	Two USB 3.0, two USB 2.0, two optional USB 2.0, serial (9-pin), optional 2nd serial (9-pin), optional parallel (25-pin), ethernet (RJ-45), one VGA, one DisplayPort, two PS/2 ports (keyboard/mouse); additional VGA, DisplayPort, DVI-I or HDMI on optional graphics on some models																																																														
Rear audio ports	Line-in (3.5mm), line-out (3.5mm), microphone-in (3.5mm)																																																														
IEEE 1394	None																																																														
Audio support	High Definition (HD) Audio, Realtek ALC662 / optional internal speaker (1.5 watt)																																																														
WLAN ¹³	<i>Some:</i> 11ac wireless, M.2 Card, Qualcomm Atheros QCA9377 (dual band), Wi-Fi + Bluetooth 4.1 combo adapter, 1x1 <i>Some:</i> 11ac wireless, M.2 Card, Qualcomm Atheros QCA6174 (dual band), Wi-Fi + Bluetooth 4.1 combo adapter, 2x2 <i>Some:</i> 11ac wireless, M.2 Card, Intel Dual Band Wireless-AC 3165, Wi-Fi + Bluetooth 4.0 combo adapter, 1x1 <i>Some:</i> 11ac wireless, M.2 Card, Intel Dual Band Wireless-AC 8260, Wi-Fi + Bluetooth 4.1 combo adapter, 2x2																																																														
Bluetooth™	<i>Some:</i> Bluetooth 4.0 or 4.1 wireless, integrated in Wi-Fi + BT combo adapter																																																														
Ethernet	Gigabit ethernet, Realtek RTL8111GN, Wake on LAN®																																																														
Modem	None																																																														
Manageability	None																																																														
Security chip	Trusted Platform Module, TCG 1.2-compliant																																																														

See footnotes for more detailed information

Model	Region	Processor	vPro	Graphics	Monitor Cable	Memory	Storage	Optical	Optional 2nd 2.5" Bay	Media Reader	WLAN + Bluetooth	Optional Front Ports	Optional Rear Ports	Chassis Intrusion Switch	Cable Lock	Dust Filter	Keyboard / Mouse	Stand	Power Supply	Operating System	Warranty	Ann Date (m/y)
10GT002DUS	US	i3-6100	No	Intel HD 530	None	4GBx1	500GB 7200rpm 3.5"	DVD±RW	Optional 2nd 2.5" Bay	None	None	None	None	None	None	None	USB / USB	Floor Stand	210W 85%	Win10 DG Win7 Pro 64	3-year, Onsite	01/16
10GT002EUS	US	i5-6400	No	Intel HD 530	None	4GBx1	500GB 7200rpm 3.5"	DVD±RW	Optional 2nd 2.5" Bay	None	None	None	None	None	None	None	USB / USB	Floor Stand	210W 85%	Win10 DG Win7 Pro 64	3-year, Onsite	01/16
10GT002FUS	US	Pentium G4400	No	Intel HD 510	None	4GBx1	500GB 7200rpm 3.5"	DVD±RW	Optional 2nd 2.5" Bay	None	None	None	None	None	None	None	USB / USB	Floor Stand	210W 85%	Win10 DG Win7 Pro 64	3-year, Onsite	01/16
10GT002GUS	US	i7-6700	No	Intel HD 530	None	8GBx1	1TB 7200rpm 3.5"	DVD±RW	Optional 2nd 2.5" Bay	None	None	None	None	None	None	None	USB / USB	Floor Stand	210W 85%	Win10 DG Win7 Pro 64	3-year, Onsite	01/16
10GT002HUS	US	i5-6400	No	Intel HD 530	None	8GBx1	128GB SSD	DVD±RW	Optional 2nd 2.5" Bay	None	None	None	None	None	None	None	USB / USB	Floor Stand	210W 85%	Win10 DG Win7 Pro 64	3-year, Onsite	01/16
10GT002JUS	US	i7-6700	No	Intel HD 530	None	8GBx1	1TB 7200rpm 3.5"	DVD±RW	None	None	None	None	None	None	None	None	USB / USB	Floor Stand	210W 85%	Win10 DG Win7 Pro 64	3-year, Onsite	01/16
10GT002KUS	US	i7-6700	No	Intel HD 530	None	8GBx1	192GB SSD	DVD±RW	None	None	None	None	None	None	None	None	USB / USB	Floor Stand	210W 85%	Win10 DG Win7 Pro 64	3-year, Onsite	01/16
10GT002LUS	US	i7-6700	No	GT 720 1GB	None	8GBx1	1TB 7200rpm 3.5"	DVD±RW	None	None	Intel 8260 ac, 2x2 + BT4.1	None	None	None	None	None	USB / USB	Floor Stand	210W 85%	Win10 DG Win7 Pro 64	3-year, Onsite	01/16
10GT002MUS	US	i7-6700	No	Intel HD 530	None	8GBx1	1TB 7200rpm 3.5"	DVD±RW	None	None	Intel 8260 ac, 2x2 + BT4.1	None	None	None	None	None	USB / USB	Floor Stand	210W 85%	Win10 DG Win7 Pro 64	3-year, Onsite	01/16
10GT002NUS	US	i5-6400	No	GT 720 2GB	None	8GBx1	1TB 7200rpm 3.5"	DVD±RW	None	None	Intel 8260 ac, 2x2 + BT4.1	None	None	None	None	None	USB / USB	Floor Stand	210W 85%	Win10 DG Win7 Pro 64	3-year, Onsite	01/16
10GT002PUS	US	i5-6400	No	Intel HD 530	None	4GBx1	500GB 7200rpm 3.5"	DVD±RW	None	None	None	None	None	None	None	None	USB / USB	Floor Stand	210W 85%	Win10 DG Win7 Pro 64	3-year, Onsite	01/16
10GT002QUS	US	i7-6700	No	Intel HD 530	None	8GBx1	120GB SSD	DVD±RW	None	None	None	None	None	None	None	None	USB / USB	Floor Stand	210W 85%	Win10 DG Win7 Pro 64	3-year, Onsite	01/16
10GT002RUS	US	i7-6700	No	Intel HD 530	None	8GBx1	500GB 7200rpm 3.5"	DVD±RW	None	None	None	None	None	None	None	None	USB / USB	Floor Stand	210W 85%	Win10 DG Win7 Pro 64	3-year, Onsite	01/16
10GT002SUS	US	i5-6400	No	Intel HD 530	None	8GBx1	1TB 7200rpm 3.5"	DVD±RW	None	None	None	None	None	None	None	None	USB / USB	Floor Stand	210W 85%	Win10 DG Win7 Pro 64	3-year, Onsite	01/16
10GT002TUS	US	i7-6700	No	Intel HD 530	None	8GBx1	256GB SSD Opal	DVD±RW	None	None	None	None	None	None	None	None	USB / USB	Floor Stand	210W 85%	Win10 DG Win7 Pro 64	3-year, Onsite	01/16
10GT002UUS	US	i5-6400	No	Intel HD 530	None	4GBx1	500GB 7200rpm 3.5"	DVD±RW	None	None	Intel 8260 ac, 2x2 + BT4.1	None	None	None	None	None	USB / USB	Floor Stand	210W 85%	Win10 DG Win7 Pro 64	3-year, Onsite	01/16
10GT002VUS	US	i5-6400	No	Intel HD 530	None	8GBx1	500GB 7200rpm 3.5"	DVD±RW	None	None	Intel 8260 ac, 2x2 + BT4.1	None	None	None	None	None	USB / USB	Floor Stand	210W 85%	Win10 DG Win7 Pro 64	3-year, Onsite	01/16
10GT002WUS	US	i5-6400	No	Intel HD 530	None	8GBx1	500GB 7200rpm 3.5"	DVD±RW	None	None	None	None	None	None	None	None	USB / USB	Floor Stand	210W 85%	Win10 DG Win7 Pro 64	3-year, Onsite	01/16
10GT0036US	US	i5-6400	No	Intel HD 530	None	8GBx1	256GB SSD Opal	DVD±RW	None	None	None	None	None	None	None	None	USB / USB	Floor Stand	210W 85%	Win10 DG Win7 Pro 64	3-year, Onsite	01/16
10GT0037US	US	i5-6400	No	Intel HD 530	None	8GBx1	192GB SSD	DVD±RW	None	None	None	None	None	None	None	None	USB / USB	Floor Stand	210W 85%	Win10 DG Win7 Pro 64	3-year, Onsite	01/16

Model	Region	Processor	vPro	Graphics	Monitor Cable	Memory	Storage	Optical	Optional 2nd 2.5" Bay	Media Reader	WLAN + Bluetooth	Optional Front Ports	Optional Rear Ports	Chassis Intrusion Switch	Cable Lock	Dust Filter	Keyboard / Mouse	Stand	Power Supply	Operating System	Warranty	Ann Date (m/y)
10GT0038US	US	i5-6400	No	Intel HD 530	None	8GBx1	120GB SSD	DVD±RW	None	None	None	None	None	None	None	None	USB / USB	Floor Stand	210W 85%	Win10 DG Win7 Pro 64	3-year, Onsite	01/16
10GT0039US	US	i3-6100	No	Intel HD 530	None	4GBx1	500GB 7200rpm 3.5"	DVD±RW	None	None	None	None	None	None	None	None	USB / USB	Floor Stand	210W 85%	Win10 DG Win7 Pro 64	3-year, Onsite	01/16
10GT003AUS	US	i3-6100	No	Intel HD 530	None	4GBx1	500GB 7200rpm 3.5"	DVD±RW	None	None	Intel 3165 ac, 1x1 + BT4.0	None	None	None	None	None	USB / USB	Floor Stand	210W 85%	Win10 DG Win7 Pro 64	3-year, Onsite	01/16
10GT003BUS	US	i3-6100	No	Intel HD 530	None	4GBx1	500GB 7200rpm 3.5"	DVD±RW	None	None	Intel 8260 ac, 2x2 + BT4.1	None	None	None	None	None	USB / USB	Floor Stand	210W 85%	Win10 DG Win7 Pro 64	3-year, Onsite	01/16
10GT003CUS	US	Pentium G4400	No	Intel HD 510	None	4GBx1	500GB 7200rpm 3.5"	DVD±RW	None	None	None	None	None	None	None	None	USB / USB	Floor Stand	210W 85%	Win10 DG Win7 Pro 64	3-year, Onsite	01/16
10GT003DUS	US	i7-6700	No	Intel HD 530	None	8GBx1	1TB 7200rpm 3.5"	DVD±RW	None	None	Intel 8260 ac, 2x2 + BT4.1	None	None	None	None	None	None / USB	Floor Stand	210W 85%	Win10 Pro 64	3-year, Onsite	01/16
10GT003EUS	US	i5-6400	No	Intel HD 530	None	4GBx1	500GB 7200rpm 3.5"	DVD±RW	None	None	Intel 8260 ac, 2x2 + BT4.1	None	None	None	None	None	None / USB	Floor Stand	210W 85%	Win10 Pro 64	3-year, Onsite	01/16
10GT003FUS	US	i3-6100	No	Intel HD 530	None	4GBx1	500GB 7200rpm 3.5"	DVD±RW	None	None	Intel 3165 ac, 1x1 + BT4.0	None	None	None	None	None	None / USB	Floor Stand	210W 85%	Win10 Pro 64	3-year, Onsite	01/16
10GT003GUS	US	Pentium G4400	No	Intel HD 510	None	4GBx1	500GB 7200rpm 3.5"	DVD±RW	None	None	Intel 3165 ac, 1x1 + BT4.0	None	None	None	None	None	None / USB	Floor Stand	210W 85%	Win10 Pro 64	3-year, Onsite	01/16
10GT004GUS	US	i5-6500	No	Intel HD 530	None	8GBx1	128GB SSD	DVD±RW	Optional 2nd 2.5" Bay	None	None	None	None	None	None	None	USB / USB	Floor Stand	210W 85%	Win10 DG Win7 Pro 64	3-year, Onsite	03/16
10GT004HUS	US	i5-6500	No	Intel HD 530	None	8GBx1	500GB 7200rpm 3.5"	DVD±RW	Optional 2nd 2.5" Bay	None	None	None	None	None	None	None	USB / USB	Floor Stand	210W 85%	Win10 DG Win7 Pro 64	3-year, Onsite	03/16
10GT004YUS	US	i5-6400	No	Intel HD 530	None	4GBx1	500GB 7200rpm 3.5"	DVD±RW	Optional 2nd 2.5" Bay	None	Intel 3165 ac, 1x1 + BT4.0	None	None	None	None	None	USB / USB	Floor Stand	210W 85%	Win10 Pro 64	3-year, Onsite	05/16
10GT0050US	US	i3-6100	No	Intel HD 530	None	4GBx1	500GB 7200rpm 3.5"	DVD±RW	Optional 2nd 2.5" Bay	None	None	None	None	None	None	None	USB / USB	Floor Stand	210W 85%	Win10 Pro 64	3-year, Onsite	05/16
10GT0051US	US	i5-6400	No	Intel HD 530	None	8GBx1	1TB 7200rpm 3.5"	DVD±RW	Optional 2nd 2.5" Bay	None	None	None	None	None	None	None	USB / USB	Floor Stand	210W 85%	Win10 Pro 64	3-year, Onsite	05/16
10GT0052US	US	i7-6700	No	Intel HD 530	None	8GBx1	1TB 7200rpm 3.5"	DVD±RW	Optional 2nd 2.5" Bay	None	None	None	None	None	None	None	USB / USB	Floor Stand	210W 85%	Win10 Pro 64	3-year, Onsite	05/16
10GT0053US	US	i7-6700	No	Intel HD 530	None	8GBx1	256GB SSD Opal	DVD±RW	Optional 2nd 2.5" Bay	None	None	None	None	None	None	None	USB / USB	Floor Stand	210W 85%	Win10 Pro 64	3-year, Onsite	05/16
10GT0054US	US	i7-6700	No	Intel HD 530	None	8GBx1	180GB SSD Opal	DVD±RW	Optional 2nd 2.5" Bay	None	None	None	None	None	None	None	USB / USB	Floor Stand	210W 85%	Win10 Pro 64	3-year, Onsite	05/16
10GT0055US	US	i7-6700	No	Intel HD 530	None	4GBx1	128GB SSD	DVD±RW	Optional 2nd 2.5" Bay	None	None	None	None	None	None	None	USB / USB	Floor Stand	210W 85%	Win10 Pro 64	3-year, Onsite	05/16
10GT0056US	US	i7-6700	No	GT 720 1GB	None	8GBx1	1TB 7200rpm 3.5"	DVD±RW	Optional 2nd 2.5" Bay	None	None	None	None	None	None	None	USB / USB	Floor Stand	210W 85%	Win10 Pro 64	3-year, Onsite	05/16
10GT005EUS	US	i7-6700	No	GT 720 1GB	None	8GBx1	1TB 7200rpm 3.5"	DVD±RW	Optional 2nd 2.5" Bay	None	None	None	None	None	None	None	USB / USB	Floor Stand	210W 85%	Win10 Pro 64	3-year, Onsite	10/16

Model	Region	Processor	vPro	Graphics	Monitor Cable	Memory	Storage	Optical	Optional 2nd 2.5" Bay	Media Reader	WLAN + Bluetooth	Optional Front Ports	Optional Rear Ports	Chassis Intrusion Switch	Cable Lock	Dust Filter	Keyboard / Mouse	Stand	Power Supply	Operating System	Warranty	Ann Date (m/y)
10GT005FUS	US	i7-6700	No	GT 720 1GB	None	8GBx1	1TB 7200rpm 3.5"	DVD±RW	Optional 2nd 2.5" Bay	None	Intel 8260 ac, 2x2 + BT4.1	None	None	None	None	None	USB / USB	Floor Stand	210W 85%	Win10 DG Win7 Pro 64	3-year, Onsite	10/16
10GT005GUS	US	i7-6700	No	GT 720 1GB	None	8GBx1	1TB 7200rpm 3.5"	DVD±RW	Optional 2nd 2.5" Bay	None	None	None	None	None	None	None	USB / USB	Floor Stand	210W 85%	Win10 DG Win7 Pro 64	3-year, Onsite	10/16
10GT005HUS	US	i7-6700	No	GT 720 1GB	None	8GBx1	1TB 7200rpm 3.5"	DVD±RW	Optional 2nd 2.5" Bay	None	Intel 8260 ac, 2x2 + BT4.1	None	None	None	None	None	USB / USB	Floor Stand	210W 85%	Win10 Pro 64	3-year, Onsite	10/16



ThinkCentre M700 Tiny Platform Specifications

Product Specifications Reference (PSREF)

<p>Processor</p>	<p>Intel® Celeron®, Intel Pentium®, or 6th Generation Intel Core™ i3 / i5 / i7 Processor</p> <table border="1"> <thead> <tr> <th>Processor</th> <th>Cores / Threads</th> <th>Frequency Base/Max(GHz)</th> <th>Cache</th> <th>Memory Types</th> <th>Integrated Graphics</th> </tr> </thead> <tbody> <tr> <td>Pentium G4400T</td> <td>2 / 2</td> <td>2.9 G</td> <td>3 MB</td> <td>DDR4-2133</td> <td>HD 510</td> </tr> <tr> <td>Pentium G4500T</td> <td>2 / 2</td> <td>3.0 G</td> <td>3 MB</td> <td>DDR4-2133</td> <td>HD 530</td> </tr> <tr> <td>Core i3-6100T</td> <td>2 / 4</td> <td>3.2 G</td> <td>3 MB</td> <td>DDR4-2133</td> <td>HD 530</td> </tr> <tr> <td>Core i3-6300T</td> <td>2 / 4</td> <td>3.3 G</td> <td>4 MB</td> <td>DDR4-2133</td> <td>HD 530</td> </tr> <tr> <td>Core i5-6400T</td> <td>4 / 4</td> <td>2.2 G / 2.8 G</td> <td>6 MB</td> <td>DDR4-2133</td> <td>HD 530</td> </tr> <tr> <td>Core i5-6500T</td> <td>4 / 4</td> <td>2.5 G / 3.1 G</td> <td>6 MB</td> <td>DDR4-2133</td> <td>HD 530</td> </tr> <tr> <td>Core i5-6600T</td> <td>4 / 4</td> <td>2.7 G / 3.5 G</td> <td>6 MB</td> <td>DDR4-2133</td> <td>HD 530</td> </tr> <tr> <td>Core i7-6700T</td> <td>4 / 8</td> <td>2.8 G / 3.6 G</td> <td>8 MB</td> <td>DDR4-2133</td> <td>HD 530</td> </tr> </tbody> </table>	Processor	Cores / Threads	Frequency Base/Max(GHz)	Cache	Memory Types	Integrated Graphics	Pentium G4400T	2 / 2	2.9 G	3 MB	DDR4-2133	HD 510	Pentium G4500T	2 / 2	3.0 G	3 MB	DDR4-2133	HD 530	Core i3-6100T	2 / 4	3.2 G	3 MB	DDR4-2133	HD 530	Core i3-6300T	2 / 4	3.3 G	4 MB	DDR4-2133	HD 530	Core i5-6400T	4 / 4	2.2 G / 2.8 G	6 MB	DDR4-2133	HD 530	Core i5-6500T	4 / 4	2.5 G / 3.1 G	6 MB	DDR4-2133	HD 530	Core i5-6600T	4 / 4	2.7 G / 3.5 G	6 MB	DDR4-2133	HD 530	Core i7-6700T	4 / 8	2.8 G / 3.6 G	8 MB	DDR4-2133	HD 530	<p>Keyboard</p> <p><i>Some:</i> Preferred Pro USB Keyboard (USB connector), Lenovo logo <i>Some:</i> Lenovo Slim USB Keyboard (USB connector), black, Lenovo logo <i>Some:</i> Lenovo USB Fingerprint Keyboard (USB connector) <i>Some:</i> Ultrasmil Plus Wireless Keyboard (2.4GHz via USB receiver), black <i>Some:</i> Enhanced Optical USB Mouse, black, Lenovo logo <i>Some:</i> Ultrasmil Plus Wireless Mouse (2.4GHz via USB receiver), black</p> <p>Mouse</p>
Processor	Cores / Threads	Frequency Base/Max(GHz)	Cache	Memory Types	Integrated Graphics																																																			
Pentium G4400T	2 / 2	2.9 G	3 MB	DDR4-2133	HD 510																																																			
Pentium G4500T	2 / 2	3.0 G	3 MB	DDR4-2133	HD 530																																																			
Core i3-6100T	2 / 4	3.2 G	3 MB	DDR4-2133	HD 530																																																			
Core i3-6300T	2 / 4	3.3 G	4 MB	DDR4-2133	HD 530																																																			
Core i5-6400T	4 / 4	2.2 G / 2.8 G	6 MB	DDR4-2133	HD 530																																																			
Core i5-6500T	4 / 4	2.5 G / 3.1 G	6 MB	DDR4-2133	HD 530																																																			
Core i5-6600T	4 / 4	2.7 G / 3.5 G	6 MB	DDR4-2133	HD 530																																																			
Core i7-6700T	4 / 8	2.8 G / 3.6 G	8 MB	DDR4-2133	HD 530																																																			
<p>Memory</p>	<p>32GB max, DDR4 2133, two 260-pin SO-DIMM sockets, dual-channel capable</p>	<p>Mechanical</p> <p>Tiny (1L), black color; metal case M700 Tiny only: 7.05" W X 7.20" D X 1.36" H 179mm W X 182.9mm D X 34.5mm H 2.9 lb (1.3 kg), weight may vary by configuration With VESA mount & ODD box: 7.42" W X 7.30" D X 2.48" H 188.4mm W X 185.38mm D X 63mm H 4.12 lb (1.87 kg), weight may vary by configuration With VESA mount & I/O box: 7.42" W X 7.30" D X 2.62" H 188.4mm W X 185.38mm D X 66.6mm H 3.53 lb (1.6 kg), weight may vary by configuration Optional VESA mount bracket kit, supports VESA 75mm and 100mm Optional system floor stand for vertical orientation</p> <p>VESA mount Floor Stand</p>																																																						
<p>Disk</p>	<p><i>Some:</i> SATA 6.0Gb/s, 2.5" Wide, 5400 rpm or 7200 rpm <i>Some:</i> 500GB (5400 rpm) Solid State Hybrid Drive (SSHD) / with 8GB MLC NAND flash memory, SATA 6.0Gb/s, 2.5" wide <i>Some:</i> Solid State Drive (SSD) / SATA 6.0Gb/s, 2.5" Wide <i>Some:</i> M.2 Solid State Drive (SSD) / SATA interface</p>	<p>Power supply</p> <p>65 watts AC/DC adapter, autosensing, 88% PSU (not included for TIO models) 90 watts AC/DC adapter, autosensing, 88% PSU (only for models with I/O box)</p>																																																						
<p>Optical</p>	<p><i>Some:</i> external ODD box with DVD-ROM, 9.5mm high, via USB <i>Some:</i> external ODD box with DVD±RW, 9.5mm high, via USB <i>Some:</i> external ODD box (for TIO) with DVD-ROM, 9.5mm high, via USB <i>Some:</i> external ODD box (for TIO) with DVD±RW, 9.5mm high, via USB</p>	<p>Limited warranty³</p> <p><i>Some:</i> 1-year or 3-year, depot service / service upgrades available <i>Some:</i> 1-year or 3-year, limited onsite service / service upgrades available <i>Some:</i> 3-year, limited onsite service, OID (Onsite International Delivery) / service upgrades available For Lenovo service upgrade options, please go to S-TC sheet</p>																																																						
<p>Onboard SATA Media reader</p>	<p>One SATA cable (1-drop to device), one SATA 6.0Gb/s connector on planar None</p>	<p>Preload</p> <p><i>Some:</i> Windows® 7 Professional 32/64 preinstalled through downgrade rights in Windows 10 Pro 64-bit <i>Some:</i> Windows 7 Professional 32/64 <i>Some:</i> Windows 10 Pro 64-bit <i>Some:</i> Windows 10 Home 64-bit</p> <p><i>Some:</i> Windows® Embedded Standard 7 (WES 7) <i>Some:</i> LeTOS (Lenovo Terminal Operating System, Linux-based)</p> <p>Preloaded applications (only some listed)</p> <ul style="list-style-type: none"> Desktop Power Manager Lenovo Solution Center Lenovo REACHit Lenovo SHAREit Lenovo Bluetooth Lock (for models with Wi-Fi/BT card) McAfee® LiveSafe™ (30-day trial) Microsoft Office preloaded; purchase a product key to activate PowerDVD Create (DVD±RW) Lenovo ThinkVantage Tools Intel Unite (vPro models only) <p>- Only for Window 10</p> <ul style="list-style-type: none"> Lenovo Companion Cyberlink PowerDVD (DVD, DVD±RW) Lenovo QuickOptimizer <p>- Only for Window 7</p> <ul style="list-style-type: none"> Rescue and Recovery Password Manager ThinkVantage System Update Lenovo Message Center Plus Adobe® Reader® 																																																						
<p>Graphics</p>	<p>Intel HD Graphics 510/530 in processor, uses main memory, DirectX® 12, two DisplayPort™, one optional HDMI, VGA, or 3rd DP, up to 3 independent displays; Max resolution: 4096x2304 (DP) @60Hz; 4096x2160 (HDMI) @24Hz; 1920x1200 (VGA) @60Hz</p>	<p>DP cable</p> <p>Optional DP to VGA, DP to DVI-D (single link), or DP to HDMI 1.4 dongle</p>																																																						
<p>Chipset</p>	<p>Intel B150 Chipset</p>	<p>Front ports</p> <p>Two USB 3.0 (one is Always On and fast charge), one microphone (stereo, 3.5mm), one headphone / microphone combo jack (stereo, 3.5mm)</p> <p>Rear ports</p> <p>Four USB 3.0 (optional external optical box or external I/O box occupies one or two specific USB 3.0 on some models), ethernet (RJ-45), two DisplayPort, one optional port (VGA, 3rd DP, HDMI, or serial on some models), one headphone</p> <p>I/O box</p> <p>Optional external I/O box, extends two USB 2.0, two USB 3.0, and one serial on rear, two USB 2.0 on front, via USB (occupy two specific USB 3.0 of M700 Tiny)</p> <p>Audio support</p> <p>High Definition (HD) Audio, Realtek ALC223 / optional internal speaker (1 watt)</p> <p>WLAN¹³</p> <p><i>Some:</i> 11ac wireless, M.2 Card, Realtek RTL8821AE (dual band), Wi-Fi + Bluetooth 4.0 combo adapter, 1x1 <i>Some:</i> 11ac wireless, M.2 Card, Qualcomm Atheros QCA9377 (dual band), Wi-Fi + Bluetooth 4.1 combo adapter, 1x1 <i>Some:</i> 11ac wireless, M.2 Card, Qualcomm Atheros QCA6174 (dual band), Wi-Fi + Bluetooth 4.1 combo adapter, 2x2 <i>Some:</i> 11ac wireless, M.2 Card, Intel Dual Band Wireless-AC 3165, Wi-Fi + Bluetooth 4.0 combo adapter, 1x1 <i>Some:</i> 11ac wireless, M.2 Card, Intel Dual Band Wireless-AC 8260, Wi-Fi + Bluetooth 4.1 combo adapter, 2x2</p> <p>Bluetooth™</p> <p><i>Some:</i> Bluetooth 4.0 or 4.1 wireless, integrated in Wi-Fi + BT combo adapter</p> <p>Ethernet</p> <p>Gigabit ethernet, Intel Ethernet Connection I219-LV (Jacksonville), Wake on LAN®</p> <p>Modem</p> <p>None</p> <p>Manageability</p> <p>None</p> <p>Security chip</p> <p>Trusted Platform Module, TCG 1.2-compliant</p> <p>Security features</p> <ul style="list-style-type: none"> Security slot (in rear for optional Kensington® MicroSaver® cable) Padlock loop Smart USB protection, allows keyboard/mouse only, blocks all storage devices Power-on password Administrator password Hard disk password Boot sequence control Boot without keyboard and mouse Individual USB port disablement Chassis intrusion switch <p>Environment</p> <p>ENERGY STAR® 6.0*, EPEAT™ Gold rating* (*for Windows models only); ErP Lot 3; GREENGUARD®; RoHS-compliant</p> <p>MIL-SPEC test</p> <p>MIL-STD-810G military certification (Low Pressure [Altitude], High Temperature, Low Temperature, Temperature Shock, Humidity, Sand and Dust, Vibration, Shock)</p> <p>Accessories</p> <p>For compatible accessories, please go to TC-AQP sheet</p>																																																						

See footnotes for more detailed information

Model	Region	Processor	vPro	Graphics	Monitor Cable	Memory	Storage(HDD/SSD)	External Optical / I/O Box	WLAN + Bluetooth	Optional Rear Ports	Chassis Intrusion Switch	Kensington Cable Lock	Speaker	Adapter Cage	Toolless Chassis Screw	Dust Filter	Keyboard / Mouse	VESA Mount	Stand	Power Supply	Operating System	Warranty	Ann Date (m/y)
10HY0004US	US	i5-6400T	No	Intel HD 530	None	4GBx1	120GB SSD	None	Intel 8260 ac, 2x2 + BT4.1	None	Switch	None	1Wx1	None	None	None	USB / USB	None	Floor Stand	65W Adapter 88%	Win10 Pro 64	3-year, Onsite	01/16
10HY0005US	US	i5-6400T	No	Intel HD 530	None	4GBx1	180GB SSD Opal	None	Intel 8260 ac, 2x2 + BT4.1	None	Switch	None	1Wx1	None	None	None	USB / USB	None	Floor Stand	65W Adapter 88%	Win10 Pro 64	3-year, Onsite	01/16
10HY0006US	US	i5-6500T	No	Intel HD 530	None	4GBx1	120GB SSD	None	Intel 8260 ac, 2x2 + BT4.1	None	Switch	None	1Wx1	None	None	None	USB / USB	None	Floor Stand	65W Adapter 88%	Win10 Pro 64	3-year, Onsite	01/16
10HY0007US	US	i5-6500T	No	Intel HD 530	None	4GBx1	500GB 7200rpm 2.5"	None	Intel 8260 ac, 2x2 + BT4.1	None	Switch	None	1Wx1	None	None	None	USB / USB	None	Floor Stand	65W Adapter 88%	Win10 Pro 64	3-year, Onsite	01/16
10HY0008US	US	i5-6400T	No	Intel HD 530	None	4GBx1	500GB 7200rpm 2.5"	None	Intel 8260 ac, 2x2 + BT4.1	None	Switch	None	1Wx1	None	None	None	USB / USB	None	Floor Stand	65W Adapter 88%	Win10 Pro 64	3-year, Onsite	01/16
10HY0009US	US	i5-6400T	No	Intel HD 530	None	4GBx1	500GB 7200rpm 2.5"	DVD±RW	Intel 8260 ac, 2x2 + BT4.1	None	Switch	None	1Wx1	None	None	None	USB / USB	VESA Mount	None	65W Adapter 88%	Win10 Pro 64	3-year, Onsite	01/16
10HY000AUS	US	i7-6700T	No	Intel HD 530	None	8GBx1	500GB 7200rpm 2.5"	None	Intel 8260 ac, 2x2 + BT4.1	None	Switch	None	1Wx1	None	None	None	USB / USB	None	Floor Stand	65W Adapter 88%	Win10 Pro 64	3-year, Onsite	01/16
10HY000BUS	US	i7-6700T	No	Intel HD 530	None	8GBx1	120GB SSD	DVD±RW	Intel 8260 ac, 2x2 + BT4.1	None	Switch	None	1Wx1	None	None	None	USB / USB	VESA Mount	None	65W Adapter 88%	Win10 Pro 64	3-year, Onsite	01/16
10HY000CUS	US	i7-6700T	No	Intel HD 530	None	8GBx1	120GB SSD	None	Intel 8260 ac, 2x2 + BT4.1	None	Switch	None	1Wx1	None	None	None	USB / USB	None	Floor Stand	65W Adapter 88%	Win10 Pro 64	3-year, Onsite	01/16
10HY000DUS	US	i5-6400T	No	Intel HD 530	None	4GBx1	500GB 7200rpm 2.5"	DVD±RW	Intel 8260 ac, 2x2 + BT4.1	None	Switch	None	1Wx1	None	None	None	USB / USB	VESA Mount	None	65W Adapter 88%	Win10 DG Win7 Pro 64	3-year, Onsite	01/16
10HY000EUS	US	i7-6700T	No	Intel HD 530	None	8GBx1	120GB SSD	None	Intel 8260 ac, 2x2 + BT4.1	None	Switch	None	1Wx1	None	None	None	USB / USB	None	Floor Stand	65W Adapter 88%	Win10 DG Win7 Pro 64	3-year, Onsite	01/16
10HY000FUS	US	i7-6700T	No	Intel HD 530	None	8GBx1	120GB SSD	DVD±RW	Intel 8260 ac, 2x2 + BT4.1	None	Switch	None	1Wx1	None	None	None	USB / USB	VESA Mount	None	65W Adapter 88%	Win10 DG Win7 Pro 64	3-year, Onsite	01/16
10HY000GUS	US	i5-6400T	No	Intel HD 530	None	4GBx1	500GB 7200rpm 2.5"	None	Intel 8260 ac, 2x2 + BT4.1	None	Switch	None	1Wx1	None	None	None	USB / USB	None	Floor Stand	65W Adapter 88%	Win10 DG Win7 Pro 64	3-year, Onsite	01/16
10HY000HUS	US	i5-6500T	No	Intel HD 530	None	4GBx1	120GB SSD	None	Intel 8260 ac, 2x2 + BT4.1	None	Switch	None	1Wx1	None	None	None	USB / USB	None	Floor Stand	65W Adapter 88%	Win10 DG Win7 Pro 64	3-year, Onsite	01/16
10HY000JUS	US	i5-6400T	No	Intel HD 530	None	4GBx1	120GB SSD	None	Intel 8260 ac, 2x2 + BT4.1	None	Switch	None	1Wx1	None	None	None	USB / USB	None	Floor Stand	65W Adapter 88%	Win10 DG Win7 Pro 64	3-year, Onsite	01/16
10HY000KUS	US	i5-6500T	No	Intel HD 530	None	4GBx1	500GB 7200rpm 2.5"	None	Intel 8260 ac, 2x2 + BT4.1	None	Switch	None	1Wx1	None	None	None	USB / USB	None	Floor Stand	65W Adapter 88%	Win10 DG Win7 Pro 64	3-year, Onsite	01/16
10HY0013US	US	i7-6700T	No	Intel HD 530	None	8GBx1	500GB 7200rpm 2.5"	None	Intel 8260 ac, 2x2 + BT4.1	VGA	Switch	None	1Wx1	None	None	None	USB / USB	None	Floor Stand	65W Adapter 88%	Win10 Pro 64	3-year, Onsite	01/16
10HY0014US	US	i7-6700T	No	Intel HD 530	None	8GBx1	500GB 7200rpm 2.5"	None	Intel 8260 ac, 2x2 + BT4.1	HDMI	Switch	None	1Wx1	None	None	None	USB / USB	None	Floor Stand	65W Adapter 88%	Win10 Pro 64	3-year, Onsite	01/16
10HY0015US	US	i5-6400T	No	Intel HD 530	None	4GBx1	500GB 7200rpm 2.5"	None	Intel 8260 ac, 2x2 + BT4.1	HDMI	Switch	None	1Wx1	None	None	None	USB / USB	None	Floor Stand	65W Adapter 88%	Win10 Pro 64	3-year, Onsite	01/16
10HY0016US	US	i5-6400T	No	Intel HD 530	None	4GBx1	500GB 7200rpm 2.5"	None	Intel 8260 ac, 2x2 + BT4.1	3rd DP	Switch	None	1Wx1	None	None	None	USB / USB	None	Floor Stand	65W Adapter 88%	Win10 Pro 64	3-year, Onsite	01/16

Model	Region	Processor	vPro	Graphics	Monitor Cable	Memory	Storage(HDD/SSD)	External Optical / I/O Box	WLAN + Bluetooth	Optional Rear Ports	Chassis Intrusion Switch	Kensington Cable Lock	Speaker	Adapter Cage	Toolless Chassis Screw	Dust Filter	Keyboard / Mouse	VESA Mount	Stand	Power Supply	Operating System	Warranty	Ann Date (m/y)
10HY0017US	US	i5-6400T	No	Intel HD 530	None	4GBx1	500GB 7200rpm 2.5"	None	Intel 8260 ac, 2x2 + BT4.1	VGA	Switch	None	1Wx1	None	None	None	USB / USB	None	Floor Stand	65W Adapter 88%	Win10 Pro 64	3-year, Onsite	01/16
10HY0018US	US	i7-6700T	No	Intel HD 530	None	8GBx1	500GB 7200rpm 2.5"	None	Intel 8260 ac, 2x2 + BT4.1	3rd DP	Switch	None	1Wx1	None	None	None	USB / USB	None	Floor Stand	65W Adapter 88%	Win10 Pro 64	3-year, Onsite	01/16
10HY0019US	US	i5-6400T	No	Intel HD 530	None	4GBx1	500GB 7200rpm 2.5"	None	Intel 8260 ac, 2x2 + BT4.1	3rd DP	Switch	None	1Wx1	None	None	None	USB / USB	None	Floor Stand	65W Adapter 88%	Win10 DG Win7 Pro 64	3-year, Onsite	01/16
10HY001AUS	US	i7-6700T	No	Intel HD 530	None	8GBx1	500GB 7200rpm 2.5"	None	Intel 8260 ac, 2x2 + BT4.1	HDMI	Switch	None	1Wx1	None	None	None	USB / USB	None	Floor Stand	65W Adapter 88%	Win10 DG Win7 Pro 64	3-year, Onsite	01/16
10HY001BUS	US	i7-6700T	No	Intel HD 530	None	8GBx1	500GB 7200rpm 2.5"	None	Intel 8260 ac, 2x2 + BT4.1	VGA	Switch	None	1Wx1	None	None	None	USB / USB	None	Floor Stand	65W Adapter 88%	Win10 DG Win7 Pro 64	3-year, Onsite	01/16
10HY001CUS	US	i7-6700T	No	Intel HD 530	None	8GBx1	128GB SSD	None	Intel 8260 ac, 2x2 + BT4.1	HDMI	Switch	None	1Wx1	None	None	None	USB / USB	None	Floor Stand	65W Adapter 88%	Win10 DG Win7 Pro 64	3-year, Onsite	01/16
10HY001DUS	US	i5-6400T	No	Intel HD 530	None	4GBx1	500GB 7200rpm 2.5"	None	Intel 8260 ac, 2x2 + BT4.1	VGA	Switch	None	1Wx1	None	None	None	USB / USB	None	Floor Stand	65W Adapter 88%	Win10 DG Win7 Pro 64	3-year, Onsite	01/16
10HY001EUS	US	i7-6700T	No	Intel HD 530	None	8GBx1	180GB SSD Opal	None	Intel 8260 ac, 2x2 + BT4.1	None	Switch	None	1Wx1	None	None	None	USB / USB	None	Floor Stand	65W Adapter 88%	Win10 DG Win7 Pro 64	3-year, Onsite	01/16
10HY001FUS	US	i5-6400T	No	Intel HD 530	None	4GBx1	180GB SSD Opal	None	Intel 8260 ac, 2x2 + BT4.1	None	Switch	None	1Wx1	None	None	None	USB / USB	None	Floor Stand	65W Adapter 88%	Win10 DG Win7 Pro 64	3-year, Onsite	01/16
10HY001GUS	US	i7-6700T	No	Intel HD 530	None	8GBx1	500GB 7200rpm 2.5"	None	Intel 8260 ac, 2x2 + BT4.1	3rd DP	Switch	None	1Wx1	None	None	None	USB / USB	None	Floor Stand	65W Adapter 88%	Win10 DG Win7 Pro 64	3-year, Onsite	01/16
10HY001HUS	US	i7-6700T	No	Intel HD 530	None	8GBx1	128GB SSD	DVD±RW	Intel 8260 ac, 2x2 + BT4.1	HDMI	Switch	None	1Wx1	None	None	None	USB / USB	VESA Mount	None	65W Adapter 88%	Win10 DG Win7 Pro 64	3-year, Onsite	01/16
10HY001JUS	US	i5-6400T	No	Intel HD 530	None	4GBx1	500GB 7200rpm 2.5"	None	Intel 8260 ac, 2x2 + BT4.1	HDMI	Switch	None	1Wx1	None	None	None	USB / USB	None	Floor Stand	65W Adapter 88%	Win10 DG Win7 Pro 64	3-year, Onsite	01/16
10HY001KUS	US	i7-6700T	No	Intel HD 530	None	8GBx1	180GB SSD Opal	None	Intel 8260 ac, 2x2 + BT4.1	3rd DP	Switch	None	1Wx1	None	None	None	USB / USB	None	Floor Stand	65W Adapter 88%	Win10 DG Win7 Pro 64	3-year, Onsite	01/16
10HY001LUS	US	i7-6700T	No	Intel HD 530	None	8GBx1	128GB SSD	None	Intel 8260 ac, 2x2 + BT4.1	None	Switch	None	1Wx1	None	None	None	USB / USB	None	Floor Stand	65W Adapter 88%	Win10 DG Win7 Pro 64	3-year, Onsite	01/16
10HY001MUS	US	i5-6500T	No	Intel HD 530	None	4GBx1	180GB SSD Opal	None	Intel 8260 ac, 2x2 + BT4.1	None	Switch	None	1Wx1	None	None	None	USB / USB	None	Floor Stand	65W Adapter 88%	Win10 DG Win7 Pro 64	3-year, Onsite	01/16
10HY001NUS	US	i5-6400T	No	Intel HD 530	None	4GBx1	500GB 7200rpm 2.5"	DVD±RW	Intel 8260 ac, 2x2 + BT4.1	HDMI	Switch	None	1Wx1	None	None	None	USB / USB	VESA Mount	None	65W Adapter 88%	Win10 DG Win7 Pro 64	3-year, Onsite	01/16
10HY001PUS	US	i5-6400T	No	Intel HD 530	None	4GBx1	128GB SSD	None	Intel 8260 ac, 2x2 + BT4.1	None	Switch	None	1Wx1	None	None	None	USB / USB	None	Floor Stand	65W Adapter 88%	Win10 Pro 64	3-year, Onsite	01/16
10HY001QUS	US	i5-6400T	No	Intel HD 530	None	8GBx1	128GB SSD	None	Intel 8260 ac, 2x2 + BT4.1	None	Switch	None	1Wx1	None	None	None	USB / USB	None	None	65W Adapter 88%	Win10 DG Win7 Pro 64	3-year, Onsite	01/16
10HY001RUS	US	i5-6500T	No	Intel HD 530	None	8GBx1	128GB SSD	None	Intel 8260 ac, 2x2 + BT4.1	None	Switch	None	1Wx1	None	None	None	USB / USB	None	None	65W Adapter 88%	Win10 DG Win7 Pro 64	3-year, Onsite	01/16
10HY001SUS	US	i3-6100T	No	Intel HD 530	None	4GBx1	500GB 7200rpm 2.5"	None	Intel 3165 ac, 1x1 + BT4.0	None	Switch	None	1Wx1	None	None	None	USB / USB	None	Floor Stand	65W Adapter 88%	Win10 DG Win7 Pro 64	3-year, Onsite	01/16

Model	Region	Processor	vPro	Graphics	Monitor Cable	Memory	Storage(HDD/SSD)	External Optical / I/O Box	WLAN + Bluetooth	Optional Rear Ports	Chassis Intrusion Switch	Kensington Cable Lock	Speaker	Adapter Cage	Toolless Chassis Screw	Dust Filter	Keyboard / Mouse	VESA Mount	Stand	Power Supply	Operating System	Warranty	Ann Date (m/y)
10HY001TUS	US	i3-6100T	No	Intel HD 530	None	4GBx1	128GB SSD	None	Intel 3165 ac, 1x1 + BT4.0	3rd DP	Switch	None	1Wx1	None	None	None	USB / USB	None	Floor Stand	65W Adapter 88%	Win10 Pro 64	3-year, Onsite	01/16
10HY001UUS	US	i3-6100T	No	Intel HD 530	None	4GBx1	500GB 7200rpm 2.5"	DVD±RW	Intel 3165 ac, 1x1 + BT4.0	3rd DP	Switch	None	1Wx1	None	None	None	USB / USB	VESA Mount	None	65W Adapter 88%	Win10 Pro 64	3-year, Onsite	01/16
10HY001VUS	US	i3-6100T	No	Intel HD 530	None	4GBx1	128GB SSD	None	Intel 3165 ac, 1x1 + BT4.0	None	Switch	None	1Wx1	None	None	None	USB / USB	None	Floor Stand	65W Adapter 88%	Win10 DG Win7 Pro 64	3-year, Onsite	01/16
10HY001WUS	US	i3-6100T	No	Intel HD 530	None	4GBx1	128GB SSD	None	Intel 3165 ac, 1x1 + BT4.0	3rd DP	Switch	None	1Wx1	None	None	None	USB / USB	None	Floor Stand	65W Adapter 88%	Win10 DG Win7 Pro 64	3-year, Onsite	01/16
10HY001XUS	US	i3-6100T	No	Intel HD 530	None	4GBx1	500GB 7200rpm 2.5"	None	Intel 3165 ac, 1x1 + BT4.0	3rd DP	Switch	None	1Wx1	None	None	None	USB / USB	None	Floor Stand	65W Adapter 88%	Win10 DG Win7 Pro 64	3-year, Onsite	01/16
10HY001YUS	US	i3-6100T	No	Intel HD 530	None	4GBx1	500GB 7200rpm 2.5"	None	Intel 3165 ac, 1x1 + BT4.0	3rd DP	Switch	None	1Wx1	None	None	None	USB / USB	None	Floor Stand	65W Adapter 88%	Win10 Pro 64	3-year, Onsite	01/16
10HY0020US	US	i3-6100T	No	Intel HD 530	None	4GBx1	500GB 7200rpm 2.5"	None	Intel 3165 ac, 1x1 + BT4.0	VGA	Switch	None	1Wx1	None	None	None	USB / USB	None	Floor Stand	65W Adapter 88%	Win10 DG Win7 Pro 64	3-year, Onsite	01/16
10HY0021US	US	i3-6100T	No	Intel HD 530	None	8GBx1	128GB SSD	None	Intel 3165 ac, 1x1 + BT4.0	None	Switch	None	1Wx1	None	None	None	USB / USB	None	Floor Stand	65W Adapter 88%	Win10 DG Win7 Pro 64	3-year, Onsite	01/16
10HY0022US	US	i3-6100T	No	Intel HD 530	None	4GBx1	500GB 7200rpm 2.5"	DVD±RW	Intel 3165 ac, 1x1 + BT4.0	3rd DP	Switch	None	1Wx1	None	None	None	USB / USB	VESA Mount	None	65W Adapter 88%	Win10 DG Win7 Pro 64	3-year, Onsite	01/16
10HY0023US	US	i3-6100T	No	Intel HD 530	None	4GBx1	128GB SSD	DVD±RW	Intel 3165 ac, 1x1 + BT4.0	3rd DP	Switch	None	1Wx1	None	None	None	USB / USB	VESA Mount	None	65W Adapter 88%	Win10 DG Win7 Pro 64	3-year, Onsite	01/16
10HY0024US	US	i5-6500T	No	Intel HD 530	None	4GBx1	128GB SSD	None	Intel 8260 ac, 2x2 + BT4.1	None	Switch	None	1Wx1	None	None	None	USB / USB	None	Floor Stand	65W Adapter 88%	Win10 DG Win7 Pro 64	3-year, Onsite	01/16
10HY0025US	US	i7-6700T	No	Intel HD 530	None	8GBx1	128GB SSD	DVD±RW	Intel 8260 ac, 2x2 + BT4.1	None	Switch	None	1Wx1	None	None	None	USB / USB	VESA Mount	None	65W Adapter 88%	Win10 Pro 64	3-year, Onsite	01/16
10HY0026US	US	i7-6700T	No	Intel HD 530	None	8GBx1	128GB SSD	None	Intel 8260 ac, 2x2 + BT4.1	None	Switch	None	1Wx1	None	None	None	USB / USB	None	Floor Stand	65W Adapter 88%	Win10 Pro 64	3-year, Onsite	01/16
10HY0027US	US	Pentium G4400T	No	Intel HD 510	None	4GBx1	500GB 7200rpm 2.5"	None	Intel 3165 ac, 1x1 + BT4.0	None	Switch	None	1Wx1	None	None	None	USB / USB	None	Floor Stand	65W Adapter 88%	Win10 DG Win7 Pro 64	3-year, Onsite	01/16
10HY0028US	US	i5-6400T	No	Intel HD 530	None	4GBx1	256GB SSD Opal	None	Intel 8260 ac, 2x2 + BT4.1	3rd DP	Switch	None	1Wx1	None	None	None	USB / USB	None	Floor Stand	65W Adapter 88%	Win10 DG Win7 Pro 64	3-year, Onsite	01/16
10HY0029US	US	i5-6500T	No	Intel HD 530	None	4GBx1	256GB SSD Opal	None	Intel 8260 ac, 2x2 + BT4.1	3rd DP	Switch	None	1Wx1	None	None	None	USB / USB	None	Floor Stand	65W Adapter 88%	Win10 DG Win7 Pro 64	3-year, Onsite	01/16
10HY002AUS	US	i5-6500T	No	Intel HD 530	None	8GBx1	256GB SSD Opal	None	Intel 8260 ac, 2x2 + BT4.1	3rd DP	Switch	None	1Wx1	None	None	None	USB / USB	None	Floor Stand	65W Adapter 88%	Win10 DG Win7 Pro 64	3-year, Onsite	01/16
10HY002BUS	US	i5-6400T	No	Intel HD 530	None	8GBx1	256GB SSD Opal	None	Intel 8260 ac, 2x2 + BT4.1	3rd DP	Switch	None	1Wx1	None	None	None	USB / USB	None	Floor Stand	65W Adapter 88%	Win10 DG Win7 Pro 64	3-year, Onsite	01/16
10HY002CUS	US	i5-6400T	No	Intel HD 530	None	4GBx1	128GB SSD	None	Intel 8260 ac, 2x2 + BT4.1	None	Switch	None	1Wx1	None	None	None	USB / USB	None	Floor Stand	65W Adapter 88%	Win10 DG Win7 Pro 64	3-year, Onsite	01/16
10HY003HUS	US	i5-6500T	No	Intel HD 530	None	8GBx1	128GB SSD	None	Intel 8260 ac, 2x2 + BT4.1	VGA	Switch	None	1Wx1	None	None	None	USB / USB	None	Floor Stand	65W Adapter 88%	Win10 DG Win7 Pro 64	3-year, Onsite	03/16

Model	Region	Processor	vPro	Graphics	Monitor Cable	Memory	Storage(HDD/SSD)	External Optical / I/O Box	WLAN + Bluetooth	Optional Rear Ports	Chassis Intrusion Switch	Kensington Cable Lock	Speaker	Adapter Cage	Toolless Chassis Screw	Dust Filter	Keyboard / Mouse	VESA Mount	Stand	Power Supply	Operating System	Warranty	Ann Date (m/y)
10HY003JUS	US	i5-6600T	No	Intel HD 530	None	8GBx1	500GB 7200rpm 2.5"	None	Intel 8260 ac, 2x2 + BT4.1	3rd DP	Switch	None	1Wx1	None	None	None	USB / USB	None	Floor Stand	65W Adapter 88%	Win10 DG Win7 Pro 64	3-year, Onsite	03/16
10HY003KUS	US	i5-6600T	No	Intel HD 530	None	8GBx1	128GB SSD	None	Intel 8260 ac, 2x2 + BT4.1	3rd DP	Switch	None	1Wx1	None	None	None	USB / USB	None	Floor Stand	65W Adapter 88%	Win10 DG Win7 Pro 64	3-year, Onsite	03/16
10HY0057US	US	i5-6500T	No	Intel HD 530	None	8GBx1	256GB SSD Opal	None	Intel 8260 ac, 2x2 + BT4.1	3rd DP	Switch	None	1Wx1	None	None	None	USB / USB	None	Floor Stand	65W Adapter 88%	Win10 Pro 64	3-year, Onsite	07/16
10HY0058US	US	i5-6500T	No	Intel HD 530	None	8GBx1	128GB SSD	None	Intel 8260 ac, 2x2 + BT4.1	None	Switch	None	1Wx1	None	None	None	USB / USB	None	Floor Stand	65W Adapter 88%	Win10 Pro 64	3-year, Onsite	07/16
10HY0059US	US	i3-6100T	No	Intel HD 530	None	8GBx1	128GB SSD	None	Intel 3165 ac, 1x1 + BT4.0	None	Switch	None	1Wx1	None	None	None	USB / USB	None	Floor Stand	65W Adapter 88%	Win10 Pro 64	3-year, Onsite	07/16
10HY0068US	US	i3-6100T	No	Intel HD 530	None	8GBx1	500GB 7200rpm 2.5"	None	Intel 3165 ac, 1x1 + BT4.0	VGA	Switch	None	1Wx1	None	None	None	USB / USB	None	Floor Stand	65W Adapter 88%	Win10 Pro 64	3-year, Onsite	10/16
10HY0069US	US	i3-6100T	No	Intel HD 530	None	8GBx1	500GB 7200rpm 2.5"	None	Intel 3165 ac, 1x1 + BT4.0	3rd DP	Switch	None	1Wx1	None	None	None	USB / USB	None	Floor Stand	65W Adapter 88%	Win10 Pro 64	3-year, Onsite	10/16

Model	Region	Processor	vPro	Graphics	Monitor Cable	Memory	Storage(HDD/SSD)	External Optical / I/O Box	WLAN + Bluetooth	Optional Rear Ports	Chassis Intrusion Switch	Kensington Cable Lock	Speaker	Adapter Cage	Toolless Chassis Screw	Dust Filter	Keyboard / Mouse	VESA Mount	Stand	Power Supply	Operating System	Warranty	Ann Date (m/y)
10JQ0000US	US	Pentium G4400T	No	Intel HD 510	None	4GBx1	16GB SSD M.2	None	QCA6174 ac, 2x2 + BT4.1	None	Switch	None	1Wx1	None	None	None	USB / USB	None	Floor Stand	65W Adapter 88%	WES 7	3-year, Onsite	03/16
10JQ0001US	US	Pentium G4400T	No	Intel HD 510	None	4GBx1	16GB SSD M.2	None	QCA6174 ac, 2x2 + BT4.1	VGA	Switch	None	1Wx1	None	None	None	USB / USB	None	Floor Stand	65W Adapter 88%	WES 7	3-year, Onsite	03/16
10JQ0002US	US	i3-6100T	No	Intel HD 530	None	4GBx1	16GB SSD M.2	None	QCA6174 ac, 2x2 + BT4.1	3rd DP	Switch	None	1Wx1	None	None	None	USB / USB	None	Floor Stand	65W Adapter 88%	WES 7	3-year, Onsite	03/16
10JQ0003US	US	Pentium G4400T	No	Intel HD 510	None	4GBx1	16GB SSD M.2	None	QCA6174 ac, 2x2 + BT4.1	3rd DP	Switch	None	1Wx1	None	None	None	USB / USB	None	Floor Stand	65W Adapter 88%	WES 7	3-year, Onsite	03/16
10JQ0004US	US	Pentium G4400T	No	Intel HD 510	None	4GBx1	16GB SSD M.2	None	QCA6174 ac, 2x2 + BT4.1	Serial	Switch	None	1Wx1	None	None	None	USB / USB	None	Floor Stand	65W Adapter 88%	WES 7	3-year, Onsite	03/16
10JQ0005US	US	Pentium G4400T	No	Intel HD 510	None	4GBx1	16GB SSD M.2	None	QCA6174 ac, 2x2 + BT4.1	VGA	Switch	None	1Wx1	None	None	None	USB / USB	None	Floor Stand	65W Adapter 88%	LeTOS	3-year, Onsite	03/16
10JQ0006US	US	Pentium G4400T	No	Intel HD 510	None	4GBx1	16GB SSD M.2	None	QCA6174 ac, 2x2 + BT4.1	3rd DP	Switch	None	1Wx1	None	None	None	USB / USB	None	Floor Stand	65W Adapter 88%	LeTOS	3-year, Onsite	03/16
10JQ0007US	US	Pentium G4400T	No	Intel HD 510	None	4GBx1	16GB SSD M.2	None	QCA6174 ac, 2x2 + BT4.1	Serial	Switch	None	1Wx1	None	None	None	USB / USB	None	Floor Stand	65W Adapter 88%	LeTOS	3-year, Onsite	03/16
10JQ0008US	US	i3-6100T	No	Intel HD 530	None	4GBx1	16GB SSD M.2	None	QCA6174 ac, 2x2 + BT4.1	3rd DP	Switch	None	1Wx1	None	None	None	USB / USB	None	Floor Stand	65W Adapter 88%	LeTOS	3-year, Onsite	03/16
10JQ000EUS	US	Pentium G4400T	No	Intel HD 510	None	4GBx1	16GB SSD M.2	None	QCA6174 ac, 2x2 + BT4.1	None	Switch	None	1Wx1	None	None	None	USB / USB	None	Floor Stand	65W Adapter 88%	WES 7	3-year, Onsite	01/17
10JQ000FUS	US	Pentium G4400T	No	Intel HD 510	None	4GBx1	16GB SSD M.2	None	QCA6174 ac, 2x2 + BT4.1	3rd DP	Switch	None	1Wx1	None	None	None	USB / USB	None	Floor Stand	65W Adapter 88%	LeTOS	3-year, Onsite	01/17
10JQ000GUS	US	Pentium G4400T	No	Intel HD 510	None	4GBx1	16GB SSD M.2	None	QCA6174 ac, 2x2 + BT4.1	VGA	Switch	None	1Wx1	None	None	None	USB / USB	None	Floor Stand	65W Adapter 88%	WES 7	3-year, Onsite	01/17
10JQ000HUS	US	i3-6100T	No	Intel HD 530	None	4GBx1	16GB SSD M.2	None	QCA6174 ac, 2x2 + BT4.1	3rd DP	Switch	None	1Wx1	None	None	None	USB / USB	None	Floor Stand	65W Adapter 88%	WES 7	3-year, Onsite	01/17
10JQ000JUS	US	Pentium G4400T	No	Intel HD 510	None	4GBx1	16GB SSD M.2	None	QCA6174 ac, 2x2 + BT4.1	Serial	Switch	None	1Wx1	None	None	None	USB / USB	None	Floor Stand	65W Adapter 88%	LeTOS	3-year, Onsite	01/17
10JQ000KUS	US	Pentium G4400T	No	Intel HD 510	None	4GBx1	16GB SSD M.2	None	QCA6174 ac, 2x2 + BT4.1	VGA	Switch	None	1Wx1	None	None	None	USB / USB	None	Floor Stand	65W Adapter 88%	LeTOS	3-year, Onsite	01/17
10JQ000LUS	US	Pentium G4400T	No	Intel HD 510	None	4GBx1	16GB SSD M.2	None	QCA6174 ac, 2x2 + BT4.1	3rd DP	Switch	None	1Wx1	None	None	None	USB / USB	None	Floor Stand	65W Adapter 88%	WES 7	3-year, Onsite	01/17
10JQ000MUS	US	Pentium G4400T	No	Intel HD 510	None	4GBx1	16GB SSD M.2	None	QCA6174 ac, 2x2 + BT4.1	Serial	Switch	None	1Wx1	None	None	None	USB / USB	None	Floor Stand	65W Adapter 88%	WES 7	3-year, Onsite	01/17
10JQ000NUS	US	Pentium G4400T	No	Intel HD 510	None	4GBx1	16GB SSD M.2	None	QCA6174 ac, 2x2 + BT4.1	None	Switch	None	1Wx1	None	None	None	USB / USB	None	Floor Stand	65W Adapter 88%	LeTOS	3-year, Onsite	01/17



ThinkCentre M700 Tower Platform Specifications

Product Specifications Reference (PSREF)

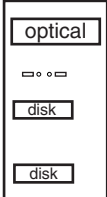
Processor	Intel® Celeron®, Intel Pentium®, or 6th Generation Intel Core™ i3 / i5 / i7 Processor	Security features	<ul style="list-style-type: none"> One lock to secure both cover and entire system to fixed object: <ul style="list-style-type: none"> -Padlock loop (in rear for opt padlock) -Security slot (in rear for optional Kensington® MicroSaver® cable) Optional cable lock to physically lock both keyboard and mouse <ul style="list-style-type: none"> Power-on password Administrator password Hard disk password Boot sequence control Boot without keyboard and mouse Individual USB port disablement Optional chassis intrusion switch 																																																												
	<table border="1"> <thead> <tr> <th>Processor</th> <th>Cores / Threads</th> <th>Frequency Base/Max(GHz)</th> <th>Cache</th> <th>Memory Types</th> <th>Integrated Graphics</th> </tr> </thead> <tbody> <tr> <td>Celeron G3900</td> <td>2 / 2</td> <td>2.8 G</td> <td>2 MB</td> <td>DDR4-2133</td> <td>HD 510</td> </tr> <tr> <td>Pentium G4400</td> <td>2 / 2</td> <td>3.3G</td> <td>3 MB</td> <td>DDR4-2133</td> <td>HD 510</td> </tr> <tr> <td>Pentium G4500</td> <td>2 / 2</td> <td>3.5G</td> <td>3 MB</td> <td>DDR4-2133</td> <td>HD 530</td> </tr> <tr> <td>Core i3-6100</td> <td>2 / 4</td> <td>3.7 G</td> <td>3 MB</td> <td>DDR4-2133</td> <td>HD 530</td> </tr> <tr> <td>Core i3-6300</td> <td>2 / 4</td> <td>3.8 G</td> <td>4 MB</td> <td>DDR4-2133</td> <td>HD 530</td> </tr> <tr> <td>Core i5-6400</td> <td>4 / 4</td> <td>2.7 G / 3.3 G</td> <td>6 MB</td> <td>DDR4-2133</td> <td>HD 530</td> </tr> <tr> <td>Core i5-6500</td> <td>4 / 4</td> <td>3.2 G / 3.6 G</td> <td>6 MB</td> <td>DDR4-2133</td> <td>HD 530</td> </tr> <tr> <td>Core i5-6600</td> <td>4 / 4</td> <td>3.3 G / 3.9 G</td> <td>6 MB</td> <td>DDR4-2133</td> <td>HD 530</td> </tr> <tr> <td>Core i7-6700</td> <td>4 / 8</td> <td>3.4 G / 4.0 G</td> <td>8 MB</td> <td>DDR4-2133</td> <td>HD 530</td> </tr> </tbody> </table>	Processor	Cores / Threads	Frequency Base/Max(GHz)	Cache	Memory Types	Integrated Graphics	Celeron G3900	2 / 2	2.8 G	2 MB	DDR4-2133	HD 510	Pentium G4400	2 / 2	3.3G	3 MB	DDR4-2133	HD 510	Pentium G4500	2 / 2	3.5G	3 MB	DDR4-2133	HD 530	Core i3-6100	2 / 4	3.7 G	3 MB	DDR4-2133	HD 530	Core i3-6300	2 / 4	3.8 G	4 MB	DDR4-2133	HD 530	Core i5-6400	4 / 4	2.7 G / 3.3 G	6 MB	DDR4-2133	HD 530	Core i5-6500	4 / 4	3.2 G / 3.6 G	6 MB	DDR4-2133	HD 530	Core i5-6600	4 / 4	3.3 G / 3.9 G	6 MB	DDR4-2133	HD 530	Core i7-6700	4 / 8	3.4 G / 4.0 G	8 MB	DDR4-2133	HD 530	Keyboard	<i>Some:</i> PS/2 Keyboard (PS/2 connector), Lenovo logo <i>Some:</i> Preferred Pro USB Keyboard (USB connector), Lenovo logo <i>Some:</i> Lenovo USB Fingerprint Keyboard (USB connector) <i>Some:</i> Ultralim Plus Wireless Keyboard (2.4GHz via USB receiver), black
Processor	Cores / Threads	Frequency Base/Max(GHz)	Cache	Memory Types	Integrated Graphics																																																										
Celeron G3900	2 / 2	2.8 G	2 MB	DDR4-2133	HD 510																																																										
Pentium G4400	2 / 2	3.3G	3 MB	DDR4-2133	HD 510																																																										
Pentium G4500	2 / 2	3.5G	3 MB	DDR4-2133	HD 530																																																										
Core i3-6100	2 / 4	3.7 G	3 MB	DDR4-2133	HD 530																																																										
Core i3-6300	2 / 4	3.8 G	4 MB	DDR4-2133	HD 530																																																										
Core i5-6400	4 / 4	2.7 G / 3.3 G	6 MB	DDR4-2133	HD 530																																																										
Core i5-6500	4 / 4	3.2 G / 3.6 G	6 MB	DDR4-2133	HD 530																																																										
Core i5-6600	4 / 4	3.3 G / 3.9 G	6 MB	DDR4-2133	HD 530																																																										
Core i7-6700	4 / 8	3.4 G / 4.0 G	8 MB	DDR4-2133	HD 530																																																										
		Mouse	<i>Some:</i> PS/2 Optical Wheel Mouse, black, Lenovo logo <i>Some:</i> Enhanced Optical USB Mouse, black, Lenovo logo <i>Some:</i> Ultralim Plus Wireless Mouse (2.4GHz via USB receiver), black																																																												
Memory	32GB max, UDIMM, DDR4 2133, two 288-pin DIMM sockets, dual-channel capable	Mechanical	<ul style="list-style-type: none"> Tower (20L), black color, metal case (WxDxH) 6.3" X 15.5" X 15.7"; 160mm X 394.5mm X 398mm 19.8 lb (9.0 kg) Optional handle Optional dust filter <p>Bay 1: 5.25", 1.6" high, access, std optical / opt front access HDD Bay 2: 3.5", 1" high, no access, std disk Bay 3: 3.5", 1" high, no access, opt disk Bay 4: N/A, N/A, external, opt reader Slot 1: half-length, full-height, PCIe 3.0 x16 Slot 2: half-length, full-height, PCIe 2.0 x1 Slot 3: half-length, full-height, PCIe 2.0 x1</p> 																																																												
Disk	<i>Some:</i> Hard disk, SATA 6.0Gb/s, 2.5"/ 3.5" wide, 5400 / 7200 rpm <i>Some:</i> Solid State Hybrid Drive (SSHD), 500GB (5400 rpm, 2.5") / 1TB or 2TB (7200 rpm, 3.5"), with 8GB NAND flash memory, SATA 6.0Gb/s <i>Some:</i> Solid State Drive (SSD) / SATA 6.0Gb/s, 2.5" Wide <i>Some:</i> Front accessible and removable HDD, 3.5", lockable via physical key	Power supply	<i>Some:</i> 180 watts, autosensing, 85% PSU <i>Some:</i> 250 watts, autosensing, 85% PSU																																																												
Optical	<i>Some:</i> DVD-ROM SATA 1.5Gb/s Drive <i>Some:</i> Super Multi-Burner DVD±RW SATA 1.5Gb/s Drive	Limited warranty ³	<i>Some:</i> 1-year or 3-year, depot service / service upgrades available <i>Some:</i> 1-year or 3-year, limited onsite service / service upgrades available <i>Some:</i> 3-year, limited onsite service, OID (Onsite International Delivery) / service upgrades available <i>For Lenovo service upgrade options, please go to S-TC sheet</i>																																																												
Onboard SATA Media reader	Three onboard SATA 6.0Gb/s connectors, Optional 9-in-1 media reader	Preload	Preloaded operating system <i>Some:</i> Windows® 7 Professional 32/64 preinstalled through downgrade rights in Windows 10 Pro 64-bit <i>Some:</i> Windows 7 Professional 32/64 <i>Some:</i> Windows 10 Pro 64-bit <i>Some:</i> Windows 10 Home 64-bit																																																												
Graphics	Intel HD Graphics 510/530 in processor, uses main memory, DirectX® 12, one VGA, one DisplayPort™, supports two independent displays, works along with discrete graphics to support more displays; <i>Max resolution:</i> 4096x2304 (DP) @60Hz; 1920x1200 (VGA)@60Hz <i>Some:</i> NVIDIA® Quadro® K420 , DirectX 12, 2GB, PCIe 2.0 x16 adapter, one DVI-I, one DisplayPort, 41 watts; <i>Max resolution:</i> 3840x2160 (DisplayPort)@60Hz; 2560x1600 (DVI-I)@60Hz <i>Some:</i> NVIDIA GeForce® GT 720 , DirectX 12, 2GB, PCIe 2.0 x8 adapter, one VGA, one HDMI, 25 watts; <i>Max resolution:</i> 1920x1080 (HDMI)@60Hz; 2048x1536 (VGA)@85Hz <i>Some:</i> NVIDIA GeForce GT 720 , DirectX 12, 1GB, PCIe 2.0 x8 adapter, two DisplayPort, 25 watts; <i>Max resolution:</i> 3840x2160 (DisplayPort)@60Hz;		Preloaded applications (only some listed) <ul style="list-style-type: none"> Desktop Power Manager Lenovo Solution Center Lenovo REACHit Lenovo SHAREit Lenovo Bluetooth Lock (for models with Wi-Fi/BT card) McAfee® LiveSafe™ (30-day trial) Microsoft Office preloaded; purchase a product key to activate PowerDVD Create (DVD±RW) Lenovo ThinkVantage Tools - Only for Window 10 Lenovo Companion Cyberlink PowerDVD (DVD, DVD±RW) Lenovo QuickOptimizer - Only for Window 7 Rescue and Recovery Password Manager ThinkVantage System Update Lenovo Message Center Plus Adobe® Reader® 																																																												
DP cable	Optional DP to VGA, DP to DVI-D (single link), or DP to HDMI 1.4 dongle	Environment	ENERGY STAR® 6.0*, EPEAT™ Gold rating* (*Need 85% PSU and Windows OS); ErP Lot 3; GREENGUARD ; RoHS-compliant																																																												
Chipset	Intel H110 Chipset	Accessories	For compatible accessories, please go to TC-AQP sheet																																																												
Front ports	Two USB 3.0, two optional USB 2.0, microphone (3.5mm), headphone (3.5mm)																																																														
Rear ports	Two USB 3.0, two USB 2.0, two optional USB 2.0, serial (9-pin), optional 2nd serial (9-pin), optional parallel (25-pin), ethernet (RJ-45), one VGA, one DisplayPort, two PS/2 ports (keyboard/mouse); additional VGA, DisplayPort, DVI-I or HDMI on optional graphics on some models																																																														
Rear audio ports	Line-in (3.5mm), line-out (3.5mm), microphone-in (3.5mm)																																																														
IEEE 1394	None																																																														
Audio support	High Definition (HD) Audio, Realtek ALC662 / optional internal speaker (1.5 watt)																																																														
WLAN ¹³	<i>Some:</i> 11ac wireless, M.2 Card, Qualcomm Atheros QCA9377 (dual band), Wi-Fi + Bluetooth 4.1 combo adapter, 1x1 <i>Some:</i> 11ac wireless, M.2 Card, Qualcomm Atheros QCA6174 (dual band), Wi-Fi + Bluetooth 4.1 combo adapter, 2x2 <i>Some:</i> 11ac wireless, M.2 Card, Intel Dual Band Wireless-AC 3165, Wi-Fi + Bluetooth 4.0 combo adapter, 1x1 <i>Some:</i> 11ac wireless, M.2 Card, Intel Dual Band Wireless-AC 8260, Wi-Fi + Bluetooth 4.1 combo adapter, 2x2																																																														
Bluetooth™	<i>Some:</i> Bluetooth 4.0 or 4.1 wireless, integrated in Wi-Fi + BT combo adapter																																																														
Ethernet	Gigabit ethernet, Realtek RTL8111GN, Wake on LAN®																																																														
Modem	None																																																														
Manageability	None																																																														
Security chip	Trusted Platform Module, TCG 1.2-compliant																																																														

See footnotes for more detailed information

Model	Region	Processor	vPro	Graphics	Monitor Cable	Memory	Storage	Optical	Media Reader	WLAN + Bluetooth	Optional Front Ports	Optional Rear Ports	Chassis Intrusion Switch	Cable Lock	Front Access HDD	Dust Filter	Keyboard / Mouse	Carry Handle	Power Supply	Operating System	Warranty	Ann Date (m/y)
10GR001MUS	US	i7-6700	No	Intel HD 530	None	8GBx1	1TB 7200rpm 3.5"	DVD±RW	None	None	None	None	None	None	None	None	None / USB	Carry Handle	250W 85%	Win10 DG Win7 Pro 64	3-year, Onsite	01/16
10GR001NUS	US	Pentium G4400	No	Intel HD 510	None	4GBx1	500GB 7200rpm 3.5"	DVD±RW	None	None	None	None	None	None	None	None	None / USB	Carry Handle	250W 85%	Win10 DG Win7 Pro 64	3-year, Onsite	01/16
10GR001PUS	US	i3-6100	No	Intel HD 530	None	4GBx1	500GB 7200rpm 3.5"	DVD±RW	None	None	None	None	None	None	None	None	None / USB	Carry Handle	250W 85%	Win10 DG Win7 Pro 64	3-year, Onsite	01/16
10GR001QUS	US	i5-6400	No	Intel HD 530	None	4GBx1	500GB 7200rpm 3.5"	DVD±RW	None	None	None	None	None	None	None	None	None / USB	Carry Handle	250W 85%	Win10 DG Win7 Pro 64	3-year, Onsite	01/16
10GR001RUS	US	i7-6700	No	Intel HD 530	None	8GBx1	256GB SSD Opal	DVD±RW	None	None	None	None	None	None	None	None	USB / USB	Carry Handle	250W 85%	Win10 DG Win7 Pro 64	3-year, Onsite	01/16
10GR001SUS	US	i7-6700	No	Intel HD 530	None	8GBx1	500GB 7200rpm 3.5"	DVD±RW	None	None	None	None	None	None	None	None	USB / USB	Carry Handle	250W 85%	Win10 DG Win7 Pro 64	3-year, Onsite	01/16
10GR001TUS	US	i7-6700	No	GT 720 1GB	None	8GBx1	1TB 7200rpm 3.5"	DVD±RW	None	Intel 8260 ac, 2x2 + BT4.1	None	None	None	None	None	None	USB / USB	Carry Handle	250W 85%	Win10 DG Win7 Pro 64	3-year, Onsite	01/16
10GR001UUS	US	i7-6700	No	Intel HD 530	None	8GBx1	1TB 7200rpm 3.5"	DVD±RW	None	None	None	None	None	None	None	None	USB / USB	Carry Handle	250W 85%	Win10 DG Win7 Pro 64	3-year, Onsite	01/16
10GR001VUS	US	i7-6700	No	Intel HD 530	None	8GBx1	120GB SSD	DVD±RW	None	None	None	None	None	None	None	None	USB / USB	Carry Handle	250W 85%	Win10 DG Win7 Pro 64	3-year, Onsite	01/16
10GR001WUS	US	i7-6700	No	Intel HD 530	None	8GBx1	128GB SSD	DVD±RW	None	None	None	None	None	None	None	None	USB / USB	Carry Handle	250W 85%	Win10 DG Win7 Pro 64	3-year, Onsite	01/16
10GR001XUS	US	i7-6700	No	Intel HD 530	None	8GBx1	1TB 7200rpm 3.5"	DVD±RW	None	Intel 8260 ac, 2x2 + BT4.1	None	None	None	None	None	None	USB / USB	Carry Handle	250W 85%	Win10 DG Win7 Pro 64	3-year, Onsite	01/16
10GR001YUS	US	i5-6400	No	Intel HD 530	None	8GBx1	500GB 7200rpm 3.5"	DVD±RW	None	Intel 8260 ac, 2x2 + BT4.1	None	None	None	None	None	None	USB / USB	Carry Handle	250W 85%	Win10 DG Win7 Pro 64	3-year, Onsite	01/16
10GR0020US	US	i5-6400	No	Intel HD 530	None	4GBx1	500GB 7200rpm 3.5"	DVD±RW	None	None	None	None	None	None	None	None	USB / USB	Carry Handle	250W 85%	Win10 DG Win7 Pro 64	3-year, Onsite	01/16
10GR0021US	US	i5-6400	No	Intel HD 530	None	4GBx1	500GB 7200rpm 3.5"	DVD±RW	None	Intel 8260 ac, 2x2 + BT4.1	None	None	None	None	None	None	USB / USB	Carry Handle	250W 85%	Win10 DG Win7 Pro 64	3-year, Onsite	01/16
10GR0022US	US	i5-6400	No	Intel HD 530	None	8GBx1	192GB SSD	DVD±RW	None	None	None	None	None	None	None	None	USB / USB	Carry Handle	250W 85%	Win10 DG Win7 Pro 64	3-year, Onsite	01/16
10GR0023US	US	i5-6400	No	Intel HD 530	None	8GBx1	1TB 7200rpm 3.5"	DVD±RW	None	None	None	None	None	None	None	None	USB / USB	Carry Handle	250W 85%	Win10 DG Win7 Pro 64	3-year, Onsite	01/16
10GR0024US	US	i5-6400	No	Intel HD 530	None	8GBx1	500GB 7200rpm 3.5"	DVD±RW	None	None	None	None	None	None	None	None	USB / USB	Carry Handle	250W 85%	Win10 DG Win7 Pro 64	3-year, Onsite	01/16
10GR0025US	US	i5-6400	No	GT 720 1GB	None	8GBx1	1TB 7200rpm 3.5"	DVD±RW	None	Intel 8260 ac, 2x2 + BT4.1	None	None	None	None	None	None	USB / USB	Carry Handle	250W 85%	Win10 DG Win7 Pro 64	3-year, Onsite	01/16
10GR0026US	US	i5-6400	No	Intel HD 530	None	8GBx1	120GB SSD	DVD±RW	None	None	None	None	None	None	None	None	USB / USB	Carry Handle	250W 85%	Win10 DG Win7 Pro 64	3-year, Onsite	01/16
10GR0027US	US	i5-6400	No	Intel HD 530	None	8GBx1	256GB SSD Opal	DVD±RW	None	None	None	None	None	None	None	None	USB / USB	Carry Handle	250W 85%	Win10 DG Win7 Pro 64	3-year, Onsite	01/16

Model	Region	Processor	vPro	Graphics	Monitor Cable	Memory	Storage	Optical	Media Reader	WLAN + Bluetooth	Optional Front Ports	Optional Rear Ports	Chassis Intrusion Switch	Cable Lock	Front Access HDD	Dust Filter	Keyboard / Mouse	Carry Handle	Power Supply	Operating System	Warranty	Ann Date (m/y)
10GR0028US	US	i3-6100	No	Intel HD 530	None	4GBx1	500GB 7200rpm 3.5"	DVD±RW	None	Intel 8260 ac, 2x2 + BT4.1	None	None	None	None	None	None	USB / USB	Carry Handle	250W 85%	Win10 DG Win7 Pro 64	3-year, Onsite	01/16
10GR0029US	US	i3-6100	No	Intel HD 530	None	4GBx1	500GB 7200rpm 3.5"	DVD±RW	None	None	None	None	None	None	None	None	USB / USB	Carry Handle	250W 85%	Win10 DG Win7 Pro 64	3-year, Onsite	01/16
10GR002AUS	US	i3-6100	No	Intel HD 530	None	4GBx1	500GB 7200rpm 3.5"	DVD±RW	None	Intel 3165 ac, 1x1 + BT4.0	None	None	None	None	None	None	USB / USB	Carry Handle	250W 85%	Win10 DG Win7 Pro 64	3-year, Onsite	01/16
10GR002BUS	US	Pentium G4400	No	Intel HD 510	None	4GBx1	500GB 7200rpm 3.5"	DVD±RW	None	None	None	None	None	None	None	None	USB / USB	Carry Handle	250W 85%	Win10 DG Win7 Pro 64	3-year, Onsite	01/16
10GR002CUS	US	i7-6700	No	Intel HD 530	None	8GBx1	1TB 7200rpm 3.5"	DVD±RW	None	Intel 8260 ac, 2x2 + BT4.1	None	None	None	None	None	None	USB / USB	Carry Handle	250W 85%	Win10 Pro 64	3-year, Onsite	01/16
10GR002DUS	US	Pentium G4400	No	Intel HD 510	None	4GBx1	500GB 7200rpm 3.5"	DVD±RW	None	Intel 3165 ac, 1x1 + BT4.0	None	None	None	None	None	None	USB / USB	Carry Handle	250W 85%	Win10 Pro 64	3-year, Onsite	01/16
10GR002EUS	US	i5-6400	No	Intel HD 530	None	4GBx1	500GB 7200rpm 3.5"	DVD±RW	None	Intel 8260 ac, 2x2 + BT4.1	None	None	None	None	None	None	USB / USB	Carry Handle	250W 85%	Win10 Pro 64	3-year, Onsite	01/16
10GR004FUS	US	i7-6700	No	GT 720 1GB	None	8GBx1	1TB 7200rpm 3.5"	DVD±RW	None	None	None	None	None	None	None	None	USB / USB	Carry Handle	250W 85%	Win10 Pro 64	3-year, Onsite	06/16
10GR004GUS	US	Pentium G4400	No	Intel HD 510	None	4GBx1	500GB 7200rpm 3.5"	DVD±RW	None	None	None	None	None	None	None	None	USB / USB	Carry Handle	250W 85%	Win10 Pro 64	3-year, Onsite	06/16
10GR004HUS	US	i5-6400	No	Intel HD 530	None	4GBx1	500GB 7200rpm 3.5"	DVD±RW	None	None	None	None	None	None	None	None	USB / USB	Carry Handle	250W 85%	Win10 Pro 64	3-year, Onsite	06/16
10GR004JUS	US	i3-6100	No	Intel HD 530	None	4GBx1	500GB 7200rpm 3.5"	DVD±RW	None	None	None	None	None	None	None	None	USB / USB	Carry Handle	250W 85%	Win10 Pro 64	3-year, Onsite	06/16
10GR004KUS	US	i3-6100	No	Intel HD 530	None	4GBx1	128GB SSD	DVD±RW	None	None	None	None	None	None	None	None	USB / USB	Carry Handle	250W 85%	Win10 Pro 64	3-year, Onsite	06/16
10GR004LUS	US	i5-6400	No	GT 720 1GB	None	8GBx1	1TB 7200rpm 3.5"	DVD±RW	None	None	None	None	None	None	None	None	USB / USB	Carry Handle	250W 85%	Win10 Pro 64	3-year, Onsite	06/16
10GR004MUS	US	i5-6400	No	Intel HD 530	None	8GBx1	1TB 7200rpm 3.5"	DVD±RW	None	None	None	None	None	None	None	None	USB / USB	Carry Handle	250W 85%	Win10 Pro 64	3-year, Onsite	06/16
10GR004NUS	US	i5-6400	No	Intel HD 530	None	8GBx1	256GB SSD Opal	DVD±RW	None	None	None	None	None	None	None	None	USB / USB	Carry Handle	250W 85%	Win10 Pro 64	3-year, Onsite	06/16
10GR004PUS	US	i5-6400	No	Intel HD 530	None	8GBx1	128GB SSD	DVD±RW	None	None	None	None	None	None	None	None	USB / USB	Carry Handle	250W 85%	Win10 Pro 64	3-year, Onsite	06/16
10GR004QUS	US	Pentium G4400	No	Intel HD 510	None	4GBx1	128GB SSD	DVD±RW	None	None	None	None	None	None	None	None	USB / USB	Carry Handle	250W 85%	Win10 Pro 64	3-year, Onsite	06/16
10GR004RUS	US	i7-6700	No	Intel HD 530	None	8GBx1	1TB 7200rpm 3.5"	DVD±RW	None	None	None	None	None	None	None	None	USB / USB	Carry Handle	250W 85%	Win10 Pro 64	3-year, Onsite	06/16
10GR004SUS	US	i7-6700	No	Intel HD 530	None	8GBx1	256GB SSD Opal	DVD±RW	None	None	None	None	None	None	None	None	USB / USB	Carry Handle	250W 85%	Win10 Pro 64	3-year, Onsite	06/16
10GR004TUS	US	i3-6100	No	Intel HD 530	None	8GBx1	128GB SSD	DVD±RW	None	None	None	None	None	None	None	None	USB / USB	Carry Handle	250W 85%	Win10 Pro 64	3-year, Onsite	06/16

Model	Region	Processor	vPro	Graphics	Monitor Cable	Memory	Storage	Optical	Media Reader	WLAN + Bluetooth	Optional Front Ports	Optional Rear Ports	Chassis Intrusion Switch	Cable Lock	Front Access HDD	Dust Filter	Keyboard / Mouse	Carry Handle	Power Supply	Operating System	Warranty	Ann Date (m/y)
10GR004UUS	US	i5-6400	No	Intel HD 530	None	8GBx1	1TB 7200rpm 3.5"	DVD±RW	None	Intel 3165 ac, 1x1 + BT4.0	None	None	None	None	None	None	USB / USB	Carry Handle	250W 85%	Win10 Pro 64	3-year, Onsite	06/16
10GR0056US	US	i7-6700	No	GT 720 1GB	None	8GBx1	1TB 7200rpm 3.5"	DVD±RW	None	None	None	None	None	None	None	None	USB / USB	Carry Handle	250W 85%	Win10 DG Win7 Pro 64	3-year, Onsite	10/16
10GR0057US	US	i5-6400	No	GT 720 1GB	None	8GBx1	1TB 7200rpm 3.5"	DVD±RW	None	Intel 8260 ac, 2x2 + BT4.1	None	None	None	None	None	None	USB / USB	Carry Handle	250W 85%	Win10 Pro 64	3-year, Onsite	10/16
10GR0058US	US	i7-6700	No	GT 720 1GB	None	8GBx1	1TB 7200rpm 3.5"	DVD±RW	None	Intel 8260 ac, 2x2 + BT4.1	None	None	None	None	None	None	USB / USB	Carry Handle	250W 85%	Win10 Pro 64	3-year, Onsite	10/16
10GR0059US	US	i5-6400	No	GT 720 1GB	None	8GBx1	1TB 7200rpm 3.5"	DVD±RW	None	Intel 8260 ac, 2x2 + BT4.1	None	None	None	None	None	None	USB / USB	Carry Handle	250W 85%	Win10 DG Win7 Pro 64	3-year, Onsite	10/16
10GR005AUS	US	i7-6700	No	GT 720 1GB	None	8GBx1	1TB 7200rpm 3.5"	DVD±RW	None	None	None	None	None	None	None	None	USB / USB	Carry Handle	250W 85%	Win10 Pro 64	3-year, Onsite	10/16
10GR005BUS	US	i5-6400	No	GT 720 1GB	None	8GBx1	1TB 7200rpm 3.5"	DVD±RW	None	None	None	None	None	None	None	None	USB / USB	Carry Handle	250W 85%	Win10 DG Win7 Pro 64	3-year, Onsite	10/16
10GR005CUS	US	i7-6700	No	GT 720 1GB	None	8GBx1	1TB 7200rpm 3.5"	DVD±RW	None	Intel 8260 ac, 2x2 + BT4.1	None	None	None	None	None	None	USB / USB	Carry Handle	250W 85%	Win10 DG Win7 Pro 64	3-year, Onsite	10/16
10GR005DUS	US	i5-6400	No	GT 720 1GB	None	8GBx1	1TB 7200rpm 3.5"	DVD±RW	None	None	None	None	None	None	None	None	USB / USB	Carry Handle	250W 85%	Win10 Pro 64	3-year, Onsite	10/16
10GR005EUS	US	i3-6100	No	Intel HD 530	None	8GBx1	500GB 7200rpm 3.5"	DVD±RW	None	None	None	None	None	None	None	None	USB / USB	Carry Handle	250W 85%	Win10 Pro 64	3-year, Onsite	10/16

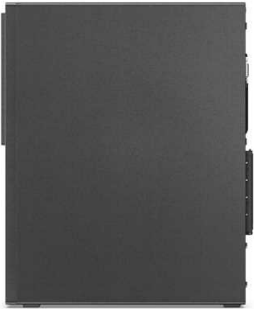

ThinkCentre M710 SFF Platform Specifications

Product Specifications Reference (PSREF)

Processor	Intel® Celeron®, Intel Pentium®, or 6/7th Generation Intel Core™ i3 / i5 / i7 Processor						Security features <ul style="list-style-type: none"> • Security slot (in rear for optional Kensington® MicroSaver® cable) • Padlock loop • Smart USB protection, allows keyboard/mouse only, blocks all storage devices • Optional cable lock to physically lock both keyboard and mouse <ul style="list-style-type: none"> • Power-on password • Administrator password • Hard disk password • Boot sequence control • Boot without keyboard and mouse • Individual USB port disablement • Optional chassis intrusion switch
	Processor	Cores / Threads	Frequency Base/Max(GHz)	Cache	Memory Support (Up to)	Integrated Graphics	
	Pentium G4400	2 / 2	3.3G	3 MB	DDR4-2133	HD 510	
	Pentium G4560	2 / 4	3.5G	3 MB	DDR4-2400	HD 610	
	Pentium G4600	2 / 4	3.6G	3 MB	DDR4-2400	HD 630	
	Core i3-6100	2 / 4	3.7G	3 MB	DDR4-2133	HD 530	
	Core i5-6500	4 / 4	3.2G / 3.6G	6 MB	DDR4-2133	HD 530	
	Core i7-6700	4 / 8	3.4G / 4.0G	8 MB	DDR4-2133	HD 530	
	Core i3-7100	2 / 4	3.9G	3 MB	DDR4-2400	HD 630	
	Core i5-7400	4 / 4	3.0G / 3.5G	6 MB	DDR4-2400	HD 630	
	Core i5-7500	4 / 4	3.4G / 3.8G	6 MB	DDR4-2400	HD 630	
Core i5-7600	4 / 4	3.5G / 4.1G	6 MB	DDR4-2400	HD 630		
Core i7-7700	4 / 8	3.6G / 4.2G	8 MB	DDR4-2400	HD 630		
Memory	64GB max, UDIMM, DDR4-2400, four 288-pin DIMM sockets, non-ECC, dual-channel capable* * System automatically clocks down for the processors with lower memory controller						
Storage	<i>Some:</i> Hard Drive / SATA 6.0Gb/s, 2.5" or 3.5", 5400 rpm or 7200 rpm <i>Some:</i> Solid State Drive (SSD) / SATA 6.0Gb/s, 2.5" <i>Some:</i> M.2 Solid State Drive (SSD) / PCIe NVMe, PCIe 3.0 x 4, 32Gb/s <i>Some:</i> Intel Optane™ Memory Ready (models with 7th gen Core processor), M.2 <i>Some:</i> DVD-ROM SATA 1.5Gb/s Drive, slim (9.0mm) <i>Some:</i> DVD Burner (DVD±RW), SATA 1.5Gb/s Drive, slim (9.0mm)						
Optical	Three onboard SATA 6.0Gb/s connectors Optional 7-in-1 media reader						
Onboard SATA Media reader	Optional 7-in-1 media reader						
Graphics	Intel HD Graphics 510/530/610/630 in processor, uses main memory, DirectX® 12, one VGA, two DisplayPort™, supports 3 independent displays, works along with discrete graphics to support more displays; <i>Max resolution:</i> 4096x2304 (DP) @60Hz; 2048x1536 (VGA) @50Hz <i>Some:</i> NVIDIA GeForce® GT 730 , DirectX 12, 2GB, PCIe 2.0 x8 adapter, two DisplayPort, 35 watts; <i>Max resolution:</i> 3840x2160 (DisplayPort) @60Hz;						
Monitor cable	Optional DP to VGA, DP to DVI-D (single link), DP to dual DP, or DP to HDMI 1.4						
Chipset	Intel B250 Chipset						
Front ports	Four USB 3.1 Gen1, optional two USB 3.1 Type-C Gen 2 (only available via special bid), microphone (3.5mm), headphone (3.5mm)						
Rear ports	Two USB 3.1 Gen1, two USB 2.0, optional two USB 2.0, serial (9-pin), optional 2nd serial (9-pin), optional parallel (25-pin), ethernet (RJ-45), one VGA, two DisplayPort, two PS/2 ports (keyboard/mouse); additional DisplayPort on optional graphics on some models						
Rear audio ports IEEE 1394	Line-in (3.5mm), line-out (3.5mm), microphone-in (3.5mm) None						
Audio support	High Definition (HD) Audio, Realtek ALC662 / optional internal speaker (1.5 watt)						
WLAN ¹³	<i>Some:</i> 11ac wireless, M.2 Card, Qualcomm Atheros QCA9377A (dual band), Wi-Fi + Bluetooth 4.1 combo adapter, 1x1 <i>Some:</i> 11ac wireless, M.2 Card, Qualcomm Atheros QCA6174A (dual band), Wi-Fi + Bluetooth 4.1 combo adapter, 2x2 <i>Some:</i> 11ac wireless, M.2 Card, Intel Dual Band Wireless-AC 3165, Wi-Fi + Bluetooth 4.1 combo adapter, 1x1 <i>Some:</i> 11ac wireless, M.2 Card, Intel Dual Band Wireless-AC 8265, Wi-Fi + Bluetooth 4.1 combo adapter, 2x2						
Bluetooth™ Ethernet Modem	<i>Some:</i> Bluetooth 4.1 wireless, integrated in Wi-Fi + BT combo adapter Gigabit ethernet, Realtek RTL8111GN, Wake on LAN® None						
Manageability Security chip	None TPM (Trusted Platform Module) 2.0, TCG Certified * Downgrade to TPM1.2 for the models with Win10 DG Win7 32 OS						
Floor Stand	<ul style="list-style-type: none"> • SFF (8.4L), black color; metal case • (WxDxH) 3.6" X 11.4" X 13.5"; 92.5mm X 290.5mm X 343.5mm • Approx. 13.2 lb (6.0 kg), weight may vary by configuration • Toolless cover, disk, optical removal • Optional dust filter Bay 1: Slim external ODD bay Bay 2: 3.5", 1" high, internal, HDD/SSD Bay 3: 2.5", internal, HDD/SSD (optional bay) Slot 1: Low Profile, PCIe 3.0 x16* Slot 2: Low Profile, PCIe 3.0 x1* Slot 3: Low Profile, PCIe 3.0 x1* Slot 4: no slot, only bracket for optional port extension* M.2 card slots: Two (one for WLAN, one for SSD/Optane) * Optional front USB3.1 Type-C x2 module occupies PCIe x16 slot (x4 card), optional rear 2x USB2.0 / parallel / 2nd serial occupies one expansion slot Optional system floor stand for vertical orientation						
Power supply	<i>Some:</i> 180 watts, autosensing, 85% PSU <i>Some:</i> 210 watts, autosensing, 85% PSU <i>Some:</i> 210 watts, autosensing, 92% PSU (only available via special bid)						
Limited warranty ³	<i>Some:</i> 1-year or 3-year, depot service / service upgrades available <i>Some:</i> 1-year or 3-year, limited onsite service / service upgrades available						
Preload	Preloaded operating system <i>Some:</i> Windows® 7 Professional 32/64 preinstalled through downgrade rights in Windows 10 Pro 64-bit (not available with 7th Gen Intel processor) <i>Some:</i> Windows 10 Pro 64-bit <i>Some:</i> Windows 10 Home 64-bit Preloaded applications (only some listed) <ul style="list-style-type: none"> • Microsoft Office preloaded; purchase a product key to activate • Cyberlink PowerDVD Create (DVD±RW) <ul style="list-style-type: none"> - Only for Window 10 • Lenovo Companion • Lenovo ID • Cyberlink PowerDVD (DVD, DVD±RW) <ul style="list-style-type: none"> - Only for Window 7 • Lenovo Solution Center • Lenovo ThinkVantage Tools • Create Recovery Media • Adobe® Reader® 						
Environment	ENERGY STAR® 6.1, EPEAT™ Gold rating (North America), ErP Lot 3, GREENGUARD®, RoHS-compliant, TUV low noise verified (on some models)						
Accessories	For compatible accessories, please go to http://www.lenovoquickpick.com						

See footnotes for more detailed information

Model	Region	Processor	vPro	Graphics	Monitor Cable	Memory	Storage(HDD/SSD)	Optical	Optional 2nd 2.5" Bay	Media Reader	WLAN + Bluetooth	Optional Front Ports	Optional Rear Ports	Chassis Intrusion Switch	Cable Lock	Speaker	Dust Filter	Keyboard / Mouse	Stand	Power Supply	Operating System	Warranty	Ann Date (mm/yy)	End of Support
10M7000DUS	US	i7-7700	No	GT 730 2GB	None	8GBx1	1TB 7200rpm 3.5"	DVD±RW	Optional 2nd 2.5" Bay	None	3165 ac, 1x1 + BT4.0	None	None	None	None	1.5Wx1	None	USB / USB	Floor Stand	210W 85%	Win10 Pro 64	3-year, Onsite	02/17	Mar 21, 2023
10M7000EUS	US	i7-7700	No	Intel HD 630	None	8GBx1	256GB SSD M.2 PCIe NVMe Opal	DVD±RW	Optional 2nd 2.5" Bay	None	3165 ac, 1x1 + BT4.0	None	None	None	None	1.5Wx1	None	USB / USB	Floor Stand	210W 85%	Win10 Pro 64	3-year, Onsite	02/17	Mar 21, 2023
10M7000FUS	US	i7-7700	No	Intel HD 630	None	8GBx1	1TB 7200rpm 3.5"	DVD±RW	Optional 2nd 2.5" Bay	None	None	None	None	None	None	1.5Wx1	None	USB / USB	Floor Stand	210W 85%	Win10 Pro 64	3-year, Onsite	02/17	Mar 21, 2023
10M7000GUS	US	i7-7700	No	Intel HD 630	None	8GBx1	512GB SSD M.2 PCIe NVMe Opal	DVD±RW	Optional 2nd 2.5" Bay	None	None	None	None	None	None	1.5Wx1	None	USB / USB	Floor Stand	210W 85%	Win10 Pro 64	3-year, Onsite	02/17	Mar 21, 2023
10M7000HUS	US	i5-7400	No	Intel HD 630	None	4GBx1	500GB 7200rpm 3.5"	DVD±RW	Optional 2nd 2.5" Bay	None	3165 ac, 1x1 + BT4.0	None	None	None	None	1.5Wx1	None	USB / USB	Floor Stand	210W 85%	Win10 Pro 64	3-year, Onsite	02/17	Mar 21, 2023
10M7000JUS	US	i5-7400	No	Intel HD 630	None	8GBx1	512GB SSD M.2 PCIe NVMe Opal	DVD±RW	Optional 2nd 2.5" Bay	None	3165 ac, 1x1 + BT4.0	None	None	None	None	1.5Wx1	None	USB / USB	Floor Stand	210W 85%	Win10 Pro 64	3-year, Onsite	02/17	Mar 21, 2023
10M7000KUS	US	i7-7700	No	GT 730 2GB	None	8GBx1	256GB SSD M.2 PCIe NVMe Opal	DVD±RW	Optional 2nd 2.5" Bay	None	3165 ac, 1x1 + BT4.0	None	None	None	None	1.5Wx1	None	USB / USB	Floor Stand	210W 85%	Win10 Pro 64	3-year, Onsite	02/17	Mar 21, 2023
10M7000LUS	US	i5-7400	No	Intel HD 630	None	8GBx1	256GB SSD M.2 PCIe NVMe Opal	DVD±RW	Optional 2nd 2.5" Bay	None	3165 ac, 1x1 + BT4.0	None	None	None	None	1.5Wx1	None	USB / USB	Floor Stand	210W 85%	Win10 Pro 64	3-year, Onsite	02/17	Mar 21, 2023
10M7000MUS	US	i7-7700	No	GT 730 2GB	None	8GBx1	1TB 7200rpm 3.5"	DVD±RW	Optional 2nd 2.5" Bay	None	None	None	None	None	None	1.5Wx1	None	USB / USB	Floor Stand	210W 85%	Win10 Pro 64	3-year, Onsite	02/17	Mar 21, 2023
10M7000NUS	US	i7-7700	No	GT 730 2GB	None	8GBx1	256GB SSD M.2 PCIe NVMe Opal	DVD±RW	Optional 2nd 2.5" Bay	None	None	None	None	None	None	1.5Wx1	None	USB / USB	Floor Stand	210W 85%	Win10 Pro 64	3-year, Onsite	02/17	Mar 21, 2023
10M7000PUS	US	i5-7400	No	Intel HD 630	None	4GBx1	500GB 7200rpm 3.5"	DVD±RW	Optional 2nd 2.5" Bay	None	None	None	None	None	None	1.5Wx1	None	USB / USB	Floor Stand	210W 85%	Win10 Pro 64	3-year, Onsite	02/17	Mar 21, 2023
10M7000QUS	US	i5-7400	No	Intel HD 630	None	8GBx1	256GB SSD M.2 PCIe NVMe Opal	DVD±RW	Optional 2nd 2.5" Bay	None	None	None	None	None	None	1.5Wx1	None	USB / USB	Floor Stand	210W 85%	Win10 Pro 64	3-year, Onsite	02/17	Mar 21, 2023
10M7000RUS	US	i7-7700	No	Intel HD 630	None	8GBx1	256GB SSD M.2 PCIe NVMe Opal	DVD±RW	Optional 2nd 2.5" Bay	None	None	None	None	None	None	1.5Wx1	None	USB / USB	Floor Stand	210W 85%	Win10 Pro 64	3-year, Onsite	02/17	Mar 21, 2023
10M7000SUS	US	i5-7400	No	Intel HD 630	None	8GBx1	1TB 7200rpm 3.5"	DVD±RW	Optional 2nd 2.5" Bay	None	None	None	None	None	None	1.5Wx1	None	USB / USB	Floor Stand	210W 85%	Win10 Pro 64	3-year, Onsite	02/17	Mar 21, 2023
10M7000TUS	US	i7-7700	No	Intel HD 630	None	8GBx1	1TB 7200rpm 3.5"	DVD±RW	Optional 2nd 2.5" Bay	None	3165 ac, 1x1 + BT4.0	None	None	None	None	1.5Wx1	None	USB / USB	Floor Stand	210W 85%	Win10 Pro 64	3-year, Onsite	02/17	Mar 21, 2023
10M7002WUS	US	i5-7400	No	Intel HD 630	None	8GBx1	1TB 7200rpm 3.5"	DVD±RW	Optional 2nd 2.5" Bay	None	3165 ac, 1x1 + BT4.0	None	None	None	None	1.5Wx1	None	USB / USB	Floor Stand	210W 85%	Win10 Pro 64	3-year, Onsite	03/17	Apr 28, 2023
10M7002XUS	US	Pentium G4560	No	Intel HD 610	None	4GBx1	500GB 7200rpm 3.5"	DVD±RW	Optional 2nd 2.5" Bay	None	3165 ac, 1x1 + BT4.0	None	None	None	None	1.5Wx1	None	USB / USB	Floor Stand	210W 85%	Win10 Pro 64	3-year, Onsite	03/17	Apr 28, 2023
10M7002YUS	US	i3-7100	No	Intel HD 630	None	8GBx1	128GB SSD M.2 PCIe NVMe	DVD±RW	Optional 2nd 2.5" Bay	None	None	None	None	None	None	1.5Wx1	None	USB / USB	Floor Stand	210W 85%	Win10 Pro 64	3-year, Onsite	03/17	Apr 28, 2023
10M70030US	US	i5-6500	No	Intel HD 530	None	8GBx1	1TB 7200rpm 3.5"	DVD±RW	Optional 2nd 2.5" Bay	None	None	None	None	None	None	1.5Wx1	None	USB / USB	Floor Stand	210W 85%	Win10 DG Win7 Pro 64	3-year, Onsite	03/17	Apr 28, 2023
10M70031US	US	i3-7100	No	Intel HD 630	None	4GBx1	500GB 7200rpm 3.5"	DVD±RW	Optional 2nd 2.5" Bay	None	None	None	None	None	None	1.5Wx1	None	USB / USB	Floor Stand	210W 85%	Win10 Pro 64	3-year, Onsite	03/17	Apr 28, 2023

Model	Region	Processor	vPro	Graphics	Monitor Cable	Memory	Storage(HDD/SSD)	Optical	Optional 2nd 2.5" Bay	Media Reader	WLAN + Bluetooth	Optional Front Ports	Optional Rear Ports	Chassis Intrusion Switch	Cable Lock	Speaker	Dust Filter	Keyboard / Mouse	Stand	Power Supply	Operating System	Warranty	Ann Date (mm/yy)	End of Support
10M70032US	US	i7-6700	No	GT 730 2GB	None	8GBx1	256GB SSD M.2 PCIe NVMe Opal	DVD±RW	Optional 2nd 2.5" Bay	None	3165 ac, 1x1 + BT4.0	None	None	None	None	1.5Wx1	None	USB / USB	Floor Stand	210W 85%	Win10 DG Win7 Pro 64	3-year, Onsite	03/17	Apr 28, 2023
10M70033US	US	i7-6700	No	GT 730 2GB	None	8GBx1	1TB 7200rpm 3.5"	DVD±RW	Optional 2nd 2.5" Bay	None	3165 ac, 1x1 + BT4.0	None	None	None	None	1.5Wx1	None	USB / USB	Floor Stand	210W 85%	Win10 DG Win7 Pro 64	3-year, Onsite	03/17	Apr 28, 2023
10M70034US	US	i5-7400	No	Intel HD 630	None	4GBx1	128GB SSD M.2 PCIe NVMe	DVD±RW	Optional 2nd 2.5" Bay	None	None	None	None	None	None	1.5Wx1	None	USB / USB	Floor Stand	210W 85%	Win10 Pro 64	3-year, Onsite	03/17	Apr 28, 2023
10M70035US	US	i7-6700	No	GT 730 2GB	None	8GBx1	256GB SSD M.2 PCIe NVMe Opal	DVD±RW	Optional 2nd 2.5" Bay	None	None	None	None	None	None	1.5Wx1	None	USB / USB	Floor Stand	210W 85%	Win10 DG Win7 Pro 64	3-year, Onsite	03/17	Apr 28, 2023
10M70036US	US	Pentium G4400	No	Intel HD 510	None	4GBx1	500GB 7200rpm 3.5"	DVD±RW	Optional 2nd 2.5" Bay	None	3165 ac, 1x1 + BT4.0	None	None	None	None	1.5Wx1	None	USB / USB	Floor Stand	210W 85%	Win10 DG Win7 Pro 64	3-year, Onsite	03/17	Apr 28, 2023
10M70037US	US	i3-6100	No	Intel HD 530	None	8GBx1	1TB 7200rpm 3.5"	DVD±RW	Optional 2nd 2.5" Bay	None	None	None	None	None	None	1.5Wx1	None	USB / USB	Floor Stand	210W 85%	Win10 DG Win7 Pro 64	3-year, Onsite	03/17	Apr 28, 2023
10M70038US	US	i5-6500	No	Intel HD 530	None	8GBx1	1TB 7200rpm 3.5"	DVD±RW	Optional 2nd 2.5" Bay	None	3165 ac, 1x1 + BT4.0	None	None	None	None	1.5Wx1	None	USB / USB	Floor Stand	210W 85%	Win10 DG Win7 Pro 64	3-year, Onsite	03/17	Apr 28, 2023
10M70039US	US	i5-6500	No	Intel HD 530	None	4GBx1	500GB 7200rpm 3.5"	DVD±RW	Optional 2nd 2.5" Bay	None	None	None	None	None	None	1.5Wx1	None	USB / USB	Floor Stand	210W 85%	Win10 DG Win7 Pro 64	3-year, Onsite	03/17	Apr 28, 2023
10M7003AUS	US	i7-6700	No	Intel HD 530	None	8GBx1	256GB SSD M.2 PCIe NVMe Opal	DVD±RW	Optional 2nd 2.5" Bay	None	3165 ac, 1x1 + BT4.0	None	None	None	None	1.5Wx1	None	USB / USB	Floor Stand	210W 85%	Win10 DG Win7 Pro 64	3-year, Onsite	03/17	Apr 28, 2023
10M7003BUS	US	Pentium G4560	No	Intel HD 610	None	4GBx1	500GB 7200rpm 3.5"	DVD±RW	Optional 2nd 2.5" Bay	None	None	None	None	None	None	1.5Wx1	None	USB / USB	Floor Stand	210W 85%	Win10 Pro 64	3-year, Onsite	03/17	Apr 28, 2023
10M7003CUS	US	i3-6100	No	Intel HD 530	None	8GBx1	1TB 7200rpm 3.5"	DVD±RW	Optional 2nd 2.5" Bay	None	3165 ac, 1x1 + BT4.0	None	None	None	None	1.5Wx1	None	USB / USB	Floor Stand	210W 85%	Win10 DG Win7 Pro 64	3-year, Onsite	03/17	Apr 28, 2023
10M7003DUS	US	i3-7100	No	Intel HD 630	None	8GBx1	1TB 7200rpm 3.5"	DVD±RW	Optional 2nd 2.5" Bay	None	3165 ac, 1x1 + BT4.0	None	None	None	None	1.5Wx1	None	USB / USB	Floor Stand	210W 85%	Win10 Pro 64	3-year, Onsite	03/17	Apr 28, 2023
10M7003EUS	US	i7-6700	No	Intel HD 530	None	8GBx1	512GB SSD M.2 PCIe NVMe Opal	DVD±RW	Optional 2nd 2.5" Bay	None	None	None	None	None	None	1.5Wx1	None	USB / USB	Floor Stand	210W 85%	Win10 DG Win7 Pro 64	3-year, Onsite	03/17	Apr 28, 2023
10M7003FUS	US	i3-6100	No	Intel HD 530	None	8GBx1	128GB SSD M.2 PCIe NVMe	DVD±RW	Optional 2nd 2.5" Bay	None	None	None	None	None	None	1.5Wx1	None	USB / USB	Floor Stand	210W 85%	Win10 DG Win7 Pro 64	3-year, Onsite	03/17	Apr 28, 2023
10M7003GUS	US	i7-6700	No	Intel HD 530	None	8GBx1	256GB SSD M.2 PCIe NVMe Opal	DVD±RW	Optional 2nd 2.5" Bay	None	None	None	None	None	None	1.5Wx1	None	USB / USB	Floor Stand	210W 85%	Win10 DG Win7 Pro 64	3-year, Onsite	03/17	Apr 28, 2023
10M7003HUS	US	i7-6700	No	Intel HD 530	None	8GBx1	1TB 7200rpm 3.5"	DVD±RW	Optional 2nd 2.5" Bay	None	3165 ac, 1x1 + BT4.0	None	None	None	None	1.5Wx1	None	USB / USB	Floor Stand	210W 85%	Win10 DG Win7 Pro 64	3-year, Onsite	03/17	Apr 28, 2023
10M7003JUS	US	i5-6500	No	Intel HD 530	None	4GBx1	500GB 7200rpm 3.5"	DVD±RW	Optional 2nd 2.5" Bay	None	3165 ac, 1x1 + BT4.0	None	None	None	None	1.5Wx1	None	USB / USB	Floor Stand	210W 85%	Win10 DG Win7 Pro 64	3-year, Onsite	03/17	Apr 28, 2023
10M7003KUS	US	Pentium G4400	No	Intel HD 510	None	4GBx1	500GB 7200rpm 3.5"	DVD±RW	Optional 2nd 2.5" Bay	None	None	None	None	None	None	1.5Wx1	None	USB / USB	Floor Stand	210W 85%	Win10 DG Win7 Pro 64	3-year, Onsite	03/17	Apr 28, 2023
10M7003LUS	US	i3-7100	No	Intel HD 630	None	8GBx1	1TB 7200rpm 3.5"	DVD±RW	Optional 2nd 2.5" Bay	None	None	None	None	None	None	1.5Wx1	None	USB / USB	Floor Stand	210W 85%	Win10 Pro 64	3-year, Onsite	03/17	Apr 28, 2023
10M7003MUS	US	i5-6500	No	Intel HD 530	None	8GBx1	256GB SSD M.2 PCIe NVMe Opal	DVD±RW	Optional 2nd 2.5" Bay	None	None	None	None	None	None	1.5Wx1	None	USB / USB	Floor Stand	210W 85%	Win10 DG Win7 Pro 64	3-year, Onsite	03/17	Apr 28, 2023

Model	Region	Processor	vPro	Graphics	Monitor Cable	Memory	Storage(HDD/SSD)	Optical	Optional 2nd 2.5" Bay	Media Reader	WLAN + Bluetooth	Optional Front Ports	Optional Rear Ports	Chassis Intrusion Switch	Cable Lock	Speaker	Dust Filter	Keyboard / Mouse	Stand	Power Supply	Operating System	Warranty	Ann Date (mm/yy)	End of Support
10M7003NUS	US	i7-6700	No	GT 730 2GB	None	8GBx1	1TB 7200rpm 3.5"	DVD±RW	Optional 2nd 2.5" Bay	None	None	None	None	None	None	1.5Wx1	None	USB / USB	Floor Stand	210W 85%	Win10 DG Win7 Pro 64	3-year, Onsite	03/17	Apr 28, 2023
10M7003PUS	US	i3-6100	No	Intel HD 530	None	4GBx1	1TB 7200rpm 3.5"	DVD±RW	Optional 2nd 2.5" Bay	None	None	None	None	None	None	1.5Wx1	None	USB / USB	Floor Stand	210W 85%	Win10 DG Win7 Pro 64	3-year, Onsite	03/17	Apr 28, 2023
10M7003QUS	US	i7-6700	No	Intel HD 530	None	8GBx1	1TB 7200rpm 3.5"	DVD±RW	Optional 2nd 2.5" Bay	None	None	None	None	None	None	1.5Wx1	None	USB / USB	Floor Stand	210W 85%	Win10 DG Win7 Pro 64	3-year, Onsite	03/17	Apr 28, 2023
10M7003RUS	US	i5-6500	No	Intel HD 530	None	4GBx1	128GB SSD M.2 PCIe NVMe	DVD±RW	Optional 2nd 2.5" Bay	None	None	None	None	None	None	1.5Wx1	None	USB / USB	Floor Stand	210W 85%	Win10 DG Win7 Pro 64	3-year, Onsite	03/17	Apr 28, 2023
10M7003SUS	US	i5-6500	No	Intel HD 530	None	8GBx1	256GB SSD M.2 PCIe NVMe Opal	DVD±RW	Optional 2nd 2.5" Bay	None	3165 ac, 1x1 + BT4.0	None	None	None	None	1.5Wx1	None	USB / USB	Floor Stand	210W 85%	Win10 DG Win7 Pro 64	3-year, Onsite	03/17	Apr 28, 2023
10M7003TUS	US	i3-6100	No	Intel HD 530	None	4GBx1	500GB 7200rpm 3.5"	DVD±RW	Optional 2nd 2.5" Bay	None	None	None	None	None	None	1.5Wx1	None	USB / USB	Floor Stand	210W 85%	Win10 DG Win7 Pro 64	3-year, Onsite	03/17	Apr 28, 2023
10M7003UUS	US	i3-7100	No	Intel HD 630	None	4GBx1	1TB 7200rpm 3.5"	DVD±RW	Optional 2nd 2.5" Bay	None	None	None	None	None	None	1.5Wx1	None	USB / USB	Floor Stand	210W 85%	Win10 Pro 64	3-year, Onsite	03/17	Apr 28, 2023



ThinkCentre M710 Tiny Platform Specifications

Product Specifications Reference (PSREF)

Processor	Intel® Celeron®, Intel Pentium®, or 6/7th Generation Intel Core™ i3 / i5 / i7 Processor						Security features <ul style="list-style-type: none"> Security slot (in rear for optional Kensington® MicroSaver® cable) Smart USB protection, allows keyboard/mouse only, blocks all storage devices Power-on password Administrator password Hard disk password Boot sequence control Boot without keyboard and mouse Individual USB port disablement Chassis intrusion switch
	Processor	Cores / Threads	Frequency Base/Max(GHz)	Cache	Memory Support (Up to)	Integrated Graphics	
	Pentium G4400T	2 / 2	2.9G	3 MB	DDR4-2133	HD 510	
	Pentium G4560T	2 / 4	2.9G	3 MB	DDR4-2400	HD 610	
	Pentium G4600T	2 / 4	3.0G	3 MB	DDR4-2400	HD 630	
	Core i3-6100T	2 / 4	3.2G	3 MB	DDR4-2133	HD 530	
	Core i5-6500T	4 / 4	2.5G / 3.1G	6 MB	DDR4-2133	HD 530	
	Core i7-6700T	4 / 8	2.8G / 3.6G	8 MB	DDR4-2133	HD 530	
	Core i3-7100T	2 / 4	3.4G	3 MB	DDR4-2400	HD 630	
	Core i5-7400T	4 / 4	2.4G / 3.0G	6 MB	DDR4-2400	HD 630	
Core i5-7500T	4 / 4	2.7G / 3.3G	6 MB	DDR4-2400	HD 630		
Core i5-7600T	4 / 4	2.8G / 3.7G	6 MB	DDR4-2400	HD 630		
Core i7-7700T	4 / 8	2.9G / 3.8G	8 MB	DDR4-2400	HD 630		
Memory	32GB max, DDR4-2400*, two 260-pin SO-DIMM sockets, non-ECC, dual-channel capable * System automatically clocks down for the processors with lower memory controller						
Storage	<i>Some:</i> Hard Drive / SATA 6.0Gb/s, 2.5", 5400 rpm or 7200 rpm <i>Some:</i> Solid State Drive (SSD) / SATA 6.0Gb/s, 2.5" <i>Some:</i> M.2 Solid State Drive (SSD) / PCIe NVMe, PCIe 3.0 x 4, 32Gb/s <i>Some:</i> Intel Optane™ Memory Ready (models with 7th gen Core processor), M.2 <i>Some:</i> DVD-ROM, slim (9.0mm), via USB external ODD box <i>Some:</i> DVD Burner (DVD±RW), slim (9.0mm), via USB external ODD box						
Optical	One onboard SATA 6.0Gb/s connector None						
Onboard SATA Media reader	None						
Graphics	Intel HD Graphics 510/530/610/630 in processor, uses main memory, DirectX® 12, two DisplayPort™, one optional video port (HDMI, VGA, 3rd DP, or USB 3.1 Type-C with DisplayPort Alternate Mode), up to 3 independent displays; <i>Max resolution:</i> 4096x2304 (DP) @60Hz; 4096x2304 (Type-C) @60Hz; 4096x2160 (HDMI) @24Hz; 1920x1200 (VGA) @60Hz						
Monitor cable	Optional DP to VGA, DP to DVI-D (single link), DP to dual DP, or DP to HDMI 1.4						
Chipset	Intel B250 Chipset						
Front ports	Two USB 3.1 Gen1 (one is Always On and fast charge), one microphone (3.5mm), one headphone / microphone combo jack (3.5mm)						
Rear ports	Four USB 3.1 Gen1 (optional external optical box or external I/O box occupies one or two specific USB 3.1 Gen1 on some models), ethernet (RJ-45), two DisplayPort, two optional ports (Port 1 for VGA / 3rd DP / HDMI / serial / USB 3.1 Type-C Gen 1 (with DisplayPort Alternate Mode), Port 2 for serial)						
I/O box	Optional external I/O box, extends two USB 2.0, two USB 3.1 Gen1, and one serial on rear, two USB 2.0 on front, via USB cable (occupy two specific USB 3.1 Gen1 of Tiny)						
Audio support	High Definition (HD) Audio, Realtek ALC294 / optional internal speaker (1w or 2w)						
WLAN ¹³	<i>Some:</i> 11ac wireless, M.2 Card, Qualcomm Atheros QCA9377A (dual band), Wi-Fi + Bluetooth 4.1 combo adapter, 1x1 <i>Some:</i> 11ac wireless, M.2 Card, Qualcomm Atheros QCA6174A (dual band), Wi-Fi + Bluetooth 4.1 combo adapter, 2x2 <i>Some:</i> 11ac wireless, M.2 Card, Intel Dual Band Wireless-AC 3165, Wi-Fi + Bluetooth 4.1 combo adapter, 1x1 <i>Some:</i> 11ac wireless, M.2 Card, Intel Dual Band Wireless-AC 8265, Wi-Fi + Bluetooth 4.1 combo adapter, 2x2						
Bluetooth™	<i>Some:</i> Bluetooth 4.1 wireless, integrated in Wi-Fi + BT combo adapter						
Ethernet	Gigabit ethernet, Intel Ethernet Connection I219-V (Jacksonville), Wake on LAN®						
Modem	None						
Manageability	None						
Security chip	TPM (Trusted Platform Module) 2.0*, TCG Certified * Downgrade to TPM1.2 for the models with Win10 DG Win7 32 OS						
VESA mount	Optional VESA mount bracket kit, supports VESA 75mm and 100mm						
Floor Stand	Optional system floor stand for vertical orientation						
Power supply	65 watts AC/DC adapter, autosensing, 88% PSU (not included for TIO models) 90 watts AC/DC adapter, autosensing, 88% PSU (only for models with I/O box)						
Limited warranty ³	<i>Some:</i> 1-year or 3-year, depot service / service upgrades available <i>Some:</i> 1-year or 3-year, limited onsite service / service upgrades available						
Preload	<i>Some:</i> Windows® 7 Professional 32/64 preinstalled through downgrade rights in Windows 10 Pro 64-bit (not available with 7th Gen Intel processor) <i>Some:</i> Windows 10 Pro 64-bit <i>Some:</i> Windows 10 Home 64-bit Preloaded applications (only some listed) <ul style="list-style-type: none"> Microsoft Office preloaded; purchase a product key to activate Cyberlink PowerDVD Create (DVD±RW) - Only for Window 10 Lenovo Companion Lenovo ID Cyberlink PowerDVD (DVD, DVD±RW) - Only for Window 7 Lenovo Solution Center Lenovo ThinkVantage Tools Create Recovery Media Adobe® Reader® 						
Environment	ENERGY STAR® 6.1, EPEAT™ Gold rating (North America), ErP Lot 3, GREENGUARD®, RoHS-compliant, TUV low noise verified (on some models)						
MIL-SPEC test	MIL-STD-810G military certification (Low Pressure [Altitude], High Temperature, Low Temperature, Temperature Shock, Humidity, Sand and Dust, Vibration, Shock, Fungus, Solar Radiation)						
Accessories	For compatible accessories, please go to http://www.lenovoquickpick.com						

See footnotes for more detailed information

Model	Region	Processor	vPro	Graphics	Monitor Cable	Memory	Storage(HDD/SSD)	External Optical / I/O Box	WLAN + Bluetooth	Optional Rear Ports	Chassis Intrusion Switch	Kensington Cable Lock	Speaker	Adapter Cage	Toolless Chassis Screw	Dust Filter	Keyboard / Mouse	VESA Mount	Stand	Power Supply	Operating System	Warranty	Ann Date (mm/yy)	End of Support
10MR0001US	US	i7-7700T	No	Intel HD 630	None	8GBx1	500GB 7200rpm 2.5"	DVD±RW	8265 ac, 2x2 + BT4.1	HDMI	Switch	None	1Wx1	None	None	None	USB / USB	VESA Mount	None	65W Adapter 88%	Win10 Pro 64	3-year, Onsite	02/17	Mar 21, 2023
10MR0002US	US	i5-7500T	No	Intel HD 630	None	4GBx1	500GB 7200rpm 2.5"	None	3165 ac, 1x1 + BT4.0	VGA	Switch	None	1Wx1	None	None	None	USB / USB	None	Floor Stand	65W Adapter 88%	Win10 Pro 64	3-year, Onsite	02/17	Mar 21, 2023
10MR0003US	US	i7-7700T	No	Intel HD 630	None	8GBx1	256GB SSD M.2 PCIe NVMe Opal	None	8265 ac, 2x2 + BT4.1	3rd DP	Switch	None	1Wx1	None	None	None	USB / USB	None	Floor Stand	65W Adapter 88%	Win10 Pro 64	3-year, Onsite	02/17	Mar 21, 2023
10MR0004US	US	i5-7500T	No	Intel HD 630	None	8GBx1	256GB SSD M.2 PCIe NVMe Opal	None	8265 ac, 2x2 + BT4.1	3rd DP	Switch	None	1Wx1	None	None	None	USB / USB	None	Floor Stand	65W Adapter 88%	Win10 Pro 64	3-year, Onsite	02/17	Feb 21, 2022
10MR0005US	US	i5-7500T	No	Intel HD 630	None	8GBx1	128GB SSD M.2 PCIe NVMe	None	3165 ac, 1x1 + BT4.0	3rd DP	Switch	None	1Wx1	None	None	None	USB / USB	None	Floor Stand	65W Adapter 88%	Win10 Pro 64	3-year, Onsite	02/17	Mar 21, 2023
10MR0006US	US	i5-7500T	No	Intel HD 630	None	8GBx1	500GB 7200rpm 2.5"	DVD±RW	8265 ac, 2x2 + BT4.1	HDMI	Switch	None	1Wx1	None	None	None	USB / USB	VESA Mount	None	65W Adapter 88%	Win10 Pro 64	3-year, Onsite	02/17	Mar 21, 2023
10MR0007US	US	i5-7500T	No	Intel HD 630	None	4GBx1	500GB 7200rpm 2.5"	None	8265 ac, 2x2 + BT4.1	3rd DP	Switch	None	1Wx1	None	None	None	USB / USB	None	Floor Stand	65W Adapter 88%	Win10 Pro 64	3-year, Onsite	02/17	Mar 21, 2023
10MR0008US	US	i5-7500T	No	Intel HD 630	None	4GBx1	500GB 7200rpm 2.5"	None	3165 ac, 1x1 + BT4.0	None	Switch	None	1Wx1	None	None	None	USB / USB	None	Floor Stand	65W Adapter 88%	Win10 Pro 64	3-year, Onsite	02/17	Mar 21, 2023
10MR0009US	US	i5-7500T	No	Intel HD 630	None	4GBx1	500GB 7200rpm 2.5"	None	3165 ac, 1x1 + BT4.0	HDMI	Switch	None	1Wx1	None	None	None	USB / USB	None	Floor Stand	65W Adapter 88%	Win10 Pro 64	3-year, Onsite	02/17	Mar 21, 2023
10MR000AUS	US	i5-7500T	No	Intel HD 630	None	4GBx1	500GB 7200rpm 2.5"	None	8265 ac, 2x2 + BT4.1	None	Switch	None	1Wx1	None	None	None	USB / USB	None	Floor Stand	65W Adapter 88%	Win10 Pro 64	3-year, Onsite	02/17	Mar 21, 2023
10MR000BUS	US	i7-7700T	No	Intel HD 630	None	8GBx1	500GB 7200rpm 2.5"	None	8265 ac, 2x2 + BT4.1	3rd DP	Switch	None	1Wx1	None	None	None	USB / USB	None	Floor Stand	65W Adapter 88%	Win10 Pro 64	3-year, Onsite	02/17	Mar 21, 2023
10MR000CUS	US	i5-7500T	No	Intel HD 630	None	8GBx1	256GB SSD M.2 PCIe NVMe Opal	None	8265 ac, 2x2 + BT4.1	HDMI	Switch	None	1Wx1	None	None	None	USB / USB	None	Floor Stand	65W Adapter 88%	Win10 Pro 64	3-year, Onsite	02/17	Mar 21, 2023
10MR000DUS	US	i5-7500T	No	Intel HD 630	None	8GBx1	128GB SSD M.2 PCIe NVMe	None	8265 ac, 2x2 + BT4.1	HDMI	Switch	None	1Wx1	None	None	None	USB / USB	None	Floor Stand	65W Adapter 88%	Win10 Pro 64	3-year, Onsite	02/17	Mar 21, 2023
10MR000EUS	US	i7-7700T	No	Intel HD 630	None	8GBx1	256GB SSD M.2 PCIe NVMe Opal	None	8265 ac, 2x2 + BT4.1	HDMI	Switch	None	1Wx1	None	None	None	USB / USB	None	Floor Stand	65W Adapter 88%	Win10 Pro 64	3-year, Onsite	02/17	Mar 21, 2023
10MR000FUS	US	i5-7500T	No	Intel HD 630	None	4GBx1	500GB 7200rpm 2.5"	None	3165 ac, 1x1 + BT4.0	3rd DP	Switch	None	1Wx1	None	None	None	USB / USB	None	Floor Stand	65W Adapter 88%	Win10 Pro 64	3-year, Onsite	02/17	Mar 21, 2023
10MR000GUS	US	i5-7500T	No	Intel HD 630	None	4GBx1	500GB 7200rpm 2.5"	None	8265 ac, 2x2 + BT4.1	HDMI	Switch	None	1Wx1	None	None	None	USB / USB	None	Floor Stand	65W Adapter 88%	Win10 Pro 64	3-year, Onsite	02/17	Mar 21, 2023
10MR000HUS	US	i7-7700T	No	Intel HD 630	None	8GBx1	500GB 7200rpm 2.5"	None	8265 ac, 2x2 + BT4.1	HDMI	Switch	None	1Wx1	None	None	None	USB / USB	None	Floor Stand	65W Adapter 88%	Win10 Pro 64	3-year, Onsite	02/17	Mar 21, 2023
10MR000JUS	US	i5-7500T	No	Intel HD 630	None	8GBx1	500GB 7200rpm 2.5"	None	8265 ac, 2x2 + BT4.1	3rd DP	Switch	None	1Wx1	None	None	None	USB / USB	None	Floor Stand	65W Adapter 88%	Win10 Pro 64	3-year, Onsite	02/17	Mar 21, 2023
10MR000KUS	US	i5-7500T	No	Intel HD 630	None	4GBx1	500GB 7200rpm 2.5"	None	3165 ac, 1x1 + BT4.0	Serial	Switch	None	1Wx1	None	None	None	USB / USB	None	Floor Stand	65W Adapter 88%	Win10 Pro 64	3-year, Onsite	02/17	Mar 21, 2023
10MR002PUS	US	i3-7100T	No	Intel HD 630	None	8GBx1	500GB 7200rpm 2.5"	None	3165 ac, 1x1 + BT4.0	VGA	Switch	None	1Wx1	None	None	None	USB / USB	None	Floor Stand	65W Adapter 88%	Win10 Pro 64	3-year, Onsite	03/17	Apr 6, 2023

Model	Region	Processor	vPro	Graphics	Monitor Cable	Memory	Storage(HDD/SSD)	External Optical / I/O Box	WLAN + Bluetooth	Optional Rear Ports	Chassis Intrusion Switch	Kensington Cable Lock	Speaker	Adapter Cage	Toolless Chassis Screw	Dust Filter	Keyboard / Mouse	VESA Mount	Stand	Power Supply	Operating System	Warranty	Ann Date (mm/yy)	End of Support
10MR002QUS	US	i3-7100T	No	Intel HD 630	None	8GBx1	500GB 7200rpm 2.5"	None	3165 ac, 1x1 + BT4.0	3rd DP	Switch	None	1Wx1	None	None	None	USB / USB	None	Floor Stand	65W Adapter 88%	Win10 Pro 64	3-year, Onsite	03/17	Apr 6, 2023
10MR002RUS	US	Pentium G4560T	No	Intel HD 610	None	4GBx1	500GB 7200rpm 2.5"	None	3165 ac, 1x1 + BT4.0	None	Switch	None	1Wx1	None	None	None	USB / USB	None	Floor Stand	65W Adapter 88%	Win10 Pro 64	3-year, Onsite	03/17	Apr 6, 2023
10MR002SUS	US	i3-7100T	No	Intel HD 630	None	8GBx1	500GB 7200rpm 2.5"	None	3165 ac, 1x1 + BT4.0	None	Switch	None	1Wx1	None	None	None	USB / USB	None	Floor Stand	65W Adapter 88%	Win10 Pro 64	3-year, Onsite	03/17	Apr 6, 2023
10MR002TUS	US	i3-7100T	No	Intel HD 630	None	8GBx1	256GB SSD M.2 PCIe NVMe Opal	None	3165 ac, 1x1 + BT4.0	3rd DP	Switch	None	1Wx1	None	None	None	USB / USB	None	Floor Stand	65W Adapter 88%	Win10 Pro 64	3-year, Onsite	03/17	Apr 6, 2023
10MR002UUS	US	i3-7100T	No	Intel HD 630	None	8GBx1	500GB 7200rpm 2.5"	None	3165 ac, 1x1 + BT4.0	Serial	Switch	None	1Wx1	None	None	None	USB / USB	None	Floor Stand	65W Adapter 88%	Win10 Pro 64	3-year, Onsite	03/17	Apr 6, 2023
10MR002VUS	US	i3-7100T	No	Intel HD 630	None	4GBx1	500GB 7200rpm 2.5"	None	3165 ac, 1x1 + BT4.0	None	Switch	None	1Wx1	None	None	None	USB / USB	None	Floor Stand	65W Adapter 88%	Win10 Pro 64	3-year, Onsite	03/17	Apr 6, 2023
10MR002WUS	US	i3-7100T	No	Intel HD 630	None	8GBx1	128GB SSD M.2 PCIe NVMe	None	3165 ac, 1x1 + BT4.0	None	Switch	None	1Wx1	None	None	None	USB / USB	None	Floor Stand	65W Adapter 88%	Win10 Pro 64	3-year, Onsite	03/17	Apr 6, 2023
10MR002XUS	US	i3-7100T	No	Intel HD 630	None	8GBx1	128GB SSD M.2 PCIe NVMe	None	3165 ac, 1x1 + BT4.0	3rd DP	Switch	None	1Wx1	None	None	None	USB / USB	None	Floor Stand	65W Adapter 88%	Win10 Pro 64	3-year, Onsite	03/17	Apr 6, 2023
10MR003UUS	US	i5-7500T	No	Intel HD 630	None	8GBx1	128GB SSD M.2 PCIe NVMe	None	8265 ac, 2x2 + BT4.1	3rd DP	Switch	None	1Wx1	None	None	None	USB / USB	None	Floor Stand	65W Adapter 88%	Win10 Pro 64	3-year, Onsite	03/17	Apr 21, 2023
10MR003VUS	US	i5-7500T	No	Intel HD 630	None	8GBx1	512GB SSD M.2 PCIe NVMe Opal	None	8265 ac, 2x2 + BT4.1	3rd DP	Switch	None	1Wx1	None	None	None	USB / USB	None	Floor Stand	65W Adapter 88%	Win10 Pro 64	3-year, Onsite	03/17	Apr 21, 2023
10MR003WUS	US	i7-7700T	No	Intel HD 630	None	8GBx1	512GB SSD M.2 PCIe NVMe Opal	None	8265 ac, 2x2 + BT4.1	3rd DP	Switch	None	1Wx1	None	None	None	USB / USB	None	Floor Stand	65W Adapter 88%	Win10 Pro 64	3-year, Onsite	03/17	Apr 21, 2023
10MR003XUS	US	i5-7400T	No	Intel HD 630	None	4GBx1	500GB 7200rpm 2.5"	None	8265 ac, 2x2 + BT4.1	3rd DP	Switch	None	1Wx1	None	None	None	USB / USB	None	Floor Stand	65W Adapter 88%	Win10 Pro 64	3-year, Onsite	03/17	Apr 21, 2023
10MR003YUS	US	i5-7400T	No	Intel HD 630	None	8GBx1	500GB 7200rpm 2.5"	None	8265 ac, 2x2 + BT4.1	3rd DP	Switch	None	1Wx1	None	None	None	USB / USB	None	Floor Stand	65W Adapter 88%	Win10 Pro 64	3-year, Onsite	03/17	Apr 21, 2023
10MR0040US	US	i5-7400T	No	Intel HD 630	None	4GBx1	500GB 7200rpm 2.5"	None	3165 ac, 1x1 + BT4.0	3rd DP	Switch	None	1Wx1	None	None	None	USB / USB	None	Floor Stand	65W Adapter 88%	Win10 Pro 64	3-year, Onsite	03/17	Apr 21, 2023
10MR0041US	US	i5-7400T	No	Intel HD 630	None	8GBx1	500GB 7200rpm 2.5"	None	3165 ac, 1x1 + BT4.0	3rd DP	Switch	None	1Wx1	None	None	None	USB / USB	None	Floor Stand	65W Adapter 88%	Win10 Pro 64	3-year, Onsite	03/17	Apr 21, 2023
10MR0042US	US	i5-7400T	No	Intel HD 630	None	8GBx1	128GB SSD M.2 PCIe NVMe	None	3165 ac, 1x1 + BT4.0	3rd DP	Switch	None	1Wx1	None	None	None	USB / USB	None	Floor Stand	65W Adapter 88%	Win10 Pro 64	3-year, Onsite	03/17	Apr 21, 2023
10MR0043US	US	i5-7400T	No	Intel HD 630	None	8GBx1	128GB SSD M.2 PCIe NVMe	None	8265 ac, 2x2 + BT4.1	3rd DP	Switch	None	1Wx1	None	None	None	USB / USB	None	Floor Stand	65W Adapter 88%	Win10 Pro 64	3-year, Onsite	03/17	Apr 21, 2023
10MR0044US	US	i5-7400T	No	Intel HD 630	None	8GBx1	256GB SSD M.2 PCIe NVMe Opal	None	8265 ac, 2x2 + BT4.1	3rd DP	Switch	None	1Wx1	None	None	None	USB / USB	None	Floor Stand	65W Adapter 88%	Win10 Pro 64	3-year, Onsite	03/17	Apr 21, 2023
10MR0045US	US	i3-6100T	No	Intel HD 530	None	4GBx1	500GB 7200rpm 2.5"	None	3165 ac, 1x1 + BT4.0	None	Switch	None	1Wx1	None	None	None	USB / USB	None	Floor Stand	65W Adapter 88%	Win10 DG Win7 Pro 64	3-year, Onsite	03/17	Apr 21, 2023
10MR0046US	US	i7-6700T	No	Intel HD 530	None	8GBx1	256GB SSD M.2 PCIe NVMe Opal	None	8265 ac, 2x2 + BT4.1	3rd DP	Switch	None	1Wx1	None	None	None	USB / USB	None	Floor Stand	65W Adapter 88%	Win10 DG Win7 Pro 64	3-year, Onsite	03/17	Apr 21, 2023

Model	Region	Processor	vPro	Graphics	Monitor Cable	Memory	Storage(HDD/SSD)	External Optical / I/O Box	WLAN + Bluetooth	Optional Rear Ports	Chassis Intrusion Switch	Kensington Cable Lock	Speaker	Adapter Cage	Toolless Chassis Screw	Dust Filter	Keyboard / Mouse	VESA Mount	Stand	Power Supply	Operating System	Warranty	Ann Date (mm/yy)	End of Support
10MR0047US	US	i5-6500T	No	Intel HD 530	None	8GBx1	256GB SSD M.2 PCIe NVMe Opal	None	8265 ac, 2x2 + BT4.1	3rd DP	Switch	None	1Wx1	None	None	None	USB / USB	None	Floor Stand	65W Adapter 88%	Win10 DG Win7 Pro 64	3-year, Onsite	03/17	Mar 21, 2022
10MR0048US	US	i5-6500T	No	Intel HD 530	None	8GBx1	500GB 7200rpm 2.5"	None	3165 ac, 1x1 + BT4.0	3rd DP	Switch	None	1Wx1	None	None	None	USB / USB	None	Floor Stand	65W Adapter 88%	Win10 DG Win7 Pro 64	3-year, Onsite	03/17	Apr 21, 2023
10MR0049US	US	i3-6100T	No	Intel HD 530	None	4GBx1	500GB 7200rpm 2.5"	None	3165 ac, 1x1 + BT4.0	3rd DP	Switch	None	1Wx1	None	None	None	USB / USB	None	Floor Stand	65W Adapter 88%	Win10 DG Win7 Pro 64	3-year, Onsite	03/17	Apr 21, 2023
10MR004AUS	US	i3-6100T	No	Intel HD 530	None	4GBx1	128GB SSD M.2 PCIe NVMe	None	3165 ac, 1x1 + BT4.0	3rd DP	Switch	None	1Wx1	None	None	None	USB / USB	None	Floor Stand	65W Adapter 88%	Win10 DG Win7 Pro 64	3-year, Onsite	03/17	Apr 21, 2023
10MR004BUS	US	i5-6500T	No	Intel HD 530	None	8GBx1	512GB SSD M.2 PCIe NVMe Opal	None	8265 ac, 2x2 + BT4.1	3rd DP	Switch	None	1Wx1	None	None	None	USB / USB	None	Floor Stand	65W Adapter 88%	Win10 DG Win7 Pro 64	3-year, Onsite	03/17	Apr 21, 2023
10MR004CUS	US	i5-6500T	No	Intel HD 530	None	8GBx1	500GB 7200rpm 2.5"	DVD±RW	8265 ac, 2x2 + BT4.1	HDMI	Switch	None	1Wx1	None	None	None	USB / USB	VESA Mount	None	65W Adapter 88%	Win10 DG Win7 Pro 64	3-year, Onsite	03/17	Apr 21, 2023
10MR004DUS	US	i7-6700T	No	Intel HD 530	None	8GBx1	500GB 7200rpm 2.5"	None	8265 ac, 2x2 + BT4.1	3rd DP	Switch	None	1Wx1	None	None	None	USB / USB	None	Floor Stand	65W Adapter 88%	Win10 DG Win7 Pro 64	3-year, Onsite	03/17	Apr 21, 2023
10MR004EUS	US	i3-6100T	No	Intel HD 530	None	8GBx1	500GB 7200rpm 2.5"	None	3165 ac, 1x1 + BT4.0	3rd DP	Switch	None	1Wx1	None	None	None	USB / USB	None	Floor Stand	65W Adapter 88%	Win10 DG Win7 Pro 64	3-year, Onsite	03/17	Apr 21, 2023
10MR004FUS	US	i5-6500T	No	Intel HD 530	None	4GBx1	500GB 7200rpm 2.5"	None	3165 ac, 1x1 + BT4.0	3rd DP	Switch	None	1Wx1	None	None	None	USB / USB	None	Floor Stand	65W Adapter 88%	Win10 DG Win7 Pro 64	3-year, Onsite	03/17	Apr 21, 2023
10MR004GUS	US	i3-6100T	No	Intel HD 530	None	8GBx1	500GB 7200rpm 2.5"	DVD±RW	3165 ac, 1x1 + BT4.0	HDMI	Switch	None	1Wx1	None	None	None	USB / USB	VESA Mount	None	65W Adapter 88%	Win10 DG Win7 Pro 64	3-year, Onsite	03/17	Apr 21, 2023
10MR004HUS	US	i5-6500T	No	Intel HD 530	None	8GBx1	128GB SSD M.2 PCIe NVMe	None	8265 ac, 2x2 + BT4.1	3rd DP	Switch	None	1Wx1	None	None	None	USB / USB	None	Floor Stand	65W Adapter 88%	Win10 DG Win7 Pro 64	3-year, Onsite	03/17	Apr 21, 2023
10MR004JUS	US	i3-6100T	No	Intel HD 530	None	8GBx1	128GB SSD M.2 PCIe NVMe	None	3165 ac, 1x1 + BT4.0	3rd DP	Switch	None	1Wx1	None	None	None	USB / USB	None	Floor Stand	65W Adapter 88%	Win10 DG Win7 Pro 64	3-year, Onsite	03/17	Apr 21, 2023
10MR004KUS	US	i7-6700T	No	Intel HD 530	None	8GBx1	512GB SSD M.2 PCIe NVMe Opal	None	8265 ac, 2x2 + BT4.1	3rd DP	Switch	None	1Wx1	None	None	None	USB / USB	None	Floor Stand	65W Adapter 88%	Win10 DG Win7 Pro 64	3-year, Onsite	03/17	Apr 21, 2023
10MR004LUS	US	i7-6700T	No	Intel HD 530	None	8GBx1	500GB 7200rpm 2.5"	DVD±RW	8265 ac, 2x2 + BT4.1	HDMI	Switch	None	1Wx1	None	None	None	USB / USB	VESA Mount	None	65W Adapter 88%	Win10 DG Win7 Pro 64	3-year, Onsite	03/17	Apr 21, 2023
10MR004MUS	US	i5-6500T	No	Intel HD 530	None	8GBx1	128GB SSD M.2 PCIe NVMe	None	3165 ac, 1x1 + BT4.0	3rd DP	Switch	None	1Wx1	None	None	None	USB / USB	None	Floor Stand	65W Adapter 88%	Win10 DG Win7 Pro 64	3-year, Onsite	03/17	Apr 21, 2023

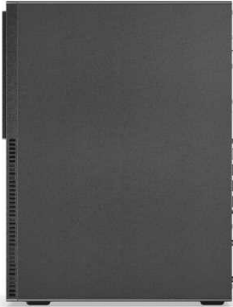

ThinkCentre M710 Tower Platform Specifications

Product Specifications Reference (PSREF)

Processor	Intel® Celeron®, Intel Pentium®, or 6/7th Generation Intel Core™ i3 / i5 / i7 Processor						Manageability	None																																																																								
	<table border="1"> <thead> <tr> <th>Processor</th> <th>Cores / Threads</th> <th>Frequency Base/Max(GHz)</th> <th>Cache</th> <th>Memory Support (Up to)</th> <th>Integrated Graphics</th> </tr> </thead> <tbody> <tr> <td>Pentium G4400</td> <td>2 / 2</td> <td>3.3G</td> <td>3 MB</td> <td>DDR4-2133</td> <td>HD 510</td> </tr> <tr> <td>Pentium G4560</td> <td>2 / 4</td> <td>3.5G</td> <td>3 MB</td> <td>DDR4-2400</td> <td>HD 610</td> </tr> <tr> <td>Pentium G4600</td> <td>2 / 4</td> <td>3.6G</td> <td>3 MB</td> <td>DDR4-2400</td> <td>HD 630</td> </tr> <tr> <td>Core i3-6100</td> <td>2 / 4</td> <td>3.7G</td> <td>3 MB</td> <td>DDR4-2133</td> <td>HD 530</td> </tr> <tr> <td>Core i5-6500</td> <td>4 / 4</td> <td>3.2G / 3.6G</td> <td>6 MB</td> <td>DDR4-2133</td> <td>HD 530</td> </tr> <tr> <td>Core i7-6700</td> <td>4 / 8</td> <td>3.4G / 4.0G</td> <td>8 MB</td> <td>DDR4-2133</td> <td>HD 530</td> </tr> <tr> <td>Core i3-7100</td> <td>2 / 4</td> <td>3.9G</td> <td>3 MB</td> <td>DDR4-2400</td> <td>HD 630</td> </tr> <tr> <td>Core i5-7400</td> <td>4 / 4</td> <td>3.0G / 3.5G</td> <td>6 MB</td> <td>DDR4-2400</td> <td>HD 630</td> </tr> <tr> <td>Core i5-7500</td> <td>4 / 4</td> <td>3.4G / 3.8G</td> <td>6 MB</td> <td>DDR4-2400</td> <td>HD 630</td> </tr> <tr> <td>Core i5-7600</td> <td>4 / 4</td> <td>3.5G / 4.1G</td> <td>6 MB</td> <td>DDR4-2400</td> <td>HD 630</td> </tr> <tr> <td>Core i7-7700</td> <td>4 / 8</td> <td>3.6G / 4.2G</td> <td>8 MB</td> <td>DDR4-2400</td> <td>HD 630</td> </tr> </tbody> </table>						Processor	Cores / Threads	Frequency Base/Max(GHz)	Cache	Memory Support (Up to)	Integrated Graphics	Pentium G4400	2 / 2	3.3G	3 MB	DDR4-2133	HD 510	Pentium G4560	2 / 4	3.5G	3 MB	DDR4-2400	HD 610	Pentium G4600	2 / 4	3.6G	3 MB	DDR4-2400	HD 630	Core i3-6100	2 / 4	3.7G	3 MB	DDR4-2133	HD 530	Core i5-6500	4 / 4	3.2G / 3.6G	6 MB	DDR4-2133	HD 530	Core i7-6700	4 / 8	3.4G / 4.0G	8 MB	DDR4-2133	HD 530	Core i3-7100	2 / 4	3.9G	3 MB	DDR4-2400	HD 630	Core i5-7400	4 / 4	3.0G / 3.5G	6 MB	DDR4-2400	HD 630	Core i5-7500	4 / 4	3.4G / 3.8G	6 MB	DDR4-2400	HD 630	Core i5-7600	4 / 4	3.5G / 4.1G	6 MB	DDR4-2400	HD 630	Core i7-7700	4 / 8	3.6G / 4.2G	8 MB	DDR4-2400	HD 630	Security chip	TPM (Trusted Platform Module) 2.0, TCG Certified * Downgrade to TPM1.2 for the models with Win10 DG Win7 32 OS
	Processor	Cores / Threads	Frequency Base/Max(GHz)	Cache	Memory Support (Up to)	Integrated Graphics																																																																										
	Pentium G4400	2 / 2	3.3G	3 MB	DDR4-2133	HD 510																																																																										
	Pentium G4560	2 / 4	3.5G	3 MB	DDR4-2400	HD 610																																																																										
	Pentium G4600	2 / 4	3.6G	3 MB	DDR4-2400	HD 630																																																																										
	Core i3-6100	2 / 4	3.7G	3 MB	DDR4-2133	HD 530																																																																										
	Core i5-6500	4 / 4	3.2G / 3.6G	6 MB	DDR4-2133	HD 530																																																																										
	Core i7-6700	4 / 8	3.4G / 4.0G	8 MB	DDR4-2133	HD 530																																																																										
	Core i3-7100	2 / 4	3.9G	3 MB	DDR4-2400	HD 630																																																																										
	Core i5-7400	4 / 4	3.0G / 3.5G	6 MB	DDR4-2400	HD 630																																																																										
Core i5-7500	4 / 4	3.4G / 3.8G	6 MB	DDR4-2400	HD 630																																																																											
Core i5-7600	4 / 4	3.5G / 4.1G	6 MB	DDR4-2400	HD 630																																																																											
Core i7-7700	4 / 8	3.6G / 4.2G	8 MB	DDR4-2400	HD 630																																																																											
						Security features	<ul style="list-style-type: none"> Security slot (in rear for optional Kensington® MicroSaver® cable) Padlock loop Smart USB protection, allows keyboard/mouse only, blocks all storage devices Optional cable lock to physically lock both keyboard and mouse Power-on password Administrator password Hard disk password Boot sequence control Boot without keyboard and mouse Individual USB port disablement Optional chassis intrusion switch 																																																																									
						Keyboard	<i>Some:</i> Lenovo Calliope Keyboard (USB connector), black <i>Some:</i> Lenovo Traditional Keyboard (USB connector), black <i>Some:</i> Lenovo Calliope Wireless Keyboard (2.4GHz via USB receiver), black <i>Some:</i> Lenovo Calliope Mouse (USB connector), black <i>Some:</i> Lenovo Calliope Wireless Mouse (2.4GHz via USB receiver), black																																																																									
						Mouse	<i>Some:</i> Lenovo Calliope Mouse (USB connector), black <i>Some:</i> Lenovo Calliope Wireless Mouse (2.4GHz via USB receiver), black																																																																									
Memory	64GB max, UDIMM, DDR4-2400*, four 288-pin DIMM sockets, non-ECC, dual-channel capable * System automatically clocks down for the processors with lower memory controller						Mechanical	<ul style="list-style-type: none"> Tower (15L), black color, metal case (WxDxH) 5.7" X 11.5" X 14.4"; 145mm X 292.7mm X 366mm Approx. 14.3 lb (6.5 kg), weight may vary by configuration Optional dust filter Bay 1: Slim external ODD bay Bay 2: 3.5", 1" high, internal, HDD/SSD Bay 3: 3.5", 1" high, internal, HDD/SSD Slot 1: half-length, full-height, PCIe 3.0 x16* Slot 2: half-length, full-height, PCIe 3.0 x1* Slot 3: half-length, full-height, PCIe 3.0 x1* Slot 4: no slot, only bracket for optional port extension* M.2 card slots: Two (one for WLAN, one for SSD/Optane) * Optional front USB3.1 Type-C x2 module occupies PCIe x16 slot (x4 card), optional rear 2x USB2.0 / parallel occupies one expansion slot 																																																																								
Storage	<i>Some:</i> Hard Drive / SATA 6.0Gb/s, 2.5" or 3.5", 5400 rpm or 7200 rpm <i>Some:</i> Solid State Drive (SSD) / SATA 6.0Gb/s, 2.5" <i>Some:</i> M.2 Solid State Drive (SSD) / PCIe NVMe, PCIe 3.0 x 4, 32Gb/s <i>Some:</i> Intel Optane™ Memory Ready (models with 7th gen Core processor), M.2 <i>Some:</i> DVD-ROM SATA 1.5Gb/s Drive, slim (9.0mm)						Power supply	<i>Some:</i> 180 watts, autosensing, 85% PSU <i>Some:</i> 210 watts, autosensing, 85% PSU <i>Some:</i> 210 watts, autosensing, 92% PSU (only available via special bid)																																																																								
Optical	<i>Some:</i> Intel Optane™ Memory Ready (models with 7th gen Core processor), M.2 <i>Some:</i> DVD-ROM SATA 1.5Gb/s Drive, slim (9.0mm) <i>Some:</i> DVD Burner (DVD±RW), SATA 1.5Gb/s Drive, slim (9.0mm)						Limited warranty ³	<i>Some:</i> 1-year or 3-year, depot service / service upgrades available <i>Some:</i> 1-year or 3-year, limited onsite service / service upgrades available																																																																								
Onboard SATA Media reader	Three onboard SATA 6.0Gb/s connectors Optional 7-in-1 media reader						Preload	Preloaded operating system <i>Some:</i> Windows® 7 Professional 32/64 preinstalled through downgrade rights in Windows 10 Pro 64-bit (not available with 7th Gen Intel processor) <i>Some:</i> Windows 10 Pro 64-bit <i>Some:</i> Windows 10 Home 64-bit																																																																								
Graphics	Intel HD Graphics 510/530/610/630 in processor, uses main memory, DirectX® 12, one VGA, two DisplayPort™, supports 3 independent displays, works along with discrete graphics to support more displays; <i>Max resolution:</i> 4096x2304 (DP) @60Hz; 2048x1536 (VGA) @50Hz <i>Some:</i> NVIDIA GeForce® GT 730 , DirectX 12, 2GB, PCIe 2.0 x8 adapter, two DisplayPort, 35 watts; <i>Max resolution:</i> 3840x2160 (DisplayPort) @60Hz; <i>Some:</i> AMD Radeon™ R7 350 , DirectX 11, 2GB, PCIe 3.0 x8 adapter, one VGA, one HDMI, 75 watts, occupies two slots; <i>Max resolution:</i> 4096x2160 (HDMI) @24Hz; 2048x1536 (VGA) @85Hz						Preloaded applications (only some listed)	<ul style="list-style-type: none"> Microsoft Office preloaded; purchase a product key to activate Cyberlink PowerDVD Create (DVD±RW) Only for Window 10 Lenovo Companion Lenovo ID Cyberlink PowerDVD (DVD, DVD±RW) Only for Window 7 Lenovo Solution Center Lenovo ThinkVantage Tools Create Recovery Media Adobe® Reader® 																																																																								
Monitor Cable	Optional DP to VGA, DP to DVI-D (single link), DP to dual DP, or DP to HDMI 1.4						Environment	ENERGY STAR® 6.1, EPEAT™ Gold rating (North America), ErP Lot 3, GREENGUARD®, RoHS-compliant, TUV low noise verified (on some models)																																																																								
Chipset	Intel B250 Chipset						Accessories	For compatible accessories, please go to http://www.lenovoquickpick.com																																																																								
Front ports	Four USB 3.1 Gen1, optional two USB 3.1 Type-C Gen 2 (only available via special bid), microphone (3.5mm), headphone (3.5mm)																																																																															
Rear ports	Two USB 3.1 Gen1, two USB 2.0, optional two USB 2.0, serial (9-pin), optional 2nd serial (9-pin), optional parallel (25-pin), ethernet (RJ-45), one VGA, two DisplayPort, two PS/2 ports (keyboard/mouse); additional VGA, DisplayPort, or HDMI on optional graphics on some models																																																																															
Rear audio ports IEEE 1394	Line-in (3.5mm), line-out (3.5mm), microphone-in (3.5mm) None																																																																															
Audio support	High Definition (HD) Audio, Realtek ALC662 / optional internal speaker (1.5 watt)																																																																															
WLAN ¹³	<i>Some:</i> 11ac wireless, M.2 Card, Qualcomm Atheros QCA9377A (dual band), Wi-Fi + Bluetooth 4.1 combo adapter, 1x1 <i>Some:</i> 11ac wireless, M.2 Card, Qualcomm Atheros QCA6174A (dual band), Wi-Fi + Bluetooth 4.1 combo adapter, 2x2 <i>Some:</i> 11ac wireless, M.2 Card, Intel Dual Band Wireless-AC 3165, Wi-Fi + Bluetooth 4.1 combo adapter, 1x1 <i>Some:</i> 11ac wireless, M.2 Card, Intel Dual Band Wireless-AC 8265, Wi-Fi + Bluetooth 4.1 combo adapter, 2x2																																																																															
Bluetooth™	<i>Some:</i> Bluetooth 4.1 wireless, integrated in Wi-Fi + BT combo adapter																																																																															
Ethernet	Gigabit ethernet, Realtek RTL8111GN, Wake on LAN®																																																																															
Modem	None																																																																															

See footnotes for more detailed information

Model	Region	Processor	vPro	Graphics	Monitor Cable	Memory	Storage(HDD/SSD)	Optical	Media Reader	WLAN + Bluetooth	Optional Front Ports	Optional Rear Ports	Chassis Intrusion Switch	Cable Lock	Speaker	Dust Filter	Keyboard / Mouse	Power Supply	Operating System	Warranty	Ann Date (mm/yy)	End of Support
10M9000EUS	US	i7-7700	No	GT 730 2GB	None	8GBx1	256GB SSD M.2 PCIe NVMe Opal	DVD±RW	None	3165 ac, 1x1 + BT4.0	None	None	None	None	1.5Wx1	None	USB / USB	210W 85%	Win10 Pro 64	3-year, Onsite	02/17	Mar 21, 2023
10M9000FUS	US	i5-7400	No	Intel HD 630	None	8GBx1	256GB SSD M.2 PCIe NVMe Opal	DVD±RW	None	None	None	None	None	None	1.5Wx1	None	USB / USB	210W 85%	Win10 Pro 64	3-year, Onsite	02/17	Feb 21, 2022
10M9000GUS	US	i7-7700	No	GT 730 2GB	None	8GBx1	1TB 7200rpm 3.5"	DVD±RW	None	None	None	None	None	None	1.5Wx1	None	USB / USB	210W 85%	Win10 Pro 64	3-year, Onsite	02/17	Mar 21, 2023
10M9000HUS	US	i5-7400	No	Intel HD 630	None	8GBx1	256GB SSD M.2 PCIe NVMe Opal	DVD±RW	None	3165 ac, 1x1 + BT4.0	None	None	None	None	1.5Wx1	None	USB / USB	210W 85%	Win10 Pro 64	3-year, Onsite	02/17	Mar 21, 2023
10M9000JUS	US	i5-7400	No	GT 730 2GB	None	8GBx1	1TB 7200rpm 3.5"	DVD±RW	None	None	None	None	None	None	1.5Wx1	None	USB / USB	210W 85%	Win10 Pro 64	3-year, Onsite	02/17	Mar 21, 2023
10M9000KUS	US	i7-7700	No	Intel HD 630	None	8GBx1	256GB SSD M.2 PCIe NVMe Opal	DVD±RW	None	3165 ac, 1x1 + BT4.0	None	None	None	None	1.5Wx1	None	USB / USB	210W 85%	Win10 Pro 64	3-year, Onsite	02/17	Mar 21, 2023
10M9000LUS	US	i7-7700	No	Intel HD 630	None	8GBx1	256GB SSD M.2 PCIe NVMe Opal	DVD±RW	None	None	None	None	None	None	1.5Wx1	None	USB / USB	210W 85%	Win10 Pro 64	3-year, Onsite	02/17	Feb 21, 2022
10M9000MUS	US	i5-7400	No	Intel HD 630	None	8GBx1	512GB SSD M.2 PCIe NVMe Opal	DVD±RW	None	None	None	None	None	None	1.5Wx1	None	USB / USB	210W 85%	Win10 Pro 64	3-year, Onsite	02/17	Feb 21, 2022
10M9000NUS	US	i5-7400	No	Intel HD 630	None	4GBx1	500GB 7200rpm 3.5"	DVD±RW	None	None	None	None	None	None	1.5Wx1	None	USB / USB	210W 85%	Win10 Pro 64	3-year, Onsite	02/17	Mar 21, 2023
10M9000PUS	US	i5-7400	No	GT 730 2GB	None	8GBx1	256GB SSD M.2 PCIe NVMe Opal	DVD±RW	None	None	None	None	None	None	1.5Wx1	None	USB / USB	210W 85%	Win10 Pro 64	3-year, Onsite	02/17	Feb 21, 2022
10M9000QUS	US	i7-7700	No	Intel HD 630	None	8GBx1	512GB SSD M.2 PCIe NVMe Opal	DVD±RW	None	None	None	None	None	None	1.5Wx1	None	USB / USB	210W 85%	Win10 Pro 64	3-year, Onsite	02/17	Feb 21, 2022
10M9000RUS	US	i5-7400	No	Intel HD 630	None	8GBx1	1TB 7200rpm 3.5"	DVD±RW	None	None	None	None	None	None	1.5Wx1	None	USB / USB	210W 85%	Win10 Pro 64	3-year, Onsite	02/17	Mar 21, 2023
10M9000SUS	US	i5-7400	No	GT 730 2GB	None	8GBx1	256GB SSD M.2 PCIe NVMe Opal	DVD±RW	None	3165 ac, 1x1 + BT4.0	None	None	None	None	1.5Wx1	None	USB / USB	210W 85%	Win10 Pro 64	3-year, Onsite	02/17	Mar 21, 2023
10M9000TUS	US	i7-7700	No	Intel HD 630	None	8GBx1	1TB 7200rpm 3.5"	DVD±RW	None	None	None	None	None	None	1.5Wx1	None	USB / USB	210W 85%	Win10 Pro 64	3-year, Onsite	02/17	Mar 21, 2023
10M9000UUS	US	i7-7700	No	GT 730 2GB	None	8GBx1	256GB SSD M.2 PCIe NVMe Opal	DVD±RW	None	None	None	None	None	None	1.5Wx1	None	USB / USB	210W 85%	Win10 Pro 64	3-year, Onsite	02/17	Feb 21, 2022
10M9002UUS	US	i3-6100	No	Intel HD 530	None	4GBx1	1TB 7200rpm 3.5"	DVD±RW	None	None	None	None	None	None	1.5Wx1	None	USB / USB	210W 85%	Win10 DG Win7 Pro 64	3-year, Onsite	03/17	Apr 28, 2023
10M9002VUS	US	i3-6100	No	Intel HD 530	None	8GBx1	1TB 7200rpm 3.5"	DVD±RW	None	None	None	None	None	None	1.5Wx1	None	USB / USB	210W 85%	Win10 DG Win7 Pro 64	3-year, Onsite	03/17	Apr 28, 2023
10M9002WUS	US	Pentium G4400	No	Intel HD 510	None	4GBx1	500GB 7200rpm 3.5"	DVD±RW	None	None	None	None	None	None	1.5Wx1	None	USB / USB	210W 85%	Win10 DG Win7 Pro 64	3-year, Onsite	03/17	Apr 28, 2023
10M9002XUS	US	i5-6500	No	Intel HD 530	None	8GBx1	256GB SSD M.2 PCIe NVMe Opal	DVD±RW	None	3165 ac, 1x1 + BT4.0	None	None	None	None	1.5Wx1	None	USB / USB	210W 85%	Win10 DG Win7 Pro 64	3-year, Onsite	03/17	Mar 28, 2022
10M9002YUS	US	i7-6700	No	Intel HD 530	None	8GBx1	512GB SSD M.2 PCIe NVMe Opal	DVD±RW	None	None	None	None	None	None	1.5Wx1	None	USB / USB	210W 85%	Win10 DG Win7 Pro 64	3-year, Onsite	03/17	Mar 28, 2022

Model	Region	Processor	vPro	Graphics	Monitor Cable	Memory	Storage(HDD/SSD)	Optical	Media Reader	WLAN + Bluetooth	Optional Front Ports	Optional Rear Ports	Chassis Intrusion Switch	Cable Lock	Speaker	Dust Filter	Keyboard / Mouse	Power Supply	Operating System	Warranty	Ann Date (mm/yy)	End of Support
10M90030US	US	i7-6700	No	GT 730 2GB	None	8GBx1	1TB 7200rpm 3.5"	DVD±RW	None	None	None	None	None	None	1.5Wx1	None	USB / USB	210W 85%	Win10 DG Win7 Pro 64	3-year, Onsite	03/17	Apr 28, 2023
10M90031US	US	i5-6500	No	Intel HD 530	None	8GBx1	256GB SSD M.2 PCIe NVMe Opal	DVD±RW	None	None	None	None	None	None	1.5Wx1	None	USB / USB	210W 85%	Win10 DG Win7 Pro 64	3-year, Onsite	03/17	Mar 28, 2022
10M90032US	US	i5-7400	No	Intel HD 630	None	4GBx1	128GB SSD M.2 PCIe NVMe	DVD±RW	None	None	None	None	None	None	1.5Wx1	None	USB / USB	210W 85%	Win10 Pro 64	3-year, Onsite	03/17	Mar 28, 2022
10M90033US	US	i7-6700	No	GT 730 2GB	None	8GBx1	256GB SSD M.2 PCIe NVMe Opal	DVD±RW	None	3165 ac, 1x1 + BT4.0	None	None	None	None	1.5Wx1	None	USB / USB	210W 85%	Win10 DG Win7 Pro 64	3-year, Onsite	03/17	Mar 28, 2022
10M90034US	US	i7-6700	No	Intel HD 530	None	8GBx1	256GB SSD M.2 PCIe NVMe Opal	DVD±RW	None	3165 ac, 1x1 + BT4.0	None	None	None	None	1.5Wx1	None	USB / USB	210W 85%	Win10 DG Win7 Pro 64	3-year, Onsite	03/17	Mar 28, 2022
10M90035US	US	i3-7100	No	Intel HD 630	None	8GBx1	128GB SSD M.2 PCIe NVMe	DVD±RW	None	None	None	None	None	None	1.5Wx1	None	USB / USB	210W 85%	Win10 Pro 64	3-year, Onsite	03/17	Mar 28, 2022
10M90036US	US	i5-6500	No	Intel HD 530	None	4GBx1	500GB 7200rpm 3.5"	DVD±RW	None	None	None	None	None	None	1.5Wx1	None	USB / USB	210W 85%	Win10 DG Win7 Pro 64	3-year, Onsite	03/17	Apr 28, 2023
10M90037US	US	i3-7100	No	Intel HD 630	None	8GBx1	1TB 7200rpm 3.5"	DVD±RW	None	None	None	None	None	None	1.5Wx1	None	USB / USB	210W 85%	Win10 Pro 64	3-year, Onsite	03/17	Apr 28, 2023
10M90038US	US	i5-6500	No	GT 730 2GB	None	8GBx1	256GB SSD M.2 PCIe NVMe Opal	DVD±RW	None	3165 ac, 1x1 + BT4.0	None	None	None	None	1.5Wx1	None	USB / USB	210W 85%	Win10 DG Win7 Pro 64	3-year, Onsite	03/17	Mar 28, 2022
10M90039US	US	i5-6500	No	Intel HD 530	None	8GBx1	1TB 7200rpm 3.5"	DVD±RW	None	None	None	None	None	None	1.5Wx1	None	USB / USB	210W 85%	Win10 DG Win7 Pro 64	3-year, Onsite	03/17	Apr 28, 2023
10M9003AUS	US	i3-6100	No	Intel HD 530	None	4GBx1	500GB 7200rpm 3.5"	DVD±RW	None	None	None	None	None	None	1.5Wx1	None	USB / USB	210W 85%	Win10 DG Win7 Pro 64	3-year, Onsite	03/17	Apr 28, 2023
10M9003BUS	US	i3-6100	No	Intel HD 530	None	8GBx1	128GB SSD M.2 PCIe NVMe	DVD±RW	None	None	None	None	None	None	1.5Wx1	None	USB / USB	210W 85%	Win10 DG Win7 Pro 64	3-year, Onsite	03/17	Mar 28, 2022
10M9003CUS	US	i3-7100	No	Intel HD 630	None	4GBx1	500GB 7200rpm 3.5"	DVD±RW	None	None	None	None	None	None	1.5Wx1	None	USB / USB	210W 85%	Win10 Pro 64	3-year, Onsite	03/17	Apr 28, 2023
10M9003DUS	US	Pentium G4560	No	Intel HD 610	None	4GBx1	500GB 7200rpm 3.5"	DVD±RW	None	None	None	None	None	None	1.5Wx1	None	USB / USB	210W 85%	Win10 Pro 64	3-year, Onsite	03/17	Apr 28, 2023
10M9003EUS	US	i7-6700	No	Intel HD 530	None	8GBx1	1TB 7200rpm 3.5"	DVD±RW	None	None	None	None	None	None	1.5Wx1	None	USB / USB	210W 85%	Win10 DG Win7 Pro 64	3-year, Onsite	03/17	Apr 28, 2023
10M9003FUS	US	i7-6700	No	Intel HD 530	None	8GBx1	256GB SSD M.2 PCIe NVMe Opal	DVD±RW	None	None	None	None	None	None	1.5Wx1	None	USB / USB	210W 85%	Win10 DG Win7 Pro 64	3-year, Onsite	03/17	Mar 28, 2022
10M9003GUS	US	i5-6500	No	Intel HD 530	None	4GBx1	128GB SSD M.2 PCIe NVMe	DVD±RW	None	None	None	None	None	None	1.5Wx1	None	USB / USB	210W 85%	Win10 DG Win7 Pro 64	3-year, Onsite	03/17	Mar 28, 2022
10M9003HUS	US	i5-6500	No	GT 730 2GB	None	8GBx1	1TB 7200rpm 3.5"	DVD±RW	None	None	None	None	None	None	1.5Wx1	None	USB / USB	210W 85%	Win10 DG Win7 Pro 64	3-year, Onsite	03/17	Apr 28, 2023
10M9003JUS	US	i5-6500	No	GT 730 2GB	None	8GBx1	256GB SSD M.2 PCIe NVMe Opal	DVD±RW	None	None	None	None	None	None	1.5Wx1	None	USB / USB	210W 85%	Win10 DG Win7 Pro 64	3-year, Onsite	03/17	Mar 28, 2022
10M9003KUS	US	i7-6700	No	GT 730 2GB	None	8GBx1	256GB SSD M.2 PCIe NVMe Opal	DVD±RW	None	None	None	None	None	None	1.5Wx1	None	USB / USB	210W 85%	Win10 DG Win7 Pro 64	3-year, Onsite	03/17	Mar 28, 2022

Model	Region	Processor	vPro	Graphics	Monitor Cable	Memory	Storage(HDD/SSD)	Optical	Media Reader	WLAN + Bluetooth	Optional Front Ports	Optional Rear Ports	Chassis Intrusion Switch	Cable Lock	Speaker	Dust Filter	Keyboard / Mouse	Power Supply	Operating System	Warranty	Ann Date (mm/yy)	End of Support
10M9003LUS	US	i3-7100	No	Intel HD 630	None	4GBx1	1TB 7200rpm 3.5"	DVD±RW	None	None	None	None	None	None	1.5Wx1	None	USB / USB	210W 85%	Win10 Pro 64	3-year, Onsite	03/17	Apr 28, 2023



ThinkCentre M715 Tiny Platform Specifications

Product Specifications Reference (PSREF)

Processor	AMD A6, A10, or A12 series APUs						Keyboard	<i>Some:</i> Fullsize USB Keyboard (USB connector), Lenovo logo <i>Some:</i> Lenovo New Slim USB Keyboard (USB connector), black, Lenovo logo <i>Some:</i> USB Optical Wheel Mouse, black, Lenovo logo	
	APU	Cores	Frequency Base/Max	L2 Cache	Memory Types	Integrated Graphics	Mouse		
	PRO A6-9500E	2	3.0 / 3.4 GHz	1 MB	DDR4-2400	Radeon R5 Series	Mechanical	Tiny (1L), black color; metal case M715 Tiny only: 7.05" W X 7.20" D X 1.36" H 179mm W X 182.9mm D X 34.5mm H 2.9 lb (1.3 kg), weight may vary by configuration With VESA mount & ODD box: 7.42" W X 7.30" D X 2.48" H 188.4mm W X 185.38mm D X 63mm H 4.12 lb (1.87 kg), weight may vary by configuration With VESA mount & I/O box: 7.42" W X 7.30" D X 2.62" H 188.4mm W X 185.38mm D X 66.6mm H 3.53 lb (1.6 kg), weight may vary by configuration Optional VESA mount bracket kit, supports VESA 75mm and 100mm Optional system floor stand for vertical orientation	
	PRO A10-9700E	4	3.0 / 3.5 GHz	2 MB	DDR4-2400	Radeon R7 Series	VESA mount		
	PRO A12-9800E	4	3.1 / 3.8 GHz	2 MB	DDR4-2400	Radeon R7 Series	Floor Stand		
	PRO A6-8570E	2	3.0 / 3.4 GHz	1 MB	DDR4-2400	Radeon R5 Series	Power supply	65 watts AC/DC adapter, autosensing, 88% PSU (not included for TIO models) 90 watts AC/DC adapter, autosensing, 88% PSU (only for models with I/O box)	
	PRO A10-8770E	4	2.8 / 3.5 GHz	2 MB	DDR4-2400	Radeon R7 Series	Limited warranty ³	<i>Some:</i> 1-year or 3-year, depot service / service upgrades available <i>Some:</i> 1-year or 3-year, limited onsite service / service upgrades available	
PRO A12-8870E	4	2.9 / 3.8 GHz	2 MB	DDR4-2400	Radeon R7 Series	Preload	Preloaded operating system <i>Some:</i> Windows 10 Pro 64-bit <i>Some:</i> Windows 10 Home 64-bit Preloaded applications (only some listed) <ul style="list-style-type: none"> • Lenovo Companion • Lenovo ID • Lenovo ThinkVantage Tools • Microsoft Office preloaded; purchase a product key to activate • Cyberlink PowerDVD (DVD, DVD±RW) • PowerDVD Create (DVD±RW) 		
Memory	32GB max, DDR4 2400, two 260-pin SO-DIMM sockets, dual-channel capable *16GB single SO-DIMM is only available via special bid models							Preloaded operating system <i>Some:</i> Windows® 7 Professional 64 preinstalled through downgrade rights in Windows 10 Pro 64-bit Preloaded applications (only some listed) <ul style="list-style-type: none"> • Lenovo Solution Center • ThinkVantage System Update • Lenovo Display Manager • Create Recovery Media • Lenovo ThinkVantage Tools • Cyberlink PowerDVD (DVD, DVD±RW) • PowerDVD Create (DVD±RW) • Microsoft Office preloaded; purchase a product key to activate • Adobe® Reader® 	
Disk	<i>Some:</i> SATA 6.0Gb/s, 2.5" Wide, 5400 rpm or 7200 rpm <i>Some:</i> M.2 Solid State Drive (SSD) / PCIe interface, NVMe <i>Some:</i> DVD-ROM, 9.0mm high, via USB external ODD box <i>Some:</i> DVD±RW, 9.0mm high, via USB external ODD box								
Optical	None								
Onboard SATA Media reader	One SATA cable (1-drop to device), one SATA 6.0Gb/s connector on planar								
Graphics	AMD Radeon™ Graphics in processor, uses main memory, DirectX® 12, two DisplayPort™, one optional port (HDMI, VGA, or 3rd DP), supports 3 independent displays (supports maximum of 2 concurrent HDMI/DVI displays when using HDMI port or DP to DVI/HDMI dongles); <i>Max resolution:</i> 4096x2160 (DP)@60Hz; 4096x2160 (HDMI)@60Hz; 1920x1200 (VGA)@60Hz								
DP cable	Optional DP to VGA, DP to DVI-D (single link), or DP to HDMI 1.4 dongle								
Chipset	AMD B300 Chipset								
Front ports	Two USB 3.0 (one is Always On and fast charge), one microphone (stereo, 3.5mm), one headphone / microphone combo jack (stereo, 3.5mm)								
Rear ports	One USB 3.0 and three USB 2.0 (optional external optical box or I/O box occupies one specific USB 2.0 on some models), ethernet (RJ-45), two DisplayPort, one optional port (VGA, 3rd DP, HDMI, or serial on some models), one headphone								
I/O box	Optional external I/O box, extends four USB 2.0 (two on front and two on rear), one serial, and two PS/2, via USB port (occupy one specific USB 2.0 of M715q Tiny)								
Audio support	High Definition (HD) Audio, Realtek ALC233-CG / internal speaker (1.5 watt)								
WLAN ¹³	<i>Some:</i> 11ac wireless, M.2 Card, Realtek RTL8821AE (dual band), Wi-Fi + Bluetooth 4.0 combo adapter, 1x1 <i>Some:</i> 11ac wireless, M.2 Card, Realtek RTL8822BE (dual band), Wi-Fi + Bluetooth 4.1 combo adapter, 2x2 <i>Some:</i> 11ac wireless, M.2 Card, Qualcomm Atheros QCA9377 (dual band), Wi-Fi + Bluetooth 4.1 combo adapter, 1x1								
Bluetooth™ Ethernet Modem	<i>Some:</i> Bluetooth 4.0 or 4.1 wireless, integrated in Wi-Fi + BT combo adapter Gigabit ethernet, Realtek RTL8111EPV, Wake on LAN® None								
Manageability Security chip Security features	DASH 1.0/1.1 Discrete TPM 2.0, TCG Certified <ul style="list-style-type: none"> • Security slot (in rear for optional Kensington® MicroSaver® cable) • Padlock loop • Smart USB protection, allows keyboard/ mouse only, blocks all storage devices • Power-on password • Administrator password • Hard disk password • Boot sequence control • Boot without keyboard and mouse • Individual USB port disablement • Chassis intrusion switch 								
Environment	ENERGY STAR® 6.1*, EPEAT™ Gold rating* (*for Windows models only); ErP Lot 3; GREENGUARD®; RoHS-compliant								
Accessories	For compatible accessories, please go to http://www.lenovoquickpick.com								

See footnotes for more detailed information

(M715 Tiny-Spec) May 2017 © Lenovo

Model	Region	Processor	vPro	Graphics	Monitor Cable	Memory	Storage(HDD/SSD)	External Optical / I/O Box	WLAN + Bluetooth	Optional Rear Ports	Speaker	Adapter Cage	Toolless Chassis Screw	Dust Filter	Keyboard / Mouse	VESA Mount	Stand	Power Supply	OS	War-ranty	End of Support	Ann Date (m/y)
10M30001US	US	AMD PRO A6-9500E	No	AMD R5 Graphics	None	4GBx1	500GB 7200rpm 2.5"	None	RTL8821AE ac, 1x1 + BT4.0	None	1Wx1	None	None	None	USB / USB	None	Floor Stand	65W Adapter 88%	Win10 Pro 64	3-year, Onsite	Dec 8, 2022	11/16
10M30002US	US	AMD PRO A10-9700E	No	AMD R7 Graphics	None	4GBx1	500GB 7200rpm 2.5"	None	RTL8821AE ac, 1x1 + BT4.0	Serial	1Wx1	None	None	None	USB / USB	None	Floor Stand	65W Adapter 88%	Win10 Pro 64	3-year, Onsite	Nov 25, 2022	10/16
10M30003US	US	AMD A10-9700E	No	AMD R7 Graphics	None	4GBx1	500GB 7200rpm 2.5"	None	RTL8821AE ac, 1x1 + BT4.0	VGA	1Wx1	None	None	None	USB / USB	None	Floor Stand	65W Adapter 88%	Win10 Pro 64	3-year, Onsite	Nov 25, 2022	10/16
10M30004US	US	AMD A10-9700E	No	AMD R7 Graphics	None	4GBx1	500GB 7200rpm 2.5"	None	RTL8821AE ac, 1x1 + BT4.0	3rd DP	1Wx1	None	None	None	USB / USB	None	Floor Stand	65W Adapter 88%	Win10 Pro 64	3-year, Onsite	Nov 25, 2022	10/16
10M30005US	US	AMD PRO A12-9800E	No	AMD R7 Graphics	None	4GBx1	500GB 7200rpm 2.5"	None	RTL8821AE ac, 1x1 + BT4.0	3rd DP	1Wx1	None	None	None	USB / USB	None	Floor Stand	65W Adapter 88%	Win10 Pro 64	3-year, Onsite	Nov 25, 2022	10/16
10M30006US	US	AMD PRO A10-9700E	No	AMD R7 Graphics	None	8GBx1	128GB SSD M.2 PCIe NVMe	None	RTL8821AE ac, 1x1 + BT4.0	3rd DP	1Wx1	None	None	None	USB / USB	None	Floor Stand	65W Adapter 88%	Win10 Pro 64	3-year, Onsite	Oct 25, 2021	10/16
10M30007US	US	AMD PRO A6-9500E	No	AMD R5 Graphics	None	4GBx1	500GB 7200rpm 2.5"	None	RTL8821AE ac, 1x1 + BT4.0	None	1Wx1	None	None	None	USB / USB	None	Floor Stand	65W Adapter 88%	Win10 Pro 64	3-year, Onsite	Nov 25, 2022	10/16
10M30008US	US	AMD PRO A10-9700E	No	AMD R7 Graphics	None	8GBx1	500GB 7200rpm 2.5"	None	RTL8821AE ac, 1x1 + BT4.0	None	1Wx1	None	None	None	USB / USB	None	Floor Stand	65W Adapter 88%	Win10 Pro 64	3-year, Onsite	Nov 25, 2022	10/16
10M30009US	US	AMD PRO A12-9800E	No	AMD R7 Graphics	None	8GBx1	128GB SSD M.2 PCIe NVMe	None	RTL8821AE ac, 1x1 + BT4.0	3rd DP	1Wx1	None	None	None	USB / USB	None	Floor Stand	65W Adapter 88%	Win10 Pro 64	3-year, Onsite	Oct 25, 2021	10/16
10M3000AUS	US	AMD PRO A12-9800E	No	AMD R7 Graphics	None	4GBx1	128GB SSD M.2 PCIe NVMe	None	RTL8821AE ac, 1x1 + BT4.0	None	1Wx1	None	None	None	USB / USB	None	Floor Stand	65W Adapter 88%	Win10 Pro 64	3-year, Onsite	Nov 25, 2022	10/16
10M3000BUS	US	AMD A10-9700E	No	AMD R7 Graphics	None	4GBx1	500GB 7200rpm 2.5"	None	RTL8821AE ac, 1x1 + BT4.0	None	1Wx1	None	None	None	USB / USB	None	Floor Stand	65W Adapter 88%	Win10 Pro 64	3-year, Onsite	Nov 25, 2022	10/16
10M3000CUS	US	AMD PRO A10-9700E	No	AMD R7 Graphics	None	4GBx1	128GB SSD M.2 PCIe NVMe	None	RTL8821AE ac, 1x1 + BT4.0	3rd DP	1Wx1	None	None	None	USB / USB	None	Floor Stand	65W Adapter 88%	Win10 Pro 64	3-year, Onsite	Nov 25, 2022	10/16
10M3000DUS	US	AMD PRO A10-9700E	No	AMD R7 Graphics	None	4GBx1	500GB 7200rpm 2.5"	DVD±RW	RTL8821AE ac, 1x1 + BT4.0	HDMI	1Wx1	None	None	None	USB / USB	VESA Mount	None	65W Adapter 88%	Win10 Pro 64	3-year, Onsite	Nov 25, 2022	10/16
10M3000NUS	US	AMD PRO A12-8870E	No	AMD R7 Graphics	None	8GBx2	512GB SSD M.2 PCIe NVMe	None	RTL8821AE ac, 1x1 + BT4.0	None	1Wx1	None	None	None	USB / USB	None	Floor Stand	65W Adapter 88%	Win10 DG Win7 Pro 64	3-year, Onsite	Feb 10, 2023	01/17
10M3000PUS	US	AMD PRO A12-9800E	No	AMD R7 Graphics	None	8GBx2	512GB SSD M.2 PCIe NVMe	None	RTL8821AE ac, 1x1 + BT4.0	None	1Wx1	None	None	None	USB / USB	None	Floor Stand	65W Adapter 88%	Win10 Pro 64	3-year, Onsite	Feb 10, 2023	01/17
10M3000QUS	US	AMD PRO A10-8770E	No	AMD R7 Graphics	None	8GBx1	256GB SSD M.2 PCIe NVMe	None	RTL8821AE ac, 1x1 + BT4.0	None	1Wx1	None	None	None	USB / USB	None	Floor Stand	65W Adapter 88%	Win10 DG Win7 Pro 64	3-year, Onsite	Feb 10, 2023	01/17
10M3000RUS	US	AMD PRO A10-8770E	No	AMD R7 Graphics	None	8GBx1	500GB 7200rpm 2.5"	None	RTL8821AE ac, 1x1 + BT4.0	None	1Wx1	None	None	None	USB / USB	None	Floor Stand	65W Adapter 88%	Win10 DG Win7 Pro 64	3-year, Onsite	Feb 10, 2023	01/17
10M3000SUS	US	AMD PRO A10-8770E	No	AMD R7 Graphics	None	8GBx1	500GB 7200rpm 2.5"	DVD±RW	RTL8821AE ac, 1x1 + BT4.0	3rd DP	1Wx1	None	None	None	USB / USB	VESA Mount	None	65W Adapter 88%	Win10 DG Win7 Pro 64	3-year, Onsite	Feb 10, 2023	01/17
10M3000TUS	US	AMD PRO A10-8770E	No	AMD R7 Graphics	None	4GBx1	500GB 7200rpm 2.5"	None	RTL8821AE ac, 1x1 + BT4.0	None	1Wx1	None	None	None	USB / USB	None	Floor Stand	65W Adapter 88%	Win10 DG Win7 Pro 64	3-year, Onsite	Feb 10, 2023	01/17

Model	Region	Processor	vPro	Graphics	Monitor Cable	Memory	Storage(HDD/SSD)	External Optical / I/O Box	WLAN + Bluetooth	Optional Rear Ports	Speaker	Adapter Cage	Toolless Chassis Screw	Dust Filter	Keyboard / Mouse	VESA Mount	Stand	Power Supply	OS	War-ranty	End of Support	Ann Date (m/y)
10M3000UUS	US	AMD PRO A10-8770E	No	AMD R7 Graphics	None	8GBx1	128GB SSD M.2 PCIe NVMe	None	RTL8821AE ac, 1x1 + BT4.0	3rd DP	1Wx1	None	None	None	USB / USB	None	Floor Stand	65W Adapter 88%	Win10 DG Win7 Pro 64	3-year, Onsite	Feb 10, 2023	01/17
10M3000VUS	US	AMD PRO A10-8770E	No	AMD R7 Graphics	None	8GBx1	256GB SSD M.2 PCIe NVMe	None	RTL8821AE ac, 1x1 + BT4.0	3rd DP	1Wx1	None	None	None	USB / USB	None	Floor Stand	65W Adapter 88%	Win10 DG Win7 Pro 64	3-year, Onsite	Feb 10, 2023	01/17
10M3000WUS	US	AMD PRO A10-9700E	No	AMD R7 Graphics	None	8GBx1	256GB SSD M.2 PCIe NVMe	None	RTL8821AE ac, 1x1 + BT4.0	None	1Wx1	None	None	None	USB / USB	None	Floor Stand	65W Adapter 88%	Win10 Pro 64	3-year, Onsite	Feb 10, 2023	01/17
10M3000XUS	US	AMD PRO A12-8870E	No	AMD R7 Graphics	None	8GBx1	256GB SSD M.2 PCIe NVMe	None	RTL8821AE ac, 1x1 + BT4.0	3rd DP	1Wx1	None	None	None	USB / USB	None	Floor Stand	65W Adapter 88%	Win10 DG Win7 Pro 64	3-year, Onsite	Feb 10, 2023	01/17
10M3000YUS	US	AMD PRO A10-8770E	No	AMD R7 Graphics	None	8GBx1	500GB 7200rpm 2.5"	None	RTL8821AE ac, 1x1 + BT4.0	3rd DP	1Wx1	None	None	None	USB / USB	None	Floor Stand	65W Adapter 88%	Win10 DG Win7 Pro 64	3-year, Onsite	Feb 10, 2023	01/17
10M30010US	US	AMD PRO A10-9700E	No	AMD R7 Graphics	None	4GBx1	500GB 7200rpm 2.5"	None	RTL8821AE ac, 1x1 + BT4.0	None	1Wx1	None	None	None	USB / USB	None	Floor Stand	65W Adapter 88%	Win10 Pro 64	3-year, Onsite	Feb 10, 2023	01/17
10M30011US	US	AMD PRO A12-8870E	No	AMD R7 Graphics	None	8GBx1	128GB SSD M.2 PCIe NVMe	None	RTL8821AE ac, 1x1 + BT4.0	None	1Wx1	None	None	None	USB / USB	None	Floor Stand	65W Adapter 88%	Win10 DG Win7 Pro 64	3-year, Onsite	Feb 10, 2023	01/17



ThinkCentre M79 SFF Platform Specifications

Product Specifications Reference (PSREF)

Processor	AMD A4, A6, A8, or A10 series APUs	<ul style="list-style-type: none"> • Cable lock to physically lock both keyboard and mouse (optional) • Power-on password • Boot without keyboard and mouse • Individual USB port disablement • Optional Chassis intrusion switch 																																																																								
	<table border="1"> <thead> <tr> <th>APU</th> <th>Cores</th> <th>Frequency (Max/Base)</th> <th>L2 Cache</th> <th>Memory Types</th> <th>Integrated Graphics</th> </tr> </thead> <tbody> <tr> <td>A4-6300B</td> <td>2</td> <td>3.9 / 3.7</td> <td>1MB</td> <td>DDR3-1600</td> <td>HD 8370D</td> </tr> <tr> <td>A4 PRO-7300B</td> <td>2</td> <td>4.0 / 3.8</td> <td>1MB</td> <td>DDR3-1600</td> <td>HD 8470D</td> </tr> <tr> <td>PRO A4-8350B</td> <td>2</td> <td>3.9 / 3.5</td> <td>1MB</td> <td>DDR3-1866</td> <td>Radeon R5 Series</td> </tr> <tr> <td>A6-6400B</td> <td>2</td> <td>4.1 / 3.9</td> <td>1MB</td> <td>DDR3-1866</td> <td>HD 8470D</td> </tr> <tr> <td>A6 PRO-7400B</td> <td>2</td> <td>3.9 / 3.5</td> <td>1MB</td> <td>DDR3-1866</td> <td>Radeon R5 Series</td> </tr> <tr> <td>PRO A6-8550B</td> <td>2</td> <td>4.0 / 3.7</td> <td>1MB</td> <td>DDR3-2133</td> <td>Radeon R5 Series</td> </tr> <tr> <td>A8-6500B</td> <td>4</td> <td>4.1 / 3.5</td> <td>4MB</td> <td>DDR3-1866</td> <td>HD 8570D</td> </tr> <tr> <td>A8 PRO-7600B</td> <td>4</td> <td>3.8 / 3.1</td> <td>4MB</td> <td>DDR3-2133</td> <td>Radeon R7 Series</td> </tr> <tr> <td>PRO A8-8650B</td> <td>4</td> <td>3.9 / 3.2</td> <td>4MB</td> <td>DDR3-2133</td> <td>Radeon R7 Series</td> </tr> <tr> <td>A10 PRO-7800B</td> <td>4</td> <td>3.9 / 3.5</td> <td>4MB</td> <td>DDR3-2133</td> <td>Radeon R7 Series</td> </tr> <tr> <td>PRO A10-8750B</td> <td>4</td> <td>4.0 / 3.6</td> <td>4MB</td> <td>DDR3-2133</td> <td>Radeon R7 Series</td> </tr> </tbody> </table>	APU	Cores	Frequency (Max/Base)	L2 Cache	Memory Types	Integrated Graphics	A4-6300B	2	3.9 / 3.7	1MB	DDR3-1600	HD 8370D	A4 PRO-7300B	2	4.0 / 3.8	1MB	DDR3-1600	HD 8470D	PRO A4-8350B	2	3.9 / 3.5	1MB	DDR3-1866	Radeon R5 Series	A6-6400B	2	4.1 / 3.9	1MB	DDR3-1866	HD 8470D	A6 PRO-7400B	2	3.9 / 3.5	1MB	DDR3-1866	Radeon R5 Series	PRO A6-8550B	2	4.0 / 3.7	1MB	DDR3-2133	Radeon R5 Series	A8-6500B	4	4.1 / 3.5	4MB	DDR3-1866	HD 8570D	A8 PRO-7600B	4	3.8 / 3.1	4MB	DDR3-2133	Radeon R7 Series	PRO A8-8650B	4	3.9 / 3.2	4MB	DDR3-2133	Radeon R7 Series	A10 PRO-7800B	4	3.9 / 3.5	4MB	DDR3-2133	Radeon R7 Series	PRO A10-8750B	4	4.0 / 3.6	4MB	DDR3-2133	Radeon R7 Series	<p>Keyboard</p> <p>Some: Preferred Pro USB Keyboard (USB connector), Lenovo logo Some: Lenovo USB Fingerprint Keyboard (USB connector) Some: Ultralim Plus Wireless Keyboard (2.4GHz via USB receiver), black</p> <p>Mouse</p> <p>Some: Enhanced Optical USB Mouse, black, Lenovo logo Some: Ultralim Plus Wireless Mouse (2.4GHz via USB receiver), black</p> <p>Mechanical</p> <ul style="list-style-type: none"> • Business black color; metal case, 11L • 13.2" W X 15.0" D X 3.9" H • 335mm W X 382mm D X 101mm H • 14.6 lb (6.6 kg) in maximum configuration Bay 1: N/A, N/A, internal, opt SSD Bay 2: 5.25", 1.6" high, external, std optical Bay 3: N/A, N/A, external, opt reader Bay 4: 3.5", 1" high, internal, std disk <p>*bay only available on models with HDD/SSD/reader installed</p> <p>Slot 1: Low Profile, PCI Express 3.0 x16 (40w max) Slot 2: Low Profile, PCIe 2.0 x1 Slot 2: Low Profile, PCIe 2.0 x1 Slot 4: Low Profile, 32-bit PCI 2.3</p> <p>Floor Stand</p> <p>Optional system floor stand for vertical orientation</p> <p>Power supply</p> <p>Some: 180 watts, autosensing, 100-240V (50-60Hz) Some: 240 watts, autosensing, 100-240V (50-60Hz) Some: 240 watts, autosensing, 85% PSU, 100-240V (50-60Hz)</p> <p>Limited warranty³</p> <p>Some: 3-years, limited onsite service / service upgrades available Some: 3-years, limited onsite service, OID (Onsite International Delivery) / service upgrades available <i>For Lenovo service upgrade options, please go to S-TC sheet</i></p> <p>Preload</p> <p>Some: Windows[®] 7 Professional 32/64 preinstalled through downgrade rights in Windows 8.1 Pro 64-bit Some: Windows 7 Professional 32 Some: Windows 7 Professional 64</p> <p>Ready to install applications (only some listed)</p> <ul style="list-style-type: none"> • Rescue and Recovery™ • Password Manager <p>Preloaded applications (only some listed)</p> <ul style="list-style-type: none"> • ThinkVantage[®] Product Recovery • ThinkVantage System Update • ThinkVantage Communication Utility • ThinkVantage Device Experience • Desktop Power Manager • View Management Utility • Lenovo Solution Center • Lenovo Message Center Plus • Norton™ Internet Security (30 days of virus definitions) • Adobe[®] Reader[®] • Skype™ • Microsoft Office preloaded; purchase a product key to activate • Cyberlink Power2Go (DVD±RW) • Cyberlink PowerProducer (DVD±RW) • Evernote[®] • Nitro Pro <p>Some: Windows 8.1 64-bit Some: Windows 8.1 Pro 64-bit Some: Windows 10 Pro 64-bit</p> <p>Preloaded applications (only some listed)</p> <ul style="list-style-type: none"> • Desktop Power Manager • Lenovo Solution Center • Lenovo Companion • Lenovo SHAREit • Lenovo REACHit • McAfee[®] LiveSafe™(30-day trial) • Microsoft Office preloaded; purchase a product key to activate • Cyberlink PowerDVD (DVD±RW, DVD) • PowerDVD Create (DVD±RW) • PC Device Stage
APU	Cores	Frequency (Max/Base)	L2 Cache	Memory Types	Integrated Graphics																																																																					
A4-6300B	2	3.9 / 3.7	1MB	DDR3-1600	HD 8370D																																																																					
A4 PRO-7300B	2	4.0 / 3.8	1MB	DDR3-1600	HD 8470D																																																																					
PRO A4-8350B	2	3.9 / 3.5	1MB	DDR3-1866	Radeon R5 Series																																																																					
A6-6400B	2	4.1 / 3.9	1MB	DDR3-1866	HD 8470D																																																																					
A6 PRO-7400B	2	3.9 / 3.5	1MB	DDR3-1866	Radeon R5 Series																																																																					
PRO A6-8550B	2	4.0 / 3.7	1MB	DDR3-2133	Radeon R5 Series																																																																					
A8-6500B	4	4.1 / 3.5	4MB	DDR3-1866	HD 8570D																																																																					
A8 PRO-7600B	4	3.8 / 3.1	4MB	DDR3-2133	Radeon R7 Series																																																																					
PRO A8-8650B	4	3.9 / 3.2	4MB	DDR3-2133	Radeon R7 Series																																																																					
A10 PRO-7800B	4	3.9 / 3.5	4MB	DDR3-2133	Radeon R7 Series																																																																					
PRO A10-8750B	4	4.0 / 3.6	4MB	DDR3-2133	Radeon R7 Series																																																																					
Memory	32GB max, UDIMM, PC3-12800 1600MHz DDR3, four 240-pin DIMM sockets																																																																									
Disk	Some: SATA 6.0Gb/s, 3.5" Wide, 7200 rpm Some: hybrid hard disk / with 8GB MLC NAND flash memory, SATA 6.0Gb/s, 5400 rpm 2.5" wide or 7200 rpm 3.5" wide																																																																									
Optical	Some: Solid State Drive (SSD) / SATA 6.0Gb/s, 2.5" Wide Some: DVD-ROM SATA 1.5Gb/s Drive Some: Super Multi-Burner DVD±RW SATA 1.5Gb/s Drive																																																																									
Onboard SATA	SATA 6.0Gb/s controller, three connectors on planar, RAID 0/1 support (only applicable on dual SSD models)																																																																									
Media reader	Optional 7-in-1 single slot media card reader																																																																									
Graphics	AMD Radeon™ Graphics in processor, uses main memory, one VGA, one DisplayPort™, one optional DP, supports up to three independent displays, works along with optional discrete graphics to support up to five independent displays; <i>Maximum resolution: 1920x1200 (VGA) @60Hz; 2560x2048 (DisplayPort) @60Hz</i> Some: AMD Radeon HD 8570 , DirectX 11, 3D Hardware Acceleration, 2GB, PCI Express 3.0 x16 adapter (8x elec), one VGA, one HDMI, 40W; <i>Max resolution: 4096x2160 (HDMI) @24Hz; 2048x1536 (VGA) @85Hz</i> Some: NVIDIA[®] GeForce[®] GT 620 , DirectX 11, 3D Hardware Acceleration, 1GB, PCI Express 2.0 x16 adapter, one VGA, one DisplayPort, 30 watts; <i>Max resolution: 2560x1600 (DisplayPort) @60Hz; 2048x1536 (VGA) @85Hz</i> Some: AMD Radeon™ HD 7450 , DirectX 11, 3D Hardware Acceleration, 1GB, PCI Express 2.0 x16 adapter, one DVI-I (includes DVI-to-VGA dongle), one DisplayPort, 25 watts; <i>Max resolution: 2560x1600 (DisplayPort, DVI-I) @60Hz</i>																																																																									
DP cable	Optional DisplayPort to DVI-D monitor cable																																																																									
Chipset	AMD A78 FCH																																																																									
Front ports	Two USB 2.0, microphone (stereo, 3.5mm), headphone (stereo, 3.5mm)																																																																									
Rear ports	Up to six USB ports (2x USB 3.0 + 2x USB 2.0 + 2x optional USB 2.0), serial (9-pin), optional 2nd serial (9-pin), optional parallel (25-pin), ethernet (RJ-45), VGA, DisplayPort (1x standard + 1x optional), two PS/2 ports																																																																									
Rear audio ports	Line-in (stereo, 3.5mm), line-out (stereo, 3.5mm), microphone (stereo, 3.5mm)																																																																									
IEEE 1394	Optional FireWire PCIe adapter, 1394a-2000, 400Mbps, two 6-pin ports on rear																																																																									
Audio support	High Definition (HD) Audio, Realtek ALC662 / internal speaker (1watt)																																																																									
WLAN ¹³	Some: 11b/g/n wireless, Realtek RTL8723BE, Wi-Fi + BT 4.0 combo, 1x1 Some: 11b/g/n wireless, Realtek RTL8192EE, Wi-Fi + BT 4.0 combo, 2x2 Some: 11ac/b/g/n wireless, Broadcom BCM4352, 2.4/5GHz, Wi-Fi + BT 4.0, 2x2																																																																									
Bluetooth™	Some: Bluetooth 4.0 wireless, integrated in Wi-Fi + Bluetooth combo adapter																																																																									
Ethernet	One gigabit ethernet port, Realtek 8111EPV, Wake on LAN [®]																																																																									
Modem	None																																																																									
Manageability	Enhanced Manageability with DASH 1.1																																																																									
Security chip	Trusted Platform Module, TCG 1.2-compliant																																																																									
Security features	<ul style="list-style-type: none"> • Padlock loop (in rear for opt padlock) • Security slot (in rear for optional Kensington[®] MicroSaver[®] cable) • Administrator password • Hard disk password • Boot sequence control 																																																																									
Environment	ENERGY STAR [®] 6.0 (Need 85% PSU and Windows OS); EPEAT™ Gold rating (Need 85% PSU and Windows OS); GREENGUARD [®] ; RoHS-compliant; Cisco EnergyWise compatible; ErP Lot 3																																																																									
Accessories	For compatible accessories, please go to TC-AQP sheet																																																																									

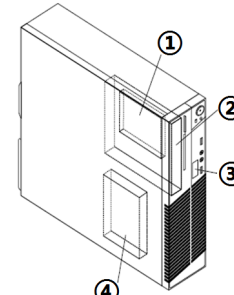

Model	Region	Processor	vPro	Graphics	Monitor Cable	Memory	Storage	Optical	Media Reader	WLAN + Bluetooth	Optional Rear Ports	Chassis Intrusion Switch	Cable Lock	Keyboard / Mouse	Stand	Power Supply	Operating System	Warranty	Ann Date (m/y)
10CV0000US	US	A6-6400B	No	AMD HD 8470D	None	4GBx1	500GB 7200rpm 3.5"	DVD±RW	None	None	None	None	None	USB / USB	None	180W	Win8.1 DG Win7 Pro 64	3-year, Onsite	07/14
10CV0001US	US	AMD A8-6500B	No	AMD HD 8570D	None	4GBx1	500GB 7200rpm 3.5"	DVD±RW	None	None	None	None	None	USB / USB	None	180W	Win8.1 DG Win7 Pro 64	3-year, Onsite	07/14
10CV0002US	US	A8 PRO-7600B	No	AMD R7 Graphics	None	4GBx1	500GB 7200rpm 3.5"	DVD±RW	None	None	None	None	None	USB / USB	None	240W	Win8.1 DG Win7 Pro 64	3-year, Onsite	07/14
10CV0003US	US	A4-6300B	No	AMD HD 8370D	None	4GBx1	500GB 7200rpm 3.5"	DVD	None	None	None	None	None	USB / USB	None	180W	Win8.1 DG Win7 Pro 64	3-year, Onsite	10/14
10CV000TUS	US	A10 PRO-7800B	No	AMD R7 Graphics	None	4GBx1	500GB 7200rpm 3.5"	DVD±RW	9-in-1	None	None	None	None	USB / USB	Floor Stand	180W	Win8.1 DG Win7 Pro 64	3-year, Onsite	02/15
10CV000UUS	US	A10 PRO-7800B	No	AMD R7 Graphics	None	8GBx1	500GB 7200rpm 3.5"	DVD±RW	9-in-1	None	None	None	None	USB / USB	Floor Stand	180W	Win8.1 DG Win7 Pro 64	3-year, Onsite	02/15
10CV000VUS	US	A6 PRO-7400B	No	AMD R5 Graphics	None	4GBx1	500GB 7200rpm 3.5"	DVD±RW	9-in-1	None	None	None	None	USB / USB	None	180W	Win8.1 DG Win7 Pro 64	3-year, Onsite	02/15
10CV000WUS	US	A8 PRO-7600B	No	AMD R7 Graphics	None	4GBx1	500GB 7200rpm 3.5"	DVD±RW	None	None	2 Rear USB 2.0	None	Cable Lock	USB / USB	Floor Stand	180W	Win8.1 DG Win7 Pro 64	3-year, Onsite	02/15
10CV000XUS	US	A8 PRO-7600B	No	AMD R7 Graphics	None	4GBx1	500GB 7200rpm 3.5"	DVD±RW	None	None	None	Switch	None	USB / USB	Floor Stand	180W	Win8.1 DG Win7 Pro 64	3-year, Onsite	07/15

Model	Region	Processor	vPro	Graphics	Monitor Cable	Memory	Storage	Optical	Media Reader	WLAN + Bluetooth	Optional Rear Ports	Chassis Intrusion Switch	Cable Lock	Keyboard / Mouse	Stand	Power Supply	Operating System	Warranty	Ann Date (m/y)
10JB0005US	US	PRO A10-8750B	No	AMD R7 Graphics	None	4GBx1	500GB 7200rpm 3.5"	DVD±RW	None	RTL8723BE b/g/n, 1x1 + BT4.0	None	Switch	Cable Lock	USB / USB	None	240W 85%	Win10 DG Win7 Pro 64	3-year, Onsite	10/15
10JB0006US	US	PRO A4-8350B	No	AMD R5 Graphics	None	4GBx1	500GB 7200rpm 3.5"	DVD±RW	None	RTL8723BE b/g/n, 1x1 + BT4.0	2nd DP	Switch	Cable Lock	USB / USB	None	240W 85%	Win10 DG Win7 Pro 64	3-year, Onsite	10/15
10JB0007US	US	PRO A8-8650B	No	AMD R7 Graphics	None	4GBx1	500GB 7200rpm 3.5"	DVD±RW	None	RTL8723BE b/g/n, 1x1 + BT4.0	2nd DP + 1394	Switch	Cable Lock	USB / USB	None	240W 85%	Win10 DG Win7 Pro 64	3-year, Onsite	10/15
10JB0008US	US	PRO A6-8550B	No	AMD R5 Graphics	None	4GBx1	500GB 7200rpm 3.5"	DVD±RW	None	RTL8723BE b/g/n, 1x1 + BT4.0	2nd DP	Switch	Cable Lock	USB / USB	None	240W 85%	Win10 DG Win7 Pro 64	3-year, Onsite	10/15
10JB0009US	US	A4 PRO-7300B	No	AMD HD 8470D	DP to DVI	4GBx1	500GB 7200rpm 3.5"	DVD±RW	None	RTL8723BE b/g/n, 1x1 + BT4.0	None	None	None	USB / USB	None	240W 85%	Win10 Pro 64	3-year, Onsite	09/15
10JB000AUS	US	A6 PRO-7400B	No	AMD R5 Graphics	DP to DVI	4GBx1	500GB 7200rpm 3.5"	DVD±RW	None	RTL8723BE b/g/n, 1x1 + BT4.0	None	None	None	USB / USB	None	240W 85%	Win10 Pro 64	3-year, Onsite	09/15
10JB000BUS	US	A4 PRO-7300B	No	AMD HD 8470D	DP to DVI	4GBx1	500GB 7200rpm 3.5"	DVD±RW	None	RTL8723BE b/g/n, 1x1 + BT4.0	None	None	None	USB / USB	None	240W 85%	Win10 DG Win7 Pro 64	3-year, Onsite	10/15
10JB000CUS	US	A6 PRO-7400B	No	AMD R5 Graphics	DP to DVI	4GBx1	500GB 7200rpm 3.5"	DVD±RW	None	RTL8723BE b/g/n, 1x1 + BT4.0	None	None	None	USB / USB	None	240W 85%	Win10 DG Win7 Pro 64	3-year, Onsite	10/15
10JB000DUS	US	A10 PRO-7800B	No	AMD R7 Graphics	DP to DVI	4GBx1	500GB 7200rpm 3.5"	DVD±RW	None	RTL8723BE b/g/n, 1x1 + BT4.0	None	None	None	USB / USB	None	240W 85%	Win10 Pro 64	3-year, Onsite	09/15
10JB000EUS	US	A10 PRO-7800B	No	AMD R7 Graphics	DP to DVI	4GBx1	500GB 7200rpm 3.5"	DVD±RW	None	RTL8723BE b/g/n, 1x1 + BT4.0	None	None	None	USB / USB	None	240W 85%	Win10 DG Win7 Pro 64	3-year, Onsite	10/15
10JB000FUS	US	A8 PRO-7600B	No	AMD R7 Graphics	DP to DVI	4GBx1	500GB 7200rpm 3.5"	DVD±RW	None	RTL8723BE b/g/n, 1x1 + BT4.0	None	None	None	USB / USB	None	240W 85%	Win10 Pro 64	3-year, Onsite	09/15
10JB000GUS	US	A8 PRO-7600B	No	AMD R7 Graphics	DP to DVI	4GBx1	500GB 7200rpm 3.5"	DVD±RW	None	RTL8723BE b/g/n, 1x1 + BT4.0	None	None	None	USB / USB	None	240W 85%	Win10 DG Win7 Pro 64	3-year, Onsite	10/15
10JB000HUS	US	A10 PRO-7800B	No	AMD R7 Graphics	None	4GBx1	500GB 7200rpm 3.5"	DVD±RW	9-in-1	None	None	None	None	USB / USB	None	240W 85%	Win10 DG Win7 Pro 64	3-year, Onsite	12/15
10JB000JUS	US	A8 PRO-7600B	No	AMD R7 Graphics	None	4GBx1	500GB 7200rpm 3.5"	DVD±RW	9-in-1	None	None	None	None	USB / USB	None	240W 85%	Win10 DG Win7 Pro 64	3-year, Onsite	12/15
10JB000KUS	US	A4 PRO-7300B	No	AMD HD 8470D	None	4GBx1	500GB 7200rpm 3.5"	DVD±RW	9-in-1	None	None	None	None	USB / USB	None	240W 85%	Win10 DG Win7 Pro 64	3-year, Onsite	12/15
10JB000LUS	US	A6 PRO-7400B	No	AMD R5 Graphics	None	4GBx1	500GB 7200rpm 3.5"	DVD±RW	9-in-1	None	None	None	None	USB / USB	None	240W 85%	Win10 DG Win7 Pro 64	3-year, Onsite	12/15

Model	Region	Processor	vPro	Graphics	Monitor Cable	Memory	Storage	Optical	Media Reader	WLAN + Bluetooth	Optional Rear Ports	Chassis Intrusion Switch	Cable Lock	Keyboard / Mouse	Stand	Power Supply	Operating System	Warranty	Ann Date (m/y)
10CT0006US	US	A4-6300B	No	AMD HD 8370D	None	2GBx1	250GB 7200rpm 3.5"	DVD	None	None	None	Switch	None	USB / USB	None	240W 85%	Win7 Pro 32	3-year, Onsite	07/14
10CT0007US	US	A6 PRO-7400B	No	AMD R5 Graphics	None	2GBx1	500GB 7200rpm 3.5"	DVD±RW	None	None	None	Switch	None	USB / USB	None	240W 85%	Win7 Pro 32	3-year, Onsite	07/14
10CT0008US	US	A6-6400B	No	AMD HD 8470D	None	4GBx1	500GB 7200rpm 3.5"	DVD±RW	None	None	None	None	None	USB / USB	None	240W 85%	Win8.1 DG Win7 Pro 64	3-year, Onsite	08/14
10CT0009US	US	A6-6400B	No	AMD HD 8470D	None	4GBx1	500GB 7200rpm 3.5"	DVD±RW	None	RTL8723BE b/g/n, 1x1 + BT4.0	None	None	None	USB / USB	None	240W 85%	Win8.1 DG Win7 Pro 64	3-year, Onsite	08/14
10CT000AUS	US	A8 PRO-7600B	No	AMD R7 Graphics	None	8GBx1	500GB 7200rpm 3.5"	DVD±RW	None	None	None	None	None	USB / USB	None	240W 85%	Win8.1 DG Win7 Pro 64	3-year, Onsite	08/14
10CT000BUS	US	A8 PRO-7600B	No	GT 620 1GB	None	8GBx1	500GB 7200rpm 3.5"	DVD±RW	None	RTL8723BE b/g/n, 1x1 + BT4.0	None	None	None	USB / USB	None	240W 85%	Win8.1 DG Win7 Pro 64	3-year, Onsite	08/14

Model	Region	Processor	vPro	Graphics	Monitor Cable	Memory	Storage	Optical	Media Reader	WLAN + Bluetooth	Optional Rear Ports	Chassis Intrusion Switch	Cable Lock	Keyboard / Mouse	Stand	Power Supply	Operating System	Warranty	Ann Date (m/y)
10CW000BUS	US	A4-6300B	No	AMD HD 8370D	None	4GBx1	500GB 7200rpm 3.5"	DVD±RW	None	None	None	None	None	USB / USB	None	180W	Win8.1 DG Win7 Pro 64	3-year, Onsite	08/14

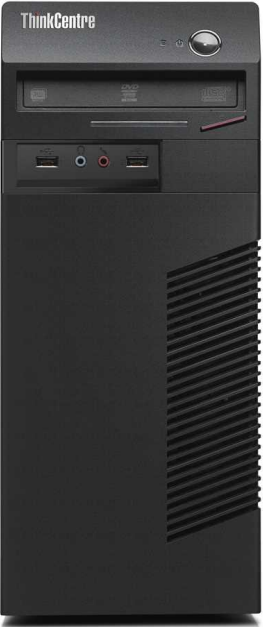

ThinkCentre M79 Tower Platform Specifications

Product Specifications Reference (PSREF)

Processor	AMD A4, A6, A8, or A10 series APUs	<ul style="list-style-type: none"> • Cable lock to physically lock both keyboard and mouse (optional) • Power-on password • Boot without keyboard and mouse • Individual USB port disablement • Optional <i>Chassis intrusion switch</i> 																																																																								
	<table border="1"> <thead> <tr> <th>APU</th> <th>Cores</th> <th>Frequency (Max/Base)</th> <th>L2 Cache</th> <th>Memory Types</th> <th>Integrated Graphics</th> </tr> </thead> <tbody> <tr> <td>A4-6300B</td> <td>2</td> <td>3.9 / 3.7</td> <td>1MB</td> <td>DDR3-1600</td> <td>HD 8370D</td> </tr> <tr> <td>A4 PRO-7300B</td> <td>2</td> <td>4.0 / 3.8</td> <td>1MB</td> <td>DDR3-1600</td> <td>HD 8470D</td> </tr> <tr> <td>PRO A4-8350B</td> <td>2</td> <td>3.9 / 3.5</td> <td>1MB</td> <td>DDR3-1866</td> <td>Radeon R5 Series</td> </tr> <tr> <td>A6-6400B</td> <td>2</td> <td>4.1 / 3.9</td> <td>1MB</td> <td>DDR3-1866</td> <td>HD 8470D</td> </tr> <tr> <td>A6 PRO-7400B</td> <td>2</td> <td>3.9 / 3.5</td> <td>1MB</td> <td>DDR3-1866</td> <td>Radeon R5 Series</td> </tr> <tr> <td>PRO A6-8550B</td> <td>2</td> <td>4.0 / 3.7</td> <td>1MB</td> <td>DDR3-2133</td> <td>Radeon R5 Series</td> </tr> <tr> <td>A8-6500B</td> <td>4</td> <td>4.1 / 3.5</td> <td>4MB</td> <td>DDR3-1866</td> <td>HD 8570D</td> </tr> <tr> <td>A8 PRO-7600B</td> <td>4</td> <td>3.8 / 3.1</td> <td>4MB</td> <td>DDR3-2133</td> <td>Radeon R7 Series</td> </tr> <tr> <td>PRO A8-8650B</td> <td>4</td> <td>3.9 / 3.2</td> <td>4MB</td> <td>DDR3-2133</td> <td>Radeon R7 Series</td> </tr> <tr> <td>A10 PRO-7800B</td> <td>4</td> <td>3.9 / 3.5</td> <td>4MB</td> <td>DDR3-2133</td> <td>Radeon R7 Series</td> </tr> <tr> <td>PRO A10-8750B</td> <td>4</td> <td>4.0 / 3.6</td> <td>4MB</td> <td>DDR3-2133</td> <td>Radeon R7 Series</td> </tr> </tbody> </table>	APU	Cores	Frequency (Max/Base)	L2 Cache	Memory Types	Integrated Graphics	A4-6300B	2	3.9 / 3.7	1MB	DDR3-1600	HD 8370D	A4 PRO-7300B	2	4.0 / 3.8	1MB	DDR3-1600	HD 8470D	PRO A4-8350B	2	3.9 / 3.5	1MB	DDR3-1866	Radeon R5 Series	A6-6400B	2	4.1 / 3.9	1MB	DDR3-1866	HD 8470D	A6 PRO-7400B	2	3.9 / 3.5	1MB	DDR3-1866	Radeon R5 Series	PRO A6-8550B	2	4.0 / 3.7	1MB	DDR3-2133	Radeon R5 Series	A8-6500B	4	4.1 / 3.5	4MB	DDR3-1866	HD 8570D	A8 PRO-7600B	4	3.8 / 3.1	4MB	DDR3-2133	Radeon R7 Series	PRO A8-8650B	4	3.9 / 3.2	4MB	DDR3-2133	Radeon R7 Series	A10 PRO-7800B	4	3.9 / 3.5	4MB	DDR3-2133	Radeon R7 Series	PRO A10-8750B	4	4.0 / 3.6	4MB	DDR3-2133	Radeon R7 Series	<ul style="list-style-type: none"> • Keyboard • Mouse • Mechanical
APU	Cores	Frequency (Max/Base)	L2 Cache	Memory Types	Integrated Graphics																																																																					
A4-6300B	2	3.9 / 3.7	1MB	DDR3-1600	HD 8370D																																																																					
A4 PRO-7300B	2	4.0 / 3.8	1MB	DDR3-1600	HD 8470D																																																																					
PRO A4-8350B	2	3.9 / 3.5	1MB	DDR3-1866	Radeon R5 Series																																																																					
A6-6400B	2	4.1 / 3.9	1MB	DDR3-1866	HD 8470D																																																																					
A6 PRO-7400B	2	3.9 / 3.5	1MB	DDR3-1866	Radeon R5 Series																																																																					
PRO A6-8550B	2	4.0 / 3.7	1MB	DDR3-2133	Radeon R5 Series																																																																					
A8-6500B	4	4.1 / 3.5	4MB	DDR3-1866	HD 8570D																																																																					
A8 PRO-7600B	4	3.8 / 3.1	4MB	DDR3-2133	Radeon R7 Series																																																																					
PRO A8-8650B	4	3.9 / 3.2	4MB	DDR3-2133	Radeon R7 Series																																																																					
A10 PRO-7800B	4	3.9 / 3.5	4MB	DDR3-2133	Radeon R7 Series																																																																					
PRO A10-8750B	4	4.0 / 3.6	4MB	DDR3-2133	Radeon R7 Series																																																																					
Memory	32GB max, UDIMM, PC3-12800 1600MHz DDR3, four 240-pin DIMM sockets																																																																									
Disk	<i>Some:</i> SATA 6.0Gb/s, 3.5" Wide, 7200 rpm <i>Some:</i> hybrid hard disk / with 8GB MLC NAND flash memory, SATA 6.0Gb/s, 5400 rpm 2.5" wide or 7200 rpm 3.5" wide																																																																									
Optical	<i>Some:</i> Solid State Drive (SSD) / SATA 6.0Gb/s, 2.5" Wide <i>Some:</i> DVD-ROM SATA 1.5Gb/s Drive <i>Some:</i> Super Multi-Burner DVD±RW SATA 1.5Gb/s Drive																																																																									
Onboard SATA Media reader	SATA 6.0Gb/s controller, three connectors on planar, RAID 0/1 support Optional 7-in-1 single slot media card reader																																																																									
Graphics	AMD Radeon™ Graphics in processor, uses main memory, one VGA, one DisplayPort™, one optional DP, supports up to three independent displays, works along with optional discrete graphics to support up to five independent displays; <i>Maximum resolution:</i> 1920x1200 (VGA)@60Hz; 2560x2048 (DisplayPort)@60Hz <i>Some:</i> AMD Radeon HD 8570 , DirectX 11, 3D Hardware Acceleration, 2GB, PCI Express 3.0 x16 adapter (8x elec), one VGA, one HDMI, 40W; <i>Max resolution:</i> 4096x2160 (HDMI)@24Hz; 2048x1536 (VGA)@85Hz <i>Some:</i> NVIDIA® GeForce® GT 620 , DirectX 11, 3D Hardware Acceleration, 1GB, PCI Express 2.0 x16 adapter, one VGA, one DisplayPort, 30 watts; <i>Max resolution:</i> 2560x1600 (DisplayPort)@60Hz; 2048x1536 (VGA)@85Hz <i>Some:</i> AMD Radeon™ HD 7450 , DirectX 11, 3D Hardware Acceleration, 1GB, PCI Express 2.0 x16 adapter, one DVI-I (includes DVI-to-VGA dongle), one DisplayPort, 25 watts; <i>Max resolution:</i> 2560x1600 (DisplayPort, DVI-I)@60Hz	<ul style="list-style-type: none"> • Power supply • Limited warranty³ • Preload 																																																																								
DP cable	Optional DisplayPort to DVI-D monitor cable	<ul style="list-style-type: none"> • Power supply • Limited warranty³ • Preload 																																																																								
Chipset	AMD A78 FCH	<ul style="list-style-type: none"> • Power supply • Limited warranty³ • Preload 																																																																								
Front ports	Two USB 2.0, microphone (stereo, 3.5mm), headphone (stereo, 3.5mm)	<ul style="list-style-type: none"> • Power supply • Limited warranty³ • Preload 																																																																								
Rear ports	Up to six USB ports (2x USB 3.0 + 2x USB 2.0 + 2x optional USB 2.0), serial (9-pin), optional 2nd serial (9-pin), optional parallel (25-pin), ethernet (RJ-45), VGA, DisplayPort (1x standard + 1x optional), two PS/2 ports	<ul style="list-style-type: none"> • Power supply • Limited warranty³ • Preload 																																																																								
Rear audio ports	Line-in (stereo, 3.5mm), line-out (stereo, 3.5mm), microphone (stereo, 3.5mm)	<ul style="list-style-type: none"> • Power supply • Limited warranty³ • Preload 																																																																								
IEEE 1394	Optional FireWire PCIe adapter, 1394a-2000, 400Mbps, two 6-pin ports on rear	<ul style="list-style-type: none"> • Power supply • Limited warranty³ • Preload 																																																																								
Audio support	High Definition (HD) Audio, Realtek ALC662 / internal speaker (1.5watt)	<ul style="list-style-type: none"> • Power supply • Limited warranty³ • Preload 																																																																								
WLAN ¹³	<i>Some:</i> 11b/g/n wireless, Realtek RTL8723BE, Wi-Fi + BT 4.0 combo, 1x1 <i>Some:</i> 11b/g/n wireless, Realtek RTL8192EE, Wi-Fi + BT 4.0 combo, 2x2 <i>Some:</i> 11ac/b/g/n wireless, Broadcom BCM4352, 2.4/5GHz, Wi-Fi + BT 4.0, 2x2	<ul style="list-style-type: none"> • Power supply • Limited warranty³ • Preload 																																																																								
Bluetooth™	<i>Some:</i> Bluetooth 4.0 wireless, integrated in Wi-Fi + Bluetooth combo adapter	<ul style="list-style-type: none"> • Power supply • Limited warranty³ • Preload 																																																																								
Ethernet	One gigabit ethernet port, Realtek 8111EPV, Wake on LAN®	<ul style="list-style-type: none"> • Power supply • Limited warranty³ • Preload 																																																																								
Modem	None	<ul style="list-style-type: none"> • Power supply • Limited warranty³ • Preload 																																																																								
Manageability	Enhanced Manageability with DASH 1.1	<ul style="list-style-type: none"> • Power supply • Limited warranty³ • Preload 																																																																								
Security chip	Trusted Platform Module, TCG 1.2-compliant	<ul style="list-style-type: none"> • Power supply • Limited warranty³ • Preload 																																																																								
Security features	<ul style="list-style-type: none"> • Padlock loop (in rear for opt padlock) • Security slot (in rear for optional Kensington® MicroSaver® cable) • Administrator password • Hard disk password • Boot sequence control 	<ul style="list-style-type: none"> • Power supply • Limited warranty³ • Preload 																																																																								
Environment	ENERGY STAR® 6.0 (Need 85% PSU and Windows OS); EPEAT™ Gold rating (Need 85% PSU and Windows OS); GREENGUARD®; RoHS-compliant; Cisco EnergyWise compatible; ErP Lot 3	<ul style="list-style-type: none"> • Power supply • Limited warranty³ • Preload 																																																																								
Accessories	For compatible accessories, please go to TC-AQP sheet	<ul style="list-style-type: none"> • Power supply • Limited warranty³ • Preload 																																																																								

ThinkCentre M79 Tower - TopSeller - 10CN

Product Specifications Reference (PSREF)

Model	Region	Processor	vPro	Graphics	Monitor Cable	Memory	Storage	Optical	Media Reader	WLAN + Bluetooth	Optional Rear Ports	Chassis Intrusion Switch	Cable Lock	Keyboard / Mouse	Power Supply	Operating System	Warranty	Ann Date (m/y)
10CN0000US	US	A4-6300B	No	AMD HD 8370D	None	4GBx1	500GB 7200rpm 3.5"	DVD±RW	None	None	None	None	None	USB / USB	180W	Win8.1 DG Win7 Pro 64	3-year, Onsite	07/14
10CN0001US	US	AMD A8-6500B	No	AMD HD 8570D	None	4GBx1	500GB 7200rpm 3.5"	DVD±RW	None	None	None	None	None	USB / USB	180W	Win8.1 DG Win7 Pro 64	3-year, Onsite	07/14
10CN0002US	US	A8 PRO-7600B	No	AMD R7 Graphics	None	4GBx1	500GB 7200rpm 3.5"	DVD±RW	None	None	None	None	None	USB / USB	280W	Win8.1 DG Win7 Pro 64	3-year, Onsite	07/14
10CN0003US	US	A6-6400B	No	AMD HD 8470D	None	4GBx1	500GB 7200rpm 3.5"	DVD±RW	None	None	None	None	None	USB / USB	180W	Win8.1 DG Win7 Pro 64	3-year, Onsite	07/14
10CN000VUS	US	A10 PRO-7800B	No	AMD R7 Graphics	None	4GBx1	500GB 7200rpm 3.5"	DVD±RW	None	None	None	None	None	USB / USB	280W	Win8.1 DG Win7 Pro 64	3-year, Onsite	11/14
10CN000WUS	US	A10 PRO-7800B	No	AMD R7 Graphics	None	8GBx1	500GB 7200rpm 3.5"	DVD±RW	None	None	None	None	None	USB / USB	280W	Win8.1 DG Win7 Pro 64	3-year, Onsite	11/14
10CN000XUS	US	A6 PRO-7400B	No	AMD R5 Graphics	None	4GBx1	500GB 7200rpm 3.5"	DVD±RW	None	None	None	None	None	USB / USB	180W	Win8.1 DG Win7 Pro 64	3-year, Onsite	02/15
10CN000YUS	US	A8 PRO-7600B	No	AMD R7 Graphics	None	4GBx1	500GB 7200rpm 3.5"	DVD±RW	9-in-1	None	None	None	None	USB / USB	180W	Win8.1 DG Win7 Pro 64	3-year, Onsite	07/15

Model	Region	Processor	vPro	Graphics	Monitor Cable	Memory	Storage	Optical	Media Reader	WLAN + Bluetooth	Optional Rear Ports	Chassis Intrusion Switch	Cable Lock	Keyboard / Mouse	Power Supply	Operating System	Warranty	Ann Date (m/y)
10J70009US	US	PRO A4-8350B	No	AMD R5 Graphics	None	4GBx1	500GB 7200rpm 3.5"	DVD±RW	None	RTL8723BE b/g/n, 1x1 + BT4.0	None	Switch	Cable Lock	USB / USB	280W 85%	Win10 DG Win7 Pro 64	3-year, Onsite	10/15
10J7000AUS	US	PRO A8-8650B	No	AMD R7 Graphics	None	4GBx1	500GB 7200rpm 3.5"	DVD±RW	None	RTL8723BE b/g/n, 1x1 + BT4.0	None	Switch	Cable Lock	USB / USB	280W 85%	Win10 DG Win7 Pro 64	3-year, Onsite	10/15
10J7000BUS	US	PRO A10-8750B	No	AMD R7 Graphics	None	4GBx1	500GB 7200rpm 3.5"	DVD±RW	None	RTL8723BE b/g/n, 1x1 + BT4.0	None	Switch	Cable Lock	USB / USB	280W 85%	Win10 DG Win7 Pro 64	3-year, Onsite	10/15
10J7000CUS	US	PRO A6-8550B	No	AMD R5 Graphics	None	4GBx1	500GB 7200rpm 3.5"	DVD±RW	None	RTL8723BE b/g/n, 1x1 + BT4.0	None	Switch	Cable Lock	USB / USB	280W 85%	Win10 DG Win7 Pro 64	3-year, Onsite	10/15
10J7000DUS	US	A4 PRO-7300B	No	AMD HD 8470D	DP to DVI	4GBx1	500GB 7200rpm 3.5"	DVD±RW	None	RTL8723BE b/g/n, 1x1 + BT4.0	None	None	None	USB / USB	280W 85%	Win10 Pro 64	3-year, Onsite	09/15
10J7000EUS	US	A8 PRO-7600B	No	AMD R7 Graphics	DP to DVI	4GBx1	500GB 7200rpm 3.5"	DVD±RW	None	RTL8723BE b/g/n, 1x1 + BT4.0	None	None	None	USB / USB	280W 85%	Win10 Pro 64	3-year, Onsite	07/16
10J7000FUS	US	A6 PRO-7400B	No	AMD R5 Graphics	DP to DVI	4GBx1	500GB 7200rpm 3.5"	DVD±RW	None	RTL8723BE b/g/n, 1x1 + BT4.0	None	None	None	USB / USB	280W 85%	Win10 Pro 64	3-year, Onsite	09/15
10J7000GUS	US	A4 PRO-7300B	No	AMD HD 8470D	DP to DVI	4GBx1	500GB 7200rpm 3.5"	DVD±RW	None	RTL8723BE b/g/n, 1x1 + BT4.0	None	None	None	USB / USB	280W 85%	Win10 DG Win7 Pro 64	3-year, Onsite	10/15
10J7000HUS	US	A10 PRO-7800B	No	AMD R7 Graphics	DP to DVI	4GBx1	500GB 7200rpm 3.5"	DVD±RW	None	RTL8723BE b/g/n, 1x1 + BT4.0	None	None	None	USB / USB	280W 85%	Win10 Pro 64	3-year, Onsite	09/15
10J7000JUS	US	A6 PRO-7400B	No	AMD R5 Graphics	DP to DVI	4GBx1	500GB 7200rpm 3.5"	DVD±RW	None	RTL8723BE b/g/n, 1x1 + BT4.0	None	None	None	USB / USB	280W 85%	Win10 DG Win7 Pro 64	3-year, Onsite	10/15
10J7000KUS	US	A10 PRO-7800B	No	AMD R7 Graphics	DP to DVI	4GBx1	500GB 7200rpm 3.5"	DVD±RW	None	RTL8723BE b/g/n, 1x1 + BT4.0	None	None	Cable Lock	USB / USB	280W 85%	Win10 DG Win7 Pro 64	3-year, Onsite	10/15
10J7000LUS	US	A8 PRO-7600B	No	AMD R7 Graphics	DP to DVI	4GBx1	500GB 7200rpm 3.5"	DVD±RW	None	RTL8723BE b/g/n, 1x1 + BT4.0	None	None	None	USB / USB	280W 85%	Win10 DG Win7 Pro 64	3-year, Onsite	10/15

ThinkCentre M79 Tower - 10CQ

Product Specifications Reference (PSREF)

Model	Region	Processor	vPro	Graphics	Monitor Cable	Memory	Storage	Optical	Media Reader	WLAN + Bluetooth	Optional Rear Ports	Chassis Intrusion Switch	Cable Lock	Keyboard / Mouse	Power Supply	Operating System	Warranty	Ann Date (m/y)
10CQ0005US	US	A4-6300B	No	AMD HD 8370D	None	2GBx1	250GB 7200rpm 3.5"	DVD	None	None	None	Switch	None	USB / USB	280W 85%	Win7 Pro 32	3-year, Onsite, OID	07/14
10CQ0006US	US	A6 PRO-7400B	No	AMD R5 Graphics	None	2GBx1	500GB 7200rpm 3.5"	DVD±RW	None	None	None	Switch	None	USB / USB	280W 85%	Win7 Pro 32	3-year, Onsite, OID	07/14
10CQ0007US	US	A8 PRO-7600B	No	AMD HD 8570 2GB	None	4GBx1	1TB 7200rpm 3.5"	DVD±RW	9 in 1	None	Parallel	Switch	None	USB / USB	280W 85%	Win7 Pro 64	3-year, Onsite, OID	07/14

ThinkCentre M79 Tower - 10CS

Product Specifications Reference (PSREF)

Model	Region	Processor	vPro	Graphics	Monitor Cable	Memory	Storage	Optical	Media Reader	WLAN + Bluetooth	Optional Rear Ports	Chassis Intrusion Switch	Cable Lock	Keyboard / Mouse	Power Supply	Operating System	Warranty	Ann Date (m/y)
10CS0003US	US	A4-6300B	No	AMD HD 8370D	None	4GBx1	500GB 7200rpm 3.5"	DVD±RW	None	None	None	None	None	USB / USB	180W	Win8.1 DG Win7 Pro 64	3-year, Onsite	08/14



ThinkCentre M800 SFF Platform Specifications

Product Specifications Reference (PSREF)

Processor	Intel® Celeron®, Intel Pentium®, or 6th Generation Intel Core™ i3 / i5 / i7 Processor	Manageability	Intel Standard Manageability																																																						
	<table border="1"> <thead> <tr> <th>Processor</th> <th>Cores / Threads</th> <th>Frequency Base/Max(GHz)</th> <th>Cache</th> <th>Memory Types</th> <th>Integrated Graphics</th> </tr> </thead> <tbody> <tr> <td>Pentium G4400</td> <td>2 / 2</td> <td>3.3G</td> <td>3 MB</td> <td>DDR4-2133</td> <td>HD 510</td> </tr> <tr> <td>Pentium G4500</td> <td>2 / 2</td> <td>3.5G</td> <td>3 MB</td> <td>DDR4-2133</td> <td>HD 530</td> </tr> <tr> <td>Core i3-6100</td> <td>2 / 4</td> <td>3.7 G</td> <td>3 MB</td> <td>DDR4-2133</td> <td>HD 530</td> </tr> <tr> <td>Core i3-6300</td> <td>2 / 4</td> <td>3.8 G</td> <td>4 MB</td> <td>DDR4-2133</td> <td>HD 530</td> </tr> <tr> <td>Core i5-6400</td> <td>4 / 4</td> <td>2.7 G / 3.3 G</td> <td>6 MB</td> <td>DDR4-2133</td> <td>HD 530</td> </tr> <tr> <td>Core i5-6500</td> <td>4 / 4</td> <td>3.2 G / 3.6 G</td> <td>6 MB</td> <td>DDR4-2133</td> <td>HD 530</td> </tr> <tr> <td>Core i5-6600</td> <td>4 / 4</td> <td>3.3 G / 3.9 G</td> <td>6 MB</td> <td>DDR4-2133</td> <td>HD 530</td> </tr> <tr> <td>Core i7-6700</td> <td>4 / 8</td> <td>3.4 G / 4.0 G</td> <td>8 MB</td> <td>DDR4-2133</td> <td>HD 530</td> </tr> </tbody> </table>	Processor	Cores / Threads	Frequency Base/Max(GHz)	Cache	Memory Types	Integrated Graphics	Pentium G4400	2 / 2	3.3G	3 MB	DDR4-2133	HD 510	Pentium G4500	2 / 2	3.5G	3 MB	DDR4-2133	HD 530	Core i3-6100	2 / 4	3.7 G	3 MB	DDR4-2133	HD 530	Core i3-6300	2 / 4	3.8 G	4 MB	DDR4-2133	HD 530	Core i5-6400	4 / 4	2.7 G / 3.3 G	6 MB	DDR4-2133	HD 530	Core i5-6500	4 / 4	3.2 G / 3.6 G	6 MB	DDR4-2133	HD 530	Core i5-6600	4 / 4	3.3 G / 3.9 G	6 MB	DDR4-2133	HD 530	Core i7-6700	4 / 8	3.4 G / 4.0 G	8 MB	DDR4-2133	HD 530	Security chip	Trusted Platform Module, TCG 1.2-compliant
Processor	Cores / Threads	Frequency Base/Max(GHz)	Cache	Memory Types	Integrated Graphics																																																				
Pentium G4400	2 / 2	3.3G	3 MB	DDR4-2133	HD 510																																																				
Pentium G4500	2 / 2	3.5G	3 MB	DDR4-2133	HD 530																																																				
Core i3-6100	2 / 4	3.7 G	3 MB	DDR4-2133	HD 530																																																				
Core i3-6300	2 / 4	3.8 G	4 MB	DDR4-2133	HD 530																																																				
Core i5-6400	4 / 4	2.7 G / 3.3 G	6 MB	DDR4-2133	HD 530																																																				
Core i5-6500	4 / 4	3.2 G / 3.6 G	6 MB	DDR4-2133	HD 530																																																				
Core i5-6600	4 / 4	3.3 G / 3.9 G	6 MB	DDR4-2133	HD 530																																																				
Core i7-6700	4 / 8	3.4 G / 4.0 G	8 MB	DDR4-2133	HD 530																																																				
		Security features	<ul style="list-style-type: none"> One lock to secure both cover and entire system to fixed object: <ul style="list-style-type: none"> -Padlock loop (in rear for opt padlock) -Security slot (in rear for optional Kensington® MicroSaver® cable) Power-on password Administrator password Hard disk password Boot sequence control Boot without keyboard and mouse Individual USB port disablement Optional chassis intrusion switch 																																																						
		Keyboard	<i>Some:</i> Preferred Pro USB Keyboard (USB connector), Lenovo logo <i>Some:</i> Lenovo USB Fingerprint Keyboard (USB connector) <i>Some:</i> Ultralim Plus Wireless Keyboard (2.4GHz via USB receiver), black																																																						
		Mouse	<i>Some:</i> Enhanced Optical USB Mouse, black, Lenovo logo <i>Some:</i> Ultralim Plus Wireless Mouse (2.4GHz via USB receiver), black																																																						
Memory	64GB max, UDIMM, DDR4 2133, four 288-pin DIMM sockets, dual-channel capable	Mechanical	<ul style="list-style-type: none"> SFF (9.7L), black color; metal case (WxDxH) 13.31" X 14.05" X 3.46"; 338mm X 357mm X 88mm 12.3 lb (5.6 kg) Toolless cover, disk, optical removal Toolless graphics, PCI adapter retention Optional dust filter Bay 1: N/A, 9.5mm high, external, std optical Bay 2: 3.5", 1" high, internal, std disk Bay 3: 2.5", N/A, internal, opt 2nd 2.5" disk (optional bay) Bay 4: N/A, N/A, external, opt reader Slot 1: Low Profile, PCI Express 3.0 x16 (45w max) Slot 2: Low Profile, PCIe 3.0 x1 Slot 3: Low Profile, PCIe 3.0 x16 (x4 elec, 45w max) Slot 4: Low Profile, optional 32-bit PCI 2.3 (via M.2 to PCI adaptor) 																																																						
Disk	<i>Some:</i> Hard disk, SATA 6.0Gb/s, 2.5"/ 3.5" wide, 5400 / 7200 rpm <i>Some:</i> Solid State Hybrid Drive (SSHD), 500GB (5400 rpm, 2.5") / 1TB or 2TB (7200 rpm, 3.5"), with 8GB NAND flash memory, SATA 6.0Gb/s																																																								
Optical	<i>Some:</i> Solid State Drive (SSD) / SATA 6.0Gb/s, 2.5" Wide <i>Some:</i> DVD-ROM SATA 1.5Gb/s Drive <i>Some:</i> Super Multi-Burner DVD±RW SATA 1.5Gb/s Drive																																																								
Onboard SATA	Four onboard SATA 6.0Gb/s connectors, one is eSATA connector for optional rear eSATA port																																																								
Media reader	Optional 9-in-1 media reader																																																								
Graphics	Intel HD Graphics 510/530 in processor, uses main memory, DirectX® 12, one VGA, two DisplayPort™, supports three independent displays, works along with discrete graphics to support more displays; <i>Max resolution:</i> 4096x2304 (DP) @60Hz; 1920x1200 (VGA) @60Hz <i>Some:</i> NVIDIA® Quadro® K420 , DirectX 12, 2GB, PCIe 2.0 x16 adapter, one DVI-I, one DisplayPort, 41 watts; <i>Max resolution:</i> 3840x2160 (DisplayPort) @60Hz; 2560x1600 (DVI-I) @60Hz <i>Some:</i> NVIDIA GeForce® GT 720 , DirectX 12, 2GB, PCIe 2.0 x8 adapter, one VGA, one HDMI, 25 watts; <i>Max resolution:</i> 1920x1080 (HDMI) @60Hz; 2048x1536 (VGA) @85Hz <i>Some:</i> NVIDIA GeForce GT 720 , DirectX 12, 1GB, PCIe 2.0 x8 adapter, two DisplayPort, 25 watts; <i>Max resolution:</i> 3840x2160 (DisplayPort) @60Hz;	Floor Stand	Optional system floor stand for vertical orientation																																																						
DP cable	Optional DP to VGA, DP to DVI-D (single link), or DP to HDMI 1.4 dongle	Power supply	210 watts, autosensing, 85% PSU																																																						
Chipset	Intel Q150 Chipset	Limited warranty ³	<i>Some:</i> 1-year or 3-year, limited onsite service / service upgrades available <i>Some:</i> 3-year, limited onsite service, OID (Onsite International Delivery) / service upgrades available <i>For Lenovo service upgrade options, please go to S-TC sheet</i>																																																						
Front ports	Two USB 3.0, two optional USB 2.0, microphone (3.5mm), headphone (3.5mm)	Preload	Preloaded operating system <i>Some:</i> Windows® 7 Professional 64 preinstalled through downgrade rights in Windows 10 Pro 64-bit <i>Some:</i> Windows 7 Professional 64 <i>Some:</i> Windows 10 Pro 64-bit <i>Some:</i> Windows 10 Home 64-bit																																																						
Rear ports	Four USB 3.0, two USB 2.0, two optional USB 2.0, serial (9-pin), optional 2nd serial (9-pin), optional parallel (25-pin), ethernet (RJ-45), one VGA, two DisplayPort, optional PS/2 ports (keyboard/mouse), one optional eSATA port additional VGA, DisplayPort, DVI-I or HDMI on optional graphics on some models		Preloaded applications (only some listed) <ul style="list-style-type: none"> Desktop Power Manager Lenovo Solution Center Lenovo REACHit Lenovo SHAREit Lenovo Bluetooth Lock (for models with Wi-Fi/BT card) McAfee® LiveSafe™ (30-day trial) Microsoft Office preloaded; purchase a product key to activate PowerDVD Create (DVD±RW) Lenovo ThinkVantage Tools - Only for Window 10 Lenovo Companion Cyberlink PowerDVD (DVD, DVD±RW) Lenovo QuickOptimizer - Only for Window 7 Rescue and Recovery Password Manager ThinkVantage System Update Lenovo Message Center Plus Adobe® Reader® 																																																						
Rear audio ports	Line-in (3.5mm), line-out (3.5mm), microphone-in (3.5mm)																																																								
IEEE 1394	None																																																								
Audio support	High Definition (HD) Audio, Realtek ALC662 / optional internal speaker (1.5 watt)	Environment	ENERGY STAR® 6.1>(*Need 85% PSU and Windows OS); ErP Lot 3; GREENGUARD®; RoHS-compliant; TUV Green Mark																																																						
WLAN ¹³	<i>Some:</i> 11ac wireless, M.2 Card, Qualcomm Atheros QCA9377 (dual band), Wi-Fi + Bluetooth 4.1 combo adapter, 1x1 <i>Some:</i> 11ac wireless, M.2 Card, Qualcomm Atheros QCA6174 (dual band), Wi-Fi + Bluetooth 4.1 combo adapter, 2x2 <i>Some:</i> 11ac wireless, M.2 Card, Intel Dual Band Wireless-AC 3165, Wi-Fi + Bluetooth 4.0 combo adapter, 1x1 <i>Some:</i> 11ac wireless, M.2 Card, Intel Dual Band Wireless-AC 8260, Wi-Fi + Bluetooth 4.1 combo adapter, 2x2	Accessories	For compatible accessories, please go to TC-AQP sheet																																																						
Bluetooth™	<i>Some:</i> Bluetooth 4.0 or 4.1 wireless, integrated in Wi-Fi + BT combo adapter																																																								
Ethernet	Gigabit ethernet, Intel Ethernet Connection I219-LM (Jacksonville), Wake on LAN®																																																								
Modem	None																																																								

See footnotes for more detailed information

Model	Region	Processor	vPro	Graphics	Monitor Cable	Memory	Storage	Optical	Optional 2nd 2.5" Bay	Media Reader	WLAN + Bluetooth	Optional Front Ports	Optional Rear Ports	Chassis Intrusion Switch	Cable Lock	PCI Slot	Dust Filter	Keyboard / Mouse	Stand	Power Supply	Operating System	Warranty	Ann Date (m/y)
10FY0004US	US	i7-6700	No	Intel HD 530	None	8GBx1	192GB SSD	DVD±RW	None	None	None	None	PS/2	None	None	None	None	USB / USB	Floor Stand	210W 85%	Win10 DG Win7 Pro 64	3-year, Onsite	11/15
10FY0005US	US	i5-6500	No	Intel HD 530	None	4GBx1	192GB SSD	DVD±RW	None	None	None	None	PS/2	None	None	None	None	USB / USB	Floor Stand	210W 85%	Win10 DG Win7 Pro 64	3-year, Onsite	11/15
10FY0006US	US	i5-6500	No	Intel HD 530	None	4GBx1	500GB 7200rpm 3.5"	DVD±RW	None	None	None	None	PS/2	None	None	None	None	USB / USB	Floor Stand	210W 85%	Win10 DG Win7 Pro 64	3-year, Onsite	11/15
10FY0007US	US	i7-6700	No	Intel HD 530	None	4GBx1	500GB 7200rpm 3.5"	DVD±RW	None	None	None	None	PS/2	None	None	None	None	USB / USB	Floor Stand	210W 85%	Win10 DG Win7 Pro 64	3-year, Onsite	11/15
10FY0008US	US	i7-6700	No	GT 720 1GB	None	8GBx1	1TB 7200rpm 3.5"	DVD±RW	None	None	None	None	PS/2	None	None	None	None	USB / USB	Floor Stand	210W 85%	Win10 DG Win7 Pro 64	3-year, Onsite	11/15
10FY0009US	US	i5-6500	No	Intel HD 530	None	4GBx1	1TB 7200rpm 3.5"	DVD±RW	None	None	None	None	PS/2	None	None	None	None	USB / USB	Floor Stand	210W 85%	Win10 DG Win7 Pro 64	3-year, Onsite	11/15
10FY000AUS	US	i7-6700	No	Intel HD 530	None	8GBx1	1TB 7200rpm 3.5"	DVD±RW	None	None	None	None	PS/2	None	None	None	None	USB / USB	Floor Stand	210W 85%	Win10 DG Win7 Pro 64	3-year, Onsite	11/15
10FY000CUS	US	i7-6700	No	Intel HD 530	None	8GBx1	1TB 7200rpm 3.5"	DVD±RW	None	None	None	None	PS/2	None	None	None	None	USB / USB	Floor Stand	210W 85%	Win10 Pro 64	3-year, Onsite	11/15
10FY000DUS	US	i5-6400	No	Intel HD 530	None	4GBx1	500GB 7200rpm 3.5"	DVD±RW	None	None	None	None	None	None	None	None	None	USB / USB	Floor Stand	210W 85%	Win10 Pro 64	3-year, Onsite	11/15
10FY000EUS	US	i7-6700	No	GT 720 1GB	None	8GBx1	1TB 7200rpm 3.5"	DVD±RW	None	None	None	None	None	None	None	None	None	USB / USB	Floor Stand	210W 85%	Win10 Pro 64	3-year, Onsite	11/15
10FY000FUS	US	i5-6500	No	Intel HD 530	None	4GBx1	500GB 7200rpm 3.5"	DVD±RW	None	None	None	None	None	None	None	None	None	USB / USB	Floor Stand	210W 85%	Win10 Pro 64	3-year, Onsite	11/15
10FY000QUS	US	i3-6100	No	Intel HD 530	None	4GBx1	500GB 7200rpm 3.5"	DVD±RW	Optional 2nd 2.5" Bay	None	None	None	None	None	None	None	None	USB / USB	Floor Stand	210W 85%	Win10 DG Win7 Pro 64	3-year, Onsite	12/15
10FY0012US	US	i3-6100	No	Intel HD 530	None	4GBx1	500GB 7200rpm 3.5"	DVD±RW	None	None	None	None	None	None	None	None	None	USB / USB	Floor Stand	210W 85%	Win10 DG Win7 Pro 64	3-year, Onsite	12/15
10FY0013US	US	i5-6400	No	Intel HD 530	None	4GBx1	500GB 7200rpm 3.5"	DVD±RW	Optional 2nd 2.5" Bay	None	None	None	None	None	None	None	None	USB / USB	Floor Stand	210W 85%	Win10 DG Win7 Pro 64	3-year, Onsite	12/15
10FY0014US	US	i5-6400	No	Intel HD 530	None	8GBx1	180GB SSD Opal	DVD±RW	Optional 2nd 2.5" Bay	None	None	None	None	None	None	None	None	USB / USB	Floor Stand	210W 85%	Win10 DG Win7 Pro 64	3-year, Onsite	12/15
10FY0015US	US	i7-6700	No	Intel HD 530	None	8GBx1	256GB SSD Opal	DVD±RW	Optional 2nd 2.5" Bay	None	None	None	None	None	None	None	None	USB / USB	Floor Stand	210W 85%	Win10 DG Win7 Pro 64	3-year, Onsite	12/15
10FY0016US	US	i7-6700	No	GT 720 1GB	None	8GBx1	1TB 7200rpm 3.5"	DVD±RW	Optional 2nd 2.5" Bay	None	None	None	None	None	None	None	None	USB / USB	Floor Stand	210W 85%	Win10 DG Win7 Pro 64	3-year, Onsite	12/15
10FY0017US	US	i7-6700	No	Intel HD 530	None	8GBx1	1TB 7200rpm 3.5"	DVD±RW	Optional 2nd 2.5" Bay	None	None	None	None	None	None	None	None	USB / USB	Floor Stand	210W 85%	Win10 DG Win7 Pro 64	3-year, Onsite	12/15
10FY0018US	US	i5-6400	No	Intel HD 530	None	8GBx1	1TB 7200rpm 3.5"	DVD±RW	Optional 2nd 2.5" Bay	None	None	None	None	None	None	None	None	USB / USB	Floor Stand	210W 85%	Win10 DG Win7 Pro 64	3-year, Onsite	12/15
10FY0019US	US	i7-6700	No	Intel HD 530	None	8GBx1	1TB 7200rpm 3.5"	DVD±RW	Optional 2nd 2.5" Bay	None	None	None	None	None	None	None	None	USB / USB	Floor Stand	210W 85%	Win10 Pro 64	3-year, Onsite	12/15

Model	Region	Processor	vPro	Graphics	Monitor Cable	Memory	Storage	Optical	Optional 2nd 2.5" Bay	Media Reader	WLAN + Bluetooth	Optional Front Ports	Optional Rear Ports	Chassis Intrusion Switch	Cable Lock	PCI Slot	Dust Filter	Keyboard / Mouse	Stand	Power Supply	Operating System	Warranty	Ann Date (m/y)
10FY001AUS	US	i7-6700	No	Intel HD 530	None	8GBx1	128GB SSD	DVD±RW	Optional 2nd 2.5" Bay	None	None	None	None	None	None	None	None	USB / USB	Floor Stand	210W 85%	Win10 DG Win7 Pro 64	3-year, Onsite	12/15
10FY001BUS	US	i5-6400	No	Intel HD 530	None	8GBx1	128GB SSD	DVD±RW	Optional 2nd 2.5" Bay	None	None	None	None	None	None	None	None	USB / USB	Floor Stand	210W 85%	Win10 DG Win7 Pro 64	3-year, Onsite	12/15
10FY001DUS	US	i5-6400	No	Intel HD 530	None	8GBx1	256GB SSD Opal	DVD±RW	Optional 2nd 2.5" Bay	None	None	None	None	None	None	None	None	USB / USB	Floor Stand	210W 85%	Win10 DG Win7 Pro 64	3-year, Onsite	12/15
10FY001EUS	US	i7-6700	No	GT 720 1GB	None	8GBx1	1TB 7200rpm 3.5"	DVD±RW	Optional 2nd 2.5" Bay	None	None	None	None	None	None	None	None	USB / USB	Floor Stand	210W 85%	Win10 Pro 64	3-year, Onsite	12/15
10FY001FUS	US	i5-6400	No	Intel HD 530	None	4GBx1	500GB 7200rpm 3.5"	DVD±RW	Optional 2nd 2.5" Bay	None	None	None	None	None	None	None	None	USB / USB	Floor Stand	210W 85%	Win10 Pro 64	3-year, Onsite	12/15
10FY001GUS	US	i7-6700	No	GT 720 1GB	None	8GBx2	1TB 7200rpm 3.5"	DVD±RW	Optional 2nd 2.5" Bay	None	None	None	None	None	None	None	None	USB / USB	Floor Stand	210W 85%	Win10 DG Win7 Pro 64	3-year, Onsite	12/15
10FY001HUS	US	i5-6400	No	Intel HD 530	None	8GBx1	500GB 7200rpm 3.5"	DVD±RW	Optional 2nd 2.5" Bay	None	None	None	None	None	None	None	None	USB / USB	Floor Stand	210W 85%	Win10 Pro 64	3-year, Onsite	12/15
10FY001JUS	US	i7-6700	No	GT 720 1GB	None	8GBx2	1TB 7200rpm 3.5"	DVD±RW	Optional 2nd 2.5" Bay	None	None	None	None	None	None	None	None	USB / USB	Floor Stand	210W 85%	Win10 Pro 64	3-year, Onsite	12/15
10FY001KUS	US	i3-6100	No	Intel HD 530	None	4GBx1	128GB SSD	DVD±RW	Optional 2nd 2.5" Bay	None	None	None	None	None	None	None	None	USB / USB	Floor Stand	210W 85%	Win10 DG Win7 Pro 64	3-year, Onsite	12/15
10FY001LUS	US	i3-6100	No	Intel HD 530	None	4GBx1	128GB SSD	DVD±RW	Optional 2nd 2.5" Bay	None	8260 ac, 2x2 + BT4.1	None	None	None	None	None	None	USB / USB	Floor Stand	210W 85%	Win10 Pro 64	3-year, Onsite	12/15
10FY001MUS	US	i3-6100	No	Intel HD 530	None	8GBx1	1TB 7200rpm 3.5"	DVD±RW	Optional 2nd 2.5" Bay	None	None	None	None	None	None	None	None	USB / USB	Floor Stand	210W 85%	Win10 DG Win7 Pro 64	3-year, Onsite	12/15
10FY001NUS	US	i3-6100	No	Intel HD 530	None	4GBx1	500GB 7200rpm 3.5"	DVD±RW	Optional 2nd 2.5" Bay	None	8260 ac, 2x2 + BT4.1	None	None	None	None	None	None	USB / USB	Floor Stand	210W 85%	Win10 DG Win7 Pro 64	3-year, Onsite	12/15
10FY001PUS	US	i3-6100	No	Intel HD 530	None	4GBx1	500GB 7200rpm 3.5"	DVD±RW	Optional 2nd 2.5" Bay	None	8260 ac, 2x2 + BT4.1	None	None	None	None	None	None	USB / USB	Floor Stand	210W 85%	Win10 Pro 64	3-year, Onsite	12/15
10FY0029US	US	i5-6400	No	Intel HD 530	None	8GBx1	1TB 7200rpm 3.5"	DVD±RW	Optional 2nd 2.5" Bay	None	None	None	None	None	None	None	None	USB / USB	Floor Stand	210W 85%	Win10 Pro 64	3-year, Onsite	10/16
10FY002GUS	US	i3-6100	No	Intel HD 530	None	4GBx1	500GB 7200rpm 2.5"	DVD±RW	Optional 2nd 2.5" Bay	None	None	None	None	None	None	None	None	USB / USB	Floor Stand	210W 85%	Win10 Pro 64	3-year, Onsite	07/16
10FY003BUS	US	i7-6700	No	GT 720 1GB	None	8GBx1	1TB 7200rpm 3.5"	DVD±RW	Optional 2nd 2.5" Bay	None	None	None	None	None	None	None	None	USB / USB	Floor Stand	210W 85%	Win10 DG Win7 Pro 64	3-year, Onsite	10/16
10FY003CUS	US	i7-6700	No	GT 720 1GB	None	8GBx2	1TB 7200rpm 3.5"	DVD±RW	Optional 2nd 2.5" Bay	None	None	None	None	None	None	None	None	USB / USB	Floor Stand	210W 85%	Win10 DG Win7 Pro 64	3-year, Onsite	10/16
10FY003DUS	US	i7-6700	No	GT 720 1GB	None	8GBx1	1TB 7200rpm 3.5"	DVD±RW	Optional 2nd 2.5" Bay	None	None	None	None	None	None	None	None	USB / USB	Floor Stand	210W 85%	Win10 Pro 64	3-year, Onsite	10/16
10FY003EUS	US	i7-6700	No	GT 720 1GB	None	8GBx2	1TB 7200rpm 3.5"	DVD±RW	Optional 2nd 2.5" Bay	None	None	None	None	None	None	None	None	USB / USB	Floor Stand	210W 85%	Win10 Pro 64	3-year, Onsite	10/16

Model	Region	Processor	vPro	Graphics	Monitor Cable	Memory	Storage	Optical	Optional 2nd 2.5" Bay	Media Reader	WLAN + Bluetooth	Optional Front Ports	Optional Rear Ports	Chassis Intrusion Switch	Cable Lock	PCI Slot	Dust Filter	Keyboard / Mouse	Stand	Power Supply	Operating System	Warranty	Ann Date (m/y)
10FX0005US	US	i5-6500	No	Intel HD 530	None	4GBx1	500GB 7200rpm 3.5"	DVD±RW	None	None	None	None	PS/2	None	None	None	None	USB / USB	Floor Stand	210W 85%	Win10 DG Win7 Pro 64	3-year, Onsite	11/15
10FX0006US	US	i7-6700	No	GT 720 1GB	None	8GBx1	1TB 7200rpm 3.5"	DVD±RW	None	None	None	None	PS/2	None	None	None	None	USB / USB	Floor Stand	210W 85%	Win10 DG Win7 Pro 64	3-year, Onsite	11/15
10FX0007US	US	i7-6700	No	Intel HD 530	None	8GBx1	120GB SSD	DVD±RW	None	None	None	None	PS/2	None	None	None	None	USB / USB	Floor Stand	210W 85%	Win10 DG Win7 Pro 64	3-year, Onsite	11/15
10FX0008US	US	i7-6700	No	Intel HD 530	None	4GBx1	500GB 7200rpm 3.5"	DVD±RW	None	None	None	None	PS/2	None	None	None	None	USB / USB	Floor Stand	210W 85%	Win10 DG Win7 Pro 64	3-year, Onsite	11/15
10FX0009US	US	i7-6700	No	Intel HD 530	None	8GBx1	1TB 7200rpm 3.5"	DVD±RW	None	None	None	None	PS/2	None	None	None	None	USB / USB	Floor Stand	210W 85%	Win10 DG Win7 Pro 64	3-year, Onsite	11/15
10FX000VUS	US	i5-6500	No	Intel HD 530	DP to HDMI	4GBx1	500GB 7200rpm 3.5"	DVD±RW	None	None	None	None	None	None	None	None	None	USB / USB	None	210W 85%	Win10 Pro 64	3-year, Onsite, OID	11/15
10FX0011US	US	i5-6500	No	GT 720 1GB	DP to VGA	4GBx1	1TB 7200rpm 3.5"	DVD±RW	None	9-in-1	None	None	None	None	None	None	None	USB / USB	None	210W 85%	Win10 Pro 64	3-year, Onsite, OID	11/15
10FX0012US	US	i5-6500	No	Intel HD 530	None	4GBx1	500GB 7200rpm 3.5"	DVD	None	None	None	None	None	None	None	None	None	USB / USB	None	210W 85%	Win10 DG Win7 Pro 64	3-year, Onsite, OID	11/15
10FX0013US	US	i5-6500	No	GT 720 1GB	None	4GBx1	1TB 7200rpm 3.5"	DVD±RW	None	9-in-1	None	None	None	None	None	None	Dust Filter	USB / USB	None	210W 85%	Win10 DG Win7 Pro 64	3-year, Onsite, OID	11/15
10FX0014US	US	i5-6500	No	Intel HD 530	None	4GBx1	500GB 7200rpm 3.5"	DVD±RW	None	None	None	None	None	None	None	None	None	USB / USB	None	210W 85%	Win10 DG Win7 Pro 64	3-year, Onsite, OID	11/15



ThinkCentre M800 Tower Platform Specifications

Product Specifications Reference (PSREF)

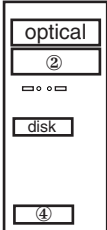
Processor	Intel® Celeron®, Intel Pentium®, or 6th Generation Intel Core™ i3 / i5 / i7 Processor	Manageability	Intel Standard Manageability																																																						
	<table border="1"> <thead> <tr> <th>Processor</th> <th>Cores / Threads</th> <th>Frequency Base/Max(GHz)</th> <th>Cache</th> <th>Memory Types</th> <th>Integrated Graphics</th> </tr> </thead> <tbody> <tr> <td>Pentium G4400</td> <td>2 / 2</td> <td>3.3G</td> <td>3 MB</td> <td>DDR4-2133</td> <td>HD 510</td> </tr> <tr> <td>Pentium G4500</td> <td>2 / 2</td> <td>3.5G</td> <td>3 MB</td> <td>DDR4-2133</td> <td>HD 530</td> </tr> <tr> <td>Core i3-6100</td> <td>2 / 4</td> <td>3.7 G</td> <td>3 MB</td> <td>DDR4-2133</td> <td>HD 530</td> </tr> <tr> <td>Core i3-6300</td> <td>2 / 4</td> <td>3.8 G</td> <td>4 MB</td> <td>DDR4-2133</td> <td>HD 530</td> </tr> <tr> <td>Core i5-6400</td> <td>4 / 4</td> <td>2.7 G / 3.3 G</td> <td>6 MB</td> <td>DDR4-2133</td> <td>HD 530</td> </tr> <tr> <td>Core i5-6500</td> <td>4 / 4</td> <td>3.2 G / 3.6 G</td> <td>6 MB</td> <td>DDR4-2133</td> <td>HD 530</td> </tr> <tr> <td>Core i5-6600</td> <td>4 / 4</td> <td>3.3 G / 3.9 G</td> <td>6 MB</td> <td>DDR4-2133</td> <td>HD 530</td> </tr> <tr> <td>Core i7-6700</td> <td>4 / 8</td> <td>3.4 G / 4.0 G</td> <td>8 MB</td> <td>DDR4-2133</td> <td>HD 530</td> </tr> </tbody> </table>	Processor	Cores / Threads	Frequency Base/Max(GHz)	Cache	Memory Types	Integrated Graphics	Pentium G4400	2 / 2	3.3G	3 MB	DDR4-2133	HD 510	Pentium G4500	2 / 2	3.5G	3 MB	DDR4-2133	HD 530	Core i3-6100	2 / 4	3.7 G	3 MB	DDR4-2133	HD 530	Core i3-6300	2 / 4	3.8 G	4 MB	DDR4-2133	HD 530	Core i5-6400	4 / 4	2.7 G / 3.3 G	6 MB	DDR4-2133	HD 530	Core i5-6500	4 / 4	3.2 G / 3.6 G	6 MB	DDR4-2133	HD 530	Core i5-6600	4 / 4	3.3 G / 3.9 G	6 MB	DDR4-2133	HD 530	Core i7-6700	4 / 8	3.4 G / 4.0 G	8 MB	DDR4-2133	HD 530	Security chip	Trusted Platform Module, TCG 1.2-compliant
Processor	Cores / Threads	Frequency Base/Max(GHz)	Cache	Memory Types	Integrated Graphics																																																				
Pentium G4400	2 / 2	3.3G	3 MB	DDR4-2133	HD 510																																																				
Pentium G4500	2 / 2	3.5G	3 MB	DDR4-2133	HD 530																																																				
Core i3-6100	2 / 4	3.7 G	3 MB	DDR4-2133	HD 530																																																				
Core i3-6300	2 / 4	3.8 G	4 MB	DDR4-2133	HD 530																																																				
Core i5-6400	4 / 4	2.7 G / 3.3 G	6 MB	DDR4-2133	HD 530																																																				
Core i5-6500	4 / 4	3.2 G / 3.6 G	6 MB	DDR4-2133	HD 530																																																				
Core i5-6600	4 / 4	3.3 G / 3.9 G	6 MB	DDR4-2133	HD 530																																																				
Core i7-6700	4 / 8	3.4 G / 4.0 G	8 MB	DDR4-2133	HD 530																																																				
		Security features	<ul style="list-style-type: none"> One lock to secure both cover and entire system to fixed object: <ul style="list-style-type: none"> -Padlock loop (in rear for opt padlock) -Security slot (in rear for optional Kensington® MicroSaver® cable) Power-on password Administrator password Hard disk password Boot sequence control Boot without keyboard and mouse Individual USB port disablement Optional chassis intrusion switch 																																																						
		Keyboard	<i>Some:</i> Preferred Pro USB Keyboard (USB connector), Lenovo logo <i>Some:</i> Lenovo USB Fingerprint Keyboard (USB connector) <i>Some:</i> Ultralim Plus Wireless Keyboard (2.4GHz via USB receiver), black																																																						
		Mouse	<i>Some:</i> Enhanced Optical USB Mouse, black, Lenovo logo <i>Some:</i> Ultralim Plus Wireless Mouse (2.4GHz via USB receiver), black																																																						
Memory	64GB max, UDIMM, DDR4 2133, four 288-pin DIMM sockets, dual-channel capable	Mechanical	<ul style="list-style-type: none"> Tower (25L), black color, metal case (WxDxH) 6.89" X 16.26" X 15.98"; 175mm X 413mm X 406mm 27.56 lb (12.5 kg) Toolless cover, disk, optical removal Toolless graphics, PCI adapter retention Optional dust filter Bay 1: 5.25", 1.6" high, access, std optical Bay 2: 5.25", 1.6" high, access, opt media reader / front access HDD Bay 3: 3.5", 1" high, no access, std disk Bay 4: 3.5", 1" high, no access, opt disk (optional 2nd 3.5" disk tray) Slot 1: half-length, full-height, PCIe 3.0 x16 (75w max) Slot 2: half-length, full-height, PCIe 3.0 x1 Slot 3: half-length, full-height, PCIe 3.0 x16 (x4 elec, 75w max) Slot 4: half-length, full-height, optional 32-bit PCI 2.3 (via M.2 to PCI adaptor) 																																																						
Disk	<i>Some:</i> Hard disk, SATA 6.0Gb/s, 2.5"/ 3.5" wide, 5400 / 7200 rpm <i>Some:</i> Solid State Hybrid Drive (SSHD), 500GB (5400 rpm, 2.5") / 1TB or 2TB (7200 rpm, 3.5"), with 8GB NAND flash memory, SATA 6.0Gb/s <i>Some:</i> Solid State Drive (SSD) / SATA 6.0Gb/s, 2.5" Wide <i>Some:</i> Front accessible and removable HDD, 3.5", lockable via physical key																																																								
Optical	<i>Some:</i> DVD-ROM SATA 1.5Gb/s Drive <i>Some:</i> Super Multi-Burner DVD±RW SATA 1.5Gb/s Drive																																																								
Onboard SATA	Four onboard SATA 6.0Gb/s connectors, one is eSATA connector for optional rear eSATA port																																																								
Media reader	Optional 29-in-1 media reader																																																								
Graphics	Intel HD Graphics 510/530 in processor, uses main memory, DirectX® 12, one VGA, two DisplayPort™, supports three independent displays, works along with discrete graphics to support more displays; <i>Max resolution:</i> 4096x2304 (DP)@60Hz; 1920x1200 (VGA)@60Hz <i>Some:</i> NVIDIA® Quadro® K420 , DirectX 12, 2GB, PCIe 2.0 x16 adapter, one DVI-I, one DisplayPort, 41 watts; <i>Max resolution:</i> 3840x2160 (DisplayPort)@60Hz; 2560x1600 (DVI-I)@60Hz <i>Some:</i> NVIDIA GeForce® GT 720 , DirectX 12, 2GB, PCIe 2.0 x8 adapter, one VGA, one HDMI, 25 watts; <i>Max resolution:</i> 1920x1080 (HDMI)@60Hz; 2048x1536 (VGA)@85Hz <i>Some:</i> NVIDIA GeForce GT 720 , DirectX 12, 1GB, PCIe 2.0 x8 adapter, two DisplayPort, 25 watts; <i>Max resolution:</i> 3840x2160 (DisplayPort)@60Hz; Optional DP to VGA, DP to DVI-D (single link), or DP to HDMI 1.4 dongle																																																								
Power supply	250 watts, autosensing, 85% PSU																																																								
DP cable	Optional DP to VGA, DP to DVI-D (single link), or DP to HDMI 1.4 dongle	Limited warranty ³	<i>Some:</i> 1-year or 3-year, limited onsite service / service upgrades available <i>Some:</i> 3-year, limited onsite service, OID (Onsite International Delivery) / service upgrades available For Lenovo service upgrade options, please go to S-TC sheet																																																						
Chipset	Intel Q150 Chipset	Preload	Preloaded operating system <i>Some:</i> Windows® 7 Professional 64 preinstalled through downgrade rights in Windows 10 Pro 64-bit <i>Some:</i> Windows 7 Professional 64 <i>Some:</i> Windows 10 Pro 64-bit <i>Some:</i> Windows 10 Home 64-bit Preloaded applications (only some listed) <ul style="list-style-type: none"> Desktop Power Manager Lenovo Solution Center Lenovo REACHit Lenovo SHAREit Lenovo Bluetooth Lock (for models with Wi-Fi/BT card) McAfee® LiveSafe™ (30-day trial) Microsoft Office preloaded; purchase a product key to activate PowerDVD Create (DVD±RW) Lenovo ThinkVantage Tools <ul style="list-style-type: none"> - Only for Window 10 • Lenovo Companion • Cyberlink PowerDVD (DVD, DVD±RW) • Lenovo QuickOptimizer - Only for Window 7 • Rescue and Recovery • Password Manager • ThinkVantage System Update • Lenovo Message Center Plus • Adobe® Reader® 																																																						
Front ports	Two USB 3.0, two optional USB 2.0, microphone (3.5mm), headphone (3.5mm)	Environment	ENERGY STAR® 6.1*(Need 85% PSU and Windows OS); ErP Lot 3; GREENGUARD®; RoHS-compliant; TUV Green Mark																																																						
Rear ports	Four USB 3.0, two USB 2.0, two optional USB 2.0, serial (9-pin), optional 2nd serial (9-pin), optional parallel (25-pin), ethernet (RJ-45), one VGA, two DisplayPort, optional PS/2 ports (keyboard/mouse), one optional eSATA port additional VGA, DisplayPort, DVI-I or HDMI on optional graphics on some models	Accessories	For compatible accessories, please go to TC-AQP sheet																																																						
Rear audio ports	Line-in (3.5mm), line-out (3.5mm), microphone-in (3.5mm)																																																								
IEEE 1394	None																																																								
Audio support	High Definition (HD) Audio, Realtek ALC662 / optional internal speaker (1.5 watt)																																																								
WLAN ¹³	<i>Some:</i> 11ac wireless, M.2 Card, Qualcomm Atheros QCA9377 (dual band), Wi-Fi + Bluetooth 4.1 combo adapter, 1x1 <i>Some:</i> 11ac wireless, M.2 Card, Qualcomm Atheros QCA6174 (dual band), Wi-Fi + Bluetooth 4.1 combo adapter, 2x2 <i>Some:</i> 11ac wireless, M.2 Card, Intel Dual Band Wireless-AC 3165, Wi-Fi + Bluetooth 4.0 combo adapter, 1x1 <i>Some:</i> 11ac wireless, M.2 Card, Intel Dual Band Wireless-AC 8260, Wi-Fi + Bluetooth 4.1 combo adapter, 2x2																																																								
Bluetooth™	<i>Some:</i> Bluetooth 4.0 or 4.1 wireless, integrated in Wi-Fi + BT combo adapter																																																								
Ethernet	Gigabit ethernet, Intel Ethernet Connection I219-LM (Jacksonville), Wake on LAN®																																																								
Modem	None																																																								

See footnotes for more detailed information

Model	Region	Processor	vPro	Graphics	Monitor Cable	Memory	Storage	Optical	Optional 2nd 3.5" Tray	Media Reader	WLAN + Bluetooth	Optional Front Ports	Optional Rear Ports	Chassis Intrusion Switch	Cable Lock	Front Access HDD	PCI Slot	Dust Filter	Keyboard / Mouse	Carry Handle	Power Supply	Operating System	Warranty	Ann Date (m/y)	
10FW0002US	US	i7-6700	No	Intel HD 530	None	4GBx1	1TB 7200rpm 3.5"	DVD±RW	None	None	None	None	None	None	None	None	None	None	None	USB / USB	Carry Handle	250W 85%	Win10 DG Win7 Pro 64	3-year, Onsite	11/15
10FW0003US	US	i7-6700	No	K420 2GB	None	8GBx1	1TB 7200rpm 3.5"	DVD±RW	None	None	None	None	None	None	None	None	None	None	None	USB / USB	Carry Handle	250W 85%	Win10 DG Win7 Pro 64	3-year, Onsite	11/15
10FW0004US	US	i7-6700	No	Intel HD 530	None	8GBx1	120GB SSD	DVD±RW	None	None	None	None	None	None	None	None	None	None	None	USB / USB	Carry Handle	250W 85%	Win10 DG Win7 Pro 64	3-year, Onsite	11/15
10FW0005US	US	i5-6500	No	Intel HD 530	None	4GBx1	500GB 7200rpm 3.5"	DVD±RW	None	None	None	None	None	None	None	None	None	None	None	USB / USB	Carry Handle	250W 85%	Win10 DG Win7 Pro 64	3-year, Onsite	11/15
10FW0006US	US	i7-6700	No	Intel HD 530	None	8GBx1	500GB 7200rpm 3.5"	DVD±RW	None	None	None	None	None	None	None	None	None	None	None	USB / USB	Carry Handle	250W 85%	Win10 DG Win7 Pro 64	3-year, Onsite	11/15
10FW0007US	US	i5-6500	No	Intel HD 530	None	4GBx1	120GB SSD	DVD±RW	None	None	None	None	None	None	None	None	None	None	None	USB / USB	Carry Handle	250W 85%	Win10 DG Win7 Pro 64	3-year, Onsite	11/15
10FW000WUS	US	i5-6400	No	Intel HD 530	None	4GBx1	500GB 7200rpm 3.5"	DVD±RW	None	None	None	None	None	None	None	None	None	None	None	USB / USB	Carry Handle	250W 85%	Win10 Pro 64	3-year, Onsite	11/15
10FW000XUS	US	i7-6700	No	GT 720 1GB	None	8GBx1	1TB 7200rpm 3.5"	DVD±RW	None	None	None	None	None	None	None	None	None	None	None	USB / USB	Carry Handle	250W 85%	Win10 Pro 64	3-year, Onsite	11/15
10FW000YUS	US	i7-6700	No	Intel HD 530	None	8GBx1	1TB 7200rpm 3.5"	DVD±RW	None	None	None	None	None	None	None	None	None	None	None	USB / USB	Carry Handle	250W 85%	Win10 Pro 64	3-year, Onsite	11/15
10FW0010US	US	i5-6500	No	Intel HD 530	None	4GBx1	500GB 7200rpm 3.5"	DVD±RW	None	None	None	None	None	None	None	None	None	None	None	USB / USB	Carry Handle	250W 85%	Win10 Pro 64	3-year, Onsite	11/15
10FW001NUS	US	i7-6700	No	Intel HD 530	None	8GBx1	1TB 7200rpm 3.5"	DVD±RW	Optional 2nd 3.5" Tray	None	None	None	None	None	None	None	None	None	None	USB / USB	Carry Handle	250W 85%	Win10 Pro 64	3-year, Onsite	12/15
10FW001PUS	US	i5-6400	No	Intel HD 530	None	8GBx1	500GB 7200rpm 3.5"	DVD±RW	Optional 2nd 3.5" Tray	None	None	None	None	None	None	None	None	None	None	USB / USB	Carry Handle	250W 85%	Win10 Pro 64	3-year, Onsite	12/15
10FW001QUS	US	i7-6700	No	GT 720 1GB	None	8GBx2	1TB 7200rpm 3.5"	DVD±RW	Optional 2nd 3.5" Tray	None	None	None	None	None	None	None	None	None	None	USB / USB	Carry Handle	250W 85%	Win10 Pro 64	3-year, Onsite	12/15
10FW001RUS	US	i7-6700	No	GT 720 1GB	None	8GBx1	1TB 7200rpm 3.5"	DVD±RW	Optional 2nd 3.5" Tray	None	None	None	None	None	None	None	None	None	None	USB / USB	Carry Handle	250W 85%	Win10 Pro 64	3-year, Onsite	12/15
10FW001SUS	US	i5-6400	No	Intel HD 530	None	4GBx1	500GB 7200rpm 3.5"	DVD±RW	Optional 2nd 3.5" Tray	None	None	None	None	None	None	None	None	None	None	USB / USB	Carry Handle	250W 85%	Win10 Pro 64	3-year, Onsite	12/15
10FW001TUS	US	i3-6100	No	Intel HD 530	None	4GBx1	500GB 7200rpm 3.5"	DVD±RW	Optional 2nd 3.5" Tray	None	8260 ac, 2x2 + BT4.1	None	None	None	None	None	None	None	None	USB / USB	Carry Handle	250W 85%	Win10 Pro 64	3-year, Onsite	12/15
10FW001UUS	US	i3-6100	No	Intel HD 530	None	4GBx1	500GB 7200rpm 3.5"	DVD±RW	Optional 2nd 3.5" Tray	None	None	None	None	None	None	None	None	None	None	USB / USB	Carry Handle	250W 85%	Win10 DG Win7 Pro 64	3-year, Onsite	12/15
10FW001VUS	US	i3-6100	No	Intel HD 530	None	4GBx1	128GB SSD	DVD±RW	Optional 2nd 3.5" Tray	None	8260 ac, 2x2 + BT4.1	None	None	None	None	None	None	None	None	USB / USB	Carry Handle	250W 85%	Win10 Pro 64	3-year, Onsite	12/15
10FW001WUS	US	i3-6100	No	Intel HD 530	None	4GBx1	500GB 7200rpm 3.5"	DVD±RW	Optional 2nd 3.5" Tray	None	8260 ac, 2x2 + BT4.1	None	None	None	None	None	None	None	None	USB / USB	Carry Handle	250W 85%	Win10 DG Win7 Pro 64	3-year, Onsite	12/15
10FW001XUS	US	i3-6100	No	Intel HD 530	None	8GBx1	1TB 7200rpm 3.5"	DVD±RW	Optional 2nd 3.5" Tray	None	None	None	None	None	None	None	None	None	None	USB / USB	Carry Handle	250W 85%	Win10 DG Win7 Pro 64	3-year, Onsite	12/15

Model	Region	Processor	vPro	Graphics	Monitor Cable	Memory	Storage	Optical	Optional 2nd 3.5" Tray	Media Reader	WLAN + Bluetooth	Optional Front Ports	Optional Rear Ports	Chassis Intrusion Switch	Cable Lock	Front Access HDD	PCI Slot	Dust Filter	Keyboard / Mouse	Carry Handle	Power Supply	Operating System	Warranty	Ann Date (m/y)
10FW001YUS	US	i3-6100	No	Intel HD 530	None	4GBx1	128GB SSD	DVD±RW	Optional 2nd 3.5" Tray	None	None	None	None	None	None	None	None	None	USB / USB	Carry Handle	250W 85%	Win10 DG Win7 Pro 64	3-year, Onsite	12/15
10FW002TUS	US	i3-6100	No	Intel HD 530	None	4GBx1	500GB 7200rpm 3.5"	DVD±RW	Optional 2nd 3.5" Tray	None	None	None	None	None	None	None	None	None	USB / USB	Carry Handle	250W 85%	Win10 Pro 64	3-year, Onsite	07/16
10FW002UUS	US	i7-6700	No	Intel HD 530	None	8GBx1	128GB SSD	DVD±RW	Optional 2nd 3.5" Tray	None	None	None	None	None	None	None	None	None	USB / USB	Carry Handle	250W 85%	Win10 Pro 64	3-year, Onsite	07/16
10FW003DUS	US	i7-6700	No	GT 720 1GB	None	8GBx2	1TB 7200rpm 3.5"	DVD±RW	Optional 2nd 3.5" Tray	None	None	None	None	None	None	None	None	None	USB / USB	Carry Handle	250W 85%	Win10 Pro 64	3-year, Onsite	10/16
10FW003EUS	US	i7-6700	No	GT 720 1GB	None	8GBx2	1TB 7200rpm 3.5"	DVD±RW	Optional 2nd 3.5" Tray	None	None	None	None	None	None	None	None	None	USB / USB	Carry Handle	250W 85%	Win10 DG Win7 Pro 64	3-year, Onsite	10/16
10FW003FUS	US	i7-6700	No	GT 720 1GB	None	8GBx1	1TB 7200rpm 3.5"	DVD±RW	Optional 2nd 3.5" Tray	None	None	None	None	None	None	None	None	None	USB / USB	Carry Handle	250W 85%	Win10 DG Win7 Pro 64	3-year, Onsite	10/16
10FW003GUS	US	i7-6700	No	GT 720 1GB	None	8GBx1	1TB 7200rpm 3.5"	DVD±RW	Optional 2nd 3.5" Tray	None	None	None	None	None	None	None	None	None	USB / USB	Carry Handle	250W 85%	Win10 Pro 64	3-year, Onsite	10/16

Model	Region	Processor	vPro	Graphics	Monitor Cable	Memory	Storage	Optical	Optional 2nd 3.5" Tray	Media Reader	WLAN + Bluetooth	Optional Front Ports	Optional Rear Ports	Chassis Intrusion Switch	Cable Lock	Front Access HDD	PCI Slot	Dust Filter	Keyboard / Mouse	Carry Handle	Power Supply	Operating System	Warranty	Ann Date (m/y)
10FV0004US	US	i7-6700	No	K420 2GB	None	8GBx1	1TB 7200rpm 3.5"	DVD±RW	None	None	None	None	None	None	None	None	None	None	USB / USB	Carry Handle	250W 85%	Win10 DG Win7 Pro 64	3-year, Onsite	11/15
10FV0005US	US	i7-6700	No	Intel HD 530	None	8GBx1	120GB SSD	DVD±RW	None	None	None	None	None	None	None	None	None	None	USB / USB	Carry Handle	250W 85%	Win10 DG Win7 Pro 64	3-year, Onsite	11/15
10FV0006US	US	i7-6700	No	Intel HD 530	None	8GBx1	500GB 7200rpm 3.5"	DVD±RW	None	None	None	None	None	None	None	None	None	None	USB / USB	Carry Handle	250W 85%	Win10 DG Win7 Pro 64	3-year, Onsite	11/15
10FV0007US	US	i5-6500	No	Intel HD 530	None	4GBx1	120GB SSD	DVD±RW	None	None	None	None	None	None	None	None	None	None	USB / USB	Carry Handle	250W 85%	Win10 DG Win7 Pro 64	3-year, Onsite	11/15
10FV0008US	US	i7-6700	No	GT 720 1GB	None	8GBx1	1TB 7200rpm 3.5"	DVD±RW	None	None	None	None	None	None	None	None	None	None	USB / USB	Carry Handle	250W 85%	Win10 DG Win7 Pro 64	3-year, Onsite	11/15
10FV0009US	US	i7-6700	No	Intel HD 530	None	8GBx1	1TB 7200rpm 3.5"	DVD±RW	None	None	None	None	None	None	None	None	None	None	USB / USB	Carry Handle	250W 85%	Win10 DG Win7 Pro 64	3-year, Onsite	11/15
10FV000AUS	US	i5-6500	No	Intel HD 530	None	4GBx1	1TB 7200rpm 3.5"	DVD±RW	None	None	None	None	None	None	None	None	None	None	USB / USB	Carry Handle	250W 85%	Win10 DG Win7 Pro 64	3-year, Onsite	11/15
10FV000BUS	US	i5-6500	No	GT 720 1GB	None	4GBx1	1TB 7200rpm 3.5"	DVD±RW	None	None	None	None	None	None	None	None	None	None	USB / USB	Carry Handle	250W 85%	Win10 DG Win7 Pro 64	3-year, Onsite	11/15
10FV000CUS	US	i5-6500	No	Intel HD 530	None	4GBx1	500GB 7200rpm 3.5"	DVD±RW	None	None	None	None	None	None	None	None	None	None	USB / USB	Carry Handle	250W 85%	Win10 DG Win7 Pro 64	3-year, Onsite	11/15
10FV000MUS	US	i5-6500	No	Intel HD 530	None	4GBx1	500GB 7200rpm 3.5"	DVD	None	None	None	None	None	None	None	None	None	None	USB / USB	None	250W 85%	Win10 Pro 64	3-year, Onsite, OID	11/15
10FV000NUS	US	i5-6500	No	GT 720 1GB	DP to HDMI	4GBx1	1TB 7200rpm 3.5"	DVD±RW	None	29-in-1	None	None	None	None	None	None	None	None	USB / USB	None	250W 85%	Win10 Pro 64	3-year, Onsite, OID	11/15
10FV000PUS	US	i5-6500	No	Intel HD 530	None	4GBx1	500GB 7200rpm 3.5"	None	None	None	None	None	None	None	None	None	None	None	USB / USB	Carry Handle	250W 85%	Win10 Pro 64	3-year, Onsite, OID	11/15
10FV000QUS	US	i5-6500	No	GT 720 1GB	None	4GBx1	1TB 7200rpm 3.5"	DVD±RW	None	29-in-1	None	None	None	None	None	None	None	Dust Filter	USB / USB	Carry Handle	250W 85%	Win10 DG Win7 Pro 64	3-year, Onsite, OID	11/15
10FV000RUS	US	i5-6500	No	Intel HD 530	None	4GBx1	500GB 7200rpm 3.5"	DVD±RW	None	None	None	None	None	None	None	None	None	None	USB / USB	None	250W 85%	Win10 DG Win7 Pro 64	3-year, Onsite, OID	11/15
10FV000SUS	US	i5-6500	No	Intel HD 530	None	4GBx1	500GB 7200rpm 3.5"	DVD	None	None	None	None	None	None	None	None	None	None	USB / USB	None	250W 85%	Win10 DG Win7 Pro 64	3-year, Onsite, OID	11/15



ThinkCentre M900 SFF Platform Specifications

Product Specifications Reference (PSREF)

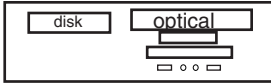
Processor	Intel® Celeron®, Intel Pentium®, or 6th Generation Intel Core™ i3 / i5 / i7 Processor							Manageability Intel Active Management Technology 11.0 (Intel AMT 11.0); Intel vPro technology on some models (require choosing a vPro-support Wi-Fi adapter to enable vPro function through wireless connection)
	Processor	Cores / Threads	Frequency Base/Max(GHz)	Cache	Memory Types	Integrated Graphics	Intel vPro	
	Pentium G4400	2 / 2	3.3G	3 MB	DDR4-2133	HD 510	No	
	Pentium G4500	2 / 2	3.5G	3 MB	DDR4-2133	HD 530	No	
	Core i3-6100	2 / 4	3.7 G	3 MB	DDR4-2133	HD 530	No	
	Core i3-6300	2 / 4	3.8 G	4 MB	DDR4-2133	HD 530	No	
	Core i5-6400	4 / 4	2.7 G / 3.3 G	6 MB	DDR4-2133	HD 530	No	
	Core i5-6500	4 / 4	3.2 G / 3.6 G	6 MB	DDR4-2133	HD 530	vPro	
Core i5-6600	4 / 4	3.3 G / 3.9 G	6 MB	DDR4-2133	HD 530	vPro		
Core i7-6700	4 / 8	3.4 G / 4.0 G	8 MB	DDR4-2133	HD 530	vPro		
Memory	64GB max, UDIMM, DDR4 2133, four 288-pin DIMM sockets, dual-channel capable							Security chip Trusted Platform Module, TCG 1.2-compliant
Disk	<i>Some:</i> Hard disk, SATA 6.0Gb/s, 2.5"/ 3.5" wide, 5400 / 7200 rpm <i>Some:</i> Solid State Hybrid Drive (SSHD), 500GB (5400 rpm, 2.5") / 1TB or 2TB (7200 rpm, 3.5"), with 8GB NAND flash memory, SATA 6.0Gb/s <i>Some:</i> Solid State Drive (SSD) / SATA 6.0Gb/s, 2.5" Wide <i>Some:</i> M.2 SSD, PCIe NVMe, PCIe 3.0 x4, 32Gb/s <i>Some:</i> DVD-ROM SATA 1.5Gb/s Drive <i>Some:</i> Super Multi-Burner DVD±RW SATA 1.5Gb/s Drive							
Optical	Four onboard SATA 6.0Gb/s connectors, one is eSATA connector for optional rear eSATA port, RAID 0, 1 support							Security features <ul style="list-style-type: none"> • One lock to secure both cover and entire system to fixed object: <ul style="list-style-type: none"> -Padlock loop (in rear for opt padlock) -Security slot (in rear for optional Kensington® MicroSaver® cable) • Power-on password • Administrator password • Hard disk password • Boot sequence control • Boot without keyboard and mouse • Individual USB port disablement • Optional chassis intrusion switch
Onboard SATA	Optional 9-in-1 media reader							
Media reader	Optional 9-in-1 media reader							Keyboard <i>Some:</i> Preferred Pro USB Keyboard (USB connector), Lenovo logo <i>Some:</i> Lenovo USB Fingerprint Keyboard (USB connector) <i>Some:</i> Ultralim Plus Wireless Keyboard (2.4GHz via USB receiver), black <i>Some:</i> Enhanced Optical USB Mouse, black, Lenovo logo <i>Some:</i> Ultralim Plus Wireless Mouse (2.4GHz via USB receiver), black
Graphics	Intel HD Graphics 510/530 in processor, uses main memory, DirectX® 12, one VGA, two DisplayPort™, supports three independent displays, works along with discrete graphics to support more displays; <i>Max resolution:</i> 4096x2304 (DP)@60Hz; 1920x1200 (VGA)@60Hz <i>Some:</i> NVIDIA® Quadro® K420 , DirectX 12, 2GB, PCIe 2.0 x16 adapter, one DVI-I, one DisplayPort, 41 watts; <i>Max resolution:</i> 3840x2160 (DisplayPort)@60Hz; 2560x1600 (DVI-I)@60Hz <i>Some:</i> NVIDIA GeForce® GT 720 , DirectX 12, 2GB, PCIe 2.0 x8 adapter, one VGA, one HDMI, 25 watts; <i>Max resolution:</i> 1920x1080 (HDMI)@60Hz; 2048x1536 (VGA)@85Hz <i>Some:</i> NVIDIA GeForce GT 720 , DirectX 12, 1GB, PCIe 2.0 x8 adapter, two DisplayPort, 25 watts; <i>Max resolution:</i> 3840x2160 (DisplayPort)@60Hz;							
DP cable	Optional DP to VGA, DP to DVI-D (single link), or DP to HDMI 1.4 dongle							Mechanical <ul style="list-style-type: none"> • SFF (9.7L), black color; metal case • (WxDxH) 13.31" X 14.05" X 3.46"; 338mm X 357mm X 88mm • 12.3 lb (5.6 kg) • Toolless cover, disk, optical removal • Toolless graphics, PCI adapter retention • Optional dust filter  <p>Bay 1: N/A, 9.5mm high, external, std optical Bay 2: 3.5", 1" high, internal, std disk Bay 3: 2.5", N/A, internal, opt 2nd 2.5" disk (optional bay) Bay 4: N/A, N/A, external, opt reader Slot 1: Low Profile, PCI Express 3.0 x16 (45w max) Slot 2: Low Profile, PCIe 3.0 x1 Slot 3: Low Profile, PCIe 3.0 x16 (x4 elec, 45w max) Slot 4: Low Profile, optional 32-bit PCI 2.3 (via M.2 to PCI adaptor)</p>
Chipset	Intel Q170 Chipset							
Front ports	Two USB 3.0, two optional USB 2.0, microphone (3.5mm), headphone (3.5mm)							Floor Stand Optional system floor stand for vertical orientation
Rear ports	Six USB 3.0, two optional USB 2.0, serial (9-pin), optional 2nd serial (9-pin), optional parallel (25-pin), ethernet (RJ-45), one VGA, two DisplayPort, optional PS/2 ports (keyboard/mouse), one optional eSATA port additional VGA, DisplayPort, DVI-I or HDMI on optional graphics on some models							
Rear audio ports	Line-in (3.5mm), line-out (3.5mm), microphone-in (3.5mm)							Power supply 210 watts, autosensing, 85% PSU
IEEE 1394	None							
Audio support	High Definition (HD) Audio, Realtek ALC662 / optional internal speaker (1.5 watt)							Limited warranty ³ <i>Some:</i> 1-year or 3-year, limited onsite service / service upgrades available <i>Some:</i> 3-year, limited onsite service, OID (Onsite International Delivery) / service upgrades available <i>For Lenovo service upgrade options, please go to S-TC sheet</i>
WLAN ¹³	<i>Some:</i> 11ac wireless, M.2 Card, Qualcomm Atheros QCA9377 (dual band), Wi-Fi + Bluetooth 4.1 combo adapter, 1x1 <i>Some:</i> 11ac wireless, M.2 Card, Qualcomm Atheros QCA6174 (dual band), Wi-Fi + Bluetooth 4.1 combo adapter, 2x2 <i>Some:</i> 11ac wireless, M.2 Card, Intel Dual Band Wireless-AC 3165, Wi-Fi + Bluetooth 4.0 combo adapter, 1x1 <i>Some:</i> 11ac wireless, M.2 Card, Intel Dual Band Wireless-AC 8260, Wi-Fi + Bluetooth 4.1 combo adapter, 2x2 <i>Some:</i> 11ac wireless, M.2 Card, Intel Dual Band Wireless-AC 8260, Wi-Fi + Bluetooth 4.1 combo adapter, Intel vPro technology support, 2x2							
Bluetooth™	<i>Some:</i> Bluetooth 4.0 or 4.1 wireless, integrated in Wi-Fi + BT combo adapter							Preload Preloaded operating system <i>Some:</i> Windows® 7 Professional 64 preinstalled through downgrade rights in Windows 10 Pro 64-bit <i>Some:</i> Windows 7 Professional 64 <i>Some:</i> Windows 10 Pro 64-bit <i>Some:</i> Windows 10 Home 64-bit
Ethernet	Gigabit ethernet, Intel Ethernet Connection I219-LM (Jacksonville), Wake on LAN®							
Modem	None							Preloaded applications (only some listed) <ul style="list-style-type: none"> • Desktop Power Manager • Lenovo Solution Center • Lenovo REACHit • Lenovo SHAREit • Lenovo Bluetooth Lock (for models with Wi-Fi/BT card) • McAfee® LiveSafe™ (30-day trial) • Microsoft Office preloaded; purchase a product key to activate • PowerDVD Create (DVD±RW) • Lenovo ThinkVantage Tools • Intel Unite (vPro models only) - Only for Window 10 • Lenovo Companion • Cyberlink PowerDVD (DVD, DVD±RW) • Lenovo QuickOptimizer - Only for Window 7 • Rescue and Recovery • Password Manager • ThinkVantage System Update • Lenovo Message Center Plus • Adobe® Reader®
Environment	ENERGY STAR® 6.1*; EPEAT™ Gold rating*; (*Need 85% PSU and Windows OS); ErP Lot 3; GREENGUARD®; RoHS-compliant; TUV Green Mark, ULE Gold							
Accessories	For compatible accessories, please go to TC-AQP sheet							

See footnotes for more detailed information

Model	Region	Processor	vPro	Graphics	Monitor Cable	Memory	Storage(HDD/SSD)	Optical	Optional 2nd 2.5" Bay	Media Reader	WLAN + Bluetooth	Optional Front Ports	Optional Rear Ports	Chassis Intrusion Switch	Cable Lock	PCI Slot	Dust Filter	Keyboard / Mouse	Stand	Power Supply	Operating System	Warranty	Ann Date (m/y)
10FH000KUS	US	i5-6500	vPro	Intel HD 530	None	4GBx1	500GB 7200rpm 3.5"	DVD±RW	None	None	None	None	None	None	None	None	None	USB / USB	Floor Stand	210W 85%	Win10 DG Win7 Pro 64	3-year, Onsite, OID	11/15
10FH000LUS	US	i7-6700	vPro	GT 720 1GB	None	8GBx1	1TB 7200rpm 3.5"	DVD±RW	None	None	8260 ac, 2x2, vPro + BT4.1	None	None	None	None	None	None	USB / USB	Floor Stand	210W 85%	Win10 Pro 64	3-year, Onsite, OID	11/15
10FH000MUS	US	i7-6700	vPro	GT 720 1GB	None	8GBx1	1TB 7200rpm 3.5"	DVD±RW	None	None	8260 ac, 2x2, vPro + BT4.1	None	None	None	None	None	None	USB / USB	Floor Stand	210W 85%	Win10 DG Win7 Pro 64	3-year, Onsite, OID	11/15
10FH000NUS	US	i5-6500	vPro	Intel HD 530	None	4GBx1	500GB 7200rpm 3.5"	DVD±RW	None	None	None	None	None	None	None	None	None	USB / USB	Floor Stand	210W 85%	Win10 Pro 64	3-year, Onsite, OID	11/15
10FH001YUS	US	i5-6500	vPro	GT 720 1GB	None	4GBx1	500GB 7200rpm 3.5"	DVD±RW	Optional 2nd 2.5" Bay	None	None	None	None	None	None	None	None	USB / USB	Floor Stand	210W 85%	Win10 DG Win7 Pro 64	3-year, Onsite	12/15
10FH0020US	US	i7-6700	vPro	GT 720 1GB	None	8GBx1	1TB 7200rpm 3.5"	DVD±RW	Optional 2nd 2.5" Bay	None	None	None	None	None	None	None	None	USB / USB	Floor Stand	210W 85%	Win10 Pro 64	3-year, Onsite	12/15
10FH0021US	US	i5-6500	vPro	Intel HD 530	None	4GBx1	180GB SSD Opal	DVD±RW	Optional 2nd 2.5" Bay	None	None	None	None	None	None	None	None	USB / USB	Floor Stand	210W 85%	Win10 DG Win7 Pro 64	3-year, Onsite	12/15
10FH0022US	US	i5-6500	vPro	Intel HD 530	None	8GBx1	256GB SSD Opal	DVD±RW	Optional 2nd 2.5" Bay	None	None	None	None	None	None	None	None	USB / USB	Floor Stand	210W 85%	Win10 DG Win7 Pro 64	3-year, Onsite	12/15
10FH0023US	US	i5-6500	vPro	Intel HD 530	None	8GBx1	192GB SSD	DVD±RW	Optional 2nd 2.5" Bay	None	None	None	None	None	None	None	None	USB / USB	Floor Stand	210W 85%	Win10 Pro 64	3-year, Onsite	12/15
10FH0024US	US	i5-6500	vPro	Intel HD 530	None	8GBx1	1TB 7200rpm 3.5"	DVD±RW	Optional 2nd 2.5" Bay	None	8260 ac, 2x2, vPro + BT4.1	None	None	None	None	None	None	USB / USB	Floor Stand	210W 85%	Win10 DG Win7 Pro 64	3-year, Onsite, OID	12/15
10FH0025US	US	i7-6700	vPro	GT 720 1GB	None	8GBx1	256GB SSD Opal	DVD±RW	Optional 2nd 2.5" Bay	None	None	None	None	None	None	None	None	USB / USB	Floor Stand	210W 85%	Win10 DG Win7 Pro 64	3-year, Onsite	12/15
10FH0026US	US	i5-6500	vPro	Intel HD 530	None	8GBx1	180GB SSD Opal	DVD±RW	Optional 2nd 2.5" Bay	None	None	None	None	None	None	None	None	USB / USB	Floor Stand	210W 85%	Win10 Pro 64	3-year, Onsite	12/15
10FH0027US	US	i7-6700	vPro	Intel HD 530	None	8GBx1	256GB SSD Opal	DVD±RW	Optional 2nd 2.5" Bay	None	None	None	None	None	None	None	None	USB / USB	Floor Stand	210W 85%	Win10 DG Win7 Pro 64	3-year, Onsite	12/15
10FH0028US	US	i5-6500	vPro	Intel HD 530	None	4GBx1	128GB SSD	DVD±RW	Optional 2nd 2.5" Bay	None	None	None	None	None	None	None	None	USB / USB	Floor Stand	210W 85%	Win10 DG Win7 Pro 64	3-year, Onsite	12/15
10FH0029US	US	i5-6500	vPro	Intel HD 530	None	4GBx1	192GB SSD	DVD±RW	Optional 2nd 2.5" Bay	None	None	None	None	None	None	None	None	USB / USB	Floor Stand	210W 85%	Win10 DG Win7 Pro 64	3-year, Onsite	12/15
10FH002AUS	US	i7-6700	vPro	Intel HD 530	None	8GBx1	256GB SSD Opal	DVD±RW	Optional 2nd 2.5" Bay	None	None	None	None	None	None	None	None	USB / USB	Floor Stand	210W 85%	Win10 Pro 64	3-year, Onsite	12/15
10FH002BUS	US	i5-6500	vPro	Intel HD 530	None	4GBx1	500GB 7200rpm 3.5"	DVD±RW	Optional 2nd 2.5" Bay	None	None	None	None	None	None	None	None	USB / USB	Floor Stand	210W 85%	Win10 DG Win7 Pro 64	3-year, Onsite, OID	12/15
10FH002CUS	US	i5-6500	vPro	Intel HD 530	None	8GBx1	500GB 7200rpm 3.5"	DVD±RW	Optional 2nd 2.5" Bay	None	None	None	None	None	None	None	None	USB / USB	Floor Stand	210W 85%	Win10 DG Win7 Pro 64	3-year, Onsite, OID	12/15
10FH002DUS	US	i7-6700	vPro	GT 720 1GB	None	8GBx1	1TB 7200rpm 3.5"	DVD±RW	Optional 2nd 2.5" Bay	None	None	None	None	None	None	None	None	USB / USB	Floor Stand	210W 85%	Win10 DG Win7 Pro 64	3-year, Onsite	12/15
10FH002EUS	US	i5-6500	vPro	GT 720 1GB	None	8GBx1	1TB 7200rpm 3.5"	DVD±RW	Optional 2nd 2.5" Bay	None	None	None	None	None	None	None	None	USB / USB	Floor Stand	210W 85%	Win10 DG Win7 Pro 64	3-year, Onsite	12/15

Model	Region	Processor	vPro	Graphics	Monitor Cable	Memory	Storage(HDD/SSD)	Optical	Optional 2nd 2.5" Bay	Media Reader	WLAN + Bluetooth	Optional Front Ports	Optional Rear Ports	Chassis Intrusion Switch	Cable Lock	PCI Slot	Dust Filter	Keyboard / Mouse	Stand	Power Supply	Operating System	Warranty	Ann Date (m/y)
10FH002FUS	US	i5-6500	vPro	Intel HD 530	None	8GBx1	1TB 7200rpm 3.5"	DVD±RW	Optional 2nd 2.5" Bay	None	None	None	None	None	None	None	None	USB / USB	Floor Stand	210W 85%	Win10 DG Win7 Pro 64	3-year, Onsite, OID	12/15
10FH002GUS	US	i5-6500	vPro	GT 720 1GB	None	8GBx1	1TB 7200rpm 3.5"	DVD±RW	Optional 2nd 2.5" Bay	None	None	None	None	None	None	None	None	USB / USB	Floor Stand	210W 85%	Win10 Pro 64	3-year, Onsite	12/15
10FH002HUS	US	i7-6700	vPro	Intel HD 530	None	8GBx1	1TB 7200rpm 3.5"	DVD±RW	Optional 2nd 2.5" Bay	None	None	None	None	None	None	None	None	USB / USB	Floor Stand	210W 85%	Win10 DG Win7 Pro 64	3-year, Onsite, OID	12/15
10FH002JUS	US	i5-6500	vPro	Intel HD 530	None	8GBx1	128GB SSD	DVD±RW	Optional 2nd 2.5" Bay	None	None	None	None	None	None	None	None	USB / USB	Floor Stand	210W 85%	Win10 Pro 64	3-year, Onsite	12/15
10FH002KUS	US	i5-6500	vPro	Intel HD 530	None	4GBx1	500GB 7200rpm 3.5"	DVD±RW	Optional 2nd 2.5" Bay	None	8260 ac, 2x2, vPro + BT4.1	None	None	None	None	None	None	USB / USB	Floor Stand	210W 85%	Win10 DG Win7 Pro 64	3-year, Onsite, OID	12/15
10FH002LUS	US	i7-6700	vPro	Intel HD 530	None	8GBx1	1TB 7200rpm 3.5"	DVD±RW	Optional 2nd 2.5" Bay	None	8260 ac, 2x2, vPro + BT4.1	None	None	None	None	None	None	USB / USB	Floor Stand	210W 85%	Win10 DG Win7 Pro 64	3-year, Onsite, OID	12/15
10FH003MUS	US	i5-6500	vPro	Intel HD 530	None	8GBx1	128GB SSD	DVD±RW	Optional 2nd 2.5" Bay	None	None	None	None	None	None	None	None	USB / USB	Floor Stand	210W 85%	Win10 DG Win7 Pro 64	3-year, Onsite	03/16
10FH003NUS	US	i5-6500	vPro	Intel HD 530	None	8GBx1	500GB 7200rpm 3.5"	DVD±RW	Optional 2nd 2.5" Bay	None	None	None	None	None	None	None	None	USB / USB	Floor Stand	210W 85%	Win10 DG Win7 Pro 64	3-year, Onsite	03/16
10FH004JUS	US	i5-6500	vPro	Intel HD 530	None	4GBx1	500GB 7200rpm 3.5"	DVD±RW	Optional 2nd 2.5" Bay	None	None	None	None	None	None	None	None	USB / USB	Floor Stand	210W 85%	Win10 Pro 64	3-year, Onsite	07/16
10FH0054US	US	i7-6700	vPro	GT 720 1GB	None	8GBx1	1TB 7200rpm 3.5"	DVD±RW	Optional 2nd 2.5" Bay	None	8260 ac, 2x2, vPro + BT4.1	None	None	None	None	None	None	USB / USB	Floor Stand	210W 85%	Win10 Pro 64	3-year, Onsite	07/16
10FH005JUS	US	i7-6700	vPro	GT 720 1GB	None	8GBx1	1TB 7200rpm 3.5"	DVD±RW	Optional 2nd 2.5" Bay	None	None	None	None	None	None	None	None	USB / USB	Floor Stand	210W 85%	Win10 DG Win7 Pro 64	3-year, Onsite	10/16
10FH005KUS	US	i7-6700	vPro	GT 720 1GB	None	8GBx1	256GB SSD Opal	DVD±RW	Optional 2nd 2.5" Bay	None	None	None	None	None	None	None	None	USB / USB	Floor Stand	210W 85%	Win10 DG Win7 Pro 64	3-year, Onsite	10/16
10FH005LUS	US	i5-6500	vPro	GT 720 1GB	None	4GBx1	500GB 7200rpm 2.5"	DVD±RW	Optional 2nd 2.5" Bay	None	None	None	None	None	None	None	None	USB / USB	Floor Stand	210W 85%	Win10 Pro 64	3-year, Onsite	10/16
10FH005MUS	US	i5-6500	vPro	GT 720 1GB	None	8GBx1	1TB 7200rpm 3.5"	DVD±RW	Optional 2nd 2.5" Bay	None	None	None	None	None	None	None	None	USB / USB	Floor Stand	210W 85%	Win10 DG Win7 Pro 64	3-year, Onsite	10/16
10FH005NUS	US	i7-6700	vPro	GT 720 1GB	None	8GBx1	1TB 7200rpm 3.5"	DVD±RW	Optional 2nd 2.5" Bay	None	None	None	None	None	None	None	None	USB / USB	Floor Stand	210W 85%	Win10 Pro 64	3-year, Onsite	10/16
10FH005PUS	US	i5-6500	vPro	GT 720 1GB	None	4GBx1	500GB 7200rpm 2.5"	DVD±RW	Optional 2nd 2.5" Bay	None	None	None	None	None	None	None	None	USB / USB	Floor Stand	210W 85%	Win10 DG Win7 Pro 64	3-year, Onsite	10/16
10FH005QUS	US	i7-6700	vPro	GT 720 1GB	None	8GBx1	1TB 7200rpm 3.5"	DVD±RW	Optional 2nd 2.5" Bay	None	8260 ac, 2x2, vPro + BT4.1	None	None	None	None	None	None	USB / USB	Floor Stand	210W 85%	Win10 DG Win7 Pro 64	3-year, Onsite	10/16
10FH005RUS	US	i5-6500	vPro	GT 720 1GB	None	8GBx1	1TB 7200rpm 3.5"	DVD±RW	Optional 2nd 2.5" Bay	None	None	None	None	None	None	None	None	USB / USB	Floor Stand	210W 85%	Win10 Pro 64	3-year, Onsite	10/16
10FH005SUS	US	i7-6700	vPro	GT 720 1GB	None	8GBx1	1TB 7200rpm 3.5"	DVD±RW	Optional 2nd 2.5" Bay	None	8260 ac, 2x2, vPro + BT4.1	None	None	None	None	None	None	USB / USB	Floor Stand	210W 85%	Win10 Pro 64	3-year, Onsite	10/16
10FH005TUS	US	i7-6700	vPro	GT 720 1GB	None	8GBx1	256GB SSD Opal	DVD±RW	Optional 2nd 2.5" Bay	None	None	None	None	None	None	None	None	USB / USB	Floor Stand	210W 85%	Win10 Pro 64	3-year, Onsite	10/16

Model	Region	Processor	vPro	Graphics	Monitor Cable	Memory	Storage(HDD/SSD)	Optical	Optional 2nd 2.5" Bay	Media Reader	WLAN + Bluetooth	Optional Front Ports	Optional Rear Ports	Chassis Intrusion Switch	Cable Lock	PCI Slot	Dust Filter	Keyboard / Mouse	Stand	Power Supply	Operating System	Warranty	Ann Date (m/y)
10FG0006US	US	i5-6500	vPro	Intel HD 530	None	4GBx1	500GB 7200rpm 3.5"	DVD±RW	None	None	None	None	None	None	None	None	None	USB / USB	Floor Stand	210W 85%	Win10 DG Win7 Pro 64	3-year, Onsite, OID	11/15
10FG0007US	US	i7-6700	vPro	GT 720 1GB	None	8GBx1	1TB 7200rpm 3.5"	DVD±RW	None	None	8260 ac, 2x2, vPro + BT4.1	None	None	None	None	None	None	USB / USB	Floor Stand	210W 85%	Win10 DG Win7 Pro 64	3-year, Onsite, OID	11/15
10FG000XUS	US	i5-6500	vPro	Intel HD 530	None	4GBx1	500GB 7200rpm 3.5"	DVD	None	None	None	None	None	None	None	None	None	USB / USB	None	210W 85%	Win10 Pro 64	3-year, Onsite, OID	11/15
10FG000YUS	US	i5-6600	vPro	Intel HD 530	None	4GBx1	500GB 7200rpm 3.5"	DVD±RW	None	None	None	None	None	None	None	None	None	USB / USB	None	210W 85%	Win10 Pro 64	3-year, Onsite, OID	11/15
10FG0013US	US	i7-6700	vPro	GT 720 1GB	None	4GBx1	1TB 7200rpm 3.5"	DVD±RW	None	9-in-1	None	None	None	None	None	None	None	USB / USB	None	210W 85%	Win10 Pro 64	3-year, Onsite, OID	11/15
10FG0014US	US	i7-6700	vPro	GT 720 1GB	None	4GBx1	1TB 7200rpm 3.5"	DVD±RW	None	9-in-1	None	None	None	None	None	None	Dust Filter	USB / USB	None	210W 85%	Win10 DG Win7 Pro 64	3-year, Onsite, OID	11/15
10FG0015US	US	i5-6600	vPro	Intel HD 530	None	4GBx1	500GB 7200rpm 3.5"	DVD±RW	None	None	None	None	None	None	None	None	None	USB / USB	None	210W 85%	Win10 DG Win7 Pro 64	3-year, Onsite, OID	11/15
10FG0016US	US	i5-6500	vPro	Intel HD 530	None	4GBx1	500GB 7200rpm 3.5"	DVD	None	None	None	None	None	None	None	None	None	USB / USB	None	210W 85%	Win10 DG Win7 Pro 64	3-year, Onsite, OID	11/15



ThinkCentre M900 Tiny Platform Specifications

Product Specifications Reference (PSREF)

Processor	Intel® Celeron®, Intel Pentium®, or 6th Generation Intel Core™ i3 / i5 / i7 Processor							Security features <ul style="list-style-type: none"> • Security slot (in rear for optional Kensington® MicroSaver® cable) • Padlock loop • Smart USB protection, allows keyboard/mouse only, blocks all storage devices • Power-on password • Administrator password • Hard disk password • Boot sequence control • Boot without keyboard and mouse • Individual USB port disablement • Chassis intrusion switch
	Processor	Cores / Threads	Frequency Base/Max(GHz)	Cache	Memory Types	Integrated Graphics	Intel vPro	
	Pentium G4400T	2 / 2	2.9 G	3 MB	DDR4-2133	HD 510	No	
	Pentium G4500T	2 / 2	3.0 G	3 MB	DDR4-2133	HD 530	No	
	Core i3-6100T	2 / 4	3.2 G	3 MB	DDR4-2133	HD 530	No	
	Core i3-6300T	2 / 4	3.3 G	4 MB	DDR4-2133	HD 530	No	
	Core i5-6400T	4 / 4	2.2 G / 2.8 G	6 MB	DDR4-2133	HD 530	No	
	Core i5-6500T	4 / 4	2.5 G / 3.1 G	6 MB	DDR4-2133	HD 530	vPro	
	Core i5-6600T	4 / 4	2.7 G / 3.5 G	6 MB	DDR4-2133	HD 530	vPro	
Core i7-6700T	4 / 8	2.8 G / 3.6 G	8 MB	DDR4-2133	HD 530	vPro		
Memory	32GB max, DDR4 2133, two 260-pin SO-DIMM sockets, dual-channel capable							
Disk	<i>Some:</i> SATA 6.0Gb/s, 2.5" Wide, 5400 rpm or 7200 rpm <i>Some:</i> 500GB (5400 rpm) Solid State Hybrid Drive (SSHD) / with 8GB MLC NAND flash memory, SATA 6.0Gb/s, 2.5" wide <i>Some:</i> Solid State Drive (SSD) / SATA 6.0Gb/s, 2.5" Wide <i>Some:</i> M.2 SSD, PCIe or SATA interface							
Optical	<i>Some:</i> external ODD box with DVD-ROM, 9.5mm high, via USB <i>Some:</i> external ODD box with DVD±RW, 9.5mm high, via USB <i>Some:</i> external ODD box (for TIO) with DVD-ROM, 9.5mm high, via USB <i>Some:</i> external ODD box (for TIO) with DVD±RW, 9.5mm high, via USB							
Onboard SATA Media reader	One SATA cable (1-drop to device), one SATA 6.0Gb/s connector on planar None							
Graphics	Intel HD Graphics 510/530 in processor, uses main memory, DirectX® 12, two DisplayPort™, one optional HDMI, VGA, or 3rd DP, up to 3 independent displays; <i>Max resolution:</i> 4096x2304 (DP) @60Hz; 4096x2160 (HDMI) @24Hz; 1920x1200 (VGA) @60Hz							
DP cable	Optional DP to VGA, DP to DVI-D (single link), or DP to HDMI 1.4 dongle							
Chipset	Intel Q170 Chipset							
Front ports	Two USB 3.0 (one is Always On and fast charge), one microphone (stereo, 3.5mm), one headphone / microphone combo jack (stereo, 3.5mm)							
Rear ports	Four USB 3.0 (optional external optical box or external I/O box occupies one or two specific USB 3.0 on some models), ethernet (RJ-45), two DisplayPort, one optional port (VGA, 3rd DP, HDMI, or serial on some models), one headphone							
I/O box	Optional external I/O box, extends two USB 2.0, two USB 3.0, and one serial on rear, two USB 2.0 on front, via USB (occupy two specific USB 3.0 of M900 Tiny)							
Audio support	High Definition (HD) Audio, Realtek ALC223 / optional internal speaker (1 watt)							
WLAN ¹³	<i>Some:</i> 11ac wireless, M.2 Card, Qualcomm Atheros QCA9377 (dual band), Wi-Fi + Bluetooth 4.1 combo adapter, 1x1 <i>Some:</i> 11ac wireless, M.2 Card, Qualcomm Atheros QCA6174 (dual band), Wi-Fi + Bluetooth 4.1 combo adapter, 2x2 <i>Some:</i> 11ac wireless, M.2 Card, Intel Dual Band Wireless-AC 3165, Wi-Fi + Bluetooth 4.0 combo adapter, 1x1 <i>Some:</i> 11ac wireless, M.2 Card, Intel Dual Band Wireless-AC 8260, Wi-Fi + Bluetooth 4.1 combo adapter, 2x2 <i>Some:</i> 11ac wireless, M.2 Card, Intel Dual Band Wireless-AC 8260, Wi-Fi + Bluetooth 4.1 combo adapter, Intel vPro technology support, 2x2							
Bluetooth™ Ethernet Modem	<i>Some:</i> Bluetooth 4.0 or 4.1 wireless, integrated in Wi-Fi + BT combo adapter Gigabit ethernet, Intel Ethernet Connection I219-LM (Jacksonville), Wake on LAN® None							
Manageability	Intel Active Management Technology 11.0 (Intel AMT 11.0); Intel vPro technology on some models (require choosing a vPro-support Wi-Fi adapter to enable vPro function through wireless connection)							
Security chip	Trusted Platform Module, TCG 1.2-compliant							
Keyboard	<i>Some:</i> Preferred Pro USB Keyboard (USB connector), Lenovo logo <i>Some:</i> Lenovo USB Fingerprint Keyboard (USB connector) <i>Some:</i> Ultralim Plus Wireless Keyboard (2.4GHz via USB receiver), black <i>Some:</i> Enhanced Optical USB Mouse, black, Lenovo logo <i>Some:</i> Ultralim Plus Wireless Mouse (2.4GHz via USB receiver), black							
Mouse	<i>Some:</i> Preferred Pro USB Keyboard (USB connector), Lenovo logo <i>Some:</i> Lenovo USB Fingerprint Keyboard (USB connector) <i>Some:</i> Ultralim Plus Wireless Keyboard (2.4GHz via USB receiver), black <i>Some:</i> Enhanced Optical USB Mouse, black, Lenovo logo <i>Some:</i> Ultralim Plus Wireless Mouse (2.4GHz via USB receiver), black							
Mechanical	Tiny (1L), black color; metal case M900 Tiny only: 7.05" W X 7.20" D X 1.36" H 179mm W X 182.9mm D X 34.5mm H 2.9 lb (1.3 kg), weight may vary by configuration With VESA mount & ODD box: 7.42" W X 7.30" D X 2.48" H 188.4mm W X 185.38mm D X 63mm H 4.12 lb (1.87 kg), weight may vary by configuration With VESA mount & I/O box: 7.42" W X 7.30" D X 2.62" H 188.4mm W X 185.38mm D X 66.6mm H 3.53 lb (1.6 kg), weight may vary by configuration Optional VESA mount bracket kit, supports VESA 75mm and 100mm Optional system floor stand for vertical orientation							
VESA mount Floor Stand	Optional VESA mount bracket kit, supports VESA 75mm and 100mm Optional system floor stand for vertical orientation							
Power supply	65 watts AC/DC adapter, autosensing, 88% PSU (not included for TIO models) 90 watts AC/DC adapter, autosensing, 88% PSU (only for models with I/O box)							
Limited warranty ³	<i>Some:</i> 1-year or 3-year, depot service / service upgrades available <i>Some:</i> 1-year or 3-year, limited onsite service / service upgrades available <i>Some:</i> 3-year, limited onsite service, OID (Onsite International Delivery) / service upgrades available <i>For Lenovo service upgrade options, please go to S-TC sheet</i>							
Preload	Preloaded operating system <i>Some:</i> Windows® 7 Professional 64 preinstalled through downgrade rights in Windows 10 Pro 64-bit <i>Some:</i> Windows 7 Professional 64 <i>Some:</i> Windows 10 Pro 64-bit <i>Some:</i> Windows 10 Home 64-bit		Preloaded applications (only some listed) <ul style="list-style-type: none"> • Desktop Power Manager • Lenovo Solution Center • Lenovo REACHit • Lenovo SHAREit • Lenovo Bluetooth Lock (for models with Wi-Fi/BT card) • McAfee® LiveSafe™ (30-day trial) • Microsoft Office preloaded; purchase a product key to activate • PowerDVD Create (DVD±RW) • Lenovo ThinkVantage Tools • Intel Unite (vPro models only) - Only for Window 10 • Lenovo Companion • Cyberlink PowerDVD (DVD, DVD±RW) • Lenovo QuickOptimizer - Only for Window 7 • Rescue and Recovery • Password Manager • ThinkVantage System Update • Lenovo Message Center Plus • Adobe® Reader® 					
Environment	ENERGY STAR® 6.1*; EPEAT™ Gold rating*; (*Need 85% PSU and Windows OS); ErP Lot 3; GREENGUARD®; RoHS-compliant; TUV Green Mark, ULE Gold							
MIL-SPEC test	MIL-STD-810G military certification (Low Pressure [Altitude], High Temperature, Low Temperature, Temperature Shock, Humidity, Sand and Dust, Vibration, Shock)							
Accessories	For compatible accessories, please go to TC-AQP sheet							

See footnotes for more detailed information

Model	Region	Processor	vPro	Graphics	Monitor Cable	Memory	Storage(HDD/SSD)	External Optical / I/O Box	WLAN + Bluetooth	Optional Rear Ports	Chassis Intrusion Switch	Kensington Cable Lock	Speaker	Adapter Cage	Toolless Chassis Screw	Dust Filter	Keyboard / Mouse	VESA Mount	Stand	Power Supply	Operating System	Warranty	Ann Date (m/y)
10FM0006US	US	i5-6500T	vPro	Intel HD 530	None	4GBx1	120GB SSD	None	8260 ac, 2x2, vPro + BT4.1	3rd DP	Switch	None	1Wx1	None	None	None	USB / USB	None	Floor Stand	65W Adapter 88%	Win10 DG Win7 Pro 64	3-year, Onsite	11/15
10FM0007US	US	i5-6500T	vPro	Intel HD 530	None	4GBx1	500GB 7200rpm 2.5"	None	8260 ac, 2x2, vPro + BT4.1	3rd DP	Switch	None	1Wx1	None	None	None	USB / USB	None	Floor Stand	65W Adapter 88%	Win10 DG Win7 Pro 64	3-year, Onsite	11/15
10FM0008US	US	i7-6700T	vPro	Intel HD 530	None	8GBx1	120GB SSD	DVD±RW	8260 ac, 2x2, vPro + BT4.1	HDMI	Switch	None	1Wx1	None	None	None	USB / USB	VESA Mount	None	65W Adapter 88%	Win10 DG Win7 Pro 64	3-year, Onsite	11/15
10FM0009US	US	i5-6500T	vPro	Intel HD 530	None	4GBx1	500GB 7200rpm 2.5"	None	8260 ac, 2x2, vPro + BT4.1	None	Switch	None	1Wx1	None	None	None	USB / USB	None	Floor Stand	65W Adapter 88%	Win10 DG Win7 Pro 64	3-year, Onsite	11/15
10FM000AUS	US	i5-6500T	vPro	Intel HD 530	None	4GBx1	120GB SSD	DVD±RW	8260 ac, 2x2, vPro + BT4.1	HDMI	Switch	None	1Wx1	None	None	None	USB / USB	VESA Mount	None	65W Adapter 88%	Win10 DG Win7 Pro 64	3-year, Onsite	11/15
10FM000BUS	US	i7-6700T	vPro	Intel HD 530	None	8GBx1	120GB SSD	None	8260 ac, 2x2, vPro + BT4.1	3rd DP	Switch	None	1Wx1	None	None	None	USB / USB	None	Floor Stand	65W Adapter 88%	Win10 DG Win7 Pro 64	3-year, Onsite	11/15
10FM0014US	US	i5-6500T	vPro	Intel HD 530	None	8GBx1	128GB SSD	DVD±RW	8260 ac, 2x2, vPro + BT4.1	HDMI	Switch	None	1Wx1	None	None	None	USB / USB	VESA Mount	None	65W Adapter 88%	Win10 DG Win7 Pro 64	3-year, Onsite	12/15
10FM0017US	US	i5-6500T	vPro	Intel HD 530	None	4GBx1	128GB SSD	None	8260 ac, 2x2, vPro + BT4.1	HDMI	Switch	None	1Wx1	None	None	None	USB / USB	None	Floor Stand	65W Adapter 88%	Win10 DG Win7 Pro 64	3-year, Onsite	12/15
10FM0018US	US	i7-6700T	vPro	Intel HD 530	None	8GBx1	180GB SSD Opal	DVD±RW	8260 ac, 2x2, vPro + BT4.1	HDMI	Switch	None	1Wx1	None	None	None	USB / USB	VESA Mount	None	65W Adapter 88%	Win10 DG Win7 Pro 64	3-year, Onsite	12/15
10FM0019US	US	i7-6700T	vPro	Intel HD 530	None	8GBx1	256GB SSD Opal	DVD±RW	8260 ac, 2x2, vPro + BT4.1	Serial	Switch	None	1Wx1	None	None	None	USB / USB	VESA Mount	None	65W Adapter 88%	Win10 DG Win7 Pro 64	3-year, Onsite	12/15
10FM001AUS	US	i7-6700T	vPro	Intel HD 530	None	8GBx1	500GB 7200rpm 2.5"	DVD±RW	8260 ac, 2x2, vPro + BT4.1	None	Switch	None	1Wx1	None	None	None	USB / USB	VESA Mount	None	65W Adapter 88%	Win10 DG Win7 Pro 64	3-year, Onsite	12/15
10FM001BUS	US	i7-6700T	vPro	Intel HD 530	None	8GBx1	256GB SSD Opal	DVD±RW	8260 ac, 2x2, vPro + BT4.1	HDMI	Switch	None	1Wx1	None	None	None	USB / USB	VESA Mount	None	65W Adapter 88%	Win10 DG Win7 Pro 64	3-year, Onsite	12/15
10FM001CUS	US	i5-6500T	vPro	Intel HD 530	None	4GBx1	500GB 7200rpm 2.5"	DVD±RW	8260 ac, 2x2, vPro + BT4.1	None	Switch	None	1Wx1	None	None	None	USB / USB	VESA Mount	None	65W Adapter 88%	Win10 DG Win7 Pro 64	3-year, Onsite	12/15
10FM001DUS	US	i7-6700T	vPro	Intel HD 530	None	8GBx1	180GB SSD Opal	DVD±RW	8260 ac, 2x2, vPro + BT4.1	3rd DP	Switch	None	1Wx1	None	None	None	USB / USB	VESA Mount	None	65W Adapter 88%	Win10 DG Win7 Pro 64	3-year, Onsite	12/15
10FM001EUS	US	i5-6500T	vPro	Intel HD 530	None	4GBx1	500GB 7200rpm 2.5"	DVD±RW	8260 ac, 2x2, vPro + BT4.1	3rd DP	Switch	None	1Wx1	None	None	None	USB / USB	VESA Mount	None	65W Adapter 88%	Win10 DG Win7 Pro 64	3-year, Onsite	12/15
10FM001FUS	US	i5-6500T	vPro	Intel HD 530	None	8GBx1	256GB SSD Opal	DVD±RW	8260 ac, 2x2, vPro + BT4.1	HDMI	Switch	None	1Wx1	None	None	None	USB / USB	VESA Mount	None	65W Adapter 88%	Win10 DG Win7 Pro 64	3-year, Onsite	12/15
10FM001GUS	US	i7-6700T	vPro	Intel HD 530	None	8GBx1	128GB SSD	None	8260 ac, 2x2, vPro + BT4.1	HDMI	Switch	None	1Wx1	None	None	None	USB / USB	None	Floor Stand	65W Adapter 88%	Win10 DG Win7 Pro 64	3-year, Onsite	12/15
10FM001HUS	US	i5-6500T	vPro	Intel HD 530	None	8GBx1	192GB SSD	DVD±RW	8260 ac, 2x2, vPro + BT4.1	HDMI	Switch	None	1Wx1	None	None	None	USB / USB	VESA Mount	None	65W Adapter 88%	Win10 DG Win7 Pro 64	3-year, Onsite	12/15
10FM001JUS	US	i7-6700T	vPro	Intel HD 530	None	8GBx1	128GB SSD	DVD±RW	8260 ac, 2x2, vPro + BT4.1	3rd DP	Switch	None	1Wx1	None	None	None	USB / USB	VESA Mount	None	65W Adapter 88%	Win10 DG Win7 Pro 64	3-year, Onsite	12/15
10FM001KUS	US	i7-6700T	vPro	Intel HD 530	None	8GBx1	192GB SSD	DVD±RW	8260 ac, 2x2, vPro + BT4.1	HDMI	Switch	None	1Wx1	None	None	None	USB / USB	VESA Mount	None	65W Adapter 88%	Win10 DG Win7 Pro 64	3-year, Onsite	12/15

Model	Region	Processor	vPro	Graphics	Monitor Cable	Memory	Storage(HDD/SSD)	External Optical / I/O Box	WLAN + Bluetooth	Optional Rear Ports	Chassis Intrusion Switch	Kensington Cable Lock	Speaker	Adapter Cage	Toolless Chassis Screw	Dust Filter	Keyboard / Mouse	VESA Mount	Stand	Power Supply	Operating System	Warranty	Ann Date (m/y)
10FM001LUS	US	i7-6700T	vPro	Intel HD 530	None	8GBx1	192GB SSD	DVD±RW	8260 ac, 2x2, vPro + BT4.1	3rd DP	Switch	None	1Wx1	None	None	None	USB / USB	VESA Mount	None	65W Adapter 88%	Win10 DG Win7 Pro 64	3-year, Onsite	12/15
10FM001MUS	US	i5-6500T	vPro	Intel HD 530	None	4GBx1	128GB SSD	DVD±RW	8260 ac, 2x2, vPro + BT4.1	3rd DP	Switch	None	1Wx1	None	None	None	USB / USB	VESA Mount	None	65W Adapter 88%	Win10 DG Win7 Pro 64	3-year, Onsite	12/15
10FM001NUS	US	i5-6500T	vPro	Intel HD 530	None	4GBx1	128GB SSD	None	8260 ac, 2x2, vPro + BT4.1	3rd DP	Switch	None	1Wx1	None	None	None	USB / USB	None	Floor Stand	65W Adapter 88%	Win10 DG Win7 Pro 64	3-year, Onsite	12/15
10FM001PUS	US	i5-6500T	vPro	Intel HD 530	None	4GBx1	500GB 7200rpm 2.5"	None	8260 ac, 2x2, vPro + BT4.1	Serial	Switch	None	1Wx1	None	None	None	USB / USB	None	Floor Stand	65W Adapter 88%	Win10 DG Win7 Pro 64	3-year, Onsite	12/15
10FM001QUS	US	i5-6500T	vPro	Intel HD 530	None	4GBx1	128GB SSD	None	8260 ac, 2x2, vPro + BT4.1	None	Switch	None	1Wx1	None	None	None	USB / USB	None	Floor Stand	65W Adapter 88%	Win10 DG Win7 Pro 64	3-year, Onsite	12/15
10FM001RUS	US	i5-6500T	vPro	Intel HD 530	None	8GBx1	192GB SSD	None	8260 ac, 2x2, vPro + BT4.1	None	Switch	None	1Wx1	None	None	None	USB / USB	None	Floor Stand	65W Adapter 88%	Win10 DG Win7 Pro 64	3-year, Onsite	12/15
10FM001SUS	US	i5-6500T	vPro	Intel HD 530	None	8GBx1	180GB SSD Opal	None	8260 ac, 2x2, vPro + BT4.1	3rd DP	Switch	None	1Wx1	None	None	None	USB / USB	None	Floor Stand	65W Adapter 88%	Win10 DG Win7 Pro 64	3-year, Onsite	12/15
10FM001TUS	US	i5-6500T	vPro	Intel HD 530	None	4GBx1	500GB 7200rpm 2.5"	None	8260 ac, 2x2, vPro + BT4.1	HDMI	Switch	None	1Wx1	None	None	None	USB / USB	None	Floor Stand	65W Adapter 88%	Win10 DG Win7 Pro 64	3-year, Onsite	12/15
10FM001UUS	US	i5-6500T	vPro	Intel HD 530	None	8GBx1	256GB SSD Opal	None	8260 ac, 2x2, vPro + BT4.1	3rd DP	Switch	None	1Wx1	None	None	None	USB / USB	None	Floor Stand	65W Adapter 88%	Win10 DG Win7 Pro 64	3-year, Onsite	12/15
10FM001VUS	US	i7-6700T	vPro	Intel HD 530	None	8GBx1	128GB SSD	None	8260 ac, 2x2, vPro + BT4.1	3rd DP	Switch	None	1Wx1	None	None	None	USB / USB	None	Floor Stand	65W Adapter 88%	Win10 DG Win7 Pro 64	3-year, Onsite	12/15
10FM001WUS	US	i7-6700T	vPro	Intel HD 530	None	8GBx1	192GB SSD	None	8260 ac, 2x2, vPro + BT4.1	3rd DP	Switch	None	1Wx1	None	None	None	USB / USB	None	Floor Stand	65W Adapter 88%	Win10 DG Win7 Pro 64	3-year, Onsite	12/15
10FM001XUS	US	i7-6700T	vPro	Intel HD 530	None	8GBx1	500GB 7200rpm 2.5"	None	8260 ac, 2x2, vPro + BT4.1	None	Switch	None	1Wx1	None	None	None	USB / USB	None	Floor Stand	65W Adapter 88%	Win10 DG Win7 Pro 64	3-year, Onsite	12/15
10FM001YUS	US	i7-6700T	vPro	Intel HD 530	None	8GBx1	180GB SSD Opal	None	8260 ac, 2x2, vPro + BT4.1	3rd DP	Switch	None	1Wx1	None	None	None	USB / USB	None	Floor Stand	65W Adapter 88%	Win10 DG Win7 Pro 64	3-year, Onsite	12/15
10FM0020US	US	i7-6700T	vPro	Intel HD 530	None	8GBx1	128GB SSD	None	8260 ac, 2x2, vPro + BT4.1	None	Switch	None	1Wx1	None	None	None	USB / USB	None	Floor Stand	65W Adapter 88%	Win10 DG Win7 Pro 64	3-year, Onsite	12/15
10FM0021US	US	i7-6700T	vPro	Intel HD 530	None	8GBx1	256GB SSD Opal	None	8260 ac, 2x2, vPro + BT4.1	3rd DP	Switch	None	1Wx1	None	None	None	USB / USB	None	Floor Stand	65W Adapter 88%	Win10 DG Win7 Pro 64	3-year, Onsite	12/15
10FM0022US	US	i7-6700T	vPro	Intel HD 530	None	8GBx1	128GB SSD	None	8260 ac, 2x2, vPro + BT4.1	3rd DP	Switch	None	1Wx1	None	None	None	USB / USB	None	Floor Stand	65W Adapter 88%	Win10 Pro 64	3-year, Onsite	12/15
10FM0023US	US	i5-6500T	vPro	Intel HD 530	None	4GBx1	500GB 7200rpm 2.5"	DVD±RW	8260 ac, 2x2, vPro + BT4.1	3rd DP	Switch	None	1Wx1	None	None	None	USB / USB	VESA Mount	None	65W Adapter 88%	Win10 Pro 64	3-year, Onsite	12/15
10FM0024US	US	i5-6500T	vPro	Intel HD 530	None	8GBx1	128GB SSD	DVD±RW	8260 ac, 2x2, vPro + BT4.1	3rd DP	Switch	None	1Wx1	None	None	None	USB / USB	VESA Mount	None	65W Adapter 88%	Win10 Pro 64	3-year, Onsite	12/15
10FM0025US	US	i7-6700T	vPro	Intel HD 530	None	8GBx1	128GB SSD	DVD±RW	8260 ac, 2x2, vPro + BT4.1	3rd DP	Switch	None	1Wx1	None	None	None	USB / USB	VESA Mount	None	65W Adapter 88%	Win10 Pro 64	3-year, Onsite	12/15
10FM0026US	US	i5-6500T	vPro	Intel HD 530	None	8GBx1	128GB SSD	None	8260 ac, 2x2, vPro + BT4.1	3rd DP	Switch	None	1Wx1	None	None	None	USB / USB	None	Floor Stand	65W Adapter 88%	Win10 Pro 64	3-year, Onsite	12/15

Model	Region	Processor	vPro	Graphics	Monitor Cable	Memory	Storage(HDD/SSD)	External Optical / I/O Box	WLAN + Bluetooth	Optional Rear Ports	Chassis Intrusion Switch	Kensington Cable Lock	Speaker	Adapter Cage	Toolless Chassis Screw	Dust Filter	Keyboard / Mouse	VESA Mount	Stand	Power Supply	Operating System	Warranty	Ann Date (m/y)
10FM0027US	US	i5-6500T	vPro	Intel HD 530	None	4GBx1	500GB 7200rpm 2.5"	None	8260 ac, 2x2, vPro + BT4.1	3rd DP	Switch	None	1Wx1	None	None	None	USB / USB	None	Floor Stand	65W Adapter 88%	Win10 Pro 64	3-year, Onsite	12/15
10FM002TUS	US	i7-6700T	vPro	Intel HD 530	None	8GBx1	256GB SSD Opal	None	8260 ac, 2x2, vPro + BT4.1	VGA	Switch	None	1Wx1	None	None	None	USB / USB	None	Floor Stand	65W Adapter 88%	Win10 DG Win7 Pro 64	3-year, Onsite	02/16
10FM002UUS	US	i5-6500T	vPro	Intel HD 530	None	4GBx1	500GB 7200rpm 2.5"	DVD±RW	8260 ac, 2x2, vPro + BT4.1	VGA	Switch	None	1Wx1	None	None	None	USB / USB	VESA Mount	None	65W Adapter 88%	Win10 DG Win7 Pro 64	3-year, Onsite	02/16
10FM002VUS	US	i5-6500T	vPro	Intel HD 530	None	4GBx1	500GB 7200rpm 2.5"	DVD±RW	8260 ac, 2x2, vPro + BT4.1	VGA	Switch	None	1Wx1	None	None	None	None / USB	VESA Mount	None	65W Adapter 88%	Win10 DG Win7 Pro 64	3-year, Onsite	02/16
10FM0030US	US	i5-6600T	vPro	Intel HD 530	None	8GBx1	128GB SSD	None	8260 ac, 2x2, vPro + BT4.1	3rd DP	Switch	None	1Wx1	None	None	None	USB / USB	None	Floor Stand	65W Adapter 88%	Win10 DG Win7 Pro 64	3-year, Onsite	03/16
10FM0031US	US	i5-6500T	vPro	Intel HD 530	None	8GBx1	128GB SSD	None	8260 ac, 2x2, vPro + BT4.1	VGA	Switch	None	1Wx1	None	None	None	USB / USB	None	Floor Stand	65W Adapter 88%	Win10 DG Win7 Pro 64	3-year, Onsite	03/16
10FM0032US	US	i5-6600T	vPro	Intel HD 530	None	8GBx1	500GB 7200rpm 2.5"	None	8260 ac, 2x2, vPro + BT4.1	3rd DP	Switch	None	1Wx1	None	None	None	USB / USB	None	Floor Stand	65W Adapter 88%	Win10 DG Win7 Pro 64	3-year, Onsite	03/16
10FM0033US	US	i7-6700T	vPro	Intel HD 530	None	8GBx1	128GB SSD	None	8260 ac, 2x2, vPro + BT4.1	HDMI	Switch	None	1Wx1	None	None	None	USB / USB	None	Floor Stand	65W Adapter 88%	Win10 Pro 64	3-year, Onsite	04/16
10FM0034US	US	i5-6500T	vPro	Intel HD 530	None	8GBx1	256GB SSD Opal	None	8260 ac, 2x2, vPro + BT4.1	3rd DP	Switch	None	1Wx1	None	None	None	USB / USB	None	Floor Stand	65W Adapter 88%	Win10 Pro 64	3-year, Onsite	04/16
10FM0039US	US	i5-6500T	vPro	Intel HD 530	None	8GBx1	500GB 7200rpm 2.5" + 128GB SSD M.2	None	8260 ac, 2x2, vPro + BT4.1	HDMI	Switch	None	1Wx1	None	None	None	USB / USB	None	Floor Stand	65W Adapter 88%	Win10 DG Win7 Pro 64	3-year, Onsite	05/16
10FM003AUS	US	i7-6700T	vPro	Intel HD 530	None	8GBx1	128GB SSD + 128GB SSD M.2 PCIe	None	8260 ac, 2x2, vPro + BT4.1	HDMI	Switch	None	1Wx1	None	None	None	USB / USB	None	Floor Stand	65W Adapter 88%	Win10 DG Win7 Pro 64	3-year, Onsite	05/16
10FM003BUS	US	i7-6700T	vPro	Intel HD 530	None	4GBx1	500GB 7200rpm 2.5"	None	8260 ac, 2x2, vPro + BT4.1	3rd DP	Switch	None	1Wx1	None	None	None	USB / USB	None	Floor Stand	65W Adapter 88%	Win10 DG Win7 Pro 64	3-year, Onsite	05/16
10FM003LUS	US	i5-6500T	vPro	Intel HD 530	None	4GBx1	500GB 7200rpm 2.5"	None	8260 ac, 2x2, vPro + BT4.1	Serial	Switch	None	1Wx1	None	None	None	USB / USB	None	Floor Stand	65W Adapter 88%	Win10 Pro 64	3-year, Onsite	07/16
10FM003YUS	US	i7-6700T	vPro	Intel HD 530	None	8GBx1	256GB SSD Opal	None	8260 ac, 2x2, vPro + BT4.1	HDMI	Switch	None	1Wx1	None	None	None	USB / USB	None	Floor Stand	65W Adapter 88%	Win10 Pro 64	3-year, Onsite	10/16

Model	Region	Processor	vPro	Graphics	Monitor Cable	Memory	Storage(HDD/SSD)	External Optical / I/O Box	WLAN + Bluetooth	Optional Rear Ports	Chassis Intrusion Switch	Kensington Cable Lock	Speaker	Adapter Cage	Toolless Chassis Screw	Dust Filter	Keyboard / Mouse	VESA Mount	Stand	Power Supply	Operating System	Warranty	Ann Date (m/y)
10NE0000US	US	i5-6500T	vPro	Intel HD 530	None	4GBx1	500GB 7200rpm 2.5"	None	8260 ac, 2x2, vPro + BT4.1	HDMI	Switch	None	1Wx1	None	None	None	USB / USB	None	Floor Stand	65W Adapter 88%	Win10 Pro 64	3-year, Onsite	07/16
10NE0001US	US	i5-6500T	vPro	Intel HD 530	None	4GBx1	500GB 7200rpm 2.5"	None	8260 ac, 2x2, vPro + BT4.1	3rd DP	Switch	None	1Wx1	None	None	None	USB / USB	None	Floor Stand	65W Adapter 88%	Win10 Pro 64	3-year, Onsite	07/16
10NE0002US	US	i5-6500T	vPro	Intel HD 530	None	8GBx1	256GB SSD Opal	None	8260 ac, 2x2, vPro + BT4.1	3rd DP	Switch	None	1Wx1	None	None	None	USB / USB	None	Floor Stand	65W Adapter 88%	Win10 Pro 64	3-year, Onsite	07/16
10NE0003US	US	i5-6500T	vPro	Intel HD 530	None	4GBx1	128GB SSD	None	8260 ac, 2x2, vPro + BT4.1	HDMI	Switch	None	1Wx1	None	None	None	USB / USB	None	Floor Stand	65W Adapter 88%	Win10 Pro 64	3-year, Onsite	07/16
10NE0004US	US	i7-6700T	vPro	Intel HD 530	None	8GBx1	128GB SSD	None	8260 ac, 2x2, vPro + BT4.1	HDMI	Switch	None	1Wx1	None	None	None	USB / USB	None	Floor Stand	65W Adapter 88%	Win10 Pro 64	3-year, Onsite	07/16
10NE0005US	US	i5-6500T	vPro	Intel HD 530	None	8GBx1	256GB SSD Opal	None	8260 ac, 2x2, vPro + BT4.1	HDMI	Switch	None	1Wx1	None	None	None	USB / USB	None	Floor Stand	65W Adapter 88%	Win10 Pro 64	3-year, Onsite	07/16
10NE000RUS	US	i7-6700T	vPro	Intel HD 530	None	8GBx1	256GB SSD Opal	None	8260 ac, 2x2, vPro + BT4.1	HDMI	Switch	None	1Wx1	None	None	None	USB / USB	None	Floor Stand	65W Adapter 88%	Win10 Pro 64	3-year, Onsite	10/16
10NE000SUS	US	i5-6500T	vPro	Intel HD 530	None	8GBx1	512GB SSD	None	8260 ac, 2x2, vPro + BT4.1	3rd DP	Switch	None	1Wx1	None	None	None	USB / USB	None	Floor Stand	65W Adapter 88%	Win10 DG Win7 Pro 64	3-year, Onsite	11/16
10NE000TUS	US	i7-6700T	vPro	Intel HD 530	None	8GBx1	512GB SSD	None	8260 ac, 2x2, vPro + BT4.1	3rd DP	Switch	None	1Wx1	None	None	None	USB / USB	None	Floor Stand	65W Adapter 88%	Win10 DG Win7 Pro 64	3-year, Onsite	11/16
10NE000UUS	US	i5-6500T	vPro	Intel HD 530	None	8GBx1	512GB SSD	None	8260 ac, 2x2, vPro + BT4.1	3rd DP	Switch	None	1Wx1	None	None	None	USB / USB	None	Floor Stand	65W Adapter 88%	Win10 Pro 64	3-year, Onsite	11/16
10NE000VUS	US	i7-6700T	vPro	Intel HD 530	None	8GBx1	512GB SSD	None	8260 ac, 2x2, vPro + BT4.1	3rd DP	Switch	None	1Wx1	None	None	None	USB / USB	None	Floor Stand	65W Adapter 88%	Win10 Pro 64	3-year, Onsite	11/16

Model	Region	Processor	vPro	Graphics	Monitor Cable	Memory	Storage(HDD/SSD)	External Optical / I/O Box	WLAN + Bluetooth	Optional Rear Ports	Chassis Intrusion Switch	Kensington Cable Lock	Speaker	Adapter Cage	Toolless Chassis Screw	Dust Filter	Keyboard / Mouse	VESA Mount	Stand	Power Supply	Operating System	Warranty	Ann Date (m/y)
10FL0003US	US	i5-6500T	vPro	Intel HD 530	None	4GBx1	500GB 7200rpm 2.5"	None	8260 ac, 2x2, vPro + BT4.1	3rd DP	Switch	None	1Wx1	None	None	None	USB / USB	None	Floor Stand	65W Adapter 88%	Win10 DG Win7 Pro 64	3-year, Onsite, OID	11/15
10FL0004US	US	i7-6700T	vPro	Intel HD 530	None	8GBx1	120GB SSD	None	8260 ac, 2x2, vPro + BT4.1	3rd DP	Switch	None	1Wx1	None	None	None	USB / USB	None	Floor Stand	65W Adapter 88%	Win10 DG Win7 Pro 64	3-year, Onsite, OID	11/15
10FL0005US	US	i5-6500T	vPro	Intel HD 530	None	4GBx1	120GB SSD	None	8260 ac, 2x2, vPro + BT4.1	3rd DP	Switch	None	1Wx1	None	None	None	USB / USB	None	Floor Stand	65W Adapter 88%	Win10 DG Win7 Pro 64	3-year, Onsite, OID	11/15
10FL0006US	US	i7-6700T	vPro	Intel HD 530	None	8GBx1	120GB SSD	DVD±RW	8260 ac, 2x2, vPro + BT4.1	HDMI	Switch	None	1Wx1	None	None	None	USB / USB	VESA Mount	None	65W Adapter 88%	Win10 DG Win7 Pro 64	3-year, Onsite, OID	11/15
10FL0007US	US	i5-6500T	vPro	Intel HD 530	None	4GBx1	500GB 7200rpm 2.5"	None	8260 ac, 2x2, vPro + BT4.1	None	Switch	None	1Wx1	None	None	None	USB / USB	None	Floor Stand	65W Adapter 88%	Win10 DG Win7 Pro 64	3-year, Onsite, OID	11/15
10FL0008US	US	i5-6500T	vPro	Intel HD 530	None	4GBx1	120GB SSD	DVD±RW	8260 ac, 2x2, vPro + BT4.1	HDMI	Switch	None	1Wx1	None	None	None	USB / USB	VESA Mount	None	65W Adapter 88%	Win10 DG Win7 Pro 64	3-year, Onsite, OID	11/15
10FL001RUS	US	i5-6600T	vPro	Intel HD 530	VGA	4GBx1	500GB 7200rpm 2.5"	None	8260 ac, 2x2 + BT4.1	VGA	Switch	None	1Wx1	None	None	None	USB / USB	None	Floor Stand	65W Adapter 88%	Win10 Pro 64	3-year, Onsite, OID	11/15
10FL001SUS	US	i5-6500T	vPro	Intel HD 530	None	4GBx1	500GB 7200rpm 2.5"	None	None	3rd DP	Switch	None	1Wx1	None	None	None	USB / USB	None	None	65W Adapter 88%	Win10 Pro 64	3-year, Onsite, OID	11/15
10FL001WUS	US	i5-6500T	vPro	Intel HD 530	None	4GBx1	500GB 7200rpm 2.5"	None	None	None	Switch	None	1Wx1	None	None	None	USB / USB	None	None	65W Adapter 88%	Win10 DG Win7 Pro 64	3-year, Onsite, OID	11/15
10FL001XUS	US	i5-6600T	vPro	Intel HD 530	None	4GBx1	500GB 7200rpm 2.5"	None	8260 ac, 2x2 + BT4.1	None	Switch	None	1Wx1	None	None	None	USB / USB	None	None	65W Adapter 88%	Win10 DG Win7 Pro 64	3-year, Onsite, OID	11/15
10FL0024US	US	i7-6700T	vPro	Intel HD 530	None	4GBx1	1TB 5400rpm 2.5"	DVD±RW	8260 ac, 2x2 + BT4.1	None	Switch	None	1Wx1	None	None	None	USB / USB	VESA Mount	None	65W Adapter 88%	Win10 Pro 64	3-year, Onsite, OID	11/15



ThinkCentre M900 Mini Tower Platform Specifications

Product Specifications Reference (PSREF)

Processor	Intel® Celeron®, Intel Pentium®, or 6th Generation Intel Core™ i3 / i5 / i7 Processor							Manageability Intel Active Management Technology 11.0 (Intel AMT 11.0); Intel vPro technology on some models (require choosing a vPro-support Wi-Fi adapter to enable vPro function through wireless connection)
	Processor	Cores / Threads	Frequency Base/Max(GHz)	Cache	Memory Types	Integrated Graphics	Intel vPro	
	Pentium G4400	2 / 2	3.3G	3 MB	DDR4-2133	HD 510	No	
	Pentium G4500	2 / 2	3.5G	3 MB	DDR4-2133	HD 530	No	
	Core i3-6100	2 / 4	3.7 G	3 MB	DDR4-2133	HD 530	No	
	Core i3-6300	2 / 4	3.8 G	4 MB	DDR4-2133	HD 530	No	
	Core i5-6400	4 / 4	2.7 G / 3.3 G	6 MB	DDR4-2133	HD 530	No	
	Core i5-6500	4 / 4	3.2 G / 3.6 G	6 MB	DDR4-2133	HD 530	vPro	
Core i5-6600	4 / 4	3.3 G / 3.9 G	6 MB	DDR4-2133	HD 530	vPro		
Core i7-6700	4 / 8	3.4 G / 4.0 G	8 MB	DDR4-2133	HD 530	vPro		
Memory	64GB max, UDIMM, DDR4 2133, four 288-pin DIMM sockets, dual-channel capable							Security chip Trusted Platform Module, TCG 1.2-compliant
Disk	<i>Some:</i> Hard disk, SATA 6.0Gb/s, 2.5"/ 3.5" wide, 5400 / 7200 rpm <i>Some:</i> Solid State Hybrid Drive (SSHD), 500GB (5400 rpm, 2.5") / 1TB or 2TB (7200 rpm, 3.5"), with 8GB NAND flash memory, SATA 6.0Gb/s <i>Some:</i> Solid State Drive (SSD) / SATA 6.0Gb/s, 2.5" Wide <i>Some:</i> M.2 SSD, PCIe NVMe, PCIe 3.0 x4, 32Gb/s <i>Some:</i> Front accessible and removable HDD, 3.5", lockable via physical key <i>Some:</i> DVD-ROM SATA 1.5Gb/s Drive <i>Some:</i> Super Multi-Burner DVD±RW SATA 1.5Gb/s Drive							
Optical	Optional 29-in-1 media reader							Security features <ul style="list-style-type: none"> • One lock to secure both cover and entire system to fixed object: <ul style="list-style-type: none"> -Padlock loop (in rear for opt padlock) -Security slot (in rear for optional Kensington® MicroSaver® cable) • Power-on password • Administrator password • Hard disk password • Boot sequence control • Boot without keyboard and mouse • Individual USB port disablement • Optional chassis intrusion switch
Onboard SATA	Four onboard SATA 6.0Gb/s connectors, one is eSATA connector for optional rear eSATA port, RAID 0, 1 support							
Media reader	Optional 29-in-1 media reader							Keyboard <i>Some:</i> Preferred Pro USB Keyboard (USB connector), Lenovo logo <i>Some:</i> Lenovo USB Fingerprint Keyboard (USB connector) <i>Some:</i> Ultraslim Plus Wireless Keyboard (2.4GHz via USB receiver), black <i>Some:</i> Enhanced Optical USB Mouse, black, Lenovo logo <i>Some:</i> Ultraslim Plus Wireless Mouse (2.4GHz via USB receiver), black
Graphics	Intel HD Graphics 510/530 in processor, uses main memory, DirectX® 12, one VGA, two DisplayPort™, supports three independent displays, works along with discrete graphics to support more displays; <i>Max resolution:</i> 4096x2304 (DP) @60Hz; 1920x1200 (VGA) @60Hz <i>Some:</i> NVIDIA® Quadro® K420 , DirectX 12, 2GB, PCIe 2.0 x16 adapter, one DVI-I, one DisplayPort, 41 watts; <i>Max resolution:</i> 3840x2160 (DisplayPort) @60Hz; 2560x1600 (DVI-I) @60Hz <i>Some:</i> NVIDIA GeForce® GT 720 , DirectX 12, 2GB, PCIe 2.0 x8 adapter, one VGA, one HDMI, 25 watts; <i>Max resolution:</i> 1920x1080 (HDMI) @60Hz; 2048x1536 (VGA) @85Hz <i>Some:</i> NVIDIA GeForce GT 720 , DirectX 12, 1GB, PCIe 2.0 x8 adapter, two DisplayPort, 25 watts; <i>Max resolution:</i> 3840x2160 (DisplayPort) @60Hz;							
Power supply	<i>Some:</i> 250 watts, autosensing, 85% PSU <i>Some:</i> 400 watts, autosensing, 92% PSU (available only via Special Bid)							
Limited warranty ³	<i>Some:</i> 1-year or 3-year, limited onsite service / service upgrades available <i>Some:</i> 3-year, limited onsite service, OID (Onsite International Delivery) / service upgrades available <i>For Lenovo service upgrade options, please go to S-TC sheet</i>							
DP cable	Optional DP to VGA, DP to DVI-D (single link), or DP to HDMI 1.4 dongle							Preload Preloaded operating system <i>Some:</i> Windows® 7 Professional 64 preinstalled through downgrade rights in Windows 10 Pro 64-bit <i>Some:</i> Windows 7 Professional 64 <i>Some:</i> Windows 10 Pro 64-bit <i>Some:</i> Windows 10 Home 64-bit
Chipset	Intel Q170 Chipset							
Front ports	Two USB 3.0, two optional USB 2.0, microphone (3.5mm), headphone (3.5mm)							Preloaded applications (only some listed) <ul style="list-style-type: none"> • Desktop Power Manager • Lenovo Solution Center • Lenovo REACHit • Lenovo SHAREit • Lenovo Bluetooth Lock (for models with Wi-Fi/BT card) • McAfee® LiveSafe™ (30-day trial) • Microsoft Office preloaded; purchase a product key to activate • PowerDVD Create (DVD±RW) • Lenovo ThinkVantage Tools • Intel Unite (vPro models only) - Only for Window 10 <ul style="list-style-type: none"> • Lenovo Companion • Cyberlink PowerDVD (DVD, DVD±RW) • Lenovo QuickOptimizer - Only for Window 7 <ul style="list-style-type: none"> • Rescue and Recovery • Password Manager • ThinkVantage System Update • Lenovo Message Center Plus • Adobe® Reader®
Rear ports	Six USB 3.0, two optional USB 2.0, serial (9-pin), optional 2nd serial (9-pin), optional parallel (25-pin), ethernet (RJ-45), one VGA, two DisplayPort, optional PS/2 ports (keyboard/mouse), one optional eSATA port additional VGA, DisplayPort, DVI-I or HDMI on optional graphics on some models							
Rear audio ports IEEC 1394	Line-in (3.5mm), line-out (3.5mm), microphone-in (3.5mm) None							
Audio support	High Definition (HD) Audio, Realtek ALC662 / optional internal speaker (1.5 watt)							
WLAN ¹³	<i>Some:</i> 11ac wireless, M.2 Card, Qualcomm Atheros QCA9377 (dual band), Wi-Fi + Bluetooth 4.1 combo adapter, 1x1 <i>Some:</i> 11ac wireless, M.2 Card, Qualcomm Atheros QCA6174 (dual band), Wi-Fi + Bluetooth 4.1 combo adapter, 2x2 <i>Some:</i> 11ac wireless, M.2 Card, Intel Dual Band Wireless-AC 3165, Wi-Fi + Bluetooth 4.0 combo adapter, 1x1 <i>Some:</i> 11ac wireless, M.2 Card, Intel Dual Band Wireless-AC 8260, Wi-Fi + Bluetooth 4.1 combo adapter, 2x2 <i>Some:</i> 11ac wireless, M.2 Card, Intel Dual Band Wireless-AC 8260, Wi-Fi + Bluetooth 4.1 combo adapter, Intel vPro technology support, 2x2							
Bluetooth™	<i>Some:</i> Bluetooth 4.0 or 4.1 wireless, integrated in Wi-Fi + BT combo adapter							
Ethernet	Gigabit ethernet, Intel Ethernet Connection I219-LM (Jacksonville), Wake on LAN®							
Modem	None							
Environment	ENERGY STAR® 6.1*; EPEAT™ Gold rating*; (*Need 85% PSU and Windows OS); ErP Lot 3; GREENGUARD®; RoHS-compliant; TUV Green Mark, ULE Gold							
Accessories	For compatible accessories, please go to TC-AQP sheet							

See footnotes for more detailed information

Model	Region	Processor	vPro	Graphics	Monitor Cable	Memory	Storage(HDD/SSD)	Optical	Optional 2nd 3.5" Tray	Media Reader	WLAN + Bluetooth	Optional Front Ports	Optional Rear Ports	Chassis Intrusion Switch	Cable Lock	Front Access HDD	PCI Slot	Dust Filter	Keyboard / Mouse	Carry Handle	Power Supply	Operating System	Warranty	Ann Date (m/y)	
10FD0007US	US	i7-6700	vPro	Intel HD 530	None	8GBx1	1TB 7200rpm 3.5"	DVD±RW	None	None	None	None	None	None	None	None	None	None	None	USB / USB	Carry Handle	250W 85%	Win10 DG Win7 Pro 64	3-year, Onsite, OID	11/15
10FD0008US	US	i5-6500	vPro	Intel HD 530	None	4GBx1	500GB 7200rpm 3.5"	DVD±RW	None	None	None	None	None	None	None	None	None	None	None	USB / USB	Carry Handle	250W 85%	Win10 DG Win7 Pro 64	3-year, Onsite, OID	11/15
10FD001WUS	US	i7-6700	vPro	Intel HD 530	None	8GBx1	1TB 7200rpm 3.5"	DVD±RW	Optional 2nd 3.5" Tray	None	None	None	None	None	None	None	None	None	None	USB / USB	Carry Handle	250W 85%	Win10 Pro 64	3-year, Onsite	11/15
10FD001XUS	US	i7-6700	vPro	Intel HD 530	None	8GBx1	1TB 7200rpm 3.5"	DVD±RW	Optional 2nd 3.5" Tray	None	None	None	None	None	None	None	None	None	None	USB / USB	Carry Handle	250W 85%	Win10 DG Win7 Pro 64	3-year, Onsite	11/15
10FD001YUS	US	i5-6500	vPro	Intel HD 530	None	4GBx1	500GB 7200rpm 3.5"	DVD±RW	Optional 2nd 3.5" Tray	None	None	None	None	None	None	None	None	None	None	USB / USB	Carry Handle	250W 85%	Win10 DG Win7 Pro 64	3-year, Onsite	11/15
10FD0020US	US	i5-6500	vPro	Intel HD 530	None	4GBx1	500GB 7200rpm 3.5"	DVD±RW	Optional 2nd 3.5" Tray	None	None	None	None	None	None	None	None	None	None	USB / USB	Carry Handle	250W 85%	Win10 Pro 64	3-year, Onsite	11/15
10FD0021US	US	i5-6500	vPro	Intel HD 530	None	8GBx1	500GB 7200rpm 3.5"	DVD±RW	Optional 2nd 3.5" Tray	None	None	None	None	None	None	None	None	None	None	USB / USB	Carry Handle	250W 85%	Win10 Pro 64	3-year, Onsite	11/15
10FD0022US	US	i5-6500	vPro	Intel HD 530	None	8GBx1	500GB 7200rpm 3.5"	DVD±RW	Optional 2nd 3.5" Tray	None	None	None	None	None	None	None	None	None	None	USB / USB	Carry Handle	250W 85%	Win10 DG Win7 Pro 64	3-year, Onsite	11/15
10FD0024US	US	i5-6500	vPro	Intel HD 530	None	4GBx1	128GB SSD	DVD±RW	Optional 2nd 3.5" Tray	None	None	None	None	None	None	None	None	None	None	USB / USB	Carry Handle	250W 85%	Win10 Pro 64	3-year, Onsite	12/15
10FD0025US	US	i5-6500	vPro	Intel HD 530	None	8GBx1	256GB SSD Opal	DVD±RW	Optional 2nd 3.5" Tray	None	None	None	None	None	None	None	None	None	None	USB / USB	Carry Handle	250W 85%	Win10 DG Win7 Pro 64	3-year, Onsite	12/15
10FD0026US	US	i7-6700	vPro	GT 720 1GB	None	8GBx1	256GB SSD Opal	DVD±RW	Optional 2nd 3.5" Tray	None	None	None	None	None	None	None	None	None	None	USB / USB	Carry Handle	250W 85%	Win10 DG Win7 Pro 64	3-year, Onsite	12/15
10FD0027US	US	i7-6700	vPro	GT 720 1GB	None	8GBx1	1TB 7200rpm 3.5"	DVD±RW	Optional 2nd 3.5" Tray	None	None	None	None	None	None	None	None	None	None	USB / USB	Carry Handle	250W 85%	Win10 Pro 64	3-year, Onsite	12/15
10FD0028US	US	i7-6700	vPro	Intel HD 530	None	8GBx1	256GB SSD Opal	DVD±RW	Optional 2nd 3.5" Tray	None	None	None	None	None	None	None	None	None	None	USB / USB	Carry Handle	250W 85%	Win10 DG Win7 Pro 64	3-year, Onsite	12/15
10FD0029US	US	i5-6500	vPro	GT 720 1GB	None	4GBx1	500GB 7200rpm 3.5"	DVD±RW	Optional 2nd 3.5" Tray	None	None	None	None	None	None	None	None	None	None	USB / USB	Carry Handle	250W 85%	Win10 DG Win7 Pro 64	3-year, Onsite	12/15
10FD002AUS	US	i5-6500	vPro	Intel HD 530	None	4GBx1	180GB SSD Opal	DVD±RW	Optional 2nd 3.5" Tray	None	None	None	None	None	None	None	None	None	None	USB / USB	Carry Handle	250W 85%	Win10 DG Win7 Pro 64	3-year, Onsite	12/15
10FD002BUS	US	i7-6700	vPro	GT 720 1GB	None	8GBx1	1TB 7200rpm 3.5"	DVD±RW	Optional 2nd 3.5" Tray	None	None	None	None	None	None	None	None	None	None	USB / USB	Carry Handle	250W 85%	Win10 DG Win7 Pro 64	3-year, Onsite	12/15
10FD002CUS	US	i7-6700	vPro	Intel HD 530	None	8GBx1	256GB SSD Opal	DVD±RW	Optional 2nd 3.5" Tray	None	None	None	None	None	None	None	None	None	None	USB / USB	Carry Handle	250W 85%	Win10 Pro 64	3-year, Onsite	12/15
10FD002DUS	US	i5-6500	vPro	Intel HD 530	None	4GBx1	128GB SSD	DVD±RW	Optional 2nd 3.5" Tray	None	None	None	None	None	None	None	None	None	None	USB / USB	Carry Handle	250W 85%	Win10 DG Win7 Pro 64	3-year, Onsite	12/15
10FD002EUS	US	i5-6500	vPro	Intel HD 530	None	8GBx1	180GB SSD Opal	DVD±RW	Optional 2nd 3.5" Tray	None	None	None	None	None	None	None	None	None	None	USB / USB	Carry Handle	250W 85%	Win10 Pro 64	3-year, Onsite	12/15
10FD002FUS	US	i5-6500	vPro	GT 720 1GB	None	8GBx1	1TB 7200rpm 3.5"	DVD±RW	Optional 2nd 3.5" Tray	None	None	None	None	None	None	None	None	None	None	USB / USB	Carry Handle	250W 85%	Win10 DG Win7 Pro 64	3-year, Onsite	12/15

Model	Region	Processor	vPro	Graphics	Monitor Cable	Memory	Storage(HDD/SSD)	Optical	Optional 2nd 3.5" Tray	Media Reader	WLAN + Bluetooth	Optional Front Ports	Optional Rear Ports	Chassis Intrusion Switch	Cable Lock	Front Access HDD	PCI Slot	Dust Filter	Keyboard / Mouse	Carry Handle	Power Supply	Operating System	Warranty	Ann Date (m/y)	
10FD002GUS	US	i5-6500	vPro	Intel HD 530	None	4GBx1	192GB SSD	DVD±RW	Optional 2nd 3.5" Tray	None	None	None	None	None	None	None	None	None	None	USB / USB	Carry Handle	250W 85%	Win10 DG Win7 Pro 64	3-year, Onsite	12/15
10FD002HUS	US	i5-6500	vPro	GT 720 1GB	None	8GBx1	1TB 7200rpm 3.5"	DVD±RW	Optional 2nd 3.5" Tray	None	None	None	None	None	None	None	None	None	None	USB / USB	Carry Handle	250W 85%	Win10 Pro 64	3-year, Onsite	12/15
10FD003PUS	US	i7-6700	vPro	GT 720 1GB	None	8GBx1	256GB SSD Opal	DVD±RW	Optional 2nd 3.5" Tray	None	None	None	None	None	None	None	None	None	None	USB / USB	Carry Handle	250W 85%	Win10 Pro 64	3-year, Onsite	10/16
10FD003QUS	US	i7-6700	vPro	GT 720 1GB	None	8GBx1	1TB 7200rpm 3.5"	DVD±RW	Optional 2nd 3.5" Tray	None	None	None	None	None	None	None	None	None	None	USB / USB	Carry Handle	250W 85%	Win10 DG Win7 Pro 64	3-year, Onsite	10/16
10FD003RUS	US	i7-6700	vPro	GT 720 1GB	None	8GBx1	1TB 7200rpm 3.5"	DVD±RW	Optional 2nd 3.5" Tray	None	None	None	None	None	None	None	None	None	None	USB / USB	Carry Handle	250W 85%	Win10 Pro 64	3-year, Onsite	10/16
10FD003SUS	US	i5-6500	vPro	GT 720 1GB	None	4GBx1	500GB 7200rpm 3.5"	DVD±RW	Optional 2nd 3.5" Tray	None	None	None	None	None	None	None	None	None	None	USB / USB	Carry Handle	250W 85%	Win10 Pro 64	3-year, Onsite	10/16
10FD003TUS	US	i7-6700	vPro	GT 720 1GB	None	8GBx1	256GB SSD Opal	DVD±RW	Optional 2nd 3.5" Tray	None	None	None	None	None	None	None	None	None	None	USB / USB	Carry Handle	250W 85%	Win10 DG Win7 Pro 64	3-year, Onsite	10/16
10FD003UUS	US	i5-6500	vPro	GT 720 1GB	None	4GBx1	500GB 7200rpm 3.5"	DVD±RW	Optional 2nd 3.5" Tray	None	None	None	None	None	None	None	None	None	None	USB / USB	Carry Handle	250W 85%	Win10 DG Win7 Pro 64	3-year, Onsite	10/16
10FD003VUS	US	i5-6500	vPro	GT 720 1GB	None	8GBx1	1TB 7200rpm 3.5"	DVD±RW	Optional 2nd 3.5" Tray	None	None	None	None	None	None	None	None	None	None	USB / USB	Carry Handle	250W 85%	Win10 Pro 64	3-year, Onsite	10/16
10FD003WUS	US	i5-6500	vPro	GT 720 1GB	None	8GBx1	1TB 7200rpm 3.5"	DVD±RW	Optional 2nd 3.5" Tray	None	None	None	None	None	None	None	None	None	None	USB / USB	Carry Handle	250W 85%	Win10 DG Win7 Pro 64	3-year, Onsite	10/16

ThinkCentre M900 Tower - 10FC

Model	Region	Processor	vPro	Graphics	Monitor Cable	Memory	Storage(HDD/SSD)	Optical	Optional 2nd 3.5" Tray	Media Reader	WLAN + Bluetooth	Optional Front Ports	Optional Rear Ports	Chassis Intrusion Switch	Cable Lock	Front Access HDD	PCI Slot	Dust Filter	Keyboard / Mouse	Carry Handle	Power Supply	Operating System	Warranty	Ann Date (m/y)	
10FC0003US	US	i5-6500	vPro	Intel HD 530	None	4GBx1	500GB 7200rpm 3.5"	DVD±RW	None	None	None	None	None	None	None	None	None	None	None	USB / USB	None	250W 85%	Win10 Pro 64	3-year, Onsite, OID	11/15
10FC0004US	US	i5-6500	vPro	Intel HD 530	None	4GBx1	500GB 7200rpm 3.5"	DVD±RW	None	None	None	None	None	None	None	None	None	None	None	USB / USB	None	250W 85%	Win10 DG Win7 Pro 64	3-year, Onsite, OID	11/15
10FC0005US	US	i7-6700	vPro	Intel HD 530	None	8GBx1	1TB 7200rpm 3.5"	DVD±RW	None	None	None	None	None	None	None	None	None	None	None	USB / USB	None	250W 85%	Win10 DG Win7 Pro 64	3-year, Onsite, OID	11/15
10FC0006US	US	i7-6700	vPro	Intel HD 530	None	8GBx1	1TB 7200rpm 3.5"	DVD±RW	None	None	None	None	None	None	None	None	None	None	None	USB / USB	None	250W 85%	Win10 Pro 64	3-year, Onsite, OID	11/15
10FC000BUS	US	i5-6600	vPro	Intel HD 530	None	4GBx1	500GB 7200rpm 3.5"	DVD±RW	None	None	None	None	None	None	None	None	None	None	None	USB / USB	Carry Handle	250W 85%	Win10 Pro 64	3-year, Onsite, OID	11/15
10FC000GUS	US	i5-6500	vPro	Intel HD 530	None	4GBx1	500GB 7200rpm 3.5"	DVD	None	None	None	None	None	None	None	None	None	None	None	USB / USB	Carry Handle	250W 85%	Win10 Pro 64	3-year, Onsite, OID	11/15
10FC000HUS	US	i7-6700	vPro	GT 720 1GB	None	4GBx1	1TB 7200rpm 3.5"	DVD±RW	None	29-in-1	None	None	None	None	None	None	None	None	None	USB / USB	Carry Handle	250W 85%	Win10 Pro 64	3-year, Onsite, OID	11/15
10FC000KUS	US	i5-6600	vPro	Intel HD 530	None	4GBx1	500GB 7200rpm 3.5"	DVD±RW	None	None	None	None	None	None	None	None	None	None	None	USB / USB	None	250W 85%	Win10 DG Win7 Pro 64	3-year, Onsite, OID	11/15
10FC000LUS	US	i7-6700	vPro	GT 720 1GB	None	4GBx1	1TB 7200rpm 3.5"	DVD±RW	None	29-in-1	None	None	None	None	None	None	None	Dust Filter	USB / USB	Carry Handle	250W 85%	Win10 DG Win7 Pro 64	3-year, Onsite, OID	11/15	
10FC000MUS	US	i5-6500	vPro	Intel HD 530	None	4GBx1	500GB 7200rpm 3.5"	DVD	None	None	None	None	None	None	None	None	None	None	None	USB / USB	None	250W 85%	Win10 DG Win7 Pro 64	3-year, Onsite, OID	11/15



ThinkCentre M900x Tiny Platform Specifications

Product Specifications Reference (PSREF)

Processor	Intel® Celeron®, Intel Pentium®, or 6th Generation Intel Core™ i3 / i5 / i7 Processor							Security features	<ul style="list-style-type: none"> • Security slot (in rear for optional Kensington® MicroSaver® cable) • Padlock loop • Smart USB protection, allows keyboard/mouse only, blocks all storage devices • Power-on password • Administrator password • Hard disk password • Boot sequence control • Boot without keyboard and mouse • Individual USB port disablement • Chassis intrusion switch 	
	Processor	Cores / Threads	Frequency Base/Max(GHz)	Cache	Memory Types	Integrated Graphics	Intel vPro			
	Core i3-6100	2 / 4	3.7 G	3 MB	DDR4-2133	HD 530	No			
	Core i3-6300	2 / 4	3.8 G	4 MB	DDR4-2133	HD 530	No			
	Core i5-6400	4 / 4	2.7 G / 3.3 G	6 MB	DDR4-2133	HD 530	No			
	Core i5-6500	4 / 4	3.2 G / 3.6 G	6 MB	DDR4-2133	HD 530	vPro			
	Core i5-6600	4 / 4	3.3 G / 3.9 G	6 MB	DDR4-2133	HD 530	vPro			
Core i7-6700	4 / 8	3.4 G / 4.0 G	8 MB	DDR4-2133	HD 530	vPro				
Memory	32GB max, DDR4 2133, two 260-pin SO-DIMM sockets, dual-channel capable							Keyboard	<i>Some:</i> Preferred Pro USB Keyboard (USB connector), Lenovo logo <i>Some:</i> Lenovo USB Fingerprint Keyboard (USB connector) <i>Some:</i> Ultralim Plus Wireless Keyboard (2.4GHz via USB receiver), black <i>Some:</i> Enhanced Optical USB Mouse, black, Lenovo logo <i>Some:</i> Ultralim Plus Wireless Mouse (2.4GHz via USB receiver), black	
Disk	<i>Some:</i> SATA 6.0Gb/s, 2.5" Wide, 5400 rpm or 7200 rpm <i>Some:</i> 500GB (5400 rpm) Solid State Hybrid Drive (SSHD) / with 8GB MLC NAND flash memory, SATA 6.0Gb/s, 2.5" wide <i>Some:</i> Solid State Drive (SSD) / SATA 6.0Gb/s, 2.5" Wide <i>Some:</i> M.2 SSD, PCIe or SATA interface									
Optical	<i>Some:</i> external ODD box with DVD-ROM, 9.5mm high, via USB <i>Some:</i> external ODD box with DVD±RW, 9.5mm high, via USB <i>Some:</i> external ODD box (for TIO) with DVD-ROM, 9.5mm high, via USB <i>Some:</i> external ODD box (for TIO) with DVD±RW, 9.5mm high, via USB <i>One:</i> SATA cable (1-drop to device), one SATA 6.0Gb/s connector on planar							Mouse		
Onboard SATA Media reader	None									
Graphics	Intel HD Graphics 510/530 in processor, uses main memory, DirectX® 12, two DisplayPort™, one optional HDMI, VGA, or 3rd DP, up to 3 independent displays; <i>Max resolution:</i> 4096x2304 (DP) @60Hz; 4096x2160 (HDMI) @24Hz; 1920x1200 (VGA) @60Hz							Mechanical	Tiny (1L), black color; metal case M900x Tiny only: 7.05" W X 7.20" D X 1.36" H 179mm W X 182.9mm D X 34.5mm H 2.9 lb (1.3 kg), weight may vary by configuration With VESA mount & ODD box: 7.42" W X 7.30" D X 2.48" H 188.4mm W X 185.38mm D X 63mm H 4.12 lb (1.87 kg), weight may vary by configuration With VESA mount & I/O box: 7.42" W X 7.30" D X 2.62" H 188.4mm W X 185.38mm D X 66.6mm H 3.53 lb (1.6 kg), weight may vary by configuration Optional VESA mount bracket kit, supports VESA 75mm and 100mm Optional system floor stand for vertical orientation	
DP cable	Optional DP to VGA, DP to DVI-D (single link), or DP to HDMI 1.4 dongle									
Chipset	Intel Q170 Chipset							VESA mount	Optional VESA mount bracket kit, supports VESA 75mm and 100mm	
Front ports	Two USB 3.0 (one is Always On and fast charge), one microphone (stereo, 3.5mm), one headphone / microphone combo jack (stereo, 3.5mm)							Floor Stand	Optional system floor stand for vertical orientation	
Rear ports	Four USB 3.0 (optional external optical box or external I/O box occupies one or two specific USB 3.0 on some models), ethernet (RJ-45), two DisplayPort, one optional port (VGA, 3rd DP, HDMI, or serial on some models), one headphone							Power supply	135 watts AC/DC adapter, autosensing, 88% PSU	
I/O box	Optional external I/O box, extends two USB 2.0, two USB 3.0, and one serial on rear, two USB 2.0 on front, via USB (occupy two specific USB 3.0 of M900x Tiny)							Limited warranty ³	<i>Some:</i> 1-year or 3-year, depot service / service upgrades available <i>Some:</i> 1-year or 3-year, limited onsite service / service upgrades available <i>Some:</i> 3-year, limited onsite service, OID (Onsite International Delivery) / service upgrades available <i>For Lenovo service upgrade options, please go to S-TC sheet</i>	
Audio support	High Definition (HD) Audio, Realtek ALC223 / optional internal speaker (1 watt)							Preload	Preloaded operating system <i>Some:</i> Windows® 7 Professional 64 preinstalled through downgrade rights in Windows 10 Pro 64-bit <i>Some:</i> Windows 7 Professional 64 <i>Some:</i> Windows 10 Pro 64-bit <i>Some:</i> Windows 10 Home 64-bit	Preloaded applications (only some listed) <ul style="list-style-type: none"> • Desktop Power Manager • Lenovo Solution Center • Lenovo REACHit • Lenovo SHAREit • Lenovo Bluetooth Lock (for models with Wi-Fi/BT card) • McAfee® LiveSafe™ (30-day trial) • Microsoft Office preloaded; purchase a product key to activate • PowerDVD Create (DVD±RW) • Lenovo ThinkVantage Tools • Intel Unite (vPro models only) - Only for Window 10 • Lenovo Companion • Cyberlink PowerDVD (DVD, DVD±RW) • Lenovo QuickOptimizer - Only for Window 7 • Rescue and Recovery • Password Manager • ThinkVantage System Update • Lenovo Message Center Plus • Adobe® Reader®
WLAN ¹³	<i>Some:</i> 11ac wireless, M.2 Card, Qualcomm Atheros QCA9377 (dual band), Wi-Fi + Bluetooth 4.1 combo adapter, 1x1 <i>Some:</i> 11ac wireless, M.2 Card, Qualcomm Atheros QCA6174 (dual band), Wi-Fi + Bluetooth 4.1 combo adapter, 2x2 <i>Some:</i> 11ac wireless, M.2 Card, Intel Dual Band Wireless-AC 3165, Wi-Fi + Bluetooth 4.0 combo adapter, 1x1 <i>Some:</i> 11ac wireless, M.2 Card, Intel Dual Band Wireless-AC 8260, Wi-Fi + Bluetooth 4.1 combo adapter, 2x2 <i>Some:</i> 11ac wireless, M.2 Card, Intel Dual Band Wireless-AC 8260, Wi-Fi + Bluetooth 4.1 combo adapter, Intel vPro technology support, 2x2									
Bluetooth™	<i>Some:</i> Bluetooth 4.0 or 4.1 wireless, integrated in Wi-Fi + BT combo adapter							Environment	ENERGY STAR® 6.1*; EPEAT™ Gold rating*; (*Need 85% PSU and Windows OS); ErP Lot 3; GREENGUARD®; RoHS-compliant	
Ethernet	Gigabit ethernet, Intel Ethernet Connection I219-LM (Jacksonville), Wake on LAN®									
Modem	None							Accessories	For compatible accessories, please go to TC-AQP sheet	
Manageability	Intel Active Management Technology 11.0 (Intel AMT 11.0); Intel vPro technology on some models (require choosing a vPro-support Wi-Fi adapter to enable vPro function through wireless connection)									
Security chip	Trusted Platform Module, TCG 1.2-compliant									

See footnotes for more detailed information

ThinkCentre M900x Tiny - TopSeller - 10LX

Product Specifications Reference (PSREF)

Model	Region	Processor	vPro	Graphics	Monitor Cable	Memory	Storage(HDD/SSD)	External Optical / I/O Box	WLAN + Bluetooth	Optional Rear Ports	Chassis Intrusion Switch	Kensington Cable Lock	Speaker	Adapter Cage	Toolless Chassis Screw	Dust Filter	Keyboard / Mouse	VESA Mount	Stand	Power Supply	Operating System	Warranty	Ann Date (mm/yy)
10LX0002US	US	i7-6700	vPro	Intel HD 530	None	8GBx1	128GB SSD	None	8260 ac, 2x2, vPro + BT4.1	3rd DP	Switch	None	1Wx1	None	None	None	USB / USB	None	Floor Stand	135W Adapter 88%	Win10 Pro 64	3-year, Onsite	07/16
10LX0003US	US	i5-6500	vPro	Intel HD 530	None	4GBx1	500GB 7200rpm 2.5"	None	8260 ac, 2x2, vPro + BT4.1	VGA	Switch	None	1Wx1	None	None	None	USB / USB	None	Floor Stand	135W Adapter 88%	Win10 Pro 64	3-year, Onsite	07/16
10LX0004US	US	i5-6500	vPro	Intel HD 530	None	4GBx1	500GB 7200rpm 2.5"	None	8260 ac, 2x2, vPro + BT4.1	3rd DP	Switch	None	1Wx1	None	None	None	USB / USB	None	Floor Stand	135W Adapter 88%	Win10 Pro 64	3-year, Onsite	07/16
10LX0005US	US	i5-6500	vPro	Intel HD 530	None	4GBx1	500GB 7200rpm 2.5"	None	8260 ac, 2x2, vPro + BT4.1	None	Switch	None	1Wx1	None	None	None	USB / USB	None	Floor Stand	135W Adapter 88%	Win10 Pro 64	3-year, Onsite	07/16
10LX0006US	US	i5-6500	vPro	Intel HD 530	None	8GBx1	128GB SSD	None	8260 ac, 2x2, vPro + BT4.1	3rd DP	Switch	None	1Wx1	None	None	None	USB / USB	None	Floor Stand	135W Adapter 88%	Win10 Pro 64	3-year, Onsite	07/16
10LX0007US	US	i7-6700	vPro	Intel HD 530	None	8GBx1	256GB SSD Opal	None	8260 ac, 2x2, vPro + BT4.1	3rd DP	Switch	None	1Wx1	None	None	None	USB / USB	None	Floor Stand	135W Adapter 88%	Win10 DG Win7 Pro 64	3-year, Onsite	09/16
10LX0008US	US	i5-6500	vPro	Intel HD 530	None	8GBx1	256GB SSD Opal	None	8260 ac, 2x2, vPro + BT4.1	3rd DP	Switch	None	1Wx1	None	None	None	USB / USB	None	Floor Stand	135W Adapter 88%	Win10 DG Win7 Pro 64	3-year, Onsite	09/16
10LX0009US	US	i5-6500	vPro	Intel HD 530	None	4GBx1	500GB 7200rpm 2.5"	None	8260 ac, 2x2, vPro + BT4.1	VGA	Switch	None	1Wx1	None	None	None	USB / USB	None	Floor Stand	135W Adapter 88%	Win10 DG Win7 Pro 64	3-year, Onsite	09/16
10LX000AUS	US	i5-6500	vPro	Intel HD 530	None	4GBx1	500GB 7200rpm 2.5"	None	8260 ac, 2x2, vPro + BT4.1	None	Switch	None	1Wx1	None	None	None	USB / USB	None	Floor Stand	135W Adapter 88%	Win10 DG Win7 Pro 64	3-year, Onsite	09/16
10LX000BUS	US	i5-6500	vPro	Intel HD 530	None	4GBx1	500GB 7200rpm 2.5"	None	8260 ac, 2x2, vPro + BT4.1	3rd DP	Switch	None	1Wx1	None	None	None	USB / USB	None	Floor Stand	135W Adapter 88%	Win10 DG Win7 Pro 64	3-year, Onsite	09/16
10LX000CUS	US	i5-6500	vPro	Intel HD 530	None	8GBx1	128GB SSD	None	8260 ac, 2x2, vPro + BT4.1	3rd DP	Switch	None	1Wx1	None	None	None	USB / USB	None	Floor Stand	135W Adapter 88%	Win10 DG Win7 Pro 64	3-year, Onsite	09/16
10LX000DUS	US	i7-6700	vPro	Intel HD 530	None	8GBx1	128GB SSD	None	8260 ac, 2x2, vPro + BT4.1	3rd DP	Switch	None	1Wx1	None	None	None	USB / USB	None	Floor Stand	135W Adapter 88%	Win10 DG Win7 Pro 64	3-year, Onsite	09/16

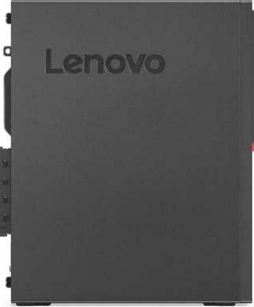

ThinkCentre M910 SFF Platform Specifications

Product Specifications Reference (PSREF)

Processor	Intel® Celeron®, Intel Pentium®, or 6/7th Generation Intel Core™ i3 / i5 / i7 Processor						Security features <ul style="list-style-type: none"> Security slot (in rear for optional Kensington® MicroSaver® cable) Padlock loop Smart USB protection, allows keyboard/mouse only, blocks all storage devices Optional cable lock to physically lock both keyboard and mouse Power-on password Administrator password Hard disk password Boot sequence control Boot without keyboard and mouse Individual USB port disablement Optional chassis intrusion switch
	Processor	Cores / Threads	Frequency Base/Max(GHz)	Cache	Memory Support (Up to)	Integrated Graphics	
	Core i5-6500	4 / 4	3.2G / 3.6G	6 MB	DDR4-2133	HD 530	
	Core i7-6700	4 / 8	3.4G / 4.0G	8 MB	DDR4-2133	HD 530	
	Core i5-7400	4 / 4	3.0G / 3.5G	6 MB	DDR4-2400	HD 630	
	Core i5-7500	4 / 4	3.4G / 3.8G	6 MB	DDR4-2400	HD 630	
	Core i5-7600	4 / 4	3.5G / 4.1G	6 MB	DDR4-2400	HD 630	
Core i7-7700	4 / 8	3.6G / 4.2G	8 MB	DDR4-2400	HD 630		
Memory	64GB max, UDIMM, DDR4-2400*, four 288-pin DIMM sockets, non-ECC, dual-channel capable * System automatically clocks down for the processors with lower memory controller						
Storage	<i>Some:</i> Hard Drive / SATA 6.0Gb/s, 2.5" or 3.5", 5400 rpm or 7200 rpm <i>Some:</i> Solid State Drive (SSD) / SATA 6.0Gb/s, 2.5" <i>Some:</i> M.2 Solid State Drive (SSD) / PCIe NVMe, PCIe 3.0 x 4, 32Gb/s <i>Some:</i> Intel Optane™ Memory Ready (models with 7th gen Core processor), M.2 <i>Some:</i> DVD-ROM SATA 1.5Gb/s Drive, slim (9.0mm) <i>Some:</i> DVD Burner (DVD±RW), SATA 1.5Gb/s Drive, slim (9.0mm)						
Optical	<i>Some:</i> DVD-ROM SATA 1.5Gb/s Drive, slim (9.0mm) <i>Some:</i> DVD Burner (DVD±RW), SATA 1.5Gb/s Drive, slim (9.0mm)						
Onboard SATA	Four onboard SATA 6.0Gb/s connectors, RAID 0/1 support (RAID preset only available via special bid model)						
Media reader	Optional 7-in-1 media reader						
Graphics	Intel HD Graphics 510/530/610/630 in processor, uses main memory, DirectX® 12, one VGA, two DisplayPort™, supports 3 independent displays, works along with discrete graphics to support more displays; <i>Max resolution:</i> 4096x2304 (DP) @60Hz; 2048x1536 (VGA) @50Hz <i>Some:</i> NVIDIA GeForce® GT 730 , DirectX 12, 2GB, PCIe 2.0 x8 adapter, two DisplayPort, 35 watts; <i>Max resolution:</i> 3840x2160 (DisplayPort) @60Hz;						
Monitor cable	Optional DP to VGA, DP to DVI-D (single link), DP to dual DP, or DP to HDMI 1.4						
Chipset	Intel Q270 Chipset						
Front ports	Four USB 3.1 Gen1, optional two USB 3.1 Type-C Gen 2 (only available via special bid), microphone (3.5mm), headphone (3.5mm)						
Rear ports	Four USB 3.1 Gen1, optional two USB 2.0, serial (9-pin), optional 2nd serial (9-pin), optional parallel (25-pin), ethernet (RJ-45), one VGA, two DisplayPort, optional two PS/2 ports (keyboard/mouse); additional DisplayPort on optional graphics on some models						
Rear audio ports	Line-in (3.5mm), line-out (3.5mm), microphone-in (3.5mm)						
IEEE 1394	None						
Audio support	High Definition (HD) Audio, Realtek ALC662 / optional internal speaker (1.5 watt)						
WLAN ¹³	<i>Some:</i> 11ac wireless, M.2 Card, Qualcomm Atheros QCA9377A (dual band), Wi-Fi + Bluetooth 4.1 combo adapter, 1x1 <i>Some:</i> 11ac wireless, M.2 Card, Qualcomm Atheros QCA6174A (dual band), Wi-Fi + Bluetooth 4.1 combo adapter, 2x2 <i>Some:</i> 11ac wireless, M.2 Card, Intel Dual Band Wireless-AC 3165, Wi-Fi + Bluetooth 4.1 combo adapter, 1x1 <i>Some:</i> 11ac wireless, M.2 Card, Intel Dual Band Wireless-AC 8265, Wi-Fi + Bluetooth 4.1 combo adapter, 2x2 <i>Some:</i> 11ac wireless, M.2 Card, Intel Dual Band Wireless-AC 8265, Wi-Fi + Bluetooth 4.1 combo adapter, Intel vPro technology support, 2x2						
Bluetooth™	<i>Some:</i> Bluetooth 4.1 wireless, integrated in Wi-Fi + BT combo adapter						
Ethernet	Gigabit ethernet, Intel Ethernet Connection I219-LM(Jacksonville), Wake on LAN®						
Modem	None						
Manageability	Intel Active Management Technology 11.0 (Intel AMT 11.0); Intel vPro technology on some models (require choosing a vPro-support Wi-Fi adapter to enable vPro function through wireless connection)						
Security chip	TPM (Trusted Platform Module) 2.0, TCG Certified * Downgrade to TPM1.2 for the models with Win10 DG Win7 32 OS						
Keyboard	<i>Some:</i> Lenovo Calliope Keyboard (USB connector), black <i>Some:</i> Lenovo Traditional Keyboard (USB connector), black <i>Some:</i> Lenovo Calliope Wireless Keyboard (2.4GHz via USB receiver), black <i>Some:</i> Lenovo Calliope Mouse (USB connector), black <i>Some:</i> Lenovo Calliope Wireless Mouse (2.4GHz via USB receiver), black						
Mouse	<i>Some:</i> Lenovo Calliope Mouse (USB connector), black <i>Some:</i> Lenovo Calliope Wireless Mouse (2.4GHz via USB receiver), black						
Mechanical	<ul style="list-style-type: none"> SFF (8.4L), black color, metal case (WxDxH) 3.6" X 11.4" X 13.5"; 92.5mm X 290.5mm X 343.5mm Approx. 11.92 lb (5.4 kg), weight may vary by configuration Toolless cover, disk, optical, graphic card removal Optional dust filter Bay 1: Slim external ODD bay Bay 2: 3.5", 1" high, internal, HDD/SSD Bay 3: 2.5", internal, HDD/SSD (optional bay) Slot 1: Low Profile, PCIe 3.0 x16* Slot 2: Low Profile, PCIe 3.0 x1* Slot 3: Low Profile, PCIe 3.0 x16 (x4 signal)* Slot 4: no slot, only bracket for optional port extension* M.2 card slots: Two (one for WLAN, one for SSD/Optane) * Optional front USB3.1 Type-C x2 module occupies PCIe x16 (x4 signal) slot, optional rear 2x USB2.0 / parallel / 2nd serial / cable lock / Wi-Fi antenna occupies one expansion slot Optional system floor stand for vertical orientation 						
Floor Stand	Optional system floor stand for vertical orientation						
Power supply	<i>Some:</i> 180 watts, autosensing, 85% PSU <i>Some:</i> 210 watts, autosensing, 85% PSU <i>Some:</i> 210 watts, autosensing, 92% PSU (only available via special bid)						
Limited warranty ³	<i>Some:</i> 1-year or 3-year, depot service / service upgrades available <i>Some:</i> 1-year or 3-year, limited onsite service / service upgrades available						
Preload	Preloaded operating system <i>Some:</i> Windows® 7 Professional 32/64 preinstalled through downgrade rights in Windows 10 Pro 64-bit (not available with 7th Gen Intel processor) <i>Some:</i> Windows 10 Pro 64-bit <i>Some:</i> Windows 10 Home 64-bit		Preloaded applications (only some listed) <ul style="list-style-type: none"> Microsoft Office preloaded; purchase a product key to activate Cyberlink PowerDVD Create (DVD±RW) Intel Unite (vPro models only) - Only for Window 10 Lenovo Companion Lenovo ID Cyberlink PowerDVD (DVD, DVD±RW) - Only for Window 7 Lenovo Solution Center Lenovo ThinkVantage Tools Create Recovery Media Adobe® Reader® 				
Environment	ENERGY STAR® 6.1, EPEAT™ Gold rating (North America), ErP Lot 3, GREENGUARD®, RoHS-compliant, TUV low noise verified (on some models)						
Accessories	For compatible accessories, please go to http://www.lenovoquickpick.com						

See footnotes for more detailed information

Model	Region	Processor	vPro	Graphics	Monitor Cable	Memory	Storage(HDD/SSD)	Optical	Optional 2nd 2.5" Bay	Media Reader	WLAN + Bluetooth	Optional Front Ports	Optional Rear Ports	Chassis Intrusion Switch	Cable Lock	Front Access HDD	Speaker	Dust Filter	Keyboard / Mouse	Stand	Power Supply	Operating System	Warranty	Ann Date (mm/yy)	End of Support
10MK000AUS	US	i7-7700	vPro	Intel HD 630	None	8GBx1	1TB 7200rpm 3.5"	DVD±RW	Optional 2nd 2.5" Bay	None	8265 ac, 2x2, vPro + BT4.1	None	None	None	None	None	1.5Wx1	None	USB / USB	Floor Stand	210W 85%	Win10 Pro 64	3-year, Onsite	02/17	Mar 21, 2023
10MK000BUS	US	i7-7700	vPro	Intel HD 630	None	8GBx1	256GB SSD M.2 PCIe NVMe	DVD±RW	Optional 2nd 2.5" Bay	None	8265 ac, 2x2, vPro + BT4.1	None	None	None	None	None	1.5Wx1	None	USB / USB	Floor Stand	210W 85%	Win10 Pro 64	3-year, Onsite	02/17	Mar 21, 2023
10MK000CUS	US	i5-7500	vPro	GT 730 2GB	None	8GBx1	1TB 7200rpm 3.5"	DVD±RW	Optional 2nd 2.5" Bay	None	None	None	None	None	None	None	1.5Wx1	None	USB / USB	Floor Stand	210W 85%	Win10 Pro 64	3-year, Onsite	02/17	Mar 21, 2023
10MK000DUS	US	i5-7500	vPro	GT 730 2GB	None	8GBx1	512GB SSD M.2 PCIe NVMe	DVD±RW	Optional 2nd 2.5" Bay	None	8265 ac, 2x2, vPro + BT4.1	None	None	None	None	None	1.5Wx1	None	USB / USB	Floor Stand	210W 85%	Win10 Pro 64	3-year, Onsite	02/17	Mar 21, 2023
10MK000EUS	US	i7-7700	vPro	GT 730 2GB	None	8GBx1	256GB SSD M.2 PCIe NVMe	DVD±RW	Optional 2nd 2.5" Bay	None	None	None	None	None	None	None	1.5Wx1	None	USB / USB	Floor Stand	210W 85%	Win10 Pro 64	3-year, Onsite	02/17	Mar 21, 2023
10MK000FUS	US	i7-7700	vPro	GT 730 2GB	None	8GBx1	512GB SSD M.2 PCIe NVMe	DVD±RW	Optional 2nd 2.5" Bay	None	8265 ac, 2x2, vPro + BT4.1	None	None	None	None	None	1.5Wx1	None	USB / USB	Floor Stand	210W 85%	Win10 Pro 64	3-year, Onsite	02/17	Mar 21, 2023
10MK000GUS	US	i5-7500	vPro	Intel HD 630	None	4GBx1	500GB 7200rpm 3.5"	DVD±RW	Optional 2nd 2.5" Bay	None	None	None	None	None	None	None	1.5Wx1	None	USB / USB	Floor Stand	210W 85%	Win10 Pro 64	3-year, Onsite	02/17	Mar 21, 2023
10MK000HUS	US	i5-7500	vPro	Intel HD 630	None	8GBx1	256GB SSD M.2 PCIe NVMe	DVD±RW	Optional 2nd 2.5" Bay	None	None	None	None	None	None	None	1.5Wx1	None	USB / USB	Floor Stand	210W 85%	Win10 Pro 64	3-year, Onsite	02/17	Mar 21, 2023
10MK000KUS	US	i5-7500	vPro	GT 730 2GB	None	8GBx1	256GB SSD M.2 PCIe NVMe	DVD±RW	Optional 2nd 2.5" Bay	None	None	None	None	None	None	None	1.5Wx1	None	USB / USB	Floor Stand	210W 85%	Win10 Pro 64	3-year, Onsite	02/17	Mar 21, 2023
10MK000LUS	US	i7-7700	vPro	GT 730 2GB	None	8GBx1	1TB 7200rpm 3.5"	DVD±RW	Optional 2nd 2.5" Bay	None	None	None	None	None	None	None	1.5Wx1	None	USB / USB	Floor Stand	210W 85%	Win10 Pro 64	3-year, Onsite	02/17	Mar 21, 2023
10MK000MUS	US	i7-7700	vPro	Intel HD 630	None	8GBx1	512GB SSD M.2 PCIe NVMe	DVD±RW	Optional 2nd 2.5" Bay	None	None	None	None	None	None	None	1.5Wx1	None	USB / USB	Floor Stand	210W 85%	Win10 Pro 64	3-year, Onsite	02/17	Mar 21, 2023
10MK000NUS	US	i7-7700	vPro	Intel HD 630	None	8GBx1	1TB 7200rpm 3.5"	DVD±RW	Optional 2nd 2.5" Bay	None	None	None	None	None	None	None	1.5Wx1	None	USB / USB	Floor Stand	210W 85%	Win10 Pro 64	3-year, Onsite	02/17	Mar 21, 2023
10MK000PUS	US	i7-7700	vPro	Intel HD 630	None	8GBx1	256GB SSD M.2 PCIe NVMe	DVD±RW	Optional 2nd 2.5" Bay	None	None	None	None	None	None	None	1.5Wx1	None	USB / USB	Floor Stand	210W 85%	Win10 Pro 64	3-year, Onsite	02/17	Mar 21, 2023
10MK000QUS	US	i5-7500	vPro	Intel HD 630	None	8GBx1	1TB 7200rpm 3.5"	DVD±RW	Optional 2nd 2.5" Bay	None	None	None	None	None	None	None	1.5Wx1	None	USB / USB	Floor Stand	210W 85%	Win10 Pro 64	3-year, Onsite	02/17	Mar 21, 2023
10MK000RUS	US	i5-7500	vPro	Intel HD 630	None	8GBx1	1TB 7200rpm 3.5"	DVD±RW	Optional 2nd 2.5" Bay	None	8265 ac, 2x2, vPro + BT4.1	None	None	None	None	None	1.5Wx1	None	USB / USB	Floor Stand	210W 85%	Win10 Pro 64	3-year, Onsite	02/17	Mar 21, 2023
10MK000SUS	US	i5-7500	vPro	Intel HD 630	None	8GBx1	512GB SSD M.2 PCIe NVMe	DVD±RW	Optional 2nd 2.5" Bay	None	None	None	None	None	None	None	1.5Wx1	None	USB / USB	Floor Stand	210W 85%	Win10 Pro 64	3-year, Onsite	02/17	Mar 21, 2023
10MK000TUS	US	i5-7500	vPro	Intel HD 630	None	8GBx1	256GB SSD M.2 PCIe NVMe	DVD±RW	Optional 2nd 2.5" Bay	None	8265 ac, 2x2, vPro + BT4.1	None	None	None	None	None	1.5Wx1	None	USB / USB	Floor Stand	210W 85%	Win10 Pro 64	3-year, Onsite	02/17	Mar 21, 2023
10MK0035US	US	i5-6500	vPro	GT 730 2GB	None	8GBx1	512GB SSD M.2 PCIe NVMe	DVD±RW	Optional 2nd 2.5" Bay	None	8265 ac, 2x2, vPro + BT4.1	None	None	None	None	None	1.5Wx1	None	USB / USB	Floor Stand	210W 85%	Win10 DG Win7 Pro 64	3-year, Onsite	03/17	Apr 28, 2023
10MK0036US	US	i5-6500	vPro	Intel HD 530	None	4GBx1	128GB SSD M.2 PCIe NVMe	DVD±RW	Optional 2nd 2.5" Bay	None	None	None	None	None	None	None	1.5Wx1	None	USB / USB	Floor Stand	210W 85%	Win10 DG Win7 Pro 64	3-year, Onsite	03/17	Apr 28, 2023
10MK0037US	US	i5-6500	vPro	Intel HD 530	None	8GBx1	256GB SSD M.2 PCIe NVMe	DVD±RW	Optional 2nd 2.5" Bay	None	8265 ac, 2x2, vPro + BT4.1	None	None	None	None	None	1.5Wx1	None	USB / USB	Floor Stand	210W 85%	Win10 DG Win7 Pro 64	3-year, Onsite	03/17	Apr 28, 2023

Model	Region	Processor	vPro	Graphics	Monitor Cable	Memory	Storage(HDD/SSD)	Optical	Optional 2nd 2.5" Bay	Media Reader	WLAN + Bluetooth	Optional Front Ports	Optional Rear Ports	Chassis Intrusion Switch	Cable Lock	Front Access HDD	Speaker	Dust Filter	Keyboard / Mouse	Stand	Power Supply	Operating System	Warranty	Ann Date (mm/yy)	End of Support
10MK0038US	US	i7-6700	vPro	Intel HD 530	None	8GBx1	256GB SSD M.2 PCIe NVMe	DVD±RW	Optional 2nd 2.5" Bay	None	None	None	None	None	None	None	1.5Wx1	None	USB / USB	Floor Stand	210W 85%	Win10 DG Win7 Pro 64	3-year, Onsite	03/17	Apr 28, 2023
10MK0039US	US	i5-6500	vPro	Intel HD 530	None	8GBx1	1TB 7200rpm 3.5"	DVD±RW	Optional 2nd 2.5" Bay	None	None	None	None	None	None	None	1.5Wx1	None	USB / USB	Floor Stand	210W 85%	Win10 DG Win7 Pro 64	3-year, Onsite	03/17	Apr 28, 2023
10MK003AUS	US	i7-6700	vPro	GT 730 2GB	None	8GBx1	512GB SSD M.2 PCIe NVMe	DVD±RW	Optional 2nd 2.5" Bay	None	8265 ac, 2x2, vPro + BT4.1	None	None	None	None	None	1.5Wx1	None	USB / USB	Floor Stand	210W 85%	Win10 DG Win7 Pro 64	3-year, Onsite	03/17	Apr 28, 2023
10MK003BUS	US	i7-6700	vPro	Intel HD 530	None	8GBx1	1TB 7200rpm 3.5"	DVD±RW	Optional 2nd 2.5" Bay	None	None	None	None	None	None	None	1.5Wx1	None	USB / USB	Floor Stand	210W 85%	Win10 DG Win7 Pro 64	3-year, Onsite	03/17	Apr 28, 2023
10MK003CUS	US	i5-6500	vPro	GT 730 2GB	None	8GBx1	1TB 7200rpm 3.5"	DVD±RW	Optional 2nd 2.5" Bay	None	None	None	None	None	None	None	1.5Wx1	None	USB / USB	Floor Stand	210W 85%	Win10 DG Win7 Pro 64	3-year, Onsite	03/17	Apr 28, 2023
10MK003DUS	US	i5-6500	vPro	Intel HD 530	None	8GBx1	1TB 7200rpm 3.5"	DVD±RW	Optional 2nd 2.5" Bay	None	8265 ac, 2x2, vPro + BT4.1	None	None	None	None	None	1.5Wx1	None	USB / USB	Floor Stand	210W 85%	Win10 DG Win7 Pro 64	3-year, Onsite	03/17	Apr 28, 2023
10MK003EUS	US	i5-6500	vPro	GT 730 2GB	None	8GBx1	256GB SSD M.2 PCIe NVMe	DVD±RW	Optional 2nd 2.5" Bay	None	None	None	None	None	None	None	1.5Wx1	None	USB / USB	Floor Stand	210W 85%	Win10 DG Win7 Pro 64	3-year, Onsite	03/17	Apr 28, 2023
10MK003FUS	US	i5-6500	vPro	Intel HD 530	None	8GBx1	512GB SSD M.2 PCIe NVMe	DVD±RW	Optional 2nd 2.5" Bay	None	None	None	None	None	None	None	1.5Wx1	None	USB / USB	Floor Stand	210W 85%	Win10 DG Win7 Pro 64	3-year, Onsite	03/17	Apr 28, 2023
10MK003GUS	US	i7-6700	vPro	Intel HD 530	None	8GBx1	256GB SSD M.2 PCIe NVMe	DVD±RW	Optional 2nd 2.5" Bay	None	8265 ac, 2x2, vPro + BT4.1	None	None	None	None	None	1.5Wx1	None	USB / USB	Floor Stand	210W 85%	Win10 DG Win7 Pro 64	3-year, Onsite	03/17	Apr 28, 2023
10MK003HUS	US	i7-6700	vPro	GT 730 2GB	None	8GBx1	1TB 7200rpm 3.5"	DVD±RW	Optional 2nd 2.5" Bay	None	None	None	None	None	None	None	1.5Wx1	None	USB / USB	Floor Stand	210W 85%	Win10 DG Win7 Pro 64	3-year, Onsite	03/17	Apr 28, 2023
10MK003JUS	US	i5-6500	vPro	Intel HD 530	None	4GBx1	500GB 7200rpm 3.5"	DVD±RW	Optional 2nd 2.5" Bay	None	None	None	None	None	None	None	1.5Wx1	None	USB / USB	Floor Stand	210W 85%	Win10 DG Win7 Pro 64	3-year, Onsite	03/17	Apr 28, 2023
10MK003KUS	US	i5-6500	vPro	Intel HD 530	None	8GBx1	256GB SSD M.2 PCIe NVMe	DVD±RW	Optional 2nd 2.5" Bay	None	None	None	None	None	None	None	1.5Wx1	None	USB / USB	Floor Stand	210W 85%	Win10 DG Win7 Pro 64	3-year, Onsite	03/17	Apr 28, 2023
10MK003LUS	US	i7-6700	vPro	GT 730 2GB	None	8GBx1	256GB SSD M.2 PCIe NVMe	DVD±RW	Optional 2nd 2.5" Bay	None	None	None	None	None	None	None	1.5Wx1	None	USB / USB	Floor Stand	210W 85%	Win10 DG Win7 Pro 64	3-year, Onsite	03/17	Apr 28, 2023
10MK003MUS	US	i5-7500	vPro	Intel HD 630	None	4GBx1	128GB SSD M.2 PCIe NVMe	DVD±RW	Optional 2nd 2.5" Bay	None	None	None	None	None	None	None	1.5Wx1	None	USB / USB	Floor Stand	210W 85%	Win10 Pro 64	3-year, Onsite	03/17	Apr 28, 2023
10MK003NUS	US	i7-6700	vPro	Intel HD 530	None	8GBx1	512GB SSD M.2 PCIe NVMe	DVD±RW	Optional 2nd 2.5" Bay	None	None	None	None	None	None	None	1.5Wx1	None	USB / USB	Floor Stand	210W 85%	Win10 DG Win7 Pro 64	3-year, Onsite	03/17	Apr 28, 2023
10MK003PUS	US	i7-6700	vPro	Intel HD 530	None	8GBx1	1TB 7200rpm 3.5"	DVD±RW	Optional 2nd 2.5" Bay	None	8265 ac, 2x2, vPro + BT4.1	None	None	None	None	None	1.5Wx1	None	USB / USB	Floor Stand	210W 85%	Win10 DG Win7 Pro 64	3-year, Onsite	03/17	Apr 28, 2023



ThinkCentre M910 Tiny Platform Specifications

Product Specifications Reference (PSREF)

Processor	Intel® Celeron®, Intel Pentium®, or 6/7th Generation Intel Core™ i3 / i5 / i7 Processor						Security features <ul style="list-style-type: none"> Security slot (in rear for optional Kensington® MicroSaver® cable) Smart USB protection, allows keyboard/mouse only, blocks all storage devices Power-on password Administrator password Hard disk password Boot sequence control Boot without keyboard and mouse Individual USB port disablement Chassis intrusion switch
	Processor	Cores / Threads	Frequency Base/Max(GHz)	Cache	Memory Support (Up to)	Integrated Graphics	
	Core i5-6500T	4 / 4	2.5G / 3.1G	6 MB	DDR4-2133	HD 530	
	Core i7-6700T	4 / 8	2.8G / 3.6G	8 MB	DDR4-2133	HD 530	
	Core i5-7500T	4 / 4	2.7G / 3.3G	6 MB	DDR4-2400	HD 630	
	Core i5-7600T	4 / 4	2.8G / 3.7G	6 MB	DDR4-2400	HD 630	
Core i7-7700T	4 / 8	2.9G / 3.8G	8 MB	DDR4-2400	HD 630		
Memory	32GB max, DDR4-2400*, two 260-pin SO-DIMM sockets, non-ECC, dual-channel capable * System automatically clocks down for the processors with lower memory controller						
Storage	<i>Some:</i> Hard Drive / SATA 6.0Gb/s, 2.5", 5400 rpm or 7200 rpm, APS <i>Some:</i> Solid State Drive (SSD) / SATA 6.0Gb/s, 2.5" <i>Some:</i> M.2 Solid State Drive (SSD) / PCIe NVMe, PCIe 3.0 x 4, 32Gb/s <i>Some:</i> Intel Optane™ Memory Ready (models with 7th gen Core processor), M.2 <i>Some:</i> DVD-ROM, slim (9.0mm), via USB external ODD box <i>Some:</i> DVD Burner (DVD±RW), slim (9.0mm), via USB external ODD box						
Optical	One onboard SATA 6.0Gb/s connector						
Onboard SATA Media reader	None						
Graphics	Intel HD Graphics 510/530/610/630 in processor, uses main memory, DirectX® 12, two DisplayPort™, one optional video port (HDMI, VGA, 3rd DP, or USB 3.1 Type-C with DisplayPort Alternate Mode), up to 3 independent displays; <i>Max resolution:</i> 4096x2304 (DP) @60Hz; 4096x2304 (Type-C) @60Hz; 4096x2160 (HDMI) @24Hz; 1920x1200 (VGA) @60Hz						
Monitor cable	Optional DP to VGA, DP to DVI-D (single link), DP to dual DP, or DP to HDMI 1.4						
Chipset	Intel Q270 Chipset						
Front ports	Two USB 3.1 Gen1 (one is Always On and fast charge), one microphone (3.5mm), one headphone / microphone combo jack (3.5mm)						
Rear ports	Four USB 3.1 Gen1 (optional external optical box or external I/O box occupies one or two specific USB 3.1 Gen1 on some models), ethernet (RJ-45), two DisplayPort, two optional ports (Port 1 for VGA / 3rd DP / HDMI / serial / USB 3.1 Type-C Gen 1 (with DisplayPort Alternate Mode), Port 2 for serial)						
I/O box	Optional external I/O box, extends two USB 2.0, two USB 3.1 Gen1, and one serial on rear, two USB 2.0 on front, via USB cable (occupy two specific USB 3.1 Gen1 of Tiny)						
Audio support	High Definition (HD) Audio, Realtek ALC294 / optional internal speaker (1w or 2w)						
WLAN ¹³	<i>Some:</i> 11ac wireless, M.2 Card, Qualcomm Atheros QCA9377A (dual band), Wi-Fi + Bluetooth 4.1 combo adapter, 1x1 <i>Some:</i> 11ac wireless, M.2 Card, Qualcomm Atheros QCA6174A (dual band), Wi-Fi + Bluetooth 4.1 combo adapter, 2x2 <i>Some:</i> 11ac wireless, M.2 Card, Intel Dual Band Wireless-AC 3165, Wi-Fi + Bluetooth 4.1 combo adapter, 1x1 <i>Some:</i> 11ac wireless, M.2 Card, Intel Dual Band Wireless-AC 8265, Wi-Fi + Bluetooth 4.1 combo adapter, 2x2						
Bluetooth™	<i>Some:</i> 11ac wireless, M.2 Card, Intel Dual Band Wireless-AC 8265, Wi-Fi + Bluetooth 4.1 combo adapter, Intel vPro technology support, 2x2 <i>Some:</i> Bluetooth 4.1 wireless, integrated in Wi-Fi + BT combo adapter						
Ethernet Modem	Gigabit ethernet, Intel Ethernet Connection I219-LM(Jacksonville), Wake on LAN® None						
Manageability	Intel Active Management Technology 11.0 (Intel AMT 11.0); Intel vPro technology on some models (require choosing a vPro-support Wi-Fi adapter to enable vPro function through wireless connection)						
Security chip	TPM (Trusted Platform Module) 2.0*, TCG Certified * Downgrade to TPM1.2 for the models with Win10 DG Win7 32 OS						
Keyboard	<i>Some:</i> Lenovo Calliope Keyboard (USB connector), black <i>Some:</i> Lenovo Traditional Keyboard (USB connector), black <i>Some:</i> Lenovo Calliope Wireless Keyboard (2.4GHz via USB receiver), black <i>Some:</i> Lenovo Calliope Mouse (USB connector), black <i>Some:</i> Lenovo Calliope Wireless Mouse (2.4GHz via USB receiver), black						
Mouse							
Mechanical	Tiny (1L), black color; metal case <ul style="list-style-type: none"> Toolless chassis open Toolless HDD, SSD, memory removal Optional toolless chassis screw Optional dust filter 						
VESA mount Floor Stand	Optional VESA mount bracket kit, supports VESA 75mm and 100mm Optional system floor stand for vertical orientation						
Power supply	65 watts AC/DC adapter, autosensing, 88% PSU (not included for TIO models) 90 watts AC/DC adapter, autosensing, 88% PSU (only for models with I/O box)						
Limited warranty ³	<i>Some:</i> 1-year or 3-year, depot service / service upgrades available <i>Some:</i> 1-year or 3-year, limited onsite service / service upgrades available						
Preload	<i>Some:</i> Windows® 7 Professional 32/64 preinstalled through downgrade rights in Windows 10 Pro 64-bit (not available with 7th Gen Intel processor) <i>Some:</i> Windows 10 Pro 64-bit <i>Some:</i> Windows 10 Home 64-bit						
Environment	ENERGY STAR® 6.1, EPEAT™ Gold rating (North America), ErP Lot 3, GREENGUARD®, RoHS-compliant, TUV low noise verified (on some models)						
MIL-SPEC test	MIL-STD-810G military certification (Low Pressure [Altitude], High Temperature, Low Temperature, Temperature Shock, Humidity, Sand and Dust, Vibration, Shock, Fungus, Solar Radiation)						
Accessories	For compatible accessories, please go to http://www.lenovoquickpick.com						

See footnotes for more detailed information

Model	Region	Processor	vPro	Graphics	Monitor Cable	Memory	Storage(HDD/SSD)	External Optical / I/O Box	WLAN + Bluetooth	Optional Rear Ports	Chassis Intrusion Switch	Kensington Cable Lock	Speaker	Adapter Cage	Toolless Chassis Screw	Dust Filter	Keyboard / Mouse	VESA Mount	Stand	Power Supply	Operating System	Warranty	Ann Date (mm/yy)	End of Support
10MV000JUS	US	i5-7500T	vPro	Intel HD 630	None	4GBx1	128GB SSD M.2 PCIe NVMe	None	8265 ac, 2x2, vPro + BT4.1	3rd DP	Switch	None	1Wx1	None	None	None	USB / USB	None	Floor Stand	65W Adapter 88%	Win10 Pro 64	3-year, Onsite	02/17	Mar 21, 2023
10MV000KUS	US	i7-7700T	vPro	Intel HD 630	None	8GBx1	256GB SSD M.2 PCIe NVMe	DVD±RW	8265 ac, 2x2, vPro + BT4.1	HDMI	Switch	None	1Wx1	None	None	None	USB / USB	VESA Mount	None	65W Adapter 88%	Win10 Pro 64	3-year, Onsite	02/17	Mar 21, 2023
10MV000LUS	US	i5-7500T	vPro	Intel HD 630	None	4GBx1	500GB 7200rpm 2.5"	None	8265 ac, 2x2, vPro + BT4.1	3rd DP	Switch	None	1Wx1	None	None	None	USB / USB	None	Floor Stand	65W Adapter 88%	Win10 Pro 64	3-year, Onsite	02/17	Mar 21, 2023
10MV000MUS	US	i5-7500T	vPro	Intel HD 630	None	8GBx1	500GB 7200rpm 2.5"	None	8265 ac, 2x2, vPro + BT4.1	HDMI	Switch	None	1Wx1	None	None	None	USB / USB	None	Floor Stand	65W Adapter 88%	Win10 Pro 64	3-year, Onsite	02/17	Mar 21, 2023
10MV000NUS	US	i5-7500T	vPro	Intel HD 630	None	8GBx1	256GB SSD M.2 PCIe NVMe	None	8265 ac, 2x2, vPro + BT4.1	3rd DP	Switch	None	1Wx1	None	None	None	USB / USB	None	Floor Stand	65W Adapter 88%	Win10 Pro 64	3-year, Onsite	02/17	Mar 21, 2023
10MV000PUS	US	i5-7500T	vPro	Intel HD 630	None	8GBx1	500GB 7200rpm 2.5"	DVD±RW	8265 ac, 2x2, vPro + BT4.1	HDMI	Switch	None	1Wx1	None	None	None	USB / USB	VESA Mount	None	65W Adapter 88%	Win10 Pro 64	3-year, Onsite	02/17	Mar 21, 2023
10MV000QUS	US	i5-7500T	vPro	Intel HD 630	None	8GBx1	256GB SSD M.2 PCIe NVMe	None	8265 ac, 2x2, vPro + BT4.1	HDMI	Switch	None	1Wx1	None	None	None	USB / USB	None	Floor Stand	65W Adapter 88%	Win10 Pro 64	3-year, Onsite	02/17	Mar 21, 2023
10MV000RUS	US	i5-7500T	vPro	Intel HD 630	None	4GBx1	128GB SSD M.2 PCIe NVMe	None	8265 ac, 2x2, vPro + BT4.1	None	Switch	None	1Wx1	None	None	None	USB / USB	None	Floor Stand	65W Adapter 88%	Win10 Pro 64	3-year, Onsite	02/17	Mar 21, 2023
10MV000SUS	US	i5-7500T	vPro	Intel HD 630	None	8GBx1	128GB SSD M.2 PCIe NVMe	None	8265 ac, 2x2, vPro + BT4.1	3rd DP	Switch	None	1Wx1	None	None	None	USB / USB	None	Floor Stand	65W Adapter 88%	Win10 Pro 64	3-year, Onsite	02/17	Mar 21, 2023
10MV000TUS	US	i5-7500T	vPro	Intel HD 630	None	8GBx1	500GB 7200rpm 2.5"	None	8265 ac, 2x2, vPro + BT4.1	3rd DP	Switch	None	1Wx1	None	None	None	USB / USB	None	Floor Stand	65W Adapter 88%	Win10 Pro 64	3-year, Onsite	02/17	Mar 21, 2023
10MV000UUS	US	i7-7700T	vPro	Intel HD 630	None	8GBx1	256GB SSD M.2 PCIe NVMe	None	8265 ac, 2x2, vPro + BT4.1	HDMI	Switch	None	1Wx1	None	None	None	USB / USB	None	Floor Stand	65W Adapter 88%	Win10 Pro 64	3-year, Onsite	02/17	Mar 21, 2023
10MV000VUS	US	i5-7500T	vPro	Intel HD 630	None	4GBx1	500GB 7200rpm 2.5"	None	8265 ac, 2x2, vPro + BT4.1	Serial	Switch	None	1Wx1	None	None	None	USB / USB	None	Floor Stand	65W Adapter 88%	Win10 Pro 64	3-year, Onsite	02/17	Mar 21, 2023
10MV000XUS	US	i5-7500T	vPro	Intel HD 630	None	4GBx1	500GB 7200rpm 2.5"	None	8265 ac, 2x2, vPro + BT4.1	None	Switch	None	1Wx1	None	None	None	USB / USB	None	Floor Stand	65W Adapter 88%	Win10 Pro 64	3-year, Onsite	02/17	Mar 21, 2023
10MV000YUS	US	i7-7700T	vPro	Intel HD 630	None	8GBx1	128GB SSD M.2 PCIe NVMe	None	8265 ac, 2x2, vPro + BT4.1	HDMI	Switch	None	1Wx1	None	None	None	USB / USB	None	Floor Stand	65W Adapter 88%	Win10 Pro 64	3-year, Onsite	02/17	Mar 21, 2023
10MV0010US	US	i7-7700T	vPro	Intel HD 630	None	8GBx1	500GB 7200rpm 2.5"	None	8265 ac, 2x2, vPro + BT4.1	HDMI	Switch	None	1Wx1	None	None	None	USB / USB	None	Floor Stand	65W Adapter 88%	Win10 Pro 64	3-year, Onsite	02/17	Mar 21, 2023
10MV0011US	US	i5-7500T	vPro	Intel HD 630	None	4GBx1	256GB SSD M.2 PCIe NVMe	None	8265 ac, 2x2, vPro + BT4.1	3rd DP	Switch	None	1Wx1	None	None	None	USB / USB	None	Floor Stand	65W Adapter 88%	Win10 Pro 64	3-year, Onsite	02/17	Mar 21, 2023
10MV0012US	US	i5-7500T	vPro	Intel HD 630	None	8GBx1	512GB SSD M.2 PCIe NVMe	None	8265 ac, 2x2, vPro + BT4.1	HDMI	Switch	None	1Wx1	None	None	None	USB / USB	None	Floor Stand	65W Adapter 88%	Win10 Pro 64	3-year, Onsite	02/17	Mar 21, 2023
10MV0013US	US	i7-7700T	vPro	Intel HD 630	None	8GBx1	512GB SSD M.2 PCIe NVMe	None	8265 ac, 2x2, vPro + BT4.1	HDMI	Switch	None	1Wx1	None	None	None	USB / USB	None	Floor Stand	65W Adapter 88%	Win10 Pro 64	3-year, Onsite	02/17	Mar 21, 2023
10MV0014US	US	i5-7500T	vPro	Intel HD 630	None	8GBx1	256GB SSD M.2 PCIe NVMe	DVD±RW	8265 ac, 2x2, vPro + BT4.1	HDMI	Switch	None	1Wx1	None	None	None	USB / USB	VESA Mount	None	65W Adapter 88%	Win10 Pro 64	3-year, Onsite	02/17	Mar 21, 2023
10MV002MUS	US	i7-6700T	vPro	Intel HD 530	None	8GBx1	512GB SSD M.2 PCIe NVMe	None	8265 ac, 2x2, vPro + BT4.1	HDMI	Switch	None	1Wx1	None	None	None	USB / USB	None	Floor Stand	65W Adapter 88%	Win10 DG Win7 Pro 64	3-year, Onsite	03/17	Apr 21, 2023

Model	Region	Processor	vPro	Graphics	Monitor Cable	Memory	Storage(HDD/SSD)	External Optical / I/O Box	WLAN + Bluetooth	Optional Rear Ports	Chassis Intrusion Switch	Kensington Cable Lock	Speaker	Adapter Cage	Toolless Chassis Screw	Dust Filter	Keyboard / Mouse	VESA Mount	Stand	Power Supply	Operating System	Warranty	Ann Date (mm/yy)	End of Support
10MV002NUS	US	i5-6500T	vPro	Intel HD 530	None	4GBx1	500GB 7200rpm 2.5"	None	8265 ac, 2x2, vPro + BT4.1	Serial	Switch	None	1Wx1	None	None	None	USB / USB	None	Floor Stand	65W Adapter 88%	Win10 DG Win7 Pro 64	3-year, Onsite	03/17	Apr 21, 2023
10MV002PUS	US	i5-7500T	vPro	Intel HD 630	None	8GBx2	512GB SSD M.2 PCIe NVMe	None	8265 ac, 2x2, vPro + BT4.1	3rd DP	Switch	None	1Wx1	None	None	None	USB / USB	None	Floor Stand	65W Adapter 88%	Win10 Pro 64	3-year, Onsite	03/17	Apr 21, 2023
10MV002QUS	US	i7-7700T	vPro	Intel HD 630	None	8GBx2	512GB SSD M.2 PCIe NVMe	None	8265 ac, 2x2, vPro + BT4.1	3rd DP	Switch	None	1Wx1	None	None	None	USB / USB	None	Floor Stand	65W Adapter 88%	Win10 Pro 64	3-year, Onsite	03/17	Apr 21, 2023
10MV002RUS	US	i7-7700T	vPro	Intel HD 630	None	8GBx1	500GB 7200rpm 2.5"	None	8265 ac, 2x2, vPro + BT4.1	3rd DP	Switch	None	1Wx1	None	None	None	USB / USB	None	Floor Stand	65W Adapter 88%	Win10 Pro 64	3-year, Onsite	03/17	Apr 21, 2023
10MV002SUS	US	i5-6500T	vPro	Intel HD 530	None	8GBx1	512GB SSD M.2 PCIe NVMe	None	8265 ac, 2x2, vPro + BT4.1	3rd DP	Switch	None	1Wx1	None	None	None	USB / USB	None	Floor Stand	65W Adapter 88%	Win10 DG Win7 Pro 64	3-year, Onsite	03/17	Apr 21, 2023
10MV002TUS	US	i7-6700T	vPro	Intel HD 530	None	16GBx1	512GB SSD M.2 PCIe NVMe	None	8265 ac, 2x2, vPro + BT4.1	3rd DP	Switch	None	1Wx1	None	None	None	USB / USB	None	Floor Stand	65W Adapter 88%	Win10 DG Win7 Pro 64	3-year, Onsite	03/17	Apr 21, 2023
10MV002UUS	US	i7-6700T	vPro	Intel HD 530	None	8GBx1	500GB 7200rpm 2.5"	None	8265 ac, 2x2, vPro + BT4.1	3rd DP	Switch	None	1Wx1	None	None	None	USB / USB	None	Floor Stand	65W Adapter 88%	Win10 DG Win7 Pro 64	3-year, Onsite	03/17	Apr 21, 2023
10MV002VUS	US	i7-7700T	vPro	Intel HD 630	None	8GBx2	500GB 7200rpm 2.5"	None	8265 ac, 2x2, vPro + BT4.1	3rd DP	Switch	None	1Wx1	None	None	None	USB / USB	None	Floor Stand	65W Adapter 88%	Win10 Pro 64	3-year, Onsite	03/17	Apr 21, 2023
10MV002WUS	US	i7-6700T	vPro	Intel HD 530	None	8GBx1	256GB SSD M.2 PCIe NVMe	None	8265 ac, 2x2, vPro + BT4.1	HDMI	Switch	None	1Wx1	None	None	None	USB / USB	None	Floor Stand	65W Adapter 88%	Win10 DG Win7 Pro 64	3-year, Onsite	03/17	Apr 21, 2023
10MV002XUS	US	i5-7500T	vPro	Intel HD 630	None	8GBx2	256GB SSD M.2 PCIe NVMe	None	8265 ac, 2x2, vPro + BT4.1	3rd DP	Switch	None	1Wx1	None	None	None	USB / USB	None	Floor Stand	65W Adapter 88%	Win10 Pro 64	3-year, Onsite	03/17	Apr 21, 2023
10MV002YUS	US	i5-6500T	vPro	Intel HD 530	None	8GBx2	512GB SSD M.2 PCIe NVMe	None	8265 ac, 2x2, vPro + BT4.1	3rd DP	Switch	None	1Wx1	None	None	None	USB / USB	None	Floor Stand	65W Adapter 88%	Win10 DG Win7 Pro 64	3-year, Onsite	03/17	Apr 21, 2023
10MV0030US	US	i5-6500T	vPro	Intel HD 530	None	4GBx1	500GB 7200rpm 2.5"	None	8265 ac, 2x2, vPro + BT4.1	None	Switch	None	1Wx1	None	None	None	USB / USB	None	Floor Stand	65W Adapter 88%	Win10 DG Win7 Pro 64	3-year, Onsite	03/17	Apr 21, 2023
10MV0031US	US	i5-6500T	vPro	Intel HD 530	None	4GBx1	500GB 7200rpm 2.5"	None	8265 ac, 2x2, vPro + BT4.1	VGA	Switch	None	1Wx1	None	None	None	USB / USB	None	Floor Stand	65W Adapter 88%	Win10 DG Win7 Pro 64	3-year, Onsite	03/17	Apr 21, 2023
10MV0032US	US	i5-6500T	vPro	Intel HD 530	None	8GBx1	256GB SSD M.2 PCIe NVMe	None	8265 ac, 2x2, vPro + BT4.1	3rd DP	Switch	None	1Wx1	None	None	None	USB / USB	None	Floor Stand	65W Adapter 88%	Win10 DG Win7 Pro 64	3-year, Onsite	03/17	Mar 21, 2022
10MV0033US	US	i7-6700T	vPro	Intel HD 530	None	8GBx1	512GB SSD M.2 PCIe NVMe	None	8265 ac, 2x2, vPro + BT4.1	3rd DP	Switch	None	1Wx1	None	None	None	USB / USB	None	Floor Stand	65W Adapter 88%	Win10 DG Win7 Pro 64	3-year, Onsite	03/17	Apr 21, 2023
10MV0034US	US	i5-6500T	vPro	Intel HD 530	None	8GBx1	128GB SSD M.2 PCIe NVMe	None	8265 ac, 2x2, vPro + BT4.1	3rd DP	Switch	None	1Wx1	None	None	None	USB / USB	None	Floor Stand	65W Adapter 88%	Win10 DG Win7 Pro 64	3-year, Onsite	03/17	Apr 21, 2023
10MV0035US	US	i7-7700T	vPro	Intel HD 630	None	8GBx2	256GB SSD M.2 PCIe NVMe	None	8265 ac, 2x2, vPro + BT4.1	3rd DP	Switch	None	1Wx1	None	None	None	USB / USB	None	Floor Stand	65W Adapter 88%	Win10 Pro 64	3-year, Onsite	03/17	Apr 21, 2023
10MV0036US	US	i5-6500T	vPro	Intel HD 530	None	8GBx1	500GB 7200rpm 2.5"	None	8265 ac, 2x2, vPro + BT4.1	3rd DP	Switch	None	1Wx1	None	None	None	USB / USB	None	Floor Stand	65W Adapter 88%	Win10 DG Win7 Pro 64	3-year, Onsite	03/17	Apr 21, 2023
10MV0037US	US	i5-6500T	vPro	Intel HD 530	None	8GBx2	256GB SSD M.2 PCIe NVMe	None	8265 ac, 2x2, vPro + BT4.1	3rd DP	Switch	None	1Wx1	None	None	None	USB / USB	None	Floor Stand	65W Adapter 88%	Win10 DG Win7 Pro 64	3-year, Onsite	03/17	Apr 21, 2023
10MV0038US	US	i5-6500T	vPro	Intel HD 530	None	4GBx1	500GB 7200rpm 2.5"	None	8265 ac, 2x2, vPro + BT4.1	3rd DP	Switch	None	1Wx1	None	None	None	USB / USB	None	Floor Stand	65W Adapter 88%	Win10 DG Win7 Pro 64	3-year, Onsite	03/17	Apr 21, 2023

Model	Region	Processor	vPro	Graphics	Monitor Cable	Memory	Storage(HDD/SSD)	External Optical / I/O Box	WLAN + Bluetooth	Optional Rear Ports	Chassis Intrusion Switch	Kensington Cable Lock	Speaker	Adapter Cage	Toolless Chassis Screw	Dust Filter	Keyboard / Mouse	VESA Mount	Stand	Power Supply	Operating System	Warranty	Ann Date (mm/yy)	End of Support
10MV0039US	US	i7-6700T	vPro	Intel HD 530	None	8GBx1	256GB SSD M.2 PCIe NVMe	None	8265 ac, 2x2, vPro + BT4.1	3rd DP	Switch	None	1Wx1	None	None	None	USB / USB	None	Floor Stand	65W Adapter 88%	Win10 DG Win7 Pro 64	3-year, Onsite	03/17	Apr 21, 2023

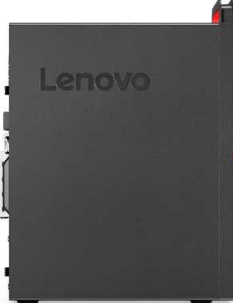

ThinkCentre M910 Tower Platform Specifications

Product Specifications Reference (PSREF)

Processor	Intel® Celeron®, Intel Pentium®, or 6/7th Generation Intel Core™ i3 / i5 / i7 Processor	Manageability	Intel Active Management Technology 11.0 (Intel AMT 11.0); Intel vPro technology on some models (require choosing a vPro-support Wi-Fi adapter to enable vPro function through wireless connection)																																										
	<table border="1"> <thead> <tr> <th>Processor</th> <th>Cores / Threads</th> <th>Frequency Base/Max(GHz)</th> <th>Cache</th> <th>Memory Support (Up to)</th> <th>Integrated Graphics</th> </tr> </thead> <tbody> <tr> <td>Core i5-6500</td> <td>4 / 4</td> <td>3.2G / 3.6G</td> <td>6 MB</td> <td>DDR4-2133</td> <td>HD 530</td> </tr> <tr> <td>Core i7-6700</td> <td>4 / 8</td> <td>3.4G / 4.0G</td> <td>8 MB</td> <td>DDR4-2133</td> <td>HD 530</td> </tr> <tr> <td>Core i5-7400</td> <td>4 / 4</td> <td>3.0G / 3.5G</td> <td>6 MB</td> <td>DDR4-2400</td> <td>HD 630</td> </tr> <tr> <td>Core i5-7500</td> <td>4 / 4</td> <td>3.4G / 3.8G</td> <td>6 MB</td> <td>DDR4-2400</td> <td>HD 630</td> </tr> <tr> <td>Core i5-7600</td> <td>4 / 4</td> <td>3.5G / 4.1G</td> <td>6 MB</td> <td>DDR4-2400</td> <td>HD 630</td> </tr> <tr> <td>Core i7-7700</td> <td>4 / 8</td> <td>3.6G / 4.2G</td> <td>8 MB</td> <td>DDR4-2400</td> <td>HD 630</td> </tr> </tbody> </table>	Processor	Cores / Threads	Frequency Base/Max(GHz)	Cache	Memory Support (Up to)	Integrated Graphics	Core i5-6500	4 / 4	3.2G / 3.6G	6 MB	DDR4-2133	HD 530	Core i7-6700	4 / 8	3.4G / 4.0G	8 MB	DDR4-2133	HD 530	Core i5-7400	4 / 4	3.0G / 3.5G	6 MB	DDR4-2400	HD 630	Core i5-7500	4 / 4	3.4G / 3.8G	6 MB	DDR4-2400	HD 630	Core i5-7600	4 / 4	3.5G / 4.1G	6 MB	DDR4-2400	HD 630	Core i7-7700	4 / 8	3.6G / 4.2G	8 MB	DDR4-2400	HD 630	Security chip	TPM (Trusted Platform Module) 2.0, TCG Certified * Downgrade to TPM1.2 for the models with Win10 DG Win7 32 OS
Processor	Cores / Threads	Frequency Base/Max(GHz)	Cache	Memory Support (Up to)	Integrated Graphics																																								
Core i5-6500	4 / 4	3.2G / 3.6G	6 MB	DDR4-2133	HD 530																																								
Core i7-6700	4 / 8	3.4G / 4.0G	8 MB	DDR4-2133	HD 530																																								
Core i5-7400	4 / 4	3.0G / 3.5G	6 MB	DDR4-2400	HD 630																																								
Core i5-7500	4 / 4	3.4G / 3.8G	6 MB	DDR4-2400	HD 630																																								
Core i5-7600	4 / 4	3.5G / 4.1G	6 MB	DDR4-2400	HD 630																																								
Core i7-7700	4 / 8	3.6G / 4.2G	8 MB	DDR4-2400	HD 630																																								
Memory	64GB max, UDIMM, DDR4-2400*, four 288-pin DIMM sockets, non-ECC, dual-channel capable * System automatically clocks down for the processors with lower memory controller	Security features	<ul style="list-style-type: none"> Security slot (in rear for optional Kensington® MicroSaver® cable) Padlock loop Smart USB protection, allows keyboard/ mouse only, blocks all storage devices Optional cable lock to physically lock both keyboard and mouse Power-on password Administrator password Hard disk password Boot sequence control Boot without keyboard and mouse Individual USB port disablement Optional chassis intrusion switch 																																										
Storage	<i>Some:</i> Hard Drive / SATA 6.0Gb/s, 2.5" or 3.5", 5400 rpm or 7200 rpm <i>Some:</i> Solid State Drive (SSD) / SATA 6.0Gb/s, 2.5" <i>Some:</i> M.2 Solid State Drive (SSD) / PCIe NVMe, PCIe 3.0 x 4, 32Gb/s <i>Some:</i> Intel Optane™ Memory Ready (models with 7th gen Core processor), M.2 <i>Some:</i> Front accessible and removable HDD, 3.5", lockable via physical key <i>Some:</i> DVD-ROM, SATA 1.5Gb/s, 5.25" or slim (9.0mm) <i>Some:</i> DVD Burner (DVD±RW), SATA 1.5Gb/s, 5.25" or slim (9.0mm) Four onboard SATA 6.0Gb/s connectors, RAID 0/1 support (RAID preset only available via special bid model)	Keyboard	<i>Some:</i> Lenovo Calliope Keyboard (USB connector), black <i>Some:</i> Lenovo Traditional Keyboard (USB connector), black <i>Some:</i> Lenovo Calliope Wireless Keyboard (2.4GHz via USB receiver), black <i>Some:</i> Lenovo Calliope Mouse (USB connector), black <i>Some:</i> Lenovo Calliope Wireless Mouse (2.4GHz via USB receiver), black																																										
Optical		Mouse																																											
Onboard SATA		Mechanical	<ul style="list-style-type: none"> Tower (18L), black color, metal case (WxDxH) 6.5" X 12.65" X 16.15"; 165mm X 321.35mm X 410.25mm Approx. 15.45 lb (7 kg), weight may vary by configuration Toolless cover, disk, optical, graphic card removal Optional carry handle, dust filter Bay 1: Slim external ODD bay Bay 2: 5.25", 1.6" high, external, ODD or optional front access HDD Bay 3: 3.5", 1" high, internal, HDD/SSD Bay 4: 3.5", 1" high, internal, HDD/SSD (optional bay, bay comes with disk) Bay 5: 2.5", internal, HDD/SSD (optional bay) Slot 1: half-length, full-height, PCIe 3.0 x16* Slot 2: half-length, full-height, PCIe 3.0 x1* Slot 3: half-length, full-height, PCIe 3.0 x16 (x4 signal)* Slot 4: no slot, only bracket for optional port extension* M.2 card slots: Two (one for WLAN, one for SSD/Optane) * Optional front USB3.1 Type-C x2 module occupies PCIe x16 (x4 signal) slot, optional rear 2x USB2.0 / parallel occupies one expansion slot 																																										
Media reader	Optional 7-in-1 media reader	Power supply	<i>Some:</i> 180 watts, autosensing, 85% PSU <i>Some:</i> 250 watts, autosensing, 85% PSU <i>Some:</i> 400 watts, autosensing, 92% PSU (only available via special bid)																																										
Graphics	Intel HD Graphics 510/530/610/630 in processor, uses main memory, DirectX® 12, one VGA, two DisplayPort™, supports 3 independent displays, works along with discrete graphics to support more displays; <i>Max resolution:</i> 4096x2304 (DP)@60Hz; 2048x1536 (VGA)@50Hz <i>Some:</i> NVIDIA GeForce® GT 730 , DirectX 12, 2GB, PCIe 2.0 x8 adapter, two DisplayPort, 35 watts; <i>Max resolution:</i> 3840x2160 (DisplayPort)@60Hz; <i>Some:</i> AMD Radeon™ R7 350 , DirectX 11, 2GB, PCIe 3.0 x8 adapter, one VGA, one HDMI, 75 watts, occupies two slots; <i>Max resolution:</i> 4096x2160 (HDMI)@24Hz; 2048x1536 (VGA)@85Hz <i>Some:</i> NVIDIA GeForce GTX™ 1080 , DirectX 12, 8GB, PCIe 3.0 x16 adapter, one DVI-D, one HDMI, three DisplayPort, 180 watts, occupies two slots; <i>Max resolution:</i> 2560x1600 (DVI-D)@60Hz; 4096x2160 (HDMI)@60Hz 7680x4320 (with Single DP)@60Hz	Limited warranty ³	<i>Some:</i> 1-year or 3-year, depot service / service upgrades available <i>Some:</i> 1-year or 3-year, limited onsite service / service upgrades available																																										
Monitor Cable	Optional DP to VGA, DP to DVI-D (single link), DP to dual DP, or DP to HDMI 1.4	Preload	Preloaded operating system <i>Some:</i> Windows® 7 Professional 32/64 preinstalled through downgrade rights in Windows 10 Pro 64-bit (not available with 7th Gen Intel processor) <i>Some:</i> Windows 10 Pro 64-bit <i>Some:</i> Windows 10 Home 64-bit Preloaded applications (only some listed) <ul style="list-style-type: none"> Microsoft Office preloaded; purchase a product key to activate Cyberlink PowerDVD Create (DVD±RW) Intel Unite (vPro models only) Only for Window 10 Lenovo Companion Lenovo ID Cyberlink PowerDVD (DVD, DVD±RW) Only for Window 7 Lenovo Solution Center Lenovo ThinkVantage Tools Create Recovery Media Adobe® Reader® 																																										
Chipset	Intel Q270 Chipset	Environment	ENERGY STAR® 6.1, EPEAT™ Gold rating (North America), ErP Lot 3, GREENGUARD®, RoHS-compliant, TUV low noise verified (on some models)																																										
Front ports	Four USB 3.1 Gen1, optional two USB 3.1 Type-C Gen 2 (only available via special bid), microphone (3.5mm), headphone (3.5mm)	Accessories	For compatible accessories, please go to http://www.lenovoquickpick.com																																										
Rear ports	Four USB 3.1 Gen1, optional two USB 2.0, serial (9-pin), optional 2nd serial (9-pin), optional parallel (25-pin), ethernet (RJ-45), one VGA, two DisplayPort, optional two PS/2 ports (keyboard/mouse); additional VGA, DisplayPort, DVI-D, or HDMI on optional graphics on some models																																												
Rear audio ports IEEE 1394	Line-in (3.5mm), line-out (3.5mm), microphone-in (3.5mm) None																																												
Audio support	High Definition (HD) Audio, Realtek ALC662 / optional internal speaker (1.5 watt)																																												
WLAN ¹³	<i>Some:</i> 11ac wireless, M.2 Card, Qualcomm Atheros QCA9377A (dual band), Wi-Fi + Bluetooth 4.1 combo adapter, 1x1 <i>Some:</i> 11ac wireless, M.2 Card, Qualcomm Atheros QCA6174A (dual band), Wi-Fi + Bluetooth 4.1 combo adapter, 2x2 <i>Some:</i> 11ac wireless, M.2 Card, Intel Dual Band Wireless-AC 3165, Wi-Fi + Bluetooth 4.1 combo adapter, 1x1 <i>Some:</i> 11ac wireless, M.2 Card, Intel Dual Band Wireless-AC 8265, Wi-Fi + Bluetooth 4.1 combo adapter, 2x2 <i>Some:</i> 11ac wireless, M.2 Card, Intel Dual Band Wireless-AC 8265, Wi-Fi + Bluetooth 4.1 combo adapter, Intel vPro technology support, 2x2																																												
Bluetooth™	<i>Some:</i> Bluetooth 4.1 wireless, integrated in Wi-Fi + BT combo adapter																																												
Ethernet	Gigabit ethernet, Intel Ethernet Connection I219-LM(Jacksonville), Wake on LAN®																																												
Modem	None																																												

See footnotes for more detailed information

Model	Region	Processor	vPro	Graphics	Monitor Cable	Memory	Storage(HDD/SSD)	Optical	Optional 2nd 2.5" Bay	Media Reader	WLAN + Bluetooth	Optional Front Ports	Optional Rear Ports	Chassis Intrusion Switch	Cable Lock	Front Access HDD	Speaker	Dust Filter	Keyboard / Mouse	Carry Handle	Power Supply	Operating System	Warranty	Ann Date (mm/yy)	End of Support
10MM000AUS	US	i5-7500	vPro	Intel HD 630	None	4GBx1	500GB 7200rpm 3.5"	DVD±RW	Optional 2.5" Bay	None	None	None	None	None	None	None	1.5Wx1	None	USB / USB	Carry Handle	250W 85%	Win10 Pro 64	3-year, Onsite	02/17	Mar 21, 2023
10MM000BUS	US	i7-7700	vPro	GT 730 2GB	None	8GBx1	256GB SSD M.2 PCIe NVMe	DVD±RW	Optional 2.5" Bay	None	None	None	None	None	None	None	1.5Wx1	None	USB / USB	Carry Handle	250W 85%	Win10 Pro 64	3-year, Onsite	02/17	Mar 21, 2023
10MM000CUS	US	i5-7500	vPro	Intel HD 630	None	8GBx1	512GB SSD M.2 PCIe NVMe	DVD±RW	Optional 2.5" Bay	None	None	None	None	None	None	None	1.5Wx1	None	USB / USB	Carry Handle	250W 85%	Win10 Pro 64	3-year, Onsite	02/17	Mar 21, 2023
10MM000DUS	US	i7-7700	vPro	Intel HD 630	None	8GBx1	256GB SSD M.2 PCIe NVMe	DVD±RW	Optional 2.5" Bay	None	None	None	None	None	None	None	1.5Wx1	None	USB / USB	Carry Handle	250W 85%	Win10 Pro 64	3-year, Onsite	02/17	Mar 21, 2023
10MM000EUS	US	i5-7500	vPro	GT 730 2GB	None	8GBx1	512GB SSD M.2 PCIe NVMe	DVD±RW	Optional 2.5" Bay	None	None	None	None	None	None	None	1.5Wx1	None	USB / USB	Carry Handle	250W 85%	Win10 Pro 64	3-year, Onsite	02/17	Mar 21, 2023
10MM000FUS	US	i5-7500	vPro	Intel HD 630	None	8GBx1	1TB 7200rpm 3.5"	DVD±RW	Optional 2.5" Bay	None	None	None	None	None	None	None	1.5Wx1	None	USB / USB	Carry Handle	250W 85%	Win10 Pro 64	3-year, Onsite	02/17	Mar 21, 2023
10MM000GUS	US	i5-7500	vPro	GT 730 2GB	None	8GBx1	1TB 7200rpm 3.5"	DVD±RW	Optional 2.5" Bay	None	None	None	None	None	None	None	1.5Wx1	None	USB / USB	Carry Handle	250W 85%	Win10 Pro 64	3-year, Onsite	02/17	Mar 21, 2023
10MM000HUS	US	i5-7500	vPro	Intel HD 630	None	8GBx1	256GB SSD M.2 PCIe NVMe	DVD±RW	Optional 2.5" Bay	None	None	None	None	None	None	None	1.5Wx1	None	USB / USB	Carry Handle	250W 85%	Win10 Pro 64	3-year, Onsite	02/17	Mar 21, 2023
10MM000JUS	US	i7-7700	vPro	GT 730 2GB	None	8GBx1	1TB 7200rpm 3.5"	DVD±RW	Optional 2.5" Bay	None	None	None	None	None	None	None	1.5Wx1	None	USB / USB	Carry Handle	250W 85%	Win10 Pro 64	3-year, Onsite	02/17	Mar 21, 2023
10MM000KUS	US	i7-7700	vPro	Intel HD 630	None	8GBx1	512GB SSD M.2 PCIe NVMe	DVD±RW	Optional 2.5" Bay	None	None	None	None	None	None	None	1.5Wx1	None	USB / USB	Carry Handle	250W 85%	Win10 Pro 64	3-year, Onsite	02/17	Mar 21, 2023
10MM000LUS	US	i7-7700	vPro	Intel HD 630	None	8GBx1	256GB SSD M.2 PCIe NVMe	DVD±RW	Optional 2.5" Bay	None	8265 ac, 2x2, vPro + BT4.1	None	None	None	None	None	1.5Wx1	None	USB / USB	Carry Handle	250W 85%	Win10 Pro 64	3-year, Onsite	02/17	Mar 21, 2023
10MM000MUS	US	i7-7700	vPro	GT 730 2GB	None	8GBx1	512GB SSD M.2 PCIe NVMe	DVD±RW	Optional 2.5" Bay	None	None	None	None	None	None	None	1.5Wx1	None	USB / USB	Carry Handle	250W 85%	Win10 Pro 64	3-year, Onsite	02/17	Mar 21, 2023
10MM000NUS	US	i5-7500	vPro	Intel HD 630	None	8GBx1	256GB SSD M.2 PCIe NVMe	DVD±RW	Optional 2.5" Bay	None	8265 ac, 2x2, vPro + BT4.1	None	None	None	None	None	1.5Wx1	None	USB / USB	Carry Handle	250W 85%	Win10 Pro 64	3-year, Onsite	02/17	Mar 21, 2023
10MM000PUS	US	i7-7700	vPro	Intel HD 630	None	8GBx1	1TB 7200rpm 3.5"	DVD±RW	Optional 2.5" Bay	None	None	None	None	None	None	None	1.5Wx1	None	USB / USB	Carry Handle	250W 85%	Win10 Pro 64	3-year, Onsite	02/17	Mar 21, 2023
10MM000QUS	US	i5-7500	vPro	GT 730 2GB	None	8GBx1	256GB SSD M.2 PCIe NVMe	DVD±RW	Optional 2.5" Bay	None	None	None	None	None	None	None	1.5Wx1	None	USB / USB	Carry Handle	250W 85%	Win10 Pro 64	3-year, Onsite	02/17	Mar 21, 2023
10MM002JUS	US	i5-6500	vPro	GT 730 2GB	None	8GBx1	256GB SSD M.2 PCIe NVMe	DVD±RW	Optional 2.5" Bay	None	8265 ac, 2x2, vPro + BT4.1	None	None	None	None	None	1.5Wx1	None	USB / USB	Carry Handle	250W 85%	Win10 DG Win7 Pro 64	3-year, Onsite	03/17	Apr 28, 2023
10MM002KUS	US	i5-6500	vPro	GT 730 2GB	None	8GBx1	512GB SSD M.2 PCIe NVMe	DVD±RW	Optional 2.5" Bay	None	None	None	None	None	None	None	1.5Wx1	None	USB / USB	Carry Handle	250W 85%	Win10 DG Win7 Pro 64	3-year, Onsite	03/17	Apr 28, 2023
10MM002LUS	US	i5-6500	vPro	Intel HD 530	None	8GBx1	256GB SSD M.2 PCIe NVMe	DVD±RW	Optional 2.5" Bay	None	None	None	None	None	None	None	1.5Wx1	None	USB / USB	Carry Handle	250W 85%	Win10 DG Win7 Pro 64	3-year, Onsite	03/17	Apr 28, 2023
10MM002MUS	US	i5-6500	vPro	Intel HD 530	None	4GBx1	128GB SSD M.2 PCIe NVMe	DVD±RW	Optional 2.5" Bay	None	None	None	None	None	None	None	1.5Wx1	None	USB / USB	Carry Handle	250W 85%	Win10 DG Win7 Pro 64	3-year, Onsite	03/17	Apr 28, 2023
10MM002NUS	US	i7-6700	vPro	GT 730 2GB	None	8GBx1	512GB SSD M.2 PCIe NVMe	DVD±RW	Optional 2.5" Bay	None	None	None	None	None	None	None	1.5Wx1	None	USB / USB	Carry Handle	250W 85%	Win10 DG Win7 Pro 64	3-year, Onsite	03/17	Apr 28, 2023

Model	Region	Processor	vPro	Graphics	Monitor Cable	Memory	Storage(HDD/SSD)	Optical	Optional 2nd 2.5" Bay	Media Reader	WLAN + Bluetooth	Optional Front Ports	Optional Rear Ports	Chassis Intrusion Switch	Cable Lock	Front Access HDD	Speaker	Dust Filter	Keyboard / Mouse	Carry Handle	Power Supply	Operating System	Warranty	Ann Date (mm/yy)	End of Support
10MM002PUS	US	i7-6700	vPro	GT 730 2GB	None	8GBx1	256GB SSD M.2 PCIe NVMe	DVD±RW	Optional 2.5" Bay	None	None	None	None	None	None	None	1.5Wx1	None	USB / USB	Carry Handle	250W 85%	Win10 DG Win7 Pro 64	3-year, Onsite	03/17	Apr 28, 2023
10MM002QUS	US	i5-7500	vPro	Intel HD 630	None	4GBx1	128GB SSD M.2 PCIe NVMe	DVD±RW	Optional 2.5" Bay	None	None	None	None	None	None	None	1.5Wx1	None	USB / USB	Carry Handle	250W 85%	Win10 Pro 64	3-year, Onsite	03/17	Apr 28, 2023
10MM002RUS	US	i7-6700	vPro	GT 730 2GB	None	8GBx1	1TB 7200rpm 3.5"	DVD±RW	Optional 2.5" Bay	None	None	None	None	None	None	None	1.5Wx1	None	USB / USB	Carry Handle	250W 85%	Win10 DG Win7 Pro 64	3-year, Onsite	03/17	Apr 28, 2023
10MM002SUS	US	i7-6700	vPro	Intel HD 530	None	8GBx1	256GB SSD M.2 PCIe NVMe	DVD±RW	Optional 2.5" Bay	None	None	None	None	None	None	None	1.5Wx1	None	USB / USB	Carry Handle	250W 85%	Win10 DG Win7 Pro 64	3-year, Onsite	03/17	Apr 28, 2023
10MM002TUS	US	i5-6500	vPro	Intel HD 530	None	4GBx1	500GB 7200rpm 3.5"	DVD±RW	Optional 2.5" Bay	None	None	None	None	None	None	None	1.5Wx1	None	USB / USB	Carry Handle	250W 85%	Win10 DG Win7 Pro 64	3-year, Onsite	03/17	Apr 28, 2023
10MM002UUS	US	i5-6500	vPro	GT 730 2GB	None	8GBx1	256GB SSD M.2 PCIe NVMe	DVD±RW	Optional 2.5" Bay	None	None	None	None	None	None	None	1.5Wx1	None	USB / USB	Carry Handle	250W 85%	Win10 DG Win7 Pro 64	3-year, Onsite	03/17	Apr 28, 2023
10MM002VUS	US	i5-6500	vPro	Intel HD 530	None	8GBx1	1TB 7200rpm 3.5"	DVD±RW	Optional 2.5" Bay	None	None	None	None	None	None	None	1.5Wx1	None	USB / USB	Carry Handle	250W 85%	Win10 DG Win7 Pro 64	3-year, Onsite	03/17	Apr 28, 2023
10MM002WUS	US	i5-6500	vPro	Intel HD 530	None	8GBx1	512GB SSD M.2 PCIe NVMe	DVD±RW	Optional 2.5" Bay	None	None	None	None	None	None	None	1.5Wx1	None	USB / USB	Carry Handle	250W 85%	Win10 DG Win7 Pro 64	3-year, Onsite	03/17	Apr 28, 2023
10MM002XUS	US	i7-6700	vPro	Intel HD 530	None	8GBx1	512GB SSD M.2 PCIe NVMe	DVD±RW	Optional 2.5" Bay	None	None	None	None	None	None	None	1.5Wx1	None	USB / USB	Carry Handle	250W 85%	Win10 DG Win7 Pro 64	3-year, Onsite	03/17	Apr 28, 2023
10MM002YUS	US	i5-6500	vPro	GT 730 2GB	None	8GBx1	1TB 7200rpm 3.5"	DVD±RW	Optional 2.5" Bay	None	None	None	None	None	None	None	1.5Wx1	None	USB / USB	Carry Handle	250W 85%	Win10 DG Win7 Pro 64	3-year, Onsite	03/17	Apr 28, 2023
10MM0030US	US	i7-6700	vPro	Intel HD 530	None	8GBx1	1TB 7200rpm 3.5"	DVD±RW	Optional 2.5" Bay	None	None	None	None	None	None	None	1.5Wx1	None	USB / USB	Carry Handle	250W 85%	Win10 DG Win7 Pro 64	3-year, Onsite	03/17	Apr 28, 2023
10MM0031US	US	i7-6700	vPro	GT 730 2GB	None	8GBx1	256GB SSD M.2 PCIe NVMe	DVD±RW	Optional 2.5" Bay	None	8265 ac, 2x2, vPro + BT4.1	None	None	None	None	None	1.5Wx1	None	USB / USB	Carry Handle	250W 85%	Win10 DG Win7 Pro 64	3-year, Onsite	03/17	Apr 28, 2023
10MM003AUS	US	i5-6500	vPro	Intel HD 530	None	8GBx1	256GB SSD M.2 PCIe NVMe	DVD±RW	Optional 2.5" Bay	None	8265 ac, 2x2, vPro + BT4.1	None	None	None	None	None	1.5Wx1	None	USB / USB	Carry Handle	250W 85%	Win10 DG Win7 Pro 64	3-year, Onsite	03/17	Apr 28, 2023
10MM003BUS	US	i7-6700	vPro	Intel HD 530	None	8GBx1	256GB SSD M.2 PCIe NVMe	DVD±RW	Optional 2.5" Bay	None	8265 ac, 2x2, vPro + BT4.1	None	None	None	None	None	1.5Wx1	None	USB / USB	Carry Handle	250W 85%	Win10 DG Win7 Pro 64	3-year, Onsite	03/17	Apr 28, 2023



ThinkCentre M910x Tiny Platform Specifications

Product Specifications Reference (PSREF)

Processor	Intel® Celeron®, Intel Pentium®, or 6/7th Generation Intel Core™ i3 / i5 / i7 Processor						Manageability Intel Active Management Technology 11.0 (Intel AMT 11.0); Intel vPro technology on some models (require choosing a vPro-support Wi-Fi adapter to enable vPro function through wireless connection) Security chip TPM (Trusted Platform Module) 2.0*, TCG Certified * Downgrade to TPM1.2 for the models with Win10 DG Win7 32 OS
	Processor	Cores / Threads	Frequency Base/Max(GHz)	Cache	Memory Support (Up to)	Integrated Graphics	
	Core i5-6500T	4 / 4	2.5G / 3.1G	6 MB	DDR4-2133	HD 530	
	Core i7-6700T	4 / 8	2.8G / 3.6G	8 MB	DDR4-2133	HD 530	
	Core i5-7500T	4 / 4	2.7G / 3.3G	6 MB	DDR4-2400	HD 630	
	Core i5-7600T	4 / 4	2.8G / 3.7G	6 MB	DDR4-2400	HD 630	
	Core i7-7700T	4 / 8	2.9G / 3.8G	8 MB	DDR4-2400	HD 630	
	Core i5-6500	4 / 4	3.2G / 3.6G	6 MB	DDR4-2133	HD 530	
	Core i7-6700	4 / 8	3.4G / 4.0G	8 MB	DDR4-2133	HD 530	
	Core i5-7500	4 / 4	3.4G / 3.8G	6 MB	DDR4-2400	HD 630	
Core i5-7600	4 / 4	3.5G / 4.1G	6 MB	DDR4-2400	HD 630		
Core i7-7700	4 / 8	3.6G / 4.2G	8 MB	DDR4-2400	HD 630		
Memory	32GB max, DDR4-2400*, two 260-pin SO-DIMM sockets, non-ECC, dual-channel capable * System automatically clocks down for the processors with lower memory controller						Security features <ul style="list-style-type: none"> Security slot (in rear for optional Kensington® MicroSaver® cable) Smart USB protection, allows keyboard/mouse only, blocks all storage devices Power-on password Administrator password Hard disk password Boot sequence control Boot without keyboard and mouse Individual USB port disablement Chassis intrusion switch
Storage	<i>Some:</i> Hard Drive* / SATA 6.0Gb/s, 2.5", 5400 rpm or 7200 rpm, APS <i>Some:</i> Solid State Drive (SSD)* / SATA 6.0Gb/s, 2.5" (* 2.5" HDD/SSD and RX 460 graphics are mutually exclusive) <i>Some:</i> M.2 SSD (support up to two M.2 SSD) / PCIe NVMe, PCIe 3.0 x 4, 32Gb/s, RAID 0/1 support (RAID preset only available via special bid model)						
Optical	<i>Some:</i> Intel Optane™ Memory Ready (models with 7th gen Core processor), M.2 <i>Some:</i> DVD-ROM, slim (9.0mm), via USB external ODD box <i>Some:</i> DVD Burner (DVD±RW), slim (9.0mm), via USB external ODD box						
Onboard SATA Media reader	One onboard SATA 6.0Gb/s connector None						
Graphics	Intel HD Graphics 510/530/610/630 in processor, uses main memory, DirectX® 12, two DisplayPort™, one optional video port (HDMI, VGA, 3rd DP, or USB 3.1 Type-C with DisplayPort Alternate Mode), up to 3 independent displays; <i>Max resolution:</i> 4096x2304 (DP) @60Hz; 4096x2304 (Type-C) @60Hz; 4096x2160 (HDMI) @24Hz; 1920x1200 (VGA) @60Hz <i>Some:</i> AMD Radeon™ RX 460 , DirectX 12, 4GB, PCIe 3.0 x8 adapter (low profile), four mini DisplayPort, 35 watts (TDP), up to 4 independent displays, works along with 2 onboard DisplayPort to support up to 6 independent displays; <i>Max resolution:</i> 5120x2880 @60Hz (up to 2 mini DisplayPort); 4096x2160 @60Hz (up to 4 mini DisplayPort)						
VESA mount Floor Stand	Optional VESA mount bracket kit, supports VESA 75mm and 100mm Optional system floor stand for vertical orientation						
Power supply	135 watts AC/DC adapter, autosensing, 88% PSU						
Limited warranty ³	<i>Some:</i> 1-year or 3-year, depot service / service upgrades available <i>Some:</i> 1-year or 3-year, limited onsite service / service upgrades available						
Preload	<i>Some:</i> Windows® 7 Professional 32/64 preinstalled through downgrade rights in Windows 10 Pro 64-bit (not available with 7th Gen Intel processor) <i>Some:</i> Windows 10 Pro 64-bit <i>Some:</i> Windows 10 Home 64-bit						
Monitor cable	Optional DP to VGA, DP to DVI-D, DP to dual DP, mini DP to DP, or DP to HDMI 1.4						
Chipset	Intel Q270 Chipset						
Front ports	Two USB 3.1 Gen1 (one is Always On and fast charge), one microphone (3.5mm), one headphone / microphone combo jack (3.5mm)						
Rear ports	Four USB 3.1 Gen1 (optional optical box or I/O box occupies one or two specific USB 3.1 Gen1), ethernet (RJ-45), two DisplayPort, two optional ports (not available for the models with RX 460 graphics): Port 1 for [VGA / 3rd DP / HDMI / serial / USB 3.1 Type-C Gen 1 (with DisplayPort Alternate Mode)]; Port 2 for [serial]						
I/O box	Optional external I/O box, extends two USB 2.0, two USB 3.1 Gen1, and one serial on rear, two USB 2.0 on front, via USB cable (occupy 2 specific USB 3.1 G1 of Tiny)						
Audio support	High Definition (HD) Audio, Realtek ALC294 / optional internal speaker (1w or 2w)						
WLAN ¹³	<i>Some:</i> 11ac wireless, M.2 Card, Qualcomm Atheros QCA9377A (dual band), Wi-Fi + Bluetooth 4.1 combo adapter, 1x1 <i>Some:</i> 11ac wireless, M.2 Card, Qualcomm Atheros QCA6174A (dual band), Wi-Fi + Bluetooth 4.1 combo adapter, 2x2 <i>Some:</i> 11ac wireless, M.2 Card, Intel Dual Band Wireless-AC 3165, Wi-Fi + Bluetooth 4.1 combo adapter, 1x1 <i>Some:</i> 11ac wireless, M.2 Card, Intel Dual Band Wireless-AC 8265, Wi-Fi + Bluetooth 4.1 combo adapter, 2x2						
Bluetooth™	<i>Some:</i> 11ac wireless, M.2 Card, Intel Dual Band Wireless-AC 8265, Wi-Fi + Bluetooth 4.1 combo adapter, Intel vPro technology support, 2x2 <i>Some:</i> Bluetooth 4.1 wireless, integrated in Wi-Fi + BT combo adapter						
Ethernet Modem	Gigabit ethernet, Intel Ethernet Connection I219-LM(Jacksonville), Wake on LAN® None						
Environment	ENERGY STAR® 6.1, EPEAT™ Gold rating (North America), ErP Lot 3, GREENGUARD®, RoHS-compliant, TUV low noise verified (on some models)						
MIL-SPEC test	MIL-STD-810G military certification (Low Pressure [Altitude], High Temperature, Low Temperature, Temperature Shock, Humidity, Sand and Dust, Vibration, Shock, Fungus, Solar Radiation)						
Accessories	For compatible accessories, please go to http://www.lenovoquickpick.com						

See footnotes for more detailed information

© Lenovo (M910x Tiny-Spec) May 2017

Model	Region	Processor	vPro	Graphics	Monitor Cable	Memory	Storage(HDD/SSD)	External Optical / I/O Box	WLAN + Bluetooth	Optional Rear Ports	Chassis Intrusion Switch	Kensington Cable Lock	Speaker	Adapter Cage	Toolless Chassis Screw	Dust Filter	Keyboard / Mouse	VESA Mount	Stand	Power Supply	Operating System	Warranty	Ann Date (mm/yy)
10N00007SS	US	i5-7600	vPro	Intel HD 630	None	8GBx1	256GB SSD M.2 PCIe NVMe	None	8265 ac, 2x2, vPro + BT4.1	3rd DP	Switch	None	1Wx1	None	None	None	USB / USB	None	Floor Stand	135W Adapter 88%	Win10 Pro 64	3-year, Onsite	04/17
10N00007US	US	i5-7600	vPro	Intel HD 630	None	8GBx1	256GB SSD M.2 PCIe NVMe	None	8265 ac, 2x2, vPro + BT4.1	3rd DP	Switch	None	1Wx1	None	None	None	USB / USB	None	Floor Stand	135W Adapter 88%	Win10 Pro 64	3-year, Onsite	04/17
10N00008SS	US	i5-7500	vPro	Intel HD 630	None	4GBx1	500GB 7200rpm 2.5"	None	8265 ac, 2x2, vPro + BT4.1	3rd DP	Switch	None	1Wx1	None	None	None	USB / USB	None	Floor Stand	135W Adapter 88%	Win10 Pro 64	3-year, Onsite	04/17
10N00008US	US	i5-7500	vPro	Intel HD 630	None	4GBx1	500GB 7200rpm 2.5"	None	8265 ac, 2x2, vPro + BT4.1	3rd DP	Switch	None	1Wx1	None	None	None	USB / USB	None	Floor Stand	135W Adapter 88%	Win10 Pro 64	3-year, Onsite	04/17
10N00009SS	US	i7-7700	vPro	Intel HD 630	None	8GBx1	500GB 7200rpm 2.5"	None	8265 ac, 2x2, vPro + BT4.1	3rd DP	Switch	None	1Wx1	None	None	None	USB / USB	None	Floor Stand	135W Adapter 88%	Win10 Pro 64	3-year, Onsite	04/17
10N00009US	US	i7-7700	vPro	Intel HD 630	None	8GBx1	500GB 7200rpm 2.5"	None	8265 ac, 2x2, vPro + BT4.1	3rd DP	Switch	None	1Wx1	None	None	None	USB / USB	None	Floor Stand	135W Adapter 88%	Win10 Pro 64	3-year, Onsite	04/17
10N0000ASS	US	i5-7500	vPro	Intel HD 630	None	8GBx1	256GB SSD M.2 PCIe NVMe	None	8265 ac, 2x2, vPro + BT4.1	3rd DP	Switch	None	1Wx1	None	None	None	USB / USB	None	Floor Stand	135W Adapter 88%	Win10 Pro 64	3-year, Onsite	04/17
10N0000AUS	US	i5-7500	vPro	Intel HD 630	None	8GBx1	256GB SSD M.2 PCIe NVMe	None	8265 ac, 2x2, vPro + BT4.1	3rd DP	Switch	None	1Wx1	None	None	None	USB / USB	None	Floor Stand	135W Adapter 88%	Win10 Pro 64	3-year, Onsite	04/17
10N0000BSS	US	i5-7500	vPro	Intel HD 630	None	8GBx1	500GB 7200rpm 2.5"	None	8265 ac, 2x2, vPro + BT4.1	3rd DP	Switch	None	1Wx1	None	None	None	USB / USB	None	Floor Stand	135W Adapter 88%	Win10 Pro 64	3-year, Onsite	04/17
10N0000BUS	US	i5-7500	vPro	Intel HD 630	None	8GBx1	500GB 7200rpm 2.5"	None	8265 ac, 2x2, vPro + BT4.1	3rd DP	Switch	None	1Wx1	None	None	None	USB / USB	None	Floor Stand	135W Adapter 88%	Win10 Pro 64	3-year, Onsite	04/17
10N00014US	US	i5-6500T	vPro	AMD RX460 4GB	None	8GBx1	256GB SSD M.2 PCIe NVMe	None	8265 ac, 2x2, vPro + BT4.1	None	Switch	None	1Wx1	None	None	None	USB / USB	None	Floor Stand	135W Adapter 88%	Win10 DG Win7 Pro 64	3-year, Onsite	04/17
10N00015SS	US	i5-6500	vPro	Intel HD 530	None	8GBx1	512GB SSD M.2 PCIe NVMe	None	8265 ac, 2x2, vPro + BT4.1	3rd DP	Switch	None	1Wx1	None	None	None	USB / USB	None	Floor Stand	135W Adapter 88%	Win10 DG Win7 Pro 64	3-year, Onsite	04/17
10N00015US	US	i5-6500	vPro	Intel HD 530	None	8GBx1	512GB SSD M.2 PCIe NVMe	None	8265 ac, 2x2, vPro + BT4.1	3rd DP	Switch	None	1Wx1	None	None	None	USB / USB	None	Floor Stand	135W Adapter 88%	Win10 DG Win7 Pro 64	3-year, Onsite	04/17
10N00016SS	US	i7-6700	vPro	Intel HD 530	None	8GBx1	256GB SSD M.2 PCIe NVMe	None	8265 ac, 2x2, vPro + BT4.1	3rd DP	Switch	None	1Wx1	None	None	None	USB / USB	None	Floor Stand	135W Adapter 88%	Win10 DG Win7 Pro 64	3-year, Onsite	04/17
10N00016US	US	i7-6700	vPro	Intel HD 530	None	8GBx1	256GB SSD M.2 PCIe NVMe	None	8265 ac, 2x2, vPro + BT4.1	3rd DP	Switch	None	1Wx1	None	None	None	USB / USB	None	Floor Stand	135W Adapter 88%	Win10 DG Win7 Pro 64	3-year, Onsite	04/17
10N00017US	US	i7-6700T	vPro	AMD RX460 4GB	None	8GBx1	256GB SSD M.2 PCIe NVMe	None	8265 ac, 2x2, vPro + BT4.1	None	Switch	None	1Wx1	None	None	None	USB / USB	None	Floor Stand	135W Adapter 88%	Win10 DG Win7 Pro 64	3-year, Onsite	04/17
10N00018SS	US	i5-7500T	vPro	AMD RX460 4GB	None	8GBx1	256GB SSD M.2 PCIe NVMe	None	8265 ac, 2x2, vPro + BT4.1	None	Switch	None	1Wx1	None	None	None	USB / USB	None	Floor Stand	135W Adapter 88%	Win10 Pro 64	3-year, Onsite	04/17
10N00018US	US	i5-7500T	vPro	AMD RX460 4GB	None	8GBx1	256GB SSD M.2 PCIe NVMe	None	8265 ac, 2x2, vPro + BT4.1	None	Switch	None	1Wx1	None	None	None	USB / USB	None	Floor Stand	135W Adapter 88%	Win10 Pro 64	3-year, Onsite	04/17
10N00019US	US	i5-6500T	vPro	AMD RX460 4GB	None	8GBx1	512GB SSD M.2 PCIe NVMe	None	8265 ac, 2x2, vPro + BT4.1	None	Switch	None	1Wx1	None	None	None	USB / USB	None	Floor Stand	135W Adapter 88%	Win10 DG Win7 Pro 64	3-year, Onsite	04/17
10N0001ASS	US	i7-6700	vPro	Intel HD 530	None	8GBx1	500GB 7200rpm 2.5"	None	8265 ac, 2x2, vPro + BT4.1	3rd DP	Switch	None	1Wx1	None	None	None	USB / USB	None	Floor Stand	135W Adapter 88%	Win10 DG Win7 Pro 64	3-year, Onsite	04/17

Model	Region	Processor	vPro	Graphics	Monitor Cable	Memory	Storage(HDD/SSD)	External Optical / I/O Box	WLAN + Bluetooth	Optional Rear Ports	Chassis Intrusion Switch	Kensington Cable Lock	Speaker	Adapter Cage	Toolless Chassis Screw	Dust Filter	Keyboard / Mouse	VESA Mount	Stand	Power Supply	Operating System	Warranty	Ann Date (mm/yy)
10N0001AUS	US	i7-6700	vPro	Intel HD 530	None	8GBx1	500GB 7200rpm 2.5"	None	8265 ac, 2x2, vPro + BT4.1	3rd DP	Switch	None	1Wx1	None	None	None	USB / USB	None	Floor Stand	135W Adapter 88%	Win10 DG Win7 Pro 64	3-year, Onsite	04/17
10N0001BSS	US	i5-6500	vPro	Intel HD 530	None	8GBx1	256GB SSD M.2 PCIe NVMe	None	8265 ac, 2x2, vPro + BT4.1	3rd DP	Switch	None	1Wx1	None	None	None	USB / USB	None	Floor Stand	135W Adapter 88%	Win10 DG Win7 Pro 64	3-year, Onsite	04/17
10N0001BUS	US	i5-6500	vPro	Intel HD 530	None	8GBx1	256GB SSD M.2 PCIe NVMe	None	8265 ac, 2x2, vPro + BT4.1	3rd DP	Switch	None	1Wx1	None	None	None	USB / USB	None	Floor Stand	135W Adapter 88%	Win10 DG Win7 Pro 64	3-year, Onsite	04/17
10N0001CSS	US	i5-6500	vPro	Intel HD 530	None	8GBx1	500GB 7200rpm 2.5"	None	8265 ac, 2x2, vPro + BT4.1	3rd DP	Switch	None	1Wx1	None	None	None	USB / USB	None	Floor Stand	135W Adapter 88%	Win10 DG Win7 Pro 64	3-year, Onsite	04/17
10N0001CUS	US	i5-6500	vPro	Intel HD 530	None	8GBx1	500GB 7200rpm 2.5"	None	8265 ac, 2x2, vPro + BT4.1	3rd DP	Switch	None	1Wx1	None	None	None	USB / USB	None	Floor Stand	135W Adapter 88%	Win10 DG Win7 Pro 64	3-year, Onsite	04/17
10N0001DSS	US	i5-7500T	vPro	AMD RX460 4GB	None	8GBx1	512GB SSD M.2 PCIe NVMe	None	8265 ac, 2x2, vPro + BT4.1	None	Switch	None	1Wx1	None	None	None	USB / USB	None	Floor Stand	135W Adapter 88%	Win10 Pro 64	3-year, Onsite	04/17
10N0001DUS	US	i5-7500T	vPro	AMD RX460 4GB	None	8GBx1	512GB SSD M.2 PCIe NVMe	None	8265 ac, 2x2, vPro + BT4.1	None	Switch	None	1Wx1	None	None	None	USB / USB	None	Floor Stand	135W Adapter 88%	Win10 Pro 64	3-year, Onsite	04/17
10N0001ESS	US	i7-6700	vPro	Intel HD 530	None	8GBx1	512GB SSD M.2 PCIe NVMe	None	8265 ac, 2x2, vPro + BT4.1	3rd DP	Switch	None	1Wx1	None	None	None	USB / USB	None	Floor Stand	135W Adapter 88%	Win10 DG Win7 Pro 64	3-year, Onsite	04/17
10N0001EUS	US	i7-6700	vPro	Intel HD 530	None	8GBx1	512GB SSD M.2 PCIe NVMe	None	8265 ac, 2x2, vPro + BT4.1	3rd DP	Switch	None	1Wx1	None	None	None	USB / USB	None	Floor Stand	135W Adapter 88%	Win10 DG Win7 Pro 64	3-year, Onsite	04/17
10N0001FSS	US	i7-7700T	vPro	AMD RX460 4GB	None	8GBx1	256GB SSD M.2 PCIe NVMe	None	8265 ac, 2x2, vPro + BT4.1	None	Switch	None	1Wx1	None	None	None	USB / USB	None	Floor Stand	135W Adapter 88%	Win10 Pro 64	3-year, Onsite	04/17
10N0001FUS	US	i7-7700T	vPro	AMD RX460 4GB	None	8GBx1	256GB SSD M.2 PCIe NVMe	None	8265 ac, 2x2, vPro + BT4.1	None	Switch	None	1Wx1	None	None	None	USB / USB	None	Floor Stand	135W Adapter 88%	Win10 Pro 64	3-year, Onsite	04/17
10N0001GSS	US	i7-7700T	vPro	AMD RX460 4GB	None	8GBx1	512GB SSD M.2 PCIe NVMe	None	8265 ac, 2x2, vPro + BT4.1	None	Switch	None	1Wx1	None	None	None	USB / USB	None	Floor Stand	135W Adapter 88%	Win10 Pro 64	3-year, Onsite	04/17
10N0001GUS	US	i7-7700T	vPro	AMD RX460 4GB	None	8GBx1	512GB SSD M.2 PCIe NVMe	None	8265 ac, 2x2, vPro + BT4.1	None	Switch	None	1Wx1	None	None	None	USB / USB	None	Floor Stand	135W Adapter 88%	Win10 Pro 64	3-year, Onsite	04/17
10N0001HUS	US	i7-6700T	vPro	AMD RX460 4GB	None	8GBx1	512GB SSD M.2 PCIe NVMe	None	8265 ac, 2x2, vPro + BT4.1	None	Switch	None	1Wx1	None	None	None	USB / USB	None	Floor Stand	135W Adapter 88%	Win10 DG Win7 Pro 64	3-year, Onsite	04/17



ThinkCentre Tiny-in-One (TIO) 22

Product Specifications Reference (PSREF)

Model	10LKPAR6++ / 10LKPAT6++		
Form factor	Tiny-in-One, offers a full All-In-One experience when optional Tiny slots into the back of TIO 22, clean cabling and effortless setup		
Compatible Tiny:	M900 Tiny, M700 Tiny, M600 Tiny, M93/p Tiny*, M83 Tiny, M73 Tiny*, or M53 Tiny, Chromebox * Non-TIO models can't be turned on by pressing power button of TIO 22		
Panel	TFT-LCD, In-Plane Switching (IPS), White LED backlight		
Viewable image size	21.5" (546.1mm) diagonal		
Max view area (W x H)	18.74" x 10.54" / 476.06mm x 267.79mm		
Bezel Width	Top / Side: 2mm, Bottom: 16.3mm		
Optimum resolution	1920x1080		
Aspect ratio	16:9		
Pixel pitch (mm)	0.24795mm		
Dot/Pixel per Inch	102.4 dpi		
Brightness	250 nits or cd/m ² (typical)		
Contrast ratio	1000:1 (typical)		
Pixel response time	7ms		
Color gamut	72%		
Anti-reflective	Anti-glare		
Viewing angle at 10:1 CR	178° (+/- 89°) horizontal, 178° (+/- 89°) vertical		
Preset resolutions	640x350 @ 70Hz 640x480 @ 60Hz, 66Hz, 72Hz, 75Hz 720x400 @ 70Hz 800x600 @ 60Hz, 72Hz, 75Hz 1024x768 @ 60Hz, 70Hz, 75Hz 1152x864 @ 75Hz 1280x800 @ 60Hz 1280x1024 @ 60Hz, 72Hz, 75Hz 1366x768 @ 60Hz 1440x900 @ 60Hz, 75Hz 1600x1200 @ 60Hz, 70Hz, 75Hz 1680x1050 @ 60Hz 1920x1080 @ 60Hz		
Presets / user settings	Presets: 25; user settings: 25		
On screen display	On screen display with digital user controls (8 languages)		
Control features	Mode-switching (TIO mode / standalone monitor mode, switches video / audio / USB input sources) / Back button, Left shift button, Right shift / Brightness button, Selection button / Menu button, Power button		
Tiny-in-One Power On	Pressing Alt + P on keyboard or pressing Power button positioned on TIO can turn on both TIO and Tiny (only some Tiny support, see compatible list)		
Front ports	Two USB 3.0 or two USB 2.0 (when M73 or M53 installed or USB 2.0 connected via USB upstream port), one headphone / microphone combo jack (3.5mm) * The USB ports are only available when a Tiny is installed or a PC is connected via USB upstream port		
Side ports	Side ports offered by installed Tiny (optional)		
Rear ports	One DisplayPort 1.2 port, one USB upstream port, one power connector		
3-in-1 Cable	Undetachable 3-in-1 cable (Power connector, USB 3.0 [supports USB 3.0/USB 2.0], DisplayPort 1.2), only for connecting to Tiny installed (optional)		
Internal Speaker	1.5 watt x1		
Security	Security keyhole for attachment of optional cable lock (Kensington® lock compatible), locks optional Tiny with TIO 22 together, more security features offered by Tiny installed (optional)		
Mechanical	Dimensions	TIO 22 without stand	TIO 22 with stand
	W x D x H (inch)	19.25 x 2.65 x 12.47	19.25 x 9.90 x 14.02 - 18.35
	W x D x H (mm)	489.06 x 67.2 x 316.78	489.06 x 251.4 x 356.07 - 466.07
	Weight (approximately)	11.27 lb /5.11 kg (with stand)	
Mounting features	Wall or desk mounting using the extend arm or third-party accessories meeting the VESA FPMPMI® (100mm mount)		
Adjustable stand	Tilt: 35° back, -5° forward; lift: 4.3" (110mm); swivel: +/-45°		
Power supply	90 watts AC/DC adapter, 88% PSU, universal		
Power consumption	15.57 watts typical, 35 watts maximum, <0.5 watts standby / suspend		
Limited warranty ³	3-years , Customer Carry-In or Mail-In via Rapid Replacement Service		
VESA-compliant ²	VESA DDC2B/CI, VESA DPMS-compliant		
Ergonomics	ISO 9241-307		
Emission standards	FCC Class B		
Environmental	TCO 7.0, TCO Edge 2.0, WEEE, RoHS, ENERGY STAR® 7.0 EPEAT™ Gold rating, ULE Gold, TUV, VOC		
Windows certifications	Windows 7, Windows 8/8.1, and Windows 10 certified		
Ship group	TIO 22 (Monitor), detachable stand, AC/DC power adapter, power cord, user's guide and driver CD, quick start and safety poster		
Accessories	For compatible accessories, please go to http://www.lenovoquickpick.com		
ThinkCentre Tiny-in-One 22 Compatible list			
Model	M900 Tiny, M700 Tiny, M600 Tiny, M83 Tiny, M53 Tiny	M93/p Tiny, M73 Tiny	Chromebox
Turn on TIO and Tiny together via Alt + P on USB KB	All models	All models	Not support
Turn on TIO and Tiny together via TIO Power Button	All models	TIO models	All models

See footnotes for more detailed information

Model	Region	Color	Display Size	Resolution	Aspect Ratio	Pixel Pitch	Dot / Pixel Per Inch	Brightness	Contrast Ratio	Pixel Response Time	Color Gamut	View Angle (H / V)	Stand	Power Consumption (Typical / Maximum)	Power Supply	Warranty	Ann Date (mm/yy)
10LKPAR6US	US	Black	21.5"	1920x1080	16:9	0.24795mm	102.4 dpi	250 nits	1000:1	7 ms	72%	178 / 178	Adjustable Stand	15.57W / 35W	90W 88% Adapter	3-year	04/16
10LKPAT6US	US	Black	21.5"	1920x1080	16:9	0.24795mm	102.4 dpi	250 nits	1000:1	7 ms	72%	178 / 178	Adjustable Stand	15.57W / 35W	90W 88% Adapter	3-year	04/16



ThinkCentre Tiny-in-One (TIO) 24

Product Specifications Reference (PSREF)

Model	10LLPAR6++ / 10LLPAT6++														
Form factor	Tiny-in-One, offers a full All-In-One experience when optional Tiny slots into the back of TIO 24, clean cabling and effortless setup														
Compatible Tiny:	M900 Tiny, M700 Tiny, M600 Tiny, M93/p Tiny*, M83 Tiny, M73 Tiny*, or M53 Tiny, Chromebox * Non-TIO models can't be turned on by pressing power button of TIO 24														
Panel	TFT-LCD, In-Plane Switching (IPS), White LED backlight														
Viewable image size	23.8" (604.7mm) diagonal														
Max view area (W x H)	21.06" x 12.32" / 535.0mm x 313.0mm														
Bezel Width	Top / Side: 2mm, Bottom: 16.3mm														
Optimum resolution	1920x1080														
Aspect ratio	16:9														
Pixel pitch (mm)	0.2745mm														
Dot/Pixel per Inch	92.6 dpi														
Brightness	250 nits or cd/m ² (typical)														
Contrast ratio	1000:1 (typical)														
Pixel response time	7ms														
Color gamut	72%														
Anti-reflective	Anti-glare														
Viewing angle at 10:1 CR	178° (+/- 89°) horizontal, 178° (+/- 89°) vertical														
Preset resolutions	640x350 @ 70Hz 640x480 @ 60Hz, 66Hz, 72Hz, 75Hz 720x400 @ 70Hz 800x600 @ 60Hz, 72Hz, 75Hz 1024x768 @ 60Hz, 70Hz, 75Hz 1152x864 @ 75Hz 1280x800 @ 60Hz 1280x1024 @ 60Hz, 72Hz, 75Hz 1366x768 @ 60Hz 1440x900 @ 60Hz, 75Hz 1600x1200 @ 60Hz, 70Hz, 75Hz 1680x1050 @ 60Hz 1920x1080 @ 60Hz														
Presets / user settings	Presets: 25; user settings: 25														
On screen display	On screen display with digital user controls (8 languages)														
Control features	Mode-switching (TIO mode / standalone monitor mode, switches video / audio / USB input sources) / Back button, Left shift button, Right shift / Brightness button, Selection button / Menu button, Power button														
Tiny-in-One Power On	Pressing Alt + P on keyboard or pressing Power button positioned on TIO can turn on both TIO and Tiny (only some Tiny support, see compatible list)														
Front ports	Two USB 3.0 or two USB 2.0 (when M73 or M53 installed or USB 2.0 connected via USB upstream port), one headphone / microphone combo jack (3.5mm) * The USB ports are only available when a Tiny is installed or a PC is connected via USB upstream port														
Side ports	Side ports offered by installed Tiny (optional)														
Rear ports	One DisplayPort 1.2 port, one USB upstream port, one power connector														
3-in-1 Cable	Undetachable 3-in-1 cable (Power connector, USB 3.0 [supports USB 3.0/USB 2.0], DisplayPort 1.2), only for connecting to Tiny installed (optional)														
Internal Speaker	1.5 watt x1														
Security	Security keyhole for attachment of optional cable lock (Kensington® lock compatible), locks optional Tiny with TIO 24 together, more security features offered by Tiny installed (optional)														
Mechanical	<table border="1"> <thead> <tr> <th>Dimensions</th> <th>TIO 24 without stand</th> <th>TIO 24 with stand</th> </tr> </thead> <tbody> <tr> <td>W x D x H (inch)</td> <td>21.24 x 2.7 x 13.64</td> <td>21.24 x 9.90 x 15.16 - 19.46</td> </tr> <tr> <td>W x D x H (mm)</td> <td>539.6 x 68.2 x 346.45</td> <td>539.6 x 251.4 x 385.08 - 495.08</td> </tr> <tr> <td>Weight (approximately)</td> <td colspan="2">12.25 lb /5.57 kg (with stand)</td> </tr> </tbody> </table>			Dimensions	TIO 24 without stand	TIO 24 with stand	W x D x H (inch)	21.24 x 2.7 x 13.64	21.24 x 9.90 x 15.16 - 19.46	W x D x H (mm)	539.6 x 68.2 x 346.45	539.6 x 251.4 x 385.08 - 495.08	Weight (approximately)	12.25 lb /5.57 kg (with stand)	
Dimensions	TIO 24 without stand	TIO 24 with stand													
W x D x H (inch)	21.24 x 2.7 x 13.64	21.24 x 9.90 x 15.16 - 19.46													
W x D x H (mm)	539.6 x 68.2 x 346.45	539.6 x 251.4 x 385.08 - 495.08													
Weight (approximately)	12.25 lb /5.57 kg (with stand)														
Mounting features	Wall or desk mounting using the extend arm or third-party accessories meeting the VESA FPMPMI® (100mm mount)														
Adjustable stand	Tilt: 35° back, -5° forward; lift: 4.3" (110mm); swivel: +/-45°														
Power supply	90 watts AC/DC adapter, 88% PSU, universal														
Power consumption	16.7 watts typical, 35 watts maximum, <0.5 watts standby / suspend														
Limited warranty ³	3-years , Customer Carry-In or Mail-In via Rapid Replacement Service														
VESA-compliant ²	VESA DDC2B/CI, VESA DPMS-compliant														
Ergonomics	ISO 9241-307														
Emission standards	FCC Class B														
Environmental	TCO 7.0, TCO Edge 2.0, WEEE, RoHS, ENERGY STAR® 7.0 EPEAT™ Gold rating, ULE Gold, TUV, VOC														
Windows certifications	Windows 7, Windows 8/8.1, and Windows 10 certified														
Ship group	TIO 24 (Monitor), detachable stand, AC/DC power adapter, power cord, user's guide and driver CD, quick start and safety poster														
Accessories	For compatible accessories, please go to http://www.lenovoquickpick.com														
ThinkCentre Tiny-in-One 24 Compatible list															
Model	M900 Tiny, M700 Tiny, M600 Tiny, M83 Tiny, M53 Tiny	M93/p Tiny, M73 Tiny	Chromebox												
Turn on TIO and Tiny together via Alt + P on USB KB	All models	All models	Not support												
Turn on TIO and Tiny together via TIO Power Button	All models	TIO models	All models												

See footnotes for more detailed information

ThinkCentre Tiny-In-One 24 - 10LL

Product Specifications Reference (PSREF)

Model	Region	Color	Display Size	Resolution	Aspect Ratio	Pixel Pitch	Dot / Pixel Per Inch	Brightness	Contrast Ratio	Pixel Response Time	Color Gamut	View Angle (H / V)	Stand	Power Consumption (Typical / Maximum)	Power Supply	Warranty	Ann Date (mm/yy)
10LLPAR6US	US	Black	23.8"	1920x1080	16:9	0.2745mm	92.6 dpi	250 nits	1000:1	7 ms	72%	178 / 178	Adjustable Stand	16.7W / 35W	90W 88% Adapter	3-year	05/16
10LLPAT6US	US	Black	23.8"	1920x1080	16:9	0.2745mm	92.6 dpi	250 nits	1000:1	7 ms	72%	178 / 178	Adjustable Stand	16.7W / 35W	90W 88% Adapter	3-year	05/16



ThinkCentre X1 Platform Specifications

Product Specifications Reference (PSREF)

Processor	Intel® 6th Generation Intel Core™ i3 / i5 / i7 Processor							Security features	<ul style="list-style-type: none"> Security slot (in rear for attachment of optional Kensington® MicroSaver® cable; Kensington lock also locks chassis) Smart USB protection, allows keyboard/mouse only, blocks all storage devices Power-on, admin, hard disk password Boot sequence control Boot without keyboard and mouse Individual USB port disablement Optional chassis intrusion switch 												
	Processor	Cores / Threads	Frequency Base/Max(GHz)	Cache	Memory Types	Integrated Graphics	Intel vPro														
	Core i3-6100U	2 / 4	2.3 G	3 MB	DDR4-2133	HD 520	No														
	Core i5-6200U	2 / 4	2.3 G / 2.8 G	3 MB	DDR4-2133	HD 520	No														
	Core i5-6300U	2 / 4	2.4 G / 3.0 G	3 MB	DDR4-2133	HD 520	vPro														
Core i7-6600U	2 / 4	2.6 G / 3.4 G	4 MB	DDR4-2133	HD 520	vPro															
	Intel Architecture (IA) SoC that integrates Intel processor core, graphics, memory controller, and I/O interfaces into a single system-on-chip solution							Keyboard	Some: Lenovo Slim USB Keyboard (USB connector), black Some: Ultralim Plus Wireless Keyboard (2.4GHz via USB receiver), black												
Memory	16GB max, DDR4 2133, one 260-pin SO-DIMM socket							Mouse	Some: Enhanced Optical USB Mouse, black, Lenovo logo Some: Ultralim Plus Wireless Mouse (2.4GHz via USB receiver), black												
Disk	<p>Some: SATA 6.0Gb/s, 2.5" Wide, 5400 rpm or 7200 rpm</p> <p>Some: Solid State Hybrid Drive (SSHD) / with 8GB MLC NAND flash memory, SATA 6.0Gb/s, 2.5" Wide, 5400 rpm</p> <p>Some: Solid State Drive (SSD) / SATA 6.0Gb/s, 2.5" Wide</p>							Mechanical	<ul style="list-style-type: none"> Business black color, Aluminum Alloy Toolless back cover and memory removal Optional VESA mount kit (100mm) 												
Optical Media reader	None Optional 9-in-1 media card reader								<table border="1"> <thead> <tr> <th></th> <th>Dimensions (WxDxH)</th> <th>Max weight (lb / kg)</th> <th>Adjustments</th> </tr> </thead> <tbody> <tr> <td>Without stand:</td> <td>22.4 X 1.3 X 14.2 (inch); 570 X 33 X 360 (mm)</td> <td>8.8 / 4</td> <td>N/A</td> </tr> <tr> <td>With Orchid tilt stand:</td> <td>22.4 X 9.4 X 17.8 (inch); 570 X 240 X 451 (mm)</td> <td>11.0 / 5</td> <td>Tilt: 45° back, -5° forward</td> </tr> </tbody> </table>		Dimensions (WxDxH)	Max weight (lb / kg)	Adjustments	Without stand:	22.4 X 1.3 X 14.2 (inch); 570 X 33 X 360 (mm)	8.8 / 4	N/A	With Orchid tilt stand:	22.4 X 9.4 X 17.8 (inch); 570 X 240 X 451 (mm)	11.0 / 5	Tilt: 45° back, -5° forward
	Dimensions (WxDxH)	Max weight (lb / kg)	Adjustments																		
Without stand:	22.4 X 1.3 X 14.2 (inch); 570 X 33 X 360 (mm)	8.8 / 4	N/A																		
With Orchid tilt stand:	22.4 X 9.4 X 17.8 (inch); 570 X 240 X 451 (mm)	11.0 / 5	Tilt: 45° back, -5° forward																		
Graphics	<p>Intel HD Graphics 520 in processor, uses main memory, DirectX® 12, external monitor support via DisplayPort™;</p> <p>Max resolution: 4096x2304 (DP)@60Hz</p>							Power supply	90 watts adapter, autosensing, 88% PSU												
DP Dongle Display	<p>Optional DP to VGA, DP to DVI-D (single link), or DP to HDMI 1.4 dongle</p> <p>23.8" (604.5mm) Full HD 1080p (1920x1080) TFT color, IPS panel, wide viewing angle (+/- 89°), LED backlight, 250 nits, 16:9 aspect ratio, 1000:1 contrast ratio, anti-glare, work as standalone monitor via DisplayPort (DP in / out combo)</p>							Limited warranty ³	<p>Some: 1-year or 3-year, limited onsite service</p> <p>Some: 3-years, limited onsite service, OID (Onsite International Delivery) / For <i>Lenovo service upgrade options, please go to S-TC sheet</i></p>												
Light sensor	None							Preload	<p>Preloaded operating system</p> <p>Some: Windows® 7 Professional 32/64 preinstalled through downgrade rights in Windows 10 Pro 64-bit</p> <p>Some: Windows 7 Professional 64</p> <p>Some: Windows 10 Pro 64-bit</p> <p>Some: Windows 10 Home 64-bit</p>												
Multi-touch Camera	None								<p>Preloaded applications (only some listed)</p> <ul style="list-style-type: none"> Desktop Power Manager Lenovo Solution Center Lenovo REACHit Lenovo SHAREit Lenovo Bluetooth Lock (for models with Wi-Fi/BT card) McAfee® LiveSafe™ (30-day trial) Microsoft Office preloaded; purchase a product key to activate Lenovo ThinkVantage Tools <ul style="list-style-type: none"> - Only for Window 10 Lenovo Companion - Only for Window 7 Rescue and Recovery Password Manager ThinkVantage System Update Lenovo Message Center Plus Adobe® Reader® 												
Controls	2.0-megapixel camera, fixed focus, supports 1080p, with dual array digital microphone, LED indicator, physical switch on/off, Skype for Business certified Microphone mute, DP in / out switch, and power button							Environment	EPEAT™ Gold rating; ENERGY STAR® 6.1; TCO Certified Edge; TUV Green Mark; ULE Gold; ErP Lot 3; GREENGUARD® certified; RoHS-compliant												
Chipset	Intel System-on-Chip (SoC) platform							MIL-SPEC test	MIL-STD-810G military certification (Low Pressure [Altitude], High Temperature, Low Temperature, Temperature Shock, Humidity, Sand and Dust, Vibration, Shock)												
Rear ports	Three USB 3.0, ethernet (RJ-45), DisplayPort in/out combo port,							Accessories	For compatible accessories, please go to TC-AQP sheet												
Side ports	Two USB 3.0 (one is Always On and fast charge), optional card reader, one headphone / microphone combo jack (3.5mm)																				
M.2 card slot	One M.2 Card slot (for WLAN)																				
Audio support	High Definition (HD) Audio, Realtek ALC233 / two internal speakers (5W x 2), Dolby® Audio™ certified, Skype for Business certified																				
WLAN ¹³	<p>Some: 11ac wireless, M.2 Card, Qualcomm Atheros QCA6174 (dual band), Wi-Fi + Bluetooth 4.1 combo adapter, 2x2</p> <p>Some: 11ac wireless, M.2 Card, Intel Dual Band Wireless-AC 8260, Wi-Fi + Bluetooth 4.1 combo adapter, 2x2</p> <p>Some: 11ac wireless, M.2 Card, Intel Dual Band Wireless-AC 8260, Wi-Fi + Bluetooth 4.1 combo adapter, Intel vPro technology support, 2x2</p>																				
Bluetooth™ Ethernet	Some: Bluetooth 4.0 or 4.1 wireless, integrated in Wi-Fi + Bluetooth combo adapter Gigabit ethernet, Intel Ethernet Connection I219-LM (Jacksonville), Wake on LAN®																				
Manageability	Intel Active Management Technology 11.0 (Intel AMT 11.0) on some models; Intel vPro technology on some models (require choosing a vPro-support Wi-Fi adapter to enable vPro function through wireless connection)																				
Security chip	Trusted Platform Module (TPM 1.2-compliant)																				

See footnotes for more detailed information

© Lenovo
(X1-Spec) July 2016

ThinkCentre X1 AIO - TopSeller - 10KE

Product Specifications Reference (PSREF)

Model	Region	Processor	vPro	Graphics	Monitor Cable	Memory	Display	Multi-touch	Storage(HDD/SSD)	Media Reader	WLAN + Bluetooth	Camera	Chassis Intrusion Switch	Keyboard / Mouse	Stand	Power Supply	Operating System	Warranty	Global	Ann Date (mm/yy)
10KE0007US	US	i5-6200U	No	Intel HD 520	None	8GBx1	23.8" FHD (1920x1080) IPS Anti-glare	None	256GB SSD	9-in-1	8260 ac, 2x2 + BT4.1	1080p	None	2.4G / 2.4G	Orchid Tilt Stand	90W 88% Adapter	Win10 DG Win7 Pro 64	3-year, Onsite	No	01/16
10KE0008US	US	i5-6200U	No	Intel HD 520	None	4GBx1	23.8" FHD (1920x1080) IPS Anti-glare	None	120GB SSD	9-in-1	8260 ac, 2x2 + BT4.1	1080p	None	2.4G / 2.4G	Orchid Tilt Stand	90W 88% Adapter	Win10 DG Win7 Pro 64	3-year, Onsite	No	01/16
10KE001CUS	US	i5-6200U	No	Intel HD 520	None	8GBx1	23.8" FHD (1920x1080) IPS Anti-glare	None	256GB SSD	None	8260 ac, 2x2 + BT4.1	1080p	None	USB (Slim) / USB	Orchid Tilt Stand	90W 88% Adapter	Win10 Pro 64	3-year, Onsite	No	08/16
10KE001DUS	US	i5-6200U	No	Intel HD 520	None	4GBx1	23.8" FHD (1920x1080) IPS Anti-glare	None	128GB SSD	None	8260 ac, 2x2 + BT4.1	1080p	None	USB (Slim) / USB	Orchid Tilt Stand	90W 88% Adapter	Win10 Pro 64	3-year, Onsite	No	08/16
10KE001EUS	US	i5-6200U	No	Intel HD 520	None	4GBx1	23.8" FHD (1920x1080) IPS Anti-glare	None	128GB SSD	None	8260 ac, 2x2 + BT4.1	1080p	None	2.4G / 2.4G	Orchid Tilt Stand	90W 88% Adapter	Win10 Pro 64	3-year, Onsite	No	09/16
10KE001FUS	US	i5-6200U	No	Intel HD 520	None	8GBx1	23.8" FHD (1920x1080) IPS Anti-glare	None	256GB SSD	None	8260 ac, 2x2 + BT4.1	1080p	None	2.4G / 2.4G	Orchid Tilt Stand	90W 88% Adapter	Win10 Pro 64	3-year, Onsite	No	09/16
10KE001GUS	US	i5-6200U	No	Intel HD 520	None	4GBx1	23.8" FHD (1920x1080) IPS Anti-glare	None	500GB 7200rpm 2.5"	None	8260 ac, 2x2 + BT4.1	1080p	None	2.4G / 2.4G	Orchid Tilt Stand	90W 88% Adapter	Win10 Pro 64	3-year, Onsite	No	09/16
10KE001HUS	US	i5-6200U	No	Intel HD 520	None	4GBx1	23.8" FHD (1920x1080) IPS Anti-glare	None	500GB 7200rpm 2.5"	None	8260 ac, 2x2 + BT4.1	1080p	None	2.4G / 2.4G	Orchid Tilt Stand	90W 88% Adapter	Win10 DG Win7 Pro 64	3-year, Onsite	No	09/16
10KE001JUS	US	i5-6200U	No	Intel HD 520	None	4GBx1	23.8" FHD (1920x1080) IPS Anti-glare	None	128GB SSD	None	8260 ac, 2x2 + BT4.1	1080p	None	2.4G / 2.4G	Orchid Tilt Stand	90W 88% Adapter	Win10 DG Win7 Pro 64	3-year, Onsite	No	09/16
10KE001LUS	US	i5-6200U	No	Intel HD 520	None	8GBx1	23.8" FHD (1920x1080) IPS Anti-glare	None	256GB SSD Opal	9-in-1	8260 ac, 2x2 + BT4.1	1080p	None	2.4G / 2.4G	Orchid Tilt Stand	90W 88% Adapter	Win10 DG Win7 Pro 64	3-year, Onsite	No	12/16
10KE001MUS	US	i5-6200U	No	Intel HD 520	None	8GBx1	23.8" FHD (1920x1080) IPS Anti-glare	None	256GB SSD Opal	None	8260 ac, 2x2 + BT4.1	1080p	None	2.4G / 2.4G	Orchid Tilt Stand	90W 88% Adapter	Win10 Pro 64	3-year, Onsite	No	12/16
10KE001NUS	US	i5-6200U	No	Intel HD 520	None	8GBx1	23.8" FHD (1920x1080) IPS Anti-glare	None	256GB SSD Opal	None	8260 ac, 2x2 + BT4.1	1080p	None	USB (Slim) / USB	Orchid Tilt Stand	90W 88% Adapter	Win10 Pro 64	3-year, Onsite	No	12/16

This publication was developed for products and services offered in the United States and E.M.E.A countries. Lenovo may not offer the products, services or features discussed in this document in other countries. Lenovo may withdraw an offering at any time. Information is subject to change without notice. Consult your local representative for information on offerings available in your area.

Lenovo reserves the right to change specifications or other product information without notice. Lenovo is not responsible for photographic or typographical errors.

LENOVO PROVIDES THIS PUBLICATION "AS IS," WITHOUT WARRANTY OF ANY KIND, EITHER EXPRESS OR IMPLIED, INCLUDING THE IMPLIED WARRANTIES OF MERCHANTABILITY OR FITNESS FOR A PARTICULAR PURPOSE.

Some jurisdictions do not allow disclaimer of express or implied warranties in certain transactions, therefore this disclaimer may not apply to you.

Availability: All offers subject to availability. Lenovo reserves the right to alter product offerings and specifications at any time, without notice. Lenovo is not responsible for photographic or typographic errors.

General: Review key information provided by Microsoft that may apply to your system purchase, including details on Windows 10, Windows 8, Windows 7, and potential upgrades/downgrades. Lenovo makes no representation or warranty regarding third-party products or services.

Trademarks: Lenovo, ThinkPad, ThinkCentre, ThinkStation and the Lenovo logo are trademarks of Lenovo. Microsoft, Windows, Windows NT, and the Windows logo are trademarks of Microsoft Corporation. Ultrabook, Celeron, Celeron Inside, Core Inside, Intel, Intel Logo, Intel Atom, Intel Atom Inside, Intel Core, Intel Inside, Intel Inside Logo, Intel vPro, Itanium, Itanium Inside, Pentium, Pentium Inside, vPro Inside, Xeon, Xeon Phi, and Xeon Inside are trademarks of Intel Corporation in the U.S. and/or other countries. Other company, product or service names may be trademarks or service marks of others.

Warranty: For a copy of applicable warranties, write to: Lenovo Warranty Information, 1009 Think Place, Morrisville, NC, 27560. Lenovo makes no representation or warranty regarding third party products or services. The Lenovo Limited Warranty applies only to Lenovo hardware products purchased for your own use, and does not transfer upon resale.

Limited warranty: Support unrelated to a warranty issue may be subject to additional charges.

Lenovo Services:

Carry-in or Mail-in Service: Parts and labor repair coverage where the customer is responsible for shipping (including packaging) or delivery to authorized warranty provider or repair center.

Depot or Courier Service: Parts and labor repair coverage where shipping (including packaging) or delivery to the repair center is paid for by Lenovo.

Expedited Depot: Parts and labor coverage with expedited turnaround. Shipping (including packaging) or delivery to the repair center is paid for by Lenovo.

Onsite / In-home Service: Parts and labor repair coverage where labor is provided onsite at your place of business.

If Lenovo determines your product problem is covered by the product warranty and cannot be resolved over the telephone, a technician will be dispatched to arrive onsite, typically the next day.

International Warranty Service (IWS): PC repair coverage for customers who require a critical warranty repair while travelling internationally. Visit www.lenovo.com/internationalwarranty for details. Visit www.lenovo.com/warranty for Lenovo Warranty Services terms and conditions for complete details and restrictions.

Included software: may differ from its retail version (if available), and may not include user manuals or all program functionality. Software license agreements may apply.

Battery life: Battery life (and recharge times) will vary based on many factors including screen brightness, applications, features, power management, battery conditioning, and other customer preferences.

Visit <http://psref.lenovo.com/> for the latest version of Product Specifications Reference.

© Lenovo, 2017. All rights reserved.
Lenovo 1009 Think Place Morrisville, NC 27560 U.S.A.

Lenovo ThinkStation.

PSREF

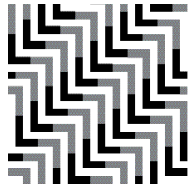

Product Specifications Reference

Version 507, May 2017

U.S.

Visit <http://psref.lenovo.com> for the latest version

Contents

Cover	1	ThinkStation P510 - TopSeller - 30B5 - 4 of 5	34
Contents	2	ThinkStation P510 - TopSeller - 30B5 - 5 of 5	35
Summary Of Change	3	ThinkStation P700	36
P Series	5	ThinkStation P700 Platform Specifications	37
ThinkStation P310 SFF	5	ThinkStation P700 - TopSeller - 30A9	38
ThinkStation P310 SFF Platform Specifications	6	ThinkStation P700 - 30A8	39
ThinkStation P310 SFF - TopSeller - 30AV - 1 of 2	7	ThinkStation P710	40
ThinkStation P310 SFF - TopSeller - 30AV - 2 of 2	8	ThinkStation P710 Platform Specifications	40
ThinkStation P310 Tower	9	ThinkStation P710 - TopSeller - 30B7 - 1 of 3	41
ThinkStation P310 Tower Platform Specifications	10	ThinkStation P710 - TopSeller - 30B7 - 2 of 3	42
ThinkStation P310 Tower - TopSeller - 30AT - 1 of 3	11	ThinkStation P710 - TopSeller - 30B7 - 3 of 3	43
ThinkStation P310 Tower - TopSeller - 30AT - 2 of 3	12	ThinkStation P910	44
ThinkStation P310 Tower - TopSeller - 30AT - 3 of 3	13	ThinkStation P910 Platform Specifications	44
ThinkStation P320 SFF	14	ThinkStation P910 - TopSeller - 30B9 - 1 of 2	45
ThinkStation P320 SFF Platform Specifications	15	ThinkStation P910 - TopSeller - 30B9 - 2 of 2	46
ThinkStation P320 SFF - TopSeller - 30BK - 1 of 3	16	Legal Information	47
ThinkStation P320 SFF - TopSeller - 30BK - 2 of 3	17		
ThinkStation P320 SFF - TopSeller - 30BK - 3 of 3	18		
ThinkStation P320 Tower	19		
ThinkStation P320 Tower Platform Specifications	20		
ThinkStation P320 Tower - TopSeller - 30BH - 1 of 4	21		
ThinkStation P320 Tower - TopSeller - 30BH - 2 of 4	22		
ThinkStation P320 Tower - TopSeller - 30BH - 3 of 4	23		
ThinkStation P320 Tower - TopSeller - 30BH - 4 of 4	24		
ThinkStation P410	25		
ThinkStation P410 Platform Specifications	25		
ThinkStation P410 - TopSeller - 30B3 - 1 of 4	26		
ThinkStation P410 - TopSeller - 30B3 - 2 of 4	27		
ThinkStation P410 - TopSeller - 30B3 - 3 of 4	28		
ThinkStation P410 - TopSeller - 30B3 - 4 of 4	29		
ThinkStation P510	30		
ThinkStation P510 Platform Specifications	30		
ThinkStation P510 - TopSeller - 30B5 - 1 of 5	31		
ThinkStation P510 - TopSeller - 30B5 - 2 of 5	32		
ThinkStation P510 - TopSeller - 30B5 - 3 of 5	33		

Summary of Changes

This section describes the changes made in this version of ThinkStation PSREF and in previous version. This edition might also include minor corrections and editorial changes which are not identified.

May 26, 2017 - Version 506

- ▶ Add ThinkStation P410/P510/P710/P910 Refresh 3.0 Wave 1 models and update platform specifications

April 19, 2017 - Version 505

- ▶ New ThinkStation P320 Tower announced on April 2017
- ▶ New ThinkStation P320 SFF announced on April 2017

March 29, 2017 - Version 504

- ▶ Added ThinkStation P310 Tower and SFF models announced on March 2017
- ▶ Added ThinkStation P410 models announced on March 2017

January 25, 2017 - Version 501

- ▶ Update quantity of PCIe SSD adapter in ThinkStation P510/P910

January 4, 2017 - Version 500

- ▶ Added ThinkStation P310 models announced on December 2016

December 14, 2016 - Version 499

- ▶ Added ThinkStation P410/P510/P710/P910 EMEA models
- ▶ Added 1TB M.2 PCIe SSD, Quadro P5000, Quadro P6000 support on ThinkStation P510/P710/P910
- ▶ Added Quadro P5000 support on ThinkStation P410
- ▶ Added 6TB 7.2K SATA6Gbs HDD support on ThinkStation P410/P510/P710/P910
- ▶ Added ThinkStation P410/P510/P710/P910 models announced on December 2016

November 23, 2016 - Version 498

- ▶ Removed ThinkStation P500/P900 due to EOL
- ▶ Added ThinkStation P310 Tower and SFF models announced on November 2016

October 12, 2016 - Version 496

- ▶ Removed flash option on ThinkStation P510/P710/P910
- ▶ Added ThinkStation P310/P410/P510/P710/P910 models announced on September 2016

August 3, 2016 - Version 493

- ▶ Removed ThinkStation P500/P700/P900 Windows 7 DG from Win8.1 U.S. models
- ▶ Added keyboard and mouse features on all ThinkStation

July 13, 2016 - Version 492

- ▶ Added ThinkStation P500, P700, and P900 Windows 10 downgrade to Windows 7 models
- ▶ Updated Maximum configuration weight of ThinkStation P410
- ▶ Added ThinkStation P710 and P910 models announced on on July 2016
- ▶ Added "Maximum drives in 3.5" bay" feature on ThinkStation P500/P510/P700/P710/P900/P910

June 22, 2016 - Version 491

- ▶ Added new product ThinkStation P410/P510
- ▶ Added NVIDIA Quadro M2000 on ThinkStation P310 Tower
- ▶ Added keyboard and mouse information on ThinkStation P710/P910
- ▶ Added internal USB information on ThinkStation P710/P910

June 2, 2016 - Version 490

- ▶ Added ThinkStation P710/P910 US models
- ▶ Updated ThinkStation P710/P910 processor information

May 19, 2016 - Version 489

- ▶ Added NVIDIA Quadro M2000 on compatible product
- ▶ Updated maximum weight on ThinkStation P710
- ▶ Removed 30AT000BUS

April 27, 2016 - Version 488

- ▶ Added ThinkStation P710 and P910 models for EMEA, announced on April 2016
- ▶ Updated Energy star information on ThinkStation P500/P700/P710/P900/P910

April 6, 2016 - Version 487

- ▶ New ThinkStation P710 and P910, announced April 5, 2016 (specification only)

March 23, 2016 - Version 486

- ▶ Added processors specifications for P310/P500/P700/P900

February 24, 2016 - Version 485

- ▶ Added ThinkStation P310 and P700 models for US, announced on February 2016
- ▶ Added ThinkStation P700 and P900 models for EMEA, announced on February 2016

December 9, 2015 - Version 482

- ▶ New ThinkStation P310 Tower and SFF, announced November 24, 2015

November 18, 2015 - Version 481

- ▶ Combines ThinkStation PSREF United States version and Western Europe version.
- ▶ Extends the supported GEO into Europe, Middle East and Africa.
- ▶ Covers all TopSeller and Relationship models for US and all focus models for EMEA



ThinkStation P310 SFF Platform Specifications

Product Specifications Reference (PSREF)

Components	Specification																																			
Chipset	Intel C236 Chipset																																			
Intel AMT	Intel Active Management Technology 11 supported on Xeon models																																			
Processor	One LGA1151 socket, supports one the following processors:																																			
	Xeon E3-1280 v5	4C/3.7GHz/8MB/80W/DDR4-2133																																		
	Xeon E3-1275 v5	4C/3.6GHz/8MB/80W/DDR4-2133																																		
	Xeon E3-1270 v5	4C/3.6GHz/8MB/80W/DDR4-2133																																		
	Xeon E3-1245 v5	4C/3.5GHz/8MB/80W/DDR4-2133																																		
	Xeon E3-1240 v5	4C/3.5GHz/8MB/80W/DDR4-2133																																		
	Xeon E3-1230 v5	4C/3.4GHz/8MB/80W/DDR4-2133																																		
	Xeon E3-1225 v5	4C/3.3GHz/8MB/80W/DDR4-2133																																		
	Xeon E3-1220 v5	4C/3GHz/8MB/80W/DDR4-2133																																		
	Core i7-6700	4C/3.4GHz/8MB/65W/DDR4-2133																																		
	Core i5-6600	4C/3.3GHz/6MB/65W/DDR4-2133																																		
	Core i5-6500	4C/3.2GHz/6MB/65W/DDR4-2133																																		
	Core i5-6400	4C/2.7GHz/6MB/65W/DDR4-2133																																		
	Core i3-6320	2C/3.9GHz/4MB/51W/DDR4-2133																																		
	Core i3-6300	2C/3.8GHz/4MB/51W/DDR4-2133																																		
Core i3-6100	2C/3.7GHz/3MB/51W/DDR4-2133																																			
Memory DIMM slots	4 DIMM slots, 2-channel (integrated memory controller in processor)																																			
Memory type/capacity	Up to 64GB ECC/non-ECC (4 x 16GB), DDR4-2133, UDIMM																																			
Intel HD Graphics in processor	Integrated Intel HD P530 in Xeon E3-12x5 v5 processors; or Intel HD 530 in Core i7, i5, or i3 processors. Works along with discrete graphics to support multi-display, enables three display connectors (2 DP, 1 VGA) on rear. Max Resolution: 4096 x 2304																																			
Discrete graphics	Two PCI Express 3.0 x16 slots for graphics adapters. Up to two Quadro K1200. Supports the following NVIDIA graphics adapters:																																			
	<table border="1"> <thead> <tr> <th>Adapter</th> <th>Cores</th> <th>Memory</th> <th>Power</th> <th>Connector</th> </tr> </thead> <tbody> <tr> <td>NVS 310</td> <td>48</td> <td>1GB</td> <td>19.5W</td> <td>2xDP</td> </tr> <tr> <td>NVS 315</td> <td>48</td> <td>1GB</td> <td>19.5W</td> <td>2xDVI-I SL/2xDP</td> </tr> <tr> <td>NVS 510</td> <td>192</td> <td>2GB</td> <td>33.4W</td> <td>4xmini DP</td> </tr> <tr> <td>Quadro K420</td> <td>192</td> <td>2GB</td> <td>41W</td> <td>1xDVI-I DL+1xDP</td> </tr> <tr> <td>Quadro K620</td> <td>384</td> <td>2GB</td> <td>45W</td> <td>1xDVI-I DL+1xDP</td> </tr> <tr> <td>Quadro K1200</td> <td>512</td> <td>4GB</td> <td>45W</td> <td>4xminiDP</td> </tr> </tbody> </table>	Adapter	Cores	Memory	Power	Connector	NVS 310	48	1GB	19.5W	2xDP	NVS 315	48	1GB	19.5W	2xDVI-I SL/2xDP	NVS 510	192	2GB	33.4W	4xmini DP	Quadro K420	192	2GB	41W	1xDVI-I DL+1xDP	Quadro K620	384	2GB	45W	1xDVI-I DL+1xDP	Quadro K1200	512	4GB	45W	4xminiDP
	Adapter	Cores	Memory	Power	Connector																															
	NVS 310	48	1GB	19.5W	2xDP																															
	NVS 315	48	1GB	19.5W	2xDVI-I SL/2xDP																															
	NVS 510	192	2GB	33.4W	4xmini DP																															
	Quadro K420	192	2GB	41W	1xDVI-I DL+1xDP																															
Quadro K620	384	2GB	45W	1xDVI-I DL+1xDP																																
Quadro K1200	512	4GB	45W	4xminiDP																																
Onboard drive controller	Five onboard SATA 6.0Gb/s connectors for optical and disk drives plus one SATA connector for optional eSATA. RAID 0, 1, 5* support * RAID 5 supports three 2.5" SSD drives only.																																			
Drive Bays	One external 5.25" bay, one internal 3.5" bay (see right). Up to one 9.5mm optical + 2 x 3.5" disk drive bays + 1 x 2.5" disk drive bay + one M.2 NVMe SSD																																			
Supporting disk drives	<table border="1"> <tbody> <tr> <td>3.5" SATA HDD (7.2K 6Gbs)</td> <td>500GB/1TB/2TB/3TB/4TB/6TB/1TB hybrid/2TB hybrid</td> </tr> <tr> <td>2.5" SATA SSD (6Gbs)</td> <td>128GB/180GB*/240GB*/256GB*/480GB*/512GB*/1TB*</td> </tr> <tr> <td>M.2 NVMe SSD</td> <td>256GB*/512GB*/1TB*, via PCIe 3.0 x4 adapter</td> </tr> </tbody> </table>	3.5" SATA HDD (7.2K 6Gbs)	500GB/1TB/2TB/3TB/4TB/6TB/1TB hybrid/2TB hybrid	2.5" SATA SSD (6Gbs)	128GB/180GB*/240GB*/256GB*/480GB*/512GB*/1TB*	M.2 NVMe SSD	256GB*/512GB*/1TB*, via PCIe 3.0 x4 adapter																													
	3.5" SATA HDD (7.2K 6Gbs)	500GB/1TB/2TB/3TB/4TB/6TB/1TB hybrid/2TB hybrid																																		
	2.5" SATA SSD (6Gbs)	128GB/180GB*/240GB*/256GB*/480GB*/512GB*/1TB*																																		
M.2 NVMe SSD	256GB*/512GB*/1TB*, via PCIe 3.0 x4 adapter																																			
	** Includes OPAL options																																			
Max internal storage	9TB (2 x 4TB 3.5" HDDs + 1 x 1TB 2.5" SSD) plus one 512GB M.2 NVMe SSD																																			
Media reader	9-in-1 card reader. Optional 29-in-1 card reader on selected models																																			
Power supply	210 watts with variable speed fan, autosensing, 85% PSU, Climate Savers Computing Bronze, 80 PLUS Bronze qualified																																			
Onboard Ethernet	One onboard gigabit ethernet, Intel I219LM, supports Wake-on-LAN																																			
HD Audio	Realtek ALC662 codec																																			
TPM	Standard, TCG 1.2-compliant																																			
Front ports	Two USB 3.0, microphone (3.5mm), headphone (3.5mm)																																			
Rear ports	1 VGA and 2 DisplayPort (functional only on Intel HD Graphics models), two USB 2.0, four USB 3.0 (blue), one serial (9-pin), one ethernet (RJ-45), three analog audio ports (line-in, line-out, mic-in)																																			
Additional ports	Supports the following optional ports: • Two IEEE 1394 (one on rear and one on front flex module) via PCIe adapter, up to one adapter per system. Supports one of the following per system: • Two rear USB 3.0 per PCIe adapter. • One front eSATA (on flex module), or one rear eSATA via cable and PCIe slot bracket, up to one eSATA port per system. • One additional serial port via cable. • One parallel port via cable																																			

Components	Specification
Mechanical	<ul style="list-style-type: none"> Raven black color; metal case 4.02"W x 15.53"D x 13.31"H 102mm W x 394.5mm D x 338mm H 17.2 lb (7.9kg) max configuration 12.9-liter
	Environmental certifications
Limited warranty	1 or 3-year limited onsite service with 9x5/NBD. Some parts are Customer Replaceable Units.

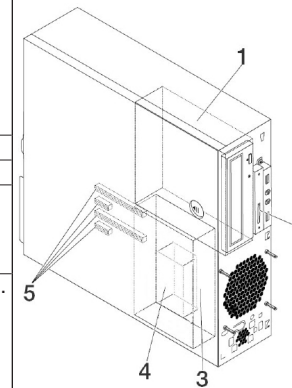

Drive Bays and PCIe Slots

Bay 1	5.25", supports one of the following: HH optical/flex module***/9.5mm optical+3.5" HDD bay/ 3.5" HDD bay/Front Access Storage Enclosure *** Flex module supports one or more of the following: 9.5mm optical/ 29-in-1 reader/front IEEE 1394/front eSATA. Up to one flex module is supported per system.
Bay 2	Optional 9-in-1 single slot reader
Bay 3	Standard 3.5" HDD bay
Bay 4	Optional 2.5" HDD bay (under Bay 3)
5 - Slots	Four PCIe slots (top-down): Slot 1: Low Profile, PCIe 3.0 x16 (near CPU) Slot 2: Low Profile, PCIe 3.0 x1 Slot 3: Low Profile, PCIe 3.0 x16 (x4 elec) Slot 4: Low Profile, PCIe 3.0 x1

For the list of ISV certifications, please visit www.thinkworkstations.com/isv-certifications/
For a list of all supported options, please visit https://download.lenovo.com/pccbbs/options_iso/ocm_december_2016.xlsx_sheet

Model	Region	Processor	Graphics	Memory (Capacity/Type)	Storage (Capacity/Type/Interface)	Optical	Media Reader	Power Supply	Add-on Ports	Discrete Ethernet	Chassis Intrusion Switch	Keyboard / Mouse	Operating System	Warranty	Global	Ann Date (mm/yy)
30AV0007US	US	Core i5-6500 4C/3.2GHz/6MB/65W/DDR4-2133	Intel HD 530	1x4GB UDIMM DDR4-2133 Non-ECC	1x1TB HDD 7.2K 3.5" SATA6Gbs	HH DVD±RW	9-in-1	210W 85%	None	None	Switch	USB / USB Optical	Win10 DG Win7 Pro 64	3-year	No	11/15
30AV0008US	US	Core i3-6100 2C/3.7GHz/3MB/51W/DDR4-2133	Intel HD 530	1x4GB UDIMM DDR4-2133 Non-ECC	1x1TB HDD 7.2K 3.5" SATA6Gbs	HH DVD±RW	9-in-1	210W 85%	None	None	Switch	USB / USB Optical	Win10 DG Win7 Pro 64	3-year	No	11/15
30AV0009US	US	Core i3-6100 2C/3.7GHz/3MB/51W/DDR4-2133	Intel HD 530	1x4GB UDIMM DDR4-2133 Non-ECC	1x500GB HDD 7.2K 3.5" SATA6Gbs	HH DVD±RW	9-in-1	210W 85%	None	None	Switch	USB / USB Optical	Win10 DG Win7 Pro 64	3-year	No	11/15
30AV000AUS	US	Core i5-6600 4C/3.3GHz/6MB/65W/DDR4-2133	Intel HD 530	1x8GB UDIMM DDR4-2133 Non-ECC	1x1TB HDD 7.2K 3.5" SATA6Gbs	HH DVD±RW	9-in-1	210W 85%	None	None	Switch	USB / USB Optical	Win10 DG Win7 Pro 64	3-year	No	11/15
30AV000BUS	US	Core i7-6700 4C/3.4GHz/8MB/65W/DDR4-2133	Intel HD 530	1x8GB UDIMM DDR4-2133 Non-ECC	1x1TB HDD 7.2K 3.5" SATA6Gbs	HH DVD±RW	9-in-1	210W 85%	None	None	Switch	USB / USB Optical	Win10 DG Win7 Pro 64	3-year	No	11/15
30AV000CUS	US	Core i7-6700 4C/3.4GHz/8MB/65W/DDR4-2133	Intel HD 530	1x8GB UDIMM DDR4-2133 Non-ECC	1x256GB SSD 2.5" SATA6Gbs Opal	HH DVD±RW	9-in-1	210W 85%	None	None	Switch	USB / USB Optical	Win10 DG Win7 Pro 64	3-year	No	11/15
30AV000DUS	US	Xeon E3-1245 v5 4C/3.5GHz/8MB/80W/DDR4-2133	Intel HD P530	1x8GB UDIMM DDR4-2133 Non-ECC	1x256GB SSD 2.5" SATA6Gbs Opal	HH DVD±RW	9-in-1	210W 85%	None	None	Switch	USB / USB Optical	Win10 DG Win7 Pro 64	3-year	No	11/15
30AV000EUS	US	Xeon E3-1240 v5 4C/3.5GHz/8MB/80W/DDR4-2133	NVIDIA Quadro K620 2GB	1x8GB UDIMM DDR4-2133 Non-ECC	1x256GB SSD 2.5" SATA6Gbs Opal	HH DVD±RW	9-in-1	210W 85%	None	None	Switch	USB / USB Optical	Win10 DG Win7 Pro 64	3-year	No	11/15
30AV000VUS	US	Core i5-6500 4C/3.2GHz/6MB/65W/DDR4-2133	Intel HD 530+NVIDIA Quadro K620 2GB	1x8GB UDIMM DDR4-2133 Non-ECC	1x1TB HDD 7.2K 3.5" SATA6Gbs	HH DVD±RW	9-in-1	210W 85%	None	None	Switch	USB / USB Optical	Win10 DG Win7 Pro 64	3-year	No	02/16
30AV000WUS	US	Core i7-6700 4C/3.4GHz/8MB/65W/DDR4-2133	Intel HD 530+NVIDIA Quadro K620 2GB	2x8GB UDIMM DDR4-2133 Non-ECC	1x256GB SSD 2.5" SATA6Gbs Opal	HH DVD±RW	9-in-1	210W 85%	None	None	Switch	USB / USB Optical	Win10 DG Win7 Pro 64	3-year	No	02/16
30AV000XUS	US	Xeon E3-1230 v5 4C/3.4GHz/8MB/80W/DDR4-2133	NVIDIA Quadro K1200 4GB	4x8GB UDIMM DDR4-2133 Non-ECC	1x512GB SSD 2.5" SATA6Gbs	HH DVD±RW	9-in-1	210W 85%	None	None	Switch	USB / USB Optical	Win10 DG Win7 Pro 64	3-year	No	02/16
30AV0012US	US	Core i7-6700 4C/3.4GHz/8MB/65W/DDR4-2133	Intel HD 530+NVIDIA Quadro K620 2GB	1x8GB UDIMM DDR4-2133 Non-ECC	1x1TB HDD 7.2K 3.5" SATA6Gbs	HH DVD±RW	9-in-1	210W 85%	None	None	Switch	USB / USB Optical	Win10 Pro 64	3-year	No	07/16
30AV001TUS	US	Core i7-6700 4C/3.4GHz/8MB/65W/DDR4-2133	Intel HD 530	1x8GB UDIMM DDR4-2133 Non-ECC	1x1TB HDD 7.2K 3.5" SATA6Gbs	HH DVD±RW	9-in-1	210W 85%	None	None	Switch	USB / USB Optical	Win10 Pro 64	3-year	No	07/16
30AV001UUS	US	Core i5-6500 4C/3.2GHz/6MB/65W/DDR4-2133	Intel HD 530	1x8GB UDIMM DDR4-2133 Non-ECC	1x1TB HDD 7.2K 3.5" SATA6Gbs	HH DVD±RW	9-in-1	210W 85%	None	None	Switch	USB / USB Optical	Win10 Pro 64	3-year	No	07/16
30AV001VUS	US	Xeon E3-1240 v5 4C/3.5GHz/8MB/80W/DDR4-2133	NVIDIA Quadro K1200 4GB	1x8GB UDIMM DDR4-2133 ECC	1x256GB SSD 2.5" SATA6Gbs Opal	HH DVD±RW	9-in-1	210W 85%	None	None	Switch	USB / USB Optical	Win10 Pro 64	3-year	No	07/16

Model	Region	Processor	Graphics	Memory (Capacity/Type)	Storage (Capacity/Type/Interface)	Optical	Media Reader	Power Supply	Add-on Ports	Discrete Ethernet	Chassis Intrusion Switch	Keyboard / Mouse	Operating System	Warranty	Global	Ann Date (mm/yy)
30AV001WUS	US	Xeon E3-1240 v5 4C/3.5GHz/8MB/80W/DDR4-2133	NVIDIA Quadro K620 2GB	1x8GB UDIMM DDR4-2133 ECC	1x1TB HDD 7.2K 3.5" SATA6Gbs	HH DVD±RW	9-in-1	210W 85%	None	None	Switch	USB / USB Optical	Win10 Pro 64	3-year	No	07/16
30AV001XUS	US	Xeon E3-1245 v5 4C/3.5GHz/8MB/80W/DDR4-2133	Intel HD P530	1x8GB UDIMM DDR4-2133 ECC	1x1TB HDD 7.2K 3.5" SATA6Gbs	HH DVD±RW	9-in-1	210W 85%	None	None	Switch	USB / USB Optical	Win10 Pro 64	3-year	No	07/16
30AV001YUS	US	Core i3-6100 2C/3.7GHz/3MB/51W/DDR4-2133	Intel HD 530	1x8GB UDIMM DDR4-2133 Non- ECC	1x1TB HDD 7.2K 3.5" SATA6Gbs	HH DVD±RW	9-in-1	210W 85%	None	None	Switch	USB / USB Optical	Win10 Pro 64	3-year	No	07/16
30AV0020US	US	Xeon E3-1245 v5 4C/3.5GHz/8MB/80W/DDR4-2133	Intel HD P530	1x8GB UDIMM DDR4-2133 ECC	1x256GB SSD 2.5" SATA6Gbs Opal	HH DVD±RW	9-in-1	210W 85%	None	None	Switch	USB / USB Optical	Win10 Pro 64	3-year	No	07/16
30AV0021US	US	Xeon E3-1220 v5 4C/3GHz/8MB/80W/DDR4-2133	NVIDIA Quadro K620 2GB	1x8GB UDIMM DDR4-2133 ECC	1x1TB HDD 7.2K 3.5" SATA6Gbs	HH DVD±RW	9-in-1	210W 85%	None	None	Switch	USB / USB Optical	Win10 Pro 64	3-year	No	07/16
30AV0022US	US	Xeon E3-1240 v5 4C/3.5GHz/8MB/80W/DDR4-2133	NVIDIA Quadro K1200 4GB	1x8GB UDIMM DDR4-2133 ECC	1x1TB HDD 7.2K 3.5" SATA6Gbs	HH DVD±RW	9-in-1	210W 85%	None	None	Switch	USB / USB Optical	Win10 Pro 64	3-year	No	07/16
30AV0023US	US	Xeon E3-1240 v5 4C/3.5GHz/8MB/80W/DDR4-2133	NVIDIA Quadro K620 2GB	1x8GB UDIMM DDR4-2133 ECC	1x256GB SSD 2.5" SATA6Gbs Opal	HH DVD±RW	9-in-1	210W 85%	None	None	Switch	USB / USB Optical	Win10 Pro 64	3-year	No	07/16
30AV002DUS	US	Core i7-6700 4C/3.4GHz/8MB/65W/DDR4-2133	Intel HD 530+NVIDIA Quadro K620 2GB	2x8GB UDIMM DDR4-2133 Non- ECC	1x1TB HDD 7.2K 3.5" SATA6Gbs	HH DVD±RW	9-in-1	210W 85%	None	None	Switch	USB / USB Optical	Win10 DG Win7 Pro 64	3-year	No	12/16
30AV002EUS	US	Core i5-6500 4C/3.2GHz/6MB/65W/DDR4-2133	Intel HD 530+NVIDIA Quadro K620 2GB	1x8GB UDIMM DDR4-2133 Non- ECC	1x256GB SSD 2.5" SATA6Gbs Opal	HH DVD±RW	9-in-1	210W 85%	None	None	Switch	USB / USB Optical	Win10 DG Win7 Pro 64	3-year	No	12/16



ThinkStation P310 Tower Platform Specifications

Product Specifications Reference (PSREF)

Components	Specification																																																		
Chipset	Intel C236 Chipset																																																		
Intel AMT	Intel Active Management Technology 11 supported on Xeon models																																																		
Processor	One LGA1151 socket, supports one the following processors:																																																		
	Xeon E3-1280 v5	4C/3.7GHz/8MB/80W/DDR4-2133																																																	
	Xeon E3-1275 v5	4C/3.6GHz/8MB/80W/DDR4-2133																																																	
	Xeon E3-1270 v5	4C/3.6GHz/8MB/80W/DDR4-2133																																																	
	Xeon E3-1245 v5	4C/3.5GHz/8MB/80W/DDR4-2133																																																	
	Xeon E3-1240 v5	4C/3.5GHz/8MB/80W/DDR4-2133																																																	
	Xeon E3-1230 v5	4C/3.4GHz/8MB/80W/DDR4-2133																																																	
	Xeon E3-1225 v5	4C/3.3GHz/8MB/80W/DDR4-2133																																																	
	Xeon E3-1220 v5	4C/3GHz/8MB/80W/DDR4-2133																																																	
	Core i7-6700	4C/3.4GHz/8MB/65W/DDR4-2133																																																	
	Core i5-6600	4C/3.3GHz/6MB/65W/DDR4-2133																																																	
	Core i5-6500	4C/3.2GHz/6MB/65W/DDR4-2133																																																	
	Core i5-6400	4C/2.7GHz/6MB/65W/DDR4-2133																																																	
	Core i3-6320	2C/3.9GHz/4MB/51W/DDR4-2133																																																	
Core i3-6300	2C/3.8GHz/4MB/51W/DDR4-2133																																																		
Core i3-6100	2C/3.7GHz/3MB/51W/DDR4-2133																																																		
Memory DIMM slots	4 DIMM slots, 2-channel (integrated memory controller in processor)																																																		
Memory type/capacity	Up to 64GB ECC/non-ECC (4 x 16GB), DDR4-2133, UDIMM																																																		
Intel HD Graphics in processor	Integrated Intel HD P530 in Xeon E3-12x5 v5 processors; or Intel HD 530 in Core i7, i5, or i3 processors. Works along with discrete graphics to support multi-display, enables three display connectors (2 DP, 1 VGA) on rear. Max resolution: 4096 x 2304																																																		
Discrete graphics	Two PCI Express 3.0 x16 slots for graphics adapters. Up to two Quadro K1200 on 250 watts models. Or up to two Quadro K2200, or up to one Quadro M4000 on 400 watts models. Supports the following NVIDIA graphics adapters:																																																		
	<table border="1"> <thead> <tr> <th>Adapter</th> <th>Cores</th> <th>Memory</th> <th>Power</th> <th>Connector</th> </tr> </thead> <tbody> <tr> <td>NVS 310</td> <td>48</td> <td>1GB</td> <td>19.5W</td> <td>2xDP</td> </tr> <tr> <td>NVS 315</td> <td>48</td> <td>1GB</td> <td>19.5W</td> <td>2xDVI-I SL/2xDP</td> </tr> <tr> <td>NVS 510</td> <td>192</td> <td>2GB</td> <td>33.4W</td> <td>4xmini DP</td> </tr> <tr> <td>Quadro K420</td> <td>192</td> <td>2GB</td> <td>41W</td> <td>1xDVI-I DL+1xDP</td> </tr> <tr> <td>Quadro K620</td> <td>384</td> <td>2GB</td> <td>45W</td> <td>1xDVI-I DL+1xDP</td> </tr> <tr> <td>Quadro K1200</td> <td>512</td> <td>4GB</td> <td>45W</td> <td>4xminiDP</td> </tr> <tr> <td>Quadro K2200</td> <td>640</td> <td>4GB</td> <td>68W</td> <td>1xDVI-I DL+2xDP</td> </tr> <tr> <td>Quadro M2000</td> <td>768</td> <td>4GB</td> <td>75W</td> <td>4xDP</td> </tr> <tr> <td>Quadro M4000</td> <td>1664</td> <td>8GB</td> <td>120W</td> <td>4xDP</td> </tr> </tbody> </table>	Adapter	Cores	Memory	Power	Connector	NVS 310	48	1GB	19.5W	2xDP	NVS 315	48	1GB	19.5W	2xDVI-I SL/2xDP	NVS 510	192	2GB	33.4W	4xmini DP	Quadro K420	192	2GB	41W	1xDVI-I DL+1xDP	Quadro K620	384	2GB	45W	1xDVI-I DL+1xDP	Quadro K1200	512	4GB	45W	4xminiDP	Quadro K2200	640	4GB	68W	1xDVI-I DL+2xDP	Quadro M2000	768	4GB	75W	4xDP	Quadro M4000	1664	8GB	120W	4xDP
	Adapter	Cores	Memory	Power	Connector																																														
	NVS 310	48	1GB	19.5W	2xDP																																														
	NVS 315	48	1GB	19.5W	2xDVI-I SL/2xDP																																														
	NVS 510	192	2GB	33.4W	4xmini DP																																														
	Quadro K420	192	2GB	41W	1xDVI-I DL+1xDP																																														
	Quadro K620	384	2GB	45W	1xDVI-I DL+1xDP																																														
	Quadro K1200	512	4GB	45W	4xminiDP																																														
	Quadro K2200	640	4GB	68W	1xDVI-I DL+2xDP																																														
Quadro M2000	768	4GB	75W	4xDP																																															
Quadro M4000	1664	8GB	120W	4xDP																																															
Onboard drive controller	Five onboard SATA 6.0Gb/s connectors for optical and disk drives plus one SATA connector for optional eSATA. RAID 0, 1, 5, 10 support																																																		
Drive Bays	Two external 5.25" bays, two internal 3.5" bays (see right). Up to one 9.5mm optical plus 4 x 3.5" disk drive bays plus one M.2 NVMe SSD																																																		
Supporting disk drives	3.5" SATA HDD (7.2K 6Gbs)	500GB/1TB/2TB/3TB/4TB/6TB/1TB hybrid/2TB hybrid																																																	
	2.5" SATA SSD (6Gbs)	128GB/180GB*/240GB*/256GB*/480GB*/512GB*/1TB*																																																	
	M.2 NVMe SSD	256GB*/512GB*/1TB*, via PCIe 3.0 x4 adapter																																																	
	** Includes OPAL options																																																		
Max internal storage	16TB (4 x 4TB 3.5" HDDs) plus 512GB M.2 NVMe SSD																																																		
Media reader	9-in-1 card reader. Optional 29-in-1 card reader on selected models																																																		
Power supply	Supports one of the following: <ul style="list-style-type: none"> 250 watts with variable speed fan, autosensing, 85% PSU, Climate Savers Computing Bronze, 80 PLUS Bronze qualified 400 watts with variable speed fan, autosensing, 92% PSU, Climate Savers Computing Platinum, 80 PLUS Platinum qualified 																																																		
Onboard Ethernet	One onboard gigabit ethernet, Intel I219LM, supports Wake-on-LAN																																																		
HD Audio	Realtek ALC662 codec																																																		
TPM	Standard, TCG 1.2-compliant																																																		
Front ports	Two USB 3.0, microphone (3.5mm), headphone (3.5mm)																																																		
Rear ports	1 VGA and 2 DisplayPort (for Intel HD Graphics models only), two USB 2.0, four USB 3.0 (blue), one serial (9-pin), one ethernet (RJ-45), three analog audio ports (line-in, line-out, mic-in)																																																		

Components	Specification
Additional ports	Supports the following optional ports: <ul style="list-style-type: none"> Two IEEE 1394 (one on rear and one on front flex module) via PCIe adapter, up to one adapter per system. Supports one of the following per system: <ul style="list-style-type: none"> Two rear USB 3.0 per PCIe adapter. One rear Thunderbolt via PCIe adapter. One front eSATA (on flex module), or one rear eSATA via cable and PCIe slot bracket, up to one eSATA port per system. One additional serial port via cable. One parallel port via cable
Mechanical	<ul style="list-style-type: none"> Raven black color; metal case 6.89"W x 16.77"D x 14.8"H 175mm W x 426mm D x 376mm H 28.66 lb (13kg) max configuration 25-liter
Environmental certifications	GREENGUARD certified/RoHS-compliant/EPEAT Gold rating/ENERGY STAR 6.1 qualified
Limited warranty	3-year limited onsite service with 9x5/NBD. Some parts are Customer Replaceable Units.

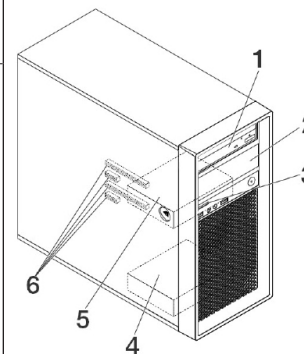

Drive Bays and PCIe Slots

Bay 1 and Bay 2	5.25", support one of the following: HH optical/flex module**/9.5mm optical+3.5" HDD bay/ 3.5" HDD bay/Front Access Storage Enclosure ** Flex module supports one or more of the following: 9.5mm optical/ 29-in-1 reader/front IEEE 1394/front eSATA Up to one flex module is supported per system.
Bay 3	Optional 9-in-1 single slot reader
Bay 4	Standard 3.5" HDD bay
Bay 5	Standard 3.5" HDD bay
6 -Slots	Four PCIe slots (top-down): Slot 1: Half length, full height, PCIe 3.0 x16 (near CPU) Slot 2: Half length, full height, PCIe 3.0 x1 Slot 3: Half length, full height, PCIe 3.0 x16 (x4 elec) Slot 4: Half length, full height, PCIe 3.0 x1

For the list of ISV certifications, please visit www.thinkworkstations.com/isv-certifications/
For a list of all supported options, please visit https://download.lenovo.com/pccbbs/options_iso/ocm_december_2016.xlsx sheet

Model	Region	Processor	Graphics	Memory (Capacity/Type)	Storage (Capacity/Type/Interface)	Optical	Media Reader	Power Supply	Add-on Ports	Discrete Ethernet	Chassis Intrusion Switch	Keyboard / Mouse	Operating System	Warranty	Global	Ann Date (mm/yy)
30AT000BUS	US	Core i7-6700 4C/3.4GHz/8MB/65W/DDR4-2133	Intel HD 530	1x8GB UDIMM DDR4-2133 ECC	1x1TB HDD 7.2K 3.5" SATA6Gbs	HH DVD±RW	9-in-1	250W 85%	None	None	Switch	USB / USB Optical	Win10 DG Win7 Pro 64	3-year	No	11/15
30AT000CUS	US	Xeon E3-1245 v5 4C/3.5GHz/8MB/80W/DDR4-2133	Intel HD P530	1x8GB UDIMM DDR4-2133 ECC	1x1TB HDD 7.2K 3.5" SATA6Gbs	HH DVD±RW	9-in-1	250W 85%	None	None	Switch	USB / USB Optical	Win10 DG Win7 Pro 64	3-year	No	11/15
30AT000EUS	US	Core i7-6700 4C/3.4GHz/8MB/65W/DDR4-2133	Intel HD 530	1x8GB UDIMM DDR4-2133 Non- ECC	1x1TB HDD 7.2K 3.5" SATA6Gbs	HH DVD±RW	9-in-1	250W 85%	None	None	Switch	USB / USB Optical	Win10 DG Win7 Pro 64	3-year	No	11/15
30AT000FUS	US	Xeon E3-1245 v5 4C/3.5GHz/8MB/80W/DDR4-2133	Intel HD P530	1x8GB UDIMM DDR4-2133 Non- ECC	1x1TB HDD 7.2K 3.5" SATA6Gbs	HH DVD±RW	9-in-1	250W 85%	None	None	Switch	USB / USB Optical	Win10 DG Win7 Pro 64	3-year	No	11/15
30AT000GUS	US	Xeon E3-1245 v5 4C/3.5GHz/8MB/80W/DDR4-2133	Intel HD P530	1x8GB UDIMM DDR4-2133 Non- ECC	1x256GB SSD 2.5" SATA6Gbs Opal	HH DVD±RW	9-in-1	250W 85%	None	None	Switch	USB / USB Optical	Win10 DG Win7 Pro 64	3-year	No	11/15
30AT000HUS	US	Xeon E3-1240 v5 4C/3.5GHz/8MB/80W/DDR4-2133	NVIDIA Quadro K620 2GB	1x8GB UDIMM DDR4-2133 Non- ECC	1x1TB HDD 7.2K 3.5" SATA6Gbs	HH DVD±RW	9-in-1	250W 85%	None	None	Switch	USB / USB Optical	Win10 DG Win7 Pro 64	3-year	No	11/15
30AT000JUS	US	Core i7-6700 4C/3.4GHz/8MB/65W/DDR4-2133	Intel HD 530+NVIDIA Quadro K620 2GB	1x8GB UDIMM DDR4-2133 Non- ECC	1x1TB HDD 7.2K 3.5" SATA6Gbs	HH DVD±RW	9-in-1	250W 85%	None	None	Switch	USB / USB Optical	Win10 DG Win7 Pro 64	3-year	No	11/15
30AT000KUS	US	Core i7-6700 4C/3.4GHz/8MB/65W/DDR4-2133	Intel HD 530+NVIDIA Quadro K2200 4GB	1x8GB UDIMM DDR4-2133 Non- ECC	1x1TB HDD 7.2K 3.5" SATA6Gbs	HH DVD±RW	9-in-1	250W 85%	None	None	Switch	USB / USB Optical	Win10 DG Win7 Pro 64	3-year	No	11/15
30AT000LUS	US	Core i7-6700 4C/3.4GHz/8MB/65W/DDR4-2133	Intel HD 530+NVIDIA Quadro K2200 4GB	2x8GB UDIMM DDR4-2133 Non- ECC	1x256GB SSD 2.5" SATA6Gbs Opal	HH DVD±RW	9-in-1	250W 85%	None	None	Switch	USB / USB Optical	Win10 DG Win7 Pro 64	3-year	No	11/15
30AT000MUS	US	Core i7-6700 4C/3.4GHz/8MB/65W/DDR4-2133	Intel HD 530	2x8GB UDIMM DDR4-2133 Non- ECC	1x256GB SSD 2.5" SATA6Gbs Opal	HH DVD±RW	9-in-1	250W 85%	None	None	Switch	USB / USB Optical	Win10 DG Win7 Pro 64	3-year	No	11/15
30AT000NUS	US	Core i5-6500 4C/3.2GHz/6MB/65W/DDR4-2133	Intel HD 530	1x8GB UDIMM DDR4-2133 Non- ECC	1x1TB HDD 7.2K 3.5" SATA6Gbs	HH DVD±RW	9-in-1	250W 85%	None	None	Switch	USB / USB Optical	Win10 DG Win7 Pro 64	3-year	No	11/15
30AT000PUS	US	Xeon E3-1245 v5 4C/3.5GHz/8MB/80W/DDR4-2133	Intel HD P530	2x8GB UDIMM DDR4-2133 Non- ECC	1x256GB SSD M.2 PCIe Opal	HH DVD±RW	9-in-1	400W 92%	None	None	Switch	USB / USB Optical	Win10 DG Win7 Pro 64	3-year	No	11/15
30AT005CUS	US	Xeon E3-1240 v5 4C/3.5GHz/8MB/80W/DDR4-2133	NVIDIA Quadro K620 2GB	1x8GB UDIMM DDR4-2133 ECC	1x256GB SSD M.2 PCIe Opal	HH DVD±RW	9-in-1	250W 85%	None	None	Switch	USB / USB Optical	Win10 Pro 64	3-year	No	07/16
30AT005DUS	US	Xeon E3-1220 v5 4C/3GHz/8MB/80W/DDR4-2133	NVIDIA Quadro K620 2GB	1x8GB UDIMM DDR4-2133 ECC	1x1TB HDD 7.2K 3.5" SATA6Gbs	HH DVD±RW	9-in-1	250W 85%	None	None	Switch	USB / USB Optical	Win10 Pro 64	3-year	No	07/16
30AT005EUS	US	Xeon E3-1240 v5 4C/3.5GHz/8MB/80W/DDR4-2133	NVIDIA Quadro M2000 4GB	1x8GB UDIMM DDR4-2133 ECC	1x256GB SSD M.2 PCIe Opal	HH DVD±RW	9-in-1	250W 85%	None	None	Switch	USB / USB Optical	Win10 Pro 64	3-year	No	07/16

Model	Region	Processor	Graphics	Memory (Capacity/Type)	Storage (Capacity/Type/Interface)	Optical	Media Reader	Power Supply	Add-on Ports	Discrete Ethernet	Chassis Intrusion Switch	Keyboard / Mouse	Operating System	Warranty	Global	Ann Date (mm/yy)
30AT005FUS	US	Xeon E3-1245 v5 4C/3.5GHz/8MB/80W/DDR4-2133	Intel HD P530	1x8GB UDIMM DDR4-2133 ECC	1x256GB SSD M.2 PCIe Opal	HH DVD±RW	9-in-1	250W 85%	None	None	Switch	USB / USB Optical	Win10 Pro 64	3-year	No	07/16
30AT005GUS	US	Core i7-6700 4C/3.4GHz/8MB/65W/DDR4-2133	Intel HD 530+NVIDIA Quadro K620 2GB	1x8GB UDIMM DDR4-2133 Non- ECC	1x1TB HDD 7.2K 3.5" SATA6Gbs	HH DVD±RW	9-in-1	250W 85%	None	None	Switch	USB / USB Optical	Win10 Pro 64	3-year	No	07/16
30AT005HUS	US	Core i7-6700 4C/3.4GHz/8MB/65W/DDR4-2133	Intel HD 530	1x8GB UDIMM DDR4-2133 Non- ECC	1x1TB HDD 7.2K 3.5" SATA6Gbs	HH DVD±RW	9-in-1	400W 92%	None	None	Switch	USB / USB Optical	Win10 Pro 64	3-year	No	07/16
30AT005JUS	US	Xeon E3-1245 v5 4C/3.5GHz/8MB/80W/DDR4-2133	Intel HD P530	1x8GB UDIMM DDR4-2133 ECC	1x1TB HDD 7.2K 3.5" SATA6Gbs	HH DVD±RW	9-in-1	400W 92%	None	None	Switch	USB / USB Optical	Win10 Pro 64	3-year	No	07/16
30AT005KUS	US	Core i5-6500 4C/3.2GHz/6MB/65W/DDR4-2133	Intel HD 530+NVIDIA Quadro K620 2GB	1x8GB UDIMM DDR4-2133 Non- ECC	1x1TB HDD 7.2K 3.5" SATA6Gbs	HH DVD±RW	9-in-1	250W 85%	None	None	Switch	USB / USB Optical	Win10 Pro 64	3-year	No	07/16
30AT005LUS	US	Core i3-6100 2C/3.7GHz/3MB/51W/DDR4-2133	Intel HD 530	1x8GB UDIMM DDR4-2133 Non- ECC	1x1TB HDD 7.2K 3.5" SATA6Gbs	HH DVD±RW	9-in-1	250W 85%	None	None	Switch	USB / USB Optical	Win10 Pro 64	3-year	No	07/16
30AT005MUS	US	Xeon E3-1245 v5 4C/3.5GHz/8MB/80W/DDR4-2133	Intel HD P530	1x8GB UDIMM DDR4-2133 ECC	1x1TB HDD 7.2K 3.5" SATA6Gbs	HH DVD±RW	9-in-1	250W 85%	None	None	Switch	USB / USB Optical	Win10 Pro 64	3-year	No	07/16
30AT005NUS	US	Xeon E3-1240 v5 4C/3.5GHz/8MB/80W/DDR4-2133	NVIDIA Quadro K620 2GB	1x8GB UDIMM DDR4-2133 ECC	1x1TB HDD 7.2K 3.5" SATA6Gbs	HH DVD±RW	9-in-1	250W 85%	None	None	Switch	USB / USB Optical	Win10 Pro 64	3-year	No	07/16
30AT005PUS	US	Core i7-6700 4C/3.4GHz/8MB/65W/DDR4-2133	Intel HD 530+NVIDIA Quadro M2000 4GB	1x8GB UDIMM DDR4-2133 Non- ECC	1x256GB SSD 2.5" SATA6Gbs Opal	HH DVD±RW	9-in-1	250W 85%	None	None	Switch	USB / USB Optical	Win10 Pro 64	3-year	No	07/16
30AT006PUS	US	Core i7-6700 4C/3.4GHz/8MB/65W/DDR4-2133	Intel HD 530+NVIDIA Quadro K1200 4GB	2x8GB UDIMM DDR4-2133 Non- ECC	1x512GB SSD 2.5" SATA6Gbs	HH DVD±RW	9-in-1	250W 85%	None	None	Switch	USB / USB Optical	Win10 DG Win7 Pro 64	3-year	No	11/16
30AT006QUS	US	Core i7-6700 4C/3.4GHz/8MB/65W/DDR4-2133	Intel HD 530+NVIDIA Quadro K620 2GB	2x8GB UDIMM DDR4-2133 Non- ECC	1x512GB SSD M.2 PCIe	HH DVD±RW	9-in-1	250W 85%	None	None	Switch	USB / USB Optical	Win10 DG Win7 Pro 64	3-year	No	11/16
30AT006RUS	US	Core i7-6700 4C/3.4GHz/8MB/65W/DDR4-2133	Intel HD 530+NVIDIA Quadro K620 2GB	2x8GB UDIMM DDR4-2133 Non- ECC	1x256GB SSD M.2 PCIe Opal	HH DVD±RW	9-in-1	250W 85%	None	None	Switch	USB / USB Optical	Win10 DG Win7 Pro 64	3-year	No	11/16
30AT006SUS	US	Core i7-6700 4C/3.4GHz/8MB/65W/DDR4-2133	Intel HD 530+NVIDIA NVS 510 2GB	2x8GB UDIMM DDR4-2133 Non- ECC	1x512GB SSD 2.5" SATA6Gbs	HH DVD±RW	9-in-1	250W 85%	None	None	Switch	USB / USB Optical	Win10 DG Win7 Pro 64	3-year	No	11/16
30AT006TUS	US	Core i7-6700 4C/3.4GHz/8MB/65W/DDR4-2133	Intel HD 530+NVIDIA Quadro K1200 4GB	2x8GB UDIMM DDR4-2133 Non- ECC	1x512GB SSD M.2 PCIe	HH DVD±RW	9-in-1	250W 85%	None	None	Switch	USB / USB Optical	Win10 DG Win7 Pro 64	3-year	No	11/16
30AT006UUS	US	Core i7-6700 4C/3.4GHz/8MB/65W/DDR4-2133	Intel HD 530+NVIDIA Quadro M2000 4GB	2x8GB UDIMM DDR4-2133 Non- ECC	1x512GB SSD M.2 PCIe	HH DVD±RW	9-in-1	250W 85%	None	None	Switch	USB / USB Optical	Win10 DG Win7 Pro 64	3-year	No	11/16

Model	Region	Processor	Graphics	Memory (Capacity/Type)	Storage (Capacity/Type/Interface)	Optical	Media Reader	Power Supply	Add-on Ports	Discrete Ethernet	Chassis Intrusion Switch	Keyboard / Mouse	Operating System	Warranty	Global	Ann Date (mm/yy)
30AT006VUS	US	Core i7-6700 4C/3.4GHz/8MB/65W/DDR4-2133	Intel HD 530+NVIDIA Quadro M2000 4GB	1x16GB UDIMM DDR4-2133 Non- ECC	1x256GB SSD 2.5" SATA6Gbs Opal	HH DVD±RW	9-in-1	250W 85%	None	None	Switch	USB / USB Optical	Win10 DG Win7 Pro 64	3-year	No	11/16
30ATA023US	US	Core i7-6700 4C/3.4GHz/8MB/65W/DDR4-2133	Intel HD 530	2x8GB UDIMM DDR4-2133 Non- ECC	1x512GB SSD 2.5" SATA6Gbs	HH DVD±RW	9-in-1	250W 85%	None	None	Switch	USB / USB Optical	Win10 DG Win7 Pro 64	3-year	No	11/16



ThinkStation P320 SFF Platform Specifications

Product Specifications Reference (PSREF)

Components	Specification																																			
Chipset	Intel C236 Chipset																																			
Intel AMT	Intel Active Management Technology 11 on Xeon models, Intel Standard Manageability on other models																																			
Processor	One Intel "Kabylake" or "Skylake" processor as listed: "Kaby Lake"																																			
	<table border="1"> <tbody> <tr><td>Xeon E3-1280 v6</td><td>4C/3.9GHz/8MB/72W/DDR4-2400</td></tr> <tr><td>Xeon E3-1275 v6</td><td>4C/3.8GHz/8MB/73W/DDR4-2400</td></tr> <tr><td>Xeon E3-1270 v6</td><td>4C/3.8GHz/8MB/72W/DDR4-2400</td></tr> <tr><td>Xeon E3-1245 v6</td><td>4C/3.7GHz/8MB/73W/DDR4-2400</td></tr> <tr><td>Xeon E3-1240 v6</td><td>4C/3.7GHz/8MB/72W/DDR4-2400</td></tr> <tr><td>Xeon E3-1230 v6</td><td>4C/3.5GHz/8MB/72W/DDR4-2400</td></tr> <tr><td>Xeon E3-1225 v6</td><td>4C/3.3GHz/8MB/73W/DDR4-2400</td></tr> <tr><td>Xeon E3-1220 v6</td><td>4C/3GHz/8MB/72W/DDR4-2400</td></tr> <tr><td>Core i7-7700</td><td>4C/3.6GHz/8MB/65W/DDR4-2400</td></tr> <tr><td>Core i5-7600</td><td>4C/3.5GHz/6MB/65W/DDR4-2400</td></tr> <tr><td>Core i5-7500</td><td>4C/3.4GHz/6MB/65W/DDR4-2400</td></tr> <tr><td>Core i5-7400</td><td>4C/3GHz/6MB/65W/DDR4-2400</td></tr> <tr><td>Core i3-7300</td><td>2C/4GHz/4MB/51W/DDR4-2400</td></tr> <tr><td>Core i3-7100</td><td>2C/3.9GHz/3MB/51W/DDR4-2400</td></tr> </tbody> </table>	Xeon E3-1280 v6	4C/3.9GHz/8MB/72W/DDR4-2400	Xeon E3-1275 v6	4C/3.8GHz/8MB/73W/DDR4-2400	Xeon E3-1270 v6	4C/3.8GHz/8MB/72W/DDR4-2400	Xeon E3-1245 v6	4C/3.7GHz/8MB/73W/DDR4-2400	Xeon E3-1240 v6	4C/3.7GHz/8MB/72W/DDR4-2400	Xeon E3-1230 v6	4C/3.5GHz/8MB/72W/DDR4-2400	Xeon E3-1225 v6	4C/3.3GHz/8MB/73W/DDR4-2400	Xeon E3-1220 v6	4C/3GHz/8MB/72W/DDR4-2400	Core i7-7700	4C/3.6GHz/8MB/65W/DDR4-2400	Core i5-7600	4C/3.5GHz/6MB/65W/DDR4-2400	Core i5-7500	4C/3.4GHz/6MB/65W/DDR4-2400	Core i5-7400	4C/3GHz/6MB/65W/DDR4-2400	Core i3-7300	2C/4GHz/4MB/51W/DDR4-2400	Core i3-7100	2C/3.9GHz/3MB/51W/DDR4-2400							
	Xeon E3-1280 v6	4C/3.9GHz/8MB/72W/DDR4-2400																																		
	Xeon E3-1275 v6	4C/3.8GHz/8MB/73W/DDR4-2400																																		
	Xeon E3-1270 v6	4C/3.8GHz/8MB/72W/DDR4-2400																																		
	Xeon E3-1245 v6	4C/3.7GHz/8MB/73W/DDR4-2400																																		
	Xeon E3-1240 v6	4C/3.7GHz/8MB/72W/DDR4-2400																																		
	Xeon E3-1230 v6	4C/3.5GHz/8MB/72W/DDR4-2400																																		
	Xeon E3-1225 v6	4C/3.3GHz/8MB/73W/DDR4-2400																																		
	Xeon E3-1220 v6	4C/3GHz/8MB/72W/DDR4-2400																																		
	Core i7-7700	4C/3.6GHz/8MB/65W/DDR4-2400																																		
	Core i5-7600	4C/3.5GHz/6MB/65W/DDR4-2400																																		
	Core i5-7500	4C/3.4GHz/6MB/65W/DDR4-2400																																		
	Core i5-7400	4C/3GHz/6MB/65W/DDR4-2400																																		
	Core i3-7300	2C/4GHz/4MB/51W/DDR4-2400																																		
	Core i3-7100	2C/3.9GHz/3MB/51W/DDR4-2400																																		
	"Skylake"																																			
		<table border="1"> <tbody> <tr><td>Xeon E3-1245 v5</td><td>4C/3.5GHz/8MB/80W/DDR4-2133</td></tr> <tr><td>Xeon E3-1240 v5</td><td>4C/3.5GHz/8MB/80W/DDR4-2133</td></tr> <tr><td>Xeon E3-1230 v5</td><td>4C/3.4GHz/8MB/80W/DDR4-2133</td></tr> <tr><td>Xeon E3-1225 v5</td><td>4C/3.3GHz/8MB/80W/DDR4-2133</td></tr> <tr><td>Xeon E3-1220 v5</td><td>4C/3GHz/8MB/80W/DDR4-2133</td></tr> <tr><td>Core i7-6700</td><td>4C/3.4GHz/8MB/65W/DDR4-2133</td></tr> <tr><td>Core i5-6500</td><td>4C/3.2GHz/6MB/65W/DDR4-2133</td></tr> <tr><td>Core i5-6400</td><td>4C/2.7GHz/6MB/65W/DDR4-2133</td></tr> <tr><td>Core i3-6100</td><td>2C/3.7GHz/3MB/51W/DDR4-2133</td></tr> </tbody> </table>	Xeon E3-1245 v5	4C/3.5GHz/8MB/80W/DDR4-2133	Xeon E3-1240 v5	4C/3.5GHz/8MB/80W/DDR4-2133	Xeon E3-1230 v5	4C/3.4GHz/8MB/80W/DDR4-2133	Xeon E3-1225 v5	4C/3.3GHz/8MB/80W/DDR4-2133	Xeon E3-1220 v5	4C/3GHz/8MB/80W/DDR4-2133	Core i7-6700	4C/3.4GHz/8MB/65W/DDR4-2133	Core i5-6500	4C/3.2GHz/6MB/65W/DDR4-2133	Core i5-6400	4C/2.7GHz/6MB/65W/DDR4-2133	Core i3-6100	2C/3.7GHz/3MB/51W/DDR4-2133																
		Xeon E3-1245 v5	4C/3.5GHz/8MB/80W/DDR4-2133																																	
		Xeon E3-1240 v5	4C/3.5GHz/8MB/80W/DDR4-2133																																	
Xeon E3-1230 v5		4C/3.4GHz/8MB/80W/DDR4-2133																																		
Xeon E3-1225 v5		4C/3.3GHz/8MB/80W/DDR4-2133																																		
Xeon E3-1220 v5		4C/3GHz/8MB/80W/DDR4-2133																																		
Core i7-6700		4C/3.4GHz/8MB/65W/DDR4-2133																																		
Core i5-6500		4C/3.2GHz/6MB/65W/DDR4-2133																																		
Core i5-6400		4C/2.7GHz/6MB/65W/DDR4-2133																																		
Core i3-6100	2C/3.7GHz/3MB/51W/DDR4-2133																																			
Memory DIMM slots	4 DIMM slots, 2-channel (integrated memory controller in processor)																																			
Memory type/capacity	Up to 64GB ECC/non-ECC (4 x 16GB), DDR4-2400. UDIMM. "Skylake" processor supports up to DDR4-2133. Core i7 and i5 processors cannot support ECC.																																			
Intel HD Graphics in processor	Integrated Intel HD P530 in Xeon E3-12x5 v5 processors; or Intel HD 530 in Core i7, i5, or i3 processors. Works along with discrete graphics to support multi-display, enables three display connectors (2 DP, 1 VGA) on rear.																																			
Discrete graphics	Two PCI Express 3.0 x16 slots for graphics adapters. Up to two NVIDIA Quadro P1000. Supports the following NVIDIA graphic adapters:																																			
	<table border="1"> <thead> <tr> <th>Adapter</th> <th>Cores</th> <th>Memory</th> <th>Power</th> <th>Connector</th> </tr> </thead> <tbody> <tr><td>NVS 310</td><td>48</td><td>1GB</td><td>19.5W</td><td>2xDP</td></tr> <tr><td>NVS 315</td><td>48</td><td>1GB</td><td>19.5W</td><td>2xDVI-I SL/2xDP</td></tr> <tr><td>NVS 510</td><td>192</td><td>2GB</td><td>33.4W</td><td>4xmini DP</td></tr> <tr><td>Quadro P400</td><td>256</td><td>2GB</td><td>30W</td><td>3xminiDP</td></tr> <tr><td>Quadro P600</td><td>384</td><td>2GB</td><td>40W</td><td>4xminiDP</td></tr> <tr><td>Quadro P1000</td><td>640</td><td>4GB</td><td>47W</td><td>4xminiDP</td></tr> </tbody> </table>	Adapter	Cores	Memory	Power	Connector	NVS 310	48	1GB	19.5W	2xDP	NVS 315	48	1GB	19.5W	2xDVI-I SL/2xDP	NVS 510	192	2GB	33.4W	4xmini DP	Quadro P400	256	2GB	30W	3xminiDP	Quadro P600	384	2GB	40W	4xminiDP	Quadro P1000	640	4GB	47W	4xminiDP
	Adapter	Cores	Memory	Power	Connector																															
	NVS 310	48	1GB	19.5W	2xDP																															
	NVS 315	48	1GB	19.5W	2xDVI-I SL/2xDP																															
	NVS 510	192	2GB	33.4W	4xmini DP																															
Quadro P400	256	2GB	30W	3xminiDP																																
Quadro P600	384	2GB	40W	4xminiDP																																
Quadro P1000	640	4GB	47W	4xminiDP																																
Onboard drive controller	Five onboard SATA 6.0Gb/s connectors for optical and disk drives plus one SATA connector for optional eSATA. RAID 0, 1, 5* support * RAID 5 needs three 2.5" SSD drives.																																			
Drive Bays	One external 5.25" bay, one internal 3.5" bay (see right). Up to one 9mm optical + 2 x 3.5" disk drive bays + 1 x 2.5" disk drive bay + two M.2 NVMe SSD																																			
Supporting disk drives	3.5" SATA HDD (7.2K 6Gbs)																																			
	2.5" SATA SSD (6Gbs)																																			
	M.2 NVMe SSD																																			
Max internal storage	10TB (2 x 4TB 3.5" HDDs + 1 x 2TB 2.5" SSD) plus two 1TB M.2 NVMe SSD																																			
Media reader	9-in-1 card reader. Optional 29-in-1 card reader on selected models																																			
Power supply	210 watts with variable speed fan, autosensing, Climate Savers Computing Bronze, 80 PLUS Bronze qualified																																			
Onboard Ethernet	One onboard gigabit ethernet, Intel I219LM, supports Wake-on-LAN																																			
HD Audio	Realtek ALC662 codec																																			
TPM	Standard, TCG 2.0-compliant																																			

Components	Specification
Front ports	Two USB 3.0, microphone (3.5mm), headphone (3.5mm)
Rear ports	1 VGA and 2 DisplayPort (for Intel HD Graphics models only), two USB 2.0, four USB 3.0, one serial (9-pin), one ethernet (RJ-45), three analog audio ports (line-in, line-out, mic-in)
Mechanical	<ul style="list-style-type: none"> Raven black color; metal case 4.02"W x 15.53"D x 13.31"H 102mm W x 394.5mm D x 338mm H 17.2 lb (7.9kg) max configuration 12.9-liter
Environmental certifications	GREENGUARD certified/RoHS-compliant/EPEAT Gold rating/ENERGY STAR 6.1 qualified
Limited warranty	1 or 3-year limited onsite service with 9x5/NBD. Some parts are Customer Replaceable Units.
ISV certifications	Please visit www.thinkworkstations.com/isv-certifications/

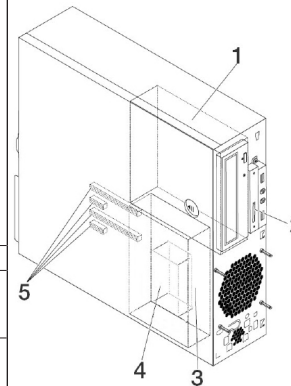

Drive Bays and PCIe Slots

Bay 1	5.25", supports one of the following: HH optical/flex module***/9mm optical+3.5" HDD bay/ 3.5" HDD bay/Front Access Storage Enclosure *** Flex module supports one or more of the following: 9mm optical/ 29-in-1 reader/front IEEE 1394/front eSATA. Up to one flex module is supported per system.
Bay 2	Optional 9-in-1 single slot reader
Bay 3	Standard 3.5" HDD bay
Bay 4	Optional 2.5" HDD bay (under Bay 3)
5 -Slots	Four PCIe slots (top-down): Slot 1: Low Profile, PCIe 3.0 x16 (near CPU) Slot 2: Low Profile, PCIe 3.0 x1 Slot 3: Low Profile, PCIe 3.0 x16 (x4 elec) Slot 4: Low Profile, PCIe 3.0 x1

ThinkStation P320 SFF - TopSeller - 30BK - 1 of 3

Product Specifications Reference (PSREF)

Model	Product	Region	Processor	Intel HD Graphics	Discrete Graphics	Memory	Internal Storage	M.2 PCIe SSD	Optical	Media Reader	Power Supply	Add-on Ports	Keyboard / Mouse	Operating System	Warranty	Global	Ann Date (mm/yy)
30BK000LUS	P320 SFF	US	Core i5-6500 4C/3.2GHz/6MB/65W/DDR4-2133	Intel HD 530	Open	1x8GB UDIMM DDR4-2400 Non-ECC	Open	1x256GB Opal	HH DVD±RW	9-in-1	210W Bronze Fixed	None	USB full/USB opt	Win7 Pro64 (Win10 Pro64 DG)	3-year	No	04/17
30BK000MUS	P320 SFF	US	Xeon E3-1240 v6 4C/3.7GHz/8MB/72W/DDR4-2400	None	Quadro P600 2GB	2x8GB UDIMM DDR4-2400 Non-ECC	1x1TB HDD 7.2K 3.5" SATA6Gbs	None	HH DVD±RW	9-in-1	210W Bronze Fixed	None	USB full/USB opt	Win10 Pro64	3-year	No	04/17
30BK000NUS	P320 SFF	US	Core i7-7700 4C/3.6GHz/8MB/65W/DDR4-2400	Intel HD 630	Quadro P600 2GB	1x8GB UDIMM DDR4-2400 Non-ECC	1x1TB HDD 7.2K 3.5" SATA6Gbs	None	HH DVD±RW	9-in-1	210W Bronze Fixed	None	USB full/USB opt	Win10 Pro64	3-year	No	04/17
30BK000PUS	P320 SFF	US	Core i5-7500 4C/3.4GHz/6MB/65W/DDR4-2400	Intel HD 630	Quadro P400 2GB	1x8GB UDIMM DDR4-2400 Non-ECC	1x1TB HDD 7.2K 3.5" SATA6Gbs	None	HH DVD±RW	9-in-1	210W Bronze Fixed	None	USB full/USB opt	Win10 Pro64	3-year	No	04/17
30BK000QUS	P320 SFF	US	Core i7-6700 4C/3.4GHz/8MB/65W/DDR4-2133	Intel HD 530	Quadro P1000 4GB	1x8GB UDIMM DDR4-2400 Non-ECC	1x1TB HDD 7.2K 3.5" SATA6Gbs	None	HH DVD±RW	9-in-1	210W Bronze Fixed	None	USB full/USB opt	Win7 Pro64 (Win10 Pro64 DG)	3-year	No	04/17
30BK000RUS	P320 SFF	US	Xeon E3-1245 v5 4C/3.5GHz/8MB/80W/DDR4-2133	Intel HD P530	Open	1x8GB UDIMM DDR4-2400 Non-ECC	Open	1x256GB Opal	HH DVD±RW	9-in-1	210W Bronze Fixed	None	USB full/USB opt	Win7 Pro64 (Win10 Pro64 DG)	3-year	No	04/17
30BK000SUS	P320 SFF	US	Xeon E3-1240 v5 4C/3.5GHz/8MB/80W/DDR4-2133	None	Quadro P600 2GB	1x8GB UDIMM DDR4-2400 Non-ECC	1x1TB HDD 7.2K 3.5" SATA6Gbs	None	HH DVD±RW	9-in-1	210W Bronze Fixed	None	USB full/USB opt	Win7 Pro64 (Win10 Pro64 DG)	3-year	No	04/17
30BK000TUS	P320 SFF	US	Core i5-7600 4C/3.5GHz/6MB/65W/DDR4-2400	Intel HD 630	Open	1x8GB UDIMM DDR4-2400 Non-ECC	1x1TB HDD 7.2K 3.5" SATA6Gbs	None	HH DVD±RW	9-in-1	210W Bronze Fixed	None	USB full/USB opt	Win10 Pro64	3-year	No	04/17
30BK000UUS	P320 SFF	US	Core i7-6700 4C/3.4GHz/8MB/65W/DDR4-2133	Intel HD 530	Open	1x8GB UDIMM DDR4-2400 Non-ECC	Open	1x256GB Opal	HH DVD±RW	9-in-1	210W Bronze Fixed	PS/2	USB full/PS2	Win7 Pro64 (Win10 Pro64 DG)	3-year	No	04/17
30BK000VUS	P320 SFF	US	Xeon E3-1245 v6 4C/3.7GHz/8MB/73W/DDR4-2400	Intel HD P630	Open	2x8GB UDIMM DDR4-2400 Non-ECC	Open	1x512GB Opal	HH DVD±RW	9-in-1	210W Bronze Fixed	PS/2	USB full/PS2	Win10 Pro64	3-year	No	04/17
30BK000WUS	P320 SFF	US	Core i7-6700 4C/3.4GHz/8MB/65W/DDR4-2133	Intel HD 530	Quadro P1000 4GB	2x8GB UDIMM DDR4-2400 Non-ECC	Open	1x512GB Opal	HH DVD±RW	9-in-1	210W Bronze Fixed	None	USB full/USB opt	Win7 Pro64 (Win10 Pro64 DG)	3-year	No	04/17
30BK000XUS	P320 SFF	US	Xeon E3-1240 v6 4C/3.7GHz/8MB/72W/DDR4-2400	None	Quadro P600 2GB	2x8GB UDIMM DDR4-2400 Non-ECC	Open	1x512GB Opal	HH DVD±RW	9-in-1	210W Bronze Fixed	None	USB full/USB opt	Win10 Pro64	3-year	No	04/17
30BK000YUS	P320 SFF	US	Core i7-7700 4C/3.6GHz/8MB/65W/DDR4-2400	Intel HD 630	Quadro P1000 4GB	1x8GB UDIMM DDR4-2400 Non-ECC	1x1TB HDD 7.2K 3.5" SATA6Gbs	None	HH DVD±RW	9-in-1	210W Bronze Fixed	None	USB full/USB opt	Win10 Pro64	3-year	No	04/17
30BK0010US	P320 SFF	US	Xeon E3-1240 v5 4C/3.5GHz/8MB/80W/DDR4-2133	None	Quadro P1000 4GB	1x8GB UDIMM DDR4-2400 Non-ECC	1x1TB HDD 7.2K 3.5" SATA6Gbs	None	HH DVD±RW	9-in-1	210W Bronze Fixed	None	USB full/USB opt	Win7 Pro64 (Win10 Pro64 DG)	3-year	No	04/17
30BK0011US	P320 SFF	US	Core i5-7500 4C/3.4GHz/6MB/65W/DDR4-2400	Intel HD 630	Open	1x8GB UDIMM DDR4-2400 Non-ECC	Open	1x256GB Opal	HH DVD±RW	9-in-1	210W Bronze Fixed	None	USB full/USB opt	Win10 Pro64	3-year	No	04/17

ThinkStation P320 SFF - TopSeller - 30BK - 2 of 3

Product Specifications Reference (PSREF)

Model	Product	Region	Processor	Intel HD Graphics	Discrete Graphics	Memory	Internal Storage	M.2 PCIe SSD	Optical	Media Reader	Power Supply	Add-on Ports	Keyboard / Mouse	Operating System	Warranty	Global	Ann Date (mm/yy)
30BK0012US	P320 SFF	US	Core i7-7700 4C/3.6GHz/8MB/65W/DDR4-2400	Intel HD 630	Open	1x8GB UDIMM DDR4-2400 Non-ECC	1x1TB HDD 7.2K 3.5" SATA6Gbs	None	HH DVD±RW	9-in-1	210W Bronze Fixed	None	USB full/USB opt	Win10 Pro64	3-year	No	04/17
30BK0013US	P320 SFF	US	Core i3-6100 2C/3.7GHz/3MB/51W/DDR4-2133	Intel HD 530	Quadro P400 2GB	1x8GB UDIMM DDR4-2400 Non-ECC	1x1TB HDD 7.2K 3.5" SATA6Gbs	None	HH DVD±RW	9-in-1	210W Bronze Fixed	None	USB full/USB opt	Win7 Pro64 (Win10 Pro64 DG)	3-year	No	04/17
30BK0014US	P320 SFF	US	Xeon E3-1240 v6 4C/3.7GHz/8MB/72W/DDR4-2400	None	Quadro P1000 4GB	1x8GB UDIMM DDR4-2400 Non-ECC	1x1TB HDD 7.2K 3.5" SATA6Gbs	None	HH DVD±RW	9-in-1	210W Bronze Fixed	None	USB full/USB opt	Win10 Pro64	3-year	No	04/17
30BK0015US	P320 SFF	US	Core i5-6500 4C/3.2GHz/6MB/65W/DDR4-2133	Intel HD 530	Quadro P400 2GB	1x8GB UDIMM DDR4-2400 Non-ECC	1x512GB SSD 2.5" SATA6Gbs Opal	None	HH DVD±RW	9-in-1	210W Bronze Fixed	None	USB full/USB opt	Win7 Pro64 (Win10 Pro64 DG)	3-year	No	04/17
30BK0016US	P320 SFF	US	Core i5-7500 4C/3.4GHz/6MB/65W/DDR4-2400	Intel HD 630	Quadro P400 2GB	1x8GB UDIMM DDR4-2400 Non-ECC	1x512GB SSD 2.5" SATA6Gbs Opal	None	HH DVD±RW	9-in-1	210W Bronze Fixed	None	USB full/USB opt	Win10 Pro64	3-year	No	04/17
30BK0017US	P320 SFF	US	Xeon E3-1225 v6 4C/3.3GHz/8MB/73W/DDR4-2400	Intel HD P630	Open	1x8GB UDIMM DDR4-2400 Non-ECC	1x1TB HDD 7.2K 3.5" SATA6Gbs	None	HH DVD±RW	9-in-1	210W Bronze Fixed	None	USB full/USB opt	Win10 Pro64	3-year	No	04/17
30BK0018US	P320 SFF	US	Core i3-6100 2C/3.7GHz/3MB/51W/DDR4-2133	Intel HD 530	Open	1x8GB UDIMM DDR4-2400 Non-ECC	1x1TB HDD 7.2K 3.5" SATA6Gbs	None	HH DVD±RW	9-in-1	210W Bronze Fixed	None	USB full/USB opt	Win7 Pro64 (Win10 Pro64 DG)	3-year	No	04/17
30BK0019US	P320 SFF	US	Xeon E3-1245 v5 4C/3.5GHz/8MB/80W/DDR4-2133	Intel HD P530	Open	1x8GB UDIMM DDR4-2400 Non-ECC	Open	1x512GB Opal	HH DVD±RW	9-in-1	210W Bronze Fixed	PS/2	USB full/PS2	Win7 Pro64 (Win10 Pro64 DG)	3-year	No	04/17
30BK001AUS	P320 SFF	US	Core i7-6700 4C/3.4GHz/8MB/65W/DDR4-2133	Intel HD 530	Quadro P600 2GB	1x8GB UDIMM DDR4-2400 Non-ECC	1x1TB HDD 7.2K 3.5" SATA6Gbs	None	HH DVD±RW	9-in-1	210W Bronze Fixed	None	USB full/USB opt	Win7 Pro64 (Win10 Pro64 DG)	3-year	No	04/17
30BK001BUS	P320 SFF	US	Core i7-7700 4C/3.6GHz/8MB/65W/DDR4-2400	Intel HD 630	Open	1x8GB UDIMM DDR4-2400 Non-ECC	Open	1x256GB Opal	HH DVD±RW	9-in-1	210W Bronze Fixed	PS/2	USB full/PS2	Win10 Pro64	3-year	No	04/17
30BK001CUS	P320 SFF	US	Core i5-7500 4C/3.4GHz/6MB/65W/DDR4-2400	Intel HD 630	Open	1x8GB UDIMM DDR4-2400 Non-ECC	1x1TB HDD 7.2K 3.5" SATA6Gbs	None	HH DVD±RW	9-in-1	210W Bronze Fixed	None	USB full/USB opt	Win10 Pro64	3-year	No	04/17
30BK001DUS	P320 SFF	US	Core i7-6700 4C/3.4GHz/8MB/65W/DDR4-2133	Intel HD 530	Open	1x8GB UDIMM DDR4-2400 Non-ECC	1x1TB HDD 7.2K 3.5" SATA6Gbs	None	HH DVD±RW	9-in-1	210W Bronze Fixed	None	USB full/USB opt	Win7 Pro64 (Win10 Pro64 DG)	3-year	No	04/17
30BK001EUS	P320 SFF	US	Xeon E3-1240 v5 4C/3.5GHz/8MB/80W/DDR4-2133	None	Quadro P600 2GB	2x8GB UDIMM DDR4-2400 Non-ECC	Open	1x512GB Opal	HH DVD±RW	9-in-1	210W Bronze Fixed	None	USB full/USB opt	Win7 Pro64 (Win10 Pro64 DG)	3-year	No	04/17
30BK001FUS	P320 SFF	US	Core i3-7100 2C/3.9GHz/3MB/51W/DDR4-2400	Intel HD 630	Quadro P400 2GB	1x8GB UDIMM DDR4-2400 Non-ECC	1x1TB HDD 7.2K 3.5" SATA6Gbs	None	HH DVD±RW	9-in-1	210W Bronze Fixed	None	USB full/USB opt	Win10 Pro64	3-year	No	04/17
30BK001GUS	P320 SFF	US	Xeon E3-1240 v5 4C/3.5GHz/8MB/80W/DDR4-2133	None	Quadro P1000 4GB	2x8GB UDIMM DDR4-2400 Non-ECC	Open	1x512GB Opal	HH DVD±RW	9-in-1	210W Bronze Fixed	PS/2	USB full/PS2	Win7 Pro64 (Win10 Pro64 DG)	3-year	No	04/17

Model	Product	Region	Processor	Intel HD Graphics	Discrete Graphics	Memory	Internal Storage	M.2 PCIe SSD	Optical	Media Reader	Power Supply	Add-on Ports	Keyboard / Mouse	Operating System	Warranty	Global	Ann Date (mm/yy)
30BK001HUS	P320 SFF	US	Core i5-6500 4C/3.2GHz/6MB/65W/DDR4-2133	Intel HD 530	Open	1x8GB UDIMM DDR4-2400 Non-ECC	1x1TB HDD 7.2K 3.5" SATA6Gbs	None	HH DVD±RW	9-in-1	210W Bronze Fixed	None	USB full/USB opt	Win7 Pro64 (Win10 Pro64 DG)	3-year	No	04/17
30BK001JUS	P320 SFF	US	Core i3-7100 2C/3.9GHz/3MB/51W/DDR4-2400	Intel HD 630	Open	1x8GB UDIMM DDR4-2400 Non-ECC	1x1TB HDD 7.2K 3.5" SATA6Gbs	None	HH DVD±RW	9-in-1	210W Bronze Fixed	None	USB full/USB opt	Win10 Pro64	3-year	No	04/17
30BK001KUS	P320 SFF	US	Xeon E3-1245 v6 4C/3.7GHz/8MB/73W/DDR4-2400	Intel HD P630	Open	1x8GB UDIMM DDR4-2400 Non-ECC	Open	1x256GB Opal	HH DVD±RW	9-in-1	210W Bronze Fixed	None	USB full/USB opt	Win10 Pro64	3-year	No	04/17
30BK001LUS	P320 SFF	US	Core i7-7700 4C/3.6GHz/8MB/65W/DDR4-2400	Intel HD 630	Quadro P1000 4GB	2x8GB UDIMM DDR4-2400 Non-ECC	Open	1x512GB Opal	HH DVD±RW	9-in-1	210W Bronze Fixed	None	USB full/USB opt	Win10 Pro64	3-year	No	04/17
30BK001MUS	P320 SFF	US	Xeon E3-1225 v5 4C/3.3GHz/8MB/80W/DDR4-2133	Intel HD P530	Open	1x8GB UDIMM DDR4-2400 Non-ECC	1x1TB HDD 7.2K 3.5" SATA6Gbs	None	HH DVD±RW	9-in-1	210W Bronze Fixed	None	USB full/USB opt	Win7 Pro64 (Win10 Pro64 DG)	3-year	No	04/17
30BK001NUS	P320 SFF	US	Core i5-6500 4C/3.2GHz/6MB/65W/DDR4-2133	Intel HD 530	Quadro P400 2GB	1x8GB UDIMM DDR4-2400 Non-ECC	1x1TB HDD 7.2K 3.5" SATA6Gbs	None	HH DVD±RW	9-in-1	210W Bronze Fixed	None	USB full/USB opt	Win7 Pro64 (Win10 Pro64 DG)	3-year	No	04/17



ThinkStation P320 Tower Platform Specifications

Components	Specification																																																		
Chipset	Intel C236 Chipset																																																		
Intel AMT	Intel Active Management Technology 11 on Xeon models, Intel Standard Manageability on other models																																																		
Processor	One Intel "Kabylake" or "Skylake" processor as listed: "Kaby Lake"																																																		
	<table border="1"> <tbody> <tr><td>Xeon E3-1280 v6</td><td>4C/3.9GHz/8MB/72W/DDR4-2400</td></tr> <tr><td>Xeon E3-1275 v6</td><td>4C/3.8GHz/8MB/73W/DDR4-2400</td></tr> <tr><td>Xeon E3-1270 v6</td><td>4C/3.8GHz/8MB/72W/DDR4-2400</td></tr> <tr><td>Xeon E3-1245 v6</td><td>4C/3.7GHz/8MB/73W/DDR4-2400</td></tr> <tr><td>Xeon E3-1240 v6</td><td>4C/3.7GHz/8MB/72W/DDR4-2400</td></tr> <tr><td>Xeon E3-1230 v6</td><td>4C/3.5GHz/8MB/72W/DDR4-2400</td></tr> <tr><td>Xeon E3-1225 v6</td><td>4C/3.3GHz/8MB/73W/DDR4-2400</td></tr> <tr><td>Xeon E3-1220 v6</td><td>4C/3GHz/8MB/72W/DDR4-2400</td></tr> <tr><td>Core i7-7700K</td><td>4C/4.2GHz/8MB/91W/DDR4-2400</td></tr> <tr><td>Core i7-7700</td><td>4C/3.6GHz/8MB/65W/DDR4-2400</td></tr> <tr><td>Core i5-7600</td><td>4C/3.5GHz/6MB/65W/DDR4-2400</td></tr> <tr><td>Core i5-7500</td><td>4C/3.4GHz/6MB/65W/DDR4-2400</td></tr> <tr><td>Core i5-7400</td><td>4C/3GHz/6MB/65W/DDR4-2400</td></tr> <tr><td>Core i3-7300</td><td>2C/4GHz/4MB/51W/DDR4-2400</td></tr> <tr><td>Core i3-7100</td><td>2C/3.9GHz/3MB/51W/DDR4-2400</td></tr> </tbody> </table>	Xeon E3-1280 v6	4C/3.9GHz/8MB/72W/DDR4-2400	Xeon E3-1275 v6	4C/3.8GHz/8MB/73W/DDR4-2400	Xeon E3-1270 v6	4C/3.8GHz/8MB/72W/DDR4-2400	Xeon E3-1245 v6	4C/3.7GHz/8MB/73W/DDR4-2400	Xeon E3-1240 v6	4C/3.7GHz/8MB/72W/DDR4-2400	Xeon E3-1230 v6	4C/3.5GHz/8MB/72W/DDR4-2400	Xeon E3-1225 v6	4C/3.3GHz/8MB/73W/DDR4-2400	Xeon E3-1220 v6	4C/3GHz/8MB/72W/DDR4-2400	Core i7-7700K	4C/4.2GHz/8MB/91W/DDR4-2400	Core i7-7700	4C/3.6GHz/8MB/65W/DDR4-2400	Core i5-7600	4C/3.5GHz/6MB/65W/DDR4-2400	Core i5-7500	4C/3.4GHz/6MB/65W/DDR4-2400	Core i5-7400	4C/3GHz/6MB/65W/DDR4-2400	Core i3-7300	2C/4GHz/4MB/51W/DDR4-2400	Core i3-7100	2C/3.9GHz/3MB/51W/DDR4-2400																				
	Xeon E3-1280 v6	4C/3.9GHz/8MB/72W/DDR4-2400																																																	
	Xeon E3-1275 v6	4C/3.8GHz/8MB/73W/DDR4-2400																																																	
	Xeon E3-1270 v6	4C/3.8GHz/8MB/72W/DDR4-2400																																																	
	Xeon E3-1245 v6	4C/3.7GHz/8MB/73W/DDR4-2400																																																	
	Xeon E3-1240 v6	4C/3.7GHz/8MB/72W/DDR4-2400																																																	
	Xeon E3-1230 v6	4C/3.5GHz/8MB/72W/DDR4-2400																																																	
	Xeon E3-1225 v6	4C/3.3GHz/8MB/73W/DDR4-2400																																																	
	Xeon E3-1220 v6	4C/3GHz/8MB/72W/DDR4-2400																																																	
	Core i7-7700K	4C/4.2GHz/8MB/91W/DDR4-2400																																																	
	Core i7-7700	4C/3.6GHz/8MB/65W/DDR4-2400																																																	
	Core i5-7600	4C/3.5GHz/6MB/65W/DDR4-2400																																																	
	Core i5-7500	4C/3.4GHz/6MB/65W/DDR4-2400																																																	
	Core i5-7400	4C/3GHz/6MB/65W/DDR4-2400																																																	
	Core i3-7300	2C/4GHz/4MB/51W/DDR4-2400																																																	
	Core i3-7100	2C/3.9GHz/3MB/51W/DDR4-2400																																																	
		"Skylake"																																																	
		<table border="1"> <tbody> <tr><td>Xeon E3-1245 v5</td><td>4C/3.5GHz/8MB/80W/DDR4-2133</td></tr> <tr><td>Xeon E3-1240 v5</td><td>4C/3.5GHz/8MB/80W/DDR4-2133</td></tr> <tr><td>Xeon E3-1230 v5</td><td>4C/3.4GHz/8MB/80W/DDR4-2133</td></tr> <tr><td>Xeon E3-1225 v5</td><td>4C/3.3GHz/8MB/80W/DDR4-2133</td></tr> <tr><td>Xeon E3-1220 v5</td><td>4C/3GHz/8MB/80W/DDR4-2133</td></tr> <tr><td>Core i7-6700</td><td>4C/3.4GHz/8MB/65W/DDR4-2133</td></tr> <tr><td>Core i5-6500</td><td>4C/3.2GHz/6MB/65W/DDR4-2133</td></tr> <tr><td>Core i5-6400</td><td>4C/2.7GHz/6MB/65W/DDR4-2133</td></tr> <tr><td>Core i3-6100</td><td>2C/3.7GHz/3MB/51W/DDR4-2133</td></tr> </tbody> </table>	Xeon E3-1245 v5	4C/3.5GHz/8MB/80W/DDR4-2133	Xeon E3-1240 v5	4C/3.5GHz/8MB/80W/DDR4-2133	Xeon E3-1230 v5	4C/3.4GHz/8MB/80W/DDR4-2133	Xeon E3-1225 v5	4C/3.3GHz/8MB/80W/DDR4-2133	Xeon E3-1220 v5	4C/3GHz/8MB/80W/DDR4-2133	Core i7-6700	4C/3.4GHz/8MB/65W/DDR4-2133	Core i5-6500	4C/3.2GHz/6MB/65W/DDR4-2133	Core i5-6400	4C/2.7GHz/6MB/65W/DDR4-2133	Core i3-6100	2C/3.7GHz/3MB/51W/DDR4-2133																															
	Xeon E3-1245 v5	4C/3.5GHz/8MB/80W/DDR4-2133																																																	
Xeon E3-1240 v5	4C/3.5GHz/8MB/80W/DDR4-2133																																																		
Xeon E3-1230 v5	4C/3.4GHz/8MB/80W/DDR4-2133																																																		
Xeon E3-1225 v5	4C/3.3GHz/8MB/80W/DDR4-2133																																																		
Xeon E3-1220 v5	4C/3GHz/8MB/80W/DDR4-2133																																																		
Core i7-6700	4C/3.4GHz/8MB/65W/DDR4-2133																																																		
Core i5-6500	4C/3.2GHz/6MB/65W/DDR4-2133																																																		
Core i5-6400	4C/2.7GHz/6MB/65W/DDR4-2133																																																		
Core i3-6100	2C/3.7GHz/3MB/51W/DDR4-2133																																																		
Memory DIMM slots	4 DIMM slots, 2-channel (integrated memory controller in processor)																																																		
Memory type/capacity	Up to 64GB ECC/non-ECC (4 x 16GB), DDR4-2400. UDIMM. "Skylake" processor supports up to DDR4-2133. Core i7 and i5 processors cannot support ECC.																																																		
Intel HD Graphics in processor	Integrated Intel HD P530 in Xeon E3-12x5 v5 processors; or Intel HD 530 in Core i7, i5, or i3 processors. Works along with discrete graphics to support multi-display, enables three display connectors (2 DP, 1 VGA) on rear.																																																		
Discrete graphics	Two PCI Express 3.0 x16 slots for graphics adapters. Up to two Quadro P1000 on 250 watts models. Or up to two Quadro P2000, or up to one Quadro P4000 on 400 watts models. Supports the following NVIDIA graphics adapters:																																																		
	<table border="1"> <thead> <tr> <th>Adapter</th> <th>Cores</th> <th>Memory</th> <th>Power</th> <th>Connector</th> </tr> </thead> <tbody> <tr><td>NVS 310</td><td>48</td><td>1GB</td><td>19.5W</td><td>2xDP</td></tr> <tr><td>NVS 315</td><td>48</td><td>1GB</td><td>19.5W</td><td>2xDVI-I SL/2xDP</td></tr> <tr><td>NVS 510</td><td>192</td><td>2GB</td><td>33.4W</td><td>4xmini DP</td></tr> <tr><td>NVS 810</td><td>1024</td><td>4GB</td><td>68W</td><td>8xmini DP</td></tr> <tr><td>Quadro P400</td><td>256</td><td>2GB</td><td>30W</td><td>3xminiDP</td></tr> <tr><td>Quadro P600</td><td>384</td><td>2GB</td><td>40W</td><td>4xminiDP</td></tr> <tr><td>Quadro P1000</td><td>640</td><td>4GB</td><td>47W</td><td>4xminiDP</td></tr> <tr><td>Quadro P2000</td><td>1024</td><td>5GB</td><td>75W</td><td>4xDP</td></tr> <tr><td>Quadro P4000</td><td>1792</td><td>8GB</td><td>105W</td><td>4xDP</td></tr> </tbody> </table>	Adapter	Cores	Memory	Power	Connector	NVS 310	48	1GB	19.5W	2xDP	NVS 315	48	1GB	19.5W	2xDVI-I SL/2xDP	NVS 510	192	2GB	33.4W	4xmini DP	NVS 810	1024	4GB	68W	8xmini DP	Quadro P400	256	2GB	30W	3xminiDP	Quadro P600	384	2GB	40W	4xminiDP	Quadro P1000	640	4GB	47W	4xminiDP	Quadro P2000	1024	5GB	75W	4xDP	Quadro P4000	1792	8GB	105W	4xDP
	Adapter	Cores	Memory	Power	Connector																																														
	NVS 310	48	1GB	19.5W	2xDP																																														
	NVS 315	48	1GB	19.5W	2xDVI-I SL/2xDP																																														
	NVS 510	192	2GB	33.4W	4xmini DP																																														
	NVS 810	1024	4GB	68W	8xmini DP																																														
	Quadro P400	256	2GB	30W	3xminiDP																																														
	Quadro P600	384	2GB	40W	4xminiDP																																														
	Quadro P1000	640	4GB	47W	4xminiDP																																														
Quadro P2000	1024	5GB	75W	4xDP																																															
Quadro P4000	1792	8GB	105W	4xDP																																															
Onboard drive controller	Five onboard SATA 6.0Gb/s connectors for optical and disk drives plus one SATA connector for optional eSATA. RAID 0, 1, 5, 10 support																																																		
Drive Bays	Two external 5.25" bays, two internal 3.5" bays (see right). Up to one 9mm optical plus 4 x 3.5" disk drive bays plus two M.2 NVMe SSD																																																		
Supporting disk drives	3.5" SATA HDD (7.2K 6Gbs)																																																		
	2.5" SATA SSD (6Gbs)																																																		
	M.2 NVMe SSD																																																		
Max internal storage	16TB (4 x 4TB 3.5" HDDs) plus 2TB (2 x 1TB) M.2 NVMe SSD																																																		
Media reader	9-in-1 card reader. Optional 29-in-1 card reader on selected models																																																		
Power supply	One 250 watts with variable speed fan, autosensing, Climate Savers Computing Bronze, 80 PLUS Bronze qualified. Or one 400 watts with variable speed fan, autosensing, Climate Savers Computing Platinum, 80 PLUS Platinum qualified. US models use 400 watts PSU																																																		

Components	Specification
Onboard Ethernet	One onboard gigabit ethernet, Intel I219LM, supports Wake-on-LAN
HD Audio	Realtek ALC662 codec
TPM	Standard, TCG 2.0-compliant
Front ports	Two USB 3.0, microphone (3.5mm), headphone (3.5mm)
Rear ports	1 VGA and 2 DisplayPort (for Intel HD Graphics models only), two USB 2.0, four USB 3.0, one serial (9-pin), one ethernet (RJ-45), three analog audio ports (line-in, line-out, mic-in)
Mechanical	<ul style="list-style-type: none"> Raven black color; metal case 6.89"W x 16.77"D x 14.8"H 175mm W x 426mm D x 376mm H 28.66 lb (13kg) max configuration 25-liter
Environmental certifications	GREENGUARD certified/RoHS-compliant/EPEAT Gold rating/ENERGY STAR 6.1 qualified
Limited warranty	1 or 3-year limited onsite service with 9x5/NBD. Some parts are Customer Replaceable Units.
ISV certifications	please visit www.thinkworkstations.com/isv-certifications/

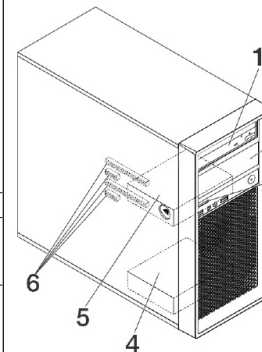

Drive Bays and PCIe Slots

Bay 1 and Bay 2	5.25", support one of the following: HH optical/flex module/9mm optical+3.5" HDD bay/ 3.5" HDD bay/Front Access Storage Enclosure (FASE) <i>Note:</i> 1. Flex module supports one or more of the following: 9mm optical/ 29-in-1 reader/front IEEE 1394/front eSATA. 2. Up to one flex module/FASE per system.
Bay 3	Optional 9-in-1 single slot reader
Bay 4	Standard 3.5" HDD bay
Bay 5	Standard 3.5" HDD bay
6 -Slots	Four PCIe slots (top-down): Slot 1: Half length, full height, PCIe 3.0 x16 (near CPU) Slot 2: Half length, full height, PCIe 3.0 x1 Slot 3: Half length, full height, PCIe 3.0 x16 (x4 elec) Slot 4: Half length, full height, PCIe 3.0 x1 <i>Note:</i> 1. Both discrete graphics adapter and M.2 NVMe SSD should be installed on slot 1 or slot 3, the maximum quantity of discrete graphics adapter and M.2 NVMe SSD is 2. 2. When two discrete graphics adapters are used, no other PCIe card can be used.

ThinkStation P320 Tower - TopSeller - 30BH - 1 of 4

Product Specifications Reference (PSREF)

Model	Product	Region	Processor	Intel HD Graphics	Discrete Graphics	Memory	Internal Storage	M.2 PCIe SSD	Optical	Media Reader	Power Supply	Add-on Ports	Keyboard / Mouse	Operating System	Warranty	Global	Ann Date (mm/yy)
30BH0022US	P320 Tower	US	Core i7-7700 4C/3.6GHz/8MB/65W/DDR4-2400	Intel HD 630	Open	1x8GB UDIMM DDR4-2400 Non-ECC	1x1TB HDD 7.2K 3.5" SATA6Gbs	None	HH DVD±RW	9-in-1	250W Bronze Fixed	None	USB full/USB opt	Win10 Pro64	3-year	No	04/17
30BH0023US	P320 Tower	US	Xeon E3-1245 v5 4C/3.5GHz/8MB/80W/DDR4-2133	Intel HD P530	Open	1x8GB UDIMM DDR4-2400 Non-ECC	Open	1x512GB Opal	HH DVD±RW	9-in-1	250W Bronze Fixed	None	USB full/USB opt	Win7 Pro64 (Win10 Pro64 DG)	3-year	No	04/17
30BH0024US	P320 Tower	US	Core i7-7700 4C/3.6GHz/8MB/65W/DDR4-2400	Intel HD 630	Open	1x8GB UDIMM DDR4-2400 Non-ECC	Open	1x512GB Opal	HH DVD±RW	9-in-1	250W Bronze Fixed	None	USB full/USB opt	Win10 Pro64	3-year	No	04/17
30BH0025US	P320 Tower	US	Core i7-6700 4C/3.4GHz/8MB/65W/DDR4-2133	Intel HD 530	Open	1x8GB UDIMM DDR4-2400 Non-ECC	Open	1x512GB Opal	HH DVD±RW	9-in-1	250W Bronze Fixed	None	USB full/USB opt	Win7 Pro64 (Win10 Pro64 DG)	3-year	No	04/17
30BH0026US	P320 Tower	US	Xeon E3-1240 v6 4C/3.7GHz/8MB/72W/DDR4-2400	None	Quadro P2000 5GB	2x8GB UDIMM DDR4-2400 Non-ECC	1x1TB HDD 7.2K 3.5" SATA6Gbs	None	HH DVD±RW	9-in-1	250W Bronze Fixed	None	USB full/USB opt	Win10 Pro64	3-year	No	04/17
30BH0027US	P320 Tower	US	Core i7-7700K 4C/4.2GHz/8MB/91W/DDR4-2400	Intel HD 630	Open	2x8GB UDIMM DDR4-2400 Non-ECC	Open	1x256GB Opal	HH DVD±RW	9-in-1	250W Bronze Fixed	None	USB full/USB opt	Win10 Pro64	3-year	No	04/17
30BH0028US	P320 Tower	US	Core i5-7500 4C/3.4GHz/6MB/65W/DDR4-2400	Intel HD 630	Open	1x8GB UDIMM DDR4-2400 Non-ECC	1x1TB HDD 7.2K 3.5" SATA6Gbs	None	HH DVD±RW	9-in-1	250W Bronze Fixed	None	USB full/USB opt	Win10 Pro64	3-year	No	04/17
30BH0029US	P320 Tower	US	Core i7-7700 4C/3.6GHz/8MB/65W/DDR4-2400	Intel HD 630	Open	2x8GB UDIMM DDR4-2400 Non-ECC	Open	1x512GB Opal	HH DVD±RW	9-in-1	250W Bronze Fixed	None	USB full/USB opt	Win10 Pro64	3-year	No	04/17
30BH002AUS	P320 Tower	US	Core i5-6500 4C/3.2GHz/6MB/65W/DDR4-2133	Intel HD 530	Open	1x8GB UDIMM DDR4-2400 Non-ECC	1x1TB HDD 7.2K 3.5" SATA6Gbs	None	HH DVD±RW	9-in-1	250W Bronze Fixed	None	USB full/USB opt	Win7 Pro64 (Win10 Pro64 DG)	3-year	No	04/17
30BH002BUS	P320 Tower	US	Xeon E3-1240 v5 4C/3.5GHz/8MB/80W/DDR4-2133	None	Quadro P600 2GB	1x8GB UDIMM DDR4-2400 Non-ECC	1x1TB HDD 7.2K 3.5" SATA6Gbs	None	HH DVD±RW	9-in-1	250W Bronze Fixed	None	USB full/USB opt	Win7 Pro64 (Win10 Pro64 DG)	3-year	No	04/17
30BH002CUS	P320 Tower	US	Core i3-7100 2C/3.9GHz/3MB/51W/DDR4-2400	Intel HD 630	Open	1x8GB UDIMM DDR4-2400 Non-ECC	1x1TB HDD 7.2K 3.5" SATA6Gbs	None	HH DVD±RW	9-in-1	250W Bronze Fixed	None	USB full/USB opt	Win10 Pro64	3-year	No	04/17
30BH002DUS	P320 Tower	US	Core i7-7700K 4C/4.2GHz/8MB/91W/DDR4-2400	Intel HD 630	Open	2x8GB UDIMM DDR4-2400 Non-ECC	1x1TB HDD 7.2K 3.5" SATA6Gbs	None	HH DVD±RW	9-in-1	250W Bronze Fixed	None	USB full/USB opt	Win10 Pro64	3-year	No	04/17
30BH002EUS	P320 Tower	US	Core i7-7700 4C/3.6GHz/8MB/65W/DDR4-2400	Intel HD 630	Quadro P1000 4GB	2x8GB UDIMM DDR4-2400 Non-ECC	1x1TB HDD 7.2K 3.5" SATA6Gbs	None	HH DVD±RW	9-in-1	250W Bronze Fixed	None	USB full/USB opt	Win10 Pro64	3-year	No	04/17
30BH002FUS	P320 Tower	US	Core i3-6100 2C/3.7GHz/3MB/51W/DDR4-2133	Intel HD 530	Open	1x8GB UDIMM DDR4-2400 Non-ECC	1x1TB HDD 7.2K 3.5" SATA6Gbs	None	HH DVD±RW	9-in-1	250W Bronze Fixed	None	USB full/USB opt	Win7 Pro64 (Win10 Pro64 DG)	3-year	No	04/17
30BH002GUS	P320 Tower	US	Core i5-6500 4C/3.2GHz/6MB/65W/DDR4-2133	Intel HD 530	Open	1x8GB UDIMM DDR4-2400 Non-ECC	Open	1x256GB Opal	HH DVD±RW	9-in-1	250W Bronze Fixed	None	USB full/USB opt	Win7 Pro64 (Win10 Pro64 DG)	3-year	No	04/17

ThinkStation P320 Tower - TopSeller - 30BH - 2 of 4

Product Specifications Reference (PSREF)

Model	Product	Region	Processor	Intel HD Graphics	Discrete Graphics	Memory	Internal Storage	M.2 PCIe SSD	Optical	Media Reader	Power Supply	Add-on Ports	Keyboard / Mouse	Operating System	Warranty	Global	Ann Date (mm/yy)
30BH002HUS	P320 Tower	US	Xeon E3-1240 v6 4C/3.7GHz/8MB/72W/DDR4-2400	None	Quadro P2000 5GB	2x8GB UDIMM DDR4-2400 Non-ECC	Open	1x512GB Opal	HH DVD±RW	9-in-1	250W Bronze Fixed	None	USB full/USB opt	Win10 Pro64	3-year	No	04/17
30BH002JUS	P320 Tower	US	Core i7-6700 4C/3.4GHz/8MB/65W/DDR4-2133	Intel HD 530	Quadro P1000 4GB	2x8GB UDIMM DDR4-2400 Non-ECC	1x1TB HDD 7.2K 3.5" SATA6Gbs	None	HH DVD±RW	9-in-1	250W Bronze Fixed	None	USB full/USB opt	Win7 Pro64 (Win10 Pro64 DG)	3-year	No	04/17
30BH002KUS	P320 Tower	US	Core i7-7700 4C/3.6GHz/8MB/65W/DDR4-2400	Intel HD 630	Open	2x8GB UDIMM DDR4-2400 Non-ECC	Open	1x256GB Opal	HH DVD±RW	9-in-1	250W Bronze Fixed	None	USB full/USB opt	Win10 Pro64	3-year	No	04/17
30BH002LUS	P320 Tower	US	Core i7-7700 4C/3.6GHz/8MB/65W/DDR4-2400	Intel HD 630	Quadro P2000 5GB	2x8GB UDIMM DDR4-2400 Non-ECC	Open	1x512GB Opal	HH DVD±RW	9-in-1	250W Bronze Fixed	None	USB full/USB opt	Win10 Pro64	3-year	No	04/17
30BH002MUS	P320 Tower	US	Core i7-7700 4C/3.6GHz/8MB/65W/DDR4-2400	Intel HD 630	Quadro P2000 5GB	2x8GB UDIMM DDR4-2400 Non-ECC	1x2TB HDD 7.2K 3.5" SATA6Gbs	1x512GB Opal	HH DVD±RW	9-in-1	250W Bronze Fixed	None	USB full/USB opt	Win10 Pro64	3-year	No	04/17
30BH002NUS	P320 Tower	US	Xeon E3-1230 v6 4C/3.5GHz/8MB/72W/DDR4-2400	None	Quadro P400 2GB	1x8GB UDIMM DDR4-2400 Non-ECC	1x1TB HDD 7.2K 3.5" SATA6Gbs	None	HH DVD±RW	9-in-1	250W Bronze Fixed	None	USB full/USB opt	Win10 Pro64	3-year	No	04/17
30BH002PUS	P320 Tower	US	Core i7-7700 4C/3.6GHz/8MB/65W/DDR4-2400	Intel HD 630	Open	2x8GB UDIMM DDR4-2400 Non-ECC	Open	1x1TB Opal	HH DVD±RW	9-in-1	250W Bronze Fixed	None	USB full/USB opt	Win10 Pro64	3-year	No	04/17
30BH002QUS	P320 Tower	US	Core i7-6700 4C/3.4GHz/8MB/65W/DDR4-2133	Intel HD 530	Open	2x8GB UDIMM DDR4-2400 Non-ECC	Open	1x256GB Opal	HH DVD±RW	9-in-1	250W Bronze Fixed	None	USB full/USB opt	Win7 Pro64 (Win10 Pro64 DG)	3-year	No	04/17
30BH002RUS	P320 Tower	US	Core i7-6700 4C/3.4GHz/8MB/65W/DDR4-2133	Intel HD 530	Open	1x8GB UDIMM DDR4-2400 Non-ECC	1x1TB HDD 7.2K 3.5" SATA6Gbs	None	HH DVD±RW	9-in-1	250W Bronze Fixed	None	USB full/USB opt	Win7 Pro64 (Win10 Pro64 DG)	3-year	No	04/17
30BH002SUS	P320 Tower	US	Xeon E3-1245 v6 4C/3.7GHz/8MB/73W/DDR4-2400	Intel HD P630	Open	2x8GB UDIMM DDR4-2400 Non-ECC	Open	1x512GB Opal	HH DVD±RW	9-in-1	250W Bronze Fixed	None	USB full/USB opt	Win10 Pro64	3-year	No	04/17
30BH002TUS	P320 Tower	US	Core i5-7500 4C/3.4GHz/6MB/65W/DDR4-2400	Intel HD 630	Open	1x8GB UDIMM DDR4-2400 Non-ECC	Open	1x256GB Opal	HH DVD±RW	9-in-1	250W Bronze Fixed	None	USB full/USB opt	Win10 Pro64	3-year	No	04/17
30BH002UUS	P320 Tower	US	Core i7-6700 4C/3.4GHz/8MB/65W/DDR4-2133	Intel HD 530	Quadro P2000 5GB	2x8GB UDIMM DDR4-2400 Non-ECC	Open	1x512GB Opal	HH DVD±RW	9-in-1	250W Bronze Fixed	None	USB full/USB opt	Win7 Pro64 (Win10 Pro64 DG)	3-year	No	04/17
30BH002VUS	P320 Tower	US	Xeon E3-1240 v5 4C/3.5GHz/8MB/80W/DDR4-2133	None	Quadro P2000 5GB	2x8GB UDIMM DDR4-2400 Non-ECC	1x1TB HDD 7.2K 3.5" SATA6Gbs	None	HH DVD±RW	9-in-1	250W Bronze Fixed	None	USB full/USB opt	Win7 Pro64 (Win10 Pro64 DG)	3-year	No	04/17
30BH002WUS	P320 Tower	US	Xeon E3-1245 v6 4C/3.7GHz/8MB/73W/DDR4-2400	Intel HD P630	Open	1x8GB UDIMM DDR4-2400 Non-ECC	Open	1x512GB Opal	HH DVD±RW	9-in-1	250W Bronze Fixed	None	USB full/USB opt	Win10 Pro64	3-year	No	04/17
30BH002XUS	P320 Tower	US	Xeon E3-1230 v5 4C/3.4GHz/8MB/80W/DDR4-2133	None	Quadro P400 2GB	1x8GB UDIMM DDR4-2400 Non-ECC	1x1TB HDD 7.2K 3.5" SATA6Gbs	None	HH DVD±RW	9-in-1	250W Bronze Fixed	None	USB full/USB opt	Win7 Pro64 (Win10 Pro64 DG)	3-year	No	04/17

ThinkStation P320 Tower - TopSeller - 30BH - 3 of 4

Product Specifications Reference (PSREF)

Model	Product	Region	Processor	Intel HD Graphics	Discrete Graphics	Memory	Internal Storage	M.2 PCIe SSD	Optical	Media Reader	Power Supply	Add-on Ports	Keyboard / Mouse	Operating System	Warranty	Global	Ann Date (mm/yy)
30BH002YUS	P320 Tower	US	Xeon E3-1270 v6 4C/3.8GHz/8MB/72W/DDR4-2400	None	Quadro P2000 5GB	2x8GB UDIMM DDR4-2400 Non-ECC	Open	1x512GB Opal	HH DVD±RW	9-in-1	250W Bronze Fixed	None	USB full/USB opt	Win10 Pro64	3-year	No	04/17
30BH0030US	P320 Tower	US	Xeon E3-1240 v5 4C/3.5GHz/8MB/80W/DDR4-2133	None	Quadro P2000 5GB	2x8GB UDIMM DDR4-2400 Non-ECC	Open	1x512GB Opal	HH DVD±RW	9-in-1	250W Bronze Fixed	None	USB full/USB opt	Win7 Pro64 (Win10 Pro64 DG)	3-year	No	04/17
30BH0031US	P320 Tower	US	Core i7-6700 4C/3.4GHz/8MB/65W/DDR4-2133	Intel HD 530	Quadro P2000 5GB	2x8GB UDIMM DDR4-2400 Non-ECC	1x2TB HDD 7.2K 3.5" SATA6Gbs	1x512GB Opal	HH DVD±RW	9-in-1	250W Bronze Fixed	None	USB full/USB opt	Win7 Pro64 (Win10 Pro64 DG)	3-year	No	04/17
30BH0032US	P320 Tower	US	Xeon E3-1240 v6 4C/3.7GHz/8MB/72W/DDR4-2400	None	Quadro P600 2GB	1x8GB UDIMM DDR4-2400 Non-ECC	1x1TB HDD 7.2K 3.5" SATA6Gbs	None	HH DVD±RW	9-in-1	250W Bronze Fixed	None	USB full/USB opt	Win10 Pro64	3-year	No	04/17
30BH0033US	P320 Tower	US	Xeon E3-1245 v5 4C/3.5GHz/8MB/80W/DDR4-2133	Intel HD P530	Open	2x8GB UDIMM DDR4-2400 Non-ECC	Open	1x512GB Opal	HH DVD±RW	9-in-1	250W Bronze Fixed	None	USB full/USB opt	Win7 Pro64 (Win10 Pro64 DG)	3-year	No	04/17
30BH0034US	P320 Tower	US	Core i7-6700 4C/3.4GHz/8MB/65W/DDR4-2133	Intel HD 530	Open	2x8GB UDIMM DDR4-2400 Non-ECC	Open	1x512GB Opal	HH DVD±RW	9-in-1	250W Bronze Fixed	None	USB full/USB opt	Win7 Pro64 (Win10 Pro64 DG)	3-year	No	04/17
30BH0035US	P320 Tower	US	Core i7-7700K 4C/4.2GHz/8MB/91W/DDR4-2400	Intel HD 630	Quadro P1000 4GB	1x8GB UDIMM DDR4-2400 Non-ECC	1x1TB SSD 2.5" SATA6Gbs Opal	None	HH DVD±RW	9-in-1	250W Bronze Fixed	None	USB full/USB opt	Win10 Pro64	3-year	No	04/17
30BH0036US	P320 Tower	US	Xeon E3-1245 v6 4C/3.7GHz/8MB/73W/DDR4-2400	Intel HD P630	Open	2x8GB UDIMM DDR4-2400 ECC	Open	1x512GB Opal	HH DVD±RW	9-in-1	250W Bronze Fixed	None	USB full/USB opt	Win10 Pro64	3-year	No	04/17
30BH0037US	P320 Tower	US	Core i5-7500 4C/3.4GHz/6MB/65W/DDR4-2400	Intel HD 630	Quadro P600 2GB	1x8GB UDIMM DDR4-2400 Non-ECC	1x512GB SSD 2.5" SATA6Gbs Opal	None	HH DVD±RW	9-in-1	250W Bronze Fixed	None	USB full/USB opt	Win10 Pro64	3-year	No	04/17
30BH0038US	P320 Tower	US	Core i7-7700K 4C/4.2GHz/8MB/91W/DDR4-2400	Intel HD 630	Quadro P400 2GB	1x8GB UDIMM DDR4-2400 Non-ECC	1x1TB SSD 2.5" SATA6Gbs Opal	None	HH DVD±RW	9-in-1	250W Bronze Fixed	None	USB full/USB opt	Win10 Pro64	3-year	No	04/17
30BH0039US	P320 Tower	US	Core i3-7100 2C/3.9GHz/3MB/51W/DDR4-2400	Intel HD 630	Quadro P600 2GB	1x8GB UDIMM DDR4-2400 Non-ECC	1x1TB HDD 7.2K 3.5" SATA6Gbs	None	HH DVD±RW	9-in-1	250W Bronze Fixed	None	USB full/USB opt	Win10 Pro64	3-year	No	04/17
30BH003AUS	P320 Tower	US	Core i7-7700 4C/3.6GHz/8MB/65W/DDR4-2400	Intel HD 630	Quadro P600 2GB	1x8GB UDIMM DDR4-2400 Non-ECC	1x512GB SSD 2.5" SATA6Gbs Opal	None	HH DVD±RW	9-in-1	250W Bronze Fixed	None	USB full/USB opt	Win10 Pro64	3-year	No	04/17
30BH003BUS	P320 Tower	US	Core i7-7700K 4C/4.2GHz/8MB/91W/DDR4-2400	Intel HD 630	Quadro P600 2GB	1x8GB UDIMM DDR4-2400 Non-ECC	1x1TB SSD 2.5" SATA6Gbs Opal	None	HH DVD±RW	9-in-1	250W Bronze Fixed	None	USB full/USB opt	Win10 Pro64	3-year	No	04/17
30BH003CUS	P320 Tower	US	Core i7-7700 4C/3.6GHz/8MB/65W/DDR4-2400	Intel HD 630	Quadro P600 2GB	1x8GB UDIMM DDR4-2400 Non-ECC	1x1TB HDD 7.2K 3.5" SATA6Gbs	None	HH DVD±RW	9-in-1	250W Bronze Fixed	None	USB full/USB opt	Win10 Pro64	3-year	No	04/17
30BH003DUS	P320 Tower	US	Core i5-7500 4C/3.4GHz/6MB/65W/DDR4-2400	Intel HD 630	Quadro P600 2GB	1x8GB UDIMM DDR4-2400 Non-ECC	1x1TB HDD 7.2K 3.5" SATA6Gbs	None	HH DVD±RW	9-in-1	250W Bronze Fixed	None	USB full/USB opt	Win10 Pro64	3-year	No	04/17

Model	Product	Region	Processor	Intel HD Graphics	Discrete Graphics	Memory	Internal Storage	M.2 PCIe SSD	Optical	Media Reader	Power Supply	Add-on Ports	Keyboard / Mouse	Operating System	Warranty	Global	Ann Date (mm/yy)
30BH003EUS	P320 Tower	US	Core i3-7100 2C/3.9GHz/3MB/51W/DDR4-2400	Intel HD 630	Quadro P600 2GB	1x8GB UDIMM DDR4-2400 Non-ECC	1x512GB SSD 2.5" SATA6Gbs Opal	None	HH DVD±RW	9-in-1	250W Bronze Fixed	None	USB full/USB opt	Win10 Pro64	3-year	No	04/17

ThinkStation P410 Platform Specifications

Product Specifications Reference (PSREF)

Components	Specification																																																																																																						
Chipset	Intel C612 Platform Controller Hub (PCH)																																																																																																						
System mgmt	Intel Active Management Technology 9																																																																																																						
Processor	Up to one 140W Intel Xeon E5-1600 v4 family processors. Some Intel Xeon E5-2600 v4 processors are also available:																																																																																																						
	E5-2637 v4	4C/3.5GHz/15MB/135W/DDR4-2400																																																																																																					
	E5-2623 v4	4C/2.6GHz/10MB/85W/DDR4-2133																																																																																																					
	E5-2620 v4	8C/2.1GHz/20MB/85W/DDR4-2133																																																																																																					
	E5-1680 v4	8C/3.4GHz/20MB/140W/DDR4-2400 333																																																																																																					
	E5-1660 v4	8C/3.2GHz/20MB/140W/DDR4-2400																																																																																																					
	E5-1650 v4	6C/3.6GHz/15MB/140W/DDR4-2400																																																																																																					
	E5-1630 v4	4C/3.7GHz/10MB/140W/DDR4-2400																																																																																																					
	E5-1620 v4	4C/3.5GHz/10MB/140W/DDR4-2400																																																																																																					
Coprocessor	None																																																																																																						
	None																																																																																																						
Memory DIMM slots	4 DIMM sockets. 4-channel capable. RDIMM. ECC. DDR4-2400																																																																																																						
Memory capacity	128GB (32GB x 4)																																																																																																						
Graphics	Two PCIe 3.0 x16 slots, up to two NVIDIA Quadro M4000, or up to one Quadro P5000																																																																																																						
Supporting Graphics and GPU computing	<table border="1"> <thead> <tr> <th>Adapter</th> <th>Cores</th> <th>Memory</th> <th>Power</th> <th>Connector***</th> <th>SLI</th> </tr> </thead> <tbody> <tr> <td>NVS 310</td> <td>48</td> <td>1GB</td> <td>19.5W</td> <td>2xDP</td> <td></td> </tr> <tr> <td>NVS 315</td> <td>48</td> <td>1GB</td> <td>19.5W</td> <td>2xDVI-I SL/2xDP</td> <td></td> </tr> <tr> <td>NVS 510</td> <td>192</td> <td>2GB</td> <td>35W</td> <td>4xmini DP</td> <td></td> </tr> <tr> <td>NVS 810</td> <td>1024</td> <td>4GB</td> <td>68W</td> <td>8xmini DP</td> <td></td> </tr> <tr> <td>Quadro K420</td> <td>192</td> <td>2GB</td> <td>41W</td> <td>DVI-I DL+DP</td> <td></td> </tr> <tr> <td>Quadro K620</td> <td>384</td> <td>2GB</td> <td>45W</td> <td>DVI-I DL+DP</td> <td></td> </tr> <tr> <td>Quadro K1200</td> <td>512</td> <td>4GB</td> <td>45W</td> <td>4xmini DP</td> <td></td> </tr> <tr> <td>Quadro M2000</td> <td>768</td> <td>4GB</td> <td>75W</td> <td>4xDP</td> <td></td> </tr> <tr> <td>Quadro M4000</td> <td>1664</td> <td>8GB</td> <td>120W</td> <td>4xDP</td> <td></td> </tr> <tr> <td>Quadro M5000</td> <td>2048</td> <td>8GB</td> <td>150W</td> <td>DVI-I DL+4xDP</td> <td></td> </tr> <tr> <td>Quadro P400</td> <td>256</td> <td>2GB</td> <td>30W</td> <td>3xminiDP</td> <td></td> </tr> <tr> <td>Quadro P600</td> <td>384</td> <td>2GB</td> <td>40W</td> <td>4xminiDP</td> <td></td> </tr> <tr> <td>Quadro P1000</td> <td>640</td> <td>4GB</td> <td>47W</td> <td>4xminiDP</td> <td></td> </tr> <tr> <td>Quadro P2000</td> <td>1024</td> <td>5GB</td> <td>75W</td> <td>4xDP</td> <td></td> </tr> <tr> <td>Quadro P4000</td> <td>1792</td> <td>8GB</td> <td>105W</td> <td>4xDP</td> <td>SLI</td> </tr> <tr> <td>Quadro P5000</td> <td>2560</td> <td>16GB</td> <td>180W</td> <td>DVI-D DL+4xDP</td> <td></td> </tr> </tbody> </table>	Adapter	Cores	Memory	Power	Connector***	SLI	NVS 310	48	1GB	19.5W	2xDP		NVS 315	48	1GB	19.5W	2xDVI-I SL/2xDP		NVS 510	192	2GB	35W	4xmini DP		NVS 810	1024	4GB	68W	8xmini DP		Quadro K420	192	2GB	41W	DVI-I DL+DP		Quadro K620	384	2GB	45W	DVI-I DL+DP		Quadro K1200	512	4GB	45W	4xmini DP		Quadro M2000	768	4GB	75W	4xDP		Quadro M4000	1664	8GB	120W	4xDP		Quadro M5000	2048	8GB	150W	DVI-I DL+4xDP		Quadro P400	256	2GB	30W	3xminiDP		Quadro P600	384	2GB	40W	4xminiDP		Quadro P1000	640	4GB	47W	4xminiDP		Quadro P2000	1024	5GB	75W	4xDP		Quadro P4000	1792	8GB	105W	4xDP	SLI	Quadro P5000	2560	16GB	180W	DVI-D DL+4xDP	
	Adapter	Cores	Memory	Power	Connector***	SLI																																																																																																	
	NVS 310	48	1GB	19.5W	2xDP																																																																																																		
	NVS 315	48	1GB	19.5W	2xDVI-I SL/2xDP																																																																																																		
	NVS 510	192	2GB	35W	4xmini DP																																																																																																		
	NVS 810	1024	4GB	68W	8xmini DP																																																																																																		
	Quadro K420	192	2GB	41W	DVI-I DL+DP																																																																																																		
	Quadro K620	384	2GB	45W	DVI-I DL+DP																																																																																																		
	Quadro K1200	512	4GB	45W	4xmini DP																																																																																																		
	Quadro M2000	768	4GB	75W	4xDP																																																																																																		
	Quadro M4000	1664	8GB	120W	4xDP																																																																																																		
	Quadro M5000	2048	8GB	150W	DVI-I DL+4xDP																																																																																																		
	Quadro P400	256	2GB	30W	3xminiDP																																																																																																		
	Quadro P600	384	2GB	40W	4xminiDP																																																																																																		
	Quadro P1000	640	4GB	47W	4xminiDP																																																																																																		
	Quadro P2000	1024	5GB	75W	4xDP																																																																																																		
	Quadro P4000	1792	8GB	105W	4xDP	SLI																																																																																																	
Quadro P5000	2560	16GB	180W	DVI-D DL+4xDP																																																																																																			
Disk drive controller	RAID 0, 1, 5, 10 with onboard SATA controller in chipset, SATA 6Gb/s. Optional RAID 0, 1, 10 with optional LSI 9340-8i PCIe adapter, 12Gb/s SAS and SATA, optional upgrade to RAID 5 is available																																																																																																						
Drive Bays	Two external 5.25" flex bays, two internal 3.5" bays. Up to one 9.5mm optical plus four 3.5"/2.5" disk drives plus three M.2 PCIe SSD (see right)																																																																																																						
Supporting storage	3.5" HDD, 7.2K SATA6Gbs	500GB/1TB/2TB/3TB/4TB/6TB, 1TB/2TB hybrid																																																																																																					
	2.5" HDD, 10K SAS12Gbs	300GB/600GB																																																																																																					
	2.5" SSD, SATA6Gbs	180GB/240GB/256GB/480GB/512GB with OPAL, 256GB/512GB/1TB without OPAL																																																																																																					
	PCIe SSD, M.2 via PCIe 3.0 x4 adapter	256GB/512GB/1TB, NVMe																																																																																																					
Flex connector	None																																																																																																						
Network interfaces	One onboard gigabit ethernet, Intel I218LM, supports Wake-on-LAN. Optional discrete ethernet adapters are available																																																																																																						
HD Audio	Realtek ALC662 codec																																																																																																						
TPM	TCG 1.2-compliant																																																																																																						
Power supply	One fixed 450 watts, autosensing, 92%, 80 PLUS Platinum qualified																																																																																																						
Front ports	Two USB 3.0, microphone (3.5mm), headphone (3.5mm)																																																																																																						
Rear ports	Two USB 2.0, four USB 3.0, one ethernet (RJ-45), three analog audio ports (line-in, line-out, mic-in)																																																																																																						

Components	Specification	
Additional ports	Supports the following optional ports: Two IEEE 1394 (one on rear and one on front flex module) via PCIe adapter, up to one adapter per system. Two rear USB 3.0 per PCIe adapter, up to three adapters per system. One rear Thunderbolt via PCIe adapter, or two front Thunderbolt (on flex module) via PCIe adapter, front and rear Thunderbolt cannot be intermixed. One rear serial via cable, up to one per system. One front eSATA (on flex module), or one rear eSATA via cable and PCIe slot bracket, up to one eSATA port per system	
Media reader	9-in-1 USB 2.0 card reader. Optional 29-in-1 USB 2.0 card reader on flex module	
Mechanical	<ul style="list-style-type: none"> 6.89"W x 16.77"D x 14.8"H 175mm W x 426mm D x 376mm H 30.86 lb (14kg) max configuration 25-liter 	
Environmental specification	Temperature - operating	50 °F to 95 °F (10 °C to 35 °C)
	Temperature - non operating (no package)	14 °F to 140 °F (-10 °C to 60 °C)
	Temperature - non operating (with package)	-40 °F to 140 °F (-40 °C to 60 °C)
	Altitude - operating	(Unpressurized): 0-10000ft (0-3048m)
	Humidity - operating	10%-80%, non-condensing
	Humidity - storage (with package)	10%-90%, non-condensing
	RoHS-compliant, GREENGUARD on all models. EPEAT Gold rating, ENERGY STAR 6.1 qualified on selected models.	
Base warranty	1 or 3-year limited onsite service with 9x5/NBD	
ISV certifications	Please visit www.thinkworkstations.com/isv-certifications/	

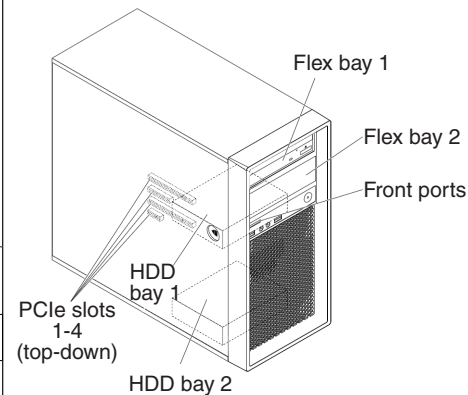

Expansion slots

Slot 1	PCIe 3.0 x16, full length, full height
Slot 2	PCIe 3.0 x8, full length, full height
Slot 3	PCIe 3.0 x16, full length, full height
Slot 4	PCIe 2.0 x4, half length, full height

Drive Bays

HDD bay 1	3.5", for one 3.5"/2.5" drive
HDD bay 2	3.5", for one 3.5"/2.5" drive
Flex bay 1	HH optical, or 3.5" HDD bay via optional conversion kit, or slim optical+3.5" HDD bay kit via optional conversion kit, or flex module
Flex bay 2	HH optical, or 3.5" HDD bay via optional conversion kit, or slim optical+3.5" HDD bay kit via optional conversion kit, or flex module

Note:

- HDD bay 2 is not available when one Quadro M5000, two Quadro M4000, or two NVS 810 are used.
- Flex module supports one or more of the following options: 9.5mm optical/29-in-1 USB 2.0 reader/one front IEEE 1394/one front eSATA/two front Thunderbolt. Up to one flex module is supported per system.
- Up to one slim optical+3.5" HDD bay kit is supported per system.

Model	Region	Processor	Graphics	Memory (Capacity/Type)	RAID Controller	Storage (Capacity/Type/Interface)	Optical	Media Reader	Power Supply	Add-on Ports	Discrete Ethernet	Chassis Intrusion Switch	Keyboard / Mouse	Operating System	Warranty	Ann Date (mm/yy)
30B3001PUS	US	Xeon E5-1620 v4 4C/3.5GHz/10MB/140W/DDR4-2400	NVIDIA Quadro K620 2GB	1x8GB RDIMM DDR4-2400 ECC	Onboard	1x256GB SSD M.2 PCIe Opal	HH DVD±RW	9-in-1	450W 92%	None	None	Switch	USB / USB Optical	Windows 10 Pro 64	3-year	06/16
30B3001QUS	US	Xeon E5-1607 v4 4C/3.1GHz/10MB/140W/DDR4-2133	Open	1x8GB RDIMM DDR4-2400 ECC	Onboard	1x1TB HDD 7.2K 3.5" SATA6Gbs	HH DVD±RW	9-in-1	450W 92%	None	None	Switch	USB / USB Optical	Windows 10 Pro 64	3-year	06/16
30B3001RUS	US	Xeon E5-1630 v4 4C/3.7GHz/10MB/140W/DDR4-2400	NVIDIA Quadro K1200 4GB	1x8GB RDIMM DDR4-2400 ECC	Onboard	1x256GB SSD M.2 PCIe Opal	HH DVD±RW	9-in-1	450W 92%	None	None	Switch	USB / USB Optical	Windows 10 Pro 64	3-year	06/16
30B3001SUS	US	Xeon E5-1630 v4 4C/3.7GHz/10MB/140W/DDR4-2400	NVIDIA Quadro M2000 4GB	2x8GB RDIMM DDR4-2400 ECC	Onboard	1x256GB SSD 2.5" SATA6Gbs Opal	HH DVD±RW	9-in-1	450W 92%	None	None	Switch	USB / USB Optical	Windows 10 Pro 64	3-year	06/16
30B3001TUS	US	Xeon E5-1620 v4 4C/3.5GHz/10MB/140W/DDR4-2400	NVIDIA Quadro K620 2GB	2x8GB RDIMM DDR4-2400 ECC	Onboard	1x1TB SSD 2.5" SATA6Gbs	HH DVD±RW	9-in-1	450W 92%	None	None	Switch	USB / USB Optical	Windows 10 Pro 64	3-year	06/16
30B3001UUS	US	Xeon E5-1620 v4 4C/3.5GHz/10MB/140W/DDR4-2400	Open	1x8GB RDIMM DDR4-2400 ECC	Onboard	1x1TB HDD 7.2K 3.5" SATA6Gbs	HH DVD±RW	9-in-1	450W 92%	None	None	Switch	USB / USB Optical	Windows 10 Pro 64	3-year	06/16
30B3001VUS	US	Xeon E5-1650 v4 6C/3.6GHz/15MB/140W/DDR4-2400	NVIDIA Quadro M2000 4GB	2x8GB RDIMM DDR4-2400 ECC	Onboard	1x256GB SSD 2.5" SATA6Gbs Opal	HH DVD±RW	9-in-1	450W 92%	None	None	Switch	USB / USB Optical	Windows 10 Pro 64	3-year	06/16
30B3001WUS	US	Xeon E5-1620 v4 4C/3.5GHz/10MB/140W/DDR4-2400	NVIDIA Quadro K620 2GB	1x8GB RDIMM DDR4-2400 ECC	Onboard	1x1TB HDD 7.2K 3.5" SATA6Gbs	HH DVD±RW	9-in-1	450W 92%	None	None	Switch	USB / USB Optical	Windows 10 Pro 64	3-year	06/16
30B3001XUS	US	Xeon E5-1630 v4 4C/3.7GHz/10MB/140W/DDR4-2400	NVIDIA Quadro K620 2GB	2x8GB RDIMM DDR4-2400 ECC	Onboard	1x256GB SSD 2.5" SATA6Gbs Opal	HH DVD±RW	9-in-1	450W 92%	None	None	Switch	USB / USB Optical	Windows 10 Pro 64	3-year	06/16
30B3001YUS	US	Xeon E5-1650 v4 6C/3.6GHz/15MB/140W/DDR4-2400	NVIDIA Quadro M4000 8GB	2x8GB RDIMM DDR4-2400 ECC	Onboard	1x1TB SSD 2.5" SATA6Gbs	HH DVD±RW	9-in-1	450W 92%	None	None	Switch	USB / USB Optical	Windows 10 Pro 64	3-year	06/16
30B30020US	US	Xeon E5-1650 v4 6C/3.6GHz/15MB/140W/DDR4-2400	Open	2x8GB RDIMM DDR4-2400 ECC	Onboard	1x1TB HDD 7.2K 3.5" SATA6Gbs	HH DVD±RW	9-in-1	450W 92%	None	None	Switch	USB / USB Optical	Windows 10 Pro 64	3-year	06/16
30B30021US	US	Xeon E5-1620 v4 4C/3.5GHz/10MB/140W/DDR4-2400	NVIDIA Quadro K1200 4GB	1x8GB RDIMM DDR4-2400 ECC	Onboard	1x256GB SSD M.2 PCIe Opal	HH DVD±RW	9-in-1	450W 92%	None	None	Switch	USB / USB Optical	Windows 10 Pro 64	3-year	06/16
30B30022US	US	Xeon E5-1650 v4 6C/3.6GHz/15MB/140W/DDR4-2400	NVIDIA Quadro K1200 4GB	2x8GB RDIMM DDR4-2400 ECC	Onboard	1x512GB SSD M.2 PCIe	HH DVD±RW	9-in-1	450W 92%	None	None	Switch	USB / CadMouse	Windows 10 Pro 64	3-year	06/16
30B3002AUS	US	Xeon E5-1607 v4 4C/3.1GHz/10MB/140W/DDR4-2133	Open	1x8GB RDIMM DDR4-2400 ECC	Onboard	1x1TB HDD 7.2K 3.5" SATA6Gbs	HH DVD±RW	9-in-1	450W 92%	None	None	Switch	USB / USB Optical	Windows 10 DG Windows 7 Pro 64	3-year	09/16
30B3002HUS	US	Xeon E5-1620 v4 4C/3.5GHz/10MB/140W/DDR4-2400	Open	1x8GB RDIMM DDR4-2400 ECC	Onboard	1x1TB HDD 7.2K 3.5" SATA6Gbs	HH DVD±RW	9-in-1	450W 92%	None	None	Switch	USB / USB Optical	Windows 10 DG Windows 7 Pro 64	3-year	09/16

Model	Region	Processor	Graphics	Memory (Capacity/Type)	RAID Controller	Storage (Capacity/Type/Interface)	Optical	Media Reader	Power Supply	Add-on Ports	Discrete Ethernet	Chassis Intrusion Switch	Keyboard / Mouse	Operating System	Warranty	Ann Date (mm/yy)
30B3003KUS	US	Xeon E5-1620 v4 4C/3.5GHz/10MB/140W/DDR4-2400	NVIDIA Quadro K620 2GB	1x8GB RDIMM DDR4-2400 ECC	Onboard	1x256GB SSD M.2 PCIe Opal	HH DVD±RW	9-in-1	450W 92%	None	None	Switch	USB / USB Optical	Windows 10 DG Windows 7 Pro 64	3-year	09/16
30B3003LUS	US	Xeon E5-1620 v4 4C/3.5GHz/10MB/140W/DDR4-2400	NVIDIA Quadro K620 2GB	2x8GB RDIMM DDR4-2400 ECC	Onboard	1x1TB SSD 2.5" SATA6Gbs	HH DVD±RW	9-in-1	450W 92%	None	None	Switch	USB / USB Optical	Windows 10 DG Windows 7 Pro 64	3-year	09/16
30B3003MUS	US	Xeon E5-1630 v4 4C/3.7GHz/10MB/140W/DDR4-2400	NVIDIA Quadro K620 2GB	2x8GB RDIMM DDR4-2400 ECC	Onboard	1x256GB SSD 2.5" SATA6Gbs Opal	HH DVD±RW	9-in-1	450W 92%	None	None	Switch	USB / USB Optical	Windows 10 DG Windows 7 Pro 64	3-year	09/16
30B3003NUS	US	Xeon E5-1650 v4 6C/3.6GHz/15MB/140W/DDR4-2400	NVIDIA Quadro M4000 8GB	2x8GB RDIMM DDR4-2400 ECC	Onboard	1x1TB SSD 2.5" SATA6Gbs	HH DVD±RW	9-in-1	450W 92%	None	None	Switch	USB / USB Optical	Windows 10 DG Windows 7 Pro 64	3-year	09/16
30B3003PUS	US	Xeon E5-1620 v4 4C/3.5GHz/10MB/140W/DDR4-2400	NVIDIA Quadro K620 2GB	1x8GB RDIMM DDR4-2400 ECC	Onboard	1x1TB HDD 7.2K 3.5" SATA6Gbs	HH DVD±RW	9-in-1	450W 92%	None	None	Switch	USB / USB Optical	Windows 10 DG Windows 7 Pro 64	3-year	09/16
30B3003QUS	US	Xeon E5-1650 v4 6C/3.6GHz/15MB/140W/DDR4-2400	NVIDIA Quadro K1200 4GB	2x8GB RDIMM DDR4-2400 ECC	Onboard	1x512GB SSD M.2 PCIe	HH DVD±RW	9-in-1	450W 92%	None	None	Switch	USB / CadMouse	Windows 10 DG Windows 7 Pro 64	3-year	09/16
30B3003RUS	US	Xeon E5-1650 v4 6C/3.6GHz/15MB/140W/DDR4-2400	Open	2x8GB RDIMM DDR4-2400 ECC	Onboard	1x1TB HDD 7.2K 3.5" SATA6Gbs	HH DVD±RW	9-in-1	450W 92%	None	None	Switch	USB / USB Optical	Windows 10 DG Windows 7 Pro 64	3-year	09/16
30B3003SUS	US	Xeon E5-1630 v4 4C/3.7GHz/10MB/140W/DDR4-2400	NVIDIA Quadro M2000 4GB	2x8GB RDIMM DDR4-2400 ECC	Onboard	1x256GB SSD 2.5" SATA6Gbs Opal	HH DVD±RW	9-in-1	450W 92%	None	None	Switch	USB / USB Optical	Windows 10 DG Windows 7 Pro 64	3-year	09/16
30B3003TUS	US	Xeon E5-1620 v4 4C/3.5GHz/10MB/140W/DDR4-2400	NVIDIA Quadro K1200 4GB	1x8GB RDIMM DDR4-2400 ECC	Onboard	1x256GB SSD M.2 PCIe Opal	HH DVD±RW	9-in-1	450W 92%	None	None	Switch	USB / USB Optical	Windows 10 DG Windows 7 Pro 64	3-year	09/16
30B3003UUS	US	Xeon E5-1650 v4 6C/3.6GHz/15MB/140W/DDR4-2400	NVIDIA Quadro M2000 4GB	2x8GB RDIMM DDR4-2400 ECC	Onboard	1x256GB SSD 2.5" SATA6Gbs Opal	HH DVD±RW	9-in-1	450W 92%	None	None	Switch	USB / USB Optical	Windows 10 DG Windows 7 Pro 64	3-year	09/16
30B3003VUS	US	Xeon E5-1630 v4 4C/3.7GHz/10MB/140W/DDR4-2400	NVIDIA Quadro K1200 4GB	1x8GB RDIMM DDR4-2400 ECC	Onboard	1x256GB SSD M.2 PCIe Opal	HH DVD±RW	9-in-1	450W 92%	None	None	Switch	USB / USB Optical	Windows 10 DG Windows 7 Pro 64	3-year	09/16
30B3004JUS	US	Xeon E5-1630 v4 4C/3.7GHz/10MB/140W/DDR4-2400	NVIDIA Quadro M2000 4GB	2x16GB RDIMM DDR4-2400 ECC	Onboard	1x512GB SSD 2.5" SATA6Gbs+1x256GB SSD M.2 PCIe Opal	None	None	450W 92%	None	None	Switch	USB / USB Optical	Windows 10 DG Windows 7 Pro 64	3-year	09/16
30B3004MUS	US	Xeon E5-1620 v4 4C/3.5GHz/10MB/140W/DDR4-2400	NVIDIA Quadro K1200 4GB	2x8GB RDIMM DDR4-2400 ECC	Onboard	1x1TB SSD M.2 PCIe NVMe Opal	HH DVD±RW	9-in-1	450W 92%	None	None	Switch	USB / USB Optical	Windows 10 DG Windows 7 Pro 64	3-year	12/16
30B3004NUS	US	Xeon E5-1620 v4 4C/3.5GHz/10MB/140W/DDR4-2400	Open	2x8GB RDIMM DDR4-2400 ECC	Onboard	1x1TB SSD M.2 PCIe NVMe Opal	HH DVD±RW	9-in-1	450W 92%	None	None	Switch	USB / USB Optical	Windows 10 DG Windows 7 Pro 64	3-year	12/16
30B3004PUS	US	Xeon E5-1620 v4 4C/3.5GHz/10MB/140W/DDR4-2400	Open	2x8GB RDIMM DDR4-2400 ECC	Onboard	1x1TB HDD 7.2K 3.5" SATA6Gbs	HH DVD±RW	9-in-1	450W 92%	None	None	Switch	USB / USB Optical	Windows 10 DG Windows 7 Pro 64	3-year	12/16

Model	Region	Processor	Graphics	Memory (Capacity/Type)	RAID Controller	Storage (Capacity/Type/Interface)	Optical	Media Reader	Power Supply	Add-on Ports	Discrete Ethernet	Chassis Intrusion Switch	Keyboard / Mouse	Operating System	Warranty	Ann Date (mm/yy)
30B3004QUS	US	Xeon E5-1630 v4 4C/3.7GHz/10MB/140W/DDR4-2400	NVIDIA Quadro P5000 16GB	2x8GB RDIMM DDR4-2400 ECC	Onboard	1x1TB SSD M.2 PCIe NVMe Opal	HH DVD±RW	9-in-1	450W 92%	None	None	Switch	USB / USB Optical	Windows 10 DG Windows 7 Pro 64	3-year	12/16
30B3004RUS	US	Xeon E5-1620 v4 4C/3.5GHz/10MB/140W/DDR4-2400	Open	2x8GB RDIMM DDR4-2400 ECC	Onboard	1x1TB HDD 7.2K 3.5" SATA6Gbs	None	9-in-1	450W 92%	None	None	Switch	USB / USB Optical	Windows 10 DG Windows 7 Pro 64	3-year	12/16
30B3004SUS	US	Xeon E5-1630 v4 4C/3.7GHz/10MB/140W/DDR4-2400	Open	2x8GB RDIMM DDR4-2400 ECC	Onboard	1x1TB SSD M.2 PCIe NVMe Opal	HH DVD±RW	9-in-1	450W 92%	None	None	Switch	USB / USB Optical	Windows 10 DG Windows 7 Pro 64	3-year	12/16
30B3004TUS	US	Xeon E5-1650 v4 6C/3.6GHz/15MB/140W/DDR4-2400	Open	2x8GB RDIMM DDR4-2400 ECC	Onboard	1x1TB SSD M.2 PCIe NVMe Opal	HH DVD±RW	9-in-1	450W 92%	None	None	Switch	USB / USB Optical	Windows 10 DG Windows 7 Pro 64	3-year	12/16
30B3004UUS	US	Xeon E5-1620 v4 4C/3.5GHz/10MB/140W/DDR4-2400	Open	2x8GB RDIMM DDR4-2400 ECC	9340-8i PCIe	1x256GB SSD M.2 PCIe Opal	HH DVD±RW	9-in-1	450W 92%	None	None	Switch	USB / USB Optical	Windows 10 DG Windows 7 Pro 64	3-year	12/16
30B3004VUS	US	Xeon E5-1607 v4 4C/3.1GHz/10MB/140W/DDR4-2133	Open	2x8GB RDIMM DDR4-2400 ECC	Onboard	1x1TB SSD M.2 PCIe NVMe Opal	HH DVD±RW	9-in-1	450W 92%	None	None	Switch	USB / USB Optical	Windows 10 DG Windows 7 Pro 64	3-year	12/16
30B3005SUS	US	Xeon E5-1630 v4 4C/3.7GHz/10MB/140W/DDR4-2400	Quadro P600 2GB	2x8GB RDIMM DDR4-2400 ECC	Onboard	1x256GB SSD 2.5" SATA6Gbs Opal	HH DVD±RW	9-in-1	450W 92%	None	None	Switch	USB / USB Optical	Windows 10 DG Windows 7 Pro 64	3-year	04/17
30B3005TUS	US	Xeon E5-1630 v4 4C/3.7GHz/10MB/140W/DDR4-2400	Quadro P1000 4GB	1x8GB RDIMM DDR4-2400 ECC	Onboard	1x256GB SSD M.2 PCIe Opal	HH DVD±RW	9-in-1	450W 92%	None	None	Switch	USB / USB Optical	Windows 10 DG Windows 7 Pro 64	3-year	04/17
30B3005UUS	US	Xeon E5-1620 v4 4C/3.5GHz/10MB/140W/DDR4-2400	Quadro P600 2GB	2x8GB RDIMM DDR4-2400 ECC	Onboard	1x1TB SSD 2.5" SATA6Gbs	HH DVD±RW	9-in-1	450W 92%	None	None	Switch	USB / USB Optical	Windows 10 DG Windows 7 Pro 64	3-year	04/17
30B3005VUS	US	Xeon E5-1620 v4 4C/3.5GHz/10MB/140W/DDR4-2400	Quadro P600 2GB	1x8GB RDIMM DDR4-2400 ECC	Onboard	1x1TB HDD 7.2K 3.5" SATA6Gbs	HH DVD±RW	9-in-1	450W 92%	None	None	Switch	USB / USB Optical	Windows 10 DG Windows 7 Pro 64	3-year	04/17
30B3005WUS	US	Xeon E5-1630 v4 4C/3.7GHz/10MB/140W/DDR4-2400	Quadro P2000 5GB	2x8GB RDIMM DDR4-2400 ECC	Onboard	1x256GB SSD 2.5" SATA6Gbs Opal	HH DVD±RW	9-in-1	450W 92%	None	None	Switch	USB / USB Optical	Windows 10 DG Windows 7 Pro 64	3-year	04/17
30B3005XUS	US	Xeon E5-1630 v4 4C/3.7GHz/10MB/140W/DDR4-2400	Quadro P600 2GB	2x8GB RDIMM DDR4-2400 ECC	Onboard	1x256GB SSD 2.5" SATA6Gbs Opal	HH DVD±RW	9-in-1	450W 92%	None	None	Switch	USB / USB Optical	Windows 10 DG Windows 7 Pro 64	3-year	04/17
30B3005YUS	US	Xeon E5-1630 v4 4C/3.7GHz/10MB/140W/DDR4-2400	Quadro P1000 4GB	1x8GB RDIMM DDR4-2400 ECC	Onboard	1x256GB SSD M.2 PCIe Opal	HH DVD±RW	9-in-1	450W 92%	None	None	Switch	USB / USB Optical	Windows 10 DG Windows 7 Pro 64	3-year	04/17
30B30060US	US	Xeon E5-1620 v4 4C/3.5GHz/10MB/140W/DDR4-2400	Quadro P600 2GB	1x8GB RDIMM DDR4-2400 ECC	Onboard	1x1TB HDD 7.2K 3.5" SATA6Gbs	HH DVD±RW	9-in-1	450W 92%	None	None	Switch	USB / USB Optical	Windows 10 DG Windows 7 Pro 64	3-year	04/17
30B30061US	US	Xeon E5-1650 v4 6C/3.6GHz/15MB/140W/DDR4-2400	Quadro P1000 4GB	2x8GB RDIMM DDR4-2400 ECC	Onboard	1x512GB SSD M.2 PCIe	HH DVD±RW	9-in-1	450W 92%	None	None	Switch	USB / USB Optical	Windows 10 DG Windows 7 Pro 64	3-year	04/17

Model	Region	Processor	Graphics	Memory (Capacity/Type)	RAID Controller	Storage (Capacity/Type/Interface)	Optical	Media Reader	Power Supply	Add-on Ports	Discrete Ethernet	Chassis Intrusion Switch	Keyboard / Mouse	Operating System	Warranty	Ann Date (mm/yy)
30B30062US	US	Xeon E5-1650 v4 6C/3.6GHz/15MB/140W/DDR4-2400	Quadro P4000 8GB	2x8GB RDIMM DDR4-2400 ECC	Onboard	1x1TB SSD 2.5" SATA6Gbs	HH DVD±RW	9-in-1	450W 92%	None	None	Switch	USB / USB Optical	Windows 10 Pro 64	3-year	04/17
30B30063US	US	Xeon E5-1620 v4 4C/3.5GHz/10MB/140W/DDR4-2400	Quadro P1000 4GB	1x8GB RDIMM DDR4-2400 ECC	Onboard	1x256GB SSD M.2 PCIe Opal	HH DVD±RW	9-in-1	450W 92%	None	None	Switch	USB / USB Optical	Windows 10 DG Windows 7 Pro 64	3-year	04/17
30B30064US	US	Xeon E5-1620 v4 4C/3.5GHz/10MB/140W/DDR4-2400	Quadro P1000 4GB	1x8GB RDIMM DDR4-2400 ECC	Onboard	1x256GB SSD M.2 PCIe Opal	HH DVD±RW	9-in-1	450W 92%	None	None	Switch	USB / USB Optical	Windows 10 Pro 64	3-year	04/17
30B30065US	US	Xeon E5-1650 v4 6C/3.6GHz/15MB/140W/DDR4-2400	Quadro P2000 5GB	2x8GB RDIMM DDR4-2400 ECC	Onboard	1x256GB SSD 2.5" SATA6Gbs Opal	HH DVD±RW	9-in-1	450W 92%	None	None	Switch	USB / USB Optical	Windows 10 DG Windows 7 Pro 64	3-year	04/17
30B30066US	US	Xeon E5-1650 v4 6C/3.6GHz/15MB/140W/DDR4-2400	Quadro P2000 5GB	2x8GB RDIMM DDR4-2400 ECC	Onboard	1x256GB SSD 2.5" SATA6Gbs Opal	HH DVD±RW	9-in-1	450W 92%	None	None	Switch	USB / USB Optical	Windows 10 Pro 64	3-year	04/17
30B30067US	US	Xeon E5-1650 v4 6C/3.6GHz/15MB/140W/DDR4-2400	Quadro P4000 8GB	2x8GB RDIMM DDR4-2400 ECC	Onboard	1x1TB SSD 2.5" SATA6Gbs	HH DVD±RW	9-in-1	450W 92%	None	None	Switch	USB / USB Optical	Windows 10 DG Windows 7 Pro 64	3-year	04/17
30B30068US	US	Xeon E5-1620 v4 4C/3.5GHz/10MB/140W/DDR4-2400	Quadro P600 2GB	1x8GB RDIMM DDR4-2400 ECC	Onboard	1x256GB SSD M.2 PCIe Opal	HH DVD±RW	9-in-1	450W 92%	None	None	Switch	USB / USB Optical	Windows 10 Pro 64	3-year	04/17
30B30069US	US	Xeon E5-1630 v4 4C/3.7GHz/10MB/140W/DDR4-2400	Quadro P2000 5GB	2x8GB RDIMM DDR4-2400 ECC	Onboard	1x256GB SSD 2.5" SATA6Gbs Opal	HH DVD±RW	9-in-1	450W 92%	None	None	Switch	USB / USB Optical	Windows 10 Pro 64	3-year	04/17
30B3006AUS	US	Xeon E5-1650 v4 6C/3.6GHz/15MB/140W/DDR4-2400	Quadro P1000 4GB	2x8GB RDIMM DDR4-2400 ECC	Onboard	1x512GB SSD M.2 PCIe	HH DVD±RW	9-in-1	450W 92%	None	None	Switch	USB / USB Optical	Windows 10 Pro 64	3-year	04/17
30B3006BUS	US	Xeon E5-1620 v4 4C/3.5GHz/10MB/140W/DDR4-2400	Quadro P600 2GB	2x8GB RDIMM DDR4-2400 ECC	Onboard	1x1TB SSD 2.5" SATA6Gbs	HH DVD±RW	9-in-1	450W 92%	None	None	Switch	USB / USB Optical	Windows 10 DG Windows 7 Pro 64	3-year	04/17

ThinkStation P510 Platform Specifications

Components	Specification																																																																																																																																										
Chipset	Intel C612 Platform Controller Hub (PCH)																																																																																																																																										
System mgmt	Intel Active Management Technology 9																																																																																																																																										
Processor	Up to one 145W Intel Xeon E5-2600 v4 or E5-1600 v4 family processors. 22 cores up to 2.2GHz, 16 cores up to 2.6GHz, 14 cores up to 2.6GHz, 12 cores up to 2.2GHz, 10 cores up to 2.4GHz, 8 cores up to 3.4GHz, 6 cores up to 3.6GHz, 4 cores up to 3.7GHz Or up to one Intel Xeon E5-2600 v3 or E5-1600 v3 processors (not available in EMEA).																																																																																																																																										
Coprocessor	None																																																																																																																																										
Memory DIMM slots	8 DIMM sockets, 4-channel capable. RDIMM, ECC, DDR4, 2400MHz																																																																																																																																										
Memory capacity	256GB																																																																																																																																										
Graphics, GPU computing	Two PCIe 3.0 x16 slots for graphics and GPU computing adapters. Up to two NVIDIA Quadro M5000 SLI																																																																																																																																										
Supporting Graphics and GPU computing	<table border="1"> <thead> <tr> <th>Adapter</th> <th>Cores</th> <th>Memory</th> <th>Power</th> <th>Connector***</th> <th>SLI</th> </tr> </thead> <tbody> <tr> <td>NVS 310</td> <td>48</td> <td>1GB</td> <td>19.5W</td> <td>2xDP</td> <td></td> </tr> <tr> <td>NVS 315</td> <td>48</td> <td>1GB</td> <td>19.5W</td> <td>2xDVI-I SL/2xDP</td> <td></td> </tr> <tr> <td>NVS 510</td> <td>192</td> <td>2GB</td> <td>35W</td> <td>4xmini DP</td> <td></td> </tr> <tr> <td>NVS 810</td> <td>1024</td> <td>4GB</td> <td>68W</td> <td>8xmini DP</td> <td></td> </tr> <tr> <td>Quadro K420</td> <td>192</td> <td>2GB</td> <td>41W</td> <td>DVI-I DL+DP</td> <td></td> </tr> <tr> <td>Quadro K620</td> <td>384</td> <td>2GB</td> <td>45W</td> <td>DVI-I DL+DP</td> <td></td> </tr> <tr> <td>Quadro K1200</td> <td>512</td> <td>4GB</td> <td>45W</td> <td>4xmini DP</td> <td></td> </tr> <tr> <td>Quadro K2200</td> <td>640</td> <td>4GB</td> <td>68W</td> <td>DVI-I DL+2xDP</td> <td></td> </tr> <tr> <td>Quadro K4200</td> <td>1344</td> <td>4GB</td> <td>108W</td> <td>DVI-I DL+2xDP</td> <td></td> </tr> <tr> <td>Quadro K5200</td> <td>2304</td> <td>8GB</td> <td>150W</td> <td>DVI-I DL+DVI-D DL+2xDP</td> <td>SLI</td> </tr> <tr> <td>Quadro M2000</td> <td>768</td> <td>4GB</td> <td>75W</td> <td>4xDP</td> <td></td> </tr> <tr> <td>Quadro M4000</td> <td>1664</td> <td>8GB</td> <td>120W</td> <td>4xDP</td> <td></td> </tr> <tr> <td>Quadro M5000</td> <td>2048</td> <td>8GB</td> <td>150W</td> <td>DVI-I DL+4xDP</td> <td>SLI</td> </tr> <tr> <td>Quadro M6000</td> <td>3072</td> <td>24GB</td> <td>250W</td> <td>DVI-I DL+4xDP</td> <td></td> </tr> <tr> <td>Quadro P400</td> <td>256</td> <td>2GB</td> <td>30W</td> <td>3xminiDP</td> <td></td> </tr> <tr> <td>Quadro P600</td> <td>384</td> <td>2GB</td> <td>40W</td> <td>4xminiDP</td> <td></td> </tr> <tr> <td>Quadro P1000</td> <td>640</td> <td>4GB</td> <td>47W</td> <td>4xminiDP</td> <td></td> </tr> <tr> <td>Quadro P2000</td> <td>1024</td> <td>5GB</td> <td>75W</td> <td>4xDP</td> <td></td> </tr> <tr> <td>Quadro P4000</td> <td>1792</td> <td>8GB</td> <td>105W</td> <td>4xDP</td> <td>SLI</td> </tr> <tr> <td>Quadro P5000</td> <td>2560</td> <td>16GB</td> <td>180W</td> <td>DVI-D DL+4xDP</td> <td>SLI</td> </tr> <tr> <td>Quadro P6000</td> <td>3840</td> <td>24GB</td> <td>250W</td> <td>DVI-D DL+4xDP</td> <td></td> </tr> <tr> <td>Tesla K40</td> <td>2880</td> <td>12GB</td> <td>235W</td> <td></td> <td></td> </tr> </tbody> </table>	Adapter	Cores	Memory	Power	Connector***	SLI	NVS 310	48	1GB	19.5W	2xDP		NVS 315	48	1GB	19.5W	2xDVI-I SL/2xDP		NVS 510	192	2GB	35W	4xmini DP		NVS 810	1024	4GB	68W	8xmini DP		Quadro K420	192	2GB	41W	DVI-I DL+DP		Quadro K620	384	2GB	45W	DVI-I DL+DP		Quadro K1200	512	4GB	45W	4xmini DP		Quadro K2200	640	4GB	68W	DVI-I DL+2xDP		Quadro K4200	1344	4GB	108W	DVI-I DL+2xDP		Quadro K5200	2304	8GB	150W	DVI-I DL+DVI-D DL+2xDP	SLI	Quadro M2000	768	4GB	75W	4xDP		Quadro M4000	1664	8GB	120W	4xDP		Quadro M5000	2048	8GB	150W	DVI-I DL+4xDP	SLI	Quadro M6000	3072	24GB	250W	DVI-I DL+4xDP		Quadro P400	256	2GB	30W	3xminiDP		Quadro P600	384	2GB	40W	4xminiDP		Quadro P1000	640	4GB	47W	4xminiDP		Quadro P2000	1024	5GB	75W	4xDP		Quadro P4000	1792	8GB	105W	4xDP	SLI	Quadro P5000	2560	16GB	180W	DVI-D DL+4xDP	SLI	Quadro P6000	3840	24GB	250W	DVI-D DL+4xDP		Tesla K40	2880	12GB	235W		
	Adapter	Cores	Memory	Power	Connector***	SLI																																																																																																																																					
	NVS 310	48	1GB	19.5W	2xDP																																																																																																																																						
	NVS 315	48	1GB	19.5W	2xDVI-I SL/2xDP																																																																																																																																						
	NVS 510	192	2GB	35W	4xmini DP																																																																																																																																						
	NVS 810	1024	4GB	68W	8xmini DP																																																																																																																																						
	Quadro K420	192	2GB	41W	DVI-I DL+DP																																																																																																																																						
	Quadro K620	384	2GB	45W	DVI-I DL+DP																																																																																																																																						
	Quadro K1200	512	4GB	45W	4xmini DP																																																																																																																																						
	Quadro K2200	640	4GB	68W	DVI-I DL+2xDP																																																																																																																																						
	Quadro K4200	1344	4GB	108W	DVI-I DL+2xDP																																																																																																																																						
	Quadro K5200	2304	8GB	150W	DVI-I DL+DVI-D DL+2xDP	SLI																																																																																																																																					
	Quadro M2000	768	4GB	75W	4xDP																																																																																																																																						
	Quadro M4000	1664	8GB	120W	4xDP																																																																																																																																						
	Quadro M5000	2048	8GB	150W	DVI-I DL+4xDP	SLI																																																																																																																																					
	Quadro M6000	3072	24GB	250W	DVI-I DL+4xDP																																																																																																																																						
	Quadro P400	256	2GB	30W	3xminiDP																																																																																																																																						
	Quadro P600	384	2GB	40W	4xminiDP																																																																																																																																						
	Quadro P1000	640	4GB	47W	4xminiDP																																																																																																																																						
	Quadro P2000	1024	5GB	75W	4xDP																																																																																																																																						
Quadro P4000	1792	8GB	105W	4xDP	SLI																																																																																																																																						
Quadro P5000	2560	16GB	180W	DVI-D DL+4xDP	SLI																																																																																																																																						
Quadro P6000	3840	24GB	250W	DVI-D DL+4xDP																																																																																																																																							
Tesla K40	2880	12GB	235W																																																																																																																																								
RAID controller	Supports one of the following: RAID 0, 1, 5, 10 with onboard SATA controller in chipset, SATA 6Gb/s. RAID 0, 1, 5, 10 with optional LSI RAID flex adapter, 12Gb/s SAS and SATA. RAID 0, 1, 5, 6, 10 with optional LSI 9364-8i PCIe adapter, 1GB memory, 12Gb/s SAS and SATA																																																																																																																																										
Drive Bays	Two external 5.25" flex bays for flex module, optical drives, or optional disk drives. Four 3.5" internal bays. Each 3.5" bay can support dual drives on selected models (see right).																																																																																																																																										
Flex bay	Two 5.25" flex bays for optical drives, Front Access Storage Enclosure drives, Flex Bay Storage Enclosure drives, or flex module. • Up to two half-height optical drives or up to one 9.5mm optical drive, DVD-ROM, DVD±RW, or Blu-Ray burner • Up to one Front Access Storage Enclosure for one 3.5" or 2.5" SATA drive. • Up to two Flex Bay Storage Enclosure for two 3.5" or 2.5" SATA drives.																																																																																																																																										
Supporting storage	3.5" HDD, 7.2K SATA6Gbs	500GB/1TB/2TB/3TB/4TB/6TB/1TB hybrid/2TB hybrid																																																																																																																																									
	2.5" HDD, 15K SAS12Gbs	300GB/600GB																																																																																																																																									
	2.5" SSD, SAS12Gbs	200GB/400GB/800GB																																																																																																																																									
	2.5" SAS HDD, 10K 12Gbs	300GB																																																																																																																																									
	2.5" SSD, SATA6Gbs	180GB/240GB/256GB/480GB/512GB with OPAL, 256GB/512GB/1TB without OPAL																																																																																																																																									
	PCIe SSD, U.2	400GB																																																																																																																																									
PCIe SSD, M.2	256 GB/512GB/1TB																																																																																																																																										
PCIe SSD adapter	400GB (up to 3 per system)																																																																																																																																										
Flex connector	One flex connector, supports one of the following: • Up to one LSI RAID flex adapter for SATA/SAS RAID • Up to one Multi-I/O flex adapters for one 2.5" PCIe SSD • Up to one M.2 flex adapters for one M.2 PCIe SSD																																																																																																																																										

Components	Specification	
Network interfaces	Integrated one Gigabit Ethernet (Intel i218LM), supports Wake-on-LAN. Optional discrete Ethernet is available	
HD Audio	Realtek ALC662 codec	
TPM	TCG 1.2-compliant	
Power supply	One fixed 490 watts, autosensing, 90%, 80 PLUS Gold qualified. Or one fixed 650 watts, autosensing, 92%, 80 PLUS Platinum qualified	
Front ports	Four USB 3.0 (one Diagnostic, one Always On), one combo audio/microphone jack (3.5mm)	
Rear ports	Four USB 2.0, four USB 3.0, one serial (9-pin), one ethernet (RJ-45), three analog audio ports (line-in, line-out, mic-in), two PS/2	
Add-on ports	Supports the following optional ports: Two IEEE 1394 (one on rear and one on front flex module) via PCIe adapter, up to one adapter per system. Two rear USB 3.0 per PCIe adapter, up to three adapters per system. One rear Thunderbolt via PCIe adapter. One front eSATA (on flex module), or one rear eSATA via cable (also needs one PCIe slot), up to one eSATA port per system. One internal USB 3.0 port via cable, cannot be intermixed with 29-in-1 reader	
Media reader	9-in-1 USB 2.0 or 29-in-1 USB 3.0 card reader	
Mechanical	<ul style="list-style-type: none"> 36-liter: 175mm/6.89" W x 470mm/18.5" D x 440mm/17.32" H (with feet) Tool-less parts: all except CPU fansink 48.94 lb (22.2kg) max configuration 	
Environmental specification	Temperature - operating	50 °F to 95 °F (10 °C to 35 °C)
	Temperature - non operating (no package)	14 °F to 140 °F (-10 °C to 60 °C)
	Temperature - non operating (with package)	-40 °F to 140 °F (-40 °C to 60 °C)
	Altitude - operating	(Unpressurized): 0-10000ft (0-3048m)
Humidity - operating	Humidity - operating	10%-80%, non-condensing
	Humidity - storage (with package)	10%-90%, non-condensing
RoHS-compliant, GREENGUARD on all models. EPEAT Gold rating, ENERGY STAR 6.1 qualified on selected models.		
Base warranty	3-year limited onsite service with 9x5/NBD	
ISV certifications	Please visit www.thinkworkstations.com/isv-certifications/	

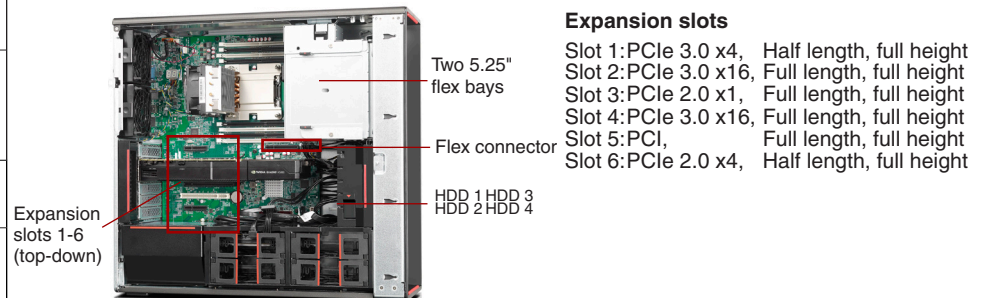

Expansion slots
Slot 1: PCIe 3.0 x4, Half length, full height
Slot 2: PCIe 3.0 x16, Full length, full height
Slot 3: PCIe 2.0 x1, Full length, full height
Slot 4: PCIe 3.0 x16, Full length, full height
Slot 5: PCI, Full length, full height
Slot 6: PCIe 2.0 x4, Half length, full height

Drive Bays
HDD 1-4: Standard 3.5" HDD bay, up to four 3.5" or 2.5" disk drives.
On selected models, each 3.5" bay can supports 2.5" (9mm or less) drive plus 3.5" drive, or two 2.5" (15mm or less) drives.
Flex bay: Two 5.25" flex bays, for HH optical drives.
Or up to one optional flex module (Flex module supports one or more of the following options: 9.5mm optical/29-in-1 USB 3.0 reader/front IEEE 1394/front eSATA).
Or up to two HDD bays for two drives, 3.5" or 2.5" each, SATA only.

Model	Region	Processor	Graphics	Memory (Capacity/Type)	RAID Controller	Max Drives in 3.5" Bays	Storage (Capacity/Type/Interface)	Optical	Media Reader	Power Supply	Add-on Ports	Discrete Ethernet	Keyboard / Mouse	Operating System	Warranty	Ann Date (mm/yy)
30B5000VUS	US	Xeon E5-1650 v4 6C/3.6GHz/ 15MB/140W/DDR4-2400	Open	1x8GB RDIMM DDR4-2400 ECC	Onboard	4	1x1TB HDD 7.2K 3.5" SATA6Gbs	HH DVD±RW	9-in-1	650W 92%	None	None	USB / USB Optical	Windows 10 Pro 64	3-year	06/16
30B50019US	US	Xeon E5-1630 v4 4C/3.7GHz/ 10MB/140W/DDR4-2400	Open	2x8GB RDIMM DDR4-2400 ECC	Onboard	4	1x256GB SSD 2.5" SATA6Gbs Opal	HH DVD±RW	9-in-1	650W 92%	None	None	USB / USB Optical	Windows 10 Pro 64	3-year	06/16
30B5001GUS	US	Xeon E5-1620 v4 4C/3.5GHz/ 10MB/140W/DDR4-2400	NVIDIA Quadro M2000 4GB	1x8GB RDIMM DDR4-2400 ECC	Onboard	4	1x1TB HDD 7.2K 3.5" SATA6Gbs	HH DVD±RW	9-in-1	490W 90%	None	None	USB / USB Optical	Windows 10 Pro 64	3-year	06/16
30B5001HUS	US	Xeon E5-1620 v4 4C/3.5GHz/ 10MB/140W/DDR4-2400	Open	1x8GB RDIMM DDR4-2400 ECC	Onboard	4	1x1TB HDD 7.2K 3.5" SATA6Gbs	HH DVD±RW	9-in-1	650W 92%	None	None	USB / USB Optical	Windows 10 Pro 64	3-year	06/16
30B5001JUS	US	Xeon E5-1620 v4 4C/3.5GHz/ 10MB/140W/DDR4-2400	NVIDIA Quadro M2000 4GB	2x8GB RDIMM DDR4-2400 ECC	Onboard	4	1x512GB SSD 2.5" SATA6Gbs	HH DVD±RW	9-in-1	490W 90%	None	None	USB / USB Optical	Windows 10 Pro 64	3-year	06/16
30B5001KUS	US	Xeon E5-1620 v4 4C/3.5GHz/ 10MB/140W/DDR4-2400	Open	1x8GB RDIMM DDR4-2400 ECC	Onboard	4	1x1TB HDD 7.2K 3.5" SATA6Gbs	HH DVD±RW	9-in-1	490W 90%	None	None	USB / USB Optical	Windows 10 Pro 64	3-year	06/16
30B5001LUS	US	Xeon E5-1607 v4 4C/3.1GHz/ 10MB/140W/DDR4-2133	NVIDIA Quadro K620 2GB	1x8GB RDIMM DDR4-2400 ECC	Onboard	4	1x1TB HDD 7.2K 3.5" SATA6Gbs	HH DVD±RW	9-in-1	490W 90%	None	None	USB / USB Optical	Windows 10 Pro 64	3-year	06/16
30B5001MUS	US	Xeon E5-1607 v4 4C/3.1GHz/ 10MB/140W/DDR4-2133	NVIDIA Quadro K620 2GB	1x8GB RDIMM DDR4-2400 ECC	Onboard	4	1x500GB HDD 7.2K 3.5" SATA6Gbs	HH DVD±RW	9-in-1	490W 90%	None	None	USB / USB Optical	Windows 10 Pro 64	3-year	06/16
30B5001NUS	US	Xeon E5-1630 v4 4C/3.7GHz/ 10MB/140W/DDR4-2400	NVIDIA Quadro M4000 8GB	2x8GB RDIMM DDR4-2400 ECC	Onboard	4	1x512GB SSD 2.5" SATA6Gbs	HH DVD±RW	9-in-1	650W 92%	None	None	USB / USB Optical	Windows 10 Pro 64	3-year	06/16
30B5001PUS	US	Xeon E5-1607 v4 4C/3.1GHz/ 10MB/140W/DDR4-2133	Open	1x8GB RDIMM DDR4-2400 ECC	Onboard	4	1x1TB HDD 7.2K 3.5" SATA6Gbs	HH DVD±RW	9-in-1	490W 90%	None	None	USB / USB Optical	Windows 10 Pro 64	3-year	06/16
30B5001QUS	US	Xeon E5-1630 v4 4C/3.7GHz/ 10MB/140W/DDR4-2400	NVIDIA Quadro M4000 8GB	2x8GB RDIMM DDR4-2400 ECC	Onboard	4	1x1TB HDD 7.2K 3.5" SATA6Gbs	HH DVD±RW	9-in-1	650W 92%	None	None	USB / USB Optical	Windows 10 Pro 64	3-year	06/16
30B50022US	US	Xeon E5-1650 v4 6C/3.6GHz/ 15MB/140W/DDR4-2400	Open	1x8GB RDIMM DDR4-2400 ECC	Onboard	4	1x1TB HDD 7.2K 3.5" SATA6Gbs	HH DVD±RW	9-in-1	650W 92%	None	None	USB / USB Optical	Windows 10 DG Windows 7 Pro 64	3-year	09/16
30B5002EUS	US	Xeon E5-1630 v4 4C/3.7GHz/ 10MB/140W/DDR4-2400	Open	2x8GB RDIMM DDR4-2400 ECC	Onboard	4	1x256GB SSD 2.5" SATA6Gbs Opal	HH DVD±RW	9-in-1	650W 92%	None	None	USB / USB Optical	Windows 10 DG Windows 7 Pro 64	3-year	09/16
30B5002TUS	US	Xeon E5-1620 v4 4C/3.5GHz/ 10MB/140W/DDR4-2400	NVIDIA Quadro K620 2GB	1x8GB RDIMM DDR4-2400 ECC	Onboard	4	1x1TB HDD 7.2K 3.5" SATA6Gbs	HH DVD±RW	9-in-1	490W 90%	None	None	USB / USB Optical	Windows 10 Pro 64	3-year	06/16
30B5002UUS	US	Xeon E5-1630 v4 4C/3.7GHz/ 10MB/140W/DDR4-2400	Open	1x8GB RDIMM DDR4-2400 ECC	Onboard	4	1x256GB SSD 2.5" SATA6Gbs Opal	HH DVD±RW	9-in-1	490W 90%	None	None	USB / USB Optical	Windows 10 Pro 64	3-year	06/16

Model	Region	Processor	Graphics	Memory (Capacity/Type)	RAID Controller	Max Drives in 3.5" Bays	Storage (Capacity/Type/Interface)	Optical	Media Reader	Power Supply	Add-on Ports	Discrete Ethernet	Keyboard / Mouse	Operating System	Warranty	Ann Date (mm/yy)
30B5002VUS	US	Xeon E5-1630 v4 4C/3.7GHz/ 10MB/140W/DDR4-2400	NVIDIA Quadro K1200 4GB	1x8GB RDIMM DDR4-2400 ECC	Onboard	4	1x256GB SSD 2.5" SATA6Gbs Opal	HH DVD±RW	9-in-1	490W 90%	None	None	USB / USB Optical	Windows 10 Pro 64	3-year	06/16
30B5002WUS	US	Xeon E5-1630 v4 4C/3.7GHz/ 10MB/140W/DDR4-2400	NVIDIA Quadro M2000 4GB	1x8GB RDIMM DDR4-2400 ECC	Onboard	4	1x256GB SSD 2.5" SATA6Gbs Opal	HH DVD±RW	9-in-1	490W 90%	None	None	USB / USB Optical	Windows 10 Pro 64	3-year	06/16
30B5002XUS	US	Xeon E5-1630 v4 4C/3.7GHz/ 10MB/140W/DDR4-2400	NVIDIA Quadro K1200 4GB	1x8GB RDIMM DDR4-2400 ECC	Onboard	4	1x1TB HDD 7.2K 3.5" SATA6Gbs	HH DVD±RW	9-in-1	490W 90%	None	None	USB / USB Optical	Windows 10 Pro 64	3-year	06/16
30B5002YUS	US	Xeon E5-1620 v4 4C/3.5GHz/ 10MB/140W/DDR4-2400	NVIDIA Quadro M4000 8GB	2x8GB RDIMM DDR4-2400 ECC	Onboard	4	1x1TB HDD 7.2K 3.5" SATA6Gbs	HH DVD±RW	9-in-1	650W 92%	None	None	USB / USB Optical	Windows 10 Pro 64	3-year	06/16
30B50030US	US	Xeon E5-1630 v4 4C/3.7GHz/ 10MB/140W/DDR4-2400	Open	1x8GB RDIMM DDR4-2400 ECC	Onboard	4	1x256GB SSD 2.5" SATA6Gbs Opal	HH DVD±RW	9-in-1	650W 92%	None	None	USB / USB Optical	Windows 10 Pro 64	3-year	06/16
30B50031US	US	Xeon E5-1630 v4 4C/3.7GHz/ 10MB/140W/DDR4-2400	NVIDIA Quadro M2000 4GB	1x8GB RDIMM DDR4-2400 ECC	Onboard	4	1x256GB SSD 2.5" SATA6Gbs Opal	HH DVD±RW	9-in-1	650W 92%	None	None	USB / USB Optical	Windows 10 Pro 64	3-year	06/16
30B50032US	US	Xeon E5-1650 v4 6C/3.6GHz/ 15MB/140W/DDR4-2400	Open	2x8GB RDIMM DDR4-2400 ECC	Onboard	4	1x256GB SSD 2.5" SATA6Gbs Opal	HH DVD±RW	9-in-1	650W 92%	None	None	USB / USB Optical	Windows 10 Pro 64	3-year	06/16
30B50033US	US	Xeon E5-1650 v4 6C/3.6GHz/ 15MB/140W/DDR4-2400	NVIDIA Quadro M2000 4GB	2x8GB RDIMM DDR4-2400 ECC	Onboard	4	1x1TB HDD 7.2K 3.5" SATA6Gbs	HH DVD±RW	9-in-1	650W 92%	None	None	USB / USB Optical	Windows 10 Pro 64	3-year	06/16
30B50034US	US	Xeon E5-1650 v4 6C/3.6GHz/ 15MB/140W/DDR4-2400	NVIDIA Quadro M4000 8GB	2x8GB RDIMM DDR4-2400 ECC	Onboard	4	1x1TB HDD 7.2K 3.5" SATA6Gbs	HH DVD±RW	9-in-1	650W 92%	None	None	USB / USB Optical	Windows 10 Pro 64	3-year	06/16
30B50035US	US	Xeon E5-1650 v4 6C/3.6GHz/ 15MB/140W/DDR4-2400	NVIDIA Quadro M4000 8GB	2x8GB RDIMM DDR4-2400 ECC	Onboard	4	1x512GB SSD 2.5" SATA6Gbs	HH DVD±RW	9-in-1	650W 92%	None	None	USB / USB Optical	Windows 10 Pro 64	3-year	06/16
30B50036US	US	Xeon E5-1650 v4 6C/3.6GHz/ 15MB/140W/DDR4-2400	NVIDIA Quadro M5000 8GB	2x8GB RDIMM DDR4-2400 ECC	Onboard	4	1x512GB SSD 2.5" SATA6Gbs	HH DVD±RW	9-in-1	650W 92%	None	None	USB / USB Optical	Windows 10 Pro 64	3-year	06/16
30B5003KUS	US	Xeon E5-1607 v4 4C/3.1GHz/ 10MB/140W/DDR4-2133	Open	1x8GB RDIMM DDR4-2400 ECC	Onboard	4	1x1TB HDD 7.2K 3.5" SATA6Gbs	HH DVD±RW	9-in-1	490W 90%	None	None	USB / USB Optical	Windows 10 DG Windows 7 Pro 64	3-year	09/16
30B5003NUS	US	Xeon E5-1620 v4 4C/3.5GHz/ 10MB/140W/DDR4-2400	NVIDIA Quadro M4000 8GB	2x8GB RDIMM DDR4-2400 ECC	Onboard	4	1x1TB HDD 7.2K 3.5" SATA6Gbs	HH DVD±RW	9-in-1	650W 92%	None	None	USB / USB Optical	Windows 10 DG Windows 7 Pro 64	3-year	09/16
30B5003UUS	US	Xeon E5-1620 v4 4C/3.5GHz/ 10MB/140W/DDR4-2400	Open	1x8GB RDIMM DDR4-2400 ECC	Onboard	4	1x1TB HDD 7.2K 3.5" SATA6Gbs	HH DVD±RW	9-in-1	490W 90%	None	None	USB / USB Optical	Windows 10 DG Windows 7 Pro 64	3-year	09/16
30B5004YUS	US	Xeon E5-1630 v4 4C/3.7GHz/ 10MB/140W/DDR4-2400	NVIDIA Quadro M4000 8GB	2x8GB RDIMM DDR4-2400 ECC	Onboard	4	1x1TB HDD 7.2K 3.5" SATA6Gbs	HH DVD±RW	9-in-1	650W 92%	None	None	USB / USB Optical	Windows 10 DG Windows 7 Pro 64	3-year	09/16

Model	Region	Processor	Graphics	Memory (Capacity/Type)	RAID Controller	Max Drives in 3.5" Bays	Storage (Capacity/Type/Interface)	Optical	Media Reader	Power Supply	Add-on Ports	Discrete Ethernet	Keyboard / Mouse	Operating System	Warranty	Ann Date (mm/yy)
30B50050US	US	Xeon E5-1630 v4 4C/3.7GHz/ 10MB/140W/DDR4-2400	NVIDIA Quadro M4000 8GB	2x8GB RDIMM DDR4-2400 ECC	Onboard	4	1x512GB SSD 2.5" SATA6Gbs	HH DVD±RW	9-in-1	650W 92%	None	None	USB / USB Optical	Windows 10 DG Windows 7 Pro 64	3-year	09/16
30B50051US	US	Xeon E5-1620 v4 4C/3.5GHz/ 10MB/140W/DDR4-2400	NVIDIA Quadro M2000 4GB	2x8GB RDIMM DDR4-2400 ECC	Onboard	4	1x512GB SSD 2.5" SATA6Gbs	HH DVD±RW	9-in-1	490W 90%	None	None	USB / USB Optical	Windows 10 DG Windows 7 Pro 64	3-year	09/16
30B50052US	US	Xeon E5-1607 v4 4C/3.1GHz/ 10MB/140W/DDR4-2133	NVIDIA Quadro K620 2GB	1x8GB RDIMM DDR4-2400 ECC	Onboard	4	1x500GB HDD 7.2K 3.5" SATA6Gbs	HH DVD±RW	9-in-1	490W 90%	None	None	USB / USB Optical	Windows 10 DG Windows 7 Pro 64	3-year	09/16
30B50053US	US	Xeon E5-1620 v4 4C/3.5GHz/ 10MB/140W/DDR4-2400	Open	1x8GB RDIMM DDR4-2400 ECC	Onboard	4	1x1TB HDD 7.2K 3.5" SATA6Gbs	HH DVD±RW	9-in-1	650W 92%	None	None	USB / USB Optical	Windows 10 DG Windows 7 Pro 64	3-year	09/16
30B50054US	US	Xeon E5-1607 v4 4C/3.1GHz/ 10MB/140W/DDR4-2133	NVIDIA Quadro K620 2GB	1x8GB RDIMM DDR4-2400 ECC	Onboard	4	1x1TB HDD 7.2K 3.5" SATA6Gbs	HH DVD±RW	9-in-1	490W 90%	None	None	USB / USB Optical	Windows 10 DG Windows 7 Pro 64	3-year	09/16
30B50055US	US	Xeon E5-1620 v4 4C/3.5GHz/ 10MB/140W/DDR4-2400	NVIDIA Quadro M2000 4GB	1x8GB RDIMM DDR4-2400 ECC	Onboard	4	1x1TB HDD 7.2K 3.5" SATA6Gbs	HH DVD±RW	9-in-1	490W 90%	None	None	USB / USB Optical	Windows 10 DG Windows 7 Pro 64	3-year	09/16
30B50056US	US	Xeon E5-1650 v4 6C/3.6GHz/ 15MB/140W/DDR4-2400	NVIDIA Quadro M4000 8GB	2x8GB RDIMM DDR4-2400 ECC	Onboard	4	1x1TB HDD 7.2K 3.5" SATA6Gbs	HH DVD±RW	9-in-1	650W 92%	None	None	USB / USB Optical	Windows 10 DG Windows 7 Pro 64	3-year	09/16
30B50057US	US	Xeon E5-1630 v4 4C/3.7GHz/ 10MB/140W/DDR4-2400	NVIDIA Quadro K1200 4GB	1x8GB RDIMM DDR4-2400 ECC	Onboard	4	1x1TB HDD 7.2K 3.5" SATA6Gbs	HH DVD±RW	9-in-1	490W 90%	None	None	USB / USB Optical	Windows 10 DG Windows 7 Pro 64	3-year	09/16
30B50058US	US	Xeon E5-1630 v4 4C/3.7GHz/ 10MB/140W/DDR4-2400	Open	1x8GB RDIMM DDR4-2400 ECC	Onboard	4	1x256GB SSD 2.5" SATA6Gbs Opal	HH DVD±RW	9-in-1	490W 90%	None	None	USB / USB Optical	Windows 10 DG Windows 7 Pro 64	3-year	09/16
30B50059US	US	Xeon E5-1630 v4 4C/3.7GHz/ 10MB/140W/DDR4-2400	NVIDIA Quadro M2000 4GB	1x8GB RDIMM DDR4-2400 ECC	Onboard	4	1x256GB SSD 2.5" SATA6Gbs Opal	HH DVD±RW	9-in-1	490W 90%	None	None	USB / USB Optical	Windows 10 DG Windows 7 Pro 64	3-year	09/16
30B5005AUS	US	Xeon E5-1650 v4 6C/3.6GHz/ 15MB/140W/DDR4-2400	NVIDIA Quadro M5000 8GB	2x8GB RDIMM DDR4-2400 ECC	Onboard	4	1x512GB SSD 2.5" SATA6Gbs	HH DVD±RW	9-in-1	650W 92%	None	None	USB / USB Optical	Windows 10 DG Windows 7 Pro 64	3-year	09/16
30B5005BUS	US	Xeon E5-1630 v4 4C/3.7GHz/ 10MB/140W/DDR4-2400	NVIDIA Quadro K1200 4GB	1x8GB RDIMM DDR4-2400 ECC	Onboard	4	1x256GB SSD 2.5" SATA6Gbs Opal	HH DVD±RW	9-in-1	490W 90%	None	None	USB / USB Optical	Windows 10 DG Windows 7 Pro 64	3-year	09/16
30B5005CUS	US	Xeon E5-1650 v4 6C/3.6GHz/ 15MB/140W/DDR4-2400	NVIDIA Quadro M2000 4GB	2x8GB RDIMM DDR4-2400 ECC	Onboard	4	1x1TB HDD 7.2K 3.5" SATA6Gbs	HH DVD±RW	9-in-1	650W 92%	None	None	USB / USB Optical	Windows 10 DG Windows 7 Pro 64	3-year	09/16
30B5005DUS	US	Xeon E5-1630 v4 4C/3.7GHz/ 10MB/140W/DDR4-2400	Open	1x8GB RDIMM DDR4-2400 ECC	Onboard	4	1x256GB SSD 2.5" SATA6Gbs Opal	HH DVD±RW	9-in-1	650W 92%	None	None	USB / USB Optical	Windows 10 DG Windows 7 Pro 64	3-year	09/16
30B5005EUS	US	Xeon E5-1650 v4 6C/3.6GHz/ 15MB/140W/DDR4-2400	Open	2x8GB RDIMM DDR4-2400 ECC	Onboard	4	1x256GB SSD 2.5" SATA6Gbs Opal	HH DVD±RW	9-in-1	650W 92%	None	None	USB / USB Optical	Windows 10 DG Windows 7 Pro 64	3-year	09/16

Model	Region	Processor	Graphics	Memory (Capacity/Type)	RAID Controller	Max Drives in 3.5" Bays	Storage (Capacity/Type/Interface)	Optical	Media Reader	Power Supply	Add-on Ports	Discrete Ethernet	Keyboard / Mouse	Operating System	Warranty	Ann Date (mm/yy)
30B5005FUS	US	Xeon E5-1650 v4 6C/3.6GHz/15MB/140W/DDR4-2400	NVIDIA Quadro M4000 8GB	2x8GB RDIMM DDR4-2400 ECC	Onboard	4	1x512GB SSD 2.5" SATA6Gbs	HH DVD±RW	9-in-1	650W 92%	None	None	USB / USB Optical	Windows 10 DG Windows 7 Pro 64	3-year	09/16
30B5005GUS	US	Xeon E5-1620 v4 4C/3.5GHz/10MB/140W/DDR4-2400	NVIDIA Quadro K620 2GB	1x8GB RDIMM DDR4-2400 ECC	Onboard	4	1x1TB HDD 7.2K 3.5" SATA6Gbs	HH DVD±RW	9-in-1	490W 90%	None	None	USB / USB Optical	Windows 10 DG Windows 7 Pro 64	3-year	09/16
30B5005HUS	US	Xeon E5-1630 v4 4C/3.7GHz/10MB/140W/DDR4-2400	NVIDIA Quadro M2000 4GB	1x8GB RDIMM DDR4-2400 ECC	Onboard	4	1x256GB SSD 2.5" SATA6Gbs Opal	HH DVD±RW	9-in-1	650W 92%	None	None	USB / USB Optical	Windows 10 DG Windows 7 Pro 64	3-year	09/16
30B5005KUS	US	Xeon E5-1620 v4 4C/3.5GHz/10MB/140W/DDR4-2400	Open	2x8GB RDIMM DDR4-2400 ECC	9364-8i PCIe	4	1x1TB SSD M.2 PCIe NVMe Opal	HH DVD±RW	9-in-1	650W 92%	None	None	USB / USB Optical	Windows 10 DG Windows 7 Pro 64	3-year	12/16
30B5005LUS	US	Xeon E5-1650 v4 6C/3.6GHz/15MB/140W/DDR4-2400	Open	2x8GB RDIMM DDR4-2400 ECC	Onboard	4	1x1TB SSD M.2 PCIe NVMe Opal	HH DVD±RW	9-in-1	650W 92%	None	None	USB / USB Optical	Windows 10 DG Windows 7 Pro 64	3-year	12/16
30B5005MUS	US	Xeon E5-1620 v4 4C/3.5GHz/10MB/140W/DDR4-2400	Open	2x8GB RDIMM DDR4-2400 ECC	Onboard	4	1x1TB SSD M.2 PCIe NVMe Opal	HH DVD±RW	9-in-1	650W 92%	None	None	USB / USB Optical	Windows 10 DG Windows 7 Pro 64	3-year	12/16
30B5005NUS	US	Xeon E5-1607 v4 4C/3.1GHz/10MB/140W/DDR4-2133	Open	2x8GB RDIMM DDR4-2400 ECC	Onboard	4	1x1TB SSD M.2 PCIe NVMe Opal	HH DVD±RW	9-in-1	650W 92%	None	None	USB / USB Optical	Windows 10 DG Windows 7 Pro 64	3-year	12/16
30B5005PUS	US	Xeon E5-1607 v4 4C/3.1GHz/10MB/140W/DDR4-2133	NVIDIA Quadro P5000 16GB	2x8GB RDIMM DDR4-2400 ECC	Onboard	4	1x1TB SSD M.2 PCIe NVMe Opal	HH DVD±RW	9-in-1	650W 92%	None	None	USB / USB Optical	Windows 10 DG Windows 7 Pro 64	3-year	12/16
30B5005QUS	US	Xeon E5-1650 v4 6C/3.6GHz/15MB/140W/DDR4-2400	NVIDIA Quadro P5000 16GB	2x8GB RDIMM DDR4-2400 ECC	Onboard	4	1x1TB SSD M.2 PCIe NVMe Opal	HH DVD±RW	9-in-1	650W 92%	None	None	USB / USB Optical	Windows 10 DG Windows 7 Pro 64	3-year	12/16
30B5005RUS	US	Xeon E5-1630 v4 4C/3.7GHz/10MB/140W/DDR4-2400	Open	2x8GB RDIMM DDR4-2400 ECC	Onboard	4	1x1TB SSD M.2 PCIe NVMe Opal	HH DVD±RW	9-in-1	650W 92%	None	None	USB / USB Optical	Windows 10 DG Windows 7 Pro 64	3-year	12/16
30B5005SUS	US	Xeon E5-1620 v4 4C/3.5GHz/10MB/140W/DDR4-2400	Open	2x8GB RDIMM DDR4-2400 ECC	Onboard	4	1x1TB SSD M.2 PCIe NVMe Opal	HH DVD±RW	9-in-1	650W 92%	None	None	USB / USB Optical	Windows 10 DG Windows 7 Pro 64	3-year	12/16
30B5005VUS	US	Xeon E5-1620 v4 4C/3.5GHz/10MB/140W/DDR4-2400	Quadro P600 2GB	1x8GB RDIMM DDR4-2400 ECC	Onboard	4	1x1TB HDD 7.2K 3.5" SATA6Gbs	HH DVD±RW	9-in-1	490W 90%	None	None	USB / USB Optical	Windows 10 DG Windows 7 Pro 64	3-year	04/17
30B5005WUS	US	Xeon E5-1620 v4 4C/3.5GHz/10MB/140W/DDR4-2400	Quadro P2000 5GB	2x8GB RDIMM DDR4-2400 ECC	Onboard	4	1x512GB SSD 2.5" SATA6Gbs	HH DVD±RW	9-in-1	490W 90%	None	None	USB / USB Optical	Windows 10 DG Windows 7 Pro 64	3-year	04/17
30B5005XUS	US	Xeon E5-1650 v4 6C/3.6GHz/15MB/140W/DDR4-2400	Quadro P2000 5GB	2x8GB RDIMM DDR4-2400 ECC	Onboard	4	1x1TB HDD 7.2K 3.5" SATA6Gbs	HH DVD±RW	9-in-1	650W 92%	None	None	USB / USB Optical	Windows 10 DG Windows 7 Pro 64	3-year	04/17
30B5005YUS	US	Xeon E5-1620 v4 4C/3.5GHz/10MB/140W/DDR4-2400	Quadro P4000 8GB	2x8GB RDIMM DDR4-2400 ECC	Onboard	4	1x1TB HDD 7.2K 3.5" SATA6Gbs	HH DVD±RW	9-in-1	650W 92%	None	None	USB / USB Optical	Windows 10 DG Windows 7 Pro 64	3-year	04/17

Model	Region	Processor	Graphics	Memory (Capacity/Type)	RAID Controller	Max Drives in 3.5" Bays	Storage (Capacity/Type/Interface)	Optical	Media Reader	Power Supply	Add-on Ports	Discrete Ethernet	Keyboard / Mouse	Operating System	Warranty	Ann Date (mm/yy)
30B50060US	US	Xeon E5-1650 v4 6C/3.6GHz/ 15MB/140W/DDR4-2400	Quadro P4000 8GB	2x8GB RDIMM DDR4-2400 ECC	Onboard	4	1x1TB HDD 7.2K 3.5" SATA6Gbs	HH DVD±RW	9-in-1	650W 92%	None	None	USB / USB Optical	Windows 10 DG Windows 7 Pro 64	3-year	04/17
30B50061US	US	Xeon E5-1650 v4 6C/3.6GHz/ 15MB/140W/DDR4-2400	Quadro P2000 5GB	2x8GB RDIMM DDR4-2400 ECC	Onboard	4	1x1TB HDD 7.2K 3.5" SATA6Gbs	HH DVD±RW	9-in-1	490W 90%	None	None	USB / USB Optical	Windows 10 DG Windows 7 Pro 64	3-year	04/17
30B50062US	US	Xeon E5-1630 v4 4C/3.7GHz/ 10MB/140W/DDR4-2400	Quadro P4000 8GB	2x8GB RDIMM DDR4-2400 ECC	Onboard	4	1x512GB SSD 2.5" SATA6Gbs	HH DVD±RW	9-in-1	650W 92%	None	None	USB / USB Optical	Windows 10 DG Windows 7 Pro 64	3-year	04/17
30B50063US	US	Xeon E5-1650 v4 6C/3.6GHz/ 15MB/140W/DDR4-2400	Quadro P2000 5GB	1x8GB RDIMM DDR4-2400 ECC	Onboard	4	1x1TB HDD 7.2K 3.5" SATA6Gbs	HH DVD±RW	9-in-1	490W 90%	None	None	USB / USB Optical	Windows 10 DG Windows 7 Pro 64	3-year	04/17
30B50064US	US	Xeon E5-1630 v4 4C/3.7GHz/ 10MB/140W/DDR4-2400	Quadro P2000 5GB	1x8GB RDIMM DDR4-2400 ECC	Onboard	4	1x256GB SSD 2.5" SATA6Gbs Opal	HH DVD±RW	9-in-1	490W 90%	None	None	USB / USB Optical	Windows 10 DG Windows 7 Pro 64	3-year	04/17
30B50065US	US	Xeon E5-1630 v4 4C/3.7GHz/ 10MB/140W/DDR4-2400	Quadro P1000 4GB	1x8GB RDIMM DDR4-2400 ECC	Onboard	4	1x256GB SSD 2.5" SATA6Gbs Opal	HH DVD±RW	9-in-1	490W 90%	None	None	USB / USB Optical	Windows 10 DG Windows 7 Pro 64	3-year	04/17
30B50066US	US	Xeon E5-1630 v4 4C/3.7GHz/ 10MB/140W/DDR4-2400	Quadro P2000 5GB	1x8GB RDIMM DDR4-2400 ECC	Onboard	4	1x256GB SSD 2.5" SATA6Gbs Opal	HH DVD±RW	9-in-1	650W 92%	None	None	USB / USB Optical	Windows 10 DG Windows 7 Pro 64	3-year	04/17
30B50067US	US	Xeon E5-1630 v4 4C/3.7GHz/ 10MB/140W/DDR4-2400	Quadro P1000 4GB	1x8GB RDIMM DDR4-2400 ECC	Onboard	4	1x1TB HDD 7.2K 3.5" SATA6Gbs	HH DVD±RW	9-in-1	490W 90%	None	None	USB / USB Optical	Windows 10 DG Windows 7 Pro 64	3-year	04/17
30B50068US	US	Xeon E5-1650 v4 6C/3.6GHz/ 15MB/140W/DDR4-2400	Quadro P4000 8GB	2x8GB RDIMM DDR4-2400 ECC	Onboard	4	1x512GB SSD 2.5" SATA6Gbs	HH DVD±RW	9-in-1	650W 92%	None	None	USB / USB Optical	Windows 10 DG Windows 7 Pro 64	3-year	04/17
30B50069US	US	Xeon E5-1607 v4 4C/3.1GHz/ 10MB/140W/DDR4-2133	Quadro P600 2GB	1x8GB RDIMM DDR4-2400 ECC	Onboard	4	1x1TB HDD 7.2K 3.5" SATA6Gbs	HH DVD±RW	9-in-1	490W 90%	None	None	USB / USB Optical	Windows 10 DG Windows 7 Pro 64	3-year	04/17
30B5006AUS	US	Xeon E5-1630 v4 4C/3.7GHz/ 10MB/140W/DDR4-2400	Quadro P600 2GB	1x8GB RDIMM DDR4-2400 ECC	Onboard	4	1x1TB HDD 7.2K 3.5" SATA6Gbs	HH DVD±RW	9-in-1	490W 90%	None	None	USB / USB Optical	Windows 10 DG Windows 7 Pro 64	3-year	04/17
30B5006BUS	US	Xeon E5-1630 v4 4C/3.7GHz/ 10MB/140W/DDR4-2400	Quadro P600 2GB	1x8GB RDIMM DDR4-2400 ECC	Onboard	4	1x256GB SSD 2.5" SATA6Gbs Opal	HH DVD±RW	9-in-1	490W 90%	None	None	USB / USB Optical	Windows 10 DG Windows 7 Pro 64	3-year	04/17
30B5006CUS	US	Xeon E5-1630 v4 4C/3.7GHz/ 10MB/140W/DDR4-2400	Quadro P4000 8GB	2x8GB RDIMM DDR4-2400 ECC	Onboard	4	1x1TB HDD 7.2K 3.5" SATA6Gbs	HH DVD±RW	9-in-1	650W 92%	None	None	USB / USB Optical	Windows 10 DG Windows 7 Pro 64	3-year	04/17

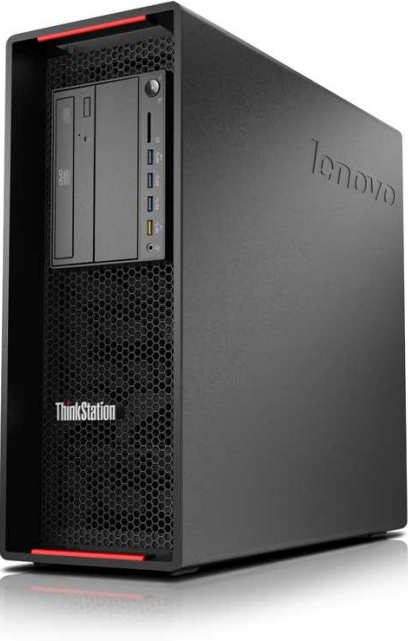

ThinkStation P700 Platform Specifications

Components	Specification
Chipset	Intel C612 Platform Controller Hub (PCH)
System mgmt	Intel Active Management Technology 9
Processor	Up to two 145W Intel Xeon E5-2600 v3 family processors, Or up to one 140W Intel Xeon E5-1600 v3 family processor:
	E5-2699 v3 18C/2.3GHz/45MB/145W/DDR4-2133
	E5-2698 v3 16C/2.3GHz/40MB/135W/DDR4-2133
	E5-2697 v3 14C/2.6GHz/35MB/145W/DDR4-2133
	E5-2695 v3 14C/2.3GHz/35MB/120W/DDR4-2133
	E5-2690 v3 12C/2.6GHz/30MB/135W/DDR4-2133
	E5-2685 v3 12C/2.6GHz/30MB/120W/DDR4-2133
	E5-2683 v3 14C/2GHz/35MB/120W/DDR4-2133
	E5-2680 v3 12C/2.5GHz/30MB/120W/DDR4-2133
	E5-2670 v3 12C/2.3GHz/30MB/120W/DDR4-2133
	E5-2667 v3 8C/3.2GHz/20MB/135W/DDR4-2133
	E5-2660 v3 10C/2.6GHz/25MB/105W/DDR4-2133
	E5-2650L v3 12C/1.8GHz/30MB/65W/DDR4-2133
	E5-2650 v3 10C/2.3GHz/25MB/105W/DDR4-2133
	E5-2643 v3 6C/3.4GHz/20MB/135W/DDR4-2133
	E5-2640 v3 8C/2.6GHz/20MB/90W/DDR4-1866
	E5-2637 v3 4C/3.5GHz/15MB/135W/DDR4-2133
	E5-2630L v3 8C/1.8GHz/20MB/55W/DDR4-1866
	E5-2630 v3 8C/2.4GHz/20MB/85W/DDR4-1866
	E5-2623 v3 4C/3GHz/10MB/105W/DDR4-1866
	E5-2620 v3 6C/2.4GHz/15MB/85W/DDR4-1866
	E5-2609 v3 6C/1.9GHz/15MB/85W/DDR4-1600
	E5-2603 v3 6C/1.6GHz/15MB/85W/DDR4-1600
	E5-1680 v3 8C/3.2GHz/20MB/140W/DDR4-2133
E5-1660 v3 8C/3GHz/20MB/140W/DDR4-2133	
E5-1650 v3 6C/3.5GHz/15MB/140W/DDR4-2133	
E5-1630 v3 4C/3.7GHz/10MB/140W/DDR4-2133	
E5-1620 v3 4C/3.5GHz/10MB/140W/DDR4-2133	
E5-1607 v3 4C/3.1GHz/10MB/140W/DDR4-1866	
E5-1603 v3 4C/2.8GHz/10MB/140W/DDR4-1866	
Coprocessor	None
Memory DIMM slots	12 DIMM sockets (6 DIMMs per processor), 8-channel capable (4-channel per processor). Supports RDIMM and LRDIMM (cannot be intermixed), ECC, DDR4-2133.
Memory capacity	768GB (LRDIMM)/384GB, 2nd CPU is needed
Graphics, GPU computing, coprocessors	Three PCIe 3.0 x16 slots, two via CPU1, one via CPU2 Up to 3 graphics, GPU computing adapters per system, 2nd CPU is needed
	PSU Maximum quantity of PCIe x16 adapters per system (by power) 650W/1x150W+2x75W (supports onboard SATA controller and up to 85W CPU) 850W/1x225W+2x75W, or 2x150W+1x75W
Disk drive controller	RAID 0, 1, 5, 10 with onboard SATA controller in chipset, SATA 6Gb/s. RAID 0, 1, 5, 10 with optional LSI RAID flex adapter, 12Gb/s SAS and SATA. RAID 0, 1, 5, 6, 10 with optional LSI 9364-8i PCIe adapter, 1GB memory, optional 1GB flash with super capacitor, 12Gb/s SAS and SATA
Drive Bays	Two external 5.25" bays, four internal 3.5" bays (see right)
Flex connector	One flex connectors (see right), supports one of the following: • Up to one LSI RAID flex adapter for SATA/SAS RAID • Up to one Multi-I/O flex adapters for two PCIe SSD • Up to one M.2 flex adapters for two M.2 SSD
Network interfaces	Integrated two Gigabit Ethernet ports, supports Wake-on-LAN. Optional discrete Ethernet is available
HD Audio	Realtek ALC662 codec
TPM	TCG 1.2-compliant
Power supply	One fixed 650 watts or 850 watts, autosensing, 92%, 80 PLUS Platinum qualified
Front ports	Four USB 3.0 (one Diagnostic, one Always On), one combo audio/microphone jack (3.5mm)
Rear ports	Four USB 2.0, four USB 3.0 (blue), one serial (9-pin), two ethernet (RJ-45), three analog audio ports (line-in, line-out, mic-in), two PS/2
IEEE 1394	Up to one 6-pin port on rear, one 6-pin port on front, 1394a-2000, 400Mbps
Thunderbolt	1 Thunderbolt via optional PCIe adapter. Uses slot 6.
Mechanical	• 36-liter: 175mm/6.89" W x 470mm/18.5" D x 440mm/17.32" H (with feet)
	• Tool-less parts: power supply, disk drive, fans, adapter retention
	• 52.25 lb (23.7kg) max configuration
Base warranty	3-year limited onsite service with 9x5/NBD

Drive Bays and Expansion slots



2 x 5.25", for half-height optical, or up to one optional flex module (Flex module supports one or more of the following options: 9.5mm optical/29-in-1 USB 3.0 reader/front IEEE 1394/front eSATA), or up to two optional front HDD bays

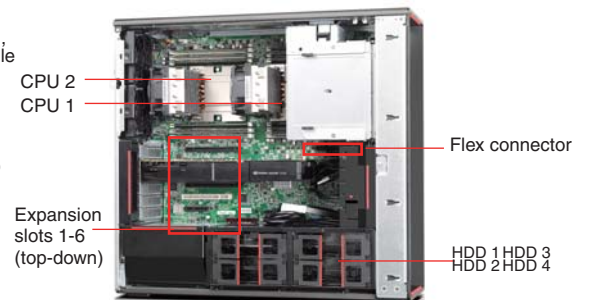

CPU 2
CPU 1

Expansion slots 1-6 (top-down)

Flex connector

HDD 1HDD 3
HDD 2HDD 4

Slot 1: PCIe 3.0 x16, Half length, full height, by CPU2
Slot 2: PCIe 3.0 x16, Full length, full height, by CPU1
Slot 3: PCIe 3.0 x8, Full length, full height, by CPU2
Slot 4: PCIe 3.0 x16, Full length, full height, by CPU1
Slot 5: PCI, Full length, full height, by PCH
Slot 6: PCIe 2.0 x4, Half length, full height, by PCH

Note:

- When LSI RAID flex adapter or 9364-8i adapter is installed, each HDD bay (HDD 1 - 4) can support 2 disk drives (1 x 3.5" drives + 2.5" SATA/SAS SSD, or 2 x 2.5" SATA/SAS SSD).
- More than 4 drives requires LSI RAID flex adapter or 9364-8i adapter.

Supporting NVIDIA graphics and GPU computing list

Adapter	Cores	Memory	Power	SLI	Connector***
NVS 310	48	1GB	19.5W		2xDP
NVS 315	48	1024MB	19.5W		2xDVI-I SL/2xDP
NVS 510	192	2048MB	33.4W		4xmini DP
Quadro 410	192	512MB	36.7W		DVI-I DL+DP
Quadro K600	192	1GB	41W		DVI-I DL+DP
Quadro K2000	384	2GB	51.1W		DVI-I DL+2xDP
Quadro K2000D	384	2GB	51.1W		DVI-I DL+DVI-D DL+mini DP
Quadro K4000	768	3GB	80W		DVI-I DL+2xDP
Quadro K5000	1536	4GB	122W		DVI-I DL+DVI-D DL+2xDP
Quadro K6000	2880	12GB	225W		DVI-I DL+DVI-D DL+2xDP
Quadro K420	192	2GB	41W		DVI-I DL+DP
Quadro K620	384	2GB	45W		DVI-I DL+DP
Quadro K2200	640	4GB	68W		DVI-I DL+2xDP
Quadro K4200	1344	4GB	108W		DVI-I DL+2xDP
Quadro K5200	2304	8GB	150W	SLI	DVI-I DL+DVI-D DL+2xDP
Quadro M4000	1664	8GB	120W		4xDP
Quadro M5000	2048	8GB	150W		DVI-I DL+4xDP
Quadro M6000	3072	12GB	250W		DVI-I DL+4xDP
Tesla K20	2496	5GB	225W		
GRID K2	3072	8GB	225W		

** DL = Dual link, SL = Single Link, DP = DisplayPort 1.2

Supporting storage list

(SAS drive needs LSI RAID flex adapter or 9364-8i adapter)

3.5" SATA	500GB/1TB/2TB/3TB/4TB/ (7.2K 6Gbs HDD)	300GB/450GB/600GB (15K 12Gbs HDD)
2.5" SAS	300GB/450GB/600GB	
2.5" SAS SSD (12Gbs)	200GB/400GB/800GB	
2.5" SATA SSD (6Gbs)	128GB/180GB/240GB/256GB/480GB/512GB/1TB (Optional OPAL)	
M.2 SSD	256 GB/512GB (Optional NVMe)	
PCIe SSD adapter	410GB/1.6TB	

Environment specification and certifications

Temperature	
Operating:	50 °F to 95 °F (10 °C to 35 °C)
Storage:	-10 °C to 60 °C, no package -40 °C to 60 °C, with package
Altitude	
Operating:	-50~10000ft (-15.2~3048m)
Humidity	
Operating:	10%~80%, non-condensing
Storage:	10%~90%, non-condensing

RoHS-compliant/EPEAT Gold rating on all model, ENERGY STAR 6.1 qualified on selected models.

For the latest list of ISV certifications, please visit www.lenovo.com/support/ISV
For a list of all supported options, please visit https://download.lenovo.com/pccbbs/options_iso/ocm_april_2016.xlsx sheet

Model	Region	Processor	Graphics	Memory (Capacity/Type)	RAID Controller	Max Drives in 3.5" Bays	Storage	Optical	Media Reader	Power Supply	Add-on Ports	Keyboard / Mouse	Operating System	Warranty	Global	Ann Date (mm/yy)
30A9001CUS	US	1xE5-2609 v3 6C/1.9GHz/15MB/85W/DDR4-1600	Open	1x4GB RDIMM DDR4-2133 ECC	Onboard	4	1x1TB HDD 7.2K 3.5" SATA6Gbs	HH DVD±RW	9-in-1	650W 92%	None	USB / USB Optical	Windows 8.1 Pro 64-bit	3-year	No	10/14
30A9001DUS	US	1xE5-2620 v3 6C/2.4GHz/15MB/85W/DDR4-1866	Open	2x4GB RDIMM DDR4-2133 ECC	Onboard	4	1x180GB SSD 2.5" SATA6Gbs	HH DVD±RW	9-in-1	650W 92%	None	USB / USB Optical	Windows 8.1 Pro 64-bit	3-year	No	10/14
30A9001EUS	US	1xE5-2640 v3 8C/2.6GHz/20MB/90W/DDR4-1866	Open	2x4GB RDIMM DDR4-2133 ECC	Onboard	4	1x256GB SSD M.2 PCIe	HH DVD±RW	9-in-1	850W 92%	None	USB / USB Optical	Windows 8.1 Pro 64-bit	3-year	No	10/14
30A9002EUS	US	1xE5-2609 v3 6C/1.9GHz/15MB/85W/DDR4-1600	Open	1x8GB RDIMM DDR4-2133 ECC	Onboard	4	1x1TB Hybrid HDD 7.2K 3.5" SATA6Gbs	HH DVD±RW	9-in-1	850W 92%	None	USB / USB Optical	Windows 10 DG Windows 7 Pro 64	3-year	No	09/15
30A9002FUS	US	1xE5-2620 v3 6C/2.4GHz/15MB/85W/DDR4-1866	Open	1x8GB RDIMM DDR4-2133 ECC	Onboard	4	1x256GB SSD M.2 PCIe Opal	HH DVD±RW	9-in-1	850W 92%	None	USB / USB Optical	Windows 10 DG Windows 7 Pro 64	3-year	No	09/15
30A9002GUS	US	1xE5-2643 v3 6C/3.4GHz/20MB/135W/DDR4-2133	Open	1x8GB RDIMM DDR4-2133 ECC	Onboard	4	1x256GB SSD M.2 PCIe Opal	HH DVD±RW	9-in-1	850W 92%	None	USB / USB Optical	Windows 10 DG Windows 7 Pro 64	3-year	No	09/15
30A9002HUS	US	2xE5-2667 v3 8C/3.2GHz/20MB/135W/DDR4-2133	Open	2x8GB RDIMM DDR4-2133 ECC	Onboard	4	1x256GB SSD M.2 PCIe Opal	HH DVD±RW	9-in-1	850W 92%	None	USB / USB Optical	Windows 10 DG Windows 7 Pro 64	3-year	No	09/15
30A9002PUS	US	2xE5-2630 v3 8C/2.4GHz/20MB/85W/DDR4-1866	NVIDIA Quadro K2200 4GB	4x8GB RDIMM DDR4-2133 ECC	Onboard	4	1x512GB SSD 2.5" SATA6Gbs	HH DVD±RW	9-in-1	650W 92%	None	USB / USB Optical	Windows 10 DG Windows 7 Pro 64	3-year	No	02/16
30A9002UUS	US	1xE5-2609 v3 6C/1.9GHz/15MB/85W/DDR4-1600	Open	1x4GB RDIMM DDR4-2133 ECC	Onboard	4	1x1TB HDD 7.2K 3.5" SATA6Gbs	HH DVD±RW	9-in-1	650W 92%	None	USB / USB Optical	Windows 10 DG Windows 7 Pro 64	3-year	No	03/16
30A9002VUS	US	1xE5-2637 v3 4C/3.5GHz/15MB/135W/DDR4-2133	Open	2x8GB RDIMM DDR4-2133 ECC	Onboard	4	1x256GB SSD M.2 PCIe Opal	HH DVD±RW	9-in-1	850W 92%	None	USB / USB Optical	Windows 10 DG Windows 7 Pro 64	3-year	No	03/16
30A9002WUS	US	2xXeon E5-2650L v3 12C/1.8GHz/30MB/65W/DDR4-2133	Open	2x8GB RDIMM DDR4-2133 ECC	LSI Flex	8	1x1TB HDD 7.2K 3.5" SATA6Gbs	HH DVD±RW	9-in-1	850W 92%	None	USB / USB Optical	Windows 10 DG Windows 7 Pro 64	3-year	No	03/16
30A9002XUS	US	1xE5-2620 v3 6C/2.4GHz/15MB/85W/DDR4-1866	Open	1x8GB RDIMM DDR4-2133 ECC	Onboard	4	1x180GB SSD 2.5" SATA6Gbs Opal	HH DVD±RW	9-in-1	650W 92%	None	USB / USB Optical	Windows 10 DG Windows 7 Pro 64	3-year	No	03/16
30A9002YUS	US	1xE5-2620 v3 6C/2.4GHz/15MB/85W/DDR4-1866	NVIDIA Quadro K4200 4GB	1x8GB RDIMM DDR4-2133 ECC	Onboard	4	1x1TB HDD 7.2K 3.5" SATA6Gbs	HH DVD±RW	9-in-1	850W 92%	None	USB / USB Optical	Windows 10 DG Windows 7 Pro 64	3-year	No	03/16
30A90030US	US	1xE5-2630 v3 8C/2.4GHz/20MB/85W/DDR4-1866	NVIDIA Quadro K4200 4GB	1x8GB RDIMM DDR4-2133 ECC	Onboard	4	1x2TB HDD 7.2K 3.5" SATA6Gbs	HH DVD±RW	9-in-1	850W 92%	None	USB / USB Optical	Windows 10 DG Windows 7 Pro 64	3-year	No	03/16

Model	Region	Processor	Graphics	Memory (Capacity/Type)	RAID Controller	Max Drives in 3.5" Bays	Storage	Optical	Media Reader	Power Supply	Add-on Ports	Keyboard / Mouse	Operating System	Warranty	Global	Ann Date (mm/yy)
30A8000LUS	US	2xE5-2620 v3 6C/2.4GHz/15MB/85W/DDR4-1866	NVIDIA Quadro K2200 4GB	2x8GB RDIMM DDR4-2133 ECC	Onboard	4	2x500GB HDD 7.2K 3.5" SATA6Gbs	HH DVD±RW	None	850W 92%	None	USB / USB Optical	Windows 8.1 Pro 64-bit	3-year	No	10/14
30A8000MUS	US	2xE5-2623 v3 4C/3GHz/10MB/105W/DDR4-1866	NVIDIA Quadro K4200 4GB	2x8GB RDIMM DDR4-2133 ECC	Onboard	4	2x180GB SSD 2.5" SATA6Gbs	HH DVD±RW	None	850W 92%	None	USB / USB Optical	Windows 8.1 Pro 64-bit	3-year	No	10/14
30A8003AUS	US	1xE5-2609 v3 6C/1.9GHz/15MB/85W/DDR4-1600	Open	2x4GB RDIMM DDR4-2133 ECC	Onboard	4	1x1TB HDD 7.2K 3.5" SATA6Gbs	HH DVD±RW	9-in-1	650W 92%	None	USB / USB Optical	Windows 8.1 Pro 64-bit	3-year	No	10/14
30A8003BUS	US	1xE5-2620 v3 6C/2.4GHz/15MB/85W/DDR4-1866	NVIDIA Quadro K620 2GB	2x4GB RDIMM DDR4-2133 ECC	Onboard	4	1x1TB HDD 7.2K 3.5" SATA6Gbs	HH DVD±RW	9-in-1	650W 92%	None	USB / USB Optical	Windows 8.1 Pro 64-bit	3-year	No	10/14
30A8003CUS	US	1xE5-2630 v3 8C/2.4GHz/20MB/85W/DDR4-1866	NVIDIA Quadro K2200 4GB	2x4GB RDIMM DDR4-2133 ECC	Onboard	4	1x180GB SSD 2.5" SATA6Gbs	HH DVD±RW	9-in-1	650W 92%	None	USB / USB Optical	Windows 8.1 Pro 64-bit	3-year	No	10/14

ThinkStation P710 Platform Specifications

Components	Specification																																																																																																																																										
Chipset	Intel C612 Platform Controller Hub (PCH)																																																																																																																																										
System mgmt	Intel Active Management Technology 9																																																																																																																																										
Processor	Up to two 145W Intel Xeon E5-2600 v4 family processors. Each processor supports up to 22 cores up to 2.2GHz, 16 cores up to 2.6GHz, 14 cores up to 2.6GHz, 12 cores up to 2.2GHz, 10 cores up to 2.4GHz, 8 cores up to 3.2GHz, 6 cores up to 3.4GHz, 4 cores up to 3.5GHz. Or up to two Intel Xeon E5-2620 v3 or E5-2609 v3 processors (not available in EMEA)																																																																																																																																										
Coprocessor	None																																																																																																																																										
Memory DIMM slots	12 DIMM sockets (6 DIMMs per processor), 8-channel capable (4-channel per processor). RDIMM, ECC, DDR4-2400																																																																																																																																										
Memory capacity	384GB, 2nd CPU is needed																																																																																																																																										
Graphics, GPU computing	Three PCIe 3.0 x16 slots, two via CPU1, one via CPU2. Up to three graphics and GPU computing adapters, 2nd CPU is needed																																																																																																																																										
	<table border="1"> <thead> <tr> <th>PSU</th> <th>Maximum quantity of PCIe x16 adapters per system (by power)</th> </tr> </thead> <tbody> <tr> <td>650W 1x150W+2x75W with onboard SATA controller and up to two 120W CPU each</td> <td>4</td> </tr> <tr> <td>850W 1x300W+2x75W (up to two 120W CPU each), or 2x150W+1x75W</td> <td>6</td> </tr> </tbody> </table>	PSU	Maximum quantity of PCIe x16 adapters per system (by power)	650W 1x150W+2x75W with onboard SATA controller and up to two 120W CPU each	4	850W 1x300W+2x75W (up to two 120W CPU each), or 2x150W+1x75W	6																																																																																																																																				
PSU	Maximum quantity of PCIe x16 adapters per system (by power)																																																																																																																																										
650W 1x150W+2x75W with onboard SATA controller and up to two 120W CPU each	4																																																																																																																																										
850W 1x300W+2x75W (up to two 120W CPU each), or 2x150W+1x75W	6																																																																																																																																										
Supporting Graphics and GPU computing	<table border="1"> <thead> <tr> <th>Adapter</th> <th>Cores</th> <th>Memory</th> <th>Power</th> <th>Connector***</th> <th>SLI</th> </tr> </thead> <tbody> <tr> <td>NVS 310</td> <td>48</td> <td>1GB</td> <td>19.5W</td> <td>2xDP</td> <td></td> </tr> <tr> <td>NVS 315</td> <td>48</td> <td>1GB</td> <td>19.5W</td> <td>2xDVI-I SL/2xDP</td> <td></td> </tr> <tr> <td>NVS 510</td> <td>192</td> <td>2GB</td> <td>35W</td> <td>4xmini DP</td> <td></td> </tr> <tr> <td>NVS 810</td> <td>1024</td> <td>4GB</td> <td>68W</td> <td>8xmini DP</td> <td></td> </tr> <tr> <td>Quadro K420</td> <td>192</td> <td>2GB</td> <td>41W</td> <td>DVI-I DL+DP</td> <td></td> </tr> <tr> <td>Quadro K620</td> <td>384</td> <td>2GB</td> <td>45W</td> <td>DVI-I DL+DP</td> <td></td> </tr> <tr> <td>Quadro K1200</td> <td>512</td> <td>4GB</td> <td>45W</td> <td>4xmini DP</td> <td></td> </tr> <tr> <td>Quadro K2200</td> <td>640</td> <td>4GB</td> <td>68W</td> <td>DVI-I DL+2xDP</td> <td></td> </tr> <tr> <td>Quadro K4200</td> <td>1344</td> <td>4GB</td> <td>108W</td> <td>DVI-I DL+2xDP</td> <td></td> </tr> <tr> <td>Quadro K5200</td> <td>2304</td> <td>8GB</td> <td>150W</td> <td>DVI-I DL+DVI-D DL+2xDP</td> <td>SLI</td> </tr> <tr> <td>Quadro M2000</td> <td>768</td> <td>4GB</td> <td>75W</td> <td>4xDP</td> <td></td> </tr> <tr> <td>Quadro M4000</td> <td>1664</td> <td>8GB</td> <td>120W</td> <td>4xDP</td> <td></td> </tr> <tr> <td>Quadro M5000</td> <td>2048</td> <td>8GB</td> <td>150W</td> <td>DVI-I DL+4xDP</td> <td>SLI</td> </tr> <tr> <td>Quadro M6000</td> <td>3072</td> <td>24GB</td> <td>250W</td> <td>DVI-I DL+4xDP</td> <td>SLI</td> </tr> <tr> <td>Quadro P400</td> <td>256</td> <td>2GB</td> <td>30W</td> <td>3xminiDP</td> <td></td> </tr> <tr> <td>Quadro P600</td> <td>384</td> <td>2GB</td> <td>40W</td> <td>4xminiDP</td> <td></td> </tr> <tr> <td>Quadro P1000</td> <td>640</td> <td>4GB</td> <td>47W</td> <td>4xminiDP</td> <td></td> </tr> <tr> <td>Quadro P2000</td> <td>1024</td> <td>5GB</td> <td>75W</td> <td>4xDP</td> <td></td> </tr> <tr> <td>Quadro P4000</td> <td>1792</td> <td>8GB</td> <td>105W</td> <td>4xDP</td> <td>SLI</td> </tr> <tr> <td>Quadro P5000</td> <td>2560</td> <td>16GB</td> <td>180W</td> <td>DVI-D DL+4xDP</td> <td>SLI</td> </tr> <tr> <td>Quadro P6000</td> <td>3840</td> <td>24GB</td> <td>250W</td> <td>DVI-D DL+4xDP</td> <td>SLI</td> </tr> <tr> <td>Tesla K40</td> <td>2880</td> <td>12GB</td> <td>235W</td> <td></td> <td></td> </tr> </tbody> </table>	Adapter	Cores	Memory	Power	Connector***	SLI	NVS 310	48	1GB	19.5W	2xDP		NVS 315	48	1GB	19.5W	2xDVI-I SL/2xDP		NVS 510	192	2GB	35W	4xmini DP		NVS 810	1024	4GB	68W	8xmini DP		Quadro K420	192	2GB	41W	DVI-I DL+DP		Quadro K620	384	2GB	45W	DVI-I DL+DP		Quadro K1200	512	4GB	45W	4xmini DP		Quadro K2200	640	4GB	68W	DVI-I DL+2xDP		Quadro K4200	1344	4GB	108W	DVI-I DL+2xDP		Quadro K5200	2304	8GB	150W	DVI-I DL+DVI-D DL+2xDP	SLI	Quadro M2000	768	4GB	75W	4xDP		Quadro M4000	1664	8GB	120W	4xDP		Quadro M5000	2048	8GB	150W	DVI-I DL+4xDP	SLI	Quadro M6000	3072	24GB	250W	DVI-I DL+4xDP	SLI	Quadro P400	256	2GB	30W	3xminiDP		Quadro P600	384	2GB	40W	4xminiDP		Quadro P1000	640	4GB	47W	4xminiDP		Quadro P2000	1024	5GB	75W	4xDP		Quadro P4000	1792	8GB	105W	4xDP	SLI	Quadro P5000	2560	16GB	180W	DVI-D DL+4xDP	SLI	Quadro P6000	3840	24GB	250W	DVI-D DL+4xDP	SLI	Tesla K40	2880	12GB	235W		
	Adapter	Cores	Memory	Power	Connector***	SLI																																																																																																																																					
	NVS 310	48	1GB	19.5W	2xDP																																																																																																																																						
	NVS 315	48	1GB	19.5W	2xDVI-I SL/2xDP																																																																																																																																						
	NVS 510	192	2GB	35W	4xmini DP																																																																																																																																						
	NVS 810	1024	4GB	68W	8xmini DP																																																																																																																																						
	Quadro K420	192	2GB	41W	DVI-I DL+DP																																																																																																																																						
	Quadro K620	384	2GB	45W	DVI-I DL+DP																																																																																																																																						
	Quadro K1200	512	4GB	45W	4xmini DP																																																																																																																																						
	Quadro K2200	640	4GB	68W	DVI-I DL+2xDP																																																																																																																																						
	Quadro K4200	1344	4GB	108W	DVI-I DL+2xDP																																																																																																																																						
	Quadro K5200	2304	8GB	150W	DVI-I DL+DVI-D DL+2xDP	SLI																																																																																																																																					
	Quadro M2000	768	4GB	75W	4xDP																																																																																																																																						
	Quadro M4000	1664	8GB	120W	4xDP																																																																																																																																						
	Quadro M5000	2048	8GB	150W	DVI-I DL+4xDP	SLI																																																																																																																																					
	Quadro M6000	3072	24GB	250W	DVI-I DL+4xDP	SLI																																																																																																																																					
	Quadro P400	256	2GB	30W	3xminiDP																																																																																																																																						
	Quadro P600	384	2GB	40W	4xminiDP																																																																																																																																						
	Quadro P1000	640	4GB	47W	4xminiDP																																																																																																																																						
	Quadro P2000	1024	5GB	75W	4xDP																																																																																																																																						
Quadro P4000	1792	8GB	105W	4xDP	SLI																																																																																																																																						
Quadro P5000	2560	16GB	180W	DVI-D DL+4xDP	SLI																																																																																																																																						
Quadro P6000	3840	24GB	250W	DVI-D DL+4xDP	SLI																																																																																																																																						
Tesla K40	2880	12GB	235W																																																																																																																																								
Disk drive controller	RAID 0, 1, 5, 10 with onboard SATA controller in chipset, SATA 6Gb/s. RAID 0, 1, 5, 10 with optional LSI RAID flex adapter, 12Gb/s SAS and SATA. RAID 0, 1, 5, 6, 10 with optional LSI 9364-8i PCIe adapter, 1GB memory, 12Gb/s SAS and SATA																																																																																																																																										
Drive Bays	Two external 5.25" flex bays, four 3.5" internal bays. Each 3.5" bay can support dual drives on selected models (see right)																																																																																																																																										
Flex bay	Two 5.25" flex bays for optical drives, Front Access Storage Enclosure drives, Flex Bay Storage Enclosure drives, or flex module. • Up to two half-height optical drives or up to one 9.5mm optical drive, DVD-ROM, DVD±RW, or Blu-Ray burner • Up to one Front Access Storage Enclosure for one 3.5" or 2.5" SATA drive. • Up to two Flex Bay Storage Enclosure for two 3.5" or 2.5" SATA drives.																																																																																																																																										
Supporting storage	3.5" SATA HDD, 7.2K 6Gbs	500GB/1TB/2TB/3TB/4TB/6TB/1TB hybrid/2TB hybrid																																																																																																																																									
	2.5" SAS HDD, 15K 12Gbs	300GB/600GB																																																																																																																																									
	2.5" SAS SSD, 12Gbs	200GB/400GB/800GB																																																																																																																																									
	2.5" SAS HDD, 10K 12Gbs	300GB																																																																																																																																									
	2.5" SSD, SATA6Gbs	180GB/240GB/256GB/480GB/512GB with OPAL, 256GB/512GB/1TB without OPAL																																																																																																																																									
	PCIe SSD, 2.5"	400GB																																																																																																																																									
	PCIe SSD, M.2	256 GB/512GB/1TB																																																																																																																																									
PCIe SSD adapter	400GB (up to 4 per system, 2nd CPU is needed)																																																																																																																																										

Components	Specification	
Flex connector	One flex connectors (see right), supports one of the following: • Up to one LSI RAID flex adapter for SATA/SAS RAID • Up to one Multi-I/O flex adapters for two PCIe SSD • Up to one M.2 flex adapters for two M.2 PCIe SSD	
Network interfaces	Integrated two-port gigabit ethernet (Intel i218LM and i210AT), supports Wake-on-LAN. Optional discrete ethernet adapters are available	
HD Audio	Realtek ALC662 codec	
TPM	TCG 1.2-compliant	
Power supply	One fixed 650 watts or 850 watts, autosensing, 92%, 80 PLUS Platinum qualified	
Front ports	Four USB 3.0 (one Diagnostic, one Always On), one combo audio/microphone jack (3.5mm)	
Rear ports	Four USB 2.0, four USB 3.0 (blue), one serial (9-pin), two ethernet (RJ-45), three analog audio ports (line-in, line-out, mic-in), two PS/2	
Add-on ports	Supports the following optional ports: Two IEEE 1394 (one on rear and one on front flex module) via PCIe adapter, up to one adapter per system. Two rear USB 3.0 per PCIe adapter, up to three adapters per system. One rear Thunderbolt via PCIe adapter. One front eSATA (on flex module), or one rear eSATA via cable (also needs one PCIe slot), up to one eSATA port per system. One internal USB 3.0 port via cable, cannot be intermixed with 29-in-1 reader	
	Media reader	9-in-1 USB 2.0 card reader. Optional 29-in-1 USB 3.0 card reader on flex module
Mechanical	• 36-liter: 175mm/6.89" W x 485mm/19.1" D x 446mm/17.6" H (with feet) • Tool-less parts: all except CPU fansink • 52.25 lb (23.7kg) max configuration	
	Environmental specification	Temperature - operating
Temperature - non operating (no package)		14 °F to 140 °F (-10 °C to 60 °C)
Temperature - non operating (with package)		-40 °F to 140 °F (-40 °C to 60 °C)
Altitude - operating		(Unpressurized): 0-10000ft (0-3048m)
Humidity - operating		10%-80%, non-condensing
	Humidity - storage (with package)	10%-90%, non-condensing
	RoHS-compliant, GREENGUARD on all models. EPEAT Gold rating, ENERGY STAR 6.1 qualified on selected models.	
Base warranty	3-year limited onsite service with 9x5/NBD	
ISV certifications	Please visit www.thinkworkstations.com/isv-certifications/	

Expansion slots
Slot 1: PCIe 3.0 x16, half length, full height, CPU2 needed (full length, full height if no flex adapter)
Slot 2: PCIe 3.0 x16, full length, full height
Slot 3: PCIe 3.0 x8, full length, full height, CPU2 needed
Slot 4: PCIe 3.0 x16, full length, full height
Slot 5: PCI, full length, full height
Slot 6: PCIe 2.0 x4, half length, full height
Also supports one flex connector

Drive Bays
HDD 1-4: Standard 3.5" HDD bay, up to four 3.5" or 2.5" disk drives.
On selected models, each 3.5" bay can supports 2.5" (9mm or less) drive plus 3.5" drive, or two 2.5" (15mm or less) drives.
Flex bay: Two 5.25" flex bays, for HH optical drives.
Or up to one optional flex module (Flex module supports one or more of the following options: 9.5mm optical/29-in-1 USB 3.0 reader/front IEEE 1394/front eSATA).
Or up to two HDD bays for two drives, 3.5" or 2.5" each, SATA only.

Model	Region	Processor	Graphics	Memory (Capacity/Type)	RAID Controller	Max Drives in 3.5" Bays	Storage (Capacity/Type/Interface)	Optical	Media Reader	Power Supply	Add-on Ports	Discrete ethernet	Keyboard / Mouse	Operating System	Warranty	Ann Date (mm/yy)
30B7000RUS	US	2xXeon E5-2623 v4 4C/2.6GHz/10MB/85W/DDR4-2133	Open	2x8GB RDIMM DDR4-2400 ECC	Onboard	4	1x256GB SSD 2.5" SATA6Gbs Opal	HH DVD±RW	9-in-1	650W 92%	None	None	USB / USB Optical	Windows 10 Pro 64	3-year	04/16
30B7000SUS	US	1xXeon E5-2623 v4 4C/2.6GHz/10MB/85W/DDR4-2133	Open	2x8GB RDIMM DDR4-2400 ECC	Onboard	4	1x256GB SSD 2.5" SATA6Gbs Opal	HH DVD±RW	9-in-1	650W 92%	None	None	USB / USB Optical	Windows 10 Pro 64	3-year	04/16
30B7000TUS	US	2xXeon E5-2620 v4 8C/2.1GHz/20MB/85W/DDR4-2133	Open	2x8GB RDIMM DDR4-2400 ECC	Onboard	4	1x1TB HDD 7.2K 3.5" SATA6Gbs	HH DVD±RW	9-in-1	850W 92%	None	None	USB / USB Optical	Windows 10 Pro 64	3-year	04/16
30B7000UUS	US	2xXeon E5-2637 v4 4C/3.5GHz/15MB/135W/DDR4-2400	Open	2x8GB RDIMM DDR4-2400 ECC	Onboard	4	1x256GB SSD 2.5" SATA6Gbs Opal	HH DVD±RW	9-in-1	850W 92%	None	None	USB / USB Optical	Windows 10 Pro 64	3-year	04/16
30B7000VUS	US	1xXeon E5-2637 v4 4C/3.5GHz/15MB/135W/DDR4-2400	Open	2x8GB RDIMM DDR4-2400 ECC	Onboard	4	1x256GB SSD 2.5" SATA6Gbs Opal	HH DVD±RW	9-in-1	850W 92%	None	None	USB / USB Optical	Windows 10 Pro 64	3-year	04/16
30B7000WUS	US	2xXeon E5-2643 v4 6C/3.4GHz/20MB/135W/DDR4-2400	NVIDIA Quadro M4000 8GB	4x8GB RDIMM DDR4-2400 ECC	Onboard	4	1x1TB SSD 2.5" SATA6Gbs	HH DVD±RW	9-in-1	850W 92%	None	None	USB / USB Optical	Windows 10 Pro 64	3-year	04/16
30B7000XUS	US	2xXeon E5-2623 v4 4C/2.6GHz/10MB/85W/DDR4-2133	NVIDIA Quadro M2000 4GB	2x8GB RDIMM DDR4-2400 ECC	Onboard	4	1x256GB SSD 2.5" SATA6Gbs Opal	HH DVD±RW	9-in-1	650W 92%	None	None	USB / USB Optical	Windows 10 Pro 64	3-year	04/16
30B7000YUS	US	1xXeon E5-2620 v4 8C/2.1GHz/20MB/85W/DDR4-2133	Open	2x8GB RDIMM DDR4-2400 ECC	Onboard	4	1x1TB HDD 7.2K 3.5" SATA6Gbs	HH DVD±RW	9-in-1	850W 92%	None	None	USB / USB Optical	Windows 10 Pro 64	3-year	04/16
30B7001MUS	US	1xXeon E5-2650 v4 12C/2.2GHz/30MB/105W/DDR4-2400	NVIDIA Quadro M4000 8GB	2x8GB RDIMM DDR4-2400 ECC	Onboard	4	1x1TB HDD 7.2K 3.5" SATA6Gbs+1x256GB SSD M.2 PCIe	HH DVD±RW	9-in-1	850W 92%	None	None	USB / USB Optical	Windows 10 Pro 64	3-year	07/16
30B7001NUS	US	2xXeon E5-2620 v4 8C/2.1GHz/20MB/85W/DDR4-2133	Open	2x8GB RDIMM DDR4-2400 ECC	Onboard	4	1x1TB HDD 7.2K 3.5" SATA6Gbs+1x256GB SSD M.2 PCIe	HH DVD±RW	9-in-1	850W 92%	None	None	USB / USB Optical	Windows 10 Pro 64	3-year	07/16
30B7001PUS	US	2xXeon E5-2620 v4 8C/2.1GHz/20MB/85W/DDR4-2133	NVIDIA Quadro M2000 4GB	2x8GB RDIMM DDR4-2400 ECC	Onboard	4	1x1TB HDD 7.2K 3.5" SATA6Gbs+1x256GB SSD M.2 PCIe	HH DVD±RW	9-in-1	850W 92%	None	None	USB / USB Optical	Windows 10 Pro 64	3-year	07/16
30B70023US	US	2xXeon E5-2620 v4 8C/2.1GHz/20MB/85W/DDR4-2133	Open	2x8GB RDIMM DDR4-2400 ECC	Onboard	4	1x1TB HDD 7.2K 3.5" SATA6Gbs+1x256GB SSD M.2 PCIe	HH DVD±RW	9-in-1	850W 92%	None	None	USB / USB Optical	Windows 10 DG Windows 7 Pro 64	3-year	09/16
30B70024US	US	1xXeon E5-2650 v4 12C/2.2GHz/30MB/105W/DDR4-2400	NVIDIA Quadro M4000 8GB	2x8GB RDIMM DDR4-2400 ECC	Onboard	4	1x1TB HDD 7.2K 3.5" SATA6Gbs+1x256GB SSD M.2 PCIe	HH DVD±RW	9-in-1	850W 92%	None	None	USB / USB Optical	Windows 10 DG Windows 7 Pro 64	3-year	09/16
30B70025US	US	2xXeon E5-2620 v4 8C/2.1GHz/20MB/85W/DDR4-2133	NVIDIA Quadro M2000 4GB	2x8GB RDIMM DDR4-2400 ECC	Onboard	4	1x1TB HDD 7.2K 3.5" SATA6Gbs+1x256GB SSD M.2 PCIe	HH DVD±RW	9-in-1	850W 92%	None	None	USB / USB Optical	Windows 10 DG Windows 7 Pro 64	3-year	09/16
30B70029US	US	2xXeon E5-2623 v4 4C/2.6GHz/10MB/85W/DDR4-2133	NVIDIA Quadro P5000 16GB	2x8GB RDIMM DDR4-2400 ECC	Onboard	4	1x1TB SSD M.2 PCIe NVMe Opal	HH DVD±RW	9-in-1	850W 92%	1xeSATA Rear	None	USB / USB Optical	Windows 10 DG Windows 7 Pro 64	3-year	12/16

Model	Region	Processor	Graphics	Memory (Capacity/Type)	RAID Controller	Max Drives in 3.5" Bays	Storage (Capacity/Type/Interface)	Optical	Media Reader	Power Supply	Add-on Ports	Discrete ethernet	Keyboard / Mouse	Operating System	Warranty	Ann Date (mm/yy)
30B7002AUS	US	1xXeon E5-2623 v4 4C/2.6GHz/10MB/85W/DDR4-2133	NVIDIA Quadro M2000 4GB	2x8GB RDIMM DDR4-2400 ECC	Onboard	4	1x512GB SSD 2.5" SATA6Gbs	HH DVD±RW	9-in-1	850W 92%	None	None	USB / USB Optical	Windows 10 DG Windows 7 Pro 64	3-year	12/16
30B7002BUS	US	1xXeon E5-2623 v4 4C/2.6GHz/10MB/85W/DDR4-2133	NVIDIA Quadro P5000 16GB	2x8GB RDIMM DDR4-2400 ECC	Onboard	4	1x1TB SSD M.2 PCIe NVMe Opal	HH DVD±RW	9-in-1	850W 92%	1xeSATA Rear	None	USB / USB Optical	Windows 10 DG Windows 7 Pro 64	3-year	12/16
30B7002CUS	US	1xXeon E5-2623 v4 4C/2.6GHz/10MB/85W/DDR4-2133	NVIDIA Quadro M2000 4GB	2x8GB RDIMM DDR4-2400 ECC	Onboard	4	1x256GB SSD 2.5" SATA6Gbs Opal	HH DVD±RW	9-in-1	650W 92%	None	None	USB / USB Optical	Windows 10 DG Windows 7 Pro 64	3-year	12/16
30B7002DUS	US	2xXeon E5-2637 v4 4C/3.5GHz/15MB/135W/DDR4-2400	NVIDIA Quadro P5000 16GB	2x16GB RDIMM DDR4-2400 ECC	Onboard	4	1x1TB SSD M.2 PCIe NVMe Opal	HH DVD±RW	9-in-1	850W 92%	1xeSATA Rear	None	USB / USB Optical	Windows 10 DG Windows 7 Pro 64	3-year	12/16
30B7002EUS	US	1xXeon E5-2623 v4 4C/2.6GHz/10MB/85W/DDR4-2133	NVIDIA Quadro M2000 4GB	2x8GB RDIMM DDR4-2400 ECC	Onboard	4	1x256GB SSD 2.5" SATA6Gbs Opal	HH DVD±RW	9-in-1	850W 92%	None	None	USB / USB Optical	Windows 10 DG Windows 7 Pro 64	3-year	12/16
30B7002FUS	US	2xXeon E5-2643 v4 6C/3.4GHz/20MB/135W/DDR4-2400	NVIDIA Quadro M4000 8GB	4x8GB RDIMM DDR4-2400 ECC	Onboard	4	1x1TB HDD 7.2K 3.5" SATA6Gbs	HH DVD±RW	9-in-1	850W 92%	None	None	USB / USB Optical	Windows 10 DG Windows 7 Pro 64	3-year	12/16
30B7002GUS	US	1xXeon E5-2623 v4 4C/2.6GHz/10MB/85W/DDR4-2133	Open	2x8GB RDIMM DDR4-2400 ECC	Onboard	4	1x1TB SSD M.2 PCIe NVMe Opal	HH DVD±RW	9-in-1	850W 92%	1xeSATA Rear	None	USB / USB Optical	Windows 10 DG Windows 7 Pro 64	3-year	12/16
30B7002MUS	US	2xXeon E5-2623 v4 4C/2.6GHz/10MB/85W/DDR4-2133	Quadro P2000 5GB	2x8GB RDIMM DDR4-2400 ECC	Onboard	4	1x256GB SSD 2.5" SATA6Gbs Opal	HH DVD±RW	9-in-1	850W 92%	None	None	USB / USB Optical	Windows 10 DG Windows 7 Pro 64	3-year	04/17
30B7002NUS	US	1xXeon E5-2650 v4 12C/2.2GHz/30MB/105W/DDR4-2400	Quadro P4000 8GB	2x8GB RDIMM DDR4-2400 ECC	Onboard	4	1x1TB HDD 7.2K 3.5" SATA6Gbs+1x256GB SSD M.2 PCIe	HH DVD±RW	9-in-1	850W 92%	None	None	USB / USB Optical	Windows 10 DG Windows 7 Pro 64	3-year	04/17
30B7002PUS	US	1xXeon E5-2623 v4 4C/2.6GHz/10MB/85W/DDR4-2133	Quadro P2000 5GB	2x8GB RDIMM DDR4-2400 ECC	Onboard	4	1x512GB SSD 2.5" SATA6Gbs	HH DVD±RW	9-in-1	850W 92%	None	None	USB / USB Optical	Windows 10 DG Windows 7 Pro 64	3-year	04/17
30B7002QUS	US	2xXeon E5-2623 v4 4C/2.6GHz/10MB/85W/DDR4-2133	Quadro P2000 5GB	2x8GB RDIMM DDR4-2400 ECC	Onboard	4	1x256GB SSD 2.5" SATA6Gbs Opal	HH DVD±RW	9-in-1	650W 92%	None	None	USB / USB Optical	Windows 10 DG Windows 7 Pro 64	3-year	04/17
30B7002RUS	US	1xXeon E5-2620 v4 8C/2.1GHz/20MB/85W/DDR4-2133	Quadro P2000 5GB	2x8GB RDIMM DDR4-2400 ECC	Onboard	4	1x1TB HDD 7.2K 3.5" SATA6Gbs	HH DVD±RW	9-in-1	850W 92%	None	None	USB / USB Optical	Windows 10 DG Windows 7 Pro 64	3-year	04/17
30B7002SUS	US	2xXeon E5-2643 v4 6C/3.4GHz/20MB/135W/DDR4-2400	Quadro P4000 8GB	4x8GB RDIMM DDR4-2400 ECC	Onboard	4	1x1TB HDD 7.2K 3.5" SATA6Gbs	HH DVD±RW	9-in-1	850W 92%	None	None	USB / USB Optical	Windows 10 Pro 64	3-year	04/17
30B7002TUS	US	2xXeon E5-2643 v4 6C/3.4GHz/20MB/135W/DDR4-2400	Quadro P4000 8GB	4x8GB RDIMM DDR4-2400 ECC	Onboard	4	1x1TB HDD 7.2K 3.5" SATA6Gbs	HH DVD±RW	9-in-1	850W 92%	None	None	USB / USB Optical	Windows 10 DG Windows 7 Pro 64	3-year	04/17
30B7002UUS	US	2xXeon E5-2623 v4 4C/2.6GHz/10MB/85W/DDR4-2133	Quadro P2000 5GB	2x8GB RDIMM DDR4-2400 ECC	Onboard	4	1x512GB SSD 2.5" SATA6Gbs	HH DVD±RW	9-in-1	850W 92%	None	None	USB / USB Optical	Windows 10 DG Windows 7 Pro 64	3-year	04/17

Model	Region	Processor	Graphics	Memory (Capacity/Type)	RAID Controller	Max Drives in 3.5" Bays	Storage (Capacity/Type/Interface)	Optical	Media Reader	Power Supply	Add-on Ports	Discrete ethernet	Keyboard / Mouse	Operating System	Warranty	Ann Date (mm/yy)
30B7002VUS	US	1xXeon E5-2620 v4 8C/2.1GHz/20MB/85W/DDR4-2133	Quadro P2000 5GB	2x8GB RDIMM DDR4-2400 ECC	Onboard	4	1x1TB HDD 7.2K 3.5" SATA6Gbs+1x256GB SSD M.2 PCIe	HH DVD±RW	9-in-1	850W 92%	None	None	USB / USB Optical	Windows 10 DG Windows 7 Pro 64	3-year	04/17
30B7002WUS	US	1xXeon E5-2650 v4 12C/2.2GHz/30MB/105W/DDR4-2400	Quadro P4000 8GB	2x8GB RDIMM DDR4-2400 ECC	Onboard	4	1x1TB HDD 7.2K 3.5" SATA6Gbs+1x256GB SSD M.2 PCIe	HH DVD±RW	9-in-1	850W 92%	None	None	USB / USB Optical	Windows 10 Pro 64	3-year	04/17

ThinkStation P910 Platform Specifications

Components	Specification					
Chipset	Intel C612 Platform Controller Hub (PCH)					
System mgmt	Intel Active Management Technology 9					
Processor	Up to two 160W Intel Xeon E5-2600 v4 family processors. Each processor supports up to 22 cores up to 2.2GHz, 16 cores up to 2.6GHz, 14 cores up to 2.6GHz, 12 cores up to 3GHz, 10 cores up to 2.4GHz, 8 cores up to 3.2GHz, 6 cores up to 3.4GHz, 4 cores up to 3.5GHz. Or up to two Intel Xeon E5-2620 v3 or E5-2609 v3 processors (not available in EMEA)					
Coprocessor	Optional. Up to one Intel Xeon Phi Coprocessor 3120A, PCIe 2.0 x16 adapter, 57 cores, 1.1GHz, 28.5MB L2 cache, 6GB memory, 300W					
Memory DIMM slots	16 DIMM sockets (8 DIMMs per processor), 8-channel capable (4-channel per processor). RDIMM or LRDIMM (cannot be intermixed), ECC, DDR4, 2400MHz					
Memory capacity	896GB (LRDIMM, 14x64GB)/512GB (RDIMM, 16x32GB), 2nd CPU is needed					
Graphics and GPU computing	Four PCIe 3.0 x16 slots for graphics and GPU computing cards, two slots per processor					
	Installed CPU	Maximum quantity of PCIe x16 adapters per system (by power)				
	1	1x300W+1x75W or 2x150W				
2	2x300W+2x75W, or 1x300W+2x150W+1x75W, or 4x150W					
Supporting Graphics and GPU computing	Adapter	Cores	Memory	Power	Connector***	SLI
	NVS 310	48	1GB	19.5W	2xDP	
	NVS 315	48	1GB	19.5W	2xDVI-I SL/2xDP	
	NVS 510	192	2GB	35W	4xmini DP	
	NVS 810	1024	4GB	68W	8xmini DP	
	Quadro K420	192	2GB	41W	DVI-I DL+DP	
	Quadro K620	384	2GB	45W	DVI-I DL+DP	
	Quadro K1200	512	4GB	45W	4xmini DP	
	Quadro K2200	640	4GB	68W	DVI-I DL+2xDP	
	Quadro K4200	1344	4GB	108W	DVI-I DL+2xDP	
	Quadro K5200	2304	8GB	150W	DVI-I DL+DVI-D DL+2xDP	SLI
	Quadro M2000	768	4GB	75W	4xDP	
	Quadro M4000	1664	8GB	120W	4xDP	
	Quadro M5000	2048	8GB	150W	DVI-I DL+4xDP	SLI
	Quadro M6000	3072	24GB	250W	DVI-I DL+4xDP	SLI
	Quadro P400	256	2GB	30W	3xminiDP	
	Quadro P600	384	2GB	40W	4xminiDP	
	Quadro P1000	640	4GB	47W	4xminiDP	
	Quadro P2000	1024	5GB	75W	4xDP	
	Quadro P4000	1792	8GB	105W	4xDP	SLI
Quadro P5000	2560	16GB	180W	DVI-D DL+4xDP	SLI	
Quadro P6000	3840	24GB	250W	DVI-D DL+4xDP	SLI	
Tesla K40	2880	12GB	235W			
Disk drive controller	RAID 0, 1, 5, 10 with onboard SATA controller in chipset, 6Gb/s SATA. RAID 0, 1, 5, 10 with optional LSI RAID flex adapter, 12Gb/s SAS and SATA. RAID 0, 1, 5, 6, 10 with optional LSI 9364-8i PCIe adapter, 1GB memory, 12Gb/s SAS and SATA					
Drive Bays	Three external 5.25" bays, four internal 3.5" dual drives bays (see right)					
Flex bay	Three 5.25" flex bays for optical drives, Front Access Storage Enclosure drives, Flex Bay Storage Enclosure drives, or flex module. • Up to three half-height optical drives or up to one 9.5mm optical drive, DVD-ROM, DVD±RW, or Blu-Ray burner • Up to one Front Access Storage Enclosure for one 3.5" or 2.5" SATA drive. • Up to two Flex Bay Storage Enclosure for two 3.5" or 2.5" SATA drives.					
Supporting storage	3.5" SATA HDD, 7.2K 6Gbs	500GB/1TB/2TB/3TB/4TB/6TB/1TB hybrid/2TB hybrid				
	2.5" SAS HDD, 15K 12Gbs	300GB/600GB				
	2.5" SAS HDD, 10K 12Gbs	300GB				
	2.5" SAS SSD, 12Gbs	200GB/400GB/800GB				
	2.5" SSD, SATA6Gbs	180GB/240GB/256GB/480GB/512GB with OPAL, 256GB/512GB/1TB without OPAL				
	PCIe SSD, 2.5"	400GB				
	PCIe SSD, M.2	256 GB/512GB/1TB				
PCIe SSD adapter	400GB (up to 4 per system, 2nd CPU is needed)					

Components	Specification	
Flex connector	Two flex connectors (see right), one per processor. Supports one of the following: • Up to one LSI RAID flex adapter for SATA/SAS RAID. • Up to two Multi-I/O adapters for four PCIe SSD (two PCIe SSD per adapter). • Up to two M.2 flex adapters for four M.2 PCIe SSD (two M.2 PCIe SSD per adapter)	
Network interfaces	Integrated two-port gigabit ethernet (Intel i218LM and i210AT), supports Wake-on-LAN. Optional discrete ethernet adapters are available	
HD Audio	Realtek ALC662 codec	
TPM	TCG 1.2-compliant	
Power supply	One fixed 1300 watts, autosensing, 92% PSU, 80 PLUS Platinum qualified <i>Note: PSU will automatically operate in 1120W (restricted mode) if the system line input is 100-110V. For other supported system line input voltages, the PSU will operate at the full 1300W.</i>	
Front ports	Four USB 3.0 (one Diagnostic, one Always On), one combo audio/microphone jack (3.5mm)	
Rear ports	Four USB 2.0, four USB 3.0 (blue), one serial (9-pin), two ethernet (RJ-45), three analog audio ports (line-in, line-out, mic-in), two PS/2	
Add-on ports	Supports the following optional ports: Two IEEE 1394 (one on rear and one on front flex module) via PCIe adapter, up to one adapter per system. Two rear USB 3.0 per USB add-on PCIe adapter, up to 3 adapters per system. One rear Thunderbolt via PCIe adapter. One front eSATA (on flex module), or one rear eSATA via cable (also needs one PCIe slot), up to one eSATA port per system. One internal USB 3.0 port via cable, cannot be intermixed with 29-in-1 reader	
	Media reader	9-in-1 USB 2.0 card reader. Optional 29-in-1 USB 3.0 card reader on flex module
Mechanical	• 55-liter: 200mm/7.87" W x 620mm/24.4" D x 446mm/17.56" H (with feet) • Tool-less parts: all except CPU fansink • 71.3 lb (32.3kg) max configuration	
Environmental specification	Temperature - operating	50 °F to 95 °F (10 °C to 35 °C)
	Temperature - non operating (no package)	14 °F to 140 °F (-10 °C to 60 °C)
	Temperature - non operating (with package)	-40 °F to 140 °F (-40 °C to 60 °C)
	Altitude - operating	(Unpressurized): 0-10000ft (0-3048m)
Humidity - operating	10%-80%, non-condensing	
Humidity - storage (with package)	10%-90%, non-condensing	
RoHS-compliant, GREENGUARD on all models. EPEAT Gold rating, ENERGY STAR 6.1 qualified on selected models.		
Base warranty	3-year limited onsite service with 9x5/NBD	
ISV certifications	Please visit www.thinkworkstations.com/isv-certifications/	

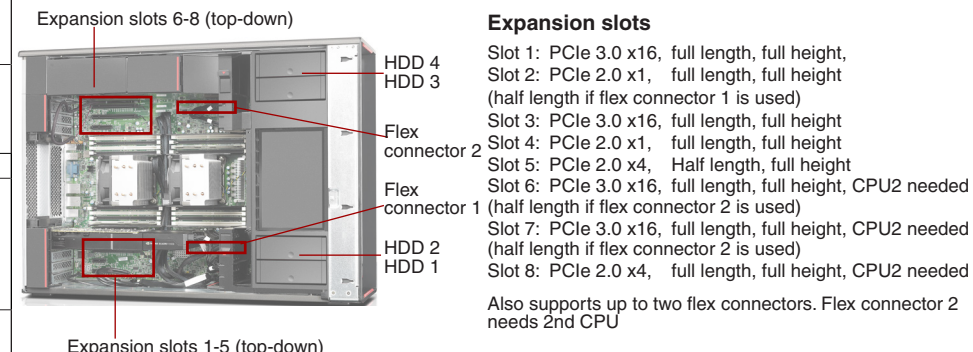

Drive bays
HDD 1-4: Standard 3.5" HDD bay, up to four 3.5" or 2.5" disk drives.
Each 3.5" bay supports 2.5" (9mm or less) drive plus 3.5" drive, or two 2.5" (15mm or less) drives. More than 4 drives requires LSI RAID flex adapter or 9364-8i adapter,
Flex bay: Three 5.25" flex bays, for HH optical drives.
Or up to one optional flex module (Flex module supports one or more of the following options: 9.5mm optical/29-in-1 USB 3.0 reader/front IEEE 1394/front eSATA).
Or up to two HDD bays for two drives, 3.5" or 2.5" each, SATA only.

Model	Region	Processor	Graphics	Memory (Capacity/Type)	RAID Controller	Max Drives in 3.5" Bays	Storage (Capacity/Type/Interface)	Optical	Media Reader	Power Supply	Add-on Ports	Discrete Ethernet	Keyboard / Mouse	Operating System	Warranty	Ann Date (mm/yy)
30B9000EUS	US	1xXeon E5-2643 v4 6C/3.4GHz/20MB/135W/DDR4-2400	Open	2x8GB RDIMM DDR4-2400 ECC	Onboard	4	1x512GB SSD 2.5" SATA6Gbs	HH DVD±RW	9-in-1	1300W 92%	None	None	USB / None	Windows 10 Pro 64	3-year	04/16
30B9000FUS	US	2xXeon E5-2650 v4 12C/2.2GHz/30MB/105W/DDR4-2400	NVIDIA Quadro M5000 8GB	4x8GB RDIMM DDR4-2400 ECC	Onboard	4	1x1TB SSD 2.5" SATA6Gbs	HH DVD±RW	9-in-1	1300W 92%	None	None	USB / None	Windows 10 Pro 64	3-year	04/16
30B9000GUS	US	2xXeon E5-2643 v4 6C/3.4GHz/20MB/135W/DDR4-2400	Open	4x8GB RDIMM DDR4-2400 ECC	Onboard	4	1x1TB SSD 2.5" SATA6Gbs	HH DVD±RW	9-in-1	1300W 92%	None	None	USB / None	Windows 10 Pro 64	3-year	04/16
30B9000HUS	US	1xXeon E5-2623 v4 4C/2.6GHz/10MB/85W/DDR4-2133	Open	2x8GB RDIMM DDR4-2400 ECC	Onboard	4	1x512GB SSD 2.5" SATA6Gbs	HH DVD±RW	9-in-1	1300W 92%	None	None	USB / None	Windows 10 Pro 64	3-year	04/16
30B9001NUS	US	2xXeon E5-2650 v4 12C/2.2GHz/30MB/105W/DDR4-2400	NVIDIA Quadro M4000 8GB	4x8GB RDIMM DDR4-2400 ECC	Onboard	4	1x1TB HDD 7.2K 3.5" SATA6Gbs+1x512GB SSD M.2 PCIe	HH DVD±RW	9-in-1	1300W 92%	None	None	USB / USB Optical	Windows 10 Pro 64	3-year	07/16
30B9001PUS	US	2xXeon E5-2650 v4 12C/2.2GHz/30MB/105W/DDR4-2400	Open	4x8GB RDIMM DDR4-2400 ECC	Onboard	4	1x1TB HDD 7.2K 3.5" SATA6Gbs+1x512GB SSD M.2 PCIe	HH DVD±RW	9-in-1	1300W 92%	None	None	USB / USB Optical	Windows 10 Pro 64	3-year	07/16
30B9001UUS	US	2xXeon E5-2650 v4 12C/2.2GHz/30MB/105W/DDR4-2400	NVIDIA Quadro M4000 8GB	4x8GB RDIMM DDR4-2400 ECC	Onboard	4	1x1TB HDD 7.2K 3.5" SATA6Gbs+1x512GB SSD M.2 PCIe	HH DVD±RW	9-in-1	1300W 92%	None	None	USB / USB Optical	Windows 10 DG Windows 7 Pro 64	3-year	09/16
30B9001VUS	US	2xXeon E5-2650 v4 12C/2.2GHz/30MB/105W/DDR4-2400	Open	4x8GB RDIMM DDR4-2400 ECC	Onboard	4	1x1TB HDD 7.2K 3.5" SATA6Gbs+1x512GB SSD M.2 PCIe	HH DVD±RW	9-in-1	1300W 92%	None	None	USB / USB Optical	Windows 10 DG Windows 7 Pro 64	3-year	09/16
30B9001WUS	US	1xXeon E5-2643 v4 6C/3.4GHz/20MB/135W/DDR4-2400	Open	2x8GB RDIMM DDR4-2400 ECC	Onboard	4	1x512GB SSD 2.5" SATA6Gbs	HH DVD±RW	9-in-1	1300W 92%	None	None	USB / None	Windows 10 DG Windows 7 Pro 64	3-year	09/16
30B9001XUS	US	2xXeon E5-2650 v4 12C/2.2GHz/30MB/105W/DDR4-2400	NVIDIA Quadro M5000 8GB	4x8GB RDIMM DDR4-2400 ECC	Onboard	4	1x1TB SSD 2.5" SATA6Gbs	HH DVD±RW	9-in-1	1300W 92%	None	None	USB / None	Windows 10 DG Windows 7 Pro 64	3-year	09/16
30B9001YUS	US	2xXeon E5-2643 v4 6C/3.4GHz/20MB/135W/DDR4-2400	Open	4x8GB RDIMM DDR4-2400 ECC	Onboard	4	1x1TB SSD 2.5" SATA6Gbs	HH DVD±RW	9-in-1	1300W 92%	None	None	USB / None	Windows 10 DG Windows 7 Pro 64	3-year	09/16
30B90020US	US	1xXeon E5-2623 v4 4C/2.6GHz/10MB/85W/DDR4-2133	Open	2x8GB RDIMM DDR4-2400 ECC	Onboard	4	1x512GB SSD 2.5" SATA6Gbs	HH DVD±RW	9-in-1	1300W 92%	None	None	USB / None	Windows 10 DG Windows 7 Pro 64	3-year	09/16
30B9002DUS	US	2xXeon E5-2620 v4 8C/2.1GHz/20MB/85W/DDR4-2133	Open	2x16GB RDIMM DDR4-2400 ECC	Onboard	4	1x1TB SSD M.2 PCIe NVMe Opal	HH DVD±RW	9-in-1	1300W 92%	None	None	USB / USB Optical	Windows 10 DG Windows 7 Pro 64	3-year	12/16
30B9002EUS	US	2xXeon E5-2620 v4 8C/2.1GHz/20MB/85W/DDR4-2133	NVIDIA Quadro P5000 16GB	2x16GB RDIMM DDR4-2400 ECC	Onboard	4	1x1TB SSD M.2 PCIe NVMe Opal	HH DVD±RW	9-in-1	1300W 92%	None	None	USB / USB Optical	Windows 10 DG Windows 7 Pro 64	3-year	12/16
30B9002FUS	US	2xXeon E5-2620 v4 8C/2.1GHz/20MB/85W/DDR4-2133	NVIDIA Quadro P6000 24GB	2x16GB RDIMM DDR4-2400 ECC	Onboard	4	1x1TB SSD M.2 PCIe NVMe Opal	HH DVD±RW	9-in-1	1300W 92%	None	None	USB / USB Optical	Windows 10 DG Windows 7 Pro 64	3-year	12/16

Model	Region	Processor	Graphics	Memory (Capacity/Type)	RAID Controller	Max Drives in 3.5" Bays	Storage (Capacity/Type/Interface)	Optical	Media Reader	Power Supply	Add-on Ports	Discrete Ethernet	Keyboard / Mouse	Operating System	Warranty	Ann Date (mm/yy)
30B9002XCA	US	1xXeon E5-2650 v4 12C/2.2GHz/30MB/105W/DDR4-2400	Quadro P4000 8GB	4x8GB RDIMM DDR4-2400 ECC	Onboard	4	1x1TB HDD 7.2K 3.5" SATA6Gbs+1x512GB SSD M.2 PCIe	HH DVD±RW	9-in-1	1300W 92%	None	None	USB / USB Optical	Windows 10 Pro 64	3-year	04/17
30B9002XCC	US	1xXeon E5-2650 v4 12C/2.2GHz/30MB/105W/DDR4-2400	Quadro P4000 8GB	4x8GB RDIMM DDR4-2400 ECC	Onboard	4	1x1TB HDD 7.2K 3.5" SATA6Gbs+1x512GB SSD M.2 PCIe	HH DVD±RW	9-in-1	1300W 92%	None	None	USB / USB Optical	Windows 10 Pro 64	3-year	04/17
30B9002XSS	US	1xXeon E5-2650 v4 12C/2.2GHz/30MB/105W/DDR4-2400	Quadro P4000 8GB	4x8GB RDIMM DDR4-2400 ECC	Onboard	4	1x1TB HDD 7.2K 3.5" SATA6Gbs+1x512GB SSD M.2 PCIe	HH DVD±RW	9-in-1	1300W 92%	None	None	USB / USB Optical	Windows 10 Pro 64	3-year	04/17
30B9002XUS	US	1xXeon E5-2650 v4 12C/2.2GHz/30MB/105W/DDR4-2400	Quadro P4000 8GB	4x8GB RDIMM DDR4-2400 ECC	Onboard	4	1x1TB HDD 7.2K 3.5" SATA6Gbs+1x512GB SSD M.2 PCIe	HH DVD±RW	9-in-1	1300W 92%	None	None	USB / USB Optical	Windows 10 Pro 64	3-year	04/17
30B9002YCA	US	1xXeon E5-2650 v4 12C/2.2GHz/30MB/105W/DDR4-2400	Quadro P4000 8GB	4x8GB RDIMM DDR4-2400 ECC	Onboard	4	1x1TB HDD 7.2K 3.5" SATA6Gbs+1x512GB SSD M.2 PCIe	HH DVD±RW	9-in-1	1300W 92%	None	None	USB / USB Optical	Windows 10 DG Windows 7 Pro 64	3-year	04/17
30B9002YCC	US	1xXeon E5-2650 v4 12C/2.2GHz/30MB/105W/DDR4-2400	Quadro P4000 8GB	4x8GB RDIMM DDR4-2400 ECC	Onboard	4	1x1TB HDD 7.2K 3.5" SATA6Gbs+1x512GB SSD M.2 PCIe	HH DVD±RW	9-in-1	1300W 92%	None	None	USB / USB Optical	Windows 10 DG Windows 7 Pro 64	3-year	04/17
30B9002YSS	US	1xXeon E5-2650 v4 12C/2.2GHz/30MB/105W/DDR4-2400	Quadro P4000 8GB	4x8GB RDIMM DDR4-2400 ECC	Onboard	4	1x1TB HDD 7.2K 3.5" SATA6Gbs+1x512GB SSD M.2 PCIe	HH DVD±RW	9-in-1	1300W 92%	None	None	USB / USB Optical	Windows 10 DG Windows 7 Pro 64	3-year	04/17
30B9002YUS	US	1xXeon E5-2650 v4 12C/2.2GHz/30MB/105W/DDR4-2400	Quadro P4000 8GB	4x8GB RDIMM DDR4-2400 ECC	Onboard	4	1x1TB HDD 7.2K 3.5" SATA6Gbs+1x512GB SSD M.2 PCIe	HH DVD±RW	9-in-1	1300W 92%	None	None	USB / USB Optical	Windows 10 DG Windows 7 Pro 64	3-year	04/17

This publication was developed for products and services offered in the United States and E.M.E.A countries. Lenovo may not offer the products, services or features discussed in this document in other countries. Lenovo may withdraw an offering at any time. Information is subject to change without notice. Consult your local representative for information on offerings available in your area.

Lenovo reserves the right to change specifications or other product information without notice. Lenovo is not responsible for photographic or typographical errors.

LENOVO PROVIDES THIS PUBLICATION "AS IS," WITHOUT WARRANTY OF ANY KIND, EITHER EXPRESS OR IMPLIED, INCLUDING THE IMPLIED WARRANTIES OF MERCHANTABILITY OR FITNESS FOR A PARTICULAR PURPOSE.

Some jurisdictions do not allow disclaimer of express or implied warranties in certain transactions, therefore this disclaimer may not apply to you.

Availability: All offers subject to availability. Lenovo reserves the right to alter product offerings and specifications at any time, without notice. Lenovo is not responsible for photographic or typographic errors.

General: Review key information provided by Microsoft that may apply to your system purchase, including details on Windows 10, Windows 8, Windows 7, and potential upgrades/downgrades. Lenovo makes no representation or warranty regarding third-party products or services.

Trademarks: Lenovo, ThinkPad, ThinkCentre, ThinkStation and the Lenovo logo are trademarks of Lenovo. Microsoft, Windows, Windows NT, and the Windows logo are trademarks of Microsoft Corporation. Ultrabook, Celeron, Celeron Inside, Core Inside, Intel, Intel Logo, Intel Atom, Intel Atom Inside, Intel Core, Intel Inside, Intel Inside Logo, Intel vPro, Itanium, Itanium Inside, Pentium, Pentium Inside, vPro Inside, Xeon, Xeon Phi, and Xeon Inside are trademarks of Intel Corporation in the U.S. and/or other countries. Other company, product or service names may be trademarks or service marks of others.

Warranty: For a copy of applicable warranties, write to: Lenovo Warranty Information, 1009 Think Place, Morrisville, NC, 27560. Lenovo makes no representation or warranty regarding third party products or services. The Lenovo Limited Warranty applies only to Lenovo hardware products purchased for your own use, and does not transfer upon resale.

Limited warranty: Support unrelated to a warranty issue may be subject to additional charges.

Lenovo Services:

Carry-in or Mail-in Service: Parts and labor repair coverage where the customer is responsible for shipping (including packaging) or delivery to authorized warranty provider or repair center.

Depot or Courier Service: Parts and labor repair coverage where shipping (including packaging) or delivery to the repair center is paid for by Lenovo.

Expedited Depot: Parts and labor coverage with expedited turnaround. Shipping (including packaging) or delivery to the repair center is paid for by Lenovo.

Onsite / In-home Service: Parts and labor repair coverage where labor is provided onsite at your place of business.

If Lenovo determines your product problem is covered by the product warranty and cannot be resolved over the telephone, a technician will be dispatched to arrive onsite, typically the next day.

International Warranty Service (IWS): PC repair coverage for customers who require a critical warranty repair while travelling internationally. Visit www.lenovo.com/internationalwarranty for details. Visit www.lenovo.com/warranty for Lenovo Warranty Services terms and conditions for complete details and restrictions.

Included software: may differ from its retail version (if available), and may not include user manuals or all program functionality. Software license agreements may apply.

Battery life: Battery life (and recharge times) will vary based on many factors including screen brightness, applications, features, power management, battery conditioning, and other customer preferences.

Visit <http://psref.lenovo.com/> for the latest version of Product Specifications Reference.

© Lenovo, 2017. All rights reserved.
Lenovo 1009 Think Place Morrisville, NC 27560 U.S.A.

Lenovo ThinkServer

PSREF

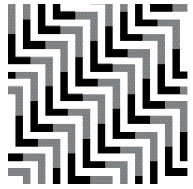

Product Specifications Reference

Version 506, May 2017

U.S.

Visit <http://psref.lenovo.com> for the latest version

Contents

Cover		
Contents		
Summary Of Change		
Racks		
ThinkServer RD350		
ThinkServer RD350 Platform Specifications		
ThinkServer RD350 - TopSeller - 70D6		
ThinkServer RD350 - TopSeller - 70D8		
ThinkServer RD350 - TopSeller - 70QK		
ThinkServer RD350 - TopSeller - 70QM		
ThinkServer RD450		
ThinkServer RD450 Platform Specifications		
ThinkServer RD450 - TopSeller - 70DA		
ThinkServer RD450 - TopSeller - 70DC		
ThinkServer RD450 - TopSeller - 70DE		
ThinkServer RD450 - TopSeller - 70DV		
ThinkServer RD450 - TopSeller - 70Q9		
ThinkServer RD450 - TopSeller - 70QQ		
ThinkServer RD450 - TopSeller - 70QS		
ThinkServer RD450 - TopSeller - 70QW		
ThinkServer RD550		
ThinkServer RD550 Platform Specifications		
ThinkServer RD550 - TopSeller - 70CV		
ThinkServer RD550 - TopSeller - 70CX		
ThinkServer RD650		
ThinkServer RD650 Platform Specifications		
ThinkServer RD650 - TopSeller - 70D0		
ThinkServer RD650 - TopSeller - 70D2		
ThinkServer RD650 - TopSeller - 70D4		
ThinkServer RD650 - TopSeller - 70DR		
ThinkServer RD650 - TopSeller - 70DT		
ThinkServer RS140		
ThinkServer RS140 Platform Specifications		
ThinkServer RS140 - TopSeller - 70F3		
ThinkServer RS140 - TopSeller - 70F9		
1	ThinkServer RS140 - 70F2	36
2	ThinkServer RS140 - 70F8	37
3	ThinkServer RS160	38
5	ThinkServer RS160 Platform Specifications	39
5	ThinkServer RS160 - TopSeller - 70TE	40
6	ThinkServer RS160 - TopSeller - 70TG	41
7	Towers	42
8	ThinkServer TD340	42
9	ThinkServer TD340 Platform Specifications	43
10	ThinkServer TD340 - TopSeller - 70B5	44
11	ThinkServer TD340 - TopSeller - 70B7 - 1 of 2	45
12	ThinkServer TD340 - TopSeller - 70B7 - 2 of 2	46
13	ThinkServer TD340 - 70B6	47
14	ThinkServer TD350	48
15	ThinkServer TD350 Platform Specifications	49
16	ThinkServer TD350 - TopSeller - 70DG	50
17	ThinkServer TD350 - TopSeller - 70DJ	51
18	ThinkServer TS150	52
19	ThinkServer TS150 Platform Specifications	52
20	ThinkServer TS150 - TopSeller - 70LV	53
21	ThinkServer TS150 - TopSeller - 70LX	54
22	ThinkServer TS150 - TopSeller - 70UB	55
23	ThinkServer TS440	56
24	ThinkServer TS440 Platform Specifications	57
25	ThinkServer TS440 - TopSeller - 70AN	58
26	ThinkServer TS440 - TopSeller - 70AQ - 1 of 2	59
27	ThinkServer TS440 - TopSeller - 70AQ - 2 of 2	60
28	ThinkServer TS440 - 70AL	61
29	ThinkServer TS440 - 70AM	62
30	ThinkServer TS460	63
31	ThinkServer TS460 Platform Specifications	64
32	ThinkServer TS460 - TopSeller - 70TR	65
33	ThinkServer TS460 - TopSeller - 70TT	66
34	Legal Information	67
35		

Summary of Changes

This section describes the changes made in this version of ThinkServer PSREF and in previous version
This edition might also include minor corrections and editorial changes which are not identified

May 26, 2017 - Version 506

Additions in this update

- ▶ Update ThinkServer RD650/RD550 platform specifications, add DDR4-2400 RDIMM memory, up to 1.92TB easy-swap NVMe SSD, and up to 3.84TB NVMe flash adapter

April 19, 2017 - Version 505

Additions in this update

- ▶ Add ThinkServer TS150 models announced April 2017
- ▶ Update ThinkServer TS150 platform specifications, add new Kaby Lake processors, DDR4-2400 memory, 10TB hard drive supports

February 15, 2017 - Version 502

Additions in this update

- ▶ Add ThinkServer RS160 models announced September 2016

Withdrawals in this update

- ▶ ThinkServer TS140 had been end of life

October 12, 2016 - Version 496

Additions in this update

- ▶ New ThinkServer RS160 product announced September 2016
- ▶ New ThinkServer TS150 models announced August and October 2016

September 14, 2016 - Version 495

Additions in this update

- ▶ New ThinkServer RS160 product announced September 2016
- ▶ New ThinkServer TS140 models announced September 2016

April 6, 2016 - Version 487

Additions in this update

- ▶ New ThinkServer TD350, RD350, and RD450 models announced April 2016
- ▶ Add Intel Xeon E5-2600 v4 processors

March 23, 2016 - Version 486

Additions in this update

- ▶ New ThinkServer TS140 models announced March 2016

February 24, 2016 - Version 485

Additions in this update

- ▶ Add 8TB SATA and SAS 72K 6Gbs hard drive on ThinkServer RD350/RD450/RD550/RD650/TD350

December 30, 2015 - Version 483

Additions in this update

- ▶ Updates ThinkServer RS140, TD340 specifications
- ▶ Updates the most recent ThinkServer RS140, TD340 models

December 9, 2015 - Version 482

Additions in this update

- ▶ Updates ThinkServer TS140, TS440 specifications
- ▶ Updates the most recent ThinkServer TS140, TS440, RD350, RD450, RD550, RD650 models

October 28, 2015 - Version 480

Additions in this update

- ▶ New ThinkServer TS140 models announced October 2015

July 30, 2015 - Version 476

Additions in this update

- ▶ New ThinkServer TD350, RD550, and RD650 models announced July 2015

May 6, 2015 - Version 473

Additions in this update

- ▶ Add 95mm optical support on TD350
- ▶ Add Red Hat Enterprise Linux 7 support on RD350/RD450/RD550/RD650/TD350
- ▶ Add 32 x 25" bay support on TD350
- ▶ Add AnyBay and 25" PCIe SSD support on RD550/RD650

April 15, 2015 - Version 471

Additions in this update

- ▶ New ThinkServer TD350 models announced March 2015

March 25, 2015 - Version 470

Additions in this update

- ▶ New ThinkServer TS140 and TS440 models announced March 2015



ThinkServer RD350 Platform Specifications

Components	Specification																																								
Dimensions	1U rack. Height: 43 mm (1.7 in), width: 482 mm (19 in), depth: 781.5 mm (30.77 in)																																								
Weight	Minimum configuration: 13 kg (28.66 lb), maximum: 19.1 kg (42.11 lb)																																								
Processor	Up to two 105W Intel Xeon E5-2600 v4 or E5-2600 v3 family processors.																																								
	<table border="1"> <tr><td>E5-2660 v4</td><td>14C/2GHz/35MB/105W/DDR4-2400</td></tr> <tr><td>E5-2650 v4</td><td>12C/2.2GHz/30MB/105W/DDR4-2400</td></tr> <tr><td>E5-2640 v4</td><td>10C/2.4GHz/25MB/90W/DDR4-2133</td></tr> <tr><td>E5-2630 v4</td><td>10C/2.2GHz/20MB/85W/DDR4-2133</td></tr> <tr><td>E5-2623 v4</td><td>4C/2.6GHz/10MB/85W/DDR4-2133</td></tr> <tr><td>E5-2620 v4</td><td>8C/2.1GHz/20MB/85W/DDR4-2133</td></tr> <tr><td>E5-2609 v4</td><td>8C/1.7GHz/20MB/85W/DDR4-1866</td></tr> <tr><td>E5-2603 v4</td><td>6C/1.7GHz/15MB/85W/DDR4-1866</td></tr> <tr><td>E5-2650L v4</td><td>14C/1.7GHz/35MB/65W/DDR4-2400</td></tr> <tr><td>E5-2630L v4</td><td>10C/1.8GHz/25MB/55W/DDR4-2133</td></tr> <tr><td>E5-2660 v3</td><td>10C/2.6GHz/25MB/105W/DDR4-2133</td></tr> <tr><td>E5-2650 v3</td><td>10C/2.3GHz/25MB/105W/DDR4-2133</td></tr> <tr><td>E5-2640 v3</td><td>8C/2.6GHz/20MB/90W/DDR4-1866</td></tr> <tr><td>E5-2630 v3</td><td>8C/2.4GHz/20MB/85W/DDR4-1866</td></tr> <tr><td>E5-2623 v3</td><td>4C/3GHz/10MB/105W/DDR4-1866</td></tr> <tr><td>E5-2620 v3</td><td>6C/2.4GHz/15MB/85W/DDR4-1866</td></tr> <tr><td>E5-2609 v3</td><td>6C/1.9GHz/15MB/85W/DDR4-1600</td></tr> <tr><td>E5-2603 v3</td><td>6C/1.6GHz/15MB/85W/DDR4-1600</td></tr> <tr><td>E5-2650L v3</td><td>12C/1.8GHz/30MB/65W/DDR4-2133</td></tr> <tr><td>E5-2630L v3</td><td>8C/1.8GHz/20MB/55W/DDR4-1866</td></tr> </table>	E5-2660 v4	14C/2GHz/35MB/105W/DDR4-2400	E5-2650 v4	12C/2.2GHz/30MB/105W/DDR4-2400	E5-2640 v4	10C/2.4GHz/25MB/90W/DDR4-2133	E5-2630 v4	10C/2.2GHz/20MB/85W/DDR4-2133	E5-2623 v4	4C/2.6GHz/10MB/85W/DDR4-2133	E5-2620 v4	8C/2.1GHz/20MB/85W/DDR4-2133	E5-2609 v4	8C/1.7GHz/20MB/85W/DDR4-1866	E5-2603 v4	6C/1.7GHz/15MB/85W/DDR4-1866	E5-2650L v4	14C/1.7GHz/35MB/65W/DDR4-2400	E5-2630L v4	10C/1.8GHz/25MB/55W/DDR4-2133	E5-2660 v3	10C/2.6GHz/25MB/105W/DDR4-2133	E5-2650 v3	10C/2.3GHz/25MB/105W/DDR4-2133	E5-2640 v3	8C/2.6GHz/20MB/90W/DDR4-1866	E5-2630 v3	8C/2.4GHz/20MB/85W/DDR4-1866	E5-2623 v3	4C/3GHz/10MB/105W/DDR4-1866	E5-2620 v3	6C/2.4GHz/15MB/85W/DDR4-1866	E5-2609 v3	6C/1.9GHz/15MB/85W/DDR4-1600	E5-2603 v3	6C/1.6GHz/15MB/85W/DDR4-1600	E5-2650L v3	12C/1.8GHz/30MB/65W/DDR4-2133	E5-2630L v3	8C/1.8GHz/20MB/55W/DDR4-1866
	E5-2660 v4	14C/2GHz/35MB/105W/DDR4-2400																																							
	E5-2650 v4	12C/2.2GHz/30MB/105W/DDR4-2400																																							
	E5-2640 v4	10C/2.4GHz/25MB/90W/DDR4-2133																																							
	E5-2630 v4	10C/2.2GHz/20MB/85W/DDR4-2133																																							
	E5-2623 v4	4C/2.6GHz/10MB/85W/DDR4-2133																																							
	E5-2620 v4	8C/2.1GHz/20MB/85W/DDR4-2133																																							
	E5-2609 v4	8C/1.7GHz/20MB/85W/DDR4-1866																																							
	E5-2603 v4	6C/1.7GHz/15MB/85W/DDR4-1866																																							
	E5-2650L v4	14C/1.7GHz/35MB/65W/DDR4-2400																																							
	E5-2630L v4	10C/1.8GHz/25MB/55W/DDR4-2133																																							
	E5-2660 v3	10C/2.6GHz/25MB/105W/DDR4-2133																																							
	E5-2650 v3	10C/2.3GHz/25MB/105W/DDR4-2133																																							
	E5-2640 v3	8C/2.6GHz/20MB/90W/DDR4-1866																																							
	E5-2630 v3	8C/2.4GHz/20MB/85W/DDR4-1866																																							
	E5-2623 v3	4C/3GHz/10MB/105W/DDR4-1866																																							
	E5-2620 v3	6C/2.4GHz/15MB/85W/DDR4-1866																																							
	E5-2609 v3	6C/1.9GHz/15MB/85W/DDR4-1600																																							
	E5-2603 v3	6C/1.6GHz/15MB/85W/DDR4-1600																																							
E5-2650L v3	12C/1.8GHz/30MB/65W/DDR4-2133																																								
E5-2630L v3	8C/1.8GHz/20MB/55W/DDR4-1866																																								
Chipset	Intel C610 Series Chipset																																								
Memory DIMMs	16 DIMM sockets. 4 channels per processor, 2 DIMMs per channel. RDIMM or LRDIMM (cannot be intermixed), DDR4-2133 or DDR4-2400																																								
Memory capacity	512GB (RDIMM, 32GB x 16)/1024GB (LRDIMM, 64GB x 16), 2nd CPU is needed																																								
Memory protection	ECC, memory mirroring, lockstep, and memory sparing																																								
RAID controller	<table border="1"> <thead> <tr> <th>RAID controller</th> <th>Drive type</th> <th>RAID support</th> <th>Compatible models</th> </tr> </thead> <tbody> <tr> <td>Onboard RAID110i</td> <td>6Gbs SATA</td> <td>0/1/10, 5 with optional key</td> <td>4x3.5" HS/ES, 8x2.5" HS</td> </tr> <tr> <td>RAID500 PCIe</td> <td>6Gbs SAS/SATA</td> <td>0/1/10, 5/50 with optional key</td> <td>4x3.5" HS, 8x2.5" HS</td> </tr> <tr> <td>RAID520i PCIe</td> <td>12Gbs SAS/SATA</td> <td>0/1/10, 5/50 with optional key</td> <td>4x3.5" HS/ES, 8x2.5" HS</td> </tr> <tr> <td>RAID710 PCIe (1GB memory)</td> <td>6Gbs SAS/SATA</td> <td>0/1/10/5/50/6/60</td> <td>4x3.5" HS, 8x2.5" HS</td> </tr> <tr> <td>RAID720i PCIe</td> <td>12Gbs SAS/SATA</td> <td>0/1/10/5/50, 6/60 with optional cache</td> <td>4x3.5" HS/ES, 8x2.5" HS</td> </tr> </tbody> </table>	RAID controller	Drive type	RAID support	Compatible models	Onboard RAID110i	6Gbs SATA	0/1/10, 5 with optional key	4x3.5" HS/ES, 8x2.5" HS	RAID500 PCIe	6Gbs SAS/SATA	0/1/10, 5/50 with optional key	4x3.5" HS, 8x2.5" HS	RAID520i PCIe	12Gbs SAS/SATA	0/1/10, 5/50 with optional key	4x3.5" HS/ES, 8x2.5" HS	RAID710 PCIe (1GB memory)	6Gbs SAS/SATA	0/1/10/5/50/6/60	4x3.5" HS, 8x2.5" HS	RAID720i PCIe	12Gbs SAS/SATA	0/1/10/5/50, 6/60 with optional cache	4x3.5" HS/ES, 8x2.5" HS																
	RAID controller	Drive type	RAID support	Compatible models																																					
	Onboard RAID110i	6Gbs SATA	0/1/10, 5 with optional key	4x3.5" HS/ES, 8x2.5" HS																																					
	RAID500 PCIe	6Gbs SAS/SATA	0/1/10, 5/50 with optional key	4x3.5" HS, 8x2.5" HS																																					
	RAID520i PCIe	12Gbs SAS/SATA	0/1/10, 5/50 with optional key	4x3.5" HS/ES, 8x2.5" HS																																					
	RAID710 PCIe (1GB memory)	6Gbs SAS/SATA	0/1/10/5/50/6/60	4x3.5" HS, 8x2.5" HS																																					
RAID720i PCIe	12Gbs SAS/SATA	0/1/10/5/50, 6/60 with optional cache	4x3.5" HS/ES, 8x2.5" HS																																						
	Optional cache for RAID 710: CacheVault flash cache with super capacitor, CacheCade Pro, or FastPath.																																								
	Optional cache for RAID 720/AnyRAID 720i and 720ix: 1GB read-only memory or 1GB/2GB/4GB flash with super capacitor. Flash options include CacheVault, CacheCade Pro, and FastPath. 720ix must have cache.																																								
	<i>Note: RAID 50 and 60 are available on 8 x 2.5" models only.</i>																																								
Disk drive bays	Up to 4x3.5" hot-swap, 4x3.5" easy-swap, or 8x2.5" hot-swap disk bays on front. Supports external RDX tape drive via USB.																																								
Maximum internal storage	3.5" model: up to 32TB with 7.2K SATA or SAS HDD, up to 7.2TB with 10K SAS HDD, up to 2.4TB with 15K SAS HDD, or up to 6.4TB with SATA SSD. 3.5" ES model: up to 12TB with 7.2K SATA, up to 24TB with 7.2K SAS. 2.5" model: up to 16TB with 7.2K SATA HDD, up to 14.4TB with 10K SAS HDD, up to 4.8TB with 15K SAS HDD, or up to 12.8TB with SATA or SAS SSD																																								
SD module	Up to 2 SDHC flash cards via optional SD module, 8GB or 32GB each																																								
Optical drive	Optional one 9.5mm optical, DVD-ROM or DVD±RW.																																								
Network interfaces	One dedicated management port, two Gigabit Ethernet ports (RJ-45). Supports optional discrete network adapters via PCIe slots																																								
Security features	Power-on and administrator password. Optional TPM (TCG 1.2-compliant) Supports ThinkServer System Manager (TSM), optional TSM Premium. UEFI. Onboard Aspeed AST2400 graphics/management processor, IPMI 2.0-compliant baseboard management controller (BMC).																																								
Systems management	Control Panel LEDs shows the status of power, ID, network, system. Supports ThinkServer management software: Diagnostics, Deployment Manager, Energy Manager, System Manager, Partner Pack for VMware vCenter and Microsoft System Center Operations Manager, Power Planner																																								

Components	Specification														
Operating systems supported	Microsoft Windows Server 2016/2012 R2/2012/2008 R2. Windows Small Business Server 2011. Red Hat Enterprise Linux 6.5/6.6/7. SUSE Linux Enterprise Server 11. VMware vSphere (ESXi) 5.1 P5/5.5 U2/6.0														
Base warranty	1 or 3-year limited onsite service with 9x5/NBD														
Power supply	Up to two redundant hot-swap 450W/550W/750W power supplies. 450 W is 80 PLUS Gold qualified. 550W is 80 PLUS Platinum qualified. 750W is 80 PLUS Platinum or Titanium qualified. 750W Titanium is 200V - 240V, others are 110V - 240V.														
	<table border="1"> <thead> <tr> <th rowspan="2">Disk bay configuration</th> <th colspan="3">PSU requirements</th> </tr> <tr> <th>450W</th> <th>550W</th> <th>750W</th> </tr> </thead> <tbody> <tr> <td>4x3.5"</td> <td>•</td> <td>•</td> <td>•</td> </tr> <tr> <td>8x2.5"</td> <td>•</td> <td>•</td> <td>•</td> </tr> </tbody> </table>	Disk bay configuration	PSU requirements			450W	550W	750W	4x3.5"	•	•	•	8x2.5"	•	•
Disk bay configuration	PSU requirements														
	450W	550W	750W												
4x3.5"	•	•	•												
8x2.5"	•	•	•												
Graphics	Onboard Aspeed AST2400 with 16MB memory, one DisplayPort on front, one VGA on rear.														
Front ports	Two USB 2.0. One DisplayPort (one VGA on E5-2600 v4 models instead)														
Rear ports	One VGA, two USB 3.0, one RJ-45 (dedicated mgmt), two ethernet, one serial (9-pin)														
Cooling	6 (5+1, dual processors) or 4 (3+1, single processor) fans, non-hot swap														
Noise emissions	Operating: < 6.5 Bels. Idle: < 5.4 Bels (Maximum configuration)														
Environmental specification	Temperature - operating	50 °F to 95 °F (10 °C to 35 °C)													
	Temperature - non operating (no package)	-10 °C to 60 °C													
	Temperature - non operating (with package)	-40 °C to 70 °C													
	Altitude - operating	(Unpressurized): 0-10000ft (0-3048m)													
	Humidity - operating	8%-90%, non-condensing													
	Humidity - storage (with package)	8%-90%, non-condensing													

Expansion slots

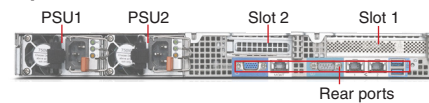

Up to two PCIe 3.0 x 16 slots:

Slot 1	PCIe 3.0 x16, half length, full height, by CPU1
Slot 2 for dual processors model	PCIe 3.0 x16, low-profile, half length, requires 2nd riser card and 2nd CPU
Slot 2 for single processor model	PCIe 3.0 x16 (x8 electrical), low-profile, half length, by CPU1, requires 2nd riser card

For a list of all supported options, please see https://download.lenovo.com/pccbbs/options_iso/ocm_september_2016_thinkserver.xlsx sheet

Model	Region	Processor	2nd CPU	Memory	RAID Controller	Disk Bays	Storage	Slots	Optical	Add-on NIC	TPM	System Mgmt	OS	Warranty	Power Supply	Ann Date (m/y)
70D6001YUX	US	1xE5-2603 v3 6C/1.6GHz/15MB/85W/DDR4-1600	4XG0F28848	1x4GB RDIMM DDR4-2133 ECC	RAID 110i	4x3.5" HS	Open	None	9.5mm DVD±RW	None	TPM	TSM	None	3-year	550Wx1 Platinum	12/14
70D60020UX	US	1xE5-2609 v3 6C/1.9GHz/15MB/85W/DDR4-1600	4XG0F28847	1x8GB RDIMM DDR4-2133 ECC	RAID 110i	4x3.5" HS	Open	1xFHHL	9.5mm DVD±RW	None	TPM	TSM	None	3-year	550Wx1 Platinum	12/14
70D60021UX	US	1xE5-2620 v3 6C/2.4GHz/15MB/85W/DDR4-1866	4XG0F28846	1x8GB RDIMM DDR4-2133 ECC	RAID 110i	4x3.5" HS	Open	1xFHHL	9.5mm DVD±RW	None	TPM	TSM	None	3-year	550Wx1 Platinum	12/14
70D60022UX	US	2xE5-2640 v3 8C/2.6GHz/20MB/90W/DDR4-1866	-	2x8GB RDIMM DDR4-2133 ECC	RAID 110i	4x3.5" HS	Open	1xFHHL+1xLP (2x16)	9.5mm DVD±RW	None	TPM	TSM	None	3-year	550Wx1 Platinum	12/14
70D60023UX	US	1xE5-2650 v3 10C/2.3GHz/25MB/105W/DDR4-2133	4XG0F28843	1x8GB RDIMM DDR4-2133 ECC	RAID 110i	4x3.5" HS	Open	1xFHHL	9.5mm DVD±RW	None	TPM	TSM	None	3-year	550Wx1 Platinum	12/14
70D60024UX	US	1xE5-2660 v3 10C/2.6GHz/25MB/105W/DDR4-2133	4XG0F28842	1x8GB RDIMM DDR4-2133 ECC	RAID 110i	4x3.5" HS	Open	1xFHHL	9.5mm DVD±RW	None	TPM	TSM	None	3-year	550Wx1 Platinum	12/14
70D60025UX	US	1xE5-2603 v3 6C/1.6GHz/15MB/85W/DDR4-1600	4XG0F28848	1x8GB RDIMM DDR4-2133 ECC	RAID 110i	4x3.5" HS	Open	1xFHHL	9.5mm DVD±RW	None	TPM	TSM	None	3-year	550Wx1 Platinum	12/14
70D60026UX	US	1xE5-2630 v3 8C/2.4GHz/20MB/85W/DDR4-1866	4XG0F28845	1x8GB RDIMM DDR4-2133 ECC	RAID 110i	4x3.5" HS	Open	1xFHHL	9.5mm DVD±RW	None	TPM	TSM	None	3-year	550Wx1 Platinum	12/14
70D60035UX	US	1xE5-2620 v3 6C/2.4GHz/15MB/85W/DDR4-1866	4XG0F28846	2x8GB RDIMM DDR4-2133 ECC	RAID 110i	4x3.5" HS	2x1TB HDD 7.2K 3.5" SATA6Gbs	1xFHHL	9.5mm DVD±RW	None	TPM	TSM Premium	None	3-year	750Wx2 Platinum	02/15
70D6003DUX	US	2xE5-2620 v3 6C/2.4GHz/15MB/85W/DDR4-1866	-	2x16GB RDIMM DDR4-2133 ECC	RAID 110i	4x3.5" HS	Open	1xFHHL+1xLP (2x16)	9.5mm DVD±RW	None	TPM	TSM	None	3-year	550Wx2 Platinum	09/15
70D6003PUX	US	1xE5-2609 v3 6C/1.9GHz/15MB/85W/DDR4-1600	4XG0F28847	4x16GB RDIMM DDR4-2133 ECC	RAID 110i	4x3.5" HS	4x1TB HDD 7.2K 3.5" SATA6Gbs	None	None	None	TPM	TSM Premium	None	3-year	550Wx2 Platinum	11/15

Model	Region	Processor	2nd CPU	Memory	RAID Controller	Disk Bays	Storage	Slots	Optical	Add-on NIC	TPM	System Mgmt	OS	Warranty	Power Supply	Ann Date (m/y)
70D8001TUX	US	1xE5-2603 v3 6C/1.6GHz/15MB/85W/DDR4-1600	4XG0F28848	1x4GB RDIMM DDR4-2133 ECC	RAID 110i	8x2.5" HS	Open	None	9.5mm DVD±RW	None	TPM	TSM	None	3-year	550Wx1 Platinum	12/14
70D8001UUX	US	1xE5-2609 v3 6C/1.9GHz/15MB/85W/DDR4-1600	4XG0F28847	1x8GB RDIMM DDR4-2133 ECC	RAID 110i	8x2.5" HS	Open	1xFHHL	9.5mm DVD±RW	None	TPM	TSM	None	3-year	550Wx1 Platinum	12/14
70D8001VUX	US	1xE5-2620 v3 6C/2.4GHz/15MB/85W/DDR4-1866	4XG0F28846	1x8GB RDIMM DDR4-2133 ECC	RAID 110i	8x2.5" HS	Open	1xFHHL	9.5mm DVD±RW	None	TPM	TSM	None	3-year	550Wx1 Platinum	12/14
70D8001WUX	US	1xE5-2640 v3 8C/2.6GHz/20MB/90W/DDR4-1866	4XG0F28844	1x8GB RDIMM DDR4-2133 ECC	RAID 110i	8x2.5" HS	Open	1xFHHL	9.5mm DVD±RW	None	TPM	TSM	None	3-year	550Wx1 Platinum	12/14
70D8001XUX	US	1xE5-2650 v3 10C/2.3GHz/25MB/105W/DDR4-2133	4XG0F28843	1x8GB RDIMM DDR4-2133 ECC	RAID 110i	8x2.5" HS	Open	1xFHHL	9.5mm DVD±RW	None	TPM	TSM	None	3-year	550Wx1 Platinum	12/14
70D8001YUX	US	1xE5-2660 v3 10C/2.6GHz/25MB/105W/DDR4-2133	4XG0F28842	1x8GB RDIMM DDR4-2133 ECC	RAID 110i	8x2.5" HS	Open	1xFHHL	9.5mm DVD±RW	None	TPM	TSM	None	3-year	550Wx1 Platinum	12/14
70D80020UX	US	1xE5-2603 v3 6C/1.6GHz/15MB/85W/DDR4-1600	4XG0F28848	1x8GB RDIMM DDR4-2133 ECC	RAID 110i	8x2.5" HS	Open	1xFHHL	9.5mm DVD±RW	None	TPM	TSM	None	3-year	550Wx1 Platinum	12/14
70D80021UX	US	1xE5-2630 v3 8C/2.4GHz/20MB/85W/DDR4-1866	4XG0F28845	1x8GB RDIMM DDR4-2133 ECC	RAID 110i	8x2.5" HS	Open	1xFHHL	9.5mm DVD±RW	None	TPM	TSM	None	3-year	550Wx1 Platinum	12/14

Model	Region	Processor	2nd CPU	Memory	RAID Controller	Disk Bays	Storage	Slots	Optical	Add-on NIC	TPM	System Mgmt	OS	Warranty	Power Supply	Ann Date (m/y)
70QK000VUX	US	1xE5-2603 v4 6C/1.7GHz/15MB/85W/DDR4-1866	4XG0G89089	1x16GB RDIMM DDR4-2400 ECC	RAID 110i	4x3.5" HS	Open	1xFHHL	None	None	TPM	TSM	None	3-year	750Wx1 Platinum	04/16
70QK000WUX	US	1xE5-2609 v4 8C/1.7GHz/20MB/85W/DDR4-1866	4XG0G89084	1x16GB RDIMM DDR4-2400 ECC	RAID 110i	4x3.5" HS	Open	1xFHHL	None	None	TPM	TSM	None	3-year	750Wx1 Platinum	04/16
70QK000XUX	US	1xE5-2620 v4 8C/2.1GHz/20MB/85W/DDR4-2133	4XG0G89079	1x16GB RDIMM DDR4-2400 ECC	RAID 110i	4x3.5" HS	Open	1xFHHL	None	None	TPM	TSM	None	3-year	750Wx1 Platinum	04/16
70QK000YUX	US	1xE5-2630 v4 10C/2.2GHz/20MB/85W/DDR4-2133	4XG0G89074	1x16GB RDIMM DDR4-2400 ECC	RAID 110i	4x3.5" HS	Open	1xFHHL	None	None	TPM	TSM	None	3-year	750Wx1 Platinum	04/16
70QK0010UX	US	1xE5-2640 v4 10C/2.4GHz/25MB/90W/DDR4-2133	4XG0G89069	1x16GB RDIMM DDR4-2400 ECC	RAID 110i	4x3.5" HS	Open	1xFHHL	None	None	TPM	TSM	None	3-year	750Wx1 Platinum	04/16
70QK0011UX	US	1xE5-2650 v4 12C/2.2GHz/30MB/105W/DDR4-2400	4XG0G89064	1x16GB RDIMM DDR4-2400 ECC	RAID 110i	4x3.5" HS	Open	1xFHHL	None	None	TPM	TSM	None	3-year	750Wx1 Platinum	04/16
70QK0012UX	US	1xE5-2660 v4 14C/2GHz/35MB/105W/DDR4-2400	4XG0G89059	1x16GB RDIMM DDR4-2400 ECC	RAID 110i	4x3.5" HS	Open	1xFHHL	None	None	TPM	TSM	None	3-year	750Wx1 Platinum	04/16
70QK0013UX	US	1xE5-2609 v4 8C/1.7GHz/20MB/85W/DDR4-1866	4XG0G89084	4x16GB RDIMM DDR4-2400 ECC	RAID 110i	4x3.5" HS	4x1TB HDD 7.2K 3.5" SATA6Gbs	1xFHHL	None	None	TPM	TSM Premium	None	3-year	750Wx2 Platinum	04/16
70QK0014UX	US	2xE5-2620 v4 8C/2.1GHz/20MB/85W/DDR4-2133	-	2x16GB RDIMM DDR4-2400 ECC	RAID 110i	4x3.5" HS	Open	1xFHHL+1xLP (2x16)	None	None	TPM	TSM Premium	None	3-year	750Wx2 Platinum	04/16

Model	Region	Processor	2nd CPU	Memory	RAID Controller	Disk Bays	Storage	Slots	Optical	Add-on NIC	TPM	System Mgmt	OS	Warranty	Power Supply	Ann Date (m/y)
70QM0010UX	US	1xE5-2603 v4 6C/1.7GHz/15MB/85W/DDR4-1866	4XG0G89089	1x16GB RDIMM DDR4-2400 ECC	RAID 110i	8x2.5" HS	Open	1xFHHL	None	None	TPM	TSM	None	3-year	750Wx1 Platinum	04/16
70QM0011UX	US	1xE5-2609 v4 8C/1.7GHz/20MB/85W/DDR4-1866	4XG0G89084	1x16GB RDIMM DDR4-2400 ECC	RAID 110i	8x2.5" HS	Open	1xFHHL	None	None	TPM	TSM	None	3-year	750Wx1 Platinum	04/16
70QM0012UX	US	1xE5-2620 v4 8C/2.1GHz/20MB/85W/DDR4-2133	4XG0G89079	1x16GB RDIMM DDR4-2400 ECC	RAID 110i	8x2.5" HS	Open	1xFHHL	None	None	TPM	TSM	None	3-year	750Wx1 Platinum	04/16
70QM0013UX	US	1xE5-2630L v4 10C/1.8GHz/25MB/55W/DDR4-2133	4XG0G89104	1x16GB RDIMM DDR4-2400 ECC	RAID 110i	8x2.5" HS	Open	1xFHHL	None	None	TPM	TSM	None	3-year	750Wx1 Platinum	04/16
70QM0014UX	US	1xE5-2630 v4 10C/2.2GHz/20MB/85W/DDR4-2133	4XG0G89074	1x16GB RDIMM DDR4-2400 ECC	RAID 110i	8x2.5" HS	Open	1xFHHL	None	None	TPM	TSM	None	3-year	750Wx1 Platinum	04/16
70QM0015UX	US	1xE5-2640 v4 10C/2.4GHz/25MB/90W/DDR4-2133	4XG0G89069	1x16GB RDIMM DDR4-2400 ECC	RAID 110i	8x2.5" HS	Open	1xFHHL	None	None	TPM	TSM	None	3-year	750Wx1 Platinum	04/16
70QM0016UX	US	1xE5-2650 v4 12C/2.2GHz/30MB/105W/DDR4-2400	4XG0G89064	1x16GB RDIMM DDR4-2400 ECC	RAID 110i	8x2.5" HS	Open	1xFHHL	None	None	TPM	TSM	None	3-year	750Wx1 Platinum	04/16
70QM0017UX	US	1xE5-2660 v4 14C/2GHz/35MB/105W/DDR4-2400	4XG0G89059	1x16GB RDIMM DDR4-2400 ECC	RAID 110i	8x2.5" HS	Open	1xFHHL	None	None	TPM	TSM	None	3-year	750Wx1 Platinum	04/16



ThinkServer RD450 Platform Specifications

Product Specifications Reference (PSREF)

Components	Specification																																								
Dimensions	2U rack. Height: 87 mm (3.4 in), width: 482 mm (19 in), depth: 764 mm (30 in)																																								
Weight	Minimum configuration: 16 kg (35.3 lb), maximum: 27 kg (59.52 lb)																																								
Processor	Up to two 105W Intel Xeon E5-2600 v4 or E5-2600 v3 family processors.																																								
	E5-2660 v4	14C/2GHz/35MB/105W/DDR4-2400																																							
	E5-2650 v4	12C/2.2GHz/30MB/105W/DDR4-2400																																							
	E5-2640 v4	10C/2.4GHz/25MB/90W/DDR4-2133																																							
	E5-2630 v4	10C/2.2GHz/20MB/85W/DDR4-2133																																							
	E5-2623 v4	4C/2.6GHz/10MB/85W/DDR4-2133																																							
	E5-2620 v4	8C/2.1GHz/20MB/85W/DDR4-2133																																							
	E5-2609 v4	8C/1.7GHz/20MB/85W/DDR4-1866																																							
	E5-2603 v4	6C/1.7GHz/15MB/85W/DDR4-1866																																							
	E5-2650L v4	14C/1.7GHz/35MB/65W/DDR4-2400																																							
	E5-2630L v4	10C/1.8GHz/25MB/55W/DDR4-2133																																							
	E5-2660 v3	10C/2.6GHz/25MB/105W/DDR4-2133																																							
	E5-2650 v3	10C/2.3GHz/25MB/105W/DDR4-2133																																							
	E5-2640 v3	8C/2.6GHz/20MB/90W/DDR4-1866																																							
	E5-2630 v3	8C/2.4GHz/20MB/85W/DDR4-1866																																							
	E5-2623 v3	4C/3GHz/10MB/105W/DDR4-1866																																							
	E5-2620 v3	6C/2.4GHz/15MB/85W/DDR4-1866																																							
E5-2609 v3	6C/1.9GHz/15MB/85W/DDR4-1600																																								
E5-2603 v3	6C/1.6GHz/15MB/85W/DDR4-1600																																								
E5-2650L v3	12C/1.8GHz/30MB/65W/DDR4-2133																																								
E5-2630L v3	8C/1.8GHz/20MB/55W/DDR4-1866																																								
Chipset	Intel C610 Series Chipset																																								
Memory DIMMs	16 DIMM sockets with 8 channels. 4 channels per processor, 2 DIMMs per channel. RDIMM or LRDIMM (cannot be intermixed), DDR4, DDR4-2133 or DDR4-2400																																								
Memory capacity	512GB (RDIMM, 32GB x 16)/1024GB (LRDIMM, 64GB x 16), 2nd CPU is needed																																								
Memory protection	ECC, memory mirroring, lockstep, and memory sparing																																								
RAID controller	<table border="1"> <thead> <tr> <th>RAID controller</th> <th>Drive type</th> <th>RAID support</th> <th>Compatible models</th> </tr> </thead> <tbody> <tr> <td>Onboard RAID110i</td> <td>6Gbs SATA</td> <td>0/1/10, 5 with optional key</td> <td>8x3.5" HS/ES, 8x2.5" HS</td> </tr> <tr> <td>RAID500 PCIe</td> <td>6Gbs SAS/SATA</td> <td>0/1/10, 5/50 with optional key</td> <td>8x3.5" HS</td> </tr> <tr> <td>RAID520i PCIe</td> <td>12Gbs SAS/SATA</td> <td>0/1/10, 5/50 with optional key</td> <td>8x3.5" HS/ES, 8x2.5" HS</td> </tr> <tr> <td>RAID710 PCIe (1GB memory)</td> <td>6Gbs SAS/SATA</td> <td>0/1/10/5/50/6/60</td> <td>8x3.5" HS</td> </tr> <tr> <td>RAID720i PCIe</td> <td>12Gbs SAS/SATA</td> <td>0/1/10/5/50, 6/60 with optional cache</td> <td>8x3.5" HS/ES, 8x2.5" HS</td> </tr> <tr> <td>AnyRAID 110i</td> <td>6Gbs SATA</td> <td>0/1/10, 5 with optional key</td> <td>8x2.5" HS</td> </tr> <tr> <td>AnyRAID 510i</td> <td>6Gbs SAS/SATA</td> <td>0/1/10, 5/50 with optional key</td> <td>8x2.5" HS</td> </tr> <tr> <td>AnyRAID 720i</td> <td>12Gbs SAS/SATA</td> <td>0/1/10/5/50, 6/60 with optional cache</td> <td>8x2.5" HS</td> </tr> <tr> <td>AnyRAID 720ix</td> <td>12Gbs SAS/SATA</td> <td>0/1/10/5/50/6/60</td> <td>16/24x2.5" HS, 8x2.5" HS+optional tape</td> </tr> </tbody> </table>	RAID controller	Drive type	RAID support	Compatible models	Onboard RAID110i	6Gbs SATA	0/1/10, 5 with optional key	8x3.5" HS/ES, 8x2.5" HS	RAID500 PCIe	6Gbs SAS/SATA	0/1/10, 5/50 with optional key	8x3.5" HS	RAID520i PCIe	12Gbs SAS/SATA	0/1/10, 5/50 with optional key	8x3.5" HS/ES, 8x2.5" HS	RAID710 PCIe (1GB memory)	6Gbs SAS/SATA	0/1/10/5/50/6/60	8x3.5" HS	RAID720i PCIe	12Gbs SAS/SATA	0/1/10/5/50, 6/60 with optional cache	8x3.5" HS/ES, 8x2.5" HS	AnyRAID 110i	6Gbs SATA	0/1/10, 5 with optional key	8x2.5" HS	AnyRAID 510i	6Gbs SAS/SATA	0/1/10, 5/50 with optional key	8x2.5" HS	AnyRAID 720i	12Gbs SAS/SATA	0/1/10/5/50, 6/60 with optional cache	8x2.5" HS	AnyRAID 720ix	12Gbs SAS/SATA	0/1/10/5/50/6/60	16/24x2.5" HS, 8x2.5" HS+optional tape
	RAID controller	Drive type	RAID support	Compatible models																																					
	Onboard RAID110i	6Gbs SATA	0/1/10, 5 with optional key	8x3.5" HS/ES, 8x2.5" HS																																					
	RAID500 PCIe	6Gbs SAS/SATA	0/1/10, 5/50 with optional key	8x3.5" HS																																					
	RAID520i PCIe	12Gbs SAS/SATA	0/1/10, 5/50 with optional key	8x3.5" HS/ES, 8x2.5" HS																																					
	RAID710 PCIe (1GB memory)	6Gbs SAS/SATA	0/1/10/5/50/6/60	8x3.5" HS																																					
	RAID720i PCIe	12Gbs SAS/SATA	0/1/10/5/50, 6/60 with optional cache	8x3.5" HS/ES, 8x2.5" HS																																					
	AnyRAID 110i	6Gbs SATA	0/1/10, 5 with optional key	8x2.5" HS																																					
	AnyRAID 510i	6Gbs SAS/SATA	0/1/10, 5/50 with optional key	8x2.5" HS																																					
	AnyRAID 720i	12Gbs SAS/SATA	0/1/10/5/50, 6/60 with optional cache	8x2.5" HS																																					
AnyRAID 720ix	12Gbs SAS/SATA	0/1/10/5/50/6/60	16/24x2.5" HS, 8x2.5" HS+optional tape																																						
Optional cache for RAID 710: CacheVault flash cache with super capacitor, CacheCade Pro, or FastPath.																																									
Optional cache for RAID 720/AnyRAID 720i and 720ix: 1GB read-only memory or 1GB/2GB/4GB flash with super capacitor. Flash options include CacheVault, CacheCade Pro, and FastPath. 720ix must have cache.																																									
Disk drive bays	Up to 8x3.5" hot-swap, 8x3.5" easy-swap, or 24x2.5" hot-swap disk bays on front. Up to one internal LTO-6 SAS tape drive on 8x2.5" and 720ix model, or external RDX tape drive via USB.																																								
Maximum internal storage	3.5" HS model: up to 64TB with 7.2K SATA or SAS HDD, up to 14.4TB with 10K SAS HDD, up to 4.8TB with 15K SAS HDD, or up to 12.8TB with SATA SSD. 3.5" ES model: up to 24TB with 7.2K SATA, up to 48TB with 7.2K SAS. 2.5" HS model: up to 48TB with 7.2K SATA HDD, up to 43.2TB with 10K SAS HDD, up to 14.4TB with 15K SAS HDD, or up to 38.4TB with SATA or SAS SSD																																								
SD module	Up to 2 SDHC flash cards via optional SD module, 8GB or 32GB each																																								
PCIe SSD adapter	Supports 1.6TB or 3.2TB SSD via PCIe adapter																																								
Optical drive	Optional one 9.5mm optical on 3.5" or 8/16 x 2.5" models, DVD-ROM or DVD±RW.																																								

Components	Specification																																		
Network interfaces	One dedicated management port, two Gigabit Ethernet ports. Supports optional discrete network adapters via PCIe slots																																		
Security features	Power-on and administrator password. Optional TPM (TCG 1.2-compliant)																																		
Systems management	Supports ThinkServer System Manager (TSM), optional TSM Premium. UEFI. Onboard Aspeed AST2400 graphics/management processor, IPMI 2.0-compliant baseboard management controller (BMC). Control Panel LEDs shows the status of power, ID, network, system. Supports ThinkServer management software: Diagnostics, Deployment Manager, Energy Manager, System Manager, Partner Pack for VMware vCenter and Microsoft System Center Operations Manager, Power Planner																																		
Operating systems supported	Microsoft Windows Server 2016/2012 R2/2012/2008 R2. Windows Small Business Server 2011. Red Hat Enterprise Linux 6.5/6.6/7. SUSE Linux Enterprise Server 11. VMware vSphere (ESXi) 5.1 P5/5.5 U2/6.0																																		
Base warranty	1 or 3-year limited onsite service with 9x5/NBD																																		
Power supply	Up to two redundant hot-swap 450W/550W/750W/1100W power supplies. 450 W is 80 PLUS Gold qualified. 550W and 1100W are 80 PLUS Platinum qualified. 750W is 80 PLUS Platinum or Titanium qualified. 750W Titanium is 200V - 240V, others are 110V - 240V.																																		
	<table border="1"> <thead> <tr> <th rowspan="2">Disk bay configuration</th> <th colspan="4">PSU requirements</th> </tr> <tr> <th>450W</th> <th>550W</th> <th>750W</th> <th>1100W</th> </tr> </thead> <tbody> <tr> <td>8x3.5"</td> <td>•</td> <td>•</td> <td>•</td> <td>•</td> </tr> <tr> <td>8x2.5"</td> <td>•</td> <td>•</td> <td>•</td> <td>•</td> </tr> <tr> <td>8x2.5" + Tape</td> <td>•</td> <td>•</td> <td>•</td> <td>•</td> </tr> <tr> <td>16x2.5"</td> <td>•</td> <td>•</td> <td>•</td> <td>•</td> </tr> <tr> <td>24x2.5"</td> <td>•</td> <td>•</td> <td>•</td> <td>•</td> </tr> </tbody> </table>	Disk bay configuration	PSU requirements				450W	550W	750W	1100W	8x3.5"	•	•	•	•	8x2.5"	•	•	•	•	8x2.5" + Tape	•	•	•	•	16x2.5"	•	•	•	•	24x2.5"	•	•	•	•
	Disk bay configuration		PSU requirements																																
		450W	550W	750W	1100W																														
	8x3.5"	•	•	•	•																														
8x2.5"	•	•	•	•																															
8x2.5" + Tape	•	•	•	•																															
16x2.5"	•	•	•	•																															
24x2.5"	•	•	•	•																															
Graphics	Onboard Aspeed AST2400 with 16MB memory																																		
Front ports	Two USB 2.0. One DisplayPort (one VGA on E5-2600 v4 models instead)																																		
Rear ports	One VGA, two USB 3.0, one RJ-45 (dedicated mgmt), two ethernet, one serial (9-pin)																																		
Cooling	4 (3+1, dual processors) or 3 (2+1, single processor) fans, non-hot swap																																		
Noise emissions	Operating: < 6.5 Bels. Idle: < 5.6 Bels (Maximum configuration)																																		
Environmental specification	Temperature - operating	50 °F to 95 °F (10 °C to 35 °C)																																	
	Temperature - non operating (no package)	-10 °C to 60 °C																																	
	Temperature - non operating (with package)	-40 °C to 70 °C																																	
	Altitude - operating	(Unpressurized): 0-10000ft (0-3048m)																																	
	Humidity - operating	8%-90%, non-condensing																																	
Humidity - storage (with package)	8%-90%, non-condensing																																		

Expansion slots



Slot 1 (riser card 1)	PCIe 3.0 x8, half length, full height, CPU1
Slot 2 (riser card 1)	PCIe 3.0 x8, half length, full height, CPU1
Slot 3 (riser card 2)	PCIe 3.0 x8, low-profile, half length, CPU2, requires 2nd riser card and 2nd CPU
Slot 4 (riser card 2)	PCIe 3.0 x8, low-profile, half length, CPU2, requires 2nd riser card and 2nd CPU
Slot 5 (riser card 2)	PCIe 3.0 x8, low-profile, half length, CPU1, requires 2nd riser card
Slot 6 (onboard)	PCIe 3.0 x16 (x8 elec), low-profile, half length, requires 2nd CPU

For a list of all supported options, please see https://download.lenovo.com/pccbbs/options_iso/ocm_september_2016_thinkserver.xlsx sheet

Model	Region	Processor	2nd CPU	Memory	RAID Controller	Disk Bays	Storage	Slots	Optical	Add-on NIC	TPM	System Mgmt	OS	Warranty	Power Supply	Ann Date (m/y)
70DA000XUX	US	1xE5-2603 v3 6C/1.6GHz/15MB/85W/DDR4-1600	4XG0F28860	1x4GB RDIMM DDR4-2133 ECC	110i (AnyRAID)	8x2.5" HS	Open	None	9.5mm DVD±RW	None	TPM	TSM	None	3-year	550Wx1 Platinum	12/14
70DA000YUX	US	1xE5-2609 v3 6C/1.9GHz/15MB/85W/DDR4-1600	4XG0F28859	1x8GB RDIMM DDR4-2133 ECC	110i (AnyRAID)	8x2.5" HS	Open	2xFH HL	9.5mm DVD±RW	None	TPM	TSM	None	3-year	550Wx1 Platinum	12/14
70DA0010UX	US	1xE5-2620 v3 6C/2.4GHz/15MB/85W/DDR4-1866	4XG0F28858	1x8GB RDIMM DDR4-2133 ECC	110i (AnyRAID)	8x2.5" HS	Open	2xFH HL	9.5mm DVD±RW	None	TPM	TSM	None	3-year	550Wx1 Platinum	12/14
70DA0011UX	US	1xE5-2630 v3 8C/2.4GHz/20MB/85W/DDR4-1866	4XG0F28857	1x8GB RDIMM DDR4-2133 ECC	110i (AnyRAID)	8x2.5" HS	Open	2xFH HL	9.5mm DVD±RW	None	TPM	TSM	None	3-year	550Wx1 Platinum	12/14
70DA0012UX	US	1xE5-2640 v3 8C/2.6GHz/20MB/90W/DDR4-1866	4XG0F28856	1x8GB RDIMM DDR4-2133 ECC	110i (AnyRAID)	8x2.5" HS	Open	2xFH HL	9.5mm DVD±RW	None	TPM	TSM	None	3-year	550Wx1 Platinum	12/14
70DA0013UX	US	1xE5-2660 v3 10C/2.6GHz/25MB/105W/DDR4-2133	4XG0F28854	1x8GB RDIMM DDR4-2133 ECC	110i (AnyRAID)	8x2.5" HS	Open	2xFH HL	9.5mm DVD±RW	None	TPM	TSM	None	3-year	550Wx1 Platinum	12/14
70DA0014UX	US	1xE5-2603 v3 6C/1.6GHz/15MB/85W/DDR4-1600	4XG0F28860	1x8GB RDIMM DDR4-2133 ECC	110i (AnyRAID)	8x2.5" HS	Open	2xFH HL	None	None	TPM	TSM	None	3-year	550Wx1 Platinum	12/14

Model	Region	Processor	2nd CPU	Memory	RAID Controller	Disk Bays	Storage	Slots	Optical	Add-on NIC	TPM	System Mgmt	OS	Warranty	Power Supply	Ann Date (m/y)
70DC001CUX	US	1xE5-2603 v3 6C/1.6GHz/15MB/85W/DDR4-1600	4XG0F28860	1x4GB RDIMM DDR4-2133 ECC	Onboard 110i (PCIe)	8x3.5" HS	Open	None	9.5mm DVD±RW	None	TPM	TSM	None	3-year	550Wx1 Platinum	12/14
70DC001DUX	US	1xE5-2609 v3 6C/1.9GHz/15MB/85W/DDR4-1600	4XG0F28859	1x8GB RDIMM DDR4-2133 ECC	Onboard 110i (PCIe)	8x3.5" HS	Open	2xFH HL	9.5mm DVD±RW	None	TPM	TSM	None	3-year	550Wx1 Platinum	12/14
70DC001EUX	US	1xE5-2620 v3 6C/2.4GHz/15MB/85W/DDR4-1866	4XG0F28858	1x8GB RDIMM DDR4-2133 ECC	Onboard 110i (PCIe)	8x3.5" HS	Open	2xFH HL	9.5mm DVD±RW	None	TPM	TSM	None	3-year	550Wx1 Platinum	12/14
70DC001FUX	US	1xE5-2630 v3 8C/2.4GHz/20MB/85W/DDR4-1866	4XG0F28857	1x8GB RDIMM DDR4-2133 ECC	Onboard 110i (PCIe)	8x3.5" HS	Open	2xFH HL	9.5mm DVD±RW	None	TPM	TSM	None	3-year	550Wx1 Platinum	12/14
70DC001GUX	US	1xE5-2640 v3 8C/2.6GHz/20MB/90W/DDR4-1866	4XG0F28856	1x8GB RDIMM DDR4-2133 ECC	Onboard 110i (PCIe)	8x3.5" HS	Open	2xFH HL	9.5mm DVD±RW	None	TPM	TSM	None	3-year	550Wx1 Platinum	12/14
70DC001HUX	US	1xE5-2650 v3 10C/2.3GHz/25MB/105W/DDR4-2133	4XG0F28855	1x8GB RDIMM DDR4-2133 ECC	Onboard 110i (PCIe)	8x3.5" HS	Open	2xFH HL	9.5mm DVD±RW	None	TPM	TSM	None	3-year	550Wx1 Platinum	12/14
70DC001JUX	US	1xE5-2660 v3 10C/2.6GHz/25MB/105W/DDR4-2133	4XG0F28854	1x8GB RDIMM DDR4-2133 ECC	Onboard 110i (PCIe)	8x3.5" HS	Open	2xFH HL	9.5mm DVD±RW	None	TPM	TSM	None	3-year	550Wx1 Platinum	12/14
70DC001KUX	US	1xE5-2603 v3 6C/1.6GHz/15MB/85W/DDR4-1600	4XG0F28860	1x8GB RDIMM DDR4-2133 ECC	Onboard 110i (PCIe)	8x3.5" HS	Open	2xFH HL	9.5mm DVD±RW	None	TPM	TSM	None	3-year	550Wx1 Platinum	12/14
70DC002EUX	US	1xE5-2620 v3 6C/2.4GHz/15MB/85W/DDR4-1866	4XG0F28858	2x8GB RDIMM DDR4-2133 ECC	Onboard 110i (PCIe)	8x3.5" HS	2x1TB HDD 7.2K 3.5" SATA6Gbs	2xFH HL	9.5mm DVD±RW	None	TPM	TSM Premium	None	3-year	750Wx2 Platinum	02/15
70DC002GUX	US	2xE5-2620 v3 6C/2.4GHz/15MB/85W/1866MH	-	2x16GB RDIMM DDR4-2133 ECC	Onboard 110i (PCIe)	8x3.5" HS	Open	2xFH HL+4xLP HL	9.5mm DVD±RW	None	TPM	TSM Premium	None	3-year	750Wx2 Platinum	09/15
70DC002UUX	US	1xE5-2630 v3 8C/2.4GHz/20MB/85W/DDR4-1866	4XG0F28857	4x16GB RDIMM DDR4-2133 ECC	Onboard 110i (PCIe)	8x3.5" HS	4x1TB HDD 7.2K 3.5" SATA6Gbs	None	None	None	TPM	TSM Premium	None	3-year	550Wx2 Platinum	11/15

Model	Region	Processor	2nd CPU	Memory	RAID Controller	Disk Bays	Storage	Slots	Optical	Add-on NIC	TPM	System Mgmt	OS	Warranty	Power Supply	Ann Date (m/y)
70DE000BUX	US	1xE5-2650 v3 10C/2.3GHz/25MB/105W/DDR4-2133	4XG0F28855	1x16GB RDIMM DDR4-2133 ECC	720ix+1GB RAM (AnyRAID)	24x2.5" HS	Open	2xFH HL	None	None	TPM	TSM Premium	None	3-year	750Wx1 Platinum	12/14
70DE000CUX	US	2xE5-2620 v3 6C/2.4GHz/15MB/85W/1866MH	-	8x16GB RDIMM DDR4-2133 ECC	720ix+1GB RAM (AnyRAID)	24x2.5" HS	8x300GB HDD 10K 2.5" SAS6Gbs	2xFH HL+4xLP HL	None	None	TPM	TSM Premium	None	3-year	750Wx2 Platinum	12/14
70DE000HUX	US	1xE5-2609 v3 6C/1.9GHz/15MB/85W/DDR4-1600	4XG0F28859	1x4GB RDIMM DDR4-2133 ECC	720ix+1GB RAM (AnyRAID)	24x2.5" HS	Open	None	None	None	TPM	TSM	None	3-year	750Wx1 Platinum	12/14
70DE000JUX	US	1xE5-2620 v3 6C/2.4GHz/15MB/85W/DDR4-1866	4XG0F28858	1x8GB RDIMM DDR4-2133 ECC	720ix+1GB RAM (AnyRAID)	24x2.5" HS	Open	2xFH HL	None	None	TPM	TSM	None	3-year	750Wx1 Platinum	12/14
70DE000KUX	US	1xE5-2640 v3 8C/2.6GHz/20MB/90W/DDR4-1866	4XG0F28856	1x8GB RDIMM DDR4-2133 ECC	720ix+1GB RAM (AnyRAID)	24x2.5" HS	Open	2xFH HL	None	None	TPM	TSM	None	3-year	750Wx1 Platinum	12/14

Model	Region	Processor	2nd CPU	Memory	RAID Controller	Disk Bays	Storage	Slots	Optical	Add-on NIC	TPM	System Mgmt	OS	Warranty	Power Supply	Ann Date (m/y)
70DV0008UX	US	1xE5-2603 v3 6C/1.6GHz/15MB/85W/DDR4-1600	4XG0F28860	1x4GB RDIMM DDR4-2133 ECC	720ix+1GB RAM (AnyRAID)	16x2.5" HS	Open	None	None	None	TPM	TSM	None	3-year	750Wx1 Platinum	12/14
70DV0009UX	US	1xE5-2620 v3 6C/2.4GHz/15MB/85W/DDR4-1866	4XG0F28858	1x8GB RDIMM DDR4-2133 ECC	720ix+1GB RAM (AnyRAID)	16x2.5" HS	Open	2xFH HL	None	None	TPM	TSM	None	3-year	750Wx1 Platinum	12/14
70DV000AUX	US	1xE5-2640 v3 8C/2.6GHz/20MB/90W/DDR4-1866	4XG0F28856	1x8GB RDIMM DDR4-2133 ECC	720ix+1GB RAM (AnyRAID)	16x2.5" HS	Open	2xFH HL	None	None	TPM	TSM	None	3-year	750Wx1 Platinum	12/14

Model	Region	Processor	2nd CPU	Memory	RAID Controller	Disk Bays	Storage	Slots	Optical	Add-on NIC	TPM	System Mgmt	OS	Warranty	Power Supply	Ann Date (m/y)
70Q9001DUX	US	1xE5-2603 v4 6C/1.7GHz/15MB/85W/DDR4-1866	4XG0G89090	1x16GB RDIMM DDR4-2400 ECC	110i (PCIe)	8x2.5" HS	Open	2xFH HL	None	None	TPM	TSM	None	3-year	750Wx1 Platinum	03/16
70Q9001EUX	US	1xE5-2609 v4 8C/1.7GHz/20MB/85W/DDR4-1866	4XG0G89085	1x16GB RDIMM DDR4-2400 ECC	110i (PCIe)	8x2.5" HS	Open	2xFH HL	None	None	TPM	TSM	None	3-year	750Wx1 Platinum	03/16
70Q9001FUX	US	1xE5-2620 v4 8C/2.1GHz/20MB/85W/DDR4-2133	4XG0G89080	1x16GB RDIMM DDR4-2400 ECC	110i (PCIe)	8x2.5" HS	Open	2xFH HL	None	None	TPM	TSM	None	3-year	750Wx1 Platinum	03/16
70Q9001GUX	US	1xE5-2630 v4 10C/2.2GHz/20MB/85W/DDR4-2133	4XG0G89075	1x16GB RDIMM DDR4-2400 ECC	110i (PCIe)	8x2.5" HS	Open	2xFH HL	None	None	TPM	TSM	None	3-year	750Wx1 Platinum	03/16
70Q9001HUX	US	1xE5-2640 v4 10C/2.4GHz/25MB/90W/DDR4-2133	4XG0G89070	1x16GB RDIMM DDR4-2400 ECC	110i (PCIe)	8x2.5" HS	Open	2xFH HL	None	None	TPM	TSM	None	3-year	750Wx1 Platinum	03/16
70Q9001JUX	US	1xE5-2650 v4 12C/2.2GHz/30MB/105W/DDR4-2400	4XG0G89065	1x16GB RDIMM DDR4-2400 ECC	110i (PCIe)	8x2.5" HS	Open	2xFH HL	None	None	TPM	TSM	None	3-year	750Wx1 Platinum	03/16
70Q9001KUX	US	1xE5-2660 v4 14C/2GHz/35MB/105W/DDR4-2400	4XG0G89060	1x16GB RDIMM DDR4-2400 ECC	110i (PCIe)	8x2.5" HS	Open	2xFH HL	None	None	TPM	TSM	None	3-year	750Wx1 Platinum	03/16

Model	Region	Processor	2nd CPU	Memory	RAID Controller	Disk Bays	Storage	Slots	Optical	Add-on NIC	TPM	System Mgmt	OS	Warranty	Power Supply	Ann Date (m/y)
70QQ0013UX	US	1xE5-2603 v4 6C/1.7GHz/15MB/85W/DDR4-1866	4XG0G89090	1x16GB RDIMM DDR4-2400 ECC	110i (PCIe)	8x3.5" HS	Open	2xFH HL	None	None	TPM	TSM	None	3-year	750Wx1 Platinum	03/16
70QQ0014UX	US	1xE5-2609 v4 8C/1.7GHz/20MB/85W/DDR4-1866	4XG0G89085	1x16GB RDIMM DDR4-2400 ECC	110i (PCIe)	8x3.5" HS	Open	2xFH HL	None	None	TPM	TSM	None	3-year	750Wx1 Platinum	03/16
70QQ0015UX	US	1xE5-2620 v4 8C/2.1GHz/20MB/85W/DDR4-2133	4XG0G89080	1x16GB RDIMM DDR4-2400 ECC	110i (PCIe)	8x3.5" HS	Open	2xFH HL	None	None	TPM	TSM	None	3-year	750Wx1 Platinum	03/16
70QQ0016UX	US	1xE5-2630 v4 10C/2.2GHz/20MB/85W/DDR4-2133	4XG0G89075	1x16GB RDIMM DDR4-2400 ECC	110i (PCIe)	8x3.5" HS	Open	2xFH HL	None	None	TPM	TSM	None	3-year	750Wx1 Platinum	03/16
70QQ0017UX	US	1xE5-2640 v4 10C/2.4GHz/25MB/90W/DDR4-2133	4XG0G89070	1x16GB RDIMM DDR4-2400 ECC	110i (PCIe)	8x3.5" HS	Open	2xFH HL	None	None	TPM	TSM	None	3-year	750Wx1 Platinum	03/16
70QQ0018UX	US	1xE5-2650 v4 12C/2.2GHz/30MB/105W/DDR4-2400	4XG0G89065	1x16GB RDIMM DDR4-2400 ECC	110i (PCIe)	8x3.5" HS	Open	2xFH HL	None	None	TPM	TSM	None	3-year	750Wx1 Platinum	03/16
70QQ0019UX	US	1xE5-2660 v4 14C/2GHz/35MB/105W/DDR4-2400	4XG0G89060	1x16GB RDIMM DDR4-2400 ECC	110i (PCIe)	8x3.5" HS	Open	2xFH HL	None	None	TPM	TSM	None	3-year	750Wx1 Platinum	03/16
70QQ001AUX	US	1xE5-2630 v4 10C/2.2GHz/20MB/85W/DDR4-2133	4XG0G89075	4x16GB RDIMM DDR4-2400 ECC	110i (PCIe)	8x3.5" HS	4x1TB HDD 7.2K 3.5" SATA6Gbs	2xFH HL	None	None	TPM	TSM Premium	None	3-year	750Wx2 Platinum	03/16
70QQ001BUX	US	2xE5-2620 v4 8C/2.1GHz/20MB/85W/DDR4-2133	-	2x16GB RDIMM DDR4-2400 ECC	110i (PCIe)	8x3.5" HS	Open	2xFH HL+4xLP HL	None	None	TPM	TSM Premium	None	3-year	750Wx2 Platinum	03/16

Model	Region	Processor	2nd CPU	Memory	RAID Controller	Disk Bays	Storage	Slots	Optical	Add-on NIC	TPM	System Mgmt	OS	Warranty	Power Supply	Ann Date (m/y)
70QS0000UX	US	1xE5-2603 v4 6C/1.7GHz/15MB/85W/DDR4-1866	4XG0G89090	1x16GB RDIMM DDR4-2400 ECC	720ix+1GB Flash (AnyRAID)	24x2.5" HS	Open	2xFH HL	None	None	TPM	TSM	None	3-year	750Wx1 Platinum	03/16
70QS0001UX	US	1xE5-2609 v4 8C/1.7GHz/20MB/85W/DDR4-1866	4XG0G89085	1x16GB RDIMM DDR4-2400 ECC	720ix+1GB Flash (AnyRAID)	24x2.5" HS	Open	2xFH HL	None	None	TPM	TSM	None	3-year	750Wx1 Platinum	03/16
70QS0002UX	US	1xE5-2620 v4 8C/2.1GHz/20MB/85W/DDR4-2133	4XG0G89080	1x16GB RDIMM DDR4-2400 ECC	720ix+1GB Flash (AnyRAID)	24x2.5" HS	Open	2xFH HL	None	None	TPM	TSM	None	3-year	750Wx1 Platinum	03/16
70QS0003UX	US	1xE5-2630 v4 10C/2.2GHz/20MB/85W/DDR4-2133	4XG0G89075	1x16GB RDIMM DDR4-2400 ECC	720ix+1GB Flash (AnyRAID)	24x2.5" HS	Open	2xFH HL	None	None	TPM	TSM	None	3-year	750Wx1 Platinum	03/16
70QS0004UX	US	1xE5-2640 v4 10C/2.4GHz/25MB/90W/DDR4-2133	4XG0G89070	1x16GB RDIMM DDR4-2400 ECC	720ix+1GB Flash (AnyRAID)	24x2.5" HS	Open	2xFH HL	None	None	TPM	TSM	None	3-year	750Wx1 Platinum	03/16
70QS0005UX	US	1xE5-2650 v4 12C/2.2GHz/30MB/105W/DDR4-2400	4XG0G89065	1x16GB RDIMM DDR4-2400 ECC	720ix+1GB Flash (AnyRAID)	24x2.5" HS	Open	2xFH HL	None	None	TPM	TSM	None	3-year	750Wx1 Platinum	03/16
70QS0006UX	US	1xE5-2660 v4 14C/2GHz/35MB/105W/DDR4-2400	4XG0G89060	1x16GB RDIMM DDR4-2400 ECC	720ix+1GB Flash (AnyRAID)	24x2.5" HS	Open	2xFH HL	None	None	TPM	TSM	None	3-year	750Wx1 Platinum	03/16

Model	Region	Processor	2nd CPU	Memory	RAID Controller	Disk Bays	Storage	Slots	Optical	Add-on NIC	TPM	System Mgmt	OS	Warranty	Power Supply	Ann Date (m/y)
70QW0004UX	US	1xE5-2603 v4 6C/1.7GHz/15MB/85W/DDR4-1866	4XG0G89090	1x16GB RDIMM DDR4-2400 ECC	720ix+1GB Flash (AnyRAID)	16x2.5" HS	Open	2xFH HL	None	None	TPM	TSM	None	3-year	750Wx1 Platinum	03/16
70QW0005UX	US	1xE5-2609 v4 8C/1.7GHz/20MB/85W/DDR4-1866	4XG0G89085	1x16GB RDIMM DDR4-2400 ECC	720ix+1GB Flash (AnyRAID)	16x2.5" HS	Open	2xFH HL	None	None	TPM	TSM	None	3-year	750Wx1 Platinum	03/16
70QW0006UX	US	1xE5-2620 v4 8C/2.1GHz/20MB/85W/DDR4-2133	4XG0G89080	1x16GB RDIMM DDR4-2400 ECC	720ix+1GB Flash (AnyRAID)	16x2.5" HS	Open	2xFH HL	None	None	TPM	TSM	None	3-year	750Wx1 Platinum	03/16
70QW0007UX	US	1xE5-2630 v4 10C/2.2GHz/20MB/85W/DDR4-2133	4XG0G89075	1x16GB RDIMM DDR4-2400 ECC	720ix+1GB Flash (AnyRAID)	16x2.5" HS	Open	2xFH HL	None	None	TPM	TSM	None	3-year	750Wx1 Platinum	03/16
70QW0008UX	US	1xE5-2640 v4 10C/2.4GHz/25MB/90W/DDR4-2133	4XG0G89070	1x16GB RDIMM DDR4-2400 ECC	720ix+1GB Flash (AnyRAID)	16x2.5" HS	Open	2xFH HL	None	None	TPM	TSM	None	3-year	750Wx1 Platinum	03/16
70QW0009UX	US	1xE5-2650 v4 12C/2.2GHz/30MB/105W/DDR4-2400	4XG0G89065	1x16GB RDIMM DDR4-2400 ECC	720ix+1GB Flash (AnyRAID)	16x2.5" HS	Open	2xFH HL	None	None	TPM	TSM	None	3-year	750Wx1 Platinum	03/16
70QW000AUX	US	1xE5-2660 v4 14C/2GHz/35MB/105W/DDR4-2400	4XG0G89060	1x16GB RDIMM DDR4-2400 ECC	720ix+1GB Flash (AnyRAID)	16x2.5" HS	Open	2xFH HL	None	None	TPM	TSM	None	3-year	750Wx1 Platinum	03/16

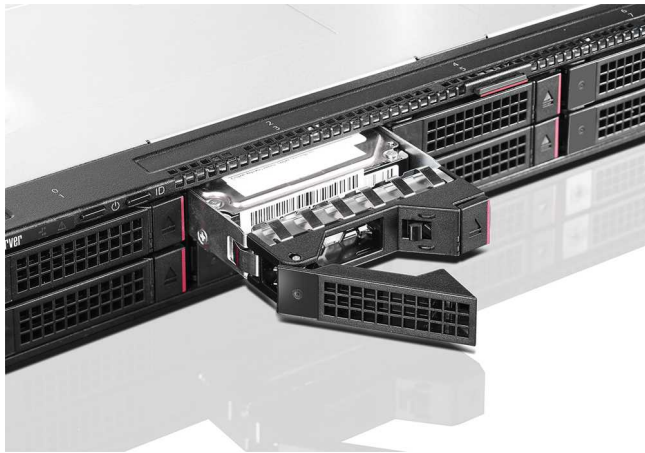

ThinkServer RD550 Platform Specifications

Product Specifications Reference (PSREF)

Components	Specification																									
Dimensions	1U rack. Height: 43 mm (1.7 in), width: 482 mm (19 in), depth: 780 mm (30.7 in)																									
Weight	Minimum configuration: 13.5 kg (29.76 lb), maximum: 21 kg (46.3 lb)																									
Processor	Up to two 145W Intel Xeon E5-2600 v3 family (code name: Haswell) processors with 18 cores up to 2.3GHz, 16 cores up to 2.3GHz, 14 cores up to 2.6GHz, 12 cores up to 2.6GHz, 10 cores up to 2.6GHz, 8 cores up to 3.2GHz, 6 cores up to 3.4GHz, 4 cores up to 3.5GHz. Two QPI link up to 9.6 GT/s. Up to 2133MHz memory speed. Up to 45MB cache																									
Chipset	Intel C610 Series Chipset																									
Memory DIMMs	24 DIMM sockets (12 DIMMs per processor), 8-channel capable (4-channel per processor). RDIMM and LRDIMM (cannot be intermixed), DDR4, LRDIMM up to DDR4-2133, RDIMM up to DDR4-2400																									
Memory capacity	384GB (RDIMM, 16GB x 24)/768GB (LRDIMM, 32GB x 24)																									
Memory protection	ECC, memory mirroring, lockstep, and memory sparing																									
AnyRAID support	RAID 0, 1, 10 with AnyRAID 110i. 6Gb/s SATA, optional key for RAID 5. RAID 0, 1, 10 with AnyRAID 510i, 6Gb/s SAS/SATA, optional key for RAID 5/50. RAID 0, 1, 10, 5, 50, 6, 60 with AnyRAID 720i/720ix. 12Gb/s SAS/SATA. 720i needs cache for RAID 6/60 support. 720ix must have cache. Optional cache for 720i/720ix: 1GB read-only memory. 1GB/2GB/4GB flash with super capacitor. Flash options include CacheVault, CacheCade Pro, and FastPath <i>Note: At least 6 disk drives is required for RAID 50 and 60.</i>																									
Disk drive bays	Up to 4 3.5" or 12 2.5" hot-swap disk bays on front. Up to 2 of 12 2.5" bays can support easy-swap PCIe SSD via optional Anybay kit (consumes one PCIe slot). Up to 2 2.5" rear mounted hot-swap disk bays on 3.5" models, optional. Up to 2 M.2 SSD drives via optional M.2 module. Supports external RDX tape drive via USB. <table border="1"> <thead> <tr> <th>Disk bay configuration</th> <th colspan="4">AnyRAID requirements and optional drives supported</th> </tr> <tr> <th></th> <th>RAID110i</th> <th>RAID510i</th> <th>RAID720i</th> <th>RAID720ix</th> </tr> </thead> <tbody> <tr> <td>4x3.5"</td> <td>• (optional rear bay/M.2)</td> <td>• (optional rear bay/M.2)</td> <td>• (optional rear bay/M.2)</td> <td></td> </tr> <tr> <td>8x2.5"</td> <td>•</td> <td>•</td> <td>•</td> <td></td> </tr> <tr> <td>12x2.5"</td> <td></td> <td></td> <td></td> <td>• (optional Anybay/M.2)</td> </tr> </tbody> </table> <i>Note: 1. Rear disk drive and M.2 SSD can not be supported simultaneously. Only one can be selected per system. 2. On AnyRAID 110i and 8x2.5" model, 6 of 8 drives can be configured as RAID</i>	Disk bay configuration	AnyRAID requirements and optional drives supported					RAID110i	RAID510i	RAID720i	RAID720ix	4x3.5"	• (optional rear bay/M.2)	• (optional rear bay/M.2)	• (optional rear bay/M.2)		8x2.5"	•	•	•		12x2.5"				• (optional Anybay/M.2)
Disk bay configuration	AnyRAID requirements and optional drives supported																									
	RAID110i	RAID510i	RAID720i	RAID720ix																						
4x3.5"	• (optional rear bay/M.2)	• (optional rear bay/M.2)	• (optional rear bay/M.2)																							
8x2.5"	•	•	•																							
12x2.5"				• (optional Anybay/M.2)																						
Internal disk drive	3.5" HDD up to 8TB (SATA/SAS). 2.5" HDD up to 1.8TB (SAS)/2TB (SATA). 2.5" SSD up to 1.6TB (SATA/SAS). Easy-swap PCIe SSD up to 1.92TB. PCIe SSD adapter up to 3.84TB. M.2 SSD up to 120GB. 2.5" SSD and HDD are compatible with 3.5" bay																									
SD module	Up to 2 SDHC flash cards via optional SD module, 8GB or 32GB each																									
Optical drive	Optional one 9.5mm optical drive on 3.5" model. DVD-ROM or DVD±RW																									
Network interfaces	One dedicated management port. One (3.5" model) or two (2.5" model) AnyFabric slots for customized LOM. Optional discrete network adapters via PCIe slots																									
Security features	Power-on and administrator password. Optional TPM (TCG 1.2-compliant)																									
Systems management	Supports ThinkServer System Manager (TSM), optional TSM Premium. UEFI. Onboard Aspeed AST2400 graphics/management processor, IPMI 2.0-compliant baseboard management controller (BMC). Control Panel LEDs shows the status of power, ID, network, system. Supports ThinkServer management software: Diagnostics, Deployment Manager, Energy Manager, System Manager, Partner Pack for VMware vCenter and Microsoft System Center Operations Manager, Power Planner																									

Components	Specification															
Operating systems supported	Microsoft Windows Server 2016/2012 R2/2012/2008 R2. Windows Small Business Server 2011. Red Hat Enterprise Linux 6.5/6.6/7. SUSE Linux Enterprise Server 11. VMware vSphere (ESXi) 5.1 P5/5.5 U2/6.0															
Base warranty	3-year limited onsite service with 9x5/NBD. Some parts are Customer Replaceable Units															
Power supply	Up to two redundant hot-swap 550W/750W/1100W power supplies. 550W and 1100W are 80 PLUS Platinum qualified. 750W is 80 PLUS Platinum or Titanium qualified. <table border="1"> <thead> <tr> <th rowspan="2">Disk bay configuration</th> <th colspan="3">PSU requirements</th> </tr> <tr> <th>550W</th> <th>750W</th> <th>1100W</th> </tr> </thead> <tbody> <tr> <td>4x3.5"</td> <td>•</td> <td>•</td> <td>•</td> </tr> <tr> <td>12x2.5"</td> <td>•</td> <td>•</td> <td>•</td> </tr> </tbody> </table> <i>Note: 750W Titanium is 200V - 240V, others are 110V - 240V.</i>	Disk bay configuration	PSU requirements			550W	750W	1100W	4x3.5"	•	•	•	12x2.5"	•	•	•
Disk bay configuration	PSU requirements															
	550W	750W	1100W													
4x3.5"	•	•	•													
12x2.5"	•	•	•													
Graphics	Onboard Aspeed AST2400 with 16MB memory, one DisplayPort on front, one DisplayPort on rear. Maximum resolution: 1920x1200@60Hz															
Front ports	(Only 3.5" model) Two USB 2.0, one DisplayPort															
Rear ports	One DisplayPort, two USB 3.0, one RJ-45 (dedicate mgmt), one serial (9-pin)															
Cooling	8 (7+1, dual processors) or 6 (5+1, single processor), hot-swap															
Noise emissions	Operating: < 6.5 Bels. Idle: < 6 Bels (Maximum configuration)															
Environmental specification	<table border="1"> <tbody> <tr> <td>Temperature - operating</td> <td>41 °F to 113 °F (5 °C to 45 °C)</td> </tr> <tr> <td>Temperature - non operating (no package)</td> <td>-10 °C to 60 °C</td> </tr> <tr> <td>Temperature - non operating (with package)</td> <td>-40 °C to 60 °C</td> </tr> <tr> <td>Altitude - operating</td> <td>(Unpressurized): 0-10000ft (0-3048m)</td> </tr> <tr> <td>Humidity - operating</td> <td>8%-90%, non-condensing</td> </tr> <tr> <td>Humidity - storage (with package)</td> <td>8%-90%, non-condensing</td> </tr> </tbody> </table> <i>Note: 45 °C continuous operation configuration limitation: no 145W CPU/no 135W 4, 6, or 8 cores CPU/no GPU card/redundant PSU/no FLFH card/no PCIe SSD adapter/no 1100W PSU.</i>	Temperature - operating	41 °F to 113 °F (5 °C to 45 °C)	Temperature - non operating (no package)	-10 °C to 60 °C	Temperature - non operating (with package)	-40 °C to 60 °C	Altitude - operating	(Unpressurized): 0-10000ft (0-3048m)	Humidity - operating	8%-90%, non-condensing	Humidity - storage (with package)	8%-90%, non-condensing			
Temperature - operating	41 °F to 113 °F (5 °C to 45 °C)															
Temperature - non operating (no package)	-10 °C to 60 °C															
Temperature - non operating (with package)	-40 °C to 60 °C															
Altitude - operating	(Unpressurized): 0-10000ft (0-3048m)															
Humidity - operating	8%-90%, non-condensing															
Humidity - storage (with package)	8%-90%, non-condensing															

Expansion slots

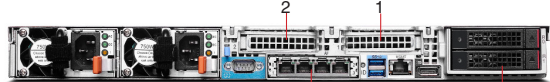
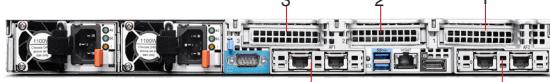
3.5" model	
Slot 1 (riser card 1)	PCIe 3.0 x 16, low-profile, half length
Slot 2 (riser card 2)	PCIe 3.0 x 16, low-profile, half length, requires 2nd riser card and 2nd CPU
2.5" model	
Slot 1 (riser card 1)	PCIe 3.0 x 16 (x8 wired), low-profile, half length
Slot 2 (riser card 1)	PCIe 3.0 x 16 (x8 wired), low-profile, half length
Slot 3 (riser card 2)	PCIe 3.0 x 16, low-profile, half length, requires 2nd riser card and 2nd CPU

Model	Region	Processor	2nd CPU	Memory	RAID Controller	Disk Bays	Storage	Slots	Optical	Add-on NIC	TPM	System Mgmt	OS	Warranty	Power Supply	Ann Date (m/y)
70CV001CUX	US	1xXeon E5-2609 v3 6C/1.9GHz/15MB/85W/DDR4-1600	4XG0F28803	1x8GB RDIMM DDR4-2133 ECC	AnyRAID 110i	4x3.5" HS	Open	1xLP HL	9.5mm DVD±RW	None	TPM	TSM	None	3-year	750Wx1 Platinum	09/14
70CV001DUX	US	1xXeon E5-2620 v3 6C/2.4GHz/15MB/85W/DDR4-1866	4XG0F28802	1x8GB RDIMM DDR4-2133 ECC	AnyRAID 110i	4x3.5" HS	Open	1xLP HL	9.5mm DVD±RW	None	TPM	TSM	None	3-year	750Wx1 Platinum	09/14
70CV001EUX	US	1xXeon E5-2640 v3 8C/2.6GHz/20MB/90W/DDR4-1866	4XG0F28800	1x8GB RDIMM DDR4-2133 ECC	AnyRAID 510i	4x3.5" HS	Open	1xLP HL	9.5mm DVD±RW	None	TPM	TSM	None	3-year	750Wx1 Platinum	09/14
70CV001FUX	US	1xXeon E5-2650 v3 10C/2.3GHz/25MB/105W/DDR4-2133	4XG0F28799	1x8GB RDIMM DDR4-2133 ECC	AnyRAID 510i	4x3.5" HS	Open	1xLP HL	9.5mm DVD±RW	None	TPM	TSM	None	3-year	750Wx1 Platinum	09/14
70CV001GUX	US	1xXeon E5-2670 v3 12C/2.3GHz/30MB/120W/DDR4-2133	4XG0F28797	1x8GB RDIMM DDR4-2133 ECC	AnyRAID 720i+1GB RAM	4x3.5" HS	Open	1xLP HL	9.5mm DVD±RW	None	TPM	TSM	None	3-year	750Wx1 Platinum	09/14
70CV001JUX	US	1xXeon E5-2609 v3 6C/1.9GHz/15MB/85W/DDR4-1600	4XG0F28803	1x8GB RDIMM DDR4-2133 ECC	AnyRAID 510i	4x3.5" HS	Open	1xLP HL	9.5mm DVD±RW	None	TPM	TSM	None	3-year	750Wx1 Platinum	10/14
70CV001KUX	US	1xXeon E5-2620 v3 6C/2.4GHz/15MB/85W/DDR4-1866	4XG0F28802	1x8GB RDIMM DDR4-2133 ECC	AnyRAID 510i	4x3.5" HS	Open	1xLP HL	9.5mm DVD±RW	None	TPM	TSM	None	3-year	750Wx1 Platinum	10/14
70CV001LUX	US	1xXeon E5-2630 v3 8C/2.4GHz/20MB/85W/DDR4-1866	4XG0F28801	1x8GB RDIMM DDR4-2133 ECC	AnyRAID 510i	4x3.5" HS	Open	1xLP HL	9.5mm DVD±RW	None	TPM	TSM	None	3-year	750Wx1 Platinum	10/14
70CV001MUX	US	2xXeon E5-2630 v3 8C/2.4GHz/20MB/85W/DDR4-1866	-	2x8GB RDIMM DDR4-2133 ECC	AnyRAID 510i	4x3.5" HS	Open	2xLP HL	9.5mm DVD±RW	None	TPM	TSM	None	3-year	750Wx1 Platinum	10/14
70CV001NUX	US	1xXeon E5-2603 v3 6C/1.6GHz/15MB/85W/DDR4-1600	4XG0F28804	1x8GB RDIMM DDR4-2133 ECC	AnyRAID 110i	4x3.5" HS	Open	No	None	None	TPM	TSM	None	3-year	550Wx1 Platinum	10/14
70CV001SUX	US	1xXeon E5-2630 v3 8C/2.4GHz/20MB/85W/DDR4-1866	4XG0F28801	2x8GB RDIMM DDR4-2133 ECC	AnyRAID 110i	4x3.5" HS	2x1TB HDD 7.2K 3.5" SATA6Gbs	1xLP HL	9.5mm DVD±RW	GbEx4 RJ-45 AnyFabric	TPM	TSM Premium	None	3-year	750Wx2 Platinum	02/15
70CV001TUX	US	2xXeon E5-2620 v3 6C/2.4GHz/15MB/85W/DDR4-1866	-	2x16GB RDIMM DDR4- 2133 ECC	AnyRAID 110i	4x3.5" HS	Open	2xLP HL	9.5mm DVD±RW	GbEx4 RJ-45 AnyFabric	TPM	TSM Premium	None	3-year	750Wx2 Platinum	09/15

Model	Region	Processor	2nd CPU	Memory	RAID Controller	Disk Bays	Storage	Slots	Optical	Add-on NIC	TPM	System Mgmt	OS	Warranty	Power Supply	Ann Date (m/y)
70CX001XUX	US	1xXeon E5-2620 v3 6C/2.4GHz/15MB/85W/DDR4-1866	4XG0F28802	1x8GB RDIMM DDR4-2133 ECC	AnyRAID 510i+Key	8x2.5" HS	Open	2xLP HL	None	None	TPM	TSM	None	3-year	750Wx1 Platinum	09/14
70CX001YUX	US	1xXeon E5-2640 v3 8C/2.6GHz/20MB/90W/DDR4-1866	4XG0F28800	1x8GB RDIMM DDR4-2133 ECC	AnyRAID 510i+Key	8x2.5" HS	Open	2xLP HL	None	None	TPM	TSM	None	3-year	750Wx1 Platinum	09/14
70CX0020UX	US	1xXeon E5-2650 v3 10C/2.3GHz/25MB/105W/DDR4-2133	4XG0F28799	1x8GB RDIMM DDR4-2133 ECC	AnyRAID 720ix+1GB RAM	12x2.5" HS	Open	2xLP HL	None	None	TPM	TSM	None	3-year	750Wx1 Platinum	09/14
70CX0021UX	US	1xXeon E5-2670 v3 12C/2.3GHz/30MB/120W/DDR4-2133	4XG0F28797	1x8GB RDIMM DDR4-2133 ECC	AnyRAID 720ix+1GB RAM	12x2.5" HS	Open	2xLP HL	None	None	TPM	TSM	None	3-year	750Wx1 Platinum	09/14
70CX0023UX	US	1xXeon E5-2620 v3 6C/2.4GHz/15MB/85W/DDR4-1866	4XG0F28802	1x8GB RDIMM DDR4-2133 ECC	AnyRAID 720ix+1GB RAM	12x2.5" HS	Open	2xLP HL	None	None	TPM	TSM	None	3-year	750Wx1 Platinum	10/14
70CX0024UX	US	1xXeon E5-2630 v3 8C/2.4GHz/20MB/85W/DDR4-1866	4XG0F28801	1x8GB RDIMM DDR4-2133 ECC	AnyRAID 720ix+1GB RAM	12x2.5" HS	Open	2xLP HL	None	None	TPM	TSM	None	3-year	750Wx1 Platinum	10/14
70CX0025UX	US	1xXeon E5-2630 v3 8C/2.4GHz/20MB/85W/DDR4-1866	4XG0F28801	1x8GB RDIMM DDR4-2133 ECC	AnyRAID 510i	8x2.5" HS	Open	2xLP HL	None	None	TPM	TSM	None	3-year	750Wx1 Platinum	10/14
70CX0027UX	US	1xXeon E5-2603 v3 6C/1.6GHz/15MB/85W/DDR4-1600	4XG0F28804	1x8GB RDIMM DDR4-2133 ECC	AnyRAID 110i	8x2.5" HS	Open	No	None	None	TPM	TSM	None	3-year	750Wx1 Platinum	10/14
70CX002VUX	US	1xXeon E5-2620 v3 6C/2.4GHz/15MB/85W/DDR4-1866	4XG0F28802	2x16GB RDIMM DDR4-2133 ECC	AnyRAID 510i+Key	8x2.5" HS	2x300GB HDD 15K 2.5" SAS12Gbs	No	None	GbEx4 RJ-45 AnyFabric	TPM	TSM Premium	None	3-year	750Wx2 Platinum	02/16

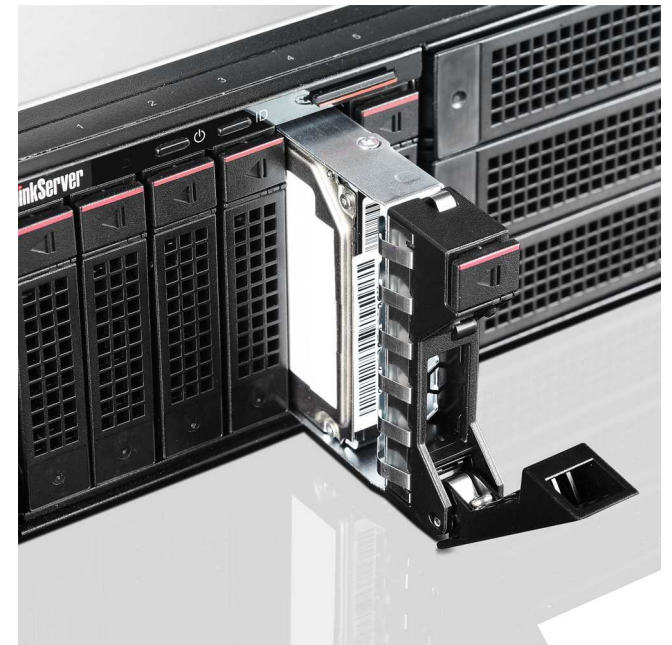

ThinkServer RD650 Platform Specifications

Components	Specification																																							
Dimensions	2U rack. Height: 87 mm (3.4 in), width: 482 mm (19 in), depth: 764 mm (30 in)																																							
Weight	Minimum configuration: 16 kg (35.3 lb), maximum: 32 kg (70.5 lb)																																							
Processor	Up to two 145W Intel Xeon E5-2600 v3 family (code name: Haswell) processors with 18 cores up to 2.3GHz, 16 cores up to 2.3GHz, 14 cores up to 2.6GHz, 12 cores up to 2.6GHz, 10 cores up to 2.6GHz, 8 cores up to 3.2GHz, 6 cores up to 3.4GHz, 4 cores up to 3.5GHz. Two QPI link up to 9.6 GT/s. Up to 2133MHz memory speed. Up to 45MB cache																																							
Chipset	Intel C610 Series Chipset																																							
Memory DIMMs	24 DIMM sockets (12 DIMMs per processor), 8-channel capable (4-channel per processor). RDIMM and LRDIMM (cannot be intermixed), DDR4, LRDIMM up to DDR4-2133, RDIMM up to DDR4-2400																																							
Memory capacity	384GB (RDIMM, 16GB x 24)/768GB (LRDIMM, 32GB x 24)																																							
Memory protection	ECC, memory mirroring, lockstep, and memory sparing																																							
AnyRAID support	RAID 0, 1, 10 with AnyRAID 110i. 6Gb/s SATA, optional key for RAID 5. RAID 0, 1, 10 with AnyRAID 510i. 6Gb/s SAS/SATA, optional key for RAID 5/50. RAID 0, 1, 10, 5, 50, 6, 60 with AnyRAID 720i/720ix. 12Gb/s SAS/SATA. 720i needs cache for RAID 6/60 support. 720ix must have cache. Optional cache for 720i/720ix: 1GB read-only memory. 1GB/2GB/4GB flash with super capacitor. Flash options include CacheVault, CacheCade Pro, and FastPath																																							
Disk drive bays	Up to 12 3.5", 24 2.5", or 6 2.5" plus 9 3.5" hot-swap disk bays on front. Up to 4 2.5" bays on 24 2.5" or 2.5" + 3.5" models can support easy-swap PCIe SSD via optional Anybay kit (consumes two PCIe slots). Up to 2 2.5" rear mounted hot-swap disk bays, optional. Up to 2 M.2 SSD drives via optional M.2 module. Up to one internal LTO-6 SAS tape drive on 8 x 2.5" and 720ix model, or external RDX tape drive via USB.																																							
	<table border="1"> <thead> <tr> <th rowspan="2">Disk bay configuration</th> <th colspan="4">AnyRAID requirements and optional drives supported</th> </tr> <tr> <th>RAID110i</th> <th>RAID510i</th> <th>RAID720i</th> <th>RAID720ix</th> </tr> </thead> <tbody> <tr> <td>6x3.5"</td> <td>•</td> <td>•</td> <td>•</td> <td></td> </tr> <tr> <td>12x3.5"</td> <td></td> <td></td> <td></td> <td>• (optional rear bay/M.2)</td> </tr> <tr> <td>8x2.5"</td> <td></td> <td>•</td> <td>•</td> <td>• (optional tape/rear bay/M.2)</td> </tr> <tr> <td>16x2.5"</td> <td></td> <td></td> <td></td> <td>• (optional rear bay/M.2)</td> </tr> <tr> <td>24x2.5"</td> <td></td> <td></td> <td></td> <td>• (optional Anybay/rear bay/M.2)</td> </tr> <tr> <td>6x2.5"+9x3.5"</td> <td></td> <td></td> <td></td> <td>• (optional Anybay/rear bay/M.2)</td> </tr> </tbody> </table>	Disk bay configuration	AnyRAID requirements and optional drives supported				RAID110i	RAID510i	RAID720i	RAID720ix	6x3.5"	•	•	•		12x3.5"				• (optional rear bay/M.2)	8x2.5"		•	•	• (optional tape/rear bay/M.2)	16x2.5"				• (optional rear bay/M.2)	24x2.5"				• (optional Anybay/rear bay/M.2)	6x2.5"+9x3.5"				• (optional Anybay/rear bay/M.2)
Disk bay configuration	AnyRAID requirements and optional drives supported																																							
	RAID110i	RAID510i	RAID720i	RAID720ix																																				
6x3.5"	•	•	•																																					
12x3.5"				• (optional rear bay/M.2)																																				
8x2.5"		•	•	• (optional tape/rear bay/M.2)																																				
16x2.5"				• (optional rear bay/M.2)																																				
24x2.5"				• (optional Anybay/rear bay/M.2)																																				
6x2.5"+9x3.5"				• (optional Anybay/rear bay/M.2)																																				
Internal disk drive	3.5" HDD up to 8TB (SATA/SAS). 2.5" HDD up to 1.8TB (SAS)/2TB (SATA). 2.5" SSD up to 1.6TB (SATA/SAS). Easy-swap PCIe SSD up to 1.92TB. PCIe SSD adapter up to 3.84TB. M.2 SSD up to 120GB. 2.5" SSD and HDD are compatible with 3.5" bay																																							
SD module	Up to 2 SDHC flash cards via optional SD module, 8GB or 32GB each																																							
Optical drive	Optional one 9.5mm optical drive on 8 or 16 x 2.5" model, DVD-ROM or DVD±RW																																							
Network interfaces	One dedicated management port, one AnyFabric slot for customized LOM. Discrete network options is also available via PCIe slots																																							
Security features	Power-on and administrator password. Optional TPM (TCG 1.2-compliant) Supports ThinkServer System Manager (TSM), optional TSM Premium. UEFI. Onboard Aspeed AST2400 graphics/management processor, IPMI 2.0-compliant baseboard management controller (BMC). Control Panel LEDs shows the status of power, ID, network, system.																																							
Systems management	Supports ThinkServer management software: Diagnostics, Deployment Manager, Energy Manager, System Manager, Partner Pack for VMware vCenter and Microsoft System Center Operations Manager, Power Planner																																							

Components	Specification																																							
Operating systems supported	Microsoft Windows Server 2016/2012 R2/2012/2008 R2. Windows Small Business Server 2011. Red Hat Enterprise Linux 6.5/6.6/7. SUSE Linux Enterprise Server 11. VMware vSphere (ESXi) 5.1 P5/5.5 U2/6.0																																							
Base warranty	3-year limited onsite service with 9x5/NBD.																																							
Power supply	Up to two redundant hot-swap 550W/750W/1100W/1600W power supplies. 550W, 1100W, and 1600W are 80 PLUS Platinum qualified. 750W is 80 PLUS Platinum or Titanium qualified.																																							
	<table border="1"> <thead> <tr> <th rowspan="2">Disk bay configuration</th> <th colspan="4">PSU requirements</th> </tr> <tr> <th>550W</th> <th>750W</th> <th>1100W</th> <th>1600W</th> </tr> </thead> <tbody> <tr> <td>6x3.5"</td> <td>•</td> <td>•</td> <td>•</td> <td>•</td> </tr> <tr> <td>12x3.5"</td> <td colspan="4">• (up to 135W CPU)</td> </tr> <tr> <td>8x2.5"</td> <td>•</td> <td>•</td> <td>•</td> <td>•</td> </tr> <tr> <td>16x2.5"</td> <td colspan="4">• (up to 105W CPU+24 DIMMs or 135W+16 DIMMs)</td> </tr> <tr> <td>24x2.5"</td> <td>•</td> <td>•</td> <td>•</td> <td>•</td> </tr> <tr> <td>2.5"+3.5"</td> <td>•</td> <td>•</td> <td>•</td> <td>•</td> </tr> </tbody> </table>	Disk bay configuration	PSU requirements				550W	750W	1100W	1600W	6x3.5"	•	•	•	•	12x3.5"	• (up to 135W CPU)				8x2.5"	•	•	•	•	16x2.5"	• (up to 105W CPU+24 DIMMs or 135W+16 DIMMs)				24x2.5"	•	•	•	•	2.5"+3.5"	•	•	•	•
	Disk bay configuration		PSU requirements																																					
		550W	750W	1100W	1600W																																			
	6x3.5"	•	•	•	•																																			
12x3.5"	• (up to 135W CPU)																																							
8x2.5"	•	•	•	•																																				
16x2.5"	• (up to 105W CPU+24 DIMMs or 135W+16 DIMMs)																																							
24x2.5"	•	•	•	•																																				
2.5"+3.5"	•	•	•	•																																				
	<i>Note: 1. 750W Titanium is 200V - 240V, others are 110V - 240V. 2. 1600W will automatically operate in 1100W if the system line input is 100-127V.</i>																																							
Graphics	Onboard Aspeed AST2400 with 16MB memory, one DisplayPort on rear																																							
Front ports	(Only 2.5" bay models) Two USB 2.0, one DisplayPort																																							
Rear ports	One DisplayPort, two USB 3.0, one RJ-45 (dedicate mgmt), one serial (9-pin)																																							
Cooling	Six (5+1, dual processors) or four (3+1, single processor), hot-swap																																							
Noise emissions	Operating: < 6.5 Bels. Idle: < 6 Bels (Maximum configuration)																																							
Environmental specification	<table border="1"> <tbody> <tr> <td>Temperature - operating</td> <td>41 °F to 113 °F (5 °C to 45 °C)</td> </tr> <tr> <td>Temperature - non operating (no package)</td> <td>-10 °C to 60 °C</td> </tr> <tr> <td>Temperature - non operating (with package)</td> <td>-40 °C to 60 °C</td> </tr> <tr> <td>Altitude - operating</td> <td>(Unpressurized): 0-10000ft (0-3048m)</td> </tr> <tr> <td>Humidity - operating</td> <td>8%-90%, non-condensing</td> </tr> <tr> <td>Humidity - storage (with package)</td> <td>8%-90%, non-condensing</td> </tr> </tbody> </table>	Temperature - operating	41 °F to 113 °F (5 °C to 45 °C)	Temperature - non operating (no package)	-10 °C to 60 °C	Temperature - non operating (with package)	-40 °C to 60 °C	Altitude - operating	(Unpressurized): 0-10000ft (0-3048m)	Humidity - operating	8%-90%, non-condensing	Humidity - storage (with package)	8%-90%, non-condensing																											
Temperature - operating	41 °F to 113 °F (5 °C to 45 °C)																																							
Temperature - non operating (no package)	-10 °C to 60 °C																																							
Temperature - non operating (with package)	-40 °C to 60 °C																																							
Altitude - operating	(Unpressurized): 0-10000ft (0-3048m)																																							
Humidity - operating	8%-90%, non-condensing																																							
Humidity - storage (with package)	8%-90%, non-condensing																																							
	<i>Note: 45 °C continuous operation configuration limitation: no 135W or 145W CPU/no GPU card/redundant PSU/no FLFH card/no PCIe SSD adapter.</i>																																							

Expansion slots

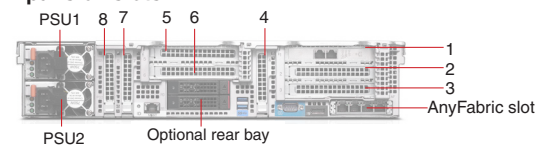

Slot 1 (riser card 1)	PCIe 3.0 x 16, half length, full height
Slot 2 (riser card 1)	PCIe 3.0 x 16, half length, full height
Slot 3 (riser card 1)	PCIe 3.0 x 16, half length, full height
Slot 4 (onboard)	PCIe 3.0 x 16, low-profile, half length, requires 2nd CPU
Slot 5 (riser card 2)	PCIe 3.0 x 16, half length, full height, requires 2nd riser card and 2nd CPU
Slot 6 (riser card 2)	PCIe 3.0 x 16, half length, full height, requires 2nd riser card and 2nd CPU
Slot 7 (onboard)	PCIe 3.0 x 16, low-profile, half length, requires 2nd CPU
Slot 8 (onboard)	PCIe 3.0 x 16, low-profile, half length, requires 2nd CPU

Notes:
On 2.5" disk bay models, slots 1 and 2 can be replaced with one PCIe 3.0 x 16 slot, double wide, full length, full height. Slots 5 and 6 can be replaced with one PCIe 3.0 x 16 slot, double wide, full length, full height.

Model	Region	Processor	2nd CPU	Memory	RAID Controller	Disk Bays	Storage	Slots	Optical	Add-on NIC	TPM	System Mgmt	OS	Warranty	Power Supply	Ann Date (m/y)
70D0000FUX	US	1xE5-2609 v3 6C/1.9GHz/15MB/85W/DDR4-1600	4XG0F28820	1x8GB RDIMM DDR4-2133 ECC	AnyRAID 720ix+1GB RAM	12x3.5" HS	Open	3xFH HL	None	None	TPM	TSM	None	3-year	1100Wx1 Platinum	09/14
70D0000GUX	US	1xE5-2620 v3 6C/2.4GHz/15MB/85W/DDR4-1866	4XG0F28819	1x8GB RDIMM DDR4-2133 ECC	AnyRAID 720ix+1GB RAM	12x3.5" HS	Open	3xFH HL	None	None	TPM	TSM	None	3-year	1100Wx1 Platinum	09/14
70D0000HUX	US	1xE5-2640 v3 8C/2.6GHz/20MB/90W/DDR4-1866	4XG0F28817	1x8GB RDIMM DDR4-2133 ECC	AnyRAID 720ix+1GB RAM	12x3.5" HS	Open	3xFH HL	None	None	TPM	TSM	None	3-year	1100Wx1 Platinum	09/14
70D0000JUX	US	1xE5-2650 v3 10C/2.3GHz/25MB/105W/DDR4-2133	4XG0F28816	1x8GB RDIMM DDR4-2133 ECC	AnyRAID 720ix+1GB RAM	12x3.5" HS	Open	3xFH HL	None	None	TPM	TSM	None	3-year	1100Wx1 Platinum	09/14
70D0000KUX	US	1xE5-2690 v3 12C/2.6GHz/30MB/135W/DDR4-2133	4XG0F28811	1x8GB RDIMM DDR4-2133 ECC	AnyRAID 720ix+1GB RAM	12x3.5" HS	Open	3xFH HL	None	None	TPM	TSM	None	3-year	1100Wx1 Platinum	09/14
70D00025UX	US	1xE5-2630 v3 8C/2.4GHz/20MB/85W/DDR4-1866	4XG0F28818	1x8GB RDIMM DDR4-2133 ECC	AnyRAID 720ix+1GB RAM	12x3.5" HS	Open	3xFH HL	None	None	TPM	TSM	None	3-year	1100Wx1 Platinum	10/14
70D00026UX	US	1xE5-2603 v3 6C/1.6GHz/15MB/85W/DDR4-1600	4XG0F28821	1x8GB RDIMM DDR4-2133 ECC	AnyRAID 110i	6x3.5" HS	Open	No	None	None	TPM	TSM	None	3-year	550Wx1 Platinum	10/14
70D0002BUX	US	1xE5-2630 v3 8C/2.4GHz/20MB/85W/DDR4-1866	4XG0F28818	1x8GB RDIMM DDR4-2133 ECC	AnyRAID 720ix+1GB RAM	12x3.5" HS	Open	3xFH HL	None	None	TPM	TSM	None	3-year	750Wx1 Platinum	02/15

ThinkServer RD650 - TopSeller - 70D2

Product Specifications Reference (PSREF)

Model	Region	Processor	2nd CPU	Memory	RAID Controller	Disk Bays	Storage	Slots	Optical	Add-on NIC	TPM	System Mgmt	OS	Warranty	Power Supply	Ann Date (m/y)
70D20024UX	US	1xE5-2603 v3 6C/1.6GHz/15MB/85W/DDR4-1600	4XG0F28821	1x8GB RDIMM DDR4-2133 ECC	AnyRAID 720ix+1GB RAM	24x2.5" HS	Open	No	None	None	TPM	TSM	None	3-year	750Wx1 Platinum	10/14

Model	Region	Processor	2nd CPU	Memory	RAID Controller	Disk Bays	Storage	Slots	Optical	Add-on NIC	TPM	System Mgmt	OS	Warranty	Power Supply	Ann Date (m/y)
70D4000CUX	US	1xE5-2620 v3 6C/2.4GHz/15MB/85W/DDR4-1866	4XG0F28819	1x8GB RDIMM DDR4-2133 ECC	AnyRAID 720ix+1GB RAM	6+9 HS	Open	3xFH HL	None	None	TPM	TSM	None	3-year	1100Wx1 Platinum	09/14
70D4000DUX	US	1xE5-2640 v3 8C/2.6GHz/20MB/90W/DDR4-1866	4XG0F28817	1x8GB RDIMM DDR4-2133 ECC	AnyRAID 720ix+1GB RAM	6+9 HS	Open	3xFH HL	None	None	TPM	TSM	None	3-year	1100Wx1 Platinum	09/14
70D4000EUX	US	1xE5-2650 v3 10C/2.3GHz/25MB/105W/DDR4-2133	4XG0F28816	1x8GB RDIMM DDR4-2133 ECC	AnyRAID 720ix+1GB RAM	6+9 HS	Open	3xFH HL	None	None	TPM	TSM	None	3-year	1100Wx1 Platinum	09/14
70D4000FUX	US	1xE5-2690 v3 12C/2.6GHz/30MB/135W/DDR4-2133	4XG0F28811	1x8GB RDIMM DDR4-2133 ECC	AnyRAID 720ix+1GB RAM	6+9 HS	Open	3xFH HL	None	None	TPM	TSM	None	3-year	1100Wx1 Platinum	09/14
70D4001RUX	US	1xE5-2603 v3 6C/1.6GHz/15MB/85W/DDR4-1600	4XG0F28821	1x8GB RDIMM DDR4-2133 ECC	AnyRAID 720ix+1GB RAM	6+9 HS	Open	No	None	None	TPM	TSM	None	3-year	750Wx1 Platinum	10/14
70D4001UUX	US	1xE5-2650 v3 10C/2.3GHz/25MB/105W/DDR4-2133	4XG0F28816	1x8GB RDIMM DDR4-2133 ECC	AnyRAID 720ix+1GB RAM	6+9 HS	Open	3xFH HL	None	None	TPM	TSM	None	3-year	750Wx1 Platinum	02/15
70D40025UX	US	2xE5-2620 v3 6C/2.4GHz/15MB/85W/DDR4-1866	-	2x16GB RDIMM DDR4-2133 ECC	AnyRAID 720ix+1GB Flash	6+9 HS	Open	5xFH HL+3xLP HL	None	10GbEx2 RJ-45 AnyFabric	TPM	TSM Premium	None	3-year	750Wx2 Platinum	09/15
70D40026UX	US	2xE5-2690 v3 12C/2.6GHz/30MB/135W/DDR4-2133	-	8x16GB RDIMM DDR4-2133 ECC	AnyRAID 720ix+1GB RAM	6+9 HS	4x600GB HDD 10K 2.5" SAS12Gbs	3xLP HL	None	GbEx4 RJ-45 AnyFabric	TPM	TSM Premium	None	3-year	1100Wx2 Platinum	02/16
70D40027UX	US	1xE5-2650 v3 10C/2.3GHz/25MB/105W/DDR4-2133	4XG0F28816	4x16GB RDIMM DDR4-2133 ECC	AnyRAID 720ix+1GB RAM	6+9 HS	2x300GB HDD 15K 2.5" SAS12Gbs+2x2TB HDD 7.2K 3.5" SATA6Gbs	No	None	GbEx4 RJ-45 AnyFabric	TPM	TSM Premium	None	3-year	1100Wx2 Platinum	02/16
70D40028UX	US	2xE5-2650 v3 10C/2.3GHz/25MB/105W/DDR4-2133	-	8x16GB RDIMM DDR4-2133 ECC	AnyRAID 720ix+1GB RAM	6+9 HS (AnyBay)	2x120GB 2.5" SSD SATA6Gbs	3xFH HL+3xLP HL	None	GbEx4 RJ-45 AnyFabric	TPM	TSM Premium	None	3-year	750Wx2 Platinum	11/15
70D40029UX	US	2xE5-2690 v3 12C/2.6GHz/30MB/135W/DDR4-2133	-	8x16GB RDIMM DDR4-2133 ECC	AnyRAID 720ix+1GB RAM	6+9 HS (AnyBay)	2x120GB 2.5" SSD SATA6Gbs	3xFH HL+3xLP HL	None	GbEx4 RJ-45 AnyFabric	TPM	TSM Premium	None	3-year	750Wx2 Platinum	11/15

Model	Region	Processor	2nd CPU	Memory	RAID Controller	Disk Bays	Storage	Slots	Optical	Add-on NIC	TPM	System Mgmt	OS	Warranty	Power Supply	Ann Date (m/y)
70DR000QUX	US	1xE5-2609 v3 6C/1.9GHz/15MB/85W/DDR4-1600	4XG0F28820	1x8GB RDIMM DDR4-2133 ECC	AnyRAID 510i	8x2.5" HS	Open	3xFH HL	9.5mm DVD±RW	None	TPM	TSM	None	3-year	1100Wx1 Platinum	09/14
70DR000RUX	US	1xE5-2620 v3 6C/2.4GHz/15MB/85W/DDR4-1866	4XG0F28819	1x8GB RDIMM DDR4-2133 ECC	AnyRAID 510i	8x2.5" HS	Open	3xFH HL	9.5mm DVD±RW	None	TPM	TSM	None	3-year	1100Wx1 Platinum	09/14
70DR000SUX	US	1xE5-2640 v3 8C/2.6GHz/20MB/90W/DDR4-1866	4XG0F28817	1x8GB RDIMM DDR4-2133 ECC	AnyRAID 510i	8x2.5" HS	Open	3xFH HL	9.5mm DVD±RW	None	TPM	TSM	None	3-year	1100Wx1 Platinum	09/14
70DR000TUX	US	1xE5-2650 v3 10C/2.3GHz/25MB/105W/DDR4-2133	4XG0F28816	1x8GB RDIMM DDR4-2133 ECC	AnyRAID 510i	8x2.5" HS	Open	3xFH HL	9.5mm DVD±RW	None	TPM	TSM	None	3-year	1100Wx1 Platinum	09/14
70DR002KUX	US	1xE5-2630 v3 8C/2.4GHz/20MB/85W/DDR4-1866	4XG0F28818	1x8GB RDIMM DDR4-2133 ECC	AnyRAID 510i	8x2.5" HS	Open	3xFH HL	None	None	TPM	TSM	None	3-year	1100Wx1 Platinum	10/14
70DR002LUX	US	2xE5-2630 v3 8C/2.4GHz/20MB/85W/DDR4-1866	-	2x8GB RDIMM DDR4-2133 ECC	AnyRAID 510i	8x2.5" HS	Open	3xFH HL+3xLP HL	None	None	TPM	TSM	None	3-year	1100Wx1 Platinum	10/14
70DR002MUX	US	1xE5-2603 v3 6C/1.6GHz/15MB/85W/DDR4-1600	4XG0F28821	1x8GB RDIMM DDR4-2133 ECC	AnyRAID 510i	8x2.5" HS	Open	3xFH HL	None	None	TPM	TSM	None	3-year	750Wx1 Platinum	10/14
70DR002RUX	US	1xE5-2620 v3 6C/2.4GHz/15MB/85W/DDR4-1866	4XG0F28819	2x8GB RDIMM DDR4-2133 ECC	AnyRAID 720i+1GB RAM	8x2.5" HS	2x300GB HDD 10K 2.5" SAS6Gbs	3xFH HL	None	GbEx4 RJ-45 AnyFabric	TPM	TSM Premium	None	3-year	750Wx2 Platinum	02/15
70DR002SUX	US	1xE5-2620 v3 6C/2.4GHz/15MB/85W/DDR4-1866	4XG0F28819	1x8GB RDIMM DDR4-2133 ECC	AnyRAID 510i	8x2.5" HS	Open	3xFH HL	None	None	TPM	TSM	None	3-year	750Wx1 Platinum	02/15

Model	Region	Processor	2nd CPU	Memory	RAID Controller	Disk Bays	Storage	Slots	Optical	Add-on NIC	TPM	System Mgmt	OS	Warranty	Power Supply	Ann Date (m/y)
70DT000CUX	US	1xE5-2603 v3 6C/1.6GHz/15MB/85W/DDR4-1600	4XG0F28821	1x8GB RDIMM DDR4-2133 ECC	AnyRAID 720ix+1GB Flash	16x2.5" HS	Open	No	None	None	TPM	TSM	None	3-year	750Wx1 Platinum	10/14

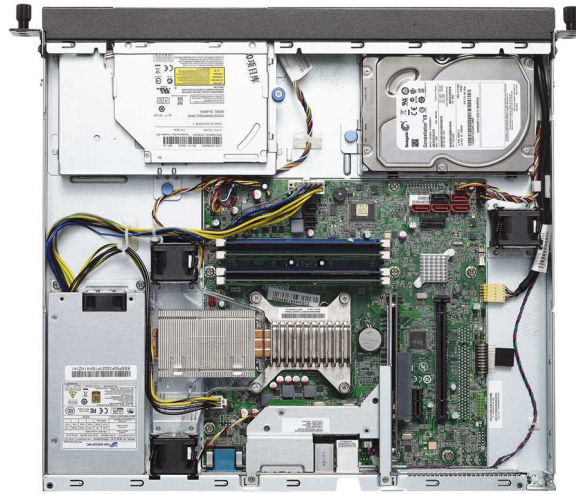
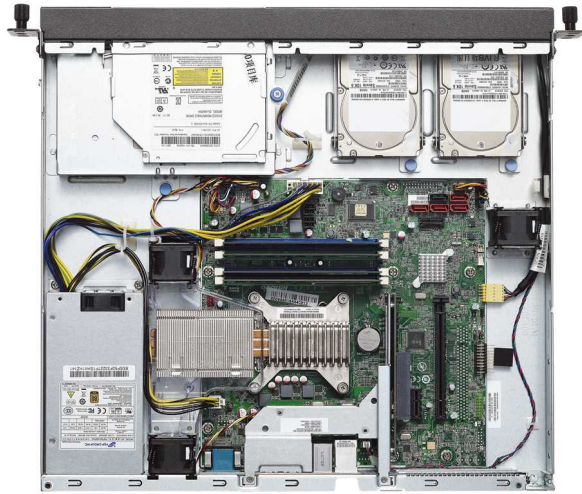

ThinkServer RS140 Platform Specifications

Components	Specification												
Dimensions	1U rack. Height: 43.5 mm (1.71 in), width: 430 mm (16.9 in), depth: 411 mm (16.2 in)												
Weight	Maximum configuration: 16.2 lb (7.36kg)												
Processor	Supports one of the following Intel processors (code name: Haswell): <ul style="list-style-type: none"> Xeon E3-1200 v3: up to 4C/3.7GHz/8MB/84W/1600MHz Core i3: up to 2C/3.7GHz/4MB/54W/1600MHz Pentium: up to 2C/3.4GHz/3MB/53W/1600MHz Celeron: up to 2C/2.9GHz/2MB/53W/1333MHz Note: Supports processors with integrated graphics only.												
Chipset	Intel C226 Platform Controller Hub (PCH)												
Memory DIMMs	4 DIMM sockets, 2-channel capable. UDIMM, DDR3												
Memory capacity	32GB (4 x 8GB)												
Memory protection	ECC												
RAID controller	RAID 0, 1, 5, 10 with onboard RAID 100, 6Gb/s SATA. RAID 0, 1, 10 with RAID 500, PCIe adapter, 6Gb/s SAS/SATA, optional key for RAID5. RAID 0, 1, 10, 5, 6 with RAID 700, PCIe adapter, 6Gb/s SAS/SATA, optional Intelligent Battery Backup Unit (iBBU08) Note: RAID 5, 6, and 10 needs 4 x 2.5" bays.												
Disk drive bays	Up to 2 3.5" disk bays or up to 4 2.5" disk bays. Direct cabled, non-hot swap. Supports optional external USB RDX tape drive												
Supporting disk drives	<table border="1"> <tbody> <tr> <td rowspan="2">For 3.5" bay</td> <td>3.5" SATA HDD</td> <td>7.2K 6Gbs: 500GB/1TB/2TB/3TB/4TB/6TB</td> </tr> <tr> <td>3.5" SAS HDD</td> <td>7.2K 6Gbs: 1TB/2TB/3TB/4TB</td> </tr> <tr> <td rowspan="3">For 2.5" bay</td> <td>2.5" SATA HDD</td> <td>7.2K 6Gbs: 500GB/1TB</td> </tr> <tr> <td>2.5" SAS HDD</td> <td>10K 6Gbs: 300GB/600GB/900GB. 15K 6Gbs: 146GB/300GB</td> </tr> <tr> <td>2.5" SATA SSD</td> <td>6Gbs: 120GB/240GB/300GB/480GB/600GB</td> </tr> </tbody> </table>	For 3.5" bay	3.5" SATA HDD	7.2K 6Gbs: 500GB/1TB/2TB/3TB/4TB/6TB	3.5" SAS HDD	7.2K 6Gbs: 1TB/2TB/3TB/4TB	For 2.5" bay	2.5" SATA HDD	7.2K 6Gbs: 500GB/1TB	2.5" SAS HDD	10K 6Gbs: 300GB/600GB/900GB. 15K 6Gbs: 146GB/300GB	2.5" SATA SSD	6Gbs: 120GB/240GB/300GB/480GB/600GB
For 3.5" bay	3.5" SATA HDD		7.2K 6Gbs: 500GB/1TB/2TB/3TB/4TB/6TB										
	3.5" SAS HDD	7.2K 6Gbs: 1TB/2TB/3TB/4TB											
For 2.5" bay	2.5" SATA HDD	7.2K 6Gbs: 500GB/1TB											
	2.5" SAS HDD	10K 6Gbs: 300GB/600GB/900GB. 15K 6Gbs: 146GB/300GB											
	2.5" SATA SSD	6Gbs: 120GB/240GB/300GB/480GB/600GB											
Optical drive	Up to one 9.5mm optical. DVD-ROM or DVD±RW												
Network interfaces	Two Gigabit Ethernet ports by Intel I210, on riser card. One Gigabit Ethernet port by Intel I217, dedicate/share management												
Security features	Power-on and administrator password. TPM (TCG 1.2-compliant).												
Systems management	Intel Active Management Technology 9 on models with Xeon processor. Remote presence is supported on models with Xeon processors. Supports ThinkServer EasyStartup/EasyUpdate												
Operating systems supported	Microsoft Windows Server 2016/2012 R2/2012/2008 R2. Windows Small Business Server 2011. Red Hat Enterprise Linux 6.5. SUSE Linux Enterprise Server 11 SP3. VMware vSphere (ESXi) 5.5 Note: VMware requires add-on network adapter.												

Components	Specification	
Base warranty	1 or 3-year limited onsite service with 9x5/NBD.	
Power supply	One fixed 300 watts power supply, 80 PLUS Gold qualified	
Graphics	Integrated Intel HD Graphics in processor	
Front ports	Two USB 2.0	
Rear ports	Four USB 3.0, two USB 2.0, one serial (9-pin), two ethernet (RJ-45), one RJ-45 (dedicate/share mgmt), one VGA, one DisplayPort. Optional two serial ports via PCIe adapter	
Noise emissions	Operating: < 5.2 Bels. Idle: < 5.0 Bels (Mainstream configuration)	
Environmental specification	RoHS-compliant.	
	Temperature - operating	50 °F to 95 °F (10 °C to 35 °C)
	Temperature - storage (with package)	-40 o C to 70 o C
	Altitude - operating	Supported Altitude (unpressurized): 0-10000ft (0-3048m)
	Humidity - operating	10%-80%, non-condensing
	Humidity - storage (with package)	10%-90%, non-condensing

Expansion slots and disk bays

Supports one PCI-Express slot via riser card, half-length, full-height, PCIe 3.0 x8

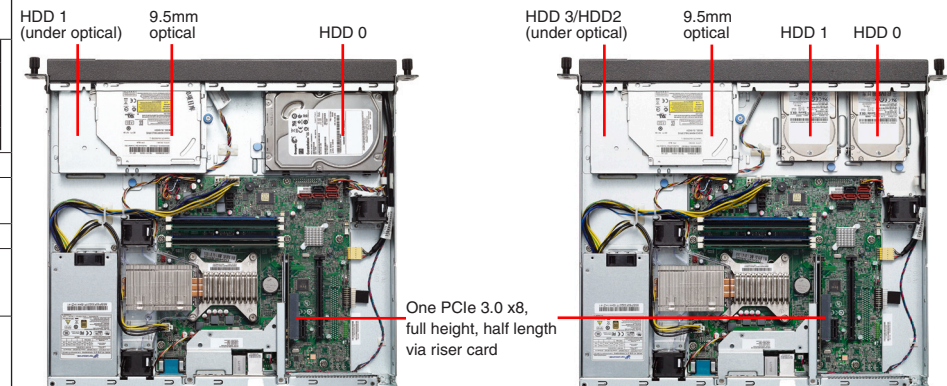

Model	Region	Processor	Memory	RAID Controller	Disk Bays	Storage	Optical	Add-on NIC	Add-on Ports	System Mgmt	OS	Warranty	Power Supply	Ann Date (m/y)
70F30006UX	US	Core i3-4130 2C/3.4GHz/3MB/54W/DDR3-1600	1x4GB UDIMM DDR3-1600 ECC	RAID 100	4x2.5" DC	Open	9.5mm DVD±RW	None	None	AMT9	None	1-year	300W Gold Fixed	06/14
70F30007UX	US	Xeon E3-1225 v3 4C/3.2GHz/8MB/84W/DDR3-1600	1x4GB UDIMM DDR3-1600 ECC	RAID 100	4x2.5" DC	Open	9.5mm DVD±RW	None	None	AMT9	None	1-year	300W Gold Fixed	06/14
70F30008UX	US	Xeon E3-1245 v3 4C/3.4GHz/8MB/84W/DDR3-1600	1x4GB UDIMM DDR3-1600 ECC	RAID 100	4x2.5" DC	Open	9.5mm DVD±RW	None	None	AMT9	None	1-year	300W Gold Fixed	06/14
70F30009UX	US	Xeon E3-1225 v3 4C/3.2GHz/8MB/84W/DDR3-1600	1x4GB UDIMM DDR3-1600 ECC	RAID 500	4x2.5" DC	Open	9.5mm DVD±RW	None	None	AMT9	None	1-year	300W Gold Fixed	06/14
70F3000AUX	US	Xeon E3-1245 v3 4C/3.4GHz/8MB/84W/DDR3-1600	1x4GB UDIMM DDR3-1600 ECC	RAID 500	4x2.5" DC	Open	9.5mm DVD±RW	None	None	AMT9	None	1-year	300W Gold Fixed	06/14
70F3000BUX	US	Xeon E3-1245 v3 4C/3.4GHz/8MB/84W/DDR3-1600	1x8GB UDIMM DDR3-1600 ECC	RAID 500+Key	4x2.5" DC	Open	9.5mm DVD±RW	None	None	AMT9	None	1-year	300W Gold Fixed	06/14
70F3000CUX	US	Xeon E3-1245 v3 4C/3.4GHz/8MB/84W/DDR3-1600	1x8GB UDIMM DDR3-1600 ECC	RAID 700	4x2.5" DC	Open	9.5mm DVD±RW	None	None	AMT9	None	1-year	300W Gold Fixed	06/14
70F3000DUS	US	Xeon E3-1225 v3 4C/3.2GHz/8MB/84W/DDR3-1600	2x4GB UDIMM DDR3-1600 ECC	RAID 500+Key	4x2.5" DC	2x500GB HDD 7.2K 2.5" SATA6Gbs	9.5mm DVD±RW	None	None	AMT9	2012 R2 Standard	1-year	300W Gold Fixed	06/14
70F3000EUS	US	Xeon E3-1245 v3 4C/3.4GHz/8MB/84W/DDR3-1600	2x8GB UDIMM DDR3-1600 ECC	RAID 700	4x2.5" DC	4x500GB HDD 7.2K 2.5" SATA6Gbs	9.5mm DVD±RW	None	None	AMT9	2012 R2 Standard	1-year	300W Gold Fixed	06/14
70F30017UX	US	Core i3-4150 2C/3.5GHz/3MB/54W/DDR3-1600	1x4GB UDIMM DDR3-1600 ECC	RAID 100	4x2.5" DC	Open	9.5mm DVD±RW	None	None	AMT9	None	1-year	300W Gold Fixed	09/14
70F30018UX	US	Xeon E3-1226 v3 4C/3.3GHz/8MB/84W/DDR3-1600	1x4GB UDIMM DDR3-1600 ECC	RAID 100	4x2.5" DC	Open	9.5mm DVD±RW	None	None	AMT9	None	1-year	300W Gold Fixed	09/14
70F30019UX	US	Xeon E3-1246 v3 4C/3.5GHz/8MB/84W/DDR3-1600	1x4GB UDIMM DDR3-1600 ECC	RAID 100	4x2.5" DC	Open	9.5mm DVD±RW	None	None	AMT9	None	1-year	300W Gold Fixed	09/14
70F3001AUX	US	Xeon E3-1226 v3 4C/3.3GHz/8MB/84W/DDR3-1600	1x4GB UDIMM DDR3-1600 ECC	RAID 500	4x2.5" DC	Open	9.5mm DVD±RW	None	None	AMT9	None	1-year	300W Gold Fixed	09/14
70F3001BUX	US	Xeon E3-1246 v3 4C/3.5GHz/8MB/84W/DDR3-1600	1x4GB UDIMM DDR3-1600 ECC	RAID 500	4x2.5" DC	Open	9.5mm DVD±RW	None	None	AMT9	None	1-year	300W Gold Fixed	09/14
70F3001EUS	US	Xeon E3-1226 v3 4C/3.3GHz/8MB/84W/DDR3-1600	1x4GB UDIMM DDR3-1600 ECC	RAID 100	4x2.5" DC	2x500GB HDD 7.2K 2.5" SATA6Gbs	9.5mm DVD±RW	None	None	AMT9	2012 R2 Foundations	1-year	300W Gold Fixed	09/14
70F3001FUS	US	Xeon E3-1226 v3 4C/3.3GHz/8MB/84W/DDR3-1600	1x4GB UDIMM DDR3-1600 ECC	RAID 100	4x2.5" DC	2x500GB HDD 7.2K 2.5" SATA6Gbs	9.5mm DVD±RW	None	None	AMT9	2012 R2 Essentials	1-year	300W Gold Fixed	09/14
70F3001GUS	US	Xeon E3-1226 v3 4C/3.3GHz/8MB/84W/DDR3-1600	1x4GB UDIMM DDR3-1600 ECC	RAID 100	4x2.5" DC	2x120GB SSD 2.5" SATA6Gbs	9.5mm DVD±RW	None	None	AMT9	2012 R2 Foundations	1-year	300W Gold Fixed	09/14
70F3001HUS	US	Xeon E3-1226 v3 4C/3.3GHz/8MB/84W/DDR3-1600	1x4GB UDIMM DDR3-1600 ECC	RAID 100	4x2.5" DC	2x120GB SSD 2.5" SATA6Gbs	9.5mm DVD±RW	None	None	AMT9	2012 R2 Essentials	1-year	300W Gold Fixed	09/14

Model	Region	Processor	Memory	RAID Controller	Disk Bays	Storage	Optical	Add-on NIC	Add-on Ports	System Mgmt	OS	Warranty	Power Supply	Ann Date (m/y)
70F90007UX	US	Core i3-4130 2C/3.4GHz/3MB/54W/DDR3-1600	1x4GB UDIMM DDR3-1600 ECC	RAID 100	2x3.5" DC	Open	9.5mm DVD±RW	None	None	AMT9	None	1-year	300W Gold Fixed	06/14
70F90008UX	US	Xeon E3-1225 v3 4C/3.2GHz/8MB/84W/DDR3-1600	1x4GB UDIMM DDR3-1600 ECC	RAID 100	2x3.5" DC	Open	9.5mm DVD±RW	None	None	AMT9	None	1-year	300W Gold Fixed	06/14
70F90009UX	US	Xeon E3-1245 v3 4C/3.4GHz/8MB/84W/DDR3-1600	1x4GB UDIMM DDR3-1600 ECC	RAID 100	2x3.5" DC	Open	9.5mm DVD±RW	None	None	AMT9	None	1-year	300W Gold Fixed	06/14
70F9000AUX	US	Core i3-4130 2C/3.4GHz/3MB/54W/DDR3-1600	1x4GB UDIMM DDR3-1600 ECC	RAID 500	2x3.5" DC	Open	9.5mm DVD±RW	None	None	AMT9	None	1-year	300W Gold Fixed	06/14
70F9000BUX	US	Xeon E3-1225 v3 4C/3.2GHz/8MB/84W/DDR3-1600	1x4GB UDIMM DDR3-1600 ECC	RAID 500	2x3.5" DC	Open	9.5mm DVD±RW	None	None	AMT9	None	1-year	300W Gold Fixed	06/14
70F9000CUX	US	Xeon E3-1245 v3 4C/3.4GHz/8MB/84W/DDR3-1600	1x4GB UDIMM DDR3-1600 ECC	RAID 500	2x3.5" DC	Open	9.5mm DVD±RW	None	None	AMT9	None	1-year	300W Gold Fixed	06/14
70F9000DUX	US	Xeon E3-1225 v3 4C/3.2GHz/8MB/84W/DDR3-1600	2x4GB UDIMM DDR3-1600 ECC	RAID 500	2x3.5" DC	Open	9.5mm DVD±RW	None	None	AMT9	None	1-year	300W Gold Fixed	06/14
70F9000EUX	US	Xeon E3-1245 v3 4C/3.4GHz/8MB/84W/DDR3-1600	2x8GB UDIMM DDR3-1600 ECC	RAID 500	2x3.5" DC	Open	9.5mm DVD±RW	None	None	AMT9	None	1-year	300W Gold Fixed	06/14
70F9000FUS	US	Xeon E3-1225 v3 4C/3.2GHz/8MB/84W/DDR3-1600	2x4GB UDIMM DDR3-1600 ECC	RAID 500	2x3.5" DC	2x500GB HDD 7.2K 3.5" SATA6Gbs	9.5mm DVD±RW	None	None	AMT9	2012 R2 Standard	1-year	300W Gold Fixed	06/14
70F9000GUS	US	Xeon E3-1245 v3 4C/3.4GHz/8MB/84W/DDR3-1600	2x8GB UDIMM DDR3-1600 ECC	RAID 500	2x3.5" DC	2x500GB HDD 7.2K 3.5" SATA6Gbs	9.5mm DVD±RW	None	None	AMT9	2012 R2 Standard	1-year	300W Gold Fixed	06/14
70F9000HUS	US	Xeon E3-1225 v3 4C/3.2GHz/8MB/84W/DDR3-1600	2x4GB UDIMM DDR3-1600 ECC	RAID 500	2x3.5" DC	2x500GB HDD 7.2K 3.5" SATA6Gbs	9.5mm DVD±RW	None	None	AMT9	2012 R2 Essentials	1-year	300W Gold Fixed	06/14
70F9001MUX	US	Core i3-4150 2C/3.5GHz/3MB/54W/DDR3-1600	1x4GB UDIMM DDR3-1600 ECC	RAID 100	2x3.5" DC	Open	9.5mm DVD±RW	None	None	AMT9	None	1-year	300W Gold Fixed	09/14
70F9001NUX	US	Xeon E3-1226 v3 4C/3.3GHz/8MB/84W/DDR3-1600	1x4GB UDIMM DDR3-1600 ECC	RAID 100	2x3.5" DC	Open	9.5mm DVD±RW	None	None	AMT9	None	1-year	300W Gold Fixed	09/14
70F9001PUX	US	Xeon E3-1246 v3 4C/3.5GHz/8MB/84W/DDR3-1600	1x4GB UDIMM DDR3-1600 ECC	RAID 100	2x3.5" DC	Open	9.5mm DVD±RW	None	None	AMT9	None	1-year	300W Gold Fixed	09/14
70F9001QUX	US	Xeon E3-1226 v3 4C/3.3GHz/8MB/84W/DDR3-1600	1x4GB UDIMM DDR3-1600 ECC	RAID 500	2x3.5" DC	Open	9.5mm DVD±RW	None	None	AMT9	None	1-year	300W Gold Fixed	09/14
70F9001RUX	US	Xeon E3-1246 v3 4C/3.5GHz/8MB/84W/DDR3-1600	1x4GB UDIMM DDR3-1600 ECC	RAID 500	2x3.5" DC	Open	9.5mm DVD±RW	None	None	AMT9	None	1-year	300W Gold Fixed	09/14
70F9001UUS	US	Xeon E3-1226 v3 4C/3.3GHz/8MB/84W/DDR3-1600	1x4GB UDIMM DDR3-1600 ECC	RAID 100	2x3.5" DC	2x500GB HDD 7.2K 3.5" SATA6Gbs	9.5mm DVD±RW	None	None	AMT9	2012 R2 Foundations	1-year	300W Gold Fixed	09/14
70F9001VUS	US	Xeon E3-1226 v3 4C/3.3GHz/8MB/84W/DDR3-1600	1x4GB UDIMM DDR3-1600 ECC	RAID 100	2x3.5" DC	2x500GB HDD 7.2K 3.5" SATA6Gbs	9.5mm DVD±RW	None	None	AMT9	2012 R2 Essentials	1-year	300W Gold Fixed	09/14

ThinkServer RS140 - 70F2

Product Specifications Reference (PSREF)

Model	Region	Processor	Memory	RAID Controller	Disk Bays	Storage	Optical	Add-on NIC	Add-on Ports	System Mgmt	OS	Warranty	Power Supply	Ann Date (m/y)
70F20001UX	US	Xeon E3-1225 v3 4C/3.2GHz/8MB/84W/DDR3-1600	2x4GB UDIMM DDR3-1600 ECC	RAID 100	4x2.5" DC	Open	None	None	None	AMT9	None	3-year	300W Gold Fixed	06/14
70F20002UX	US	Xeon E3-1245 v3 4C/3.4GHz/8MB/84W/DDR3-1600	2x8GB UDIMM DDR3-1600 ECC	RAID 700	4x2.5" DC	Open	None	None	None	AMT9	None	3-year	300W Gold Fixed	06/14

ThinkServer RS140 - 70F8

Product Specifications Reference (PSREF)

Model	Region	Processor	Memory	RAID Controller	Disk Bays	Storage	Optical	Add-on NIC	Add-on Ports	System Mgmt	OS	Warranty	Power Supply	Ann Date (m/y)
70F80000UX	US	Xeon E3-1225 v3 4C/3.2GHz/8MB/84W/DDR3-1600	2x4GB UDIMM DDR3-1600 ECC	RAID 100	2x3.5" DC	Open	9.5mm DVD±RW	None	None	AMT9	None	3-year	300W Gold Fixed	06/14
70F80001UX	US	Xeon E3-1245 v3 4C/3.4GHz/8MB/84W/DDR3-1600	2x8GB UDIMM DDR3-1600 ECC	RAID 500	2x3.5" DC	Open	9.5mm DVD±RW	None	None	AMT9	None	3-year	300W Gold Fixed	06/14



ThinkServer RS160 Platform Specifications

Components	Specification	Components	Specification		
Dimensions	1U rack. Height: 43.2 mm (1.7 in), width: 438.5 mm (17.26 in), depth: 393.7 mm (15.5 in)	Power supply	One fixed 300 watts power supply, Non-hot swap. 80 PLUS Gold qualified		
Weight	Minimum configuration: 6.2 kg (13.67 lb), maximum: 7.6 kg (16.76 lb)	Graphics	Onboard Aspeed AST2400		
Processor	Up to one Intel Xeon E3-1200 v5, Core i3, Pentium, or Celeron family processor.	Front ports	Two USB 2.0		
	Xeon E3-1280 v5	4C/3.7GHz/8MB/80W/DDR4-2133	Rear ports	One VGA, four USB 3.0, one RJ-45 (dedicated mgmt), two ethernet, one serial (9-pin)	
	Xeon E3-1270 v5	4C/3.6GHz/8MB/80W/DDR4-2133	Cooling	3 fans for processor, PCIe slot, and disk drives	
	Xeon E3-1240 v5	4C/3.5GHz/8MB/80W/DDR4-2133	Noise emissions	Operating: < 5.9 Bels. Idle: < 5.2 Bels (Maximum configuration)	
	Xeon E3-1230 v5	4C/3.4GHz/8MB/80W/DDR4-2133	Environmental specification	Temperature - operating	50 °F to 95 °F (10 °C to 35 °C)
	Xeon E3-1220 v5	4C/3GHz/8MB/80W/DDR4-2133		Temperature - non operating (with package)	-40 °C to 60 °C
	Xeon E3-1260L v5	4C/2.9GHz/8MB/45W/DDR4-2133		Altitude - operating	(Unpressurized): 0-10000ft (0-3048m)
	Xeon E3-1240L v5	4C/2.1GHz/8MB/25W/DDR4-2133		Humidity - operating	8%-80%, non-condensing
	Xeon E3-1225 v5	4C/3.3GHz/8MB/80W/DDR4-2133		Humidity - storage (with package)	10%-90%, non-condensing
	Core i3-6320	2C/3.9GHz/4MB/51W/DDR4-2133		Expansion slots and disk bays	
	Core i3-6300	2C/3.8GHz/4MB/51W/DDR4-2133	Supports one PCIe slot via optional riser card, PCIe 3.0 x16, half length, half height		
	Core i3-6100	2C/3.7GHz/3MB/51W/DDR4-2133	Core options for ThinkServer RS160 (partial)		
	Pentium G4520	2C/3.6GHz/3MB/51W/DDR4-2133	ThinkServer 8GB 2RX8 PC4-2133-E CL15 DDR4-2133 ECC-UDIMM	4X70G88316	
	Pentium G4500	2C/3.5GHz/3MB/51W/DDR4-2133	ThinkServer 16GB 2RX8 PC4-2133-E CL15 DDR4-2133 ECC-UDIMM	4X70G88317	
	Pentium G4400	2C/3.3GHz/3MB/54W/DDR4-2133	ThinkServer 3.5" 8TB 7.2K Enterprise SATA 6Gbps 512e Hard Drive for RS-Series	4XB0K12297	
	Celeron G3920	2C/2.9GHz/2MB/51W/DDR4-2133	ThinkServer 2.5" 1.2TB 10K Enterprise SAS 12Gbps Hard Drive for RS-Series	4XB0K12306	
	Celeron G3900	2C/2.8GHz/2MB/51W/DDR4-2133	ThinkServer 2.5" 2TB 7.2K Enterprise SATA 6Gbps Hard Drive for RS-Series	4XB0K12302	
	Celeron G3900T	2C/2.6GHz/2MB/35W/DDR4-2133	ThinkServer 2.5" 480GB S3510 Enterprise Entry SATA 6Gbps SSD for RS-Series	4XB0K12321	
Chipset	Intel C232 Platform Controller Hub (PCH)	ThinkServer M.2 32GB Value Read-Optimized SATA 6Gbps Solid State Drive	4XB0K12310		
Memory DIMMs	4 DIMM sockets with 2 channels, 2 DIMMs per channel. UDIMM . DDR4-2133	ThinkServer RAID 520i RAID 5 Upgrade	4XC0G88841		
Memory capacity	64GB (16GB x 4)	ThinkServer RS160 Slim SATA DVD-RW Optical Disk Drive	4XA0G88613		
Memory protection	ECC	Lenovo ThinkServer Gen 5 Trusted Platform Module v1.2 (Worldwide except China)	4XF0G45868		
RAID controller	RAID controller	Drive type	RAID support	Compatible models	
	Onboard RAID12i	6Gbs SATA	0/1/5/10	2x3.5", 4x2.5"	
	RAID520i PCIe	12Gbs SAS/SATA	0/1/10, 5 with optional key	2x3.5", 4x2.5"	
RAID720i PCIe	12Gbs SAS/SATA	0/1/10/5, 6 with optional cache	2x3.5", 4x2.5"		
	Optional cache for RAID720i: 1GB memory. 1GB, 2GB, or 4GB flash with super capacitor.				
Disk drive bays	Supports two 3.5" or four 2.5" disk drive bays. Non-hot swap. Cables are connected to onboard SATA connectors or PCIe RAID controller. Also supports one M.2 SATA SSD				
Supporting storage	3.5" HDD, 7.2K SATA6Gbs	1TB/2TB/4TB/6TB/8TB			
	3.5" HDD, 7.2K SAS12Gbs	1TB/2TB/4TB/6TB/8TB			
	2.5" HDD, 7.2K SATA6Gbs	1TB/2TB			
	2.5" HDD, 10K SAS12Gbs	300GB/600GB/900GB/1.2TB			
	2.5" SSD, SATA6Gbs	120GB/240GB/480GB/960GB			
M.2 SATA SSD	32GB/128GB				
Optical drive	Optional one 9.5mm optical. DVD-ROM or DVD±RW				
Network interfaces	One dedicated management port, two Gigabit Ethernet ports. Supports optional discrete network adapters via riser card				
Security features	Power-on and administrator password. Optional TPM, TCG 1.2 or 2.0 compliant.				
Systems management	UEFI. Onboard Aspeed AST2400 graphics/management processor, IPMI 2.0-compliant baseboard management controller (BMC). Control Panel LEDs shows the status of power, ID, disk drives, network, system. Supports the following management software: EasyStartup, Power Planner. On November 2016, EasyUpdate, Lenovo ThinkServer Diagnostics Standalone, ToolsCenter Suite CLI inventory module on ThinkServer, and Lenovo xClarity Administrator will be available				
Operating systems	Microsoft Windows Server 2016 (Standard and Essentials)/2012 R2/2012. Windows 10 Pro. Red Hat Enterprise Linux 6.7/6.8/7.2. SUSE Linux Enterprise Server 11/12. VMware vSphere (ESXi) 6.0U2				
Base warranty	1 or 3-year limited onsite service with 9x5/NBD				

Model	Region	Processor	Memory	RAID Controller	Disk Bays	Storage(HDD/SSD)	Optical	Add-on NIC	Slots	TPM	OS	Warranty	Power Supply	Ann Date (m/y)
70TE000DUX	US	Xeon E3-1220 v5 4C/3GHz/8MB/80W/DDR4-2133	1x8GB UDIMM DDR4-2133 ECC	RAID 121i	4x2.5" NHS	Open	None	None	None	TPM	None	1-year	300W 85% Fixed	09/16
70TE000EUX	US	Xeon E3-1230 v5 4C/3.4GHz/8MB/80W/DDR4-2133	1x8GB UDIMM DDR4-2133 ECC	RAID 121i	4x2.5" NHS	Open	None	None	None	TPM	None	1-year	300W 85% Fixed	09/16
70TE000FUX	US	Xeon E3-1240 v5 4C/3.5GHz/8MB/80W/DDR4-2133	1x8GB UDIMM DDR4-2133 ECC	RAID 121i	4x2.5" NHS	Open	None	None	None	TPM	None	1-year	300W 85% Fixed	09/16
70TE000GUX	US	Xeon E3-1270 v5 4C/3.6GHz/8MB/80W/DDR4-2133	1x8GB UDIMM DDR4-2133 ECC	RAID 121i	4x2.5" NHS	Open	None	None	None	TPM	None	1-year	300W 85% Fixed	09/16
70TE000HUX	US	Xeon E3-1280 v5 4C/3.7GHz/8MB/80W/DDR4-2133	1x8GB UDIMM DDR4-2133 ECC	RAID 121i	4x2.5" NHS	Open	None	None	None	TPM	None	1-year	300W 85% Fixed	09/16
70TER001UX	US	Xeon E3-1220 v5 4C/3GHz/8MB/80W/DDR4-2133	1x8GB UDIMM DDR4-2133 ECC	RAID 121i	4x2.5" NHS	Open	None	None	1xHHHL	TPM	None	1-year	300W 85% Fixed	09/16
70TER002UX	US	Xeon E3-1230 v5 4C/3.4GHz/8MB/80W/DDR4-2133	1x8GB UDIMM DDR4-2133 ECC	RAID 121i	4x2.5" NHS	Open	None	None	1xHHHL	TPM	None	1-year	300W 85% Fixed	09/16
70TER003UX	US	Xeon E3-1270 v5 4C/3.6GHz/8MB/80W/DDR4-2133	1x8GB UDIMM DDR4-2133 ECC	RAID 121i	4x2.5" NHS	Open	None	None	1xHHHL	TPM	None	1-year	300W 85% Fixed	09/16

Model	Region	Processor	Memory	RAID Controller	Disk Bays	Storage(HDD/SSD)	Optical	Add-on NIC	Slots	TPM	OS	Warranty	Power Supply	Ann Date (m/y)
70TG000JUX	US	Pentium G4400 2C/3.3GHz/3MB/54W/DDR4-2133	1x8GB UDIMM DDR4-2133 ECC	RAID 121i	2x3.5" NHS	Open	None	None	None	TPM	None	1-year	300W 85% Fixed	09/16
70TG000KUX	US	Xeon E3-1220 v5 4C/3GHz/8MB/80W/DDR4-2133	1x8GB UDIMM DDR4-2133 ECC	RAID 121i	2x3.5" NHS	Open	None	None	None	TPM	None	1-year	300W 85% Fixed	09/16
70TG000LUX	US	Xeon E3-1230 v5 4C/3.4GHz/8MB/80W/DDR4-2133	1x8GB UDIMM DDR4-2133 ECC	RAID 121i	2x3.5" NHS	Open	None	None	None	TPM	None	1-year	300W 85% Fixed	09/16
70TG000MUX	US	Xeon E3-1240 v5 4C/3.5GHz/8MB/80W/DDR4-2133	1x8GB UDIMM DDR4-2133 ECC	RAID 121i	2x3.5" NHS	Open	None	None	None	TPM	None	1-year	300W 85% Fixed	09/16
70TG000NUX	US	Xeon E3-1270 v5 4C/3.6GHz/8MB/80W/DDR4-2133	1x8GB UDIMM DDR4-2133 ECC	RAID 121i	2x3.5" NHS	Open	None	None	None	TPM	None	1-year	300W 85% Fixed	09/16
70TG000PUX	US	Xeon E3-1280 v5 4C/3.7GHz/8MB/80W/DDR4-2133	1x8GB UDIMM DDR4-2133 ECC	RAID 121i	2x3.5" NHS	Open	None	None	None	TPM	None	1-year	300W 85% Fixed	09/16
70TGR001UX	US	Pentium G4400 2C/3.3GHz/3MB/54W/DDR4-2133	1x8GB UDIMM DDR4-2133 ECC	RAID 121i	2x3.5" NHS	Open	None	None	1xHHHL	TPM	None	1-year	300W 85% Fixed	09/16
70TGR002UX	US	Xeon E3-1220 v5 4C/3GHz/8MB/80W/DDR4-2133	1x8GB UDIMM DDR4-2133 ECC	RAID 121i	2x3.5" NHS	Open	None	None	1xHHHL	TPM	None	1-year	300W 85% Fixed	09/16
70TGR003UX	US	Xeon E3-1230 v5 4C/3.4GHz/8MB/80W/DDR4-2133	1x8GB UDIMM DDR4-2133 ECC	RAID 121i	2x3.5" NHS	Open	None	None	1xHHHL	TPM	None	1-year	300W 85% Fixed	09/16

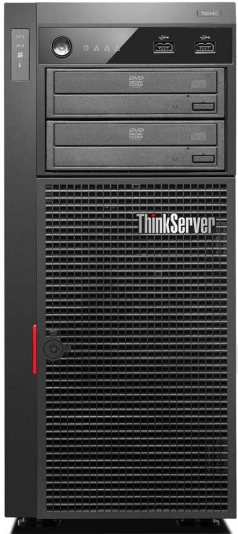

ThinkServer TD340 Platform Specifications

Components	Specification																																									
Dimensions	Tower or 5U rack. Height: 430 mm (16.9 in), width: 195 mm (7.68 in), depth: 595 mm (23.4 in)																																									
Weight	Maximum: 26 kg (57.3 lb)																																									
Processor	Up to two 95W Intel Xeon E5-2400 v2 family (code name: Ivy Bridge EN) processors with 10 cores up to 2.4GHz, 8 cores up to 2.5GHz, 6 cores up to 2.5GHz, 4 cores up to 2.4GHz. One QPI link up to 8.0 GT/s. Up to 1600MHz memory speed. Up to 25MB cache. Or up to two Intel Xeon E5-2420 (code name: Sandy Bridge EN) processors with 6 cores, 1.9GHz, 15MB cache, 95W, up to 1333MHz memory speed, one 7.2GT/s QPI link																																									
Chipset	Intel C606 Platform Controller Hub (PCH)																																									
Memory DIMMs	12 DIMM sockets (6 DIMMs per processor). 6-channel capable (3-channel per processor). RDIMM, LV RDIMM and LV UDIMM (cannot be intermixed). DDR3. Up to 1866MHz (RDIMM), 1600MHz (LV RDIMM) or 1600MHz (LV UDIMM)																																									
Memory capacity	192GB (RDIMM and LV RDIMM), 16GB x 12/48GB (LV UDIMM, 4GB x 12)																																									
Memory protection	ECC, memory mirroring, memory sparing																																									
AnyRAID support	Supports one of the following: RAID 0, 1, 10 with onboard RAID 100, 6Gb/s SATA, optional key for RAID 5. RAID 0, 1, 10 with onboard RAID 300, 6Gb/s SAS/SATA, optional key for RAID 5. RAID 0, 1, 10 with RAID 500, PCIe adapter, 6Gb/s SAS/SATA, optional key for RAID 5, 50. RAID 0, 1, 10, 5, 50, 6, 60 with RAID 700, PCIe adapter, 512MB cache, optional intelligent Battery Backup Unit (iBBU08). RAID 0, 1, 10, 5, 50, 6, 60 with RAID 710, PCIe adapter, 1GB cache, optional CacheVault flash cache with super capacitor/CacheCade Pro 2.0/FastPath key <i>Note: At least 6 disk drives is required for RAID 50 and 60.</i>																																									
Disk drive bays	Up to 8 3.5" hot-swap bays, or up to 16 2.5" hot-swap bays, or up to 4 3.5" non-hot swap bays. On front. Supports internal RDX tape drive, consumes 5.25" bay, also supports optional external SAS tape drive, additional SAS HBA card is needed. <table border="1"> <thead> <tr> <th rowspan="2">Disk bay configuration</th> <th colspan="5">RAID controller requirements</th> </tr> <tr> <th>RAID100</th> <th>RAID300</th> <th>RAID500</th> <th>RAID700</th> <th>RAID710</th> </tr> </thead> <tbody> <tr> <td>4x3.5" non-hot swap</td> <td>•</td> <td></td> <td></td> <td></td> <td></td> </tr> <tr> <td>4x3.5" HS</td> <td>•</td> <td>•</td> <td>•</td> <td>•</td> <td>•</td> </tr> <tr> <td>8x3.5" HS</td> <td></td> <td>•</td> <td>•</td> <td>•</td> <td>•</td> </tr> <tr> <td>8x2.5" HS</td> <td></td> <td>•</td> <td>•</td> <td>•</td> <td>•</td> </tr> <tr> <td>16x2.5" HS</td> <td></td> <td></td> <td>•</td> <td>•</td> <td>•</td> </tr> </tbody> </table>	Disk bay configuration	RAID controller requirements					RAID100	RAID300	RAID500	RAID700	RAID710	4x3.5" non-hot swap	•					4x3.5" HS	•	•	•	•	•	8x3.5" HS		•	•	•	•	8x2.5" HS		•	•	•	•	16x2.5" HS			•	•	•
Disk bay configuration	RAID controller requirements																																									
	RAID100	RAID300	RAID500	RAID700	RAID710																																					
4x3.5" non-hot swap	•																																									
4x3.5" HS	•	•	•	•	•																																					
8x3.5" HS		•	•	•	•																																					
8x2.5" HS		•	•	•	•																																					
16x2.5" HS			•	•	•																																					
Supporting disk drives	<table border="1"> <tbody> <tr> <td>3.5" SATA HDD (both HS and NHS)</td> <td>7.2K 6Gbs: 7.2K 6Gbs: 500GB/1TB/2TB/3TB/4TB</td> </tr> <tr> <td>3.5" SAS HDD (HS)</td> <td>7.2K 6Gbs: 1TB/2TB/3TB/4TB. 15K 6Gbs: 300GB/600GB</td> </tr> <tr> <td>2.5" SATA HDD (HS)</td> <td>7.2K 6Gbs: 500GB/1TB. 10K 6Gbs: 300GB/600GB/900GB</td> </tr> <tr> <td>2.5" SAS HDD (HS)</td> <td>15K 6Gbs: 146GB/300GB/600GB</td> </tr> <tr> <td>2.5" SATA SSD (HS, also supports 3.5" HS bay)</td> <td>6Gbs: 120GB/240GB/300GB/480GB/600GB</td> </tr> <tr> <td>2.5" SAS SSD (HS, also supports 3.5" HS bay)</td> <td>12Gbs: 200GB/400GB/800GB</td> </tr> <tr> <td>PCIe SSD</td> <td>1.4TB, via PCIe 2.0 x8 adapter</td> </tr> </tbody> </table> <p><i>Note: Supports up to 2 SSD drives on 8 x 3.5" HS model, up to 4 SSD drives on 16 x 2.5" HS model.</i></p>	3.5" SATA HDD (both HS and NHS)	7.2K 6Gbs: 7.2K 6Gbs: 500GB/1TB/2TB/3TB/4TB	3.5" SAS HDD (HS)	7.2K 6Gbs: 1TB/2TB/3TB/4TB. 15K 6Gbs: 300GB/600GB	2.5" SATA HDD (HS)	7.2K 6Gbs: 500GB/1TB. 10K 6Gbs: 300GB/600GB/900GB	2.5" SAS HDD (HS)	15K 6Gbs: 146GB/300GB/600GB	2.5" SATA SSD (HS, also supports 3.5" HS bay)	6Gbs: 120GB/240GB/300GB/480GB/600GB	2.5" SAS SSD (HS, also supports 3.5" HS bay)	12Gbs: 200GB/400GB/800GB	PCIe SSD	1.4TB, via PCIe 2.0 x8 adapter																											
3.5" SATA HDD (both HS and NHS)	7.2K 6Gbs: 7.2K 6Gbs: 500GB/1TB/2TB/3TB/4TB																																									
3.5" SAS HDD (HS)	7.2K 6Gbs: 1TB/2TB/3TB/4TB. 15K 6Gbs: 300GB/600GB																																									
2.5" SATA HDD (HS)	7.2K 6Gbs: 500GB/1TB. 10K 6Gbs: 300GB/600GB/900GB																																									
2.5" SAS HDD (HS)	15K 6Gbs: 146GB/300GB/600GB																																									
2.5" SATA SSD (HS, also supports 3.5" HS bay)	6Gbs: 120GB/240GB/300GB/480GB/600GB																																									
2.5" SAS SSD (HS, also supports 3.5" HS bay)	12Gbs: 200GB/400GB/800GB																																									
PCIe SSD	1.4TB, via PCIe 2.0 x8 adapter																																									
Optical drive	Two 5.25" bays for optical drive. DVD-ROM or DVD±RW. Half-height																																									
Network interfaces	Two Gigabit Ethernet port via two Intel 82574L. One port is shared with ThinkServer Management Module. Supports optional discrete network adapters via PCIe slots																																									

Components	Specification	
Security features	Power-on and administrator password. Optional TPM (TCG 1.2-compliant)	
Intelligent Diagnostics Module (IDM)	Supports IDM or IDM Premium on selected models, IDM LED lights indicate failing component category, IDM Premium LED lights indicate individual failing part	
Systems management	Supports ThinkServer Management Module (TMM), optional TMM Premium for remote presence. Onboard Aspeed AST2300 graphics/management processor, IPMI 2.0-compliant baseboard management controller (BMC). Front control panel LEDs shows the status of power, hard drive activity, network, system. Supports EasyStartup, EasyManage, EasyUpdate.	
Operating systems supported	Microsoft Windows Server 2012 R2/2012/2008 R2/2008. Windows Small Business Server 2011. Red Hat Enterprise Linux 7.1/7/6.7/6.5/6.4/5.10/5.9. SUSE Linux Enterprise Server 11/10. VMware vSphere (ESXi) 5.5/5.1	
Base warranty	1 or 3-year limited onsite service with 9x5/NBD.	
Power supply	One fixed 625 watts, universal, 80 PLUS Bronze qualified. Or up to two redundant 800 watts, two maximum, rear access, hot-swap, 80 PLUS Gold qualified, redundant with two power supplies	
Graphics	Onboard Aspeed AST2300 graphics/management processor	
Front ports	Two USB 2.0	
Rear ports	Four USB 2.0, one serial (9-pin), two ethernet (RJ-45, one for dedicate/share mgmt), one analog VGA DB-15 connector	
Noise emissions	Operating: < 42 dB(A). Idle: < 38 dB(A) (Maximum configuration)	
Environmental specification	Energy Star Server 1.1 qualified for 625W models, Energy Star Server 2.0 qualified for 800W models. RoHS-compliant.	
	Temperature - operating	50 °F to 95 °F (10 °C to 35 °C)
	Temperature - storage (with package)	-40 °C to 60 °C
	Altitude - operating	Supported Altitude (unpressurized): 0-10000ft (0-3048m)
	Humidity - operating	10%~80%, non-condensing
Humidity - storage (with package)	8%~90%, non-condensing	



Expansion slots

Slot 1 (PCH)	32-bit PCI 2.3, half-length, full-height
Slot 2 (CPU1)	PCIe 3.0 x8 (x4 elec), half-length, full-height
Slot 3 (CPU2)	PCIe 3.0 x8, half-length, full-height
Slot 4 (CPU2)	PCIe 3.0 x8, half-length, full-height
Slot 5 (CPU1)	PCIe 3.0 x16, half-length, full-height
Slot 6 (CPU2)	PCIe 3.0 x8, half-length, full-height

ThinkServer TD340 - TopSeller - 70B5

Product Specifications Reference (PSREF)

Model	Region	Processor	Memory	RAID Controller	Disk Bays	Storage	Optical	Add-on NIC	TPM	Diagnostics	System Mgmt	OS	Warranty	Power Supply	Ann Date (m/y)
70B5001TUX	US	1xE5-2403 v2 4C/1.8GHz/10MB/80W/DDR3-1333	1x8GB RDIMM DDR3-1600 ECC	RAID 300	4x3.5" HS	Open	HH DVD±RW	None	TPM	IDM Premium	TMM	None	1-year	625W Bronze Fixed	05/14

Model	Region	Processor	Memory	RAID Controller	Disk Bays	Storage	Optical	Add-on NIC	TPM	Diagnostics	System Mgmt	OS	Warranty	Power Supply	Ann Date (m/y)
70B7002GUX	US	1xE5-2403 v2 4C/1.8GHz/10MB/80W/DDR3-1333	1x8GB RDIMM DDR3-1600 ECC	RAID 300	4x3.5" HS	Open	HH DVD±RW	None	TPM	IDM	TMM	None	1-year	800Wx1 Gold	01/14
70B7002HUX	US	1xE5-2407 v2 4C/2.4GHz/10MB/80W/DDR3-1333	1x8GB RDIMM DDR3-1600 ECC	RAID 300	4x3.5" HS	Open	HH DVD±RW	None	TPM	IDM	TMM	None	1-year	800Wx1 Gold	01/14
70B7002JUX	US	1xE5-2403 v2 4C/1.8GHz/10MB/80W/DDR3-1333	1x8GB RDIMM DDR3-1600 ECC	RAID 300	4x3.5" HS	Open	HH DVD±RW	None	TPM	IDM Premium	TMM	None	3-year	800Wx1 Gold	01/14
70B7002KUX	US	1xE5-2407 v2 4C/2.4GHz/10MB/80W/DDR3-1333	1x8GB RDIMM DDR3-1600 ECC	RAID 300	4x3.5" HS	Open	HH DVD±RW	None	TPM	IDM Premium	TMM	None	3-year	800Wx1 Gold	01/14
70B7002LUX	US	1xE5-2420 v2 6C/2.2GHz/15MB/80W/DDR3-1600	1x8GB RDIMM DDR3-1600 ECC	RAID 300	4x3.5" HS	Open	HH DVD±RW	None	TPM	IDM Premium	TMM	None	3-year	800Wx1 Gold	01/14
70B7002MUX	US	1xE5-2430 v2 6C/2.5GHz/15MB/80W/DDR3-1600	1x8GB RDIMM DDR3-1600 ECC	RAID 300	4x3.5" HS	Open	HH DVD±RW	None	TPM	IDM Premium	TMM	None	3-year	800Wx1 Gold	01/14
70B7002NUX	US	1xE5-2440 v2 8C/1.9GHz/20MB/95W/DDR3-1600	1x8GB RDIMM DDR3-1600 ECC	RAID 300	4x3.5" HS	Open	HH DVD±RW	None	TPM	IDM Premium	TMM	None	3-year	800Wx1 Gold	01/14
70B7002PUX	US	1xE5-2450 v2 8C/2.5GHz/20MB/95W/DDR3-1600	1x8GB RDIMM DDR3-1600 ECC	RAID 300	4x3.5" HS	Open	HH DVD±RW	None	TPM	IDM Premium	TMM	None	3-year	800Wx1 Gold	01/14
70B7002QUX	US	1xE5-2470 v2 10C/2.4GHz/25MB/95W/DDR3-1600	1x8GB RDIMM DDR3-1600 ECC	RAID 300	4x3.5" HS	Open	HH DVD±RW	None	TPM	IDM Premium	TMM	None	3-year	800Wx1 Gold	01/14
70B7002RUX	US	1xE5-2420 v2 6C/2.2GHz/15MB/80W/DDR3-1600	1x8GB RDIMM DDR3-1600 ECC	RAID 300	8x3.5" HS	Open	HH DVD±RW	None	TPM	IDM Premium	TMM	None	3-year	800Wx1 Gold	01/14
70B7002SUX	US	1xE5-2430 v2 6C/2.5GHz/15MB/80W/DDR3-1600	1x8GB RDIMM DDR3-1600 ECC	RAID 300	8x3.5" HS	Open	HH DVD±RW	None	TPM	IDM Premium	TMM	None	3-year	800Wx1 Gold	01/14
70B7002TUX	US	1xE5-2440 v2 8C/1.9GHz/20MB/95W/DDR3-1600	1x8GB RDIMM DDR3-1600 ECC	RAID 300	8x3.5" HS	Open	HH DVD±RW	None	TPM	IDM Premium	TMM	None	3-year	800Wx1 Gold	01/14
70B7002UUX	US	1xE5-2450 v2 8C/2.5GHz/20MB/95W/DDR3-1600	1x8GB RDIMM DDR3-1600 ECC	RAID 300	8x3.5" HS	Open	HH DVD±RW	None	TPM	IDM Premium	TMM	None	3-year	800Wx1 Gold	01/14
70B7002VUX	US	1xE5-2470 v2 10C/2.4GHz/25MB/95W/DDR3-1600	1x8GB RDIMM DDR3-1600 ECC	RAID 300	8x3.5" HS	Open	HH DVD±RW	None	TPM	IDM Premium	TMM	None	3-year	800Wx1 Gold	01/14
70B7002WUX	US	1xE5-2420 v2 6C/2.2GHz/15MB/80W/DDR3-1600	1x8GB RDIMM DDR3-1600 ECC	RAID 300	8x2.5" HS	Open	HH DVD±RW	None	TPM	IDM Premium	TMM	None	3-year	800Wx1 Gold	01/14
70B7002XUX	US	1xE5-2430 v2 6C/2.5GHz/15MB/80W/DDR3-1600	1x8GB RDIMM DDR3-1600 ECC	RAID 300	8x2.5" HS	Open	HH DVD±RW	None	TPM	IDM Premium	TMM	None	3-year	800Wx1 Gold	01/14
70B7002YUX	US	1xE5-2440 v2 8C/1.9GHz/20MB/95W/DDR3-1600	1x8GB RDIMM DDR3-1600 ECC	RAID 300	8x2.5" HS	Open	HH DVD±RW	None	TPM	IDM Premium	TMM	None	3-year	800Wx1 Gold	01/14

Model	Region	Processor	Memory	RAID Controller	Disk Bays	Storage	Optical	Add-on NIC	TPM	Diagnostics	System Mgmt	OS	Warranty	Power Supply	Ann Date (m/y)
70B70030UX	US	1xE5-2450 v2 8C/2.5GHz/20MB/95W/DDR3-1600	1x8GB RDIMM DDR3-1600 ECC	RAID 300	8x2.5" HS	Open	HH DVD±RW	None	TPM	IDM Premium	TMM	None	3-year	800Wx1 Gold	01/14
70B70031UX	US	1xE5-2470 v2 10C/2.4GHz/25MB/95W/DDR3-1600	1x8GB RDIMM DDR3-1600 ECC	RAID 300	8x2.5" HS	Open	HH DVD±RW	None	TPM	IDM Premium	TMM	None	3-year	800Wx1 Gold	01/14
70B70032UX	US	1xE5-2420 v2 6C/2.2GHz/15MB/80W/DDR3-1600	1x8GB RDIMM DDR3-1600 ECC	RAID 700	16x2.5" HS	Open	HH DVD±RW	None	TPM	IDM Premium	TMM	None	3-year	800Wx1 Gold	01/14
70B70033UX	US	1xE5-2430 v2 6C/2.5GHz/15MB/80W/DDR3-1600	1x8GB RDIMM DDR3-1600 ECC	RAID 700	16x2.5" HS	Open	HH DVD±RW	None	TPM	IDM Premium	TMM	None	3-year	800Wx1 Gold	01/14
70B70034UX	US	1xE5-2440 v2 8C/1.9GHz/20MB/95W/DDR3-1600	1x8GB RDIMM DDR3-1600 ECC	RAID 700	16x2.5" HS	Open	HH DVD±RW	None	TPM	IDM Premium	TMM	None	3-year	800Wx1 Gold	01/14
70B70035UX	US	1xE5-2450 v2 8C/2.5GHz/20MB/95W/DDR3-1600	1x8GB RDIMM DDR3-1600 ECC	RAID 710	16x2.5" HS	Open	HH DVD±RW	None	TPM	IDM Premium	TMM	None	3-year	800Wx1 Gold	01/14
70B70036UX	US	1xE5-2470 v2 10C/2.4GHz/25MB/95W/DDR3-1600	1x8GB RDIMM DDR3-1600 ECC	RAID 710	16x2.5" HS	Open	HH DVD±RW	None	TPM	IDM Premium	TMM	None	3-year	800Wx1 Gold	01/14
70B7004DUX	US	2xE5-2420 v2 6C/2.2GHz/15MB/80W/DDR3-1600	2x16GB RDIMM DDR3-1866 ECC	RAID 300	8x3.5" HS	Open	HH DVD±RW	None	TPM	IDM Premium	TMM Premium	None	3-year	800Wx2 Gold	09/15

Model	Region	Processor	Memory	RAID Controller	Disk Bays	Storage	Optical	Add-on NIC	TPM	Diagnostics	System Mgmt	OS	Warranty	Power Supply	Ann Date (m/y)
70B60002UX	US	1xE5-2420 v2 6C/2.2GHz/15MB/80W/DDR3-1600	4x8GB RDIMM DDR3-1600 ECC	RAID 500+Key	4x3.5" HS	4x2TB HDD 7.2K 3.5" SATA6Gbs	HH DVD±RW	2xGbE	TPM	IDM Premium	TMM Premium	None	3-year	800Wx2 Gold	01/14
70B60003UX	US	2xE5-2440 v2 8C/1.9GHz/20MB/95W/DDR3-1600	8x8GB RDIMM DDR3-1600 ECC	RAID 700	8x3.5" HS	8x2TB 3.5" SAS6Gbs 7.2K	HH DVD±RW	2xGbE	TPM	IDM Premium	TMM Premium	None	3-year	800Wx2 Gold	01/14
70B60004UX	US	2xE5-2450 v2 8C/2.5GHz/20MB/95W/DDR3-1600	12x8GB RDIMM DDR3-1600 ECC	RAID 710+CacheVault	16x2.5" HS	8x300GB HDD 15K 2.5" SAS6Gbs	HH DVD±RW	4xGbE	TPM	IDM Premium	TMM Premium	None	3-year	800Wx2 Gold	01/14
70B60005UX	US	1xE5-2407 v2 4C/2.4GHz/10MB/80W/DDR3-1333	1x8GB RDIMM DDR3-1600 ECC	RAID 300+Key	4x3.5" HS	Open	HH DVD±RW	None	TPM	IDM Premium	TMM	None	3-year	800Wx1 Gold	04/14
70B60006UX	US	1xE5-2420 v2 6C/2.2GHz/15MB/80W/DDR3-1600	1x8GB RDIMM DDR3-1600 ECC	RAID 500	8x3.5" HS	Open	HH DVD±RW	None	TPM	IDM Premium	TMM	None	3-year	800Wx1 Gold	04/14
70B60007UX	US	1xE5-2420 v2 6C/2.2GHz/15MB/80W/DDR3-1600	1x8GB RDIMM DDR3-1600 ECC	RAID 700	8x3.5" HS	Open	HH DVD±RW	None	TPM	IDM Premium	TMM Premium	None	3-year	800Wx2 Gold	04/14
70B60008UX	US	1xE5-2440 v2 8C/1.9GHz/20MB/95W/DDR3-1600	1x8GB RDIMM DDR3-1600 ECC	RAID 700	8x2.5" HS	Open	HH DVD±RW	None	TPM	IDM Premium	TMM	None	3-year	800Wx1 Gold	04/14
70B60009UX	US	1xE5-2450 v2 8C/2.5GHz/20MB/95W/DDR3-1600	1x16GB RDIMM DDR3-1600 ECC	RAID 710	16x2.5" HS	Open	HH DVD±RW	None	TPM	IDM Premium	TMM Premium	None	3-year	800Wx2 Gold	04/14



ThinkServer TD350 Platform Specifications

Product Specifications Reference (PSREF)

Components	Specification																												
Dimensions	Tower or 4U rack. Tower: Height: 459 mm (18.1 in), width: 251 mm (9.9 in), depth: 686 mm (27 in) Rack: height: 173 mm (6.8 in), width: 482 mm (19 in), depth: 686 mm (27 in)																												
Weight	Minimum configuration: 22 kg (48.5 lb), maximum: 41.4 kg (91.27 lb)																												
Processor	Up to two 135W Intel Xeon E5-2600 v4 or E5-2600 v3 family processors.																												
	E5-2698 v4 20C/2.2GHz/50MB/135W/DDR4-2400																												
	E5-2695 v4 18C/2.1GHz/45MB/120W/DDR4-2400																												
	E5-2690 v4 14C/2.6GHz/35MB/135W/DDR4-2400																												
	E5-2683 v4 16C/2.1GHz/40MB/120W/DDR4-2400																												
	E5-2680 v4 14C/2.4GHz/35MB/120W/DDR4-2400																												
	E5-2667 v4 8C/3.2GHz/25MB/135W/DDR4-2400																												
	E5-2660 v4 14C/2GHz/35MB/105W/DDR4-2400																												
	E5-2650L v4 14C/1.7GHz/35MB/65W/DDR4-2400																												
	E5-2650 v4 12C/2.2GHz/30MB/105W/DDR4-2400																												
	E5-2643 v4 6C/3.4GHz/20MB/135W/DDR4-2400																												
	E5-2640 v4 10C/2.4GHz/25MB/90W/DDR4-2133																												
	E5-2637 v4 4C/3.5GHz/15MB/135W/DDR4-2400																												
	E5-2630L v4 10C/1.8GHz/25MB/55W/DDR4-2133																												
	E5-2630 v4 10C/2.2GHz/20MB/85W/DDR4-2133																												
	E5-2623 v4 4C/2.6GHz/10MB/85W/DDR4-2133																												
	E5-2620 v4 8C/2.1GHz/20MB/85W/DDR4-2133																												
	E5-2609 v4 8C/1.7GHz/20MB/85W/DDR4-1866																												
	E5-2603 v4 6C/1.7GHz/15MB/85W/DDR4-1866																												
	E5-2698 v3 16C/2.3GHz/40MB/135W/DDR4-2133																												
	E5-2695 v3 14C/2.3GHz/35MB/120W/DDR4-2133																												
	E5-2690 v3 12C/2.6GHz/30MB/135W/DDR4-2133																												
	E5-2685 v3 12C/2.6GHz/30MB/120W/DDR4-2133																												
	E5-2683 v3 14C/2GHz/35MB/120W/DDR4-2133																												
	E5-2680 v3 12C/2.5GHz/30MB/120W/DDR4-2133																												
	E5-2670 v3 12C/2.3GHz/30MB/120W/DDR4-2133																												
	E5-2667 v3 8C/3.2GHz/20MB/135W/DDR4-2133																												
	E5-2660 v3 10C/2.6GHz/25MB/105W/DDR4-2133																												
	E5-2650L v3 12C/1.8GHz/30MB/65W/DDR4-2133																												
	E5-2650 v3 10C/2.3GHz/25MB/105W/DDR4-2133																												
	E5-2643 v3 6C/3.4GHz/20MB/135W/DDR4-2133																												
	E5-2640 v3 8C/2.6GHz/20MB/90W/DDR4-1866																												
	E5-2637 v3 4C/3.5GHz/15MB/135W/DDR4-2133																												
E5-2630L v3 8C/1.8GHz/20MB/55W/DDR4-1866																													
E5-2630 v3 8C/2.4GHz/20MB/85W/DDR4-1866																													
E5-2623 v3 4C/3GHz/10MB/105W/DDR4-1866																													
E5-2620 v3 6C/2.4GHz/15MB/85W/DDR4-1866																													
E5-2609 v3 6C/1.9GHz/15MB/85W/DDR4-1600																													
E5-2603 v3 6C/1.6GHz/15MB/85W/DDR4-1600																													
Chipset	Intel C610 Series Chipset																												
Memory DIMMs	16 DIMM sockets (8 DIMMs per processor), 8-channel capable (4-channel per processor). RDIMM and LRDIMM (cannot be intermixed), DDR4, up to 2400MHz																												
Memory capacity	512GB (RDIMM, 32GB x 16)/1024GB (LRDIMM, 64GB x 16), 2nd CPU is needed																												
Memory protection	ECC, memory mirroring, lockstep, and memory sparing																												
RAID controller	<table border="1"> <thead> <tr> <th>RAID controller</th> <th>Drive type</th> <th>RAID support</th> <th>Compatible models</th> </tr> </thead> <tbody> <tr> <td>Onboard RAID110i</td> <td>6Gbs SATA</td> <td>0/1/10,5 with optional key</td> <td>5x3.5" HS/ES, 8x2.5" HS</td> </tr> <tr> <td>RAID520i PCIe</td> <td>12Gbs SAS/SATA</td> <td>0/1/10,5/50 with optional key</td> <td>5x3.5" HS, 8x2.5" HS</td> </tr> <tr> <td>RAID720i PCIe</td> <td>12Gbs SAS/SATA</td> <td>0/1/10/5/50,6/60 with optional cache</td> <td>5x3.5" HS, 8x2.5" HS</td> </tr> <tr> <td>AnyRAID 510i</td> <td>6Gbs SAS/SATA</td> <td>0/1/10,5/50 with optional key</td> <td>5x3.5" HS, 8x2.5" HS</td> </tr> <tr> <td>AnyRAID 720i</td> <td>12Gbs SAS/SATA</td> <td>0/1/10/5/50,6/60 with optional cache</td> <td>5x3.5" HS, 8x2.5" HS</td> </tr> <tr> <td>AnyRAID 720ix</td> <td>12Gbs SAS/SATA</td> <td>0/1/10/5/50/6/60</td> <td>15x3.5" HS, 16/32x2.5" HS</td> </tr> </tbody> </table>	RAID controller	Drive type	RAID support	Compatible models	Onboard RAID110i	6Gbs SATA	0/1/10,5 with optional key	5x3.5" HS/ES, 8x2.5" HS	RAID520i PCIe	12Gbs SAS/SATA	0/1/10,5/50 with optional key	5x3.5" HS, 8x2.5" HS	RAID720i PCIe	12Gbs SAS/SATA	0/1/10/5/50,6/60 with optional cache	5x3.5" HS, 8x2.5" HS	AnyRAID 510i	6Gbs SAS/SATA	0/1/10,5/50 with optional key	5x3.5" HS, 8x2.5" HS	AnyRAID 720i	12Gbs SAS/SATA	0/1/10/5/50,6/60 with optional cache	5x3.5" HS, 8x2.5" HS	AnyRAID 720ix	12Gbs SAS/SATA	0/1/10/5/50/6/60	15x3.5" HS, 16/32x2.5" HS
	RAID controller	Drive type	RAID support	Compatible models																									
	Onboard RAID110i	6Gbs SATA	0/1/10,5 with optional key	5x3.5" HS/ES, 8x2.5" HS																									
	RAID520i PCIe	12Gbs SAS/SATA	0/1/10,5/50 with optional key	5x3.5" HS, 8x2.5" HS																									
	RAID720i PCIe	12Gbs SAS/SATA	0/1/10/5/50,6/60 with optional cache	5x3.5" HS, 8x2.5" HS																									
	AnyRAID 510i	6Gbs SAS/SATA	0/1/10,5/50 with optional key	5x3.5" HS, 8x2.5" HS																									
AnyRAID 720i	12Gbs SAS/SATA	0/1/10/5/50,6/60 with optional cache	5x3.5" HS, 8x2.5" HS																										
AnyRAID 720ix	12Gbs SAS/SATA	0/1/10/5/50/6/60	15x3.5" HS, 16/32x2.5" HS																										
	Optional cache for RAID 720/AnyRAID 720i and 720ix: 1GB read-only memory or 1GB/2GB/4GB flash with super capacitor. Flash options include CacheVault, Cache-Cade Pro, and FastPath. 720ix must have cache.																												
Disk drive bays	Up to 15 3.5" or 32 2.5" hot-swap bays, or up to 5 3.5" easy-swap bays, on front. Up to 2 M.2 SSD drives via optional M.2 module. Up to one internal LTO-6 SAS tape drive on 720ix model, or external RDX tape drive via USB.																												

Components	Specification																																						
Maximum internal storage	3.5" model: up to 120TB with 7.2K SATA or SAS HDD, up to 27TB with 10K SAS HDD, up to 9TB with 15K SAS HDD, or up to 24TB with SATA or SAS SSD. 2.5" model: up to 64TB with 7.2K SATA HDD, up to 57.6TB with 10K SAS HDD, up to 19.2TB with 15K SAS HDD, or up to 51.2TB with SATA or SAS SSD																																						
SD module	Up to 2 SDHC flash cards via optional SD module, 8GB or 32GB each																																						
Optical drive	Two 5.25" bays for optical drive. DVD-ROM or DVD±RW. Half-height or 9.5mm																																						
Network interfaces	One dedicate management port, two gigabit ethernet ports. Supports optional discrete network adapters via PCIe slots																																						
Security features	Power-on and administrator password. Optional TPM (TCG 1.2 or 2.0-compliant)																																						
Systems management	Supports ThinkServer System Manager (TSM), optional TSM Premium for remote presence. UEFI. Onboard Aspeed AST2400 graphics/management processor, IPMI 2.0-compliant baseboard management controller (BMC). Control Panel LEDs shows the status of power, ID, network, system. Supports ThinkServer Diagnostics, ThinkServer Deployment Manager, ThinkServer Energy Manager, ThinkServer System Manager CLI, Lenovo ThinkServer Partner Pack for VMware vCenter and Microsoft System Center Operations Manager, ThinkServer Power Planner.																																						
Operating systems supported	Microsoft Windows Server 2016/2012 R2/2012/2008 R2. Windows Small Business Server 2011. Red Hat Enterprise Linux 6.5/6.6/7. SUSE Linux Enterprise Server 11. VMware vSphere (ESXi) 5.1 P5/5.5 U2/6.0																																						
Base warranty	1 or 3-year limited onsite service with 9x5/NBD.																																						
Power supply	Up to two redundant hot-swap 450W/550W/750W/1100W power supplies. 450 W is 80 PLUS Gold qualified. 550W and 1100W are 80 PLUS Platinum qualified. 750W is 80 PLUS Platinum or Titanium qualified. 750W Titanium is 200V - 240V, others are 110V - 240V.																																						
	<table border="1"> <thead> <tr> <th rowspan="2">Disk bay configuration</th> <th colspan="4">PSU requirements</th> </tr> <tr> <th>450W</th> <th>550W</th> <th>750W</th> <th>1100W</th> </tr> </thead> <tbody> <tr> <td>5x3.5" ES</td> <td>• (up to 1 CPU)</td> <td>•</td> <td>•</td> <td>•</td> </tr> <tr> <td>5x3.5" HS</td> <td>• (up to 1 CPU)</td> <td>•</td> <td>•</td> <td>•</td> </tr> <tr> <td>15x3.5" HS</td> <td>•</td> <td>•</td> <td>•</td> <td>•</td> </tr> <tr> <td>8x2.5" HS</td> <td>• (up to 1 CPU)</td> <td>•</td> <td>•</td> <td>•</td> </tr> <tr> <td>16x2.5" HS</td> <td>• (up to 1 CPU)</td> <td>•</td> <td>•</td> <td>•</td> </tr> <tr> <td>32x2.5" HS</td> <td>•</td> <td>•</td> <td>•</td> <td>•</td> </tr> </tbody> </table>	Disk bay configuration	PSU requirements				450W	550W	750W	1100W	5x3.5" ES	• (up to 1 CPU)	•	•	•	5x3.5" HS	• (up to 1 CPU)	•	•	•	15x3.5" HS	•	•	•	•	8x2.5" HS	• (up to 1 CPU)	•	•	•	16x2.5" HS	• (up to 1 CPU)	•	•	•	32x2.5" HS	•	•	•
Disk bay configuration	PSU requirements																																						
	450W	550W	750W	1100W																																			
5x3.5" ES	• (up to 1 CPU)	•	•	•																																			
5x3.5" HS	• (up to 1 CPU)	•	•	•																																			
15x3.5" HS	•	•	•	•																																			
8x2.5" HS	• (up to 1 CPU)	•	•	•																																			
16x2.5" HS	• (up to 1 CPU)	•	•	•																																			
32x2.5" HS	•	•	•	•																																			
Graphics	Onboard Aspeed AST2400 with 16MB memory, one VGA on rear																																						
Front ports	Two USB 2.0																																						
Rear ports	One VGA, four USB 3.0, one RJ-45 (dedicate/share mgmt), two ethernet (RJ-45), one serial (9-pin)																																						
Cooling	4 (3+1), hot-swap																																						
Noise emissions	Operating: < 6.5 Bels. Idle: < 6 Bels (Maximum configuration)																																						
Environmental specification	<table border="1"> <thead> <tr> <th>ASHRAE Class</th> <th>A4</th> <th>A3</th> <th>A2</th> </tr> </thead> <tbody> <tr> <td>Temperature - operating</td> <td>41 °F to 113 °F (5 °C to 45 °C)</td> <td>41 °F to 104 °F (5 °C to 40 °C)</td> <td>50 °F to 95 °F (10 °C to 35 °C)</td> </tr> <tr> <td>Temperature - storage (with package)</td> <td colspan="3">-40 °C to 60 °C</td> </tr> <tr> <td>Altitude - operating</td> <td colspan="3">(Unpressurized): 0-10000ft (0-3048m)</td> </tr> <tr> <td>Humidity - operating (non-condensing)</td> <td>8%-90%</td> <td>8%-85%</td> <td>20%-80%</td> </tr> <tr> <td>Humidity - storage (with package)</td> <td colspan="3">8%-90%, non-condensing</td> </tr> </tbody> </table>	ASHRAE Class	A4	A3	A2	Temperature - operating	41 °F to 113 °F (5 °C to 45 °C)	41 °F to 104 °F (5 °C to 40 °C)	50 °F to 95 °F (10 °C to 35 °C)	Temperature - storage (with package)	-40 °C to 60 °C			Altitude - operating	(Unpressurized): 0-10000ft (0-3048m)			Humidity - operating (non-condensing)	8%-90%	8%-85%	20%-80%	Humidity - storage (with package)	8%-90%, non-condensing																
	ASHRAE Class	A4	A3	A2																																			
	Temperature - operating	41 °F to 113 °F (5 °C to 45 °C)	41 °F to 104 °F (5 °C to 40 °C)	50 °F to 95 °F (10 °C to 35 °C)																																			
	Temperature - storage (with package)	-40 °C to 60 °C																																					
	Altitude - operating	(Unpressurized): 0-10000ft (0-3048m)																																					
Humidity - operating (non-condensing)	8%-90%	8%-85%	20%-80%																																				
Humidity - storage (with package)	8%-90%, non-condensing																																						
	ASHRAE Class A4: ES or 8x2.5" HS bays/Lenovo-qualified CPU; maximum of 120W thermal design power; not low-power type (no L-suffix in the CPU name)/No internal tape/Two PSU installed for redundancy/Lenovo-qualified PCIe card; power consumption of each PCIe card does not exceed 15W. 32 x 2.5" models support ASHRAE Class A2, the other models support ASHRAE Class A3.																																						
	Expansion slots																																						
	<table border="1"> <tbody> <tr> <td>Slot 1 (CPU1)</td> <td>PCIe 3.0 x16, full height, full length, double-wide</td> </tr> <tr> <td>Slot 2 (CPU1)</td> <td>PCIe 3.0 x16 (x8 elec), full height, full length</td> </tr> <tr> <td>Slot 3 (CPU1)</td> <td>PCIe 3.0 x16 (x8 elec), full height, full length</td> </tr> <tr> <td>Slot 4 (CPU2)</td> <td>PCIe 3.0 x16 (x8 elec), full height, full length</td> </tr> <tr> <td>Slot 5 (CPU2)</td> <td>PCIe 3.0 x16, full height, full length</td> </tr> <tr> <td>Slot 6 (CPU2)</td> <td>PCIe 3.0 x16 (x8 elec), full height, full length</td> </tr> <tr> <td>Slot 7 (CPU2)</td> <td>PCIe 3.0 x16 (x8 elec), full height, full length</td> </tr> </tbody> </table>	Slot 1 (CPU1)	PCIe 3.0 x16, full height, full length, double-wide	Slot 2 (CPU1)	PCIe 3.0 x16 (x8 elec), full height, full length	Slot 3 (CPU1)	PCIe 3.0 x16 (x8 elec), full height, full length	Slot 4 (CPU2)	PCIe 3.0 x16 (x8 elec), full height, full length	Slot 5 (CPU2)	PCIe 3.0 x16, full height, full length	Slot 6 (CPU2)	PCIe 3.0 x16 (x8 elec), full height, full length	Slot 7 (CPU2)	PCIe 3.0 x16 (x8 elec), full height, full length																								
Slot 1 (CPU1)	PCIe 3.0 x16, full height, full length, double-wide																																						
Slot 2 (CPU1)	PCIe 3.0 x16 (x8 elec), full height, full length																																						
Slot 3 (CPU1)	PCIe 3.0 x16 (x8 elec), full height, full length																																						
Slot 4 (CPU2)	PCIe 3.0 x16 (x8 elec), full height, full length																																						
Slot 5 (CPU2)	PCIe 3.0 x16, full height, full length																																						
Slot 6 (CPU2)	PCIe 3.0 x16 (x8 elec), full height, full length																																						
Slot 7 (CPU2)	PCIe 3.0 x16 (x8 elec), full height, full length																																						

For a list of all supported options, please see https://download.lenovo.com/pcbbbs/options_iso/ocm_september_2016_thinkserver.xlsx sheet

Model	Region	Processor	2nd CPU	Memory	RAID Controller	Disk Bays	Storage	Optical	Add-on NIC	Add-on Ports	TPM	System Mgmt	OS	Warranty	Power Supply	Ann Date (m/y)
70DG0003UX	US	2xE5-2620 v3 6C/2.4GHz/15MB/85W/DDR4-1866	-	4x8GB RDIMM DDR4-2133 ECC	AnyRAID 110i+Key	5x3.5" HS	Open	HH DVD±RW	None	None	TPM 1.2	TSM	None	3-year	750Wx1 Platinum	09/14
70DG0007UX	US	1xE5-2603 v3 6C/1.6GHz/15MB/85W/DDR4-1600	4XG0F28787	1x8GB RDIMM DDR4-2133 ECC	AnyRAID 110i+Key	5x3.5" HS	Open	HH DVD±RW	None	None	TPM 1.2	TSM	None	3-year	550Wx1 Platinum	09/14
70DG0008UX	US	1xE5-2609 v3 6C/1.9GHz/15MB/85W/DDR4-1600	4XG0F28786	1x8GB RDIMM DDR4-2133 ECC	AnyRAID 110i+Key	5x3.5" HS	Open	HH DVD±RW	None	None	TPM 1.2	TSM	None	3-year	550Wx1 Platinum	09/14
70DG0009UX	US	1xE5-2620 v3 6C/2.4GHz/15MB/85W/DDR4-1866	4XG0F28785	1x8GB RDIMM DDR4-2133 ECC	AnyRAID 720ix+1GB RAM	15x3.5" HS	Open	HH DVD±RW	None	None	TPM 1.2	TSM	None	3-year	750Wx1 Platinum	09/14
70DG000AUX	US	1xE5-2640 v3 8C/2.6GHz/20MB/90W/DDR4-1866	4XG0F28783	1x8GB RDIMM DDR4-2133 ECC	AnyRAID 720ix+1GB RAM	15x3.5" HS	Open	HH DVD±RW	None	None	TPM 1.2	TSM	None	3-year	750Wx1 Platinum	09/14
70DG000BUX	US	1xE5-2650 v3 10C/2.3GHz/25MB/105W/DDR4-2133	4XG0F28782	1x8GB RDIMM DDR4-2133 ECC	AnyRAID 720ix+1GB RAM	15x3.5" HS	Open	HH DVD±RW	None	None	TPM 1.2	TSM	None	3-year	750Wx1 Platinum	09/14
70DG000CUX	US	1xE5-2670 v3 12C/2.3GHz/30MB/120W/DDR4-2133	4XG0F28780	1x8GB RDIMM DDR4-2133 ECC	AnyRAID 720ix+1GB RAM	15x3.5" HS	Open	HH DVD±RW	None	None	TPM 1.2	TSM	None	3-year	750Wx1 Platinum	09/14
70DG006NUX	US	1xE5-2603 v4 6C/1.7GHz/15MB/85W/DDR4-1866	4XG0G89088	1x16GB RDIMM DDR4-2400 ECC	Onboard 110i	5x3.5" HS	Open	None	None	None	TPM 1.2	TSM	None	3-year	750Wx1 Platinum	04/16
70DG006PUX	US	1xE5-2609 v4 8C/1.7GHz/20MB/85W/DDR4-1866	4XG0G89083	1x16GB RDIMM DDR4-2400 ECC	Onboard 110i	5x3.5" HS	Open	None	None	None	TPM 1.2	TSM	None	3-year	750Wx1 Platinum	04/16
70DG006QUX	US	1xE5-2620 v4 8C/2.1GHz/20MB/85W/DDR4-2133	4XG0G89078	1x16GB RDIMM DDR4-2400 ECC	Onboard 110i	5x3.5" HS	Open	None	None	None	TPM 1.2	TSM	None	3-year	750Wx1 Platinum	04/16
70DG006RUX	US	1xE5-2630 v4 10C/2.2GHz/20MB/85W/DDR4-2133	4XG0G89073	1x16GB RDIMM DDR4-2400 ECC	AnyRAID 720ix+1GB Flash	15x3.5" HS	Open	None	None	None	TPM 1.2	TSM	None	3-year	750Wx1 Platinum	04/16
70DG006SUX	US	1xE5-2640 v4 10C/2.4GHz/25MB/90W/DDR4-2133	4XG0G89068	1x16GB RDIMM DDR4-2400 ECC	AnyRAID 720ix+1GB Flash	15x3.5" HS	Open	None	None	None	TPM 1.2	TSM	None	3-year	750Wx1 Platinum	04/16
70DG006TUX	US	1xE5-2650 v4 12C/2.2GHz/30MB/105W/DDR4-2400	4XG0G89063	1x16GB RDIMM DDR4-2400 ECC	AnyRAID 720ix+1GB Flash	15x3.5" HS	Open	None	None	None	TPM 1.2	TSM	None	3-year	750Wx1 Platinum	04/16
70DG006UUX	US	1xE5-2660 v4 14C/2GHz/35MB/105W/DDR4-2400	4XG0G89058	1x16GB RDIMM DDR4-2400 ECC	AnyRAID 720ix+1GB Flash	15x3.5" HS	Open	None	None	None	TPM 1.2	TSM	None	3-year	750Wx1 Platinum	04/16
70DG006VUX	US	1xE5-2680 v4 14C/2.4GHz/35MB/120W/DDR4-2400	4XG0G89055	1x16GB RDIMM DDR4-2400 ECC	AnyRAID 720ix+1GB Flash	15x3.5" HS	Open	None	None	None	TPM 1.2	TSM	None	3-year	750Wx1 Platinum	04/16
70DG006WUX	US	2xE5-2620 v4 8C/2.1GHz/20MB/85W/DDR4-2133	-	2x16GB RDIMM DDR4-2400 ECC	AnyRAID 110i	5x3.5" HS	Open	None	None	None	TPM 1.2	TSM Premium	None	3-year	750Wx2 Platinum	04/16
70DG007QUX	US	1xE5-2620 v4 8C/2.1GHz/20MB/85W/DDR4-2133	4XG0G89078	1x16GB RDIMM DDR4-2400 ECC	AnyRAID 720ix+1GB RAM	15x3.5" HS	Open	None	None	None	TPM 1.2	TSM	None	3-year	750Wx1 Platinum	06/16

Model	Region	Processor	2nd CPU	Memory	RAID Controller	Disk Bays	Storage	Optical	Add-on NIC	Add-on Ports	TPM	System Mgmt	OS	Warranty	Power Supply	Ann Date (m/y)
70DJ006NUX	US	1xE5-2640 v4 10C/2.4GHz/25MB/90W/DDR4-2133	4XG0G89068	1x16GB RDIMM DDR4-2400 ECC	AnyRAID 720i+1GB RAM	8x2.5" HS	Open	None	None	None	TPM 2.0	TSM	None	3-year	750Wx1 Platinum	04/16

ThinkServer TS150 Platform Specifications

Product Specifications Reference (PSREF)

Components	Specification
Dimensions	Tower or 4U rack. Height: 375 mm (14.76 in), width: 175 mm (6.89 in), depth: 431 mm (16.97 in)
Weight	Maximum configuration: 27.6 lb (12.5kg)
Processor	One Intel "Kaby Lake" or "Skylake" processor as listed: "Kaby Lake" processors:
	Xeon E3-1280 v6 4C/3.9GHz/8MB/72W/DDR4-2400
	Xeon E3-1275 v6 4C/3.8GHz/8MB/73W/DDR4-2400
	Xeon E3-1270 v6 4C/3.8GHz/8MB/72W/DDR4-2400
	Xeon E3-1245 v6 4C/3.7GHz/8MB/73W/DDR4-2400
	Xeon E3-1240 v6 4C/3.7GHz/8MB/72W/DDR4-2400
	Xeon E3-1230 v6 4C/3.5GHz/8MB/72W/DDR4-2400
	Xeon E3-1225 v6 4C/3.3GHz/8MB/73W/DDR4-2400
	Xeon E3-1220 v6 4C/3GHz/8MB/72W/DDR4-2400
	Core i3-7320 2C/4.1GHz/4MB/51W/DDR4-2400
	Core i3-7300T 2C/3.5GHz/4MB/35W/DDR4-2400
	Core i3-7300 2C/4GHz/4MB/51W/DDR4-2400
	Core i3-7100T 2C/3.4GHz/3MB/35W/DDR4-2400
	Core i3-7100 2C/3.9GHz/3MB/51W/DDR4-2400
	Pentium G4620 2C/3.7GHz/3MB/51W/DDR4-2400
	Pentium G4600T 2C/3GHz/3MB/35W/DDR4-2400
	Pentium G4600 2C/3.6GHz/3MB/51W/DDR4-2400
	Pentium G4560T 2C/2.9GHz/3MB/35W/DDR4-2400
	Pentium G4560 2C/3.5GHz/3MB/54W/DDR4-2400
	Celeron G3950 2C/3GHz/2MB/51W/DDR4-2133
	Celeron G3930T 2C/2.7GHz/2MB/35W/DDR4-2133
	Celeron G3930 2C/2.9GHz/2MB/51W/DDR4-2133
	"Skylake" processors:
	Xeon E3-1280 v5 4C/3.7GHz/8MB/80W/DDR4-2133
	Xeon E3-1270 v5 4C/3.6GHz/8MB/80W/DDR4-2133
	Xeon E3-1240 v5 4C/3.5GHz/8MB/80W/DDR4-2133
	Xeon E3-1230 v5 4C/3.4GHz/8MB/80W/DDR4-2133
	Xeon E3-1220 v5 4C/3GHz/8MB/80W/DDR4-2133
	Xeon E3-1275 v5 4C/3.6GHz/8MB/80W/DDR4-2133
	Xeon E3-1245 v5 4C/3.5GHz/8MB/80W/DDR4-2133
	Xeon E3-1225 v5 4C/3.3GHz/8MB/80W/DDR4-2133
	Core i3-6320 2C/3.9GHz/4MB/51W/DDR4-2133
	Core i3-6300 2C/3.8GHz/4MB/51W/DDR4-2133
	Core i3-6300T 2C/3.3GHz/4MB/35W/DDR4-2133
	Core i3-6100 2C/3.7GHz/3MB/51W/DDR4-2133
	Core i3-6100T 2C/3.2GHz/3MB/35W/DDR4-2133
	Pentium G4520 2C/3.6GHz/3MB/51W/DDR4-2133
	Pentium G4500 2C/3.5GHz/3MB/51W/DDR4-2133
	Pentium G4500T 2C/3GHz/3MB/35W/DDR4-2133
	Pentium G4400 2C/3.3GHz/3MB/54W/DDR4-2133
Pentium G4400T 2C/2.9GHz/3MB/35W/DDR4-2133	
Celeron G3920 2C/2.9GHz/2MB/51W/DDR4-2133	
Celeron G3900 2C/2.8GHz/2MB/51W/DDR4-2133	
Celeron G3900T 2C/2.6GHz/2MB/35W/DDR4-2133	
Chipset	Intel C236 Platform Controller Hub (PCH)
Memory DIMMs	4 DIMM sockets with 2 channels, 2 DIMMs per channel. UDIMM. Up to DDR4-2400
Memory capacity	64GB (16GB x 4)
Memory protection	ECC
RAID controller	RAID controller
	Drive type
RAID controller	Onboard RAID121i 6Gbs SATA 0/1/5/10
	RAID520i PCIe 12Gbs SAS/SATA 0/1/10, 5 with optional key
Disk bays	Supports up to four 3.5" or hybrid 3.5" + 2.5" disk drives, or up to five 2.5" disk drives, one 9.5mm optical (see right). Non-hot swap. Cables are connected to onboard SATA connectors or PCIe RAID controller. Supports one optional internal USB RDX Tape drive
Supporting storage	3.5" HDD, 7.2K SATA6Gbs 500GB/1TB/2TB/3TB/4TB/5TB/6TB/10TB
	2.5" HDD, 7.2K SATA6Gbs 500GB/1TB/2TB
	2.5" SSD, SATA6Gbs 120GB/240GB/480GB/600GB/800GB/960GB

Components	Specification	
SD module	Optional. Up to 2 SDHC flash cards via SD module, 8GB each	
Optical drive	Up to two half-height optical drives or one 9.5mm optical. DVD-ROM or DVD±RW	
Network interfaces	One Gigabit Ethernet port, Intel i219LM. Supports optional discrete network adapters via PCIe slots	
Security features	Power-on and administrator password. TPM (TCG 1.2-compliant)	
Systems management	UEFI, system LEDs, EasyStartup, EasyUpdate, Power Planner, and Diagnostics. Intel Active Management Technology 11 on models with Xeon processors. Intel Standard Manageability on models with Core i3, Pentium, or Celeron processors. KVM is supported on models with Xeon E3-12x5 v5 processors	
Operating systems	Microsoft Windows Server 2016/2012 R2/2012, Windows MultiPoint Server 2012, Windows 10 Pro. Red Hat Enterprise Linux 6.7/7.2. SUSE Linux Enterprise Server 11/12. VMware vSphere (ESXi) 5.5U3/6.0U2	
Base warranty	1 or 3-year limited onsite service with 9x5/NBD	
Power supply	Supports one of the following: • One fixed 250 watts, autosensing, 85%, 80 PLUS Bronze qualified • One fixed 400 watts, autosensing, 92%, 80 PLUS Platinum qualified	
Graphics	Integrated Intel HD Graphics on Xeon E3-12x5 v5, Core i3, Pentium, and Celeron processors. Uses main memory, works along with discrete graphics to support multi-display, enables two display connectors (1 DP, 1 VGA) on rear ports. Also supports the following discrete graphics adapter options: • NVIDIA Quadro NVS 315, 1GB • NVIDIA Quadro K620, 2GB	
HD Audio	Realtek ALC662 codec	
Front ports	Two USB 3.0	
Rear ports	One VGA, one DisplayPort, six USB 3.0, one RJ-45, one serial (9-pin), three analog audio ports (line-in, line-out, mic-in). Optional parallel or serial ports via PCIe adapters	
Noise emissions	Operating: < 35 dB(A). Idle: < 34 dB(A) (Maximum configuration)	
Environmental specification	Temperature - operating	50 °F to 95 °F (10 °C to 35 °C)
	Temperature - non operating (with package)	-40 °C to 60 °C
	Altitude - operating	(Unpressurized): 0-10000ft (0-3048m)
	Humidity - operating	8%-80%, non-condensing
	Humidity - storage (with package)	10%-90%, non-condensing

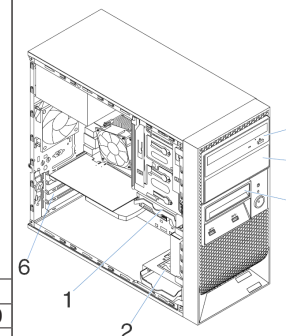

Note:
1. PCIe cards are optional.
2. Disk tray comes with the disk drive.

Disk Bays and PCIe Slots			
	4 x 3.5"	5 x 2.5"	4 x hybrid 3.5" + 2.5"
Bay 1	1st HDD bay	1st HDD bay	1st HDD bay, 3.5"/2.5"
Bay 2	2nd HDD bay	2nd HDD bay	2nd HDD bay, 3.5"/2.5"
Bay 3	Not supported	3rd HDD bay	Not supported on standard models. Supports one 2.5" disk drive for special bid only
Bay 4	2nd half-height optical, or RDX tape drive, or 3rd HDD bay	2nd half-height optical, or RDX tape drive, or 4th HDD bay	2nd half-height optical, or RDX tape drive, or 3rd HDD bay (3.5"/2.5")
Bay 5	1st half-height optical, or 9.5mm optical + 4th HDD bay	1st half-height optical, or 9.5mm optical + 5th HDD bay	1st half-height optical, or 9.5mm optical + 4th HDD bay (3.5"/2.5")
6	Four PCIe slots (top-down): Slot 1: PCIe 3.0 x16, full height, half length (near CPU) Slot 2: PCIe 3.0 x1, full height, half length Slot 3: PCIe 3.0 x16 (x4 elec), full height, half length Slot 4: PCIe 3.0 x1, full height, half length		

ThinkServer TS150 - TopSeller - 70LV

Product Specifications Reference (PSREF)

Model	Region	Processor	Memory	RAID Controller	Disk Bays	Storage	Optical	Add-on NIC	Add-on Ports	System Mgmt	OS	Warranty	Power Supply	Ann Date (m/y)
70LV002XUX	US	Xeon E3-1225 v5 4C/3.3GHz/8MB/80W/DDR4-2133	1x8GB UDIMM DDR4-2133 ECC	RAID 121i	Up to 5x2.5" DC	Open	None	None	None	AMT	None	1-year	Fixed 250W Bronze	08/16
70LV002YUX	US	Xeon E3-1245 v5 4C/3.5GHz/8MB/80W/DDR4-2133	1x8GB UDIMM DDR4-2133 ECC	RAID 121i	Up to 5x2.5" DC	Open	None	None	None	AMT	None	1-year	Fixed 250W Bronze	08/16
70LV0030UX	US	Xeon E3-1275 v5 4C/3.6GHz/8MB/80W/DDR4-2133	1x8GB UDIMM DDR4-2133 ECC	RAID 121i	Up to 5x2.5" DC	Open	None	None	None	AMT	None	1-year	Fixed 250W Bronze	08/16
70LV0031UX	US	Xeon E3-1225 v5 4C/3.3GHz/8MB/80W/DDR4-2133	1x8GB UDIMM DDR4-2133 ECC	RAID 121i	Up to 4x3.5" DC	Open	None	None	None	AMT	None	1-year	Fixed 250W Bronze	08/16
70LV0032UX	US	Xeon E3-1245 v5 4C/3.5GHz/8MB/80W/DDR4-2133	1x8GB UDIMM DDR4-2133 ECC	RAID 121i	Up to 4x3.5" DC	Open	None	None	None	AMT	None	1-year	Fixed 250W Bronze	08/16
70LV0033UX	US	Xeon E3-1275 v5 4C/3.6GHz/8MB/80W/DDR4-2133	1x8GB UDIMM DDR4-2133 ECC	RAID 121i	Up to 4x3.5" DC	Open	None	None	None	AMT	None	1-year	Fixed 250W Bronze	08/16
70LV0034UX	US	Core i3-6100T 2C/3.2GHz/3MB/35W/DDR4-2133	1x8GB UDIMM DDR4-2133 ECC	RAID 121i	Up to 4x3.5" DC/3 available	Open	HH DVD±RW	None	None	ISM	None	1-year	Fixed 250W Bronze	08/16
70LV0035UX	US	Core i3-6100T 2C/3.2GHz/3MB/35W/DDR4-2133	1x8GB UDIMM DDR4-2133 ECC	RAID 121i	Up to 4x3.5" DC	Open	None	None	None	ISM	None	1-year	Fixed 250W Bronze	08/16
70LV0036UX	US	Xeon E3-1225 v5 4C/3.3GHz/8MB/80W/DDR4-2133	1x8GB UDIMM DDR4-2133 ECC	RAID 121i	Up to 4x3.5" DC	Open	9.5mm DVD±RW	None	None	AMT	None	1-year	Fixed 250W Bronze	08/16
70LV0037UX	US	Xeon E3-1245 v5 4C/3.5GHz/8MB/80W/DDR4-2133	1x8GB UDIMM DDR4-2133 ECC	RAID 121i	Up to 4x3.5" DC	Open	9.5mm DVD±RW	None	None	AMT	None	1-year	Fixed 250W Bronze	08/16
70LV0038UX	US	Xeon E3-1275 v5 4C/3.6GHz/8MB/80W/DDR4-2133	1x8GB UDIMM DDR4-2133 ECC	RAID 121i	Up to 4x3.5" DC	Open	9.5mm DVD±RW	None	None	AMT	None	1-year	Fixed 250W Bronze	08/16
70LV0039UX	US	Xeon E3-1225 v5 4C/3.3GHz/8MB/80W/DDR4-2133	1x8GB UDIMM DDR4-2133 ECC	RAID 121i	Up to 5x2.5" DC	Open	9.5mm DVD±RW	None	None	AMT	None	1-year	Fixed 250W Bronze	08/16
70LV003AUX	US	Xeon E3-1245 v5 4C/3.5GHz/8MB/80W/DDR4-2133	1x8GB UDIMM DDR4-2133 ECC	RAID 121i	Up to 5x2.5" DC	Open	9.5mm DVD±RW	None	None	AMT	None	1-year	Fixed 250W Bronze	08/16
70LV003BUX	US	Xeon E3-1275 v5 4C/3.6GHz/8MB/80W/DDR4-2133	1x8GB UDIMM DDR4-2133 ECC	RAID 121i	Up to 5x2.5" DC	Open	9.5mm DVD±RW	None	None	AMT	None	1-year	Fixed 250W Bronze	08/16

ThinkServer TS150 - TopSeller - 70LX

Product Specifications Reference (PSREF)

Model	Region	Processor	Memory	RAID Controller	Disk Bays	Storage	Optical	Add-on NIC	Add-on Ports	System Mgmt	OS	Warranty	Power Supply	Ann Date (m/y)
70LX0017UX	US	Xeon E3-1275 v5 4C/3.6GHz/8MB/80W/DDR4-2133	1x8GB UDIMM DDR4-2133 ECC	RAID 121i	Up to 4x3.5" DC	Open	None	None	None	AMT	None	1-year	Fixed 400W Platinum	08/16
70LX0018UX	US	Xeon E3-1275 v5 4C/3.6GHz/8MB/80W/DDR4-2133	1x8GB UDIMM DDR4-2133 ECC	RAID 121i	Up to 5x2.5" DC	Open	None	None	None	AMT	None	1-year	Fixed 400W Platinum	08/16

ThinkServer TS150 - TopSeller - 70UB

Product Specifications Reference (PSREF)

Model	Region	Processor	Memory	RAID Controller	Disk Bays	Storage	Optical	Add-on NIC	Add-on Ports	System Mgmt	OS	Warranty	Power Supply	Ann Date (m/y)
70UB0009UX	US	Xeon E3-1225 v6 4C/3.3GHz/8MB/73W/DDR4-2400	1x8GB UDIMM DDR4-2400 ECC	RAID 121i	Up to 4x3.5" DC	Open	None	None	None	AMT	None	1-year	Fixed 250W Bronze	04/17
70UB000AUX	US	Xeon E3-1225 v6 4C/3.3GHz/8MB/73W/DDR4-2400	1x8GB UDIMM DDR4-2400 ECC	RAID 121i	Up to 4x3.5" DC	Open	9.5mm DVD±RW	None	None	AMT	None	1-year	Fixed 250W Bronze	04/17
70UB000BUX	US	Xeon E3-1245 v6 4C/3.7GHz/8MB/73W/DDR4-2400	1x8GB UDIMM DDR4-2400 ECC	RAID 121i	Up to 4x3.5" DC	Open	9.5mm DVD±RW	None	None	AMT	None	1-year	Fixed 250W Bronze	04/17
70UB000CUX	US	Xeon E3-1245 v6 4C/3.7GHz/8MB/73W/DDR4-2400	1x8GB UDIMM DDR4-2400 ECC	RAID 121i	Up to 4x3.5" DC	Open	None	None	None	AMT	None	1-year	Fixed 250W Bronze	04/17
70UB000DUX	US	Xeon E3-1275 v6 4C/3.8GHz/8MB/73W/DDR4-2400	1x8GB UDIMM DDR4-2400 ECC	RAID 121i	Up to 4x3.5" DC	Open	None	None	None	AMT	None	1-year	Fixed 250W Bronze	04/17
70UB000EUX	US	Xeon E3-1275 v6 4C/3.8GHz/8MB/73W/DDR4-2400	1x8GB UDIMM DDR4-2400 ECC	RAID 121i	Up to 4x3.5" DC	Open	9.5mm DVD±RW	None	None	AMT	None	1-year	Fixed 250W Bronze	04/17
70UB001WUX	US	Core i3-6100T 2C/3.2GHz/3MB/35W/DDR4-2133	1x8GB UDIMM DDR4-2400 ECC	RAID 121i	Up to 4x3.5" DC/3 available	Open	HH DVD±RW	None	None	ISM	None	1-year	Fixed 250W Bronze	04/17
70UB001XUX	US	Core i3-6100T 2C/3.2GHz/3MB/35W/DDR4-2133	1x8GB UDIMM DDR4-2400 ECC	RAID 121i	Up to 4x3.5" DC	Open	None	None	None	ISM	None	1-year	Fixed 250W Bronze	04/17



ThinkServer TS440 Platform Specifications

Components	Specification																							
Dimensions	Tower or 5U rack. Height: 430 mm (16.9 in), width: 195 mm (7.68 in), depth: 595 mm (23.4 in)																							
Weight	Maximum configuration: 61.7 lb (28kg)																							
Processor	Supports one of the following Intel processors (code name: Haswell): • Xeon E3-1200 v3: up to 4C/3.7GHz/8MB/84W/1600MHz																							
Chipset	Intel C226 Platform Controller Hub (PCH)																							
Memory DIMMs	4 DIMM sockets, 2-channel capable. UDIMM, DDR3, up to 1600MHz																							
Memory capacity	32GB																							
Memory protection	ECC																							
RAID controller	Supports one of the following onboard or PCIe RAID adapters: • RAID 0, 1, 5, 10 with onboard RAID 100, 6Gb/s SATA. • RAID 0, 1, 10 with RAID 500, PCIe adapter, 6Gb/s SAS/SATA, optional key for RAID5/50. • RAID 0, 1, 5, 6, 10, 50, 60 with RAID 700, PCIe adapter, 6Gb/s SAS/SATA, optional Intelligent Battery Backup Unit (iBBU08). <i>Note: RAID 50 and 60 are supported on 8 hard drive bays models only.</i>																							
Disk drive bays	Up to 4 3.5" disk bays, non-hot swap, direct cable. Or up to 8 3.5" disk bays, hot-swap. Or up to 8 2.5" disk bays, hot-swap. On front. Supports internal RDX tape drive, consumes 5.25" bay, also supports optional external USB RDX tape drive. <table border="1" data-bbox="283 581 919 695"> <thead> <tr> <th rowspan="2">Disk bay configuration</th> <th colspan="3">RAID controller requirements and optional drives supported</th> </tr> <tr> <th>RAID100</th> <th>RAID500</th> <th>RAID700</th> </tr> </thead> <tbody> <tr> <td>4x3.5" non-hot swap</td> <td>•</td> <td></td> <td></td> </tr> <tr> <td>4x3.5" HS</td> <td>•</td> <td>•</td> <td>•</td> </tr> <tr> <td>8x3.5" HS</td> <td></td> <td>•</td> <td>•</td> </tr> <tr> <td>8x2.5" HS</td> <td></td> <td>•</td> <td>•</td> </tr> </tbody> </table>	Disk bay configuration	RAID controller requirements and optional drives supported			RAID100	RAID500	RAID700	4x3.5" non-hot swap	•			4x3.5" HS	•	•	•	8x3.5" HS		•	•	8x2.5" HS		•	•
Disk bay configuration	RAID controller requirements and optional drives supported																							
	RAID100	RAID500	RAID700																					
4x3.5" non-hot swap	•																							
4x3.5" HS	•	•	•																					
8x3.5" HS		•	•																					
8x2.5" HS		•	•																					
Maximum internal storage	3.5" non-hot swap model: up to 24TB with 7.2K SATA HDD. 3.5" hot swap model: up to 48TB with 7.2K SATA HDD, up to 32TB with 7.2K SAS HDD, up to 4.8TB with 15K SAS HDD, up to 2.4TB with SATA SSD 2.5" hot swap model: up to 8TB with 7.2K SATA HDD, up to 7.2TB with 10K SAS HDD, up to 4.8TB with 15K SAS HDD, up to 2.4TB with SATA SSD <i>Note: Supports up to 4 SSD drives.</i>																							
Optical drive	Two 5.25" bays for optical. DVD-ROM or DVD±RW. Half-height																							
Network interfaces	One onboard gigabit ethernet, Intel I217, shared with AMT. Supports optional discrete network adapters via PCIe slots																							
Security features	Power-on and administrator password. TPM (TCG 1.2-compliant). Optional padlock loop, Kensington cable lock																							
Systems management	Intel Active Management Technology 9 on models with Xeon processor. Remote presence is supported on models with Xeon E3-12x5 v3 or E3-12x6 v3 processor																							
Operating systems supported	Microsoft Windows Server 2016/2012 R2/2012/2008 R2. Windows Small Business Server 2011. Windows 8.1/8/7(except Home edition). Red Hat Enterprise Linux 6.4/6.5/6.7/7/7.1. SUSE Linux Enterprise Server 11/12. VMware vSphere (ESXi) 5.1 U1/5.1 U2/5.5/5.5 U1/5.5 U2/5.5 U3, Citrix Xen server 6.2 <i>Note: VMware requires processors with Intel HD, add-on network adapters, and PCIe RAID adapters.</i>																							

Components	Specification	
Base warranty	1 or 3-year limited onsite service with 9x5/NBD.	
Power supply	Supports one of the following, depending on models: • One fixed 450 watts, universal, 80 PLUS Platinum qualified. • Up to two redundant 450 watts, two maximum, rear access, hot-swap, 80 PLUS Gold qualified, redundant with two power supplies	
Graphics	Integrated Intel HD Graphics on Xeon E3-12x6 v3, Xeon E3-12x5 v3 processors. Uses main memory, works along with discrete graphics to support multi-display, enables one VGA connector on rear. Also supports the following optional discrete graphics adapters: • NVIDIA Quadro NVS 300, PCIe adapter, 512MB • NVIDIA Quadro NVS 315, PCIe adapter, 1GB	
Front ports	Two USB 3.0 (blue)	
Rear ports	One VGA for models with Intel HD Graphics, two USB 2.0, four USB 3.0 (blue), one serial (9-pin), one ethernet (RJ-45). Optional parallel or serial ports via PCI or PCIe adapters	
Noise emissions	Operating: < 42 dB(A). Idle: < 38 dB(A) (Maximum configuration)	
Environmental specification	GREENGUARD certified, Energy Star Server 1.1 qualified, RoHS-compliant	
	Temperature - operating	50 °F to 95 °F (10 °C to 35 °C)
	Temperature - storage (with package)	-40 °C to 70 °C
	Altitude - operating	Supported Altitude (unpressurized): 0-10000ft (0-3048m)
	Humidity - operating	10%-80%, non-condensing
	Humidity - storage (with package)	10%-90%, non-condensing

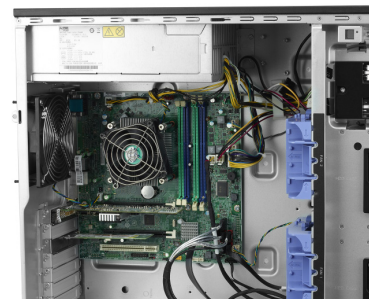

Expansion slots

- Four PCIe slots (top-down):
Slot 1: PCIe 3.0 x16, full height, half length (near CPU)
Slot 2: PCIe 3.0 x1, full height, half length
Slot 3: PCIe 2.0 x16 (x4 elec), full height, half length
Slot 4: PCI 2.3, full height, half length
Note: All PCI/PCIe adapters are optional.

ThinkServer TS440 - TopSeller - 70AN

Product Specifications Reference (PSREF)

Model	Region	Processor	Memory	RAID Controller	Disk Bays	Storage	Optical	Add-on NIC	System Mgmt	OS	Warranty	Power Supply	Ann Date (m/y)
70AN0001UX	US	Xeon E3-1225 v3 4C/3.2GHz/8MB/84W/DDR3-1600	1x4GB UDIMM DDR3-1600 ECC	RAID 100	4x3.5" HS	Open	HH DVD	None	AMT9	None	1-year	450W Platinum Fixed	09/13
70AN0002UX	US	Xeon E3-1225 v3 4C/3.2GHz/8MB/84W/DDR3-1600	1x4GB UDIMM DDR3-1600 ECC	RAID 100	4x3.5" HS	Open	HH DVD	None	AMT9	None	3-year	450W Platinum Fixed	09/13
70AN000KUX	US	Xeon E3-1226 v3 4C/3.3GHz/8MB/84W/DDR3-1600	1x4GB UDIMM DDR3-1600 ECC	RAID 100	4x3.5" HS	Open	HH DVD	None	AMT9	None	1-year	450W Platinum Fixed	09/14

Model	Region	Processor	Memory	RAID Controller	Disk Bays	Storage	Optical	Add-on NIC	System Mgmt	OS	Warranty	Power Supply	Ann Date (m/y)
70AQ0005US	US	Xeon E3-1225 v3 4C/3.2GHz/8MB/84W/DDR3-1600	1x4GB UDIMM DDR3-1600 ECC	RAID 100	4x3.5" HS	2x500GB HDD 7.2K 3.5" SATA6Gbs	HH DVD±RW	None	AMT9	2012 Foundations	3-year	450Wx1 Gold	09/13
70AQ0006US	US	Xeon E3-1225 v3 4C/3.2GHz/8MB/84W/DDR3-1600	1x4GB UDIMM DDR3-1600 ECC	RAID 100	4x3.5" HS	2x500GB HDD 7.2K 3.5" SATA6Gbs	HH DVD±RW	None	AMT9	2012 Essentials	3-year	450Wx1 Gold	09/13
70AQ0007US	US	Xeon E3-1225 v3 4C/3.2GHz/8MB/84W/DDR3-1600	1x4GB UDIMM DDR3-1600 ECC	RAID 100	4x3.5" HS	2x500GB HDD 7.2K 3.5" SATA6Gbs	HH DVD±RW	None	AMT9	2012 Standard	3-year	450Wx1 Gold	09/13
70AQ0009UX	US	Xeon E3-1225 v3 4C/3.2GHz/8MB/84W/DDR3-1600	1x4GB UDIMM DDR3-1600 ECC	RAID 100	4x3.5" HS	Open	HH DVD±RW	None	AMT9	None	1-year	450Wx1 Gold	09/13
70AQ000AUX	US	Xeon E3-1225 v3 4C/3.2GHz/8MB/84W/DDR3-1600	1x4GB UDIMM DDR3-1600 ECC	RAID 100	4x3.5" HS	Open	HH DVD±RW	None	AMT9	None	3-year	450Wx1 Gold	09/13
70AQ000BUX	US	Xeon E3-1245 v3 4C/3.4GHz/8MB/84W/DDR3-1600	1x4GB UDIMM DDR3-1600 ECC	RAID 100	4x3.5" HS	Open	HH DVD±RW	None	AMT9	None	3-year	450Wx1 Gold	09/13
70AQ000CUX	US	Xeon E3-1245 v3 4C/3.4GHz/8MB/84W/DDR3-1600	1x4GB UDIMM DDR3-1600 ECC	RAID 500	8x3.5" HS	Open	HH DVD±RW	None	AMT9	None	3-year	450Wx1 Gold	09/13
70AQ000DUX	US	Xeon E3-1225 v3 4C/3.2GHz/8MB/84W/DDR3-1600	1x4GB UDIMM DDR3-1600 ECC	RAID 500	8x3.5" HS	Open	HH DVD±RW	None	AMT9	None	3-year	450Wx1 Gold	09/13
70AQ000EUX	US	Xeon E3-1225 v3 4C/3.2GHz/8MB/84W/DDR3-1600	1x4GB UDIMM DDR3-1600 ECC	RAID 500	8x2.5" HS	Open	HH DVD±RW	None	AMT9	None	3-year	450Wx1 Gold	09/13
70AQ000FUX	US	Xeon E3-1245 v3 4C/3.4GHz/8MB/84W/DDR3-1600	1x4GB UDIMM DDR3-1600 ECC	RAID 500	8x2.5" HS	Open	HH DVD±RW	None	AMT9	None	3-year	450Wx1 Gold	09/13
70AQ000GUX	US	Xeon E3-1275 v3 4C/3.5GHz/8MB/84W/DDR3-1600	1x4GB UDIMM DDR3-1600 ECC	RAID 100	4x3.5" HS	Open	HH DVD±RW	None	AMT9	None	3-year	450Wx1 Gold	09/13
70AQ000HUX	US	Xeon E3-1225 v3 4C/3.2GHz/8MB/84W/DDR3-1600	1x4GB UDIMM DDR3-1600 ECC	RAID 700	8x3.5" HS	Open	HH DVD±RW	None	AMT9	None	3-year	450Wx1 Gold	09/13
70AQ000NUX	US	Xeon E3-1225 v3 4C/3.2GHz/8MB/84W/DDR3-1600	1x4GB UDIMM DDR3-1600 ECC	RAID 500	4x3.5" HS	Open	HH DVD	None	AMT9	None	1-year	450Wx1 Gold	09/13
70AQ000PUX	US	Xeon E3-1225 v3 4C/3.2GHz/8MB/84W/DDR3-1600	1x4GB UDIMM DDR3-1600 ECC	RAID 500	4x3.5" HS	Open	HH DVD	None	AMT9	None	3-year	450Wx1 Gold	09/13
70AQ000XUX	US	Xeon E3-1225 v3 4C/3.2GHz/8MB/84W/DDR3-1600	1x4GB UDIMM DDR3-1600 ECC	RAID 500	8x3.5" HS	Open	HH DVD±RW	None	AMT9	None	1-year	450Wx1 Gold	05/14
70AQ000YUX	US	Xeon E3-1245 v3 4C/3.4GHz/8MB/84W/DDR3-1600	1x4GB UDIMM DDR3-1600 ECC	RAID 500	8x3.5" HS	Open	HH DVD±RW	None	AMT9	None	1-year	450Wx1 Gold	05/14
70AQ001JUX	US	Xeon E3-1226 v3 4C/3.3GHz/8MB/84W/DDR3-1600	1x4GB UDIMM DDR3-1600 ECC	RAID 100	4x3.5" HS	Open	HH DVD±RW	None	AMT9	None	1-year	450Wx1 Gold	09/14

Model	Region	Processor	Memory	RAID Controller	Disk Bays	Storage	Optical	Add-on NIC	System Mgmt	OS	Warranty	Power Supply	Ann Date (m/y)
70AQ001KUX	US	Xeon E3-1226 v3 4C/3.3GHz/8MB/84W/DDR3-1600	1x4GB UDIMM DDR3-1600 ECC	RAID 500	8x3.5" HS	Open	HH DVD±RW	None	AMT9	None	1-year	450Wx1 Gold	09/14
70AQ001LUX	US	Xeon E3-1226 v3 4C/3.3GHz/8MB/84W/DDR3-1600	1x4GB UDIMM DDR3-1600 ECC	RAID 100	4x3.5" HS	Open	HH DVD	None	AMT9	None	1-year	450Wx1 Gold	09/14
70AQ001MUS	US	Xeon E3-1226 v3 4C/3.3GHz/8MB/84W/DDR3-1600	1x4GB UDIMM DDR3-1600 ECC	RAID 100	4x3.5" HS	2x500GB HDD 7.2K 3.5" SATA6Gbs	HH DVD±RW	None	AMT9	2012 R2 Foundations	1-year	450Wx1 Gold	09/14
70AQ001NUS	US	Xeon E3-1226 v3 4C/3.3GHz/8MB/84W/DDR3-1600	1x4GB UDIMM DDR3-1600 ECC	RAID 100	4x3.5" HS	2x500GB HDD 7.2K 3.5" SATA6Gbs	HH DVD±RW	None	AMT9	2012 R2 Essentials	1-year	450Wx1 Gold	09/14
70AQ001PUS	US	Xeon E3-1226 v3 4C/3.3GHz/8MB/84W/DDR3-1600	1x4GB UDIMM DDR3-1600 ECC	RAID 100	4x3.5" HS	2x500GB HDD 7.2K 3.5" SATA6Gbs	HH DVD±RW	None	AMT9	2012 R2 Standard	1-year	450Wx1 Gold	09/14
70AQ001QUX	US	Xeon E3-1246 v3 4C/3.5GHz/8MB/84W/DDR3-1600	1x4GB UDIMM DDR3-1600 ECC	RAID 100	4x3.5" HS	Open	HH DVD±RW	None	AMT9	None	1-year	450Wx1 Gold	09/14
70AQ001RUX	US	Xeon E3-1246 v3 4C/3.5GHz/8MB/84W/DDR3-1600	1x4GB UDIMM DDR3-1600 ECC	RAID 500	8x3.5" HS	Open	HH DVD±RW	None	AMT9	None	1-year	450Wx1 Gold	09/14
70AQ001SUX	US	Xeon E3-1246 v3 4C/3.5GHz/8MB/84W/DDR3-1600	1x4GB UDIMM DDR3-1600 ECC	RAID 500	8x2.5" HS	Open	HH DVD±RW	None	AMT9	None	1-year	450Wx1 Gold	09/14
70AQ001TUX	US	Xeon E3-1276 v3 4C/3.6GHz/8MB/84W/DDR3-1600	1x4GB UDIMM DDR3-1600 ECC	RAID 700	8x3.5" HS	Open	HH DVD±RW	None	AMT9	None	1-year	450Wx1 Gold	09/14
70AQ001UUX	US	Xeon E3-1276 v3 4C/3.6GHz/8MB/84W/DDR3-1600	1x4GB UDIMM DDR3-1600 ECC	RAID 700	8x2.5" HS	Open	HH DVD±RW	None	AMT9	None	1-year	450Wx1 Gold	09/14

Model	Region	Processor	Memory	RAID Controller	Disk Bays	Storage	Optical	Add-on NIC	System Mgmt	OS	Warranty	Power Supply	Ann Date (m/y)
70AL0000US	US	Xeon E3-1225 v3 4C/3.2GHz/8MB/84W/DDR3-1600	3x8GB UDIMM DDR3-1600 ECC	RAID 100	4x3.5" HS	3x3TB HDD 7.2K 3.5" SATA6Gbs	HH DVD±RW	2xGbE	AMT9	2012 Foundations	1-year	450W Platinum Fixed	09/13
70AL0001US	US	Xeon E3-1245 v3 4C/3.4GHz/8MB/84W/DDR3-1600	1x4GB UDIMM DDR3-1600 ECC	RAID 500	8x2.5" HS	1x500GB HDD 7.2K 2.5" SATA6Gbs	2xHH DVD±RW	4xGbE	AMT9	2012 Foundations	1-year	450W Platinum Fixed	09/13
70AL0002UX	US	Xeon E3-1225 v3 4C/3.2GHz/8MB/84W/DDR3-1600	1x4GB UDIMM DDR3-1600 ECC	RAID 100	4x3.5" HS	1x500GB HDD 7.2K 3.5" SATA6Gbs	HH DVD	None	AMT9	None	3-year	450W Platinum Fixed	09/13
70AL0003UX	US	Xeon E3-1225 v3 4C/3.2GHz/8MB/84W/DDR3-1600	1x4GB UDIMM DDR3-1600 ECC	RAID 100	4x3.5" HS	Open	HH DVD	None	AMT9	None	3-year	450W Platinum Fixed	09/13

Model	Region	Processor	Memory	RAID Controller	Disk Bays	Storage	Optical	Add-on NIC	System Mgmt	OS	Warranty	Power Supply	Ann Date (m/y)
70AM0000US	US	Xeon E3-1225 v3 4C/3.2GHz/8MB/84W/DDR3-1600	2x2GB UDIMM DDR3-1600 ECC	RAID 100	4x3.5" DC	2x500GB HDD 7.2K 3.5" SATA6Gbs	HH DVD	1xGbE	AMT9	2012 Foundations	1-year	450Wx1 Gold	09/13
70AM0001US	US	Xeon E3-1275 v3 4C/3.5GHz/8MB/84W/DDR3-1600	4x2GB UDIMM DDR3-1600 ECC	RAID 500+Key	8x3.5" HS	8x2TB HDD 7.2K 3.5" SATA6Gbs	2xHH DVD±RW	1xGbE	AMT9	2012 Foundations	1-year	450Wx2 Gold	09/13
70AM0002UX	US	Xeon E3-1280 v3 4C/3.6GHz/8MB/82W/DDR3-1600	3x4GB UDIMM DDR3-1600 ECC	RAID 700	8x2.5" HS	3x600GB HDD 10K 2.5" SAS6Gbs	HH DVD	4xGbE	AMT9	None	1-year	450Wx1 Gold	09/13
70AM0003US	US	Xeon E3-1285 v3 4C/3.6GHz/8MB/84W/DDR3-1600	4x8GB UDIMM DDR3-1600 ECC	RAID 700	8x2.5" HS	8x900GB HDD 10K 2.5" SAS6Gbs	HH DVD±RW	2xGbE	AMT9	2012 Foundations	1-year	450Wx2 Gold	09/13
70AM0004UX	US	Xeon E3-1225 v3 4C/3.2GHz/8MB/84W/DDR3-1600	1x4GB UDIMM DDR3-1600 ECC	RAID 100	4x3.5" HS	Open	HH DVD	None	AMT9	None	3-year	450Wx1 Gold	09/13



ThinkServer TS460 Platform Specifications

Product Specifications Reference (PSREF)

Components	Specification																																											
Dimensions	42L tower or 4U rack. Height: 443.5 mm (17.46 in) with foot stands. Width: 173 mm (6.81 in). Depth: 593 mm (23.35 in) including front door and handle of hot-swap power supply																																											
Weight	Maximum configuration: 57.32 lb (26.5 kg)																																											
Processor	Supports one of the following Intel "Skylake" processors:																																											
	Xeon E3-1280 v5	4C/3.7GHz/8MB/80W/DDR4-2133																																										
	Xeon E3-1270 v5	4C/3.6GHz/8MB/80W/DDR4-2133																																										
	Xeon E3-1240 v5	4C/3.5GHz/8MB/80W/DDR4-2133																																										
	Xeon E3-1230 v5	4C/3.4GHz/8MB/80W/DDR4-2133																																										
	Xeon E3-1220 v5	4C/3GHz/8MB/80W/DDR4-2133																																										
	Core i3-6320	2C/3.9GHz/4MB/51W/DDR4-2133																																										
	Core i3-6300T	2C/3.3GHz/4MB/35W/DDR4-2133																																										
	Core i3-6300	2C/3.8GHz/4MB/51W/DDR4-2133																																										
	Core i3-6100T	2C/3.2GHz/3MB/35W/DDR4-2133																																										
	Core i3-6100	2C/3.7GHz/3MB/51W/DDR4-2133																																										
	Pentium G4520	2C/3.6GHz/3MB/51W/DDR4-2133																																										
	Pentium G4500T	2C/3GHz/3MB/35W/DDR4-2133																																										
Pentium G4500	2C/3.5GHz/3MB/51W/DDR4-2133																																											
Pentium G4400T	2C/2.9GHz/3MB/35W/DDR4-2133																																											
Pentium G4400	2C/3.3GHz/3MB/54W/DDR4-2133																																											
Chipset	Intel C232 Platform Controller Hub (PCH)																																											
Memory DIMMs	4 DIMM sockets with 2-channels. UDIMM. DDR4-2133.																																											
Memory capacity	Up to 64GB (16GB x 4)																																											
Memory protection	ECC																																											
RAID controller	<table border="1"> <thead> <tr> <th>RAID controller</th> <th>Drive type</th> <th>RAID support</th> </tr> </thead> <tbody> <tr> <td>Onboard RAID121i</td> <td>6Gbps SATA</td> <td>0/1/5/10</td> </tr> <tr> <td>RAID520i PCIe</td> <td>12Gbps SAS/SATA</td> <td>0/1/10, 5 with optional key</td> </tr> <tr> <td>RAID720i PCIe</td> <td>12Gbps SAS/SATA</td> <td>0/1/10/5/50, 6/60 with optional cache</td> </tr> </tbody> </table>	RAID controller	Drive type	RAID support	Onboard RAID121i	6Gbps SATA	0/1/5/10	RAID520i PCIe	12Gbps SAS/SATA	0/1/10, 5 with optional key	RAID720i PCIe	12Gbps SAS/SATA	0/1/10/5/50, 6/60 with optional cache																															
	RAID controller	Drive type	RAID support																																									
	Onboard RAID121i	6Gbps SATA	0/1/5/10																																									
	RAID520i PCIe	12Gbps SAS/SATA	0/1/10, 5 with optional key																																									
RAID720i PCIe	12Gbps SAS/SATA	0/1/10/5/50, 6/60 with optional cache																																										
Optional cache for RAID720i: 1GB memory, or 1GB, 2GB, 4GB flash with super capacitor.																																												
Supports one of the following configurations:																																												
<table border="1"> <thead> <tr> <th rowspan="2">Disk bays configuration</th> <th rowspan="2">RAID controller</th> <th rowspan="2">Optical</th> <th colspan="2">Tape drive</th> </tr> <tr> <th>RDX</th> <th>LTO</th> </tr> </thead> <tbody> <tr> <td>4x3.5" SATA non-hot swap</td> <td>121i</td> <td>up to 2</td> <td>up to 1</td> <td>-</td> </tr> <tr> <td>4x3.5" SATA hot-swap</td> <td>121i</td> <td>up to 2</td> <td>up to 1</td> <td>-</td> </tr> <tr> <td>4x3.5" SATA/SAS hot-swap</td> <td>520i or 720i</td> <td>up to 2</td> <td>up to 1</td> <td>up to 1, 520i only</td> </tr> <tr> <td>8x3.5" SATA/SAS hot-swap</td> <td>520i or 720i</td> <td>up to 2</td> <td>up to 1</td> <td>-</td> </tr> <tr> <td>8x2.5" SATA/SAS hot-swap</td> <td>520i or 720i</td> <td>up to 2</td> <td>up to 1</td> <td>-</td> </tr> <tr> <td>16x2.5" SATA/SAS hot-swap</td> <td>520i or 720i</td> <td>up to 2</td> <td>up to 1</td> <td>-</td> </tr> <tr> <td>4x3.5" + 8x2.5" SATA/SAS hot-swap</td> <td>520i or 720i</td> <td>up to 2</td> <td>up to 1</td> <td>-</td> </tr> </tbody> </table>			Disk bays configuration	RAID controller	Optical	Tape drive		RDX	LTO	4x3.5" SATA non-hot swap	121i	up to 2	up to 1	-	4x3.5" SATA hot-swap	121i	up to 2	up to 1	-	4x3.5" SATA/SAS hot-swap	520i or 720i	up to 2	up to 1	up to 1, 520i only	8x3.5" SATA/SAS hot-swap	520i or 720i	up to 2	up to 1	-	8x2.5" SATA/SAS hot-swap	520i or 720i	up to 2	up to 1	-	16x2.5" SATA/SAS hot-swap	520i or 720i	up to 2	up to 1	-	4x3.5" + 8x2.5" SATA/SAS hot-swap	520i or 720i	up to 2	up to 1	-
Disk bays configuration	RAID controller	Optical				Tape drive																																						
			RDX	LTO																																								
4x3.5" SATA non-hot swap	121i	up to 2	up to 1	-																																								
4x3.5" SATA hot-swap	121i	up to 2	up to 1	-																																								
4x3.5" SATA/SAS hot-swap	520i or 720i	up to 2	up to 1	up to 1, 520i only																																								
8x3.5" SATA/SAS hot-swap	520i or 720i	up to 2	up to 1	-																																								
8x2.5" SATA/SAS hot-swap	520i or 720i	up to 2	up to 1	-																																								
16x2.5" SATA/SAS hot-swap	520i or 720i	up to 2	up to 1	-																																								
4x3.5" + 8x2.5" SATA/SAS hot-swap	520i or 720i	up to 2	up to 1	-																																								
4 x 3.5" HS can be upgraded to 8 x 3.5" HS or 4 x 3.5" + 8 x 2.5" HS, 8 x 2.5" HS can be upgraded to 16 x 2.5" HS or 4 x 3.5" + 8 x 2.5" HS, redundant PSU models only, RAID520i/RAID720i and expansion kit is needed, more that 8 disk bays needs expander card. Also supports one M.2 SATA SSD, 32GB or 128GB.																																												
Supporting disk drives	3.5" SATA HDD, 7.2K 6Gbs, HS or NHS	1TB/2TB/3TB/4TB/6TB/8TB																																										
	3.5" SAS HDD, 7.2K 12Gbs, HS	1TB/2TB/3TB/4TB/6TB/8TB																																										
	2.5" SAS HDD, 10K 12Gbs, HS, 2.5" or 3.5" bay	300GB/600GB/900GB/1.2TB/1.8TB																																										
	2.5" SATA SSD, 6Gbs, HS, 2.5" or 3.5" bay	120GB/240GB/480GB/800GB/960GB																																										
	2.5" SATA HDD, 7.2K 6Gbs, HS	1TB/2TB																																										
	M.2 SATA SSD	32GB/128GB																																										
Maximum internal storage	Up to 64TB with 8TB 3.5" SAS or SATA HDDs, 8 x 3.5" HS bay																																											
Optical drive	Two 5.25" bays. Up to 2 optical drives. DVD-ROM or DVD±RW. Half-height. 2nd optical drive will be disable if M.2 SATA SSD is used																																											
Tape drive	Supports one tape drive in 5.25" bay. RDX or LTO. LTO Tape drive needs RAID520i																																											
Network interfaces	Two integrated Gigabit Ethernet 1000BASE-T ports (RJ-45) with Intel i210. One dedicate management port with Realtek RTL8211E																																											
Systems management	UEFI. Onboard Aspeed AST2400 graphics/management processor, IPMI 2.0-compliant baseboard management controller (BMC). Control Panel LEDs shows the status of power, disk drives, network, system. On rear system ID. Supports EasyStartup, Power Planner, Lenovo ThinkServer Diagnostics Standalone, ToolsCenter Suite CLI inventory module on ThinkServer, Lenovo xClarity Administrator																																											

Components	Specification			
Security features	Power-on and administrator password. Optional TPM, TCG 1.2 or 2.0 compliant.			
Operating systems	Microsoft Windows Server 2016/2012 R2. Red Hat Enterprise Linux 6.8. VMware vSphere (ESXi) 6.0U2/6.5			
Base warranty	1 or 3-year limited onsite service with 9x5/NBD.			
Power supply	Supports one of the following, depending on models: • One fixed 300 watts, universal, 80 PLUS Bronze qualified. • Up to two redundant 450 watts, two maximum, rear access, hot-swap, 80 PLUS Gold qualified, universal, redundant with two power supplies			
Graphics	Integrated in onboard Aspeed AST2400 graphics/management processor			
Front ports	Two USB 3.0 (blue)			
Rear ports	One VGA, four USB 3.0, one RJ-45 (dedicated mgmt), two ethernet, one serial (9-pin). Add-on parallel or serial ports via optional PCIe adapters			
Noise emissions	Operating: < 43.6 dB(A). Idle: < 33 dB(A) (Maximum configuration)			
Environmental specification	All models supports ASHARE B. Models with the following configuration supports ASHARE A3: Xeon E3-1230 v5/8GBx2/DVD±RW/1TB SATAx4/RAID520i/450Wx2/TPM			
	Temperature - operating	ASHRAE A2 10°C to 35°C (50°F to 95°F)	ASHRAE A3 5°C to 40°C (41°F to 104°F)	ASHRAE B 5°C to 35°C (41°F to 95°F)
	Temperature - storage (with package)	-40°C to 60°C (-40°F to 140°F)	-40°C to 60°C (-40°F to 140°F)	-40°C to 60°C (-40°F to 140°F)
	Altitude - operating	20% to 80% (non-condensing)	8% to 85% (non-condensing)	8% to 80% (non-condensing)
	Humidity - storage (with package)	10% to 90% (non-condensing)	10% to 90% (non-condensing)	10% to 90% (non-condensing)
	Altitude - operating	0 m to 3048 m (0 ft to 10 000 ft) in an unpressurized environment		
	GREENGUARD certified, RoHS-compliant, Energy Star Server 2.1 qualified on redundant PSU models			

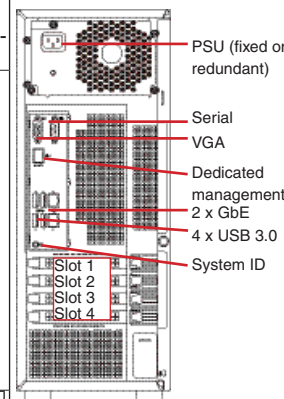

Expansion slots
4 PCIe 3.0 slots (top-down):
Slot 1: PCIe 3.0 x4, full height, full length, open-end, from PCH
Slot 2: PCIe 3.0 x16, full height, full length, from CPU
Slot 3: PCIe 3.0 x1, full height, half length, from PCH
Slot 4: PCIe 3.0 x8, full height, half length, open-end, from CPU

Note:
1. If a PCIe card is connected to slot 4, both slot 2 and slot 4 will work at PCIe x8.
2. If a discrete graphics card is used, slot 2 will work at PCIe x16 and slot 4 will be disable.

Core options for ThinkServer TS460 (partial)

ThinkServer 8GB 2RX8 PC4-2133-E CL15 DDR4-2133 ECC-UDIMM	4X70G88316
ThinkServer 16GB 2RX8 PC4-2133-E CL15 DDR4-2133 ECC-UDIMM	4X70G88317
ThinkServer 8TB 7.2K 3.5" Enterprise 6Gb SATA Hard Drive - NHS	4XB0K12347
ThinkServer 8TB 7.2K 3.5" Enterprise 12Gb SAS Hot Swap Hard Drive	4XB0K12254
ThinkServer 2TB 7.2K 2.5" Enterprise 6Gb SATA Hot Swap Hard Drive	4XB0G88774
ThinkServer 2.5" 1.8TB 10K SAS 12Gbps Hot Swap Hard Drive	4XB0G88737
HS Intel S3520 960G 6Gbps SATA 2.5" SSD with 3.5" Tray	4XB0K12333
HS Intel S3520 960G 6Gbps SATA 2.5" SSD	4XB0K12332
128GB SATA M.2 SSD	4XB0K12311
450W 1+1 Redundant PSU - Gold -Single module 110V to 240V AC input	4X20G87846
ThinkServer 3.5" Hot-Swap HDD Expansion Kit for Tower	4XF0G88945
ThinkServer 2.5" Hot-Swap HDD Expansion Kit for Tower	4XF0G88946
Lenovo ThinkServer SAS 12G Expander PCIe Card	4XC0G88843
Tower to Rack Conversion Kit	4XF0G88937

ThinkServer TS460 - TopSeller - 70TR

Product Specifications Reference (PSREF)

Model	Region	Processor	Memory	RAID Controller	Disk Bays	Storage	Optical	Add-on NIC	Add-on Ports	System Management	Operating System	Warranty	Power Supply	Ann Date (mm/yy)
70TR000LUX	US	Xeon E3-1220 v5 4C/3GHz/8MB/80W/DDR4-2133	1x8GB UDIMM DDR4-2133 ECC	RAID121i	4x3.5" HS	Open	Open	None	None	TPM2.0	None	1-year	Fixed 300W Bronze	02/17
70TR000MUX	US	Xeon E3-1230 v5 4C/3.4GHz/8MB/80W/DDR4-2133	1x8GB UDIMM DDR4-2133 ECC	RAID121i	4x3.5" HS	Open	Open	None	None	TPM2.0	None	1-year	Fixed 300W Bronze	02/17
70TR000NUX	US	Xeon E3-1240 v5 4C/3.5GHz/8MB/80W/DDR4-2133	1x8GB UDIMM DDR4-2133 ECC	RAID121i	4x3.5" HS	Open	Open	None	None	TPM2.0	None	1-year	Fixed 300W Bronze	02/17
70TR000PUX	US	Xeon E3-1270 v5 4C/3.6GHz/8MB/80W/DDR4-2133	1x8GB UDIMM DDR4-2133 ECC	RAID121i	4x3.5" HS	Open	Open	None	None	TPM2.0	None	1-year	Fixed 300W Bronze	02/17
70TR000QUX	US	Xeon E3-1220 v5 4C/3GHz/8MB/80W/DDR4-2133	1x8GB UDIMM DDR4-2133 ECC	RAID520i	8x2.5" HS	Open	Open	None	None	TPM2.0	None	1-year	Fixed 300W Bronze	02/17
70TR000RUX	US	Xeon E3-1230 v5 4C/3.4GHz/8MB/80W/DDR4-2133	1x8GB UDIMM DDR4-2133 ECC	RAID520i	8x2.5" HS	Open	Open	None	None	TPM2.0	None	1-year	Fixed 300W Bronze	02/17
70TR000SUX	US	Xeon E3-1240 v5 4C/3.5GHz/8MB/80W/DDR4-2133	1x8GB UDIMM DDR4-2133 ECC	RAID520i	8x2.5" HS	Open	Open	None	None	TPM2.0	None	1-year	Fixed 300W Bronze	02/17
70TR000TUX	US	Xeon E3-1270 v5 4C/3.6GHz/8MB/80W/DDR4-2133	1x8GB UDIMM DDR4-2133 ECC	RAID520i	8x2.5" HS	Open	Open	None	None	TPM2.0	None	1-year	Fixed 300W Bronze	02/17
70TR000UUX	US	Xeon E3-1220 v5 4C/3GHz/8MB/80W/DDR4-2133	1x8GB UDIMM DDR4-2133 ECC	RAID121i	4x3.5" NHS	Open	Open	None	None	TPM2.0	None	1-year	Fixed 300W Bronze	02/17
70TR000VUX	US	Xeon E3-1230 v5 4C/3.4GHz/8MB/80W/DDR4-2133	1x8GB UDIMM DDR4-2133 ECC	RAID121i	4x3.5" NHS	Open	Open	None	None	TPM2.0	None	1-year	Fixed 300W Bronze	02/17
70TR000WUX	US	Xeon E3-1240 v5 4C/3.5GHz/8MB/80W/DDR4-2133	1x8GB UDIMM DDR4-2133 ECC	RAID121i	4x3.5" NHS	Open	Open	None	None	TPM2.0	None	1-year	Fixed 300W Bronze	02/17
70TR000XUX	US	Xeon E3-1270 v5 4C/3.6GHz/8MB/80W/DDR4-2133	1x8GB UDIMM DDR4-2133 ECC	RAID121i	4x3.5" NHS	Open	Open	None	None	TPM2.0	None	1-year	Fixed 300W Bronze	02/17
70TR000YUX	US	Pentium G4400 2C/3.3GHz/3MB/54W/DDR4-2133	1x8GB UDIMM DDR4-2133 ECC	RAID121i	4x3.5" NHS	Open	Open	None	None	TPM2.0	None	1-year	Fixed 300W Bronze	02/17

Model	Region	Processor	Memory	RAID Controller	Disk Bays	Storage	Optical	Add-on NIC	Add-on Ports	System Management	Operating System	Warranty	Power Supply	Ann Date (mm/yy)
70TT000JUX	US	Xeon E3-1220 v5 4C/3GHz/8MB/80W/DDR4-2133	1x8GB UDIMM DDR4-2133 ECC	RAID121i	4x3.5" HS	Open	Open	None	None	TPM2.0	None	1-year	1x450W Gold	02/17
70TT000KUX	US	Xeon E3-1230 v5 4C/3.4GHz/8MB/80W/DDR4-2133	1x8GB UDIMM DDR4-2133 ECC	RAID121i	4x3.5" HS	Open	Open	None	None	TPM2.0	None	1-year	1x450W Gold	02/17
70TT000LUX	US	Xeon E3-1240 v5 4C/3.5GHz/8MB/80W/DDR4-2133	1x8GB UDIMM DDR4-2133 ECC	RAID121i	4x3.5" HS	Open	Open	None	None	TPM2.0	None	1-year	1x450W Gold	02/17
70TT000MUX	US	Xeon E3-1270 v5 4C/3.6GHz/8MB/80W/DDR4-2133	1x8GB UDIMM DDR4-2133 ECC	RAID121i	4x3.5" HS	Open	Open	None	None	TPM2.0	None	1-year	1x450W Gold	02/17
70TT000NUX	US	Xeon E3-1220 v5 4C/3GHz/8MB/80W/DDR4-2133	1x8GB UDIMM DDR4-2133 ECC	RAID520i	8x2.5" HS	Open	Open	None	None	TPM2.0	None	1-year	1x450W Gold	02/17
70TT000PUX	US	Xeon E3-1230 v5 4C/3.4GHz/8MB/80W/DDR4-2133	1x8GB UDIMM DDR4-2133 ECC	RAID520i	8x2.5" HS	Open	Open	None	None	TPM2.0	None	1-year	1x450W Gold	02/17
70TT000QUX	US	Xeon E3-1240 v5 4C/3.5GHz/8MB/80W/DDR4-2133	1x8GB UDIMM DDR4-2133 ECC	RAID520i	8x2.5" HS	Open	Open	None	None	TPM2.0	None	1-year	1x450W Gold	02/17
70TT000RUX	US	Xeon E3-1270 v5 4C/3.6GHz/8MB/80W/DDR4-2133	1x8GB UDIMM DDR4-2133 ECC	RAID520i	8x2.5" HS	Open	Open	None	None	TPM2.0	None	1-year	1x450W Gold	02/17

This publication was developed for products and services offered in the United States and E.M.E.A countries. Lenovo may not offer the products, services or features discussed in this document in other countries. Lenovo may withdraw an offering at any time. Information is subject to change without notice. Consult your local representative for information on offerings available in your area.

Lenovo reserves the right to change specifications or other product information without notice. Lenovo is not responsible for photographic or typographical errors.

LENOVO PROVIDES THIS PUBLICATION "AS IS," WITHOUT WARRANTY OF ANY KIND, EITHER EXPRESS OR IMPLIED, INCLUDING THE IMPLIED WARRANTIES OF MERCHANTABILITY OR FITNESS FOR A PARTICULAR PURPOSE.

Some jurisdictions do not allow disclaimer of express or implied warranties in certain transactions, therefore this disclaimer may not apply to you.

Availability: All offers subject to availability. Lenovo reserves the right to alter product offerings and specifications at any time, without notice. Lenovo is not responsible for photographic or typographic errors.

General: Review key information provided by Microsoft that may apply to your system purchase, including details on Windows 10, Windows 8, Windows 7, and potential upgrades/downgrades. Lenovo makes no representation or warranty regarding third-party products or services.

Trademarks: Lenovo, ThinkPad, ThinkCentre, ThinkStation and the Lenovo logo are trademarks of Lenovo. Microsoft, Windows, Windows NT, and the Windows logo are trademarks of Microsoft Corporation. Ultrabook, Celeron, Celeron Inside, Core Inside, Intel, Intel Logo, Intel Atom, Intel Atom Inside, Intel Core, Intel Inside, Intel Inside Logo, Intel vPro, Itanium, Itanium Inside, Pentium, Pentium Inside, vPro Inside, Xeon, Xeon Phi, and Xeon Inside are trademarks of Intel Corporation in the U.S. and/or other countries. Other company, product or service names may be trademarks or service marks of others.

Warranty: For a copy of applicable warranties, write to: Lenovo Warranty Information, 1009 Think Place, Morrisville, NC, 27560. Lenovo makes no representation or warranty regarding third party products or services. The Lenovo Limited Warranty applies only to Lenovo hardware products purchased for your own use, and does not transfer upon resale.

Limited warranty: Support unrelated to a warranty issue may be subject to additional charges.

Lenovo Services:

Carry-in or Mail-in Service: Parts and labor repair coverage where the customer is responsible for shipping (including packaging) or delivery to authorized warranty provider or repair center.

Depot or Courier Service: Parts and labor repair coverage where shipping (including packaging) or delivery to the repair center is paid for by Lenovo.

Expedited Depot: Parts and labor coverage with expedited turnaround. Shipping (including packaging) or delivery to the repair center is paid for by Lenovo.

Onsite / In-home Service: Parts and labor repair coverage where labor is provided onsite at your place of business.

If Lenovo determines your product problem is covered by the product warranty and cannot be resolved over the telephone, a technician will be dispatched to arrive onsite, typically the next day.

International Warranty Service (IWS): PC repair coverage for customers who require a critical warranty repair while travelling internationally. Visit www.lenovo.com/internationalwarranty for details. Visit www.lenovo.com/warranty for Lenovo Warranty Services terms and conditions for complete details and restrictions.

Included software: may differ from its retail version (if available), and may not include user manuals or all program functionality. Software license agreements may apply.

Battery life: Battery life (and recharge times) will vary based on many factors including screen brightness, applications, features, power management, battery conditioning, and other customer preferences.

Visit <http://psref.lenovo.com/> for the latest version of Product Specifications Reference.

© Lenovo, 2017. All rights reserved.
Lenovo 1009 Think Place Morrisville, NC 27560 U.S.A.

LenovoTM

ThinkVision

PSREF



Product Specifications Reference

Version 507, May 2017

U.S.

Visit <http://psref.lenovo.com> for the latest version

Contents

Cover		
Contents		
Summary Of Change		
17 Inch - 20 Inch		
ThinkVision E1922s		
ThinkVision E1922s Platform Specifications		
ThinkVision E2054		
ThinkVision E2054 Platform Specifications		
ThinkVision LT1913p Square		
ThinkVision LT1913p Square Platform Specifications		
ThinkVision LT2024		
ThinkVision LT2024 Platform Specifications		
ThinkVision T1714		
ThinkVision T1714 Platform Specifications		
ThinkVision T1714p		
ThinkVision T1714p Platform Specifications		
ThinkVision T2054p		
ThinkVision T2054p Platform Specifications		
21 Inch - 24 Inch		
ThinkVision LT2423		
ThinkVision LT2423 Platform Specifications		
ThinkVision P24h		
ThinkVision P24h Platform Specifications		
ThinkVision P24q		
ThinkVision P24q Platform Specifications		
ThinkVision T2224d		
ThinkVision T2224d Platform Specifications		
ThinkVision T2224z		
ThinkVision T2224z Platform Specifications		
ThinkVision T2254p		
ThinkVision T2254p Platform Specifications		
ThinkVision T22i		
ThinkVision T22i Platform Specifications		
ThinkVision T2324d		
ThinkVision T2324d Platform Specifications		
1 ThinkVision T2364t	34	
2 ThinkVision T2364t Platform Specifications	35	
3 ThinkVision T23i	36	
4 ThinkVision T23i Platform Specifications	37	
4 ThinkVision T2424z	38	
5 ThinkVision T2424z Platform Specifications	39	
6 ThinkVision T2454p	40	
7 ThinkVision T2454p Platform Specifications	41	
8 ThinkVision T24i	42	
9 ThinkVision T24i Platform Specifications	43	
10 ThinkVision X24	44	
11 ThinkVision X24 Platform Specifications	45	
12 ThinkVision X24 Pro	46	
13 ThinkVision X24 Pro Platform Specifications	47	
14 Above 25 Inch	48	
15 ThinkVision P27	48	
16 ThinkVision P27 Platform Specifications	49	
17 ThinkVision P27h	50	
18 ThinkVision P27h Platform Specifications	51	
18 ThinkVision P27q	52	
19 ThinkVision P27q Platform Specifications	53	
20 ThinkVision Pro2820	54	
21 ThinkVision Pro2820 Platform Specifications	55	
22 ThinkVision X1	56	
23 ThinkVision X1 Platform Specifications	57	
24 Legal Information	58	
25		
26		
27		
28		
29		
30		
31		
32		
33		

Summary of Changes

This section describes the technical changes made in this edition.

This edition might also include minor corrections and editorial changes which are not identified.

May 31, 2017 - Version 507

Additions in this update

▶ **New product(s)**

None

▶ **New model(s)**

None

▶ **Others**

None

Changes in this update

None

Withdrawals in this update

ThinkVision T2224p withdraw May 2017

ThinkVision T2324p withdraw May 2017

ThinkVision T2424p withdraw May 2017



<p>Name E1922s Wide Flat Panel Monitor Case color Black Type-model 60G2AAT6US / 60G2AAR6US / 60G2AAT6EU Panel TFT-LCD, twisted nematic (TN), White LED backlight Viewable image size 18.5" (470mm) diagonal Max view area (W x H) 16.1" x 9.1" / 409.8mm x 230.4mm Native resolution 1366x768 Aspect ratio 16:9 Pixel pitch (mm) 0.3mm Dot/Pixel per Inch 85 dpi Brightness 200 nits or cd/m² (typical) Contrast ratio 600:1 (typical) Pixel response time 5ms (typical) Color gamut 72% Viewing angle at 10:1 CR 180° (+/- 90°) horizontal, 100° (+/- 50°) vertical Stand Tilt adjustable stand Bezel width Sides: 0.73" (18.5mm) Dimensions (HxWxD) 13.44" H x 17.65" W x 6.58" D; 341.5mm H x 448.4mm W x 167.2mm D Power supply 13.7 watts typical, 17 watts maximum, <0.5 watts standby/suspend, universal, integrated (no external brick-like power supply) Weight 6.03 lb; 2.74 kg Limited warranty⁴ 3 year (includes backlight) Available date March 2014</p>	<p>Features</p> <ul style="list-style-type: none"> • Widescreen 18.5-inch monitor • Supports HD 1366x768 resolution • Supports VESA mount (100mm) • Mercury free panel and arsenic free glass • Kensington lock slot ready for enhanced security • Support Lenovo Tiny PC via VESA mount • Supports optional soundbar • Microsoft® Windows® 7 certified • Microsoft Windows 8 / Windows 8.1 certified 				
<p>VESA-compliant² VESA DPMS-compliant Power management ENERGY STAR® 7.0 Ergonomics ISO 9241-307 Emission standards FCC Class B Environmental TCO (TCO Displays 7.0), WEEE, RoHS, EPEAT™ Gold rating</p>	 <p>ThinkVision E1922s Wide Monitor</p>				
<p>Preset resolutions VGA: 640x350, 640x480, 720x400 SVGA: 800x600, 832x624 XGA: 1024x768, 1152x864 SXGA: 1280x1024 WXGA: 1366x768</p> <p>Presets / user settings Standard presets: 15 user settings: 16</p>					
<p>Viewing adjustments Tilt: 20° backward, -5° forward Rotating screen None On screen display On screen display with digital user controls (8 languages) Control features Direct access (control buttons on front) for automatic image setup and adjustment for brightness Multiple input None Monitor connectors VGA 15-pin D-shell, analog, blue Signal cables detachable, VGA 15-pin D-shell at each end, analog, 1.8 meter Mounting features Wall or desk mounting using the Extend Arm or third-party accessories meeting the VESA FPMPI® (100mm mount) Security Security keyhole for attachment of optional cable lock (Kensington® lock-compatible)</p>					
<p>Ship group Monitor with stand, 1.8 meter analog signal cable, 1.8 meter black power cord</p>					
<p>Limited Warranty See details at http://support.lenovo.com/en_US/guides-and-manuals/detail.page?DocID=UM008281</p>	<p>Accessories</p> <table border="0"> <tr> <td>Kensington MicroSaver Cable Lock</td> <td>73P2582</td> </tr> <tr> <td>Kensington Twin Head Cable Lock</td> <td>45K1620</td> </tr> </table> <p>See details at www.lenovo.com/support/monitoraccessories</p> <p>See all monitors at www.lenovo.com/thinkvision</p>	Kensington MicroSaver Cable Lock	73P2582	Kensington Twin Head Cable Lock	45K1620
Kensington MicroSaver Cable Lock	73P2582				
Kensington Twin Head Cable Lock	45K1620				



<p>Name E2054 Wide Flat Panel Monitor Case color Raven black Type-model 60DFAAR1US / 60DFAAT1US / 60DFAAT1EU Panel TFT-LCD, In-Plane Switching (IPS), LED backlight Viewable image size 19.5" (494mm) diagonal Max view area (W x H) 16.48" x 10.33" / 418.6mm x 262.4mm Native resolution 1440x900 Aspect ratio 16:10 Pixel pitch (mm) 0.097mm x 0.292mm Dot/Pixel per Inch 87 dpi Brightness 250 nits or cd/m² (typical) Contrast ratio 1000:1 (typical) Pixel response time 7ms (typical) Color gamut 72% Viewing angle at 10:1 CR 178° (+/- 89°) horizontal, 178° (+/- 89°) vertical Stand Tilt adjustable stand Bezel width Top: 0.71" (18.0mm) Bottom: 0.70" (17.9mm) Sides: 1.02" (26.0mm) Dimensions (HxWxD) 14.65" H x 17.95" W x 7.41" D; 372.0mm H x 456.0mm W x 188.3mm D Power supply 16 watts typical, 20 watts maximum, <0.5 watts standby/suspend, universal, integrated (no external brick-like power supply) Weight 6.17 lb; 2.8 kg Limited warranty 3 year (includes backlight) Available date November 2015</p>	<p style="text-align: center;">Features</p> <ul style="list-style-type: none"> • Widescreen 19.5-inch monitor • Supports HD 1440x900 resolution • Supports VESA mount (100mm) • Mercury free panel and arsenic free glass • Kensington lock slot ready for enhanced security • Support Lenovo Tiny PC via VESA mount • Microsoft® Windows® 7 certified • Microsoft Windows 8 / Windows 8.1 certified • Microsoft Windows 10 certified
<p>VESA-compliant VESA DPMS-compliant Power management ENERGY STAR® 6.0 Ergonomics ISO 9241-307 Emission standards FCC Class B Environmental TCO (TCO Displays 6.0), WEEE, RoHS, EPEAT™ Silver rating</p>	<div style="text-align: center;">  <p>ThinkVision E2054 Wide Monitor</p> </div>
<p>Preset resolutions VGA: 640x480, 720x400 SVGA: 800x600 XGA: 1024x768 SXGA: 1280x768, 1280x1024 WXGA: 1366x768 WXGA+: 1440x900</p> <p>Presets / user settings Standard presets: 18 user settings: 10</p>	
<p>Viewing adjustments Tilt: 22° backward, -5° forward Rotating screen None On screen display On screen display with digital user controls (8 languages) Control features Direct access (control buttons on front) for automatic image setup and adjustment for brightness Multiple input None Monitor connectors VGA 15-pin D-shell, analog, blue Signal cables detachable, VGA 15-pin D-shell at each end, analog, 1.8 meter Mounting features Wall or desk mounting using the Extend Arm or third-party accessories meeting the VESA FPMPI® (100mm mount) Security Security keyhole for attachment of optional cable lock (Kensington® lock-compatible)</p>	
<p>Ship group Monitor with stand, 1.8 meter analog signal cable, 1.8 meter black power cord</p>	

<p style="text-align: center;">Limited Warranty</p> <p>See details at http://support.lenovo.com/en_US/guides-and-manuals/detail.page?DocID=UM008281</p>	<p style="text-align: center;">Accessories</p> <table border="0"> <tr> <td>Kensington MicroSaver Cable Lock</td> <td style="text-align: right;">73P2582</td> </tr> <tr> <td>Kensington Twin Head Cable Lock</td> <td style="text-align: right;">45K1620</td> </tr> </table> <p>See details at www.lenovo.com/support/monitoraccessories</p> <p>See all monitors at www.lenovo.com/thinkvision</p>	Kensington MicroSaver Cable Lock	73P2582	Kensington Twin Head Cable Lock	45K1620
Kensington MicroSaver Cable Lock	73P2582				
Kensington Twin Head Cable Lock	45K1620				



<p>Name LT1913p Square Flat Panel Monitor Case color Black Type-model 60FBHAR1US / 60FBHAT1US / 60FBHAT1EU Panel TFT-LCD, In-Plane Switching (IPS), White LED backlight Viewable image size 19.0" (480.0mm) diagonal Max view area (W x H) 14.76" x 11.80" (374.7mm x 299.8mm) Optimum resolution 1280x1024 Max pixel rate 205MHz (VGA), 165MHz (DVI) Aspect ratio 5:4 Pixel pitch (mm) 0.0976 (H) x 0.2928 (V) mm Dot/Pixel per Inch 86.8 dpi Brightness 250 nits or cd/m² (typical) Contrast ratio 1000:1 (typical) Pixel response time 7ms (typical) Color gamut 72% Viewing angle at 10:1 CR 178° horizontal, 178° vertical Stand Tilt, swivel, pivot, and height adjustable stand Bezel width Sides: 0.68" (17.4mm); top: 0.68" (17.4mm); bottom: 0.68" (17.4mm) Dimensions (HxWxD) 14.63" H x 16.18" W x 10.40" D; 371.5mm H x 411.0mm W x 264.2mm D Power supply 24 watts typical, 27 watts maximum, <0.5 watts standby/suspend, universal, integrated (no external brick-like power supply) Weight 10.69 lb; 4.85kg Limited warranty⁴ 3 year (includes backlight) Available date April 2015</p>	<p>Features</p> <ul style="list-style-type: none"> • 19-inch Square IPS LED backlight panel • Supports 1280x1024 resolution • Supports ThinkCentre Tiny Clamp Bracket • Mercury and arsenic free glass • Low Halogen • Recycled content in plastic material • Supports optional soundbar • Microsoft® Windows® 7 certified • Microsoft Windows 8 / Windows 8.1 certified • Microsoft Windows 10 certified 								
<p>VESA-compliant² VESA DDC2B/C1, EDID 1.3 Power management ENERGY STAR® 7.0 Ergonomics ISO 9241-307 Emission standards FCC Class B Environmental TCO Displays 7.0, TCO Certified Edge 1.1, WEEE, RoHS, EPEAT™ Gold rating, ULE Gold</p> <p>Preset resolutions VGA: 640x350, 640x480, 720x400 SVGA: 800x600, 823x624 XGA: 1024x768, 1152x864, 1152x900 SXGA: 1280x1024</p> <p>Presets / user settings Standard presets: 20; user settings: 20</p>	 <p>ThinkVision LT1913p Square Monitor</p>								
<p>Viewing adjustments Tilt: 30° back, -5° forward; lift: 4.3" (110mm); swivel: +/- 45° Rotating screen Screen pivots 90 degrees from landscape to portrait On screen display On screen display with digital user controls (8 languages) Control features Direct access (buttons on front) for automatic image setup, input switch, and brightness Multiple input Dual input (two different PCs attach to two different connectors; one PC shows image; select via button) Monitor connectors (1) VGA 15-pin D-shell, analog, blue (2) Digital Visual Interface (DVI-D), digital, white, HDCP-compliant Signal cables (1) detachable, VGA 15-pin D-shell at each end, analog, 1.8 meter (2) detachable, DVI-D at each end, digital, 1.8 meter Mounting features Wall or desk mounting using the Extend Arm or third-party accessories meeting the VESA FPMPI® (100mm mount) Security Security keyhole for attachment of optional cable lock (Kensington® lock-compatible)</p> <p>Ship group Monitor, attached stand, Setup poster, Safety and Warranty Information, 1.8 meter analog signal cable, 1.8 meter DVI-D cable, 1.8 meter black power cord</p>									
<p>Limited Warranty</p> <p>See details at http://support.lenovo.com/en_US/guides-and-manuals/detail.page?DocID=UM008281</p>	<p>Accessories</p> <table border="0"> <tr> <td>Kensington MicroSaver Cable Lock</td> <td>73P2582</td> </tr> <tr> <td>Kensington Twin Head Cable Lock</td> <td>45K1620</td> </tr> <tr> <td>Lenovo Security Cable Lock</td> <td>57Y4303</td> </tr> <tr> <td>Lenovo Easy Reach Monitor Stand</td> <td>55Y9258</td> </tr> </table> <p>See details at www.lenovo.com/support/monitoraccessories</p> <p>See all monitors at www.lenovo.com/thinkvision</p>	Kensington MicroSaver Cable Lock	73P2582	Kensington Twin Head Cable Lock	45K1620	Lenovo Security Cable Lock	57Y4303	Lenovo Easy Reach Monitor Stand	55Y9258
Kensington MicroSaver Cable Lock	73P2582								
Kensington Twin Head Cable Lock	45K1620								
Lenovo Security Cable Lock	57Y4303								
Lenovo Easy Reach Monitor Stand	55Y9258								



<p>Name LT2024 Wide Flat Panel Monitor Case color Business black Type-model 60B9HAR1US Panel TFT-LCD, twisted nematic (TN), White LED backlight Viewable image size 20.0" (508mm) diagonal Max view area (W x H) 17.4" x 9.8" (442.8mm x 249.1mm) Native resolution 1600x900 Aspect ratio 16:9 Pixel pitch (mm) .276mm Dot/Pixel per Inch 92 dpi Brightness 250 nits or cd/m² (typical) Contrast ratio 1000:1 (typical) Pixel response time 5ms (typical) Color gamut 72% Viewing angle at 10:1 CR 170° (+/- 85°) horizontal, 160° (+/- 80°) vertical Stand Tilt adjustable stand Bezel width Sides: 0.567" (14.4mm) Dimensions (HxWxD) 13.68" H x 18.83" W x 6.33" D; 347.4mm H x 478.4mm W x 160.7mm D Power supply 19 watts typical, 22 watts maximum, <0.5 watts standby/suspend, universal, integrated (no external brick-like power supply) Weight 6.75 lb; 3.07 kg Limited warranty⁴ 3 year (includes backlight) Available date March 2014</p>	<p style="text-align: center;">Features</p> <ul style="list-style-type: none"> • Widescreen 20-inch monitor • Supports 1600x900 resolution • Includes dual input connection for attachment to two systems concurrently (analog and digital) • Arsenic / Mercury free glass • EPEAT Gold certified • Supports optional soundbar • Support Lenovo Tiny PC and 3rd party thin client • Microsoft® Windows® 7 certified • Microsoft Windows 8 / Windows 8.1 certified 				
<p>VESA-compliant² VESA DDC2B/CI Power management ENERGY STAR® qualified Ergonomics ISO 9241-307 Emission standards FCC Class B Environmental TCO Displays 6.0, TCO Certified Edge 1.2, WEEE, RoHS, EPEAT™ Gold rating</p>	<div style="text-align: center;">  <p>ThinkVision LT2024 Wide Monitor</p> </div>				
<p>Preset resolutions VGA: 640x350, 640x480, 720x400 SVGA: 800x600, 832x624 XGA: 1024x768, 1152x864 SXGA: 1280x1024 WXGA: 1366x768 WXGA+: 1440x900, 1600x900</p> <p>Presets / user settings Standard presets: 24 user settings: 24</p>					
<p>Viewing adjustments Tilt: 22° backward, -5° forward Rotating screen None On screen display On screen display with digital user controls (8 languages) Control features Direct access (buttons on front) for automatic image setup, dual input and brightness Multiple input Dual input (two different PCs attach to two different connectors; one PC shows image; select via button) Monitor connectors (1) VGA 15-pin D-shell, analog, blue (2) Digital Visual Interface (DVI-D), digital, white, HDCP-compliant Signal cables (1) detachable, VGA 15-pin D-shell at each end, analog, 1.8 meter Mounting features Wall or desk mounting using the Extend Arm or third-party accessories meeting the VESA FPMPI® (100mm mount) Security Security keyhole for attachment of optional cable lock (Kensington® lock-compatible)</p>					
<p>Ship group Monitor with stand, Safety and Warranty Information, 1.8 meter analog signal cable, 1.8 meter black power cord</p>					
<p style="text-align: center;">Limited Warranty</p> <p>See details at http://support.lenovo.com/en_US/guides-and-manuals/detail.page?DocID=UM008281</p>	<p style="text-align: center;">Accessories</p> <table border="0"> <tr> <td>Kensington MicroSaver Cable Lock</td> <td style="text-align: right;">73P2582</td> </tr> <tr> <td>Kensington Twin Head Cable Lock</td> <td style="text-align: right;">45K1620</td> </tr> </table> <p>See details at www.lenovo.com/support/monitoraccessories</p> <p>See all monitors at www.lenovo.com/thinkvision</p>	Kensington MicroSaver Cable Lock	73P2582	Kensington Twin Head Cable Lock	45K1620
Kensington MicroSaver Cable Lock	73P2582				
Kensington Twin Head Cable Lock	45K1620				

See footnotes for important warranty information
 US model announced February 18, 2014



<p>Name T1714 Square Flat Panel Monitor Case color Black Type-model 60FDHAT1EU / 60FDHAR1US / 60FDHAT1EU Panel TFT-LCD, twisted nematic (TN), White LED backlight Viewable image size 17.0" (432mm) diagonal Max view area (W x H) 13.3" x 10.6" (337.9mm x 270.3mm) Optimum resolution 1280x1024 Aspect ratio 5:4 Pixel pitch (mm) 0.264mm Dot/Pixel per Inch 96 dpi Brightness 250 nits or cd/m² (typical) Contrast ratio 1000:1 (typical) Pixel response time 5ms (typical) Color gamut 72% Viewing angle at 10:1 CR 170° (+/- 85°) horizontal, 160° (+/- 80°) vertical Stand Tilt stand Bezel width Sides: 0.69" (17.5mm) Dimensions (HxWxD, including stand) 14.72" H x 14.74" W x 7.87" D; 373.9mm H x 374.5mm W x 200mm D Power supply 14.0 watts typical, 18.0 watts maximum, <0.5 watts standby/suspend, universal, integrated (no external brick-like power supply) Weight 5.75 lb; 2.61kg Limited warranty 3 year (includes backlight) Available date September 2015</p>	<p>Features</p> <ul style="list-style-type: none"> • 17-inch Square LCD monitor • Supports SXGA 1280x1024 resolution • Includes dual input connection for attachment to two systems concurrently (analog and digital) • Mercury Arsenic free glass • Supports optional soundbar • Microsoft® Windows® 7 certified • Microsoft Windows 8 certified • Microsoft Windows 8.1 certified • Microsoft Windows 10 certified 						
<p>VESA-compliant VESA DDC2B/CI Power management ENERGY STAR® 7.0 Ergonomics ISO 9241-307 Emission standards FCC Class B Environmental TCO Displays 7.0, TCO Certified Edge 2.0, WEEE, RoHS, EPEAT™ Gold rating</p>	<div style="text-align: center;">  <p>ThinkVision T1714 Monitor</p> </div>						
<p>Preset resolutions VGA: 640x350, 640x480, 720x400 SVGA: 800x600 XGA: 1024x768, 1152x864, SXGA: 1280x800, 1280x1024</p> <p>Presets / user settings Standard presets: 17; user settings: 17</p>							
<p>Viewing adjustments Tilt: 22° back, -5° forward Rotating screen None On screen display On screen display with digital user controls (8 languages) Control features Direct access (buttons on front) for automatic image setup and brightness Multiple input Dual input (two different PCs attach to two different connectors; one PC shows image; select via button) Monitor connectors (1) VGA 15-pin D-shell, analog, blue (2) Digital Visual Interface (DVI-D), digital, white, HDCP-compliant Signal cables (1) detachable, VGA 15-pin D-shell at each end, analog, 1.8 meter (2) detachable, DVI-D at each end, digital, 1.8 meter Mounting features Wall or desk mounting using the Extend Arm or third-party accessories meeting the VESA FPMPI® (100mm mount) Security Security keyhole for attachment of optional cable lock (Kensington® lock-compatible)</p>							
<p>Ship group Monitor and stand, Setup poster, Safety and Warranty Information, 1.8 meter analog signal cable, 1.8 meter DVI-D cable, 1.8 meter black power cord</p>							
<p style="text-align: center;">Limited Warranty</p> <p>See details at http://support.lenovo.com/en_US/guides-and-manuals/detail.page?DocID=UM008281</p>	<p style="text-align: center;">Accessories</p> <table border="0"> <tr> <td>Kensington MicroSaver Cable Lock</td> <td style="text-align: right;">73P2582</td> </tr> <tr> <td>Kensington Twin Head Cable Lock</td> <td style="text-align: right;">45K1620</td> </tr> <tr> <td>Lenovo Easy Reach Monitor Stand</td> <td style="text-align: right;">55Y9258</td> </tr> </table> <p>See details at www.lenovo.com/support/monitoraccessories</p> <p>See all monitors at www.lenovo.com/thinkvision</p>	Kensington MicroSaver Cable Lock	73P2582	Kensington Twin Head Cable Lock	45K1620	Lenovo Easy Reach Monitor Stand	55Y9258
Kensington MicroSaver Cable Lock	73P2582						
Kensington Twin Head Cable Lock	45K1620						
Lenovo Easy Reach Monitor Stand	55Y9258						



<p>Name T1714p Square Flat Panel Monitor Case color Black Type-model 60FELAT1US / 60FELAR1US / 60FELAT1EU Panel TFT-LCD, twisted nematic (TN), White LED backlight Viewable image size 17.0" (432mm) diagonal Max view area (W x H) 13.3" x 10.6" (337.9mm x 270.3mm) Optimum resolution 1280x1024 Aspect ratio 5:4 Pixel pitch (mm) 0.264mm Dot/Pixel per Inch 96 dpi Brightness 250 nits or cd/m² (typical) Contrast ratio 1000:1 (typical) Pixel response time 5ms (typical) Color gamut 72% Viewing angle at 10:1 CR 170° (+/- 85°) horizontal, 160° (+/- 80°) vertical Stand Tilt height adjustable stand Bezel width Sides: 0.69" (17.5mm) Dimensions 17.63" H x 14.74" W x 9.61" D; (HxWxD, including stand) 447.9mm H x 374.5mm W x 244.2mm D Power supply 14.0 watts typical, 18.0 watts maximum, <0.5 watts standby/suspend, universal, integrated (no external brick-like power supply) Weight 8.71 lb; 3.95kg Limited warranty 3 year (includes backlight) Available date September 2015</p>	<p>Features</p> <ul style="list-style-type: none"> • 17-inch Square LCD monitor • Supports SXGA 1280x1024 resolution • Includes dual input connection for attachment to two systems concurrently (analog and digital) • Mercury Arsenic free glass • Supports Lenovo Tiny PC and 3rd party thin client via optional Lenovo bracket • Supports optional soundbar • Microsoft® Windows® 7 certified • Microsoft Windows 8 certified • Microsoft Windows 8.1 certified • Microsoft Windows 10 certified 						
<p>VESA-compliant VESA DDC2B/CI Power management ENERGY STAR® 7.0 Ergonomics ISO 9241-307 Emission standards FCC Class B Environmental TCO Displays 7.0, TCO Certified Edge 2.0, WEEE, RoHS, EPEAT™ Gold rating</p>	<div style="text-align: center;">  <p>ThinkVision T1714p Monitor</p> </div>						
<p>Preset resolutions VGA: 640x350, 640x480, 720x400 SVGA: 800x600 XGA: 1024x768, 1152x864, SXGA: 1280x800, 1280x1024 Presets / user settings Standard presets: 22; user settings: 22</p>							
<p>Viewing adjustments Tilt: 22° back, -5° forward; lift: 4.3" (110mm) Rotating screen None On screen display On screen display with digital user controls (8 languages) Control features Direct access (buttons on front) for automatic image setup and brightness Multiple input Dual input (two different PCs attach to two different connectors; one PC shows image; select via button) Monitor connectors (1) VGA 15-pin D-shell, analog, blue (2) Digital Visual Interface (DVI-D), digital, white, HDCP-compliant (3) DisplayPort, digital, black, HDCP-compliant Signal cables (1) detachable, VGA 15-pin D-shell at each end, analog, 1.8 meter (2) detachable, DVI-D at each end, digital, 1.8 meter Mounting features Wall or desk mounting using the Extend Arm or third-party accessories meeting the VESA FPMPI® (100mm mount) Security Security keyhole for attachment of optional cable lock (Kensington® lock-compatible)</p>	<p>Ship group Monitor and stand, Setup poster, Safety and Warranty Information, 1.8 meter analog signal cable, 1.8 meter DVI-D cable, 1.8 meter black power cord</p>						
<p style="text-align: center;">Limited Warranty</p> <p>See details at http://support.lenovo.com/en_US/guides-and-manuals/detail.page?DocID=UM008281</p>	<p style="text-align: center;">Accessories</p> <table border="0"> <tr> <td>Kensington MicroSaver Cable Lock</td> <td style="text-align: right;">73P2582</td> </tr> <tr> <td>Kensington Twin Head Cable Lock</td> <td style="text-align: right;">45K1620</td> </tr> <tr> <td>Lenovo Easy Reach Monitor Stand</td> <td style="text-align: right;">55Y9258</td> </tr> </table> <p>See details at www.lenovo.com/support/monitoraccessories</p> <p>See all monitors at www.lenovo.com/thinkvision</p>	Kensington MicroSaver Cable Lock	73P2582	Kensington Twin Head Cable Lock	45K1620	Lenovo Easy Reach Monitor Stand	55Y9258
Kensington MicroSaver Cable Lock	73P2582						
Kensington Twin Head Cable Lock	45K1620						
Lenovo Easy Reach Monitor Stand	55Y9258						



<p>Name T2054p Wide Flat Panel Monitor Bezel color Raven black Type-model 60G1MAR2US / 60G1MAT2US / 60G1MAT2EU Panel TFT-LCD, In-Plane Switching (IPS), White LED backlight</p> <p>Viewable image size 19.5" (495mm) diagonal Max view area (W x H) 16.48" x 10.33" (418.6mm x 262.4mm) Native resolution 1440x900 Aspect ratio 16:10 Pixel pitch (mm) 0.2915 x 0.2915 mm Dot/Pixel per Inch 87 dpi Brightness 250 nits or cd/m² (typical) Contrast ratio 1000:1 (typical) Pixel response time 7ms (typical) Color gamut 72% Viewing angle at 10:1 CR 178° (+/- 89°) horizontal, 178° (+/- 89°) vertical Stand Tilt, swivel, and height adjustable Bezel width Sides: 0.67" (17.0mm) Dimensions (HxWxD) 13.62" H x 17.88" W x 9.55" D; 345.9mm H x 454.2mm W x 242.6mm D</p> <p>Power supply 14.5 watts typical, 21 watts maximum, <0.3 watts standby/suspend, universal, integrated (no external brick-like power supply)</p> <p>Weight 8.16 lb; 3.70 kg Limited warranty⁴ 3 year (includes backlight) Available date September 2015</p>	<p style="text-align: center;">Features</p> <ul style="list-style-type: none"> • Widescreen 19.5-inch monitor • Supports 1440x900 resolution • Supports ThinkCentre Tiny Clamp Bracket • Includes dual input connection for attachment to two systems concurrently (analog and digital) • EPEAT Gold certified • Supports optional soundbar • Microsoft® Windows® 7 certified • Microsoft Windows 8 / Windows 8.1 certified • Microsoft Windows 10 certified 				
<p>VESA-compliant² VESA DDC2B/CI Power management ENERGY STAR® qualified Ergonomics ISO 9241-307 Emission standards FCC Class B Environmental TCO Displays 7.0, TCO Certified Edge 2.0, WEEE, RoHS, EPEAT™ Gold rating</p>	<div style="text-align: center;">  <p>ThinkVision T2054p Wide Monitor</p> </div>				
<p>Preset resolutions VGA: 640x480, 720x400, 720x576 SVGA: 800x600 XGA: 1024x768, 1152x864 SXGA: 1280x800, 1280x1024 WXGA: 1366x768 WXGA+: 1440x900</p> <p>Presets / user settings Standard presets: 22 user settings: 16</p>					
<p>Viewing adjustments Tilt: 22° backward, -5° forward; lift: 4.3" (110mm); swivel: +/-45°; detachable stand Rotating screen None On screen display On screen display with digital user controls (8 languages) Control features Direct access (buttons on front) for automatic image setup, dual input and brightness Multiple input Dual input (two different PCs attach to two different connectors; one PC shows image; select via button) Monitor connectors (1) VGA 15-pin D-shell, analog, blue (2) HDMI (1.4), digital, HDCP-compliant (3) DisplayPort, digital, black, HDCP-compliant</p> <p>Signal cables (1) detachable, VGA 15-pin D-shell at each end, analog, 1.8 meter (2) detachable, DisplayPort at each end, digital, 1.8 meter</p> <p>Mounting features Wall or desk mounting using the Extend Arm or third-party accessories, 100mm x 100mm mount Security Security keyhole for attachment of optional cable lock (Kensington® lock-compatible)</p> <p>Ship group Monitor with stand, Safety and Warranty Information, 1.8 meter analog signal cable, 1.8 meter DP signal cable, 1.8 meter black power cord</p>					
<p style="text-align: center;">Limited Warranty</p> <p>See details at http://support.lenovo.com/en_US/guides-and-manuals/detail.page?DocID=UM008281</p>	<p style="text-align: center;">Accessories</p> <table border="0"> <tr> <td>Kensington MicroSaver Cable Lock</td> <td style="text-align: right;">73P2582</td> </tr> <tr> <td>Kensington Twin Head Cable Lock</td> <td style="text-align: right;">45K1620</td> </tr> </table> <p>See details at www.lenovo.com/support/monitoraccessories</p> <p>See all monitors at www.lenovo.com/thinkvision</p>	Kensington MicroSaver Cable Lock	73P2582	Kensington Twin Head Cable Lock	45K1620
Kensington MicroSaver Cable Lock	73P2582				
Kensington Twin Head Cable Lock	45K1620				



<p>Name LT2423 Wide Flat Panel Monitor Case color Business black Type-model 60A8KAR2US / 60A8KAT2US / 60A8KAT2EU Panel TFT-LCD, twisted nematic (TN), White LED backlight Viewable image size 24" (610mm) diagonal Max view area (W x H) 20.9" x 11.8" (531.4mm x 298.9mm) Optimum resolution 1920x1080 Max pixel rate 205MHz Aspect ratio 16:9 Pixel pitch (mm) 0.278mm Dot/Pixel per Inch 92 dpi Brightness 250 nits or cd/m² (typical) Contrast ratio 1000:1 (typical) Contrast ratio 2000000:1 Pixel response time 5ms Color gamut 72% Viewing angle at 10:1 CR 170° horizontal, 160° vertical Stand Tilt stand Bezel width Sides: 0.67" (17.0mm); top: 0.67" (17.0mm); bottom: 1.02" (26.0mm) Dimensions (HxWxD, excluding stand) 13.53" H x 22.33" W x 1.97" D; Dimensions (HxWxD, including stand) 343.7mm H x 567.1mm W x 50.0mm D Dimensions (HxWxD, including stand) 16.30" H x 22.33" W x 8.50" D; Dimensions (HxWxD, including stand) 414.3mm H x 567.1mm W x 216.7mm D Power supply 21 watts typical, 31 watts maximum, <0.5 watts standby/suspend, universal, integrated (no external brick-like power supply) Weight 8.30 lb; 3.76kg Limited warranty⁴ 3 year (includes backlight) Available date July 2013</p>	<p>Features</p> <ul style="list-style-type: none"> • Widescreen 24-inch monitor • Supports 1920x1080 resolution • Two 3W stereo speakers • Audio in (3.5mm) • Supports VGA and HDMI 1.4 interfaces • Supports optional soundbar • Support Lenovo Tiny PC and 3rd party thin client via optional Lenovo bracket • Microsoft® Windows® 8 certified • Arsenic/Lead/Mercury free 										
<p>VESA-compliant² VESA DDC2B/CI Power management ENERGY STAR® 6.0 Ergonomics ISO 9241-307 Emission standards MPR-2, FCC Class B Environmental TCO Displays 6.0, TCO Certified Edge 1.2, WEEE, RoHS, EPEAT™ Gold rating, ULE Gold</p> <p>Preset resolutions VGA: 640x350, 640x480, 720x400 SVGA: 800x600, 832x624 XGA: 1024x768, 1152x864 SXGA: 1280x1024 WXGA: 1366x768 WXGA+: 1440x900, 1600x900 WSXGA+: 1680x1050 Full HD: 1920x1080</p> <p>Presets / user settings Standard presets: 24; User settings: 20</p>	 <p>ThinkVision LT2423 Wide Monitor</p>										
<p>Viewing adjustments Tilt: 22° back, -5° forward Rotating screen None On screen display On screen display with digital user controls (8 languages) Control features Direct access (buttons on front) for automatic image setup, input switch, and brightness Multimedia Integrated stereo speakers (3 watts x 2) Multiple input Dual input (two different PCs attach to two different connectors; one PC shows image; select via button) Monitor connectors (1) VGA 15-pin D-shell, analog, blue (2) HDMI (1.4), digital, HDCP-compliant Signal cables (1) detachable, VGA 15-pin D-shell at each end, analog, 1.8 meter Mounting features Wall or desk mounting using the Extend Arm or third-party accessories meeting the VESA FPMPI® (100mm mount) Security Security keyhole for attachment of optional cable lock (Kensington® lock-compatible)</p>											
<p>Ship group Monitor, attached stand, Setup poster, Safety and Warranty Information, 1.8 meter analog signal cable, 1.8 meter Audio cable, 1.8 meter black power cord</p>											
<p>Limited Warranty</p> <p>See details at http://support.lenovo.com/en_US/guides-and-manuals/detail.page?DocID=UM008281</p>	<p>Accessories</p> <table border="0"> <tr> <td>Kensington MicroSaver Cable Lock</td> <td>73P2582</td> </tr> <tr> <td>Kensington Twin Head Cable Lock</td> <td>45K1620</td> </tr> <tr> <td>Lenovo Security Cable Lock</td> <td>57Y4303</td> </tr> <tr> <td>ThinkCentre Extend Arm</td> <td>57Y4352</td> </tr> <tr> <td>Lenovo Easy Reach Monitor Stand</td> <td>55Y9258</td> </tr> </table> <p>See details at www.lenovo.com/support/monitoraccessories</p> <p>See all monitors at www.lenovo.com/thinkvision</p>	Kensington MicroSaver Cable Lock	73P2582	Kensington Twin Head Cable Lock	45K1620	Lenovo Security Cable Lock	57Y4303	ThinkCentre Extend Arm	57Y4352	Lenovo Easy Reach Monitor Stand	55Y9258
Kensington MicroSaver Cable Lock	73P2582										
Kensington Twin Head Cable Lock	45K1620										
Lenovo Security Cable Lock	57Y4303										
ThinkCentre Extend Arm	57Y4352										
Lenovo Easy Reach Monitor Stand	55Y9258										

See footnotes for important warranty information
 US model announced June 25, 2013



<p>Name P24h Wide Flat Panel Monitor Bezel color Black Type-model 61AEGAR3US / 61AEGAT3EU Panel TFT-LCD, In-Plane Switching (IPS), White LED backlight Viewable image size 23.8" (604.7mm) diagonal Max view area (W x H) 20.74" x 11.67" (526.9mm x 296.4mm) Native resolution 2560x1440 Aspect ratio 16:9 Pixel pitch (mm) 0.2058x 0.2058 mm Dot/Pixel per Inch 124 dpi Brightness 300 nits or cd/m² (typical) Contrast ratio 1000:1 (typical) Pixel response time 4ms (extreme) / 6ms (typical) Color gamut 99% sRGB Viewing angle at 10:1 CR 178° (+/- 89°) horizontal, 178° (+/- 89°) vertical Stand Tilt, swivel, pivot, and height adjustable stand Bezel width <i>Sides:</i> 0.08" (2.0mm) Dimensions (HxWxD) 14.7" H x 21.26" W x 10.3" D; 373.4mm H x 540.2mm W x 261.75mm D Power supply 24 watts typical, 120 watts maximum (with USB 3.0 hub), <0.5 watts standby/suspend, universal, integrated (no external brick-like power supply) Weight 12.54 lb; 5.69 kg Limited warranty 3 year (includes backlight) Available date April 2017</p>	<p style="text-align: center;">Features</p> <ul style="list-style-type: none"> • Widescreen 23.8-inch monitor • Supports 2560x1440 resolution • Supports optional soundbar • Supports ThinkCentre Tiny Clamp Bracket • Includes dual input connection for attachment to two systems concurrently • EPEAT Gold certified • Microsoft® Windows® 7 certified • Microsoft Windows 10 certified 				
<p>VESA-compliant VESA DDC2B/CI Power management ENERGY STAR® qualified Ergonomics ISO 9241-307 Emission standards FCC Class B Environmental TCO Displays 7.0, TCO Certified Edge 2.0, WEEE, RoHS, EPEAT™ Gold rating</p>	<div style="text-align: center;">  <p>ThinkVision P24h Wide Monitor</p> </div>				
<p>Preset resolutions VGA: 640x480, 720x400 SVGA: 800x600 XGA: 1024x768 SXGA: 1280x1024 WXGA: 1366x768 WXGA+: 1440x900, 1680x900 WSXGA+: 1680x1050 Full HD: 1920x1080, 1920x1200 QHD: 2560x1440 Presets display modes HDMI: 22; DP: 14</p>					
<p>Viewing adjustments <i>Tilt:</i> 30° back, -5° forward; <i>lift:</i> 4.3" (110mm); <i>swivel:</i> +/-45°; detachable stand Rotating screen Screen pivots 90 degrees from landscape to portrait On screen display On screen display with digital user controls (8 languages) Control features Direct access (buttons on front) for power, menu, input source select and brightness USB hub USB Hub: one USB Type-C upstream port, four USB 3.0 downstream ports Multimedia Audio-out, optional sound bar supported Camera None Multiple input Support HDMI, DisplayPort, USB 3.1 Type-C, DisplayPort-out Monitor connectors (1) 2*HDMI (1.4), digital, HDCP-compliant (2) DisplayPort (1.2), digital, HDCP-compliant (3) DisplayPort-out, digital (4) USB 3.1 Type-C Signal cables (1) USB 3.1 Type-C cable, 1.8 meter Mounting features Wall or desk mounting using the Extend Arm or third-party accessories, 100mm x 100mm mount Security Security keyhole for attachment of optional cable lock (Kensington® lock-compatible)</p>					
<p>Ship group Monitor with stand, Safety and Warranty Information, 1.8 meter USB 3.1 Type-C cable, 1.8 meter black power cord</p>	<p style="text-align: center;">Accessories</p> <table border="0" style="width: 100%;"> <tr> <td>Kensington MicroSaver Cable Lock</td> <td style="text-align: right;">73P2582</td> </tr> <tr> <td>Kensington Twin Head Cable Lock</td> <td style="text-align: right;">45K1620</td> </tr> </table> <p>See details at www.lenovo.com/support/monitoraccessories</p> <p>See all monitors at www.lenovo.com/thinkvision</p>	Kensington MicroSaver Cable Lock	73P2582	Kensington Twin Head Cable Lock	45K1620
Kensington MicroSaver Cable Lock	73P2582				
Kensington Twin Head Cable Lock	45K1620				



<p>Name P24q Wide Flat Panel Monitor Case color Black Type-model 61A5GAR3US / 61A5GAT3EU Panel TFT-LCD, IPS (In-Plane Switching), White LED backlight Viewable image size 23.8" (604.5mm) diagonal Max view area (W x H) 20.74" x 11.67" (526.85mm x 296.35mm) Optimum resolution 2560x1440 Max pixel rate 300MHz Aspect ratio 16:9 Pixel pitch (mm) 0.2058 x 0.2058mm Dot/Pixel per Inch 123 dpi Brightness 300 nits or cd/m² (typical) Contrast ratio 1000:1 (typical) Pixel response time 4ms Color gamut 99% sRGB Viewing angle at 10:1 CR 178° horizontal, 178° vertical Stand Tilt, swivel, pivot, and height adjustable stand Bezel width Sides: 0.08" (2mm) Dimensions (HxWxD, including stand) 373.4mm H x 540.2mm W x 261.75mm D Power supply 24 watts typical, 67 watts maximum (with USB), <0.5 watts sleep/off; <0.5 watts switch off integrated (no external brick-like power supply) Weight 12.35 lb; 5.6kg (including stand) Limited warranty 3 year Available date January 2017</p>	<p>Features</p> <ul style="list-style-type: none"> • 23.8-inch IPS LED backlight monitor • Supports 2560x1440 resolution • 5-Ports USB hub, support USB 3.0 • Support ThinkCentre Tiny • Supports optional soundbar • Microsoft® Windows® 7 certified • Microsoft Windows 10 certified 						
<p>VESA-compliant VESA DDC2B/CI Power management ENERGY STAR® 7.0 Ergonomics ISO 9241-307 Emission standards FCC Class B Environmental TCO Displays 7.0, RoHS, EPEAT™ Gold rating, ULE Gold</p>	 <p>ThinkVision P24q Monitor</p>						
<p>Preset resolutions VGA: 640x480, 720x400 SVGA: 800x600 XGA: 1024x768 SXGA: 1280x1024 WXGA: 1366x768 WXGA+: 1440x900, 1600x900 WSXGA+: 1680x1050 Full HD: 1920x1080, 1920x1200 QHD: 2560x1440</p> <p>Presets / user settings Standard presets: 20; user settings: 24</p>							
<p>Viewing adjustments <i>Tilt: 30° back, -5° forward; lift: 4.33" (110mm); swivel: +/-45°</i> Rotating screen Screen pivots 90 degrees from landscape to portrait On screen display On screen display with digital user controls (8 languages) Control features Direct access for menu, source switch, and brightness USB hub USB Hub: one USB 3.0 upstream port, four USB 3.0 downstream ports Multimedia Audio-out, optional sound bar supported Camera None Multiple input Support HDMI, DisplayPort, mini DisplayPort, DisplayPort-out Monitor connectors (1) 2*HDMI (1.4), digital, HDCP-compliant (2) DisplayPort (1.2), digital, HDCP-compliant (3) Mini DisplayPort, digital, HDCP-compliant Signal cables (1) detachable, mini DisplayPort to DisplayPort, digital, 1.8 meter Mounting features Wall or desk mounting using the Extend Arm or third-party accessories meeting the VESA FPMPI® (100mm mount) Security Security keyhole for attachment of optional cable lock (Kensington® lock-compatible)</p>							
<p>Ship group Monitor, detachable stand, Quick start and safety poster, 1.8 meter USB 3.0 cable, 1.8 meter mini DP to DP cable, 1.8 meter black power cord</p>	<p>Limited Warranty</p> <p>See details at http://support.lenovo.com/en_US/guides-and-manuals/detail.page?DocID=UM008281</p> <p>Accessories</p> <table border="0"> <tr> <td>Kensington MicroSaver Cable Lock</td> <td>73P2582</td> </tr> <tr> <td>Kensington Twin Head Cable Lock</td> <td>45K1620</td> </tr> <tr> <td>Lenovo Security Cable Lock</td> <td>57Y4303</td> </tr> </table> <p>See details at www.lenovo.com/support/monitoraccessories</p> <p>See all monitors at www.lenovo.com/thinkvision</p>	Kensington MicroSaver Cable Lock	73P2582	Kensington Twin Head Cable Lock	45K1620	Lenovo Security Cable Lock	57Y4303
Kensington MicroSaver Cable Lock	73P2582						
Kensington Twin Head Cable Lock	45K1620						
Lenovo Security Cable Lock	57Y4303						



<p>Name T2224d Wide Flat Panel Monitor Bezel color Black Type-model 61B1JAR1US / 61B1JAT1EU Panel TFT-LCD, In-Plane Switching (IPS), White LED backlight Viewable image size 21.5" (546mm) diagonal Max view area (W x H) 18.74" x 10.54" (476.1mm x 267.8mm) Native resolution 1920x1080 Aspect ratio 16:9 Pixel pitch (mm) 0.248 x 0.248 mm Dot/Pixel per Inch 102 dpi Brightness 250 nits or cd/m² (typical) Contrast ratio 1000:1 (typical) Pixel response time 7ms (typical); 4ms (extreme mode) Color gamut 72% Viewing angle at 10:1 CR 178° (+/- 89°) horizontal, 178° (+/- 89°) vertical Stand Tilt stand Bezel width <i>Sides:</i> 0.69" (17.6mm) Dimensions (HxWxD) 15.02" H x 20.19" W x 8.06" D; 381.4mm H x 512.9mm W x 204.9mm D Power supply 20 watts typical, 25 watts maximum <0.5 watts standby/suspend, universal, integrated (no external brick-like power supply) Weight 6.48 lb; 2.94 kg Limited warranty 3 year (includes backlight) Available date March 2017</p>	<p style="text-align: center;">Features</p> <ul style="list-style-type: none"> • Widescreen 21.5-inch monitor • Supports 1920x1080 resolution • Supports optional soundbar • Supports ThinkCentre Tiny via VESA back mount • Includes dual input connection for attachment to two systems concurrently (analog and digital) • EPEAT Gold certified • Microsoft® Windows® 7 certified • Microsoft Windows 10 certified 				
<p>VESA-compliant VESA DDC2B/CI Power management ENERGY STAR® qualified Ergonomics ISO 9241-307 Emission standards FCC Class B Environmental TCO Displays 7.0, TCO Certified Edge 2.0, WEEE, RoHS, EPEAT™ Gold rating</p>	<div style="text-align: center;">  <p>ThinkVision T2224d Wide Monitor</p> </div>				
<p>Preset resolutions VGA: 640x350, 640x480, 720x400 SVGA: 800x600 XGA: 1024x768, 1152x864 SXGA: 1280x1024 WXGA: 1280x768, 1280x800, 1366x768 WXGA+: 1440x900 WSXGA+: 1680x1050 Full HD: 1920x1080 Presets / user settings Standard presets: 22; user settings: 22</p>					
<p>Viewing adjustments <i>Tilt:</i> 22° back, -5° forward Rotating screen None On screen display On screen display with digital user controls (8 languages) Control features Direct access (buttons on front) for automatic image setup, dual input and brightness USB hub None Multiple input Dual input (two different PCs attach to two different connectors; one PC shows image; select via button) Monitor connectors (1) VGA 15-pin D-shell, analog, blue (2) DisplayPort, digital, black, HDCP-compliant Signal cables (1) detachable, VGA 15-pin D-shell at each end, analog, 1.8 meter (2) detachable, DisplayPort at each end, digital, 1.8 meter Mounting features Wall or desk mounting using the Extend Arm or third-party accessories, 100mm x 100mm mount Security Security keyhole for attachment of optional cable lock (Kensington® lock-compatible)</p>					
<p>Ship group Monitor with stand, Safety and Warranty Information, 1.8 meter analog signal cable, 1.8 meter DP signal cable, 1.8 meter black power cord</p>					
<p style="text-align: center;">Limited Warranty</p> <p>See details at http://support.lenovo.com/en_US/guides-and-manuals/detail.page?DocID=UM008281</p>	<p style="text-align: center;">Accessories</p> <table border="0" style="width: 100%;"> <tr> <td>Kensington MicroSaver Cable Lock</td> <td style="text-align: right;">73P2582</td> </tr> <tr> <td>Kensington Twin Head Cable Lock</td> <td style="text-align: right;">45K1620</td> </tr> </table> <p>See details at www.lenovo.com/support/monitoraccessories</p> <p>See all monitors at www.lenovo.com/thinkvision</p>	Kensington MicroSaver Cable Lock	73P2582	Kensington Twin Head Cable Lock	45K1620
Kensington MicroSaver Cable Lock	73P2582				
Kensington Twin Head Cable Lock	45K1620				



<p>Name T2224z Wide Flat Panel Monitor Bezel color Raven black Type-model 60F5MAR6US / 60F5MAT6US / 60F5MAT6EU Panel TFT-LCD, In-Plane Switching (IPS), White LED backlight</p> <p>Viewable image size 21.5" (546mm) diagonal Max view area (W x H) 18.74" x 10.54" (476.1mm x 267.8mm) Native resolution 1920x1080 Aspect ratio 16:9 Pixel pitch (mm) 0.248 x 0.248 mm Dot/Pixel per Inch 102 dpi Brightness 250 nits or cd/m² (typical) Contrast ratio 1000:1 (typical) Pixel response time 7ms (typical) Color gamut 72% Viewing angle at 10:1 CR 178° (+/- 89°) horizontal, 178° (+/- 89°) vertical Stand Tilt, swivel, pivot, and height adjustable stand Bezel width <i>Sides:</i> 0.69" (17.6mm) Dimensions (HxWxD) 14.08" H x 20.19" W x 9.55" D; 357.8mm H x 512.9mm W x 242.7mm D</p> <p>Power supply 21 watts typical, 25 watts maximum (without USB 3.0 hub), 45 watts maximum (with USB 3.0 hub), <0.5 watts standby/suspend, universal, integrated (no external brick-like power supply)</p> <p>Weight 10.63 lb; 4.83 kg Limited warranty 3 year (includes backlight) Available date March 2015</p>	<p style="text-align: center;">Features</p> <ul style="list-style-type: none"> • Widescreen 21.5-inch monitor • Supports 1920x1080 resolution • Supports ThinkCentre Tiny Clamp Bracket • Supports optional soundbar • Includes dual input connection for attachment to two systems concurrently (analog and digital) • EPEAT Gold certified • Microsoft® Windows® 7 certified • Microsoft Windows 8 / Windows 8.1 certified • Microsoft Windows 10 certified 				
<p>VESA-compliant VESA DDC2B/CI Power management ENERGY STAR® qualified Ergonomics ISO 9241-307 Emission standards FCC Class B Environmental TCO Displays 7.0, TCO Certified Edge 2.0, WEEE, RoHS, EPEAT™ Gold rating</p>	<div style="text-align: center;">  <p>ThinkVision T2224z Wide Monitor</p> </div>				
<p>Preset resolutions VGA: 640x350, 640x480, 720x400 SVGA: 800x600 XGA: 1024x768, 1152x864 SXGA: 1280x1024 WXGA: 1280x768, 1280x800, 1366x768 WXGA+: 1440x900 WSXGA+: 1680x1050 Full HD: 1920x1080</p> <p>Presets / user settings Standard presets: 27; user settings: 20</p>					
<p>Viewing adjustments <i>Tilt:</i> 30° back, -5° forward; <i>lift:</i> 4.3" (110mm); <i>swivel:</i> +/-45°; detachable stand Rotating screen Screen pivots 90 degrees from landscape to portrait On screen display On screen display with digital user controls (8 languages) Control features Direct access (buttons on front) for automatic image setup, dual input and brightness USB hub USB 3.0 Hub: 1 port into PC (USB 3.0); 2 ports for accessories (2 USB 3.0) Multimedia Integrated digital speakers (3 watts x 2) Camera Integrated camera (Full HD) and digital dual array microphone Multiple input Dual input (two different PCs attach to two different connectors; one PC shows image; select via button) Monitor connectors (1) VGA 15-pin D-shell, analog, blue (2) HDMI (1.4), digital, HDCP-compliant (3) DisplayPort, digital, black, HDCP-compliant</p> <p>Signal cables (1) detachable, VGA 15-pin D-shell at each end, analog, 1.8 meter (2) detachable, DisplayPort at each end, digital, 1.8 meter</p> <p>Mounting features Wall or desk mounting using the Extend Arm or third-party accessories, 100mm x 100mm mount Security Security keyhole for attachment of optional cable lock (Kensington® lock-compatible)</p>					
<p>Ship group Monitor with stand, Safety and Warranty Information, 1.8 meter analog signal cable, 1.8 meter DP signal cable, 1.8 meter USB signal cable, 1.8 meter black power cord</p>					
<p style="text-align: center;">Limited Warranty</p> <p>See details at http://support.lenovo.com/en_US/guides-and-manuals/detail.page?DocID=UM008281</p>	<p style="text-align: center;">Accessories</p> <table border="0" style="width: 100%;"> <tr> <td>Kensington MicroSaver Cable Lock</td> <td style="text-align: right;">73P2582</td> </tr> <tr> <td>Kensington Twin Head Cable Lock</td> <td style="text-align: right;">45K1620</td> </tr> </table> <p>See details at www.lenovo.com/support/monitoraccessories</p> <p>See all monitors at www.lenovo.com/thinkvision</p>	Kensington MicroSaver Cable Lock	73P2582	Kensington Twin Head Cable Lock	45K1620
Kensington MicroSaver Cable Lock	73P2582				
Kensington Twin Head Cable Lock	45K1620				



<p>Name T2254p Wide Flat Panel Monitor Bezel color Raven black Type-model 60CCMAR2US / 60CCMAT2US / 60CCMAT2EU Panel TFT-LCD, twisted nematic (TN), White LED backlight Viewable image size 22.0" (559mm) diagonal Max view area (W x H) 18.70" x 11.70" (473.8mm x 296.1mm) Native resolution 1680x1050 Aspect ratio 16:10 Pixel pitch (mm) 0.282 x 0.282 mm Dot/Pixel per Inch 90 dpi Brightness 250 nits or cd/m² (typical) Contrast ratio 1000:1 (typical) Pixel response time 5ms (typical) Color gamut 72% Viewing angle at 10:1 CR 170° (+/- 85°) horizontal, 160° (+/- 80°) vertical Stand Tilt, swivel, pivot, and height adjustable stand Bezel width Sides: 0.67" (17.1mm) Dimensions (HxWxD) 14.63" H x 20.01" W x 9.55" D; 371.7mm H x 509.3mm W x 242.7mm D Power supply 20 watts typical, 25 watts maximum, <0.5 watts standby/suspend, universal, integrated (no external brick-like power supply) Weight 10.14 lb; 4.60 kg Limited warranty 3 year (includes backlight) Available date March 2015</p>	<p style="text-align: center;">Features</p> <ul style="list-style-type: none"> • Widescreen 22.0-inch monitor • Supports 1680x1050 resolution • Supports ThinkCentre Tiny Clamp Bracket • Supports optional soundbar • Includes dual input connection for attachment to two systems concurrently (analog and digital) • EPEAT Gold certified • Microsoft® Windows® 7 certified • Microsoft Windows 8 / Windows 8.1 certified • Microsoft Windows 10 certified 				
<p>VESA-compliant VESA DDC2B/CI Power management ENERGY STAR® qualified Ergonomics ISO 9241-307 Emission standards FCC Class B Environmental TCO Displays 7.0, TCO Certified Edge 2.0, WEEE, RoHS, EPEAT™ Gold rating</p>	<div style="text-align: center;">  <p>ThinkVision T2254p Wide Monitor</p> </div>				
<p>Preset resolutions VGA: 640x350, 640x480, 720x400 SVGA: 800x600 XGA: 1024x768, 1152x864 SXGA: 1280x1024 WXGA: 1280x768, 1280x800, 1366x768 WXGA+: 1440x900 WSXGA+: 1600x900, 1680x1050 Presets / user settings Standard presets: 28; user settings: 20</p>					
<p>Viewing adjustments Tilt: 30° back, -5° forward; lift: 4.3" (110mm); swivel: +/-45°; detachable stand Rotating screen Screen pivots 90 degrees from landscape to portrait On screen display On screen display with digital user controls (8 languages) Control features Direct access (buttons on front) for automatic image setup, dual input and brightness USB hub None Multiple input Dual input (two different PCs attach to two different connectors; one PC shows image; select via button) Monitor connectors (1) VGA 15-pin D-shell, analog, blue (2) HDMI (1.4), digital, HDCP-compliant (3) DisplayPort, digital, black, HDCP-compliant Signal cables (1) detachable, VGA 15-pin D-shell at each end, analog, 1.8 meter (2) detachable, DisplayPort at each end, digital, 1.8 meter Mounting features Wall or desk mounting using the Extend Arm or third-party accessories, 100mm x 100mm mount Security Security keyhole for attachment of optional cable lock (Kensington® lock-compatible)</p>					
<p>Ship group Monitor with stand, Safety and Warranty Information, 1.8 meter analog signal cable, 1.8 meter DP signal cable, 1.8 meter black power cord</p>					
<p style="text-align: center;">Limited Warranty</p> <p>See details at http://support.lenovo.com/en_US/guides-and-manuals/detail.page?DocID=UM008281</p>	<p style="text-align: center;">Accessories</p> <table border="0"> <tr> <td>Kensington MicroSaver Cable Lock</td> <td style="text-align: right;">73P2582</td> </tr> <tr> <td>Kensington Twin Head Cable Lock</td> <td style="text-align: right;">45K1620</td> </tr> </table> <p>See details at www.lenovo.com/support/monitoraccessories</p> <p>See all monitors at www.lenovo.com/thinkvision</p>	Kensington MicroSaver Cable Lock	73P2582	Kensington Twin Head Cable Lock	45K1620
Kensington MicroSaver Cable Lock	73P2582				
Kensington Twin Head Cable Lock	45K1620				



<p>Name T22i Wide Flat Panel Monitor Bezel color Black Type-model 61A9MAR1US / 61A9MAT1EU Panel TFT-LCD, In-Plane Switching (IPS), White LED backlight Viewable image size 21.5" (546mm) diagonal Max view area (W x H) 18.74" x 10.54" (476.1mm x 267.8mm) Native resolution 1920x1080 Aspect ratio 16:9 Pixel pitch (mm) 0.248 x 0.248 mm Dot/Pixel per Inch 102 dpi Brightness 250 nits or cd/m² (typical) Contrast ratio 1000:1 (typical) Pixel response time 6ms (typical); 4ms (extreme mode) Color gamut 72% Viewing angle at 10:1 CR 178° (+/- 89°) horizontal, 178° (+/- 89°) vertical Stand Tilt, swivel, pivot, and height adjustable stand Bezel width <i>Sides:</i> 0.08" (2.0mm) Dimensions (HxWxD) 14.08" H x 19.28" W x 9.92" D; 357.6mm H x 489.7mm W x 251.9mm D Power supply 16.5 watts typical, 55 watts maximum (with USB 3.0 hub), <0.5 watts standby/suspend, universal, integrated (no external brick-like power supply) Weight 10.85 lb; 4.92 kg Limited warranty 3 year (includes backlight) Available date April 2017</p>	<p style="text-align: center;">Features</p> <ul style="list-style-type: none"> • Widescreen 21.5-inch monitor • Supports 1920x1080 resolution • Supports optional soundbar • Supports ThinkCentre Tiny via VESA back mount • Includes dual input connection for attachment to two systems concurrently • EPEAT Gold certified • Microsoft® Windows® 7 certified • Microsoft Windows 10 certified 				
<p>VESA-compliant VESA DDC2B/CI Power management ENERGY STAR® qualified Ergonomics ISO 9241-307 Emission standards FCC Class B Environmental TCO Displays 7.0, TCO Certified Edge 2.0, WEEE, RoHS, EPEAT™ Gold rating</p>	<div style="text-align: center;">  <p>ThinkVision T22i Wide Monitor</p> </div>				
<p>Preset resolutions VGA: 640x350, 640x480, 720x400 SVGA: 800x600 XGA: 1024x768, 1152x864 SXGA: 1280x1024 WXGA: 1280x768, 1366x768 WXGA+: 1440x900, 1680x900 WSXGA+: 1680x1050 Full HD: 1920x1080 Presets display modes HDMI: 17; DP: 17</p>					
<p>Viewing adjustments <i>Tilt:</i> 30° back, -5° forward; <i>lift:</i> 4.3" (110mm); <i>swivel:</i> +/-45°; detachable stand Rotating screen Screen pivots 90 degrees from landscape to portrait On screen display On screen display with digital user controls (8 languages) Control features Direct access (buttons on front) for power, menu, input source select and brightness USB hub USB 3.0 Hub: 1 port into PC (USB 3.0); 4 ports for accessories (4 USB 3.0) Multiple input Dual input (two different PCs attach to two different connectors; one PC shows image; select via button) Monitor connectors (1) VGA 15-pin D-shell, analog, blue (2) HDMI (1.4), digital, HDCP-compliant (3) DisplayPort, digital, black, HDCP-compliant Signal cables (1) detachable, VGA 15-pin D-shell at each end, analog, 1.8 meter (2) detachable, DisplayPort at each end, digital, 1.8 meter Mounting features Wall or desk mounting using the Extend Arm or third-party accessories, 100mm x 100mm mount Security Security keyhole for attachment of optional cable lock (Kensington® lock-compatible)</p>					
<p>Ship group Monitor with stand, Safety and Warranty Information, 1.8 meter analog signal cable, 1.8 meter DP signal cable, 1.8 meter USB signal cable, 1.8 meter black power cord</p>					
<p style="text-align: center;">Limited Warranty</p> <p>See details at http://support.lenovo.com/en_US/guides-and-manuals/detail.page?DocID=UM008281</p>	<p style="text-align: center;">Accessories</p> <table border="0"> <tr> <td>Kensington MicroSaver Cable Lock</td> <td style="text-align: right;">73P2582</td> </tr> <tr> <td>Kensington Twin Head Cable Lock</td> <td style="text-align: right;">45K1620</td> </tr> </table> <p>See details at www.lenovo.com/support/monitoraccessories</p> <p>See all monitors at www.lenovo.com/thinkvision</p>	Kensington MicroSaver Cable Lock	73P2582	Kensington Twin Head Cable Lock	45K1620
Kensington MicroSaver Cable Lock	73P2582				
Kensington Twin Head Cable Lock	45K1620				



<p>Name T2324d Wide Flat Panel Monitor Bezel color Black Type-model 60F3JAR2US / 60F3JAT2US / 60F3JAT2EU Panel TFT-LCD, twisted nematic (TN), White LED backlight Viewable image size 23.0" (584mm) diagonal Max view area (W x H) 20.07" x 11.29" (509.8mm x 286.7mm) Native resolution 1920x1080 Aspect ratio 16:9 Pixel pitch (mm) 0.2655 x 0.2655 mm Dot/Pixel per Inch 96 dpi Brightness 250 nits or cd/m² (typical) Contrast ratio 1000:1 (typical) Pixel response time 5ms (typical) Color gamut 72% Viewing angle at 10:1 CR 170° (+/- 85°) horizontal, 160° (+/- 80°) vertical Stand Tilt stand Bezel width Sides: 0.68" (17.3mm) Dimensions (HxWxD) 15.75" H x 21.48" W x 8.06" D; 400.3mm H x 545.8mm W x 204.9mm D Power supply 20 watts typical, 27 watts maximum <0.3 watts standby/suspend, universal, integrated (no external brick-like power supply) Weight 7.06 lb; 3.20 kg Limited warranty 3 year (includes backlight) Available date June 2016</p>	<p style="text-align: center;">Features</p> <ul style="list-style-type: none"> • Widescreen 23.0-inch monitor • Supports 1920x1080 resolution • Supports optional soundbar • Supports ThinkCentre Tiny via VESA back mount • Includes dual input connection for attachment to two systems concurrently (analog and digital) • EPEAT Gold certified • Microsoft® Windows® 7 certified • Microsoft Windows 10 certified 				
<p>VESA-compliant VESA DDC2B/CI Power management ENERGY STAR® qualified Ergonomics ISO 9241-307 Emission standards FCC Class B Environmental TCO Displays 7.0, TCO Certified Edge 2.0, WEEE, RoHS, EPEAT™ Gold rating</p>	<div style="text-align: center;">  <p>ThinkVision T2324d Wide Monitor</p> </div>				
<p>Preset resolutions VGA: 640x350, 640x480, 720x400 SVGA: 800x600 XGA: 1024x768, 1152x864 SXGA: 1280x1024 WXGA: 1280x768, 1280x800, 1366x768 WXGA+: 1440x900 WSXGA+: 1680x1050 Full HD: 1920x1080</p> <p>Presets / user settings Standard presets: 26; user settings: 16</p>					
<p>Viewing adjustments Tilt: 22° back, -5° Rotating screen None On screen display On screen display with digital user controls (8 languages) Control features Direct access (buttons on front) for automatic image setup, dual input and brightness USB hub None Multiple input Dual input (two different PCs attach to two different connectors; one PC shows image; select via button) Monitor connectors (1) VGA 15-pin D-shell, analog, blue (2) DisplayPort, digital, black, HDCP-compliant Signal cables (1) detachable, VGA 15-pin D-shell at each end, analog, 1.8 meter (2) detachable, DisplayPort at each end, digital, 1.8 meter Mounting features Wall or desk mounting using the Extend Arm or third-party accessories, 100mm x 100mm mount Security Security keyhole for attachment of optional cable lock (Kensington® lock-compatible)</p>					
<p>Ship group Monitor with stand, Safety and Warranty Information, 1.8 meter analog signal cable, 1.8 meter DP signal cable, 1.8 meter black power cord</p>	<p style="text-align: center;">Accessories</p> <table border="0" style="width: 100%;"> <tr> <td>Kensington MicroSaver Cable Lock</td> <td style="text-align: right;">73P2582</td> </tr> <tr> <td>Kensington Twin Head Cable Lock</td> <td style="text-align: right;">45K1620</td> </tr> </table> <p>See details at www.lenovo.com/support/monitoraccessories</p> <p>See all monitors at www.lenovo.com/thinkvision</p>	Kensington MicroSaver Cable Lock	73P2582	Kensington Twin Head Cable Lock	45K1620
Kensington MicroSaver Cable Lock	73P2582				
Kensington Twin Head Cable Lock	45K1620				
<p style="text-align: center;">Limited Warranty</p> <p>See details at http://support.lenovo.com/en_US/guides-and-manuals/detail.page?DocID=UM008281</p>					



<p>Name T2364t Wide Flat Panel Monitor Bezel color Black Type-model 60E9MAR1US / 60E9MAT1US / 60E9MAT1EU Panel TFT-LCD, In-Plane Switching (IPS), White LED backlight</p> <p>Viewable image size 23.0" (584mm) diagonal Max view area (W x H) 20.05" x 11.28" (509.2mm x 286.4mm) Native resolution 1920x1080</p> <p>Touch Supports 10-point touch</p> <p>Aspect ratio 16:9 Pixel pitch (mm) 0.2652 x 0.2652 mm Dot/Pixel per Inch 95 dpi Brightness 250 nits or cd/m² (typical) Contrast ratio 1000:1 (typical) Pixel response time 7ms (typical) Color gamut 72%</p> <p>Viewing angle at 10:1 CR 178° (+/- 89°) horizontal, 178° (+/- 89°) vertical</p> <p>Stand Tilt adjustable stand Bezel width <i>Sides:</i> 0.079" (2.0mm) Dimensions (HxWxD) 12.53" H x 20.56" W x 2.86" D; 318.2mm H x 522.2mm W x 72.7mm D</p> <p>Power supply 22 watts typical, 45 watts maximum, <0.5 watts standby/suspend, universal, integrated (no external brick-like power supply)</p> <p>Weight 9.24 lb; 4.32 kg Limited warranty 3 year (includes backlight) Available date June 2015</p>	<p style="text-align: center;">Features</p> <ul style="list-style-type: none"> • Widescreen 23.0-inch monitor • Supports 1920x1080 resolution • Includes dual input connection for attachment to two systems concurrently • EPEAT Gold certified • Supports optional soundbar • 10-point touch screen • Microsoft® Windows® 7 certified • Microsoft Windows 10 certified
<p>VESA-compliant VESA DDC2B/C1 Power management ENERGY STAR® qualified Ergonomics ISO 9241-307 Emission standards FCC Class B Environmental TCO Displays 7.0, TCO Certified Edge 2.0, WEEE, RoHS, EPEAT™ Gold rating</p> <p>Preset resolutions VGA: 640x350, 640x480, 720x400, 700x570 SVGA: 800x600, 832x624 XGA: 1024x768, 1152x864 SXGA: 1280x1024 WXGA: 1366x768 WXGA+: 1440x900, 1600x900 WSXGA+: 1680x1050 Full HD: 1920x1080</p> <p>Presets / user settings User settings: 20</p>	  <p style="text-align: center;">ThinkVision T2364t</p>
<p>Viewing adjustments <i>Tilt:</i> 10° - 70° degrees; detachable stand Rotating screen None On screen display On screen display with digital user controls (8 languages) Control features Direct access (buttons on front) for automatic image setup, dual input and brightness USB hub USB 3.0 Hub: 1 port into PC (USB 3.0); 3 ports for accessories (3 USB 3.0) Multiple input Dual input (two different PCs attach to two different connectors; one PC shows image; select via button) Monitor connectors (1) VGA 15-pin D-shell, analog, blue (2) HDMI (1.4), digital, HDCP-compliant (3) DisplayPort, digital, black, HDCP-compliant</p> <p>Signal cables (1) detachable, VGA 15-pin D-shell at each end, analog, 1.8 meter (2) detachable, HDMI at each end, digital, 1.8 meter (3) detachable, DisplayPort at each end, digital, 1.8 meter</p> <p>Mounting features Wall or desk mounting using the Extend Arm or third-party accessories, 100mm x 100mm mount Security Security keyhole for attachment of optional cable lock (Kensington® lock-compatible)</p> <p>Ship group Monitor with stand, Safety and Warranty Information, 1.8 meter analog signal cable, 1.8 meter HDMI cable, 1.8 meter DisplayPort cable, 1.8 meter USB signal cable, 1.8 meter black power cord</p>	

<p style="text-align: center;">Limited Warranty</p> <p>See details at http://support.lenovo.com/en_US/guides-and-manuals/detail.page?DocID=UM008281</p>	<p style="text-align: center;">Accessories</p> <table border="0"> <tr> <td>Kensington MicroSaver Cable Lock</td> <td style="text-align: right;">73P2582</td> </tr> <tr> <td>Kensington Twin Head Cable Lock</td> <td style="text-align: right;">45K1620</td> </tr> </table> <p>See details at www.lenovo.com/support/monitoraccessories</p> <p>See all monitors at www.lenovo.com/thinkvision</p>	Kensington MicroSaver Cable Lock	73P2582	Kensington Twin Head Cable Lock	45K1620
Kensington MicroSaver Cable Lock	73P2582				
Kensington Twin Head Cable Lock	45K1620				



<p>Name T23i Wide Flat Panel Monitor Bezel color Black Type-model 61ABMAR1US / 61ABMAT1EU Panel TFT-LCD, In-Plane Switching (IPS), White LED backlight Viewable image size 23" (584.2mm) diagonal Max view area (W x H) 20.36" x 11.92" (517.2mm x 302.8mm) Native resolution 1920x1080 Aspect ratio 16:9 Pixel pitch (mm) 0.2652 x 0.2652 mm Dot/Pixel per Inch 95.8 dpi Brightness 250 nits or cd/m² (typical) Contrast ratio 1000:1 (typical) Pixel response time 6ms (typical) Color gamut 72% Viewing angle at 10:1 CR 178° (+/- 89°) horizontal, 178° (+/- 89°) vertical Stand Tilt, swivel, pivot, and height adjustable stand Bezel width Sides: 0.08" (2.0mm) Dimensions (HxWxD) 13.3" H x 20.56" W x 10.4" D; 337.7mm H x 522.2mm W x 264.2mm D Power supply 16 watts typical, 45 watts maximum (with USB 3.0 hub), <0.5 watts standby/suspend, universal, integrated (no external brick-like power supply) Weight 10.85 lb; 4.92 kg Limited warranty 3 year (includes backlight) Available date April 2017</p>	<p style="text-align: center;">Features</p> <ul style="list-style-type: none"> • Widescreen 23-inch monitor • Supports 1920x1080 resolution • Supports ThinkCentre Tiny Clamp Bracket • Supports optional soundbar • Includes dual input connection for attachment to two systems concurrently • EPEAT Gold certified • Microsoft® Windows® 7 certified • Microsoft Windows 10 certified 				
<p>VESA-compliant VESA DDC2B/CI Power management ENERGY STAR® qualified Ergonomics ISO 9241-307 Emission standards FCC Class B Environmental TCO Displays 7.0, TCO Certified Edge 2.0, WEEE, RoHS, EPEAT™ Gold rating</p>	<div style="text-align: center;">  <p>ThinkVision T23i Wide Monitor</p> </div>				
<p>Preset resolutions VGA: 640x480, 720x400 SVGA: 800x600 XGA: 1024x768, 1152x864 SXGA: 1280x1024 WXGA+: 1440x900 WSXGA+: 1680x1050 Full HD: 1920x1080</p> <p>Presets display modes HDMI: 18; DP: 18</p>					
<p>Viewing adjustments Tilt: 30° back, -5° forward; lift: 4.3" (110mm); swivel: +/-45°; detachable stand Rotating screen Screen pivots 90 degrees from landscape to portrait On screen display On screen display with digital user controls (8 languages) Control features Direct access (buttons on front) for power, menu, input source select and brightness and automatic image setup USB hub USB 3.0 Hub: 1 port into PC (USB 3.0); 4 ports for accessories (4 USB 3.0) Multiple input Dual input (two different PCs attach to two different connectors; one PC shows image; select via button) Monitor connectors (1) VGA 15-pin D-shell, analog, blue (2) HDMI (1.4), digital, HDCP-compliant (3) DisplayPort, digital, black, HDCP-compliant Signal cables (1) detachable, VGA 15-pin D-shell at each end, analog, 1.8 meter (2) detachable, DisplayPort at each end, digital, 1.8 meter Mounting features Wall or desk mounting using the Extend Arm or third-party accessories, 100mm x 100mm mount Security Security keyhole for attachment of optional cable lock (Kensington® lock-compatible)</p>					
<p>Ship group Monitor with stand, Safety and Warranty Information, 1.8 meter analog signal cable, 1.8 meter DP signal cable, 1.8 meter USB signal cable, 1.8 meter black power cord</p>					
<p style="text-align: center;">Limited Warranty</p> <p>See details at http://support.lenovo.com/en_US/guides-and-manuals/detail.page?DocID=UM008281</p>	<p style="text-align: center;">Accessories</p> <table border="0"> <tr> <td>Kensington MicroSaver Cable Lock</td> <td style="text-align: right;">73P2582</td> </tr> <tr> <td>Kensington Twin Head Cable Lock</td> <td style="text-align: right;">45K1620</td> </tr> </table> <p>See details at www.lenovo.com/support/monitoraccessories</p> <p>See all monitors at www.lenovo.com/thinkvision</p>	Kensington MicroSaver Cable Lock	73P2582	Kensington Twin Head Cable Lock	45K1620
Kensington MicroSaver Cable Lock	73P2582				
Kensington Twin Head Cable Lock	45K1620				



<p>Name T2424z Wide Flat Panel Monitor Bezel color Raven black Type-model 60F8MAR1US / 60F8MAT1US / 60F8MAT1EU Panel TFT-LCD, In-Plane Switching (IPS), White LED backlight</p> <p>Viewable image size 23.8" (604.7mm) diagonal Max view area (W x H) 20.75" x 11.67" (527.0mm x 296.5mm) Native resolution 1920x1080 Aspect ratio 16:9 Pixel pitch (mm) 0.2745 x 0.2745 mm Dot/Pixel per Inch 92 dpi Brightness 250 nits or cd/m² (typical) Contrast ratio 1000:1 (typical) Pixel response time 7ms (typical) Color gamut 72% Viewing angle at 10:1 CR 178° (+/- 89°) horizontal, 178° (+/- 89°) vertical Stand Tilt, swivel, pivot, and height adjustable stand Bezel width Sides: 0.69" (17.5mm) Dimensions (HxWxD) 19.53" H x 22.19" W x 10.39" D; 496.0mm H x 563.6mm W x 264.2mm D</p> <p>Power supply 22 watts typical, 40 watts maximum (without USB 3.0 hub), <0.5 watts standby/suspend, universal, integrated (no external brick-like power supply)</p> <p>Weight 12.90 lb; 5.85 kg Limited warranty 3 year (includes backlight) Available date June 2016</p>	<p style="text-align: center;">Features</p> <ul style="list-style-type: none"> • Widescreen 23.8-inch monitor • Supports 1920x1080 resolution • Supports ThinkCentre Tiny Clamp Bracket • Includes dual input connection for attachment to two systems concurrently (analog and digital) • EPEAT Gold certified • Supports optional soundbar • Microsoft® Windows® 7 certified • Microsoft Windows 8 / Windows 8.1 certified • Microsoft Windows 10 certified 				
<p>VESA-compliant VESA DDC2B/CI Power management ENERGY STAR® qualified Ergonomics ISO 9241-307 Emission standards FCC Class B Environmental TCO Displays 7.0, TCO Certified Edge 2.0, WEEE, RoHS, EPEAT™ Gold rating</p>	<div style="text-align: center;">  <p>ThinkVision T2424z Wide Monitor</p> </div>				
<p>Preset resolutions VGA: 640x350, 640x480, 720x400 SVGA: 800x600 XGA: 1024x768, 1152x864 SXGA: 1280x1024 WXGA+: 1440x900, 1600x900 WSXGA+: 1680x1050 Full HD: 1920x1080</p> <p>Presets / user settings Standard presets: 31; user settings: 20</p>					
<p>Viewing adjustments Tilt: 30° back, -5° forward; lift: 4.3" (110mm); swivel: +/-45°; detachable stand Rotating screen Screen pivots 90 degrees from landscape to portrait On screen display On screen display with digital user controls (8 languages) Control features Direct access (buttons on front) for automatic image setup, dual input and brightness USB hub USB 3.0 Hub: 1 port into PC (USB 3.0); 2 ports for accessories (2 USB 3.0) Multimedia Integrated digital speakers (3 watts x 2) Camera Integrated camera (Full HD) and digital dual array microphone Multiple input Dual input (two different PCs attach to two different connectors; one PC shows image; select via button) Monitor connectors (1) VGA 15-pin D-shell, analog, blue (2) HDMI (1.4), digital, HDCP-compliant (3) DisplayPort, digital, black, HDCP-compliant</p> <p>Signal cables (1) detachable, VGA 15-pin D-shell at each end, analog, 1.8 meter (2) detachable, DisplayPort at each end, digital, 1.8 meter</p> <p>Mounting features Wall or desk mounting using the Extend Arm or third-party accessories, 100mm x 100mm mount Security Security keyhole for attachment of optional cable lock (Kensington® lock-compatible)</p>					
<p>Ship group Monitor with stand, Safety and Warranty Information, 1.8 meter analog signal cable, 1.8 meter DP signal cable, 1.8 meter USB signal cable, 1.8 meter black power cord</p>	<p style="text-align: center;">Accessories</p> <table border="0" style="width: 100%;"> <tr> <td>Kensington MicroSaver Cable Lock</td> <td style="text-align: right;">73P2582</td> </tr> <tr> <td>Kensington Twin Head Cable Lock</td> <td style="text-align: right;">45K1620</td> </tr> </table> <p>See details at www.lenovo.com/support/monitoraccessories</p> <p>See all monitors at www.lenovo.com/thinkvision</p>	Kensington MicroSaver Cable Lock	73P2582	Kensington Twin Head Cable Lock	45K1620
Kensington MicroSaver Cable Lock	73P2582				
Kensington Twin Head Cable Lock	45K1620				
<p style="text-align: center;">Limited Warranty</p> <p>See details at http://support.lenovo.com/en_US/guides-and-manuals/detail.page?DocID=UM008281</p>					



<p>Name T2454p Wide Flat Panel Monitor Bezel color Raven black Type-model 60F9MAR1US / 60F9MAT1US / 60F9MAT1EU Panel TFT-LCD, In-Plane Switching (IPS), White LED backlight</p> <p>Viewable image size 24.0" (609.6mm) diagonal Max view area (W x H) 20.41" x 12.76" (518.4mm x 324.0mm) Native resolution 1920x1200 Aspect ratio 16:10 Pixel pitch (mm) 0.270 x 0.270 mm Dot/Pixel per Inch 94 dpi Brightness 300 nits or cd/m² (typical) Contrast ratio 1000:1 (typical) Pixel response time 7ms (typical) Color gamut 77.4% Viewing angle at 10:1 CR 178° (+/- 89°) horizontal, 178° (+/- 89°) vertical Stand Tilt, swivel, pivot, and height adjustable stand Bezel width Sides: 0.74" (18.8mm) Dimensions (HxWxD) 15.85" H x 21.94" W x 10.39" D; 402.5mm H x 557.4mm W x 264.2mm D</p> <p>Power supply 24 watts typical, 27 watts maximum (without USB 3.0 hub), 54 watts maximum (with USB 3.0 hub), <0.5 watts standby/suspend, universal, integrated (no external brick-like power supply) Weight 13.60 lb; 6.15 kg Limited warranty 3 year (includes backlight) Available date March 2015</p>	<p style="text-align: center;">Features</p> <ul style="list-style-type: none"> • Widescreen 24.0-inch monitor • Supports 1920x1200 resolution • Supports ThinkCentre Tiny Clamp Bracket • Supports optional soundbar • Includes dual input connection for attachment to two systems concurrently (analog and digital) • EPEAT Gold certified • Microsoft® Windows® 7 certified • Microsoft Windows 8 / Windows 8.1 certified • Microsoft Windows 10 certified 				
<p>VESA-compliant VESA DDC2B/CI Power management ENERGY STAR® qualified Ergonomics ISO 9241-307 Emission standards FCC Class B Environmental TCO Displays 7.0, TCO Certified Edge 2.0, WEEE, RoHS, EPEAT™ Gold rating</p> <p>Preset resolutions VGA: 640x350, 640x480, 720x400 SVGA: 800x600 XGA: 1024x768 SXGA: 1280x1024 WXGA: 1280x720, 1280x768, 1280x800 WXGA+: 1440x900 WSXGA+: 1680x1050, 1600x1200 Full HD: 1920x1080, 1920x1200</p> <p>Presets / user settings Standard presets: 21; user settings: 20</p>	 <p style="text-align: center;">ThinkVision T2454p Wide Monitor</p>				
<p>Viewing adjustments Tilt: 30° back, -5° forward; lift: 4.3" (110mm); swivel: +/-45°; detachable stand Rotating screen Screen pivots 90 degrees from landscape to portrait On screen display On screen display with digital user controls (8 languages) Control features Direct access (buttons on front) for automatic image setup, dual input and brightness USB hub USB 3.0 Hub: 1 port into PC (USB 3.0); 4 ports for accessories (4 USB 3.0) Multiple input Dual input (two different PCs attach to two different connectors; one PC shows image; select via button) Monitor connectors (1) VGA 15-pin D-shell, analog, blue (2) HDMI (1.4), digital, HDCP-compliant (3) DisplayPort, digital, black, HDCP-compliant</p> <p>Signal cables (1) detachable, VGA 15-pin D-shell at each end, analog, 1.8 meter (2) detachable, DisplayPort at each end, digital, 1.8 meter</p> <p>Mounting features Wall or desk mounting using the Extend Arm or third-party accessories, 100mm x 100mm mount Security Security keyhole for attachment of optional cable lock (Kensington® lock-compatible)</p>					
<p>Ship group Monitor with stand, Safety and Warranty Information, 1.8 meter analog signal cable, 1.8 meter DisplayPort cable, 1.8 meter USB signal cable, 1.8 meter black power cord</p>					
<p style="text-align: center;">Limited Warranty</p> <p>See details at http://support.lenovo.com/en_US/guides-and-manuals/detail.page?DocID=UM008281</p>	<p style="text-align: center;">Accessories</p> <table border="0"> <tr> <td>Kensington MicroSaver Cable Lock</td> <td style="text-align: right;">73P2582</td> </tr> <tr> <td>Kensington Twin Head Cable Lock</td> <td style="text-align: right;">45K1620</td> </tr> </table> <p>See details at www.lenovo.com/support/monitoraccessories</p> <p>See all monitors at www.lenovo.com/thinkvision</p>	Kensington MicroSaver Cable Lock	73P2582	Kensington Twin Head Cable Lock	45K1620
Kensington MicroSaver Cable Lock	73P2582				
Kensington Twin Head Cable Lock	45K1620				



<p>Name T24i Wide Flat Panel Monitor Bezel color Black Type-model 61A6MAR3US / 61A6MAT3EU Panel TFT-LCD, In-Plane Switching (IPS), White LED backlight Viewable image size 23.8" (604.7mm) diagonal Max view area (W x H) 20.75" x 11.67" (527.04mm x 296.5mm) Native resolution 1920x1080 Aspect ratio 16:9 Pixel pitch (mm) 0.2745 x 0.2745 mm Dot/Pixel per Inch 93 dpi Brightness 250 nits or cd/m² (typical) Contrast ratio 1000:1 (typical) Pixel response time 6ms (typical) Color gamut 72% Viewing angle at 10:1 CR 178° (+/- 89°) horizontal, 178° (+/- 89°) vertical Stand Tilt, swivel, pivot, and height adjustable stand Bezel width Sides: 0.08" (2.0mm) Dimensions (HxWxD) 14.7" H x 21.26" W x 10.3" D; 373.4mm H x 540.2mm W x 261.75mm D Power supply 16.5 watts typical, 55 watts maximum (with USB 3.0 hub), <0.5 watts standby/suspend, universal, integrated (no external brick-like power supply) Weight 11.57 lb; 5.25 kg Limited warranty 3 year (includes backlight) Available date April 2017</p>	<p style="text-align: center;">Features</p> <ul style="list-style-type: none"> • Widescreen 23.8-inch monitor • Supports 1920x1080 resolution • Supports ThinkCentre Tiny Clamp Bracket • Supports optional soundbar • Includes dual input connection for attachment to two systems concurrently • EPEAT Gold certified • Microsoft® Windows® 7 certified • Microsoft Windows 10 certified 				
<p>VESA-compliant VESA DDC2B/CI Power management ENERGY STAR® qualified Ergonomics ISO 9241-307 Emission standards FCC Class B Environmental TCO Displays 7.0, TCO Certified Edge 2.0, WEEE, RoHS, EPEAT™ Gold rating</p>	<div style="text-align: center;">  <p>ThinkVision T24i Wide Monitor</p> </div>				
<p>Preset resolutions VGA: 640x480, 720x400 SVGA: 800x600 XGA: 1024x768 SXGA: 1280x1024 WXGA: 1366x768 WXGA+: 1440x900, 1680x900 WSXGA+: 1680x1050 Full HD: 1920x1080 Presets display modes HDMI: 17; DP: 17</p>					
<p>Viewing adjustments <i>Tilt:</i> 30° back, -5° forward; <i>lift:</i> 4.3" (110mm); <i>swivel:</i> +/-45°; detachable stand Rotating screen Screen pivots 90 degrees from landscape to portrait On screen display On screen display with digital user controls (8 languages) Control features Direct access (buttons on front) for power, menu, input source select and brightness and automatic image setup USB hub USB 3.0 Hub: 1 port into PC (USB 3.0); 4 ports for accessories (4 USB 3.0) Multiple input Dual input (two different PCs attach to two different connectors; one PC shows image; select via button) Monitor connectors (1) VGA 15-pin D-shell, analog, blue (2) HDMI (1.4), digital, HDCP-compliant (3) DisplayPort, digital, black, HDCP-compliant Signal cables (1) detachable, VGA 15-pin D-shell at each end, analog, 1.8 meter (2) detachable, DisplayPort at each end, digital, 1.8 meter Mounting features Wall or desk mounting using the Extend Arm or third-party accessories, 100mm x 100mm mount Security Security keyhole for attachment of optional cable lock (Kensington® lock-compatible)</p>	<p>Viewing adjustments <i>Tilt:</i> 30° back, -5° forward; <i>lift:</i> 4.3" (110mm); <i>swivel:</i> +/-45°; detachable stand Rotating screen Screen pivots 90 degrees from landscape to portrait On screen display On screen display with digital user controls (8 languages) Control features Direct access (buttons on front) for power, menu, input source select and brightness and automatic image setup USB hub USB 3.0 Hub: 1 port into PC (USB 3.0); 4 ports for accessories (4 USB 3.0) Multiple input Dual input (two different PCs attach to two different connectors; one PC shows image; select via button) Monitor connectors (1) VGA 15-pin D-shell, analog, blue (2) HDMI (1.4), digital, HDCP-compliant (3) DisplayPort, digital, black, HDCP-compliant Signal cables (1) detachable, VGA 15-pin D-shell at each end, analog, 1.8 meter (2) detachable, DisplayPort at each end, digital, 1.8 meter Mounting features Wall or desk mounting using the Extend Arm or third-party accessories, 100mm x 100mm mount Security Security keyhole for attachment of optional cable lock (Kensington® lock-compatible)</p>				
<p>Ship group Monitor with stand, Safety and Warranty Information, 1.8 meter analog signal cable, 1.8 meter DP signal cable, 1.8 meter USB signal cable, 1.8 meter black power cord</p>					
<p style="text-align: center;">Limited Warranty</p> <p>See details at http://support.lenovo.com/en_US/guides-and-manuals/detail.page?DocID=UM008281</p>	<p style="text-align: center;">Accessories</p> <table border="0"> <tr> <td>Kensington MicroSaver Cable Lock</td> <td style="text-align: right;">73P2582</td> </tr> <tr> <td>Kensington Twin Head Cable Lock</td> <td style="text-align: right;">45K1620</td> </tr> </table> <p>See details at www.lenovo.com/support/monitoraccessories</p> <p>See all monitors at www.lenovo.com/thinkvision</p>	Kensington MicroSaver Cable Lock	73P2582	Kensington Twin Head Cable Lock	45K1620
Kensington MicroSaver Cable Lock	73P2582				
Kensington Twin Head Cable Lock	45K1620				



<p>Name X24 Wide Flat Panel Monitor Bezel color Raven black Type-model 60FAGAR1US / 60FAGAT1US / 60FAGAT1EU Panel TFT-LCD, AH-IPS (In-Plane Switching), White LED backlight Viewable image size 23.8" (604.5mm) diagonal Max view area (W x H) 20.75" x 11.67" (527.0mm x 296.5mm) Native resolution 1920x1080 Aspect ratio 16:9 Pixel pitch (mm) 0.2745 x 0.2745 mm Dot/Pixel per Inch 92 dpi Brightness 250 nits or cd/m² (typical) Contrast ratio 1000:1 (typical) Pixel response time 7ms (typical) Color gamut 72% Viewing angle at 10:1 CR 178° (+/- 89°) horizontal, 178° (+/- 89°) vertical Stand Tilt stand Bezel width <i>Sides:</i> 0.08" (2.0mm) Dimensions (HxWxD) 16.25" H x 21.30" W x 8.66" D; 412.8mm H x 540.9mm W x 220.0mm D Power supply 20 watts typical, 27 watts maximum, <0.5 watts standby/suspend, universal, external power supply Weight 8.60 lb; 3.90 kg Limited warranty 3 year (includes backlight) Available date April 2015</p>	<p style="text-align: center;">Features</p> <ul style="list-style-type: none"> • Widescreen 23.8-inch monitor • Supports 1920x1080 resolution • Includes dual input connection for attachment to two systems concurrently (analog and digital) • EPEAT Silver certified • Microsoft® Windows® 7 certified • Microsoft Windows 8 / Windows 8.1 certified • Microsoft Windows 10 certified 				
<p>Power management ENERGY STAR® qualified Ergonomics ISO 9241-307 Emission standards FCC Class B Environmental TCO Displays 6.0, WEEE, RoHS, EPEAT™ Silver rating</p>	<div style="text-align: center;">  <p>ThinkVision X24 Wide Monitor</p> </div>				
<p>Preset resolutions VGA: 640x350, 640x480, 720x400 SVGA: 800x600 XGA: 1024x768 SXGA: 1280x1024 WXGA: 1366x768 WXGA+: 1440x900, 1600x900 WSXGA+: 1680x1050 Full HD: 1920x1080 Presets / user settings Standard presets: 20; user settings: 16</p>					
<p>Viewing adjustments <i>Tilt:</i> 22° back, -5° forward Rotating screen None On screen display On screen display with digital user controls Control features Direct access (buttons on side bezel) for dual input and brightness USB hub None Multiple input Dual input (two different PCs attach to two different connectors; one PC shows image; select via button) Monitor connectors (1) HDMI (1.4), digital, HDCP-compliant (2) DisplayPort, digital, black, HDCP-compliant Signal cables (1) detachable, HDMI at each end, digital, 1.8 meter (2) detachable, DisplayPort at each end, digital, 1.8 meter Mounting features None Security None</p>					
<p>Ship group Monitor with stand, Safety and Warranty Information, 1.8 meter HDMI signal cable (consumer channel only), 1.8 meter DisplayPort signal cable (commercial channel only), 1.8 meter black power cord</p>	<p style="text-align: center;">Limited Warranty</p> <p>See details at http://support.lenovo.com/en_US/guides-and-manuals/detail.page?DocID=UM008281</p> <p style="text-align: center;">Accessories</p> <table border="0"> <tr> <td>Kensington MicroSaver Cable Lock</td> <td style="text-align: right;">73P2582</td> </tr> <tr> <td>Kensington Twin Head Cable Lock</td> <td style="text-align: right;">45K1620</td> </tr> </table> <p>See details at www.lenovo.com/support/monitoraccessories</p> <p>See all monitors at www.lenovo.com/thinkvision</p>	Kensington MicroSaver Cable Lock	73P2582	Kensington Twin Head Cable Lock	45K1620
Kensington MicroSaver Cable Lock	73P2582				
Kensington Twin Head Cable Lock	45K1620				



<p>Name X24 Pro Wide Flat Panel Monitor Bezel color Black Type-model 60E4ECR1US / 60E4ECT1US / 60E4ECT1EU Panel TFT-LCD, AH-IPS (In-Plane Switching), White LED backlight Viewable image size 23.8" (604.5mm) diagonal Max view area (W x H) 20.75" x 11.67" (527.0mm x 296.5mm) Native resolution 1920x1080 Aspect ratio 16:9 Pixel pitch (mm) 0.2745 x 0.2745 mm Dot/Pixel per Inch 92 dpi Brightness 250 nits or cd/m² (typical) Contrast ratio 1000:1 (typical) Pixel response time 7ms (typical) Color gamut 72% Viewing angle at 10:1 CR 178° (+/- 89°) horizontal, 178° (+/- 89°) vertical Stand Tilt stand Bezel width <i>Sides:</i> 0.09" (2.3mm) Dimensions (HxWxD) 17.61" H x 21.30" W x 9.39" D; 447.4mm H x 540.9mm W x 238.4mm D Power supply 20 watts typical, 90 watts maximum, <0.5 watts standby/suspend, universal, external power supply Weight 9.26 lb; 4.20 kg Limited warranty 1 year (includes backlight) Available date July 2016</p>	<p style="text-align: center;">Features</p> <ul style="list-style-type: none"> • Widescreen 23.8-inch monitor • Supports 1920x1080 resolution • Includes dual input connection for attachment to two systems concurrently • EPEAT Silver certified • Intel RealSense 3D camera • Stereo speakers 3 watts x 2 • One cable docking through USB 3.1 Type C with power delivery • Windows Hello certified • Microsoft® Windows® 10 certified 				
<p>Power management ENERGY STAR® qualified Ergonomics ISO 9241-307 Emission standards FCC Class B Environmental TCO Displays 6.0, WEEE, RoHS, EPEAT™ Silver rating</p> <p>Preset resolutions VGA: 640x350, 640x480, 720x400 SVGA: 800x600 XGA: 1024x768 SXGA: 1280x1024 WXGA: 1366x768 WXGA+: 1440x900, 1600x900 WSXGA+: 1680x1050 Full HD: 1920x1080</p> <p>Presets / user settings Standard presets: 16; user settings: 20</p>	<div style="text-align: center;">  <p>ThinkVision X24 Pro Wide Monitor</p> </div>				
<p>Viewing adjustments <i>Tilt:</i> 22° back, -5° forward Rotating screen None On screen display On screen display with digital user controls Control features Direct access (buttons on side bezel) for dual input and brightness USB hub USB Hub: two USB 3.0 Type-C and one USB 3.0 ports Multimedia Integrated stereo speakers (3 watts x 2), built-in microphone Camera RealSense 3D camera SR300 Multiple input Dual input (two different PCs attach to two different connectors; one PC shows image; select via button) Monitor connectors (1) mDP, Mini DisplayPort, digital, HDCP-compliant (2) USB Type-C, digital Signal cables (1) detachable, mDP to DP, digital, 2.0 meter (2) DP to mDP adaptor (3) USB 3.0 cable Mounting features None Security Security keyhole for attachment of optional cable lock (Kensington® lock-compatible)</p>	<p>Ship group Monitor with stand, Safety and Warranty Information, 2.0 meter Mini DisplayPort to DisplayPort signal cable, ThinkPad 90W Square tip power adaptor</p>				
<p style="text-align: center;">Limited Warranty</p> <p>See details at http://support.lenovo.com/en_US/guides-and-manuals/detail.page?DocID=UM008281</p>	<p style="text-align: center;">Accessories</p> <table border="0"> <tr> <td>Kensington MicroSaver Cable Lock</td> <td style="text-align: right;">73P2582</td> </tr> <tr> <td>Kensington Twin Head Cable Lock</td> <td style="text-align: right;">45K1620</td> </tr> </table> <p>See details at www.lenovo.com/support/monitoraccessories</p> <p>See all monitors at www.lenovo.com/thinkvision</p>	Kensington MicroSaver Cable Lock	73P2582	Kensington Twin Head Cable Lock	45K1620
Kensington MicroSaver Cable Lock	73P2582				
Kensington Twin Head Cable Lock	45K1620				

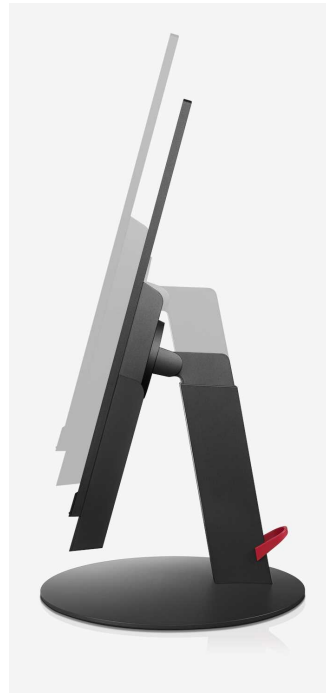

<p>Name P27 Wide Flat Panel Monitor Case color Black Type-model 60E3GAR1US / 60E3GAT1US / 60E3GAT1EU Panel TFT-LCD, IPS (In-Plane Switching), White LED backlight Viewable image size 27" (684.7mm) diagonal Max view area (W x H) 23.49" x 13.21" (596.7mm x 335.7mm) Optimum resolution 3840x2160 Max pixel rate 600MHz Aspect ratio 16:9 Pixel pitch (mm) 0.16 x 0.16mm Dot/Pixel per Inch 163 dpi Brightness 300 nits or cd/m² (typical) Contrast ratio 1300:1 (typical) Pixel response time 6ms Color gamut 99% Viewing angle at 10:1 CR 178° horizontal, 178° vertical Stand Tilt, swivel, pivot, and height adjustable stand Bezel width Sides: 0.088" (2.23mm) Dimensions 18.59" H x 24.19" W x 11.81" D; (HxWxD, including stand) 472.3mm H x 614.5mm W x 299.9mm D Power supply 40 watts typical, 70 watts maximum (with USB), <0.5 watts sleep/off; <0.5 watts switch off Weight 15.12 lb; 6.86kg (including stand) Limited warranty⁴ 3 year Available date March 2016</p>	<p>Features</p> <ul style="list-style-type: none"> • 27-inch IPS LED backlight monitor with speaker • Supports 3840x2160 resolution • 5-Ports USB hub, support USB 3.0 • 3watts x 2 stereo speakers • Microsoft® Windows® 7 certified • Microsoft Windows 10 certified 						
<p>VESA-compliant² VESA DDC2B/CI Power management ENERGY STAR® 7.0 Ergonomics ISO 9241-307 Emission standards FCC Class B Environmental TCO Displays 7.0, RoHS, EPEAT™ Gold rating, ULE Gold</p>	 <p>ThinkVision P27 Monitor</p>						
<p>Preset resolutions VGA: 640x350, 640x480, 720x400 SVGA: 800x600 XGA: 1024x768, 1152x864 SXGA: 1280x1024 WXGA: 1280x720, 1280x768, 1280x800, 1360x768 WXGA+: 1440x900, 1600x900 WSXGA+: 1680x1050 Full HD: 1920x1080, 1920x1200 UHD: 3840x2160</p> <p>Presets / user settings Standard presets: 20; user settings: 20</p>							
<p>Viewing adjustments Tilt: 30° back, -5° forward; lift: 3.15" (80mm); swivel: +/-45° Rotating screen Screen pivots 90 degrees from landscape to portrait On screen display On screen display with digital user controls (8 languages) Control features Direct access (touch buttons on front) for menu, mute, volume up/down, and brightness USB hub USB Hub: one USB 3.0 upstream port, four USB 3.0 downstream ports Multimedia Integrated stereo speakers (3 watts x 2) Camera None Multiple input Support HDMI, DisplayPort Monitor connectors (1) HDMI (2.0), digital, HDCP-compliant (2) DisplayPort (1.2), digital, HDCP-compliant Signal cables (1) detachable, DisplayPort at each end, digital, 1.8 meter Mounting features Wall or desk mounting using the Extend Arm or third-party accessories meeting the VESA FPMPI® (100mm mount) Security Security keyhole for attachment of optional cable lock (Kensington® lock-compatible)</p>							
<p>Ship group Monitor, detachable stand, Quick start and safety poster, 1.8 meter DisplayPort cable, 1.8 meter USB 3.0 cable, 1.8 meter black power cord, mini DP to DP adapter, power adapter (90W)</p>	<p>Limited Warranty</p> <p>See details at http://support.lenovo.com/en_US/guides-and-manuals/detail.page?DocID=UM008281</p> <p>Accessories</p> <table border="0"> <tr> <td>Kensington MicroSaver Cable Lock</td> <td>73P2582</td> </tr> <tr> <td>Kensington Twin Head Cable Lock</td> <td>45K1620</td> </tr> <tr> <td>Lenovo Security Cable Lock</td> <td>57Y4303</td> </tr> </table> <p>See details at www.lenovo.com/support/monitoraccessories</p> <p>See all monitors at www.lenovo.com/thinkvision</p>	Kensington MicroSaver Cable Lock	73P2582	Kensington Twin Head Cable Lock	45K1620	Lenovo Security Cable Lock	57Y4303
Kensington MicroSaver Cable Lock	73P2582						
Kensington Twin Head Cable Lock	45K1620						
Lenovo Security Cable Lock	57Y4303						

See footnotes for important warranty information



<p>Name P27h Wide Flat Panel Monitor Case color Black Type-model 61AFGAR1US / 61AFGAT1EU Panel TFT-LCD, IPS (In-Plane Switching), White LED backlight Viewable image size 27" (685.8mm) diagonal Max view area (W x H) 23.49" x 13.21" (596.7mm x 335.7mm) Optimum resolution 2560x1440 Max pixel rate 300MHz Aspect ratio 16:9 Pixel pitch (mm) 0.2331 x 0.2331mm Dot/Pixel per Inch 109 dpi Brightness 350 nits or cd/m² (typical) Contrast ratio 1000:1 (typical) Pixel response time 4ms (extreme) / 6ms (typical) Color gamut 99% sRGB Viewing angle at 10:1 CR 178° horizontal, 178° vertical Stand Tilt, swivel, pivot, and height adjustable stand Bezel width <i>Sides:</i> 0.08" (2mm) Dimensions 20.21" H x 24.08" W x 10.62" D; (HxWxD, including stand) 513mm H x 611.6mm W x 269.8mm D Power supply 38 watts typical, 140 watts maximum (with USB), <0.5 watts sleep/off; <0.5 watts switch off integrated (no external brick-like power supply) Weight 15.43 lb; 7.0kg (including stand) Limited warranty 3 year Available date April 2017</p>	<p style="text-align: center;">Features</p> <ul style="list-style-type: none"> • 27-inch IPS LED backlit monitor • Supports 2560x1440 resolution • 5-Ports USB hub, support USB 3.0 • Supports optional soundbar • Support ThinkCentre Tiny • Microsoft® Windows® 7 certified • Microsoft Windows 10 certified 						
<p>VESA-compliant VESA DDC2B/CI Power management ENERGY STAR® 7.0 Ergonomics ISO 9241-307 Emission standards FCC Class B Environmental TCO Displays 7.0, RoHS, EPEAT™ Gold rating, ULE Gold</p>	<div style="text-align: center;">  <p>ThinkVision P27h Monitor</p> </div>						
<p>Preset resolutions VGA: 640x480, 720x400 SVGA: 800x600 XGA: 1024x768 SXGA: 1280x1024 WXGA: 1366x768 WXGA+: 1440x900, 1680x900 WSXGA+: 1680x1050 Full HD: 1920x1080, 1920x1200 QHD: 2560x1440</p> <p>Presets display modes HDMI: 22; DP: 14</p>							
<p>Viewing adjustments <i>Tilt:</i> 30° back, -5° forward; <i>lift:</i> 4.33" (110mm); <i>swivel:</i> +/-45° Rotating screen Screen pivots 90 degrees from landscape to portrait On screen display On screen display with digital user controls (8 languages) Control features Direct access (buttons on front) for power, menu, input source select and brightness USB hub USB Hub: one USB Type-C upstream port, four USB 3.0 downstream ports Multimedia Audio-out, optional sound bar supported Camera None Multiple input Support HDMI, DisplayPort, USB 3.1 Type-C, DisplayPort-out Monitor connectors (1) 2*HDMI (1.4), digital, HDCP-compliant (2) DisplayPort (1.2), digital, HDCP-compliant (3) DisplayPort-out, digital (4) USB 3.1 Type-C Signal cables (1) USB 3.1 Type-C cable, 1.8 meter Mounting features Wall or desk mounting using the Extend Arm or third-party accessories meeting the VESA FPMPI® (100mm mount) Security Security keyhole for attachment of optional cable lock (Kensington® lock-compatible)</p>							
<p>Ship group Monitor, detachable stand, Quick start and safety poster, 1.8 meter USB 3.1 Type-C cable, 1.8 meter black power cord</p>							
<p style="text-align: center;">Limited Warranty</p> <p>See details at http://support.lenovo.com/en_US/guides-and-manuals/detail.page?DocID=UM008281</p>	<p style="text-align: center;">Accessories</p> <table border="0"> <tr> <td>Kensington MicroSaver Cable Lock</td> <td style="text-align: right;">73P2582</td> </tr> <tr> <td>Kensington Twin Head Cable Lock</td> <td style="text-align: right;">45K1620</td> </tr> <tr> <td>Lenovo Security Cable Lock</td> <td style="text-align: right;">57Y4303</td> </tr> </table> <p>See details at www.lenovo.com/support/monitoraccessories</p> <p>See all monitors at www.lenovo.com/thinkvision</p>	Kensington MicroSaver Cable Lock	73P2582	Kensington Twin Head Cable Lock	45K1620	Lenovo Security Cable Lock	57Y4303
Kensington MicroSaver Cable Lock	73P2582						
Kensington Twin Head Cable Lock	45K1620						
Lenovo Security Cable Lock	57Y4303						



<p>Name P27q Wide Flat Panel Monitor Case color Black Type-model 61A8GAR1US / 61A8GAT1EU Panel TFT-LCD, IPS (In-Plane Switching), White LED backlight Viewable image size 27" (685.8mm) diagonal Max view area (W x H) 23.49" x 13.21" (596.7mm x 335.7mm) Optimum resolution 2560x1440 Max pixel rate 300MHz Aspect ratio 16:9 Pixel pitch (mm) 0.2331 x 0.2331mm Dot/Pixel per Inch 109 dpi Brightness 350 nits or cd/m² (typical) Contrast ratio 1000:1 (typical) Pixel response time 4ms Color gamut 99% sRGB Viewing angle at 10:1 CR 178° horizontal, 178° vertical Stand Tilt, swivel, pivot, and height adjustable stand Bezel width <i>Sides:</i> 0.08" (2mm) Dimensions 20.21" H x 24.17" W x 10.62" D; (HxWxD, including stand) 513mm H x 614mm W x 269.8mm D Power supply 38 watts typical, 75 watts maximum (with USB), <0.5 watts sleep/off; <0.3 watts switch off integrated (no external brick-like power supply) Weight 15.43 lb; 7.0kg (including stand) Limited warranty 3 year Available date January 2017</p>	<p>Features</p> <ul style="list-style-type: none"> • 27-inch IPS LED backlight monitor • Supports 2560x1440 resolution • 5-Ports USB hub, support USB 3.0 • Support ThinkCentre Tiny • Supports optional soundbar • Microsoft® Windows® 7 certified • Microsoft Windows 10 certified 						
<p>VESA-compliant VESA DDC2B/CI Power management ENERGY STAR® 7.0 Ergonomics ISO 9241-307 Emission standards FCC Class B Environmental TCO Displays 7.0, RoHS, EPEAT™ Gold rating, ULE Gold</p>	 <p>ThinkVision P27q Monitor</p>						
<p>Preset resolutions VGA: 640x480, 720x400 SVGA: 800x600 XGA: 1024x768 SXGA: 1280x1024 WXGA: 1366x768 WXGA+: 1440x900, 1600x900 WSXGA+: 1680x1050 Full HD: 1920x1080, 1920x1200 QHD: 2560x1440</p> <p>Presets / user settings Standard presets: 20; user settings: 24</p>							
<p>Viewing adjustments <i>Tilt:</i> 30° back, -5° forward; <i>lift:</i> 4.33" (110mm); <i>swivel:</i> +/-45° Rotating screen Screen pivots 90 degrees from landscape to portrait On screen display On screen display with digital user controls (8 languages) Control features Direct access for menu, source switch, and brightness USB hub USB Hub: one USB 3.0 upstream port, four USB 3.0 downstream ports Multimedia Audio-out, optional sound bar supported Camera None Multiple input Support HDMI, DisplayPort, mini DisplayPort, DisplayPort-out Monitor connectors (1) 2*HDMI (1.4), digital, HDCP-compliant (2) DisplayPort (1.2), digital, HDCP-compliant (3) Mini DisplayPort, digital, HDCP-compliant Signal cables (1) detachable, mini DisplayPort to DisplayPort, digital, 1.8 meter Mounting features Wall or desk mounting using the Extend Arm or third-party accessories meeting the VESA FPMPI® (100mm mount) Security Security keyhole for attachment of optional cable lock (Kensington® lock-compatible)</p>							
<p>Ship group Monitor, detachable stand, Quick start and safety poster, 1.8 meter USB 3.0 cable, 1.8 meter mini DP to DP cable, 1.8 meter black power cord</p>	<p>Limited Warranty</p> <p>See details at http://support.lenovo.com/en_US/guides-and-manuals/detail.page?DocID=UM008281</p> <p>Accessories</p> <table border="0"> <tr> <td>Kensington MicroSaver Cable Lock</td> <td>73P2582</td> </tr> <tr> <td>Kensington Twin Head Cable Lock</td> <td>45K1620</td> </tr> <tr> <td>Lenovo Security Cable Lock</td> <td>57Y4303</td> </tr> </table> <p>See details at www.lenovo.com/support/monitoraccessories</p> <p>See all monitors at www.lenovo.com/thinkvision</p>	Kensington MicroSaver Cable Lock	73P2582	Kensington Twin Head Cable Lock	45K1620	Lenovo Security Cable Lock	57Y4303
Kensington MicroSaver Cable Lock	73P2582						
Kensington Twin Head Cable Lock	45K1620						
Lenovo Security Cable Lock	57Y4303						



<p>Name Pro2820 Wide Flat Panel Monitor Case color Black Type-model 60FCRAR6US / 60FCRAT6US / 60FCRAT6EU Panel TFT-LCD, with wide viewing angle (WVA) technology, White LED backlight Viewable image size 28" (711mm) diagonal Max view area (W x H) 24.44" x 13.44" (620.9mm x 341.3mm) Optimum resolution 1920x1080 Max pixel rate 205MHz (VGA); 165MHz(DP/ HDMI); 149MHz (MHL) Frequency Supports 1920 x 10800 @ 60Hz Aspect ratio 16:9 Pixel pitch (mm) 0.32 x 0.32mm Dot/Pixel per Inch 79 dpi Brightness 300 nits or cd/m² (typical) Contrast ratio 3000:1 (typical) Pixel response time 6.5ms Color gamut 72% Viewing angle at 10:1 CR 178° horizontal, 178° vertical Stand Tilt, swivel, and height adjustable stand Bezel width Sides: 0.86" (21.85mm) Dimensions (HxWxD, excluding stand) 17.45" H x 26.21" W x 2.30" D; Dimensions (HxWxD, including stand) 443.3mm H x 665.9mm W x 58.2mm D Power supply 60 watts typical, 90 watts typical (with USB), 65 watts maximum, 95 watts maximum (with USB), <1.2 watts sleep/off; <0.5 watts switch off integrated (no external brick-like power supply) Weight 17.84 lb; 8.11kg (including stand) Limited warranty⁴ 3 year (includes backlight) Available date September 2014</p>	<p>Features</p> <ul style="list-style-type: none"> • 28-inch MVA (Multi-domain Vertical Alignment) panel LED backlit monitor • Supports 1920x1080 resolution • 5-Ports USB hub, support USB 3.0 • Arsenic/Mercury free • Microsoft® Windows® 7 • Windows 8/ Windows 8.1 certified 																		
<p>VESA-compliant² VESA DDC2B/CI Power management ENERGY STAR® 6.0 Ergonomics ISO 9241-307 Emission standards FCC Class B Environmental TCO Displays 6.0, TCO Certified Edge 1.2, RoHS, EPEAT™ Gold rating, ULE Gold</p> <p>Preset resolutions</p> <table border="0"> <tr><td>VGA:</td><td>640x480, 720x400</td></tr> <tr><td>SVGA:</td><td>800x600</td></tr> <tr><td>XGA:</td><td>1024x768, 1024x760</td></tr> <tr><td>SXGA:</td><td>1280x1024</td></tr> <tr><td>WXGA:</td><td>1280x720, 1280x800, 1366x768</td></tr> <tr><td>WXGA+:</td><td>1440x900, 1600x900</td></tr> <tr><td>WSXGA+:</td><td>1680x1050</td></tr> <tr><td>Full HD:</td><td>1920x1080</td></tr> <tr><td>Others:</td><td>1152x864</td></tr> </table> <p>Presets / user settings Standard presets: 17; user settings: 17</p>	VGA:	640x480, 720x400	SVGA:	800x600	XGA:	1024x768, 1024x760	SXGA:	1280x1024	WXGA:	1280x720, 1280x800, 1366x768	WXGA+:	1440x900, 1600x900	WSXGA+:	1680x1050	Full HD:	1920x1080	Others:	1152x864	 <p style="text-align: center;">ThinkVision Pro2820 Monitor</p>
VGA:	640x480, 720x400																		
SVGA:	800x600																		
XGA:	1024x768, 1024x760																		
SXGA:	1280x1024																		
WXGA:	1280x720, 1280x800, 1366x768																		
WXGA+:	1440x900, 1600x900																		
WSXGA+:	1680x1050																		
Full HD:	1920x1080																		
Others:	1152x864																		
<p>Viewing adjustments Tilt: 25° back, -5° forward; lift: 4.3" (110mm); swivel: +/-45° Rotating screen Screen pivots 90 degrees from landscape to portrait On screen display On screen display with digital user controls (8 languages) Control features Direct access (touch buttons on front) for automatic image setup, input switch, and brightness USB hub USB Hub: one USB 3.0 upstream port, four USB 3.0 downstream ports Multimedia None Camera None Multiple input Support VGA, HDMI, DisplayPort, MHL connections (Mobile High-definition Link) Monitor connectors (1) VGA 15-pin D-shell, analog (2) HDMI (1.4), digital, HDCP-compliant (3) DisplayPort (1.2), digital, HDCP-compliant</p> <p>Signal cables (1) detachable, VGA 15-pin D-shell at each end, analog, 1.8 meter (2) detachable, DisplayPort at each end, digital, 1.8 meter</p> <p>Mounting features Wall or desk mounting using the Extend Arm or third-party accessories meeting the VESA FPMPI® (100mm mount) Security Security keyhole for attachment of optional cable lock (Kensington® lock-compatible)</p>																			
<p>Ship group Monitor, detachable stand, Quick start and safety poster, 1.8 meter DisplayPort cable, 1.8 meter VGA cable, 1.8 meter USB 3.0 cable, 1.8 meter black power cord</p>																			
<p style="text-align: center;">Limited Warranty</p> <p>See details at http://support.lenovo.com/en_US/guides-and-manuals/detail.page?DocID=UM008281</p>	<p style="text-align: center;">Accessories</p> <table border="0"> <tr><td>Kensington MicroSaver Cable Lock</td><td>73P2582</td></tr> <tr><td>Kensington Twin Head Cable Lock</td><td>45K1620</td></tr> <tr><td>Lenovo Security Cable Lock</td><td>57Y4303</td></tr> </table> <p>See details at www.lenovo.com/support/monitoraccessories</p> <p>See all monitors at www.lenovo.com/thinkvision</p>	Kensington MicroSaver Cable Lock	73P2582	Kensington Twin Head Cable Lock	45K1620	Lenovo Security Cable Lock	57Y4303												
Kensington MicroSaver Cable Lock	73P2582																		
Kensington Twin Head Cable Lock	45K1620																		
Lenovo Security Cable Lock	57Y4303																		

See footnotes for important warranty information



<p>Name X1 Wide Flat Panel Monitor Case color Black Type-model 60E2GAR1US / 60E2GAT1US / 60E2GAT1EU Panel TFT-LCD, IPS (In-Plane Switching), White LED backlight Viewable image size 27" (684.7mm) diagonal Max view area (W x H) 23.49" x 13.21" (596.7mm x 335.7mm) Optimum resolution 3840x2160 Max pixel rate 600MHz Aspect ratio 16:9 Pixel pitch (mm) 0.16 x 0.16mm Dot/Pixel per Inch 163 dpi Brightness 300 nits or cd/m² (typical) Contrast ratio 1300:1 (typical) Pixel response time 6ms Color gamut 99% Viewing angle at 10:1 CR 178° horizontal, 178° vertical Stand Tilt stand Bezel width Sides: 0.088" (2.23mm) Dimensions (HxWxD, including stand) 19.35" H x 24.19" W x 10.63" D; 491.4mm H x 614.5mm W x 270.0mm D Power supply 40 watts typical, 130 watts maximum (with USB), <0.5 watts sleep/off; <0.5 watts switch off Weight 14.11 lb; 6.40kg (including stand) Limited warranty⁴ 3 year Available date March 2016</p>	<p>Features</p> <ul style="list-style-type: none"> • 27-inch IPS LED backlight monitor with speaker • Supports 3840x2160 resolution • 5-Ports USB hub, support USB Type-C • 3watts x 2 stereo speakers • Microsoft® Windows® 7 certified • Microsoft Windows 10 certified 						
<p>VESA-compliant² VESA DDC2B/CI Power management ENERGY STAR® 7.0 Ergonomics ISO 9241-307 Emission standards FCC Class B Environmental TCO Displays 7.0, RoHS, EPEAT™ Silver rating, ULE Gold</p>	 <p style="text-align: center;">ThinkVision X1 Monitor</p>						
<p>Preset resolutions VGA: 640x350, 640x480, 720x400 SVGA: 800x600 XGA: 1024x768, 1152x864 SXGA: 1280x1024 WXGA: 1280x720, 1280x768, 1280x800, 1360x768 WXGA+: 1440x900, 1600x900 WSXGA+: 1680x1050 Full HD: 1920x1080, 1920x1200 UHD: 3840x2160</p> <p>Presets / user settings Standard presets: 20; user settings: 20</p>							
<p>Viewing adjustments <i>Tilt: 22° back, -5° forward;</i> Rotating screen None On screen display On screen display with digital user controls (8 languages) Control features Direct access (touch buttons on front) for menu, mute, volume up/down, and brightness USB hub USB Hub: one USB 3.0 Type-C upstream port, four USB 3.0 downstream ports Multimedia Integrated stereo speakers (3 watts x 2), built-in microphone Camera Full HD camera with LED light Multiple input Support HDMI, DisplayPort Monitor connectors (1) HDMI (1.4), digital, HDCP-compliant (2) DisplayPort (1.2), digital, HDCP-compliant Signal cables (1) detachable, HDMI at each end, digital, 1.8 meter (2) detachable, DisplayPort at each end, digital, 1.8 meter Mounting features Wall or desk mounting using the Extend Arm or third-party accessories meeting the VESA FPMPI® (100mm mount) Security Security keyhole for attachment of optional cable lock (Kensington® lock-compatible)</p>							
<p>Ship group Monitor, detachable stand, Quick start and safety poster, 1.8 meter DisplayPort cable, 1.8 meter HDMI cable, 1.8 meter USB Type-C cable, 1.8 meter USB Type-C to Type-A cable, 1.8 meter black power cord, mini DP to DP adapter, power adapter (135W)</p>	<p style="text-align: center;">Limited Warranty</p> <p>See details at http://support.lenovo.com/en_US/guides-and-manuals/detail.page?DocID=UM008281</p> <p style="text-align: center;">Accessories</p> <table border="0"> <tr> <td>Kensington MicroSaver Cable Lock</td> <td style="text-align: right;">73P2582</td> </tr> <tr> <td>Kensington Twin Head Cable Lock</td> <td style="text-align: right;">45K1620</td> </tr> <tr> <td>Lenovo Security Cable Lock</td> <td style="text-align: right;">57Y4303</td> </tr> </table> <p>See details at www.lenovo.com/support/monitoraccessories</p> <p>See all monitors at www.lenovo.com/thinkvision</p>	Kensington MicroSaver Cable Lock	73P2582	Kensington Twin Head Cable Lock	45K1620	Lenovo Security Cable Lock	57Y4303
Kensington MicroSaver Cable Lock	73P2582						
Kensington Twin Head Cable Lock	45K1620						
Lenovo Security Cable Lock	57Y4303						

See footnotes for important warranty information

This publication was developed for products and services offered in the United States and E.M.E.A countries. Lenovo may not offer the products, services or features discussed in this document in other countries. Lenovo may withdraw an offering at any time. Information is subject to change without notice. Consult your local representative for information on offerings available in your area.

Lenovo reserves the right to change specifications or other product information without notice. Lenovo is not responsible for photographic or typographical errors.

LENOVO PROVIDES THIS PUBLICATION "AS IS," WITHOUT WARRANTY OF ANY KIND, EITHER EXPRESS OR IMPLIED, INCLUDING THE IMPLIED WARRANTIES OF MERCHANTABILITY OR FITNESS FOR A PARTICULAR PURPOSE.

Some jurisdictions do not allow disclaimer of express or implied warranties in certain transactions, therefore this disclaimer may not apply to you.

Availability: All offers subject to availability. Lenovo reserves the right to alter product offerings and specifications at any time, without notice. Lenovo is not responsible for photographic or typographic errors.

General: Review key information provided by Microsoft that may apply to your system purchase, including details on Windows 10, Windows 8, Windows 7, and potential upgrades/downgrades. Lenovo makes no representation or warranty regarding third-party products or services.

Trademarks: Lenovo, ThinkPad, ThinkCentre, ThinkStation and the Lenovo logo are trademarks of Lenovo. Microsoft, Windows, Windows NT, and the Windows logo are trademarks of Microsoft Corporation. Ultrabook, Celeron, Celeron Inside, Core Inside, Intel, Intel Logo, Intel Atom, Intel Atom Inside, Intel Core, Intel Inside, Intel Inside Logo, Intel vPro, Itanium, Itanium Inside, Pentium, Pentium Inside, vPro Inside, Xeon, Xeon Phi, and Xeon Inside are trademarks of Intel Corporation in the U.S. and/or other countries. Other company, product or service names may be trademarks or service marks of others.

Warranty: For a copy of applicable warranties, write to: Lenovo Warranty Information, 1009 Think Place, Morrisville, NC, 27560. Lenovo makes no representation or warranty regarding third party products or services. The Lenovo Limited Warranty applies only to Lenovo hardware products purchased for your own use, and does not transfer upon resale.

Limited warranty: Support unrelated to a warranty issue may be subject to additional charges.

Lenovo Services:

Carry-in or Mail-in Service: Parts and labor repair coverage where the customer is responsible for shipping (including packaging) or delivery to authorized warranty provider or repair center.

Depot or Courier Service: Parts and labor repair coverage where shipping (including packaging) or delivery to the repair center is paid for by Lenovo.

Expedited Depot: Parts and labor coverage with expedited turnaround. Shipping (including packaging) or delivery to the repair center is paid for by Lenovo.

Onsite / In-home Service: Parts and labor repair coverage where labor is provided onsite at your place of business.

If Lenovo determines your product problem is covered by the product warranty and cannot be resolved over the telephone, a technician will be dispatched to arrive onsite, typically the next day.

International Warranty Service (IWS): PC repair coverage for customers who require a critical warranty repair while travelling internationally. Visit www.lenovo.com/internationalwarranty for details. Visit www.lenovo.com/warranty for Lenovo Warranty Services terms and conditions for complete details and restrictions.

Included software: may differ from its retail version (if available), and may not include user manuals or all program functionality. Software license agreements may apply.

Battery life: Battery life (and recharge times) will vary based on many factors including screen brightness, applications, features, power management, battery conditioning, and other customer preferences.

Visit <http://psref.lenovo.com/> for the latest version of Product Specifications Reference.

© Lenovo, 2017. All rights reserved.
Lenovo 1009 Think Place Morrisville, NC 27560 U.S.A.